

*Amateur*

# RADIO

For all two-way radio enthusiasts

**Contest forum:  
when to compete in 1985**

**50MHz explored**

**Beginners' workshop**

**BUMPER  
READERS'  
ADS**



**On test:  
MMT144/28R  
2m transverter**

**PASS THE RAE:  
BACK TO BASICS,  
RADIO  
Q & A**

# POST A PART ELECTRONICS

6 CHAPMAN COURT, CHARFLEETS ROAD  
(AR) CANVEY ISLAND, ESSEX S88 0PQ

Telephone 0268 690868  
Telex 99305 ROSSER G



TRADE COUNTER NOW OPEN

ORDERS DESPATCHED SAME DAY  
ADD 60p P&P, THEN 15% VAT.  
ADD POSTAGE FOR OVERSEAS ORDERS.  
ORDERS WITH AEROSOLS, PLEASE ADD 25p PER CAN.

Thorn 10Q 20W (3500) R751 Safety Resistor	75p
Pye 713 Speaker 8" x 3" 70Ω	1.00
Pye 713 Complete Tube Base Panel with Focus Slider & Leads	2.75
Pye 713 Control Knob	4 for 90p
Tube Base Socket ITT CVC32	45p
Tube Base Socket Thorn 3000/8000 etc	50p
IC Insertor 16 Pin	50p
Large IC Extractor	50p
Crystal 4.43MHz	85p
EHT Lead & Cap for Split Diode Lopt	90p
Anode Cap	47p
Sanyo Anode Cap Assy + Lead. 12TCD-CT-1G	85p
Degauss Thermistors. PT37P. ITT/GEC	35p
Degauss VDR E2980/HP230 3000/8000	25p
Casters Set of 4	1.90
Double Fuse Holder on Small Pax Board 20mm type	10p
Single Fuse Holder on Small Pax Board 20mm type	5p
Direct Panel Mounting 20mm Fuse Clips (pair) 15p	
Single Fuse Holder on Small Pax Board. As per early 3000 mains input	6p
EHT Cable	Metre 25p
13A Plugs 12 for 4.80	
BF259 with Heatsink	14p
TIP110 with Heatsink	40p
L129/130/131 Coil	10p
50MHz Ceramic Filter	25p
DL700 (Philips) Chrome Delay Line	1.00
DL500 Chrome Delay Line	1.00
F9006A Lum Delay Line	1.00
8K5/9K Lum. Delay Line	65p
Plastic Cover for 3K5 SP8385	5p
TX9 Back Ground Control 10K	15p
TX9 Gain Control 100R	15p
1500 Metal Chassis Supports Pair	40p
Thorn 8K5 Focus Pot	2.75
Thorn 4000 Focus Pot	2.75
Thorn 18Q 9W (3K5) R752	30p

### SERVICE AIDS

Ambersil MSA Silicone Grease	12oz 2.15
Ambersil Freezer	12oz 1.99
Ambersil Amberlube	6oz 1.89
Ambersil Ambertron	16oz 1.95
Ambersil Anti-Static Screen Cleaner	7oz 1.95
Ambersil 40+ Protective Lubricant	14.1oz 2.15
Ambersil Ambercens Foaming Cleaner	13oz 1.26
Ambersil Circuit Lacquer	14oz 2.15

### THICK FILM RESISTOR UNITS

3500 Thorn (5 Pin Connection) video	1.70
4000 Thorn (4 Pin Connection)	1.90
725/731 Pye (6 Pin Connection)	2.20
713 Pye (6 Pin Connection)	2.20

### FUSES

50MA 10 for 70p	250MA 10 for 65p
315MA A/S 10 for 50p	750MA 10 for 65p
500MA 10 for 50p	7A 10 for 50p
1A 10 for 50p	10A 10 for 50p
2.5A 10 for 1.00	20A 10 for 50p
3.15A 10 for 1.00	50A 10 for 50p

Thorn Mains TX 3000/3500	7.50
Thorn Mains TX 8000/8500	10.00
Thorn S.D.P.T 8000/8500	3.50
Thorn Scan TX 3000/3500	5.00
Thorn EHT TX 3000/3500	6.00
Thorn LDPT 9600	12.00
Thorn LDPT 1615	7.25
Thorn LDPT 1590/91	7.25
Thorn LDPT 8000	9.80
Thorn LDPT 8500	9.80
Thorn LDPT TX9	9.85
Pye LDPT 713	10.00
Pye LDPT 725	9.85
Pye LDPT 731	10.18
Philips LDPT G9	8.80
Philips LDPT G11	13.75
GEC LDPT 3113	7.40
Diode Split LDPT AT2076/35	6.75
Sanyo LDPT AM-WM-21	7.30
Sanyo LDPT AM-WM-4	7.30
Philips LDPT G8	7.80
Sanyo LDPT (CW21) 4-2751-44700	5.00
ITT LDPT CVC5-9	9.60
ITT LDPT CVC30	8.75
ITT LDPT CVC45	9.75
Baird 8750	10.25
Baird 8752	10.25
Korting AZ9100	10.25
Korting B92-170	10.25
Korting AZ2101	10.25
Korting AZ2103	10.25
Korting ZTR1001	10.25
Siemens V1155	11.75
Siemens V1823	11.75
Zanussi BS2222	10.25
Zanussi BS2223	10.25
Salora FR0057	10.25
Salora FR0029	10.25

300 Mixed Resistors	1.50
300 Mixed Capacitors	1.50
150 Mixed Electrolytics	2.00
100 W/W Resistors	1.00
20 Mixed Conv Pots	1.00
40 Mixed Pots	1.50
20 Mixed Sliders	1.00
40 Mixed Presets	60p
20 Mixed VDR & Thermistors	1.00
20 Mixed Ferrite Cores	50p
100 Mixed Ceramic Discs	1.00
20 Mixed Valve Bases	1.00

AC128	39	BC172	9	BC559	8
AC131	40	BC1748	23	BC595	8
AC138	40	BC177	24	BCX33	22
AC141K	39	BC182LB	12	BCX34	11
AC142K	39	BC183L	12	BD115	49
AC153	39	BC184L	13	BD131	38
AC176	33	BC187	24	BD132	46
AC178K/	33	BC204	15	BD133	59
AC128K	93	BC208	9	BD139	36
AC188	38	BC212L	9	BD140	38
AD142	1.18	BC213L	12	BD144	1.70
AD149	1.06	BC237	12	BD150	50
AD161	32	BC238B	8	BD163	98
AD162	32	BC238L	8	BD201	74
AD263	1.05	BC250A	15	BD203	78
AF127	45	BC252A	8	BD204	99
AF139	38	BC254	20	BD222	48
AF239	41	BC301	37	BD225	52
BC107	15	BC303	32	BD232	50
BC108	15	BC307	10	BD233	60
BC109	15	BC308	8	BD237	60
BC115	16	BC309	10	BD238	65
BC117	21	BC327	18	BD241	59
BC125	26	BC328	18	BD244	85
BC126	23	BC337	17	BD278A	81
BC139	27	BC338	17	BD366	68
BC141	34	BC347	8	BD433	71
BC142	30	BC394	8	BD437	83
BC143	31	BC454	8	BD589	1.20
BC147	12	BC455	8	BD592	1.20
BC148	12	BC456	10	BD677G	1.35
BC149	12	BC460	40	BD707	95
BC153	16	BC463	22	BD708	95
BC1540R	16	BC546	8	BDX10	93
BC154YL	16	BC547	12	BDY20	1.09
BC157	12	BC548	12	BDY82	99
BC158	12	BC549	8	BF137	20
BC159	15	BC557	10	BF153	20
BC171	9	BC558	10	BF154	25

### INTEGRATED CIRCUITS

BRC1330	1.40	SN7613ND	1.80	TBA530	1.26
BRC3064	1.00	SN7623N	1.80	TBA540	1.00
BRC/M/200	1.00	SN76033N	2.00	TBA560C	1.82
BRC/M/300	1.00	SN76115	2.00	TBA560D	1.50
CA3060	1.58	SN76131N	1.50	TBA641	2.05
LM1303P	1.48	SN76226N	1.25	TBA651	2.50
LM231B	2.20	SN76227N	1.00	TBA750	2.49
LM237B	2.00	SN76530P	1.30	TBA750A	2.20
LM239B	2.86	SN76622N	1.00	TBA810S	1.62
MC1327AP	1.25	SN76660N	80p	TBA810S	1.00
MC1358P	1.30	SN76666N	75p	TBA920	2.08
MC1455P	18p	SN76744	1.92	TBA950	1.95
MC14516BCP	60p	TA7117P	1.00	TCEP100	3.48
SAA1025	7.20	TA7109AP	2.80	TEA1009	1.95
SAA1124	4.50	TA7117P	1.00	MC14426P	4.80
SAA5010	6.00	TBA120B	1.20	MC14429P	5.00
SL432A	1.80	TBA120C	1.20	MC14514	4.50
SL1430	2.50	TBA120CC	70p	UA758PC	2.50
SN15846N	60p	TBA120S	70p	UA758PC	2.50
SN74123N	65p	TBA120U	1.00	UPL2116A	1.25
SN74154N	1.40	TBA395	1.00	UPL21170S	1.50
SN76001N	1.40	TBA480Q	1.40	UPC1365C	5.75
SN76110N	1.14	TBA510	1.90	UPC1365C	1.25

Thorn B/8K5 ex equip panels untested	2.88	PSU	3.75	Thorn 4000 PSU panel ex-factory	2.50
FTB	3.75	LTB	2.50	Thorn 3K5 beam limiter board	1.75
Decoder	4.00	Video Chroma	2.00	Thorn 3K5 PSU bottom board	2.75
Thorn 9K ex equip panels untested	12.00	IF	1.75	Thorn 3K5 IF panel new	2.00
PSU	5.00	Conv. 3K	3.00	Thorn 3/3K5. EHT & scan TX	1.80
Decoder	5.75	Conv. 3K5	3.75	Thorn 8/8K5 damaged FTB for boxed	1.25
Thorn 9K6 ex equip panels untested	5.75	Autovox Decoder FG/01	5.00	Thorn B/8K5 damaged decoder ex-factory	2.25
UHF TV Aerial for portable	50p	Coax Plugs	10 for 1.65		
Indoor Aerial Parabolic Type Reflector to Help Combat Ghosting Problems	2.50	Band Change Switch Assy, Pye 725	40p		
Line Connectors	38p	Flush Mounting TV/FM Diplexer	1.00		
		Switched Flush Fitting Aerial Outlet	1.00		

10 Spark Gaps	1.00
10-16 pin Quil IC Socket	90p
20 Assorted TV Knobs	1.00
10-16 pin Quil to Dil IC Socket	90p
100 Mixed Diodes	1.00
50 Mixed Mica Washers	65p
300 Mixed Resistors & Capacitors	1.50
10-16 pin Dil to Dil IC Socket	1.00
50 Electrolytics & 50 Capacitors	1.00
50 Mixed Poly Capacitors	1.00
30 Mixed Neons & Bulbs	1.00

BF167	24	BFR62	28	NKT276	20
BF173	29	BFR81	29	NKT453	1.65
BF179	32	BFR87	25	DT112	1.92
BF180	33	BFR90	1.74	DT121	2.08
BF181	30	BFR91	2.08	R1038	80
BF185	30	BF742	30	R1039	80
BF194	16	BF743	30	R2008B	1.40
BF195	16	BF738	40	R2108B	1.10
BF196	16	BF750	30	R2030	1.00
BF197	16	BFY1	34	R2365	1.30
BF198	15	BFY2	34	R2305	80
BF199	19	BC116	1.50	R2322	50
BF223	15	BRC1693	1.43	R2443	25
BF224	18	BU105	1.00	RCA16446	30
BU126	19	BU126	1.10	RCA16599	1.25
BU207	20	BU207	1.05	RCA16600	1.40
BU240	9	BU240	1.15	RCA16799	1.13
BU241	21	BU208A	1.15	RCA16800	1.42
BU255	10	BU262A	1.30	RCA16802	1.38
BU407	1.70	SI299	2.25		
BU408	2.76	S28000	1.25		
BU500	2.30	S6080A/B	1.30		
BU526	2.46	T6050V	1.30		
BU807	2.94	T6052V	1.30		
CI129	9	T9003V	1.25		
CI172B	34	CI172B	9	T9010V	1.45
ES386	54	T9053V	1.30		
ES903	28	T9054V	1.00		
E3005	25	T9059V	1.10		
ME0404	10	TIC45X	50		
ME0412	10	TIC46	48		
ME0602	10	TIC106C	40		
MJ2501	2.36	TIP29	42		
MJ3001	2.21	TIP30	42		
MJE182	47	TIP31	35		
MJE340	50	TIP32	43		
MJE350	50	TIP33	61		
MJE2855	1.40	TIP41	42		
MJE355	1.50	TIP42	45		
MKT241W	8	TIP110	61		
NKT241G	8	TIS91	25		
NKT241Y	8	ZTX550	30		

Pye 78+161	50p	EHT TRAYS	
Pye 147+250	50p	Thorn 3000	5.50
Thorn 56+1K+47+12	1.24	Thorn 8000	3.50
Thorn 50+40+1K5	60p	Thorn 8500	6.00
Thorn 128+16+1K7+	90p	Thorn 9000	7.90
116+462+126	50p	Thorn 9600	6.00
Thorn 120+72+300	50p	Thorn 900/950	1.50
RBM 250+14+58	63p		
(TV161)		Pye 713 5 lead	5.97
Pye 3R5+15+45 (713)	50p	Pye 725	6.35
Philips 2R2+682	90p	Decca Bradford	5.00
Philips 47R	52p	Baird 8750	7.10
Thorn 350+20+148+	1.40	Korting AZ9100	7.10
1K5+317	92p	Philips G8 (520)	6.50
Thorn 6+1+100	92p	Philips G8 (550)	6.50
Thorn 3000 Metal	1.45	Universal	5.00
Thorn 8/8500 Plastic	1.45		

MULTISECTION CAPACITORS	
100+150+150	200+200+100
220+47	350V 50p
200+150+50	350V 60p
200+200+100	350V 60p
50+50+8	350V 60p
100+50+100	350V 55p
100+150+50	350V 55p
32+32+16	325V 54p
200+200+100+32	2500+2500 (Thorn 8K)
	350V 70p
	150+150+100
	100+400
	200V 72p
	32+32+16
	350V 52p
	200+32+300+100
	350V 70p
	175+100+100
	350V 50p
	200+200+100
	350V 70p
	200+100
	325V 65p
	200+100+100+50
	350V 60p

CAN TYPES	
1250MF 40V	50p
2MF 250V	50p
2MF 250V	5



# ANGUS MCKENZIE

## TESTS

## MICROWAVE MODULES MMT144/28R 2m TRANSVERTER

Microwave Modules has been established for well over a decade as a British manufacturer marketing VHF and UHF converters, transverters and solid-state linears. In the past, their transverters have been built into simple diecast boxes, originally having no external finish, but more recently supplied in a utilitarian black finish, sometimes in black crackle. This has improved the presentation but the basic circuitry in many of their models has remained the same for years and years.

Their earlier transverters were supplied with BNC sockets for inputs and outputs, but more recently they have been fitted with SO239s for the 2m versions, although BNCs and N-types can be supplied to special order. They have always used locking 270 degree five pin DIN sockets for 13V dc and PTT interconnections, and these are retained in this new model, pin-1 being PTT override, pin-3 negative earth and pin-5 13V positive. On some models pins 2 and 4 were used for external switching of special repeater shifts but now repeater switching is by a switch on the front of the rig.

### Circuitry

Previously, their 2m transverter from 28MHz did not incorporate repeater shift, and the output power was rated at 10W although 20W could be obtained quite easily with optimum adjustment around the PA unit. The transmit performance was always reasonably good but it was in the receiver that some problems had been encountered because of rather old circuit designs. The new model incorporates an NE411 dual-gate GaAsFET feeding into an STE M14 high level diode ring mixer with optimised matching.

The 116MHz crystal local oscillator has its output fed through the crystal itself to improve purity and to reject sideband noise rather better. This output is amplified by a JFET having a bandpass filter around it, which then supplies the mixer injection. The output from the receive mixer feeds into a low gain output stage at 28MHz, also employing a JFET.

The receive configuration is thus completely new, whereas the transmit strip uses their older double FET push/pull mixer and low level amplification stages. The final driver stage employs a 0.5W driver instead of a 100mW device, but is run at a maximum output level of around 50mW for improved intermodulation performance.

The design of the PA stage is totally new, employing a driver type 2N6082, feeding the PA itself, a type SD1278 50W device, which is reasonably linear at the maximum 25W output level designed into the new transverter.



The PA output feeds through three matching circuits, which include traps, and then through to a pin diode switch. An ALC loop is fed right from the output, the sensed level also being fed to a bar graph display controlled by a regulated dc supply. This display incorporates 10 indicators, the highest level coming on at around 23W. The ALC also feeds back to a diode attenuator immediately before the mixer and a preset can be set to give the required maximum output level.

The 28MHz input drive is sensed by a lightly coupled RF circuit and amplified with an op-amp IC, providing much more sensitivity for RF switching than was available in earlier transverters. The input drive is fed through a preset which can adjust maximum drive level for full output from 300mW down to around 250µW. This allows the transverter to be used with almost any HF rig on the market fitted with a transverter drive facility, and it can thus be fed directly from the latest Yaesu and Icom rigs which have transverter drives well below 1mW.

All the low level stages are in Class A, again to improve linearity and the local oscillator feeds into the mixer, again with a JFET filtered buffer. The PA bias supply is now regulated from a very low source impedance and this again contributes to improved PA performance.

The PTT switching is now much faster than before, high value capacitors being avoided so as to allow AMTOR to be used

with this transverter. The RF sensing circuitry is vastly improved, and a pot on the front panel is provided to adjust the Tx hold time from very short indeed (around 15mS) to around 1.5 seconds. Other controls on the front panel include an on/off switch and a simplex/repeater/reverse repeater miniature toggle which allows repeater operation with HF rigs not having dual VFOs for Tx and Rx.

A dc fuse is provided on the back panel and the 13.8V input is also reverse diode protected. Whilst two SO239 sockets are provided for 28MHz input and output, just a single 144MHz SO239 socket is now fitted, for the manufacturers feel that anyone wanting a separate socket could fit it for themselves. Apparently market surveys indicated that only a very small proportion of users actually use the independent receive socket of the old model. I feel it is a pity that this has been omitted, but whilst I used to use it, frankly, it is fairly superfluous unless you have a special requirement.

### Styling

As will be seen from the photograph, the styling is totally different from any previous MM product, and I think it shows a very considerable improvement. I would have preferred more robust switches but, presumably, costs had to be kept down. I feel that provision of the input drive preset is a very significant advantage, but I also found that one could drive the rig at least 10dB into ALC

# Amateur RADIO



**Editor:**  
Jim Chalmers  
**Editorial Assistant:**  
Anita Ley  
**Advertisement Manager:**  
Anne Haden  
**Subscriptions:**  
01-684 3157  
**Accounts:**  
Clare Brinkman  
**Publisher:**  
Peter Williams  
**General Manager:**  
Alan Golbourn  
**On sale:** Fourth Thursday of the month preceding cover date  
**Next issue:** Cover date April 1985 on sale 28 March 1985  
**Published by:** Amateur Radio Magazines, Sovereign House, Brentwood, Essex CM14 4SE, England (0277) 219876  
**Printed:** In England  
**ISSN:** 0264-2557  
**News Trade Sales by:** Argus Press Sales & Distribution Ltd, 12-18 Paul Street, London EC2A 4JS. 01-247 8233

**Front cover:** Microwave Modules MMT144/28R 2m transverter, reviewed this month (p21). Photo by Jay Moss-Powell G6XIB and Pete Galvin.

Whilst every care is taken when accepting advertisements we cannot accept responsibility for unsatisfactory transactions. We will, however, thoroughly investigate any complaints. The views expressed by contributors are not necessarily those of the publishers. Every care is also taken to ensure that the contents of *Amateur Radio* are accurate, we assume no responsibility for any effect from errors or omissions.

Audit Bureau of Circulations membership applied for  
© Copyright 1985  
Amateur Radio Magazines

## 6 Letters

Your opinions on topics of interest

## 8 Straight and Level

All the latest news, comment and developments on the amateur radio scene

## 14 DX Diary

Don Field G3XTT with this month's DX news

## 16 Contest Forum

A calendar of the 1985 contests on the HF bands

## 21 Angus McKenzie tests

This month G3OSS reviews the Microwave Modules MMT144/28R 2m transverter and the Icom IC551 50MHz rig

## 29 SWL

Trevor Morgan GW4OXB gets involved with an educational project

## 31 Beginners' workshop

Rev George Dobbs G3RJV takes the cheaper road with home construction. This month: getting the bits

## 38 On the Beam

Glen Ross G8MWR with all the latest news from VHF, UHF and Microwaves

## 40 The dreaded Decibel

J Glanville G3TZG removes the myth surrounding this unit of loss and gain

## 42 Multi P6+

Bill Sparks G8FBX reviews the Rolls Royce of aeriels

## 44 CB conversions

This month a look at the dedicated PLL chips used in American CB rigs, and how to get around them

## 47 Back to basics

This month Bill Mantovani G4ZVB explains the theory behind transmitters

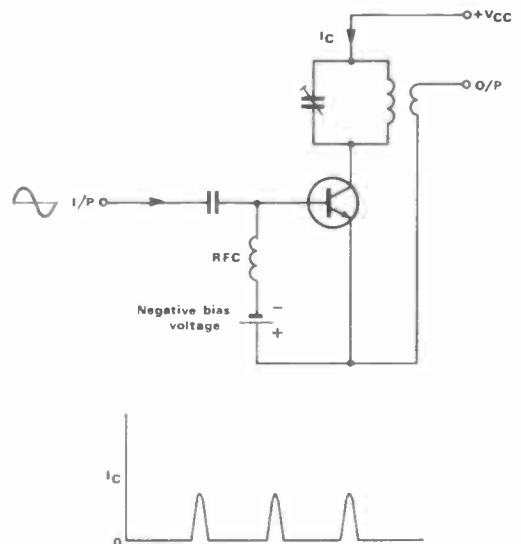

## 54 Questions and answers

Multiple choice questions to test you on your knowledge of the RAE syllabus

## 57 Coming next month

What's in store for you

## 58 Secondhand

Hugh Allison G3XSE looks at some more common faults found in equipment

## 60 Free Classified Ads

The market for buying and selling

## SERVICES

34 Newsagents order form

59 Subscription order form

63 Free Classified Ad form

65 Radio and Electronics World subscription order form

66 Advertisers Index

66 Advertising rates and information



# LOWE SHOPS TRIO TS830S

Whenever you enter a **LOWE ELECTRONICS'** shop, be it Glasgow, Darlington, Cambridge, Cardiff, London or here at Matlock, then you can be certain that, along with a courteous welcome, you will receive straightforward advice. Advice given, not with the intention of 'making' a sale, but the sort which is given freely by one radio amateur to another. Of course, if you decide to purchase then you have the knowledge that **LOWE ELECTRONICS** are the company that set the standard for amateur radio shops and after-sales service. The shops are open Tuesday to Friday from 9.00 to 5.30 pm, Saturday from 9.00 to 5.00 pm except Glasgow, which on Tuesdays opens at 10.00 am. For lunchtime closing arrangements, please check with the individual shop.

**In Glasgow the LOWE ELECTRONICS' shop** (the telephone number is 041 945 2626) is managed by Sim GM3SAN. Its address is 4/5 Queen Margaret's Road, off Queen Margaret's Drive. That's the right turn off Great Western Road at the Botanical Gardens' traffic lights. Street parking is available outside the shop and afterwards the Botanical Gardens are well worth a visit.

**In the North East the LOWE ELECTRONICS' shop** is found in the delightful market town of Darlington (the telephone number is 0325 486121) and is managed by Don G3GEA. The shop's address is 56 North Road, Darlington. That is on the A167 Durham road out of town. A huge free car park across the road, a large supermarket and bistro restaurant combine to make a visit to Darlington a pleasure for the whole family.

**Cambridge, not only a University town but the location of a LOWE ELECTRONICS' shop** managed by Tony G4NBS. The address is 162 High Street, Chesterton, Cambridge (the telephone number is 0223 311230). From the A45 just to the north of Cambridge turn off into the town on the A1309, past the science park and turn left at the first roundabout, signposted Chesterton. After passing a children's playground on your left turn left again (between the shops) into Green End Road. Very quickly, and without you noticing it, Green End Road becomes High Street. Easy and free street parking is available outside the shop.

**For South Wales, the LOWE ELECTRONICS' shop** is located in Cardiff. Managed by Richard GW4NAD, who hails from Penarth, the shop (the telephone number is 0222 464154) is within the premises (on the first floor) of South Wales Carpets, Clifton Street, Cardiff. Clifton Street is easily found, being a left turn off Newport Road just before the Infirmary. Once in Clifton Street, South Wales Carpets is the modern red brick building at the end of the street on the right hand side. Enter the shop, follow the arrows past the carpets, up the stairs and the 'Emporium' awaits you. Free street parking is available outside the shop.

**LOWE ELECTRONICS' London shop** is located at 223/225 Field End Road, Eastcote, Middlesex (the telephone number is 01 429 3256). The shop, managed by Andy G4DHQ is easily found, being part of Eastcote tube station buildings and as such being on the Metropolitan and Piccadilly lines (approximately 30 minutes from Baker Street main junction). For the motorist, we are only about 10 minutes' driving time from the M40, A40, North Circular Road (at Hanger Lane) and the new M25 junction at Denham. Immediately behind the shop is a large car park where you can currently park for the day for 20p. There is also free street parking outside the shop.

**Although not a shop** there is on the South Coast a source of good advice and equipment - John G3JYG. His address is 16 Harvard Road, Ringmer, Lewes, Sussex (telephone 0273 812071). An evening or weekend telephone call will put you in touch with John.

**Finally, here in Matlock,** David G4KFN is in charge. Located in an area of scenic beauty a visit to the shop can combine amateur radio with an outing for the whole family. May I suggest a meal in one of the town's inexpensive restaurants or a picnic on the hill tops followed by a spell of portable operation.



## hf transceiver

**The TRIO TS830S is for the operator who wants a dedicated amateur bands only transceiver,** who is used to and wants a pair of rugged 6146B valves in the PA stage and who wants a compact rig which has its own in-built power supply. The TS830S is for the radio amateur who requires a rig capable of rising above today's crowded band conditions, a rig that has, as standard, the necessary features that will produce consistently good contacts where other lesser equipment would fail. The TRIO TS830S, a proven rig with an impeccable pedigree.

**The TS830S covers** on USB, LSB and CW the full amateur bands from 160 through to 10 metres.

**Convenient to use,** the transceiver has its own in-built power supply.

**VBT (variable bandwidth tuning)** enables the operator to, at will, vary the IF filter passband width and establish optimum IF bandwidth relative to the interference being experienced.

**The IF shift control** allows the IF passband to be moved up or down in frequency without having to retune the receiver. Hence, an unwanted signal, present in the IF passband, may be attenuated significantly by moving the passband in the appropriate direction.

**As the IF shift and VBT are independently** adjustable they can, to advantage, be used together.

**The tunable notch filter** in the TS830S is a high-Q active circuit in the 455KHz second IF. Sharp, deep notch characteristics will eliminate a strong interfering carrier within the passband of the receiver section.

**The RF speech processor** in the TS830S provides added audio punch and increases the average SSB output power whilst suppressing sideband splatter. Compression levels can be monitored and controlled from the front panel.

**To cope with pulse type (such as ignition) noise,** the transceiver has an in-built noise blander.

**For perfect listening,** a tone control adjusts receiver audio frequency response to suit operating conditions.

**Both RIT and XIT,** transmitter as well as receiver incremental tuning are included to aid operating, XIT being a distinct advantage when calling a station that is listening 'off frequency'.

**It is possible** to monitor the transmitted audio in order to assess the effects of the speech processor: a most useful feature ensuring perfect signal reports.

**TS830S** amateur band transceiver.....£832.75 inc VAT, carr £7.00

## LOWE ELECTRONICS

Chesterfield Road, Matlock, Derbyshire. DE4 5LE.

Telephone 0629 2817, 2430, 4057, 4995. Telex 377482.



# TH41E

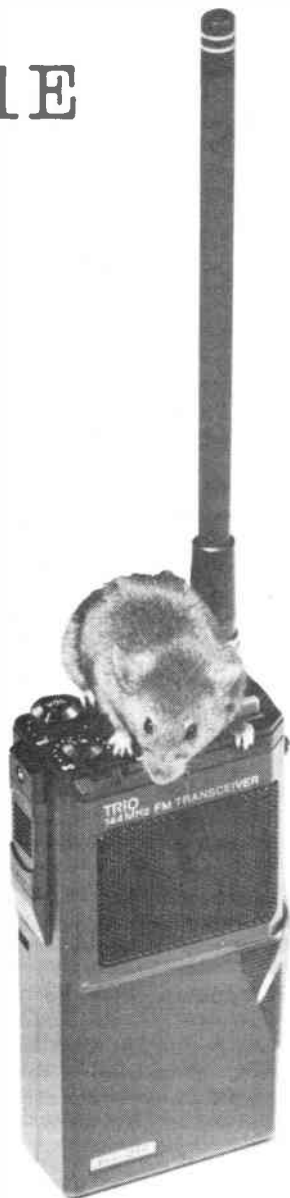

Up and down the country are many 70 centimetre repeaters, some 118 as compared with the 62 on 2 metres. Perhaps it is this wealth of equipment that can be summoned up at the sound of a 1750 Hz tone that now accounts for the increase in activity on 70 centimetres.

TR10, with the introduction of the TH41E, have a worthy transceiver for the 70 centimetre band. The rig is small but size is not its most important feature. It's just the way the transceiver feels when picked up, impossible to put down. I am not going to give its dimensions, just compare it with the mouse.

Power output is switchable, 1 watt high and 150 milliwatts low. Operation could not be easier. Frequency selection is by means of thumbwheel switches and the TH41E not only has simplex and 1.6 MHz repeater shift but full reverse repeater as well enabling you to quickly check the input, if possible QSY and make for better use of the band.

I have personally used a TH41E through my local repeater, GB3DY and I must admit that after years of listening and operating nothing has given me as much pleasure as operating the TH41E. As an owner and with the rig always on your person, the hobby of amateur radio expands to an all-day event. Never miss a contact, never miss a friend.

**1 watt output** in high power position, 150 mW in low position.

**Full coverage** of the 70 centimetre band from 430 to 440 MHz. (TH21E . . . 2 metre band from 144 to 146 MHz.)

**Frequency selection** by simple thumbwheel switches.

**Full repeater facilities** including reverse repeater.

The transceiver comes complete with nicad pack, wrist strap, antenna and charger.

**TH41E** . . . 70 centimetre micro transceiver .....£214.50 inc vat.

**TH21E** . . . 2 metre micro transceiver.....£188.46 inc vat.

# TS430S



The TS430S combines the facilities of a solid state HF transceiver with those of a general coverage receiver. It's the ideal rig for the radio amateur who not only wants to communicate with his fellows but also enjoys listening to the world. As an amateur band transceiver the rig covers top band to ten metres, as a short wave receiver coverage is from 150KHz to 30MHz. Operating on AM, FM, USB, LSB and CW the TS430S is extremely compact and, as such, is the perfect transceiver for mobile, portable or base station operation.

TS430S HF transceiver with general coverage receiver .....£769.50 inc VAT.

# TW4000A



Taking into account the amount of activity on the 2 metre FM channels it is not surprising that many people have turned their attention to the wide open spaces of 70 centimetres. With the TW4000A, TRIO have produced a dual band FM transceiver that gives its owner the best of both worlds. Facilities include 10 memories, two VFO's, priority channel, full repeater operation, band scan and memory scan. In memory scan mode the rig can be instructed to look for either 2 metre or 70 centimetre signals. The transceiver produces 25 watt RF output on both bands and comes complete with mobile mount and microphone. For greater safety whilst mobile the optional VS1 board will announce frequency, memory channel and whether or not the rig is set on repeater shift.

TW4000A dual band FM mobile.....£536.51 inc VAT.

# R600



For those who are banned from the house and have to operate from the shed at the bottom of the garden, why not consider an R600 to monitor the bands from the comfort of the fireside. No wife would forbid such an attractive looking receiver in the lounge, after all it could also be used to listen to *Women's Hour*. The R600 is a basic receiver covering from 150KHz to 30MHz and having switched upper and lower sidebands, wide and narrow am and cw. It has a 20dB attenuator and a noise blanker fitted as standard. Operation is simple, select the mode of operation, turn the MHz dial to the correct band and, by using the VFO knob, tune to the desired frequency. The clear digital readout makes station selection simple. The TRIO R600, your passport to comfortable listening.

R600 general coverage receiver.....£299.52 inc VAT.

## LOWE ELECTRONICS

Chesterfield Road, Matlock, Derbyshire. DE4 5LE.

Telephone 0629 2817, 2430, 4057, 4995. Telex 377482.





# L·E·T·T·E·R·S

## NO AXE TO GRIND

I have read with interest the correspondence re the democracy of the RSGB, and wonder if a few comments from someone with no particular axe to grind will help put things into perspective.

Perhaps I should explain that I am still very much a beginner, having been an SWL for two years, although I have done a fair amount of reading. I have also obtained as much literature as possible from both the licensing authorities and the RSGB, with a view to applying for membership of the latter to assist my ambition to become a transmitting amateur.

I must say that it seems a national pastime for various people to 'snipe' at the RSGB from time to time.

Sometimes they speak for a minority with some particular aspect in mind such as novice licences, but more often it is one individual who *claims* to speak for others.

All we get are vague references like 'new blood', 'living in the past', or 'old guard' – never any list of their supporters or details of changes they would like to see, either in the licensing conditions or the RSGB itself, or indeed whether they intend setting up an organisation to rival the RSGB.

After all, unlike the motorist who has a choice of two, we have only one national society. Probably just as well, unless the organising ability of some of the critics is more impressive than their logic!

All this is disquieting enough, but imagine my feelings when, upon obtaining another radio magazine recently, I found therein a letter from a so-called 'amateur' accusing the RSGB of lying, misrepresentation and manipulation. Whatever happened to 'Ham Spirit'? Perhaps I should change to a more gentlemanly hobby!

However to revert to your pages, in particular the letter from Mr Crosland G6JNS, surely the RSGB is justified in claiming to represent all amateurs in the UK. After all, the state of the hobby today is, for good or evil, largely due

to moves instigated by the Society and the licence concessions obtained, which are taken advantage of by members and non-members alike.

Admittedly a much smaller percentage of the current licensees are now members of the RSGB, but I think it dangerous to assume that all the non-members are anti-RSGB. Many reasons for failure to join spring to mind – financial considerations due to unemployment etc, general apathy, even not knowing of the Society's existence because their press and public relations set-up does not seem as vigorous as, say, the CB lobby was fairly recently.

I would certainly like to know how Mr Crosland knows the percentage of UK amateurs who agree with his views; has he canvassed them all? In no organisation does one find that all members agree with *every* aspect of its affairs, but the members I have spoken to seem in wide general agreement with RSGB policy.

Yes, we all know about the dinosaurs. Many of us have also met many 'new brooms' who were going to work wonders, and we know what happened to them.

I certainly intend to apply to join the RSGB (warts and all), having read the pros and cons, and trust that every thinking amateur will do likewise.

**Kenneth Purdy, Surrey**

## HAPPY MEMORIES

I must thank you for the pleasure you gave me in your January edition.

The first item that came to my notice was the article on the Marconi V2A by 'Old Ham'. It took me back to my first job after being pushed out of an elementary school in 1930.

I worked in a music and radio shop and we had a V2A with an amplifier, box and horn speaker under the bench. My father bought it with MT and LT and it was our first 'wireless'. I also found a 'Presto' with swinging coils and bright-emitter valves for my own use.

My father used to put his head in the speaker horn to

hear it better!

The other item I found of interest was the T1154/R1155 article which reminded me of my RAFVR days. Yes, those were the days when radio was very interesting.

Thank you for an interesting magazine.

**T Williams G4SAZ, Kendal**

## ENTHRALLING

What an enthralling article in the January '85 issue of *Amateur Radio*. It took me back to my days in the RAF where I serviced, modified and installed the equipment.

There are still remote parts of the service where these are used, but only last year a great many of these were released by the RAF as surplus to requirements. Many fortunate amateurs managed to buy these, complete and working.

Once, I owned two of them, but the receivers seemed to suffer from a substantial amount of electrolytic and small condenser trouble. I still have my air publication on the gear and one day may put it to good use, if I ever manage to buy another 54/55 combination.

The output bottles were PT15s, a pair in parallel. They were capable of handling more power, but this was not necessary as some of the older ex-WW2 aircrew used to talk of 5 and 9 signals between the UK and above the Ruhr valley, although keying was sometimes chirpy and the keying relay had a tendency to chatter if one attempted really fast CW.

One of my recollections was the use of the equipment in the Air Training Corps during the 1960s. I was responsible for the servicing of several of these sets, also some of the installations. I also worked one at weekends for an ATC unit in the south of England; I was a civilian instructor to the ATC.

During the fifties, we used them in the Royal Air Force quite extensively, particularly in the far east. Now that once hostile area regularly sends commercial radio equipment for sale in the United Kingdom. However, one thing is certain, no Korean gear will ever surpass the old Marconi

1154/1155 sets. Incidentally, if anyone has a 1082/1083 set to sell, please remember me.

**Ron Irving G3SYX, Lincs.**

## MANUAL OFFER

With reference to the January issue which included an article on the T1154/R1155: I have a copy of an Air Ministry manual on these sets which covers the T1154 A through N, R1155 A through N, circuit diagrams, test procedures, component values, test set type 65, artificial aerial, loop aerial, etc.

I would like to pass the book on but I don't know how to ensure that anyone interested in this type of radio could benefit. I am not as yet a licensed amateur but I am in the process of studying. I do not think the book will ever be of use to me personally but must be of value to someone, possibly a vintage or collectors club?

Perhaps you could give this note a mention in the *Letters* page in case anyone knows someone who could make good use of this original manual.

Thanks for a very interesting mag even if half of it leaves me cold. Keep up the good work but remember us dumb ones by including something a little biased towards the minority of amateurs who find the study hard work.

**C E Ladley, Lincs**

## GERMAN OM

I'm a German OM who would like to start a friendship with an English OM.

I read your magazine and would be most grateful if you could print the following text in the *Letters* page:

I take my holidays in England and would like an amateur radio friend to teach me the English language and to QSO with. He should be in the area of Stevenage, Herts, because I stay in Buntingford with my friends for three weeks each year.

Any offers welcome. Please write to: *Ulf Precker DL5IG, Im Oesterling 9, 6951 Binau, W Germany.*

Thank you very much for your help!

# L·E·T·T·E·R·S

## PERTURBED

Once in a while, I am tempted to buy your magazine, most recently for G3OSS on 13cm equipment. Perusing the letters section I was rather perturbed to read Peter Dodson's reply to G1DJV's letter. I did not see the original article on SWR measurements but G1DJV made an excellent job of criticising a somewhat poor article. Mr Dodson's reply however, indicates a complete disregard for criticism, however correct it may be.

Without resorting to more criticism of Mr Dodson, I feel I

must make a few points on the general subject of technical journalism.

Amateur radio is primarily a science-based hobby and is precise in all its technical aspects, so the author should aim to present a set of 100% correct facts. How far these facts are diluted for understanding and the article padded out depends on the author and the editor who should set the overall style. A chatty style of writing is a bonus in electronics journalism, which may help sell magazines, but accuracy should be of prime importance.

The more traditional magazines are often accused of being staid or stuffy but I doubt if they have ever received a letter such as G1DJV's. Quite simply, most magazines have reviewers who are technically qualified and experienced. If the article is inaccurate it will not be published.

Whether an author is writing 2000 words on a subject, or 20000 words in a series, he should remember that his words are read by many less qualified people who will take his words as gospel. As a professional (writer or engineer?) he

should be striving to maintain excellence and to encourage amateurs to an understanding of the technicalities of the subject, not churning out fallacies which cause confusion and misunderstanding. 2000 words of fact are much more use than 20000 words of pleasant-sounding drivel.

A magazine has to appoint its own gurus and in most cases *Amateur Radio* has excellent ones, but possibly a technical reviewer (with teeth) would be a useful addition to the staff.  
**John Wilkinson G4HGT, Leeds**

## WITH INTEREST

With some interest I read the long letter from Mr Whitelegg G1DJV, regarding the articles written by Mr Peter Dodson. I do not wish to enter the controversy regarding SWR readings, for perfect explanations of antenna matching appear in many reputable publications and handbooks. I am surprised that so many misconceptions surround the topic of SWR readings and that often these are printed and appear later in further publications and articles.

The question of Peter Dodson's callsign is intriguing. Most of us who pen articles for the amateur radio press are only too eager to have our correct names and callsigns below our efforts (despite drawing the attentions of the Tax Man!), and I must only surmise that 'Peter Dodson' is a *nom de plume* hiding the real name of a licensed amateur. It is inconceivable that Dodson's articles could have been written by someone not having experience as a transmitting amateur. Why is our friend so eager to hide his true identity?

I must before concluding take task with Dodson on one point which I feel is important. Has he actually tried and used the antennae that he describes, or is he just 're-hashing' existing information from other sources? I only write about antennae that have been personally made and used by myself and would consider

myself something of a charlatan were I to enthuse about an antenna that I had only read or heard about at secondhand. On the few occasions in my articles that I mention an aerial system that I have not used myself I make such a point quite clear to the reader.

**John D Heys G3BDQ, Hastings**

## APPALLING BARRAGE

As radio amateurs, we often refer proudly to our membership of a great international fraternity. An admirable concept of course, but in one respect at least it does not hold good.

I refer to common DX hunting practices, when the surfacing of a good DX station immediately banishes all semblance of brotherly respect and tolerance from the bands. For prolonged periods the rare bird is subjected to an appalling barrage of bedlamic noise, as dozens of shouting predators descend upon him. Nobody ever dreams of giving way to the other fellow, and the pernicious doctrine of 'might is right' sadly prevails.

Surely this picture leaves much room for improvement, if operational courtesy on the air is not to join the dodo in extinction.

I'm glad to say that this is my only beef after eight years of otherwise enjoyable involvement.

Meanwhile, congratulations on your excellent magazine, which I

await eagerly each month.  
**Pat Mooney EI6DA, Dublin**

## SUGGESTIONS PLEASE

At present I have no involvement with amateur radio and would class myself as relatively ignorant in this respect. However, I am very interested in taking up this pastime and would be most grateful if anyone could suggest the best and, I might add, least expensive method of doing so. Perhaps, in addition, someone could recommend some appropriate reading matter.

May I take this opportunity to compliment *Amateur Radio* on what I consider to be a well written, balanced and informative magazine.  
**M W Anderson, Newcastle-upon-Tyne**

## CAN YOU HELP?

I am a reader of *Amateur Radio* and would like to ask your readers if they can help me.

I would like to know if my rig can be converted to cover the 2m and 144MHz bands for use when I pass the RAE.

I have a Pye Westminster VHF, AM, type 15AM transceiver which has a 10 channel Tx/Rx with crystals. At present it covers the 68-74MHz band and is used with a mains power supply, although it has a 12V connection.

As I am a pensioner I cannot afford an expensive rig, yet I wish to enjoy this hobby to the full before age catches up with me.

Thank you for an excellent magazine. Keep up the good work.

**Richard Freeman, Sunderland**

## INCENSED

I have just read the article *Justice/Injustice* by Hugh Allison G3XSE in the February edition of *Amateur Radio* and I am appalled. In fairness both the Police and the RSGB should now be invited to answer Mr Allison's allegations.

The matter is a desperately serious one. Either certain policemen in the Harlow area are quite insufferable and unfit for their jobs, and G3XSE is justifiably incensed, or there were reasonable grounds for their behaviour.

Can we hear their side of it? If G3XSE is justified then what has been done to restore the Police force involved to good behaviour?

**Ronald J Marshall, Gourock**

## GB STATIONS

Apart from contests, undoubtedly the worst operating can be heard from the 'experts' who hold forth with such pomposity when in charge of the mike at a 'special event' station given a GB callsign!

So might I have the audacity to suggest that in future these stations be licensed to use CW only; that would cut the cackle, and incidentally, prove to be much more interesting.

**Douglas Byrne G3KPO, Ryde**



# STRAIGHT & LEVEL

All the latest news, comment and developments on the amateur radio scene

## CIRCUIT MAKER

Electrolube have introduced the CM100 Circuit Maker Kit which they claim is one of the first DIY kits on the market to offer a complete and easy-to-use system for producing printed circuit boards. It is ideal for the expert hobbyist or those wishing to try their hand at electronics.

This versatile kit enables hobbyists to produce layouts from magazines and other sources using an easy four-step system which is explained in a detailed set of step-by-step instructions. These steps include producing a film positive master of the chosen PCB design, etching of the board using photo-resist, removal of the photo-resist and finally drilling and component assembly.

Advantages of the CM100 kit include the photographic development system which allows professional quality circuit boards to be produced without a darkroom, camera equipment or ultra violet lights, and the ease of use makes previous photographic experience unnecessary.

Electrolube now offers items from the CM100 Circuit Maker Kit separately, which will allow hobbyists to supplement their existing equipment and supplies. Included in this list of items is a specially designed universal assembly frame which is useful for drilling and component assembly, developers, fixer and clearing solutions for the auto-positive film, photo-resist and developer, and double-sided copper clad boards.

A useful asset for electronics hobbyists, the CM100 Circuit Maker Kit is very adaptable and can be tailored to suit the needs and demands of various situations.

Electrolube Limited, Blakes

Road, Wargrave, Berkshire  
RG10 3014. Tel: (073) 522 3014.



## ANALOGUE MULTIMETER

TMK Test Instruments have announced the VF3, a small pocket size analogue multimeter, featuring a full range of functions with a high sensitivity of 2000 ohms/volt on all dc and ac ranges, assuring accurate measurements without unnecessary loading of the circuit under test. Included in the 16 measurement ranges are dc and ac volts, dc current, ohms and decibels.

Rugged and reliable with a high impact resistant case, the VF3 is very easy to use. It has a single rotary switch giving analogue indication on a mirror arc scale to reduce parallax error and the meter movement is protected against accidental over-load.

The VF3 comes complete with test leads and a long-lasting battery. It weighs approximately 90gms and its dimensions are 90 x 60 x 29mm.

TMK Test Instruments, 138  
Grays Inn Road, London  
WC1X 8AX. Tel: (01) 837 7937.

## RTTY CONTEST

Peter Adams G6LZB has sent us some information on the BARTG Autumn RTTY Contest 1984:

'The vast increase in our membership certainly

showed in the number of stations active throughout the contest. However, I still only received 22 logs for the single operator section and 13 for the multi-operator section. I wonder why stations don't send them in?

'Conditions certainly improved during the contest and a number of stations worked well into the Continent. The best DX contact appeared to be the one between GW2OP and PE1IML at 682Km.

'With such a large number of stations active, the possibility of claims for the VHF Century Award seem very good.'

G6LZB reports that 191 British stations participated.

The Spring VHF/UHF RTTY Contest will take place between 1800 GMT on Saturday 13 April and 1200 GMT on Sunday 14 April. Further information and contest rules are available from the BARTG Contest Manager, Peter Adams G6LZB, 464 Whippen-dell Road, Watford, Herts WD1 7PT. Completed logs should also be sent to this address.

## ATV CONTEST

Congratulations to G8MNY for coming first on 70cm and to G8VBC for winning the 23cm section in the September ATV contest. Certainly conditions were not at their best: G6WOR/P, who could almost see the Channel, worked no continentals and ON7ZI and GU8FBO were the only DX stations available in the south - and then for only a few minutes at a time!

However, the level of activity on both 70 and 23 was better than ever and shows just how much interest continues to grow in ATV.

We received the following comments from contestants: 'We hoped this year would

have better weather but a storm in the middle of the night took out the 70cm mast at 45 feet; it snapped in two but was put up to 28 feet within an hour at 0345!' - G8MNY.

'Conditions were horrible but I enjoyed it.' - G8VBC.

'The 23cm receiver could have been better if we had fitted the mast-head pre-amp the right way round!' - Anon.

ATV enthusiasts' attention is drawn to the annual Summerfun Contest scheduled for 0900 to 1600GMT on Sunday 16 June, this being the first ATV contest using the new Maidenhead locators. Contest rules appear in CQ-TV no129.

Please note that the contest organiser (G3VZV QThr) prefers entries on BATC log sheets, available from him on receipt of an SAE.

## MISPRINT

In the Dodson at Random feature in the January issue of *Amateur Radio* entitled 'CW reception' a misprint was included in Table 1. The table listed the components and their values required for the conversion of a receiver for CW reception.

The resistors numbered R2, 3, 4, 10 and 13 should have had the value of 24K $\Omega$  and not 240K $\Omega$  as printed.

We apologise for the mistake and regret any inconvenience caused.

## TINNING

In the January edition of *Amateur Radio* the *Beginners' Workshop* feature, written by Rev George Dobbs G3RJV, included some advice on the tinning of soldering iron bits.

On the magazine's publication we received a letter from Antex (Electronics) Ltd which made the following point:

'The advice given regarding

the tinning of the bit is erroneous. The bits are plated with a heavy deposit of iron followed by a layer of chromium and nickel; the object being to save them from the extremely corrosive effects of the flux which is so essential to the soldering process.

'We estimate that filing the tip back to bare metal, as the author advocates on page 28, would reduce the projected life of the tip by about 75%, when life is the number of joints which can be soldered before the form of the tip has corroded beyond use.'

## FROM THE BOOKSHELF

This month we take a look at three books which may be of interest to the hobbyist. The first is objectively titled *Amateur Radio, Super Hobby!*, written by Vince Luciani K2VJ.



As the author's callsign indicates, the book is of American origin and therein lie the two major drawbacks for the British reader. Firstly, much of the useful 'getting started' information provided by the book is completely irrelevant on this side of the Atlantic, and many of the lyrical descriptions of the hobby just do not apply here.

Secondly, and perhaps more infuriating to the potential reader in the UK, is that the author's pseudo non-technical style often amounts to little more than cliché-ridden West Coast American jargonese (typified by the book's sub-title, 'What it is, who we are, how to join', which given the author's name seems to make the whole book sound like a recruitment leaflet for the

QST mafia).

The book may have succeeded in creating interest in the hobby in the US, where at least it is accurate and relevant, but to suggest it could ever perform the same function here is both cynical and erroneous.

Even for US readers, a book which contains such predictable chapters as those on Barry Goldwater (K7UGA—for those few on this side of the Atlantic who don't know), Wayne Green *et al.* must surely lay its integrity and usefulness on the line as clearly as it does its carefully contrived vision of 'ham' camaraderie (been listening to any of those polite, high power US stations during any of the recent contests?).

The book is of interest for some of its anecdotes, and as an insight to how American amateurs see their own fraternity ('how to join' again), but its 'foreign' nature and self-congratulatory smugness make its purchase a waste of money, and its reading agonising and ultimately a waste of time.

If it was in your local library I'd advise you to get it out for a week; if you were a librarian asking for suggestions for books on the hobby, I'd tell you not to touch it—even if you had a bloody great barge pole.

What the book does do is suggest that there should be a readable introduction to the hobby as it exists on these shores, something which perhaps our friends at the RSGB could be looking into (to complement Pat Hawker's excellent *Guide to Amateur Radio*, which is nonetheless aimed at those who have already decided to enter the hobby).

To this end, any suggestions for a title for such a book would be gratefully received by the Editor. Hopefully these will be less crass than 'Super Hobby!'—the best will be sent to the RSGB, and just to make it all worthwhile, whoever sends in that 'gem' will receive a free copy of that epic volume *Amateur Radio, Super Hobby!*, which is no longer required at this address.

The second book looked at this month is also 'foreign', but despite struggling against (and suffering from) translation from the original German, brings greater

rewards to the interested reader. *Ninety Nine Nights on Medium Wave* provides an enthusiastic and functional introduction to MW DX.

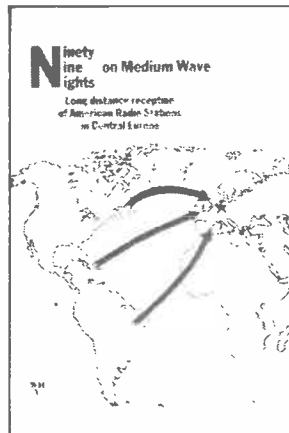

The book is based around a survey of DX conditions and results over a three month period. Apart from showing what can be achieved through regular listening on these bands, the book provides essential information for the beginner in the form of names, frequencies and addresses of the more common stations to be logged, along with technical information and advice on this challenging form of BC DXing.

Above all, this book belies its simple form and sometimes ragged grammar to convey the enthusiasm and dedication required in this branch of the radio hobby in a way which makes *Amateur Radio, Super Hobby!* look like the result of too many monks with too many typewriters.

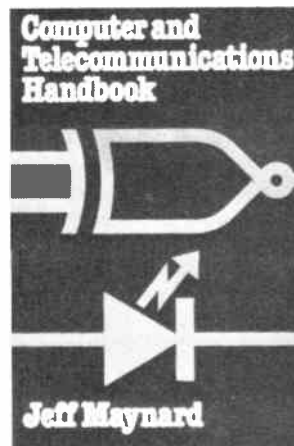

The third of this month's books is one that comes heartily recommended: the *Computer and Telecommunications Handbook*, by Jeff Maynard. Surprisingly

enough, this book is not American, or German, but British! It is also invaluable, expensive (well, it is British) and worth the money.

The book is a source of reference that brings together many pieces of information which previously had to be dug out from a variety of sources, and is, quite simply, a compendium of those 'silly-little-facts-that-must-be-lying-around-somewhere' that we all need from time to time.

If your hexadecimal has got a bit rusty, or if you can't for the life of you remember the meaning of QSC during an SOS call; if you want a useful bandplan up to 150MHz; if you're not quite sure whether ASCII is a form of computer code or an engineering degree; if you want the facts about FAX and a lot of other facts as well; you could do much worse than invest in this book.

Calculations, standards, codes, components, symbols, theories, callsigns, conventions and maths: they are all here, waiting to be of help.

Maybe if there's enough demand this book will appear in paperback; when it does, it will become required reading for all in the hobby—particularly those who through the use of data transmission attempt to fling the hobby into the twenty-first century. Other twentieth century mortals may prefer *Amateur Radio, Super Hobby!*: I hope not. For God, BARTG and the 21st century, I hope we realise that even 'pulp' can be well-presented, even 'talking down' to beginners need not involve condescension.

If the *Computer and Telecommunications Handbook* is merely a source of reference to the world which *Amateur Radio, Super Hobby!* supposedly describes, then for the time being I'll stick to the dictionary, and skip the novel.

*Amateur Radio, Super Hobby!* McGraw-Hill Book Co (UK) Ltd, Shoppenhangers Rd, Maidenhead, Berks.

*Ninety Nine Nights on Medium Wave.* Wilhelm Herbst, PO Box 45 05 06, D-5000 Köln 41, Fed Rep of Germany.

*Computer and Telecommunications Handbook.* Collins Professional and Technical Books, 8 Grafton St, London W1.



## CLUB NEWS

### 25th anniversary

It is with pleasure that the Blackwood and District Amateur Radio Society announce the 25th anniversary of the club.

As part of the celebrations the club has put together an award to help bring B&D ARS to the attention of other amateurs.

The contest/awards are open to non-members only, although the member whose callsign appears most frequently on the claimants' log sheets will be awarded a certificate. There is also an award for the SWL member of the B&D ARS who logs the highest number of members' callsigns in the twelve month period.

Applications for rule sheets and information to: *Blackwood and District ARS, c/o GW4VVX, PO Box 21, Blackwood, Gwent.*

### STARS Award

The Stowbridge and District Amateur Radio Society is offering the STARS Award to both licensed amateurs and listeners who work/hear STARS members on at least two amateur bands.

Applicants have to have worked a minimum of 9 society members, and by taking one letter from the suffix of 5 of the members' callsigns spell out STARS.

There are no mode restrictions.

Full details are given in the list of rules available from: *John Sheils G6VAT, 5 Ombersley Road, Halesowen, West Midlands B63 4PJ. Please enclose an SAE.*

### Bury Radio Society

At the general meeting on 11 December several changes were made to the committee of the Bury Radio Society. Their chairman is now Mike Bainbridge G4GSY whilst G3VNU has taken over as editor of 'Feedback', the society's bi-monthly journal.

The journal includes all club news and articles of interest, such as one entitled *French lessons for the radio amateur.*

The society meets every Tuesday evening at 8.00pm in the Mosses Community Centre, Cecil Street, Bury. The main meetings are held on the second Tuesday of the month; the remaining meetings are informal.

For further information please contact:

*Hon Secretary Brian Tyldsley G4TBT, 4 Colne Road, Burnley. Tel: Burnley 24254.*

### Bridgend and District ARC

The Bridgend and District Amateur Radio Club has appointed a new chairman: Mr Don Sedgebeer GW3RUG.

The club meets on the first and third Friday of every month at the YMCA, Bridgend, Mid Glamorgan. Meetings start at 7.30pm and further information is available from the secretary at the undermentioned address.

*T C Morgan GW4SML, 4 Rhiw Tremean, Brackla, Bridgend, Mid Glam, South Wales.*

### East Lancashire ARC

The East Lancashire Amateur Radio Club (G3NTJ, G1ELC) meets twice a month at the Conservative Club, Cliffe Street.

On the first Tuesday of every month at 7.30pm they have a lecture or demonstration and on the last Tuesday an informal meeting. On the Tuesdays they do not meet there is a club net on 145.400MHz at 7.30pm.

On the schedule for the next two formal meetings, on 5 March and 2 April, they have a surplus equipment sale and a visit from the local police for a talk on crime prevention.

Further information regarding meetings and club events can be obtained from: *Stuart Westall G6LXU, 19 Sussex Road, Rishton, Blackburn, Lancashire BB1 4BJ.*

### Components fair

The Pontefract and District Amateur Radio Society (G3FYQ, G1FYQ) are holding their components fair on Sunday 10 March from 11.00am to 4.30pm at the Carleton Community Centre, Pontefract.

The event is based on the mobile radio rally but it is aimed at the home constructor and the do-it-yourself enthusiast.

Traders are invited to sell components, surplus equipment, instruments and antennae. New black box type of equipment is not allowed at this event.

For further information please contact the organisers: *N Whittingham G4ISU; Tel: (0977) 792784. R Greenhough G4KMW; Tel: (0977) 792654.*

### Southend RS Rally

The Southend and District Radio Society will be holding a mobile rally at the Rocheway Centre, Rochford, Essex on 28 April.

Talk-in on S22 145.550MHz FM is available, although there will be adequate road signs. There is ample parking, including on site facilities for disabled visitors.

Black boxes, components and bring-and-buy stalls are some of the attractions which will be supported by the statutory refreshments and licensed bar.

For further information contact: *Bryn G4DEZ; Tel: (0702) 617749 or Brian G4RDS; Tel: (03745) 50494.*

### Radio and Computer Fair

The North Wakefield Radio Club is holding an Amateur Radio and Computer Fair at Bretton Hall College, Bretton on 8 April.

Doors open at 11.00am (10.30am for disabled visitors) and all the usual attractions including radio, computers, electronics and bring-and-buy stalls will be included, with the addition of handicraft stalls and film shows for the rest of the family.

Talk-in will be available on S22 and GB3WV (RB15).

For dealer or visitor enquiries contact: *Steve Thompson G4RCH, 2 Alden Close, Morley, Leeds LS27 0SG. Tel: (0532) 536633.*

### BATC rally

The BATC will be holding its Amateur Rally at The Post House Hotel, Crick on 5 May. This pleasant location for a rally is located less than 200 yards from the M1 at Junction 18. The doors open at 10.00am and admission is free.

All the usual traders will be in attendance. There will also be a full supporting lecture programme including talks on colour SSTV, interfacing to the Spectrum computer, and amateur television techniques.

The famous Post House lunch is available by prior arrangement as is overnight accommodation at special terms for those attending.

To make bookings contact: *The Post House. Tel: (0788) 822107.*

### 2nd Anglo-Scottish Rally

Following their highly successful inaugural event in 1984, the joint organisers

Kelso, Borders and Galashiels amateur radio societies will be hosting the 2nd Anglo-Scottish Rally in Kelso's Tait Hall on Sunday 5 May 1985 from 11.00am to 5.00pm.

There will be the usual stalls, talk-in on S22, CW testing station, bar, hot and cold snacks, raffles etc.

Entrance will be £1.00 - junior ops, YLs and XYLs very welcome and admitted free. Something to do for everyone.

For further information, including accommodation, contact: *André Saunders GM3VLB, Physics Dept, Kelso High School, or Bruce Cavers GM4UIB, QThr. Tel: (0573) 24664 and 24654 (evenings only).*

### WIA 75 Award

The world's first and oldest radio society, the Wireless Institute of Australia, celebrates its 75th anniversary during 1985.

One of the many planned activities is the WIA 75 award which will be available during the period March 1 to December 31 1985.

To qualify, radio amateurs (and short wave listeners) need to contact (log) 75 members of the Wireless Institute of Australia. A contact will only be valid if the WIA member's individual membership number is logged.

No more than 30 WIA members may be logged in any one callsign area.

Claims should include a log extract of the 75 WIA members contacted, \$2 (Aust) to cover the certificate, handling and postage costs, and be sent to:

*WIA 75 Award Manager, Wireless Institute of Australia, 412 Brunswick Street, Fitzroy 3065. Victoria, Australia.*

### Amateurs help charity

The Southgate Amateur Radio Club will be operating a special amateur radio Station, for 48 hours over the weekend of 30/31 March 1985. In support of the Mayor of Enfield's charity appeal, the club will be sponsored for every country that they make contact with (there are over 350 countries in the world).

Further information is available from: *Mr R F Snary, SARC, 12 Borden Avenue, Enfield EN1 2BZ.*

# R WITHERS COMMUNICATIONS



**584 HAGLEY ROAD WEST, OLDBURY, WARLEY  
B68 0BS (QUINTON, BIRMINGHAM) WEST MIDS.  
Tel: 021-421 8201/2 (24 HR ANSWERPHONE)**



**RWC SPECIAL OFFERS**



**PLEASE ASK ABOUT THE RWC CREDITCARD  
AVAILABLE NOW VIA LOMBARD TRICITY**

**M5  
JUNCT  
3**

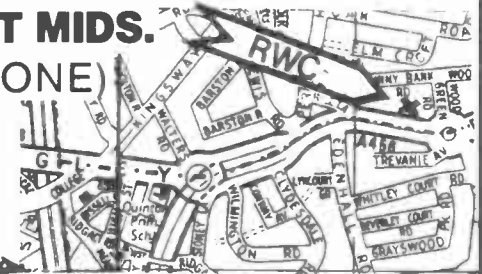

## "WITHERS WINDOWS" – BARGAIN PRICED OFFERS

<p><b>YAESU FT290R with free travelling Jim</b> <b>£299</b> Ni-cads &amp; charger available for <b>£20.00</b> WHILE STOCKS LAST</p>	<p><b>TURN THAT BEAM KOPEK ROTATORS</b> 50KG LOAD-ING FULL 1 YEAR WARRANTY OUTSTANDING VALUE <b>£38.50</b></p>	<p><b>GOOD QUALITY FIELD-STRENGTH VSWR METERS</b> IN-LINE DESIGN WORK VERY WELL ON 2 METRES <b>£9.50 inc post ONLY 50 AT THIS PRICE</b></p>	<p><b>YAESU FT708R 'HANDIE'</b> <b>FREE * HB9CV</b> <b>*NI-CADS *CASE</b> <b>£199 *CHARGER 3 LEFT*POST INC</b></p>
<p><b>NEW RANGE OF LINEAR AMPLIFIERS FROM RAYCOM LTD SEND SAE FOR FULL DETAILS</b></p>	<p><b>10 MTR MOD KIT FOR DNT 40FM AND LCL2740 INC 2-XTALS + XTAL FILTER 1x-TALFILTER 2 CAPACITORS</b> RWC BEST SELLER <b>£12.95</b></p>	<p><b>'R.W.C. Special' Revco RS 2000 Ext Coverage 60-179 &amp; 380-520MHz</b> AM+FM <b>THIS PRICE INCLUDES</b> *70 MEMORIES *AC-DC SUPPLY *AUTO SEARCH *LOCK PRIORITY *Plus usual functions <b>£259.00</b></p>	<p><b>LCL 10MTR MOBILE LAST TEN</b> *6W *40CM *INC BRACKET <b>£48.50</b></p>
<p><b>10 METRES FM QUALITY LOWE TX40G</b> *SUPER SENSITIVE RECEIVER *4WATTS OUTPUT *4KHZ DEVIATION FM *REPEATER OFFSET INCLUDED ONLY 50 AVAILABLE JOIN IN THE GROWING ACTION ON TEN-FM. ONLY <b>£49.50</b></p>	<p><b>STOP PRESS ... STOP PRESS ... STOP PRESS ...</b> RWC MOD KIT FOR LC71367 CHIPS (IE MOST CB RIGS) NOW AVAILABLE IT WILL MODIFY ANY CB RADIO. WITH THE ABOVE PLL CHIP UP TO AND BEYOND 30MHz IN 10KHz 40 CHANNEL STEPS. THE UNIT HAS BUILT IN REPEATER OFFSET, AND HAS ONLY 8 WIRES TO SOLDER INTO EXISTING RADIO. WITH RE-ADJUSTMENTS ON VCO. RX. RF &amp; TXRF PRICE ONLY <b>£22.50</b> FOR BUILT AND TESTED MODULE AND FULL INSTRUCTIONS. SEE OTHER ADVERTISEMENTS</p>	<p><b>WANTED</b> FT225R/D, IC202E/S, FRG-7, IC2E, TR2300 BEST PRICES PAID - WORKING OR NOT</p>	<p>Professional 4 channel 27MHz hand holds inc case &amp; batteries. "Crystals fitted." Superb quality easily convts to 10 Mtrs. Fantastic value only <b>£37.95</b> "Ni-Cads and charger available." "2 watts output"</p>
<p><b>FARNELL 10 AMP OK ON 2MTU</b> PSU REGULATED AND FULLY PROTECTED SWITCH (LIST £185) MODE LAST FEW <b>£39.50</b></p>	<p><b>AKD WAVE METER. A MUST FOR ALL VHF STATIONS</b> <b>£24.95 inc P</b> THE BEST</p>	<p><b>SPECIAL '8 C SIZE NI-CADS 1800MaH</b> <b>£18.50</b></p>	<p><b>RWC'S HB9CV</b> 2 Mtrs <b>£6.99.</b> 70Cms <b>£5.99</b> post &amp; pck <b>£1.00.</b></p>
<p><b>6 METRES BARGAIN 5 ONLY TONNA 5 ELEMENT YAGI SUPER SPECIAL</b> <b>£25.00</b></p>	<p><b>HOXIN DC GROUND 1/2 WAVE MOBILE ANT</b> INC PL259 + CO-AX <b>£9.50</b> TO CLEAR</p>	<p><b>NEW LINE 10 METRE DIPOLE (RIGID) TELESCOPIC QUALITY CONSTRUCTION</b> <b>£9.50</b></p>	<p><b>SUN HIGH QUALITY GUTTER MOUNT KITS INC 4Mtrs CO-AX AND PL 259 ANODISED</b> BLACK FINISH ONLY <b>£9.95</b></p>
<p><b>TRAVELLING JIM</b> 2M 70CMS INC LEAD 2M <b>£7.95</b> + PL259 70CM <b>£8.95</b></p>	<p><b>R.W.C. BARGAIN PACK</b> BNC KIT SILVER + NICKEL PLATED ELBOWS WORTH <b>£10</b> PLUGSET ONLY <b>£6.99</b></p>	<p><b>USA MADE PUSH ON PL259</b> LAST 300 TO CLEAR FOR UR67 UR43 <b>99p FOR THREE!</b></p>	<p><b>WARNING</b> PRICES ON IMPORTED GOODS WILL SHORTLY HAVE TO RISE. DUE TO THE STATE OF THE POOR OLD POUNDS STERLING! WE CANNOT GUARANTEE PRICES ON ANY FUTURE STOCKS - NOW IS A GOOD TIME TO BUY -</p>
<p><b>YAESU FT102 AM FILTERS XF 8.2 GA</b> YAESU <b>£19.50</b></p>	<p><b>RF TRANSISTORS OVER 20,000W IN STOCK FOR ALL HF/VHF/UHF RADIOS</b> EG. 2SC 1947 <b>£7.50</b> 2SC 2290 @ <b>£24.00</b></p>	<p><b>VERY HEAVY CHROME PLATE MORSE KEY BLOCK SUIT HK705 ETC. WITH FREE 1/4" JACK + LEAD</b> <b>£6.95</b></p>	<p><b>MINI HEADPHONES 3.5MM + 1/4" JACKS</b> MONO SUPER STEREO QUALITY LIGHTWEIGHT DESIGN <b>£3.95 INC P&amp;P</b></p>
<p><b>SAVE OVER £40!</b></p>	<p><b>70cms</b></p>	<p><b>POWER MODULES FOR FDK YAESU ICOM TRIO</b> ETC. EG 25W 2 MTR WRITE FOR FULL LIST, FROM <b>£35.00</b></p>	<p><b>BARGAIN ONE ONLY COMPUTATOR ROTATOR CT1000 1/2 PRICE</b> <b>£299</b></p>
<p><b>STOP PRESS LOW PASS TVI FILTER BY TELCO LIST</b> <b>£39.95</b> 12 ONLY <b>£12.50</b> MADE IN USA</p>	<p><b>HF AERIAL TRAPS GBKW-W3DZZ TYPE</b> HIGH QUALITY 7.1MHZ <b>£8.95</b> PAIR POST FREE</p>	<p><b>HEAVY DUTY MAGNETIC MOUNT S0239 MOUNT 3M COAX + PL259</b> <b>SPECIAL PRICE £8.95</b></p>	<p><b>QSRV HF MULTI-BAND DIPOLE ANTENNA</b> FULL SIZE <b>£14.95</b> 1/2 SIZE <b>£12.95</b> POST &amp; PACKING FREE!</p>
<p><b>CCTV LENS 39MM JAP 'C' TYPE FIXING 16mm FOCAL LENGTH</b></p>	<p><b>KENWOOD TRIO MC-35S NOISE CANCELLING DYNAMIC MIKE SUPER QUALITY</b> <b>£12.80</b> LAST FIVE</p>	<p><b>LAST FIVE</b></p>	<p><b>LAST FIVE</b></p>

All offers subject to availability on a first come first served basis. Prices subject to change without notice, all correct at time of going to press, E&OE. **TERMS:** No COD. Barclaycard and Access accepted. Post free over £50, under £50 add £2.50 post and handling, unless stated. Please send SAE with all enquiries and for latest secondhand list.





*You haven't shown  
any TRIO prices,  
Bernie!*

# NEC SHOW SPEC

## SUPERB 2 METRE BASE STATION



**ICOM IC271E**  
2m base station for the eighties, 25w O/P, 32 memories, scanning, 10/100Hz auto shift tuning rates + (as options) voice frequency synthesiser, internal 12V psu, GaAS FET preamp.

**£659**  
OR  
**£689 WITH**  
ICSM6 ELECTRET  
BASE STATION MIC  
OR  
AG20 INTERNAL GaAS  
FET ICOM PREAMP

## HOW LOW CAN WE GO!

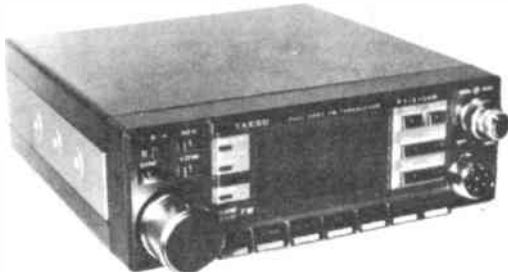

**YAESU FT2700**  
DUO BANDS  
2 M & 70cm  
Full DUPLEX operation  
25 watts on each band

**£499 with**  
Antenna  
Duplexer **FREE**



PRICES CORRECT AT TIME OF GOING TO PRESS  
ALL OFFERS SUBJECT TO AVAILABILITY  
ALL PRICES INCLUDE V.A.T.

\* NEC Special Offers are available to the public only at NEC—and to ARE Club Members at time of publication.

## STILL THE BEST



**ICOM ICR71**  
The latest superior grade receiver, with keyboard entry, 32 tunable memories, three rates of tuning + (as options) infra red remote, F.M., voice frequency synthesiser, additional filters.

**£669**  
OR  
**£699**  
WITH  
REMOTE UNIT  
OR FM BD

## REACH FOR THE SKY & CATCH A SATELLITE



**YAESU FT726R**  
Multiband base station transceiver.

**£775**

**EXTRA-SPECIAL OFFER**  
FT726R WITH 70cm CARD FITTED £1,099—WITH  
DUPLEXER/SATELLITE MODULE WORTH £100!

## EXTRA VERY SPECIALS

- MUTEK 6M Transverter 2M to 6M **£169**
- SX400—The Professional Scanner **£549**
- AOR2001 Scanner Rec Gen Coverage 25-525mHz **£325**
- CENTURY Gen Cov HF Rec **£169**

# SPECIALS\* FROM A.R.E.

## WORLD BEATER



**YAESU FT290R**  
The design team on this one at YAESU definitely deserve full marks – probably the best selling 2m multimode in the world.

**£299 WITH MUTEK BOARD OR NICADS & CHARGER**



## RECEIVE THIS



**YAESU FRG 8800**  
Receiver with very special features:

**£495**

- Frequency coverage 500 kc to 30 MHz
- Memory and scan facilities
- VHF converters available



*I'm keeping low on those until the SHOW!*

### KENWOOD/TRIO SPECIAL OFFERS

- |        |        |
|--------|--------|
| TS930  | TS530  |
| TS430  | TS2600 |
| TW4000 | TS3600 |
| TS830  |        |

**HURRY!! LIMITED STOCKS ONLY!!**

## ICOM AT ITS BEST



**ICOM IC745**  
H.F. transceiver/gen. coverage receiver. The IC740 was, and still is, popular – the introduction of the IC745 with its additional features makes it our recommendation for the serious H.F. operator.

**£898 WITH FREE ICSM6 BASE STATION MIC AND ICEX242 FM MODULE**

## THE ULTIMATE



**YAESU FT757GX TRANSCEIVER**  
Compact – dual VFO's – general coverage – 100W O/P. FM/SSB/CW. All options fitted incl. CW Filter and electronic keyer.

**£739 WITH FREE AERIAL TUNING UNIT**

**CLOSED – MONDAYS**  
**OPEN – TUES, WED, THURS, FRI 9.30-5.30.**  
**SAT 9.30-5.00.**



LONDON.  
373 UXBRIDGE ROAD,  
ACTON,  
LONDON W3 9RH  
Tel: 01-992 5765/6

NORTHERN  
38 BRIDGE STREET  
EARLESTOWN, NEWTON LE WILLOWS,  
MERSEYSIDE WA12 9BA  
Tel: 092 52 29881

*more on your wavelength*

AMATEUR RADIO EXCHANGE LTD



# DX DIARY

News for HF operators compiled by Don Field G3XTT

The low frequency bands started the year well and by mid-January much exotic DX was being worked, including such stations as HC1BI, 9Y4VU, 6Y5IC, 3B9CD, AP2SQ, W6, W7 and JAs, and all of this on 160 metres! In addition, the CQ WW 160 metre CW Contest at the end of the month produced contacts for UK stations with KV4FZ, YV1OB, RT5UL/UJ and others.

Compared with all this there was very little to report on 20 and 15 metres and nothing whatsoever on 10. What is more, there has been some debate about whether the sunspot minimum might actually come later than originally anticipated, so we could well have to put up with these (or worse) conditions for another 3 or 4 years at least. Time perhaps to put up that 40 metre beam or the phased verticals that you have always promised yourself.

## Cyprus - now two 'countries'

In January the ARRL Awards Committee approved the earlier recommendation of the DX Advisory Committee that the British Sovereign Base areas on Cyprus count as a separate DXCC country. This is the first new 'country' to be added to the DXCC list since 1981 when 1A0 (Sovereign Military Order of Malta) was accepted.

This latest addition follows a submission to the ARRL which included evidence showing that, when the remainder of the island was given its independence in 1960, the British government

specifically excluded those areas where the two British bases (Episkopi and Akrotiri) were located. Britain retains complete sovereignty over those areas which cover some 100 square miles in total. British law applies and, most importantly from the amateur radio point of view, licences are issued by the Joint Signals Board, RAF Episkopi, rather than by the Cyprus authorities. A British amateur living outside the

base areas but working within one of them would need both a 5B4 and a ZC4 licence if he wished to be able to operate from both his home and his work QTH.

There is no reason to expect this ARRL decision to open the floodgates to other applications for 'country' status. To take an example, the US air bases in Britain are all leased from the UK government and are still British sovereign territory. Guanta-

namo Bay on the mainland of Cuba does, of course, count as a separate country (with the prefix KG4), although it is leased by the Americans from Cuba. However, it would not be acceptable as a DXCC 'country' under the rules which currently apply.

## How to claim the new one

The burning question for DX-minded amateurs is how they get the new country added to their DXCC total. The ARRL has said that cards may be submitted any time after 1 June. All 5B4 cards, and all ZC4 cards for contacts prior to 16 August 1960, count as Cyprus. Since that date ZC4 cards may count for either Cyprus or the British Sovereign Base areas (to confuse matters, not all ZC4 operations in the past have actually been from the Base areas). If, therefore, your existing DXCC credit for Cyprus is a ZC4 card you will need to resubmit it so that ARRL can make a ruling on which 'country' it counts for. The best bet is to send a 5B4 card if you have one, along with several ZC4 cards, one of which will, hopefully, be accepted as counting for the new country.

## Now 316 countries

The addition of ZC4 to the list brings the number of current DXCC countries to 316. There has occasionally been talk in the past about moves to have ZC4 counted, but no one seems to have got as far as a formal submission to the ARRL. There may be some ZC4 amateurs who are less than happy about their

ZC4 and 5B4 are now two countries

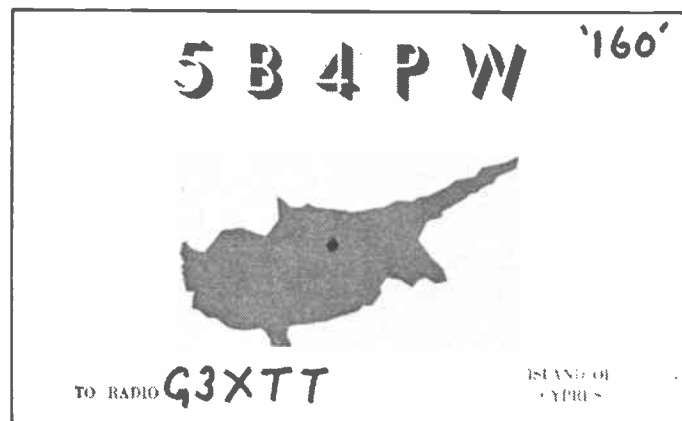

newly acquired fame, but one cannot stand in the way of the facts. ZC4 and 5B4 have, in fact, much greater claim to be separate countries than do, say, England and Wales or France and Corsica.

## Clipperton Island

The Clipperton Island expedition which I mentioned in the January column is still scheduled to depart San Diego on 27 March, collect the operators in Mexico on the 30th, and start operations on 3 April. They will stay on the island for 7 or 8 days depending upon the exact date of arrival. The boat used will be a 115ft sport fishing vessel, the 'Royal Polaris'. Hiring a boat in the USA is more expensive than hiring in Mexico, but the group hope it will avoid a repeat of last year's debacle when the boat failed to materialise.

The operators will include W6SZN, W6OAT, W6RGG, N6GJ, KK6X, N7NG, K3NA, WA7NIN, F6GXB, F9LX, DJ9ZB, TI2CF, XE1ZZA, JG3LZG, FO8HL and FO8GW. No callsign has been allocated to the expedition at the time of writing. The group hope to have 3 stations operating round the clock on 10-160 metres with CW, SSB and RTTY if possible. They may also be equipped for 6 metres and for Oscar. Incidentally, don't be surprised to hear them on both CW and SSB simultaneously on a single band.

## Costs

Costs of the expedition will be \$3500 per operator and contributions are urgently sought. These should be sent to the Northern California DX Foundation via W6OAT and all donations will be acknowledged in writing. QSLs will be handled by the YASME Foundation whose address has appeared in earlier columns.

It now looks as though no operation will take place from the Mexican island of Revilla Gigedo en route to Clipperton, but a Mexican group were talking about making their own trip to XF4 in late February or early March.

## Other news . . .

K4LTA was scheduled to be active from Dominica (J7) from 15 February to 5 March. From past experience I would suggest looking for him



Mike G4IUF in his shack

around 14025 and 7005KHz and also on 10MHz.

## Port Talbot

GB2SDD is a special event call to be used on 1 March by the Port Talbot Amateur Radio Society to commemorate St David's Day. A certificate is available for contacting GB2SDD and 10 other GW stations during February and March. Claims should be sent (with 6 IRCs or equivalent) to R Jones GW4HOQ. Incidentally, if any readers are planning to use a GB call for a special event I shall be happy to publish information in this column provided you give me sufficient notice.

AB4Y has been reported operational from Mozambique with the callsign C90A; QSL to WM4N. Although there have been several operations from Mozambique since its independence from Portugal, none have been legitimate. We can only hope this is the exception. It is interesting to reflect that, as recently as the early 70s, CR7 calls from Mozambique were some of the most frequently heard on the bands.

## Special prefixes

A number of special prefixes have recently been on the air from the USSR to commemorate victory in Europe. EM, EO, EV, EW and other similar prefixes have been heard. Don't forget to work them towards your *Amateur Radio magazine Prefix Award*. In fact, you can kill two birds with one stone because the 'Pobeda 40' award will be available from Box 88, Moscow for working 40 of these special stations.

Also counting towards this latter award are a number of war veterans who are using their own call, /R.

## Navassa Island

If you still need a contact with Navassa Island, stay by your rig on 6/7 April because a group of Jamaican amateurs have been talking about an operation from there. Navassa is quite easy to reach from Jamaica, but is uninhabited and with steep cliffs, so getting gear, generators, etc, ashore is always a problem.

## Montserrat

Dave W2WSE should be active now as VP2MDB and will be there until 17 March. I was interested to have the opportunity recently to see G4JVG's slides of the October 1984 contest operation from Montserrat as VP2MW by a group of UK amateurs. Two holiday homes are available for hire on the island, fully equipped with stations, towers and antennae, for use by visiting amateurs. Air fares tend to be prohibitive in the main tourist season, but pick the right time of the year and you can have a combined holiday/DXpedition for a fairly reasonable sum, especially if you go with a small group of others to share the cost of the holiday home.

In November I mentioned that George Collins VE3FXTF was planning a trip taking in 100 countries during 1985. Unfortunately George's wife VE3COA/G3YXT passed away recently and George has abandoned his trip. Another cancelled trip is that to Southern Africa by Lloyd and Iris Colvin. In their case the

cancellation was due to business commitments in their native California.

YI1BGD in Baghdad has recently been quite active on 80 and 40 and has now been given permission to operate on the new 18 and 24MHz bands. YI1BGD is a club station and the only station currently active from Iraq.

Another country from which little is heard at present is Thailand. Latest news is that the Minister of Telecommunications has made representations to his government colleagues to allow amateurs back on the air, so keep your fingers crossed. Meanwhile there are occasional operations by the club station HS0A by special permit.

4X5DS is the call to be used from 0800 on 6 April to 0800 on 13 April. This station will operate from the lowest lying land on earth, at Ein Gedi near the Dead Sea. Special QSLs will be issued, as will an award for working the station on: (1) at least 3 days of the expedition, (2) at least 3 bands, or (3) all 3 modes (CW, SSB, RTTY). Activity will be on 80-10 metres.

## DX News Sheet

In July of last year I devoted much of this column to sources of DX information. The UK's principal organ is the RSGB's DX News Sheet which, since 1 January, has been edited by Brendan McCartney G4DYO. If you want to subscribe to DXNS then drop a line to the RSGB.

## US Conventions

Also for those of you with a desire to travel, the Californian DX Convention takes place on the weekend of 19-21 April, this year back at its old venue of Fresno. The Dayton Hamvention, an enormous affair which always has a number of visitors from the UK, takes place on 26-28 April.

## And Finally . . .

Did you work PA6FLD in February? This was a special station to celebrate the opening of a new transmitter site by Radio Nederland. The station was able to use the massive curtain array antennae (20dB gain or thereabouts) before they went into service for short wave broadcasting. Wonder if they would mind lending the station out for a contest . . . ?





# CONTEST FORUM



Most major national amateur radio societies in the world organise a programme of HF contests. The RSGB is no exception! The RSGB currently runs 17 HF contests each year as well as a series of HF cumulative contests. Whereas most national societies run one or two major HF contests each year, the RSGB runs a mixture of major and minor HF contests.

## The majors

For example, in the US the ARRL runs two very major contests: the ARRL DX CW and SSB contests which are held annually. For stations outside the USA and Canada, the idea is to contact as many USA and Canadian stations as possible on all of the HF bands.

The German society (DARC) also organises a series of major international contests. The DARC runs the pan-European contests, WAE-CW, WAE-SSB and WAE-RTTY, in which European stations make contact with stations outside Europe.

Once-a-year major contests such as the ARRL DX contests, the WAE contests and the CQ Worldwide DX contests usually run for a full 48 hours.

Many other national societies organise HF contests at different times throughout the year. Most national HF contests are held on the 'same weekend' in each year. For example, the ARRL DX CW Contest is always on the third 'full' weekend in February and the SSB section is on the first 'full' weekend in March. The first full weekend is when both the Saturday and the Sunday are in the same month.

Defining the timing of major international contests in this way avoids the confusion that would arise by using just the dates alone. Traditionally many weekends in the year have been 'booked' for years by particular contests. Any proposals for dates for new contests always have to take into account the existing 'status quo' of the international contest calendar in order to avoid contests clashing with each other.

## RSGB

Rather than having a single once-and-for-all major HF contest each year, the RSGB runs a range of different HF contests for both inter-G working and outside-G working on the HF bands. Over the years the RSGB has built up a tradition of smaller and more specialised contests. RSGB HF contests are usually on just one or two bands and are of short duration.

Short sharp contests are now very popular and with good reason too. There are not many radio amateurs who can easily devote a whole weekend to taking part in a radio contest. 48 hours is just too long (well, more than once or twice a year anyway!). But contests that last four or five hours are popular because the short length of the contest means that participants can be there all the time and are

## A CALENDAR OF 1985 EVENTS

### NIGEL CAWTHORNE G3TXF

Contest	Mode	Dates (1985)	Day : Time	Band (MHz)
AFS	CW	Jan 13	Sun 13Z to 17Z	3.5
RSGB 7 SSB	SSB	Feb 2-3	Sat 12Z to Sun 09Z	7
First 1.8MHz	CW	Feb 9-10	Sat 21Z to Sun 01Z	1.8
RSGB 7 CW	CW	Feb 23-24	Sat 12Z to Sun 09Z	7
Commonwealth	CW	Mar 9-10	Sat 12Z to Sun 12Z	3.5 to 28
Town & County	SSB	Mar 16	Sat 21Z to 24Z	1.8
ROPOCO I	CW	Apr 7	Sun 08Z to 10Z	3.5
Low Power Fixed	CW	Apr 21	Sun 07-11Z & 13-17Z	3.5 & 7
Region-Round-up	CW	May 19	Sun 07Z to 12Z	3.5 & 7
NFD-HF CW Field Day	CW	Jun 1-2	Sat 16Z to Sun 16Z	1.8 to 28
Summer 1.8MHz	CW	Jun 22-23	Sat 21Z to Sun 01Z	1.8
Low Power Field Day	CW	Jul 21	Sun 09Z to 12Z & Sun 13Z to 16Z	3.5 7
ROPOCO II	CW	Aug 25	Sun 08Z to 10Z	3.5
IARU SSB Field Day	SSB	Sep 7-8	Sat 15Z to Sun 15Z	3.5 to 28
RSGB 21/28 SSB	SSB	Oct 13	Sun 07Z to 19Z	21 & 28
RSGB 21 CW	CW	Oct 20	Sun 07Z to 19Z	21
Second 1.8MHz	CW	Nov 9-10	Sat 21Z to Sun 01Z	1.8

able to work as much as they can within the time, without having to take too much time away from other commitments.

In the RSGB's HF contest calendar there are now ten contests which are short and sharp. These are the four Top Band contests, the two ROPOCOs, Region-Round-up, the two low power contests and the Affiliated Societies Contest (AFS).

## AFS

The Affiliated Societies CW Contest runs for just four hours on 3.5MHz on a January Sunday afternoon. Along with the HF National Field Day, AFS is arguably one of the best operating events of the year on the RSGB's contest calendar. Over 20,000 QSOs were made in AFS last year in just four hours!

Each entrant makes as many contacts as he can during the four hours of the contest. Logs are then passed to the AFS entry co-ordinator for each club or society, who puts the logs together and prepares a club/society summary sheet. Operating teams consist of up to five members in each team. Clubs may enter more than one team. Some clubs enter up to three teams.

The team score is the sum of scores made by each member of the team. As well as a team listing, there is also an individual operator listing in the results.

No doubt because of its convenient length and timing, AFS has become a major inter-G HF CW operating event over recent years.

## HF National Field Day

HF NFD has been running for over fifty years and is a well supported event. Many HF CW operators who may never touch a key during the rest of the year make a special effort to get on the air for

NFD! NFD is a team event too. Unlike AFS where each member of the team operates from his home QTH, for NFD the team comes together to put a multi-operator club station on the air. After weeks of planning and preparation, the NFD club team sets up a portable HF station and keeps it running for the 24 hours of the contest.

The RSGB's NFD is deliberately timed to coincide with similar field day events being organised by other European societies. Large numbers of contacts with German, Swiss and Belgian portable stations are easily made on the lower bands. During this one weekend there are hundreds of portable HF amateur stations operating all over Europe. There are also occasional DX portable stations active during NFD, but for the most part NFD is a contest for working UK and European portables.

NFD is not just an operating event for the contesters, but can also be a major social event for many radio clubs and societies. Setting up tents in damp fields, keeping cows and other beasts away from the operating tent and the kitchen area, as well as keeping the generator chugging over are all the sort of tasks made easier by many hands.

Even if you have never taken part in any radio contest at all, find out whether any of your local clubs are putting on a station for NFD this year and volunteer to go along and help out.

Many clubs and societies hold NFD planning meetings months before the event, so now is the time to find out if any of your local clubs are planning an entry. If you cannot find one, then form your own group for NFD. Operating portable for 24 hours in early June is great fun!

NFD is a participative amateur radio operating event. It is designed not only

## CONTEST FORUM

as an HF contest which is taken seriously by many, but also as an operating and social amateur radio event which can be enjoyed by all club members. NFD is amateur radio at its best!

### Top Band contests

The RSGB organises four Top Band (160 metre) contests each year. Three are on CW and one is on SSB. The contests are all of short duration. The CW contests start at 2100Z on the Saturday evening and run for just four hours through to 0100Z on the Sunday. A high level of activity is usually to be found on Top Band not only from UK stations, but also from many European and DX stations who make a point of getting on the band to work the UK stations during these RSGB 1.8MHz contests.

The RSGB's Town and County Top Band Contest is on SSB and runs from 2100Z to 2400Z on a Saturday in March. The operating times are designed not only to be of convenient length, but also to be at a time of night when Top Band conditions are likely to be good for inter-G, European and also possibly for DX working.

### ROPOCOs

The two ROPOCO contests organised by the RSGB are very short (they are only two hours long each) but they have a special twist to them! Rather than exchanging serial numbers and RST reports as is the case in many contests, in the ROPOCO contests the exchange is RST and a postcode.

The postcode sent in the first QSO is the operator's own postcode, but for the second and successive QSOs the postcode sent is the postcode that has just been received in the previous QSO. In

this way the same postcode changes hands many times during the contest. It is not uncommon for a station to give you your own postcode back later in the contest. After it has been handed around between several stations, the original may well have become distorted.

The exchange of postcodes in ROPOCO is a simple form of message handling exercise; operating and logging accuracy is an important feature of ROPOCO. The postcode exchange makes a welcome change from the rather bland exchanges that have become commonplace in many contests. ROPOCOs are held from 0800Z to 1000Z on two Sunday mornings during the year.

### Region Round-up

Region Round-up is another Sunday morning inter-G CW contest run by the RSGB. Lasting for just 5 hours from 0700-1200Z on the third Sunday in May, this contest runs on two bands together: 3.5 and 7MHz. Stations give their RSGB region (01-20) as part of the exchange. The multiplier (max 40) is the total number of different regions worked on each of the two bands.

### Low power contests

Designed specifically for the QRP CW enthusiast, the RSGB runs two low power contests during the year. The first is the Low Power Fixed Contest which is held in two sessions on the third Sunday in April. The morning session is from 0700-1100Z and the second session in the afternoon is from 1300-1700Z. QSOs can be made on both 3.5 and 7MHz CW. Extra points are earned by contacting other QRP stations, but QRO stations can be worked too.

The second QRP event is the Low

Power Field Day held in July. Again this contest is in two sessions (to allow a lunch break!) for the convenience of operators. The morning session is on 3.5MHz and the afternoon session is on 7MHz. QRP field day operation is made very simple with modern rigs. The logistics required in getting on the air for a few hours during the Low Power Field Day Contest are very simple! Low Power Field Day is an opportunity to combine QRP operating with a summer's day in the fresh air!

### Commonwealth Contest

Still referred to by many as BERU (British Empire Radio Union), the Commonwealth Contest is the RSGB's only major all-band HF international DX contest. Lasting just 24 hours it is designed for Commonwealth stations to work each other. Non-Commonwealth stations cannot take part.

From the UK the largest quantities of stations to be contacted are in Canada VE, Australia VK and New Zealand ZL. During any BERU there is always a sprinkling of activity from many of the rarer Commonwealth areas such as Jamaica 6Y5, Malta 9H1, Zambia 9J2, Gibraltar ZB2 and some of the Caribbean islands VP2M etc.

### 21MHz CW and 21/28MHz SSB

These HF band contests are both just 12 hours long and are for G stations to contact as many stations and countries as possible anywhere outside the UK. The 21 CW contest held in October is a single-band event, whereas the 21/28 SSB contest covers two bands. In the years of good HF conditions these contests provide large numbers of QSOs but, as the sunspot cycle continues its dive to ever lower depths, the number of QSOs to be made in these contests diminishes rapidly.

### 7MHz CW/7MHz SSB

Whatever the sunspots are doing, there is nearly always plenty of activity on 7MHz! These two single-band contests run for 21 hours each and are designed for UK stations to work as many non-UK stations and DX countries as possible on the 7MHz band. The CW and SSB events are on different weekends.

During these contests UK stations can usually run strings of stations on 7MHz, because it is the UK stations that are sought after by the rest of the world. For overseas stations, contacts with UK stations are the only ones valid for the contest. RSGB 7MHz contests (particularly the CW one) are very popular, not only with UK participants but also with overseas entrants.

### IARU SSB Field Day

The SSB Field Day held on the first full weekend of September is an IARU Region 1 event. UK participation in this multi-national contest is looked after by the RSGB. This is also a popular club and social event as well as a major HF SSB field day contest.

*Denis G3MXJ adjusting his homebrew six-band field-day special ATU, during 1984 NFD while operating as G4DAA/P. The author sits back and watches how its done.*





# CONTEST FORUM

## SWL Contest

The 13/14th July 1985 has been chosen for the first of a new series of SWL contests organised by the RSGB. Fuller details will be published nearer the time, but the dates for this new SWL contest have been chosen to coincide with the IARU Radiosport Contest which is a major international DX contest for transmitting amateurs on both CW and SSB. Having an SWL contest on the same weekend as a major DX contest means that there will be no shortage of stations to log!

## Cumulatives

As well as the HF contests described above, the RSGB also runs a series of cumulative activity contests at various times on 1.8, 3.5, 7 and 28MHz. These are short operating periods aimed at giving newcomers to contesting and old-timers alike a chance to make some contacts in a contest format, but without there being any strictly competitive element. Participation and operator training are important factors in the ever increasing popularity of HF cumulative contests.

## Championship

The RSGB runs an annual HF contest championship table for both transmitting amateurs and for SWLs. These championships are designed to encourage participation by RSGB members.

RSGB contests are organised for the benefit of RSGB members in the UK and for non-UK contest operators worldwide. UK entrants and operators in RSGB contests must be members of the RSGB.

## Rules and results

The details given here are intended only as a broad outline of the RSGB's HF contest programme. Full details, rules and results are given every month in *Radio Communication*.

UK participants should note that, in order to avoid the unnecessary redistribution of large quantities of mail following every contest, the logs from UK members should always be sent directly to the adjudicator shown in the rules.

For overseas entrants only, there is now a separate address which can be used for all of the RSGB HF contests.

## CQ Worldwide 160

Don G3XTT, compiler of *DX Diary* and keen Top Band DXer has reminded me that 'serial numbers' are no longer given in the CQ Worldwide 160m contests. This was incorrectly stated in the potted version of the rules that appeared in the January issue of *Amateur Radio*.

Up until a few years ago, serial numbers were exchanged in the CQ WW 160m contests (as opposed to the CQ Worldwide CW and SSB contests, where

as far back as the writer can remember, serial numbers have never been used). Don N4IN, the CQ WW 160 adjudicator requests views from participants on whether serials should be used or not.

By the time that this is read the 1985 CQ Worldwide 160m Contest will be long over, and it is hoped that anyone who did take part for the first time as a result of reading the write-up was not too confused when they found that no serial numbers were being exchanged!

The number of UK stations that get on the band during CQ WW 160 is quite high, but the number of log entries is low! Using a computer, Don N4IN analysed the 136,000 different loggings for last year's contests. This showed that 225 different Gs made QSOs during the CW leg of the contest and 186 Gs during the SSB leg. The number of logs received from G for the CW section was only 11! Don N4IN makes the plea that no matter how small your score, please send in a log!

## Send It In!

This is a plea that can be echoed for any contest! However small your contest score, it is always worth sending it in to the organisers. The 17 HF contests organised by the RSGB provide plenty of opportunity for making many interesting contacts as well as improving HF operating techniques.

## SANDPIPER COMMUNICATIONS

AERIALS (STAINLESS STEEL ELEMENTS)

	P&P
14 Elements/2mtr	3.00
2x 7m Collinear	£20.00 4.00
3x 7m Collinear	£20.00 4.00
6 El Yagi	£14.00 4.00
10 El Yagi	£20.00 4.00
12 El Yagi	£28.00 4.00
6 El Yagi Crossed	£23.00 4.00
10 El Yagi Crossed	£28.00 4.00
<b>430m/70cm</b>	
4+ F/glass Collinear	£25.00 2.00
17 Element	£18.00 4.00
Double Delta	£35.00 4.00
8 Turn Helical	£35.00 4.00
<b>1200/23cm &amp; 934/32cm</b>	
Mobile Collinear	£25.00 2.00
Base Collinear	£39.95 2.00
20 Turn Helical	£33.00 4.00
Para Delta	£45.00 5.00
6ft 6in Parabolic Dish	£95.00 9.00

### DIY Versions

Available in most models Also 4mtr & 6mtr PMR Weather Satellite/s 70cm TV, 24cm TV and all one/off frequencies.

### Power Splitters

2 mtr  
70cm  
23/32cm  
2 way & 4 way  
Lots more available.

FIBRE GLASS MASTS/TUBES  
3/8in to 1 3/4in e.g. 1 1/2in dia = £5 per mtr.

SAE FOR FULL LISTS

40 Trehafod Rd, Trehafod,  
Pontypridd, Mid Glam.

Tel: Porth 685515 Aberdare 870425

Delivery Cash/P.O. Return Cheque 7 Days

## SELECTRONIC

RADIO, TV AND RADIO COMMUNICATION SPECIALISTS

THE UK'S LEADING SUPPLIER OF 934 MHz PERSONAL RADIO EQUIPMENT AND ACCESSORIES

★ Everything you need for 934MHz, plugs, cables, masts, towers, SWR/signal meters, aerials, switches etc.

★ Cybernet delli 1 now in stock

★ The largest specialist stock of 934MHz in the UK

★ Stockist of MET antennae (including 934 MHz)

Full service facilities on all equipment

We have practical and technical experience. Please call us for friendly help and advice. Credit terms and mail order facilities available

For further information please ring Mike Machin on (0268) 691481



203, HIGH STREET,  
CANVEY ISLAND, ESSEX



04782  
05782  
04782  
01888A

# DON'T VAT THE PRESS

There are strong reasons to believe the Chancellor of the Exchequer is planning to impose VAT on your magazine.

Such a move would turn the clock back 130 years – the last tax on newspapers and journals was repealed in 1855. Since then 'No tax on knowledge' has been a principle agreed by all Governments, even in the darkest days of war.

A free Press is a tax-free Press

No Government should be given the power to impose financial pressure on a Press it may not like.

Tell your MP to say 'NO' to any tax on reading.

Issued by the Periodical Publishers Association, London

KAGA 12" MONITORS B/W OR ANTI GLARE SCREEN 18MHZ VIDEO BANDWIDTH COMPOSITE VIDEO INPUT NEW UNCASD NEED 12V 1.3A SUPPLY CALLERS ONLY..... **£45**

**ELMASET INSTRUMENT CASE**  
300x133x217mm deep..... **£10.00 ea (£11.50)**

**REGULATORS**

LM317T Plastic T0220 variable..... **£1.00**  
LM317 Metal..... **£2.20**  
7812 Metal 12v 1A..... **£1.00**  
7805/12/15/24 plastic..... **50p**  
7905/12/15/24 plastic..... **50p**  
CA3085 T099 Variable regulator..... **£1.00**

**EPROMS/MEMORIES**

27128-300nS..... **£14.00**  
2764 INTEL/FUJITSU 300ns..... **£5**  
2716, 2708, 1702 EX EQUIPMENT £2..... 10/**£17.00**  
2732 EX EQPT..... **£2.50**  
2114 EX EQPT 60p 4116 EX EQPT..... **70p**  
4164-200nS EX EQPT **£2.50**..... NEW **£3.50**  
MC6810P..... **£1.00**

**POWER TRANSISTORS**

TIP141, 142, 147 £1 ea, TIP112, 125, 42B..... 2/**£1.00**  
TIP35B £1, 30 TIP35C..... **£1.50**  
SE9302 100V 10A DARL SIM TIP121..... 2/**£1.00**  
2N3055 Ex eqpt tested..... 4/**£1.00**  
Plastic 3055 or 2955 equiv 50p..... 100/**£30.00**  
2N5302 NPN 30A 60V SIM 2N3771..... **80p**  
2N3773 NPN 25A 160V £1.80..... 10/**£16.00**

**DISPLAYS**

Futaba 4 digit clock, fluorescent display 5-LT 16..... **£1.50**  
Futaba 8 digit calculator, fluorescent display 9CT-01-3L..... **£1.50**  
LCD Clock display 0.7" digits..... **£3.00**  
Large LCD Clock display 1" digits..... **£3.00**  
7 seg 0.3" display comm cathode..... 2/**£1.00**

**QUARTZ HALOGEN LAMPS**

A1/216 24v 150w..... **£2.25**  
H1 12v 55w (car spot)..... **£1.25**

**MISCELLANEOUS**

NEW BRITISH TELECOM PLUG+LEAD..... **£1.50**  
1.25" Panel Fuseholders..... 5/**£1.00**  
5.25" floppy discs..... box 10/**£15**  
MAINS ROCKER SWITCHES 6A SPST..... 5/**£1**  
4700µF 63v ITT 10A RIPPLE..... **£1**  
STAINLESS STEEL HINGES 14.5" BY 1" OPEN £1.00 each..... 10/**£7.00**

MAINS TRANSIENT SUPPRESSORS 245v..... 3/**£1.00**  
TOK KEY SWITCH 2 POLE 3 KEYS - ideal for car/home alarms £3 £100+..... **£2.00**  
12V 1.2w small wire ended lamps fit AUDI/VW TR7 VOLVO SAAB..... 10/**£1.00**  
Heat shrink sleeving pack..... **£1.00**  
PTFE sleeving pack asstd colours..... **£1.00**  
250 mixed res diodes, zeners..... **£1.00**  
Mixed electrolytic caps..... 100/**£2.00**  
Stereo cassette deck..... **£5.00 (£1.50)**  
Stereo cass R/P head..... **£2.50**  
Mono head £1, Erase head..... **50p**  
Thermal cut-outs 50, 77, 85, 120°C..... ea **80p**  
Thermal fuse 121°C 240v 15A..... 5/**£1.00**  
Vero pins fit 0.1" Vero..... 200/**£1.00**  
Double sided PCB pins..... 200/**£1.00**  
TO220 Micas + bushes 10/50p..... 100/**£2.00**  
TO3 Micas + bushes..... 20/**£1**  
RELAYS 240v AC coil PCB mounting 2 pole changeover £1 3 pole c/o..... **£1.00**  
Fig. 8 mains cassette leads..... 3/**£1.00**  
KYNAR wire wrapping wire 2oz reel..... **£1.00**  
PTFE min. screened cable..... 10m/**£1.00**

TOKIN MAINS RFI FILTER 250v 15A..... **£3.00**  
IEC CHASSIS PLUG/RFI FILTER 10A..... **£3.00**  
Epoxy potting compound 500g..... **£2.00**  
Mercury tilt switch small..... **£1.00**  
Min. rotary sw. 4p c/o 1/8" shaft..... 2/**£1.00**  
Thorn 9000 TV audio o/p stage..... 2/**£1.00**  
10m7 CERAMIC FILTER 50p..... 100/**£20.00**  
6m or 9m CERAMIC FILTER 50p..... 100/**£25.00**  
240v AC FAN 4.6" SQUARE NEW..... **£5.50 (£1.60)**  
240/115v AC FAN 4.6" SQ. NEW..... **£7.00 (£1.60)**  
KLIPPON terminal block EKS 12/4  
12-way 20A term block..... 3/**£1.00**  
BELLING-LEE 12-way block L1469..... 4/**£1.00**  
POTENTIOMETERS short spindle  
2k5 10k Lin..... 5/**£1**  
500k lin 500k log long spindle..... 4/**£1**  
40KHZ ULTRASONIC TRANSDUCERS EX-EQPT.  
NO DATA..... PAIR/**£1.00**  
STICK-ON CABINET FEET..... 30/**£1.00**  
T03 TRANSISTOR COVERS..... 10/**£1.00**  
TRANSISTOR MOUNTING PADS T05/T018 £3/1K  
DIL REED RELAY 2 POLE N/O CONTACTS..... **£1.00**

**RECTIFIERS**

120v 35A stud..... **50p**  
2FR400 12A 400v small stud..... 4/**£1.50**  
BY127 1200V 1.2A..... 10/**£1.00**  
BY254 800v 3A..... 8/**£1.00**  
BY255 1300v 3A..... 6/**£1.00**  
1A 800v bridge rectifier..... 4/**£1.00**  
6A 100v bridge..... **50p**  
10A 600v bridge..... **£1.50**  
15A 100v bridge..... **£1.50**  
25A 200v bridge £2.00 ea..... 10/**£18.00**  
25A 400v bridge £2.50..... 10/**£22.00**

**SCRs**

MCR72-6 400v £1 BTX95 800V 15A..... **£1.50**  
BTX95 800v 15A..... **£1.50**  
35A 800v stud..... **£2.00**  
70A 500v large stud..... **£3.00**  
MCR106 equiv. 4A 400v..... **40p**  
2N5061 800mA 60V T092..... 4/**£1.00**  
TICV106D .8A 400v T092 3/£1..... 100/**£15.00**  
MEU21 Prog. unijunction..... 3/**£1.00**

**TRIACS**

TXAL225 8A 400V 5mA gate 2/£1.00..... 100/**£35.00**  
TXAL228 8A 400v isol. tab 2/£1.00..... 100/**£35.00**  
25A 400v ex eqpt. tested..... **£1.50**

**CONNECTORS (EX EQPT. price per pair)**

'D' 9-way £1; 15-way £1.50; 25-way..... **£2.00**  
37-way £2; 50-way £3.50; covers 50p ea  
NEW 25-way PCB SKT. STRAIGHT..... **£1.00**  
D9 PCB PLUG 90 deg..... **£1.50**  
0.1" double sided edge connector, 32-way ideal  
ZX81/SPECTRUM..... **£1.50**  
0.1" d/sided pcb plug 24+25-way..... **£1.50**  
2 pole sub min. connectors ideal radio control RS  
466/472/488/343 5 pairs..... **£2.00**

**IDC CONNECTORS**

25 WAY 'D' PLG or SKT. D37 PLUG..... ea **£2.00**  
20-WAY SOCKET (BBC USER PORT)..... **£1.00**  
26-WAY SOCKET (BBC PRINTER)..... **£1.50**  
34-WAY SOCKET (BBC DISC DRIVE)..... **£2.00**  
40-WAY SOCKET..... **£2.00**

**MADE UP DISC DRIVE CABLES**

34 IDC TO 34 WAY CARD EDGE  
SINGLE DRIVE **£6** DOUBLE DRIVE **£8**

**WIRE WOUND RESISTORS**

W21 or sim 2.5W 10 OF ONE VALUE FOR..... **£1.00**

1R0 2R0 2R7 3R9 5R0 10R 12R 15R 18R 20R 27R 33R 36R  
47R 120R 180R 200R 330R 390R 470R 560R 680R 820R  
910R 1K 1K15 1K2 1K3 1K5 1K8 2K4 2K7 3K3 10K  
W22 or sim 6 watt 7 OF ONE VALUE for..... **£1.00**  
R22 1R5 9R1 10R 12R 20R 33R 51R 56R 62R 120R 180  
270R 390R 560R 620R 1K 1K2 2K2 3K3 3K9 10K

W23 or sim 9 watt 6 OF ONE VALUE for..... **£1.00**

R22 1R0 3R0 6R8 56R 62R 100R 220R 270R 390R 680R  
1K 1K8 10K

W24/ sim. 12 watt 4 OF ONE VALUE for..... **£1.00**

R50 2R0 10R 18R 47R 68R 75R 82R 150R 180R 200R  
270R 400R 620R 820R 1K

**PHOTO DEVICES**

Slotted opto-switch OPCOA OPB815..... **£1.30**  
2N5777 50p..... 100/**£25.00**  
TIL81 T018 Photo transistor..... **£1.00**  
TIL38 Infra red LED 2/50p..... 100/**£16.00**  
OPI2252 Opto isolator..... **50p**  
Photo diode 50p..... 6/**£2.00**  
MEL12 (Photo darlington base n/c)..... **50p**  
RPY58A LDR 50p ORP12 LDR..... **85p**  
LEDs RED 3mm or 5mm 12/£1..... 100/**£6.00**  
GREEN or YELLOW 3 or 5mm 10/£1..... 100/**£6.50**  
FLASHING RED 5mm 50p..... 100/**£30.00**

**DIODES**

1N4148..... 100/**£1.50**  
1S3740 Germanium..... 100/**£2.00**  
1N4004 or SD4 1A 300v..... 100/**£3.00**  
1N5401 3A 100V..... 10/**£1.00**  
BA157 1A 400V Fast recovery..... 100/**£2.50**  
BA159 1A 1000V Fast recovery..... 100/**£3.50**

**MULTI TURN PRESETS**

10R 20R 100R 200R 500R..... **40p**  
2K 5K 22K 50K 100K 200K

**IC SOCKETS**

8-pin 12/£1; 14-pin 10/£1.00; 18/20-pin 7/£1; 100/£12;  
1k/£50; 22/28-pin 25p; 24-pin 25p; 100/£20; 1k/£100;  
40-pin 30p; 16-pin 12/£1; 100/£6

**TRIMMER CAPACITORS small**

GREY 1.5-6.4pF GREEN 2-22pF..... 5 for **50p**  
GREY larger type 2-25pF..... 5 for **50p**

**SOLID STATE RELAYS NEW 10A 250v AC**

Zero voltage switching  
Control voltage 8-28v DC..... **£2.50**  
VARIAC 0 to 130v 6A new uncased..... **£6.00 (£2)**

**POLYESTER/POLYCARB CAPS**

10n/15n/22n/33/47n/68n 10mm rad..... 100/**£3.00**  
100N 250V radial 10mm 100/£3..... 1000/**£25.00**  
1u5 P/carb 15mm rad..... 100/**£7.00 (£1)**  
2u2 160v rad 22mm..... 100/**£10.00 (£1.50)**  
470n 250v AC X rated rad..... 4/**£1.00**  
33n/47n 250v AC X rated rad 15mm..... 10/**£1.00**  
10n 250v AC X rated rad 10mm..... 10/**£1.00**  
100n 600V SPRAGUE axial 10/£1..... 100/**£6.00**

**BEAD THERMISTORS**

GLASS BEAD NTC Res @ 20°C..... **80p**  
250R 1K2 50K 220K 1M4  
R53 THERMISTOR..... **£2.00**

**BEAD TANTALUM CAPS**

6u8 25V 47u 3V 68u 6V 12/£1..... 100/**£6.00**  
2u2 20V 8/£1..... 100/**£8.00**

**MONOLOTHIC CERAMIC CAPS**

100N 50v 100/£6 10N 50V..... 100/**£3.00**  
470N 50v 100/£7 1uF 50V..... 100/**£8.00**  
10N 50v dil package 0.3" rad. £4/100..... **£30/1k**

**STEPPER MOTOR 4 PHASE 2 9v WINDINGS**

£3.50..... 10/**£30.00**

**KEYTRONICS**

**332 LEY STREET, ILFORD, ESSEX**

**Shop open Mon-Sat 10am-2pm**

**TELEPHONE: 01-553 1863**

MIN ORDER £3.00 OFFICIAL ORDERS WELCOME  
UNIVERSITIES COLLEGES SCHOOLS GOVT DEPARTMENTS  
MIN. ACCOUNT ORDER £10  
P&P AS SHOWN IN BRACKETS (HEAVY ITEMS)  
65p OTHERWISE (LIGHT ITEMS)

**ADD 15% VAT TO TOTAL**

**ELECTRONIC COMPONENTS BOUGHT FOR CASH**





# MARCO TRADING



**1985 CATALOGUE AVAILABLE** — Many prices reduced — range increased — 123 pages fully illustrated. Price 65p, per copy (free upon request with orders over £5) — includes 30p Credit Notes, special offer sheets, order form and pre-paid envelope. **SEND NOW FOR YOUR COPY.**

74LS		TRANSISTORS		DIODES		Type		Type		Type		Type		Type		Type		Type	
Part No.	Price (£)	Type	Price (£)	Type	Price (£)	Type	Price (£)	Type	Price (£)	Type	Price (£)	Type	Price (£)	Type	Price (£)	Type	Price (£)	Type	Price (£)
LS00	28p	AC127	0.30	BC108	0.12	BC302	0.32	BD244A	0.65	BF258	0.30	BT101/300	1.15	BYX36/150	0.22	TIC106A	0.70	2AC1449	0.63
LS01	28p	AC128	0.30	A B or C	0.12	BC303	0.32	BD375	0.32	BF259	0.32	BT101/500	1.25	BYX36/600	0.22	TIP30A	0.48	2SC1157	0.63
LS02	28p	AC128K	0.34	BC113	0.14	BC307	0.10	BD410	0.76	BF262	0.30	BT102/300	1.35	BYX48/300	0.72	TIP31C	0.54	2SC1678	1.06
LS03	28p	AC132	0.55	BC114	0.12	BC308A	0.10	BD434	0.68	BF263	0.30	BT102/500	1.65	BYX48/600	0.47	TIP32	0.40	2SC1758	0.68
LS04	32p	AC141	0.26	BC115	0.12	BC323	0.99	BD436	0.68	BF270	0.30	BT106	1.80	BYX55/350	0.28	TIP32C	0.60	2SC1909	1.20
LS08	28p	AC141K	0.48	BC116	0.15	BC327	0.14	BD437	0.74	BF271	0.18	BT108	1.30	BYX55/600	0.33	TIP33A	0.63	2SC1923	0.30
LS09	28p	AC142	0.26	BC118	0.22	BC328	0.14	BD438	0.75	BF273	0.18	BT109	1.18	BYX71/600	0.18	TIP34A	0.62	2SC1945	2.88
LS10	28p	AC142K	0.48	BC119	0.17	BC337	0.12	BD439	0.68	BF274	0.32	BT116	1.25	BYZ12	0.42	TIP44C	0.48	2SC1953	0.74
LS11	28p	AC151	0.45	BC120	0.10	BC338	0.12	BD507	0.48	BF323	0.92	BT119	3.62	IC106D	0.80	TIP42A	0.52	2SC1957	0.78
LS12	28p	AC152	0.45	BC125	0.12	BC350	0.14	BD508	0.53	BF336	0.26	BT120	3.60	E1222	0.40	TIP47	0.60	2SC1969	2.88
LS13	33p	AC176K	0.48	BC140	0.28	BC340	0.30	BD509	0.54	BF337	0.26	BT121	3.02	E502T	0.30	TIP110	0.88	2SC2026	0.73
LS14	55p	AC176K	0.48	BC141	0.42	BC341	0.32	BD510	0.48	BF338	0.26	BT138/600	1.30	GET872	0.48	TIP255	0.60	2SC2029	2.10
LS15	28p	AC187K	0.68	BC142	0.30	BC342	0.32	BD511	0.38	BF355	0.42	BT151/560R	0.90	ITT44	0.04	TIP305	0.80	2SC2078	1.05
LS20	28p	AC188	0.44	BC143	0.30	BC347	0.12	BD520	0.66	BF363	0.82	BT151/300R	1.15	ITT2002	0.11	ITS43	0.32	2SC2091	0.73
LS21	28p	AC188K	0.50	A or B	0.10	BC548	0.12	BD699	1.25	BF367	0.24	BTY79/400R	2.80	ME0402	0.20	TIS68	0.20	2SC2098	2.90
LS22	28p	AC188K	0.50	A or B	0.10	BC549	0.12	BD707	0.88	BF371	0.27	BU100A	2.30	ME040/2	0.24	TIS90	0.45	2SC2122A	3.20
LS22	28p	AC188K	0.50	A or B	0.10	BC550	0.18	BDX18	2.35	BF422	0.38	BU104	2.00	MEU21	0.80	TIS91	0.28	2SC2166	1.20
LS30	33p	AD143	1.10	A or C	0.10	BC550C	0.18	BDX32	2.10	BF450	0.38	BU105	1.20	MAJ00	1.25	ZTX108	0.18	2SC2314	0.60
LS32	28p	AD149	0.96	BC157	0.10	BC558	0.12	BF117	0.84	BF458	0.38	BU105/02	1.58	MJ2955	0.90	ZTX109	0.12	2SC2335	1.50
LS37	28p	AD161	0.42	BC158	0.10	BCX34	0.27	BF119	0.82	BF459	0.44	BU108	1.80	MJ3000	1.98	ZTX122	0.28	2SC2371	0.90
LS74	36p	AD162	0.42	BC159	0.10	BCY70	0.15	BF120	0.38	BF493	0.22	BU126	1.25	MJE240	0.60	IN4001	0.05	2SC2749	2.70
LS122	70p	AD161/162	0.98	BC160	0.30	BCY71	0.17	BF123	0.40	BF494	0.22	BU133	1.80	MJE370	0.48	IN4002	0.05	2SC2752	0.60
LS138	45p	AF114	0.48	BC161	0.30	BCY72	0.17	BF125	0.42	BF495	0.22	BU134	1.80	MJE520	0.48	IN4004	0.09	2SC2754	0.64
LS139	68p	AF115	2.10	BC169C	0.10	BCZ11	1.58	BF127	0.38	BF511	0.30	BU205	1.30	MJE2955	0.90	IN4007	0.07	2SD986	0.82
LS151	75p	AF116	2.10	BC170	0.14	BD124P	0.80	BF152	0.16	BF512	0.32	BU206	1.70	MJE3055	0.70	IN4148	0.05	2S150	5.20
LS155	50p	AF117	2.10	BC170B	0.12	BD124P	0.80	BF154	0.23	BF512	0.32	BU207	1.55	MPS10L	0.28	IN5400	0.12	2SK134	3.80
LS157	45p	AF118	0.85	BC171	0.10	BD131	0.30	BF157	0.40	BF512	0.32	BU208	1.35	MRF475	2.50	IN5402	0.15	2SK135	4.60
LS158	58p	AF121	0.85	BC172	0.10	BD131/132	0.34	BF158	0.22	BF512	0.32	BU209	1.70	MRF479	5.20	IN5405	0.18	3N126	1.90
LS160	60p	AF124	0.48	BC173	0.10	BD132	0.32	BF159	0.22	BF512	0.32	BU210	1.35	MRF479	5.20	IN5406	0.18	3N211	2.52
LS161	70p	AF125	0.48	BC172	0.08	BD135	0.32	BF160	0.23	BF512	0.32	BU211	1.65	OA47	0.10	IN5408	0.20	3SK45	0.76
LS162	70p	AF126	0.48	A or B	0.12	BD136	0.36	BF173	0.25	BF512	0.32	BU407D	1.80	OA90	0.08	IS920	0.08	3SK88	0.66
LS163	80p	AF127	0.48	BC177	0.20	BD137	0.36	BF177	0.42	BF512	0.32	BU407D	1.80	OA91	0.09	IS920	0.08	3SK135	5.20
LS166	1.85	AF139	0.68	BC178A	0.22	BD138	0.38	BF178	0.30	BF512	0.32	BU407D	1.80	OA91	0.09	IS920	0.08		
LS170	1.78	AF176	0.68	BC182	0.09	BD139	0.38	BF179	0.32	BF512	0.32	BU407D	1.80	OA91	0.09	IS920	0.08		
LS244	1.00	AF279S	0.75	BC182L	0.09	BD144	1.60	BF181	0.35	BF512	0.32	BU407D	1.80	OA91	0.09	IS920	0.08		
LS245	2.00	AL100	2.50	A or C	0.09	BD145	1.82	BF182	0.32	BF512	0.32	BU407D	1.80	OA91	0.09	IS920	0.08		
LS257	73p	AL102	5.90	BC183	0.09	BD150A	0.51	BF183	0.32	BF512	0.32	BU407D	1.80	OA91	0.09	IS920	0.08		
LS257	73p	AL102	5.90	BC183	0.09	BD150A	0.51	BF183	0.32	BF512	0.32	BU407D	1.80	OA91	0.09	IS920	0.08		
LS257	73p	AL102	5.90	BC183	0.09	BD150A	0.51	BF183	0.32	BF512	0.32	BU407D	1.80	OA91	0.09	IS920	0.08		
LS257	73p	AL102	5.90	BC183	0.09	BD150A	0.51	BF183	0.32	BF512	0.32	BU407D	1.80	OA91	0.09	IS920	0.08		
LS257	73p	AL102	5.90	BC183	0.09	BD150A	0.51	BF183	0.32	BF512	0.32	BU407D	1.80	OA91	0.09	IS920	0.08		
LS257	73p	AL102	5.90	BC183	0.09	BD150A	0.51	BF183	0.32	BF512	0.32	BU407D	1.80	OA91	0.09	IS920	0.08		
LS257	73p	AL102	5.90	BC183	0.09	BD150A	0.51	BF183	0.32	BF512	0.32	BU407D	1.80	OA91	0.09	IS920	0.08		
LS257	73p	AL102	5.90	BC183	0.09	BD150A	0.51	BF183	0.32	BF512	0.32	BU407D	1.80	OA91	0.09	IS920	0.08		
LS257	73p	AL102	5.90	BC183	0.09	BD150A	0.51	BF183	0.32	BF512	0.32	BU407D	1.80	OA91	0.09	IS920	0.08		
LS257	73p	AL102	5.90	BC183	0.09	BD150A	0.51	BF183	0.32	BF512	0.32	BU407D	1.80	OA91	0.09	IS920	0.08		
LS257	73p	AL102	5.90	BC183	0.09	BD150A	0.51	BF183	0.32	BF512	0.32	BU407D	1.80	OA91	0.09	IS920	0.08		
LS257	73p	AL102	5.90	BC183	0.09	BD150A	0.51	BF183	0.32	BF512	0.32	BU407D	1.80	OA91	0.09	IS920	0.08		
LS257	73p	AL102	5.90	BC183	0.09	BD150A	0.51	BF183	0.32	BF512	0.32	BU407D	1.80	OA91	0.09	IS920	0.08		
LS257	73p	AL102	5.90	BC183	0.09	BD150A	0.51	BF183	0.32	BF512	0.32	BU407D	1.80	OA91	0.09	IS920	0.08		
LS257	73p	AL102	5.90	BC183	0.09	BD150A	0.51	BF183	0.32	BF512	0.32	BU407D	1.80	OA91	0.09	IS920	0.08		
LS257	73p	AL102	5.90	BC183	0.09	BD150A	0.51	BF183	0.32	BF512	0.32	BU407D	1.80	OA91	0.09	IS920	0.08		
LS257	73p	AL102	5.90	BC183	0.09	BD150A	0.51	BF183	0.32	BF512	0.32	BU407D	1.80	OA91	0.09	IS920	0.08		
LS257	73p	AL102	5.90	BC183	0.09	BD150A	0.51	BF183	0.32	BF512	0.32	BU407D	1.80	OA91	0.09	IS920	0.08		
LS257	73p	AL102	5.90	BC183	0.09	BD150A	0.51	BF183	0.32	BF512	0.32	BU407D	1.80	OA91	0.09	IS920	0.08		
LS257	73p	AL102	5.90	BC183	0.09	BD150A	0.51	BF183	0.32	BF512	0.32	BU407D	1.80	OA91	0.09	IS920	0.08		
LS257	73p	AL102	5.90	BC183	0.09	BD150A	0.51	BF183	0.32	BF512	0.32	BU407D	1.80	OA91	0.09	IS920	0.08		
LS257	73p	AL102	5.90	BC183	0.09	BD150A	0.51	BF183	0.32	BF512	0.32	BU407D	1.80	OA91	0.09	IS920	0.08		
LS257	73p	AL102	5.90	BC															

# G3OSS TESTS

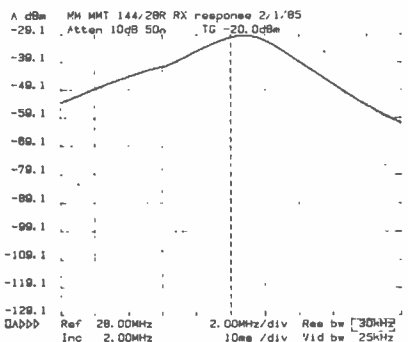

Fig 1 Receiver response

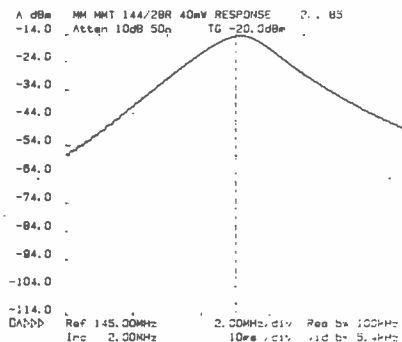

Fig 2 Transmitter response

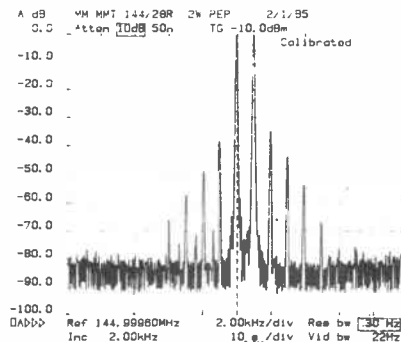

Fig 3 2W two-tone intermod

without any apparent performance degradation, which is excellent.

## Subjective trials

I used an early sample at the beginning of January and obtained some extremely good reports, some stations stating that the transmissions were about as narrow as they have heard on 2m, even though I was running the transverter at no more than 1.5W into my Dressler linear, again underrun to produce just 100W PEP output. After the transverter had warmed up I did not seem to have any drift problems, although when underrunning the transverter, which obviously meant driving it well below the ALC threshold, I did notice that the power output reduced a little with time.

It was so amazingly convenient to be able to set the input gain to give the required output, and if I wanted to use the rig at higher power for 'barefoot' testing I just took out a 20dB attenuator which then caused the rig to go into ALC and produce the full rated output. This was said to be cleaner than average by those who reported on my transmissions.

The receive noise figure was easily good enough for all normal uses and I did not note any particular input intermodulation problem developing, unless I switched in my muTek masthead pre-amp. Even then, I only experienced slight troubles when very strong stations were on the band. However, the general band noise this winter has, unfortunately, been far worse than I have ever known it before; thermostat, computer and Christmas tree light switching interferences running riot with the band!

## Stability

The receiver seemed to be stable and the lower gain of the new model is very much an advantage as it reduces any possibility of overloading the main HF receiver. Even so, I am slightly puzzled about the gain distribution of the new transverter, for there is some padding in between the front end and the mixer which should not really be necessary.

It was useful to have the repeater shift facility, although I did not use it on the band as my TS830 does not have an FM capability, which is actually a good thing in the context of optimum performance on SSB and CW. I did not note any spurious within the band, but with the masthead pre-amp switched on I still noted slight

intermodulation wash produced by the Euston Tower digital transmissions from below the band, although this virtually disappeared when the muTek pre-amp was switched off. This is a very significant improvement over the performance of the old transverter which produced so much wash from the same source, even when no masthead was on, especially when I beamed across Euston. This clearly indicates a very clear improvement in the RFIM distortion.

## Laboratory tests

We checked the receiver input noise figure to be around 2.2dB using a Rohde and Schwarz SKTU meter, although this figure could be at least 0.25dB in error. The GaAsFET has, therefore, no significant advantage over a device such as BF981. Personally, I do not quite approve of the use of GaAsFETs for specmanship purposes, but such is life! The input intercept point, however, is far better than that of the old model, but even so I feel that it could have been appreciably better using virtually the same components much more carefully matched, with perhaps a slightly different circuit around them.

The overall gain is reduced from around 30dB in the old model to 21dB in the new one and this is a great advantage to avoid receiver overload. We plotted the Rx passband using a tracking generator with a spectrum analyser together with a mixing technique.

Figure 1 shows that the peak gain is just under 29MHz output frequency, and at band edges the gain is reduced by an average of 2.5dB, which is not of too much consequence.

Note that at 140/24MHz the response is 12dB down, whilst at 150/34MHz the response is around 18dB down. This is a narrower response than that of the old transverter but I would have preferred an even more rapid fall-off outside the band. No serious anomalous breakthroughs were noted on the 28MHz output.

We undertook many tests on the transmitter side and found that the input sensitivity was very high indeed, full output being reached with well below -6dBm input with the preset drive level appropriately adjusted. The RF sensing was extremely sensitive, the rig going over to Tx for an input level well below 1mW. Nevertheless, I strongly recom-

mend the use of the PTT line which stops the transverter from continually switching between Tx and Rx whilst the main rig is on Tx.

Figure 2 is a plot of the 28MHz to 144MHz low level response, the input preset being adjusted for an output level of around 40mW, a level chosen to be miles below any possible ALC threshold. As there are far more tuned circuits the response can be seen to be much sharper, which is all to the good, but at band edges the fall-off was just 3dB average, which is reasonable enough.

## Harmonics

We had a good look for the presence of harmonics and other output sprogs. I have to emphasise here that the review sample was a prototype but, even so, I was a little disappointed with the harmonics suppression which was not as good as I might have expected. We also noted the 5th harmonic of the input drive present on the output, 28.2MHz producing 141MHz at around -63dB ref 25W.

Another sprog at 147.4MHz baffled me at first until John and I put on our thinking caps, calculating the -56dB carrier to be twice the LO, minus three times the input frequency. This may be quite a low level, but it is slap in the middle of the Police band! If this is amplified by a linear, the output level could actually be at around 1mW if the main output were at 400W peak. At least one has the advantage that the sprog would be horizontally polarised while the Police use vertical polarisation. It is worth watching and the explanation might sort out a problem here and there!

The 116MHz breakthrough on the output was totally insignificant and no 28MHz breakthrough was noted. The worst harmonic was the 3rd at -45dB which might irritate somebody on 70cm but, in fact, I am more concerned that the 2nd, 4th and 5th need to be a little better.

We plotted many two tone intermodulation tests, again using the new spectrum analyser. The signal sources were two Marconi 2019 generators mixing in a hybrid with its output feeding directly into the transverter.

We used drive levels of up to 0dBm (1mW) and set the input drive preset appropriately. The two tone plot for 2W PEP (Figure 3) can be seen to be superb, the transverter performance probably being better than any 28MHz drive



# G3OSS TESTS

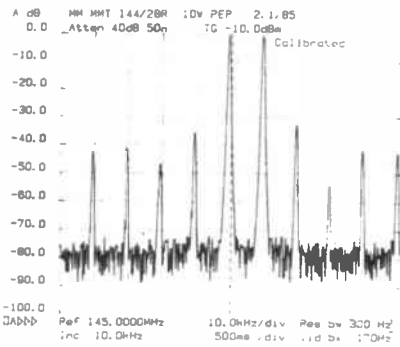

Fig 4 10W two-tone intermod

would be other than that produced by a modified Trio TS830 or 530. Do not forget that a two tone test gives results which are the worst possible indicators and under normal speech drive IPs would be somewhat lower.

It was at around this drive level that reports were obtained which were extremely complimentary about the transmission. One station using a bomb proof receiver (IC251E with muTek front end) incorporating a narrow 1.8KHz IF filter, commented that I was occupying no more than around 4.5KHz bandwidth, including that of his filter. It can thus be seen that, in effect, the combination was not producing any significant products at all outside the transmitted IF passband.

We then took two plots at the 10W PEP level, one with 10KHz spacing between carriers and the other with 1KHz spacing. The 10KHz spaced plot, Figure 4, shows the 3rd order IPs to be well down, and very significantly better than the performance of the old model. A 20W PEP plot gave 3rd order products of -31.5dB average, so we went even higher up to 25W PEP. Figure 5 shows the performance from two carriers spaced 1KHz apart, the 3rd order performance still being relatively good. Orders between 5th and 9th show reasonably good attenuation but higher orders still do come up a bit, although they are at

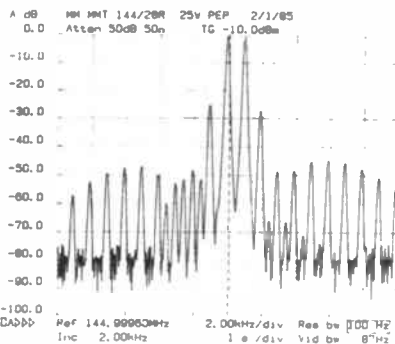

Fig 5 25W two-tone intermod

reasonably low levels. Again, in practice, higher orders should be well down on speech.

The final plot, Figure 6, shows the two tone performance with the rig driven hard into ALC, thus showing the worst possible performance. The 3rd order products are not too bad, and higher order products can be seen not to fall down as fast as they did at lower levels. My conclusion regarding all these plots is that I would prefer to see the rig set up for 20W PEP for the onset of ALC, but 25W PEP is not too bad provided the drive itself is clean.

The entire set-up will need to be very carefully adjusted if the transverter is to feed a linear, and the best way to do this is to set the input drive with a saturated signal from the main rig so that you are at least 8dB into ALC. You should then adjust the ALC preset very carefully indeed to back off the output down to perhaps the 5W PEP level for driving most linears.

My colleague, Jonathan, developed a neat little computer program to measure output power and frequency versus time, taking measurements every 15 seconds or so in 10 minute runs. Each of these runs was interspersed with 3 minute cool-off periods. The basic transversion frequency accuracy was well within 1KHz, and once the whole rig had

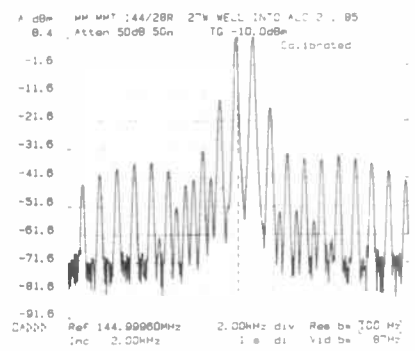

Fig 6 27W two-tone intermod

warmed up and settled down, the average error was around 100Hz for lower output drive levels, but up to 400Hz when delivering full power. The frequency drift noted is perfectly reasonable for FM and, of course, the duty cycle of SSB would keep drift much lower. On AMTOR, though, you might need to watch drift and twitch the main transceiver a little until everything had warmed up and stabilised.

At full power, output power drift was minimal, the ALC holding it up extremely well. At lower levels though (ie 5W carrier) the gain drifted by up to 2dB in a 10 minute period. If one wanted to use lower power regularly but keep the maximum power constant, the measurement shows that it is again highly advisable to use the ALC internal preset rather than back off the input gain to take the rig well below the ALC threshold.

## Alignment

Microwave Modules should be detailing user alignment in their instruction book, but they strongly advise that other presets should not be touched, for any maladjustment could cause chaos, so you will have to be very, very careful to twiddle the right one! Note that there is another preset for adjusting the thresholds of the power indicators and this should not be touched.

Two separate crystal oscillators are provided with switching for repeater use, and the 600KHz offset was accurate to around 500Hz. There could, of course, be considerable variations between crystals, so you may need to watch this, together with any heat drift susceptibility.

The current drawn when transmitting a 25W carrier was 5.7A, and I recommend that you use a good power supply. I have heard so many badly regulated ones with ripple on them which are better suited for driving light bulbs. A first-class power supply is a must in a shack and do not underestimate its importance, particularly if the same supply is running other equipment, which might include a linear, at the same time. Always go for a supply that has a capability of delivering around 50% more current than you think you may need, for inevitably you will want to add on various bits and pieces which you might not think about at first.

All our tests were carried out at 13.8V stabilised, but the transverter should

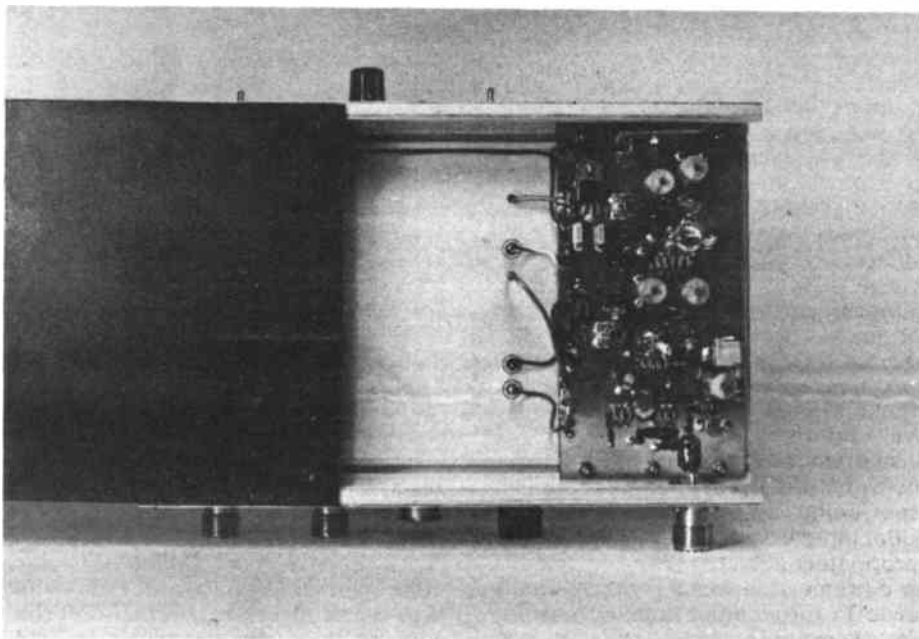

work satisfactorily from dc inputs over quite a range from, say, 12V up to 14.5V, although the manufacturers state that not more than 13.8V should be used. In actual use on the bands I received no reports of any frequency pulling on transients, even though the actual voltage being delivered to the transverter was probably varying several hundred mV in my normal set-up because of leads and switches. In the lab tests the voltage was held very steady.

### Conclusions

This product had been rumoured for around 18 months and I very much looked forward to reviewing it. It is obviously far better than the old one but, frankly, it needed to be, for competition is now entering the field. MM were right to give it a higher power capability and this is just about right for average requirements. Both the transmit and receive

section showed significant performance improvements but it is in the ergonomics that I feel that the advantages are of great importance.

There is still one problem which this new model has not fixed and that is that there is no ALC feed to go back to the main exciter, which would have gilded the lily. The provision of an ALC internal loop, however, with careful adjustment of the input drive level, will allow you to work the mic gain on the main rig sensibly, thus keeping the exciter drive clean, even if you lift your voice a bit. We checked the ALC loop time constant to be many seconds long, and this is again excellent as its operation would be almost unnoticeable in practice. I have not seen the new instruction book yet as it is in the course of preparation.

I feel that this is the best product that Microwave Modules have introduced for many years. I highly recommend its

purchase, although it is a lot more expensive than the older model. I understand that both will run in parallel for a while until market forces dictate the possible demise of the old version. The transverter should suit virtually all purposes but it does fall short of the ideal just a little. There is likely to be some competition though, in a few months time, and then the choice will be controlled by cost, and I do consider that this new model is quite reasonably priced considering its much higher power capability and better overall performance than the old model.

### Thanks

The price tag of £215 includes VAT. I would like to take this opportunity of thanking Microwave Modules for their co-operation, and Jonathan Honeyball and Myles Capstick for helping me make all the measurements.

# ICOM IC551: A LOOK AT STARTING ON 50MHz

In 1977, I first became interested in the potential of 50MHz receiving with a simple Microwave Modules converter, and using a 13 element horizontal log periodic beam which covers the frequency range 50 to 500MHz.

During 1979, the peak year for sunspot activity, I enjoyed very many crossband QSOs between 10 and 6 metres with stations all over the Americas and in some other continents. I can well remember one particularly startling contact with VE1ASJ in which I still received him on 6m when he had reduced power to only 10mW.

It seems possible that this low power QSO was a record for the lowest power across the band, although I feel sure that it could easily be repeated at the next sunspot maximum.

### By application

I applied for one of the first forty 6m licences but was not granted one apparently because the DTI did not want to licence anyone in a large urban area, but having re-applied in 1984 I was delighted to be one of the new licensees from November.

Many of the 6m licence-holders have built their own transverters, but just as many have purchased a commercial rig in order to get on the band quickly. As the band has not previously been allocated in the UK hardly any rigs are available here, but Thanet had already taken the decision to import the IC551 in readiness for the next batch of licensees, and kindly supplied one to me for review.

I first started my transmissions on the band using a little Kenwood-Trio rig, TS660, with 10W capability on FM, CW, SSB and AM. This rig covers 21, 24, 28 to 29.7 and the whole of the 6m band and is a delight to use as it is simple and reasonably effective. However, its receive performance is not particularly outstanding, the IF filter characteristics



being its main let down as it is very wide well down the skirts.

### IC551

When the IC551 arrived I was very keen to put it on the air and try it out. Immediately I realised that the Trio was incapable of receiving many of the weak signals that the Icom coped with reasonably well. The 551 (basic cost £495 including VAT) has fairly similar facilities to the 251 (now discontinued) and is frankly quite an old model which may soon be superseded. The basic version only includes CW, SSB and AM; an FM board (£126.39 including VAT) being an optional extra which nobody seems to want! The smoothly rotating VFO knob

covers the whole band from 50 to 54MHz in either 100Hz or 1KHz steps (5 or 50KHz per rotation).

Facilities included in the basic model are: two VFOs, three memories, memory scan and programme frequency scan (between frequencies stored in memory 2 and 3), squelch working on all modes, RF and AF gains mounted coaxially, passband tuning (optional extra £110.60 including VAT) and VOX control on mic/CW (optional extra £54.95 including VAT). In addition, levers switch in: RIT, noise blanker, AGC fast/slow, frequency lock and VOX on/off and Rx/Tx.

Mic gain and compressor threshold with on/off are also provided on rotary pots. A 4-pin mic connector is fitted



# G3OSS TESTS

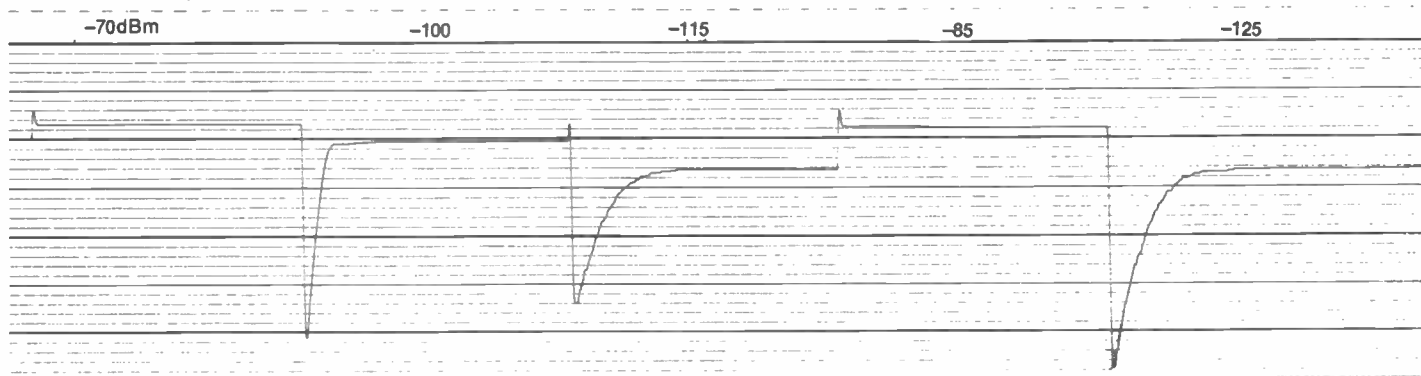

Icom IC551 AGC action fast, pen speed 250mm/S, paper speed 10mm/S

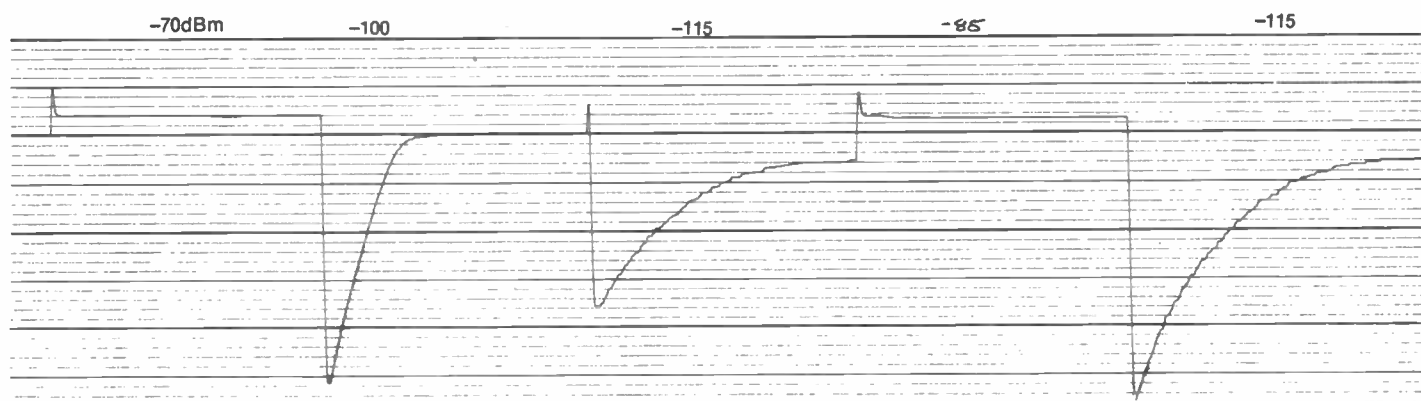

Icom IC551 AGC action slow, pen speed 200mm/S, paper speed 10mm/S

which, therefore, does not allow for a mic to control frequency. A headphone jack is fitted on the front panel, and the frequency readout is the usual green digital display in 100Hz increments. Mode status is also indicated on the display.

A bug hatch cover opens up on the top panel to expose six presets: scan speed, CW delay, CW monitor level, anti-VOX level, VOX gain and VOX delay. The rig is supplied to operate on 240V ac mains or 13V dc inputs. The antenna socket is an SO239, an earthed wing nut also being provided.

An accessory socket has 24 pins, including facilities for: squelch operation detection, 13V dc output switched (max 0.3A), external PTT control, Rx audio fixed output level, mic amp audio output, 8V/5mA on Tx only, ALC input and a ground connection. The connections are on pins 1 to 8 inclusive, the remainder of the pins being unconnected.

The loudspeaker is on the underneath of the chassis, and the front includes a bail stand which, when lifted, allows the audio to be reflected forwards from the table under the rig. Additional interconnections on the back include: external speaker, scope, Rx antenna breakpoint in/out and a 3.5mm CW keyjack.

## Laboratory tests

The RF input sensitivity of the IC551 measured very well and is certainly good enough for even the quietest locations under normal conditions, although I

noted a very slight improvement when I switched in the very low noise pre-amp on the Lunar Electronics linear which I obtained direct from California. The RF intercept point was acceptable but not particularly good for distance spacings, but close into the carrier it degraded by around 8dB due to the wide first IF roofing filter.

The latter is one of those unfortunate facts of life if a rig has to incorporate an FM facility, even if this is not actually fitted. Whilst at the moment there is not too much QRM on the band, one day we will undoubtedly need every bit of selectivity and freedom from blocking that we will be able to obtain.

The IF selectivity measured extremely well down to -40dB but the 60dB selectivity showed that the skirt did widen quite noticeably. The S-meter covered a range of 20dB from S1 to S9, which is not really enough, and the scale above S9 gave from 11 to 16dB for each indicated 20dB step.

## AGC charts

The product detector distortion measured well, and audio quality was quite good. Maximum audio power was just about enough for normal purposes but I would have liked a little more in hand. Fast AGC was very fast indeed and there was plenty of IF gain so that even low level signals were brought up to quite a high audio level. The slow AGC chart showed that full recovery took around 3 seconds, which is just about right for me.

The recovery for weaker signal changes was somewhat longer, however, but this seems quite usual these days.

The audio response fell very rapidly below 400Hz with PBT either not fitted or adjusted centrally when fitted. There was clearly some HF attenuation in the audio output partly due to the effect of the IF filter, and 2KHz was some 4dB down, whilst 2.5KHz measured 6.5dB down, the IF filter cutting very steeply above this frequency.

I have to say yet again that I do wish we could have a flat passband with the response being controlled entirely by the IF filter, but Icom seem to think otherwise on almost all their rigs.

We applied our usual two tone tests to the transmitter section, injecting appropriate frequencies into the mic socket with the rig's output interconnected with the analyser via an attenuator dummy load. At the 10W PEP level the intermodulation products were at a very low level (Figure 1), but there was evidently some third order distortion cancellation between the PA stage and its driver, for fifth order was actually worse than third! We also noted some audio distortion within the IF passband produced from the two tones.

We managed to get 20W PEP out of the rig after much pushing and shoving, and the IPs can be seen in Figure 2 to have deteriorated dramatically, showing that it is advisable to limit the rig's output to 10W by altering the internal ALC threshold control.

# G3OSS TESTS

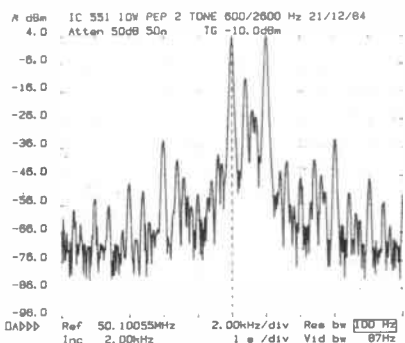

Fig 1 10W two-tone intermod

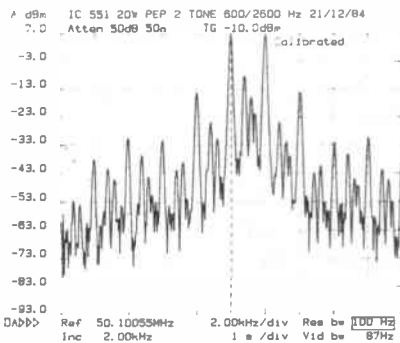

Fig 2 20W two-tone intermod

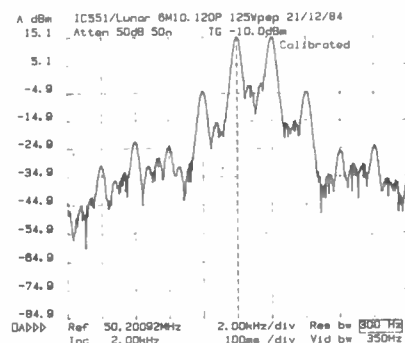

Fig 3 125W two-tone intermod

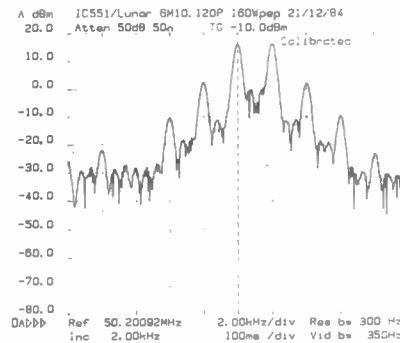
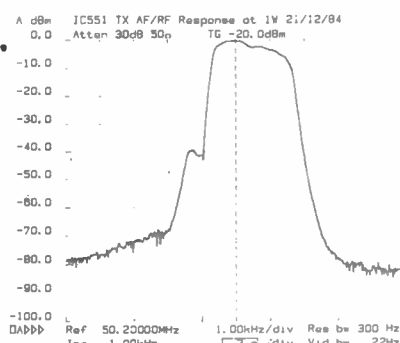

Fig 4 160W two-tone intermod

Fig 5 AF/RF transceiver response



(Figure 5). This ensured that the plot would not be affected by any ALC action. Note that the position of the carrier is offset to the left of centre by 1KHz, as we were still learning to drive the equipment at the time!

The LSB rejection is 40dB at worst, the carrier breakthrough below -42dB, whilst the IF passband can be seen to slope down above 1KHz, which makes transmissions a little muffled well before it reaches the beginning of the real filter action. It is fascinating that a rejection of 60dB can be noted at 3.3KHz above the carrier, which is actually a lot better than we noted on Rx, which is puzzling. By 4KHz the response can be seen to be down to around -80dB which is excellent.

Note that the lower sideband does show some noise breakthrough, which is not present on the USB. It is clear that the transmit IF passband is, in effect, narrower than the receive one, as any effective widening of a filter due to reciprocal mixing problems will only occur if the 'noisy mixer' is before, rather

than after, the filter, hence the inferior Rx IF shape.

We had a good look at the harmonic and spig output of the Tx section. Second, third, fourth and fifth harmonics were all below -80dB which should please the DTI, the carrier level being set at 10W. There were, however, three sprogs at 45.052MHz (-76.8dB), 45.005MHz (-72.5dB) and at 55.348MHz (-72.7dB). I only mention these for academic interest as I don't think they should disturb anybody.

We then drove the rig into the Lunar Electronics linear to a level of 100W carrier, and noted the second harmonic from the linear output to be at -57dB which is not really good enough as it is slap in the middle of band 2. Very considerable attention will have to be paid to second harmonic rejection from 50MHz if we are all to be given the band, so watch it!

The maximum power on CW was measured at 13W, and the frequency accuracy on Tx showed a maximum error of 40Hz. On Rx the SSB frequency error reference carrier was -150Hz, whilst CW was 800Hz high. Icom's policy, though, is to offset CW anyway, thus explaining part of the apparent error.

## Subjective trials

I enjoyed using this rig very much indeed on the band, and in practice I did find it necessary to control the power output level very carefully indeed to avoid spreading when using the Lunar linear. Transmit quality was said to be adequate, although HF lacked a little clarity. Transmissions were a little on the thin side, and this confirms the results of the frequency plot. I did not notice any drifting, and there did not seem to be any spurious receiving problems, although there was some interference from the strongest television carriers until the wretched things were finally turned off in the first week of January.

I found the rig very easy to use, although I personally still prefer to use a transverter with my main station rig, a Trio TS830. Just before writing this review, Thanet very kindly sent the passband tuning and VOX control options. The PBT greatly helps in CW reception and life without the VOX unit was incredibly tiresome on CW, since I had to use the VOX switch all the time. The VOX accessory is therefore almost vital if you are to take CW seriously on the band, which I think is a must anyway. However, I found the VOX unit caused severe degradation to the audio quality, for it includes a bucket brigade time delay of around 50ms which cannot be switched out, even with VOX off.

This delay causes brain congestion if you are either monitoring your own transmission or you are working duplex, for the echo of your own voice may well jam you up! Even CW is delayed by the same amount, and it would thus be impossible to use the equipment for AMTOR if the VOX unit is fitted. Without the unit, transmitted audio distortion was



## ICOM IC551 LABORATORY RESULTS

### RECEIVER TESTS

Sensitivity, SSB (level required to give 12dB Sinad)		-125dBm (0.125µV)
Selectivity, SSB	3dB bandwidth	2.0KHz
	6dB bandwidth	2.2KHz
	40dB bandwidth	3.2KHz
	60dB bandwidth	5.5KHz

Product detector distortion at -80dBm	1.1%
AGC threshold for -3dB audio level ref high level	-110dBm (0.7µV)
Calculated intercept point at 100/200KHz spaced carriers	-12.5dBm (52mV)
Close in (20/40KHz spaced carriers) intercept point deteriorating to -20dBm	(22mV)

Maximum audio power (10% THD)	8 ohms;	1.8W
	4 ohms;	2.7W

### TRANSMITTER TESTS

Maximum power output on CW	13W
Maximum attainable PEP power on SSB	20W
Carrier suppression ref 10W	52dB
Worst LSB breakthrough	-40dB

Weight 6.6Kg  
Size 111mm(H) x 241mm(W) x 31mm(D)

acceptable, but stations reported to me that with the unit fitted my modulation was very rough, spikey and harsh, even with the compressor switched off.

The PBT unit includes the compressor, and if you want to alter output power with this unit fitted, you cannot without the compressor being in. The compressor seemed to produce, in combination with the bucket brigade gadget, very rough background noise, and advancing the compressor/power control more than 1/4 way severely reduced readability, which was harshly criticised.

As fitted, minimum power was 4W PEP and it would be necessary to readjust the

internal presets if you want this to go down to 1W. After extremely careful adjustment, and having accepted the dreadful harshness caused by the VOX unit, compression did improve readability for DX quite dramatically, so probably the PBT unit is a good buy. However, you should only buy the VOX unit if you absolutely must have VOX operation on CW. Alternatively, you might choose to dig into the circuit and modify it so that when VOX is switched off, the entire unit is bypassed.

Incidentally, this novel VOX circuitry did produce very effective VOX operation on speech, better than most others

that I have encountered, but I personally cannot abide any add-on that severely degrades speech quality for normal contacts. I am most disappointed that Icom do not provide any CW filter option for the set, an omission which is all too common these days.

### Conclusions

The price of the rig is very high indeed, but you get some very good performance for your money. The IC551 is by no means the most economic way of getting on the band, but those who own them have, in the main, made many of the best DX contacts. It is useful to have a separate rig for the band in order to make cross band contacts with HF much simpler, and so I conclude by giving a good recommendation if you can stomach the price.

I must applaud Thanet for at least making the rig available as a stock item, and I can just imagine the rush for rigs when the DTI are finally convinced that the band should be opened for all class A licensees. At the moment, I have heard that the problem is primarily some minor objections from Ireland, Belgium and France, but one by one other countries are being allocated the band on a restricted basis (eg Norway). Let's hope we all have the band soon.

Thanks to Jonathan Honeyball and Myles Capstick (G4RCE), to the 50MHz fraternity for all the assistance in preparing this review, and to Thanet Electronics for the loan of the review sample.

## 13cm UPDATE: EME 1325 VALVE LINEAR

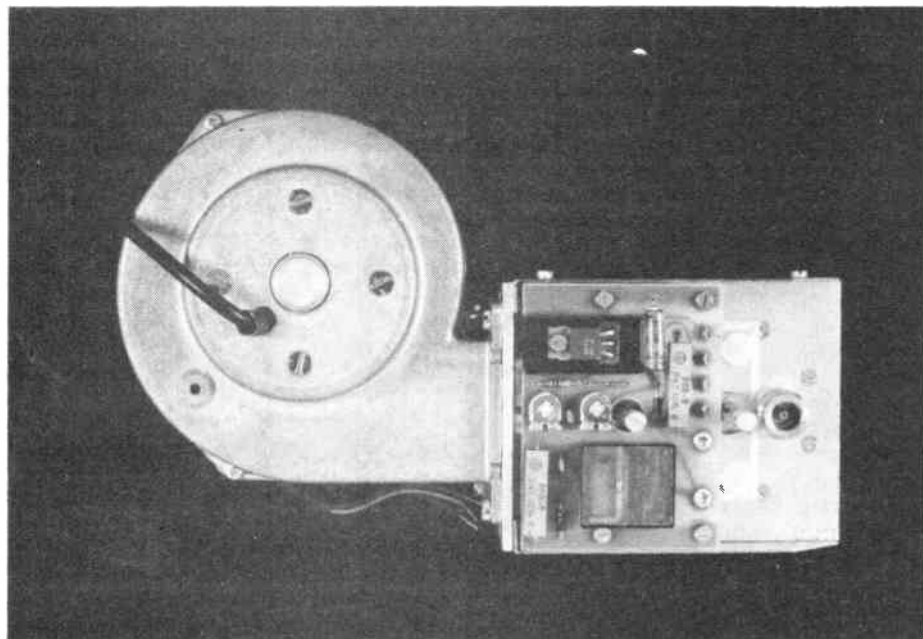

I recently reviewed in this magazine the SSB Products 13cm transverter and solid-state PA. The set-up gave a maximum output of just over 3W, although the importers explain that newer devices should bring the solid-state linear output up to 4W. I have already had many good DX contacts on the band running just 3W PEP up the coax, which worked out at roughly 1W into the dish. My next step was to add the EME valve PA to the system, and replace the turning loop of UR67 cable between the dish and the Andrews LDF 550 with semi-flexible Andrews FSJ450A.

As now installed, the complete set-up produces a maximum power of 25W PEP out of the transmitter, and around 15W into the dish. Of course, this is a very substantial power increase which made a dramatic difference to the received signal strengths of my transmissions. I now find that on average, taking the power differential into account, 13cm signal paths are not more than an S-point or two down on 23cm signals under normal conditions, but of course almost anything can happen in a tropo-product.

### Problems

I felt that in this article I might usefully tell readers about the problems we had getting the linear to work, for we certainly did have a lot of trouble to begin with.

When the linear was first installed, with



a 3CX100A5 valve in it, we could get no more than 5W output for 3W in, and this was a bitter disappointment. The input SWR was well nigh perfect, the standing current and maximum anode current seemed to be about right, but we just could not suck out the RF into the load. The rig was returned to the importers who tried several other valves of the same type, all of which proved to give a very low RF output.

At this stage, I discussed the matter with Dr Charles Suckling G3WDG. We discussed 13cm cavities and valve types for quite a while, and he kindly loaned me some 2C39BA valves to see if they would give better results. All four were checked with a low level drive and their gains varied from around 10dB to 13dB, the best one giving 12.5W output for around 500mW input. We then applied the drive from the SSB Products solid-state linear, and after some tuning up we heard a disturbingly loud bang just as the power reached 25W!

We had originally decided to try 1250V dc and after investigation we discovered that this voltage jumped over the anode supply decoupling capacitor, causing the anode supply feed blocking resistor to burn out in a few mS. We tried to replace this resistor with another one, taking more care with the loading, but again a loud bang blew the resistor, so we decided to reduce the anode supply volts to 1KV. Having again replaced the resistor all seemed to be fine until we tried pushing the system a bit harder, when there was yet another bang and this time the fuse went but not the resistor (or so we thought). We again tried, being much more careful, and eventually produced a good 25W (measured with the EME power meter reviewed recently) and the system seemed to work fine.

### Flash! Bang! Wallop!

I had a most exciting contact at 5/9 both ways with a station in south-east Belgium, but a few minutes later on hearing a German station calling CQ, disaster struck again. My wife, Fiona, was in the shack, and shouted, 'Turn off, turn off quick', as I started calling the station. I could already hear frying noises but Fiona explained that the entire linear amplifier was lighting up like a fire-cracker, and she could see lots of little lights moving rapidly inside behind the protection mesh. Some of these brilliant meteors were actually coming through the mesh.

I had to choose between my strong desire to make my first DL contact and my concern for imminent disaster, and

this decision was made all the more difficult when the DL actually returned and called 'QRZ G30--'. I tried just once more but a brilliant flash caused immediate QRT!

Upon investigation we discovered that the anode feed replacement resistor had been burning steadily, and had a cold resistance of around 0.5Mohm, and obviously HT was trying to jump over it, through it or around it with somewhat alarming results. This was replaced with a large hairy wire wound, and the rig has worked successfully ever since, although I admit to being somewhat nervous about attempting any reloading!

It is quite clear from these spectacular happenings that we should never have attempted 1.25KV, but it was worth trying! I am assured, by many who know the valves intimately, that it is better to work them at higher HT voltages with lower currents for optimum linearity, but it seems that EME's special capacitor is inadequate so they will need to have a look at this in their design.

I have discussed the valve problem with many 13cm band enthusiasts, and whilst one amateur may swear by his 3CX100A5, another feels that the 2C39BA is the best thing since sliced bread, so the situation needed resolving. It seems that the anode capacities of the two valves are quite different, and the lower capacity of the 2C39BA thus requires a larger cavity to tune it properly. I must then theorise that the EME anode cavity, which they advertise as being compatible with 2C39BAs, is clearly slightly too large for the other valves, including the 7289. Some amateurs who have made their own cavities may well find that they suit the 3CX100A5 perfectly well, but then they will be too small for the 2C39BA.

This may well be the root of a discussion point which has been aired for months. We did note that maximum output from the original 3CX100A5 was obtained with the tuning control hard up one way, and this would seem to be quite a good indicator that the cavity was incompatible, but if anyone has got other viable theories I hope they will write to the Editor to express their views. As far as I am concerned I shall keep to the valve recommended by EME but, unfortunately, they are extremely difficult to obtain at any reasonable price: I have actually been quoted around £65 for a brand new one, and there do not seem to be any government surplus ones around.

The linear is supplied with the bias circuit board, cooling fan, cavities and complete input and output circuits, and the importers (Piper Communications) can supply suitable HT transformers. The circuit includes input trimmers for adjusting input SWR, frequency tuning for the input cavity and output loading and tuning for the anode cavity.

The brass cavities are highly polished internally, then plated with a 5 micron silver layer. Input and output connections are on N-type sockets and the bias control allows the standing current to be

adjusted from cut-off to well over the required 50mA or so. It is recommended that the equipment should peak at no more than 150mA, but under maximum drive conditions my own one actually takes slightly more: around 165mA.

The fan is designed to cool both the anode and cathode cavities, and having set the heater voltage at 5.6V on transmit and 6.0V on receive, I found very much less power drift than I might have expected. Many amateurs have found it necessary to retune their 13cm cavities continually, but I have not had to touch mine for weeks, for every time I check the power it is between 20 and 25W on keydown after three or four seconds.

The cavities are turned to a thickness of 5mm out of high quality brass. The bypass capacitors are made from polished brass isolated with 0.25mm Teflon foils. We all felt that the construction was to a very high standard and so my only real point of criticism is of the rather dodgy Teflon dielectric capacitors.

### Conclusions

The availability of this linear has brought many people on to the band with extremely good signals, and it may well be responsible for much 13cm activity in Europe. I think it will be a long time before we see any reliable high power solid-state linears, mainly because of the colossal price of PA devices, and so this EME linear has become very popular for the band, and can therefore be strongly recommended.

Despite the fact that there is obviously a considerable amount of compression on peaks at full power, the actual intermodulation products, judging by comments from other amateurs, seem to be reasonably low, and this appears to be one of the strange phenomena of this type of valve used on microwave. A good valve should give around 15W output from 1W drive and such a power on the band should produce extremely good results. However, cable losses are far more severe on this band than on any lower frequency so to make it worthwhile to run such a linear in your shack rather than put the entire transverter and solid-state PA at masthead, you will have to invest in extremely high quality co-ax, especially if there is a run of more than a few metres.

With the latest SSB Products gear at the masthead, you could get 4W into the dish and even with only just over 2dB loss in 23 metres of co-ax at vast expense, I am only achieving one S-point advantage, so there is a lot to be said for keeping everything solid-state at masthead, especially if you need a long cable run.

The cost of the linear, including fan but excluding valve, is £218.00 including VAT; with HT transformer costing around £34.00 including VAT extra.

Many thanks to Dave Aram of Piper Communications for his tremendous help and co-operation in assisting me in the preparation of this review.



# SHORT WAVE LISTENER

TREVOR MORGAN GW40XB

With the *Amateur Radio* prefix award now well under way, some readers may be thinking that a great deal of time is necessary to be able to qualify and, depending on their own circumstances, may believe that the number of prefixes required would be difficult to obtain given the time available.

As an experiment, I decided to see just what could be heard by someone with extremely limited time available for listening. I know it's taking things to the extreme, perhaps, but I allocated myself 30 minutes in each session with one session a day over a week. However, as it was Christmas week, I took two sessions on the Sunday before Christmas to make up for the 'lost' day.

The table shows date, time of listening period and the prefixes heard. To qualify as a 'contact' it is necessary to have heard the station claimed, ie if the station is calling you can claim it, but if the callsign of the station is mentioned during 'handover' but you cannot actually hear it, you do not claim the prefix. No cheating please!

Looking at the table you will note that there is a distinct absence of a lot of the 'easy' ones (particularly the Russians who didn't seem to be around at the times I wanted them to lift the score... typical!). One annoying factor was the number of nets on air who passed between stations without a callsign being given at all which wasted a lot of time (the Americans were the worst on this score).

I think this shows that even with conditions being adverse (time of year, low sunspot period) and given only very limited time, a good score can still be made. Bet there were a lot more around that I didn't hear too!

Nevertheless, I see no reason why we should not have a good response to the award scheme and I look forward to receiving your claims.

The contest season is here and hooking on to a couple of

contest operators can net some good prefixes.

So, now for something completely different.

## Educational project

During November, I had the pleasure of working with fellow members of the Swansea Radio Amateur Constructors Club at an event set up by the Swansea Maritime and Industrial Museum. The idea was to present amateur radio to local schoolchildren as part of an educational project. Many local schools took up the offer and sent children to the museum by coach to see the exhibition and see the radio station in action.

The project was held over a week and we were on air using the call GB2MEP. Despite bad propagation conditions, we had an interesting week and were surprised by the interest shown in the station by youngsters from the age of only 10 years... especially the girls!

There are two reasons for mentioning the project. Firstly, the success of the station has resulted in a number of enquiries, not from radio enthusiasts but from local schools asking us to put on demonstrations of the use of amateur radio, including short wave listening. Secondly, a few days after the event we received a very unusual piece of SWL reporting that certainly deserves mentioning.

The report, from Nick Bainbridge in Glasgow, not only gave us a signal report for one contact but a graph giving us comparison reports of our signals as received over a period. As a result of this fine piece of reporting, Nick not only received the requested QSL card but the club chairman and the members presented Nick with the 'Gower Award' for his excellent effort.

Of course, the average amateur would not expect to receive such a report but for a special event station it is a useful observation.

A lot of schools have science projects that could be enhanced by a demonstration of amateur radio and/or short wave listening and the experience gained is very useful to the operators as well as the students. Why not try your local school?

## Complaining bitterly

I noticed in one of our companion magazines that some short wave listeners are complaining bitterly about non-receipt of replies to their reports.

Conversely, amateurs are complaining about the terrible standards of cards they are receiving. Not, I add, from listeners, but from licensed amateurs after a card for their DXCC or other award. I have often mentioned the importance of accurate and useful reporting but it appears that

not only listeners are guilty of bad reports. One amateur complained that a QSL card received not only got the callsign of the contacted station wrong but had the frequency incorrect, the time incorrect and gave a '5 x 9 both ways' signal report which, considering the location of the sender, was a virtual impossibility!

It appears that if a card is wanted for an award claim some people think that just any old thing will do. This sort of reporting is not only useless but an insult to the intelligence of the station operator.

Listen to the QSO and report anything unusual in the transmissions, any variations in signal strength or audio quality. If there is a station from the same area on an adjacent frequency, is his signal better or worse?

What about the distance? Is the station closer to you than he is to his contact? Remember, the operator knows he can be heard in the area of his contact so a report from that region would be pointless. Also, unless he is using a directional antenna (or propagation is a bit wierd at the time) he can be reasonably sure that he can be heard within a radius of his station equal to the distance between himself and his contact. However, if he is using a 5-element multibander and you can give an accurate

23.12.84	0730-0800	80m	CT1 DA1 DJ0 DJ5 DL9 DM7 EA1 EA7 F6 FD1 G3 HK0 KB8 ON7 TK5 YU3 WB1 WB3
23.12.84	1730-1800	20m 40m	EA7 GW4 GD4 KB2 KA1 PA3 W2 W3 WA1 EA8 I8 UB5
24.12.84	1345-1415	20m	DF4 F6 GW4 GI4 HA4 HK4 I5 I8 JB4 KB9 KC3 OE6 OH6 OH8 OK9 P11 SM5 SM3 SP3 SP4 UB4 UB5 VO1 W1 W2 W8 WB1 WB2 ZB2 9M2
26.12.84	1610-1640	20m	DL6 G4 GW4 PA3 PY4 YU3 ZS2 5N3 6W1 W2
27.12.84	1640-1710	20m	DL8 DJ2 ED4 GW4 K2 KC7 N6 V2 W3 WA2 ZB3 ZS1
28.12.84	0725-0755	20m 80m	CT1 CT5 EA8 EA7 EA9 G4 IT9 JA4 JA3 JB7 LZ1 PY2 4X4 9H1 AE8 DL8 DJ0 DF4 EA8 G2 CW3 NF4 Y57
Total time involved: 3 hours			Total prefixes: 85

# SWL

report off the 'back end' of his beam, he may be interested.

Funny thing is that wire antennae seem to have peculiarities that are not covered by the theoretical diagrams to be seen in the textbooks. For instance, my G5RV is set up with, theoretically, the main lobes of the radiated signal to the east and west. However I get consistently good '5 x 9' reports from the North and particularly good reports from mobile stations using vertical whips. Any genius out there with an answer to that one?

The G-QRP Club have their spring QRP CW activity weekend over the 16/17 March, and their late spring SSB activity weekend over

the 4/5 May. The QRP boys are always keen to hear how far their signals are getting so if you want a bit of a challenge tune in to the QRP calling frequencies below.

The G-QRP members can be heard around these frequencies at any time but the activity periods are a good time to try your arm (perhaps that should be ears?).

Well, that's it for another month. Next time we will be looking at the multiband version of the 'Dipole of Delight' and a new RTTY program for the Spectrum computer, as well as some points of interest from the many letters received from readers. Until then, keep listening and good luck with the DX. 73, Trevor.

### QRP calling frequencies

Times	CW QRG	SSB QRG
0900-1100	14060, 21060, 28060	14285, 21285, 28885
1100-1300	3560, 7030	3690, 7090
1300-1400	10106	
1400-1700	14060, 21060, 28060	14285, 21285, 28885
1700-1900	3560, 7030	3690, 7090
1900-2100	14060	14285
2100-2300	3560, 7030	3690, 7090

## NEW FOR 1985



### AMATEUR RADIO HF PREFIX AWARD (TWO-WAY AND SWL)

To qualify for an award you have to have worked/heard and logged:

250 prefixes for the Bronze award  
500 prefixes for the Silver award  
1000 prefixes for the Gold award

The opening date is 1 January 1985 and further details are available in SWL (page 37)

### AMATEUR RADIO MICROWAVE AWARD

To qualify for an award on one of these bands you have to fulfil each category

	Countries	Countries	Squares	Distance
144MHz				
Bronze	7	20	20	500 Km
Silver	14	35	40	800 Km
Gold	21	50	60	1200 Km
432 MHz				
Bronze	5	15	40	400 Km
Silver	10	15	30	800 Km
Gold	15	25	45	900 Km
1296MHz				
Bronze	3	10	10	300 Km
Silver	6	15	20	500 Km
Gold	9	20	30	700 Km

The opening date is 1 January 1985 and further details are available in *On the Beam* (page 44)

### KEEP IN TUNE WITH AMATEUR RADIO AND THE AMATEUR RADIO AWARDS

Start working towards your chosen award now!

All winners will receive free certificates - and find their names in *Amateur Radio Magazine* (worth it for that alone).

All entries or queries should be sent to:

Trevor Morgan GW4OXB, Glen Ross G8MWR or Amateur Radio.

# GOING GOING GONE!

Selling your rig can be fast, easy and painless when you use the services of G3RCQ ELECTRONICS. We advertise BIG in all the magazines, our turnover of equipment is fast, this means we can offer the BEST PART EXCHANGE deal and the BEST CASH DEAL. Our advertising is there to help you sell your used equipment without delay. REMEMBER if you are selling USED EQUIPMENT - Contact G3RCQ. Tel: (040-24) 55733.

## AUCTION

Auction your surplus equipment from the comfort of your own home! HOW? Let's say you have an 'XYZ' rig for disposal and you value it at £150 you send me 10% (£15) for inclusion into the auction, plus FREE entry into LIST-A-RIG your estimated price of £150 will not be quoted so you may even receive bids over and above what you expect. There are no further charges. If your rig does not sell within 2 months (that's two auctions) your 10% fee will be returned in full.

## NATIONAL ADVERTISING FREE

I will advertise nationally in all monthly magazines on a rotation basis lists of items to be auctioned. Potential purchasers will be invited to submit their bids by post to me before a specified date (auctions are monthly). All bids will be forwarded to you the seller. It is then up to you to contact the bidder of your choice and conduct the sale.

## LIST-A-RIG

Imagine a data base which is constantly being updated and contains items for sale or wanted the list encompasses Dealers and Readers adverts. LIST-A-RIG is sent FREE upon receipt of a S.A.E. To include your own advert the fee is £2 for TWO MONTHS ADVERTISING.

## A FAIR DEAL IS MY POLICY

When you deal with G3RCQ you get a straight deal. A full no quibble guarantee, coupled with free advice covering 25 years of Amateur Radio.

## BUY & TRY

If you buy a rig from me you have one month to change your mind! If during the first month of purchase you decide that you have made a mistake or you simply cannot get on with the rig I will allow you 90% in part exchange for another rig of equal or greater value. If you want cash back without another rig I will give you 80% of your purchase price.

## MARCH AUCTION (Equipment may be sold by private treaty).

ICOM IC2KL LINEAR  
SEARCH 9 2M FM RECEIVER  
ICOM IC 740 HF TRANSCIEVER  
YAESU FP700 20AMP PSU  
TV CAMERA & MONITOR  
TECH TE20D SIGNAL GENERATOR  
FDK MULTI 2000 MULTIMODE  
YAESU FT757GX HF TRANSCIEVER

KW 2000B HF TRANSCIEVER  
HF TRAP DIAPOLE WITH FEEDER  
SX200 N SCANNER  
WELZ SP15 SWR/POWER METER  
ADVANCE VALVE VOLTMETER  
AMTOR AMT 1 AS NEW BOXED  
DATONG PC-1 GEN/COV 2M CONV.  
TANDY TRS80, MONITOR, CASSETTE

TRIO 2500 2M HANDHELD  
STANDARD C146 2M HANDIE  
ICOM BASE MIC, IC SM6  
QM70 2M LINEAR AMPLIFIER  
ALENCO 70CMS LINEAR  
ICOM AT500 ANTENNA TUNER  
YAESU FT1101 & 1012D & 277ZD  
TRIO TS 530S

ICOM 720A + PS15 PSU  
MM 144/50S & MM432/30L  
TRIO 9130 AS NEW 2 MONTHS OLD  
YAESU FT720RU 70CMS FM  
KW204 TRANSMITTER  
TRIO 201A AND SPEAKER 2M FM  
YAESU FT 480R  
TRIO SIG GENERATOR SG-402

If you are interested in purchasing any of the above please send your bids to the address below.

Send S.A.E. today for current list and full information  
**USED EQUIPMENT CENTRE, G3RCQ ELECTRONICS**  
**65, CECIL AVENUE, HORNCHURCH, ESSEX**

TELEPHONE HORNCHURCH (040-24) 55733

Please leave a message on the answer phone 73's de DAVE & CORAL G3RCQ & G4RCQ.



VISA



## WORKSHOP

A series for the would-be constructor

### PART TWO: GETTING THE BITS

Rev George Dobbs G3RJV

A few months ago I had a long letter of complaint from a reader about an article I wrote in an amateur radio magazine. It was not about the technical content of the article, nor about the style of prose, but centred upon his inability to get hold of some of the major components required for the project in the article. The writer was even kind enough to send me a list of his missing items and a space under each one to name suppliers. I managed to fill the spaces in about 5 minutes.

In some cases I did not have enough room to write in the three or four suppliers of an item. He seemed to assume that I had some mysterious source of supply of components not made available to lesser mortals when, in fact, I had no more access to sources than him or anyone else.

I did venture to suggest to him that part of the enjoyment of home construction of equipment is finding the cheapest possible supplier of the components required.

#### Problem

Failure to locate specific items does seem to be a problem for the beginner in electronic construction or, worse still, failure to find the items at a reasonable cost. The problem is not the major barrier that many assume and, with a little pre-thought and planning, most projects can be built at reasonable cost without scouring the whole world to find all the bits and pieces.

If you do not mind paying high prices the problem quickly disappears, but I would like to suggest ways in which components can be found with an eye to the total cost.

Gone are the days when the market was flooded with government surplus items, all of which contained useful bits for the budding constructor. The few boxes in the corner of a shed which would yield everything the radio constructor was likely to require are now, sadly, a thing of the past.

However, I believe it is easier and cheaper to obtain useful components than it ever was in the past. It might not be possible to have lots of surplus junk casually strewn about the place from which to cull required components, but it is very possible to keep and maintain a basic stock of items to reduce the problem and expense of buying in components for every project.

#### A few simple rules

Try to avoid getting into the situation where all the components for a particular project have to be bought together. This is where the 'basic stock' idea comes into play. The wary constructor can have in his stock most of the 'bread and butter' components which occur commonly in projects.

The real buying, and parting with hard earned money, can be left to the supply

#### A BASIC LIST OF USEFUL COMPONENTS

Resistors	There are several very commonly used values, 100K, 10K, 1K, 47K etc, but the only real answer is to have all of the E12 series of preferred values from 10R to 1M in ¼ or ½ watt resistors.
Capacitors	The stock could be almost endless but certain types are used very frequently. Perhaps most common of all are the RF decoupling values: 0.1µF, 0.01µF, 0.02µF, 0.0µF in about that order of usefulness. Electrolytic capacitors can be expensive, so if prices seem cheap, get them. The commonest seem to be: 10, 100, 220, 2.2, 22 and 50µF in about that order. Silver mica capacitors for RF work are also very expensive, so buy when cheap, especially: 100, 560, 27, 39, 68, 330, 270, 10, 470, 18, 47, 56, 180, 750pF etc in that sort of order. Polystyrene capacitors make good substitutes for silver mica types in tuned circuits and are cheaper, the same values as above are common.
Variable capacitors	These can be financial killers! The airspaced variable if bought new will cost you an arm and a leg. See them cheap – buy them. Values very often required are 10, 25, 50, 75, 100, 500pF.
Potentiometers	10K and 5K log and 1K, 5K, 10K and 50K lin types seem to be commonly required.
Trimmer capacitors	3-60pF, 2-20pF and 100pF are common.
Semiconductors	A little minefield, so many types are used, but if common types come up cheaply buy them.
Diodes	Always have some general purpose silicon diodes in stock (1N914 or similar) and a selection of zener diodes (9.1V, 6.8V, 8.2V, 5.6V are common). Get some cheap red LED indicators.
General	I collect various coil formers, ⅜ inch diameter being my favourite type, ferrite type, ferrite beads, cheap RF chokes, and usually keep in some Amidon iron dust cores.
Hardware	This is where the basic stock really comes into its own! This stuff costs the earth. Any seasoned constructor will tell you that cases, knobs and switches can cost more than the entire electronics inside the box. Buy it when it's cheap – old cases can be fitted with new fronts; cheap knobs, if there are a few matching ones at low cost; switches, especially miniature toggle switches; a few wafer switches (look for 3 pole 4 way, 4 pole 3 way, 2 pole 6 way and 1 pole 12 way); moving coil meters, the little cheap ex-tape recorder or CB equipment ones are very useful. Slow motion drives for tuning controls can be difficult and expensive to find, look for the little epicyclic, in line, reduction drives. Plug sockets, fuseholders, indicator lamps, in fact any of the stuff that goes onto front or back panels is worth buying when the price is right.

of more specialist items, such as particular semiconductors, inductors etc, required for the project in hand. It should be possible to dip into the stock to find 80% of the components for most projects.

Never begin a project until you have obtained, or at least located, all the required components. That spells frustration.

Become a hoarder of stuff and buy common components in reasonable numbers when the price is right. The

next time you want seven 0.01µF capacitors they will probably cost five times more than you paid for the last lot.

Shop around; ask your wife about that, or, if you are a wife, remember how you buy shampoo. The differences in price between various suppliers in electronic components can be truly amazing. Like any wise purchaser of anything, study the market.

Now to expand a few of those rules. What are the best 'basic stock' items? These are the components used most

frequently in radio construction. The experienced constructors will know these anyway. One of the ways in which the less experienced constructor can find them out is to read as many radio construction articles as he can lay his hands upon and see which items come up over and over again in circuits.

The table is my attempt at a list of items which seem to occur commonly in many radio projects. This is a very subjective list based upon my own needs as a constructor of mainly HF band equipment. This list is not exclusive but having most of these items would be a good starting point for a would-be constructor.

So much for what might be required... but where can it be bought? The first piece of advice is to avoid, if at all possible, the plush component shop or the mail order companies with a glossy expensive catalogue. We pay for these worldly trappings. Leave them for items that cannot be found elsewhere. The friendly corner junk shop has all but disappeared but it has been replaced with, I believe, a better phenomena – the amateur radio rally.

## Radio rallies

All radio amateurs should know about radio rallies: they are the meetings of hobbyists and traders held throughout the summer in locations up and down the country. Check the amateur radio press for events local to you.

All the big boys turn up with their sumptuous stands of far eastern grey and black boxes ready to take our cheques and card numbers, but we are only interested in the traders in the dirty jumpers with one or two stalls of small items. I buy at least 75% of all the components I use at such events and I do not attend very many – unfortunately they are usually on a Sunday.

The whole event can be great fun. Try to get rid of the wife and kids; trailing around after a constructor hunting for components is a real pain in the neck. If time allows do a once-around the stalls before buying: the prices vary a lot and the next tent or room may have it cheaper. However, if a bargain price is attached to an item that seems to be in short supply on the stall then get it before someone else.

The untidy small stalls are often cheaper than the smartly laid out stalls. It is easy to forget what has been bought and often components are poorly or mysteriously marked, so carry a pen. A few small paper bags are useful too in case the trader puts it all into one bag. Individually bagged and marked components are much easier to sort out at the end.

The sort out at the end is perhaps the best part of the day. I have spent many happy Sunday evenings sifting through the bargains of the day bought at rallies.

Live in some remote spot? No rallies within range? Well all is not lost because there are a number of reasonable mail order companies which offer compo-

## Some useful smaller mail order companies

**Marco Trading**, The Matlings, High Street, Wem, Shropshire, SY4 5EN. Tel: (0939) 32763.

Very good prices on basic components like resistors and capacitors. Catalogue 65p inc postage.

**J Birkett**, 25 The Strait, Lincoln, LN2 1JF. Tel: (0522) 20767.

John Birkett is my favourite component trader, good range, good prices. Issues lists which do not do justice to his wide ranging stock.

**BCD Electronic Services**, 200 Hessle Road, Hull, HU3 3BE. Tel: (0482) 225437.

Good range with interesting list of semiconductors and ICs.

**ACE Mailtronix Ltd**, 3A Commercial St, Batley, W Yorks, WF17 5HJ.

Good range, some good prices, catalogue at 30p.

**Lightning Electronic Components**, PO Box 8, Tamworth, Staffs. Tel: (0827) 65767.

Good range, catalogue at 70p.

**D S Electronics**, 16 Eagle St, Hanley, Stoke-on-Trent, Staffs. Tel: (0782) 29898.

Some interesting stuff in a useful catalogue.

**Electrovalue**, 28 St Jude's Road, Englefield Green, Egham, TW20 0HB. Tel: (0784) 33603.

Wide range of components, good on ICs. Free illustrated catalogue.

**Minffordd Engineering**, Sund Street, Ffestiniog, Gwynedd, LL41 4NE. Tel: (076676) 2572.

'Phil the box', who must be the cheapest place for cases and aluminium boxes. Every constructor ought to have his list of equipment cases and aluminium boxes.

The above list is far from exclusive but is merely a few of the traders I have used with satisfaction. Many others exist and are very good. Most issue some form of catalogue or list. I have stated prices where these are known. If in doubt send them something to cover the costs when asking for a list.

nents at good prices. The bigger boys in the field can be expensive and probably only ought to be used when other avenues have failed. Most radio magazines have a host of medium and small scale traders advertising in small column space. Many of these produce lists or small catalogues and it is worth having a good range of such catalogues to be able to mail order shop around. I have included some names of companies in the table above.

One useful company I have used for basic items, like resistors, is Marco Trading of Wem. They sell resistor kits of ten each of the whole E12 series at very reasonable cost. The problem with this is that although it initially sets up the constructor with his complete selection, these are not all used with the same frequency. The less common values remain in good numbers when the common values are all gone.

Marco Trading also do a very good deal in resistors if bought in quantities of 100. Not very useful if these have to be all of one value but these can be made up of ten of any ten values, so the commonly used types can be replaced at reasonable cost. Other companies do similar good deals; watch out for them.

It can be very useful to buy some items in bulk. Some radio clubs make up bulk orders of commonly used items which are shared out amongst interested members. Many small traders are pleased to quote a price for components at 100 or more off of each value.

Hardware is none too easy to obtain cheaply by mail order but the small company Minffordd Engineering in Ffestiniog supply the cheapest equipment cases and boxes I have ever seen, and a good range of hardware, nuts and bolts. They will also make up cases and boxes to a customer's own dimensions and drill and make holes in panels to order.

## Storage

Holding a stock of components implies that some storage space will be required. Thankfully radio components these days are much smaller than they used to be and the majority of the basic stock could go into one reasonable sized drawer.

I store resistors in cheap small buff envelopes bought at Woolworths. The value is written at the top of the envelope and they are filed in value order in a shoe box.

The same approach can be used for smaller capacitors (I also store my transistors in this manner).

My larger components are mainly stored in 2Kg margarine plastic boxes or 1 and 2 litre ice cream boxes. The compact plastic storage boxes which fit into racks are excellent for storage but are expensive. I bought some from a company that was winding up for a very good price.

Having matching boxes or cartons not only looks better but it also enables the containers to be stacked and stored in less space. Damp garages and sheds, although convenient, are not the best



places to keep the components. I know more than one constructor who keeps his component store underneath a spare bed.

Try to be reasonably methodical and neat when storing components. Buying stuff and then just throwing the bags into a drawer may be convenient at the time but later an amazing amount of time can be wasted sifting through to find the desired items... which are 'in there somewhere'. It really is worth marking containers with accurate notices of their content. It is also worth, if time allows, grading and sorting out values to split up components of similar type.

The constructor who keeps every resistor in one big box, and some do, will spend almost as much time sorting out the components as building the project. Component gathering is no small part in building up electronic circuitry so make the task as easy as possible.

## A simple project – an HF wavemeter

In the first article of this series I advised the use of a kit for the complete beginner to cut his teeth in construction. What follows here is a very simple but useful item for the radio station that can be built by anyone at low cost. The project also illustrates the principle of using cheap and cheerful components and adapting items to suit the pocket or their availability.

The wavemeter is not only useful to have around the shack but fulfills the legal requirement for a radio amateur to be able to check his transmissions for harmonic outputs. The circuit is shown in Figure 1.

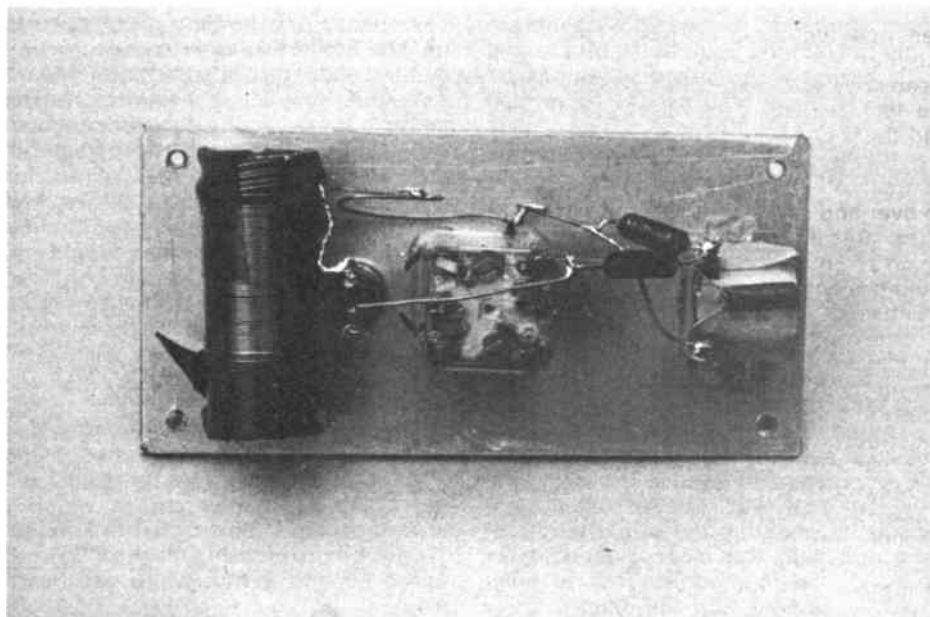

Very simple – it is really just a crystal set with a meter taking the place of the headphones. Any schoolboy who can build a crystal set can build this wavemeter. The meter will indicate the presence of RF signals from 1.8MHz to well over 30MHz. There are two ranges to enable this frequency coverage.

The signals are received on a piece of pick-up wire and tuned by the tuned circuit C1/L1. Two germanium diodes form a voltage doubler detector circuit, a single capacitor provides RF decoupling and the output is indicated on the meter.

All of the components are simple and

cheap. The inductor (posh word for a coil) is wound on a piece of 1/2in outer diameter plastic tubing. Anything of this size would serve, but I just happened to find a piece of suitable tubing around the place.

The tuning capacitor is of the 'polycon' semi-airspaced type so common in the cheap and nasty far eastern AM radios. This could be salvaged from an old non-working AM set... there are a lot about, or it could be bought from one of the many suppliers who stock such items.

If the capacitor comes from an old radio it might be possible to salvage the two diodes from the same source. These should be germanium diodes, which are usual in any detector circuits in radio sets. If your junk diodes come from old computer boards or industrial sources, then probably most of the diodes will be silicon, rather than germanium.

The meter is a cheapie sold commonly by many amateur radio traders, originally designed for use in a cassette recorder. Almost any small moving coil meter would do the job, although the full scale deflection of the meter should be under 1mA. Meters around 500µA are ideal, and the one I found seemed to have a full scale deflection of about 200µA. All of these are very common items, so look and scrounge around before laying down good money.

## Wind the coil

The first job is to wind the coil. This requires 26swg enamelled wire. If you are winding a coil for the first time, the procedure is very simple.

Begin by anchoring the wire (leave about 6in free) to the end of the former that will go to 'S1 (low)' in Figure 1. Secure it with sticky tape, then wind the wire along the former to make a neat coil, laying the turnings neatly side by side. This is called *close winding*. When 65 turns have been completed pull out enough wire to make a loop around 6in long. Twist the wire in the loop until it is

Fig 1 Circuit diagram and coil details

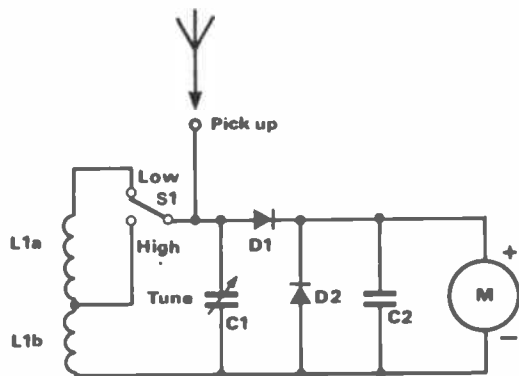

## Values

- L1 – see text
- S1 – change over toggle switch (small)
- C1 – 350pF polycon variable capacitor
- D1/2 – OA81 or similar germanium diodes
- C2 – 0.02µF mica
- M – 500µA or less moving coil meter (see text)
- Plastic case – 2x4 1/4 x 1 1/4 ins
- Knob/cursor – see text
- Terminal – for pick up

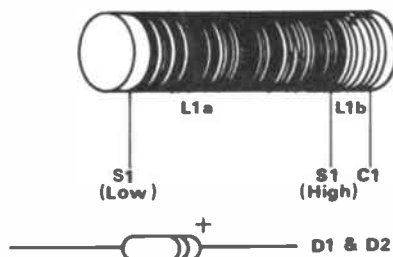

# BEGINNERS' WORKSHOP

tight against the former. This is simply to hold the tapping point between L1a and L1b. So the wire marked 'S1 (high)' on Figure 1 is, in fact, two wires twisted together.

That having been done, L1b can now be wound. This has only 6 turns but they are not close wound. They need to be spaced apart by about the diameter of the wire. This can be done neatly by winding the turns with another piece of 26swg wire alongside the winding wire. The extra piece of wire can be removed when the winding is completed. Alternatively, like me, you can just guess the spacing and wind it with care.

The end marked C1 in Figure 1 must now be secured with sticky tape. It is good practice to secure the complete winding and this may be done quite easily by smearing the whole length of the coil with the clear glue sold for making plastic models. This is polystyrene cement and although I know others who buy all kinds of fancy cements designed for the job it does work very well on coil windings and seems to cause no electrical problems.

The whole circuit is built up using point to point wiring on the underside of the front panel on the case. I used a plastic case, made I believe by Vero, which I happened to have in stock. There are lots of plastic cases to choose from and there is no reason why those so inclined could not use a wooden box.



Figure 2 shows how the circuit is wired up. The actual size of the case may well depend upon the available meter. Mount the variable capacitor, the switch and the meter in similar positions to those shown in Figure 2 and the wiring can begin around these components as anchor points. A slide type switch could be used for SW1 although I usually avoid slide switches as experience has taught me that they can be prone to poor contacts, but they are much cheaper than toggle switches. The wiring follows the layout in Figure 2.

## Calibration

Once the wavemeter is completed it requires calibration. A pointer knob and a cardboard scale could be used but I made up a perspex cursor which I attached to a suitable knob with Araldite. To give a more pleasing finish to the front panel I made a thin white cardboard front.

This was marked with rubdown lettering to indicate the scale and also the control functions.

It is possible to calibrate the wavemeter by checking the frequency of the tuned circuit at various points using a dip meter but it is easier, and quicker, to use the wavemeter in conjunction with a transmitted signal to calibrate the scale. When the tuned circuit is aligned to the frequency of a transmitted signal the meter will show a peak reading.

The method of measuring this signal depends upon the amount of transmitter power, the length of the pick-up wire, how close the wire is to the signal source and the sensitivity of the meter.

It would be easy to be a nuisance when calibrating the wavemeter by transmitting signals onto an amateur band just to calibrate the scale. The best method is to use low transmitter power and to feed it into a dummy load via unscreened leads. The pick-up wire can be laid alongside these leads to receive the signals. Some experimentation will be required to sort out how long the pick-up lead will have to be and how close it must be placed to the leads on the dummy load.

The best technique for calibration is to transmit a signal into the load at a known frequency and then look for a peak on the

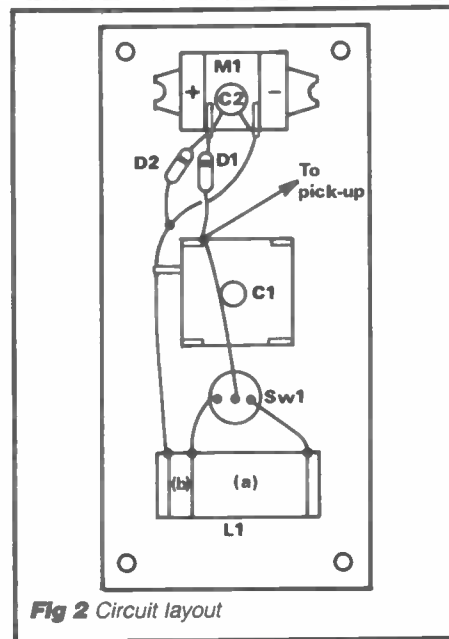

appropriate range of the tuned circuit. Make a small faint pencil mark at each calibration point, then remove the knob and cursor and make up the scale by hand or with rubdown numbers.

My prototype has markings for 1.8, 3.5 and 7KHz on the low range and 10, 14, 21, 28 and 30MHz on the high range. A high level of accuracy is not required as the harmonics are a long way from the fundamental frequencies on the scales. The wavemeter is not an instrument for measuring frequency but for showing if there are outputs at undesirable frequencies.

The final touch is added by covering the paper front panel with a layer of transparent plastic sticky-backed film to add protection and a shiny finish.

The wavemeter can now become part of the shack instrumentation. Some further experimentation may be required to determine a suitable length and placement for the pick-up wire so that readings may be taken of actual transmitted signals.

The next article will discuss some other methods of electronic construction and describe a useful, but mysterious, item of shack equipment.

## NEWSAGENT ORDER FORM

Amateur  
**RADIO**

To (name of newsagent) For all two-way radio enthusiasts

Please order a copy of *Amateur Radio* for me every month

NAME.....

ADDRESS.....

Newstrade distributors: Argus Press, Sales & Distribution Ltd, 12-18 Paul Street, London EC2A 4JS. (Tel: 01-247-8233)

## RTTY AND CW TRANSCEIVE WITH NO TERMINAL UNIT

This fantastic program interfaces direct with your rig, slashing the cost of previous systems. Split screen, type ahead, all the usual features and more. Tape and kit for the very simple interface, including PCB and User Port connector, for only £20.00. Ready-made interfaces available. For CBM64, BBC-B, and VIC20 (+ at least 8k). CW-only version for SPECTRUM £10.

### And four superb programs for CBM64, VIC20, BBC-B, SPECTRUM

**LOCATOR QTR** or Maidenhead locator or lat/long. Distance, headings, contest points, converts between locator and lat/long. Tape £8.

**LOGBOOK** Date, band, mode, call and remarks. Superfast call sign search. Easy, fast updating of files. Screen/printer output. VIC20 needs at least 8k expansion. Tape £8.

**MORSE TUTOR** Britain's best. Learn fast in easy stages from absolute beginner to over 40 wpm. Join the hundreds who have succeeded with this program. Tape and full learning guide £8. For ZX81-16k also.

**RAE MATHS** All the practice and testing you need. Tape and comprehensive reference sheet detailing all you need to know £8. VIC20 needs expansion (any). For ZX81-16k also. Don't let maths make you fail. PASS with this program.

All programs are very easy to use and come with full instructions.

Prices include p&p 1st Class by return. Add £1 per tape if outside UK or Ireland.

**technical software (AR)**  
FRON, UPPER LLANDWROG, CAERNARFON,  
GWYNEDD LL54 7RF. Tel. 0286 881886



# WOOD & DOUGLAS



## VHF/UHF COMMUNICATION PRODUCTS

A NEW RALLY SEASON BEGINS!

During the next months you can meet our happy smiling staff at events up and down the country. Our new illustrated catalogue will be released at the NEC in April along with the new high quality products we have been devising in our winter hibernation!

See you there!

### Package Prices

	KIT
1. 500mW TV Transmit	(70FM05T4 + TVM1 + BPF433) 35.00
2. 500mW TV Transceiver	(As 1 above plus TVUP2 + PSI433) 60.00
3. 10W TV Transmit	(As 1 above plus 70FM10 + BDX35) 65.00
4. 10W TV Transceiver	(As 2 above plus 70FM10 + BDX35) 90.00
5. 70cms 500mW FM Transceiver	(70T4 + 70R5 + SSR1 + BPF) 75.00
6. 70cms 10W FM Transceiver	(As 5 above plus 70FM10) 105.00
7. 2M Linear/Pre-amp 10W	(144PA/S + 144LIN10B) 40.00
8. 2M Linear/Pre-amp 25W	(144PA4/S + 144LIN25B) 42.00
9. 70cms Synthesised 10W Transceiver	(R5 + SY + AX + MOD + SSR + 70FM10) 150.00
10. 2M Synthesised 10W Transceiver	(R5 + SY + SY2T + SSR + 144FM10A) 120.00
11. 2M Crystal Controlled 10W Transceiver	(R5 + T3 + BPF + 144FM10 + SSR) 85.00
12. 70cms Linear/Pre-amp	(70LIN10 + 70PA2/S) 45.00

### 70cms EQUIPMENT

#### Transceiver Kits and Accessories

	CODE	ASSEMBLED	KIT
FM Transmitter (0.5W)	70FM05T4	48.00	28.75
FM Receiver (with PIN RF c/o)	70FM05R5	65.40	45.80
Transmitter 6 Channel Adaptor	70MC06T	21.30	14.25
Receiver 6 Channel Adaptor	70MC06R	25.20	17.90
Synthesiser (2 PCBs)	70SY25B	88.00	62.25
Synthesiser Transmit Amp	A-X3U-06F	34.15	22.10
Synthesiser Modulator	MOD 1	8.95	5.50
Bandpass Filter	BPF 433	6.50	3.30
PIN RF Switch	PSI 433	7.55	5.35
Converter (2M or 10M I.f.)	70RX2/2	27.10	20.10

#### TV Products

Receiver Converter (Ch 36 Output)	TVUP2	27.50	22.80
Pattern Generator (Mains PSU)	TVPG1	42.25	36.50
TV Modulator (For Transmission)	TVM1	9.85	5.75
Ch 36 Modulator (For TV Injection)	TVMOD1	9.80	5.50

#### Power Amplifiers (FM/CW Use)

50mW to 500mW	70FM1	18.45	12.80
500mW to 3W	70FM3	23.45	17.80
500mW to 10W	70FM10	41.45	33.45
3W to 10W	70FM3/10	23.95	18.30
10W to 40W	70FM40	65.10	52.35
Combined Power Amp/Pre-Amp (Auto Changeover)	70PA/FM10	56.80	40.15

#### Linears

500mW to 3W (Straight amp. no changeover)	70LIN3/LT	27.90	19.90
3W to 10W (Auto Changeover)	70LIN3/10E	41.05	30.15
1W to 7W (Auto Changeover)	70LIN10	44.25	32.50

#### Pre-Amplifiers

Bipolar Miniature (13dB)	70PA2	8.10	6.50
MOSFET Miniature (14dB)	70PA3	9.65	7.50
RF Switched (30W)	70PA2/S	24.25	15.25
GaAs FET (16dB)	70PA5	20.10	12.80

#### 6M EQUIPMENT

Converter (2M I.f.)	6RX2	28.40	20.80
---------------------	------	-------	-------

#### 2M EQUIPMENT

##### Transceiver Kits and Accessories

FM Transmitter (1.5W)	144FM2T3	39.35	26.30
FM Receiver (with PIN RF Changeover)	144FM2R5	65.50	47.20
Synthesiser (2 PCBs)	144SY25B	78.75	60.05
Synthesiser Multi/Amp (1.5W O/P)	SY2T	27.90	20.65
Bandpass Filter	BPF 144	6.50	3.30
PIN RF Switch	PSI 144	7.55	5.35

##### Power Amplifiers (FM/CW Use)

1.5W to 10W (No Changeover)	144FM10A	24.15	18.50
1.5W to 10W (Auto Changeover)	144FM10B	36.11	26.25

#### Linears

1.5W to 10W (SSB/FM) (Auto Changeover)	144LIN10B	38.40	28.50
2.5W to 25W (SSB/FM) (Auto Changeover)	144LIN25B	40.25	29.95
1.0W to 25W (SSB/FM) (Auto Changeover)	144LIN25C	44.25	32.95

#### Pre-Amplifiers

Low Noise, Miniature	144PA3	8.60	7.40
Low Noise, Improved Performance	144PA4	12.86	8.40
Low Noise, RF Switched, Full Changeover	144PA4/S	24.30	15.30

#### GENERAL ACCESSORIES

Toneburst	TB2	6.70	4.25
Piptone	PT3	7.50	4.45
Kaytone	PTK3	8.75	6.05
Relayed Kaytone	PTK4R	12.70	8.20
Regulator (12V, low differential)	REG1	6.95	4.40
Solid State Supply Switch	SSR1	5.85	3.70
Microphone Pre-Amplifier	MPA2	8.10	3.50
Reflectometer	SWR1	6.35	5.35
CW Filter	CWF1	8.55	5.80
TVI Filter (Boxed)	HPF1	5.95	-

#### FM TV MODULES

50mW 420MHz Source (Video Input)	UFM01	26.95	19.80
50MHz I.f. Processor	VIDIF	54.25	38.95
Varactor Multiplier (Boxed)	WDV400/1200	63.95	-
1250MHz Downconverter	1250DC50	69.95	-

Further details on our product range will gladly be forwarded on receipt of an A5 size SAE. Technical help is available by phone (NEW NUMBER) during normal office hours. Kits are usually available by return of post but please allow 28 days for unforeseen delays. Please add 75 pence to your total order for postage and handling. Credit card orders are gladly accepted, please give us a call.

ANYONE CAN SELL A KIT . . . REPUTATION SELLS OURS

UNIT 13, YOUNGS INDUSTRIAL ESTATE  
ALDERMASTON, READING RG7 4PQ  
Tel: (073 58) 71444 Telex: 848702



# RSGB BOOKS

## RSGB PUBLICATIONS

A Guide to Amateur Radio (19th edn)	£3.91
Amateur Radio Awards (2nd edn)	£3.68
Amateur Radio Call Book (1984 edn)	£7.14
HF Antennas for All Locations	£7.35
Microwave Newsletter Technical Collection	£6.83
Morse Code for Radio Amateurs	£1.64
Radio Amateurs' Examination Manual	£3.84
Radio Communication Handbook (paperback)	£11.79
Teleprinter Handbook (2nd edn)	£12.72
Television Interference Manual	£2.31
World at their Fingertips	£7.75
VHF/UHF Manual (4th edn)	£10.58
Meteor Scatter Data	£3.51

## Logbooks

Amateur Radio Logbook	£2.77
Mobile Logbook	£1.23
Receiving Station Logbook	£2.87

## Maps

Great Circle DX Map	£2.43
Locator Map of Europe (wall)	£1.95
World Prefix Map in full colour (wall)	£2.53

## OTHER PUBLICATIONS

Active Filter Cookbook (Sams)	£12.71
All About Cubical Quad Antennas (RPT)	£5.83
Amateur Single Sideband (Ham Radio)	£5.46
Revised Amateur Television Handbook (BATC)	£2.95
Antenna Anthology (ARRL)	£6.00
ARRL Electronics Data Book	£4.47
Beam Antenna Handbook (RPI)	£6.83
Better Short Wave Reception (RPI)	£6.83
Care and Feeding of Power Grid Tubes (Varian)	£6.99
CMOS Cookbook (Sams)	£13.07
Complete DX'er (W9KNI)	£7.77
Complete Shortwave Listener's Handbook (Tab)	£12.21
Design of VMOS Circuits with experiments (Sams)	£8.50
FM and Repeaters for the Amateur (ARRL)	£4.30
G-QRP Club Circuit Handbook	£4.52
Guide to Oscar Operating (AMSAT)	£1.78
Hints and Kinks for the Radio Amateur (ARRL)	£4.47
How to Troubleshoot and Repair AR Equipment	£10.47
IC Op-amp Cookbook (Sams)	£11.76
International VHF FM Guide	£2.45
Newcomer's Guide to Simplex and Repeaters on 2M	£1.24
Radio Amateurs Handbook 1985 (hardback) ARRL	£21.90
Radio Amateurs Handbook 1985 (paperback) ARRL	£15.80
Radio Amateurs Handbook 1984 (ARRL)	£6.66
Radio Frequency Interference (ARRL)	£4.18
Satellite Experimenters Handbook (ARRL)	£10.11
Satellite Tracking Software for the Radio Amateur (AMSAT-UK)	£4.47
Secrets of Ham Radio DXing (Tab)	£7.92
Semiconductor Data Book (Newnes)	£7.97
Shortwave Propagation Handbook (Cowan)	£7.79
Simple Low Cost Wire Antennas (RPI)	£6.83
Solid State Design for the Radio Amateur (ARRL)	£7.87
Television for Amateurs (BATC)	£2.23
UHF-Compendium Parts 1&2	£14.93
Understanding Amateur Radio (ARRL)	£4.73
VHF Propagation Handbook (Nampa)	£3.75
Weekend Projects for the Radio Amateur (ARRL)	£4.95
World Atlas (RACI)	£3.35

## OTHER ITEMS

Morse Cassette stage 1 (to 5wpm)	£3.84
DX Edge (HF propagation prediction aid)	£13.98

Membership of the Radio Society of Great Britain is open to all Radio Amateur and Listeners. For details of subscription and the benefits of membership, please contact the Membership Services Department. All items in this advertisement include post and packing. Members of the Society are entitled to discounts on these prices. Personal callers may obtain goods minus postage and packing charges.



## RSGB Publications

Lambola House, Cranborne Road,  
Potters Bar, Herts EN6 3JW  
Telephone: (0707) 59015

# ICOM AT 1

## Come and hear the ICOM range on stand A68-70 at the RSGB National Amateur Radio Exhibition

This year at the NEC, Thanet Electronics will have demonstration facilities only on our main stand, but the range and scope of these will enable you to appreciate fully the superb specifications and quality of all ICOM Amateur Radio Equipment.

You will be able to try out receivers and transceivers as base stations, mobiles and hand-portables in all the popular frequency ranges.

Buying ICOM equipment at the NEC, will not be a problem as it will be readily available at any of the authorised ICOM dealers exhibiting at the show.

A new exciting set will be seen at this years show, it is the ICOM IC-3200E FM Dual-band transceiver (144-430/440 MHz). This is the smallest transceiver available.

The IC-3200E employs a function key for low-priority operations to simplify the front panel. LCD display is easy to read in bright places, showing frequency, VFO A/B, memory channel duplex mode and S/R/F meter information.

Other features include a 10 channel memory able to store operating frequencies, Simplex or Duplex. A memory lock-out function allows the memory scan to skip programmed channels when not required. The IC-3200E has a built-in duplexer and can operate on one antenna for both VHF and UHF. Options include: IC-PS45 DC, power supply, HS-15 mobile mic, SM6 and SM8 desk mics, SP-10 external speaker and UT-23 speech synthesizer.

A great future is predicted for the IC-3200E against its rivals, due to the reasonable price of this model. For more details come and see us on stand A68-70. BCNU.



**New!**  
**IC-3200E**

## IC-290D/290E



290D is the state of the art 2 meter mobile, it has 5 memories and VFO's to store your favourite repeaters and a priority channel to check your most important frequency automatically. Programmable offsets are included for odd repeater splits, tuning is 5KHz or 1KHz.

The squelch on SSB silently scans for signals, while 2 VFO's with equalising capability mark your signal frequency with the touch of a button. Other features include: RIT, 1 KHz or 100Hz tuning/CW sidetone, AGC slow or fast in SSB and CW, Noise blanker to suppress, pulse type noises on SSB/CW.

You can scan the whole band between VFO's/scan memories and VFO's. Adjustable scan rate 144 to 146 MHz, remote tuning with optional IC-HM1 microphone. Digital frequency display, Hi/Low power switch. Optional Nicad battery system allows retention of memory.

**Soon to be announced!**  
**IC-735 New Compact HF, R7000 VHF/UHF Receiver.**

Thanet ICOM  
Thanet ICOM  
Thanet ICOM  
Thanet ICOM  
Thanet ICOM  
Thanet ICOM  
Thanet ICOM  
Thanet ICOM  
Thanet ICOM  
Thanet ICOM



# THE N.E.C.

## IC-02E, IC-04E

The direct entry microprocessor controlled IC-02E is a 2 metre handheld features include: scanning, 10 memories, duplex offset storage in memory and odd offsets also stored in memory. Internal Lithium battery backup and repeater tone are included. Keyboard entry is made through the 16 button pad allowing easy access to frequencies, duplex, memories, memory scan and priority.

The IC-02E has an LCD readout indicating frequency, memory channel, signal strength, transmitter output and scanning functions. New HS-10 Headset, with earphone and boom microphone, which operates with either of the following: HS 10-SB Switch box with pre-amplifier giving biased toggle on, off and continuous transmit. HS 10-SA Voice operated switch box, with pre-amplifier, mic gain, vox gain and delay. The IC-2E and 4E continue to be available.



**Authorised Icom dealers in the UK**

Alyxian Electronics Ltd. Edinburgh, 031-554 2591  
 Alyntronic, Newcastle, 0632-761002  
 Amateur Radio Exchange, London (Ealing), 01-992 5765  
 Amcomm, London (S. Harrow), 01-422 9585  
 Arrow Electronics Ltd., Chelmsford Essex, 0245-381673 26  
 Beamrite, Cardiff, 0222-486884  
 Booth Holding (Bath) Ltd., Bristol, 02217-2402  
 Bredhurst Electronics Ltd., W. Sussex, 0444-400786  
 Dressler (UK) Ltd., London (S. Harrow), 01-558 0854  
 D.W. Electronics, Widnes Cheshire, 051-420 2559  
 Hobbytronics, Knutsford Cheshire, 0565-4040  
 Photo Acoustics Ltd., Buckinghamshire, 0908-610625  
 Radcomm Electronics, Co. Cork, Ireland, 01035321-632725  
 Radio Shack Ltd., London NW6, 01-624 7174  
 Scotcomms, Edinburgh, 031-657 2430  
 Tyrone Amateur Electronics, Co. Tyrone, N. Ireland, 0662 2043  
 Reg Ward & Co. Ltd., S.W. England, 0297-34918  
 Waters & Stanton Electronics, Hockley Essex, 0702-206835

**Listed here are authorised dealers who can demonstrate ICOM equipment all year round. This list covers most areas of the U.K., but if you have difficulty finding a dealer near you, contact Thanet Electronics and we will be able to help you.**

## Cue Dee Antennas Special Offer!

CUE DEE antennas are designed to last for decades – the best possible aluminium alloy for this purpose is used (SIS 4212-06).

The booms are made of 28mm tubing with 1.5mm wall, with colour marks clearly indicating where to fit the elements. By using tubular boom, and a synthetic guy wire on the long yagis, the windload is reduced by a factor 0.66 compared to using square shaped material for boom and guying.

The driver element is made of 12mm tubing and features a PTFE (Teflon) insulated gamma match which is pre-tuned at the factory and made for 50 ohm feeder with a PL 259 type connector. No further adjustments or power consuming balun needed. This matching system ensures a clean radiation pattern and transfers the power without losses.

The parasitic elements are made of 6mm solid rod and mounted to the boom with the aid of a CUE DEE element washer, boom to element part and a screw. This, together with our intelligible assembly manual, makes an extremely easy and solid assembly which assures the long life of a CUE DEE antenna.

- 2 metre Yagis.**  
 4144A – 4 element, 8dBd gain £19.00.  
 10144 – 10 element, 11.4dBd gain £37.00.  
 15144 – 15 element, 14dBd gain £49.00.  
 Order now while stocks last.

You can get what you want just by picking up the telephone. Our mail-order dept. offers you: free, same-day despatch whenever possible, instant credit, interest-free H.P., telephone Barclaycard and Access facility and a 24 hour answering service.

Please note that we now have a new retail branch at 95, Mortimer Street, Herne Bay, Kent. Tel: 369464. Give it a visit, BCNU.

## Tono Linear Amplifiers

- 2M – 100W, £79.00.  
 MR – 150W, £139.00.  
 Also available, new G-series with GaAs FET pre-amp.  
 2M – 130G, £159.00.  
 2M – 90G, £149.00.  
 2M – 40G, £ 89.00.  
 4M – 70G, £179.00.  
 all inc. VAT.

Carriage charge is free for Cue Dee and Tono special offers.



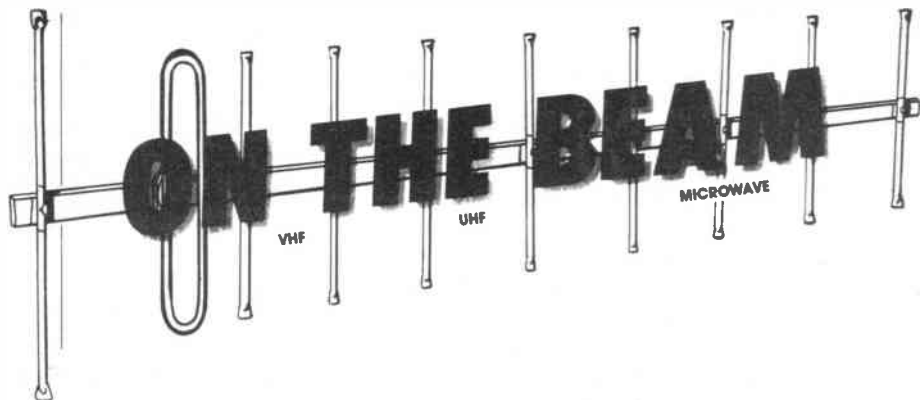

## News and comment from Glen Ross G8MWR

### Locators

The new system seems to be getting well established judging by the number of people using them, the only snag at the moment is in visualising just where the other person is. Thinking in terms of 'DL' square has become automatic and easily visualised but 'OJ31' is not that easy. However, all will become clear with a bit of practice.

The response to our offer to calculate your Maidenhead locator for you has been tremendous, with over 300 letters in the first three weeks of the year. It is clear that although there have been several articles published on the subject, a lot of people have not fully grasped what is required to calculate the new code accurately.

First, it is *not* possible to work it out correctly from the existing 'QRA' locator because the large squares that coincide with the smaller ones actually overlap in latitude but not in longitude. The actual error which is generated by a direct conversion is not large and over normal DX distances it is doubtful if it would be at all significant unless you are chasing the last kilometre for a distance award. Although I have not calculated them it looks as though more significant errors could be introduced by assuming, as most programs seem to do, that the earth is a sphere, which of course it is not.

Perhaps we are all getting too concerned with the idea of measuring to the 'nth' degree. You may have noticed that when you used an analogue meter you set the five volt rail to the mark on the meter and left it at that, but when using a digital meter you struggle to get it right to the last .001 of a volt, and the fact that the circuit will work quite happily plus or minus a quarter of a volt is lost sight of!

We digress, however. If you are sending for your new locator please estimate your latitude and longitude to within 10 seconds if you want the most accurate result, and please enclose an SAE.

### NEC Morse tests

Permission has been given for Morse tests to be taken at the RSGB NEC rally.

There will be a certain amount of time set aside for disabled people, but there will be ample opportunity for everyone to have a crack at it. It is not an 'on the spot' affair, and you will need to book your test in advance in the normal way.

The arrangements are being made by the coast station at Highbridge and you should be able to book through them. This should prove to be a popular facility so please get your application in well ahead of time. Thanks are also due to the test staff for giving up a weekend to come to the show.

### Class B Morse

Whilst we are on the subject of Morse remember that class B Morse arrives on 1 April, or it will do if you have sent in your application for a letter of variation. This should be sent to the RSGB, Lambda House, Cranbourne Road, Potters Bar, Herts EN6 3JW. You must enclose two stamps and please mark the envelope 'Class B Morse' to make life a little easier for them.

It is known that well over a thousand applications have been received and that the letters will be issued from 1 February.

There seems to be little restriction on where you can operate, all your normal bands are available. One thing that is *essential* is that you must announce your callsign in telephony at the start and finish of every transmission. This effectively means that to send true CW you should use the all mode section of the band, never the CW segment.

You could of course use a keyed audio oscillator picked up on your microphone for practice transmission purposes and you could then use the normal simplex channels. This might well reduce your popularity and it would seem sense to keep all CW sending to the all mode parts of the bands.

### Send 'em in!

Please send in an application even if you do not intend to use the facility: the DTI are monitoring the interest and the only way we can be sure to get it continued after the initial one year trial

period is to show that there is a great demand for class B Morse.

### Repeater news

We are now getting regular news sheets from several of the repeater groups but we would like even more to help keep up to date on happenings in this area.

GB3SF is the first SSB repeater in this country and is now operational from Sheffield. The big problem in getting into this repeater is the fact that you have to transmit a reduced level carrier to it, and this means digging into your rig and doing a little tweak to allow some carrier leakage. From then on, of course, all your normal contacts will complain about the amount of carrier on your signal.

For more information on this project, plus a discussion of SSB repeaters generally, see my article in the January 1984 edition of the magazine. At least it is running, and if you want more information on using the machine the man to talk to is Tony G3RKL.

The Aylesbury group have proposals in the pipeline for 145 and 433MHz units to be installed in the Hemel Hempstead area with the callsigns GB3VB and GB3BV respectively.

The North Yorkshire group were carrying out site tests at the proposed new site for GB3NY, the Scarborough UHF unit.

GB3WI in North Cambridgeshire is in need of funds to extend its activities and donations should be sent to G6XMU or G4NPH. They also produce a newsletter which is available for an SAE and a small donation. GB3GR, the UHF repeater in Grantham, should have now returned to RB11 from its new site.

The new Isle of Man repeater GB3GD (incidentally a callsign 'borrowed' from the Leicester data repeater) should give excellent coverage from its site on the top of Snaefell. To reduce co-channel problems this repeater is having to use a tilted aerial array. It will be interesting to see just how this affects the coverage.

### Space

The pressure for space is getting so great that it must now be time to introduce 12.5KHz spacing. This is a feature which has been available on rigs for a long time and yet seems to be little used. If you do try it please do not QSY up half a channel from S20 and expect to get no problems.

This idea, if applied to repeaters and with some consideration for geographical spacing, should enable less mutual interference or a much extended repeater system.

Amateur radio is supposed to be a forward looking hobby and yet we shy away from such a simple thing.

### More repeaters

The proposed change of site for what was GB3YJ and is now GB3WK seems to have died the death, for it is still on the old site and giving excellent coverage. The Leicester run must be one of the most comprehensive ranges of repeaters in the country, having either a repeater or a beacon on most bands. At



## ON THE BEAM

the moment they are planning a 10GHz input to GB3LE, the 70cm repeater.

GB3NK in North Kent is now back on the air after some service work, and in Cambridge the 70cm repeater has been moved into the town and is giving good results plus a higher level of activity.

### Odds and ends

News of another experiment comes to hand. The Austrian authorities have recently issued a licence similar to our own class B. The operators are limited to a frequency range of 144.025 to 144.100MHz for training purposes only; presumably this is a CW extension of their licence. They have also made available a general allocation in the range 2305 to 2320MHz, which is just below the normally used part of this band, but a slight tweak of the local oscillator or a second crystal should enable some nice DX to be worked on 13cm. These allocations are on a secondary basis and are only valid until the end of 1988.

### New beacons

Two new beacons are now operational from Greenland, but at present the callsigns are not known. On 50.045MHz it runs 20 watts to a ground plane and the 144.902MHz unit has 10 watts to a Yagi. The 50MHz unit should give a good signal into Great Britain under lift conditions.

The American Radio Relay League has published a document on packet radio detailing the AX25 link protocols. This can be obtained from them or by sending an enquiry to the RSGB.

We have heard of quite a number of things which are knocked out by strong RF fields and the latest to join the group are the Maestro, Cavalier and Sierra cars. Think twice before fitting 100 watt linears in these as you could come to a grinding halt half way through your over as the petrol injection system goes on the blink. The RSGB would like to hear of any problems you may have with these and also with the new 'Ambassador' telephones.

### Workshops

You may get this just in time for the next microwave workshop which will be run by the Droitwich club on 25 March, starting at 7.30pm. This follows the very successful event held last autumn. The venue is close to a motorway exit and there will be talk-in on S22. There is a probability of another meeting being held in Sheffield in the spring; more details when we get them or contact Barry G8AGN.

### Cobwebs?

The Microwave Society are running their usual 'Cobweb clobbering' event on 21 April, giving 10GHz operators a

chance to get the gear out of cold storage and make a start to the year's activities.

The RSGB has still not announced the dates for this year's 10GHz cumulative contests, nor for that matter the winners of last year's event; just how long does it take to sort out approximately thirty entries?

### Barking Contest

No, not quite what it seems! This is one of those 144MHz contests run by a local club, but which gathers ever wider support. It takes place on 31 March between 1300 and 1700GMT and is run in two sections, one for full legal limit and the low power section where the power limit is 20 watts PEP. You exchange the usual RST plus serial number report, but you also have to exchange the county name. Ideal for county chasing for our new awards.

The scoring is on the basis of one point per contact with the club calls G3XBF and G8XBF counting for 10 points each. Your final score is the number of points multiplied by the number of counties worked, and entries should be sent to *BRS31976, 32 Wellington Road, Rayleigh, Essex SS6 8EZ*, to arrive not later than 13 April.

The winner will receive a...no, I think we will keep quiet about that, send an entry and find out!

**FOR QUALITY COMPONENTS  
BY MAIL ORDER**

**ELECTROVALUE**

**FREE**  
44 PAGE  
PRICED AND  
ILLUSTRATED  
CATALOGUE  
ON REQUEST

FREE POSTAGE  
GOOD DISCOUNTS  
GOOD SERVICE  
THOUSANDS OF  
STOCK ITEMS  
PHONE YOUR ORDER  
ACCESS OR  
BARCLAYCARD

**ELECTROVALU LTD** 28 St. Jude's Road, Englefield Green, Egham,  
Surrey TW20 0HB Phone Egham (0784) 33603. Telex 264475  
North Branch, 680 Burnage Lane, Manchester M19 1NA  
Phone 061 432 4945  
Please mention this publication when replying

**CENTRE ELECTRONICS SPECIALISTS IN THE SALE AND SERVICING  
OF VALVE TYPE RADIO EQUIPMENT**

**OFFER** EDDYSTONE MODEL 1590 General Coverage Receiver Ex Works Demonstration examples as new condition with one years works guarantee £620.00

**OTHER RECEIVERS FOR SALE** include the following RACAL RA17 @ £175, RA17/L @ £195, RA17/E @ £250. EDDYSTONE MODELS 830/9 @ £155, 730/6 @ £145, 770U @ £115. Also a selection of Vintage Communication Receivers HRO's, AR88's, S27, 358X, S504 etc; LISTS OF OTHER RECEIVERS AND ITEMS ETC: AVAILABLE

ADMIRALTY B40 Single Side Band Adaptor Units £50 each including connector leads.

Large stocks of assorted vintage components (1920's - 60's) to clear Callers only

**SPECIAL OFFER TWIN AXIAL COAX CABLE** (100ohms) uses include Data Transfer, Inter connecting word processors, micro computers etc 12p per metre of £10 per 100 metre roll. (Free sample on request)

ALL PRICES INCLUDE PACKAGING AND DELIVERY

<b>SPECIAL DOOR TO DOOR DELIVERY SERVICE</b>	<b>CENTRE ELECTRONICS</b> 345 STOCKFIELD ROAD, YARDLEY, BIRMINGHAM, W MIDLANDS B25 8JP SHOP OPENING HOURS 10 - 5.30PM THURSDAYS, FRIDAYS, SATURDAYS ONLY. TELEPHONE ENQUIRIES 0676 32560 ANYTIME
--------------------------------------------------	-----------------------------------------------------------------------------------------------------------------------------------------------------------------------------------------------------------------

**AMATEUR ELECTRONICS UK**

06XBHR.A.S. (Nottingham)08SU8

**Radio Amateur Supplies**  
Tel: 0602 280267

**Visit your Local Emporium**  
Large Selection of New/Used Equipment on Show

<p><b>AGENTS FOR:</b> F.D.K AZDEN ICOM YAesu PORTOP ATV</p>	<p><b>ACCESSORIES:</b> Wet Range Microwave Modules Adonis Mics Mutek Pre-Amps Bareoco Mast Supports DRAE PSU and Wave Meters</p>
---------------------------------------------------------------------------------	--------------------------------------------------------------------------------------------------------------------------------------------------------------

AERIAL: Tonna, Halbar, New Diamond Range of Mobile Whips  
**PLUS OWN**  
'Special' Q.R.P. GW5 HF5 Band Beams  
**JUST GIVE US A RING**  
Monday: CLOSED Tuesday - Saturday: 10.00am to 5.00pm

**3 Farndon Green, Wollaton Park, Nottingham, Off Ring Road  
Between A52 (Derby Road) & A609 (Ilkeston Road)**

# THE DREADED

# DECIBEL

J GLANVILLE G3TZG

Whilst it may be alliterative exaggeration to state that the Decibel inspires dread, it certainly puzzles some radio enthusiasts. This may be due to the fact that it is a logarithmic unit, and 'logs' were traditionally considered to be a subject for the high-flying maths chaps. This is far from the truth, for logs are simply a method of easily handling a wide range of numbers. Apart from their use in the Decibel system, logs are used in other ways in electronics and communications. For example log scales on graphs are very convenient in certain applications, and on the practical side some potentiometers are designed to exhibit a logarithmic change of resistance.

What is a log? Well a log is the power to which a number must be raised to produce another given number. 'Power' in this sense does not mean electrical or mechanical power in watts, but is a maths expression signifying multiplying a number by itself a certain number of times. Squaring or cubing a number is raising that number 'to a power'.

Assuming that 'a', 'N', and 'x', are different numbers, then if  $a^x = N$ , then  $x = \log_a N$ .

The latter expression is read as 'x equals log to the base 'a' of N'. The log to the base 'a' of N is the power to which 'a' must be raised to produce N. Again note that the word power is used in a mathematical sense.

Logs to the base ten are the most usual and are named 'common logarithms'. However, logs to other bases are sometimes used in communication techniques. Napierian, or hyperbolic logs are such a system. Sometimes referred to as natural logs they are named after Charles Napier, and are calculated to the rather odd-looking base of 2.71828. This number is given the special symbol 'e', and is derived from the series:

$$2.71828 = 1 + 1 + \frac{1}{2!} + \frac{1}{3!} + \frac{1}{4!}$$

Where the exclamation mark is the mathematical factorial sign. Napierian logs have given rise to a special unit, the 'Neper', which is used in network attenuation calculations.

The attenuation in Nepers is given as:

$$\text{Nepers} = \log_e \frac{I_{in}}{I_{out}}$$

where  $I_{in}$  is the current entering the network, and  $I_{out}$  is the current leaving the network. The Neper, being based on exponential logs, is generally used in the more theoretical calculations. During more mundane day-to-day expressions of power ratios the Decibel is used.

The Decibel uses logs to the base ten, and is named after Alexander Graham Bell, the father of the telephone. Originally the unit was a 'Bel'. A Bel was defined as:

$$\log_{10} \frac{P_1}{P_2}$$

where  $P_1$  is the power to be compared, and  $P_2$  is the reference power. The Bel

was a trifle inconvenient as a practical unit so a factor of ten was introduced making the 'Decibel'. A Decibel is one tenth of a Bel, and is defined as:

$$10 \times \log_{10} \frac{P_1}{P_2}$$

where  $P_1$  is the power to be compared and  $P_2$  is the reference power. This is often read as 'ten log ten  $P_1$  over  $P_2$ '.

The use of the Decibel is illustrated as follows:

Assume that we have an amplifier into which we insert a power of 10 watts, and the output power is 20 watts. Using the input power as the reference power  $P_2$  this becomes:

$$\text{Power gain in Decibels} = 10 \log_{10} \frac{20}{10}$$

which is ten multiplied by the log of two. Looking in the log tables for the log of two gives us .3010. Multiplying this by ten makes 3.010. Neglecting the third digit we round off the figure to 3 Decibels.

Table 1 indicates how a range of increasing power levels in an amplifier could be expressed using an input of 10 watts as the reference power. The table also illustrates that a doubling of power generally taken as 3dB is actually 3.010dB. However, in general use 3dB is quite adequate, for in practice it is often quite difficult to measure fractions of a Decibel.

In the example given above the reference power was 10 watts, but other reference powers may be used in the Decibel system. For example one thousandth of a watt, or 1 milliwatt is often used as the  $P_2$  reference power. Decibels used in this form may be written as 'dB ref 1mW', or simply as dBm. Sometimes the 'm' is printed as a small letter slightly below the line. This is known as a subscript. Other subscripts may occur in specific applications, notably dB<sub>i</sub>, which expresses the power gain (or loss!) of an antenna compared with an isotropic radiator, transmitting equally in all directions. It must be emphasised that the Decibel is an indication of power ratios, and is not an absolute unit such as the volt, or ampere.

Table 1

Input watts	Output watts	Log of ratio	dB
10	20	.3010	3.0
10	30	.4771	4.7
10	40	.6021	6.0
10	50	.6990	7.0
10	60	.7782	7.8
10	70	.8451	8.6
10	80	.9031	9.0

Although it is basically a unit of power ratio, the Decibel may be used to express voltage or current ratios, or even airborne noise levels when measuring sound for research or environmental control purposes. For example to express the powers expended in two equal resistors one can measure the voltages, and the formula then becomes:

$$\text{dB} = 20 \log_{10} \frac{V_1}{V_2}$$

where  $V_2$  is the reference voltage.

'Where does the 20 come from?', is a question frequently asked. Well, in comparing quantities such as voltages, or pressures with respect to power levels, the squares of numbers are involved. In logs a number is squared by multiplying it by 2. This turns the 10 in the power formula into a 20 in the voltage expression.

A similar indication of power can be made by using the current flowing in two equal resistors. The formula then becomes:

$$\text{dB} = 20 \log_{10} \frac{I_1}{I_2}$$

where  $I_2$  is the reference current. For this type of calculation the resistors must be of equal value. Again the figure 20 appears in the formula for the same reason as in the voltage case. Table 2 illustrates a list of voltage ratios based on a reference level of 10 millivolts. It should be noted that a doubling of voltage is an increase of 6 Decibels, whilst a doubling of power (Table 1), is an increase of 3 Decibels. The difference is the result of the squared relationship of voltage with respect to power.

Decibels can be used to give an indication of air pressure, or to be more exact, an indication of the small air pressure variations that we know as sound or noise. These alternating pressures are specified as Sound Pressure Levels (root mean square) in Decibels with regard to an internationally agreed reference pressure. The currently accepted reference pressure is  $2 \times 10^{-5}$  Pascals. The Pascal is a pressure unit named after Blaise Pascal who

$V_2$	$V_1$	Log of ratio	20 x log of ratio
10mV	20mV	.3010	6.0dB
10mV	30mV	.4771	9.5dB
10mV	40mV	.6021	12dB
10mV	50mV	.6990	14dB
10mV	60mV	.7782	15.5dB
10mV	70mV	.8451	17dB
10mV	80mV	.9031	18dB



## THE DREADED DECIBEL

developed a law concerning the pressure of confined fluids.

### Small variation

This reference air pressure is an exceptionally small variation, and it represents the lower limit of hearing for a healthy person. To gauge some idea of this minute pressure, consider the 'bar' which is about average steady state atmospheric pressure. Meteorologists measure slow changes in millibars, with 1013.25 millibars often taken as a standard atmosphere for aerodynamic purposes. However a variation of  $2 \times 10^{-5}$  Pascals is a pressure variation of .0002 microbars, which is much less than one millionth of atmospheric pressure. The human ear is a sensitive transducer!

The formula for Sound Pressure Level becomes:-

$$\text{SPL dB} = 20 \log_{10} \frac{P_1}{P_2}$$

where  $P_2$  is the reference pressure variation of  $2 \times 10^{-5}$  Pascals or .0002 microbars.

The 20 factor is analogous to that in the voltage formula, for voltage is a form of electrical pressure. A doubling of sound pressure level results in an increase of 6 Decibels.

The formula for sound power levels is:  
 Sound power in dB =  $10 \log_{10} \frac{\text{Power 1}}{\text{Power 2}}$   
 where Power 2 is the reference power of

$10^{-12}$  watts per square centimetre. Again this is a very small number, illustrating the sensitivity of the ear, and the desirability of using logs to deal with a wide range of numbers. Using the sound power formula, a doubling of power results in an increase of 3 Decibels.

### Sensitivity

Decibels may be used to state microphone sensitivity. This is usually quoted in volts for a given sound pressure level in SPL dB. The specification for communication microphones is usually in Decibels below the output of a fictitious microphone assumed to have an output of 1 volt for an SPL of 1 microbar.

On these terms a carbon microphone would have a sensitivity of about -39dB. A tie clip microphone operating on the electret principle would have a sensitivity of about -60dB ref 1 volt per microbar.

Microphones of a precision nature used for research or environmental control purposes usually adopt a different SPL reference pressure of 1 Pascal. (The Pascal is 10 microbars, or 1 Newton per square metre). One Pascal represents 94dB SPL so a typical precision microphone would be quoted as -38dB reference one volt per Pascal SPL. This latter microphone would produce an

open circuit voltage of about 12.5 millivolts when subjected to an SPL of 94dB. This level of 94dB represents a fairly loud noise, for 90dB SPL is generally considered to be the limit of safety for a person exposed to such a noise for normal daily working hours.

Some of the above may appear to be a trifle theoretical to the average radio enthusiast, but there are other uses of the Decibel which relate to the practical day-to-day working of an amateur radio station. In the past, British regulations stipulated the power limits of an amateur transmitter in terms of the direct current applied to the final stage. In future, power limits will be specified in dBW, that is Decibels relative to 1 Watt. Being able to handle Decibels is therefore of considerable practical use.

### Log It!

Readers who wish to increase their skill at using Decibels should obtain a set of common log tables, and work out some Decibel lists for themselves. Log tables appear in the back of many text books, or they may be obtained in the form of reasonably cheap four figure log booklets. These booklets often include instructions on their use, or 'how to enter the tables', as it is said. A little time spent with the log tables will improve confidence, and make the dread of the Decibel a thing of the past.

# ICS

## RM-1 RADIO MODEM

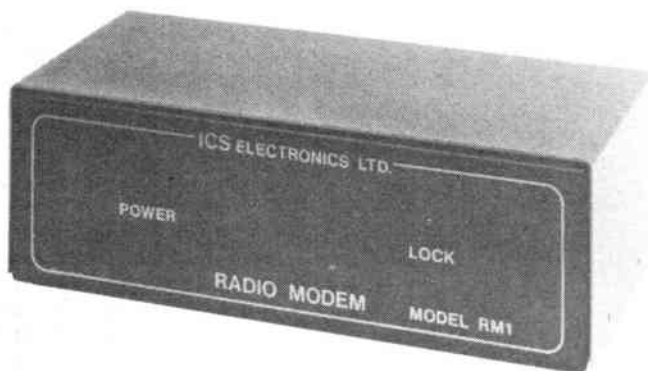

Made in U.K.

Price: £89.50 inc VAT  
 £1.50 P & P

### Specification

The RM-1 is a ruggedly built, steel cased unit, capable of use on all standard amateur data communication modes:

- RTTY: 170Hz shift transceiver (425, 850Hz receive) (IARU tones frequencies) – data rate up to 100 Bauds.
- ASCII: 800Hz shift transceiver (IARU tones) – data rate up to 1200 Bauds.
- CW: Transceiver.
- AMTOR: 170Hz shift transceiver – data rate at 100 Bauds.

Computer interfaces at both TTL and RS232 levels are provided and the front panel lock indicator doubles as a tuning indicator.

Power input is 12V D.C. at 150mA.

The RM-1 is intended for use with suitable software in your computer – much of which is available from ICS.

### Compatible Software

RM-1/CBM-64	RTTY/ASCII/CW software, cable .....	£39.00
RM-1/VIC-20	RTTY/ASCII/CW software, cable .....	£39.00
RM-1/BBC-B	RTTY/CW software, cable only .....	£39.00
MBA-TOR	Amtor/RTTY/CW/ASCII software, cable .....	£69.00

Please add P & P: £1.00 each



**ICS ELECTRONICS LTD**  
 PO BOX 2, ARUNDEL, WEST SUSSEX BN 18 0NX  
 Phone: (024 365) 590



# THE MULTI P6 2m / 70cm MOBILE AERIAL

Reviewed by Bill Sparks G8FBX

When reading reviews of commercial equipment one feature is commonly experienced: the reviewer invariably subjects the equipment to searching laboratory tests and then finalises his review with a short paragraph on the practical use of the equipment. Since the majority of potential users are interested in the uses to which they personally can put the equipment, or the benefits they can receive in practical day to day use, the technical guff is not of primary interest to them. What they want to know is, 'Does it work?', and if so, 'How good is it?'

In view of this, the approach taken in reviewing the P6 was to evaluate its performance in practice and later to take some comparative measurements to establish a standard of performance.

## Design considerations

Aerials designed for mobile use at VHF are essentially a compromise, since any one aerial will only give its best performance when set up in relation to its immediate surrounding, hardly possible in a widely varying situation. The condition affected to the greatest degree in mobile use is the relationship to earth, so that an aerial in which this

condition is given prime consideration must by virtue of its design offer some advantage.

The P6 is basically a shorted quarter-wave section of line, the line impedance being in the order of 350/450 ohms. The significance of this will become obvious later. This means that the open end of the line can be adapted to feed a variety of aerial loads.

The section itself performs adequately as a quarter-wave, and radiation in accordance with the normal quarter-wave pattern is as expected. The major advantage is that the stub section, being correctly matched, does appear to be slightly 'gainier' than a normal quarter-wave in the same position. Since the stub consists of two parallel stainless steel rods some  $\frac{3}{8}$  of a wavelength long secured into a mounting block, the use of a sliding solid stainless steel block, which can be adjusted along the stub, enables a true quarter-wave point to be established.

Coaxial cable fed to a further sliding block, this time of high quality insulation, enables the matching point to be clearly established. Once these two points are finalised the aerial is ready for use. The stub area is shown in the diagram.

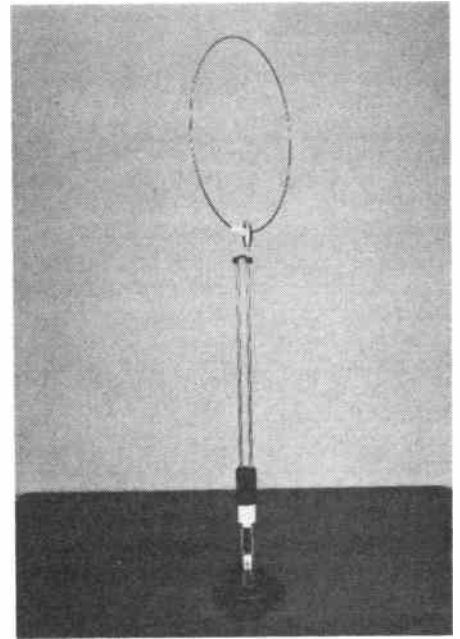

During the tests, in comparison with the quarter-wave the height of the main lobe in relation to the car roof was considered to be relevant to the improved performance of the P6 over the equivalent quarter-wave on a mag mount.

The true earth point of the P6 is actually the shorting block and not the base fixing. Hence the unit worked effectively irrespective of the ground plane, an obvious advantage to caravan owners and mobile use in fibreglass roofed vehicles.

A boss is mounted on one of the stub elements, with a knurled screw driving into a slot cut into the boss. This allows various attachments to be fitted, one of which is a half-wave length of stainless steel rod.

The method of attachment permits the length of the element to be adjusted. In this configuration the aerial becomes a J aerial and the current loop is effectively pushed up the half-wave section, thereby giving true radiation in the horizontal field with very little vertical, the ideal requirement for vertically polarised FM signals. Measured against a  $\frac{5}{8}$  whip one feature was immediately apparent: the susceptibility to flutter was less pronounced. There was a marginal gain increase over a  $\frac{5}{8}$  whip and the performance was slightly down on a  $\frac{7}{8}$  whip. The aerial as such is a very close relation to the Slim Jim.

By removing the half-wave rod and replacing it with a stainless steel ring the aerial then becomes:

- a variation of the Halo with the ring in the horizontal position;
- a DF loop with respectable sensitivity with the ring in the vertical position.

With (a), and operating sideband in contact with fixed stations, an immediate improvement was noticed. The 'around

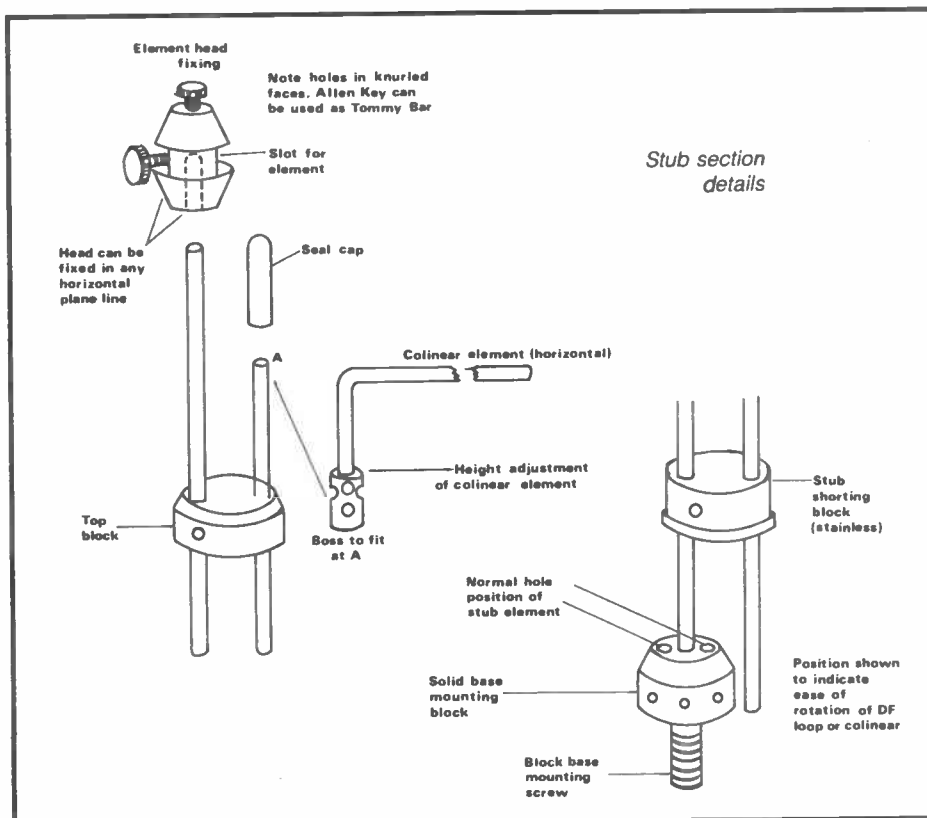



town' operation was immeasurably improved, giving no reflection effects as received with vertical aeri-als, and because of the polarisation gain giving a marked increase in signal level. One significant feature of this 'Halo' was the absence of the usual null in the radiation pattern. Only a slight variation was measured.

With (b), the advantage of being able to achieve a certain discrimination between signals off the side when operating from a static position was apparent. Although only simple forms of DF operation were attempted the possibility of using the techniques on VHF DF hunts was considered viable.

## Collinear

The end of the second stub element is protected by a plastic sheath. Upon removal of this sheath a third element may be fitted, and by changing the angle of the original half-wave vertical into the horizontal plane a 'double zepp' type of aerial is created, ie a 2 half-wave collinear.

The 350 ohm feed is now significant, since maximum gain is achieved with two half-wave aeri-als fed in phase and close-spaced when fed with 350/400 ohm. The effect is to give some 2dB gain over a dipole when the two half-waves are in the same plane. By varying the included angle a further slight increase of gain is obtainable in a favoured (included angle) direction, but not of any great value: again, more later (see diagram).

By leaving the new section in position and returning the half-wave section to vertical some rather interesting effects occurred. Looking at the 145MHz down-link on Oscar 10, a certain degree of directivity was observed with a vertical angle at a maximum of around 35°. This is mentioned in passing and is not a sales point as claimed, but is well worth further investigation since the next point of discussion is the fact that all the above are repeatable on 70cm.

## Re-adjustment

The only variation to be considered before discussing the 70cm performance is that when using the aerial as a collinear it is necessary to re-adjust the feed-point of the co-ax. The purist would probably use a balun at this point to equalise the currents in the two stubs more effectively, but it will be noticed that one stub leg is slightly longer than the other. Measurement of stub current with an RF sniffer indicated a reasonable

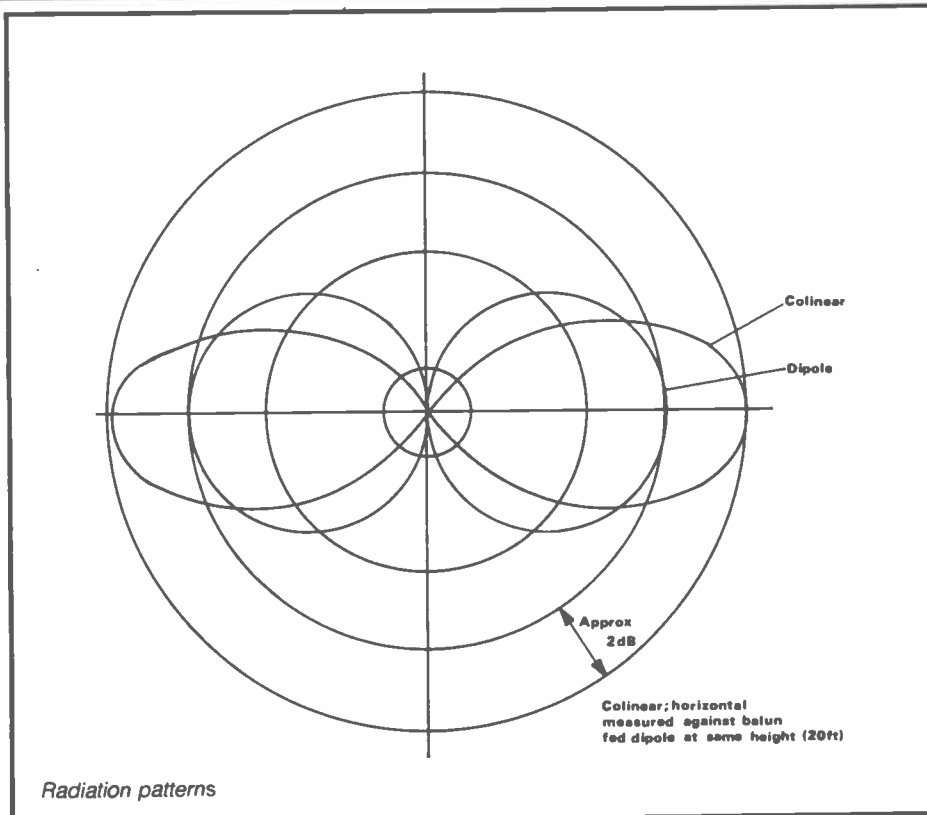
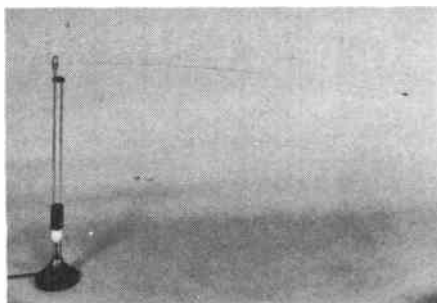

balance, and one wonders whether this leg length variation is of significance.

## 70cm

The performance on 70cm was initially viewed with a certain scepticism, since compromise indicates to the writer a failure to achieve. However, after carrying out many tests on both SSB and FM, vertical and horizontal, the results were very encouraging. The use of the collinear from a good spot was an eye-opener, and after further investigation some 5 or 6dB of gain was measured. The fact that 2 x 3 half-waves were now being fed in phase led to a rapid session with classic radiation patterns and a pencil to try to understand why.

It appears that successive cancellations and additions in the forward pattern result in a quite sharp forward beam with a very low angle of radiation. The other characteristics of the aerial were equally impressive.

The equipment is made from stainless steel metalwork throughout, and is manufactured to a degree of quality rarely seen in amateur aerial construction.

The use of Allen screws to fix some of the components may give rise to problems in mobile use due to vibration, although none was experienced during the tests. The Halo ring itself may be improved mechanically, since a certain degree of floppiness was noticed. This did not have any effect on the performance and may appear trivial, but we must remember that the reviewer of the Rolls Royce did complain about the noise of the clock ticking, and when one is evaluating a Rolls Royce of aeri-als such criticism is valid.

To the writer's mind the aerial is a valuable piece of equipment both to the serious experimenter and the mobile user. Although initially intended for mobile application its versatility makes it an ideal base unit for further experimentation. The writer's version is definitely not being returned after review, since many hours of fun are envisaged with it!

## Further experiment

Some consideration may be given to extending the collinear sections from half-waves to 0.65 waves. This will in effect give a further 1.5dB gain, and the aerial then becomes bi-directional with approximately 3.5dB gain over a dipole: a rather useful device when out mobile on a picnic or operating from a caravan, or when an opening suddenly appears when you are far from home. Purchasers of the equipment will think up all sorts of applications since it is virtually an aerial experimenter's Lego set, besides having a very effective practical day to day use as originally supplied.

Briefly, the aerial can be used as a simple mobile, from a static site, as a collinear beam capable of rotation, possibly (requires further check) Oscar 10 from static positions or even mobile, DF hunts, SSB mobile, and V beam when static, all of these being optimised, ie the aerial is really effective on all the above situations.

After many years of work on amateur aeri-als the writer's only complaint is that he did not think of it first. The versatility is quite impressive, and its small dimensions when dismantled makes it an ideal aerial for hotel use, picnics and caravan holidays besides its mobile applications.

# THE 11m CB TO 10m AMATEUR BAND CONVERSION GUIDE

## PART FOUR

A look at the dedicated PLL chips used in American CB rigs which prevent modification for use on other frequencies

ROGER ALBAN GW3SPA

BSc. C ENG, MIEE

On Wednesday 4th August 1976 the Federal Communications Commission (FCC) reviewed the operating rules for Citizen Band radio in the USA, increasing the number of channels from 23 to 40. This change was prompted by the large number of imported sets that were illegal because they were capable of operating on more than 40 channels, since they contained a PLL chip that meant the rig could easily be converted to cover additional channels (such as the MC145106 or PLL02). The FCC were keen to pressurise the manufacturers of CB rigs to design their sets to contain dedicated PLL chips that were not easily converted to cover additional channels.

The CB manufacturers under pressure began to use some very sophisticated ways to prevent equipment from being modified to operate on any frequency other than the American CB channels. Their main method was to use a PLL chip which, first of all, only requires a single crystal, and secondly, is internally programmed to reject any non-legal channel codes on its program pins. What happens is that the PLL chip has a permanent memory inside it which can only recognise programming logic codes that are part of this memory.

### Sanyo LC7120

One of the first chips to enter the American market was the Sanyo LC7120 or equivalent MPD 2810C (Figure 1). This chip contains a code converter or Read Only Memory (ROM) which stores the required program code required for transmit and receive on each channel. The advantage of doing this is to overcome the problem of the previous examples where complicated mixing methods were used to obtain the correct frequencies for the receiver 1st mixer and transmit frequency. The transmit/receive 'divide-by-N' number is selected by having the logic level on pin 8 logic '1' for receive and logic '0' for transmit.

To alter the program code from one

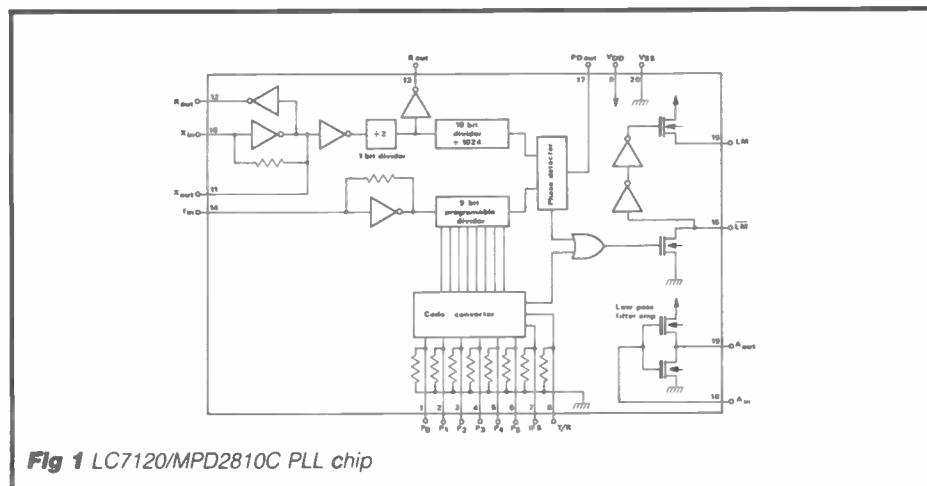

Fig 1 LC7120/MPD2810C PLL chip

channel to another the code converter is fed with a unique code on pins P<sub>0</sub> through to P<sub>5</sub>. This code is shown in the truth table (Figure 2). You will note that P<sub>0</sub> to P<sub>3</sub> represent the least significant digit of the channel number, and P<sub>4</sub> and P<sub>5</sub> represent the most significant digit of the channel number with the exception of Channel 40 (being represented by the code 00). If one tries to select an unlisted code such as 315 with all the program inputs at logic level '1' the chip will not accept the code and will in turn select Channel 40 and set the lock monitor to inhibit the transmitter. Thus it is difficult to use this particular chip for other applications because of the strange frequency jumps in American CB.

However, the technology of this chip is that 'Fin' must be kept under 4.5MHz, therefore down-mixing must be incorporated between the VCO and 'Fin'. It is therefore possible to use this chip on 10m FM, with the disadvantage of some channels not having sequential 10KHz increments.

The LC7120 chip is used in the Colt 444 and Super Star 95 American rigs (Figure 3 shows the block diagram). On transmit the frequency of the VCO is added in a

mixer to the reference oscillator of 10.24MHz to arrive at the transmit frequency. On receive the frequency of the VCO is fed direct into the receiver 1st mixer and is subtracted from the wanted incoming signal to arrive at the 1st IF frequency of 10.695MHz. With the

Fig 2 LC7120 truth table

Function	P <sub>5</sub>	P <sub>4</sub>	P <sub>3</sub>	P <sub>2</sub>	P <sub>1</sub>	P <sub>0</sub>
2 <sup>n</sup>	2	1	8	4	2	1
Channel						
01	0	0	0	0	0	1
02	0	0	0	0	1	0
03	0	0	0	0	1	1
04	0	0	0	1	0	0
05	0	0	0	1	0	1
08	0	0	0	1	1	0
07	0	0	0	1	1	1
08	0	0	1	0	0	0
09	0	0	1	0	0	1
10	0	1	0	0	0	0
...	...	...	...	...	...	...
14	0	1	0	1	0	0
...	...	...	...	...	...	...
25	1	0	0	1	0	1
...	...	...	...	...	...	...
36	1	1	0	1	1	0
...	...	...	...	...	...	...
39	1	1	1	0	0	1
40	0	0	0	0	0	0



# CONVERSIONS

flexibility over 'divide-by-N' number between transmit and receive, only one mixer crystal oscillator is required.

If the rig is to be used on 10m FM, the mixer crystal oscillator will require to be exchanged for a 17.655MHz crystal if Channel 30 is to correspond to the calling frequency of 29.6MHz. On Channel 30, the VCO will be operating at 19.36MHz on transmit and 18.905MHz on receive. Following down-mixing with the 17.655MHz crystal oscillator 'Fin' will be 1.705MHz on transmit and 1.25MHz on receive. Please note that the 'divide-by-R' ratio is 2048 and the reference frequency at the phase detector is 5KHz.

When converting these American CB sets to 10m FM, it has also been found necessary to alter the capacitance of some of the tuned circuits. In general terms the rule of thumb seems to indicate that the tuned capacitance should be exchanged for the next lowest preferred value.

To identify a circuit configuration, first of all examine the type of phase locked loop chip being used, and the frequencies of the crystal mixer oscillator. This will certainly assist in identifying the circuit.

## Sanyo LC7130

Towards the end of the 1970s an improved PLL chip emerged from the Sanyo stables with an improved maximum 'Fin' of 20MHz. This chip was known as the LC7130 and featured in the majority of American CB sets manufactured in the early 80s. The main advantage of having a chip capable of handling a high frequency 'Fin' is that you can dispense with the down-mixing equipment and thus make the set difficult to modify for use on other frequencies.

Figure 4 shows the pin out arrangements and the block construction of the chip. The code converter here is called a Read-Only-Meaning (ROM). The 'miss code' (MC) pin has been separated from the 'lock monitor' (LM) on this chip. Other features include the ability to select Channel 19 and Channel 9 by putting logic level '1' on either pin 8 or pin 9. If you happen to put logic level '1' on both pin 8 and pin 9 then the miss code output pin will be at logic level '1' indicating a coding error. Unfortunately you cannot cheat with the chip by trying to select an undefined input code. The permitted codes and 'divide-by-N' ratios are given in Figure 5.

## No down-mixing

The 'divide-by-N' numbers were devised by the manufacturer to be used in the circuit configuration shown in Figure 6. One will note that for the first time due to the high frequency capability of 'Fin' there is no down-mixing used within the phase locked loop circuit. The transmit frequency is derived by mixing the VCO with the crystal oscillator reference frequency of 10.24MHz. On the receiver side the VCO is fed directly to

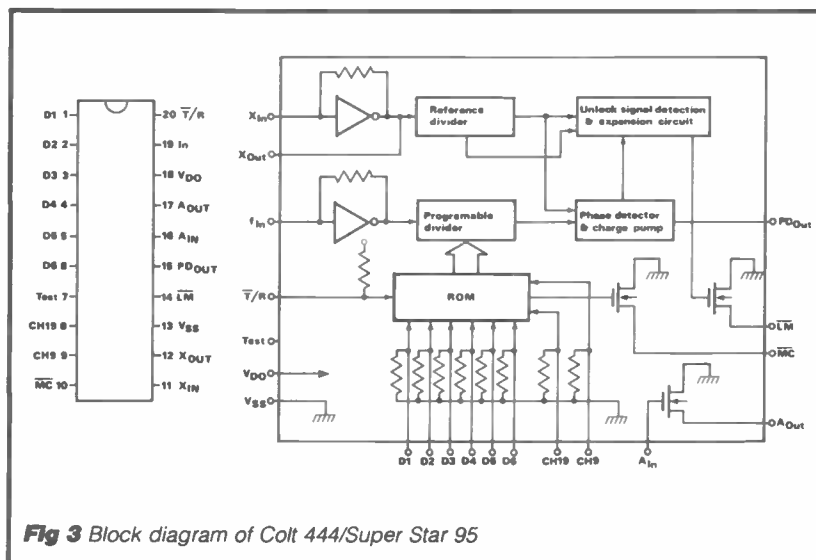

Fig 3 Block diagram of Colt 444/Super Star 95

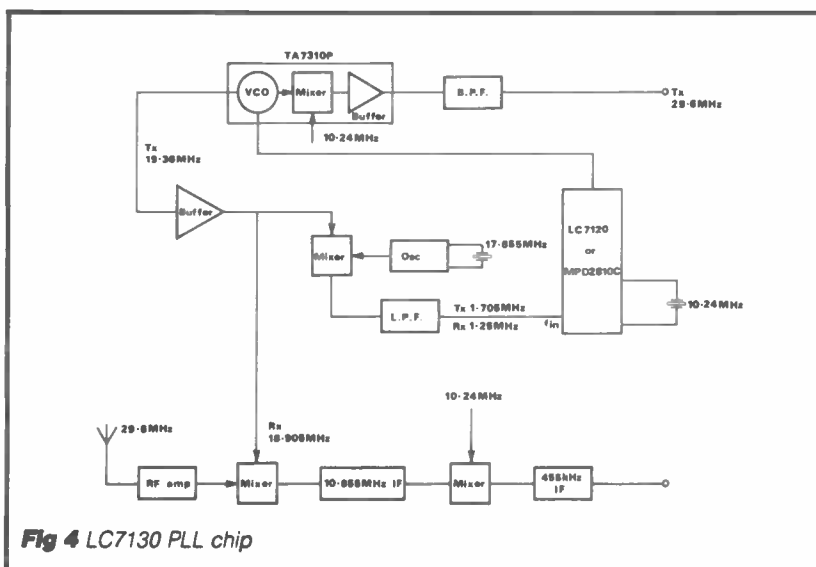

Fig 4 LC7130 PLL chip

Fig 5 LC7130 program data and ÷N ratio

CHANNEL NUMBER	P <sub>5</sub>	P <sub>4</sub>	P <sub>3</sub>	P <sub>2</sub>	P <sub>1</sub>	P <sub>0</sub>	Rx ÷N	Tx ÷N
1	0	0	0	0	0	1	3254	3345
2	0	0	0	0	1	0	3256	3347
3	0	0	0	0	1	1	3258	3349
4	0	0	0	1	0	0	3262	3353
5	0	0	0	1	0	1	3264	3355
6	0	0	0	1	1	0	3266	3357
7	0	0	0	1	1	1	3268	3359
8	0	0	1	0	0	0	3272	3363
9	0	0	1	0	0	1	3274	3365
10	0	1	0	0	0	0	3276	3367
11	0	1	0	0	0	1	3278	3369
12	0	1	0	0	1	0	3282	3373
13	0	1	0	0	1	1	3284	3375
14	0	1	0	1	0	0	3286	3377
15	0	1	0	1	0	1	3288	3379
16	0	1	0	1	1	0	3292	3383
17	0	1	0	1	1	1	3294	3385
18	0	1	1	0	0	0	3296	3387
19	0	1	1	0	0	1	3298	3389
20	1	0	0	0	0	0	3302	3393
21	1	0	0	0	0	1	3304	3395
22	1	0	0	0	0	1	3306	3397
23	1	0	0	0	1	1	3312	3403
24	1	0	0	1	0	0	3308	3399
25	1	0	0	1	0	1	3310	3401
26	1	0	0	1	1	0	3314	3405
27	1	0	0	1	1	1	3316	3407
28	1	0	1	0	0	0	3318	3409
29	1	0	1	0	0	1	3320	3411
30	1	1	0	0	0	0	3322	3413
31	1	1	0	0	0	1	3524	3415
32	1	1	0	0	1	0	3326	3417
33	1	1	0	0	1	1	3328	3419
34	1	1	0	1	0	0	3330	3421
35	1	1	0	1	0	1	3332	3423
36	1	1	0	1	1	0	3334	3425
37	1	1	0	1	1	1	3336	3427
38	1	1	1	0	0	0	3338	3429
39	1	1	1	0	0	1	3340	3431
40	0	0	0	0	0	0	3342	3433

# CONVERSIONS

the receiver 1st mixer - Figure 6 shows the circuit operating on Channel 30 American AM at a frequency of 27.305MHz.

The designs of the LC7130 certainly made it very difficult for American CBers to modify this circuit to give them additional channels, but it is relatively easy to modify for use on 10m FM.

## LC7130 conversion to 10m

One must introduce a mixer and crystal oscillator into the phase locked loop to ensure that the frequency appearing at 'Fin' remains the same as for the American CB band. Figure 7 shows the transceiver operating on Channel 30 with the phase locked loop mixer in circuit. From the previous example 'Fin' on transmit should be 17.065MHz. With a transmit frequency of 29.6MHz the VCO needs to operate at 19.36MHz, giving a difference between the VCO frequency at 'Fin' of 2.295MHz. Again on receive the difference between the VCO frequency and 'Fin' remains at 2.295MHz. This is a simple way of converting this American CB design to operate on 10m.

It is worth noting that some of the channels will not increment the frequency in 10KHz steps due to the American designation of channel and frequency allocation previously discussed. However, this modification should prove to be successful and reasonably cheap to perform. For those of you contemplating this modification, a typical circuit diagram of an American CB set

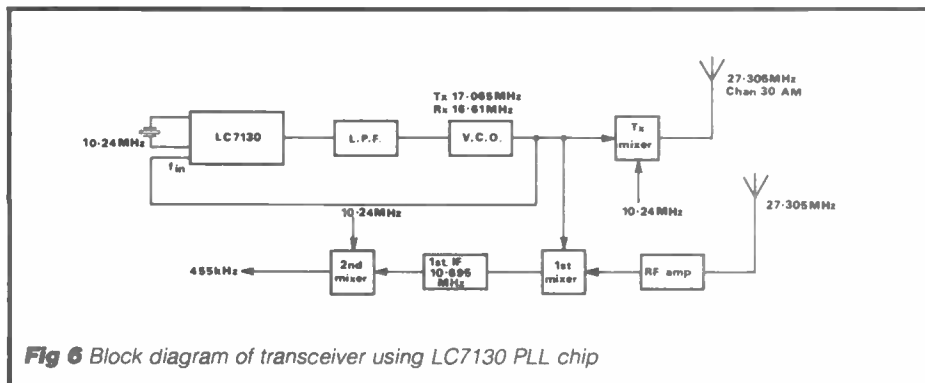

Fig 6 Block diagram of transceiver using LC7130 PLL chip

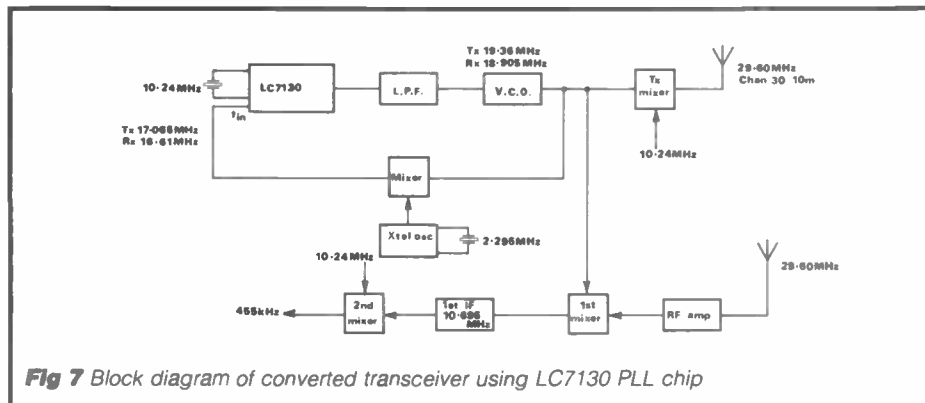

Fig 7 Block diagram of converted transceiver using LC7130 PLL chip

using the LC7130 is shown in Figure 8. The circuit of this American set was designed for amplitude modulation and details of providing FM will be given later in this series.

## Next month

In the next part of this series we look at UK CB specification and the conversion of rigs using the LC7137 PLL chip to the 10m amateur band.

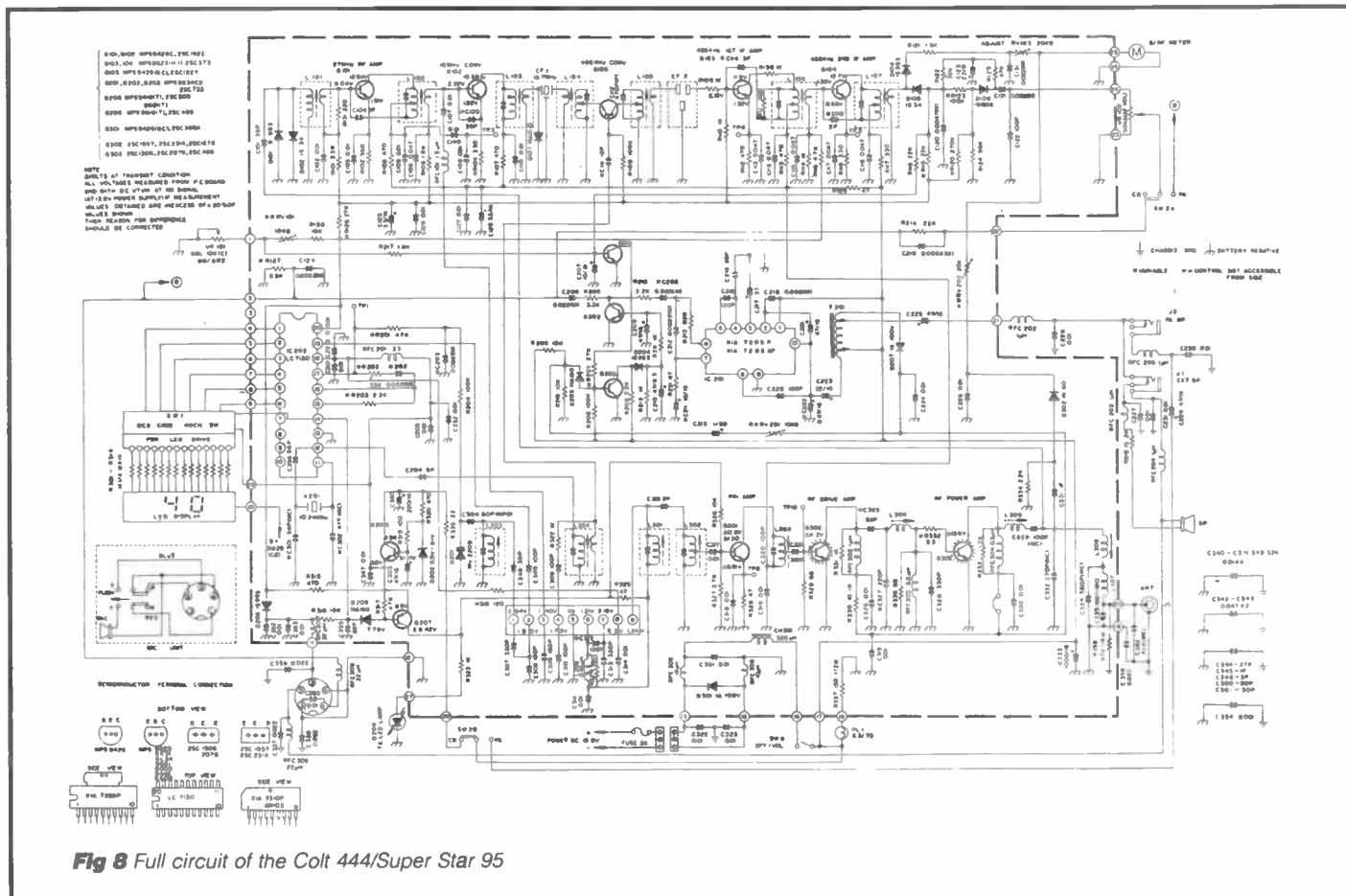

Fig 8 Full circuit of the Colt 444/Super Star 95



# BACK TO BASICS

Last month we dealt with the ins and outs of the receiver, so in this issue we tackle transmitters. The subject of transmitters is a very important one. It is easy to see that a transmitter, in the hands of an unknowledgeable operator, could well cause widespread interference, not only to other users of the amateur bands but also to services outside of those frequencies on which the transmitter is operating.

## Out of band

The majority of the amateur bands are shared with other services but by far the most common cases of interference from transmitting equipment arise out of it not being set up or tuned correctly, allowing it to give off spurious signals that find their way into other equipment situated locally. Examples of such equipment include a neighbour's television receiver, radio or even hi-fi amplifier.

Even a well set up transmitter can cause interference to nearby receivers in a multitude of ways, some of which will be discussed as we progress and others of which will be looked at later on in the series.

You can soon see why certain aspects of transmitter design are very important; take the oscillator for instance. Just as the oscillator in a receiver must be stable enough to stop the receiver drifting off the wanted frequency, so the design of the oscillator used in a transmitter must be such that it does not allow the transmitter to move away from the frequency that it is tuned to. Not only would this be inconvenient for those receiving the transmission but it could cause the transmitter to drift onto someone else's frequency, or even out of the allocated frequency band altogether.

As well as the oscillator stage, you are also expected to understand the basics related to the other transmitter stages, such as *frequency changers* or *multipliers* and *power amplifiers*. Having seen from last month's chapter on receivers that there are various modes of emission in current use we shall, in a few moments, also look at the methods for generating those different modulation modes. Before that though a brief word about transmitters in general.

## Transmitters

The role of the transmitter is to generate radio frequency power. The RF signal produced may be keyed or modulated in a number of ways, so that it can convey information to a receiving station. Up until fairly recently, amateur transmitters were relatively easy to design and build compared with communication receivers, their circuitry being based on valves and the number of stages they used being few in number. That was in the days when the more common modes of transmission were *amplitude modulation* (AM) or CW, but

## Bill Mantovani G4ZVB continues his common-sense approach to passing the RAE. This month: TRANSMITTERS

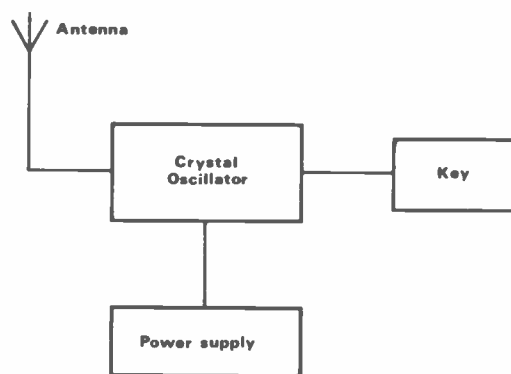

**Fig 1** Block diagram of a simple telegraphy transmitter

with the rapid increase in popularity over recent years of single-sideband operation, all that has now changed and today's amateur transmitter design is somewhat more sophisticated than its predecessor.

The significant changes that transmitters underwent during the late '60s and '70s also brought about the now common practice of incorporating the transmitter and the receiver in the same design, hence the transceiver.

All of this does not mean that the traditional transmitter designs are no longer suitable and in fact many amateurs who build their own equipment still do so along the old lines. CW transmitters in particular need not be all singing, all-dancing in order to achieve good results and this should not be forgotten by the newcomer who suddenly finds himself confronted by today's crop of 'do everything' black boxes.

From *Figure 1* you can see that a simple transmitter need consist only of a keyed oscillator connected to an antenna, an entirely suitable and extremely cheap way of getting on the air on CW on a particular band or spot frequency. To operate on different bands or in other modes we need to add a few more stages but before continuing, let us look at the oscillator stage in more detail.

*Table 1* lists the UK HF amateur bands together with the three new bands that became available as a result of the 1979 World Administrative Radio Conference.

The WARC bands, as they have become known, are too new to have had any influence on transmitter design over the years, so we shall leave them for a moment and examine first the previously available HF bands. A quick study of the bands reveals that they are harmonically related and this is shown in the right hand column of *Table 1*. This, and the fact that these bands also had a harmonic relationship to certain TV channels, led to the emergence of a fairly standardised approach to the design of transmitters so as to keep any possible interference to television (TVI) to a minimum.

It is obvious from *Table 1* that an oscillator having a maximum frequency range of 1750 – 2000KHz could be used to cover all of these amateur bands if the output frequency from the oscillator were multiplied by the appropriate factor. For example, to work on the 160m band (or Top Band, as it is known) no multiplication is necessary but to work on the 20m band a frequency multiplication of 8 times is required. An alternative

*Table 1*

Harmonic relationship of the HF bands	
Band (MHz)	Multiplication factor
1.8-2	x 1
3.5-3.8	x 2
7.0-7.1	x 4
14.0-14.35	x 8
21.0-21.45	x 12
28.0-29.7	x 16

# BACK TO BASICS

approach to the above for the generation of the frequencies would be to use a mixer and two oscillators, but this would be much more complex.

The mixer is used to mix the outputs of a *variable frequency oscillator* (VFO) and a fixed frequency, crystal controlled oscillator. This arrangement can be made to produce a frequency output in any band required by switching in crystals of the appropriate frequency, whilst the VFO is used to tune across the band as normal. It is this type of circuit that can be used to cover the new, non-harmonically related WARC bands and as it is also an arrangement found in SSB transmitters, it will be looked at later.

## TVI

A note here about TVI. The TV frequencies most susceptible to interference from amateur transmitters were in, the VHF band 1 range but these fortunately ceased to be used for television broadcasting at the beginning of January this year. This does not however mean that interference to these frequencies is no longer a problem for the amateur because the band will eventually be assigned to other services, which could be just as susceptible as the old 405-line TVs were to this sort of interference. You can therefore be sure that the design philosophy that has existed up until now will continue to be adopted for some time yet, particularly by those constructing home-brew equipment.

Taking the simple transmitter block diagram of *Figure 1* a little further produces the typical transmitter arrangement shown in *Figure 2*. It consists of a VFO followed by a *frequency multiplier* (collectively known as the *exciter*), the output of which is fed into a power amplifier stage and then to the antenna.

Where a number of frequency multiplication stages are used, for output on a variety of bands, the output from each multiplier stage must be switched to the input of the power amplifier in turn, as shown in *Figure 3*.

The variable frequency oscillator allows the transmitter to be tuned to the desired frequency, and the term *netting* refers to the tuning up onto a frequency that is already in use by another operator, in order to reply to his call or to join in with a conversation. The more commonly used circuits for a VFO are the Colpitts or the Clapp-Gouriet type oscillators, but any of the other oscillator circuits may be used.

## Frequency stability

As already mentioned, an important factor in the design of the VFO is its *frequency stability*. This will prevent the transmitter from possibly drifting outside of the permitted band or outside of the bandpass of a receiver (see last month's Part 4 on receiver bandpass). SSB transmitters in particular should have good stability and because the resonant frequency of a tuned circuit is

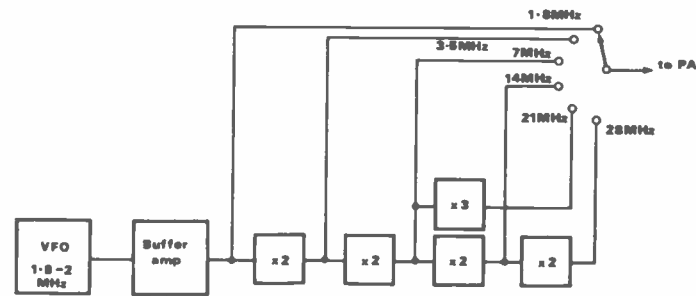

**Fig 2** Block diagram of a typical transmitter arrangement

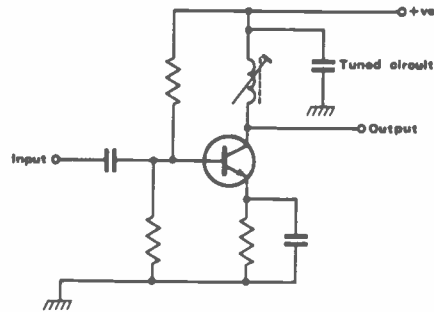

**Fig 3** Block diagram of an exciter designed to cover all bands from a VFO tuning 1.8-2MHz

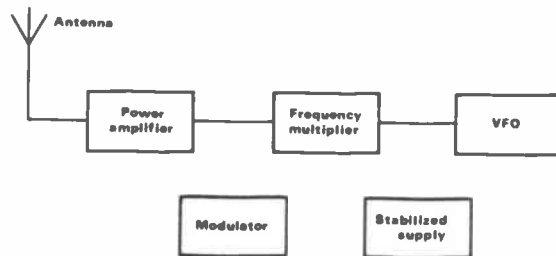

**Fig 4** A typical frequency multiplier circuit

governed by the value of any inductor and capacitor making up that circuit, the construction of the VFO should be such that things like mechanical shock in no way cause the values of L or C to change.

Coils should be tightly wound on grooved formers and the variable capacitor must be of good mechanical construction. The wiring between inductor and capacitor should be kept as short as possible and rigid enough to prevent mechanical vibration. Another factor that could affect the stability of the VFO is changes in ambient temperature.

The effects of temperature on a VFO may be kept at a minimum by situating it as far as possible from any heat source and by using an air-cored coil as and where necessary. In a transistor oscillator, the circuit should be designed such that the effects of changes in transistor capacitances are kept to a minimum. This is readily explained in Chapter 5 of the *RAE Manual* but make a note of the use of a capacitor having a negative temperature coefficient to compensate for any changes in value to temperature of the capacitors making up the tuned circuit. Remember then, use only good quality components for the tuned circuit of a VFO and make sure it is soundly made.

## External factors

There are also external factors that have an influence on the VFO, such as how much loading the following stage exerts or whether the power supply voltage fluctuates. Loading on the VFO should be light as heavy loading could stop it oscillating altogether or could cause the generation of excess heat if it has to deliver too great an output voltage. Consider the VFO as a constant frequency small signal source and ideally isolate it from following stages by a Class A *buffer amplifier*. As for keeping the power supply at a constant level, this can be done by using a simple Zener diode to stabilize the supply voltage.

It is not usually advisable to key the VFO as this too can affect frequency stability. Going back to *Figure 3*, with the VFO running at the lowest frequency which is fed into frequency multipliers, any possible frequency drift would also be effectively multiplied in these preceding stages, so you can see why this is such an important subject. Remember too that when a transmitter is first switched on from cold some frequency drift is almost inevitable during the first few minutes. This is why it is always advisable to switch the transmitter on



# BACK TO BASICS

some 15 minutes before it will actually be used, to allow the VFO to settle at its operating temperature.

## Frequency multipliers

A *frequency multiplier* is normally a low power device operating in Class C mode to produce an output which is rich in harmonics. A typical circuit of a transistor frequency multiplier is shown in *Figure 4*. The tuned circuit connected to the collector is set to resonate at  $n \times f$ , where  $n$  is the multiplication factor required (ie, times 2 or times 3) and  $f$  is the frequency of the input voltage. A higher multiplication factor than 2 or 3 may be used but the output then becomes progressively lower.

The tuned circuit itself may consist of a small, possibly slug-tuned coil and a variable or fixed capacitor, but at higher frequency ranges the capacitor can often be omitted and the coil persuaded to resonate using only stray circuit capacitance of a few pF. The output from the frequency multiplier is connected to the following stage via a capacitor, the value of which will vary according to frequency.

For VHF (70MHz and 144MHz) and UHF (432MHz) bands, exciter design normally follows that used for HF equipment but, because of increased circuit losses at these higher frequencies, it is often necessary to incorporate a buffer amplifier before the output stage. Because of stability problems, crystal oscillators were most often used but the mixer-type VFO and *phase-locked loop* techniques are now becoming much more common. From the block diagram in *Figure 5* of a 144MHz transmitter you can see that the addition of an extra tripler stage would give an output on 432MHz, and that by using a slightly different crystal frequency in the oscillator and the first two multiplying stages an output on 70MHz is achieved.

## Power amplifiers

Now let's look at the *power amplifier* (PA). Valve PA design differs considerably from transistor RF power amplifiers, mainly because the transistor has a much lower input and output impedance compared to the valve and because these impedances decrease as the power level increases. Transistors are also very vulnerable to excessive heat and will stand nowhere near as much misuse as a valve.

This means that with high power transistor PAs, close attention must be paid to mechanical construction with regard to heatsinking. The rating factor for the devices used should be very conservative and, when in use, care must be taken to ensure that the antenna is correctly matched to the PA output stage to avoid any possible damage. Commercial transistor RF power amplifiers and transmitters usually incorporate some protection circuitry to reduce drive if the antenna presents a serious mis-match to the output, another reason why antenna matching to a transistor PA is important.

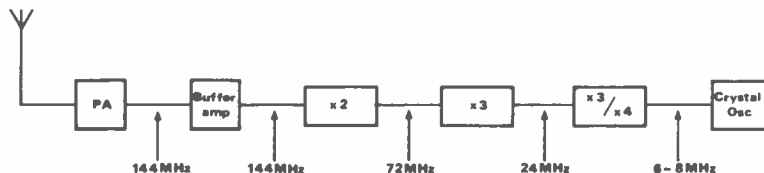

**Fig 5** Block diagram of a VHF transmitter

At VHF, low power outputs of, say, 25 watts or less are quite common and can easily be achieved with the use of relatively cheap transistors. This is a popular solution for portable or mobile working and a separate higher power PA stage can be added as and when required. A typical circuit for a low power 144MHz transistor PA is given in the *RAE Manual*, together with a brief description. This shows the generally preferred L-pi output circuit arrangement, which should be noted. For medium and high power levels at VHF and UHF though, the transistor normally has to make way for valves in the power output stage.

HF power amplifiers are usually required to operate over several bands at higher powers than the above. Because of a transistor's low output impedance, somewhere in the order of 1-10 ohms for a typical 100W PA, the conventional pi-network output arrangement becomes impractical due to the values of L and C that would be required.

The increasing availability of high-power field-effect transistors helps designers get over this problem but a more common solution is to use *broadband transformers* on the input and output of the transistor. The input impedance is first transformed down to below 50 ohms and then the broadband transformer on the transistor output raises the impedance at this end of the circuit back to the normal 50 ohms. A broadband transformer typically consists of just a few turns of wire on a torroid core, with the primary and secondary windings either twisted together or wound together as a *bifilar pair*.

Such a transformer, being broadband, can operate over a wide frequency range. If this range is designed to cover a number of amateur bands, such as from 3-30MHz, and the drive circuits also designed similarly, then the transmitter itself becomes broadband and apart from the VFO, requires no bandswitching or re-tuning.

One major problem of such a design is

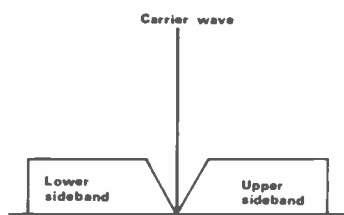

**Fig 6** An AM signal

that because the RF circuits are broadband, any spurious frequency or harmonics which may be generated also get amplified and appear at the output. The output must be adequately filtered therefore with the use of low-pass filters to prevent these unwanted frequencies from reaching the antenna and being radiated. Most of today's commercial and home constructed transistor PAs use broadband techniques.

## Modulation

Modulation is the term used to describe the process of acting upon the carrier wave produced by a transmitter in order to transmit intelligence. This can be speech, Morse code, a video picture or music. Because the carrier wave is an ac current of constant frequency, amplitude and, with respect to a fixed point in time, phase, it can be modulated by variation of either the frequency (*frequency modulation* or FM) or the amplitude (*amplitude modulation* or AM).

All the modulation processes produce side frequencies, both above and below the carrier wave, that are termed *sidebands*. With amplitude modulation, the highest sideband can be determined by adding together the carrier frequency and the highest frequency of the modulating signal whilst the lowest sideband is found by subtraction. Thus the difference in frequency between the highest sideband and the lowest sideband is termed the *bandwidth* occupied by the transmission.

To reproduce music adequately, it is necessary to have quite a wide bandwidth so that frequencies over the whole audio range can be transmitted, but for a communication system where intelligibility is the prime factor, the bandwidth can be considerably reduced. For the transmission of speech then, a bandwidth of only 5-6KHz is adequate for an amplitude modulation transmitter as we only need to transmit frequencies of up to 2.5-3KHz. The audio bandwidth is restricted by using a low-pass filter in the transmitter's modulation circuit which has a cut-off frequency of about 2.5KHz.

## Deviation

For FM things become a little more complex because, theoretically, the sidebands in an FM system are infinitely wide. Here the carrier is known as the *centre frequency*, and the change in the frequency of the carrier (which is both positive and negative) is called the *deviation*. This deviation is proportional to the amplitude of the modulating signal and its limits are determined by the

# BACK TO BASICS

peaks of the modulating voltage. The rate of deviation of the carrier is equal to the frequency of the modulating signal and is unaffected by changes in the amplitude of the latter.

It is the deviation which is affected by the amplitude of the modulating signal, and the ratio of the maximum deviation to the highest modulating frequency is termed the *deviation ratio*. The relationship between the deviation and the frequency of the modulating signal is called the *modulating index*. For FM communication, a mode known as NBFM or *narrow band frequency modulation* is used where the deviation is limited to  $\pm 2.5\text{KHz}$ : approximately the same as for an AM transmission.

Figure 7 shows an amplitude modulated carrier wave at various levels of modulation. The *modulation factor*, or modulation depth, is the ratio of the modulation amplitude to the amplitude of the unmodulated carrier and can be expressed as a percentage. The shaded area is termed the *modulation envelope*. 100% modulation (modulation factor of 1) is achieved when the amplitude of the modulating signal has been increased to the point where its negative peak has reduced the amplitude of the carrier to zero, whilst its positive peak has increased the carrier amplitude to twice the unmodulated value, as shown.

Any further increase in the amplitude

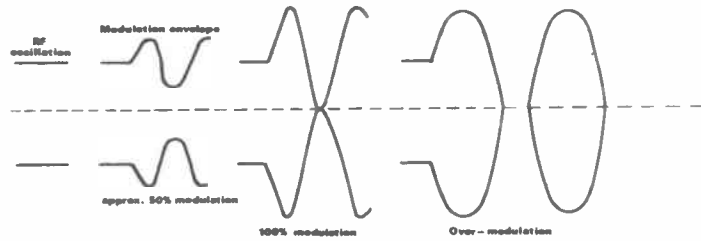

Fig 7 Modulated carrier wave

of the modulating signal will result in over-modulation of the carrier and is a condition to be avoided as this causes distortion. It also introduces unwanted harmonics of the modulating signal into the transmission, making it occupy a greater bandwidth than necessary and becoming the source of possible interference to nearby receivers as outlined last month. This is known as *splatter* and is a situation which must be avoided.

Overmodulation of an FM signal would simply increase the bandwidth of the transmission, making it more like FM than NBFM.

There is another mode of transmission yet to be described: single sideband. Referring back to Figure 6 we see two things. The carrier wave does not contain any intelligence itself and the two sidebands, being identical, both carry the same intelligence. Therefore, it is possible to remove the carrier and one of the sidebands from the signal before

transmission and still transmit all of the intelligence. This is the system known as *single sideband suppressed carrier*, or simply SSB.

## Next month

Next month we conclude modulation and transmitters and turn our attention to power supplies. Meanwhile, make sure you are familiar with the oscillator circuits in chapter 5 of the *RAE Manual* and in particular the importance of frequency stability and the factors which affect it. Remember also the use of a low-pass filter.

## Acknowledgements and references

'Radio Amateurs' Examination Manual' - G L Benbow, G3HB (RSGB)  
*A Guide to Amateur Radio* - Pat Hawker, G3VA (RSGB)  
*Radio Communication Handbook* (fifth edition) - RSGB  
 City and Guilds of London Institute.

# LOOK! BARGAINS GALORE

## OLD STOCK & END OF LINE ITEMS MUST BE CLEARED

YAESU		PRICE	P&P
FT208R	VHF hand held	165.00	3.50
FP700	20 amp PSU	105.00	3.50
FRV700	VHF converter 'A'	65.00	2.50
YC500	Bench counter with oven	200.00	2.50
TV430	70cm converter 107/707/902	150.00	2.50
FF501DX	Low pass filter	17.50	1.00
FSP1	Mobile speaker	8.95	1.00
YH77	Light weight headphones	8.95	1.00
CSC1A	Leatherette case 290R	2.50	0.50
SC1	Consol for 480/780R	69.00	3.00
FT ONE	AM filter 6KHz	13.95	0.50
FT ONE	FM unit	34.95	0.50
FT102	CW Filter 300Hz narrow	14.95	0.50
FT101Z	AM unit	18.95	0.50
FT101Z	FM unit	28.95	0.50
FV101Z	VFO	67.00	3.00
NC11C	Charger 290R	5.95	1.00
YM24A	Speaker mic	17.95	1.50
MH-1B8	Mic 8 pin	9.95	1.50
YM48	Condenser mic	10.95	1.50
M49	Speaker mic	14.95	1.50

ICOM		PRICE	P&P
ICPS15	20A PSU	95.00	4.00
ICM11	Scan mic	14.95	1.50
ICM9	Speaker mic	11.95	1.50
ICFL34	10.75 AM filter	19.95	1.00
ICCP1	Mobile charger lead	2.95	1.00
ICE57	FM unit R70	21.95	1.00
ICL23	Leather case IC2E	2.50	1.00

ACCESSORIES		PRICE	P&P
Vangorden	HI Q-1 balun 1-1	8.95	0.90
Vangorden	Trap formers pair	4.95	0.50
Drae	PSU 6 amps	38.95	3.50
SMC	PSU 4-5 amps	11.95	3.00
Drae	Morse tutor	42.95	2.00
SA450	Coaxial switch good quality	9.95	0.50
Dummy load	VHF 150W	24.95	1.00
Datong	Direction finder complete	129.95	3.50
Electronically locked slider mount		8.95	2.50
Keylocked slider mount Q1		4.95	2.00
Keylocked slider mount Q2		3.95	2.00



A well known + trusted Japanese name this 2 mtr. Hand held similar to IC2E comes complete with flexible Ant, charger, earphones, and carrying strap.

	PRICE	P&P
KT 200EE	125.00	3.75
Soft case	4.50	F.W.A.
Speaker Mic	14.95	F.W.A.
Mobile Ch/Lead	7.95	F.W.A.
Spare Batt/Pack	17.95	F.W.A.

F.W.A. = Free with above

AZTEC UHF/VHF ANTENNAS		PRICE	P+P
HB9CV	2 Ell. Yagi complete 2 mtr	4.50	1.50
AZZY8	8 Ell Yagi complete 2 mtr	16.00	3.50
AZZY10	10 Ell Yagi complete 2 mtr	19.50	4.50
AZZYX10	10 Ell crossed Yagi complete 2 mtr	22.95	5.00
AZZDY6	6 Ell Quad Driven Yagi 2 mtr	17.00	4.50
AZZY5	5 Ell Yagi 2 mtr kit	5.50	2.50
AZZY8	8 Ell Yagi 2 mtr kit	8.00	3.50
AZZY10	10 Ell 2 mtr kit	14.00	4.50
AZZYX5	5 Ell crossed Yagi kit	9.50	3.50
AZZYX10	10 Ell crossed Yagi kit	17.00	5.00
AZZY12	12 Ell crossed Yagi kit	23.00	7.50
AZZFD	Slim Jim 2 mtr	5.00	1.00
AZZFD	Slim Jim 2 mtr kit	3.50	1.00
AZZQ6	6 Ell Quad 2 mtr kit	14.00	5.00
AZZQ10	10 Ell Quad 2 mtr kit	22.50	7.50
AZZC158	2 x 3/8 CO/LIN complete	18.00	2.50
AZZCL5/8	2 x 3/8 CO/LIN kit	11.00	2.50
AZZY10D	2 x 10 Ell Yagi 70 cm complete	10.50	2.50
AZZY10D	2 x 10 Ell Yagi 70 cm dual boom complete	16.50	4.00
AZPM 11/6	Porto mast 116" complete	5.00	2.00
AZPM 17/6	Porto mast 176" complete	12.50	3.00
AZPM 23/3	Porto mast 2332 complete	19.50	4.50
AR1002	UHF/VHF Rotator	26.95	3.00
T.K. Brackets	12" Pair	3.50	2.00
- Do -	18" - Do -	4.50	2.25
- Do -	24" - Do -	5.50	2.50
Chimney Mounting Brackets Coup 6"		3.00	2.00
- Do - 12"		5.50	3.00

HIGH QUALITY SWR/PWR MTRS		PRICE	P&P
RF2000	3.5-150MHz 2Kw	15.95	1.50
YM11E	3.5-150MHz 200W	17.95	1.75
T435	144-435MHz W/thru line Watt mtr	29.95	2.00

OSCAR BLOCK AMONG THE VERY BEST		PRICE	P&P
SWR 200	3.5-150MHz 2KW	42.50	2.00
SWR 145	144MHz	34.95	2.00
427H	1.8-150MHz Auto SWR/peak power	62.95	5.00

HI MOUND MORSE EQUIPMENT		PRICE	P&P
HK808	Straight key marble base	29.95	2.00
MK705	Squeeze paddle marble base	17.95	2.00
MK703	Squeeze paddle shop/soiled	12.95	2.00
BK100	Mechanical bug	17.95	2.00

ANTENNAS MOBILE HF/VHF		PRICE	P&P
Oscar 10SE	10 mtrs. fold over	10.95	1.50
Oscar 15SE	15 mtrs fold over	11.95	1.50
Oscar 20SE	20 mtrs fold over	12.95	1.50
Oscar 78F	2 mtrs 7/8 fold over	10.95	1.50

SUN ANTENNAS SIMILAR TO OSCAR		PRICE	P&P
KG309 SE2	5/8 2 mtr	10.95	1.50
KG208 SE2	2 mtrs 7/8 fold over	11.95	1.50
KG5	2 mtr Co/lin	9.95	1.50
J BEAM	2 mtr Co/lin	7.95	1.50

BASE ANTENNA HF/VHF		PRICE	P&P
J BEAM	4 Ell Quad	24.95	3.50
J BEAM	BM 28/70 multi beam 70cm	17.95	2.75
J BEAM	VR3 10-15-20 mtr vertical	38.95	2.75
HYGAIN	12 AVQS 10-15-20 mtr vertical	44.95	2.75
OSCAR	3 x 3/8 CO/LIN 2 mtr S/S	29.95	3.50
SUN	LM 144 2 mtr/Dual Bander	11.95	2.00
SUN	LM 72 - Ditto	11.50	2.00

INSTANT CREDIT FOR ALL LICENCED AMATEURS  
**VIEWFLINT LIMITED**  
 ORKAY-MASTER, PENYCAEWAIR, NR USK, GWENT, S WALES  
 TEL 02915-352



# COMPUTER WAREHOUSE

1000's OF BARGAINS FOR CALLERS

## THE 'ALADDIN'S' CAVE OF COMPUTER AND ELECTRONIC EQUIPMENT

### RECHARGEABLE BATTERIES

Dry Fit Maintenance FREE by Sonnenschein.  
A300 07191315 12v 3 AH same as RS 591-770 NEW £13.95. A300 07191202 6.0 1.8 AH same as RS 591-382 EX EQUIP £4.99. Miniature PCB mount 3.6v 100 Mah as RS 591-477 NEW £1.00. SAFT VR2C 1.2v "C" size NICADS in 18 cell ex equipment pack. Good condition - easily split to single cells £10.50 + pp £1.90

### EX-STOCK INTEGRATED CIRCUITS

2732 ex equip £3.25. 27128 - 250ns NEW £12.00.  
6116-200 £4.50. 6116-250 £3.95.  
6284LP-150 £22.00. 4184-200 £3.50. 4864-150 £4.00.  
4118-300 £1.20. 2114 £1.75. 6800 £2.50. 6821 £1.00.  
68A09 £8.00. 68B09 £10.00. 68B09E £14.50.  
DB085AH-2 £12.00. DB086 £2.00. Z80A £2.99.

### HOT LINE DATA BASE

## DISTEL ©

THE ORIGINAL FREE OF CHARGE dial up data base  
1000's of stock items and one off bargains  
ON LINE NOW - 300 baud, full duplex CCITT tones. 8 bit word, no parity  
**01-679 1888**

### COMPUTER 'CAB'

All in one quality computer cabinet with integral switched mode PSU, Mains filtering, and twin fan cooling. Originally made for the famous DEC PDP8 computer system costing thousands of pounds. Made to run 24 hours per day the PSU is fully screened and will deliver a massive +5V DC at 17 amps, +15V DC at 1 amp and -15V DC at 5 amps. The complete unit is fully enclosed with removable top lid, filtering, trip switch, 'Power' and 'Run' LEDs mounted on Ali front panel, rear cable entries, etc. Units are in good but used condition - supplied for 240v operation complete with full circuit and tech man. Give your system that professional finish for only £49.95 + Carr Dim 19" wide 16" deep 10.5" high. Useable area 16" w. 10.5" h. 11.5" d. Also available LESS PSU with FANS etc. Internal dim 19" w. 16" d. 10.5" h. £19.95. Carriage & insurance £9.50

### COOLING FANS

Keep your hot parts COOL and RELIABLE with our range of BRAND NEW professional cooling fans.  
ETRI 90XUOI Dim. 92 x 92 x 25 mm. Miniature 240 v equipment fan complete with finger guard. £9.95.  
GOULD JB-3AR Dim. 3" x 3" x 2.5" compact very quiet running 240 v operation NEW £6.95.  
BUHLER 69.11.22. 8-16 v DC micro miniature reversible fan. Uses a brushless servo motor for extremely high air flow, almost silent running and guaranteed 10,000 hr life. Measures only 62 x 62 x 22 mm. Current cost £32.00. OUR PRICE ONLY £12.95 complete with data.  
MUFFIN-CENTAUR standard 4" x 4" x 1.25" fan supplied tested EX EQUIPMENT 240 v at £6.25 or 110 v at £4.95 or BRAND NEW 240 v at £10.50. 1000's of other fans Ex Stock. Call for Details. Post & Packing on all fans £1.60

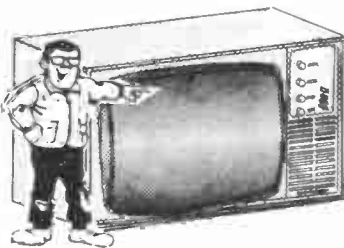

## PRICE BARRIER SHATTERED ON 16" RGB CASED COLOUR MONITORS

A scoop purchase from a major London Hotel enables us to offer this special converted DECCA 100 COLOUR video TV at a super low price of £99.00!! Low enough to suit any budget!! Solid state modular construction, 16" high definition PIL tube, which eliminates convergence problems and our own special modification results in 80 + column text definition and picture quality not seen on monitors costing three times as much!! In fact we guarantee you will be delighted with this product, the quality has to be seen to be believed. Supplied complete and ready to plug direct to a BBC MICRO COMPUTER or any other system with a TTL RGB output. Other features include internal audio amp and speaker, compact dimensions only 52cm W x 34 H x 24 D, auto degaussing circuit, attractive teak finished case, 30 day guarantee.

ONLY £99.00 + £10.00 CARR.

Also available unmodified complete with mod data (Mod costs less than £12.00) £80.00.

### EPROM COPIERS

The amazing SOFTY 2 The 'Complete Toolkit' for copying, writing, modifying and listing EPROMS of the 2516, 2716, 2532, 2732 range. Many other functions include integral keyboard, cassette interface, serial and parallel data i/o, UHF modulator, ZIF socket etc. ONLY £195.00 + PP £2.50.  
"GANG OF EIGHT" intelligent Z80 controlled gang programmer for ALL single 5v rail EPROMS upto 27128. Will copy 8 27128 in 10 min. ONLY 3 MINUTES!! Internal LCD display and checking routines for IDIOT PROOF operation. ONLY £395.00 + PP £3.00.  
"GANG OF EIGHT PLUS" same spec as above but with additional RS232 serial interface for down line loading data from computer etc. ONLY £445.00 + PP £3.00.  
Data sheets on request.

### SPECIAL 300 BAUD MODEM OFFER

Another GIGANTIC purchase of these EX BRITISH TELECOM, BRAND NEW or little used 2B data modems allows US to make the FINAL REDUCTION, and for YOU to join the exciting world of data communications at an UNHEARD OF PRICE OF ONLY £29.95. Made to the highest POST OFFICE APPROVED spec at a cost of hundreds of pounds each, the 2B has all the standard requirements for data base, business or hobby communications. All this and more!!

- 300 baud full duplex
- Full remote control
- CCITT tone standards
- Supplied with full data
- Modular construction
- Direct isolated connection
- CALL, ANSWER and AUTO modes
- Standard RS232 serial interface
- Built in test switching
- 240v Mains operation
- 1 year full guarantee
- Just 2 wires to comms line

NOW ONLY £29.95

Order now - while stocks last. Carriage and Ins. £10.00

### BUDGET RANGE VIDEO MONITORS

At a price YOU can afford, our range of EX EQUIPMENT video monitors defy competition!! All are for 240v working with standard composite video input. Units are pre tested and set for up to 80 col use on BBC micro. Even where MINOR screen burns MAY exist - normal data displays are unaffected.

1000's SOLD TO DATE  
12" KGM 320-321, high bandwidth input, will display up to 132 columns x 25 lines. Housed in attractive fully enclosed brushed alloy case. B/W only £32.95 GREEN screen £39.95  
24" KGM large screen black & white monitor fully enclosed in light alloy case. Ideal schools, shops, clubs etc. ONLY £55.00 Carriage £10.00

### DATA MODEMS

Join the communications revolution with our super range of DATA MODEMS with prices and types to suit all applications and budgets!! Most modems are EX BRITISH TELECOM and are made to the highest standard for continuous use and reliability. RS232 interfaces are standard to all our modems, so will connect to ANY micro etc. with an RS232 serial interface.

DATEL 2B see SPECIAL OFFER centre of this ad  
MODEM 13A, 300 baud. Compact unit only 2" high and same size as telephone base. Standard CCITT tones, CALL mode only. Tested with data. ONLY £45.00 + PP £4.95.  
MODEM 20-1, 75-1200 baud. Compact unit for use as subscriber end to PRESTEL, MICRONET or TELECOM GOLD. Tested with data. £39.95 + PP £6.50.  
MODEM 20-2 same as 20-1 but 1200-75 baud £99.00.  
TRANSDATA 307A. 300 baud acoustic coupler. Brand new with RS232 interface. £95.00 + PP £6.50.  
DACOM DSL2123 Multi Standard Modem, switchable CCITT or USA BELL 103 standard. V21 300-300, V23 75-1200, V23 1200-75 or 1200-1200 half duplex. Auto answer via MODEM or CPU. CALL or ANSWER modes plus LED status indication. Dim 2.5 x 8.5 x 9 BRAND NEW fully guaranteed ONLY £268.00 + PP £4.50.  
DATEL 2412 Made by SE LABS for BT this two part unit is for synchronous data links at 1200 or 2400 baud using 2780/3780 protocol. Many features include Auto answer, 2 or 4 wire working etc. COST OVER £800. OUR PRICE £185.00.  
DATEL 4800, RACAL MPS4800 high speed good condition £285.00 CARR £10.00

### SAVE £250 SUPER PRINTER SCOOP

BRAND NEW CENTRONICS 739-2



ONLY £199

The "Do Everything Printer" at a price that will NEVER be repeated. Standard CENTRONICS parallel interface for direct connection to BBC, ORIC, DRAGON etc. Superb print quality with full pin addressable graphics and 4 type fonts plus HIGH DEFINITION internal PROPORTIONAL SPACED MODE for WORD PROCESSOR applications 80-132 columns, single sheet sprocket or roll paper handling plus much more. Available ONLY from DISPLAY ELECTRONICS at the ridiculous price of ~~£419.95~~ + VAT. Complete with full manual etc. Limited quantity - Hurry while stocks last.  
Options: Interface cable (specify for BBC, ORIC, DRAGON or CENTRONICS 36 way pig £12.50. Spare ribbon £3.50 each. BBC graphics screen dump utility program £8.60. Carriage and Ins £10.00 + VAT

### HUNDREDS OF PRINTERS EX STOCK FROM £49.00. Call Sales Office for Details.

1 only large CALCOMP 1036 AO 3 pen drum plotter and offline 915 magtape controller. Good working order. £2500.00.

### DISK DRIVE SPECIALS

SIEMENS FDD-100-5 5 1/4" 40 track single sided. Ex new equipment tested, guaranteed working. Complete with data £73.00  
SHUGART SA400 5 1/4" 35 track, single sided. Ex equipment, guaranteed working £33.00  
SHUGART SA800, SA850 8" drives plus spares EX Stock call for prices.  
Hard disk drives.  
Large quantities of HARD DISK drives currently EX STOCK including:  
DRE series 30 mb Front Load for DEC, NOVA etc  
DIABLO 44/DRE 4000 A, B 5+5 mb cartridge drive  
CDC HAWK 5+5 mb cartridge drive as new condition  
CDC 9762 80 mb DEC RM03 compatible  
PERTEC D3422 5+5 cartridge drive  
Large quantities of spares and controllers available for S100, DEC, HONEYWELL, DATA GENERAL. Call sales office for details.  
IN HOUSE disk drive refurbishing service - call for competitive quotations!!  
**ADD VAT TO ALL PRICES**

### EX STOCK DEC CORNER

PDP 1140 System comprising of CPU, 124k memory + MMU 16 line RS232 interface, RP02 40 MB hard disk drive, TU10 9 track 800 BPI Mag tape drive, dual rack system, VT52 VDU etc. etc. Tested and run ining. £3750.00  
BA11 MB 3.5" Box, PSU, LTC £385.00  
DH11-AD 16 x RS232 DMA interface £2100.00  
DLV11-J 4 x EIA interface £310.00  
DUP11 Sych. Serial data i/o £850.00  
DQ200 Dilog - multi RK controller £495.00  
DZ11-B 8 line RS232 mux board £650.00  
LA36 Decwriter EIA or 20 ma loop £270.00  
LAXX-NP LA180 RS232 serial interface and buffer option £130.00  
LAX34-AL LA34 tractor feed £85.00  
MS11-JP Unibus 32 kb Ram £80.00  
MS11-LB Unibus 128 kb Ram £450.00  
MS11-LD Unibus 256 kb Ram £850.00  
MSC4804 Qbus (Equip MSV11-L) 256 kb £499.00  
PDP11/05 Cpu, Ram, i/o, etc. £450.00  
PDP11/40 Cpu, 124k MMU £1850.00  
RT11 ver. 3B documentation kit £70.00  
RK05-J 2.5 Mb disk drives £650.00  
KLBJA PDP 8 async i/o £175.00  
MIBE PDP 8 Bootstrap option £75.00  
VT50 VDU and Keyboard - current loop £175.00  
VT52 VDU with RS232 interface £230.00

1000's of EX STOCK spares for DEC PDP8, PDP11, PDP11 systems & peripherals. Call for details. All types of Computer equipment and spares wanted for PROMPT CASH PAYMENT.

# DISPLAY ELECTRONICS

All prices quoted are for U.K. Mainland, paid cash with order in Pounds Sterling PLUS VAT. Minimum order value £2.00. Minimum Credit Card order £10.00. Minimum BONA FIDE account orders from Government Depts., Schools, Universities and established companies £20.00. Where post and packing not indicated please ADD £1.00 + VAT. Warehouse open Mon-Fri 9.30-5.30. Sat 10.30-5.30. We reserve the right to change prices and specifications without notice. Trade, Bulk and Export  
32 Biggin Way, Upper Norwood, London SE19 3XF  
Telephone 01-679 4414 Telex 27924



**PHONE**  
0474 813225  
3 LINES



**P.M. COMPONENTS LTD**  
DEPT AR SELECTION HOUSE, WROTHAM ROAD  
MEOPHAM GREEN, MEOPHAM, KENT DA13 0QY

**TELEX**  
966371  
**PM COMP**

**INTEGRATED CIRCUITS**

AN124	2.50	MC1327Q	0.96	STK415	7.95	TBA750Q	2.85
AN209	2.50	MC1330P	1.10	STK435	5.95	TBA800	0.89
AN239	2.50	MC1345P	1.20	STK435	7.95	TBA810A5	0.89
AN240P	2.50	MC1350P	0.98	STK437	1.00	TBA810P	1.06
AN264	2.50	MC1349P	1.20	STK461	11.50	TBA820M	0.75
AN612	2.16	MC1350P	0.95	TA7061AP	1.50	TBA850	2.50
AN362L	2.50	MC1351P	1.50	TA7108P	1.50	TBA920	1.06
AN7140	3.50	MC1357	2.35	TA7120P	1.85	TBA950/2X	
AN7145	3.50	MC1358	1.58	TA7129P	2.50		
AN7145M	3.06	MC1496	3.00	TA7130P	1.50		
AN7150	2.95	MC1496	1.25	TA7137P	1.00		
BA521	3.35	MC145106P		TA7146	3.95		
CA1352E	1.76	MC1723	0.50	TA7176AP	2.95		
CA3086	0.48	MC3357	2.75	TA7203	2.95		
CA3140E	1.06	SA45010	1.75	TA7204P	2.95		
CA3140T	1.15	SA5560S	1.75	TA7205AP	2.15		
ET7016	2.50	SA5570S	1.75	TA7222AP	4.8		
HA1335A	2.95	SA5580	2.85	TA7227P	1.2		
HA1366W	3.75	SA/5B/77U		TA7310P	1.8		
HA1377	2.50	SL9019	1.00	TA7313AP	2.9		
HA1156W	1.80	SL917B	6.85	TA7317P	1.04		
HA1551	2.95	SL1310	1.80	TA7317P	2.05		
LA1230	1.15	SL1327	1.10	TA7314P	1.05		
LA4102	2.95	SN7603N	1.85	TA7321P	2.25		
LA4140	2.95	SN7603N	1.85	TA7619P	3.15		
LA4031P	1.95	SN7603N	1.85	TA7619P	2.95		
LA4410	2.95	SN76110N	0.89	TA7619P	2.95		
LA4461	3.95	SN76115N	1.25	TA7619P	2.95		
LA4250	2.95	SN7622N	1.30	TA7619P	2.95		
LA4420	1.95	SN7622N	1.30	TA7619P	2.95		
LA4430	2.95	SN7622N	1.30	TA7619P	2.95		
LA4400	4.15	SN7622N	1.30	TA7619P	2.95		
LA4422	2.95	SN7622N	1.30	TA7619P	2.95		
LA4461	3.95	SN7622N	1.30	TA7619P	2.95		
LC7120	3.25	SN7622N	1.30	TA7619P	2.95		
LC7130	3.50	SN7622N	1.30	TA7619P	2.95		
LC7131	3.50	SN7622N	1.30	TA7619P	2.95		
LC7137	8.10	SN7622N	1.30	TA7619P	2.95		
LM1011	3.50	SN7622N	1.30	TA7619P	2.95		
LM324N	0.48	SN7622N	1.30	TA7619P	2.95		
LM3808N	1.80	SN7622N	1.30	TA7619P	2.95		
LM3808N	1.75	SN7622N	1.30	TA7619P	2.95		
LM3837	2.95	SN7622N	1.30	TA7619P	2.95		
M51513L	2.90	SN7622N	1.30	TA7619P	2.95		
M5155L	2.95	SN7622N	1.30	TA7619P	2.95		
M51521L	1.90	SN7622N	1.30	TA7619P	2.95		
MB3712	1.90	SN7622N	1.30	TA7619P	2.95		
MB3756	2.50	SN7622N	1.30	TA7619P	2.95		
MC1307P	1.00	SN7622N	1.30	TA7619P	2.95		
MC1310P	0.95	SN7622N	1.30	TA7619P	2.95		
MC1327	1.85	SN7622N	1.30	TA7619P	2.95		

**NEW BRANDED CATHODE RAY TUBES**

TDA2560	2.18	D14-270GH/50	75.00	M26-13LG	40.00	V3191	95.00
TDA2571	2.98	D14-310W	110.00	M26-13GR	40.00	V4150LC	86.00
TDA2571	2.25	D14-320GH	85.00	M26-131GR	85.00	V4254B	86.00
TDA2582	2.95	D14-340GH/82	85.00	M26-132GM	85.00	V4274GH	86.00
TDA2593	2.95	D14-340GH/KM	48.00	M26-133GM	85.00	V4283W	86.00
TDA2600	3.95	D14-340KA	48.00	M31-100GH	85.00	V5002LD	86.00
TDA2610	2.50	D16-100GH	85.00	M31-101GH	85.00	V5004GR	86.00
TDA2611A	1.95	D16-100GH/65	85.00	M31-182GR	85.00	V5004LD	86.00
TDA2640	2.60	D16-100GH/7	85.00	M31-182GR	85.00	V8001GH	86.00
TDA2680A	2.75	D16-100GH/79	85.00	M31-184W	85.00	V8002GH	86.00
TDA2690	2.45	D16-100GH/79A	85.00	M31-184GH	85.00	V8007GH	86.00
TDA2730	2.95	D16-100GH/79A	85.00	M31-184GH	85.00	V8008GH	86.00
TDA2800	2.50	D16-100GH/79A	85.00	M31-185GH/VR	85.00	V8009GH	86.00
TDA2903	3.15	D16-100GH/79A	85.00	M31-186W	85.00	V8010GH	86.00
TDA3560	3.95	D16-100GH/79A	85.00	M31-190GR	85.00	V8011GH	86.00
TEA1099	1.35	D16-100GH/79A	85.00	M31-190GR	85.00	V8012GH	86.00
UPC566H	2.95	D16-100GH/79A	85.00	M31-190GR	85.00	V8013GH	86.00
UPC1025H	1.85	D16-100GH/79A	85.00	M31-190GR	85.00	V8014GH	86.00
UPC1028H	1.95	D16-100GH/79A	85.00	M31-190GR	85.00	V8015GH	86.00
UPC1032H	1.50	D16-100GH/79A	85.00	M31-190GR	85.00	V8016GH	86.00
UPC1156H	2.75	D16-100GH/79A	85.00	M31-190GR	85.00	V8017GH	86.00
UPC1158H	0.75	D16-100GH/79A	85.00	M31-190GR	85.00	V8018GH	86.00
UPC1167C	1.15	D16-100GH/79A	85.00	M31-190GR	85.00	V8019GH	86.00
UPC1181H	1.25	D16-100GH/79A	85.00	M31-190GR	85.00	V8020GH	86.00
UPC1182H	2.95	D16-100GH/79A	85.00	M31-190GR	85.00	V8021GH	86.00
UPC1185H	3.95	D16-100GH/79A	85.00	M31-190GR	85.00	V8022GH	86.00
UPC1191V	1.50	D16-100GH/79A	85.00	M31-190GR	85.00	V8023GH	86.00
UPC1350C	2.95	D16-100GH/79A	85.00	M31-190GR	85.00	V8024GH	86.00
UPC1353C	2.48	D16-100GH/79A	85.00	M31-190GR	85.00	V8025GH	86.00
UPC1355C	3.95	D16-100GH/79A	85.00	M31-190GR	85.00	V8026GH	86.00
UPC2002H	1.95	D16-100GH/79A	85.00	M31-190GR	85.00	V8027GH	86.00
555	0.35	D16-100GH/79A	85.00	M31-190GR	85.00	V8028GH	86.00
556	0.42	D16-100GH/79A	85.00	M31-190GR	85.00	V8029GH	86.00
723	0.50	D16-100GH/79A	85.00	M31-190GR	85.00	V8030GH	86.00
741	0.35	D16-100GH/79A	85.00	M31-190GR	85.00	V8031GH	86.00
747	0.50	D16-100GH/79A	85.00	M31-190GR	85.00	V8032GH	86.00
748	0.35	D16-100GH/79A	85.00	M31-190GR	85.00	V8033GH	86.00
7808	0.85	D16-100GH/79A	85.00	M31-190GR	85.00	V8034GH	86.00
7805	0.85	D16-100GH/79A	85.00	M31-190GR	85.00	V8035GH	86.00
7815	0.85	D16-100GH/79A	85.00	M31-190GR	85.00	V8036GH	86.00

**SEMICONDUCTORS**

AA12	0.28	BC178	0.15	BD237	0.40	BFW92	0.85
AC126	0.48	BC182	0.10	BD238	0.40	BFX29	0.30
AC127	0.20	BC182LB	0.10	BD242	0.85	BFX84	0.26
AC128	0.20	BC183	0.10	BD246	0.78	BFX85	0.32
AC128K	0.32	BC183L	0.09	BD376	0.32	BFX86	0.30
AC141	0.28	BC184	0.09	BD410	0.85	BFX88	0.25
AC141K	0.34	BC184LB	0.09	BD434	0.85	BFY50	0.21
AC142K	0.30	BC207B	0.13	BD437	0.78	BFY52	0.25
AC176	0.22	BC208B	0.13	BD438	0.78	BFY90	0.77
AC176K	0.31	BC212L	0.09	BD538	0.85	BLY48	1.75
AC187	0.28	BC212L	0.09	BD538	0.85	BR100	0.26
AC187K	0.28	BC212LA	0.09	BD597	1.25	BR101	0.49
AC188K	0.37	BC213	0.09	BD701	1.25	BR303	0.55
AD142	0.70	BC213L	0.09	BD702	1.28	BR303	0.55
AD143	0.82	BC214C	0.09	BD707	1.00	BR303	0.55
AD149	0.70	BC214L	0.09	BDX32	1.80	BRC443	1.15
AD161	0.39	BC237B	0.09	BDY51	1.85	BT100A/020.85	
AD162	0.39	BC238	0.09	BF115	0.35	BT106	1.49
AD1612	0.90	BC239	0.12	BF127	0.85	BT116	1.20
AF108	0.50	BC251A	0.12	BF158	0.20	BT119	3.15
AF114	1.86	BC252A	0.12	BF158	0.22	BT210	1.85
AF121	0.80	BC258A	0.39	BF160	0.27	BT210	1.85
AF124	0.86	BC284	0.30	BF167	0.27	BT210	1.85
AF125	0.38	BC300	0.30	BF177	0.22	BU124	1.25
AF126	0.32	BC301	0.30	BF178	0.22	BU126	1.60
AF127	0.85	BC303	0.28	BF179	0.34	BU204	1.95
AF139	0.40	BC307B	0.09	BF180	0.29	BU205	1.30
AF150	0.80	BC321	0.10	BF181	0.29	BU208	1.39
AF178	1.95	BC322	0.10	BF182	0.29	BU208A	1.52
AF239	0.42	BC323	0.10	BF183	0.29	BU209D	1.65
AU106	4.80	BC337	0.10	BF184	0.29	BU326	1.10
AU107	3.50	BC338	0.09	BF185	0.29	BU326S	1.50
AU110	2.80	BC347A	0.13	BF186	0.29	BU407	1.24
AY102	2.95	BC461	0.35	BF194	0.11	BU500	2.25
BC107A	0.11	BC478	0.20	BF195	0.11	BU526	1.90
BC107B	0.11	BC527	0.20	BF196	0.11	BU807	2.25
BC108	0.10	BC548	0.10	BF197	0.11	BU900	2.15
BC108A	0.11	BC549A	0.10	BF198	0.11	BU900	2.15
BC109	0.10	BC550	0.14	BF199	0.14	MJ3000	1.98
BC109B	0.12	BC557	0.08	BF241	0.18	MJE340	0.40
BC110C	0.12	BC557B	0.08	BF245	0.30	MJE520	0.48
BC114A	0.09	BC558	0.10	BF257	0.28	MJE2955	
BC115A	0.19	BC558/10	0.30	BF258	0.28	MPSA13	0.20
BC116	0.19	BC559	0.10	BF259	0.28	MPSA92	0.30
BC119	0.24	BD115	0.60	BF271	0.28	MRF237	3.45
BC125	0.28	BD116	0.60	BF273	0.18	MRF450A	
BC139	0.20	BD124P	0.59	BF336	0.34	12.50	
BC140	0.31	BD131	0.42	BF337	0.32	MRF453	17.50
BC141	0.28	BD132	0.42	BF338	0.32	MRF454	23.50
BC142	0.21	BD133	0.42	BF355	0.37	MRF475	2.50
BC143	0.24	BD135	0.30	BF362	0.38	MRF477	10.00
BC147A	0.09	BD136	0.30	BF363	0.38	OC16W	1.95
BC147B	0.09	BD137	0.32	BF371	0.25	OC29	1.50
BC148A	0.09	BD138	0.32	BF374	0.25	OC29	2.25
BC148B	0.09	BD139	0.32	BF422	0.32	OC36	2.25
BC149	0.09	BD140	0.30	BF423	0.28	OC42	0.55
BC153	0.20	BD144	0.10	OC45	0.55	OC44	0.75
BC157	0.12	BD150C	0.29	OC70			





# QUESTIONS & ANSWERS

RAE PRACTICE DEvised BY R.E.G. PETRI G8CCJ

1. The PN junction shown in *Figure 1* is:  
 (a) forward biased  
 (b) reverse biased  
 (c) back biased  
 (d) non-conducting

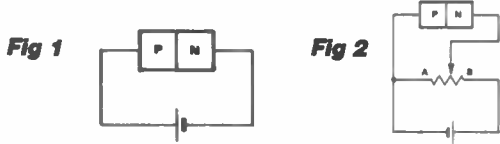

2. When the wiper of the potentiometer shown in *Figure 2* reaches the positive end at B the:  
 (a) deflection layer will be at its widest  
 (b) deflection layer will oscillate  
 (c) diode will conduct  
 (d) battery will be short-circuited

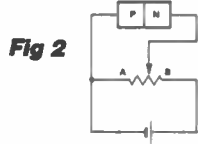

3. *Figure 3* shows a forward biased silicon diode. What potential difference would you expect to measure between the anode and cathode (X)?  
 (a) 0.25V  
 (b) 0.40V  
 (c) 0.70V  
 (d) 0.95V

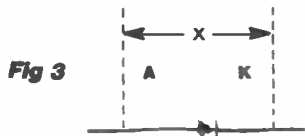

4. If the diode shown in *Figure 3* is substituted for a forward biased germanium diode what will be the expected potential difference across the diode (X)?  
 (a) 0.25V  
 (b) 0.40V  
 (c) 0.70V  
 (d) 0.95V



5. *Figure 4* shows a semiconductor device. Which one of the following symbols is most likely to represent it?



6. The symbol chosen for your answer to question 5 is that of a:  
 (a) dual-gate MosFET  
 (b) triac  
 (c) field-effect transistor  
 (d) NPN transistor
7. The maximum reverse voltage that a diode can withstand before breakdown is known as the:  
 (a) maximum load voltage  $V_L$   
 (b) peak load voltage  $V_{PK}$   
 (c) maximum back EMF  $V_{BEMF}$   
 (d) peak inverse voltage  $P_{IV}$

8. *Figure 5* shows the circuit symbol of a:  
 (a) charger rectifier  
 (b) charger diode  
 (c) Zener diode  
 (d) light-emitting diode

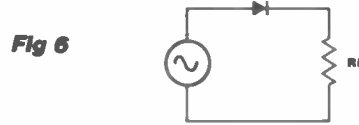

9. Which one of the following waveforms would be observed as an oscilloscope connected across the load resistor  $R_L$  (*Figure 6*)?

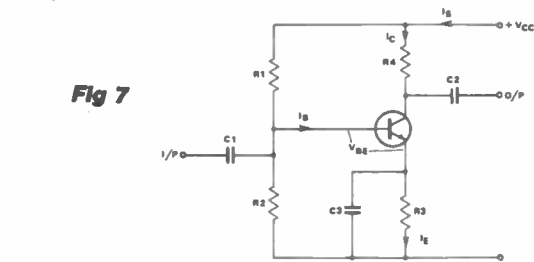
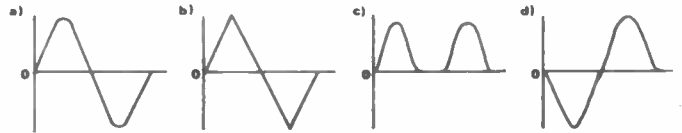

10. *Figure 7* shows the circuit of a typical:  
 (a) common-emitter amplifier  
 (b) common-base amplifier  
 (c) common-collector amplifier  
 (d) common-drain amplifier
11. Referring to *Figure 7*, for good dc stability, the bleed current flowing in the potential divider  $R_1$  and  $R_2$  should be:  
 (a) at least equal to the base current  
 (b) about one tenth of the base current  
 (c) twice the supply current  $I_S$   
 (d) about ten times the base current  $I_B$
12. Referring to *Figure 7*, the capacitor  $C_3$  should have a low reactance at the operating frequencies to:  
 (a) produce negative feedback  
 (b) prevent negative feedback and subsequent reduction in gain  
 (c) prevent oscillation  
 (d) change the sign of the input waveform
13. The current flowing in the emitter resistor  $R_3$ , *Figure 7*, is:  
 (a) equal to the base current  $I_B$   
 (b) the sum of the base current and the collector current  $I_B + I_C$   
 (c) the collector current minus the base current  $I_C - I_B$   
 (d) the supply current plus the collector current  $I_S + I_C$
14. For the common-emitter circuit it may be said that the:  
 (a) emitter is common to both the input and the output  
 (b) circuit is rather common and should be avoided  
 (c) emitter supplies the power for the amplifier  
 (d) collector supplies the power for the amplifier
15. Typical values of input/output impedance for the common emitter amplifier could be about:  
 (a) 10-50 $\Omega$ /10-50 $\Omega$   
 (b) 50-500 $\Omega$ /100-500 $\Omega$   
 (c) 1-5K $\Omega$ /5-30K $\Omega$   
 (d) 1-5M $\Omega$ /5-50M $\Omega$



# QUESTIONS & ANSWERS

**Fig 8**

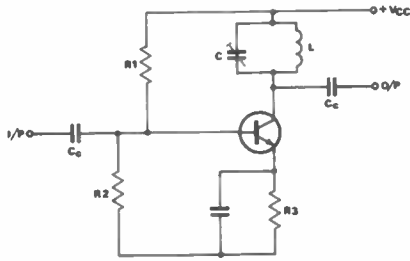

16. Figure 8 shows a common-emitter tuned collector amplifier. The selectivity is determined by the:
- ratio  $R1/R2$
  - current gain of the transistor
  - supply voltage  $V_c$
  - tuned circuit

**Fig 9**

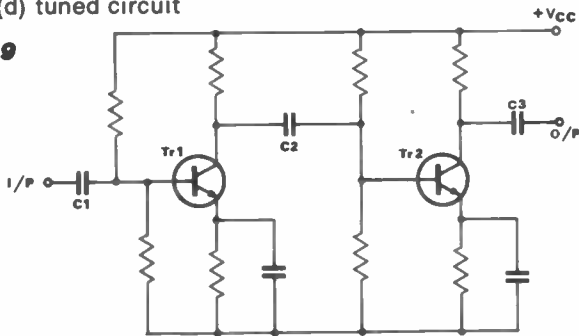

17. Figure 9 shows the circuit of a two stage RC coupled amplifier. One of the factors which limit the high frequency response is:
- stray capacitance which shunts the signal
  - the amount of ripple on the supply voltage
  - solar activity
  - orientation of the amplifier relative to the Earth's magnetic field
18. Referring to Figure 9, what is the purpose of capacitor C2?
- to improve low frequency response
  - to set the bias voltage for Tr1
  - to couple the signal from Tr1 to Tr2 without blocking the dc conditions
  - to prevent oscillation due to the high voltage gain of the two stages

19. What is the configuration of the circuits shown below?

- common-emitter
- common-base
- common-collector
- split stator

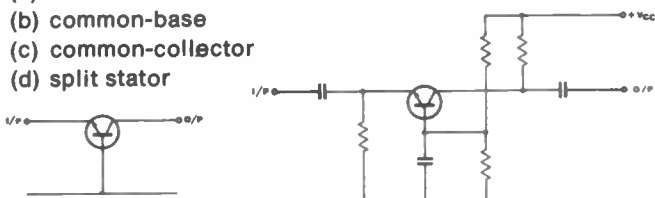

20. The current gain of the common-base amplifier is:

- less than unity,  $<1$
- greater than unity,  $>1$
- unity
- 10-100 amps

21. What values of input/output impedance would be fairly typical of a common-base amplifier?

- 10-200 $\Omega$ /100K $\Omega$ -1M $\Omega$
- 1-5K $\Omega$ /5-30K $\Omega$
- 1-5M $\Omega$ /5-30M $\Omega$
- 10-20K $\Omega$ /5-30M $\Omega$

**Fig 10**

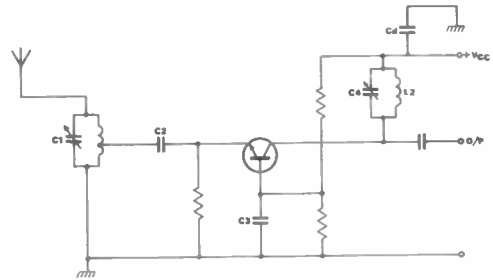

22. Figure 10 shows the circuit of a typical:
- common-emitter RF amplifier
  - common-base RF amplifier
  - common-collector power amplifier
  - low-noise dc amplifier

**Fig 11**

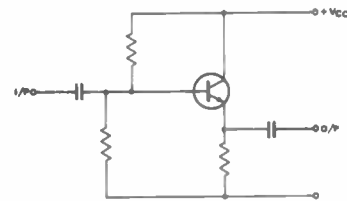

23. What is the circuit configuration of the amplifier shown in Figure 11?

- common-emitter
- common-collector
- common-drain
- insulated base

24. What is the voltage gain of the amplifier shown in Figure 11?

- less than unity,  $<1$
- greater than unity,  $>1$
- unity
- greater than 100

25. The common-collector amplifier (emitter follower) is useful:

- when high voltage gains are required
- when negative power gains are required
- for matching low voltage batteries to high voltage circuits
- for matching high to low impedances

**Fig 12**

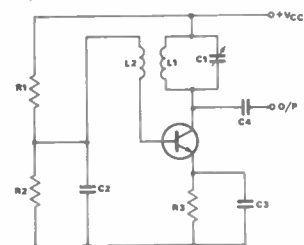

26. What is the circuit shown in Figure 12?

- common-collector RF amplifier
- common-base RF amplifier
- common-emitter tuned collector oscillator
- common-base tuned emitter oscillator

27. The frequency of the oscillator shown in Figure 12 is determined by components:

- $R1$  and  $R2$
- $R3$  and  $C3$
- $L2$  and  $C2$
- $L1$  and  $C1$

# QUESTIONS & ANSWERS

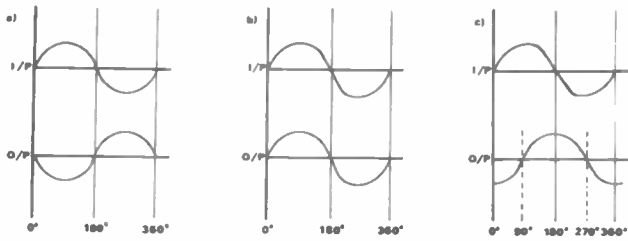

28. Arrange the waveforms shown above to represent the phase relationship of the input and output signals of common-emitter, common-base and common-collector amplifiers respectively.

- (a) a, b, b      (b) a, a, b      (c) c, b, a      (d) a, b, c

**Fig 13**

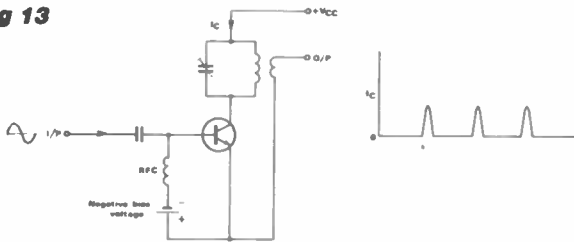

29. Figure 13 shows the typical circuit and collector current waveform of a:

- (a) class A AF amplifier  
(b) class B AF amplifier  
(c) class A RF amplifier  
(d) class C RF amplifier

30. A common application for the circuit shown in Figure 13 is:

- (a) high power audio amplification  
(b) general purpose audio amplification  
(c) medium power rectification  
(d) RF power amplification

**Fig 14**

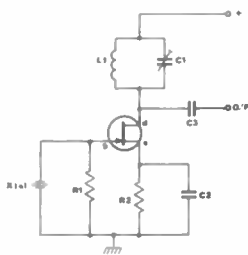

31. The circuit shown in Figure 14 uses a field-effect transistor (FET). What is the circuit?

- (a) a high stability mixer stage  
(b) a crystal controlled IF amplifier  
(c) a crystal controlled oscillator  
(d) a microphone amplifier

32. The three connections or lead-outs of the junction FET shown in Figure 14 are:

- (a) drain, grid, screen  
(b) diode, silicon, getter  
(c) source, drain, gate  
(d) screen, grid, detect

33. Fine tuning of the output frequency of the circuit shown in Figure 14 is achieved in practice by:

- (a) placing a variable capacitor of suitable value across the crystal  
(b) slowly swapping the positions of L1 & C1  
(c) replacing R2 with a 10-60pF variable capacitor  
(d) adjusting the battery voltage

**Fig 15**

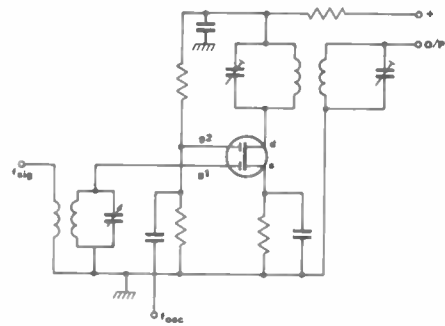

34. The circuit shown in Figure 15 is that of a typical dual-gate MosFET:

- (a) attenuation circuit  
(b) power amplifier stage  
(c) mixer, or frequency changer stage  
(d) voltage controlled oscillator

35. The advantages of using a dual-gate MosFET in the circuit of Figure 15 include:

- (a) heavy loading of both the input signals and the power supply  
(b) low impedance at g1 and variable impedance at g2  
(c) low conversion gain and high intermodulation  
(d) high input impedances at g1 and g2 and high conversion gain

This is the second part of a series of multiple choice questions and answers which I have prepared to follow Bill Mantovani's series *Back to Basics*.

The questions will hopefully provide the stimulus and guidance for more in-depth reading of this part of the syllabus.

Attempt to understand some of the basic physics, especially the PN junction

diode, remembering in which direction it is forward and back biased. This is a favourite question and is of course important to know when experimenting in the shack.

Practice circuit recognition from diagrams in the magazines, and remember that your RAE lecturer cannot cover every possible circuit arrangement that you might encounter.

## Now let's plug the book . . .

For more question and answer practice Ray Petri's book *The Radio Amateurs' Q & A reference manual* is available from:

W P Publications,  
11 Wayville Road,  
Dartford, Kent DA1 1RL.  
Price £5.95 & £1.00 P&P

The book contains 20 sections of multiple choice questions and answers which follows the RAE syllabus in roughly the same order than any recognised RAE course would progress, making it an ideal source of course homework.

The book is also available from your local emporium.

Now turn the magazine upside down and see how many you got right!

## ANSWERS

1 - a; 2 - a; 3 - c; 4 - a; 5 - b; 6 - d; 7 - d; 8 - c; 9 - c; 10 - a; 11 - d; 12 - b; 13 - b; 14 - a; 15 - c; 16 - d; 17 - a; 18 - c; 19 - b; 20 - a; 21 - a; 22 - b; 23 - b; 24 - a; 25 - d; 26 - c; 27 - d; 28 - a; 29 - d; 30 - d; 31 - c; 32 - c; 33 - a; 34 - c; 35 - d.



# WPO COMMUNICATIONS

20 FARNHAM AVENUE, HASSOCKS G3WPO  
WEST SUSSEX BN6 8NS MAIL ORDER ONLY

24hr  
ANSAPHONE

07918 6149



## DSB/CW DSB80 2w+

Still our most popular kit with over 1000 sold! Suits beginners and will build a sensitive 80 metre VFO controlled Tx/Rx for DSB or CW — kit can be modded for 160m if preferred. Basic pcb kit (only needs psu/mic/speaker) complete for £37.45. Punched case & Hardware @ £24.45 and digital display option at £24.10.

All above for £79.00 + 12v operation.



only  
£37.45  
Basic Kit

## UNIVERSAL MORSE MEMORY

Our unique design which works with Hand keys! 10-120 sec message length at any input/output speed. Memory back-up, sidetone, battery or external supply. SPECIAL MS VERSION now available with 1-15 sec message length.



£49.50  
READY  
BUILT

See previous ads for more details

## ALPHA — SINGLE BAND SSB/CW 50W TRANSCEIVER KIT

160M  
or  
20M



NEW LOW PRICE — £179.95 complete! To quote a customer 'Very pleased with the kit, and you must be congratulated on the standard of the design, which is excellent'. 90dB + Dynamic range, PLL VFO, Digital display, Blanker, IF Gain, Custom Finished Case with mobile bracket etc etc. Join the ALPHA builders! Comprehensive instructions & drawings.

WE SPECIALISE in kits for the home constructor. Why not try something from us soon? Many kits are suitable for beginners and come with comprehensive instructions, drilled board pcb and pot/wire etc. Our products are used worldwide and can help YOU get on the air to work the world or the locals. Many other products under development — watch this space for details. Most kits have pcbs and instructions only available. Our full catalogue is available for 50p in stamps (no cheques etc) or short form for SAE. Kits are sent in 10 days but allow up to 20 days for delivery of popular items if not in stock. Export Europe (inc UK) (inc Rest of World UK 15% A/P) plus outside post & VAT. Leave your credit card orders on our ansaphone.

## BUILD AS PORTABLE OR BASE STATION 2m TRANSCEIVER

Get on 2m FM! 6 channel max. 1W+ Tx and ideal for beginners. These are popular kits with Rx @ £39.50 & Tx £32.90. Both kits for £68. Verocase (undrilled) to make portable rig £7.50. 2M FM TRANSCEIVER

£68!



## VFO & OTHER KITS

MINISYNTH — As used in the DSB2. 1 band simple PLL VFO — versions for most bands and i.f.'s. Full kit with tuning cap ONLY £29.70. VHF MINISYNTH, 2 Meter version with 2 MHz coverage for Rx & Tx, repeater options — full kit £38.50. SPEECH PROCESSOR — very popular kit to get through to the DX — ONLY £13.90. 1 — 30 MHz RF PREAMP — 15dB gain (usable with G3ZVC/G4CLF i.f.'s) — Kit only £13.50. Coming soon — sort out that microphone (or your voice) with our unique fully tunable PARAMETRIC EQUALISER — drop us an SAE for more details.

## NEW micron



OUR LATEST TRANSCEIVER KIT, sets new standards in QRP performance — LOOK AT THESE FEATURES — a 6 band CW only 8/10W output rig covering the 80, 40, 30, 20, 15 & 10m bands (bottom 200KHz of each). 0.25uV sensitivity receiver, featuring AGC, with S Meter. Stable 2 speed VFO with IRT (Spot facility), 1W AF output to speaker, and 3 position LC filter + switchable attenuator. Silent solid state Rx/Tx switching with fast semi break-in and shaped keying. Sidetone facility. Fully variable RF power output from OW to full power metering. Needs +12v/14v supply.

PLUS CUSTOM punched & painted aluminium case/hard-ware and speaker with unique facility for optional INTERNAL ATU (Transmatch type) & SWR metering. DIGITAL READOUT option. The MICRON uses a compact single pcb design with easy step-by-step assembly instructions and drawings designed for the relative newcomer — minimal test equipment needed! Mostly prewound coils and transformers.

PRICES: Basic pcb kit inc VFO capacitor/drive/ enclosure, for 2 bands (state which) £99.45 — extra bands £11.75 each. Full pcb kit for 6 bands Tx/Rx £145. Case £46.20. COMPLETE KIT WITH CASE/6 BANDS £182.50. Optional extras — Digital readout (LCD) kit £33.56, and ATU Kit (for internal mounting) with SWR/Power metering at £37.00. COMPLETE KIT/CASE WITH DISPLAY AND ATU — £241.00.

Please phone or write for full brochure on the MICRON or place your order now!

**NEXT MONTH**

# Amateur RADIO

all the regulars. . .

DX Diary  
On the Beam  
Back to Basics  
SWL  
Straight and Level  
Your letters and features covering the whole of Amateur Radio

## RECEIVER SPECIAL

A beast that got so big we couldn't fit it in this month - classic receivers, receiver reviews, receiver alignment and the new state-of-the-art FRG 8800 on test.

## ANGUS MCKENZIE TESTS

The muTek 50MHz transverter, the Trio TH41E 70cm 'talk man' - and an amazing new rig from Japan.

**DON'T MISS THE APRIL ISSUE**  
On sale 28 March

# SECONDHAND EQUIPMENT GUIDE



The day after I posted last month's copy to the printers I received two letters, both detailing good examples of the common faults I had just described. The first was from G8GI and refers to a common fault on the TS530S, whereby the aerial changeover relay case distorts as it gets warm. This eventually prevents the relay contacts moving properly, leading to the PA running into no load and resulting in PA failure. Thanks for the tip.

The second letter was from G3JKV, who details a common fault on the IC720: poor receive sensitivity after band changing due to no dc flowing through the switch contacts. As G3JKV rightly points out, a momentary touch of the transmit switch will restore performance, but there is a mod to cure the fault. G3JKV admits to being lazy, and hasn't bothered to modify his rig. He has however repaired dry joints in an IC2, an IC251 and an IC255. I find this interesting because Icom gear is not noted for poor workmanship and I only occasionally find dry joints. The most usual failure of any Icom gear I repair is purely random component failure. I thus welcome your letters since my faults are obviously different to other peoples' and I am only too pleased to pass on faults other people have come across.

## Dressler D200S

These 2m linear amplifiers have been around for about three years now and seem to be eating PA valves at horrendous rates. There are several causes of valve failure, so I suggest that you check out the following possible weaknesses before you fit a replacement.

Some variants of the rig have a heater transformer with the correct output voltage stamped on it (5.9V) but, unfortunately, the wrong input (220V rather than 240V). Eimac recommend a 5.9V heater voltage at the valve pins.

Some informed sources say that a 3% increase in heater voltage will half the valves' life, so that 5.9V is essential. There are two ways to drop the volts, either with a 0.22 ohm resistor in the heater circuit or an 18 ohm resistor (adjust to suit) in the transformer primary.

Believe it or not, the anode line is grounded by rivets. These rivets are subject to both physical heat and circulating RF currents and are often open circuit. The best solution I have found is to drill them out and fit nuts and bolts, preferably with star washers.

Another failure on these amplifiers concerns the antenna load variable capacitor. Although this is provided with an earthing tag, the amplifier relies on

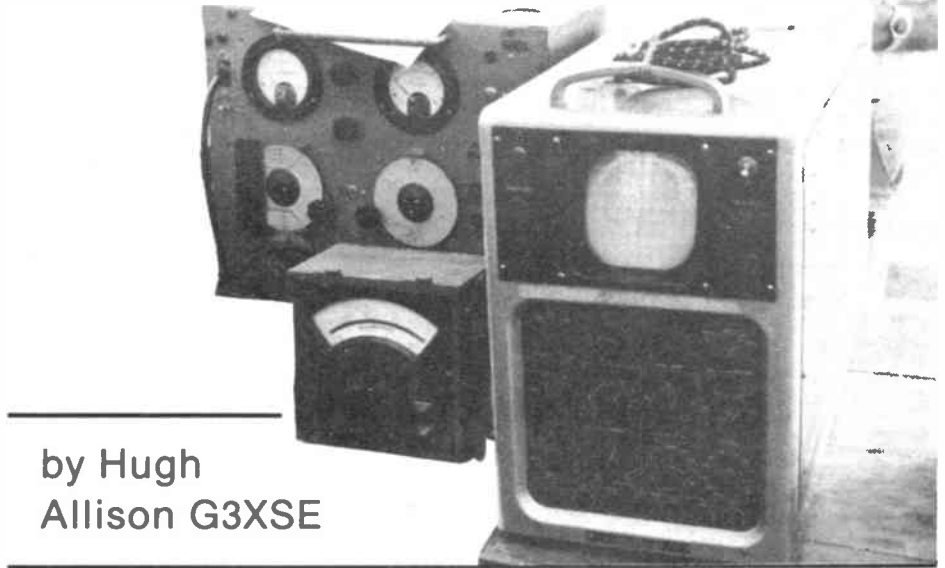

by Hugh Allison G3XSE

the shaft of the capacitor to provide the earth. The shaft very often doesn't provide a good enough earth and this can lead to poor amplifier efficiency. It is fairly easy to solder an earthing strap onto the capacitor shaft and make a good job of it. Incidentally, this was the cure for an amplifier that was 'splattering' all over the band. I suspect that the shaft was radiating within the case and causing RF instability. If you are offered a cheap example of this amplifier secondhand, I suggest you check it out carefully. Proper Eimac valves are very expensive (£50+).

## Audio output ICs

I have had several letters recently asking about integrated circuit audio amplifiers. Most people often suspect that they have died but are reluctant to buy and fit a replacement until they are sure. Firstly, check that there is a good earth to the IC. This should be fairly easy

to find. Next, check that there is a supply to the chip. Fairly straightforward so far. The trick now is to locate the output pin and check its dc level.

The diagram shows a simplified schematic of the typical audio output stage. Remember, there will probably be headphone and/or extension speaker sockets between the speaker and the printed circuit board. It's worth remembering that the changeover switches incorporated in the speaker and headphone sockets can often go open circuit—the quickest way to check these out is to plug in an external speaker. However, I digress.

The output pin should be at half rail, ie if the chip has a x12 volt supply, then the output pin should be at 6 volts. If it isn't, then the IC is probably dead. I normally unsolder the input pin (or pins) first and re-check. It isn't unknown for the input coupling capacitor to go a short, thus upsetting the bias. This is particularly

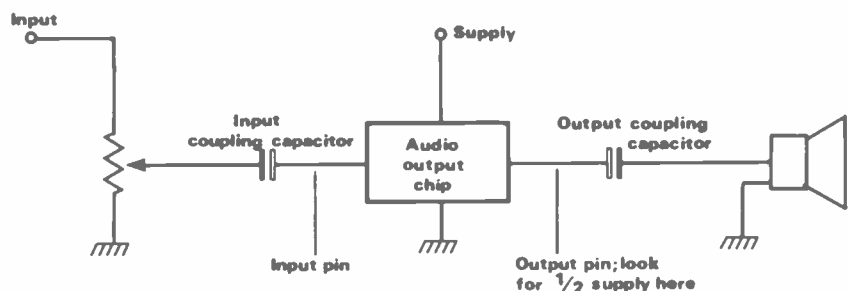

A typical audio output stage





# FREE CLASSIFIED ADS

## FREE CLASSIFIED ADS CAN WORK FOR YOU

We are pleased to be able to offer you the opportunity to sell your unwanted equipment advertise your 'wants'.

Simply complete the order form at the end of these ads, feel free to use an extra sheet of paper if there is not enough space. We will accept ads not on our order form.

Send to: *Amateur Radio Classified Ads*, Sovereign House, Brantwood, Essex CM14 4SE.

## DEADLINE AND CONDITIONS

Advertisements will be published in the first available issue on a first come first served basis. We reserve the right to edit or exclude any ad. Trade advertisements are not accepted.

## FOR SALE

■ Trio TR7800 and PS10 PSU with memory back up supply £150. Belcom LS20XE 2m hand held. £75. MFJ-901 versa tuner, tunes coax, wire and balanced lines, (1:4 balun built in), imported from USA, new unused £50. Cordless telephone new unused 120V only hence £25. GM4DHJ. Tel: (041) 889 9010.

■ Icom 251E all mode two metre transceiver inc service manual. Baby forces sale £350 mint, no offers please. R Oakes, 3 Rumbold St, Abbey Hey, Gorton, Manchester M8 7LU Tel: (061) 231 4854.

■ Eddystone 840C 500 to 30MHz 5 bands in FB cond'x Rx. Buyer inspects and collects £85, or would consider xchange for any tele cine gear, camera, less lenses, and recorder. Projector not required. Cash adjustment. R W Jennings, 20 Newhouse Close, Thanington Without, Canterbury, Kent. Tel: Canterbury 65200.

■ Yaesu FRV7700, VHF converter, new unused £50.00. A Clark, 37 Burmarsh Road, Hythe, Kent CT21 6QL. Tel: (Hythe Kent) 68132.

■ Yaesu FRG7700 and FRT7700 ATU mint condition £220 or xchange Ham Int Jumbo or auto scan CB 40 chan, cash adjustment either way. David Harvey, 93 Lochend Road, Gartcosh, Nr Glasgow. Tel: Glen Boig 872656.

■ KW 202 Rx £120. KW viceroy mark 3A Tx. OK SSB needs attention on CW £35. Heathkit RF signal gen £20. Advance audio signal gen £25. Short wave mag with index - Nov 1964 to April 1979 £15. Practical Wireless Sept 1982 to Feb 1984 £3. Ham Radio Today June 1983 to Oct 1984 (less two issues) £4. Buyer to collect. Not on phone. G3WXT, 36 Hart Road, Byfleet, Surrey KT14 7NH.

■ Icom IC290D all mode 25W 2m Tx less than one year old. Fitted with G3WPO preamp £300 or will exchange for FT101ZD with or without ATU or any comparable Tx with digital readout. Sale includes all accessories inc PSU rotator and 12 ele zL special. W Smith, 41 Rockleigh Ave, Aberargoed, Mid Glam CF8 9BQ. Tel: (0443) 820617 after 6pm.

■ Amateur radio enthusiasts, old Bird electric organ full of spares £50 ono. Mains transformer only faulty. If interested Tel: Warwick 498770.

■ Crystal calibrator by GEC old, six valves. 100KHz 1000KHz 5000KHz input, output, phones, also variable oscillator tuning scale 13 x 9 x 7in £5. Mobile whip (G3FIF) long telescopic, 160m coil, base, £10. 80m coil £8. Mains transformer, output 4.5V 5-10A £4. 'Belling-Lee' set lead interference filter 2A £4. .5mFd condenser 2500 VDC working £2. 'Gilson' output transformer HT, A, S twice out 15Ω, 3.7Ω, £3. Edwards, 244 Ballards Lane, London N12 0EP. Tel: 01 445 4321.

■ FT707 brand new three months old, never been used as a Tx only Rx, have lost all interest in radio sell for £400 ovno. Also I have a JEN SX1000 mono synth ideal for a beginner cost over £350 new, just 18 months old, sell for £85.00. Please Tel: (0283) 33526 after 6pm.

■ Yaesu FR101 with matching speaker VHF 2 metres and 6 metres in excellent condition £250. Kenwood headphones HS5 new £19.00, ideal for SWL. Many text books for homestudy course for RAE. Tel: 01 253 6725.

■ Standard C78 430MHz transceiver + UHF FM 10 watt booster + mobile bracket, all boxed, 2 months old, may P/x on cordless phone or sell cash complete outfit cost £320, for quick sale £200. Jim Shepherd, 6 Bergen Walk, Corby, Northants. Tel: Great Oakley 743807.

■ SEM Z match ATU 10m to 80m new Aug 1984 £55. Ezitune noise bridge new July 1984 £25. Packing and carriage included. Tel: G5CDE Egham 33500.

■ RC11 infra red remote controller for Icom R71 receiver, £32. Global AT 1000 antenna tuning unit £30. Both mint condition boxed still under guarantee. Tel: 01 570 5603.

■ Datong morse keyboard, as new, four indepen-

dent memories plus keyboard memory. Speeds 5 to 130 wpm, many special features and a joy to operate. Having sold rig must now sell ancillaries. Also CP5 five band vertical antenna with five tuned radials, a super DX antenna. Keyboard £80 and antenna £50. Two bargains. Tel: Sapcote 2955.

■ Exchange or sell Racal 17L (17T) complete with instructions and a Perbrowns type F headphone, good condition £250, or exchange for FRG7700 with ATU etc, also for sale Redefon International unit VHF FM radio telephone type 11, no mike, but with spare chassis £50 ono. T Hoyle, 35 Marton Grove, Inglemire Lane, Hull, Humberside HU6 8NZ. Tel: 801771.

■ Burndept BE471 UHF H held six channel Xtalled R80, SU8, RB14, only. Complete with stand, charger, 2 sets, good nicads. Also new mobile mount for same. Absolutely mint cond. Also Pye T460 UHF base station Xtalled RB0 very nice cond poss swap both for FT290 with cash adjustment or sell BE471 with accessories £165 + T460 £85. Mr P A Soden, G8WAL. Tel: Albrighton 2393 ext 563 office hours only.

■ 10m, 15m, 20m, 40m, 80m, 160m reception over CW, AM, USB, LSB, slot filter BFO pitch AF gain peak RF, IF and RF gain. In brand new condition includes manual swap for FRC7 with VHF or Racal RA17, must be in good condition, or sell for £130. Prefer to swap consider FRC7 and 10m rig power supply twig mike or FRC7 and homebase GB. 27 Dodge Holme Gardens, Wheatley, Halifax, West Yorks. Tel: (0422) 240201 evenings.

■ FT726R two and seventy fitted. Boxes and all handbooks. Divorce forces sale £750. Tel: Wolverhampton 763387.

■ New brain computer with disc controller, 800K + 800K disc drive, and 3 megabyte software. Runs CPM software ie word star and most languages. Original cost £2000. Also book single disc drive. Would exchange TS780 with cash adjustment. G6UDM QTHr. Tel: (0902) 783338.

■ Yaesu F50B amateur band receiver 10 to 80 metres for sale £75 or exchange for good 9.5mm projector or super 8mm projector and camera. Robins G8BSK, 290 Priory Road, St Denys, Southampton SO2 1LS.

■ The worlds smallest TV Sinclair pocket TV with Sinclair mains PSU under warranty, £70ono. What about a 1923 Columbia Gramofona on oak pedestal. Tins, needles 73s etc. Sounds nostalgic to those over 60, offers. Fifteen complete vols of RSGB Rad Com free to anyone if collected. Tel: (0582) 25519.

■ Revtec 934MHz CB transceiver, complete with Cobra power mike and 5 amp PU, recently serviced by Revtec and fitted with new frequencies. £200 ono. 19 Palamos Road, Leyton, London E10 7JF. Tel: 01 254 6621.

■ Yaesu FRG7700 receiver as new, digital clock and timer, handbook, £250. G3HRO QTHr. Tel: 01 460 7660.

■ Ham International Jumbo very good condition classic base station works must go so sensible offers around £175. Also ZX81 48K plus data recorder and Alphacom printer, again sensible offers or will swap either/both for any HF trans old or new cash either way. Might consider 2 metre SSB stuff, antennae, transverts, even parabolics or WHY. Will travel anywhere for the right gear. Tel: (0244) 383180 anytime.

■ Gresham p/s GX30/10/13 10amp 30V £25. SX27 VHF Rx 27-143MHz works OK but really needs a pre-amp £20. Heathkit SB102 Tx/Rx 10-80 amateur bands immaculate condx, inc p/pack, spkr, mike and junker key £210. AVO CT38 240V multimeter £10. Very rare Howard 450Rx, c1937, xtal filter etc, a collectors Rx. £90. US signal corp freq meter BC906D, needs VT172 tube + 45V £10. Hy-gain 18AVT/WB vertical £35. Hokushin HF5R ground plane for above £20. Exchanges for Rx on above gear. Wanted Racal RA63 or RA98 SSB adaptor.

Tel: (0908) 314095.

■ Antenna change over relay, heavy £5. Oscar SMC 2 metre/mobile whip with gutter mount £10. Jaybeam 8 el 2 mtr beam £5. 4 el and 3 el 2 mtr beams with alloy poles £5 each. Heath valve volt meter £10. Res/cap bridge £7.50. BC221 wavemeter £10. English equivalent £10. SWR meters £10. High quality CB set with K40 mag mount £30. All G3RCO. Tel: Seaton 21016.

■ Yaesu FT227 RB mobile 2M rig, six memories scanning from mic, excellent cond, with bracket £135. Also Pye PFI pocket phones Rx/Tx unmodified £15 the pair. Tel: (Hull) 802706.

■ Chinon CE4 auto manual 35mm camera, 50mm, 28mm and 135mm lenses, case, flash gun, cokin and screw in filters case mint condition £120. Also Practica TL1000 35mm camera and case, 50mm lense new £40. Pye pocket phones Tx Rx £10 (not converted). Exchange lot for HF general coverage Rx or for HF gear WHY. Derek Wilkinson, 43 Turnshaws Road, Kirkburton, Huddersfield. Tel: (0484) 807866.

■ FTDX401 HF transceiver, complete with CW filter and matching speaker, top band thru 10m. Spare set of valves included, £250 ono. Tel: (0533) 891960 after 5.30.

■ SS105S 5 band HF rig, TL120 200 watt PEP linear, Tytan 8.5A PSK, Ham International 15A PSK, Reace RS106 SWR/Pwr/mod meter, cost £720 new, 12 months old for £580 ono. Bremi 10 amp PSU, new unused boxed £50. MMT144/18 transverter 12 months old £85. Ham International Concorde II multi-mode ex-CB now 28-29.799 £200. Alpha channel switch fitted, equipment sold due to bereavement. Mr J D Bolton, 10 Bowness Road, Coniston Park Estate, Timberley, Cheshire.

■ Yaesu FT-480R 2m transceiver, 8 months old, never been used, guaranteed for 12 months, £250 ono. A Cocking, 31 Dryden Crescent, Stafford ST17 9YH.

■ 9mm Specto projector, type B with wide angle lens. Pathe Prince camera with holder for zenoscope lens and view finder wide angle screen, offers WHY or cash. Howland West audio stereo headphones CIS 550 £10. Microwave Modules RTTY to TV converter MM2000 £50. G3WPO 2M pre-amp 12V dc £5. 29MHz pre-amp Telford Communications £7. Dr A C Gee, 21 Romany Road, Oulton Broad, Lowestoft, Suffolk. HR32 3PJ. Tel: 0502 65726.

■ Yaesu FT902DM transceiver plus matching transverter FTV902, as new condition £685. Tel: (31) 54264 Great Bookham, Surrey.

■ FT101B just realigned. FC902 as new. Yaesu FF501 filter boxed new. Altai dip meter boxed new. HyGain 12 AVQ 3 band vertical boxed new. Icom 10mtr FM converted CB rig. Spare valves for 101. £440 or best offer. N Bleek, 35 George Ave, Easington, Co Durham. Tel: (Easington) 272702.

■ TR2200G 2m FM transceiver 12 channels, 6 with crystals complete with Nicads, charger and carrying case. Good condition £70 ono. Tel: (0344) 778155 (near Camberley).

■ Lots of old service sheets and manuals for amateur radio, vintage wireless, test equipment, audio, TV video etc. Copies available. Large SAE with 'wants' and I'll try and help. Maurice Small, 8 Cherry Tree Road, Chinnor, Oxon OX9 4QY.

■ ZX81 computer + 32K rampack & books. Also a good selection of software including Morse reader & tutor, QRA and Maidenhead Locator logbook programs, £40 ono. David Crossley G6ZXP, 15 Mylgrove, Roman Way, Coventry. Tel: (0203) 412861.

■ 48K Spectrum 2 months old, leads, manuals, PSU + £70 worth of software, and Currah speech unit £90. Collectors item R1155B immaculate, unmodified handbook for all models, PSU/test unit with pre-amp and speaker built in £65 ovno. Ferranti valve interstage transformer air ministry



# FREE CLASSIFIED ADS

variable voltage PSU 1-15V approx requires meter in USB case, offers invited, buyers collect or carriage extra. Borthwick, 92 Linglie Road, Selkirk, PBorders Region, Scotland.

■ For sale American made bug key very good cond. £10.00. post paid. Also HE5 5 band VERT ant, no radials, buyer collects. AE Sutton, 60 Birch Road, Hurstead, Rochdale, Lancs. Tel: (0706) 76848, any time.

■ 32 band comm Rx digital, 0-30MHz USB/LSB, DR32-3100L batt/mains, Panasonic RF3100, £110 + post. Tandy TRS80 model 4 64V twin disks with printer DMP110 all four months old, inc 100 disks, disk storage, many books programs, paper, also CTR80A composer cassette, so you've got the best of both worlds. Ideal for home/trade. Total value £2900, sell for 1/2 price ono. Consider WHY exchange with cash adjust. Buyer must collect. Tel: (0473) 85526 anytime.

■ FT290R for sale nicads, charger, manual but no case. £200 VGC. Contact Les, G6LOK, evenings. Tel: Rochdale 525490.

■ FL2100B Linear amp mint £275 ono. Heathkit HW8 incl PSU built March 1983, in mint condition £125 ovno. GHFKZ. Tel: (061) 624 2808.

■ Yaesu FRG7 receiver excellent cond with manual £125. Buyer to collect or arrange carriage. WC Brock, 22 Fountain Head, Seaton Sluice, Tyne Wear NE26 4HU. Tel: (0632) 371994.

■ KW2000E in reasonable condition, some spare valves £200. Semi automatic bug key £15 ono. Office dictating machines Grundig £5 ono. Contact GW4NBY QTHr. Tel: (0656) 56576.

■ Kenwood R600 communications receiver. Cost £263 vgc with manual will sell for £190. Tel: (021) 783 0268.

■ Yaesu FRG7000 communication receiver mint condition, digital display, hardly used; original case instruction manual, gift £110. Dave G6KTI Tel: Burnham-on-Sea 788970.

■ Lowe SRX30 communications receiver. Hardly used £50 ono. Mr G Lander, 87 Hartfield Ave, Elstree, Herts WD6 3JJ. Tel: 01 953 9780.

■ FRG7700 Rx, FRV7700/C converter 130-160MHz FRT7700 ATU all mint cond boxed £350 ono. G6NWN not QTHr Tel: (0623) 512369.

■ FRG7700 £180, FRV7700DA £40, Trio 9R59DS x-cal fitted speaker spare set valves £50. All mint cond, manuals original packing. Lafayette HE40 £20. Carr on above extra. Tel: Smyth (0436) 71181.

■ Yaesu sommer kampt 767 Dx (707). Good condition 26MHz 27MHz will convert back to normal bands. All other bands HF as standard. Also Yaesu ATU £385. Tel: (0625) 617821.

■ Azden mic DX354 £18. Datong speech processor ASP/A £40. Q Multiplier RQ10 (valve) £8.50. Akai stereo amp AM u1 £30. Philips VCR £20. SP102 Ext speaker £35. SWR bridge SMCT3-170L 3.5-170MHz £15. K G Atkins, 30 The Brow, Woodingdean, Brighton, Sussex. Tel: (0273) 309127.

■ Spectrum 48K computer, currah speech unit + £70 worth of games as new exchange for Eddystone EC10 MKII receiver, must have battery container and handbook, and in good condition. R1155 receiver immaculate unmodified collectors item + PSU/test unit built in speaker and amplifier, new handbook exchange for Vega 402DE TV must be in good condition with handbook. Borthwick, Torwood, Lilliesleaf, Melrose, Borders Region. Tel: (06357) 314.

■ Simpson digital volt, ohm, milli ammeter, 1000V 600V to 200 milli volt, five ranges, 20m to 200ohm, six ranges 10 amp ac-dc to 2 milli amp five ranges. Nicad cells built in recharge facility mint condition, £80. Tel: (0532) 735543.

■ AR40 rotator one year old inc cable £45. Jaybeam 8 ele quad 2 metres complete £22. Buyer collects no offers at these prices. D Dicks, G4YJG. Tel: (0442) 40467 after 6pm.

■ Hy-gain 12AVQ 10-15-20 meter vertical. Brand new. Still in box cost £54 will take best offer. Norman Bleek, 35 George Ave, Easington Colliery, County Durham. Tel: Easington 272702 evenings.

■ RCA AR88D receiver, 0.54 to 32MHz, immaculate, good performance, handbook. £60. Buyer collects. Bill G4YZE Tel: (0204) 41317.

■ FT757GX station comprising of FT757GX HF transceiver FP757HD heavy duty PSU MH-1B8 mic FC902 ATU. Never used. Still in box with warranty, £800 ono. 118 Wilsden Ave, Luton, Beds. Tel: (0582) 422810.

■ Realistic DX300 receiver good condition with instruction manual 0.1-30MHz AM, SSB, CW, £100. J Stancliffe, Plot 56, Smithfield Road, Alphington, Exeter EX2 8YD. Tel: Exeter 39990.

■ Liner 2 piptone, power pack good condition £60. Mutek SLNA 144S pre-amp, ex-performer, suitable for liner 2 £20. G4XSM, Bury St Edmunds. Tel: (0284) 68084.

■ LS707 (Belcom) 70cms multi mode SSB FM CW AM 10W, trans mic etc, near mint boxed £220 ono. Yaesu FT480R 2m multi mode 10W mobile vgc £260. FT101B HF trans valve PA (Yaesu) £195. Tel: (0305) 786930.

■ Trio JR310 HF Rx 1.8 to 28 £70. Icom IC215 Tx/Rx 15ch with all xtals, Nicads, £65. 2m 8el beam £5. Pye PF2 with 70cm xtals 3ch needs some attn £30. Wanted SSB unit for Grundig 'Satellit' 2000 Rx. G8MPG. Tel: (0603) 810831.

■ Lafayette HA700 general coverage receiver, 150KHz - 30MHz. Good condition, £60 ono. Also, Awa AD3500 cassette deck, with Dolby B and C nr 3 head, soft touch control, Variable bias, good condition, £60 ono or Px for Yaesu FRG7 (Digital read out model). Tel: Leeds 663814, after 1pm.

■ Yaesu FRT7700 aerial tuning unit as new with instructions £30. ACE SWR bridge with 0-5W power meter £5. Both plus postage. Tel: (0795) 873100.

■ Trio 9R59DS Rx vgc boxed £45. Datong ANF CW notch filter mint £30. Drae 6 amp 13.5 vdc PSU Vgc £30. FX1 (Lowe) wave meter 1.6MHz to 250MHz £20 FT221R 2m multi mode trans 10W vgc £220 FT101ZD MKII HF trans vgc £395. Trio TS130V HF trans CW filter 10W vgc £360. FT200 FP200 HF trans valve PA £170. Tel: (0305) 786930.

■ Frequency counter £45, Eddystone 750 £75, Nato 2000 FM all frequencies. Tel: (0283) 221870.

■ Drake MN2700 ATU, £200. IC740 with FM, in-built PSU, filters. £800. Lunar PAE432-5 pre-amp (NF 0.9dB). £20. MML 144/100 2m linear with pre-amp. £100. MMT 1296/144. £120. MMT 432/144 with repeater shifts. £120. MMT 432/28 with repeater shifts. £110. MMC 50/26 converter. £15. SSB Electronics 23cm GaAsFET pre-amp. £50. Write: G3OSS, Angus McKenzie, 57 Fitzalan Road, London N3 3PG.

■ MM2001 RTTY to TV converter. £140 ono. Or swap for SX200N or Bearcat scanner. Steven Rake, 80 Cripps Avenue, Tredegar, Gwent NP2 3PB.

■ Yaesu FRG7700M Rx, in excellent condition, only 7 months old. Together with Datong active antenna, 6 months old. Original total cost £480, will offer £310 or nearest offer. Nigel Lloyd. Tel: (0422) 884113 evenings.

■ Morse Tutor 'Drae'. Only 6 months old, still as new. Single letters (with repeat). Groups of 5 random letters. Continuous Morse. Built-in practice oscillator. Built-in mains power supply. (Cost £52). Bargain at £35. Buyer inspects and collects. Seaford, Sussex. Tel: (0323) 898515.

■ Trio JR-599 Custom Special X communications receiver. SSB, FM, CW, AM, all solid state circuits. Crystal filters. 1.8 to 29.7MHz, amateur bands, also 50MHz and 144MHz converter, and WWW. Excellent condition, (can be used with a Tx599 for transceiver, receiver operation), complete with service manual. Buyer inspects and collects. £150 ono. (G1EMQ). Tel: (0323) 898515.

■ Yaesu FT7, good condition. £230 or nearest offer, or will exchange for high power valve two metre linear amp or 70cm multimode with cash either way. Jim. Tel: Swansea (0792) 793464 after 6pm.

■ President Grant FM/AM USB/LSB 25.625MHz to 28.305MHz. £160. Tel: Worthing 505296.

■ Emigrating, must sell quick. Therefore, all going cheap bird thr/line plus six elements. £150. NRD505 Rx b/new. £800. FT290, FT790. £150 each. BBC b. £200. TRS80 model 4 printer DMP110 twin disks, many disks and books, also WP programs plus many other computer inventory for this system. Also B/N valued at £3,000, sell £1,300 ono. All items view, demo, post or collect. Also cash only please. Ring me, John, and haggle for quick bargain. Tel: (0473) 85526 day or night.

■ Two 40 channel FM CB rigs. £8 for both. Not working 40 channel FM mobile. £15. 2 metre scanning receiver. £25. Two metre transceiver base station. £75. Eagle communications Rx. £50. M De Wynter, 2 Woodside, Wimbledon, London SW19. No telephone number.

■ Lafayette, AM, FM, SSB. Any offers? Tel: (0283)

221870.

■ BBC complete ham program, including digital clock alarm, erasable notepad, logging with full editing and auto mode/band/date facility, full global search etc. 2m/70cm repeaters shown on map of UK input suffix or QTH for full repeater details, QTH locator input co-ordinates and QTH pinpointed on map of UK, full graphics and professional presentation, fully menu driven comp instructions. This program has been designed to give the op everything at his fingertips on disc £7. Also electronic keyer himoun EK103Z new. £35. Curtis KB4900 ASLI baudot CW keyboard and electronic keyer, see QST for spec, new, bargain. £120. HK808 Morse key new. £25. All plus postage. Tel: John G4TEN. (0258) 53075 weekends.

■ Microwave 24GHz; directional coupler and detector with crystal. £28. Slotted line SWR meter (£700 new). £190. Variable attenuator. £35, also bends, twists etc. Microwave 10GHz; 75mW klystron micrometer tuned with WG mount. £18. 25mW klystron. £4. Professional micrometer wavemeter. £78. Variable attenuator and detector with crystal. £48. 1-2GHz wavemeter. £18. Veroboard 0.1in brand new, 11 x 3.75ms, 5 sheets for £5. Mann. Tel: Cambridge (0223) 860150.

■ Panasonic 3100 100-30MHz receiver plus FM broadcasts bands and SSB. Modified by owner for use with loopant. List price new £219. One year old, in first class condition. Sell for £115 ono, plus postage. Mr Ron Hall, 23 White House Court, Ushaw Moor, County Durham DH7 7NH. No telephone number.

■ Marconi Marine multi standard TV receiver. UHF, VHF, 525, 625, line system NTSC, SECAM and PAL system. 4.5MHz, 5.5MHz, 6MHz, 6.5MHz sound. Complete with full service manual and operating instructions. Ideal for DX TV or ATV, at only £135 ono. Dave. Tel: (0202) 745136 or (0202) 730207.

■ Datong RF speech processor, model ASP. £60. Datong up-converter, model UC/1. Converts HF up to 144MHz, also 28MHz. Listen to HF on 2m rig or 10m rig with 29-1MHz bands. £75. Now have HF rig. FDK multi 750E 2 mtr multimode. RF, SSB, FM, CW, good condition. £250 or exchange for FT221 2 mtr multimode with cash adjustment. Len G6ZSG, Birmingham. Tel: (021 453) 9762 anytime.

■ Yaesu FT980 boxed, as new, £400 below normal price, £930 only no offers. Cobra 148 GTL DX 10m transceiver, very good condition, boxed. £115 ono. Microwave Module 28MHz to 144MHz transverter, boxed, as new. £65 ono. G4VIO QTHr. Tel: Bishop Auckland (0388) 763501.

■ National Panasonic computer-controlled communications receiver, continuous synthesised manual/auto scan tuning, LW/MW/SW/FM, programmable frequency/clock/timer/calendar function, 1 1/2 years old. Immaculate. Any demonstration by appointment. Cost £2,250, asking £950 ono for this extraordinary machine. Tel: (0293) 32003.

■ Realistic DX 100L gen cov Rx. £35. Also Audioline FM CB rig. £15. Buyer collects or arranges carriage. Tel: Tony. (0925) 601041.

■ Trio TR2500 hand-held, as new. £190. ST2 base charger, also as new. £40. Both surplus to requirements, will not split, buyer collects. Cash only, no cheques. Jaybeam 48 element 70cm. £20. Tel: 01-540 3959.

■ Trio TS7002 metre multimode, plus VOX3, mike, also fitted, pre-amplifier to improve front end plus R2 R4 R5 R6 R7 fix channels. £310. Yaesu FT707 HF SSB transceiver, FC707 ATU, FU707DM VFO, FP707 PSU, YM35, mobile mounting bracket, CW filter fitted, still under guarantee, 6 months old. Used for SWL. £710. Both in excellent condition. Buyer collects. David G11DS, Bungalow, Hollinhall, Hardcastle Crags, Hebden Bridge, Yorkshire. Tel: Hebden Bridge 842243.

■ Microwave Modules 2m 23cms transverter (new model). £185 ono. Tonna 23cms Yagis. £23 each. Stacking frame (4 Yagis). £15. NEC very high resolution mono chrome video monitor (as new). £75. 23/24cms filter (per VHF/UHF manual) beautifully built. £28. Paul G4XHF. Tel: (0293) 515201.

■ Yaesu F50B 80-10m amateur band receiver, best offer, or exchange for super 8mm projector and camera, or 9.5mm projector, Pathe 200B+, VOX, etc. Will consider reflector telescope. P G Robins, 290 Priory Road, St Denys, Southampton SO2 1LS.

■ SX400 with power supply, less than 4 months

# FREE CLASSIFIED ADS

old, cost £630, offers of £550 or nearest offer. Tel: John. 01-688 8502, after 6pm weekdays and anytime weekends.

■ Linear amp 2 metre band KLM electronics 160 watts, 13.5V dc, new unused. £100. Datong Morse keyboard model MK. £75. G E Goodfellow, 'Springbok', Poulders Road, Sandwich, Kent CT13 0BB. Tel: (0304) 612420.

■ Eddystone 730/4 valve receiver 540KHz to 30MHz in five bands. AM/SSB/CW. Has slight stability fault, otherwise in good condition. £50. Drake SPR-4 solid state receiver AM/SSB/CW full coverage of medium and short wave bands. Can be fitted with accessory crystals to cover amateur bands. (80m fitted) in excellent condition, with manual. £120. Buyer to collect please. Mr R Wooden, 50 Langley Road, Staines, Middlesex TW18 2EH.

■ Microwave Modules 2m 100W linear MML 144/100-S 10W in 100W out. As new. £120 ono. Dave Sweetland, 48 Upland Road, Billericay, Essex. Tel: (02774) 58489.

■ Large package of CB equipment, including 5 radios (working), mobile and base antennas, power pack, pre-amp, SWR power meters, matcher, various mikes, 50-60 CB magazines etc. £220 complete. No offers. SAE for complete list. Mrs S A Kirkwood, 1 Netherview, Wennington, Nr Lancaster LA2 8NP.

■ Have SX200N scanner 26 to 520, VHF, UHF. Also TV DX antiference aerial MH473 VHF covers 1 to 3 bands, also Realistic PRO47 scanner, with 10 ham, 10 maritime crystals, fitted. Would sell or split. Offers. Tel: (051 922) 9632 evenings.

■ JR310 radio amateur receiver. £90 and SWL lar omni match antenna tuning unit, does not work with Trio. 1 Kenwood R2000 communications receiver. £29.75. Tel: Clochen 378.

■ American RTTY rev terminal unit type CV-89A-URA-8A. £35. Also American T-M corpn digital readout VFO. Gives 3 watts into 50 ohms between 2 and 8MHz. £35. Buyer collects. Nev Kirk, 54 Allendale Road, Rotherham, Yorks S65 3BY.

■ Sharp MZBOB computer 72K RAM, 40/80 character display, typewriter style keyboard and numeric pad, monitor and cassette deck built in. Basic, assembler, books, software. £395 ono. Or swap for amateur radio gear. Tel: Abingdon 27703.

■ Multi 700EX variable power etc, mint condition and slightly damaged Ringo Ranger. Will swap for FRG7700. Tel: Ireland 905788 after 7pm.

■ Hallicrafters HT37 Tx. £125. Hallicrafters SR400 Tx/Rx 400W. £200. Collins 32V3 Tx. £250. Collins 75A4 Rx. £375. G3GBB. Tel: (0284) 66496 evenings and weekends.

■ Icom IC255E 2m FM 25W transceiver, scanning mic, mobile mount, boxed. £125. Tel: Earls Colne (07875) 3442.

■ AOR2001 scanning receiver, complete as new. Very little use, 5 months old. £290. G Joseph, 15 Eden Close, Wembley, Middlesex. Tel: 01-997 0837.

■ Yeasu FRG7700M general coverage receiver, twelve months old, very little used. Also FRT7700 ATU and CWR610E, CW RTTY and ASC11 decoder, all with manuals and original packing. All in excellent condition. £450 or nearest offer. Philip Cole, 20 Paultow Road, Bedminster, Bristol. Tel: (0272) 632400.

■ Eddystone EA12 HF receiver, covers 1.8 to 30MHz, excellent condition, handsome receiver. £140 ono. Or swap for Racal RA17 around same value, or swap for FRG7 and 10m FM rig twig PSU or AR88 and 10m FM rig twig PSU, or FR101 HF receiver fitted with 6m and 2m, or Lowe SRX 30 prefer RA17 or FRG7 plus FM 10m rig. Please reply asap, going in for RAE. D Haigh, 27 Dodge Holme Gardens, Mixenden, Halifax, West Yorks. Tel: (0422) 240201 daytime only.

■ 18 volt power supply input 240V ac output 18V dc 1.1 amp, this transformer is ideal for use on most 12 volt model railway systems. Beautifully made. £5.50 plus £1.80 post. Plans for mini transmitter, has 6 mile range but has only 15 components, can be picked up on FM radio. Plans £2. Also camera repair manual for Praktica LLC plus parts list with exploded views of LLC, LTL, L, super TL. £13.50. D Martin, 29 St John's Close, Leatherhead, Surrey.

■ Cushcraft R3 Tri-band trapped vertical antenna. Remote tuned from shack. 1/2 wave on 20, 15, 10m, no radials required. 2KW traps. Complete with 20 yards hore control cable. Proven DXer. Total cost

over £250, bargain £125. Yaesu FRG7 Rx, digital, fine tuning, SSB filter with mod instructions. Excellent condition. £120 ono. Buyer to collect or pay carriage. GM3DPKQTHr. Tel: (02612) 5373 after 6pm.

■ FC902 as new, original packing manual. £95. Shure mic CB43 controlled magnetic, unused boxed. £12. Practical Wireless, 50 issues, Amateur Radio, 20 issues, Ham Radio To-day, 22 issues, QST, 48 issues 1976-1979. Offers. Ace SWR meter plus 0-5W power reading, new boxed. £5. SAE lists, valves, books, spares. All plus postage. Trowell, 'Hamlyn', Saxon Avenue, Minster, Sheerness, Kent ME12 2RP. Tel: (0795) 873100.

## WANTED

■ Circuit diagram or handbook for Eddystone 730/1A receiver. Alan Brooks. Tel: Basingstoke 473202 ext 3054 daytime.

■ Five pounds paid for circuit diagram of Sharp model IT-51CZ TV camera - can be original or photostat. But must be as complete as possible. Also require manual for Shibaden video tape recorder or circuit diagram showing all socket info. Nev Kirk, 54 Allendale Rd, Rotherham, Yorks S65 3BY.

■ IC22A, Sommerkamp TS580FM or very similar 2m rig. Collect any distance. G4EUW, QTHr. Tel: (020630) 3071 Brightlingsea.

■ Circuit diagram for Marconi TF2201 oscilloscope, with manual if poss, for copying, all expenses paid. Tel: Penzance (0736) 68788.

■ Back issues of Radio & Electronics World, Jan-Feb 1982. Can collect. Tel: (07914) 2823.

■ General coverage receiver or low frequency receiver. Tel: Clevedon (0272) 87 5181.

■ Alti meter ex-WD type, barometric with millibars readout in good order. Can exchange good wall hanging barometer, also some dismantled. Also someone to convert Tristar 777 CB to 28-29.7MHz for amateur use. Have manual. Alan Edwards (G3MBL), 244 Ballards Lane, North Finchley, London N12 0EP. Tel: 01-445 4321.

■ RAF base station key, type 'D' or Marconi marine type 365A. Any semi automatic bug keys by McElroy, Lionel, Vibroplex etc, any condition, damaged or incomplete inc. Details and price to G3TSS. Tel: (043) 471 3125.

■ Heavy duty tower, can collect and dismantle if necessary, also Trio TS700 TNX. Price, Penyrallt, Llanddeusant, Holyhead, Anglesey, LL65 4AE. Tel: (0407) 730636 after 6pm.

■ 1KW HF linear, reasonable price. Will collect. G3HMT. Tel: 01-794 2807.

■ Non-working HRO receivers or parts for spares condition unimportant. Also original HRO power supply units and speaker units. Tel: St Albans 39333.

■ HRO senior Rx in good clean condition, would buy or exchange for any of the following: Codar AT5 15W HF Tx, Heathkit DX100 100W HF Tx (both with manuals and in very good clean condition), 33 foot fibre glass vertical antenna in approx 4 foot screw-in sections complete with base mount plate. Would prefer local (Yorks) exchange. Tel: Harry, Castleford 552862.

■ Heavy duty rotator, top quality HF beam, tilt over mast or tower, etc. Mervyn Collicott, G1GTC, 10 Tor Rd, Hartley, Plymouth, Devon. Tel: (0752) 777777.

■ Wanted for 10m SSB operation, liner 2 or liner 10 Tx/Rx, or WHY for 10 SSB. Tel: G4ANW (0730) 61859.

■ Yaesu YK901 keyboard to use with a Yaesu YR901 CW/RTTY reader. Tel: Colchester 394336.

■ Crystal sets, valve sets, swan-necked loud speakers, early carbon microphones and Sullivan earphones, also good components and working valves from the 1920s and before. Ron Irving G3SYX, Fir Glen, Beesby Rd, Maltby-le-Marsh, near Alford, Lincs LN13 0JJ.

■ Bird 43 thurline watt meter inserts. Please ring giving power handling and freq available. Mike Buckley, 12 Ranmore Ave, Croydon, Surrey CRO 5QA. Tel: 01-654 2582.

■ HP test gear such as 410C, 8405A, 8601A, 250B, 4815A or what have you? Change wheels for AVO wave winder or would consider complete wave winder. Enamelled copper wire, especially fabric covered. Sulzer frequency standard. S J Branson, 111 Park Road, Peterborough PE1 2TR. Tel: (0733) 67604.

■ Exchange VIC20 computer C2N cassette manuals plus adventure land game for HF Tx/Rx for new class A op, eg FR50B FLK50B, etc or WHY. Must be in good cond, no mods. GOAIF. Tel: (0258) 53670 (evenings).

■ Decent frequency counter, six or eight digit. D Peach, 56 Basford Park Road, Maybank, Newcastle-Under-Lyme, ST5 0PS. Tel: (0782) 625661.

■ Ex military gear, plugs, sockets, junction boxes, connectors, books, manuals etc. Tel: Jim G4XWD, (0562) 36740.

■ Handbook and/or workshop manual for Hewlett Packard 400D valve voltmeter. Buy or loan. Mr R W Goad G4EFA, Flat No2, Osborne Chambers, 59A Osborne Road, Southsea, Hants, PO5 3LS.

■ Manual or copy for Yaesu FT7B also frequency counter YC7B or similar wanted. J C, 56 Clough Lane, Halifax HX2 8SW. Tel: (0422) 244046 after 5.30pm.

■ I require a secondhand LMH AM/FM SSB transceiver in good condition and good working order. Highgains or 148 Cobra if possible. In price bracket between £50-100. Tel: (0503) 20798 with details.

■ FT250/FT200 matching VFO fixed channel kit. DFC CW filter any matching extras also any info on FM board. C E Ladley, Sunnyside, Spinney Close, Grimoldby, Louth, Lincs LN11 8SY. Tel: (0507) 628026.

■ 16mm GSAP Bell and Howell gun camera (ex Govt) (American) electric drive with or without lens. Also Pioneer turntable PL340 (motor unit only required) but complete unit considered. Tel: (0225) 706795 (Melksham).

■ 813 valves and bases. G3DWQ, 191 Higher Walton Road, Walton-le-Dale, PR5 4HS. Tel: (0772) 53810.

■ KWM380 and T&R bulletins 20's 1930 and some 1940 and 1942. Duplicate QST, CQ, bulls from 1930s to sell or swap. SWM wanted for July, Aug of 1959 and Jan 1948, Mar and July 1946 and pre-war. Many SWMs from 1946 to sell or swap. Six metre transceiver wanted. Write Baker, New Bungalow, Bontnewydd, Aberystwyth, Dyfed.

■ Ex-Halifax bomber Wop seeks TR1154/55 + data. Reasonably priced. Tel: Felixstowe 284198.

■ IC202S with linear, also ICBP3 power packs for IC2E or AM, interested in any 2m multimode, reasonable price. Chamberlain G6NUJ, 45 Wheat-sheaf Gdns, Sheerness, Kent. Tel: (0795) 662991.

■ Base for VCR 139 3 inch cathode ray tube. Contact Harold G8YCG stating price. Tel: (0538) 382550.

■ Yaesu FT290R 2m, multimode portable also VHF antenna rotator, cash waiting. Ian, 82 Granville Tce, Binchester, County Durham, DL12 8AT. Tel: (0388) 662630.

■ Would anyone sell a recent obsolete World Radio and TV Handbook to a keen SW DXer who is retired and really can't afford the current price? Brierley, 108 Bolton Road, Rochdale OL11 4QX. Tel: (0706) 33108.

■ Wanted old ARRL Handbooks. Marris, 35 Kingswood House, Farnham Road, Slough, Berks.

■ Trio TS820S in FB condition, plus 'extras', external VFO, ATU, speaker, plus 12AVQ antenna. MacKay, 16 Henley Drive, Timperley, Cheshire, PWA15 6RY. Tel: (061 928) 6894.

■ Urgently required: owner's manual, Kenwood 7600 Tx, will borrow or buy. Alan Kirby, Bradgate, Sessay, Thirsk, North Yorks YO7 3BE.

■ AR88D Rx, working or not, also 19 set or 19 set chassis, variometer, spares etc and crystal calibrator Mk10. Mr P M Cleaver, 86 Main Road, Dovercourt, Harwich, Essex CO12 3LH. Tel: Harwich 502195.

■ Hallicrafter SX28 required, good condition no mods. Rowbotham, 19 Carisbrooke Road, Bushbury, Wolverhampton. Tel: 481726.

■ Xtals for two metres 44MHz fundamental frequency manual, or information on Belcom FS1007P transceiver manual or information for Eagle Rx80 communications receiver. Bearcat scanning receiver wanted to buy, and Harvard 4/0T hand-held. M De-Wynter, 2 Woodside, Wimbledon, London SW19.

■ Oscilloscope dc to 30MHz with manual and circuit diagram, must be complete and in working order. Will pay up to £70. All replies answered. A Campbell, 81 Larch Avenue, Bishopbriggs, Glasgow G64 1TB. Tel: (041) 772 5280.





# Amateur RADIO SMALL ADS

**PNP Communications**  
**Modular terminal units**  
 for  
**RTTY — MORSE — AMTOR**

PL1 RTTY mod/demod .....	£14.50k	£18.50a
MF1 Morse demod .....	£12.50k	£18.50a
FP1 Power supply/amp .....	£11.50k	£14.50a

a = assembled PCB, k = kit of parts. Software available for — Dragon VIC20 CBM 64 BBC Amstrad CPC464 Acorn ATOM. Please ADD VAT at the current rate.

**ACCESS & VISA welcome**  
**62 Lawes Avenue, NEWHAVEN**  
**East Sussex BN9 9SB**  
**Telephone (0273) 514465**  
**LARGE SAE for full Catalogue**

**MORSE TUTOR**  
 £4.00 on cassette. £8.50 on microdrive for Sinclair Spectrum. 4 to 19 words per minute, variable spacing, variable groups of random letters, numbers or mixed; Random sentences, own message, single characters and variable pitch. Feedback on screen, printer, or speech (Currah Microspeech 48K only) and repeat facility. 16K and 48K versions on one cassette 48K only on microdrive.

**WD SOFTWARE**  
 Hilltop, St. Mary, Jersey, C.Islands  
 Telephone (0534) 81392

**Telephone the advertising department on: 0277 219876 for details**

**QSL Cards**  
 Printed on white or colour gloss cards, printed to your own design.  
 Please send SAE for sample to:  
**Caswell Press**  
**21 Homethorpe Ave, Redhill, Surrey**  
**Tel: (Redhill) 71023**

**XXX ADULT VIDEO CLUB**  
 For the genuine adult films. Available only from ourselves. Ring  
**0924-471811 (24hrs)**  
 For the intimate details or write  
**ADULT VIDEO CLUB**  
 P.O. Box 12, Batley, W. Yorks.

**RTTY/MORSE RADIO SOFTWARE**  
**RTTY/MORSE READER** For 48K Spectrum. The ultimate RX Program. Features include. 45.5 Baud RTTY reception—Full character set supported. Morse reception—auto speed control (5-35 WPM), punctuation and wordspace. Also includes 40 page text memory, and copy facility for printer. No extra hardware required—simple connection to radio via computer EAR Socket. **Price — £6.00.**  
**MORSE TX/RX** Program for 48K Spectrum. Allows full transceive operation, includes comprehensive morse tutor. No extra hardware required. **Price £7.50.**  
**MORSE RX** Program for 16K Spectrum and 1K ZX81. Spectrum version includes comprehensive Morse Tutor. **Price £5.20.**  
 All above Programs 100% Machine Code.  
**P Anderson, Wellands, Pilton, Shepton Mallet, Somerset.**

**MORSE READING PROGS**  
 Work on clean signals without hardware interface ZX81 1K UNEXPANDED MEMORY. Translated code, with word and line spaces for easy reading. Automatic scroll action. £7.00 incl. SPECTRUM 16-48K. Scroll action with 10 page scrolling memory. Instantly accessible page by page £8.00 inc. All types variable speeds. Feed signal direct into EAR socket.  
**Pinetural Data Studios, 60 Pinetural Park, West Moor Wimbome, Dorset BH22 0BP.**

**SOUTH-DOWN: 40 TERMINUS RD (opp. EASTBOURNE Railway Stn.)**  
**RADIO SUPPLIES Tel: (0323) 639351**  
**Open: Mon-Sat 10-6 (Closed Tues)**  
 Amateur Radio Equipment Yaesu, Icom, Standard, Tonna, Drae, Kenpro, Halbar, Wood & Douglas, Daiwa Howes kits & MET antennas

**USED AMATEUR EQUIPMENT ? I BUY, SELL & EXCHANGE!**  
 My low overheads mean the best Possible Deal for YOU!  
 Whether Buying or selling Phone Dave on HORNCHURCH (040 24) 57722 ANYTIME, or send SAE for latest list to:  
**G4TNY ELECTRONICS**  
 132 Albany Road, Hornchurch, Essex. RM12 4AQ.  
 New Equipment Supplied at Competitive Prices!  
 Marine Radio also Bought and Sold.

★ **SERVICE MANUALS** ★  
 For ALL Amateur Radio, Vintage Wireless, Audio, Television, Video, Test Equipment etc, etc. Thousands stocked. LSAE enquiries and quote by return plus FREE catalogue.  
 ★ **MAURITRON TECHNICAL SERVICES** ★  
 Dept AR, 8 Cherrytree Rd  
 Chinnor, Oxon OX9 4QY

# Amateur RADIO SMALL ADS

This method of advertising is available in multiples of a single column centimetres — (minimum 2cms). Copy can be changed every month.

**RATES**  
 per single column centimetre:  
 1 insertion £7.00, 3 — £6.60, 6 — £6.30, 12 — £5.60.

**AMATEUR RADIO SMALL AD ORDER FORM**

**TO: Amateur Radio · Sovereign House**  
**Brentwood · Essex CM14 4SE · England · (0277) 219876**

**PLEASE RESERVE**.....centimetres by.....columns

**FOR A PERIOD OF** 1 issue..... 3 issues..... 6 issues..... 12 issues.....

**COPY** enclosed..... to follow.....

**PAYMENT ENCLOSED:**.....  Cheques should be made payable to Amateur Radio. Overseas payments by International Money Order

**CHARGE TO MY ACCOUNT**.....

**COMPANY** .....

**ADDRESS** .....

**SIGNATURE** ..... **TELEPHONE**.....





# ADVERTISERS INDEX

Amateur Radio Exchange ..... 12,13	ICS Electronics..... 41	RAS (Nottingham) ..... 39
P. Anderson..... 64		
Armstrong Kirkwood Development ..... 65	Interproducts ..... 65	Sandpiper Communication ..... 18
	Keytronics..... 19	Selectronics ..... 18
Cabelec..... 65	Low Electronics..... 4,5	WD Software ..... 64
Caswell Press ..... 64		Southdown Radio ..... 64
Centre Electronics ..... 39	Marco Trading..... 20	Technical Software ..... 34
PM Components..... 52,53	Mauritron Electronics ..... 65	Thanet Electronics..... 36,37
PNP Communications..... 64	Microwave Modules ..... Outside Back Cover	Used Equipment Centre ..... 30
WPO Communication..... 57		
Display Electronics ..... 51	Paul Sergent..... 65	Viewflint Ltd..... 50
Eastern Communication..... 65	Pinehurst Data Studio ..... 64	Vortex..... 64
Electrovalue..... 39	Post-a-Part..... Inside Front Cover	
DW Electronics..... 65	RSGB..... 35	R Withers ..... 11, Inside Back Cover
G4TNY Electronics ..... 64		Wood & Douglas..... 35

## Amateur RADIO

## ADVERTISING RATES & INFORMATION

ABC membership approved pending first audit Jan-Dec 1985

DISPLAY AD RATES		series rates for consecutive insertions			
depth mm x width mm	ad space	1 issue	3 issues	6 issues	12 issues
61 x 90	1/8 page	£86.00	£82.00	£59.00	£53.00
128 x 90 or 61 x 186	1/4 page	£115.00	£110.00	£105.00	£92.00
128 x 186 or 263 x 90	1/2 page	£225.00	£210.00	£200.00	£180.00
263 x 186	1 page	£430.00	£405.00	£385.00	£345.00
263 x 394	double page	£830.00	£780.00	£740.00	£660.00

COLOUR AD RATES		series rates for consecutive insertions			
depth mm x width mm	ad space	1 issue	3 issues	6 issues	12 issues
128 x 186 or 263 x 90	1/2 page	£305.00	£290.00	£275.00	£245.00
263 x 186	1 page	£590.00	£550.00	£530.00	£470.00
263 x 394	double page	£1,130.00	£1,070.00	£1,010.00	£900.00

SPECIAL POSITIONS	Covers:	Outside back cover 20% extra, inside covers 10% extra
	Bleed:	10% extra [Bleed area = 307 x 220]
	Facing Matter:	15% extra

DEADLINES		*Dates affected by public holidays			
issue	colour & mono proof ad	mono no proof & small ad	mono artwork	on sale thurs	
April 85	28 Feb 85	5 Mar 85	6 Mar 85	28 Mar 85	
May 85	28 Mar 85	3 Apr 85	4 Apr 85*	25 Apr 85	
Jun 85	25 Apr 85	1 May 85	3 May 85	23 May 85	
Jul 85	30 May 85	5 Jun 85	7 Jun 85	27 Jun 85	

CONDITIONS & INFORMATION			
<p><b>SERIES RATES</b> Series rates also apply when larger or additional space to that initially booked is taken. An ad of at least the minimum space must appear in consecutive issues to qualify for series rates. Previous copy will automatically be repeated if no further copy is received. A 'hold ad' is acceptable for maintaining your series rate contract. This will automatically be inserted if no further copy is received. Display Ad and Small Ad series rate contracts are not interchangeable.</p>	<p>If series rate contract is cancelled, the advertiser will be liable to pay the unearned series discount already taken. <b>COPY</b> Except for County Guides copy may be changed monthly. No additional charges for typesetting or illustrations (except for colour separations). For illustrations just send photograph or artwork. Colour Ad rates do not include the cost of separations.</p>	<p>Printed — web-offset. <b>PAYMENT</b> All single insertion ads are accepted on a pre-payment basis only, unless an account is held. Accounts will be opened for series rate advertisers subject to satisfactory credit references. Accounts are strictly net and must be settled by the publication date. Overseas payments by International Money Order or credit card. <b>FOR FURTHER INFORMATION CONTACT</b> Amateur Radio, Sovereign House, Brentwood, Essex CM14 4SE (0277) 219875</p>	<p>Commission to approved advertising agencies is 10%. <b>CONDITIONS</b> 10% discount if advertising in both Amateur Radio and Radio &amp; Electronics World. A voucher copy will be sent to Display and Colour advertisers only. Ads accepted subject to our standard conditions, available on request.</p>



Well, I've bought a 2M Rig that has lots of facilities. Now, how many aerials do I need to get the best out of it?

For mobile, the  $\frac{1}{4}$  wave worked very well in town on my old FM Rig, and it was no problem getting into multi-storey car parks etc. Still, I will need something better for motorway and open country.

The  $\frac{5}{8}$  wave is a good performer — low angle radiation. Not too long and whippy, like some of the long colinears.

What about S.S.B. mobile? I'll need to be horizontal to do any good. Maybe a halo and a gutter mount would be a good idea.

I must try some hill top D.X. this summer. That will need a small beam and some means of rotating it.

Musn't forget Fox Hunting — need a D.F. Loop for that.

I must think about portable aerials.

Would be good to get one to do it all!



If you are thinking this way, have a look at the first ever aerial to give you the choice of working modes. Built like a brick outhouse (**the Multi P.6**) serves all needs on or off the car 2M (and 70cms)

**SEE REVIEW IN THIS ISSUE**



# R WITHERS COMMUNICATIONS

584 HAGLEY ROAD WEST, OLDBURY, WARLEY  
B68 OBS (QUINTON, BIRMINGHAM) WEST MIDS.

Tel: 021-421 8201/2 (24 HR ANSWERPHONE)



## ARM MULTI P6

INTRODUCTORY OFFER, £29.50 £2.00 P&P  
SAE FOR FURTHER DETAILS ALLOW 3-7 DAYS DELIVERY



# MICROWAVE MODULES LTD



## 2 METRE MULTIMODE TRANSVERTER MMT144/28-R

# NEW RELEASE

### FEATURES

- ★ 25 watts Tx output
- ★ GaAsFET RF stage
- ★ Transmit ALC circuit
- ★ 13.8V DC operated
- ★ Repeater shift (normal, simplex, reverse)
- ★ High level DBM mixer
- ★ LED Bargraph Power Meter
- ★ RF Vox – Adjustable delay & manual override

### SPECIFICATION

#### General

Input freq range	: 28-30MHz
Output freq range	: 144-146MHz
Repeater shift	: Simplex, normal, reverse
DC requirements	: 13.8V DC & 6 Amps

#### Transmit Section

Output power	: 25 watts +/- 1dB
Input level range	: 1/4 to 300mW
ALC range	: 20dB
Modes of operation	: SSB, FM, CW, AM
Spurious outputs	: -65dB or better

#### Receive Section

Gain	: 20dB min
N.F.	: 2dB or better
3rd order intercept	: +19dBm (output)

### DESCRIPTION

This new transverter has been designed to allow users of existing HF band transceivers to establish a first-class transceiver facility on the 144MHz band. The MMT144/28-R incorporates many new and exciting features which combine to make this product simply superb.

#### Receive Section

An NEC GaAsFET is employed in a noise-matched configuration feeding a high level double balanced mixer via a bandpass filter. IF gain is achieved by a JFET post amplifier. This combination produces a good signal to noise ratio, excellent immunity to overload and cross modulation, resulting in a rugged receive system having a third order output intercept point of +19dBm.

Two separate low-noise oscillators, operating at 116.00 and 115.40MHz are included, running from a regulated 8.2 volt supply. Selection of the wanted oscillator is achieved by a quad op-amp circuit, controlled by the front panel mounted 'MODE' switch. This provides simplex, repeater and reverse repeater operation. The output of each oscillator feeds a JFET buffer amplifier via the quartz crystal which acts as a filtering element to reduce amplitude noise and reciprocal mixing products. The resultant high level injection is extremely pure and free from harmonics.

#### Transmit Section

The incoming 28MHz signal, in the range 1/4 to 300mW, is initially fed to the RF VOX circuit, ALC control circuit and the input level control. This signal is then fed into a pair of MOSFETs in a balanced mixer configuration, together with the local oscillator injection, to produce the wanted signal in the range 144-146MHz. This signal is then amplified by several linear stages up to the specified output power of 25 watts. A visual indication of relative output power is provided by a front panel mounted LED bargraph display. A rear panel mounted level control allows the user to adjust the sensitivity of the transverter to suit the transceiver in use, and a front panel mounted RF VOX delay control allows adjustment to suit SSB/FM modes. The ALC circuit has a 20dB dynamic range and has been incorporated to ensure that a totally clean signal is produced by the transverter. This is a particularly useful feature which will virtually eliminate compressed signals and the resultant problems caused to local stations.

**PRICE : £215 inc VAT (p+p £3.50)**

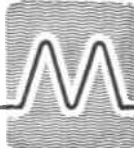

**MICROWAVE MODULES LTD**  
**Brookfield Drive, Aintree, Liverpool L9 7AN,**  
**England.**  
**Telephone: 051-523 4011.**  
**Telex: 628608 MICRO G.**

**HOURS:**  
**MONDAY – FRIDAY**  
**9-12.30. 1-5.00**  
**AR**

