

CS4070 SCANNER

PRODUCT REFERENCE GUIDE



CS4070 SCANNER PRODUCT REFERENCE GUIDE

MN000762A07

Revision A

December 2020

No part of this publication may be reproduced or used in any form, or by any electrical or mechanical means, without permission in writing. This includes electronic or mechanical means, such as photocopying, recording, or information storage and retrieval systems. The material in this manual is subject to change without notice.

The software is provided strictly on an “as is” basis. All software, including firmware, furnished to the user is on a licensed basis. We grant to the user a non-transferable and non-exclusive license to use each software or firmware program delivered hereunder (licensed program). Except as noted below, such license may not be assigned, sublicensed, or otherwise transferred by the user without our prior written consent. No right to copy a licensed program in whole or in part is granted, except as permitted under copyright law. The user shall not modify, merge, or incorporate any form or portion of a licensed program with other program material, create a derivative work from a licensed program, or use a licensed program in a network without written permission. The user agrees to maintain our copyright notice on the licensed programs delivered hereunder, and to include the same on any authorized copies it makes, in whole or in part. The user agrees not to decompile, disassemble, decode, or reverse engineer any licensed program delivered to the user or any portion thereof.

Zebra reserves the right to make changes to any product to improve reliability, function, or design.

Zebra does not assume any product liability arising out of, or in connection with, the application or use of any product, circuit, or application described herein. No license is granted, either expressly or by implication, estoppel, or otherwise under any patent right or patent, covering or relating to any combination, system, apparatus, machine, material, method, or process in which Zebra products might be used. An implied license exists only for equipment, circuits, and subsystems contained in Zebra products.

Warranty

For the complete hardware product warranty statement, go to: www.zebra.com/warranty.

Revision History

Changes to the original manual are listed below:

Change	Date	Description
-01 Rev A	8/2014	Initial release
-02 Rev A	12/2014	Rebranded; various updates to connection and operation information, updated default for Sleep and BTSleep, updated 123Scan ² chapter, updated index
-03 Rev A	3/2015	Updated URLs, added auto-reconnect beep description, added note to Scan Data Transmission Format
-04 Rev A	9/2015	<ul style="list-style-type: none"> - Added Bluetooth button press requirement and Note for unpairing - Added 2 minute value to Connection Interval option - Added Notes to Prefix and Suffix descriptions in config.ini table - Added Unpair function to LED Indications table - Updated Auto-reconnect default - Added General Decoder Modes and User Preferences to User Preferences chapter - Added Bluetooth HID Keyboard Features section/parameters to User Preferences chapter - Added USB HID Keyboard Features (Dongle) chapter - Removed Bi-directional Redundancy parameter - Updated ADF chapter - Removed PF Key Standard Default Table in Appendix G
-05 Rev A	1/2017	<ul style="list-style-type: none"> - Updated Notes under Batch Connection and Unpairing - Added Note to Editing the Configuration File section - Updated Config.ini table (Table 1-1) as follows: <ul style="list-style-type: none"> - Removed BarcodeDB - Updated description for ConnectionInterval - Added values to CountryKeyboardType - Updated Prefix entry cross-reference - Updated Scanner Parameters entry - Added details to Separator option - Added Note and a value to TimeFormat option - Changed default for WakeUpLED - Deleted Note for Deleting Bar Codes - Updated Transferring Data from a Batch Scanner information - Updated LED Indications table - Updated Clear All beeper indication - Added SSI numbers to all parameters - Reorganized User Preferences chapter - Added the following parameters to User Preferences/Bluetooth Options section: <ul style="list-style-type: none"> - Bluetooth Friendly Name - Link Supervision Timeout - Bluetooth HID Host Name - Added option information and Important note to Bluetooth Profile parameter - Updated Connection Interval parameter title and description - Added the following parameters to User Preferences/Bluetooth HID - Keyboard Features section: <ul style="list-style-type: none"> - Country Keyboard Type - Fast Bluetooth HID Keyboard

Change	Date	Description
-05 Rev A (continued)	1/2017	<ul style="list-style-type: none"> - Added the following parameters to User Preferences/General Decode Settings section: - Batch Mode - Automatic Day/Night Mode - Out of Range Electric Fence - Continuous Bar Code Read, Unique Bar Code Reporting, Decode Session Timeout, Timeout Between Decodes (Same and Different Symbols) - WiFi Friendly Mode - Deleted Enable Hand-held Decode Aiming Pattern on PDF option - Deleted Illumination Brightness parameter - Added Note to Mute Beeper - Added Country Keyboard Type parameter to USB HID Keyboard Parameters - Added GS1 Data Matrix parameter - Added Chapter 6 Cordless Bluetooth Wedge - Updated 123Scan chapter and removed ADF chapter - Replaced Restore Defaults bar code in Troubleshooting with link to Reset Factory Defaults bar code - Added new code types to Code ID tables - Deleted statement after Character Equivalents table - Added Appendix G Alphanumeric Bar Codes - Updated ALT Key table in Appendix H - Added Appendix I CJK Decode Control
-06 Rev A	4/2018	<ul style="list-style-type: none"> - Updated URLs (removed http://) - Updated copyright statement - Updated 123Scan chapter - Updated 123Scan2 to 123Scan
-07 Rev A	12/2020	<ul style="list-style-type: none"> - Replaced master/slave references with central/peripheral.

TABLE OF CONTENTS

Warranty	ii
Revision History	iii

About This Guide

Introduction	xv
Configurations	xv
Accessories	xv
Chapter Descriptions	xvi
Notational Conventions	xvii
Related Documents	xvii
Service Information	xviii

Chapter 1: Getting Started

Introduction	1-1
Unpacking the Scanner	1-2
Inserting and Removing the Battery	1-2
Inserting the Battery	1-2
Removing the Battery	1-3
Charging Batteries	1-4
Charging the Battery in a CS4070	1-4
Charging Spare Batteries	1-4
Charging Temperature	1-4
Connecting to the Host Computer	1-5
Batch Connection	1-5
Bluetooth Connection: Development Options	1-5
Serial Port Profile	1-5
Human Interface Device Emulation	1-5
Pairing	1-6
Supported Devices	1-6
Unpairing	1-7
Deleting the CS4070 from the Device List	1-7
Configuring the Scanner	1-8

123Scan	1-8
Parameter Bar Codes and Config.ini	1-8
Staging Multiple Scanners	1-8
Updating Scanner Firmware	1-8
Editing the Configuration File	1-9

Chapter 2: Scanning

Introduction	2-1
Scanning	2-1
Deleting Bar Codes	2-2
Transmitting Bar Code Data to Host	2-2
Transferring Data from a Batch Scanner	2-2
Clearing Bar Code Data	2-2
Autorun Feature	2-3
Transferring Data from a Bluetooth Scanner	2-3
Out of Range Behavior	2-3
User Interface Definitions	2-4
LED Indications	2-4
Beeper Indications	2-7

Chapter 3: User Preferences

Introduction	3-1
Scanning Sequence Examples	3-1
Errors While Scanning	3-1
User Preferences Default Parameters	3-2
Reset Factory Defaults	3-5
Set Date and Time	3-6
Set Date	3-6
Set Time	3-6
Cancel Date and Time Setting	3-6
Numeric Bar Codes for Date and Time Settings	3-7
Bluetooth Options	3-8
Bluetooth Friendly Name	3-8
Central/Peripheral Set Up	3-9
Peripheral	3-9
Central	3-9
Bluetooth Unpair	3-10
Bluetooth Profile	3-10
Clear Data	3-11
Auto-reconnect	3-12
Connection Interval and Discovery Mode Timeout	3-13
Link Supervision Timeout	3-14
Bluetooth HID Host Name	3-15
Examples	3-15
HID Security	3-18
Radio Output Power	3-18
Set HID CoD to Zero	3-19
Bluetooth HID Keyboard Features	3-20
Country Keyboard Type	3-20

HID CAPS Lock Override	3-23
HID Ignore Unknown Characters	3-23
Emulate Keypad	3-24
HID Keyboard FN1 Substitution	3-25
FN1 Substitution Values	3-25
HID Function Key Mapping	3-26
Simulated Caps Lock	3-26
Convert Case	3-27
Fast Bluetooth HID Keyboard	3-28
General Decoder Settings	3-29
Hand-Held Trigger Mode	3-29
Hand-Held Decode Aiming Pattern	3-30
Presentation Mode Field of View	3-31
Decoding Illumination	3-32
Direct Decode Indicator	3-33
Low Light Scene Detection	3-34
Parameter Bar Code Scanning	3-35
Beep After Good Decode	3-35
Beeper Volume	3-36
Beeper Tone	3-37
Mute Beeper	3-38
Decode Pager Motor (CS4070HC only)	3-38
Decode Pager Motor Duration (CS4070HC only)	3-39
Picklist Mode	3-40
Fuzzy 1D Processing	3-41
Mirrored Image	3-41
Mobile Phone/Display Mode	3-42
PDF Prioritization	3-43
PDF Prioritization Timeout	3-43
Batch Mode	3-44
Modes of Operation	3-44
Batch Action Bar Codes	3-46
Automatic Day/Night Mode	3-47
Automatic Day/Night Mode Start/Stop Time	3-48
Automatic Day/Night Mode Shift Profiles	3-49
Automatic Day/Night Mode 123Scan Programmable Shift Start Time	3-50
Automatic Day/Night Mode 123Scan Programmable Shift Stop Time	3-50
Out of Range Electric Fence	3-51
Out of Range Electric Fence Alarm	3-51
Out of Range Electric Fence Trigger Timeout	3-52
Out of Range Electric Fence Alarm Timeout	3-53
Continuous Bar Code Read	3-55
Unique Bar Code Reporting	3-55
Decode Session Timeout	3-56
Timeout Between Decodes, Same Symbol	3-56
Timeout Between Decodes, Different Symbols	3-57
Wi-Fi Friendly Mode	3-58
Notes	3-58
Wi-Fi Friendly Channel Exclusion	3-59
Data Options	3-61
Transmit Code ID Character	3-61

Prefix/Suffix Values	3-62
Scan Data Transmission Format	3-63
Transmit “No Read” Message	3-64
Send Versions	3-65
Firmware Version	3-65
Scan Engine Version	3-65
Dongle Version	3-65

Chapter 4: USB HID Keyboard Features (Dongle)

Introduction	4-1
Scanning Sequence Examples	4-1
Errors While Scanning	4-1
USB HID Keyboard Default Parameters	4-2
USB HID Keyboard Features (Dongle)	4-3
Country Keyboard Type	4-3
USB Keystroke Delay	4-6
USB CAPS Lock Override	4-7
USB Send Bar Codes with Unknown Characters	4-7
Emulate Keypad	4-8
Emulate Keypad with Leading Zero	4-8
Quick Keypad Emulation	4-9
USB Keyboard FN 1 Substitution	4-10
FN1 Substitution Values	4-10
Function Key Mapping	4-11
Simulated Caps Lock	4-11
Convert Case	4-12

Chapter 5: Symbolologies

Introduction	5-1
Scanning Sequence Examples	5-1
Errors While Scanning	5-2
Symbology Default Parameters	5-2
Enable/Disable All Code Types	5-7
UPC/EAN	5-8
Enable/Disable UPC-A	5-8
Enable/Disable UPC-E	5-8
Enable/Disable UPC-E1	5-9
Enable/Disable EAN-8/JAN-8	5-9
Enable/Disable EAN-13/JAN-13	5-10
Enable/Disable Bookland EAN	5-10
Bookland ISBN Format	5-11
Decode UPC/EAN/JAN Supplementals	5-12
User-Programmable Supplementals	5-15
UPC/EAN/JAN Supplemental Redundancy	5-15
UPC/EAN/JAN Supplemental AIM ID Format	5-16
Transmit UPC-A Check Digit	5-17
Transmit UPC-E Check Digit	5-17
Transmit UPC-E1 Check Digit	5-18
UPC-A Preamble	5-19

UPC-E Preamble	5-20
UPC-E1 Preamble	5-21
Convert UPC-E to UPC-A	5-22
Convert UPC-E1 to UPC-A	5-22
EAN-8/JAN-8 Extend	5-23
UCC Coupon Extended Code	5-23
Coupon Report	5-24
ISSN EAN	5-24
Code 128	5-25
Enable/Disable Code 128	5-25
Set Lengths for Code 128	5-25
Enable/Disable GS1-128 (formerly UCC/EAN-128)	5-27
Enable/Disable ISBT 128	5-27
ISBT Concatenation	5-28
Check ISBT Table	5-29
ISBT Concatenation Redundancy	5-29
Code 128 Security Level	5-30
Code 39	5-31
Enable/Disable Code 39	5-31
Enable/Disable Trioptic Code 39	5-31
Convert Code 39 to Code 32	5-32
Code 32 Prefix	5-33
Set Lengths for Code 39	5-33
Code 39 Check Digit Verification	5-35
Transmit Code 39 Check Digit	5-35
Code 39 Full ASCII Conversion	5-36
Code 39 Security Level	5-37
Code 93	5-38
Enable/Disable Code 93	5-38
Set Lengths for Code 93	5-38
Code 11	5-40
Code 11	5-40
Set Lengths for Code 11	5-40
Code 11 Check Digit Verification	5-42
Transmit Code 11 Check Digits	5-43
Interleaved 2 of 5 (ITF)	5-44
Enable/Disable Interleaved 2 of 5	5-44
Set Lengths for Interleaved 2 of 5	5-44
I 2 of 5 Check Digit Verification	5-46
Transmit I 2 of 5 Check Digit	5-47
Convert I 2 of 5 to EAN-13	5-47
I 2 of 5 Security Level	5-48
Discrete 2 of 5 (DTF)	5-49
Enable/Disable Discrete 2 of 5	5-49
Set Lengths for Discrete 2 of 5	5-49
Codabar (NW - 7)	5-51
Enable/Disable Codabar	5-51
Set Lengths for Codabar	5-51
CLSI Editing	5-53
NOTIS Editing	5-53
Codabar Upper or Lower Case Start/Stop Characters Detection	5-54

MSI	5-55
Enable/Disable MSI	5-55
Set Lengths for MSI	5-55
MSI Check Digits	5-57
Transmit MSI Check Digit(s)	5-57
MSI Check Digit Algorithm	5-58
Chinese 2 of 5	5-59
Enable/Disable Chinese 2 of 5	5-59
Matrix 2 of 5	5-60
Enable/Disable Matrix 2 of 5	5-60
Set Lengths for Matrix 2 of 5	5-60
Matrix 2 of 5 Check Digit	5-62
Transmit Matrix 2 of 5 Check Digit	5-62
Korean 3 of 5	5-63
Enable/Disable Korean 3 of 5	5-63
Inverse 1D	5-64
GS1 DataBar	5-65
GS1 DataBar-14	5-65
GS1 DataBar Limited	5-65
GS1 DataBar Expanded	5-66
Convert GS1 DataBar to UPC/EAN	5-66
GS1 DataBar Limited Security Level	5-67
Composite	5-68
Composite CC-C	5-68
Composite CC-A/B	5-68
Composite TLC-39	5-69
UPC Composite Mode	5-70
GS1-128 Emulation Mode for UCC/EAN Composite Codes	5-71
Postal Codes	5-72
US Postnet	5-72
US Planet	5-72
Transmit US Postal Check Digit	5-73
UK Postal	5-73
Transmit UK Postal Check Digit	5-74
Japan Postal	5-74
Australia Post	5-75
Australia Post Format	5-76
Netherlands KIX Code	5-77
USPS 4CB/One Code/Intelligent Mail	5-77
UPU FICS Postal	5-78
2D Symbologies	5-79
Enable/Disable PDF417	5-79
Enable/Disable MicroPDF417	5-79
Code 128 Emulation	5-80
Data Matrix	5-81
GS1 Data Matrix	5-81
Data Matrix Inverse	5-82
Decode Mirror Images (Data Matrix Only)	5-83
Maxicode	5-84
QR Code	5-84
QR Inverse	5-85

MicroQR	5-86
Aztec	5-86
Aztec Inverse	5-87
Han Xin	5-88
Han Xin Inverse	5-89
Symbology-Specific Security Levels	5-90
Redundancy Level	5-90
Redundancy Level 1	5-90
Redundancy Level 2	5-90
Redundancy Level 3	5-90
Redundancy Level 4	5-91
Security Level	5-92
Intercharacter Gap Size	5-93

Chapter 6: Cordless Bluetooth Wedge

Introduction	6-1
--------------------	-----

Chapter 7: 123Scan and Software Tools

Introduction	7-1
123Scan	7-1
123Scan Requirements	7-2
123Scan Information	7-2
Scanner SDK, Other Software Tools, and Videos	7-2
Scanner Control App	7-3
Scan-To-Connect (STC) Utility	7-3
Advanced Data Formatting (ADF)	7-3

Chapter 8: Maintenance and Technical Specifications

Introduction	8-1
Maintenance	8-1
Troubleshooting	8-2
Technical Specifications	8-3

Appendix A: Standard Default Parameters

Appendix B: Accessories

Overview	B-1
Accessories Summary	B-2
Single-Slot CS4070 Charging Cradle with Spare Battery Charger	B-3
Battery Charging Indications	B-4
Spare Battery Charging Indications	B-4
Bluetooth Connectivity	B-4
Eight-Slot CS4070 Charging Cradle	B-5
Battery Charging Indications	B-6
Bluetooth Connectivity	B-6
Eight-Slot Spare Battery Charger	B-7

Battery Charging Indications	B-8
LED Indications	B-8
Wall Mount Brackets	B-9
KT-102376-01R Bracket	B-9
Included Hardware	B-9
Mounting Instructions	B-10
KT-102375-01R Bracket	B-11
Included Hardware	B-11
Mounting Instructions	B-12
Bluetooth to USB HID Dongle	B-14
Pairing to a USB HID Device	B-15
Lanyard with Clip	B-16
Attaching and Removing the Lanyard	B-16

Appendix C: Bluetooth Connection Examples

Overview	C-1
iPad Pairing Example	C-2
Android Pairing Example	C-3
Accessing the Android Phone Keyboard	C-4
Windows 7 Pairing Example	C-5
Windows 8 Pairing Example	C-7
PIN Entry Bar Codes	C-9

Appendix D: Programming Reference

Code Type IDs	D-1
Symbol Code Identifiers	D-4
AIM Code Identifiers	D-6
GS1-128 (formerly UCC/EAN-128)	D-11
Setting Prefixes and Suffixes	D-12

Appendix E: Sample Bar Codes

UPC-A	E-1
UPC-E	E-1
UPC-E1	E-2
EAN-13	E-2
EAN-8	E-2
Code 39	E-2
Trioptic Code 39	E-3
Code 93	E-3
Code 11	E-3
Codabar	E-4
MSI	E-4
Interleaved 2 of 5	E-4
GS1 DataBar-14	E-5
PDF417	E-5
Data Matrix	E-5
Maxicode	E-5
QR Code	E-6

Han Xin	E-6
US Postnet	E-6
UK Postal	E-6

Appendix F: Numeric Bar Codes

Numeric Bar Codes	F-1
Cancel	F-3

Appendix G: Alphanumeric Bar Codes

Alphanumeric Keyboard	G-1
-----------------------------	-----

Appendix H: ASCII Character Sets

Appendix I: CJK Decode Control

Introduction	I-1
CJK Decode Control Parameters	I-2
Unicode Output Control	I-2
CJK Output Method to Windows Host	I-3
Unicode/CJK Decode Setup with Windows Host	I-4
Setting Up the Windows Registry Table for Unicode Universal Output	I-4
Adding CJK IME on Windows	I-4
Selecting the Simplified Chinese Input Method on the Host	I-5
Selecting the Traditional Chinese Input Method on the Host	I-5

Index

ABOUT THIS GUIDE

Introduction

The *CS4070 Scanner Product Reference Guide* provides general instructions for setting up, operating, maintaining, and troubleshooting the scanner.

Configurations

The CS4070 scanner is available in the following configurations:

- CS4070SR - Standard range, cordless Bluetooth
- CS4070HC - Healthcare, cordless Bluetooth

Each scanner includes a micro USB host cable.

Accessories

See [Table B-1 on page B-2](#) for a list of accessories.

Chapter Descriptions

Topics covered in this guide are as follows:

- [Chapter 1, Getting Started](#) provides a product overview and describes how to charge, connect, and configure the scanner.
- [Chapter 2, Scanning](#) provides instructions for how to scan bar codes and send the data to a host, as well as beeper and LED definitions.
- [Chapter 3, User Preferences](#) describes each user preference feature and provides the programming bar codes for selecting these features for the scanner. It also includes wireless communication parameters and commonly used bar codes to customize how data is transmitted to the host device.
- [Chapter 4, USB HID Keyboard Features \(Dongle\)](#) describes each USB HID keyboard feature and provides the programming bar codes for selecting these features for the scanner.
- [Chapter 5, Symbologies](#) describes all symbology features and provides the programming bar codes for selecting these features.
- [Chapter 6, Cordless Bluetooth Wedge](#) provides information on the Zebra Cordless Bluetooth Wedge Windows application utility.
- [Chapter 7, 123Scan and Software Tools](#) provides information on the PC-based scanner configuration tool 123Scan.
- [Chapter 8, Maintenance and Technical Specifications](#) provides information on how to care for the scanner, troubleshooting, and technical specifications.
- [Appendix A, Standard Default Parameters](#) provides a table of all host devices and miscellaneous scanner defaults.
- [Appendix B, Accessories](#) provides information on CS4070 accessories, which provide a variety of product support capabilities.
- [Appendix C, Bluetooth Connection Examples](#) provides pairing examples for several host devices.
- [Appendix D, Programming Reference](#) provides a table of AIM code identifiers, ASCII character conversions, and keyboard maps.
- [Appendix E, Sample Bar Codes](#) includes sample bar codes.
- [Appendix F, Numeric Bar Codes](#) includes numeric bar codes for parameters requiring specific numeric values.
- [Appendix G, Alphanumeric Bar Codes](#) includes bar codes for the alphanumeric keyboard.
- [Appendix H, ASCII Character Sets](#) includes character set tables.
- [Appendix I, CJK Decode Control](#) describes control parameters for CJK (Chinese, Japanese, Korean) bar code decode through USB HID (Dongle) and Bluetooth HID Keyboard Emulation mode.

Notational Conventions

The following conventions are used in this document:

- *Italics* are used to highlight the following:
 - Chapters and sections in this and related documents
- **Bold** text is used to highlight the following:
 - Key names on a keypad
 - Button names on a screen or window.
- bullets (•) indicate:
 - Action items
 - Lists of alternatives
 - Lists of required steps that are not necessarily sequential
- Sequential lists (e.g., those that describe step-by-step procedures) appear as numbered lists.
- Throughout the programming bar code menus, asterisks (*) are used to denote default parameter settings.



✓ **NOTE** This symbol indicates something of special interest or importance to the reader. Failure to read the note will not result in physical harm to the reader, equipment or data.



CAUTION This symbol indicates that if this information is ignored, the possibility of data or material damage may occur.



WARNING! This symbol indicates that if this information is ignored the possibility that serious personal injury may occur.

Related Documents

- *CS4070 Scanner Quick Reference Guide* (p/n MN000763Axx) provides general information to help the user get started with the scanner, including basic setup and operation instructions.
- *Advanced Data Formatting (ADF) Programmer Guide* (p/n 72E-69680-xx) provides information and programming bar codes for ADF.

For the latest version of this guide and all guides, go to: www.zebra.com/support.

Service Information

If you have a problem using the equipment, contact your facility's technical or systems support. If there is a problem with the equipment, they will contact Global Customer Support at: www.zebra.com/support. When contacting support, please have the following information available:

- Serial number of the unit
- Model number or product name
- Software type and version number

Zebra responds to calls by e-mail, telephone or fax within the time limits set forth in service agreements.

If your problem cannot be solved by support, you may need to return your equipment for servicing and will be given specific directions. Zebra is not responsible for any damages incurred during shipment if the approved shipping container is not used. Shipping the units improperly can possibly void the warranty.

If you purchased your business product from a Zebra business partner, please contact that business partner for support.

CHAPTER 1 GETTING STARTED

Introduction

The CS4070 Scanner captures and stores bar codes for a variety of uses, and transmits bar code data to a host via USB connection or Bluetooth.

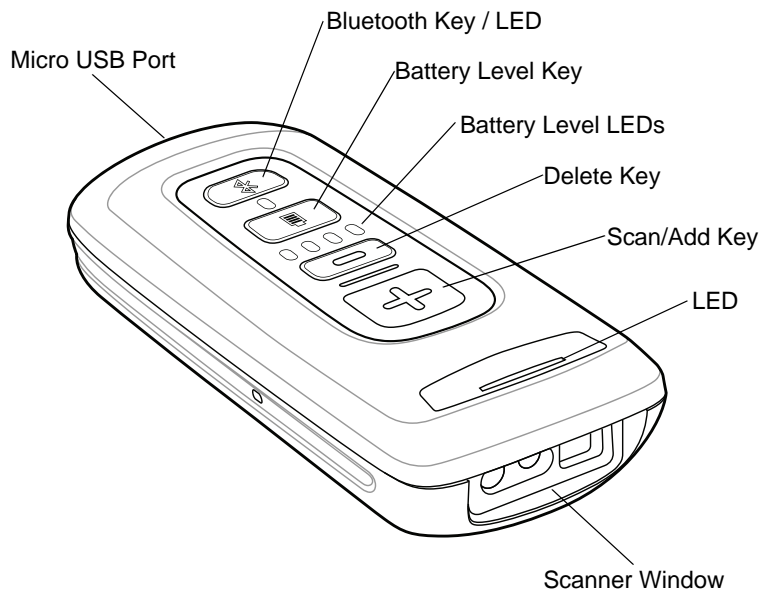

Figure 1-1 CS4070 Scanner

This scanner supports the following host interfaces:

- USB - The scanner connects to a USB host as a removable storage device, via a cradle or USB cable.
- Bluetooth - The scanner supports Bluetooth HID connection to a host (the default) where the scanner emulates a keyboard, as well as Serial Port Profile (SPP) connection where the scanner behaves as if there is a serial connection.

Unpacking the Scanner

Carefully remove all protective material from the scanner and save the shipping container for later storage and shipping. Verify that you received the following equipment:

- CS4070
- Lithium-ion battery
- Micro USB cable
- Quick Start Guide.

Inspect the equipment. If any equipment is missing or damaged, contact support. See [page xviii](#) for contact information.

Inserting and Removing the Battery

Inserting the Battery

Before using the scanner, insert the lithium-ion battery provided with the device.

1. Insert the battery, bottom first, into the battery compartment in the back of the device.
2. Press the battery down into the battery compartment until the battery release latch snaps into place.

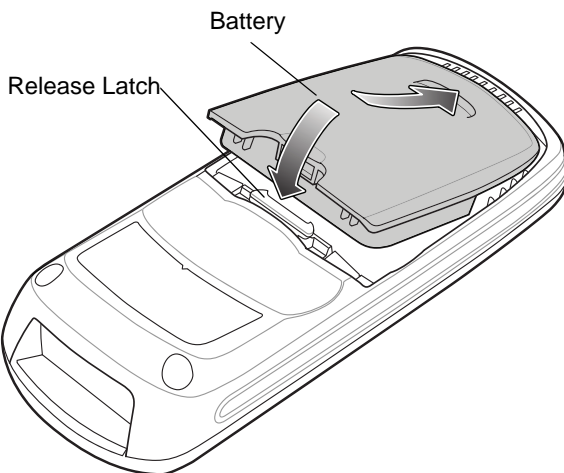

Figure 1-2 *Inserting the Battery*

- ✓ **NOTE** Position the battery correctly, with the battery charging contacts pointing towards the bottom of the scanner.

Removing the Battery

To remove the battery, pull the release latch upward with one finger, and use a finger from your other hand to pull back on the indent in the bottom of the battery housing. The battery rotates about the bottom edge and the latch end of the battery pops up, enabling you to lift it out from the sides.

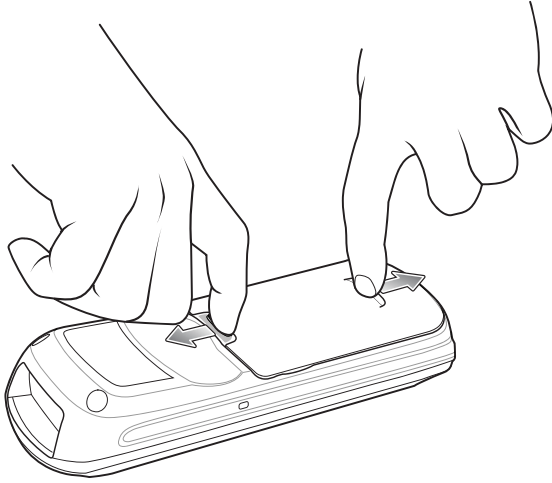

Figure 1-3 *Lift Release Latch*

Charging Batteries

Before using the CS4070 for the first time, charge the battery using the micro USB cable or a cradle until the green charge status LED lights. See [Table 2-1 on page 2-4](#) for charge status indications. For information about the charging accessories available for the device, see [Appendix B, Accessories](#).



NOTE If the battery is removed or replaced, the device cold boots. The internal back up battery retains the real-time clock.

Charging the Battery in a CS4070

Use one of the following methods to charge the battery when installed in a CS4070:

- Connect the micro USB cable to the micro USB port on the device, and the other end to a USB port on a host computer. Note that the scanner can not scan when connected to a host computer.
- Connect the micro USB cable to the micro USB port on the device, and the other end to a USB power adapter plugged into an AC outlet.
- Insert the CS4070 into a powered single-slot or 8-slot charging cradle. See [Single-Slot CS4070 Charging Cradle with Spare Battery Charger on page B-3](#) or [Eight-Slot CS4070 Charging Cradle on page B-5](#) for more information.

The CS4070 begins charging. The charge status LED flashes amber while charging, then turns solid green when fully charged. See [Table 2-1 on page 2-4](#) for charging indications.

Charging Spare Batteries

To charge a spare battery, insert the battery into a slot of a powered spare battery charging accessory with the charging contacts facing down, contacting the charging pins in the cradle. See [Single-Slot CS4070 Charging Cradle with Spare Battery Charger on page B-3](#) or [Eight-Slot Spare Battery Charger on page B-7](#).

The battery begins charging. The charge LED on the cradle lights to show the charge status.

Charging Temperature



IMPORTANT:

Charge batteries in temperatures from 0°C to 35°C (32°F to 95°F).

Note that at temperatures above 30°C the charging temperature is monitored and controlled by the device and the charging accessory. Charging is halted at temperatures above 35°C.

The device or accessory indicates when charging is disabled due to abnormal temperatures via its LED and/or battery icon. See [Table 2-1 on page 2-4](#), [Table B-2 on page B-4](#), and [Table B-3 on page B-8](#).

Connecting to the Host Computer

Batch Connection

The micro USB cable enables communication between the CS4070 and a PC, and charges the battery in the CS4070.

✓ **NOTE** To enter batch scanning mode, see *Batch Mode on page 3-44*.

To connect the CS4070 to a USB device:

1. Connect the USB A end of the USB cable to a USB port of the host or device.
2. Connect the micro USB connector of the cable to the CS4070.

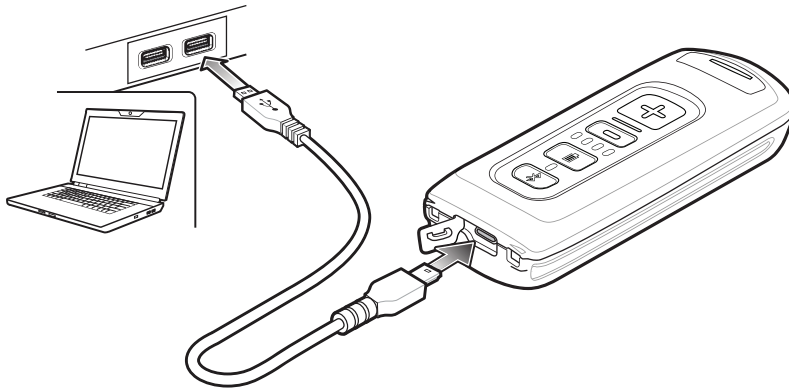

Figure 1-4 *Micro USB Cable Communication*

Bluetooth Connection: Development Options

✓ **NOTE** Multiple scanners can connect to a single host via SPP or HID. The host application must sort the data it receives from the scanner.

Serial Port Profile

This Bluetooth profile emulates a serial cable to provide a simply implemented wireless replacement for existing RS-232 based serial communications applications, including familiar control signals. It is the preferred communication profile implementation because accidental key strokes from the keyboard or touch screen on the host are not entered into the bar code data stream.

Human Interface Device Emulation

This Bluetooth profile is a lightweight wrapper of the Human Interface Device protocol defined for USB. Data transmitted from the Bluetooth scanner appears as keyboard entries to the Bluetooth host (Smartphone, PC, etc).

✓ **NOTE** Wedge data appears within whichever application has input focus.

Pairing

Pairing the CS4070 with a host device typically requires holding the Bluetooth button to place the scanner in discoverable mode, then scanning a pairing PIN if required. The CS4070 remembers the PIN for the last eight devices to which it paired, and can establish connection to these devices without customer input after the initial pairing.

- ✓ **NOTE** When using the dongle, simply scan the pairing bar code on the dongle to connect. No PIN is required. Note that the dongle allows a single connection only.

Supported Devices

The CS4070 supports connection to the following types of devices:

- iOS
- Android
- Windows 8 Pro
- Windows 7 Pro
- Windows XP (Microsoft, Broadcom, and other commonly available Bluetooth stacks)
- Windows RT
- Windows Embedded Compact (CE7)

To pair to a Bluetooth-enabled host:

1. Press the scan button (+) to wake the scanner.
2. Press and hold the Bluetooth button until the scanner beeps and the blue LED begins to flash to indicate that the scanner is discoverable by the host.
3. On the host, launch the Bluetooth pairing application and place the application into discover Bluetooth device mode.
4. Select the CS4070 from the discovered device list. The Bluetooth application may prompt you to scan a PIN it generated, or for you to create and then scan the PIN.
5. If required, scan *PIN Entry Bar Codes on page C-9* that correspond to the PIN, then scan Enter.

The Bluetooth button blinks slowly to indicate that the scanner paired with the host.

- ✓ **NOTE** Bluetooth pairing suspends temporarily while charging via a USB cable. Disconnecting the cable re-establishes Bluetooth pairing.

- ✓ **NOTE** When pairing with an iPad, press the delete key (-) on the CS4070 to toggle the virtual keyboard on and off.

For pairing examples, see [Appendix C, Bluetooth Connection Examples](#).

Unpairing

To temporarily unpair the scanner and host, press and hold the Bluetooth button for 2 seconds, then release. This disables Bluetooth and the Bluetooth button stops blinking. Pressing the Bluetooth button again re-pairs the scanner with the host.

- ✓ **NOTE** If the Bluetooth button is held for longer than 5 seconds, the scanner terminates the wireless connection, if already paired and connected to a host system. The scanner then enters discovery mode, searching for a new host with which to pair and establish a new wireless connection.

To permanently unpair the scanner and host, scan *Unpair on page 3-10*. This allows the scanner to pair to a different host device.

- ✓ **NOTE** To enter batch scanning mode, see *Batch Mode on page 3-44*.

Deleting the CS4070 from the Device List

To delete the device from the discovered devices list, tap and hold the device and select **Delete**.

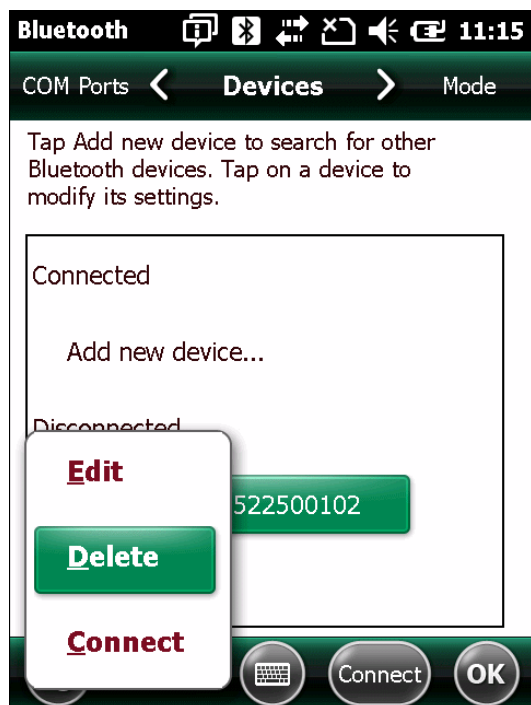

Figure 1-5 Deleting Device

Configuring the Scanner

123Scan

To configure the scanner via 123Scan, use this utility to generate a 2D bar code with the desired configuration options. Scan the bar code to configure the scanner with these options. Note that the CS4070 does not support 1D configuration bar codes. See [Chapter 7, 123Scan and Software Tools](#).

Parameter Bar Codes and Config.ini

To configure the scanner:

1. Scan the parameter bar codes in [Chapter 3, User Preferences](#) and [Chapter 5, Symbologies](#) to customize scanner operation.
2. For additional customization, edit the **Config.ini** file on the scanner using the options in [Editing the Configuration File on page 1-9](#).
3. When deploying the new configuration to multiple scanners, to ensure unique CS4070 serial numbers appear in the host's discovery window, edit the **Config.ini** file to either remove the **BTName** entry or set it to blank ("BTName=") to ensure that each scanner uses the default BT name of **CS4070:<serial number>**.

Staging Multiple Scanners

After creating a **config.ini** file for one "golden" scanner with all desired settings, create a copy of the file from this scanner and copy it to other scanners via USB connection. Set the time and date on the "cloned" scanners by scanning bar codes from [Set Date and Time on page 3-6](#).

- ✓ **NOTE** When deploying the new configuration to multiple scanners, to ensure unique CS4070 serial numbers appear in the host's discovery window, edit the **Config.ini** file to either remove the **BTName** entry or set it to blank ("BTName=") to ensure that each scanner uses the default BT name of **CS4070:<serial number>**.

Updating Scanner Firmware

To update scanner firmware:

1. Connect the micro USB cable from the host to the CS4070.
2. Copy the .dat and .bin files to the root directory of the scanner.
3. Disconnect the cable when the host indicates that it is safe to remove.

After several minutes the LED turns green to indicate that the firmware was successfully installed.

Editing the Configuration File

Use a text editor such as Notepad to set configuration values in the **Config.ini** editable text file in the **\Parameters** folder on the CS4070. [Table 1-1](#) lists the programmable contents of the file.

- ✓ **NOTE** All values in the **Config.ini** file are hexadecimal.
- ✓ **NOTE** If you make errors while editing the **Config.ini** file, the file LOG.TXT is created in the **\Parameters** folder. Consult this log file to determine the errors and make corrections.

Table 1-1 *Config.ini* File Content

Name	Description	Values	Default
AutoReconnect	Enable or disable automatic Bluetooth reconnection to dongle or another device.	1 = Enabled 0 = Disabled	Enabled
BarcodeFile	Name of file to store batched data.	String	BARCODES.TXT
BTName	Bluetooth friendly name	String	CS4070
BTPin	Bluetooth PIN code	String	1234
BTProfile	Selected Bluetooth profile	0 = HID 1 = SPP 2 = SSI 3 = MFi_SPP 4 = MFi_SSI	HID
BtRfPower	Controls Bluetooth radio output power (100 m vs. 10 m)	0 = Class 1 1 = Class 2	Class 1
BTSleep	Time in seconds before device enters sleep mode while paired to another Bluetooth device if no activity is detected. Note: Set this value equal to or less than the Sleep setting.	Word	14400 (4 hours)
ButtonBT	Enable or disable the Bluetooth button.	1 = Enabled 0 = Disabled	Enabled
ButtonMinus	Enable or disable the delete (minus) button.	1 = Enabled 0 = Disabled	Enabled
ButtonPlus	Enable or disable the scan/add (plus) button.	1 = Enabled 0 = Disabled	Enabled
CodeID	Enable or disable saving CodeID in scanned bar codes file.	1 = Enabled 0 = Disabled	Enabled
ConnectionInterval	Amount of time to try to establish connection/auto-reconnect and the timeout for discovery mode.	30 seconds 1 minute 2 minutes 5 minutes	30 seconds

Table 1-1 *Config.ini File Content (Continued)*

Name	Description	Values	Default
CountryKeyboardType	Country keyboard code	North American Windows Belgian French Windows French Windows German Windows Canadian Windows Spanish Windows Italian Windows Swedish Windows UK Windows Japan Windows Portuguese Brazil Windows Swiss German Windows Swiss French Windows Simplified Chinese GBK Windows Simplified Chinese UTF-8 Windows Traditional Chinese BIG5 Windows Traditional Chinese UTF-8 Windows Russian Windows Russian Typewriter	North American
DateFormat	Date format	0= MM/DD/YY 1 = DD/MM/YY 2 = MM/DD/YYYY 3 = DD/MM/YYYY	MM/DD/YY
DisableProtectToggle	Enable or disable the scan bar code function.	1 = Enabled 0 = Disabled	Disabled
HIDSecurity	Set HID security Notes: Some devices do not allow a connection in HID mode if this is set to low. Set security to low to connect to Android devices in HID mode without entering a PIN code.	2 = High (keyboard only - secure simple pairing capability) 3 = Low (no input/ no output - secure simple pairing capability)	High
KeystrokeDelay	For HID only, set the delay, in milliseconds, between emulated keystrokes. Note: When pairing with the Android, set this to 70 ms to avoid data loss.	Word (0 to 100)	0
LEDBlue	Enable or disable the blue LED for normal operations and wake up.	1 = Enabled 0 = Disabled	Enabled
LEDGreen	Enable or disable the green LED for normal operations and wake up.	1 = Enabled 0 = Disabled	Enabled
LEDRed	Enable or disable the red LED for normal operations and wake up.	1 = Enabled 0 = Disabled	Enabled

Table 1-1 *Config.ini File Content (Continued)*

Name	Description	Values	Default
LEDAmber	Enable or disable the amber LED for normal operations and wake up.	1 = Enabled 0 = Disabled	Enabled
Mute	Mute beeper	1 = Enabled 0 = Disabled	Off
PagerMotor (CS4070HC only)	Enable or disable the pager motor which vibrates the scanner for a period of time upon successful decode.	1 = Enabled 0 = Disabled	Enabled
PagerMotorDuration (CS4070HC only)	Set the period of time for which the scanner vibrates.	150 - 750 msec	200 msec
Prefix	Add prefix to decode data. Note: This field must contain a printable keystroke ASCII hex code as defined in Table D-6 on page D-12 . To program non-printable and non-ASCII characters shown in the Appendix H, ASCII Character Sets tables, use parameter bar code programming in <i>Data Options on page 3-61</i> .	Byte	<none>
ScanLED	Enable or disable the LEDs that illuminate while the laser scanner is active.	1 = Enabled 0 = Disabled	Enabled
<Scanner Parameters>	All other scanner parameters defined in this guide. These parameters have self-documenting names with associated hexadecimal numbers and values. Multiple entries are allowed. The format is: <parameter name><hexadecimal parameter number><hexadecimal parameter value> For example: Code39=00,01 UPC-A=01,01 UPC-E=02,01	Variable	N/A
Separator	An ASCII character that acts as a delimiter in the Barcode.txt file between the Time and Date Stamp and the barcode data.	Byte	';
Sleep	Time in seconds before device enters sleep mode if no activity is detected.	Word	14400 (4 hours)
Suffix	Add suffix to decode data. Note: This field must contain a printable keystroke ASCII hex code as defined in Table D-6 on page D-12 . To program non-printable and non-ASCII characters shown in the Appendix H, ASCII Character Sets tables, use parameter bar code programming in <i>Data Options on page 3-61</i> .	Byte	<none>

Table 1-1 *Config.ini File Content (Continued)*

Name	Description	Values	Default
TimeFormat	Time format for data stored in batch. Note: If you set this to blank, there is no time and date stamp stored with batched data in the Barcodes.txt file.	1 = 12h 0 = 24h 2 = Blank or <Space>	24h
WakeUpBeep	Enable or disable wake up beep.	1 = Enabled 0 = Disabled	Disabled
WakeUpLED	Enable or disable wake up LEDs.	1 = Enabled 0 = Disabled	Enabled
ZeroOutHIDClassOfDevice	Some versions of Broadcom stack experience issues when connecting to HID devices. Enable this feature if this is the case.	1 = Enabled 0 = Disabled	Disabled

CHAPTER 2 SCANNING

Introduction

This chapter provides instructions for how to scan bar codes and send the data to a host. Beeper and LED definitions are also included.

Scanning

See [Chapter 1, Getting Started](#) to install and program the scanner. To scan:

1. Aim the scanner at the bar code.
2. Press the scan (+) button.

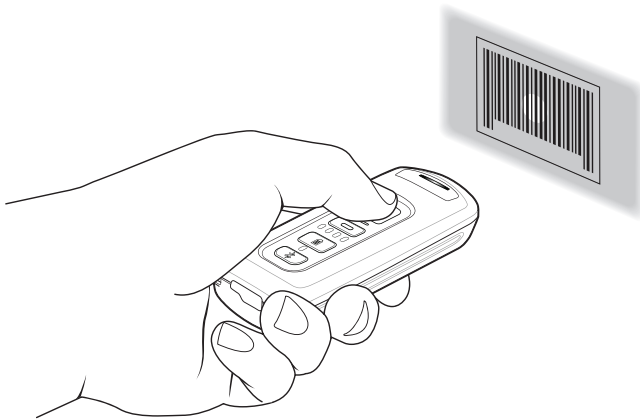

Figure 2-1 Scanning

3. Ensure the aiming dot is centered on the bar code.

The scanner beeps and the LED turns green to indicate a successful decode. See [Table 2-1](#) and [Table 2-2](#) for beeper and LED definitions..

✓ **NOTE** The scanner cannot scan bar codes when it is connected to the host via the USB host cable.

- ✓ **NOTE** Hold down the + button for 10 seconds to toggle the beeper functionality on and off.

Deleting Bar Codes

In batch mode, to delete a bar code aim the scanner at the bar code and press the delete (-) button.

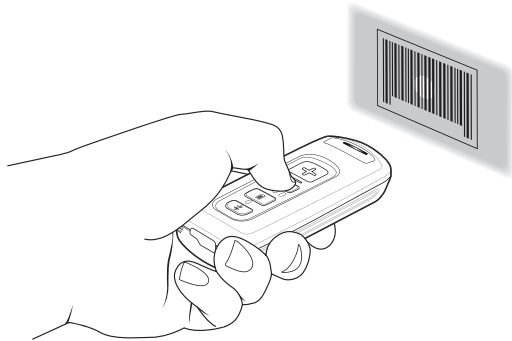

Figure 2-2 Deleting a Bar Code in Batch Mode

Transmitting Bar Code Data to Host

Transferring Data from a Batch Scanner

The BarcodeFile.txt file within the **\Scanned Barcodes** directory on the scanner stores scanned bar code data. To transfer data, perform one of the following:

- Connect the scanner to the host via USB cable when in **Batch Only** mode (see *Batch Mode* on page 3-44) and use Windows Explorer to navigate to the scanner. Cut and paste the bar code data file to the host.
- Scan *Send Batch Data* on page 3-46 when the scanner is in a **Standard Batch Mode** (see *Batch Mode* on page 3-44). The contents of the BarcodeFile.txt file transmit over Bluetooth to the host application.
- ✓ **IMPORTANT** Before scanning **Send Batch Data**, ensure the host application is ready to receive the contents of the BarcodeFile.txt file or the data is lost because, for security reasons, the scanner deletes this file after sending it. The CS4070 sends all Bluetooth data using the standard encryption formats within the Bluetooth protocol.
- ✓ **NOTE** When the scanner is in **Batch ONLY Mode**, **Out of Range Batch Mode**, or **Standard Batch Mode**, you can also copy or cut and paste the BarcodeFile.txt file to the host.

Clearing Bar Code Data

To clear the bar code data, delete the BarcodeFile.txt file from the scanner, or scan the **Clear Data** bar code on [page 3-11](#).

- ✓ **NOTE** The scanner does not allow changing the Batch Mode state until the BarcodeFile.txt file is deleted or completely cleared.

Autorun Feature

The scanner supports an autorun feature where you can build an autorun.inf file to automatically copy the data to the host upon connection. Autorun.inf is a text-based configuration file that defines, upon connecting the scanner, which executable or application to run on the host, which icon represents the scanner, and which menu commands appear when you right-click the scanner icon from Windows Explorer. For more information, search **autorun.inf** on any search engine.

Transferring Data from a Bluetooth Scanner

When the scanner is paired to a host via Bluetooth, data transmits to the host after each scan and is not stored on the device.

Out of Range Behavior

If the scanner moves out of range of the host, and does not re-pair with the host within the timeout period, scanned data is lost and the scanner emits a 3-beep error tone.

When the radio loses connection, the Bluetooth LED stops its slow, consistent blinking and the beeper emits a short high low beep. The Bluetooth LED blinks at a faster rate for a period of time while the device attempts to reestablish pairing with the host, and when it returns within range the device repairs. If repairing is unsuccessful the Bluetooth LED stops blinking.

To manually reestablish pairing when the device returns to range, press the Bluetooth LED button. Upon Bluetooth pairing, the beeper emits a short low high beep and the Bluetooth LED starts its slow, consistent blinking again.

User Interface Definitions

The scanner uses beeper and LED sequences to indicate various system events. [Table 2-1](#) and [Table 2-2](#) define these sequences and events.

LED Indications

Table 2-1 *LED Indications*

Function Performed	User Action	LED Feedback	Other
Bar Code Data Indications			
Scan attempt	Press scan (+) button	Flashing green	Imager on
Successful bar code scan		Solid green	Imager off
Delete bar code (when in batch mode)	Press & hold delete (-) button	Flashing amber	Imager on
Successful bar code deletion		Solid amber	Imager off
Unsuccessful deletion - item doesn't exist (when in batch mode)		Solid red	Imager off
Clear all bar code data (when delete (-) button enabled)	Hold delete (-) button 3 seconds past scan time	Flashing amber	Imager on
Successful clear all		Solid amber	Imager off

Table 2-1 LED Indications (Continued)

Function Performed	User Action	LED Feedback	Other
Charging Indications			
Battery charge status	Press battery charge button. If scanner is in sleep mode, press scan (+) button to wake it.	4 green	Full charge (12 hours in a busy environment)
		3 green	Approximately 3/4 charge
		2 green	Approximately 1/2 charge
		1 green	Approximately 1/4 charge
Charge scanner	Connect scanner to a host PC USB port.	Flashing amber	Scanner connects in mass storage mode, auto-run application on PC launches
	Insert scanner in charging cradle.	Flashing amber	The battery is above the low battery threshold of 3.4 volts. The scanner turns on if removed from the charging source.
		Flashing red	The battery is trickle charging but is well below the low battery threshold of 3.4 volts. The scanner does not turn on if removed from the charging source.
Charge complete		Solid green	The scanner turns on if removed from the charging source.
Charge error	Connect scanner to a host PC USB port or insert scanner in charging cradle.	Solid amber	The battery is above the low battery threshold but is not charging due to a faulty battery or charging source. Re-seat the scanner in the charging cradle or connect it to a host PC USB port. If the problem persists replace the charger or the battery.
		Solid red	The battery is not installed or is faulty. Re-seat the scanner in the charging cradle or connect it to a host PC USB port. If the problem persists replace the battery.

Table 2-1 LED Indications (Continued)

Function Performed	User Action	LED Feedback	Other
Data Protection Indications			
Toggle data protection on or off (when enabled)	Press & hold both scan (+) and delete (-) buttons for 6 seconds.	None	
Successful data protection setting		Solid amber	
Bluetooth Indications			
Enable Bluetooth radio	Hold Bluetooth button.	Rapidly flashing blue LED	Bluetooth is enabled but has not paired with a host.
Bluetooth radio pairing	Press Bluetooth button.	Slowly flashing blue LED	
Bluetooth radio paired with host and in range		Very slowly flashing blue LED	
Unpair scanner from host	Hold Bluetooth button for 2 seconds.	Off	
Bluetooth radio out of range of host		Blue LED rapidly flashes for 2 minutes, then turns off	Stops transmitting beacons.
Bluetooth radio returns to communication range of host	Press any button.	Very slowly flashing blue LED	Re-pairs device with host.
Special Conditions			
Memory low scan	Press & hold scan (+) button.	Flashing red, then normal operation	
Delete/Clear All	Press & hold delete (-) button.	Normal operation	
Memory Full Scan	Press & hold scan (+) button.	Solid red	
Memory Full Delete/Clear All	Press & hold delete (-) button.	Normal operation	
Data protection (enabled and on)	Scan/function/host com	Rapidly flashing red	
Unexpected failure	Scan/function/dock	Flashing red, green and amber for 5 seconds	Contact support
Battery depleted	Scan/function/dock	None	

Beeper Indications

Table 2-2 *Beeper Indications*

Function Performed	Beeper Feedback	Other
Successful bar code scan	Short high beep	Imager off
Successful bar code deletion	Short medium beep	Imager off
Unsuccessful deletion - item doesn't exist (when in batch mode)	Long short short beep	Imager off
Successful clear all	Warble (high low high low) beep	Imager off
Successful data protection setting	Short long short beep	
Connect scanner to a host PC USB port to charge scanner	Low high beep	
Enable Bluetooth radio	Short beep	Hold Bluetooth button
Bluetooth radio pairing	Short low high beep	
Bluetooth radio out of range of host	Short high low beep	Stops transmitting beacons
Bluetooth radio returns to communication range of host	Short low high beep	Re-pairs device with host
Bluetooth automatic reconnect to host or disconnect from host	2 short beeps	<i>Auto-reconnect on page 3-12 must be enabled</i>
Attempt to scan when out of Bluetooth radio range	4 high beeps	No Bluetooth transmission
Memory Full Scan	Long beep for 5 seconds or until scan button released	

CHAPTER 3 USER PREFERENCES

Introduction

This chapter describes each user preference feature and provides the programming bar codes for selecting these features for the scanner.

The scanner ships with the settings shown in the [User Preferences Default Table on page 3-2](#) (also see [Appendix A, Standard Default Parameters](#) for all host device and miscellaneous scanner defaults). If the default values suit the requirements, programming is not necessary. To change these values, scan a single bar code or a short bar code sequence. The new settings are stored in non-volatile memory and are preserved when the scanner powers down.

To return all features to their default values, scan the [Reset Factory Defaults](#) bar code on [page 3-5](#). Throughout the programming bar code menus, default values are indicated with asterisks (*).



Scanning Sequence Examples

In most cases, scan only one bar code to set a parameter value. For example, to set the beeper tone to high, scan the **High Frequency** (beeper tone) bar code under [Beeper Tone on page 3-37](#). The scanner issues a fast warble beep and the LED turns green, indicating a successful parameter entry.

Other parameters, such as **Data Transmission Formats**, require scanning several bar codes. See the parameter description for this procedure.

Errors While Scanning

Unless otherwise specified, if an error is made during a scanning sequence, re-scan the correct parameter.

User Preferences Default Parameters

Table 3-1 lists the defaults for user preference parameters. To change any option, scan the appropriate bar code(s) provided in this chapter.

✓ **NOTE** See [Appendix A, Standard Default Parameters](#) for all default parameters.

Table 3-1 User Preferences Default Table

Parameter	Parameter Number	SSI Number	Factory Default	Page Number
Reset Factory Defaults	N/A	N/A	N/A	3-5
Set Date	N/A	N/A	N/A	3-6
Set Time	N/A	N/A	N/A	3-6
Cancel Date and Time Settings	N/A	N/A	N/A	3-6
Bluetooth Options				
Bluetooth Friendly Name	N/A	N/A	N/A	3-8
Pairing Bar Code Format	N/A	N/A	N/A	3-9
Bluetooth Unpair	N/A	N/A	N/A	3-10
Bluetooth Profile	N/A	N/A	HID	3-10
Clear Data	N/A	N/A	N/A	3-11
Auto-reconnect	N/A	N/A	Enable	3-12
Connection Interval and Discovery Mode Timeout	1339	F8h 05h 3Bh	2 Minutes	3-13
Link Supervision Timeout	1698	F4h 06h A2h	0.5 Seconds	3-14
Bluetooth HID Host Name	Host 1: 1397 Host 2: 1398 Host 3: 1399	Host 1: F8h 05h 75h Host 2: F8h 05h 76h Host 3: F8h 05h 77h	N/A	3-15
HID Security	911	F2h 8Fh	High	3-18
Radio Output Power	N/A	N/A	Class 1	3-18
Set HID CoD to Zero	N/A	N/A	Disable	3-19
Bluetooth HID Keyboard Features				
Country Keyboard Type	1392	F8h 05h 70h	Windows North American	3-20
HID Caps Lock Override	1372	F8h 05h 5Ch	Disable	3-23
HID Ignore Unknown Characters	1373	F8h 05h 5Dh	Enable	3-23

Table 3-1 User Preferences Default Table (Continued)

Parameter	Parameter Number	SSI Number	Factory Default	Page Number
Emulate Keypad	1374	F8h 05h 5Eh	Disable	3-24
HID Keyboard FN1 Substitution	1375	F8h 05h 5Fh	Disable	3-25
FN1 Substitution Values:			N/A	3-25
Key Category	103	67h		
Decimal Value	109	6Dh		
HID Function Key Mapping	1377	F8h 05h 61h	Disable	3-26
Simulate Caps Lock	1378	F8h 05h 62h	Disable	3-26
Convert Case	1379	F8h 05h 63h	No Case Conversion	3-27
Fast Bluetooth HID Keyboard	1429	F8h 05h 95h	Fast HID Enable	3-28
General Decoder Settings				
Hand-Held Trigger Mode	138	8Ah	Level (Standard)	3-29
Hand-Held Decode Aiming Pattern	306	F0h 32h	Enable	3-30
Presentation Mode Field of View	609	F1h 61h	Full	3-31
Decoding Illumination	298	F0h 2Ah	Enable	3-32
Direct Decode Indicator	859	F2h 5Bh	Disable	3-33
Low Light Scene Detection	810	F2h 2Ah	No Low Light Scene Detection	3-34
Beeper Volume	140	8Ch	High	3-36
Beeper Tone	145	91h	Medium Frequency	3-37
Mute Beeper	N/A	N/A	Do Not Mute	3-38
Decode Pager Motor (CS4070HC only)	613	F1h 65h	Enable	3-38
Decode Pager Motor Duration (CS4070HC only)	626	F1h 72h	200 msec	3-39
Picklist Mode	402	F0h 92h	Disabled Always	3-40
Fuzzy 1D Processing	514	F1h 02h	Enable	3-41
Mirrored Image	624	F1h 70h	Disable	3-41
Mobile Phone/Display Mode	716	F1h CCh	Disable	3-42
PDF Prioritization	719	F4h F1h CFh	Disable	3-43
PDF Prioritization Timeout	720	F1h D0h	200 ms	3-43
Batch Mode	544	F1h 20h	Normal (Do Not Batch Data)	3-44
Automatic Day/Night Mode	1393	F8h 05h 71h	Disable	3-47
Automatic Day/Night Mode Start/Stop Time	N/A	N/A	N/A	3-48

Table 3-1 User Preferences Default Table (Continued)

Parameter	Parameter Number	SSI Number	Factory Default	Page Number
Automatic Day/Night Mode Shift Profiles	1394	F8h 05h 72h	Enable	3-49
Automatic Day/Night Mode 123Scan Programmable Shift Start Time	1395	F8h 05h 73h	N/A	3-50
Automatic Day/Night Mode 123Scan Programmable Shift Stop Time	1396	F8h 05h 74h	N/A	3-50
Out of Range Electric Fence Alarm	1426	F8h 05h 92h	Disable	3-51
Out of Range Electric Fence Trigger Timeout	1427	F8h 05h 93h	3 Seconds	3-52
Out of Range Electric Fence Alarm Timeout	1428	F8h 05h 94h	3 Seconds	3-53
Continuous Bar Code Read	649	F1h 89h	Disable	3-55
Unique Bar Code Reporting	723	F1h D3h	Enable	3-55
Decode Session Timeout	136	88h	5.0 Sec	3-56
Timeout Between Decodes, Same Symbol	137	89h	0.5 Sec	3-56
Timeout Between Decodes, Different Symbols	144	90h	0.1 sec	3-57
Wi-Fi Friendly Mode	1299	F8h 05h 13h	Disable	3-58
Wi-Fi Friendly Channel Exclusion	1297	F8h 05h 11h	Use All Channels	3-59
Data Options				
Transmit Code ID Character	45	2Dh	None	3-61
Prefix Value	99, 105	63h, 69h	7013 <CR><LF>	3-62
Suffix 1 Value Suffix 2 Value	98, 104 100, 106	62h, 68h 64h, 6Ah	7013 <CR><LF>	3-62
Transmit "No Read" Message	94	5E	Disable	3-64
Scan Data Transmission Format	235	EBh	Data as is	3-63
Version Options				
Send Firmware Version	N/A	N/A	N/A	3-65
Send Scan Engine Version	N/A	N/A	N/A	3-65
Send Dongle Version	N/A	N/A	N/A	3-65

Reset Factory Defaults

To reset the scanner to factory defaults, scan the following bar code. This rebuilds the configuration file from program memory.



Reset Factory Defaults

Set Date and Time

- ✓ **NOTE** You must scan the configuration bar codes to set the time and date stamp on the scanner. The time and date can not be set or edited in the **config.ini** file. This setting persists for three months if the scanner is not used.

Set Date

Scan the **Set Date** bar code, then scan six numeric digits in the format **mmddyy** from [Numeric Bar Codes for Date and Time Settings on page 3-7](#) (first two for the month, second two for the day, third two for the year).

- ✓ **NOTE** To change the date format from **mmddyy**, see [DateFormat on page 1-10](#).

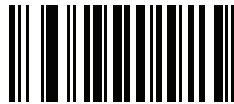

Set Date

Set Time

Scan the **Set Time** bar code, then scan four numeric digits in the format **hhmm** from [Numeric Bar Codes for Date and Time Settings on page 3-7](#) representing the time according to the 24 hour clock (first two for the hour, second two for the minute).

For example, to set the time to 8:45 in the morning, scan the following bar code, then scan 0, 8, 4, 5. To set the time to 3:07 in the afternoon, scan 1, 5, 0, 7.

- ✓ **NOTE** To change the time format between **12h** and **24h**, see [TimeFormat on page 1-12](#).



Set Time

Cancel Date and Time Setting

Scan the **Cancel Set Date/Time** bar code to cancel the date and time settings.



Cancel Set Date/Time

Numeric Bar Codes for Date and Time Settings



0



2



4



6



8



Enter



1



3

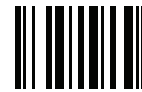

5

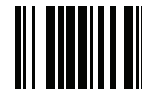

7



9

Bluetooth Options

Bluetooth Friendly Name

You can set a meaningful name for the scanner that appears in the application during device discovery. The default name is the scanner name followed by its serial number, e.g., **CS4070: 123456789ABCDEF**. Scanning **Reset Factory Defaults** reverts the scanner to this name; use 123Scan set defaults to maintain the user-programmed name through a **Set Defaults** operation.

To set a new Bluetooth Friendly Name, scan the following bar code, then scan up to 23 characters from [Appendix G, Alphanumeric Bar Codes](#). If the name contains less than 23 characters, scan *End of Message on page G-7* after entering the name.



NOTE If your application allows you to set a device name, this takes precedence over the Bluetooth Friendly Name.



Bluetooth Friendly Name

Central/Peripheral Set Up

The scanner can be set up as a central or peripheral. When the scanner is set up as a peripheral, it is discoverable and connectible to other devices. When the scanner is set up as a central, the Bluetooth address of the remote device to which a connection is requested is required.

Peripheral

When the scanner is set up as a peripheral device, the scanner accepts an incoming connection request from a remote device.

✓ **NOTE** The number of scanners is dependent on the host's capability.

Setting the scanner up as a peripheral typically requires holding the Bluetooth button to place the scanner in discoverable mode, then scanning a pairing PIN. See [Appendix C, Bluetooth Connection Examples](#) for more information.

Central

When the scanner is set up as a central, it initiates the radio connection to a peripheral device. Initiate the connection in one of two ways:

- Scan the bar code on the dongle. See *Bluetooth to USB HID Dongle on page B-14*.
- Create and scan a pairing bar code with the remote device address. See *Pairing Bar Code Format*.

Pairing Bar Code Format

When connecting the scanner as a central to a remote Bluetooth device, you must create a pairing bar code for the device. The Bluetooth address of the remote device must be known. Pairing bar codes are Code 128 bar codes and are formatted as follows:

<Fnc 3>Bxxxxxxxxxxx

where:

- **B** (or **LNKB**) is the prefix
- xxxxxxxxxxxx represents the 12-character Bluetooth address.

For example, if the remote device to which the scanner can connect has a Bluetooth address of 11:22:33:44:55:66, then the pairing bar code is:



Bluetooth Unpair

Scan the following bar code to unpair the scanner from the host.



Unpair

Bluetooth Profile

Scan a bar code below to select a Bluetooth profile:

- **Bluetooth HID Profile** - The scanner emulates a keyboard. Includes USB Dongle Keyboard HID.
- **Bluetooth Serial Port Profile (SPP)** - The scanner emulates a serial connection. Includes USB Dongle CDC Host.
- **Bluetooth SSI Profile** - The scanner uses SSI. Includes SSI Dongle Over USB CDC.
- **Bluetooth MFi SPP** - allows the scanner to connect to a serial port on iOS devices such as iPad and iPhone.
- **Bluetooth MFi SSI** - allows bi-directional (command and control) communication between the CS4070 and iOS devices.



IMPORTANT Zebra CDC Windows device drivers must be loaded on the Windows host system when configuring the scanner for USB Dongle CDC Host or SSI Dongle over USB CDC, and pairing and connecting to the dongle. Download the Windows CDC drivers from www.zebra.com/support.

Bluetooth Profile (continued)



***Bluetooth HID Profile**



Bluetooth SPP

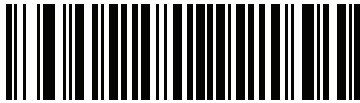

Bluetooth SSI Profile

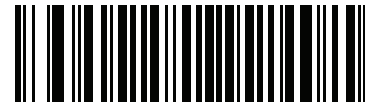

Bluetooth MFi_SPP



Bluetooth MFi_SSI

Clear Data

Scan the following bar code to clear all batch bar code data on the scanner. This deletes the BarcodeFile.txt from the scanner.



Clear Data

Auto-reconnect

When auto-reconnect is enabled, the scanner automatically tries to reconnect to a remote device when a disconnection occurs that is due to the radio losing communication. This can happen if the scanner goes out of range with the remote device, or if the remote device powers down. The scanner tries to reconnect for the period of time specified by the [Connection Interval and Discovery Mode Timeout on page 3-13](#). During that time the blue LED continues to blink.

If the auto-reconnect process fails due to page timeouts, the scanner sounds a timeout beep (long low/long high) and turns off the radio. To re-start the auto-reconnect process press the scan '+' or delete '-' key.

If the auto-reconnect process fails because the remote device rejects the connection attempt, the scanner sounds a connection reject beep sequence and deletes the remote pairing address. If this happens, you must scan a pairing bar code to attempt a new connection to the remote device.

- ✓ **NOTE** If you scan a bar code during the auto-reconnect sequence, the scanner emits a transmission error beep sequence and does not transmit the data to the host. Normal scanning operation resumes after re-establishing the connection. For error beep sequence definitions, see [Table 2-2 on page 2-7](#).

Scan a bar code below to enable or disable automatic Bluetooth reconnection to the dongle or another device.



***Enable Auto-reconnect**



Disable Auto-reconnect

Connection Interval and Discovery Mode Timeout

Parameter # 1339

SSI # F8h 05h 3Bh

Select the time period that the scanner attempts to connect or auto-reconnect to another device, as well as the timeout for discovery mode.

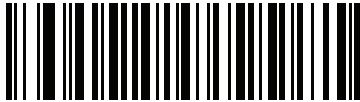

30 Seconds
(0)



1 Minute
(1)

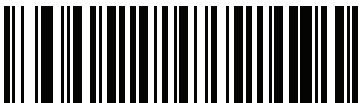

***2 Minutes**
(3)



5 Minutes
(2)

Link Supervision Timeout

Parameter # 1698

SSI # F4h 06h A2h

Scan one of the following bar codes to select how quickly the scanner senses that the Bluetooth radio lost connection to the remote device. A lower value minimizes data loss at the edge of the operating range, while a larger value minimizes disconnects due to the remote device not responding in time. If you are experiencing occasional disconnects and the scanner is able to reconnect, increase the link supervision timeout value.

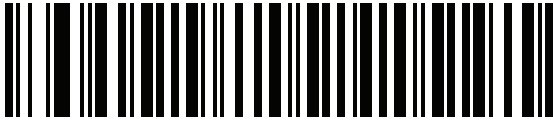

***0.5 Seconds
(800)**

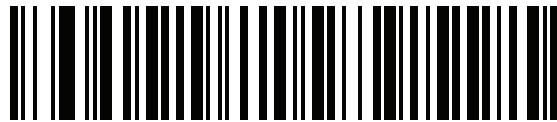

**2 Seconds
(3200)**

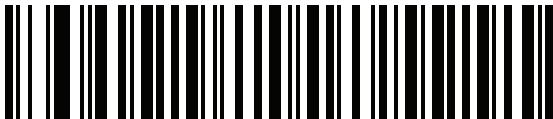

**5 Seconds
(8000)**

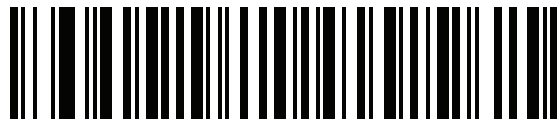

**10 Seconds
(16000)**

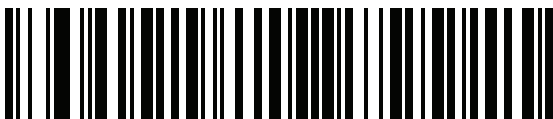

**20 Seconds
(32000)**

Bluetooth HID Host Name

Host 1: Parameter # 1397

SSI # F8h 05h 75h

Host 2: Parameter # 1398

SSI # F8h 05h 76h

Host 3: Parameter # 1399

SSI # F8h 05h 77h

You can enter up to three Bluetooth (BT) HID Host Names when configuring multiple scanners using 123Scan and/or the CS4070/Parameters/support_table.ini file on the scanner.

By entering a BT HID Host Name, *HID Security* can be set to High so that authentication is disabled when pairing and connecting to a Windows or Android device (i.e., no pin code entry is required to connect). To enable authentication, leave this blank in 123Scan or delete the name from the CS4070/Parameters/support_table.ini file.

Examples

Finding the Bluetooth HID Host Name on a Windows PC

1. In Windows Explorer, right-click **Computer** on the left-hand side of the dialog window.
2. Select **Properties** in the drop-down menu to open the **Control Panel**.
3. Enter the information indicated in the **Computer name** field (<Windows_XXXXXXX >) on the lower right-hand side of the **Control Panel** home page into one of the three **Bluetooth HID Host Name** text boxes in 123Scan. This allows the CS4070 *HID Security* parameter to remain high while not having to enter a PIN code on the PC when pairing and connecting to the CS4070.

✓ **NOTE** Windows_XXXXXXX is an example name used for illustration purposes only. Every Windows PC has a unique computer name.

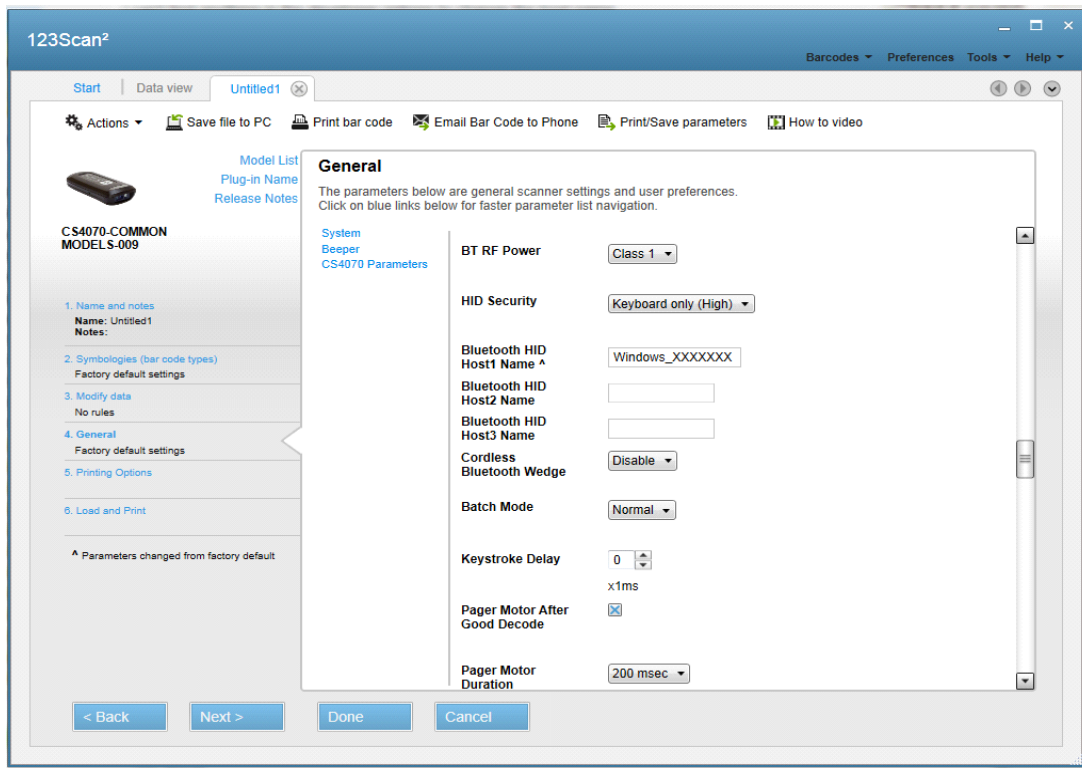

Figure 3-1 Entering Windows Host Name in 123Scan

Finding the Bluetooth HID Host Name on an Android Device

1. On the Android device, go to **Settings > WiFi** and turn on WiFi.
2. Tap the **WiFi** text to open the configuration screen.
3. Tap the **WiFi Direct** button, or open the options menu and tap **WiFi Direct**.
 - a. Note the name of the Android device under **My device name**, typically in the format `Android_#####`.
 - b. Enter this device name into one of the three **Bluetooth HID Host Name** text boxes in 123Scan. This allows the CS4070 *HID Security* parameter to remain high while not having to enter a PIN code on the Android device when pairing and connecting to the CS4070.

✓ **NOTE** `Android_#####` is an example name used for illustration purposes only. Every Android device has a unique **My device name**.

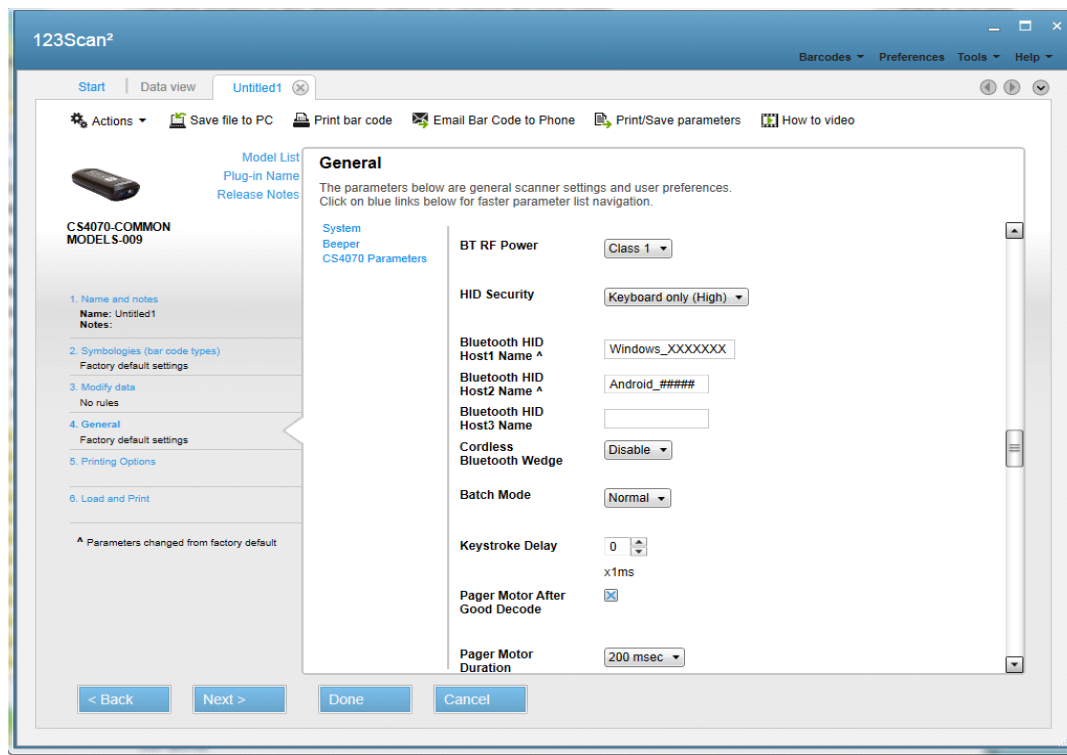

Figure 3-2 Entering Android Host Name in 123Scan

HID Security

Parameter # 911

SSI # F2h 8Fh

Scan one of the following bar codes to set HID security as follows:

- High - keyboard only, secure simple pairing capability (select this for iOS devices)
- Low - no input/no output, secure simple pairing capability (select this for Android devices)

✓ **NOTE** Some devices do not allow a connection in HID mode if this is set to low.
Set security to low to connect to Android devices in HID mode without entering a PIN code.



***HID Security High
(2)**



**HID Security Low
(3)**

Radio Output Power

The CS4070 uses a Class 1 Bluetooth radio with a transmission range of up to 100m. To place the radio in a Class 2 operating mode to restrict the transmission range to 10m and reduce the effect of the radio on neighboring wireless systems, scan the **Bluetooth Class 2** bar code.

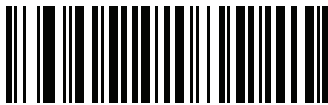

***Bluetooth Class 1**



Bluetooth Class 2

Set HID CoD to Zero

Some versions of Broadcom stack experience issues when connecting to HID devices. If experiencing issues, delete the CS4070 device from the Broadcom stack, enable [ZeroOutHIDClassOfDevice on page 1-12](#) or scan the **Set HID CoD to Zero** bar code below, and reconnect.

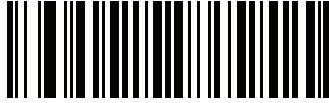

***Use HID CoD**

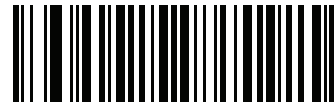

Set HID CoD to Zero

Bluetooth HID Keyboard Features

Country Keyboard Type

Parameter # 1392

SSI # F8h 05h 70h

Select the country keyboard code type.



***Windows North American
(0)**



**Windows Belgian French
(8)**

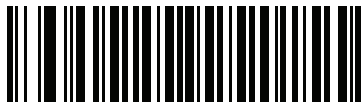

**Windows French
(9)**



**Windows German
(10)**



**Windows Canadian
(11)**



**Windows Spanish
(12)**

Country Keyboard Type (continued)



**Windows Italian
(13)**



**Windows Swedish
(14)**



**Windows UK
(15)**

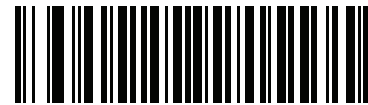

**Windows Japan (ASCII)
(16)**



**Windows Portuguese Brazil
(18)**



**Windows Swiss German
(19)**

Country Keyboard Type (continued)



**Windows Swiss French
(20)**

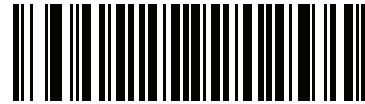

**Windows Simplified Chinese GBK
(21)**



**Windows Simplified Chinese UTF-8
(22)**

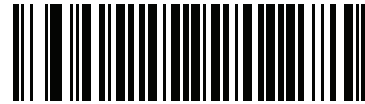

**Windows Traditional Chinese BIG5
(23)**

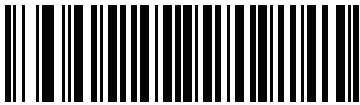

**Windows Traditional Chinese UTF-8
(24)**

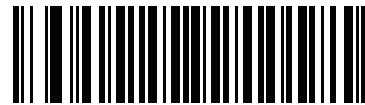

**Windows Russian
(25)**



**Windows Russian Typewriter
(32)**

HID CAPS Lock Override

Parameter # 1372

SSI # F8h 05h 5Ch

When enabled, the case of the data is preserved regardless of the state of the caps lock key. This setting is always enabled for the “Japanese, Windows (ASCII)” keyboard type and can not be disabled.

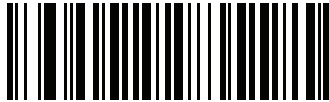

***Do Not Override Caps Lock Key (Disable)**
(0)

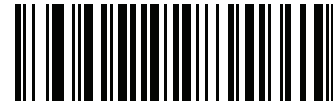

Override Caps Lock Key (Enable)
(1)

HID Ignore Unknown Characters

Parameter # 1373

SSI # F8h 05h 5Dh

Unknown characters are characters the host does not recognize. When **Send Bar Codes With Unknown Characters** is scanned, all bar code data is sent except for unknown characters, and no error beeps sound. When **Do Not Send Bar Codes With Unknown Characters** is scanned, bar codes containing at least one unknown character are not sent to the host, and an error beep sounds.



***Send Bar Codes With Unknown Characters**
(Enable)
(1)



Do Not Send Bar Codes With Unknown Characters
(Disable)
(0)

Emulate Keypad

Parameter # 1374

SSI # F8h 05h 5Eh

When enabled, all characters are sent as ASCII sequences over the numeric keypad. For example, ASCII A is sent as "ALT make" 0 6 5 "ALT Break."

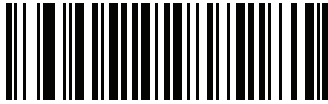

***Disable Keypad Emulation
(0)**

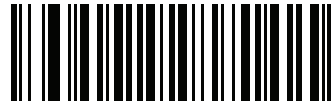

**Enable Keypad Emulation
(1)**

HID Keyboard FN1 Substitution

Parameter # 1375

SSI # F8h 05h 5Fh

When enabled, this parameter allows replacement of any FN1 character in an EAN128 bar code with a key category and value chosen by the user. See [FN1 Substitution Values](#) to set the key category and key value.

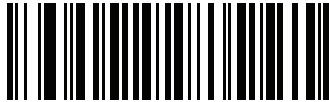

***Disable Keyboard FN1 Substitution
(0)**



**Enable Keyboard FN1 Substitution
(1)**

FN1 Substitution Values

Key Category Parameter # 103

SSI # 67h

Decimal Value Parameter # 109

SSI # 6Dh

Enabling [HID Keyboard FN1 Substitution](#) substitutes any FN1 character (0x1d) in an EAN128 bar code with a value. This value defaults to 7013 (Enter Key).

When using host commands to set the FN1 substitution value, set the key category parameter to 1, then set the 3-digit keystroke value. See [Table H-1 on page H-1](#) for the desired value.

To select a FN1 substitution value via bar code menus:

1. Scan the bar code below.



Set FN1 Substitution Value

2. Locate the keystroke desired for FN1 Substitution in [Table H-1 on page H-1](#). Enter the 4-digit ASCII value by scanning each digit in [Appendix F, Numeric Bar Codes](#).

To correct an error or change the selection, scan **Cancel**.

HID Function Key Mapping

Parameter # 1377

SSI # F8h 05h 61h

ASCII values under 32 are normally sent as control-key sequences. When this parameter is enabled, the keys in bold are sent in place of the standard key mapping (see [Table H-1 on page H-1](#)).

Table entries that do not have a bold entry remain the same whether or not this parameter is enabled.



***Disable Function Key Mapping
(0)**



**Enable Function Key Mapping
(1)**

Simulated Caps Lock

Parameter # 1378

SSI # F8h 05h 62h

When enabled, the scanner inverts upper and lower case characters on the scanner bar code as if the Caps Lock state is enabled on the keyboard. This inversion is done regardless of the current state of the keyboard Caps Lock state.



***Disable Simulated Caps Lock
(0)**



**Enable Simulated Caps Lock
(1)**

Convert Case

Parameter # 1379

SSI # F8h 05h 63h

When enabled, the scanner converts all bar code data to the selected case.

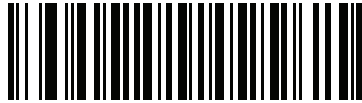

***No Case Conversion
(0)**



**Convert All to Upper Case
(1)**



**Convert All to Lower Case
(2)**

Fast Bluetooth HID Keyboard

Parameter # 1429

SSI # F8h 05h 95h

Enable this to transmit Bluetooth HID keyboard data at a faster rate.

✓ **NOTE** Disable this if the connected Bluetooth HID host displays multiple characters or drops characters.



***Enable Fast Bluetooth HID Keyboard
(1)**

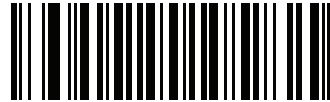

**Disable Fast Bluetooth HID Keyboard
(0)**

General Decoder Settings

Hand-Held Trigger Mode

Parameter # 138

SSI # 8Ah

Select one of the following trigger modes for the scanner.

- **Standard (Level)** - A trigger press (i.e., (+) or (-) button) activates decode processing. Decode processing continues until the bar code decodes, you release the trigger, or the decode session times out.
- **Presentation (Blink)** - The scanner activates decode processing when it detects a bar code in its field of view. After a period of non-use, the scanner enters a low power mode, in which the LEDs turn off until the scanner senses motion.



IMPORTANT Presentation (Blink) mode cannot be enabled if the scanner system is in either a Bluetooth SSI Profile mode or a Bluetooth MFi_SSI Profile mode. See [Bluetooth Profile on page 3-10](#). The scanner sounds an error beep and leaves the Hand-Held Trigger Mode in its present state.

Likewise, if the Hand-Held Trigger Mode is set to Presentation (Blink) mode and you attempt to configure the scanner for Bluetooth SSI Profile or Bluetooth MFi_SSI Profile, the scanner sounds an error beep and leaves Hand-Held Trigger Mode set to Presentation (Blink) mode.

- **Auto Aim** - This trigger mode projects the aiming dot when you lift the scanner. A trigger press activates decode processing. After 2 seconds of inactivity the aiming dot shuts off.

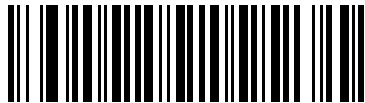

*Level (Standard)
(0)



Presentation (Blink)
(7)



Auto Aim
(9)

Hand-Held Decode Aiming Pattern

Parameter # 306

SSI # F0h 32h

Select **Enable Hand-Held Decode Aiming Pattern** to project the aiming dot during bar code capture, or **Disable Hand-Held Decode Aiming Pattern** to turn the aiming dot off.



NOTE With [Picklist Mode on page 3-40](#) enabled, the decode aiming dot flashes even when the **Hand-Held Decode Aiming Pattern** is disabled.



*Enable Hand-Held Decode Aiming Pattern
(2)

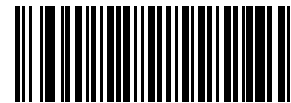

Disable Hand-Held Decode Aiming Pattern
(0)

Presentation Mode Field of View

Parameter # 609

SSI # F1h 61h

In presentation mode, by default the scanner searches the larger area of the aiming pattern (**Full Field of View**).

To search for a bar code in a smaller region around the aiming dot's center in order to speed search time, select **Small Field of View** or **Medium Field of View**.



Small Field of View
(0)



Medium Field of View
(1)

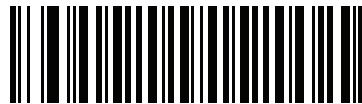

***Full Field of View**
(2)

Decoding Illumination

Parameter # 298

SSI # F0h 2Ah

Selecting **Enable Decoding Illumination** causes the scanner to flash illumination to aid decoding. Select **Disable Decoding Illumination** to prevent the scanner from using decoding illumination.

Enabling illumination usually results in superior images. The effectiveness of the illumination decreases as the distance to the target increases.



***Enable Decoding Illumination
(1)**



**Disable Decoding Illumination
(0)**

Direct Decode Indicator

Parameter # 859

SSI # F2h 5Bh

This feature is only supported in Auto Aim and Standard (Level) trigger modes. Scan a bar code below to select optional blinking of the illumination on a successful decode:

- **Disable Direct Decode Indicator** - illumination does not blink on a successful decode.
- **1 Blink** - illumination blinks once upon a successful decode.
- **2 Blinks** - illumination blinks twice upon a successful decode.



***Disable Direct Decode Indicator
(0)**



**1 Blink
(1)**



**2 Blinks
(2)**

Low Light Scene Detection

Parameter # 810

SSI # F2h 2Ah

This parameter allows the scanner to detect motion in dim to dark illumination environments when in presentation mode.

- ✓ **NOTE** If both Low Light Scene Detection and *Decoding Illumination* are enabled, *Decoding Illumination* takes precedence.
- **No Low Light Scene Detection:** The scanner attempts to detect motion as best it can with the aim dot and illumination turned off when the scanner is idle.
 - **Aiming Dot Low Light Assist Scene Detection:** Illumination is turned off, but the aim dot is turned on when the scanner is idle to assist in scene detection.
 - **Dim Illumination Low Light Assist Scene Detection:** The aim dot is turned off, but illumination is turned on at a dim level to assist in scene detection.



*No Low Light Assist Scene Detection
(0)



Aiming Dot Low Light Assist Scene Detection
(1)



Dim Illumination Low Light Assist Scene Detection
(2)

Parameter Bar Code Scanning

Parameter # 236

To disable the decoding of parameter bar codes, including the **Set Defaults** parameter bar codes, scan the **Disable Parameter Scanning** bar code below. To enable decoding of parameter bar codes, scan **Enable Parameter Scanning**.



*Enable Parameter Bar Code Scanning
(1)



Disable Parameter Bar Code Scanning
(0)

Beep After Good Decode

Parameter # 56

Scan a bar code below to select whether or not the scanner beeps after a good decode. If selecting **Do Not Beep After Good Decode**, the beeper still operates during parameter menu scanning and to indicate error conditions.



*Beep After Good Decode (Enable)
(1)

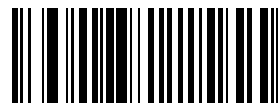

Do Not Beep After Good Decode (Disable)
(0)

Beeper Volume

Parameter # 140

SSI # 8Ch

To select a decode beep volume, scan the appropriate bar code.



**Low Volume
(2)**



**Medium Volume
(1)**



***High Volume
(0)**

Beeper Tone

Parameter # 145

SSI # 91h

To select a decode beep frequency (tone), scan the appropriate bar code.

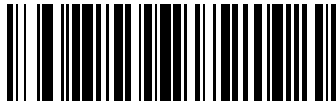

**Low Frequency
(2)**

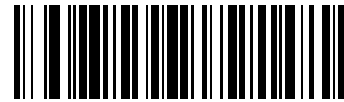

***Medium Frequency
(1)**

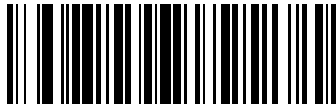

**High Frequency
(0)**

Mute Beeper

Scan the **Mute Beeper** bar code to mute the beeper.

- ✓ **NOTE** Scan the appropriate bar codes that follow to mute the beeper and/or disable the pager, and/or use the config.ini file to disable all LEDs, when using the following SSI commands for scanner command and control applications:
- SSI Beeper command
 - Pager Motor Activation command
 - LED commands
 - CMD_ACK_ACTION command

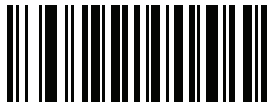

**Mute Beeper
(1)**



***Do Not Mute Beeper
(0)**

Decode Pager Motor (CS4070HC only)

Parameter # 613

SSI # F1h 65h

The scanner includes a pager motor which, when enabled, vibrates the scanner for a period of time when a successful decode occurs.

Scan a bar code below to enable or disable the pager motor. If enabled, scan the appropriate bar code to set the period of time in which to vibrate the scanner using [Decode Pager Motor Duration \(CS4070HC only\)](#).



**Pager Motor Disable
(0)**



***Pager Motor Enable
(1)**

Decode Pager Motor Duration (CS4070HC only)

Parameter # 626

SSI # F1h 72h



150 msec
(15)



*200 msec
(20)



250 msec
(25)



300 msec
(30)



400 msec
(40)



500 msec
(50)

Decode Pager Motor Duration (continued)

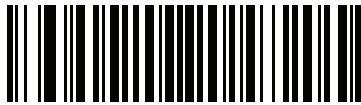

600 msec
(60)



750 msec
(75)

Picklist Mode

Parameter # 402

SSI # F0h 92h

Picklist mode enables the scanner to decode only bar codes aligned under the center of the aiming pattern. Select one of the following picklist modes:

- **Disabled Always** - Picklist mode is always disabled.
- **Enabled Always** - Picklist mode is always enabled.



*Disabled Always
(0)



Enabled Always
(2)

Fuzzy 1D Processing

Parameter # 514

SSI # F1h 02h

This option is enabled by default to optimize decode performance on 1D bar codes, including damaged and poor quality symbols. Disable this only if you experience time delays when decoding 2D bar codes, or in detecting a no decode.



***Enable Fuzzy 1D Processing
(1)**



**Disable Fuzzy 1D Processing
(0)**

Mirrored Image

Parameter # 624

SSI # F1h 70h

Enable this to scan images in reverse, or mirrored, as if seen through a mirror. This mode is useful in applications requiring scanning through a mirror and using symbologies that do not decode in reverse.

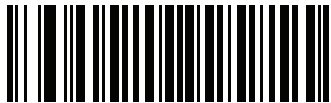

***Disable Mirrored Image
(0)**



**Enable Mirrored Image
(1)**

Mobile Phone/Display Mode

Parameter # 716

SSI # F1h CCh

This mode improves bar code reading performance with target bar codes displayed on mobile phones and electronic displays.

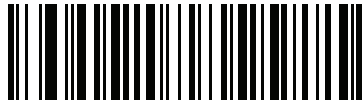

***Disable Mobile Phone/Display Mode
(0)**

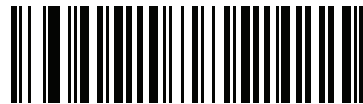

**Enable Mobile Phone/Display Mode
(3)**

PDF Prioritization

Parameter # 719

SSI # F4h F1h CFh

Enable this feature to delay decoding a 1D bar code (Code 128 of 8 to 25 characters length) by the value specified in *PDF Prioritization Timeout*. During that time the scanner attempts to decode a PDF417 symbol (e.g., on a US driver's license), and if successful reports this only. If it does not decode (can not find) a PDF417 symbol, it reports the 1D symbol after the timeout. The 1D symbol must be in the device's field of view for the scanner to report it. This parameter does not affect decoding other symbologies.



*Disable PDF Prioritization
(0)



Enable PDF Prioritization
(1)

PDF Prioritization Timeout

Parameter # 720

SSI # F1h D0h

When *PDF Prioritization* is enabled, this timeout specifies how long the scanner attempts to decode a PDF417 symbol before reporting the 1D bar code in the field of view.

Scan the following bar code, then scan four digits from [Appendix F, Numeric Bar Codes](#) that specify the timeout in milliseconds. For example, to enter 400 ms, scan the following bar code, then scan 0400. The range is 0 to 5000 ms, and the default is 200 ms.



PDF Prioritization Timeout

Batch Mode

Parameter # 544

SSI # F1h 20h

When a cordless scanner is configured for batch mode, it attempts to store bar code data until transmission is initialized, or the batch storage buffer is full (i.e., the Barcode.txt file is at maximum memory on the CS4070 only). Parameter bar codes are not stored. When a bar code is saved successfully, a good decode beep sounds and the LED flashes green. If the scanner is unable to store a new bar code, a long beep sounds until the scan button is released, indicating the scanner is out of memory.

- ✓ **IMPORTANT!** If the batch mode selection is changed while there is batched data, the new batch mode takes effect only after all the previously batched data is sent.
- ✓ **NOTE** Always delete the Barcode.txt file before changing the batch mode state, either by holding the delete key (-) for 3 seconds, or scanning [Clear Data on page 3-11](#).

Modes of Operation

- **Normal Batch Mode (default)** - The scanner does not batch decoded data but transmits all decoded data to the host over Bluetooth. If the scanner is not paired to a host and you attempt to scan and decode a bar code, the scanner emits 4 short high beeps.
- **Out of Range Batch Mode** - The scanner batches data whenever it loses connection to a remote device, moves out of range, or is not paired. It suppresses batching decoded data if paired to a remote device and transmits decoded data to the host device.
- ✓ **NOTE** Transmission halts if the scanner moves out of range. When the scanner moves back into range, it automatically re-connects to the Bluetooth host and resumes transmission. Scanning is disabled until all batched data is sent to the host.
- ✓ **NOTE** In this mode, if an abnormal Bluetooth termination occurs (e.g., removing the battery) while the CS4070 is transmitting batched data over Bluetooth, the scanner resends the data on a reset and auto-reconnection to ensure that no data is lost.
- **Standard Batch Mode** - The scanner begins storing bar code data after scanning the **Enter Batch Mode** bar code. Scan **Send Batch Data** to trigger data transmission and dump the contents of the Barcode.txt file stored in \CS4070<drive>:\Scanned Barcodes\.
- **Batch Only Mode** - The scanner radio is off (never turned on) and the scanner stores all bar code data.
- ✓ **NOTE** To dump the batched data stored in the /CS4070/Scanned Barcodes/Barcode.txt file, connect via USB and either run the autorun.ini Windows script (see [Autorun Feature on page 2-3](#)) to copy and paste the data into another PC program, OR cut and paste the file onto another network drive.
- ⚠ **CAUTION** If you copy and paste the Barcode.txt file from the CS4070 scanner to a network drive or a local PC drive, delete the file afterward. The scanner does not change the batch mode state if the Barcode.txt has stored batch data.

Batch Mode (continued)



***Normal Batch Mode
(0)**



**Out of Range Batch Mode
(1)**



**Standard Batch Mode
(2)**



**Batch Only Mode
(3)**

Batch Action Bar Codes

- In **Standard Batch Mode**, scan **Enter Batch Mode** to begin batching data. This stores the decoded data in the /CS4070/Scanned Barcodes/Barcode.txt file on the device.
- In **Standard Batch Mode**, scan **Send Batch Data** to send all stored batch data to the Bluetooth host system.



CAUTION The scanner sounds 4 short high beeps if you scan **Send Batch Data** when the scanner is out of range, when the scanner contains no batch data, or if the scanner is configured in **Normal Batch Mode** or **Batch Only Mode**.



NOTE A carriage return (i.e., ASCII hex code = 0x0D / extended keypad ENTER key) keystroke is automatically appended to the end of scanned data in the /CS4070/Scanned Barcodes/Barcodes.txt file and when transmitted to the host system, the receiving host program (e.g., Microsoft Word, Notepad, Microsoft Excel) displays the batch data in exactly the same format as it appears in the Barcodes.txt file. If this does not happen, enable Bluetooth [HID Function Key Mapping on page 3-26](#) or USB Dongle [Function Key Mapping on page 4-11](#).



Enter Batch Mode



Send Batch Data

Automatic Day/Night Mode

Parameter # 1393

SSI # F8h 05h 71h

Scan **Enable Automatic Day/Night Mode** to mute the beeper for all actions defined in [Table 2-2 on page 2-7](#) from the Automatic Day/Night Start Time to the Automatic Day/Night Mode Stop Time OR based on the Automatic Day/Night Mode Shift Profiles setting. This also enables the [Decode Pager Motor \(CS4070HC only\)](#) during this time period.

✓ **NOTE** There are two ways to temporarily disable Night Mode (Night Mode start/stop times remain intact):

- Scan [*Do Not Mute Beeper \(0\) on page 3-38](#) or
- Hold the scan (+) button for greater than 10 seconds.

Night Mode is re-enabled (i.e., the beeper is muted) on pressing the scan (+) button for greater than 10 seconds or on the next Automatic Day/Night Mode start time.



CAUTION If this feature is enabled, the scanner sounds an error beep if the scanner Real Time Clock (RTC) is not synchronized with the PC RTC. In this case, the Automatic Day/Night Mode start and stop times may not trigger at the correct times. Use the RTCSync.exe utility on www.zebra.com/support to synchronize the scanner and PC RTC from a factory defaults state or after removing and re-installing the battery.



**Enable Automatic Day/Night Mode
(1)**



***Disable Automatic Day/Night Mode
(0)**

Automatic Day/Night Mode Start/Stop Time

To set the Automatic Day/Night Mode start and stop time:

1. Scan the **Automatic Day/Night Mode Start Time** bar code.
2. Scan four *Numeric Bar Codes for Date and Time Settings on page 3-7* representing the start time in the format hhmm for the time according to the 24 hour clock (hh for the hour, mm for the minute).
3. Scan the **Automatic Day/Night Mode Stop Time** bar code.
4. Scan four *Numeric Bar Codes for Date and Time Settings on page 3-7* representing the stop time in the format hhmm for the time according to the 24 hour clock (hh for the hour, mm for the minute).

For example, to set the start time to 8:15 in the morning and the stop time to 5:07 in the afternoon, scan **Automatic Day/Night Mode Start Time**, scan 0, 8, 1, 5, scan **Automatic Day/Night Mode Stop Time**, and then scan 1, 7, 0, 7.

✓ **NOTE** These times are set based on the CS4070 Real Time Clock settings. Ensure the Real Time Clock on the scanner reflects the correct time zone. To set the Real Time Clock on the scanner use the RTCSync.exe utility on www.zebra.com/support.



Automatic Day/Night Mode Start Time



Automatic Day/Night Mode Stop Time

Automatic Day/Night Mode Shift Profiles

Parameter # 1394

SSI # F8h 05h 72h

Scan one of the following bar codes to set the start and stop times for the Automatic Day/Night Mode feature.

- **Enable Shift 1** - 8 PM (20:00) to 8 AM (08:00)
- **Enable Shift 2** - 11 PM (23:00) to 4 AM (04:00)
- **Enable Shift 3** - 1 AM (01:00) to 8 AM (08:00)
- **24 Hour Shift** - The scanner enters Automatic Day/Night Mode at 8:00 PM in the evening and remains in this mode until 8:00 PM the following evening. It then becomes inactive over the next 24 hour period from 8:00 PM to 8:00 PM, and repeats this cycle until disabled.

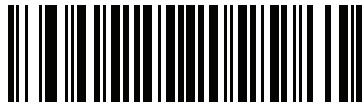

***Enable Shift 1
(0)**

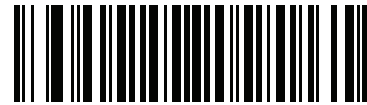

**Enable Shift 2
(1)**



**Enable Shift 3
(2)**



**24 Hour Shift
(3)**

Automatic Day/Night Mode 123Scan Programmable Shift Start Time

Parameter # 1395

SSI # F8h 05h 73h

Use Zebra's 123Scan tool to program the Automatic Day/Night Mode shift start time. If *Automatic Day/Night Mode on page 3-47* is enabled, the scanner enters Night Mode at this start time. The beeper is muted and the vibration pager motor feedback is active until the programmed shift stop time.

To set the start time, enter military time in the range of 0001 (12:01 AM) to 2400 (12:00 AM). For example, to start Night Mode at 4:00 PM, enter 1600 in the 123Scan text box for this parameter.

For more information, see [Chapter 7, 123Scan and Software Tools](#) or go to: www.zebra.com/123Scan.

Automatic Day/Night Mode 123Scan Programmable Shift Stop Time

Parameter # 1396

SSI # F8h 05h 74h

Use Zebra's 123Scan tool to program the Automatic Day/Night Mode shift stop time. If *Automatic Day/Night Mode on page 3-47* is enabled, the scanner exits night mode and enters Day Mode at this time. The beeper is no longer muted and the vibration pager motor feedback is inactive during Day Mode.

To set the stop time, enter military time in the range of 0001 (12:01 AM) to 2400 (12:00 AM). For example, to stop Night Mode at 8:00 AM, enter 2000 in the 123Scan text box for this parameter.

For more information, see [Chapter 7, 123Scan and Software Tools](#) or go to: www.zebra.com/123Scan.

Out of Range Electric Fence

Out of Range Electric Fence Alarm

Parameter # 1426

SSI # F8h 05h 92h

This feature prevents scanners from going missing from a fixed location. Enable this to create an alarm that generates a constant beep tone, vibration feedback, and rapidly flashes the LED between red and amber if the scanner moves out of range of a Bluetooth host system for a programmable amount of time.

- ✓ **NOTE** To turn the alarm off, press and hold the minus button for greater than three seconds.
- ✓ **NOTE** This alarm is automatically disabled if [Batch Mode on page 3-44](#) is set to Standard Batch Mode (i.e., after scanning the Enter Batch Mode bar code), Out of Range Batch Mode, or Batch Mode Only.



Enable Out of Range Electric Fence Alarm
(1)



*Disable Out of Range Electric Fence Alarm
(0)

Out of Range Electric Fence Trigger Timeout

Parameter # 1427

SSI # F8h 05h 93h

Scan one of the following bar codes to set the amount of time the scanner can be out of range before the alarm triggers.

For example, if the scanner moves out of range of the Bluetooth host and remains out of range for greater than three consecutive seconds (default), the alarm triggers. If the scanner moves back into range in less than three consecutive seconds, this timer resets and the alarm does not trigger.



0 Seconds
(0)



***3 Seconds**
(1)



5Seconds
(2)

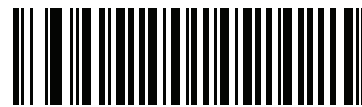

10 Seconds
(3)



30 Seconds
(4)



1 Minute
(5)

Out of Range Electric Fence Trigger Timeout (continued)



**3 Minutes
(6)**



**5 Minutes
(7)**

Out of Range Electric Fence Alarm Timeout

Parameter # 1428

SSI # F8h 05h 94h

Scan one of the following bar codes to set the amount of time the alarm sounds once triggered.



NOTE The alarm shuts down under any one of the following conditions:

- This Out of Range Electric Fence Timeout occurs.
- You hold the minus button for greater than three seconds and then release it.
- The scanner comes back into range.
- The scanner is placed into Standard Batch Mode, an Out of Range Batch Mode, or a Batch Only Mode.
- The scanner is connected to a new host.

This alarm is disabled if the scanner is placed into a [Batch Mode on page 3-44](#).



***3 Seconds
(0)**



**5 Seconds
(1)**

Out of Range Electric Fence Alarm Timeout (continued)



**10 Seconds
(2)**

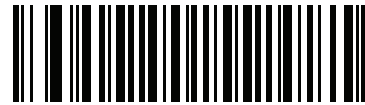

**30 Seconds
(3)**

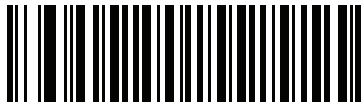

**1 Minute
(4)**



**2 Minutes
(5)**



**5 Minutes
(6)**



**10 Minutes
(7)**

Continuous Bar Code Read

Parameter # 649

SSI # F1h 89h

Enable this to report every bar code while the scan (+) button is held.

- ✓ **NOTE** Zebra strongly recommends enabling [Picklist Mode on page 3-40](#) with this feature. Disabling Picklist Mode can cause accidental decodes when more than one bar code is in the scanner's field of view.
- ✓ **NOTE** Enabling this feature disables deleting batch data from the Barcode.txt batch file by pressing the delete (minus) key. To clear data in Continuous Bar Code Read mode, see [Clear Data on page 3-11](#).



***Disable Continuous Bar Code Read
(0)**

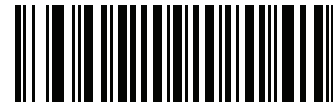

**Enable Continuous Bar Code Read
(1)**

Unique Bar Code Reporting

Parameter # 723

SSI # F1h D3h

Enable this to report only unique bar codes while the scan (+) button is held. This option only applies when **Continuous Bar Code Read** is enabled.

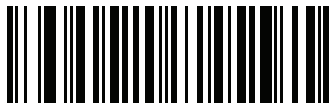

**Disable Continuous Bar Code Read Uniqueness
(0)**



***Enable Continuous Bar Code Read Uniqueness
(1)**

Decode Session Timeout

Parameter # 136

SSI # 88h

This parameter sets the maximum time decode processing continues during a scan attempt. It is programmable in 0.1 second increments from 0.5 to 5.0 seconds. The default timeout is 5.0 seconds.

To set a Decode Session Timeout, scan the following bar code. Next, scan two numeric bar codes from [Appendix F, Numeric Bar Codes](#) that correspond to the desired on time. Enter a leading zero for single digit numbers. For example, to set a Decode Session Timeout of 0.5 seconds, scan the bar code below, then scan the **0** and **5** bar codes. To correct an error or change the selection, scan *Cancel on page F-3*.



Decode Session Timeout

Timeout Between Decodes, Same Symbol

Parameter # 137

SSI # 89h

Use this option in Continuous Bar Code Read mode to prevent the beeper from continuously beeping when a symbol is left in the scanner's field of view. The bar code must be out of the field of view for the timeout period before the scanner reads the same consecutive symbol. It is programmable in 0.1 second increments from 0.0 to 5.0 seconds. The default interval is 0.5 seconds.

To select the timeout between decodes for the same symbol, scan the bar code below, then scan two numeric bar codes from [Appendix F, Numeric Bar Codes](#) that correspond to the desired interval, in 0.1 second increments.



Timeout Between Decodes, Same Symbol

Timeout Between Decodes, Different Symbols

Parameter # 144

SSI # 90h

Use this option in presentation mode or Continuous Bar Code Read to control the time the scanner is inactive between decoding different symbols. It is programmable in 0.1 second increments from 0.1 to 5.0 seconds. The default is 0.1 seconds.

To select the timeout between decodes for different symbols, scan the bar code below, then scan two numeric bar codes from [Appendix F, Numeric Bar Codes](#) that correspond to the desired interval, in 0.1 second increments.

✓ **NOTE** Timeout Between Decodes, Different Symbols cannot be greater than or equal to the Decode Session Timeout.



Timeout Between Decodes, Different Symbols

Wi-Fi Friendly Mode

Parameter # 1299

SSI # F8h 05h 13h

Scanners configured for Wi-Fi friendly mode behave as follows:

- The scanner remains in sniff mode, and exits sniff mode only during firmware update.
- If any Wi-Fi channel is excluded from the hopping sequence, AFH turns off.
- Scanner (and dongle) avoid the selected Wi-Fi channels after establishing connection.

Notes

- If using this feature, configure all scanners in the area for Wi-Fi friendly mode.
- By default, no Wi-Fi channels are excluded.
- Since Bluetooth requires a minimum of 20 channels when Wi-Fi channels 1, 6, and 11 are excluded, a smaller number of channels are cut from the hopping sequence.
- Updating Wi-Fi friendly settings before Bluetooth connection is recommended.
- This mode is automatically disabled when connected to a Panasonic Toughpad.

Scan a one of the following bar codes to enable or disable **Wi-Fi Friendly Mode**, then see [Wi-Fi Friendly Channel Exclusion](#) to select any channels to exclude.

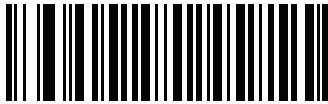

***Disable Wi-Fi Friendly Mode
(0)**

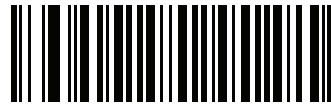

**Enable Wi-Fi Friendly Mode
(1)**

Wi-Fi Friendly Channel Exclusion

Parameter # 1297

SSI # F8h 05h 11h

Select the channels to exclude:

- **Exclude Wi-Fi channel 1:** Bluetooth channels 0-21 are excluded from hopping sequence (2402-2423 MHz).
- **Exclude Wi-Fi channel 6:** Bluetooth channels 25-46 are excluded from hopping sequence (2427 - 2448 MHz).
- **Exclude Wi-Fi channel 11:** Bluetooth channels 50-71 are excluded from hopping sequence (2452 - 2473 MHz).
- **Exclude Wi-Fi channel 1, 6 and 11:** Bluetooth channels 2-19 (2404-2421 MHz), 26-45 (2428 - 2447 MHz) and 51-69 (2453 - 2471 MHz) are excluded from hopping sequence.
- **Exclude Wi-Fi channels 1 and 6:** Bluetooth channels 0-21 (2402-2423 MHz) and 25-46 (2427 - 2448 MHz) are excluded from hopping sequence.
- **Exclude Wi-Fi channels 1 and 11:** Bluetooth channels 0-21 (2402-2423 MHz) and 50-71 (2452 - 2473 MHz) are excluded from hopping sequence.
- **Exclude Wi-Fi channel 6 and 11:** Bluetooth channels 25-46 (2427 - 2448 MHz) and 50-71 (2452 - 2473 MHz) are excluded from hopping sequence.

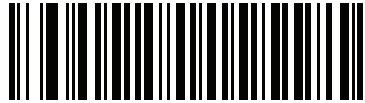

*Use All Channels (Standard AFH)
(0)



Exclude Wi-Fi Channel 1
(1)



Exclude Wi-Fi Channel 6
(2)



Exclude Wi-Fi Channel 11
(3)

Wi-Fi Friendly Channel Exclusion (continued)

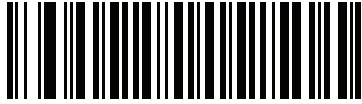

Exclude Wi-Fi Channels 1, 6, and 11
(4)

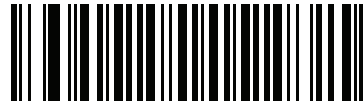

Exclude Wi-Fi Channels 1 and 6
(5)

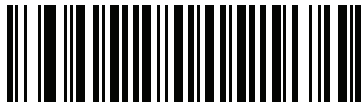

Exclude Wi-Fi Channels 1 and 11
(6)

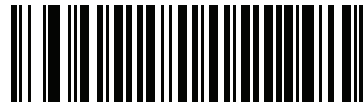

Exclude Wi-Fi Channels 6 and 11
(7)

Data Options

Transmit Code ID Character

Parameter # 45

SSI # 2Dh

A Code ID character identifies the code type of a scanned bar code. This is useful when decoding more than one code type. In addition to any single character prefix already selected, the Code ID character is inserted between the prefix and the decoded symbol.

Select no Code ID character, a Symbol Code ID character, or an AIM Code ID character. For Code ID Characters, see [Appendix D, Programming Reference](#).

✓ **NOTE** If you enable Symbol Code ID Character or AIM Code ID Character, and enable [Transmit "No Read" Message on page 3-64](#), the scanner appends the code ID for Code 39 to the NR message.

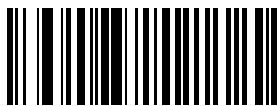

Symbol Code ID Character
(2)

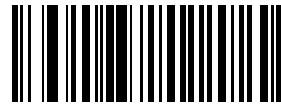

AIM Code ID Character
(1)

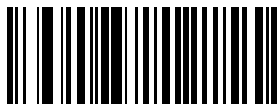

*None
(0)

Prefix/Suffix Values

Key Category Parameter # P = 99, S1 = 98, S2 = 100

SSI # P = 63h, S1 = 62h, S2 = 64h

Decimal Value Parameter # P = 105, S1 = 104, S2 = 106

SSI # P = 69h, S1 = 68h, S2 = 6Ah

You can append a prefix and/or one or two suffixes to scan data for use in data editing. To set a value for a prefix or suffix, scan a four-digit number (i.e., four bar codes from [Appendix F, Numeric Bar Codes](#)) that corresponds to that value. See [Appendix H, ASCII Character Sets](#) for the four-digit codes.

When using host commands to set the prefix or suffix, set the key category parameter to 1, then set the 3-digit decimal value. See [Appendix H, ASCII Character Sets](#) for the four-digit codes.

To correct an error or change a selection, scan *Cancel on page F-3*.

✓ **NOTE** To use Prefix/Suffix values, first set the [Scan Data Transmission Format on page 3-63](#).

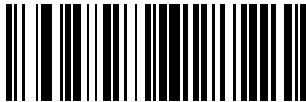

**Scan Prefix
(7)**

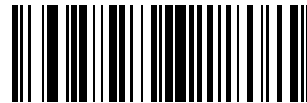

**Scan Suffix 1
(6)**



**Scan Suffix 2
(8)**



Data Format Cancel

Scan Data Transmission Format

Parameter # 235

SSI # EBh

To change the scan data format, scan one of the following eight bar codes corresponding to the desired format.

✓ *NOTE* If using this parameter do not use ADF rules to set the prefix/suffix.

✓ *NOTE* To append a carriage return to data, scan the **<data><suffix1>** bar code.

If [Bluetooth Profile on page 3-10](#) is set to **BT SPP** and you select **<data><suffix1>**, then set **Suffix=0x0A** in the **Config.ini** file to enable linefeed to move the cursor to the next line in a text file.

To set values for the prefix and/or suffix, see [Prefix/Suffix Values on page 3-62](#).



*Data As Is
(0)



<DATA> <SUFFIX 1>
(1)



<DATA> <SUFFIX 2>
(2)



<DATA> <SUFFIX 1> <SUFFIX 2>
(3)



<PREFIX> <DATA >
(4)

Scan Data Transmission Format (continued)

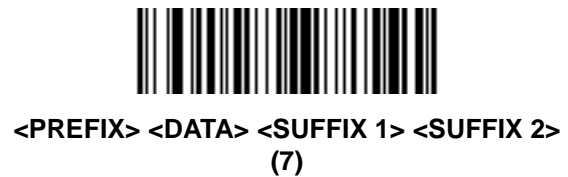
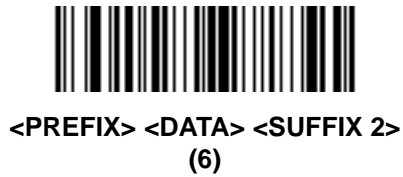
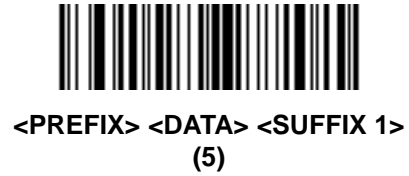

Transmit “No Read” Message

Parameter # 94

SSI # 5Eh

Scan a bar code below to select whether or not to transmit a No Read message. Enable this to transmit the characters NR when a successful decode does not occur before trigger release or during the timeout period. Disable this to send nothing to the host if a symbol does not decode.

- ✓ **NOTE** If you enable **Transmit No Read**, and also enable Symbol Code ID Character or AIM Code ID Character for [Transmit Code ID Character on page 3-61](#), the scanner appends the code ID for Code 39 to the NR message.



Send Versions

Firmware Version

Scan the following bar code to send the firmware version to the host.



Firmware Version

Scan Engine Version

Scan the following bar code to send the scan engine version to the host.



Scan Engine Version

Dongle Version

Scan the following bar code to send the dongle version to the host.



Dongle Version

CHAPTER 4 USB HID KEYBOARD FEATURES (DONGLE)

Introduction

This chapter describes each USB HID keyboard feature and provides the programming bar codes for selecting these features for the scanner.

The scanner ships with the settings shown in the [USB HID Keyboard Default Table on page 4-2](#) (also see [Appendix A, Standard Default Parameters](#) for all host device and miscellaneous scanner defaults). If the default values suit the requirements, programming is not necessary. To change these values, scan a single bar code or a short bar code sequence. The new settings are stored in non-volatile memory and are preserved when the scanner powers down.

To return all features to their default values, scan the [Reset Factory Defaults](#) bar code on [page 3-5](#). Throughout the programming bar code menus, default values are indicated with asterisks (*).



* Indicates Default *Disable Quick Keypad Emulation Feature/Option

Scanning Sequence Examples

In most cases, scan only one bar code to set a parameter value. For example, to enable keypad emulation, scan the **Enable** bar code under [Emulate Keypad on page 4-8](#). The scanner issues a fast warble beep and the LED turns green, indicating a successful parameter entry.

Other parameters require scanning several bar codes. See the parameter description for this procedure.

Errors While Scanning

Unless otherwise specified, if an error is made during a scanning sequence, re-scan the correct parameter.

USB HID Keyboard Default Parameters

Table 4-1 lists the defaults for user preference parameters. To change any option, scan the appropriate bar code(s) provided in this chapter.

✓ **NOTE** See [Appendix A, Standard Default Parameters](#) for all default parameters.

Table 4-1 USB HID Keyboard Default Table

Parameter	Parameter Number	SSI Number	Factory Default	Page Number
Country Keyboard Type	960	F2h C0h	Windows North American	4-3
USB Keystroke Delay	1380	F8h 05h 64h	No Delay	4-6
USB CAPS Lock Override	1381	F8h 05h 65h	Disable	4-7
USB Ignore Unknown Characters	1382	F8h 05h 66h	Send	4-7
Emulate Keypad	1383	F8h 05h 67h	Disable	4-8
Emulate Keypad with Leading Zero	1384	F8h 05h 68h	Disable	4-8
Quick Keypad Emulation	1385	F8h 05h 69h	Disable	4-9
USB FN1 Substitution	1386	F8h 05h 6Ah	Disable	4-10
FN1 Substitution Values: Key Category Decimal Value	103 109	67h 6Dh	N/A	4-10
Function Key Mapping	1388	F8h 05h 6Ch	Disable	4-11
Simulated Caps Lock	1389	F8h 05h 6Dh	Disable	4-11
Convert Case	1390	F8h 05h 6Eh	No Case Conversion	4-12

USB HID Keyboard Features (Dongle)

Country Keyboard Type

Parameter # 960

SSI # F2h C0h

Select the country keyboard code type.



***Windows North American
(0)**



**Windows Belgian French
(8)**



**Windows French
(9)**

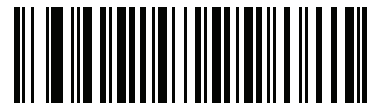

**Windows German
(10)**



**Windows Canadian
(11)**



**Windows Spanish
(12)**

Country Keyboard Type (continued)



**Windows Italian
(13)**

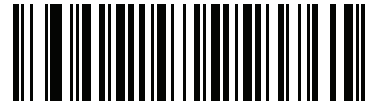

**Windows Swedish
(14)**



**Windows UK
(15)**

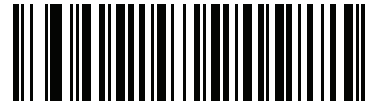

**Windows Japan (ASCII)
(16)**



**Windows Brazil
(18)**

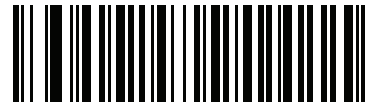

**Windows Swiss German
(19)**

Country Keyboard Type (continued)



**Windows Swiss French
(20)**

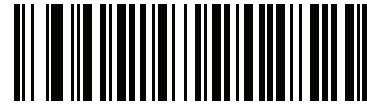

**Windows Simplified Chinese GBK
(21)**



**Windows Simplified Chinese UTF-8
(22)**

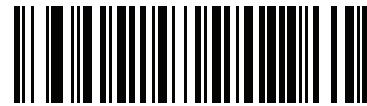

**Windows Traditional Chinese BIG5
(23)**



**Windows Traditional Chinese UTF-8
(24)**



**Windows Russian
(25)**



**Windows Russian Typewriter
(32)**

USB Keystroke Delay

Parameter # 1380

SSI # F8h 05h 64h

This parameter sets the delay, in milliseconds, between emulated keystrokes. Scan a bar code below to increase the delay when hosts require a slower transmission of data.

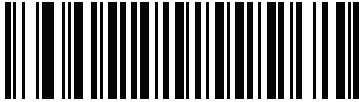

***No Delay
(0)**



**Medium Delay (20 msec)
(1)**



**Long Delay (40 msec)
(2)**

USB CAPS Lock Override

Parameter # 1381

SSI # F8h 05h 65h

This option applies only to the USB Keyboard (HID) device. When enabled, the case of the data is preserved regardless of the state of the caps lock key. This setting is always enabled for the “Japanese, Windows (ASCII)” keyboard type and can not be disabled.



Override Caps Lock Key (Enable)
(1)



***Do Not Override Caps Lock Key (Disable)**
(0)

USB Send Bar Codes with Unknown Characters

Parameter # 1382

SSI # F8h 05h 66h

This option applies only to the USB Keyboard (HID) device and a BT HID device. Unknown characters are characters the host does not recognize. When **Send Bar Codes With Unknown Characters** is selected, all bar code data is sent except for unknown characters, and no error beeps sound. When **Do Not Send Bar Codes With Unknown Characters** is selected, bar code data is sent up to the first unknown character, then the digital scanner issues an error beep.



***Send Bar Codes with Unknown Characters**
(1)



Do Not Send Bar Codes with Unknown Characters
(0)

Emulate Keypad

Parameter # 1383

SSI # F8h 05h 67h

When enabled, all characters are sent as ASCII sequences over the numeric keypad. For example ASCII A would be sent as "ALT make" 0 6 5 "ALT Break."



***Disable Keypad Emulation
(0)**

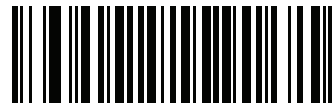

**Enable Keypad Emulation
(1)**

Emulate Keypad with Leading Zero

Parameter # 1384

SSI # F8h 05h 68h

Enable this to send character sequences sent over the numeric keypad as ISO characters which have a leading zero. For example ASCII A transmits as "ALT MAKE" 0 0 6 5 "ALT BREAK".



***Disable Keypad Emulation with Leading Zero
(0)**



**Enable Keypad Emulation with Leading Zero
(1)**

Quick Keypad Emulation

Parameter # 1385

SSI # F8h 05h 69h

This option applies only to the USB Keyboard (HID) device and if Emulate Keypad is enabled. This parameter enables a quicker method of keypad emulation where ASCII sequences are only sent for ASCII characters not found on the keyboard. The default value is **Disable**.



**Enable Quick Keypad Emulation
(1)**



***Disable Quick Keypad Emulation
(0)**

USB Keyboard FN 1 Substitution

Parameter # 1386

SSI # F8h 05h 6Ah

This option applies only to the USB Keyboard (HID) device. When enabled, this allows replacement of any FN1 characters in an EAN 128 bar code with a key category and value chosen by the user. See [FN1 Substitution Values](#) to set the key category and key value.



**Enable FN1 Substitution
(1)**



***Disable FN1 Substitution
(0)**

FN1 Substitution Values

Key Category Parameter # 103

SSI # 67h

Decimal Value Parameter # 109

SSI # 6Dh

Enabling [USB Keyboard FN 1 Substitution](#) substitutes any FN1 character (0x1d) in an EAN128 bar code with a value. This value defaults to 7013 (Enter Key).

When using host commands to set the FN1 substitution value, set the key category parameter to 1, then set the 3-digit keystroke value. See [Table H-1 on page H-1](#) for the desired value.

To select a FN1 substitution value via bar code menus:

1. Scan the bar code below.

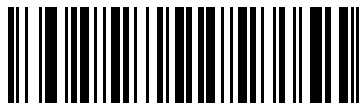

Set FN1 Substitution Value

2. Locate the keystroke desired for FN1 Substitution in [Table H-1 on page H-1](#). Enter the 4-digit ASCII value by scanning each digit in [Appendix F, Numeric Bar Codes](#).

To correct an error or change the selection, scan **Cancel**.

Function Key Mapping

Parameter # 1388

SSI # F8h 05h 6Ch

ASCII values under 32 are normally sent as a control-key sequences (see [Table H-1 on page H-1](#)). When this parameter is enabled, the keys in bold are sent in place of the standard key mapping. Table entries that do not have a bold entry remain the same whether or not this parameter is enabled.

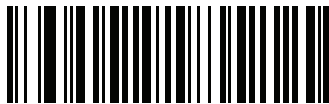

***Disable Function Key Mapping
(0)**



**Enable Function Key Mapping
(1)**

Simulated Caps Lock

Parameter # 1389

SSI # F8h 05h 6Dh

When enabled, the digital scanner inverts upper and lower case characters on the digital scanner bar code as if the Caps Lock state is enabled on the keyboard. This inversion is done regardless of the current state of the keyboard's Caps Lock state.



***Disable Simulated Caps Lock
(0)**



**Enable Simulated Caps Lock
(1)**

Convert Case

Parameter # 1390

SSI # F8h 05h 6Eh

When enabled, the digital scanner converts all bar code data to the selected case.



***No Case Conversion
(0)**



**Convert All to Upper Case
(1)**



**Convert All to Lower Case
(2)**

CHAPTER 5 SYMBOLOGIES

Introduction

This chapter describes symbology features and provides the programming bar codes for selecting these features for the scanner. Before programming, follow the instructions in [Chapter 1, Getting Started](#).

The scanner ships with the settings in [Table 5-1 on page 5-2](#) (also see [Appendix A, Standard Default Parameters](#) for all scanner defaults). If the default values suit requirements, programming is not necessary. Set a feature value by scanning a single bar code or a short bar code sequences.

✓ **NOTE** Most computer monitors allow scanning the bar codes directly on the screen. When scanning from the screen, be sure to set the document magnification to a level where the bar code can be seen clearly, and bars and/or spaces are not merging.

To return all features to default values, see [Reset Factory Defaults on page 3-5](#). Throughout the programming bar code menus, asterisks (*) indicate default values.



* Indicates Default — *Enable UPC-A — Feature/Option
(1) — Option Value

Scanning Sequence Examples

In most cases, scan only one bar code to set a parameter value. For example, to transmit bar code data without the UPC-A check digit, scan the **Do Not Transmit UPC-A Check Digit** bar code under [Transmit UPC-A Check Digit on page 5-17](#). The scanner issues a fast warble beep and the LED turns green, indicating a successful parameter entry.

Other parameters, such as **Set Length(s) for D 2 of 5** require scanning several bar codes in sequence. See the parameter description for this procedure.

Errors While Scanning

Unless otherwise specified, to correct an error during a scanning sequence, re-scan the correct parameter.

Symbology Default Parameters

[Table 5-1](#) lists the defaults for all symbologies parameters. To change any option, scan the appropriate bar code(s) in this chapter.

✓ **NOTE** See [Appendix A, Standard Default Parameters](#) for all default parameters.

Table 5-1 Symbology Parameter Defaults

Parameter	Parameter Number	SSI Number	Default	Page Number
Enable/Disable All Code Types				5-7
1D Symbologies				
UPC/EAN				
UPC-A	1	01h	Enable	5-8
UPC-E	2	02h	Enable	5-8
UPC-E1	12	0Ch	Disable	5-9
EAN-8/JAN 8	4	04h	Enable	5-9
EAN-13/JAN 13	3	03h	Enable	5-10
Bookland EAN	83	53h	Disable	5-10
Bookland ISBN Format	576	F1h 40h	ISBN-10	5-11
Decode UPC/EAN/JAN Supplementals (2 and 5 digits)	16	10h	Ignore	5-13
User-Programmable Supplementals			000	5-15
Supplemental 1:	579	F4h F1h 43h		
Supplemental 2:	580	F4h F1h 44h		
UPC/EAN/JAN Supplemental Redundancy	80	50h	10	5-15
Decode UPC/EAN/JAN Supplemental AIM ID	672	F1h A0h	Combined	5-16
Transmit UPC-A Check Digit	40	28h	Enable	5-17
Transmit UPC-E Check Digit	41	29h	Enable	5-17
Transmit UPC-E1 Check Digit	42	2Ah	Enable	5-18
UPC-A Preamble	34	22h	System Character	5-19

Table 5-1 Symbology Parameter Defaults (Continued)

Parameter	Parameter Number	SSI Number	Default	Page Number
UPC-E Preamble	35	23h	System Character	5-19
UPC-E1 Preamble	36	24h	System Character	5-21
Convert UPC-E to A	37	25h	Disable	5-22
Convert UPC-E1 to A	38	26h	Disable	5-22
EAN-8/JAN-8 Extend	39	27h	Disable	5-23
UCC Coupon Extended Code	85	55h	Disable	5-23
Coupon Report	730	F1h DAh	New Coupon Format	5-24
ISSN EAN	617	F1h 69h	Disable	5-24
Code 128				
Code 128	8	08h	Enable	5-25
Set Length(s) for Code 128	209, 210	D1h, D2h	1 to 55	5-25
GS1-128 (formerly UCC/EAN-128)	14	0Eh	Enable	5-27
ISBT 128	84	54h	Enable	5-27
ISBT Concatenation	577	F1h 41h	Autodiscriminate	5-28
Check ISBT Table	578	F1h 42h	Enable	5-29
ISBT Concatenation Redundancy	223	DFh	10	5-29
Code 128 Security Level	751	F1h EFh	Security Level 1	5-30
Code 39				
Code 39	0	00h	Enable	5-31
Trioptic Code 39	13	0Dh	Disable	5-31
Convert Code 39 to Code 32 (Italian Pharmacy Code)	86	56h	Disable	5-32
Code 32 Prefix	231	E7h	Disable	5-33
Set Length(s) for Code 39	18, 19	12h, 13h	1 to 55	5-33
Code 39 Check Digit Verification	48	30h	Disable	5-35
Transmit Code 39 Check Digit	43	2Bh	Disable	5-35
Code 39 Full ASCII Conversion	17	11h	Disable	5-36
Code 39 Security Level	750	F1h EEh	Security Level 1	5-37

Table 5-1 Symbology Parameter Defaults (Continued)

Parameter	Parameter Number	SSI Number	Default	Page Number
Code 93				
Code 93	9	09h	Enable	5-38
Set Length(s) for Code 93	26, 27	1Ah, 1Bh	1 to 55	5-38
Code 11				
Code 11	10	0Ah	Disable	5-40
Set Lengths for Code 11	28, 29	1Ch, 1Dh	4 to 55	5-40
Code 11 Check Digit Verification	52	34h	Disable	5-42
Transmit Code 11 Check Digit(s)	47	2Fh	Disable	5-43
Interleaved 2 of 5 (ITF)				
Interleaved 2 of 5 (ITF)	6	06h	Enable	5-44
Set Lengths for I 2 of 5	22, 23	16h, 17h	6 to 55	5-44
I 2 of 5 Check Digit Verification	49	31h	Disable	5-46
Transmit I 2 of 5 Check Digit	44	2Ch	Disable	5-47
Convert I 2 of 5 to EAN 13	82	52h	Disable	5-47
I 2 of 5 Security Level	1121	F8h 04h 61h	Security Level 1	5-48
Discrete 2 of 5 (DTF)				
Discrete 2 of 5	5	05h	Disable	5-49
Set Length(s) for D 2 of 5	20, 21	14h 15h	1 to 55	5-49
Codabar (NW - 7)				
Codabar	7	07h	Enable	5-51
Set Lengths for Codabar	24, 25	18h, 19h	4 to 55	5-51
CLSI Editing	54	36h	Disable	5-53
NOTIS Editing	55	37h	Disable	5-53
Codabar Upper or Lower Case Start/Stop Characters Detection	855	F2h 57h	Upper Case	
MSI				
MSI	11	0Bh	Disable	5-55
Set Length(s) for MSI	30, 31	1Eh, 1Fh	4 to 55	5-55
MSI Check Digits	50	32h	One	5-57
Transmit MSI Check Digit	46	2Eh	Disable	5-57
MSI Check Digit Algorithm	51	33h	Mod 10/Mod 10	5-58

Table 5-1 Symbology Parameter Defaults (Continued)

Parameter	Parameter Number	SSI Number	Default	Page Number
Chinese 2 of 5				
Chinese 2 of 5	408	F0h 98h	Disable	5-59
Matrix 2 of 5				
Matrix 2 of 5	618	F1h 6Ah	Disable	5-60
Matrix 2 of 5 Lengths	619, 620	F1h 6Bh F1h 6Ch	4 to 55	5-60
Matrix 2 of 5 Check Digit	622	F1h 6Eh	Disable	5-62
Transmit Matrix 2 of 5 Check Digit	623	F1h 6Fh	Disable	5-62
Korean 3 of 5				
Korean 3 of 5	581	F1h 45h	Disable	5-63
Inverse 1D	586	F1h 4Ah	Regular	5-63
GS1 DataBar				
GS1 DataBar-14	338	F0h 52h	Enable	5-65
GS1 DataBar Limited	339	F0h 53h	Enable	5-65
GS1 DataBar Expanded	340	F0h 54h	Enable	5-66
Convert GS1 DataBar to UPC/EAN	397	F0h 8Dh	Disable	5-66
GS1 DataBar Limited Security Level	728	F1h D8h	Level 3	5-67
Composite				
Composite CC-C	341	F0h 55h	Disable	5-68
Composite CC-A/B	342	F0h 56h	Disable	5-68
Composite TLC-39	371	F0h 73h	Disable	5-69
UPC Composite Mode	344	F0h 58h	Never Linked	5-70
GS1-128 Emulation Mode for UCC/EAN Composite Codes	427	F0h ABh	Disable	5-71
Postal Codes				
US Postnet	89	59h	Disable	5-72
US Planet	90	5Ah	Disable	5-72
Transmit US Postal Check Digit	95	5Fh	Enable	5-73
UK Postal	91	5Bh	Disable	5-73
Transmit UK Postal Check Digit	96	60h	Enable	5-74
Japan Postal	290	F0h 22h	Disable	5-74

Table 5-1 Symbology Parameter Defaults (Continued)

Parameter	Parameter Number	SSI Number	Default	Page Number
Australia Post	291	F0h 23h	Disable	5-75
Australia Post Format	718	F1h CEh	Autodiscriminate	5-76
Netherlands KIX Code	326	F0h 46h	Disable	5-77
USPS 4CB/One Code/Intelligent Mail	592	F1h 50h	Disable	5-77
UPU FICS Postal	611	F1h 63h	Disable	5-78
2D Symbologies				
PDF417	15	0Fh	Enable	5-79
MicroPDF417	227	E3h	Disable	5-79
Code 128 Emulation	123	7Bh	Disable	5-80
Data Matrix	292	F0h 24h	Enable	5-81
GS1 Data Matrix	1336	F8h 05h 38h	Disable	5-81
Data Matrix Inverse	588	F1h 4Ch	Inverse Autodetect	5-82
Decode Mirror Images (Data Matrix Only)	537	F1h 19h	Auto	5-83
Maxicode	294	F0h 26h	Disable	5-84
QR Code	293	F0h 25h	Enable	5-84
QR Inverse	587	F1h 4Bh	Regular	5-85
MicroQR	573	F1h 3Dh	Enable	5-86
Aztec	574	F1h 3Eh	Enable	5-86
Aztec Inverse	589	F1h 4Dh	Inverse Autodetect	5-87
Han Xin	1167	F8h 04h 8Fh	Disable	5-88
Han Xin Inverse	1168	F8h 04h 90h	Regular	5-89
Symbology-Specific Security Levels				
Redundancy Level	78	4Eh	1	5-90
Security Level	77	4Dh	1	5-92
Intercharacter Gap Size	381	F0h 7Dh	Normal	5-93

Enable/Disable All Code Types

To disable all symbologies, scan **Disable All Code Types** below. This is useful when enabling only a few code types.

Scan **Enable All Code Types** turn on (enable) all code types. This is useful when you want to read all codes, or when you want to disable only a few code types.

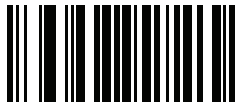

Disable All Code Types



Enable All Code Types

UPC/EAN

Enable/Disable UPC-A

Parameter # 1

SSI # 01h

To enable or disable UPC-A, scan the appropriate bar code below.

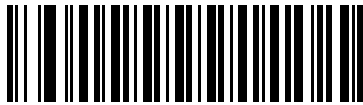

***Enable UPC-A
(1)**

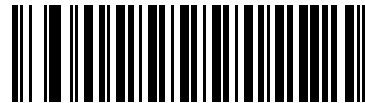

**Disable UPC-A
(0)**

Enable/Disable UPC-E

Parameter # 2

SSI # 02h

To enable or disable UPC-E, scan the appropriate bar code below.



***Enable UPC-E
(1)**



**Disable UPC-E
(0)**

Enable/Disable UPC-E1

Parameter # 12

SSI # 0Ch

UPC-E1 is disabled by default.

To enable or disable UPC-E1, scan the appropriate bar code below.

✓ *NOTE* UPC-E1 is not a UCC (Uniform Code Council) approved symbology.

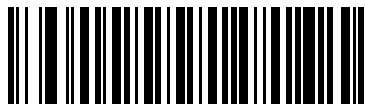

Enable UPC-E1
(1)

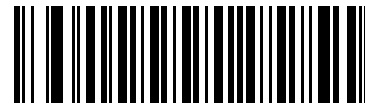

*Disable UPC-E1
(0)

Enable/Disable EAN-8/JAN-8

Parameter # 4

SSI # 04h

To enable or disable EAN-8/JAN-8, scan the appropriate bar code below.

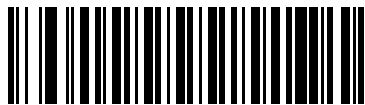

*Enable EAN-8/JAN-8
(1)

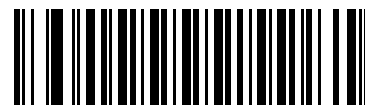

Disable EAN-8/JAN-8
(0)

Enable/Disable EAN-13/JAN-13

Parameter # 3

SSI # 03h

To enable or disable EAN-13/JAN-13, scan the appropriate bar code below.

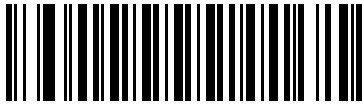

*Enable EAN-13/JAN-13
(1)



Disable EAN-13/JAN-13
(0)

Enable/Disable Bookland EAN

Parameter # 83

SSI # 53h

To enable or disable Bookland EAN, scan the appropriate bar code below.

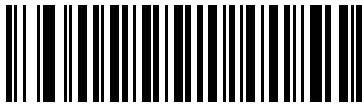

Enable Bookland EAN
(1)

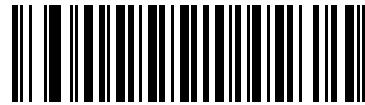

*Disable Bookland EAN
(0)



NOTE If you enable Bookland EAN, select a [Bookland ISBN Format on page 5-11](#). Also select either Decode UPC/EAN Supplementals, Autodiscriminate UPC/EAN Supplementals, or Enable 978/979 Supplemental Mode in [Decode UPC/EAN/JAN Supplementals on page 5-12](#).

Bookland ISBN Format

Parameter # 576

SSI # F1h 40h

If you enabled Bookland EAN using [Enable/Disable Bookland EAN on page 5-10](#), select one of the following formats for Bookland data:

- **Bookland ISBN-10** - The scanner reports Bookland data starting with 978 in traditional 10-digit format with the special Bookland check digit for backward-compatibility. Data starting with 979 is not considered Bookland in this mode.
- **Bookland ISBN-13** - The scanner reports Bookland data (starting with either 978 or 979) as EAN-13 in 13-digit format to meet the 2007 ISBN-13 protocol.



***Bookland ISBN-10
(0)**



**Bookland ISBN-13
(1)**



NOTE For Bookland EAN to function properly, first enable Bookland EAN using [Enable/Disable Bookland EAN on page 5-10](#), then select either Decode UPC/EAN Supplementals, Autodiscriminate UPC/EAN Supplementals, or Enable 978/979 Supplemental Mode in [Decode UPC/EAN/JAN Supplementals on page 5-12](#).

Decode UPC/EAN/JAN Supplementals

Parameter # 16

SSI # 10h

Supplementals are bar codes appended according to specific format conventions (e.g., UPC A+2, UPC E+2, EAN 13+2). The following options are available:

- If you select **Ignore UPC/EAN with Supplementals**, and the scanner is presented with a UPC/EAN plus supplemental symbol, the scanner decodes UPC/EAN and ignores the supplemental characters.
- If you select **Decode UPC/EAN with Supplementals**, the scanner only decodes UPC/EAN symbols with supplemental characters, and ignores symbols without supplementals.
- If you select **Autodiscriminate UPC/EAN Supplementals**, the scanner decodes UPC/EAN symbols with supplemental characters immediately. If the symbol does not have a supplemental, the scanner must decode the bar code the number of times set via [UPC/EAN/JAN Supplemental Redundancy on page 5-15](#) before transmitting its data to confirm that there is no supplemental.
- If you select one of the following **Supplemental Mode** options, the scanner immediately transmits EAN-13 bar codes starting with that prefix that have supplemental characters. If the symbol does not have a supplemental, the scanner must decode the bar code the number of times set via [UPC/EAN/JAN Supplemental Redundancy on page 5-15](#) before transmitting its data to confirm that there is no supplemental. The scanner transmits UPC/EAN bar codes that do not have that prefix immediately.
 - **Enable 378/379 Supplemental Mode**
 - **Enable 978/979 Supplemental Mode**

✓ **NOTE** If you select 978/979 Supplemental Mode and are scanning Bookland EAN bar codes, see [Enable/Disable Bookland EAN on page 5-10](#) to enable Bookland EAN, and select a format using [Bookland ISBN Format on page 5-11](#).

- **Enable 977 Supplemental Mode**
- **Enable 414/419/434/439 Supplemental Mode**
- **Enable 491 Supplemental Mode**
- **Enable Smart Supplemental Mode** - applies to EAN-13 bar codes starting with any prefix listed previously.
- **Supplemental User-Programmable Type 1** - applies to EAN-13 bar codes starting with a 3-digit user-defined prefix. Set this 3-digit prefix using [User-Programmable Supplementals on page 5-15](#).
- **Supplemental User-Programmable Type 1 and 2** - applies to EAN-13 bar codes starting with either of two 3-digit user-defined prefixes. Set the 3-digit prefixes using [User-Programmable Supplementals on page 5-15](#).
- **Smart Supplemental Plus User-Programmable 1** - applies to EAN-13 bar codes starting with any prefix listed previously or the user-defined prefix set using [User-Programmable Supplementals on page 5-15](#).
- **Smart Supplemental Plus User-Programmable 1 and 2** - applies to EAN-13 bar codes starting with any prefix listed previously or one of the two user-defined prefixes set using [User-Programmable Supplementals on page 5-15](#).

✓ **NOTE** To minimize the risk of invalid data transmission, select either to decode or ignore supplemental characters.

Decode UPC/EAN/JAN Supplementals (continued)

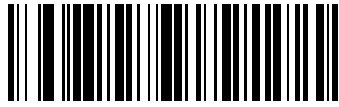

Decode UPC/EAN/JAN Only With Supplementals
(1)



*Ignore Supplementals
(0)

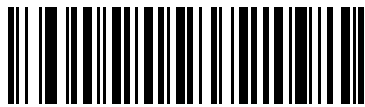

Autodiscriminate UPC/EAN/JAN Supplementals
(2)



Enable 378/379 Supplemental Mode
(4)



Enable 978/979 Supplemental Mode
(5)



Enable 977 Supplemental Mode
(7)

Decode UPC/EAN/JAN Supplementals (continued)



Enable 414/419/434/439 Supplemental Mode
(6)



Enable 491 Supplemental Mode
(8)



Enable Smart Supplemental Mode
(3)



Supplemental User-Programmable Type 1
(9)



Supplemental User-Programmable Type 1 and 2
(10)



Smart Supplemental Plus User-Programmable 1
(11)



Smart Supplemental Plus User-Programmable 1 and 2
(12)

User-Programmable Supplementals

Supplemental 1: Parameter # 579

SSI # F4h F1h 43h

Supplemental 2: Parameter # 580

SSI # F4h F1h 44h

If you selected a Supplemental User-Programmable option from [Decode UPC/EAN/JAN Supplementals on page 5-12](#), select **User-Programmable Supplemental 1** to set the 3-digit prefix. Then select the 3 digits using the numeric bar codes beginning on [page F-1](#). Select **User-Programmable Supplemental 2** to set a second 3-digit prefix. Then select the 3 digits using the numeric bar codes beginning on [page F-1](#). The default is 000 (zeroes).



User-Programmable Supplemental 1



User-Programmable Supplemental 2

UPC/EAN/JAN Supplemental Redundancy

Parameter # 80

SSI # 50h

If you selected **Autodiscriminate UPC/EAN/JAN Supplementals**, this option adjusts the number of times to decode a symbol without supplementals before transmission. The range is from two to thirty times. Five or above is recommended when decoding a mix of UPC/EAN/JAN symbols with and without supplementals. The default is 10.

Scan the bar code below to set a decode redundancy value. Next, scan two numeric bar codes in [Appendix F; Numeric Bar Codes](#). Enter a leading zero for single digit numbers. To correct an error or change a selection, scan [Cancel on page F-3](#).



UPC/EAN/JAN Supplemental Redundancy

UPC/EAN/JAN Supplemental AIM ID Format

Parameter # 672

SSI # F1h A0h

Select an output format when reporting UPC/EAN/JAN bar codes with Supplementals with *Transmit Code ID Character on page 3-61* set to **AIM Code ID Character**:

- **Separate** - transmit UPC/EAN with supplementals with separate AIM IDs but one transmission, i.e.:
]E<0 or 4><data>]E<1 or 2>[supplemental data]
- **Combined** – transmit UPC/EAN with supplementals with one AIM ID and one transmission, i.e.:
]E3<data+supplemental data>
- **Separate Transmissions** - transmit UPC/EAN with supplementals with separate AIM IDs and separate transmissions, i.e.:
]E<0 or 4><data>
]E<1 or 2>[supplemental data]



**Separate
(0)**



***Combined
(1)**



**Separate Transmissions
(2)**

Transmit UPC-A Check Digit

Parameter # 40

SSI # 28h

The check digit is the last character of the symbol used to verify the integrity of the data. Scan the appropriate bar code below to transmit the bar code data with or without the UPC-A check digit. It is always verified to guarantee the integrity of the data.

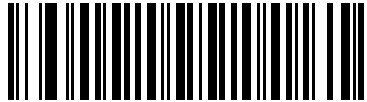

***Transmit UPC-A Check Digit
(1)**

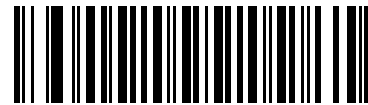

**Do Not Transmit UPC-A Check Digit
(0)**

Transmit UPC-E Check Digit

Parameter # 41

SSI # 29h

The check digit is the last character of the symbol used to verify the integrity of the data. Scan the appropriate bar code below to transmit the bar code data with or without the UPC-E check digit. It is always verified to guarantee the integrity of the data.

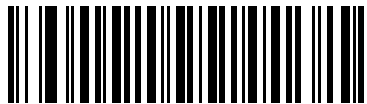

***Transmit UPC-E Check Digit
(1)**

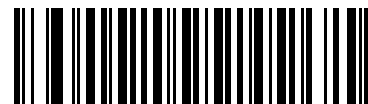

**Do Not Transmit UPC-E Check Digit
(0)**

Transmit UPC-E1 Check Digit

Parameter # 42

SSI # 2Ah

The check digit is the last character of the symbol used to verify the integrity of the data. Scan the appropriate bar code below to transmit the bar code data with or without the UPC-E1 check digit. It is always verified to guarantee the integrity of the data.

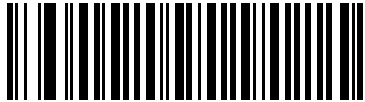

***Transmit UPC-E1 Check Digit
(1)**

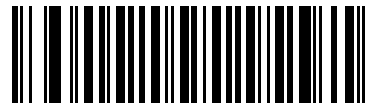

**Do Not Transmit UPC-E1 Check Digit
(0)**

UPC-A Preamble

Parameter # 34

SSI # 22h

Preamble characters are part of the UPC symbol, and include Country Code and System Character. There are three options for transmitting a UPC-A preamble to the host device: transmit System Character only, transmit System Character and Country Code ("0" for USA), and transmit no preamble. Select the appropriate option to match the host system.

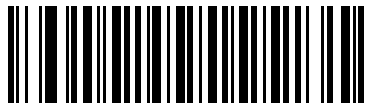

No Preamble (<DATA>)
(0)

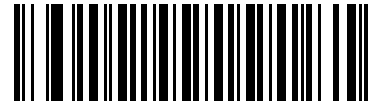

*System Character (<SYSTEM CHARACTER>
<DATA>)
(1)

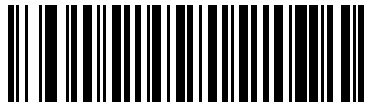

System Character & Country Code
(< COUNTRY CODE> <SYSTEM CHARACTER>
<DATA>)
(2)

UPC-E Preamble

Parameter # 35

SSI # 23h

Preamble characters are part of the UPC symbol, and include Country Code and System Character. There are three options for transmitting a UPC-E preamble to the host device: transmit System Character only, transmit System Character and Country Code ("0" for USA), and transmit no preamble. Select the appropriate option to match the host system.

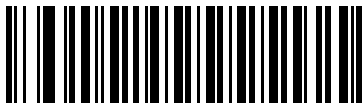

No Preamble (<DATA>)
(0)

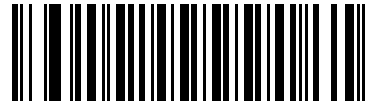

*System Character (<SYSTEM CHARACTER>
<DATA>)
(1)

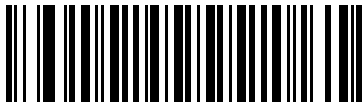

System Character & Country Code
(< COUNTRY CODE> <SYSTEM CHARACTER>
<DATA>)
(2)

UPC-E1 Preamble

Parameter # 36

SSI # 24h

Preamble characters are part of the UPC symbol, and include Country Code and System Character. There are three options for transmitting a UPC-E1 preamble to the host device: transmit System Character only, transmit System Character and Country Code ("0" for USA), and transmit no preamble. Select the appropriate option to match the host system.

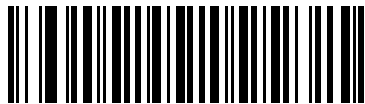

No Preamble (<DATA>)
(0)

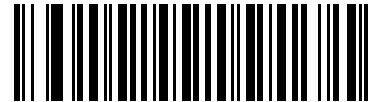

*System Character (<SYSTEM CHARACTER> <DATA>)
(1)

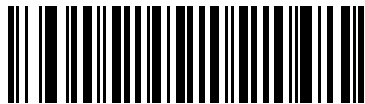

System Character & Country Code
(< COUNTRY CODE> <SYSTEM CHARACTER> <DATA>)
(2)

Convert UPC-E to UPC-A

Parameter # 37

SSI # 25h

Enable this to convert UPC-E (zero suppressed) decoded data to UPC-A format before transmission. After conversion, the data follows UPC-A format and is affected by UPC-A programming selections (e.g., Preamble, Check Digit).

Disable this to transmit UPC-E decoded data as UPC-E data, without conversion.

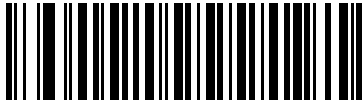

Convert UPC-E to UPC-A (Enable)
(1)

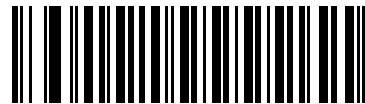

***Do Not Convert UPC-E to UPC-A (Disable)**
(0)

Convert UPC-E1 to UPC-A

Parameter # 38

SSI # 26h

Enable this to convert UPC-E1 decoded data to UPC-A format before transmission. After conversion, the data follows UPC-A format and is affected by UPC-A programming selections (e.g., Preamble, Check Digit).

Disable this to transmit UPC-E1 decoded data as UPC-E1 data, without conversion.

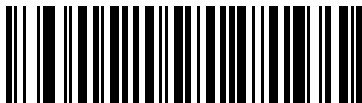

Convert UPC-E1 to UPC-A (Enable)
(1)



***Do Not Convert UPC-E1 to UPC-A (Disable)**
(0)

EAN-8/JAN-8 Extend

Parameter # 39

SSI # 27h

Enable this parameter to add five leading zeros to decoded EAN-8 symbols to make them compatible in format to EAN-13 symbols. Disable this to transmit EAN-8 symbols as is.

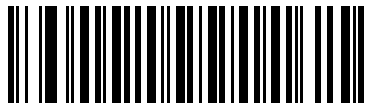

**Enable EAN/JAN Zero Extend
(1)**

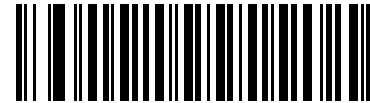

***Disable EAN/JAN Zero Extend
(0)**

UCC Coupon Extended Code

Parameter # 85

SSI # 55h

Enable this parameter to decode UPC-A bar codes starting with digit '5', EAN-13 bar codes starting with digit '99', and UPC-A/GS1-128 Coupon Codes. UPCA, EAN-13, and GS1-128 must be enabled to scan all types of Coupon Codes.

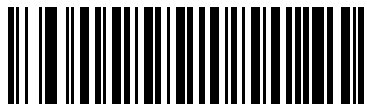

**Enable UCC Coupon Extended Code
(1)**



***Disable UCC Coupon Extended Code
(0)**



NOTE See [UPC/EAN/JAN Supplemental Redundancy on page 5-15](#) to control autodiscrimination of the GS1-128 (right half) of a coupon code.

Coupon Report

Parameter # 730

SSI # F1h DAh

Select an option to determine which type of coupon format to support.

- Select **Old Coupon Format** to support UPC-A/GS1-128 and EAN-13/GS1-128.
- Select **New Coupon Format** as an interim format to support UPC-A/GS1-DataBar and EAN-13/GS1-DataBar.
- If you select **Autodiscriminate Format**, the scanner supports both **Old Coupon Format** and **New Coupon Format**.



Old Coupon Format
(0)



***New Coupon Format**
(1)



Autodiscriminate Coupon Format
(2)

ISSN EAN

Parameter # 617

SSI # F1h 69h

To enable or disable ISSN EAN, scan the appropriate bar code below.



Enable ISSN EAN
(1)



***Disable ISSN EAN**
(0)

Code 128

Enable/Disable Code 128

Parameter # 8

SSI # 08h

To enable or disable Code 128, scan the appropriate bar code below.

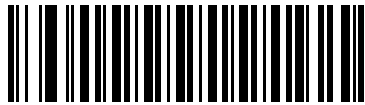

*Enable Code 128
(1)

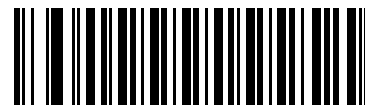

Disable Code 128
(0)

Set Lengths for Code 128

L1 = Parameter # 209

SSI # D1h

L2 = Parameter # 210

SSI # D2h

The length of a code refers to the number of characters (i.e., human readable characters), including check digit(s) the code contains. Set lengths for Code 128 to any length, one or two discrete lengths, or lengths within a specific range. The default is 1 to 55.

✓ **NOTE** When setting lengths for different bar code types, enter a leading zero for single digit numbers.

- **One Discrete Length** - Select this option to decode only Code 128 symbols containing a selected length. Select the length using the numeric bar codes in [Appendix F, Numeric Bar Codes](#). For example, to decode only Code 128 symbols with 14 characters, scan **Code 128 - One Discrete Length**, then scan 1 followed by 4. To correct an error or change the selection, scan [Cancel on page F-3](#).
- **Two Discrete Lengths** - Select this option to decode only Code 128 symbols containing either of two selected lengths. Select lengths using the numeric bar codes in [Appendix F, Numeric Bar Codes](#). For example, to decode only Code 128 symbols containing either 2 or 14 characters, select **Code 128 - Two Discrete Lengths**, then scan 0, 2, 1, and then 4. To correct an error or change the selection, scan [Cancel on page F-3](#).
- **Length Within Range** - Select this option to decode a Code 128 symbol with a specific length range. Select lengths using numeric bar codes in [Appendix F, Numeric Bar Codes](#). For example, to decode Code 128 symbols containing between 4 and 12 characters, first scan **Code 128 - Length Within Range**. Then scan 0, 4, 1, and 2 (enter a leading zero for single digit numbers). To correct an error or change the selection, scan [Cancel on page F-3](#).

Set Lengths for Code 128 (continued)

- **Any Length** - Select this option to decode Code 128 symbols containing any number of characters within the scanner's capability.

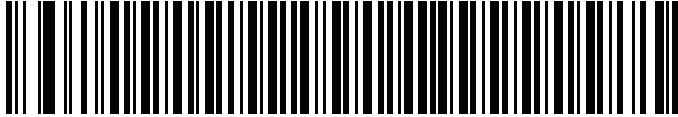

Code 128 - One Discrete Length

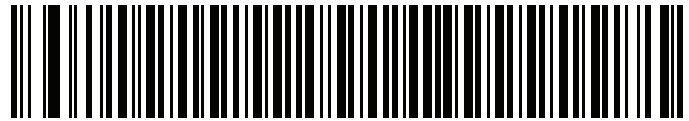

Code 128 - Two Discrete Lengths

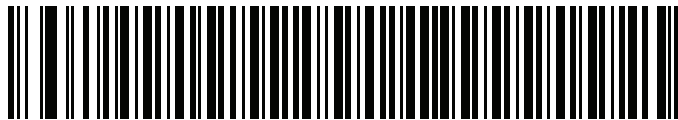

Code 128 - Length Within Range

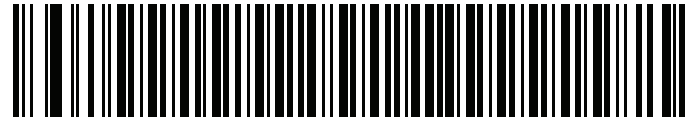

Code 128 - Any Length

Enable/Disable GS1-128 (formerly UCC/EAN-128)**Parameter # 14****SSI # 0Eh**

To enable or disable GS1-128, scan the appropriate bar code below.

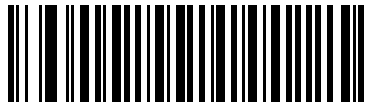

***Enable GS1-128
(1)**

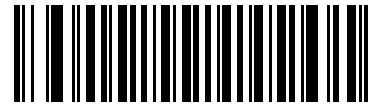

**Disable GS1-128
(0)**

Enable/Disable ISBT 128**Parameter # 84****SSI # 54h**

ISBT 128 is a variant of Code 128 used in the blood bank industry. Scan a bar code below to enable or disable ISBT 128. If necessary, the host must perform concatenation of the ISBT data.



***Enable ISBT 128
(1)**

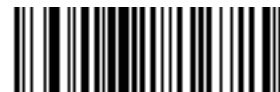

**Disable ISBT 128
(0)**

ISBT Concatenation

Parameter # 577

SSI # F1h 41h

Select an option for concatenating pairs of ISBT code types:

- If you select **Disable ISBT Concatenation**, the scanner does not concatenate pairs of ISBT codes it encounters.
- If you select **Enable ISBT Concatenation**, there must be two ISBT codes in order for the scanner to decode and perform concatenation. The scanner does not decode single ISBT symbols.
- If you select **Autodiscriminate ISBT Concatenation**, the scanner decodes and concatenates pairs of ISBT codes immediately. If only a single ISBT symbol is present, the scanner must decode the symbol the number of times set via [ISBT Concatenation Redundancy on page 5-29](#) before transmitting its data to confirm that there is no additional ISBT symbol.



**Disable ISBT Concatenation
(0)**



**Enable ISBT Concatenation
(1)**



***Autodiscriminate ISBT Concatenation
(2)**

Check ISBT Table

Parameter # 578

SSI # F1h 42h

The ISBT specification includes a table that lists several types of ISBT bar codes that are commonly used in pairs. If you set **ISBT Concatenation** to **Enable**, enable **Check ISBT Table** to concatenate only those pairs found in this table. Other types of ISBT codes are not concatenated.



*Enable Check ISBT Table
(1)



Disable Check ISBT Table
(0)

ISBT Concatenation Redundancy

Parameter # 223

SSI # DFh

If you set **ISBT Concatenation** to **Autodiscriminate**, use this parameter to set the number of times the scanner must decode an ISBT symbol before determining that there is no additional symbol.

Scan the bar code below, then scan two numeric bar codes in [Appendix F, Numeric Bar Codes](#) to set a value between 2 and 20. Enter a leading zero for single digit numbers. To correct an error or change a selection, scan [Cancel on page F-3](#). The default is 10.



ISBT Concatenation Redundancy

Code 128 Security Level

Parameter # 751

SSI # F1h EFh

Code 128 bar codes are vulnerable to misdecodes, particularly when Code 128 Lengths is set to **Any Length**. The scanner offers four levels of decode security for Code 128 bar codes. There is an inverse relationship between security and scanner aggressiveness. Increasing the level of security can reduce scanning aggressiveness, so select only the level of security necessary.

- **Code 128 Security Level 0:** This setting allows the scanner to operate in its most aggressive state, while providing sufficient security in decoding most in-spec bar codes.
- **Code 128 Security Level 1:** A bar code must be successfully read twice, and satisfy certain safety requirements before being decoded. This default setting eliminates most misdecodes.
- **Code 128 Security Level 2:** Select this option with greater bar code security requirements if **Security Level 1** fails to eliminate misdecodes.
- **Code 128 Security Level 3:** If you selected **Security Level 2**, and misdecodes still occur, select this security level to apply the highest safety requirements. A bar code must be successfully read three times before being decoded.

✓ **NOTE** Selecting this option is an extreme measure against mis-decoding severely out-of-spec bar codes. Selecting this level of security significantly impairs the decoding ability of the scanner. If this level of security is required, try to improve the quality of the bar codes.

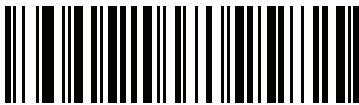

Code 128 Security Level 0
(0)



*Code 128 Security Level 1
(1)

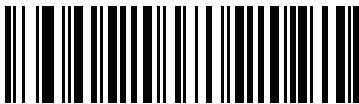

Code 128 Security Level 2
(2)



Code 128 Security Level 3
(3)

Code 39

Enable/Disable Code 39

Parameter # 0

SSI # 00h

To enable or disable Code 39, scan the appropriate bar code below.

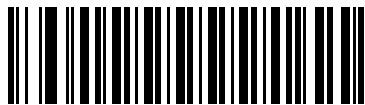

***Enable Code 39**
(1)



Disable Code 39
(0)

Enable/Disable Trioptic Code 39

Parameter # 13

SSI # 0Dh

Trioptic Code 39 is a variant of Code 39 used in the marking of computer tape cartridges. Trioptic Code 39 symbols always contain six characters. To enable or disable Trioptic Code 39, scan the appropriate bar code below.

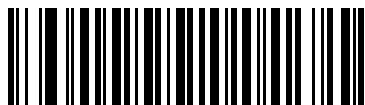

Enable Trioptic Code 39
(1)



***Disable Trioptic Code 39**
(0)



NOTE You cannot enable Trioptic Code 39 and Code 39 Full ASCII simultaneously.

Convert Code 39 to Code 32

Parameter # 86

SSI # 56h

Code 32 is a variant of Code 39 used by the Italian pharmaceutical industry. Scan the appropriate bar code below to enable or disable converting Code 39 to Code 32.

✓ *NOTE* Code 39 must be enabled for this parameter to function.



**Enable Convert Code 39 to Code 32
(1)**

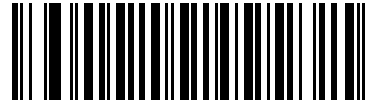

***Disable Convert Code 39 to Code 32
(0)**

Code 32 Prefix

Parameter # 231

SSI # E7h

Scan the appropriate bar code below to enable or disable adding the prefix character "A" to all Code 32 bar codes.

✓ *NOTE* Convert Code 39 to Code 32 must be enabled for this parameter to function.

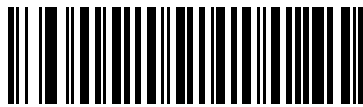

Enable Code 32 Prefix
(1)

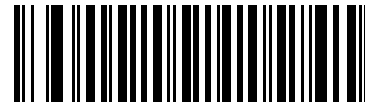

*Disable Code 32 Prefix
(0)

Set Lengths for Code 39

L1 = Parameter # 18

SSI # 12h

L2 = Parameter # 19

SSI # 13h

The length of a code refers to the number of characters (i.e., human readable characters), including check digit(s) the code contains. Set lengths for Code 39 to any length, one or two discrete lengths, or lengths within a specific range. If Code 39 Full ASCII is enabled, **Length Within a Range** or **Any Length** are the preferred options. The default is 1 to 55.

✓ *NOTE* When setting lengths for different bar code types, enter a leading zero for single digit numbers.

- **One Discrete Length** - Select this option to decode only Code 39 symbols containing a selected length. Select the length using the numeric bar codes in [Appendix F, Numeric Bar Codes](#). For example, to decode only Code 39 symbols with 14 characters, scan **Code 39 - One Discrete Length**, then scan **1** followed by **4**. To correct an error or change the selection, scan [Cancel on page F-3](#).
- **Two Discrete Lengths** - Select this option to decode only Code 39 symbols containing either of two selected lengths. Select lengths using the numeric bar codes in [Appendix F, Numeric Bar Codes](#). For example, to decode only Code 39 symbols containing either 2 or 14 characters, select **Code 39 - Two Discrete Lengths**, then scan **0, 2, 1**, and then **4**. To correct an error or change the selection, scan [Cancel on page F-3](#).

Set Lengths for Code 39 (continued)

- **Length Within Range** - Select this option to decode a Code 39 symbol with a specific length range. Select lengths using numeric bar codes in [Appendix F, Numeric Bar Codes](#). For example, to decode Code 39 symbols containing between 4 and 12 characters, first scan **Code 39 - Length Within Range**. Then scan **0, 4, 1, and 2** (enter a leading zero for single digit numbers). To correct an error or change the selection, scan [Cancel on page F-3](#).
- **Any Length** - Select this option to decode Code 39 symbols containing any number of characters within the scanner's capability.

**Code 39 - One Discrete Length****Code 39 - Two Discrete Lengths****Code 39 - Length Within Range****Code 39 - Any Length**

Code 39 Check Digit Verification

Parameter # 48

SSI # 30h

Enable this feature to check the integrity of all Code 39 symbols to verify that the data complies with specified check digit algorithm. Only Code 39 symbols which include a modulo 43 check digit are decoded. Enable this feature if the Code 39 symbols contain a Modulo 43 check digit.

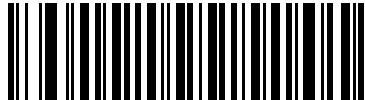

Enable Code 39 Check Digit
(1)

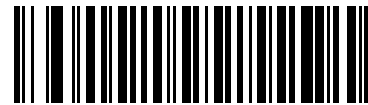

*Disable Code 39 Check Digit
(0)

Transmit Code 39 Check Digit

Parameter # 43

SSI # 2Bh

Scan a bar code below to transmit Code 39 data with or without the check digit.

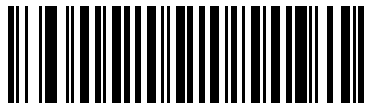

Transmit Code 39 Check Digit (Enable)
(1)



*Do Not Transmit Code 39 Check Digit (Disable)
(0)



NOTE Code 39 Check Digit Verification must be enabled for this parameter to function.

Code 39 Full ASCII Conversion

Parameter # 17

SSI # 11h

Code 39 Full ASCII is a variant of Code 39 which pairs characters to encode the full ASCII character set. To enable or disable Code 39 Full ASCII, scan the appropriate bar code below.

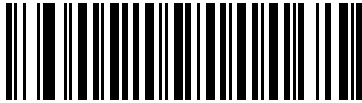

**Enable Code 39 Full ASCII
(1)**

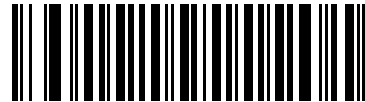

***Disable Code 39 Full ASCII
(0)**



NOTE You cannot enable Trioptic Code 39 and Code 39 Full ASCII simultaneously.

Code 39 Security Level

Parameter # 750

SSI # F1h EEh

The scanner offers four levels of decode security for Code 39 bar codes. There is an inverse relationship between security and scanner aggressiveness. Increasing the level of security can reduce scanning aggressiveness, so select only the level of security necessary.

- **Code 39 Security Level 0:** This setting allows the scanner to operate in its most aggressive state, while providing sufficient security in decoding most in-spec bar codes.
- **Code 39 Security Level 1:** This default setting eliminates most misdecodes.
- **Code 39 Security Level 2:** Select this option with greater bar code security requirements if **Security Level 1** fails to eliminate misdecodes.
- **Code 39 Level 3:** If you selected **Security Level 2**, and misdecodes still occur, select this security level to apply the highest safety requirements.

✓ **NOTE** Selecting this option is an extreme measure against mis-decoding severely out-of-spec bar codes. Selecting this level of security significantly impairs the decoding ability of the scanner. If this level of security is required, try to improve the quality of the bar codes.



Code 39 Security Level 0
(0)



*Code 39 Security Level 1
(1)



Code 39 Security Level 2
(2)



Code 39 Security Level 3
(3)

Code 93

Enable/Disable Code 93

Parameter # 9

SSI # 09h

To enable or disable Code 93, scan the appropriate bar code below.

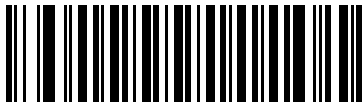

*Enable Code 93
(1)

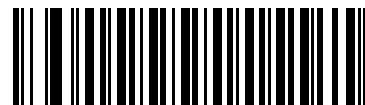

Disable Code 93
(0)

Set Lengths for Code 93

L1 = Parameter # 26

SSI # 1Ah

L2 = Parameter # 27

SSI # 1Bh

The length of a code refers to the number of characters (i.e., human readable characters), including check digit(s) the code contains. Set lengths for Code 93 to any length, one or two discrete lengths, or lengths within a specific range. The default is 1 to 55.

- **One Discrete Length** - Select this option to decode only Code 93 symbols containing a selected length. Select the length using the numeric bar codes in [Appendix F, Numeric Bar Codes](#). For example, to decode only Code 93 symbols with 14 characters, scan **Code 93 - One Discrete Length**, then scan **1** followed by **4**. To correct an error or to change the selection, scan [Cancel on page F-3](#).
- **Two Discrete Lengths** - Select this option to decode only Code 93 symbols containing either of two selected lengths. Select lengths using the numeric bar codes in [Appendix F, Numeric Bar Codes](#). For example, to decode only Code 93 symbols containing either 2 or 14 characters, select **Code 93 - Two Discrete Lengths**, then scan **0**, **2**, **1**, and then **4**. To correct an error or to change the selection, scan [Cancel on page F-3](#).
- **Length Within Range** - Select this option to decode a Code 93 symbol with a specific length range. Select lengths using the numeric bar codes in [Appendix F, Numeric Bar Codes](#). For example, to decode Code 93 symbols containing between 4 and 12 characters, first scan **Code 93 - Length Within Range**. Then scan **0**, **4**, **1**, and **2** (enter a leading zero for single digit numbers). To correct an error or change the selection, scan [Cancel on page F-3](#).
- **Any Length** - Scan this option to decode Code 93 symbols containing any number of characters within the scanner's capability.

Set Lengths for Code 93 (continued)



Code 93 - One Discrete Length



Code 93 - Two Discrete Lengths



Code 93 - Length Within Range



Code 93 - Any Length

Code 11

Code 11

Parameter # 10

SSI # 0Ah

To enable or disable Code 11, scan the appropriate bar code below.

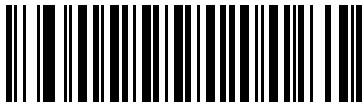

Enable Code 11
(1)



***Disable Code 11**
(0)

Set Lengths for Code 11

L1 = Parameter # 28

SSI # 1Ch

L2 = Parameter # 29

SSI # 1Dh

The length of a code refers to the number of characters (i.e., human readable characters), including check digit(s) the code contains. Set lengths for Code 11 to any length, one or two discrete lengths, or lengths within a specific range. The default is 4 to 55.

- **One Discrete Length** - Select this option to decode only Code 11 symbols containing a selected length. Select the length using the numeric bar codes in [Appendix F, Numeric Bar Codes](#). For example, to decode only Code 11 symbols with 14 characters, scan **Code 11 - One Discrete Length**, then scan **1** followed by **4**. To correct an error or to change the selection, scan [Cancel on page F-3](#).
- **Two Discrete Lengths** - Select this option to decode only Code 11 symbols containing either of two selected lengths. Select lengths using the numeric bar codes in [Appendix F, Numeric Bar Codes](#). For example, to decode only Code 11 symbols containing either 2 or 14 characters, select **Code 11 - Two Discrete Lengths**, then scan **0**, **2**, **1**, and then **4**. To correct an error or to change the selection, scan [Cancel on page F-3](#).
- **Length Within Range** - Select this option to decode a Code 11 symbol with a specific length range. Select lengths using numeric bar codes in [Appendix F, Numeric Bar Codes](#). For example, to decode Code 11 symbols containing between 4 and 12 characters, first scan **Code 11 - Length Within Range**. Then scan **0**, **4**, **1**, and **2** (enter a leading zero for single digit numbers). To correct an error or change the selection, scan [Cancel on page F-3](#).
- **Any Length** - Scan this option to decode Code 11 symbols containing any number of characters within the scanner's capability.

Set Lengths for Code 11 (continued)



Code 11 - One Discrete Length



Code 11 - Two Discrete Lengths



Code 11 - Length Within Range



Code 11 - Any Length

Code 11 Check Digit Verification

Parameter # 52

SSI # 34h

This feature allows the scanner to check the integrity of all Code 11 symbols to verify that the data complies with the specified check digit algorithm. This selects the check digit mechanism for the decoded Code 11 bar code. The options are to check for one check digit, check for two check digits, or disable the feature.

To enable this feature, scan the bar code below corresponding to the number of check digits encoded in the Code 11 symbols.

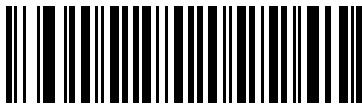

***Disable
(0)**

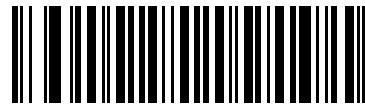

**One Check Digit
(1)**

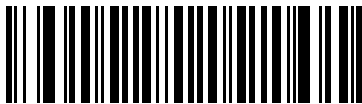

**Two Check Digits
(2)**

Transmit Code 11 Check Digits

Parameter # 47

SSI # 2Fh

This feature selects whether or not to transmit the Code 11 check digit(s).

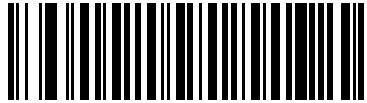

Transmit Code 11 Check Digit(s) (Enable)
(1)

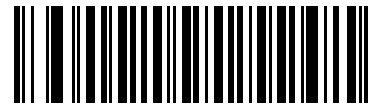

*Do Not Transmit Code 11 Check Digit(s) (Disable)
(0)



NOTE Code 11 Check Digit Verification must be enabled for this parameter to function.

Interleaved 2 of 5 (ITF)

Enable/Disable Interleaved 2 of 5

Parameter # 6

SSI # 06h

To enable or disable Interleaved 2 of 5, scan the appropriate bar code below, and select an Interleaved 2 of 5 length from the following pages.

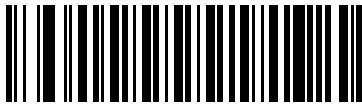

*Enable Interleaved 2 of 5
(1)

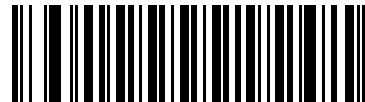

Disable Interleaved 2 of 5
(0)

Set Lengths for Interleaved 2 of 5

L1 = Parameter # 22

SSI # 16h

L2 = Parameter # 23

SSI # 17h

The length of a code refers to the number of characters (i.e., human readable characters), including check digit(s) the code contains. Set lengths for I 2 of 5 to any length, one or two discrete lengths, or lengths within a specific range. The range for Interleaved 2 of 5 lengths is 0 - 55. The default is 6 to 55.

- **One Discrete Length** - Select this option to decode only I 2 of 5 symbols containing a selected length. Select the length using the numeric bar codes in [Appendix F, Numeric Bar Codes](#). For example, to decode only I 2 of 5 symbols with 14 characters, scan **I 2 of 5 - One Discrete Length**, then scan **1** followed by **4**. To correct an error or to change the selection, scan [Cancel on page F-3](#).
- **Two Discrete Lengths** - Select this option to decode only I 2 of 5 symbols containing either of two selected lengths. Select lengths using the numeric bar codes in [Appendix F, Numeric Bar Codes](#). For example, to decode only I 2 of 5 symbols containing either 2 or 14 characters, select **I 2 of 5 - Two Discrete Lengths**, then scan **0**, **2**, **1**, and then **4**. To correct an error or to change the selection, scan [Cancel on page F-3](#).
- **Length Within Range** - Select this option to decode an I 2 of 5 symbol with a specific length range. Select lengths using numeric bar codes in [Appendix F, Numeric Bar Codes](#). For example, to decode I 2 of 5 symbols containing between 4 and 12 characters, first scan **I 2 of 5 - Length Within Range**. Then scan **0**, **4**, **1**, and **2** (enter a leading zero for single digit numbers). To correct an error or change the selection, scan [Cancel on page F-3](#).

Set Lengths for Interleaved 2 of 5 (continued)

- **Any Length** - Scan this option to decode I 2 of 5 symbols containing any number of characters within the scanner's capability.
- ✓ **NOTE** Due to the construction of the I 2 of 5 symbology, it is possible for a scan line covering only a portion of the code to transmit as a complete scan, yielding less data than is encoded in the bar code. To prevent this, select specific lengths (I 2 of 5 - One Discrete Length, Two Discrete Lengths) for I 2 of 5 applications.

**I 2 of 5 - One Discrete Length****I 2 of 5 - Two Discrete Lengths****I 2 of 5 - Length Within Range****I 2 of 5 - Any Length**

I 2 of 5 Check Digit Verification

Parameter # 49

SSI # 31h

Enable this feature to check the integrity of all I 2 of 5 symbols to verify the data complies with either the specified Uniform Symbology Specification (USS), or the Optical Product Code Council (OPCC) check digit algorithm.



***Disable**
(0)



USS Check Digit
(1)



OPCC Check Digit
(2)

Transmit I 2 of 5 Check Digit

Parameter # 44

SSI # 2Ch

Scan the appropriate bar code below to transmit I 2 of 5 data with or without the check digit.

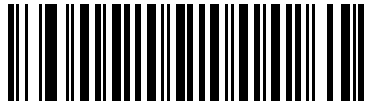

Transmit I 2 of 5 Check Digit (Enable)
(1)

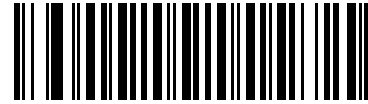

*Do Not Transmit I 2 of 5 Check Digit (Disable)
(0)

Convert I 2 of 5 to EAN-13

Parameter # 82

SSI # 52h

Enable this parameter to convert 14-character I 2 of 5 codes to EAN-13, and transmit to the host as EAN-13. To accomplish this, the I 2 of 5 code must be enabled, and the code must have a leading zero and a valid EAN-13 check digit.

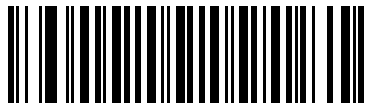

Convert I 2 of 5 to EAN-13 (Enable)
(1)

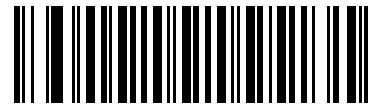

*Do Not Convert I 2 of 5 to EAN-13 (Disable)
(0)

I 2 of 5 Security Level

Parameter # 1121

SSI # F8h 04h 61h

Interleaved 2 of 5 bar codes are vulnerable to misdecodes, particularly when I 2 of 5 Lengths is set to **Any Length**. The scanner offers four levels of decode security for Interleaved 2 of 5 bar codes. There is an inverse relationship between security and scanner aggressiveness. Increasing the level of security can reduce scanning aggressiveness, so select only the level of security necessary.

- **I 2 of 5 Security Level 0:** This setting allows the scanner to operate in its most aggressive state, while providing sufficient security in decoding most in-spec bar codes.
- **I 2 of 5 Security Level 1:** A bar code must be successfully read twice, and satisfy certain safety requirements before being decoded. This default setting eliminates most misdecodes.
- **I 2 of 5 Security Level 2:** Select this option with greater bar code security requirements if **Security Level 1** fails to eliminate misdecodes.
- **I 2 of 5 Security Level 3:** If you selected **Security Level 2**, and misdecodes still occur, select this security level. The highest safety requirements are applied. A bar code must be successfully read three times before being decoded.

✓ **NOTE** Selecting this option is an extreme measure against mis-decoding severely out-of-spec bar codes. Selecting this level of security significantly impairs the decoding ability of the scanner. If this level of security is required, try to improve the quality of the bar codes.

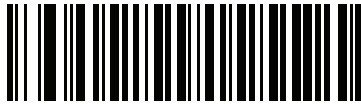

I 2 of 5 Security Level 0
(0)

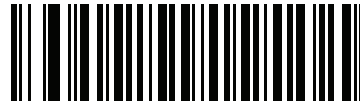

*I 2 of 5 Security Level 1
(1)



I 2 of 5 Security Level 2
(2)



I 2 of 5 Security Level 3
(3)

Discrete 2 of 5 (DTF)

Enable/Disable Discrete 2 of 5

Parameter # 5

SSI # 05h

To enable or disable Discrete 2 of 5, scan the appropriate bar code below.

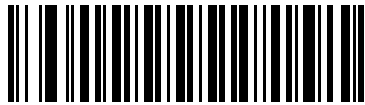

Enable Discrete 2 of 5
(1)



*Disable Discrete 2 of 5
(0)

Set Lengths for Discrete 2 of 5

L1 = Parameter # 20

SSI # 14h

L2 = Parameter # 21

SSI # 15h

The length of a code refers to the number of characters (i.e., human readable characters), including check digit(s) the code contains. Set lengths for D 2 of 5 to any length, one or two discrete lengths, or lengths within a specific range. The range for Discrete 2 of 5 lengths is 1 - 55.

- One Discrete Length** - Select this option to decode only D 2 of 5 symbols containing a selected length. Select the length using the numeric bar codes in [Appendix F, Numeric Bar Codes](#). For example, to decode only D 2 of 5 symbols with 14 characters, scan **D 2 of 5 - One Discrete Length**, then scan **1** followed by **4**. To correct an error or to change the selection, scan [Cancel on page F-3](#).
- Two Discrete Lengths** - Select this option to decode only D 2 of 5 symbols containing either of two selected lengths. Select lengths using the numeric bar codes in [Appendix F, Numeric Bar Codes](#). For example, to decode only D 2 of 5 symbols containing either 2 or 14 characters, select **D 2 of 5 - Two Discrete Lengths**, then scan **0, 2, 1**, and then **4**. To correct an error or to change the selection, scan [Cancel on page F-3](#).
- Length Within Range** - Select this option to decode a D 2 of 5 symbol with a specific length range. Select lengths using numeric bar codes in [Appendix F, Numeric Bar Codes](#). For example, to decode D 2 of 5 symbols containing between 4 and 12 characters, first scan **D 2 of 5 - Length Within Range**. Then scan **0, 4, 1**, and **2** (enter a leading zero for single digit numbers). To correct an error or change the selection, scan [Cancel on page F-3](#).

Set Lengths for Discrete 2 of 5 (continued)

- **Any Length** - Scan this option to decode D 2 of 5 symbols containing any number of characters within the scanner's capability.

✓ **NOTE** Due to the construction of the D 2 of 5 symbology, it is possible for a scan line covering only a portion of the code to transmit as a complete scan, yielding less data than is encoded in the bar code. To prevent this, select specific lengths (**D 2 of 5 - One Discrete Length, Two Discrete Lengths**) for D 2 of 5 applications.



D 2 of 5 - One Discrete Length



D 2 of 5 - Two Discrete Lengths



D 2 of 5 - Length Within Range



D 2 of 5 - Any Length

Codabar (NW - 7)

Enable/Disable Codabar

Parameter # 7

SSI # 07h

To enable or disable Codabar, scan the appropriate bar code below.

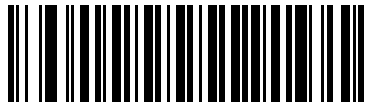

*Enable Codabar
(1)



Disable Codabar
(0)

Set Lengths for Codabar

L1 = Parameter # 24

SSI # 18h

L2 = Parameter # 25

SSI # 19h

The length of a code refers to the number of characters (i.e., human readable characters), including check digit(s) the code contains. Set lengths for Codabar to any length, one or two discrete lengths, or lengths within a specific range. The default is 4 to 55.

- One Discrete Length** - Select this option to decode only Codabar symbols containing a selected length. Select the length using the numeric bar codes in [Appendix F, Numeric Bar Codes](#). For example, to decode only Codabar symbols with 14 characters, scan **Codabar - One Discrete Length**, then scan **1** followed by **4**. To correct an error or to change the selection, scan [Cancel on page F-3](#).
- Two Discrete Lengths** - Select this option to decode only Codabar symbols containing either of two selected lengths. Select lengths using the numeric bar codes in [Appendix F, Numeric Bar Codes](#). For example, to decode only Codabar symbols containing either 2 or 14 characters, select **Codabar - Two Discrete Lengths**, then scan **0, 2, 1**, and then **4**. To correct an error or to change the selection, scan [Cancel on page F-3](#).
- Length Within Range** - Select this option to decode a Codabar symbol with a specific length range. Select lengths using numeric bar codes in [Appendix F, Numeric Bar Codes](#). For example, to decode Codabar symbols containing between 4 and 12 characters, first scan **Codabar - Length Within Range**. Then scan **0, 4, 1**, and **2** (enter a leading zero for single digit numbers). To correct an error or change the selection, scan [Cancel on page F-3](#).
- Any Length** - Scan this option to decode Codabar symbols containing any number of characters within the scanner's capability.

Set Lengths for Codabar (continued)



Codabar - One Discrete Length



Codabar - Two Discrete Lengths



Codabar - Length Within Range



Codabar - Any Length

CLSI Editing

Parameter # 54

SSI # 36h

Enable this parameter to strip the start and stop characters and insert a space after the first, fifth, and tenth characters of a 14-character Codabar symbol. Enable this feature if the host system requires this data format.

✓ *NOTE* Symbol length does not include start and stop characters.

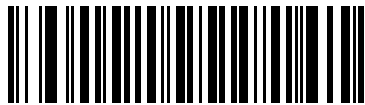

Enable CLSI Editing
(1)

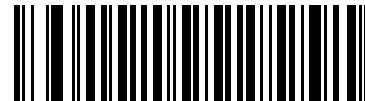

*Disable CLSI Editing
(0)

NOTIS Editing

Parameter # 55

SSI # 37h

Enable this parameter to strip the start and stop characters from a decoded Codabar symbol. Enable this feature if the host system requires this data format.



Enable NOTIS Editing
(1)

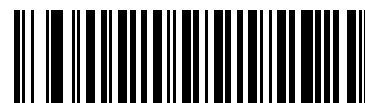

*Disable NOTIS Editing
(0)

Codabar Upper or Lower Case Start/Stop Characters Detection

Parameter # 855

SSI # F2h 57h

Select whether to detect upper case or lower case Codabar start/stop characters.

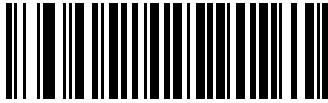

Lower Case
(1)

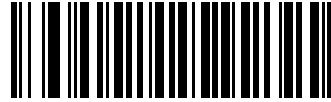

*Upper Case
(0)

MSI

Enable/Disable MSI

Parameter # 11

SSI # 0Bh

To enable or disable MSI, scan the appropriate bar code below.

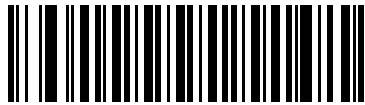

Enable MSI
(1)

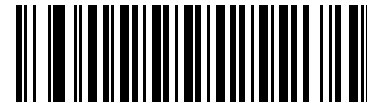

*Disable MSI
(0)

Set Lengths for MSI

L1 = Parameter # 30

SSI # 1Eh

L2 = Parameter # 31

SSI # 1Fh

The length of a code refers to the number of characters (i.e., human readable characters), including check digit(s) the code contains. Set lengths for MSI to any length, one or two discrete lengths, or lengths within a specific range. The default is 4 to 55.

- **One Discrete Length** - Select this option to decode only MSI symbols containing a selected length. Select the length using the numeric bar codes in [Appendix F, Numeric Bar Codes](#). For example, to decode only MSI symbols with 14 characters, scan **MSI - One Discrete Length**, then scan **1** followed by **4**. To correct an error or to change the selection, scan [Cancel on page F-3](#).
- **Two Discrete Lengths** - Select this option to decode only MSI symbols containing either of two selected lengths. Select lengths using the numeric bar codes in [Appendix F, Numeric Bar Codes](#). For example, to decode only MSI symbols containing either 2 or 14 characters, select **MSI - Two Discrete Lengths**, then scan **0, 2, 1**, and then **4**. To correct an error or to change the selection, scan [Cancel on page F-3](#).
- **Length Within Range** - Select this option to decode a MSI symbol with a specific length range. Select lengths using numeric bar codes in [Appendix F, Numeric Bar Codes](#). For example, to decode MSI symbols containing between 4 and 12 characters, first scan **MSI - Length Within Range**. Then scan **0, 4, 1**, and **2** (enter a leading zero for single digit numbers). To correct an error or change the selection, scan [Cancel on page F-3](#).
- **Any Length** - Scan this option to decode MSI symbols containing any number of characters within the scanner's capability.

Set Lengths for MSI (continued)

✓ **NOTE** Due to the construction of the MSI symbology, it is possible for a scan line covering only a portion of the code to transmit as a complete scan, yielding less data than is encoded in the bar code. To prevent this, select specific lengths (**MSI - One Discrete Length, Two Discrete Lengths**) for MSI applications.



MSI - One Discrete Length



MSI - Two Discrete Lengths



MSI - Length Within Range



MSI - Any Length

MSI Check Digits

Parameter # 50

SSI # 32h

With MSI symbols, one check digit is mandatory and always verified by the reader. The second check digit is optional. If the MSI codes include two check digits, scan the **Two MSI Check Digits** bar code to enable verification of the second check digit.

See [MSI Check Digit Algorithm on page 5-58](#) for the selection of second digit algorithms.

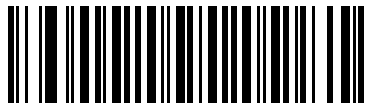

***One MSI Check Digit
(0)**

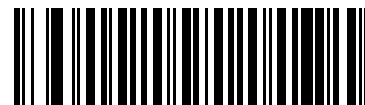

**Two MSI Check Digits
(1)**

Transmit MSI Check Digit(s)

Parameter # 46

SSI # 2Eh

Scan a bar code below to transmit MSI data with or without the check digit.

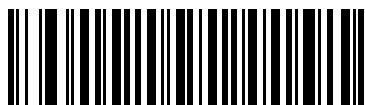

**Transmit MSI Check Digit(s) (Enable)
(1)**

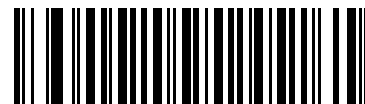

***Do Not Transmit MSI Check Digit(s) (Disable)
(0)**

MSI Check Digit Algorithm

Parameter # 51

SSI # 33h

Two algorithms are possible for the verification of the second MSI check digit. Select the bar code below corresponding to the algorithm used to encode the check digit.

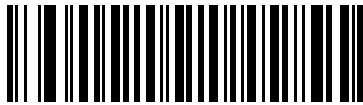

MOD 10/MOD 11
(0)

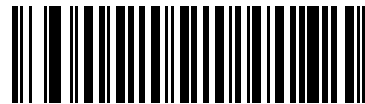

*MOD 10/MOD 10
(1)

Chinese 2 of 5

Enable/Disable Chinese 2 of 5

Parameter # 408

SSI # F0h 98h

To enable or disable Chinese 2 of 5, scan the appropriate bar code below.



Enable Chinese 2 of 5
(1)

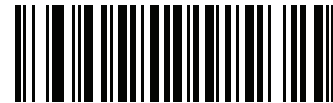

*Disable Chinese 2 of 5
(0)

Matrix 2 of 5

Enable/Disable Matrix 2 of 5

Parameter # 618

SSI # F1h 6Ah

To enable or disable Matrix 2 of 5, scan the appropriate bar code below.



Enable Matrix 2 of 5
(1)

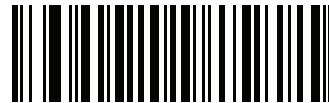

*Disable Matrix 2 of 5
(0)

Set Lengths for Matrix 2 of 5

L1 = Parameter # 619

SSI # F1h 6Bh

L2 = Parameter # 620

SSI # F1h 6Ch

The length of a code refers to the number of characters (i.e., human readable characters), including check digit(s) the code contains. Set lengths for Matrix 2 of 5 to any length, one or two discrete lengths, or lengths within a specific range. The default is 4 to 55.

- **One Discrete Length** - Select this option to decode only Matrix 2 of 5 symbols containing a selected length. Select the length using the numeric bar codes in [Appendix F, Numeric Bar Codes](#). For example, to decode only Matrix 2 of 5 symbols with 14 characters, scan **Matrix 2 of 5 - One Discrete Length**, then scan **1** followed by **4**. To correct an error or to change the selection, scan [Cancel on page F-3](#).
- **Two Discrete Lengths** - Select this option to decode only Matrix 2 of 5 symbols containing either of two selected lengths. Select lengths using the numeric bar codes in [Appendix F, Numeric Bar Codes](#). For example, to decode only Matrix 2 of 5 symbols containing either 2 or 14 characters, select **Matrix 2 of 5 - Two Discrete Lengths**, then scan **0, 2, 1**, and then **4**. To correct an error or to change the selection, scan [Cancel on page F-3](#).
- **Length Within Range** - Select this option to decode a Matrix 2 of 5 symbol with a specific length range. Select lengths using the numeric bar codes in [Appendix F, Numeric Bar Codes](#). For example, to decode Matrix 2 of 5 symbols containing between 4 and 12 characters, first scan **Matrix 2 of 5 - Length Within Range**. Then scan **0, 4, 1, and 2** (enter a leading zero for single digit numbers). To correct an error or change the selection, scan [Cancel on page F-3](#).
- **Any Length** - Scan this option to decode Matrix 2 of 5 symbols containing any number of characters within the scanner's capability.

Set Lengths for Matrix 2 of 5 (continued)



***Matrix 2 of 5 - One Discrete Length**



Matrix 2 of 5 - Two Discrete Lengths

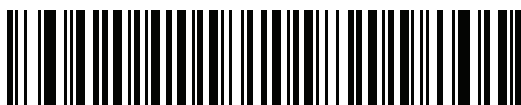

Matrix 2 of 5 - Length Within Range



Matrix 2 of 5 - Any Length

Matrix 2 of 5 Check Digit

Parameter # 622

SSI # F1h 6Eh

The check digit is the last character of the symbol used to verify the integrity of the data. Scan the appropriate bar code below to transmit the bar code data with or without the Matrix 2 of 5 check digit.



Enable Matrix 2 of 5 Check Digit
(1)

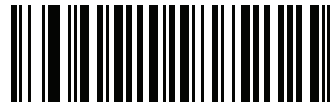

*Disable Matrix 2 of 5 Check Digit
(0)

Transmit Matrix 2 of 5 Check Digit

Parameter # 623

SSI # F1h 6Fh

Scan a bar code below to transmit Matrix 2 of 5 data with or without the check digit.



Transmit Matrix 2 of 5 Check Digit
(1)



*Do Not Transmit Matrix 2 of 5 Check Digit
(0)

Korean 3 of 5

Enable/Disable Korean 3 of 5

Parameter # 581

SSI # F1h 45h

To enable or disable Korean 3 of 5, scan the appropriate bar code below.

✓ *NOTE* The length for Korean 3 of 5 is fixed at 6.



Enable Korean 3 of 5
(1)



*Disable Korean 3 of 5
(0)

Inverse 1D

Parameter # 586

SSI # F1h 4Ah

This parameter sets the 1D inverse scanner setting. Options are:

- **Regular Only** - the scanner decodes regular 1D bar codes only.
- **Inverse Only** - the scanner decodes inverse 1D bar codes only.
- **Inverse Autodetect** - the scanner decodes both regular and inverse 1D bar codes.



***Regular
(0)**



**Inverse Only
(1)**



**Inverse Autodetect
(2)**

GS1 DataBar

The variants of GS1 DataBar are DataBar-14, DataBar Expanded, and DataBar Limited. The limited and expanded versions have stacked variants. Scan the appropriate bar codes to enable or disable each variant of GS1 DataBar.

GS1 DataBar-14

Parameter # 338

SSI # F0h 52h

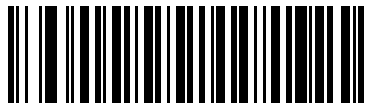

***Enable GS1 DataBar-14
(1)**

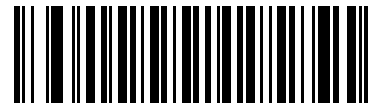

**Disable GS1 DataBar-14
(0)**

GS1 DataBar Limited

Parameter # 339

SSI # F0h 53h

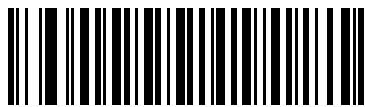

***Enable GS1 DataBar Limited
(1)**

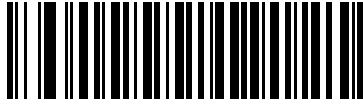

**Disable GS1 DataBar Limited
(0)**

GS1 DataBar Expanded**Parameter # 340****SSI # F0h 54h**

***Enable GS1 DataBar Expanded
(1)**

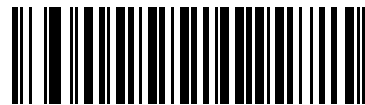

**Disable GS1 DataBar Expanded
(0)**

Convert GS1 DataBar to UPC/EAN**Parameter # 397****SSI # F0h, 8Dh**

This parameter only applies to GS1 DataBar-14 and GS1 DataBar Limited symbols not decoded as part of a Composite symbol. Enable this to strip the leading '010' from DataBar-14 and DataBar Limited symbols encoding a single zero as the first digit, and report the bar code as EAN-13.

For bar codes beginning with two or more zeros but not six zeros, this parameter strips the leading '0100' and reports the bar code as UPC-A. The UPC-A Preamble parameter that transmits the system character and country code applies to converted bar codes. Note that neither the system character nor the check digit can be stripped.

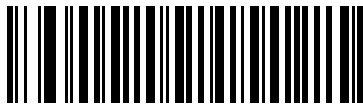

**Enable Convert GS1 DataBar to UPC/EAN
(1)**



***Disable Convert GS1 DataBar to UPC/EAN
(0)**

GS1 DataBar Limited Security Level

Parameter # 728

SSI # F1h D8h

The scanner offers four levels of decode security for GS1 DataBar Limited bar codes. There is an inverse relationship between security and scanner aggressiveness. Increasing the level of security may result in reduced aggressiveness in scanning, so choose only that level of security necessary.

- Level 1 – No clear margin required. This complies with the original GS1 standard, yet might result in erroneous decoding of the DataBar Limited bar code when scanning some UPC symbols that start with digits “9” and “7”
- Level 2 – Automatic risk detection. This level of security may result in erroneous decoding of DataBar Limited bar codes when scanning some UPC symbols. The scanner defaults to Level 3, otherwise to Level 1.
- Level 3 – Security level reflects newly proposed GS1 standard that requires a 5 times trailing clear margin.
- Level 4 – Security level extends beyond the standard required by GS1. This level of security requires a 5 times leading and trailing clear margin.



GS1 DataBar Limited Security Level 1
(1)



GS1 DataBar Limited Security Level 2
(2)



***GS1 DataBar Limited Security Level 3**
(3)



GS1 DataBar Limited Security Level 4
(4)

Composite

Composite CC-C

Parameter # 341

SSI # F0h 55h

Scan a bar code below to enable or disable Composite bar codes of type CC-C.

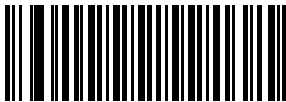

Enable CC-C
(1)



*Disable CC-C
(0)

Composite CC-A/B

Parameter # 342

SSI # F0h 56h

Scan a bar code below to enable or disable Composite bar codes of type CC-A/B.



Enable CC-A/B
(1)



*Disable CC-A/B
(0)

Composite TLC-39**Parameter # 371****SSI # F0h 73h**

Scan a bar code below to enable or disable Composite bar codes of type TLC-39.

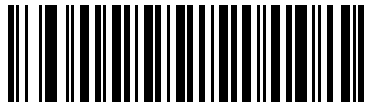

**Enable TLC39
(1)**

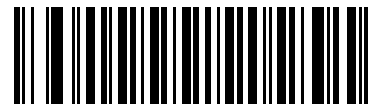

***Disable TLC39
(0)**

UPC Composite Mode

Parameter # 344

SSI # F0h 58h

Select an option for linking UPC symbols with a 2D symbol during transmission as if they were one symbol:

- Select **UPC Never Linked** to transmit UPC bar codes regardless of whether a 2D symbol is detected.
- Select **UPC Always Linked** to transmit UPC bar codes and the 2D portion.
If 2D is not present, the UPC bar code does not transmit.
- If you select **Autodiscriminate UPC Composites**, the scanner determines if there is a 2D portion, then transmits the UPC, as well as the 2D portion if present.



***UPC Never Linked
(0)**



**UPC Always Linked
(1)**

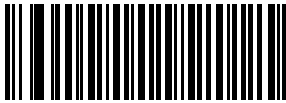

**Autodiscriminate UPC Composites
(2)**

GS1-128 Emulation Mode for UCC/EAN Composite Codes

Parameter # 427

SSI # F0h, ABh

Select whether to enable or disable this mode.



**Enable GS1-128 Emulation Mode for
UCC/EAN Composite Codes
(1)**



***Disable GS1-128 Emulation Mode for
UCC/EAN Composite Codes
(0)**

Postal Codes

US Postnet

Parameter # 89

SSI # 59h

To enable or disable US Postnet, scan the appropriate bar code below.



**Enable US Postnet
(1)**



***Disable US Postnet
(0)**

US Planet

Parameter # 90

SSI # 5Ah

To enable or disable US Planet, scan the appropriate bar code below.



**Enable US Planet
(1)**



***Disable US Planet
(0)**

Transmit US Postal Check Digit

Parameter # 95

SSI # 5Fh

Select whether to transmit US Postal data, which includes both US Postnet and US Planet, with or without the check digit.

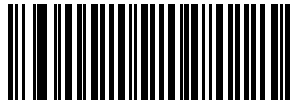

*Transmit US Postal Check Digit
(1)

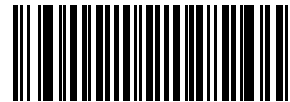

Do Not Transmit US Postal Check Digit
(0)

UK Postal

Parameter # 91

SSI # 5Bh

To enable or disable UK Postal, scan the appropriate bar code below.



Enable UK Postal
(1)

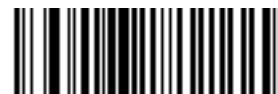

*Disable UK Postal
(0)

Transmit UK Postal Check Digit

Parameter # 96

SSI # 60h

Select whether to transmit UK Postal data with or without the check digit.



***Transmit UK Postal
Check Digit
(1)**



**Do Not Transmit UK Postal Check Digit
(0)**

Japan Postal

Parameter # 290

SSI # F0h, 22h

To enable or disable Japan Postal, scan the appropriate bar code below.



**Enable Japan Postal
(1)**



***Disable Japan Postal
(0)**

Australia Post**Parameter # 291****SSI # F0h, 23h**

To enable or disable Australia Post, scan the appropriate bar code below.



**Enable Australia Post
(1)**



***Disable Australia Post
(0)**

Australia Post Format

Parameter # 718

SSI # F1h, CEh

To select one of the following formats for Australia Post, scan the appropriate bar code below:

- **Autodiscriminate** (or Smart mode) - Attempt to decode the Customer Information Field using the N and C Encoding Tables.

✓ **NOTE** This option increases the risk of misdecodes because the encoded data format does not specify the Encoding Table used for encoding.

- **Raw Format** - Output raw bar patterns as a series of numbers 0 through 3.
- **Alphanumeric Encoding** - Decode the Customer Information Field using the C Encoding Table.
- **Numeric Encoding** - Decode the Customer Information Field using the N Encoding Table.

For more information on Australia Post Encoding Tables, refer to the *Australia Post Customer Barcoding Technical Specifications* available at www.auspost.com.au.



*Autodiscriminate
(0)



Raw Format
(1)



Alphanumeric Encoding
(2)



Numeric Encoding
(3)

Netherlands KIX Code

Parameter # 326

SSI # F0h, 46h

To enable or disable Netherlands KIX Code, scan the appropriate bar code below.



**Enable Netherlands KIX Code
(1)**



***Disable Netherlands KIX Code
(0)**

USPS 4CB/One Code/Intelligent Mail

Parameter # 592

SSI # F1h 50h

To enable or disable USPS 4CB/One Code/Intelligent Mail, scan the appropriate bar code below.



**Enable USPS 4CB/One Code/Intelligent Mail
(1)**



***Disable USPS 4CB/One Code/Intelligent Mail
(0)**

UPU FICS Postal

Parameter # 611

SSI # F1h 63h

To enable or disable UPU FICS Postal, scan the appropriate bar code below.



**Enable UPU FICS Postal
(1)**



***Disable UPU FICS Postal
(0)**

2D Symbologies

Enable/Disable PDF417

Parameter # 15

SSI # 0Fh

To enable or disable PDF417, scan the appropriate bar code below.



***Enable PDF417
(1)**



**Disable PDF417
(0)**

Enable/Disable MicroPDF417

Parameter # 227

SSI # E3h

To enable or disable MicroPDF417, scan the appropriate bar code below.



**Enable MicroPDF417
(1)**



***Disable MicroPDF417
(0)**

Code 128 Emulation

Parameter # 123

SSI # 7Bh

Enable this parameter to transmit data from certain MicroPDF417 symbols as Code 128. *AIM Code ID Character (1) on page 3-61* must be selected for this parameter to work.

Enable Code 128 Emulation to transmit these MicroPDF417 symbols with one of the following prefixes:

-]C1 if the first codeword is 903-905
-]C2 if the first codeword is 908 or 909
-]C0 if the first codeword is 910 or 911

Disable Code 128 Emulation to transmit these MicroPDF417 symbols with one of the following prefixes:

-]L3 if the first codeword is 903-905
-]L4 if the first codeword is 908 or 909
-]L5 if the first codeword is 910 or 911

Scan a bar code below to enable or disable Code 128 Emulation.



NOTE Linked MicroPDF codewords 906, 907, 912, 914, and 915 are not supported. Use GS1 Composites instead.



**Enable Code 128 Emulation
(1)**



***Disable Code 128 Emulation
(0)**

Data Matrix

Parameter # 292

SSI # F0h, 24h

To enable or disable Data Matrix, scan the appropriate bar code below.



***Enable Data Matrix
(1)**



**Disable Data Matrix
(0)**

GS1 Data Matrix

Parameter # 1336

SSI # F8h 05h 38h

To enable or disable GS1 Data Matrix, scan the appropriate bar code below.



**Enable GS1 Data Matrix
(1)**



***Disable GS1 Data Matrix
(0)**

Data Matrix Inverse

Parameter # 588

SSI # F1h 4Ch

This parameter sets the Data Matrix inverse scanner setting. Options are:

- **Regular Only** - the scanner decodes regular Data Matrix bar codes only.
- **Inverse Only** - the scanner decodes inverse Data Matrix bar codes only.
- **Inverse Autodetect** - the scanner decodes both regular and inverse Data Matrix bar codes.



**Regular
(0)**



**Inverse Only
(1)**



***Inverse Autodetect
(2)**

Decode Mirror Images (Data Matrix Only)**Parameter # 537****SSI # F1h 19h**

Select an option for decoding mirror image Data Matrix bar codes:

- Always - decode only Data Matrix bar codes that are mirror images
- Never - do not decode Data Matrix bar codes that are mirror images
- Auto - decode both mirrored and unmirrored Data Matrix bar codes.



**Never
(0)**



**Always
(1)**



*** Auto
(2)**

Maxicode

Parameter # 294

SSI # F0h, 26h

To enable or disable Maxicode, scan the appropriate bar code below.



**Enable Maxicode
(1)**



***Disable Maxicode
(0)**

QR Code

Parameter # 293

SSI # F0h, 25h

To enable or disable QR Code, scan the appropriate bar code below.



***Enable QR Code
(1)**



**Disable QR Code
(0)**

QR Inverse

Parameter # 587

SSI # F1h 4Bh

This parameter sets the QR inverse scanner setting. Options are:

- **Regular Only** - the scanner decodes regular QR bar codes only.
- **Inverse Only** - the scanner decodes inverse QR bar codes only.
- **Inverse Autodetect** - the scanner decodes both regular and inverse QR bar codes.



***Regular
(0)**



**Inverse Only
(1)**



**Inverse Autodetect
(2)**

MicroQR

Parameter # 573

SSI # F1h 3Dh

To enable or disable MicroQR, scan the appropriate bar code below.



***Enable MicroQR
(1)**



**Disable MicroQR
(0)**

Aztec

Parameter # 574

SSI # F1h 3Eh

To enable or disable Aztec, scan the appropriate bar code below.



***Enable Aztec
(1)**



**Disable Aztec
(0)**

Aztec Inverse

Parameter # 589

SSI # F1h 4Dh

This parameter sets the Aztec inverse scanner setting. Options are:

- **Regular Only** - the scanner decodes regular Aztec bar codes only.
- **Inverse Only** - the scanner decodes inverse Aztec bar codes only.
- **Inverse Autodetect** - the scanner decodes both regular and inverse Aztec bar codes.



**Regular
(0)**



**Inverse Only
(1)**



***Inverse Autodetect
(2)**

Han Xin

Parameter # 1167

SSI # F8h 04h 8Fh

To enable or disable Han Xin, scan the appropriate bar code below.



**Enable Han Xin
(1)**

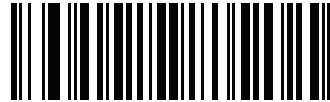

***Disable Han Xin
(0)**

Han Xin Inverse

Parameter # 1168

SSI # F8h 04h 90h

Select a Han Xin inverse scanner setting:

- **Regular Only** - the scanner decodes Han Xin bar codes with normal reflectance only.
- **Inverse Only** - the scanner decodes Han Xin bar codes with inverse reflectance only.
- **Inverse Autodetect** - the scanner decodes both regular and inverse Han Xin bar codes.

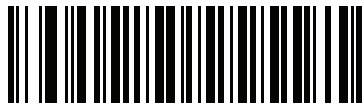

*Regular
(0)

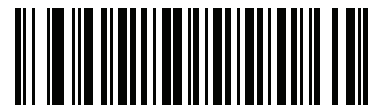

Inverse Only
(1)



Inverse Autodetect
(2)

Symbology-Specific Security Levels

Redundancy Level

Parameter # 78

SSI # 4Eh

The scanner offers four levels of decode redundancy. Select higher redundancy levels for decreasing levels of bar code quality. As redundancy levels increase, the scanner's aggressiveness decreases.

Select the redundancy level appropriate for the bar code quality.

Redundancy Level 1

The following code types must be successfully read twice before being decoded:

Table 5-2 *Redundancy Level 1 Codes*

Code Type	Code Length
Codabar	8 characters or less
MSI	4 characters or less
D 2 of 5	8 characters or less
I 2 of 5	8 characters or less

Redundancy Level 2

The following code types must be successfully read twice before being decoded:

Table 5-3 *Redundancy Level 2 Codes*

Code Type	Code Length
All	All

Redundancy Level 3

Code types other than the following must be successfully read twice before being decoded. The following codes must be read three times:

Table 5-4 *Redundancy Level 3 Codes*

Code Type	Code Length
MSI	4 characters or less
D 2 of 5	8 characters or less
I 2 of 5	8 characters or less
Codabar	8 characters or less

Redundancy Level 4

The following code types must be successfully read three times before being decoded:

Table 5-5 *Redundancy Level 4 Codes*

Code Type	Code Length
All	All

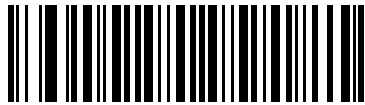

*Redundancy Level 1
(1)

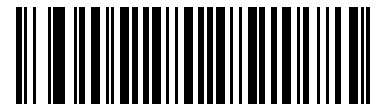

Redundancy Level 2
(2)

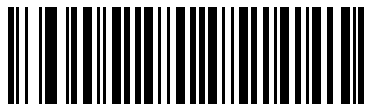

Redundancy Level 3
(3)



Redundancy Level 4
(4)

Security Level

Parameter # 77

SSI # 4Dh

The scanner offers four levels of decode security for delta bar codes, which include the Code 128 family, UPC/EAN, and Code 93. Select increasing levels of security for decreasing levels of bar code quality. There is an inverse relationship between security and scanner aggressiveness, so choose only that level of security necessary for any given application.

- **Security Level 0:** This setting allows the scanner to operate in its most aggressive state, while providing sufficient security in decoding most “in-spec” bar codes.
- **Security Level 1:** This default setting eliminates most misdecodes.
- **Security Level 2:** Select this option if Security level 1 fails to eliminate misdecodes.
- **Security Level 3:** If you selected Security Level 2 and misdecodes still occur, select this security level. Be advised, selecting this option is an extreme measure against mis-decoding severely out of spec bar codes. Selecting this level of security significantly impairs the decoding ability of the scanner. If you need this level of security, try to improve the quality of the bar codes.

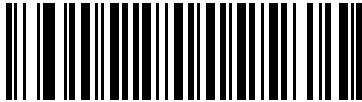

Security Level 0
(0)



*Security Level 1
(1)



Security Level 2
(2)



Security Level 3
(3)

Intercharacter Gap Size

Parameter # 381

SSI # F0h, 7Dh

The Code 39 and Codabar symbologies have an intercharacter gap that is typically quite small. Due to various bar code-printing technologies, this gap can grow larger than the maximum size allowed, preventing the scanner from decoding the symbol. If this problem occurs, scan the **Large Intercharacter Gaps** parameter to tolerate these out-of-specification bar codes.



***Normal Intercharacter Gaps
(6)**



**Large Intercharacter Gaps
(10)**

CHAPTER 6 CORDLESS BLUETOOTH WEDGE

Introduction

The CS4070 scanner supports connection to the Zebra Cordless Bluetooth Wedge Windows application utility located at www.zebra.com/support.

The Cordless Bluetooth Wedge application runs on a tablet, phone, or PC, and allows one or more cordless Bluetooth scanners to scan bar code data into an application and present the decoded data to the host as HID keyboard input. The application displays a bar code on the device screen for one-step pairing of the scanner to the device.

The Zebra Cordless Bluetooth Wedge Windows application:

- Consolidates bar code data transmitted from up to seven cordless Bluetooth scanners into any third party keyboard-enabled application.
- Supports Operating Systems Windows XP, 7, or 8.1.
- Simplifies wireless connection, using the computer's existing Microsoft Bluetooth device drivers.

CHAPTER 7 123SCAN AND SOFTWARE TOOLS

Introduction

This chapter briefly describes the Zebra software tools available for customizing scanner operation.

123Scan

123Scan is a software tool that simplifies scanner setup and more.

Intuitive enough for first time users, the 123Scan wizard guides users through a streamlined setup process. Settings are saved in a configuration file that can be printed as a single programming bar code for scanning or emailed to a smart phone for scanning from its screen.

Through 123Scan a user can accomplish the following.

- Configure a scanner using a wizard.
 - Program the following scanner settings:
 - Beeper tone / volume settings.
 - Enable / disable symbologies.
 - Modify data before transmission to a host using:
 - Advanced Data Formatting (ADF) - Scan one bar code per trigger pull.
 - Load parameter settings to a scanner via:
 - Bar code scanning.
 - Scan a paper bar code.
 - Scan a bar code from a PC screen.
 - Scan a bar code from a smart phone screen.
 - Generate the following reports:
 - Bar Code Report - Programming bar code, included parameter settings, and supported scanner models.
 - Parameter Report - Lists parameters programmed within a configuration file.

For more information go to: www.zebra.com/123Scan.

123Scan Requirements

- Host computer with Windows XP, 7, 8, or 10

123Scan Information

For more information on 123Scan, go to: www.zebra.com/123Scan.

For a 1 minute tour of 123Scan, go to: www.zebra.com/ScannerHowToVideos.

To see a list of all of our free software tools, go to: www.zebra.com/scannersoftware.

Scanner SDK, Other Software Tools, and Videos

To tackle all scanner programming needs, use Zebra's diversified set of software tools. Whether staging a device or developing a fully featured application with image and data capture, as well as asset management, these tools help you every step of the way. To download any of the following free tools, go to:

www.zebra.com/scannersoftware.

- 123Scan configuration utility
- SDKs
 - Scanner SDK for Android
 - Scanner SDK for iOS
- Mobile Apps
 - Scanner Control App
 - Android
 - iOS
 - Zebra AppGallery
 - Scan-To-Connect Utility
 - Android
 - Windows
- How-To-Videos

Scanner Control App

The Scanner Control App (SCA) allows you to control a Bluetooth scanner from a phone or tablet without a cradle. Use this app to showcase Zebra Bluetooth scanner capabilities and ease of control right from your phone.

The Scanner Control App supports Scan-To-Connect technology for one-step Bluetooth pairing and allows you to control the following scanner functions:

- Program the beeper and LEDs
- Enable and disable symbologies
- Remotely trigger a scan

The app displays scanned bar code data, and can query scanner asset information and battery health statistics.

The Scanner Control app is available on the Android Play, iOS App, and Zebra AppGallery stores. Source code is available within the Zebra Scanner SDK for Android and iOS.

To watch a 1 minute tour of the Scanner Control App, go to: www.zebra.com/scannercontrolapp.

Scan-To-Connect (STC) Utility

In one step, connect a Zebra Bluetooth scanner to a phone, tablet or PC by simply scanning an STC bar code. Available as a standalone utility for Windows and Android operating systems from www.zebra.com/scantoconnect.

Source code is also available for easy app integration.

✓ **NOTE** The STC utility allows you to pair a Bluetooth scanner to a phone, tablet or PC without using a cradle.

Advanced Data Formatting (ADF)

Advanced Data Formatting (ADF) is a means of customizing data before transmission to the host device. Use ADF to edit scan data to suit host application requirements. With ADF you scan one bar code per trigger pull. ADF is programmed using 123Scan.

To watch a video on Creating an Advanced Data Formatting (ADF) Rule, go to:

<http://www.zebra.com/ScannerHowToVideos>.

For additional information, refer to the Advanced Data Formatting Programmer Guide, p/n 72E-69680-xx.

CHAPTER 8 MAINTENANCE AND TECHNICAL

Introduction

This chapter provides suggested scanner maintenance, troubleshooting, and technical specifications.

Maintenance

Cleaning the scan window is the only maintenance required. A dirty window can affect scanning accuracy.

- Do not allow any abrasive material to touch the window.
- Remove any dirt particles with a damp cloth.
- Wipe the window using a tissue moistened with ammonia/water.
- Do not spray water or other cleaning liquids directly onto the window.

Troubleshooting

Table 8-1 *Troubleshooting*

Problem	Possible Causes	Possible Solutions
Imager comes on, but scanner does not decode the bar code.	Scanner is not programmed for the correct bar code type.	Ensure the scanner is programmed to read the type of bar code being scanned.
	Bar code symbol is unreadable.	Check the symbol to ensure it is not defaced. Try scanning test bar codes of the same bar code type. See Appendix E, Sample Bar Codes for test bar codes.
	Bar code is out of range of the scanner.	Move scanner closer to or further from bar code.
Scanner emits long beeps for 5 seconds when scanning a bar code.	Memory is full.	Download bar code data to the host and clear the memory.
Scanner does not decode the bar code and the LED blinks amber, red, green.	Scanner needs to be reset.	Scan Reset Factory Defaults on page 3-5 .
Scanner LED turns solid red for a few seconds.	Battery is low.	Charge the battery. See Charging Batteries on page 1-4 .
Scanner does not fully charge.	Attempt to charge on a non-powered USB hub.	Connect the scanner to a powered USB hub (5V, 500mA max).
Bluetooth LED turns off.	Scanner is out of range of the Bluetooth host.	Move closer to the host and press any key to re-pair with the host.
Can't see the scanner drive after connecting scanner to host.	Scanner is mapping to a drive used by another device.	Use Windows' map drive function to change the scanner drive letter.
Program connecting Broadcom stack to HID device.	Some versions of Broadcom stack experience issues when connecting to HID devices.	See Set HID CoD to Zero on page 3-19 .



NOTE If problems still occur, contact the distributor or support. See [page xviii](#) for contact information.

Before contacting support, view the **sysinfo.txt** file in the **\Parameters** folder on the CS4070. This indicates the device's serial number, software version, Bluetooth version, and scan engine version and is useful when troubleshooting the scanner.

Technical Specifications

For the latest technical specification information for the CS4070, visit: www.zebra.com/cs4070.

APPENDIX A STANDARD DEFAULT PARAMETERS

Table A-1 *Default Table*

Parameter	Parameter Number	SSI Number	Factory Default	Page Number
Reset Factory Defaults	N/A	N/A	N/A	3-5
Set Date	N/A	N/A	N/A	3-6
Set Time	N/A	N/A	N/A	3-6
Cancel Date and Time Settings	N/A	N/A	N/A	3-6
Bluetooth Options				
Bluetooth Friendly Name	N/A	N/A	N/A	3-8
Pairing Bar Code Format	N/A	N/A	N/A	3-9
Bluetooth Unpair	N/A	N/A	N/A	3-10
Bluetooth Profile	N/A	N/A	HID	3-10
Clear Data	N/A	N/A	N/A	3-11
Auto-reconnect	N/A	N/A	Enable	3-12
Connection Interval and Discovery Mode Timeout	1339	F8h 05h 3Bh	2 Minutes	3-13
Link Supervision Timeout	1698	F4h 06h A2h	0.5 Seconds	3-14
Bluetooth HID Host Name	Host 1: 1397 Host 2: 1398 Host 3: 1399	Host 1: F8h 05h 75h Host 2: F8h 05h 76h Host 3: F8h 05h 77h	N/A	3-15
HID Security	911	F2h 8Fh	High	3-18

Table A-1 Default Table (Continued)

Parameter	Parameter Number	SSI Number	Factory Default	Page Number
Radio Output Power	N/A	N/A	Class 1	3-18
Set HID CoD to Zero	N/A	N/A	Disable	3-19
Bluetooth HID Keyboard Features				
Country Keyboard Type	1392	F8h 05h 70h	Windows North American	3-20
HID Caps Lock Override	1372	F8h 05h 5Ch	Disable	3-23
HID Ignore Unknown Characters	1373	F8h 05h 5Dh	Enable	3-23
Emulate Keypad	1374	F8h 05h 5Eh	Disable	3-24
HID Keyboard FN1 Substitution	1375	F8h 05h 5Fh	Disable	3-25
FN1 Substitution Values:			N/A	3-25
Key Category	103	67h		
Decimal Value	109	6Dh		
HID Function Key Mapping	1377	F8h 05h 61h	Disable	3-26
Simulate Caps Lock	1378	F8h 05h 62h	Disable	3-26
Convert Case	1379	F8h 05h 63h	No Case Conversion	3-27
Fast Bluetooth HID Keyboard	1429	F8h 05h 95h	Fast HID Enable	3-28
General Decoder Settings				
Hand-Held Trigger Mode	138	8Ah	Level (Standard)	3-29
Hand-Held Decode Aiming Pattern	306	F0h 32h	Enable	3-30
Presentation Mode Field of View	609	F1h 61h	Full	3-31
Decoding Illumination	298	F0h 2Ah	Enable	3-32
Direct Decode Indicator	859	F2h 5Bh	Disable	3-33
Low Light Scene Detection	810	F2h 2Ah	No Low Light Scene Detection	3-34
Beeper Volume	140	8Ch	High	3-36
Beeper Tone	145	91h	Medium Frequency	3-37
Mute Beeper	N/A	N/A	Do Not Mute	3-38
Decode Pager Motor (CS4070HC only)	613	F1h 65h	Enable	3-38
Decode Pager Motor Duration (CS4070HC only)	626	F1h 72h	200 msec	3-39
Picklist Mode	402	F0h 92h	Disabled Always	3-40
Fuzzy 1D Processing	514	F1h 02h	Enable	3-41
Mirrored Image	624	F1h 70h	Disable	3-41

Table A-1 Default Table (Continued)

Parameter	Parameter Number	SSI Number	Factory Default	Page Number
Mobile Phone/Display Mode	716	F1h CCh	Disable	3-42
PDF Prioritization	719	F4h F1h CFh	Disable	3-43
PDF Prioritization Timeout	720	F1h D0h	200 ms	3-43
Batch Mode	544	F1h 20h	Normal (Do Not Batch Data)	3-44
Automatic Day/Night Mode	1393	F8h 05h 71h	Disable	3-47
Automatic Day/Night Mode Start/Stop Time	N/A	N/A	N/A	3-48
Automatic Day/Night Mode Shift Profiles	1394	F8h 05h 72h	Enable	3-49
Automatic Day/Night Mode 123Scan Programmable Shift Start Time	1395	F8h 05h 73h	N/A	3-50
Automatic Day/Night Mode 123Scan Programmable Shift Stop Time	1396	F8h 05h 74h	N/A	3-50
Out of Range Electric Fence Alarm	1426	F8h 05h 92h	Disable	3-51
Out of Range Electric Fence Trigger Timeout	1427	F8h 05h 93h	3 Seconds	3-52
Out of Range Electric Fence Alarm Timeout	1428	F8h 05h 94h	3 Seconds	3-53
Continuous Bar Code Read	649	F1h 89h	Disable	3-55
Unique Bar Code Reporting	723	F1h D3h	Enable	3-55
Decode Session Timeout	136	88h	5.0 Sec	3-56
Timeout Between Decodes, Same Symbol	137	89h	0.5 Sec	3-56
Timeout Between Decodes, Different Symbols	144	90h	0.1 sec	3-57
Wi-Fi Friendly Mode	1299	F8h 05h 13h	Disable	3-58
Wi-Fi Friendly Channel Exclusion	1297	F8h 05h 11h	Use All Channels	3-59
Data Options				
Transmit Code ID Character	45	2Dh	None	3-61
Prefix Value	99, 105	63h, 69h	7013 <CR><LF>	3-62
Suffix 1 Value Suffix 2 Value	98, 104 100, 106	62h, 68h 64h, 6Ah	7013 <CR><LF>	3-62
Transmit "No Read" Message	94	5E	Disable	3-64
Scan Data Transmission Format	235	EBh	Data as is	3-63

Table A-1 Default Table (Continued)

Parameter	Parameter Number	SSI Number	Factory Default	Page Number
Version Options				
Send Firmware Version	N/A	N/A	N/A	3-65
Send Scan Engine Version	N/A	N/A	N/A	3-65
Send Dongle Version	N/A	N/A	N/A	3-65
USB HID Keyboard Features (Dongle)				
Country Keyboard Type	960	F2h C0h	Windows North American	4-3
USB Keystroke Delay	1380	F8h 05h 64h	No Delay	4-6
USB CAPS Lock Override	1381	F8h 05h 65h	Disable	4-7
USB Send Bar Codes with Unknown Characters	1382	F8h 05h 66h	Send	4-7
Emulate Keypad	1383	F8h 05h 67h	Disable	4-8
Emulate Keypad with Leading Zero	1384	F8h 05h 68h	Disable	4-8
Quick Keypad Emulation	1385	F8h 05h 69h	Disable	4-9
USB FN1 Substitution	1386	F8h 05h 6Ah	Disable	4-10
FN1 Substitution Values:			N/A	4-10
Key Category	103	67h		
Decimal Value	109	6Dh		
Function Key Mapping	1388	F8h 05h 6Ch	Disable	4-11
Simulated Caps Lock	1389	F8h 05h 6Dh	Disable	4-11
Convert Case	1390	F8h 05h 6Eh	No Case Conversion	4-12
Symbologies				
Enable/Disable All Code Types				5-7
UPC/EAN				
UPC-A	1	01h	Enable	5-8
UPC-E	2	02h	Enable	5-8
UPC-E1	12	0Ch	Disable	5-9
EAN-8/JAN 8	4	04h	Enable	5-9
EAN-13/JAN 13	3	03h	Enable	5-10
Bookland EAN	83	53h	Disable	5-10
Bookland ISBN Format	576	F1h 40h	ISBN-10	5-11
Decode UPC/EAN/JAN Supplementals (2 and 5 digits)	16	10h	Ignore	5-12

Table A-1 *Default Table (Continued)*

Parameter	Parameter Number	SSI Number	Factory Default	Page Number
User-Programmable Supplementals			000	5-15
Supplemental 1:	579	F4h F1h 43h		
Supplemental 2:	580	F4h F1h 44h		
UPC/EAN/JAN Supplemental Redundancy	80	50h	10	5-15
Decode UPC/EAN/JAN Supplemental AIM ID	672	F1h A0h	Combined	5-16
Transmit UPC-A Check Digit	40	28h	Enable	5-17
Transmit UPC-E Check Digit	41	29h	Enable	5-17
Transmit UPC-E1 Check Digit	42	2Ah	Enable	5-18
UPC-A Preamble	34	22h	System Character	5-19
UPC-E Preamble	35	23h	System Character	5-20
UPC-E1 Preamble	36	24h	System Character	5-21
Convert UPC-E to A	37	25h	Disable	5-22
Convert UPC-E1 to A	38	26h	Disable	5-22
EAN-8/JAN-8 Extend	39	27h	Disable	5-23
UCC Coupon Extended Code	85	55h	Disable	5-23
Coupon Report	730	F1h DAh	New Coupon Format	5-24
ISSN EAN	617	F1h 69h	Disable	5-24
Code 128				
Code 128	8	08h	Enable	5-25
Set Length(s) for Code 128	209, 210	D1h, D2h	1 to 55	5-25
GS1-128 (formerly UCC/EAN-128)	14	0Eh	Enable	5-27
ISBT 128	84	54h	Enable	5-27
ISBT Concatenation	577	F1h 41h	Autodiscriminate	5-28
Check ISBT Table	578	F1h 42h	Enable	5-29
ISBT Concatenation Redundancy	223	DFh	10	5-29
Code 128 Security Level	751	F1h EFh	Security Level 1	5-30

Table A-1 Default Table (Continued)

Parameter	Parameter Number	SSI Number	Factory Default	Page Number
Code 39				
Code 39	0	00h	Enable	5-31
Trioptic Code 39	13	0Dh	Disable	5-31
Convert Code 39 to Code 32 (Italian Pharmacy Code)	86	56h	Disable	5-32
Code 32 Prefix	231	E7h	Disable	5-33
Set Length(s) for Code 39	18, 19	12h, 13h	1 to 55	5-33
Code 39 Check Digit Verification	48	30h	Disable	5-35
Transmit Code 39 Check Digit	43	2Bh	Disable	5-35
Code 39 Full ASCII Conversion	17	11h	Disable	5-36
Code 39 Security Level	750	F1h EEh	Security Level 1	5-37
Code 93				
Code 93	9	09h	Enable	5-38
Set Length(s) for Code 93	26, 27	1Ah, 1Bh	1 to 55	5-38
Code 11				
Code 11	10	0Ah	Disable	5-40
Set Lengths for Code 11	28, 29	1Ch, 1Dh	4 to 55	5-40
Code 11 Check Digit Verification	52	34h	Disable	5-42
Transmit Code 11 Check Digit(s)	47	2Fh	Disable	5-43
Interleaved 2 of 5 (ITF)				
Interleaved 2 of 5 (ITF)	6	06h	Enable	5-44
Set Lengths for I 2 of 5	22, 23	16h, 17h	6 to 55	5-44
I 2 of 5 Check Digit Verification	49	31h	Disable	5-46
Transmit I 2 of 5 Check Digit	44	2Ch	Disable	5-47
Convert I 2 of 5 to EAN 13	82	52h	Disable	5-47
I 2 of 5 Security Level	1121	F8h 04h 61h	Security Level 1	5-48
Discrete 2 of 5 (DTF)				
Discrete 2 of 5	5	05h	Disable	5-49
Set Length(s) for D 2 of 5	20, 21	14h 15h	1 to 55	5-49

Table A-1 Default Table (Continued)

Parameter	Parameter Number	SSI Number	Factory Default	Page Number
Codabar (NW - 7)				
Codabar	7	07h	Enable	5-51
Set Lengths for Codabar	24, 25	18h, 19h	4 to 55	5-51
CLSI Editing	54	36h	Disable	5-53
NOTIS Editing	55	37h	Disable	5-53
Codabar Upper or Lower Case Start/Stop Characters Detection	855	F2h 57h	Upper Case	5-54
MSI				
MSI	11	0Bh	Disable	5-55
Set Length(s) for MSI	30, 31	1Eh, 1Fh	4 to 55	5-55
MSI Check Digits	50	32h	One	5-57
Transmit MSI Check Digit	46	2Eh	Disable	5-57
MSI Check Digit Algorithm	51	33h	Mod 10/Mod 10	5-58
Chinese 2 of 5				
Chinese 2 of 5	408	F0h 98h	Disable	5-59
Matrix 2 of 5				
Matrix 2 of 5	618	F1h 6Ah	Disable	5-60
Matrix 2 of 5 Lengths	619, 620	F1h 6Bh F1h 6Ch	4 to 55	5-60
Matrix 2 of 5 Check Digit	622	F1h 6Eh	Disable	5-62
Transmit Matrix 2 of 5 Check Digit	623	F1h 6Fh	Disable	5-62
Korean 3 of 5				
Korean 3 of 5	581	F1h 45h	Disable	5-63
Inverse 1D	586	F1h 4Ah	Regular	5-64
GS1 DataBar				
GS1 DataBar-14	338	F0h 52h	Enable	5-65
GS1 DataBar Limited	339	F0h 53h	Enable	5-65
GS1 DataBar Expanded	340	F0h 54h	Enable	5-66
Convert GS1 DataBar to UPC/EAN	397	F0h 8Dh	Disable	5-66
GS1 DataBar Limited Security Level	728	F1h D8h	Level 3	5-67

Table A-1 Default Table (Continued)

Parameter	Parameter Number	SSI Number	Factory Default	Page Number
Composite				
Composite CC-C	341	F0h 55h	Disable	5-68
Composite CC-A/B	342	F0h 56h	Disable	5-68
Composite TLC-39	371	F0h 73h	Disable	5-69
UPC Composite Mode	344	F0h 58h	Never Linked	5-70
GS1-128 Emulation Mode for UCC/EAN Composite Codes	427	F0h ABh	Disable	5-71
Postal Codes				
US Postnet	89	59h	Disable	5-72
US Planet	90	5Ah	Disable	5-72
Transmit US Postal Check Digit	95	5Fh	Enable	5-73
UK Postal	91	5Bh	Disable	5-73
Transmit UK Postal Check Digit	96	60h	Enable	5-74
Japan Postal	290	F0h 22h	Disable	5-74
Australia Post	291	F0h 23h	Disable	5-75
Australia Post Format	718	F1h CEh	Autodiscriminate	5-76
Netherlands KIX Code	326	F0h 46h	Disable	5-77
USPS 4CB/One Code/Intelligent Mail	592	F1h 50h	Disable	5-77
UPU FICS Postal	611	F1h 63h	Disable	5-78
2D Symbolologies				
PDF417	15	0Fh	Enable	5-79
MicroPDF417	227	E3h	Disable	5-79
Code 128 Emulation	123	7Bh	Disable	5-80
Data Matrix	292	F0h 24h	Enable	5-81
GS1 Data Matrix	1336	F8h 05h 38h	Disable	5-81
Data Matrix Inverse	588	F1h 4Ch	Inverse Autodetect	5-82
Decode Mirror Images (Data Matrix Only)	537	F1h 19h	Auto	5-83
Maxicode	294	F0h 26h	Disable	5-84
QR Code	293	F0h 25h	Enable	5-84
QR Inverse	587	F1h 4Bh	Regular	5-85

Table A-1 *Default Table (Continued)*

Parameter	Parameter Number	SSI Number	Factory Default	Page Number
MicroQR	573	F1h 3Dh	Enable	5-86
Aztec	574	F1h 3Eh	Enable	5-86
Aztec Inverse	589	F1h 4Dh	Inverse Autodetect	5-87
Han Xin	1167	F8h 04h 8Fh	Disable	5-88
Han Xin Inverse	1168	F8h 04h 90h	Regular	5-89
Symbology-Specific Security Levels				
Redundancy Level	78	4Eh	1	5-90
Security Level	77	4Dh	1	5-92
Intercharacter Gap Size	381	F0h 7Dh	Normal	5-93

APPENDIX B ACCESSORIES

Overview

CS4070 accessories provide a variety of product support capabilities. Accessories include a micro USB cable, cradles, spare battery charger, wall mounts, and lanyard. See [Table B-1](#) for a full list of accessories and descriptions.

Accessories Summary

Table B-1 lists the accessories available for the CS4070.

Table B-1 CS4070 Accessories

Accessory	Part Number	Description	Page
Cradles and Battery Accessories			
1-slot terminal and spare battery charger	CHS5000-1000CR	Single-slot cradle for charging one CS4070 (with battery installed) and one spare battery simultaneously. Includes power supply and DC line cord.	B-3
8-slot terminal charger	CHS5000-8000CR	8-slot cradle for charging up to eight CS4070 devices simultaneously. Includes power supply and DC line cord.	B-5
8-slot battery charger	SAC5000-8000CR	8-slot battery charger for charging up to eight CS4070 batteries simultaneously. Includes power supply and DC line cord.	B-7
Replacement batteries	BTRY-CS40EAB00-04	One CS4070-SR battery.	N/A
	BTRY-CS40EAB00-0B	One CS4070-HC battery.	N/A
	BT10-CS40EAB00-04	10 CS4070-SR batteries.	N/A
	BT10-CS40EAB00-0B	10 CS4070-HC batteries.	N/A
Miscellaneous Accessories			
Lanyard (with clip)	21-102377-01	Clip with neck cord, used to wear the CS4070 around user's neck.	B-16
Wall mount bracket for 8-slot battery charger	KT-102376-01R	Wall mounts the 8-slot battery charger.	B-9
Wall mount bracket for 8-slot terminal charger	KT-102375-01R	Wall mounts the 8-slot terminal charger.	B-11
Bluetooth dongle	BT-CS1-0BR	Bluetooth to HID dongle.	B-14
Dongle cable	CBA-U21-S07ZAR	Replacement USB cable for dongle.	B-14

Single-Slot CS4070 Charging Cradle with Spare Battery Charger

The single-slot CS4070 charging cradle:

- Provides 5.1 VDC power for operating the device.
- Charges the CS4070 battery in the device.
- Charges one spare battery.

✓ **NOTE** Use only genuine Zebra batteries (p/n 82-83172-01) with CS4070 devices and charging accessories.

Use only an approved power supply 50-14000-147R output rated 12 Vdc and minimum 3.3 A with AC line cord 50-16000-182R. The power supply is certified to EN60950-1 with SELV outputs. Use of an alternative power supply invalidates any approval given to this device and may be dangerous.

To charge batteries in the single-slot cradle:

1. Connect the cradle to power.
2. To charge the battery in the device, insert the CS4070 into the device slot.
To charge a spare battery, insert it in the spare battery charging well.

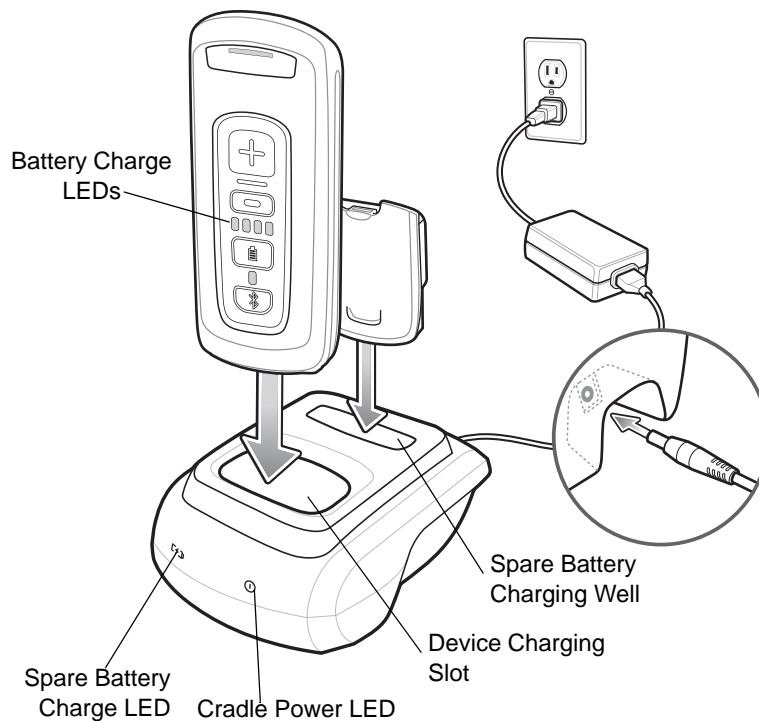

Figure B-1 Single-Slot Cradle Power Connection

Battery Charging Indications

The single-slot cradle charges the device battery and a spare battery simultaneously.

The device battery level LEDs indicate the status of the battery charging in the device. See [Table 2-1 on page 2-4](#) for charging status indications.

The spare battery charging LED on the cradle indicates the status of the spare battery charging in the cradle. See [Table B-2](#) for charging status indications.

The battery fully charges in approximately three hours. See [Charging Temperature on page 1-4](#) for charging temperature information.

Spare Battery Charging Indications

Table B-2 Spare Battery Charging Indications

Spare Battery LED (on cradle)	Indication
Solid Red	Spare battery is charging
Solid Green	Spare battery is fully charged
Blinking Red	Charging error
Off	No battery inserted
Cradle Power	
Solid Green	Power on
Off	Power off

Bluetooth Connectivity

When a CS4070 is inserted into a charging cradle, it maintains Bluetooth communication over the wireless network.

Eight-Slot CS4070 Charging Cradle

The eight-slot CS4070 charging cradle provides 5.1 VDC power for operating the device and charges the CS4070 battery in the device.

✓ **NOTE** Use only genuine Zebra batteries (p/n 82-83172-01) with CS4070 devices and charging accessories.

Use only an approved power supply KT-14000-148R output rated 12 Vdc and minimum 3.3 A with AC line cord 23844-00-00. The power supply is certified to EN60950-1 with SELV outputs. Use of an alternative power supply invalidates any approval given to this device and may be dangerous.

To charge batteries in the eight-slot charging cradle:

1. Connect the cradle to power.
2. To charge the device battery, insert the CS4070 into a device slot.

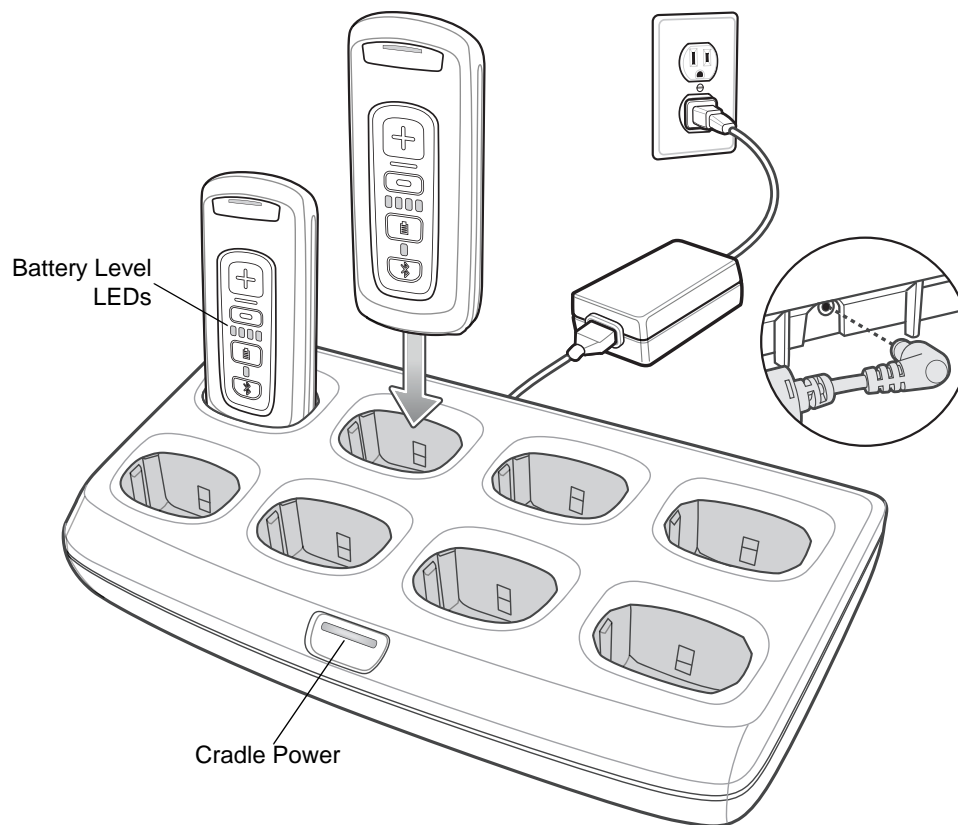

Figure B-2 Eight-Slot Cradle Power Connection

Battery Charging Indications

The eight-slot cradle charges up to eight CS4070 devices simultaneously.

The LEDs on each CS4070 indicate the charging status of the battery in the device. See [Table 2-1 on page 2-4](#) for status indications.

Batteries nominally take three hours to charge at ambient temperatures of 30° C or below. See [Charging Temperature on page 1-4](#) for charging temperature information.

Bluetooth Connectivity

When a CS4070 is inserted into a charging cradle, it maintains Bluetooth communication over the wireless network.

✓ **NOTE** CS4070 cradles do not support wired ethernet communication.

Eight-Slot Spare Battery Charger

This section describes how to use the eight-slot spare battery charger to charge up to eight spare batteries.

✓ **NOTE** Use only genuine Zebra batteries (p/n 82-83172-01) with CS4070 devices and charging accessories.

Use only an approved power supply KT-14000-148R output rated 12 Vdc and minimum 3.3 A with AC line cord 23844-00-00. The power supply is certified to EN60950-1 with SELV outputs. Use of an alternative power supply invalidates any approval given to this device and may be dangerous.

To charge spare batteries in the eight-slot spare battery charger:

1. Connect the power supply to the power port on the back of the charger as shown in [Figure B-3](#).

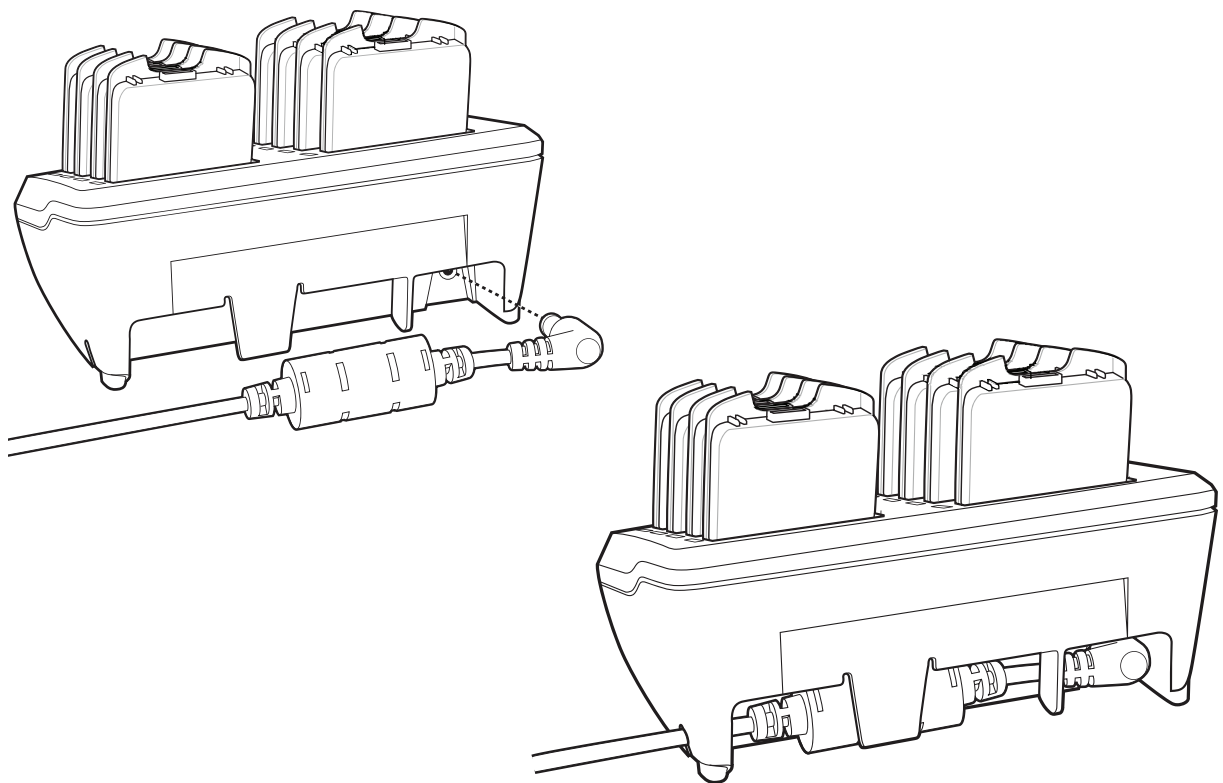

Figure B-3 Connecting Power

2. Connect the other end of the power supply to a power source.

3. Insert the spare battery into a spare battery charging well and gently press down on the battery to ensure proper contact.

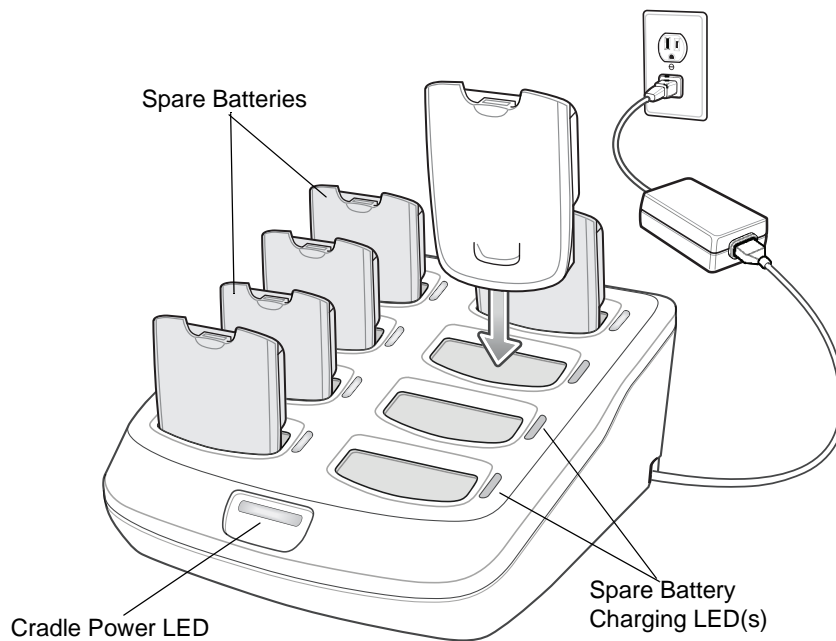

Figure B-4 Spare Battery Installation

Battery Charging Indications

An LED is provided for each battery charging well. See [Table B-3](#) for charging status indications. The battery fully charges in approximately three hours. See [Charging Temperature on page 1-4](#) for charging temperature information.

LED Indications

Table B-3 LED Indications

LED	Indication
Solid Green	Spare battery charging is complete
Solid Red	Spare battery is charging
Blinking Red	Charge error; check placement of spare battery
Off	No battery inserted

Wall Mount Brackets

Two optional wall mount brackets are available for mounting a CS4070 battery charger and/or a spare battery charger to a wall.

- The KT-102376-01R wall mount bracket is used to mount one SAC5000-8000CR (eight-slot) battery charger.
- The KT-102375-01R wall mount bracket is used to mount one CHS5000-8000CR (eight-slot) CS4070 charger, or two SAC5000-8000CR (eight-slot) battery chargers.

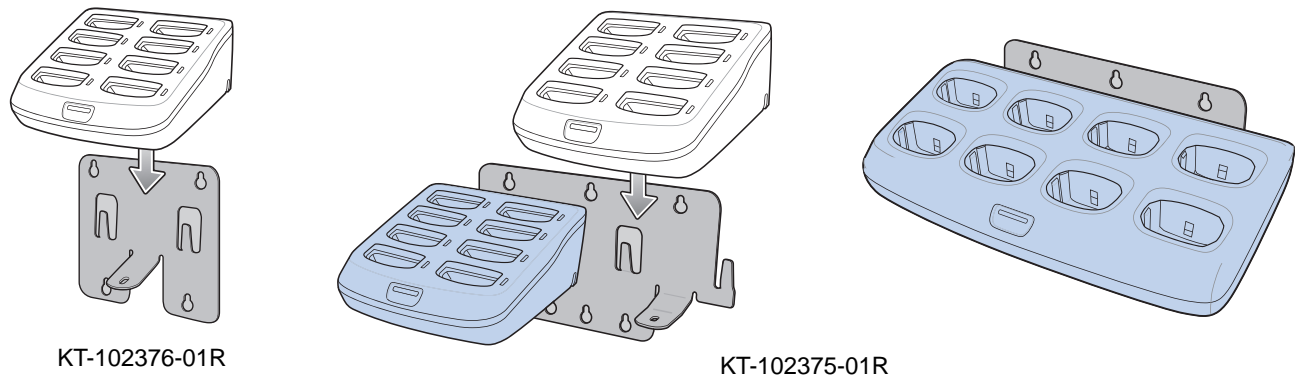

Figure B-5 Wall Mount Brackets

KT-102376-01R Bracket

The KT-102376-01R bracket mounts one SAC5000-8000CR (eight-slot) spare battery charger to a wall. Use the wall mount bracket as a template to mark the locations of the four mounting screws.

Included Hardware

- One KT-102376-01R Mounting Bracket
- One black .5" Phillips round head, thread cutting screw.

✓ **NOTE** Use the .5" Phillips round head screw supplied in mounting bracket kit to attach the eight-slot spare battery charger to the mounting bracket. This screw is not intended for mounting the bracket on a wall.

For safety and stability, it is recommended that you use the appropriate wall mounting hardware for installation. For safe mounting, it is essential to use wall anchors appropriate to the wall type (i.e. plaster, drywall, concrete, etc.). Mount to wood studs whenever possible.

The wall mount bracket mounting slots are designed for a fastener with a #8 pan head.

Mounting Instructions

- ✓ **NOTE** Connect an approved power supply to the cradle prior to attaching the cradle to the wall mount bracket. See [Eight-Slot Spare Battery Charger on page B-7](#) for power supply information.

1. Slide the two bracket mounting tabs into the receptacles on the bottom of the cradle as shown. Ensure the screw hole in the bracket flange aligns with the screw hole in the cradle.

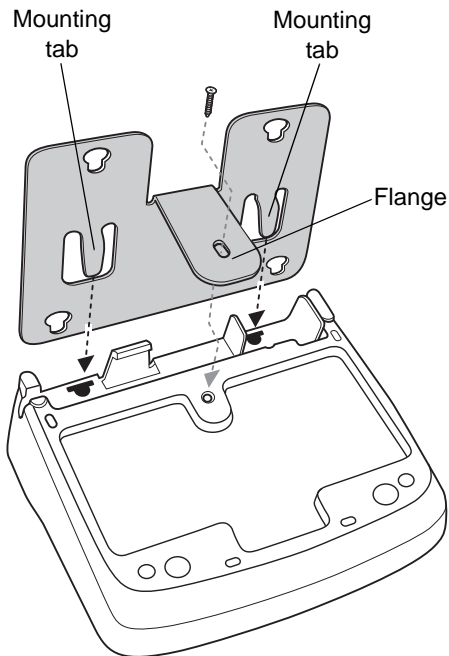

Figure B-6 *Insert Bracket into Cradle*

2. Screw the .5" Phillips screw (supplied) into the bracket flange and tighten until the cradle is securely attached to the bracket.

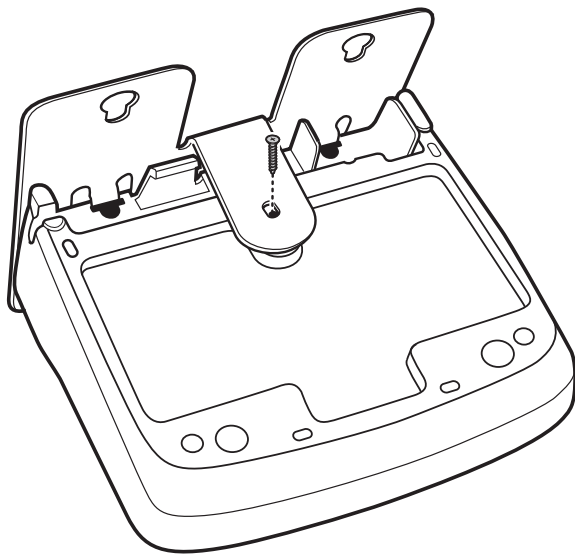

Figure B-7 *Attach Flange with Screw*

- Use four screws to mount the bracket to a wall. Ensure to use additional wall mounting hardware, as needed, for safe mounting to the wall type.

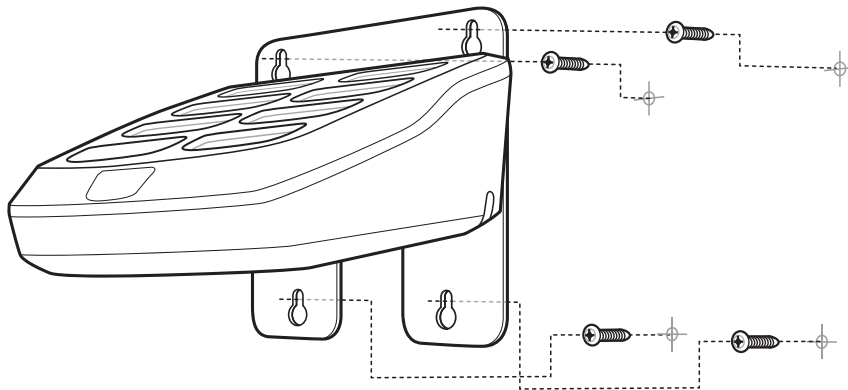

Figure B-8 Mount to Wall

KT-102375-01R Bracket

The KT-102375-01R bracket mounts one CHS5000-8000CR (eight-slot) CS4070 charger, or two SAC5000-8000CR (eight-slot) spare battery chargers to a wall. Use the wall mount brackets as a template to mark the locations of the four mounting screws.

Included Hardware

- Two KT-102375-01R Mounting Bracket
- One black .5" Phillips round head, thread cutting screw.

✓ **NOTE** Use the .5" Phillips round head screw supplied in mounting bracket kit to attach the eight-slot spare battery charger to the mounting bracket. This screw is not intended for mounting the bracket on a wall.

For safety and stability, it is recommended that you use the appropriate wall mounting hardware for installation. For safe mounting, it is essential to use wall anchors appropriate to the wall type (i.e. plaster, drywall, concrete, etc.). Mount to wood studs whenever possible.

The wall mount bracket mounting slots are designed for a fastener with a #8 pan head.

Mounting Instructions

- ✓ **NOTE** Connect an approved power supply to the cradle(s) prior to attaching the cradle(s) to the wall mount bracket. See [Eight-Slot Spare Battery Charger on page B-7](#) and [Eight-Slot CS4070 Charging Cradle on page B-5](#) for power supply information.

1. When mounting one eight-slot CS4070 battery charger (CHS5000-8000CR), slide the four bracket mounting tabs into the receptacles on the bottom of the charger as shown in [Figure B-9](#). Ensure the screw holes in the bracket flanges align with the screw holes in the cradle.

When mounting two eight-slot battery chargers (SAC5000-8000CR), slide two bracket mounting tabs into each battery charger as shown in [Figure B-10](#).

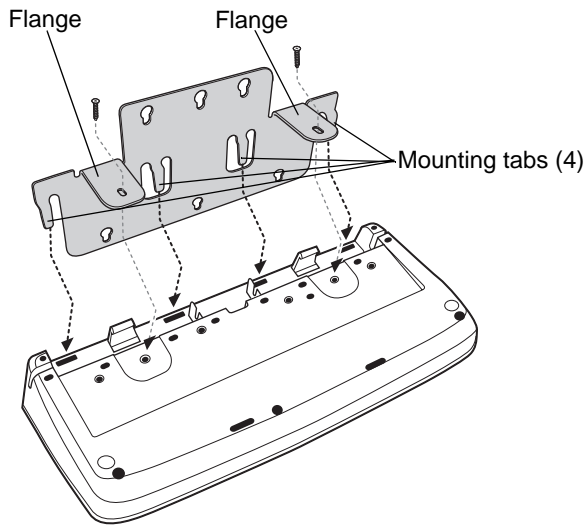

Figure B-9 Insert Bracket into CHS5000-8000CR Cradle

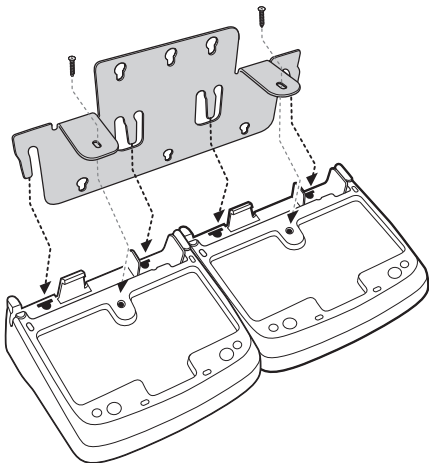

Figure B-10 Insert Bracket into SAC5000-8000CR Cradle

2. Screw the bracket to the cradle(s).
CHS5000-8000CR: Screw the two supplied .5" Phillips screws into the two bracket flanges and tighten until the cradle is securely attached to the bracket (as shown in drawing A, [Figure B-11](#)).

SAC5000-8000CR: Screw one supplied .5" Phillips screw in each flange and tighten one flange to each cradle (as shown in drawing B, [Figure B-11](#)).

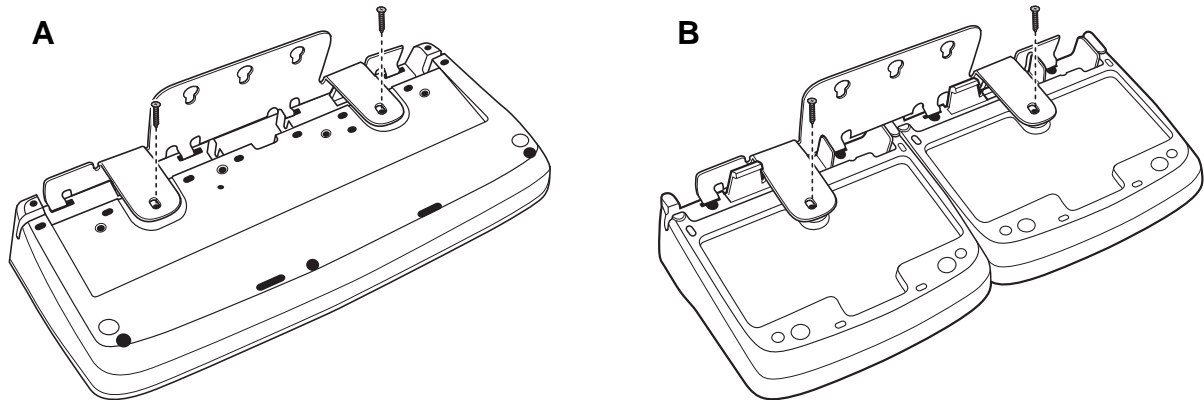

Figure B-11 *Screw the Bracket to the Cradle*

3. Use six screws (not supplied) to mount the bracket(s) to a wall.

✓ **NOTE** Ensure to use additional wall mounting hardware, as needed, for safe mounting to the wall type.

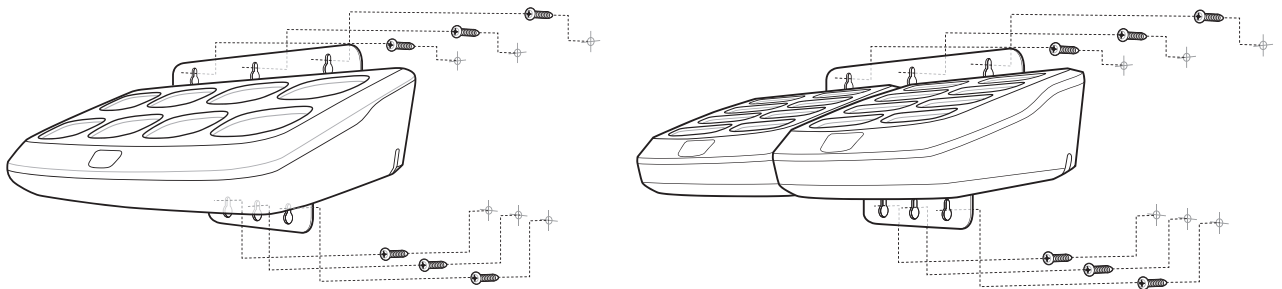

Figure B-12 *Mount Bracket(s)*

Bluetooth to USB HID Dongle

The Bluetooth to USB HID dongle pairs the scanner with an HID host simply by scanning the bar code on the dongle. The dongle is available for the CS4070HC only, and pairs to a single scanner at a time.

The dongle has the following features:

- USB bus powered
- Power consumption less than 100 mA
- Wall or surface mounting features
- Pairing bar code printed on label on front of device, visible when mounted
- IP40 sealing
- USB connection:
 - RJ45 connector
 - Standard Zebra USB cables
 - USB HID keyboard profile (US English only)
 - No drivers required for connection to host PC, Windows, and Linux 32 and 64-bit systems
- Bluetooth:
 - Class 1 radio
 - Bluetooth stack version 2.1 + EDR
 - Blue LED for Bluetooth status (Off = not paired, solid = paired)
 - Allows only a single BT connection
 - HID Bluetooth profiles
 - No Bluetooth pings or other transmissions when not paired

Pairing to a USB HID Device

To use the dongle to pair to a USB HID device:

1. If desired, mount the dongle to a wall using #3 wood screws with pan head (2.52 mm max thread diameter), or M2.5 machine screws with socket or pan head (2.5 mm max thread diameter) (not provided).

✓ **NOTE** Ensure to use additional wall mounting hardware, as needed, for safe mounting to the wall type.

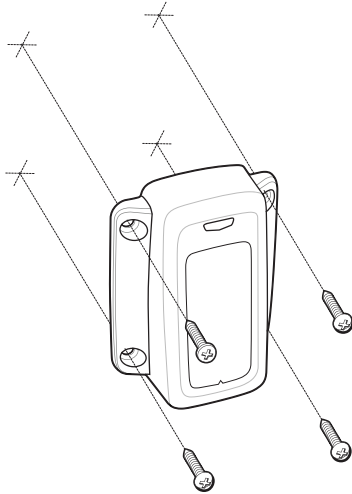

Figure B-13 Wall Mounting Dongle

2. Connect the RJ45 cable to the dongle RJ45 port, and the other end of the cable to a USB port on the HID device.

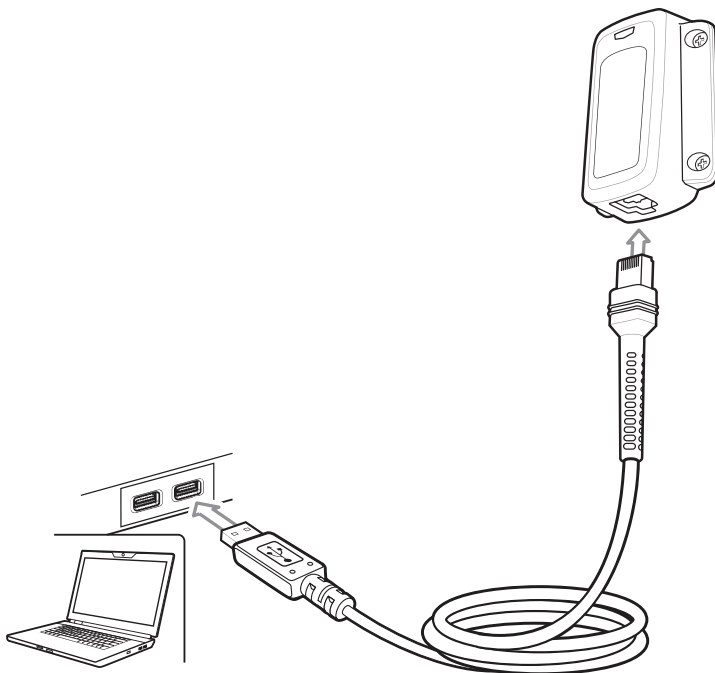

Figure B-14 Connecting Dongle to HID Device

3. Using the CS4070, scan the bar code on the dongle to pair the scanner with the HID device.

Lanyard with Clip

For ease of use, attach the CS4070 to the lanyard with clip in order to wear the device around the neck as shown in [Figure B-15](#).



Figure B-15 Wearing Lanyard

Attaching and Removing the Lanyard

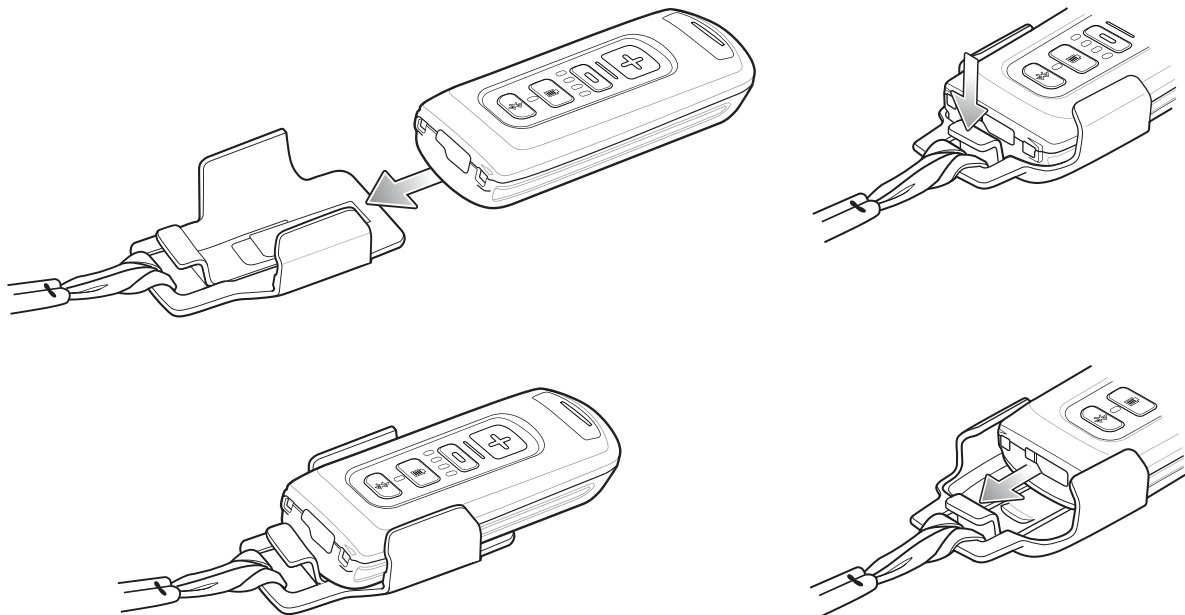

Figure B-16 Attaching and Removing the Lanyard

APPENDIX C BLUETOOTH CONNECTION

Overview

Pairing the CS4070 with a host device typically requires holding the Bluetooth button to place the scanner in discoverable mode, then entering a pairing PIN. To enter the PIN on the CS4070, use the [PIN Entry Bar Codes on page C-9](#). For the host device, use the data entry method required for that device to enter the PIN.

This section provides the following connection examples:

- [iPad Pairing Example](#)
- [Android Pairing Example on page C-3](#)
- [Windows 7 Pairing Example on page C-5](#)
- [Windows 8 Pairing Example on page C-7](#)

iPad Pairing Example

1. Press the scan button (+) to wake the scanner.
2. Scan the **Bluetooth HID Profile** bar code on [page 3-10](#).
3. Press and hold the Bluetooth button for five seconds. The scanner beeps and the Bluetooth button blinks quickly to indicate that the scanner is discoverable by the host.
4. On the iPad, tap the **Settings** icon.
5. Tap **General** from the list of options that appears.
6. Tap **Bluetooth**. If Bluetooth is not enabled, swipe to enable it. The CS4070 appears in the **Devices** list, indicated by its model name.

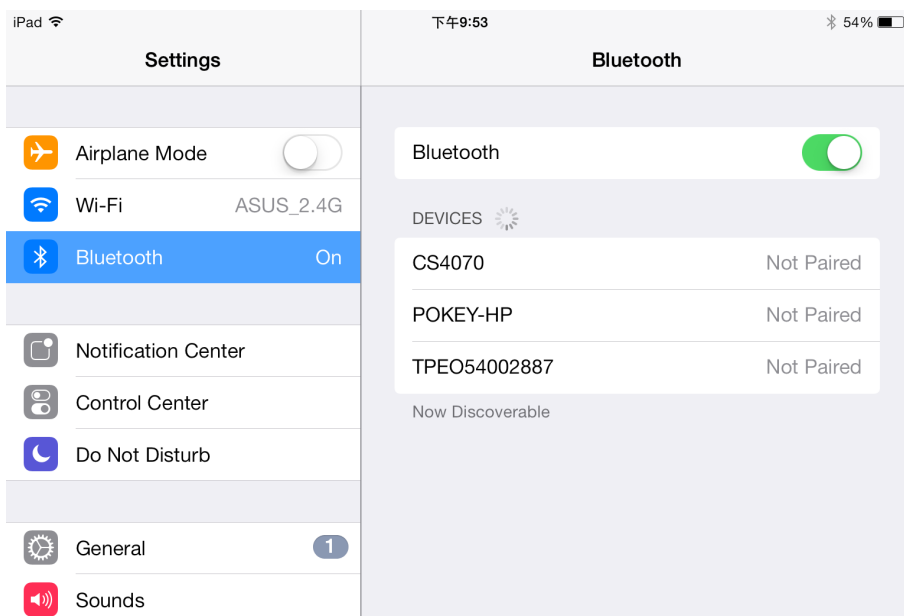

Figure C-1 Bluetooth Devices

7. Select the CS4070 from the list. In HID mode, the CS4070 doesn't have to scan a PIN code to authenticate pairing.

The scanner beeps to indicate it has paired with the iPad, and the iPad displays **Connected** next to the CS4070 device name.

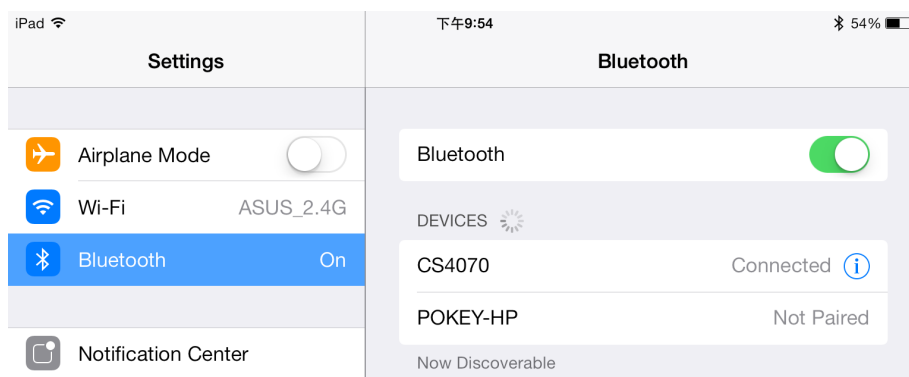

Figure C-2 CS4070 Connected

Android Pairing Example

✓ **NOTE** To avoid data loss, set *KeystrokeDelay on page 1-10* to 70 ms before pairing with the Android.

1. Press the scan button (+) to wake the scanner.
2. Press and hold the Bluetooth button for five seconds. The scanner beeps and the Bluetooth button blinks quickly to indicate that the scanner is discoverable by the host.
3. On the Samsung Galaxy Tab 2, tap the **Settings** icon.
4. Tap **Bluetooth**. If Bluetooth is not enabled, swipe to enable it. The CS4070 appears in the **Available devices** list, indicated by its model name and serial number.

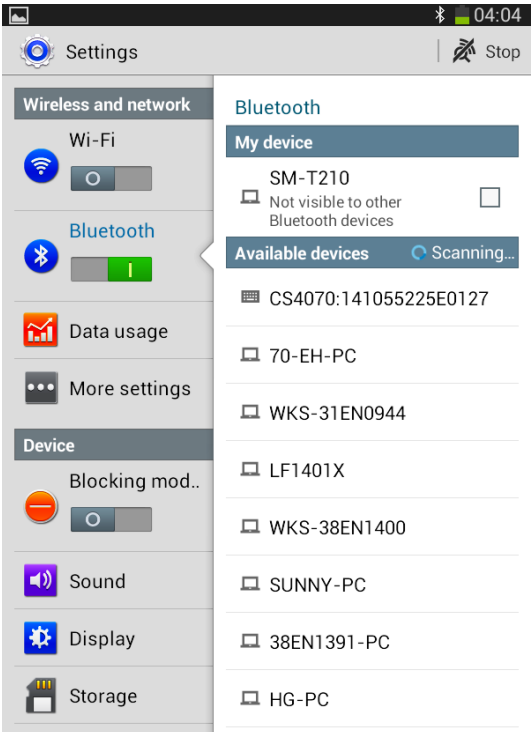

Figure C-3 Samsung Available Devices List

5. Select the CS4070 from the list. A window prompts for a PIN generated by the Samsung Galaxy Tab 2.

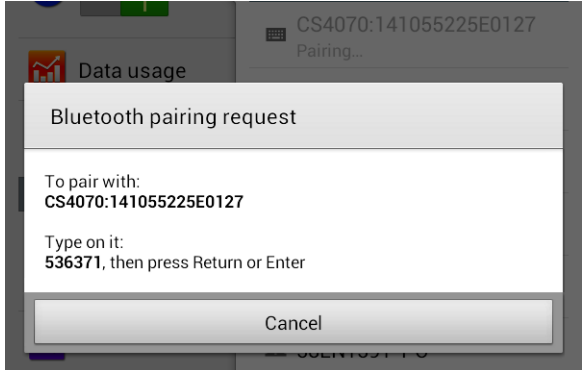

Figure C-4 Samsung Pairing Request Window

- With the CS4070, scan the PIN using the *PIN Entry Bar Codes on page C-9* and scan **Enter**.

The scanner beeps to indicate it has paired with the Samsung Galaxy Tab 2, and the Samsung Galaxy Tab 2 displays **Connected** below the CS4070 device name.

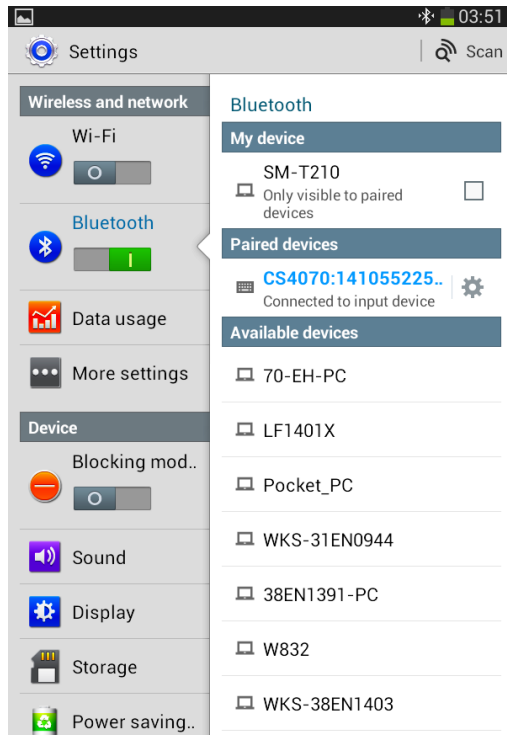

Figure C-5 Device Connected

Accessing the Android Phone Keyboard

To activate the **Choose Input Method** notification, multiple keyboards must be available. To accomplish this:

- Select **Settings > Language and Input**.
- Under **Keyboard & Input Methods**, select the box next to another keyboard, such as the **iWnn IME Emoji Input** or **Google Pinyin Input**.
- Optionally, if no other keyboards are available, install a third party keyboard from the Play Store such as the **NullKeyboard** or **AnySoftKeyboard**. In **Language and Input** settings, select the box next to the installed third party keyboard. Select **OK** on the warning message window.
- Open any text input box. A **Choose Input Method** notification appears in the notification bar (top left).
- Tap the notification (not **Select Keyboard Layout**).
- Select **Off** for the **Hardware** on/off slider.
- Use the radio buttons to select the software keyboard.
- Tap the **Back** button. The on-screen keyboard appears, and the Bluetooth keyboard is still functional.

Windows 7 Pairing Example

1. Press the scan button (+) to wake the scanner.
2. Press and hold the Bluetooth button for five seconds. The scanner beeps and the Bluetooth button blinks quickly to indicate that the scanner is discoverable by the host.
3. On the HP NB (WIN7 OS), tap the **Start** menu, then **Devices and printers**.
4. Tap **Add a device**. Ensure the CS4070 is discoverable in the **Devices** list, indicated by its model name and serial number.

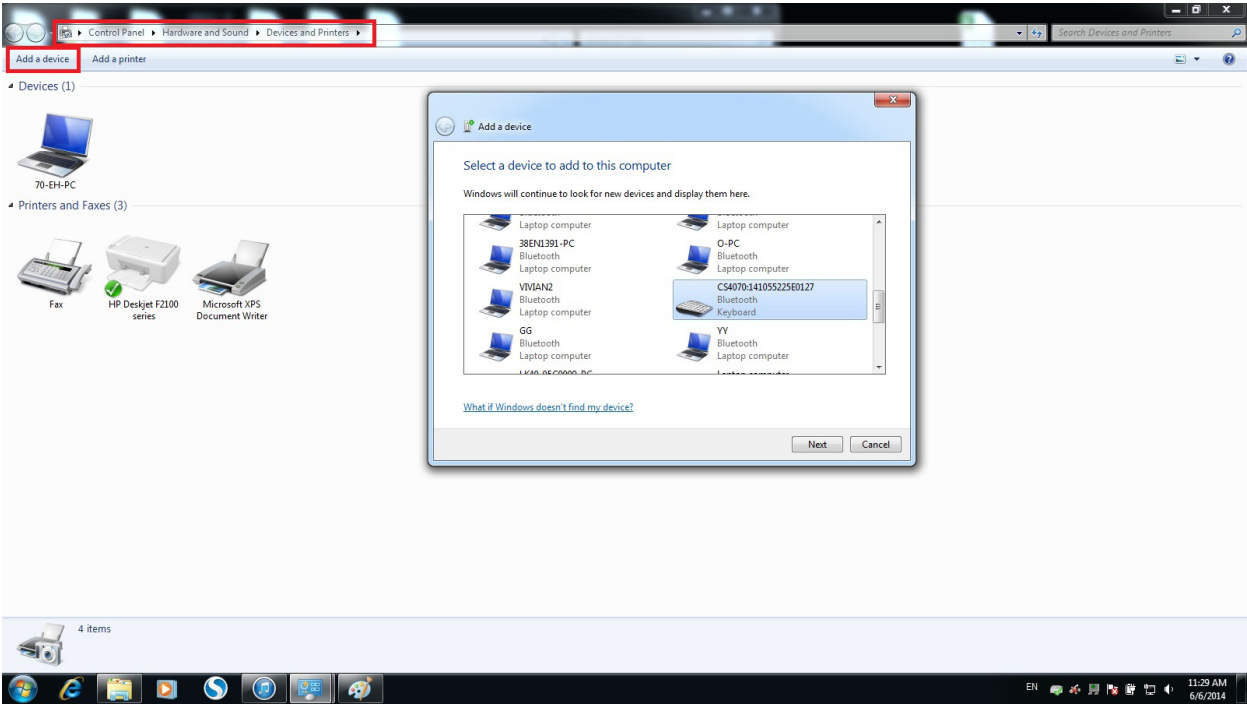

Figure C-6 Device List

5. Select the CS4070 from the list. A window prompts for a PIN generated by the HP NB (WIN7 OS).



Figure C-7 PIN Prompt

6. With the CS4070, scan the PIN using the [PIN Entry Bar Codes on page C-9](#) and scan **Enter**. The scanner beeps to indicate it has paired with the HP NB (WIN7 OS), and the HP NB displays a success window.

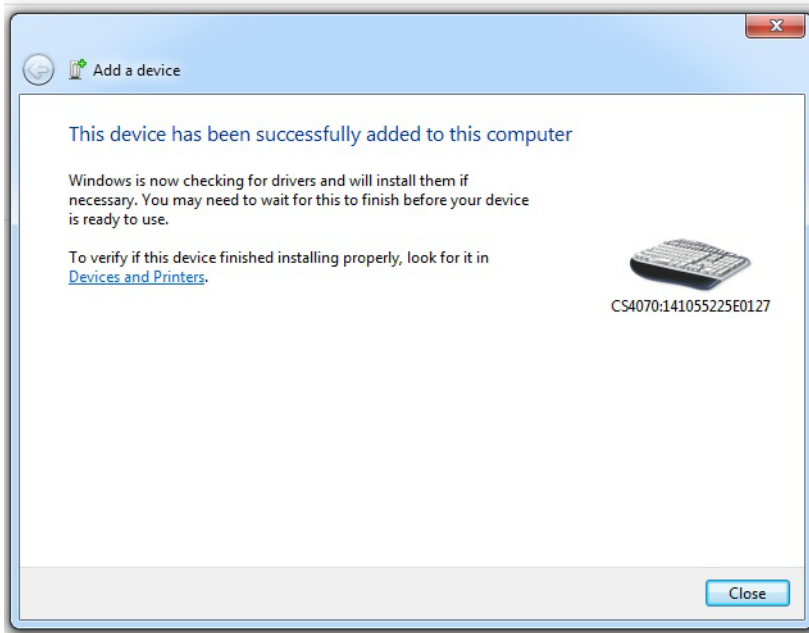

Figure C-8 CS4070 Connected

7. Ensure the CS4070 device icon displays in devices list.

Windows 8 Pairing Example

1. Press the scan button (+) to wake the scanner.
2. Press and hold the Bluetooth button for five seconds. The scanner beeps and the Bluetooth button blinks quickly to indicate that the scanner is discoverable by the host.
3. On the Lenovo ThinkPad Tablet, slide the right side of screen to invoke the **Start** menu, and tap the **Settings** icon.
4. Tap **Change PC Settings** to invoke the PC settings list, and tap **PC and devices**.
5. Tap **Bluetooth**. If Bluetooth is not enabled, swipe to enable it. The CS4070 appears in the **Devices** list, indicated by its model name.
6. Select the CS4070 from the list. A window prompts for a PIN generated by the Lenovo ThinkPad Tablet.

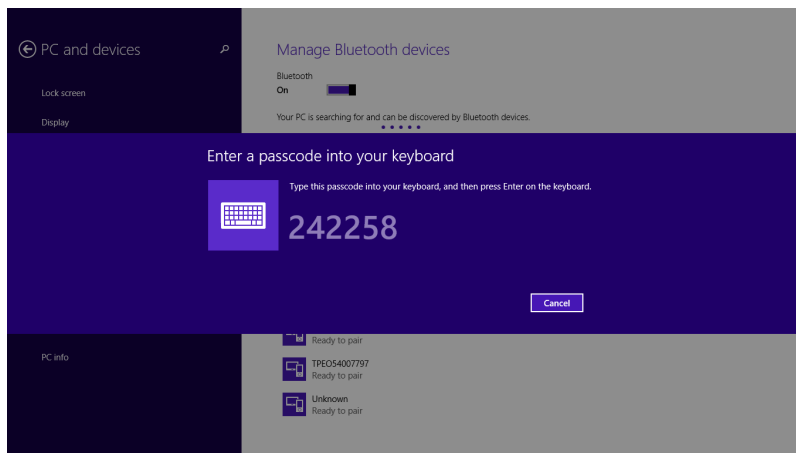

Figure C-9 ThinkPad Pairing Request Window

7. With the CS4070, scan the PIN using the *PIN Entry Bar Codes on page C-9* and scan **Enter**. The scanner beeps to indicate it has paired with the Lenovo ThinkPad Tablet, and the Lenovo ThinkPad Tablet displays Connected below the CS4070 device name.

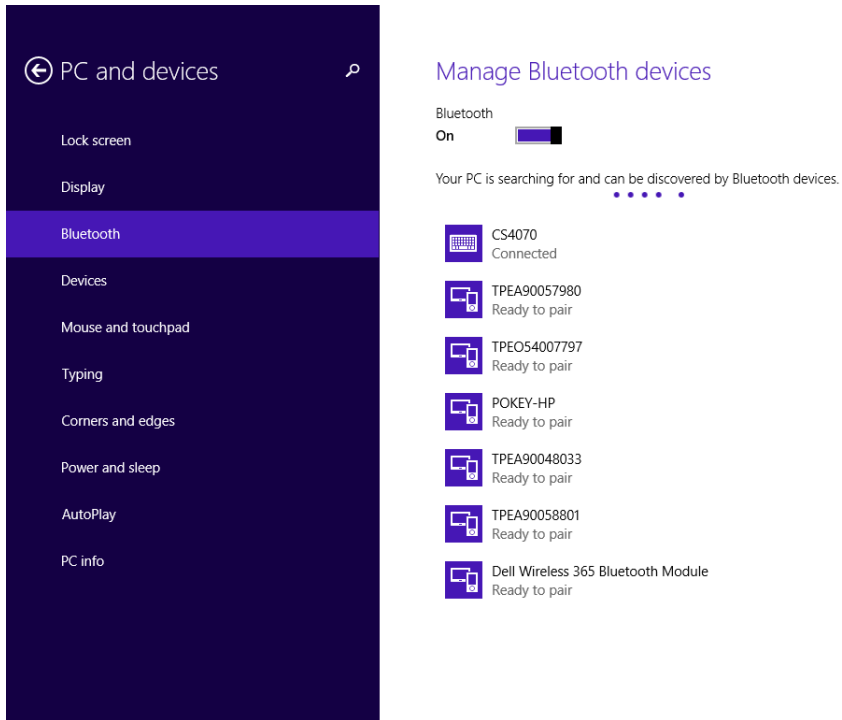
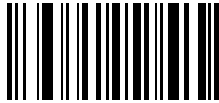

Figure C-10 CS4070 Connected

PIN Entry Bar Codes

Use the following bar codes for PIN entry for Bluetooth connection.



0



1

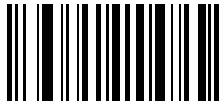

2

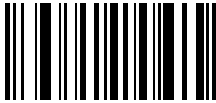

3

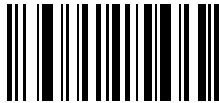

4



5

PIN Entry Bar Codes (continued)



6

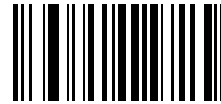

7



8

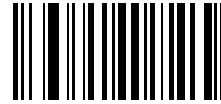

9



Enter



Cancel

APPENDIX D PROGRAMMING REFERENCE

Code Type IDs

Table D-1 *Bar Code Type Identifiers*

SDL Code Type ID	Bar Code Type
1	Code 39
2	Codabar
3	Code 128
4	Discrete (Standard) 2 of 5
5	IATA
6	Interleaved 2 of 5
7	Code 93
8	UPC-A
9	UPC-E0
10	EAN-8
11	EAN-13
12	Code 11
13	Code 49
14	MSI
15	EAN-128
16	UPC-E1
17	PDF417

Table D-1 Bar Code Type Identifiers (Continued)

SDL Code Type ID	Bar Code Type
18	Code 16K
19	Code 39 Full ASCII
20	UPC-D
21	Code 39 Trioptic
22	Bookland
23	Coupon Code
24	NW-7
25	ISBT-128
26	MicroPDF
27	DataMatrix
28	QR Code
29	MicroPDF CCA
30	PostNet US
31	Planet Code
32	Code 32
33	ISBT-128 Con
34	Japan Postal
35	Australian Postal
36	Dutch Postal
37	MaxiCode
38	Canadian Postal
39	UK Postal
40	Macro PDF
41	Macro QR
44	MicroQR
45	Aztec
46	Aztec Rune
48	GS1 DataBar-14
49	GS1 DataBar Limited
50	GS1 DataBar Expanded
52	USPS 4CB

Table D-1 Bar Code Type Identifiers (Continued)

SDL Code Type ID	Bar Code Type
53	UPU 4State
54	ISSN
55	Scanlet
56	CueCode
57	Matrix 2 of 5
72	UPC-A + 2 Supplemental
73	UPC-E0 + 2 Supplemental
74	EAN-8 + 2 Supplemental
75	EAN-13 + 2 Supplemental
80	UPC-E1 + 2 Supplemental
81	CCA EAN-128
82	CCA EAN-13
83	CCA EAN-8
84	CCA GS1 DataBar Expanded
85	CCA GS1 DataBar Limited
86	CCA GS1 DataBar-14
87	CCA UPC-A
88	CCA UPC-E
89	CCC EAN-128
90	TLC-39
97	CCB EAN-128
98	CCB EAN-13
99	CCB EAN-8
100	CCB GS1 DataBar Expanded
101	CCB GS1 DataBar Limited
102	CCB GS1 DataBar-14
103	CCB UPC-A
104	CCB UPC-E
105	Signature Capture
114	Chinese 2 of 5
115	Korean 3 of 5

Table D-1 Bar Code Type Identifiers (Continued)

SDL Code Type ID	Bar Code Type
136	UPC-A + 5 supplemental
137	UPC-E0 + 5 supplemental
138	EAN-8 + 5 supplemental
139	EAN-13 + 5 supplemental
144	UPC-E1 + 5 Supplemental
154	Macro MicroPDF
180	GS1 Databar Coupon
183	Han Xin

Symbol Code Identifiers

Table D-2 Symbol Code Characters

Code Character	Code Type
A	UPC-A, UPC-E, UPC-E1, EAN-8, EAN-13
B	Code 39, Code 32
C	Codabar
D	Code 128, ISBT 128, ISBT 128 Concatenated
E	Code 93
F	Interleaved 2 of 5
G	Discrete 2 of 5, or Discrete 2 of 5 IATA
H	Code 11
J	MSI
K	GS1-128
L	Bookland EAN
M	Trioptic Code 39
N	Coupon Code
R	GS1 DataBar Family
S	Matrix 2 of 5
T	UCC Composite, TLC 39
U	Chinese 2 of 5

Table D-2 *Symbol Code Characters (Continued)*

Code Character	Code Type
V	Korean 3 of 5
X	ISSN EAN, PDF417, Macro PDF417, MicroPDF417
z	Aztec, Aztec Rune
P00	Data Matrix
P01	QR Code, MicroQR
P02	Maxicode
P03	US Postnet
P04	US Planet
P05	Japan Postal
P06	UK Postal
P08	Netherlands KIX Code
P09	Australia Post
P0A	USPS 4CB/One Code/Intelligent Mail
P0B	UPU FICS Postal
P0C	Mailmark
P0G	GS1 Data Matrix
P0H	Han Xin
P0Q	GS1 QR
P0X	Signature Capture

AIM Code Identifiers

Each AIM Code Identifier contains the three-character string **jcm** where:

- j = Flag Character (ASCII 93)
- c = Code Character (see [Table D-3](#))
- m = Modifier Character (see [Table D-4](#))

Table D-3 *Aim Code Characters*

Code Character	Code Type
A	Code 39, Code 39 Full ASCII, Code 32
C	Code 128, ISBT 128, ISBT 128 Concatenated, GS1-128, Coupon (Code 128 portion)
d	Data Matrix, GS1 Data Matrix
E	UPC/EAN, Coupon (UPC portion)
e	GS1 DataBar Family
F	Codabar
G	Code 93
H	Code 11
h	Han Xin
I	Interleaved 2 of 5
L	PDF417, Macro PDF417, MicroPDF417
L2	TLC 39
M	MSI
Q	QR Code, MicroQR, GS1 QR
S	Discrete 2 of 5, IATA 2 of 5
U	Maxicode
z	Aztec, Aztec Rune
X	Bookland EAN, ISSN EAN, Trioptic Code 39, Chinese 2 of 5, Matrix 2 of 5, Korean 3 of 5, US Postnet, US Planet, UK Postal, Japan Postal, Australia Post, Netherlands KIX Code, USPS 4CB/One Code/ Intelligent Mail, UPU FICS Postal, Mailmark, Signature Capture

The modifier character is the sum of the applicable option values based on [Table D-4](#).

Table D-4 *Modifier Characters*

Code Type	Option Value	Option
Code 39	0	No check character or Full ASCII processing.
	1	Reader has checked one check character.
	3	Reader has checked and stripped check character.
	4	Reader has performed Full ASCII character conversion.
	5	Reader has performed Full ASCII character conversion and checked one check character.
	7	Reader has performed Full ASCII character conversion and checked and stripped check character.
	Example: A Full ASCII bar code with check character W, A+I+MI+DW , is transmitted as JA7AIMID where $7 = (3+4)$.	
Trioptic Code 39	0	No option specified at this time. Always transmit 0.
	Example: A Trioptic bar code 412356 is transmitted as JX0412356	
Code 128	0	Standard data packet, no Function code 1 in first symbol position.
	1	Function code 1 in first symbol character position.
	2	Function code 1 in second symbol character position.
	Example: A Code (EAN) 128 bar code with Function 1 character ^{FNC1} in the first position, AIMID is transmitted as JC1AIMID	
I 2 of 5	0	No check digit processing.
	1	Reader has validated check digit.
	3	Reader has validated and stripped check digit.
	Example: An I 2 of 5 bar code without check digit, 4123, is transmitted as J104123	
Codabar	0	No check digit processing.
	1	Reader has checked check digit.
	3	Reader has stripped check digit before transmission.
	Example: A Codabar bar code without check digit, 4123, is transmitted as JF04123	
Code 93	0	No options specified at this time. Always transmit 0.
	Example: A Code 93 bar code 012345678905 is transmitted as JG0012345678905	
MSI	0	Check digits are sent.
	1	No check digit is sent.
	Example: An MSI bar code 4123, with a single check digit checked, is transmitted as JM14123	

Table D-4 *Modifier Characters (Continued)*

Code Type	Option Value	Option
D 2 of 5	0	No options specified at this time. Always transmit 0.
	Example: A D 2 of 5 bar code 4123, is transmitted as JS04123	
UPC/EAN	0	Standard data packet in full EAN format, i.e. 13 digits for UPC-A, UPC-E, and EAN-13 (not including supplemental data).
	1	Two digit supplemental data only.
	2	Five digit supplemental data only.
	3	Combined data packet comprising 13 digits from EAN-13, UPC-A or UPC-E symbol and 2 or 5 digits from supplemental symbol.
	4	EAN-8 data packet.
	Example: A UPC-A bar code 012345678905 is transmitted as JE00012345678905	
Bookland EAN	0	No options specified at this time. Always transmit 0.
	Example: A Bookland EAN bar code 123456789X is transmitted as JX0123456789X	
ISSN EAN	0	No options specified at this time. Always transmit 0.
	Example: An ISSN EAN bar code 123456789X is transmitted as JX0123456789X	
Code 11	0	Single check digit
	1	Two check digits
	3	Check characters validated but not transmitted.
GS1 DataBar Family		No option specified at this time. Always transmit 0. GS1 DataBar-14 and GS1 DataBar Limited transmit with an Application Identifier "01". Note: In GS1-128 emulation mode, GS1 DataBar is transmitted using Code 128 rules (i.e., J C1).
	Example: A GS1 DataBar-14 bar code 0110012345678902 is transmitted as Je00110012345678902 .	
EAN.UCC Composites (GS1 DataBar, GS1-128, 2D portion of UPC composite)		Native mode transmission. Note: UPC portion of composite is transmitted using UPC rules.
	0	Standard data packet.
	1	Data packet containing the data following an encoded symbol separator character.
	2	Data packet containing the data following an escape mechanism character. The data packet does not support the ECI protocol.
	3	Data packet containing the data following an escape mechanism character. The data packet supports the ECI protocol.
		GS1-128 emulation Note: UPC portion of composite is transmitted using UPC rules.
	1	Data packet is a GS1-128 symbol (i.e., data is preceded with J C1).

Table D-4 Modifier Characters (Continued)

Code Type	Option Value	Option
PDF417, MicroPDF417	0	Reader set to conform to protocol defined in 1994 PDF417 symbology specifications. Note: When this option is transmitted, the receiver cannot reliably determine whether ECIs have been invoked or whether data byte 92 _{DEC} has been doubled in transmission.
	1	Reader set to follow the ECI protocol (Extended Channel Interpretation). All data characters 92 _{DEC} are doubled.
	2	Reader set for Basic Channel operation (no escape character transmission protocol). Data characters 92 _{DEC} are not doubled. Note: When decoders are set to this mode, unbuffered Macro symbols and symbols requiring the decoder to convey ECI escape sequences cannot be transmitted.
	3	The bar code contains a GS1-128 symbol, and the first codeword is 903-907, 912, 914, 915.
	4	The bar code contains a GS1-128 symbol, and the first codeword is in the range 908-909.
	5	The bar code contains a GS1-128 symbol, and the first codeword is in the range 910-911.
	Example: A PDF417 bar code ABCD, with no transmission protocol enabled, is transmitted as]L2ABCD.	
Data Matrix	0	ECC 000-140, not supported.
	1	ECC 200.
	2	ECC 200, FNC1 in first or fifth position.
	3	ECC 200, FNC1 in second or sixth position.
	4	ECC 200, ECI protocol implemented.
	5	ECC 200, FNC1 in first or fifth position, ECI protocol implemented.
	6	ECC 200, FNC1 in second or sixth position, ECI protocol implemented.
GS1 Data Matrix	2	ECC 200, FNC1 in first or fifth position.
MaxiCode	0	Symbol in Mode 4 or 5.
	1	Symbol in Mode 2 or 3.
	2	Symbol in Mode 4 or 5, ECI protocol implemented.
	3	Symbol in Mode 2 or 3, ECI protocol implemented in secondary message.

Table D-4 *Modifier Characters (Continued)*

Code Type	Option Value	Option
QR Code	0	Model 1 symbol.
	1	Model 2 / MicroQR symbol, ECI protocol not implemented.
	2	Model 2 symbol, ECI protocol implemented.
	3	Model 2 symbol, ECI protocol not implemented, FNC1 implied in first position.
	4	Model 2 symbol, ECI protocol implemented, FNC1 implied in first position.
	5	Model 2 symbol, ECI protocol not implemented, FNC1 implied in second position.
	6	Model 2 symbol, ECI protocol implemented, FNC1 implied in second position.
GS1 QR	3	Model 2 symbol, ECI protocol not implemented, FNC1 implied in first position.
Aztec	0	Aztec symbol.
	C	Aztec Rune symbol.
Han Xin	0	Generic data, no special features are set. The transmitted data does not follow the AIM ECI protocol.
	1	ECI protocol enabled. There is at least one ECI mode encoded. Transmitted data must follow the AIM ECI protocol.
Mailmark	0	No option specified at this time. Always transmit 0.

GS1-128 (formerly UCC/EAN-128)

GS1-128 is a convention for printing data fields with standard Code 128 bar code symbols. GS1-128 symbols are distinguished by a leading FNC 1 character as the first or second character in the symbol. Other FNC 1 characters are used to delineate fields.

When GS1-128 symbols are read, they are transmitted after special formatting strips off the leading FNC 1 character, and replaces other FNC 1 characters with the ASCII 29 (GS) control character.

When AIM symbology identifiers are transmitted, the modifier character indicates the position of the leading FNC 1 character according to AIM guidelines. For example, **jc1** indicates a GS1-128 symbol with a leading FNC1 character.

Standard Code 128 bar codes which do not have a leading FNC 1 may still be used, but are not encoded according to the GS1-128 convention. Standard Code 128 and GS1-128 may be mixed in an application. The CS3070 autodiscriminates between these symbols, and can enable or disable one or both code types. [Table D-5](#) indicates the behavior of the CS3070 in each of the four possible parameter settings.

Table D-5 Reading Standard Code 128 & GS1-128

Standard Code 128	GS1-128	Effect and Example
Disable	Disable	No Code 128 symbols can be read.
Disable	Enable	Read only symbols with leading FNC 1. Examples: FNC1ABCD ^{FNC1} E are read as ABCD ²⁹ E A ^{FNC1} BCD ^{FNC1} E are read as ABCD ²⁹ E FNC1FNC1ABCD ^{FNC1} E are read as ABCD ²⁹ E ABCD ^{FNC1} E cannot be read ABCDE cannot be read
Enable	Disable	Read only symbols without leading FNC 1. Examples: FNC1ABCD ^{FNC1} E cannot be read A ^{FNC1} BCD ^{FNC1} E cannot be read FNC1FNC1ABCD ^{FNC1} E cannot be read ABCD ^{FNC1} E is read as ABCD ²⁹ E ABCDE is read as ABCDE
Enable	Enable	Read both types of symbols. Examples: FNC1ABCD ^{FNC1} E are read as ABCD ²⁹ E A ^{FNC1} BCD ^{FNC1} E are read as ABCD ²⁹ E FNC1FNC1ABCD ^{FNC1} E are read as ABCD ²⁹ E ABCD ^{FNC1} E is read as ABCD ²⁹ E ABCDE is read as ABCDE

Setting Prefixes and Suffixes

To append a prefix and suffixes to the decode data:

1. Set the Scan Data Transmission Format (parameter 235, EBh) to the desired option.
2. Enter the required value(s) for Prefix (105, 69h), Suffix1 (104, 68h) or Suffix2 (106, 6Ah) using the hex values for the desired ASCII value from [Table D-6](#).

Table D-6 Character Equivalents

Scan Value	Hex Value	Full ASCII Code 39 Encode Char.	Keystroke
1000	00h	%U	CTRL 2
1001	01h	\$A	CTRL A
1002	02h	\$B	CTRL B
1003	03h	\$C	CTRL C
1004	04h	\$D	CTRL D
1005	05h	\$E	CTRL E
1006	06h	\$F	CTRL F
1007	07h	\$G	CTRL G
1008	08h	\$H	CTRL H
1009	09h	\$I	CTRL I
1010	0Ah	\$J	CTRL J
1011	0Bh	\$K	CTRL K
1012	0Ch	\$L	CTRL L
1013	0Dh	\$M	CTRL M
1014	0Eh	\$N	CTRL N
1015	0Fh	\$O	CTRL O
1016	10h	\$P	CTRL P
1017	11h	\$Q	CTRL Q
1018	12h	\$R	CTRL R
1019	13h	\$S	CTRL S
1020	14h	\$T	CTRL T
1021	15h	\$U	CTRL U
1022	16h	\$V	CTRL V
1023	17h	\$W	CTRL W
1024	18h	\$X	CTRL X

Table D-6 *Character Equivalents (Continued)*

Scan Value	Hex Value	Full ASCII Code 39 Encode Char.	Keystroke
1025	19h	\$Y	CTRL Y
1026	1Ah	\$Z	CTRL Z
1027	1Bh	%A	CTRL [
1028	1Ch	%B	CTRL \
1029	1Dh	%C	CTRL]
1030	1Eh	%D	CTRL 6
1031	1Fh	%E	CTRL -
1032	20h	Space	Space
1033	21h	/A	!
1034	22h	/B	“
1035	23h	/C	#
1036	24h	/D	\$
1037	25h	/E	%
1038	26h	/F	&
1039	27h	/G	‘
1040	28h	/H	(
1041	29h	/I)
1042	2Ah	/J	*
1043	2Bh	/K	+
1044	2Ch	/L	,
1045	2Dh	-	-
1046	2Eh	.	.
1047	2Fh	/	/
1048	30h	0	0
1049	31h	1	1
1050	32h	2	2
1051	33h	3	3
1052	34h	4	4
1053	35h	5	5
1054	36h	6	6
1055	37h	7	7

Table D-6 *Character Equivalents (Continued)*

Scan Value	Hex Value	Full ASCII Code 39 Encode Char.	Keystroke
1056	38h	8	8
1057	39h	9	9
1058	3Ah	/Z	:
1059	3Bh	%F	;
1060	3Ch	%G	<
1061	3Dh	%H	=
1062	3Eh	%I	>
1063	3Fh	%J	?
1064	40h	%V	@
1065	41h	A	A
1066	42h	B	B
1067	43h	C	C
1068	44h	D	D
1069	45h	E	E
1070	46h	F	F
1071	47h	G	G
1072	48h	H	H
1073	49h	I	I
1074	4Ah	J	J
1075	4Bh	K	K
1076	4Ch	L	L
1077	4Dh	M	M
1078	4Eh	N	N
1079	4Fh	O	O
1080	50h	P	P
1081	51h	Q	Q
1082	52h	R	R
1083	53h	S	S
1084	54h	T	T
1085	55h	U	U
1086	56h	V	V

Table D-6 *Character Equivalents (Continued)*

Scan Value	Hex Value	Full ASCII Code 39 Encode Char.	Keystroke
1087	57h	W	W
1088	58h	X	X
1089	59h	Y	Y
1090	5Ah	Z	Z
1091	5Bh	%K	[
1092	5Ch	%L	\
1093	5Dh	%M]
1094	5Eh	%N	^
1095	5Fh	%O	_
1096	60h	%W	`
1097	61h	+A	a
1098	62h	+B	b
1099	63h	+C	c
1100	64h	+D	d
1101	65h	+E	e
1102	66h	+F	f
1103	67h	+G	g
1104	68h	+H	h
1105	69h	+I	i
1106	6Ah	+J	j
1107	6Bh	+K	k
1108	6Ch	+L	l
1109	6Dh	+M	m
1110	6Eh	+N	n
1111	6Fh	+O	o
1112	70h	+P	p
1113	71h	+Q	q
1114	72h	+R	r
1115	73h	+S	s
1116	74h	+T	t
1117	75h	+U	u

Table D-6 *Character Equivalents (Continued)*

Scan Value	Hex Value	Full ASCII Code 39 Encode Char.	Keystroke
1118	76h	+V	v
1119	77h	+W	w
1120	78h	+X	x
1121	79h	+Y	y
1122	7Ah	+Z	z
1123	7Bh	%P	{
1124	7Ch	%Q	
1125	7Dh	%R	}
1126	7Eh	%S	~
1127	7Fh		Undefined

APPENDIX E SAMPLE BAR CODES

UPC-A



UPC-E



UPC-E1



NOTE To enable this symbology in order to scan the sample, see [Enable/Disable UPC-E1 on page 5-9](#).



EAN-13



EAN-8



Code 39



Trioptic Code 39

- ✓ *NOTE* To enable this symbology in order to scan the sample, see [Enable/Disable Trioptic Code 39 on page 5-31](#).



Code 93

- ✓ *NOTE* To enable this symbology in order to scan the sample, see [Enable/Disable Code 93 on page 5-38](#).



Code 11

- ✓ *NOTE* To enable this symbology in order to scan the sample, see [Code 11 on page 5-40](#).



Codabar

- ✓ *NOTE* To enable this symbology in order to scan the sample, see [Enable/Disable Codabar on page 5-51](#).



MSI

- ✓ *NOTE* To enable this symbology in order to scan the sample, see [Enable/Disable MSI on page 5-55](#).



Interleaved 2 of 5



GS1 DataBar-14

✓ *NOTE* DataBar-14 must be enabled to read the bar code below (see [GS1 DataBar-14 on page 5-65](#)).



7612341562341

PDF417

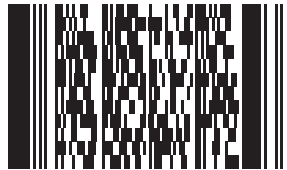

Data Matrix



Maxicode

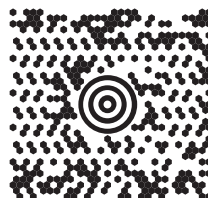

QR Code



Han Xin

US Postnet



UK Postal



APPENDIX F NUMERIC BAR CODES

Numeric Bar Codes

For parameters requiring specific numeric values, scan the appropriately numbered bar code(s).



0



1



2



3

Numeric Bar Codes (continued)

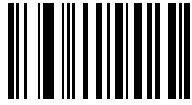

4

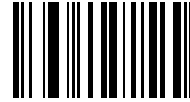

5

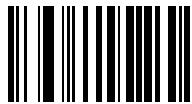

6

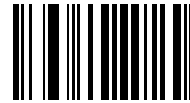

7

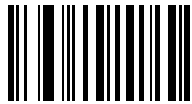

8

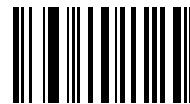

9

Cancel

To correct an error or change a selection, scan the bar code below.



Cancel

APPENDIX G ALPHANUMERIC BAR CODES

Alphanumeric Keyboard



Space

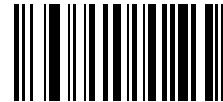

#

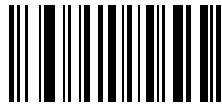

\$



%

Alphanumeric Keyboard (continued)



*



+

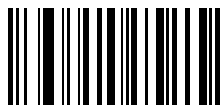

-

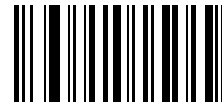

.

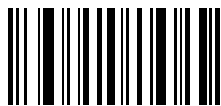

/

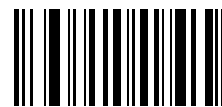

!

Alphanumeric Keyboard (continued)

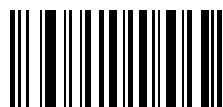

“



&

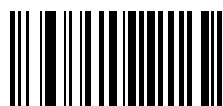

’

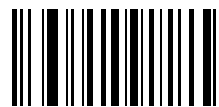

(

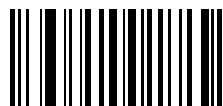

)



:

Alphanumeric Keyboard (continued)



;

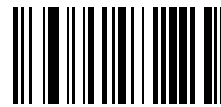

<



=

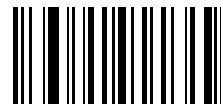

>



?

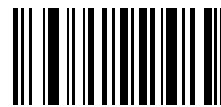

@

Alphanumeric Keyboard (continued)



[

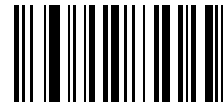

\



]



^



-



,

Alphanumeric Keyboard (continued)

✓ *NOTE* The bar codes that follow should not be confused with those on the numeric keypad.

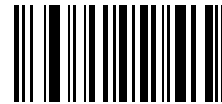

0



1

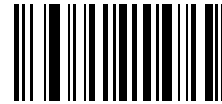

2

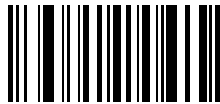

3

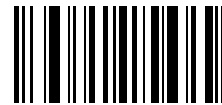

4

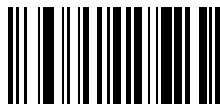

5

Alphanumeric Keyboard (continued)

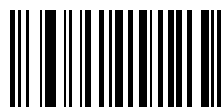

6



7



8



9



End of Message



Cancel

Alphanumeric Keyboard (continued)



A

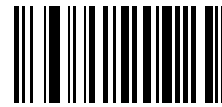

B



C

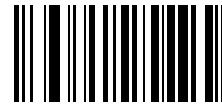

D



E

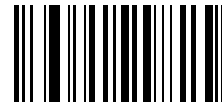

F

Alphanumeric Keyboard (continued)



G

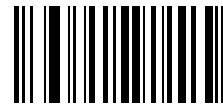

H



I

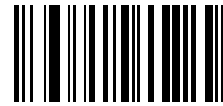

J



K

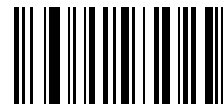

L

Alphanumeric Keyboard (continued)



M

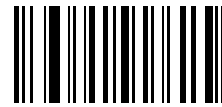

N



O



P

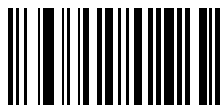

Q



R

Alphanumeric Keyboard (continued)



S



T



U

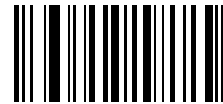

V

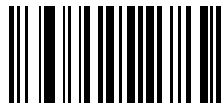

W

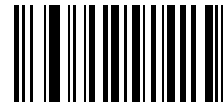

X

Alphanumeric Keyboard (continued)



Y

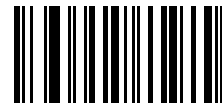

Z

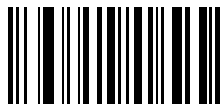

a

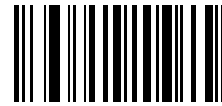

b



c

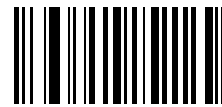

d

Alphanumeric Keyboard (continued)

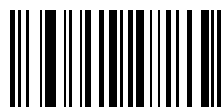

e



f



g



h



i



j

Alphanumeric Keyboard (continued)



k

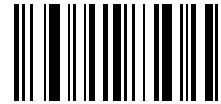

l

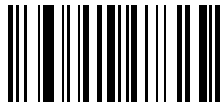

m

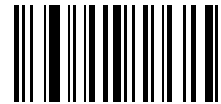

n

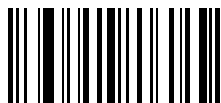

o



p

Alphanumeric Keyboard (continued)



q



r

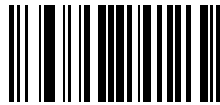

s

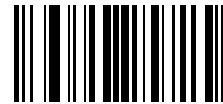

t



u

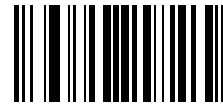

v

Alphanumeric Keyboard (continued)



w

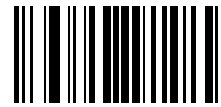

x

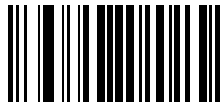

y

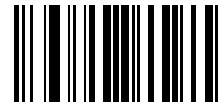

z



{

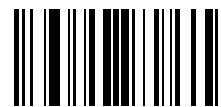

|

Alphanumeric Keyboard (continued)

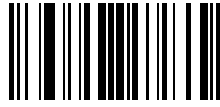

}

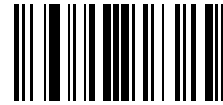

~

APPENDIX H ASCII CHARACTER SETS

Table H-1 ASCII Value Table

ASCII Value	Full ASCII Code 39 Encode Char	Keystroke
1000	%U	CTRL 2
1001	\$A	CTRL A
1002	\$B	CTRL B
1003	\$C	CTRL C
1004	\$D	CTRL D
1005	\$E	CTRL E
1006	\$F	CTRL F
1007	\$G	CTRL G
1008	\$H	CTRL H/ BACKSPACE ¹
1009	\$I	CTRL I/ HORIZONTAL TAB ¹
1010	\$J	CTRL J
1011	\$K	CTRL K
1012	\$L	CTRL L
1013	\$M	CTRL M/ ENTER ¹
1014	\$N	CTRL N
1015	\$O	CTRL O

The keystroke in bold transmits only if you enabled Function Key Mapping. Otherwise, the unbold keystroke transmits.

Table H-1 ASCII Value Table (Continued)

ASCII Value	Full ASCII Code 39 Encode Char	Keystroke
1016	\$P	CTRL P
1017	\$Q	CTRL Q
1018	\$R	CTRL R
1019	\$S	CTRL S
1020	\$T	CTRL T
1021	\$U	CTRL U
1022	\$V	CTRL V
1023	\$W	CTRL W
1024	\$X	CTRL X
1025	\$Y	CTRL Y
1026	\$Z	CTRL Z
1027	%A	CTRL [
1028	%B	CTRL \
1029	%C	CTRL]
1030	%D	CTRL 6
1031	%E	CTRL -
1032	Space	Space
1033	/A	!
1034	/B	"
1035	/C	#
1036	/D	\$
1037	/E	%
1038	/F	&
1039	/G	'
1040	/H	(
1041	/I)
1042	/J	*
1043	/K	+
1044	/L	,

The keystroke in bold transmits only if you enabled Function Key Mapping. Otherwise, the unbold keystroke transmits.

Table H-1 ASCII Value Table (Continued)

ASCII Value	Full ASCII Code 39 Encode Char	Keystroke
1045	-	-
1046	.	.
1047	/o	/
1048	0	0
1049	1	1
1050	2	2
1051	3	3
1052	4	4
1053	5	5
1054	6	6
1055	7	7
1056	8	8
1057	9	9
1058	/Z	:
1059	%F	;
1060	%G	<
1061	%H	=
1062	%I	>
1063	%J	?
1064	%V	@
1065	A	A
1066	B	B
1067	C	C
1068	D	D
1069	E	E
1070	F	F
1071	G	G
1072	H	H
1073	I	I

The keystroke in bold transmits only if you enabled Function Key Mapping. Otherwise, the unbold keystroke transmits.

Table H-1 ASCII Value Table (Continued)

ASCII Value	Full ASCII Code 39 Encode Char	Keystroke
1074	J	J
1075	K	K
1076	L	L
1077	M	M
1078	N	N
1079	O	O
1080	P	P
1081	Q	Q
1082	R	R
1083	S	S
1084	T	T
1085	U	U
1086	V	V
1087	W	W
1088	X	X
1089	Y	Y
1090	Z	Z
1091	%K	[
1092	%L	\
1093	%M]
1094	%N	^
1095	%O	_
1096	%W	`
1097	+A	a
1098	+B	b
1099	+C	c
1100	+D	d
1101	+E	e
1102	+F	f

The keystroke in bold transmits only if you enabled Function Key Mapping. Otherwise, the unbold keystroke transmits.

Table H-1 ASCII Value Table (Continued)

ASCII Value	Full ASCII Code 39 Encode Char	Keystroke
1103	+G	g
1104	+H	h
1105	+I	i
1106	+J	j
1107	+K	k
1108	+L	l
1109	+M	m
1110	+N	n
1111	+O	o
1112	+P	p
1113	+Q	q
1114	+R	r
1115	+S	s
1116	+T	t
1117	+U	u
1118	+V	v
1119	+W	w
1120	+X	x
1121	+Y	y
1122	+Z	z
1123	%P	{
1124	%Q	
1125	%R	}
1126	%S	~

The keystroke in bold transmits only if you enabled Function Key Mapping. Otherwise, the unbold keystroke transmits.

Table H-2 *ALT Key Standard Default Tables*

ALT Keys	Keystroke
2045	ALT -
2050	ALT 2
2054	ALT 6
2064	ALT @
2065	ALT A
2066	ALT B
2067	ALT C
2068	ALT D
2069	ALT E
2070	ALT F
2071	ALT G
2072	ALT H
2073	ALT I
2074	ALT J
2075	ALT K
2076	ALT L
2077	ALT M
2078	ALT N
2079	ALT O
2080	ALT P
2081	ALT Q
2082	ALT R
2083	ALT S
2084	ALT T
2085	ALT U
2086	ALT V
2087	ALT W
2088	ALT X
2089	ALT Y
2090	ALT Z

Table H-2 *ALT Key Standard Default Tables (Continued)*

ALT Keys	Keystroke
2091	ALT [
2092	ALT \
2093	ALT]

Table H-3 *USB GUI Key Character Set*

GUI Key	Keystroke
3000	Right Control Key
3048	GUI 0
3049	GUI 1
3050	GUI 2
3051	GUI 3
3052	GUI 4
3053	GUI 5
3054	GUI 6
3055	GUI 7
3056	GUI 8
3057	GUI 9
3065	GUI A
3066	GUI B
3067	GUI C
3068	GUI D
3069	GUI E
3070	GUI F
3071	GUI G
3072	GUI H
3073	GUI I
3074	GUI J
3075	GUI K

Note: GUI Shift Keys - The Apple™ iMac keyboard has an apple key on either side of the space bar. Windows-based systems have a GUI key to the left of the left ALT key, and to the right of the right ALT key.

Table H-3 *USB GUI Key Character Set (Continued)*

GUI Key	Keystroke
3076	GUI L
3077	GUI M
3078	GUI N
3079	GUI O
3080	GUI P
3081	GUI Q
3082	GUI R
3083	GUI S
3084	GUI T
3085	GUI U
3086	GUI V
3087	GUI W
3088	GUI X
3089	GUI Y
3090	GUI Z

Note: GUI Shift Keys - The Apple™ iMac keyboard has an apple key on either side of the space bar. Windows-based systems have a GUI key to the left of the left ALT key, and to the right of the right ALT key.

Table H-4 *F Key Standard Default Table*

F Keys	Keystroke
5001	F 1
5002	F 2
5003	F 3
5004	F 4
5005	F 5
5006	F 6
5007	F 7
5008	F 8
5009	F 9
5010	F 10
5011	F 11
5012	F 12
5013	F 13
5014	F 14
5015	F 15
5016	F 16
5017	F 17
5018	F 18
5019	F 19
5020	F 20
5021	F 21
5022	F 22
5023	F 23
5024	F 24

Table H-5 *Numeric Key Standard Default Table*

Numeric Keypad	Keystroke
6042	*
6043	+
6044	Undefined
6045	-
6046	.
6047	/
6048	0
6049	1
6050	2
6051	3
6052	4
6053	5
6054	6
6055	7
6056	8
6057	9
6058	Enter
6059	Num Lock

Table H-6 *Extended Keypad Standard Default Table*

Extended Keypad	Keystroke
7001	Break
7002	Delete
7003	Pg Up
7004	End
7005	Pg Dn
7006	Pause
7007	Scroll Lock
7008	Backspace
7009	Tab
7010	Print Screen
7011	Insert
7012	Home
7013	Enter
7014	Escape
7015	Up Arrow
7016	Dn Arrow
7017	Left Arrow
7018	Right Arrow

APPENDIX ICJK DECODE CONTROL

Introduction

This appendix describes control parameters for CJK (Chinese, Japanese, Korean) bar code decode through USB HID (Dongle) and Bluetooth HID Keyboard Emulation mode.

- ✓ *NOTE* Because ADF does not support CJK character processing, there is no format manipulation for CJK output.
The CS4070 does not support Korean keyboards.

CJK Decode Control Parameters

Unicode Output Control

Parameter # 973

For a Unicode encoded CJK bar code, select one of the following options for unicode output:

- **Universal Output to Unicode and MBCS Application** - This default method applies to Unicode and MBCS expected applications, such as MS Word and Notepad on a Windows host.
- ✓ *NOTE* To support Unicode universal output, set up the registry table for the Windows host. See [Unicode/CJK Decode Setup with Windows Host on page I-4](#).
- **Output to Unicode Application Only** - This method applies only to Unicode expected applications, such as MS Word and WordPad, but not Notepad.



***Universal Output
(0)**

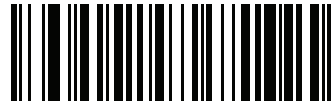

**Unicode Application Only
(1)**

CJK Output Method to Windows Host

Parameter # 972

For a national standard encoded CJK bar code, select one of the following options for CJK output to a Windows host:

- **Universal CJK Output** - This is the default universal CJK output method for US English IME or Chinese/Japanese/Korean ASCII IME on a Windows host. This method converts CJK characters to Unicode and emulates the characters when transmitting to the host. Use the [Unicode Output Control](#) parameter to control Unicode output.
- **Other options for CJK output** - With the following methods, the scanner sends the CJK character hexadecimal internal code (Nei Ma) value to host, or converts the CJK character to Unicode and sends the hexadecimal Unicode value to host. When using these methods, the Windows host must select the corresponding IME to accept the CJK character. See [Unicode/CJK Decode Setup with Windows Host on page I-4](#).
 - **Simplified Chinese GBK Code Output**
 - **Traditional Chinese Big5 Code Output (Windows 7)**

✓ **NOTE** To support universal CJK output, set up the registry table for the Windows host. See [Unicode/CJK Decode Setup with Windows Host on page I-4](#).

The Unicode emulate output method depends on the host system (Windows XP or Windows 7).
The CS4070 does not support Windows XP.

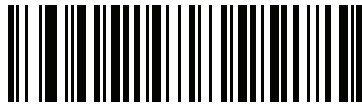

***Universal CJK Output
(0)**



**Chinese (Simplified) GBK Output
(1)**



**Chinese (Traditional) Big5 Output (Windows 7)
(19)**

Unicode/CJK Decode Setup with Windows Host

This section describes how to set up CJK decode with a Windows host.

Setting Up the Windows Registry Table for Unicode Universal Output

To support the Unicode universal output method, set up the Windows host registry table as follows:

1. Select **Start > Run > regedt32** to start the registry editor.
2. Under **HKEY_Current_User\Control Panel\Input Method**, set **EnableHexNumpad** to **1** as follows:
[HKEY_CURRENT_USER\Control Panel\Input Method]
"EnableHexNumpad"="1"
If this key does not exist, add it as type **REG_SZ** (string value).
3. Reboot the computer to implement the registry change.

Adding CJK IME on Windows

To add the desired CJK input language:

1. Click **Start > Control Panel**.
2. If the Control Panel opens in category view, select **Switch to Classic View** in the top left corner.
3. Select **Regional and Language Options**.
4. Click the **Language** tab.
5. Under **Supplemental Language Support**, select the **Install Files for East Asian Languages** check box if not already selected, and click **Apply**. This may require a Windows installation CD to install the required files. This step ensures that the East Asian Languages (CJK) are available.
6. Under **Text Services and Input Language**, click **Details**.
7. Under **Installed Services**, click **Add**.
8. In the **Add Input Language** dialog box, choose the CJK input language and keyboard layout or Input Method Editor (IME) to add.
9. Click **OK** twice. The language indicator appears in the system tray (at bottom right corner of the desktop by default). To switch between input languages (keyboard languages) select the language indicator in the system tray.
10. Select the language indicator in the system tray to select the desired country keyboard type.
11. Verify that the characters displayed on each country's keyboard appear.

Selecting the Simplified Chinese Input Method on the Host

Select Unicode/GBK input on Windows7: **Chinese (Simplified) - Microsoft Pinyin New Experience Input Style**, then select **Tool Menu > Secondary Inputs > Unicode Input** or **GB Code Input**.

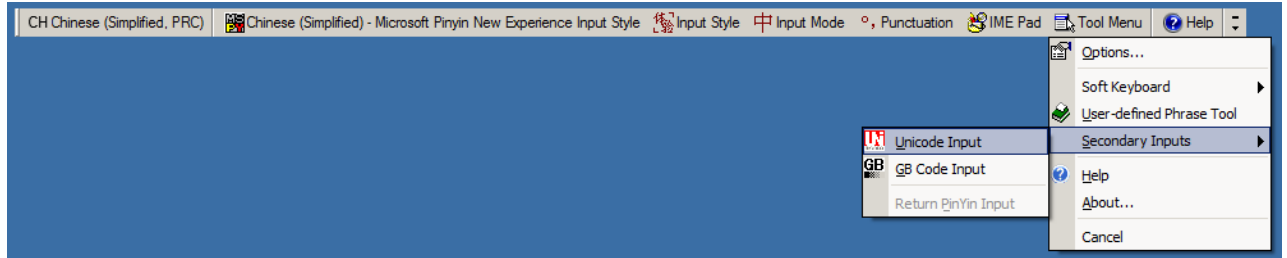

Selecting the Traditional Chinese Input Method on the Host

Select Unicode/Big5 input on Windows 7: **Chinese (Traditional) - New Quick**. This option support both Unicode and Big5 input.

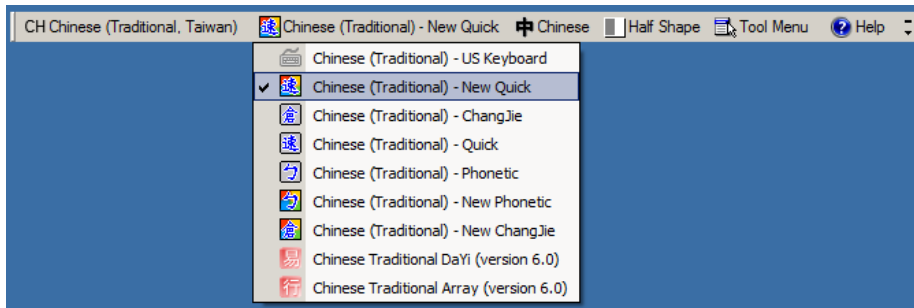

INDEX

Numerics

123Scan	1-8
options	7-1
requirements	7-2
software tools	7-2
videos	7-2
2D bar codes	
aztec	5-86
aztec inverse	5-87
code 128 emulation	5-80
data matrix	5-81
data matrix inverse	5-82
decode mirror images	5-83
GS1 data matrix	5-81
han xin	5-88
han xin inverse	5-89
maxicode	5-84
microPDF417	5-79
microQR	5-86
PDF417	5-79
QR code	5-84
QR inverse	5-85

A

accessories	
dongle	B-14
eight-slot charging cradle	B-5
eight-slot spare battery charger	B-7
lanyard	B-2, B-16
single-slot cradle	B-2, B-3
wall mount bracket	B-2, B-9, B-11
ADF	7-3
advanced data formatting	7-3
aiming	2-1
ALT key values	H-6

Android pairing	C-3
accessing phone keyboard	C-4
ASCII values	H-1
autoreconnect	3-12
autorun	2-3

B

bar codes	
Australia post	5-75
Australia post format	5-76
aztec	5-86
aztec inverse	5-87
batch mode	3-44, 3-45
beep after good decode	3-35
beeper tone	3-37
beeper volume	3-36
bluetooth friendly name	3-8
bluetooth options	3-8
bluetooth profile	3-10
bookland EAN	5-10
bookland ISBN	5-11
cancel	F-3
check ISBT table	5-29
Chinese 2 of 5	5-59
clear data	3-11
codabar	5-51
codabar CLSI editing	5-53
codabar lengths	5-51
codabar NOTIS editing	5-53
codabar start and stop characters	5-54
code 11	5-40
code 11 check digit verification	5-42
code 11 check digits	5-43
code 11 lengths	5-40
code 128	5-25
code 128 emulation	5-80

code 128 lengths	5-25	HID security	3-18
code 128 security level	5-30	I 2 of 5	5-44
code 32 prefix	5-33	I 2 of 5 check digit verification	5-46
code 39	5-31	I 2 of 5 convert to EAN-13	5-47
code 39 check digit verification	5-35	I 2 of 5 lengths	5-44
code 39 full ASCII	5-36	I 2 of 5 security level	5-48
code 39 lengths	5-33	I 2 of 5 transmit check digit	5-47
code 39 security level	5-37	illumination	3-32
code 39 transmit check digit	5-35	intercharacter gap size	5-93
code 93	5-38	inverse 1D	5-64
code 93 lengths	5-38	ISBT 128	5-27
composite CC-A/B	5-68	ISBT concatenation	5-28
composite CC-C	5-68	ISBT concatenation redundancy	5-29
composite code emulation mode	5-71	ISSN EAN	5-24
composite TLC-39	5-69	Japan postal	5-74
connection interval and discovery mode timeout	3-13	Korean 3 of 5	5-63
continuous bar code read	3-55	low light scene detection	3-34
convert case	3-27	matrix 2 of 5	5-60
convert code 39 to code 32	5-32	matrix 2 of 5 check digit	5-62
convert GS1 databar to UPC/EAN	5-66	matrix 2 of 5 lengths	5-60
convert UPC-E to UPC-A	5-22	maxicode	5-84
convert UPC-E1 to UPC-A	5-22	microPDF417	5-79
country keyboard type 3-20, 3-21, 3-22, 4-3, 4-4, 4-5		microQR	5-86
D 2 of 5	5-49	mirrored image	3-41
D 2 of 5 lengths	5-49	mobile phone/display mode	3-42
data matrix	5-81	MSI	5-55
GS1 data matrix	5-81	MSI check digit algorithm	5-58
data matrix decode mirror images	5-83	MSI check digits	5-57
data matrix inverse	5-82	MSI lengths	5-55
decode pager motor	3-38	MSI transmit check digit	5-57
decode pager motor duration	3-39	mute beeper	3-38
decode session timeout	3-56	Netherlands KIX code	5-77
disable all code types	5-7	numeric	F-1
EAN zero extend	5-23	numeric for pin entry	C-9
EAN-13/JAN-13	5-10	pager motor	3-38
EAN-8/JAN-8	5-9	parameter scanning	3-35
emulate keypad	3-24	PDF prioritization	3-43
enable all code types	5-7	PDF prioritization timeout	3-43
fast bluetooth HID keyboard	3-28	PDF417	5-79
FN1 substitution values	3-25	picklist mode	3-40
fuzzy 1D processing	3-41	postal	5-72
GS1 databar	5-65	prefix/suffix values	3-62
GS1 databar expanded	5-66	presentation mode field of view	3-31
GS1 databar limited	5-65	QR code	5-84
GS1 databar limited security level	5-67	QR inverse	5-85
GS1 databar-14	5-65	radio output power	3-18
GS1-128	5-27	redundancy level	5-90
han xin	5-88	reset to factory defaults	3-5
han xin inverse	5-89	sample	E-1
HID caps lock override	3-23	scan data options	3-63
HID CoD	3-19	security level	5-92
HID function key mapping	3-26	send versions	3-65
HID ignore unknown characters	3-23	set date and time	3-6
HID keyboard FN1 substitution	3-25	simulated caps lock	3-26

- supplementals 5-12
 - symbolologies
 - default table 5-2
 - timeout between decodes, different symbols . . . 3-57
 - timeout between decodes, same symbol 3-56
 - transmit code ID character 3-61
 - transmit matrix 2 of 5 check digit 5-62
 - transmit no read message 3-64
 - transmit UK postal check digit 5-74
 - transmit US postal check digit 5-73
 - trigger mode 3-29
 - trioptic code 39 5-31
 - UCC coupon extended code 5-23
 - UK postal 5-73
 - unicode output control I-2
 - unique bar code reporting 3-55
 - unpair 3-10
 - UPC composite mode 5-70
 - UPC/EAN supplemental redundancy 5-15
 - UPC/EAN/JAN supplemental AIM ID format . . . 5-16
 - UPC-A 5-8
 - UPC-A preamble 5-19
 - UPC-A/E/E1 check digit 5-17, 5-18
 - UPC-E 5-8
 - UPC-E preamble 5-20
 - UPC-E1 5-9
 - UPC-E1 preamble 5-21
 - UPU FICS postal 5-78
 - US planet 5-72
 - US postnet 5-72
 - USB HID
 - caps lock override 4-7
 - convert case 4-12
 - emulate keypad 4-8
 - emulate keypad with leading zero 4-8
 - FN1 substitution values 4-10
 - function key mapping 4-11
 - keyboard FN 1 sub 4-10
 - keystroke delay 4-6
 - quick emulation 4-9
 - simulated caps lock 4-11
 - unknown characters 4-7
 - user-programmable supplementals 5-15
 - USPS 4CB/One Code/Intelligent Mail 5-77
 - wi-fi friendly channel exclusion 3-59
 - wi-fi friendly mode 3-58
 - batch 1-5
 - transmitting data 2-2
 - battery
 - charge status 2-5
 - charging 1-4
 - indications B-8
 - charging in cradle B-2, B-3, B-5
 - charging indications B-4, B-6
 - charging spare 1-4, B-3, B-7
 - charging temperature 1-4
 - depleted 2-6
 - inserting 1-2
 - lithium-ion 1-2
 - removing 1-3
 - beeper
 - beep on decode 3-35
 - definitions 2-7
 - muting 1-11, 3-38
 - setting tone 3-37
 - setting volume 3-36
 - toggling 2-2
 - troubleshooting 8-2
 - bluetooth 1-1
 - address 1-8
 - bar codes 3-8
 - beeper definitions 2-7
 - central/peripheral set up 3-9
 - connecting 1-5
 - disable button 1-9
 - dongle B-14
 - dongle mounting B-15
 - dongle pairing B-15
 - HID 1-5
 - set security 1-10
 - HID host name 3-15
 - HID profile 3-10
 - HID security 3-18
 - LED definitions 2-6
 - network connectivity B-4, B-6
 - out of range 2-3, 8-2
 - pairing 1-6
 - pairing bar code format 3-9
 - PIN code 1-9
 - profiles 3-10
 - radio output power 3-18
 - serial number 1-8
 - serial port profile 1-5
 - SPP profile 3-10
 - SSI profile 3-10
 - transmitting data 2-3
 - unpairing 3-10
 - booting the device 1-4
 - bullets xvii
 - buttons 1-1
 - bluetooth 1-9
 - delete 2-2
- ## C
- cable 1-5
 - communication setup 1-5
 - charging

LED definitions 2-5
 charging battery 1-4, B-2, B-8
 in cradle B-3, B-5
 in spare battery charger B-7
 indications B-4, B-6
 charging indications B-4, B-6, B-8
 charging temperature 1-4
 Chinese 2 of 5 bar codes 5-59
 CJK I-1
 cleaning 8-1
 clearing data 3-11
 codabar bar codes 5-51
 CLSI editing 5-53
 lengths 5-51
 NOTIS editing 5-53
 start and stop characters 5-54
 code 11 bar codes 5-40
 check digit verification 5-42
 check digits 5-43
 lengths 5-40
 code 128 bar codes
 check ISBT table 5-29
 code 128 5-25
 GS1-128 5-27
 ISBT 128 5-27
 ISBT concatenation 5-28
 ISBT concatenation redundancy 5-29
 lengths 5-25
 security level 5-30
 code 128 emulation bar codes 5-80
 code 39 bar codes
 check digit verification 5-35
 code 32 prefix 5-33
 code 39 5-31
 convert to code 32 5-32
 full ASCII 5-36
 lengths 5-33
 security level 5-37
 transmit check digit 5-35
 trioptic Code 39 5-31
 code 93 bar codes 5-38
 lengths 5-38
 code identifiers
 AIM D-6
 code type IDs D-1
 modifier characters D-7
 Symbol D-4
 cold boot 1-4
 communication setup 1-5
 composite bar codes
 composite CC-A/B 5-68
 composite CC-C 5-68
 composite TLC-39 5-69
 emulation mode 5-71

UPC composite mode 5-70
 configuration file 1-8
 editing 1-9
 parameters 1-9
 configuring scanner 1-8
 123Scan 1-8
 configuration file 1-8
 editing configuration file 1-9
 multiple scanners 1-8
 updating firmware 1-8
 connecting
 batch 1-5
 bluetooth 1-5
 pairing 1-6
 to host 1-5
 connection interval 3-13
 connectivity
 bluetooth B-4, B-6
 conventions
 notational xvii
 cradles
 eight-slot B-5
 eight-slot spare charger B-7
 mounting B-9, B-11
 setting up B-3, B-5, B-7
 single-slot B-2, B-3

D

data matrix bar codes 5-81
 decode mirror images 5-83
 GS1 data matrix 5-81
 inverse 5-82
 date
 setting 3-6, 3-7
 date format 1-10
 default parameters 3-2, 4-2, A-1
 symbolologies 5-2
 USB HID keyboard 4-2
 user preferences 3-2
 default table A-1
 deleting bar codes 2-2, 2-4
 deleting device 1-7
 devices supported 1-6
 discovery mode timeout 3-13
 discrete 2 of 5 bar codes 5-49
 lengths 5-49
 dongle B-14, B-15
 mounting B-15

E

error indications
 unknown characters 4-7

- exposure options
 - illumination 3-32
 - presentation mode field of view 3-31
- extended keypad values H-11

- F**
- F key values H-9
- firmware
 - updating 1-8

- G**
- GS1 databar bar codes 5-65
 - convert to UPC/EAN 5-66
 - expanded 5-66
 - GS1 databar-14 5-65
 - limited 5-65
 - limited security level 5-67
- GS1-128 D-11

- H**
- host connection 1-5
- human interface device (HID) 1-5
 - host name 3-15
 - security 3-18
 - set security 1-10
 - setting 3-10

- I**
- illumination 3-32
 - low light scene detection 3-34
- inserting battery 1-2
- interfaces 1-1
- interleaved 2 of 5 bar codes 5-44
 - check digit verification 5-46
 - convert to EAN-13 5-47
 - lengths 5-44
 - security level 5-48
 - transmit check digit 5-47
- iPad pairing C-2

- K**
- Keypad 4-8
- Korean 3 of 5 bar codes 5-63

- L**
- lanyard B-2, B-16
- LED
 - charging indications B-8
 - definitions 2-4
 - enabling 1-10
 - scanning 2-4
 - troubleshooting 8-2
- lithium-ion battery 1-2

- M**
- maintenance 8-1
- matrix 2 of 5 bar codes 5-60
 - check digit 5-62
 - lengths 5-60
 - transmit check digit 5-62
- maxicode bar codes 5-84
- microPDF417 bar codes 5-79
- MSI bar codes 5-55
 - check digit algorithm 5-58
 - check digits 5-57
 - lengths 5-55
 - transmit check digit 5-57

- N**
- notational conventions xvii
- numeric bar codes
 - for pin entry C-9
- numeric key values H-10

- O**
- operating systems supported 1-6

- P**
- pager
 - duration 3-39
 - enabling 1-11, 3-38
- pairing 1-5, 1-6
 - address 3-12
 - bar code format 3-9
 - LED 2-6
 - using scan-to-connect 7-3
 - via dongle B-15
- pairing examples C-1
 - Android C-3
 - iPad C-2
 - Windows 7 C-5
 - Windows 8 C-7
- parameters
 - configuration file 1-9
 - default A-1
 - defaults 3-2, 4-2
 - enable scanning 3-35
 - scanning 3-2, 4-2

setting date and time	3-6
parts diagram	1-1
PDF417 bar codes	5-79
picklist mode	3-40
pin	
numeric bar codes	C-9
postal codes	5-72
Australia post	5-75
Australia post format	5-76
Japan postal	5-74
Netherlands KIX code	5-77
transmit UK postal check digit	5-74
transmit US postal check digit	5-73
UK postal	5-73
UPU FICS postal	5-78
US planet	5-72
US postnet	5-72
USPS 4CB/One Code/Intelligent Mail	5-77
power off cradle	B-4
prefix/suffix values	3-62
prefixes	D-12
presentation mode field of view	3-31

Q

QR code bar codes	5-84
inverse	5-85
microQR	5-86

R

radio output power	3-18
removing battery	1-3
resetting scanner	
to factory defaults	3-5

S

sample bar codes	E-1
scanner control app	7-2, 7-3
scanner defaults	3-2, 4-2, A-1
scanning	2-1
aiming	2-1
beeper	2-7
disable functionality	1-10
errors	3-1, 4-1, 4-7, 5-2
LED	2-4
parameters	3-1, 4-1
sequence example	5-1
transmitting data	2-2
scan-to-connect utility	7-3
serial port profile	1-5
setting	3-10
service information	xviii

setup	
123Scan	1-8
Android pairing	C-3
bluetooth	1-5
charging battery	1-4
configuration file	1-8
configuring scanner	1-8
connecting to host	1-5
editing configuration file	1-9
eight-slot cradle	B-5
eight-slot spare charger	B-7
inserting battery	1-2
iPad pairing	C-2
multiple scanners	1-8
pairing	1-6
single-slot cradle	B-3
unpacking	1-2
updating firmware	1-8
wall mount bracket	B-9, B-11
Windows 7 pairing	C-5
Windows 8 pairing	C-7
single-slot cradle	B-2
software tools	7-2
scanner control app	7-3
scan-to-connect utility	7-3
spare batteries	1-4
charging in cradle	B-3, B-7
spare battery charger	B-2
specifications	8-3
STC	7-3
suffixes	D-12
support	xviii
supported devices	1-6
symbology default parameters	5-2

T

technical specifications	8-3
temperature	
charging battery	1-4
time	
setting	3-6, 3-7
transmitting data	2-2
bluetooth	2-3
trigger mode	3-29
troubleshooting	8-2

U

unicode	
output control	1-2
unpacking	1-2
unpairing	1-7, 3-10
UPC/EAN bar codes	

bookland EAN	5-10
bookland ISBN	5-11
check digit	5-17, 5-18
convert UPC-E to UPC-A	5-22
convert UPC-E1 to UPC-A	5-22
EAN zero extend	5-23
EAN-13/JAN-13	5-10
EAN-8/JAN-8	5-9
ISSN EAN	5-24
supplemental AIM ID format	5-16
supplemental redundancy	5-15
supplementals	5-12
UCC coupon extended code	5-23
UPC-A	5-8
UPC-A preamble	5-19
UPC-E	5-8
UPC-E preamble	5-20
UPC-E1	5-9
UPC-E1 preamble	5-21
user-programmable supplementals	5-15
updating firmware	1-8
USB	1-1
USB cable	1-5
USB GUI key values	H-7
USB HID keyboard parameters	4-2
user interface	2-4
LED definitions	2-4
user preferences bar codes	
batch mode	3-44, 3-45
user preferences parameters	3-2

V

value tables	
ALT key	H-6
ASCII	H-1
extended keypad	H-11
F keys	H-9
numeric keys	H-10
USB GUI keys	H-7
version	
bar codes	3-65

W

wall mount bracket	B-2, B-9, B-11
wi-fi friendly mode	3-58
channel exclusion	3-59
Windows 7 pairing	C-5
Windows 8 pairing	C-7



Zebra Technologies Corporation
Lincolnshire, IL U.S.A.
www.zebra.com

©2018 ZIH Corp and/or its affiliates. All rights reserved. ZEBRA and the stylized Zebra head are trademarks of ZIH Corp, registered in many jurisdictions worldwide. All other trademarks are the property of their respective owners.