



Zoom-Zoom

All children instinctively know it.

A few adults still remember it.

One unique car company refuses to outgrow it.

In grown-up language, it means the exhilaration and

liberation that come from experiencing sheer motion.

But as usual, children put it much better and simply call it "Go Zoom-Zoom."

We practice it every day.

It's why we build the kind of cars we do.

Zoom-Zoom.

Can we re-awaken it in you today?

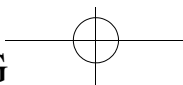

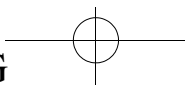
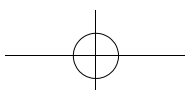

A Word to Mazda Owners

Thank you for choosing a Mazda. We at Mazda design and build vehicles with complete customer satisfaction in mind.

To help ensure enjoyable and trouble-free operation of your Mazda, read this manual carefully and follow its recommendations.

An Authorized Mazda Dealer knows your vehicle best. So when maintenance or service is necessary, that's the place to go.

Our nationwide network of Mazda professionals is dedicated to providing you with the best possible service.

We assure you that all of us at Mazda have an ongoing interest in your motoring pleasure and in your full satisfaction with your Mazda product.

Mazda Motor Corporation
HIROSHIMA, JAPAN

Important Notes About This Manual

Keep this manual in the glove box as a handy reference for the safe and enjoyable use of your Mazda. Should you resell the vehicle, leave this manual with it for the next owner.

All specifications and descriptions are accurate at the time of printing. Because improvement is a constant goal at Mazda, we reserve the right to make changes in specifications at any time without notice and without obligation.

Event Data Recorder

This vehicle is equipped with an event data recorder. In the event of a crash, this device records data related to vehicle dynamics and safety systems for a short period of time. These data can help provide a better understanding of the circumstances in which crashes and injuries occur and lead to the designing of safer vehicles.

Air Conditioning and the Environment

Your Mazda's genuine air conditioner is filled with HFC134a (R134a), a refrigerant that has been found not to damage the earth's ozone layer. If the air conditioner does not operate properly, consult an Authorized Mazda Dealer.

Please be aware that this manual applies to all models, equipment and options. As a result, you may find some explanations for equipment not installed on your vehicle.

©2005 Mazda Motor Corporation
Printed in Japan July 2005(Print1)

How to Use This Manual

We want to help you get the most driving pleasure from your vehicle. Your owner's manual, when read from cover to cover, can do that in many ways.

Illustrations complement the words of the manual to best explain how to enjoy your Mazda. By reading your manual, you can find out about the features, important safety information, and driving under various road conditions.

The symbol below in this manual means "Do not do this" or "Do not let this happen".

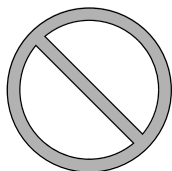

Index: A good place to start is the Index, an alphabetical listing of all information in your manual.

You'll find several **WARNINGS**, **CAUTIONS**, and **NOTES** in the manual.

WARNING

*A **WARNING** indicates a situation in which serious injury or death could result if the warning is ignored.*

CAUTION

A **CAUTION** indicates a situation in which bodily injury or damage to your vehicle, or both, could result if the caution is ignored.

NOTE

A **NOTE** provides information and sometimes suggests how to make better use of your vehicle.

The symbol below, located on some parts of the vehicle, indicates that this manual contains information related to the part. Please refer to the manual for a detailed explanation.



Table of Contents

Your Vehicle at a Glance Interior, exterior views and part identification of your Mazda.	1
Essential Safety Equipment Use of safety equipment, including seats, seat belt system, SRS air bags and child-restraint systems.	2
Knowing Your Mazda Explanation of basic operations and controls; opening/closing and adjustment of various parts.	3
Before Driving Your Mazda Important information about driving your Mazda.	4
Driving Your Mazda Explanation of instruments and controls.	5
Interior Comfort Use of various features for drive comfort, including air-conditioning and audio system.	6
In Case of an Emergency Helpful information on what to do in an emergency.	7
Maintenance and Care How to keep your Mazda in top condition.	8
Customer Information and Reporting Safety Defects Important consumer information including warranties and add-on equipment.	9
Specifications Technical information about your Mazda.	10
Index	11
Navigation System	

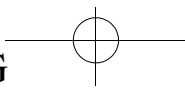
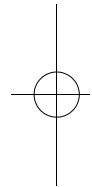
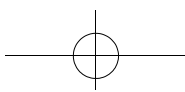



1 Your Vehicle at a Glance

Interior, exterior views and part identification of your Mazda.

Dashboard and Interior Overview	1-2
Exterior Overview	1-4

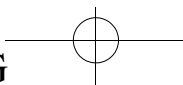

Your Vehicle at a Glance

Dashboard and Interior Overview

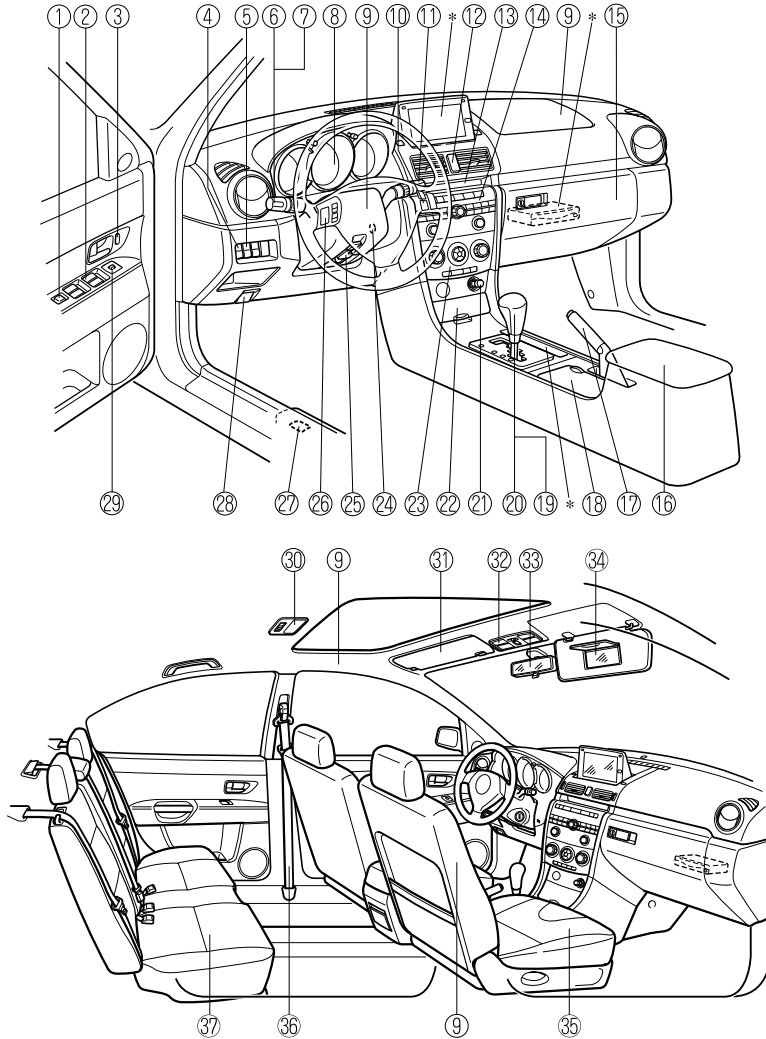

The equipment and installation position varies by grade.
 *Refer to Navigation System at the end of the manual.

- ① Power window lock switch page 3-18
- ② Power window switches page 3-17
- ③ Power door lock switch page 3-8

1-2

Your Vehicle at a Glance

Dashboard and Interior Overview

④ Headlight leveling switch	page 5-48
⑤ Dashboard illumination	page 5-32
⑥ Lighting control/Turn signals	page 5-46
⑦ Fog light switch	page 5-49
⑧ Instrument cluster	page 5-28
⑨ Air bags	page 2-38
⑩ Cruise control switches	page 5-18
⑪ Wiper and washer lever	page 5-50
⑫ Hazard warning flasher switch	page 5-55
⑬ Information display	page 6-45
⑭ Audio system	page 6-16
⑮ Glove box	page 6-52
⑯ Center console	page 6-53
⑰ Parking brake	page 5-5
⑱ Cup holder	page 6-51
⑲ MT shift lever	page 5-9
⑳ AT shift lever (Sport AT)	page 5-11
㉑ Lighter	page 6-50
㉒ Ashtray	page 6-50
㉓ Climate control system	page 6-2
㉔ Ignition switch	page 5-2
㉕ Steering column release lever	page 3-28
㉖ Audio control switch	page 6-38
㉗ Remote fuel-filler lid release	page 3-19
㉘ Hood release handle	page 3-20
㉙ Outside mirror switch	page 3-28
㉚ Interior light	page 6-42
㉛ Sunvisor	page 6-42
㉜ Map light	page 6-43
㉝ Rearview mirror	page 3-30
㉞ Vanity mirror	page 6-42
㉟ Front seats	page 2-2
㊱ Seat belt	page 2-9
㊲ Rear seat	page 2-5

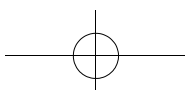

Your Vehicle at a Glance

Exterior Overview

4 Door

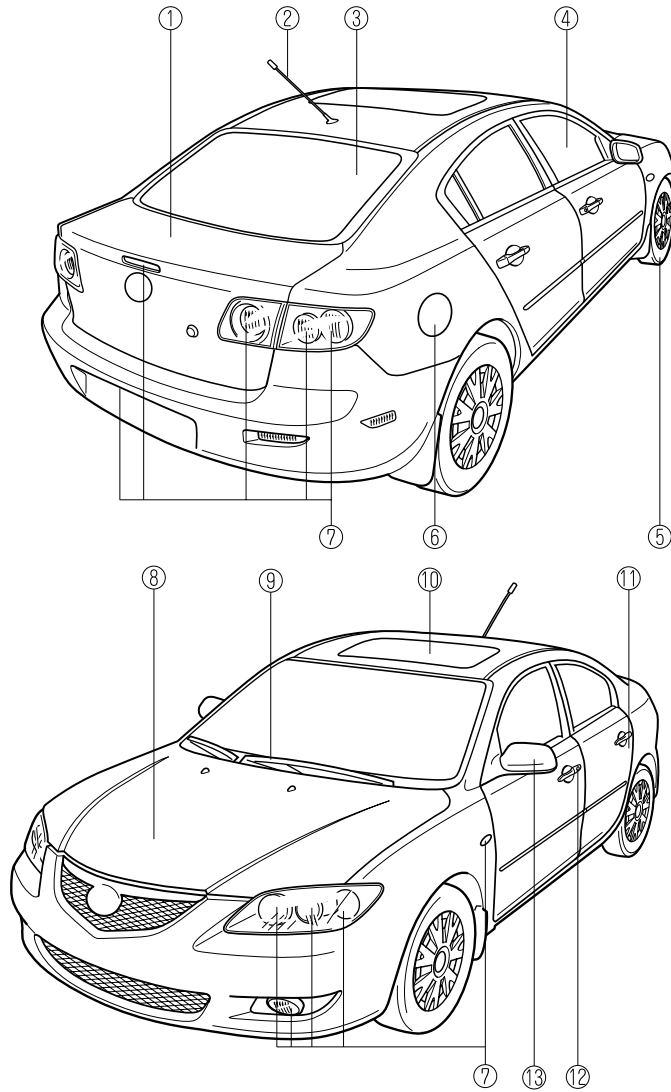

The equipment and installation position varies by grade.

1-4

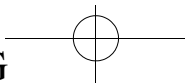

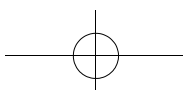

Your Vehicle at a Glance

Exterior Overview

① Trunk lid	page 3-12
② Antenna	page 6-16
③ Rear window defroster	page 5-54
④ Power windows	page 3-16
⑤ Tires	page 8-30
⑥ Fuel-filler lid	page 3-18
⑦ Light bulbs	page 8-35
⑧ Hood	page 3-20
⑨ Windshield wiper blades	page 8-23
⑩ Moonroof	page 3-22
⑪ Child safety locks	page 3-9
⑫ Doors and keys	page 3-7
⑬ Outside mirror	page 3-28

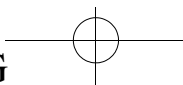
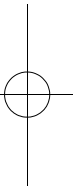
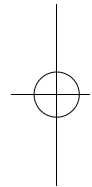

Your Vehicle at a Glance

Exterior Overview

5 Door

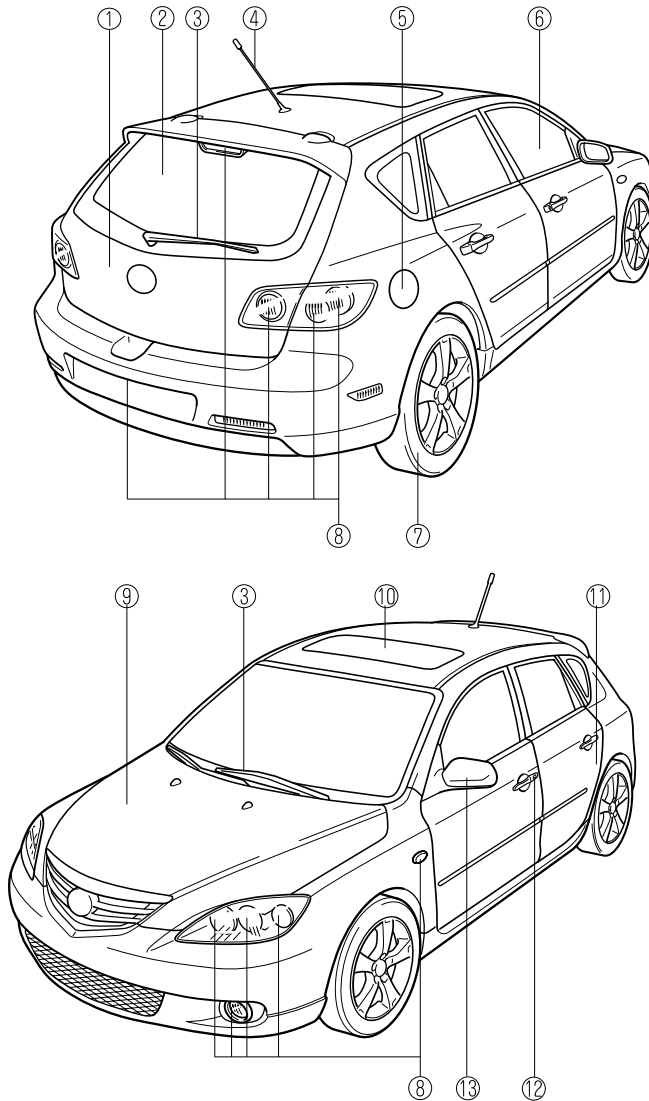

The equipment and installation position varies by grade.

1-6

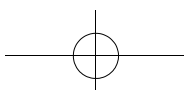

Your Vehicle at a Glance
Exterior Overview

① Liftgate	page 3-9
② Rear window defroster	page 5-54
③ Windshield wiper blades	page 8-23
④ Antenna	page 6-16
⑤ Fuel-filler lid	page 3-18
⑥ Power windows	page 3-16
⑦ Tires	page 8-30
⑧ Light bulbs	page 8-35
⑨ Hood	page 3-20
⑩ Moonroof	page 3-22
⑪ Child safety locks	page 3-9
⑫ Doors and keys	page 3-7
⑬ Outside mirror	page 3-28

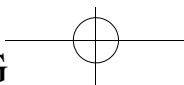
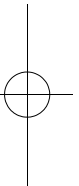
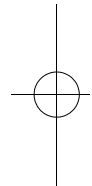

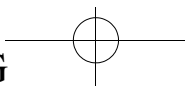

2 Essential Safety Equipment

Use of safety equipment, including seats, seat belt system, SRS air bags and child-restraint systems.

Seats	2-2
Front Seats	2-2
Rear Seat	2-5
Seat Belt Systems	2-9
Seat Belt Precautions	2-9
Seat Belt (Except Center-Rear Position)	2-12
Front Seat Belt Pretensioner and Load Limiting Systems	2-14
Center-Rear Position Seat Belt (3-Point Type)	2-16
Seat Belt Extender	2-18
Seat Belt Warning Light/Beep	2-19
Child Restraint	2-21
Child Restraint Precautions	2-21
Installing Child-Restraint Systems	2-25
LATCH Child-Restraint Systems	2-33
SRS Air Bags	2-38
Supplemental Restraint Systems (SRS) Precautions	2-38
Supplemental Restraint System Components	2-42
How the Air Bags Work	2-45

Essential Safety Equipment

Seats

Front Seats

WARNING

Modification of the Front Seats:
Modifying or replacing the front seats such as replacing the upholstery or loosening any bolts is dangerous. The front seats contain air bag components essential to the supplemental restraint system. Such modifications could damage the supplemental restraint system and result in serious injury. Consult an Authorized Mazda Dealer if there is any need to remove or reinstall the front seats.

Damaged Front Seats:
Driving with damaged front seats is dangerous. A collision, even one not strong enough to inflate the air bags, could damage the front seats which contain essential air bag components. If there was a subsequent collision, the air bag may not deploy which could lead to injuries. Always have an Authorized Mazda Dealer inspect the front seats, front seat belt pretensioners and air bags after a collision.

Securing the Seats:
Adjustable seats and seatbacks that are not securely locked are dangerous. In a sudden stop or collision, the seat or seatback could move, causing injury. Make sure the adjustable components of the seat are locked in place by attempting to slide the seat forward and backward and rocking the seatback.

▼ Seat Slide

WARNING

Driver's Seat Adjustment:
Adjusting the driver's seat while the vehicle is moving is dangerous. The driver could lose control of the vehicle and have an accident. Adjust the driver's seat only when the vehicle is stopped.

To move a seat forward or backward, raise the lever and slide the seat to the desired position and release the lever.

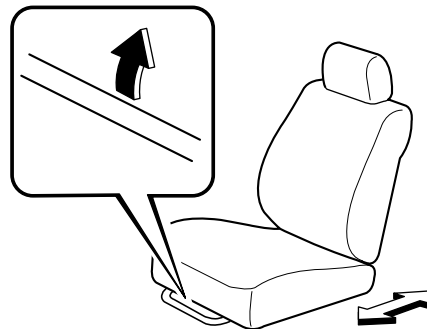

Make sure the lever returns to its original position and the seat is locked in place by attempting to push it forward and backward.

▼ **Seat Recline**

! WARNING

Reclining:

Sitting in a reclined position while the vehicle is moving is dangerous because you don't get the full protection from seat belts. During sudden braking or a collision, you can slide under the lap belt and suffer serious internal injuries. For maximum protection, sit well back and upright.

Reclining the Front Passenger Seat Can Turn Off the Front Passenger Air Bags

If your vehicle is equipped with front passenger seat weight sensors, sitting in the front passenger seat improperly out of position or with the seatback reclined too far while the vehicle is moving is dangerous as it can take off weight from the seat bottom and affect the decision of the front passenger sensing system. The front passenger will not have the supplementary protection of the air bags and pretensioner, which could result in serious injury. Always sit upright against your seatback, with your feet on the floor.

! WARNING

Unlocked Seatback:

The seatback plays an important role in your protection in a vehicle. Leaving the seatback unlocked is dangerous as it can allow passengers to be ejected or thrown around and baggage to strike occupants in a sudden stop or collision, resulting in severe injury. After adjusting the seatback at any time, even when there are no other passengers, rock the seatback to make sure it is locked in place.

To change the seatback angle, lean forward slightly while raising the lever. Then lean back to the desired position and release the lever.

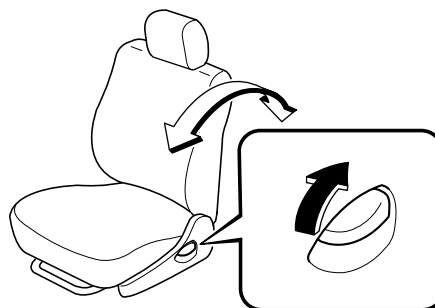

Make sure the lever returns to its original position and the seatback is locked in place by attempting to push it forward and backward.

Essential Safety Equipment

Seats

⚠ CAUTION

When returning a rear-reclined seatback to its upright position, make sure you hold onto the seatback with your other hand while operating the lever. If the seatback is not supported, it will flip forward suddenly and could cause injury.

▼ Height Adjustment (Driver's Seat) *

By moving the seat lever up or down, the seat bottom height can be adjusted.

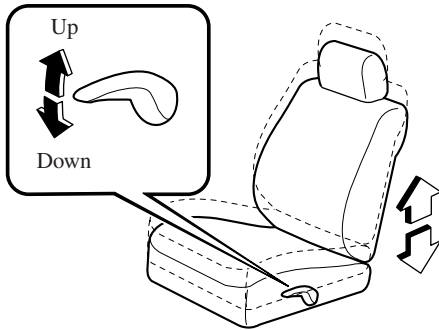

▼ Lumbar Support Adjustment (Driver's Seat) *

To adjust the lumbar support, pull the lever forward.

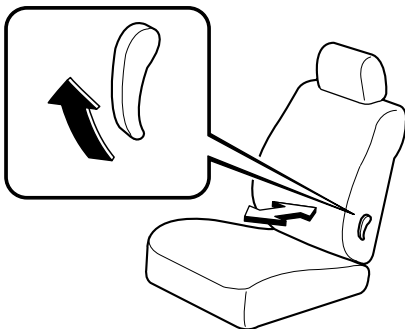

▼ Head Restraint

⚠ WARNING

Head Restraints Adjustment:
Driving with the head restraints adjusted too low or removed is dangerous. With no support behind your head, your neck could be seriously injured in a collision. Always drive with the head restraints inserted when seats are being used and make sure they are properly adjusted.

Height adjustment

To raise a head restraint, pull it up to the desired position.

To lower the head restraint, press the stop-catch release, then push the head restraint down.

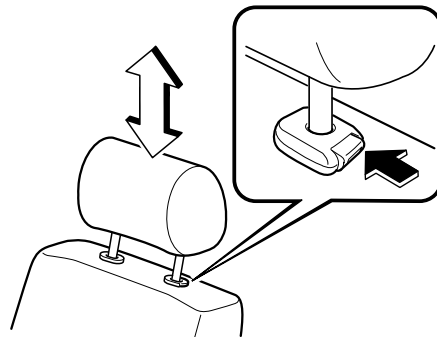

Adjust the head restraint so that the top is even with the top of the passenger's ears, never the passenger's neck.

▼ **Seat Warmer***

The front seats are electrically heated. The ignition switch must be in the ON position.

Press the switch to turn the seat warmer on or off. When the switch is in the ON position, the indicator light will come on.

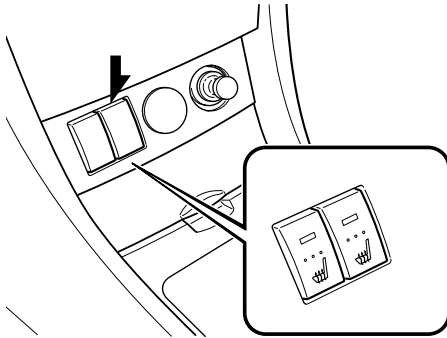

NOTE

The seat temperature is regulated automatically by a thermostat. Other than turning it on or off, it cannot be adjusted.

Rear Seat

⚠ WARNING

Stacking Cargo:

Stacking luggage or other cargo higher than the seatbacks, and placing articles on the rear package tray or on the luggage compartment cover is dangerous. During sudden braking or a collision, objects can fly around and become projectiles that may hit and injure passengers. Don't stack cargo higher than the seatbacks or on the luggage compartment cover.

Not Securing Luggage and Cargo:

Not securing cargo while driving is dangerous as it could move or be crushed during sudden braking or a collision and cause injury. Make sure luggage and cargo is secured before driving.

Securing Seats:

Adjustable seats that are not securely locked are dangerous. In a sudden stop or collision, the seat or seatback could move, causing injury. Make sure the adjustable components of the seat are locked in place.

*Some models.

Essential Safety Equipment

Seats

WARNING

Unlocked Seatback:

The seatback plays an important role in your protection in a vehicle.

Leaving the seatback unlocked is dangerous as it can allow passengers to be ejected or thrown around and baggage to strike occupants in a sudden stop or collision, resulting in severe injury. After returning the seatback at any time, even when there are no other passengers, rock the seatback to make sure it is locked in place.

Passenger on the Folded Seatback:

Driving with a passenger on the folded seatback is dangerous. Allowing a child to sit up on the folded seatback while the vehicle is moving is particularly dangerous. In a sudden stop or even a minor collision, a child not in a proper seat or child-restraint system and seat belt could be thrown forward, back or even out of the vehicle resulting in serious injuries or death. The child in the baggage area could be thrown into other occupants and cause serious injury. Never allow a passenger to sit or stand on the folded seatback while the vehicle is moving.

Children and the Folding Rear Seats:

Playing with the folding rear seats is dangerous. Do not give the car keys to children and do not allow them to play in the vehicle.

NOTE

When returning a rear seat to its original position, also replace the seat belt to its normal position. Verify that the seat belt pulls out and retracts.

▼ Split-Folding Rear Seatback

To fold the seatbacks

CAUTION

When operating the rear seatback knob, make sure you support the seatback with your hand. If the seatback is not supported with your hand, it will flip forward suddenly and could cause injury to the finger that pushes the rear seatback knob down.

1. Unfasten the lap portion of the center-rear seat belt (page 2-16).

CAUTION

Always unfasten the lap portion of the belt before folding the rear-left seatback. Leaving the lap portion of the belt fastened could cause damage to the seat belt, buckle and seatback.

2. Position the outboard seat belts to the side when folding the seatbacks down.
3. Support the seatback with your hand.

Essential Safety Equipment
Seats

4. Push the rear seatback knob down.

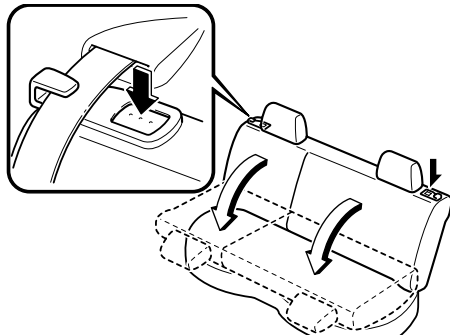

To return the seatbacks to the upright position

1. Position the outboard seat belts to the side.
2. Lift the seatbacks upright.
3. Make sure the seat belts are fully pulled out from under the seatbacks.
4. Pull on the top of the seatbacks from inside the vehicle to make sure they are locked.
5. Fasten the center-rear lap/shoulder belt and check that all seat belts are routed properly for passenger use (page 2-16).

⚠ WARNING

Seat Belts Caught Under Seatbacks:
A seat belt caught under a seatback after the seatback is returned to its upright position is dangerous. In a collision or sudden stop, the seat belt cannot provide adequate protection. Always make sure the seat belts are fully pulled out from under the seatbacks.

Returning Rear Seatbacks to the Upright Position:
A rear seatback not fully returned and locked in the upright position is dangerous. Sudden stops or maneuvering could cause a seatback to flip forward suddenly resulting in injury. If the red indicator is visible on the back of the rear seatback knob, the seatback is not locked in the upright position. When returning the seatback to the upright position, make sure there is no red indication.

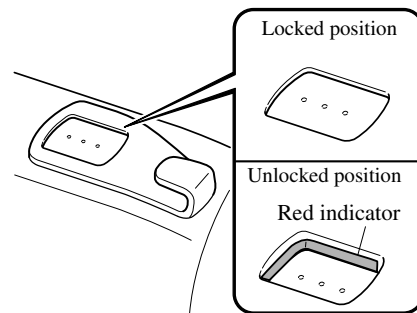

Essential Safety Equipment

Seats

▼ Rear Seatback Lock (4 Door)

To lock or unlock a seatback, move the lever.

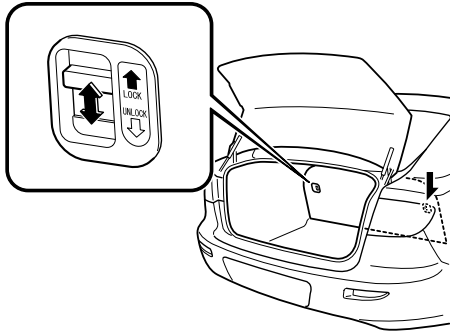

NOTE

The seatback locks are part of the trunk security system (page 3-14).

▼ Head Restraint

WARNING

Head Restraints Adjustment: Driving with the head restraints adjusted too low or removed is dangerous. With no support behind your head, your neck could be seriously injured in a collision. Always drive with the head restraints inserted when seats are being used and make sure they are properly adjusted.

Height adjustment

To raise a head restraint, pull it up to the desired position.

To lower the head restraint, press the stop-catch release, then push the head restraint down.

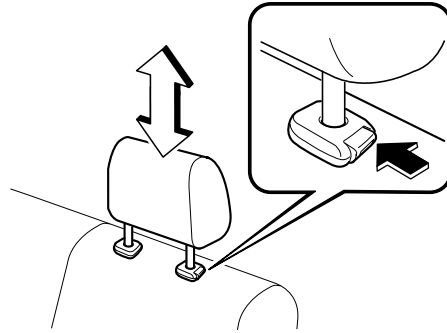

Adjust the head restraint so that the top is even with the top of the passenger's ears, never the passenger's neck.

Removal

To remove the head restraint, press the stop-catch release, then pull up on the head restraint.

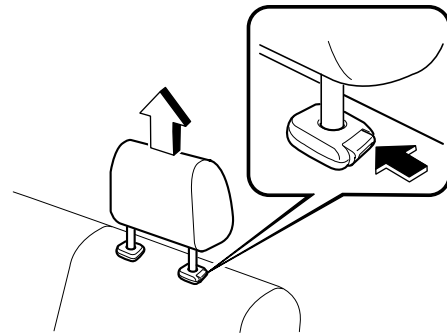

Essential Safety Equipment
Seat Belt Systems

Seat Belt Precautions

Seat belts help to decrease the possibility of severe injury during accidents and sudden stops. Mazda recommends that the driver and all passengers always wear seat belts.

All of the seat belt retractors are designed to keep the lap/shoulder belts out of the way when not in use.

The driver's seat belt has no provisions for child-restraint systems and has only an emergency locking mode. The driver may wear it comfortably, and it will lock during a collision.

However, the front passenger's seat lap/shoulder belt retractors operate in two modes: emergency locking mode, and for child-restraint systems, automatic locking mode. While we recommend you put all children in the rear seats, if you must use the front passenger seat for a child, slide the front passenger seat as far back as possible and make sure any child-restraint system is secured properly.

WARNING

Not Wearing Seat Belts:

Not wearing a seat belt is extremely dangerous. During a collision, occupants not wearing seat belts could hit someone or things inside the vehicle or even be thrown out of the vehicle. They could be seriously injured or even killed. In the same collision, occupants wearing seat belts would be much safer. Always wear your seat belt and make sure all occupants are properly restrained.

Seat Belt Damaged During an Accident:

Using a damaged seat belt is dangerous. An accident could damage the belt webbing of the seat belt in use. A damaged seat belt cannot provide adequate protection in a collision. Front air bags and pretensioners work together, but whether a front seat was occupied or not, if any air bag deployed and whether a seat belt pretensioner deployed or not, all front seat belts and air bags must be inspected and replaced if necessary. Have an Authorized Mazda Dealer inspect all seat belt systems in use during an accident before they are used again.

Twisted Seat Belts:

Twisted seat belts are dangerous. In a collision, the full width of the belt isn't available to absorb the impact. This puts more force on the bones beneath the belt, which could cause serious injury or death. Don't wear twisted seat belts.

Essential Safety Equipment

Seat Belt Systems

WARNING

One Belt, One Passenger:

Using one seat belt for more than one person at a time is dangerous. A seat belt used in this way can't spread the impact forces properly and the two passengers could be crushed together and seriously injured or even killed. Never use one belt for more than one person at a time and always operate the vehicle with each occupant properly restrained.

CAUTION

Belt retraction may become difficult if the belts and rings are soiled, so try to keep them clean.

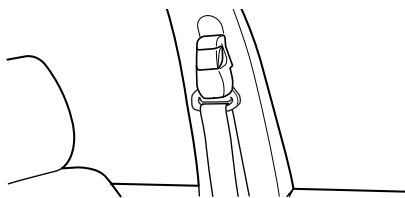

▼ Pregnant Women and Persons with Serious Medical Conditions

Pregnant women should wear seat belts. Ask your doctor for specific recommendations. The lap belt should be worn **SNUGLY AND AS LOW AS POSSIBLE OVER THE HIPS**. The shoulder belt should be worn across your shoulder properly, but never across the stomach area.

Persons with serious medical conditions also should wear seat belts. Check with your doctor for any special instructions regarding specific medical conditions.



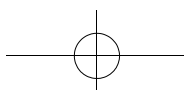

Essential Safety Equipment
Seat Belt Systems

▼ Emergency Locking Mode

In the emergency locking mode, the belt remains comfortable on the occupant and the retractor will lock in position during a collision. When the seat belt is retracted, it will always be in the emergency locking mode until it is switched to automatic locking mode by pulling it all the way out to its full length. If the belt feels tight and hinders comfortable movement while the vehicle is stopped or in motion, it may be in the automatic locking mode because the belt has been pulled too far out. To return to the belt more comfortable emergency locking mode, wait until the vehicle has stopped in a safe, level area, retract the belt fully to convert it back to emergency locking mode and then extend it around you again.

▼ Automatic Locking Mode

Always use the automatic locking mode to keep the child-restraint system from shifting to an unsafe position in the event of an accident. To enable seat belt automatic locking mode, pull it all the way out and connect it as instructed on the child-restraint system. It will retract down to the child-restraint system and stay locked on it. See the section on child restraint (page 2-21).

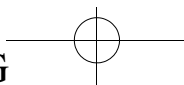
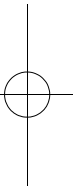
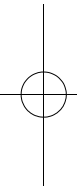

Essential Safety Equipment

Seat Belt Systems

Seat Belt (Except Center-Rear Position)

NOTE

When using the center-rear seat belt, refer to “Center-Rear Position Seat Belt” (page 2-16).

▼ Fastening the Seat Belts

1. Grasp the tongue.
2. Slowly pull out the lap/shoulder belt.

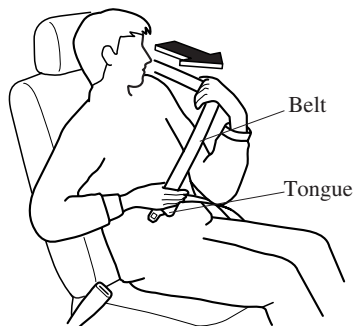

3. Insert the tongue into the buckle until you hear a click.

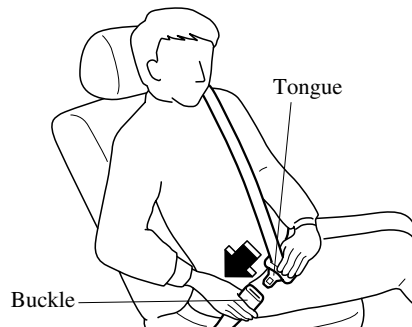

WARNING

Positioning the Shoulder Portion of the Seat Belt:

Improper positioning of the shoulder portion of the seat belt is dangerous. Always make sure the shoulder portion of the seat belt is positioned across your shoulder and near your neck, but never under your arm, on your neck, or on your upper arm.

4. Make sure the shoulder belt is snugly fitted against your body.

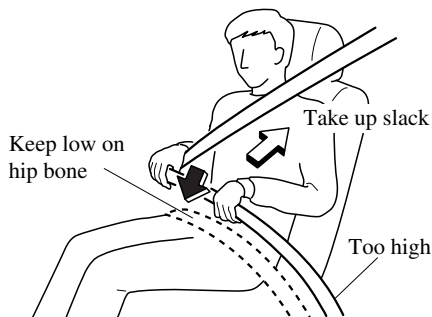

WARNING

Positioning the Lap Portion of the Seat Belt:

The lap portion of the seat belt worn too high is dangerous. In a collision, this would concentrate the impact force directly on the abdominal area, causing serious injury. Wear the lap portion of the belt snugly and as low as possible.

Essential Safety Equipment
Seat Belt Systems

▼ **Unfastening the Seat Belts**

Depress the button on the buckle.

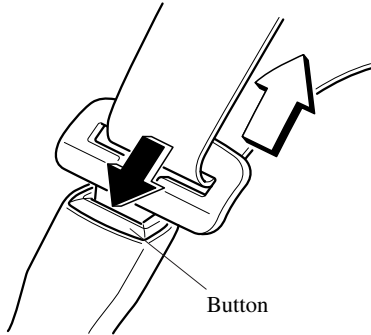

NOTE

If a belt does not fully retract, inspect it for kinks and twists. If it is still not retracting properly, have it inspected at an Authorized Mazda Dealer.

▼ **Shoulder Belt Adjuster**

Adjust the height of the shoulder belt if the seat belt touches your neck, or if it crosses your arm instead of your shoulder. To raise the shoulder belt adjuster, push the adjuster up. To lower the shoulder belt adjuster, pull the adjuster and slide it down. Make sure the adjuster is locked.

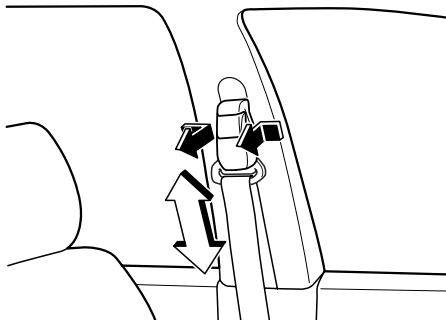

! WARNING

Positioning the Shoulder Portion of the Seat Belt:

Improper positioning of the shoulder portion of the seat belt is dangerous. Always make sure the shoulder portion of the seat belt is positioned across your shoulder and near your neck, but never under your arm, on your neck, or on your upper arm.

Essential Safety Equipment

Seat Belt Systems

Front Seat Belt Pretensioner and Load Limiting Systems

For optimum protection, the driver and front passenger seat belts are equipped with pretensioner and load limiting systems.

In moderate or greater frontal or near-frontal accidents, the front air bag and pretensioner systems deploy simultaneously. The pretensioners take up slack in the front seat belts as the air bags are expanding. The seat belt pretensioner system cannot provide adequate protection in an accident if the seat belt is not fastened properly. The load limiting system releases belt webbing in a controlled manner to reduce belt force on the occupant's chest.

WARNING

Incorrect Positioning of the Driver and Front Passenger Seat Belts:
Incorrect positioning of the driver and passenger seat belts is dangerous. Without proper positioning, the pretensioner and load limiting systems cannot provide adequate protection in an accident and this could result in serious injury. Wear seat belts only as recommended in this owner's manual (page 2-12).

WARNING

Expended Seat Belt Pretensioners:
One or both front air bags may deploy, and the corresponding pretensioner(s) will also deploy at the same time. Use of front seat belts with the pretensioner system expended is dangerous. Like the air bags, the seat belt pretensioners will only function once. After they are expended, they will not function again and must be replaced immediately. If the seat belt pretensioners are not replaced, the risk of injury in a collision will increase. Always have an Authorized Mazda Dealer inspect the seat belt pretensioners and air bags after any collision. Expended seat belt pretensioners and air bags must be replaced after any collision which caused them to deploy. Additionally, the load limiter will only limit loads on the chest once in a collision and is another reason to have the front seat belts inspected.

Modification or Testing of the Pretensioner System:
Modifying the components or wiring of the pretensioner system, including the use of electronic testing devices is dangerous. You could accidentally activate it or make it inoperable which would prevent it from activating in an accident. The occupants or repairers could be seriously injured. Never modify the components or wiring, or use electronic testing devices on the pretensioner system.

Essential Safety Equipment
Seat Belt Systems

 **WARNING**

Pretensioner System Disposal:
Improper disposal of the pretensioner system or a vehicle with non-deactivated pretensioners is dangerous. Unless all safety procedures are followed, injury could result. Ask an Authorized Mazda Dealer how to safely dispose of the pretensioner system or how to scrap a pretensioner-equipped vehicle.

NOTE

- The pretensioner system will only activate in a moderate or greater frontal or near-frontal collision. It will not activate in most rollovers, side or rear impacts.
- Some smoke (non-toxic gas) will be released when the air bags and pretensioners deploy. This does not indicate a fire. This gas normally has no effect on occupants, however, those with sensitive skin may experience light skin irritation. If residue from the deployment of the air bags or the front pretensioner system gets on the skin or in the eyes, wash it off as soon as possible.

▼ **Air Bag/Front Seat Belt Pretensioner System Warning Light**



If the air bag/front seat belt pretensioner system is normal, the warning light illuminates when the ignition switch is turned to the ON position or after the engine is cranked. After about 6 seconds it goes out.

A system malfunction is indicated when the warning light constantly illuminates or doesn't illuminate at all when the ignition switch is turned to the ON position. If any of these occur, consult an Authorized Mazda Dealer as soon as possible. The system may not work in an accident.

 **WARNING**

Self-Servicing the Air Bag/Pretensioner Systems:
Self-servicing or tampering with the systems is dangerous. An air bag/pretensioner could accidentally activate or become disabled. This could cause serious injuries. Never tamper with the systems and always have an Authorized Mazda Dealer perform all servicing and repairs.

Essential Safety Equipment

Seat Belt Systems

▼ Air Bag/Front Seat Belt Pretensioner System Warning Beep

If a malfunction is detected in the air bag/front seat belt pretensioner systems and the warning light, a warning beep sound will be heard for about 5 seconds every minute.

The air bag and seat belt pretensioner system warning beep sound will continue to be heard for approximately 35 minutes. Have your vehicle inspected at an Authorized Mazda Dealer as soon as possible.

WARNING

Air Bag/Front Seat Belt Pretensioner System Warning Beep:

Driving the vehicle with the air bag/front seat belt pretensioner system warning beep sounding is dangerous.

In a collision, the air bags and the front seat belt pretensioner system will not deploy and this could result in death or serious injury.

Do not drive the vehicle with the air bag/front seat belt pretensioner system warning beep sounding. Contact an Authorized Mazda Dealer to have the vehicle inspected as soon as possible.

Center-Rear Position Seat Belt (3-Point Type)

Before using the center-rear lap/shoulder belt make sure tongue (A) and anchor buckle (B) are fastened.

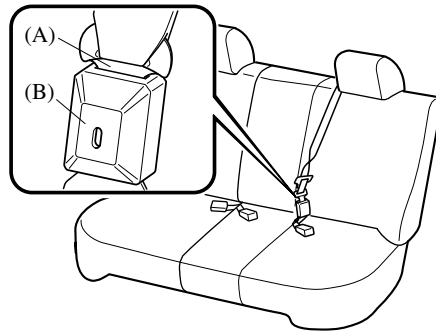

▼ Fastening the Seat Belt

1. Grasp the tongue (C).
2. Slowly pull out the lap/shoulder belt.
3. Insert the tongue (C) into the buckle (D) until you hear a click.

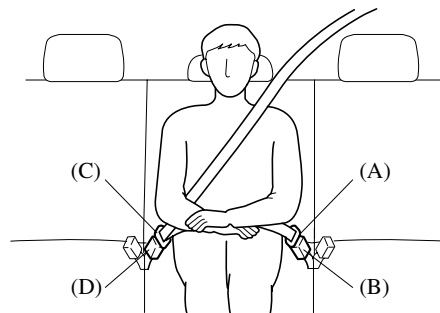

Essential Safety Equipment Seat Belt Systems

! WARNING

Fastening the Center-Rear Seat Belt with Only One Buckle:

Fastening the center-rear seat belt with only one buckle is dangerous. If only one pair of seat belt tongue and buckle, either tongue (A) and anchor buckle (B) or tongue (C) and anchor buckle (D), is fastened, the seat belt cannot provide full protection. In a sudden stop or collision, the user could slide under the belt and suffer serious injuries. Always make sure that both pairs of seat belt tongues and buckles are fastened properly.

Positioning the Shoulder Portion of the Seat Belt:

Improper positioning of the shoulder portion of the seat belt is dangerous. Always make sure the shoulder portion of the seat belt is positioned across your shoulder and near your neck, but never under your arm, on your neck, or on your upper arm.

4. Make sure the shoulder belt is snugly fitted against your body.

! WARNING

Positioning the Lap Portion of the Seat Belt:

The lap portion of the seat belt worn too high is dangerous. In a collision, this would concentrate the impact force directly on the abdominal area, causing serious injury. Wear the lap portion of the belt snugly and as low as possible.

▼ Unfastening the Seat Belt

Depress the button on the buckle.

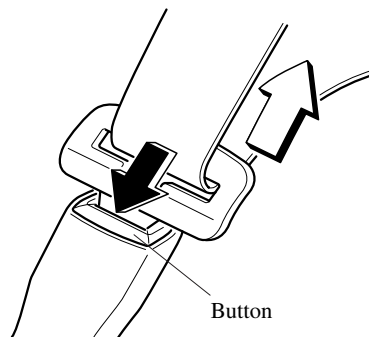

▼ Unfastening the Lap Portion of the Seat Belt

Insert a small object such as a key in the anchor buckle (B) slot.

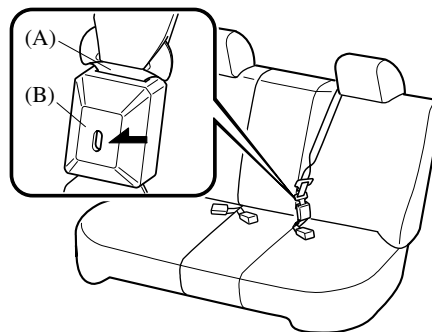

! CAUTION

Always unfasten the lap portion of the belt before folding the left-rear seatback. Leaving the lap portion of the belt fastened could cause damage to the seat belt, buckle and seatback.

Essential Safety Equipment

Seat Belt Systems

NOTE

To encourage rear seat passengers to wear their seat belts, we suggest leaving the center-rear lap position of the belt fastened at all times except when folding the rear seat forward.

▼ Fastening the Lap Portion of the Seat Belt

Grasp tongue (A) and insert it into the anchor buckle (B) until you hear a click. It is now secure for passenger use.

NOTE

After returning the left-rear seatback to its upright position, fasten the lap portion of the belt.

Seat Belt Extender

If your seat belt is not long enough, even when fully extended, a seat belt extender may be available to you at no charge from your Authorized Mazda Dealer.

This extender will be only for you and for the particular vehicle and seat. Even if it plugs into other seat belts, it may not hold in the critical moment of a crash.

When ordering an extender, only order one that provides the necessary additional length to fasten the seat belt properly. Please contact your Authorized Mazda Dealer for more information.

WARNING

Unnecessary Use of an Extender:
Using a seat belt extender when not necessary is dangerous. The seat belt will be too long and not fit properly. In an accident, the seat belt will not provide adequate protection and you could be seriously injured. Only use the extender when it is required to fasten the seat belt properly.

Using an Improper Extender:
Using a seat belt extender that is for another person or a different vehicle or seat is dangerous. The seat belt will not provide adequate protection and the user could be seriously injured in an accident. Only use the extender provided for you and for the particular vehicle and seat. NEVER use the extender in a different vehicle or seat.

Essential Safety Equipment
Seat Belt Systems

! WARNING

Using an Extender That is Too Long:
Using an extender that is too long is dangerous. The seat belt will not fit properly. In an accident, the seat belt will not provide adequate protection and you could be seriously injured. Don't use the extender or choose one shorter in length if the distance between the extender's buckle and the center of the user's body is less than 15cm (6 in).

NOTE

When not in use, remove the seat belt extender and store it in the vehicle. If the seat belt extender is left connected, the seat belt extender might get damaged as it will not retract with the rest of the seat belt and can easily fall out of the door when not in use and be damaged the seat belt warning light will not illuminate and function properly.

Seat Belt Warning Light/Beep



The seat belt warning light illuminates and a beep sound will be heard if the driver's seat belt is not fastened when the ignition switch is turned to the ON position.

Conditions of operation

Condition	Result
The driver's seat belt is not fastened when the ignition switch is turned to the ON position.	The warning light illuminates for about 1 minute and a beep sound will be heard for about 6 seconds.
The driver's seat belt is fastened while the warning light and the beep sound are activated.	The warning light turns off and the beep sound stops.
The driver's seat belt is fastened before the ignition switch is turned to the ON position.	The warning light will not illuminate and the beep sound will not be heard.

Essential Safety Equipment

Seat Belt Systems

▼ Belt Minder

The belt minder is a supplemental warning to the seat belt warning function. This feature provides additional reminders to the driver that the driver's seat belt is not fastened by intermittently sounding a beep sound and flashing the seat belt warning light in the instrument cluster.

Condition	Result
The driver's seat belt is not fastened when the vehicle speed reaches 8 km/h (5 mph) and about 1 minute has elapsed since the ignition switch was turned to the ON position.	The warning light flashes and the beep sound will be heard for about 6 seconds every 30 seconds, for a period of about 5 minutes.
The driver's seat belt is fastened while the warning light and the beep sound are activated.	The warning light turns off and the beep sound stops.
The driver's seat belt is fastened before the ignition switch is turned to the ON position.	The warning light will not illuminate and the beep sound will not be heard.

NOTE

The belt minder can be deactivated by the following methods.

- **(Temporary deactivation)**
To temporarily deactivate the belt minder, turn the ignition switch to the ON position, fasten the driver's seat belt for about 2 seconds or longer, and then unfasten it within 20 seconds. The belt minder will be deactivated until the ignition switch is turned to the ON position again.
- **(Long-term deactivation)**
To deactivate the belt minder over the long term, consult an Authorized Mazda Dealer. If the belt minder is long-term deactivated, the belt minder will not activate until it is restored at the Authorized Mazda Dealer.

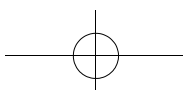

Essential Safety Equipment
Child Restraint

Child Restraint Precautions

Mazda strongly urges the use of child-restraint systems for children small enough to use them.

You are required by law to use a child-restraint system for children in the U.S. and Canada. Check your local and state or provincial laws for specific requirements regarding the safety of children riding in your vehicle.

Whatever child-restraint system you consider, please pick the appropriate one for the age and size of the child, obey the law and follow the instructions that come with the individual child-restraint system.

A child who has outgrown child-restraint systems should sit in the rear and use seat belts, both lap and shoulder. If the shoulder belt crosses the neck or face, move the child closer to the center of the vehicle in the outboard seats, and towards the buckle on the right if the child is seated on the center seat.

Statistics confirm that the rear seat is the best place for all children up to 12 years of age, and more so with a supplemental restraint system (air bags).

A rear-facing child-restraint system should **NEVER** be used on the front seat with the air bag system activated. The front passenger's seat is also the least preferred seat for other child-restraint systems.

To reduce the chance of injuries caused by deployment of the front passenger air bag, the front passenger seat weight sensors work as a part of the supplemental restraint system. This system deactivates the front passenger front and side air bags and also the front passenger seat belt pretensioner system when the total seated weight on the front passenger seat is less than approximately 30 kg (66 lb).

When an infant or small child sits on the front passenger seat, the system shuts off the front passenger front and side air bags and seat belt pretensioner system, so make sure the front passenger air bag deactivation indicator light illuminates.

Even if the front passenger air bag is shut off, Mazda strongly recommends that children be properly restrained and child-restraint systems of all kinds are properly secured on the rear seats which are the best place for children.

For more details, refer to "Front passenger seat weight sensors (page 2-45)".

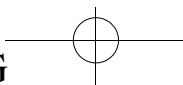

Essential Safety Equipment

Child Restraint

WARNING

Proper Size of Child-Restraint System:

For effective protection in vehicle accidents and sudden stops, a child must be properly restrained using a seat belt or child-restraint system depending on age and size. If not, the child could be seriously injured or even killed in an accident.

Follow the Manufacturer's Instructions and Always Keep the Child-Restraint System Buckled Down:

An unsecured child-restraint system is dangerous. In a sudden stop or a collision it could move causing serious injury or death to the child or other occupants. Make sure any child-restraint system is properly secured in place according to the child-restraint system manufacturer's instructions. When not in use, remove it from the vehicle or fasten it with a seat belt, or latch it down to BOTH LATCH lower anchors for LATCH child-restraint systems and the corresponding tether anchor.

Holding a Child While the Vehicle is Moving:

Holding a child in your arms while the vehicle is moving is extremely dangerous. No matter how strong the person may be, he or she cannot hold onto a child in a sudden stop or collision and it could result in serious injury or death to the child or other occupants. Even in a moderate accident, the child may be exposed to air bag forces that could result in serious injury or death to the child, or the child may be slammed into the adult, injuring the adult. Always secure a child in a proper child-restraint system.

Rear-Facing Child-Restraint System:

Rear-facing child-restraint systems on the front seat are particularly dangerous. The child-restraint system can be hit by a deploying air bag and moved violently backward resulting in serious injury or death to the child. Even though you may feel assured that a front passenger air bag will not deploy based on the fact that the front passenger air bag deactivation indicator light illuminates, NEVER use a rear-facing child-restraint system in the front seat with an air bag that could deploy even in a moderate collision.

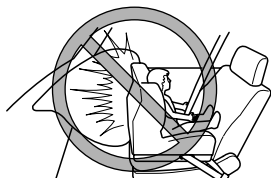

Essential Safety Equipment
Child Restraint

 **WARNING**

Seating Children in a Child-Restraint System on the Front Passenger Seat:

If your vehicle is equipped with front passenger seat weight sensors, the vehicle is also equipped with an air bag deactivation indicator light (page 2-30). Even with the front passenger seat weight sensors, if you must use the front passenger seat for children, seating a child in a child-restraint system on the front passenger seat under the following conditions increases the danger of the front passenger air bag deploying and could result in serious injury or death to the child.

- ***The total seated weight of the child with the child-restraint system on the front passenger seat is approximately 30 kg (66 lb) or more with a child in the child-restraint system.***
- ***Luggage or other items are placed on the seat with the child in the child-restraint system.***
- ***A rear passenger or luggage push or pull down on the front passenger seatback.***
- ***A rear passenger puts their feet on the front seat rails.***
- ***Luggage or other items are placed on the seatback or hung on the head restraint.***
- ***The seat is washed.***
- ***Liquids are spilled on the seat.***
- ***The front passenger seat is moved backward, pushing into luggage or other items placed behind it.***
- ***The front passenger seatback contacts the rear seat.***
- ***Luggage or other items are placed between the front passenger seat and driver seat.***
- ***Any accessories which might increase the total seated weight on the front passenger seat are attached to the front passenger seat.***

The designated positions with seat belts on the rear seats are the safest places for children. Always use seat belts and child restraints.

Children and Seating Position with Side and Curtain Air Bags:

Allowing anyone to lean over or against the side window, the area of the front passenger seat, front and rear window pillars and the roof edge along both sides from which the side and curtain air bags deploy, even if a child-restraint system is used, is dangerous. If the vehicle is equipped with side and curtain air bags, the impact of inflation could cause serious injury or death to the child. Furthermore, leaning over or against the front door could block the side and curtain air bags and eliminate the advantages of supplemental protection. With the front air bag and the additional side air bag that comes out of the front seat, the rear seat is always a better location for children. Do not allow a child to lean over or against the side window, even if the child is seated in a child-restraint system.

Essential Safety Equipment

Child Restraint

WARNING

One Belt, One Passenger:

Using one seat belt for more than one person at a time is dangerous. A seat belt used in this way can't spread the impact forces properly and the two passengers could be crushed together and seriously injured or even killed. Never use one belt for more than one person at a time and always operate the vehicle with each occupant properly restrained.

CAUTION

A seat belt or child-restraint system can become very hot in a closed vehicle during warm weather. To avoid burning yourself or a child, check them before you or your child touches them.

NOTE

Your Mazda is equipped with LATCH lower anchors for attachment of specially designed LATCH child-restraint systems in the rear seat. When using these anchors to secure a child-restraint system, refer to "LATCH Child-Restraint Systems" (page 2-33).

Essential Safety Equipment
Child Restraint

Installing Child-Restraint Systems

Accident statistics reveal that a child is safer in the rear seat. The front passenger's seat is clearly the worst choice for any child under 12, and with rear-facing child-restraint systems it is clearly unsafe due to air bags.

Some child-restraint systems now come with tethers and therefore must be installed on the seats that take tethers to be effective. In your Mazda, tethered child-restraint systems can only be accommodated in the three positions on the rear seat.

Even if your vehicle is equipped with the front passenger air bag cut-off system (page 2-45), which automatically deactivates the front passenger air bag, a rear seat is the safest place for a child of any age or size.

Some child-restraint systems also employ specially designed LATCH attachments; refer to "LATCH Child-Restraint Systems" (page 2-33).

WARNING

Tethered Child-Restraint Systems Work Only on Tether-Equipped Rear Seats:

Installation of a tether equipped child-restraint system in the front passenger's seat defeats the safety design of the system and will result in an increased chance of serious injury if the child-restraint system goes forward without benefit of being tethered.

Place tether equipped child-restraint systems where there are tether anchors.

▼ Rear Seat Child-Restraint System Installation

Follow these instructions when using a child-restraint system, unless you are attaching a LATCH-equipped child-restraint system to the rear LATCH lower anchors. Refer to "LATCH Child-Restraint Systems" (page 2-33).

NOTE

Follow the child-restraint system manufacturer's instructions carefully. If you are not sure whether you have a LATCH system or tether, check in the child-restraint system manufacturer's instructions and follow them accordingly. Depending on the type of child-restraint system, it may not employ seat belts which are in automatic locking mode.

Essential Safety Equipment

Child Restraint

1. Make sure the seatback is securely latched by pushing it back until it is fully locked.
2. Secure the child-restraint system with the lap portion of the lap/shoulder belt. See the manufacturer's instructions on the child-restraint system for belt routing instructions.
3. To get the retractor into the automatic locking mode, pull the shoulder belt portion of the seat belt until the entire length of the belt is out of the retractor.

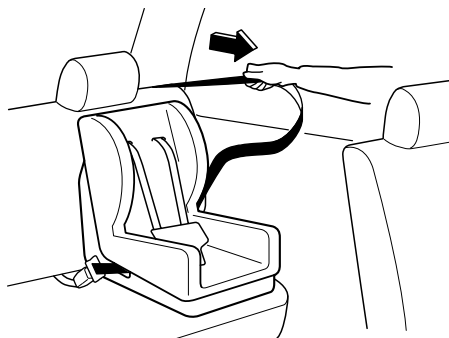

4. Push the child-restraint system firmly into the vehicle seat. Be sure the belt retracts as snugly as possible. Clicking from the retractor will be heard during retraction if the system is in the automatic locking mode. If the belt does not lock the seat down tight, repeat this step.

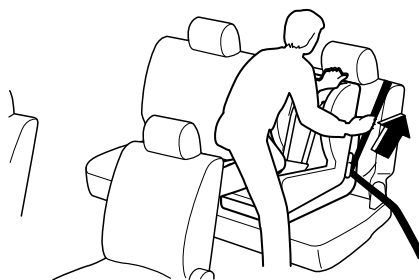

NOTE

Inspect this function before each use of the child-restraint system. You should not be able to pull the shoulder belt out of the retractor while the system is in the automatic locking mode. When you remove the child-restraint system, be sure the belt fully retracts to return the system to emergency locking mode before occupants use the seat belts.

5. If your child-restraint system requires the use of a tether strap, hook and tighten the tether strap after raising the head restraint (except center position) by following the manufacturer's instructions.

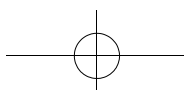

Essential Safety Equipment
Child Restraint

Anchor bracket location (4 Door)

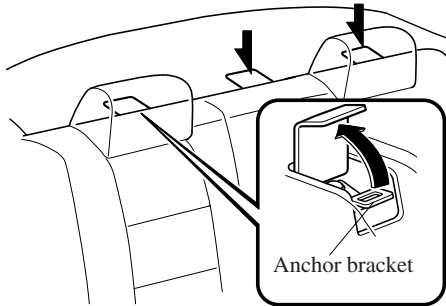

Tether strap position (5 Door outboard position)

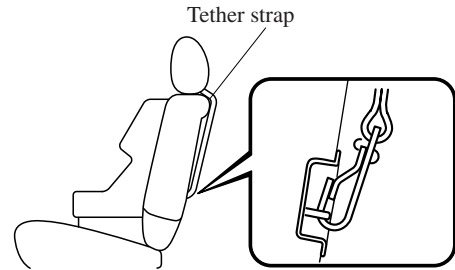

Tether strap position (4 Door)

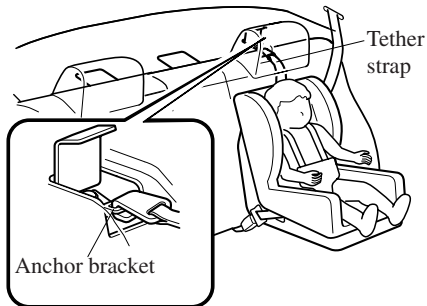

Anchor bracket location (5 Door center position)

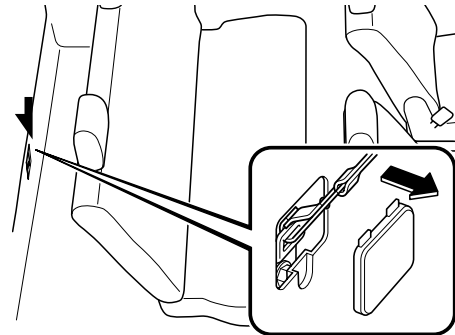

Anchor bracket location (5 Door outboard position)

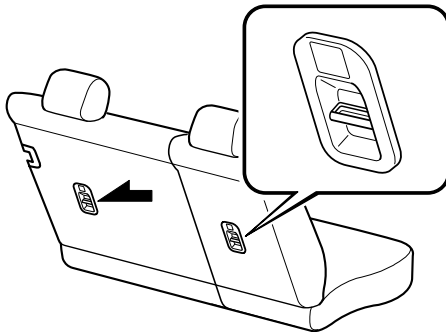

Tether strap position (5 Door center position)

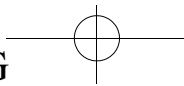
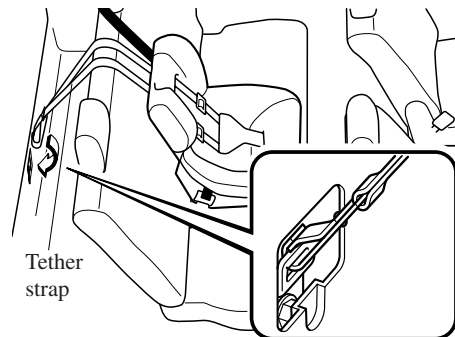

Essential Safety Equipment

Child Restraint

WARNING

Child-Restraint Tether Usage:
Using the tether or tether anchor to secure anything but a child-restraint system is dangerous. This could weaken or damage the tether or tether anchor and result in injury. Use the tether and tether anchor only for a child-restraint system.

Incorrect Attachment of the Tether Strap (Except center position):
Routing the tether strap on top of the head restraint is dangerous. In a collision, the tether strap could slide off the head restraint, and loosen the child-restraint system. The child-restraint system could move which may result in death or injury to the child. Always route the tether strap between the head restraint posts.

▼ **If You Must Use the Front Seat for Children**

If you cannot put all children in the rear seat, at least put the smallest children in the rear and be sure the largest child up front uses the shoulder belt over the shoulder.

NEVER put a rear-facing child-restraint system on the front passenger seat, even with a seat weight sensor equipped vehicle.

This seat is also not set up for tethered child-restraint systems, put them in one of the rear seat positions set up with tether anchors.

Likewise the LATCH child-restraint system cannot be secured in the front passenger's seat and should be used in the rear seat.

Don't allow anyone to sleep against the side window if you have an optional side and curtain air bag, it could cause serious injuries to an out of position occupant. As children more often sleep in cars, it is better to put them in the rear seat. If installing the child-restraint system on the front seat is unavoidable, follow these instructions when using a front-facing child-restraint system in the front passenger's seat.

Essential Safety Equipment
Child Restraint

NOTE

- To check if your front seats have side air bags:
Every Mazda side air bag will have a “SRS AIRBAG” tag on the outboard shoulder of the front seats.
- To check if your vehicle has curtain air bags:
Every Mazda curtain air bag will have an “SRS AIRBAG” marking on the front and rear window pillars along the roof edge.

 **WARNING**

Front Passenger's Seat Position:
As your vehicle has front air bags and doubly so if your vehicle has side air bags, a front-facing child-restraint system should be put on the front seat only when it is unavoidable. Even if the front passenger air bag deactivation indicator light illuminates, always move the seat as far back as possible, because the force of a deploying air bag could cause serious injury or death to the child.

 **WARNING**

Rear-Facing Child-Restraint System:
Rear-facing child-restraint systems on the front seat are particularly dangerous. The child-restraint system can be hit by a deploying air bag and moved violently backward resulting in serious injury or death to the child. Even though you may feel assured that the front passenger air bag will not deploy based on the fact that the front passenger air bag deactivation indicator light illuminates, NEVER use a rear-facing child-restraint system in the front seat with an air bag that could deploy even in a moderate collision.

Essential Safety Equipment

Child Restraint

WARNING

Children and Seating Position with Side and Curtain Air Bags:

Allowing anyone to lean over or against the side window, the area of the front passenger seat, front and rear window pillars and the roof edge along both sides from which the side and curtain air bags deploy, even if a child-restraint system is used, is dangerous. If the vehicle is equipped with side and curtain air bags, the impact of inflation could cause serious injury or death to the child.

Furthermore, leaning over or against the front door could block the side and curtain air bags and eliminate the advantages of supplemental protection. With the front air bag and the additional side air bag that comes out of the front seat, the rear seat is always a better location for children. Do not allow a child to lean over or against the side window, even if the child is seated in a child-restraint system.

▼ **Front Passenger's Seat Child-Restraint System Installation**

1. Slide the seat as far back as possible.

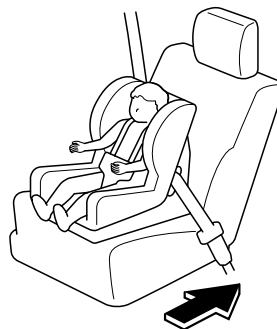

2. Secure the child-restraint system with the lap portion of the lap/shoulder belt. See the manufacturer's instructions on the child-restraint system for belt routing instructions.
3. To get the retractor into the automatic locking mode, pull the shoulder belt portion of the seat belt until the entire length of the belt is out of the retractor.
4. Push the child-restraint system firmly into the vehicle seat. Be sure the belt retracts as snugly as possible. Clicking from the retractor will be heard during retraction if the system is in automatic locking mode. If the belt does not lock the seat down tight, repeat the previous step and also this one.

Essential Safety Equipment
Child Restraint

NOTE

- Inspect this function before each use of the child-restraint system. You should not be able to pull the shoulder belt out of the retractor while the system is in the automatic locking mode. When you remove the child-restraint system, be sure the belt fully retracts to return the system to emergency locking mode before occupants use the seat belts.
- Follow the child-restraint system manufacturer's instructions carefully. Depending on the type of child-restraint system, it may not employ seat belts which are in automatic locking mode.

5. Make sure the front passenger air bag deactivation indicator light illuminates after installing a child-restraint system on the front passenger seat. Refer to Front passenger air bag deactivation indicator light on page 2-45.

With seat warmer

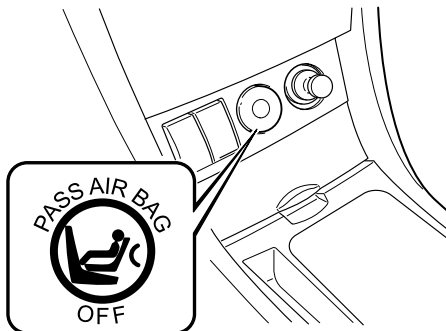

Without seat warmer

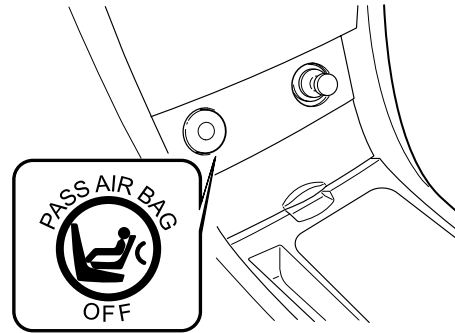

Essential Safety Equipment

Child Restraint

WARNING

Seating a Child in a Child-Restraint System on the Front Passenger Seat With the Front Passenger Air Bag Deactivation Indicator Light Not Illuminated:

Seating a child in a child-restraint system installed on the front passenger seat with the front passenger air bag deactivation indicator light not illuminated is dangerous. If this indicator light does not illuminate even when the total seated weight is less than approximately 30 kg (66 lb), this means that the front passenger front and side air bags, and seat belt pretensioner are ready for deployment. If an accident were to deploy an air bag, a child sitting in the front passenger seat could be seriously injured or killed. If the indicator light does not illuminate after installing a child-restraint system on the front passenger seat, install the child-restraint system on the rear seat and consult an Authorized Mazda Dealer as soon as possible. While it is always better to install any child-restraint system on the rear seat, it is essential to do so if the front passenger air bag deactivation indicator light does not illuminate (page 2-45).

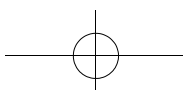

Essential Safety Equipment
Child Restraint

LATCH Child-Restraint Systems

Your Mazda is equipped with LATCH lower anchors for attachment of specially designed LATCH child-restraint systems in the rear seat. Both anchors must be used, otherwise the seat will bounce around and put the child in danger. Most LATCH child-restraint systems must also be used in conjunction with a tether to be effective. If they have a tether you must use it to better assure your child's safety.

WARNING

Manufacturer's Instructions for Child-Restraint System:

An unsecured child-restraint system is dangerous. In a sudden stop or a collision it could move causing serious injury or death to the child or other occupants. Make sure the child-restraint system is properly secured in place according to the child-restraint system manufacturer's instructions.

Attaching Two Child-Restraint Systems to the Same LATCH Lower Anchor:

Attaching two child-restraint systems to the same LATCH lower anchor is dangerous. In a collision, one anchor may not be strong enough to hold two child-restraint system attachments and may break, causing serious injury or death. If you use the seat position for another child-restraint system when an outboard LATCH position is occupied, use the center seat belts instead, and the tether if tether-equipped.

Unsecured Child-Restraint System:

An unsecured child-restraint system is dangerous. In a sudden stop or a collision it could move causing serious injury or death to the child or other occupants. Follow the child-restraint system manufacturer's instructions on belt routing to secure the seat just as you would with a child in it so that nobody is tempted to put a child in an improperly secured seat later on. When not in use, remove it from the vehicle or fasten it with a seat belt, or latch it down to BOTH LATCH lower anchors for LATCH child-restraint systems.

LATCH Child-Restraint Systems:

Not following the child-restraint system manufacturer's instructions when installing the child-restraint system is dangerous. If seat belts or a foreign object prevent the child-restraint system from being securely attached to the LATCH lower anchors and the child-restraint system is installed improperly, the child-restraint system could move in a sudden stop or collision causing serious injury or death to the child or other occupants. When installing the child-restraint system, make sure there are no seat belts or foreign objects near or around the LATCH lower anchors. Always follow the child-restraint system manufacturer's instructions.

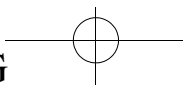

Essential Safety Equipment

Child Restraint

▼ Child-Restraint System Installation Procedure (Rear Outboard Seats)

1. Make sure the seatback is securely latched by pushing it back until it is fully locked.
2. Expand the area between the seat bottom and the seatback slightly to verify the locations of the LATCH lower anchors.

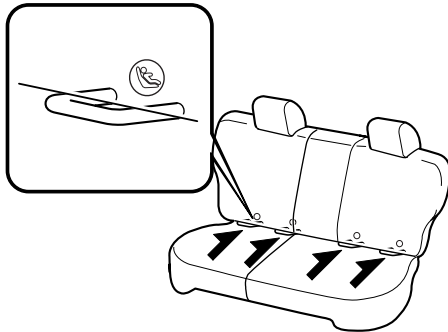

NOTE

The markings above the LATCH lower anchors indicate the locations of LATCH lower anchors for the attachment of a child-restraint system.

3. Secure the child-restraint system using BOTH LATCH lower anchors, following the child-restraint system manufacturer's instruction.
4. If your child-restraint system came equipped with a tether, that probably means it is very important to properly secure the tether for child safety, please carefully follow the child-restraint system manufacturer's instructions when installing tethers.

Anchor bracket location (4 Door)

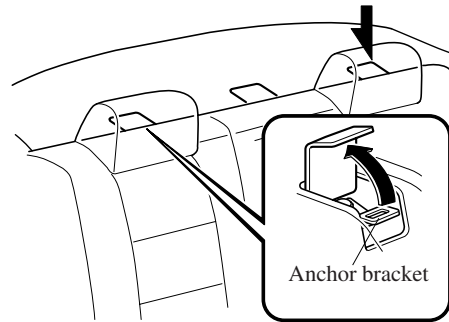

Tether strap position (4 Door)

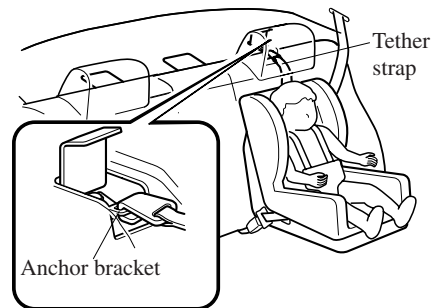

Anchor bracket location (5 Door)

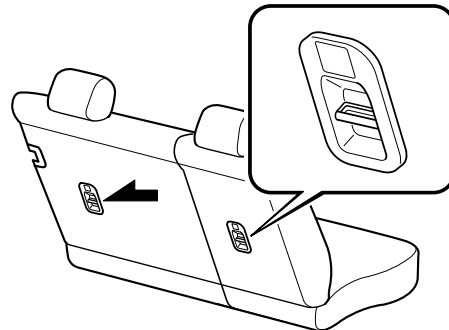

Essential Safety Equipment
Child Restraint

Tether strap position (5 Door)

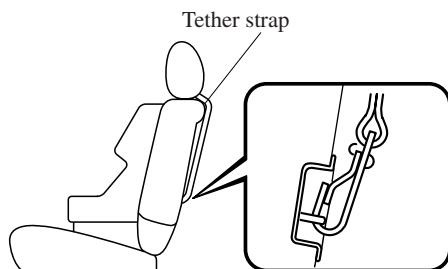

! WARNING

Child-Restraint Tether Usage:

Using the tether or tether anchor to secure anything but a child-restraint system is dangerous. This could weaken or damage the tether or tether anchor and result in injury. Use the tether and tether anchor only for a child-restraint system.

Incorrect Attachment of the Tether Strap:

Routing the tether strap on top of the head restraint is dangerous. In a collision, the tether strap could slide off the head restraint, and loosen the child-restraint system. The child-restraint system could move which may result in death or injury to the child. Always route the tether strap between the head restraint posts.

▼ Child-Restraint System Installation Procedure (Rear Center Seat)

The LATCH lower anchors at the center of the rear seat are much further apart than the sets of LATCH lower anchors for child-restraint system installation at other seating positions. Child-restraint systems with rigid LATCH attachments cannot be installed on the center seating position. Some LATCH equipped child-restraint systems can be placed in the center position and will reach the nearest LATCH lower anchors which are 400 mm (15.75 in) apart. LATCH compatible child-restraint systems (with attachments on belt webbing) can be used at this seating position only if the child-restraint system manufacturer's instructions state that the child-restraint system can be installed to LATCH lower anchors that are 400 mm (15.75 in) apart. Do not attach two child-restraint systems to the same LATCH lower anchor. If your child-restraint system has a tether, it must also be used for your child's optimum safety.

1. Make sure the seatback is securely latched by pushing it back until it is fully locked.

Essential Safety Equipment

Child Restraint

- Expand the area between the seat bottom and the seatback slightly to verify the locations of the LATCH lower anchors.

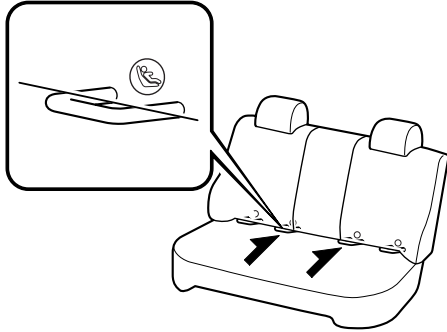

NOTE

The markings above the LATCH lower anchors indicate the locations of LATCH lower anchors for the attachment of a child-restraint system.

- Secure the child-restraint system using BOTH LATCH lower anchors, following the child-restraint system manufacturer's instructions.
- If your child-restraint system came equipped with a tether, that probably means it is very important to properly secure the tether for child safety, please carefully follow the child-restraint system manufacturer's instructions when installing tethers.

Anchor bracket location (4 Door)

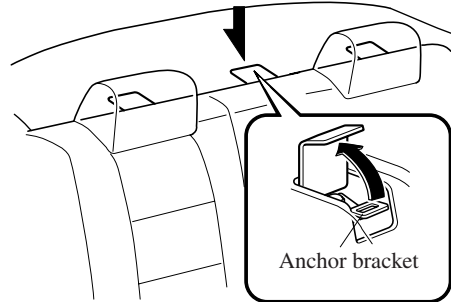

Tether strap position (4 Door)

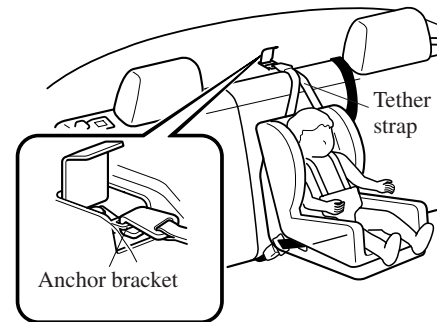

Anchor bracket location (5 Door)

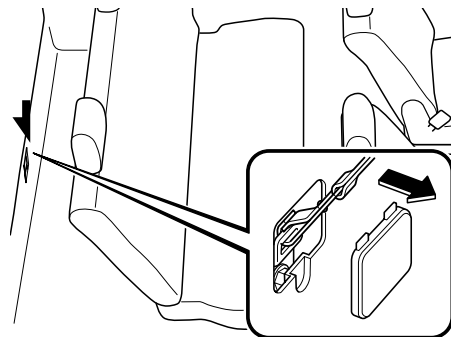

Essential Safety Equipment
Child Restraint

Tether strap position (5 Door)

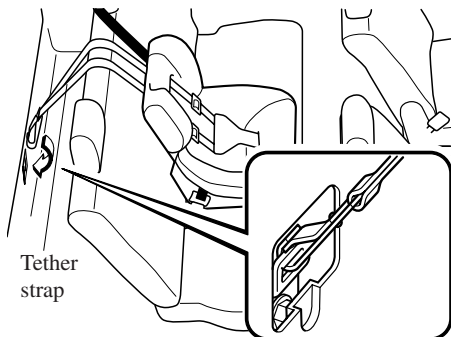

! WARNING

Child-Restraint Tether Usage:
Using the tether or tether anchor to secure anything but a child-restraint system is dangerous. This could weaken or damage the tether or tether anchor and result in injury. Use the tether and tether anchor only for a child-restraint system.

Essential Safety Equipment

SRS Air Bags

Supplemental Restraint Systems (SRS) Precautions

The front and side supplemental restraint systems (SRS) include up to 6 air bags (verify “SRS AIRBAG” location indicator marks).

They are located in:

- The steering wheel hub (driver air bag)
- The front passenger dashboard (front passenger air bag)
- The outboard sides of the front seatbacks (side air bags)*
- The front and rear window pillars, and the roof edge along both sides (curtain air bags)*

These systems operate independently depending on the type of accident encountered; if you have side and curtain air bags, the side and curtain air bags are not likely to deploy on both sides in the same accident because a vehicle is not often hit from both sides. The side and curtain air bags and the frontal air bag system will not normally deploy during the same type of accident unless a combination of frontal and side impacts occur.

The air bag supplemental restraint systems are designed to provide supplemental protection only in the front seats in certain situations and the rear outside passenger positions only in same-side collisions, so seat belts are always important in the following ways:

Without seat belt usage, the air bags cannot provide adequate protection during an accident. Seat belt usage is necessary to:

- Keep the occupant from being thrown into an inflating air bag.
- Reduce the possibility of injuries during an accident that is not designed for air bag inflation, such as roll-over or rear impact.
- Reduce the possibility of injuries in frontal or side collisions that are not severe enough to activate the air bags.
- Reduce the possibility of being thrown from your vehicle.
- Reduce the possibility of injuries to lower body and legs during an accident because the air bags provide no protection to these parts of the body.
- Hold the driver in a position which allows better control of the vehicle.

Small children must be protected by a child-restraint system as stipulated by law in every state and province. In certain states and provinces, larger children must use a child-restraint system (page 2-21).

Carefully consider which child-restraint system is necessary for your child and follow the installation directions in this Owner's Manual as well as the child-restraint system manufacturer's instructions.

2-38 *Some models.

Essential Safety Equipment
SRS Air Bags

! WARNING

Air Bags without Seat Belts:

Depending only on the air bags for protection during an accident is dangerous. Alone, air bags may not prevent serious injuries. The appropriate air bags can be expected to inflate only in the first collision with frontal, near frontal or side forces that are at least moderate. Vehicle occupants should always wear seat belts.

Child in the Front Seat:

Placing a child, 12 years or under, in the front seat is dangerous. The child could be hit by a deploying air bag and be seriously injured or even killed. Even if the front passenger air bag deactivation indicator light illuminates, always move the front passenger seat as far back as possible. A sleeping child is more likely to lean against the door and be hit by the side air bag in a moderate, right-side collision. Whenever possible, always secure a child 12 years and under on the rear seat with an appropriate child-restraint system for the child's age and size.

Rear-Facing Child-Restraint System:

Rear-facing child-restraint systems on the front seat are particularly dangerous. The child-restraint system can be hit by a deploying air bag and moved violently backward resulting in serious injury or death to the child. Even though you may feel assured that a front passenger air bag will not deploy based on the fact that the front passenger air bag deactivation indicator light illuminates, NEVER use a rear-facing child-restraint system in the front seat with an air bag that could deploy even in a moderate collision.

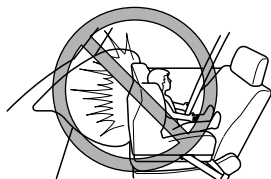

Seating Position with Front Air Bags:

Sitting too close to the air bag modules or placing hands or feet on them is extremely dangerous. Front air bags inflate with great force and speed. Serious injuries could occur if someone is too close. The driver should always hold onto only the rim of the steering wheel. The front seat passenger should keep both feet on the floor. Front seat occupants should adjust their seats as far back as possible and always sit upright against the seatbacks with seat belts worn properly.

Essential Safety Equipment

SRS Air Bags

WARNING

Seating Position with Side and Curtain Air Bags:

Sitting too close to the side air bag modules or placing hands on them is extremely dangerous. The side air bags inflate with great force and speed directly out of the outboard side of the front seat and expand along the front door on the side the car is hit. Serious injury could occur if someone is sitting too close to the door or leaning against a window, or if rear seat occupants grab the sides of the front seatbacks. Furthermore, sleeping up against the door or hanging out the windows in the vehicle could block the side and curtain air bags and eliminate the advantages of supplemental protection. Give the side and curtain air bags room to work by sitting in the center of the seat while the vehicle is moving with seat belts worn properly.

Front Air Bag Modules Located in the Steering Wheel Hub and the Dashboard:

Attaching an object to the front air bag modules or placing something in front of them is dangerous. In an accident, the object could interfere with front air bag inflation and injure the occupants.

Always keep the front air bag modules free of objects.

Side Air Bag Modules:

Attaching things to the front seat in such a way as to cover the outboard side of the seat in any way is dangerous. In an accident the object could interfere with the side air bag, which inflates from the outboard side of the front seats, impeding the added protection of the side air bag system or redirecting the air bag in a way that is dangerous. Furthermore, the bag could be cut open spewing exhaust.

Do not hang net bags, map pouches or backpacks with side straps on the front seats. Never use seat covers on the front seats. Always keep the side air bag modules in your front seats free to deploy in the event of a side collision.

Curtain Air Bag Modules:

Attaching objects to the areas where the curtain air bag activates such as on the windshield glass, side door glass, front and rear window pillars and along the roof edge and assist grips is dangerous. In an accident the object could interfere with the curtain air bag, which inflates from the front and rear window pillars and along the roof edge, impeding the added protection of the curtain air bag system or redirecting the air bag in a way that is dangerous. Furthermore, the bag could be cut open spewing exhaust.

Do not place hangers or any other objects on the assist grips. When hanging clothes, hang them on the coat hook directly. Always keep the curtain air bag modules free to deploy in the event of a side collision.

Essential Safety Equipment
SRS Air Bags

 **WARNING**

Hot Air Bag Inflators:

Hot air bag inflators are dangerous. Immediately after inflation, the inflators in the steering wheel, dashboard, seatbacks, or the front and rear window pillars and along the roof edge are very hot. You could get burned. Don't touch the internal components of the air bag modules after the bags have inflated.

Installation of Front-End Equipment:

Installation of front-end equipment, such as frontal protection bar (kangaroo bar, bull bar, push bar, etc.), snowplow, or winches, is dangerous. The air bag crash sensor system could be affected. This could cause air bags to inflate unexpectedly, or it could prevent the air bags from inflating during an accident. Front occupants could be seriously injured. Never install any front-end equipment to your vehicle.

Suspension Adjustment:

Adjusting the vehicle suspension is dangerous. If the vehicle's height or the suspension is changed, the vehicle will be unable to accurately detect a collision resulting in incorrect or unexpected air bag deployment and the possibility of serious injuries.

Modification of the Supplemental Restraint System:

Modifying the components or wiring of the supplemental restraint system is dangerous. You could accidentally activate it or make it inoperable. Don't make any modifications to the supplemental restraint system. This includes installing trim, badges, or anything else over the air bag modules. It also includes installing extra electrical equipment on or near system components or wiring. An Authorized Mazda Dealer can provide the special care needed in the removal and installation of front seats. It is important to protect the air bag wiring and connections to assure that the bags do not accidentally deploy, the driver seat slide position sensor and front passenger seat weight sensors are not damaged and that the seats retain an undamaged air bag connection.

NOTE

- When an air bag deploys, a loud inflation noise can be heard and some smoke will be released. Neither is likely to cause injury, however, the texture of the air bags may cause light skin injuries on body parts not covered with clothing through friction.
- Should you sell your Mazda, we urge you to tell the new owner of its air bag systems and that familiarization with all instructions about them, from the Owner's Manual, is important.

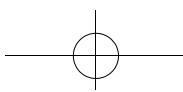

Essential Safety Equipment

SRS Air Bags

Supplemental Restraint System Components

The supplemental restraint systems (SRS) have two basic subsystems:

- The air bag system with inflators and air bags.
- The electrical system with crash sensors and diagnostic module.

The air bags are mounted in the following locations:

- The steering wheel hub
- The front passenger dashboard
- The outboard sides of the front seatbacks *
- The front and rear window pillars, and the roof edge along both sides *

The air bags are out of sight until activated.

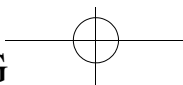

Essential Safety Equipment
SRS Air Bags

▼ **Front Air Bag System Components**

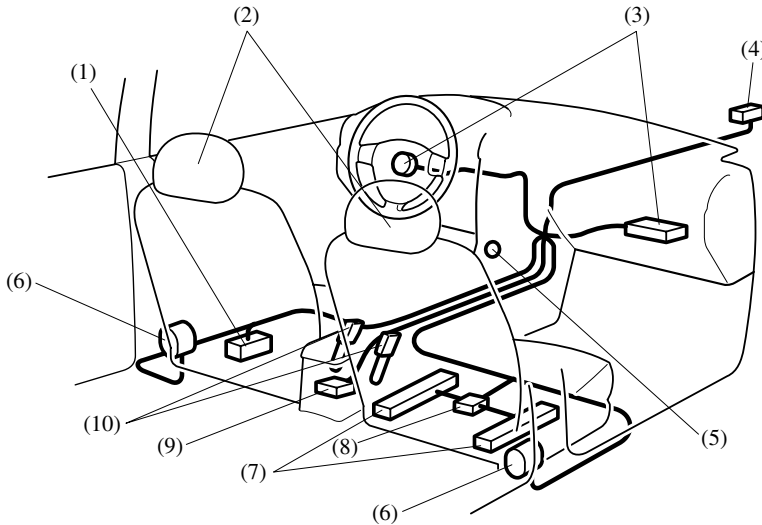

- (1) Driver seat slide position sensor (page 2-45)
- (2) Front seats
- (3) Front dual stage inflators and air bags
- (4) Front air bag sensor
- (5) Front passenger air bag deactivation indicator light (page 2-45)
- (6) Front seat belt pretensioner and load limiting systems (page 2-14)
- (7) Front passenger seat weight sensors (page 2-45)
- (8) Front passenger seat weight sensor control module
- (9) Crash sensors and diagnostic module (SAS unit)
- (10) Driver and front passenger seat belt buckle switches (page 2-45)

Essential Safety Equipment
SRS Air Bags

▼ **Side and Curtain Air Bag System Components ***

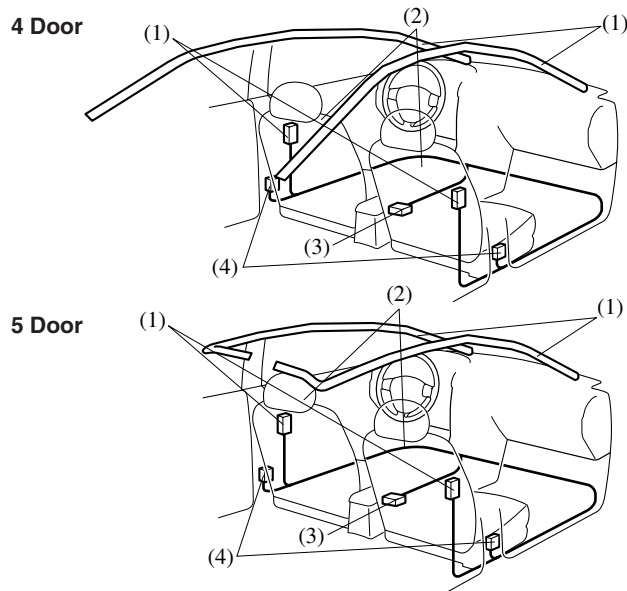

- (1) Side and curtain inflators and air bags
- (2) Front seats
- (3) Crash sensors and diagnostic module (SAS unit)
- (4) Side crash sensor

How the Air Bags Work

▼ How the Front Air Bags Work

When air bag crash sensors detect a frontal impact of greater than moderate force, an electrical current is sent to the inflators.

Gases are produced to inflate the front air bags and after the inflation, the front air bags quickly deflate.

The front air bags will function only once. After that, **the front air bags will not work again and must be replaced.**

Only an Authorized Mazda Dealer can replace the system components.

The front, dual stage air bags control air bag inflation in two energy stages. During an impact of moderate severity the front air bags deploy with lesser energy, whereas during more severe impacts, they deploy with more energy. Deployment of the front air bags may differ between the driver and the front passenger depending on the driver seat position, front passenger weight and front seat belt usage, which allow for further controlling of the system.

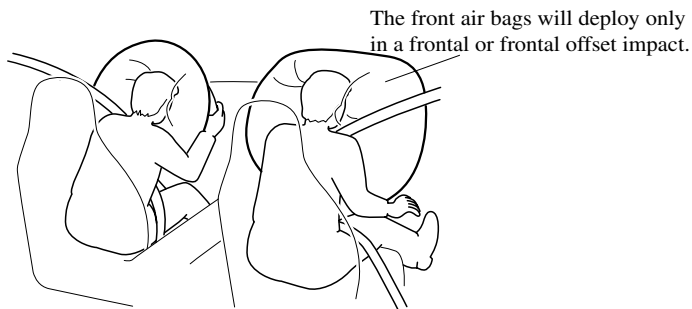

Driver seat slide position sensor

Your vehicle is equipped with a driver seat slide sensor as a part of the supplemental restraint system. The sensor is located under the driver seat. The sensor determines whether the driver seat is fore or aft of a reference position and sends the seat position to the crash sensors and diagnostic module (SAS unit). The sensor is also designed to control the deployment of the driver air bag depending on how close the driver seat is to the steering wheel.

The air bag/front seat belt pretensioner system warning light flashes if the sensor has a possible malfunction (page 2-53).

Essential Safety Equipment

SRS Air Bags

Front passenger seat weight sensors

If your vehicle is equipped with front passenger seat weight sensors, a front passenger air bag deactivation indicator light is also equipped (page 2-30). These sensors are located under both of the front passenger seat rails. These sensors determine the total seated weight on the front passenger seat. The sensors are also designed to prevent the front passenger front and side air bags and seat belt pretensioner system from inflating if the total seated weight is less than approximately 30 kg (66 lb).

To reduce the chance of injuries caused by deployment of the front passenger air bag, the system deactivates the front passenger front and side air bags and also the seat belt pretensioner system when:

- There is no passenger in the front passenger seat. (The front passenger air bag deactivation indicator light does not illuminate.)
- The total seated weight on the front passenger seat is less than approximately 30 kg (66 lb). (The front passenger air bag deactivation indicator light illuminates.)

This system shuts off the front passenger front and side air bags and seat belt pretensioner system, so make sure the front passenger air bag deactivation indicator light illuminates according to the chart below.

The air bag/front seat belt pretensioner system warning light flashes and the front passenger air bag deactivation indicator light illuminates if the sensors have a possible malfunction. If this happens, the front passenger front and side air bags and seat belt pretensioner system will not deploy.

Front passenger air bag deactivation indicator light

This indicator light illuminates to remind you that the front passenger front and side air bags and seat belt pretensioner will not deploy during a collision.

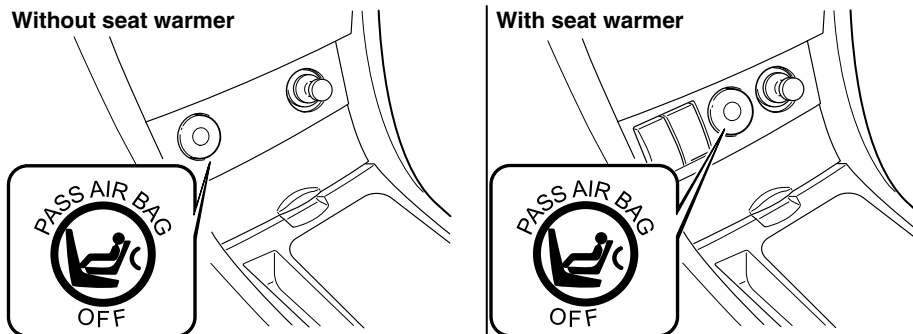

If the front passenger weight sensors are normal, the indicator light illuminates when the ignition switch is turned to the ON position. After about 6 seconds it goes out.

Essential Safety Equipment
SRS Air Bags

The front passenger air bag deactivation indicator light illuminates or is off under the following conditions:

Total seated weight on the front passenger seat	Front passenger air bag deactivation indicator light	Front passenger front and side air bags	Front passenger seat belt pretensioner system
Empty (Not occupied)*	OFF	OFF	OFF
Less than approx. 30 kg (66 lb)	ON	OFF	OFF
Approx. 42 kg (93 lb) or more	OFF	ON	ON

* If the front passenger seat belt is buckled, the front passenger air bag deactivation indicator light illuminates, however this does not indicate a malfunction.

If the front passenger air bag deactivation indicator light does not illuminate when the ignition switch is turned to the ON position and does not illuminate as indicated in the above chart, do not allow a child to sit in the front passenger seat and consult an Authorized Mazda Dealer as soon as possible. The system may not work properly in an accident.

⚠ WARNING

Decreasing the Total Seated Weight on the Front Passenger Seat:

When an adult or large child sits on the front passenger seat, decreasing the total seated weight on the front passenger seat from the total seated weight of approximately 42 kg (93 lb) required for air bag deployment is dangerous. The front passenger seat weight sensors will detect the reduced total seated weight condition and the front passenger front and side air bags and seat belt pretensioner system will not deploy during an accident. The front passenger will not have the supplementary protection of the air bag, which could result in serious injury. Decreasing the total seated weight on the front passenger seat from the total seated weight of approximately 42 kg (93 lb) could result in an air bag not deploying under the following conditions, for example:

- ***A rear passenger pushes up on the front passenger seat with the feet.***
- ***Luggage or other items placed under the front passenger seat or between the front passenger seat and driver seat that push up the front passenger seat bottom.***
- ***The front passenger seat occupant sits in a manner that does not place the entire weight of the occupant on the seat such as by sitting too close to the door, grasping the rim of the moonroof and sitting with the seatback reclined too far.***
- ***Any accessories which might decrease the total seated weight on the front passenger seat are attached to the front passenger seat.***

The front passenger front and side air bags and seat belt pretensioner systems will deactivate if the total seated weight on the front passenger seat is close to 30 kg (66 lb) and they will reactivate before the weight exceeds 42 kg (93 lb).

Essential Safety Equipment

SRS Air Bags

WARNING

Increasing the Total Seated Weight on the Front Passenger Seat:

When an infant or small child sits on the front passenger seat, increasing the total seated weight on the front passenger seat from the total seated weight of approximately 30 kg (66 lb) is dangerous. The front passenger seat weight sensors will detect the increased total seated weight, which could result in the unexpected deployment of the front passenger front and side air bags and seat belt pretensioner system in an accident and serious injury. Increasing the total seated weight on the front passenger seat beyond the total seated weight of approximately 30 kg (66 lb) could result in the front passenger front and side air bags and seat belt pretensioner system deployment in an accident under the following conditions, for example:

- ***Luggage or other items are placed on the seat with the child in the child-restraint system.***
- ***A rear passenger or luggage push or pull down on the front passenger seatback.***
- ***A rear passenger steps on the front passenger seat rails with the feet.***
- ***Luggage or other items are placed on the seatback or hung on the head restraint.***
- ***The seat is washed.***
- ***Liquids are spilled on the seat.***
- ***The front passenger seat is moved backward, pushing into luggage or other items placed behind it.***
- ***The front passenger seatback contacts the rear seat.***
- ***Luggage or other items are placed between the front passenger seat and driver seat.***
- ***Any accessories which might increase the total seated weight on the front passenger seat are attached to the front passenger seat.***

The front passenger front and side air bags and seat belt pretensioner systems will deactivate if the total seated weight on the front passenger seat is close to 30 kg (66 lb) and they will reactivate before the weight exceeds 42 kg (93 lb).

CAUTION

- To assure proper deployment of the front air bag and to prevent damage to the sensors in the front seat bottoms:
 - Do not place sharp objects on the front seat bottoms or leave heavy luggage on them.
 - Do not spill any liquids on the front seats or under the front seats.
- To allow the sensors to function properly, always perform the following:
 - Adjust the front seats as far back as possible and always sit upright against the seatbacks with seat belts worn properly.
 - If you place your child on the front passenger seat, secure the child-restraint system properly and slide the front passenger seat as far back as possible (page 2-30).

Essential Safety Equipment SRS Air Bags

NOTE

- The system requires about 10 seconds to alternate between turning the front passenger front and side air bags and seat belt pretensioner system on or off.
- The front passenger air bag deactivation indicator light may illuminate repeatedly if luggage or other items are put on the front passenger seat, or if the temperature of the vehicle's interior changes suddenly.
- The front passenger air bag deactivation indicator light may illuminate for 10 seconds if the total seated weight on the front passenger seat changes.
- If the front passenger air bag deactivation indicator light does not illuminate after installing a child-restraint system on the front passenger seat, install the child-restraint system on the rear seat and consult an Authorized Mazda Dealer as soon as possible.

Driver and front passenger buckle switches

The buckle switches on the front seat belts detect whether or not the front seat belts are securely fastened and further control the deployment of the air bags.

▼ How the Side and Curtain Air Bags Work *

When air bag crash sensors detect a side impact of greater than moderate force, an electrical current is sent to the inflators.

Gases are produced to inflate the side and curtain air bags and after the inflation, the side and curtain air bags quickly deflate.

The side and curtain air bags will function only once. After that, **the side and curtain air bags will not work again and must be replaced.** Only an Authorized Mazda Dealer can replace the systems.



The side and curtain air bags will deploy only on the side the vehicle receives the force of the impact.

*Some models. **2-49**

Essential Safety Equipment

SRS Air Bags

WARNING

Damaged Side and Curtain Air Bag Wiring under the Seats:

Placing luggage or other objects under the front seats is dangerous. The side and curtain air bag wiring could be damaged, and in the event of a side collision, the side and curtain air bags may not deploy, which could result in death or serious injury. To prevent damage to the side and curtain air bag wiring, do not place luggage or other objects under the front seats.

▼ Air Bag Activation/Deactivation

NOTE

If the front passenger seat weight sensors detect a total seated weight on the front passenger seat is less than approximately 42 kg (93 lb), the front passenger front and side air bags and seat belt pretensioner may not inflate (page 2-45).

Front air bag activation

A greater than moderate impact will cause the front air bags to inflate in the following cases:

- Hitting a solid wall straight on at greater than about 22 km/h (14 mph).

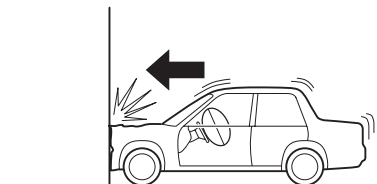

- Hitting a curb, pavement edge or hard object.

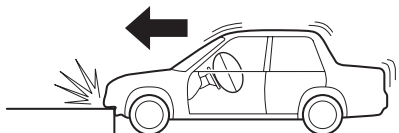

- Landing hard or the vehicle falling.

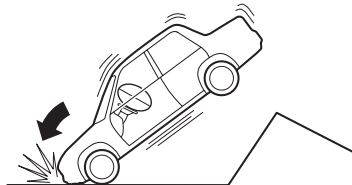

- Frontal impact within about a 30 degree range from head-on to the vehicle.

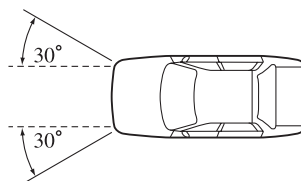

Essential Safety Equipment
SRS Air Bags

- Driving into a big hole or hitting the far side of a hole.



Limitations to front air bag activation

Depending on the severity of impact, the front air bags may not inflate in the following cases:

- Impacts involving trees or poles cause severe cosmetic damage but may not have enough stopping force to activate the air bag.

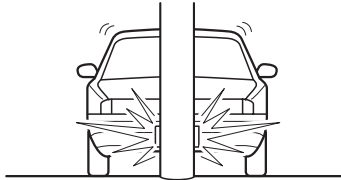

- Frontal offset impact to the vehicle may not provide the stopping force necessary for air bag deployment.

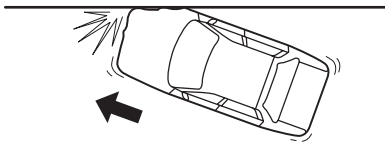

- Rear-ending or running under a truck's tail gate may not provide the stopping force necessary for air bag deployment.

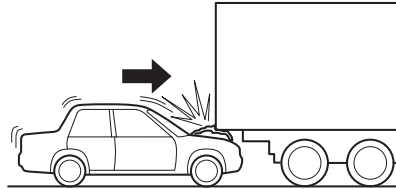

Non-activation of front air bags

Front air bags will not normally inflate in the following cases:

- Collision from the rear.



- Impact to the side, but it may deploy the side and curtain air bags.

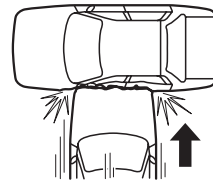

- Vehicle roll-over, may deploy the side and curtain air bags but not the front air bags.



Essential Safety Equipment

SRS Air Bags

Side and curtain air bag activation *

Greater than moderate impact to one side of the vehicle (driver or passenger side areas) will cause the side and curtain air bags on that side to inflate, but it will not normally deploy the front air bags.

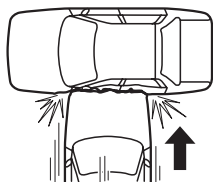

Limitations to side and curtain air bag activation *

Depending on the severity of impact, the side and curtain air bags may not inflate in the following cases:

- Frontal offset impact may not provide enough side impact to deploy the side and curtain air bags.

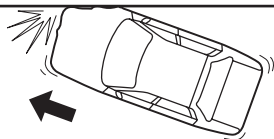

- Side impacts involving trees or poles can cause severe cosmetic damage but may not have enough impact force to activate the side and curtain air bags.

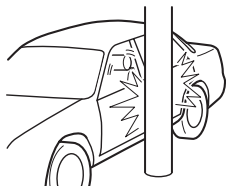

- Vehicle roll-over may not provide enough side force to deploy the side and curtain air bags.



- Side impacts with two-wheeled vehicles may not provide enough force to deploy the side and curtain air bags.



Non-activation of side and curtain air bag *

The side and curtain air bags will not normally inflate in the following cases:

- Collision from the rear.



- Collision from the front, but it may deploy the front air bags.

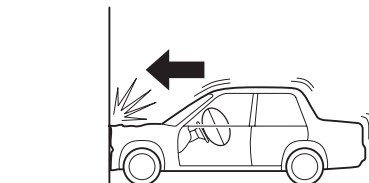

▼ Constant Monitoring

The following components of the air bag systems are monitored by a diagnostic system:

- SAS unit
- Front air bag sensor
- Air bag modules
- Side crash sensors *
- Front seat belt pretensioners
- Related wiring
- Driver seat slide position sensor
- Front passenger seat weight sensors
- Driver and front passenger seat belt buckle switches

The diagnostic module continuously monitors the system's readiness. This begins when the ignition switch is turned to the ON position and continues while the vehicle is being driven.

▼ Air Bag/Front Seat Belt Pretensioner System Warning Light



If the air bag/front seat belt pretensioner system is normal, the warning light illuminates when the ignition switch is turned to the ON position or after the engine is cranked. After about 6 seconds it goes out.

A system malfunction is indicated when the warning light constantly illuminates or doesn't illuminate at all when the ignition switch is turned to the ON position. If any of these occur, consult an Authorized Mazda Dealer as soon as possible. The system may not work in an accident.

WARNING

Self-Servicing the Air Bag/ Pretensioner Systems:

Self-servicing or tampering with the systems is dangerous. An air bag/pretensioner could accidentally activate or become disabled. This could cause serious injuries. Never tamper with the systems and always have an Authorized Mazda Dealer perform all servicing and repairs.

▼ Air Bag/Front Seat Belt Pretensioner System Warning Beep

If a malfunction is detected in the air bag/front seat belt pretensioner systems and the warning light, a warning beep sound will be heard for about 5 seconds every minute.

The air bag and seat belt pretensioner system warning beep sound will continue to be heard for approximately 35 minutes. Have your vehicle inspected at an Authorized Mazda Dealer as soon as possible.

Essential Safety Equipment

SRS Air Bags

WARNING

Air Bag/Front Seat Belt Pretensioner System Warning Bleep:

Driving the vehicle with the air bag/front seat belt pretensioner system warning beep sounding is dangerous. In a collision, the air bags and the front seat belt pretensioner system will not deploy and this could result in death or serious injury.

Do not drive the vehicle with the air bag/front seat belt pretensioner system warning beep sounding. Contact an Authorized Mazda Dealer to have the vehicle inspected as soon as possible.

▼ **Maintenance**

The air bag systems do not require regular maintenance. But if any of the following occurs, take your vehicle to an Authorized Mazda Dealer as soon as possible:

- The air bag system warning light flashes.
- The air bag system warning light remains illuminated.
- The air bag system warning light does not illuminate when the ignition switch is turned to the ON position.
- The air bags have deployed.
- Front passenger air bag deactivation indicator light does not illuminate when the ignition switch is turned to the ON position or does not illuminate as indicated in the chart. For more details about this indicator light and this chart, refer to “Front passenger seat weight sensors” (page 2-45).

WARNING

Damaged Air Bag/Seat Belt Pretensioner System Components:
Expend or damaged air bag or seat belt pretensioner units must be replaced after any collision which caused them to deploy or damage them. Only a trained Authorized Mazda Dealer can fully evaluate these systems to see that they will work in the next accident. Driving with an expended or damaged air bag or pretensioner units will provide you reduced protection in the next accident and you could be injured or killed.

Removing Interior Parts:
Removing any components such as the front seats, front dashboard, the steering wheel or parts on the front and rear window pillars and along the roof edge, containing air bag parts or sensors is dangerous. These parts contain essential air bag components. The air bag could accidentally activate and cause serious injuries. Always have an Authorized Mazda Dealer remove these parts.

Air Bag Disposal:
Improper disposal of an air bag or a vehicle with live air bags in it can be extremely dangerous. Unless all safety procedures are followed, injury can result. Ask an Authorized Mazda Dealer how to safely dispose of an air bag or how to scrap an air bag equipped vehicle.

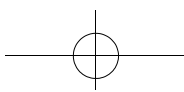

Essential Safety Equipment
SRS Air Bags

NOTE

If it becomes necessary to have the components or wiring system for the supplementary restraint system modified to accommodate a person with certain medical conditions in accordance with a certified physician, contact an Authorized Mazda Dealer, refer to “Customer Assistance (U.S.A.)” (page 9-2).

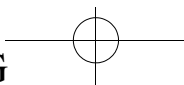
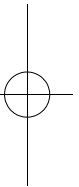
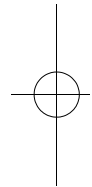

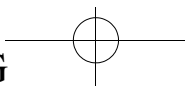
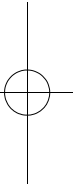
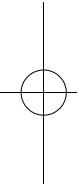

3 Knowing Your Mazda

Explanation of basic operations and controls; opening/closing and adjustment of various parts.

Doors and Locks	3-2
Keys	3-2
Keyless Entry System *	3-3
Door Locks	3-6
Liftgate (5 Door)	3-9
Trunk Lid (4 Door)	3-12
Inside Trunk Release Lever (4 Door)	3-15
Power Windows *	3-16
Fuel-Filler Lid and Cap	3-18
Hood	3-20
Moonroof*	3-21
Security System	3-23
Immobilizer System	3-23
Theft-Deterrent System *	3-26
Steering Wheel and Mirrors	3-28
Steering Wheel	3-28
Mirrors	3-28

*Some models. **3-1**

Knowing Your Mazda

Doors and Locks

Keys

WARNING

Keys and Children:

Leaving children in a vehicle with the key is dangerous. This could result in someone being badly injured or even killed. They could play with power windows or other controls, or even make the vehicle move. Don't leave the keys in your vehicle with children and keep them in a place where your children will not find or play with them.

NOTE

- Refer to Immobilizer System (page 3-23) for information regarding keys and engine starting.
- **(With theft-deterrent system)**
Refer to Theft-Deterrent System (page 3-26) for information regarding keys and the prevention of vehicle and vehicle contents theft.

The keys operate all locks.

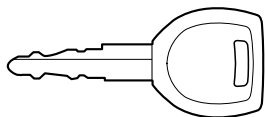

 — Key code number plate

A code number is stamped on the plate attached to the key set; detach this plate and store it in a safe place (not in the vehicle) for use if you need to make a replacement key.

NOTE

Write down the code number and keep it in a separate, safe and convenient place, but not in the vehicle. If your key is lost, consult your Authorized Mazda Dealer and have your code number ready.

Knowing Your Mazda Doors and Locks

Keyless Entry System *

This system remotely locks and unlocks the doors and the liftgate. It can also help you signal for attention. Press the button slowly and carefully.

CAUTION

To avoid damage to the transmitter, do not:

- Drop it.
- Get it wet.
- Disassemble it.
- Expose it to heat or sunlight.

NOTE

- The keyless entry system is designed to operate up to about 2.5 m (8 ft) from the center of the vehicle, but this may vary due to local conditions.
- The system doesn't operate when the key is in the ignition switch.
- If the transmitter does not operate when pressing a button or the operation range becomes too small, the battery may be dead. To install a new battery, refer to Maintenance (page 3-5).
- Additional transmitters can be obtained at an Authorized Mazda Dealer. Up to 3 transmitters can be used with the keyless entry system per vehicle. Bring all transmitters to an Authorized Mazda Dealer when the electronic codes need to be reset.

▼ Transmitter

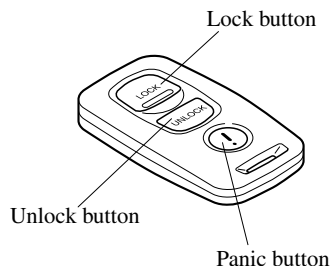

NOTE

- **(U.S.A.)**
This device complies with Part 15 of the FCC Rules. Operation is subject to the following two conditions: (1) this device may not cause harmful interference, and (2) this device must accept any interference received, including interference that may cause undesired operation.
- **(CANADA)**
This device complies with RSS-210 of Industry CANADA. Operation is subject to the following two conditions: (1) this device may not cause interference, and (2) this device must accept any interference, including interference that may cause undesired operation of the device.

Lock button

To lock the doors and the liftgate, press the lock button and the hazard warning lights will flash once.

*Some models.

Knowing Your Mazda

Doors and Locks

To confirm that all doors and the liftgate have been locked, press the lock button again within 5 seconds. If they are closed and locked, the horn will sound.

NOTE

(Without theft-deterrent system)

The hazard warning lights will flash once to indicate that all doors and the liftgate are locked.

(With theft-deterrent system)

- The hazard warning lights will not flash.
- The hazard warning lights only flash when the theft deterrent system is armed, refer to the theft-deterrent system (page 3-26).

NOTE

- All doors and the liftgate cannot be locked when either front door is open and the key is in the ignition switch.
- Confirm that all doors and the liftgate are locked visually or audibly by use of the double click.

Unlock button

To unlock the driver's door, press the unlock button and the hazard warning lights will flash twice.

To unlock all doors and the liftgate, press the unlock button again within 5 seconds.

NOTE

(Without theft-deterrent system)

The hazard warning lights will flash twice to indicate that all doors and the liftgate are unlocked.

(With theft-deterrent system)

- The hazard warning lights will not flash.
- The hazard warning lights only flash when the theft deterrent system is turned off, refer to the theft-deterrent system (page 3-26).

NOTE

After unlocking with the transmitter, all doors and the liftgate will automatically lock if one of the doors or the liftgate is not opened within about 30 seconds.

Panic button

If you witness from a distance someone attempting to break into or damage your vehicle, pressing the panic button will activate the vehicle's alarm.

NOTE

The panic button will work whether any door or the liftgate is open or closed.

Turning on the alarm

Pressing the panic button once will trigger the alarm for about 2 minutes and 30 seconds, and the following will occur:

- The horn sounds intermittently.
- The hazard warning lights flash.

Knowing Your Mazda
Doors and Locks

Turning off the alarm

Press any button on the transmitter.

▼ **Transmitter Maintenance**

 **CAUTION**

- Install the battery with the positive pole (+) facing up. Battery leakage could occur if it is not installed correctly.
- When replacing the battery, be careful not to bend the electrical terminals or get oil on them. Also be careful not to get dirt in the transmitter as it could be damaged.
- There is the danger of explosion if the battery is not correctly replaced.
- Replace only with the same type battery (CR2025 or equivalent).
- Dispose of used batteries according to the following instructions.
 - Insulate the plus and minus terminals of the battery using cellophane or equivalent tape.
 - Never disassemble.
 - Never throw the battery into fire and/or water.
 - Never deform or crush.

Replacing the transmitter battery

1. Insert a small screwdriver into the slot and gently pry open the transmitter.

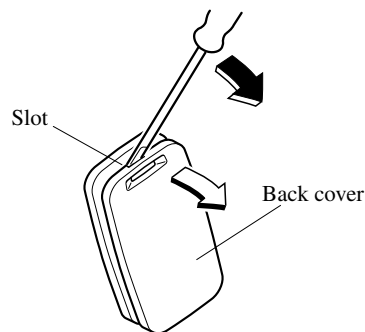

2. Press the portion of the battery indicated by A and remove the battery.

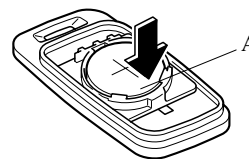

Knowing Your Mazda

Doors and Locks

3. Install a new battery (CR2025 or equivalent) into the front portion of the holder with the positive pole (+) facing up. Press on the B portion of the battery to set the battery.

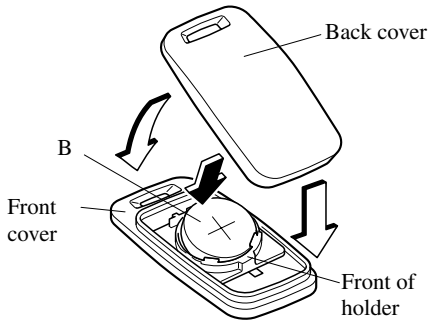

4. Align the front and back covers and snap the transmitter shut.

▼ Service

If you have a problem with the keyless entry system, consult an Authorized Mazda Dealer.

If your transmitter is lost or stolen, bring all remaining transmitters to an Authorized Mazda Dealer as soon as possible for a replacement and to make the lost or stolen transmitter inoperative.

⚠ CAUTION

Radio equipment like this is governed by laws in the United States. Changes or modifications not expressly approved by the party responsible for compliance could void the user's authority to operate the equipment.

Door Locks

⚠ WARNING

Unattended Children and Pets:
Leaving a child or an animal unattended in a parked vehicle is dangerous. In hot weather, temperatures inside a vehicle can become high enough to cause brain damage or even death. Always take all children and animals with you or leave a responsible person with them.

Keys and Children:
Leaving children in a vehicle with the key is dangerous. This could result in someone being badly injured or even killed. They could play with power windows or other controls, or even make the vehicle move. Don't leave the keys in your vehicle with children and keep them in a place where your children will not find or play with them.

Unlocked Doors:
Unlocked doors in a moving vehicle are dangerous. Passengers can fall out if a door is accidentally opened and can more easily be thrown out in an accident. So keep all doors locked when driving.

Knowing Your Mazda Doors and Locks

WARNING

Vehicles Left Unlocked: (Except 4 Door)

Leaving your vehicle unlocked is dangerous as children could lock themselves in a hot vehicle, which could result in death. Also, a vehicle left unlocked becomes an easy target for thieves and intruders. Always close all the windows, lock the doors and take the key with you when leaving your vehicle unattended.

(4 Door)

Leaving your vehicle unlocked is dangerous as children could lock themselves in a hot vehicle, or become trapped by climbing into the trunk, which could result in death. Also, a vehicle left unlocked becomes an easy target for thieves and intruders. Always close all the windows, lock the doors and take the key with you when leaving your vehicle unattended.

NOTE

If your vehicle is equipped with a front passenger door key slot, the door can be locked/unlocked with the key.

▼ Locking, Unlocking with Transmitter*

The doors can be locked/unlocked by operating the keyless entry system transmitter, refer to Keyless Entry System (page 3-3).

▼ Locking, Unlocking with Door-Lock Knob

To lock any door from the inside, push the door-lock knob.
To unlock, pull it out.
This does not operate the other door locks.

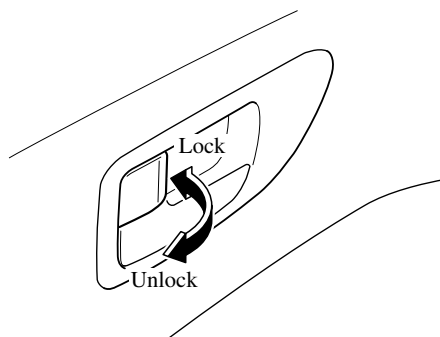

▼ Locking, Unlocking with Key

The driver's door can be locked/unlocked with the key.
Turn the key toward the front to unlock,
toward the back to lock.

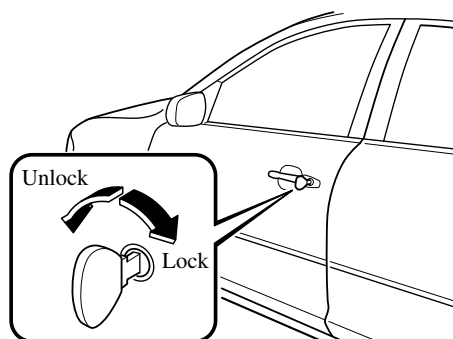

*Some models.

Knowing Your Mazda

Doors and Locks

To lock any door with the door-lock knob from the outside, push the door-lock knob to the lock position and close the door. This does not operate the other door locks.

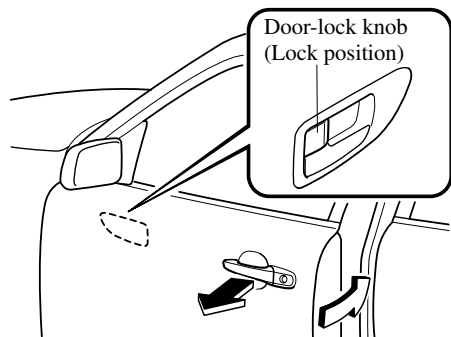

NOTE

When locking the doors this way, be careful not to leave the key inside the vehicle.

▼ Power Door Locks

Vehicle lock-out prevention

The vehicle lock-out prevention feature prevents you from locking yourself out of the vehicle. With the key in the ignition switch, all doors and the liftgate will automatically unlock if they are locked using the power door locks with either front door open.

Locking, unlocking with key

All doors and the liftgate lock automatically when the driver's door is locked with the key. All doors and the liftgate unlock when the driver's door is unlocked and the key is held in the unlock position for one second or longer.

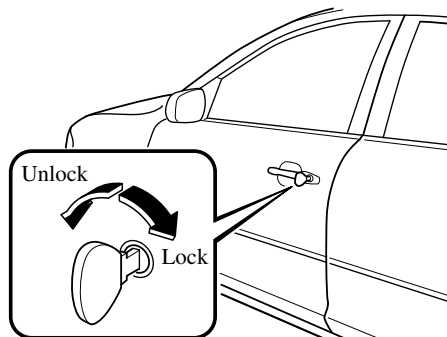

NOTE

Holding the key in the unlocked position in the driver's door lock for about a second unlocks all doors and the liftgate. To unlock only the driver's door, insert the key into the driver's door lock and turn the key briefly to the unlock position and then immediately return it to the center position.

Knowing Your Mazda
Doors and Locks

Locking, unlocking with door-lock switch

All doors and the liftgate lock automatically when LOCK is pushed. They all unlock when the unmarked part of the door-lock switch is pushed.

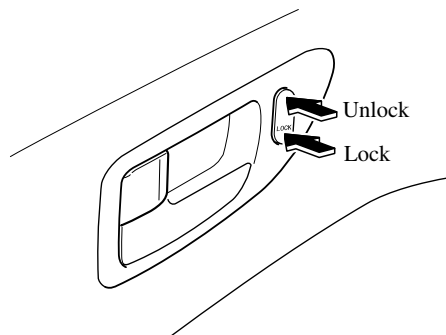

▼ Rear Door Child Safety Locks

These locks are intended to help prevent children from accidentally opening the rear doors. Use them both whenever a child rides in the vehicle.

If you insert the key and turn the child safety lock to the lock position before closing that door, the door cannot be opened from the inside. The door can be opened only by lifting the outside handle.

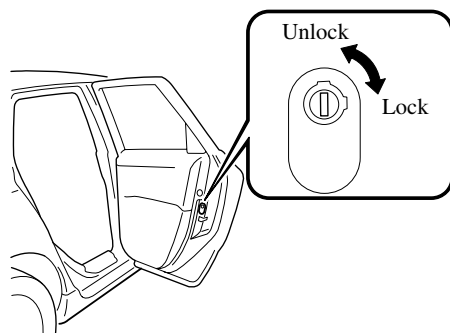

Liftgate (5 Door)

⚠ WARNING

Open Liftgate and Exhaust Gas:
Exhaust gas in the cabin of a vehicle is dangerous. An open liftgate in a moving vehicle will cause exhaust gas to be drawn into the cabin. This gas contains CO (carbon monoxide), which is colorless, odorless, and highly poisonous, and it can cause loss of consciousness and death. Moreover, an open liftgate could cause occupants to fall out in an accident. Do not drive with the liftgate open.

▼ Locking, Unlocking with Transmitter

The liftgate can be locked/unlocked by operating the keyless entry system transmitter, refer to Keyless Entry System (page 3-3).

▼ Locking, Unlocking with Door-Lock Switch

The liftgate can be locked/unlocked by operating the door-lock switch, refer to Power Door Locks (page 3-8).

Knowing Your Mazda

Doors and Locks

▼ Opening and Closing the Liftgate

Opening the liftgate

Pull the handle and lift up the liftgate.

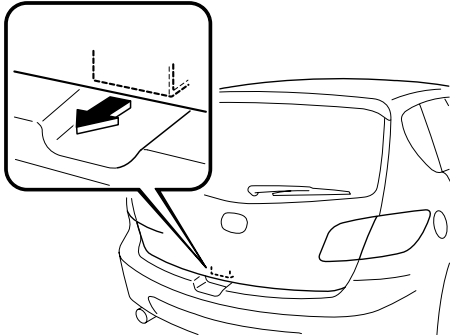

NOTE

If the vehicle battery is dead or there is a malfunction in the electrical system and the liftgate cannot be unlocked, perform the following procedure as an emergency measure to unlock it:

1. Remove the cap on the interior surface of the liftgate with a flathead screwdriver.

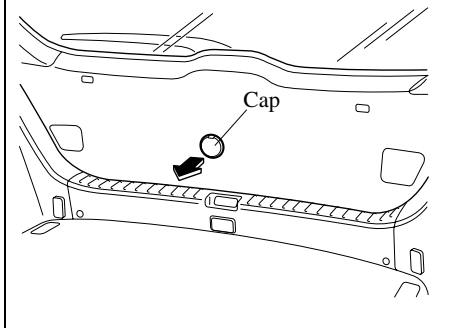

NOTE

2. Turn the lever to the right to unlock the liftgate.

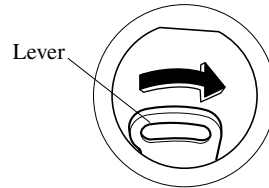

After performing this emergency measure, have the vehicle inspected at an Authorized Mazda Dealer as soon as possible.

Closing the liftgate

Use both hands to push the liftgate down until the lock snaps shut. Do not slam it. Pull up on the liftgate to make sure it is securely latched.

Knowing Your Mazda Doors and Locks

▼ Luggage Compartment

WARNING

Placing Cargo on the Cover:

Placing luggage or other cargo on top of the luggage compartment cover is dangerous. During sudden braking or a collision, the cargo could become a projectile that could hit and injure someone. The vehicle has a light weight luggage compartment cover to keep the contents of your luggage area out of sight; it will not retain heavy objects that are not tied down in an accident like a rollover. Tie down all heavy objects, whether luggage or cargo, using the tie down hooks. Don't place anything on top of the cover.

Not Securing Luggage and Cargo:

Not securing cargo while driving is dangerous as it could move or be crushed during sudden braking or a collision and cause injury. Make sure luggage and cargo is secured before driving.

CAUTION

Make sure the luggage compartment cover is firmly secured. If it is not firmly secured, it could unexpectedly disengage resulting in injury.

Luggage compartment cover strap

The luggage compartment can be accessed by opening the liftgate when the straps are attached to the sides of the liftgate.

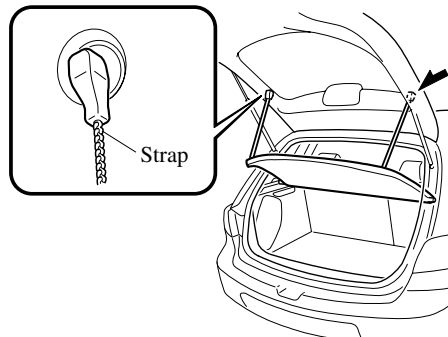

Luggage compartment cover

The luggage compartment can be accessed by opening the luggage compartment cover from the inside of the vehicle.

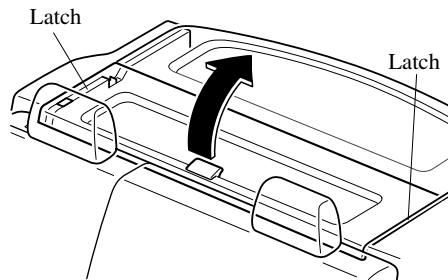

Knowing Your Mazda

Doors and Locks

CAUTION

To prevent cargo from shifting while driving or during sudden deceleration, be careful of the following:

- Do not open the luggage compartment cover while the vehicle is moving.
- Do not overload the luggage compartment so that the cover cannot be closed.
- Do not allow cargo to interfere with the luggage compartment cover latch.

This cover can be removed for more room. To do this, just unfasten the straps; then lift and pull it out.

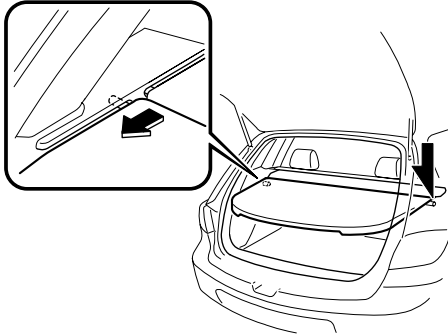

Trunk Lid (4 Door)

WARNING

Open Trunk and Exhaust Gas:
Exhaust gas in the cabin of a vehicle is dangerous. This gas contains CO (carbon monoxide), which is colorless, odorless, and highly poisonous. If inhaled, it can cause loss of consciousness and death. Because exhaust gas can get into the cabin through an open trunk, keep the trunk closed when driving.

Knowing Your Mazda Doors and Locks

▼ Opening and Closing the Trunk

WARNING

Open Trunk Lid and Children:
Leaving the trunk lid open or leaving children in the vehicle with the keys is dangerous. Children could open the trunk lid and climb inside resulting in possible injury or death from heat exposure. Close the trunk lid, lock the rear seatbacks and do not allow children to play inside the vehicle.

Unattended Children and Pets:
Leaving children or animals unattended in a parked vehicle is dangerous. Babies left sleeping and kids who lock themselves in cars or trunks can die very quickly from heat prostration. Don't leave your children or pets alone in a car at any time. Don't leave the car, the rear folding seats or the trunk unlocked. Always keep the car from being a tempting place to play by locking rear seats, doors and the trunk, and keeping the keys where children won't play with them.

CAUTION

For vehicles equipped with a rear spoiler, do not lift the trunk lid by the spoiler. Lifting up the trunk lid by the rear spoiler could cause damage to the rear spoiler and the trunk lid.

Opening the trunk lid with the key

Insert the key into the slot and turn it clockwise.

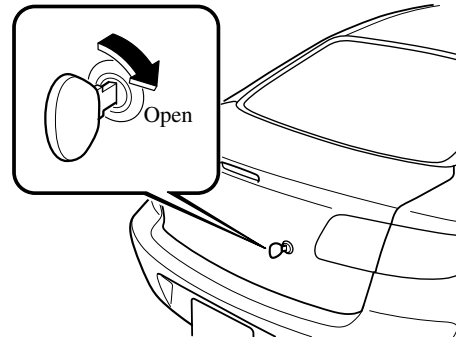

Opening the trunk lid with the remote release lever

Pull up the release lever next to the driver's seat.

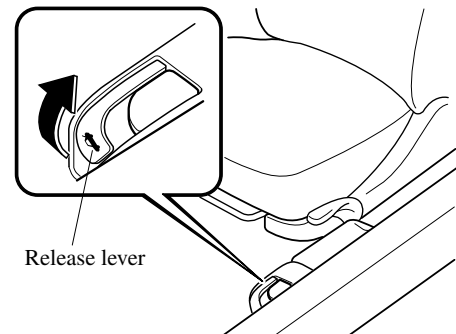

Closing the trunk lid

Use both hands to push the trunk lid down until the lock snaps shut. Do not slam it. Pull up on the trunk lid to make sure it is secure.

Knowing Your Mazda

Doors and Locks

▼ Trunk Security

In some situations you may want to prevent the trunk from being opened with the remote trunk lid release lever.

Give your key only to someone you trust.

To secure the trunk lid, lock the rear seatbacks (page 2-8), push the trunk lock lever up, and close the trunk.

To cancel the security feature, insert the key into the lock, turn the key clockwise, and pull the trunk lock lever down.

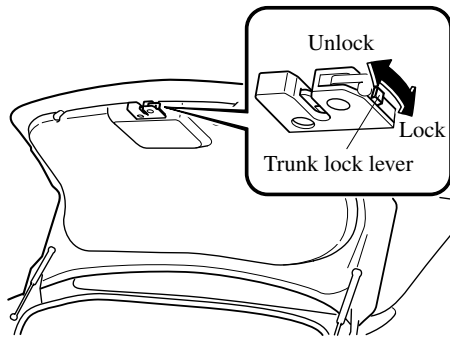

▼ Trunk Light

The trunk light is on when the lid is open and off when it's closed.

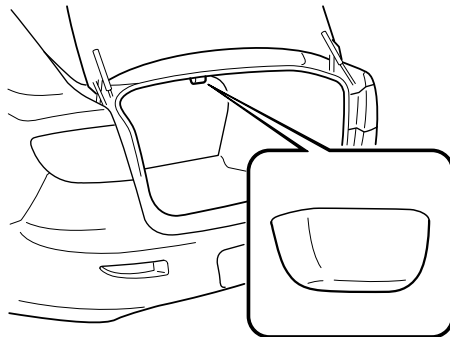

NOTE

To prevent the battery from being discharged, do not leave the trunk open for a long period when the engine is not running.

Doors and Locks

Inside Trunk Release Lever (4 Door)

Your vehicle is equipped with an inside trunk release lever that provides a means of escape for children and adults in the event they become locked inside the trunk.

No matter how careful adults might be with keys and locking their cars, parents should be aware that children may be tempted to play around vehicles and use the trunk as a hiding place.

Adults are advised to familiarize themselves with the operation and location of the inside trunk release lever so that all children can be told about it in an appropriate way, keeping in mind that most vehicles don't have such levers.

WARNING

Trunk Access and Children:
Leaving the trunk lid open or leaving children in the vehicle with the keys is dangerous. Children could open the trunk lid and climb inside resulting in possible injury or death from heat exposure. Close the trunk lid, lock the rear seatbacks and do not allow children to play inside the vehicle.

Unattended Children and Pets:
Leaving children or animals unattended in a parked vehicle is dangerous. Babies left sleeping and kids who lock themselves in cars or trunks can die very quickly from heat prostration. Don't leave your children or pets alone in a car at any time. Don't leave the car, the rear folding seats or the trunk unlocked. Always keep the car from being a tempting place to play by locking rear seats, doors and the trunk, and keeping the keys where children can not play with them.

Knowing Your Mazda

Doors and Locks

▼ Opening the Trunk Lid from the Inside

Slide the inside trunk release lever in the direction of the arrow. The lever is made of material that will glow for hours in the darkness of the trunk following a brief exposure to ambient light.

The inside trunk release lever is located on the inside of the trunk lid.

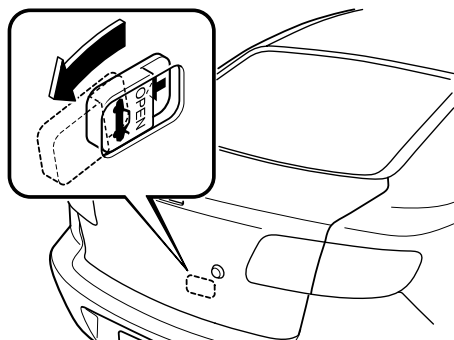

Power Windows*

The ignition switch must be in the ON position for the power windows to operate.

WARNING

Closing Power Windows:
Closing power windows are dangerous. A person's hands, head, or even neck could be caught by the window and result in serious injury or even death. This warning applies especially to children. Make sure the opening is clear before closing a window.

Children and Power Windows:
Leaving the power window switches unlocked while children are in the vehicle is dangerous. Power window switches that are not locked with the power window lock switch would allow children to operate power windows unintentionally which could result in serious injury if a child's hands, head or neck becomes caught by the window. Always lock all passenger power windows with the power window lock switch on the driver's side while children are in the vehicle, and never allow children to play with power window switches.

CAUTION

To prevent burning out the fuse and damaging the power window system, don't open or close more than three windows at once.

Knowing Your Mazda
Doors and Locks

▼ **Operating the Driver's Side Power Window**

Manual opening/closing

To open the window to the desired position, lightly hold down the switch.
To close the window to the desired position, lightly pull up the switch.

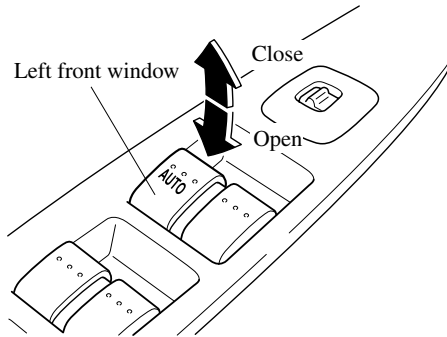

Auto-opening

To fully open the window automatically, press the switch completely down.

To stop the window partway, lightly pull up the switch and then release it.

▼ **Operating the Passenger Power Windows**

The power windows may be operated when the power window lock switch on the driver's door is in the unlocked position.

The passenger windows may be opened or closed by the power window master control switches on the driver's door.

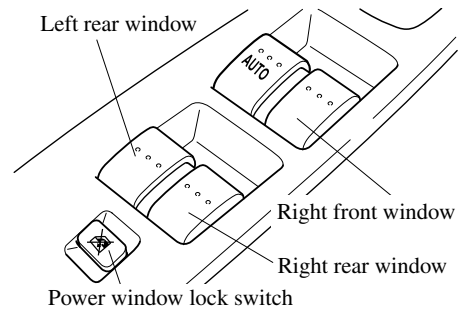

To open the window to the desired position, hold down the switch.
To close the window to the desired position, pull up the switch.

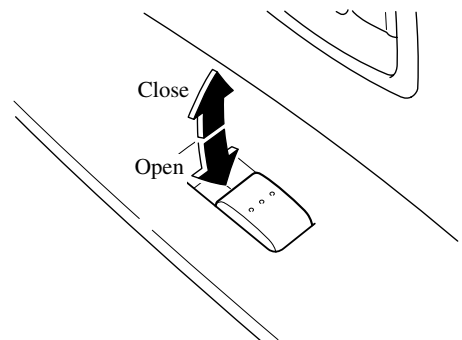

Knowing Your Mazda

Doors and Locks

▼ Power Window Lock Switch

With the lock switch in the unlocked position, all power windows on each door can be operated.

With the lock switch in the locked position, only the driver's side power window can be operated.

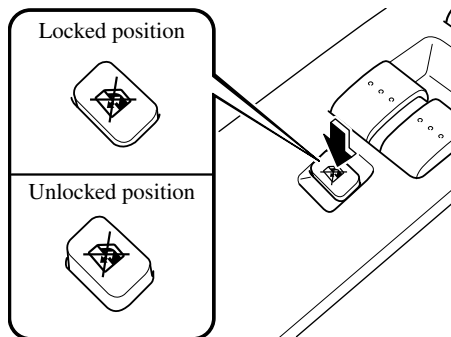

WARNING

Unintentional Window Operation:
Unintentional power window operation is dangerous. A person's hands, head, or neck could be caught by the window and result in serious injury. Unless a passenger needs to operate a power window, keep the power window lock switch in the locked position.

Fuel-Filler Lid and Cap

WARNING

Fuel Spray:

Fuel spray is dangerous. Fuel can burn skin and eyes and cause illness if ingested. Fuel spray is released when there is pressure in the fuel tank and the fuel cap is removed too quickly. When removing the fuel cap, loosen the cap slightly and wait for any hissing to stop. Then remove it.

Fuel Vapor:

Fuel vapor is dangerous. It could be ignited by sparks or flames causing serious burns and injuries. Before refueling, stop the engine, and always keep sparks and flames away from the filler neck. Additionally, use of the incorrect fuel filler cap or not using a fuel filler cap may result in fuel leak, which could result in serious burns or death in an accident.

CAUTION

Always use only a genuine Mazda fuel cap or an approved equivalent, available at an Authorized Mazda Dealer. The wrong cap can result in a serious malfunction of the fuel and emission control systems. It may also cause the check engine light in the instrument cluster to illuminate.

Knowing Your Mazda
Doors and Locks

▼ **Fuel-Filler Lid**

To open, pull up the remote fuel-filler lid release.

4 Door

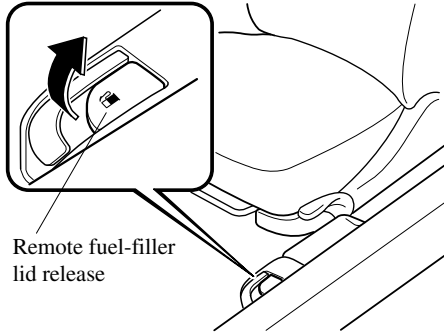

5 Door

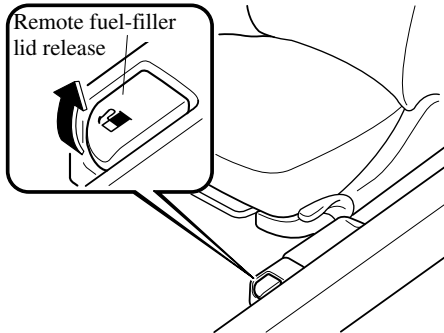

▼ **Fuel-Filler Cap**

To remove the filler cap, turn it counterclockwise.

To close the filler cap, turn it clockwise until it clicks.

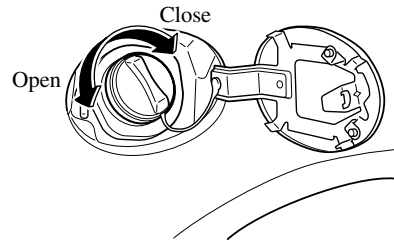

⚠ CAUTION

Make sure the fuel-filler cap is tightened securely. The check engine light may illuminate when the cap isn't tightened securely. If the light remains on (even after you have tightened the cap securely, driven, and restarted the engine several times), it may indicate a different problem. Contact an Authorized Mazda Dealer as soon as possible.

Knowing Your Mazda

Doors and Locks

Hood

WARNING

Closed and Securely Locked Hood:
A hood that is not closed and securely locked is dangerous as it could fly open while the vehicle is moving and block the driver's vision which could result in a serious accident. Always check that the hood is closed and securely locked.

▼ Opening the Hood

1. With the vehicle parked, pull the release handle to unlock the hood.

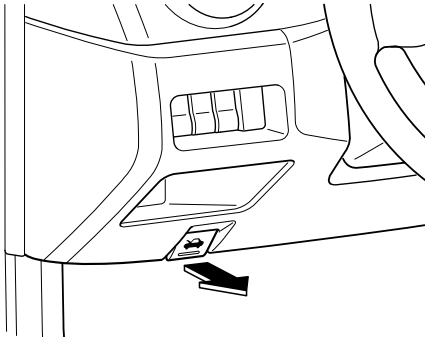

2. Slide the hood latch and lift the hood.

4 Door

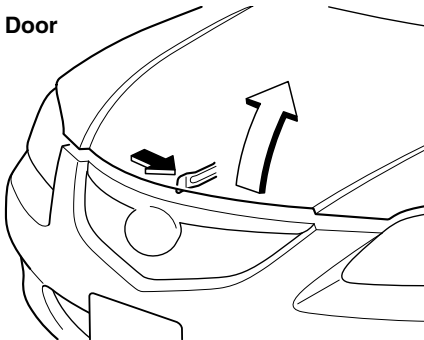

5 Door

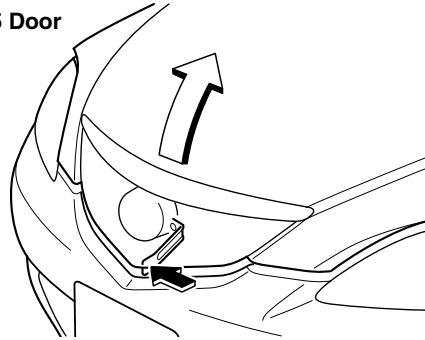

3. Grasp the support rod in the padded area indicated by the arrow.

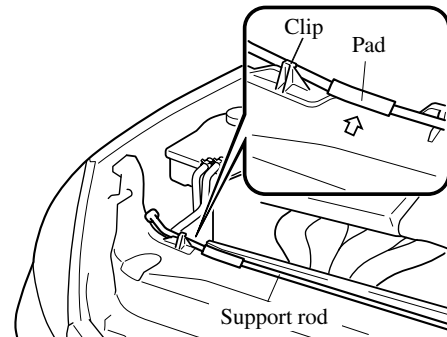

4. Secure the support rod in the stay hole indicated by the arrow to hold the hood open.

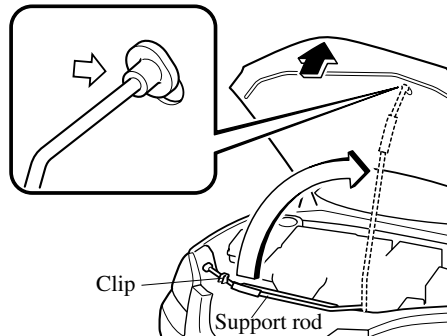

Knowing Your Mazda
Doors and Locks

▼ **Closing the Hood**

1. Check under the hood area to make certain all filler caps are in place and all loose items (e.g. tools, oil containers, etc.) have been removed.
2. Insert the support rod in its clip while holding up the hood. Verify that the support rod is secured in the clip before closing the hood.
3. Close the hood so that it locks securely.

Moonroof*

The moonroof can be opened or closed electrically only when the ignition switch is in the ON position.

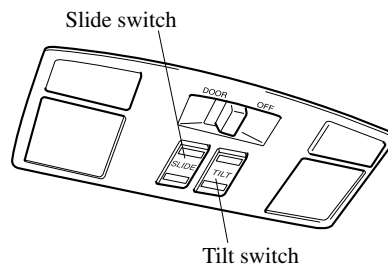

! WARNING

Extending the Head or Arms Through the Moonroof:

Extending the head, arms, or other parts of the body through the moonroof is dangerous. The head or arms could hit something while the vehicle is moving. This could cause serious injury or death. Don't let passengers stand up or extend anything through the open moonroof while the vehicle is moving.

Closing the Moonroof:

A closing moonroof is dangerous. The hands, head, or even neck of a person—especially a child—could be caught in it as it closes, causing serious injury or even death. Make sure the opening is clear before closing the moonroof.

Knowing Your Mazda

Doors and Locks

NOTE

After washing your Mazda or after a rain, wipe the water off the moonroof before operating it to avoid water penetration which could cause rust and water damage to your headliner.

▼ Tilt Operation

The rear of the moonroof can be tilted open to provide more ventilation.

To fully tilt automatically, push the rear of the tilt switch.

To stop tilting partway, push any part of the tilt or slide switch.

To close to the desired position, push the front of the tilt or slide switch.

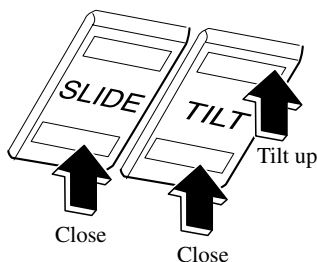

▼ Slide Operation

To fully open automatically, push the rear of the slide switch.

To stop sliding partway, push any part of the tilt or slide switch.

To close to the desired position, push the front of the tilt or slide switch.

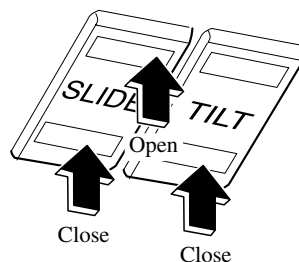

▼ Sunshade

The sunshade can be opened and closed by hand.

The sunshade opens automatically when the moonroof is opened, but must be closed by hand.

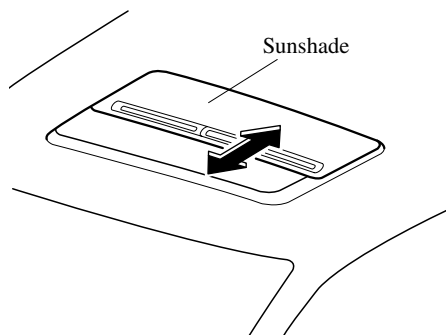

⚠ CAUTION

The sunshade doesn't tilt. To avoid damaging the sunshade, don't push up on it.

Knowing Your Mazda
Security System

Immobilizer System

The immobilizer system allows the engine to start only with a key the system recognizes.

If someone attempts to start the engine with an unrecognized key, the engine will not start, thereby helping to prevent the theft of your vehicle.

CAUTION

- Radio equipment like this is governed by laws in the United States.
Changes or modifications not expressly approved by the party responsible for compliance could void the user's authority to operate the equipment.
- To avoid damage to the key, do not:
 - Drop the key.
 - Get the key wet.
 - Expose the key to any kind of magnetic field.
 - Expose the key to high temperatures on places such as the dashboard or hood, under direct sunlight.

CAUTION

When starting the engine do not allow the following, as the engine may not start due to the electronic signal from the ignition key not being transmitted correctly.

- A key ring rests on the key grip.

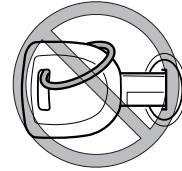

- Metal parts of other keys or metal objects touch the key grip.

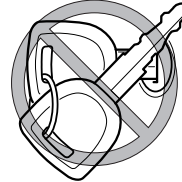

- Spare keys or keys for other vehicles equipped with an immobilizer system touch or come near the key grip.

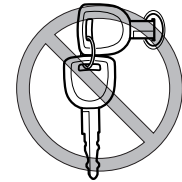

- Devices for electronic purchases, or security passage touch or come near the key.

Knowing Your Mazda

Security System

NOTE

- **(U.S.A.)**
This device complies with Part 15 of the FCC Rules. Operation is subject to the following two conditions: (1) this device may not cause harmful interference, and (2) this device must accept any interference received, including interference that may cause undesired operation.
- **(CANADA)**
This device complies with RSS-210 of Industry CANADA. Operation is subject to the following two conditions: (1) this device may not cause interference, and (2) this device must accept any interference, including interference that may cause undesired operation of the device.

▼ Operation

Arming

The system is armed when the ignition switch is turned from the ON to the ACC position.

The security indicator light in the instrument panel flashes every 2 seconds until the system is disarmed.



Disarming

The system is disarmed when the ignition switch is turned to the ON position with the correct ignition key.

The security indicator light illuminates for about 3 seconds and goes out.

If the engine doesn't start with the correct ignition key, and the security indicator light keeps illuminating or flashing, the system may have a malfunction. Consult an Authorized Mazda Dealer.

NOTE

- If the security indicator light comes on and stays on when the ignition switch is turned to the ON position, the engine will not start.
- Signals from a TV or radio station, or from a transceiver or a mobile telephone, could interfere with your immobilizer system. If you are using the proper key and your engine fails to start, check the security indicator light. If it is flashing, remove the ignition key and wait 2 seconds or more, then reinsert it and try starting the engine again. If it doesn't start after 3 or more tries, contact an Authorized Mazda Dealer.
- If the security indicator light flashes continuously while you are driving, don't shut off the engine. Go to an Authorized Mazda Dealer and have it checked. If you shut off the engine while the light is flashing you won't be able to restart it.

Knowing Your Mazda
Security System

NOTE

- Since the electronic codes are reset when repairing the immobilizer system, the keys are needed. Bring all the existing keys to an Authorized Mazda Dealer.

▼ Maintenance

If you have a problem with the immobilizer system or the key, consult an Authorized Mazda Dealer.

NOTE

- The keys carry a unique electronic code. For this reason, and to assure your safety, obtaining replacement key requires some waiting time. They are only available through an Authorized Mazda Dealer.
- Always keep a spare key, in case one is lost. If a key is lost, contact an Authorized Mazda Dealer as soon as possible.
- If you lose a key, an Authorized Mazda Dealer will reset the electronic codes of your remaining keys and immobilizer system. Bring all the remaining keys to an Authorized Mazda Dealer to reset. Starting the vehicle with a key that has not been reset is not possible.

▼ Modification and Add-On Equipment

Mazda cannot guarantee the immobilizer system's operation if the system has been modified or if any add-on equipment has been installed to it.

 **CAUTION**

To avoid damage to your vehicle, do not modify the system or install any add-on equipment to the immobilizer system or the vehicle.

Knowing Your Mazda

Security System

Theft-Deterrent System *

The theft-deterrent system is designed to prevent your vehicle or its contents from being stolen when all doors, hood, and trunk lid/liftgate are locked.

If forcible entry is attempted, the system sounds the horn and flashes the hazard warning lights.

NOTE

- The theft-deterrent system operates with the key or the keyless entry system transmitter.
- The system will not function unless it is properly armed. To properly secure the vehicle, always make sure all windows are completely closed and all doors and the trunk lid/liftgate are locked before leaving the vehicle. Remember to take your key and transmitter.

▼ Operation

System triggering conditions

The horn sounds intermittently and the hazard warning lights flash for about 3 minutes when the system is triggered by any one of the following:

- Forcing open a door, the hood or the trunk lid/liftgate.
- Opening a door, the hood or the trunk lid by operating an inside door-lock knob, the hood release handle or the trunk lid release lever.

If the system is triggered again, the lights and horn will activate until a door or the trunk lid is unlocked with the key or with the transmitter.

3-26 *Some models.

▼ How to Arm the System

1. Remove the key from the ignition switch.
2. Make sure the hood is closed. Close and lock all doors and the liftgate/trunk lid from the outside using the key. If you have the keyless entry system, press the lock button on the transmitter. The hazard warning lights will flash once to indicate that the system is armed.

The following method will also arm the theft-deterrent system:

Close the hood and the liftgate/trunk lid. Press the area on the door-lock switch marked "LOCK" once. Close all doors.

NOTE

Locking the doors with the inside door-lock knob will not arm the system.

▼ To Turn off an Armed System

An armed system can be turned off by any one of the following methods:

- Unlock a door or the trunk lid with the key.
- Press the unlock button on the keyless entry system transmitter.
- Insert the key into the ignition switch and turn it to the ON position.

▼ To Stop an Alarm

A triggered alarm can be turned off by any one of the following methods:

- Unlock a door or the trunk lid with the key.

Knowing Your Mazda Security System

- Press the unlock button on the keyless entry system transmitter.

NOTE

If you have any problem with the theft-deterrent system, consult an Authorized Mazda Dealer.

▼ Theft-Deterrent Labels



A label indicating that your vehicle is equipped with a Theft-Deterrent System is in the glove box.

Mazda recommends that you affix it to the lower rear corner of a front door window.

Knowing Your Mazda

Steering Wheel and Mirrors

Steering Wheel

WARNING

Adjusting the Steering Wheel:
Adjusting the steering wheel while the vehicle is moving is dangerous. Moving it can very easily cause the driver to abruptly turn to the left or right. This can lead to loss of control or an accident. Never adjust the steering wheel while the vehicle is moving.

▼ **Steering Wheel Adjustment**

To change the angle or length of the steering wheel:

1. Stop the vehicle, pull down the lock release lever under the steering column.

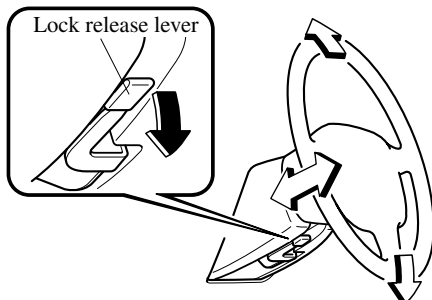

2. Tilt the steering wheel and/or adjust the steering column length to the desired positions, push the lever up to lock the column.
3. Push the wheel up and down to be certain it's locked before driving.

3-28

Mirrors

▼ **Outside Mirrors**

Check the mirror angles before driving.

Mirror type

Flat type (driver's side)

Flat surface mirror.

Convex type (front passenger side)

The mirror has single curvature on its surface.

WARNING

Convex Mirror:

Changing lanes without taking into account the actual distance of the vehicle in the convex mirror is dangerous. You could have a serious accident. What you see in the convex mirror is closer than it appears. Be sure to look over your shoulder before changing lanes.

Power control mirror

The ignition switch must be in the ACC or ON position.

To adjust:

1. Move the selector switch to the left or right to choose the left or right side mirror.

Steering Wheel and Mirrors

2. Depress the mirror switch in the appropriate direction.

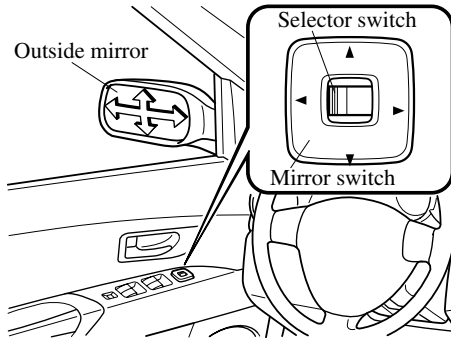

After adjusting the mirror, lock the control by moving the selector switch to the middle position.

Manual control mirror

To adjust, move the mirror's control lever, just inside the door.

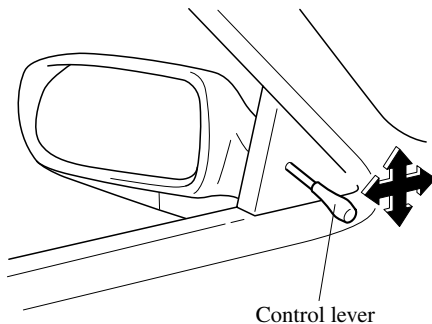

Folding the mirror

Fold the outside mirror rearward until it is flush with the vehicle.

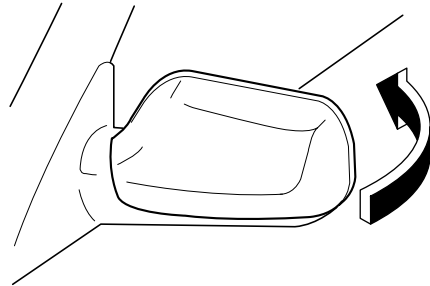

! WARNING

Driving with Mirrors Folded In:
Driving with the outside mirrors folded in is dangerous. Your rear view will be restricted, and you could have an accident. Always return the outside mirrors to the driving position before you start driving.

Mirror defroster*

To turn on the mirror defrosters, turn the ignition switch to the ON position and push the rear window defroster switch (page 5-54).

Knowing Your Mazda

Steering Wheel and Mirrors

▼ Rearview Mirror

Rearview mirror adjustment

Before driving, adjust the rearview mirror to center on the scene through the rear window.

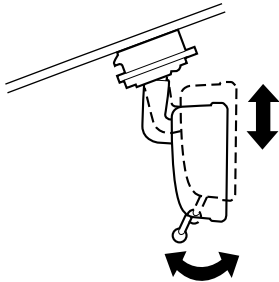

Reducing glare from headlights

Do this with the day/night lever in the day position.

Push the lever forward for day driving.
Pull it back to reduce glare from headlights.

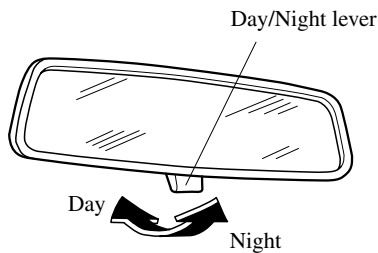

WARNING

Blocked View:

Cargo stacked higher than the seatbacks is dangerous. It can block your view in the rearview mirror, which might cause you to hit another car when changing lanes. Don't stack things higher than the seatbacks.

4

Before Driving Your Mazda

Important information about driving your Mazda.

Fuel and Engine Exhaust Precautions	4-2
Fuel Requirements	4-2
Emission Control System	4-3
Engine Exhaust (Carbon Monoxide)	4-5
Before Starting the Engine	4-6
Before Getting In	4-6
After Getting In	4-6
Driving Tips	4-7
Break-In Period	4-7
Money-Saving Suggestions	4-7
Hazardous Driving	4-8
Rocking the Vehicle	4-8
Winter Driving	4-9
Driving In Flooded Area	4-11
Overloading	4-11
Towing	4-12
Trailer Towing	4-12

Before Driving Your Mazda

Fuel and Engine Exhaust Precautions

Fuel Requirements

Vehicles with catalytic converters or oxygen sensors must use **ONLY UNLEADED FUEL**, which will reduce exhaust emissions and keep spark plug fouling to a minimum.

Your Mazda will perform best with fuel listed in the table.

Fuel	Octane Rating* (Anti-knock index)
Regular unleaded fuel	87 [(R+M)/2 method] or above (91 RON or above)

* U.S. federal law requires that octane ratings be posted on gasoline station pumps.

Fuel with a rating lower than 87 octane (91 RON) could cause the emission control system to lose effectiveness. It could also cause engine knocking and serious engine damage.

CAUTION

- **USE ONLY UNLEADED FUEL.**
Leaded fuel is harmful to the catalytic converter or the oxygen sensor. The lead will accumulate on the oxygen sensor and the catalyst inside the converter. This will result in a malfunction of the emission control system, causing poor performance.
- Your vehicle can only use oxygenated fuels containing no more than 10% ethanol by volume. Damage to your vehicle may occur when ethanol exceeds this recommendation, or if the gasoline contains any methanol. Stop using gasohol of any kind if your vehicle engine is performing poorly.
- Never add fuel system additives. Never add cleaning agents other than those specified by Mazda. Other cleaning agents and additives may damage the system. Consult an Authorized Mazda Dealer.

Gasoline blended with oxygenates such as alcohol or ether compounds are generally referred to as oxygenated fuels. The common gasoline blend that can be used with your vehicle is ethanol blended at no more than 10%. Gasoline containing alcohol, such as ethanol or methanol, may be marketed under the name "Gasohol".

Vehicle damage and drivability problems resulting from the use of the following may not be covered by the Mazda warranty.

- Gasohol containing more than 10% ethanol.
- Gasoline or gasohol containing methanol.
- Leaded fuel or leaded gasohol.

Before Driving Your Mazda

Fuel and Engine Exhaust Precautions

Emission Control System

Your vehicle is equipped with an emission control system (the catalytic converter is part of this system) that enables your vehicle to comply with existing exhaust emissions requirements.

WARNING

Parking Over Flammable Objects:

Parking over or near anything flammable, such as dry grass, is dangerous. Even with the engine turned off, the exhaust system could ignite it because the exhaust system gets very hot during normal use. A resulting fire could cause serious injury or death. Never park over or near anything flammable.

CAUTION

Ignoring the following precautions could cause lead to accumulate on the catalyst inside the converter or cause the converter to get very hot. Either condition will damage the converter and cause poor performance.

- USE ONLY UNLEADED FUEL.
- Don't drive your Mazda with any sign of engine malfunction.
- Don't coast with the ignition switch turned off.
- Don't descend steep grades in gear with the ignition switch turned off.
- Don't operate the engine at high idle for more than 5 minutes.
- Don't tamper with the emission control system. All inspections and adjustments must be made by a qualified technician.
- Don't push-start or pull-start your vehicle.

NOTE

Under U.S. federal law, any modification to the original-equipment emission control system before the first sale and registration of a vehicle is subject to penalties. In some states, such modification made on a used vehicle is also subject to penalties.

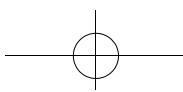

Before Driving Your Mazda

Fuel and Engine Exhaust Precautions

NOTE

While the engine is off, the sound of a valve opening and closing can be heard at the rear of the right side of the vehicle, however this does not indicate an abnormality. Your vehicle has a self-checking device and it operates while the engine is off.

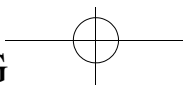

Before Driving Your Mazda

Fuel and Engine Exhaust Precautions

Engine Exhaust (Carbon Monoxide)

WARNING

Carbon Monoxide:

Engine exhaust gas is dangerous. This gas contains carbon monoxide (CO), which is colorless, odorless, and poisonous. When inhaled, it can cause loss of consciousness and death. If you smell exhaust gas inside your vehicle, keep all windows fully open and contact an Authorized Mazda Dealer immediately.

Exhaust Gas in Enclosed Area:

Running the engine inside an enclosed area, such as a garage, is dangerous. Exhaust gas, which contains poisonous carbon monoxide, could easily enter the cabin. Loss of consciousness or even death could occur. Don't run the engine when inside an enclosed area.

Idling with the Windows Closed:

Exhaust gas is dangerous. When your vehicle is stopped with the windows closed and the engine running for a long time even in an open area, exhaust gas, which contains poisonous carbon monoxide, could enter the cabin. Loss of consciousness or even death could occur. Open the windows or adjust the heating or cooling system to draw fresh air.

Snow Blocking the Exhaust Gas:

Running the engine when a vehicle is stopped in deep snow is dangerous. The exhaust pipe could be blocked by the snow, allowing exhaust gas to enter the cabin. Because exhaust gas contains poisonous carbon monoxide, anyone in the cabin could be injured or killed. Clear the snow from underneath and around your vehicle, particularly the tail pipe, before starting the engine.

Before Driving Your Mazda

Before Starting the Engine

Before Getting In

- Be sure the windows, outside mirrors, and outside lights are clean.
- Inspect inflation pressures and condition of tires.
- Look under the vehicle for any sign of a leak.
- If you plan to back up, make sure nothing is in your way.

NOTE

Engine oil, engine coolant, brake/clutch fluid, washer fluid, and other fluid levels should be inspected. See Maintenance, Section 8.

After Getting In

- Are all doors closed and locked?
- Is the seat adjusted properly?
- Are the inside and outside mirrors adjusted?
- Is everyone's seat belt fastened?
- Check all gauges.
- Check all warning lights when the ignition switch is turned to the ON position.
- Release the parking brake and make sure the brake warning light goes off.

Always be thoroughly familiar with your Mazda.

Driving Tips

Break-In Period

No special break-in is necessary, but a few precautions in the first 1,000 km (600 miles) may add to the performance, economy, and life of your Mazda.

- Don't race the engine.
- Don't maintain one constant speed, either slow or fast, for a long period of time.
- Don't drive constantly at full-throttle or high engine rpm for extended periods of time.
- Avoid unnecessary hard stops.
- Avoid full-throttle starts.

Money-Saving Suggestions

How you operate your Mazda determines how far it will travel on a tank of fuel. Use these suggestions to help save money on fuel and repairs.

- Avoid long warm-ups. Once the engine runs smoothly, begin driving.
- Avoid fast starts.
- Keep the engine tuned. Follow the maintenance schedule (page 8-3) and have an Authorized Mazda Dealer perform inspections and servicing.
- Use the air conditioner only when necessary.
- Slow down on rough roads.
- Keep the tires properly inflated.
- Don't carry unnecessary weight.
- Don't rest your foot on the brake pedal while driving.
- Keep the wheels in correct alignment.
- Keep windows closed at high speeds.
- Slow down when driving in crosswinds and headwinds.

WARNING

Coasting:

Stopping the engine when going down a hill is dangerous. This causes the loss of power steering and power brake control, and may cause damage to the drivetrain. Any loss of steering or braking control could cause an accident. Never stop the engine when going down a hill.

Before Driving Your Mazda

Driving Tips

Hazardous Driving

WARNING

Downshifting on Slippery Surfaces:
Downshifting into lower gear while driving on slippery surfaces is dangerous. The sudden change in tire speed could cause the tires to skid. This could lead to loss of vehicle control and an accident. If it is necessary to downshift on slippery surfaces, be very careful.

When driving on ice or in water, snow, mud, sand, or similar hazard:

- Be cautious and allow extra distance for braking.
- Avoid sudden braking and quick steering.
- If your vehicle is not equipped with ABS, brake with the pedal by using a light up-down motion. Don't hold the pedal down constantly.
If your vehicle is equipped with ABS, don't pump the brakes. Continue to press down on the brake pedal.
- If you get stuck, select a lower gear and accelerate slowly. Don't spin the front wheels.
- For more traction in starting on slippery surfaces such as ice or packed snow, use sand, rock salt, chains, carpeting, or other nonslip material under the front wheels.

NOTE

Use snow chains only on the front wheels.

Rocking the Vehicle

WARNING

Spinning the Wheels:
When the vehicle is stuck, spinning the wheels at high speed is dangerous. The spinning tire could overheat and explode. This could cause serious injuries. Don't spin the wheels at more than 56 km/h (35 mph), and don't allow anyone to stand behind a wheel when pushing the vehicle.

CAUTION

Too much rocking may cause engine overheating, transaxle failure, and tire damage.

If you must rock the vehicle to free it from snow, sand or mud, depress the accelerator slightly and slowly move the shift lever from 1 (D) to R.

Winter Driving

- Carry emergency gear, including tire chains, window scraper, flares, a small shovel, jumper cables, and a small bag of sand or salt.

Ask an Authorized Mazda Dealer to perform the following precautions:

- Have the proper ratio of antifreeze in the radiator.
- Inspect the battery and its cables. Cold reduces battery capacity.
- Inspect the ignition system for damage and loose connections.
- Use washer fluid made with antifreeze—but don't use engine coolant antifreeze for washer fluid (page 8-20).
- Don't use the parking brake in freezing weather as the parking brake may freeze. Instead, shift to P with an automatic transaxle and to 1 or R with a manual transaxle. Block the rear wheels.

▼ Snow Tires

Use snow tires on all four wheels

Don't go faster than 120 km/h (75 mph) while driving with snow tires. Inflate snow tires 30 kPa (0.3 kgf/cm², 4.3 psi) more than recommended on the tire pressure label (driver's door frame), but never more than the maximum cold-tire pressure shown on the tires.

Your vehicle is originally equipped with all season radials designed to be used all year around. In some extreme climates you may find it necessary to replace them with snow tires during the winter months to further improve traction on snow and ice covered roads.

WARNING

Mixing Tire Types:

Using tires different in size or type is dangerous. Your vehicle's handling could be greatly affected and result in an accident. Use only the same size and type tires (snow, radial, or non-radial) on all four wheels.

CAUTION

Check local regulations before using studded tires.

NOTE

If your vehicle is equipped with the tire pressure monitoring system, the system may not function correctly when using tires with steel wire reinforcement in the sidewalls (page 5-25).

Before Driving Your Mazda

Driving Tips

▼ Tire Chains

Check local regulations before using tire chains.

CAUTION

- Chains may scratch or chip aluminum wheels. Install tire chains on steel wheels only.
- Chains may affect handling.
- Don't go faster than 50 km/h (30 mph) or the chain manufacturer's recommended limit, whichever is lower.
- Drive carefully and avoid bumps, holes, and sharp turns.
- Avoid locked-wheel braking.
- Don't use chains on a temporary spare tire; it may result in damage to the vehicle and to the tire.
- Don't use chains on roads that are free of snow or ice. The tires and chains could be damaged.

NOTE

If your vehicle is equipped with the tire pressure monitoring system, the system may not function correctly when using tire chains.

Install the chains on the front tires.
Don't use chains on the rear tires.
Use only SAE Class "S" chains, and make sure they fit.

Installing the chains

1. Secure the chains on the front tires as tightly as possible. Always follow the chain manufacturer's instructions.
2. Retighten the chains after driving 1/2—1 km (1/4—1/2 mile).

Before Driving Your Mazda

Driving Tips

Driving In Flooded Area

WARNING

Driving with Wet Brakes:
Driving with wet brakes is dangerous. Increased stopping distance or the vehicle pulling to one side when braking could result in a serious accident. Light braking will indicate whether the brakes have been affected. Dry the brakes by driving very slowly and applying the brakes lightly until brake performance returns to normal.

CAUTION

Make sure water does not enter the vehicle interior or the engine area. Interior materials could get moldy, and many electronic devices in the cabin and the engine could be damaged.

Overloading

WARNING

Vehicle Load Weight:
The gross axle weight rating (GAWR) and the gross vehicle weight rating (GVWR) of your vehicle are on the Motor Vehicle Safety Standard Label on the driver's door frame. Exceeding these ratings can cause an accident or vehicle damage. You can estimate the weight of your load by weighing the items (or people) before putting them in the vehicle. Be careful not to overload your vehicle.

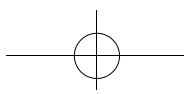

Before Driving Your Mazda

Towing

Trailer Towing

The Mazda3 is not designed for towing.
Never tow a trailer with your Mazda3.

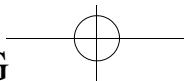

5 Driving Your Mazda

Explanation of instruments and controls.

Starting and Driving	5-2
Ignition Switch	5-2
Starting the Engine	5-3
Brake System	5-4
Manual Transaxle Operation	5-9
Automatic Transaxle Controls	5-11
Power Steering	5-17
Cruise Control *	5-18
Tire Pressure Monitoring System *	5-22
Instrument Cluster and Indicators	5-28
Meters and Gauges	5-28
Warning/Indicator Lights and Beep Sounds	5-33
Warning/Indicator Lights	5-33
Beep Sounds	5-44
Switches and Controls	5-46
Lighting Control	5-46
Turn and Lane-Change Signals	5-49
Fog Lights *	5-49
Windshield Wipers and Washer	5-50
Rear Window Wiper and Washer (5 Door)	5-53
Rear Window Defroster	5-54
Horn	5-55
Hazard Warning Flasher	5-55

*Some models. **5-1**

Driving Your Mazda

Starting and Driving

Ignition Switch

▼ Ignition Switch Positions

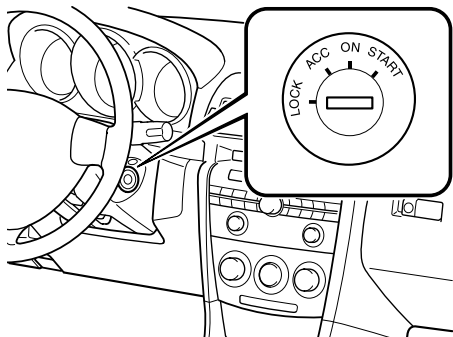

LOCK

The steering wheel locks to protect against theft. Only in this position can the key be removed.

To turn the key from the ACC to the LOCK position, push the button when the key is at the ACC position, then turn the key to the LOCK position.

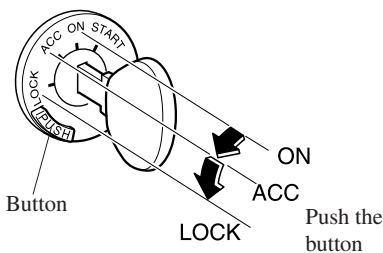

Automatic transaxle

To turn the key from the ACC to the LOCK position, the shift lever must be in the P position.

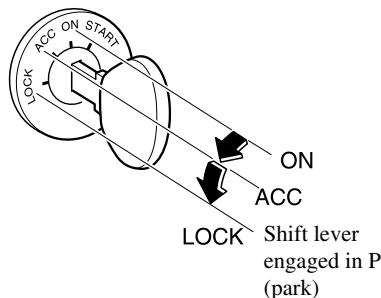

! WARNING

Removing the Key:

It's dangerous to remove the key from the ignition switch while the vehicle is moving. Removing the key allows the steering wheel to lock. You will lose steering control and a serious accident could occur.

Remove the key only when the vehicle is parked.

Not Setting the Parking Brake:

Leaving the driver's seat without setting the parking brake is dangerous. Unexpected vehicle movement could occur if the parking brake is not set. This could cause an accident. Before leaving the driver's seat, always set the parking brake and make sure the shift lever is in P with an automatic transaxle or in 1 or R with a manual transaxle.

Starting and Driving

NOTE

If turning the key is difficult, jiggle the steering wheel from side to side.

ACC (Accessory)

The steering wheel unlocks and some electrical accessories will operate.

ON

This is the normal running position after the engine is started. The warning lights (except brakes) should be inspected before the engine is started (page 5-33).

NOTE

When the ignition switch is turned to the ON position, the sound of the fuel pump motor operating near the fuel tank can be heard. This does not indicate an abnormality.

START

The engine is started in this position. It will crank until you release the key; then it returns to the ON position. The brake warning light can be checked after the engine is started (page 5-33).

▼ Ignition Key Reminder

If the ignition switch is in the LOCK or ACC position with the key inserted, a continuous beep sound will be heard when the driver's door is opened.

Starting the Engine

NOTE

Engine-starting is controlled by the spark ignition system. This system meets all Canadian Interference-Causing Equipment Standard requirements regulating the impulse electrical field strength of radio noise.

1. Occupants should fasten their seat belts.
2. Make sure the parking brake is on.
3. Depress the brake pedal.
4. **(Manual transaxle)**
Depress the clutch pedal all the way and shift into neutral. Keep the clutch pedal depressed while cranking the engine.
(Automatic transaxle)
Put the vehicle in park (P). If you must restart the engine while the vehicle is moving, shift into neutral (N).

NOTE

(Manual transaxle)
The starter will not operate if the clutch pedal is **not** depressed all the way.
(Automatic transaxle)
The starter will not operate if the shift lever is **not** in P or N.

5. Turn the ignition switch to the START position and hold (up to 10 seconds at a time) until the engine starts.

Driving Your Mazda

Starting and Driving

CAUTION

Don't try the starter for more than 10 seconds at a time. If the engine stalls or fails to start, wait 10 seconds before trying again. Otherwise, you may damage the starter and drain the battery.

6. After starting the engine, let it idle for about 10 seconds.

NOTE

- In extremely cold weather, below -18°C (0°F), or after the vehicle has not been driven in several days, let the engine warm up without operating the accelerator.
- Whether the engine is cold or warm, it should be started without use of the accelerator.

Brake System

▼ Foot Brake

Your Mazda has power-assisted brakes that adjust automatically through normal use.

Should power-assist fail, you can stop by applying greater force than normal to the brake pedal. But the distance required to stop will be greater than usual.

WARNING

Coasting with the Engine Off:
Continuing to coast when the engine is stalled or turned off is dangerous. Braking will require more effort, and the brake's power-assist could be depleted if you pump the brake. This will cause longer stopping distances or even an accident. Don't continue coasting when the engine is stalled or turned off, find a safe place to stop.

Riding the Brakes:
Driving with your foot continuously on the brake pedal or steadily applying the brakes for long distances is dangerous. This causes overheated brakes, resulting in longer stopping distances or even total brake failure. This could cause loss of vehicle control and a serious accident. Avoid continuous application of the brakes. Shift to a lower gear when going down steep hills.

Driving Your Mazda
Starting and Driving

⚠ WARNING

Driving with Wet Brakes:
Driving with wet brakes is dangerous. Increased stopping distance or the vehicle pulling to one side when braking could result in a serious accident. Light braking will indicate whether the brakes have been affected. Dry the brakes by driving very slowly and applying the brakes lightly until brake performance is normal.

▼ Parking Brake

⚠ WARNING

Not Setting the Parking Brake:
Leaving the driver's seat without setting the parking brake is dangerous. Unexpected vehicle movement could occur if the parking brake is not set. This could cause an accident. Before leaving the driver's seat, always set the parking brake and make sure the shift lever is in P with an automatic transaxle or in 1 or R with a manual transaxle.

⚠ CAUTION

Driving with the parking brake on will cause excessive wear of the brake linings or pads.

NOTE

For parking in snow, refer to Winter Driving (page 4-9) regarding parking brake use.

Setting the parking brake

Depress the brake pedal and then firmly pull the parking brake lever fully upwards with a greater amount of force than is required so that the vehicle holds in the stationary position.

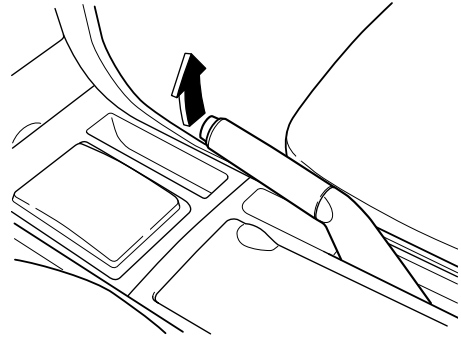

Releasing the parking brake

Depress the brake pedal and pull the parking brake lever upwards, then press the release button. While holding the button, lower the parking brake lever all the way down to the released position.

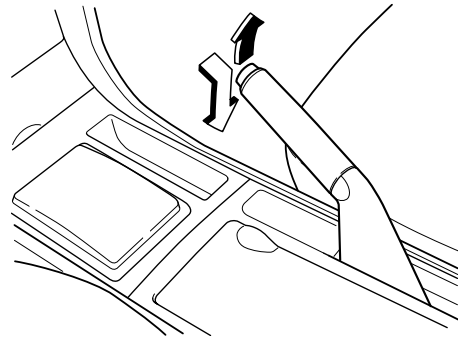

Driving Your Mazda

Starting and Driving

▼ Brake System Warning Light



This warning has the following functions:

Parking brake warning

The light comes on when the parking brake is applied with the ignition switch in the START or ON position. It goes off when the parking brake is fully released.

Low brake fluid level warning

If the light stays on after the parking brake is fully released, you may have a brake problem.

Drive to the side of the road and park off the right-of-way.

You may notice that the pedal is harder to push or that it may go closer to the floor. In either case, it will take longer to stop the vehicle.

1. With the engine stopped, check the brake fluid level immediately and add fluid as required (page 8-16).
2. After adding fluid, check the light again.

If the warning light remains on, or if the brakes do not operate properly, do not drive the vehicle. Have it towed to an Authorized Mazda Dealer.

Even if the light goes out have your brake system inspected as soon as possible by an Authorized Mazda Dealer.

NOTE

Having to add brake fluid is sometimes an indicator of leakage. Consult an Authorized Mazda Dealer as soon as possible even if the brake light is no longer illuminated.

WARNING

Brake Warning Light:
Driving with the brake system warning light on is dangerous. It indicates that your brakes may not work at all or that they could completely fail at any time. If this light remains on, after checking that the parking brake is fully released, have the brakes inspected immediately. Don't drive with this light on, have the vehicle towed to an Authorized Mazda Dealer to have the brakes inspected as soon as possible.

▼ Anti-Lock Brake System (ABS)*

The ABS control unit continuously monitors the speed of each wheel. If one is about to lock up, the ABS responds by automatically releasing and reapplying that wheel's brake.

The driver will feel a slight vibration in the brake pedal and may hear a chattering noise from the brake system. This is normal when the ABS operates. Don't pump the brakes, continue to press down on the brake pedal.

Driving Your Mazda
Starting and Driving

 **WARNING**

ABS:

The ABS cannot compensate for unsafe and reckless driving, excessive speed, tailgating (following another vehicle too closely), driving on ice and snow, and hydroplaning (reduced tire friction and road contact because of water on the road surface). You can still have an accident. So don't rely on ABS as a substitute for safe driving.

NOTE

Braking distances may be longer on loose surfaces (snow or gravel, for example) which usually have a hard foundation. A vehicle with a normal braking system may require less distance to stop under these conditions because the tires will build up a wedge of surface layer when the wheels skid.

▼ **ABS Warning Light***



The warning light stays on for a few seconds when the ignition switch is turned to the ON position.

If the ABS warning light stays on while you're driving, the ABS control unit has detected a system malfunction. If this occurs, your brakes will function normally as if the vehicle had no ABS. Should this happen, consult an Authorized Mazda Dealer as soon as possible.

NOTE

When the engine is jump-started to charge the battery, uneven rpm occurs and the ABS warning light comes on. This is due to a weak battery, not a malfunction. Recharge the battery.

▼ **Electronic Brake Force Distribution System Warning***

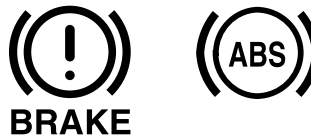

If the electronic brake force distribution control unit determines that some components are operating incorrectly, the control unit may turn the brake system warning light and the ABS warning light on at the same time. The problem is likely to be an electronic brake force distribution system.

*Some models.

Driving Your Mazda

Starting and Driving

WARNING

ABS Warning Light and Brake Warning Light on at the Same Time: Driving when the brake system warning light and ABS warning light are on at the same time is dangerous. When both lights are on, the rear wheels could lock more quickly in an emergency stop than under normal circumstances. Don't drive with both lights on, have the vehicle towed to an Authorized Mazda Dealer to have the brakes inspected as soon as possible.

▼ Brake Assist*

During emergency braking situations when it is necessary to depress the brake pedal with greater force, the brake assist system provides braking assistance, thus enhancing braking performance.

When the brake pedal is depressed hard or depressed more quickly, the brakes apply more firmly.

NOTE

- When the brake pedal is depressed hard or depressed more quickly, the pedal will feel softer but the brakes will apply more firmly. This is a normal effect of the brake assist operation and does not indicate an abnormality.
- When the brake pedal is depressed hard or depressed more quickly, a clicking noise from the brake booster may be heard. This is a normal effect of the brake assist and does not indicate an abnormality.
- The brake assist equipment does not supersede the functionality of the vehicle's main braking system.

Driving Your Mazda Starting and Driving

Manual Transaxle Operation

▼ Manual Transaxle Shift Pattern

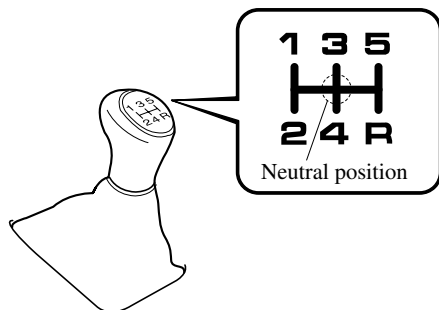

The shift pattern of the transaxle is conventional, as shown.

Depress the clutch pedal all the way down while shifting; then release it slowly.

A safety feature prevents accidental shifting from 5 to R (reverse). The shift lever must be put in neutral before being shifted to R.

! WARNING

Sudden Engine-Braking:
Shifting down while driving on wet, snowy, or frozen roads, or while driving at high speeds causes sudden engine braking, which is dangerous. The sudden change in tire speed could cause the tires to skid. This could lead to loss of vehicle control and an accident. Do not use sudden engine braking on slippery road surfaces or at high speeds.

! CAUTION

- Keep your foot off the clutch pedal except when shifting gears. Also, don't use the clutch to hold the vehicle on an upgrade. Riding the clutch will cause needless clutch wear and damage.
- Make sure the vehicle comes to a complete stop before shifting to R. Shifting to R while the vehicle is still moving may damage the transaxle.

NOTE

If shifting to R is difficult, shift back into neutral, release the clutch pedal, and try again.

▼ Recommendations for Shifting

Upshifting

For normal acceleration, we recommend these shift points.

Gear	Vehicle speed
1 to 2	21 km/h (13 mph)
2 to 3	39 km/h (24 mph)
3 to 4	55 km/h (34 mph)
4 to 5	78 km/h (49 mph)

For cruising

Gear	Vehicle speed
1 to 2	18 km/h (11 mph)
2 to 3	29 km/h (18 mph)
3 to 4	47 km/h (29 mph)
4 to 5	68 km/h (42 mph)



Driving Your Mazda

Starting and Driving

Downshifting

When you must slow down in heavy traffic or on a steep **upgrade**, downshift before the engine starts to overwork. This reduces the chance of stalling and gives better acceleration when you need more speed.

On a steep **downgrade**, downshifting helps maintain safe speed and prolongs brake life.

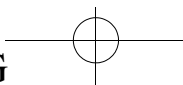

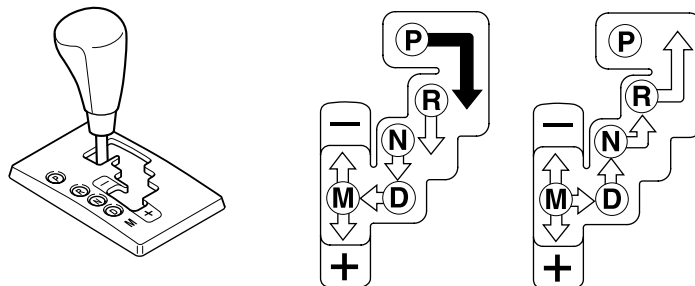

Driving Your Mazda
Starting and Driving

Automatic Transaxle Controls



Various Lockouts:

-  Indicates that you must depress the brake pedal to shift (The ignition switch must be in the ON position).
-  Indicates the shift lever can be shifted freely into any position.

▼ Transaxle Ranges

The shift lever must be in P or N to operate the starter.

P (Park)

P locks the transaxle and prevents the front wheels from rotating.

 **WARNING**

Holding the Vehicle with P:
Only setting the shift lever to the P position without using the parking brake to hold the vehicle is dangerous. If P fails to hold, the vehicle could move and cause an accident. To hold the vehicle, set the shift lever to P AND set the parking brake.

 **CAUTION**

- Shifting into P, N or R while the vehicle is moving can damage your transaxle.
- Shifting into a driving gear or reverse when the engine is running faster than idle can damage the transaxle.

R (Reverse)

In position R, the vehicle moves only backward. You must be at a complete stop before shifting to or from R, except under rare circumstances as explained in Rocking the Vehicle (page 4-8).

Driving Your Mazda

Starting and Driving

N (Neutral)

In N, the wheels and transaxle are not locked. The vehicle will roll freely even on the slightest incline unless the parking brake or brakes are on.

WARNING

Shifting from N or P:

It's dangerous to shift from N or P into a driving gear when the engine is running faster than idle. If this is done, the vehicle could move suddenly, causing an accident or serious injury. If the engine is running faster than idle, don't shift from N or P into a driving gear.

Shifting into N while Driving:

Shifting into N while driving is dangerous. Engine braking cannot be applied when decelerating which could lead to an accident or serious injury. Do not shift into N when driving the vehicle.

CAUTION

Do not shift into N when driving the vehicle. Doing so can cause transaxle damage.

D (Drive)

D is the normal driving position. From a stop, the transaxle will automatically shift through a 4-gear/5-gear* sequence.

* 2.3-liter engine model

M (Manual)

M is the manual shift mode position. Gears can be shifted up or down by operating the shift lever. Refer to Manual Shift Mode (page 5-13).

▼ Shift-Lock System

The shift-lock system prevents shifting out of P unless the brake pedal is depressed.

To shift from P:

1. Depress and hold the brake pedal.
2. Start the engine.
3. Move the shift lever.

NOTE

- When the ignition switch is in the ACC or LOCK position, the shift lever cannot be shifted from P.
- To be sure the vehicle is in park, **the ignition key cannot be removed unless the shift lever is in P.**

▼ Shift-Lock Override

If the shift lever won't move from P using the proper shift procedure, continue to hold down the pedal.

1. Remove the shift-lock override cover with a screwdriver.

Driving Your Mazda Starting and Driving

2. Insert a screwdriver and push it down.

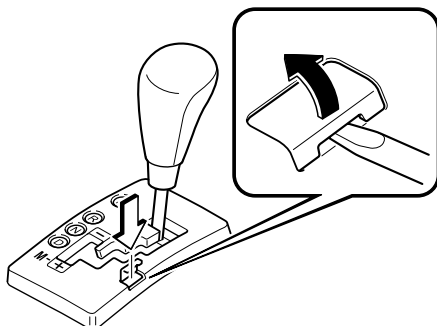

3. Move the shift lever.

4. Take the vehicle to an Authorized Mazda Dealer to have the system checked.

▼ Manual Shift Mode

This mode gives you the feel of driving a manual transaxle vehicle by operating the shift lever and allows you to control engine rpm and torque to the front wheels much like a manual transaxle when more control is desired.

To change to manual shift mode, shift the lever from D to M.

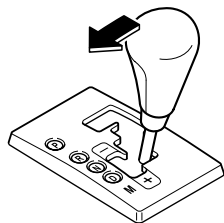

To return to automatic shift mode, shift the lever from M to D.

NOTE

- If you change to manual shift mode when the vehicle is stopped, the gear will shift to M1.
- If you shift up once when the vehicle is stopped and the gear is at M1, the gear will shift to M2. M2 is helpful for starting on slippery surfaces.
- **(2.3-liter engine model)**
If you change to manual shift mode without depressing the accelerator pedal when driving in D range, 5th gear, the gear will shift to M4.

Indicators

Shift position indicator

In manual shift mode, the “M” of the shift position indicator in the instrument panel illuminates.

Gear position indicator

The numeral for the selected gear illuminates.

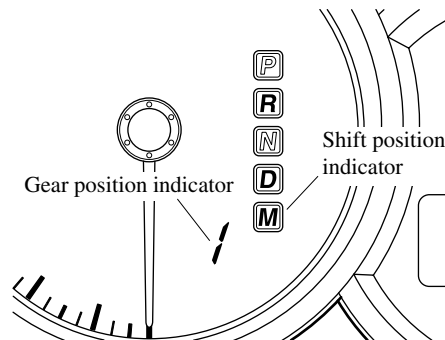

Driving Your Mazda

Starting and Driving

NOTE

- If the gears cannot be shifted down when driving at higher speeds, the gear position indicator will flash twice to signal that the gears cannot be shifted down.
- If the automatic transaxle fluid (ATF) temperature becomes too high, there is the possibility that the transaxle will switch to automatic shift mode, canceling manual shift mode and turning off the gear position indicator illumination. This is a normal function to protect the AT. After the ATF temperature has decreased, the gear position indicator illumination turns back on and driving in manual shift mode is restored.

Shifting

Manually Shifting up

(M1→M2→M3→M4→M5*)

To shift up to a higher gear, tap the shift lever back (+) once.

* 2.3-liter engine model

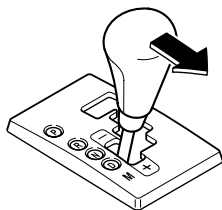

NOTE

- When driving slowly, the gears may not shift up depending on vehicle speed.
- In manual shift mode, gears do not shift up automatically. Don't run the engine with the tachometer needle in the RED ZONE. If the tachometer needle enters the RED ZONE, you may feel engine-braking because the fuel delivery will be stopped to protect the engine. However, this does not indicate an abnormality.
- When depressing the accelerator fully, the transaxle will shift to a lower gear, depending on vehicle speed.

Manually Shifting down

(M5*→M4→M3→M2→M1)

To shift down to a lower gear, tap the shift lever forward (-) once.

* 2.3-liter engine model

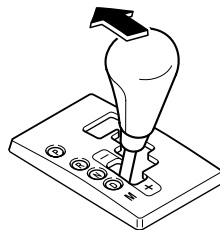

Starting and Driving

WARNING

Sudden Engine-Braking:
Shifting down while driving on wet, snowy, or frozen roads, or while driving at high speeds causes sudden engine braking, which is dangerous. The sudden change in tire speed could cause the tires to skid. This could lead to loss of vehicle control and an accident. Do not use sudden engine braking on slippery road surfaces or at high speeds.

NOTE

- When driving at high speeds, the gear may not shift down depending on vehicle speed.
- During deceleration, the gear may automatically shift down depending on vehicle speed.
- When depressing the accelerator fully, the transaxle will shift to a lower gear, depending on vehicle speed.

Second gear fixed mode

When the shift lever is tapped back (+) while the vehicle is stopped or driven at the following speeds, the transaxle is set in the second gear fixed mode.

2.0-liter engine model:

14 km/h (8 mph) or less

2.3-liter engine model:

20 km/h (12 mph) or less

The gear is fixed in second while in this mode for easier starting and driving on slippery roads. If the shift lever is tapped back (+) or forward (-) while in the second gear fixed mode, the mode will be canceled.

Shifting specification (2.0-liter engine model)

Shifting up

If the vehicle speed is lower than the speed specified for each gear, the gear cannot be shifted up to a higher gear.

Gear	Vehicle speed
M1→M2	You can shift up to M2 whether the vehicle is stopped or moving.
M2→M3	20 km/h (12 mph)
M3→M4	40 km/h (24 mph)

Shifting down

If the vehicle speed is higher than the speed specified for each gear, the gear cannot be shifted down to a lower gear.

Gear	Vehicle speed
M4→M3	180 km/h (112 mph)
M3→M2	119 km/h (74 mph)
M2→M1	47 km/h (30 mph)

During deceleration, the gears shift down automatically when speed is reduced to the following:

Gear	Vehicle speed
M4→M3	36 km/h (22 mph)
M3 or M2→M1	12 km/h (7 mph)

NOTE

The gear does not shift down to M1 automatically while in the second gear fixed mode.

Driving Your Mazda

Starting and Driving

If the vehicle is kicked down at the following speeds or lower, the gears shift down automatically:

Gear	Vehicle speed
M4→M3	170 km/h (105 mph)
M3→M2	72 km/h (44 mph)

Shifting specification (2.3-liter engine model)

Shifting up

If the vehicle speed is lower than the speed specified for each gear, the gear cannot be shifted up to a higher gear.

Gear	Vehicle speed
M1→M2	You can shift up to M2 whether the vehicle is stopped or moving.
M2→M3	20 km/h (12 mph)
M3 or M4→M5	33 km/h (20 mph)

Shifting down

If the vehicle speed is higher than the speed specified for each gear, the gear cannot be shifted down to a lower gear.

Gear	Vehicle speed
M5→M4	191 km/h (118 mph)
M4→M3	137 km/h (85 mph)
M3→M2	89 km/h (55 mph)
M2→M1	44 km/h (27 mph)

During deceleration, the gears shift down automatically when speed is reduced to the following:

Gear	Vehicle speed
M5 or M4→M3	30 km/h (18 mph)
M3 or M2→M1	10 km/h (6 mph)

NOTE

The gear does not shift down to M1 automatically while in the second gear fixed mode.

If the vehicle is kicked down at the following speeds or lower, the gears shift down automatically:

Gear	Vehicle speed
M5→M4	182 km/h (113 mph)
M4→M3	133 km/h (82 mph)
M3→M2	48 km/h (30 mph)
M2→M1	12 km/h (7 mph)

Recommendations for shifting

Upshifting

For normal acceleration and cruising, we recommend these shift points.

(2.0-liter engine model)

Gear	Vehicle speed
M1 to M2	24 km/h (15 mph)
M2 to M3	40 km/h (25 mph)
M3 to M4	65 km/h (40 mph)

(2.3-liter engine model)

Gear	Vehicle speed
M1 to M2	24 km/h (15 mph)
M2 to M3	40 km/h (25 mph)
M3 to M4	65 km/h (40 mph)
M4 to M5	73 km/h (45 mph)

Downshifting

When you must slow down in heavy traffic or on a steep **upgrade**, downshift before the engine starts to overwork. This gives better acceleration when you need more speed.

On a steep **downgrade**, downshifting helps maintain safe speed and prolongs brake life.

Driving Your Mazda Starting and Driving

▼ Driving Tips

Passing

For extra power when passing another vehicle or climbing steep grades, depress the accelerator fully. The transaxle will shift to a lower gear, depending on vehicle speed.

Climbing steep grades from a stop

To climb a steep grade from a stopped position:

1. Depress the brake pedal.
2. Shift to D or M1, depending on the load weight and grade steepness.
3. Release the brake pedal while gradually accelerating.

Descending steep grades

When descending a steep grade, shift to lower gears, depending on load weight and grade steepness. Descend slowly, using the brakes only occasionally to prevent them from overheating.

Power Steering

Power steering is only operable when the engine is running. If the engine is off or if the power steering system is inoperable, you can still steer, but it requires more physical effort.

If the steering feels rigid during normal driving, consult an Authorized Mazda Dealer.

CAUTION

Never hold the steering wheel to the extreme left or right for more than 5 seconds with the engine running. This could damage the power steering system.

▼ Power Steering Malfunction Indicator Light



This indicator light illuminates when the ignition switch is turned to the ON position and goes off when the engine is started.

Driving Your Mazda

Starting and Driving

The light illuminates to indicate that the power steering is inoperable. If the light illuminates, turn off the engine and restart it.

If the light does not illuminate after restarting the engine, this indicates that the power steering is restored and normal steering is possible.

If the light remains illuminated, the power steering is still inoperable. Consult an Authorized Mazda Dealer.

NOTE

The power steering system is inoperable when the power steering malfunction indicator light illuminates. Steering is possible, but requires more physical effort.

Cruise Control*

With cruise control, you can set and automatically maintain any speed of more than about 30 km/h (19 mph).

WARNING

Cruise Control Use:
Using cruise control in the following conditions could cause you to lose control of the vehicle:

- ***Hilly terrain***
- ***Steep inclines***
- ***Heavy or unsteady traffic***
- ***Slippery or winding roads***
- ***Similar restrictions that require inconsistent speed***

Don't use cruise control in these situations.

▼ Cruise Main Indicator Light

CRUISE MAIN

This light comes on when the ON/OFF switch is pressed and the cruise control system is activated.

Driving Your Mazda
Starting and Driving

▼ **Cruise Set Indicator Light**

CRUISE

This light comes on when a cruising speed is set.

▼ **Activation/Deactivation**

To activate the system, press the ON/OFF switch.

The cruise main indicator light illuminates.

To deactivate the system, press the switch again.

The cruise main indicator light turns off.

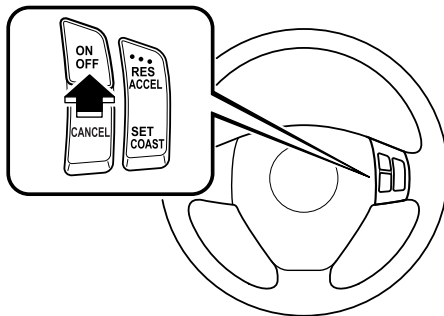

! WARNING

Cruise Main Switch:
Leaving the ON/OFF switch on when not using the cruise control is dangerous as it may be switched on accidentally. This could result in loss of vehicle control. Keep the ON/OFF switch off when cruise control is not in use.

▼ **To Set Speed**

1. Activate the cruise control system by pressing the ON/OFF switch.
2. Accelerate to the desired speed, which must be more than 30 km/h (19 mph).
3. Press the SET/COAST button and release it at the speed you want. Release the accelerator at the same time.

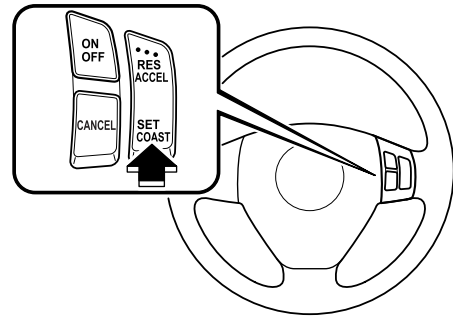

Don't continue to hold in the button. Until you release it, speed will continue to drop (unless you continue to accelerate) and you'll miss the desired speed.

Driving Your Mazda

Starting and Driving

NOTE

- The SET function can't be activated until about 2 seconds after the ON/OFF switch has been engaged.
- On a steep grade, the vehicle may momentarily slow down going up or speed up while going down.

▼ To Increase Cruising Speed

Follow either of these procedures.

- Press the RES/ACCEL button and hold it. Your vehicle will accelerate. Release the button at the speed you want.

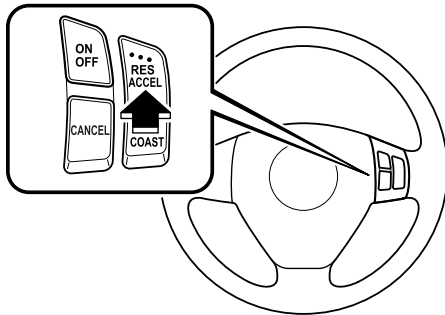

Your vehicle has a tap-up feature that allows you to increase your current speed in increments of 1.6 km/h (1 mph) by a momentary tap of the RES/ACCEL button. Multiple taps will increase your vehicle speed 1.6 km/h (1 mph) for each tap.

- Accelerate to the desired speed. Press the SET/COAST button and release it immediately.

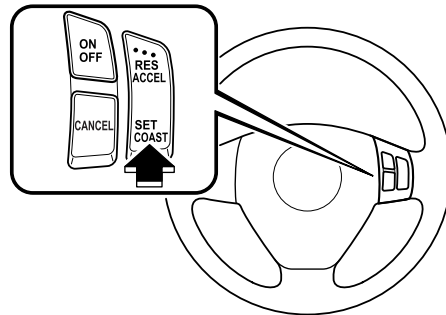

NOTE

Accelerate if you want to speed up temporarily when the cruise control is on. Greater speed will not interfere with it or change the set speed. Take your foot off the accelerator to return to the set speed.

Driving Your Mazda Starting and Driving

▼ To Decrease Cruising Speed

Press the SET/COAST button and hold it. The vehicle will gradually slow. Release the button at the speed you want.

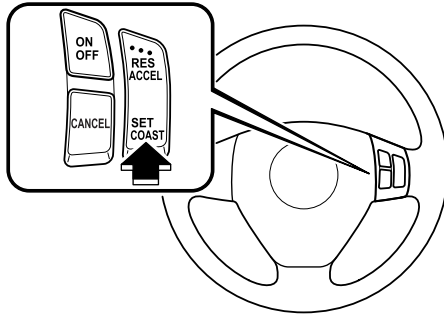

Your vehicle has a tap-down feature that allows you to decrease your current speed in decrements of 1.6 km/h (1 mph) by a momentary tap of the SET/COAST button. Multiple taps will decrease your vehicle speed 1.6 km/h (1 mph) for each tap.

▼ To Resume Cruising Speed at More Than 30 km/h (19 mph)

If some other method besides the ON/OFF switch was used to cancel cruising speed and the system is still activated, the most recent set speed will automatically resume when the RES/ACCEL button is pressed.

If vehicle speed is below 30 km/h (19 mph), increase the vehicle speed up to 30 km/h (19 mph) and press the RES/ACCEL button.

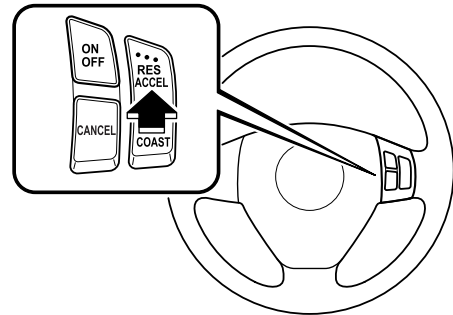

▼ To Cancel

To turn off the system, use **one** of these methods:

- Press the ON/OFF switch.
- Slightly depress the brake pedal.
- Depress the clutch pedal (Manual transaxle only).

Driving Your Mazda

Starting and Driving

- Press the CANCEL button.

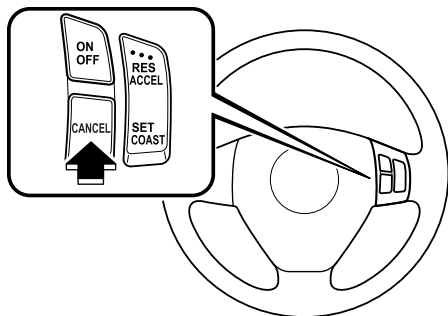

The system is off when the ignition is off.

NOTE

Cruise control will cancel at about 15 km/h (9 mph) below the preset speed or below 30 km/h (19 mph).

Tire Pressure Monitoring System *

The tire pressure monitoring system (TPMS) monitors the pressure for each tire.

If tire pressure is too low in one or more tires, the system will inform the driver via the warning light in the instrument panel and by the warning beep sound.

The tire pressure sensors installed on each wheel send tire pressure data by radio signal to the receiver unit in the vehicle.

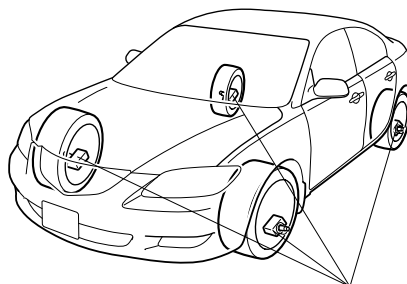

Tire pressure sensors

NOTE

When the ambient temperature is low due to seasonal changes, tire temperatures are also lower. If the tire temperature lowers, the air pressure lowers as well, and the TPMS warning light illuminates more frequently. Inspect the tire pressure daily **before** driving, and check the tire pressures monthly with a tire pressure gauge. When checking the tire pressures, use of a digital tire pressure gauge is recommended.

Driving Your Mazda
Starting and Driving

TPMS does not alleviate your need to check the pressure and condition of all four tires before you drive each day.

 **CAUTION**

- Each tire, including the spare (if provided), should be checked monthly when cold and inflated to the inflation pressure recommended by the vehicle manufacturer on the vehicle placard or tire inflation pressure label. (If your vehicle has tires of a different size than the size indicated on the vehicle placard or tire inflation pressure label, you should determine the proper tire inflation pressure for those tires.) As an added safety feature, your vehicle has been equipped with a tire pressure monitoring system (TPMS) that illuminates a low tire pressure telltale when one or more of your tires is significantly under-inflated. Accordingly, when the low tire pressure telltale illuminates, you should stop and check your tires as soon as possible, and inflate them to the proper pressure. Driving on a significantly under-inflated tire causes the tire to overheat and can lead to tire failure. Under-inflation also reduces fuel efficiency and tire tread life, and may affect the vehicle's handling and stopping ability. Please note that the TPMS is not a substitute for proper tire maintenance, and it is the driver's responsibility to maintain correct tire pressure, even if under-inflation has not reached the level to trigger illumination of the TPMS low tire pressure telltale.

 **CAUTION**

- To avoid false readings, the system samples for a little while before indicating a problem. As a result it will not instantaneously register a rapid tire deflation or blow out.

NOTE

This device complies with part 15 of the FCC Rules. Operation is subject to the following two conditions: (1) This device may not cause harmful interference, and (2) this device must accept any interference received, including interference that may cause undesired operation.

▼ **Tire Pressure Monitoring System Warning Light**



This warning light illuminates for a few seconds when the ignition switch is turned to the ON position.

Thereafter, the warning light illuminates when tire pressure is too low in one or more tires, and flashes when there is a system malfunction.

Driving Your Mazda

Starting and Driving

WARNING

Vehicle Handling When Tire Pressure Monitoring System Warning Light Illuminates/Flashes:

When the tire pressure monitoring system warning light illuminates or flashes, or the tire pressure warning beep sound is heard, it is dangerous to drive the vehicle at high speeds, or perform sudden maneuvering or braking. Vehicle drivability could worsen and result in an accident.

When the tire pressure monitoring system warning light illuminates or flashes, or the tire pressure warning beep sound is heard, decrease vehicle speed immediately and avoid sudden maneuvering and braking. Have the system and tires checked or perform the appropriate repair as soon as possible by an Authorized Mazda Dealer.

Ignoring the Warning Light:
Ignoring the warning light is dangerous, even if you know why it is illuminated. Have the problem taken care of as soon as possible before it develops into a more serious situation that could lead to tire failure and a dangerous accident.

Warning light illuminates/Warning beep sounds

When the warning light illuminates, and the warning beep sound is heard (about 3 seconds), tire pressure is too low in one or more tires.

Adjust the tire pressure to the correct tire pressure. Refer to the specification charts (page 10-7).

CAUTION

When replacing/repairing the tires or wheels or both, have the work done by an Authorized Mazda Dealer, or the tire pressure sensors may be damaged.

NOTE

- Perform tire pressure adjustment when the tires are cold. Tire pressure will vary according to the tire temperature, therefore let the vehicle stand for 1 hour or only drive it 1.6 km (1 mile) or less before adjusting the tire pressures. When pressure is adjusted on hot tires to the cold inflation pressure, the TPMS warning light/beep may turn on after the tires cool and pressure drops below specification. Also, an illuminated TPMS warning light, resulting from the tire air pressure dropping due to cold ambient temperature, may go out if the ambient temperature rises. In this case, it will also be necessary to adjust the tire air pressures. If the TPMS warning light illuminates due to a drop in tire air pressure, make sure to check and adjust the tire air pressures.

Driving Your Mazda Starting and Driving

NOTE

- After adjusting the tire air pressures, it may require some time for the TPMS warning light to go out. If the TPMS warning light remains illuminated, drive the vehicle at a speed of at least 25 km/h (16 mph) for 10 minutes, and then verify that it goes out.

If the warning light illuminates again even after the tire pressures are adjusted, there may be a tire puncture. Replace the punctured tire with the temporary spare tire (page 7-6).

NOTE

A tire pressure sensor is not installed to the temporary spare tire. The warning light will flash continuously while the temporary spare tire is being used.

Warning light flashes

When the warning light flashes, there may be a system malfunction. Consult an Authorized Mazda Dealer.

▼ System Error Activation

When the warning light flashes, there may be a system malfunction. Consult an Authorized Mazda Dealer.

A system error activation may occur in the following cases:

- When there is equipment or a device near the vehicle using the same radio frequency as that of the tire pressure sensors.

- When a large metallic object (e.g. a large electric household appliance or a desk-top computer) is placed on the right side of the rear seat, which may block radio signals from the tire pressure sensor to the receiver unit.
- When using the following devices in the vehicle that may cause radio interference with the receiver unit.
 - A digital device such as a personal computer.
 - A current converter device such as a DC-AC converter.
- When excess snow or ice adheres to the vehicle, especially around the wheels.
- When the tire pressure sensor batteries are exhausted.
- When using a wheel with no tire pressure sensor installed.
- When using tires with steel wire reinforcement in the side walls.
- When using tire chains.

▼ Tires and Wheels

CAUTION

When inspecting or adjusting the tire air pressures, do not apply excessive force to the stem part of the wheel unit. The stem part could be damaged.

Changing tires and wheels

The following procedure allows the TPMS to recognize a tire pressure sensor's unique ID signal code whenever tires or wheels are changed, such as changing to and from winter tires.

Driving Your Mazda

Starting and Driving

NOTE

Each tire pressure sensor has a unique ID signal code. The signal code must be registered with the TPMS before it can work. The easiest way to do it is to have an Authorized Mazda Dealer change your tire and complete ID signal code registration.

When having tires changed at an Authorized Mazda Dealer

Tire pressure sensor ID signal code registration is completed when an Authorized Mazda Dealer changes your vehicle's tires.

When changing tires yourself

If you or someone else changes tires, you or someone else can also undertake the steps for the TPMS to complete the ID signal code registration.

1. After tires have been changed, turn the ignition switch to the ON position, then turn it back to the ACC or LOCK position.
2. Wait for about 15 minutes.
3. After about 15 minutes, drive the vehicle at a speed of at least 25 km/h (16 mph) for 10 minutes and the tire pressure sensor ID signal code will be registered automatically.

NOTE

If the vehicle is driven within about 15 minutes of changing tires, the tire pressure monitoring system warning light will flash because the sensor ID signal code would not have been registered. If this happens, park the vehicle for about 15 minutes, after which the sensor ID signal code will register upon driving the vehicle for 10 minutes.

Replacing tires and wheels

CAUTION

- When replacing/repairing the tires or wheels or both, have the work done by an Authorized Mazda Dealer, or the tire pressure sensors may be damaged.
- The wheels equipped on your Mazda are specially designed for installation of the tire pressure sensors. Do not use non-genuine wheels, otherwise it may not be possible to install the tire pressure sensors.

Be sure to have the tire pressure sensors installed whenever tires or wheels are replaced.

When having a tire or wheel or both replaced, the following types of tire pressure sensor installation are possible.

- The tire pressure sensor is removed from the old wheel and installed to the new one.
- The same tire pressure sensor is used with the same wheel. Only the tire is replaced.

Driving Your Mazda
Starting and Driving

- A new tire pressure sensor is installed to a new wheel.

NOTE

- The tire pressure sensor ID signal code must be registered when a new tire pressure sensor is purchased. For purchase of a tire pressure sensor and registration of the tire pressure sensor ID signal code, consult an Authorized Mazda Dealer.
- When reinstalling a previously removed tire pressure sensor to a wheel, replace the grommet for the tire pressure sensor.

Driving Your Mazda

Instrument Cluster and Indicators

Meters and Gauges

(Black-out meter)

When the ignition switch is in the ON position, the dashboard gauges illuminate.

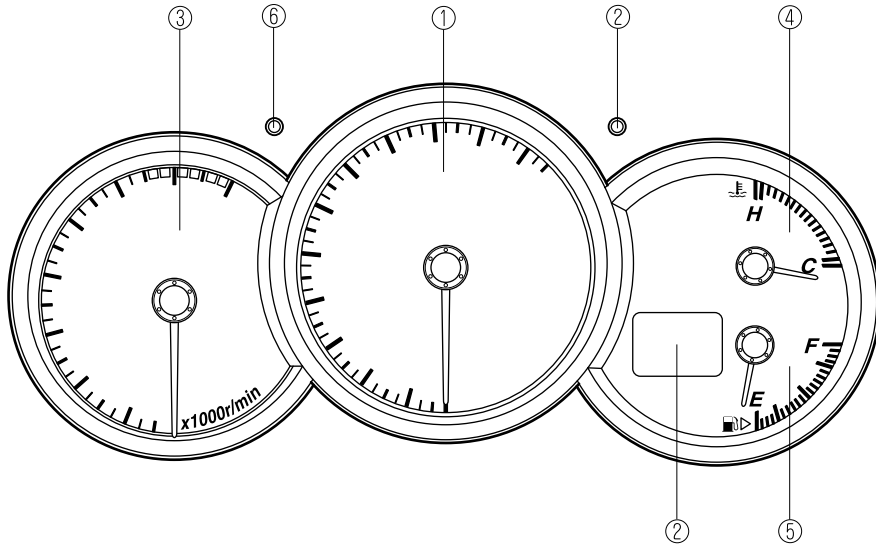

- ① Speedometer page 5-29
- ② Odometer, Trip Meter and Trip Meter Selector page 5-29
- ③ Tachometer page 5-31
- ④ Engine Coolant Temperature Gauge page 5-31
- ⑤ Fuel Gauge page 5-31
- ⑥ Instrument Cluster Dimmer Select Button (Black-out meter) page 5-32

Driving Your Mazda Instrument Cluster and Indicators

▼ Speedometer

The speedometer indicates the speed of the vehicle.

▼ Odometer, Trip Meter and Trip Meter Selector

The display mode can be changed between trip meter A and trip meter B by pressing the selector while one of them is displayed.

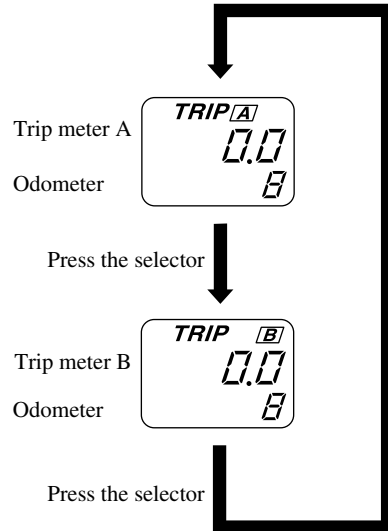
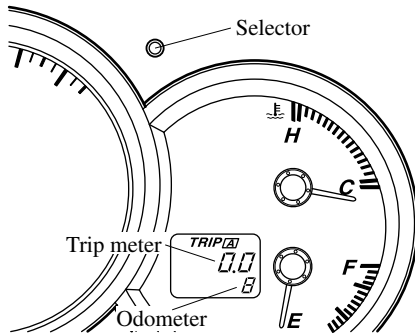

Driving Your Mazda

Instrument Cluster and Indicators

NOTE

- **(Standard meter)**

The odometer and trip meter can be displayed as follows even when the ignition switch is in the ACC or LOCK position.

- Displays for 10 minutes after the ignition switch is turned to the ACC or LOCK position from the ON position.
- Displays for 10 minutes after the driver's door is opened.

- **(Black-out meter)**

When the ignition switch is in the ACC or LOCK position, the odometer or trip meters cannot be displayed, however, pressing the selector button can inadvertently switch the trip meters or reset them during an approximate ten-minute period in the following cases:

- After the ignition switch is turned to the ACC or LOCK position from the ON position.
- After the driver's door is opened.

Odometer

The odometer records the total distance the vehicle has been driven.

Trip meter

The trip meter can record the total distance of two trips. One is recorded in trip meter A, and the other is recorded in trip meter B.

For instance, trip meter A can record the distance from the point of origin, and trip meter B can record the distance from where the fuel tank is filled.

When trip meter A is selected, pressing the selector again within one second will change to trip meter B mode.

When trip meter A is selected, TRIP A will be displayed. When trip meter B is selected, TRIP B will be displayed.

The trip meter records the total distance the vehicle is driven until the meter is again reset. Return it to "0.0" by holding the selector depressed for more than 1 second. Use this meter to measure trip distances and to compute fuel consumption.

NOTE

- Only the trip meters record tenths of kilometers (miles).
- The trip record will be erased when:
 - The power supply is interrupted (blown fuse or the battery is disconnected).
 - The vehicle is driven over 999.9 km (mile).

Driving Your Mazda Instrument Cluster and Indicators

▼ Tachometer

The tachometer shows engine speed in thousands of revolutions per minute (rpm).

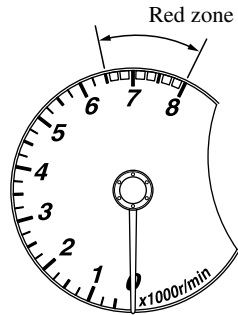

⚠ CAUTION

Don't run the engine with the tachometer needle in the RED ZONE. This may cause severe engine damage.

▼ Engine Coolant Temperature Gauge

The engine coolant temperature gauge shows the temperature of the engine coolant.

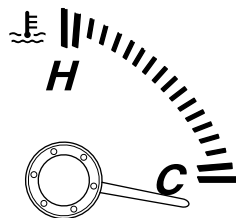

If the needle is near H, it indicates overheating.

⚠ CAUTION

Driving with an overheated engine can cause serious engine damage (page 7-12).

▼ Fuel Gauge

The fuel gauge shows approximately how much fuel is in the tank. We recommend keeping the tank over 1/4 full. When the low fuel warning light illuminates or when the needle is near E, refuel as soon as possible.

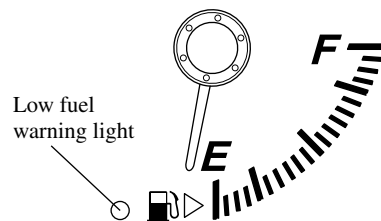

NOTE

The direction of the arrow (➔) shown next to the low fuel warning light indicates that the fuel-filler lid is on the right side of the vehicle.

Driving Your Mazda

Instrument Cluster and Indicators

▼ Dashboard Illumination

When the exterior lights are on, rotate the thumb-wheel to adjust the brightness of the dashboard lights.

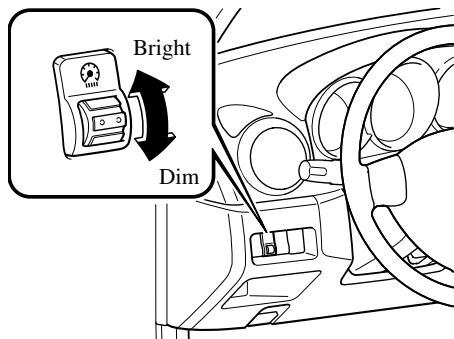

NOTE

Black-out meter

When the instrument cluster dimmer is canceled, the instrument cluster illumination intensity will not change by rotating the thumb-wheel.

▼ Instrument Cluster Dimmer Select Button (Black-out meter)

The instrument cluster dimmer select button is operable when the ignition switch is in the ON position.

Instrument cluster dimmer select button

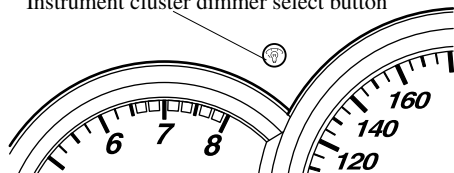

Adjusting the instrument cluster illumination intensity (With exterior lights off)

When the exterior lights are off, the instrument cluster illumination can be adjusted to one of five levels by successively pressing the instrument cluster dimmer select button.

Canceling the instrument cluster illumination dimmer (With exterior lights on)





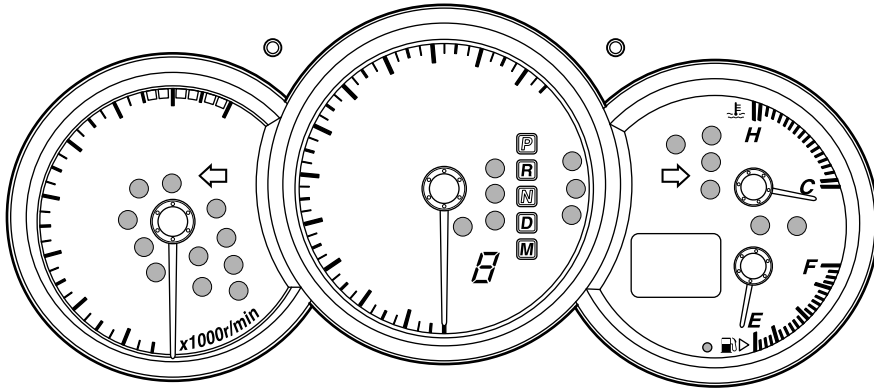

When the exterior lights are on, the instrument cluster illumination dims. When driving on snowy or foggy roads, or in other situations when the instrument cluster's visibility is reduced due to glare from surrounding brightness, the instrument cluster dimmer select button increases the illumination intensity. Press the button to increase the intensity of the instrument cluster illumination. Press the button again to return to the previous illumination intensity.

Warning/Indicator Lights and Beep Sounds

Warning/Indicator Lights











Warning/Indicator lights will appear in any of the highlighted areas

Signal	Warning/Indicator Lights	Page
 BRAKE	Brake System Warning Light	5-35
	Charging System Warning Light	5-36
	Engine Oil Pressure Warning Light	5-37
	Check Engine Light	5-37
	ABS Warning Light	5-35
	Air Bag/Front Seat Belt Pretensioner System Warning Light	5-38
	Low Fuel Warning Light	5-38

Driving Your Mazda

Warning/Indicator Lights and Beep Sounds

Signal	Warning/Indicator Lights	Page
	Seat Belt Warning Light/Beep	5-38
	Door-Ajar Warning Light	5-39
	Low Washer Fluid Level Warning Light	5-40
AT	Automatic Transaxle Warning Light	5-40
	Tire Pressure Monitoring System Warning Light	5-40
	Security Indicator Light	5-42
	Headlight High-Beam Indicator Light	5-42
<i>P R N D M</i>	Shift Position Indicator Light	5-42
CRUISE MAIN	Cruise Main Indicator Light	5-43
CRUISE	Cruise Set Indicator Light	5-43
	Light-On Indicator Light	5-43
	Power Steering Malfunction Indicator Light	5-43
	Turn Signal/Hazard Warning Indicator Lights	5-44

5-34

Warning/Indicator Lights and Beep Sounds

▼ Brake System Warning Light



This warning has the following functions:

Parking brake warning

The light comes on when the parking brake is applied with the ignition switch in the START or ON position. It goes off when the parking brake is fully released.

Low brake fluid level warning

If the light stays on after the parking brake is fully released, you may have a brake problem.

Drive to the side of the road and park off the right-of-way.

You may notice that the pedal is harder to push or that it may go closer to the floor. In either case, it will take longer to stop the vehicle.

1. With the engine stopped, check the brake fluid level immediately and add fluid as required (page 8-16).
2. After adding fluid, check the light again.

If the warning light remains on, or if the brakes do not operate properly, do not drive the vehicle. Have it towed to an Authorized Mazda Dealer.

Even if the light goes out have your brake system inspected as soon as possible by an Authorized Mazda Dealer.

NOTE

Having to add brake fluid is sometimes an indicator of leakage. Consult an Authorized Mazda Dealer as soon as possible even if the brake light is no longer illuminated.

WARNING

Brake Warning Light:
Driving with the brake system warning light on is dangerous. It indicates that your brakes may not work at all or that they could completely fail at any time. If this light remains on, after checking that the parking brake is fully released, have the brakes inspected immediately. Don't drive with this light on, have the vehicle towed to an Authorized Mazda Dealer to have the brakes inspected as soon as possible.

▼ ABS Warning Light*



The warning light stays on for a few seconds when the ignition switch is turned to the ON position.

Driving Your Mazda

Warning/Indicator Lights and Beep Sounds

If the ABS warning light stays on while you're driving, the ABS control unit has detected a system malfunction. If this occurs, your brakes will function normally as if the vehicle had no ABS. Should this happen, consult an Authorized Mazda Dealer as soon as possible.

NOTE

When the engine is jump-started to charge the battery, uneven rpm occurs and the ABS warning light comes on. This is due to a weak battery, not a malfunction.
Recharge the battery.

▼ Electronic Brake Force Distribution System Warning*



BRAKE



If the electronic brake force distribution control unit determines that some components are operating incorrectly, the control unit may turn the brake system warning light and the ABS warning light on at the same time. The problem is likely to be an electronic brake force distribution system.

WARNING

ABS Warning Light and Brake Warning Light on at the Same Time: Driving when the brake system warning light and ABS warning light are on at the same time is dangerous. When both lights are on, the rear wheels could lock more quickly in an emergency stop than under normal circumstances. Don't drive with both lights on, have the vehicle towed to an Authorized Mazda Dealer to have the brakes inspected as soon as possible.

▼ Charging System Warning Light



This warning light illuminates when the ignition switch is turned to the ON position and turns off when the engine is started.

If the warning light illuminates while driving, it indicates a malfunction of the alternator or of the charging system. Drive to the side of the road and park off the right-of-way. Consult an Authorized Mazda Dealer.

Warning/Indicator Lights and Beep Sounds

CAUTION

Don't continue driving when the charging system warning light is illuminated because the engine could stop unexpectedly.

▼ Engine Oil Pressure Warning Light



This warning light illuminates when the ignition switch is turned to the ON position and turns off when the engine is started.

This warning light indicates low engine oil pressure.

If the light illuminates while driving:

1. Drive to the side of the road and park off the right-of-way on level ground.
2. Turn off the engine and wait 5 minutes for the oil to drain back into the oil pan.
3. Inspect the engine oil level (page 8-12). If it's low, add oil.
4. Check the warning light.

If the light remains illuminated even after you add oil, have your vehicle towed to an Authorized Mazda Dealer.

CAUTION

Don't run the engine if oil pressure is low. It could result in extensive engine damage.

▼ Check Engine Light



If this light comes on while driving, the vehicle may have a problem. It is important to note the driving conditions when the light came on and consult an Authorized Mazda Dealer.

The check engine light may come on in the following cases:

- The fuel tank level being very low or approaching empty.
- The engine's electrical system has a problem.
- The emission control system has a problem.
- The fuel-filler cap is missing or not tightened securely.

If the check engine light remains on or flashes continuously, do not drive at high speeds and consult an Authorized Mazda Dealer as soon as possible.

Driving Your Mazda

Warning/Indicator Lights and Beep Sounds

▼ Air Bag/Front Seat Belt Pretensioner System Warning Light



If the air bag/front seat belt pretensioner system is normal, the warning light illuminates when the ignition switch is turned to the ON position or after the engine is cranked. After about 6 seconds it goes out.

A system malfunction is indicated when the warning light constantly illuminates or doesn't illuminate at all when the ignition switch is turned to the ON position. If any of these occur, consult an Authorized Mazda Dealer as soon as possible. The system may not work in an accident.

WARNING

Self-Servicing the Air Bag/Pretensioner Systems:
Self-servicing or tampering with the systems is dangerous. An air bag/pretensioner could accidentally activate or become disabled. This could cause serious injuries. Never tamper with the systems and always have an Authorized Mazda Dealer perform all servicing and repairs.

▼ Low Fuel Warning Light

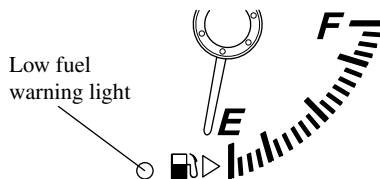

This warning light in the fuel gauge signals that the fuel tank will soon be empty. Refuel as soon as possible.

▼ Seat Belt Warning Light/Beep



The seat belt warning light illuminates and a beep sound will be heard if the driver's seat belt is not fastened when the ignition switch is turned to the ON position.

Conditions of operation

Condition	Result
The driver's seat belt is not fastened when the ignition switch is turned to the ON position.	The warning light illuminates for about 1 minute and a beep sound will be heard for about 6 seconds.
The driver's seat belt is fastened while the warning light and the beep sound are activated.	The warning light turns off and the beep sound stops.
The driver's seat belt is fastened before the ignition switch is turned to the ON position.	The warning light will not illuminate and the beep sound will not be heard.

Warning/Indicator Lights and Beep Sounds

Belt minder

The belt minder is a supplemental warning to the seat belt warning function. This feature provides additional reminders to the driver that the driver's seat belt is not fastened by intermittently sounding a beep sound and flashing the seat belt warning light in the instrument cluster.

Condition	Result
The driver's seat belt is not fastened when the vehicle speed reaches 8 km/h (5 mph) and about 1 minute has elapsed since the ignition switch was turned to the ON position.	The warning light flashes and the beep sound will be heard for about 6 seconds every 30 seconds, for a period of about 5 minutes.
The driver's seat belt is fastened while the warning light and the beep sound are activated.	The warning light turns off and the beep sound stops.
The driver's seat belt is fastened before the ignition switch is turned to the ON position.	The warning light will not illuminate and the beep sound will not be heard.

NOTE

The belt minder can be deactivated by the following methods.

- **(Temporary deactivation)**
 To temporarily deactivate the belt minder, turn the ignition switch to the ON position, fasten the driver's seat belt for about 2 seconds or longer, and then unfasten it within 20 seconds. The belt minder will be deactivated until the ignition switch is turned to the ON position again.
- **(Long-term deactivation)**
 To deactivate the belt minder over the long term, consult an Authorized Mazda Dealer. If the belt minder is long-term deactivated, the belt minder will not activate until it is restored at the Authorized Mazda Dealer.

▼ **Door-Ajar Warning Light**



This warning light comes on when any door isn't securely closed.

Driving Your Mazda

Warning/Indicator Lights and Beep Sounds

▼ Low Washer Fluid Level Warning Light*

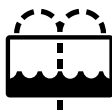

This warning light indicates that little washer fluid remains. Add fluid (page 8-20).

▼ Automatic Transaxle Warning Light

AT

This warning light stays on for a few seconds when the ignition switch is turned to the ON position. The light illuminates when the transaxle has a problem.

CAUTION

If the automatic transaxle warning light illuminates, the transaxle has an electrical problem. Continuing to drive your Mazda in this condition could cause damage to your transaxle. Consult an Authorized Mazda Dealer as soon as possible.

▼ Tire Pressure Monitoring System Warning Light*



This warning light illuminates for a few seconds when the ignition switch is turned to the ON position.

Thereafter, the warning light illuminates when tire pressure is too low in one or more tires, and flashes when there is a system malfunction.

WARNING

Vehicle Handling When Tire Pressure Monitoring System Warning Light Illuminates/Flashes:

When the tire pressure monitoring system warning light illuminates or flashes, or the tire pressure warning beep sound is heard, it is dangerous to drive the vehicle at high speeds, or perform sudden maneuvering or braking. Vehicle drivability could worsen and result in an accident.

When the tire pressure monitoring system warning light illuminates or flashes, or the tire pressure warning beep sound is heard, decrease vehicle speed immediately and avoid sudden maneuvering and braking. Have the system and tires checked or perform the appropriate repair as soon as possible by an Authorized Mazda Dealer.

Warning/Indicator Lights and Beep Sounds

WARNING

***Ignoring the Warning Light:
Ignoring the warning light is dangerous, even if you know why it is illuminated. Have the problem taken care of as soon as possible before it develops into a more serious situation that could lead to tire failure and a dangerous accident.***

Warning light illuminates/Warning beep sounds

When the warning light illuminates, and the warning beep sound is heard (about 3 seconds), tire pressure is too low in one or more tires.

Adjust the tire pressure to the correct tire pressure. Refer to the specification charts (page 10-7).

CAUTION

When replacing/repairing the tires or wheels or both, have the work done by an Authorized Mazda Dealer, or the tire pressure sensors may be damaged.

NOTE

- Perform tire pressure adjustment when the tires are cold. Tire pressure will vary according to the tire temperature, therefore let the vehicle stand for 1 hour or only drive it 1.6 km (1 mile) or less before adjusting the tire pressures. When pressure is adjusted on hot tires to the cold inflation pressure, the TPMS warning light/beep may turn on after the tires cool and pressure drops below specification. Also, an illuminated TPMS warning light, resulting from the tire air pressure dropping due to cold ambient temperature, may go out if the ambient temperature rises. In this case, it will also be necessary to adjust the tire air pressures. If the TPMS warning light illuminates due to a drop in tire air pressure, make sure to check and adjust the tire air pressures.
- After adjusting the tire air pressures, it may require some time for the TPMS warning light to go out. If the TPMS warning light remains illuminated, drive the vehicle at a speed of at least 25 km/h (16 mph) for 10 minutes, and then verify that it goes out.

If the warning light illuminates again even after the tire pressures are adjusted, there may be a tire puncture. Replace the punctured tire with the temporary spare tire (page 7-6).

Driving Your Mazda

Warning/Indicator Lights and Beep Sounds

NOTE

A tire pressure sensor is not installed to the temporary spare tire. The warning light will flash continuously while the temporary spare tire is being used.

Warning light flashes

When the warning light flashes, there may be a system malfunction. Consult an Authorized Mazda Dealer.

▼ Security Indicator Light



This indicator light starts flashing every 2 seconds when the ignition switch is turned from the ON to the ACC position and the immobilizer system is armed.

The light stops flashing when the ignition switch is turned to the ON position with the correct ignition key. At this time, the immobilizer system is disarmed and the light illuminates for about 3 seconds and then goes out.

If the engine doesn't start with the correct ignition key, and the security indicator light keeps illuminating or flashing, the system may have a malfunction. Consult an Authorized Mazda Dealer.

▼ Headlight High-Beam Indicator Light



This light indicates one of two things:

- The high-beam headlights are on.
- The turn signal lever is in the flash-to-pass position.

▼ Shift Position Indicator Light (Automatic Transaxle)

This indicates the selected shift position when the ignition switch is in the ON position.



Gear position indicator

Warning/Indicator Lights and Beep Sounds

Gear position indicator

When the shift lever is in the D or M position, the numeral for the selected gear displays.

▼ Cruise Main Indicator Light*

CRUISE MAIN

This light comes on when the ON/OFF switch is pressed and the cruise control system is activated.

▼ Cruise Set Indicator Light*

CRUISE

This light comes on when a cruising speed is set.

▼ Light-On Indicator Light (Black-out meter)



This indicator light comes on when the exterior lights and dashboard illumination are on.

▼ Power Steering Malfunction Indicator Light



This indicator light illuminates when the ignition switch is turned to the ON position and goes off when the engine is started.

The light illuminates to indicate that the power steering is inoperable. If the light illuminates, turn off the engine and restart it.

If the light does not illuminate after restarting the engine, this indicates that the power steering is restored and normal steering is possible.

If the light remains illuminated, the power steering is still inoperable. Consult an Authorized Mazda Dealer.

NOTE

The power steering system is inoperable when the power steering malfunction indicator light illuminates. Steering is possible, but requires more physical effort.

Driving Your Mazda

Warning/Indicator Lights and Beep Sounds

▼ Turn-Signal/Hazard Warning Indicator Lights

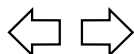

When operating the turn signal lights, the left or right turn signal indicator light flashes to indicate which turn signal light is operating (page 5-49).

When operating the hazard warning lights, both turn signal indicator lights flash (page 5-55).

NOTE

If an indicator light remains illuminated (does not flash) or if it flashes abnormally, one of the turn signal bulbs may be burned out.

Beep Sounds

▼ Air Bag/Front Seat Belt Pretensioner System Warning Beep

If a malfunction is detected in the air bag/front seat belt pretensioner systems and the warning light, a warning beep sound will be heard for about 5 seconds every minute.

The air bag and seat belt pretensioner system warning beep sound will continue to be heard for approximately 35 minutes. Have your vehicle inspected at an Authorized Mazda Dealer as soon as possible.

WARNING

Air Bag/Front Seat Belt Pretensioner System Warning Beep:

Driving the vehicle with the air bag/front seat belt pretensioner system warning beep sounding is dangerous. In a collision, the air bags and the front seat belt pretensioner system will not deploy and this could result in death or serious injury.

Do not drive the vehicle with the air bag/front seat belt pretensioner system warning beep sounding. Contact an Authorized Mazda Dealer to have the vehicle inspected as soon as possible.

Warning/Indicator Lights and Beep Sounds

▼ Seat Belt Warning Beep

If the driver's seat belt is not fastened when the ignition switch is turned to the ON position, a beep sound will be heard for about 6 seconds.

The beep sound will be heard again for about 6 seconds every 30 seconds, for a period of about 5 minutes if the driver's seat belt is not fastened afterwards. Refer to Seat Belt Warning Light/Beep (page 5-38).

▼ Ignition Key Reminder

If the ignition switch is in the LOCK or ACC position with the key inserted, a continuous beep sound will be heard when the driver's door is opened.

▼ Lights-On Reminder

If lights are on and the key is removed from the ignition switch, a continuous beep sound will be heard when the driver's door is opened.

▼ Tire Inflation Pressure Warning Beep*

The warning beep sound will be heard for about 3 seconds when there is any abnormality in tire inflation pressures (page 5-22).

Driving Your Mazda

Switches and Controls

Lighting Control

▼ Headlights

Type A (Without AUTO position)

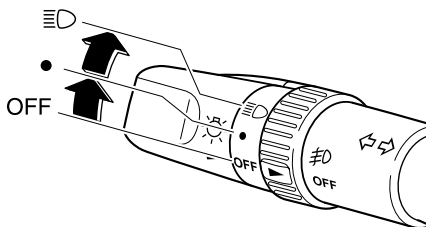

Turn the headlight switch to turn the headlights, other exterior lights and dashboard illumination on or off.

Switch Position	OFF	●	☰
Headlights	Off	Off	On
Taillights			
Parking lights			
License lights	Off	On	On
Side-marker lights			
Dashboard illumination			

NOTE

To prevent discharging the battery, don't leave the lights on while the engine is off unless safety requires them.

Type B (With AUTO position)

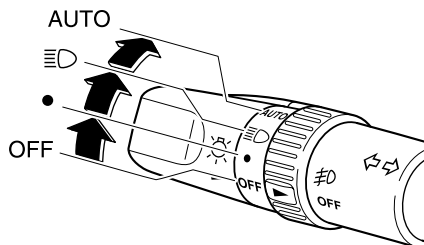

Turn the headlight switch to turn the headlights, other exterior lights and dashboard illumination on or off.

Switch Position	OFF	●	☰	AUTO
Headlights	Off	Off	On	
Taillights				
Parking lights				
License lights				Auto
Side-marker lights	Off	On	On	
Dashboard illumination				

NOTE

To prevent discharging the battery, don't leave the lights on while the engine is off unless safety requires them.

AUTO(Auto-light control)

When the headlight switch is in the AUTO position and the ignition switch is in the ON position, the light sensor senses the surrounding lightness or darkness and automatically turns on or off the headlights, other exterior lights and dashboard illumination (see chart above).

Switches and Controls

CAUTION

- Do not shade the light sensor by adhering a sticker or a label on the windshield. Otherwise the light sensor will not operate correctly.

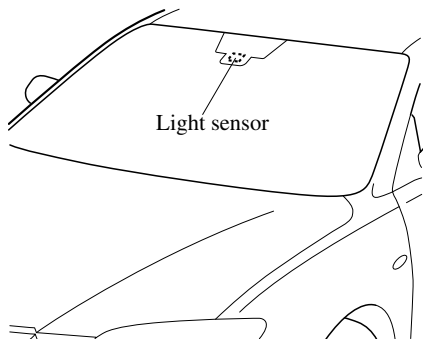

- The light sensor also works as a rain sensor for the auto-wiper control. When the wiper lever is in the AUTO position and the ignition switch is in the ON position, the wipers may move automatically. Be careful not to pinch hands or fingers as it may cause injury, or damage the wipers (page 5-50).

NOTE

- When the headlight switch is in the AUTO position and the ignition switch is turned to the ACC or LOCK position, the headlights, other exterior lights and dashboard illumination will turn off.
- The timing for turning on the headlights, other exterior lights and dashboard illumination can be delayed by adjusting the sensitivity of the light sensor. Consult an Authorized Mazda Dealer regarding sensor adjustment.

Xenon fusion headlight bulbs*

The low-beam bulbs of the headlights have xenon fusion bulbs that produce a bright white beam over a wide area.

WARNING

Xenon Fusion Bulb Replacement:
Replacing the xenon fusion bulbs by yourself is dangerous. Because the xenon fusion bulbs require high voltage, you could receive an electric shock if the bulbs are handled incorrectly. Do not replace the xenon fusion bulbs by yourself. Consult an Authorized Mazda Dealer when the replacement is necessary.

NOTE

If the headlights flash, or the brightness weakens, the bulb-life may be depleted and a replacement is necessary. Consult an Authorized Mazda Dealer.

Driving Your Mazda

Switches and Controls

▼ Lights-On Reminder

If lights are on and the key is removed from the ignition switch, a continuous beep sound will be heard when the driver's door is opened.

▼ Headlight High-Low Beam

Push the lever forward for high beam. Pull back to original position for low beam.

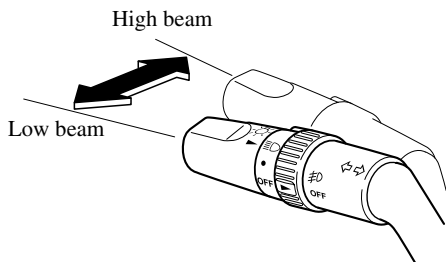

▼ Flashing the Headlights

To flash the headlights, pull the lever fully toward you. The headlight switch does not need to be on, and the lever will return to the normal position when released.

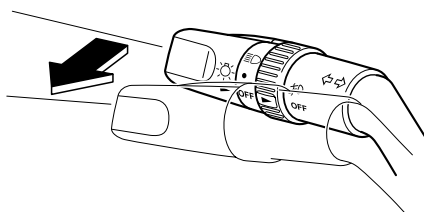

▼ Headlight Leveling*

The number of riders and weight of cargo in the luggage compartment change the angle of the headlights.

The headlight leveling switch adjusts this angle.

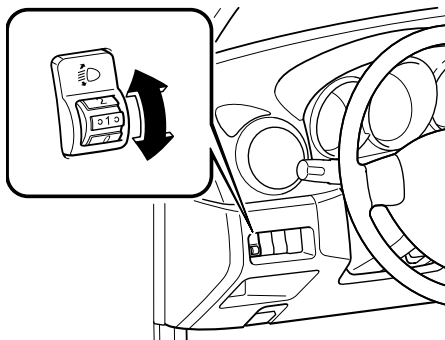

Select the proper setting from the following chart.

Front seat		Rear seat	Load	Switch Position
Driver	Passenger			
×	—	—	—	0
×	×	—	—	0
×	×	×	—	1
×	×	×	×	2
×	—	—	×	3

×: Yes

—: No

▼ Daytime Running Lights (Canada)

In Canada, vehicles must be driven with the headlights on during daytime operation.

For that reason, the daytime running lights automatically turn on when the ignition switch is turned to the ON position.

NOTE

The Daytime Running Lights turn off when the parking brake is applied.

Driving Your Mazda Switches and Controls

Turn and Lane-Change Signals

▼ Turn Signal

Move the signal lever down (for a left turn) or up (for a right turn) to the stop position. The signal will self-cancel after the turn is completed.

If the indicator light continues to flash after a turn, manually return the lever to its original position.

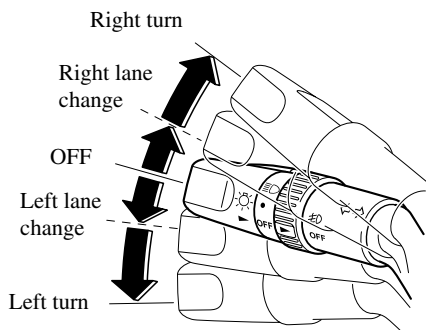

Green indicators on the dashboard show which signal is working.

Lane-change signals

Move the lever slightly toward the direction of the change —until the indicator flashes— and hold it there. It will return to the off position when released.

NOTE

If an indicator light stays on without flashing or if it flashes abnormally, one of the turn signal bulbs may be burned out.

Fog Lights*

The fog lights help you to see as well as to be seen.

The headlights must be turned on to turn on the front fog lights.

To turn the front fog lights on, rotate the fog light switch to the $\#D$ position.

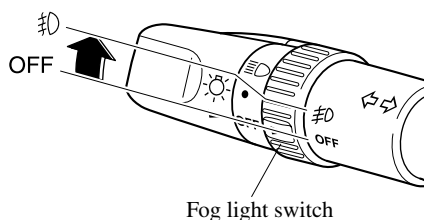

To turn the front fog lights off, rotate the fog light switch to the OFF position or turn the headlights off.

NOTE

- The fog lights will turn off when the headlights are set at high beam.
- **(With auto-light control)**
If the headlight switch is in the AUTO position, the front fog lights can be turned on when the headlights, the exterior lights and dashboard illumination are on.

Driving Your Mazda

Switches and Controls

Windshield Wipers and Washer

The ignition switch must be in the ON position.

WARNING

Substitute Washer Fluid:

Using radiator antifreeze as washer fluid is dangerous. If sprayed on the windshield, it will dirty the windshield, affect your visibility, and could result in an accident. Use only windshield washer fluid or plain water in the reservoir.

Frozen Washer Fluid:

Using windshield washer fluid without anti-freeze protection in freezing temperatures is dangerous. The washer fluid could freeze on the windshield and block your vision. You could have an accident. Don't use the washer without first warming the windshield and never use plain tap water.

NOTE

Because heavy ice and snow can jam the wiper blades, the wiper motor is protected from motor breakdown, overheating and possible fire by a circuit breaker. This mechanism will automatically stop operation of the blades, but only for about 5 minutes. If this happens, turn off the wiper switch and park off the right-of-way, and remove the snow and ice. After 5 minutes, turn on the switch and the blades should operate normally. If they don't resume functioning, consult an Authorized Mazda Dealer as soon as possible. Drive to the side of the road and park off the right-of-way. Wait until the weather clears before trying to drive with the wipers inoperative.

▼ Windshield Wipers

Type A (With INT position)

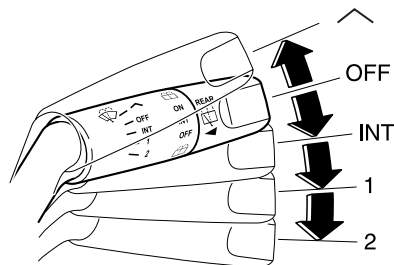

Turn the wipers on by pulling the lever down.

-  — Mist
- INT** — Intermittent
- 1** — Low speed
- 2** — High speed

Driving Your Mazda Switches and Controls

For a single wiping cycle, push the lever up to .

Variable-speed intermittent wipers *

Set the lever to INT and choose the interval timing by rotating the ring.

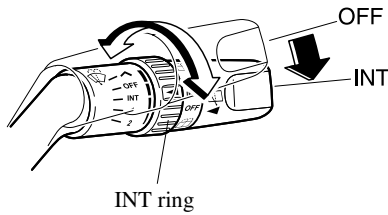

Type B (With AUTO position)

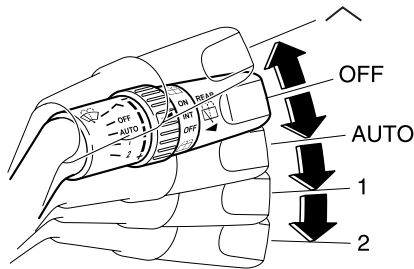

Turn the wipers on by pulling the lever down.

 — Mist

AUTO — Auto control

1 — Low speed

2 — High speed

For a single wiping cycle, push the lever up to .

AUTO (Auto-wiper control)

When the wiper lever is in the AUTO position, the rain sensor senses the amount of rainfall on the windshield and turns the wiper on or off automatically (off—intermittent—low speed—high speed).

The sensitivity of the rain sensor can be adjusted by turning the switch on the wiper lever.

From the center position (normal), turn the switch towards (+) for higher sensitivity (faster response) or turn the switch towards (-) for less sensitivity (slower response).

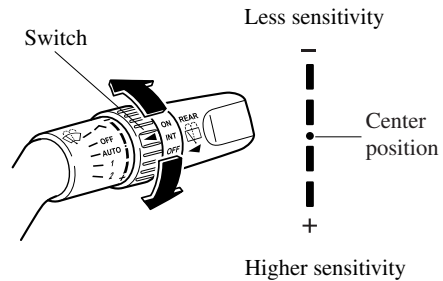

Driving Your Mazda

Switches and Controls

⚠ CAUTION

- Do not shade the rain sensor by adhering a sticker or a label on the windshield. Otherwise the rain sensor will not operate correctly.

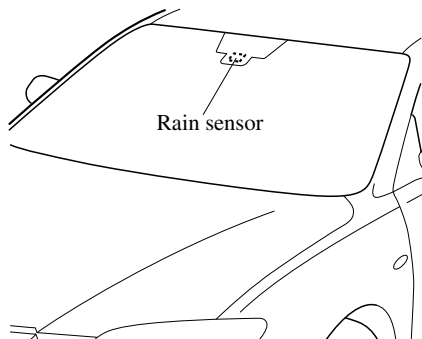

- When the wiper lever is in the AUTO position and the ignition switch is in the ON position, the wipers may move automatically in the following cases:
 - If the windshield above the rain sensor is touched.
 - If the windshield above the rain sensor is wiped with a cloth.
 - If the windshield is struck with a hand or other object.
 - If the rain sensor is struck with a hand or other object from inside the vehicle.

Be careful not to pinch hands or fingers as it may cause injury, or damage the wipers. When washing or servicing your Mazda, make sure the wiper lever is in the OFF position.

NOTE

- The auto-wiper control may not operate when the rain sensor temperature is about -10°C (14°F) or lower, or about 85°C (185°F) or higher.
- If the windshield is coated with water repellent, the rain sensor may not be able to sense the amount of rainfall correctly and auto-wiper control may not operate properly.
- If dirt or foreign matter (e.g. ice or matter containing salt water) adheres to the windshield above the rain sensor or if the windshield is iced, it could cause the wipers to move automatically. However, if the wipers cannot remove this ice, dirt or foreign matter, the auto-wiper control will stop operation. In this case, pull the wiper lever to the 1 or 2 position for manual operation, or remove the ice, dirt or foreign matter by hand to restore the auto-wiper operation.

▼ Windshield Washer

Pull the lever toward you and hold it to spray washer fluid.

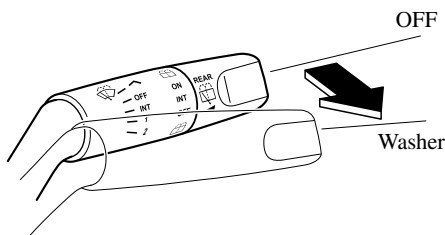

Driving Your Mazda
Switches and Controls

NOTE

With the wiper lever in the OFF or INT (Type A)/AUTO (Type B) position, the wipers will operate continuously until the lever is released.

If the washer doesn't work, inspect the fluid level (page 8-20). If it's OK, consult an Authorized Mazda Dealer.

Rear Window Wiper and Washer (5 Door)

The ignition switch must be in the ON position.

▼ **Rear Window Wiper**

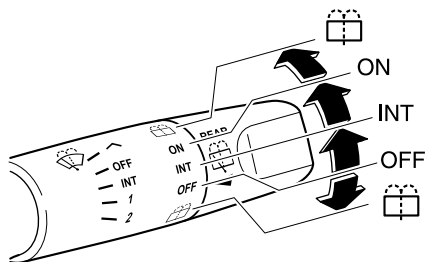

Turn the wiper on by turning the rear wiper/washer switch.

ON — Normal

INT — Intermittent

▼ **Rear Window Washer**

To spray washer fluid, turn the rear wiper/washer switch to the  position. After the switch is released, the washer will stop.

NOTE

There are two washer positions: up and down. In the down washer position, the wiper will not be activated.

If the washer doesn't work, inspect the fluid level (page 8-20). If it's OK and the washer still doesn't work, consult an Authorized Mazda Dealer.

Driving Your Mazda

Switches and Controls

Rear Window Defroster

The rear window defroster clears frost, fog, and thin ice from the rear window.

The ignition switch must be in the ON position.

Press the switch to turn on the rear window defroster. The rear window defroster operates for about 10—15 minutes and turns off automatically. The indicator light illuminates during operation.

To turn off the rear window defroster before the 10—15 minutes has elapsed, press the switch again.

Manual Type Air-Conditioning

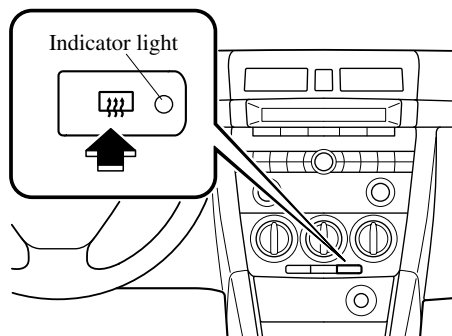

Fully Automatic Type Air-Conditioning

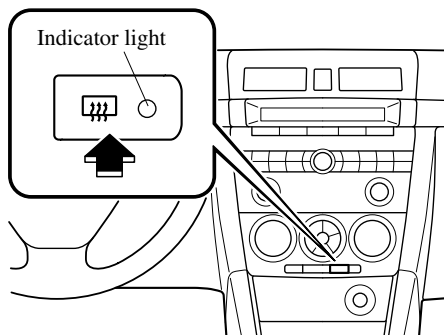

CAUTION

Don't use sharp instruments or window cleaners with abrasives to clean the inside of the rear window surface. They may damage the defroster grid inside the window.

NOTE

This defroster is not designed for melting snow. If there is an accumulation of snow on the rear window, remove it before using the defroster.

Driving Your Mazda
Switches and Controls

Horn

To sound the horn, press around the  mark on the steering wheel.

Hazard Warning Flasher

The hazard warning lights should always be used when you stop on or near a roadway.

The hazard warning lights warn other drivers that your vehicle is a traffic hazard and that they must take extreme caution when near it.

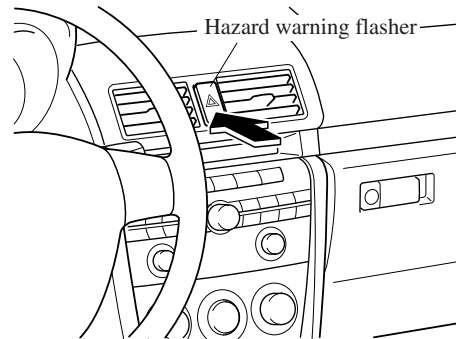

Depress the hazard warning flasher and all four turn signals will flash.

NOTE

- The turn signals don't work when the hazard warning lights are on.
- Check local regulations about the use of hazard warning lights while the vehicle is being towed. They may forbid it.

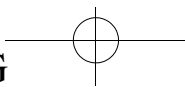
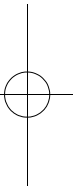
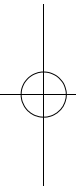
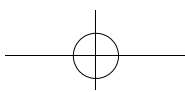

6 Interior Comfort

Use of various features for drive comfort, including air-conditioning and audio system.

Climate Control System	6-2
Operating Tips	6-2
Vent Operation	6-3
Types of the Climate Control System	6-5
Manual Type	6-6
Fully Automatic Type *	6-11
Audio System	6-16
Antenna	6-16
Operating Tips for Audio System	6-16
Audio Set	6-23
Audio Control Switch Operation (Steering Wheel) *	6-38
Safety Certification	6-41
Interior Equipment	6-42
Sunvisors	6-42
Interior Lights	6-42
Information Display	6-45
Lighter	6-50
Ashtray	6-50
Cup Holder	6-51
Bottle Holder	6-52
Storage Compartments	6-52

*Some models. **6-1**

Interior Comfort

Climate Control System

Operating Tips

▼ Operating the Climate Control System

Operate the climate control system with the engine running.

NOTE

To prevent the battery from being discharged, do not leave the fan control dial on for a long period of time with the ignition switch in the ACC position when the engine is not running.

▼ Clearing the Air Inlet

Clear all obstructions like leaves, snow and ice from the hood and the air inlet in the cowl grille to improve the system efficiency.

▼ Foggy Windows

The windows may fog up easily in humid weather. Use the climate control system to defog the windows.

To help defog the windows, operate the air conditioner to dehumidify the air.

NOTE

The air conditioner may be used along with the heater to dehumidify the air.

▼ Outside/Recirculated Air Position

Use the outside air position in normal conditions. The recirculated air position should be used only when driving on dusty roads or for quick cooling of the interior.

▼ Parking in Direct Sunlight

If the vehicle has been parked in direct sunlight during hot weather, open the windows to let warm air escape, then run the climate control system.

▼ Not Using for a Long Period

Run the air conditioner about 10 minutes at least once a month to keep internal parts lubricated.

▼ Check the Refrigerant before the Weather Gets Hot

Have the air conditioner checked before the weather gets hot. Lack of refrigerant may make the air conditioner less efficient. Consult an Authorized Mazda Dealer for refrigerant inspection.

The air conditioner is filled with HFC134a (R134a), a refrigerant that will not damage the ozone layer. If the air conditioner is low on refrigerant or has a malfunction, consult an Authorized Mazda Dealer.

▼ Replacement of the Cabin Air Filter

If your vehicle is equipped with an air filter for the air conditioner, it is necessary to change the filter periodically as indicated in scheduled maintenance (page 8-3). Consult an Authorized Mazda Dealer for replacement of the cabin air filter.

Interior Comfort
Climate Control System

Vent Operation

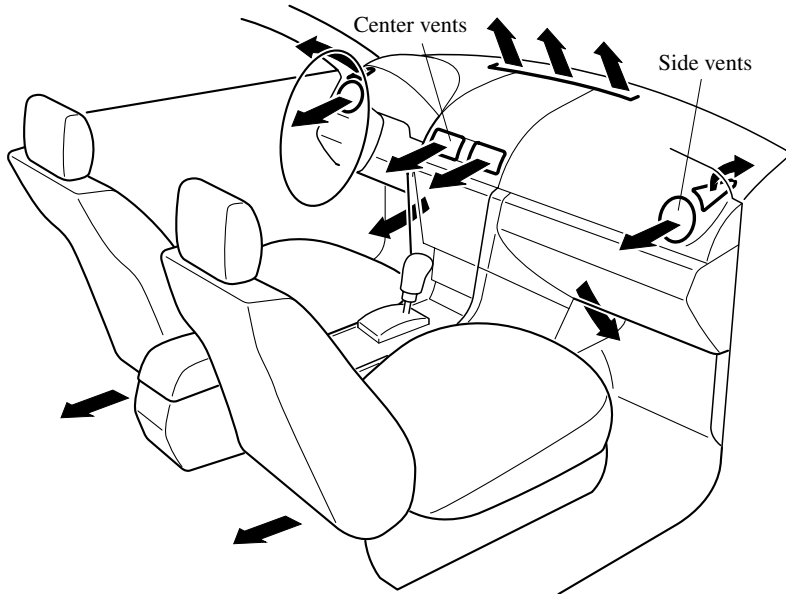

▼ Adjusting the Vents

Directing airflow

Side Vents

To adjust the direction of airflow, open the vents and rotate them left and right.

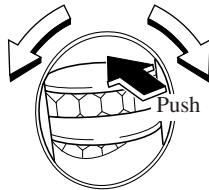

Center Vents

To adjust the direction of airflow, move the adjustment knob.

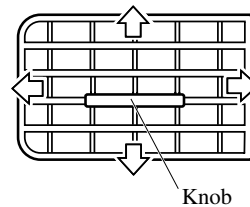

NOTE

When using the air conditioner, mist may come out from the vents. This is not a sign of trouble but a result of humid air being suddenly cooled.

Interior Comfort

Climate Control System

▼ Selecting the Airflow Mode

Dashboard Vents

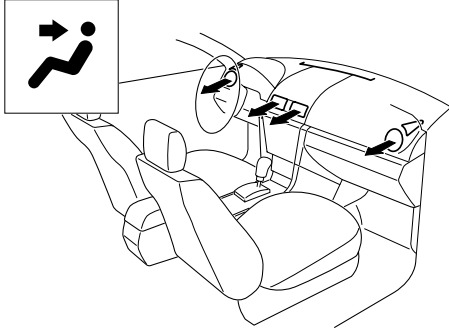

Defroster and Floor Vents

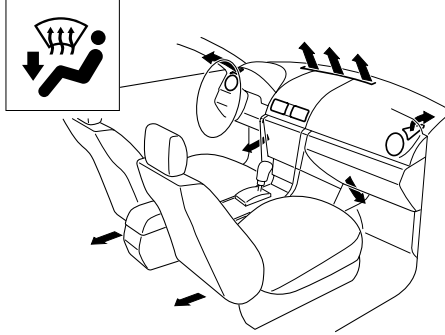

Dashboard and Floor Vents

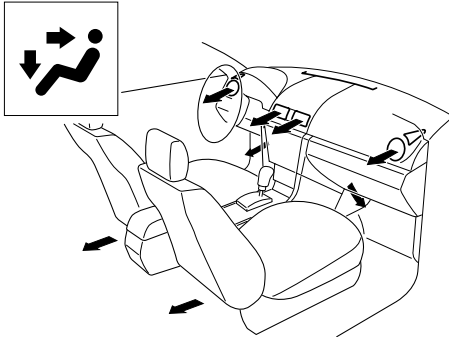

Defroster Vents

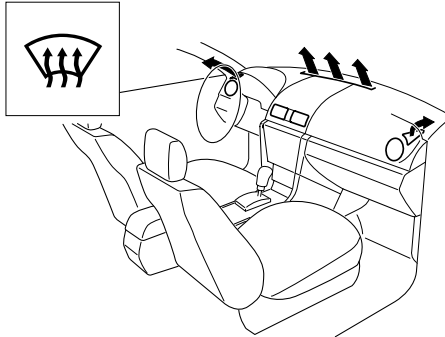

Floor Vents

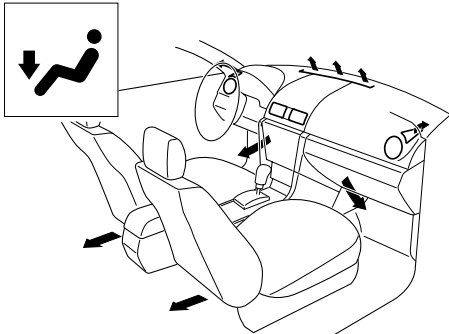

Interior Comfort
Climate Control System

Types of the Climate Control System

Manual type and fully automatic type climate control systems are explained separately.
Check your vehicle's climate control type and read the appropriate pages.
Climate control information is displayed on the information display.

Manual Type page 6-6

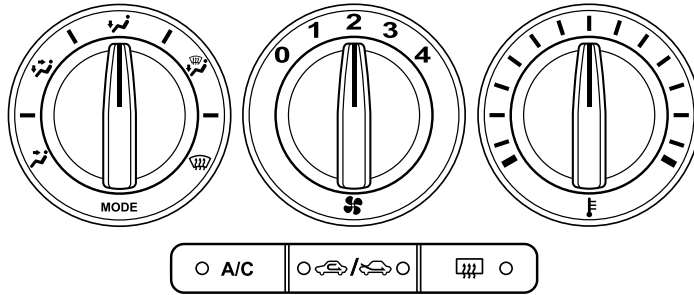

Fully Automatic Type page 6-11

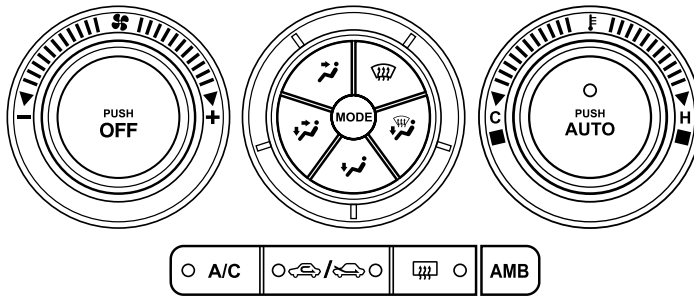

Interior Comfort

Climate Control System

Manual Type

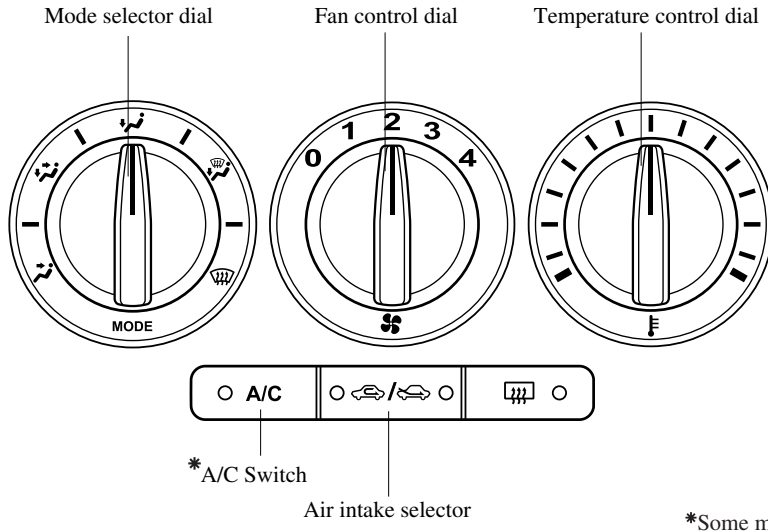

▼ Control Switches

Temperature control dial

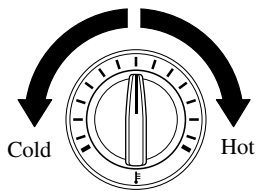

This dial controls temperature. Turn it clockwise for hot and counterclockwise for cold.

Fan control dial

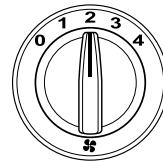

This dial allows variable fan speeds.

- 0—Fan off
- 1—Low speed
- 2—Medium low speed
- 3—Medium high speed
- 4—High speed

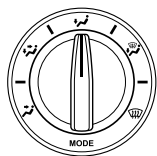

Climate Control System

Mode selector dial



Turn the mode selector dial to select airflow mode (page 6-4).

NOTE

- If you want to slightly adjust the airflow amount, set the mode selector dial at **I**.
- For example, when the mode selector dial is at the **I** position between the  and  positions, airflow from the floor vent is less than that of the  position.

A/C switch *



Push the A/C switch to turn the air conditioner on. The indicator light on the switch will illuminate when the fan control dial is set at position 1, 2, 3, or 4.

Push the switch once again to turn the air conditioner off.



NOTE

The air conditioner may not function when the outside temperature approaches 0 °C (32 °F).

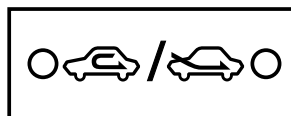
Air intake selector



This switch controls the source of air entering the vehicle.

Press the switch to alternate between the  and  positions. The indicator light for the selected mode will illuminate.

It is recommended that under normal conditions the switch be kept in the outside air position.

Outside air position ()

Outside air is taken into the vehicle. Use this position for normal ventilation and heating.

Recirculated air position ()

Outside air is shut off. Air within the vehicle is recirculated.



This position can be used when driving on a dusty road or in similar conditions. It also helps to provide quicker cooling of the interior.

*Some models.

Interior Comfort

Climate Control System











WARNING

The Recirculated Air Position:
Using the  position in cold or rainy weather will cause the windows to fog up. Your vision will be hampered, which could lead to a serious accident. Do not use the  position in cold or rainy weather.

▼ Heating

1. Set the mode selector dial to the  position.
2. Set the temperature control dial to the hot position.
3. Set the fan control dial to the desired speed.

NOTE

- If the windshield fogs up easily, set the mode selector dial to the  position.
- If cooler air is desired at face level, set the mode selector dial at the  position and adjust the temperature control dial to maintain maximum comfort.
- The air to the floor is warmer than air to the face (except when the temperature control dial is set at the extreme hot or cold position).
- In the , , or  position, the air conditioner is automatically turned on (however, the indicator light does not illuminate) and the  position is automatically selected to defrost the windshield. In the  or  position, the  position cannot be changed to the  position.

▼ Cooling (With Air Conditioner)

1. Set the mode selector dial to the  position.
2. Set the temperature control dial to the cold position.
3. Set the fan control dial to the desired speed.
4. Turn on the air conditioner by pressing the A/C switch.
5. Adjust the fan control dial and temperature control dial to maintain maximum comfort.



Climate Control System

CAUTION



When using the air conditioner while driving up long hills or in heavy traffic, closely monitor the temperature gauge (page 5-31).

The air conditioner may cause engine overheating. If the gauge indicates overheating, turn the air conditioner off (page 7-12).

NOTE

- When maximum cooling is desired, set the temperature control dial to the extreme cold position and set the air intake selector to the  position, then set the fan control dial to position 4.
- If warmer air is desired at floor level, set the mode selector dial at the  position and adjust the temperature control dial to maintain maximum comfort.
- The air to the floor is warmer than air to the face (except when the temperature control dial is set at the extreme hot or cold position).

▼ Ventilation



1. Set the mode selector dial to the  position.
2. Set the air intake selector to the  position.
3. Set the temperature control dial to the desired position.
4. Set the fan control dial to the desired speed.

▼ Windshield Defrosting and Defogging









1. Set the mode selector dial to the  position.
2. Set the temperature control dial to the desired position.
3. Set the fan control dial to the desired speed.

WARNING

Foggy Windshield:

Using the  position with the temperature control set to the cold position will cause the outside of the windshield to fog up. Your vision will be hampered, which could lead to a serious accident. Set the temperature control to the hot or warm position when using the  position.

NOTE

- For maximum defrosting, set the temperature control dial to the extreme hot position and the fan control dial to position 4.
- If warm air is desired at the floor, set the mode selector dial to the  position.
- In the , , or  position, the air conditioner is automatically turned on (however, the indicator light does not illuminate) and the  position is automatically selected to defrost the windshield. In the  or  position, the  position cannot be changed to the  position.

Interior Comfort

Climate Control System

▼ Dehumidifying (With Air Conditioner)

Operate the air conditioner in cool or cold weather to help defog the windshield and side windows.

1. Set the mode selector dial to the desired position.
2. Set the air intake selector to the  position.
3. Set the temperature control dial to the desired position.
4. Set the fan control dial to the desired speed.
5. Turn on the air conditioner by pressing the A/C switch.

NOTE

One of the functions of the air conditioner is dehumidifying the air and, to use this function, the temperature does not have to be set to cold. Therefore, set the temperature control dial to the desired position (hot or cold) and turn on the air conditioner when you want to dehumidify the cabin air.

Interior Comfort Climate Control System

Fully Automatic Type*

Climate control information is displayed on the information display.

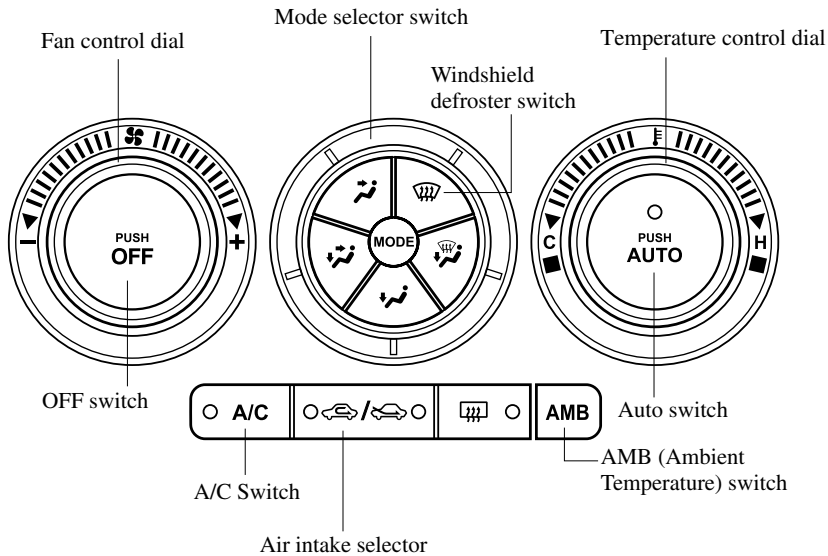

▼ Control Switches

AUTO switch

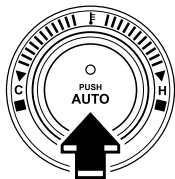

By pressing the AUTO switch the following functions will be automatically controlled in accordance with the set temperature:

- Airflow temperature
- Amount of airflow

- Selection of airflow mode
- Outside/Recirculated air selection
- Air conditioner operation
- A/C or A/C ECO selection

*Some models.

Interior Comfort

Climate Control System

NOTE

AUTO switch indicator light

- When on, it indicates AUTO operation, and the system will function automatically.
- When off, indicates the operation of other switches such as the mode selector switch, fan control dial, A/C switch and windshield defroster switch. Other functions will continue to operate automatically.

OFF switch

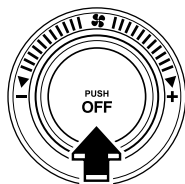

Pressing the OFF switch shuts off the climate control system.

Temperature control dial

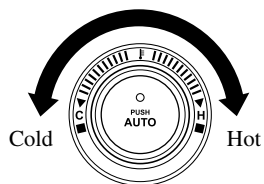

This dial controls temperature. Turn it clockwise for hot and counterclockwise for cold.

Fan control dial

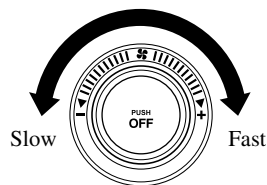

The fan has seven speeds. The selected speed will be displayed.

Mode selector switch

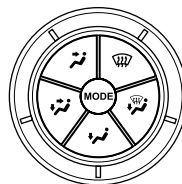

The desired airflow mode can be selected (page 6-4).

NOTE

With the airflow mode set to  position and the temperature control dial set at a medium temperature, heated air is directed to the feet and a comparably lower air temperature will flow through the central, left and right vents.

Climate Control System

A/C switch



With the AUTO or fan control dial ON, press the A/C switch to select the air conditioning (cooling/dehumidifying functions) on or off.

NOTE

- Selection of A/C and A/C ECO is done automatically. Although air conditioning and defogging ability is reduced, the A/C ECO function is designed to economize use of the air conditioning system.
- The air conditioner may not function when the outside temperature approaches 0 °C (32 °F). (Indicator remains on even when system is off.)

Air intake selector

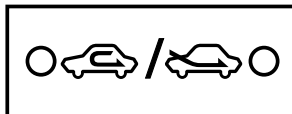

Outside or recirculated air positions can be selected. Press the switch to select outside/recirculated air positions.

Recirculated air position (🚗)

Use this position when going through tunnels, driving in congested traffic (high engine exhaust areas) or when quick cooling is desired.

Outside air position (🚗)

Use this position for normal conditions and defogging.

WARNING

The Recirculated Air Position:
Using the 🚗 position in cold or rainy weather will cause the windows to fog up. Your vision will be hampered, which could lead to a serious accident. Do not use the 🚗 position in cold or rainy weather.

AMB (Ambient Temperature) switch

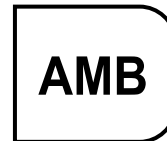

Press the AMB button to display the ambient temperature.

Interior Comfort

Climate Control System

NOTE

- The displayed ambient temperature may vary from the actual ambient temperature depending on the surrounding area and vehicle conditions.
- Press the AMB button again to switch the display from ambient temperature to the temperature set for the air conditioner.

Windshield defroster switch

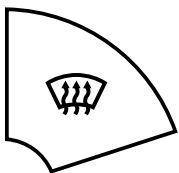

Press the switch to defrost the windshield and front door windows.

▼ Operation of Automatic Air Conditioning

1. Press the AUTO switch. Selection of the airflow mode, air intake selector and amount of airflow will be automatically controlled.

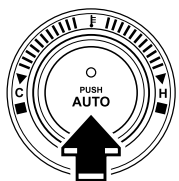

2. Use the temperature control dial to select a desired temperature.

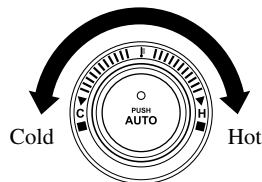

To turn off the system, press the OFF switch.

NOTE

- For an optimal cabin temperature, set the temperature close to “72°F”. Adjust to the desired temperature if necessary.
- Setting the temperature to maximum high or low will not provide the desired temperature at a faster rate.
- When selecting heat, the system will restrict airflow until it has warmed to prevent cold air from blowing out of the vents.

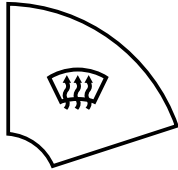

Interior Comfort
Climate Control System

▼ **Windshield Defrosting and Defogging**



Press the windshield defroster switch. In this position, the  position is automatically selected, and the air conditioner automatically turned on. The air conditioner will direct dehumidified air to the front windshield and side windows (page 6-4). Airflow amount will be increased.

! WARNING

Foggy Windshield:
Using the  position with the temperature control set to the cold position will cause the outside of the windshield to fog up. Your vision will be hampered, which could lead to a serious accident. Set the temperature control to hot or warm position when using the  position.

NOTE

Use the temperature control dial to increase the air flow temperature and defog the windshield more quickly.

▼ **Sunlight/Temperature Sensor**

The fully automatic air conditioner function measures inside and outside temperatures, and sunlight. It then sets temperatures inside the passenger compartment accordingly. Don't obstruct the sensor.

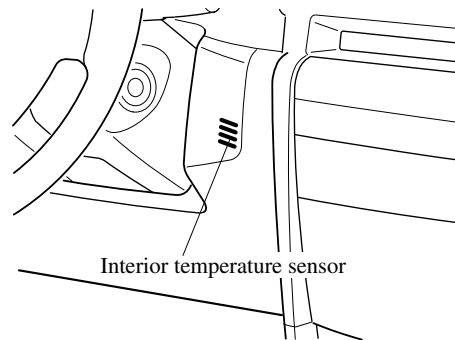
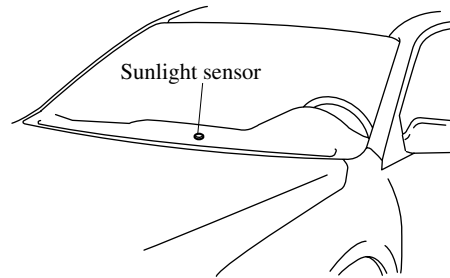

Interior Comfort

Audio System

Antenna

▼ Detachable Type

To remove the antenna, turn it counterclockwise.

To install the antenna, turn it clockwise. Make sure the antenna is securely installed.

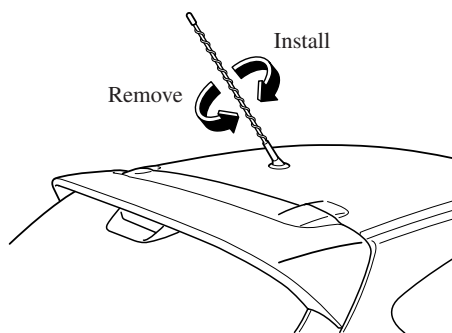

⚠ CAUTION

To prevent damage to the antenna, remove it before entering a car wash facility or passing beneath a low overhead clearance.

NOTE

When leaving your vehicle unattended, we recommend that you remove the antenna and store it inside the vehicle.

Operating Tips for Audio System

⚠ WARNING

Do Not Adjust Audio While Driving the Vehicle:

Adjusting the audio while driving the vehicle is dangerous as it could distract your attention from the vehicle operation which could lead to a serious accident. Always adjust the audio while the vehicle is stopped. Even if the audio control switches are equipped on the steering wheel, learn to use the switches without looking down at them so that you can keep your maximum attention on the road while driving the vehicle.

⚠ CAUTION

For the purposes of safe driving, adjust the audio volume to a level that allows you to hear sounds outside of the vehicle.

NOTE

- Do not use the audio for long periods of time while the engine is off. Otherwise the battery could go dead.
- If a digital cellular phone or CB radio is used in or near the vehicle, it could cause noise to occur from the audio system, however, this does not indicate that the system has been damaged.

Interior Comfort
Audio System

▼ **Radio Reception**

AM characteristics

AM signals bend around such things as buildings or mountains and bounce off the ionosphere. Therefore, they can reach longer distances than FM signals. Because of this, two stations may sometimes be picked up on the same frequency at the same time.

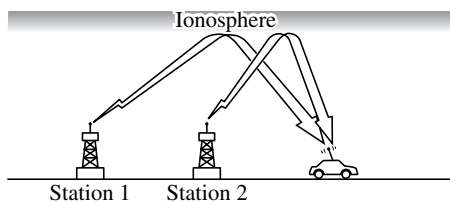

FM characteristics

An FM broadcast range is usually about 40—50 km (25—30 miles) from the source. Because of extra coding needed to break the sound into two channels, stereo FM has even less range than monaural (non-stereo) FM.

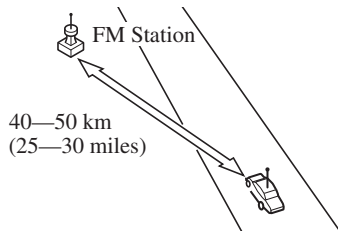

Signals from an FM transmitter are similar to beams of light because they do not bend around corners, but they do reflect. Unlike AM signals, FM signals cannot travel beyond the horizon. Therefore, FM stations cannot be received at the great distances possible with AM reception.

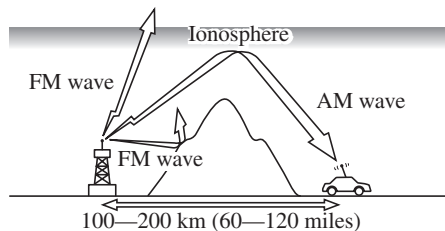

Atmospheric conditions can also affect FM reception. High humidity will cause poor reception. However, cloudy days may provide better reception than clear days.

Multipath noise

Since FM signals can be reflected by obstructions, it is possible to receive both the direct signal and the reflected signal at the same time. This causes a slight delay in reception and may be heard as a broken sound or a distortion. This problem may also be encountered when in close proximity to the transmitter.

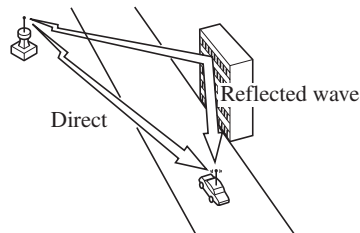

Interior Comfort

Audio System

Flutter/Skip noise

Signals from an FM transmitter move in straight lines and become weak in valleys between tall buildings, mountains, and other obstacles. When a vehicle passes through such an area, the reception conditions may change suddenly, resulting in annoying noise.

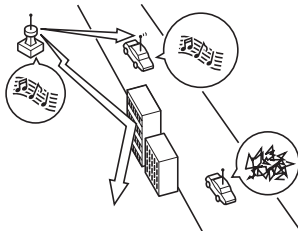

Weak signal noise

In suburban areas, broadcast signals become weak because of distance from the transmitter. Reception in such fringe areas is characterized by sound breakup.

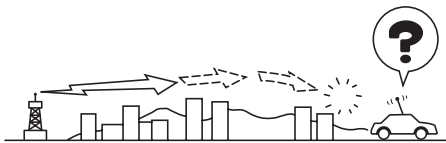

Strong signal noise

This occurs very close to a transmitter tower. The broadcast signals are extremely strong, so the result is noise and sound breakup at the radio receiver.

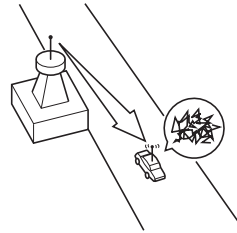

Station drift noise

When a vehicle reaches the area of two strong stations broadcasting at similar frequencies, the original station may be temporarily lost and the second station picked up. At this time there will be some noise from this disturbance.

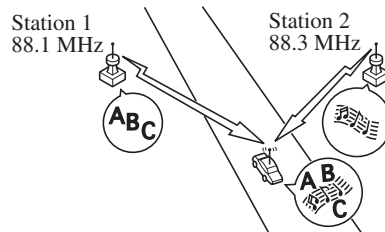

Interior Comfort
Audio System

▼ **Operating Tips for Cassette Tape Player**

Cleaning the cassette tape player

The tape head, capstans, and pinch rollers will gather oxide residue from cassette tapes. This can cause weak or wavering sounds and damage to the cassette tapes and player. Use a good quality head-cleaning tape or a liquid cleaner cassette tape to remove it.

Should the unit not operate normally, consult an Authorized Mazda Dealer. Never attempt to repair it or insert a screwdriver or anything else.

Handling the cassette tape player

The following precautions should be observed.

- Do not spill any liquid on the audio system.

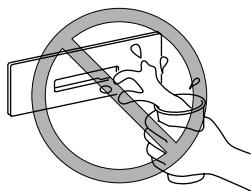

- Do not insert any objects, other than cassette tape, into the slot.

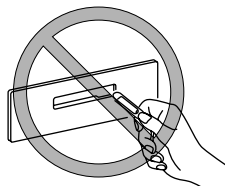

- If the cassette tape is loose, it may produce poor sound or performance during playback. Use a pencil or something similar to remove any slack.

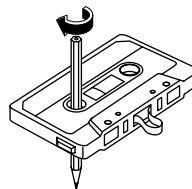

- Only cassette tapes that play no longer than 90 minutes should be used. Cassette tape exceeding 90 minutes are thin and may easily break.
- Do not leave a cassette tape in the tape player slot when not in use. Remove it completely to permit the slot door to close and to protect the mechanism from dust.
- Store cassette tapes away from extreme heat, magnetic fields, and direct sunlight. Protect the exposed cassette tape from dirt and damage. Store cassette tapes in their original cases or other protective cases.

Interior Comfort

Audio System

▼ Operating Tips for CD Player/In-Dash CD Changer

Condensation phenomenon

Immediately after turning on the heater when the vehicle is cold, the CD or optical components (prism and lens) in the CD player/changer may become clouded with condensation. At this time, the CD will eject immediately when placed in the unit. A clouded CD can be corrected simply by wiping it with a soft cloth. Clouded optical components will clear naturally in about an hour. Wait for normal operation to return before attempting to use the unit.

Handling the CD player/In-dash CD changer

The following precautions should be observed.

- Do not spill any liquid on the audio system.

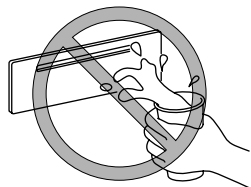

- Do not insert any objects, other than CDs, into the slot.

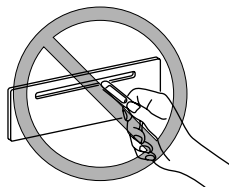

- The CD revolves at high speed within the unit. Defective (cracked or badly bent) CDs should never be used.

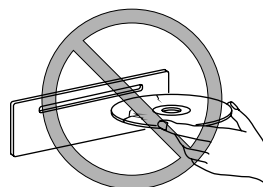

- Do not use non-conventional discs such as heart-shaped, octagonal discs, etc. The CD player/changer could be damaged.

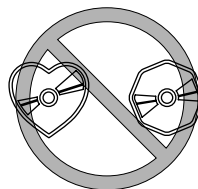

- A new CD may have rough edges on its inner and outer perimeters. If a disc with rough edges is used, proper setting will not be possible and the CD player/changer will not play the CD. Remove the rough edges in advance by using a ball-point pen or pencil as shown below. To remove the rough edges, rub the side of the pen or pencil against the inner and outer perimeter of the CD.

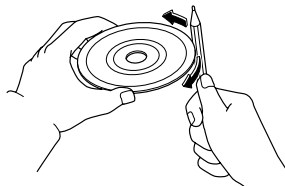

Interior Comfort
Audio System

- When driving over uneven surfaces, the sound may jump.

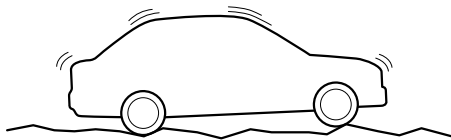

- The CD player/changer has been designed to play CDs bearing the identification logo as shown. No other discs can be played.



- Be sure never to touch the signal surface when handling the CDs. Pick up a CD by grasping the outer edge or the edge of the hole and the outer edge.

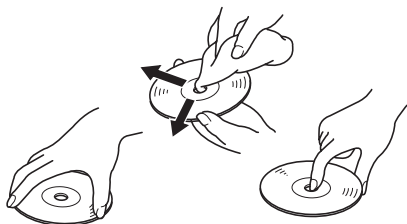

- Do not stick paper or tape on the CD. Avoid scratching the reverse side (the side without a label).

- Dust, finger smudges, and dirt can decrease the amount of light reflected from the signal surface, thus affecting sound quality. If the CD should become soiled, gently wipe it with a soft cloth from the center of the CD to the edge.
- Do not use record sprays, antistatic agents, or household spray cleaners. Volatile chemicals such as benzine and thinner can also damage the surface of the CD and must not be used. Anything that can damage, warp, or fog plastic should never be used to clean CDs.
- CDs, like traditional audio records, are made of plastic. To avoid warping, keep the CDs in their cases and do not store them where they will be exposed to direct sunlight.
- The CD player/changer ejects the CD if the CD is inserted upside down. Also dirty and/or defective CDs may be ejected.
- An 8 cm (3 in) CD can be played in the CD player.
- An 8 cm (3 in) CD cannot be played in the In-dash CD changer even if an 8 cm (3 in) CD adapter is used.
- Do not insert cleaning discs in the CD player/changer.
- Do not insert any disc with a peel-off or seal on it.



MEMO

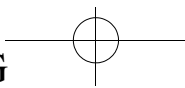
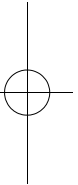
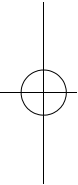

Interior Comfort
Audio System

Audio Set

Audio information is displayed on the information display.

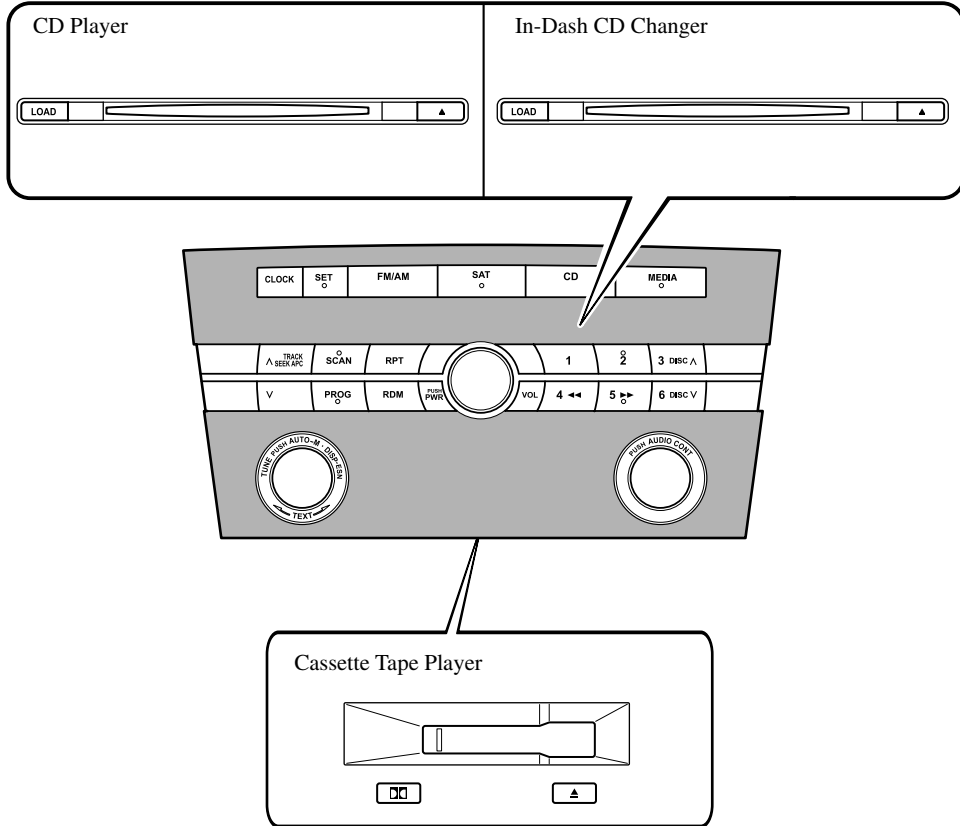
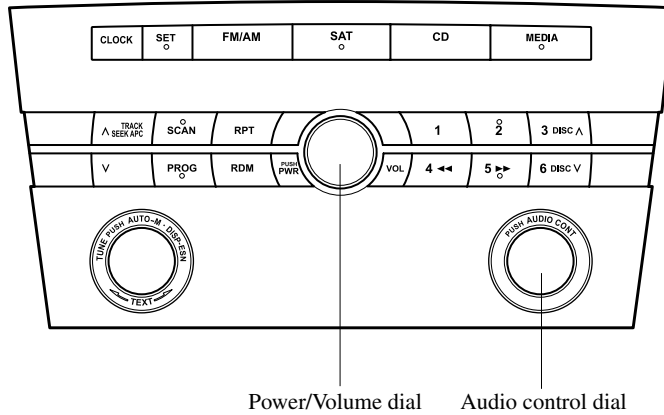

Illustration is of a representative audio unit.

Power/Volume/Sound Controls page 6-24
Operating the Radio page 6-28
Operating the Cassette Tape Player page 6-30
Operating the Compact Disc (CD) Player page 6-32
Operating the In-Dash CD Changer page 6-34
Error Indications page 6-37

Interior Comfort Audio System

▼ Power/Volume/Sound Controls



Power ON/OFF

Turn the ignition switch to the ACC or ON position.

Press the power/volume dial to turn the audio system on.
Press the power/volume dial again to turn the audio system off.

NOTE

To prevent the battery from being discharged, do not leave the audio system on for a long period of time when the engine is not running.

Volume adjustment

To adjust the volume, turn the power/volume dial.

Turn the power/volume dial to the right to increase volume, to the left to decrease it.

Audio sound adjustment

1. Press the audio control dial to select the function. The selected function will be indicated.

Standard audio-equipped model

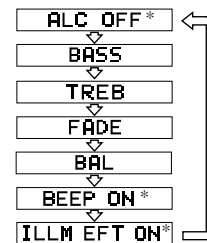

* Depending on the mode selected, the indication changes.

Interior Comfort
Audio System

BOSE Sound System-equipped model

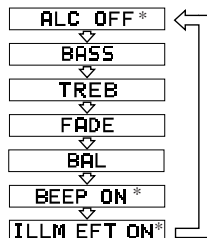

* Depending on the mode selected, the indication changes.

- Turn the audio control dial to adjust the selected functions as follows:

Standard audio-equipped model

Indication	Turn Left	Turn Right
ALC	Select mode	
BASS	Decrease bass	Increase bass
TREB	Decrease treble	Increase treble
FADE	Shift the sound to the front	Shift the sound to the rear
BAL	Shift the sound to the left	Shift the sound to the right
BEEP	OFF	ON
ILLM EFT	OFF	ON

BOSE Sound System-equipped model

Indication	Turn Left	Turn Right
ALC	Select mode	
BASS	Decrease bass	Increase bass
TREB	Decrease treble	Increase treble
FADE	Shift the sound to the front	Shift the sound to the rear
BAL	Shift the sound to the left	Shift the sound to the right
BEEP	OFF	ON
ILLM EFT	OFF	ON

NOTE

About 5 seconds after selecting any mode, the volume function will be automatically selected. To reset bass, treble, fade, and balance, press the audio control dial for 2 seconds. The unit will beep and "CLEAR" will be displayed.

Automatic Level Control (ALC)

The automatic level control is a feature that automatically adjusts audio volume and sound quality according to the vehicle speed.

The volume increases in accordance with the increase in vehicle speed, and decreases as vehicle speed decreases.

Interior Comfort
Audio System

The following four modes are available.
Select the desired mode.

Mode	Volume change
ALC OFF	No change
ALC LEVEL 1	Minimum
ALC LEVEL 2	Medium
ALC LEVEL 3	Maximum

Turn the audio control dial to select the ALC OFF, ALC LEVEL1—3 mode. The selected mode will be indicated.

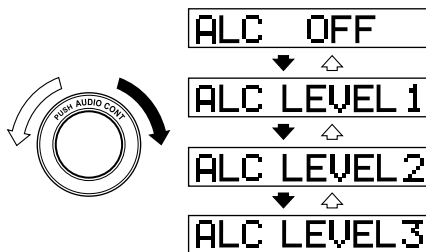

BEEP setting

The beep-sound when operating the audio system can be set on or off.

ILLM EFT setting (Illumination setting during operation)

The audio system illumination during operation can be set on or off.

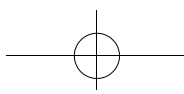

MEMO

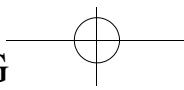
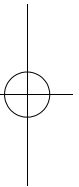
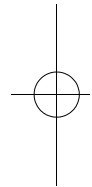

Interior Comfort Audio System

▼ Operating the Radio

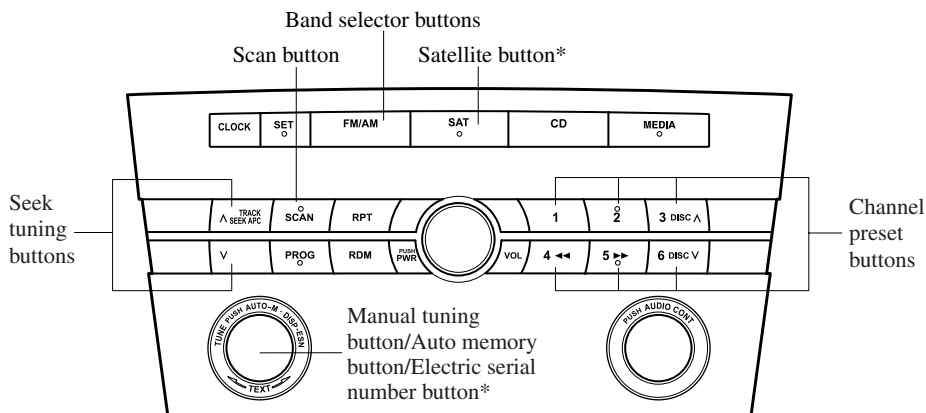

*For reception of optional SIRIUS digital satellite radio.

Used on vehicles equipped with the separately sold SIRIUS digital satellite radio unit.

For information on use, read the manual accompanying the SIRIUS unit.

Subscription of SIRIUS digital satellite radio service is available in the U.S. (Except Alaska and Hawaii).

Radio ON

Press a band selector button (**FM/AM**) to turn the radio on.

Band selection

Successively pressing the band selector button (**FM/AM**) switches the bands as follows: FM1→FM2→AM.

The selected mode will be indicated. If FM stereo is being received, "ST" will be displayed.

NOTE

If the FM broadcast signal becomes weak, reception automatically changes from STEREO to MONO for reduced noise, and the "ST" indicator will go out.

Tuning

The radio has the following tuning methods: Manual, Seek, Scan, Preset channel, and Auto memory tuning. The easiest way to tune stations is to set them on preset channels.

NOTE

If the power supply is interrupted (fuse blows or the battery is disconnected), the preset channels will be canceled.

Manual tuning

Turning the manual tuning dial will change the frequency higher or lower.

Interior Comfort
Audio System

Seek tuning

Pressing the seek tuning button (\wedge , \vee) will cause the tuner to seek a higher or lower frequency automatically.

NOTE

If you continue to press and hold the button, the frequency will continue changing without stopping.

Scan tuning

Press the scan button (**SCAN**) to automatically sample strong stations. Scanning stops at each station for about 5 seconds. To hold a station, press the scan button (**SCAN**) again during this interval.

Preset channel tuning

The 6 preset channels can be used to store 6 AM and 12 FM stations.

1. To set a channel first select AM, FM1, or FM2. Tune to the desired station.
2. Depress a channel preset button for about 2 seconds until a beep sound is heard. The preset channel number and station frequency will be displayed. The station is now held in the memory.
3. Repeat this operation for the other stations and bands you want to store. To tune one in the memory, select AM, FM1, or FM2 and then press its channel preset button. The station frequency and the channel number will be displayed.

NOTE

If the power supply is interrupted (fuse blows or the battery is disconnected), the preset channels will be canceled.

Auto memory tuning

This is especially useful when driving in an area where the local stations are not known. Additional AM/FM stations can be stored without disturbing the previously set channels.

Press and hold the auto memory button (**AUTO-M**) for about 2 seconds until a beep sound is heard; the system will automatically scan and temporarily store up to 6 stations with the strongest frequencies in each selected band in that area.

After scanning is completed, the station with the strongest frequency will be tuned and its frequency displayed.

Press and release the auto memory button (**AUTO-M**) to recall stations from the auto-stored stations. One stored station will be selected each time; its frequency and channel number will be displayed.

NOTE

If no stations can be tuned after scanning operations, "A" will be displayed.

Interior Comfort Audio System

▼ Operating the Cassette Tape Player*

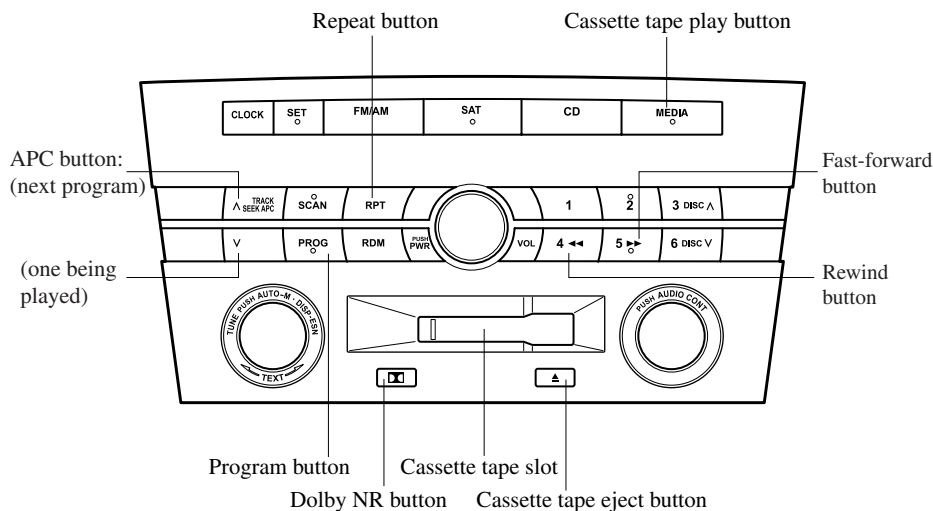

Cassette tape insert

Insert the cassette tape into the slot, open edge to the right and cassette tape will begin play, and "TAPE PLAY" will be displayed. At the end of the cassette tape, the unit automatically reverses cassette tape play. When ▲ is lit, the cassette tape's top side is playing. When ▼ is lit, the bottom side is on.

Playing

Press the cassette tape play button (MEDIA) to start play when a cassette tape is in the unit. If there isn't a cassette tape in the unit when the cassette tape play button (MEDIA) is pressed, "NO TAPE" will flash on and off.

Dolby noise reduction

When using a tape with Dolby NR*, push the Dolby NR button (DOLBY NR). The DOLBY NR symbol will be displayed. To play a tape without Dolby NR, push the button once again.

* Noise reduction system manufactured under license from Dolby Laboratories Licensing Corporation. Dolby and the double-D symbol DOLBY are trademarks of Dolby Laboratories Licensing Corporation.

Ejecting the cassette tape

Press the cassette tape eject button (EJECT) to eject the cassette tape.

Interior Comfort
Audio System

NOTE

The cassette tape can be ejected when the ignition switch is in the OFF position.

Fast-forward/Rewind

Press the fast-forward button (▶▶) to fast-forward.

Press the rewind button (◀◀) to rewind. To stop this operation and play the cassette tape, press the button again.

NOTE

When the cassette tape ends during fast-forward or rewind, it automatically stops and starts playing.

Reversing

Press the program button (PROG) to change cassette tape-play direction.

NOTE

When the cassette tape ends, the unit automatically reverses play.

Automatic program control (APC)

APC is used to find the beginning of either the next program or the one being played.

Press the APC button (Λ) to the beginning of the next selection. Press the APC button (∨) to the beginning of the one being played. To stop this operation and play the cassette tape, press the button again.

NOTE

APC may not operate properly if:

- A tape was recorded at a low level.
- A tape has long, silent intervals.
- A tape is a live recording.
- A tape has very short intervals of less than 3 seconds.

Repeat play

This operation makes it possible to listen to a selection repeatedly.

Press the repeat button (RPT) during play. The current selection playing will be repeated ("RPT" will be displayed). Press the repeat button (RPT) once again to cancel repeat play.

NOTE

RPT may not operate properly if:

- A tape was recorded at a low level.
- A tape has long, silent intervals.
- A tape is a live recording.
- A tape has very short intervals of less than 3 seconds.

Interior Comfort Audio System

▼ Operating the Compact Disc (CD) Player *

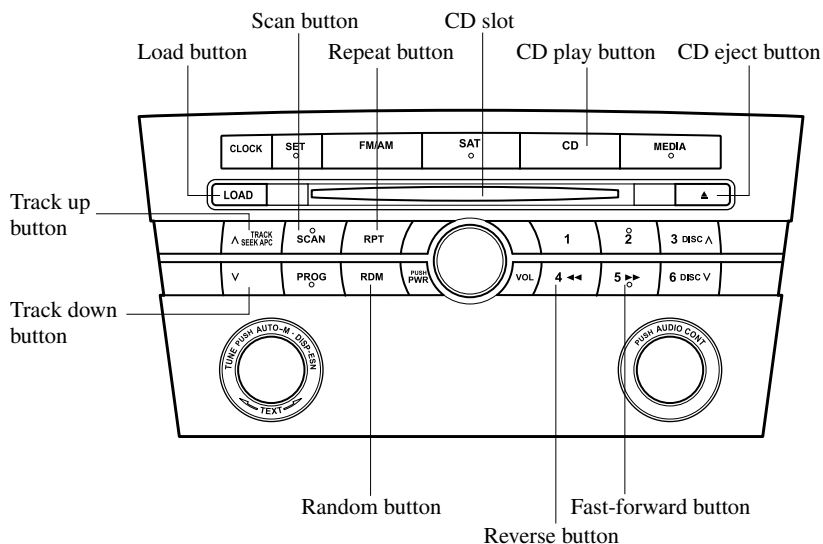

Inserting the CD

Insert the CD into the slot, label-side up. The auto-loading mechanism will set the CD and begin play. There will be a short lapse before play begins while the player reads the digital signals on the CD.

Playing

Press the CD play button (▶) to start play when a CD is in the unit. If there isn't a CD in the unit when the CD play button (▶) is pressed, "NO DISC" will flash on and off.

NOTE

When the load button (LOAD) is pressed, the CD will load and play even if the CD eject button (▲) had been previously pressed.

Ejecting the CD

Press the CD eject button (▲) to eject the CD.

Fast-forward/Reverse

Press and hold the fast-forward button (▶▶) to advance through a track at high speed.

Press and hold the reverse button (◀◀) to reverse through a track at high speed.

Track search

Press the track up button (▲) once to skip forward to the beginning of the next track. Press the track down button (▼) once to skip back to the beginning of the current track.

Interior Comfort
Audio System

Music scan

This feature helps to find a program by playing about the first 10 seconds of each track.

Press the scan button (**SCAN**) during play to start scan play operation (the track number will flash).
Press the scan button (**SCAN**) once again to cancel scan play.

NOTE
If the unit is left in scan, normal play will resume where scan was selected.

Repeat play

This feature makes it possible to listen to a selection repeatedly.

Press the repeat button (**RPT**) during play. The current selection will be repeated ("RPT" will be displayed).
Press the repeat button (**RPT**) once again to cancel repeat play.

Random play

This feature allows the CD player to randomly select the order of the songs.

Press the random button (**RDM**) during play. The next selection will be randomly selected ("RDM" will be displayed).
Press the random button (**RDM**) once again to cancel random play.

Interior Comfort Audio System

▼ Operating the In-Dash CD Changer *

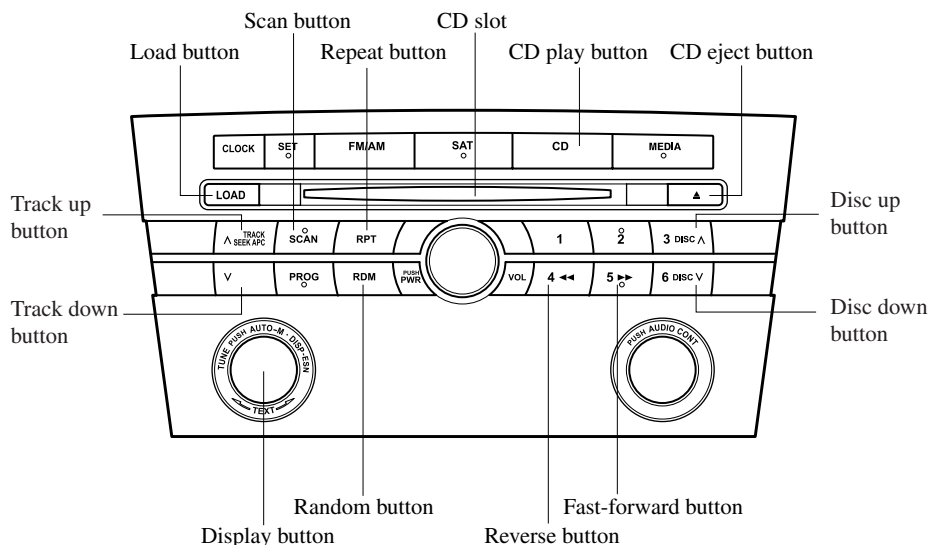

Inserting the CD

The CD must be label-side up when inserting. The auto-loading mechanism will set the CD and begin play. There will be a short lapse before play begins while the player reads the digital signals on the CD.

The disc number and the track number will be displayed.

NOTE

A CD cannot be inserted while the display reads "WAIT". A beeping sound can be heard during this waiting time. Simultaneously pressing the power/volume dial and the load button (LOAD) for about 2 seconds will turn this beeping sound ON or OFF.

Normal insertion

1. Press the load button (LOAD).
2. When "IN" is displayed, insert the CD.

Inserting CDs into desired tray number

1. Press and hold the load button (LOAD) for about 2 seconds until a beep sound is heard.
2. Press the channel preset button for the desired tray number while "WAIT" is displayed.
3. When "IN" is displayed, insert the CD.

NOTE

The CD cannot be inserted to the desired tray number if the number is already occupied.

Interior Comfort
Audio System

Multiple insertion

1. Press and hold the load button (LOAD) for about 2 seconds until a beep sound is heard.
2. Press the load button (LOAD) again while "WAIT" is displayed.

NOTE

If the button is not operated while "WAIT" is displayed, the display changes to "IN" and the CD can be inserted.

3. When "IN" is displayed, insert the CD.
4. When "IN" is displayed again, insert the next CD.

NOTE

The first-inserted CD will be played automatically when:

- No other CD is inserted within 15 seconds after "IN" is displayed.
- The CD trays are full.

Displaying the CD-inserted tray number

When you want to know the number for a CD-inserted tray, press the display button (DISP). The tray number will be displayed for 5 seconds.

Ejecting the CD

Normal ejection

1. Press the CD eject button (▲). The disc number and "DISC" "OUT" will be displayed.
2. Pull out the CD.

NOTE

When the CD is ejected during play, the next CD will be played automatically.

Ejecting CDs from desired tray number

1. Press and hold the CD eject button (▲) for about 2 seconds until a beep sound is heard.
The "DISC" "OUT" display flashes.
2. Press the channel preset button for the desired CD number for less than 5 seconds after the beep sound is heard.
3. Pull out the CD.

Multiple ejection

1. Press and hold the CD eject button (▲) for about 2 seconds until a beep sound is heard.
The "DISC" "OUT" display flashes.
2. Press the CD eject button (▲) again for less than 5 seconds after the beep sound is heard.

NOTE

If the button is not pressed and about 5 seconds have elapsed while "DISC" "OUT" is flashing, CDs are automatically ejected.

3. Pull out the CD, then the next CD will be ejected.

Interior Comfort

Audio System

NOTE

- CDs will be ejected starting with the one with the lowest number.
- All CDs in the tray will be ejected continuously.
- CDs can be ejected when the ignition switch is off. Press and hold the CD eject button (▲) for about 2 seconds and all CDs will eject.

Playing

Press the CD play button (CD) to start play when a CD is in the unit.

If there isn't a CD in the unit when the CD play button (CD) is pressed, "NO DISC" will flash on and off.

Fast-forward/Reverse

Press and hold the fast-forward button (▶▶) to advance through a track at high speed.

Press and hold the reverse button (◀◀) to reverse through a track at high speed.

Track search

Press the track up button (Λ) once to skip forward to the beginning of the next track. Press the track down button (∇) once to skip back to the beginning of the current track.

Disc search

Press the disc up button (DISCΛ) to skip forward to the beginning of the next CD. Press the disc down button (DISC∇) to skip back to the beginning of the previous CD.

Music scan

This feature helps to find a program by playing about the first 10 seconds of each track.

Press the scan button (SCAN) during play to start scan play operation (the track number will flash).

Press the scan button (SCAN) once again to cancel scan play.

NOTE

If the unit is left in scan, normal play will resume where scan was selected.

Repeat play

This feature makes it possible to listen to a selection repeatedly.

Press the repeat button (RPT) during play. The current selection will be repeated ("RPT" will be displayed).

Press the repeat button (RPT) once again to cancel repeat play.

Random play

This feature allows the CD player to randomly select the order of the songs.

Press the random button (RDM) during play. The next selection will be randomly selected ("RDM" will be displayed).

Press the random button (RDM) once again to cancel random play.

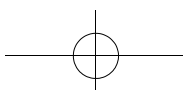

Interior Comfort
Audio System

▼ Error Indications

If you see an error indication on the display, find the cause in the chart. If you cannot clear the error indication, take the vehicle to an Authorized Mazda Dealer.

Indication	Cause	Solution
CHECK CD	CD is inserted upside down	Insert the CD properly. If the error indication does not disappear, consult an Authorized Mazda Dealer
	CD is defective	Insert another CD properly. If the error indication does not disappear, consult an Authorized Mazda Dealer

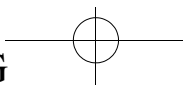
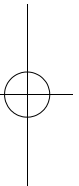
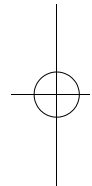

Interior Comfort

Audio System

Audio Control Switch Operation (Steering Wheel)*

When the audio unit is turned on, operation of the audio unit from the steering wheel is possible.

NOTE

Because the audio unit will be turned off under the following conditions, the switches will be inoperable.

- When the ignition switch is turned to the LOCK position.
- When the power button on the audio unit is pressed and the audio unit is turned off.
- When a cassette tape/CD being played is ejected. (For the In-dash CD changer, when all CDs are ejected.)

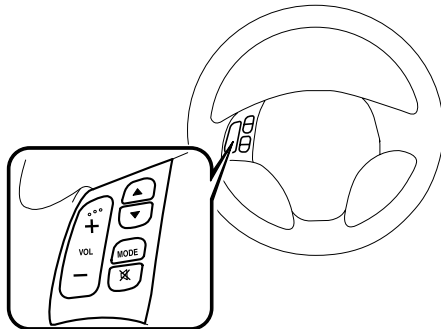

NOTE

Mazda has installed this system to prevent distraction while driving the vehicle and using audio controls on the dashboard.

Always make safe driving your first priority.

▼ Adjusting the Volume

To increase the volume, press the volume button (+).

To decrease the volume, press the volume button (-).

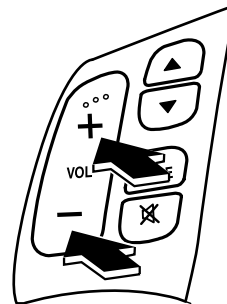

Interior Comfort
Audio System

▼ **Changing the Source**

Press the mode switch (MODE) to change the audio source (FM1 radio> FM2 radio> AM radio> CD player or CD changer> Cassette tape player> SIRIUS1> SIRIUS2> SIRIUS3> cyclical).

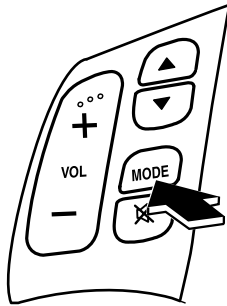

NOTE

Cassette tape, CD, CD changer and SIRIUS digital satellite radio modes cannot be selected in the following cases:

- A cassette deck, CD, CD changer, or SIRIUS digital satellite radio unit is not equipped on the audio system.
- A cassette tape, or CD has not been inserted.

▼ **Seek Switch**

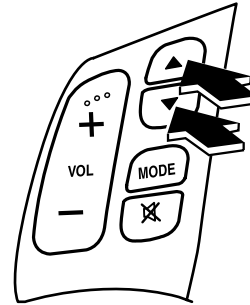

When listening to the radio

Press the seek switch (▲, ▼), the radio switches to the next/previous stored station in the order that it was stored (1—6).

Press the seek switch (▲, ▼) for about 2 seconds until a beep sound is heard to seek all usable stations at a higher or lower frequency whether programmed or not.

When playing a cassette tape

Press the seek switch (▲), release, and it will advance to the next selection.
Press the seek switch (▼), release, and it will repeat the selection being played.

When playing a CD

Press the seek switch (▲) to skip to the next track.
Press the seek switch (▼) to repeat the current track.

Interior Comfort

Audio System

▼ Mute Switch

Press the mute switch (⌘) once to mute audio, press it again to resume audio output.

NOTE

If the ignition switch is turned to the LOCK position with the audio muted, the mute will be canceled.
Therefore, when the engine is restarted, the audio is not muted. To mute the audio again, press the mute switch (⌘).

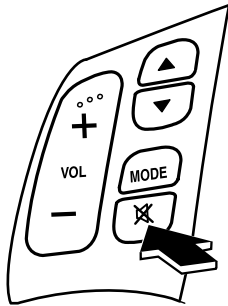

Interior Comfort
Audio System

Safety Certification

This CD player is made and tested to meet exacting safety standards. It meets FCC requirements and complies with safety performance standards of the U.S. Department of Health and Human Services.

CAUTION

- This CD player should not be adjusted or repaired by anyone except qualified service personnel.
If servicing is required, contact an Authorized Mazda Dealer.
- Use of controls or adjustments or performance of procedures other than those specified herein may result in hazardous laser exposure. Never operate the CD player with the top case of the unit removed.
- Changes or modifications not expressly approved by the party responsible for compliance could void the user's authority to operate this equipment.

NOTE

For CD player section:

This device complies with part 15 of the FCC Rules. Operation is subject to the following two conditions: (1) This device may not cause harmful interference, and (2) this device must accept any interference received, including interference that may cause undesired operation.

NOTE

This equipment has been tested and found to comply with the limits for a Class B digital device, pursuant to part 15 of the FCC Rules. These limits are designed to provide reasonable protection against harmful interference in a residential installation. This equipment generates, uses, and can radiate radio frequency energy and, if not installed and used in accordance with the instructions, may cause harmful interference to radio communications. However, there is no guarantee that interference will not occur in a particular installation.

Interior Comfort

Interior Equipment

Sunvisors

When you need a sunvisor, lower it for use in front or swing it to the side.

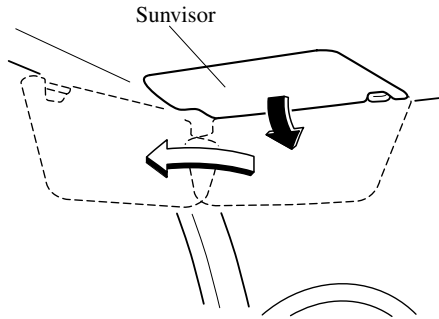

▼ Vanity Mirrors

To use the vanity mirror, lower the sunvisor.

Interior Lights

▼ Illuminated Entry System *

When the illuminated entry system operates, the overhead light (switch is in the DOOR position) turns on for:

- About 30 seconds after the driver's door is unlocked and the ignition key is removed.
- About 15 seconds after all doors are closed.
- About 15 seconds after the key is removed from the ignition with all doors closed.

The light also turns off when:

- The ignition switch is turned to the ON position and all doors are closed.
- The driver's door is locked.

NOTE

Battery saver

If any door is left opened, the light goes out after about 5 minutes to save the battery.

The light turns on again when the ignition switch is turned to the ON position, or when any door is opened after all doors have been closed.

Interior Equipment

▼ Overhead Lights *

Front

With moonroof

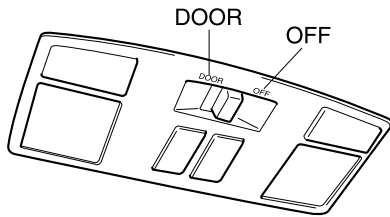

Without moonroof

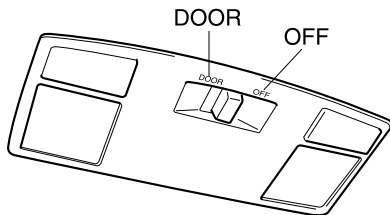

Switch Position	Front Overhead Lights
OFF	Light off
DOOR	<ul style="list-style-type: none"> Light on when any door is open (With illuminated entry system) Light on or off when the illuminated entry system is on

Rear

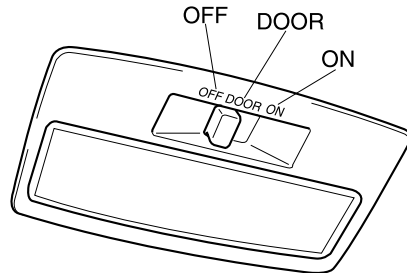

Switch Position	Rear Overhead Lights
OFF	Light off
DOOR	<ul style="list-style-type: none"> Light on when any door is open (With illuminated entry system) Light on or off when the illuminated entry system is on
ON	Light on

▼ Map Lights *

The map lights are switched on or off by pressing the switches.

With moonroof

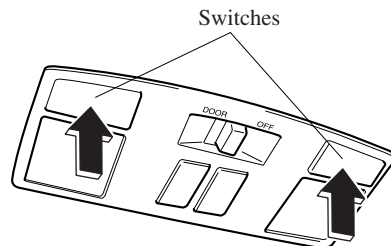

Interior Comfort

Interior Equipment

Without moonroof

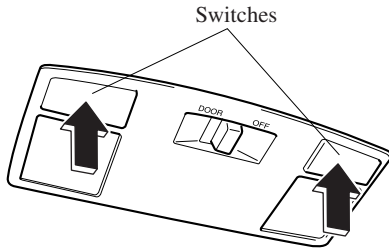

▼ Luggage Compartment Light (5 Door)

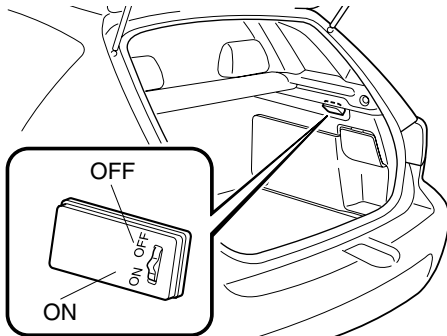

Switch Position	Luggage Compartment Light
OFF	Light off
ON	Light on when the liftgate is open

Interior Comfort
Interior Equipment

Information Display

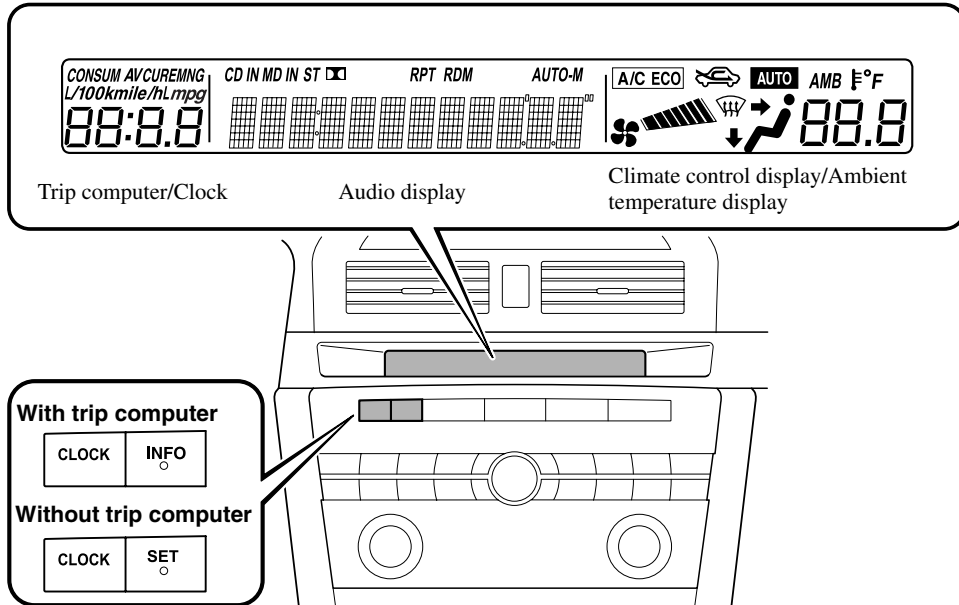

▼ **Information Display Functions**

The information display has the following functions:

- Clock
- Ambient Temperature Display (Outside Temperature Display)*
- Climate Control Display (Fully Automatic Type)
- Audio Display
- Trip Computer*

*Some models. **6-45**

Interior Comfort

Interior Equipment

▼ Clock

NOTE

When the trip computer is being displayed, press the CLOCK button to change the display to the time.

When the ignition switch is in the ACC or ON position, the time is displayed.



10:00

Time setting

NOTE

For trip computer-equipped vehicles, press the INFO button instead of the SET button when setting the time.

1. Press the CLOCK button until a beep sounds, and “12Hr” and “24Hr” will be displayed.
2. Press the SET button to switch between “12Hr” and “24Hr” displays. The selected display will flash. To select the desired clock setting, press the CLOCK button again while the preferred setting is flashing.

3. “Hr. ADJUST” will be displayed next, and the hour portion of the display will flash. Press the SET button to set the hour, then press the CLOCK button.
4. “Min. ADJUST” will be displayed next, and the minutes portion of the display will flash. Press the SET button to set the minutes, then press the CLOCK button.

Time resetting

NOTE

For trip computer-equipped vehicles, press the INFO button instead of the SET button when resetting the time.

While the clock is displayed, press the SET button 1.5 seconds or more. When the button is released, a beep will sound and the clock will be reset as follows:

(Example)

12:01—12:29→12:00

12:30—12:59→1:00

NOTE

When the SET button is released, the seconds are reset to “00”.

▼ Ambient Temperature Display*

With manual type air conditioner

When the ignition switch is in the ON position, the ambient temperature is displayed.

Interior Equipment

With fully automatic type air conditioner

When the ignition switch is in the ON position, press the AMB button (page 6-11) on the air conditioner control panel to display the ambient temperature. Press the AMB button again to switch the display from ambient temperature to the temperature set for the air conditioner.

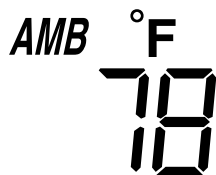

NOTE

The displayed ambient temperature may vary from the actual ambient temperature depending on the surrounding area and vehicle conditions.

▼ Climate Control Display (Fully Automatic Type)

The climate control system status is displayed. To operate the climate control system, refer to “Climate Control System” (page 6-2).

▼ Audio Display

The audio system status is displayed. To operate the audio system, refer to “Audio System” (page 6-16).

▼ Trip Computer *

The trip computer can display the following:

- The current fuel economy.
- The average fuel economy.
- The approximate distance you can travel on the available fuel.
- The average vehicle speed.

The ignition switch must be in the ON position. Press the INFO button to change the display mode.

NOTE

When the time is being displayed, press the INFO button to change the display to the trip computer.

If you have any problems with your trip computer, consult an Authorized Mazda Dealer.

Current fuel economy mode

This mode displays the current fuel economy by calculating the amount of fuel consumption and the distance traveled.

Current fuel economy will be calculated and displayed every 2 seconds.

When this mode is selected, CONSUM CUR will be displayed.

Interior Comfort

Interior Equipment

U.S.A.

CONSUM CUR
mpg
22.4

CANADA

CONSUM CUR
L/100km
10.5

When you've slowed to about 5 km/h (3 mph), — L/100 km (—mpg) will be displayed.

Average fuel economy mode

This mode displays the average fuel economy by calculating the fuel consumption and the distance traveled since connecting the battery or resetting the data.

Average fuel economy will be calculated and displayed every minute.

When this mode is selected, CONSUM AV will be displayed.

6-48

U.S.A.

CONSUM AV
mpg
22.4

CANADA

CONSUM AV
L/100km
10.5

To clear the data being displayed, press the INFO button for more than 1 second. After pressing the INFO button, — L/100 km (—mpg) will be displayed for 1 minute before the fuel economy is recalculated and displayed.

Distance-to-empty mode

This mode displays the approximate distance you can travel on the remaining fuel based on the fuel economy.

The distance-to-empty will be calculated and displayed every minutes.

When this mode is selected, REMNG will be displayed.

Interior Comfort
Interior Equipment

U.S.A.

REMNG
mile
100

CANADA

REMNG
km
160

NOTE

- Even though the distance-to-empty display may indicate a sufficient amount of remaining mileage before refueling is required, refuel as soon as possible if the fuel gauge needle nears E or the low fuel warning light illuminates.
- The display won't change unless you add more than approximately 20 L (5.3 gal) of fuel.

Average vehicle speed mode

This mode displays the average vehicle speed by calculating the distance and the time traveled since connecting the battery or resetting the data.

Average vehicle speed will be calculated and displayed every 10 seconds.

When this mode is selected, AV will be displayed.

U.S.A.

AV
mile/h
25

CANADA

AV
km /h
40

To clear the data being displayed, press the INFO button for more than 1 second. After pressing the INFO button, — km/h (— mile/h) will be displayed for about 1 minute before the vehicle speed is recalculated and displayed.

Interior Comfort

Interior Equipment

Lighter

The ignition switch must be in the ACC or ON position.

Press the lighter in and release it. When ready for use, it automatically pops out.

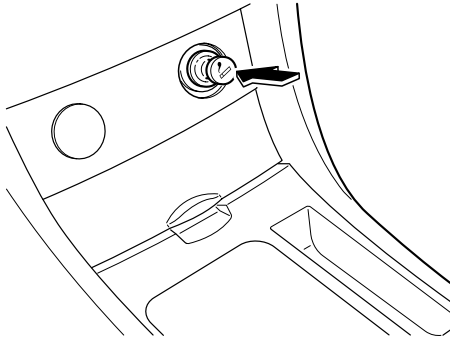

⚠ CAUTION

- Don't touch the metal part of the lighter, you may burn yourself.
- Don't hold the lighter in because it will overheat.
- Don't use the lighter socket for plug-in accessories such as shavers and coffee pots. They may damage it or cause electrical failure. Use only a genuine Mazda lighter or the equivalent.
- If the lighter doesn't pop out within 30 seconds, remove it to prevent overheating.

Ashtray

⚠ CAUTION

Don't use the ashtray for trash. You might start a fire.

To use, open the cover.

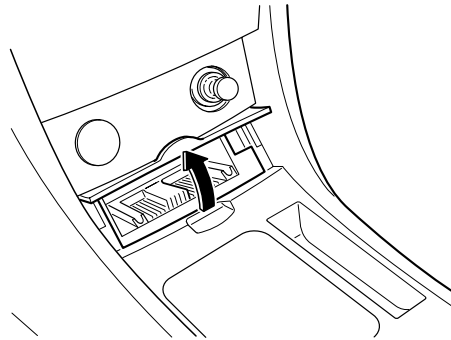

To remove, open the cover and pull up the ashtray.

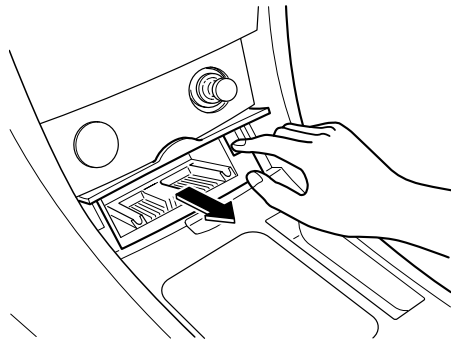

Interior Comfort
Interior Equipment

Cup Holder

WARNING

Using Cup Holder:

Using a cup holder to hold hot liquids while the vehicle is moving is dangerous. If the contents spill, you could be scalded. Never use a cup holder to hold hot liquids while the vehicle is moving.

Don't Put Anything Other Than Cups or Drink cans in Cup Holder:

Putting objects other than cups or drink cans in a cup holder is dangerous.

During sudden braking or maneuvering, occupants could be hit and injured, or objects could be thrown around the vehicle, causing interference with the driver and the possibility of an accident. Only use a cup holder for cups or drink cans.

CAUTION

To reduce the possibility of injury in an accident or a sudden stop, keep cup holders closed when not in use.

To use, open the cover.

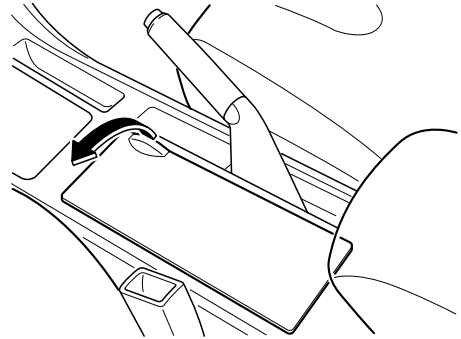

Interior Comfort

Interior Equipment

Bottle Holder

Bottle holders are on the inside of the front doors.

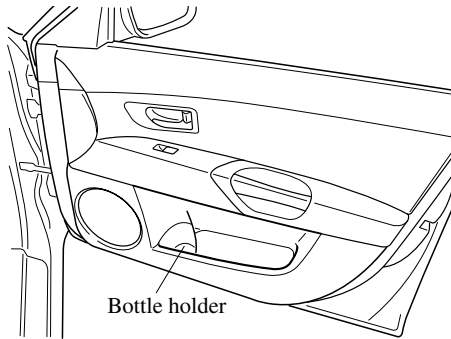

⚠ CAUTION

Don't use the bottle holders for containers without caps. The contents may spill when the door is opened or closed.

Storage Compartments

⚠ WARNING

Open Storage Boxes:
Driving with the storage boxes open is dangerous. To reduce the possibility of injury in an accident or a sudden stop, keep the storage boxes closed when driving.

⚠ CAUTION

Don't leave lighters or eyeglasses in the storage boxes while parked under the sun. A lighter could explode or the plastic material in eyeglasses could deform and crack from high temperature.

▼ Glove Box

To open the glove box, pull the latch toward you.
If the glove box has a lock, insert the key and turn it clockwise to lock, counterclockwise to unlock.

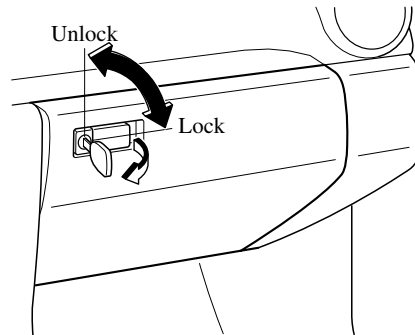

Interior Equipment

▼ Center Console

To open, pull the lower release catch.

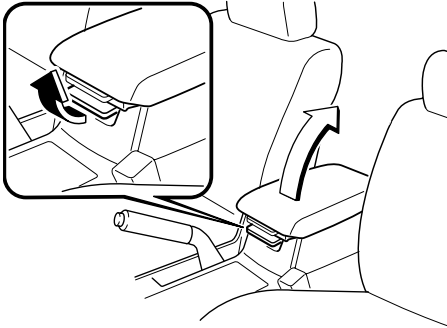

Small items can be placed in the tray of the center console lid.

To open it, pull the upper release catch.

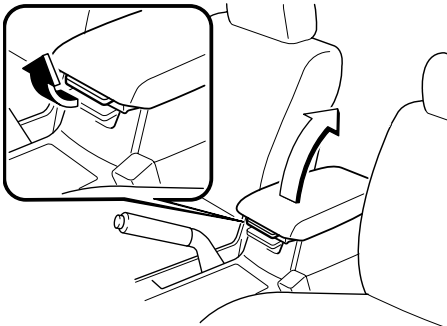

▼ Cargo Securing Loops (5 Door)

WARNING

Not Securing Luggage and Cargo:
Not securing cargo while driving is dangerous as it could move or be crushed during sudden braking or a collision and cause injury. Make sure luggage and cargo is secured before driving.

Use the loops in the luggage compartment to secure cargo with a rope or net. The tensile strength of the loops is 196 N (20 kgf, 44 lbf). Do not apply excessive force to the loops as it will damage them.

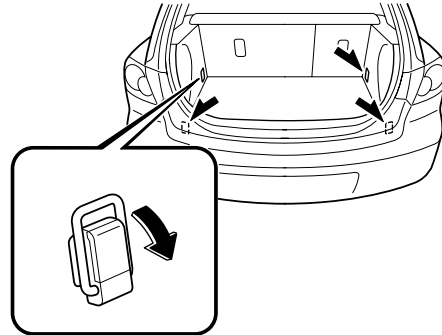

NOTE

To secure cargo with a rope or net, the trunk board loops can be used in the same way as the cargo securing loops (page 6-54).

▼ Cargo Sub-Compartment (5 Door)

With flexible floor board

To use the cargo sub-compartment, partially open or remove the trunk boards.

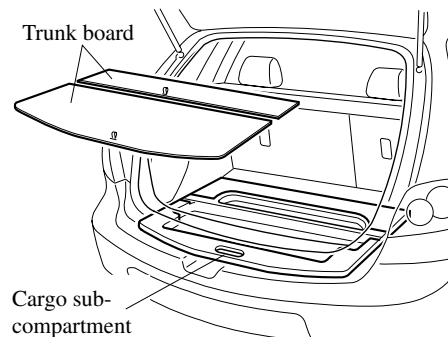

Interior Comfort

Interior Equipment

Without flexible floor board

To use the cargo sub-compartment, remove or lift the trunk board.

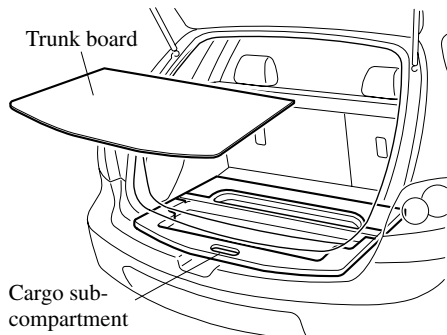

▼ Flexible Floor Board (5 Door) *

The luggage compartment can be separated vertically and/or horizontally, using the trunk board and the trunk board loops.

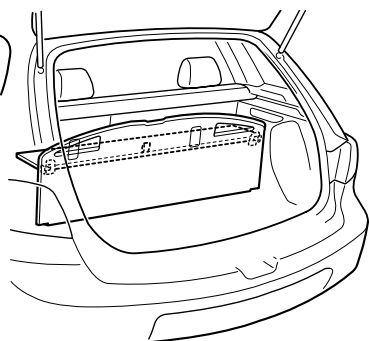

⚠ CAUTION

Make sure the trunk board is firmly secured when it is fitted into the trunk board loops. If it is not firmly secured, it could unexpectedly disengage causing damage to the trunk board loops or the trunk board.

NOTE

The trunk board loops can be used in the same way as the cargo securing loops. The tensile strength of the loops is 147 N (15 kgf, 33 lbf). Do not apply excessive force to the trunk board loops as it will damage them (page 6-53).

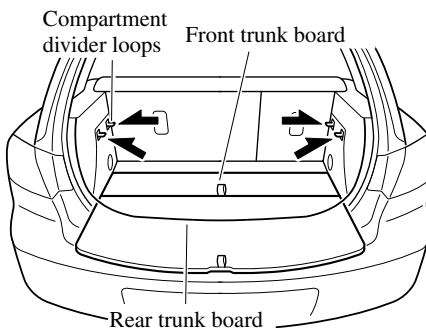

To separate vertically

Use the rear trunk board to separate the luggage compartment vertically.

1. Pull the trunk board loops out.

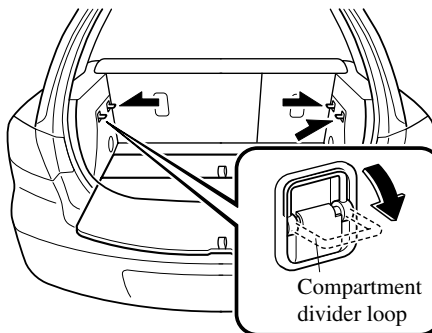

Interior Comfort
Interior Equipment

2. Insert the trunk board loops into the trunk board slits.

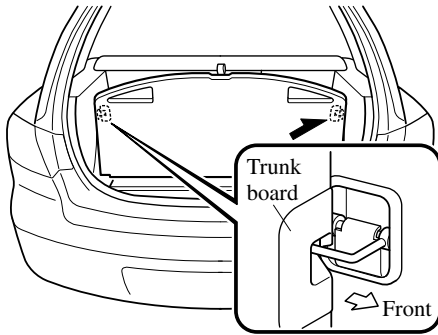

NOTE

To facilitate insertion of the trunk board loops into the trunk board slits, first insert the bottom of the rear trunk board into the groove of the luggage sub-compartment.

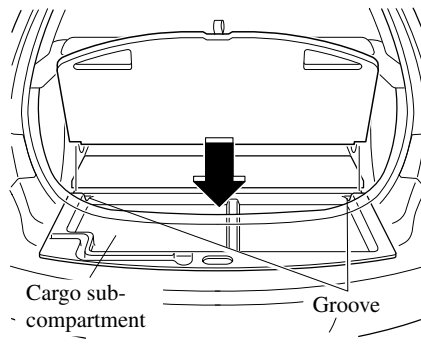

3. Rock the trunk board to make sure the board is installed securely.

To separate horizontally

Use the front trunk board to separate the luggage compartment horizontally.

⚠ CAUTION

- Do not place heavy objects on the trunk board or apply excessive force as they could damage the trunk board. The permissible weight is about 5 kg (11 lb).
- Do not use the rear trunk board to separate the luggage compartment horizontally. The rear trunk board cannot be locked to the trunk board loops and it could move and cause injury while the vehicle is moving.

1. Pull the trunk board loops out.

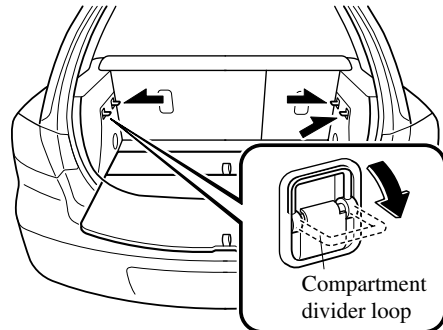

2. Insert the trunk board loop into slit A.

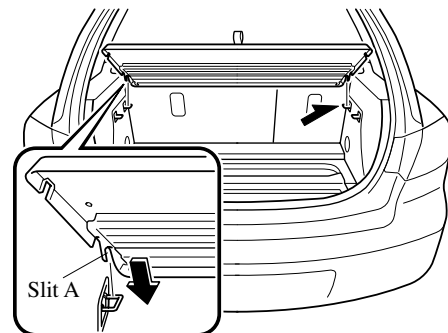

Interior Comfort

Interior Equipment

3. Insert the other trunk board loop into slit B until a click sound is heard.

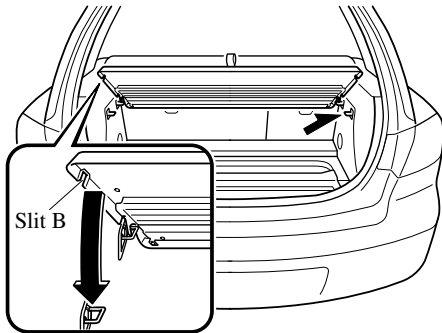

4. Rock the trunk board to make sure the board is installed securely.

⚠ CAUTION

Do not place or remove luggage via the rear passenger seat area while the vehicle is moving. The trunk board or luggage could move and cause injury.

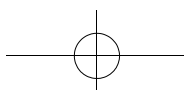

7

In Case of an Emergency

Helpful information on what to do in an emergency.

Parking in an Emergency	7-2
Parking in an Emergency	7-2
Flat Tire	7-3
Spare Tire and Tool Storage	7-3
Changing a Flat Tire	7-6
Overheating	7-12
Overheating	7-12
Emergency Starting	7-14
Starting a Flooded Engine	7-14
Jump-Starting	7-15
Push-Starting	7-18
Emergency Towing	7-19
Towing Description	7-19
Tiedown Hook	7-20
Recreational Towing	7-22

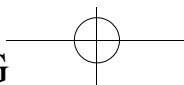

In Case of an Emergency

Parking in an Emergency

Parking in an Emergency

The hazard warning lights should always be used when you stop on or near a roadway.

The hazard warning lights warn other drivers that your vehicle is a traffic hazard and that they must take extreme caution when near it.

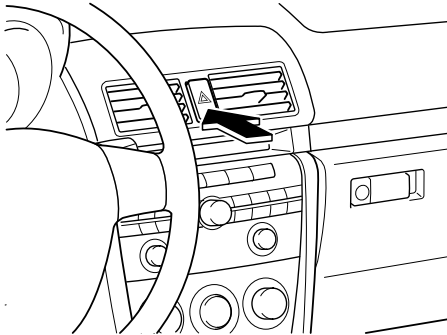

Depress the hazard warning flasher and all four turn signals will flash.

NOTE

- The turn signals don't work when the hazard warning lights are on.
- Check local regulations about the use of hazard warning lights while the vehicle is being towed. They may forbid it.

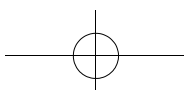

In Case of an Emergency
Flat Tire

Spare Tire and Tool Storage

Spare tire and tools are stored in the locations illustrated in the diagram.

4 Door

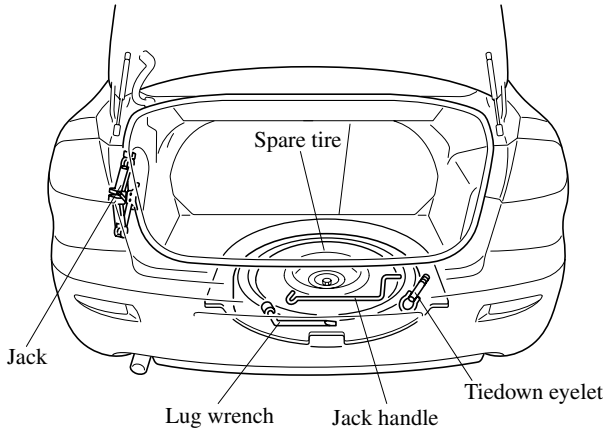

5 Door

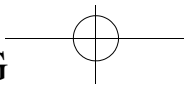
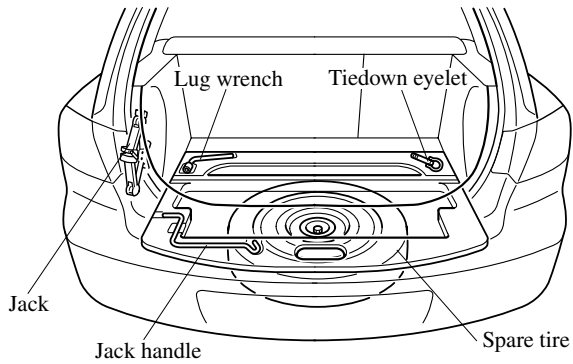

In Case of an Emergency

Flat Tire

▼ Jack

To remove the jack

1. Turn the knob and remove the cover.

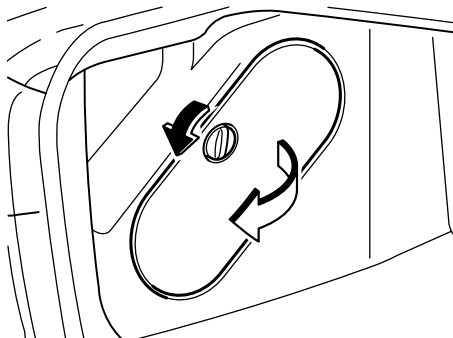

2. Turn the wing bolt counterclockwise.

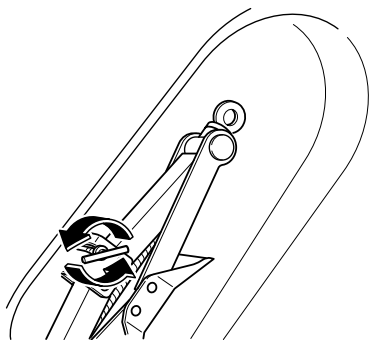

To secure the jack

Perform the removal procedure in reverse.

▼ Spare Tire

Your Mazda has a temporary spare tire. The temporary spare tire is lighter and smaller than a conventional tire, and is designed only for emergency use and should be used only for VERY short periods. Temporary spares should NEVER be used for long drives or extended periods.

⚠ **WARNING**

Driving with a Temporary Spare Tire on Ice or Snow:

Driving with a spare tire on the front (driving) wheels on ice or snow is dangerous. Handling will be affected. You could lose control of the vehicle and have an accident. Put the spare tire on the rear axle and move a regular tire to the front.

⚠ **CAUTION**

- When using the temporary spare tire, driving stability may decrease compared to when using only the conventional tire. Drive carefully.
- To avoid damage to the temporary spare or to the vehicle, observe the following precautions:
 - Don't exceed 80 km/h (50 mph).
 - Avoid driving over obstacles. Also, don't drive through an automatic car wash. This tire's diameter is smaller than a conventional tire's, so the ground clearance is reduced about 25 mm (1 in).
 - Don't use a tire chain on this tire because it won't fit properly.
 - Don't use your temporary spare on any other vehicle; it has been designed only for your Mazda.
 - Use only one temporary spare tire on your vehicle at the same time.

In Case of an Emergency

Flat Tire

NOTE

(With Tire Pressure Monitoring System)

A tire pressure sensor is not installed to the temporary spare tire. The warning light will flash continuously while the temporary spare tire is being used (page 5-23).

To remove the spare tire

(4 Door)

1. Remove the trunk mat and trunk board.

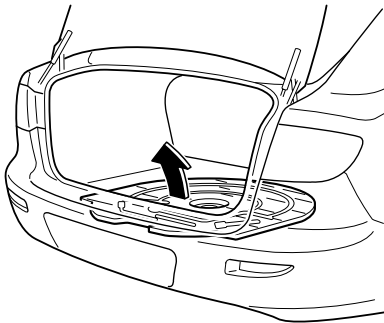

2. Turn the tire hold-down bolt counterclockwise with the lug wrench.

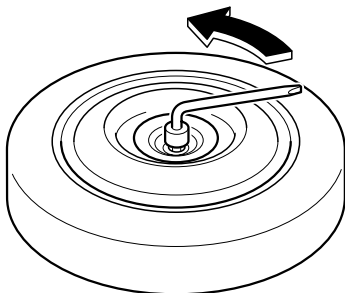

(5 Door)

1. Remove the trunk mat, trunk board and cargo sub-compartment.

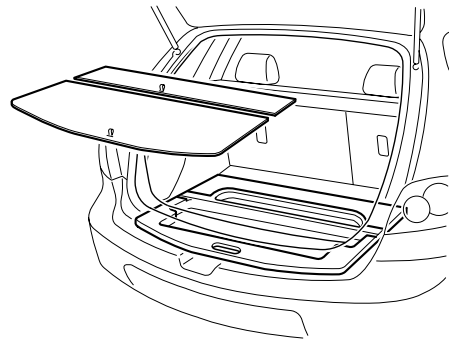

2. Turn the tire hold-down bolt counterclockwise with the lug wrench.

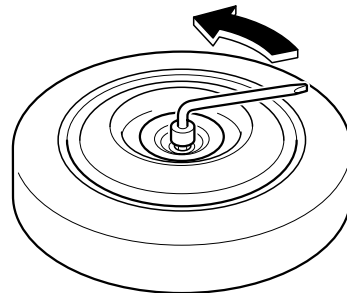

In Case of an Emergency

Flat Tire

Changing a Flat Tire

NOTE

If the following occurs while driving, it could indicate a flat tire.

- Steering becomes difficult.
- The vehicle begins to vibrate excessively.
- The vehicle pulls in one direction.

If you have a flat tire, drive slowly to a level spot that is well off the road and out of the way of traffic to change the tire. Stopping in traffic or on the shoulder of a busy road is dangerous.

WARNING

Jacking a Vehicle:

Changing a tire is dangerous if not done properly. The vehicle can slip off the jack and seriously injure someone. Be sure to follow the directions for changing a tire, and never get under a vehicle that is supported only by a jack.

Passenger in Vehicle Supported by a Jack:

Allowing someone to remain in a vehicle supported by a jack is dangerous. The occupant could cause the vehicle to fall resulting in serious injury. Never allow anyone inside a vehicle supported by a jack.

CAUTION

(With Tire Pressure Monitoring System)

The wheels equipped on your Mazda are specially designed for installation of the tire pressure sensors. Do not use non-genuine wheels, otherwise it may not be possible to install the tire pressure sensors.

NOTE

- Make sure the jack is well lubricated before using it.

(With Tire Pressure Monitoring System)

- Be sure to register the tire pressure sensor ID signal code whenever tires or wheels are changed (page 5-25).

1. Park on a level surface off the right-of-way and firmly set the parking brake.
2. Put a vehicle with an automatic transaxle in Park (P), a manual transaxle in Reverse (R) or 1, and turn off the engine.
3. Turn on the hazard warning flasher.
4. Have everyone get out of the vehicle and away from the vehicle and traffic.
5. Remove the jack, tool, and spare tire (page 7-3).

In Case of an Emergency

Flat Tire

6. Block the wheel diagonally opposite the flat tire. When blocking a wheel, place a tire block both in front and behind the tire.

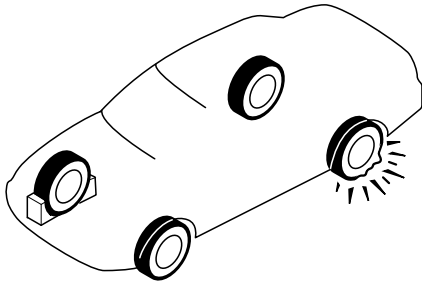

NOTE

When blocking a tire, use rocks or wood blocks of sufficient size to hold the tire in place.

▼ Removing a Flat Tire

1. If your vehicle is equipped with a wheel cover, pry off the wheel cover with the beveled end of the lug wrench.

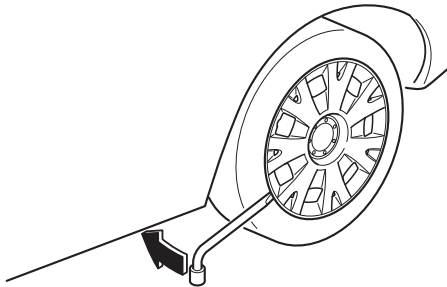

NOTE

Force the end of the lug wrench firmly between wheel and cover, or removal will be difficult.

⚠ CAUTION

There is a valve-stem mark inside the wheel cap. When installing the wheel cap, align this mark with the tire's valve stem.

Damage could occur during installation if the wheel cover is not properly aligned.

2. Loosen the lug nuts by turning them counterclockwise one turn each, but don't remove any lug nuts until the tire has been raised off the ground.

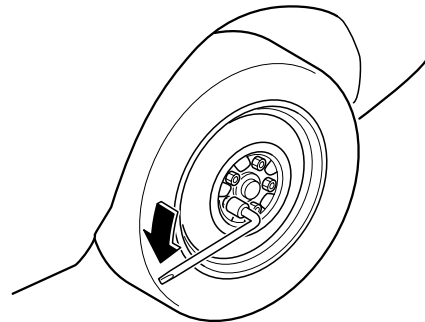

In Case of an Emergency

Flat Tire

- Place the jack under the jacking position closest to the tire being changed.

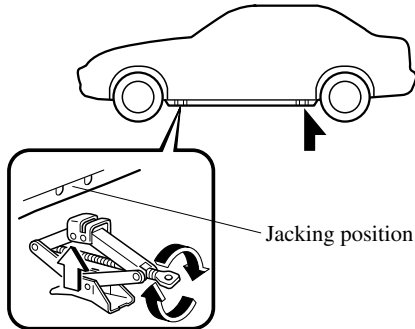

! WARNING

Incorrect Jacking Position:
Attempting to jack the vehicle in positions other than those recommended in this manual is dangerous. The vehicle could slip off the jack and seriously injure or even kill someone. Use only the front and rear jacking positions recommended in this manual.

Improper Jack:
Using a jack that isn't designed for your Mazda is dangerous. The vehicle could slip off the jack and seriously injure someone. Use only the jack provided with your Mazda.

Placing Objects Under the Jack:
Jacking the vehicle with an object under the jack is dangerous. The jack could slip and someone could be seriously injured by the jack or the falling vehicle. Never place objects under the jack.

- Insert the jack handle into the jack.
- Turn the jack handle clockwise and raise the vehicle high enough so that the spare tire can be installed. Before removing the lug nuts, make sure your Mazda is firmly in position and that it cannot slip or move.

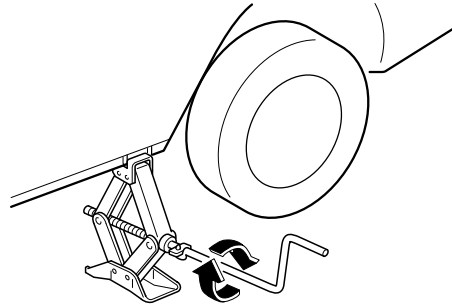

- Remove the lug nuts by turning them counterclockwise; then remove the wheel and center cap.

Flat Tire

▼ Locking Lug Nuts*

If your vehicle has optional anti-theft wheel lug nuts, one on each wheel will lock the tires and you must use a special key to unlock them. This key is attached to the lug wrench and is stored with the spare tire. Register them with the lock manufacturer by filling out the card provided in the glove box and mailing it in the accompanying envelope. If you lose this key, consult an Authorized Mazda Dealer or use the lock manufacturer's order form, which is with the registration card.

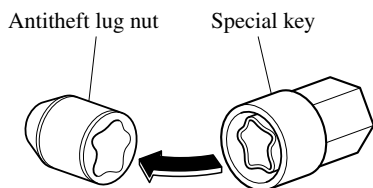

To remove an anti-theft lug nut

1. Obtain the key for the anti-theft lug nut.
2. Place it on top of the nut, and be sure to hold the key square to it. If you hold the key at an angle, you may damage both key and nut. Don't use a power impact wrench.
3. Place the lug wrench on top of the key and apply pressure. Turn the wrench counterclockwise.

To install the nut

1. Place the key on top of the nut.
2. Place the lug wrench on top of the key, apply pressure, and turn it clockwise.

▼ Mounting the Spare Tire

1. Remove dirt and grime from the mounting surfaces of the wheel and hub, including the hub bolts, with a cloth.

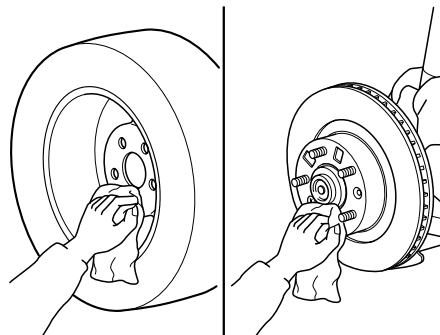

⚠ WARNING

Removing Dirt and Grime from Wheels, Hubs and Hub Bolts:

When changing or replacing a tire, not removing dirt and grime from the mounting surfaces of the wheel, hub and hub bolts is dangerous. The lug nuts could loosen while driving and cause the tire to come off, resulting in an accident. Make sure the mounting surfaces of the wheel, hub and lug nuts are clean before changing or replacing tires.

2. Mount the spare tire.

*Some models.

In Case of an Emergency

Flat Tire

3. Install the lug nuts with the beveled edge inward; tighten them by hand.

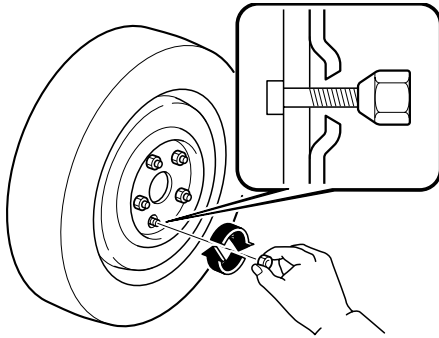

⚠ WARNING

Don't Apply Oil or Grease to Lug Nuts, Bolts:

Applying oil or grease to lug nuts and bolts is dangerous. The lug nuts could loosen while driving and cause the tire to come off, resulting in an accident. In addition, lug nuts and bolts could be damaged if tightened more than necessary. Do not apply oil or grease to lug nuts and bolts and do not tighten the lug nuts beyond the recommended tightening torque.

4. Turn the jack handle counterclockwise and lower the vehicle. Use the lug wrench to tighten the nuts in the order shown.

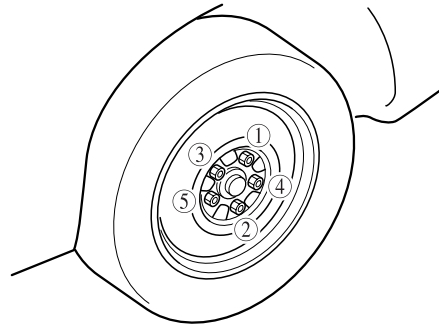

If you're unsure of how tight the nuts should be, have them inspected at an Authorized Mazda Dealer.

Nut tightening torque	
N·m (kgf·m, ft·lbf)	88—117 (9—11, 65—93)

In Case of an Emergency

Flat Tire

WARNING

Loose Lug Nuts:

Improperly or loosely tightened lug nuts are dangerous. The wheel could wobble or come off. This could result in loss of vehicle control and cause a serious accident. Always securely and correctly tighten the lug nuts.

Metric Studs and Lug Nuts:

Because the wheel studs and lug nuts on your Mazda have metric threads, using a non-metric nut is dangerous. On a metric stud, it would not secure the wheel and would damage the stud, which could cause the wheel to slip off and cause an accident. Be sure to reinstall the same nuts you removed or replace them with metric nuts of the same configuration.

5. Store the damaged tire, using the tire hold-down bolt to hold it in place.

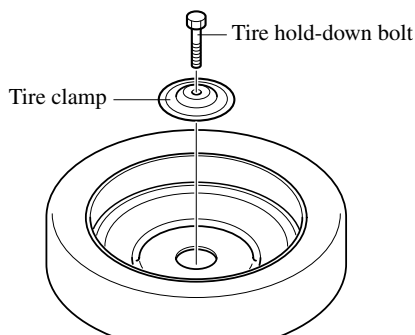

6. Check the inflation pressure. Refer to the specification charts on page 10-7.
7. Have the flat tire repaired or replaced as soon as possible.

WARNING

Incorrect Tire Air Pressure:

Driving on tires with incorrect air pressure is dangerous. Tires with incorrect pressure could affect handling and result in an accident. Don't drive with any tires that have incorrect air pressure. When you check the regular tires' air pressure, check the spare tire, too.

NOTE

(With Tire Pressure Monitoring System)

A tire pressure sensor is not installed to the temporary spare tire. The warning light will flash continuously while the temporary spare tire is being used (page 5-23).

NOTE

To prevent the jack and tool from rattling, store them properly.

In Case of an Emergency

Overheating

Overheating

If the temperature gauge indicates overheating, the vehicle loses power, or you hear a loud knocking or pinging noise, the engine is probably too hot.

WARNING



Cooling Fan and Engine

Inspection:

Inspecting the engine with the ignition switch in the ON position is dangerous. The cooling fan could turn on unexpectedly even when the engine isn't running. You could be seriously injured by the fan. Turn the ignition switch off and remove the key from the ignition switch when you inspect the engine.



Cooling System Cap:

When the engine and radiator are hot, scalding coolant and steam may shoot out under pressure and cause serious injury. Don't remove the cooling system cap when the engine and radiator are hot.

Steam from Overheated Engine:

Steam from an overheated engine is dangerous. The escaping steam could seriously burn you. Open the hood ONLY after steam is no longer escaping from the engine.

If the temperature gauge indicates overheating:

1. Drive safely to the side of the road and park off the right-of-way.
2. Put a vehicle with an automatic transaxle in park (P), a manual transaxle in neutral. Apply the parking brake.
3. Turn off the air conditioner.
4. Check whether coolant or steam is escaping from under the hood or from the engine compartment.

If steam is coming from the engine compartment:

Don't go near the front of the vehicle. Stop the engine. Wait until the steam dissipates, then open the hood and start the engine.

If neither coolant nor steam is escaping:

Open the hood and idle the engine until it cools.

CAUTION

If the cooling fan does not operate while the engine is running, the engine temperature will increase. Stop the engine and call an Authorized Mazda Dealer.

5. Make sure the cooling fan is operating, then turn off the engine after the temperature has decreased.
6. When cool, check the coolant level. If it's low, look for coolant leaks from the radiator and hoses.

In Case of an Emergency
Overheating

If you find a leak or other damage, or if coolant is still leaking:

Stop the engine and call an Authorized Mazda Dealer.

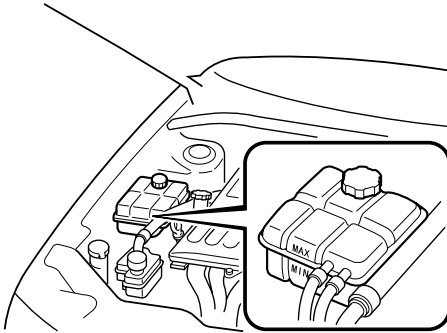

If you find no problems, the engine is cool, and no leaks are obvious:

Carefully add coolant as required (page 8-14).

⚠ CAUTION

If the engine continues to overheat or frequently overheats, have the cooling system inspected. The engine could be seriously damaged unless repairs are made. Consult an Authorized Mazda Dealer.

In Case of an Emergency

Emergency Starting

Starting a Flooded Engine

If the engine fails to start, it may be flooded (excessive fuel in the engine).

Follow this procedure:

1. Depress the accelerator all the way and hold it there.
2. Turn the ignition switch to the START position and hold it there—for up to 10 seconds. If the engine starts, release the key and accelerator immediately because the engine will suddenly rev up.
3. If the engine fails to start, crank it without depressing the accelerator—for up to 10 seconds.

In Case of an Emergency
Emergency Starting

Jump-Starting

Jump-starting is dangerous if done incorrectly. So follow the procedure carefully. If you feel unsure about jump-starting, we strongly recommend that you have a competent service technician do the work.

WARNING



Follow These Precautions Carefully:

To ensure safe and correct handling of the battery, read the following precautions carefully before using the battery or inspecting it.



Eye Protection:

*Working without eye protection is dangerous. Battery fluid contains **SULFURIC ACID** which could cause blindness if splashed into your eyes. Also, hydrogen gas produced during normal battery operation, could ignite and cause the battery to explode. Always wear eye protection when working near the battery.*



Spilled Battery Fluid:

Spilled battery fluid is dangerous.

*Battery fluid contains **SULFURIC ACID** which could cause serious injuries if it gets in eyes, skin or clothing. If this happens, immediately flush your eyes with water for 15 minutes or wash your skin thoroughly and get medical attention. Wear eye protection and protective gloves to prevent contact with battery fluid.*



Children and Batteries:

Allowing children to play near batteries is dangerous. Battery fluid could cause serious injuries if it gets in the eyes or on the skin. Always keep batteries out of the reach of children.

In Case of an Emergency

Emergency Starting

WARNING



Keep Flames Away:

Flames and sparks near open battery cells are dangerous. Hydrogen gas, produced during normal battery operation, could ignite and cause the battery to explode. An exploding battery can cause serious burns and injuries. Keep all flames including cigarettes and sparks away from open battery cells. When working near a battery, do not allow metal tools to contact the positive (+) or negative (-) terminal of the battery. Do not allow the positive (+) terminal to contact the vehicle body.



Battery-Related Explosion:

Flames and sparks near open battery cells are dangerous. Hydrogen gas, produced during normal battery operation, could ignite and cause the battery to explode. An exploding battery can cause serious burns and injuries. Keep all flames, including cigarettes, and sparks away from open battery cells.

Low Fluid Level or Frozen Battery:

*Jump-starting a frozen battery or one with a low fluid level is dangerous. It may rupture or explode, causing serious injury.
Don't jump-start a frozen battery or one with a low fluid level.*

Connecting to Negative Terminal:

*Connecting the end of the second cable to the negative (-) terminal of the discharged battery is dangerous.
A spark could cause the gas around the battery to explode and injure someone.
Connect the negative cable to a good ground point away from the battery.*

Connecting Jumper Cable to Moving Parts:

Connecting a jumper cable near or to moving parts (cooling fans, belts) is dangerous. The cable could get caught when the engine starts and cause serious injury. Never connect a jumper cable to or near any part that moves.

CAUTION

Use only a 12 V booster system. You can damage a 12 V starter, ignition system, and other electrical parts beyond repair with a 24 V power supply (two 12 V batteries in series or a 24 V motor generator set).

In Case of an Emergency
Emergency Starting

Connect cables in numerical order and disconnect in reverse order.

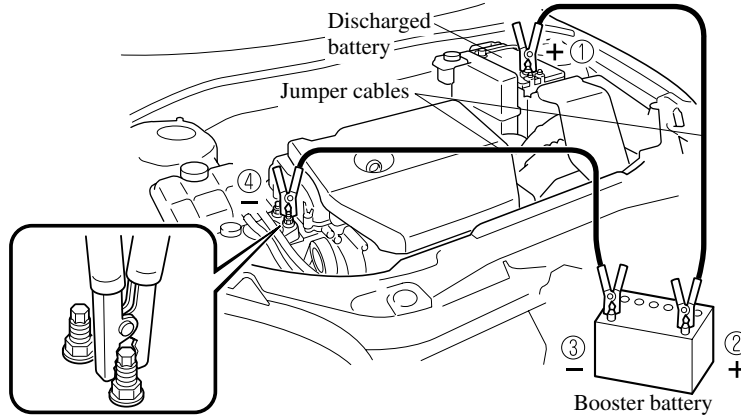

1. Remove the battery cover from its front side.

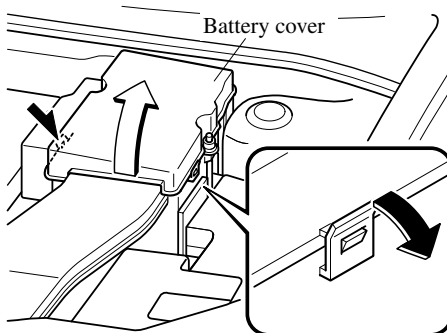

2. Make sure the booster battery is 12 V and that its negative terminal is grounded.
3. If the booster battery is in another vehicle, don't allow both vehicles to touch. Turn off the engine of the vehicle with the booster battery and all unnecessary electrical loads in both vehicles.

4. Connect the jumper cables in the exact sequence as in the illustration.

- Connect one end of a cable to the positive terminal on the discharged battery (1).
- Attach the other end to the positive terminal on the booster battery (2).
- Connect one end of the other cable to the negative terminal of the booster battery (3).
- Connect the other end to a solid, stationary, exposed metallic point (for example, the right hand side engine mounting bolt) away from the discharged battery (4).

5. Start the engine of the booster vehicle and run it a few minutes. Then start the engine of the other vehicle.
6. When finished, carefully disconnect the cables in the reverse order described in the illustration.

In Case of an Emergency

Emergency Starting

NOTE

Verify that the covers are securely installed.

Push-Starting

WARNING

Towing a Vehicle to Start It:
Towing a vehicle to start it is dangerous. The vehicle being towed could surge forward when its engine starts, causing the two vehicles to collide. The occupants could be injured. Never tow a vehicle to start it.

You can't start a vehicle with an automatic transaxle by pushing it.

CAUTION

Do not push-start a vehicle that has a manual transaxle. It can damage the emission control system.

In Case of an Emergency
Emergency Towing

Towing Description

We recommend that towing be done only by an Authorized Mazda Dealer or a commercial tow-truck service.

Proper lifting and towing are necessary to prevent damage to the vehicle. Government and local laws must be followed.

A towed vehicle usually should have its front wheels off the ground. If excessive damage or other conditions prevent this, use wheel dollies.

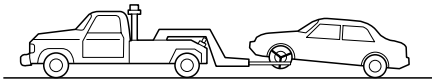

Wheel dollies

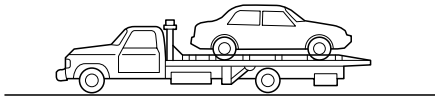

When towing with the rear wheels on the ground, release the parking brake.

CAUTION

Don't tow the vehicle pointed backward with driving wheels on the ground. This may cause internal damage to the transaxle.

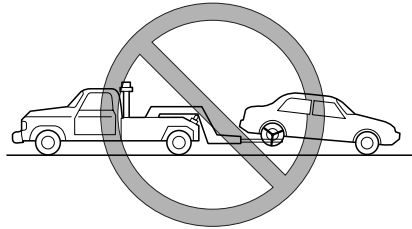

CAUTION

Don't tow with sling-type equipment. This could damage your vehicle. Use wheel-lift or flatbed equipment.

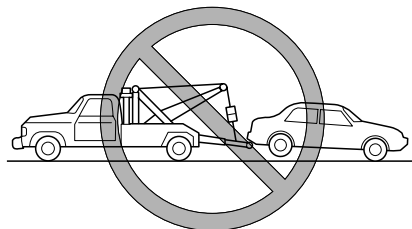

In Case of an Emergency

Emergency Towing

CAUTION

Do not use the hooks under the rear bumper for towing and tying down, as they cannot hold the load and it will damage the bumper.

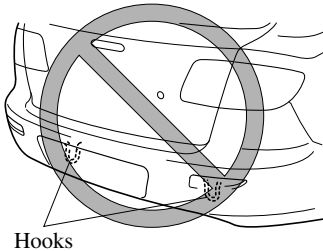

Tiedown Hook

CAUTION

Don't use the tiedown hook under the rear for towing.
It is designed **ONLY** for tying down the vehicle when it's being transported.
Using it for towing will damage the bumper.

NOTE

When towing with chain or cable, wrap the chain or cable with a soft cloth near the bumper to prevent damage to the bumper.

▼ Tiedown Hook-Front

1. Remove the tiedown eyelet and the lug wrench from the trunk (page 7-3).
2. Wrap a flathead screwdriver or similar tool with a soft cloth to prevent damage to the bumper and open the cap located on the front bumper.

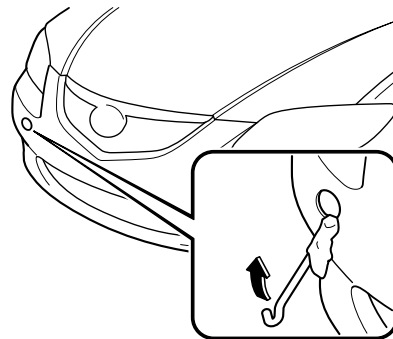

In Case of an Emergency
Emergency Towing

⚠ CAUTION

The cap cannot be completely removed. Do not use excessive force as it may damage the cap or scratch the painted bumper surface.

3. Securely install the tiedown eyelet using the lug wrench.

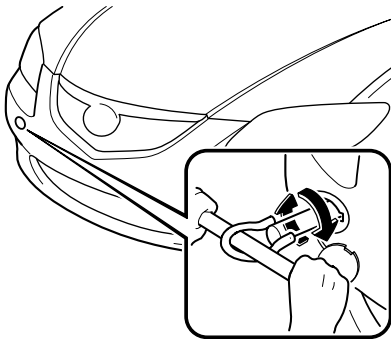

4. Hook the tying rope to the tiedown eyelet.

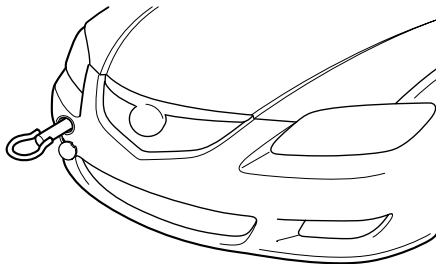

⚠ CAUTION

If the tiedown eyelet is not securely tightened, it may loosen or disengage from the bumper when tying down the vehicle. Make sure that the tiedown eyelet is securely tightened to the bumper.

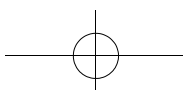

In Case of an Emergency

Emergency Towing

Recreational Towing

An example of “recreational towing” is towing your vehicle behind a motorhome. The transaxle is not designed for towing this vehicle on all 4 wheels.

When doing recreational towing refer to “Towing Description” (page 7-19) and “Tiedown Hook” (page 7-20) and carefully follow the instructions.

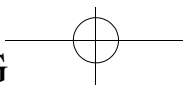

8 Maintenance and Care

How to keep your Mazda in top condition.

Introduction	8-2
Introduction	8-2
Scheduled Maintenance	8-3
Scheduled Maintenance	8-3
Owner Maintenance	8-8
Owner Maintenance Schedule	8-8
Owner Maintenance Precautions	8-9
Engine Compartment Overview	8-10
Engine Oil	8-11
Engine Coolant	8-14
Brake/Clutch Fluid	8-16
Power Steering Fluid	8-17
Automatic Transaxle Fluid (ATF)	8-18
Washer Fluid	8-20
Body Lubrication	8-21
Air Filter	8-22
Wiper Blades	8-23
Battery	8-27
Tires	8-30
Light Bulbs	8-35
Fuses	8-45
Appearance Care	8-52
How to Minimize Environmental Paint Damage	8-52
Exterior Care	8-54
Interior Care	8-57

Maintenance and Care

Introduction

Introduction

Be extremely careful and prevent injury to yourself and others or damage to your vehicle when using this manual for inspection and maintenance.

If you're unsure about any procedure it describes, we strongly urge you to have a reliable and qualified service shop perform the work, preferably an Authorized Mazda Dealer.

Factory-trained Mazda technicians and genuine Mazda parts are best for your vehicle. Without this expertise and the parts that have been designed and made especially for your Mazda, inadequate, incomplete, and insufficient servicing may result in problems. This could lead to vehicle damage or an accident and injuries.

For expert advice and quality service, consult an Authorized Mazda Dealer.

The owner should retain evidence that proper maintenance has been performed as prescribed.

Claims against the warranty resulting from lack of maintenance, as opposed to defective materials or authorized Mazda workmanship, will not be honored.

Any auto repair shop using parts equivalent to your Mazda's original equipment may perform maintenance. **But we recommend that it always be done by an Authorized Mazda Dealer using genuine Mazda parts.**

Maintenance and Care
Scheduled Maintenance

Scheduled Maintenance

Follow Schedule 1 if the vehicle is operated mainly where none of the following conditions apply.

If any do apply, follow Schedule 2 (Canada and Puerto Rico residents follow Schedule 2).

- Repeated short-distance driving
- Driving in dusty conditions
- Driving with extended use of brakes
- Driving in areas where salt or other corrosive materials are being used
- Driving on rough or muddy roads
- Extended periods of idling or low-speed operation
- Driving for long periods in cold temperatures or extremely humid climates

NOTE

After the prescribed period, continue to follow the described maintenance at the recommended intervals.

Maintenance and Care

Scheduled Maintenance

▼ Schedule 1

Maintenance Interval	Number of months or kilometers (miles), whichever comes first								
	Months	6	12	18	24	30	36	42	48
	×1000 km	12	24	36	48	60	72	84	96
	×1000 miles	7.5	15	22.5	30	37.5	45	52.5	60
ENGINE									
Engine valve clearance	Audible inspect every 120,000 km (75,000 miles), if noisy, adjust								
Drive belts (tension)					I				
Engine oil	R	R	R	R	R	R	R	R	R
Engine oil filter	R	R	R	R	R	R	R	R	R
COOLING SYSTEM									
Cooling system				I					I
Engine coolant	FL22 type*1	Replace at first 192,000 km (120,000 miles) or 10 years ; after that, every 96,000 km (60,000 miles) or 5 years							
	Others	Replace at first 96,000 km (60,000 miles) or 4 years ; after that, every 2 years							
FUEL SYSTEM									
Air filter					R				
Fuel lines and hoses*2				I					I
Hoses and tubes for emission*2									I
IGNITION SYSTEM									
Spark plugs	Replace every 120,000 km (75,000 miles)								
CHASSIS and BODY									
Brake lines, hoses and connections				I					I
Disc brakes		I		I		I			I
Tire (rotation)	Rotate every 12,000 km (7,500 miles)								
Steering operation and linkages				I					I
Front and rear suspension and ball joints				I					I
Driveshaft dust boots				I					I
Exhaust system and heat shields	Inspect every 72,000 km (45,000 miles) or 60 months								
All locks and hinges	L	L	L	L	L	L	L	L	L

Maintenance and Care

Scheduled Maintenance

Maintenance Interval	Number of months or kilometers (miles), whichever comes first								
	Months	6	12	18	24	30	36	42	48
	×1000 km	12	24	36	48	60	72	84	96
	×1000 miles	7.5	15	22.5	30	37.5	45	52.5	60
AIR CONDITIONER SYSTEM (if installed)									
Cabin air filter		Replace every 40,000 km (25,000 miles) or 24 months							

Chart symbols

I: Inspect and repair, clean, adjust, or replace if necessary.

R: Replace

L: Lubricate

Remarks

- *1 Use FL22 type coolant in vehicles with the inscription "FL22" on the radiator cap itself or the surrounding area. Use FL22 when replacing the coolant.
- *2 According to state/provincial and federal regulations, failure to perform maintenance on these items will not void your emissions warranties. However, Mazda recommends that all maintenance services be performed at the recommended time or mileage/kilometer period to ensure long-term reliability.

Maintenance and Care

Scheduled Maintenance

▼ Schedule 2

Maintenance Interval	Number of months or kilometers (miles), whichever comes first												
	Months	4	8	12	16	20	24	28	32	36	40	44	48
	×1000 km	8	16	24	32	40	48	56	64	72	80	88	96
	×1000 miles	5	10	15	20	25	30	35	40	45	50	55	60
ENGINE													
Engine valve clearance	Audible inspect every 120,000 km (75,000 miles), if noisy, adjust												
Drive belts (tension)								I					
Engine oil	Puerto Rico	Replace every 5,000 km (3,000 miles) or 3 months											
	Others	R	R	R	R	R	R	R	R	R	R	R	R
Engine oil filter		R	R	R	R	R	R	R	R	R	R	R	R
COOLING SYSTEM													
Cooling system							I						I
Engine coolant	FL22 type*1	Replace at first 192,000 km (120,000 miles) or 10 years ; after that, every 96,000 km (60,000 miles) or 5 years											
	Others	Replace at first 96,000 km (60,000 miles) or 4 years ; after that, every 2 years											
Engine coolant level		I	I	I	I	I	I	I	I	I	I	I	I
FUEL SYSTEM													
Air filter	Puerto Rico						R						R
	Others							R					
Fuel lines and hoses*2							I						I
Hoses and tubes for emission*2													I
IGNITION SYSTEM													
Spark plugs	Replace every 120,000 km (75,000 miles)												
ELECTRICAL SYSTEM													
Function of all lights		I	I	I	I	I	I	I	I	I	I	I	I
CHASSIS and BODY													
Brake lines, hoses and connections							I						I
Brake and clutch fluid level		I	I	I	I	I	I	I	I	I	I	I	I
Disc brakes				I			I			I			I
Tire (rotation)	Rotate every 8,000 km (5,000 miles)												
Tire inflation pressure and tire wear		I	I	I	I	I	I	I	I	I	I	I	I
Steering operation and linkages							I						I
Power steering fluid level		I	I	I	I	I	I	I	I	I	I	I	I
Front and rear suspension and ball joints							I						I
Driveshaft dust boots							I						I
Exhaust system and heat shields	Inspect every 72,000 km (45,000 miles) or 60 months												
All locks and hinges		L	L	L	L	L	L	L	L	L	L	L	L
Washer fluid level		I	I	I	I	I	I	I	I	I	I	I	I

Maintenance and Care
Scheduled Maintenance

Maintenance Interval	Number of months or kilometers (miles), whichever comes first												
	Months	4	8	12	16	20	24	28	32	36	40	44	48
	×1000 km	8	16	24	32	40	48	56	64	72	80	88	96
	×1000 miles	5	10	15	20	25	30	35	40	45	50	55	60
AIR CONDITIONER SYSTEM (if installed)													
Cabin air filter	Replace every 40,000 km (25,000 miles) or 24 months												

Chart symbols

- I:** Inspect and repair, clean, adjust, or replace if necessary.
- R:** Replace
- L:** Lubricate

Remarks

- *1 Use FL22 type coolant in vehicles with the inscription "FL22" on the radiator cap itself or the surrounding area. Use FL22 when replacing the coolant.
- *2 According to state/provincial and federal regulations, failure to perform maintenance on these items will not void your emissions warranties. However, Mazda recommends that all maintenance services be performed at the recommended time or mileage/kilometer period to ensure long-term reliability.

Maintenance and Care

Owner Maintenance

Owner Maintenance Schedule

The owner or a qualified service technician should make these vehicle inspections at the indicated intervals to ensure safe and dependable operation.

Bring any problem to the attention of an Authorized Mazda Dealer or qualified service technician as soon as possible.

▼ When Refueling

- Brake and clutch fluid level (page 8-16)
- Engine coolant level (page 8-14)
- Engine oil level (page 8-12)
- Washer fluid level (page 8-20)

▼ At Least Monthly

Tire inflation pressures (page 8-30)

▼ At Least Twice a Year (For Example, Every Spring and Fall)

- Automatic transaxle fluid level (page 8-18)
- Power steering fluid level (page 8-17)

You can do the following scheduled maintenance items if you have some mechanical ability and a few basic tools and if you closely follow the directions in this manual.

- Air filter (page 8-22)
- Engine coolant (page 8-14)
- Engine oil (page 8-12)

Maintenance and Care
Owner Maintenance

Owner Maintenance Precautions

Improper or incomplete service may result in problems. This section gives instructions only for items that are easy to perform.

As explained in the Introduction (page 8-2), several procedures can be done only by a qualified service technician with special tools.

Improper owner maintenance during the warranty period may affect warranty coverage. For details, read the separate Mazda Warranty statement provided with the vehicle. If you're unsure about any servicing or maintenance procedure, have it done by an Authorized Mazda Dealer.

There are strict environmental laws regarding the disposal of waste oil and fluids. Please dispose of your waste properly and with due regard to the environment.

We recommend that you entrust the oil and fluid changes of your vehicle to an Authorized Mazda Dealer.

WARNING

Maintenance Procedures:

Performing maintenance work on a vehicle is dangerous if not done properly. You can be seriously injured while performing some maintenance procedures. If you lack sufficient knowledge and experience or the proper tools and equipment to do the work, have it done by a qualified technician.

Running the Engine:

Working under the hood with the engine running is dangerous. It becomes even more dangerous when you wear jewelry or loose clothing.

Either can become entangled in moving parts and result in injury.

Therefore, if you must run the engine while working under the hood, make certain that you remove all jewelry (especially rings, bracelets, watches, and necklaces) and all neckties, scarves, and similar loose clothing before getting near the engine or cooling fan which may turn on unexpectedly.

Electrical Fan and Engine Inspection:

Inspecting the engine with the ignition switch in the ON position is dangerous. The cooling fan could come on unexpectedly even when the engine isn't running. You could be seriously injured by the fan. Turn the ignition switch off and remove the key from the ignition switch when you inspect the engine.

Maintenance and Care

Owner Maintenance

Engine Compartment Overview

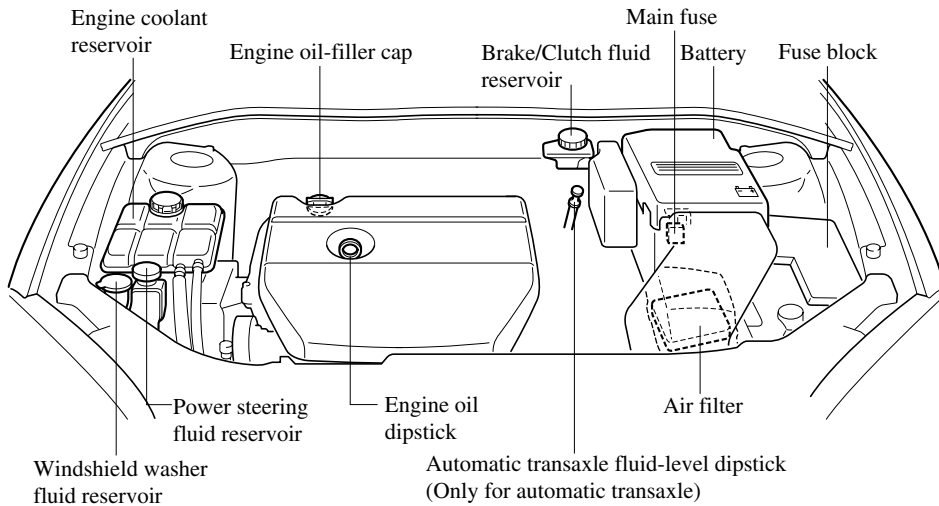

Maintenance and Care
Owner Maintenance

Engine Oil

▼ Recommended Oil

Use SAE 5W-20 engine oil.

Oil container labels provide important information.

A chief contribution this type of oil makes to fuel economy is reducing the amount of fuel necessary to overcome engine friction.

U.S.A. and CANADA



(ILSAC)

Only use oils "Certified For Gasoline Engines" by the American Petroleum Institute (API). An oil with this trademark symbol conforms to the current engine and emission system protection standards and fuel economy requirements of the International Lubricant Standardization and Approval Committee (ILSAC), comprised of U.S. and Japanese automobile manufacturers.

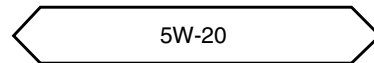
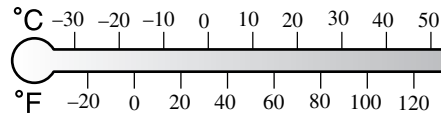

Except U.S.A. and CANADA



(ILSAC)

Maintenance and Care

Owner Maintenance

The quality designation SL, or ILSAC must be on the label.

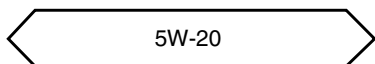
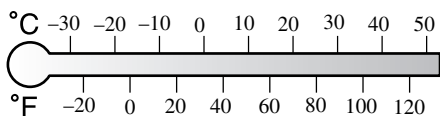

▼ Inspecting Engine Oil Level

1. Be sure the vehicle is on a level surface.
2. Warm up the engine to normal operating temperature.
3. Turn it off and wait at least 5 minutes for the oil to return to the oil pan.
4. Pull out the dipstick, wipe it clean, and reinsert it fully.

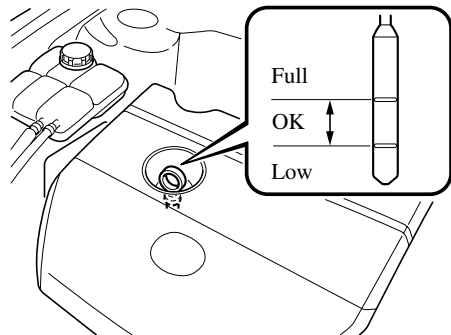

5. Pull it out again and examine the level. It's OK between Low and Full. But if it's near or below Low, add enough oil to bring the level to Full.

⚠ CAUTION

Don't add engine oil over Full. This may cause engine damage.

6. Make sure the O-ring on the dipstick is positioned properly before reinserting the dipstick.

The distance between Low and Full on the dipstick represents the following:

Oil capacity	
L (US qt, Imp qt)	0.75 (0.79, 0.66)

▼ Changing Engine Oil and Filter

Change engine oil and filter according to Scheduled Maintenance (page 8-3).

Please act responsibly—protect the environment and take used oil to a recycling facility. Ask your dealer or a service station for information.

⚠ WARNING

Handling Used Engine Oil:
Continuous contact with used engine oil is dangerous. It could cause skin cancer. Always wash with soap and water immediately after changing oil and filter.

⚠ CAUTION

Remove any oil splatter from the exhaust manifold, the exhaust pipe and the shield. Oil left on these areas will smoke when the engine is running.

Maintenance and Care
Owner Maintenance

Changing engine oil

! WARNING

Checking or Changing Engine Oil:
Hot engine oil is dangerous. If the engine has been running, the engine oil becomes very hot. You could be seriously burned. Don't check or change the engine oil when the engine is hot.

1. Warm up the engine for a few minutes and turn it off. Remove the oil-filler cap.
2. Remove the drain plug and drain the oil into a suitable container.
3. Replace the drain plug washer after the oil has thoroughly drained.
4. Reinstall the plug tightly.
5. Fill the engine with new oil to the MAX mark on the dipstick.
6. Securely reinstall the oil-filler cap.

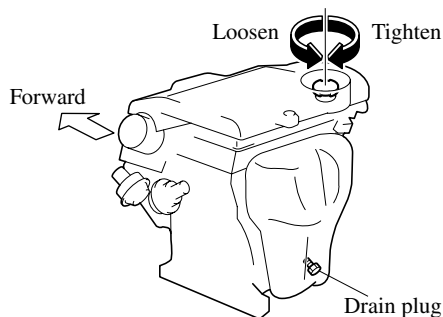

7. Start the engine and inspect around the drain plug for leaks.
8. Turn it off and wait 5 minutes for the oil to return to the oil pan.

Check the oil level and fill to the MAX mark if necessary.

With oil filter replacement

Oil capacity (reference only)	
L (US qt, Imp qt)	4.3 (4.5, 3.8)

Without oil filter replacement

Oil capacity (reference only)	
L (US qt, Imp qt)	3.9 (4.1, 3.4)

NOTE

- The indicated engine oil capacities are for general reference purposes only. When adding or changing oil, verify the engine oil level with the oil dipstick.
- Use only specified engine oil (page 10-4).

Changing oil filter

Because you need a special tool to retighten the filter, an Authorized Mazda Dealer should do the work.

Maintenance and Care

Owner Maintenance

Engine Coolant

▼ Inspecting Coolant Level

WARNING

Hot Engine:

*A hot engine is dangerous. If the engine has been running, parts of the engine compartment can become very hot. You could be burned. Carefully inspect the engine coolant in the coolant reservoir, but do not open it. Do not use a match or live flame in the engine compartment. **DO NOT ADD COOLANT WHEN THE ENGINE IS HOT.***



Cooling Fan and Engine

Inspection:

Inspecting the engine with the ignition switch in the ON position is dangerous. The cooling fan could turn on unexpectedly even when the engine isn't running. You could be seriously injured by the fan. Turn the ignition switch off and remove the key from the ignition switch when you inspect the engine.



Cooling System Cap:

When the engine and radiator are hot, scalding coolant and steam may shoot out under pressure and cause serious injury. Don't remove the cooling system cap when the engine and radiator are hot.

Inspect the antifreeze protection and coolant level in the coolant reservoir at least once a year—at the beginning of the winter season—and before traveling where temperatures may drop below freezing.

Inspect the condition and connections of all cooling system and heater hoses. Replace any that are swollen or deteriorated.

The coolant should be at full in the radiator and between the MAX and MIN marks on the coolant reservoir when the engine is cool.

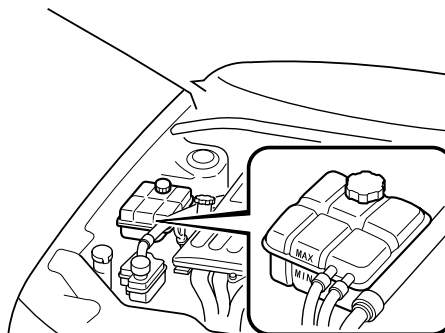

If it's at or near MIN, add enough coolant to the coolant reservoir to provide freezing and corrosion protection and to bring the level to MAX.

CAUTION

Radiator coolant will damage paint. Rinse it off quickly if spilled.

If the coolant reservoir is empty or new coolant is required frequently, consult an Authorized Mazda Dealer.

Maintenance and Care
Owner Maintenance

▼ **Changing Coolant**

Change coolant according to Scheduled Maintenance (page 8-3).

CAUTION

- Use only soft (demineralized) water in the coolant mixture. Water that contains minerals will cut down on the coolant's effectiveness.
- Don't add only water. Always add a proper coolant mixture.
- The engine has aluminum parts and must be protected by an ethylene-glycol-based coolant to prevent corrosion and freezing.
- **DO NOT USE** coolants Containing Alcohol, methanol, Borate or Silicate.
 These coolants could damage the cooling system.
- **DO NOT MIX** alcohol or methanol with the coolant. This could damage the cooling system.
- Don't use a solution that contains more than 60% antifreeze.
 This would reduce effectiveness.

NOTE

If the "FL22" mark is shown on or near the cooling system cap, use FL22 type engine coolant. If engine coolant other than FL22 type is used, the engine coolant must be replaced earlier than the specified replacement interval indicated in the scheduled maintenance (page 8-3).

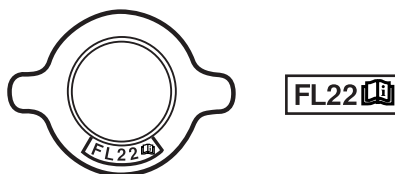

Except FL22 type

For mixture percentage:

Protection	Volume	
	Antifreeze solution	Demineralized water
Above -16°C (3°F)	35%	65%
Above -26°C (-15°F)	45%	55%
Above -40°C (-40°F)	55%	45%

FL22 type

FL22 type engine coolant concentration is factory adjusted. Use the product as it is without diluting it.

Maintenance and Care

Owner Maintenance

To change coolant

WARNING

Removing the Cooling System Cap:
Removing the cooling system cap while the engine is running or hot is dangerous. This might lead to cooling system and engine damage and could result in serious injury from escaping hot coolant or steam. Turn off the engine and wait until it's cool. Even then, be very careful when removing the cap.

Wrap a thick cloth around the cap and slowly turn it counterclockwise about two and a half rotations.

Step back while the pressure escapes. When you're sure all the pressure has escaped, turn the cap counterclockwise — still using a cloth — and remove the cap.

Brake/Clutch Fluid

▼ Inspecting Brake/Clutch Fluid Level

The brakes and clutch draw fluid from the same reservoir.

Inspect the fluid level in the reservoir regularly. It should be kept at MAX.

The level normally drops with accumulated distance, a condition associated with wear of brake and clutch linings. If it is excessively low, have the brake/clutch system inspected by an Authorized Mazda Dealer.

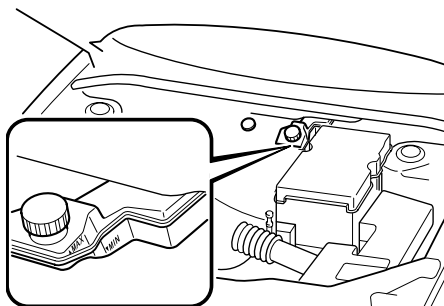

Maintenance and Care
Owner Maintenance

▼ Adding Brake/Clutch Fluid

! WARNING

Spilled Brake Fluid:

Spilled brake fluid is dangerous. If it gets in your eyes, they could be seriously injured. If this happens, immediately flush your eyes with water and get medical attention. Brake fluid spilled on a hot engine could cause a fire. Be careful not to spill brake fluid on yourself or on the engine.

Low Brake/Clutch Fluid Levels:

Low brake/clutch fluid levels are dangerous. Low levels could signal brake lining wear or a brake system leak. Your brakes could fail and cause an accident. If you find a low fluid level, have the brakes and clutch inspected.

If the fluid level is low, add fluid until it reaches MAX.
Before adding fluid, thoroughly clean the area around the cap.

! CAUTION

- Brake and clutch fluid will damage painted surfaces. If brake or clutch fluid does get on a painted surface, wipe it off immediately.
- Using nonspecified brake and clutch fluids (page 10-4) will damage the systems. Mixing different fluids will also damage them.
If the brake/clutch system frequently requires new fluid, consult an Authorized Mazda Dealer.

Power Steering Fluid

▼ Inspecting Power Steering Fluid Level

! CAUTION

To avoid damage to the power steering pump, don't operate the vehicle for long periods when the power steering fluid level is low.

NOTE

Use specified power steering fluid (page 10-4).

Inspect the fluid level in the reservoir at each engine oil change with the engine off and cold. Add fluid if necessary; it does not require periodic changing.

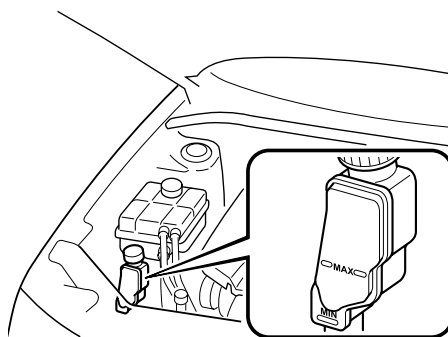

The level must be kept between MIN and MAX.

Visually examine the lines and hoses for leaks and damage.

If new fluid is required frequently, consult an Authorized Mazda Dealer.

Maintenance and Care

Owner Maintenance

Automatic Transaxle Fluid (ATF)

▼ Inspecting Automatic Transaxle Fluid Level

The automatic transaxle fluid level should be inspected regularly. Measure it as described below.

2.3-liter engine

⚠ CAUTION

- Always check the automatic transaxle fluid level according to the following procedure. If the procedure is not done correctly, the automatic transaxle fluid level cannot be measured accurately which could lead to automatic transaxle damage.
- A low fluid level can cause transaxle slippage. Overfilling can cause foaming, loss of fluid, and transaxle malfunction.
- Use only the specified fluid. A non-specified fluid could result in transaxle malfunction and failure.

1. Park on a level surface and set the parking brake firmly.
2. Make sure there is no ATF leakage from the ATF hose or the housing.
3. Shift the shift lever to the park position (P), start the engine and warm it up.

⚠ CAUTION

Do not shift the shift lever while the engine is warming up. If the ATF level is extremely low, the automatic transaxle could be damaged.

4. While the engine is still idling, pull out the dipstick and wipe it clean, and then put it back.
5. Check the ATF level. If there is no ATF adhering 5 mm from the end of the dipstick, add ATF.

⚠ CAUTION

If there is no ATF adhering to the dipstick even after the engine has been warmed up, do not drive the vehicle. Otherwise, the automatic transaxle could be damaged.

6. Shift the shift lever to each range and position, and make sure there is no abnormality.
7. Drive the vehicle on city roads for 5 km (3.1 mile) or more.
8. Park on a level surface and set the parking brake firmly.

Maintenance and Care
Owner Maintenance

- Shift the shift lever to the park position (P), check the ATF level while the engine is idling, and make sure that the ATF level is within the proper level. If the ATF level is not within the proper level, add ATF.
The proper fluid level is marked on the dipstick as follows.

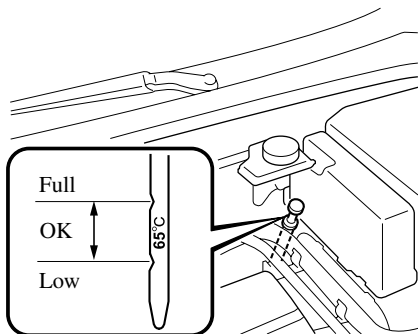

2.0-liter engine

The volume of fluid changes with the temperature. Fluid must be checked at idle without driving at normal operating temperature.

CAUTION

- Low fluid level causes transaxle slippage. Overfilling can cause foaming, loss of fluid, and transaxle malfunction.
- Use specified fluid (page 10-4). A nonspecified fluid could result in transaxle malfunction and failure.

- Park on a level surface and set the parking brake firmly.
- Start the engine and depress the brake pedal.

- Move the shift lever through all ranges and set it at P.

WARNING

Sudden Vehicle Movement:
Shifting the shift lever without first depressing the brake pedal is dangerous. The vehicle could move suddenly and cause an accident. Make sure the brake pedal is applied before shifting the shift lever.

- With the engine still idling, pull out the dipstick, wipe it clean, and put it back.
- Pull it out again.
The proper fluid level is marked on the dipstick as follows.

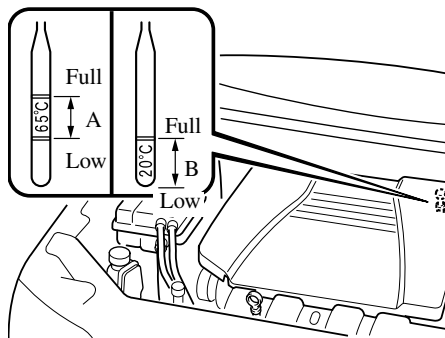

Fluid hot scale A

When the vehicle has been driven and the fluid is at normal operating temperature, about 65°C (150°F), the level must be between Full and Low.

Maintenance and Care

Owner Maintenance

Fluid cold scale B

When the engine has not been running and the outside temperature is about 20°C (70°F), the fluid level should be close to, but not above, the bottom notch on the dipstick.

CAUTION

- Use the cold scale only as a reference.
- If outside temperature is lower than about 20°C (70°F), start the engine and inspect the fluid level after the engine reaches operating temperature.
- If the vehicle has been driven for an extended period at high speeds or in city traffic in hot weather, inspect the level only after stopping the engine and allowing the fluid to cool for 30 minutes.

Fully insert the dipstick. When adding fluid, inspect with the dipstick to make sure it doesn't pass full.

NOTE

Inspect the fluid on both sides of the dipstick in a well lit area for an accurate reading.

Washer Fluid

▼ Inspecting Washer Fluid Level

WARNING

Substitute Washer Fluid:
Using radiator antifreeze as washer fluid is dangerous. If sprayed on the windshield, it will dirty the windshield, affect your visibility, and could result in an accident. Use only windshield washer fluid or plain water in the reservoir.

Using Washer Fluid Without Anti-freeze Protection in Cold Weather:
Operating your vehicle in temperatures below 4 degrees C (40 degrees F) using washer fluid without anti-freeze protection is dangerous as it could cause impaired windshield vision and result in an accident. In cold weather, always use washer fluid with anti-freeze protection.

NOTE

State or local regulations may restrict the use of volatile organic compounds (VOCs), which are commonly used as anti-freeze agents in washer fluid. A washer fluid with limited VOC content should be used only if it provides adequate freeze resistance for all regions and climates in which the vehicle will be operated.

Maintenance and Care
Owner Maintenance

Inspect fluid level in the washer fluid reservoir; add fluid if necessary.

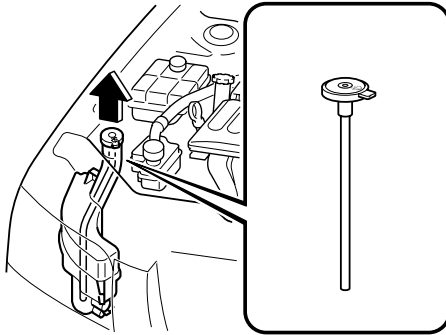

To inspect the washer fluid level in the front reservoir, pull off the cap. Then, holding your thumb over the hole in the center of the cap, lift it straight up. The fluid level can be seen from the fluid column in the pipe. Add fluid if necessary.

Use plain water if washer fluid is unavailable. But use only washer fluid in cold weather to prevent it from freezing.

NOTE

Front and rear washer fluid is supplied from the same reservoir.

Body Lubrication

All moving points of the body, such as door and hood hinges and locks, should be lubricated each time the engine oil is changed. Use a nonfreezing lubricant on locks during cold weather.

Make sure the hood's secondary latch keeps the hood from opening when the primary latch is released.

Maintenance and Care

Owner Maintenance

Air Filter

⚠ CAUTION

Don't drive without an air filter. This could result in excessive engine wear.

This air filter may be cleaned with compressed air and reused, or replaced, depending on its condition. Unless it is very dirty, simply shake it to remove foreign particles. Each time you inspect it, wipe inside the air cleaner housing with a damp cloth.

▼ Replacing the Air Filter

NOTE

If the vehicle is operated in very dusty or sandy areas, replace the filter more often than the recommended intervals.

⚠ CAUTION

Use a Mazda genuine air filter. Use of other filters could damage the airflow sensor.

1. Make sure the ignition switch is turned off.
2. Remove the battery cover and battery duct.

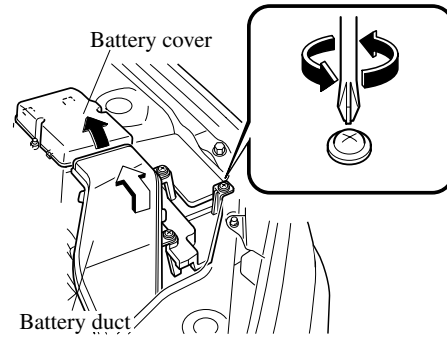

3. Unfasten the clamps.

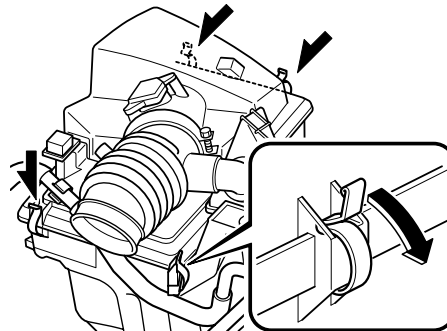

4. Lift off the air filter cover and remove the filter.

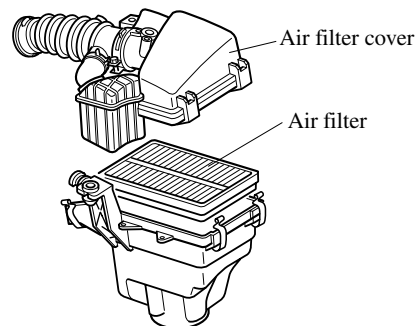

Owner Maintenance

5. Wipe inside the air cleaner housing with a damp cloth.
6. Clean or replace the filter.
7. Install in the reverse order of removal.

Replace the filter according to the Scheduled Maintenance (page 8-3).

Wiper Blades

CAUTION

- Hot waxes applied by automatic car washers have been known to affect the wiper's ability to clean windows.
- To prevent damage to the wiper blades, don't use gasoline, kerosene, paint thinner, or other solvents on or near them.
- When the wiper lever is in the AUTO position and the ignition switch is in the ON position, the wipers may move automatically in the following cases:
 - If the windshield above the rain sensor is touched.
 - If the windshield above the rain sensor is wiped with a cloth.
 - If the windshield is struck with a hand or other object.
 - If the rain sensor is struck with a hand or other object from inside the vehicle.

Be careful not to pinch hands or fingers as it may cause injury, or damage the wipers. When washing or servicing your Mazda, make sure the wiper lever is in the OFF position.

Contamination of either the windshield or the blades with foreign matter can reduce wiper effectiveness. Common sources are insects, tree sap, and hot wax treatments used by some commercial car washes.

Maintenance and Care

Owner Maintenance

If the blades are not wiping properly, clean the window and blades with a good cleaner or mild detergent; then rinse thoroughly with clean water. Repeat if necessary.

▼ Replacing Windshield Wiper Blades

When the wipers no longer clean well, the blades are probably worn or cracked. Replace them.

⚠ CAUTION

To prevent damage to the wiper arms and other components, don't try to sweep the wiper arm by hand.

1. Raise the wiper arm and turn the blade assembly to expose the plastic locking clip. Slide the assembly downward; then lift it off the arm.

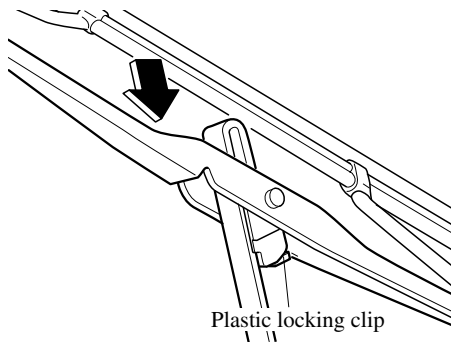

⚠ CAUTION

To prevent damage to the windshield let the wiper arm down easily, don't let it slap down on the windshield.

2. Pull down the blade rubber and slide it out of blade holder.

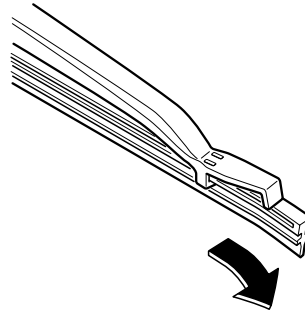

3. Remove the metal stiffeners from the blade rubber and install them in new blades.

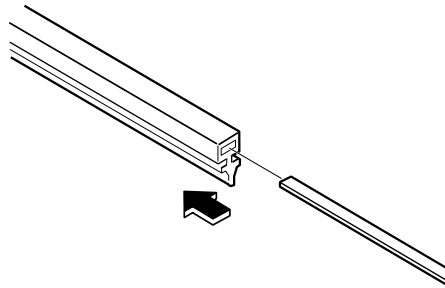

Maintenance and Care
Owner Maintenance

⚠ CAUTION

- Don't bend or discard the stiffeners. You need to use them again.
- If the metal stiffeners are switched, the blade's wiping efficiency could be reduced. So don't use the driver's side metal stiffeners on the passenger's side, or vice versa.
- Be sure to reinstall the metal stiffeners in the new blade rubber so that the curve is the same as it was in the old blade rubber.

4. Carefully insert the new blade rubber. Then install the blade assembly in the reverse order of removal.

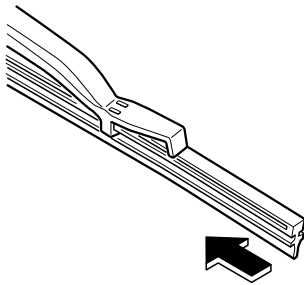

▼ Replacing Rear Wiper Blade (5 Door)

When the wiper no longer cleans well, the blade is probably worn or cracked. Replace it.

⚠ CAUTION

To prevent damage to the wiper arm and other components, don't try to sweep the wiper arm by hand.

1. Raise the wiper arm and rotate the wiper blade to the right until it unlocks, then remove the blade.

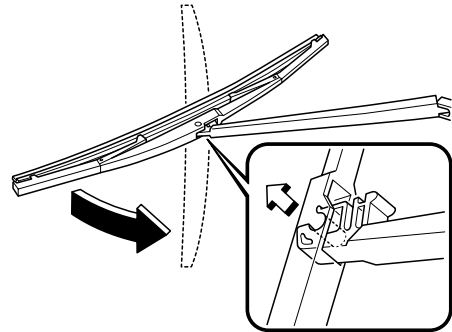

⚠ CAUTION

To prevent damage to the rear window let the wiper arm down easily, don't let it slap down on the rear window.

2. Pull down the blade rubber and slide it out of the blade holder.

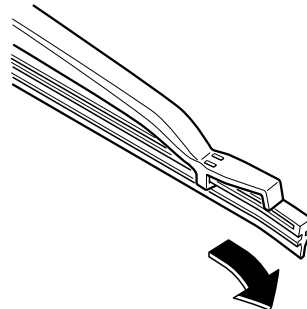

Maintenance and Care

Owner Maintenance

3. Remove the metal stiffeners from the blade rubber and install them in new blades.

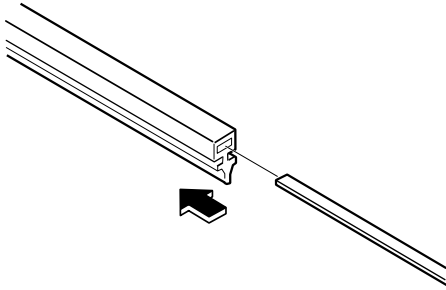

⚠ CAUTION

Don't bend or discard the stiffeners.
You need to use them again.

4. Carefully insert the new blade rubber.
Then install the blade assembly in the reverse order of removal.

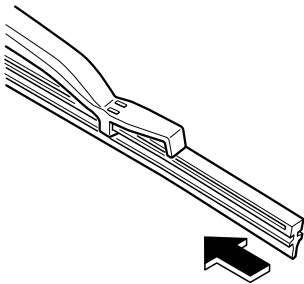

Maintenance and Care
Owner Maintenance

Battery

 **WARNING**

Battery-Related Lead Materials:

Battery posts, terminals and related accessories contain lead and lead compounds, chemicals known to the State of California to cause cancer and reproductive harm. Wash hands after handling.



Follow These Precautions Carefully:

To ensure safe and correct handling of the battery, read the following precautions carefully before using the battery or inspecting it.



Eye Protection:

*Working without eye protection is dangerous. Battery fluid contains **SULFURIC ACID** which could cause blindness if splashed into your eyes. Also, hydrogen gas produced during normal battery operation, could ignite and cause the battery to explode. Always wear eye protection when working near the battery.*



Spilled Battery Fluid:

*Spilled battery fluid is dangerous. Battery fluid contains **SULFURIC ACID** which could cause serious injuries if it gets in eyes, skin or clothing. If this happens, immediately flush your eyes with water for 15 minutes or wash your skin thoroughly and get medical attention. Wear eye protection and protective gloves to prevent contact with battery fluid.*



Children and Batteries:

Allowing children to play near batteries is dangerous. Battery fluid could cause serious injuries if it gets in the eyes or on the skin. Always keep batteries out of the reach of children.

Maintenance and Care

Owner Maintenance

WARNING



Keep Flames Away:

Flames and sparks near open battery cells are dangerous. Hydrogen gas, produced during normal battery operation, could ignite and cause the battery to explode. An exploding battery can cause serious burns and injuries. Keep all flames including cigarettes and sparks away from open battery cells. When working near a battery, do not allow metal tools to contact the positive (+) or negative (-) terminal of the battery. Do not allow the positive (+) terminal to contact the vehicle body.



Battery-Related Explosion:

Flames and sparks near open battery cells are dangerous. Hydrogen gas, produced during normal battery operation, could ignite and cause the battery to explode. An exploding battery can cause serious burns and injuries. Keep all flames, including cigarettes, and sparks away from open battery cells.

Owner Maintenance

NOTE

Remove the battery cover before performing battery maintenance.

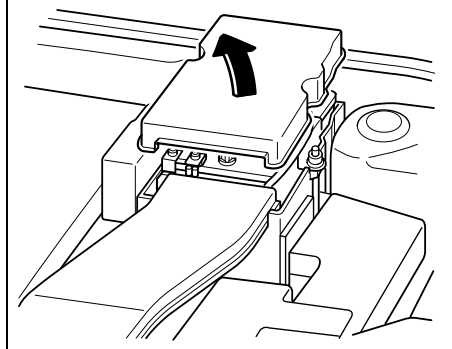

▼ Battery Maintenance

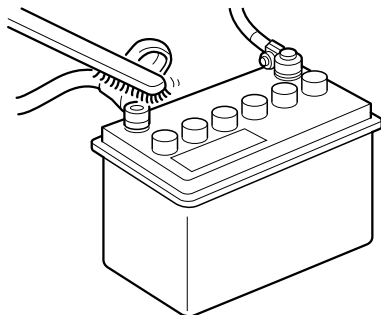

To get the best service from a battery:

- Keep it securely mounted.
- Keep the top clean and dry.
- Keep terminals and connections clean, tight, and coated with petroleum jelly or terminal grease.
- Rinse off spilled electrolyte immediately with a solution of water and baking soda.

- If the vehicle will not be used for an extended time, disconnect the battery cables.

▼ Inspecting Electrolyte Level

A low level of electrolyte fluid will cause the battery to discharge quickly.

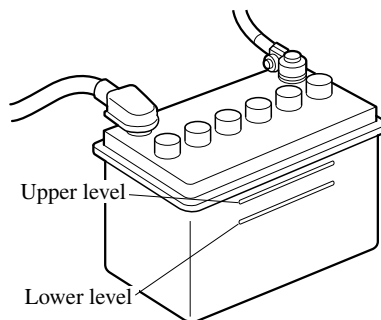

Inspect the electrolyte level at least once a week. If it's low, remove the cap and add enough distilled water to bring the level between the upper and lower level (illustration).

Don't overfill.

Examine the specific gravity of the electrolyte with a hydrometer, especially during cold weather. If it's low, recharge the battery.

Maintenance and Care

Owner Maintenance

Tires

For reasons of proper performance, safety, and better fuel economy, always maintain recommended tire inflation pressures and stay within the recommended load limits and weight distribution.

WARNING

Using Different Tire Types:

Driving your vehicle with different types of tires is dangerous. It could cause poor handling and poor braking; leading to loss of control. Except for the limited use of the temporary spare tire, use only the same type tires (radial, bias-belted, bias-type) on all four wheels.

Using Wrong-Sized Tires:

Using any other tire size than what is specified for your Mazda (page 10-7) is dangerous. It could seriously affect ride, handling, ground clearance, tire clearance, and speedometer calibration. This could cause you to have an accident. Use only tires that are the correct size specified for your Mazda.

▼ Tire Inflation Pressure

WARNING

Incorrect Tire Inflation:

Overinflation or underinflation of tires is dangerous. Adverse handling or unexpected tire failure could result in a serious accident. Always inflate the tires to the correct pressure (page 10-7).

The Tire Pressure Monitoring System* does not alleviate the need to check the tire condition every day, including whether the tires all look inflated properly. Inspect all tire pressure monthly (including the spare) when the tires are cold. Maintain recommended pressures for the best ride, top handling, and minimum tire wear. When checking the tire pressures, use of a digital tire pressure gauge is recommended.

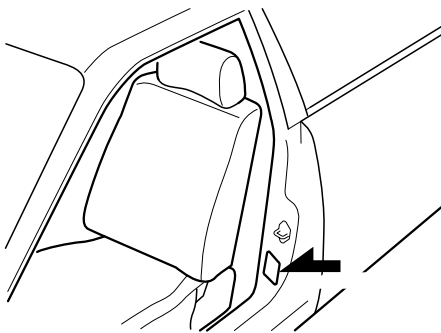

Refer to the specification charts (page 10-7).

Maintenance and Care
Owner Maintenance

NOTE

- Always check tire pressure when tires are cold.
- Warm tires normally exceed recommended pressures. Don't release air from warm tires to adjust the pressure.
- Underinflation can cause reduced fuel economy, uneven and accelerated tire wear, and poor sealing of the tire bead, which will deform the wheel and cause separation of tire from rim.
- Overinflation can produce a harsh ride, uneven and accelerated tire wear, and a greater possibility of damage from road hazards. Keep your tire pressure at the correct levels. If one frequently needs inflating, have it inspected.

▼ Tire Rotation

To equalize tread wear, rotate the tires every 12,000 km (7,500 miles)/8,000 km* (5,000 miles) or sooner if irregular wear develops. During rotation, inspect them for correct balance.

* Unique driving conditions for U.S.A., Canada and Puerto Rico

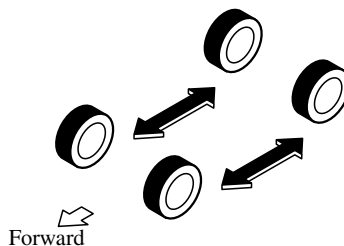

Do not include (TEMPORARY USE ONLY) spare tire in rotation.

Also, inspect them for uneven wear and damage. Abnormal wear is usually caused by one or a combination of the following:

- Incorrect tire pressure
- Improper wheel alignment
- Out-of-balance wheel
- Severe braking

After rotation, inflate all tire pressures to specification (page 10-7) and inspect the lug nuts for tightness.

⚠ CAUTION

Rotate unidirectional tires and radial tires that have an asymmetrical tread pattern or studs only from front to rear, not from side to side. Tire performance will be weakened if rotated from side to side.

Maintenance and Care

Owner Maintenance

▼ Replacing a Tire

WARNING

Worn Tires:

Driving with worn tires is dangerous. Reduced braking, steering, and traction could result in an accident. Always use tires that are in good condition.

CAUTION

(With Tire Pressure Monitoring System)

When replacing/repairing the tires or wheels or both, have the work done by an Authorized Mazda Dealer, or the tire pressure sensors may be damaged.

NOTE

(With Tire Pressure Monitoring System)

- When tires with steel wire reinforcement in the sidewalls are used, the system may not function correctly even with a genuine wheel. Refer to System Error Activation on page 5-25.
- Be sure to install the tire pressure sensors whenever tires or wheels are replaced. Refer to Tires and Wheels on page 5-25.

If a tire wears evenly, a wear indicator will appear as a solid band across the tread.

Replace the tire when this happens.

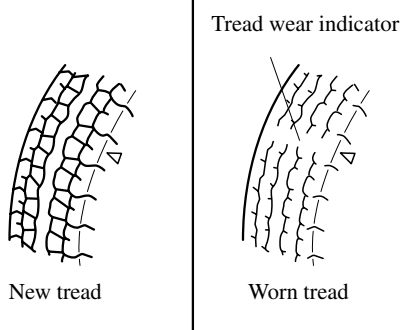

You should replace it before the band is across the entire tread.

NOTE

Tires degrade over time, even when they are not being used on the road. It is recommended that tires generally be replaced when they are 6 years or older. Heat caused by hot climates or frequent high loading conditions can accelerate the aging process. You should replace the spare tire when you replace the other road tires due to the aging of the spare tire. Regarding the manufacturing week and year is indicated with 4 digit. Refer to The tire labeling on page 9-21.

Maintenance and Care
Owner Maintenance

▼ **Temporary Spare Tire**

Inspect the temporary spare tire at least monthly to make sure it's properly inflated and stored.

NOTE

The temporary spare tire condition gradually deteriorates even if it has not been used.

The temporary spare tire is easier to handle because of its construction. It is lighter and smaller than a conventional tire and should be used only for an emergency and only for a short distance.

Use the temporary only until the conventional tire is repaired, which should be as soon as possible.

Maintain its pressure at 420 kPa (4.2 kgf/cm² or bar, 60 psi).

 **CAUTION**

- Don't use your temporary spare tire rim with a snow tire or a conventional tire. Neither will properly fit and could damage both tire and rim.
- The temporary spare tire has a tread life of less than 5,000 km (3,000 miles). The tread life may be shorter depending on driving conditions.
- The temporary spare tire is for limited use, however, if the tread wear solid-band indicator appears, replace the tire with the same type of temporary spare (page 8-32).

NOTE

Tires degrade over time, even when they are not being used on the road. It is recommended that tires generally be replaced when they are 6 years or older. Heat caused by hot climates or frequent high loading conditions can accelerate the aging process. You should replace the spare tire when you replace the other road tires due to the aging of the spare tire. Regarding the manufacturing week and year is indicated with 4 digit. Refer to The tire labeling on page 9-21.

▼ **Replacing a Wheel**

 **WARNING**

Using a Wrong-Sized Wheel:
Using a wrong-sized wheel is dangerous. Braking and handling could be affected, leading to loss of control and an accident. Always use wheels of the correct size on your vehicle.

Maintenance and Care

Owner Maintenance

CAUTION

- A wrong-sized wheel may adversely affect:
 - Tire fit
 - Wheel and bearing life
 - Ground clearance
 - Snow-chain clearance
 - Speedometer calibration
 - Headlight aim
 - Bumper height
 - Tire Pressure Monitoring System
- **(With Tire Pressure Monitoring System)**
 - When replacing/repairing the tires or wheels or both, have the work done by an Authorized Mazda Dealer, or the tire pressure sensors may be damaged.
 - The wheels equipped on your Mazda are specially designed for installation of the tire pressure sensors. Do not use non-genuine wheels, otherwise it may not be possible to install the tire pressure sensors.

NOTE

Be sure to install the tire pressure sensors whenever tires or wheels are replaced. Refer to Tires and Wheels on page 5-25.

When replacing a wheel, make sure the new one is the same as the original factory wheel in diameter, rim width, and offset.

Proper tire balancing provides the best riding comfort and helps reduce tread wear. Out-of-balance tires can cause vibration and uneven wear, such as cupping and flat spots.

Maintenance and Care
Owner Maintenance

Light Bulbs

4 Door

* Overhead light/Map lights (Front)

Headlights (Low beam)

Headlights
(High beam)

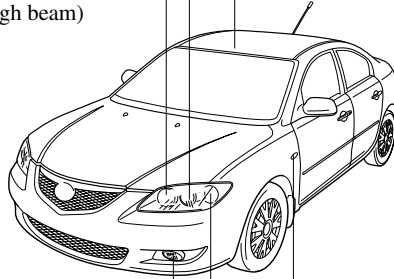

* Fog lights

Front turn signal
lights/Side-marker lights

Side turn signal lights

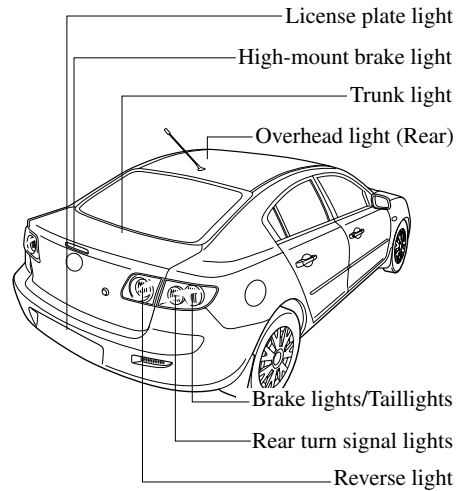

License plate light

High-mount brake light

Trunk light

Overhead light (Rear)

Brake lights/Taillights

Rear turn signal lights

Reverse light

5 Door

* Overhead light/Map lights (Front)

Headlights (Low beam)

Headlights
(High beam)

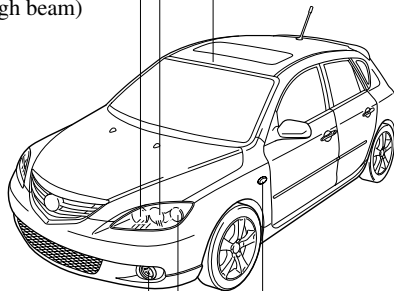

* Fog lights

Front turn signal lights/Side-
marker lights

Side turn signal lights

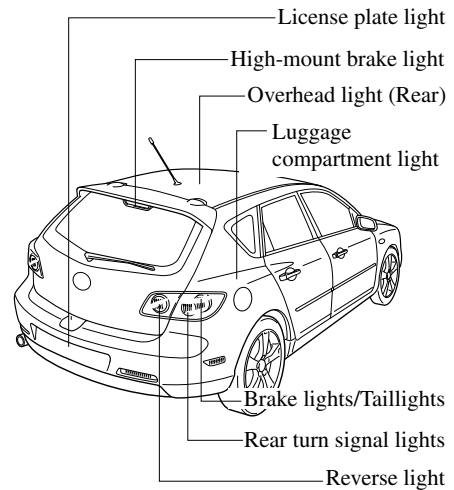

License plate light

High-mount brake light

Overhead light (Rear)

Luggage
compartment light

Brake lights/Taillights

Rear turn signal lights

Reverse light

*Some models.

Maintenance and Care

Owner Maintenance

WARNING

Xenon Fusion Bulb Replacement:
Replacing the xenon fusion bulbs yourself is dangerous. Because the xenon fusion bulbs require high voltage, you could receive an electric shock if the bulbs are handled incorrectly. Do not replace the xenon fusion bulbs yourself. Consult an Authorized Mazda Dealer when the replacement is necessary.

Handling Halogen Bulbs:
When a halogen bulb breaks, it is dangerous. These bulbs contain pressurized gas. If one is broken, it will explode and serious injuries could be caused by the flying glass. If the glass portion is touched with bare hands, body oil could cause the bulb to overheat and explode when lit. Never touch the glass portion of the bulb with your bare hands and always wear eye protection when handling or working around halogen bulbs.

Children and Halogen Bulbs:
Playing with a halogen bulb is dangerous. Serious injuries could be caused by dropping a halogen bulb or breaking it some other way. Always keep halogen bulbs out of the reach of children.

▼ Replacing Exterior Light Bulbs

Replacing a headlight bulb

1. Make sure the ignition switch is turned off and the headlight switch is off.
2. Lift the hood.

3. Do the following procedure when replacing the left headlight bulb.
Turn the screws counterclockwise and remove them and the cover.

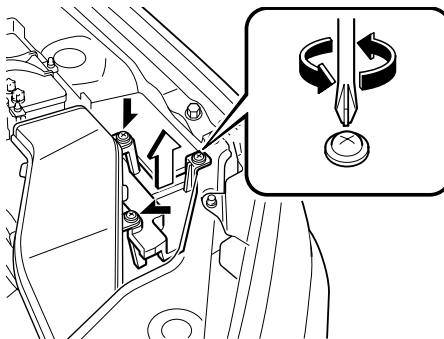

4. Find the high and low beam bulbs in the rear of the headlight unit.
The outboard bulb is the LOW beam, and the inboard one is the HIGH beam. Refer to Light Bulbs on page 8-35.

Maintenance and Care
Owner Maintenance

High-beam bulb

1. Turn the socket and bulb assembly counterclockwise and remove it. Carefully remove the headlight bulb from its socket in the reflector by gently pulling it straight backward out of the socket.
2. Disconnect the bulb from the electrical connector by pressing the tab on the connector with your finger and pulling the bulb upward.

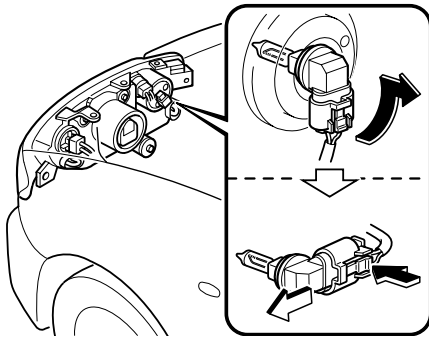

3. Install the new bulb in the reverse order of removal.

NOTE

- To replace the bulb, contact an Authorized Mazda Dealer.
- If the halogen bulb is accidentally touched, it should be cleaned with rubbing alcohol before being used.
- Use the protective cover and carton for the replacement bulb to dispose of the old bulb promptly and out of the reach of children.

Low-beam bulb

(Xenon fusion bulb)

You cannot replace the low beam bulbs by yourself.
The bulbs must be replaced at an Authorized Mazda Dealer.

(Halogen bulbs)

1. Detach the electrical connector from the bulb by pulling it to the rear.

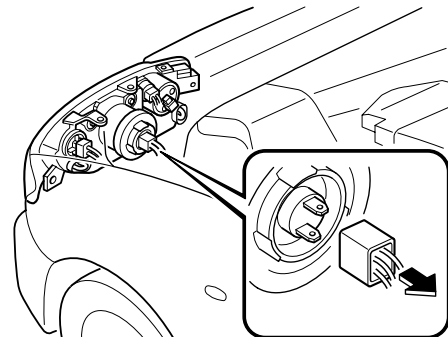

2. Pull off the sealing cover.
3. Unhook the bulb retaining spring.

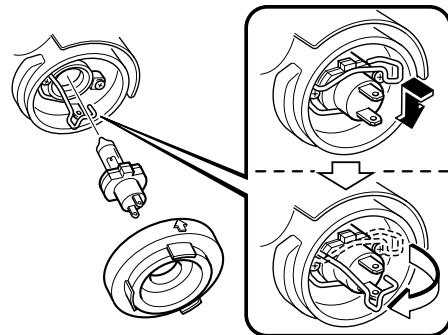

4. Swing the retaining spring out and away to free the headlight bulb.
5. Carefully remove the headlight bulb from the socket by pulling it straight back.

Maintenance and Care

Owner Maintenance

6. Replace the bulb.
7. Install the new bulb in the reverse order of removal.

NOTE

- To replace the bulb, contact an Authorized Mazda Dealer.
- If the halogen bulb is accidentally touched, it should be cleaned with rubbing alcohol before being used.
- Use the protective cover and carton for the replacement bulb to dispose of the old bulb promptly and out of the reach of children.
- When reinstalling the sealing cover, make sure ↑ faces up.

Replacing a fog light bulb*

1. Turn the screw counterclockwise and remove it and partially peel back the mudguard.

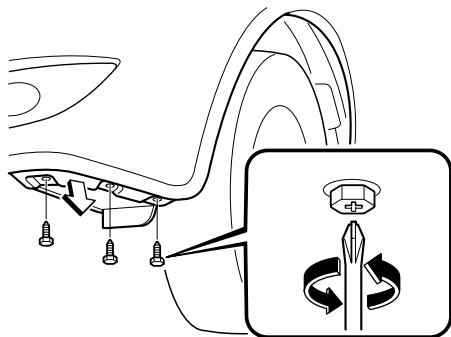

2. Turn the socket and bulb assembly counterclockwise and remove it. Carefully remove the fog light bulb from its socket in the reflector by gently pulling it straight backward out of the socket.

3. Disconnect the bulb from the electrical connector by pressing the tab on the connector with your finger and pulling the bulb upward.

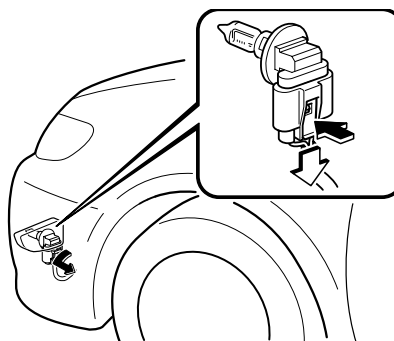

4. Install the new bulb in the reverse order of removal.

NOTE

- To replace the bulb, contact an Authorized Mazda Dealer.
- If the halogen bulb is accidentally touched, it should be cleaned with rubbing alcohol before being used.
- Use the protective cover and carton for the replacement bulb to dispose of the old bulb promptly and out of the reach of children.

Front turn signal lights/Side-marker lights

Due to the complexity and difficulty of the procedure, the bulbs should be replaced by an Authorized Mazda Dealer.

Side turn signal lights

1. Slide the unit as shown in the figure to remove it.

Maintenance and Care
Owner Maintenance

2. Detach the electrical connector from the unit by pulling it to the rear.

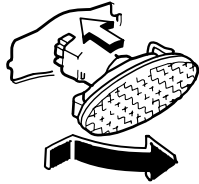

3. Install the new side turn signal unit in the reverse order of removal.

NOTE

Bulb replacement is not possible because it is built into the unit. Replace the unit.

Brake lights/Taillights, Rear turn signal lights (4 Door)

1. Pull the center of each plastic retainer and remove the retainers and the trunk end trim.

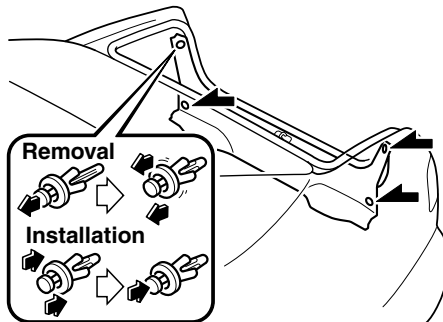

2. Pull the center of each plastic retainer and remove the retainers and partially open the trunk side trim.

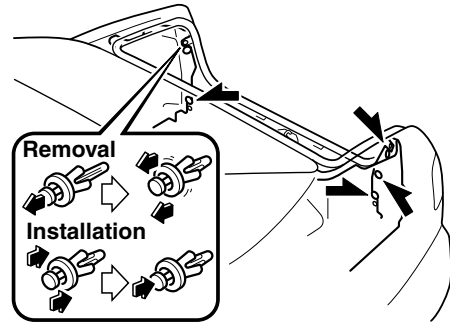

3. Turn the socket and bulb assembly counterclockwise and remove it.
4. Disconnect the bulb from the socket.

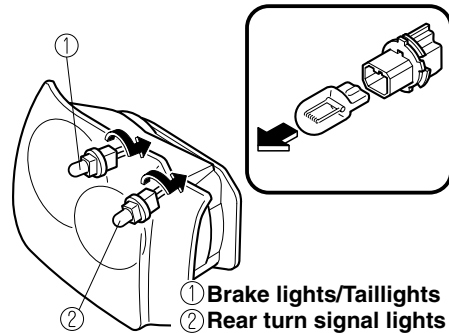

5. Install the new bulb in the reverse order of removal.

NOTE

To replace the bulb, contact an Authorized Mazda Dealer.

Maintenance and Care

Owner Maintenance

Brake lights/Taillights (5 Door)

With LED bulb

Due to the complexity and difficulty of the procedure, the LED bulbs should be replaced by an Authorized Mazda Dealer.

NOTE

LED bulb replacement is not possible.
The rear combination component must be replaced.

With Non-LED bulb

1. Remove the cover.

Left side

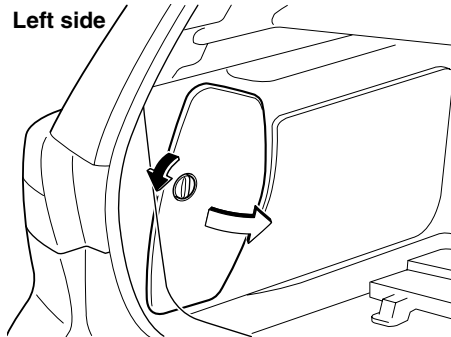

Right side

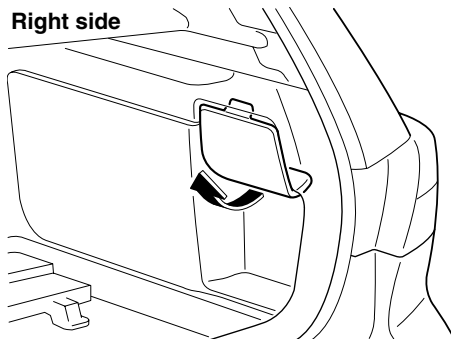

2. Turn the socket and bulb assembly counterclockwise and remove it.

3. Disconnect the bulb from the socket.

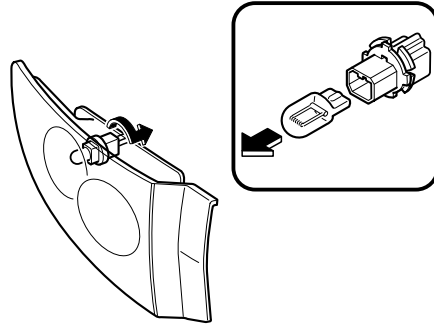

4. Install the new bulb in the reverse order of removal.

NOTE

To replace the bulb, contact an Authorized Mazda Dealer.

Rear turn signal lights (5 Door)

1. Remove the cover.

Left side

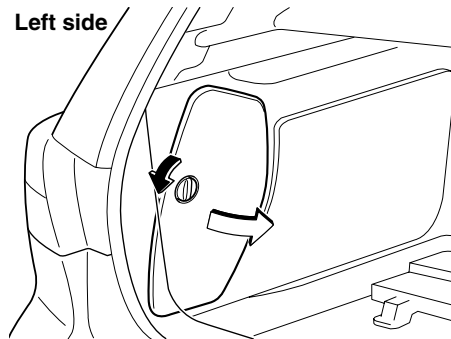

Maintenance and Care
Owner Maintenance

Right side

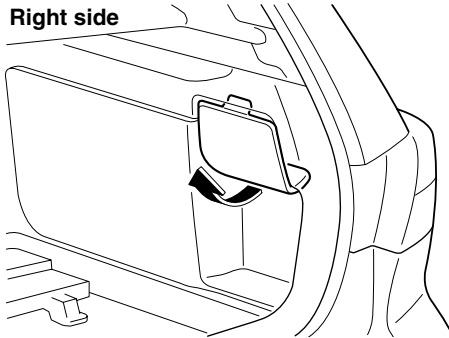

2. Turn the socket and bulb assembly counterclockwise and remove it.
3. Disconnect the bulb from the socket.

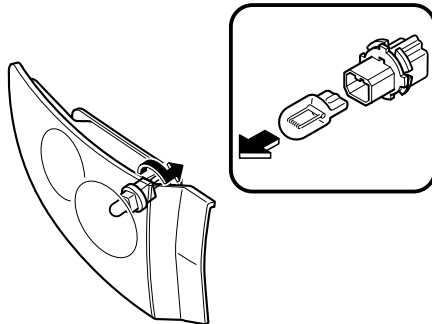

4. Install the new bulb in the reverse order of removal.

NOTE

To replace the bulb, contact an Authorized Mazda Dealer.

Reverse light

4 Door

1. Pull the center section of the plastic retainer and remove the retainers, then remove the trunk rear trim.

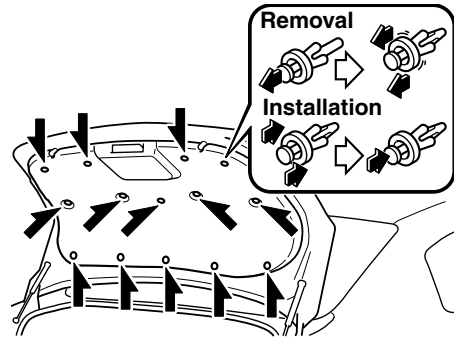

2. Turn the socket and bulb assembly counterclockwise and remove it.
3. Disconnect the bulb from the socket.

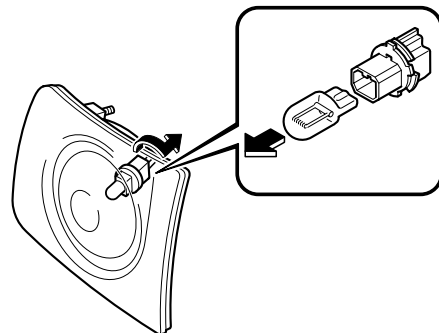

4. Install the new bulb in the reverse order of removal.

NOTE

To replace the bulb, contact an Authorized Mazda Dealer.

Maintenance and Care

Owner Maintenance

5 Door

1. Remove the cover.
2. Turn the socket and bulb assembly counterclockwise and remove it.
3. Disconnect the bulb from the socket.

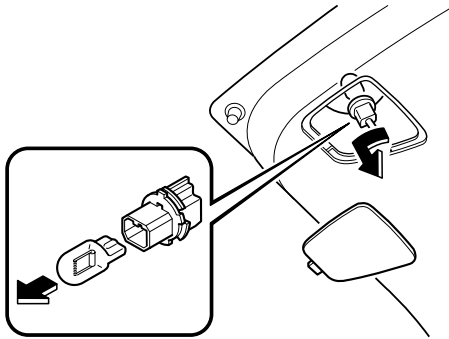

4. Install the new bulb in the reverse order of removal.

NOTE

To replace the bulb, contact an Authorized Mazda Dealer.

High-mount brake light

4 Door

1. Pull the center of each plastic retainer and remove the retainers and the trunk rear trim.

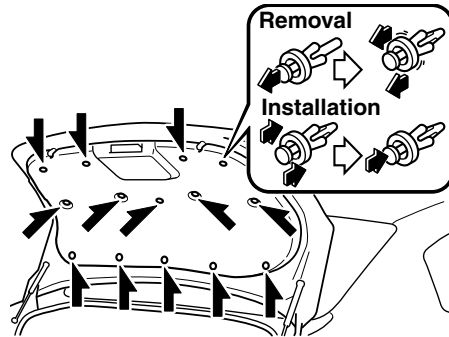

2. Disconnect the electrical connector from the socket.
3. Turn the socket and bulb assembly counterclockwise and remove it.
4. Disconnect the bulb from the socket.

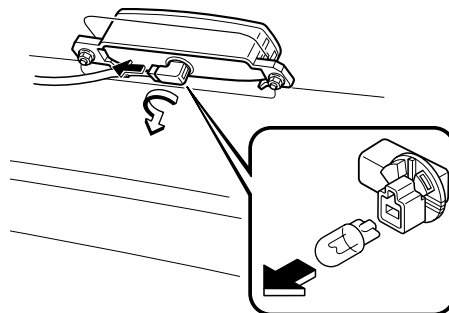

5. Install the new bulb in the reverse order of removal.

NOTE

To replace the bulb, contact an Authorized Mazda Dealer.

Maintenance and Care
Owner Maintenance

5 Door

1. Remove the liftgate upper trim.

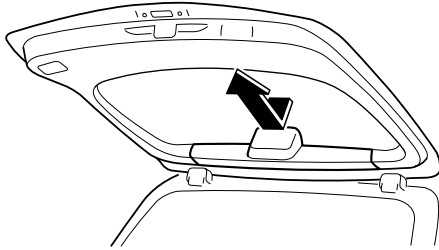

2. Disconnect the electrical connector from the socket.
3. Turn the socket and bulb assembly counterclockwise and remove it.
4. Disconnect the bulb from the socket.

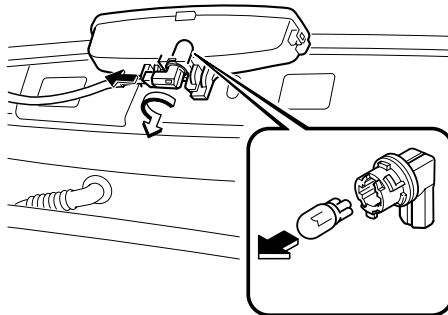

5. Install the new bulb in the reverse order of removal.

NOTE

To replace the bulb, contact an Authorized Mazda Dealer.

License plate lights

1. Wrap a flathead screwdriver with a soft cloth to prevent damage to the lens and remove the lens by carefully prying on the edge of the lens with a flathead screwdriver.
2. Disconnect the bulb by pulling it out.

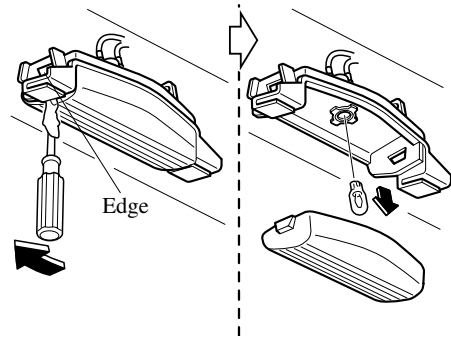

3. Install the new bulb in the reverse order of removal.

▼ Replacing Interior Light Bulbs

Overhead light/Map lights (Front)*

1. Wrap a flathead screwdriver with a soft cloth to prevent damage to the trim and gently insert it in the overhead light as shown in the figure, and then remove the overhead light unit.

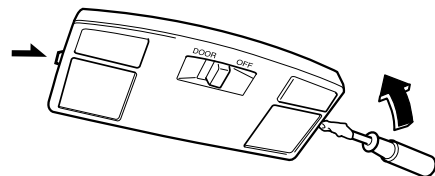

*Some models. **8-43**

Maintenance and Care

Owner Maintenance

2. Turn the socket and bulb assembly counterclockwise and remove it.
3. Disconnect the bulb from the socket.

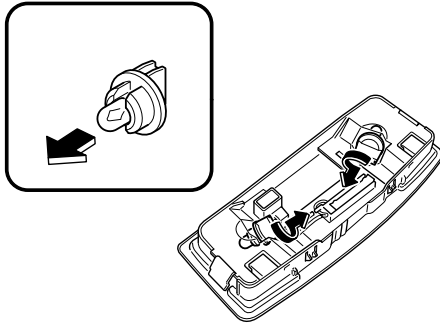

4. Install the new bulb in the reverse order of removal.

Overhead light (Rear)

1. Wrap a small flathead screwdriver with a soft cloth to prevent damage to the lens and remove the lens by carefully prying on the edge of the lens with the flathead screwdriver.
2. Disconnect the bulb by pulling it out.

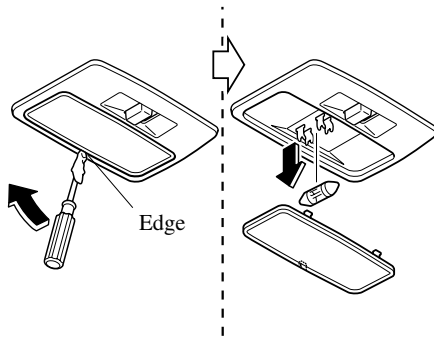

3. Install the new bulb in the reverse order of removal.

Trunk light(4 Door)

1. Press both sides of the lens cap to remove it.
2. Disconnect the bulb by pulling it out.

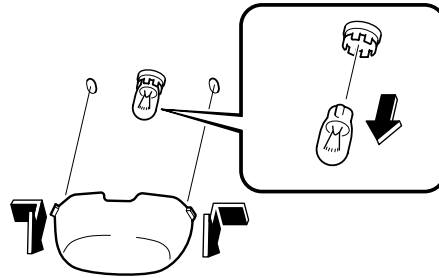

3. Install the new bulb in the reverse order of removal.

Luggage compartment light (5 Door)

1. Insert your finger as shown in the figure and remove the unit.

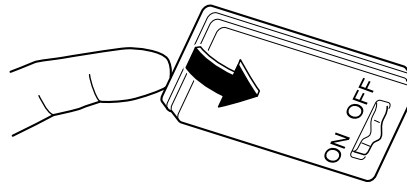

2. Wrap a small flathead screwdriver with a soft cloth to prevent damage to the lens and remove the lens by carefully prying on the edge of the lens with the flathead screwdriver.

Maintenance and Care
Owner Maintenance

3. Disconnect the bulb by pulling it out.

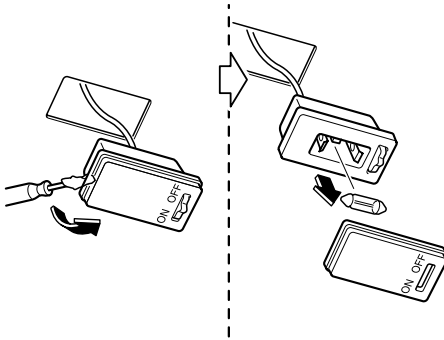

4. Install the new bulb in the reverse order of removal.

Fuses

Your vehicle's electrical system is protected by fuses.

If any lights, accessories, or controls don't work, inspect the appropriate circuit protector. If a fuse has blown, the inside element will be melted.

If the same fuse blows again, avoid using that system and consult an Authorized Mazda Dealer as soon as possible.

▼ Fuse Replacement

Replacing the fuses on the front passenger's side below the glove box

If the electrical system doesn't work, first inspect fuses on the front passenger's side below the glove box.

1. Turn off the ignition switch and other switches.
2. Remove the cover.

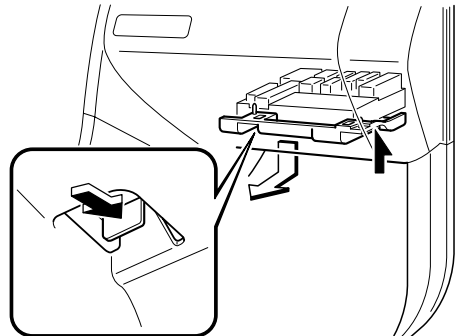

Maintenance and Care

Owner Maintenance

3. Turn the knobs counterclockwise and lower the fuse block.

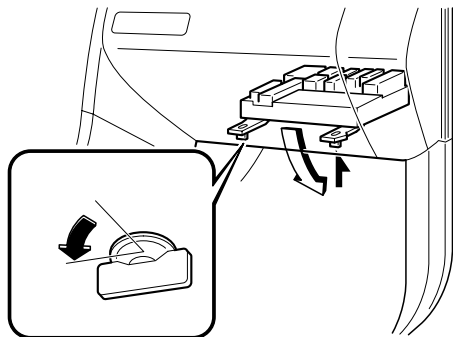

4. Locate the position of the suspected fuse by using the chart inside the fuse block cover.
5. Pull the fuse straight out with the fuse puller provided on the inside of the engine compartment fuse block cover.

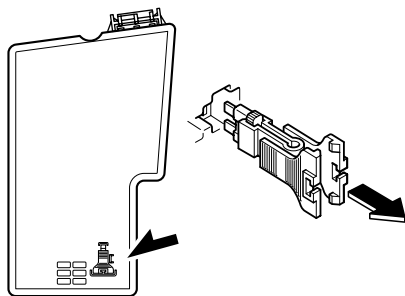

6. Inspect it and replace if it's blown.

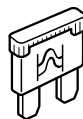

Normal



Blown

7. Push in a new fuse of the same amperage rating, and make sure it fits tightly. If it doesn't, have an Authorized Mazda Dealer install it.
If you have no spare fuses, borrow one of the same rating from a circuit not essential to vehicle operation, such as the MIRROR or CIGAR circuit.

WARNING

Always replace a fuse with one of the same rating. Otherwise you may damage the electric system.

Replacing the fuses under the hood

If the headlights or other electrical components don't work and the fuses in the cabin are OK, inspect the fuse block under the hood. If a fuse is blown, it must be replaced. Follow these steps:

1. Turn off the ignition switch and all other switches.

Maintenance and Care
Owner Maintenance

2. Remove the fuse block cover.

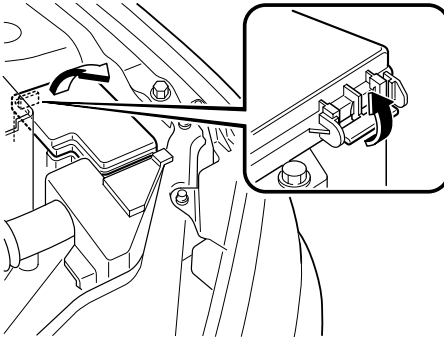

3. If a fuse is blown, replace it with a new one of the same amperage rating.

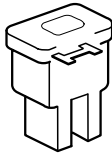

Normal

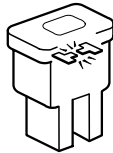

Blown

NOTE

To replace the MAIN fuse, contact an Authorized Mazda Dealer.

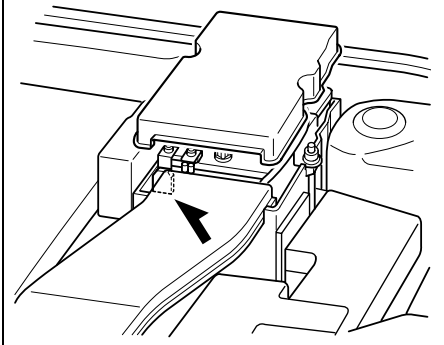

Maintenance and Care

Owner Maintenance

▼ Fuse Panel Description

Fuse block (Engine compartment)

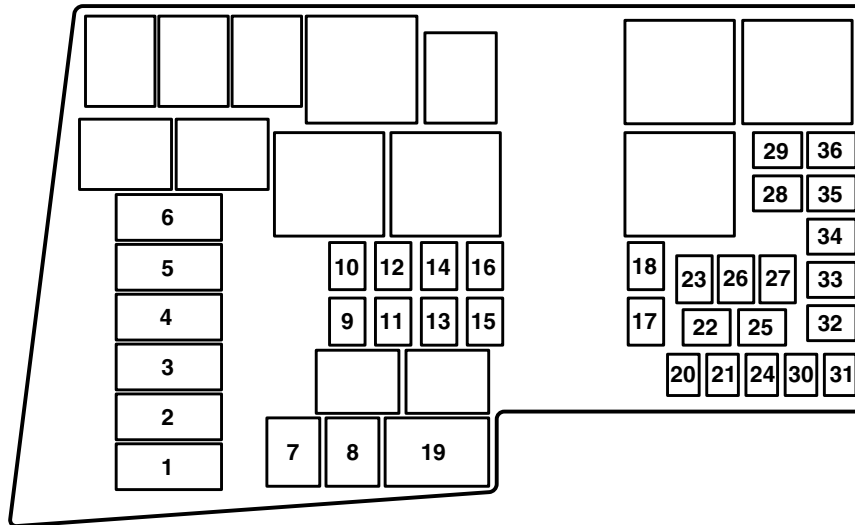

DESCRIPTION	FUSE RATING	PROTECTED COMPONENT	
1	FAN	40 A	Cooling fan
2	P/ST	80 A	EHPAS
3	BTN	40 A	For protection of various circuits
4	HEAD	40 A	Headlights
5	PTC	80 A	—
6	GLOW	60 A	—
7	ABS 1	30 A	ABS *
8	ABS 2	20 A	ABS *
9	ENGINE	30 A	For protection of various circuits
10	—	—	—
11	IG KEY 1	30 A	Ignition switch
12	STARTER	20 A	Starter clutch
13	IG KEY 2	30 A	Ignition switch
14	—	—	—
15	HEATER	40 A	Blower motor
16	—	—	—
17	DEFOG	40 A	Rear window defroster

8-48 *Some models.

Maintenance and Care
Owner Maintenance

DESCRIPTION		FUSE RATING	PROTECTED COMPONENT
18	AUDIO	30 A	Audio system (BOSE Sound System-equipped model)
19	ABS IG	10A	ABS *
20	FOG	15 A	Fog lights *
21	HORN	15 A	Horn
22	—	—	—
23	H/CLEAN	20 A	—
24	F/PUMP	15 A	Fuel pump
25	P/ST IG	10A	Power steering
26	A/C MAG	10A	Air conditioner
27	TCM	15A	Transmission control module
28	—	—	—
29	—	—	—
30	ENG +B	10A	PCM
31	ROOM	15 A	Interior lights
32	ENG BAR 4	10A	O ₂ heater
33	ENG BAR 3	10A	O ₂ heater
34	EGI INJ	10A	Injector
35	ENG BAR 1	10A	Air flow sensor
36	ENG BAR 2	10A	EGR control valve

*Some models. **8-49**

Maintenance and Care

Owner Maintenance

Fuse block (Passenger's side)

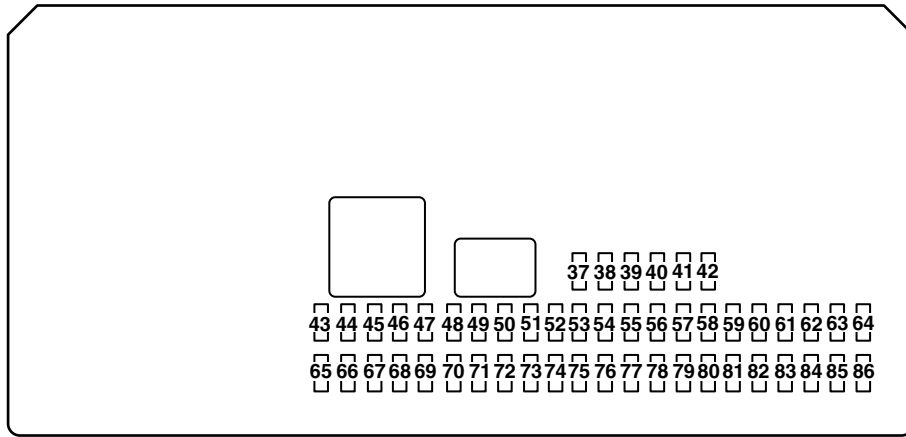

DESCRIPTION	FUSE RATING	PROTECTED COMPONENT
37	15 A	Power door lock
38	10A	Stop lights
39	10A	Headlight high beams (LH)
40	10A	Headlight high beams (RH)
41	—	—
42	—	—
43	15 A	Lighter
44	7.5 A	Audio system
45	10A	Power control mirror
46	7.5 A	Taillight (RH), Parking lights (RH) License plate lights
47	10A	For protection of various circuits
48	—	—
49	20 A	—
50	10A	Control unit
51	15 A	Turn signals, Hazard warning flashers
52	20 A	Moonroof*
53	20 A	Front washer, Rear window wiper and washer
54	—	—
55	30 A	—

8-50 *Some models.

Maintenance and Care
Owner Maintenance

DESCRIPTION		FUSE RATING	PROTECTED COMPONENT
56	P/WIND L	30 A	—
57	ALARM	7.5 A	—
58	M/DEF	7.5 A	Mirror Defroster
59	—	—	—
60	HEAD LOW R	15 A	Headlight low beams (RH), Headlight leveling*
61	HEAD LOW L	15 A	Headlight low beams (LH)
62	—	—	—
63	—	—	—
64	—	—	—
65	SAS	10A	Supplemental restraint system
66	METER	10A	Instrument cluster, Immobilizer system, Shift lock system
67	IGNITION	20 A	ABS*, EHPAS
68	WIPER	20 A	Windshield wiper
69	ENGINE	20 A	For protection of various circuits
70	IG SIG	10A	Auto wiper*
71	SAS 2	7.5 A	Supplemental restraint system
72	—	—	—
73	—	—	—
74	SEAT WARM	20 A	—
75	D/LOCK 1	25 A	Power door lock
76	A/C	10A	Air conditioner, Heater control unit
77	P/WIND L	30 A	Power window (LH)*
78	P/WIND R	30 A	Power window (RH)*
79	BACK	10A	Reverse lights
80	SUN ROOF	7.5 A	Moonroof*
81	TAIL L	7.5 A	Taillights (LH), Parking lights (LH)
82	ILLUMI	7.5 A	Illumination
83	—	—	—
84	—	—	—
85	—	—	—
86	—	—	—

*Some models. **8-51**

Maintenance and Care

Appearance Care

How to Minimize Environmental Paint Damage

The paintwork on your Mazda represents the latest technical developments in composition and methods of application.

Environmental hazards, however, can harm the paint's protective properties, if proper care is not taken.

Here are some examples of possible damage, with tips on how to prevent them.

▼ Etching Caused by Acid Rain or Industrial Fallout

Occurrence

Industrial pollutants and vehicle emissions drift into the air and mix with rain or dew to form acids. These acids can settle on a vehicle's finish. As the water evaporates, the acid becomes concentrated and can damage the finish.

And the longer the acid remains on the surface, the greater the chance is for damage.

Prevention

It is necessary to wash and wax your vehicle to preserve its finish according to the instructions in this section. These steps should be taken immediately after you suspect that acid rain has settled on your vehicle's finish.

▼ Damage Caused by Bird Dropping, Insects, or Tree Sap

Occurrence

Bird droppings contain acids. If these aren't removed they can eat away the clear and color base coat of the vehicle's paintwork.

When insects stick to the paint surface and decompose, corrosive compounds form. These can erode the clear and color base coat of the vehicle's paintwork if they are not removed.

Tree sap will harden and adhere permanently to the paint finish. If you scratch the sap off while it is hard, some vehicle paint could come off with it.

Prevention

It is necessary to have your Mazda washed and waxed to preserve its finish according to the instructions in this section. This should be done as soon as possible.

Bird droppings can be removed with a soft sponge and water. If you are traveling and these are not available, a moistened tissue may also take care of the problem. The cleaned area should be waxed according to the instructions in this section.

Insects and tree sap are best removed with a soft sponge and water or a commercially available chemical cleaner.

Another method is to cover the affected area with dampened newspaper for one to two hours. After removing the newspaper, rinse off the loosened debris with water.

Appearance Care

▼ Water Marks

Occurrence

Rain, fog, dew, and even tap water can contain harmful minerals such as salt and lime. If moisture containing these minerals settles on the vehicle and evaporates, the minerals will concentrate and harden to form white rings. The rings can damage your vehicle's finish.

Prevention

It is necessary to wash and wax your vehicle to preserve its finish according to the instructions in this section. These steps should be taken immediately after you find water marks on your vehicle's finish.

▼ Paint Chipping

Occurrence

Paint chipping occurs when gravel thrown in the air by another vehicle's tires hits your vehicle.

How to avoid paint chipping

Keeping a safe distance between you and the vehicle ahead reduces the chances of having your paint chipped by flying gravel.

NOTE

- The paint chipping zone varies with the speed of the vehicle. For example, when traveling at 90 km/h (56 mph), the paint chipping zone is 50 m (164 ft).
- In low temperatures a vehicle's finish hardens. This increases the chance of paint chipping.
- Chipped paint can lead to rust forming on your Mazda. Before this happens, repair the damage by using Mazda touch-up paint according to the instructions in this section. Failure to repair the affected area could lead to serious rusting and expensive repairs.

Maintenance and Care

Appearance Care

Exterior Care

Follow **all** label and container directions when using a chemical cleaner or polish. Read all warnings and cautions.

▼ Maintaining the Finish

Washing

CAUTION

When the wiper lever is in the AUTO position and the ignition switch is in the ON position, the wipers may move automatically in the following cases:

- If the windshield above the rain sensor is touched.
- If the windshield above the rain sensor is wiped with a cloth.
- If the windshield is struck with a hand or other object.
- If the rain sensor is struck with a hand or other object from inside the vehicle.

Be careful not to pinch hands or fingers as it may cause injury, or damage the wipers. When washing or servicing your Mazda, make sure the wiper lever is in the OFF position.

To help protect the finish from rust and deterioration, wash your Mazda thoroughly and frequently, at least once a month, with lukewarm or cold water.

If the vehicle is washed improperly, the paint surface could be scratched. Here are some examples of how scratching could occur.

Scratches occur on the paint surface when:

- The vehicle is washed without first rinsing off dirt and other foreign matter.
- The vehicle is washed with a rough, dry, or dirty cloth.
- The vehicle is washed at a car wash that uses brushes that are dirty or too stiff.
- Cleansers or wax containing abrasives are used.

NOTE

- Mazda is not responsible for scratches caused by automatic car washes or improper washing.
- Scratches are more noticeable on vehicles with darker paint finishes.

To minimize scratches on the vehicle's paint finish:

- Rinse off any dirt or other foreign matter using lukewarm or cold water before washing.
- Use plenty of lukewarm or cold water and a soft cloth when washing the vehicle. Do not use a nylon cloth.
- Rub gently when washing or drying the vehicle.
- Take your vehicle only to a car wash that keeps its brushes well maintained.
- Don't use abrasive cleansers or wax that contain abrasives.

Appearance Care

CAUTION

- Don't use steel wool, abrasive cleaners, or strong detergents containing highly alkaline or caustic agents on chrome-plated or anodized aluminum parts. This may damage the protective coating; also, cleaners and detergents may discolor or deteriorate the paint.
- To prevent damaging the antenna, remove it before entering a car wash facility or passing beneath a low overhead clearance.

Pay special attention to removing salt, dirt, mud, and other foreign material from the underside of the fenders, and make sure the drain holes in the lower edges of the doors and rocker panels are clean.

Insects, tar, tree sap, bird droppings, industrial fallout, and similar deposits can damage the finish if not removed immediately. When prompt washing with plain water is ineffective, use a mild soap made for use on vehicles.

Thoroughly rinse off all soap with lukewarm or cold water. Don't allow soap to dry on the finish.

After washing the vehicle, dry it with a clean chamois to prevent water spots from forming.

WARNING

Driving with Wet Brakes:
Driving with wet brakes is dangerous. Increased stopping distance or the vehicle pulling to one side when braking could result in a serious accident. Light braking will indicate whether the brakes have been affected. Dry the brakes by driving very slowly and applying the brakes lightly until brake performance is normal.

Waxing

Your vehicle needs to be waxed when water no longer beads on the finish. Always wash and dry the vehicle before waxing it. In addition to the vehicle body, wax the metal trim to maintain its luster.

1. Use wax which contains no abrasives. Waxes containing abrasive will remove paint and could damage bright metal parts.
2. Use a good grade of natural wax for metallic, mica, and solid colors.
3. When waxing, coat evenly with the sponge supplied or a soft cloth.
4. Wipe off the wax with a soft cloth.

NOTE

A spot remover to remove oil, tar, and similar materials will usually also take off the wax. Rewax these areas even if the rest of the vehicle doesn't need it.

Maintenance and Care

Appearance Care

▼ Repairing Damage to the Finish

Deep scratches or chips on the finish should be repaired promptly. Exposed metal quickly rusts and can lead to major repairs.

CAUTION

If your Mazda is damaged and needs metal parts repaired or replaced, make sure the body shop applies anti-corrosion materials to all parts, both repaired and new. This will prevent them from rusting.

▼ Bright-Metal Maintenance

- Use tar remover to remove road tar and insects. Never do this with a knife or similar tool.
- To prevent corrosion on bright-metal surfaces, apply wax or chrome preservative and rub it to a high luster.
- During cold weather or in coastal areas, cover bright-metal parts with a coating of wax or preservative heavier than usual. It would also help to coat them with noncorrosive petroleum jelly or some other protective compound.

CAUTION

Don't use steel wool, abrasive cleaners, or strong detergents containing highly alkaline or caustic agents on chrome-plated or anodized aluminum parts. This may result in damage to the protective coating and cause discoloration or paint deterioration.

▼ Underbody Maintenance

Road chemicals and salt used for ice and snow removal and solvents used for dust control may collect on the underbody. If not removed, they will speed up rusting and deterioration of such underbody parts as fuel lines, frame, floor pan, and exhaust system, even though these parts may be coated with anti-corrosive material.

Thoroughly flush the underbody and wheel housings with lukewarm or cold water at the end of each winter. Try also to do this every month.

Pay special attention to these areas because they easily hide mud and dirt. **It will do more harm than good to wet down the road grime without removing it.**

The lower edges of doors, rocker panels, and frame members have drain holes that should not be clogged. Water trapped there will cause rusting.

WARNING

Driving with Wet Brakes:
Driving with wet brakes is dangerous. Increased stopping distance or the vehicle pulling to one side when braking could result in a serious accident. Light braking will indicate whether the brakes have been affected. Dry the brakes by driving very slowly and applying the brakes lightly until brake performance is normal.

Appearance Care

▼ Aluminum Wheel Maintenance

A protective coating is provided over the aluminum wheels. Special care is needed to protect this coating.

NOTE

- Don't use a wire brush or any abrasive cleaner, polishing compound, or solvent on aluminum wheels. They may damage the coating.
- Only use a mild soap or neutral detergent and always use a sponge or soft cloth to clean the wheels. Rinse thoroughly with lukewarm or cold water. Also, be sure to clean the wheels after driving on dusty or salted roads. This helps prevent corrosion.
- Avoid washing your vehicle in an automatic car wash that uses high-speed or hard brushes.
- If your aluminum wheels lose luster, wax the wheels.

Interior Care

▼ Dashboard Precautions

Prevent caustic solutions such as perfume and cosmetic oils from contacting the dashboard. They'll damage and discolor it. If these solutions get on the dashboard, wipe them off immediately.

⚠ CAUTION

Do not use glazing agents. Glazing agents contain ingredients which may cause discoloration, wrinkling, cracks and peeling.

▼ Cleaning the Upholstery and Interior Trim

Vinyl

Remove dust and loose dirt from vinyl with a whisk broom or vacuum cleaner. Clean vinyl with a leather-and-vinyl cleaner.

Leather*

Real leather isn't uniform and may have scars, scratches, and wrinkles. Clean it with a leather cleaner or mild soap.

Wipe it with a **damp** soft cloth; then dry and buff it with a **dry** soft cloth.

Fabric

Remove dust and loose dirt from fabric with a whisk broom or vacuum cleaner. Clean it with a mild soap solution good for upholstery and carpets. Remove fresh spots immediately with a fabric spot cleaner.

Maintenance and Care

Appearance Care

To keep the fabric looking clean and fresh, take care of it. Otherwise its color will be affected, it can be stained easily, and its fire-resistance may be reduced.

CAUTION

Use only recommended cleaners and procedures. Others may affect appearance and fire-resistance.

Piano black panel*

The following parts are fitted with panels that have been treated with a special coating that resists scratching.

- Instrument panel side garnish
- Steering wheel (partial)

When the panel needs to be cleaned, use a soft cloth to wipe off dirt from the surface.

NOTE

Scratches or nicks on the panels resulting from the use of a hard brush or cloth may not be repairable.

▼ Cleaning the Lap/Shoulder Belt Webbing

Clean the webbing with a mild soap solution recommended for upholstery or carpets. Follow instructions. Don't bleach or dye the webbing; this may weaken it.

After cleaning the belts, thoroughly dry the belt webbing and make sure there is no remaining moisture before retracting them.

WARNING

Damaged Seat Belt:
Using damaged seat belts is dangerous. In a collision, damaged belts cannot provide adequate protection. Have an Authorized Mazda Dealer replace damaged belts immediately.

▼ Cleaning the Window Interiors

If the windows become covered with an oily, greasy, or waxy film, clean them with glass cleaner. Follow the directions on the container.

CAUTION

Don't scrape or scratch the inside of the rear window. You may damage the rear window defroster grid.

9

Customer Information and Reporting Safety Defects

Important consumer information including warranties and add-on equipment.

Customer Assistance	9-2	Tire Information (U.S.A.)	9-21
Customer Assistance (U.S.A.)	9-2	Tire Labeling	9-21
Customer Assistance (Canada)	9-4	Location of the Tire Label (Placard)	9-27
Customer Assistance (Puerto Rico)	9-7	Tire Maintenance	9-30
Customer Assistance (Mexico)	9-8	Vehicle Loading	9-33
 		Steps for Determining the Correct Load Limit:	9-40
Mazda Importer/Distributors	9-10	 	
Importer/Distributor	9-10	Reporting Safety Defects	9-41
Distributor in Each Area	9-10	Reporting Safety Defects (U.S.A.)	9-41
 		Reporting Safety Defects (Canada) ...	9-42
Warranty	9-12	 	
Warranties for Your Mazda	9-12	Service Publications	9-43
Outside the United States	9-13	Service Publications	9-43
Outside Canada	9-14		
Registering Your Vehicle in A Foreign Country (Except United States and Canada)	9-15		
Add-On Non-Genuine Parts and Accessories	9-16		
Cell Phones	9-17		
Cell Phones Warning	9-17		
Type Approval of Equipment	9-18		
Type Approval of Equipment	9-18		
Uniform Tire Quality Grading System (UTQGS)	9-19		
Uniform Tire Quality Grading System (UTQGS)	9-19		

Customer Information and Reporting Safety Defects

Customer Assistance

Customer Assistance (U.S.A.)

Your complete and permanent satisfaction is our business. We are here to serve you. All Authorized Mazda Dealers have the knowledge and the tools to keep your Mazda vehicle in top condition.

If you have any questions or recommendations for improvement regarding the service of your Mazda vehicle or servicing by Mazda Dealer personnel, we recommend that you take the following steps:

NOTE

If it becomes necessary to have the components or wiring system for the supplementary restraint system modified to accommodate a person with certain medical conditions in accordance with a certified physician, contact an Authorized Mazda Dealer.

▼STEP 1: Contact Your Mazda Dealer

Discuss the matter with an Authorized Mazda Dealer. This is the quickest and best way to address the issue.

- If your concern has not been resolved by the CUSTOMER RELATIONS, SALES, SERVICE, or PARTS MANAGER, then please contact the GENERAL MANAGER of the dealership or the OWNER.
- If it becomes necessary to have the components or wiring system for the supplementary restraint system modified to accommodate a person with certain medical conditions in accordance with a certified physician, go to STEP2.

▼STEP 2: Contact Mazda North American Operations

If for any reason you feel the need for further assistance after contacting your dealership management and it becomes necessary to have the components or wiring system for the supplementary restraint system modified to accommodate a person with certain medical conditions in accordance with a certified physician, you can reach Mazda North American Operations by one of the following ways.

Log on: at www.mazdaUSA.com

Answers to many questions, including how to locate or contact a local Mazda dealership in the U.S., can be found here.

E-mail: click on "Contact Us" at the bottom of the page at www.mazdaUSA.com

By phone at:1 (800) 222-5500

9-2

Customer Information and Reporting Safety Defects

Customer Assistance

By letter at:

Attn: Customer Assistance
Mazda North American Operations
7755 Irvine Center Drive
Irvine, CA 92618-2922
P.O. Box 19734
Irvine, CA 92623-9734

In order to serve you efficiently and effectively, please help us by providing the following information:

1. Your name, address, and telephone number
2. Year and model of vehicle
3. Vehicle Identification Number (17 digits, noted on your registration or title or located on the upper driver's side corner of the dash)
4. Purchase date and current mileage
5. Your dealer's name and location
6. Your question(s)

If you live outside the U.S.A., please contact your nearest Mazda Distributor.

Customer Information and Reporting Safety Defects

Customer Assistance

Customer Assistance (Canada)

▼ Satisfaction Review Process

Your complete and permanent satisfaction is of primary concern to Mazda. All Authorized Mazda Dealers have both the knowledge and tools to keep your Mazda in top condition. In our experience, any questions, problems, or complaints regarding the operation of your Mazda or any other general service transactions are most effectively resolved by your dealer. If the cause of your dissatisfaction cannot adequately be addressed by normal dealership procedures, we recommend that you take the following steps:

▼ STEP 1: Contact the Mazda Dealer

Discuss the matter with a member of dealership management. If the Service Manager has already reviewed your concerns, contact the owner of the dealership or its General Manager.

▼ STEP 2: Contact the Mazda Regional Office

If you feel that you still require assistance, ask the dealer Service Manager to arrange for you to meet the local Mazda Service Representative. If more expedient, contact Mazda Canada Inc. Regional Office nearest you for such arrangements. Regional Office address and phone numbers are shown (page 9-6).

▼ STEP 3: Contact the Mazda Customer Relations Department

If still not substantially satisfied, contact the Customer Relations Department, Mazda Canada Inc., 55 Vogell Road, Richmond Hill, Ontario, L4B 3K5 Canada TEL:1 (800) 263-4680.

Provide the Department with the following information:

1. Your name, address and telephone number
2. Year and model of vehicle
3. Vehicle Identification Number (VIN). Refer to the "Vehicle Identification Labels" page of section 10 of this manual for the location of the VIN.
4. Purchase date
5. Present odometer reading
6. Your dealer's name and location
7. The nature of your problem and/or cause of dissatisfaction

The Department, in cooperation with the local Mazda Service Representative, will review the case to determine if everything possible has been done to ensure your satisfaction.

9-4

Customer Assistance

Please recognize that the resolution of service problems in most cases requires the use of your Mazda dealer's service facilities, personnel and equipment. We urge you to follow the above three steps in sequence for most effective results.

▼ Mediation/Arbitration Program

Occasionally a customer concern cannot be resolved through Mazda's Customer Satisfaction Program. If after exhausting the procedures in this manual your concern is still not resolved, you have another option.

Mazda Canada Inc. participates in an arbitration program administered by the Canadian Motor Vehicle Arbitration Plan (CAMVAP). CAMVAP will advise you about how your concern may be reviewed and resolved by an independent third party through binding arbitration.

Your complete satisfaction is the goal of Mazda Canada Inc. and our dealers. Mazda's participation in CAMVAP makes a valuable contribution to our achieving that goal. There is no charge for using CAMVAP. CAMVAP results are fast, fair and final as the award is binding on both you and Mazda Canada Inc.

▼ Canadian Motor Vehicle Arbitration Plan (CAMVAP)

If a specific item of concern arises, where a solution cannot be reached between an owner, Mazda, and/or one of its dealers (that all parties cannot agree upon), the owner may wish to use the services offered by the Canadian Motor Vehicle Arbitration Plan (CAMVAP).

CAMVAP uses the services of Provincial Administrators to assist consumers in scheduling and preparing for their arbitration hearings. However, before you can proceed with CAMVAP you must follow your Mazda dispute resolution process as outlined previously.

Customer Information and Reporting Safety Defects

Customer Assistance

CAMVAP is fully implemented in all provinces and territories. Consumers wishing to obtain further information about the Program should contact the Provincial Administrator at 1 (800) 207-0685, or by contacting the Canadian Motor Vehicle Arbitration Plan Office at:

Canadian Motor Vehicle Arbitration Plan
 235 Yorkland Boulevard, suite 300
 North York, Ontario
 M2J 4Y8
<http://camvap.ca>

Provincial Administrators may be reached locally as listed below:

Province/Territory	CAMVAP Number
British Columbia & Yukon Territories	1 (800) 207-0685
Alberta & Northwest Territories	1 (800) 207-0685
Saskatchewan	1 (800) 207-0685
Manitoba	1 (800) 207-0685
Ontario	1 (800) 207-0685
Atlantic Canada	1 (800) 207-0685
Quebec	1 (800) 207-0685

▼ Regional Offices

REGIONAL OFFICES	AREAS COVERED
MAZDA CANADA INC. WESTERN REGION 8171 ACKROYD ROAD SUITE 2000 RICHMOND B.C. V6X 3K1 (604) 303-5670	ALBERTA, BRITISH COLUMBIA, MANITOBA, SASKATCHEWAN, YUKON
MAZDA CANADA INC. CENTRAL/ATLANTIC REGION 55 VOGELL ROAD, RICHMOND HILL, ONTARIO, L4B 3K5 (905) 787-7000	ONTARIO
MAZDA CANADA INC. QUEBEC REGION 6111 ROUTE TRANS CANADIENNE POINTE CLAIRE, QUEBEC H9R 5A5 (514) 694-6390	QUEBEC, NEW BRUNSWICK, NOVA SCOTIA, PRINCE EDWARD ISLAND, NEWFOUNDLAND

Customer Assistance

Customer Assistance (Puerto Rico)

Your complete and permanent satisfaction is our business. That is why all Authorized Mazda Dealers have the knowledge and the tools to keep your Mazda vehicle in top condition.

If you have any questions or recommendations for improvement regarding the service of your Mazda vehicle or servicing by Mazda Dealer personnel, we recommend that you take the following steps:

▼STEP 1

Discuss the matter with an Authorized Mazda Dealer. This is the quickest and best way to address the issue. If your concern has not been resolved by the CUSTOMER RELATIONS, SALES, SERVICE, or PARTS MANAGER, then please contact the GENERAL MANAGER of the dealership or the OWNER.

▼STEP 2

If, after following STEP 1, you feel the need for further assistance, please contact your area's Mazda representative (Indicated on the next page).

Please help us by providing the following information:

1. Your name, address, and telephone number
2. Year and model of vehicle
3. Vehicle Identification Number (17 digits, noted on your registration or title or located on the upper driver's side corner of the dash)
4. Purchase date and current mileage
5. Your dealer's name and location
6. Your question(s)

Customer Information and Reporting Safety Defects

Customer Assistance

Customer Assistance (Mexico)

Your complete and permanent satisfaction is our business. We are here to serve you. All Authorized Mazda Dealers have the knowledge and the tools to keep your Mazda vehicle in top condition.

If you have any questions or recommendations for improvement regarding the service of your Mazda vehicle or servicing by Mazda Dealer personnel, we recommend that you take the following steps:

▼STEP 1: Contact Your Mazda Dealer

Discuss the matter with an Authorized Mazda Dealer. This is the quickest and best way to address the issue.

- If your concern has not been resolved by the CUSTOMER RELATIONS, SALES, SERVICE, or PARTS MANAGER, then please contact the GENERAL MANAGER of the dealership or the OWNER.
- If it becomes necessary to have the components or wiring system for the supplementary restraint system modified to accommodate a person with certain medical conditions in accordance with a certified physician, go to STEP2.

▼STEP 2: Contact Mazda Motor de Mexico

If for any reason you feel the need for further assistance after contacting your dealership management and it becomes necessary to have the components or wiring system for the supplementary restraint system modified to accommodate a person with certain medical conditions in accordance with a certified physician, you can reach Mazda Motor de Mexico by one of the following ways.

Log on: at www.MazdaMexico.com.mx

Answers to many questions, including how to locate or contact a local Mazda dealership in Mexico, can be found here.

E-mail: click on "Contactanos" at the top of the page at www.MazdaMexico.com.mx

By phone at:1 (866) 315 0220

Customer Information and Reporting Safety Defects

Customer Assistance

By letter at:

Attn: Customer Assistance
Mazda North American Operations
7755 Irvine Center Drive
Irvine, CA 92618-2922
P.O. Box 19734
Irvine, CA 92623-9734

In order to serve you efficiently and effectively, please help us by providing the following information:

1. Your name, address, and telephone number
2. Year and model of vehicle
3. Vehicle Identification Number (17 digits, noted on your registration or title or located on the upper driver's side corner of the dash)
4. Purchase date and current mileage
5. Your dealer's name and location
6. Your question(s)

Customer Information and Reporting Safety Defects

Mazda Importer/Distributors

Importer/Distributor

▼ U.S.A.

Mazda North American Operations

7755 Irvine Center Drive

Irvine, CA 92618-2922 U.S.A.

P.O. Box 19734

Irvine, CA 92623-9734 U.S.A.

TEL: 1 (800) 222-5500 (in U.S.A.)

(949) 727-1990 (outside U.S.A.)

Distributor in Each Area

▼ CANADA

Mazda Canada Inc.

55 Vogell Road, Richmond Hill,

Ontario, L4B 3K5 Canada

TEL: 1 (800) 263-4680 (in Canada)

(905) 787-7000 (outside Canada)

▼ PUERTO RICO/U.S. Virgin Island

Plaza Motors Corp. (Mazda de Puerto Rico)

P.O. Box 362722, San Juan, Puerto Rico

00936-2722

TEL: (787) 641-9300

▼ MEXICO

Mazda Motor de Mexico

Circuito Guillermo Gonzalez Camarena

No. 1500

Col. Centro de Ciudad Santa Fe, 01210

Mexico, D.F.

TEL: 1 (866)315-0220

▼ GUAM

Triple J Motors

157 South Marine Drive, Tamuning,

GUAM 96911 USA

P.O. Box 6066 Tamuning, Guam 96931

TEL: (671) 649-6555

▼ SAIPAN

Pacific International Marianas, Inc. (d.b.a. Midway Motors)

P.O. Box 887 Saipan, MP 96950

TEL: (670) 234-7524

Customer Information and Reporting Safety Defects
Mazda Importer/Distributors

Triple J Saipan, Inc.
(d.b.a. Triple J Motors)
P.O. Box 500487 Saipan, MP 96950-0487
TEL: (670) 234-7133/3051

▼ AMERICAN SAMOA

Polynesia Motors, Inc.
P.O. Box 1120, Pago Pago, American
Samoa 96799
TEL: (684) 699-9347

Customer Information and Reporting Safety Defects

Warranty

Warranties for Your Mazda

- New Vehicle Limited Warranty
- Distributor Major Component Limited Warranty (Canada only)
- Safety Restraint System Limited Warranty
- Anti-perforation Limited Warranty
- Federal Emission Control Warranty (U.S.A. only)
 - Emission Defect Warranty
 - Emission Performance Warranty
- California Emission Control Warranty (U.S.A. only)
- Emission Control Warranty (Canada only)
- Replacement Parts and Accessories Limited Warranty
- Tire Warranty

NOTE
Detailed warranty information is provided with your Mazda.

Warranty

Outside the United States

Government regulations in the United States require that automobiles meet specific emission regulations and safety standards. Therefore, vehicles built for use in the United States may differ from those sold in other countries.

The differences may make it difficult or even impossible for your vehicle to receive satisfactory servicing in other countries. We strongly recommend that you NOT take your Mazda outside the United States. However, in the event that you are moving to Canada permanently, Mazda vehicles built for use in the United States could be eligible for exportation to Canada with specific vehicle modifications to comply with the Canadian Motor Vehicle Safety requirements (CMVSS).

NOTE

The above is applicable for a permanent import/export situation and not related to travelers on vacation.

You may have the following problems if you do take your vehicle outside of the United States:

- Recommended fuel may be unavailable. Any kind of leaded fuel or low-octane fuel will affect vehicle performance and damage the emission controls and engine.
- Proper repair facilities, tools, testing equipment, and replacement parts may not be available.

Please refer to your Manufacturer's Warranty Booklet for more information.

Customer Information and Reporting Safety Defects

Warranty

Outside Canada

Government regulations in Canada require that automobiles meet specific emission regulations and safety regulations. Therefore, vehicles built for use in Canada may differ from those sold in other countries.

The differences may make it difficult or even impossible for your vehicle to receive satisfactory servicing in other countries. We strongly recommend that you NOT take your Mazda outside Canada. However, in the event that you are moving to the United States permanently, Mazda vehicles built for use in Canada could be eligible for exportation to the United States with specific vehicle modifications to comply with the United States Federal Motor Vehicle Safety Standards (FMVSS).

NOTE

The above is applicable for a permanent import/export situation and not related to travelers on vacation.

You may have the following problems if you do take your vehicle outside of Canada:

- Recommended fuel may be unavailable. Any kind of leaded fuel or low-octane fuel will affect vehicle performance and damage the emission controls and engine.
- Proper repair facilities, tools, testing equipment, and replacement parts may not be available.

Please refer to your Manufacturer's Warranty Booklet for more information.



Registering Your Vehicle in A Foreign Country (Except United States and Canada)

Government regulations in your country could require that automobiles meet specific emission and safety standards.

Vehicles built for your country may differ from those built for other countries. In addition to registration problems, satisfactory service may be difficult or even impossible in another country.

The fuel specified for your vehicle may be unavailable.

Parts, servicing techniques, and tools necessary to maintain and repair your vehicle may be unavailable.

There might not be an Authorized Mazda Dealer in the country you plan to take your vehicle.

The Mazda warranty is valid only in certain countries.

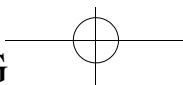
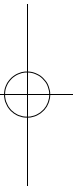
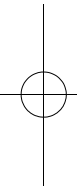

Customer Information and Reporting Safety Defects

Warranty

Add-On Non-Genuine Parts and Accessories

Non-genuine parts and accessories for Mazda vehicles can be found in stores. These may fit your vehicle, but they are not approved by Mazda for use with Mazda vehicles. When you install non-genuine parts or accessories, they could affect your vehicle's performance or safety systems; the Mazda warranty doesn't cover this. Before you install any non-genuine parts or accessories, consult an Authorized Mazda Dealer.

WARNING

Installation of Non-Genuine Parts or Accessories:

Installation of non-genuine parts or accessories is dangerous. Improperly designed parts or accessories could seriously affect your vehicle's performance or safety systems. This could cause you to have an accident or increase your chances of injuries in an accident. Always consult an Authorized Mazda Dealer before you install non-genuine parts or accessories.

Add-On Electrical and Electronic Equipment:

Incorrectly choosing or installing improper add-on equipment or choosing an improper installer is dangerous. Essential systems could be damaged, causing engine stalling, air-bag (SRS) activation, ABS inactivation, or a fire in the vehicle. Be very careful in choosing and installing add-on electrical equipment, such as mobile telephones, two-way radios, stereo systems, and car alarm systems.

Mazda assumes no responsibility for death, injury, or expenses that may result from the installation of add-on non-genuine parts or accessories.



Cell Phones

Cell Phones Warning

WARNING

Use of Cell Phones and Other Devices by Driver:

Use of any electrical devices such as cell phones, computers, portable radios, vehicle navigation or other devices by the driver while the vehicle is moving is dangerous.

Dialing a number on a cell phone while driving also ties-up the driver's hands. Use of these devices will cause the driver to be distracted and could lead to a serious accident.

If a passenger is unable to use the device, pull off the right-of-way to a safe area before use. If use of a cell phone is necessary despite this warning, use a hands-free system to at least leave the hands free to drive the vehicle. Never use a cell phone or other electrical devices while the vehicle is moving and, instead, concentrate on the full-time job of driving.

Please comply with the legal regulations concerning the use of communication equipment in vehicles in your country.

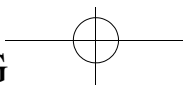

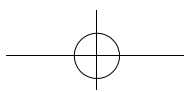

Customer Information and Reporting Safety Defects

Type Approval of Equipment

Type Approval of Equipment

Immobilizer system

Type approval of the Antenna Coil Transceiver	
Country	Approval Number
(CDN)	Canada: 3043104475A5 3
(USA)	FCC ID: NT8-15607PAT3XCVR

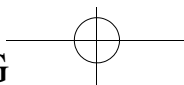

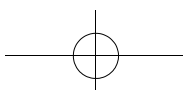

Uniform Tire Quality Grading System (UTQGS)

Uniform Tire Quality Grading System (UTQGS)

This information relates to the tire grading system developed by the U.S. National Highway Traffic Safety Administration for grading tires by tread wear, traction, and temperature performance.

▼ Tread Wear

The tread wear grade is a comparative rating based on the wear rate of the tire when tested under controlled conditions on a specified government test course. For example, a tire graded 150 would wear one-and-a-half times as well on the government course as a tire graded 100.

The relative performance of tires depends upon the actual conditions of their use, however, and may depart significantly from the norm because of variations in driving habits, service practices and differences in road characteristics and climate.

▼ Traction-AA, A, B, C

The traction grades, from highest to lowest, are AA, A, B, and C. These grades represent the tire's ability to stop on wet pavement as measured under controlled conditions on specified government test surfaces of asphalt and concrete. A tire marked C may have poor traction performance.

WARNING

The traction grade assigned to this tire is based on braking (straight ahead) traction tests and does not include acceleration cornering (turning), hydroplaning, or peak traction characteristics.

▼ Temperature-A, B, C

The temperature grades A (the highest), B, and C, represent the tire's resistance to the generation of heat and its ability to dissipate heat when tested under controlled conditions on a specified indoor laboratory test wheel.

Sustained high temperature can cause the material of the tire to degenerate and reduce tire life, and excessive temperatures can lead to sudden tire failure.

Grade C corresponds to a level of performance which all passenger vehicle tires must meet under the Federal Motor Vehicle Safety Standard No. 109. Grades B and A represent higher levels of performance on the laboratory test wheel than the minimum required by law.

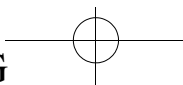

Customer Information and Reporting Safety Defects

Uniform Tire Quality Grading System (UTQGS)

WARNING

The temperature grade for this tire is established for a tire that is properly inflated and not overloaded. Excessive speed, underinflation, or excessive loading, either separately or in combination, can cause heat buildup and possible tire failure.

These grades will be added to the sidewalls of passenger vehicle tires over the next several years according to a schedule established by the NHTSA and the tire manufacturers.

The grade of tires available as standard or optional equipment on Mazda vehicles may vary with respect to grade.

ALL PASSENGER VEHICLE TIRES MUST CONFORM TO THESE GRADES AND TO ALL OTHER FEDERAL TIRE-SAFETY REQUIREMENTS.

▼ Uniform Tire Quality Grading

Quality grades can be found where applicable on the tire sidewall between tread shoulder and maximum section width.

For example:

Treadwear 200 Traction AA Temperature A

UTQGS MARK (example)

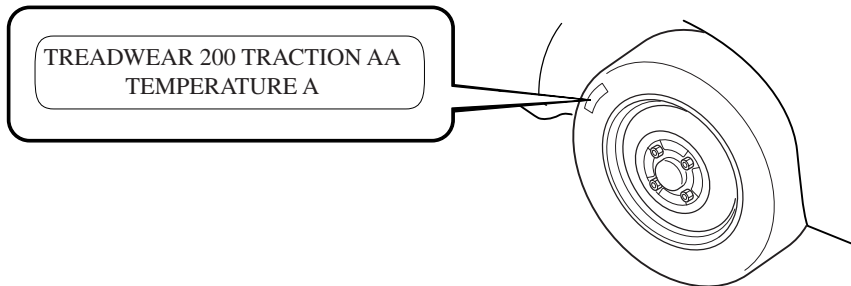

Customer Information and Reporting Safety Defects
Tire Information (U.S.A.)

Tire Labeling

Federal law requires tire manufacturers to place standardized information on the sidewall of all tires. This information identifies and describes the fundamental characteristics of the tire and also provides a tire identification number for safety standard certification and in case of a recall.

▼ Information on Passenger Vehicle Tires

Please refer to the diagram below.

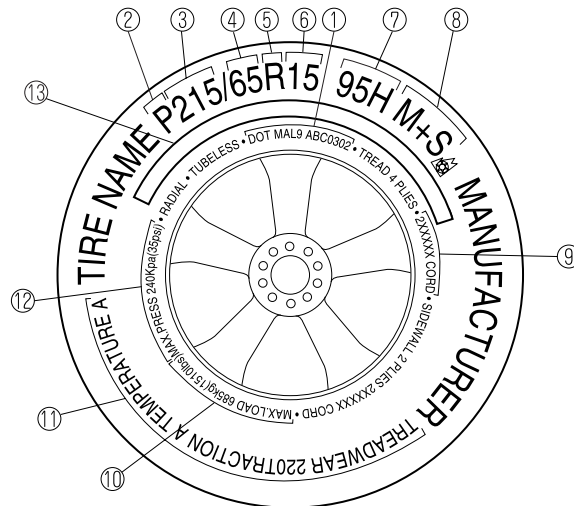

1. TIN: U.S. DOT tire identification number
2. Passenger car tire
3. Nominal width of tire in millimeters
4. Ratio of height to width (aspect ratio)
5. Radial
6. Rim diameter code
7. Load index & speed symbol
8. Severe snow conditions
9. Tire ply composition and materials used
10. Max. load rating

Customer Information and Reporting Safety Defects

Tire Information (U.S.A.)

11. Tread wear, traction and temperature grades
12. Max. permissible inflation pressure
13. SAFETY WARNING

P215/65R15 95H is an example of a tire size and load index rating. Here is an explanation of the various components of that tire size and load index rating. Note that the tire size and load index rating may be different from the example.

P

Indicates a tire that may be installed on cars, SUVs, minivans and light trucks as designated by the Tire and Rim Association (T&RA).

NOTE
If your tire size does not begin with a letter this may mean it is designated by either ETRTO (European Tire and Rim Technical Organization) or JATMA (Japan Tire Manufacturing Association).

215

“215” is the nominal width of the tire in millimeters. This three-digit number gives the width in millimeters of the tire from sidewall edge to sidewall edge. In general, the larger the number, the wider the tire.

65

“65” is the aspect ratio. This two-digit number indicates the tire's ratio of height to width.

R

“R” is the tire construction symbol. R indicates “Radial ply construction”.

15

“15” is the wheel rim diameter in inches.

95

“95” is the Load Index. This two-or three-digit number indicates how much weight each tire can support.

Customer Information and Reporting Safety Defects
Tire Information (U.S.A.)

H

“H” is the speed rating. The speed rating denotes the maximum speed for which the use of the tire is rated.

Letter Rating	Speed Rating
Q	99 mph
R	106 mph
S	112 mph
T	118 mph
U	124 mph
H	130 mph
V	149 mph
W	168* mph
Y	186* mph

* For tires with a maximum speed capability over 149 mph, tire manufacturers sometimes use the letters ZR. For tires with a maximum speed capability over 186 mph, tire manufacturers always use the letters ZR.

M+S or M/S: Mud and Snow

AT: All Terrain.

AS: All Season. The “M+S” or “M/S” indicates that the tire has some functional use in mud and snow.

U.S. DOT Tire Identification Number (TIN)

This begins with the letters “DOT” which indicates the tire meets all federal standards. The next two numbers or letters are the plant code where it was manufactured, and the last four numbers represent the week and year the tire was manufactured. For example, the numbers 457 means the 45st week of 1997. After 2000 the numbers go to four digits. For example, the number 2102 means the 21th week of 2002. The other numbers are marketing codes used at the manufacturer's discretion. This information is used to contact consumers if a tire defect requires a recall.

Tire Ply Composition and Materials Used

The number of plies indicates the number of layers of rubber-coated fabric in the tire. In general, the greater the number of plies, the more weight a tire can support. Tire manufacturers also must indicate the tire materials, which include steel, nylon, polyester, and other.

Maximum Load Rating

This number indicates the maximum load in kilograms and pounds that can be carried by the tire.

Maximum Permissible Inflation Pressure

This number is the greatest amount of air pressure that should ever be put in the tire under normal driving conditions.

Customer Information and Reporting Safety Defects

Tire Information (U.S.A.)

Tread Wear, Traction and Temperature Grades

Tread wear: The tread wear grade is a comparative rating based on the wear rate of the tire when tested under controlled conditions on a specified government test course. For example, a tire graded 150 would wear one and one-half (1 1/2) times as well on the government course as a tire graded 100.

Traction: The traction grades, from highest to lowest are AA, A, B, and C. The grades represent the tire's ability to stop on wet pavement as measured under controlled conditions on specified government test surfaces of asphalt and concrete. A tire marked C may have poor traction performance.

Temperature: The temperature grades are A (the highest), B and C, representing the tire's resistance to the generation of heat and its ability to dissipate heat when tested under controlled conditions on a specified indoor laboratory test wheel.

Snow Tires

In some heavy snow areas, local governments may require true snow tires, those with very deeply cut tread. These tires should only be used in pairs or placed on all four wheels. Make sure you purchase snow tires that are the same size and construction type as the other tires on your vehicle.

SAFETY WARNING

The following safety warning appears on the tire's sidewall.

SERIOUS INJURY MAY RESULT FROM:

- EXPLOSION OF TIRE/RIM ASSEMBLY DUE TO IMPROPER MOUNTING-MATCH TIRE DIAMETER TO RIM DIAMETER; NEVER EXCEED 40 psi (275 kPa) TO SEAT BEADS-ONLY SPECIALLY TRAINED PERSONS SHOULD MOUNT TIRES.
- TIRE FAILURE DUE TO UNDER-INFLATION/OVERLOADING/DAMAGE-FOLLOW OWNER'S MANUAL AND PLACARD IN VEHICLE-FREQUENTLY CHECK INFLATION PRESSURE AND INSPECT FOR DAMAGE.

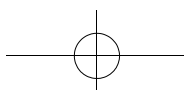

Customer Information and Reporting Safety Defects
Tire Information (U.S.A.)

▼ **Information on Temporary Tires**

Please refer to the diagram below.

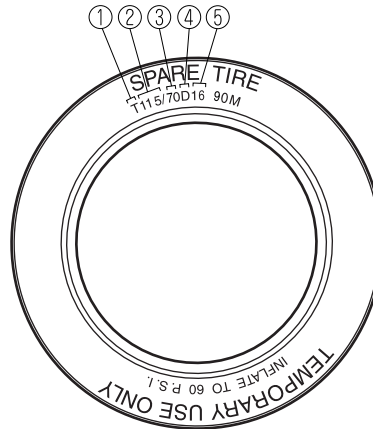

1. Temporary tires
2. Nominal width of tire in millimeters
3. Ratio of height to width (aspect ratio)
4. Diagonal
5. Rim diameter code

T115/70D 16 is an example of a tire size and load index rating. Here is an explanation of the various components of that tire size and load index rating. Note that the tire size and load index rating may be different from the example.

T

Indicates a tire that may be installed on cars, SUVs, minivans and light trucks as designated by the Tire and Rim Association (T&RA).

115

“115” is the nominal width of the tire in millimeters. This three-digit number gives the width in millimeters of the tire from sidewall edge to sidewall edge. In general, the larger the number, the wider the tire.

70

“70” is the aspect ratio. This two-digit number indicates the tire's ratio of height to width.

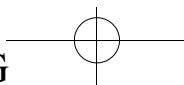

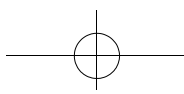

Customer Information and Reporting Safety Defects

Tire Information (U.S.A.)

D

“D” is the tire construction symbol. D indicates “diagonal ply construction”.

16

“16” is the wheel rim diameter in inches.

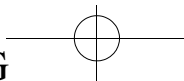

Customer Information and Reporting Safety Defects
Tire Information (U.S.A.)

Location of the Tire Label (Placard)

You will find the tire label containing tire inflation pressure by tire size and other important information on the driver's side B-pillar or on the edge of the driver's door frame.

SAMPLE



TIRE AND LOADING INFORMATION

SEATING CAPACITY : TOTAL 5 : FRONT 2 : REAR 3

The combined weight of occupants and cargo should never exceed 385 kg or 850 lbs.

TIRE	SIZE	COLD TIRE PRESSURE	SEE OWNER'S
FRONT	P 195/65R 15	230KPA, 33PSI	MANUAL FOR
REAR	P 195/65R 15	230KPA, 33PSI	ADDITIONAL
SPARE	T 115/70D15	420KPA, 60PSI	INFORMATION

(XXXX)

▼ Recommended Tire Inflation Pressure

On the tire label you will find the recommended tire inflation pressure in both kPa and psi for the tires installed as original equipment on the vehicle. It is very important that the inflation pressure of the tires on your vehicle is maintained at the recommended pressure. You should check the tire pressure regularly to insure that the proper inflation pressure is maintained.

Refer to Tires on page 10-7.

NOTE

Tire pressures listed on the vehicle placard or tire information label indicate the recommended cold tire inflation pressure, measured when the tires are cold, after the vehicle has been parked for at least 3 hours. As you drive, the temperature in the tire warms up, increasing the tire pressure.

Customer Information and Reporting Safety Defects

Tire Information (U.S.A.)

WARNING

Tire Under-Inflation:

Driving your vehicle with under-inflated tires is dangerous.

Under-inflation is the most common cause of failures in any kind of tire and may result in severe cracking, tread separation or “blowout”, with unexpected loss of vehicle control and increased risk of injury. Under-inflation increases sidewall flexing and rolling resistance, resulting in heat buildup and internal damage to the tire. It results in unnecessary tire stress, irregular wear, loss of control and accidents. A tire can lose up to half of its air pressure and not appear to be flat!

It is impossible to determine whether or not tires are properly inflated just by looking at them.

Always check the tire inflation pressures on a regular basis according to the recommended tire inflation pressure on the tire label and in conjunction with the information in this owner's manual.

▼ **Checking Tire Pressure**

1. When you check the air pressure, make sure the tires are cold —meaning they are not hot from driving even a mile.
2. Remove the cap from the valve on one tire.
3. Firmly press a tire gauge onto the valve.
4. Add air to achieve recommended air pressure.
5. If you overfill the tire, release air by pushing on the metal stem in the center of the valve. Then recheck the pressure with your tire gauge.
6. Replace the valve cap.
7. Repeat with each tire, including the spare.

NOTE

Some spare tires require higher inflation pressure.

8. Visually inspect the tires to make sure there are no nails or other objects embedded that could poke a hole in the tire and cause an air leak.
9. Check the sidewalls to make sure there are no gouges, cuts, bulges, cracks or other irregularities.

9-28

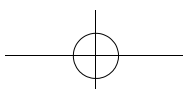

Tire Information (U.S.A.)

NOTE

Warm tires normally exceed recommended pressures. Don't release air from warm tires to adjust the pressure.
Under-inflation can cause serious failures and accidents.
Over-inflation can produce a harsh ride and the greater possibility of damage from road hazards.

▼ Glossary of Terms

Tire Placard: A label indicating the OE tire sizes, recommended inflation pressure, and the maximum weight the vehicle can carry.

Tire Identification Number (TIN): A number on the sidewall of each tire providing information about the tire brand and manufacturing plant, tire size, and date of manufacture.

Inflation Pressure: A measure of the amount of air in a tire.

kPa: Kilopascal, the metric unit for air pressure.

psi: Pounds per square inch, the English unit for air pressure.

B-pillar: The structural member at the side of the vehicle behind the front door.

Original Equipment (OE): Describes components originally equipped on the vehicle.

Vehicle Load Limit: The maximum value of the combined weight of occupants and cargo.

Bead Area of the Tire: Area of the tire next to the rim.

Sidewall Area of the Tire: Area between the bead area and the tread.

Tread Area of the Tire: Area on the perimeter of the tire that contacts the road when it's mounted on the vehicle.

Seating capacity means the total allowable number of vehicle occupants. Seating capacity is described on the tire label.

Production options weight is the combined weight of installed regular production options weighing over 2.3 kilograms in excess of the standard items which they replace, and not previously considered in the curb weight or accessory weight, including heavy duty brakes, ride levelers, roof rack, heavy duty battery, and special trim.

Rim is the metal support (wheel) for a tire or a tire and tube assembly upon which the tire beads are seated.

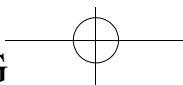

Customer Information and Reporting Safety Defects

Tire Information (U.S.A.)

Tire Maintenance

Improper or inadequate vehicle maintenance can cause tires to wear abnormally. Here are some important maintenance points:

▼ Tire Inflation Pressure

Inspect all tire pressure monthly (including the spare) when the tires are cold. Maintain recommended pressures for the best ride, top handling, and minimum tire wear. Use the pressures specified on the vehicle tire information placard or tire label for optimum service.

▼ Tire Rotation

To equalize tread wear, rotate the tires every 12,000 km (7,500 miles) or sooner if irregular wear develops. During rotation, inspect them for correct balance.

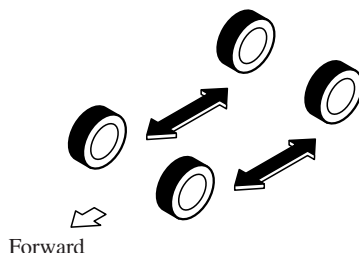

Inspect the tires for uneven wear and damage. Abnormal wear is usually caused by one or a combination of the following:

- Incorrect tire pressure
- Improper wheel alignment
- Out-of-balance wheel
- Severe braking

After rotation, inflate all tire pressures to specification (page 10-7) and inspect the lug nuts for tightness.

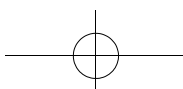

Customer Information and Reporting Safety Defects

Tire Information (U.S.A.)

CAUTION

Rotate unidirectional tires and radial tires that have an asymmetrical tread pattern or studs only from front to rear, not from side to side. Tire performance will be weakened if rotated from side to side.

(With limited-slip differential)

Don't use the following:

- Tires not of the designated size
- Tires of different sizes or types at the same time
- Tires not sufficiently inflated

If these instructions aren't followed, the rotation of the left and right wheels will be different and will thus apply a constant load on the limited-slip differential. This will cause a malfunction.

▼ Replacing a Tire

WARNING

Worn Tires:

Driving with worn tires is dangerous. Reduced braking, steering, and traction could result in an accident. Always use tires that are in good condition.

If a tire wears evenly, a wear indicator will appear as a solid band across the tread. Replace the tire when this happens.



New tread

Tread wear indicator

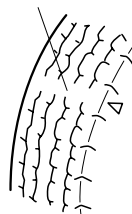

Worn tread

You should replace it before the band is across the entire tread.

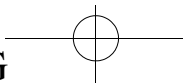

Customer Information and Reporting Safety Defects

Tire Information (U.S.A.)

NOTE

Tires degrade over time, even when they are not being used on the road. It is recommended that tires generally be replaced when they are 6 years or older. Heat caused by hot climates or frequent high loading conditions can accelerate the aging process. You should replace the spare tire when you replace the other road tires due to the aging of the spare tire. Regarding the manufacturing week and year is indicated with 4 digit. Refer to The tire labeling on page 9-21.

▼ Safety Practices

The way you drive has a great deal to do with your tire mileage and safety. So cultivate good driving habits for your own benefit.

- Observe posted speed limits
- Avoid fast starts, stops and turns
- Avoid potholes and objects on the road
- Do not run over curbs or hit the tire against the curb when parking

CAUTION

If you feel a sudden vibration or ride disturbance while driving or you suspect your tire or vehicle has been damaged, immediately reduce your speed. Drive with caution until you can safely pull off the road. Stop and inspect the tire for damage. If the tire is under-inflated or damaged, deflate it, remove the tire and rim and replace it with your spare tire. If you cannot detect a cause, have the vehicle towed to the nearest vehicle or tire dealer to have the vehicle inspected.

Tire Information (U.S.A.)

Vehicle Loading

NOTE

This vehicle is not designed to tow a trailer.

This section will guide you in the proper loading of your vehicle and/or trailer, to keep your loaded vehicle weight within its design rating capability, with or without a trailer. Properly loading your vehicle will provide maximum return of vehicle design performance. Before loading your vehicle, familiarize yourself with the following terms for determining your vehicle's weight ratings, with or without a trailer, from the vehicle's Safety Certification Label and Tire and Load Information Label:

WARNING

Overloaded Vehicle:

Overloading a vehicle is dangerous. The results of overloading can have serious consequences in terms of passenger safety. Too much weight on a vehicle's suspension system can cause spring or shock absorber failure, brake failure, handling or steering problems, irregular tire wear, tire failure or other damage.

Overloading makes a vehicle harder to drive and control. It also increases the distance required for stopping. In cases of serious overloading, brakes can fail completely, particularly on steep grades. The load a tire will carry safely is a combination of the size of the tire, its load range, and corresponding inflation pressure.

Never overload the vehicle and always observe the vehicle's weight ratings from the vehicle's Safety Certification and Tire and Load Information labels.

Base Curb Weight is the weight of the vehicle including a full tank of fuel and all standard equipment. It does not include passengers, cargo, or optional equipment.

Customer Information and Reporting Safety Defects

Tire Information (U.S.A.)

Vehicle Curb Weight is the weight of your new vehicle when you picked it up from your dealer plus any aftermarket equipment.

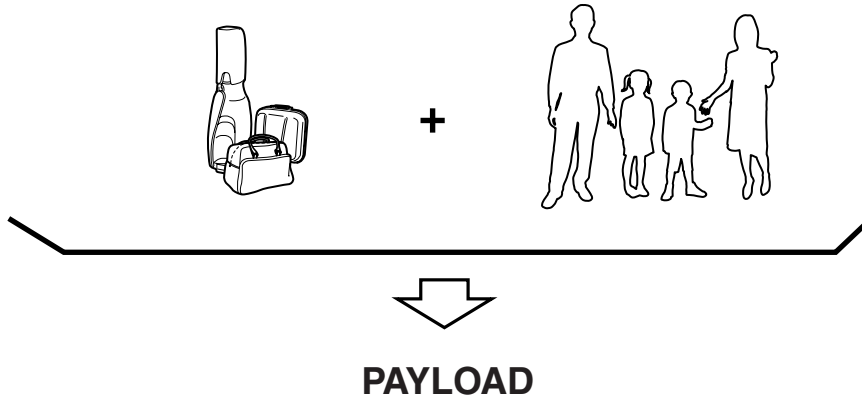

Payload is the combined weight of cargo and passengers that the vehicle is designed to carry. The maximum payload for your vehicle can be found on the Tire and Load Information label on the driver's door frame or door pillar. Look for "THE COMBINED WEIGHT OF OCCUPANTS AND CARGO SHOULD NEVER EXCEED XXX kg or XXX lbs" for your maximum payload. The payload listed on the tire label is the maximum payload for the vehicle as built by the assembly plant. If any aftermarket or dealer installed equipment has been installed on the vehicle, the weight of the equipment must be subtracted from the payload listed on the tire label in order to be accurate.

Customer Information and Reporting Safety Defects
Tire Information (U.S.A.)

SAMPLE



TIRE AND LOADING INFORMATION

SEATING CAPACITY : TOTAL 5 : FRONT 2 : REAR 3

The combined weight of occupants and cargo should never exceed 385 kg or 850 lbs.

TIRE	SIZE	COLD TIRE PRESSURE	SEE OWNER'S
FRONT	P 195/65R 15	230KPA, 33PSI	MANUAL FOR
REAR	P 195/65R 15	230KPA, 33PSI	ADDITIONAL
SPARE	T 115/70D 15	420KPA, 60PSI	INFORMATION

(XXXX)



CARGO

Cargo Weight includes all weight added to the Base Curb Weight, including cargo and optional equipment. When towing, trailer tongue load or king pin weight is also part of cargo weight.

The cargo weight limit decreases depending on the number of vehicle occupants. The cargo weight limit can be calculated by subtracting the total weight of the vehicle occupants from the “combined weight of occupants and cargo should never exceed” value on the tire label.

Customer Information and Reporting Safety Defects

Tire Information (U.S.A.)

Examples: Based on a single occupant weight of 68 kg, and a value of 385 kg for the “combined weight of occupants and cargo should never exceed”:

The cargo weight limit with one occupant is $385 \text{ kg} - 68 \text{ kg} = 317 \text{ kg}$

The cargo weight limit with two occupants is $385 \text{ kg} - (68 \times 2) \text{ kg} = 249 \text{ kg}$

If the weight of the occupant increases, the cargo weight limit decreases by that much.

GAW (Gross Axle Weight) is the total weight placed on each axle (front and rear) - including vehicle curb weight and all payload.

GAWR (Gross Axle Weight Rating) is the maximum allowable weight that can be carried by a single axle (front or rear). **These numbers are shown on the Safety Compliance Certification Label located on the driver's door frame or door pillar. The total load on each axle must never exceed its GAWR.**

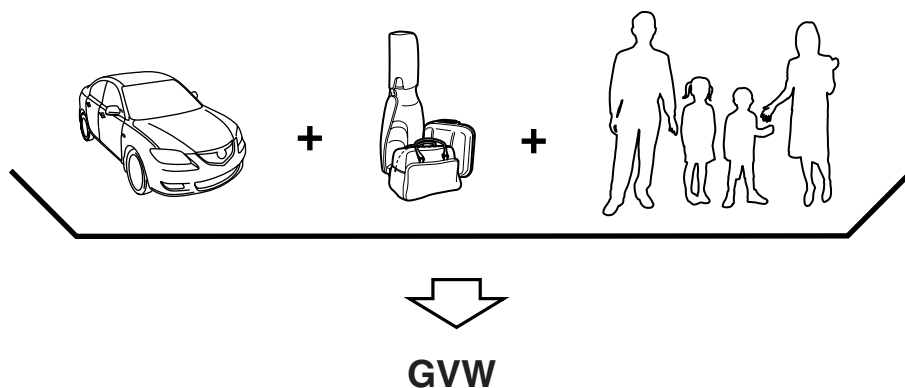

GVW (Gross Vehicle Weight) is the Vehicle Curb Weight + cargo + passengers.

GVWR (Gross Vehicle Weight Rating) is the maximum allowable weight of the fully loaded vehicle (including all options, equipment, passengers and cargo). **The GVWR is shown on the Safety Compliance Certification Label located on the driver's door frame or door pillar. The GVW must never exceed the GVWR.**

Customer Information and Reporting Safety Defects

Tire Information (U.S.A.)

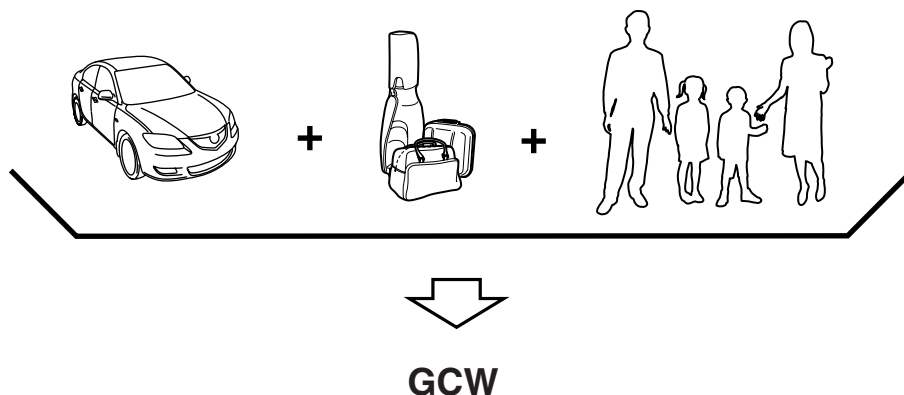

GCW (Gross Combined Weight) is the weight of the loaded vehicle (GVW) plus the weight of the fully loaded trailer.

GCWR (Gross Combined Weight Rating) is the maximum allowable weight of the vehicle and the loaded trailer - including all cargo and passengers - that the vehicle can handle without risking damage. (Important: The towing vehicle's braking system is rated for operation at GVWR, not at GCWR. Separate functional brakes should be used for safe control of towed vehicles and for trailers weighing more than 1,500 lbs). **The GCW must never exceed the GCWR.**

Maximum Loaded Trailer Weight is the highest possible weight of a fully loaded trailer the vehicle can tow. It assumes a vehicle with only mandatory options, no cargo (internal or external), a tongue load of 10–15% (conventional trailer) or king pin weight of 15–25% (fifth-wheel trailer), and driver only (150 lbs). **Consult your dealership (or the RV and Trailer Towing Guide provided by your dealership) for more detailed information.** **Tongue Load or Fifth-Wheel King Pin Weight** refers to the amount of the weight that a trailer pushes down on a trailer hitch.

Examples: For a 5000 lb conventional trailer, multiply 5000 by 0.10 and 0.15 to obtain a proper tongue load range of 500 to 750 lbs. For an 11,500 lb fifth-wheel trailer, multiply by 0.15 and 0.25 to obtain a proper king pin load range of 1,725 to 2,875 lbs.



Customer Information and Reporting Safety Defects
Tire Information (U.S.A.)

 **WARNING**

Exceeding GVWR or GAWR Specifications:

Exceeding the GVWR or the GAWR specified on the certification label is dangerous. Exceeding any vehicle rating limitation could result in a serious accident, injury, or damage to the vehicle.

Do not use replacement tires with lower load carrying capacities than the originals because they may lower the vehicle's GVWR and GAWR limitations. Replacement tires with a higher limit than the originals do not increase the GVWR and GAWR limitations.

Never exceed the GVWR or the GAWR specified on the certification label.

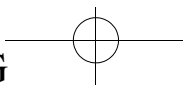

Customer Information and Reporting Safety Defects

Tire Information (U.S.A.)

Steps for Determining the Correct Load Limit:

Steps for Determining Correct Load Limit:

- (1) Locate the statement “The combined weight of occupants and cargo should never exceed XXX kg or XXX lbs” on your vehicle's placard.
- (2) Determine the combined weight of the driver and passengers that will be riding in your vehicle.
- (3) Subtract the combined weight of the driver and passengers from XXX kg or XXX lbs.
- (4) The resulting figure equals the available amount of cargo and luggage load capacity. For example, if the “XXX” amount equals 1400 lbs. and there will be five 150 lb passengers in your vehicle, the amount of available cargo and luggage load capacity is 650 lbs. (1400– 750 (5 × 150) = 650 lbs.)
- (5) Determine the combined weight of luggage and cargo being loaded on the vehicle. That weight may not safely exceed the available cargo and luggage load capacity calculated in Step 4.
- (6) If your vehicle will be towing a trailer, the load from your trailer will be transferred to your vehicle. Consult this manual to determine how this reduces the available cargo and luggage load capacity of your vehicle.

Reporting Safety Defects

Reporting Safety Defects (U.S.A.)

If you believe that your vehicle has a defect which could cause a crash or could cause injury or death, you should immediately inform the National Highway Traffic Safety Administration (NHTSA) in addition to notifying Mazda Motor Corporation (Your Mazda Importer/Distributor).

If NHTSA receives similar complaints, it may open an investigation, and if it finds that a safety defect exists in a group of vehicles, it may order a recall and remedy campaign. However, NHTSA cannot become involved in individual problems between you, your dealer, or Mazda Motor Corporation (Your Mazda Importer/Distributor).

To contact NHTSA, you may either call the Auto Safety Hotline toll-free at 1 (800) 424-9393 (or 366-0123 in Washington, D.C. area) or write to: NHTSA, U.S. Department of Transportation, Washington, D.C. 20590. You can also obtain other information about motor vehicle safety from the Hotline.

NOTE

If you live in the U.S.A., all correspondence to Mazda Motor Corporation should be forwarded to:

Mazda North American Operations
7755 Irvine Center Drive
Irvine, California 92618-2922
P.O. Box 19734
Irvine, CA 92623-9734
Customer Assistance Center or toll free at 1 (800) 222-5500

If you live outside of the U.S.A., please contact the nearest Mazda Distributor shown (page 9-10) in this booklet.



Customer Information and Reporting Safety Defects

Reporting Safety Defects

Reporting Safety Defects (Canada)

Canadian customers who wish to report a safety-related defect to Transport Canada, Defect Investigations and Recalls, may telephone the toll free hotline 1-800-333-0510, or contact Transport Canada by mail at: Transport Canada, ASFAD, Place de Ville Tower C, 330 Sparks Street, Ottawa ON K1A 0N5.

For additional road safety information, please visit the Road Safety website at:
<http://www.tc.gc.ca/roadsafety/menu.htm>

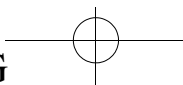

Service Publications

Service Publications

Factory-authorized Mazda service publications are available for owners who wish to do some of their own maintenance and repair.

When requesting any of our publications through an Authorized Mazda Dealer, refer to the chart below.

If they don't have what you need in stock, they can order it for you.

PUBLICATION ORDER NUMBER	PUBLICATION DESCRIPTION
9999-95-017B-06	2006 WORKSHOP MANUAL (English)
9999-95-019G-06	2006 WIRING DIAGRAM (English)
9999-95-038C-06 (U.S.A. only)	2006 OWNER'S MANUAL
9999-EC-038C-06 (Canada only)	2006 OWNER'S MANUAL
9999-PR-038C-06 (Puerto Rico, Mexico only)	2006 OWNER'S MANUAL

▼ WORKSHOP MANUAL:

Covers recommended maintenance and repair procedures of the drive train, body and chassis.

▼ WIRING DIAGRAM:

Provides electrical schematics as well as component location for the entire electrical system.

▼ OWNER'S MANUAL:

This booklet contains information regarding the proper care and operation of your vehicle. This is not a technician's manual.

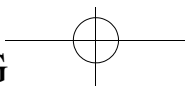
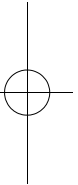
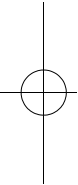
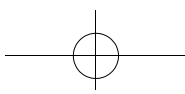



10 Specifications

Technical information about your Mazda.

Identification Numbers	10-2
Vehicle Information Labels	10-2
Specifications	10-4
Specifications	10-4

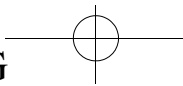

Identification Numbers

Vehicle Information Labels

▼ Vehicle Identification Number

The vehicle identification number legally identifies your vehicle. The number is on a plate attached the cowl panel located on the left corner of the dashboard. This plate can easily be seen through the windshield.

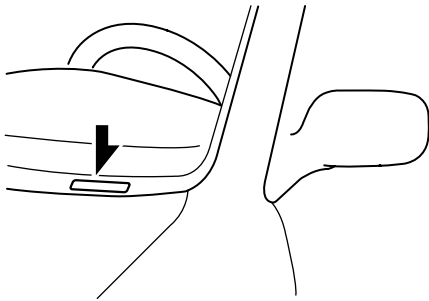

▼ Motor Vehicle Safety Standard Label

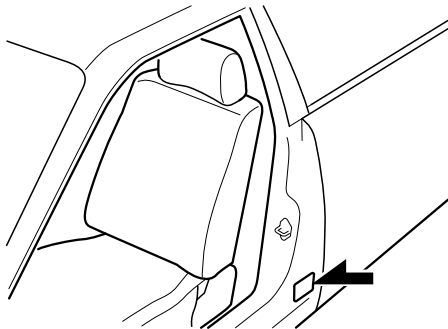

▼ Chassis Number

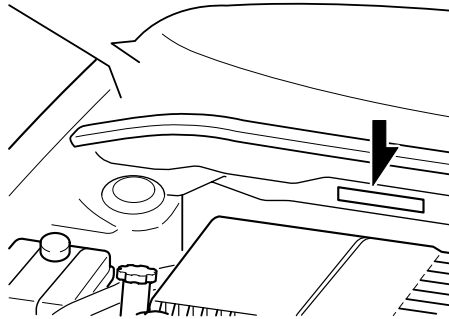

▼ Vehicle Emission Control Information Label

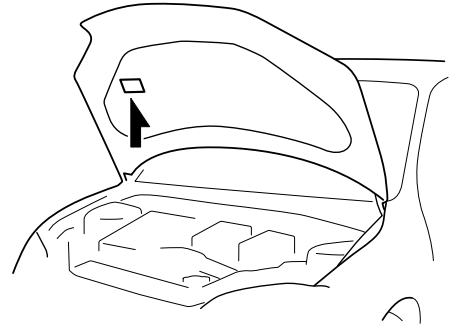

▼ Tire Pressure Label

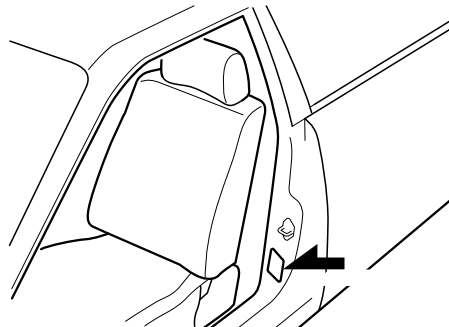

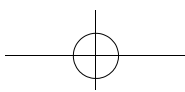

Identification Numbers

▼ Engine Number

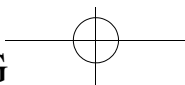
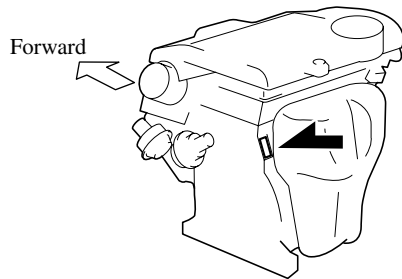

Specifications

Specifications

▼ Engine

Item	Model	
	2.0-liter engine	2.3-liter engine
Type	DOHC-16V in-line, 4-cylinder	
Bore×Stroke	87.5 × 83.1 mm (3.44 × 3.27 in)	87.5 × 94.0 mm (3.44 × 3.70 in)
Displacement	1,999 ml (1,999 cc, 121.9 cu in)	2,261 ml (2,261 cc, 137.9 cu in)
Compression ratio	10.0	9.7

▼ Electrical System

Item	Classification
Battery	12V-40AH/5HR, 12V-52AH/5HR, 12V-55AH/5HR
Alternator	12 V - 90 A
Starter	2.0-liter engine
	2.3-liter engine
Spark-plug number	LFG1 18 110C*
Spark-plug gap	1.25—1.35mm (0.050—0.053 in)

* ex factory

NOTE

When cleaning the iridium plugs, do not use a wire brush. The fine particulate coating on the iridium alloy and platinum tips could be damaged.

▼ Lubricant Quality

Lubricant	Classification
Engine oil	Refer to the recommended SAE viscosity numbers on page 8-11.
Manual transaxle oil	Any temperature
	Above 10°C (50°F)
	Automatic transaxle fluid
	Power steering fluid
Brake/Clutch fluid	

Specifications

▼ Capacities

(Approximate Quantities)

Item		Capacity
Engine oil	With oil filter replacement	4.3 L (4.5 US qt, 3.8 Imp qt)
	Without oil filter replacement	3.9 L (4.1 US qt, 3.4 Imp qt)
Coolant	With heater	7.5 L (7.9 US qt, 6.6 Imp qt)
	Without heater	6.9 L (7.3 US qt, 6.1 Imp qt)
Manual transaxle oil		2.87 L (3.03 US qt, 2.53 Imp qt)
Automatic transaxle fluid	4-speed transaxle	7.2 L (7.6 US qt, 6.3 Imp qt)
	5-speed transaxle	8.14 L (8.60 US qt, 7.16 Imp qt)
Fuel tank		55 L (15 US gal, 12 Imp gal)

Check oil and fluid levels with dipsticks or reservoir gauges.

▼ Dimensions

Item		Model	
		4 Door	5 Door
Overall length	(STD)	4,530 mm (178.3 in)	—
	(SAP)	4,540 mm (178.7 in)	4,485 mm (176.6 in)
Overall width*		1,755 mm (69.1 in)	1,755 mm (69.1 in)
Overall height		1,465 mm (57.7 in)	1,465 mm (57.7 in)
Front tread		1,530 mm (60.2 in)	1,530 mm (60.2 in)
Rear tread		1,515 mm (59.6 in)	1,515 mm (59.6 in)
Wheelbase		2,640 mm (103.9 in)	2,640 mm (103.9 in)

* With side protector

▼ Weights

4 Door

2.0-liter engine

Item		Weight	
		Manual transaxle	Automatic transaxle
GVWR (Gross Vehicle Weight Rating)		1,702 kg (3,752 lb), 1,708 kg (3,765 lb)* ¹	1,721 kg (3,794 lb), 1,727 kg (3,807 lb)* ¹
GAWR (Gross Axle Weight Rating)	Front	904 kg (1,993 lb)	924 kg (2,037 lb)
	Rear	798 kg (1,759 lb), 804 kg (1,772 lb)* ¹	797 kg (1,757 lb), 803 kg (1,770 lb)* ¹

*1 P-ZEV

Specifications

2.3-liter engine

Item	Weight	
	Manual transaxle	Automatic transaxle
GVWR (Gross Vehicle Weight Rating)	1,732 kg (3,818 lb)	1,760 kg (3,880 lb)
GAWR (Gross Axle Weight Rating)	Front	928 kg (2,046 lb)
	Rear	804 kg (1,772 lb)
		803 kg (1,770 lb)

5 Door

Item	Weight	
	Manual transaxle	Automatic transaxle
GVWR (Gross Vehicle Weight Rating)	1,743 kg (3,843 lb)	1,771 kg (3,904 lb)
GAWR (Gross Axle Weight Rating)	Front	930 kg (2,050 lb)
	Rear	813 kg (1,793 lb)
		811 kg (1,788 lb)

▼ Air Conditioner

Gas complies with SAE J639	Maximum operating charge
HFC134a (R-134a)	0.5 kg (17.55 oz)

▼ Light Bulbs

Exterior light

Light bulb		Category			
		Wattage	ECE R	SAE	
Headlights	High beam	60	HB3	—	
	Low beam	Halogen	55	H7	—
		Xenon fusion	35	D2S	—
Front turn signal lights/Side-marker lights		27/8	—	#1157NA	
Fog lights *		55	H11	—	
Side turn signal lights * ¹		5	WY5W	—	
High-mount brake light		18	W16W	#921	
Rear turn signal lights		21	W21W	#7440	
Brake lights/Taillights	With Non-LED bulb	21/5	W21/5W	#7443	
	With LED bulb * ²	4/0.8	—	—	
Reverse light		21	W21W	#7440	
License plate light		5	W5W	—	

*1 Bulb replacement is not possible because it is built into the unit. Replace the unit.

*2 Bulb replacement is not possible. The rear combination component must be replaced.

10-6 *Some models.

Specifications

Interior light

Light bulb	Category	
	Wattage	ECE R
Trunk light (4 Door)	5	W5W
Luggage compartment light (5 Door)		—
Overhead light/Map lights (Front) *		W5W
Overhead light (Rear)	10	—

▼ Tires

NOTE
The tires have been optimally matched with the chassis of your vehicle. When replacing tires, Mazda recommends that you replace tires of the same type originally fitted to your vehicle. For details, contact an Authorized Mazda Dealer.

Check the tire pressure label for tire size and inflation pressure.

Refer to Tire Inflation Pressure on page 8-30.

Standard tire

Tire size	Inflation pressure	Inflation pressure
P195/65R15 89H	230 kPa (33 psi)	230 kPa (33 psi)
P205/55R16 89H	220 kPa (32 psi)	220 kPa (32 psi)
P205/50R17 88V	220 kPa (32 psi)	220 kPa (32 psi)

Temporary spare tire

Tire size	Inflation pressure
T115/70D15	420 kPa (60 psi)
T125/70D16	

▼ Fuses

Refer to the fuse rating on page 8-45.

*Some models. **10-7**

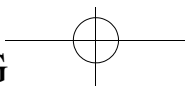
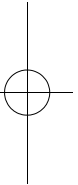
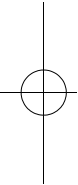
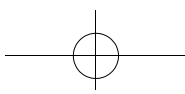

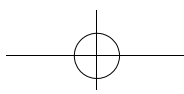

11 Index

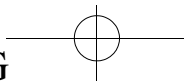

Index

A

- Add-On Non-Genuine Parts and Accessories 9-16
- Air Bag Systems 2-38
- Air Filter 8-22
- Ambient Temperature Display 6-46
- Antenna 6-16
- Anti-Lock Brake System (ABS) 5-6
 - Warning light 5-7
- Appearance Care 8-52
- Ashtray 6-50
- Audio System 6-16
 - Audio control switch 6-38
 - Audio Set 6-23
 - Operating tips for audio system 6-16
 - Safety certification 6-41
- Automatic Transaxle
 - Driving tips 5-17
 - Fluid 8-18
 - Manual shift mode 5-13
 - Shift-lock override 5-12
 - Shift-lock system 5-12
 - Transaxle ranges 5-11

B

- Battery
 - Emergency starting 7-14
 - Maintenance 8-27
 - Specifications 10-4
- Beep Sounds
 - Ignition key reminder 5-45
 - Lights-on reminder 5-45
 - Seat belt warning beep Sounds... 5-45
 - Tire inflation pressure warning beep 5-45

B

- Before Starting the Engine 4-6
 - After getting in 4-6
 - Before getting in 4-6
- Body Lubrication 8-21
- Bottle Holder 6-52
- Brake/Clutch
 - Fluid 8-16
- Brakes
 - Anti-lock brake system (ABS) 5-6
 - Brakes assist 5-8
 - Foot brake 5-4
 - Parking brake 5-5
 - Warning light 5-6
- Break-In Period 4-7
- Bulb Replacement 8-35

C

- Capacities 10-5
- Carbon Monoxide 4-5
- Cargo Securing Loops 6-53
- Cargo Sub-Compartment 6-53
- Catalytic Converter 4-3
- Cell Phones 9-17
- Center Console 6-53
- Child Restraint
 - Child restraint precautions 2-21
 - Installing child-restraint systems 2-25
 - LATCH child-restraint systems 2-33
- Child Safety Locks for Rear Doors 3-9
- Cigarette Lighter 6-50
- Climate Control System 6-2
 - Gas specifications 10-6
- Clock 6-46
- Cruise Control 5-18
- Cup Holder 6-51

Index

C

Customer Assistance 9-2

D

Dashboard Illumination 5-32
Daytime Running Lights 5-48
Defroster
 Rear window 5-54
Dimensions 10-5
Door Locks 3-6
Driving In Flooded Area 4-11
Driving Tips 4-7
 Automatic transaxle 5-17
 Break-in period 4-7
 Driving in flooded area 4-11
 Hazardous driving 4-8
 Money-saving suggestions 4-7
 Rocking the vehicle 4-8
 Winter driving 4-9

E

Emergency Starting 7-14
 Flooded engine 7-14
 Jump-starting 7-15
 Push-starting 7-18
Emergency Towing 7-19
Emission Control System 4-3
Engine
 Coolant 8-14
 Exhaust gas 4-5
 Hood release 3-20
 Oil 8-11
 Overheating 7-12
 Starting 5-3
Engine Compartment Overview 8-10
Engine Coolant
 Overheating 7-12

E

Engine Coolant Temperature
Gauge 5-31
Exhaust Gas 4-5
Exterior Care 8-54

F

Flasher
 Hazard warning 5-55
 Headlights 5-46
Flat Tire 7-3
 Changing 7-6
 Spare tire and tool storage 7-3
Flexible Floor Board 6-54
Fluids
 Classification 10-4
 Owner maintenance 8-8
Fog Lights 5-49
Foot Brake 5-4
Front Seats 2-2
Fuel
 Filler lid and cap 3-18
 Gauge 5-31
 Requirements 4-2
 Tank capacity 10-5
Fuses 8-45
 Panel description 8-48
 Replacement 8-45

G

Glove Box 6-52

H

Hazard Warning Flasher 5-55
Hazardous Driving 4-8

Index

H

Headlights	
Control	5-46
Flashing	5-48
High-low beam	5-48
Leveling	5-48
On reminder	5-48
Hood Release	3-20
Horn	5-55

I

Ignition	
Keys	3-2
Switch	5-2
Illuminated Entry System	6-42
Immobilizer System	3-23
Indicator Lights	5-33
Cruise main	5-43
Cruise set	5-43
Headlight high-beam	5-42
Power steering malfunction	5-43
Security	5-42
Shift position	5-42
Turn-signal/hazard warning	5-44
Information Display	6-45
Ambient temperature display	6-46
Audio display	6-47
Climate control display	6-47
Clock	6-46
Information display functions	6-45
Trip computer	6-47
Inside Trunk Release Lever	3-15
Instrument Cluster	5-28
Instrument Cluster Dimmer Select	
Button	5-32
Interior Care	8-57
Interior Lights	6-42

J

Jump-Starting	7-15
---------------------	------

K

Keyless Entry System	3-3
Keys	3-2

L

Label Information	10-2
Lane-Change Signals	5-49
Liftgate	3-9
Luggage compartment	3-11
Light Bulbs	
Replacement	8-35
Specifications	10-6
Lighter	6-50
Lighting Control	5-46
Lubricant Quality	10-4
Luggage Compartment Light	6-44

M

Maintenance	
Introduction	8-2
Owner maintenance precautions	8-9
Owner maintenance schedule	8-8
Scheduled	8-3
Manual Transaxle Operation	5-9
Recommendations for shifting	5-9
Map Lights	6-43
Mirrors	
Outside mirrors	3-28
Rearview mirror	3-30
Money-Saving Suggestions	4-7
Moonroof	3-21

Index

O

Odometer and Trip Meter	5-29
Outside Mirrors	3-28
Overhead Lights	6-43
Overheating	7-12
Overloading	4-11

P

Paint Damage	8-52
Parking Brake	5-5
Parking in an Emergency	7-2
Power Door Locks	3-8
Power Steering	5-17
Fluid	8-17
Power steering malfunction indicator light	5-17
Power Windows	3-16
Push-Starting	7-18

R

Rear Door Child Safety Locks	3-9
Rear Seat	2-5
Rear Window Defroster	5-54
Rear Window Washer	5-53
Rear Window Wiper	5-53
Rearview Mirror	3-30
Recreational Towing	7-22
Registering Your Vehicle in A Foreign Country	9-15
Rocking the Vehicle	4-8

S

Safety Defects, Reporting	9-41
---------------------------------	------

S

Seat Belt System	
Automatic locking	2-11
Belt minder	2-20
Center-rear position	2-16
Emergency locking	2-11
Except center-rear position	2-12
Extender	2-18
Pregnant women	2-10
Pretensioner and load limiting	2-14
Seat belt precautions	2-9
Warning light/beep	2-19
Seats	
Front seat	2-2
Rear seat	2-5
Security System	
Immobilizer system	3-23
Theft-deterrent system	3-26
Service Publications	9-43
Spare Tire and Tool Storage	7-3
Specifications	10-4
Speedometer	5-29
SRS Air Bags	
How the Air Bags Work	2-45
Supplemental restraint systems precautions	2-38
Starting the Engine	5-3
Steering Wheel	3-28
Horn	5-55
Storage Compartments	6-52
Cargo securing loops	6-53
Cargo sub-compartment	6-53
Center console	6-53
Flexible Floor Board	6-54
Glove box	6-52
Sunshade	3-22
Sunvisors	6-42

Index

T

Tachometer	5-31
Temporary Spare Tire	8-33
Theft-Deterrent System	3-26
Tiedown	
Hook	7-20
Tire Information	9-21
Tire Pressure Monitoring System	5-22
System error activation	5-25
Tire pressure monitoring system warning light	5-23
Tires and wheels	5-25
Tires	
Inflation pressure	8-30
Replacement	8-32
Rotation	8-31
Snow tires	4-9
Spare tire and tool storage	7-3
Specifications	10-7
Flat Tire	7-3
Tire chains	4-10
Uniform tire quality grading system (UTQGS)	9-19
Tool	7-3
Towing	
Description	7-19
Emergency towing	7-19
Recreational towing	7-22
Trip Meter	5-29
Trunk Lid	3-12
Trunk Light	3-14
Turn and Lane-Change Signals	5-49

V

Vanity Mirrors	6-42
Vehicle Information Labels	10-2

W

Warning Lights	5-33
ABS	5-35
Air bag system	5-38
Automatic transaxle	5-40
Brake system	5-35
Charging system	5-36
Check engine	5-37
Door-ajar	5-39
Engine oil pressure	5-37
Front seat belt pretensioner system	5-38
Low fuel	5-38
Low washer fluid level	5-40
Seat belt	5-38
Tire pressure monitoring system	5-40
Warranty	9-12
Washer Fluid	8-20
Weights	10-5
Wheel Replacement	8-33
Windows	
Power windows	3-16
Windshield Washer	5-52
Windshield Wipers	5-50
Blades replacement	8-23
Winter Driving	4-9

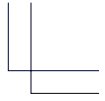

NAVIGATION SYSTEM

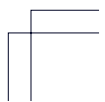



Contents, Accessories, and Laser

Before Use

Accessories

Please contact an Authorized Mazda Dealer if you are missing any of the following accessories.



● Map Disc

CAUTION:
THIS PRODUCT IS A CLASS I LASER PRODUCT. HOWEVER THIS PRODUCT USES A VISIBLE/ INVISIBLE LASER BEAM WHICH COULD CAUSE HAZARDOUS RADIATION EXPOSURE IF DIRECTED. BE SURE TO OPERATE THIS PRODUCT CORRECTLY AS INSTRUCTED. USE OF CONTROLS OR ADJUSTMENTS OR PERFORMANCE OF PROCEDURES OTHER THAN THOSE SPECIFIED HEREIN MAY RESULT IN HAZARDOUS RADIATION EXPOSURE. DO NOT OPEN COVERS AND DO NOT REPAIR YOURSELF. REFER SERVICING TO QUALIFIED PERSONNEL.

Laser products:
Wave length: 650 nm
Laser power: No hazardous radiation is emitted with safety protection.

Preparation

Immediate use

Advanced use

If necessary

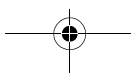
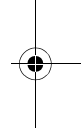
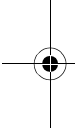

Product

Accessories	2	Before Use
Laser Product	2	
Contents	3	
Safety Information	4	
Introduction	6	
Names and Functions	8	
Activation	10	Getting started
Screen names and functions	12	
Screen change	14	
● Changing the Map Orientation/Scale	15	
Destination Entry and Route Search	16	Routing
● Change (Change Search Area)		
● Point of interest		
● Memory Point		
● Preset Destination		
● Intersection		
● Phone number		
● Select from map		
● Address		
● Emergency		
● Home		
● Previous Destination		
● Freeway On/Off Ramp		
● Coordinates		
Use POI	22	
Character Entry	23	
Direct Destination Input	24	
POI Icons on Maps / Delete Destination	25	
Route Options	26	
Address Book	32	Address Book
Navigation Set Up	38	Navigation Set Up
Precautions/System Performance	46	As necessary
● Voice Guidance		
● Map Matching		
● Route Guide		
Troubleshooting	52	
● GPS		
● Positioning Accuracy		
● Route Search		
Maintenance	53	
● Verification First		
● Error Messages		



Safety Information

Before Use

- Read this owner's manual for your Navigation System carefully before using the system. They contain instructions about how to use the system in a safe and effective manner. Mazda assumes no responsibility for any problems resulting from failure to observe the instructions given in this manual.
- This manual uses pictographs to show you how to use the product safely and to alert you to potential dangers resulting from improper connections and operation. The meanings of the pictographs are explained below. It is important that you fully understand the pictographs and explanations in order to use this manual and the system properly.



Warning

Warning

The presence of this Warning symbol in the text is intended to alert you to the importance of heeding the operation instructions. Failure to heed the instructions may result in severe injury or death.



Warnings

- **Do not keep your eyes fixed on the monitor screen or operate the system while driving.**

Do not change the settings and destination locations while driving. Minimize the time spent on viewing the monitor screen and listening to the voice guidance while driving. Operating the system will distract the driver from looking ahead of the vehicle and can cause accidents. Always stop the vehicle in a safe location and use the parking brake before operating the system.

- **Always obey local traffic regulations.**

Your guided route may include roads that are not open to vehicles or are closed due to traffic regulations. Comply with the local traffic regulations and take another route.

- **Do not use the unit when it is out of order.**

If the unit is out of order (no image, no sound) or in an abnormal state (has foreign matter in it, is exposed to water, is smoking, or smells), then turn it off immediately and consult with an Expert repairer, we recommend an Authorized Mazda Repairer. Using the unit in an out-of-order condition may lead to accidents, fires, or electric shocks.

- **Use the proper power supply.**

This product is designed for operation with a negative grounded 12 V DC battery system.

- **Do not disassemble.**

Do not disassemble the product or attempt to repair it yourself. If the product needs to be repaired, take it to an Expert repairer, we recommend an Authorized Mazda Repairer.

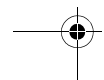
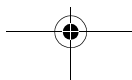



Caution

Caution

The presence of this Caution symbol in the text is intended to alert you to the importance of heeding the operation instructions. Failure to heed the instructions may result in injury or material damage.

Before Use



Cautions

- **Do not use the product where it is exposed to water, moisture, or dust.**
Exposure to water, moisture, or dust may lead to smoke, fire, or other damage to the unit. Make especially sure that the unit does not get wet in car washes or on rainy days.
- **Keep the voice guidance volume at an appropriate level.**
Keep the volume level low enough to be aware of road and traffic conditions while driving.
- **Protect the Deck Mechanism.**
Do not insert any foreign objects into the slot of this unit.
- **This navigation system is designed use for exclusively in automobiles.**
This navigation system should only be installed in an automobile. Do not install it in a ship, aircraft, or any other vehicles except an automobile. Do not use it detached from the vehicle.
- **Do not insert or allow your hand or fingers to be caught in the unit.**
To prevent injury, do not get your hand or fingers caught in moving parts or in the disc slot. Especially watch out for infants.

Operation is subject to the following two conditions;

- (1) this device may not cause interference, and
- (2) this device must accept any interference, including interference that may cause undesired operation of the device.

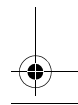
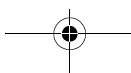
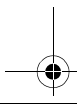
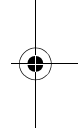
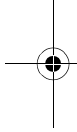



Introduction

Before Use

Use This Product Safety

■ Extremely low or high temperatures may interfere with normal operation

The inside of the vehicle can become very hot or cold when it is parked for extended periods in direct sunlight or in cold places with the engine turned off. The navigation system may not operate normally under such circumstances. Turn off the navigation system until the inside of the vehicle has cooled down or warmed up. If the system does not operate thereafter, consult an Expert repairer, we recommend an Authorized Mazda Dealer.

Navigation System

This navigation system utilizes GPS* satellite signals, Speed sensor and Gyrosensor to track and display your vehicle's current position, and to guide you from your starting point to your destination along a calculated route.

* : GPS (Global Positioning System) is a position detecting system utilizing the signals from GPS satellites deployed by the U.S. Defense Department.

Screens

Screens displayed in this manual may differ from those on the actual display.

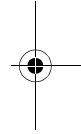
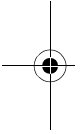

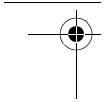

Before Use

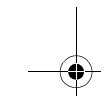
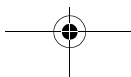
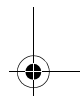
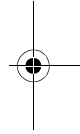
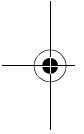

Names and Functions

Before Use

Joystick

- Selects items by tilting it up, down, right, and left.
- Scrolls map.

RET key

Returns to the previous screen.

VOICE key

- Initiates vocal guidance for route maneuvers.
- Adjusts screen quality. ( page 13)

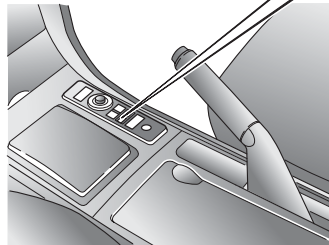
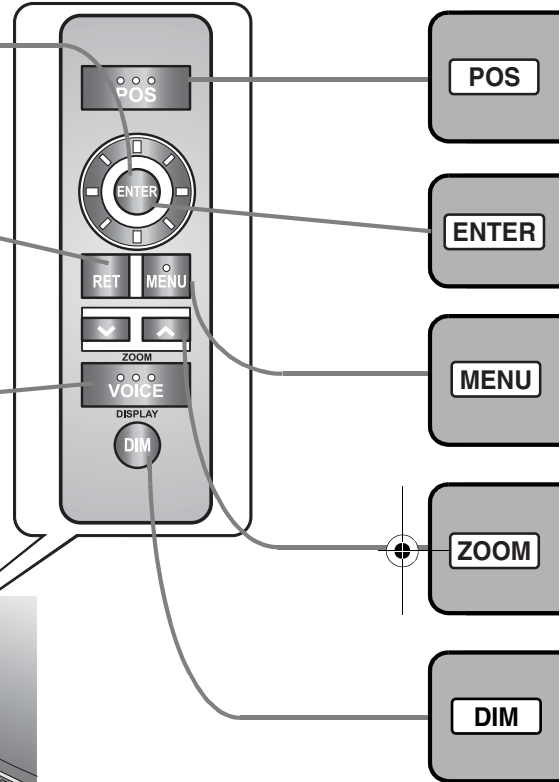

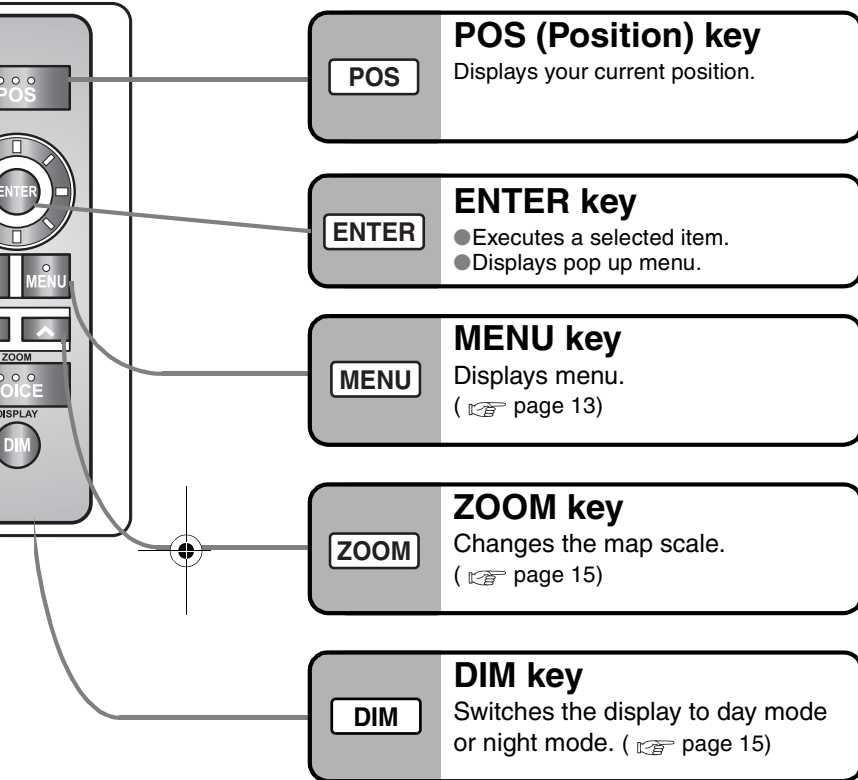

Before Use

Switching the Display Mode

When the headlight switch is in the ● or ☰ position, the display switches to night mode.

Press the DIM key to switch to day mode.

To return to night mode, press the DIM key again.

Activation

Insert the map disc into the unit to start the Mobile Navigation System.



■ Map Disc

- Refer to “Handling and Care of Map Discs” to know how to handle a map disc (page 53).

Note

- The map disc cannot be inserted or ejected while the ignition switch is in the OFF position.
- Remember that the battery can run down if the ignition switch is kept in the ON or ACC position for a long time while the engine not running.

Getting started

- 1 Turn the ignition switch to the ON position and press **OPEN** to open the display.

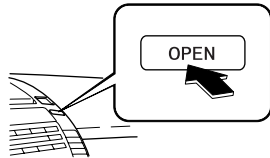

Note

- This display angle can be adjusted by pressing **TILT**.

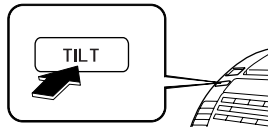

When the **TILT** is pressed, the display angle changes in stages.

- Press **OPEN** to close the display.

- 2 Insert the map disc with the printed side facing up.



Note

- The main unit is located in the glove box compartment.
- Condensation may form on the optical lens or the map disc inside the unit when the temperature in the vehicle increases in a short time such as when heating the car on a cold day. This condensation may cause malfunctions. If so, unload the map disc and do not operate the unit for approximately 1 hour. Wipe the condensation off the map disc with a soft cloth. If the unit does not operate correctly after 1 hour, consult an Authorized Mazda Dealer.

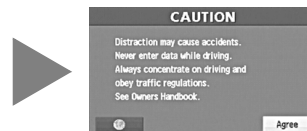
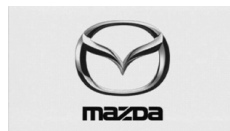

[CAUTION] screen



3 Read CAUTION carefully, and select **Agree** and press **ENTER**.

ENTER



- The Current Position screen appears.

Note

- You can select the language by select  and press **ENTER**. You can also change the selected language using Language Selection. ( page 45)
- The CAUTION screen remains on the display unless you select **Agree** and press **ENTER**.



Most functions are inhibited while the vehicle is in motion. Please read the handbook for operation instructions. Always obey traffic regulations.



Getting started

Removing the Map Disc

When the ignition switch is in the ACC position and press **▲ (EJECT)**.

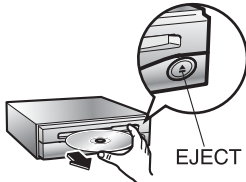



Do not get your hand or fingers caught in moving parts or in the disc slot. This can cause injuries. Children are inquisitive, try to install or remove the map disc without infants looking on.

Buttons on the screen

Select the buttons by using Joystick and press **ENTER**. Colors for unavailable buttons will be pale.

Screen names and functions

Screens Before Setting Route

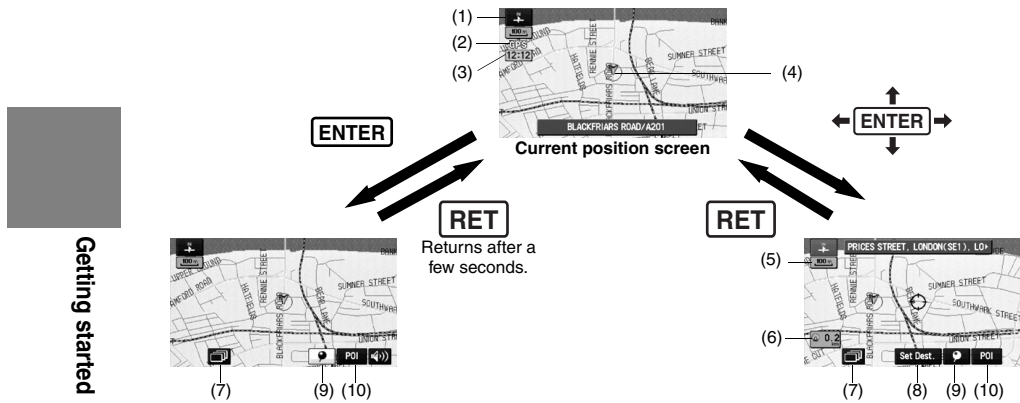

- (1) **Map Orientation control**
(☞ page 15)
- (2) **GPS (Global Positioning System) marker**
(☞ page 47)
- (3) **Clock**
Clock will be displayed when you set up Clock on Navigation Set Up On.
- (4) **Vehicle marker**
Shows the current position and direction of your vehicle.
- (5) **Scale display**
Displays the scale of the map.
- (6) **Distance from current position**
Displays the distance from the current position to the position pointed by ☉.
- (7) **Screen Configuration**
(☞ page 14)
- (8) **Set Destination button**
The destination or way point will be set at the position pointed by ☉ in the scroll screen.
- (9) **Store Memory Point button**
Stores markers on the map.
- (10) **POI (Point of Interest) Display button**
(☞ page 22)

Screens During Route Guidance

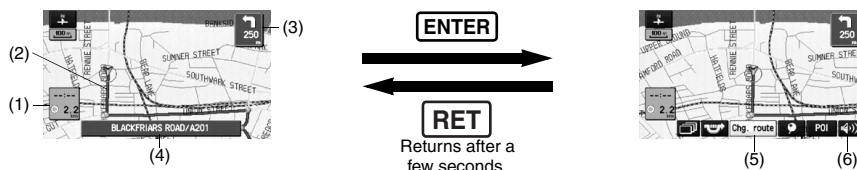

- (1) **Distance and Time to Destination display**
Displays the time* and distance to the destination or way point. Selecting this will display the next and further information on the way point or time and distance to the destination. (* Either required time or estimated time arrival)
- (2) **Route display**
Shows the provided route as a thick blue line.
- (3) **Turn Arrow display**
Shows the direction to turn at the next junction and the distance to the junction.
- (4) **Current Road Name**
Shows the name of the road you are currently driving on.
- (5) **Change Route button**
Displays the Route Option menu so that settings for route calculation can be changed.
- (6) **Volume button**
Displays the volume adjustment screen.

Menu

Menu appears when pressing **MENU**.

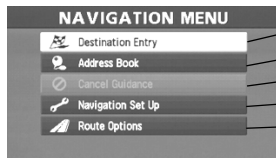

- Destination Entry and Route Search (page 16)
- Address Book (page 32)
- Cancel Guidance (page 25)
- Navigation Set Up (page 38)
- Route Options (page 26)

Screen adjustments and settings

Display Menu screen will be shown when you press **VOICE** (DISP) and hold.

Note

Display Menu screen will be disappeared when they have been unused during a few seconds.

■ Adjusting the screen quality

- Adjusts the screen brightness

Select "ADJ.", press **ENTER**, and then select "BRIGHT", press **ENTER** and the screen will be brighter when scrolling it to the right, or darker when scrolling it to the left.

- Adjusts the screen contrast

Select "ADJ.", press **ENTER**, and then select "CONTRAST", press **ENTER** and the screen will be lighter when scrolling it to the right, or deeper when scrolling it to the left.

Note

- Adjust by scrolling the Joystick to the right and left.
- Restore the adjustment value to the default when selecting "RESET", press **ENTER**.

■ Clearing the screen

Select "DISP OFF", press **ENTER** and the screen will disappear.
The screen will appear again when pressing any buttons.

■ Daytime screen/Night screen

When the headlights are on, daytime mode can also be selected (if extra screen certain nighttime conditions). This selection can only be done when the headlights are on. Press



ENTER to switch between day and night modes.

- Alternatively, you can carry out the same operation by using **DIM**.

Screen change

Getting started

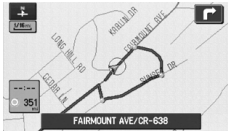
Current position map
Shows the current position of your vehicle on the scale selected.

Route and flags
When the route has been set, the blue line represents the route and the following two flags appear on the map.

 Press **ENTER** and Select 

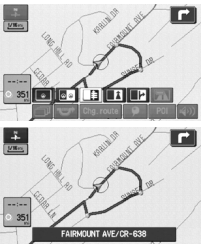

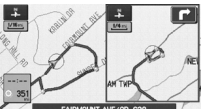
Map configuration

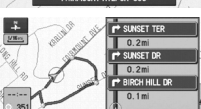
Single map
 One-screen display of map possible.

Dual map
 Dual screen display of map.

Turn List
 While using route guidance, the directions for the next junction where you have to turn are shown as Turn List.

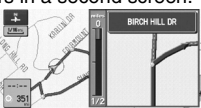
Turn Arrow
 While using route guidance, the directions for the next junction where you have to turn are shown as Turn Arrow.

Enlarged Junction Diagram
 Before a fork in the road, an enlarged diagram of the junction automatically appears in a second screen. This is to make route guidance even clearer.

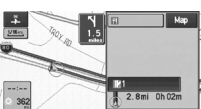

During route guidance, an enlarged diagram of an approaching fork or junction appears. When you drive past the junction, the enlarged diagram disappears.

During route guidance, an enlarged diagram of the freeway automatically appears in a second screen as you approach a fork on the freeway. This is to make route guidance even clearer.

Freeway information
 A simplified diagram of the freeway can be displayed.

Changing the Map Orientation/Scale



Warning

Do not keep your eyes fixed on the monitor screen or operate the system while driving

Do not change the settings and destination locations while driving. Minimize the time spent viewing the monitor screen and listening to the voice guidance while driving. Operating the system will distract the driver from looking ahead of the vehicle and may cause an accident. Always stop the vehicle in a safe location and use the parking brake before operating the system.

Map orientation

- 1 Press **ENTER**
- 2 Select ,  and press **ENTER**

● North Up: Geographic north is up.





● Head Up: The direction you are heading is up.







Getting started

Map scale

- 1 **ZOOM**

● The map can be displayed in 13 steps with scales from  to .



	Imperial display	Metric display
	128 mi (mile)	256 km
	16 mi (mile)	32 km
	2 mi (mile)	4 km
	1/4 mi (mile)	500 m
	1/32 mi (mile)	50 m

Position before change

<Scale bar>

● ZOOM OUT: Enlarges the map.



ZOOM

● ZOOM IN: Reduces the map. (more detail.)



Destination Entry and Route Search

● You can set the destination using various methods provided by the system.

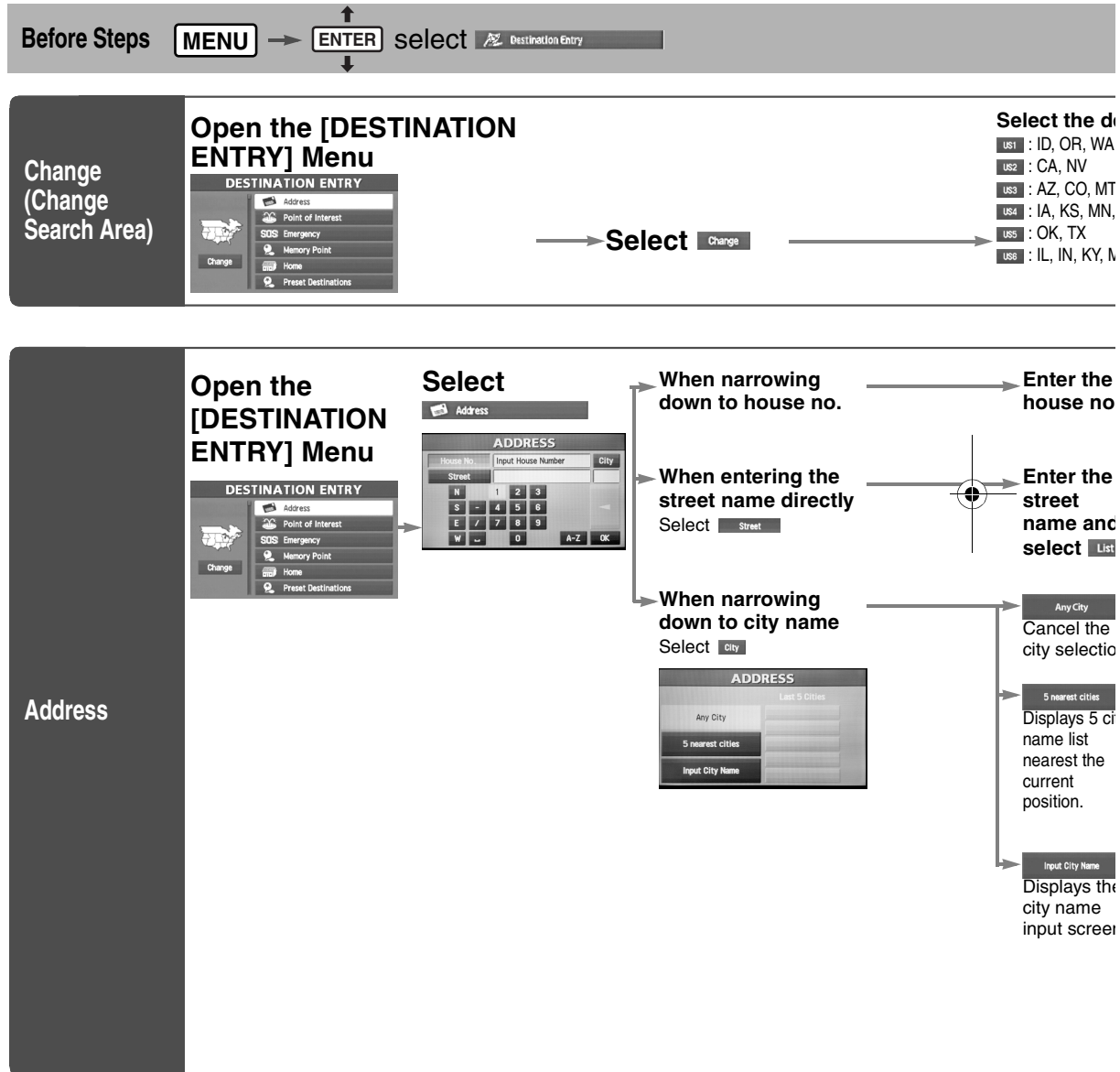



Warnings

- **Do not keep your eyes fixed on the monitor screen or operate the system while driving.** Do not change the settings and destination locations while driving. Minimize the time spent viewing the monitor screen and listening to the voice guidance while driving. Operating the system will distract the driver from looking ahead of the vehicle and may cause an accident. Always stop the vehicle in a safe location before operating the system.
- Route searches with the navigation system can include roads that you can not drive on and roads that you are prohibited from driving on due to traffic regulations. Please comply with the traffic regulations.

Select the desired Search Area

- | | |
|----------------------------------|--------------------------------------|
| US1 : ID, OR, WA, | US7 : AR, AL, LA, MS, TN |
| US2 : CA, NV | US8 : CT, MA, ME, NH, NJ, NY, RI, VT |
| US3 : AZ, CO, MT, NM, UT, WY | US9 : DC, DE, MD, PA, VA, WV |
| US4 : IA, KS, MN, MO, ND, NE, SD | US10 : FL, GA, NC, SC |
| US5 : OK, TX | CAN : CANADA |
| US6 : IL, IN, KY, MI, OH, WI | |

DESTINATION ENTRY Menu screen appears
Select

Routing

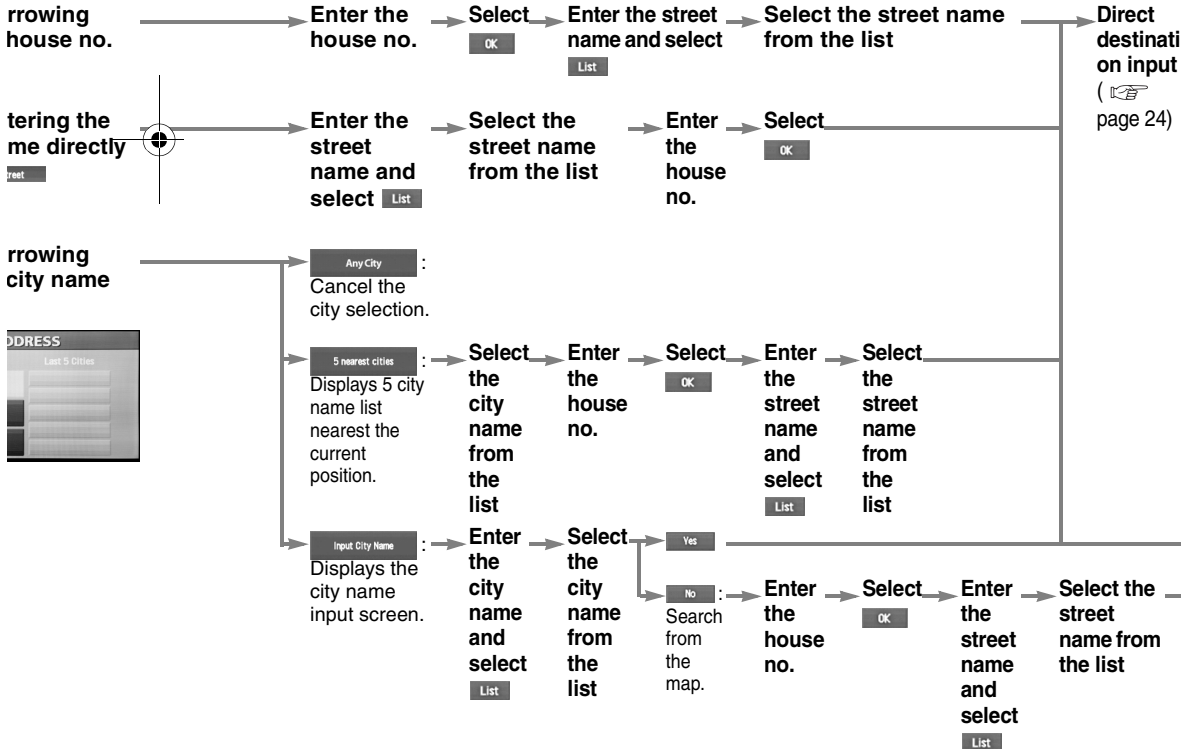

● For Character Entry, please refer to page 23.

Destination Entry and Route Search

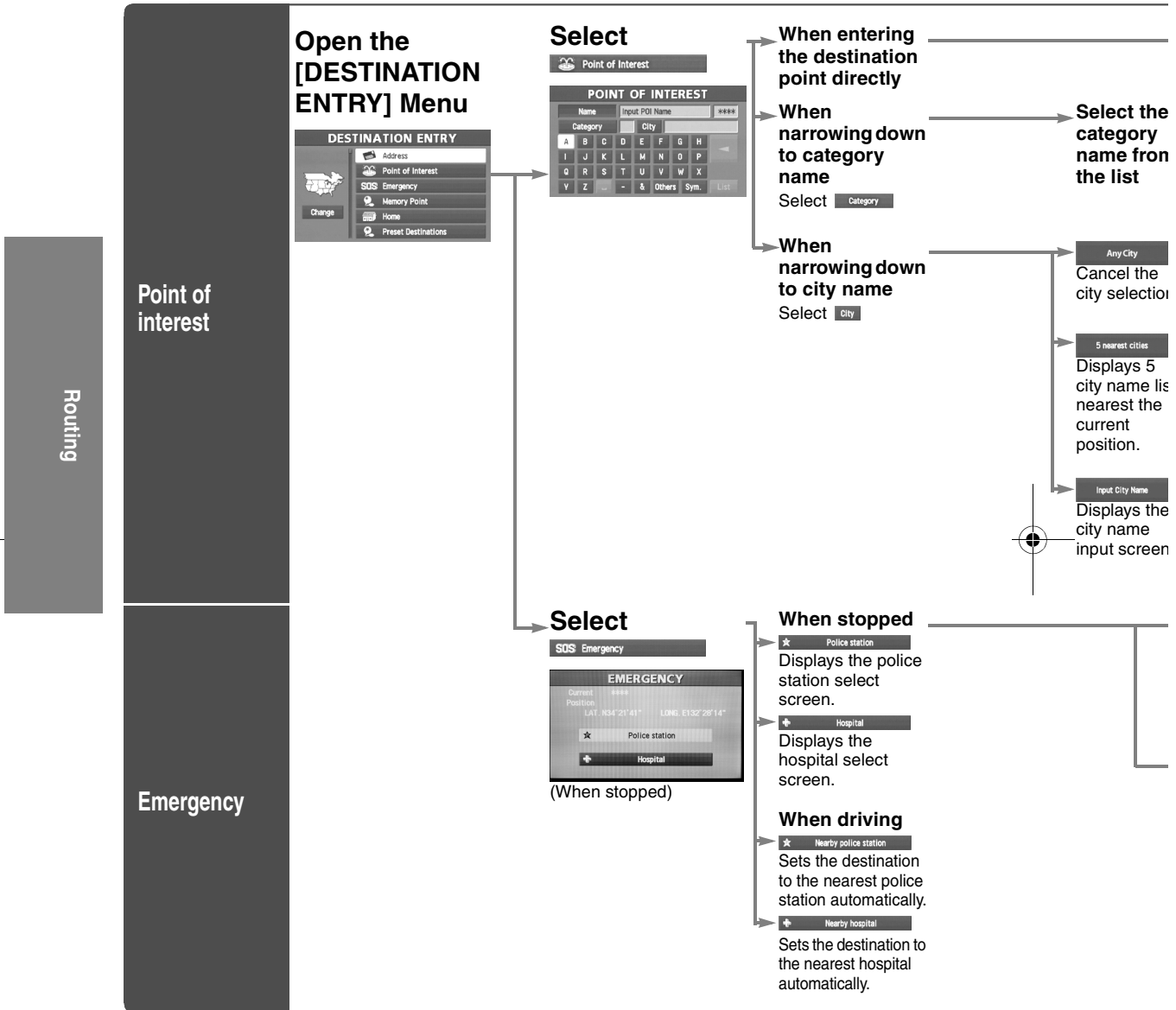

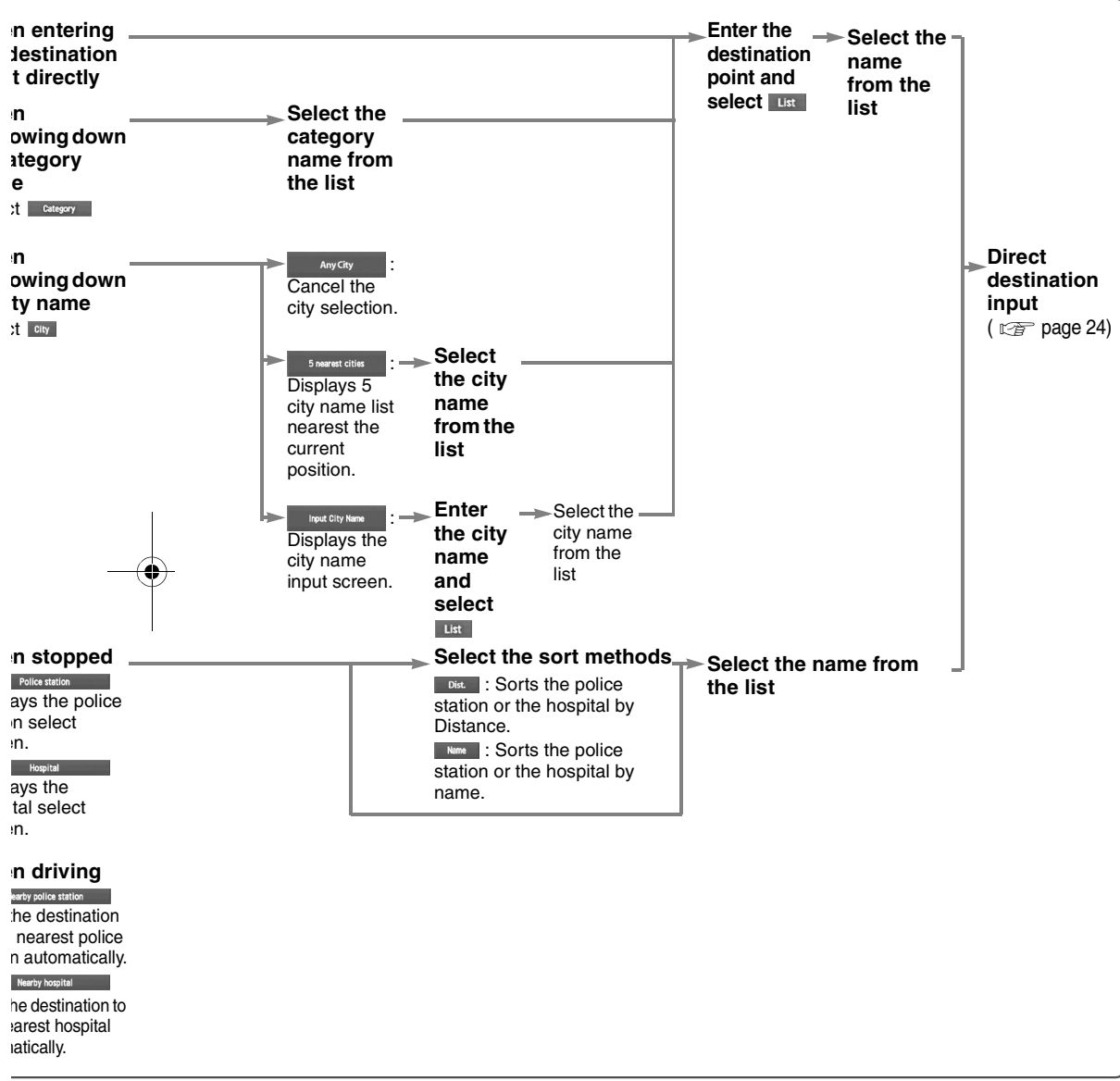

Routing

● For Character Entry, please refer to page 23.

Destination Entry and Route Search

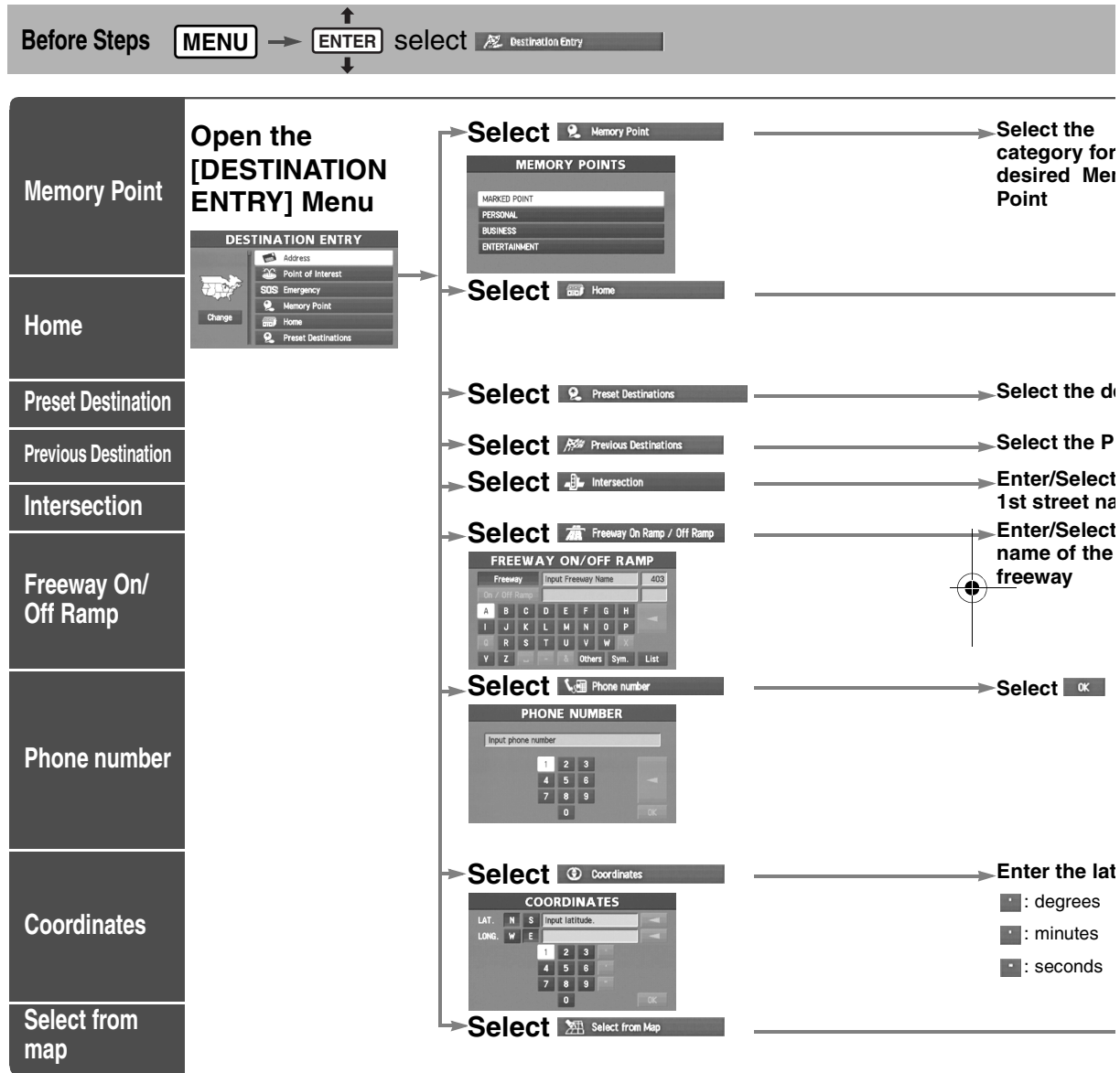

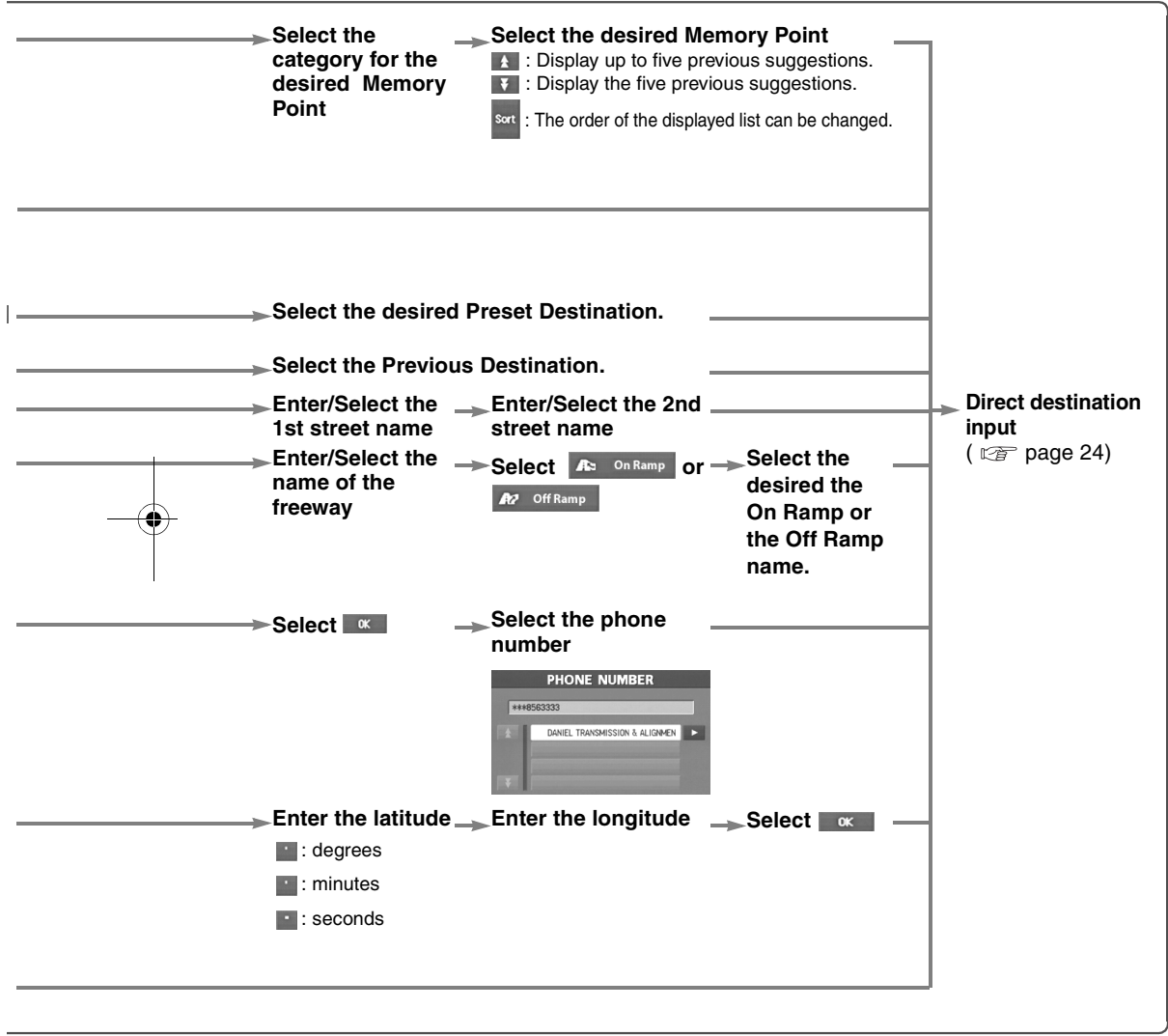

● For Character Entry, please refer to page 23.

Use POI

- You can select one of the six categories on the menu or List Categories and then select the POI(s) to be displayed on the map.

Before Steps

ENTER → ← **ENTER** → Select **POI**

Routing

Displaying POI(s) on a Map

Open the [QUICK POI]



Local Search

Select the categories to be displayed up to a maximum of five.

- POI icon chart (page 25)

For categories other than the six displayed, select **List Categories** and select them from the list shown.

Deleting POI Markers

Select the POI you want to find from the listed categories.

After you make a selection, the point of interest you selected appears on the map.

Route: Search POI along the route during the guidance and show the list.

Before Steps

Displaying POI(s) on a Map (page 25 above)

Showing POI Data

Display the POI.

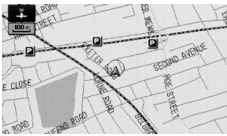

Select the desired POI by moving the cursor on top of the POI icon. The name of the selected POI appears. If no data is stored for the selected POI, the POI name is not displayed.

Select Info (Information) The POI(s) data is displayed.

Info: Stores the location of POI as a memory point.

Character Entry

To enter the street name, city name, and other.

Select the first several characters on the screen.

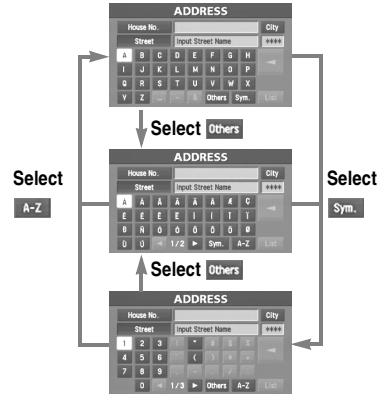

- ◀ : Move the cursor to the previous position and delete a character.
- List : The list appears.

● Examples
Street: ANBERG
Enter by selecting characters:
A N [] [] [] [] [] []
Street: ACHATWEG
Enter by selecting characters:
A C H A T [] [] [] []

Select your target in the list.

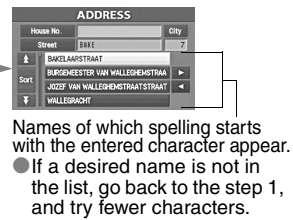

- Names of which spelling starts with the entered character appear.
- If a desired name is not in the list, go back to the step 1, and try fewer characters.
- ▲ : Display up to five previous suggestions.
- ▼ : Display the previous suggestions.
- ▶ : Text flow (Right)
- ◀ : Text flow (Left)
- Sort : The order of the displayed list can be changed. (Displayed list varies or **Sort** may not be displayed depending on what was input.)
- Input Name : Text can be input again. (Input Name may not be displayed depending on what was input. Input Name may be displayed when **Sort** is selected.)

Street: STRASSE DES 17. JUNI
Enter by selecting characters:
D E S [] [] [] [] [] []

To enter the house phone number, and other.

Select the characters on the screen.

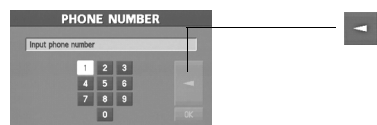

- ▶ Select OK
- ◀ : Move the cursor to the previous position and delete a character.

Routing

Direct Destination Input

Routing

Direct Destination Input

1



Position the cursor on your destination on the map

Scroll the map and change the map scale if necessary.



2



Select

Set Dest.



3

Select Dest. (Destination).

Route calculation will be carried out and the entire route will be displayed on the map.

Select Way Pt (Way point) to set the address as a way point on your route (page 32). You can set up to 5 way-points per trip.

4

Select Guide.

Route guidance begins using displayed route.

Note

- If your desired route cannot be found, Chg. route (Change route) allows the route option settings to be changed. (page 26)
- Selecting Guide for five seconds or more will launch the Demo mode.

Operate after Step 3 of [Direct Destination Input]

Selecting Route

4

Select 3 Routes.

The calculation route can be selected from one of three types namely, Quick (the fastest route), Altern. (the standard route), or Short (the shortest route).

5

Select Info. (Information).

Details regarding the individual routes (i.e., required time total distance, roads used, etc.)

Select either Quick, Altern., or Short, and then select Calculate when you have decided on the route to be used.

INFO FOR 3 ROUTES						
	Quick		Altern.		Short	
	0h 3m	1.3 miles	0h 3m	1.3 miles	0h 3m	1.3 miles
	0.0 miles	0.0 miles	0.0 miles	0.0 miles	0.0 miles	0.0 miles
	0.0 miles	0.0 miles	0.0 miles	0.0 miles	0.0 miles	0.0 miles
	0.0 miles	0.0 miles	0.0 miles	0.0 miles	0.0 miles	0.0 miles

POI Icons on Maps / Delete Destination

POI (Point of Interest) Icons

The following are POI icons shown on maps.

Restaurant All restaurants American Chinese Continental Fast Food French Italian Japanese Mexican Seafood Thai Other Restaurants	Automotive Automobile Club Gas Station Parking Auto Service & Maintenance	Recreation Amusement Park Casino Golf Course Historical Monument Marina Museum Ski Resort Sports Complex Performing Arts Tourist Attraction Tourist Information Winery	Community City Center Convention Center Court House Government Offices Higher Education Hospital Library Park & Recreation Police Station School
Shopping Grocery Store Shopping Mall	Travel Airport Bus Station Ferry Terminal Hotel Rental Car Agency Rest Area Train Station	Other Business Facility	Banking Bank ATM

Routing

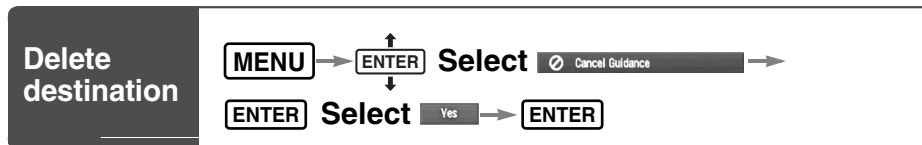

Route Options

- During route guidance you can change the route options, stop or check the route.

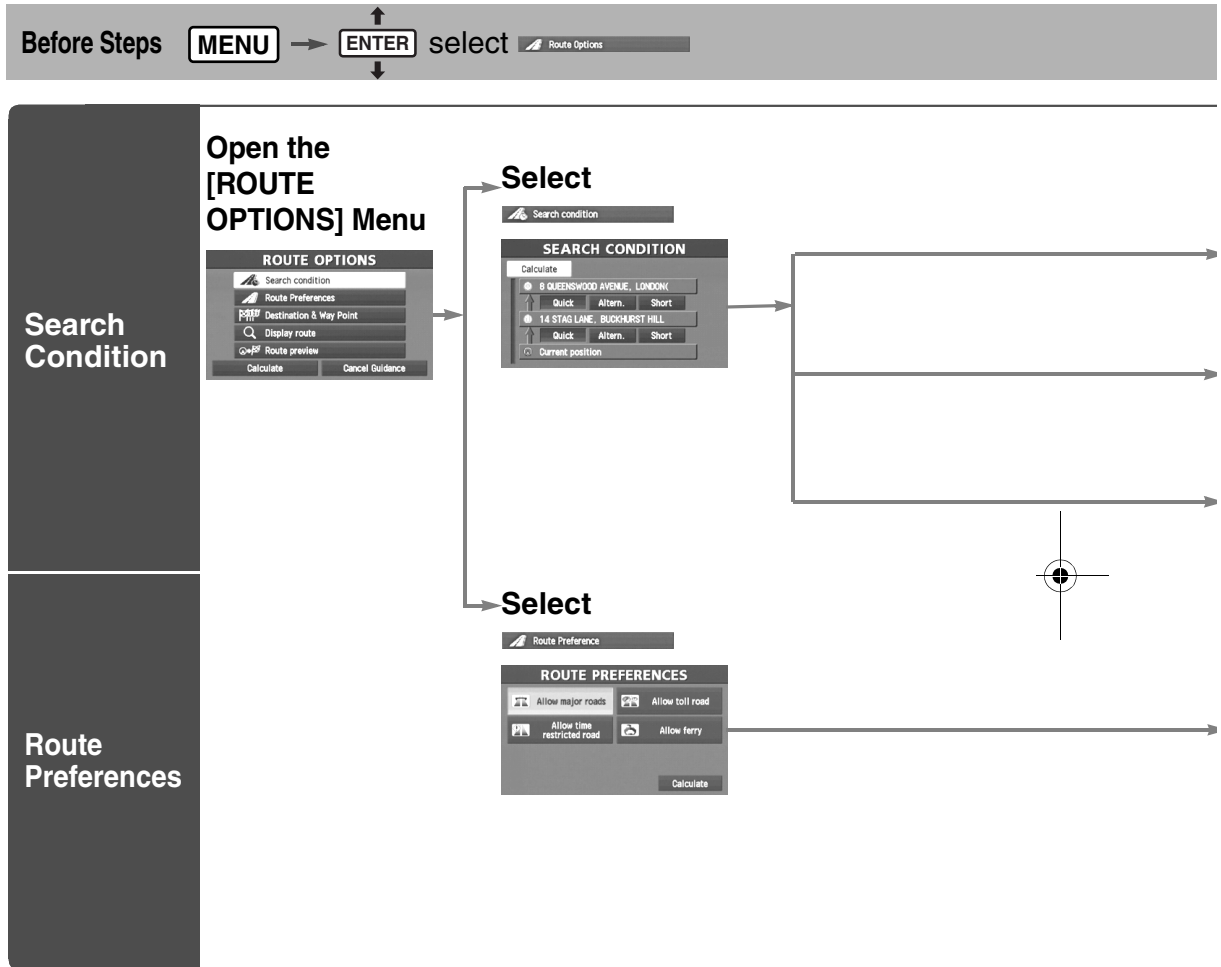



Do not keep your eyes fixed on the monitor screen or operate the system while driving

Do not change the settings and destination locations while driving. Minimize the time spent viewing the monitor screen and listening to the voice guidance while driving. Operating the system will distract the driver from looking ahead of the vehicle and may cause an accident. Always stop the vehicle in a safe location and use the parking brake before operating the system.

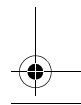
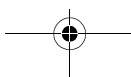
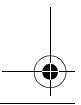
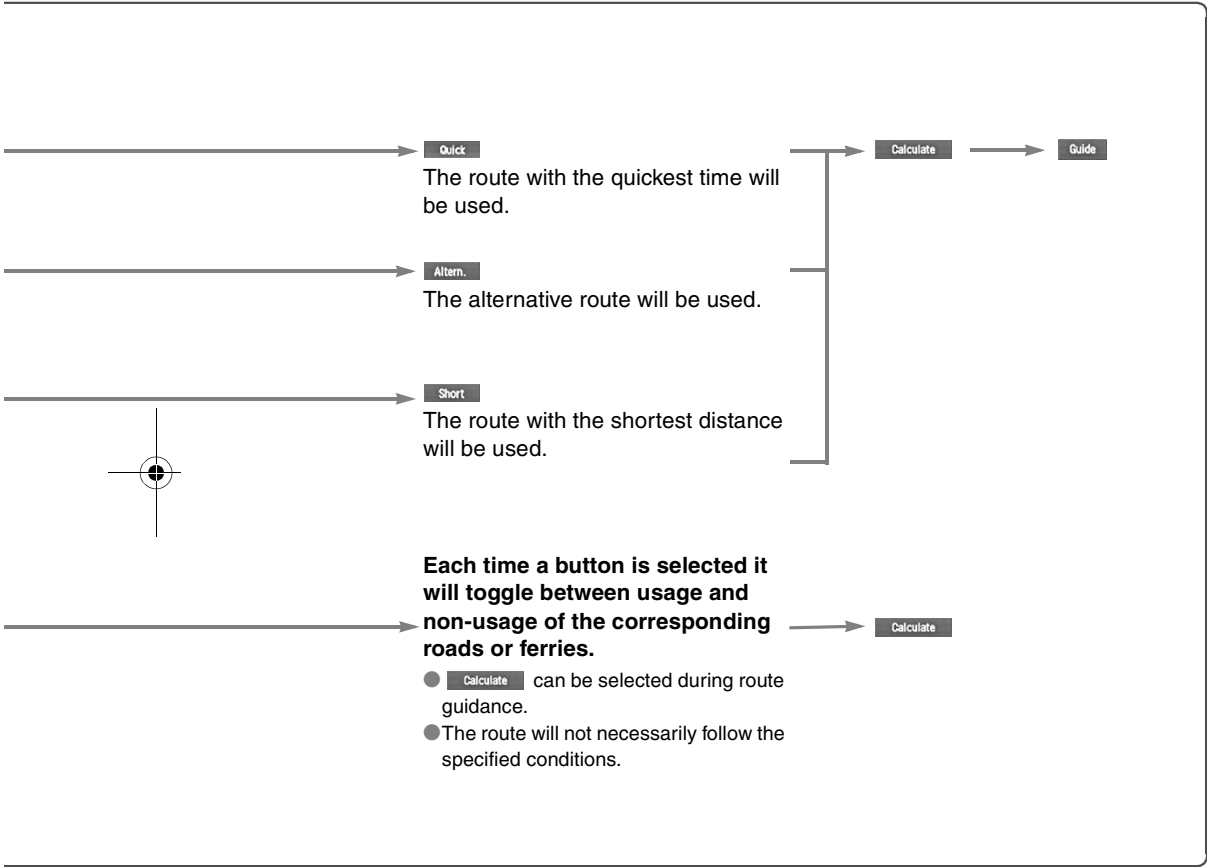

Route Options

Before Steps **MENU** → **ENTER** select 

Routing

Addition of Way points

Modification of Destination or Way Point Positions

Modification of the Visiting Order

Deletion of Destination or Way Points

Deletion of Destination and All Way Points

Open the [ROUTE OPTIONS] Menu



Select 

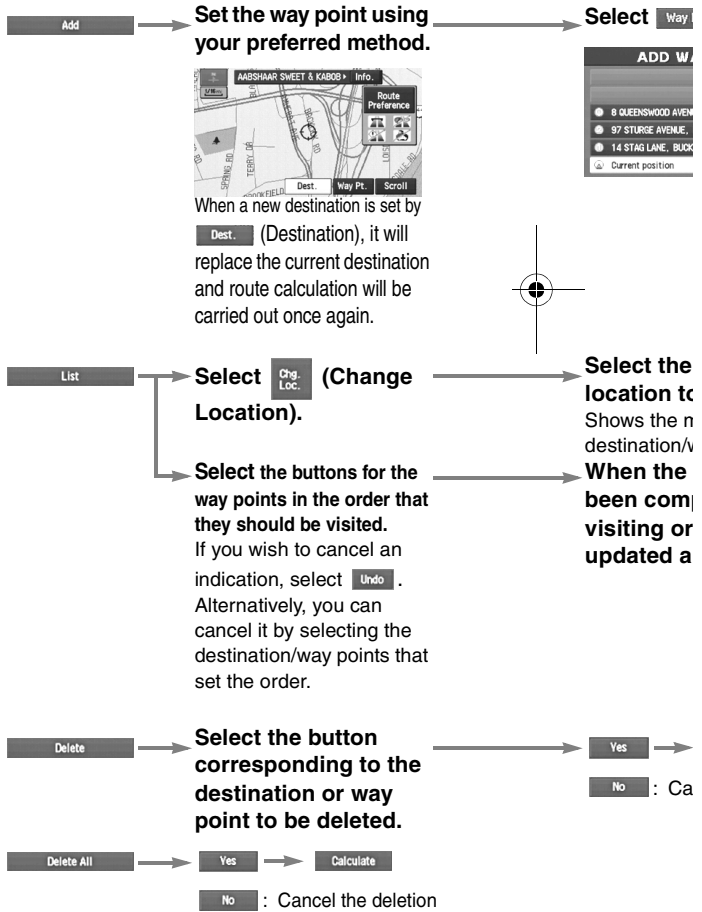

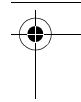
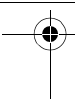

Way point using the entered method.

Select **Way Pt**

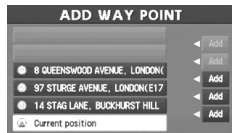

When the required way points have been setup, indicate the order in which they are to be visited.

Choose the location to be added, and then select **Add**.

When setting up the 2nd way point you also need to indicate the order.

Repeat from the selected steps **Add**, when you want to set up more than three way-points.

When the destination is set by the current destination, it will be calculated once again.



(Change)

Select the button for the location to be modified.

Shows the map for the destination/way points.

Move **○** to location and then press **ENTER**.



Buttons for the order that they are to be visited. To cancel an order, select **Undo**. Alternatively, you can cancel by selecting the way points that you want to delete.

When the sequence has been completed, the visiting order will be updated automatically.



When the **Yes** button is pressed, the way point will be deleted.



No: Cancel the deletion



Cancel the deletion

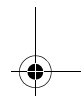
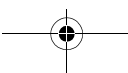
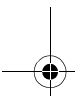
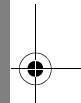
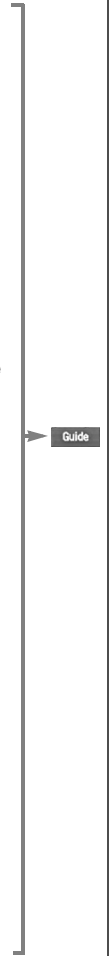

Route Options

Before Steps **MENU** → **ENTER** select 

Routing

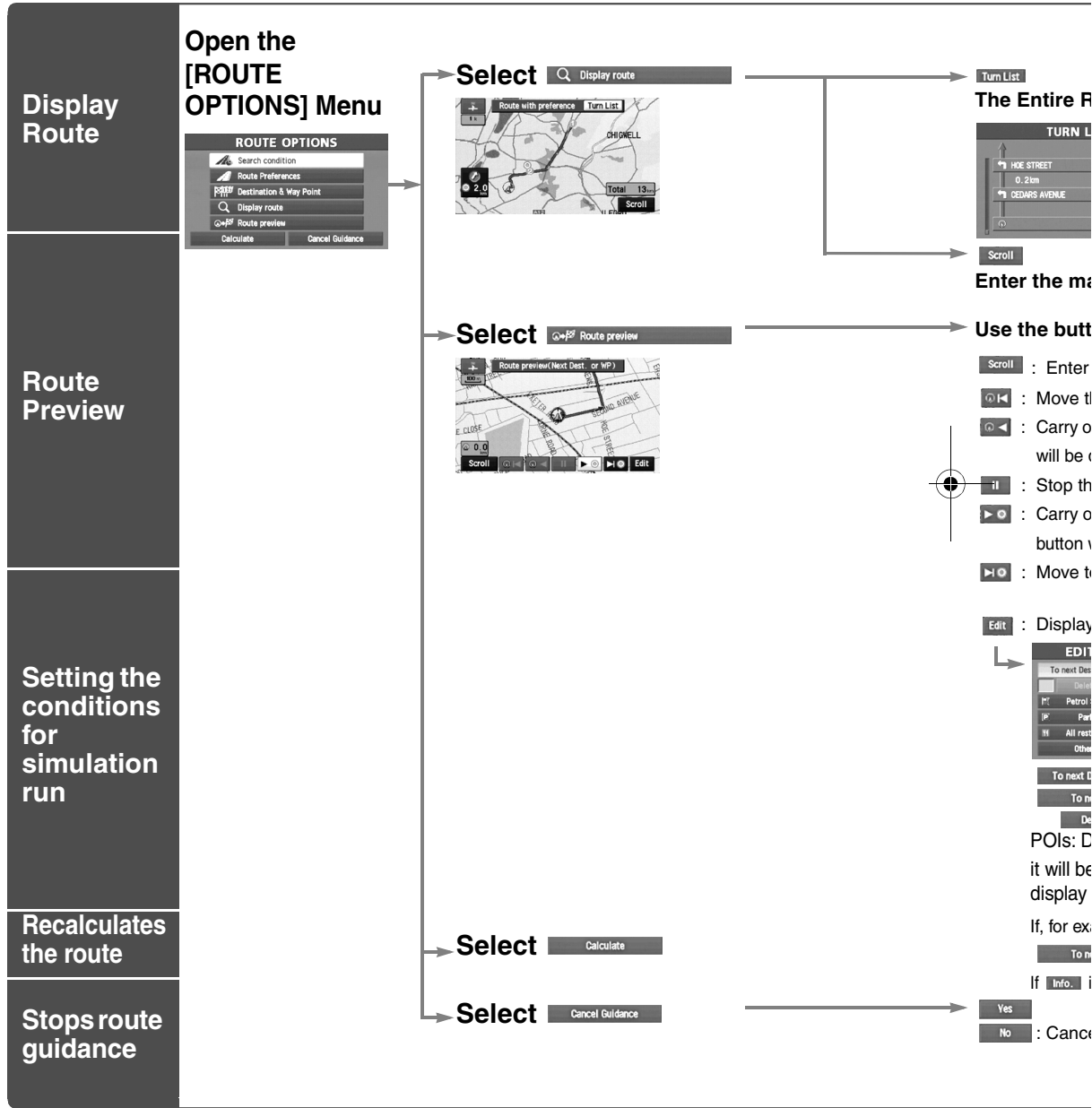

Turn List
The Entire Route screen appears.



Scroll
Enter the map scroll.

Use the buttons displayed on screen to carry out a simulation run.

- Scroll** : Enter the map scroll.
- : Move the start point.
- : Carry out a simulation run in the direction of the start point. When the run has been started, this button will be displayed as , and when selected, it will cause running to take place at high speed.
- : Stop the simulation run.
- : Carry out a simulation run in the direction of the destination. When the run has been started, this button will be displayed as , and when selected, it will cause running to take place at high speed.
- : Move to the destination.

Edit : Displays the EDIT ROUTE PREVIEW screen.

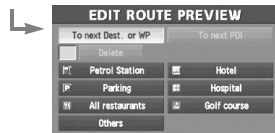

- To next Dest. or WP** : Stops at the destination or the next way point.
- To next POI** : Stops at a point of interest which has been setup on the route.
- Delete** : Delete the POI which has been selected.

POIs: Display the six POIs from Quick-POI storage. When one of these is selected, it will be displayed on the map; furthermore, **Others** can be selected to display items other than shown here. For more details, refer to page 41.

If, for example, **Restaurant** is selected for POIs and a simulation run is started using **To next POI**, this will then stop at a restaurant on the route.

If **Info.** is selected here, the system will display information relating to the establishment question.

- Yes**
- No** : Cancel the Cancel Guidance.

Routing

RET

Address Book

● You can, edit, or delete any destinations, way points, or marked point.

Before Steps

MENU

ENTER

select

Address Book

Memory Point Storage

Open the [ADDRESS BOOK]

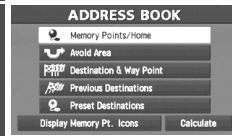

Select

Memory Points/Home

Select the category from the list.

Add

List

Memory Point Confirmation and Modification

Memory Point Deletion

All Memory Point Deletion

Category Name Modification

Address Book

Delete

Delete #

Edit Categ

Changes t category n

Select the category from list.

Add

Set a memory point using your preferred method.

List

Select a memory point to be modified

Icon

: Allows the display icon to be selected. Page 1 and 2 contain standard icons, whereas the With Sound page contains icons which also playback sounds.

Category

: Allows the storage category to be changed. Select the button corresponding to the new category.

Name

: Allows the name to be changed. When editing has been completed, select **OK**. Furthermore, select **On** to display names on the map, or **Off** if these names are not to be displayed.

Position

: Allows memory points to be checked and modified on the map screen. After checking.

Tel.

: Allows the telephone number to be modified. When editing has been completed, select **OK**.

OK

Delete

Select a memory point to be deleted.

Yes

No

: Cancel the deletion.

Delete All

Yes

No

: Cancel the deletion.

Edit Category

Erase letters using **←**, enter the new letter, and then select **OK**.

Changes the selected category name

Address Book

Address Book

Before Steps **MENU** → **ENTER** select  Address Book

Avoid Area Storage

Open the [ADDRESS BOOK]

Avoid Area Confirmation and Modification

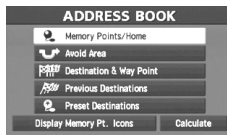

Select



Avoid Area Deletion

All Avoid Area Deletion

Category Name Modification

Add

List

Delete

Delete #

Address Book

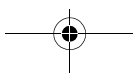
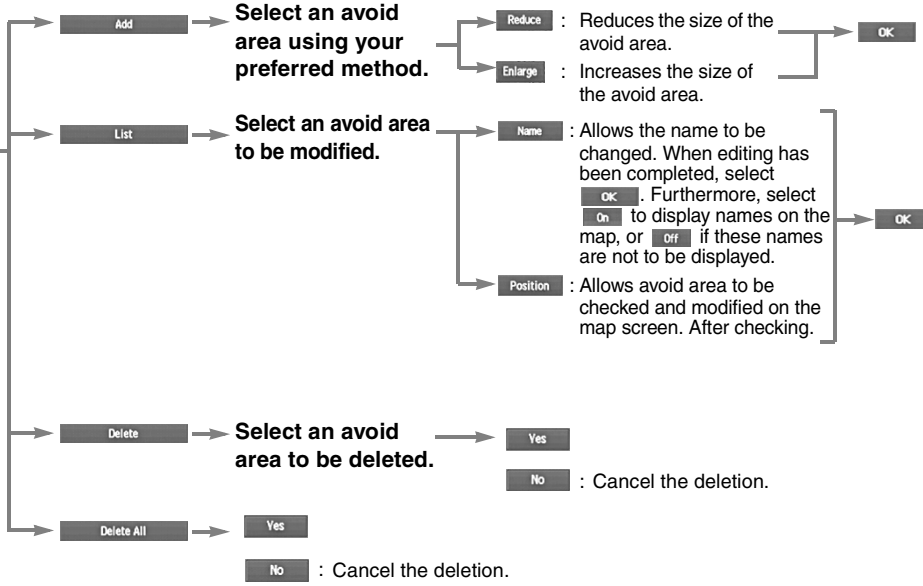

Address Book

Before Steps **MENU** → **ENTER** select  Address Book

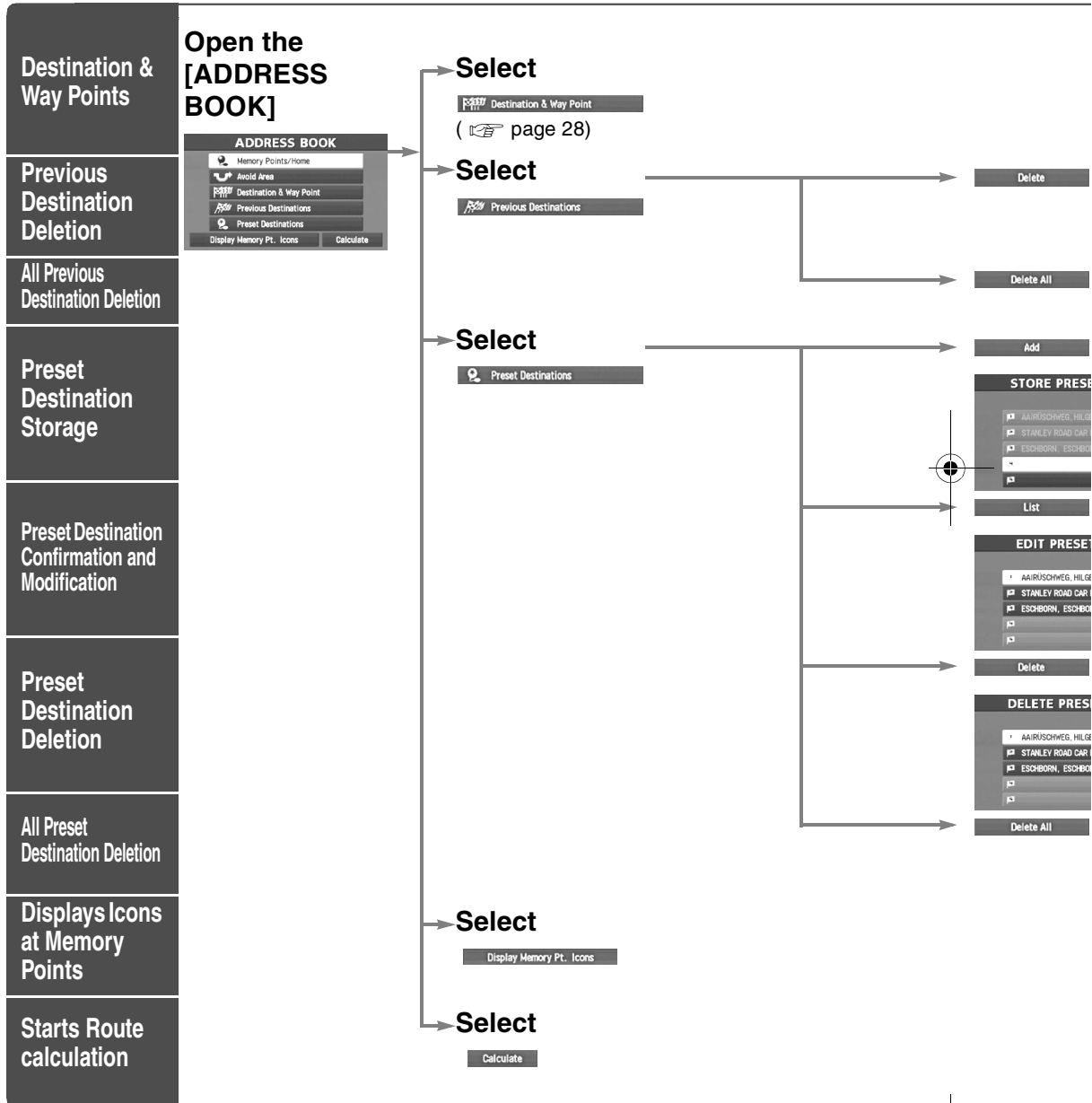

Address Book

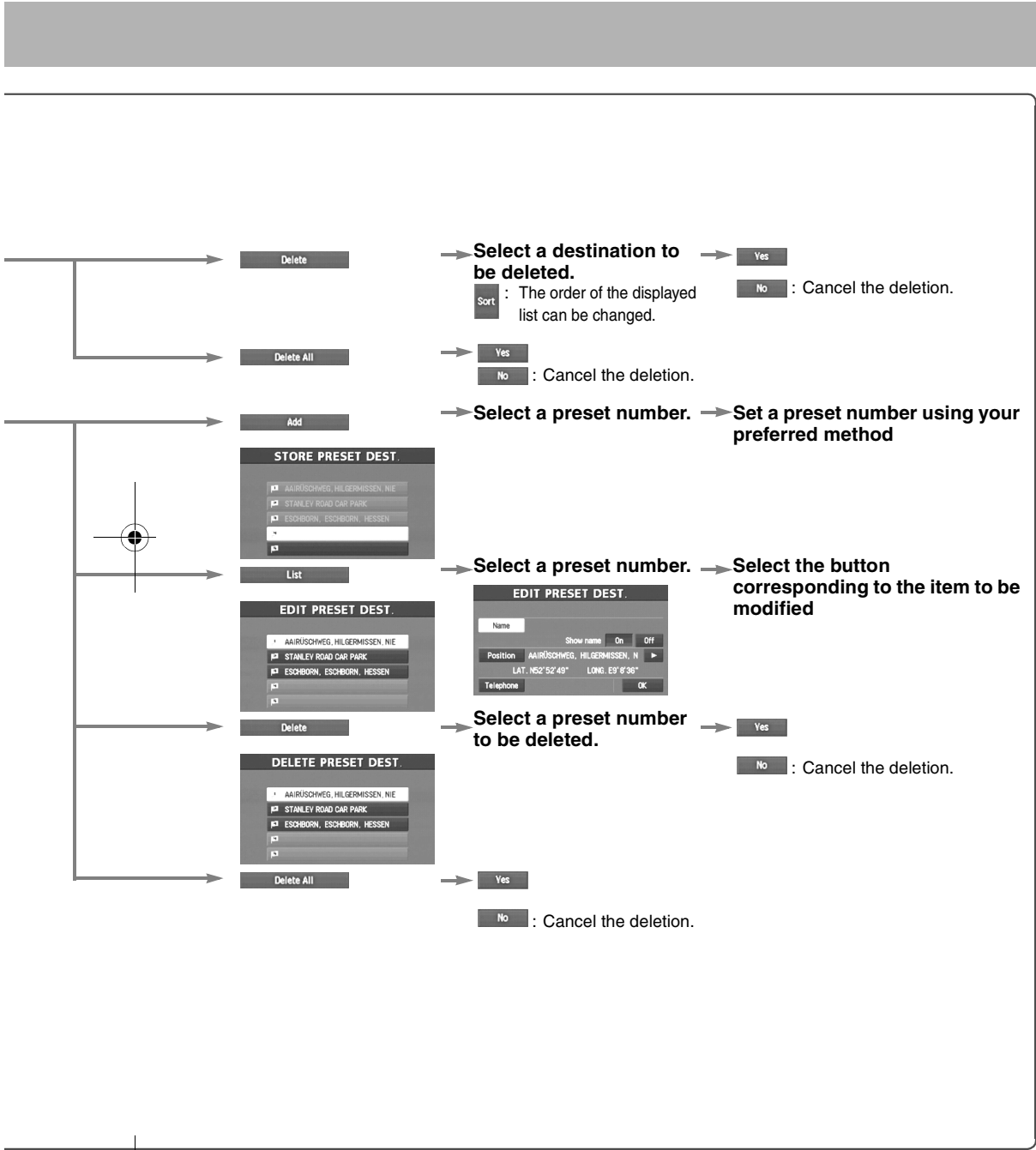

Address Book

Navigation Set Up

- You can alter the map display conditions, the route guidance conditions and show the system information.



Warning

■ **Stop your vehicle before the following operations.**









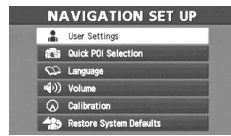



Do not change the settings and destination locations while driving. Minimize the time spent viewing the monitor screen and listening to the voice guidance while driving. Operating the system will distract the driver from looking ahead of the vehicle and may cause an accident. Always stop the vehicle in a safe location and put the parking brake on before operating the system.

Before Steps **MENU** → **ENTER** select  Navigation Set Up → **ENTER**

Open

[NAVIGATION SET UP]



-  User Settings ( page 39)
-  Quick POI Selection ( page 41)
-  Language ( page 45)
-  Volume ( page 45)
-  Calibration ( page 42)
-  Restore System Defaults ( page 44)

Navigation Set Up

User Setting

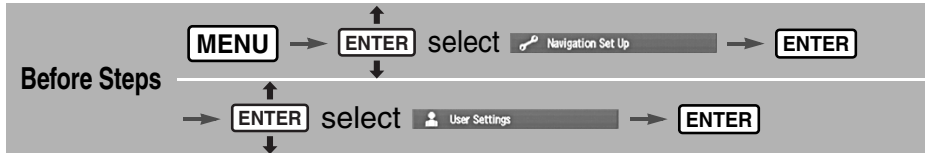

Open the [USER SETTINGS] screen

Select page 1

USER SETTINGS			
Page	1	2	3
Map Colour	1	2	3
Map Mode	Auto	Day	Night
1/3 Distance	Metric	Imper.	
Notify traffic restriction	On	Off	
Arrival Time	⏰ ⏱		

MAP Color

Map Colour 1 2 3

Select a screen color from 1 of 3 options.

Map Mode

Map Mode Auto Day Night

- Auto : The display will automatically switch between Day and Night illumination mode when the headlights are turned off and on respectively.
- Day : The display will be presented in Day illumination mode regardless of whether the headlights are on or off.
- Night : The display will be presented in Night illumination mode regardless of whether the headlights are on or off.

Distance

Distance Metric Imper.

Select the distance unit from Metric or Imper.

Notify traffic restriction

Notify traffic restriction On Off

The display of warnings during route guidance when passing through areas with traffic restrictions can be turned on or off

Arrival Time

Arrival Time ⏰ ⏱

The time which is displayed until the destination or a way point can be set as an estimated arrival time or the remaining time. Select ⏰ to display the estimated arrival time, or ⏱ to display the remaining time.

How to exit

OK

Navigation Set Up

Navigation Set Up

User Setting

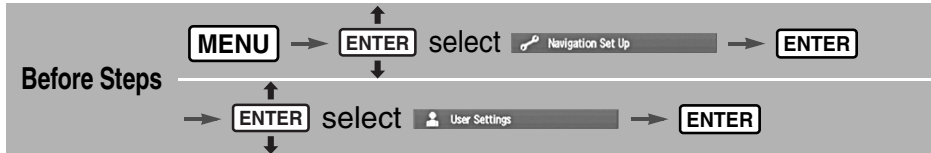

Open the [USERSETTINGS] screen

Select page 2

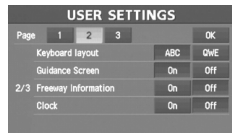

Keyboard layout

Keyboard layout ABC QwE

The layout of input keys can be selected as **ABC** or **QwE**.

Guidance Screen

Guidance Screen On Off

Select whether Enlarged Junction diagram screen is displayed automatically.

freeway information

Freeway information On Off

Allows selection of whether guidance screen is to be displayed while driving on freeway.

Clock

Clock On Off

Allows selection of whether clock is to be displayed.

Select page 3

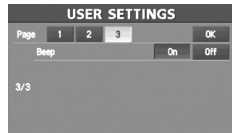

Beep

Beep On Off

Allows selection of whether beep will sound.

How to exit

OK

Navigation Set Up

Navigation Set Up

Quick POI Selection

This function allows you set the categories on the area displayed when the (Point of interest) menu is selected on the map. Quick POI enables you store up to six different kinds category which you use most regularly.

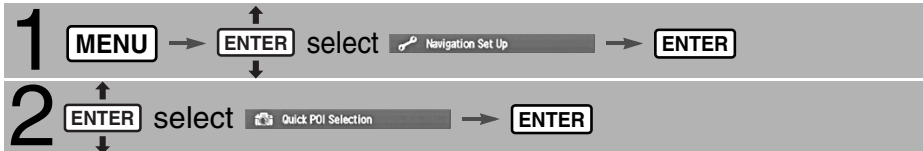

Open the [QUICK POI SELECTION] screen

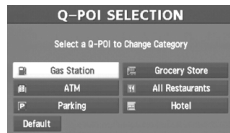

Select the button for Quick POI storage.

Note

- Select the category to be changed

Default : This button allows you to restore the factory setting.

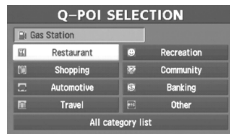

Select a category.

Once selected, subcategories will be displayed.

List all Categories : Subcategories from all of the individual categories will be displayed together.



Select the subcategories to be displayed on the map.

Repeat the above steps to add further POI markers displayed on the menu.

Navigation Set Up

Calibration

This function allows you to correct any error in the position or direction of your vehicle display.

Before Steps MENU → ENTER select Navigation Set Up

Adjusting Current Position and Direction

ENTER select Position / Direction → ENTER

Open the [Position calibration] screen



Move the red dot to the correct position and select ENTER.



Use the left or right arrow keys to adjust the direction in which you are heading, and select OK.

Distance

This function automatically corrects any error in the display of the current position that might occur after tire replacement.

ENTER select Distance → ENTER

Distance is displayed

You will have to drive about 6 miles (10 km) before distance correction is complete.

Set Clock

The current time is displayed on a GPS screen.

ENTER

Open the



Map View

The map view function.

ENTER

Map and



ENTER → ENTER select Calibration → ENTER

Set Clock

The current time is set using this function. Since time notification is provided by a GPS satellite, time-zone adjustment can be carried out automatically.

ENTER select Set Clock → ENTER

Open the [SET CLOCK] screen



Select **24h** if you would prefer 24-hour display; **12h** for 12-hour display.

Select **+1 hour** to move the setting ahead by one hour, and similarly, select **-1 hour** to move it back by one hour.

How to exit **OK**.

Map Version

The map and software version numbers can be confirmed by using this function.

ENTER select Map Version → ENTER

Map and software versions are now displayed.



Navigation Set Up

Navigation Set Up

Restore System Defaults

This function replaces all the settings in the mobile navigation system with the initial default settings.

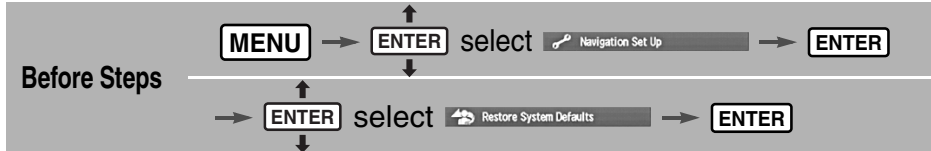

Open the [SYSTEM DEFAULTS] screen

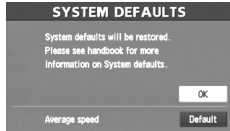

Select **OK**.

Default : Restores the average speed setting to the initial value upon factory setting.

If you execute Restore System Defaults, all of your Stored setting data will be deleted.

[Default List]

Item	Initial condition
Menu names	
For maps (one screen and dual screen)	North up
Map display mode	single-screen display
Map Display scale/Map scale for Dual-screen is not object of backup.	Single-screen: 10,000 map (1/16 mi) Dual-screen: 40,000 map (1/4 mi)
Display guidance language	English
Q-POI map display	All Off
Q-POI Selection	A : Gas station B : ATM C : Parking D : Grocery store E : All Restaurant F : Hotel
Search Area	U9 (including Washington DC)
Map Color	1
Day/Night/Auto Setting	Auto
Distance Units (Miles/KM) (Global setting)	Miles
Volume Presets	4 (1 to 7)
Right Screen Setting, POI	On
Time display change (12h/24h)	24h
Keyboard layout	ABC
Arrival Time	Time
Navigation Setup (Clock)	Off
Navigation Setup (Beep)	On
Map display	
freeway Information	Off
Guidance Screen	ON

Navigation Set Up

Navigation Set Up

Language

You can change the language of the menu and the voice guidance.

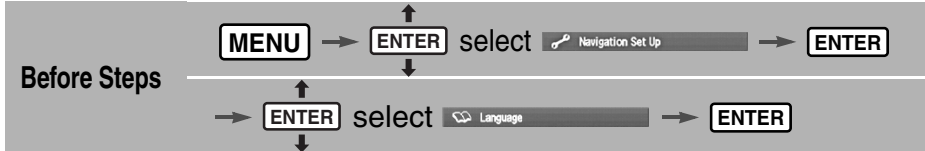

Open the [LANGUAGE] screen



Select your preferred language from the list.

Volume Adjustment

You can adjust the volume control for the voice guidance.

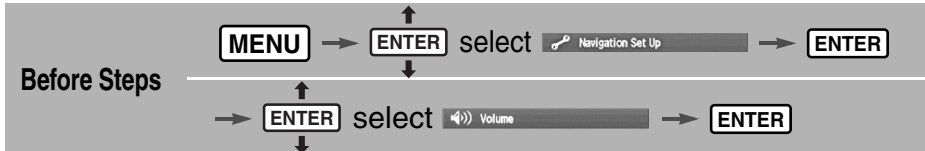

Open the [VOLUME] screen



Select the appropriate button to set the volume to between **1** (minimum) and **7** (maximum).

Off : Sound output will be muted.

Navigation Set Up

Precautions/System Performance

Voice Guidance



Warnings

- The navigation system is just a support system for the driver. The driver should always pay attention to the traffic situation to safely make decisions. You may be unable at times to arrive at your destination due to out-of-date information on a map disc. You should be especially careful when selecting an urgent destination such as a hospital or a police station.
- Your route may sometimes include roads that are not open to vehicles or are closed due to traffic regulations. Please comply with the local traffic regulations.
- Do not change the settings and destination locations while driving. Minimize the time spent viewing the monitor screen and listening to the voice guidance while driving. Operating the system will distract the driver from looking ahead of the vehicle and may cause an accident. Always stop the vehicle in a safe location and use the parking brake before operating the system.

Voice guidance has the following functions:

■ Intersection guidance

- The system voice announces the distance to an upcoming turn and the turning direction.
 - ➔ This guidance function is automatic. Therefore, you do not have to set it, and it cannot be disabled.
- The system vocally announces the distance to an upcoming highway branching point or junction.

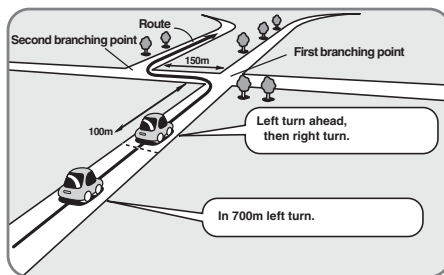

When two intersections are close together, the voice guidance may be late.

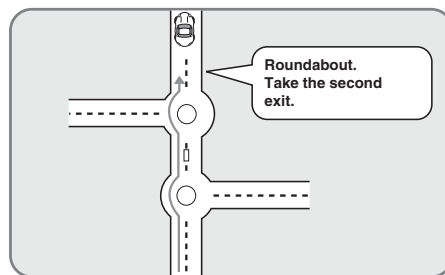

When two roundabouts are close together, the voice guidance for the second may be late.

As necessary

GPS

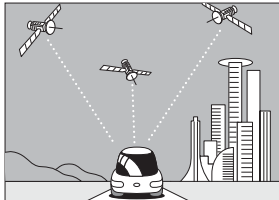

GPS is a position detecting system utilizing the signals from GPS satellites deployed by the U.S. Department of Defense. The Mobile Navigation System uses input from three or more satellites and calculates the vehicle position based on the principle of triangulation. The positioning accuracy of the system corresponds to the error display of the GPS which is from about 30 to 200 meters.

- If you are using the system for the first time, or if you have not used it for some time, it takes about 5 minutes (or about 2 minutes in open areas) to calculate your vehicle's position.

■ GPS signal reception is poor in the following places

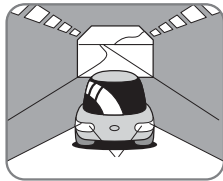

In tunnels

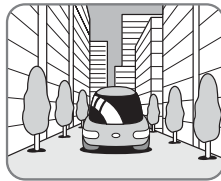

Among high-rise buildings

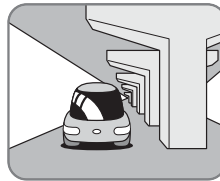

Under elevated roads

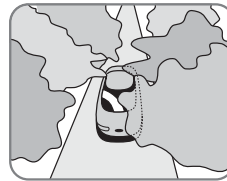

In wooded areas

- The GPS satellites are controlled by the U.S. Defense Department, which may intentionally lower positioning accuracy. In such cases, there may be vehicle position deviations.
- There may be vehicle position deviations for some time until GPS signals are received after turning on the ignition.

Map Matching

This function compares your vehicle's tracking data with the road data on the map disc, applies dead reckoning to determine the road you are driving on, and displays your vehicle on that road on the map.

- Intelligent map matching addresses the following problems to achieve high accuracy in vehicle positioning.

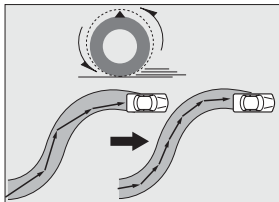

Position Correction for Elevated Roads

Position accuracy is improved by detecting if the vehicle is running on or under an elevated road.

Position Correction for Parking Garages

Position accuracy is improved by detecting if the vehicle is driving in an elevated or underground parking garage.

High-precision Gyro sensor

A gyro detects turns with an accuracy of 0.05° per second. Combined with a speed sensor, it enables the system to display the current vehicle position even where GPS signals may be blocked.

- Using a spare tire in place of the regular one may cause vehicle position deviations.
- Any difference between the direction which your vehicle actually travels and that shown on the map is automatically eliminated by azimuth correction.

As necessary

Precautions/System Performance

Positioning Accuracy

In the following situations, your vehicle position may not be displayed correctly on the map. But, as you keep driving, your vehicle position will be automatically corrected utilizing map matching and GPS data.



Running on an elevated road

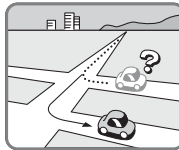

Making a turn after driving on a long straight road



Running on a steep mountain road

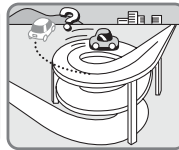

Running on a spiral road



Entering an intersection where a road branches off at a small angle

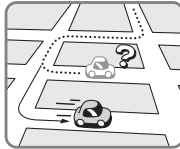

Running on gridiron layout of roads



Running on a slippery road with tire chains

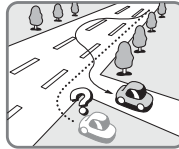

Snaking on a wide road

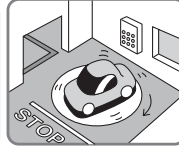

When your vehicle is on a turntable with the ignition turned off



After getting off a ferryboat or vehicle train

Route Guide

Although you may encounter the following problems in route guide, there is nothing wrong with the system.

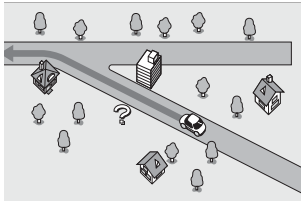

For certain intersection shapes, the upcoming turn or the name of the intersection may not be announced.

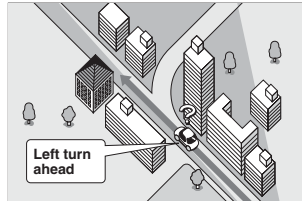

For certain intersection shapes, you may be prompted to turn right or left when you should actually stay on the same road.

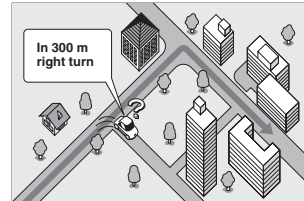

Voice guidance for the planned route may continue even after you have deviated from that route such as having turned too early.

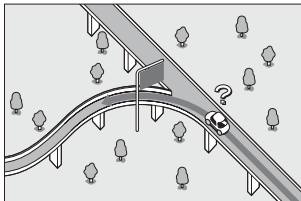

Some points where the road divides on highways or toll roads may not be displayed or announced.

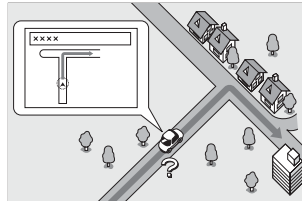

The Intersection Zoom Map may not always agree with the actual shape of the intersection.

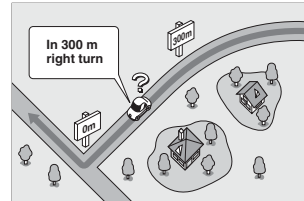

The announced distance to an upcoming turn may differ slightly from reality.

As necessary



The navigation system is just a support system for the driver. The driver should always pay attention to the traffic situation to safely make decisions. You may be unable to arrive at your destination due to out-of-date information on a map disc. You should be especially careful when selecting an urgent destination such as a hospital or a police station.

Route Search

Although you may encounter the following problems in a route search, there is nothing wrong with the system.

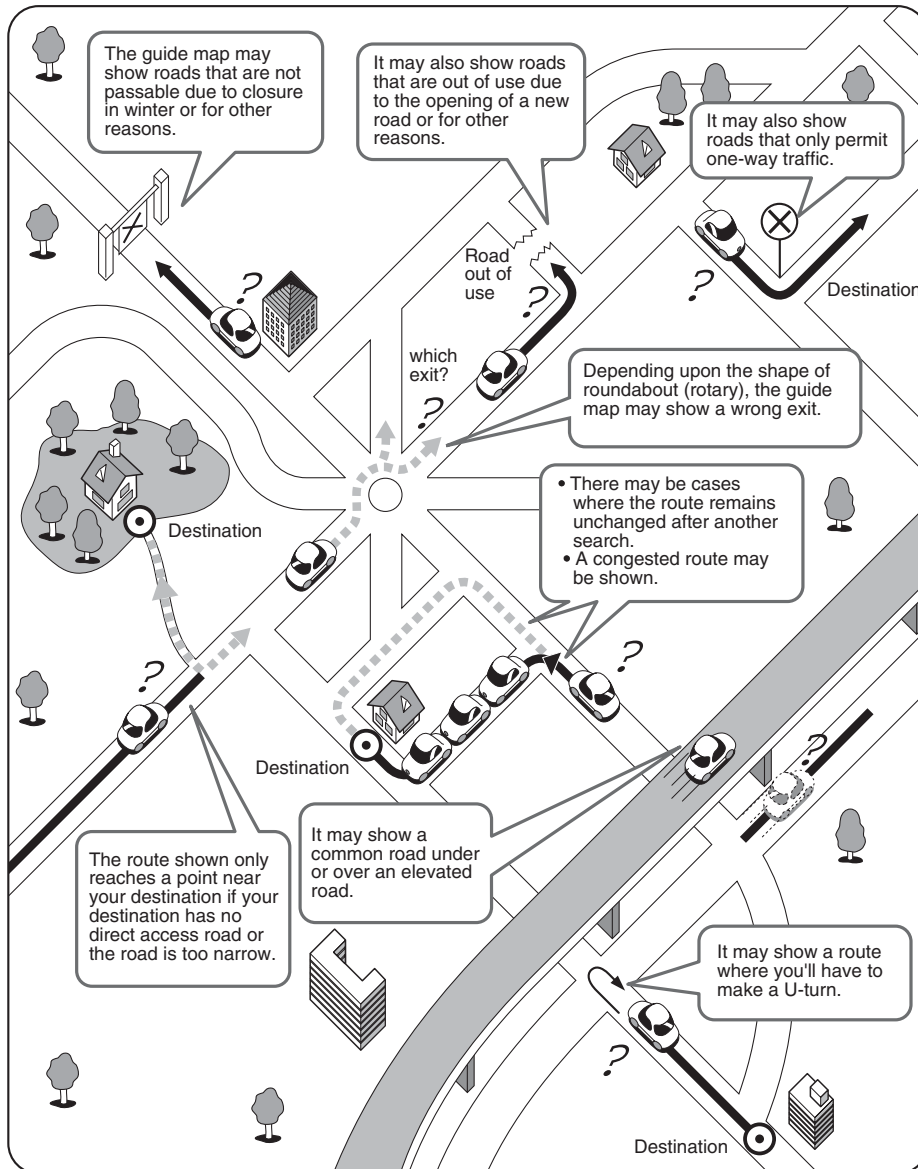

As necessary

Troubleshooting

Verification First

Note

There may be some problems due to operational errors or mistakes. Please read this manual again and verify that there really is a problem before calling an Expert repairer, we recommend an Authorized Mazda Repairer to ask for repair services.

Symptom	Check point
No picture	<ul style="list-style-type: none"> ● Check if a fuse has been blown. <ul style="list-style-type: none"> ➔ Consult an Expert repairer, we recommend an Authorized Mazda Repairer. ● Check if the voltage level of the vehicle battery is low. <ul style="list-style-type: none"> ➔ Recharge the battery or change batteries.
Display doesn't open or close	
The vehicle position is not correct	<ul style="list-style-type: none"> ● Check if the vehicle position changed when ACC was set to OFF. <p>When, for example,</p> <ul style="list-style-type: none"> • The vehicle was transported by a ferry boat. • The vehicle was rotated on a turn table in a parking lot. • The vehicle was transported by a tow track or other such vehicle. <ul style="list-style-type: none"> ➔ Drive the vehicle for a while where you are receiving GPS signals.

As necessary

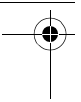
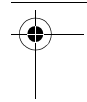

Symptom	Check point
<p>No GPS symbols are displayed</p>	<ul style="list-style-type: none"> ● GPS signals may not be received because of obstructions. After moving the vehicle away from obstructions, the GPS signals can be received.
<p>The vehicle position is not displayed</p>	<ul style="list-style-type: none"> ● Check if the mode is set to the current position screen. <ul style="list-style-type: none"> ➔ Press POS
<p>No voice guidance</p>	<ul style="list-style-type: none"> ● Check if the volume control for the voice guidance has been turned off. ● Check if the vehicle is off the route. <ul style="list-style-type: none"> ➔ Repeat the route search while checking the route guide screen. ● Check if you are driving the vehicle in the wrong direction on the route. <ul style="list-style-type: none"> ➔ Repeat the route search checking the direction of the destination.
<p>Buttons in the remote control do not beep</p>	<ul style="list-style-type: none"> ● Check if [Beep] is set to [Off] ( page 40).

As necessary

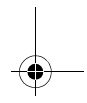
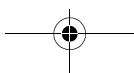
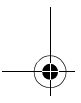
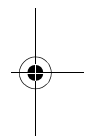
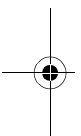

Troubleshooting

Error Messages

Error message	Solution
Please insert a MAP DVD.	<ul style="list-style-type: none">● The disc is not installed.<ul style="list-style-type: none">➔ Check if the disc is installed. If installed, check if the installed disc is correct.
MAP DVD-Read Error	<ul style="list-style-type: none">● The disc is wet, dirty, scratched, or upside down, or the disc cannot be played with this unit or the incorrect disc is installed.<ul style="list-style-type: none">➔ Eject the disc and check it.
The disc installed is not a MAP DVD.	

As necessary

Maintenance

Care of the Product

■ Cleaning this product

Use a dry, soft cloth to wipe it.

■ Cautions for cleaning

Never use solvents such as benzene and thinners, they could mar the surface of the unit.

■ Map disc

If you require the latest map disc, consult an Expert repairer, we recommend an Authorized Mazda Repairer.

Handling and Care of Map Discs

■ How to hold the disc

- Do not touch the underside of the disc.
- Do not scratch the disc.
- Do not bend the disc.
- When not in use, keep the disc in the case.

■ Disc Cleaning

- Use a dry, soft cloth to wipe from the center outward.

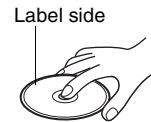

<Right>



<Wrong>

■ Do not leave discs in the following places:

- Direct sunlight
- Near car heaters
- In dirty, dusty and damp areas
- On seats and dashboards

As necessary

