

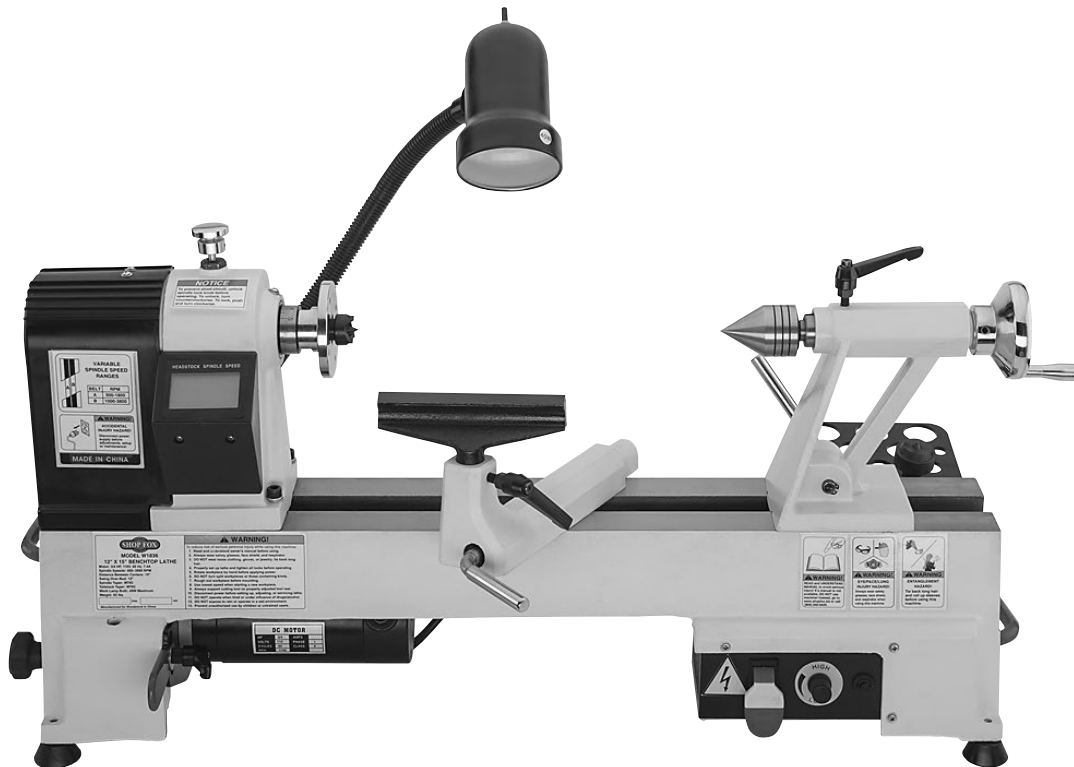

**MODEL W1836**

**12" X 15" BENCHTOP WOOD LATHE**



# **OWNER'S MANUAL**

***(FOR MODELS MANUFACTURED SINCE 04/15)***

**Phone: (360) 734-3482 • Online Technical Support: [techsupport@woodstockint.com](mailto:techsupport@woodstockint.com)**

**COPYRIGHT © MAY, 2015 BY WOODSTOCK INTERNATIONAL, INC.**

**WARNING: NO PORTION OF THIS MANUAL MAY BE REPRODUCED IN ANY SHAPE OR FORM WITHOUT**

**THE WRITTEN APPROVAL OF WOODSTOCK INTERNATIONAL, INC.**

**#17402BB Printed in China**



## **WARNING!**

This manual provides critical safety instructions on the proper setup, operation, maintenance, and service of this machine/tool. Save this document, refer to it often, and use it to instruct other operators.

Failure to read, understand and follow the instructions in this manual may result in fire or serious personal injury—including amputation, electrocution, or death.

The owner of this machine/tool is solely responsible for its safe use. This responsibility includes but is not limited to proper installation in a safe environment, personnel training and usage authorization, proper inspection and maintenance, manual availability and comprehension, application of safety devices, cutting/sanding/grinding tool integrity, and the usage of personal protective equipment.

The manufacturer will not be held liable for injury or property damage from negligence, improper training, machine modifications or misuse.



## **WARNING!**

Some dust created by power sanding, sawing, grinding, drilling, and other construction activities contains chemicals known to the State of California to cause cancer, birth defects or other reproductive harm. Some examples of these chemicals are:

- Lead from lead-based paints.
- Crystalline silica from bricks, cement and other masonry products.
- Arsenic and chromium from chemically-treated lumber.

Your risk from these exposures varies, depending on how often you do this type of work. To reduce your exposure to these chemicals: Work in a well ventilated area, and work with approved safety equipment, such as those dust masks that are specially designed to filter out microscopic particles.

# Contents

<b>INTRODUCTION</b> .....	<b>2</b>	<b>ACCESSORIES</b> .....	<b>31</b>
Contact Info.....	2	Wood Lathe Accessories.....	31
Manual Accuracy.....	2	<b>MAINTENANCE</b> .....	<b>32</b>
Identification .....	5	General .....	32
Controls & Features .....	6	Cleaning & Protecting .....	32
<b>SAFETY</b> .....	<b>7</b>	Lubrication .....	32
Standard Machinery Safety Instructions .....	7	<b>SERVICE</b> .....	<b>33</b>
Additional Safety for Wood Lathes.....	9	General .....	33
<b>ELECTRICAL</b> .....	<b>10</b>	Tensioning & Replacing Belt .....	33
Circuit Requirements .....	10	Changing Motor Brushes.....	34
Grounding Requirements.....	11	Troubleshooting.....	35
Extension Cords .....	11	Electrical Safety Instructions.....	37
<b>SETUP</b> .....	<b>12</b>	Electrical Component Connections.....	38
Unpacking .....	12	Wiring Diagram .....	39
Inventory .....	12	<b>PARTS</b> .....	<b>40</b>
Machine Placement .....	13	Main .....	40
Cleaning Machine.....	13	Labels & Cosmetics .....	42
Bench Mounting.....	14	<b>WARRANTY</b> .....	<b>45</b>
Assembly.....	15		
Test Run.....	16		
<b>OPERATIONS</b> .....	<b>17</b>		
General .....	17		
Operation Overview .....	18		
Stock Inspection & Requirements .....	18		
Engaging/Releasing Spindle Lock .....	19		
Changing Spindle Speeds.....	20		
Adjusting Tool Rest.....	22		
Adjusting Tailstock Position.....	23		
Installing/Removing Headstock Center .....	24		
Installing/Removing Tailstock Center .....	25		
Removing/Installing Faceplate .....	25		
Selecting Turning Tools .....	26		
Spindle Turning .....	27		
Faceplate Turning .....	29		
Sanding/Finishing .....	30		





# INTRODUCTION

## Contact Info

We are committed to customer satisfaction. If you have any questions or need help, use the information below to contact us.

**IMPORTANT: Before contacting, please get the original purchase receipt, serial number, and manufacture date of your machine. This information is required for all Technical Support calls and it will help us help you faster.**

Woodstock International Technical Support  
 Phone: (360) 734-3482  
 Email: techsupport@woodstockint.com

We want your feedback on this manual. What did you like about it? Where could it be improved? Please take a few minutes to give us feedback.

Technical Documentation Manager  
 P.O. Box 2309  
 Bellingham, WA 98227  
 Email: manuals@woodstockint.com

## Manual Accuracy

We are proud to provide a high-quality owner's manual with your new machine!

We made every effort to be exact with the instructions, specifications, drawings, and photographs contained inside. Sometimes we make mistakes, but our policy of continuous improvement also means that **sometimes the machine you receive will be slightly different than what is shown in the manual.**

If you find this to be the case, and the difference between the manual and machine leaves you confused about a procedure, check our website for an updated version. We post current manuals and manual updates for free on our website at [www.woodstockint.com](http://www.woodstockint.com).

Alternatively, you can call our Technical Support for help. Before calling, make sure you write down the **Manufacture Date** and **Serial Number** from the machine ID label (see below). Also, if available, have a copy of your **original purchase receipt** on hand. This information is required for all Tech Support calls.

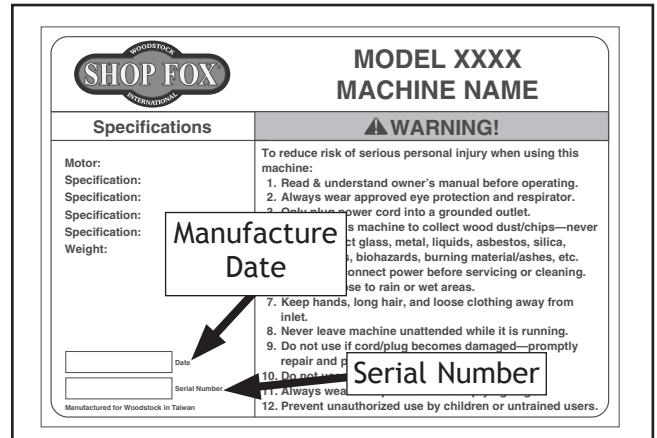



# MACHINE SPECIFICATIONS



© Woodstock International, Inc. • Phone: (800) 840-8420 • Web: www.shopfox.biz

## MODEL W1836 12" X 15" BENCHTOP WOOD LATHE

### Product Dimensions

Weight..... 79 lbs.  
 Width (side-to-side) x Depth (front-to-back) x Height..... 38-1/2 x 15-1/2 x 17 in.  
 Footprint (Length x Width)..... 8 x 31-1/2 in.

### Shipping Dimensions

Type..... Cardboard Box  
 Content..... Machine  
 Weight..... 85 lbs.  
 Length x Width x Height..... 36 x 13 x 19 in.  
 Must Ship Upright..... Yes

### Electrical

Power Requirement..... 110V, Single-Phase, 60 Hz  
 Full-Load Current Rating..... 7.4A  
 Minimum Circuit Size..... 15A  
 Connection Type..... Cord & Plug  
 Power Cord Included..... Yes  
 Power Cord Length..... 6 ft.  
 Power Cord Gauge..... 18 AWG  
 Plug Included..... Yes  
 Included Plug Type..... 5-15  
 Switch Type..... Paddle Safety Switch w/Removable Key

### Motors

#### Main

Horsepower..... 3/4 HP  
 Phase..... Single-Phase  
 Amps..... 7.4A  
 Speed..... 3000 RPM  
 Type..... Universal Brush-Type  
 Power Transfer ..... Direct Drive  
 Bearings..... Shielded & Permanently Lubricated  
 Centrifugal Switch/Contacts Type..... N/A



**Main Specifications**

**Operation Information**

Swing Over Bed.....	12 in.
Swing Over Tool Rest Base.....	9 in.
Distance Between Centers.....	15 in.
Max. Distance Tool Rest to Spindle Center.....	5-1/2 in.
No of Spindle Speeds.....	2
Spindle Speed Range.....	500-3800 RPM
Floor to Center Height.....	13-1/2 in.

**Spindle Information**

Spindle Taper.....	MT#2
Spindle Thread Size.....	1" x 8 TPI
Spindle Thread Direction.....	Right Hand
Spindle Bore.....	0.393 in.
Type of Included Spindle Center.....	Spur
Indexed Spindle Increments.....	15 deg.
No of Indexes.....	24

**Tool Rest Information**

Tool Rest Width.....	6"
Tool Rest Post Diameter.....	16 mm
Tool Rest Post Length.....	2-7/8 in.
Tool Rest Base Height.....	1-1/2 in.

**Tailstock Information**

Tailstock Taper.....	MT#2
Type of Included Tailstock Center.....	Live

**Construction**

Bed.....	Cast Iron
Headstock.....	Cast Iron
Tailstock.....	Cast Iron
Paint Type/Finish.....	Enamel

**Other Related Information**

Bed Width.....	4-3/8 in.
Faceplate Size.....	3 in.

**Other**

Country of Origin .....	China
Warranty .....	2 Years
Approximate Assembly & Setup Time .....	30 Minutes
Serial Number Location .....	ID Label
ISO 9001 Factory .....	No
Certified by a Nationally Recognized Testing Laboratory (NRTL) .....	No

# Identification

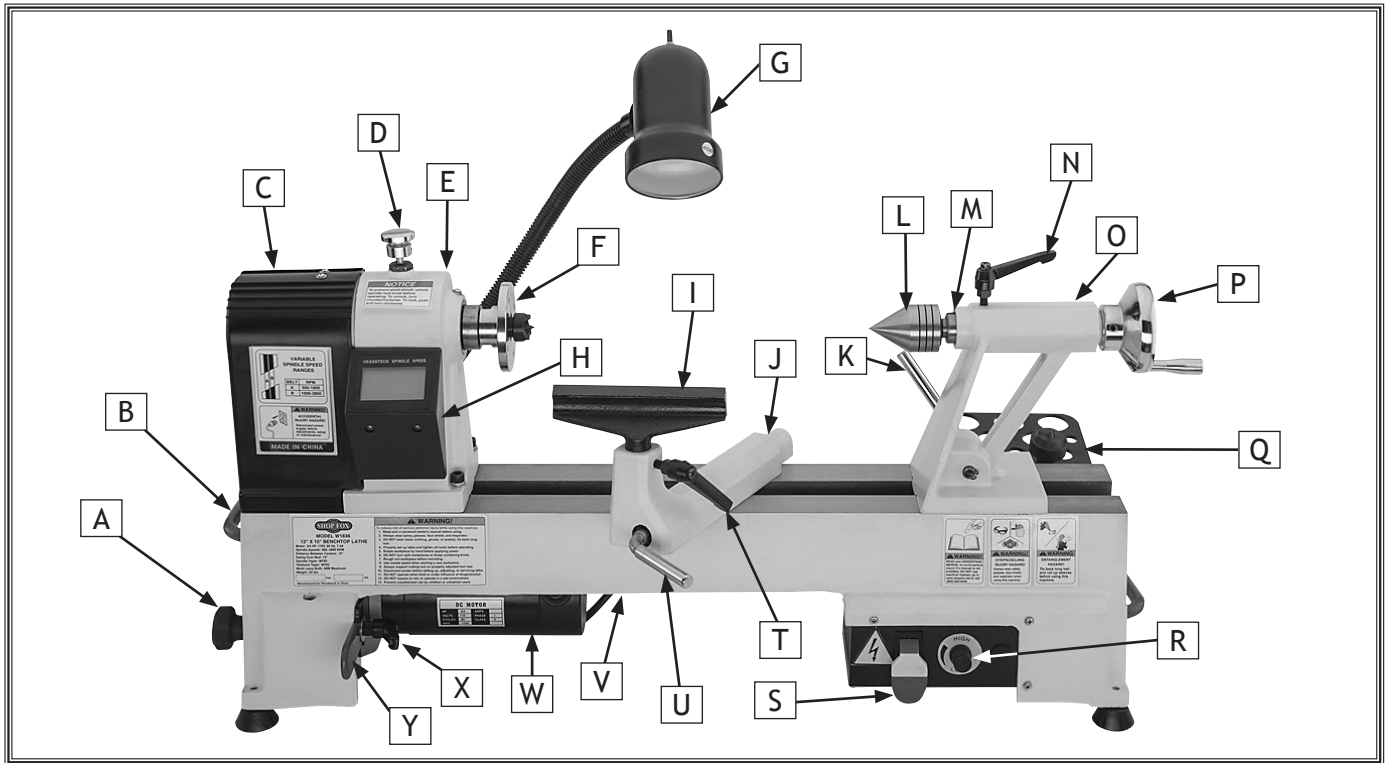

- |                             |                                |
|-----------------------------|--------------------------------|
| A. Access Door Release Knob | N. Quill Lock Handle           |
| B. Lathe Carrying Handle    | O. Tailstock                   |
| C. Belt Cover               | P. Quill Handwheel             |
| D. Spindle Lock Knob        | Q. Tool Holder                 |
| E. Headstock                | R. Variable-Speed Control Knob |
| F. Faceplate                | S. ON/OFF Safety Paddle Switch |
| G. Work Lamp                | T. Tool Rest Lock Handle       |
| H. Digital Readout          | U. Tool Rest Lock Lever        |
| I. Tool Rest                | V. Lathe Bed                   |
| J. Tool Rest Holder         | W. Motor                       |
| K. Tailstock Lock Lever     | X. Belt Tension Lock Handle    |
| L. Live Center              | Y. Belt Tension Lever          |
| M. Quill                    |                                |

## Controls & Features

Use descriptions and following figures to become familiar with basic controls of your lathe.

**Access Door Release Knob:** Spring loaded knob that opens access door when pulled.

**Belt Tension Lock Handle:** Releases tension on belt to change speeds or replace belt.

**Belt Tension Lever:** Locks or Unlocks belt tension.

**Belt Cover:** Protective cover over belt and spindle pulley. Removed by pulling away from lathe.

**Digital Readout:** Displays spindle speed in revolutions per minute (RPM).

**Spindle Lock Knob:** Locks the spindle into place for easy removal of faceplate. Spindle is released when knob is up, and locked when knob is flush with headstock.

**ON/OFF Safety Paddle Switch:** Turns power ON/OFF to lathe motor, which rotates spindle.

**Variable-Speed Dial:** Adjusts speed of the spindle within current belt position speed range.

**Tool Rest:** Provides a stable resting position for turning tools.

**Tool Rest Lock Handle:** Locks tool rest in position relative to tool rest base.

**Tool Rest Lock Lever:** Lock and unlocks tool rest base and allows it to be repositioned along lathe bed.

**Quill:** Holds centers or tooling. Can be moved toward and away from spindle.

**Quill Handwheel:** Moves quill in and out to allow clamping or releasing of workpiece.

**Quill Lock Handle:** Locks quill in place to prevent loosening during operation of lathe.

**Tailstock Lock Lever:** Unlocks tailstock to allow quick position adjustments.

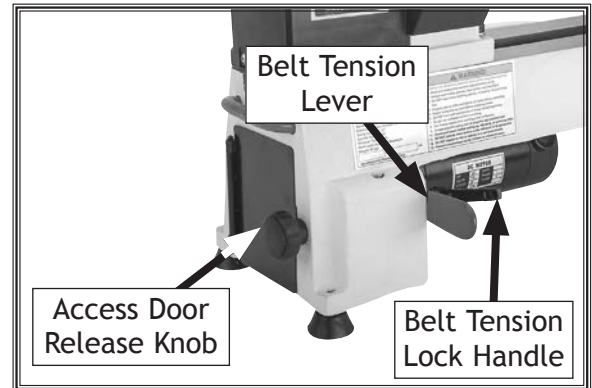

Figure 1. Belt tension controls.

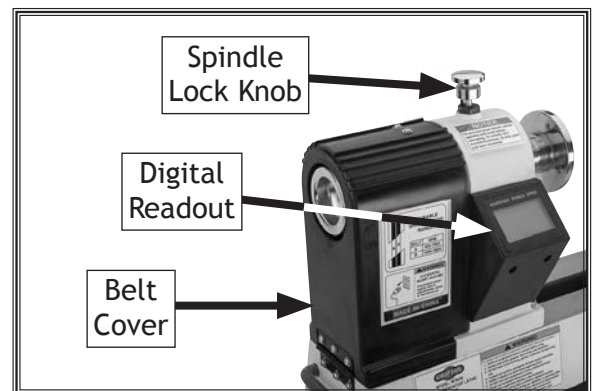

Figure 2. Spindle controls and features.

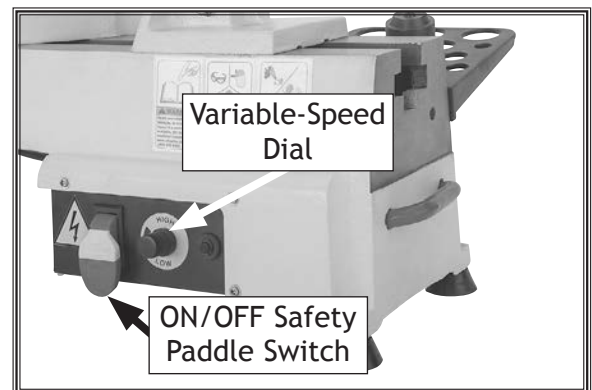

Figure 3. Electrical box controls.

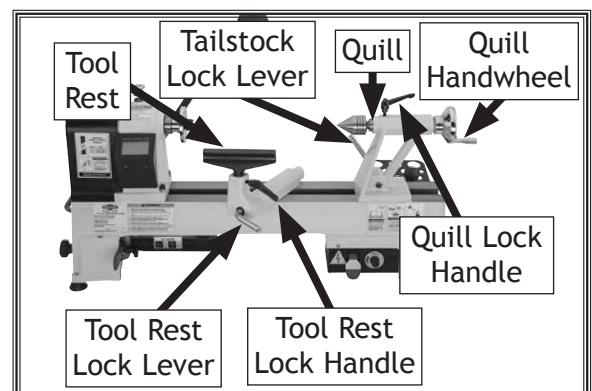

Figure 4. Tool rest and tailstock controls.



# SAFETY

## For Your Own Safety, Read Manual Before Operating Machine

The purpose of safety symbols is to attract your attention to possible hazardous conditions. This manual uses a series of symbols and signal words intended to convey the level of importance of the safety messages. The progression of symbols is described below. Remember that safety messages by themselves do not eliminate danger and are not a substitute for proper accident prevention measures—this responsibility is ultimately up to the operator!



Indicates an imminently hazardous situation which, if not avoided, **WILL** result in death or serious injury.



Indicates a potentially hazardous situation which, if not avoided, **COULD** result in death or serious injury.



Indicates a potentially hazardous situation which, if not avoided, **MAY** result in minor or moderate injury.

### NOTICE

This symbol is used to alert the user to useful information about proper operation of the equipment or a situation that may cause damage to the machinery.

## Standard Machinery Safety Instructions

**OWNER'S MANUAL.** Read and understand this owner's manual **BEFORE** using machine.

**TRAINED OPERATORS ONLY.** Untrained operators have a higher risk of being hurt or killed. Only allow trained/supervised people to use this machine. When machine is not being used, disconnect power, remove switch keys, or lock-out machine to prevent unauthorized use—especially around children. Make workshop kid proof!

**DANGEROUS ENVIRONMENTS.** Do not use machinery in areas that are wet, cluttered, or have poor lighting. Operating machinery in these areas greatly increases the risk of accidents and injury.

**MENTAL ALERTNESS REQUIRED.** Full mental alertness is required for safe operation of machinery. Never operate under the influence of drugs or alcohol, when tired, or when distracted.

**ELECTRICAL EQUIPMENT INJURY RISKS.** You can be shocked, burned, or killed by touching live electrical components or improperly grounded machinery. To reduce this risk, only allow an electrician or qualified service personnel to do electrical installation or repair work, and always disconnect power before accessing or exposing electrical equipment.

**DISCONNECT POWER FIRST.** Always disconnect machine from power supply **BEFORE** making adjustments, changing tooling, or servicing machine. This eliminates the risk of injury from unintended startup or contact with live electrical components.

**EYE PROTECTION.** Always wear ANSI-approved safety glasses or a face shield when operating or observing machinery to reduce the risk of eye injury or blindness from flying particles. Everyday eyeglasses are not approved safety glasses.

**WEARING PROPER APPAREL.** Do not wear clothing, apparel, or jewelry that can become entangled in moving parts. Always tie back or cover long hair. Wear non-slip footwear to avoid accidental slips, which could cause loss of workpiece control.

**HAZARDOUS DUST.** Dust created while using machinery may cause cancer, birth defects, or long-term respiratory damage. Be aware of dust hazards associated with each workpiece material, and always wear a NIOSH-approved respirator to reduce your risk.

**HEARING PROTECTION.** Always wear hearing protection when operating or observing loud machinery. Extended exposure to this noise without hearing protection can cause permanent hearing loss.

**REMOVE ADJUSTING TOOLS.** Tools left on machinery can become dangerous projectiles upon startup. Never leave chuck keys, wrenches, or any other tools on machine. Always verify removal before starting!

**INTENDED USAGE.** Only use machine for its intended purpose—never make modifications without prior approval from Woodstock International. Modifying machine or using it differently than intended will void the warranty and may result in malfunction or mechanical failure that leads to serious personal injury or death!

**AWKWARD POSITIONS.** Keep proper footing and balance at all times when operating machine. Do not overreach! Avoid awkward hand positions that make workpiece control difficult or increase the risk of accidental injury.

**CHILDREN & BYSTANDERS.** Keep children and bystanders at a safe distance from the work area. Stop using machine if they become a distraction.

**GUARDS & COVERS.** Guards and covers reduce accidental contact with moving parts or flying debris—make sure they are properly installed, undamaged, and working correctly.

**FORCING MACHINERY.** Do not force machine. It will do the job safer and better at the rate for which it was designed.

**NEVER STAND ON MACHINE.** Serious injury may occur if machine is tipped or if the cutting tool is unintentionally contacted.

**STABLE MACHINE.** Unexpected movement during operation greatly increases risk of injury or loss of control. Before starting, verify machine is stable and mobile base (if used) is locked.

**USE RECOMMENDED ACCESSORIES.** Consult this owner's manual or the manufacturer for recommended accessories. Using improper accessories will increase risk of serious injury.

**UNATTENDED OPERATION.** To reduce the risk of accidental injury, turn machine **OFF** and ensure all moving parts completely stop before walking away. Never leave machine running while unattended.

**MAINTAIN WITH CARE.** Follow all maintenance instructions and lubrication schedules to keep machine in good working condition. A machine that is improperly maintained could malfunction, leading to serious personal injury or death.

**CHECK DAMAGED PARTS.** Regularly inspect machine for any condition that may affect safe operation. Immediately repair or replace damaged or mis-adjusted parts before operating machine.

**MAINTAIN POWER CORDS.** When disconnecting cord-connected machines from power, grab and pull the plug—NOT the cord. Pulling the cord may damage the wires inside, resulting in a short. Do not handle cord/plug with wet hands. Avoid cord damage by keeping it away from heated surfaces, high traffic areas, harsh chemicals, and wet/damp locations.

**EXPERIENCING DIFFICULTIES.** If at any time you experience difficulties performing the intended operation, stop using the machine! Contact Technical Support at (360) 734-3482.

# Additional Safety for Wood Lathes

**MAIN INJURY HAZARDS:** Death or crushing injury from getting entangled in rotating spindle or workpiece; death, blindness, or broken bones from being struck by a workpiece that breaks apart or comes loose during rotation, turning tool kickback, or flying wood chips. To minimize your risk of these hazards, always heed the following warning information:

**INTEGRITY OF STOCK.** Verify each workpiece is free of knots, splits, nails, or foreign material to ensure it can safely rotate on spindle without breaking apart or causing turning tool kickback.

**WORKPIECE PREPARATION.** Before mounting, cut off waste portions with a bandsaw or other tool to ensure workpiece has no large edges to catch turning tool, and it will rotate without dangerous wobbling.

**SECURING LOCKS.** Verify tool rest, headstock, and tailstock are secure before turning lathe **ON**.

**SECURING WORKPIECE.** An improperly secured workpiece can fly off spindle with deadly force. Use proven setup techniques and always verify workpiece is well-secured before starting lathe. Only use high-quality fasteners with non-tapered heads for faceplate attachment.

**TOOL SUPPORT.** An improperly supported tool may be grabbed or ejected. Adjust tool rest approximately  $\frac{1}{4}$ " away from workpiece and  $\frac{1}{8}$ " above workpiece center line to provide proper support for turning tool. Firmly hold turning tool with both hands against tool rest.

**TOOL KICKBACK.** Occurs when turning tool is ejected from workpiece with great force, striking operator or bystanders. Commonly caused by poor workpiece selection/preparation, improper tool usage, or improper machine setup or tool rest adjustment.

**ADJUSTMENT TOOLS.** Remove all chuck keys, wrenches, and adjustment tools before turning lathe **ON**. A tool left on the lathe can become a deadly projectile when spindle is started.

**SAFE CLEARANCES.** Before starting spindle, verify workpiece has adequate clearance by hand-rotating it through its entire range of motion.

**EYE/FACE PROTECTION.** Always wear a face shield and safety glasses when operating lathe.

**PROPER APPAREL.** Do not wear gloves, necktie or loose clothing. Keep long hair away from rotating spindle.

**SPEED RATES.** Select correct spindle speed for workpiece size, type, shape, and condition. Use low speeds when roughing or when turning large, long, or non-concentric workpieces. Allow spindle to reach full speed before turning.

**NEW SETUPS.** Test each new setup by starting spindle rotation at the lowest speed and standing to the side of the lathe until workpiece reaches full speed and you can verify safe rotation.

**ROUGHING.** Use correct tool. Take light cuts, use low speeds, and firmly support tool with both hands.

**SHARP TOOLS.** Only use sharp turning tools—they cut with less resistance than dull tools. Dull turning tools can catch or grab and pull your hands into the rotating workpiece.

**STOPPING SPINDLE.** Always allow spindle to completely stop on its own. Never put hands or another object on spinning workpiece.

**ADJUSTMENTS/MAINTENANCE.** Make sure wood lathe is turned **OFF**, disconnected from power, and all moving parts are completely stopped before doing adjustments or maintenance.

**MEASURING WORKPIECE.** Only measure workpiece after it has stopped. Trying to measure a spinning workpiece increases entanglement risk.

**SANDING/POLISHING.** To reduce entanglement risk, remove tool rest before sanding. Never completely wrap sandpaper around workpiece.

# ELECTRICAL

## Circuit Requirements

This machine must be connected to the correct size and type of power supply circuit, or fire or electrical damage may occur. Read through this section to determine if an adequate power supply circuit is available. If a correct circuit is not available, a qualified electrician **MUST** install one before you can connect the machine to power.

A power supply circuit includes all electrical equipment between the breaker box or fuse panel in the building and the machine. The power supply circuit used for this machine must be sized to safely handle the full-load current drawn from the machine for an extended period of time. (If this machine is connected to a circuit protected by fuses, use a time delay fuse marked D.)

### Full-Load Current Rating

The full-load current rating is the amperage a machine draws at 100% of the rated output power. On machines with multiple motors, this is the amperage drawn by the largest motor or sum of all motors and electrical devices that might operate at one time during normal operations.

Full-Load Current Rating at 110V ..... 7.4 Amps

### Circuit Requirements for 110V

This machine is prewired to operate on a power supply circuit that has a verified ground and meets the following requirements:

- Circuit Type ..... 110V/120V, 60 Hz, Single-Phase
- Circuit Size ..... 15 Amps
- Plug/Receptacle ..... NEMA 5-15

**⚠ WARNING**

The machine must be properly set up before it is safe to operate. **DO NOT** connect this machine to the power source until instructed to do so later in this manual.

**⚠ WARNING**



Incorrectly wiring or grounding this machine can cause electrocution, fire, or machine damage. To reduce this risk, only an electrician or qualified service personnel should do any required electrical work on this machine.

**NOTICE**

The circuit requirements listed in this manual apply to a dedicated circuit—where only one machine will be running at a time. If this machine will be connected to a shared circuit where multiple machines will be running at the same time, consult with an electrician to ensure that the circuit is properly sized for safe operation.

ELECTRICAL

# Grounding Requirements

This machine **MUST** be grounded. In the event of certain types of malfunctions or breakdowns, grounding provides a path of least resistance for electric current to travel—in order to reduce the risk of electric shock.

Improper connection of the equipment-grounding wire will increase the risk of electric shock. The wire with green insulation (with/without yellow stripes) is the equipment-grounding wire. If repair or replacement of the power cord or plug is necessary, do not connect the equipment-grounding wire to a live (current carrying) terminal.

Check with a qualified electrician or service personnel if you do not understand these grounding requirements, or if you are in doubt about whether the tool is properly grounded. If you ever notice that a cord or plug is damaged or worn, disconnect it from power, and immediately replace it with a new one.

## Extension Cords

We do not recommend using an extension cord with this machine. Extension cords cause voltage drop, which may damage electrical components and shorten motor life. Voltage drop increases with longer extension cords and smaller gauge sizes (higher gauge numbers indicate smaller sizes).

Any extension cord used with this machine must contain a ground wire, match the required plug and receptacle, and meet the following requirements:

- Minimum Gauge Size at 110V** ..... 14 AWG
- Maximum Length (Shorter is Better)**..... 50 ft.

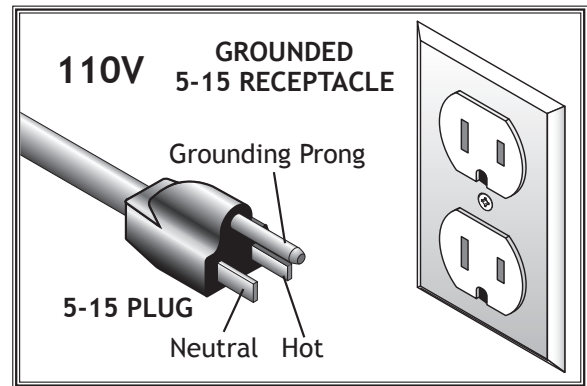
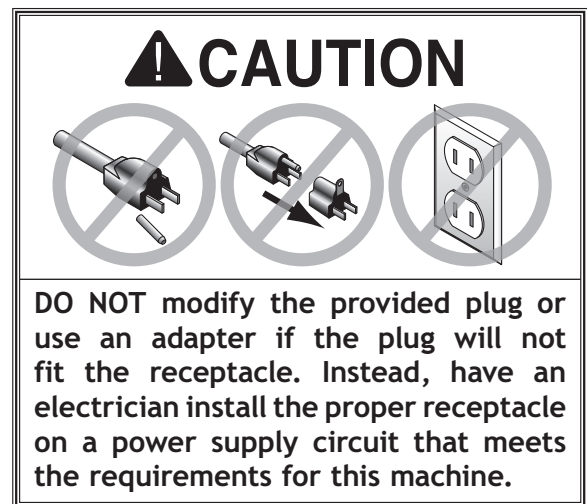

Figure 5. NEMA 5-15 plug & receptacle.



ELECTRICAL

# SETUP

## Unpacking

This machine has been carefully packaged for safe transportation. If you notice the machine has been damaged during shipping, please contact your authorized Shop Fox dealer immediately.

## Inventory

The following is a description of the main components shipped with the Model W1836. Lay the components out to inventory them.

**Note:** *If you can't find an item on this list, check the mounting location on the machine or examine the packaging materials carefully. Occasionally we pre-install certain components for safer shipping.*

Box Inventory (Figure 6)	Qty
A. Live Center .....	1
B. Knock-Out Bar .....	1
C. Spur Center .....	1
D. Handwheel Handle .....	1
E. Tool Rack .....	1
F. Cord Wrap Mounts .....	2

Hardware (Not Shown)	
– Shoulder Bolt M6-1 X 10, 7 X 44 .....	1
– Phillips Head Screws M5-.8 X 12 .....	6
– Flat Washers 5mm .....	6

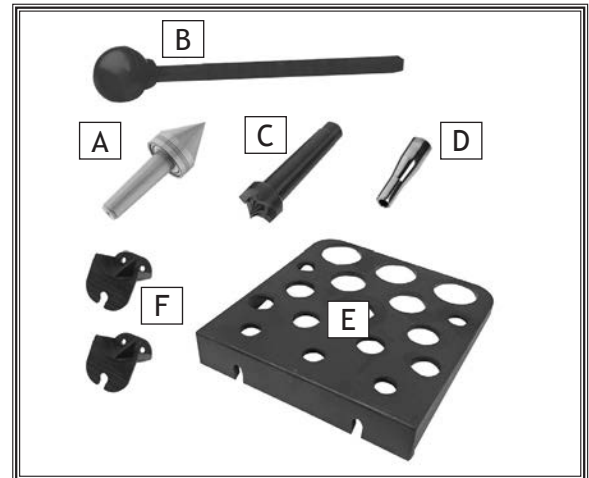
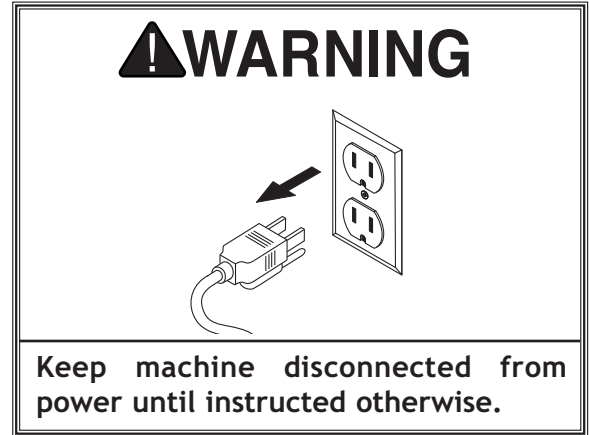

Figure 6. W1836 inventory.

SETUP

# Machine Placement

- **Working Clearances:** Consider existing and anticipated needs, size of material to be processed through the machine, and space for auxiliary stands, work tables, or other machinery when determining where to locate this machine.
- **Lighting:** Lighting should be bright enough to eliminate shadow and prevent eye strain.
- **Electrical:** Electrical circuits must be dedicated or large enough to handle amperage requirements. Outlets must be located near each machine, so power or extension cords are clear of high-traffic areas. Follow local electrical codes for proper installation of new lighting, outlets, or circuits.

	<p><b>⚠ CAUTION</b>  <b>INJURY HAZARD!</b> Untrained users can injure themselves with this machine. Restrict access to machine when you are away, especially if it is installed where children are present.</p>
--	---

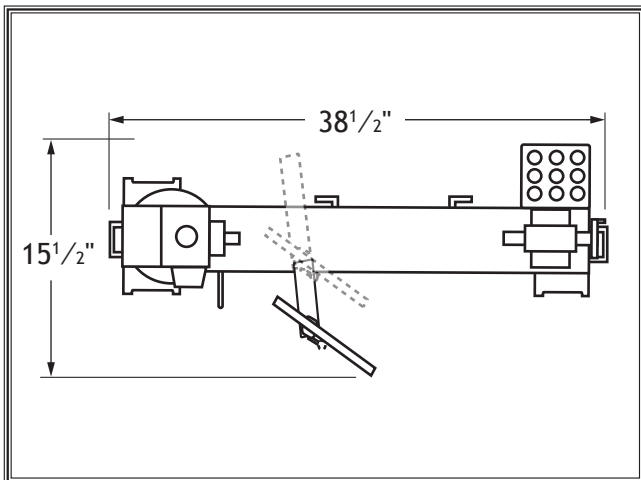

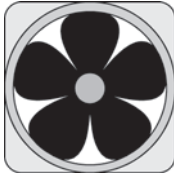



Figure 7. Working clearances.

# Cleaning Machine

The table and other unpainted parts of your machine are coated with a waxy grease that protects them from corrosion during shipment. Clean this grease off with a solvent cleaner or citrus-based degreaser. **DO NOT** use chlorine-based solvents such as brake parts cleaner or acetone—if you happen to splash some onto a painted surface, you will ruin the finish.

	<p><b>⚠ WARNING</b>  <b>NEVER</b> clean with gasoline or other petroleum-based solvents. Most have low flash points, which make them extremely flammable. A risk of explosion and burning exists if these products are used. Serious personal injury may occur if this warning is ignored!</p>
--	--

	<p><b>⚠ CAUTION</b>  <b>ALWAYS</b> work in well-ventilated areas far from possible ignition sources when using solvents to clean machinery. Many solvents are toxic when inhaled or ingested. Use care when disposing of waste rags and towels to be sure they <b>DO NOT</b> create fire or environmental hazards.</p>
	
	

SETUP

# Bench Mounting

Number of Mounting Holes..... 4  
 Dia. of Mounting Hardware Needed.....6mm

The base of this machine has mounting holes that allow it to be fastened to a workbench or other mounting surface to prevent it from moving during operation and causing accidental injury or damage. The rubber feet on this machine must be removed before bench mounting.

The strongest mounting option is a "Through Mount" (see **Figure 8**) where holes are drilled all the way through the workbench—and hex bolts, washers, and hex nuts are used to secure the machine in place.

Another option is a "Direct Mount" (see **Figure 9**) where the machine is secured directly to the workbench with lag screws and washers.

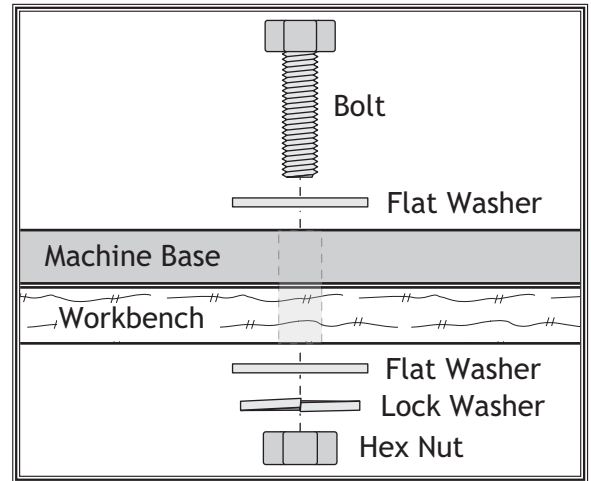

**Figure 8.** Typical "Through Mount" setup.

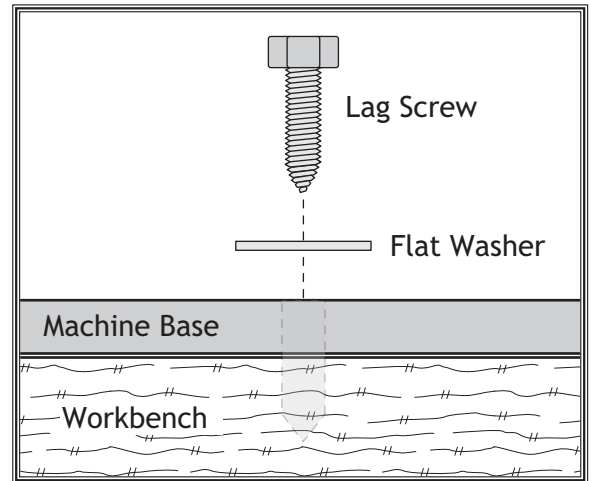

**Figure 9.** Typical "Direct Mount" setup.

SETUP



# Assembly

The Model W1836 comes mostly assembled from the factory. The quill handwheel handle, tool holder, and cord holders must be attached to complete assembly.

To complete assembly, do these steps:

1. Attach quill handwheel handle to quill handwheel with (1) M6-1 X 10, 7 X 44 shoulder bolt (see **Figure 10**).
2. Attach cord holder brackets to back of lathe bed with (4) M5-.8 X 12 Phillips head screws and (4) 5mm flat washers (see **Figure 11**).
3. Attach tool holder to back of lathe bed using (2) M5-.8 X 12 Phillips head screws and (2) 5mm flat washers (see **Figure 11**).

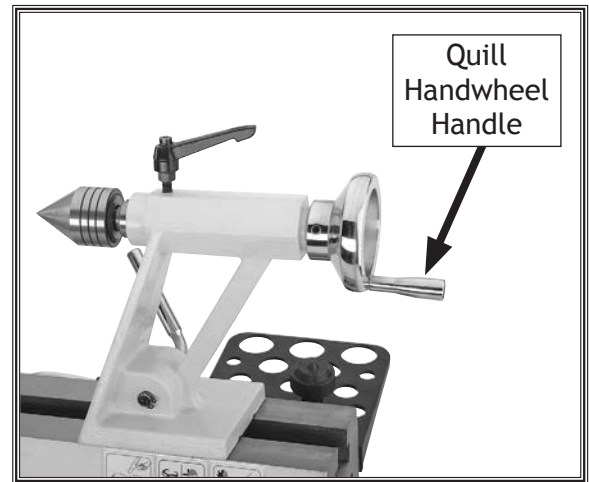

**Figure 10.** Quill handwheel handle installed.

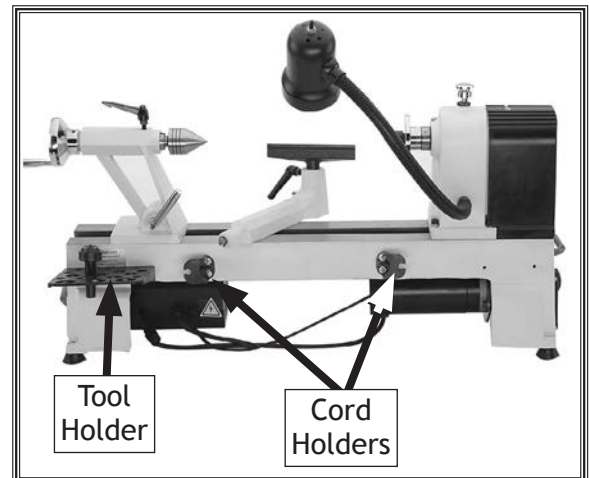

**Figure 11.** Tool holder and cord holder installed.

SETUP

# Test Run

Once assembly is complete, test run the machine to make sure it runs properly and is ready for regular operation.

If, during the test run, you cannot easily locate the source of an unusual noise or vibration, stop using the machine immediately, then review **Troubleshooting** on **Page 35**. If you still cannot remedy a problem, contact our Tech Support for assistance.

The test run consists of verifying the following: 1) The motor powers up and runs correctly, and 2) the safety disabling mechanism on the switch works correctly.

To test run machine, do these steps:

1. Make sure you understand safety instructions at beginning of manual, and clear all tools and objects away from machine.
2. Ensure spindle lock is released (see **Page 19**).
3. Rotate variable-speed dial completely counterclockwise to low (see **Figure 12**).
4. Connect machine to power source.
5. Verify machine is operating correctly by turning machine **ON** with paddle switch, then rotating variable-speed dial clockwise to start spindle rotation.
  - When operating correctly, machine runs smoothly with little or no vibration or rubbing noises.
  - Investigate and correct strange or unusual noises or vibrations before operating machine further. Always disconnect machine from power when investigating or correcting potential problems.
6. Turn machine **OFF**.
7. Remove switch disabling key (see **Figure 12**).
8. Try to start machine with paddle switch.
  - If machine *does not* start, switch disabling feature is working as designed.
  - If machine *does* start, immediately stop machine. Switch disabling feature is not working correctly. Call Tech Support for help.

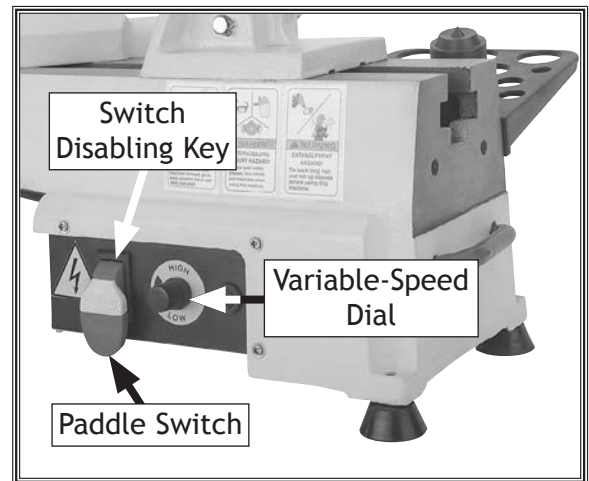

**Figure 12.** Location of variable-speed dial and paddle switch.

SETUP



# OPERATIONS



## General



This machine will perform many types of operations that are beyond the scope of this manual. Many of these operations can be dangerous or deadly if performed incorrectly.

The instructions in this section are written with the understanding that the operator has the necessary knowledge and skills to operate this machine. If at any time you are experiencing difficulties performing any operation, stop using the machine!

The overview below provides the novice machine operator with a basic understanding of how the machine is used during operation, so the machine controls/components discussed later in this manual are easier to understand. Due to its generic nature, this overview is **NOT** intended to be an instructional guide.

 <b>WARNING</b> 
<b>To reduce your risk of serious injury or damage to the machine, read this entire manual BEFORE using machine.</b>

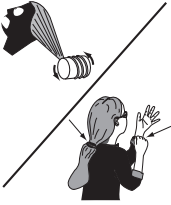
 <b>WARNING</b>  
<b>To reduce the risk of eye injury and long-term respiratory damage, always wear safety glasses and a respirator while operating this machine.</b>

	 <b>WARNING</b> <b>Tie back long hair, roll up long sleeves, and remove loose clothing, jewelry, or gloves to prevent getting caught in moving parts.</b>
--	---

OPERATIONS

## Operation Overview

The purpose of this overview is to provide the novice machine operator with a basic understanding of how the machine is used during operation, so the machine controls/components discussed later in this manual are easier to understand.

Due to the generic nature of this overview, it is **not** intended to be an instructional guide. To learn more about specific operations, read this entire manual and seek additional training from experienced machine operators, and do additional research outside of this manual by reading "how-to" books, trade magazines, or websites.

To complete a typical operation, the operator does the following:

1. Examines workpiece to make sure it is suitable for turning. No extreme bows, knots, or cracks should exist.
2. Prepares and trims workpiece to make it roughly concentric.
3. Installs workpiece between centers, or attaches it to faceplate or chuck.
4. Adjusts tool rest to  $\frac{1}{8}$ " above workpiece centerline, and sets minimum clearance between the workpiece and lip of tool rest to  $\frac{1}{4}$ ".
5. Rotates workpiece by hand to verify that the spindle and workpiece rotate freely throughout the range of motion.
6. Positions dust collection hood near work piece to collect wood chips secure in place.
7. Ties back loose hair and clothing, and puts on face shield and respirator. Takes all other required safety precautions.
8. Starts lathe, adjusts lathe speed, and carefully begins turning operation, keeping chisel against tool rest entire time it is cutting.

## Stock Inspection & Requirements

Some workpieces are not safe to turn or may require modification before they are safe to turn. **Before turning a workpiece, inspect all workpieces for the following:**

- **Workpiece Type:**  
This machine is intended for cutting natural and man-made wood products, and some plastics. Never attempt to cut any metal, stone, or rubber workpiece; cutting these materials can lead to machine damage or severe injury.
- **Foreign Objects:**  
Nails, staples, dirt, rocks and other foreign objects are often embedded in wood. While cutting, these objects can become dislodged and hit the operator, cause tool grab, or break the turning tool, which might then fly apart. Always visually inspect your workpiece for these items. If they can't be removed, **DO NOT** turn the workpiece.
- **Large/Loose Knots:**  
Loose knots can become dislodged during the turning operation. Large knots can cause a workpiece to completely break in half during turning and cause machine damage and personal injury. Choose workpieces that do not have large/loose knots.
- **Excessive Warping or Twists:**  
Workpieces with excessive bowing or twisting are unstable and unbalanced. Never turn these workpieces at high speed, or instability will be magnified and the workpiece can be ejected from the lathe causing impact injuries. Only turn concentric workpieces!

## Engaging/Releasing Spindle Lock

This lathe is equipped with a spindle lock that can be engaged to aid in installing and removing the faceplate. The spindle lock must be released before turning lathe **ON**.

The spindle lock knob has a detent hole and pin that holds it up and away from the spindle during operation. Pulling up on the spindle lock knob and rotating it in any direction allows you to set the spindle lock to the *Run* position. The spindle lock knob will have a noticeable gap between the bottom of it and the headstock when set properly (see **Figure 13**).

Alternately, you can set the spindle lock knob so it locks into the spindle. In the *Locked* position, the knob will be flush with the top of the headstock (see **Figure 14**). You may need to rotate the spindle slightly to allow the spindle lock to fully seat itself.

### **NOTICE**

Always unlock spindle lock knob before operating. Not heeding this notice could cause motor overload or damage to other lathe parts.

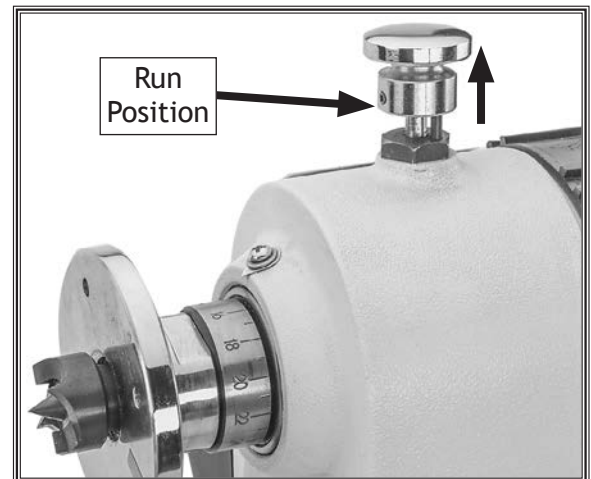

**Figure 13.** Spindle lock knob in *Run* position.

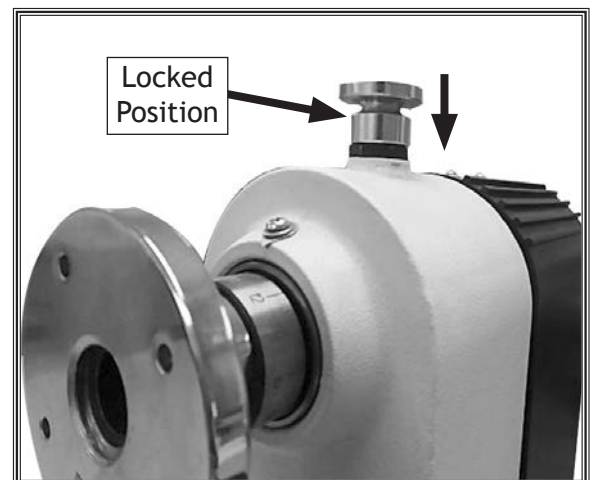

**Figure 14.** Spindle lock knob in *Locked* position.

SETUP

# Changing Spindle Speeds

This lathe has two overlapping speed ranges to ensure maximum spindle torque within each range. These ranges are selected by changing belt positions on the motor and spindle pulleys (see Figure 15).

High range (B) is best when turning a workpiece where a clean finish is required and only light cuts are made. Low range (A), which has more torque, is best when turning a workpiece where a lot of material must be removed and a rough finish does not matter. Use the speed dial to adjust the spindle speed within each range.

Refer to the speed recommendations chart below to choose the appropriate RPM for your operation. Then choose the speed range that will include the selected RPM.

Diameter of Workpiece	Roughing RPM	General Cutting RPM	Finishing RPM
Under 2"	1520	3000	3000
2-4"	760	1600	2480
4-6"	510	1080	1650
6-8"	380	810	1240
8-10"	300	650	1000
10-12"	255	540	830

**⚠ WARNING**

Always choose correct spindle speed for your operation. Using an incorrect speed may lead to workpiece breaking loose or being thrown from lathe at a high rate of speed, causing fatal or severe impact injuries.

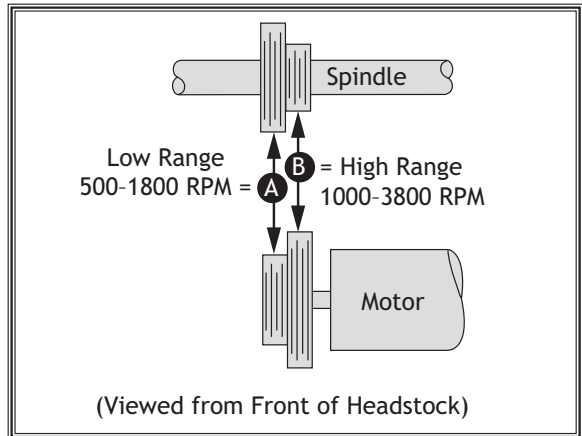

Figure 15. Belt position for each spindle speed range.

## Changing Spindle Speed Range

1. DISCONNECT MACHINE FROM POWER!
2. Fold back belt cover to expose spindle pulley. Pull access door release knob and open access door to expose motor pulley (see Figure 16).
3. Loosen belt tension lock handle. Move belt tension lever up to reduce tension on belt.
4. Locate desired speed on belt-cover speed chart, and move belt to desired grooves on motor and spindle pulleys.

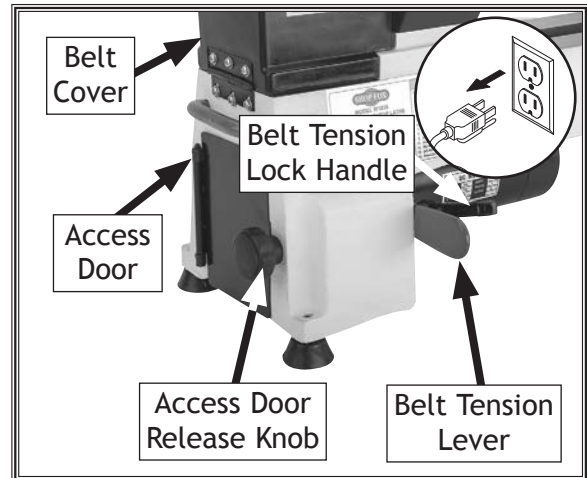

Figure 16. Location of components used when changing spindle speed ranges.

5. Push down on belt tension lever, then tighten belt tension lock handle.

**Note:** When properly tensioned, the belt should deflect about  $\frac{1}{2}$ " when moderate pressure is applied to the belt mid-way between upper and lower pulleys, as shown in **Figure 17**.

6. Close belt cover and access door.

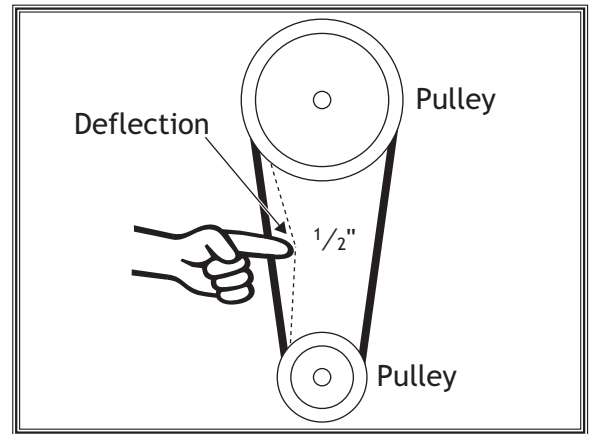

Figure 17. Proper belt deflection.

### Adjusting Spindle Speed

To change spindle speed, rotate variable-speed dial clockwise to increase spindle RPM or counterclockwise to decrease spindle RPM (see **Figure 18**). The current spindle RPM is displayed on the digital readout.

**Note:** Make it a habit to always rotate variable-speed dial completely counterclockwise when stopping the lathe. This will prevent unexpected rotational speeds or surprises the next time the lathe is started.

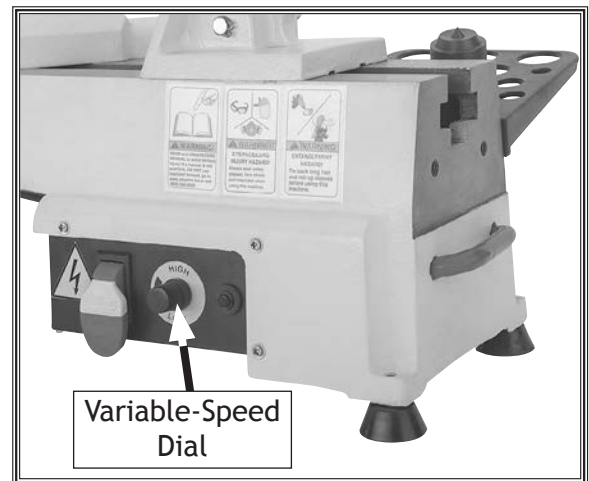

Figure 18. Location of variable-speed dial.

# Adjusting Tool Rest

The tool rest is equipped with a cam-action clamping system to secure it to the lathe bed. When the tool rest lock lever is engaged, a locking plate lifts up and secures the tool rest base to the bed.

## Positioning Along Bed

1. Loosen tool rest lock lever and slide tool rest base along bed (see **Figure 19**).
2. Tighten tool rest lock lever to lock tool rest base in place.
  - If release lever will not lock tool rest base onto bed (either too loose or too tight), then loosen or tighten lock nut (located on underside of tool rest base) in small increments as needed to achieve proper clamping pressure.

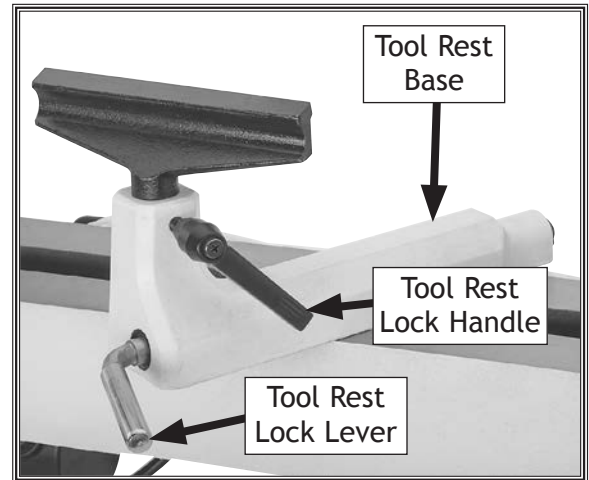

**Figure 19.** Tool rest controls.

## **WARNING**

Always operate lathe with tool rest assembly firmly locked in position. Otherwise, serious personal injury may occur by tool being pulled from operator's hands.

## Adjusting Angle or Height

1. Loosen tool rest base lock lever and tool rest lock handle to adjust position of tool rest.
2. Position tool rest approximately  $\frac{1}{4}$ " away from workpiece and approximately  $\frac{1}{8}$ " above workpiece center line, as shown in **Figure 20**.
3. Re-tighten tool rest lock handle and tool rest lock lever to secure tool rest in position.

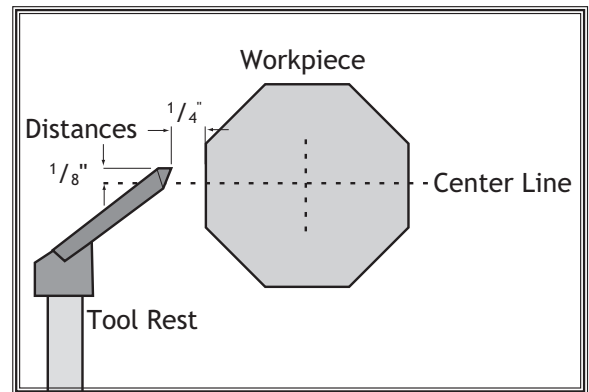

**Figure 20.** Tool rest position relative to workpiece.



# Adjusting Tailstock Position

The tailstock is equipped with a cam-action clamping system to secure it to the lathe bed. When the lever is tightened, a locking plate lifts up and secures the tool rest to the bed.

To position tailstock along bed, do these steps:

1. Loosen lock lever and slide tailstock to desired position (see Figure 21).
2. Re-engage lock lever.
  - If lock lever does not firmly lock tailstock down onto bed (either too loose or too tight), loosen or tighten lock nut (located on the underside of the tailstock) in small increments as needed to achieve the proper clamping pressure.

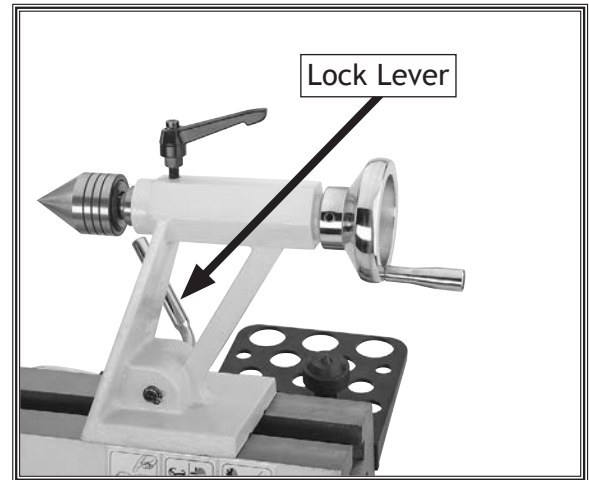

Figure 21. Location of tailstock lock lever for moving tailstock along bed.

# Installing/Removing Headstock Center

The included MT#2 spur center installs into the headstock spindle with a taper fit. Clean the mating surfaces of the center and spindle carefully to ensure a proper fit.

## Installing Headstock Center

1. DISCONNECT MACHINE FROM POWER!
2. Always make sure mating surfaces of center and spindle are free of debris or oily substances before inserting center to ensure a good fit and reduce runout.
3. Insert tapered end of center into spindle, and push it in with a quick firm motion (see Figure 22).
4. Make sure center is securely installed by attempting to pull it out by hand—a properly installed center will not pull out easily.

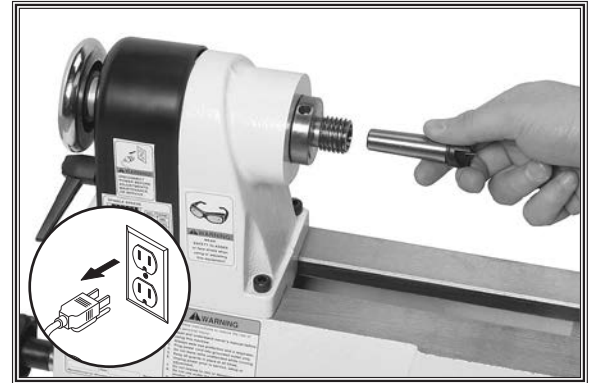

Figure 22. Example of inserting spur center into a spindle.

## Removing Headstock Center

1. DISCONNECT MACHINE FROM POWER!
2. Hold a clean rag under spindle or wear leather glove to catch center when you remove it.
3. Insert knock-out bar through outboard end of spindle and firmly tap back of center, catching it as it falls out (see Figure 23).



Figure 23. Example of removing spur center using knock-out bar.

# Installing/Removing Tailstock Center

The included MT#2 live center installs into the tailstock quill with a tapered fit. Clean the mating surfaces of the center and spindle carefully to ensure a proper fit.

## Installing Tailstock Center

1. Loosen quill lock handle, and rotate handwheel clockwise until tailstock quill extends about  $\frac{3}{4}$ ".
2. Always make sure surfaces of center and quill are free of debris or oily residue before inserting center to ensure a good fit and reduce runout.
3. Firmly insert tapered end of center into tailstock, as shown in **Figure 24**.
4. Make sure center is securely installed by attempting to pull it out by hand—a properly installed center will not pull out easily.
5. Tighten quill lock handle.

## Removing Tailstock Center

Turn quill handwheel counterclockwise until tailstock quill fully retracts, causing center to be forced out of quill.

# Removing/Installing Faceplate

These instructions only cover removing and installing the faceplate. To mount a workpiece to your faceplate, refer to **Faceplate Turning on Page 29**.

## Removing Faceplate

1. DISCONNECT MACHINE FROM POWER!
2. Lock spindle lock knob (**Figure 25**), then rotate faceplate counterclockwise until it is removed.

## Installing Faceplate

1. DISCONNECT MACHINE FROM POWER!
2. Lock spindle lock knob, then thread faceplate onto spindle shaft until secure against shoulder.

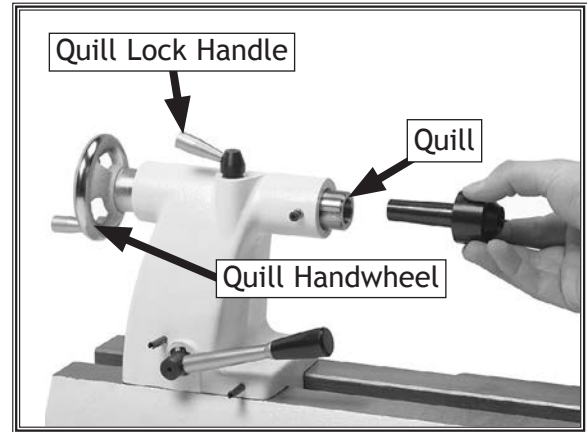
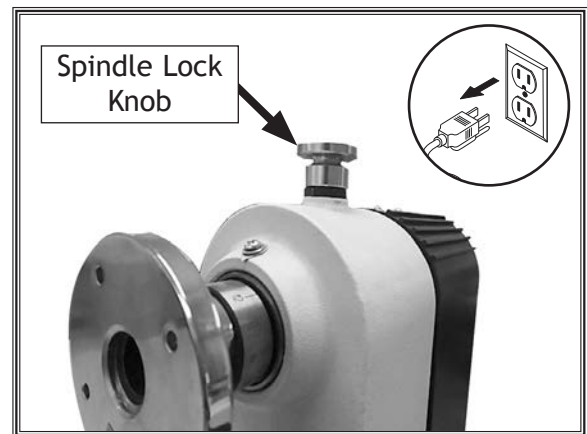

**Figure 24.** Example of installing live center in tailstock.

**⚠ WARNING**

Tailstock quill lock handle must always be locked down while lathe is in use. The workpiece can be thrown from lathe if this step is not observed. Also, tailstock quill should not protrude from tailstock housing more than 2" or quill will not be supported enough. Failure to follow these warnings may result in personal injury.

OPERATIONS



**Figure 25.** Spindle lock knob in *Locked* position.

# Selecting Turning Tools

Lathe tools come in a variety of shapes and sizes and usually fall into five major categories.

- **Gouges**—Mainly used for rough cutting, detail cutting, and cove profiles. The rough gouge is a hollow, double-ground tool with a round nose, and the detail gouge is a hollow, double-ground tool with either a round or pointed nose. **Figure 26** shows an example of a gouge.
- **Skew Chisel**—A very versatile tool that can be used for planing, squaring, V-cutting, beading, and parting off. The skew chisel is flat, double-ground with one side higher than the other (usually at an angle of 20-40°). **Figure 27** shows an example of a skew chisel.
- **Scrapers**—Mainly used where access for other tools is limited, such as hollowing operations. This is a flat, double-ground tool that comes in a variety of profiles (Round Nose, Spear Point, Square Nose, etc.) to match many different contours. **Figure 28** shows an example of a round nose scraper.
- **Parting Tools**—Used for sizing and cutting off work. This is a flat tool with a sharp pointed nose that may be single- or double-ground. **Figure 29** shows an example of a parting tool.
- **Specialty Tools**—These are the unique, special function tools to aid in hollowing, bowl making, cutting profiles, etc.

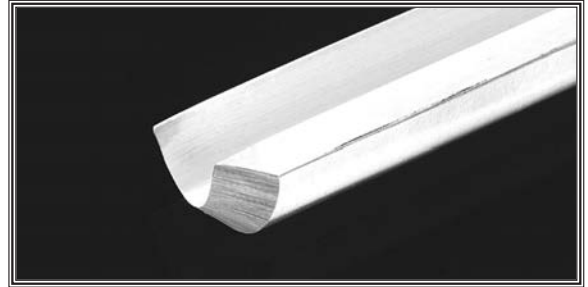

Figure 26. Gouge.

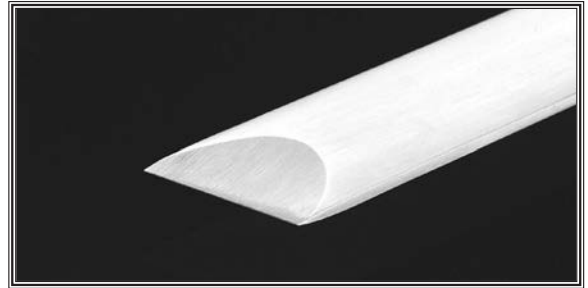

Figure 27. Skew chisel.



Figure 28. Round nose scraper.

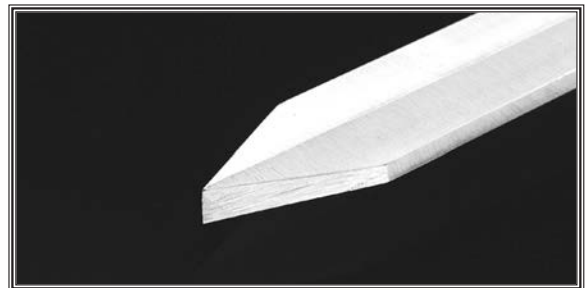

Figure 29. Parting tool.

# Spindle Turning

Spindle turning is the operation performed when a workpiece is mounted between the headstock and the tailstock, as shown in **Figure 30**.

To set up a spindle turning operation, do these steps:

1. Find center point of both ends of your workpiece by drawing diagonal lines from corner to corner across end of workpiece, as shown in **Figure 31**.
2. Make center mark by using wood mallet and tapping point of spur center into center of workpiece on both ends.
3. Using  $\frac{1}{4}$ " drill bit, drill  $\frac{1}{4}$ " deep hole at center mark on end of workpiece to be mounted on headstock spur center.
4. To help embed spur center into workpiece, cut  $\frac{1}{8}$ " deep saw kerfs in headstock end of workpiece along diagonal lines marked in **Step 1**.

**Note:** If your workpiece is over 2" x 2", cut corners off workpiece lengthwise to make turning safer and easier (see **Figure 34**).

5. Drive spur center into center mark with wood mallet to embed it at least  $\frac{1}{4}$ " into workpiece, as shown in **Figure 32**.
6. With workpiece still attached, insert spur center into headstock spindle (refer to **Installing/Removing Headstock Center** on **Page 24** for additional instructions).

**Note:** Use the tool rest to support the opposite end of workpiece so that the workpiece and spur center do not separate during installation.

7. Install live center into tailstock quill and tighten quill lock handle to lock quill in position (refer to **Page 25** for additional instructions).
8. Slide tailstock toward workpiece until point of live center touches workpiece center mark, then lock tailstock in this position.
9. Loosen quill lock handle and rotate tailstock handwheel to push live center into workpiece at least a  $\frac{1}{4}$ ".

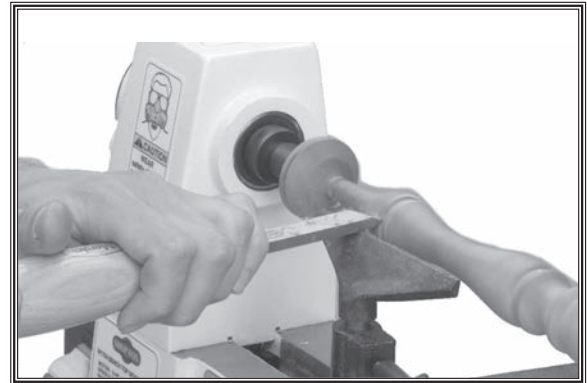

**Figure 30.** Example of typical spindle turning operation (tailstock not shown).

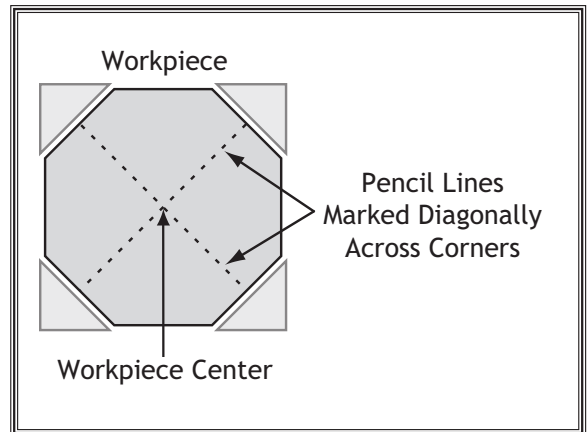

**Figure 31.** End of workpiece with corners removed and diagonal marks from corner to corner to find workplace center point.

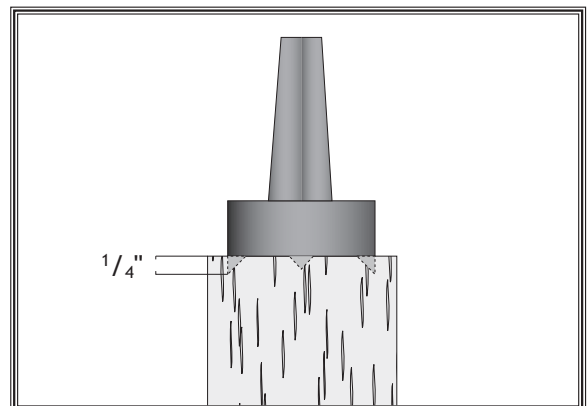

**Figure 32.** Spur center properly embedded in workpiece.

OPERATIONS

10. Properly adjust tool rest to workpiece (see **Adjusting Tool Rest** on Page 22).
11. Before beginning lathe operation, rotate workpiece by hand at least one full rotation to ensure safe clearance on all sides.

### Spindle Turning Tips:

- When turning lathe **ON**, stand away from path of spinning workpiece until spindle reaches full speed and you can verify workpiece will not come loose.
- Always use the slowest speed when starting and stopping the lathe.
- Always use the proper speed for the size of your workpiece (refer to **Adjusting Spindle Range** on Page 20).
- Keep turning tool on tool rest the ENTIRE time it is in contact with the workpiece.
- Learn the correct techniques for each turning tool you use. If you are unsure about how to use any individual tool, read books or magazines about lathe techniques, and seek training from experienced and knowledgeable lathe users.



**⚠ WARNING**

Do not press workpiece too firmly with tailstock or the bearings will bind and overheat. Likewise, do not adjust too loosely or workpiece will spin off lathe. Use good judgement. Serious personal injury could result if care is not taken.

**⚠ WARNING**

Keep lathe tool resting on tool rest ENTIRE time that it is in contact with workpiece or when preparing to make contact between lathe tool and workpiece. Otherwise, spinning workpiece could force lathe tool out of your hands or entangle your hands with workpiece. Failure to heed this warning could result in serious personal injury.

**⚠ WARNING**

To reduce the risk of eye injury and long-term respiratory damage, always wear safety glasses and a respirator while operating this machine.

# Faceplate Turning

Faceplate turning (see **Figure 33**) is when a workpiece is mounted to the faceplate, which is mounted to the headstock spindle. This type of turning is usually done with open-faced workpieces, such as bowls.

## Mounting Workpiece to Faceplate

1. Mark workpiece center in same manner as described in **Spindle Turning** (see **Page 25**).

**Note:** Cut off corners of workpiece to make it as close to round as possible, as described in **Spindle Turning** on **Page 27**.

2. Center faceplate on workpiece, securely attach workpiece to faceplate—only use wood screws WITHOUT tapered heads (see **Figure 34**).
3. Thread and secure faceplate onto headstock spindle, as described in **Removing/Installing Faceplate** on **Page 25**.
  - If wood screws cannot be placed in workpiece, faceplate can be mounted to a backing block attached to the workpiece, as described below.

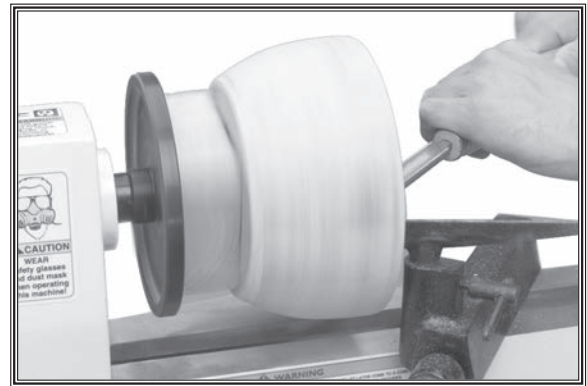

**Figure 33.** Typical faceplate turning operation.

## Mounting Workpiece to Backing Block

1. Make backing block from a suitable size piece of scrap wood.

**Note:** All faces of backing block must be flat and parallel to each other. Uneven surfaces will cause workpiece to spin eccentrically, causing unnecessary vibration and runout. Mount backing block to faceplate and turn outer surface flat prior to mounting workpiece.

2. Locate and mark center of workpiece and backing block.
3. Drill a 1/4" hole through center of backing block.
4. Look through hole in backing block to line up center with workpiece, then glue and clamp backing block to workpiece.

**Note:** Allow the glue to cure according to manufacturer instructions.

5. Mount workpiece and backing block to faceplate, as described above. See example in **Figure 35**.

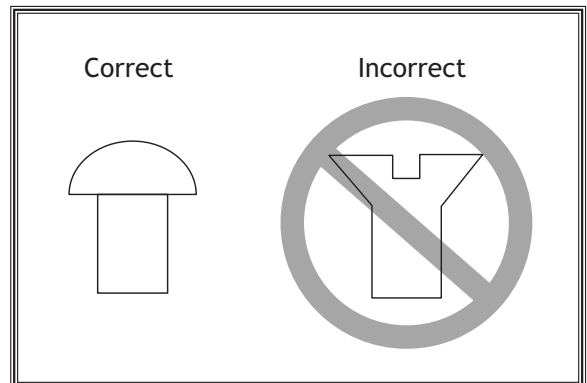

**Figure 34.** Correct/incorrect screw types for mounting faceplate to workpiece.

**NOTICE**

Only use screws with non-tapered heads to attach faceplate to workpiece. Screws with tapered heads can split faceplate or snap off during operation

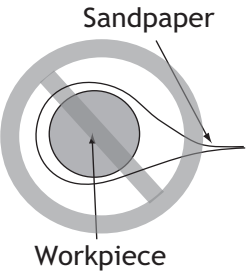

**Figure 35.** Example of mounting workpiece to a faceplate using a backing block.

OPERATIONS

## Sanding/Finishing

After the turning operations are complete, the workpiece can be sanded and finished before removing it from the lathe, as shown in Figure 36.

	<p><b>⚠ WARNING</b></p> <p><b>ENTANGLEMENT HAZARD!</b> Wrapping sandpaper completely around workpiece could pull your hands into moving workpiece and cause serious injury. Never wrap sandpaper or finishing materials completely around the workpiece!</p>
---	--

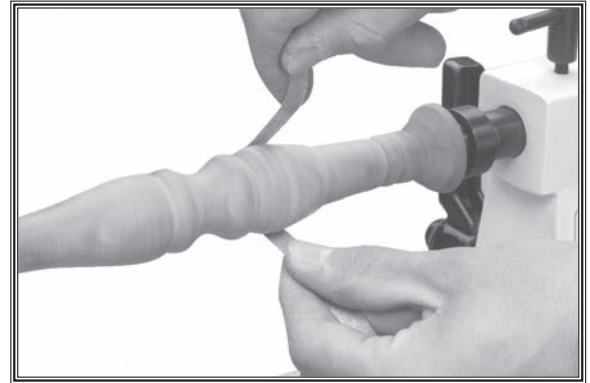

Figure 36. Typical sanding operation.

**Note:** Whenever sanding or finishing, move the tool rest holder out of the way to increase personal safety and gain adequate working room.



# ACCESSORIES

## Wood Lathe Accessories

The following wood lathe accessories may be available through your local Woodstock International Inc. Dealer. If you do not have a dealer in your area, these products are also available through online dealers. Please call or e-mail Woodstock International Inc. Customer Service to get a current listing of dealers at: 1-800-840-8420 or at [sales@woodstockint.com](mailto:sales@woodstockint.com).

The **D3640 Tool Table Plus** accommodates larger bench top machines. The table has a butcher block finish and measures 14" x 40" x 1 1/4" thick. The wide A-frame stand has a 700 lb. capacity and measures 33" high. Includes stand frame and top.



The **D2304 6-Piece Deluxe HSS Lathe Chisel Set** features beefy ash handles for unsurpassed control, brass ferrules and high speed steel blades. Includes: a 17" long 13/16" Parting Tool, 13/16" Round Nose and 3/8" Gouge, a 19" long 1" Skew, a 5/8" Gouge and a 22 3/4" long 3/8" Gouge.



The **D4562 Bed Extension for W1836 Lathe** will get you the capacity of a much larger lathe at a fraction of the price. This extension bed increases the capacity of your W1836 Shop Fox 12" Wood Lathe to handle pieces up to 38" long.



OPERATIONS

# MAINTENANCE

## General

Regular periodic maintenance on your machine will ensure its optimum performance. Make a habit of inspecting your machine each time you use it.

Check for the following conditions and repair or replace when necessary:

- Loose mounting bolts.
- Worn switch.
- Worn or damaged cords and plugs.
- Damaged V-belt.
- Any other condition that could hamper the safe operation of this machine.

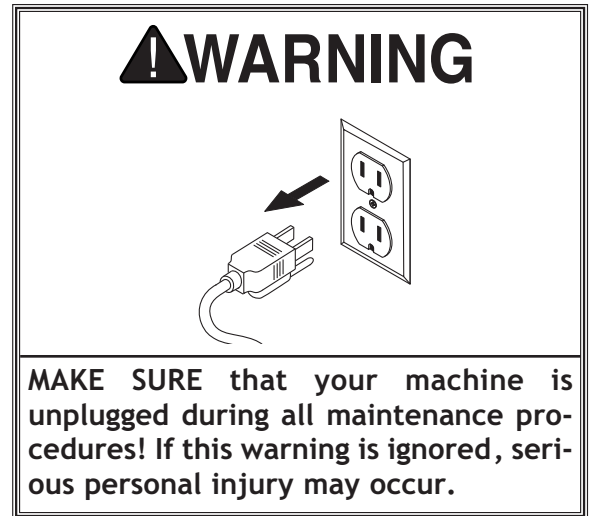

## Cleaning & Protecting

Cleaning the Model W1836 is relatively easy. Vacuum excess wood chips and sawdust, and wipe off the remaining dust with a dry cloth. If any resin has built up, use a resin dissolving cleaner to remove it.

Remove any debris or oily substances from the inside of the spindle and quill.

Protect the unpainted cast iron lathe bed by wiping it clean after every use—this ensures moisture from wood dust does not remain on the bare metal surfaces. Keep your lathe bed rust-free with regular applications of quality lubricants.

## Lubrication

Lubricate the locations shown in Figure 37 with light machine oil.

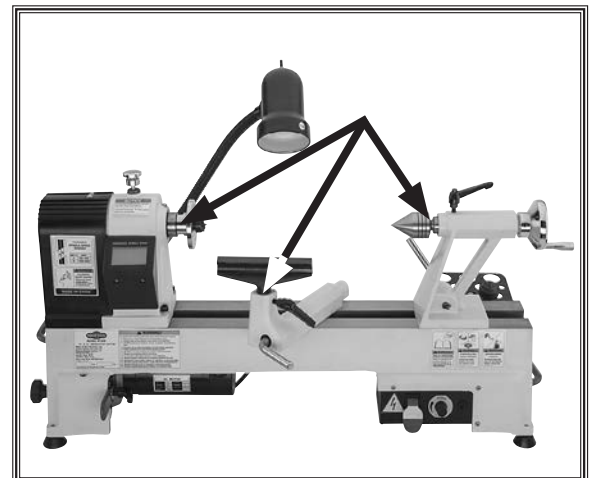

Figure 37. Lubrication locations.

# SERVICE

## General

This section covers the most common service adjustments or procedures that may need to be made during the life of your machine.

If you require additional machine service not included in this section, please contact Woodstock International Technical Support at (360) 734-3482 or send e-mail to: [techsupport@woodstockint.com](mailto:techsupport@woodstockint.com).

## Tensioning & Replacing Belt

The drive belt stretches as the lathe is used. Most of the stretching will occur during the first 16 hours, but may continue with further use. If the lathe loses power while making a cut, the belt may be slipping and need tensioning. If the belt shows signs of excessive wear, or damage, replace it.

### Tensioning Belt

1. DISCONNECT MACHINE FROM POWER!
2. Open belt cover and loosen belt tension lock handle (see Figure 38).
3. Press belt tension lever down, then tighten belt tension lock handle.
4. Press belt with moderate pressure in center to check tension. Belt is correctly tensioned when there is approximately  $\frac{1}{2}$ " deflection when pushed as shown in Figure 17.
  - If there is more than  $\frac{1}{2}$ " deflection repeat the tensioning procedure until it is correct. If tension cannot be achieved replace belt.
5. Close belt cover.

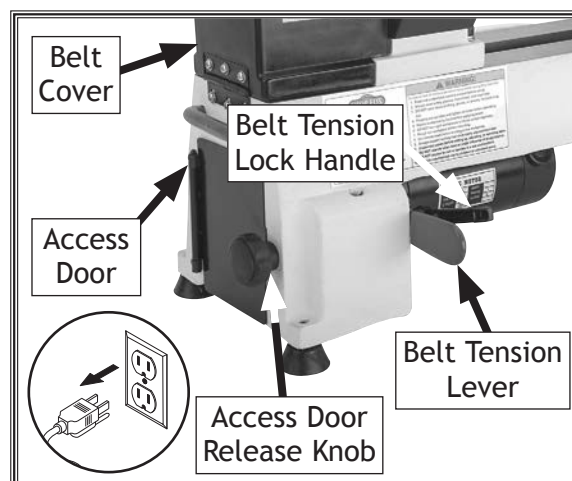
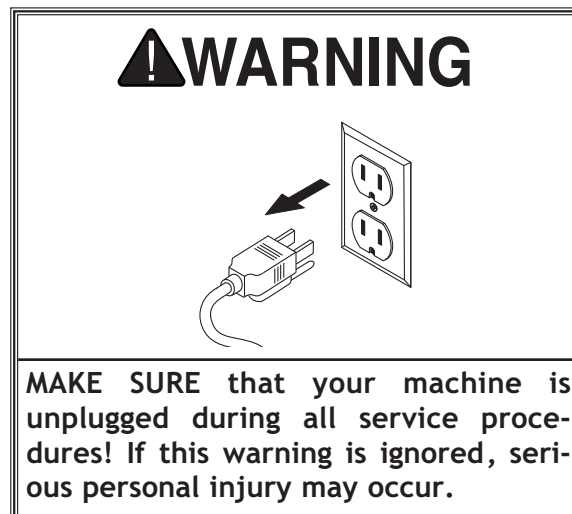

Figure 38. Location of components used when tensioning or replacing belt.

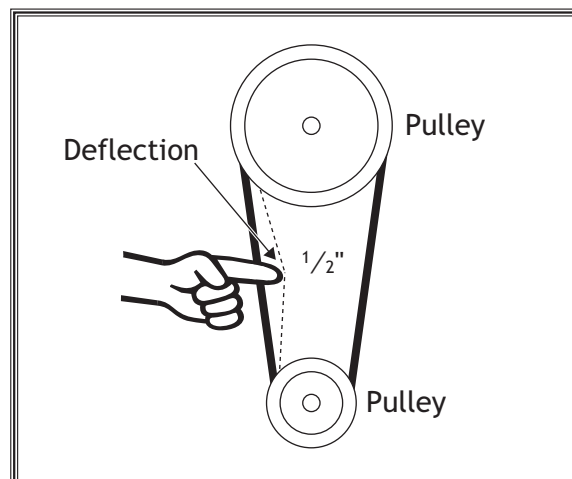
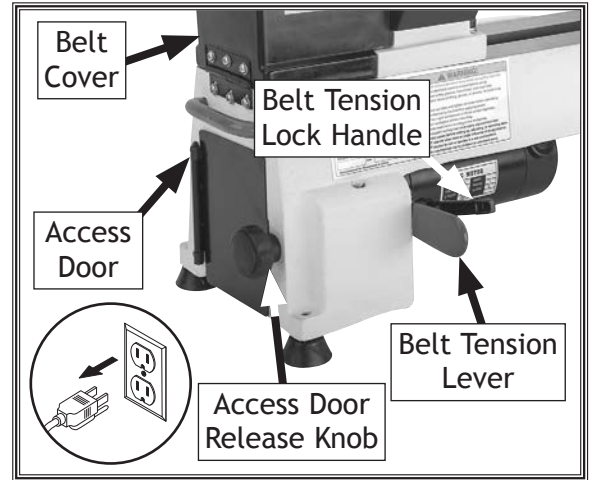

Figure 39. Checking belt deflection.

## Replacing Belt

1. DISCONNECT MACHINE FROM POWER!
2. Open belt cover and access door (see **Figure 40**).
3. Release belt tension, then remove belt from pulleys.
4. Place new belt over pulleys, then raise belt tension lever, and spin spindle handwheel to seat belt.
5. Follow **Steps 3-4** in the **Tensioning Belt** procedure to set belt tension.
6. Close belt cover and access door.



**Figure 40.** Location of access door release knob.

## Changing Motor Brushes

This machine is equipped with a universal motor that uses two carbon brushes to transmit electrical current inside the motor. These brushes are considered to be regular "wear items" or "consumables" that will eventually need to be replaced. The frequency of this replacement is directly related to how much the motor is used and how hard it is pushed.

Replace the carbon brushes when the motor no longer reaches full power, or when the brushes measure less than 1/4" long (new brushes are 5/8" long).

Tool Needed	Qty
Flat Head Screwdriver #2.....	1

To replace motor brushes, do these steps:

1. DISCONNECT MACHINE FROM POWER!
2. Gain access to motor brushes by following **Steps 1-3** in **Replacing Belt**.
3. Unscrew brush cap with flat head screwdriver.
4. Carefully remove brush from motor (see **Figure 41**).
5. Install new brush and re-install brush cap.
6. Repeat **Steps 2-4** to replace brush on opposite side of motor.
7. Follow **Steps 4-6** in **Replacing Belt**, then run machine for 5 minutes before using on workpiece.

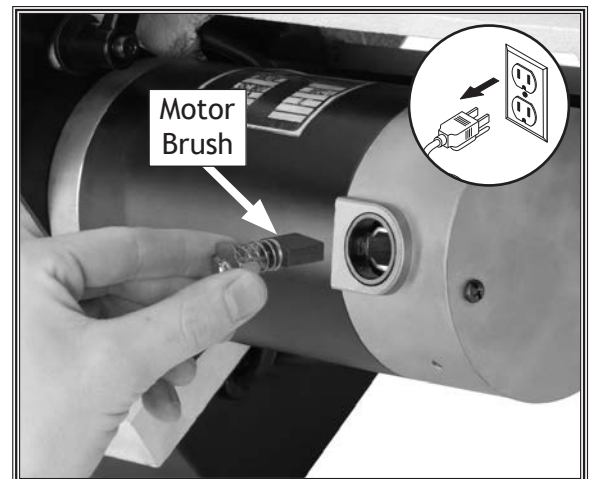

**Figure 41.** Example of removing motor brush from motor (1 of 2).

# Troubleshooting

Review the troubleshooting and procedures in this section if a problem develops with your machine. If you need replacement parts or additional help with a procedure, call our Technical Support. **Note:** Please gather the serial number and manufacture date of your machine before calling. Also, if available, have your original purchase receipt on hand.

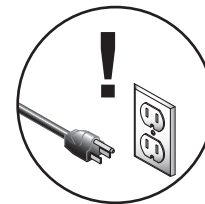

## Motor and Electrical

Symptom	Possible Cause	Possible Solution
Machine does not start or a breaker trips.	<ol style="list-style-type: none"> <li>1. Safety key removed from paddle switch/switch at fault.</li> <li>2. Incorrect power supply voltage.</li> <li>3. Power supply circuit breaker tripped or fuse blown.</li> <li>4. Motor wires connected incorrectly.</li> <li>5. Wiring open/has high resistance.</li> <li>6. Motor brushes at fault.</li> <li>7. Potentiometer/variable-speed dial controller at fault.</li> <li>8. Motor at fault.</li> </ol>	<ol style="list-style-type: none"> <li>1. Insert safety key into switch; replace if not working properly.</li> <li>2. Ensure correct power supply voltage.</li> <li>3. Ensure circuit is sized correctly and free of shorts. Reset circuit breaker or replace fuse.</li> <li>4. Correct motor wiring connections.</li> <li>5. Check/fix broken, disconnected, or corroded wires.</li> <li>6. Test/replace.</li> <li>7. Test/replace.</li> <li>8. Test/repair/replace.</li> </ol>
Machine stalls or is underpowered.	<ol style="list-style-type: none"> <li>1. Machine undersized for task.</li> <li>2. Workpiece material not suitable for machine.</li> <li>3. Feed rate/cutting speed too fast.</li> <li>4. Belt(s) slipping.</li> <li>5. Motor wired incorrectly.</li> <li>6. Plug/receptacle at fault.</li> <li>7. Motor overheated.</li> <li>8. Pulley slipping on shaft.</li> </ol>	<ol style="list-style-type: none"> <li>1. Use sharp chisels; reduce feed rate/depth of cut.</li> <li>2. Only cut wood.</li> <li>3. Decrease feed rate/cutting speed.</li> <li>4. Tension/replace belt(s); ensure pulleys are aligned and free of oil or grease.</li> <li>5. Wire motor correctly.</li> <li>6. Test for good contacts/correct wiring.</li> <li>7. Clean motor, let cool, and reduce workload.</li> <li>8. Replace loose pulley/shaft.</li> </ol>
Machine has vibration or noisy operation.	<ol style="list-style-type: none"> <li>1. Motor or component loose.</li> <li>2. Belt worn, damaged, or loose.</li> <li>3. Motor mount loose/broken.</li> <li>4. Pulley loose.</li> <li>5. Machine incorrectly mounted or sits unevenly on bench.</li> <li>6. Belt slapping cover.</li> <li>7. Workpiece/faceplate at fault.</li> <li>8. Motor bearings at fault.</li> </ol>	<ol style="list-style-type: none"> <li>1. Inspect/replace damaged bolts/nuts, and retighten with thread locking fluid.</li> <li>2. Inspect/replace belt.</li> <li>3. Tighten/replace.</li> <li>4. Re-align/replace shaft, pulley set screw, and key.</li> <li>5. Tighten/replace mounting bolts in bench; relocate/shim machine; adjust feet.</li> <li>6. Replace/realign belt.</li> <li>7. Center workpiece in chuck/faceplate; reduce RPM.</li> <li>8. Test by rotating shaft; rotational grinding/loose shaft requires bearing replacement.</li> </ol>

## Operation and Work Results

Symptom	Possible Cause	Possible Solution
Bad surface finish.	<ol style="list-style-type: none"> <li>1. Spindle speed is incorrect for workpiece size/type.</li> <li>2. Dull tooling or wrong tool selection.</li> <li>3. Tool height is not at spindle centerline.</li> <li>4. Belt is worn, damaged, or loose.</li> </ol>	<ol style="list-style-type: none"> <li>1. Adjust for appropriate spindle speed.</li> <li>2. Sharpen tooling or select a better tool for intended operation.</li> <li>3. Adjust tool rest so tool is even with spindle centerline (<b>Page 22</b>).</li> <li>4. Inspect belt. Tighten or replace as necessary (<b>Page 34</b>).</li> </ol>
Excessive vibration upon startup (when workpiece is installed).	<ol style="list-style-type: none"> <li>1. Workpiece is mounted incorrectly.</li> <li>2. Workpiece is hitting stationary object.</li> <li>3. Headstock, tailstock, or tool rest is not securely clamped to lathe bed.</li> <li>4. Workpiece is warped, out of round, or flawed.</li> <li>5. Spindle speed is set too fast for mounted workpiece.</li> <li>6. Belt pulleys are not properly aligned.</li> <li>7. Lathe is resting on an uneven surface.</li> <li>8. Motor mount bolts are loose.</li> <li>9. Belt is worn or damaged.</li> <li>10. Spindle bearings are worn.</li> </ol>	<ol style="list-style-type: none"> <li>1. Remount workpiece, making sure that centers are embedded in true center of workpiece.</li> <li>2. Stop lathe and fix interference problem.</li> <li>3. Check clamp levers and tighten if necessary.</li> <li>4. Cut workpiece to correct, or use a different workpiece.</li> <li>5. Reduce spindle speed.</li> <li>6. Align belt pulleys.</li> <li>7. Shim stand or adjust feet on stand to remove any wobbling.</li> <li>8. Tighten motor mount bolts.</li> <li>9. Replace belt (<b>Page 34</b>).</li> <li>10. Replace spindle bearings.</li> </ol>
Chisels grab or dig into workpiece.	<ol style="list-style-type: none"> <li>1. Wrong chisel/tool is being used.</li> <li>2. Chisel/tool is dull.</li> <li>3. Tool rest is set too low.</li> <li>4. Tool rest is set too far from workpiece.</li> </ol>	<ol style="list-style-type: none"> <li>1. Use correct chisel/tool.</li> <li>2. Sharpen or replace chisel/tool.</li> <li>3. Set tool rest higher (<b>Page 22</b>).</li> <li>4. Move tool rest closer to workpiece (<b>Page 22</b>).</li> </ol>
Tailstock moves under load.	<ol style="list-style-type: none"> <li>1. Tailstock mounting bolt is loose.</li> <li>2. Bed surface is too oily or greasy.</li> </ol>	<ol style="list-style-type: none"> <li>1. Tighten mounting bolt.</li> <li>2. Clean bed surface to remove excess oil/grease.</li> </ol>
Spindle lacks turning power or starts up slowly.	<ol style="list-style-type: none"> <li>1. Belt is slipping.</li> </ol>	<ol style="list-style-type: none"> <li>1. Tighten/Adjust belt (<b>Page 33</b>).</li> </ol>
Quill will not move forward when handwheel is turned	<ol style="list-style-type: none"> <li>1. Keyway is not aligned with quill lock lever.</li> </ol>	<ol style="list-style-type: none"> <li>1. Align quill keyway and quill lock lever and slightly tighten lever to engage keyway.</li> </ol>

# Electrical Safety Instructions

These pages are current at the time of printing. However, in the spirit of improvement, we may make changes to the electrical systems of future machines. Compare the manufacture date of your machine to the one stated in this manual, and study this section carefully.

If there are differences between your machine and what is shown in this section, call Technical Support at (360) 734-3482 for assistance BEFORE making any changes to the wiring on your machine. An updated wiring diagram may be available. **Note:** Please gather the serial number and manufacture date of your machine before calling. This information can be found on the main machine label.

## ⚠ WARNING

**SHOCK HAZARD.** Working on wiring that is connected to a power source is extremely dangerous. Touching electrified parts will result in personal injury including but not limited to severe burns, electrocution, or death. Disconnect the power from the machine before servicing electrical components!

**QUALIFIED ELECTRICIAN.** Due to the inherent hazards of electricity, only a qualified electrician should perform wiring tasks on this machine. If you are not a qualified electrician, get help from one before attempting any kind of wiring job.

**WIRE CONNECTIONS.** All connections must be tight to prevent wires from loosening during machine operation. Double-check all wires disconnected or connected during any wiring task to ensure tight connections.

**WIRE/COMPONENT DAMAGE.** Damaged wires or components increase the risk of serious personal injury, fire, or machine damage. If you notice that any wires or components are damaged while performing a wiring task, replace those wires or components before completing the task.

**MODIFICATIONS.** Using aftermarket parts or modifying the wiring beyond what is shown in the diagram may lead to unpredictable results, including serious injury or fire.

**MOTOR WIRING.** The motor wiring shown in these diagrams is current at the time of printing, but it may not match your machine. Always use the wiring diagram inside the motor junction box.

**CAPACITORS/INVERTERS.** Some capacitors and power inverters store an electrical charge for up to 10 minutes after being disconnected from the power source. To reduce the risk of being shocked, wait at least this long before working on capacitors.

**CIRCUIT REQUIREMENTS.** You MUST follow the requirements at the beginning of this manual when connecting your machine to a power source.

**EXPERIENCING DIFFICULTIES.** If you are experiencing difficulties understanding the information included in this section, contact our Technical Support at (360) 734-3482.

### NOTICE

The photos and diagrams included in this section are best viewed in color. You can view these pages in color at [www.shopfox.biz](http://www.shopfox.biz).

### WIRING DIAGRAM COLOR KEY

BLACK — Bk	BLUE — Bl	YELLOW — Yl	LIGHT BLUE — Lb
WHITE — Wt	BROWN — Br	YELLOW GREEN — Yg	BLUE — Bw
GREEN — Gn	GRAY — Gy	PURPLE — Pu	WHITE — Tu
RED — Rd	ORANGE — Or	PINK — Pk	TURQUOISE

SERVICE

# Electrical Component Connections

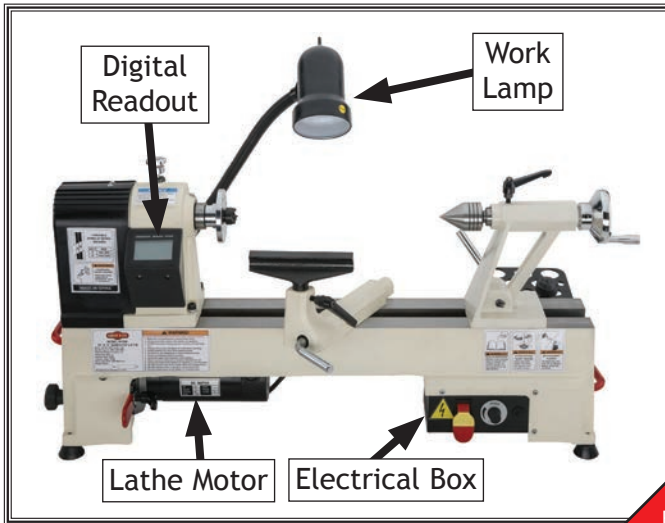

Figure 42. Electrical component locations.

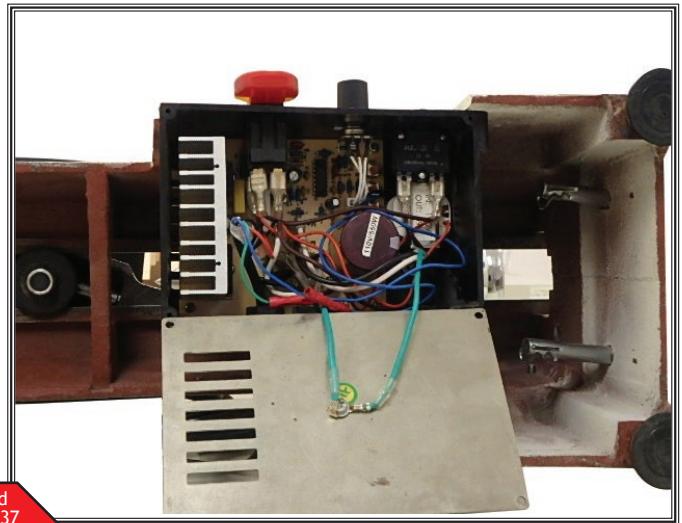

Figure 44. Electrical box wiring.

Read  
Page 37  
**STOP**  
Before  
Wiring

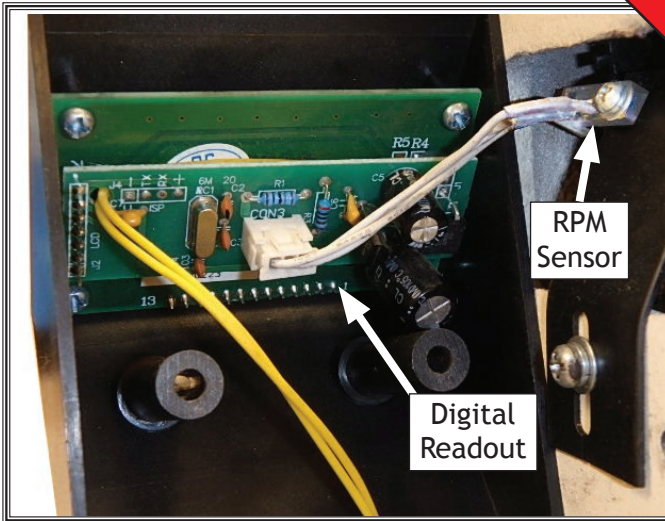

Figure 43. Digital readout and RPM sensor wiring.

DC MOTOR			
HP	3/4	AMPS	
VOLTS	110	PHASE	1
CYCLES	60	CLASS	E
RPM	1700		

Figure 45. Motor plate.



# Wiring Diagram

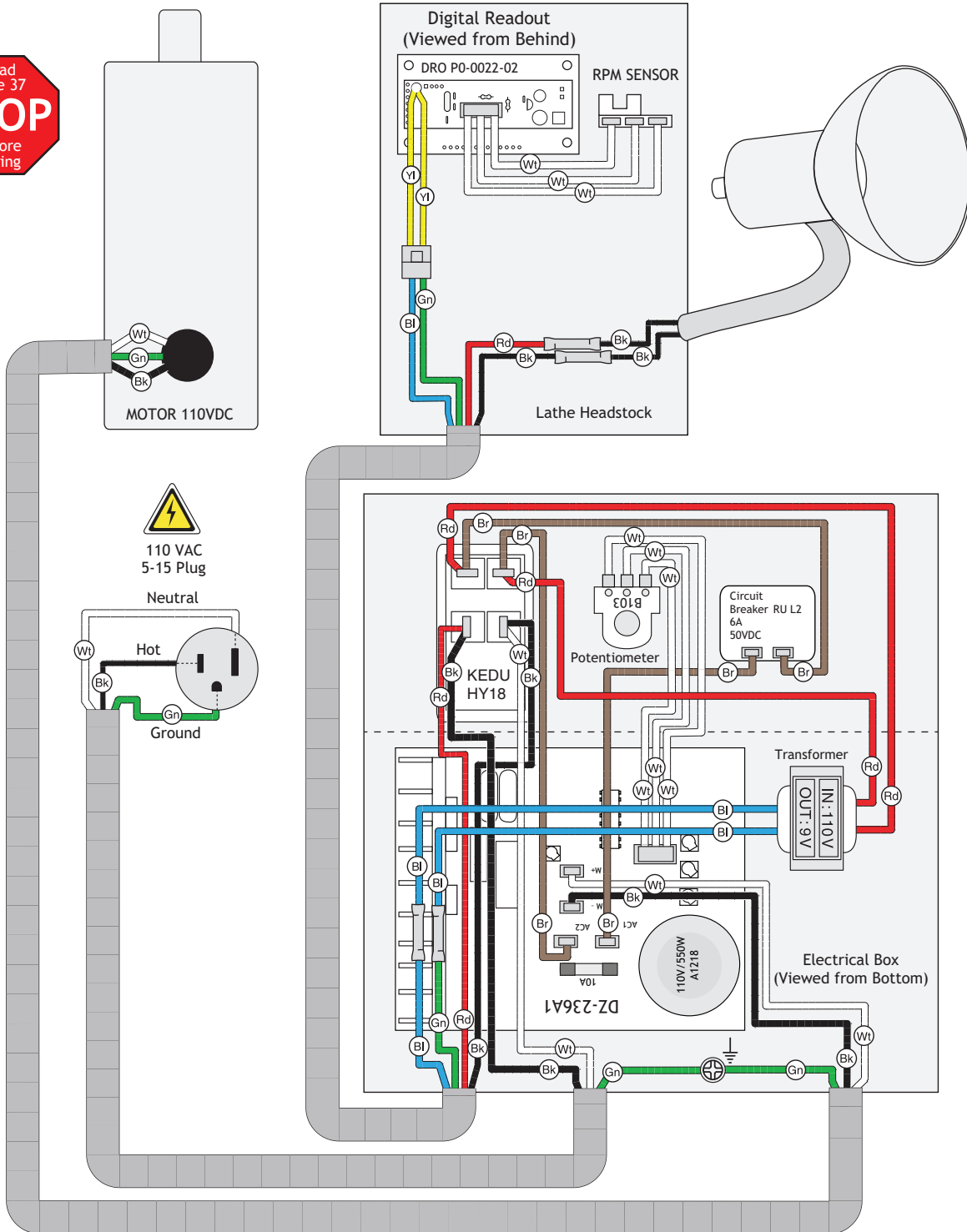

**NOTICE**  
 This motor wiring diagram is current at the time of printing; however, always use the diagram on the inside of the junction box cover when rewiring your motor!

SERVICE

# PARTS

## Main

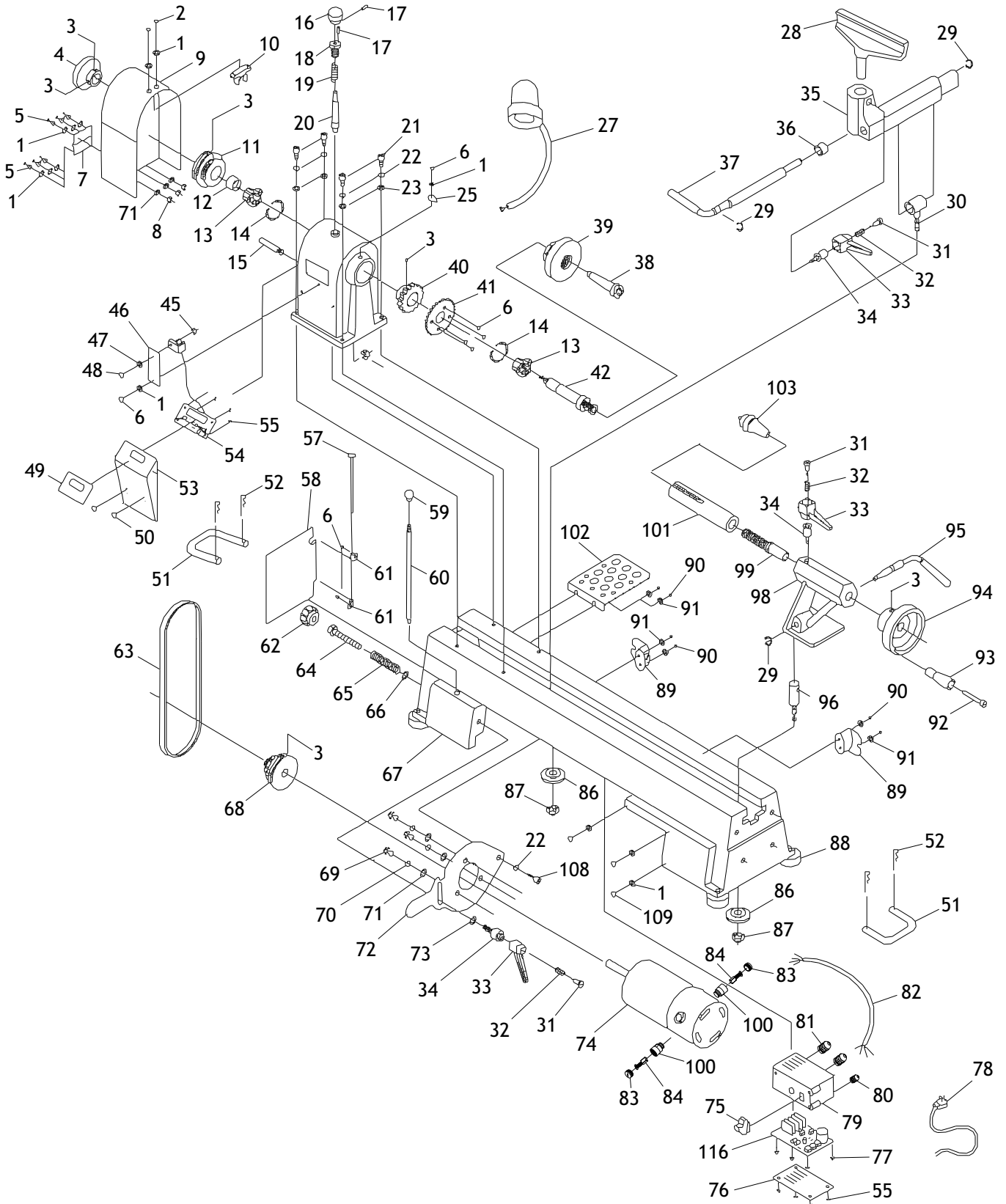

# Main Parts List

REF PART #	DESCRIPTION	REF PART #	DESCRIPTION		
1	X1836001	FLAT WASHER 4MM	55	X1836055	TAP SCREW M3 X 8
2	X1836002	PHLP HD SCR M4-.7 X 8	57	X1836057	HINGE PIN
3	X1836003	SET SCREW M6-1 X 12	58	X1836058	ACCESS DOOR
4	X1836004	HANDWHEEL 59MM, HOLE: M20-1.5 LH	59	X1836059	ROUND KNOB M8-1.25
5	X1836005	PHLP HD SCR M4-.7 X 10	60	X1836060	KNOCKOUT BAR M8-1.25 X 10, 270L
6	X1836006	PHLP HD SCR M4-.7 X 6	61	X1836061	HINGE
7	X1836007	BELT COVER HINGE	62	X1836062	ACCESS DOOR RELEASE KNOB
8	X1836008	HEX NUT M4-.7	63	X1836063	V-BELT 270J3
9	X1836009	BELT COVER	64	X1836064	HEX BOLT M8-1.25 X 90
10	X1836010	BELT COVER CLIP	65	X1836065	COMPRESSION SPRING 1 X 14 X 85
11	X1836011	SPINDLE PULLEY	66	X1836066	LOCK NUT M8-1.25
12	X1836012	SPACER	67	X1836067	LATHE BODY
13	X1836013	BALL BEARING 6005ZZ	68	X1836068	MOTOR PULLEY
14	X1836014	INT RETAINING RING 47MM	69	X1836069	CAP SCREW M6-1 X 16
15	X1836015	SHAFT M8-1.25 X 8, 45L	70	X1836070	LOCK WASHER 6MM
16	X1836016	SPINDLE LOCK KNOB	71	X1836071	FLAT WASHER 6MM
17	X1836017	ROLL PIN 3 X 12	72	X1836072	MOTOR MOUNT PLATE
18	X1836018	INDEX PIN SLEEVE M16-1.5 X 20	73	X1836073	FENDER WASHER 8MM
19	X1836019	COMPRESSION SPRING	74	X1836074	MOTOR 3/4 HP 110V 1-PH
20	X1836020	INDEX PIN	75	X1836075	SHOP FOX PADDLE SWITCH 110V
21	X1836021	CAP SCREW M8-1.25 X 30	76	X1836076	SWITCH BOX COVER
22	X1836022	LOCK WASHER 8MM	77	X1836077	TAP SCREW M3 X 10
23	X1836023	FLAT WASHER 8MM	78	X1836078	POWER CORD 18G 3W 72" 5-15P
25	X1836025	POINTER	79	X1836079	SWITCH BOX
27	X1836027	WORK LIGHT	80	X1836080	STRAIN RELIEF PG7 TYPE-3
28	X1836028	TOOL REST 148L (POST 16 X 75)	81	X1836081	STRAIN RELIEF PG9 TYPE-3
29	X1836029	EXT RETAINING RING 10MM	82	X1836082	MOTOR CORD 18G 3W 16"
30	X1836030	TOOL REST CAM FOLLOWER M10-1.25 X 30	83	X1836083	CARBON BRUSH COVER
31	X1836031	SHOULDER SCREW M5-.8 X 6, 6 X 8	84	X1836084	CARBON BRUSH 2-PC SET
32	X1836032	COMPRESSION SPRING	86	X1836086	LOCK PLATE
33	X1836033	ADJUSTABLE HANDLE	87	X1836087	LOCK NUT M10-1.5
34	X1836034	LOCK BOLT M8-1.25 X 18, INT THREAD M5-.8	88	X1836088	RUBBER FOOT
35	X1836035	TOOL REST BASE	89	X1836089	CORD WRAP MOUNT
36	X1836036	BUSHING	90	X1836090	PHLP HD SCR M5-.8 X 12
37	X1836037	TOOL REST LOCK LEVER	91	X1836091	FLAT WASHER 5MM
38	X1836038	SPUR CENTER MT#2	92	X1836092	SHOULDER SCREW M6-1 X 10, 7 X 44
39	X1836039	FACEPLATE 80MM, HOLE: M25-3	93	X1836093	HANDWHEEL HANDLE 50MM
40	X1836040	GEAR 24T	94	X1836094	HANDWHEEL 82MM, HOLE: 15MM
41	X1836041	GEAR COVER PLATE	95	X1836095	TAILSTOCK LOCK LEVER
42	X1836042	SPINDLE	96	X1836096	TAILSTOCK CAM FOLLOWER M8-1.25 X 30
45	X1836045	HEX NUT M3-.5	98	X1836098	TAILSTOCK
46	X1836046	RPM SENSOR MOUNTING PLATE	99	X1836099	TAILSTOCK LEADSCREW
47	X1836047	FLAT WASHER 3MM	100	X1836100	CARBON BRUSH HOLDER
48	X1836048	PHLP HD SCR M3-.5 X 12	101	X1836101	QUILL
49	X1836049	DIGITAL READOUT LABEL	102	X1836102	TOOL RACK
50	X1836050	PHLP HD SCR M4-.7 X 12	103	X1836103	LIVE CENTER MT#2
51	X1836051	LATHE CARRYING HANDLE	108	X1836108	CAP SCREW M8-1.25 X 16
52	X1836052	COTTER PIN 3/8-1/2 X 1-5/8 HAIRPIN	109	X1836109	PHLP HD SCR M4-.7 X 20
53	X1836053	DIGITAL READOUT COVER	116	X1836116	CIRCUIT BOARD DZ-236A1
54	X1836054	DIGITAL READOUT WP0011A-01			

# Labels & Cosmetics

## ⚠️ WARNING

Safety labels warn about machine hazards and how to prevent serious personal injury. The owner of this machine **MUST** maintain the original location and readability of all labels on this machine. If any label is removed or becomes unreadable, **REPLACE** that label before allowing machine to be operated again. Contact us at (360) 734-3482 or [www.shopfoxtools.com](http://www.shopfoxtools.com) to order new labels.

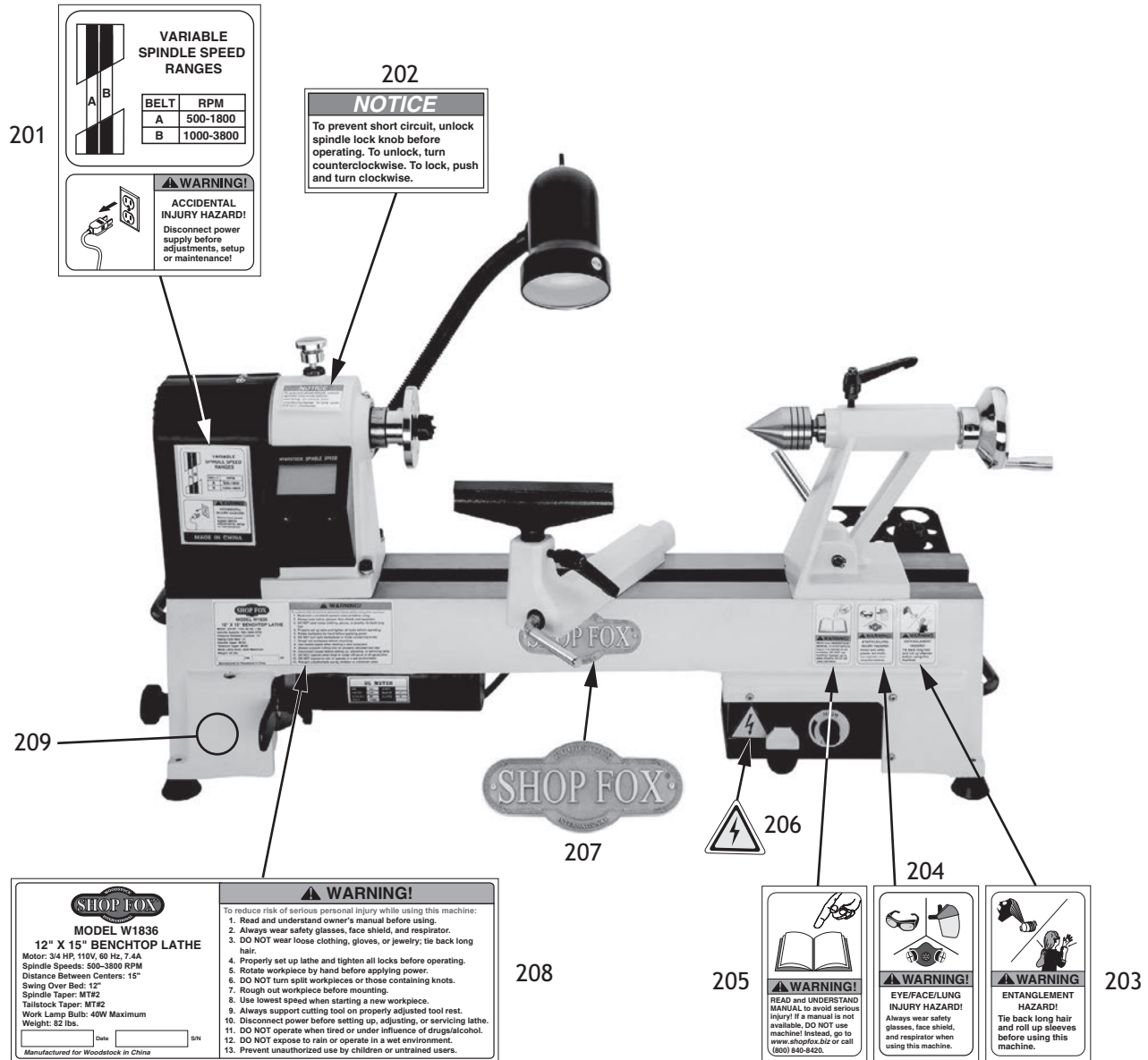

REF PART #	DESCRIPTION
201	X1836201 SPINDLE SPEED / DISCONNECT POWER LABEL
202	X1836202 UNLOCK SPINDLE NOTICE LABEL
203	X1836203 ENTANGLEMENT HAZARD LABEL
204	X1836204 EYE / FACE / LUNG INJURY LABEL
205	X1836205 READ MANUAL LABEL

REF PART #	DESCRIPTION
206	X1836206 ELECTRICITY LABEL
207	X1836207 SHOP FOX NAMEPLATE
208	X1836208 MACHINE ID LABEL
209	X1836209 SHOP FOX WHITE TOUCH-UP PAINT



# Warranty Registration

Name \_\_\_\_\_  
 Street \_\_\_\_\_  
 City \_\_\_\_\_ State \_\_\_\_\_ Zip \_\_\_\_\_  
 Phone # \_\_\_\_\_ Email \_\_\_\_\_ Invoice # \_\_\_\_\_  
 Model # \_\_\_\_\_ Serial # \_\_\_\_\_ Dealer Name \_\_\_\_\_ Purchase Date \_\_\_\_\_

The following information is given on a voluntary basis. It will be used for marketing purposes to help us develop better products and services. Of course, all information is strictly confidential.

- How did you learn about us?  
 Advertisement       Friend       Local Store  
 Mail Order Catalog       Website       Other:
- How long have you been a woodworker/metalworker?  
 0-2 Years       2-8 Years       8-20 Years       20+ Years
- How many of your machines or tools are Shop Fox?  
 0-2       3-5       6-9       10+
- Do you think your machine represents a good value?       Yes       No
- Would you recommend Shop Fox products to a friend?       Yes       No
- What is your age group?  
 20-29       30-39       40-49  
 50-59       60-69       70+
- What is your annual household income?  
 \$20,000-\$29,000       \$30,000-\$39,000       \$40,000-\$49,000  
 \$50,000-\$59,000       \$60,000-\$69,000       \$70,000+
- Which of the following magazines do you subscribe to?  

<input type="checkbox"/> Cabinet Maker	<input type="checkbox"/> Popular Mechanics	<input type="checkbox"/> Today's Homeowner
<input type="checkbox"/> Family Handyman	<input type="checkbox"/> Popular Science	<input type="checkbox"/> Wood
<input type="checkbox"/> Hand Loader	<input type="checkbox"/> Popular Woodworking	<input type="checkbox"/> Wooden Boat
<input type="checkbox"/> Handy	<input type="checkbox"/> Practical Homeowner	<input type="checkbox"/> Woodshop News
<input type="checkbox"/> Home Shop Machinist	<input type="checkbox"/> Precision Shooter	<input type="checkbox"/> Woodsmith
<input type="checkbox"/> Journal of Light Cont.	<input type="checkbox"/> Projects in Metal	<input type="checkbox"/> Woodwork
<input type="checkbox"/> Live Steam	<input type="checkbox"/> RC Modeler	<input type="checkbox"/> Woodworker West
<input type="checkbox"/> Model Airplane News	<input type="checkbox"/> Rifle	<input type="checkbox"/> Woodworker's Journal
<input type="checkbox"/> Modeltec	<input type="checkbox"/> Shop Notes	<input type="checkbox"/> Other:
<input type="checkbox"/> Old House Journal	<input type="checkbox"/> Shotgun News	

9. Comments: \_\_\_\_\_  
 \_\_\_\_\_  
 \_\_\_\_\_  
 \_\_\_\_\_  
 \_\_\_\_\_

CUT ALONG DOTTED LINE

FOLD ALONG DOTTED LINE

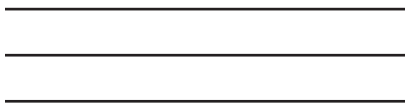

Place  
Stamp  
Here



WOODSTOCK INTERNATIONAL INC.  
P.O. BOX 2309  
BELLINGHAM, WA 98227-2309



FOLD ALONG DOTTED LINE

TAPE ALONG EDGES--PLEASE DO NOT STAPLE

# WARRANTY

Woodstock International, Inc. warrants all Shop Fox machinery to be free of defects from workmanship and materials for a period of two years from the date of original purchase by the original owner. This warranty does not apply to defects due directly or indirectly to misuse, abuse, negligence or accidents, lack of maintenance, or reimbursement of third party expenses incurred.

Woodstock International, Inc. will repair, replace, or arrange for a dealer refund, at its expense and option, the Shop Fox machine or machine part proven to be defective for its designed and intended use, provided that the original owner returns the product prepaid to an authorized warranty or repair facility as designated by our Bellingham, Washington office with proof of their purchase of the product within two years, and provides Woodstock International, Inc. reasonable opportunity to verify the alleged defect through inspection. If it is determined there is no defect, or that the defect resulted from causes not within the scope of Woodstock International Inc.'s warranty, then the original owner must bear the cost of storing and returning the product.

This is Woodstock International, Inc.'s sole written warranty and any and all warranties that may be implied by law, including any merchantability or fitness, for any particular purpose, are hereby limited to the duration of this written warranty. We do not warrant that Shop Fox machinery complies with the provisions of any law, acts or electrical codes. We do not reimburse for third party repairs. In no event shall Woodstock International, Inc.'s liability under this limited warranty exceed the purchase price paid for the product, and any legal actions brought against Woodstock International, Inc. shall be tried in the State of Washington, County of Whatcom. We shall in no event be liable for death, injuries to persons or property or for incidental, contingent, special or consequential damages arising from the use of our products.

Every effort has been made to ensure that all Shop Fox machinery meets high quality and durability standards. We are committed to continuously improving the quality of our products, and reserve the right to change specifications at any time.



## High Quality Machines and Tools

Woodstock International, Inc. carries thousands of products designed to meet the needs of today's woodworkers and metalworkers.

Ask your dealer about these fine products:

**BROSENA**  
PRECISION STOP BLOCK

**JOINTER PAL**<sup>®</sup>

**Rotacator**<sup>®</sup>

**THE REBEL**<sup>®</sup>

**DURASTICK**<sup>®</sup>

**Gutmann**<sup>®</sup>

**BOARD BUDDIES**<sup>®</sup>



*Junglee*<sup>®</sup>

**PLANER PAL**<sup>®</sup>

**PARROT VISE**<sup>®</sup>

*SLICKPLANE*<sup>®</sup>

**PRO-STIK**<sup>®</sup>  
ABRASIVE BELT & DISC CLEANER

**ACCU-SHARP**<sup>®</sup>

*Aluma-Classic*<sup>®</sup>



**STEELEX**<sup>®</sup>  
FINE TOOLS

**STEELEX**<sup>®</sup>  
*PLUS*



**WHOLESALE ONLY**

**WOODSTOCK INTERNATIONAL, INC.**

Phone: (360) 734-3482 • Fax: (360) 671-3053 • Toll Free Fax: (800) 647-8801

P.O.Box 2309 • Bellingham, WA 98227

**SHOPFOX.BIZ**