



**ResMed**

**Stellar™ series**

Non-invasive/invasive ventilators



Clinical Guide  
English

## Setting up for noninvasive use

For full setup, see page 14.



## Setting up for invasive use

For full setup, see page 16.

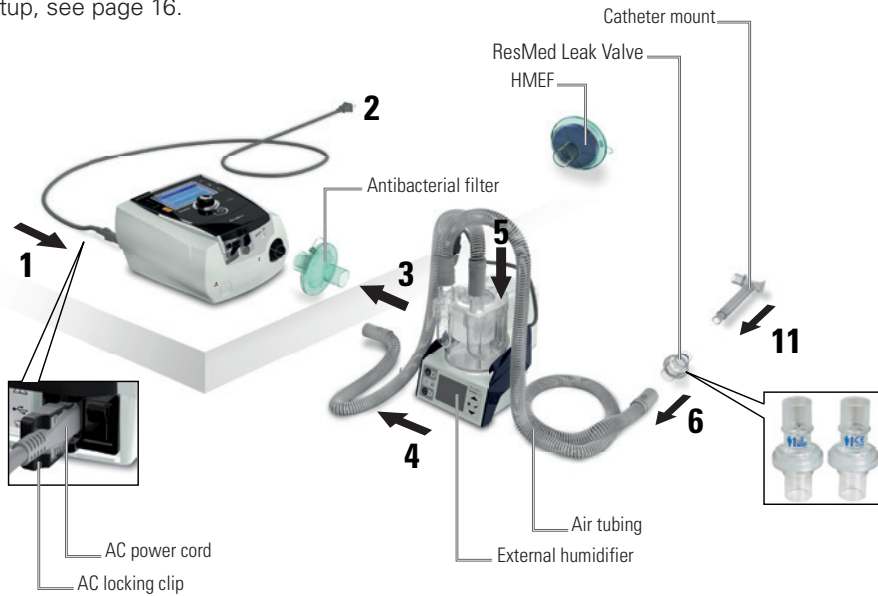

## Accessing Clinical Mode



# Contents

<b>Introduction</b> .....	1
Indications for use	1
Contraindications	1
Adverse effects	1
<b>About Stellar therapy modes</b> .....	2
Common setting parameters	2
More about iVAPS	4
<b>Ensuring successful ventilation with Stellar</b> .....	7
Learn Circuit	7
Vsync and mask selection	8
TiControl	9
Trigger/Cycle sensitivities	9
Rise/Fall Time	10
Pathology Defaults	10
<b>Stellar at a glance</b> .....	11
Patient interface	12
Humidification	12
Internal battery	12
ResMed USB stick	13
Use on an aircraft	13
Mobile use	13
Remote Alarm	13
<b>Setting up for noninvasive use</b> .....	14
Attaching the H4i heated humidifier	15
<b>Setting up for invasive use</b> .....	16
<b>Detecting circuit disconnection and decannulation</b> .....	18
<b>Using the Stellar device for the first time</b> .....	18
<b>Setting up for home therapy</b> .....	18
<b>Working with other optional accessories</b> .....	19
Attaching a pulse oximeter	19
Adding supplemental oxygen	20
Using the FiO2 monitoring sensor	21
Attaching an antibacterial filter	22
<b>Stellar basics</b> .....	23
About the control panel	23
<b>Starting therapy</b> .....	24
Performing a functional test	24
Starting therapy	25
Stopping therapy	26
Turning off the power	26
Working with alarms	26
Tailoring treatment setup options	28
Using mask-fit	29
<b>Using the menus</b> .....	30
<b>Monitoring menu</b> .....	33
<b>Setup menu</b> .....	36
Accessing Clinical mode	36
Setup menu: Clinical Settings	36
Setup menu: Alarm Settings	40
Testing the alarms	42
Setup menu: Options	45
Setup menu: Configuration Menu	46

<b>Info menu</b> .....	49
Event Summary	49
General therapy information	49
Apnoea/Apnoea Hypopnoea Index	50
Used Hours	50
Device information	50
Reminders	51
<b>Configuring iVAPS</b> .....	51
Using Learn Targets	52
Manually setting iVAPS	53
Assessing the clinical outcome	54
<b>Data management</b> .....	56
<b>Cleaning and maintenance</b> .....	57
Daily	57
Weekly	57
Monthly	57
Replacing the air filter	58
Multipatient use	59
Servicing	59
<b>Clinical titration guide</b> .....	60
Mouth leaks	60
Setting TiControl	60
EPAP/PEEP	61
Trigger/cycle sensitivities	62
<b>Troubleshooting</b> .....	63
Alarm troubleshooting	63
Other troubleshooting	66
<b>Technical specifications</b> .....	69
Guidance and manufacturer's declaration – electromagnetic emissions and immunity	73
Symbols	74
<b>General warnings and cautions</b> .....	75
<b>Limited warranty</b> .....	77

# Introduction

Read the entire manual before using the device.

## Indications for use

The Stellar 100/150 is intended to provide ventilation for non-dependent, spontaneously breathing adult and paediatric patients (13kg and above) with respiratory insufficiency, or respiratory failure, with or without obstructive sleep apnoea. The device is for noninvasive use, or invasive use (with the use of the ResMed Leak Valve). Operation of the device includes both stationary, such as in hospital or home, or mobile, such as wheelchair usage.

## Contraindications

The Stellar is contraindicated in patients who are unable to endure more than brief interruptions in ventilation. The Stellar is not a life support ventilator.

The use of the device may be contraindicated in patients with:

- pneumothorax or pneumomediastinum
- pathologically low blood pressure, particularly if associated with intravascular volume depletion
- cerebrospinal fluid leak, recent cranial surgery or trauma
- severe bullous lung disease
- dehydration.

The use of the Stellar or pulse oximetry (including XPOD) is contraindicated in an MRI environment.

AutoEPAP is contraindicated for invasive use.

## Adverse effects

Patients should report unusual chest pain, severe headache or increased breathlessness.

The following side effects may arise during the course of noninvasive ventilation with the device:

- drying of the nose, mouth or throat
- nosebleed
- bloating
- ear or sinus discomfort
- eye irritation
- skin rashes.

# About Stellar therapy modes

Stellar provides a number of therapy modes to suit a variety of ventilation requirements. Regardless of the mode, Stellar assists spontaneous breathing by providing two pressures in response to the patient flow or a preset fixed time.

## Common setting parameters

The **inspiratory positive airway pressure** (IPAP, or the sum of PEEP and Pressure Support/PS) assists inspiration. The lower **expiratory positive airway pressure** (EPAP or PEEP) eliminates exhaled air through the exhaust vent. This pressure also provides a stent to maintain an open upper airway, improves small airway recruitment and therefore oxygenation and may improve triggering in some patients with intrinsic PEEP.

The difference of the two pressures—Pressure Support/PS—contributes to improved patient ventilation.

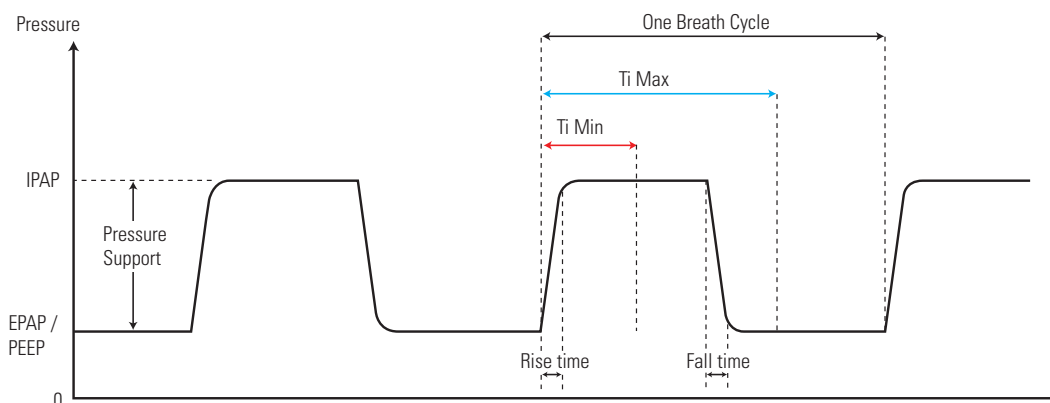

Stellar provides the following modes:

- **CPAP** mode—a fixed pressure is delivered.
- **S (Spontaneous)** mode—the device senses the patient breath and triggers IPAP in response to an increase in flow, and cycles into EPAP at the end of inspiration. The breath rate and the respiratory pattern will be determined by the patient.
- **ST (Spontaneous/Timed) or PS (Pressure Support) mode**—the device augments any breath initiated by the patient, but will also supply additional breaths should the patient breath rate fall below the clinician's set 'backup' breath rate.
- **T (Timed) mode**—the fixed breath rate and the fixed inspiration time set by the clinician are supplied regardless of patient effort.
- **PAC (Pressure Assist Control)**—the inspiration time is preset in the PAC mode. There is no spontaneous/flow cycling. The inspiration can be triggered by the patient when respiratory rate is above a preset value, or time triggered breaths will be delivered at the backup breath rate.
- **iVAPS<sup>1</sup> (intelligent Volume Assured Pressure Support)**—designed to maintain a preset target alveolar ventilation by monitoring delivered ventilation, adjusting the pressure support and providing an intelligent backup breath automatically. Optionally AutoEPAP automatically adjusts the EPAP to maintain upper airway patency. The iVAPS therapy mode is indicated for patients 30 kg and above.

---

<sup>1</sup> iVAPS mode is only available on Stellar 150.

These therapy modes (excluding CPAP mode—where a single level of continuous pressure is delivered) are shown below.

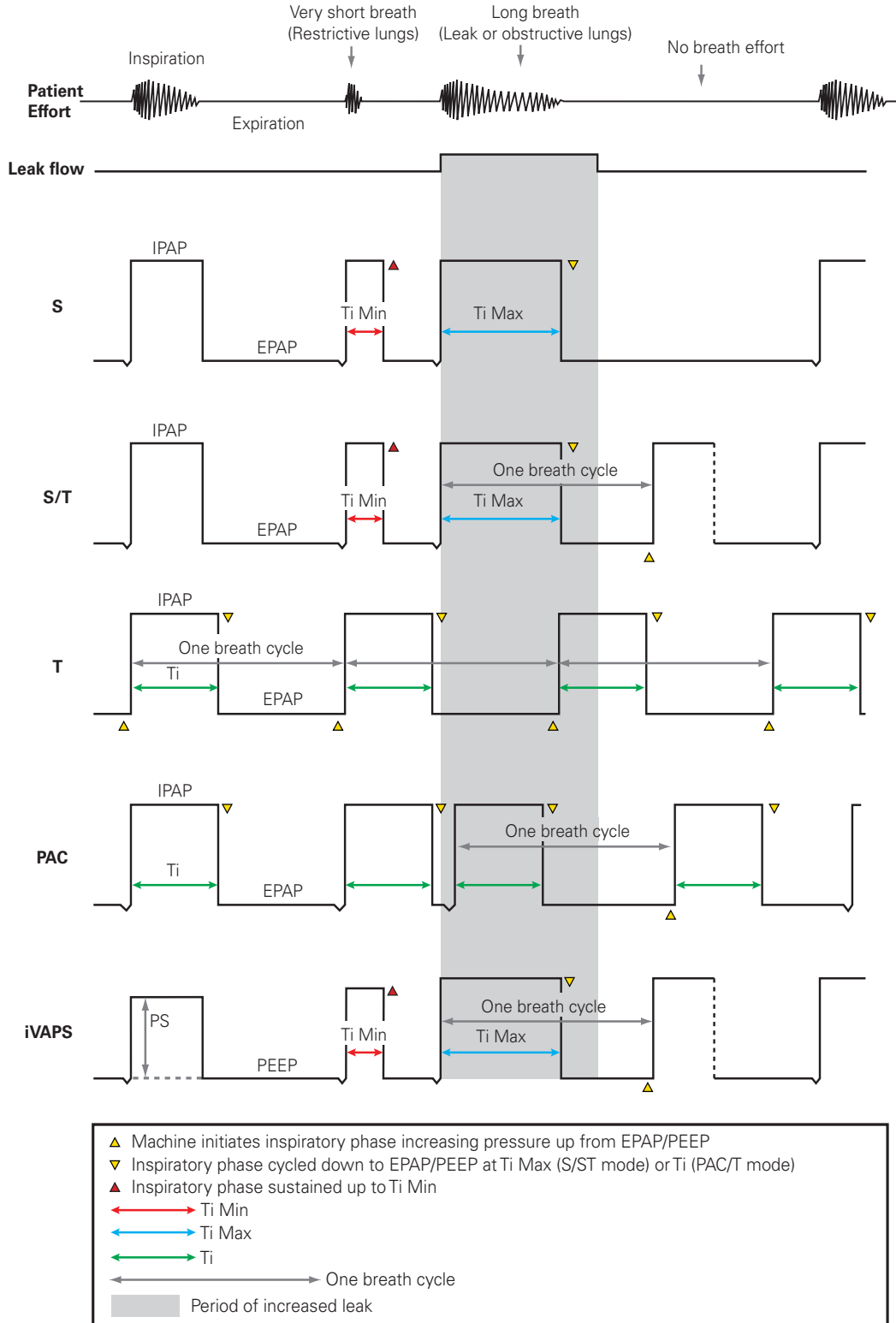

## More about iVAPS

The iVAPS therapy mode is indicated for patients 30 kg and above.

You may prefer some assurance that the patient's ventilatory needs will be maintained if their condition varies. A variety of 'dual mode' schemes exist, that aim to combine the benefits of pressure target and volume target, most of which can be categorised generically as volume-assured pressure support, or VAPS modes.

With VAPS devices in general, the ventilatory assistance (pressure support) aims to automatically adjust to changes in patient condition over time, typically to maintain a target tidal volume.

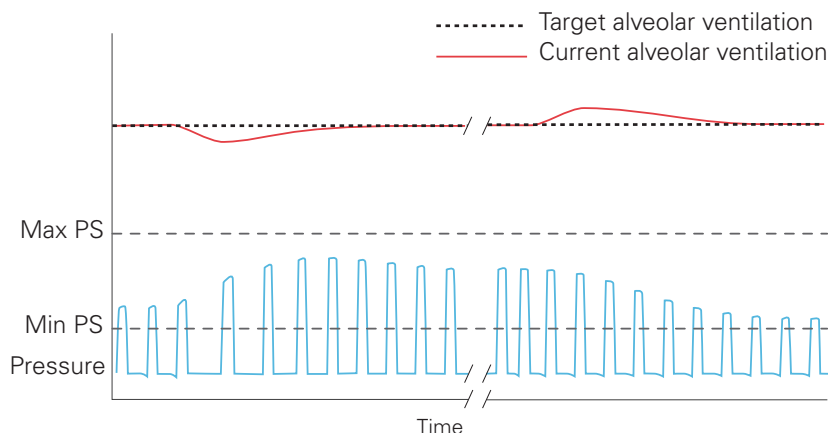

iVAPS offers the comfort and synchrony of pressure support, but with the assurance offered by a volume target. iVAPS has the following advantages over traditional VAPS schemes:

- iVAPS is a unique combination for a servo-controlled ventilator, in that iVAPS has the goal of regulating alveolar ventilation to a prescribed target, and iVAPS has a rapid but gentle servo-control response. iVAPS is tuned to be fast enough to avoid blood-gas derangement associated with most breathing challenges, including during sleep, but is gentle enough to avoid disruption.
- iVAPS has an intelligent Backup Rate (iBR) which aims to keep 'out of the way' while the patient is breathing, yet during sustained apnoea will mimic the patient's own breath rate. This contributes to iVAPS' ability to maintain its ventilation target and so stabilise blood gases even during sleep.
- iVAPS has ResMed's robust leak compensation feature (Vsync), a product of ResMed's long experience in noninvasive ventilation. This promotes synchrony and comfort even during significant leak.

Pressure support is adjusted continuously during the inspiration phase breath to breath, aiming to maintain target alveolar ventilation. If ventilation falls, pressure support is increased until the target is reached. Conversely, if alveolar ventilation rises above target, pressure support falls. The range of pressure support adjustment is constrained within Min PS and Max PS.

The rate of increase in pressure support can reach up to 0.7 cm H<sub>2</sub>O/sec. The breath to breath changes in pressure support depend on the breath rate and how far the patient is from the target alveolar ventilation. Typically the change in pressure support does not exceed 3 cm H<sub>2</sub>O per breath.

iVAPS provides benefits across a range of situations. For example, it can benefit patients with a progressive lung condition, because the ventilation target can be maintained despite degradation of lung mechanics or muscle function. Similarly, iVAPS offers advantage in nocturnal hypoventilation. iVAPS, by providing pressure support when required, is more comfortable and better tolerated.

Some key concepts important to clinical understanding of iVAPS operation are discussed below, ahead of guidance on the iVAPS setup procedure on Stellar 150. See "Configuring iVAPS" on page 51.



## Target alveolar ventilation

iVAPS targets **alveolar ventilation**. Alveolar ventilation was chosen because it is at the level of the alveoli that gas exchange occurs. Total ventilation includes the ventilation devoted to the conducting airways, whereas alveolar ventilation best represents the useful portion of ventilation that reaches the alveoli.

Alveolar ventilation cannot be measured directly, so iVAPS estimates it using a height approximated value of anatomical deadspace as shown in the graph below. **Anatomic deadspace** is the amount of breath that remains in the conducting airways, which does not reach alveoli and does not contribute to gas exchange. Its contribution is proportional to breath rate. By using alveolar ventilation as a servo-ventilation target, as opposed to tidal volume or total ventilation, the effect of respiratory rate change on effective ventilation is negated.

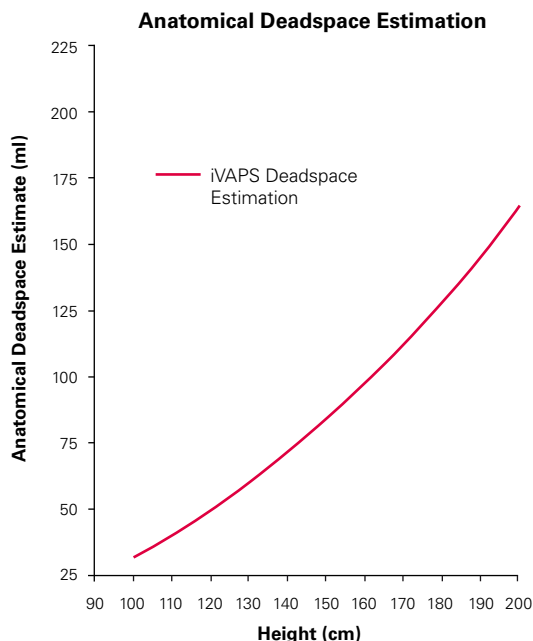

Adapted from Hart MC et al. Journal Applied Physiology.18(3), p519-522. 1963

## Target Patient Rate

iVAPS has a novel approach to providing a backup rate. Instead of mandating a fixed backup rate, iVAPS' **intelligent Backup Rate (iBR)** will shift automatically between two limits, according to the context. The benefit of this approach is improved synchrony, while maximising iVAPS' ability to maintain the target ventilation, at *minimal pressure support*.

- During sustained apnoea, the iBR will adopt a pre-configured **Target Patient Rate**. This Target Patient Rate defines the upper boundary for iBR. You set the Target Patient Rate to **match** the patient's average spontaneous rate (unlike a traditional backup rate).
- During spontaneous ventilation, the iBR adjusts to remain well in the background, at 2/3rd of the Target Patient Rate. This 'background' backup rate gives the patient maximum opportunity to spontaneously trigger.
- When spontaneous triggering ceases (eg, at the onset of an apnoea), the iBR adjusts from its background frequency to its Target Patient Rate. It will adjust quickest typically (within 4-5 breaths) when ventilation is below the target ventilation.
- A single spontaneous triggered breath resets the iBR to its background rate (2/3rds of Target Patient Rate).

## iBR brings the patient back on target when back-up breaths are required

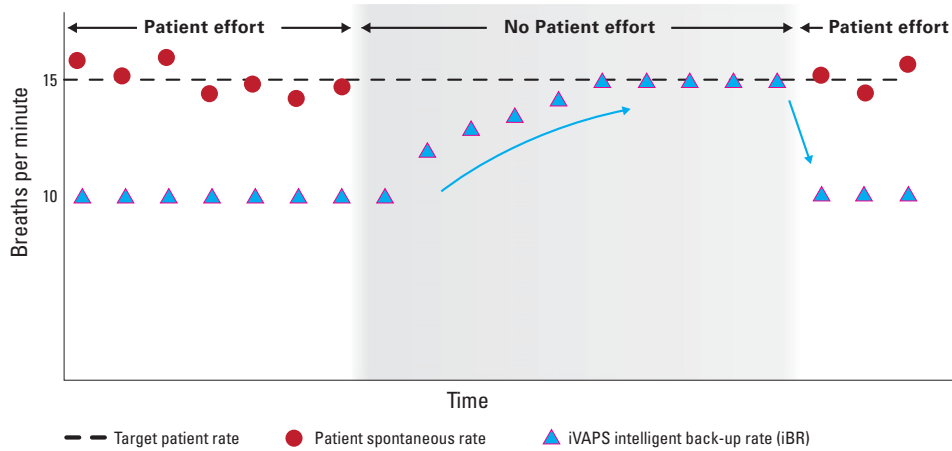

### Min/Max PS

The default settings for maximum and minimum pressure support are normally adequate, but you may wish to alter them in some patients.

Min PS and Max PS define the range of pressure support adjustment available to the iVAPS algorithm as it regulates alveolar ventilation.

It is recommended that Max PS be set high enough to allow the alveolar ventilation target to be met, while exercising clinical judgement over considerations such as patient comfort and tolerance, lung mechanics, age, mask seal, etc.

It is recommended that Min PS is left at the level set when learning the patient's ventilation target unless the patient finds this too little for comfort.

### AutoEPAP<sup>1</sup>

iVAPS mode only

The purpose of AutoEPAP is to maintain upper airway patency. AutoEPAP automatically adjusts pressure in response to flow limitation or obstruction of the upper airway. EPAP is adjusted within Min EPAP and Max EPAP settings with the response depending on the degree of the upper airway obstruction.

Pressure support is adjusted on top of the AutoEPAP. The maximum delivered pressure, EPAP plus pressure support, is limited to the maximum pressure of the device (i.e. 40 cm H<sub>2</sub>O). If the sum of AutoEPAP plus pressure support exceeds the maximum pressure limit, pressure support is sacrificed to maintain airway patency (ie, EPAP). However, pressure support will not drop below the set minimum pressure (Min PS).

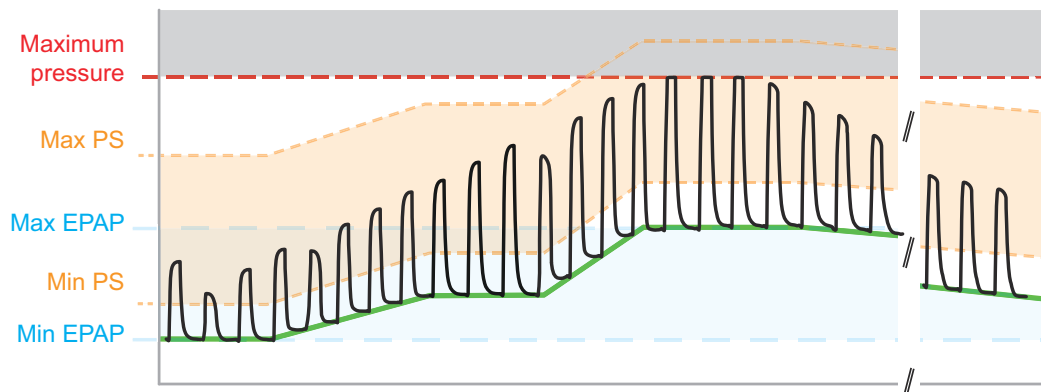

<sup>1</sup> This feature is not available in all countries.

- a) For flow limitation, EPAP will increase at a maximum rate of 0.5 cm H<sub>2</sub>O maximum per breath.
- b) For obstructive apnoea, EPAP will increase at a rate of approximately 1 cm H<sub>2</sub>O per second on termination of the apnoea.
- c) EPAP will start to decrease from the first breath after upper airway obstruction has resolved and will continue to decrease slowly until either another upper airway condition or Min EPAP is reached.

The AutoEPAP algorithm does not address any other titration target such as lung recruitment to improve oxygenation or offset intrinsic PEEP. Min EPAP should be set to treat lower airway conditions.

## Ensuring successful ventilation with Stellar

Successful ventilation, whether using a mask or tracheostomy tube, relies on improving gas exchange and reducing the work of breathing for the patient. Maintaining **patient-device synchrony** and **managing leak** is critical to achieving this.

A good device should help this by:

- monitoring and compensating for leak
- accurately sensing the start and end of a patient's inspiratory effort for triggering and cycling
- responding quickly to reach and maintain the set pressure
- offering flexibility of settings to accommodate pathological variations in the patient's respiratory timing/pattern.

Stellar effectively provides this capability through:

- **Learn Circuit**—method to calculate circuit impedance so that pressure can be controlled and estimated at the patient's airway
- **Vsync**— an automatic algorithm to compensate for unintentional leak
- **Mask selection**—a correct selection indicates to Stellar how much leak through the mask vent or ResMed Leak Valve can be expected as the therapy pressure varies
- **Mask fit**—ensures an optimal seal for the patient interface to avoid unintentional leak
- **TiControl**—offers control over the inspiratory time limits between which the patient can spontaneously cycle
- **Trigger/Cycle sensitivities**—five sensitivities for triggering and cycling offer flexibility to personalise therapy and accommodate a range of patient conditions
- **Rise/Fall Time**—adjustable duration for transitions to both inspiration and expiration offer opportunity for maximal comfort
- **Pathology Defaults**—offer a choice of disease-specific preset setting values to facilitate a quick and sensible starting point to therapy.

### Learn Circuit

The Learn Circuit procedure permits optimal therapy and monitoring accuracy, by measuring and storing the breathing system impedance up to and including the vent. This allows the device to accurately estimate the therapy pressure. For more information on performing a Learn Circuit, see "Setup menu: Options" on page 45.

## Vsync and mask selection

Stellar's unique leak management combines **Vsync** and Mask Selection to monitor leak ie, unintentional mask leak and vent leak, and effectively compensate for its potentially detrimental effect on therapy.

It is important for a device to monitor the patient's respiratory flow, which provides information about lung ventilation and timing of the patient's effort. Using the respiratory flow signal, the device is able to trigger and cycle breaths that synchronise closely with the patient's effort.

Leak flow, both unintentional and from the mask/inline vent, adds to the Total Flow measured by the device's flow sensor and obscures the true Respiratory Flow. Without leak compensation, this would cause asynchronous triggering and cycling, as well as inaccurate data monitoring which may impact clinical decision-making.

Stellar is able to extract the patient's Respiratory Flow from the Total Flow. It uses information from Mask Selection to accommodate for mask/in-line Vent Leak, and Vsync to compensate for Unintentional Leak. That is:

$$\text{Estimated Respiratory Flow} = \text{Total Flow} - (\text{Vent Leak} + \text{Unintentional Leak})$$

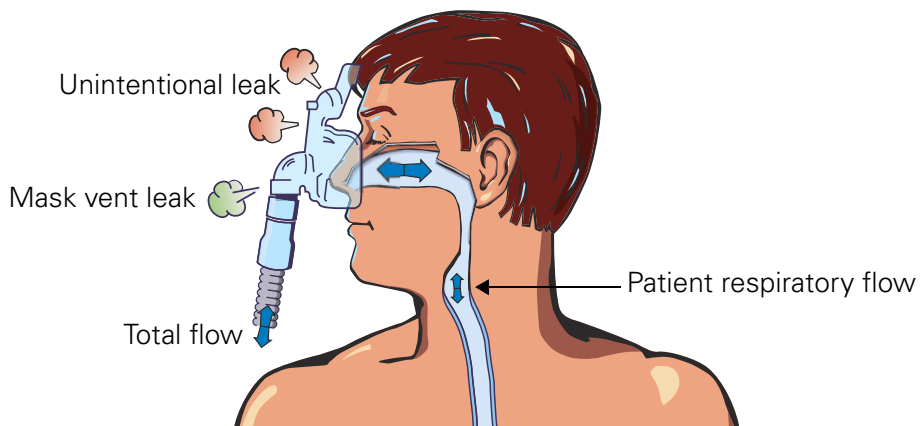

Unintentional leak may arise due to factors such as poor mask fit, mask movement during sleep, and fast therapy pressure transitions. When an unintentional leak is introduced (see below graph), synchrony between the device and the patient is disrupted. The increased flow from a leak can be interpreted as patient inhalation and cause the ventilator to trigger from EPAP to IPAP out of time with the patient's actual effort (A). Vsync responds rapidly to correct the disruption and restore synchrony within 2-6 breaths (B) depending on the patient's respiratory rate and the size of the leak.

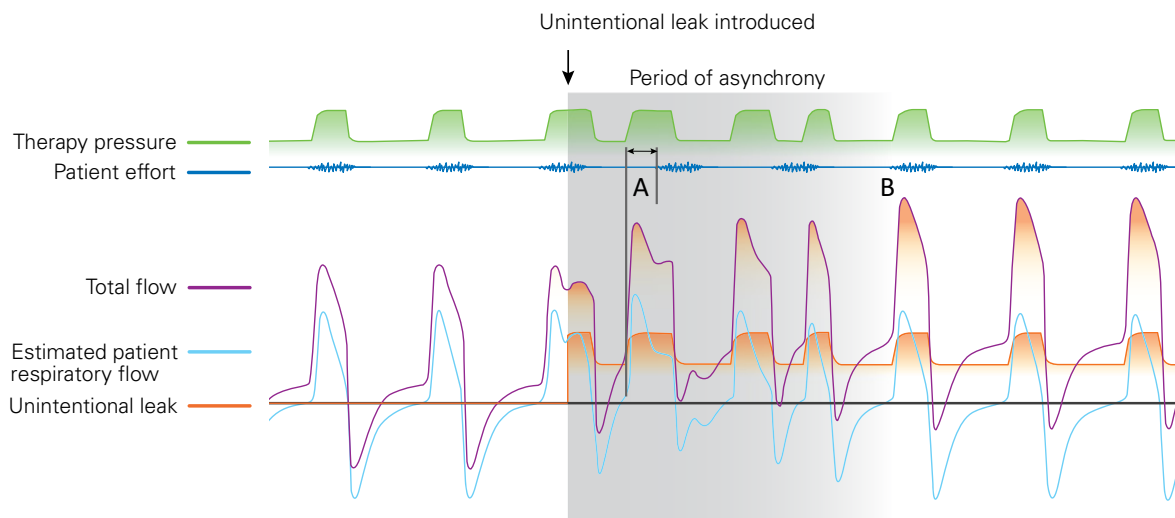

Unintentional leak flow varies with changes to therapy pressure or the size of the leak opening. Vsync calculates changing leak by:

- monitoring average pressure and flow
- assuming that on average volume delivered to the patient is equal to volume exhaled by the patient
- using this information to continuously estimate the size of the leak opening as it changes
- calculating the air flowing through the opening, knowing its size and the therapy pressure.

## TiControl

TiControl™ allows the clinician to set minimum and maximum inspiratory time limits. Ti Min and Ti Max can be set to either side of the patient's ideal spontaneous inspiratory time, ensuring adequate time for gas exchange and offering a 'window of opportunity' to cycle into EPAP.

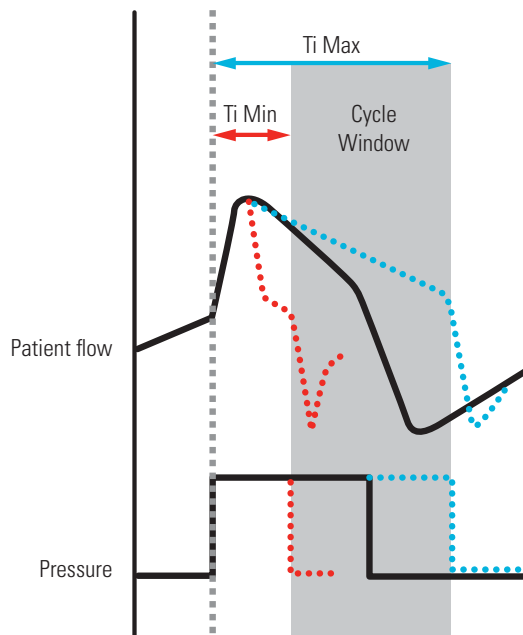

For some patients whose inspiratory effort or flow are weak and insufficient, Ti Min prevents the premature cycling to EPAP. Premature cycling to EPAP can result in insufficiently supported breaths.

When breath detection becomes difficult due to excessive leak or inhibited exhalation effort or flow, Ti Max effectively prevents prolonged inspiration. See "Setting TiControl" on page 60.

## Trigger/Cycle sensitivities

Under normal conditions, the device **triggers** (initiates IPAP) and **cycles** (terminates IPAP and changes to EPAP) as it senses the change in patient flow. Patient breath detection is enhanced by the device's automatic leak management feature—Vsync.

In addition, the device has five adjustable trigger/cycle sensitivities to optimise the sensing level according to patient conditions.

For more information, see "Trigger/cycle sensitivities" on page 62. For characteristic data, see "Technical specifications" on page 69.

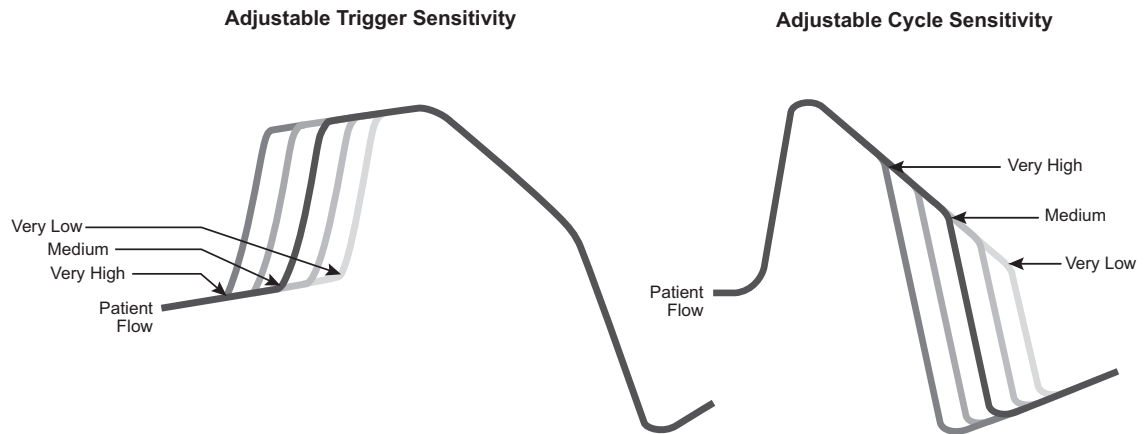

## Rise/Fall Time

**Rise Time** sets the time taken for the device to reach the set inspiratory pressure after triggering. The greater the Rise Time value, the longer it takes for pressure to increase from **EPAP to IPAP**. A controllable Rise Time allows the clinician to optimise the patient’s work of breathing, comfort and synchrony.

**Fall Time** sets the time taken for the device to reach the set expiratory pressure after cycling. The greater the Fall Time value, the longer it takes for pressure to decrease from **IPAP to EPAP**. Adjustable Fall Time may in certain patients improve breathing comfort and synchrony.

For more information, see “Advanced Settings - Factory default settings and parameter ranges” on page 39.

## Pathology Defaults

The Pathology Defaults offer a choice of disease-specific preset setting values to facilitate efficient commencement of therapy. You can select from four sets of respiratory system mechanics. Before use you will need to review the set parameters on the *Clinical Settings* screen.

Setting	S	ST	T	PAC	iVAPS	Obstructive lung disease	Restrictive lung disease	Obesity Hypoventilation Syndrome	Normal lung mechanics
IPAP [cm H <sub>2</sub> O]	✓	✓	✓	✓		13	11	16	11
EPAP or PEEP [cm H <sub>2</sub> O]	✓	✓	✓	✓	✓	5	5	8	5
PS [cm H <sub>2</sub> O]	✓	✓	✓	✓		8	6	8	6
Rise Time [ms]*	✓	✓	✓	✓	✓	150	300	300	200
Fall Time [ms]*	✓	✓	✓	✓	✓	200	200	200	200
Trigger sensitivity	✓	✓		✓	✓	Medium	Medium	Medium	Medium
Cycle sensitivity	✓	✓			✓	High	Low	Medium	Medium
Min PS [cm H <sub>2</sub> O]					✓	4	4	4	2
Max PS [cm H <sub>2</sub> O]					✓	20	20	18	20
Min EPAP [cm H <sub>2</sub> O]					✓	5	5	8	5
Max EPAP [cm H <sub>2</sub> O]					✓	15	15	15	15
Ti Min [sec]	✓	✓			✓	0.3	0.5	0.5	0.5
Ti Max [sec]	✓	✓			✓	1.0	1.5	1.5	1.5

\*The Rise/Fall Time milliseconds scale is an approximate only.

# Stellar at a glance



The Stellar comprises:

- Stellar device • Hypoallergenic air filter • AC Power cord • Carry bag • 2 m air tubing
- ResMed USB stick • Low pressure oxygen connector.

The following optional components are compatible with Stellar:

- 3 m air tubing • SlimLine™ air tubing • clear air tubing (disposable) • H4i™ heated humidifier
- Antibacterial filter • Heat moisture exchanger filter (HMEF) • ResMed XPOD oximeter
- Nonin™ pulse oximetry sensors • FiO<sub>2</sub> monitoring kit (external cable, T-piece adapter)
- FiO<sub>2</sub> monitoring sensor • Stellar Mobility bag • ResMed Leak Valve • Tubing wrap • Stellar DC/DC converter.<sup>1</sup>

<sup>1</sup> Remote alarm connection is product model dependent.



## WARNING

The Stellar should only be used with air tubing and accessories recommended by ResMed. Connection of other air tubing or accessories could result in injury or damage to the device.

ResMed regularly releases new products. Please check the catalogue of ventilation accessories on our website at [www.resmed.com](http://www.resmed.com).

## Patient interface

Both masks and tracheostomy tubes can be used with Stellar. To set the patient interface type go to the *Setup* menu, select *Clinical Settings*, then *Advanced Settings*.

For information on using masks, see the mask manual. For a full list of compatible masks for this device, see the Mask/Device Compatibility List on [www.resmed.com](http://www.resmed.com) on the **Products** page under **Service & Support**. If you do not have internet access, please contact your ResMed representative.

## Humidification

A humidifier is recommended especially for patients experiencing dryness of the nose, throat or mouth. For information on using a humidifier as part of:

- noninvasive ventilation, see “Setting up for noninvasive use” on page 14.
- invasive ventilation, see “Setting up for invasive use” on page 16.

## Internal battery



### CAUTION

Over time, the capacity of the internal battery will decrease. This depends on individual use and ambient conditions. As the battery degrades, the battery charge level indicator may lose accuracy. This will mean battery-related and system alarms may not activate as intended. ResMed recommends the battery be tested after two years to assess the remaining battery life. Testing and replacement of the internal battery should only be performed by an authorised service agent.

*Note: The battery duration depends on the state of charge, the environmental conditions, the condition and age of battery, the device settings and the patient circuit configuration.*

In case of a mains power disruption, the device will operate using the internal battery if there is no external battery connected to the device. The internal battery will operate for approximately two hours under normal conditions (see “Technical specifications” on page 69). The power status of the battery is displayed on top of the LCD screen. Check the battery status regularly while operating the device with the internal battery and connect the device in time to mains power or alternatively to the external battery.

Additionally the Internal battery use alarm will be displayed. Press the Alarm mute button to clear the alarm.

To recharge the internal battery, connect the device to mains power. It can take up to three hours to fully recharge the internal battery, however this can vary depending on environmental conditions and if the device is in use.

## Maintenance

The internal battery has to be discharged and recharged every six months.

- 1 Remove the power cord while the Stellar is turned on (stand-by or in operation) and let the device operate with the internal battery to a charge level of 50%.
- 2 Reconnect the power cord to the mains power. The internal battery will be fully recharged.



## Storing

If the device is stored for a longer period the internal battery should be at the charge level of approximately 50% to increase the durability.

*Note: Check the charge level every six months, if necessary recharge the internal battery to a charge level of 50%.*

## ResMed USB stick

A ResMed USB stick may be used with the device either to help you to monitor the patient's treatment, to provide the patient with updated device settings or to transfer settings from one device to another. For more information, see "Data management" on page 56.

## Use on an aircraft

ResMed confirms that the Stellar can be used during all phases of air travel without further testing or approval by the airline operator. See "Technical specifications" on page 69.

## Mobile use

The Stellar Mobility bag allows the Stellar to be used in mobile situations, eg, in a wheelchair. For setup and correct use, see the Stellar Mobility Bag User Guide. For extended mobile use, the ResMed Power Station II external power supply unit can be used as an additional power source.

Limitations apply to the use of oxygen with the Stellar Mobility Bag. For more information, contact your local ResMed representative.

## Remote Alarm

The Remote Alarm may be used to transfer audible and visual alarms by a direct cable connection. For more information on using the Remote Alarm, see the Remote Alarm user guide.

*Note: Remote alarm connection is product model dependent.*

## Setting up for noninvasive use



### WARNING

- The air filter cover protects the device in the event of accidental liquid spillage onto the device. Ensure that the air filter and air filter cover are fitted at all times.
- Make sure that all the air inlets at the rear of the device and under the device and vents at the mask are unobstructed. If you put the device on the floor, make sure the area is free from dust and clear of bedding, clothes or other objects that could block the air inlets.
- Hoses or tubes must be non-conductive and antistatic.
- Do not leave long lengths of the air tubing or the cable for the finger pulse sensor around the top of the bed. It could twist around the patient's head or neck while sleeping.



### CAUTION

- Be careful not to place the device where it can be bumped or where someone is likely to trip over the power cord.
- Make sure the area around the device is dry and clean.

### Notes:

- ResMed recommends using the AC power cord supplied with the unit. If a replacement power cord is required, contact your ResMed Service Centre.
- Place the device on a flat surface near the head of the bed.



**1** Connect the power cord.

**2** Plug the free end of the power cord into a power outlet.

**3** Attach the H4i heated humidifier to the front of the Stellar.

If the H4i is not in use, and if applicable, connect the antibacterial filter firmly onto the air outlet of the device (see "Attaching an antibacterial filter" on page 22).

**Note:** Other external humidifiers can be used for noninvasive setup. ResMed recommends using a breathing system (including antibacterial filter, air tubings, external humidifier) with an impedance of maximum 2 cm H<sub>2</sub>O at 30 L/min, 5 cm H<sub>2</sub>O at 60 L/min and 16 cm H<sub>2</sub>O at 120 L/min.

**4** Connect one end of the air tubing firmly onto the air outlet of the H4i.

- 5 Connect the mask system to the free end of the air tubing.
- 6 Press the power switch on the back to turn on the device.
- 7 Select the mask type (select *Setup* menu, then *Clinical Settings*, then *Advanced Settings*).
- 8 Perform a Learn Circuit (see “Setup menu: Options” on page 45).

## Attaching the H4i heated humidifier

The Stellar can be used with the H4i heated humidifier for noninvasive use when stationary. It will be automatically detected when the Stellar is turned on.

A humidifier is recommended especially for patients experiencing:

- nasal stuffiness/congestion
- rhinorrhea following the use of mask ventilation
- dryness of the nose, throat or mouth
- patients with thick secretions (eg, cystic fibrosis, bronchiectasis, etc)
- patients using oxygen.

Humidification may be required for patients who experience nasal and upper airway dryness as a consequence of the high flow of air being directed through the nasal and oral passages. It may also be required in those individuals who have tenacious secretions.

Mouth leaks occurring during the use of positive pressure therapy can significantly increase nasal resistance. This increase in nasal resistance associated with mouth leaks may be prevented by fully humidifying the inspired air. In most cases, using heated humidification is the most effective way to decrease nasal resistance.

For information on using the H4i, see the H4i user guide.



### WARNING

- Always place the H4i on a level surface below the level of the patient to prevent the mask and tubing from filling with water.
- Make sure that the water chamber is empty and thoroughly dried before transporting the humidifier.
- The H4i humidifier is not intended for mobile use.
- Do not overfill the water chamber, as during use this will cause water to spill into the air circuit. Check the air circuit regularly for accumulated water. If you observe water has spilled into the air circuit, clear the water and check that the water chamber is not overfilled. When using the H4i at high pressures (above 25 cm H<sub>2</sub>O) the use of a water trap will avoid water spillage back into the air circuit.
- For optimal accuracy and synchrony, perform a Learn Circuit with a change of the circuit configuration, in particular when adding or removing high impedance components (eg, antibacterial filter, external humidifier, water trap, nasal pillow type mask or air tubing). See “Setup menu: Options” on page 45.



### CAUTION

Check the air circuit for water condensation. Use a water trap or a tubing wrap if humidification is causing water condensation within the tube.

#### Notes:

- A humidifier increases resistance in the air circuit and may affect triggering and cycling, and accuracy of display and delivered pressures. Therefore perform the Learn Circuit function (see “Setup menu: Options” on page 45). The device adjusts the airflow resistance.
- The heating feature of the H4i is disabled when the device is not mains powered.

## Setting up for invasive use

The Stellar can be used invasively only with the ResMed Leak Valve, or using an uncuffed or deflated cuff tracheostomy tube with the ResMed Leak Port (24976).

AutoEPAP is contraindicated for invasive use.



### WARNING

- Make sure that all the air inlets at the rear of the device and under the device and vents at the mask or at the ResMed Leak Valve are unobstructed. If you put the device on the floor, make sure the area is free from dust and clear of bedding, clothes or other objects that could block the air inlets.
- Replace the HMEF regularly as specified in the instructions provided with the HMEF.
- The H4i is contraindicated for invasive use. An external humidifier approved for invasive use is recommended according to EN ISO 8185 with an absolute humidity of > 33 mg/L and a maximum flow within the technical specifications of Stellar.
- For optimal accuracy and synchrony, perform a Learn Circuit when a new circuit is used or with a change of the circuit configuration, in particular when adding or removing high impedance components (eg, antibacterial filter, external humidifier, water trap or different type of air tubing). Do not connect patient interfaces prior to performing the Learn Circuit. Patient interfaces include any components placed after the ResMed Leak Valve (eg, HMEF, catheter mount, tracheostomy tube). See "Setup menu: Options" on page 45.



### CAUTION

When using a humidifier, use a water trap and check the air circuit regularly for accumulated water.

#### Notes:

- When the mask type is set to *Trach*, the Non-Vented Mask alarm will be automatically enabled to alert the user when the ResMed Leak Valve has no vent holes or when the vent holes are blocked.
- ResMed recommends using a breathing system (including antibacterial filter, air tubings, external humidifier and ResMed Leak Valve) with an impedance of maximum 2 cm H<sub>2</sub>O at 30 L/min, 5 cm H<sub>2</sub>O at 60 L/min and 16 cm H<sub>2</sub>O at 120 L/min.
- When the Mask Type is set to Trach AutoEPAP has to be turned off.

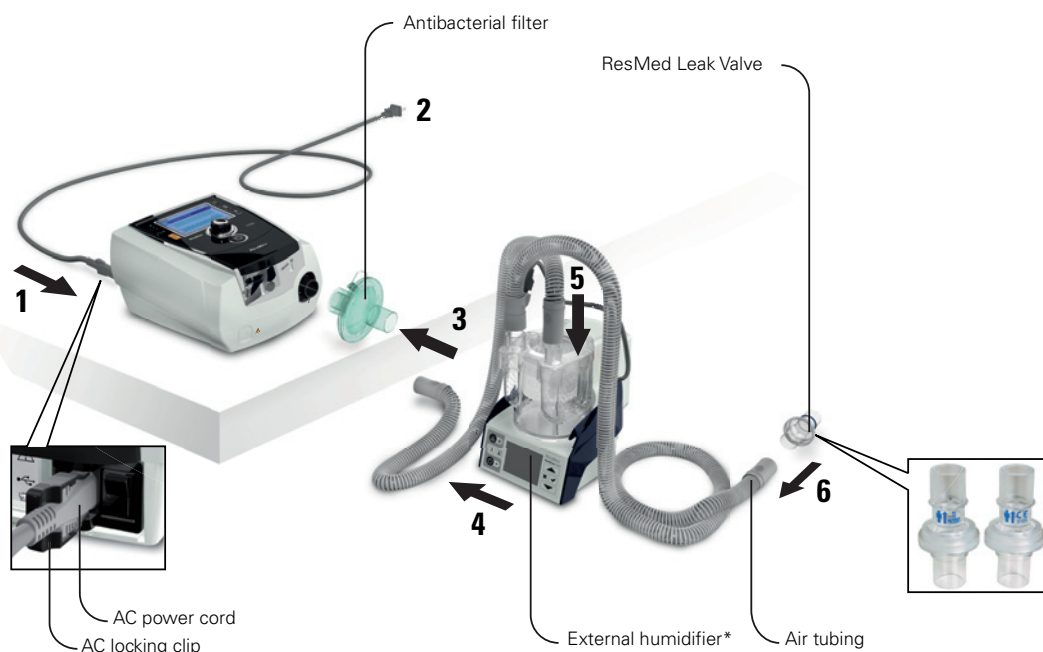

- 1 Connect the power cord.
- 2 Plug the free end of the power cord into a power outlet.
- 3 Connect the antibacterial filter firmly onto the air outlet of the device.
- 4 Connect the external humidifier to the other side of the antibacterial filter.  
\*If not using an external humidifier, connect the HMEF to the ResMed Leak Valve (at step 10).
- 5 Connect the air tubing to the external humidifier.
- 6 Connect the ResMed Leak Valve to the air tubing. Position the ResMed Leak Valve so that air from the vent holes does not blow directly onto the patient's chest.



### WARNING

Always set up the ResMed Leak Valve in the breathing circuit with the arrows and the symbol  pointing in the direction of air flow from the Stellar to the patient.

- 7 Press the power switch on the back to turn on the device.
- 8 Select the mask type **Trach** (select *Setup* menu, then *Clinical Settings*, then *Advanced Settings*).
- 9 Perform a Learn Circuit (see “Setup menu: Options” on page 45) according to the following setup illustrations.

#### With an external humidifier

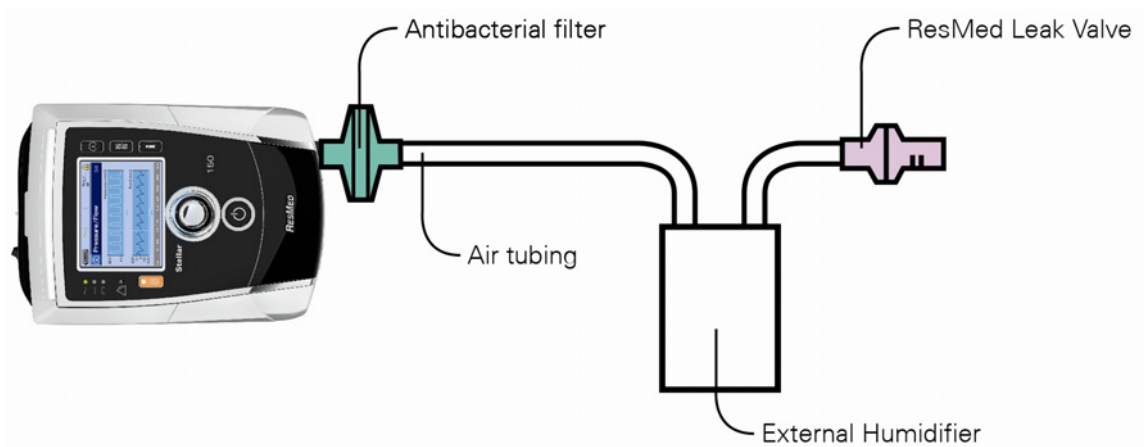

#### Without an external humidifier

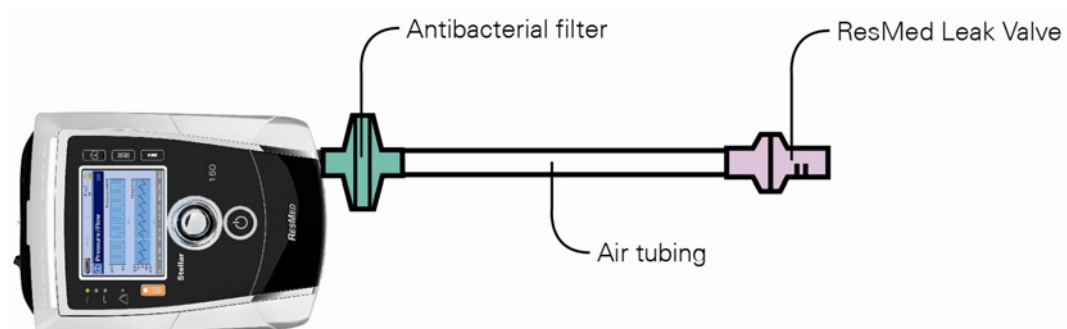

- 10 If an external humidifier is not being used, connect the HMEF to the patient side of the ResMed Leak Valve.
- 11 Connect the catheter mount.



\*\* The ResMed Leak Valve or the HMEF can be connected to standardised tracheostomy interfaces including connector pieces like catheter mounts.

The catheter mount and the external humidifier are not part of the ResMed component.

## Detecting circuit disconnection and decannulation

Alarms should be configured and tested that circuit disconnection and decannulation is detected (see "Testing the alarms" on page 42).

If Circuit Disconnected alarm does not adequately activate, consider using the High Leak, Low Minute Ventilation, Low Pressure, Low Respiratory Rate, Apnoea and Low SpO<sub>2</sub> alarms. Independent monitoring can be used as an alternative.

## Using the Stellar device for the first time

When using the Stellar device for the first time, ensure that all components are in working condition and perform a functional test (see "Performing a functional test" on page 24). Alarms should also be checked when setting up a new patient (see "Testing the alarms" on page 42).

## Setting up for home therapy

You may be required to set up a device for a patient to use at home. There are a number of things to be aware of:

- 1 Before sending the device home with a patient and to ensure the same therapy is delivered then, parameters and oxygen levels for the configuration must be set to match the way in which it will be used in the patient's home (eg, same mask system, with the humidifier connected, the oxygen line entrained at the same place, the same oxygen source, filters in the same position, and same length air tubing) so that the therapy is working correctly. Make sure the alarms are working as expected (see "Testing the alarms" on page 42).
- 2 Set the device to Patient mode .
- 3 Make sure that the patient has a contact phone number in case of emergency. A good place to write this is in the front of the User Guide.

# Working with other optional accessories

## Attaching a pulse oximeter



### WARNING

Only use compatible NONIN finger pulse sensors.



### CAUTION

Factors that may degrade pulse oximeter performance or affect the accuracy of the measurement include the following: excessive ambient light, excessive motion, electrosurgical interference, blood flow restrictors (arterial catheters, blood pressure cuffs, infusing lines, etc.), moisture in the sensor, improperly applied sensor, incorrect sensor type, poor pulse quality, venous pulsations, anemia or low hemoglobin concentrations, cardiogreen or other intravascular dyes, carboxyhemoglobin, methemoglobin, dysfunctional hemoglobin, artificial nails or fingernail polish, or a sensor not at heart level.

**Note:** The pulse oximeter does not meet the defibrillation-proof requirement as per IEC 60601-1: 1990, clause 17.h.

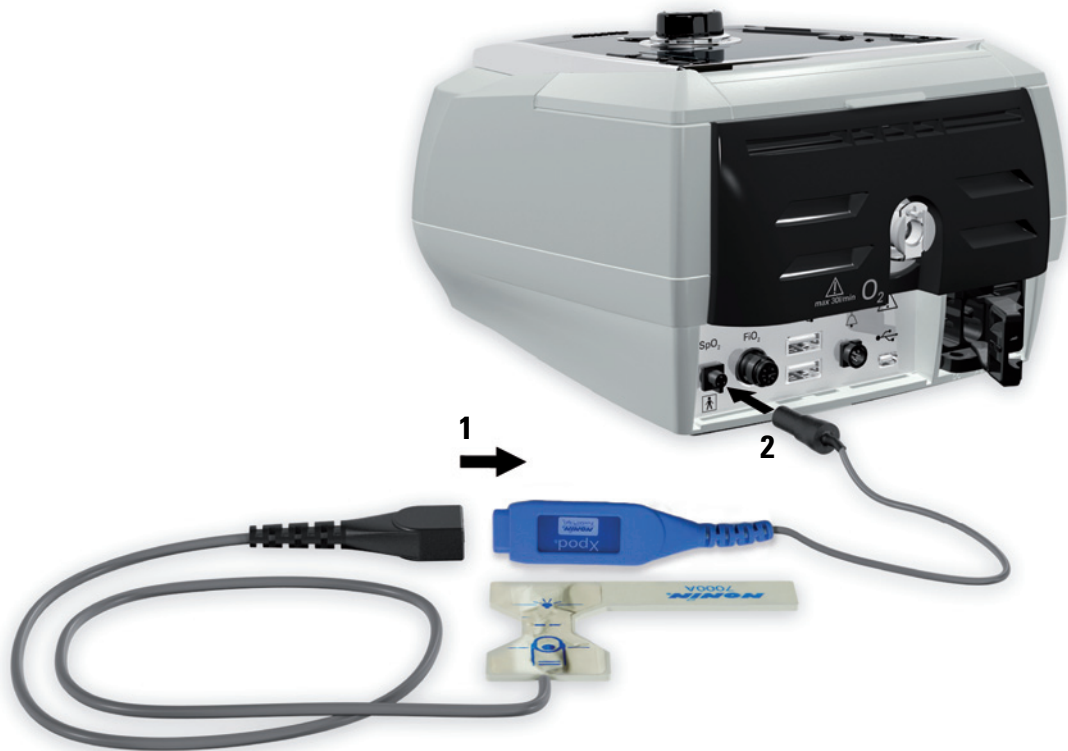

- 1 Connect the plug of the finger pulse sensor to the plug of the pulse oximeter.
- 2 Connect the plug of the pulse oximeter at the rear of the device.  
To view the oximetry values, from the *Monitoring* menu, select *Monitoring*.

## Adding supplemental oxygen



### WARNING

- Oxygen flow must be turned off when the device is not operating, so that unused oxygen does not accumulate within the device and create a risk of fire.
- ResMed strongly recommends adding oxygen into Stellar's oxygen inlet at the rear of the device. Entraining oxygen elsewhere, ie into the breathing system via a side port or at the mask, has potential to impair triggering and accuracy of therapy/monitoring and alarms (eg, High Leak alarm, Non-vented mask alarm). If used in this way, therapy and alarm operation must be verified each time oxygen flow is adjusted.
- Oxygen supports combustion. Oxygen must not be used while smoking or in the presence of an open flame. Only use oxygen supply in well-ventilated rooms.
- The breathing system and the oxygen source must be kept at a minimum distance of 2 m away from any sources of ignition (eg, electrical devices).
- Use only certified, clean oxygen sources.
- Oxygen must not be used while the device is being operated within the mobility bag.

**Note:** Up to 30 L/min can be added.

### To add supplemental oxygen

- 1 Unlock the low flow oxygen inlet on the back of the device by pushing up on the locking clip.
- 2 Insert one end of the oxygen supply tubing into the oxygen connector port. The tubing automatically locks into place.
- 3 Attach the other end of the oxygen supply tubing to the oxygen supply.
- 4 Start ventilation.
- 5 Turn on the oxygen source and adjust to the desired flow rate.

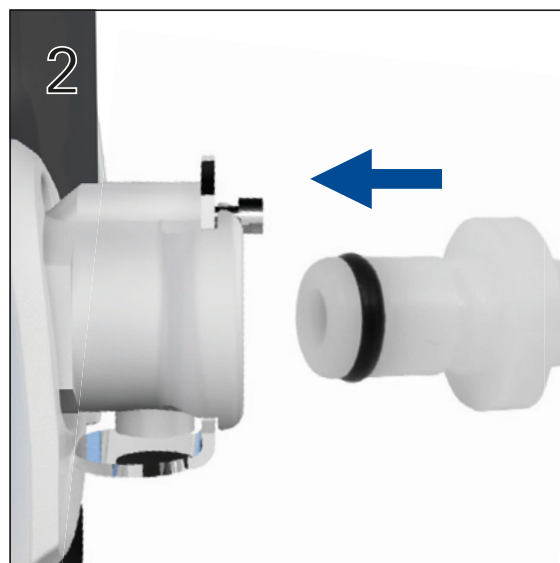
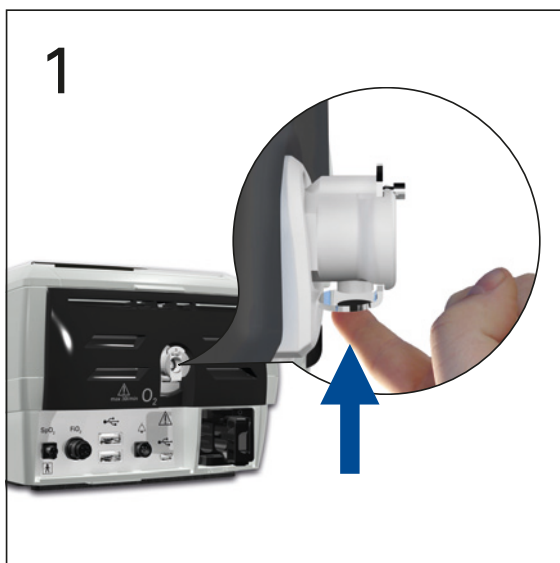



## To remove supplemental oxygen

Before you remove supplemental oxygen from the device, ensure the oxygen supply has been turned off.

- 1 Unlock the low flow oxygen inlet on the back of the device by pushing up on the locking clip.
- 2 Remove the oxygen supply tubing from the oxygen connector port.

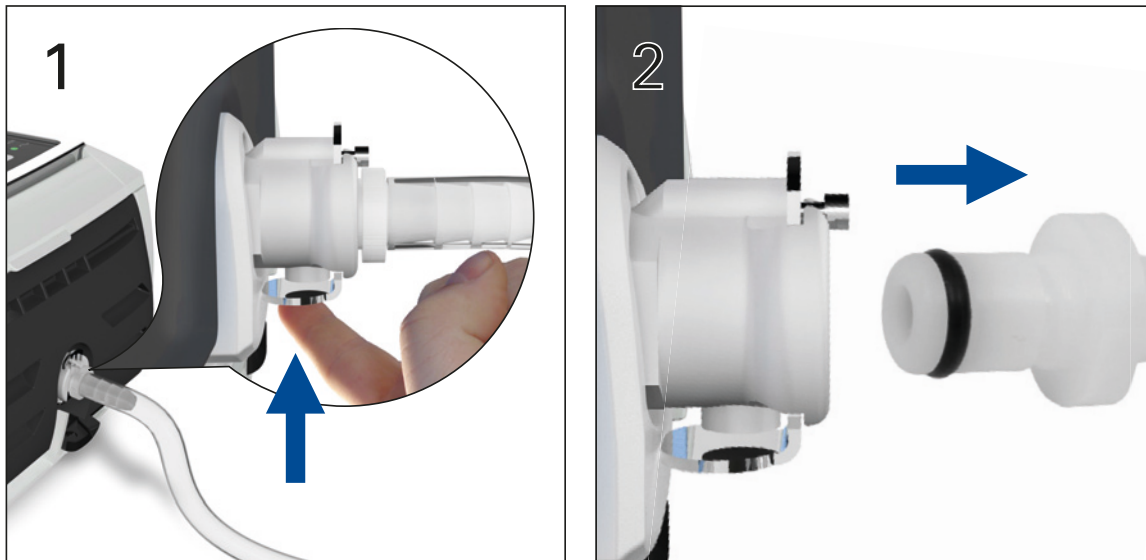

## Using the FiO<sub>2</sub> monitoring sensor



### CAUTION

Do not use the FiO<sub>2</sub> monitoring sensor with the H4i humidifier.

### Preparing to use a new sensor

- 1 Before use, leave the FiO<sub>2</sub> monitoring sensor open to the air for 15 minutes.
- 2 Attach a new FiO<sub>2</sub> monitoring sensor (as shown below).
- 3 Perform the sensor calibration (see "Setup menu: Options" on page 45).

**Note:** The FiO<sub>2</sub> monitoring sensor must be replaced every 12 months. In conditions where oxygen is less than 18% the device will display monitoring sensor disconnected.



## Connecting a sensor

- 1 Connect the air tubing to the T-piece adapter.
- 2 Connect the FiO<sub>2</sub> monitoring sensor to the T-piece adapter.
- 3 Connect the adapter to the air outlet of the device.
- 4 Connect one end of the cable to the FiO<sub>2</sub> monitoring sensor.
- 5 Connect the other end of the cable to the rear of the device.
- 6 Start calibration (see "Setup menu: Options" on page 45). This should be repeated periodically as per the facility policy.

## Attaching an antibacterial filter

The use of an antibacterial filter can be recommended as per facility policy. Antibacterial filters can be purchased separately from ResMed.

Regularly check the filter for entry of moisture or other contaminants. The filter must be replaced according to the manufacturer's specifications.

**Note:** ResMed recommends using a filter with a low impedance (less than 2 cm H<sub>2</sub>O at 60 L/min, eg, PALL BB 50 filter).



### WARNING

- An antibacterial filter is mandatory if the device is used on multiple patients.
- Do not use an antibacterial filter with the H4i.







- 1 Fit the antibacterial filter to the air outlet of the device.
- 2 Attach the air tubing to the other side of the filter.
- 3 Attach the mask system to the free end of the air tubing.
- 4 Perform the Learn Circuit function (see "Setup menu: Options" on page 45). From the *Setup* menu, select *Options*. This enables the device to compensate for the impedance introduced by the filters.

# Stellar basics

## About the control panel



Key	Function
<b>Start/Stop</b> 	<ul style="list-style-type: none"> <li>Starts or stops treatment.</li> <li>Extended hold for at least three seconds starts the mask-fitting feature.</li> </ul>
<b>Alarm mute</b> 	<ul style="list-style-type: none"> <li>During therapy: Press once to mute an alarm. Press a second time to un-mute an alarm. If the problem is still present, the alarm will sound again after two minutes (see "Working with alarms" on page 26).</li> <li>In stand-by mode: Extended hold for at least three seconds starts the LED and the alarm buzzer test.</li> </ul>
<b>Menu keys</b> 	Press the appropriate menu button (Monitoring, Setup, Info) to enter and scroll through the relevant menu.
<b>Push dial</b> 	Turning the dial allows you to scroll through the menu and change settings. Pushing the dial allows you to enter into a menu or confirm your choice.

## The LCD screen

The LCD screen displays the menus, treatment screens and alarm status.

Values on this LCD screen and other screens throughout the Clinical Guide are examples only.

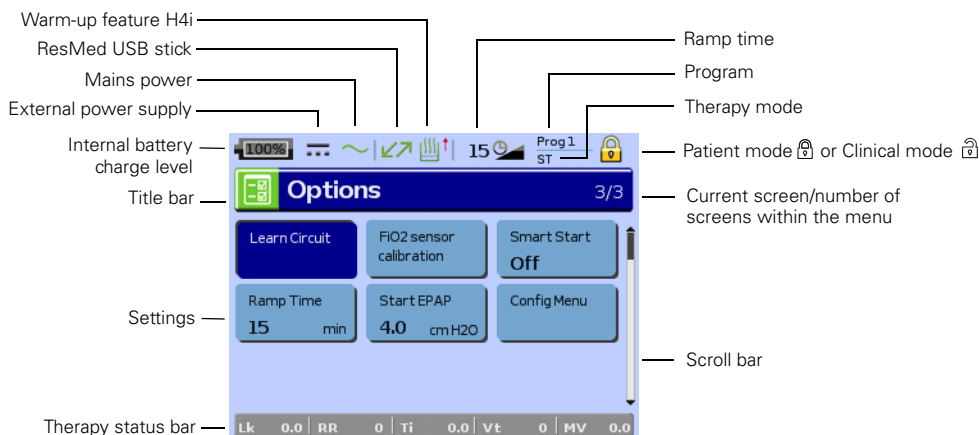

## Starting therapy

### Performing a functional test

Perform a functional test under any of the following circumstances:

- prior to the initial use of Stellar
- in between patients
- on long-term use patients, periodically as per the facility policy.

If any problems occur, see "Troubleshooting" on page 63. Please also check other provided User Instructions for troubleshooting information.

**1** Turn off the device by pressing the power switch at the back of the device.

**2** Check condition of device and accessories.

Inspect the device and all the provided accessories. If there are any visible defects, the system should not be used.

**3** Check the circuit configuration.

Check the integrity of the circuit configuration (device and provided accessories) according to the setup descriptions in this Clinical Guide and that all connections are secure.

**4** Turn on the device and check alarms.

Press the power switch at the back of the device once to turn on the device.

Check that the alarm sounds a test beep and the LEDs (visual indicator) for the alarm signal and the Alarm mute button flash. The device is ready for use when the *Treatment* screen is displayed. If the display shows the *Reminder* screen, follow the instructions, then press  to display the *Treatment* screen.

**5** Check batteries.

Disconnect the device from the mains and external battery (if in use) so that the device is powered by the internal battery. Check that the Battery use alarm will be displayed and the battery LED is on.

**Note:** If the charge state of the internal battery is too low, or if the battery is empty an alarm occurs. See the Alarm troubleshooting section on page 63 for further information.

Reconnect the external battery (if in use) and check that the LED for the external power supply is lit. The External DC power use alarm will be displayed and the Alarm LED will light.

Reconnect the device to the mains.

## 6 Check the H4i heated humidifier (if in use).

Check that the warm-up feature is displayed on the *Treatment* screen. Start the warm-up feature. Check that the humidifier warm-up symbol is displayed on top of the screen.



You can use the warm-up feature to pre-heat the water in the humidifier prior to starting treatment. The humidifier will be automatically detected when the device is turned on. The *Treatment* screen provides the option to start warming the humidifier. If the humidifier is heating, the related symbol is displayed at the top of the LCD screen.

For more information, see the H4i User Guide.

**Note:** The H4i in heating mode can only be used when the device is connected to mains supply.

## 7 Check the FiO<sub>2</sub> monitoring sensor (if in use).

Start the FiO<sub>2</sub> sensor calibration. Select *Setup* menu, then *Options* (see "Setup menu: Options" on page 45). Follow the instructions on the display.

## 8 Check pulse oximeter (if in use).

Attach the accessories according to the setup descriptions (see "Attaching a pulse oximeter" on page 19). From the *Monitoring* menu, go to the *Monitoring* screen. Check that the values for SpO<sub>2</sub> and Heart rate are displayed.

## 9 Check oxygen connection (if in use).

Attach the accessories according to the setup descriptions (see "Adding supplemental oxygen" on page 20).

## Starting therapy



### WARNING

Always ensure that the values in the ventilator therapy and alarm settings are appropriate before starting therapy.

#### Notes:

- When the device is turned on it operates in Patient mode where settings are restricted. You can switch the device into Clinical mode, see "Setup menu" on page 36.
- Always ensure that you verify the correct operation of triggering and cycling, and activation of High Leak alarm.

1 Press the power switch at the back to turn on the device.

2 To start treatment press  or if the SmartStart function is enabled instruct the patient to breathe into the patient interface and treatment will begin.

**Note:** When the ResMed Leak Valve is used, check that the anti-asphyxia valve (membrane) within the ResMed Leak Valve stays closed during the entire breathing cycle. Increase the EPAP if necessary.

## Stopping therapy

You can stop therapy at any time, simply remove the patient interface and press  to stop airflow **or** if SmartStart/Stop is enabled, simply remove the patient interface, and treatment will stop automatically.

Alternatively if the Ramp Down feature is enabled, turn the push dial and select Ramp Down on the Treatment screen. When the device has ramped down, remove the patient interface (see "Ramp Down" on page 29).

### Notes:

- *SmartStop may not work if **Full face** or **Trach** is selected as mask type; the High Leak alarm or the Low Min Vent alarm is enabled; "Confirm Therapy Stop" is enabled; or the mask-fitting feature is running.*
- *When the device is stopped and operating in standby mode with an integrated humidifier connected, it will continue to blow air gently to assist cooling of the humidifier's heater plate.*
- *Masks with high resistance (eg, paediatric masks) may cause the operation of the SmartStop feature to be restricted.*
- *When using with oxygen, turn off oxygen flow when stopping therapy.*

## Turning off the power

- 1 Stop the therapy.
- 2 Press the power switch at the back of the device once and follow the instructions on the display.

**Note:** To disconnect the device from the mains power pull out the mains plug from the power socket.

## Working with alarms



### WARNINGS

- Carefully review the alarm settings prior to use to ensure that the alarm settings are appropriate for each individual patient.
- When adjusting alarm volume, ensure that the alarm can be heard above the ambient noise levels that the patient may experience in a variety of settings, including use in noisy environments or inside mobility bags.
- This device is not intended to be used for vital signs monitoring. If vital signs monitoring is required, a dedicated device should be used for this purpose.

The device is fitted with alarms to alert you to changes that will affect the patient's treatment.



Alarm messages are displayed along the top of the screen. High priority alarms are displayed in **red**, medium priority alarms in **yellow** and low priority alarms in **light blue**. The Alarm LED lights **red** during high priority alarms and **yellow** during medium and low priority alarms.

The alarm volume can be set Low, Medium or High. From the *Setup* menu, select *Alarm Settings*. After the set value has been confirmed, the alarm will sound and the alarm LED lights.

For more information on reviewing and changing alarm settings, see “Setup menu: Alarm Settings” on page 40.

You can mute an alarm by pressing  once. By pressing the Alarm mute key again, the alarm sounds again. When an alarm is muted, the Alarm mute key LED will light constantly. For a high or medium priority alarm, if after two minutes the problem is still present, the alarm will sound again. Any active low priority alarm will be permanently muted and the Internal Battery Use alarm will be cleared until the alarm condition is fulfilled again.

Fixed alarms	User adjustable alarms
<p><b>High priority alarms:</b></p> <ul style="list-style-type: none"> <li>• Circuit disconnected—when leak exceeds 105 L/min (1.75 L/sec) for at least 15 sec</li> <li>• Over pressure</li> <li>• Blocked tube</li> <li>• Internal battery empty—when its charge level is less than 15%, the system may stop operating in as little as two minutes</li> <li>• Pressure sensor failure (system failure 7)</li> <li>• Motor failure (system failure 6)</li> <li>• Critical software failure (system failure 38)</li> </ul> <p><b>Medium priority alarms:</b></p> <ul style="list-style-type: none"> <li>• High temperature (internal components such as motor)</li> <li>• System failure (self test, flow sensor, software, calibration)</li> <li>• Internal battery low—when its charge level falls below 30%</li> </ul> <p><b>Low priority alarms:</b></p> <ul style="list-style-type: none"> <li>• External DC power use</li> <li>• Internal battery use</li> <li>• Keypad failure</li> <li>• Finger sensor failure</li> <li>• System failure (software, system component)</li> <li>• Disconnected FiO<sub>2</sub> sensor</li> <li>• Disconnected XPOD pulse oximetry</li> <li>• High temperature attention (internal components such as motor)</li> </ul>	<p><b>High priority alarms:</b></p> <ul style="list-style-type: none"> <li>• Non-Vented Mask</li> </ul> <p><b>Medium priority alarms:</b></p> <ul style="list-style-type: none"> <li>• Low Min Vent</li> <li>• High Leak</li> <li>• High Pressure</li> <li>• Low Pressure</li> <li>• High Respiratory Rate</li> <li>• Low Respiratory Rate</li> <li>• Apnoea</li> <li>• High FiO<sub>2</sub> level</li> <li>• Low FiO<sub>2</sub> level</li> <li>• Low SpO<sub>2</sub> level</li> </ul>

## Resetting alarms

When the Alarm mute key is pressed during therapy for at least three seconds, the following alarm messages and the audible alarm will be temporarily cleared:

- |                   |                         |
|-------------------|-------------------------|
| • High Pressure   | • High Breath Rate      |
| • Low Pressure    | • Low Breath Rate       |
| • High Leak       | • High FiO <sub>2</sub> |
| • Non-Vented Mask | • Low FiO <sub>2</sub>  |
| • Low Min Vent    | • Apnoea                |
|                   | • Low SpO <sub>2</sub>  |

## Tailoring treatment setup options

### Setting Ramp

If the patient experiences difficulty falling asleep with full pressure, they may wish to make use of Ramp where the pressure starts very gently and slowly increases to the set treatment pressure over a selected time period (see "Setup menu: Options" on page 45).

In iVAPS mode, EPAP, Min PS and Max PS slowly increase to the set treatment pressure over Ramp time. AutoEPAP is disabled during the Ramp time. It will automatically become enabled at the end of the Ramp time.

The *Treatment* screen following shows Max Ramp set at 15 minutes, while the graph shows the pressures experienced during ramp while in bilevel mode.



### CAUTION

EPAP/PEEP and Pressure Support achieve their configured values at the end of the ramp period. Some patients require full support from the commencement of therapy. Ramp may not be appropriate in such cases.

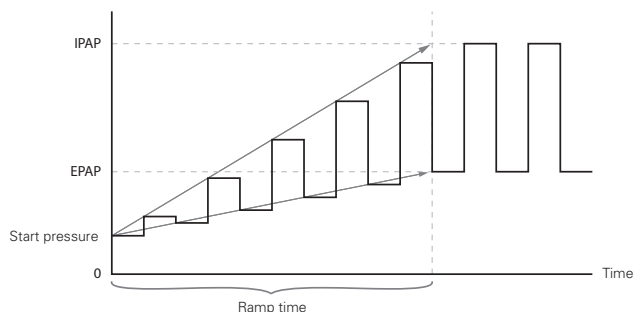
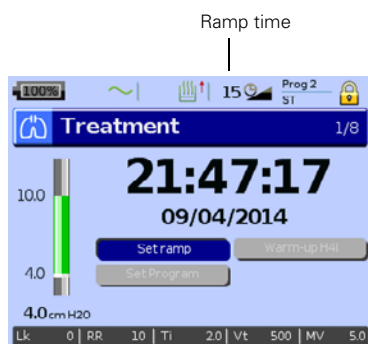

### Programs



Up to two sets of therapy settings (Programs) can be saved for different device configurations (eg, individual Learn Circuit results) in addition to ventilation and alarm settings. They are stored while in the *Clinical Settings* menu. If both, ie, dual, is selected, the patient can choose the program to use on the *Treatment* screen. If only a single program is selected, the option does not display.

Single or dual programs can be set in the *Setup* menu, *Options*, *Configuration* menu.

The Program names can be personalised using ResScan (eg, Day and Night).

When configuring a new program, connect the appropriate circuit and perform a Learn Circuit.

**Note:** Each program retains its own circuit configuration. When switching between programs, ensure you use the correct circuit as 'learned' for that program.



## Ramp Down

If difficulties are experienced in taking off the ventilation, the patient can use the *Ramp Down* feature. This feature reduces the treatment pressure to Start EPAP/PEEP over five minutes. After five minutes the therapy stops. The patient can enable the *Ramp Down* feature when it is selected in the *Options* menu.

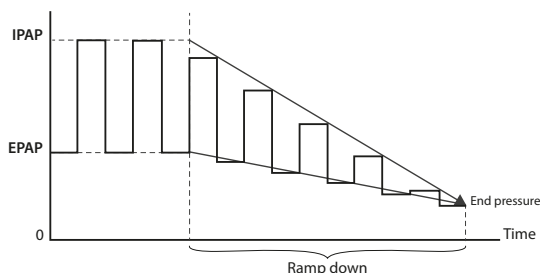
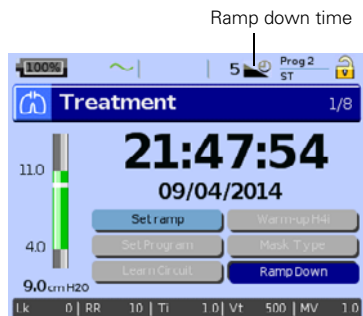

### Notes:

- Therapy can be stopped at any time by pressing the therapy start/stop button, including during the Ramp Down time.
- During the Ramp Down time the low pressure alarm is not active.
- This feature is not available in all countries.



## Mask Type and Learn Circuit



Selecting the mask type and performing a Learn circuit enables to calculate the impedance and leak for controlled therapy pressure. See "Setup menu: Options" on page 45.

## Using mask-fit

The patient can use mask-fit to help you fit the mask properly. This feature delivers constant treatment pressure for a three-minute period, prior to starting treatment, during which the patient can check and adjust the mask-fit to minimise leaks. The mask-fit pressure is the set CPAP or EPAP pressure or 10 cm H<sub>2</sub>O, whichever is greater.

- 1 Instruct the patient to lie down in bed or in their typical usage position and to put the mask on according to the mask user guide.
- 2 Hold down  for at least three seconds until pressure delivery starts.
- 3 Adjust the mask, mask cushion and headgear until the patient has a good mask-fit. After three minutes at the mask-fit pressure, the prescribed treatment mode and pressures will commence. Mask-fit can be stopped at any time by pressing .

### Notes:

- Press  for at least three seconds during mask-fit to start treatment immediately. The Treatment screen will be displayed.
- The mask-fitting feature is disabled when the mask type *Trach* is selected.
- Availability of this feature is country dependent.

## Using the menus

The device has three menus (*Monitoring, Setup, Info*) accessed by the equivalent buttons on the right of the LCD screen. In each menu there are screens that display settings, device or therapy information. The menu structure is the same in Patient and Clinical modes. Differences mainly exist in the settings that will be described in the following pages.

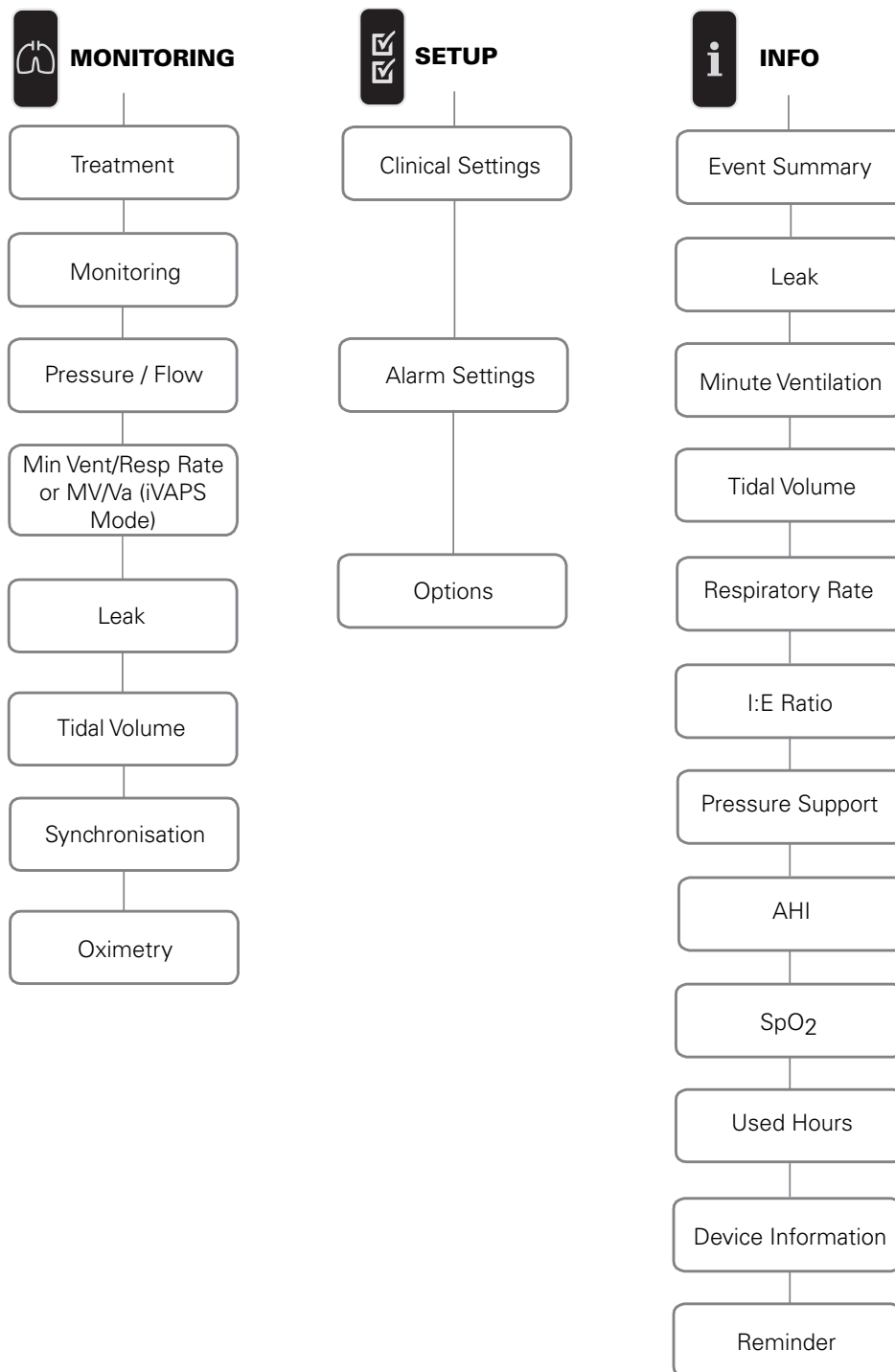

# Setup menu: Clinical Settings

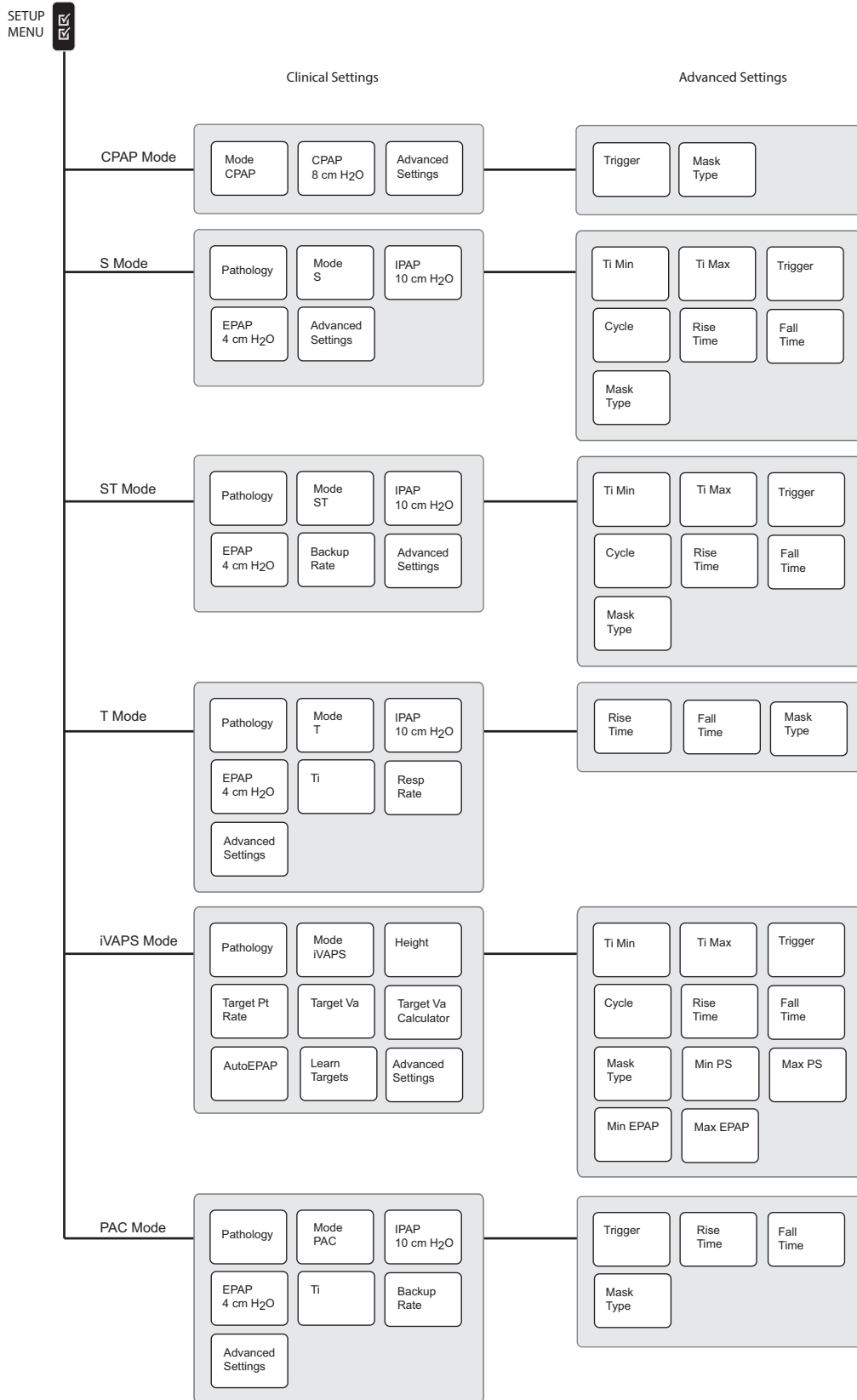

**Note:** When the Option Multi Program is set to dual, the setting Program is displayed in the Clinical Settings menu. See "Setup menu: Clinical Settings" on page 36.

# Setup menu: Alarm Settings and Options

SETUP  
MENU



## Alarm Settings

- Set all alarms off?
- Low Min Vent
- High Leak
- Non-Vented Mask
- High Pressure
- Low Pressure
- High Resp Rate
- Low Resp Rate
- Low SpO<sub>2</sub>
- High FiO<sub>2</sub> Alarm
- Low FiO<sub>2</sub> Alarm
- Apnoea Alarm
- Alarm Volume

## Options

- |               |                                     |               |
|---------------|-------------------------------------|---------------|
| Learn Circuit | FiO <sub>2</sub> sensor calibration | Smart Start   |
| Ramp Time     | Start CPAP/Start PEEP               | Max Ramp Time |
| Ramp Down     | Factory Defaults                    | Config Menu   |

## Configuration Menu

- |             |               |             |
|-------------|---------------|-------------|
| Language    | Brightness    | Backlight   |
| Time        | Date          | Time Format |
| Date Format | Pressure Unit | Flow Unit   |

- |               |              |                 |
|---------------|--------------|-----------------|
| Therapy LED   | Confirm Stop | Pressure Naming |
| Multi Program | Height Unit  | Auto Scaling    |
| Erase Data    |              |                 |

# Monitoring menu

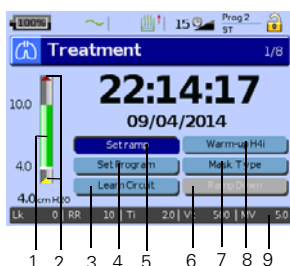

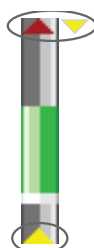

## Screen 1: Treatment

- 1 Pressure bar graph with the set pressure limits and measured pressure.
- 2 Machine breath indicators:



Machine cycled breath:

-  the inspiratory phase is sustained up to Ti Min.
-  the inspiratory phase is cycled down to EPAP/PEEP at Ti Max (S/ST mode) or Ti (PAC/T mode).

Machine triggered breath:

-  the machine initiates the inspiratory phase increasing pressure up from EPAP/PEEP.

- 3 Perform a Learn Circuit (see “Mask Type and Learn Circuit” on page 29).\*
- 4 Set program (see “Programs” on page 28).
- 5 Set Ramp (see “Setting Ramp” on page 28).
- 6 Warm-up the humidifier (see step 6 on page 25).
- 7 Set the Mask Type (see “Mask Type and Learn Circuit” on page 29).\*
- 8 Start Ramp Down (see “Ramp Down” on page 29).
- 9 The Therapy status bar allows you to view treatment data while therapy is running.

\* Feature is only available in clinical mode.

## Therapy status bar - parameter descriptions

Parameter	Range (Resolution)	Description
Leak (Lk)	0–120 L/min (1 L/min)	Current average unintentional leak. Leak is an output of the Vsync algorithm (see “Learn Circuit” on page 7). Unintentional leak is calculated by subtracting expected interface vent flow (based on the Mask Type in the <i>Settings</i> menu) from total leak. Averaging is typically over 2-6 breaths and can be shorter in the presence of unstable leak.
Respiratory Rate (RR)	5–60 bpm (1 bpm)	The number of breaths per minute, averaged over the last five breaths. A breath is considered as a respiratory cycle if it exceeds 50 mL, either spontaneously or machine triggered.
Inspiration Time (Ti)	0.1–4 sec (0.1 sec)	The duration of the ventilator inspiratory phase. This is a set Ti value in Timed and PAC modes.
Tidal Volume (Vt)	50–3000 mL (10 mL)	Tidal Volume is an estimate of quantity of inhaled air per breath, calculated as an integral of respiratory flow: based on the leak flow, the mask vent flow and the total flow rate. The display is based on a five-breath moving average, updated every breath.
Minute Ventilation (MV)	0.6–60 L/min (0.1 L/min)	Minute Ventilation is the product of Respiratory Rate and Tidal Volume. The display is based on a five-breath moving average, updated every breath.

**Note:** Preferences for pressure and flow units can be set in the in the Setup menu, Options, Configuration menu.

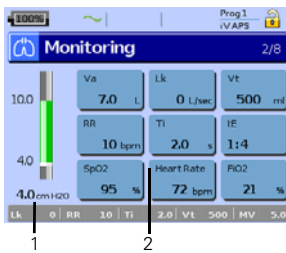

## Screen 2: Monitoring

- 1 Pressure bargraph with the set pressure limits.
- 2 The following therapy parameters are displayed:
  - Leak, Vt, RR, Ti (refer to Therapy status bar in Treatment screen).
  - Alveolar Ventilation (Va): minute volume without deadspace (Unit: L), displayed in iVAPS mode.
  - Inspiration to expiration ratio per breath (I:E).
  - Pulse oximeter measurements from Nonin: Heart rate and SpO<sub>2</sub> are both averaged over four beats of the pulse. Data is only displayed when an oximeter is connected to the device.
  - FiO<sub>2</sub>: Average fraction of oxygen level in the air outlet. Displayed when an oxygen sensor is connected.

**Note:** The SpO<sub>2</sub> and FiO<sub>2</sub> values are not appropriate to be used for diagnostic purposes. The displayed FiO<sub>2</sub> values range from 0% to 99%.

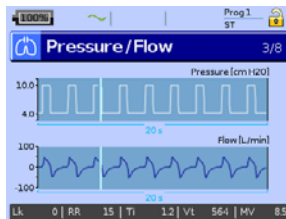

## Screen 3: Pressure/Flow\*\*

Pressure: Therapy pressure refreshed at 10 Hz (0.1 sec)

Flow: Estimated respiratory flow refreshed at 10 Hz (0.1 sec) (Unit: L/min, L/sec).

Each graph displays the last 20 seconds of data.

You can scroll back to view past data from the start of the session. Press  then turn it anti-clockwise.

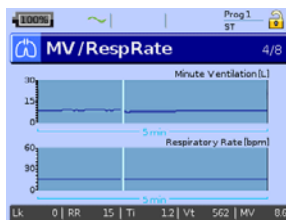

## Screen 4: Minute Ventilation/Respiratory Rate\*\*

The last five minutes of data averaged over five breaths are displayed.

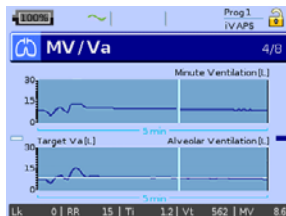

## Screen 4: (iVAPS only) Minute Ventilation/Alveolar Ventilation\*\*

The last five minutes of data averaged over five breaths are displayed.

Alveolar Ventilation has a guideline of Target Va.

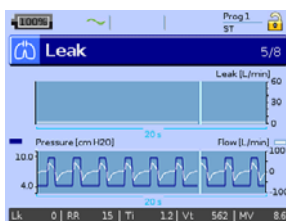

## Screen 5: Leak\*\*

Average instantaneous leak: Sampled variably depending on leak change (Unit: L/min, L/sec).

Pressure/Flow graph: Therapy pressure and estimated respiratory flow sampled at 10 Hz (0.1 sec).

Each graph displays the last 20 seconds of data.

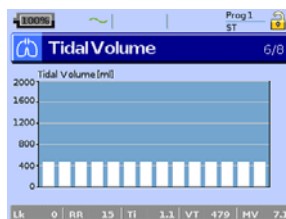

## Screen 6: Tidal Volume\*\*

The last 14 breaths of data averaged over five breaths are displayed.

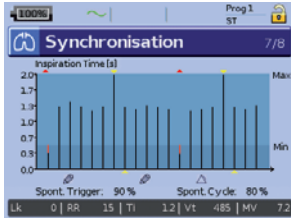

### Screen 7: Synchronisation

Diagram of the measured inspiration phases of the last 20 breaths.

The last 20 breaths of measured inspiration time (sec). The height of the bar indicates the inspiration time. In S/ST modes, Ti Min/Ti Max thresholds are shown as Min/Max.

- Settings changed.
- Alarm activated.
- Spont. Trigger: Percentage of spontaneous patient triggered breaths, measured from the last 20 breaths.
- Spont. Cycle: Percentage of spontaneous patient cycled breaths, measured from the last 20 breaths.

Additional information is displayed on the Event summary page.

- The inspiratory phase is sustained up to Ti Min (S/ST mode).
- The red bar indicates for how long the inspiratory phase is sustained up to Ti Min (S/ST mode) or Ti (PAC/T mode).
- The inspiratory phase is cycled down to EPAP/PEEP at Ti Max (S/ST mode) or Ti (PAC/T mode).
- The machine initiates the inspiratory phase increasing pressure up from EPAP/PEEP.

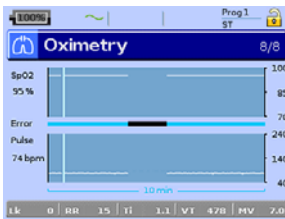

### Screen 8: Oximetry

SpO<sub>2</sub>: The oxygen saturation level.

Heart Rate: Display of heart rate measurement (Unit: BPM).

Each graph displays the last 10 minutes.

Error trace: Displays errors in measuring oximetry data.

\*\*When Auto Scaling is enabled (see "Setup menu: Options" on page 45) the Y axis scale changes automatically.

## Setup menu

The *Setup* menu allows you to view and change therapy, alarm and device settings.



### Accessing Clinical mode



#### CAUTION

- For home treatment the device must be set to Patient mode .
- Only trained and authorised personnel must make changes to clinical settings.



To activate Clinical mode , hold down  and  simultaneously for at least three seconds. You will be prompted for how long the device should stay in this mode. After the set period of inactivity or next power cycle (power on/off), the device automatically switches back to the patient mode and the device beeps.

When Clinical mode is enabled, the lock symbol in the header changes to unlocked and the device beeps.

### Setup menu: Clinical Settings

On this screen, Clinical Settings are displayed according to the set therapy mode and can be changed. Additional settings are located on the *Advanced Settings* screen.

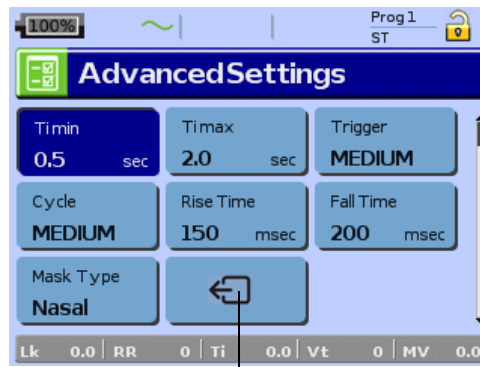
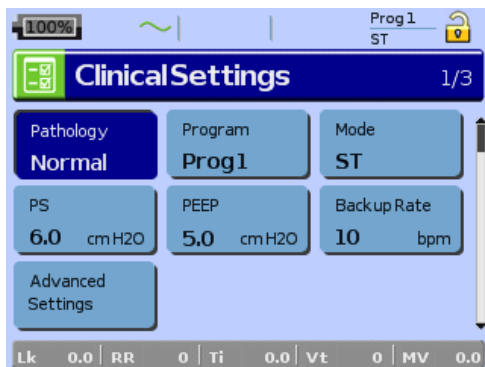

Return to Clinical Settings



## Factory default settings and parameter ranges

Parameter	Mode						Default	Description
	CPAP	S	ST (PS)	T	iVAPS	PAC		
Pathology		✓	✓	✓	✓	✓	Normal	Disease-specific preset setting values to facilitate efficient commencement of therapy (see page 10). <b>Note:</b> <i>If the default pathology settings have been changed, the button is marked with an asterisk.</i> <b>Options:</b> Obstructive, restrictive, normal, obesity hypoventilation
Program	✓	✓	✓	✓	✓	✓	Prog 1	The program setting is only available if the option Multi program in the <i>Configuration</i> menu is set to Dual. Clinical settings, alarms and circuit configurations can be stored in two different programs (see page 28). <b>Note:</b> <i>The program name can be set via ResScan.</i> <b>Options:</b> Prog 1, Prog 2
Mode	✓	✓	✓	✓	✓	✓	ST	Sets the therapy mode (see page 2). <b>Options:</b> CPAP, S, ST (PS), T, iVAPS, PAC
CPAP	✓						8.0 cm H <sub>2</sub> O	Continuous Positive Airway Pressure Sets the fixed treatment pressure (in CPAP mode). <b>Note:</b> <i>When changing from CPAP to bilevel mode, the set CPAP pressure becomes the new IPAP and EPAP pressure.</i> <b>Options:</b> 4–20 cm H <sub>2</sub> O; 0.2 cm H <sub>2</sub> O increments
IPAP		✓	✓	✓		✓	10.0 cm H <sub>2</sub> O	Inspiratory Positive Airway Pressure IPAP is the pressure which will be delivered to the patient when the device is triggered into inspiration. <b>Options:</b> 2–40 cm H <sub>2</sub> O; 0.2 cm H <sub>2</sub> O increments
EPAP or PEEP		✓	✓	✓	✓	✓	4.0 cm H <sub>2</sub> O	Expiratory Positive Airway Pressure EPAP is the pressure which will be delivered to the patient when the device is cycled into expiration (see page 61). <b>Options:</b> 2–25 cm H <sub>2</sub> O (always below or equal to IPAP); 0.2 cm H <sub>2</sub> O increments
AutoEPAP					✓		On	Sets AutoEPAP. AutoEPAP automatically adjusts EPAP within Min EPAP and Max EPAP settings. <b>Options:</b> On, Off
PS		✓	✓	✓		✓	6.0 cm H <sub>2</sub> O	Pressure support; PS = IPAP-EPAP The pressure support is the pressure increase (above EPAP/PEEP) delivered during inspiratory phase. <b>Options:</b> 0–38 cm H <sub>2</sub> O; 0.2 cm H <sub>2</sub> O increments
Ti				✓		✓	2.0 sec	Sets the inspiratory time. <b>Options:</b> 0.2–4 sec or 2/3 of one breath cycle defined by Respiratory or Backup Rate; 0.1 sec increments

Parameter	Mode						Default	Description
	CPAP	S	ST (PS)	T	iVAPS	PAC		
Backup Rate			✓			✓	10 bpm	Sets the breaths per minute (bpm). <b>Options:</b> 5–60 bpm, 1 bpm increments
Respiratory Rate				✓			10 bpm	Sets the fixed number of breaths per minute (bpm). The patient cannot spontaneously trigger the machine in this mode. <b>Options:</b> 5–60 bpm, 1 bpm increments
Target Patient Rate					✓		15 bpm	The rate input to the iVAPS algorithm. This should be set at the patient's actual respiratory rate. See "Target Patient Rate" on page 5. <b>Options:</b> 8–30 bpm, 1 bpm increments
Target Va					✓		5.2 L/min	An input to the iVAPS algorithm. See "Target alveolar ventilation" on page 5. <b>Options:</b> 1–30 L/min; 0.1 L increments
Target Va Calculator					✓		-	Tool used to set iVAPS target. See "Manually setting iVAPS" on page 53.
Height					✓		175 cm 69 in	The body height is needed for the calculation of the dead space. You can enter the arm span instead. <b>Options:</b> 110-250 cm (43 in - 98 in); 5 cm (2 in) increments
Learn Targets					✓		-	Tool used to set iVAPS targets. See "Using Learn Targets" on page 52.

## Advanced Settings - Factory default settings and parameter ranges

Parameter	Mode						Default	Description
	CPAP	S	ST (PS)	T	iVAPS	PAC		
Min PS					✓		4 cm H <sub>2</sub> O	Minimum pressure support in iVAPS mode. <b>Options:</b> 0-20 cm H <sub>2</sub> O (Min PS always below Max PS); 0.2 cm H <sub>2</sub> O increment
Max PS					✓		20 cm H <sub>2</sub> O	Maximum pressure support in iVAPS mode. <b>Options:</b> 0-30 cm H <sub>2</sub> O (8-30 cm H <sub>2</sub> O when AutoEPAP is on); 0.2 cm H <sub>2</sub> O increments
Rise Time		✓	✓	✓	✓	✓	150	Rise Time sets the time taken for the device to pressurise to IPAP (see page 10). <b>Notes:</b> <ul style="list-style-type: none"> <li>The Rise/Fall Time milliseconds scale is an approximate only.</li> <li>The actual Rise Time achieved is influenced by factors including compliance, resistance, leak, pressure differential and patient breathing patterns.</li> <li>Prolonged Rise Time inhibits pressurisation; Care should be taken to ensure Rise Time is set according to the patients inspiratory flow and work of breathing. Patients with a high work of breathing, short Ti and fast Respiratory Rate will require shorter rise times than those with lower Respiratory Rate, quiet breathing and normal Ti.</li> <li>Ti takes priority over Rise Time.</li> </ul> <b>Options:</b> min, 150–900 (limited to 2/3 of Ti Max or Ti); 50 increments
Fall Time		✓	✓	✓	✓	✓	200	Fall Time sets the time taken for the device to depressurise to EPAP/PEEP when cycling occurs (see page 10). <b>Notes:</b> <ul style="list-style-type: none"> <li>The Rise/Fall Time milliseconds scale is an approximate only.</li> <li>The actual Fall Time achieved is influenced by factors including compliance, resistance, leak, pressure differential and patient breathing patterns.</li> </ul> <b>Options:</b> min, 100–400; 100 increments
Ti Min		✓	✓		✓		0.3 sec	Sets the minimum limit on the time the device spends in IPAP (see page 9). <b>Options:</b> 0.1 sec–Ti Max; 0.1 sec increments
Ti Max		✓	✓		✓		2.0 sec	Sets the maximum limit on the time the device allows the patient to spend in inspiration (see page 9). <b>Options:</b> 0.3–4 sec or 2/3 of one breath cycle defined by Backup Rate; 0.1 sec increments

Parameter	Mode						Default	Description
	CPAP	S	ST (PS)	T	iVAPS	PAC		
Trigger	✓	✓	✓		✓	✓	Medium	Sets the sensitivity for triggering. Triggering occurs when inspiratory flow increases above a certain level and the device changes from EPAP to IPAP (see page 9). <b>Options:</b> very high, high, medium, low, very low
Cycle		✓	✓		✓		Medium	Sets the sensitivity for cycling. Cycling occurs when inspiratory flow decreases below a certain level and the device changes from IPAP to EPAP (see page 9). <b>Options:</b> very high, high, medium, low, very low
Mask Type	✓	✓	✓	✓	✓	✓	FULL FACE	Selection of the mask type. <b>Options:</b> Nasal, Ultra, Pillow, Full Face, Trach, Pediatric <b>Notes:</b> <ul style="list-style-type: none"> <li>When the Mask Type is set to <b>Trach</b> the Non-Vented Mask alarm automatically turns on and AutoEPAP has to be turned off.</li> <li>When the Mask Type is set to <b>Full Face</b> the Non-Vented Mask alarm automatically turns on.</li> </ul> For a full list of compatible masks for this device, see the Mask/Device Compatibility List on <a href="http://www.resmed.com">www.resmed.com</a> on the Products page under Service & Support. If you do not have internet access, please contact your ResMed representative.
Min EPAP					✓		4 cm H <sub>2</sub> O	Sets the Min EPAP pressure when AutoEPAP is on. <b>Options:</b> 2-25 cm H <sub>2</sub> O; 0.2 cm H <sub>2</sub> O increments
Max EPAP					✓		15 cm H <sub>2</sub> O	Sets the Max EPAP pressure when AutoEPAP is on. <b>Options:</b> 2-25 cm H <sub>2</sub> O; 0.2 cm H <sub>2</sub> O increments

## Setup menu: Alarm Settings

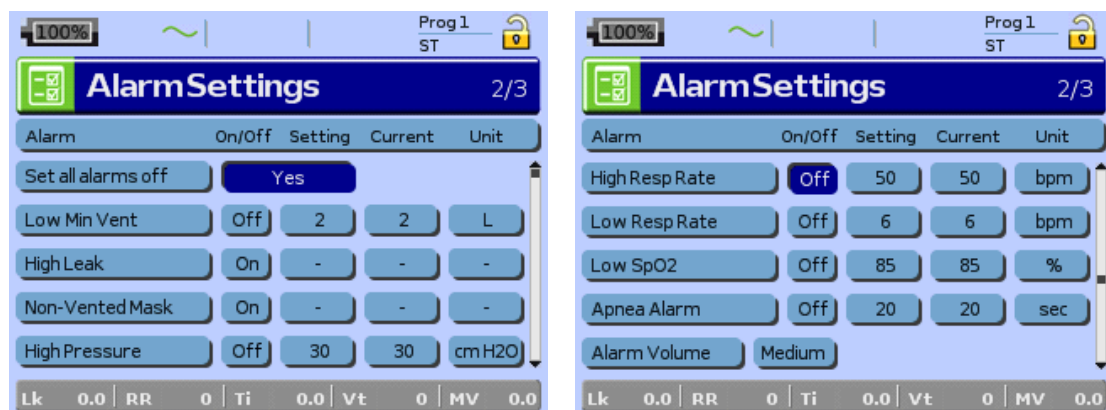

The following alarms that can be set in while in Clinical mode.

Alarm Setting	Default	Description
Set all alarms off?	Yes	Sets all user selectable alarms off. <b>Note:</b> When the mask type is set to <i>Trach the Non-Vented Mask</i> alarm will stay ON.
Low Min Vent (Low minute ventilation)	Off	Sets the minimum minute ventilation. Activates at least 30 sec after the measured level remains below the set limit. <sup>1</sup> <b>Range:</b> On, Off, 1–30 L, 0.5 L/min increments
High Leak	On	Enables/disables High Leak alarm. When enabled, leaks > 40 L/min (0.7 L/sec) for > 20 sec result in the alarm sounding and a High leak message. <sup>1</sup> <b>Options:</b> On, Off
Non-Vented Mask	On	This alarm activates within 30 sec of therapy being delivered with a non-vented interface attached or a vented mask with occluded vents. <b>Note:</b> When the mask type is set to <i>Full Face</i> or <i>Trach the Non-Vented Mask</i> alarm will be enabled automatically to ensure the circuit configuration has an intentional leak. It can then be turned off for <i>Full Face</i> . <b>Options:</b> On, Off
High Pressure	Off	Sets the high pressure limit. Activates when the pressure exceeds the set limit in two consecutive cycles or for a period of 5 sec. <b>Range:</b> On, Off; 4–45 cm H <sub>2</sub> O, 1 cm H <sub>2</sub> O increments
Low Pressure	Off	Sets the maximum drop in pressure with reference to a set IPAP or CPAP pressure during the inspiration phase. Activates when the pressure drops by more than the set level within 18 sec. <b>Notes:</b> <ul style="list-style-type: none"> <li>• This alarm is not enabled in <i>iVAPS</i> mode.</li> <li>• When <i>SmartStart/Stop</i> is enabled, <i>SmartStop</i> activates before the Low Pressure alarm.</li> </ul> <b>Range:</b> On, Off, -2 to -10 cm H <sub>2</sub> O, 1 cm H <sub>2</sub> O increments
High Respiratory Rate	Off	Sets the maximum respiratory rate. Activates when the measured respiratory rate exceeds the set level for four breath cycles. <b>Note:</b> This alarm is not enabled in <i>T</i> mode. <b>Range:</b> On, Off, 5-60 bpm, 1 bpm increments
Low Respiratory Rate	Off	Sets the minimum allowed respiratory rate. Activates when the measured respiratory rate remains below the set level for four breath cycles. <b>Note:</b> This alarm is not enabled in <i>T</i> mode. <b>Range:</b> On, Off, 5-30 bpm, 1 bpm increments
Low SpO <sub>2</sub>	Off	Sets the minimum allowed SpO <sub>2</sub> value. Activates when the measured SpO <sub>2</sub> level remains below the set level for at least 5 sec. <b>Note:</b> This alarm is only selectable when the pulse oximetry accessory is connected. <b>Range:</b> On, Off, 70-95%; 1% increments

Alarm Setting	Default	Description
High FiO <sub>2</sub>	Off	<p>Sets the maximum allowed average oxygen fraction. Activates when the measured FiO<sub>2</sub> fraction is greater than the set level for more than 15 sec.</p> <p><i>Note: This alarm is only selectable when the FiO<sub>2</sub> monitoring sensor is connected.</i></p> <p><b>Range:</b> On, Off, 30–100%, 1% increments</p>
Low FiO <sub>2</sub>	Off	<p>Sets the minimum allowed average oxygen fraction. Activates when the measured FiO<sub>2</sub> fraction is less than the set level for more than 15 sec.</p> <p><i>Note: This alarm is only enabled when the FiO<sub>2</sub> monitoring sensor is connected.</i></p> <p><b>Range:</b> On, Off, 18–80%, 1% increments</p>
Apnoea	Off	<p>Sets the maximum apnoea time. Activates when there is no inspiration (either patient or machine triggered) detected from the previous beginning of inspiration. Two consecutive inspirations (either patient or machine triggered) resets the Apnoea alarm.</p> <p><b>Range:</b> On, Off, 10–60 sec, 1 sec increments</p>
Alarm Volume	Medium	<p>Sets the alarm volume.</p> <p><b>Options:</b> Low, medium, high</p>

1 When the High Leak or Low Min Vent alarms are set to ON, SmartStop is automatically disabled.

## Testing the alarms

When the device is turned on, the Alarm LED and the Alarm mute key LED will flash, and the alarm will sound to confirm that the alarm is working. If required, you can test the alarm manually by holding down the Alarm mute button for at least three seconds when therapy is not running and no alarm is active.

### Initial setup

1. Turn off all configurable alarms.
2. Set up the device with the air tubing attached, but no patient interface (eg, mask).
3. Set Ramp Time to 0 mins.
4. Set SmartStart/Stop to Off.

### Alarm simulation

Alarm	Testing interval
High Pressure	On patient titration.
<ol style="list-style-type: none"> <li>1. On the <i>Setup, Clinical Settings</i> menu, set Mode to T and EPAP to 4 cm H<sub>2</sub>O.</li> <li>2. Set Pressure Support to 10 cm H<sub>2</sub>O.</li> <li>3. On the <i>Setup, Alarm Settings</i> menu, set All alarms off to Yes.</li> <li>4. Now set the High Pressure Alarm Setting to 7 cm H<sub>2</sub>O, and change the alarm to be On.</li> <li>5. Block the air tubing.</li> <li>6. Start ventilation.</li> </ol>	

Alarm	Testing interval
<b>Low Pressure</b> <ol style="list-style-type: none"> <li>1. Set the Low Pressure Alarm to -2 cm H<sub>2</sub>O.</li> <li>2. Set IPAP and EPAP to 25 cm H<sub>2</sub>O.</li> <li>3. Start ventilation.</li> <li>4. Partially block the open end of the tube with your hand. The alarm activates within 15 seconds. If the Blocked Tube or Circuit Disconnected Alarm activates repeat the test.</li> <li>5. Stop therapy.</li> </ol>	On patient titration.
<b>Low Min Vent (Low minute ventilation)</b> <ol style="list-style-type: none"> <li>1. Set the Low Min Vent Alarm to 30 L/min.</li> <li>2. Start ventilation.</li> <li>3. Partially block the open end of the tube with your hand so that the measured MV in the therapy status bar displays lower value than 30 L/min. The alarm activates within 30 seconds. If the Blocked Tube or Circuit Disconnected Alarm activates repeat the test.</li> <li>4. Stop therapy.</li> </ol>	On patient titration.
<b>High Respiratory Rate</b> <ol style="list-style-type: none"> <li>1. On the <i>Setup, Clinical Settings</i> menu, set Mode to ST and Backup Rate to 30 bpm.</li> <li>2. On the <i>Setup, Alarm Settings</i> menu, set All alarms off to Yes.</li> <li>3. Now set High Resp Rate Alarm Setting to 10 bpm, and change the alarm to be On.</li> <li>4. Block the air tubing.</li> <li>5. Start ventilation.</li> </ol>	Each new patient.
<b>Low Respiratory Rate</b> <ol style="list-style-type: none"> <li>1. On the <i>Setup, Clinical Settings</i> menu, set Mode to ST and Backup Rate to 10 bpm.</li> <li>2. On the <i>Setup, Alarm Settings</i> menu, set All alarms off to Yes.</li> <li>3. Now set Low Resp Rate Alarm Setting to 30 bpm, and change the alarm to be On.</li> <li>4. Block the air tubing.</li> <li>5. Start ventilation.</li> </ol>	Each new patient.
<b>Low FiO<sub>2</sub></b> <ol style="list-style-type: none"> <li>1. Connect FiO<sub>2</sub> cell.</li> <li>2. Calibrate the FiO<sub>2</sub> cell.</li> <li>3. On the <i>Setup, Clinical Settings</i> menu, set Mode to T.</li> <li>4. Set Respiratory Rate to 10 bpm.</li> <li>5. On the <i>Setup, Alarm Settings</i> menu, set All alarms off to Yes.</li> <li>6. Now set Low FiO<sub>2</sub> Alarm Setting to 80%, and change the alarm to be On.</li> <li>7. Start ventilation.</li> </ol>	Always when oxygen is used and the FiO <sub>2</sub> cell has been recalibrated.
<b>High FiO<sub>2</sub></b> <ol style="list-style-type: none"> <li>1. Connect the FiO<sub>2</sub> cell.</li> <li>2. Calibrate the FiO<sub>2</sub> cell.</li> <li>3. Set the High FiO<sub>2</sub> Alarm setting to 30%.</li> <li>4. Start ventilation.</li> <li>5. Start O<sub>2</sub> supply to provide higher FiO<sub>2</sub> level than alarm threshold. The alarm activates within 15 seconds.</li> </ol>	Always when oxygen is used and the FiO <sub>2</sub> cell has been recalibrated.

Alarm	Testing interval
<p><b>High Leak</b></p> <p>This test must be carried out using the patient's actual circuit and interface (including catheter mount and cannula if in use). If oxygen is in use, include the oxygen flow entrained to the oxygen inlet at the rear of the device.</p> <ol style="list-style-type: none"> <li>1. On the <i>Setup, Clinical Settings</i> menu, set Mode to T and Respiratory Rate to 30 bpm.</li> <li>2. Set the High Leak Alarm to ON.</li> <li>3. Start therapy.</li> <li>4. Partially block the air tubing. The alarm is triggered when leak exceeds 40 L/min (0.67 L/sec) for at least 20 sec. If too much leak occurs, the Circuit Disconnected alarm may be activated.</li> </ol>	<p>On each new patient.</p>
<p><b>Circuit Disconnected</b></p> <ol style="list-style-type: none"> <li>1. Set up the device with the patient circuit configuration.</li> <li>2. Start therapy.</li> <li>3. Disconnect the tube from the mask or the ResMed leak valve and check the alarm activation. The alarm activates when leak exceeds 105 L/min (1.75 L/sec) for at least 15 seconds.</li> <li>4. Reconnect the air tubing and stop therapy.</li> <li>5. Repeat steps 2, 3 and 4, disconnecting the circuit at different connection points (eg, at the device air outlet).</li> </ol> <p>If the Circuit Disconnected alarm does not activate as expected, it is due to the circuit resistance. Consider using the High Leak, Low Minute Ventilation, Low Pressure, Low Respiratory Rate, Apnoea or Low SpO<sub>2</sub> alarms.</p>	<p>Whenever a change is made to the patient circuit configuration and/or device settings.</p>
<p><b>Non-Vented Mask</b></p> <ol style="list-style-type: none"> <li>1. With the device set up to deliver therapy using the patient's mask and circuit, start therapy.</li> <li>2. Block the mask's vent holes. The alarm should sound within 30 sec.</li> </ol>	<p>When considered necessary by the clinician.</p>
<p><b>Blocked Tube</b></p> <ol style="list-style-type: none"> <li>1. Start therapy.</li> <li>2. Block the air tubing with your hand. The alarm is triggered when tubing is blocked for at least 15 sec.</li> </ol>	<p>If required for the patient.</p>
<p><b>FiO<sub>2</sub> sensor disconnected</b></p> <ol style="list-style-type: none"> <li>1. With the device set up to deliver therapy, and the FiO<sub>2</sub> cell and circuit connected, start therapy.</li> <li>2. Disconnect the FiO<sub>2</sub> cell. The alarm should sound within 5 sec.</li> </ol>	<p>If required for the patient.</p>
<p><b>SpO<sub>2</sub> Finger Sensor Failure</b></p> <ol style="list-style-type: none"> <li>1. Connect the finger sensor.</li> <li>2. Start therapy.</li> <li>3. Disconnect the sensor or remove it from the patient's finger. The alarm should sound within 30 sec.</li> </ol>	<p>If measurement problems are expected with the finger sensor.</p>

### Completing alarm testing





Return all settings to their original settings appropriate to the patient ahead of delivering therapy.



## Setup menu: Options

The optional device settings are available from the *Options* menu and its *Configuration* submenu.



Parameter	Default	Description
Learn Circuit <sup>1</sup>	-	<ol style="list-style-type: none"> <li>Ensure that the therapy is turned off before performing a Learn Circuit.</li> <li>If in use, turn off the oxygen flow.</li> <li>Select the mask type.</li> <li>Set up the air circuit including accessories and patient interface. <b>Note:</b> When performing a Learn Circuit for invasive use, do not connect a catheter mount, tracheostomy tube or HMEF (see "Setting up for invasive use" on page 16).</li> <li>Leave the air circuit unobstructed and open to the air.</li> <li>Press  to start the Learn Circuit.</li> <li>Wait for the device to complete its automated tests (&lt;30 sec). The results are displayed when complete. If the circuit configuration has been successfully learnt,  displays. If unsuccessful,  displays (see "Troubleshooting" on page 63).</li> </ol> <p>If the Learn Circuit fails, the last Learn Circuit characteristics apply.</p>
FiO <sub>2</sub> Sensor Calibration <sup>1</sup>	-	<p>The device starts the calibration of the FiO<sub>2</sub> monitoring sensor to measure the oxygen concentration of the breathable air.</p> <ol style="list-style-type: none"> <li>Press  to start the FiO<sub>2</sub> sensor calibration.</li> <li>Wait for the device to complete its calibration. The results are displayed when complete.</li> </ol> <p><b>Note:</b> Turn off the oxygen flow.</p>
SmartStart/ Stop	Off	<p>If enabled, the device will start automatically when the patient breathes into the patient interface and will stop automatically (SmartStop) when the mask is taken off. This means the Start/Stop key does not have to be pressed to begin/end treatment.</p> <p><b>Note:</b> The SmartStop feature is disabled if:</p> <ul style="list-style-type: none"> <li>Full face or Trach is selected as mask option</li> <li>High leak or Low minute ventilation alarms are set to ON</li> <li>Mask fit operation is proceeding</li> <li>Confirm therapy stop option is enabled.</li> </ul> <p><b>Options:</b> On, Off</p>
Ramp Time <sup>1</sup>	Off	<p>If Max Ramp Time has been set, the patient may select any value up to this time.</p> <p><b>Options:</b> 0 min-Max Ramp Time (max 45 minutes, 5 minutes increments)</p>

Parameter	Default	Description
Start CPAP	4.0 cm H <sub>2</sub> O	Sets the pressure at the beginning of the Ramp Time in CPAP mode. When Ramp Down is on, the treatment pressure reduces to this pressure setting. <b>Options:</b> 4 cm H <sub>2</sub> O–CPAP, 0.2 cm H <sub>2</sub> O increments
Start EPAP or Start PEEP	4.0 cm H <sub>2</sub> O	Sets the pressure at the beginning of the ramp time in bilevel modes (S, ST/PS, T, iVAPS, PAC). When Ramp Down is on, the treatment pressure reduces to this pressure setting. <b>Options:</b> 2 cm H <sub>2</sub> O–EPAP, 0.2 cm H <sub>2</sub> O increments
Max Ramp Time	Off	Maximum setting for Ramp Time. <b>Options:</b> 0–45 min; 5 minute increments <b>Notes:</b> <ul style="list-style-type: none"> <li>If the Max Ramp Time is set to 0 min the Ramp Time setting does not appear in Patient mode.</li> <li>Limit the Max Ramp Time to avoid hypoventilation. Some patients require full support from the beginning of therapy.</li> </ul>
Ramp down	Off	If enabled, the patient may select Ramp down. The treatment pressure reduces to Start EPAP/PEEP over five minutes. <b>Options:</b> On, Off
Factory Defaults	-	Resets machine default settings. You will be asked to confirm your selection. <b>Note:</b> Restoring factory defaults will not affect the Motor run hours, logged data (eg, patient therapy data), the clock, the reminder settings, LED brightness and backlight.

1 Parameter can be set by the patient.

## Setup menu: Configuration Menu

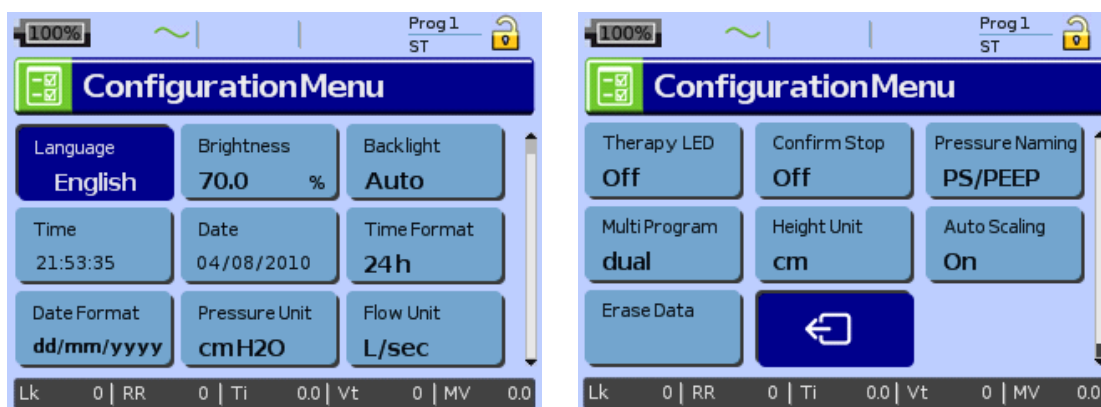

Parameter	Default	Description
Language <sup>1</sup>	English	Sets the display language. <b>Options:</b> Depending on regional configuration
Brightness <sup>1</sup>	70%	Sets the LCD backlight brightness. <b>Options:</b> 20-100%, 10% increments
Backlight <sup>1</sup>	Auto	Enables the LCD and keypad backlight. If the AUTO setting is selected the backlight turns dark after five minutes without any actions and turns on again if any button is pressed again or an alarm occurs. <b>Options:</b> On, Auto

Parameter	Default	Description
Time <sup>1</sup>	-	Sets the current time. <b>Note:</b> Changing the time setting backwards will erase all logged data. <b>Options:</b> hours, minutes, seconds
Date <sup>1</sup>	-	Sets the current date. <b>Note:</b> Changing the date setting backwards will erase all logged data. <b>Options:</b> day, month, year
Time Format <sup>1</sup>	24 hrs	Sets the time format. <b>Options:</b> 24 hrs, 12 hrs
Date Format <sup>1</sup>	dd/mm/ YYYY	Sets the date format. <b>Options:</b> dd/mm/yyyy, mm/dd/yyyy
Pressure Unit	cm H <sub>2</sub> O	Selection of the display units for pressure. <b>Options:</b> cm H <sub>2</sub> O, hPa
Flow Unit	L/min	Selection of the display units for flow. <b>Options:</b> L/min, L/sec
Therapy LED	Off	Enables or disables the therapy LED. If enabled, the blue therapy LED in the Start/Stop button is lit while the device is delivering therapy. <b>Options:</b> On, Off
Confirm Stop	On	This feature helps to avoid anyone inadvertently stopping therapy. When enabled (On), if you press  during therapy, the <i>Confirm Stop</i> screen will appear. If YES is selected, therapy stops. If NO is selected or any other key is pressed, therapy continues. <b>Options:</b> On, Off
Pressure Naming	IPAP/ EPAP	Choose the terminology type used through the screens displays. <b>Options:</b> PS/PEEP, IPAP/EPAP
Multi Program	single	You have the option to define two different programs for therapy and alarm settings. Each therapy program saves the results of the Learn Circuit (circuit impedance). The program selection can be made in the <i>Clinical Settings</i> menu if this option is set to dual. If dual is selected, the patient can select between the two programs in the <i>Treatment</i> screen.  When configuring a new program, connect the appropriate circuit and perform a Learn Circuit. <b>Note:</b> Ensure the correct circuit is used as learned for the selected program. <b>Options:</b> single, dual
Height Unit	cm	Selection of the unit of measure for patient height for iVAPS setup. <b>Options:</b> cm/inches
Erase Data	-	You can erase the following data that is logged during therapy. <ul style="list-style-type: none"> <li>• Used hours (therapy run hours)</li> <li>• High resolution data (patient flow, therapy pressure, oximetry data)</li> <li>• Breath-by-breath data (eg, pressure and flow related data)</li> <li>• Summary data (statistics in the Summary menu)</li> <li>• Alarm events</li> <li>• Settings changes</li> <li>• System events (eg, Learn Circuit passed/cancelled).</li> </ul> When erasing the data you will be prompted to confirm the action before the data is erased. <b>Note:</b> Motor run hours, Power on hours and all settings cannot be reset with this option.

Parameter	Default	Description
Auto scaling	On	In the Monitoring menu, the Y axis scale changes automatically when this function is enabled (flow trace in Pressure/Flow page, Va and RR traces in Minute Ventilation/Respiratory/Alveolar Ventilation page, leak and flow traces in Leak page, tidal volume in Tidal Volume page). <b>Options:</b> On, Off

---

To return to the *Options* screen press the Return button 

---

1 Parameter appears in both the patient and clinical mode.

## Info menu

The *Info* menu provides event summary, therapy results, device information and reminders. Stellar stores usage and summary data up to 365 treatment sessions. The stored data can be accessed in the *Info* menu or using ResScan.

### Event Summary

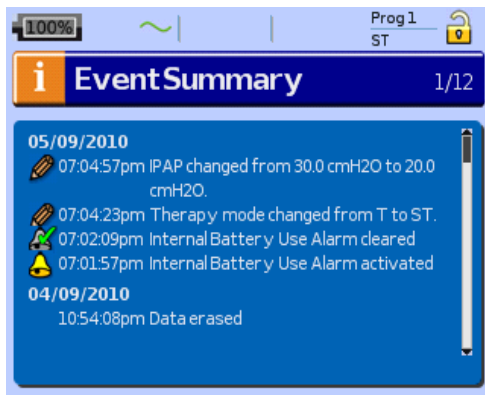

Event summary displays the summary of three types of events: changes in settings, alarms and system events (eg, data erased, connection of ResMed USB stick). There are up to 200 events of each type, displayed in chronological order, with the most recent event displayed at the top by default.

**Note:** When the capacity of 200 logged events is reached, the oldest log record is overwritten.

### General therapy information

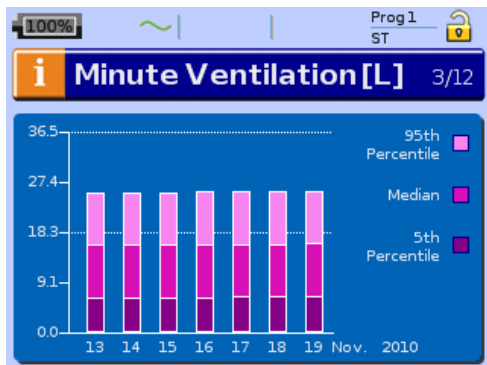

Information on the following categories is displayed for a period of seven days, where each day is defined as from midday to midday:

- Leak
- Minute Ventilation
- Tidal Volume
- Respiratory Rate
- I:E ratio
- Pressure Support
- AHI
- SpO<sub>2</sub>.

Press and turn the Push Dial  to view data for data up to 365 days in the past. The statistical data is displayed in a bar graph in 5<sup>th</sup> and 95<sup>th</sup> percentile and median values. These values are averaged across total therapy duration per day.

**Note:** If therapy is not running for at least 10 minutes, data will not be captured.

## Apnoea/Apnoea Hypopnoea Index

This screen displays the apnoeas and hypopnoeas measured per hour for one day. The daily index values will be displayed for a period of seven days and can be compared to data from the last 365 days.

An **apnoea** is scored when flow decreased by more than 75% of baseline (ie, to 25% or below from the baseline) for more than 10 seconds. An **hypopnoea** is scored when flow decreases to 50% but greater than 25% of baseline for more than 10 seconds. The **Apnoea Index (AI)** and **Apnoea Hypopnoea Index (AHI)** are calculated by dividing the total number of events that occurred by the total mask-on therapy period in hours.

*Note: The accuracy of apnoea and hypopnoea logging are degraded by high mask leak.*

## Used Hours

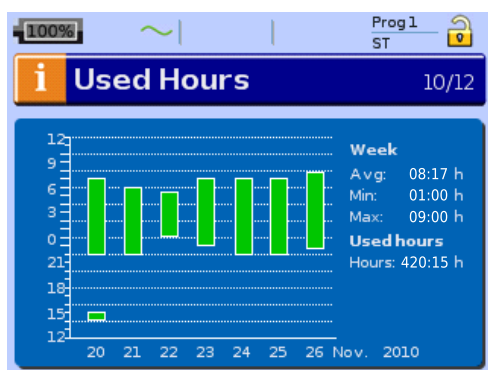

Used Hours during the last seven days of treatment are displayed in a bar graph and can be compared to the data of the last 365 days. The daily recordings start at 12:00 o'clock and finish at 12:00 o'clock on the following day (eg, on November 20th the patient took a nap from 14:00 o'clock to 15:00 o'clock, the second therapy session on that day started at 22:00 o'clock and stopped at 7:00 o'clock on November 21st. The time is displayed on the vertical axis. The horizontal axis displays the date of the recording. The related average, minimum and maximum values are displayed as numeric values per week.

Used Hours (within the graph legend) displays how long the device has been used for treatment since the first treatment session or data was last erased.

## Device information

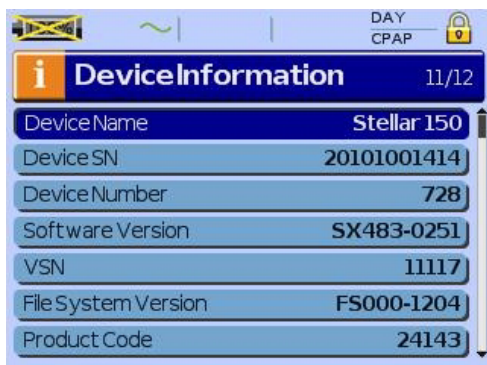

This screen shows the serial number (displayed as Device SN), device number, software version and other component versions. Data on this screen may be requested for servicing or as part of problem-solving by a technician.

## Reminders



You can use the Reminders menu to alert the patient to specific events; for example, when to replace their mask, when to replace the filter and so on. Using ResScan, you can select which Reminder message to show when and its recurrence frequency (Off, 1–24 months). The reminder appears in yellow as the date approaches (within 10% of the reminder period). The reminder also displays when the device is powered on. Patients can clear a reminder message by selecting 'Reset', which clears the current reminder date to OFF, or displays the next pre-set Reminder date.

**Note:** When the motor run hour is below two hours, Reminders can be set, but will not display. After two hours of the motor running, the correct date displays.

## Configuring iVAPS

There are two ways in which you can configure iVAPS mode:

- using Learn Targets—which learns the patient's breathing pattern and calculates the targets automatically; or
- directly entering the targets.

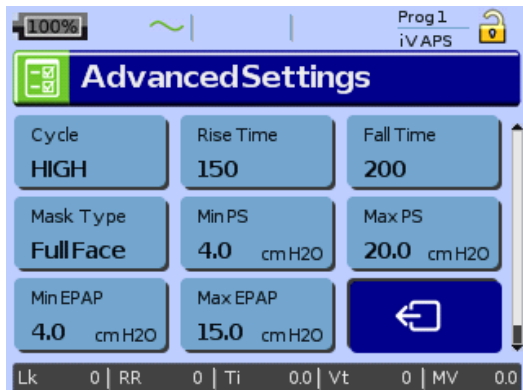
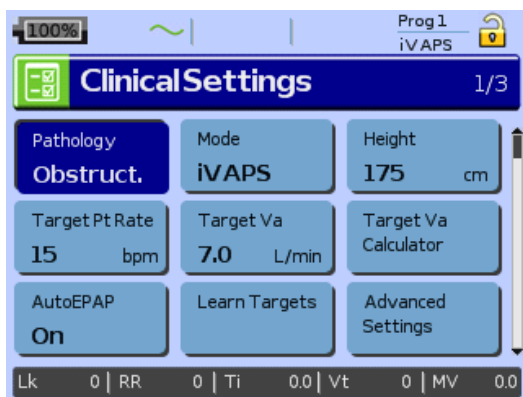

## Using Learn Targets

Learn Targets monitors the patient's resting ventilation, with the goal of learning the patient's Target Alveolar Ventilation and Target Patient Rate in preparation for iVAPS mode. It is recommended that the patient be set up in a quiet place, preferably with a distraction to ensure they don't fall asleep. During Learn Targets, the device delivers two pressures; EPAP/PEEP and Pressure Support without backup breath (like S mode). These parameters are available on the *Learn Targets* screen.

- 1 Perform a Learn Circuit on the current circuit configuration, ensuring you select the appropriate mask setting (see "Setup menu: Options" on page 45).
- 2 Set Pathology Defaults (see "Pathology Defaults" on page 10).
- 3 Select iVAPS mode.
- 4 Enter the patient Height (approximate or arm span).
- 5 Connect the patient.
- 6 Select Learn Targets.  
The device has to be in Standby to commence the Learn Targets procedure.

I Turn on oxygen if in use.

II Configure primary therapy controls.

Enter the preliminary EPAP or PEEP (see page 61).

It is recommended that you start at 4–6 cm H<sub>2</sub>O which most patients can tolerate.

III Adjust Pressure Support.

The level of Pressure Support during the Learn Targets procedure should be individually assessed. Excessive Pressure Support during the learn session can result in an alveolar ventilation target that is in excess of the patient's metabolic need. For patients who enjoy adequate daytime ventilation but who have significant problems during sleep (ie, OHS), the goal is to capture the resting daytime ventilation with minimal Pressure Support such that the patient is breathing comfortably but not excessively ventilated. For patients with significant daytime hypercapnia, an increased pressure support (ie, 6-10 cm H<sub>2</sub>O) may be appropriate, ie, such that an assisted daytime ventilation is measured.

IV View data.

The *Learn Targets* screen displays a blank graph on which up to 15 min of live data (monitored Alveolar Ventilation (Va) and Respiratory Rate (RR)) will be plotted as time passes. The values are calculated from the median within a 5 min range.

You can select the 5 min portion that best represents stable Va and RR, by using the dial to highlight the 5 min of interest. It is recommended to choose where the lines of Va and RR look stable, usually 10–15 minutes after starting this process.

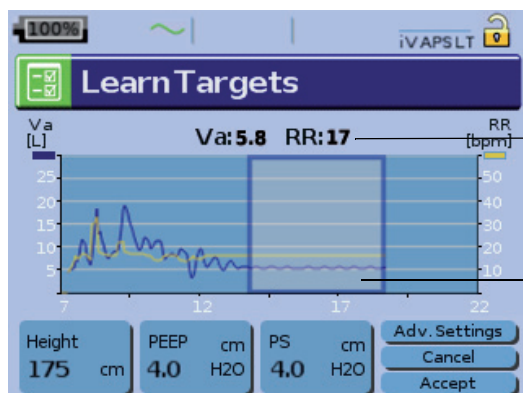

Va and RR are calculated from the median within a 5 min range

Adjustable 5 min window to be used for calculation of median target values



- V If the target values are viewed as:
  - acceptable, select **Accept**, and therapy will commence in iVAPS mode. Typically,  $V_a$  should be below 7 L/min for non-COPD patients and below 11 L/min for COPD patients.
  - not acceptable, or to exit Learn Targets without altering settings, select **Cancel**. This stops the Learn Targets process, the menu returns to *Clinical Settings*, and therapy terminates.
  - iVAPS and AutoEPAP will only be initiated once Learn Target values are accepted.

7 Press *Monitoring* or *Info* key to scroll through the related pages (eg, Breath Rate, MV, Vt) if necessary. When press *Setup* menu key you come back to Learn Targets.



### CAUTION

Because **Cancel** will terminate therapy, the patient should be disconnected from the ventilator unless ventilation is to be resumed immediately.

- 8 Review the secondary therapy settings in *Advanced Settings* (eg, Min PS, Max PS, Min EPAP, Max EPAP) and AutoEPAP, see “Setup menu: Clinical Settings” on page 36.
- 9 Start therapy.
- 10 Refine EPAP/PEEP to suit the type of therapy required. For more information, see “Assessing the clinical outcome” on page 54.

## Manually setting iVAPS

While the Learn Targets procedure offers the best means of obtaining an initial ventilation estimate, iVAPS also allows manual entry of its target, using an entered minute ventilation, spontaneous rate, and patient height. From these iVAPS can calculate the target alveolar ventilation and adopt its Target Patient Rate.

- 1 Perform a Learn Circuit on the current circuit configuration, ensuring you select the appropriate mask setting (see “Setup menu: Options” on page 45).
- 2 Set Pathology Defaults (see “Pathology Defaults” on page 10).
- 3 Select iVAPS mode.
- 4 Configure primary therapy controls.  
Enter the preliminary EPAP or PEEP (see page 61). It is recommended that you start at 4–6 cm H<sub>2</sub>O which most patients can tolerate.  
When AutoEPAP is on enter Min EPAP/Max EPAP.
- 5 Select Target  $V_a$  calculator.

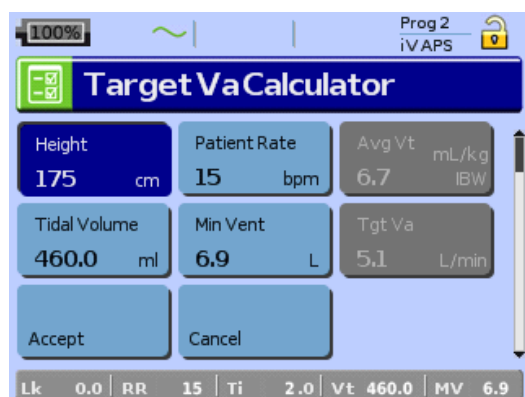

- I Enter the patient’s Height.
- II Enter the patient’s spontaneous breath rate.
- III Enter a previously measured Minute Ventilation (MV) or Tidal Volume (Vt).  
**Note:** Press *Monitoring* or *Info* key to scroll through the related pages (eg, Breath Rate, MV, Vt) if necessary.

#### IV Check the Target Va.

The calculator returns a Target Alveolar Ventilation (Tgt Va) using this information to estimate anatomical deadspace.

$$\begin{aligned}\text{Target Va} &= [\text{Tidal Volume} - \text{Deadspace (Height)}] \times \text{Patient Rate} \\ &= \text{Minute Ventilation} - [\text{Deadspace (Height)} \times \text{Patient Rate}]\end{aligned}$$

The Target Va Calculator displays an estimate of the Average Tidal Volume (Avg Vt) as a function of ideal body weight (IBW).

$$\text{Average Vt (mL/kg)} = \text{Tidal Volume} / [48 + 0.91 \times (\text{Height} - 152.4)]^1$$

**Note:** Typically, Va should be below 7 L/min for non-COPD patients and below 11 L/min for COPD patients.

#### V Accept to apply this Target Va to iVAPS therapy settings.

- 6** Review the secondary therapy settings in *Advanced Settings* (eg, Min PS, Max PS, Min EPAP, Max EPAP), and AutoEPAP, see “Setup menu: Clinical Settings” on page 36.
- 7** Connect the patient.
- 8** Start therapy.
- 9** Refine EPAP/PEEP to suit the type of therapy required. For more information, see “Assessing the clinical outcome” on page 54.

## Assessing the clinical outcome

If the patient sleeps well on the Stellar and SpO<sub>2</sub>, if available, shows adequate oxygen saturation throughout the night, this can be a good indication of successful therapy.

ResScan may assist you assessing the therapy outcome. A close look at the Detail graph in statistics is useful to evaluate the quality of treatment. Splitting the screen allows you to view the:

- overview of navigation window (8 hrs) with SpO<sub>2</sub>, pressure, leak, minute ventilation
- detail window (5 min), showing leak, flow, pressure may present a suggestion to readjust the settings or mask.

For more information, see “Data management” on page 56.

---

1 Adapted from DA Dongelmans et al. Determinants of Tidal Volumes with Adaptive Support Ventilation: A Multicenter Observational Study. *Critical Care and Trauma*, 2007. 107 (3). P932 -937

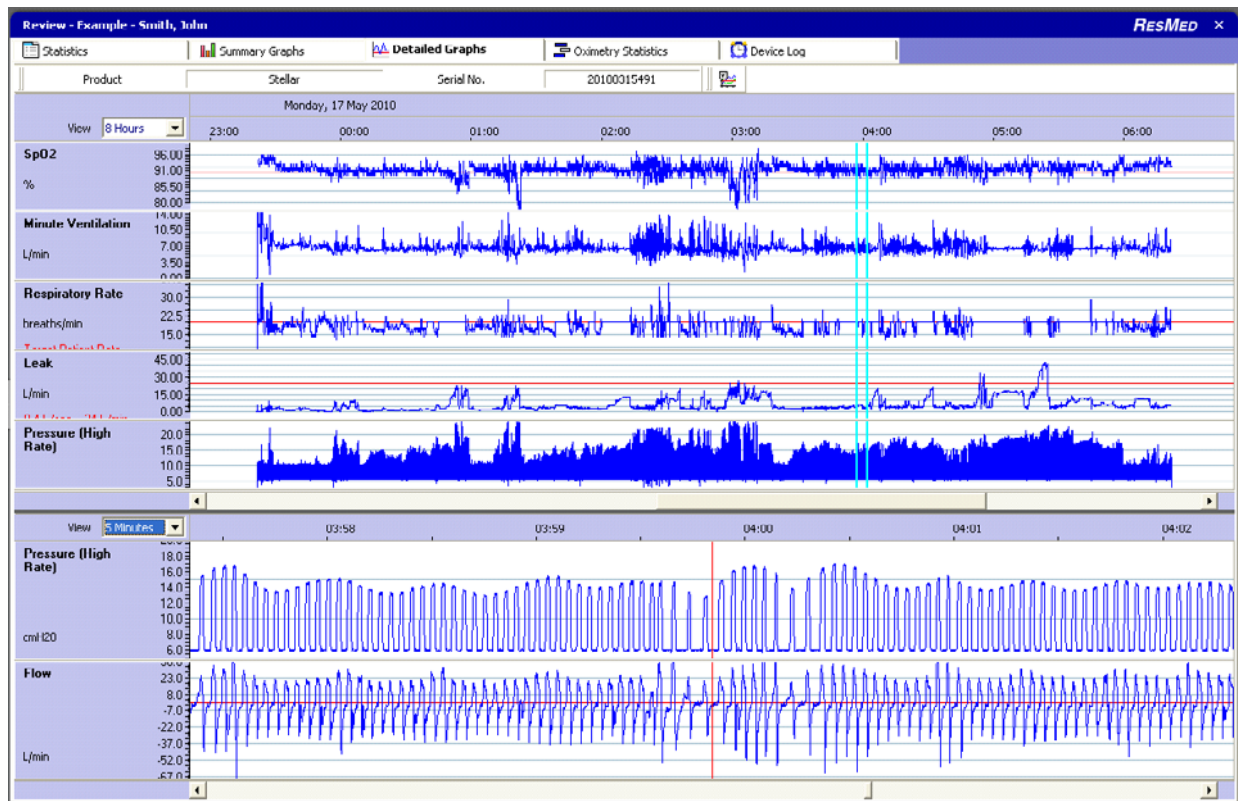

It is ideal to observe changes of pressure support level (or IPAP) throughout the session or night. If the pressure support remains at the same level for a long period of time (often towards at maximum pressure support level), it may indicate:

- the Target  $V_a$  is too high
- Max PS is set too low to adequately maintain the ventilation
- EPAP is too low to treat upper airway obstruction.

Hints to identify upper-airway obstruction include:

- episodes of desaturation
- small flattened breaths on the flow trace
- large levels of pressure support without associated respiratory flow.

## Data management

Apart from the data available to view directly on the device, you can view and update data via ResMed's applications that assist with compliance management. These are **ResScan** and **EasyCare Tx**.

When using ResScan, you can view therapy data as well as change settings on the device. To transfer data between the device and a PC, you can use the ResMed USB Stick.

Use EasyCare Tx for the remote display of real-time (live) data and adjustment of settings.

For more information, see the PC application's manual.

There are two data ports at the rear of the device for connecting a USB stick (see "Stellar at a glance" on page 11). Therapy and device data can be stored on it or read from it.



### **WARNING**

Do not connect any device to the data ports other than specially designed devices recommended by ResMed. Connection of other devices could result in injury, or damage to the Stellar (see "General warnings and cautions" on page 75).



### **CAUTION**

Do not disconnect the ResMed USB stick while data transfer is in progress. Otherwise loss of data or incorrect data may result. The download time depends on the data volume.

#### *Notes:*

- *You cannot connect two ResMed USB sticks simultaneously for data communication.*
- *If data transfer is not possible or failed please read the troubleshooting section.*
- *Do not store files on the USB stick other than those created by the device or application. Unknown files may be lost during data transfer.*

- 1** Plug the ResMed USB stick to one of the two USB connections on the rear side of the device. The first dialogue for the USB data transfer is displayed automatically on the LCD. The device checks if there is enough memory capacity on the USB stick and if readable data is available.
- 2** Select one of the available options
  - **Read settings**

You will be prompted to decide if the device should read the ResScan configuration or the device configuration. The ResScan configuration contains settings changes. The device configuration contains settings of another device. To read the device configuration the device has to be in clinical mode. The device configuration must contain a different serial number.
  - **Write settings**

Settings of the device will be stored on the ResMed USB stick.
  - **Write settings and loggings**

Settings and loggings (eg, breath-by-breath data) of the device will be stored on the ResMed USB stick.
  - **Cancel**
- 3** Confirm the data transfer.

## Cleaning and maintenance

The cleaning and maintenance described in this section should be carried out regularly. This also helps to prevent the risk of cross contamination. Refer to the mask, humidifier and other accessories user guide for detailed instructions for care and maintenance.



### WARNING

- Beware of electric shock. Do not immerse the device, pulse oximeter or power cord in water. Turn off the device, unplug the power cord from the power socket and the device before cleaning and be sure that it is dry before reconnecting.
- The mask system and air tubing are subject to normal wear and tear. Inspect them regularly for damage.



### CAUTION

The Stellar cannot be sterilised.

### Daily

Disconnect the air tubing from the device (and humidifier, if used) and hang it in a clean, dry place until next use. If the device is visibly soiled, wipe the exterior surfaces of the device and the pulse oximeter (if used) with a damp cloth and mild detergent.



### CAUTION

- Do not hang the air tubing in direct sunlight as the tubing may harden over time and eventually crack.
- Do not use bleach, chlorine, alcohol or aromatic-based solutions (including all scented oils), moisturising or antibacterial soaps to clean the air tubing or the device on a daily basis (other than the approved cleaning agents Mikrozyd<sup>®</sup> AF or CaviCide<sup>®</sup>). These solutions may cause hardening and reduce the life of the product.  
The use of cleaners and disinfecting solutions containing alcohol (other than the approved cleaning agents) is acceptable for periodic cleaning of the device, such as for cleaning between patients or especially for service periods, but not recommended for daily use.

### Weekly

- 1 Remove the air tubing from the device *and* the patient interface.
- 2 Wash the air tubing in warm water using mild detergent.
- 3 Rinse thoroughly, hang and allow to dry.
- 4 Reconnect the air tubing to the air outlet and patient interface.
- 5 If the device is visibly soiled, wipe the exterior surfaces of the device and the pulse oximeter (if used) with a damp cloth and mild detergent.

### Monthly

- 1 Wipe the exterior of the device and the pulse oximeter (if used) with a damp cloth and mild detergent.
- 2 Visually inspect the air filter to check if it is blocked by dirt or contains holes.

## Replacing the air filter

Replace the air filter every six months (or more often if necessary).



### **WARNING**

Do not wash the air filter. The air filter is not washable or reusable.

- 1** Remove the air filter cover at the back of the device.
- 2** Remove and discard the old air filter.
- 3** Insert a new filter.
- 4** Refit the air filter cover.

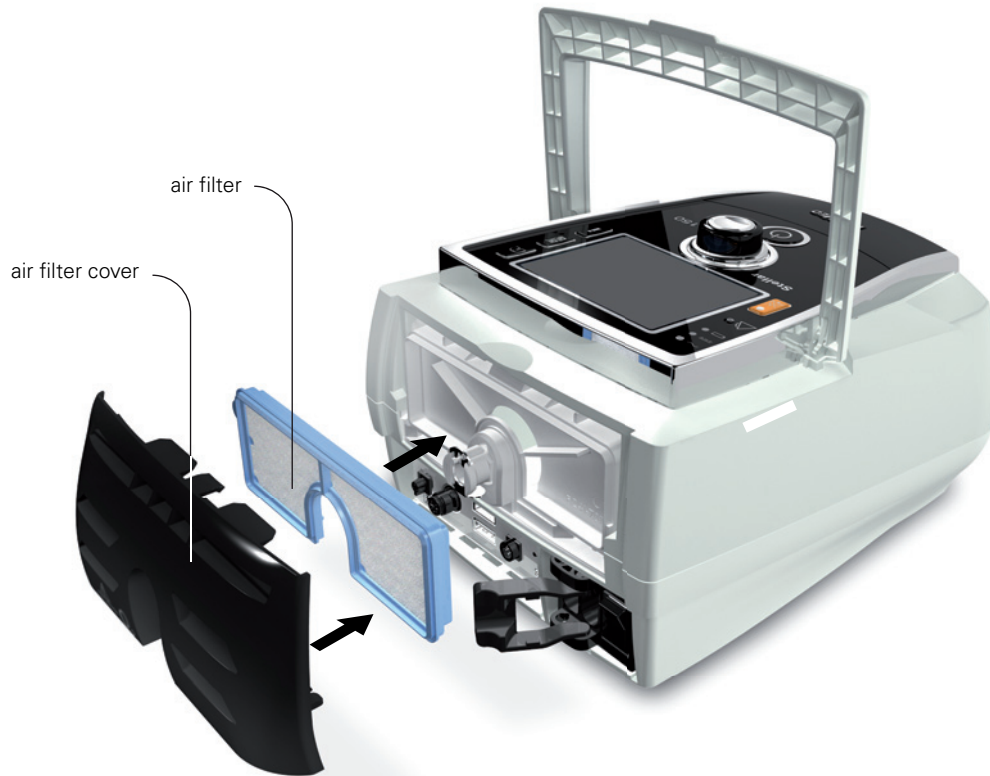

## Multipatient use



### WARNING

- An antibacterial filter is mandatory if the device is used on multiple patients.
- In a multipatient use environment, you must perform the following before the device is provided to a new patient:

Mask	Reprocess; Cleaning, disinfection and sterilisation instructions are available from the ResMed website, <a href="http://www.resmed.com/masks/sterilization">www.resmed.com/masks/sterilization</a> . If you do not have Internet access, please contact your ResMed representative.
Air tubing	Replace the air tubing. Alternatively, consult the air tubing instructions for cleaning and disinfection information.
Device	Disinfect the Stellar as follows: Use an anti-bacterial cleaning/disinfectant solution such as MikroZid® AF or CaviCide® with a clean non-dyed disposable cloth to clean and disinfect the exterior surfaces of the device. Wipe all accessible surfaces of the device, including the air outlet (avoid liquid entering any openings in the device). Follow the manufacturer's recommended cleaning instructions.
Humidifier	As instructions for humidifiers vary, see the user guide for the humidifier in use. For multipatient use environment, use the H4i water chamber (disposable) in place of the H4i reusable water chamber.

## Servicing



### CAUTION

Inspection and repair should only be performed by an authorised agent. Under no circumstances should you attempt to open, service or repair the device yourself.

This product should be inspected by an authorised ResMed service centre five years from the date of manufacture, except for the internal battery which ResMed recommends be tested after two years to assess the remaining battery life. Prior to this, the device is intended to provide safe and reliable operation provided that it is operated and maintained in accordance with the instructions provided by ResMed. Applicable ResMed warranty details are provided with the device at the time of original supply. Of course, as with all electrical devices, if any irregularity becomes apparent, you should exercise caution and have the device inspected by an authorised ResMed service centre.

# Clinical titration guide

## Mouth leaks

If mouth leaks are a persistent problem, the patient may benefit from humidification, a chin strap or a full face mask. The chin strap fits over the patient's head and helps to hold their mouth closed during the night. Full face masks cover both the nose and mouth, preventing mouth leaks, and are available from ResMed. Contact your supplier for more details or see [www.resmed.com](http://www.resmed.com). ResScan detailed data also provides a visual representation of leak.

## Setting TiControl

The Ti Max and Ti Min settings (S, ST and iVAPS mode) allow you to vary the minimum and maximum amount of inspiratory time (see "Ensuring successful ventilation with Stellar" on page 7).

## Setting Ti Max

Under conditions of high or variable leaks (eg, mouth leak), or where respiratory flow is restricted (eg, COPD), Ti Max provides an inspiratory time limit which prevents late cycling and can provide a better match to the patient's ideal inspiratory time.

Ti Max can be set between 0.3–4 sec or 2/3 of one breath cycle defined by Backup Rate. So for a patient with a Backup Rate of 15 bpm (ie, one breath cycle of 4 sec), the maximum value that can be set for Ti Max would be 2.6 sec.

**Note:** Care should be taken not to set Ti Max shorter than the patient's actual inspiratory time, as this may lead to a decrease in the effectiveness of pressure support and result in discomfort for the patient. If the patient complains that inspiratory time is too short, consider increasing the value.

- 1 Observe the patient's inspiration time and respiratory pattern.
- 2 Set the Ti Max slightly longer (eg, 1.5 sec for an adult patient) than the patient's spontaneous inspiratory time, (eg, if the patient has a spontaneous inspiratory time of 1.5 sec, a Ti Max time of 1.6 sec may be chosen).

**Note:** For COPD patients, ensure the resultant I:E ratio is at least 1:2 (ideally 1:3) to allow sufficient time for exhalation. You may need to shorten Ti Max or readjust the cycle sensitivity to provide a more appropriate I:E ratio.

## Setting Ti Min

Ti Min may be useful in patients who have a tendency to cycle inspiration early (or prematurely). Patients with restrictive disorders (eg, chest-wall deformity, neuromuscular diseases) often have a decreased compliance of the respiratory system which when using PS modes tends to contribute to early flow cycling. Patients in this situation may complain that the device finishes inspiration before they do. Lengthening the Ti Min setting may help to ensure that an appropriate inspiratory time, and thus minute ventilation, is maintained in these conditions.

Most patients with obstructive pulmonary disease do not have problems with premature cycling, therefore the Ti Min setting can remain at the default setting.

**Note:** Care should be taken not to set Ti Min longer than the patient's spontaneous inspiratory time, as this may fight against the patient attempts to exhale, creating discomfort and increased work of breathing. If the patient complains that inspiratory time is too long, consider reducing the value.

- 1 Observe the patient's inspiration time and spontaneous respiratory rate. (The measured Ti and I:E ratio on the *Monitoring* and *Synchronisation* screen may help.)
- 2 Adjust the Ti Min in accordance with the measured Ti (see table below). Check that the patient doesn't feel that the inspiratory time is too long. The patient's spontaneous rate can be found in the monitoring summary.
- 3 Observe the patient to determine if the Ti Min should be shortened (eg, 0.2 or 0.3 sec shorter than patient inspiration time).



## TiControl calculation guide

The following table is a guide to selecting the Ti Max and Ti Min values that best correspond to the patient's respiratory rate (ideally while using the ventilator at rest).

Patient breaths per min	T <sub>tot</sub> = 60 ÷ breaths per min (sec)	I:E = 1:2 (eg, normal lungs)	I:E = 1:1 (eg, restrictive lungs)		I:E = 1:3 (eg, obstructive lungs)
			Ti Min	Ti Max	Ti Max
10	6	2	1.0	2.5	1.5
15	4	1.3	1.0	1.7	1.3
20	3	1.0	0.8	1.5	1.0
25	2.4	0.8	0.7	1.2	0.8
30	2	0.7	0.6	1.0	0.7
35	1.7	0.6	0.5	0.8	0.7
40	1.5	0.5	0.5	0.7	0.7

## EPAP/PEEP

The appropriate setting of PEEP (or EPAP) is fundamental to modern ventilation practice, across most modes of therapy. Examples of its use include:

- Recruiting and/or maintaining lung volume, aiding gas exchange, improving lung compliance, or minimising lung injury.
- In obstructive lung disease—to offset intrinsic PEEP, to reduce work of breathing, and/or maximise effective triggering.
- To splint open or stabilise the upper-airway during sleep.

For nocturnal ventilation, a starting pressure of 5 cm H<sub>2</sub>O is recommended. If there is any indication of symptoms such as daytime sleepiness, obesity, an anatomically narrow airway or neuromuscular disease, or pressure support frequently reaching the maximum level, an additional 1 – 3 cm H<sub>2</sub>O may be helpful.

Stellar provides monitoring—such as optional integrated SpO<sub>2</sub> and high resolution flow data—to assist with titrating EPAP/PEEP in order to maintain upper airway patency. Evidence of desaturation or flow limitation may lead to EPAP/PEEP adjustment.

The iVAPS mode offers the option of AutoEPAP. The purpose of AutoEPAP is to maintain upper airway patency. The AutoEPAP algorithm does not address any other titration target such as lung recruitment to improve oxygenation or offset intrinsic PEEP. Min EPAP should be set to treat lower airway conditions.

## **Trigger/cycle sensitivities**

High trigger sensitivity decreases the flow threshold necessary for the device to move from EPAP to IPAP, making it easier for the patient to trigger. So, for example, for patients who have insufficient inspiratory effort (flow), set the trigger setting to 'High' or 'Very High' to increase sensitivity to patient effort. So the patient needs to exert less effort to trigger the device.

Less sensitive settings—'Low' and 'Very Low'—provide flexibility for patients prone to auto-triggering, caused by restrictive lung diseases and cardiogenic artefact. Cardiogenic artefact refers to impulses within in the respiratory flow signal that originate from cardiac activity rather than respiratory effort. It can result in false triggering, if the impulses exceed the trigger flow threshold.

High cycle sensitivity will result in an earlier transition from IPAP to EPAP and low cycle sensitivity will delay this transition. For example, for patients who cannot maintain inspiratory flow, or who complain of having their breath 'cut off', set the cycle setting to 'Low' or 'Very Low' which will delay the transition from IPAP to EPAP. This will tend to prolong inspiratory time.

For characteristic data, see "Technical specifications" on page 69.

# Troubleshooting

If there is a problem, try the following suggestions. If the problem cannot be solved, contact ResMed.

## Alarm troubleshooting

The most common reason for an alarm to sound is because the system has not been properly assembled. Check that the air tubing has been properly attached to the device and patient interface (and humidifier if used).

### Notes:

- The alarm actions listed below are based on having the appropriate alarm settings for the patient's therapy. When a user adjustable alarm is activated, re-confirm the alarm settings.
- The alarm log and alarm settings are maintained when the device is powered down and in the event of a power loss.
- If multiple alarms are active simultaneously, the alarm with the highest priority will be displayed first.
- If an alarm activates repeatedly, discontinue use and return the device for servicing.

Problem/Possible cause	Action
<b>LCD: Internal Battery Empty!</b>	
The remaining battery charge is below 15%. The device can be powered by the internal battery for maximum 2 minutes.	Connect the device to mains power. <i>Note: In case of a total power failure, the therapy settings will be stored and therapy will resume when the device is powered again.</i>
<b>LCD: System Failure!</b>	
Component failure. The device stops delivering air pressure (system failure 6, 7, 9, 22, 38). Therapy cannot be started (system failure 21).	1. Power-off the device. 2. Power-on the device again. If the problem persists return the device for servicing.
The device internal temperature is too low for the device to start/deliver therapy (system failure 21).	1. Ensure that ambient temperature is above 5°C. If the device has been stored below 5°C, allow sufficient time for it to acclimatise before use. 2. Power-off the device. 3. Power-on the device again. If the problem persists, return the device for servicing.
The self test of the device fails and therapy cannot be started (system failure 21).	1. Power-off the device. 2. Power-on the device again. If the problem persists, return the device for servicing.
Component failure (system failure 8, 25).	1. Power-off the device, if the system failure is continuously present. 2. Power-on the device again. If the problem persists return the device for servicing.
The following system failures can occur: motor failure (system failure 6), pressure sensor failure (system failure 7), software failure (system failure 8), calibration fault (system failure 9), self test failure (system failure 21), flow sensor failure (system failure 22), system component failure (system failure 25), critical software failure (system failure 38).	

Problem/Possible cause	Action
<b>LCD: Over Pressure!</b>	
The device generates a pressure that is greater than 59 cm H <sub>2</sub> O. Treatment will be stopped.	<ol style="list-style-type: none"> <li>1. Power-off the device.</li> <li>2. Check that the air tubing is connected properly.</li> <li>3. Power-on the device again.</li> <li>4. Start Learn Circuit function.</li> </ol> <p><i>Note: If the alarm activates repeatedly internal components may be defective. Discontinue use and return the device for servicing.</i></p>
<b>LCD: Blocked Tube!</b>	
Air path is blocked.	<ol style="list-style-type: none"> <li>1. Check the air path for any blockages.</li> <li>2. Remove the blockages.</li> <li>3. If the alarm is not cleared, stop treatment.</li> <li>4. Re-start treatment.</li> </ol>
<b>LCD: High Temperature [10, 11, 12, 23]!</b>	
The temperature inside the device is too high. Treatment may lead to stop.	Ensure the ambient temperature is within the specified operating range. If the problem persists within the specified operating conditions please return the device for servicing.
<b>LCD: High Pressure!</b>	
Therapy pressure exceeds pre-set alarm level.	<ol style="list-style-type: none"> <li>1. Stop treatment.</li> <li>2. Check the alarm and pressure settings.</li> <li>3. Re-start treatment.</li> </ol>
<b>LCD: Low Pressure!</b>	
The air tubing is not connected properly.	<ol style="list-style-type: none"> <li>1. Check the air circuit integrity and reconnect.</li> <li>2. If the alarm doesn't get cleared, stop treatment.</li> <li>3. Re-start treatment.</li> </ol>
<b>LCD: Circuit disconnected!</b>	
The air circuit is not connected properly.	<ol style="list-style-type: none"> <li>1. Check the air circuit integrity and reconnect.</li> <li>2. If the alarm is not cleared, stop treatment.</li> <li>3. Re-start treatment.</li> </ol>
<b>LCD: Low Minute Ventilation!</b>	
Minute ventilation level has dropped below the alarm setting level.	<ul style="list-style-type: none"> <li>• Reassess the patient to ensure adequate therapy.</li> <li>• Ensure the alarm setting is appropriate for the patient.</li> </ul>
<b>LCD: High Respiratory Rate!</b>	
The respiratory rate level has exceeded the pre-set alarm level.	<ul style="list-style-type: none"> <li>• Reassess the patient to ensure adequate therapy.</li> <li>• Ensure the alarm setting is appropriate for the patient.</li> </ul>
<b>LCD: Low Respiratory Rate</b>	
The respiratory rate level has dropped below the pre-set alarm level.	<ul style="list-style-type: none"> <li>• Reassess the patient to ensure adequate therapy.</li> <li>• Ensure the alarm setting is appropriate for the patient.</li> </ul>
<b>LCD: High Leak!</b>	
High mask leak for more than 20 seconds.	<ul style="list-style-type: none"> <li>• Adjust the mask to minimise leak (see "Using mask-fit" on page 29).</li> <li>• Check the air circuit integrity and reconnect.</li> <li>• Check that the anti-asphyxia valve is fully closed.</li> </ul>

Problem/Possible cause	Action
<b>LCD: Non-Vented Mask!</b>	
<ul style="list-style-type: none"> <li>• Connection of a non-vented mask.</li> <li>• Mask vents may be blocked.</li> <li>• ResMed Leak Valve is missing or vent is blocked.</li> </ul>	<ul style="list-style-type: none"> <li>• Ensure the mask has vents.</li> <li>• Ensure the mask vents are not blocked.</li> <li>• Ensure the ResMed Leak Valve is installed and that the vent is not blocked.</li> <li>• Ensure oxygen (if in use) has only been connected at the rear of the device.</li> </ul>
<b>LCD: Apnoea!</b>	
The device detects an apnoea that has exceeded the pre-set alarm level.	<ul style="list-style-type: none"> <li>• Reassess the patient to ensure adequate therapy.</li> <li>• Ensure the alarm setting is appropriate for the patient.</li> </ul>
<b>LCD: Internal Battery Low!</b>	
The internal battery capacity is below 30%.	Connect the device to mains power.
<b>LCD: Low SpO2!</b>	
SpO <sub>2</sub> has dropped below pre-set alarm level.	<ul style="list-style-type: none"> <li>• Check the attachment of the sensor.</li> <li>• Reassess the patient to ensure adequate therapy.</li> </ul>
<b>LCD: SpO2 finger sensor failure!</b>	
The finger sensor is not connected properly or delivers faulty values.	Check if the finger sensor is attached properly to the finger and connection to the pulse oximeter.
<b>LCD: Xpod oximeter disconnected!</b>	
The pulse oximeter is disconnected.	Check if the pulse oximeter is connected properly to the device.
<b>LCD: Low FiO2 Level!</b>	
FiO <sub>2</sub> has dropped below the pre-set alarm level.	<ul style="list-style-type: none"> <li>• Perform FiO<sub>2</sub> sensor calibration.</li> <li>• Reassess the patient to ensure adequate therapy.</li> </ul>
<b>LCD: High FiO2 Level!</b>	
FiO <sub>2</sub> has exceeded the pre-set alarm level.	<ul style="list-style-type: none"> <li>• Perform FiO<sub>2</sub> sensor calibration.</li> <li>• Reassess the patient to ensure adequate therapy.</li> </ul>
<b>LCD: FiO2 sensor disconnected!</b>	
The FiO <sub>2</sub> monitoring sensor is not connected.	Connect the FiO <sub>2</sub> monitoring sensor or replace it with a new one.
<b>LCD: Keypad Failure!</b>	
One of the keys was held down for more than 10 sec or got stuck.	Remove any blockages from the keypad.
<b>LCD: Attention: High Temp [42, 43, 44, 45]!</b>	
The temperature inside the device is high.	Ensure the ambient temperature conditions are within the specified operating range.
<b>LCD: Internal Battery Use!</b>	
The device is using the internal battery.	Check if the power cord is properly connected to the device if you want to run from mains power. Press the Alarm mute button  to cancel the alarm.
<b>LCD: External DC Power Use!</b>	
The device is powered by an external battery.	Check if the AC power cord is properly connected to the device if you want to run from mains power. <i>Note: The alarm will be cleared automatically after one minute.</i>

## Other troubleshooting

Problem/Possible cause	Action
<b>No display</b>	
Power failure. The device stops delivering air pressure.	<ul style="list-style-type: none"> <li>Remove the mask or the catheter mount from the tracheostomy tube until power is restored.</li> <li>Check the power cable connection between the mains power or external battery and the device.</li> <li>As the internal battery ages, the available capacity decreases. When the remaining battery capacity is low, it can affect the battery charge level indication and lead to power failure without activating Low or Empty battery alarms. ResMed recommends the battery be tested after two years to assess the remaining battery life (see "Internal battery" on page 12).</li> </ul>
Power not connected or device is not switched on.	Ensure the power cord is connected and press the switch at the back of the device once.
<b>Treatment pressure seems low</b>	
Ramp time is in use.	Wait for air pressure to build up.
Air filter is dirty.	Replace air filter.
Air tubing is kinked or punctured.	Straighten or replace tubing.
Air tubing is not connected properly.	Connect the air tubing firmly at both ends.
Mask and headgear not positioned correctly.	Adjust position of mask and headgear.
Plug(s) missing from access port(s) on mask.	Replace plug(s).
Pressure required for treatment may have changed.	Conduct a clinical assessment and adjust pressure if necessary.
There is a large impedance (eg, antibacterial filter) in the air circuit.	Perform the Learn Circuit function.
Humidifier control dial set too high, resulting in accumulation of water in the air tubing.	Turn humidifier control down and empty the water from the air tubing.
<b>Treatment pressure seems high</b>	
Pressure required for treatment may have changed.	Conduct a clinical assessment and adjust pressure if necessary.
There is a change in the impedance in the circuit configuration.	Perform the Learn Circuit function.
<b>The device does not start when the patient breathes into the mask</b>	
SmartStart/Stop not on.	Enable SmartStart/Stop.
Breath is not deep enough to trigger SmartStart.	Ask the patient to take a deep breath in and out through the mask.
There is excessive leak.	Adjust position of mask and headgear.
Plug(s) missing from port(s) on mask.	Replace plug(s).
Air tubing is not connected properly.	Connect firmly at both ends.
Air tubing is kinked or punctured.	Straighten or replace tubing.
There is a large impedance (eg, antibacterial filter) in the air circuit.	Perform the Learn Circuit function.
<b>The device does not stop when the patient removes their mask</b>	
SmartStart/Stop is disabled.	Enable SmartStart/Stop.

Problem/Possible cause	Action
Use of a full face mask or tracheostomy tube.	SmartStart is disabled if Full Face or Trach are selected as interface.
Incompatible accessories (eg, humidifier or mask system) with high resistance being used.	Use only equipment as recommended and supplied by ResMed.
High Leak or Low Min Vent alarms are set to On.	SmartStop is disabled when High Leak or Low Min Vent alarms are set to On.
“Confirm stop” is enabled.	Disable Confirm stop.
<b>High Leak Alarm is enabled, but alarm does not activate when the mask is removed during treatment</b>	
Incompatible air delivery system being used.	Use only equipment as recommended and supplied by ResMed.
Pressure settings are too low for the air delivery components being used.	Perform the Learn Circuit function to adjust the therapy pressure according to the patients air tubing system.
<b>Learn Circuit failed</b>	
<ul style="list-style-type: none"> <li>The circuit configuration is inappropriate as the impedance detected is too high.</li> <li>Too many components have been included or the impedance of accessories in use is above ResMed’s recommendation, eg, type of filter, external humidifier, air tubing.</li> </ul>	Review the components included in the circuit configuration and adjust as appropriate, then rerun Learn Circuit (see “Setup menu: Options” on page 45).
<b>The delivered airflow is not humid/heated although the H4i humidifier is in use</b>	
The humidifier is not properly attached.	Correctly attach the humidifier.
The humidifier does not heat.	The device is currently powered by battery use or not connected to the mains.
The humidifier does not work.	Return the device and the humidifier for servicing.
The water chamber is empty.	Fill the water chamber of the humidifer.
<b>Date or time in data files is wrong</b>	
Date or time on the device is wrong.	Correct the current time and date in the <i>Options</i> menu. <i>Note: Changing the time or date setting backwards will erase all logged data.</i>
<b>Unable to read or write settings from USB stick</b>	
Wrong Serial number.	Please check the serial number of the Stellar in the <i>Device Information</i> screen of the <i>Summary</i> menu. Write the Serial number via ResScan on the USB stick.
USB stick contains unreadable data.	<ul style="list-style-type: none"> <li>Store the file once again on the USB stick and try again to readout data.</li> <li>If the problem persists return the USB stick for servicing.</li> <li>The USB stick contains data of the same device.</li> </ul>
USB stick is not compliant with USB 2.0.	Use only equipment as recommended and supplied by ResMed.
USB stick contains no data.	Transfer data to the USB stick either form another device or from ResScan.
USB stick is defective.	Return the USB stick for servicing.

Problem/Possible cause	Action
<b>Unable to write settings to USB stick</b>	
There is not enough space on the USB stick.	Connect the USB stick to a PC and delete data that is not needed. Reconnect the USB stick to the Stellar then retry writing data to the USB stick.
USB stick is not compliant with USB 2.0 or write protected.	Use only equipment as recommended and supplied by ResMed.
USB stick is defective.	Return the USB stick for servicing.
<b>Data transfer failed</b>	
Incorrect data.	Try data transfer again. If the problem persists return the USB stick for servicing.
<b>FiO<sub>2</sub> sensor calibration failure</b>	
FiO <sub>2</sub> sensor is not attached properly.	For the correct attachment of the FiO <sub>2</sub> sensor see "Using the FiO <sub>2</sub> monitoring sensor" on page 21.
FiO <sub>2</sub> sensor is used or defective.	If the lifetime of the FiO <sub>2</sub> sensor has exceeded one year please replace the FiO <sub>2</sub> sensor and start calibration again.
<b>LCD:  is displayed in the header.</b>	
Battery is not charging.	<ul style="list-style-type: none"> <li>• Ensure the ambient temperature conditions are within the specified operating range. If the problem persists within the specified operating conditions please return the device for servicing.</li> <li>• Power off the device.</li> <li>• Power on the device.</li> </ul>



# Technical specifications

Operating pressure range	<ul style="list-style-type: none"> <li>• IPAP: 2 cm H<sub>2</sub>O to 40 cm H<sub>2</sub>O (in S, ST, T, PAC mode)</li> <li>• PS: 0 cm H<sub>2</sub>O to 38 cm H<sub>2</sub>O (in S, ST, T, PAC mode)</li> <li>• EPAP/PEEP: 2 cm H<sub>2</sub>O to 25 cm H<sub>2</sub>O (in S, ST, T, iVAPS, PAC mode)</li> <li>• CPAP: 4 cm H<sub>2</sub>O to 20 cm H<sub>2</sub>O (in CPAP mode only)</li> <li>• Min PS: 0 cm H<sub>2</sub>O to 20 cm H<sub>2</sub>O (in iVAPS mode)</li> <li>• Max PS: 0 cm H<sub>2</sub>O to 30 cm H<sub>2</sub>O; 8 cm H<sub>2</sub>O to 30 cm H<sub>2</sub>O when AutoEPAP is on (in iVAPS mode)</li> <li>• Min EPAP/Max EPAP: 2 cm H<sub>2</sub>O to 25 cm H<sub>2</sub>O (in iVAPS mode when AutoEPAP is set to on)</li> </ul>
Maximum single fault pressure	60 cm H <sub>2</sub> O (in all modes)
Maximum breathing resistance under single fault	2 cm H <sub>2</sub> O at 30 L/min; 7.2 cm H <sub>2</sub> O at 60 L/min
Therapy pressure tolerance	<p>IPAP: <math>\pm 0.5</math> cm H<sub>2</sub>O <math>\pm 10\%</math> of set pressure (end of inspiration)            EPAP or PEEP: <math>\pm 0.5</math> cm H<sub>2</sub>O <math>\pm 4\%</math> of set pressure            CPAP: <math>\pm 0.5</math> cm H<sub>2</sub>O <math>\pm 10\%</math> of set pressure</p> <p>Test condition: T mode, IPAP: 40 cm H<sub>2</sub>O, EPAP: 2 cm H<sub>2</sub>O, Rise Time: MIN, Fall Time: MIN, Ti: 4.0 sec, Respiratory Rate: 10 bpm, with ResMed calibration cap.</p>
Flow accuracy	<p><math>\pm 5</math> L/min or 20% measured value, whichever is greater</p> <p>Test condition: T mode, IPAP: 40 cm H<sub>2</sub>O, EPAP: 2 cm H<sub>2</sub>O, Rise Time: MIN, Fall Time: MIN, Ti: 4.0 sec, Respiratory Rate: 10 bpm, with ResMed calibration cap.</p>
Maximum flow	> 200 L/min at 20 cm H <sub>2</sub> O
Inspiratory trigger (nominal) characteristics	<p>The minimum flow required to initiate IPAP by ASL5000 simulator with chronically weak efforts (R20, C20, BPM20):</p> <ul style="list-style-type: none"> <li>• For Very High setting: 2.4 L/min</li> <li>• For High setting: 4.2 L/min</li> <li>• For Medium setting: 6.0 L/min</li> <li>• For Low setting: 10.2 L/min</li> <li>• For Very Low setting: 15.0 L/min</li> </ul> <p>Accuracy <math>\pm 20\%</math> or <math>+2.0/-1.5</math> L/min whichever is greater.</p> <p>When tested with IPAP = 15 cm H<sub>2</sub>O, EPAP = 5 cm H<sub>2</sub>O, Rise Time = Min, 2 m air tubing, Ultra Mirage mask, zero leak.</p>
Expiratory cycle (nominal) characteristics	<p>The expiratory cycle occurs at the following flow rates:</p> <ul style="list-style-type: none"> <li>• For Very High setting: 50% of peak inspiratory flow</li> <li>• For High setting: 35% of peak inspiratory flow</li> <li>• For Medium setting: 25% of peak inspiratory flow</li> <li>• For Low setting: 15% of peak inspiratory flow</li> <li>• For Very Low setting: 8% of peak inspiratory flow.</li> </ul> <p>Accuracy <math>+10\%/-25\%</math> or <math>\pm 1.3</math> L/min whichever is greater.</p> <p>When tested with IPAP = 15 cm H<sub>2</sub>O, EPAP = 5 cm H<sub>2</sub>O, Rise Time = Min, 2 m air tubing, Ultra Mirage mask, zero leak.</p>
Sound pressure level	31 dBA with uncertainty of 3 dBA as measured according to ISO 17510 – 1:2007.
Sound power level	39 dBA with uncertainty of 3 dBA as measured according to ISO17510 – 1:2007
Alarm Volume Range	<p>High, medium and low priority alarm (measured according to IEC 60601-1-8: 2012):</p> <p>minimum 42 dB</p> <p>maximum 79 dB</p>

<b>Data storage</b>	7 days of respiratory flow, calculated therapy pressure, SpO <sub>2</sub> , pulse rate, breath-by-breath data (EPAP, pressure support, minute ventilation, leak, respiratory rate, tidal volume, inspiration time, expiration time, spontaneously or machine triggered or cycled breaths) 365 days of 5th -, 50th -, 95th percentile data (leak, SpO <sub>2</sub> , minute ventilation, tidal volume, respiratory rate, I:E, pressure support, AHI, AI)
<b>Dimensions (L x W x H)</b>	230 mm x 170 mm x 120 mm
<b>Weight</b>	2.1 kg
<b>LCD screen</b>	Dimension (L x W x H): 76.9 mm x 63.9 mm x 3.15 mm Resolution: 320 x 240 pixels
<b>Air outlet</b>	22 mm taper, compatible with ISO 5356-1:2004 Anaesthetic & Respiratory Equipment – Conical Connectors
<b>Pressure measurement</b>	Internally mounted pressure transducer
<b>Flow measurement</b>	Internally mounted flow transducer
<b>Power supply</b>	AC 100–240V, 50–60Hz, 2.2 A, max. 65 W
<b>External DC Power Supply (isolated)</b>	24V, 3 A
<b>Internal battery</b>	Lithium-Ion battery, 14.4 V, 1.6 Ah, 23 Wh Operating hours: 2 h with a new battery under normal conditions (see below). Patient type: home chronic; pressure: IPAP/EPAP 15/5 cm H <sub>2</sub> O; mask type: Ultra Mirage; air tubing: 2 m; leak: 0; respiratory rate: 20 bpm; battery capacity: 100% Patient type: hospital acute; pressure: IPAP/EPAP 20/5 cm H <sub>2</sub> O; mask type: Ultra Mirage; air tubing: 2 m; leak: 0; respiratory rate: 45 bpm; battery capacity: 100%
<b>Housing construction</b>	Flame retardant engineering thermoplastic
<b>Environmental conditions Stellar</b>	<ul style="list-style-type: none"> <li>• Operating temperature: 0°C to + 35°C</li> <li>• Operating humidity: 10%–95% non-condensing</li> <li>• Storage and transport temperature: -20°C to +60°C (+50°C*)</li> <li>• Storage and transport humidity: 10%–95% non-condensing</li> <li>• Air pressure: 680 hPa to 1,100 hPa; Altitude: max. 3,000 m</li> </ul> <i>Note: The performance may be limited below 800 hPa.</i> *NONIN XPOD
<b>Electromagnetic compatibility</b>	Product complies with all applicable electromagnetic compatibility requirements (EMC) according to IEC60601-1-2, for residential, commercial and light industry environments. For further details see “Guidance and manufacturer’s declaration – electromagnetic emissions and immunity” on page 73.
<b>Air filter</b>	Electrostatic fibre mesh with TPE frame structure. Bacterial filtration efficiency of 99.540% on area weight 100g/m <sup>2</sup> .
<b>Air tubing</b>	Flexible plastic, 2 m or 3 m length (22 mm diameter)
<b>SlimLine air tubing</b>	Flexible plastic, 1.83 m length (15 mm diameter)
<b>IEC 60601-1 classifications</b>	<ul style="list-style-type: none"> <li>• Class II (Clause 3.14—double insulation). This adherence means the need for an protective earthing (ie, an earthed plug) is not necessary.</li> <li>• Type BF</li> <li>• Continuous operation</li> </ul>

<b>Air travel requirements</b>	Medical-Portable Electronic Devices (M-PED) that meet the Federal Aviation Administration (FAA) requirements of RTCA/DO-160 can be used during all phases of air travel without further testing or approval by the airline operator. ResMed confirms that the Stellar meets RTCA/DO-160 requirements.
--------------------------------	---

This device is not suitable for use in the presence of a flammable anesthetic mixture.

**Notes:**

- The manufacturer reserves the right to change these specifications without notice.
- Pressure may be displayed in cm H<sub>2</sub>O or hPa.

**Displayed values**

Value	Range	Accuracy	Display Resolution
<b>Flow sensor in device<sup>1</sup></b>			
Leak <sup>2,3</sup>	0–120 L/min	± 12 L/min or ± 20%, whichever is greater	1 L/min
Tidal volume <sup>2,3</sup>	50–3,000 mL	± 20% or 30 mL whichever is greater	10 mL
Respiratory rate	5–60 bpm	±1 bpm <sup>4</sup>	1 bpm
Minute ventilation / Alveolar minute ventilation <sup>2</sup>	0.6–60 L	± 0.5 L or 20% whichever is greater	0.1 L
Ti	0.0–4 sec	± 0.1 sec or ±10%, whichever is greater	0.1 sec
Pressure	0-40 cm H <sub>2</sub> O	IPAP: ± 0.5 cm H <sub>2</sub> O ± 10% of set pressure (end of inspiration); EPAP or PEEP: ± 0.5 cm H <sub>2</sub> O ± 4% of set pressure CPAP: ± 0.5 cm H <sub>2</sub> O ± 10% of set pressure	0.1 cm H <sub>2</sub> O

- 1 Results may be inaccurate in the presence of leaks and may be affected by vent characteristics.
- 2 Results are expressed at STPH (Standard Temperature Pressure, ambient humidity)
- 3 Results may be inaccurate in the presence of leak and supplemental oxygen > 10 L/min. If necessary for therapy, use external monitoring.
- 4 Results may be inaccurate if the tidal volume is below 50 mL.

**Pressure-flow table**

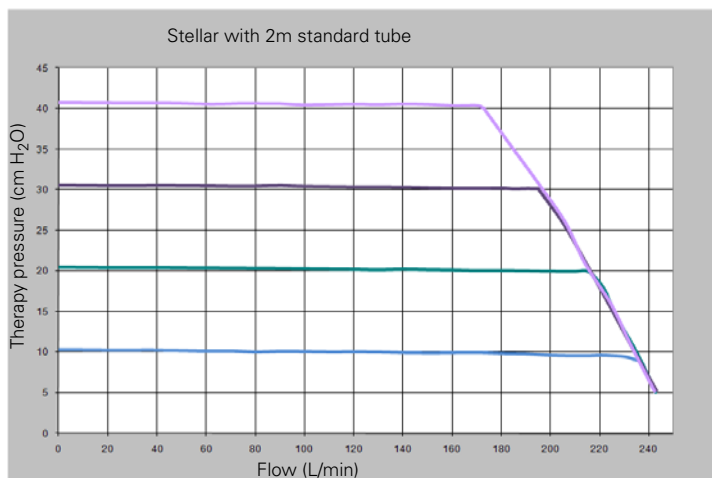

## FiO<sub>2</sub> measurement

FiO<sub>2</sub> concentration measurement at EPAP/IPAP 5/10 cm H<sub>2</sub>O (blue curve), 5/20 cm H<sub>2</sub>O (red curve) and 5/30 cm H<sub>2</sub>O (green curve), R/C 5/20, respiratory rate 20 bpm, full face mask.

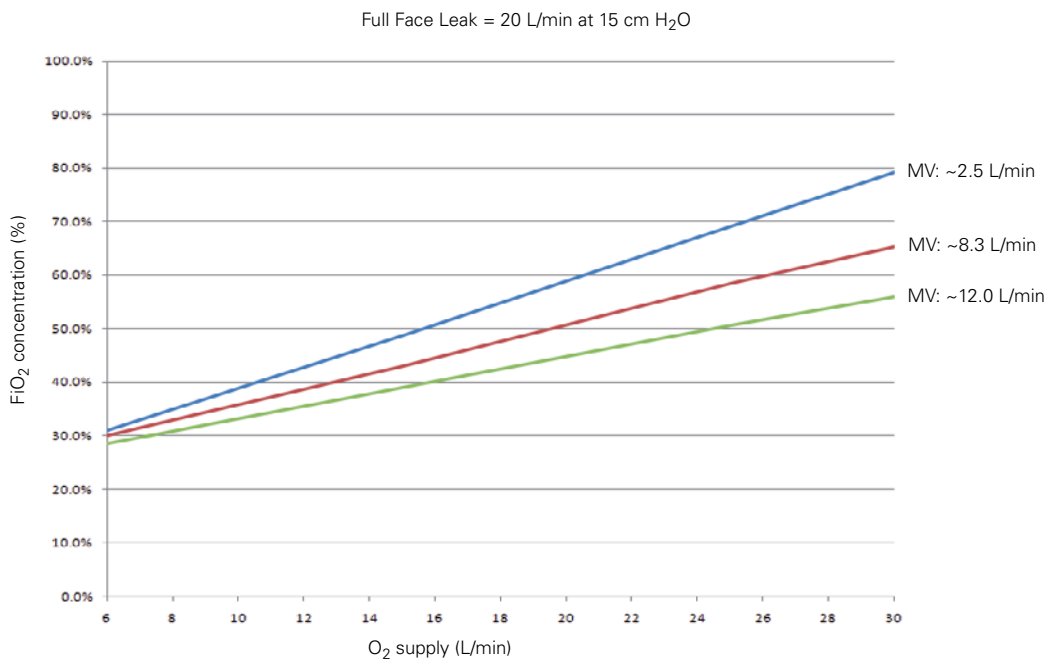
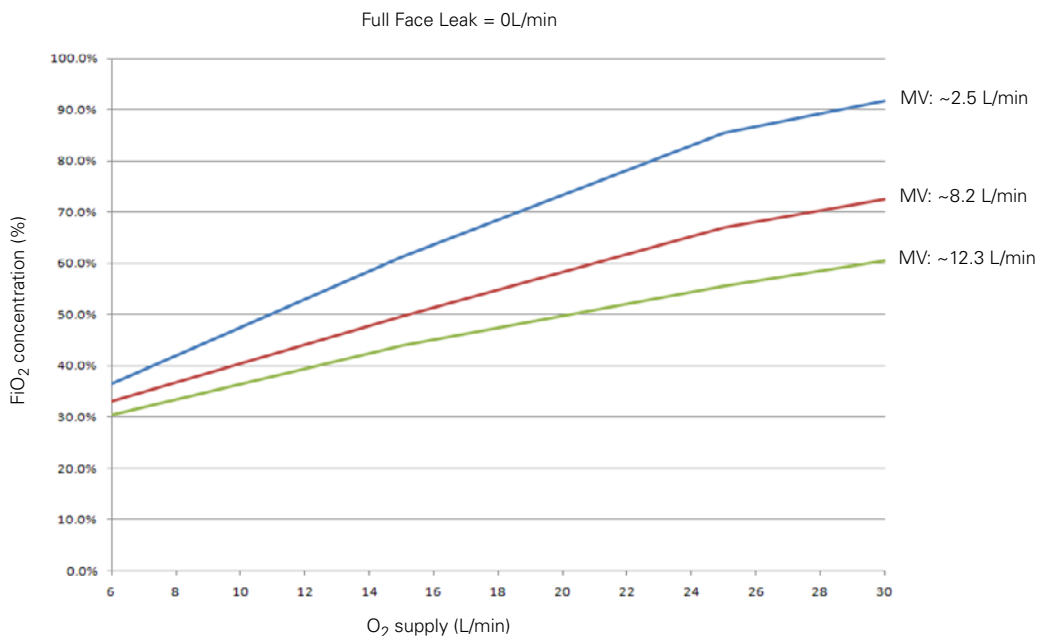

## Pneumatic flow path

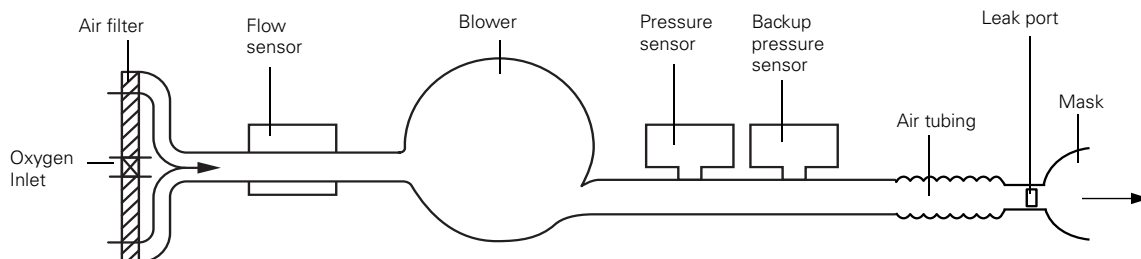

# Guidance and manufacturer's declaration – electromagnetic emissions and immunity

## Guidance and manufacturer's declaration – electromagnetic emissions

The device is intended for use in the electromagnetic environment specified below. The customer or the user of the device should assure that it is used in such an environment.

Emissions test	Compliance	Electromagnetic environment - guidance
RF emissions CISPR11	Group 1	The device uses RF energy only for its internal function. Therefore, its RF emissions are very low and are not likely to cause any interference in nearby electronic equipment.
RF emissions CISPR 11 Harmonic Emissions IEC 61000-3-2	Class B Class A	The device is suitable for use in all establishments, including domestic establishments and those directly connected to the public low-voltage network that supplies buildings used for domestic purposes.
Voltage Fluctuations/Flicker Emissions IEC 61000-3-3	Complies	

Medical Electrical Equipment needs special precautions regarding EMC and needs to be installed and put into service according to EMC information provided in this document.

**Warnings:** The device should not be used adjacent to or stacked with other equipment.

If adjacent or stacked use is necessary, the device should be observed to verify normal operation in the configuration in which it will be used.

The use of accessories (e.g. humidifiers) other than those specified in this manual is not recommended. They may result in increased emissions or decreased immunity of the device.

## Guidance and manufacturer's declaration – electromagnetic immunity

The device is intended for use in the electromagnetic environment specified below. The customer or the user of the device should assure that it is used in such an environment.

Immunity test	IEC60601-1-2 test level	Compliance level	Electromagnetic environment –guidance
Electrostatic discharge (ESD) IEC 61000-4-2	±6 kV contact ±8 kV air	±6 kV contact ±8 kV air	Floors should be wood, concrete or ceramic tile. If floors are covered with synthetic material, the relative humidity should be at least 30%.
Electrical fast transient/burst IEC 61000-4-4	±2 kV for power supply lines ±1 kV for input/output lines	±2 kV ±1 kV	Mains power quality should be that of a typical commercial or hospital environment.
Surge IEC 61000-4-5	±1 kV differential mode ±2 kV common mode	±1 kV differential mode ±2 kV common mode	Mains power quality should be that of a typical commercial or hospital environment.
Voltage dips, short interruptions and voltage variations on power supply input lines IEC 61000-4-11	<5% Ut (>95% dip in Ut) for 0.5 cycle 40% Ut (60% dip in Ut) for 5 cycles 70% Ut (30% dip in Ut) for 25 cycles <5% Ut (>95% dip in Ut) for 5 sec	< 12 V (>95% dip in 240V) for 0.5 cycle 96 V (60% dip in 240 V) for 5 cycles 168 V (30% dip in 240 V) for 25 cycles <12 V (>95% dip in 240 V) for 5 sec	Mains power quality should be that of a typical commercial or hospital environment. If the user of the device requires continued operation during power mains interruptions, it is recommended that the device be powered from an uninterruptible power source.
Power frequency (50/60 Hz) magnetic field IEC 61000-4-8	3 A/m	3 A/m	Power frequency magnetic fields should be at levels characteristic of a typical location in a typical commercial or hospital environment.
Conducted RF IEC 61000-4-6	3 Vrms 150 kHz to 80 MHz	3 Vrms	Portable and mobile RF communications equipment should be used no closer to any part of the device, including cables, than the recommended separation distance calculated from the equation applicable to the frequency of the transmitter. Recommended separation distance: $d = 1.17 \sqrt{P}$  $d = 1.17 \sqrt{P}$ 80 MHz to 800 MHz $d = 2.33 \sqrt{P}$ 800 MHz to 2.5 GHz where P is the maximum output power rating of the transmitter in watts (W) according to the transmitter manufacturer and d is the recommended separation distance in metres (m). Field strengths from fixed RF transmitters, as determined by an electromagnetic site survey, <sup>a</sup> should be less than the compliance level in each frequency range. <sup>b</sup> Interference may occur in the vicinity of equipment marked with the following symbol: 
Radiated RF IEC 61000-4-3	3 V/m 80 MHz to 2.5 GHz	3 V/m	

NOTE 1: Ut is the AC mains voltage prior to application of the test level.

NOTE 2: At 80 MHz and 800 MHz, the higher frequency range applies.

NOTE 3: These guidelines may not apply in all situations. Electromagnetic propagation is affected by absorption and reflection from structures, objects and people.

<sup>a</sup> Field strengths from fixed transmitters, such as base stations for radio (cellular/cordless) telephones and land mobile radios, amateur radio, AM and FM radio broadcast and TV broadcast cannot be predicted theoretically with accuracy. To assess the electromagnetic environment due to fixed RF transmitters, an electromagnetic site survey should be considered. If the measured field strength in the location in which the device is used exceeds the applicable RF compliance level above, the device should be observed to verify normal operation. If abnormal performance is observed, additional measures may be necessary, such as reorienting or relocating the device.

<sup>b</sup> Over the frequency range 150 kHz to 80 MHz, field strengths should be less than 3 V/m.

### Recommended separation distances between portable and mobile RF communications equipment and the device

The device is intended for use in an environment in which radiated RF disturbances are controlled. The customer or the user of the device can help prevent electromagnetic interference by maintaining a minimum distance between portable and mobile RF communications equipment (transmitters) and the device as recommended below, according to the maximum output power of the communications equipment.

Rated maximum output power of transmitter (W)	Separation distance according to frequency of transmitter (m)		
	150 kHz to 80 MHz $d = 1.17 \sqrt{P}$	80 MHz to 800 MHz $d = 1.17 \sqrt{P}$	800 MHz to 2.5 GHz $d = 2.33 \sqrt{P}$
0.01	0.12	0.12	0.23
0.1	0.37	0.37	0.74
1	1.17	1.17	2.33
10	3.70	3.70	7.37
100	11.70	11.70	23.30

For transmitters rated at a maximum output power not listed above, the recommended separation distance  $d$  in metres (m) can be determined using the equation applicable to the frequency of the transmitter, where  $P$  is the maximum output power rating of the transmitter in watts (W) according to the transmitter manufacturer.

NOTE 1: At 80 MHz and 800 MHz, the separation distance for the higher frequency range applies.

NOTE 2: These guidelines may not apply in all situations. Electromagnetic propagation is affected by absorption and reflection from structures, objects and people.

## Symbols

Follow instructions for use; Class II equipment; Type BF applied part; Bell (Remote Alarm); IP31 Device is protected against solid foreign objects of 2.5 mm diameter and greater and vertically falling water drops; Caution; General warning sign (see H4i connector plug and AC connection on the device); Standby or preparatory state for a part of equipment; O<sub>2</sub> Connection for oxygen supply; **max 30 l/min** (max 30 l/min) Data port; CE labelling in accordance with EC directive 93/42/EEC, class II b; Temperature limitation for storage and transport; Handle with care; Maximum humidity; Keep dry; Manufacturer; Upside; REF Catalogue number; SN Serial number; LOT Batch code; Do not re-use; Use by date; Keep away from sunlight; Do not use if package is damaged; Latex-free; 5 years of China environmental protection use period; Contains no China environmental hazardous substances.

**Environmental information** This device must be disposed of in accordance with the laws and regulations of the country in which disposal occurs.

The crossed-out wheeled bin symbol indicates that the product bearing this symbol may not be disposed of together with general household waste, but instead requires separate disposal. This requirement for separate disposal is based on the European Directive 2012/19/EU for electrical and electronic equipment, and the European Directive 2006/66/EC for batteries. You can hand in the product at a municipal collection point, for example. This reduces the impact on natural resources and prevents contamination of the environment through the release of hazardous substances.

Batteries containing more than 0.0005 percent of mercury by mass, more than 0.002 percent of cadmium by mass or more than 0.004 percent of lead by mass are marked below the crossed-bin symbol with the chemical symbols (Hg, Cd, Pb) of the metals for which the limit is exceeded.

For further information regarding product disposal, please contact your local ResMed office or your specialist distributor, or visit our website at [www.resmed.com](http://www.resmed.com).

Dispose of used air filters and air tubing according to the directives in your country.

# General warnings and cautions



## WARNINGS

A warning alerts you to possible injury.

- Read the entire manual before using the device.
- The device and the accessories are to be used for the specified intended use only.
- A User Guide is supplied with the device. Please ensure the patient has the User Guide.
- The device must only be used with masks (and connectors<sup>1</sup>) recommended by ResMed, or by a clinician or respiratory therapist. A mask should not be used unless the device is turned on and operating properly. The vent hole or holes associated with the mask should never be blocked.

**Explanation:** The device is intended to be used with special masks (or connectors) which have vent holes to allow continuous flow of air out of the mask. When the device is turned on and functioning properly, new air from the device flushes the exhaled air out through the mask vent holes. However, when the device is not operating, insufficient fresh air will be provided through the mask, and the exhaled air may be rebreathed. Rebreathing of exhaled air for longer than several minutes can, in some circumstances, lead to suffocation. This applies to most Positive Airway Pressure devices.

- In the event of power failure<sup>2</sup> or machine malfunction, remove the mask or the catheter mount from the tracheostomy tube.
- Explosion hazard—do not use in the vicinity of flammable anesthetics.
- The device should not be used with anaesthetised patients, whose breathing depends entirely on mechanical ventilation.
- Do not use the device if there are obvious external defects, unexplained changes in performance.
- Only use original and approved ResMed accessories and parts.
- The use of an antibacterial filter is obligatory in situations in which cross contamination is possible.
- Use only accessories from the original package. If the packaging is damaged, the respective product must not be used, and should be disposed along with the packaging.
- Before using the device and the accessories for the first time, ensure that all components are in a proper condition and that their operational safety is guaranteed. If there are any defects, the system should not be used.
- Additional equipment connected to medical electrical equipment must comply with the respective IEC or ISO standards (e.g. IEC 60950 for data processing equipment). Furthermore all configurations shall comply with the requirements for medical electrical systems (see IEC 60601-1-1 or clause 16 of the 3Ed. of IEC 60601-1, respectively). Anybody connecting additional equipment to medical electrical equipment configures a medical system and is therefore responsible that the system complies with the requirements for medical electrical systems. Attention is drawn to the fact that local laws take priority over the above mentioned requirements. If in doubt, consult your local representative or the technical service department.
- No modification of this equipment is allowed.

---

1 Ports may be incorporated into the mask or in connectors that are near the mask.

2 During partial (below rated minimum voltage) or total power failure, therapy pressures will not be delivered. When power is restored, operation can proceed with no change to settings.



## CAUTIONS

A **caution** explains special measures for the safe and effective use of the device.

- When using accessories, read the manufacturer's User Manual. For consumables, important information can be provided on the packaging. For more information, see "Symbols" on page 74.
- At low pressures, the flow through the mask vent holes may be inadequate to clear all exhaled gases, and some rebreathing may occur.
- The device may not be exposed to excessive force.
- If the device should fall accidentally on the ground, please contact an authorised service agent.
- Pay attention to leaks and other unusual sounds. If there is a problem, contact an authorised service agent.
- Do not replace any parts in the breathing circuit while the device is in operation. Stop operation before changing parts.

### **Notes:**

*A note advises to special product features.*

- *The above are general warnings and cautions. Further specific warnings, cautions and notes appear next to the relevant instructions in the manual.*
- *Position the device ensuring the power cord can be easily removed from the power outlet.*



## Limited warranty

ResMed Ltd. (hereafter 'ResMed') warrants that your ResMed product shall be free from defects in material and workmanship from the date of purchase for the period specified below.

Product	Warranty period
<ul style="list-style-type: none"> <li>• Mask systems (including mask frame, cushion, headgear and tubing)—excluding single-use devices</li> <li>• Accessories—excluding single-use devices</li> <li>• Flex-type finger pulse sensors</li> <li>• Humidifier water tubs</li> </ul>	90 days
<ul style="list-style-type: none"> <li>• Batteries for use in ResMed internal and external battery systems</li> </ul>	6 months
<ul style="list-style-type: none"> <li>• Clip-type finger pulse sensors</li> <li>• CPAP and bilevel device data modules</li> <li>• Oximeters and CPAP and bilevel device oximeter adapters</li> <li>• Humidifiers and humidifier cleanable water tubs</li> <li>• Titration control devices</li> </ul>	1 year
<ul style="list-style-type: none"> <li>• CPAP, bilevel and ventilation devices (including external power supply units)</li> <li>• Battery accessories</li> <li>• Portable diagnostic/screening devices</li> </ul>	2 years

This warranty is only available to the initial consumer. It is not transferable.

If the product fails under conditions of normal use, ResMed will repair or replace, at its option, the defective product or any of its components.

This limited warranty does not cover: a) any damage caused as a result of improper use, abuse, modification or alteration of the product; b) repairs carried out by any service organization that has not been expressly authorized by ResMed to perform such repairs; c) any damage or contamination due to cigarette, pipe, cigar or other smoke; and d) any damage caused by water being spilled on or into an electronic device.

Warranty is void on product sold, or resold, outside the region of original purchase.

Warranty claims on defective product must be made by the initial consumer at the point of purchase.

This warranty replaces all other expressed or implied warranties, including any implied warranty of merchantability or fitness for a particular purpose. Some regions or states do not allow limitations on how long an implied warranty lasts, so the above limitation may not apply to you.

ResMed shall not be responsible for any incidental or consequential damages claimed to have resulted from the sale, installation or use of any ResMed product. Some regions or states do not allow the exclusion or limitation of incidental or consequential damages, so the above limitation may not apply to you.

This warranty gives you specific legal rights, and you may also have other rights which vary from region to region. For further information on your warranty rights, contact your local ResMed dealer or ResMed office.

R001-325/2 09 09



## Index

### A

- Aircraft
  - Use on 13
- Alarm
  - Messages 26
  - Mute 23
  - Troubleshooting 63
  - Volume 26, 42
- Alarms
  - Fixed 27
  - High priority 27
  - Low priority 27
  - Medium 27
  - Mute 27
  - Priorities 27
  - Resetting 27
  - Testing 42
  - User adjustable 27
  - Working with 26
- Anatomic deadspace 5
- Antibacterial filter 22
- Auto scaling 48
- AutoEPAP 6, 37, 61

### B

- Backup Rate 38

### C

- Clinical mode 36
- Confirm Stop 47
- Control panel 23
- CPAP 37
- CPAP mode 2
- Cycle 40

### D

- Date 47
- Date Format 47
- Default settings 37

### E

- EPAP/PEEP 2, 37, 61
- Erase Data 47

### F

- FiO<sub>2</sub> monitoring sensor 21, 25
- FiO<sub>2</sub> Sensor Calibration 45
- Flow Unit 47
- Functional test 24

### H

- Height 38
- Height Unit 47
- Humidification 12, 25, 60
  - Attaching H4i 15

### I

- iBR 5
- Info menu 49
- Inspiration Time 33
- Internal battery 12, 23, 24, 27, 70

- Invasive use 16
- IPAP 2, 37
- iVAPS 2, 4, 53
  - Indications for use 4

### L

- Language 46
- LCD screen 24, 70
- Leak 33
- Learn Circuit 7, 15, 16, 45
- Learn Targets 38, 52

### M

- Mask fit 29
- Mask Type 40
- Max PS 6, 39
- Medium priority alarms 27
- Menu
  - Info 49
  - Monitoring 33
  - Setup 36
    - Advanced Settings 39
    - Alarm Settings 32, 40
    - Clinical Settings 31, 36
    - Configuration 46
    - Options 32, 45
- Menus 30
- Min PS 6, 39
- Minute Ventilation 33
- Mobile use 13
- Modes 2
- Multi Program 47

### O

- Optional components 11
- Oxygen connection 25

### P

- PAC (Pressure Assist Control) mode 2
- Pathology 37
- Pathology Defaults 7, 10
- Patient interface
  - Compatible types 12
- PEEP 2, 61
- Power
  - Off 26
- Pressure Naming 47
- Pressure Support 2
- Pressure Unit 47
- Programs 28, 37
- PS 37
- PS (Pressure Support) mode 2
- Pulse oximeter 25
- Push dial 23

### R

- Ramp
  - Setting 28
- Ramp down 29, 46
- Ramp Time 45
- Respiratory Rate 33, 38
- Rise/Fall Time 7, 10, 39

## **S**

S (Spontaneous) mode 2

Setup

Antibacterial filter 22

FiO2 monitoring sensor 21

Home therapy 18

Invasive use 16

Pulse oximeter 19

Supplemental oxygen 20

SmartStart/Stop 45

ST (Spontaneous/Timed) mode 2

Start/Stop 23

Supplemental oxygen 20

## **T**

T (Timed) mode 2

Target alveolar ventilation 5

Target Patient Rate 5, 38

Target Va 38

Calculator 38, 53

Therapy

Start 25

Stop 26

Therapy modes 37

Therapy status bar 33

Ti 37

Ti Max 39, 60

Ti Min 39, 60

TiControl 7, 9, 60

Tidal Volume 33

Time 47

Time Format 47

Trigger 40

Trigger/Cycle sensitivities 7, 9

## **U**

USB stick 56

User adjustable alarms 27

## **V**

Vsync 7

# Using the menus

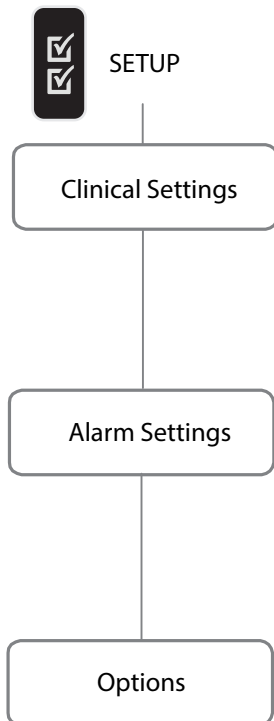
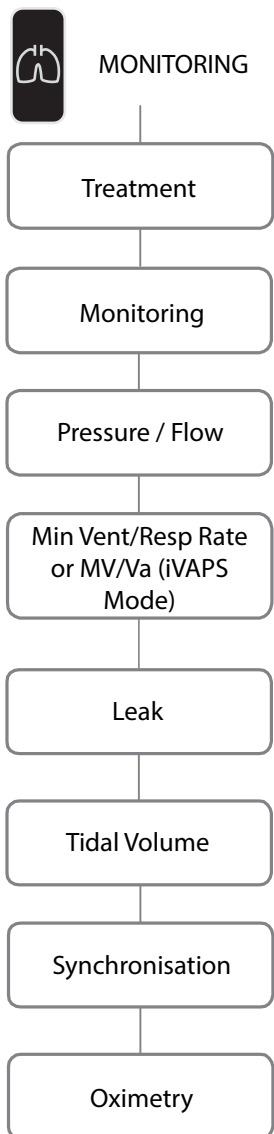

For full Setup menu details, see:

- Clinical Settings on page 37
- Alarm Settings on page 40
- Options on page 45

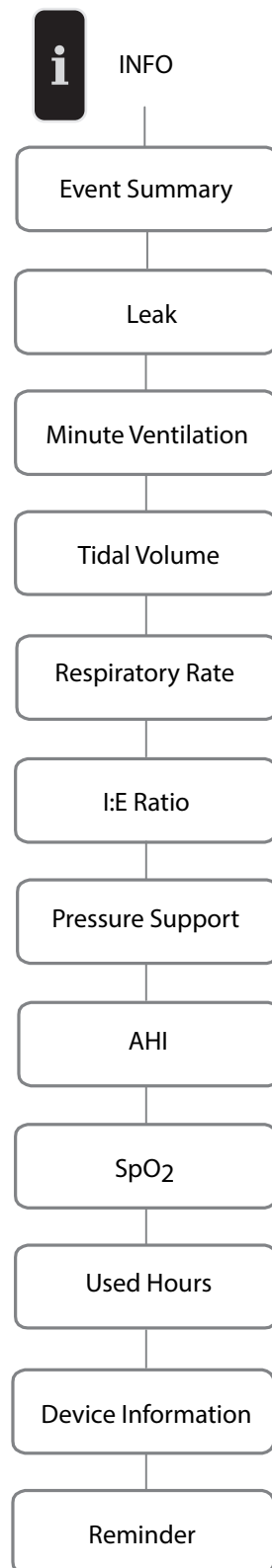



**ResMed Ltd.**

**MANUFACTURER** 1 Elizabeth Macarthur Drive Bella Vista NSW 2153 Australia

See ResMed.com for other ResMed locations worldwide. ResMed, SlimLine, SmartStart, Stellar and TiCONTROL are trademarks and/or registered trademarks of the ResMed family of companies. For patent and other intellectual property information, see ResMed.com/ip.

© 2018 ResMed Ltd 248892/3 2018-07

ResMed.com

CE 0123