

Sound Source and Impact Sound Source for Building Acoustics:

OmniPower™ Sound Source Type 4292-L, Tapping Machine Type 3207 and Power Amplifiers Type 2734-A and 2734-B

For proper building acoustics measurements, a sound source that fulfils the relevant standards (for example, ISO 140) is required. Brüel & Kjær offers a complete range of sound sources for building acoustics measurements including Tapping Machine Type 3207 and 12-speaker omnidirectional OmniPower Sound Source Type 4292-L. Power Amplifier Type 2734 can drive the sound source. Optional carrying cases for the sound sources are available, as well as wireless control systems for use with Hand-held Analyzer Type 2250 and the dual-channel Type 2270.



Uses and Features

Uses

- Architectural and building acoustics
- Measurement of:
 - Airborne sound insulation
 - Reverberation time
 - Impact sound level

Features

- Part of a complete building acoustics system featuring Brüel & Kjær's Hand-held Analyzer Type 2250 or 2270
- An omnidirectional noise source that gives reproducible and reliable results for airborne noise transmission measurements
- A tapping machine for impact sound level measurements
- Remote operation via cable and wireless audio system
- Satisfies national and international standards
- Robust
- Easily portable

Architectural and building acoustic measurements require a range of noise sources for airborne noise and impact noise transmission measurements.

For airborne noise transmission measurements, an omnidirectional sound source is needed. Brüel & Kjær offers OmniPower Sound Source Type 4292-L.

For impact sound measurements, Brüel & Kjær offers Tapping Machine Type 3207, a robust and portable device that fulfils national and international standards.

For a complete measurement system, combine the sound sources with a driving amplifier (such as Power Amplifier Type 2734-A or 2734-B), a sound level analyzer (such as Hand-held Analyzer Type 2250 or 2270), and a PC with Reverberation Time Software BZ-7227 and/or Building Acoustic Software BZ-7228 analysis and reporting.

Brüel & Kjær also supplies additional accessories and a range of carrying cases for storage and transportation:

- Flight Case KE-0449 and Carrying Case KE-0462 for packing and transportation
- Cables and wireless control accessories
- Battery Kit UA-1477 for Type 3207

The Omnidirectional Sound Source

For most building acoustics measurements, the sound source must radiate sound evenly in all directions to give reproducible and reliable results; therefore, the relevant building acoustics measurements standards (ISO 140 and ISO 3382) require the use of an omnidirectional sound source.

OmniPower Sound Source Type 4292-L

Fig. 1
OmniPower Sound Source Type 4292-L



OmniPower Sound Source Type 4292-L is an omnidirectional sound source that uses a cluster of 12 loudspeakers in a dodecahedral configuration that radiates sound evenly with a spherical distribution. All 12 speakers are connected in a series-parallel network to ensure both in-phase operation and an impedance that matches the power amplifier. The entire assembly weighs no more than 8 kg and is fitted with a convenient lifting handle that does not measurably interfere with the sound field.

Powered by Power Amplifier Type 2734-A or 2734-B, the sound source can deliver a maximum sound power of 122 dB re 1 pW (100 – 3150 Hz). The high power output of Type 4292-L makes it ideal for sound insulation measurements.

Type 4292-L satisfies the requirements of DIN 52210, ISO 140 and ISO 3382 standards (see Fig. 2 through Fig. 5). Its directional response for the horizontal plane is shown in Fig. 6.

Fig. 2
Frequency response for $1/3$ -octave sound power levels for OmniPower Type 4292-L using Power Amplifier Type 2734 and its internal pink noise generator

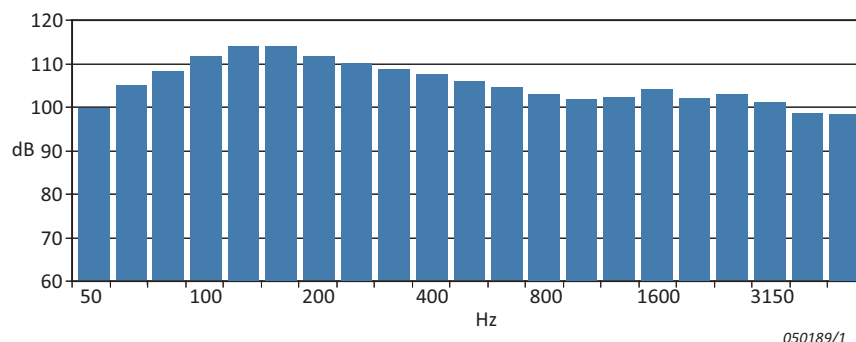

050189/1

Fig. 3
 Frequency response for $1/1$ -octave sound power levels for OmniPower Type 4292-L using Power Amplifier Type 2734 and its internal pink noise generator

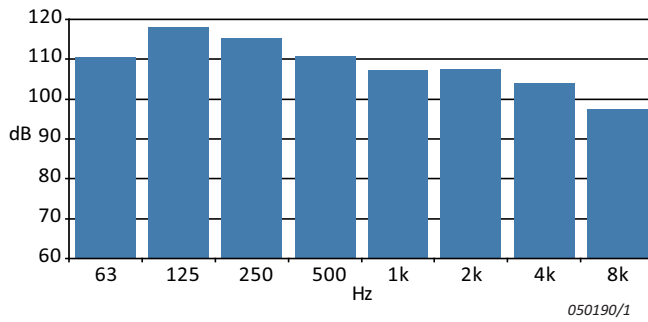

Fig. 4
 Directivity for OmniPower Type 4292-L according to ISO 140: Maximum deviation from mean for 'gliding' 30° arc. Upper and lower curves are the ISO 140 tolerances

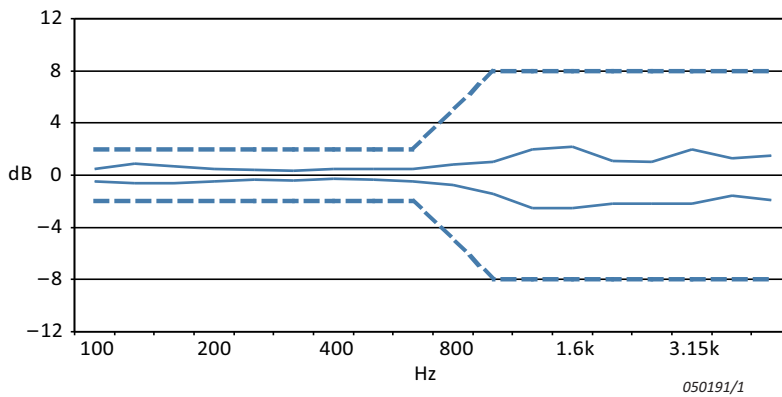

Fig. 5
 Directivity for OmniPower Type 4292-L according to ISO 3382: Maximum deviation from mean for 'gliding' 30° arc. Upper and lower curves are the ISO 3382 tolerances

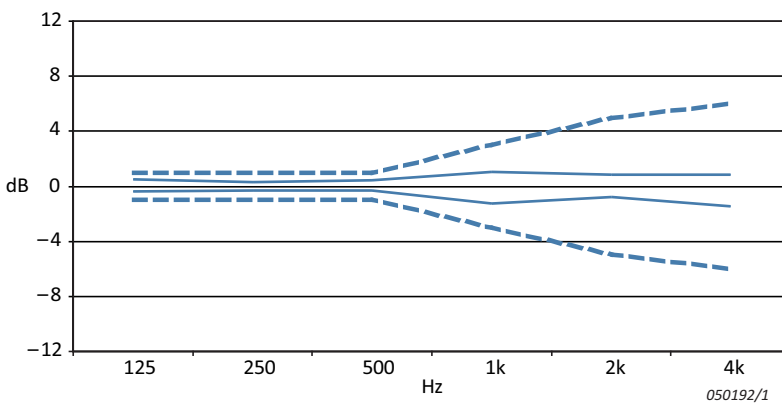
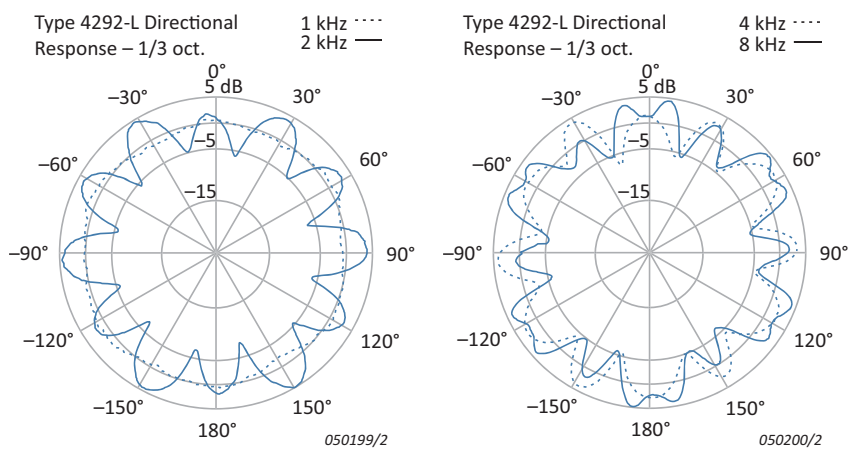

Fig. 6
 Type 4292-L's directional response for the horizontal plane, measured in 1/3-octaves. Below 1 kHz there is no significant deviation from omnidirectionality



Tapping Machine Type 3207

Fig. 7
Top: Tapping Machine Type 3207
Bottom: Accessories for tapping machine, Battery Kit UA-1477



980417/1e

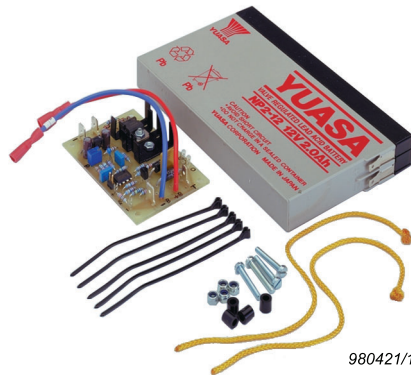

980421/1e

Tapping Machine Type 3207 is an impact sound generator. It can be used for impact sound measurements to national and international standards. The unit is available with an optional battery kit.

Type 3207 uses five hammers each weighing 500 g and operating at 2 Hz dropping from a height of 40 mm, giving an operating frequency of 10 Hz. This fulfils national and international standards. The hammers are operated via tappets on a single shaft. The shaft is driven by a DC motor via a toothed belt and gearbox.

The unit is based around a welded aluminium chassis. Both size and weight have been minimised for easy transportation. Three extendable legs support the unit during operation with rubber feet that are height adjustable with supplied gauges. This gives stable and level mounting during operation in accordance with the relevant standards.

The unit is powered via the supplied mains adaptor or the optional battery kit, and can be remotely switched on and off via cable AQ-0633.

The Power Amplifier

Fig. 8
Top: Type 2734 are built into robust flight cases
Bottom: Type 2734-A showing front mounted controls and connectors



090139



090136

Type 2734 is designed to power sound sources during building and room acoustic field measurements. Compact, lightweight and built into a robust flight case, it is easy and safe to carry and transport to the measurement location. All connectors and controls are on the front for easy access.

It is simple to get the output level right and reproduce previous settings using the power amplifier's calibrator controls and level indicators. For flexibility, it has XLR, jack and BNC input sockets and BNC line and speaker output sockets. A sensitivity selector in 10 dB steps allows the amplifier to adapt to a variety of source signal levels and sound source ratings. Hand-held Analyzer Type 2250/2270's generator signal can be connected to the amplifier input, to provide the pink or white noise used in building acoustics.

Type 2734 has a built-in generator providing pink or white noise in the 50 – 5000 Hz range.

Fig. 9
Type 2734-B, which includes Wireless Audio System UL-0256



Type 2734-B includes a wireless audio system to accommodate cable-free transmission of the building acoustics test signal, which could be white, pink or band-limited noise; or swept sine. Wireless operation also makes source and receiver position changes more convenient. Type 2734-A can be upgraded to Type 2734-B by installing optional Wireless Audio System UL-0256.

Cases

Fig. 10
Carrying Bag KE-0462

Carrying Bag KE-0462



Carrying Bag KE-0462 is included with the OmniPower sound source. Padded and with handles as well as a shoulder strap, it offers basic protection.

Fig. 11
Flight Case KE-0449

Flight Case KE-0449



An optional transportation and storage case, Flight Case KE-0449, is available for the OmniPower sound source. It is custom-designed, features a foam lining to protect Type 4292-L and has two handles for ease of carriage.

Fig. 12
Carrying Case KE-0364

Carrying Case KE-0364



For the sound source's tripod, Carrying Case KE-0364, is equipped with both a shoulder strap and handles.

Fig. 13
Complete system

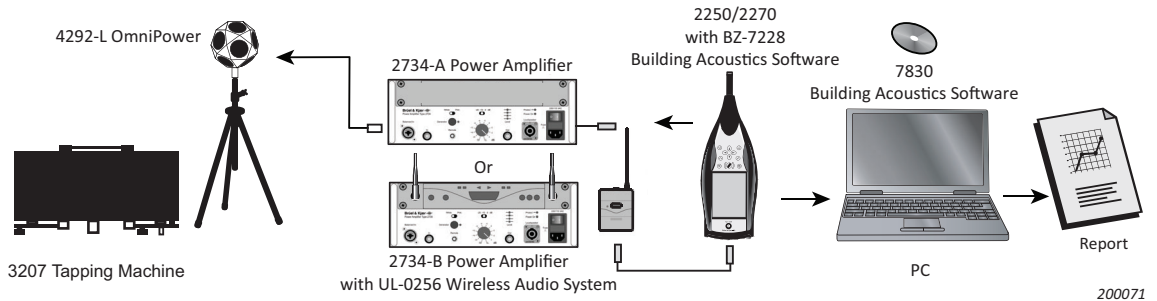

The sound sources mentioned above belong to a range of complete measurement systems from Brüel & Kjær, including power amplifiers, sound level meters, hand-held analyzers and PC software for analysing documenting results.

Hand-held Analyzer Types 2250 and 2270

Fig. 14
Hand-held Analyzer
Types 2250 and 2270



Types 2250 and 2270 are robust, hand-held analyzers designed to host a wide range of sound and vibration measurement applications. Their uses range from assessing environmental and workplace noise to industrial quality control and product development. Built for the tough environment of field measurements, they will work reliably in rain, dust, heat, frost, day or night, and can be placed on a tripod.

Their easy-to-use, light and ergonomic design enables competent one-handed operation. High-resolution colour touchscreens show the instrument setup, status and data at a glance, and let you select what you want to see with the tap of a stylus. The ‘traffic light’ indicator, positioned centrally on the push button panel, shows you the current measurement status, even from a distance.

For documentation, you can add spoken or written comments to your measurements, and make sound recordings during any of the measurements. Sound recording requires Sound Recording Option BZ-7226.

Type 2250 is a single-channel analyzer, and Type 2270 is dual-channel with additional features such as a built-in camera allowing you to attach photos to your measurements and a LAN interface.

The high-precision hand-held analyzers offer a wide range of optional software application modules, including prominent applications such as Reverberation Time Software and Building Acoustics Software.

Reverberation Time and Building Acoustics Software

Reverberation Time

Reverberation time is an important feature of spaces where sound level, the intelligibility of speech, or perception of music is important. It is the time that it takes for a sound to decay by 60 dB. Usually, the time taken for the signal to drop 20 or 30 dB is measured and extrapolated to find the time that it would take the signal to dissipate by 60 dB.

Fig. 15
Reverberation time measurements measured using the interrupted noise method



Reverberation time is measured, using an impulse or an interrupted noise, at several positions, which are then averaged together.

To measure with Reverberation Time Software BZ-7227, simply press the start/pause push button on the hand-held analyzer and, if you are using impulse excitation, burst the balloon.

A yellow 'smiley' icon indicates that you may be able to improve the measurement at one (or more) frequency bands, a red smiley indicates that the measurement should be retaken. Tap the relevant smiley icon to read the explanation.

Fig. 16
Left: Reverberation time spectrum;
Centre: Reverberation decay curve;
Right: Overview of results

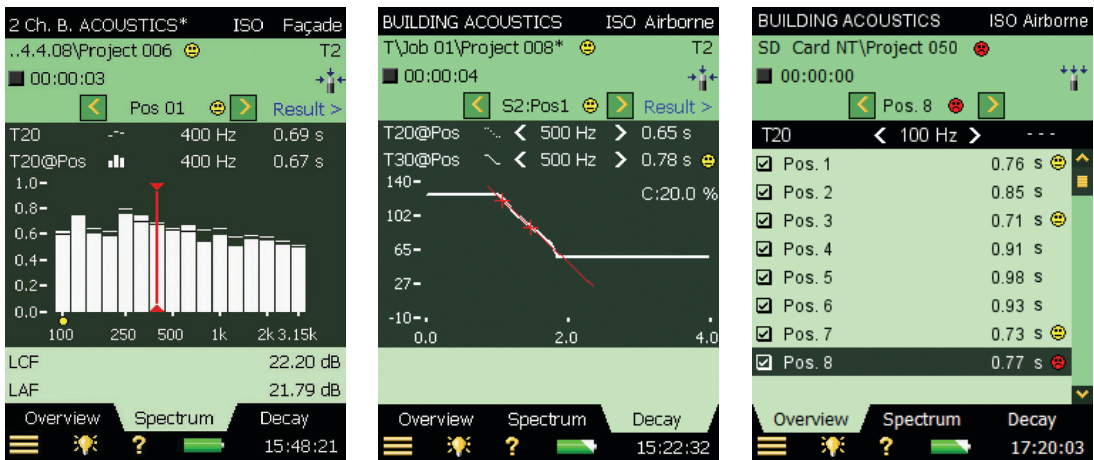

Building Acoustics

Building acoustics is the assessment of airborne, façade or impact sound insulation in buildings. The assessment is based on measured 1/1-octave or 1/3-octave spectra within the 50–5000 Hz range. Measurements may be serial (one frequency band at a time) or parallel (all bands simultaneously).

Airborne Sound Insulation

Fig. 17
Sound source and microphone positions for measuring airborne sound insulation

L1 = Source room level
L2 = Receiving room level
B2 = Background level
T2 = Reverberation Time

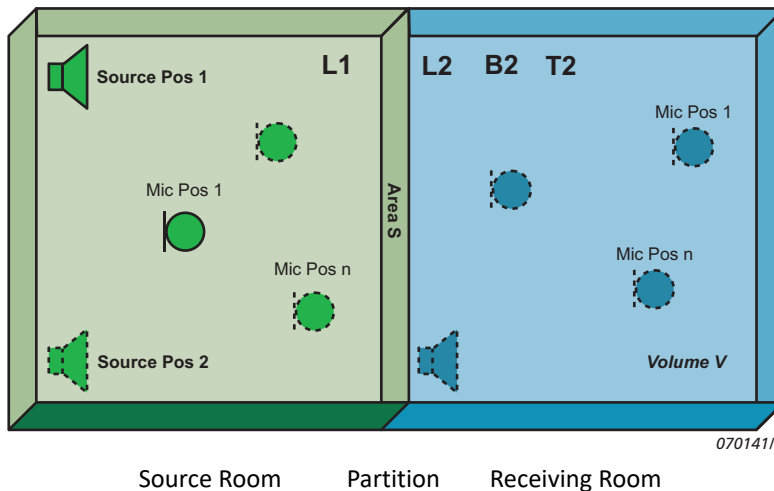

07014111

Fig. 17 shows a typical airborne task setup using a loudspeaker (emitting pink noise) and a number of microphone positions to measure the average source room spectrum L1, and the average receiving room spectrum L2. The average background noise spectrum B2 is measured to verify the true L2 spectrum. The average reverberation time spectrum T2 is measured, to correct for the amount of absorption in the receiving room. Finally the single number result (for example D_{nTW}) is calculated from the L1, L2, B2 and T2 spectra, and the result can then be compared with the minimum requirements stated in the building regulations.

The sound level depends on the position in the rooms, so several microphone positions are used to measure the average of the source room level, L1, the average of the receiving room level L2 and the average of the background noise level B2. The average reverberation time T2 is also measured using several positions.

Examples of measurements and results using Building Acoustics Software BZ-7228 are shown below.

Fig. 18
Examples of building acoustic measurements using Type 2250/2270:
Left: L2 average and L2 at one position;
Centre: Overview of measurements;
Right: Final result

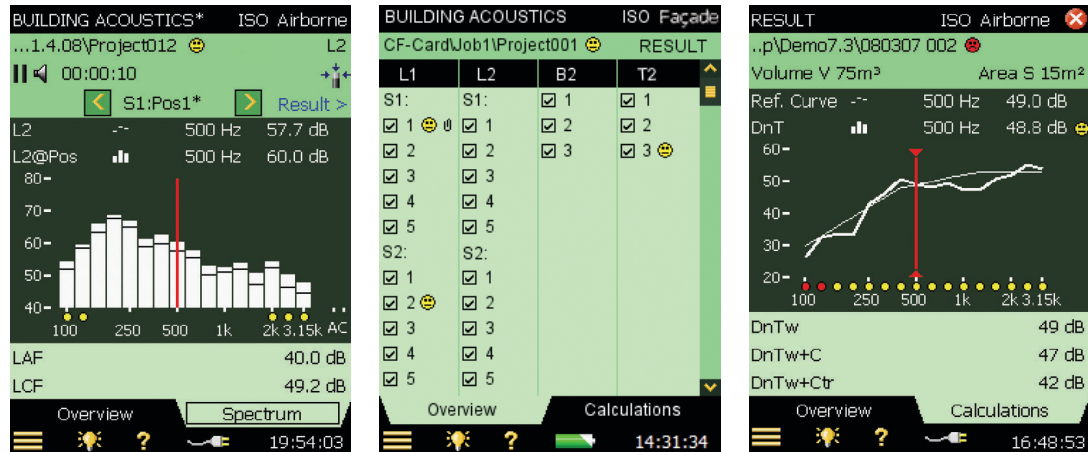

Façade Sound Insulation

Façade sound insulation is a variant of airborne sound insulation, with its own standards. The source room is the space outside the façade, and the sound source may be road traffic or a loudspeaker representing outdoor noise. When using traffic noise, the indoor and outdoor sound levels must be measured simultaneously, requiring dual-channel measurements (Type 2270). The outdoor microphone positions are flush with the façade, or 2 m in front of it. Calculations are similar to those of airborne sound insulation, but take the pressure increase at the microphone positions into account.

Impact Sound Insulation

Impact sound is typically caused by footsteps, and to measure impact sound insulation a standardised impact sound source (tapping machine) is placed in the source room. The receiving room levels are measured as for airborne sound insulation, with several positions of the tapping machine. Calculations are like those for airborne sound insulation, except the results represent absolute (not relative) levels.

Compliance with Environmental Standards for Type 4292-L

| | |
|--------------------|--|
| Temperature | IEC 60068-2-1 & IEC 60068-2-2: Environmental Testing. Cold and Dry Heat. Operating Temperature: +5 to +40 °C (+41 to 104 °F) Storage Temperature: –25 to +70 °C (–13 to +158 °F) IEC 60068-2-14: Change of Temperature: –10 to +40 °C (2 cycles, 1 °C/min.) |
| Humidity | IEC 60068-2-78: Damp Heat: 93% RH (non-condensing at +40 °C (+104 °F)) |
| Mechanical | Non-operating: IEC 60068-2-6: Vibration: 0.3 mm, 20 m/s ² , 10 – 500 Hz IEC 60068-2-27: Shock: 1000 m/s ² IEC 60068-2-29: Bump: 1000 bumps at 250 m/s ² |

STANDARDS

Conforms to the following:

- ISO 140-3
- ISO 3382
- DIN 52210

NOMINAL IMPEDANCE

6 Ω

POWER HANDLING

300 W continuous broadband
1000 W short duration (duty cycle 1/10, on time 10 s)

OPERATING FREQUENCY RANGE

50 – 5000 Hz (1/3-octave band centre frequencies)

CONNECTION

Four-pin Neutrik® Speakon® socket, pins 1+ and 1–

SOUND POWER LEVEL

(with Power Amplifier Type 2734, duty cycle 1/3, 100 – 3150 Hz pink-noise signal)

Broadband: 122 dB re 1 pW

Spectral: Min. 100 dB/1 pW in each 1/3-octave band

TRIPOD

Adjustable to give a speaker height of between 131 and 207 cm

FLOOR MOUNTING

Rubber feet provided for floor mounting

DIAMETER

Speaker Enclosure: 39 cm (15.35")

WEIGHT

Speaker Enclosure: 8.0 kg (17.6 lb)

Tripod: 2.3 kg (5.1 lb)

Compliance with Regulations and Environmental Standards for Type 3207

| | |
|--|--|
|  | CE-mark indicates compliance with: EMC Directive, Low Voltage Directive and Machinery Directive. C-Tick mark indicates compliance with the EMC requirements of Australia and New Zealand. |
| Safety | EN/IEC 61010-1 and UL 61010-1: Safety requirements for electrical equipment for measurement, control and laboratory use. |
| EMC Emission | EN/IEC 61000-6-3: Generic emission standard for residential, commercial and light-industrial environments. CISPR 22: Radio disturbance characteristics of information technology equipment. Class B limits. FCC Rules, Part 15: Complies with the limits for a Class B digital device. This ISM device complies with Canadian ICES–001. |
| EMC Immunity | EN/IEC 61000-6-2: Generic standards – Immunity for industrial environments. EN/IEC 61326: Electrical equipment for measurement, control and laboratory use – EMC requirements. NOTE: The above is only guaranteed using accessories listed in this document. |
| Temperature | IEC 60068-2-1 & IEC 60068-2-2: Environmental testing. Cold and dry heat. Operating Temperature: 0 to +40 °C (+32 to 104 °F) Storage Temperature: –25 to +70 °C (–13 to +158 °F) |
| Humidity | IEC 60068-2-78: Damp heat: 90% RH (non-condensing at +40 °C (+104 °F)) |
| Mechanical | Non-operating: IEC 60068-2-6: Vibration: 0.3 mm, 20 m/s ² , 10 – 500 Hz IEC 60068-2-27: Shock: 500 m/s ² , 6 directions IEC 60068-2-29: Bump: 1000 bumps at 250 m/s ² |
| Enclosure | IEC 60529: Protection provided by enclosures: IP 20 |

STANDARDS

- ISO 140
- ISO 717
- DIN 52210
- BS 5821
- ASTME 492

HAMMERS

Five in line, 100 mm between each hammer, single hammer weight 500±12 g

IMPACT FREQUENCY

Each hammer operates at 2 Hz, tapping frequency for unit is 10±0.5 Hz

IMPACT DYNAMICS

Equivalent free-fall height of hammers 40 mm, extra drop below impact plane at least 4 mm

REMOTE OPERATION

Socket: LEMO 4-pole

Pin 1: 0 V DC, GND

Pin 2: Power supply for external unit, max. 24 V DC, 1 A

Pin 3: For "On": +5 V DC (TTL-Level)

Pin 4: For "On": connect to Pin 1

Housing: Shield

BATTERY KIT UA-1477 (OPTIONAL)

Mounting Position: Internally in-unit housing

Battery Life: 1.5 hours

Battery Type: Maintenance free 12 V/2 Ah lead acid battery

Charger Type: Same as mains adaptor (see below)

Charging Time: 24 hours for a completely discharged battery

ON/OFF SWITCH

3 Positions: Remote, Off, On

MAINS ADAPTOR

10.5 – 35 V DC, min. 25 W

Socket: LEMO coaxial (can also be used as charging socket)

Middle Pin: +10.5 – 35 V DC, Outer ring: 0 V

Mains Adaptor: Mains Adaptor ZG-0429

100 – 240 V AC input, 24 V DC output, max. 45 W

Operating temperature max. +40 °C

Can also be used to charge optional battery pack

SUPPORTS

3 extendable and height adjustable feet

DIMENSIONS

W × H × D: 480 × 273 × 155 mm (18.9 × 10.7 × 6.1") – feet retracted

W × H × D: 590 × 273 × 285 mm (23.2 × 10.7 × 11.2") – feet extended

Weight: 11.5 kg (25 lb) with mains adaptor

MAINTENANCE REQUIREMENTS

After 24 h operation or once a year (whichever comes first), lubricate with the supplied sewing machine oil according to instructions

Specifications – Power Amplifier Types 2734-A and 2734-B

Compliance with Regulations and Environmental Standards for Type 2734

| | |
|--|--|
|  | CE-mark indicates compliance with: EMC Directive and Low Voltage Directive. C-Tick mark indicates compliance with the EMC requirements of Australia and New Zealand. |
| Safety | EN/IEC 61010-1 and ANSI/UL 61010-1: Safety requirements for electrical equipment for measurement, control and laboratory use. |
| EMC Emission | EN/IEC 61000-6-4: Generic emission standard for industrial environments. CISPR 22: Radio disturbance characteristics of information technology equipment. Class A Limits. FCC Rules, Part 15: Complies with the limits for a Class A digital device. |
| EMC Immunity | EN/IEC 61000-6-1: Generic standards – Immunity for residential, commercial and light-industrial environments. EN/IEC 61000-6-2: Generic standards - Immunity for industrial environments. EN/IEC 61326-1: Electrical equipment for measurement, control and laboratory use – EMC requirements. NOTE: The above is only guaranteed using accessories included in this document. |
| Temperature | IEC 60068-2-1 & IEC 60068-2-2: Environmental Testing. Cold and Dry Heat. Operating Temperature: 0 to +50 °C (+32 to 122 °F) Storage Temperature: 0 to +70 °C (+32 to 158 °F) |
| Humidity | IEC 60068-2-78: Damp Heat: 90% RH (non-condensing at +40 °C (+104 °F)) |
| Mechanical | Non-operating: IEC 60068-2-6: Vibration: 2 g _{rms} 3 × 20 min IEC 60068-2-27: Bump: 1000 bumps at 10 g, 6 directions IEC 60068-2-27: Shock: 70 g, 6 directions |
| Enclosure | IEC 60529 (1989): Protection provided by enclosures: IP 20 |

MAXIMUM OUTPUT POWER

(TA = 25 °C, 1 kHz, 0.1% THD)

4 Ω: 500 W

6 Ω: 330 W

8 Ω: 250 W

CONTINUOUS OUTPUT POWER (1 kHz, 6 Ω)

With Air Filter: TA = 25 °C: 250 W

Without Air Filter:

TA = 25 °C: 330 W

TA = 35 °C: 175 W

INPUT VOLTAGE

Nominal voltage @ Sensitivity =

0 dB: 0.3 V

-10 dB: 1 V

-20 dB: 3 V

Headroom at nominal input voltage

Balanced: 18 dB

Unbalanced @ Sensitivity =

0 dB: 17 dB

-10 dB: 15 dB

-20 dB: 12 dB

Common Mode Rejection (1 kHz): >50 dB

Maximum DC Voltage: ±25 V

INPUT IMPEDANCE

1 kHz:

Balanced: 20 kΩ ±1%

Unbalanced: 10 kΩ ±1%

DC:

Balanced: 220 kΩ ±1%

Unbalanced: 110 kΩ ±1%

OUTPUT VOLTAGE

Line Output Peak Voltage: 9 V

Power Output Peak Voltage: 80 V

Power Output DC Voltage: 40 V

OUTPUT IMPEDANCE (1 kHz)

Line Output: 100 Ω

Line Output Load: ≥0 Ω

Power Output: 10 mΩ

Power Output Load: ≥2 Ω

FREQUENCY RESPONSE (20 Hz – 20 kHz)

Line Output: +0, -1 dB

Power Output: ±1 dB

See also figure 1 below

SNR (MAX POWER 1 kHz)/(SILENCE 0...20 kHz)

Line Output: 101 dB

Power Output: 90 dB

THD+N (20 Hz – 20 kHz)

Line Output: 1 kHz: < -78 dB

Power Output: 1 – 500 W, 4 Ω: < -60 dB

SENSITIVITY, ATTENUATION AND GAIN

Sensitivity: -20, -10, 0 dB

Sensitivity Error (no error @ 0 dB): ±0.1 dB

Attenuation: -30, -24, -18, -12, -9, -6, -5, -4, -3, -2, -1, 0 dB

Attenuation Error (no error @ 0 dB): ±0.1 dB

Total Gain (Sensitivity = Attenuation = 0 dB):

Any Input to Line Output: 16 ±0.2 dB

Any Input to Power Output: 43.1 ±0.4 dB

LEVEL INDICATOR

Trigger levels re power output clip level

Red LED: +3 dB

Yellow LED: 0 dB (power output clip indicator)

Green LED: -6 dB

Blue LED: -30 dB (signal present indicator)

FAN

Switch On Heatsink Temperature: 40 °C

L_w at Min Speed: 25 dB re 1 pW

L_w at Max Speed: 52 dB re 1 pW

NOISE GENERATOR

Noise Types: white, pink

Frequency Range: 50 – 5000 Hz 1/3 octave bands

Crest Factor: 12 dB

Period Time: 22.5 s

Third Octave Spectral Error: ±0.3 dB

Line Output Voltage (Sensitivity = Attenuation = 0 dB): 2.16 V_{rms}

Switch Off: Equivalent RT in 1/3 octaves: <50 ms @ 50 Hz, <4 ms @ 5 kHz

CONNECTORS

Balanced Input Socket: Neutrik® Combo XLR-type: 3-pin and ¼" jack

Unbalanced Input Socket: BNC

Unbalanced Line Output Socket: BNC

Power (Speaker) Output Socket: Neutrik® 4-pole Speakon® type

Mains Power Inlet: IEC type

CONTROLS

Generator Button: Toggling between on and off

Generator Slide Switch: 2-state, white/pink noise sensitivity slide switch: 3-state, -20, -10, 0 dB

Attenuation Rotary Knob: 12-state, -30, -24, -18, -12, -9, -6, -5, -4, -3, -2, -1, 0 dB

Mains Power Rocker Switch: 2-pole

STATUS INDICATORS

Protect Indicator: Red LED, power output over-current, overheat, overload or long-term high frequency

Power On Indicator: Green LED

MAINS POWER

Voltage Selector (Rear Panel): 230/115 V

Mains Voltage Range:

@ 230 V: 200 – 240 V

@ 115 V: 100 – 125 V

Mains Frequency Range: 45 – 65 Hz

Fuse: Wickmann/Littlefuse series 215 (or 181)

@ 230 V: T 3.15 AH 250 V

@ 115 V: T 6.3 AH 125 V

Maximum Power Consumption: 650 W

MECHANICAL

Weight (including mains cord in lid):

Type 2734-A: 6.0 kg

Type 2734-B: 7.0 kg

Dimensions W × H × D: 330 × 130 × 310 mm (13 × 5.1 × 12")

TRANSMITTER AKG PT 450 (OPTIONAL)

Specifications from manufacturer's technical data

RF Carrier Frequency Ranges: 7 channels over 650 – 865 MHz

Modulation: FM

Audio Bandwidth: 35 to 20,000 Hz

THD (typical at rated deviation/1 kHz): <0.7%

S/N Ratio: 120 dB(A)

RF Output: 50 mW max. (ERP)

Battery Life:

1.5 V AA Dry Battery: 6 hours; 1.2 V NiMH, 2100 mAh AA size

Rechargeable Battery: 8 h

Size: 60 × 73.5 × 30 mm (2.4 × 2.9 × 1.2")

Net Weight: 90 g (3.2 oz)

RECEIVER AKG SR 450 (OPTIONAL)

Specifications from manufacturer's technical data

RF Carrier Frequency Ranges: 7 channels over 650 – 865 MHz

Modulation: FM

Audio Bandwidth: 35 to 20,000 Hz

THD at 1 kHz: <0.3%

S/N Ratio: 120 dB(A)

Audio Outputs: Balanced XLR and unbalanced TS 1/4" jack, balanced level switchable to -30 or 0 dBm

MECHANICAL

Dimensions: 200 × 44 × 190 mm (7.8 × 1.7 × 7.4")

Weight: 972 g (2.2 lb)

Fig. 1 Frequency Responses measured at a 0 dB output power of 300 W into 6 Ω up to 20 kHz and of 20 W up from 20 kHz

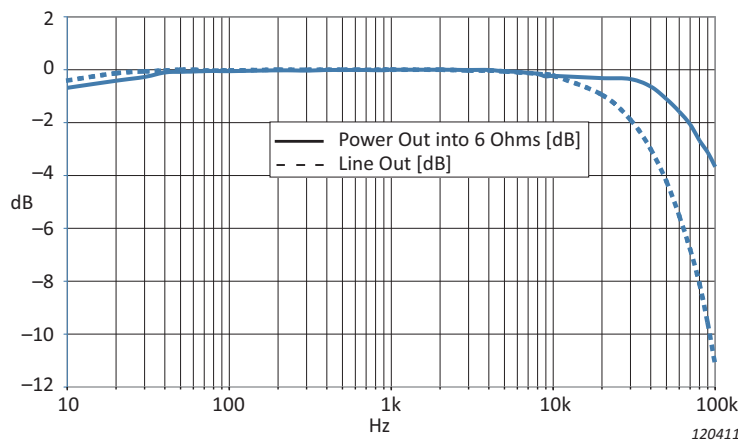

Type 4292-L OmniPower Sound Source

includes:

- KE-0462: Carrying Bag for Type 4292-L
- UA-1690: Tripod

Type 3207 Tapping Machine

includes:

- ZG-0429: Mains Adaptor (mains cable country-dependent)
- 2 Gauges for drop-height adjustment
- Oil canister for maintenance

System Components

POWER AMPLIFIER

- Type 2734-A Power Amplifier
- Type 2734-B Power Amplifier with built-in UL-0256 Wireless Audio System
- UL-0256 Wireless Audio System

HAND-HELD ANALYZER

- Type 2250-S Hand-held Analyzer with free-field microphone and preamplifier

includes following software:

- BZ-7222: Sound Level Meter Software
- BZ-7223: Frequency Analysis Software
- BZ-7231: Tone Assessment Option
- BZ-7232: Noise Monitoring Software

- Type 2270-S 2-channel Hand-held Analyzer with free-field microphone and preamplifier

includes following software:

- BZ-7222: Sound Level Meter Software
- BZ-7223: Frequency Analysis Software
- BZ-7231: Tone Assessment Option
- BZ-7232: Noise Monitoring Software
- BZ-7229: 2-channel Option

SOFTWARE AVAILABLE SEPARATELY

- BZ-7224 Logging Software (including memory card)
- BZ-7225 Enhanced Logging Software (including memory card)
- BZ-7226 Signal Recording Option
- BZ-7227 Reverberation Time Software
- BZ-7228 Building Acoustics Software

Accessories

- KE-0449 Flight Case for Type 4292-L
- KE-0364 Carrying Case for Type 4292 Tripod (UA-1690)
- UA-0801 Lightweight Tripod
- AO-0523 Signal cable from hand-held analyzer to Power Amplifier, 10 m (32.8 ft)
- AO-0524 Signal cable from hand-held analyzer to BNC, 10 m (32.8 ft)
- AQ-0673 Speaker cable from Type 2734 to Type 4292 or equivalent, 10 m (32.8 ft)

ACCESSORIES FOR TYPE 3207

- AQ-0633 Remote Cable connecting Type 3207 to Investigator Type 2260, 10 m (32.8 ft)
- UA-1477 Battery Kit
- QB-0055 Replacement Battery

Building Acoustics Kits

SINGLE-CHANNEL MEASUREMENTS

The following kits are designed to provide Types 2250 and 2270 users with the necessary accessories to perform single-channel building acoustics measurements:

- BZ-7228-200 Building Acoustics Kit for single-channel airborne sound insulation, including:
 - BZ-7228: Building Acoustics Software (includes Reverberation Time Software BZ-7227)
 - Type 2734-A: Power Amplifier
 - Type 4292-L: OmniPower Sound Source (tripod and carrying bag KE-0462 included)
 - AO-0523-D-100: Signal Cable, triaxial LEMO to XLR3M, 10 m (33 ft)
 - AQ-0673: Speaker Cable, speakON® 4-pin (M) to speakON 4-pin (M), 10 m (33 ft)
 - KE-0364: Carrying bag for Type 4292-L Tripod
 - UA-0801: Tripod for Type 2250

NOTE: Flight case KE-0449 for OmniPower sound source must be purchased separately

- BZ-7228-300 Building Acoustics Kit for single-channel airborne or impact sound insulation

includes the same items as BZ-7228-200 plus:

- Type 3207: Tapping Machine
- UA-1477: Battery Kit for Type 3207

TWO-CHANNEL MEASUREMENTS

ONLY Type 2270 users can upgrade a BZ-7228-200 or BZ-7228-300 kit to perform 2-channel building acoustics measurements with a combination the following accessories, depending on your measurement scenario:

- BZ-7229: 2-Channel Option
- Type 4189: Prepolarized Free-field ½" Microphone
- AO-0697-D-100: Microphone Extension Cable, 10-pin LEMO, 10 m (33 ft)
- AR-0199: Flat Cable, 10-pin LEMO, 0.5 m (1.64 ft)
- JP-1041: Dual 10-pole Adaptor Cable
- UA-0801: Lightweight Tripod
- UA-1317: ½" Microphone Holder
- ZC-0032: Microphone Preamplifier

For help determining the type and quantity of required accessories, please contact your local Brüel & Kjær sales representative

Go to www.bksv.com for more information on [Types 2250 and 2270](#) and Brüel & Kjær's [Building Acoustics](#) applications.

