



From lab to production,
providing a window into the process



ViscoSensor Melt Rheometer

Operating Manual

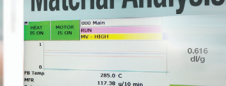
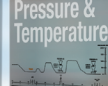

Contents

- 1 SAFETY INSTRUCTIONS
 - 1.1 Warnings and Danger Symbols
 - 1.2 Safety summary
 - 1.2.1 Keep away from live circuits
 - 1.2.2 Wear protective clothing
 - 1.2.3 Provide adequate ventilation
 - 1.2.4 Avoid hot surfaces
 - 1.3 Obligation of the operator to exercise due care
 - 1.4 Obligation of the personnel to exercise due care
 - 1.5 IMPORTANT INTRINSICALLY SAFE INFORMATION
- 2 SYSTEM DESCRIPTION
 - 2.1 ViscoSensor Control Unit
 - 2.2 ViscoSensor
 - 2.3 Field Wiring
 - 2.4 Equipment List
 - 2.5 Equipment required – but not supplied
 - 2.6 General Specifications
 - 2.6.1 System Power Requirements
 - 2.6.2 ViscoSensor Rheometer
 - 2.6.3 ViscoSensor Control Unit
 - 2.6.4 Physical Characteristics
- 3 THEORY OF OPERATION
 - 3.1 Introduction
 - 3.2 Measurement of Melt Flow Rate
 - 3.3 Measurement of Melt Viscosity
- 4 TYPICAL VISCOSENSOR OPERATION
 - 4.1 Local operation – operating the ViscoSensor from the HMI
 - 4.2 Remote operation
- 5 TRANSPORTATION AND UNPACKING THE EQUIPMENT
- 6 INSTALLATION
 - 6.1 Introduction
 - 6.2 ViscoSensor Control Unit
 - 6.3 ViscoSensor Installation
 - 6.4 Interconnecting Field Wiring
 - 6.5 PIV Skin Temperature Controller Setup (if option purchased)
 - 6.6 Grounding
 - 6.7 VCU Purging System (if option purchased)
- 7 OPERATION
 - 7.1 Introduction
 - 7.2 Software operation
 - 7.2.1 Timing
 - 7.2.2 Alarm/Fault Logic
 - 7.2.3 WARNINGS

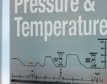

- 7.2.4 FAULTS
- 7.2.5 CPU OK Indicator
- 7.3 Hardware description
 - 7.3.1 AC Power Protection
 - 7.3.2 AC Power Relays
 - 7.3.3 Power Supplies
 - 7.3.4 Microprocessor/PLC Module (CPU)
 - 7.3.5 Analog Signal Conditioning
 - 7.3.6 Digital Signal Conditioning
 - 7.3.7 PLC Relays
 - 7.3.8 Temperature Indication and Control
 - 7.3.9 Motor Indication And Control
 - 7.3.10 Hardware Interlocks
 - 7.3.11 VCU Parts List
 - 7.3.12 PLC MODULE LIST
 - 7.3.13 PLC DIGITAL I/O
 - 7.3.14 PLC RELAY LIST
- 8 HUMAN MACHINE INTERFACE (HMI)
 - 8.1 Introduction
 - 8.2 Environmental considerations
 - 8.3 Security and Change Privileges
 - 8.4 Screens
 - Start-up Screen
 - 8.4.1 Main Screens (000)
 - 8.4.2 Menu Screens (100, 200, 300)
 - 8.4.3 Process Setpoints (110)
 - 8.4.4 Equation Constants (120-123)
 - 8.4.5 Operator Setup (130-138)
 - 8.4.6 Recipes (140)
 - 8.4.7 Process Status (150)
 - 8.4.8 Equation Results (160)
 - 8.4.9 Alarm Status (screens 170-172)
 - 8.4.10 Trending Graphs (180-196)
 - 8.4.11 Temperature Calibration (210)
 - 8.4.12 Pressure Calibration (220-222, 230-232)
 - 8.4.13 Analog I/O Calibration (240-245)
 - 8.4.14 Machine Configuration (250-259, 25A, 25B, 25C)
 - 8.4.15 Manual Purge (260)
 - 8.4.16 Shear Sweep (261)
 - 8.4.17 Error Log (270-272)
 - 8.4.18 Diagnostics (340-348)
 - 8.4.19 IO STATUS (310)
 - 8.4.20 Machine Hours (330)
 - 8.4.21 Setup IP Addr (320)

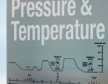

- 8.5 Local Display System Operations
- 8.6 Display Contrast
- 8.7 Touch Screen Calibration
- 8.8 Resetting Display Systems Data
- 8.9 Range Checking
- 9 VISCOSENSOR RHEOMETER
 - 9.1 Introduction
 - 9.2 General Operation
 - 9.2.1 Pressure Measurement System
 - 9.2.2 Speed Measurement System
 - 9.2.3 Motor Speed Control System - Pressure Control Loop
 - 9.2.4 Motor Speed Control System - Speed Control Loop
 - 9.2.5 Temperature Control System
 - 9.3 Process Isolation Valve (PIV)
- 10 MAINTENANCE
 - 10.1 Anti-Seize Compound
 - 10.2 Capillary Removal / Replacement
 - 10.2.1 Capillary Removal
 - 10.2.2 Installing Capillary
 - 10.3 Transducer Removal
 - 10.4 Transducer Installation
 - 10.5 Introduction
 - 10.6 Equipment required to calibrate system
 - 10.7 Pressure transducer calibration
 - 10.7.1 Changing Transducer Range
 - 10.7.2 Automatic Pressure Calibration
 - 10.7.3 Transducer Low-End Sensitivity
 - 10.8 Stripchart Output Level Test
 - 10.9 Temperature Calibration
- 11 CPU
 - 11.1 CPU Indicators
 - 11.2 CPU Switch Position Meaning Description
 - 11.3 CPU Memory Reset
 - 11.4 Memory card installation







1 SAFETY INSTRUCTIONS

All safety instructions must be heeded and observed. Non-observance of safety instructions may cause damage to life and health of persons, environmental damage and/or extensive damage to property. Observing the safety instructions included in the operating instructions will help to avoid dangers, to operate the installation profitably and to secure the full use of the product.

1.1 Warnings and Danger Symbols

General safety instructions concerning the activities are given at the beginning of the relevant chapter. Special safety instructions concerning the individual steps of action will be given together with the corresponding step of action.

The following pictographs are used in the present operating instructions

 Danger	<ul style="list-style-type: none"> This symbol indicates that death, serious bodily injuries or considerable damage to property will occur if the corresponding safety measures are not observed!
 Warning	<ul style="list-style-type: none"> This symbol indicates that death, serious bodily injuries or considerable damage to property may occur if the corresponding safety measures are not observed!
 Caution	<ul style="list-style-type: none"> This symbol indicates that death, minor bodily injuries or minor damage to property may occur if the corresponding safety measures are not observed!
	<ul style="list-style-type: none"> This symbol indicates that special danger to the life and health of persons will be given due to electric potential!
	<ul style="list-style-type: none"> This symbol indicates that special danger to the life and health of persons will be given due to hot surfaces!
	<ul style="list-style-type: none"> This symbol indicates that sufficient personal protective equipment must be worn when working with the Dynisco component. The type of personal protective equipment will be defined in detail!
	<ul style="list-style-type: none"> This symbol signals user hints and other special information, which may be useful. This symbol does not signalise safety instructions!

Please also note that a safety symbol may never substitute the text of a safety instruction - therefore, the text of a safety instruction must always be read completely!

1.2 Safety summary

The following are recommended safety precautions unrelated to any specific procedures in this manual and therefore do not appear elsewhere. Personnel must understand and apply them as appropriate during all phases of operation and maintenance. IN ALL CASES, BE PRUDENT.

1.2.1 Keep away from live circuits

	<p>Do not replace components or make adjustments inside equipment with power turned on. To avoid injuries, always remove power and discharge and ground a circuit before touching it. When making electrical connections, the services of a qualified electrician must be employed. Contact with live electrical circuits can cause serious personal injury or death. Be sure no circuits are energized during installation, connection or removal of any electrical cables or lines.</p>
---	---

1.2.2 Wear protective clothing

	<p>Wear protective clothing (gloves, apron, goggles, etc.) approved for the materials and tools being used.</p>
--	---

1.2.3 Provide adequate ventilation

 <p>Warning</p>	<p>Provide ventilation to remove heat and noxious odors and to prevent the accumulation of asphyxiates such as nitrogen gas.</p>
--	--

1.2.4 Avoid hot surfaces

	<p>Keep hands away from hot surfaces and materials. Contact with hot surfaces or materials can cause blistering and third degree burns. Wear approved, clean, thermally insulated gloves when handling these components. Should injury occur; immerse injured area in cold water and get immediate medical attention.</p>
---	---



1.3 Obligation of the operator to exercise due care

The ViscoSensor melt rheometer D9070 was planned and constructed taking into consideration a hazard analysis and after having carefully selected the harmonised standards as well as further technical specifications. Thus, the Dynisco component conforms to the state of the art technology and ensures a maximum of safety.

In practical operation, this safety can, however, be achieved only if all necessary measures are taken. The obligation of the plant operator to exercise due care includes planning these measures and supervising their execution.

Especially, the operator has to ensure that

- The Dynisco component will be used only in accordance with the intended purpose.
- The Dynisco component will be operated in a flawless, functionally efficient condition and that, in particular, the functional efficiency of the safety devices will be checked at regular intervals.
- The necessary personal protective equipment for the operating, maintenance, and service personnel will be available and used by them.
- The operating instructions are always available completely and fully legibly at the installation location of the Dynisco component. It must be guaranteed that all persons who have to work with the Dynisco component can consult the operating instructions at any time.
- Only sufficiently qualified and authorized personnel will operate, maintain, and repair the Dynisco component.
- Instructions concerning all relevant questions of industrial safety and environmental protection will regularly be given to the personnel, and that these persons will know and understand the operating instructions and, particularly, the safety instructions contained.
- All safety and warning instructions, attached to the Dynisco component, will not be removed and will remain fully legible.
- The service instructions in accordance with the industrial safety legislation and the ordinance for the use of work materials will have to be made available as a supplement to the operating instructions.

1.4 Obligation of the personnel to exercise due care

The ViscoSensor melt rheometer D9070 may only be operated by persons trained, instructed and authorized to do so. These persons must know the operating instructions and act accordingly. The respective competences of the staff must be clearly determined.

The following work described in the operating instructions may be carried out by qualified persons only:

- Assembly
- Start-Up
- Operation
- Servicing

Especially, the staff has to ensure that

- Operating personnel to be instructed at first only works with the Dynisco component and/or if supervised by an experienced person.
- All persons operating and maintaining the Dynisco component read the operating instructions and confirm by their signature that they understood the operating instructions.



- Unauthorized persons do not stay in the working area of the Dynisco component.
- The working area will be left only if all movable parts have come to a stop after having switched off the Dynisco component.
- Additionally to the operating instructions, the service instructions within the meaning of the industrial safety legislation and the ordinance for the use of work materials will be observed.
- In case of malfunctions, the operator or the supervisors will be informed.
- The necessary personal protective equipment for the operating, maintenance, and service personnel will be used.

1.5 IMPORTANT INTRINSICALLY SAFE INFORMATION

This information is specifically for equipment supplied to meet the requirements of Class 1, Division 2, Groups C & D.

WARNING: EXPLOSION HAZARD—SUBSTITUTION OF COMPONENTS MAY IMPAIR SUITABILITY FOR CLASS I, DIVISION 2, GROUPS C & D RATING.

If the RCU cabinet is equipped with a BEBCO EPS cabinet purge system. The requirements for this purge system are:

Operating Temperature: -20°F to 120°F (-30°C to 50°C)

Operating Pressure: 80 PSI to 120 PSI Maximum

Capacity & Filtration: 3.8 Oz. @ 40 Microns

Gas Supply: Clean Air or Inert Gas

Exchange Pressure: 3" to 5"

Exchange Flow Rate: 10 SCFM

Exchange Time: 1 Minutes per each 2.5 Cubic Feet (RCU cabinet is 7.3 ft3)

NOTE: A minimum purge time of 5 minutes is recommended before operation

There are no switching components in the rheometer head, therefore no purge is required, but it is recommended for cooling.

If the cabinet seal is broken, the control system will detect this failure, shut the control outputs off and set an alarm. The alarm should be wired to an external alarm system that is located in a constantly occupied area. The temperature of the incoming material must not exceed 350°C (660°F).

2 SYSTEM DESCRIPTION

The DYNISCO POLYMER TEST On-Line ViscoSensor is a PLC based rheometer designed specifically for the polymer process industry to make rheological measurements on the general class of thermoflow polymers, blends and variations as well as other thermoflow materials.

The ViscoSensor performs capillary rheology at a test temperature on a small sample stream of polymer melt taken from the process extruder. Extruder pressure is required to feed the ViscoSensor metering pump. The ViscoSensor uses a "stacked" or two- section metering pump. The first section of the metering pump controls the flow rate through the test capillary and two pressure transducers measure the capillary pressure drop. The section of the metering pumps returns the polymer to the process extruder The ViscoSensor can

be set up to provide a constant pressure test (ASTM) measuring flow rate to calculate “Melt Flow” units, or the ViscoSensor can be set up to provide a constant flow rate test, measure pressure drop across a capillary and calculate “Viscosity” units.

FIGURE 1 – ViscoSensor Flow Diagram

2.1

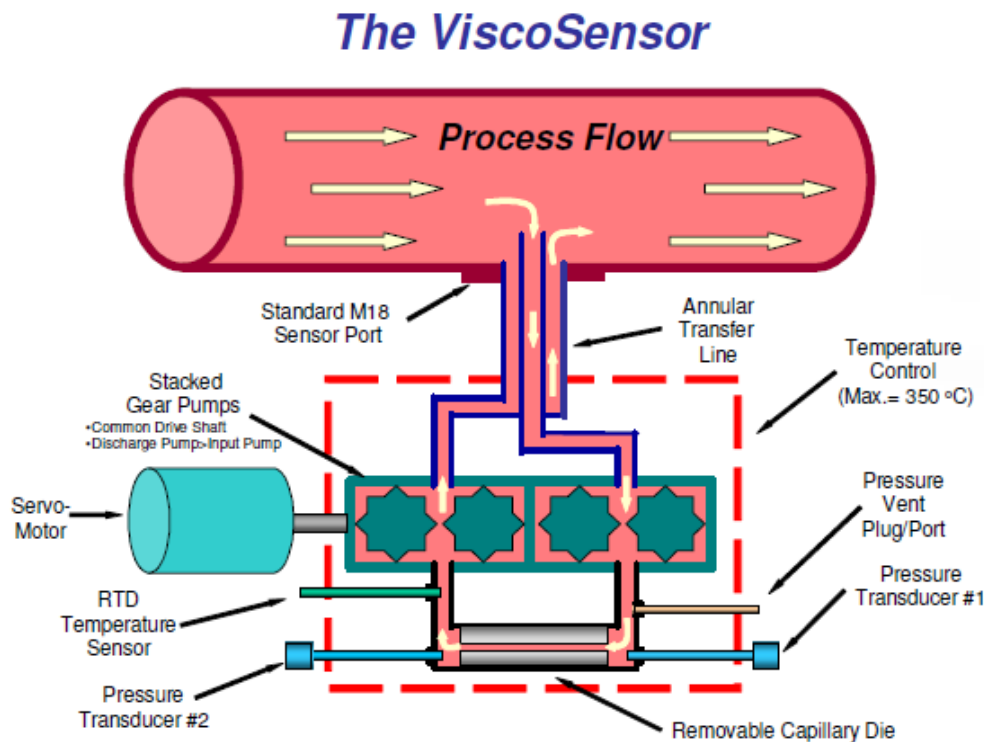

ViscoSensor Control Unit

The ViscoSensor Control Unit (VCU) contains the control and display components of the ViscoSensor. It is comprised of the PLC, power supplies, and logic control circuitry to drive the ViscoSensor. The VCU also provides analog output signals. The VCU is designed to operate in a non-hazardous location or, with appropriate purge equipment, in a classified area.

2.2 ViscoSensor

The ViscoSensor contains the flow producing and flow measurement components of the ViscoSensor. It is comprised of the positive displacement metering pump, variable speed DC motor, pressure transducer, capillary, temperature sensors and heaters. The ViscoSensor must be close-coupled to the customer's polymer melt source.

2.3 Field Wiring

Customer provided field wiring connects the VCU to the ViscoSensor and the analog and digital signals to the remote process computer. The field wiring is provided by the customer unless otherwise specified.



2.4 Equipment List

Because of the system options available, the customer should refer to his/her purchase order for the particular configuration and accessories. However, the following items are part of the standard DYNISCO Polymer Test ViscoSensor system:

- Orifices
- Orifice removal tool

2.5 Equipment required – but not supplied

The two pieces of equipment required for calibration of the ViscoSensor are a dead weight tester, with sufficient range to cover the pressure of interest, and a temperature simulator. Trouble shooting routines will isolate to the module level and should require only a multimeter.

2.6 General Specifications

2.6.1 System Power Requirements

230VAC (refer to field wiring diagram) 50/60Hz, 1 phase
2400 watt heat-up 1200 watt nominal (Wattage rating is dependent upon an auxillary heater not exceeding 150 Watts).

2.6.2 ViscoSensor Rheometer

Melt Flow Rate	:	0.02 to 1500 g/10mins
Viscosity	:	10 to 10 ⁵ Pa-Sec
Shear Stress	:	3 to 80 X10 ⁵ Pa
Shear Rate	:	1 to 4000 sec ⁻¹ (with standard dies)
Capillary Dies	:	1 to 5 mm (std), L/D = 10 to 40
Temperature	:	40 to 350°C
Temperature Probes - Melt Temperature:		100Ω RTD (0.385α) optional sample transfer line: 100Ω RTD (0.385α)
Pressure Transducer	:	2 X 3000 PSI Combined Error: 0.5% Full Scale Output (FSO) Repeatability: 0.1% FSO
Pressure Range	:	2 X 10 ⁵ to 3.5 X 10 ⁷ Pa (30 to 5000 PSI)
Metering Pump	:	0.3 cc/rev (standard), 0.650 cc/rev optional
Gear reducer	:	23.95:1 ratio
Heaters	:	600 watts Capillary/Melt Zone Varies for PIV Specified (600 Watts for standard)
Motor	:	Servomotor with resolver feedback
Pump Speed	:	0.5 to 80 RPM



2.6.3 ViscoSensor Control Unit

Analog Output Signals 4-20 mA DC – maximum load 650W

- 7 output channels available
- User selectable from a list that includes
 - MFR
 - Viscosity
 - pump speed
 - melt temperature
 - PIV temperature
 - Pressure

- Each output is individually scalable

Analog Input Signals 4-20 mA DC – remote sourced

- 2 input channels available
- User selectable from a list that includes
 - Pressure
 - Speed
 - Temperature

- Each input is individually scalable

Digital Output Signals – Nine Dry contact relays

- 24 VDC 2 A maximum
- System Fault Alarm (contacts open for an alarm condition)
- Warning signal (contacts open for a warning condition)
- Local/Remote operation (contacts open while controlling from the Local HMI)
- Pump Status (contacts open while pump is OFF)
- Material Status (contacts open when material is out of range)
- Recipe 1-4 Active (contacts close when recipe is selected)

Digital Input Signals – Seven Relay coils

- 24 VDC 10 mA
- 1 second software de-bounce
- Remote Heat ON/OFF (energize to enable the heat)
- Remote Motor/Start ON/OFF (energize to enable the motor and heat)
- Remote Mode Pressure/Speed (energize for pressure mode)
- Remote Recipe Select (1-4) (energize to select recipe)

2.6.4 Physical Characteristics

See enclosed drawings.

3 THEORY OF OPERATION

3.1 Introduction

Melt viscosity and melt flow rate (MFR) measurements provide one of the most used specifications for polymers and plastics. As they are related to the molecular properties of the polymers, these data provide the user with a measure of the physical properties of the polymer as well as its processability.

The Dynisco Polymer Test “ViscoSensor” has been developed to provide continuous “real time” measurements of melt viscosity and/or melt flow rate to the resin producer, compounder, or plastics processor. For simplicity in interfacing with processing machinery, this “zero discharge” on-line rheometer is designed to be mounted through standard types of instrumentation ports. The functional goal of this instrument is to provide a simple, reliable, and low cost solution to monitoring the flow properties of molten polymers for both quality and process control.

A schematic drawing of the ViscoSensor is shown in Figure 2. When it is mounted into a process stream, molten polymer flows into the instrument through the central tube of the annular melt transfer line. This tube protrudes into the stream to collect flowing material away from the more stagnant wall region. In the standard transfer line design a pressure of about 1000 psi (68 bar), for a 1.0 melt flow resin, is required to adequately feed the stacked melt pump. (Lower viscosity materials require lower process pressure.)

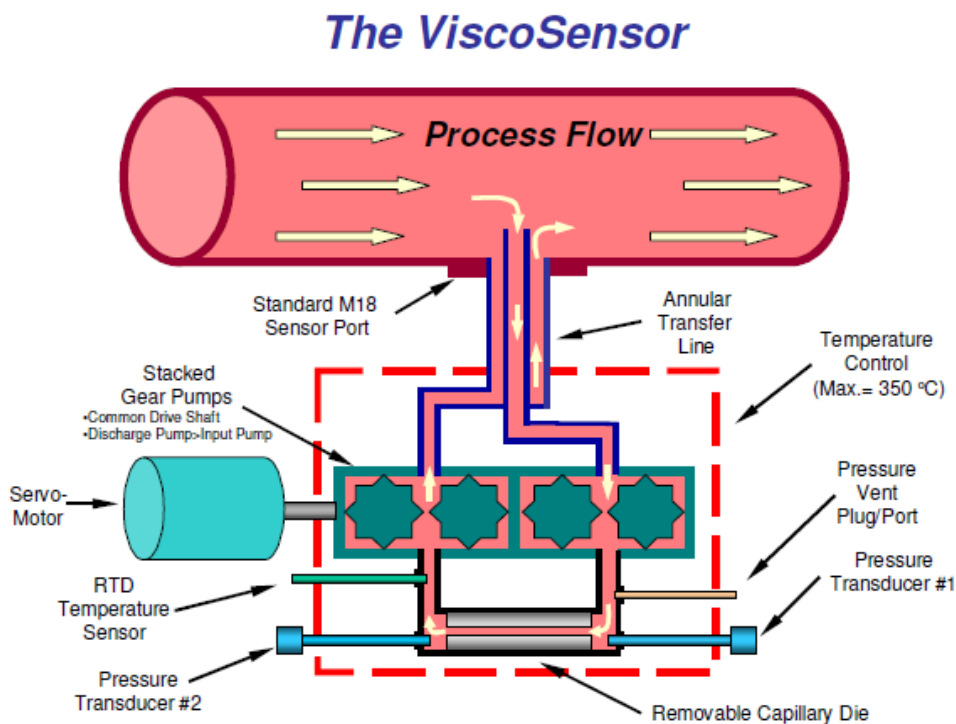

FIGURE 2 – ViscoSensor Flow Diagram

The molten polymer is fed into and pumped through a capillary die by the first of a pair of stacked melt pumps, driven by a single servo motor. This pump accurately controls the rate of polymer flow through the capillary die. The temperature in the system is controlled, to $\pm 0.2^{\circ}\text{C}$, by two cartridge heaters mounted in the die block. These heaters are controlled from an RTD directly immersed in the molten polymer. After passing through the capillary die the molten polymer is returned to the process, through the outer tube of the transfer line, by the second of the stacked melt pumps. Two melt pressure transducers are used to measure the pressure drop that occurs as the polymer flows through the capillary. The rpm of the pump and the pressure drop across the capillary are used, together with the die geometry, to determine the viscosity or the melt flow rate.

3.2 Measurement of Melt Flow Rate

The melt flow rate (MFR) is generally measured in the laboratory on a melt index tester similar to that shown below. The geometry of the instrument and die, temperature and weight accuracy requirements (shown in Figure 3) plus test conditions for many polymers are specified in the ASTM Test Method D-1238 and ISO 1133.

Laboratory Melt Indexer

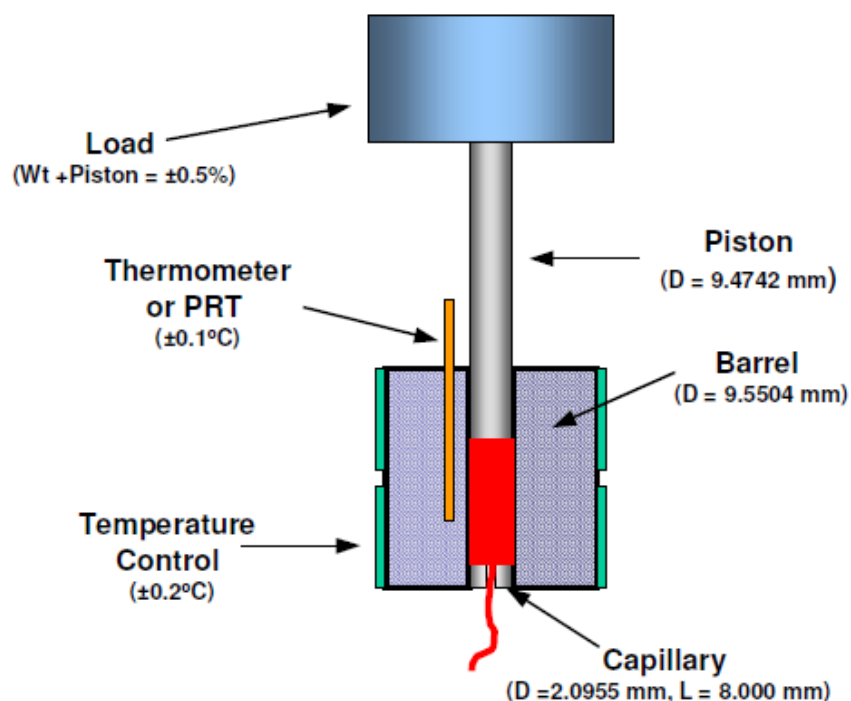

FIGURE 3 – Laboratory Melt Indexer

For the ASTM melt-flow rate test, a weighed sample of polymer is poured into the heated barrel of the instrument, which contains a standard MFR die. With the piston in place, the sample is heated for a specified melt time. A specified weight is then applied to the piston and molten polymer is allowed to extrude through the die. As the piston passes through a defined position in the barrel, samples of extruded polymer are collected over a fixed period. These samples are then weighed and the grams extruded in 10 minutes, the melt flow rate, are calculated.

The ViscoSensor can be configured to simulate the operation of the laboratory melt-flow indexer and produce continuous measurements of melt flow rate during a manufacturing process. To accomplish this, the system is configured to operate in a mode where the pressure is held constant while the flow rate of the polymer is measured. This configuration is illustrated in the Figure 4 below.

Direct MFR Mode ViscoSensor Configuration

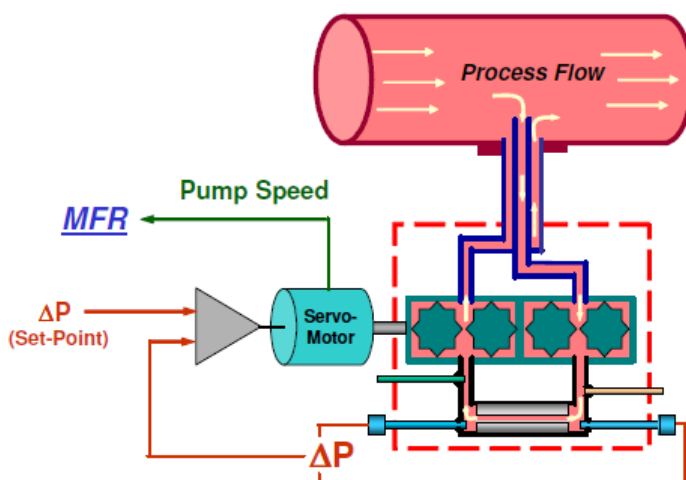

FIGURE 4 – ViscoSensor Direct MFR Mode

In ASTM D-1238 the shear stress on the melt is specified by the system geometry and the weight used in a test. When the ViscoSensor is run in the direct MFR mode the shear stress on the melt is controlled to the value specified in the ASTM test procedure. The capillary used in the ViscoSensor may or may not have the same dimensions as those specified in the standard test method. Thus, it is necessary to calculate the set point pressure drop required to obtain the correct shear stress condition. This is done in the following manner:

The shear stress at the capillary wall (τ_w) is defined as:

$$\tau_w = \frac{\Delta P D_c}{4 L_c} = \frac{\Delta P}{4(L_c/D_c)}$$



Where: Dc = capillary diameter

Lc = capillary length

DP= pressure drop across the capillary

Since the shear stress is defined by the ASTM test protocol, the pressure needed to obtain the required value can be calculated from the following:

$$\Delta P = 4\tau_{w,ASTM} \left(\frac{L_c}{D_c} \right)$$

Where $\tau_{w,ASTM}$ is the test specified shear stress. The table below shows the shear stresses generated by several of the standard weights used in the laboratory test.

Shear Stresses in ASTM D-1238 Tests

Test Load (weight + piston) (g)	Shear Stress (psi)	Shear Stress (Mpa)
325	0.4256	2.932
1050	1.3750	9.474
1200	1.5714	10.827
2160	2.8318	19.511
3800	4.9762	34.286
5000	6.5476	45.113
10000	13.0952	90.226
12500	16.3690	114.256
21600	28.318	195.11

Thus for a test condition using the 2160 g weight and the standard L/D = 3.818 die, the pressure required will be 43.25 psi.

Example:

If we use a die with an L/D = 15 the required pressure will be

$$DP = 4 (2.8318 \text{ psi}) (15) = 169.9 \text{ psi.}$$

This pressure is then used as the set point pressure to be maintained by the system as it is run at the specified test temperature. The melt pump is then run at the rate required to maintain this pressure drop across the die. The rpm of the pump, the volume flow/rev of the pump, plus the melt density of the polymer (at the test temperature) are used to determine the weight of polymer extruded per unit time.

This data are entered into the equation shown below to calculate the melt flow rate in units of grams/10 minutes.



Direct MFR Mode

(System run under pressure control)

Melt Flow Rate (g/10 min.) =

$$MFR = 10 V S d (C) \left[\frac{2.0955 \text{ mm}}{D} \right]^3$$

Where:

V=Pump volume (cc/rev)

S=Pump speed (rpm)

d=Polymer melt density (g/cc)

D=Capillary diameter used (mm)

C=Correlation factor

Example:

If, when the pump volume = 0.3 cc/rev, the capillary diameter = 2.0mm and the melt density at the test temperature = 0.76 g/cc, a pump speed of 7.43 rpm is required to maintain a constant pressure of 169.9 psi, then

$$MFR = 10 (0.3 \text{ cc/rev}) (7.43 \text{ rev/min}) (0.76 \text{ g/cc}) (1) (2.0955 \text{ mm} / 2.0 \text{ mm}) = 17.75 \text{ g} / 10 \text{ min.}$$

The standard melt indexer uses a very short capillary (8.00 mm) with an L/D of 3.818 and a flat die entrance. This type of geometry emphasizes the contribution of any elasticity that may exist in the melt. This elasticity may strongly affect the melt flow rate, resulting in two materials with the same MFR having much different viscosities and elasticities. This may also affect the measurements made by the ViscoSensor, especially when a die of greater L/D is used. In addition, whereas the melt is forced to flow by a more or less static load in the lab melt indexer, the melt pump in the ViscoSensor introduces a dynamic deformation of the material. Elastic elements or polymer “memory” may cause this deformation to produce in differences in melt flow, from those measured in the lab test, and thus the MFR. For this reason, we recommend that the lab melt indexer be used periodically to audit ViscoSensor measurements when it is monitoring the MFR for QA purposes. To utilize this audit, we include a correlation factor (C) in the above equation, which corrects for deviations from the laboratory measurements due to the factor as discussed above. The correlation factor is defined as the ratio

$$C = \frac{(MFR)_{Lab}}{(MFR)_{VS}}$$

This correlation factor should be checked periodically when a single material is being run and whenever there is a product change, especially for materials with significant viscoelasticity.

Example:

If, for the example shown above, the laboratory obtains an MFR value of 18.00 g/10 minutes then

$$C = (18.00) / (17.75) = 1.04$$

When this value for C is entered into the equation, the MFR is corrected to the laboratory value.

Viscosity Mode

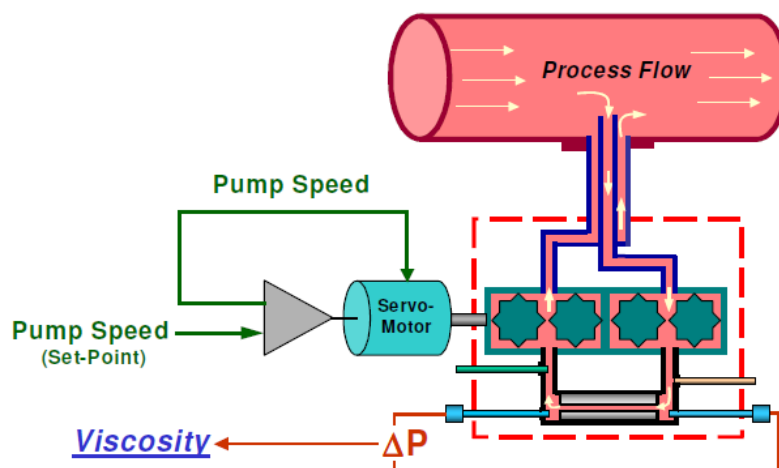

FIGURE 5 – ViscoSensor Viscosity Mode

3.3 Measurement of Melt Viscosity

In the viscosity mode of operation the ViscoSensor is configured to run with the melt pump controlled at a constant speed. The pressure drop across the capillary, measured by two melt pressure transducers, is logged as the independent variable. The speed of the motor, the volume/rev of the melt pump and the die diameter are used to calculate the shear rate from the relationship:

$$\text{Shear rate (sec}^{-1}\text{)} = \dot{\gamma} = \frac{169.76 V S}{D^3}$$

Where: V= Pump volume (cc/rev)

S= Pump speed (rpm)

D= Capillary diameter (mm).

The shear stress is calculated from the pressure drop across the capillary die and the die geometry using the equation



$$\text{Shear stress (Pa)} = \tau_w = \frac{\Delta P}{4(L/D)} = \frac{1723 .69 (\Delta P)}{(L/D)}$$

Where: DP = Pressure drop (psi)
D = Capillary diameter (mm)
L = Capillary length (mm)
Since the viscosity is defined as

$$\eta_a = \frac{\text{Shear stress}}{\text{Shear rate}} = \frac{\tau_w}{\dot{\gamma}}$$

We can develop the relationship shown below.

Viscosity Mode

(System run under rate control)

Apparent Viscosity (Pa-s) =

$$\eta_a = \frac{10.15(\Delta P)D^3}{V S(L/D)}$$

Where:

V= Pump volume (cc/rev)
S= Pump speed (rpm)
 $\Delta P = P_2 - P_1$ = Pressure drop
across capillary (psi).
D= Capillary diameter (mm)
L= Capillary length (mm)

Example:

If V = 0.3 cc / rev, D = 2.0 mm, L = 30.0 mm and operating the pump at a rate of 30 rpm produces a DP of 550 psi, then:

Shear rate = $169.76(0.3)(30) / (2)^3 = 191 \text{ sec}^{-1}$

Viscosity = $10.15(550)(2)^3 / (0.3)(30)(15) = 331 \text{ Pa-s}$



4 TYPICAL VISCOSENSOR OPERATION

This portion of the manual provides information on how to operate the ViscoSensor. NOTE: Any special operations or special sequences will be discussed in the CLIENT SPECIFIC SUPPLEMENT. Review Section 8 on the Local Operator Display for information on each display screen.

4.1 Local operation – operating the ViscoSensor from the HMI

Heat ON

1. Apply power to the VCU control cabinet. Allow the Dynisco startup screen to appear. The 000 MAIN operator screen appears after a few seconds.
2. Press the “Heat is OFF” button. The button will change to “Heat is ON” if no fault conditions are preventing the heat from being enabled. After 2 to 3 minutes, the indicated temperature should start to climb. Change the temperature setpoint in the 110 Setpoints screen.
3. Ensure polymer vent plug is open at least 2 turns.
4. While the ViscoSensor is heating to the test temperature, review the test parameters. These parameters are listed on the SETUP SCREEN and in the Local Operator display section of this manual.

Heat OFF

1. Press the “Heat is ON” button. The button will change to “Heat is OFF”

OPEN POLYMER VENT 2 TURNS

Motor ON

1. Install the test capillary as below and shown in section 5 of this manual.
2. Depending on what test is needed, pressure (MFR) or speed (viscosity) control, select that mode on the 110 Setpoints screen. Confirm that the Pressure setpoint and Speed setpoints show the correct setpoint.
3. Make sure the pressure relief valve is CLOSED (Figure 6).
4. On the Pressure Calibration screen, confirm that the calibration method field shows “Automatic”. If the calibration method is not “Automatic”, perform the pressure transducer calibration given in the Calibration section of this manual.
5. The heat must be on and at temperature. Press the “Motor is OFF” button. The button will change to “Motor is ON”. Change the speed setpoint in the Setpoint screen.
6. Verify that the pump speed and pressure slowly increases to the setpoint.
7. Depending on the required test, speed or pressure, the speed or pressure should settle at the appropriate setpoint. For most MFR tests, the mode of operation is PRESSURE and the pressure set point is 43.2 PSI.
8. Verify that the indicated pressure is within the pressure transducer’s nominal range (between 10% and 90% of full scale range).

Motor OFF

1. Press the “Motor is ON” button. The button will change to “Motor is OFF”.

IMPORTANT! If the rheometer will remain at the test temperature, it is not necessary to open the polymer vent valve.

4.2 Remote operation

(As selected from the local display)

Heat ON

1. Apply power to the rheometer control cabinet.
2. In screen 253 CFG – Comm, the heat must be enabled for control from a remote source. Enable the remote control in screen 110 Setpoints.
3. When the Remote Process Computer closes the contacts, the heaters are enabled. After 2 to 3 minutes, the indicated temperature should start to climb.

Heat OFF

1. The command to disable the heaters may come from the Remote Process computer.
2. When the Remote Process Computer opens the contacts, the heaters are disabled.

Motor ON

1. In screen 253 CFG – Comm, the motor must be enabled for control from a remote source. Enable the remote control in screen 110 Setpoints.
2. The command to enable the motor may come from the remote process computer. When the remote contact is closed, the motor will be enabled, and when the remote contact is opened, the motor will be disabled.

Motor OFF

1. The command to disable the motor may come from the Remote Process computer.
2. When the Remote Process Computer opens the contacts, the motor is disabled.

5 TRANSPORTATION AND UNPACKING THE EQUIPMENT

Provide adequate handling equipment and personnel when moving the packaged equipment. This electric instrumentation equipment should be handled with care to prevent damage during unpacking and installation.

Before opening the packing crates ensure that the equipment is oriented properly (refer to markings on crates to determine which end is up).

Open crates and boxes with proper equipment so as not to puncture and damage breakable equipment inside.

After removing the equipment from the crates, carefully inspect each item for shipping damage. Check for dents, scratches, chipped paint, etc., that could have been incurred during transit or while opening the crates.

Open the Control Unit and ViscoSensor and check for broken parts and wires.



Check the equipment received against the packing list to make sure that all equipment listed has been received. Use established procedures and report immediately any damage or shortages to the carrier.



6 INSTALLATION

6.1 Introduction

This section contains installation information for the DYNISCO Polymer Test VCU, ViscoSensor, and interconnecting wiring.

6.2 ViscoSensor Control Unit

The ViscoSensor is designed to be installed in a process environment. The VCU is housed in a NEMA 4 cabinet and should be located near the ViscoSensor. Refer to the OUTLINE DIMENSION (VCU) for mounting information.

Considerations for ViscoSensor Control Unit Location and Installation

1. Locate the VCU so that the operator interface on the front panel is easily accessible and at eye level for easy operator access.
2. Clearance must be provided to open the VCU door for service and trouble shooting.

6.3 ViscoSensor Installation

The ViscoSensor is installed at the source of polymer melt. Refer to the OUTLINE DIMENSION (ViscoSensor) for mounting information.

Considerations for ViscoSensor Location and Installation

1. Free access is available to change capillaries and to calibrate the transducer.
2. Access is available to the extruder adapter shutoff and bleed valves.
3. Extrudate from the capillary and extruder bleed valves can be easily removed.
4. The ViscoSensor does not interfere with other equipment.
5. Attach the PIV (Process Isolation Valve) with the end marked "Process" connected to the extruder and the end marked "Visco" connected to the ViscoSensor.

6.4 Interconnecting Field Wiring

Refer to the Field Wiring Diagram for Remote Control Unit to ViscoSensor wiring and Remote Control Unit to customer equipment wiring. The Field Wiring diagram also gives required wire size information.

6.5 PIV Skin Temperature Controller Setup (if option purchased)

See 2208e_TempCtrl.pdf for instructions on high temperature limit setup. Once skin temperature goes above limit, a relay onboard the controller turns on to set an alarm on the RCU.

6.6 Grounding

All equipment must be grounded in accordance with applicable electrical codes

6.7 VCU Purging System (if option purchased)

To maintain the VCU safety ratings, the purging system must be installed and set-up according to the manufacturer's instructions. Set the Enclosure Pressure to be in the GOOD range before applying air to the Vortec enclosure cooler.

An alarm or indicator must be connected to the purging system to detect the loss of safe enclosure pressure.



7 OPERATION

7.1 Introduction

This manual section covers the operation of the RCU (Rheometer Control Unit) software and hardware. This discussion assumes access to the local operator display. Operation of the local operator display is discussed in another section of this manual.

The RCU controls the operation of the rheometer. The RCU is able to display data and receive commands from the local display, respond to digital commands from a remote process computer, and provide analog signals to the remote process computer. The RCU can be controlled from a remote IBM-PC compatible computer running optional control software.

The primary functions of the RCU software are: (1) executing feedback control loops (temperature control and motor control), (2) checking for alarm conditions (high temperature, high pressure, high speed, etc.), and (3) communicating with the operator via the local display, the remote control signals and/or the optional remote PC, and (4) performing the system calculations.

On power up, the RCU enters the “IDLE-NOT READY” process state. The process state and the process status are displayed in the HMI fixed window. The process states are Idle-Not Ready, Warm-up, Idle-Ready, Run, Soak, and Standby. Figure 7 shows the process states.

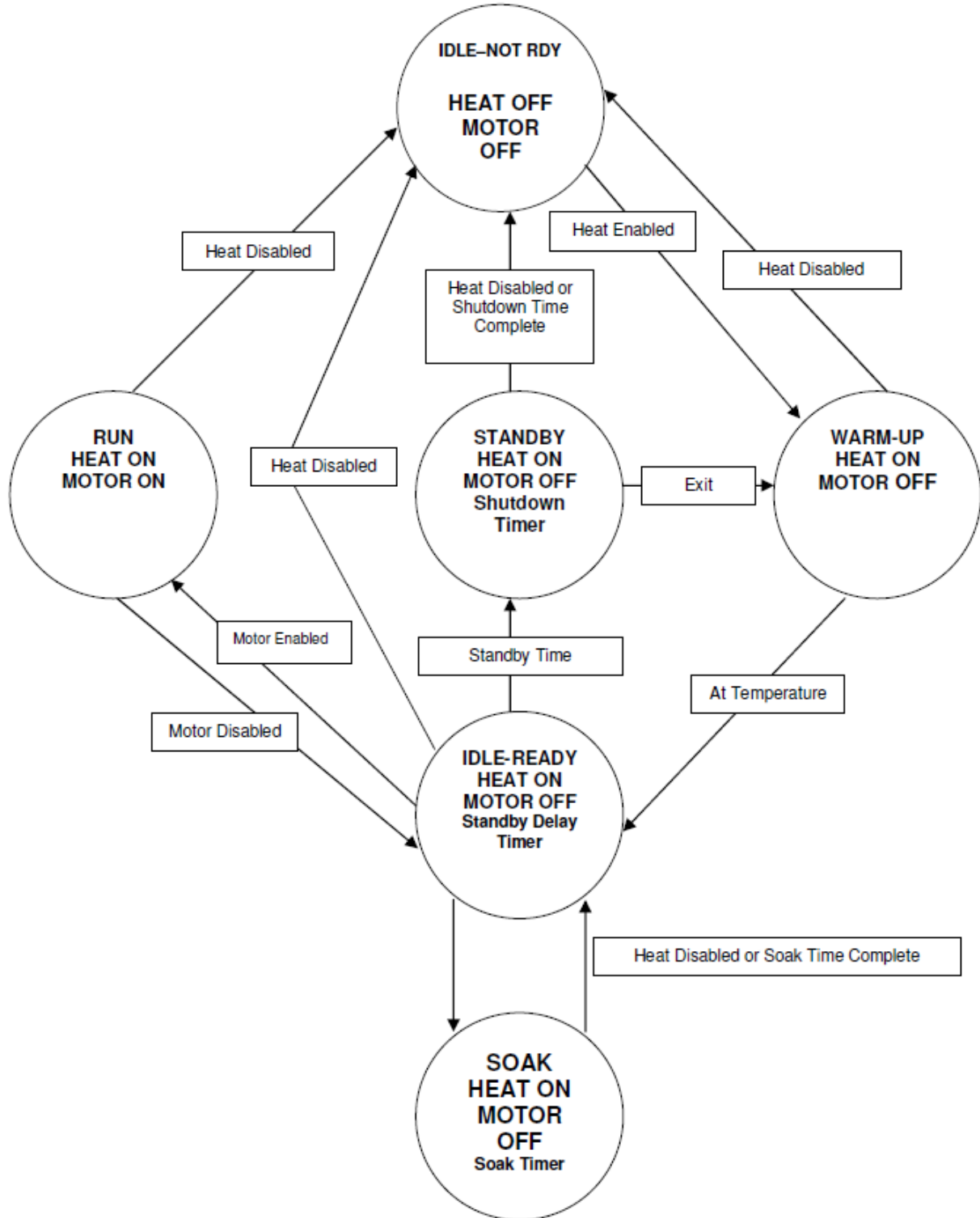



7.2 Software operation

A computer program (software) resides in the CPU module in the VCU. This program controls the operation of the rheometer head.

7.2.1 Timing

In the main loop the following functions are performed at the given intervals:

- Check for alarms -- 500 msec interval
- Update the machine state -- 500 msec interval
- Read 4-20 mA setpoints -- 1 second interval
- Read remote discrete inputs -- 1 second interval
- Write to HMI -- 1 second interval
- Write 4-20 mA outputs -- 1 second interval
- Write RS-232 outputs --- 1 second interval
- Acknowledge alarms -- 1 second interval
- Perform rheometer calculations -- 2 second interval
- Update HMI faults/warnings -- 2 second interval

Every 250 milliseconds, a CYCLIC INTERRUPT routine is executed. The cyclic interrupt controls the timing for the following functions:

- All pressures are sampled every 250 milliseconds and converted to the desired engineering units. The sampled values are averaged over a 5 second window to produce the pressure value. When the motor is running, the motor PID loop controls the motor depending on the mode selected (PRESSURE or SPEED).
- The metering pump speed is sampled every 250 milliseconds and converted to engineering units (RPM). The sampled values are averaged over a 1 second window to produce the speed value. When the motor is running, the motor PID loop controls the motor depending on the mode selected (PRESSURE or SPEED).
- The temperatures are sampled every 500 milliseconds and converted to engineering units (degrees Celsius). The sampled values are averaged over a 5 second window to produce the temperature value. When the heat is on, all temperature PID loops are controlling the temperatures.

Every minute an interrupt routine is executed. This routine handles the soak/standby/shutdown/purge timers along with the machine hour statistics. The accuracy of the timers is +/- 1 minute.

Test parameters and transducer calibrations values are stored in the EEPROM memory and will be “remembered” if the rheometer is powered off. If a PROGRAM ERROR occurs (any error that could “lock up” the CPU), the motor and heaters will be turned off.



7.2.2 Alarm/Fault Logic

One of the major functions of the RCU control system is to check for various alarms detailed below. Some of these alarms are "warnings". Warnings appear in yellow in the process status on the HMI. Warnings also deactivate the warning relay (contacts will open). Warnings exist for information only. In these cases, the RCU takes no further action beyond the indication. Faults are conditions that can result from a hardware failure and could result in equipment damage. Faults appear in red in the process status on the HMI. Faults deactivate the fault relay (contacts will open). Each alarm is described below along with the action the RCU will take.

7.2.3 WARNINGS

Temperature Low

- CAUSE: The heat is enabled, the motor is disabled, and the temperature is below the low limit as set in screen 257 CFG – Limits

Temperature High

- CAUSE: The heat is enabled and the temperature is above the high limit as set in screen 257 CFG – Limits

Pressure Low

- CAUSE: Pressure is below the low limit as set in screen 257 CFG – Limits
- CAUSE: Pressure is below 10% of the full scale transducer range

Pressure High

- CAUSE: Pressure is above the high limit as set in screen 257 CFG - Limits

Speed Low

- CAUSE: In speed mode, the motor is enabled and the speed is below the low limit as set in screen 257 CFG – Limits
- CAUSE: Speed is less than the minimal allowable speed (1 RPM)

Speed High

- CAUSE: In speed mode, the motor is enabled and the speed is above the high limit as set in screen 257 CFG – Limits
- CAUSE: Speed is 1% over the maximum allowable speed (40 RPM)

MFR/MV/RV/IV Low

- CAUSE: The material property selected in screen 132 Setup-Warning is below the low limit selected.

MFR/MV/RV/IV High

- CAUSE: The material property selected in screen 132 Setup-Warning is above the high limit selected.



7.2.4 FAULTS

Temperature Low

CAUSE: The heat is enabled and the motor is enabled (RUN state) and the temperature is below the low limit as set in screen 257 CFG – Limits

ACTION: Shuts off the motor

Temperature High

CAUSE: The temperature exceeds the maximum temperature as set in screen 257 CFG – Limits.

ACTION: Shuts off the motor - Shuts off the heater

Pressure Low

CAUSE: The scaled pressure transducer reading is 5% below the transducer's zero output.

ACTION: Shuts off the motor

Pressure High

CAUSE: The scaled pressure transducer reading exceeds the full scale range of the transducer by 5%.

ACTION: Shuts off the motor

Motor Fault

CAUSE: A motor fault has occurred

ACTION: Shuts off the motor

Emergency Stop

CAUSE: The emergency stop input has been deactivated.

ACTION: Shuts off the motor – Shuts off the heater

Calib Error

CAUSE: Occurs when attempting to calibrate the pressure transducer under the following conditions

- Heat is OFF.
- Rheometer is “Below Temp”.
- Motor is running.

ACTION: Unable to start the Motor

Temperature Fault

CAUSE: No sensor or faulty sensor connected to the PLC module

ACTION: Shuts off the motor - Shuts off the heater

Pressure Fault

CAUSE: No sensor or faulty sensor connected to the PLC module

ACTION: Shuts off the motor

Speed Fault

CAUSE: No sensor or faulty sensor connected to the PLC module

ACTION: Shuts off the motor



7.2.5 CPU OK Indicator

To indicate the PLC software is executing, PLC module 9 the last LED (second group channel 7) will flash. This is the CPU is alive indicator. To indicate communication to the HMI, the LED above the CPU alive indicator will flash. This is the HMI is alive indicator.

7.3 Hardware description

RCU and Power Box components include AC power devices, DC power supplies, MSC's (Motor Speed Controllers), the PLC modules including analog and digital signal conditioning modules.

7.3.1 AC Power Protection

Main power is supplied through Main Power switch S-1. Breaker BR1 provides protection for the VCU cabinet. The AC power is filtered to reduce the risk of EMI.

7.3.2 AC Power Relays

There is one high current relay to switch line power to the heater circuits. In the heat control circuit, SSR's (solid state relays) send the line AC power to each individual heater.

7.3.3 Power Supplies

There are three DC power supplies in the VCU. A 24 VDC power supply provides power for the analog and digital modules (external power), the heater control relays, power enable relays and the motor overtemperature switch. A 10 VDC power supply provides power for the pressure transducers. The PLC has an internal 24 VDC power supply that also provides power for the CPU and the local display panel.

7.3.4 Microprocessor/PLC Module (CPU)

The CPU module is the "brain" of the VCU. Major functions include supervising the rheometer heaters and drive motor, providing the operator display feature, and communicating data to the optional PC and/or network.



7.3.5 Analog Signal Conditioning

Low-level analog signals generated by RTD's pressure transducers, and tachometer voltages are not compatible with the digital circuits that comprise the CPU. These analog signals must be converted into a form suitable for the CPU.

Analog Input Modules

The PLC uses two analog input modules. The first input module is setup to read the RTD sensors inputs. The second input module is setup to read the pressure transducer millivolts, the tachometer voltage, and any optional remote analog input signals.

Shown below is an example of how the remote analog inputs are converted into set points. The remote analog inputs are selected on screen 255 CFG mA in. The analog inputs are calibrated and scaled on screen 241Ana In Cal 2.

$$\left(\frac{(\text{input}_{\text{mADC}} - 4_{\text{mADC}})}{16_{\text{mADC}}} \right) \times \text{RANGE} + 4_{\text{mA_value}} = \text{SP}_{\text{eng}}$$

$$\text{RANGE} = 20_{\text{mA_value}} - 4_{\text{mA_value}}$$

(Set the 20 mA and 4 mA limits in screen 241 Ana In Cal 2.)

$$\text{SP} = \text{setpoint}_{\text{engineering units}}$$

With the 4-20 mA input scaled to 0-100 RPM, a 6 mA input produces a speed setpoint of 12.5 RPM.

$$\left(\frac{(6.00_{\text{mADC}} - 4_{\text{mADC}})}{16_{\text{mADC}}} \right) \times (100 - 0)_{\text{RPM}} + (0)_{\text{RPM}} = 12.5_{\text{RPM}}$$

Analog Output Modules

The PLC uses two analog output modules. This module provides a 0 to 10 VDC control signal to the motor speed controller and the 4 to 20 mADC output signals for the remote process computer.

Shown below is an example of how values are converted into a 4 to 20 mA DC output signal. The remote analog outputs are selected on screen 256 CFG mA out. The analog outputs are calibrated and scaled on screens 242 Ana Out Cal 1, 243 Ana Out Cal 2, and 244 Ana Out Cal 3.



$$\left(\frac{PV_{eng} - PV_{min}}{PVFS_{eng}} \right) \times 16_{mADC} + 4_{mADC} = Output_{mADC}$$

PV = Process variable_{engineering units}

PVmin = min mA value

PVFS = Process variable full scale_{engineering units} = max mA value – min mA value

Max and Min mA values are set in screens 242-244

With a temperature of 200 C, a min scaled value of 0.0 C, and a max scaled value of 400.0 C, the output is 12 mA.

$$\left(\frac{200.0C - 0.0C}{400.0C - 0.0C} \right) \times 16_{mADC} + 4_{mADC} = 12.00_{mADC}$$

7.3.6 Digital Signal Conditioning

DIGITAL INPUT MODULE

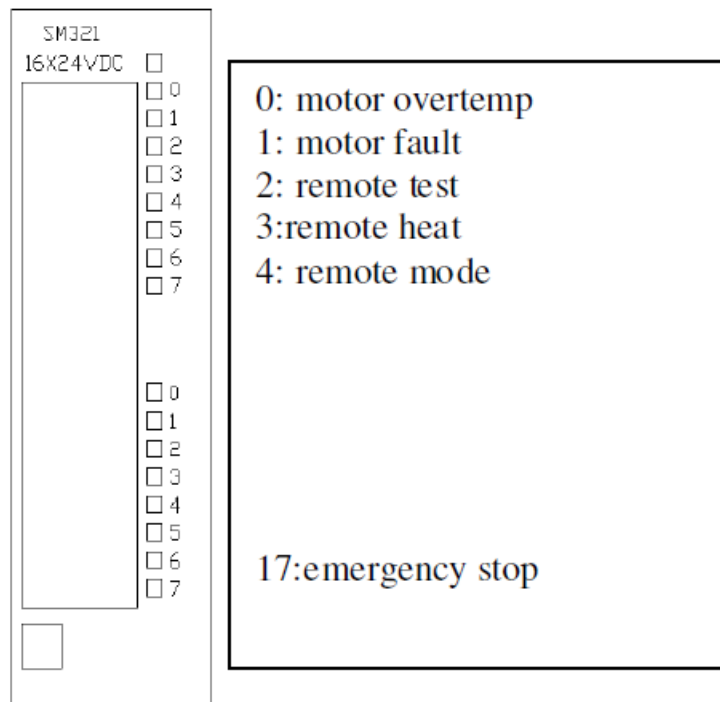

FIGURE 8 – Digital Input Module



Digital Input Module

All digital input signals to the PLC are 0 (zero) or 24 VDC. The digital input signals are generated internally (safety voltage, etc.) or from an external source (Remote Test Start/Stop, etc.). The internal digital input signals are connected directly to the digital input module. The remote digital input signals are connected to a PLC RELAY. The PLC RELAYS are used to isolate each PLC digital channel. The PLC RELAYS are discussed elsewhere in this section. Each digital input channel has an LED to indicate when an input signal is present.

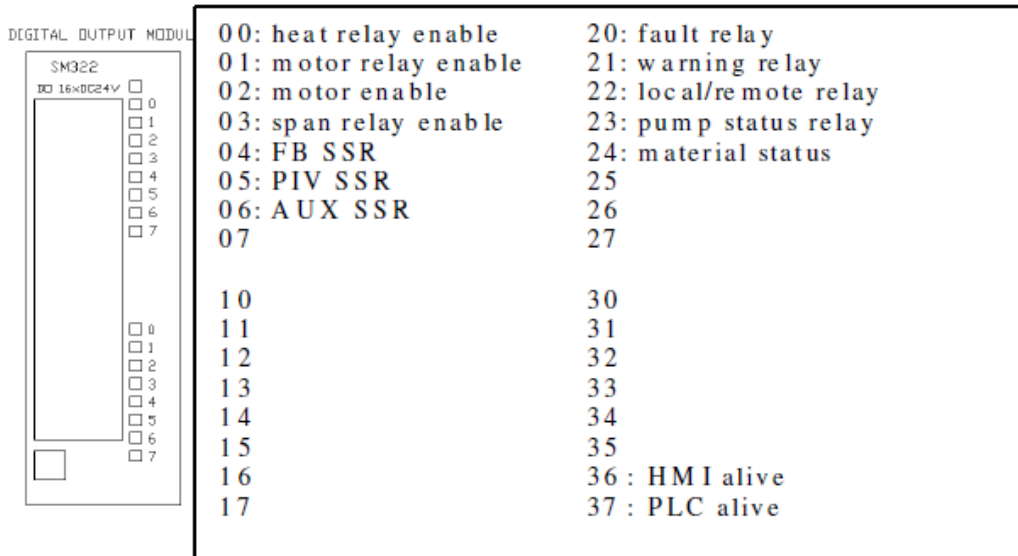

FIGURE 9 – Digital Output Module

Digital Output Module

All digital output signals from the PLC are 0 (zero) or 24 VDC. The digital output signals are used internally to drive various relays (Heat Enable, Temperature Control, etc.) or provide a dry contact for an external device. The internal digital output signals are connected directly to a control relay. The digital input signals used for an external device are connected to a PLC RELAY. The PLC RELAYS are used to isolate each PLC digital channel. The PLC RELAYS are discussed elsewhere in this section. Each digital input channel has an LED to indicate when an output signal is present.

7.3.7 PLC Relays

The purpose of the PLC-RELAYS is to isolate the PLC from external devices, both input and output. The RCU uses a single pole single throw normally open PLC-RELAY. 24 VDC input coils are used unless otherwise specified.

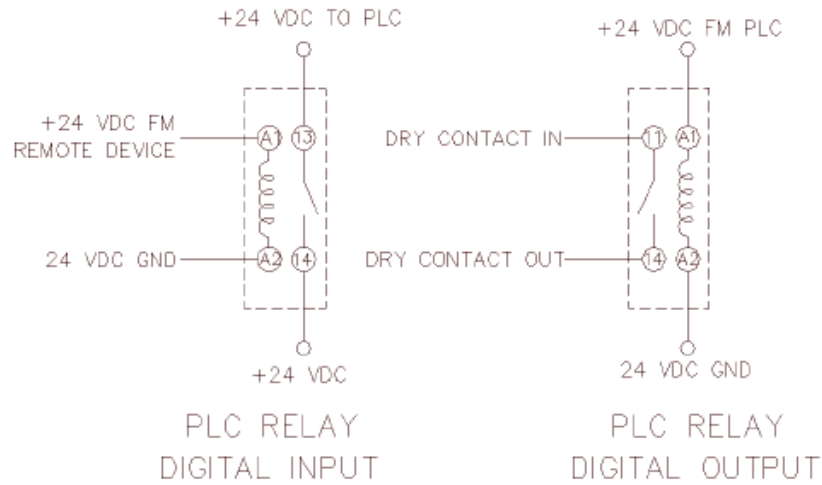

FIGURE 10 – PLC RELAYS

7.3.8 Temperature Indication and Control

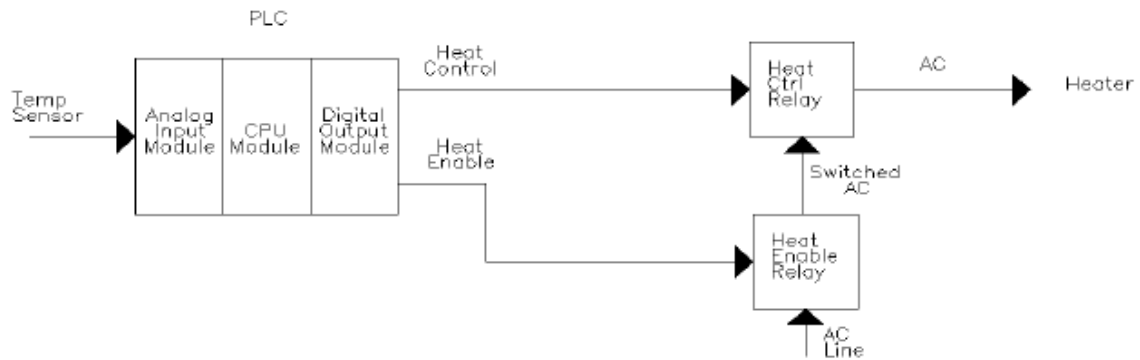

FIGURE 11 – Simplified Temperature Indication and Control

Temperature Indication

The individual temperature is read by its sensor (grade " A " 100W RTD). This low-level temperature signal is connected to the rheometer control unit via the field wiring. The low-level signal is fed to the ANALOG INPUT MODULE where it is converted into a digital code. This digital code is used by the PLC's firmware to calculate the indicated temperature in engineering units.

Temperature Control

The indicated temperature is compared to the temperature setpoint in the temperature PID control loop. The output of the temperature control loop is the value necessary to maintain the temperature setpoint. This output value is 0 to 100%. The output signal is known as a TPO (Time Proportional Output) signal. Figure 12 (top) shows an example of a 50% duty cycle heater control signal for 2 one-second cycles.

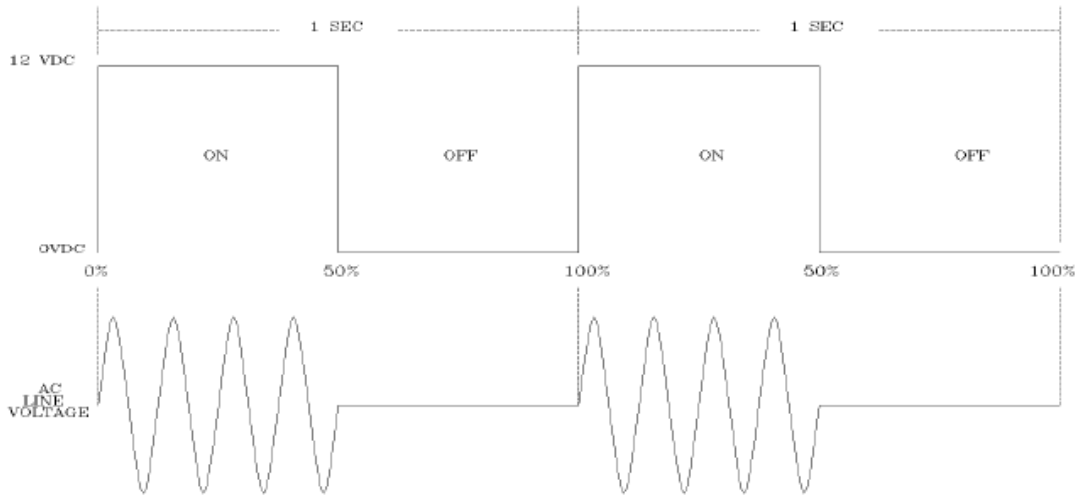

FIGURE 12 – Time Proportional Control Signal

The TPO heater control signal is fed via the cabinet wiring to the HEAT CONTROL PLC Relay and then to the SSR (solid state relay). When the LED on the PLC DIGITAL OUTPUT MODULE for that TPO channel is ON, the DC TPO control signal is fed to the heat control SSR. The CPU also switches the AC power to the HEAT ENABLE relay. When the operator turns the HEAT ON, the PLC enables the HEAT ENABLE relay. When the LED on the PLC DIGITAL OUTPUT MODULE for that channel is ON the HEAT ENABLE relay feeds the line AC voltage to each HEATER CONTROL SSR. When the heat control SSR relay is on, it acts like a switch and allows the line AC voltage to be delivered to the heater (based on the control signals duty cycle). Figure 12 (bottom) shows a 50% duty cycle DC control signal and the associated heater AC signal.



7.3.9 Motor Indication And Control

Pressure Indication

The capillary pressure is read by a pressure transducer (unbonded strain gauge wheat stone bridge). The low-level pressure signal is connected to the RCU via the field wiring. The low-level signal is fed to the PLC ANALOG INPUT MODULE where it is converted into a digital code. The digital code and the pressure calibration data are used by the CPU's firmware to calculate the pressure in engineering units.

Speed Indication

The output of the motor speed controller is a 0 to 10 VDC signal. The low-level signal is fed to the PLC ANALOG INPUT MODULE where it is converted into a digital code. The digital code and the speed calibration data are used by the CPU's firmware to calculate the pump speed in engineering units.

Motor Control

The meter pump speed or capillary pressure (depending on the mode selected) is compared to the motor setpoint in the CPU. The output of the motor control loop is the value necessary to maintain the motor setpoint. This output value is scale to the range of 0 to 100 %. This signal is fed to the ANALOG OUTPUT MODULE where it is converted into a 0 to 10 VDC motor control signal. The motor control signal is fed via the cabinet wiring to the MOTOR SPEED CONTROLLER. The CPU enables the MOTOR ENABLE on the MOTOR SPEED CONTROLLER.

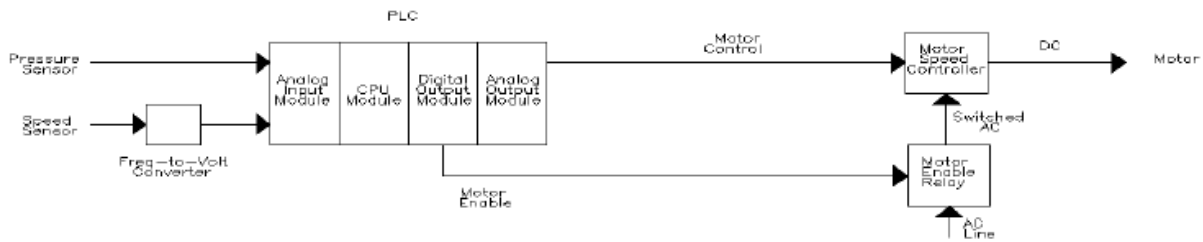
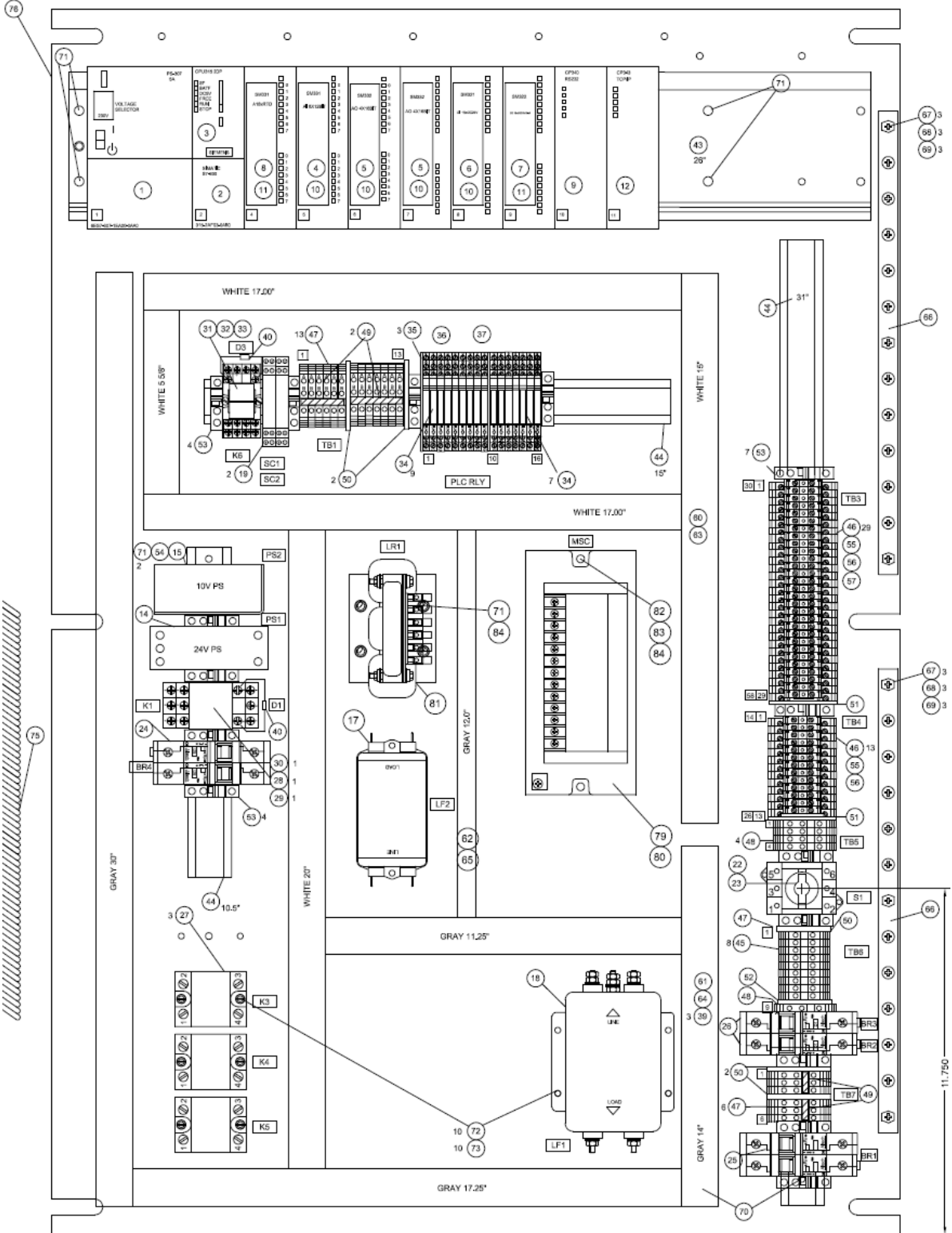

FIGURE 14 – Simplified Motor Indication and Control

7.3.10 Hardware Interlocks

Voltage from the 24 VDC power supply is provided to a fault relay on the servo motor drive in the VCU. This motor drive fault signal is sent to the PLC Digital input module. When the motor drive senses a fault with the servo motor the signal path is broken, indicating an error with the servo motor. The PLC then disables the motor and heaters until the alarm condition is cleared.

Optional External Skin Temperature monitors are available that measure the heater temperature. In event of a heater thermal overrun condition, the 24V supply voltage is removed from the PLC Digital output module which in turn disables the heater zones. The PLC also monitors this alarm signal and indicates a skin temp alarm on the HMI screen. Heat cannot be restored until the alarm condition is corrected.





7.3.11 VCU Parts List

FIGURE 16 –
VCU Parts List

		PARTS LIST			
ITEM NO.	QTY	PLC NO.	PLC QTY	DESCRIPTION	
PLC	01	997-4308	1	POWER SUPPLY W/AC PWR 24VDC	
	02	997-4317	1	PLC MEMORY	
	03	997-4330	3	DI/DI24 NO-CONT. CARD, 5VDC/24V	
	04	997-4330	1	ANALOG INPUT	
	05	997-4330	2	ANALOG OUTPUT	
	06	997-4330	3	DIGITAL INPUT - 24	
	07	997-4330	3	DIGITAL OUTPUT - 24	
	08	997-4330	3	MODULE - 24V INPUT 5VDC/24V	
	09	997-4330	3	PLC MODULE 24VDC	
	10	997-4330	4	TERMINAL BLOCK 20 PIN	
	11	997-4330	2	TERMINAL BLOCK 40 PIN	
	12	997-500	1	OPTIONAL PLC COMMUNICATION MODULE - RS-485	
	13				
MODULES	14	997-4330	1	POWER SUPPLY 24V 24VDC	
	15	997-4330	1	POWER SUPPLY 24V 24VDC	
	17	997-4330	1	FILTER POWER	W300
	18	997-4330	1	INDIC. POWER INPUT	W300
RELAYS & BREAKERS	19	997-4330	2	DIAGN. LED/INDICATOR	W300
	20				
	21				
	22	997-4330	1	DIAGNOSTIC SWITCH, 3 POLE	
	23	997-4330	1	DIAGNOSTIC SWITCH, 3 POLE	
	24	997-4330	1	DIAGNOSTIC SWITCH, 3 POLE	
	25	997-4330	1	DIAGNOSTIC SWITCH, 3 POLE	
	26	997-4330	1	DIAGNOSTIC SWITCH, 3 POLE	
	27	997-4330	1	DIAGNOSTIC SWITCH, 3 POLE	
	28	997-4330	1	DIAGNOSTIC SWITCH, 3 POLE	
	29	997-4330	1	DIAGNOSTIC SWITCH, 3 POLE	
	30	997-4330	1	DIAGNOSTIC SWITCH, 3 POLE	
	31	997-4330	1	DIAGNOSTIC SWITCH, 3 POLE	
	32	997-4330	1	DIAGNOSTIC SWITCH, 3 POLE	
	ELECTRONICS	33	997-4330	3	DIAGNOSTIC SWITCH, 3 POLE
34		997-4330	3	DIAGNOSTIC SWITCH, 3 POLE	
35		997-4330	3	DIAGNOSTIC SWITCH, 3 POLE	
36		997-4330	3	DIAGNOSTIC SWITCH, 3 POLE	
TERMINALS & DIN RAIL	37	997-4330	3	DIAGNOSTIC SWITCH, 3 POLE	
	38	997-4330	3	DIAGNOSTIC SWITCH, 3 POLE	
	39	997-4330	3	DIAGNOSTIC SWITCH, 3 POLE	
	40	997-4330	3	DIAGNOSTIC SWITCH, 3 POLE	
	41	997-4330	3	DIAGNOSTIC SWITCH, 3 POLE	
	42	997-4330	3	DIAGNOSTIC SWITCH, 3 POLE	
	43	997-4330	3	DIAGNOSTIC SWITCH, 3 POLE	
	44	997-4330	3	DIAGNOSTIC SWITCH, 3 POLE	
	45	997-4330	3	DIAGNOSTIC SWITCH, 3 POLE	
	46	997-4330	3	DIAGNOSTIC SWITCH, 3 POLE	
	47	997-4330	3	DIAGNOSTIC SWITCH, 3 POLE	
	48	997-4330	3	DIAGNOSTIC SWITCH, 3 POLE	
RACEWAY	49	997-4330	3	DIAGNOSTIC SWITCH, 3 POLE	
	50	997-4330	3	DIAGNOSTIC SWITCH, 3 POLE	
	51	997-4330	3	DIAGNOSTIC SWITCH, 3 POLE	
	52	997-4330	3	DIAGNOSTIC SWITCH, 3 POLE	
	53	997-4330	3	DIAGNOSTIC SWITCH, 3 POLE	
	54	997-4330	3	DIAGNOSTIC SWITCH, 3 POLE	
	55	997-4330	3	DIAGNOSTIC SWITCH, 3 POLE	
	56	997-4330	3	DIAGNOSTIC SWITCH, 3 POLE	
	57	997-4330	3	DIAGNOSTIC SWITCH, 3 POLE	
	58	997-4330	3	DIAGNOSTIC SWITCH, 3 POLE	
HARDWARE	59	997-4330	3	DIAGNOSTIC SWITCH, 3 POLE	
	60	997-4330	3	DIAGNOSTIC SWITCH, 3 POLE	
	61	997-4330	3	DIAGNOSTIC SWITCH, 3 POLE	
	62	997-4330	3	DIAGNOSTIC SWITCH, 3 POLE	
	63	997-4330	3	DIAGNOSTIC SWITCH, 3 POLE	
	64	997-4330	3	DIAGNOSTIC SWITCH, 3 POLE	
	65	997-4330	3	DIAGNOSTIC SWITCH, 3 POLE	
	66	997-4330	3	DIAGNOSTIC SWITCH, 3 POLE	
	67	997-4330	3	DIAGNOSTIC SWITCH, 3 POLE	
	68	997-4330	3	DIAGNOSTIC SWITCH, 3 POLE	
ViscoSensor	69	997-4330	3	DIAGNOSTIC SWITCH, 3 POLE	
	70	997-4330	3	DIAGNOSTIC SWITCH, 3 POLE	
	71	997-4330	3	DIAGNOSTIC SWITCH, 3 POLE	
	72	997-4330	3	DIAGNOSTIC SWITCH, 3 POLE	
	73	997-4330	3	DIAGNOSTIC SWITCH, 3 POLE	

7.3.12 PLC MODULE LIST	
MODULE	TYPE
1	Power Supply
2	CPU
3	Not used (reserved for expansion rack)
4	Analog Input (RTD)



5	Analog Input (Voltage/Current)
6	Analog Output
7	Analog Output
8	Digital Input
9	Digital Output
10	RS-232 Serial ASCII data string output

7.3.13 PLC DIGITAL I/O		DIGITAL OUTPUTS Module 9	
Term#	Function	Term#	Function
2	Not Used	2	Heat Relay Enable
3	Motor Fault	3	Motor Drive Enable
4	Remote Test/Start	4	Not Used
5	Remote Heat	5	Xd Span
6	Remote Mode	6	Flow Block heater SSR
7	Load Recipe 1	7	PIV heater SSR
8	Load Recipe 2	8	AUX heater SSR
9	Load Recipe 3	9-15,20,21	Not Used
10-11	Not used	16-19	Recipes 1-4 Active
12	BEBCO (optional)	22	Fault Relay
13	Skin temp (optional)	23	Warning Relay
14	Load Recipe 4	24	Local/remote Relay
15-18	Not used	25	Motor/pump is on Relay
19	Emergency stop	26	Material Status Relay
		27-29	Not used
		30	HMI is alive indicator
		31	CPU is alive Indicator

7.3.14 PLC RELAY LIST		
Module	Function	I/O
1	Fault	Output
2	Warning	Output
3	Local/remote status	Output
4	Pump run status	Output
5	Material status	Output
6	Recipe 1 Active	Output
7	Recipe 2 Active	Output
8	Recipe 3 Active	Output
9	Recipe 4 Active	Output
10	Remote motor start	Input
11	Remote heat enable	Input
12	Remote mode (pressure/speed)	Input
13	Load Recipe 1	Input
14	Load Recipe 2	Input
15	Load Recipe 3	Input
16	Load Recipe 4	Input

8 HUMAN MACHINE INTERFACE (HMI)

8.1 Introduction

The DYNISCO Polymer Test RCU is equipped with an operator interface device mounted in the RCU cabinet or in a remote location determined by the customer. The operator interface is used to view and modify the system variables. This includes current measured values, test setpoints, trend screens, and alarm condition indicators. The display is a color touch screen.



8.2 Environmental considerations

The display will operate at temperatures between 32° and 122°F (0 to 50C). Humidity may be between 5% and 90%. The unit is rated for NEMA-4 (watertight) and NEMA-12 (dust-tight) provided the mounting gasket is intact.

8.3 Security and Change Privileges

Three levels of security are provided for operating the display. Refer to the screen structure to determine the security level required for each screen.

USERNAME	Password Authority	
Setup	330	Ability to change material specific parameters
VISCO	VISCO	Ability to change material specific parameters
Maintenance	Alpha	Access to instrument configuration and test functions
Service	Alpha	Access to instrument configuration and test functions
MAINT	ALPHA	Access to instrument configuration and test functions
Factory	call factory	Access to advanced instrument configuration

Maintenance privileges allow access to the diagnostic screens. Extreme care must be used while accessing the diagnostics since the instrument can be damaged by untrained personnel!

8.4 Screens

At the top of most screens is an area called the “Template Window”. Items in the template are labeled below. The display screens are shown on the following pages.

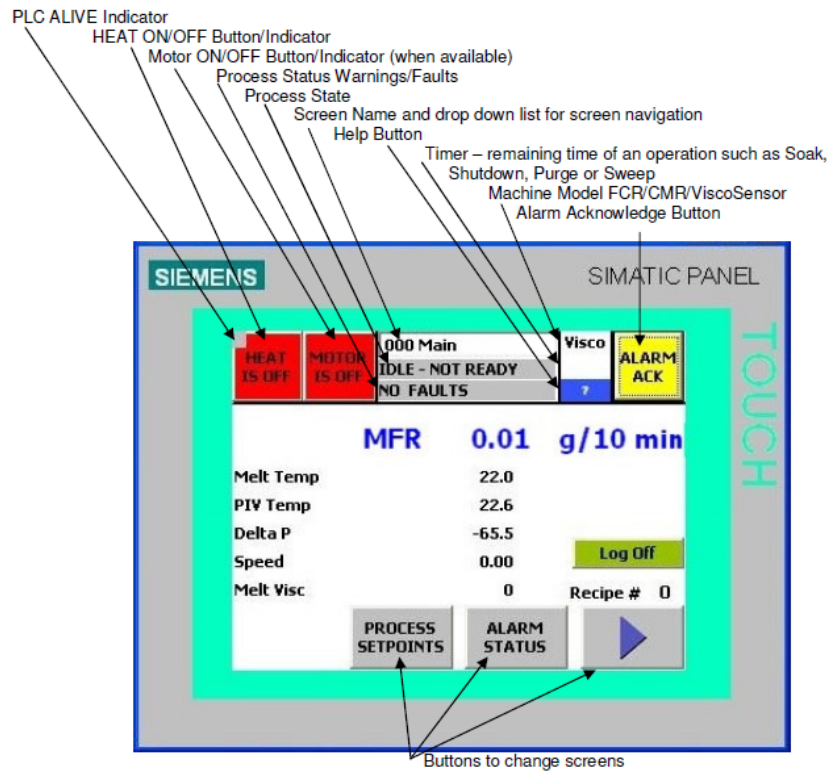



Previous screen



Next screen



Go to screen 000 Main

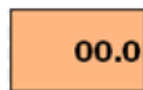

Press to enter data values



Acknowledge (clear) alarm messages



Help for the current screen



Press to enable the heat



Press to disable the heat



Press to enable the motor



Press to disable the motor

Screens on the display are divided into groups. A brief description of each group is followed by a detailed section.

A) Startup screen

B) MAIN screen and MENU screens (000,100,200,300)

- The items displayed on the MAIN screen are configured in the Operator Setup screen. The right arrow key proceeds to 3 MENU screens that are used to select the item of interest.

C) Process Setpoints (110)

- This screen is used to set the temperature, pressure, and speed control setpoints.

D) Equation Constants (120-123)

- These screens are used to set the capillary diameter, length to diameter ratio, pump volume, correlation factor, flow rate, activation energy, flow density, reference temperature, reference pressure, the intrinsic viscosity coefficient, and the intrinsic viscosity exponent.

E) Operator Setup (130-138)



These screens are used to

- Select the items to be displayed on the MAIN screen,
- Configure the soak mode,
- Configure the standby mode,
- Configure the shutdown mode,
- Configure the warning for material of range,
- Configure the sample/sweep/purge operational mode,
- Set the ASCII communication interval and the information to be communicated, and
- Set the date and time

F) Recipes (140)

- Job setup recipes are used to store the configuration of the instrument such that it can be recalled at a later date. This aids in change over from one material to another.

G) Process Status (150)

- This screen is used to observe the process temperatures, pressures, and speed.

H) Equation Results (160)

- This screen is used to observe the melt flow rate, shear rate, shear stress, melt viscosity, relative viscosity, and intrinsic viscosity.

I) Alarm Status (170-172)

- These screens show the status of the temperature RTDs, the pressure transducer, the motor, and the emergency stop.

J) Trending Graphs (180-186,190-196)

- These screens graph the selected value over a 10/60 minute time window. Trend screens are provided for temperature, pressure, speed, melt flow rate, shear rate, melt viscosity, relative viscosity, and intrinsic viscosity.

K) Temperature Calibration (210-211)

- Calibrate temperature measurements by entering offset values for the appropriate RTD temperature measurement.

L) Pressure Calibration (220-222, 230-232)

- These screens provide a method to calibrate the pressure transducers. Calibration options include default, auto cal, and manual.

M) Analog I/O Calibration (240-245)

These screens allow for

- Calibration and scaling of the motor speed input from the tachometer,
- Calibration and scaling of the 4-20 mA input setpoints,
- Calibration and scaling of the motor speed output from the PLC to the motor speed controller,
- Calibration and scaling of the 4-20 mA output values.

N) Machine Configuration (250-259, 25A, 25B and 25C)

These screens are used for configuring the instrument. The following items get configured:

- Instrument model type
- Units for length, temperature, and pressure
- RTD and pressure transducer configuration
- Installing options



- Selecting the 4-20 input and output parameters
- Setting the over temperature
- Setting the temperature, pressure, and speed warning limits
- Setting the PID control constants
- O) Manual Purge (260)
 - This screen is used to purge the system of material. The system will operate at the set speed for a given amount of time. After the time expires, the motor/pump will stop and the heat will be disabled.
- P) Shear Sweep (261)
 - This screen is used to setup and run the Shear Sweep operation.
- Q) Error Log (270-272)
 - The last 25 faults are logged with a date and time stamp.
- R) Diagnostics (340-348)
These screens allow for
 - Viewing all the analog inputs
 - Ability to force 0-10 analog outputs to 0, 5, or 10 volts
 - Ability to force 4-20 mA analog outputs to 4, 12, or 20 mA
 - Viewing all the digital inputs
 - Ability to force all digital outputs ON or OFF
 - Special motor testing ability
- S) IO Status (310)
 - This screen displays the status of major inputs and outputs on the RCU.
- T) Machine Hours (330)
 - This screen shows statistics for the number hours of instrument operation.



RHEOMETER SCREENS

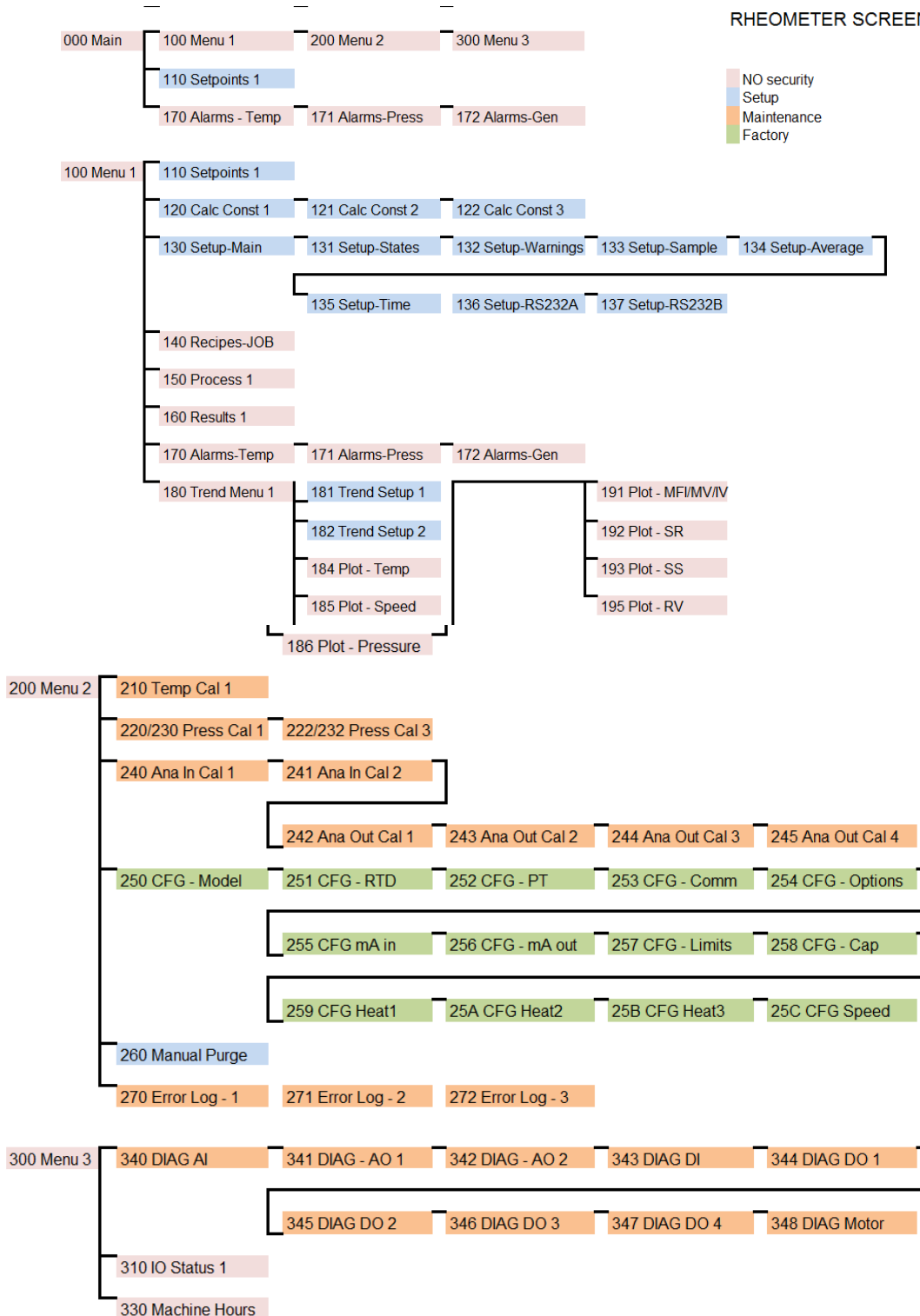

Start-up Screen

The start-up screen is displayed for about 3 seconds on power up.

The PLC software version number, HMI software version number and the instrument serial number are useful information when calling for customer service. This information is also available in screen 250 CFG-Model.

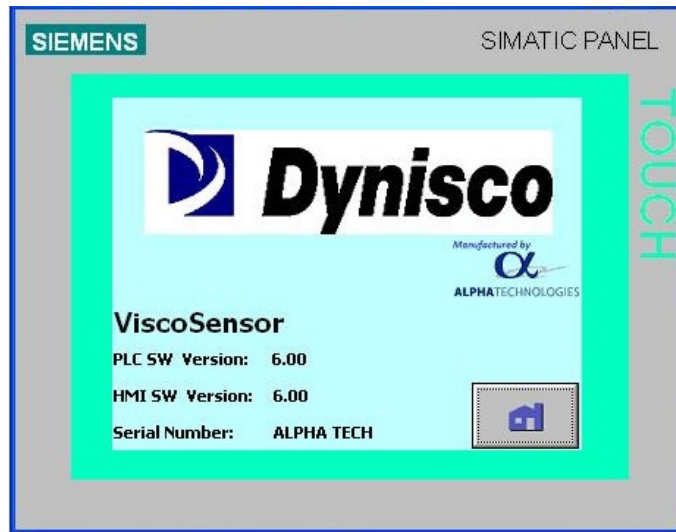

8.4.1 Main Screens (000)

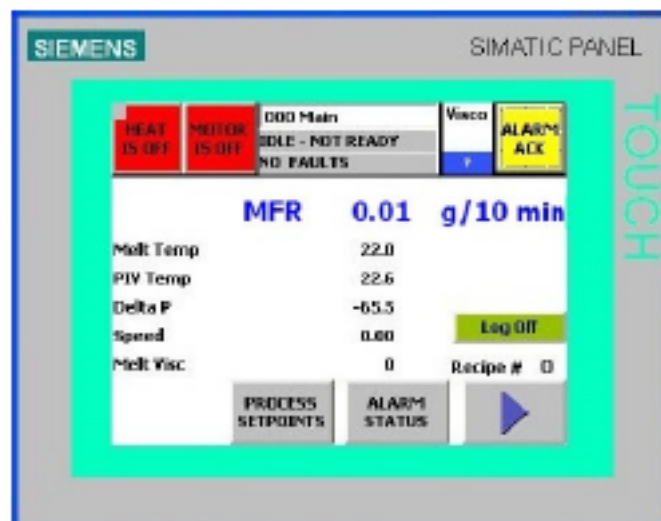

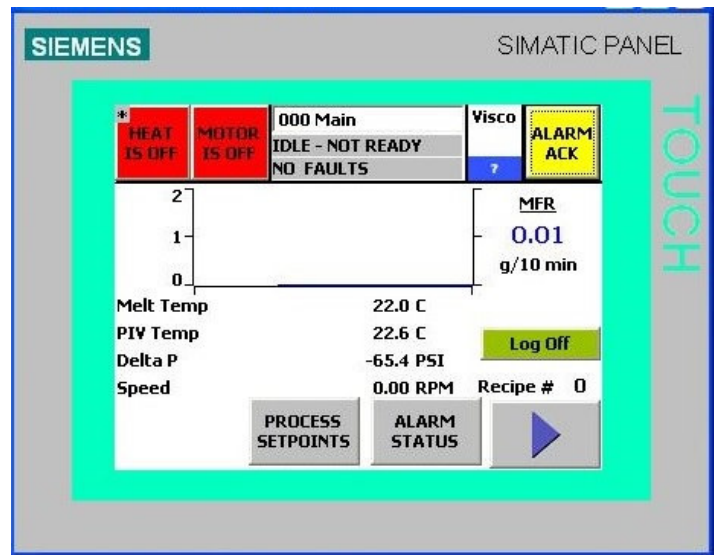

The Main screen can be configured in screen 130 Setup-Main to display a trend graph or display only data selections. The graph and the data items displayed are selectable from a list of items in the Operator Setup. The Log Off button is useful to prevent unauthorized operation or to change the level of access protection.

The trend graph shows the most recent 10 minutes of the selected parameter in real-time.

PROCESS SETPOINTS (110)

Screen for changing temperature, speed, and pressure setpoints

ALARM STATUS (170-172)

Screens for viewing the status of the temperature RTDs, pressure transducers, and the motor

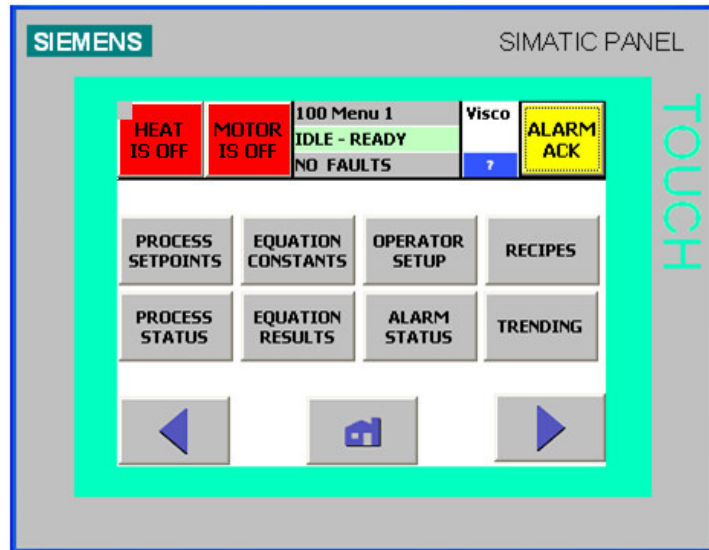

PROCESS SETPOINTS (110)

Screen for changing temperature, speed, and pressure setpoints

EQUATION CONSTANTS (120-123)

Screens for setting the capillary die size and rheological parameters

OPERATOR SETUP (130-138) – Screens for

- Selecting the data items to be displayed on the Main screen
- Setting the soak, standby, and shutdown conditions
- Setting the warning parameters
- Configuring the ASCII RS232 communication interval and data items

RECIPES (140)

Screen for saving the setup parameters as a recipe

PROCESS STATUS (150)

Screen for viewing temperatures, pressures, and motor speed

EQUATION RESULTS (160)

Screen for viewing the melt flow rate (MFR) and viscosity data

ALARM STATUS (170-172)

Screens for viewing the status of the temperature RTDs, pressure transducers, and the motor

TRENDING (180-186, 190-196)

Screens for viewing trend graphs of data over a 10 or 60 minute window

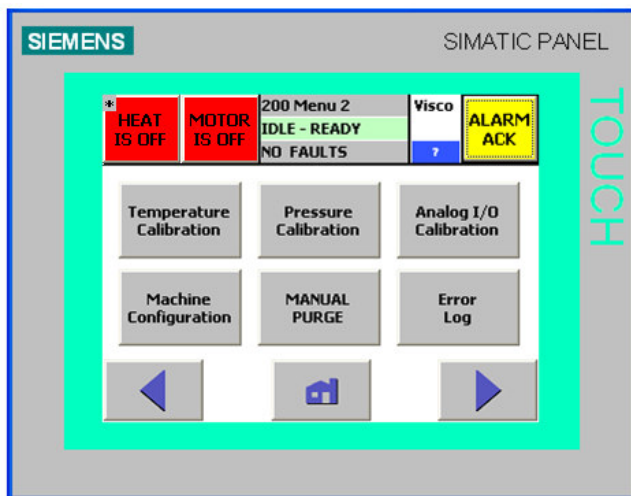

TEMPERATURE CALIBRATION (210-211)

Screens for calibrating the temperature RTDs

PRESSURE CALIBRATION (220-222, 230-232)

Screens for calibrating the pressure transducers

ANALOG I/O CALIBRATION (240-245) -- screens for

Calibrating the motor speed

Calibrating and scaling the 4-20 mA analog inputs

Calibrating and scaling the 4-20 mA analog outputs

MACHINE CONFIGURATION (250-259, 25A, 25B)

Items that can be configured include

- Units of length, temperature, and pressure
- RTDs, and pressure transducers connected to the instrument
- Communication options
- Items that can be controlled from a remote source (4-20 mA input setpoints, heat enable/disable, motor enable/disable, pressure/speed mode)
- 4-20 mA input parameter selection
- 4-20 mA output parameter selection
- Warning limits for temperature, pressure, and speed
- PID control loop constants

MANUAL PURGE (260)

Screen for performing a purge and shutdown of the instrument operation

ERROR LOG (270)

Screens for viewing the most recent 25 faults that have occurred in the instrument

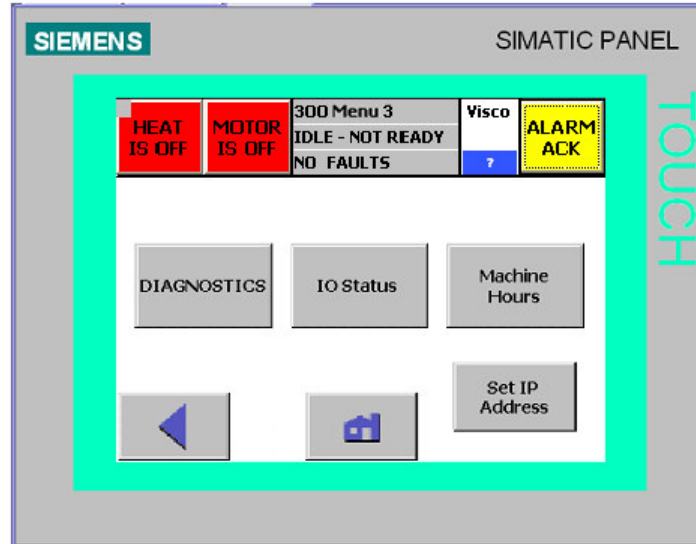

DIAGNOSTICS (340-348)

Screens for debugging instrument wiring and faults

CAUTION – ALL outputs are suspended when entering DIAGNOSTICS! This will cause an interruption in the process!

IO STATUS (310)

Screen for a view of the status of certain PLC inputs and outputs

MACHINE HOURS (330)

Screen for viewing statistics of the instrument operation. This includes the number of hours in the RUN mode.

SET IP ADDRESS - This menu item is visible only when Ethernet is enabled in the configuration. The Ethernet addressing is set through this screen.

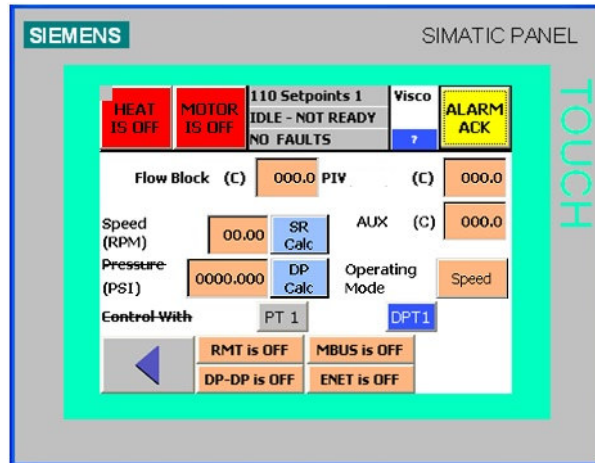

Process control Setpoints

- Flow Block (Melt) temperature
- PIV (Process Isolation Valve) temperature
- Speed while in the speed mode
- Pressure while in pressure mode

Setpoints screen with SPEED mode selected. Pressure controls are lined out.

Speed – press this button to change from speed mode to pressure mode

RMT is ON/OFF – the rheometer is being controlled externally via the heat/motor enable discrete signals and the 4-20 mA inputs for setpoints.

MBUS is ON/OFF – the rheometer is being controlled via the Modbus communication port.

DP-DP is ON/OFF - the rheometer is being controlled via the Profibus DP-DP coupler.

ENET is ON/OFF - the rheometer is being controlled via the Ethernet communication port.

NOTE: The MBUS/DP-DP/ENET buttons are only visible if the desired communication module is installed in the rheometer. The RMT communications is configured in the Machine Configuration screen 253 CFG-Comm.

SR Calc – opens a calculator to determine the needed speed for a given shear rate or the shear rate at a given speed.

DP Calc – opens a calculator to determine the needed operating pressure from the ASTM test weight used in laboratory testing.

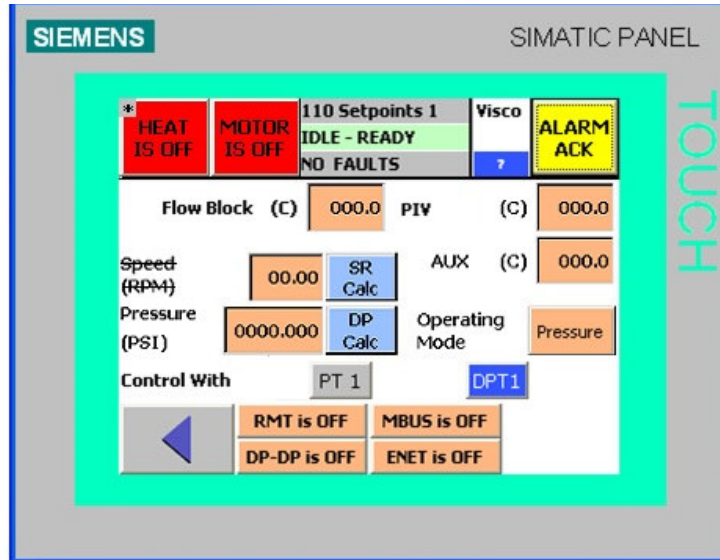

Setpoints screen with PRESSURE mode selected. Setpoints are the same, but speed controls are lined out.

Pressure – press this button to change from pressure mode to speed mode

Control With – select the pressure reading to use for the constant pressure control

PT1: pressure transducer 1

DPT1: delta pressure 1 = pressure transducer 1 – pressure transducer 3

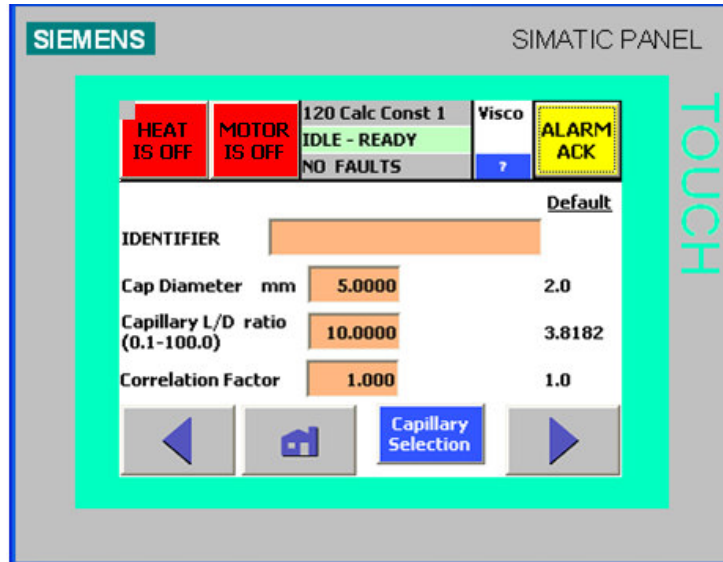

IDENTIFIER: An up to 20 character capillary identification

Cap Diameter: Diameter of the capillary die

Capillary L/D ratio: Capillary die length divided by the capillary diameter

Correlation Factor: Laboratory MFR divided by the Rheometer MFR.
This corrects for any measurement differences between the laboratory and the online instrument. The default is 1.0 – no correction. If this needs set outside the range of about 0.50 to 2.00, there may be an error in the calculation constant settings, the pump volume, or capillary dimensions may match the settings, the machine is in need of re-calibration, or a sensor has been damaged.

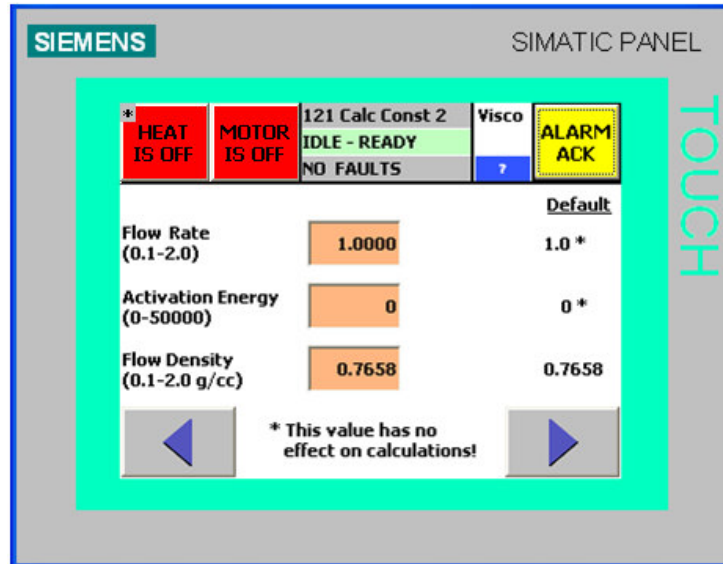

Flow Rate*:

$$\text{MFR_ref_pressure} = (\text{ref_pressure} / \text{process_pressure})^{(1 / \text{Flow_rate})}$$

Default 1.0

Activation Energy*:

$$\text{Temperature_correction} = \text{EXP}(\text{act_energy} * ((1.0 / (\text{ref_temp} + 273.15)) - (1.0 / (\text{process_temp} + 273.15))))$$

Default 0.0

*Entered Values have no effect on calculations. They are for documentation only.

Flow Density:

Material density in g/cc at operating temperature
Used for calculating the MFR

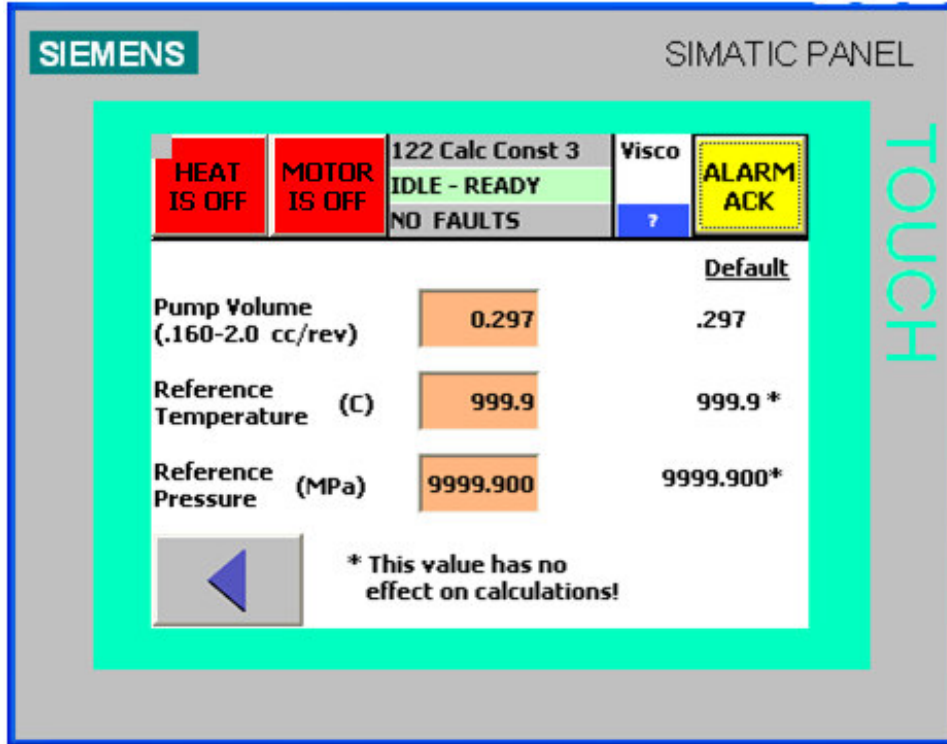

Pump Volume:

Volume of material moved by the pump for each pump revolution in cc/rev.

Reference Temperature*:

Temperature_correction =

$$\text{EXP}(\text{act_energy} * ((1.0/(\text{ref_temp} + 273.15)) - (1.0/(\text{process_temp} + 273.15))))$$

*Default value of 999.9 produces no temperature correction.

Reference Pressure*:

$$\text{MFR_ref_pressure} = (\text{ref_pressure}/\text{process_pressure}) ^{(1/\text{Flow_rate})}$$

*Default value of 9999.900 produces no pressure correction

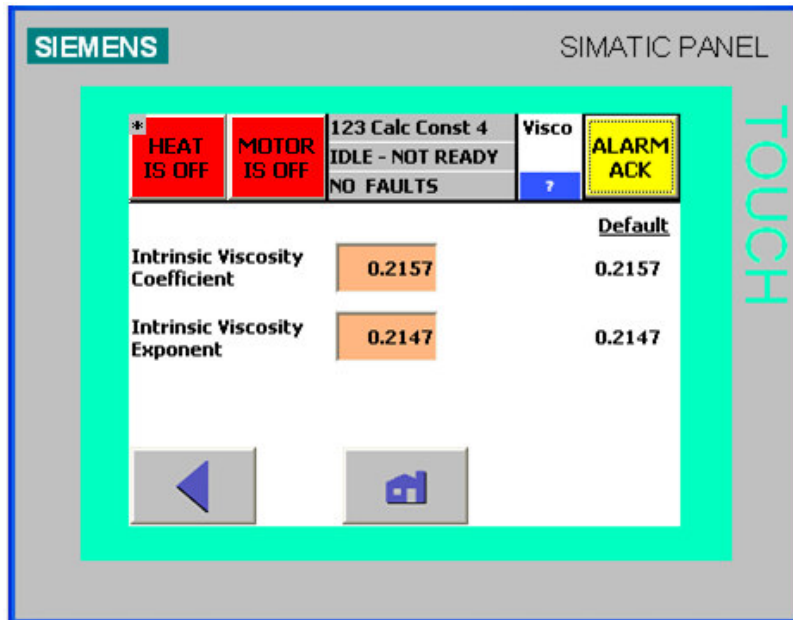

Intrinsic Viscosity Coefficient:

$$\text{Intrinsic_Viscosity (IV)} = \text{IV_coefficient} * (\text{melt_viscosity}^{IV_exponent})$$

Default value: 0.2157

Intrinsic Viscosity Exponent:

$$\text{Intrinsic_Viscosity (IV)} = \text{IV_coefficient} * (\text{melt_viscosity}^{IV_exponent})$$

Default value: 0.2147

8.4.5 Operator Setup (130-138)

MAIN – DATA ITEMS

There are two options – “Data only on Main screen” or “Show trend on Main screen”. These will show on the 000 Main Screen. After clicking on the chevron next to the option, a drop-down box contains the selections. Highlight the desired selection

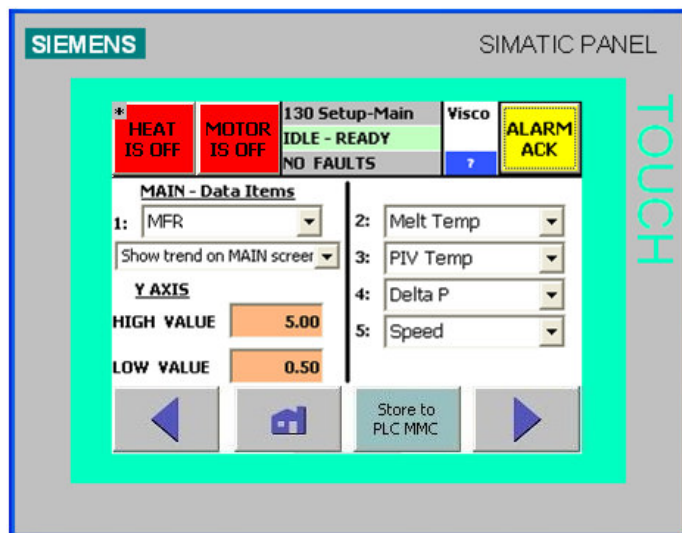
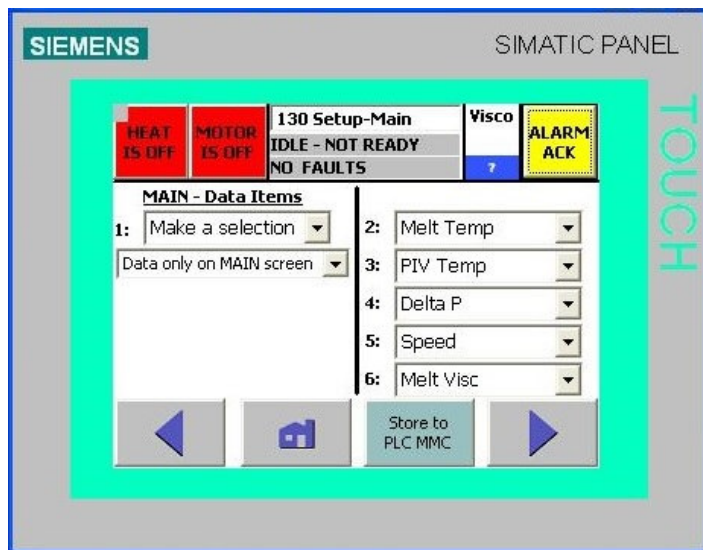

MAIN – DATA ITEMS

If “Data only on Main screen” option chosen, then up to 5 items can be selected here.

- They will be displayed on the 000 Main screen.
- The choices include temperatures, pressures, pump speed, MFR, shear rate, shear stress, melt viscosity, relative viscosity, and intrinsic viscosity.

If “Show trend on Main screen” option shown, then up to 4 items can be selected here.

- They will be displayed on the Main screen along with the trend graph. The choices include temperatures, pressures, pump speed, MFR, shear rate, shear stress, melt viscosity, relative viscosity, and intrinsic viscosity.
- A 10 minute trend graph for the selected item, chosen as #1, is shown on screen 000 MAIN. The choices include MFR, MV, IV, RV, SR, SS, pressure, and speed.
- The Y axis high and low values set the Y axis limits on the 000 Main screen trend graph

For all items, press the down arrow button on the right side of the box. A drop-down box contains the selections. Highlight the desired selection.

The Store to MMC button saves all configuratin and setup parameters to the CPU MMC. This permits all parameters to be restore when the MRES procedure is done.

NOTE: It is recommended to use Store to MMC any time a change is made to the Visco settings, otherwise, if the MRES procedure is done, all settings will require re-entry manually.

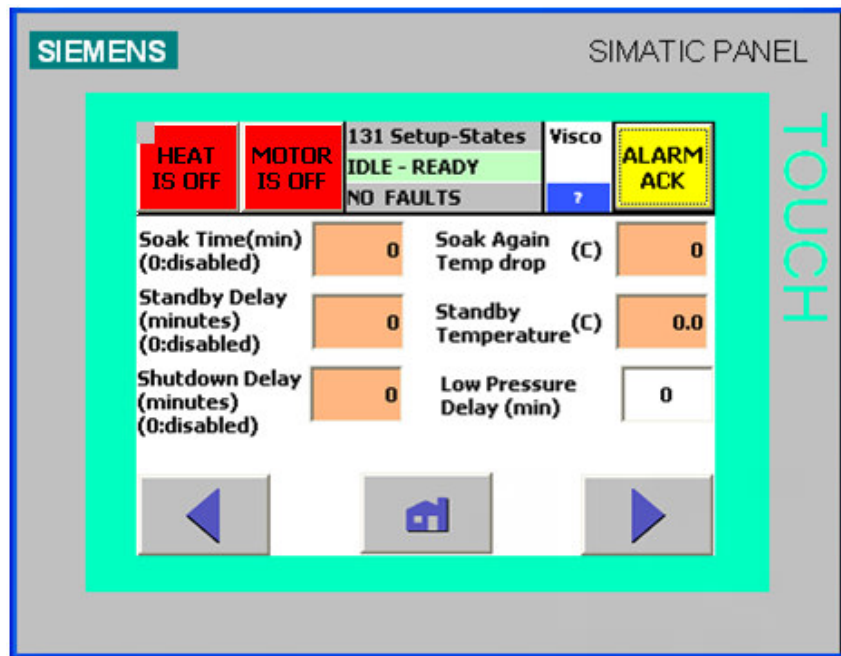

The Setup-States screen is used to configure the rheometer soak, standby, and shutdown conditions.

Soak Time (min)

The soak conditions are used to “soak” the material at a given temperature for a period of time before permitting the motor/pump to operate. On power-up, the soak time begins when there are no low temperature warnings. A soak will also be initiated if the temperature ever drops below the selected limit (temperature setpoint minus the soak again temp drop) for 1 minute. During the soak process, the instrument state will change to SOAK and the soak timer will be displayed. No motor

enable button will be visible until the soak time has completed.

The soak process can be stopped by pressing the BYPASS SOAK button. This button appears during the soak process where the Motor enable/disable button is located.

0: Soak function is disabled

Standby Delay (minutes)

If the instrument is in an IDLE – READY state for the standby delay time, the instrument state changes to STANDBY. In the standby state, the temperature setpoint changes to the standby temperature. Press the EXIT Standby button to return to the process setpoint. The standby timer is displayed while in the IDLE-READY state.

0: Standby function is disabled

Shutdown Delay (minutes)

If the instrument is in the Standby state for the shutdown delay time, the heat will be disabled and the state will change to IDLE – NOT READY. The shutdown timer is displayed while in the Standby state.

0: Shutdown function is disabled

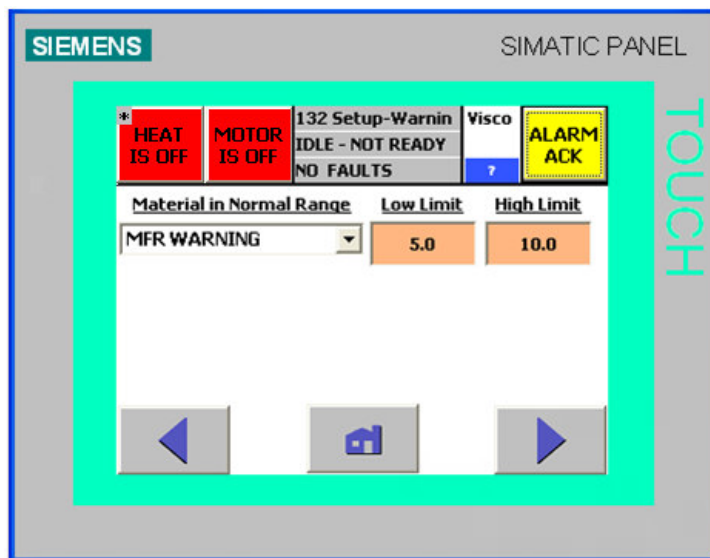

The selected material property is normal when the property is within the given low and high limits. A warning message is displayed, the warning relay is activated, and the material status relay is activated when the limits are exceeded after the motor has been operating for over 30 seconds.

Material in Normal Range selections

WARNING DISABLED No material range check

MFR WARNING

MV WARNING

IV WARNING

RV WARNING

MFR (2) WARNING

MV (2) WARNING

Low Limit

Lower limit for the selected item (MFR/MV/IV/RV)
The low limit is ignored when the warning is disabled.

High Limit

High limit for the selected item (MFR/MV/IV/RV)
The high limit is ignored when the warning is disabled.

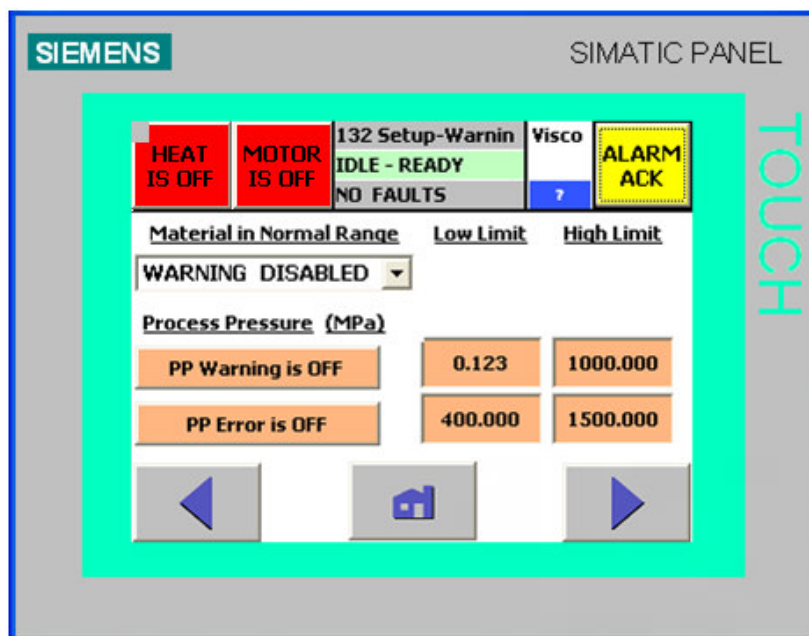

Material in Normal Range

Select the desired material property from the list in the pull down menu. The low/high limit values are ignored when WARNING DISABLED appears.

The selected material property is normal when the property is within the given low and high limits. A warning message is displayed, the warning relay is activated, and the material status relay is activated when the limits are exceeded after the motor has been operating for over 30 seconds.

To view the Process Pressure warning conditions

- 1) The Process Pressure must be enabled on screen 254 CFG-Options and
- 2) A pressure transducer must be mounted on the PIV and wired accordingly.

Process Pressure (PP) Warning

Press the button to toggle the process pressure warning on/off. The low/high limit values are ignored when the PP Warning is OFF.

The process (input) pressure is normal when the pressure is within the given low and high limits. A warning message is displayed and the warning relay is activated when the limits are exceeded.

Process Pressure (PP) Error

Press the button to toggle the process pressure error on/off. The low/high limit values are ignored when the PP Error is OFF.

The process (input) pressure is normal when the pressure is within the given low and high limits. An error message is displayed and the error relay is activated when the limits are exceeded.

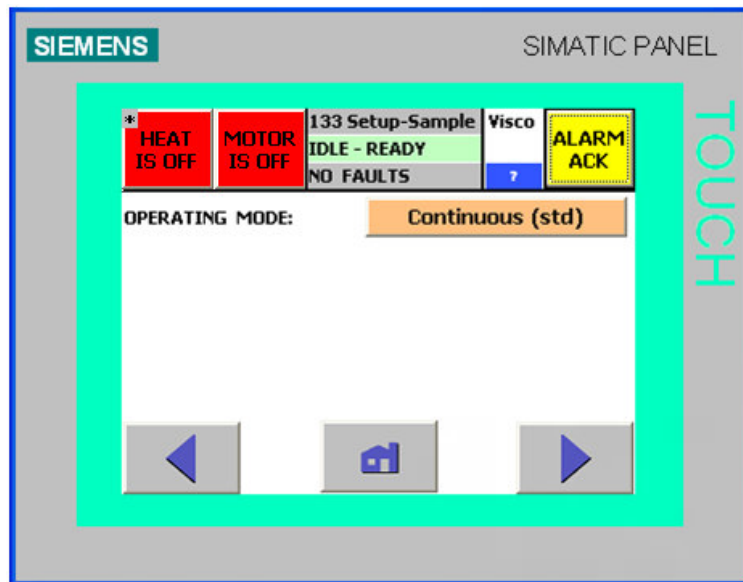

OPERATING MODE:

Continuous (std) (Normal operating mode)

The rheometer operates continuously at the set speed while in constant speed mode. The rheometer operates continuously at the set pressure while in constant pressure mode.

Sample/Purge

The rheometer operates at a constant speed/pressure while sampling the material. After the sampling time, the rheometer changes to a higher speed/pressure to purge the existing material. During this purging process, the material properties are not calculated and the last results are held constant on the display. This mode should only be used when there is a long transfer path from the process to the rheometer.

The Sample/Purge operating mode can be used when a faster response time is required.

This is beneficial when the installation requires a long transfer length and the material requires a slow pump speed.

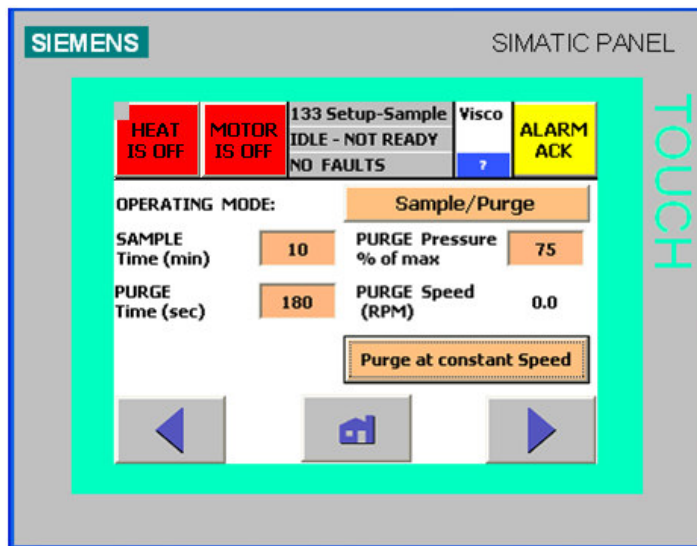

In the Sample/Purge mode, the rheometer samples the material and calculates the material properties (MFR/Viscosity) for the set amount of time. After the sample time expires, the rheometer operates at a faster speed for the set amount of time to purge the transfer line of material and to provide fresh material to the rheometer. After the purge time expires, the rheometer returns to the material sampling operation. While sampling the material, the MFR and viscosity parameters are calculated and updated on the HMI. While purging, the MFR and viscosity parameters are not calculated and the last calculated value is “frozen” on the display.

Sample Time – range 3-9999 min

Amount of time for the rheometer to operate normally

Purge Time -- range 15-900 sec

Amount of time for the rheometer to operate at a higher speed with no MFR or viscosity updates

Purge Pressure % of max

range 5 to 90% of the maximum for transducer 1

Pressure setpoint for purging at a constant pressure

Purge Speed (RPM)

range 3 RPM to the maximum allowable

Speed setpoint for purging at a constant speed

Purge at constant Speed / Purge at constant Pressure

Purge at constant Speed -- purge at the purge speed setting

Purge at constant Pressure -- purge at the constant pressure determined by the purge pressure % of max

There are two additional operations possible: Sample/Sweep/Purge and Sample/Sweep. See the description of screen 261 Shear Sweep for information on the Shear Sweep operation.

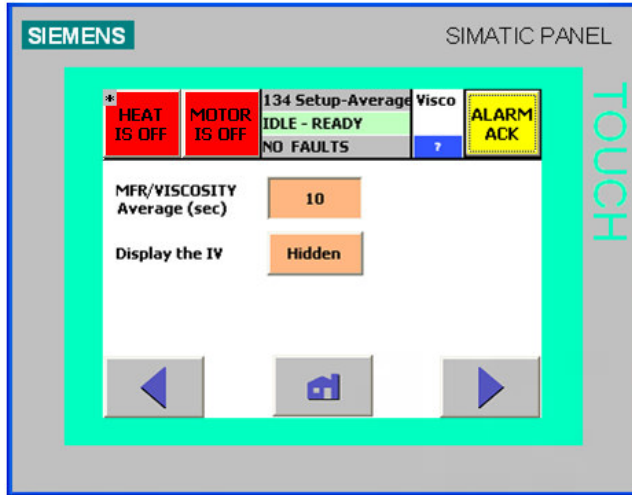

MFR/VISCOSITY Average (sec)
range 2-1800 seconds

The MFR, Melt Viscosity, and Intrinsic Viscosity measurements are averaged over the time period.

Display the IV

Visible: Intrinsic Viscosity parameters are visible on the HMI

Hidden: All Intrinsic Viscosity parameters are hidden from view on the HMI

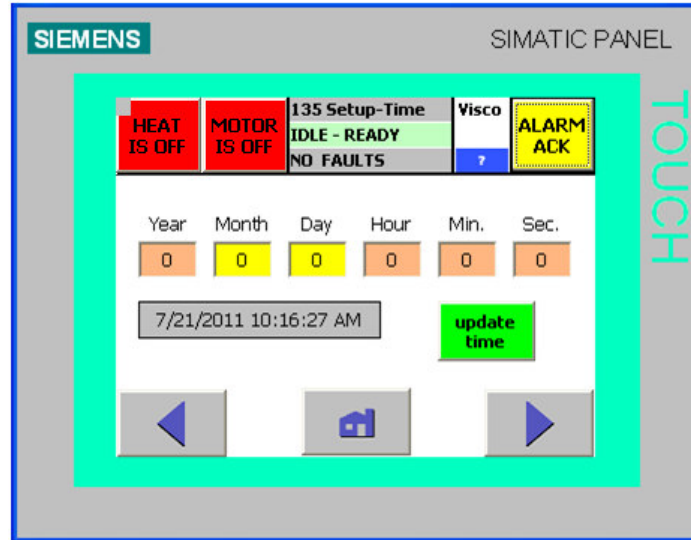

The date and time entered are used in the PLC and in the HMI. The time is used for all trend graphs and for the error log.

To set the time

1. Press each box to enter the year/month/day/hour/min value.
2. Press the Update Time box
3. The new time is then visible in the grey ##### box.

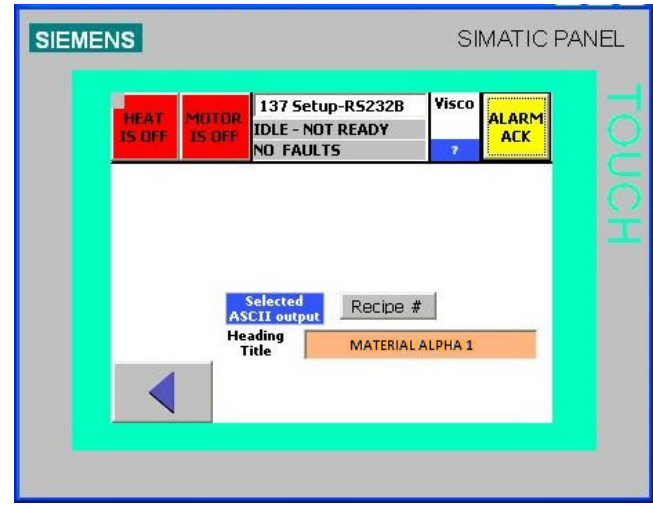
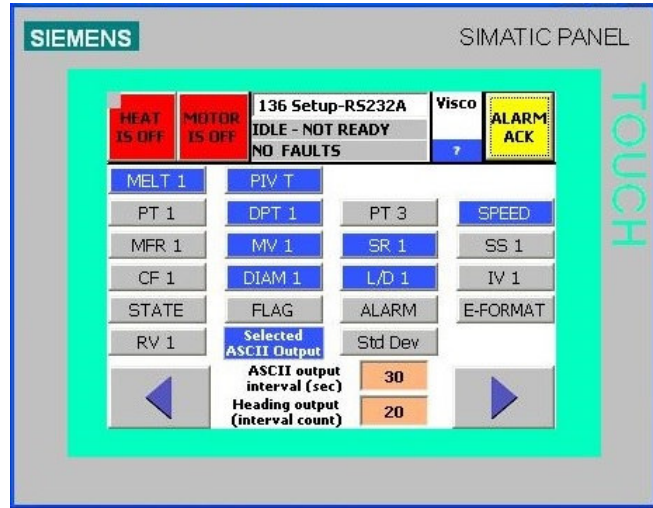

The rheometer is capable of transmitting rheometer data over an RS-232 communication port at a user set interval. A maximum of 25 data items can be selected:

The RS-232 (ASCII) output is factory set at 9600 baud, no parity, 8 data bits, 1 stop bit, and no flow control (9600:N:8:1)

Select the data items in screens 136 that are to be communicated by pressing the button for the item. Selected items are shown in blue. Press the ASCII output interval button to enter the desired interval. An interval of 0 seconds disables the output. The maximum interval is 28800 seconds (8 hours). A header can be output at the set interval count. The header includes the selected output items in proper order. A setting of 0 disables the header and 20 sets the header to be output every 20th data output. The header can include a title with up to twenty characters. A leading space or blank will disable the title output.

The data is output in text format and can be captured with a terminal program or on a flash drive with the optional datalogger, if supplied. The file can be imported into Excel as a space delimited text file.

The standard format for the data is shown below:





mm-dd-yy hh:mm:ss +xxxx.x +xxxx.x ...

The E-format is required to communicate values greater than 32767 or less than 0.001. The E-format is show below:

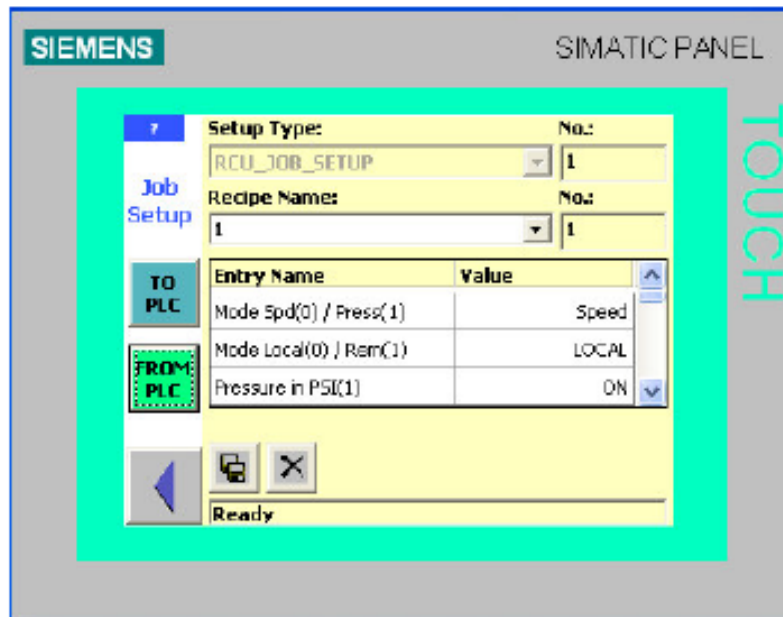
< mm-dd-yy hh:mm:ss +1.0000000E+00 +1.0000000E+00 >

8.4.6 Recipes (140)



- Recipe Name** Used to add new Recipe or recall a previously saved recipe
- Entry Name** Used to display or change the stored value in the recipe
-  Used to save a recipe file under a different or the same name
A recipe file must be saved for later recall
-  Used to delete a recipe file
-  Used to write a recipe file to the PLC to be used as the operating recipe
-  Used to read the current operating recipe from the PLC, so it can be saved to a file

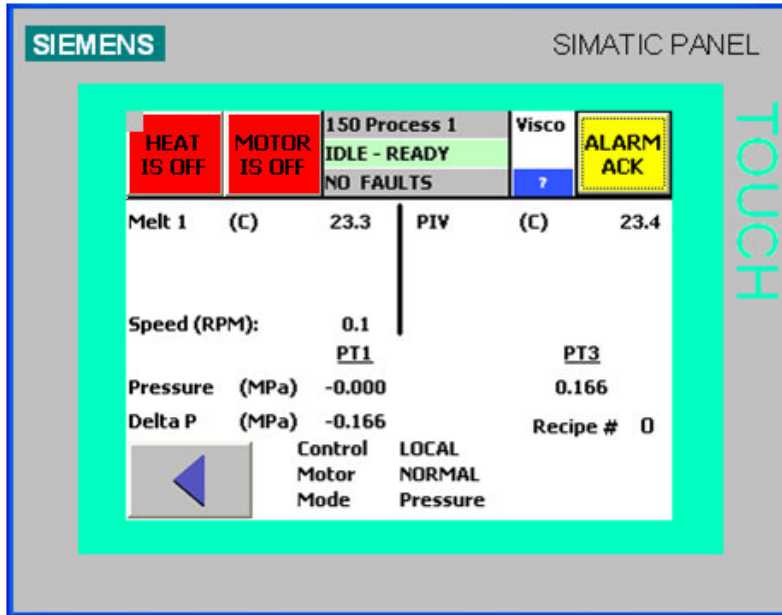

All items on screen 150 Process 1 are view only.

All temperature, pressure, and speed readings are calibrated readings.

The speed and pressure readings are calibrated readings.

CONTROL

- LOCAL - all instrument control is performed at the HMI.
- REMOTE - a remote station can perform control.

MOTOR

- NORMAL
- FAULT

MODE

- Pressure – the motor speed is controlled to provide a constant pressure
- Speed – the motor is controlled to provide a constant speed

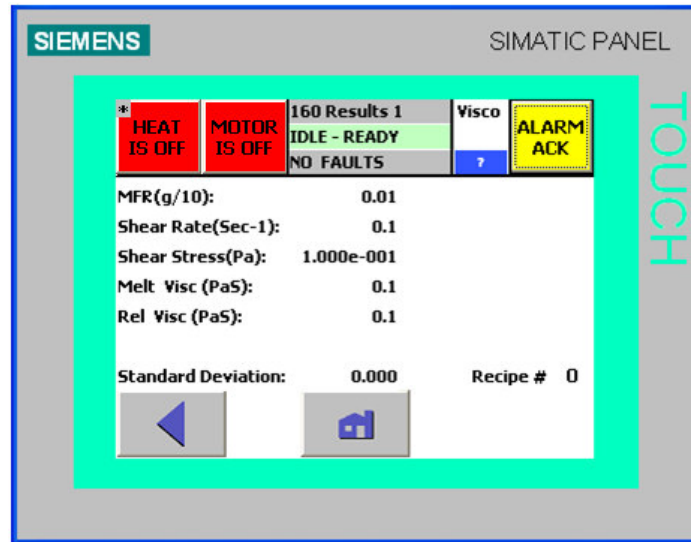

All items on screen 160 Results 1
are view only.
MFR – Melt Flow Rate
Shear Rate (SR)
Shear Stress (SS)
Melt Viscosity (MV)
Relative Viscosity (RV)



The equations used for the rheometer calculations are shown below.

$$\text{TEMP_CORR} = e^{\left(\frac{E/R}{\left(\frac{1}{\text{REF_TEM}+273.15} - \frac{1}{\text{MELT_TEMP}+273.15}\right)}\right)}$$

$$\text{MI_BASIC} = 10 * \text{PUMP_SPEED} * \text{PUMP_VOL} * \text{DENSITY} * \text{CF} * \left(\frac{1}{\text{TEMP_CORR}}\right) * \left(\frac{0.0825}{\text{CAP_DIA}}\right)^3$$

$$\text{MELT_INDEX} = \text{MI_BASIC} * \text{CAP_SHIFT} * \left(\frac{\text{REF_PRESS}}{\text{PRESSURE}}\right)^{\left(\frac{1}{\text{FLOW_INDEX}}\right)}$$

$$\text{SHEAR_STRESS} = \left(\frac{1723.69 * \text{PRESSURE}}{\text{L/D}}\right)$$

$$\text{SHEAR_RATE} = \left(\frac{0.01036 * \text{PUMP_SIZE} * \text{PUMP_SPEED}}{\text{CAP_DIA}^3}\right)$$

$$\text{VISCOSITY} = \text{TEMPCOR} * \left(\frac{\text{SHEAR_STRESS}}{\text{SHEAR_RATE}}\right)$$

$$\text{INTRINSIC VISCOSITY} = \text{IV_coefficient} * (\text{VISCOSITY} \wedge \wedge \text{IV_exponent})$$



8.4.9 Alarm Status (screens 170-172)

The following status conditions are displayed in the status screens:

- Normal (green) conditions are within the normal limits
- Low (yellow) warning that condition is below the lower limit
- Low (red) fault that condition is low
- High (yellow) warning that condition is above the upper limit
- High (red) fault that condition exceeds high limits
- Fault (red) fault that sensor is faulty or disconnected
- Alarm (red) fault caused by an alarm condition

Warning conditions activate the warning output relay. The motor/pump cannot be enabled while warnings are present. Warnings do not need to be acknowledged. Warning messages clear when the condition has returned to normal.

Fault conditions activate the fault output relay. The motor/pump cannot be enabled while faults are present. The heat cannot be enabled when a high temperature fault is present. Faults need to be acknowledged. Fault occurrences get date and time stamped and recorded in the screen 270 Error Log-1.

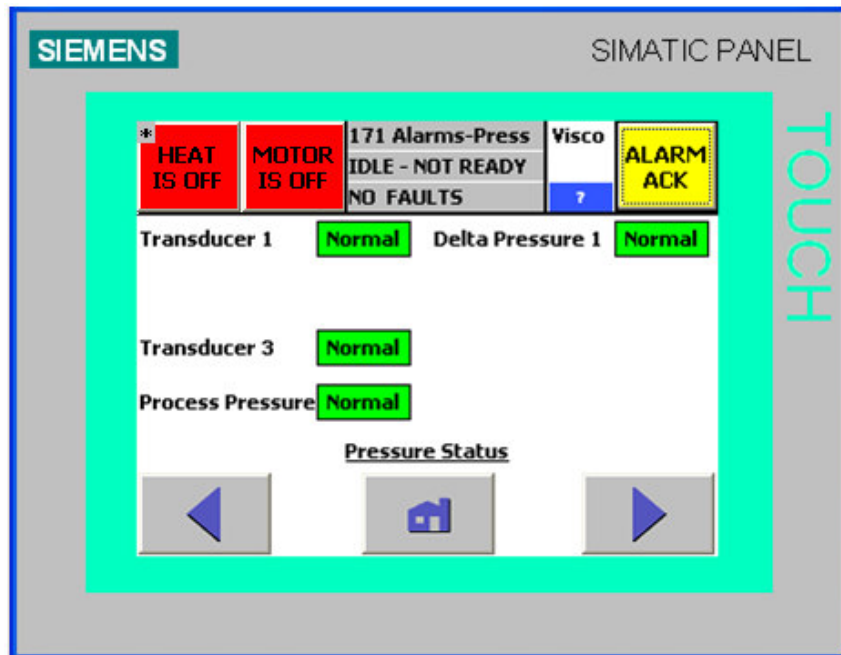
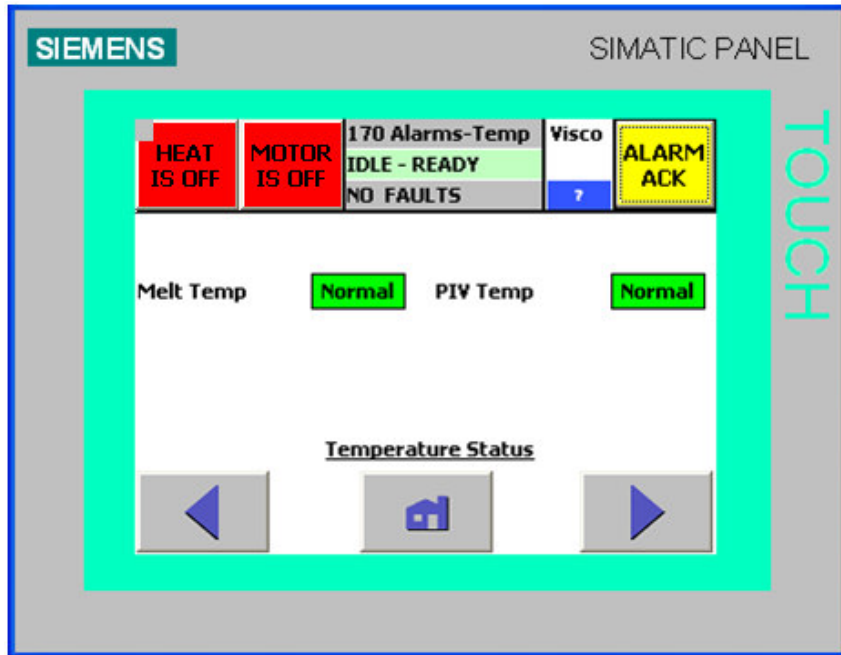

To view the Process Pressure status

- 1) The Process Pressure must be enabled on screen 254 CFG-Options and
- 2) A pressure transducer must be mounted on the PIV and wired accordingly.

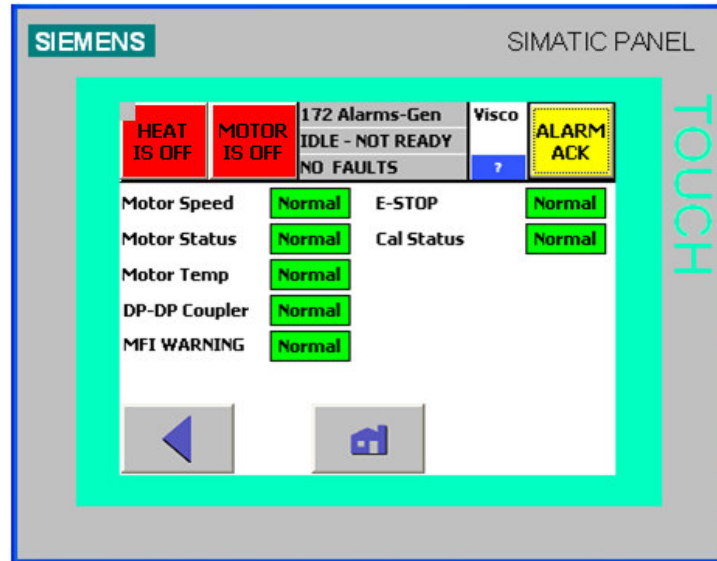

Motor Speed

Low Warning: speed less than the normal range
High Warning: speed greater than the normal range

Motor Status

Alarm: motor drive fault

DP-DP coupler

OFF: Coupler installed and disabled warning
Fault: No DP-DP coupler "ALIVE" signal detected from the DCS

Material Warning

Low Warning: Material property less than the normal range
High Warning: Material property exceeds the normal range
Set the normal range in the 132 SETUP- WARNING screen.

E-STOP

Alarm: E-stop condition

Cal Status

Fault: Error in the auto calibration of a pressure transducer



8.4.10 Trending Graphs (180-196)

Trending screens graph data over a rolling 10 or 60-minute period of time. For example, Speed-10 graphs the speed over a 10 minute window while Speed-60 graphs the speed over a 60 minute window.

Set the Y-axis limits in the TREND SETUP screens(181-183). Set the Y-axis lower limit less than the lowest data value to be displayed. Set the Y-axis high limit greater than the highest data value to be displayed. This ensures that the data will be viewable in the graph.

Press the appropriate button to view the following graphs:



Temperature-10 minutes	Temperature-60 minutes
Speed-10 minutes	Speed-60 minutes
Pressure-10 minutes	Pressure-60 minutes
MFR-10 minutes	MFR-60 minutes
SR-10 minutes	SR-60 minutes
SS – 10 minutes	SS – 60 minutes
MV-10 minutes	MV-60 minutes
RV-10 minutes	RV-60 minutes
IV-10 minutes	IV-60 minutes

While viewing a trend graph, press the left/back arrow to return to the trend menu. Press the right/next arrow to proceed to the next trend graph.

The trend menu is shown on screen 180.

The trend setup conditions are shown on screens 181-182.

The trend graphs are shown on screens 184-186 and 191-196.

When using the 60 mminute trend time axis, the  and  buttons will contract and expand, respectively, the time axis.

SIEMENS SIMATIC PANEL

TOUCH

HEAT IS OFF	MOTOR IS OFF	180 Trend Menu 1	Visco	ALARM ACK
		IDLE - READY	?	
		NO FAULTS		

MFR [dropdown] 1 hour [dropdown] Temperature Shear Rate

Y High 100.00 Speed Shear Stress

Y Low 0.00 Pressure R. Viscosity

Upper limit 100.00 MFI

Lower limit 0.00

Navigation: [Left Arrow] [Home] [Right Arrow]

SIEMENS SIMATIC PANEL

TOUCH

HEAT IS OFF	MOTOR IS OFF	181 Trend Setup 1	Visco	ALARM ACK
		IDLE - NOT READY	?	
		NO FAULTS		

RHEOMETER

	Y low	Y high
Temperature (C)	0	300
Speed (RPM)	0	80
Pressure (PSI)	0.0	3000.0

Navigation: [Left Arrow] [Home] [Right Arrow]

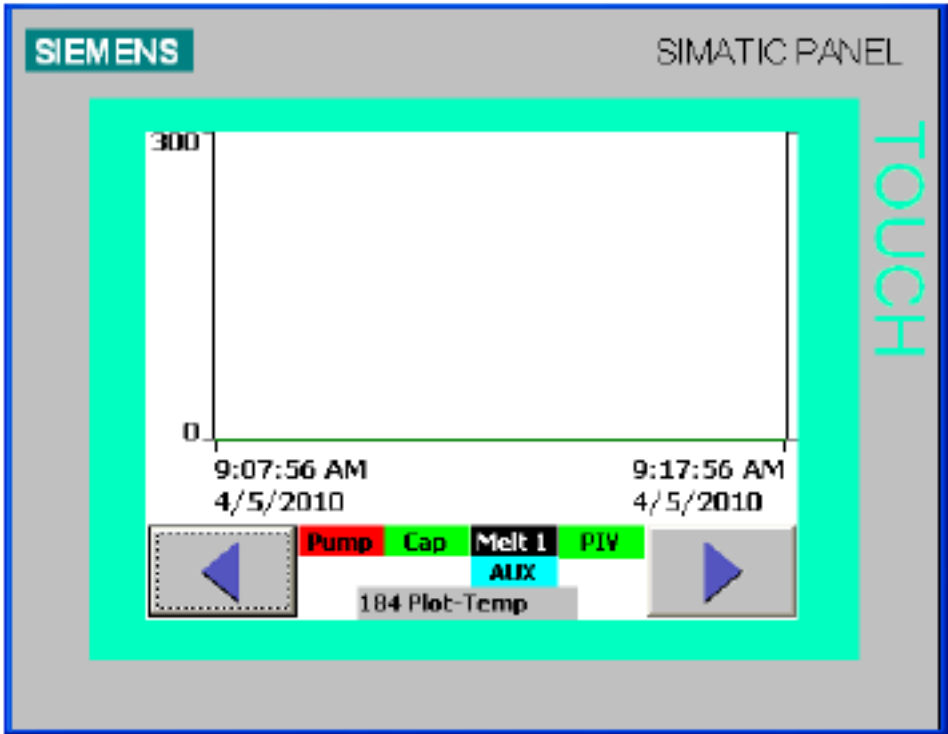
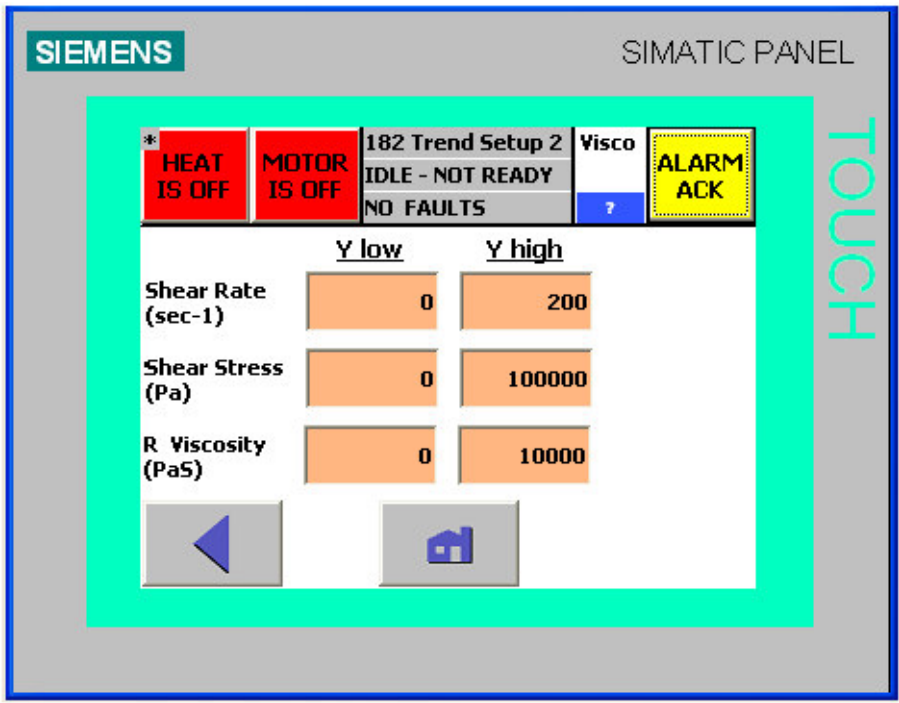

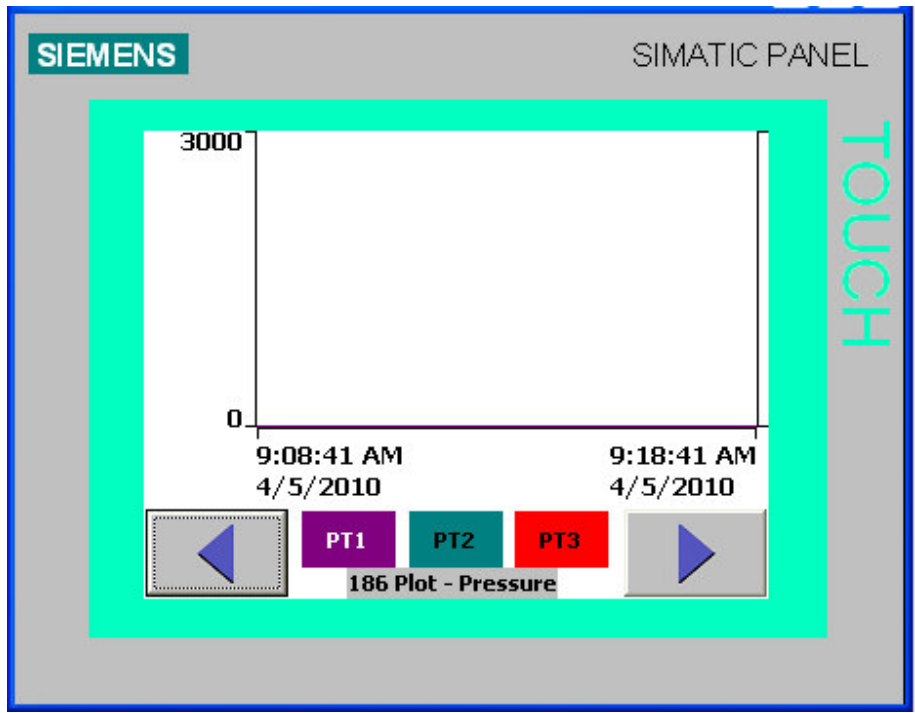
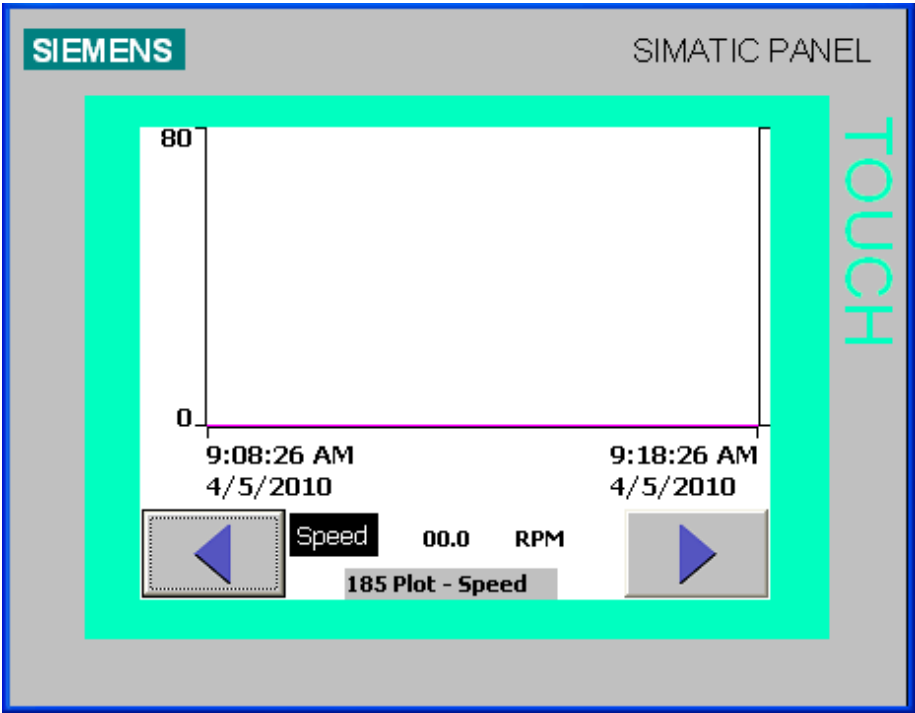

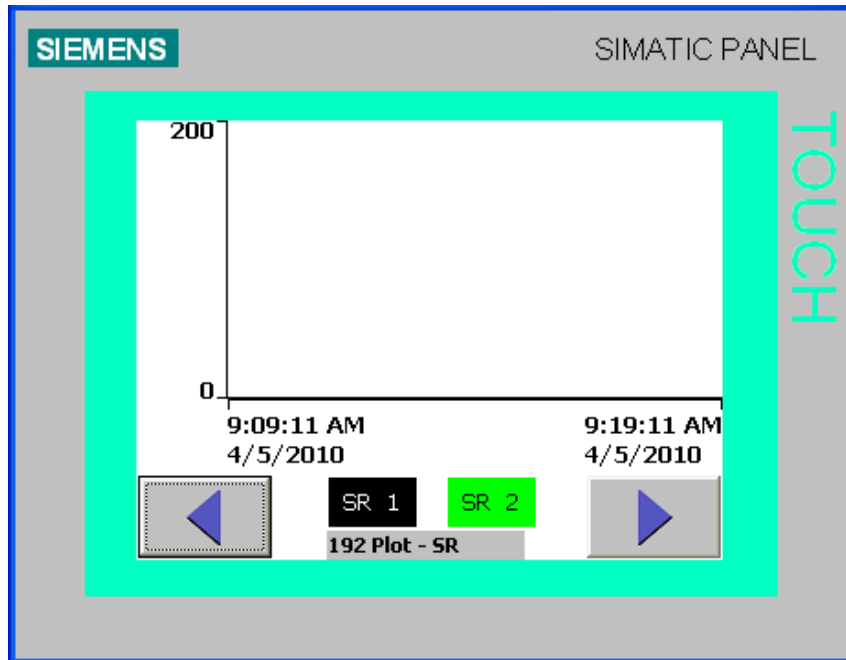
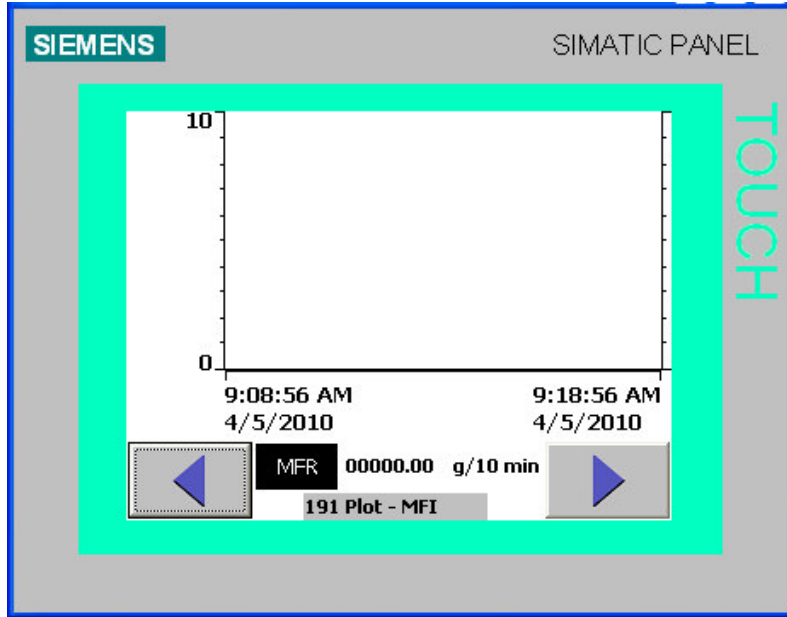

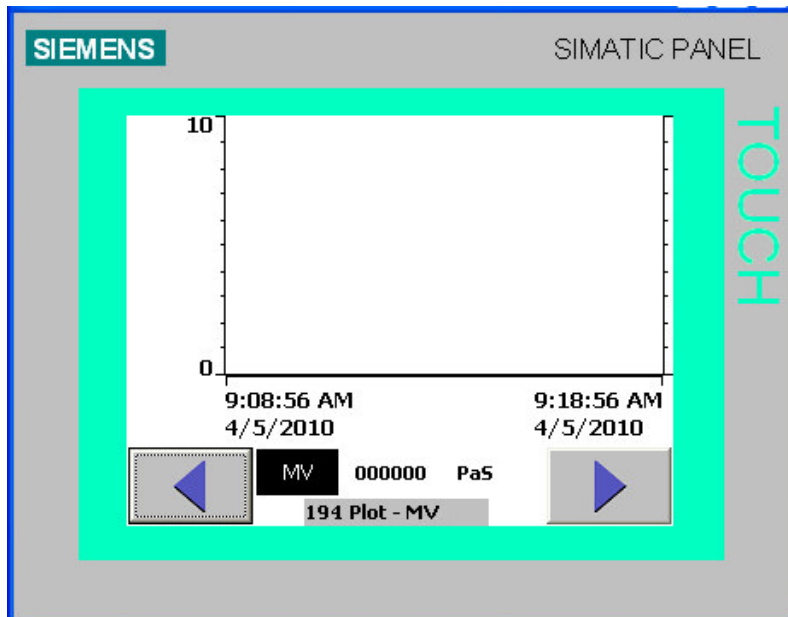
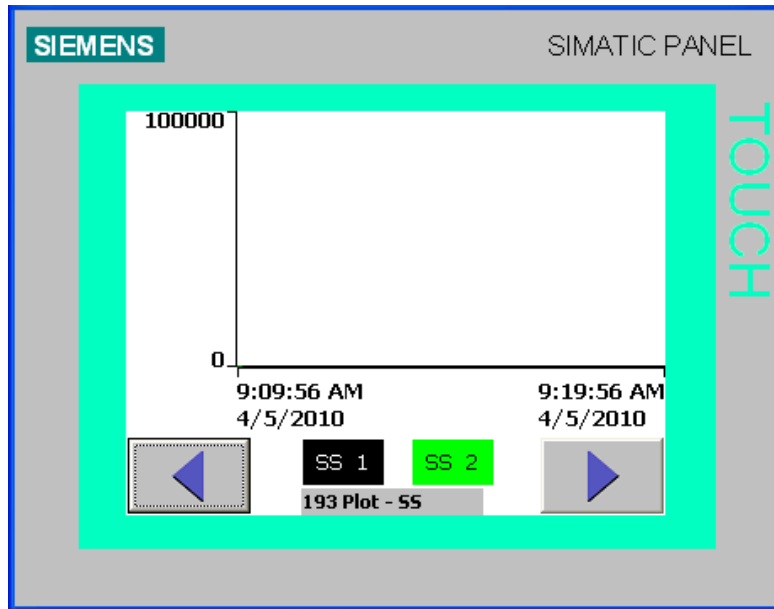

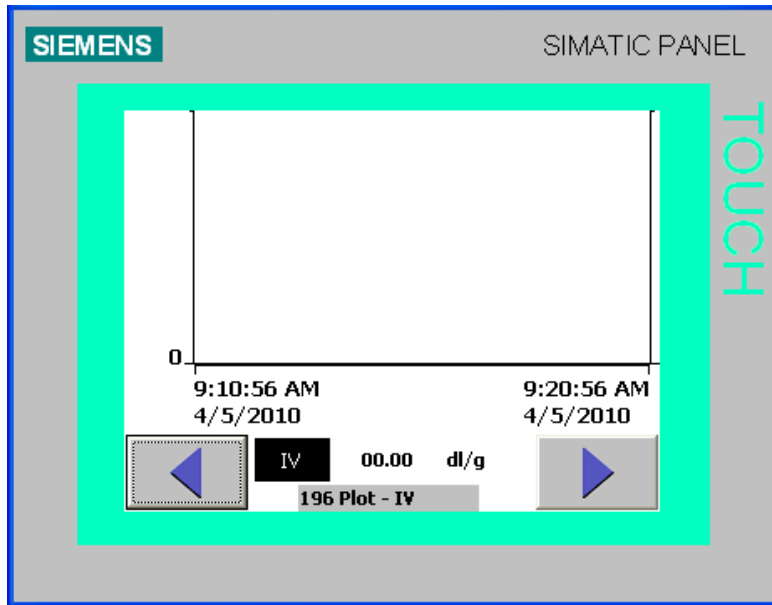
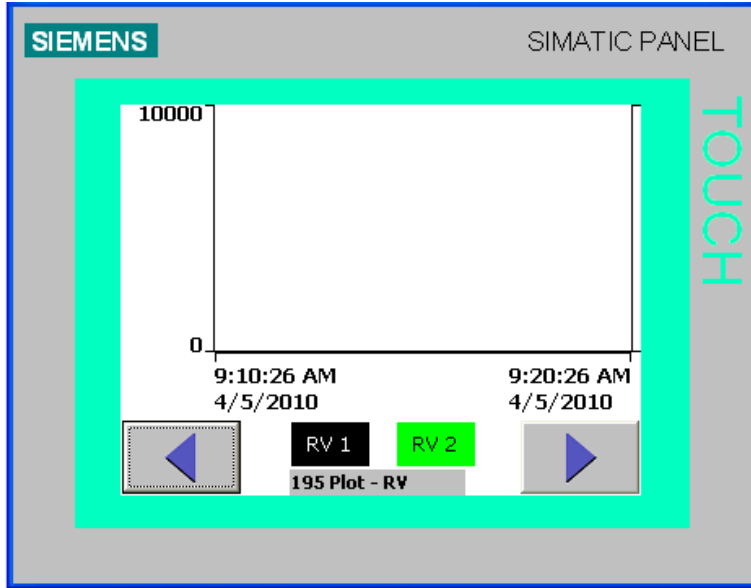



8.4.11 Temperature Calibration (210)

Calibrating a temperature measurement is performed by entering a positive or negative offset to the raw temperature measurement. Enter an offset for the RTD such that the calibrated value on the screen matches the measuring device. Press the default temperature calibration button to zero the offset values.

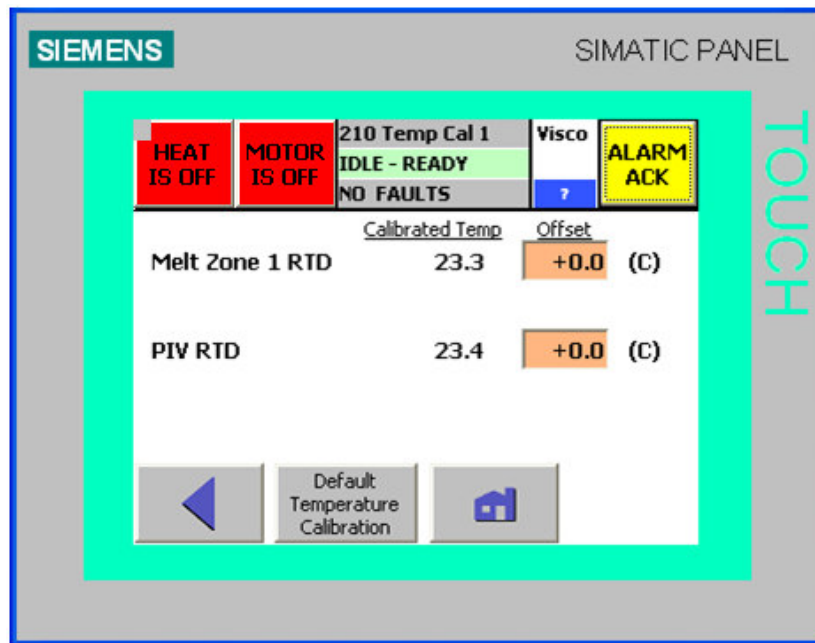

8.4.12 Pressure Calibration (220-222, 230-232)

Each pressure transducer must be calibrated individually. Pressure transducers can be calibrated in any of three different ways. These are Default, Automatic Cal, and User Cal.

Default Pressure Calibration – press the Default Settings button

Low point 0.0 mV 0.0 PSI

High point 33.3 mV maximum PSI

Automatic Pressure Calibration – press the Automatic Cal button

The automatic calibration process takes about 15 seconds.

The pressure transducers must be at ambient pressure for accurate results.

The heat must be enabled with no temperature warnings to perform the Auto Cal.

Automatic Calibration utilizes a precision resistor within the transducer.

User/manual Calibration –

mV readings and the associated pressure are manually entered for the two pressure data points. This method is the most accurate.

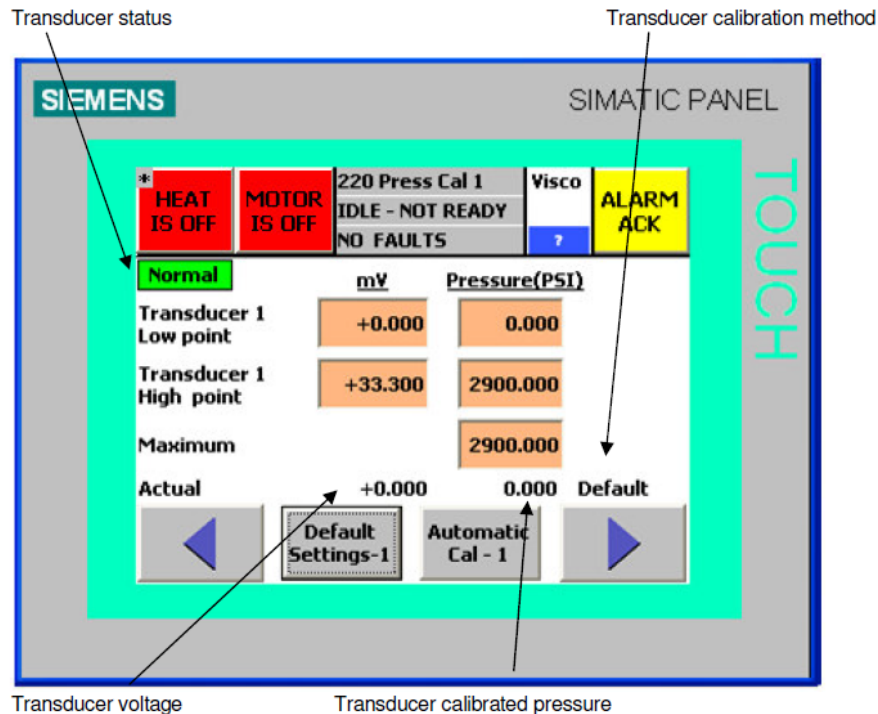

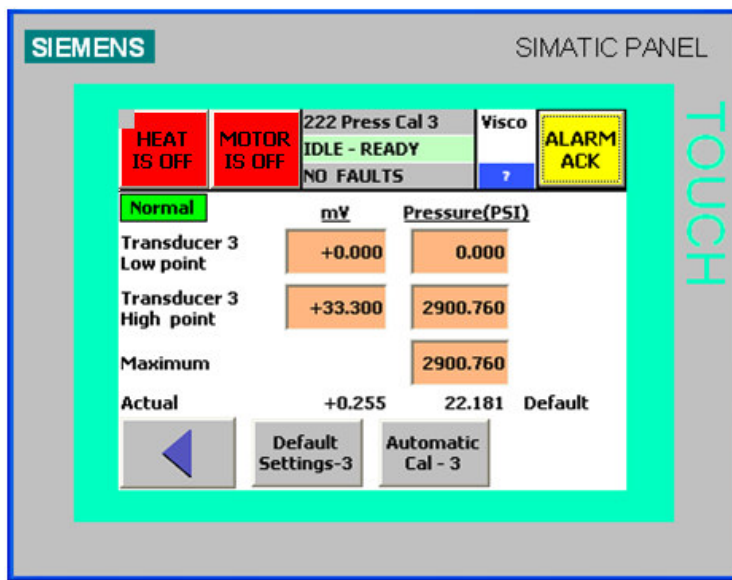

8.4.13 Analog I/O Calibration (240-245)

CAUTION: AI5 (speed) and AO1(0-10V) should only be calibrated by a trained service person!
Poor calibration will cause errors in calculations and may damage the motor and drive.

Converting an analog (4-20 mA) input to a rheometer process setpoint

1. Select the process setpoint to be set by the analog input on screen 255 CFG mA in.
2. Install the analog inputs for process control by setting 4-20 mA inputs enabled in screen 253 CFG-Comm.
3. Scale the analog input on screen 241 Ana In Cal 2. Set the 4 mA value and the 20 mA value. For example, 4 mA represents 0.0 C and 20 mA represents 100.0 C.
4. Enable the analog inputs in screen 110 Setpoints 1 by setting RMT is ON
5. If necessary, calibrate the analog input on screen 241 Ana In Cal 2 such that the actual mA on the HMI matches the DCS analog output mA .

Converting a rheometer process value to an analog (4-20 mA) output

1. Select the process parameter to output on screen 256 CFG mA out.
2. Scale the analog input on screen 241 Ana In Cal 2. Set the 4 mA value and the 20 mA value. For example, 4 mA represents 0.0 C and 20 mA represents 100.0 C.
3. If necessary, calibrate the analog output on screens 242-244 Ana Out Cal.

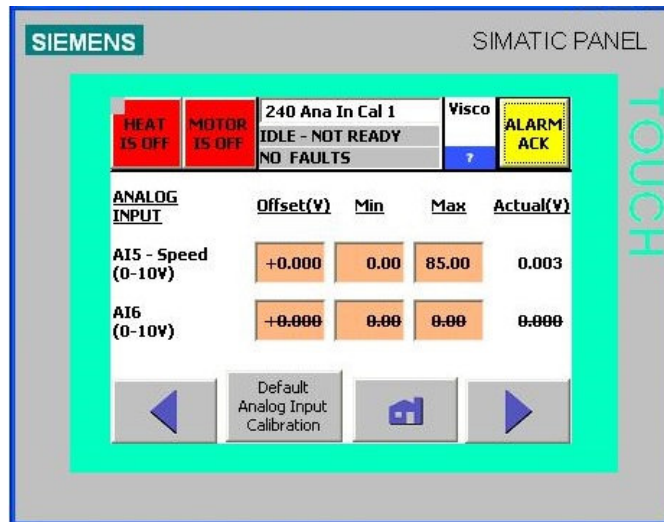

AI5-Speed is set at the factory. Do not change these settings. AI6 is deprecated.

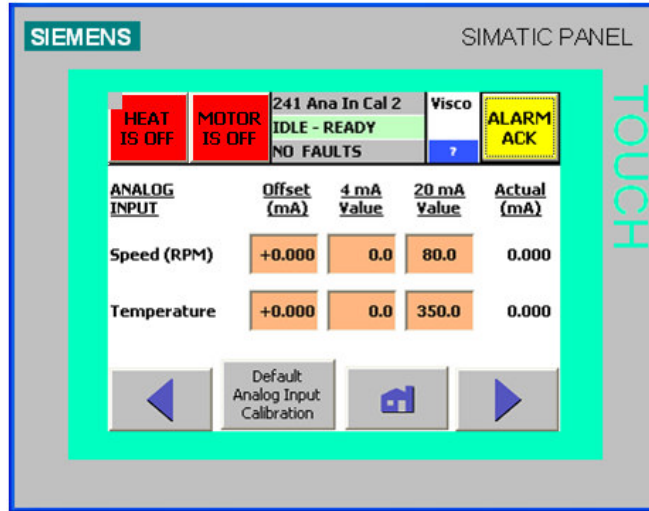

4-20 mA inputs are calibrated and scaled in screen 241. The analog inputs shown were selected in screen 255 CFG – mA in.

Offset(mA)

Used to calibrate the 4-20 mA input signal such that the Actual mA matches the mA output of the DCS.

4 mA Value

Used to scale the 4-20 mA input. For example, 4 mA may represent a temperature setpoint of 0.0 C

20 mA Value

Used to scale the 4-20 mA input. For example, 20 mA may represent a temperature setpoint of 60.0 C

Actual (mA)

mA input reading

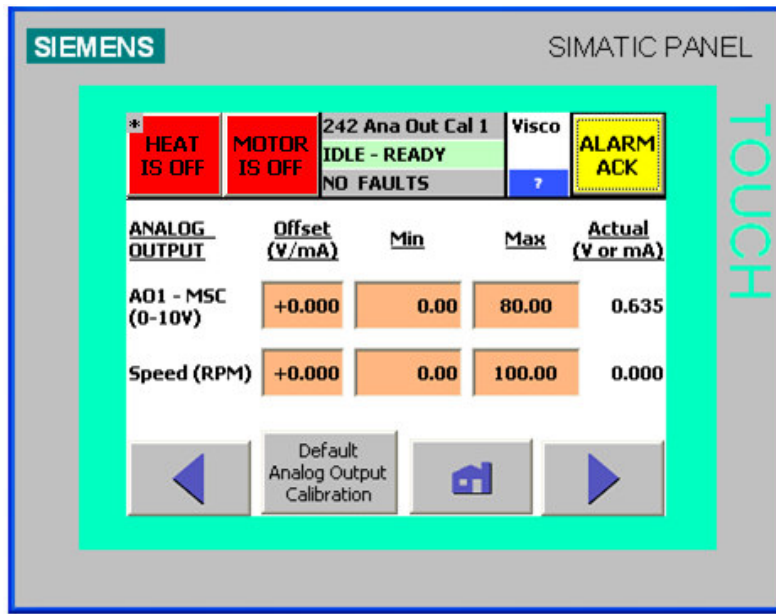

A01 – (010V) is factory set to control the motor speed output.

4-20 mA outputs are calibrated and scaled in screens 242-244. The analog outputs shown in screens 242-244 were selected in screen 256 CFG – mA out.

Offset(mA)

Used to calibrate the 4-20 mA output signal

4 mA Value

Used to scale the 4-20 mA output. For example, 4 mA may represent a Speed of 0.0 RPM.

20 mA Value

Used to scale the 4-20 mA output. For example, 20 mA may represent a Speed of 80 RPM.

Actual (V or mA)

Output value

SIEMENS SIMATIC PANEL

TOUCH

HEAT IS OFF	MOTOR IS OFF	243 Ana Out Cal 2	Visco	ALARM ACK
		IDLE - READY	?	
		NO FAULTS		
ANALOG OUTPUT	Offset (mA)	Min	Max	Actual (mA)
Melt Temp	+0.000	0.00	350.00	0.000
PIV Temp	+0.000	0.00	350.00	0.000

Default Analog Output Calibration

SIEMENS SIMATIC PANEL

TOUCH

* HEAT IS OFF	MOTOR IS OFF	244 Ana Out Cal 3	Visco	ALARM ACK
		IDLE - READY	?	
		NO FAULTS		
ANALOG OUTPUT	Offset (mA)	Min	Max	Actual (mA)
PT 1	+0.000	0.00	3000.00	0.000
PT 3	+0.000	0.00	3000.00	0.000

Default Analog Output Calibration



SIEMENS SIMATIC PANEL

TOUCH

HEAT IS OFF	MOTOR IS OFF	245 Ana Out Cal 4	Visco	ALARM ACK
		IDLE - READY	7	
		NO FAULTS		

<u>ANALOG OUTPUT</u>	<u>Offset (mA)</u>	<u>Min</u>	<u>Max</u>	<u>Actual (mA)</u>
MFR	+0.000	0.00	100.00	0.000
Melt Visc	+0.000	0.00	100000.00	0.000

Default Analog Output Calibration

8.4.14 Machine Configuration (250-259, 25A, 25B, 25C)

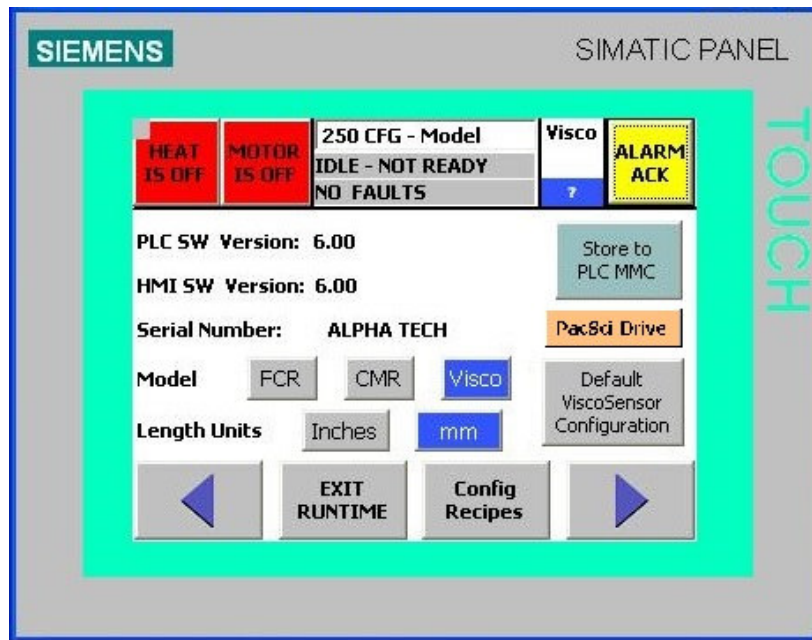

This screen should only be used if new software is loaded. All settings have already been configured at the factory.

The model Visco must be selected. Items that are selected or enabled are shown in blue. Following the Visco selection, press „PacSci Drive“ (or „AKD Drive“) to select the drive type, if different than default, and then press „Default ViscoSensor Configuration“ to load the default configuration and setup parameters.

The units of length are used when entering the capillary die diameter.

The Default ViscoSensor Configuration button will configure the default RTDs, pressure transducers, and 4-20 mA inputs and outputs for the ViscoSensor and set all values to default values.

EXIT RUNTIME is pressed to access the operating system on the HMI. EXIT runtime on the HMI to calibrate the touchpad, adjust the display contrast, or to load new HMI software.

Config Recipes is pressed to access the Machine Configuration recipe screen for saving the instrument configuration to the HMI memory card.

The Store to MMC button saves all configuration and setup parameters to the CPU MMC. This permits all parameters to be restored when the MRES procedure is done.

NOTE: It is recommended to use Store to MMC any time a change is made to the Visco settings, otherwise, if the MRES procedure is done, any un-stored settings will require re-entry manually.

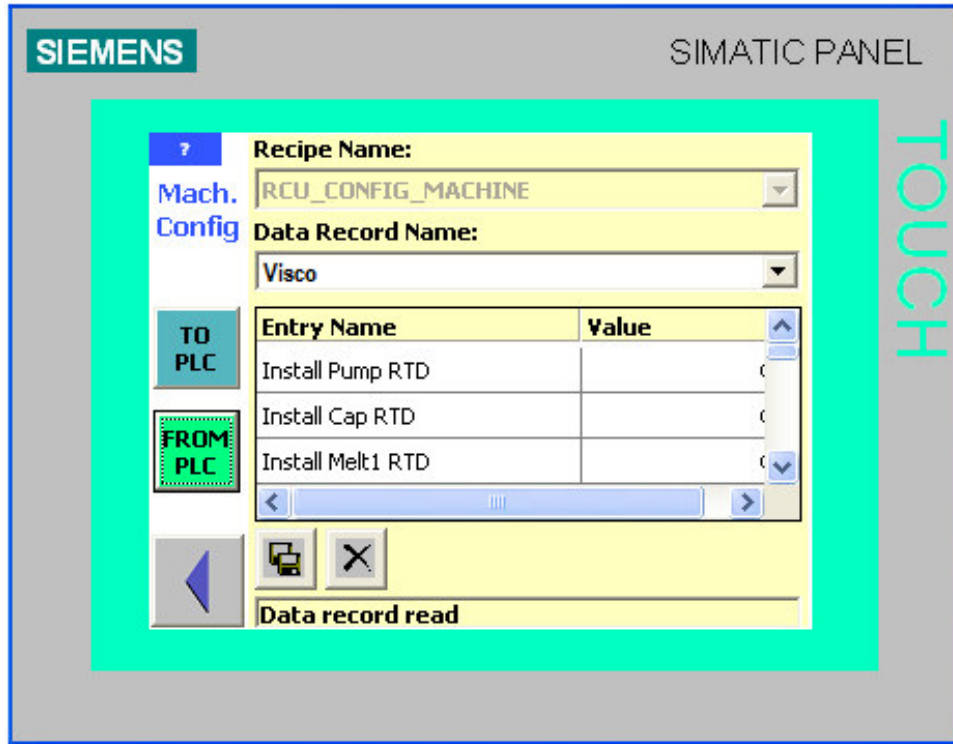

Data Record Name Used to add new configuration file or recall a previously saved configuration file

Entry Name Used to display or change a stored configuration value



Used to save a configuration file under a different or the same name
A configuration file must be saved for later recall



Used to delete a configuration file



Used to write a configuration file to the PLC as the operating configuration



Used to read the current operating configuration from the PLC, so it can be saved to a file

Note: in order for a configuration file to be properly stored after being read from the PLC, you must exit and re-enter the configuration recipe screen before saving to a file (press the left arrow button, press the Config Recipes button again, then save the configuration to a file)

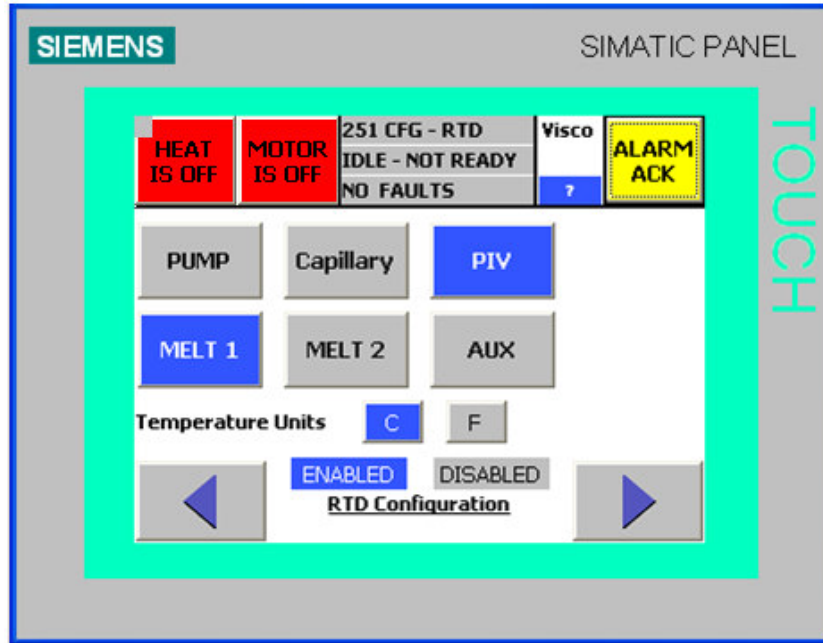

Temperature units can be displayed in either C or F. Press the button to select the desired units.

If an optional AUX heater and RTD are installed, AUX needs enabled here. Press the AUX button to enable the AUX heater and RTD.

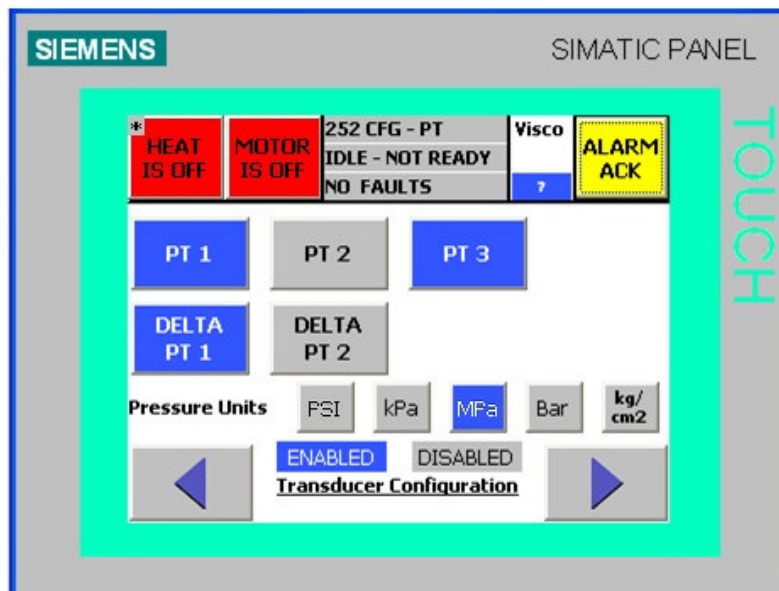

Pressure units can be displayed in either PSI, kPa, Mpa, Bar, or kg/cm².

Screen 253 shows the standard configuration for communications on a ViscoSensor. Modbus, Ethernet, and Profibus DP-DP are communications options. The RS-232 ASCII output communication module is standard. The RS-232 (ASCII) output is factory set at 9600 baud, no parity, 8 data bits, 1 stop bit, and no flow control (9600:N:8:1).

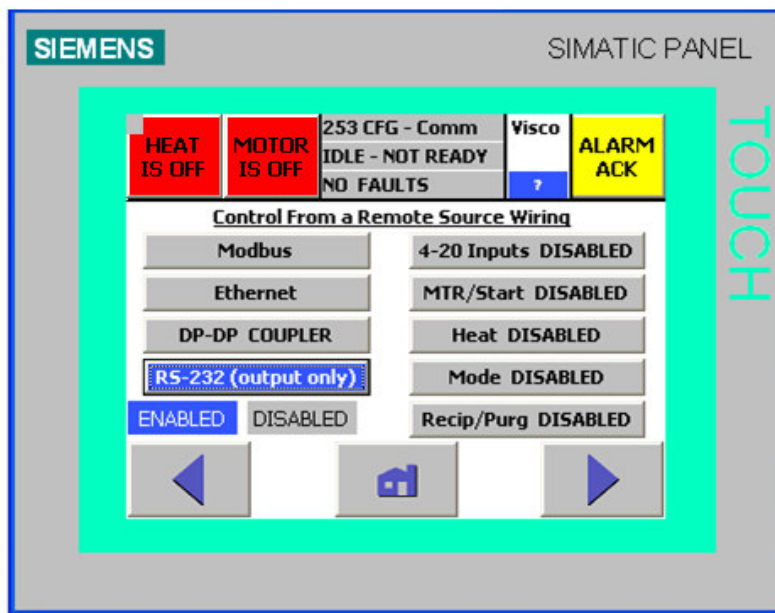

4-20 Inputs DISABLED/ENABLED

- DISABLED – 4-20 mA analog inputs are ignored with remote on and with remote off
- ENABLED – 4-20 mA analog inputs are read every second by the PLC when the remote is ON. The 4-20 mA input is converted to the input selected in screen 255 and scaled in screen 241.

Heat DISABLED/ENABLED

- DISABLED – discrete heat enable input is ignored with remote on and with remote off
- ENABLED – discrete heat enable input is read every second by the PLC when the remote is ON

Motor DISABLED/ENABLED

- DISABLED – discrete motor enable input is ignored with remote on and with remote off
- ENABLED – discrete motor enable input is read every second by the PLC when the remote is ON

Mode DISABLED/ENABLED

- DISABLED – discrete mode (speed/pressure) input is ignored with remote on and with remote off
- ENABLED – discrete mode (speed/pressure) input is read every second by the PLC when the remote is ON

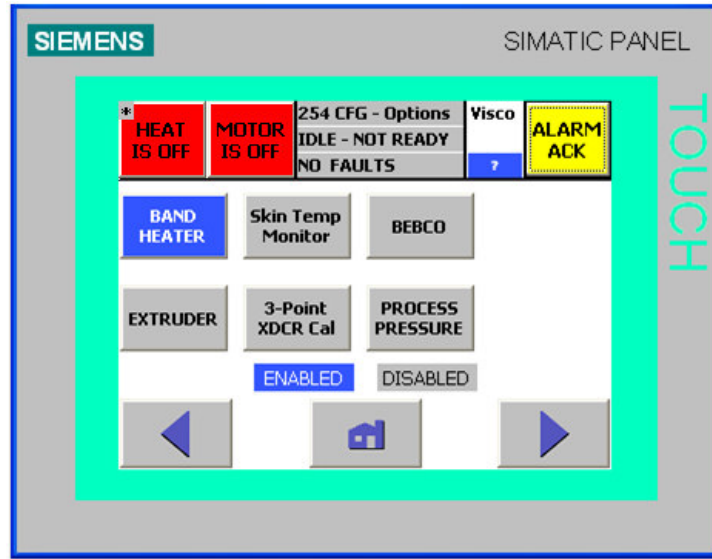

BAND/CAST HEATER

BAND Adjusts the PID heat constants for a non-hazardous band heater
 CAST Adjusts the PID heat constants for a hazardous area cast heater

Skin Temp Monitor

ENABLED Temperature monitors are wired into the system such that a skin temperature exceeding the area temperature limit causes a rheometer fault. A skin overtemperature fault activates the fault relay and disables the rheometer heat.

BEBCO

ENABLED An input signal is required to enable the heaters

EXTRUDER

ENABLED A Dynisco REX system is connected to the rheometer

3-Point XDCR Cal

DISABLED Screens 220-222 Press Cal are used for pressure calibration
 A 2-point pressure calibration curve is used to determine the pressure
 ENABLED Screens 230-232 Press Cal are used for pressure calibration
 A 2-point or 3-point pressure calibration curve can be used to determine the pressure

PROCESS PRESSURE

ENABLED A pressure transducer is attached to the PIV to monitor the input pressure to the rheometer. Low and high pressure limits can be set to activate warnings and faults. Configure the limits on screen 132 Setup-Warnings.

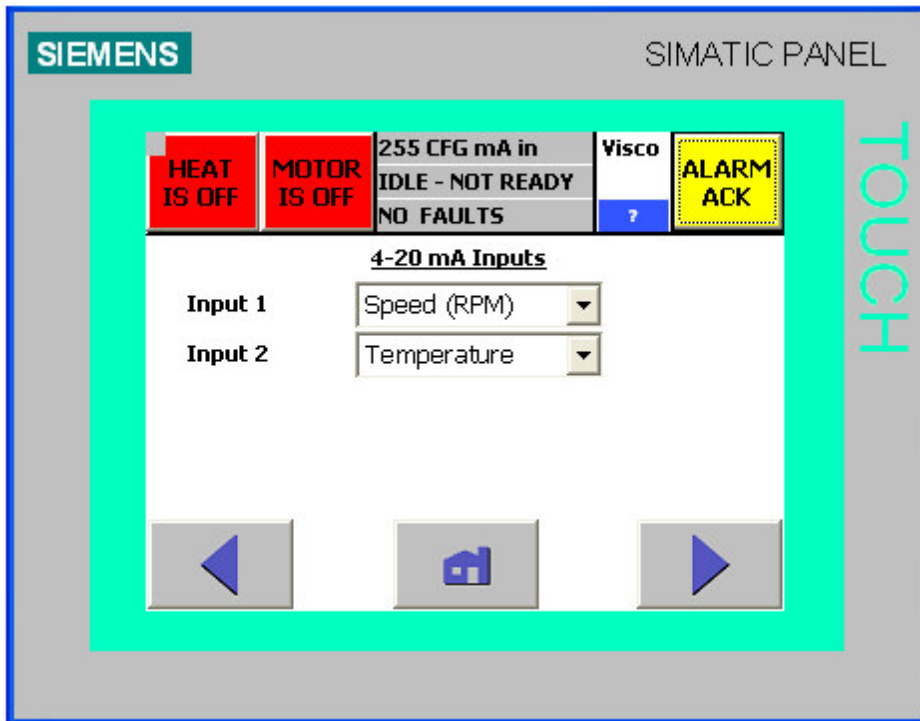

Configure the 4-20 mA inputs to set a process setpoint value. The parameter selected for Input 1 (2) is received by the rheometer on connection AI-1 (2) in the field wiring diagram. Select the parameter in this screen (255) and scale and calibrate the input in the Analog I/O Calibration screen 241.

The 4-20 mA input can be used to set the following setpoints:

- Pump temperature
- Capillary temperature
- Aux temperature
- Speed
- Pressure
- All temperatures (pump, capillary, and aux)

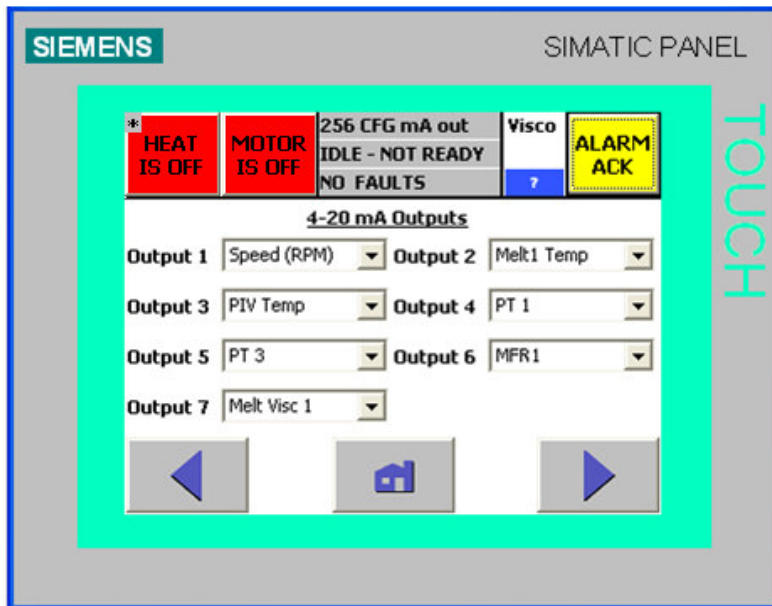

Configure the 4-20 mA outputs on the rheometer by selecting the desired parameters in this screen (256). The parameter selected for Output 1 (2/3/4/5) is transmitted by the rheometer on connection AO-1 (2/3/4/5) in the field wiring diagram. Scale and calibrate the outputs in the Analog I/O Calibration screens 242-245.

The 4-20 mA output can be selected from the following choices:

- Pump temperature
- Capillary temperature
- Melt 1 temperature
- Melt 2 temperature
- Melt temperature average
- Aux temperature
- Speed
- Pressure transducer 1 pressure
- Pressure transducer 2 pressure
- Pressure transducer 3 pressure
- Delta pressure 1
- Delta pressure 2
- MFR (capillary 1 or capillary 2)
- Shear rate (capillary 1 or capillary 2)
- Shear stress (capillary 1 or capillary 2)
- Melt viscosity (capillary 1 or capillary 2)
- Relative viscosity (capillary 1 or capillary 2)
- Intrinsic viscosity (capillary 1 or capillary 2)

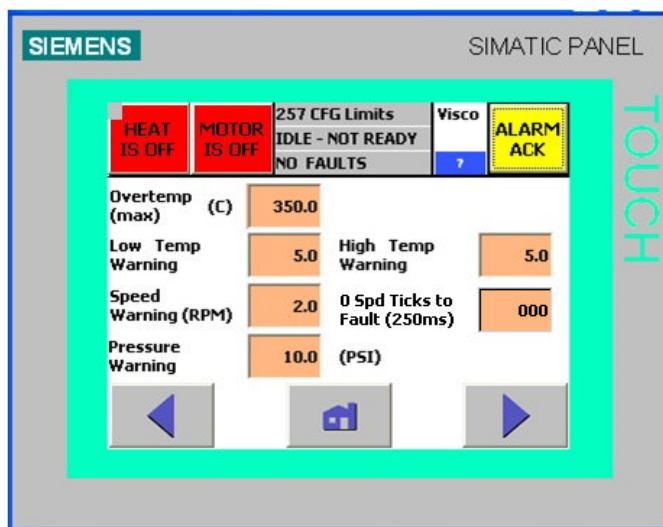

Overtemp (max)

Maximum allowable temperature of the instrument. When any of the RTD readings reach this temperature, the heat is disabled and the fault relay is opened.

Low Temp Warning

A yellow warning message is displayed when a temperature reading deviates this many degrees below the setpoint.

High Temp Warning

A yellow warning message is displayed when a temperature reading deviates this many degrees above the setpoint.

Speed Warning

In speed mode, a yellow warning message is displayed when the actual speed deviates this many RPM above/below the setpoint.

Pressure Warning

In pressure mode, a yellow warning message is displayed when the actual pressure deviates this many units above/below the setpoint.

0 Spd Ticks to Fault (250ms)

If the rheometer motor does not start and attain the set speed in this interval a motor FAULT will be raised. The interval is set in counts of 1/4 seconds.

The warning relay is closed when no warnings are present. The warning relay is open when power is OFF or a warning exists. Warnings do not need to be acknowledged.

The fault relay is closed when no faults are present. The fault relay is open when power is OFF or a fault exists. Faults need to be acknowledged and are logged in the error log.

The capillaries selected are displayed on the Capillary Selection on screen 120 Calc Const 1.

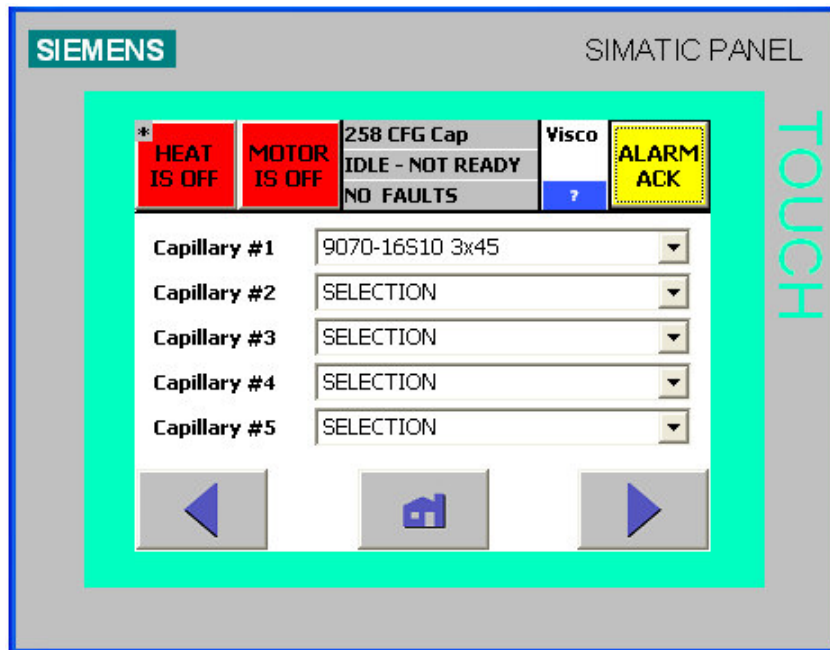

Screens 259, 25A, 25B and 25C are used for setting the PID Control loop constants. These constants have been factory set and should only be changed by trained personnel.

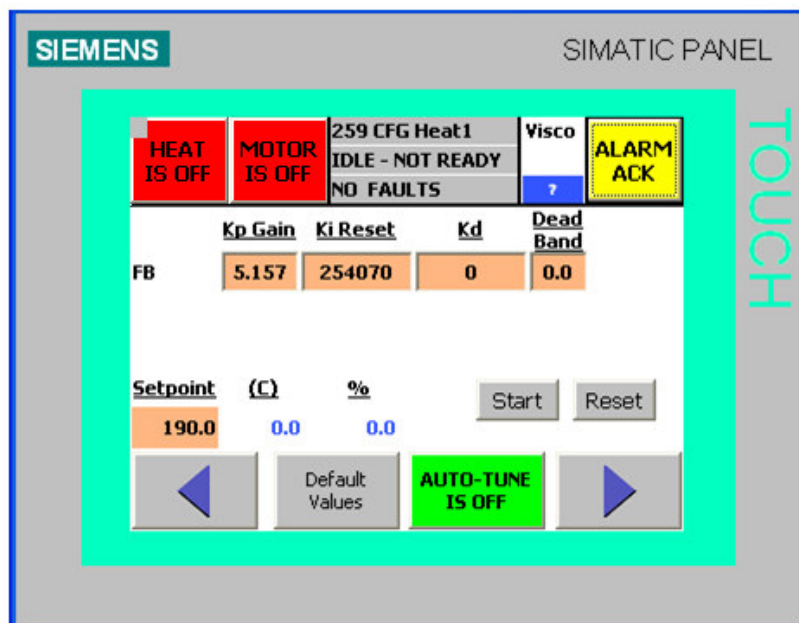

SIEMENS SIMATIC PANEL

* HEAT IS OFF	MOTOR IS OFF	25A CFG Heat2 IDLE - NOT READY NO FAULTS	Visco 7	ALARM ACK
		Ki Reset	Kd	Dead Band
PIV	9.206	367274	0	0.0
		Setpoint (C)	%	
190.0	0.0			
◀	Default Values	AUTO-TUNE IS OFF	▶	

TOUCH

SIEMENS SIMATIC PANEL

HEAT IS OFF	MOTOR IS OFF	25B CFG Heat3 IDLE - NOT READY NO FAULTS	Visco 7	ALARM ACK
		Ki Reset	Kd	Dead Band
AUX	9.206	367274	0	0.0
		Setpoint (C)	%	
◀	Default Values	AUTO-TUNE IS OFF	▶	

TOUCH

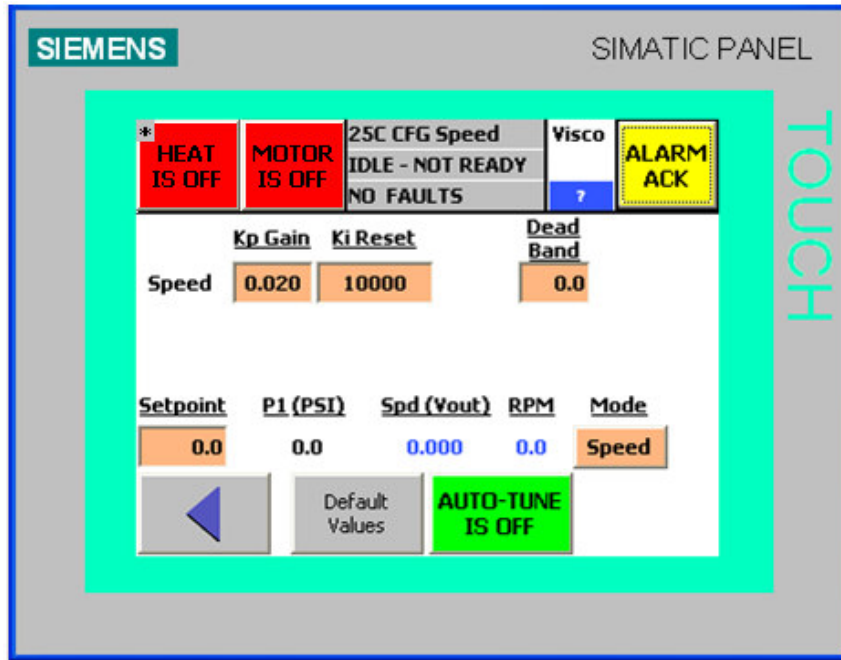

8.4.15 Manual Purge (260)

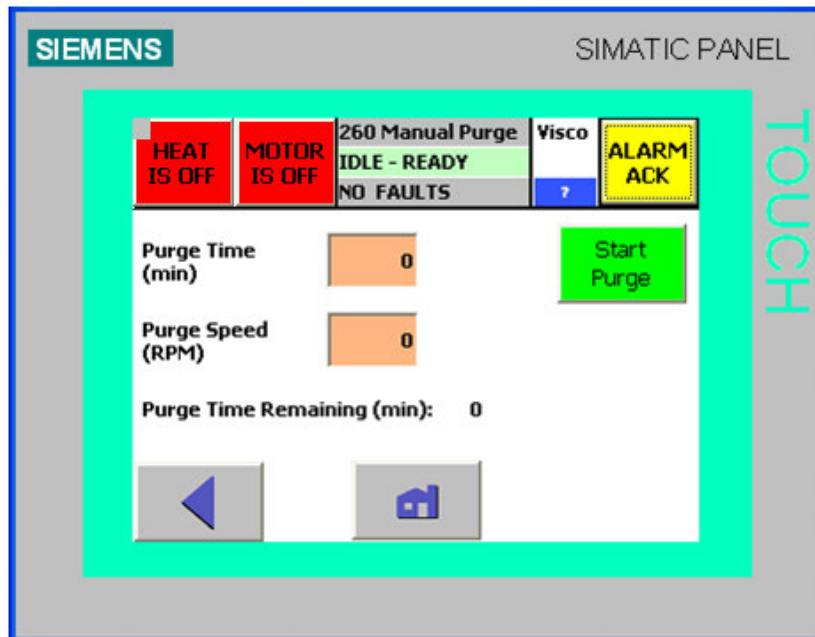

A manual purge is used to clear the rheometer of material. After the purge has completed, the rheometer heat is disabled.

Purge Time (min)
range 0-1440 minutes

Purge Speed (RPM)
Range is from the minimum to the maximum allowable speed (RPM).

Start Purge
Button is visible when the rheometer state is IDLE-READY.

Stop Purge
Button is visible while purging.
Press to interrupt the purge process.

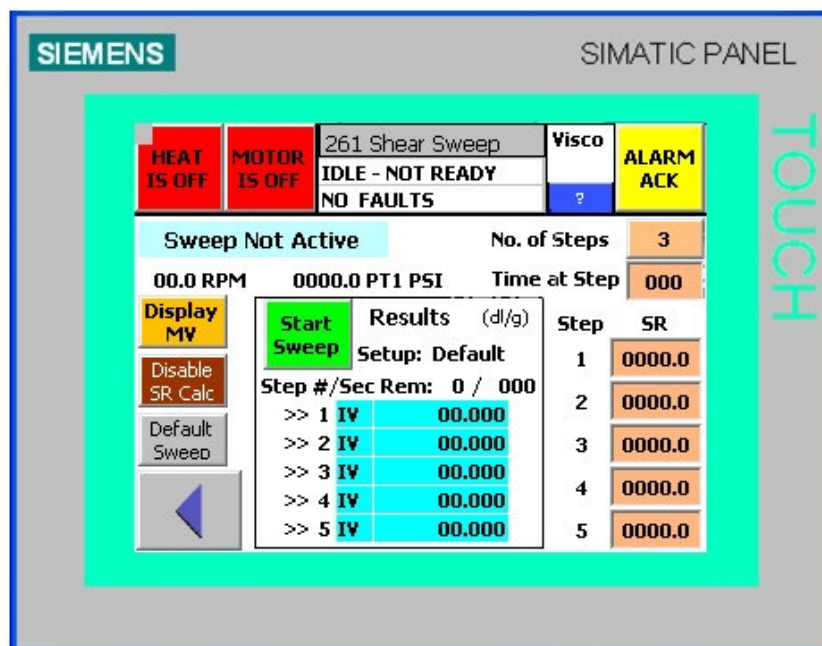

The Shear Sweep runs the material through 3 to 5 steps of varying shear rates (SR). The Default sweep has 5 steps lasting 30 seconds each and the SR at each step is an equal division between steps of the determined minimum and maximum SR that can be obtained within the speed and pressure limits and with the configured setup. The number of steps and the step time may be changed. The SR at each step may be Custom, but the step values will be limited to the possible SR limits. A sweep may be manually started when the rheometer is in run and the rheometer will be stopped at the end of the sweep. The operation can be set to be automatic on screen „133 Setup-Sample“ with the setting of Sample/Sweep/Purge or Sample/Sweep, where the rheometer is cycled through successive operations of Sample, and/or Shear Sweep, and/or Purge.



The minimum and maximum shear rates are calculated by internally setting the minimum running pressure to 5% of the pressure transducer maximum pressure and then setting the maximum running pressure to 95% of the transducer maximum. The calculation takes in to account the limits of the pump rotational speed. The calculation of the minimum and maximum SR can take up to 20 seconds each. This calculation is done at the start of each shear sweep unless the Disable SR Calc is active. In this case the calculation is done only the first time a shear sweep is run after the rheometer is started and the sweep is run by an automatic operation.

No. Of Steps

The number of shear sweep steps can be set to 5 (default), 4, or 3.

Time at Step

The time at each step can be set between 30 (default) and 300 seconds.

Step and SR

This is the step number and the SR that will be run at that step. If an SR step entry is custom, it is checked and limited to the maximum and minimum SR and it will be displayed with a different background color. The step number of a limited entry will flash during the sweep in which it was determined to be beyond the limits, but on successive runs the flashing will cease.

Start Sweep / Stop Sweep

A manual shear sweep can be started by starting the rheometer and then pressing this button. In automatic operation, a sweep can be started any time. Pressing Stop Sweep will stop the rheometer.

Display MV / Display IV

The Results display can be changed between Melt Viscosity, in Pa-s, and Intrinsic Viscosity, in dl/g, any time

Disable SR Calc/ Enable SR Calc

When Disable SR Calc is displayed, each shear sweep will start with a minimum and maximum SR calc. Pressing this will change it to Enable SR Calc and the min/max calculation will only be done the first time an automatic sweep is run after the rheometer is started. This button will appear greyed-out when the rheometer is stopped or the initial min/max calculation has not been performed.

8.4.17 Error Log (270-272)

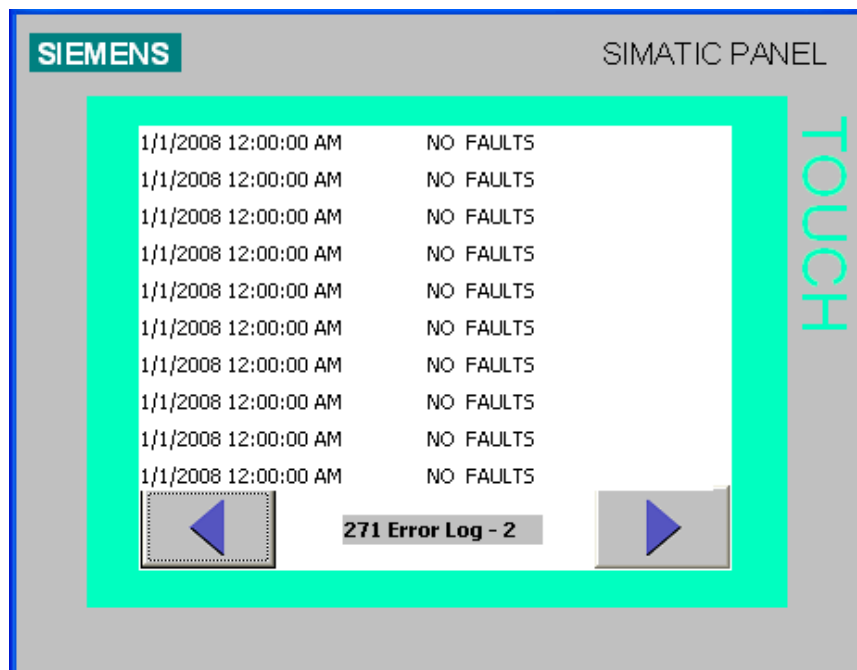
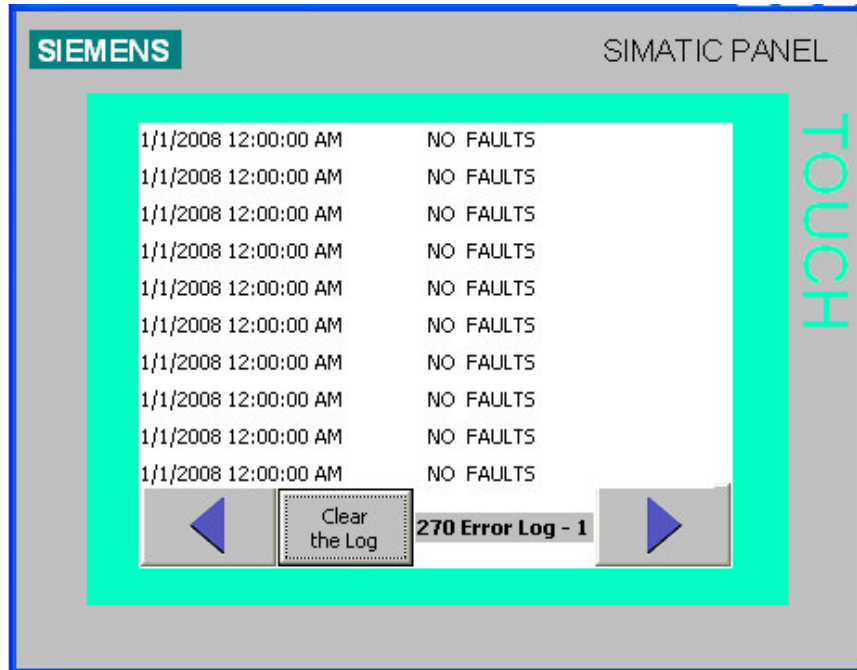

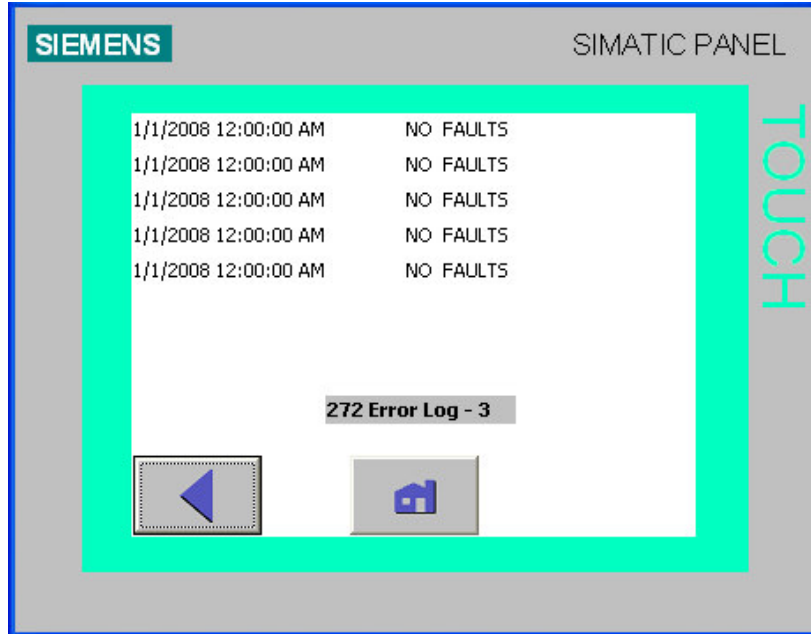

The most recent 25 faults are displayed on screens 270-272 Error Log. The most recent fault is displayed first. Faults are displayed along with the date and time of the occurrence. Clear the error log by pressing the Clear the Log button.

8.4.18 Diagnostics (340-348)

CAUTION – ALL outputs are manually controlled in the DIAGNOSTICS screens! Normal operation is suspended when using the DIAGNOSTICS!

CAUTION – DO NOT ENABLE THE MOTOR WHILE IN THE DIAGNOSTICS UNLESS THE HEAT IS AT TEMPERATURE OR THE MOTOR IS DISCONNECTED FROM THE PUMP! FAILURE TO COMPLY WILL CAUSE DAMAGE TO THE PUMP!

This Diagnostics screen shows the status of the analog inputs.

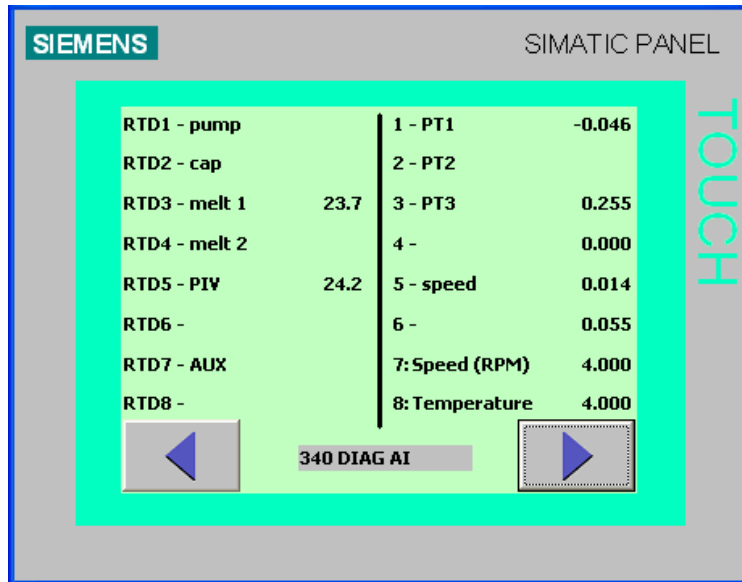

These two Diagnostic screens show the status of the analog outputs. The analog output can be forced to the value shown in the button by pressing the button. Use these for troubleshooting 4-20 mA field wiring.

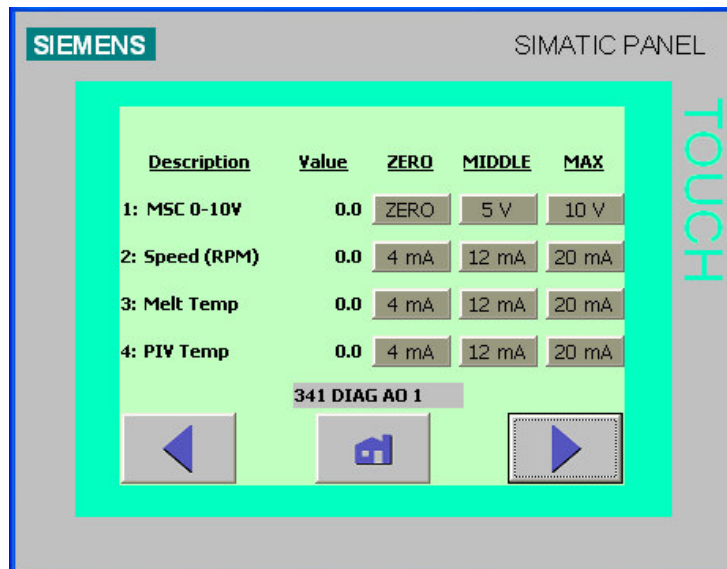

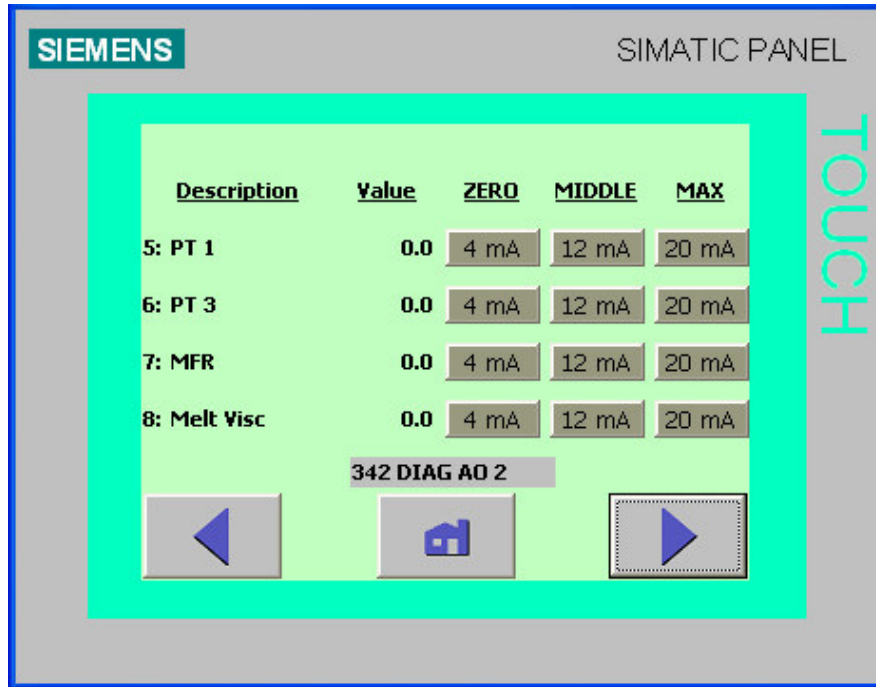

This Diagnostic screen shows the status of the digital inputs.

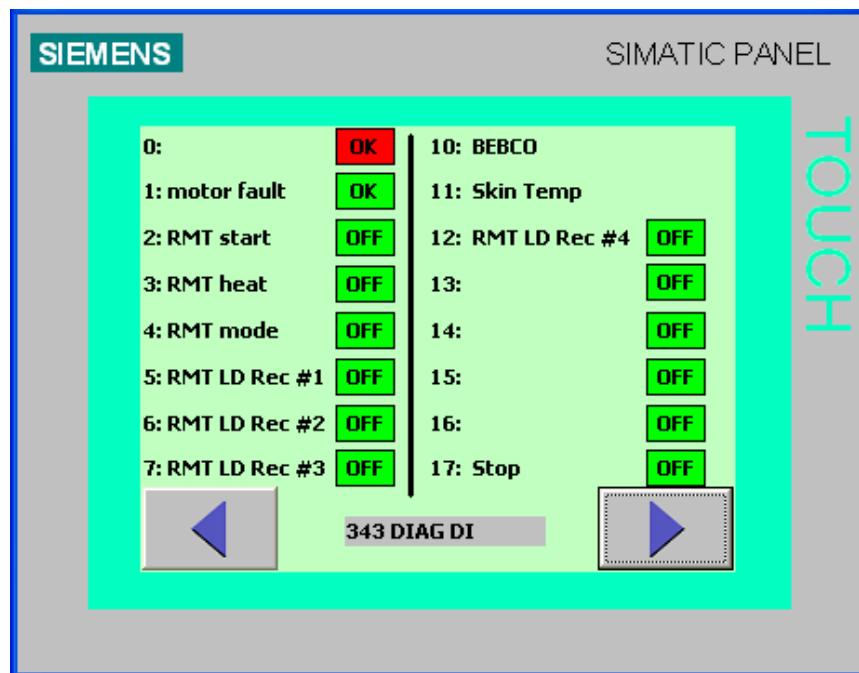

Screens 344-347 show the status of the digital outputs. Press the OFF button to force the output OFF. Press the ON button to force the output ON.

CAUTION – DO NOT ENABLE THE MOTOR WHILE IN THE DIAGNOSTICS UNLESS THE HEAT IS AT TEMPERATURE OR THE MOTOR IS DISCONNECTED FROM THE PUMP! FAILURE TO COMPLY WILL CAUSE DAMAGE TO THE PUMP!

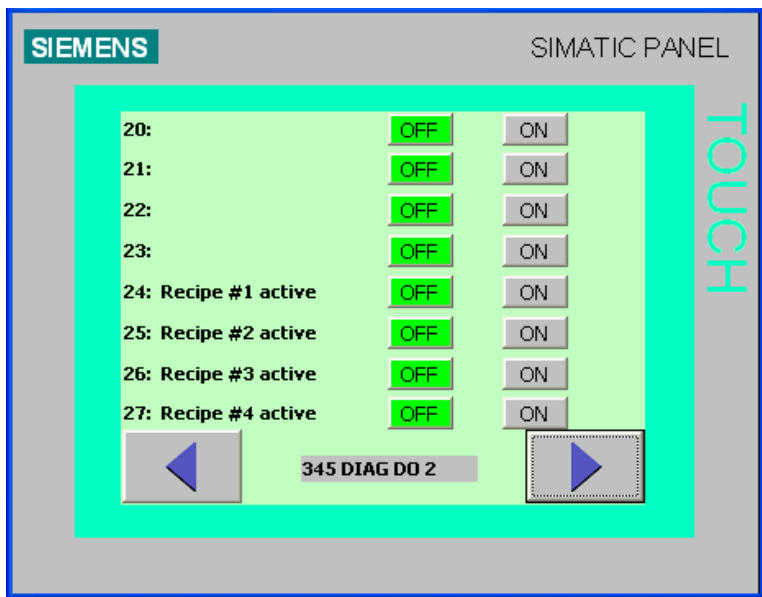
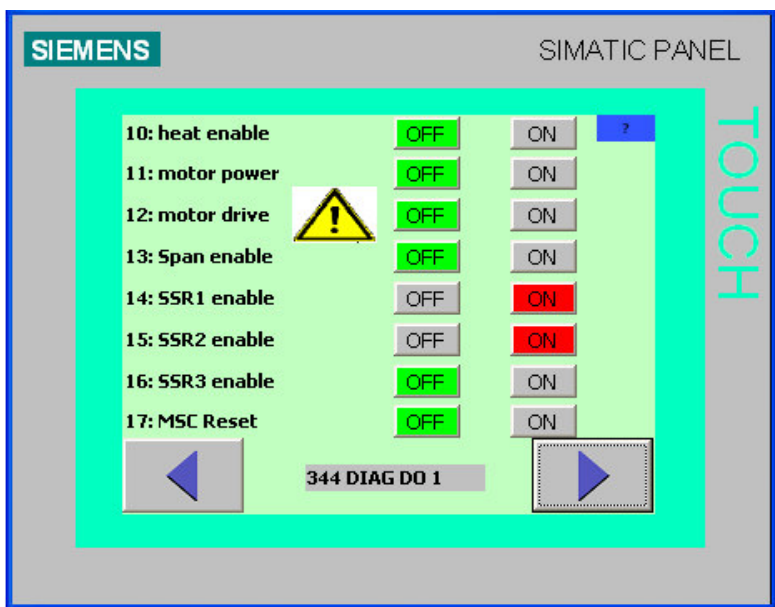

SIEMENS SIMATIC PANEL

TOUCH

30: fault relay	OFF	ON
31: warning relay	OFF	ON
32: local/remote	OFF	ON
33: motor status	OFF	ON
34: Material in range	OFF	ON
35:	OFF	ON
36:	OFF	ON
37:	OFF	ON

346 DIAG DO 3

SIEMENS SIMATIC PANEL

TOUCH

40:	OFF	ON
41:	OFF	ON
42:	OFF	ON
43:	OFF	ON
44:	OFF	ON
45:	OFF	ON
46: HMI ALIVE	OFF	ON
47: CPU Pilot	OFF	ON

347 DIAG DO 4

CAUTION – DO NOT ENABLE THE MOTOR WHILE IN THE DIAGNOSTICS UNLESS THE HEAT IS AT TEMPERATURE OR THE MOTOR IS DISCONNECTED FROM THE PUMP! FAILURE TO COMPLY WILL CAUSE DAMAGE TO THE PUMP!

This screen is to be used by trained service personnel for calibrating the motor speed. Call the factory for assistance.

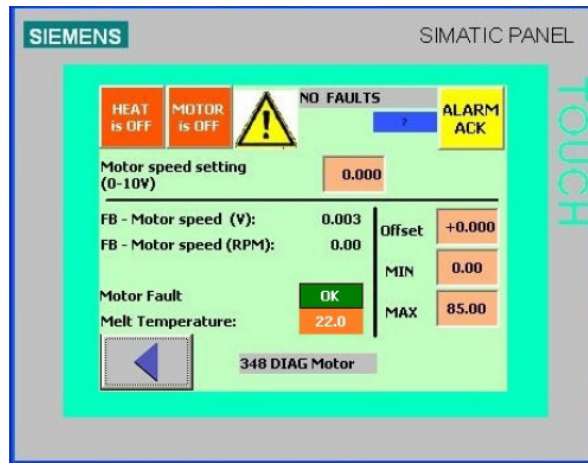

8.4.19 IO STATUS (310)

The status of inputs is shown in the left column.

The status of outputs is shown in the middle and right columns.

The HMI alive and CPU alive outputs should cycle on and off about 1 time every second. These two outputs show that the HMI and the CPU/PLC are executing.

The temperature associated with the three heat zones is shown along with the percentage of time the output is on. The AUX zone will only be shown if the optional AUX RTD is installed.

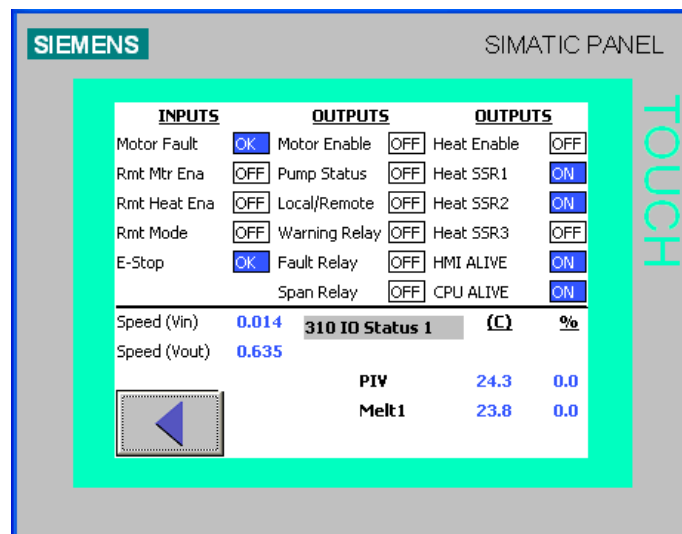

8.4.20 Machine Hours (330)

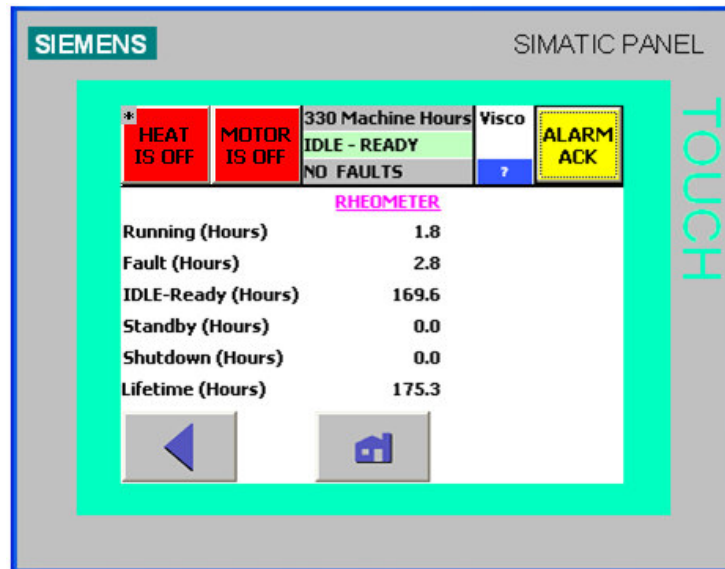

Running
number of hours the instrument has been in the RUN state

Fault
number of hours the fault relay contacts have been open or the instrument has been in a fault condition.

IDLE-Ready
number of hours the instrument has been in the IDLE-Ready state

Standby
number of hours the instrument has been in the Standby state

Lifetime
number of hours the instrument has been powered up

8.4.21 Setup IP Addr (320)

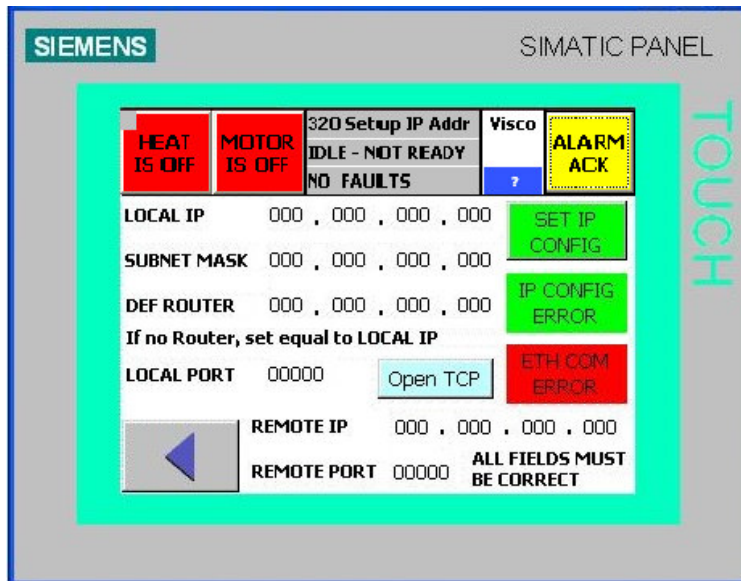

8.5 Local Display System Operations

To change the local display's setup parameters, the display's CONTROL PANEL must be accessed. Access to the CONTROL PANEL is possible when power is applied to the display and by using the EXIT RUNTIME button on screen 250 in the Machine Configuration. When power is applied to the display, a short self-test is performed, next a menu screen with multiple buttons is visible for approximately 3 seconds. If none of the buttons are pressed, the display will automatically show the Start Up screen followed by screen 000 MAIN of the application software.

The four buttons on the menu are TRANSFER, START, CONTROL PANEL, and TASK BAR. When the CONTROL PANEL button is pressed, a WINDOWS type control panel should be seen. All the WINDOWS properties will apply. To exit the CONTROL PANEL, press the "X" in the upper right corner of the screen. The TRANSFER, START, and CONTROL PANEL menu should be seen. Press START, the application software MAIN screen should be seen after a few seconds.

8.6 Display Contrast

From the display's WINDOWS control panel, double tap the OP icon. Select the DISPLAY tab from the OP PROPERTIES screen. Use the UP and DOWN buttons to adjust the display contrast. Tap the OK button to return to the CONTROL PANEL.

8.7 Touch Screen Calibration

If the display is not responding to the selected touch field, it may be necessary to recalibrate the touch panel. From the display's WINDOWS control panel, double tap the OP icon. Select the TOUCH tab from the OP PROPERTIES screen. Follow the on-screen instructions. Tap the OK button to return to the CONTROL PANEL.



8.8 Resetting Display Systems Data

A copy of the display's operating systems data is stored on a memory card located on a rear side panel of the display. It may be necessary to restore the operating system data if,

1. New display software is needed.
2. The operation of the display is erratic.

To restore the operating systems data,

1. Press the EXIT RUNTIME pushbutton on the Machine Configuration screen. The four-button menu, TRANSFER, START, and CONTROL PANEL, and TASK BAR should be seen.
2. Press the CONTROL PANEL pushbutton. A Windows type control panel should be seen. All the Windows properties will apply.
3. Press the BACKUP/RESTORE icon. Follow the RESTORE on-screen instructions.
4. To exit the CONTROL PANEL, press the "X" in the upper right corner of the screen. The TRANSFER, START, and CONTROL PANEL menu should be seen.
5. Press START, the application software MAIN screen should be seen after a few seconds.

8.9 Range Checking

Numeric entries are compared to minimum and maximum allowed values before they are accepted. If, for example, one entered a temperature setpoint that is greater than the maximum allowable value, an "Out of Range" message is displayed.



9 VISCOSENSOR RHEOMETER

9.1 Introduction

The ViscoSensor is the "sensing end" of the system. It is connected to the polymer melt to be tested through the transfer line or Process Isolation Valve (PIV) and is driven by the RCU. The Measurement Head receives the polymer melt then pumps it through a capillary orifice measuring both flow rate and pressure drop across the capillary. With these measurements the shear-rate/shear-stress relationship of a polymer can be determined and converted into such standard items as Melt Flow Rate or Apparent Viscosity.

9.2 General Operation

9.2.1 Pressure Measurement System

The pressure transducers located in the measurement head convert the cavity pressure to an electrical signal. The transducers are unbonded strain gauge (2 active arm bridge) which makes direct contact with the polymer. Changes in cavity pressure produce stress changes in the transducer bridge resistance that results in an electrical signal proportional to the pressure. The transducers are mounted deep within the capillary end of the flow passage barrel, just above the capillaries, and are specially designed to withstand the high test temperatures. Refer to the RCU Technical manual section for a further discussion of this function.

9.2.2 Speed Measurement System

There are no active speed measuring devices in the ViscoSensor. Refer to the RCU Technical manual section for a further discussion of this function.

9.2.3 Motor Speed Control System - Pressure Control Loop

In this analysis mode of operation (closed loop system), the required pressure drop across the capillary is developed by control of the polymer flow rate (pump speed). The flow rate necessary to produce this pressure drop depends on polymer viscosity and/or capillary geometry. Consequently, pump speed will increase if the polymer viscosity decreases, a larger diameter capillary is used, or the capillary L/D ratio is decreased. The pressure transducers located before and after the capillary sense polymer pressure. The transducer signal is connected via the field wiring to the RCU where the signal is fed into a signal conditioning module. In the signal-conditioning module, the pressure (millivolt) signal is converted into a $\pm 10\text{VDC}$ signal and sent to the CPU analog-to-digital converter. In the normal operate mode, the remote control unit pressure PID loop compares the pressure signal with the loop set point signal and an motor speed control signal (0-10VDC) is sent to the motor speed controller to drive the DC motor. Refer to the RCU Technical manual section for a further discussion of this function.

9.2.4 Motor Speed Control System - Speed Control Loop

In this analysis mode of operation (closed loop system), the required shear rate is developed by control of the metering pump speed. The motor speed controller located in the RCU generates the motor speed feedback signal. Refer to the RCU Technical manual section for a further discussion of this function.

9.2.5 Temperature Control System

The temperature control system maintains the polymer melt at the precise test temperature. In the flow passage barrel (measurement head), the melt temperature is regulated by two zones of closed loop temperature control (with polymer residence time, thermal mass and proper insulation). The first control



zone is around the metering pump, and largely accounts for differences between polymer feed and test temperatures. The second temperature control zone regulates temperature around the test zone itself (capillary-transducer area). The process temperature is read by a grade "A" 3-wire RTD. The RTD temperature signal is connected via the field wiring to the RCU where the signal is fed into a signal conditioning module. In the signal-conditioning module, the temperature signal is converted into a $\pm 10\text{VDC}$ signal and sent to the CPU analog-to-digital converter. In the remote control unit, the appropriate temperature PID loop compares the temperature signal with the loop set point and an time-proportional pulse is developed. This pulse is used to control a solid-state relay that controls the AC voltage to the associated heater. The polymer melt temperature is read by a melt thermocouple located opposite of the pressure transducer. Due to the characteristics of thermocouples, the RTD probes will provide a more accurate reading of the test temperature. The melt thermocouple should only be used to monitor temperature instability that can be caused by excess sample line heat or improper polymer thermal treat. Refer to the RCU Technical manual section for a further discussion of this function

9.3 Process Isolation Valve (PIV)

The PIV connects the ViscoSensor rheometer to the melt pipe of the extruder. The actual PIV depends on the customer application. Different PIVs allow mounting the ViscoSensor in different orientations, monitoring the process pressure, and purging sampled material to the shop floor.

The PIV must be attached to the extruder as shown in the customer specific drawings provided with the system. The PIV assures that material from the extruder is sampled up-stream and is returned to the extruder down-stream.

A PIV containing a pressure transducer allows the ViscoSensor to monitor the extruder process pressure. When the process pressure fall below defined limits, the ViscoSensor motor operation will stop operating. The ViscoSensor gear pump life is degraded when operating the pump without material flow.

One or two valves (stems/spools) are located on the PIV. The valves on a PIV must always be turned while the ViscoSensor motor is OFF. Turning the valves while the motor is ON may over pressurize the transducers causing failure or degradation of the pressure transducer.

The valve on a one valve PIV is used to shut-off the flow of material to and from the ViscoSensor. With the valve in the OFF position, the ViscoSensor rheometer can be installed or removed from the extruder with no interruption to production. The valve is in the OFF position when the guideline on the stem is perpendicular to the flow of material to/from the ViscoSensor. The valve is in the ON position when the guideline on the stem is parallel to the flow of material to/from the ViscoSensor.

A two valve PIV contains an ON/OFF valve and a purge valve. The ON/OFF valve is located nearer the ViscoSensor. Material flow is stopped and the valve is in the OFF position when the guideline on the spool is perpendicular to the material flow from the extruder to the ViscoSensor. The purge valve is located nearer the extruder. The ViscoSensor returns the sample material to the extruder when the guideline on the purge spool is parallel to the material flow. Sampled material is purged to the shop floor when the guideline on the purge spool is perpendicular to the material flow.

10 MAINTENANCE

Maintenance is generally limited to changing and cleaning capillaries and to occasional gear-reducer oil changes. Covers must be removed for access to pump and transducer.



All maintenance on the ViscoSensor must be done at the test temperature. This is to make sure no damage occurs due to cold polymer. All required personal protective equipment must be worn (gloves, long sleeve shirts/nomex, safety glasses, etc.)

10.1 Preventative Maintenance

The following items should be inspected/performed on a weekly basis. These can be performed while the extrusion process is running.

1. Inspection the measurement head for leaks. Remove head cover from one side of the instrument head.

a. Remove a head cover from one side of the instrument head.

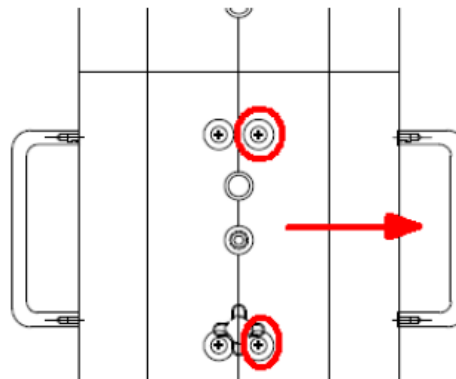

b. Visually inspect for polymer presence or pooling in the following areas:

Between the measurement flow block and the bottom head chassis:

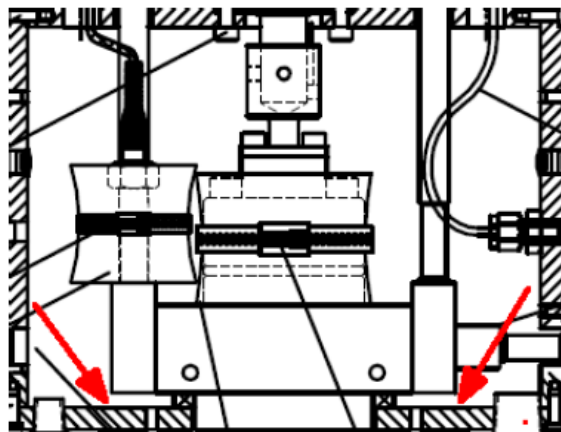

Between the measurement flow block and the system pump:

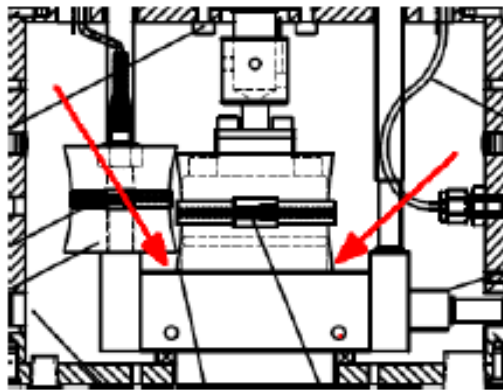

Between the measurement flow block and the flow block end caps:

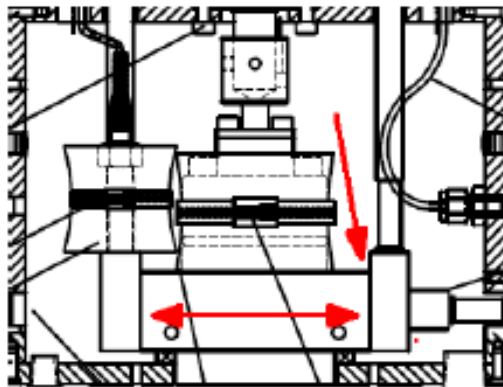

Around the valve assembly in the following areas:

The seat of the valve assembly to the measurement head.

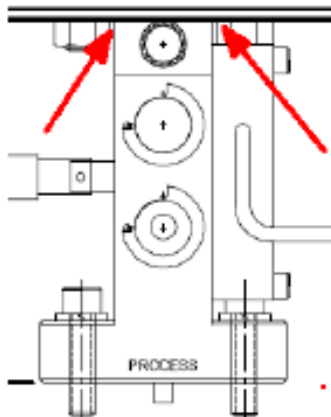

Around the seat of the valve assembly and the process/extruder mount:

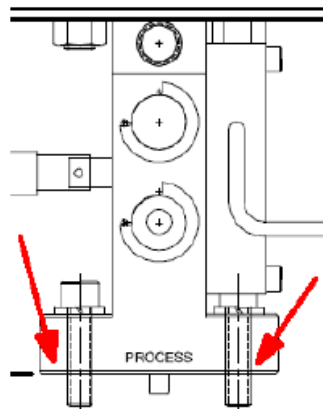

Around the valve spool ends:

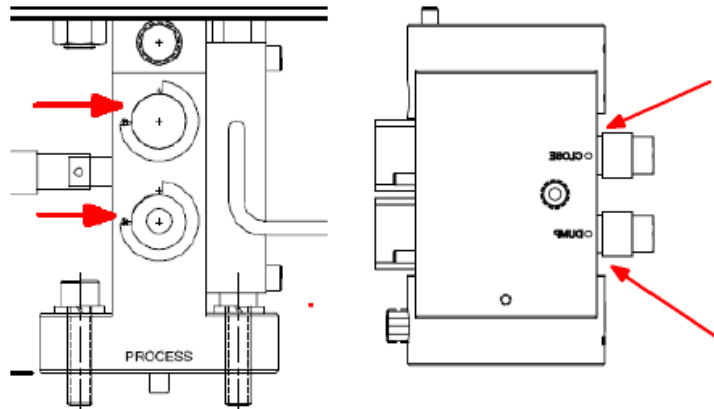

2. Exercise the PIV valves

Before exercising the valves, ensure the measurement head motor is stopped — an over pressure condition may occur, if the motor is running, which could rupture the burst plug.

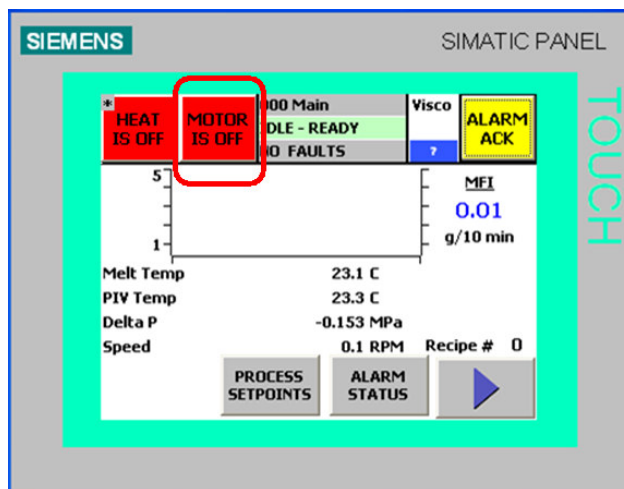

With a wrench, turn the shutoff and purge valves 90 degrees and back to their start position.

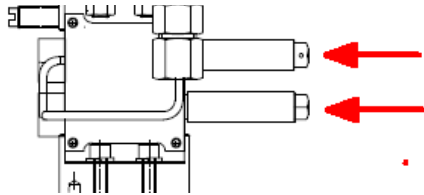

3. Perform a Pressure to PLC calibration

The instrument must be heated to the test temperature setpoint to perform this calibration. Go to the Pressure Calibration screen and perform an Auto Calibration of the pressure transducers.

Labels in the screenshot:

- Transducer status: HEAT IS OFF, MOTOR IS OFF
- Transducer calibration method: Automatic Cal - 1
- Transducer voltage: +0.000 mV
- Transducer calibrated pressure: 0.000 PSI

Press the “Automatic Cal” button to calibrate the pressure transducer.

The system may ask to login at a higher user level to perform this function, use either:

User	Password
MAINT	ALPHA
SERVICE	ALPHA

The system will set the “0” and full scale values of the pressure transducer automatically. This will take about ten seconds and will indicate when complete.

To get to another pressure transducer calibration screen, simply press the “Next Screen” arrow:



10.2 Anti-Seize Compound

When replacing components that are connected to the flow passage barrel, a "high-temperature anti-seize" compound should be used on all threads.

10.3 Capillary Removal / Replacement

Capillaries are accessed from the flow block and must be removed or changed when the measurement head is at test temperature. Use anti-seize compound on the jam nut each time, however do not let the compound build up. The following procedure is recommended:

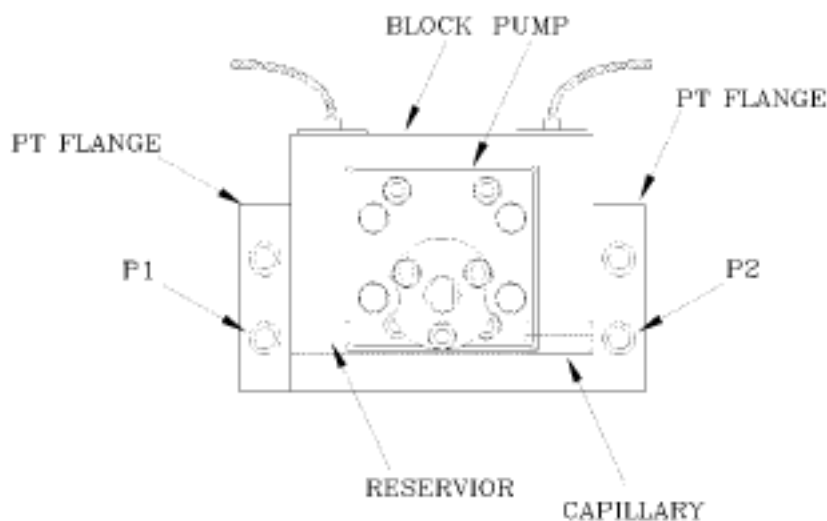

FIGURE 17 – Capillary Location

10.3.1 Capillary Removal

1. Measurement Head must be at test temperature and the pump motor stopped
2. Carefully disconnect the cables from the pressure transducers and remove them from the PT flanges.

i Make sure the cables are marked and the pressure transducers are marked. This will allow the pressure transducers to be installed in the same port as before and will ensure the consistence of the data.

3. Turn OFF the heaters and disconnect the melt temperature RTD leads (Again, mark the leads to aid in quick installation). Remove the melt temperature RTD from the PT flange.
4. Remove both PT flanges (clean excess polymer of the PT flanges) and push the capillary out of the flow block. Immediately clean the hot polymer from all surfaces. The mating faces of the flanges and sides of the flow block must be clean to prevent leakage.

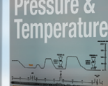

10.3.2 Installing Capillary

1. Place the capillary in the flow block. Push the capillary to the P2 end to the reservoir. Again check that the surfaces are clean. Install the two PT Flanges.
Let the rheometer heat up (5-7 minutes) then tighten the mounting screws to 120 inch-lb torque.



Do not over-tighten the jam nut; it will be difficult to remove later.

Warning

10.4 Transducer Removal

1. The Measurement Head must be at test temperature.
2. Stop the motor and open the pressure relief valve.
3. Disconnect the transducer connector.
4. Unscrew the transducer.
5. Clean the transducer seat with a soft cloth and wipe anti-seize out of threads.

10.5 Transducer Installation

1. Check that new transducer is the correct range.
2. With anti-seize on threads, screw transducer in "snugly".
3. Let transducer heat for 5 minutes and then tighten gently (100in-lbs max.).
4. Connect the transducer connector.
5. Close the pressure relief valve.
6. Run fresh polymer through system.
7. Let the transducer stabilize at test temperature and perform the transducer calibration. Refer to the Calibration section for assistance.

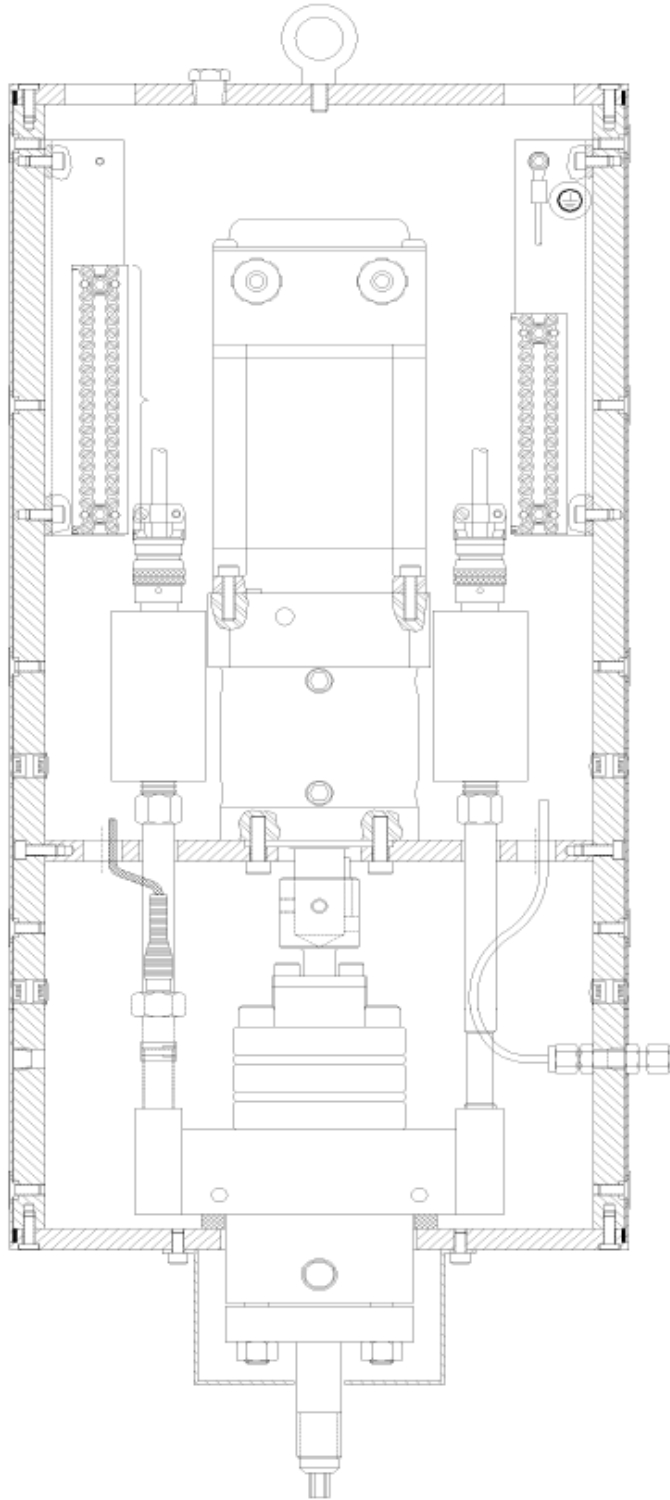

FIGURE 18 – Rheometer – ViscoSensor

P/N: M0708 | Rev: 0318 | ECO: V6.02a

www.dynisco.com



10.6 Introduction

In the Rheology Measurement System there are two components requiring calibration: the pressure transducer and the Motor Speed Controller. The 4 to 20 mADC signals provided to the remote process computer must be calibrated from the remote process computer.

10.7 Equipment required to calibrate system

There are two pieces of equipment required for calibration of the rheometer, (1) is a dead weight tester that has sufficient range to cover the pressure of interest, and (2) a multimeter. Contact DYNISCO for the manufacture information for each of these devices. Trouble shooting routines will isolate to the board level and should require only a multimeter.

10.8 Pressure transducer calibration

The software located in the CPU converts the raw millivolt signal from the pressure transducer into engineering units (PSI). During the pressure transducer calibration routines, the raw millivolts for preprogrammed pressures are stored in the CPU. Using the stored millivolts, the CPU generates a line that connects the calibrations points.

Each transducer is calibrated individually. In the software, there are three transducer curves. These are (1) default, (2) auto-cal, and (3) manual-cal. These curves are shown in Figure 19. The “default” curve passes through 0 PSI/0 mV and the theoretical 100% of pressure and millivolts. This curve is used after a Factory default setting. The simplified equation is shown below:

$$P_{\text{Reading}} = \frac{E_{\text{Meas}}}{E_{\text{FS}}} * P_{\text{FS}}$$



NOTE: The following terms will apply to all pressure formulas found in this section.

P_{Reading} – indicated pressure transducer output in PSI.

E_{meas} – pressure transducer output in millivolts.

E₀ – recorded pressure transducer output at atmosphere in millivolts.

ER_{Cal} - recorded pressure transducer output at R-Cal in millivolts.

E_{FS} – pressure transducer theoretical output at full-scale (33.33mVDC).

P_{RCal} - pressure at R-Cal (80%) in PSI.

P_{FS} - pressure full-scale value.

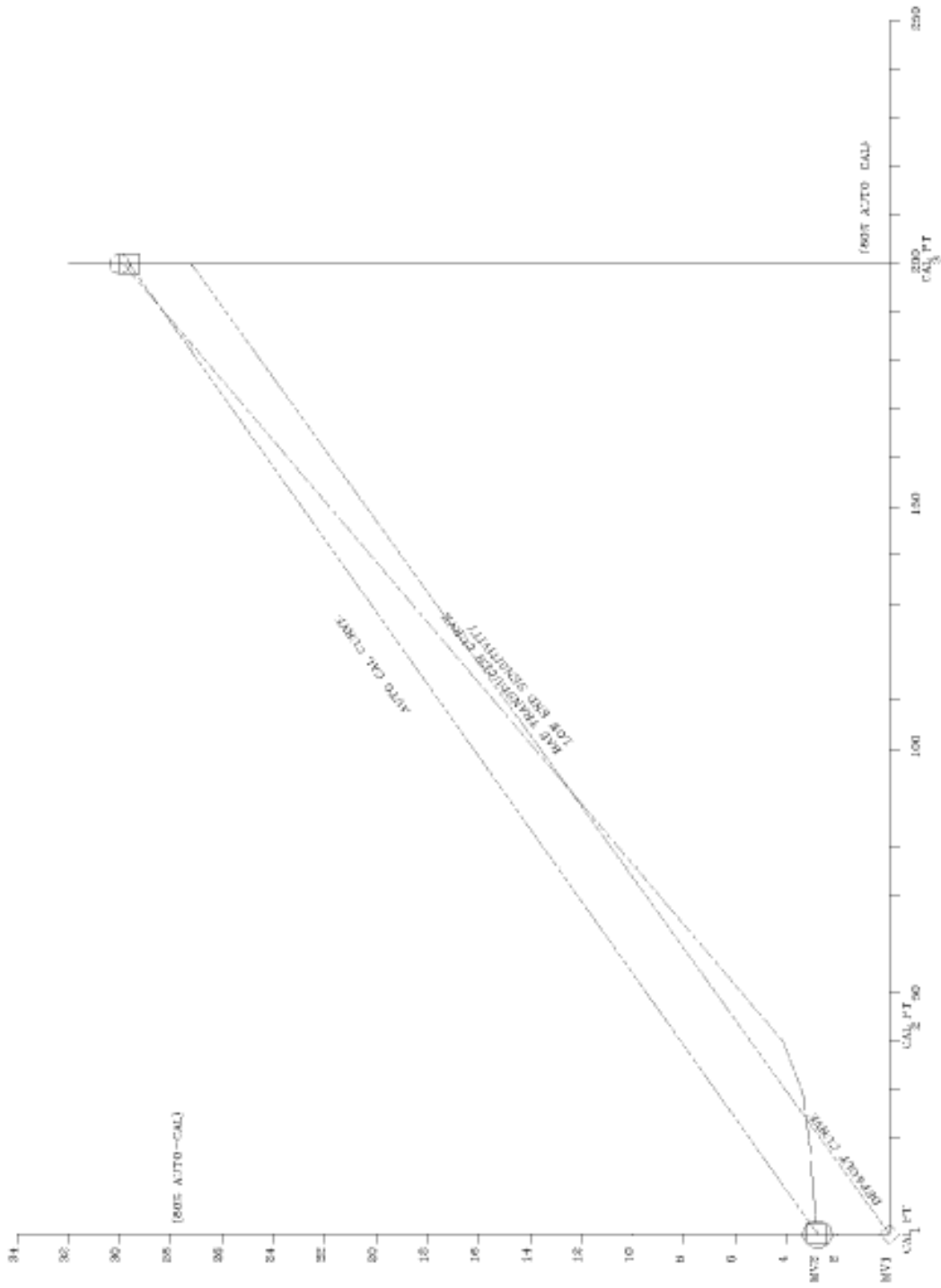

FIGURE 19 - Transducer Curves



The “auto-cal” curve uses a precision resistor etched on the sensing diaphragm of the pressure transducer to produce an electrical signal equal to 80% of the full scale millivolt output. DYNISCO recommends that the automatic calibration feature only be used after the linearity of the pressure transducer has been verified using the pressure standard. Auto calibration does not check the condition of the sensing diaphragm. The manual calibration allows the technician to put one, two or three known pressures on the diaphragm of the transducer.

i

If the test temperature is changed, recalibrate / zero shift the transducer.

10.8.1 Changing Transducer Range

The Rheology Measurement System has the ability to operate using different pressure transducer ranges. This increases the systems flexibility because it allows the client to use low pressure transducers for MFR measurements and then change to higher pressure transducers for viscosity measurements.

On the HMI, go to the pressure calibration screen for the transducer (screen 230-2) and set the Max Pressure for the given transducer. Refer to section Local Operator Display.

10.8.2 Automatic Pressure Calibration

When the AUTOMATIC CALIBRATION mode is selected, a "Span" pressure of 80% of the transducer full scale value automatically is entered into the CPU. When Automatic Cal is executed, the CPU reads the millivolt output of the pressure transducer at atmosphere and records this value. Next, the CPU closes the SPAN relay which places a calibrated resistance in parallel with one leg of the transducer strain gauge. This produces a millivolt signal equal to 80% of the pressure transducer output. This millivolt value is recorded as the span millivolts. The CPU calculates the transducer pressure by converting the transducer millivolts to a pressure using the millivolts at 0 (zero) PSI and the span millivolts at the span pressure.

$$P_{\text{Reading}} = \frac{(E_{\text{Meas}} - E_0)}{E_{\text{RCal}}} * P_{\text{RCal}}$$

i

The pressure transducer must be at atmospheric pressure before performing an Automatic Calibration!

Each transducer is calibrated individually. Perform the automatic calibration with the heat ON and no temperature errors or warnings. After a successful automatic calibration, Auto will be displayed as the transducer cal method on the pressure calibration screen.



10.8.3 Transducer Low-End Sensitivity

The bottom 10% of the transducer range is the most non-linear. Historically, most transducers fail due to a lack of low-end sensitivity. The low-end sensitivity can be quickly checked during the transducer calibration by comparing the transducer millivolt output at atmosphere and the first calibration pressure. Using a 250 psi transducer, 43.2 psi is approximately 17% of 250 psi. The expected full-scale millivolt output for the transducer is 33.3 millivolts, 17% of 33.33 millivolts is approximately 5 millivolts. In other words, you should see an increase of 5 ± 0.5 millivolts in the recorded millivolt outputs from atmosphere and the first calibration pressure.

Example 1: Output @ 0 psi 1.2 mv

Output @ 43.2 psi 6.0 mv

Conclusion - good transducer.

Example 2: Output @ 0 psi 1.2 mv

Output @ 43.2 psi 4.5 mv

Conclusion - bad transducer.

10.9 Stripchart Output Level Test

The following procedure will "force" all 4 to 20 mA DC outputs to a user defined level. This will allow the remote computer to compensate for any line loss.

1. Go to screen 341 DIAG-AO 1 (Analog Output diagnostic screen).
2. Press the desired button to force 4/12/20 mA to the selected output. Calibration offsets can be changed in screen 242 Ana Out Cal 1 to adjust for line loss.
3. For output 2 (SPEED), press the 4/12/20 mA button and verify the reading on the analog output. If necessary go to screen 242 Ana Out Cal 1 and set the offset value for the SPEED.
4. For output 3 (Flow Block melt temperature), press the 4/12/20 mA button and verify the reading on the analog output. If necessary go to screen 243 Ana Out Cal 2 and set the offset value for the melt temperature.
5. For output 4 (PIV temperature), press the 4/12/20 mA button and verify the reading on the analog output. If necessary go to screen 243 Ana Out Cal 2 and set the offset value for the PIV temperature.
6. Go to screen 342 DIAG-AO 2 that displays outputs 5-8.
7. For output 5 (PT 1), press the 4/12/20 mA button and verify the reading on the analog output. If necessary go to screen 244 Ana Out Cal 3 and set the offset value for PT1.
8. For output 6 (PT 3), press the 4/12/20 mA button and verify the reading on the analog output. If necessary go to screen 244 Ana Out Cal 3 and set the offset value for PT3.
9. For output 7 (MFR 1), press the 4/12/20 mA button and verify the reading on the analog output. If necessary go to screen 245 Ana Out Cal 4 and set the offset value for MFR 1.
10. For output 8 (MV 1), press the 4/12/20 mA button and verify the reading on the analog output. If necessary go to screen 245 Ana Out Cal 4 and set the offset value for MV 1.
11. Return to screen 000 MAIN.



10.10 Temperature Calibration

The temperature of the polymer melt is critical to achieve proper results. DYNISCO uses grade A RTD's for important temperature measurements and the client should also order grade A RTD's to use as spare parts. Along with the sensor, the associated electronics need to be checked to ensure the accuracy of the measurement.

There are two methods to test and calibrate the rheometer's temperatures. The best method is to use a controlled temperature bath (the probe, field wiring and the electronics are tested). The next best device is a probe simulator (the field wiring and electronics are tested). The procedure is the same for each method.

1. Go to screen 210 Temp Cal 1. Enter the temperature offset such that the displayed calibrated value is accurate.
2. Wait while the displayed temperature stabilizes.

11 CPU

11.1 CPU Indicators

The CPU is provided with several LED indicators that are helpful when diagnosing problems with the RCU. Each indicator is discussed below.

SF LED (RED): Indicates that a system fault has occurred. Contact Dynisco for more troubleshooting information.

BF LED (RED) Indicates that a bus fault is present in the CPU. Contact Dynisco for more troubleshooting information.

DC5V LED (Green) Indicates that the CPU has OK 5 volt level.

FRCE LED (Yellow) Indicates that a variable is being changed internally. Used only when in programming mode.

STOP LED (Yellow) Indicates that the program is in a Stop mode and the program is not running. Contact Dynisco for more troubleshooting information.

11.2 CPU Switch Position Meaning Description

RUN RUN mode The CPU executes the user program.

STOP STOP mode The CPU does not execute a user program.

MRES Refer to section 11.3 Memory Reset to reset the PLC memory.

11.3 CPU Memory Reset

It maybe necessary to reset the CPU's memory under the following conditions,

1. Installation of new software.
2. Resetting all system values to the factory default.
3. The CPU SF LED is illuminated.
4. Erratic operation.

The application software is stored on the removable flash EPROM in the CPU module. All system variables are stored in the CPU RAM. To reset the CPU memory,

1. Place the CPU RUN-STOP-MRES switch to STOP. The CPU front panel LED's should change from RUN to STOP.
2. Hold the RUN-STOP-MRES switch in the MRES position for 3 seconds. The STOP LED should flash.
3. Release the RUN-STOP-MRES switch, the switch should return to the STOP position.



4. Wait 2 seconds and again hold the RUN-STOP-MRES switch in the MRES position. The STOP LED should flash and then stay ON.
5. If the CPU SF LED is ON, repeat 2 through 5.
6. Place the RUN-STOP-MRES switch in the RUN position The CPU pilot LED on the Digital Output module should flash every 1/2 second.

11.4 Memory card installation

A Simatic Micro Memory Card (MMC) is used as memory module. You can use MMC's as load memory and as portable storage medium.

Note: These CPUs do not have an integrated load memory and thus require an MMC for operation.