

MC55A0 MC55N0 ENTERPRISE DIGITAL ASSISTANT USER GUIDE



MC55A0
MC55N0
ENTERPRISE DIGITAL ASSISTANT
USER GUIDE

72E-148113-02

Rev. A

April 2015

No part of this publication may be reproduced or used in any form, or by any electrical or mechanical means, without permission in writing from Zebra. This includes electronic or mechanical means, such as photocopying, recording, or information storage and retrieval systems. The material in this manual is subject to change without notice.

The software is provided strictly on an “as is” basis. All software, including firmware, furnished to the user is on a licensed basis. Zebra grants to the user a non-transferable and non-exclusive license to use each software or firmware program delivered hereunder (licensed program). Except as noted below, such license may not be assigned, sublicensed, or otherwise transferred by the user without prior written consent of Zebra. No right to copy a licensed program in whole or in part is granted, except as permitted under copyright law. The user shall not modify, merge, or incorporate any form or portion of a licensed program with other program material, create a derivative work from a licensed program, or use a licensed program in a network without written permission from Zebra. The user agrees to maintain Zebra’s copyright notice on the licensed programs delivered hereunder, and to include the same on any authorized copies it makes, in whole or in part. The user agrees not to decompile, disassemble, decode, or reverse engineer any licensed program delivered to the user or any portion thereof.

Zebra reserves the right to make changes to any software or product to improve reliability, function, or design.

Zebra does not assume any product liability arising out of, or in connection with, the application or use of any product, circuit, or application described herein.

No license is granted, either expressly or by implication, estoppel, or otherwise under any Zebra, intellectual property rights. An implied license only exists for equipment, circuits, and subsystems contained in Zebra products.

Revision History

Changes to the original guide are listed below:

Change	Date	Description
-01 Rev A	8/2011	Initial release.
-02 Rev A	4/2015	Zebra Rebranding

TABLE OF CONTENT

Revision History	iii
------------------------	-----

About This Guide

Introduction	xi
Documentation Set	xi
Configurations	xii
Software Versions	xii
Chapter Descriptions	xiv
Notational Conventions	xiv
Related Documents	xv
Service Information	xv

Chapter 1: Getting Started

Introduction	1-1
Unpacking	1-2
Getting Started	1-3
Installing a microSD Card (MC55A0)	1-3
Installing a microSD Card (MC55N0)	1-4
Installing the Battery	1-5
Charging the Battery	1-6
Charging the Main Battery	1-6
Charging Spare Batteries	1-7
Charging Temperature	1-7
Powering On the MC55	1-7
Calibrating the Screen	1-7
Checking Battery Status	1-7
Replacing the Battery	1-8
Removing the microSD Card (MC55A0)	1-8
Removing the microSD Card (MC55N0)	1-9
Battery Management	1-9
Changing the Power Settings	1-9
Changing the Backlight Settings	1-10
Changing the Keypad Backlight Settings	1-10

Turning Off the Radios	1-10
Handstrap Replacement	1-12
Removal	1-12
Installation	1-13

Chapter 2: Operation

Introduction	2-1
Finger Scrolling	2-1
Home Screen	2-1
Classic Today Screen	2-3
Status Bar	2-4
Tile Bar	2-6
Start Screen	2-6
UI Settings	2-11
Start Screen Settings	2-11
IE Zoom Mapping	2-12
Locking the MC55	2-13
Locking without PIN or Password	2-13
Locking with Simple PIN	2-13
Locking with Strong Password	2-14
Password Locking Setup	2-14
Battery Status Indications	2-15
Battery Reserve Options	2-16
Main Battery Temperature Notifications	2-16
Battery Health	2-17
LED Indicators	2-19
Resetting the MC55	2-19
Performing a Warm Boot	2-20
Performing a Cold Boot	2-20
Waking the MC55	2-20
Function Buttons	2-21
Stylus	2-21
Entering Data	2-22
Using Voice-Over-IP	2-22
Interactive Sensor Technology	2-23
Power Management	2-23
Display Orientation	2-23
Free Fall Detection	2-23
USB Configuration	2-24

Chapter 3: Data Capture

Introduction	3-1
Linear Scanning	3-1
Imaging	3-1
Operational Modes	3-2
Digital Camera	3-2
Scanning Considerations	3-2
Linear Scanning	3-3
Imager Scanning	3-3

Using the RS507 Hands-free Imager	3-5
Digital Camera Scanning	3-5
DataWedge	3-6
Installation	3-6
Enable DataWedge	3-6
Disable DataWedge	3-6
Taking Photos	3-7
Recording Video	3-7
Viewing Photos and Videos	3-7

Chapter 4: Bluetooth

Introduction	4-1
Adaptive Frequency Hopping	4-1
Security	4-2
Security Mode 3 (Link Level Encryption)	4-2
Microsoft Bluetooth Stack	4-2
StoneStreet One Bluetooth Stack	4-2
Bluetooth Configuration	4-3
Bluetooth Power States	4-4
Cold Boot	4-4
Warm Boot	4-4
Suspend	4-4
Resume	4-4
Using Microsoft Bluetooth Stack	4-5
Turning the Bluetooth Radio Mode On and Off	4-5
Enabling Bluetooth	4-5
Disabling Bluetooth	4-5
Discovering Bluetooth Device(s)	4-6
Available Services	4-8
Object Push Services via Beam	4-8
Internet Sharing	4-9
Serial Port Services	4-10
ActiveSync Using Serial Port Services	4-11
Phone Book Access Profile Services	4-13
Using Bluetooth StoneStreet One Bluetooth Stack	4-14
Turning the Bluetooth Radio Mode On and Off	4-14
Disabling Bluetooth	4-14
Enabling Bluetooth	4-14
Modes	4-14
Wizard Mode	4-14
Explorer Mode	4-14
Discovering Bluetooth Device(s)	4-15
Available Services	4-18
File Transfer Services	4-18
Connecting to the Internet Using an Access Point	4-20
Dial-Up Networking Services	4-20
Add a Dial-up Entry	4-22
Object Exchange Push Services	4-23
Headset Services	4-26
Serial Port Services	4-27

ActiveSync Using Serial Port Services	4-27
Personal Area Network Services	4-28
A2DP/AVRCP Services	4-29
Connect to a HID Device	4-30
Bonding with Discovered Device(s)	4-30
Bluetooth Settings	4-32
Device Info	4-32
Services	4-32
Security	4-36
Discovery	4-37
Virtual COM Port	4-38
HID	4-38
Profiles	4-39
System Parameters	4-39
Miscellaneous	4-39

Chapter 5: Accessories

Introduction	5-1
Single-slot USB Cradle	5-3
Charging the MC55 Battery	5-3
Charging the Spare Battery	5-4
Battery Charging Indicators	5-4
Charging Temperature	5-4
Single-slot Ethernet/Modem/USB Cradle	5-6
Country Settings	5-6
Connection Setup	5-6
Indicators	5-7
Operation	5-7
Ethernet Connection	5-7
Modem Connection	5-7
Four-slot Charge Only Cradle	5-8
Charging	5-8
Battery Charging Indicators	5-8
Charging Temperature	5-8
Four-slot Ethernet Cradle	5-9
Charging	5-9
Battery Charging Indicators	5-9
Charging Temperature	5-9
VCD5000 Vehicle Cradle	5-10
Charging the MC55 Battery	5-10
Removing the MC55	5-10
Battery Charging Indicators	5-11
Charging Temperature	5-11
Four-slot Battery Charger	5-12
Battery Charging	5-12
Battery Charging Indicators	5-12
Charging Temperature	5-12
Cables	5-13
Battery Charging and Operating Power	5-13
LED Charge Indications	5-14

Charging Temperature	5-14
Vehicle Holder	5-15
Installation Reminders	5-15
Device Mounting Precautions	5-15
Installation	5-16
Assembly	5-16
Windshield Installation	5-16
Flat Surface Installation	5-17
Trigger Handle	5-19
Inserting the MC55 into the Trigger Handle	5-19
Removing the MC55	5-19
Scanning	5-20

Chapter 6: Maintenance & Troubleshooting

Introduction	6-1
Maintaining the MC55	6-1
Removing the Screen Protector	6-2
Battery Safety Guidelines	6-2
Cleaning	6-3
Approved Cleanser Active Ingredients	6-3
Harmful Ingredients	6-4
Cleaning Instructions	6-4
Special Cleaning Notes	6-4
Materials Required	6-4
Cleaning the MC55	6-4
Housing	6-4
Display	6-4
Scanner Exit Window	6-4
Connector	6-4
Cleaning Cradle Connectors	6-5
Cleaning Frequency	6-5
Troubleshooting	6-6
MC55	6-6
Bluetooth Connection	6-8
Single-slot USB Cradle	6-9
Four-slot Ethernet Cradle	6-10
Vehicle Cradle	6-11
Four-slot Battery Charger	6-12
Cables	6-12
Magnetic Stripe Reader	6-13
Trigger Handle	6-13

Appendix A: Technical Specifications

MC55 Technical Specifications	A-1
MC55	A-1
MC55 Accessory Specifications	A-6
Single-slot USB Cradle	A-6
Single-slot Ethernet/Modem/USB Cradle	A-6
Four-slot Battery Charger	A-7

Four-slot Charge Only Cradle	A-7
Four-slot Ethernet Cradle	A-8
Magstripe Reader	A-9
Vehicle Cradle	A-9
Cables	A-10

Appendix B: Keypads

Numeric Keypad Configuration	B-1
Alpha-numeric Keypad Configurations	B-5
PIM Keypad Configuration	B-13
Special Character Key	B-15

Appendix C: Voice Quality Manager

Introduction	C-1
Features	C-1
Enabling VQM	C-1
Audio Modes	C-2
Changing Audio Modes	C-2
Voice Packet Prioritization	C-3
Acoustic Echo Cancellation	C-3
Limitations	C-4
Disabling VQM	C-4

Glossary

Index

ABOUT THIS GUIDE

Introduction

This guide provides information about using the MC55A0 and MC55N0 Enterprise Digital Assistant (EDA) and accessories.



NOTE Screens and windows pictured in this guide are samples and can differ from actual screens.

Documentation Set

The documentation set for the MC55A0 and MC55N0 provides information for specific user needs, and includes:

- **MC55A0/MC55N0 Quick Start Guide** - describes how to get the MC55A0 and MC55N0 EDA up and running.
- **MC55A0/MC55N0 User Guide** - describes how to use the MC55A0 and MC55N0 EDA.
- **MC55A0/MC55N0 Integrator Guide** - describes how to set up the MC55A0 and MC55N0 EDA and accessories.
- **Microsoft® Applications for Windows Mobile 6 User Guide** - describes how to use Microsoft developed applications.
- **Enterprise Mobility Application Guide** - describes how to use Enterprise Mobility developed sample applications.
- **Enterprise Mobility Developer Kit (EMDK) Help File** - provides API information for writing applications.

Configurations

This guide covers the following configurations:

Configuration	Radios	Display	Memory	Data Capture Options	Operating System	Keypads
MC55A0	WLAN: 802.11a/b/g WPAN: Bluetooth v2.0 EDR	3.5" VGA Color	256 MB RAM/ 1 GB Flash	1D laser scanner, 2D imager, 1D laser scanner and camera or 2D imager and camera	Windows Mobile 6.5.3 Classic	Numeric, QWERTY, QWERTZ, AZWERTY or PIM
MC55A0-HC	WLAN: 802.11a/b/g WPAN: Bluetooth v2.0 EDR	3.5" VGA Color	256 MB RAM/ 1 GB Flash	2D imager (SE4500-DL only) or 2D imager (SE4500-DL only) and camera	Windows Mobile 6.5.3 Classic	Numeric, QWERTY
MC55N0	WLAN: 802.11a/b/g/n WPAN: Bluetooth v2.0 EDR	3.5" VGA Color	256 MB RAM/ 1 GB Flash	1D laser scanner, 2D imager, 1D laser scanner and camera or 2D imager and camera	Windows Mobile 6.5.3 Classic	Numeric, QWERTY, QWERTZ, AZWERTY or PIM (with future configurations)

Software Versions

This guide covers various software configurations and references are made to operating system or software versions for:

- Adaptation Kit Update (AKU) version
- OEM version
- BTExplorer version
- Fusion version.

AKU Version

To determine the Adaptation Kit Update (AKU) version:

Tap  > **Settings** > **System** > **About** > **Version**.

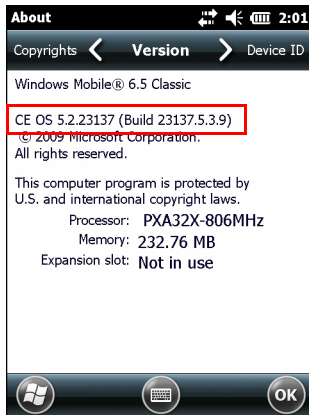

The second line lists the operating system version and the build number. The last part of the build number represents the AKU number. For example, *Build 23137.5.3.9* indicates that the device is running AKU version 5.3.9.

OEM Version

To determine the OEM software version:

Tap  > **Settings** > **System** > **System Info** > **System**.



BTEplorer Software

To determine the BTEplorer software version, tap  > **BTEplorer** > **Menu** > **About** to view version information.



Fusion Software

To determine the Fusion software version:

Tap **Wireless Strength** icon > **Wireless Status** > **Versions**.

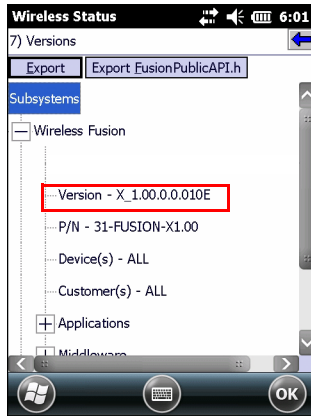

Chapter Descriptions

Topics covered in this guide are as follows:

- [Chapter 1, Getting Started](#) provides information on getting the MC55 up and running for the first time.
- [Chapter 2, Operation](#) provides basic instructions for using the MC55, including powering on and resetting the MC55.
- [Chapter 3, Data Capture](#) provides instructions for capturing data.
- [Chapter 4, Bluetooth](#) explains Bluetooth functionality on the MC55.
- [Chapter 5, Accessories](#) describes the available accessories and how to use them with the MC55.
- [Chapter 6, Maintenance & Troubleshooting](#) includes instructions on cleaning and storing the MC55, and provides troubleshooting solutions for potential problems during MC55 operation.
- [Appendix A, Technical Specifications](#) provides the technical specifications for the MC55.
- [Appendix B, Keypads](#) provides keypad layouts and functionality.
- [Appendix C, Voice Quality Manager](#) provides information on Voice Quality Manager software.

Notational Conventions

The following conventions are used in this document:

- “EDA” and “MC55” refer to the Zebra MC55A0 and MC55N0 hand-held computers.
- *Italics* are used to highlight the following:
 - Chapters and sections in this and related documents
 - Icons on a screen.

- **Bold** text is used to highlight the following:
 - Dialog box, window, and screen names
 - Drop-down list and list box names
 - Check box and radio button names
 - Key names on a keypad
 - Button names on a screen.
- bullets (•) indicate:
 - Action items
 - Lists of alternatives
 - Lists of required steps that are not necessarily sequential
- Sequential lists (e.g., those that describe step-by-step procedures) appear as numbered lists.

Related Documents

- *MC55A0/MC55N0 Quick Start Guide*, p/n 72-148111-xx.
- *MC55A0/MC55N0 Regulatory Guide*, p/n 72-148112-xx.
- *MC55A0/MC55N0 Integrator Guide*, p/n 72E-148114-xx.
- *Microsoft® Applications for Windows Mobile 6 User Guide*, p/n 72E-108299-xx.
- *Mobility Services Platform User Guide*, p/n 72E-100158-xx.
- *Enterprise Mobility Application Guide*, p/n 72E-68901-xx.
- *Enterprise Mobility Developer Kits (EMDKs)*, available at: <http://www.zebra.com/support>.
- Latest ActiveSync software, available at: <http://www.microsoft.com>.

For the latest version of this guide and all guides, go to: <http://www.zebra.com/support>.

Service Information

If you have a problem with your equipment, contact Zebra support for your region. Contact information is available at: <http://www.zebra.com/support>.

When contacting support, please have the following information available:

- Serial number of the unit (found on manufacturing label)
- Model number or product name (found on manufacturing label)
- Software type and version number.

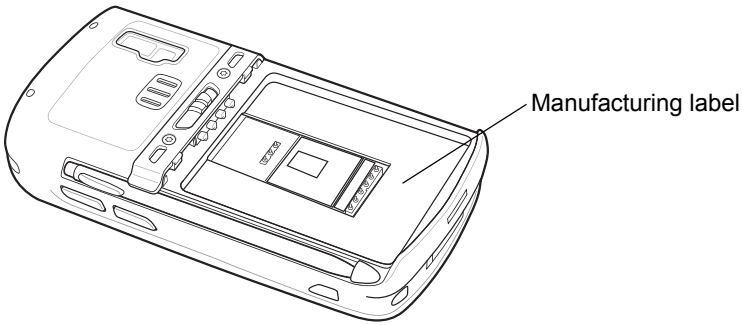

Zebra responds to calls by email, telephone or fax within the time limits set forth in support agreements.

If your problem cannot be solved by Zebra Support, you may need to return your equipment for servicing and will be given specific directions. Zebra is not responsible for any damages incurred during shipment if the approved shipping container is not used. Shipping the units improperly can possibly void the warranty.

If you purchased your business product from a Zebra business partner, contact that business partner for support.

CHAPTER 1 GETTING STARTED

Introduction

This chapter lists the parts of the MC55 and explains how to set up the MC55 for the first time.

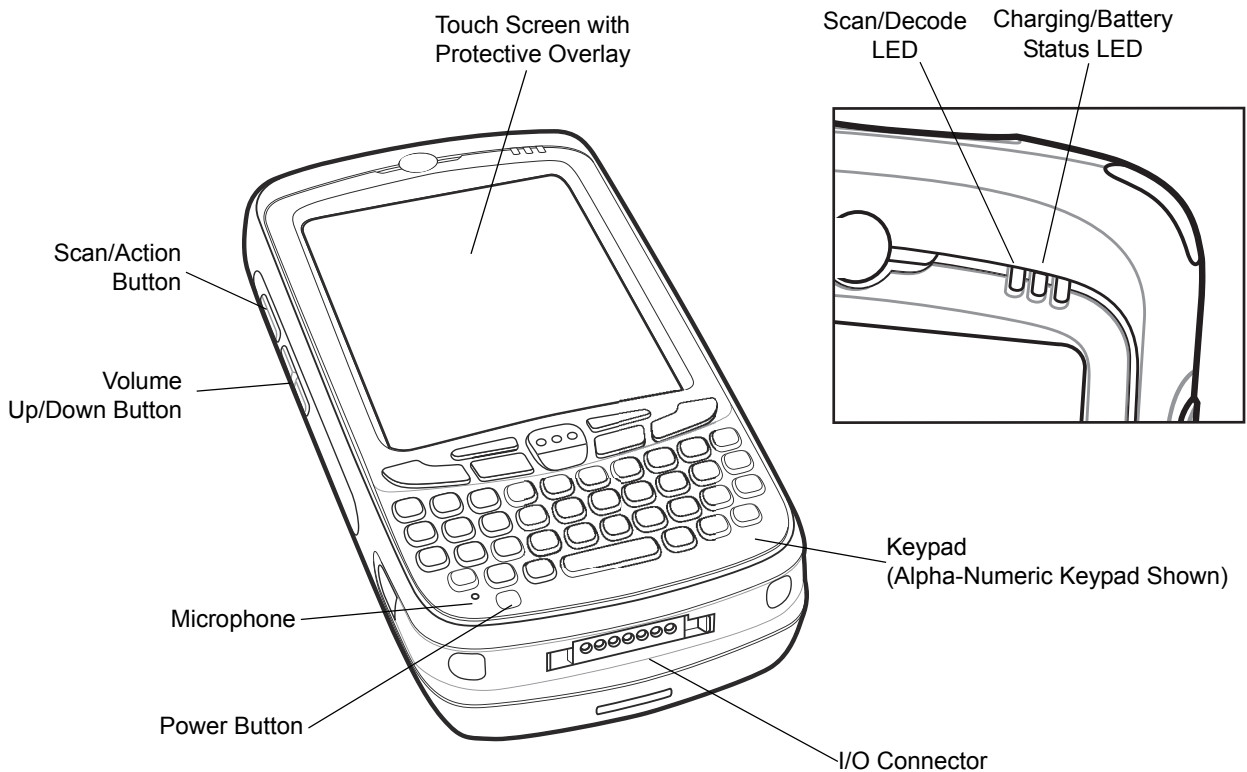

Figure 1-1 MC55 Front View

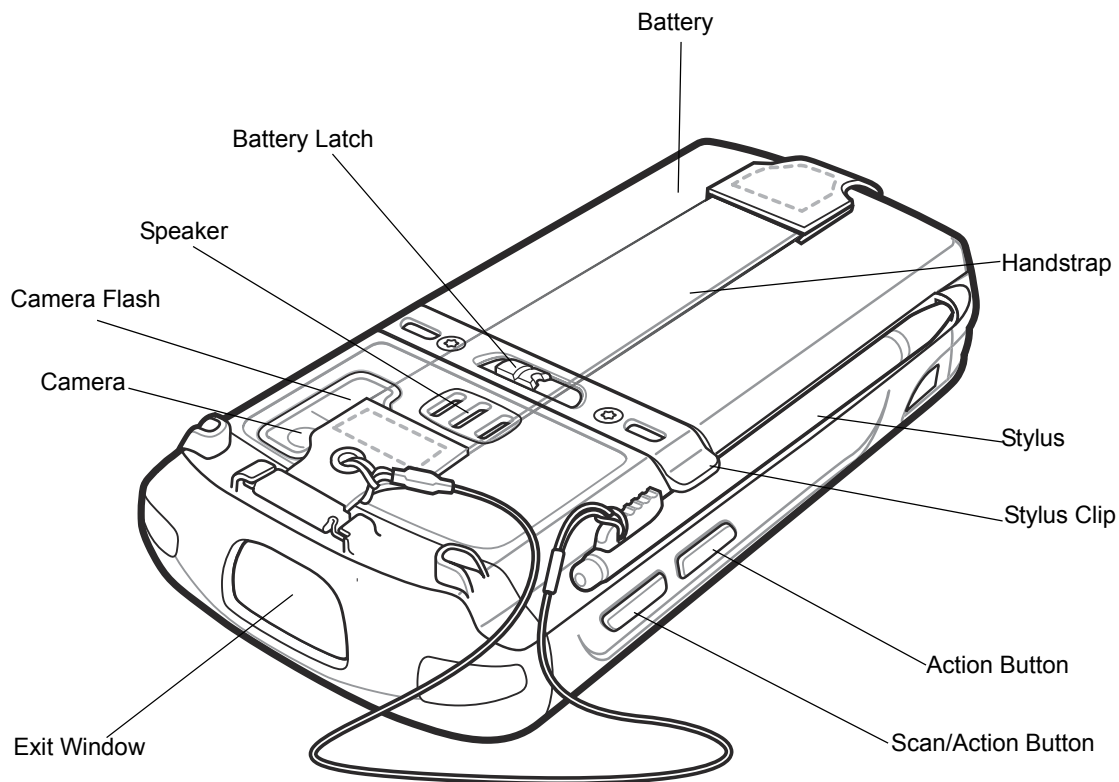

Figure 1-2 MC55 Rear View

Unpacking

Carefully remove all protective material from the MC55 and save the shipping container for later storage and shipping.

Verify that you received the following:

- MC55 EDA
- 2400 or 3600 mAh Lithium-ion battery
- stylus with tether (installed)
- screen protector, installed on display window
- Regulatory Guide
- Quick Start Guide.

Inspect the equipment for damage. If any equipment is missing or damaged, contact the Zebra Support center immediately. See [page xv](#) for contact information.

Prior to using the MC55 for the first time, remove the protective shipping film that covers the scan window, display and camera window.

Getting Started

To start using the MC55 for the first time:

- Install a microSD card (optional)
- Install the main battery.
- Charge the MC55.
- Power on the MC55.

Installing a microSD Card (MC55A0)

The microSD card slot provides secondary non-volatile storage. The slot is located under the battery. Refer to the documentation provided with the card for more information, and follow the manufacturer's recommendations for use.



CAUTION Follow proper ESD precautions to avoid damaging the SD card. Proper ESD precautions include, but are not limited to, working on an ESD mat and ensuring that the operator is properly grounded.

To install the microSD card:

1. Lift rubber access door.
2. Slide the SIM card holder door up to unlock.
3. Lift SIM card holder door.

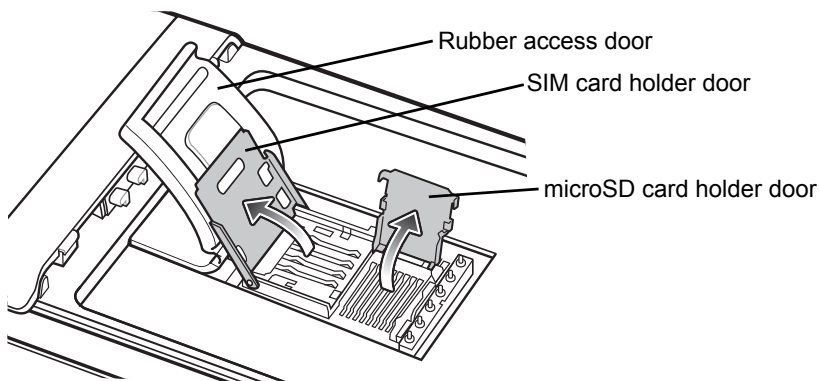

Figure 1-3 Lift SIM Slot Holder Door

4. Lift microSD card holder door.
5. Insert the microSD card into card holder door ensuring that the card slides into the holding tabs on each side of the door.

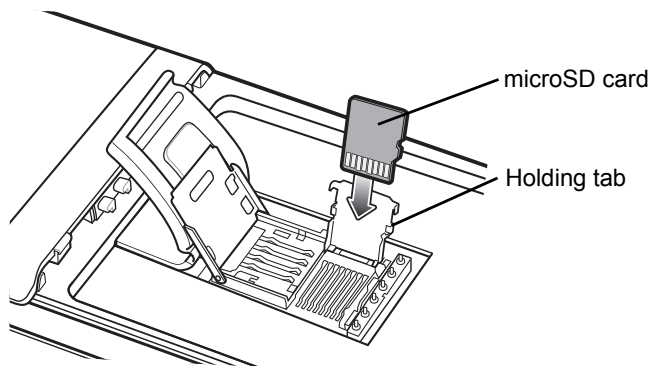

Figure 1-4 Insert microSD Card in Holder

6. Close the card holder door and push down until it is securely into place.
7. Close SIM card holder door and slide down until it locks into place.
8. Close rubber access door.

Installing a microSD Card (MC55N0)

The microSD card slot provides secondary non-volatile storage. The slot is located under the battery. Refer to the documentation provided with the card for more information, and follow the manufacturer's recommendations for use.



CAUTION Follow proper ESD precautions to avoid damaging the SD card. Proper ESD precautions include, but are not limited to, working on an ESD mat and ensuring that the operator is properly grounded.

To install the microSD card:

1. Lift rubber access door.

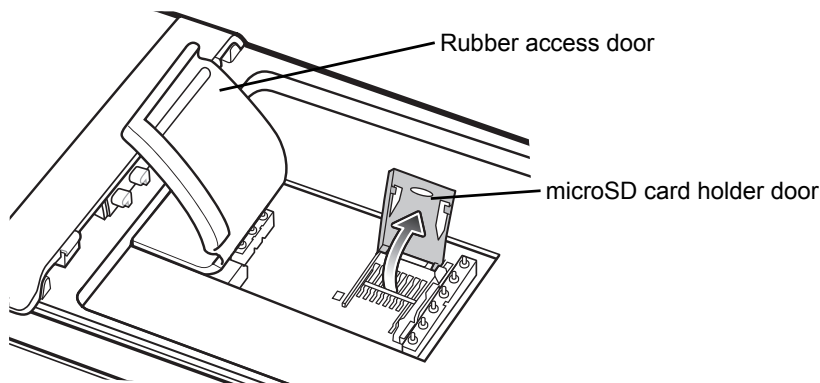

Figure 1-5 Lift SIM Slot Holder Door

2. Slide the microSD card holder door to the right to unlock.
3. Lift microSD card holder door.
4. Insert the microSD card into card holder door ensuring that the card slides into the holding tabs on each side of the door.

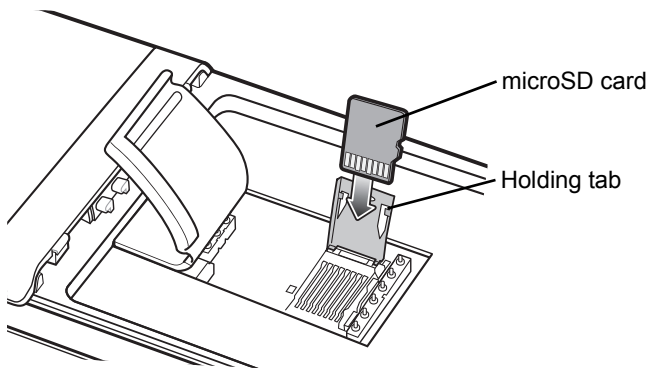

Figure 1-6 Insert microSD Card in Holder

5. Close the card holder door.
6. Slide to the left to lock into place.
7. Close rubber access door.

Installing the Battery

✓ **NOTE** The MC55 ships with either a 2400 mAh or 3600 mAh battery. The 2400 mAh battery is shown in this installation procedure.

To install the battery.

1. Insert the battery, bottom first, into the battery compartment in the back of the MC55.
2. Press the battery down into the battery compartment until the battery release latch snaps into place.

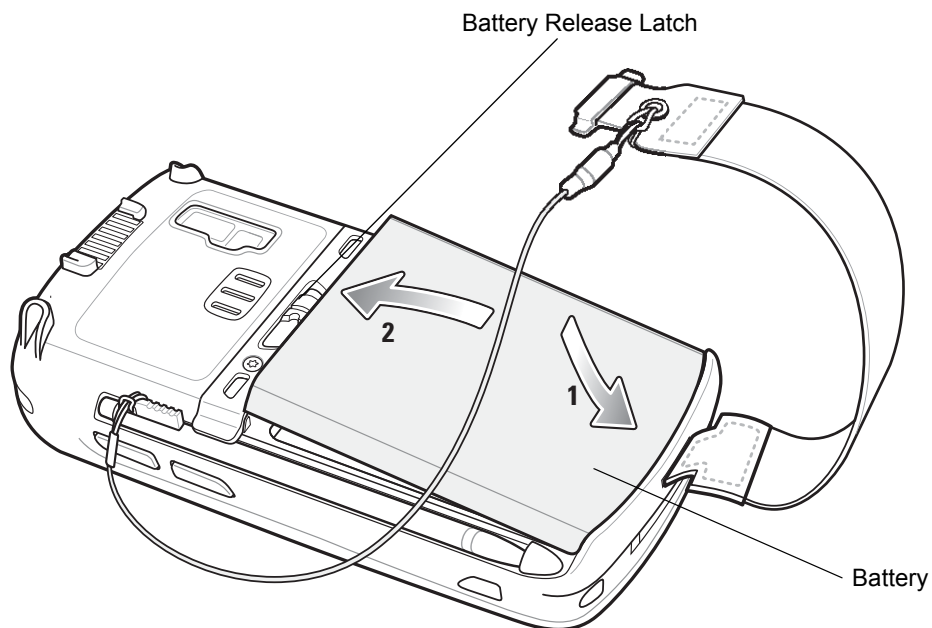

Figure 1-7 Inserting the Battery

The MC55 powers up automatically after inserting the battery if the battery has been charged previously.

Charging the Battery



CAUTION Ensure that you follow the guidelines for battery safety described in [Battery Safety Guidelines on page 6-2](#).

Charging the Main Battery

Before using the MC55 for the first time, charge the main battery until the amber Charging/Battery Status LED remains lit (see [Table 1-1 on page 1-6](#) for charge status indications). To charge the MC55, use a cable or a cradle with the appropriate power supply. For information about the accessories available for the MC55, see [Chapter 5, Accessories](#).

The MC55 is equipped with a memory backup battery which automatically charges from the fully-charged main battery. When using the MC55 for the first time, the backup battery requires approximately 40 hours to fully charge. This is also true any time the backup battery is discharged, which occurs when the main battery is removed for several hours. The backup battery retains RAM data in memory for at least 15 minutes (at room temperature) when the MC55's main battery is removed. When the MC55 reaches a very low battery state, the combination of main battery and backup battery retains RAM data in memory for at least 48 hours.

For cable and cradle setup and charging procedures refer to the *MC55 Integrator Guide*.

- USB Charging Cable
- Charge Only Cable
- Single-slot USB Cradle
- Single-slot Ethernet/Modem/USB Cradle
- Four-slot Charge Only Cradle.

To charge the main battery:

1. Connect the charging accessory to the appropriate power source.
2. Insert the MC55 into a cradle or attach to a cable. The MC55 begins charging. The Charging/Battery Status LED blinks amber while charging, then turns solid amber when fully charged. See [Table 1-1](#) for charging indications.

The 2400 mAh battery fully charges in less than four hours and the 3600 mAh battery charges in less than six hours.

Table 1-1 LED Charge Indicators

Charging/Battery Status LED	Indication
Off	MC55 is not charging. MC55 is not inserted correctly in the cradle or connected to a power source. Charger/cradle is not powered.
Slow Blinking Amber (1 blink every 2 seconds)	MC55 is charging.
Solid Amber	Charging complete. Note: When the battery is initially inserted in the MC55, the amber LED flashes once if the battery power is low or the battery is not fully inserted.

Table 1-1 LED Charge Indicators (Continued)

Charging/Battery Status LED	Indication
Fast Blinking Amber (2 blinks/second)	Charging error, e.g.: <ul style="list-style-type: none"> • Temperature is too low or too high. • Charging has gone on too long without completion (typically eight hours).
Single Blink Amber (when Power button pressed)	Battery depleted.
Blinking Amber (when Power button pressed)	Battery over-temperature condition.

Charging Spare Batteries

See [Chapter 5, Accessories](#) for information on using accessories to change spare batteries.

Charging Temperature

Charge batteries in temperatures from 0°C to 40°C (32°F to 104°F). Note that charging is intelligently controlled by the MC55.

To accomplish this, for small periods of time, the MC55 or accessory alternately enables and disables battery charging to keep the battery at acceptable temperatures. The MC55 or accessory indicates when charging is disabled due to abnormal temperatures via its LED. See [Table 1-1](#).

Powering On the MC55

After inserting the battery or when turning the MC55 on for the first time, the splash screen displays for about a minute as the MC55 initializes its flash file system, then the calibration window appears. Note that these windows also appear upon cold boot.

Calibrating the Screen

✓ **NOTE** The Calibration screen can be accessed by pressing **Blue** key then **Backspace** key.

To calibrate the screen so the cursor on the touch screen aligns with the tip of the stylus:

1. Remove the stylus from its holder on the side of the MC55.
2. Carefully press and briefly hold the tip of stylus on the center of each target that appears on the screen.
3. Repeat as the target moves around the screen, then tap the screen to continue.

Checking Battery Status

✓ **NOTE** To check battery status, remove the MC55 from any AC power source (cradle, cables, etc.)

To check the charge status of the main battery in the MC55, tap  > **Settings** > **System** > **Power** to display the **Power** window.

To save battery power, tap the **Advanced** tab and set the MC55 to turn off after a specified number of minutes.

Replacing the Battery

1. Press the red **Power** button to suspend the MC55. The **PowerKey Action** window appears.
2. Tap **Safe Battery Swap**. The Decode LED lights red and then turns off.
3. Unlatch the handstrap.
4. Use finger or stylus to slide the battery latch to the right releasing the battery. The battery ejects slightly.

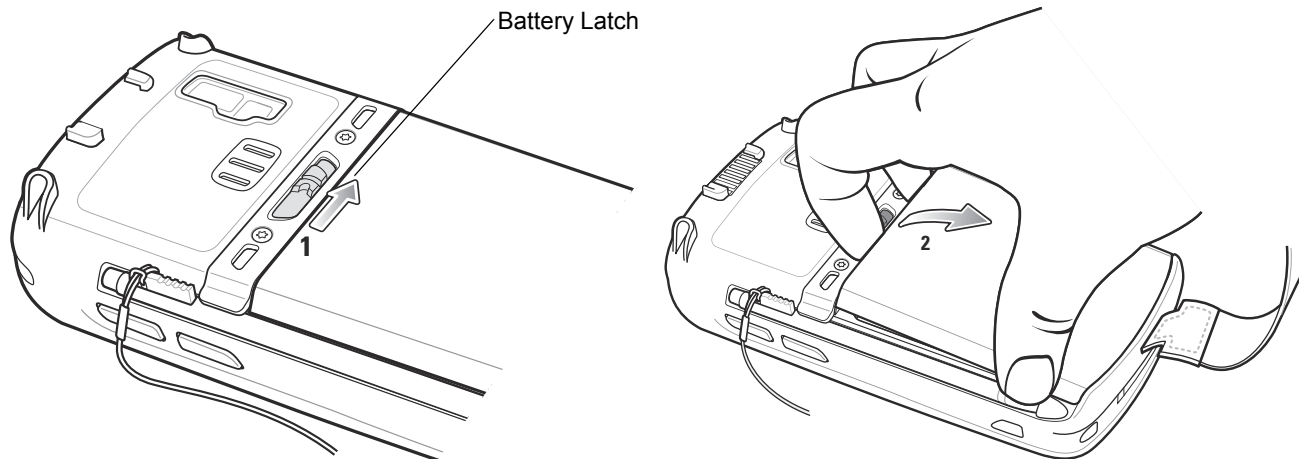

Figure 1-8 *Removing the Battery*

5. Lift the battery from the MC55.
6. Insert the replacement battery, bottom first, into the battery compartment in the back of the MC55.
7. Press the battery down until the battery release latch snaps into place.
8. Re-attach the handstrap.

Removing the microSD Card (MC55A0)

To remove an microSD card:

1. Press the red **Power** button to suspend the MC55. The **PowerKey Action** window appears.
2. Tap **Safe Battery Swap**. The Decode LED lights red and then turns off.
3. Unlatch the handstrap.
4. Remove the battery.
5. Lift the rubber access door.
6. Slide SIM card holder door up to unlock.
7. Lift SIM Card holder door.
8. Lift the microSD card holder door.
9. Remove microSD card from holder.
10. Close microSD card holder door.

11. Close SIM card holder door.
12. Slide SIM card holder door down to lock into place.
13. Close the rubber access door.
14. Replace the battery.
15. Re-attach the handstrap.

Removing the microSD Card (MC55N0)

To remove an microSD card:

1. Press the red **Power** button to suspend the MC55. The **PowerKey Action** window appears.
2. Tap **Safe Battery Swap**. The Decode LED lights red and then turns off.
3. Unlatch the handstrap.
4. Remove the battery.
5. Lift the rubber access door.
6. Slide the microSD card holder door to the right to unlock.
7. Lift the microSD card holder door.
8. Remove microSD card from holder.
9. Close microSD card holder door.
10. Slide the microSD card holder door to the left to lock.
11. Close the rubber access door.
12. Replace the battery.
13. Re-attach the handstrap.

Battery Management

Observe the following battery saving tips:

- Leave the MC55 connected to AC power at all times when not in use.
- Set the MC55 to turn off after a short period of non-use.
- Set the backlight to turn off after a short period of non-use.
- Turn off all wireless activities when not in use.

Changing the Power Settings

To set the MC55 to turn off after a short period of non-use:

1. Tap  > **Settings** > **System** > **Power** > **Advanced** tab.

2. Select the **On battery power: Turn off device if not used for** check box and select a value from the drop-down list.
3. Select **OK**.

Changing the Backlight Settings

To change the backlight settings in order to conserve more battery power:

1. Tap  > **Settings** > **System** > **Backlight** > **Battery Power**.
2. Select the **Disable backlight if device is not used for** check box and select a value from the drop-down list.
3. Select **Brightness**.
4. Tap the **Disable backlight** check box to turn off the display backlight, or use the slider to set a low value for the backlight.
5. Select **OK**.

Changing the Keypad Backlight Settings

To change the keypad backlight settings in order to conserve more battery power:

1. Tap  > **Settings** > **System** > **Keylight** > **Battery Power**.
2. Select the **On battery power: Disable keylight if device if not used for** check box and select a value from the drop-down list.
3. Select **Advanced**.
4. Tap the **Disable keylight** check box to turn off the keypad backlight.
5. Select **OK**.

Turning Off the Radios

To open **Wireless Manager**, tap status bar and then select the **Connectivity** icon.

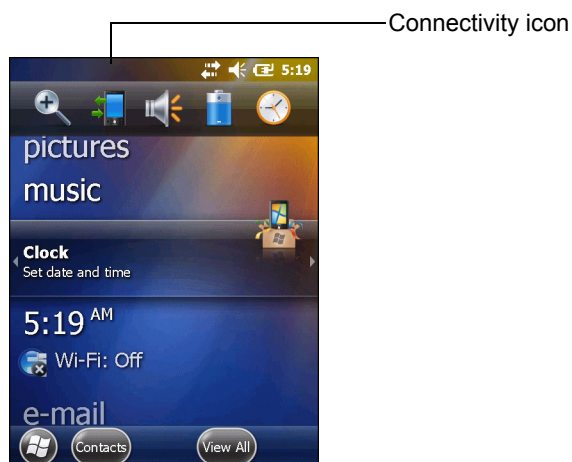

Figure 1-9 *Opening Wireless Manager*

Select **Wireless Manager**.

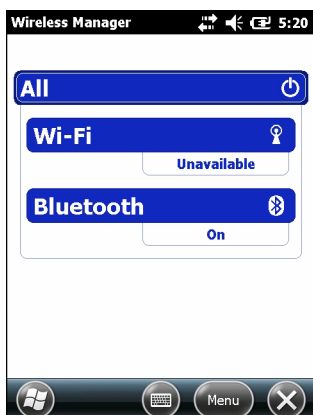

Figure 1-10 *Wireless Manager Window*

To enable or disable a wireless connection, tap the specific button.

To enable or disable all wireless connections, tap and hold the **All** button.

To configure settings for a connection, tap **Menu**.

Handstrap Replacement

Removal

To remove the handstrap:

1. Press the red **Power** button to suspend the MC55. The **PowerKey Action** window appears.
2. Tap **Safe Battery Swap**. The Decode LED lights red and then turns off.
3. Slide the handstrap clip out of the handstrap slot.

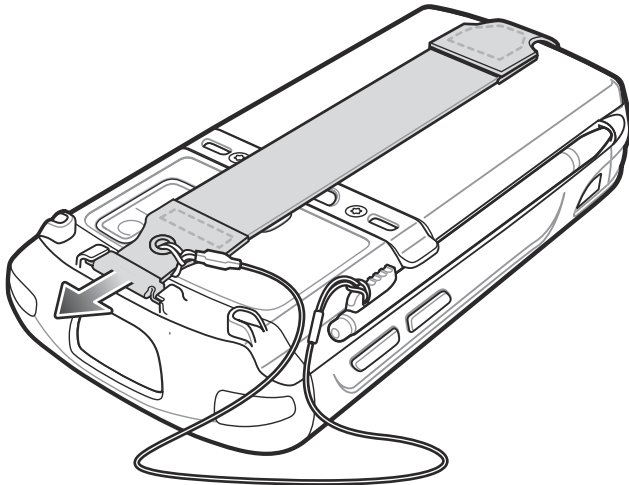

Figure 1-11 *Handstrap Clip Removal*

4. Remove the stylus tether from the handstrap.
5. Remove the battery.



CAUTION When removing handstrap pin, be carefully not to damage handstrap mounting area.

6. Using a small flat screwdriver, push the head of the screwdriver between the handstrap pin and the bottom of the housing as shown below.
7. Pry the handstrap and pin up and out of the handstrap mounting area.

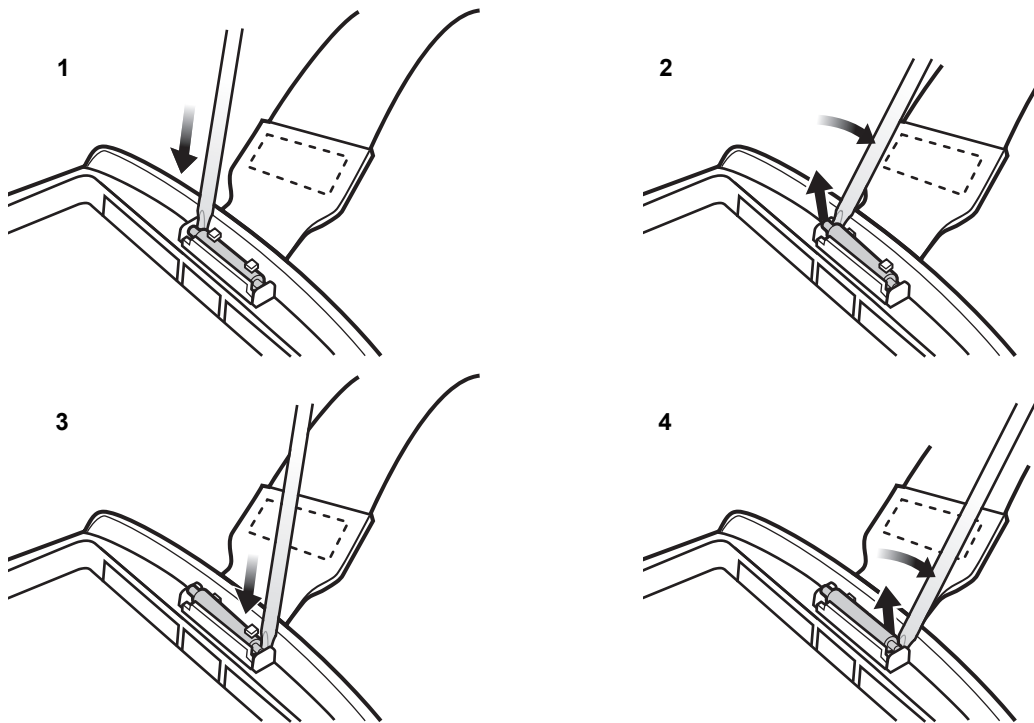

Figure 1-12 *Handstrap and Pin Removal*

8. Repeat for the other side of the handstrap.
9. Remove the pin from the handstrap.

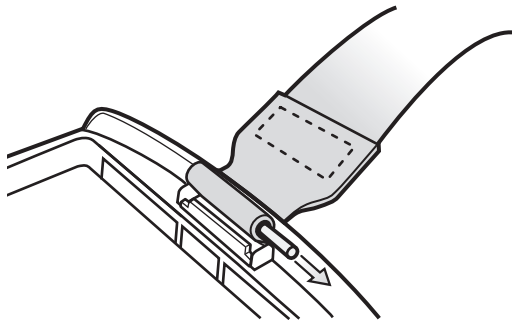

Figure 1-13 *Pin Removal*

10. Pull the handstrap through the handstrap slot.

Installation

To install the handstrap:

1. Feed the bottom end of the handstrap into the handstrap slot on the bottom of the MC55.

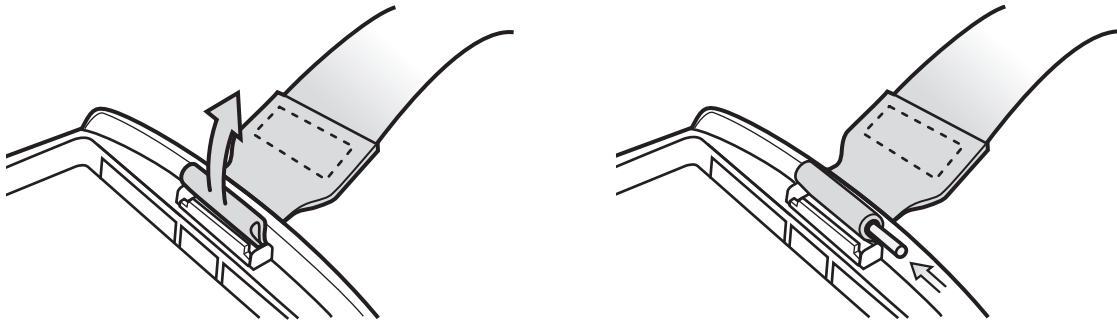

Figure 1-14 Feed Handstrap into Handstrap Slot

2. Slide the pin into the bottom of the handstrap.
3. Center the pin in the handstrap loop.

✓ **NOTE** Handstrap and pin should fit securely into the handstrap mounting area. When pulling on handstrap use enough force to engage pin into place.

4. Pull the handstrap so that the pin and bottom of the handstrap slide into position in the mounting area.

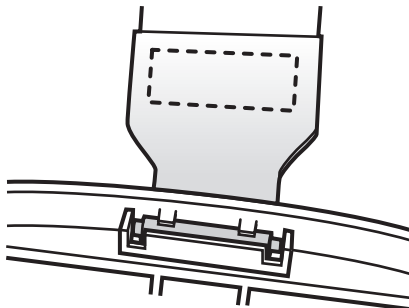

Figure 1-15 Pin and Handstrap in Mounting Area

5. Replace the battery.
6. Replace the stylus tether onto the handstrap.

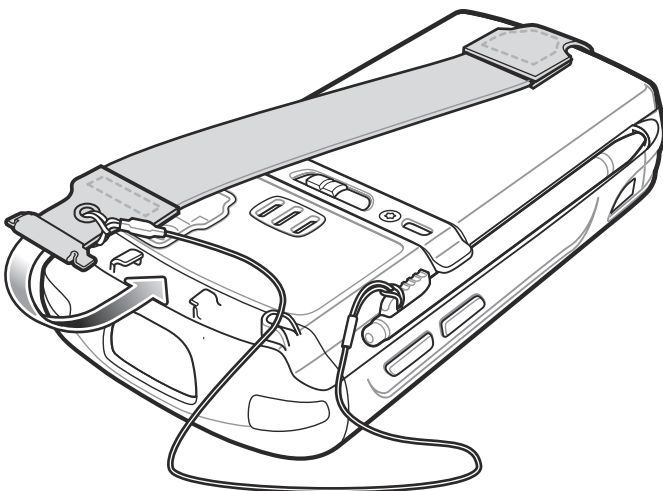

Figure 1-16 Slide Handstrap and Tether Over Handstrap Mount

7. Insert the handstrap clip into the slot on the MC55. Ensure that it is securely in place.

CHAPTER 2 OPERATION

Introduction

This chapter explains the buttons, status icons, and controls on the MC55, and provides basic instructions for using the MC55, including powering on and resetting.

Finger Scrolling

Finger scrolling can be used to scroll up and down web pages, documents, and lists such as the contacts list, file list, message list, calendar appointments list, and more.

When finger scrolling, swipe or flick your finger on the screen.

To scroll down, swipe your finger upward on the screen. To scroll up, swipe your finger downward on the screen.

To auto-scroll, flick your finger upward or downward on the screen. Touch the screen to stop scrolling.

Home Screen

The default home screen on the MC55 is the Windows Mobile Home screen. The Home screen contains a Status Bar at the top of the screen and a Tile Bar at the bottom of the screen.

The Home screen is scrollable and contains a list of application plug-ins and an Information Status bar. The Information Status bar highlights the application plug-in that is under it and provides additional information.



Figure 2-1 Windows Mobile Home Screen

Touch and hold the screen with your finger and move the Home screen up and down. As the application names move under the Information Status bar, information relevant to that application appear in the bar.

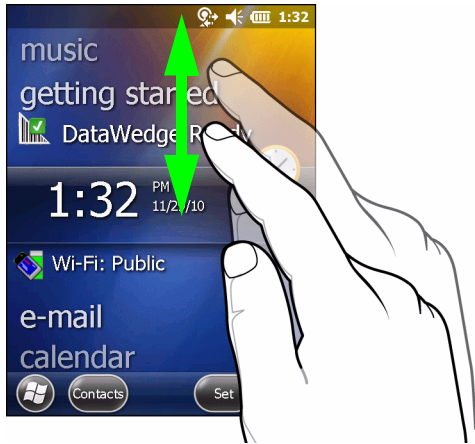

Figure 2-2 Moving Today Screen

You can also touch and hold the Information Status bar and move it up and down over an application name. Remove your finger and the Information Status bar and application name center in the screen.

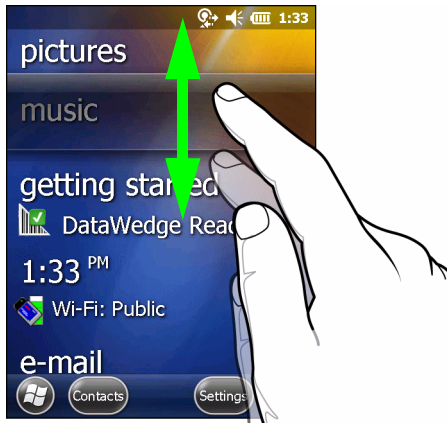

Figure 2-3 Moving Information Status Bar

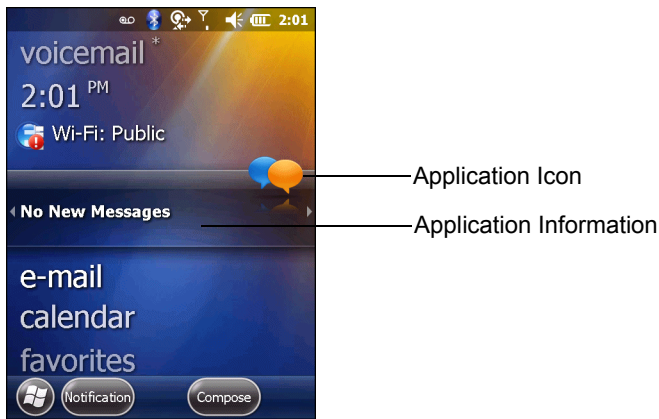

Figure 2-4 Information Bar Example

To customize the **Home** screen, tap > **Settings** > **Today**. On the horizontal scroll, use **Appearance** to customize the background and the **Items** to change the display format.

Classic Today Screen

The user can change to the classic Today screen layout that is used in Windows Mobile 6.1.

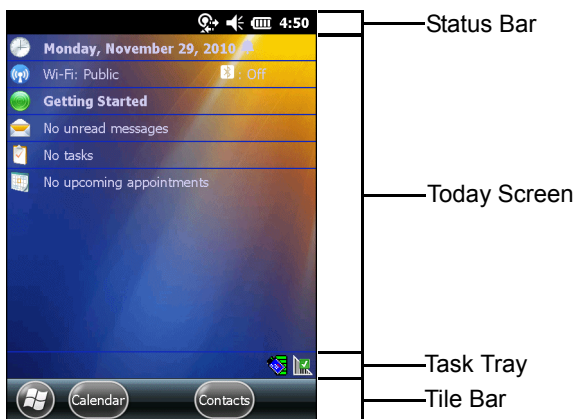

Figure 2-5 Classic Today Screen

To change to the classic view tap > **Settings** > **Home** > **Items**.

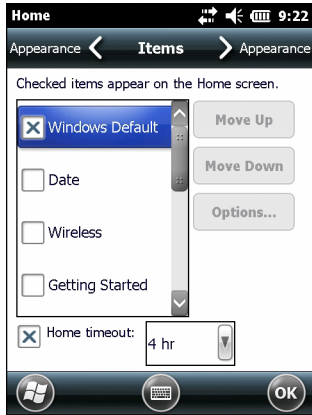





Figure 2-6 Home Screen Settings

Deselect the **Windows Default** checkbox and select any of the other checkboxes.

Tap .

The task bar at the bottom of the screen can contain the task tray icons listed in [Table 2-1](#).

Table 2-1 Task Tray Icons

Icon	Name	Description
	Wireless connection status	Wireless connection status icon. Indicates WLAN signal strength and opens the Wireless Applications menu.
	Bluetooth Enabled	The Bluetooth Enabled icon appears in the task tray and indicates that the Bluetooth radio is on (Displays only if the StoneStreet One Bluetooth stack is enabled).
	Bluetooth Disabled	The Bluetooth Disabled icon appears in the task tray and indicates that the Bluetooth radio is off (Displays only if the StoneStreet One Bluetooth stack is enabled).
	Bluetooth Communication	The Bluetooth Communication icon appears in the task tray and indicates that the mobile computer is communicating with another Bluetooth device (Displays only if the StoneStreet One Bluetooth stack is enabled).

Status Bar

The **Status Bar** at the top of the screen displays the status icons listed in [Table 2-2](#).

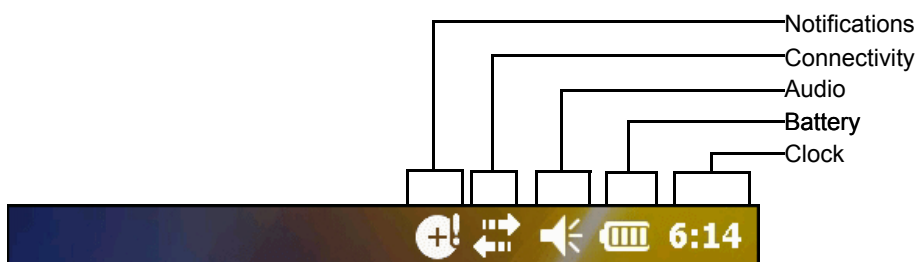

Figure 2-7 Status Bar Icons

Table 2-2 Status Bar Icons

Icon	Description	Icon	Description
Notifications			
	Indicates a reminder of an upcoming calendar event.		Notification that one or more instant messages were received.
	Notification that one or more e-mail/text messages were received.		There are more notification icons than can be displayed.
	Indicates that the backup battery is very low.		Indicates that a wireless stereo headset is connected to the MC55.
Connectivity			
	Connection is active.		Connection is not active.
	Synchronization is occurring.		Wi-Fi available.
	Wi-Fi in use.		
Audio			
	All sounds are on.		All sounds are off.
	Vibrate is on.		
Battery			
	Battery is charging.		Battery has a full charge.
	Battery has a high charge.		Battery has a medium charge.
	Battery has a low charge.		Battery has a very low charge.

Tap the Status Bar to display an icon bar. Tap an icon to get additional notification or status information.

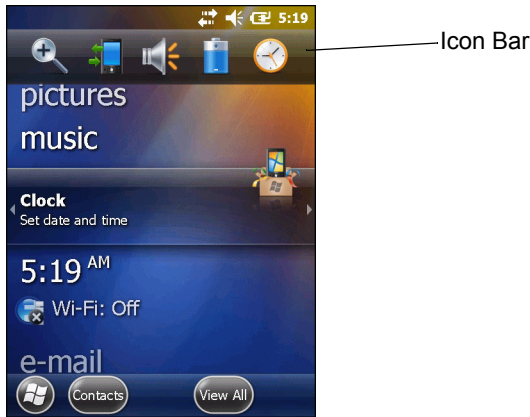

Figure 2-8 Icon Bar

Table 2-3 Task Tray Icons

Icon	Name	Description
	Magnify	Enlarges the screen.
	Notifications	Indicates that notifications are available.
	Headset	Indicates that a wireless stereo headset is connected to the MC55.
	Connectivity	Displays the Connectivity dialog box.
	Volume	Displays the Volume dialog box.
	Power	Displays the Power window.
	Clock & Alarms	Opens the Clocks & Alarms window.

Tile Bar

The **Tile Bar**, located at the bottom of the screen, contains the **Start** tile to open the **Start Menu**. It also displays tiles that vary depending upon the open application.



Figure 2-9 Tile Bar Examples

Start Screen

To open the **Start** screen, tap at the bottom left corner of the screen, or press the START key on the keypad.

Swipe upward to view more program and folder icons.

Move often-used program and folder icons anywhere on the Start screen for easy access. Press and hold the icon and drag the icon to a new location and release.

[Table 2-4](#) lists the default icons available on the Start screen.

Table 2-4 Programs on the Start Screen





















Icon	Name	Description	Icon	Name	Description
	Home	Displays the Home screen.		Text	Send an SMS text message.
	Battery Swap	Properly shuts down the MC55 during battery replacement.		E-mail	Send an Email.
	Contacts	Keep track of friends and colleagues.		Settings	Open the Settings folder. Table 2-5 lists the default icons available on the Settings folder.
	Internet Explorer	Browse Web and WAP sites as well as download new programs and files from the Internet.		Getting Started	Launch the Getting Started application.
	Calendar	Keep track of appointments and create meeting requests.		Alarms	Set the device clock to the date and time of your locale. Alarms can also be set at specified days and times of a week.
	Pictures & Videos	View and manage pictures, animated GIFs, and video files.		Messenger	Use this mobile version of Windows Live Messenger.
	Windows Media	Play back audio and video files.		Microsoft My Phone	Synchronizes the MC55's contacts, calendar, tasks, text messages, music, photos videos and documents with a Microsoft My Phone account.
	Marketplace	Purchase applications from the Marketplace.		MSN Weather	Check the local weather.
	Windows Live	Use this mobile version of Windows Live™ to find information on the web.		Games	Play games.
	MSN Money	Keep track of your finances.		Notes	Create handwritten or typed notes, drawings, and voice recordings.

Table 2-4 Programs on the Start Screen (Continued)















Icon	Name	Description	Icon	Name	Description
	Calculator	Perform basic arithmetic and calculations, such as addition, subtraction, multiplication, and division.		Tasks	Keep track of your tasks.
	Office Mobile	Use the complete suite of Microsoft® Office applications for your mobile device.		Internet Sharing	Connect a notebook computer to the Internet using the MC55's data connection.
	File Explorer	Organize and manage files on your device.		Task Manager	Enables viewing of memory and CPU allocations and stops running processes. Refer to the <i>Microsoft Applications for Windows Mobile 6 User Guide</i> for more information.
	ActiveSync	Synchronize information between the MC55 and a host computer or the Exchange Server.		Search Phone	Search contacts, data, and other information on the MC55. Refer to the <i>Microsoft Applications for Windows Mobile 6 User Guide</i> for more information.
	Help	Access on-line Help topics.		BT Information	Display information about the Bluetooth radio and generate a Bluetooth address bar code.
	Wireless Companion	Open the Wireless Companion folder.		BTScanner CtlPanel	Set com port to use with a Bluetooth scanner.
	AirBEAM Client	Allows legacy customers to deploy AirBEAM Smart™ packages to devices.		Adobe Reader	View pdf files.

Table 2-4 Programs on the Start Screen (Continued)







Icon	Name	Description	Icon	Name	Description
	Modem Link	Enables the MC55 to be used as a modem.		Remote Desktop Mobile	Log onto Windows NT server type computers and use all of the programs that are available on that computer from the MC55.
	MSP Agent	Enables management of the MC55 from an MSP Server. Requires the purchase of an appropriate MSP client license per device to suit the level of management functionality required.		Rapid Deployment Client	Allows the MC55 user to stage a device for initial use by initiating the deployment of settings, firmware, and software. Requires the purchase of an MSP client license per device.
	DEMO	Provides a link to Zebra's featured demos.		BTExplorer	Manages StoneStreet One Bluetooth connections. Refer to the <i>MC55 Series Mobile Computer Integrator Guide</i> for more information. Appears only if the StoneStreet One Bluetooth stack is enabled.

Table 2-5 Setting Applications









Icon	Name	Description	Icon	Name	Description
	Clock & Alarms	Set the device clock to the date and time of your locale. Alarms can also be set at specified days and times of a week.		Lock	Set a password for the MC55.
	Home	Customize the appearance of the Home screen and the information to display on it.		Sounds & Notifications	Enable sounds for events, notifications, and more, and set the type of notification for different events.
	Personal Folder	Contains personal setting applications.		Connections Folder	Contains connection setting applications.
	System Folder	Contains system setting applications.		Microsoft My Phone	Synchronizes the phone's contacts, calendar, tasks, text messages, music, photos, videos and other documents with your My Phone account at www.microsoft.com .

Table 2-5 Setting Applications (Continued)





























Icon	Name	Description	Icon	Name	Description
Connections Folder					
	Beam	Set the MC55 to receive incoming IrDA beams. Not supported on MC55.		Connections	Set up one or more types of modem connections for your device, such as phone dial-up, GPRS, Bluetooth, and more, so that your device can connect to the Internet or a private local network.
	Bluetooth	Open the Bluetooth application, set the MC55 to visible mode and scan for other Bluetooth devices in the area.		Domain Enroll	Make your device an AD domain member for device management and security. Refer to the <i>Microsoft Applications for Windows Mobile 6 User Guide</i> for more information.
	Wi-Fi	Setup wireless network connection and customize settings.		USB to PC	Enables or disables the enhanced network connectivity.
	Wireless Manager	Enables or disables the MC55's wireless radios and customizes Wi-Fi, and Bluetooth settings.			
Personal Folder					
	Buttons	Assign a program to a button.		Owner Information	Enter personal information on the MC55.
System Folder					
	About	View basic information such as the Windows Mobile® version and type of processor used on the MC55.		Certificates	See information about certificates installed on the MC55.
	Backlight	Set backlight settings.		Customer Feedback	Submit feedback on the Windows Mobile 6 software.
	Error Reporting	Enable or disable the Microsoft's error reporting function.		Encryption	Allow files on a storage card to be encrypted. Encrypted files are readable only on your device.
	Managed Programs	Displays the programs that were installed on the MC55 using Mobile Device Manager.		Keylight	Set the keypad backlight time-out.

Table 2-5 *Setting Applications (Continued)*

Icon	Name	Description	Icon	Name	Description
	Memory	Check the device memory allocation status and memory card information and stop currently running programs.		Regional Settings	Set the regional configuration to use, including the format for displaying numbers, currency, date, and time on the MC55.
	Power	Check battery power and set the time-out for turning off the display to conserve battery power.		Remove Programs	Remove programs that you installed on the MC55.
	Screen	Change the screen orientation, re-calibrate the screen, and change the screen text size.		System Info	Displays the MC55's software and hardware information.
	Task Manager	Stop running programs.		USBConfig	Configure the MC55 USB port.
	UI Settings	Set Start Screen layout and IE zoom feature.		DataWedge	Sample scanning application.
	IST Settings	Configure the MC55 accelerometer.			

UI Settings

Use the **UI Settings** application to change the grid view in the **Start** screen and to control Zooming in Internet Explorer.

Start Screen Settings

To change the grid view of the **Start** screen:

1. Tap  > **Settings** > **System** > **UI Settings**.
2. Tap the **Start Screen Settings** tab.

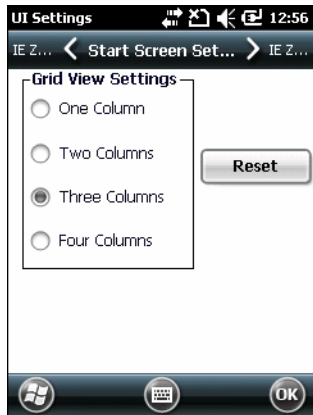

Figure 2-10 Start Screen Settings Tab

3. Select the number of columns.
4. Tap **OK**.

✓ **NOTE** Tap **Reset** to return to the default **3 Column** setting.

5. Tap **OK**.
6. Perform a warm boot.

IE Zoom Mapping

When Internet Explorer opens, the volume keys on the side of the MC55 are used to zoom in and out. To disable IE zoom mapping:

1. Tap  > **Settings** > > **System** > **UI Settings**.
2. Tap the **IE Zoom Mapping** tab.

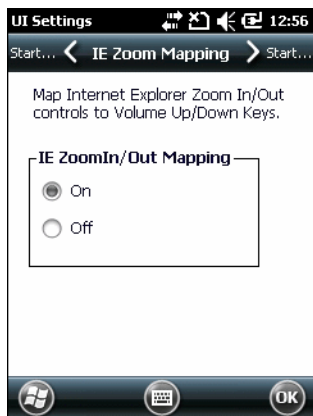

Figure 2-11 IE Zoom Mapping Tab

3. Select **Off**.
4. Tap **OK**.
5. Tap **OK** to turn off mapping.

Locking the MC55

Lock the MC55 by disabling key presses and screen tap or by requiring a password.

Locking the MC55 turns off keyboard and touch screen functionality. This is helpful when the MC55 is turned on and you want to prevent accidental key presses.

To lock the device, tap  > .

Locking without PIN or Password

When the MC55 is locked, the **Lock** screen appears.

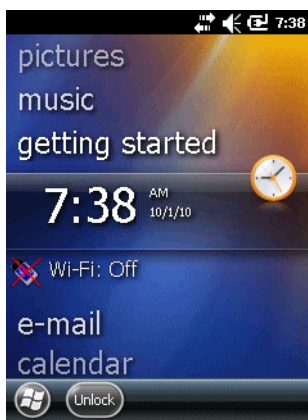

Figure 2-12 Lock Screen

Tap **Unlock** and then tap **Unlock** again.

Locking with Simple PIN

When the MC55 is locked, the **Lock** screen appears.

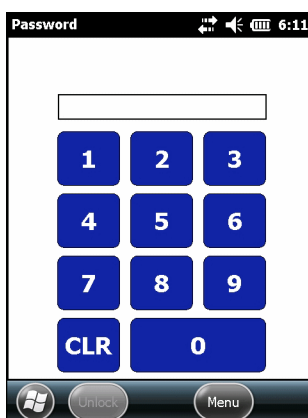

Figure 2-13 Simple PIN Lock Screen

Enter the PIN and then tap **Unlock**.

Locking with Strong Password

When the MC55 is locked, the **Lock** screen appears.

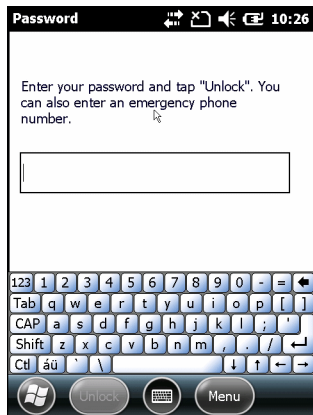

Figure 2-14 Strong Password Lock Screen

Enter the strong password and then tap **Unlock**.

Password Locking Setup

Use the **Password** window to set a password to disable unauthorized access to the MC55.



NOTE If the device is configured to connect to a network, use a strong (difficult to figure out) password to help protect network security. Password cracking tools continue to improve and the computers used to crack passwords are more powerful than ever.

1. Tap  > **Settings** > **Lock** > **Password**.

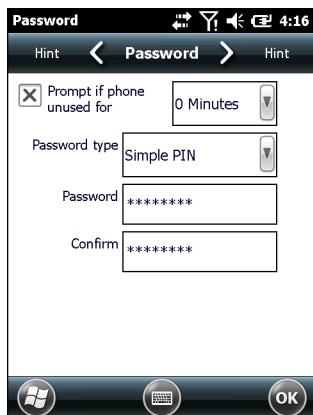

Figure 2-15 Password Window

2. Select **Prompt if device unused for** check box to enable password protection.
3. From the drop-down list, select a time value for the protection to take affect after non-use.
4. From the **Password type**: drop-down list, select either **Simple PIN** or **Strong alphanumeric**.
5. For a simple password, enter a four-digit password in the **Password** field.
For a stronger password:

- a. Enter a seven character password in the **Password:** field. A strong password must contain at least seven characters and contain at least three of the following: uppercase and lowercase letters, numerals, and punctuation.
 - b. Re-enter the password in the **Confirm:** field.
6. Tap **OK**.
 7. Tap **OK**.

Battery Status Indications

Battery icons appear on the navigation bar indicating the battery power level. When the main battery power falls below a predetermined level the icon indicates the status and a battery dialog box appears indicating the status of the battery.

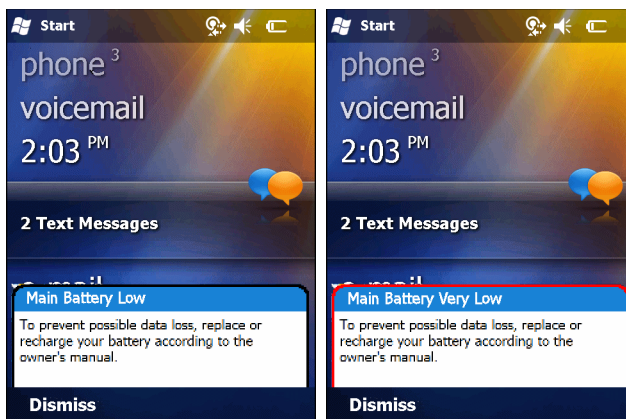



Figure 2-16 *Battery Status Dialog Box*

The **Battery** icon always appears in the **Status bar**. The icon indicates the battery power level. The message displays until the **Dismiss** button is pressed.

Also view the battery status using the **Power** window. Either:

- Tap the Status bar and then the **Battery** icon.
- Tap  > **Settings** > **System** > **Power**.

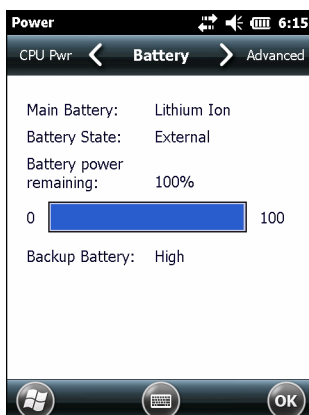



Figure 2-17 *Settings Power Window*

Battery Reserve Options

If the charge of the battery reaches a critical threshold, the MC55 shuts down. This threshold can be changed but affects the amount of time that data can be retained.

1. Tap  > **Settings** > **System** > **Power** > **RunTime**. A warning message appears.

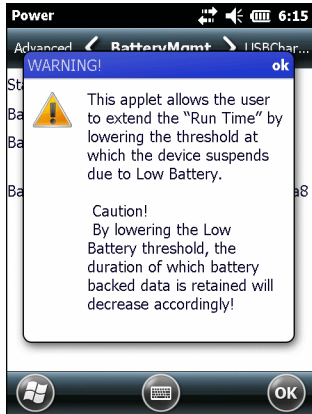

Figure 2-18 Warning Message

2. Read the warning message and tap **OK**.

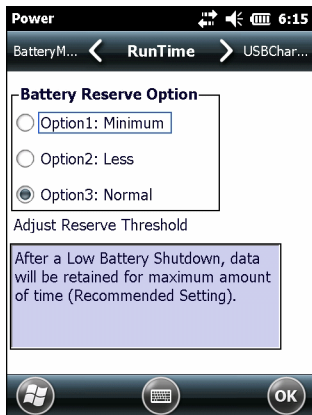

Figure 2-19 RunTime Tab

3. Select one of the **Battery Reserve Options**.
 - **Option 1: Minimum** - After a low battery shutdown, data will be retained for minimum amount of time. Battery should be replaced immediately to avoid data loss.
 - **Option 2: Less** - After a low battery shutdown, data will be retained for less than normal amount of time.
 - **Option 3: Normal** - After a low battery shutdown, data will be retained for maximum amount of time.
4. Tap **OK**.

Main Battery Temperature Notifications

The temperature notification system implements three levels of notification when the temperature within the battery exceeds specific temperature thresholds:

- **Level 1: Temperature Watch**; this level is similar to main battery low warning. It indicates that the battery temperature has reached the first threshold level. The user should move to an environment within proper operating temperature.
- **Level 2: Temperature Warning**; this level is similar to main battery very low warning. It indicates the battery temperature has reached the second threshold level. The user should close all running applications and stop using the MC55.
- **Level 3: Temperature Error**; this level indicates the battery has reached an unusable temperature threshold and immediately suspends the MC55. This level does not have any graphical notification associated with it.



Figure 2-20 Main Battery Temperature Watch Dialog Box

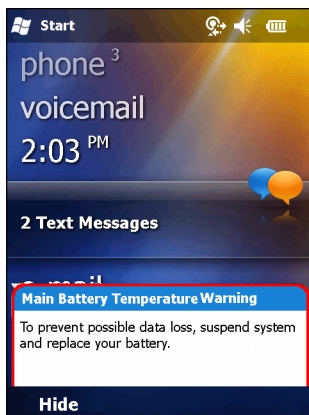



Figure 2-21 Main Battery Temperature Warning Dialog Box



NOTE The **Temperature Warning** dialog box remains visible until you tap **Hide**.

Battery Health

The health of the battery can be viewed on the MC55 Power applet. Tap  > **Settings** > **System** > **Power** > **BatteryMgmt**.

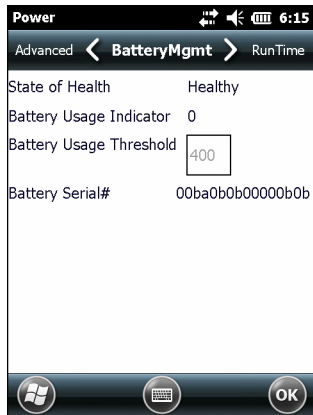

Figure 2-22 Battery Management Dialog Box

Table 2-6 Battery Information

Item	Description
State of Health	Indicates the current state of the battery (Healthy or Unhealthy).
Battery Usage Indicator	Indicates the usage of the battery.
Battery Usage Threshold	Indicates the usage indicator threshold.
Battery Serial #	Displays the serial number of the battery.

For information on changing the Battery Usage Threshold, refer to the *MC55 Integrator Guide*.

LED Indicators

The MC55 has three LED indicators. The Scan/Decode LED indicates status for scanning. The Charging/Battery Status LED indicates battery charging and status.

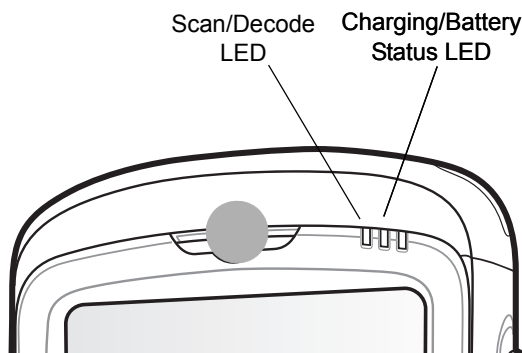

Figure 2-23 LED Indicators

Table 2-7 LED Indications

LED State	Indication
Scan/Decode LED	
Solid Green	Successful decode/capture.
Solid Red	Laser enabled, scanning/imaging in process.
Off	Not enabled.
Charging/Battery Status LED	
Slow Blinking Amber	Main battery in MC55 is charging.
Solid Amber	Main battery in MC55 is fully charged.
Fast Blinking Amber	Charging error.
Off	Not charging.
Single Blink Amber (when Power button pressed)	Battery depleted.
Blinking Amber (when Power button pressed)	Battery over-temperature condition.



NOTE For information about scanning/decoding, see [Chapter 3, Data Capture](#).

Resetting the MC55

There are two reset functions, warm boot and cold boot. A warm boot restarts the MC55 by closing all running programs. A cold boot also restarts the MC55, and also initializes some drivers. Data saved in flash memory or a memory card is not lost.







If the MC55 is not functioning properly, perform a warm boot first. If the MC55 still does not respond, perform a cold boot.

Performing a Warm Boot

Hold down the red **Power** button for approximately five seconds. As soon as the MC55 starts to boot (splash screen displays) release the **Power** button.

Performing a Cold Boot

To perform a cold boot:

- On a numeric keypad, simultaneously press the red **Power** button and the  and  keys.
- On an alphanumeric keypad, simultaneously press the red **Power** button and the  and  keys.
- On an PIM keypad, simultaneously press the red **Power** button and the  and  keys.

Waking the MC55

The wake-up conditions define what actions wake up the mobile computer after it has gone into suspend mode. The mobile computer can go into suspend mode by either pressing the Power button or automatically by Control Panel time-out settings. These settings are configurable and the factory default settings are shown in [Table 2-8](#) are subject to change/update.

Table 2-8 Wake-up Default Settings

Condition for Wake-up	Power Button	Automatic Time-out
AC power is applied.	No	Yes
Mobile computer is inserted into a cradle.	No	Yes
Mobile computer is removed from a cradle.	No	Yes
Mobile computer is connected to a USB device.	Yes	Yes
A key is pressed.	No	Yes
The scan triggered is pressed.	No	Yes
The screen is touched.	No	No
Bluetooth communication	Yes	Yes
IST activity	No	Yes
USB Host connected	No	No

Function Buttons

The MC55's buttons perform certain functions.

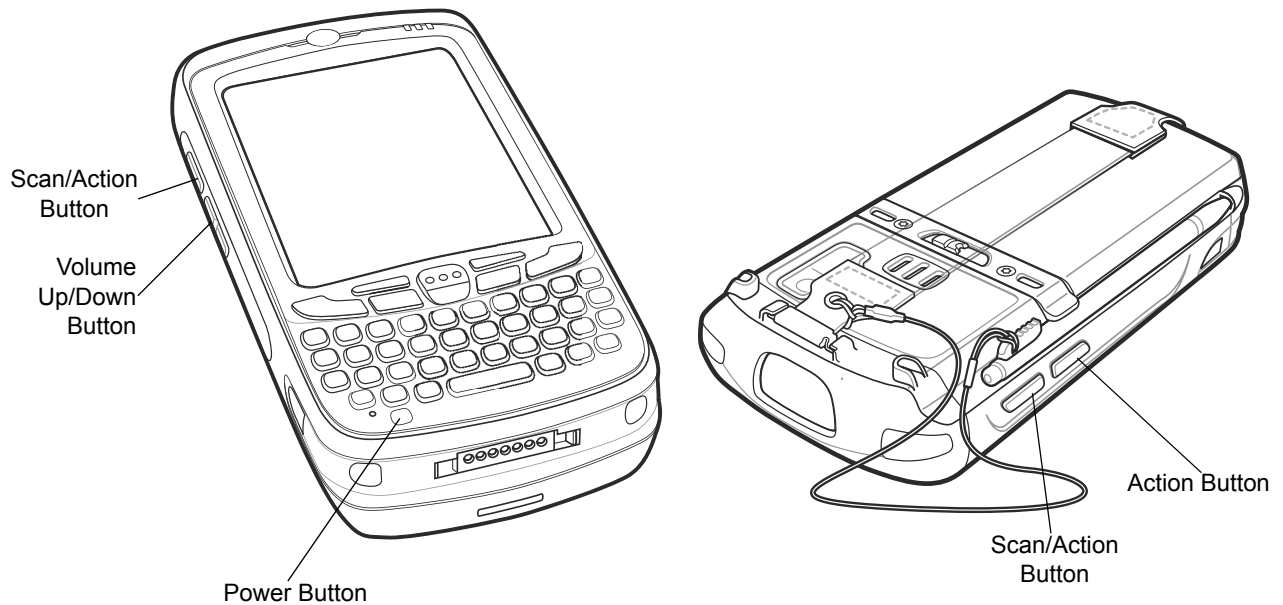

Figure 2-24 *Function Buttons*

- **Power:** Press the red **Power** button to turn the MC55 screen on and off. The MC55 is in suspend mode when the screen is off. For more information, see [Powering On the MC55 on page 1-7](#). Also use the **Power** button to reset the MC55 by performing a warm or cold boot. See [Resetting the MC55 on page 2-19](#).
- **Scan/Action:** Press to scan bar codes or capture images. See [Chapter 3, Data Capture](#). Or, press to open an application or perform a function. See the *Microsoft® Applications for Mobile 6 User Guide* to set an application to open.
- **Volume Up/Down:** Press to increase or decrease the MC55's volume.
- **Action:** Press to open an application or perform a function. See the *Microsoft® Applications for Windows Mobile 6 User Guide* to set an application to open.

Stylus

Use the MC55 stylus to select items and enter information. The stylus functions as a mouse.

- **Tap:** Touch the screen once with the stylus to press option buttons and open menu items.
- **Tap and Hold:** Tap and hold the stylus on an item to see a list of actions available for that item. On the pop-up menu that appears, tap the action to perform.
- **Drag:** Hold the stylus on the screen and drag across the screen to select text and images. Drag in a list to select multiple items.



CAUTION To prevent damage to the screen, do not use any device other than the Zebra-provided stylus.

Entering Data

When entering data on the keypad, use either the single-hand method or the two-hand method as shown in [Figure 2-25](#).

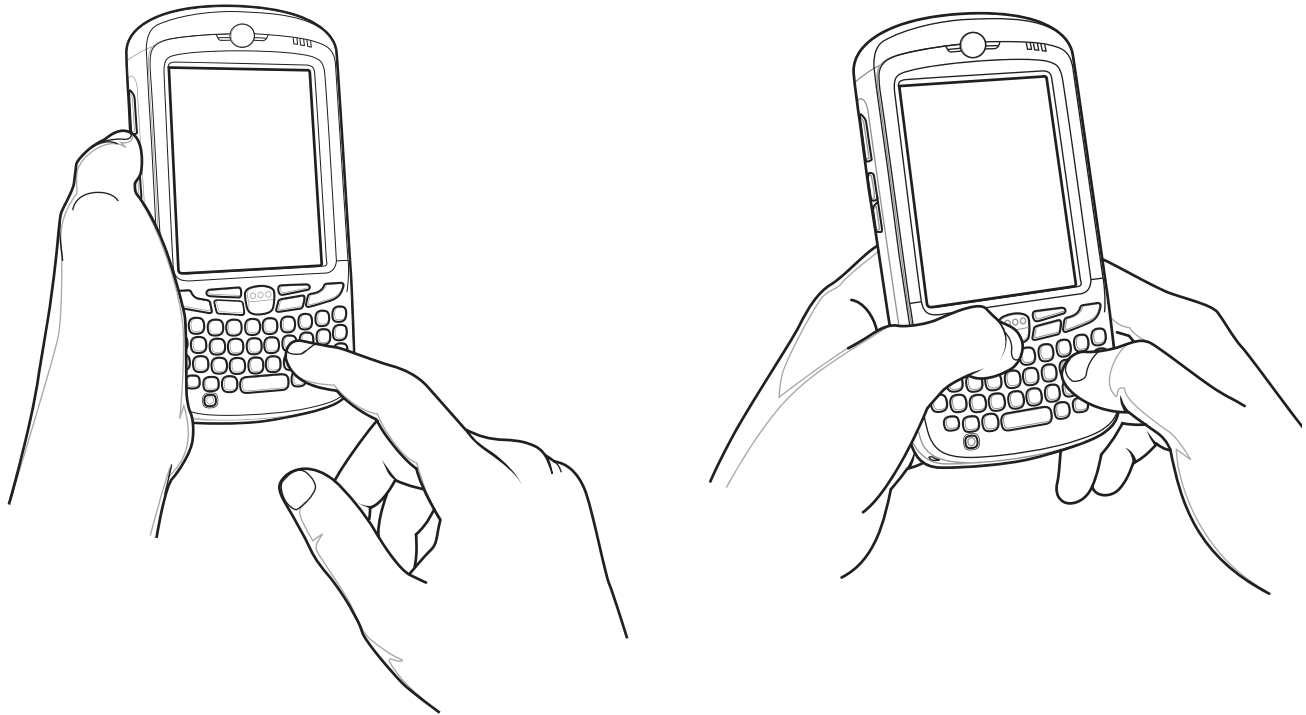

Single-hand Method

Two-hand Method

Figure 2-25 *Entering Data on the Keypad*

Using Voice-Over-IP

- ✓ **NOTE** Voice-Over-IP is currently supported on the MC55A0. It will be supported on the MC55N0 in a future update.

The MC55 supports Voice over IP over WLAN (VoWLAN) using Zebra or third party voice clients. The MC55 can communicate using VoIP either using the MC55 supports several audio outputs, including back speaker phone, front receiver or handset, and Bluetooth headset.

It is recommended that the wireless network use the 802.11a (5 GHz) band for voice applications. Using the 5 GHz band avoids some noise sources that may occur on the 802.11b/g (2.4 GHz) band due to wireless interference.

When using a Bluetooth headset with the MC55 and VoWLAN, it is required to use the Bluetooth Headset profile instead of Hands-free profile. Use the buttons on the MC55 to answer and end calls. See [Chapter 4, Bluetooth](#) for information on setting up a Bluetooth Headset Profile.

Interactive Sensor Technology

The Interactive Sensor Technology (IST) supports the following features:

- **Power Management** – manages power by configuring IST to control switching on/off the backlight, control suspend mode of the MC55 by monitoring motion and orientation.
- **Display Orientation** – switches the screen orientation to either landscape or portrait depending on the MC55 orientation.
- **Free Fall Detection** – monitors free fall duration and records the time and type of the drop event.

Power Management

The MC55 orientation and motion sensitive data can be used as an indicator of MC55 usage and can be used to manage the battery power of the mobile computer. For example, IST can be configured to control the backlight on and off functionality or go into suspend according to a user gesture by placing screen facing down. It can also be used to keep the MC55 active while it is in movement to prevent it from quickly going into suspend mode while in use.

Display Orientation

The screen can be rotated between portrait and landscape modes automatically, depending on the physical orientation of the MC55. For example, if the MC55 is rotated 90° counterclockwise, IST rotates the display counterclockwise 90° so that the screen display appears correct.

This functionality is achieved by monitoring screen angle and rotating the display to counter any changes. IST only rotates the screen in multiples of 90°.

Free Fall Detection

IST continuously monitors gravitational force on the MC55 according to its current position. When the MC55 free falls, IST detects the absence of gravitational force and records the event data if it detects a free fall more than 450 ms, which may indicate nearly a one meter drop. This data can be used as an indicator of potential abuse or misuse.

IST features a log for recording the free fall events. This log records the date, time and the time period of the free fall.

USB Configuration

The MC55 can be placed into any of the following USB modes:

- USB Client - Sets the MC55 to USB Client mode.
- USB Host - Sets the MC55 to USB Host mode.
- USB On-the-Go - Sets the MC55 to automatically determine necessary mode (default).

To place the MC55 into one of these modes:

1. Tap  > **Settings** > **System** > **USBConfig**.
2. Select one of the USB radio buttons.
3. Tap **OK**.

CHAPTER 3 DATA CAPTURE

Introduction

The MC55 offers three types of data capture options:

- Linear scanning
- Imaging
- Digital camera.



NOTE To perform data capture a scanning enabled application must be installed on the MC55. A sample scanning application can be downloaded from the Zebra Support site at <http://support.symbol.com>.

Linear Scanning

MC55 with an integrated linear scanner have the following features:

- Reading of a variety of bar code symbologies, including the most popular linear, postal, and 1-D code types.
- Intuitive aiming for easy point-and-shoot operation.

Imaging

MC55 with an integrated imager have the following features:

- Omnidirectional reading of a variety of bar code symbologies, including the most popular linear, postal, PDF417, and 2D matrix code types.
- The ability to capture and download images to a host for a variety of imaging applications.
- Advanced intuitive laser aiming cross-hair and dot aiming) for easy point-and-shoot operation.

The imager uses digital camera technology to take a digital picture of a bar code, stores the resulting image in its memory, and executes state-of-the-art software decoding algorithms to extract the data from the image.

Operational Modes

MC55 with an integrated imager support three modes of operation, listed below. Activate each mode by pressing the **Scan** button.

- **Decode Mode:** In this mode, the MC55 attempts to locate and decode enabled bar codes within its field of view. The imager remains in this mode as long as you hold the scan button, or until it decodes a bar code.



NOTE To enable Pick List Mode, download the Control Panel applet from the Support Central web site at <http://support.symbol.com>. Pick List can also be set in an application using a API command.

- **Pick List Mode:** This mode allows you to selectively decode a bar code when more than one bar code is in the MC55's field of view. To accomplish this, move the aiming crosshair or dot over the required bar code to decode only this bar code. This feature is ideal for pick lists containing multiple bar codes and manufacturing or transport labels containing more than one bar code type (either 1D or 2D).
- **Image Capture Mode:** Use this mode to capture an image within the MC55's field of view. This is useful for capturing signatures or images of items like damaged boxes.

Digital Camera

MC55 with an integrated digital camera have the following features:

- Omnidirectional reading of a variety of bar code symbologies, including the most popular linear, postal, PDF417, and 2D matrix code types.
- Advanced intuitive aiming for easy point-and-shoot operation.

The camera uses digital camera technology to take a digital picture of a bar code, stores the resulting image in its memory, and executes state-of-the-art software decoding algorithms to extract the data from the image.

Scanning Considerations

Typically, scanning is a simple matter of aim, scan, and decode and a few quick trial efforts master it. However, consider the following to optimize scanning performance:

- **Range**
Any scanning device decodes well over a particular working range — minimum and maximum distances from the bar code. This range varies according to bar code density and scanning device optics.
Scanning within range brings quick and constant decodes; scanning too close or too far away prevents decodes. Move the scanner closer and further away to find the right working range for the bar codes being scanned.
- **Angle**
Scanning angle is important for promoting quick decodes. When laser beams reflect directly back into the scanner from the bar code, this specular reflection can “blind” the scanner.
To avoid this, scan the bar code so that the beam does not bounce directly back. But don't scan at too sharp an angle; the scanner needs to collect scattered reflections from the scan to make a successful decode. Practice quickly shows what tolerances to work within.
- Hold the MC55 farther away for larger symbols.
- Move the MC55 closer for symbols with bars that are close together.

- ✓ **NOTE** Scanning procedures depend on the application and MC55 configuration. An application may use different scanning procedures from the one listed above.

Linear Scanning

To read a bar code, a scan-enabled application is required. The MC55 contains the **DataWedge** application that allows the user to enable the scanner to decode bar code data and display the bar code content.

1. Ensure that a scan enabled application (DataWedge) is loaded on the MC55. See [DataWedge on page 3-6](#).
2. Aim the scan window at the bar code.

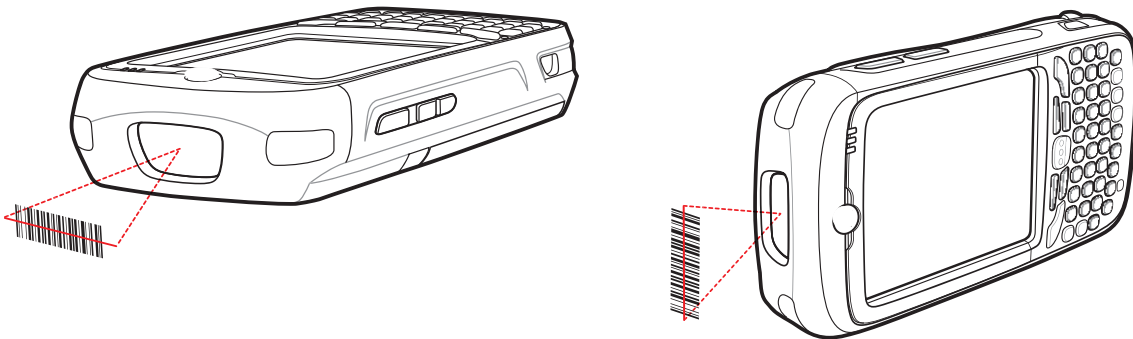

Figure 3-1 Linear Scanning

3. Press the scan button. Ensure the red scan beam covers the entire bar code. The Scan/Decode LED lights red to indicate that scanning is in process, then lights green and a beep sounds, by default, to indicate the bar code was decoded successfully.

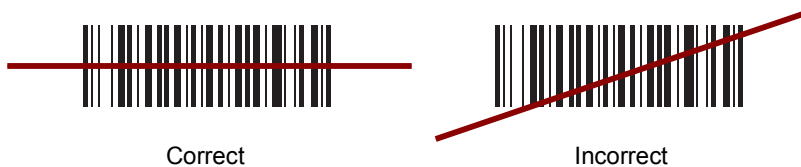

Figure 3-2 Linear Scanner Aiming Pattern

Imager Scanning

To read a bar code, a scan-enabled application is required. The MC55 contains the **DataWedge** application that allows the user to enable the scanner to decode bar code data and display the bar code content.

1. Ensure that a scan-enabled application (DataWedge) is loaded on the MC55. See [DataWedge on page 3-6](#).
2. Aim the scan window at the bar code.

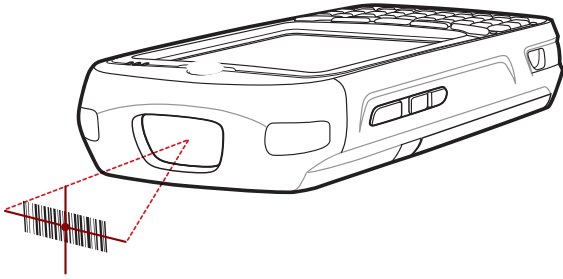

Figure 3-3 Imer Scanning

3. Press the scan button.

The red laser aiming pattern or aiming dot turns on to assist in aiming. Ensure the bar code is within the area formed by the brackets in the aiming pattern or close to the aiming dot. The aiming dot is used for increased visibility in bright lighting conditions.

The Scan/Decode LED lights red to indicate that scanning is in process, then lights green and a beep sounds, by default, to indicate the bar code was decoded successfully. Note that when the MC55 is in Pick List Mode, the imager does not decode the bar code until the crosshair or aiming dot touches the bar code.



Figure 3-4 Imer Aiming Pattern: Bar Code Centered

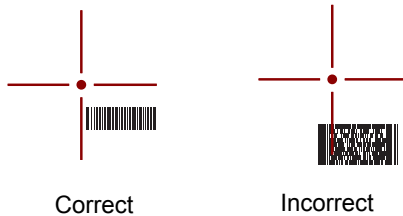

Figure 3-5 Imer Aiming Pattern: Bar Code Not Centered

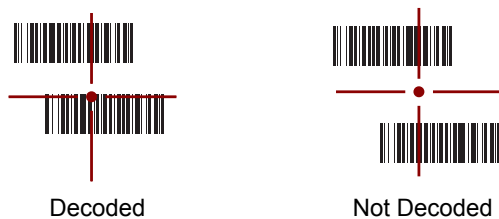

Figure 3-6 Pick List Mode with Multiple Bar Codes in Aiming Pattern



4. Release the scan button.

- ✓ **NOTE** Imager decoding usually occurs instantaneously. The MC55 repeats the steps required to take a digital picture (image) of a poor or difficult bar code as long as the scan button remains pressed.

Using the RS507 Hands-free Imager

An RS507 Hands-free Imager can be used with the MC55 to capture bar code data.

To set up the MC55 and RS507:

1. Tap  > **BTScannerCtlPanel** icon.
2. Select the **BT Scanner** checkbox and then select the appropriate Com port from the drop-down list.
3. Tap **Save and Exit**.
4. Tap  > **Display_BD_Address** icon. A bar code displays.
5. Point the RS507 to the bar code. The RS507 reads the bar code and begins pairing with the MC55. If required, enter PIN (12345).
6. Launch a scanning enabled application.
7. Point the RS507 at a bar code to read the bar code data.

Refer to the *RS507 Hands-free Imager Product Reference Guide* for more information.

Digital Camera Scanning

1. Ensure that a scan-enabled application (DataWedge) is loaded on the MC55. See [DataWedge on page 3-6](#).
2. Aim the camera lens on the back of the MC55 at a bar code.
3. Press and hold the scan button. A preview window appears on the display window with a red aiming reticle in the center. The Scan/Decode LED lights red to indicate that scanning is in process.

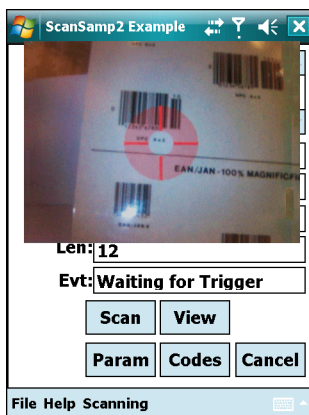

Figure 3-7 Sample Scan Application with Preview Window

4. Move the MC55 until the red aiming reticle is over the bar code to scan.
5. The Scan/Decode LED lights green and a beep sounds, by default, to indicate the bar code was decoded successfully.

✓ **NOTE** The camera decode feature is set by default to automatically decode the bar code when read. This feature can be programmed to display a green aiming rectile upon good decode indicating that the bar code has been successfully decoded and to release the scan button.

DataWedge

- ✓ **NOTE** On MC55N0, by default, DataWedge is loaded but not installed on the MC55. An installation file resides in the Windows folder.

Installation

- ✓ **NOTE** For MC55N0 only.

To install **DataWedge**:

1. Tap  > **File Explorer**.
2. Navigate to the **Windows** folder.
3. Scroll to the **DataWedge** file.
4. Tap the **DataWedge** file. The installation begins. Follow the on-screen instructions to complete the installation.

Enable DataWedge

To enable DataWedge:

1. Tap  > **Settings** > **System** > **DataWedge**.
2. Tap **Basic configuration**.
3. Tap **1. Barcode input**.
4. Tap one of the following:
 - a. **1. 1D Scanner Driver** or **1. Block Buster Imager**.
 - b. **2. Camera Scanner Driver**
 - c. **3. Bluetooth SSI Scanner Driver**
5. Ensure that a check mark is next to **1. Enabled**. If not, tap **1. Enabled**.
6. Tap **0. Back**.
7. Tap **0. Back**.
8. Tap **0. Exit** and then tap **OK**.
9. Tap **Running** to start the DataWedge process. The DataWedge Status changes to **Ready**.
10. Tap **OK**.

Disable DataWedge

To disable DataWedge:

1. Tap  > **Settings** > **System** > **DataWedge**.
2. Tap the **Running** option to end the DataWedge process. The DataWedge Status changes to **Stopped**.

3. Tap **OK**.

Taking Photos

To take a photo:

1. Tap  > **Programs** > **Pictures & Videos** icon.
2. Tap **Camera** on the command bar.
3. Check the image on the view finder, adjust if necessary.
4. Press the **Enter** key to take the picture. Hold the MC55 still until the shutter sound is heard.

Recording Video

To record a video clip:

1. Tap  > **Programs** > **Pictures & Videos** icon.
2. Tap **Camera** on the command bar.
3. Tap **Menu** > **Video** to set shooting mode to video.

The available recording time displays on the screen.

✓ **NOTE** By default, the time limit for recording videos is set to 30 seconds.

4. Press the **Enter** key to begin recording.
Recording stops when you press the **Enter** button again.

Viewing Photos and Videos

To view photos and video clips:

1. Tap  > **Programs** > **Pictures & Videos** icon.
2. Tap the picture or video clip to view.

CHAPTER 4 BLUETOOTH

Introduction

Bluetooth-equipped devices can communicate without wires, using frequency-hopping spread spectrum (FHSS) radio frequency (RF) to transmit and receive data in the 2.4 GHz Industry Scientific and Medical (ISM) band (802.15.1). Bluetooth wireless technology is specifically designed for short-range (30 feet/10 meters) communication and low power consumption.

MC55s with Bluetooth capabilities can exchange information (e.g., files, appointments, and tasks) with other Bluetooth enabled devices such as phones, printers, access points, and other mobile computers. To use the MC55 as a modem, create a dial-up modem connection between a computer and MC55.

The MC55 with Bluetooth technology uses either the StoneStreet Bluetooth stack or the Microsoft Bluetooth stack. To write an application that uses the StoneStreet One Bluetooth stack APIs, refer to the Enterprise Mobility Developer Kit (EMDK) Help.

Adaptive Frequency Hopping

Adaptive Frequency Hopping (AFH) is a method of avoiding fixed frequency interferers, and can be used with Bluetooth voice. All devices in the piconet (Bluetooth network) must be AFH-capable in order for AFH to work. There is no AFH when connecting and discovering devices. Avoid making Bluetooth connections and discoveries during critical 802.11b communications. AFH for Bluetooth consists of four main sections:

- Channel Classification - A method of detecting an interference on a channel-by-channel basis, or pre-defined channel mask.
- Link Management - Coordinates and distributes the AFH information to the rest of the Bluetooth network.
- Hop Sequence Modification - Avoids interference by selectively reducing the number of hopping channels.
- Channel Maintenance - A method for periodically re-evaluating the channels.

When AFH is enabled, the Bluetooth radio “hops around” (instead of through) the 802.11b high-rate channels. AFH coexistence allows Zebra mobile computers to operate in any infrastructure.

The Bluetooth radio in this MC55 operates as a Class 2 device power class. The maximum output power is 2.5mW and the expected range is 32.8 feet (10 meters). A definition of ranges based on power class is difficult to obtain due to power and device differences, and whether one measures open space or closed office space.



NOTE It is not recommended to perform Bluetooth wireless technology inquiry when high rate 802.11b operation is required.

Security

The current Bluetooth specification defines security at the link level. Application-level security is not specified. This allows application developers to define security mechanisms tailored to their specific need. Link-level security occurs between devices, not users, while application-level security can be implemented on a per-user basis. The Bluetooth specification defines security algorithms and procedures needed to authenticate devices, and if needed, encrypt the data flowing on the link between the devices. Device authentication is a mandatory feature of Bluetooth while link encryption is optional.

Pairing of Bluetooth devices is accomplished by creating an initialization key that is used to authenticate the devices and create a link key for them. Entering a common PIN number in the devices being paired generates the initialization key. The PIN number is never sent over the air. By default, the Bluetooth stack responds with no key when a key is requested (it is up to user to respond to the key request event). Authentication of Bluetooth devices is based-upon a challenge-response transaction. Bluetooth allows for a PIN number or passkey that is used to create other 128-bit keys used for security and encryption. The encryption key is derived from the link key used to authenticate the pairing devices. Also worthy of note is the limited range and fast frequency hopping of the Bluetooth radios that makes long-distance eavesdropping difficult.

Recommendations are:

- Perform pairing in a secure environment
- Keep PIN codes private and don't store the PIN codes in the mobile computer
- Implement application-level security.

The Microsoft stack supports Smart-pairing. For detailed information, refer to the Microsoft MSDN.

Security Mode 3 (Link Level Encryption)

The MC55 supports Security Level 3 (Link Level Encryption). Link level encryption is the data security process of encrypting information at the data link level as it is transmitted between two devices.

Microsoft Bluetooth Stack

When pairing with a remote device using the Microsoft Bluetooth UI, Security Level 3 (Link Level Encryption) is automatically used. When developing applications using the Microsoft Bluetooth stack, enable Security Mode 3 using the *BthSetEncryption* API call. Refer to the Microsoft MSDN for more information.

StoneStreet One Bluetooth Stack

To set Security Mode 3 on outgoing serial port connections, set **Encrypt Link On All Outgoing Connections** checkbox in the **Settings > Security**. See [Security on page 4-36](#) for more information.

Bluetooth Configuration

By default, the MC55 is configured to using the Microsoft Bluetooth stack. Refer to the MC55 Integrator Guide, Appendix B, for information on switching to the StoneStreet One Bluetooth stack.

[Table 4-1](#) list the services supported by the Microsoft Bluetooth stack and the StoneStreet One Bluetooth stack.

Table 4-1 *Bluetooth Services*

Microsoft Bluetooth Stack	StoneStreet One Bluetooth Stack
Dial-Up Networking Services	File Transfer Services
OBEX Object Push Services	Dial-Up Networking Services
PBAP Services	OBEX Object Push Services
Serial Port Services	Headset Audio Gateway Services
Personal Area Networking Services	Serial Port Services
A2DP/AVRCP Services	Personal Area Networking Services
	HID Host Services
	A2DP/AVRCP Services

[Table 4-2](#) list the COM ports available for the StoneStreet One Bluetooth stack and the Microsoft Bluetooth stack.

Table 4-2 *COM Ports*

Microsoft Bluetooth Stack	StoneStreet One Bluetooth Stack
COM5	COM5
COM9	COM9
	COM11
	COM21
	COM22
	COM23

Bluetooth Power States

Cold Boot

With StoneStreet One Bluetooth Stack

Performing a cold boot on the MC55 turns off Bluetooth after initialization (which takes a few moments). It is normal to see the **Bluetooth** icon appear and disappear (when using the Classic Home screen), as well as a wait cursor, when initialization proceeds in all modes.

With Microsoft Bluetooth Stack

Performing a cold boot retain the state of the Bluetooth radio prior to the cold boot.

Warm Boot

With StoneStreet One Bluetooth Stack

Performing a warm boot on the MC55 turns off Bluetooth.

With Microsoft Bluetooth Stack

Performing a warm boot retain the state of the Bluetooth radio prior to the warm boot.

Suspend

When there is an active Bluetooth connection, the Bluetooth radio goes into low power mode maintaining the active connection. When there is no active connection, the Bluetooth radio turns off.

With StoneStreet One Bluetooth Stack

- ✓ **NOTE** If there is an active Bluetooth connection between the MC55 and another Bluetooth device, the MC55 will not timeout. However, if the user presses the Power button on the MC55, the MC55 will suspend and upon receiving data from a remote Bluetooth device, the MC55 will wake from suspend mode. For example, Bluetooth scanner sending data to the MC55.

With Microsoft Bluetooth Stack

- ✓ **NOTE** If there is an active Bluetooth connection between the MC55 and another Bluetooth device and there is no data activity, the MC55 will timeout. However, if the user presses the Power button on the MC55, the MC55 will suspend and upon receiving data from a remote Bluetooth device, the MC55 will wake from suspend mode. For example, Bluetooth scanner sending data to the MC55.

Resume

When the MC55 resumes, Bluetooth turns on if it was on prior to suspend.

Using Microsoft Bluetooth Stack

The following sections provide information on using the Microsoft Bluetooth stack.

Turning the Bluetooth Radio Mode On and Off

- ✓ **NOTE** On devices with Windows Mobile 6.5.3, turn the Bluetooth radio on or off using the **Wireless Manager**. Tap the Status bar and select the **Connectivity** icon. Tap **Wireless Manager**.

Turn off the Bluetooth radio to save power or if entering an area with radio restrictions (e.g., an airplane). When the radio is off, other Bluetooth devices cannot see or connect to the MC55. Turn on the Bluetooth radio to exchange information with other Bluetooth devices (within range). Communicate only with Bluetooth radios in close proximity.

- ✓ **NOTE** To achieve the best battery life turn off radios not in use.

Enabling Bluetooth

To enable Bluetooth:

1. Tap **Wireless Manager** and then tap the **Bluetooth** bar or

Tap  > **Setting** > **Connections** > **Bluetooth** icon > **Mode**.

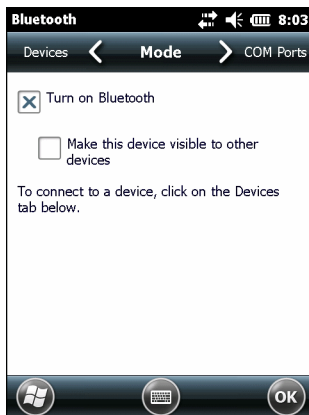



Figure 4-1 Bluetooth Mode

2. Check the **Turn On Bluetooth** checkbox.
3. Tap **OK**.

Disabling Bluetooth

To disable Bluetooth:

1. Tap **Wireless Manager** and then tap the **Bluetooth** bar or
Tap  > **Setting** > **Connections** > **Bluetooth** icon > **Mode**.
2. Un-check the **Turn On Bluetooth** checkbox.
3. Tap **OK**.

Discovering Bluetooth Device(s)

The MC55 can receive information from discovered devices without bonding. However, once bonded, the MC55 and a bonded device exchange information automatically when you turn the Bluetooth radio on. See [Bonding with Discovered Device\(s\) on page 4-30](#) for more information.

To find Bluetooth devices in the area:

1. Ensure that Bluetooth is enabled on both devices.
2. Ensure that the Bluetooth device to discover is in discoverable and connectable modes.
3. Ensure that the two devices are within 30 feet (10 meters) of one another.
4. Tap  > **Settings** > **Connections** > **Bluetooth** > **Devices**.

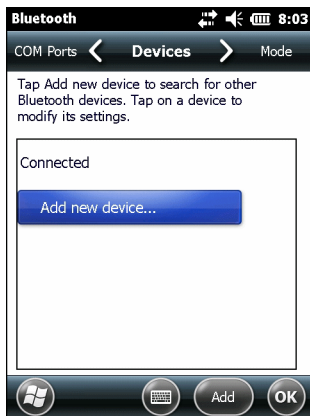

Figure 4-2 Bluetooth - Devices

5. Tap **Add new device**. The MC55 begins searching for discoverable Bluetooth devices in the area.

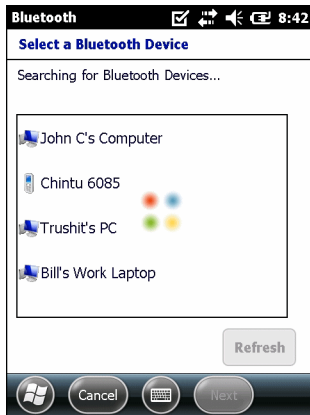

Figure 4-3 Searching for Bluetooth Devices

6. Select a device from the list.



Figure 4-4 *Select a Bluetooth Device*

7. Tap **Next**. The **Enter Passcode** window appears.



NOTE If Smart-pairing is configured and the device is requesting one of the pre-defined PINs, the **Enter Passcode** window does not appear.

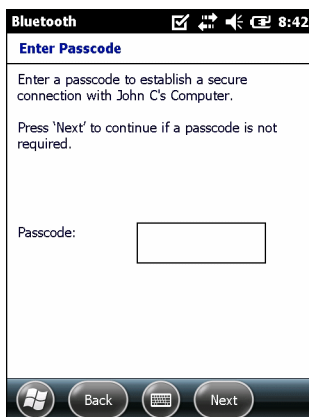

Figure 4-5 *Enter Passcode*

8. Enter the Passcode on the other device. The device is added to the Bluetooth list.

You are prompted to enter a passcode. If the device has a specific passcode, enter it in the Passcode field and tap Next. If the device does not have a specific passcode, enter one in the Passcode field and tap Next. The Bluetooth radio tries to connect with the device.

9. If you created a passcode, you will be prompted by the other device to enter the same passcode. Enter the created passcode to establish a paired connection. (If you entered a passcode from the device, you shouldn't have to do anything on the other device.)

10. When the connection is complete, a list of matching and supported services on the device appears.

11. Select the services you want to use and tap Finish. The services on the new devices have to be selected or else the pairing won't include those services, even though the devices are paired. If services are not selected, you will be continually reprompted for the passcode from the device.

12. The device appears in the list on the main window.

After the passcodes have been accepted on both sides, you have a trusted (“paired”) connection.

Available Services

✓ **NOTE** Some devices might not require a PIN. This depends upon the device's authentication.

The MC55 with Microsoft Bluetooth stack offers the following services:

- OBEX Object Push Services via Beam
- Serial Port Services
- Personal Area Networking Services
- PBAP Services
- Dial-up Networking Services
- A2DP/AVRCP Services.

See the following sections for information on these services.

Object Push Services via Beam

✓ **NOTE** You can only send files to a remote device using the Beam function.

Use the OBEX Push Service to send files and contacts to another Bluetooth device. To transfer files between the MC55 and another Bluetooth enabled device:

1. Ensure that Bluetooth is enabled and discoverable on both devices.
2. Ensure that the two devices are within 30 feet (10 meters) of one another.
3. Tap  > **Programs** > **File Explorer**.
4. Navigate to the file to transfer.
5. Tap and hold on the filename until the pop-up menu appears.

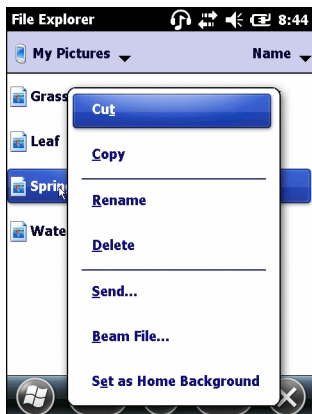

Figure 4-6 File Explorer Window

6. Select **Beam File**. The MC55 searches for Bluetooth devices in the area.
7. Tap **Tap to send** next to the Bluetooth device to send the file to. The MC55 communicates with the device and send the file. When completed, **Tap to send** changes to **Done**.

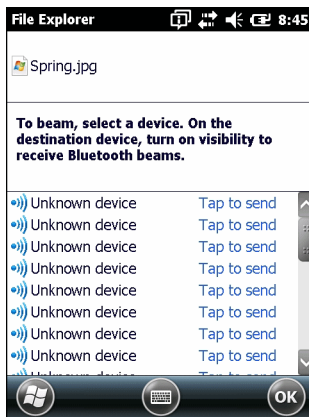

Figure 4-7 Beam File Window

To transfer a contact between the MC55 and another Bluetooth enabled device:

1. Ensure that Bluetooth is enabled and discoverable on both devices.
2. Ensure that the two devices are within 30 feet (10 meters) of one another.
3. Tap  > **Contacts**.
4. Navigate to the contact to transfer.
5. Tap and hold on the contact until the pop-up menu appears.



Figure 4-8 Contact Window

6. Select **Send Contact** > **Beam**. The MC55 searches for Bluetooth devices in the area.
7. Tap **Tap to send** next to the Bluetooth device to send the file to. The MC55 communicates with the device and send the contact. When completed, **Tap to send** changes to **Done**.

Internet Sharing

Internet Sharing allows the user to connect a computer or laptop to the MC55 and use the MC55 as a modem to connect to an office network or ISP.

To use MC55 as a modem using Bluetooth:

1. Ensure that the device is not connected to the computer or laptop.
2. On the MC55, ensure that the Phone is on and a data connection is configured.

3. Tap > **Programs > Internet Sharing**.
4. In the **PC Connection** list, select **Bluetooth PAN**.
5. In the **Network Connection** list, select the connection type.
Select the network connection that the device should use to connect to the Internet.
6. Tap **Connect**.
7. On the computer or laptop, setup a Bluetooth PAN with your device.
 - a. Select  > **Control Panel > Network Connections**.
 - b. Under **Personal Area Network**, select **Bluetooth Network Connection**.
 - c. Right-click on **Bluetooth Network Connection** and select **View Bluetooth** network devices.
 - d. In the **Bluetooth Personal Area Network Devices** window select your device.
 - e. Click **Connect**. The computer connects to the device via Bluetooth.

✓ **NOTE** If your computer is Bluetooth-enabled and you select Bluetooth as the PC connection, you must initiate and complete the Bluetooth PAN partnership before Internet Sharing will work. For more information, refer to Windows Help and Support.

8. To verify, on the PC or laptop, launch **Internet Explorer** and open a web site.
9. To end dial-up networking, on the MC55 tap **Disconnect**.

Serial Port Services

Use the wireless Bluetooth serial port connection as you would a physical serial cable connection. Configure the application that will use the connection to the correct serial port.

To establish a serial port connection:

1. Ensure that Bluetooth is enabled and discoverable on both devices.
2. Ensure that the two devices are within 30 feet (10 meters) of one another.
3. Tap  > **Settings > Connections > Bluetooth > Devices**.
4. Tap **Add new device**. The MC55 begins searching for discoverable Bluetooth devices in the area.
5. Select a device from the list.
6. Tap **Next**. The **Enter Passcode** window appears.

✓ **NOTE** If Smart-pairing is configured and the device is requesting one of the pre-defined PINs, the **Enter Passcode** window does not appear.

7. Enter the Passcode and the tap **Next**. The device is added to the Bluetooth list.
8. In the device list, tap the serial device. The **Partnership Settings** window displays.
9. Select the **Serial Port** checkbox.
10. Tap **Save**.
11. Tap **COM Ports**.
12. Tap **New Outgoing Port**. The add device window appears.

✓ **NOTE** By default, **Secure Connection** checkbox is set enabling Security Level 3 (Linked Level Encryption).

13. Select the serial device in the list and then tap **Next**.

14. Select a COM port from the drop-down list.

15. Tap **Finish**.

✓ **NOTE** No connection is made at this point. An application must open the selected COM port to trigger Microsoft Bluetooth stack to open the connection.

ActiveSync Using Serial Port Services

Use the wireless Bluetooth serial port connection for ActiveSync just as you would a physical serial cable connection. You must configure the application that will use the connection to the correct serial port.

To set up a Bluetooth ActiveSync connection:

Before setting up a Bluetooth ActiveSync connection, configure the Bluetooth function of your device.

✓ **NOTE** For additional security, disable network bridging on the computer (specifically, bridging to a Remote NDIS adapter) before connecting to the computer to pass through to the Internet or a network. For more information on network bridging, see **Windows Help** on your computer.

The instructions below are for computers that support the Windows XP SP2 or later version operating system.

1. Ensure that Bluetooth is enabled and discoverable on both devices.
2. Ensure that the two devices are within 30 feet (10 meters) of one another.
3. On the computer, click  > **Settings** > **Control Panel**.
4. Double-click **Bluetooth Devices**.
5. On the **Options** tab, select the **Turn discovery on** and **Allow Bluetooth devices to connect to this computer** checkboxes.

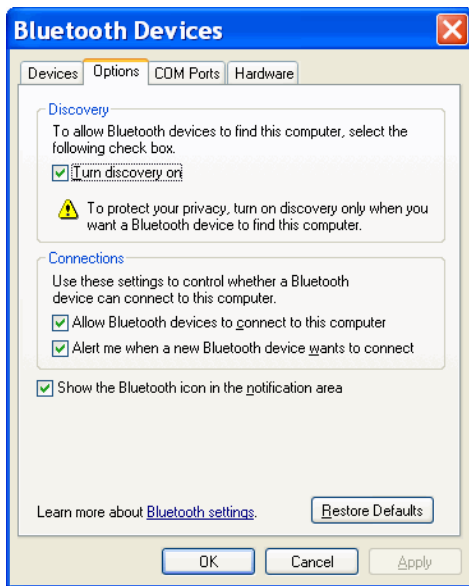

Figure 4-9 Computer Bluetooth Devices Window



6. On the **COM Ports** tab, click **Add**.
7. Select the **Incoming (device initiates the connection)** option, then click **OK**.
Note the number of the COM port that was added.
8. Click **OK**.
9. Click  > **All Programs** > **Microsoft ActiveSync**.
10. Click **File** > **Connection Settings**.



Figure 4-10 ActiveSync Connection Settings

11. On the **Allow connections to one of the following** drop-down list, select the COM port with the number you noted earlier.
12. On the MC55, tap  > **Programs** > **ActiveSync**.
13. Tap **Menu** > **Connect via Bluetooth**.

Synchronization is automatically initiated. The **ActiveSync** icon appears on the lower right corner of the **Today** screen.

If an Authentication is required, the **Enter Passcode** screen appears, type an alphanumeric passkey (PIN code), then tap **Next**; enter the same passkey on the other device.

The passkey is recommended for enhanced security. Your passkey must be between 1 to 16 alphanumeric characters.

If you do not want to use a passkey, tap **Next**.

14. To disconnect the ActiveSync connection, tap the **ActiveSync** icon on the Today screen.
15. Tap **Disconnect**.

Phone Book Access Profile Services

Phone Book Access profile (PBAP) is used to synchronize contacts between a remote device and the MC55. To establish an PBAP synchronization:

1. Ensure that Bluetooth is enabled and discoverable on both devices.
2. Ensure that the two devices are within 30 feet (10 meters) of one another.
3. Tap  > **Settings** > **Connection** > **Bluetooth** icon > **Devices**.
4. Tap **Add New Device**. The MC55 searches for a Bluetooth device, such as a Car Kit.
5. Select a device from the list.
6. Tap **Next**. The **Enter Passcode** window appears.

✓ **NOTE** If Smart-pairing is configured and the device is requesting one of the pre-defined PINs, the **Enter Passcode** window does not appear.

7. Enter the Passcode and the tap **Next**. The device is added to the Bluetooth list.
8. A dialog box appears requesting if you want to transfer contacts to the car kit.
9. Select **Yes** or **No**.
10. If **Yes** is selected, contacts from the MC55 are transferred to the car kit.

Using Bluetooth StoneStreet One Bluetooth Stack

The following sections provide information on using the Stone Street One Bluetooth stack.

Turning the Bluetooth Radio Mode On and Off

Turn off the Bluetooth radio to save power or if entering an area with radio restrictions (e.g., an airplane). When the radio is off, other Bluetooth devices cannot see or connect to the MC55. Turn on the Bluetooth radio to exchange information with other Bluetooth devices (within range). Communicate only with Bluetooth radios in close proximity.

✓ **NOTE** To achieve the best battery life turn off radios not in use.

Disabling Bluetooth

To disable Bluetooth, tap the Connection icon on the Status bar and select **Wireless Manager** in the Connectivity dialog box. Tap the blue **Bluetooth** bar to turn off the Bluetooth radio.

Enabling Bluetooth

To enable Bluetooth, tap the Connection icon on the Status bar and select **Wireless Manager** in the Connectivity dialog box. Tap the blue **Bluetooth** bar to turn on the Bluetooth radio.

Modes

The BTE Explorer application has two modes for managing Bluetooth connections: Wizard Mode and Explorer Mode. The Wizard Mode is for novice Bluetooth users and the Explorer Mode is for experienced Bluetooth users. To switch between modes, select **View > Wizard Mode** or **View > Explorer Mode**.

Wizard Mode

Wizard Mode provides a simple process for discovering and connecting to Bluetooth devices.

✓ **NOTE** Switching between Wizard Mode and Explorer Mode closes all active connections.

Wizard Mode shows the devices and services in a simple Favorites view created by following the step-by-step wizard.

Explorer Mode

The **Explorer Mode** window is easy to navigate and provides greater control to users familiar with Bluetooth. The menu bar provides quick access to the options and tools used to connect to devices. To access Explorer Mode, tap **View > Explorer Mode**.

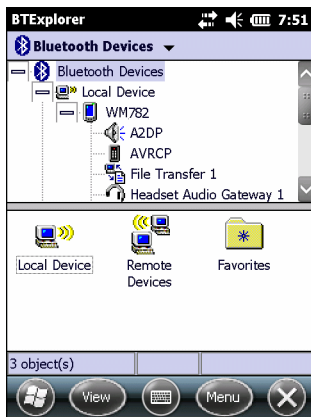

Figure 4-11 Explorer Mode Window

You can also use the “tap and hold” technique to view available options. Scroll bars and view options are similar to those on the Windows desktop. The tree structure lists the following sub-items:

- Local Device - This device
- Remote Device - Other Bluetooth devices
 - Trusted Devices - Bonded (paired) Bluetooth devices
 - Untrusted Devices - Discovered devices that are not bonded
- Favorites - Selected services that are set as *Favorite* for quick access.

✓ **NOTE** Switching between Wizard Mode and Explorer Mode closes all active connections.

Discovering Bluetooth Device(s)

The MC55 can receive information from discovered devices without bonding. However, once bonded, the MC55 and a bonded device exchange information automatically when you turn the Bluetooth radio on. See [Bonding with Discovered Device\(s\) on page 4-30](#) for more information.

To find Bluetooth devices in the area:

1. Ensure that Bluetooth is enabled on both devices.
2. Ensure that the Bluetooth device to discover is in discoverable and connectable modes.
3. Ensure that the require profile is enabled on the MC55. See [Profiles on page 4-39](#) for more information.
4. Ensure that the two devices are within 30 feet (10 meters) of one another.
5. Tap the **Bluetooth** icon and select **Show BTE Explorer**. The **BTE Explorer** window appears.

✓ **NOTE** If favorite connections have already been created, the **Favorites** screen displays. If no favorite connections have been created, the **New Connection Wizard** screen displays.

6. Tap **Menu > New Connection**. The **New Connection Wizard** appears.

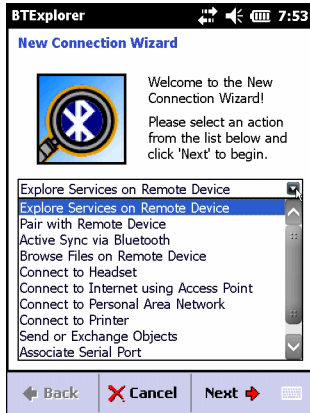

Figure 4-12 BTE Explorer Window

7. Select **Explore Services on Remote Device** or another from the drop-down list and tap **Next**.

✓ **NOTE** If a device discovery action has not been previously performed, a device discovery is automatically initiated. If a device discovery has previously been performed, the device discovery process is skipped, and the previously found list of devices displays. To start a new device discovery, tap and hold in the window and select **Discover Devices** from the pop-up menu.

8. BTE Explorer searches for Bluetooth devices in the area.

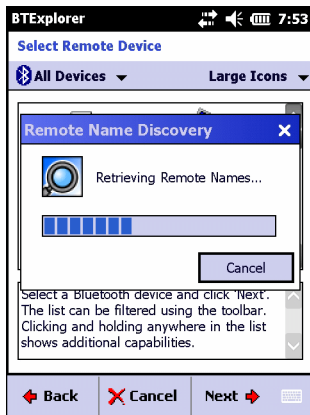

Figure 4-13 Discover Devices Dialog Box

The discovered devices display in the **Select Remote Device** window.



Figure 4-14 *Select Remote Device Window*

9. Select a device from the list and tap **Next**. The MC55 searches for services on the selected Bluetooth device.

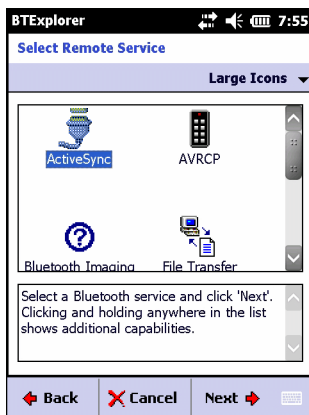

Figure 4-15 *Device Services*

✓ **NOTE** If the MC55 discovers a service but the service is not supported, the service icon is grayed-out.

10. Select a service from the list and press **Next**. The **Connection Favorite Options** window appears.



Figure 4-16 *Connection Favorite Options Window*

11. In the **Favorite Name** text box, enter a name for this service that will appear in the **Favorite** window.

12. Tap **Next**. The **Connection Summary** window appears.

13. Tap **Connect** to add the service to the **Favorite** window and connect to the service.

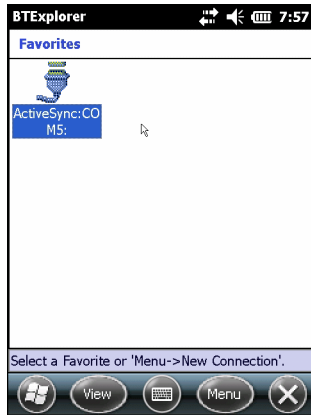

Figure 4-17 Favorites Window

Available Services

✓ **NOTE** Some devices might not require a PIN. This depends upon the device's authentication.

See the following sections for information on these services.

File Transfer Services

✓ **NOTE** Shared folders are a security risk.

To transfer files between the MC55 and another Bluetooth enabled device:

1. Ensure that OBEX File Transfer profile is enabled on the MC55. See [Profiles on page 4-39](#) for more information.

✓ **NOTE** If favorite connections have already been created, the **Favorites** screen displays. If no favorite connections have been created, the **New Connection Wizard** screen displays.

2. Use the **Connection Wizard** to search for a Bluetooth device.
3. Select the device and tap **Next**. The **Select Remote Service** window appears.
4. Select **File Transfer** and tap **Next**. The **Connection Favorite Options** window appears.
5. Tap **Next**. The **Connection Summary** window appears.
6. Tap **Connect**. The remote device's accessible folders appear.

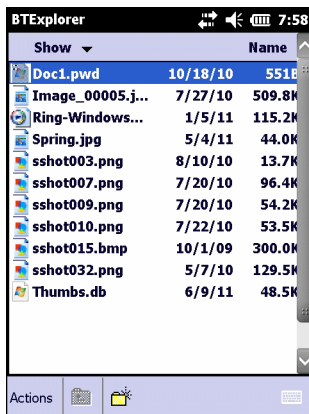

Figure 4-18 File Transfer Window

7. Double-tap the file to copy. The **Save Remote File** window appears.

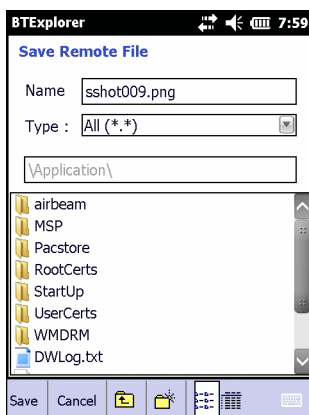

Figure 4-19 Save Remote File Window

8. Tap and hold on the file. A pop-up menu appears.

9. Select the action to perform:

- **New** - create a new file or folder on the remote device
- **Delete** - delete the selected file on the remote device.
- **Get File** - copy the file from the remote device to the MC55.
- **Put File** - copy a file from the MC55 to the remote device.

Creating a New File or Folder

To create a new folder or file on the remote device:

1. Tap and hold on the screen and select **New > Folder** or **New > File**. The **Create New Folder** or **Create New File** window appears.
2. Enter the name for the new folder or file.
3. Tap **OK** to create the new folder or file on the remote device.

Deleting a File

To delete a file from the remote device:

1. Tap and hold on the file to delete and select **Delete**.
2. In the **Delete Remote Device File** dialog box tap **Yes**.

Getting a File

To copy a file from a remote device:

1. Double-tap or tap and hold on the file and select **Get**. The **Save Remote File** window appears.
2. Navigate to the directory to save the file.
3. Tap **Save**. The file is transferred from the remote device to the MC55.

Copying a File

To copy a file to a remote device:

1. Tap **Action > Put**. The **Send Local File** window appears.
2. Navigate to the directory to save the file and select a file.
3. Tap **Open**. The file copies from the MC55 to the remote device.

Connecting to the Internet Using an Access Point

This section explains how to access a Bluetooth-enabled LAN access point (AP) for a network connection. Use Internet Explorer to connect to a server.

1. Ensure the MC55 is discoverable and connectable. See [Device Info on page 4-32](#).
2. Ensure that the **Personal Area Networking** profile is enabled on the MC55. See [Profiles on page 4-39](#) for more information.
3. Use the **Connection Wizard** to search for a Bluetooth AP.

✓ **NOTE** If favorite connections have already been created, the **Favorites** screen displays. If no favorite connections have been created, the **New Connection Wizard** screen displays.

4. Select the **Personal Area Network** or **Network Access** service and select **Connect** from the pop-up menu. The MC55 connects with the access point.
5. Tap  > **Internet Explorer**. The **Internet Explorer** window appears.
6. In the address field, enter an internet address and tap the **Enter** button. The web page loads.

✓ **NOTE** Network Access profile is not supported.

Dial-Up Networking Services

Dial-up networking allows the user to connect the MC55 to a Bluetooth Phone and use the Bluetooth Phone as a modem to connect to an office network or ISP.

Before setting up dial-up networking, obtain dial-up information and other necessary settings (username, password and domain name, if required) for the office network or ISP.

To create a new Bluetooth connection:

1. Ensure the Bluetooth Phone is discoverable and connectable.
2. Ensure that the **Dial-Up Networking** profile is enabled on the MC55. See [Profiles on page 4-39](#) for more information.
3. Tap **Menu > New Connection**.
4. Select **Explore Services on Remote Device** or another from the drop-down list and tap **Next**.
5. **BTE Explorer** searches for Bluetooth devices in the area.
The discovered devices display in the **Select Remote Device** window.
6. Select the Bluetooth Phone from the list and tap **Next**. The MC55 searches for services on the Bluetooth Phone.

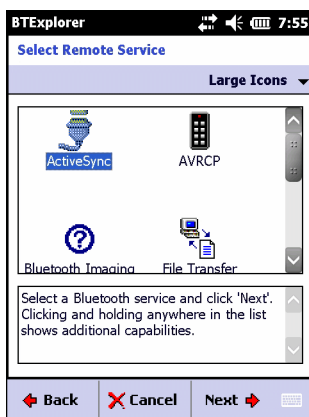

Figure 4-20 Select Remote Service Window

7. Select **Dial-up Networking Gateway** service from the list and tap **Next**. The **Connection Favorite Options** window appears.



Figure 4-21 Connection Favorite Options Window

8. In the **Favorite Name** text box, enter a name for this service that will appear in the **Favorite** window.
9. Tap **Next**. The **Connection Summary** window appears.
10. Tap **Connect**. The **Select Dial-up Networking Entry** window appears.

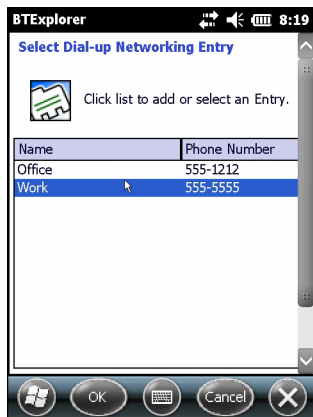

Figure 4-22 Select Dial-up Networking Entry Window

11. Select the entry and tap **OK**. The MC55 begins to communicate with the Bluetooth phone. If required, the phone requests permission to communicate with the MC55.
12. Confirm the connection on the phone. The **Network Log On** window appears.
13. In the **User name** text box, enter the user name for this connection.
14. In the **Password** text box, enter the password for this connection.
15. In the **Domain** text box, enter the domain name for this connection, if required.
16. Tap **Finish** or **Connect**.
17. The phone begins dialing and connects to the network.
18. To end a session, tap the **Connection** icon and then tap **Disconnect** in the dialog box.

Add a Dial-up Entry

To add a dial-up entry:

1. In the **Select Dial-up Networking Entry** window, tap and hold and then select **Add Entry** from the pop-up menu.

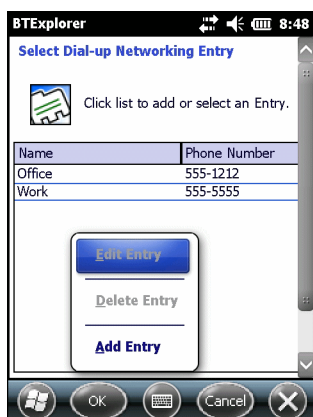

Figure 4-23 Select Dial-up Networking Entry Window

2. The **Add Phone Book Entry** window appears.

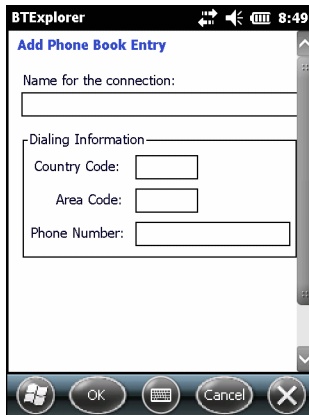

Figure 4-24 Add Phone Book Entry Window

3. In the Name for the connection text box, enter a name for this connection.
4. In the **Country Code** text box, enter the country code for the country that you are calling.
5. In the **Area Code** text box, enter the area code.
6. In the **Phone Number** text box, enter the phone number.
7. Tap **OK**.

Object Exchange Push Services

Object Exchange (OBEX) is a set of protocols that allows sharing objects such as Contacts or pictures using Bluetooth.

To exchange contact information with another Bluetooth enabled device:

1. Ensure the MC55 is discoverable and connectable. See [Device Info on page 4-32](#).
2. Ensure that the **OBEX Object Push** profile is enabled on the MC55. See [Profiles on page 4-39](#) for more information.

✓ **NOTE** If favorite connections have already been created, the **Favorites** screen displays. If no favorite connections have been created, the **New Connection Wizard** screen displays.

3. Use the **Connection Wizard** to search for a Bluetooth device.
4. Select the device and tap **Next**.
5. Select the **OBEX Object Push** service and tap **Next**. The **Connection Favorite Options** window appears.
6. Tap **Next**. The **Connection Summary** window appears.
7. Tap **Connect**. The **OBEX Object Push** window appears.
8. In the **Action** drop-down list, select one of the following options: **Send Contact Information**, **Swap Contact Information**, **Fetch Contact Information**, or **Send a Picture**.

Sending a Contact

To send a contact to another device:

- ✓ **NOTE** Prior to sending and receiving contacts, a default contact must be set up before attempting to send a contact.

1. Tap and hold on **OBEX Object Push** and select **Connect**.

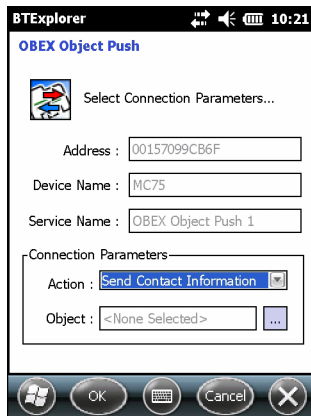



Figure 4-25 *OBEX Object Push Window*

2. In the **Action:** drop-down list, select **Send Contact Information**.
3. Tap .
4. Select a contact to send to the other device.
5. Tap **OK**.
6. Tap **OK** to send the contact to the other device and display a confirmation dialog box on the other device to accept the contact. A **Send Contact** dialog appears.
7. Tap **Ok**.

Swapping Contacts

To swap contacts with another device:

- ✓ **NOTE** Prior to swapping contacts, a default contact must be set up before attempting to send a contact.
Ensure that the MC55 is connectable.

1. Tap and hold on **OBEX Object Push** and select **Connect**. The **OBEX Object Push** window appears.

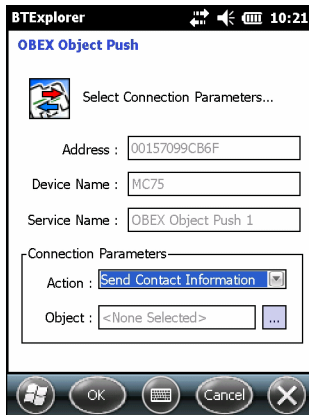

Figure 4-26 *OBEX Object Push Window*

2. In the **Action:** drop-down list, select **Swap Contact Information**.
3. Tap . The **Select Contact Entry** window appears.
4. Select a contact to send to the other device.
5. Tap **OK**.
6. Tap **OK** to swap contacts with the other device and display a confirmation dialog box on the other device to accept the contact.
7. Tap **Ok**.

Fetching a Contact

To fetch a contact from another device:

- ✓ **NOTE** Prior to sending and receiving contacts, a default contact must be set up before attempting to send a contact.

Ensure that the MC55 is connectable.

1. Tap and hold on **OBEX Object Push** and select **Connect**. The **OBEX Object Push** window appears.

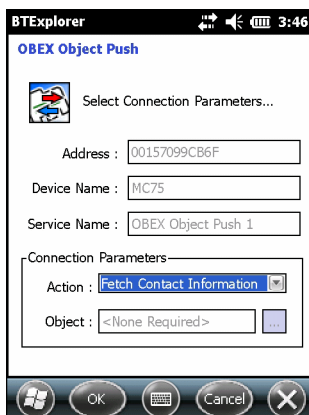

Figure 4-27 *OBEX Object Push Window*

2. In the **Action:** drop-down list, select **Fetch Contact information**.
3. Tap **OK**. The contact on the other device is copied.

Sending a Picture

To send a picture to another device:

1. Tap and hold on **OBEX Object Push** and select **Connect**. The **OBEX Object Push** window appears.

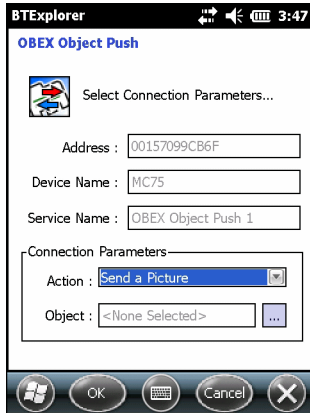



Figure 4-28 *OBEX Object Push Window*

2. In the **Action:** drop-down list, select **Send A Picture**.
3. Tap . The **Send Local Picture** window appears.

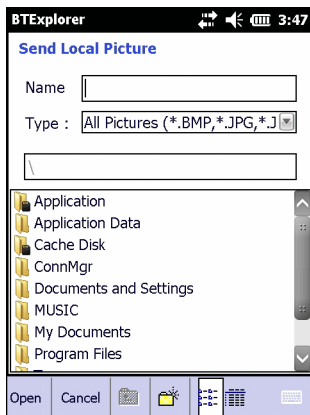

Figure 4-29 *Send Local Picture Window*

4. Navigate to the picture to send to the other device.
5. Tap **Open**.
6. Tap **OK** to send the picture to the other device and display a confirmation dialog box on the other device to accept the picture. A **Send Picture** dialog appears.
7. Tap **Ok**.

Headset Services

To connect to a Bluetooth headset:



NOTE Newer Bluetooth headsets are device dependant and remember the last device they connected to. If problems occur while connecting to the headset, place the headset in discovery mode. Refer to the headset user manual for more information.

1. Ensure the MC55 is connectable (required when automatic re-connect is initiated). See [Device Info on page 4-32](#).
2. Ensure that the **Headset** profile is enabled on the MC55. See [Profiles on page 4-39](#) for more information.
3. Use the **Connection Wizard** to search for a Bluetooth headset.
4. Select the device and tap **Next**.
5. Select the **Headset** service name and select **Connect**. The MC55 connects to the headset. Refer to the headset user manual for instructions on communicating with a Bluetooth device.

✓ **NOTE** When using a Bluetooth headset with Headset Services, you cannot accept or end a call from the headset. You must accept or end a call on the MC55.

6. Press the communication button on the headset. This routes both system and WAN call audio to the headset.
7. When a call is received on the MC55, tap the **Accept** button to answer the call.
8. Press the communication button on the headset to route the audio back to the MC55.

Serial Port Services

Use the wireless Bluetooth serial port connection as you would a physical serial cable connection. Configure the application that will use the connection to the correct serial port.

To establish a serial port connection:

1. Use the **Connection Wizard** to search for a Bluetooth serial device.
2. Select the device and tap **Next**. The **Connection Favorite Options** window appears.
3. In the **Local COM Port:** drop-down list select a COM port.
4. Tap **Finish**.

ActiveSync Using Serial Port Services

✓ **NOTE** By default, COM ports COM5, COM9, COM11, COM21, COM22 and COM23 are Bluetooth virtual ports. If an application opens one of these ports, the Bluetooth driver activates and guides you through a Bluetooth connection.

Use the wireless Bluetooth serial port connection for ActiveSync just as you would a physical serial cable connection. You must configure the application that will use the connection to the correct serial port.



Figure 4-30 ActiveSync Connection Settings Window on PC

To establish an ActiveSync connection:



NOTE When creating an ActiveSync connection, only use StoneStreet One Bluetooth Explorer in Wizard mode.

1. Use the **Connection Wizard** to search for a Bluetooth device, such as a computer. In the drop-down list select **ActiveSync via Bluetooth**.
2. Select the device and tap **Next**. The **Connection Favorite Options** window appears.
3. Tap **Connect**. The **Remote Service Connection** window appears.

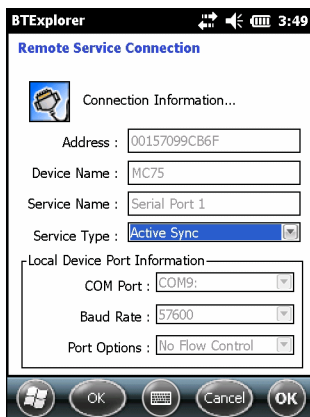

Figure 4-31 Remote Service Connection Window

4. In the **Service Type** drop-down list, select **Active Sync**.
5. Tap **OK**. The MC55 connects the PC and an ActiveSync session begins.
6. Tap **Finish**. The Connection Favorite Options window appears.
7. To end the session, tap the ActiveSync icon in the **Favorite** window and select **Disconnect** from the pop-up window.

Personal Area Network Services



NOTE This profile supports Ad-hoc and PAN User. Network Access Profile is not supported.

Connect two or more Bluetooth devices to share files, collaborate, or play multi-player games. To establish a Personal Area Network connection:

1. Ensure that the **Personal Area Networking** profile is enabled on the MC55. See [Profiles on page 4-39](#) for more information.
2. Use the **Connection Wizard** to search for a Bluetooth device.
3. Select the device and tap **Next**. The **Connection Favorite Options** window appears.
4. Tap **Next**. The **Connection Summary** window appears.
5. Tap **Connect**. The MC55 connects to the Bluetooth device.

A2DP/AVRCP Services

A2DP/AVRCP is used to connect to a high-quality stereo headset:

1. Ensure the MC55 is connectable (required when automatic re-connect is initiated). See [Device Info on page 4-32](#).
2. Ensure that the remote Bluetooth device is in discoverable mode. See the devices user manual for instructions.
3. Ensure that the **A2DP/AVRCP** profile is enabled on the MC55. See [Profiles on page 4-39](#) for more information.
4. Tap **Menu > Settings > Services**.
5. Tap **Add** button.
6. Select **Advanced Audio Distribution Services**.
7. Tap **OK**. The **Edit Local Services** window appears.
8. Tap **OK** twice.
9. Tap **Menu > New Connection**.
10. Select **Connect to High-Quality Audio** from the drop-down list.
11. Tap **Next**.
12. Select the device and tap **Next**.
13. Enter the PIN Code for the remote device and then tap **OK**. The **Connection Favorite Options** window appears.
14. Tap **Next**.
15. Tap **Connect**. The MC55 connects to the high-quality audio headset.

For stereo headsets that can use hands-free services, connect to the hands-free service after connecting to the A2DP service:

1. Tap **Menu > New Connection**.
2. Select **Connect to Headset** from the drop-down list.
3. Tap **Next**.
4. Select the stereo headset and tap **Next**.
5. Select the **Hands-Free unit** service and then tap **Next**.

6. Tap **Next**.
7. Tap **Connect**.

Connect to a HID Device

The MC55 can connect to an Human Interface Device (HID) device such as a Bluetooth keyboard:

1. Ensure the MC55 is connectable (required when automatic re-connect is initiated). See [Device Info on page 4-32](#).
2. Ensure that the remote Bluetooth device is in discoverable mode. See the device user manual for instructions.
3. Ensure that the **HID Client** profile is enabled on the MC55. See [Profiles on page 4-39](#) for more information.
4. Tap **Menu > New Connection**.
5. Select **Explore Services on Remote Device** from the drop-down list.
6. Tap **Next**.
7. Select the device and tap **Next**.
8. Select the service and tap **Next**.
9. The **Connection Favorite Options** window appears.
10. Tap **Next**.
11. Tap **Connect**. The MC55 connects to the HID device.

Bonding with Discovered Device(s)

A bond is a relationship created between the MC55 and another Bluetooth device in order to exchange information in a secure manner. Creating a bond involves entering the same PIN on the two devices. After creating a bond and turning on the Bluetooth radios, the devices recognize the bond and can exchange information without re-entering a PIN.

To bond with a discovered Bluetooth device:

- ✓ **NOTE** If favorite connections have already been created, the **Favorites** screen displays. If no favorite connections have been created, the **New Connection Wizard** screen displays.

1. Tap the **Bluetooth** icon and select **Show BTE Explorer**. The **BTE Explorer** window appears.
2. Tap **Menu > New Connection**. The **New Connection Wizard** window appears.
3. In the drop-down list, select **Pair with Remote Device**.
4. Tap **Next**. The **Select Remote Device** window appears.

- ✓ **NOTE** Devices discovered previously are listed to save time. To start a new device discovery, tap and hold on the list area and select **Discover Devices** from the pop-up menu.



Figure 4-32 *Select Remote Device Window*

5. Select a device from the list and tap **Next**. The **PIN Code Request** window appears.



Figure 4-33 *Connection Favorite Options Window*

6. In the **PIN Code** field, enter the PIN code.
7. Tap **OK**. The **Pairing Status** window displays.
8. Tap **Finish**. The devices are successfully paired. The device name moves to the **Trusted Devices** window.

Deleting a Bonded Device

To delete a device no longer needed:

1. Tap the **Bluetooth** icon and select **Show BTE Explorer**. The **BTE Explorer** window appears.
2. Tap **Menu > Trusted Devices**. The **Trusted Devices** window appears.
3. Tap and hold on the device select **Delete Link Key** in the pop-up menu.
4. A confirmation dialog appears. Tap **Yes**.

Accepting a Bond

When a remote device wants to bond with the MC55, enter a PIN when requested to grant permission.

1. Ensure that the MC55 is set to discoverable and connectable. See [Bluetooth Settings on page 4-32](#). When prompted to bond with the remote device the **PIN Code Request** window appears.



Figure 4-34 PIN Code Request Window

2. In the **PIN Code:** text box, enter the same PIN entered on the device requesting the bond. The PIN must be between 1 and 16 characters.
3. In the **Device Name:** text box, edit the name of the device requesting the bond, if desired.
4. Tap **OK** to create the bond. The MC55 can now exchange information with the other device.

Bluetooth Settings

Use the **BTE Explorer Settings** window to configure the operation of the **BTE Explorer** application. Tap **Menu > Settings**.

Device Info

Use **Device Info** to configure the MC55's Bluetooth connection modes.

Table 4-3 Device Info Data

Item	Description
Device Name	Displays the name of the MC55.
Discoverable Mode	Select whether or not the MC55 is discoverable by other Bluetooth devices.
Connectable Mode	Select whether or not the MC55 is connectable by other Bluetooth devices.

Services

- ✓ **NOTE** Ensure that the MC55 is discoverable and connectable when remote devices use MC55 services.

Use **Services** to add or delete Bluetooth services.

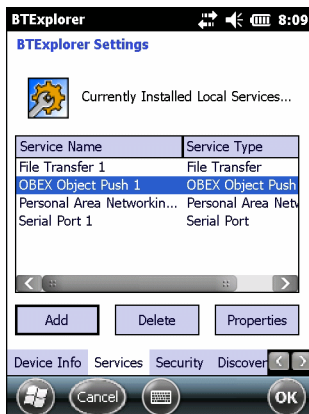

Figure 4-35 *BTE Explorer Settings - Services*

To add a service:

1. Tap **Add**.

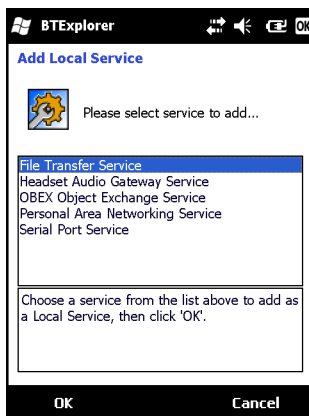

Figure 4-36 *Add Local Service Window*

2. In the list, select a service to add.
3. Tap **OK**. The **Edit Local Service** window displays for the selected service.
4. Select the appropriate information and then tap **OK**. See the following sections for information on the available services.

Dial-Up Networking Service

Dial-up Networking allows other Bluetooth devices to access a dial-up modem.

Table 4-4 *Dial-up Networking Information Data*

Item	Description
Service Name	Displays the name of the service.
Service Security	Select the type of security from the drop-down list. Options are None , Authenticate , or Authenticate/Encrypt .

Table 4-4 *Dial-up Networking Information Data*

Item	Description
Local COM Port	Select the COM port.
Local Baud Rate	Select the communication baud rate.
Local Port Options	Select the port option.

File Transfer Service

File transfer allows other Bluetooth devices to browse files.

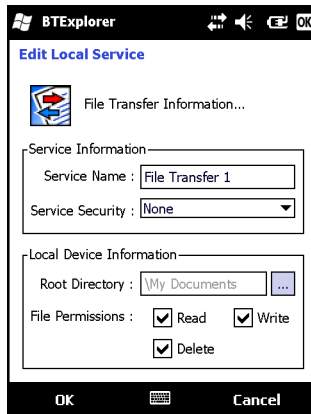
**Figure 4-37** *BTE Explorer Settings - File Transfer Information***Table 4-5** *File Transfer Information Data*

Item	Description
Service Name	Displays the name of the service.
Service Security	Select the type of security from the drop-down list. Options are None , Authenticate , or Authenticate/Encrypt .
Root Directory	Select the directory that other Bluetooth devices can access.
File Permissions	Select the file permissions for the selected directory. Check the appropriate box to grant read access, write access, and delete access.

Hands-Free Audio Gateway Service

Hands-Free Service Audio Gateway allows connection to hands-free devices.

Table 4-6 *Hands-Free Audio Gateway Data*

item	Description
Service Name	Lists the name of the audio service.

Headset Audio Gateway Service

Headset Service Audio Gateway allows connection to headset devices.

Table 4-7 Headset Audio Gateway Data

Item	Description
Service Name	Lists the name of the audio service.

IrMC Synchronization Service

The IrMC Synchronization service used to synchronize PIM contacts between a remote device and the MC55.

Table 4-8 IrMC Synchronization Data

Item	Description
Service Name	Displays the name of the service.
Service Security	Select the type of security from the drop-down list. Options are None , Authenticate , or Authenticate/Encrypt .
Phonebook	Select the Phonebook checkbox to allow synchronization with the MC55's contacts.
	Select Read , Write , Create and/or Delete to allow phonebook permissions.

OBEX Object Push Service

OBEX Object Push allows other Bluetooth devices to push contacts, business cards, pictures, appointments, and tasks to the MC55.

Table 4-9 OBEX Exchange Information Data

Item	Description
Service Name	Displays the name of the service.
Service Security	Select the type of security from the drop-down list. Options are None , Authenticate , or Authenticate/Encrypt .
Do not allow clients to push objects	Disables clients from pushing objects to the MC55.
Inbox Directory	Select a directory where another Bluetooth device can store files.

Personal Area Networking Service

Personal Area Networking hosts a Personal Area Network which allows communication with other Bluetooth devices.

Table 4-10 Personal Area Networking Data

Item	Description
Service Name	Displays the name of the service.
Service Security	Select the type of security from the drop-down list. Options are None , Authenticate , or Authenticate/Encrypt .
Support Group Ad-Hoc Networking	Select to enable Ad-Hoc networking.

Serial Port Service

Serial port allows other Bluetooth devices to access COM ports.

Table 4-11 *Serial Port Services Data*

Item	Description
Service Name	Displays the name of the service.
Service Security	Select the type of security from the drop-down list. Options are None , Authenticate , or Authenticate/Encrypt .
Local COM Port	Select the COM port.
Local Baud Rate	Select the communication baud rate.
Local Port Options	Select the port option.

Advanced Audio Distribution Service

Advanced Audio Distribution hosts connects from Bluetooth devices supporting high-quality stereo audio.

Table 4-12 *Advanced Audio Distribution Data*

Item	Description
Service Name	Lists the name of the audio service.

Audio Video Remote Control Service

Audio Video Remote Control hosts connections from Bluetooth devices supporting audio remote-control functionality.

Table 4-13 *Audio Video Remote Control Data*

Item	Description
Service Name	Lists the name of the audio service.

Security

Security settings allows you to set global security policies for Bluetooth. Note that these settings are only active on local Services that are set to **Authenticate** or **Authenticate/Encryption**. You can set authentication on local Services under Services.

To adjust the security settings for an individual service, select **Services** first, then select the individual service, then **Properties**.



Figure 4-38 BTE Explorer Settings - Security

✓ **NOTE** To use PIN Code, select **Authenticate** or **Authenticate/Encrypt** from the Service Security drop-down list on each local service.

Table 4-14 Security Data

Item	Description
Use PIN Code (Incoming Connection)	Select for automatic use of the PIN code entered in the PIN Code text box. It is recommended not to use this automatic PIN code feature. See Security on page 4-2 for more information.
PIN Code	Enter the PIN code.
Encrypt Link On All Outgoing Connections	Select to enable or disable encryption on all outgoing connections to other Bluetooth devices.

Discovery

Use **Discovery** to set and modify discovered devices.



Figure 4-39 BTE Explorer Settings - Discovery

Table 4-15 *Discovery Data*

Item	Description
Inquiry Length	Sets the amount of time the MC55 takes to discover Bluetooth devices in the area.
Name Discovery Mode	Select either Automatic or Manual to automatically attempt to discover a Bluetooth device's name after finding the device.
Discovered Devices - Delete Devices	Deletes all discovered devices and link keys from memory.
Discovered Devices - Delete Linked Keys	Removes all pairing from remote Bluetooth devices, and makes them all un-trusted.

Virtual COM Port

Virtual COM Port defines which COM ports BTE Explorer attempts to use for virtual COM ports. Check the appropriate checkbox to use the port as a virtual COM port. When finished, choose **Apply** to enforce changes, or **Revert** to restore the original settings.

Table 4-16 *Virtual COM Port Data*

Item	Description
COM5:Bluetooth	Enable or disable COM Port 5.
COM9:Bluetooth	Enable or disable COM Port 9.
COM11:Bluetooth	Enable or disable COM Port 11.
COM21:Bluetooth	Enable or disable COM Port 21.
COM22:Bluetooth	Enable or disable COM Port 22.
COM23:Bluetooth	Enable or disable COM Port 23.

HID

Use **HID** to select The Human Interface Device Profile programming interface defines the protocols and procedures to be used to implement HID capabilities.

Provides support for devices such as mice, joysticks, keyboards.

Table 4-17 *HID Data*

Item	Description
Enable Key Repeat	Enables key repeat functionality.
Delay	To increase key repeat delay, drag the Delay slider to the right. To decrease key repeat delay, drag the Delay slider to the left.
Rate	To increase key repeat speed, drag the Rate slider to the left. To decrease key repeat speed, drag the Rate slider to the right.

Profiles

Use **Profile** to load or remove Bluetooth services profiles. If a profile is not used, it can be removed to save memory.

1. Tap a check box next to the profile to load (activate).
The Serial Port profile is always active and cannot be removed.
2. Tap **Select All** to select all profiles or tap **Deselect All** to deselect all profiles.
3. Tap **Apply** to activate the profiles and then **Close** to exit the application.

System Parameters

Use **System Parameters** to set device connection settings.

Table 4-18 *System Parameters Data*

item	Description
Page Timeout	Sets the amount of time the MC55 searches for a device before moving on the next device.
Link Supervision Timeout	Sets the amount of time that the MC55 will wait for a device to come back into range after it has gone out of range. If the device does not come back into range by the set time, the MC55 drops the connection.

Miscellaneous

Use **Miscellaneous** to set color and types to better view active connections.

Table 4-19 *Miscellaneous Data*

Item	Description
Highlight Connections	Select the connection type to highlight when connected. In the Wizard Mode, the only options are <i>Favorites</i> or <i>None</i> . In the Explorer Mode the options are None , Tree View Only , List View Only , or Tree and List View .
Apply Text Style	Select the text style to apply to the connection text.
Apply Text Color	Select the text color to apply to the connection text.

CHAPTER 5 ACCESSORIES

Introduction

[Table 5-1](#) lists the accessories available for the MC55.

Table 5-1 MC55 Accessories

Accessory	Part Number	Description
Cradles		
Single-slot USB Cradle	CRD5500-1000UR	Charges the MC55 main battery and a spare battery. Synchronizes the MC55 with a host computer through a USB connection.
Single-slot Ethernet/Modem/USB Cradle	CRD5500-1000XR	Charges the MC55 main battery and a spare battery. Synchronizes the MC55 with a host computer through an Ethernet, Modem or USB connection.
Four-slot Charge Only Cradle	CRD5500-4000CR	Charges up to four MC55 devices.
Vehicle Holder	VCH5500-1000R	Provides an alternative mounting solution for the MC55 in a vehicle. Requires the Auto Charge cable for charging the MC55 battery.
Chargers		
Four-slot Spare Battery Charger	SAC5500-4000CR	Charges up to four MC55 batteries.
USB Charging Cable	KT-108022-03R	Provides power to the MC55 and USB communication with a host computer.
Charge Only Cable	25-112560-01R	Connects to a power supply to provide power to the MC55.
Auto Charge Cable	VCA5500-01R	Charges the MC55 using a vehicle's cigarette lighter.
Miscellaneous		
Magnetic Stripe Reader	MSR5500-100R	Snaps on to the MC55 and adds magnetic stripe reading capabilities.
Trigger Handle	TRG5500-100R	Adds a gun-style handle with a scanning trigger to the MC55.
DEX Cable	25-127558-01R	Connects the MC55 to a vending machine.

Table 5-1 MC55 Accessories (Continued)

Accessory	Part Number	Description
Spare 2400 mAh lithium-ion battery	BTRY-MC55EAB00 BTRY-MC55EAB00-10 BTRY-MC55EAB00-50	Replacement 2400 mAh battery (MC55 only). 10-pack. 50-pack.
Spare 3600 mAh lithium-ion battery	BTRY-MC55EAB02 BTRY-MC55EAB02-10 BTRY-MC55EAB02-50	Replacement 3600 mAh battery. 10-pack. 50-pack.
Spare 3600 mAh lithium-ion battery	BTRY-MC55EAB02-H	Replacement 3600 mAh battery (MC55-HC only).
Belt Mounted Rigid Holster	SG-MC5511110-01R	Clips onto belt to hold the MC55 when not in use.
Fabric Holster	SG-MC5521110-01R	Soft holder for added protection.
Stylus	KT-119150-03R KT-119150-50R	Replacement stylus (3-pack). Replacement stylus (50-pack).
Stylus	Stylus-HC005-03R Stylus-HC005-50R	Replacement stylus for MC55-HC (3-pack) Replacement stylus for MC55-HC (50-pack)
Spring Loaded Stylus	STYLUS-00001-03R STYLUS-00001-10R	Optional spring loaded stylus (3-pack). Optional spring loaded stylus (10-pack).
Tether	KT-122621-03R KT-122621-50R	Replacement tether (3-pack) Replacement tether (50-pack)
Anti-bacterial Handstrap	SG-MC5523341-01R	Replacement handstrap for MC55-HC only.
Wall Mounting Kit	8710-050006-01R	Use for wall mounting the Four-slot cradles.
Screen Protector	KT-67525-01R	Package of 3 screen protectors.
Software	-	Enterprise Mobility Developer Kits (EMDKs), available at: http://www.zebra.com .

Single-slot USB Cradle

This section describes how to use a Single-slot USB cradle with the MC55. For USB communication setup procedures refer to the *MC55 Integrator Guide*.

The Single-slot USB Cradle:

- Provides 5.4 VDC power for operating the MC55.
- Synchronizes information between the MC55 and a host computer. Refer to the *MC55 Integrator Guide* for information on setting up a partnership between the MC55 and a host computer.
- Charges the MC55's battery.
- Charges a spare battery.

Charging the MC55 Battery

Connect the cradle to power. Insert the MC55 into the slot to begin charging.

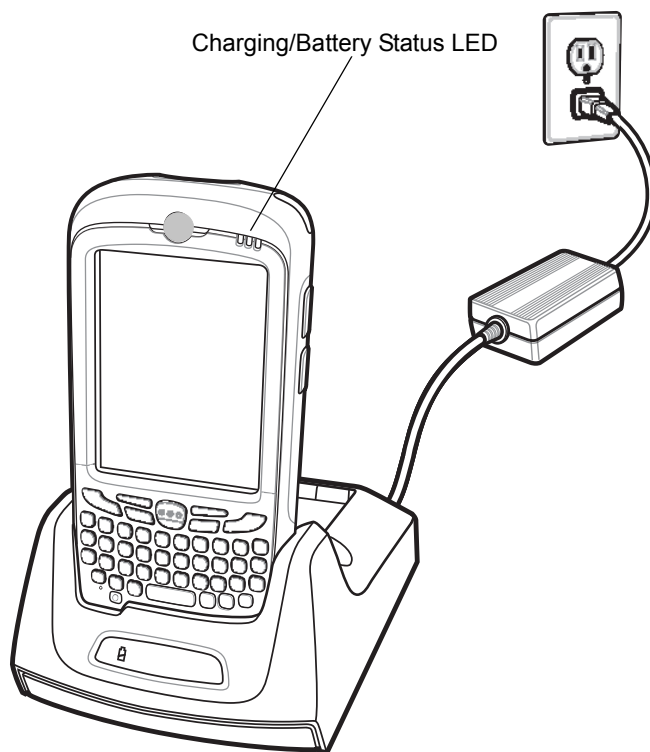

Figure 5-1 *MC55 Battery Charging*

Charging the Spare Battery

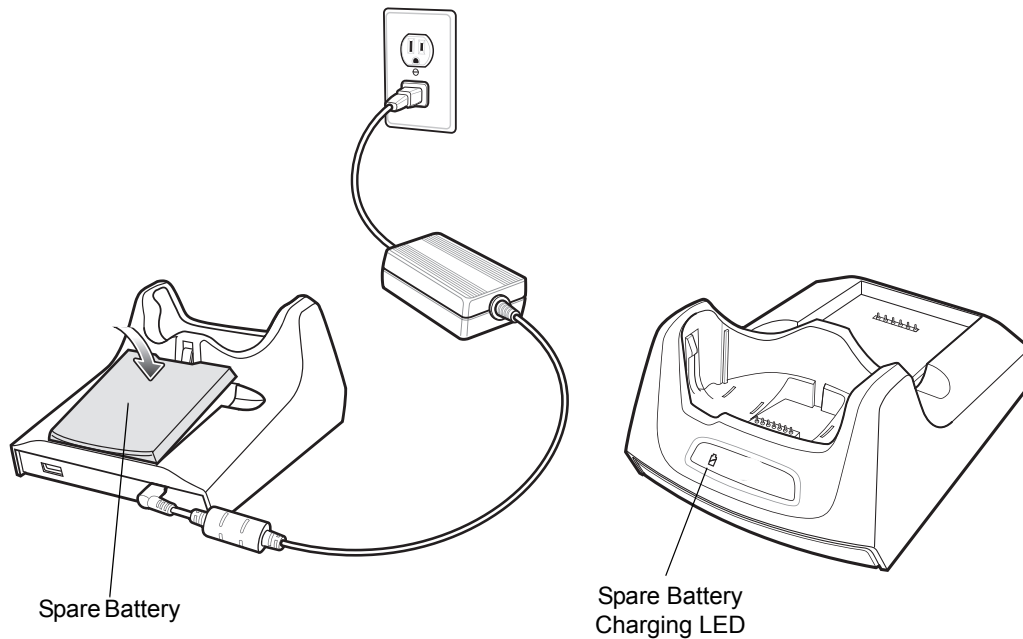

Figure 5-2 Spare Battery Charging

Battery Charging Indicators

The Single-slot USB Cradle charges the MC55's main battery and a spare battery simultaneously.

The MC55's charge LED indicates the status of the battery charging in the MC55. See [Table 1-1 on page 1-6](#) for charging status indications.

The spare battery charging LED on the cradle indicates the status of the spare battery charging in the cradle. See [Table 5-2](#) for charging status indications.

The 2400 mAh battery fully charges in less than four hours and the 3600 mAh battery fully charges in less than six hours.

Charging Temperature

Charge batteries in temperatures from 0°C to 40°C (32°F to 104°F). Charging is intelligently controlled by the MC55.

To accomplish this, for small periods of time, the MC55 or accessory alternately enables and disables battery charging to keep the battery at acceptable temperatures. The MC55 or accessory indicates when charging is disabled due to abnormal temperatures via its LED. See [Table 1-1 on page 1-6](#) and [Table 5-2](#).

Table 5-2 Spare Battery LED Charging Indicators

Spare Battery LED (on cradle)	Indication
Off	Battery is not charging; battery is not inserted correctly in the cradle; cradle is not powered
Slow Blinking Amber	Spare battery is charging.
Solid Amber	Charging complete.
Fast Blinking Amber	Charging error.

Single-slot Ethernet/Modem/USB Cradle

The CRD5500-1000XR cradle provides connection to a host computer using USB, a dial-up network using the modem or an Ethernet network.

Refer to the *MC55 Integrator Guide* for information on setting up the cradle.

Country Settings

The modem defaults to operation with US telephone networks. To operate the modem with other country telephone networks, it must be configured using an application on the MC55. Download the *Cradle Modem Country Configurator Application Software for MC55xx* package from the Zebra Support Central web site: <http://www.zebra.com/support>.

Following the instructions with the software package to install the application on the MC55.

The application includes country selections for all supported countries and automatically programs the modem and adjust its operating parameters to comply with the telephone network in the selected country.

Connection Setup

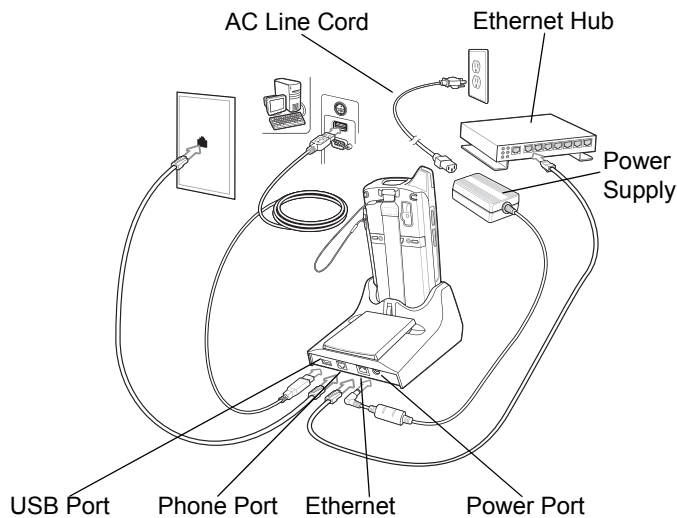

Figure 5-3 Connection Setup

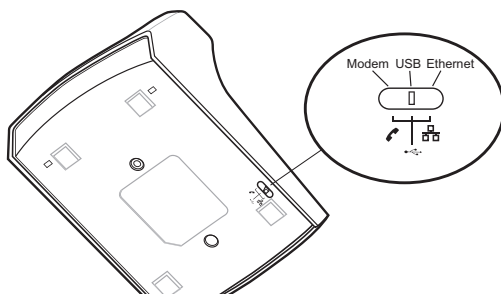

Figure 5-4 Connection Switch

Indicators

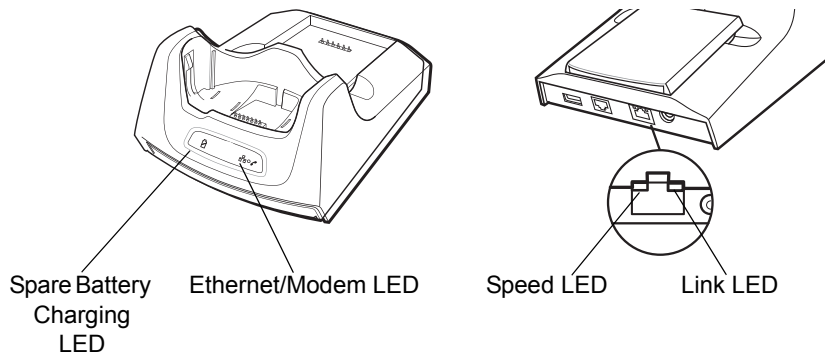

Figure 5-5 *Indicators*

- **Spare Battery Charging LED** - Indicates the charging status of the spare battery.
- **Ethernet/Modem LED** - Blink whenever Ethernet or modem connectivity is established.
- **Speed LED (green)**- Indicates that the transfer rate is 100 Mbps. When it is not lit it indicates that the transfer rate is 10 Mbps.
- **Link LED (yellow)** - Blinks to indicate activity, or stays lit to indicate that a link is established. When it is not lit it indicates there is no link.

Operation

- ✓ **NOTE** The CRD5500-1000XR does not support hot swapping between operational modes. After moving the switch into a different position, remove the MC55 from the cradle and then re-insert into the cradle.

Ethernet Connection

Place the Connection switch on the bottom of the cradle to the Ethernet position.

Place the MC55 into the cradle.

To test the connection, tap  > **Programs** > **Internet Explorer**. Enter a web address.

Modem Connection

Place the Connection switch on the bottom of the cradle to the Modem position.

Place the MC55 into the cradle.

The MC55 dials the phone number and connects to the web site.

Four-slot Charge Only Cradle

This section describes how to set up and use a Four-slot Charge Only cradle with the MC55.

The Four-slot Charge Only cradle:

- Provides 5.4 VDC power for operating the MC55.
- Simultaneously charges up to four MC55 devices.

Charging

Insert the MC55 into a slot to begin charging.

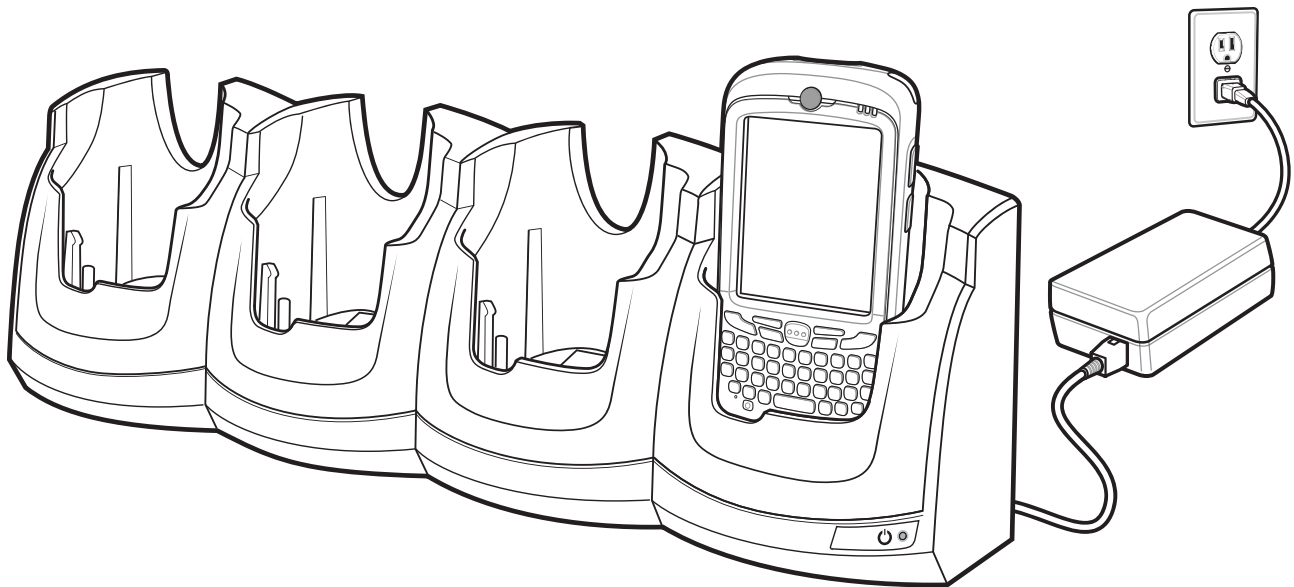

Figure 5-6 MC55 Battery Charging

Battery Charging Indicators

The MC55's charge LED shows the status of the battery charging in the MC55. See [Table 1-1 on page 1-6](#) for charging status indications.

The 2400 mAh battery fully charges in less than four hours and the 3600 mAh battery fully charges in less than six hours.

Charging Temperature

Charge batteries in temperatures from 0°C to 40°C (32°F to 104°F). Charging is intelligently controlled by the MC55.

To accomplish this, for small periods of time, the MC55 or accessory alternately enables and disables battery charging to keep the battery at acceptable temperatures. The MC55 or accessory indicates when charging is disabled due to abnormal temperatures via its LED. See [Table 1-1 on page 1-6](#).

Four-slot Ethernet Cradle

This section describes how to set up and use a Four-slot Ethernet cradle with the MC55. For cradle communication setup procedures refer to the *MC55 Integrator Guide*.

The Four-slot Ethernet cradle:

- Provides 5.4 VDC power for operating the MC55.
- Connects the MC55 (up to four) to an Ethernet network.
- Simultaneously charges up to four MC55 devices.

Charging

Insert the MC55 into a slot to begin charging.

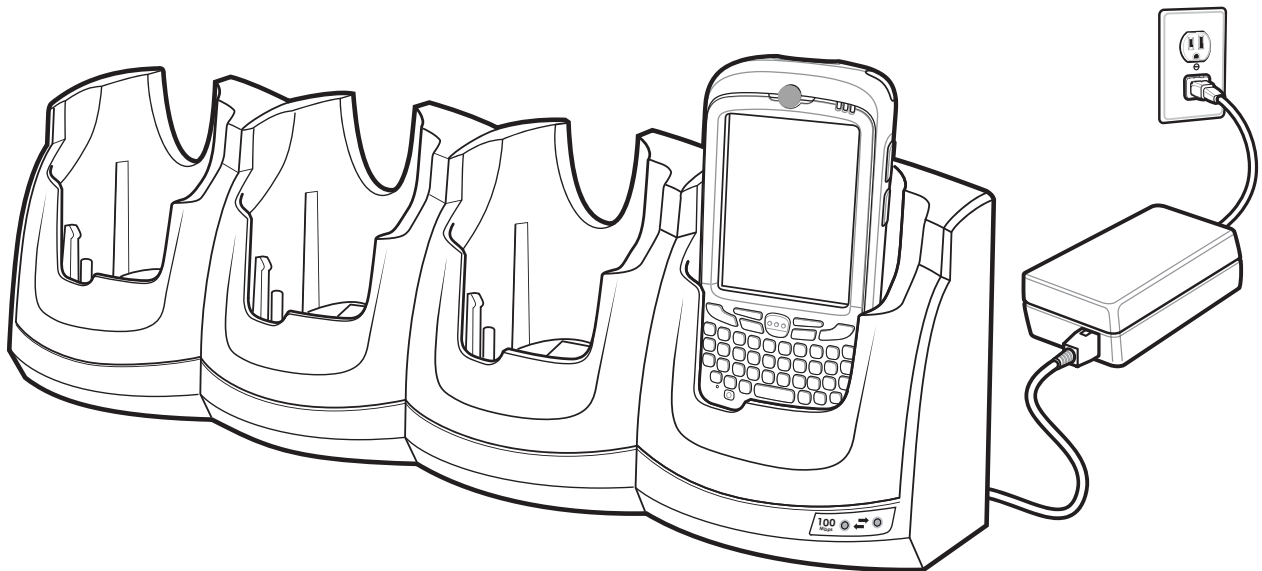

Figure 5-7 MC55 Battery Charging

Battery Charging Indicators

The MC55's charge LED shows the status of the battery charging in the MC55. See [Table 1-1 on page 1-6](#) for charging status indications.

The 2400 mAh battery fully charges in less than four hours and the 3600 mAh battery fully charges in less than six hours.

Charging Temperature

Charge batteries in temperatures from 0°C to 40°C (32°F to 104°F). Charging is intelligently controlled by the MC55.

To accomplish this, for small periods of time, the MC55 alternately enables and disables battery charging to keep the battery at acceptable temperatures. The MC55 indicates when charging is disabled due to abnormal temperatures via its LED. See [Table 1-1 on page 1-6](#).

VCD5000 Vehicle Cradle

This section describes how to use a VCD5000 vehicle cradle with the MC55. For cradle installation and communication setup procedures refer to the *MC55 Integrator Guide*.

Once installed in a vehicle, the cradle:

- holds the MC55 securely in place
- provides power for operating the MC55
- re-charges the battery in the MC55.

Charging the MC55 Battery

Insert the MC55 into the vehicle cradle to begin charging. A click indicates that the MC55 button release locking mechanism is enabled and the MC55 is locked in place.

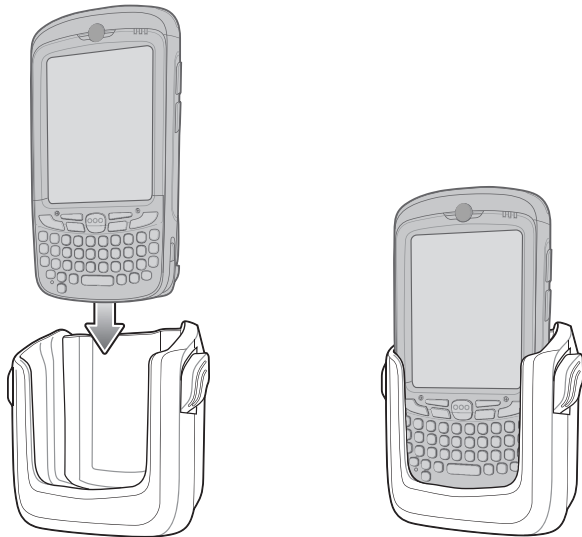

Figure 5-8 MC55 Battery Charging



CAUTION Ensure the MC55 is fully inserted in the cradle. Lack of proper insertion may result in property damage or personal injury. Zebra is not responsible for any loss resulting from the use of the products while driving.

Removing the MC55

To remove the MC55, hold back the release lever on the cradle and pull the MC55 up and out of the cradle.

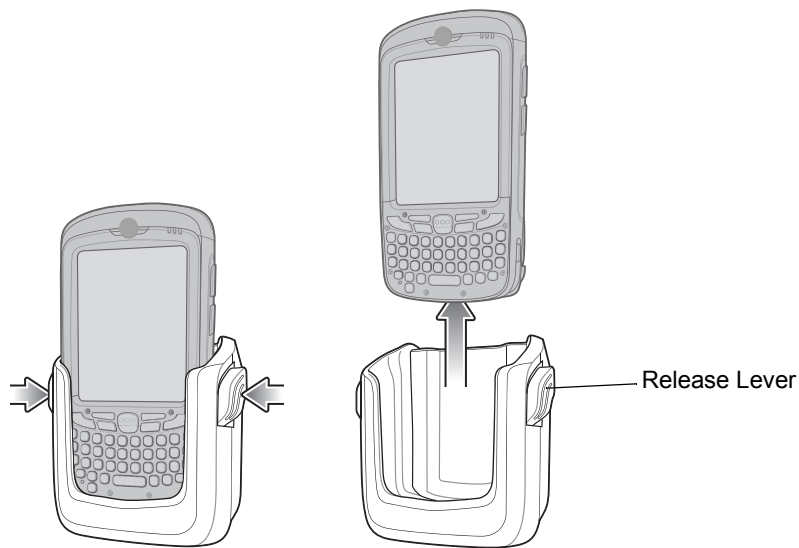

Figure 5-9 Removing the MC55

Battery Charging Indicators

The MC55's charge LED indicates the status of the battery charging in the MC55. See [Table 1-1 on page 1-6](#) for charging status indications.

The 2400 mAh battery fully charges in less than four hours and the 3600 mAh battery fully charges in less than six hours.

Charging Temperature

Charge batteries in temperatures from 0°C to 40°C (32°F to 104°F). Charging is intelligently controlled by the MC55.

To accomplish this, for small periods of time, the MC55 alternately enables and disables battery charging to keep the battery at acceptable temperatures. The MC55 indicates when charging is disabled due to abnormal temperatures via its LED. See [Table 1-1 on page 1-6](#).

Four-slot Battery Charger

This section describes how to use the Four-slot Battery Charger to charge up to four MC55 batteries.

Battery Charging

1. Connect the charger to a power source.
2. Insert the battery into a battery charging well and gently press down on the battery to ensure proper contact.

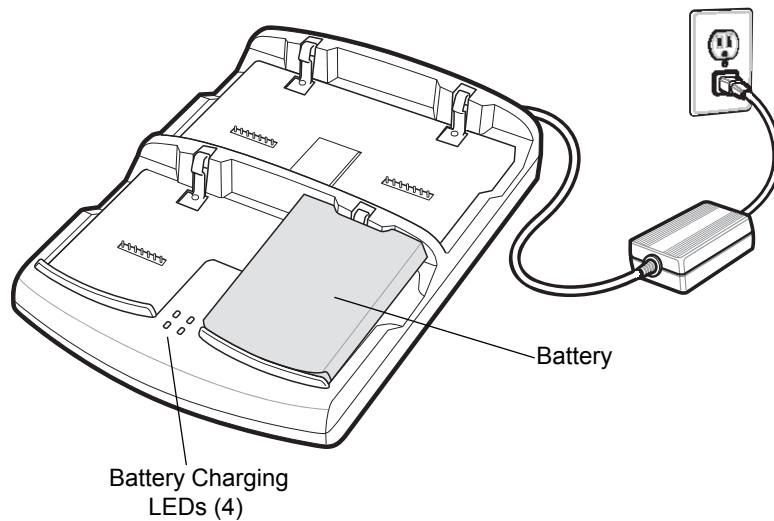

Figure 5-10 Four-slot Battery Charger

Battery Charging Indicators

The charger has an amber LED for each battery charging well. See [Table 5-3](#) for charging status indications. The 2400 mAh battery fully charges in less than four hours and the 3600 mAh battery fully charges in less than six hours.

Charging Temperature

Charge batteries in temperatures from 0°C to 40°C (32°F to 104°F). Charging is intelligently controlled by the MC55.

To accomplish this, for small periods of time, the charger alternately enables and disables battery charging to keep the battery at acceptable temperatures. The charger indicates when charging is disabled due to abnormal temperatures via its LED. See [Table 5-3](#).

Table 5-3 Battery LED Charging Indicators

LED	Indication
Off	No battery in slot; battery is not charging; battery is not inserted correctly in the charger; charger is not powered.

Table 5-3 Battery LED Charging Indicators (Continued)

LED	Indication
Slow Blinking Amber	Battery is charging.
Solid Amber	Charging complete.
Fast Blinking Amber	Charging error.

Cables

This section describes how to set up and use the cables. The cables are available with a variety of connection capabilities.

The following communication/charge cables are available:

- USB Charging cable
 - Provide the MC55 with operating and charging power when used with the Zebra approved power supply.
 - Synchronize information between the MC55 and a host computer. With customized or third party software, it can also synchronize the MC55 with corporate databases.
- Charge Only cable
 - Provide the MC55 with operating and charging power when used with the Zebra approved power supply.
- Auto Charge cable.
 - Provide the MC55 with operating and charging power when used with the Zebra approved power supply.

Battery Charging and Operating Power

The communication/charge cables can charge the MC55 battery and supply operating power.

To charge the MC55 battery:

1. Connect the communication/charge cable power input connector to the Zebra approved power source.
2. Slide the bottom of the MC55 into the connector cup end of the communication/charge cable and gently press in until it latches into the MC55.
3. Slide the two locking tabs up until they both lock into position.

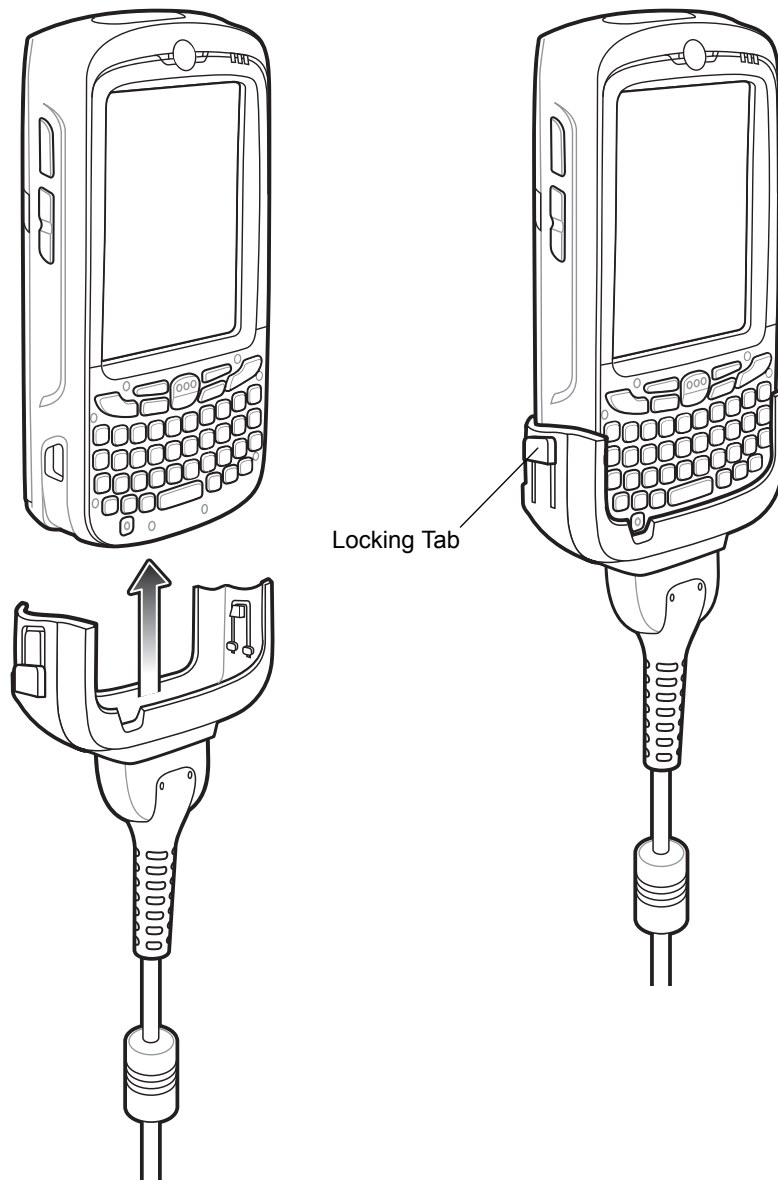

Figure 5-11 Cable Cup Locking Tabs

The MC55 amber Charge LED indicates the MC55 battery charging status. The 2400 mAh standard battery charges in less than four hours and the 3600 mAh standard battery charges in less than six hours. See [Table 1-1 on page 1-6](#) for charging status indications.

4. When charging is complete, push the two locking tab down and remove the cable from the MC55.

LED Charge Indications

The amber Charge LED on the MC55 indicates battery charging status. See [Table 1-1 on page 1-6](#) for charging status indications.

Charging Temperature

Charge batteries in temperatures from 0°C to 40°C (32°F to 104°F). Charging is intelligently controlled by the MC55.

To accomplish this, for small periods of time, the MC55 or accessory alternately enables and disables battery charging to keep the battery at acceptable temperatures. The MC55 or accessory indicates when charging is disabled due to abnormal temperatures via its LED. See [Table 1-1 on page 1-6](#).

Vehicle Holder



WARNING! Some countries prohibit the mounting of any electronic device in any location on the vehicle dashboard. Be sure to check your local laws acceptable mounting areas before installing the auto mounting kit.

Installation Reminders

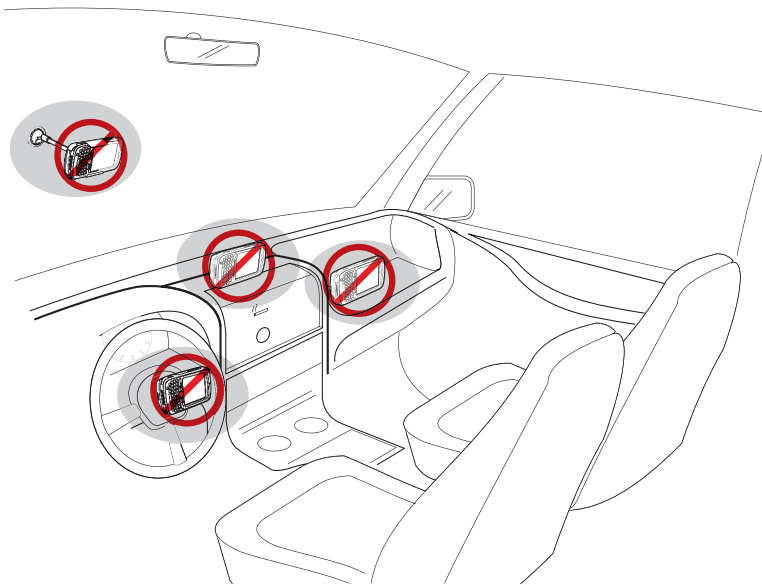

Figure 5-12 *Vehicle Holder Mounting*

- Do not mount the vehicle holder where it will obscure the driver's view of the road.
- Do not mount the vehicle holder near the driver seat air bag deployment area.
- Do not place the MC55 on top of the dashboard or anywhere without securing it in the vehicle holder.
- Do not mount the vehicle holder near the passenger seat air bag deployment area.
- Install the vehicle holder on the surface of your vehicle that is reasonably flat and free of dirt and oil.

Device Mounting Precautions

- Some countries prohibit the mounting of any electronic device in any location on the vehicle dashboard. Be sure to check your local laws acceptable mounting areas before installing the vehicle holder.
- The heating and cooling cycle of a vehicle's interior will in some cases loosen the adhesion of the suction cup. Check the vacuum seal of the vehicle mount kit for adequate adhesion each time you use the unit, and reinstall if necessary.
- If the vehicle holder has problems staying on, clean the plastic suction cup with alcohol, then reinstall.

Installation

Install the vehicle mount on the surface of your vehicle that is reasonably flat and free of dirt and oil. Clean the mounting surface with a glass cleaner and a clean cotton cloth. Install the vehicle mount on the windshield or other flat car surface using the supplied mounting disc.

Assembly

1. Insert the vehicle holder's cradle plate to the holes on the back of the cradle.
2. Push the cradle down until both parts are engaged.

Windshield Installation

1. Fix the suction cup mount to the selected area with the suction lever facing up.

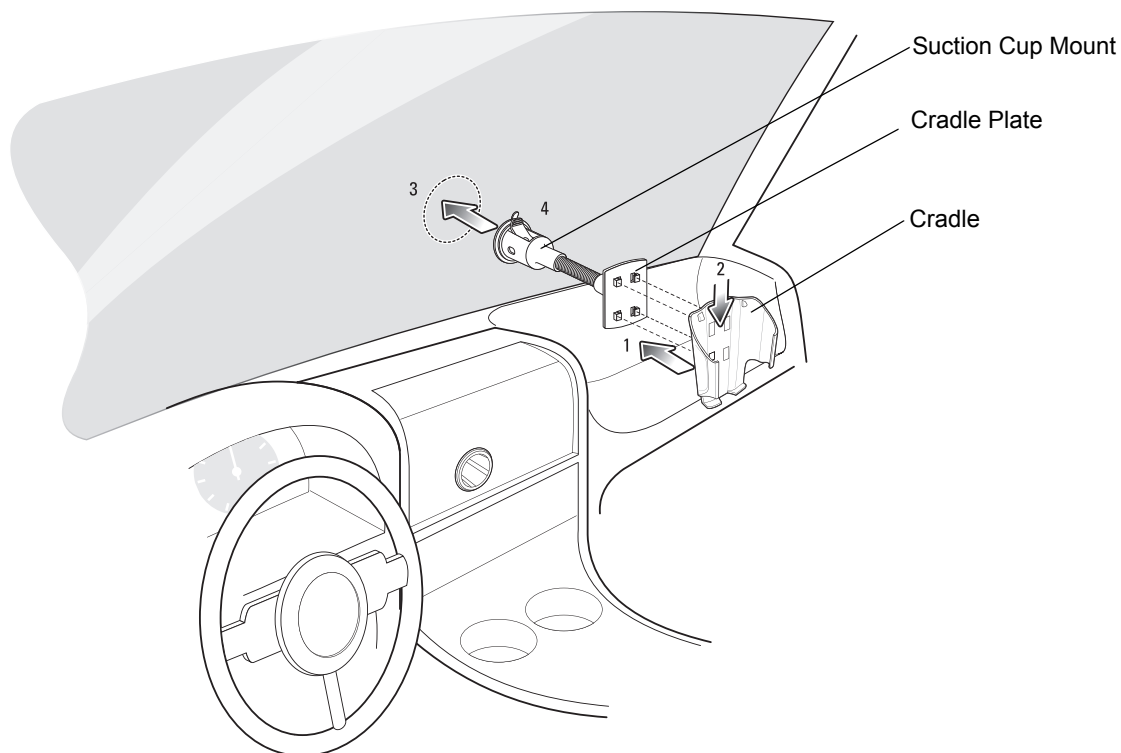

Figure 5-13 *Windshield Installation*

2. Flip the lever down to create a vacuum between the suction cup and the mounting surface.
3. Make sure that the suction bond is strong enough before proceeding to the next step.
4. Slide the MC55 into the cradle.

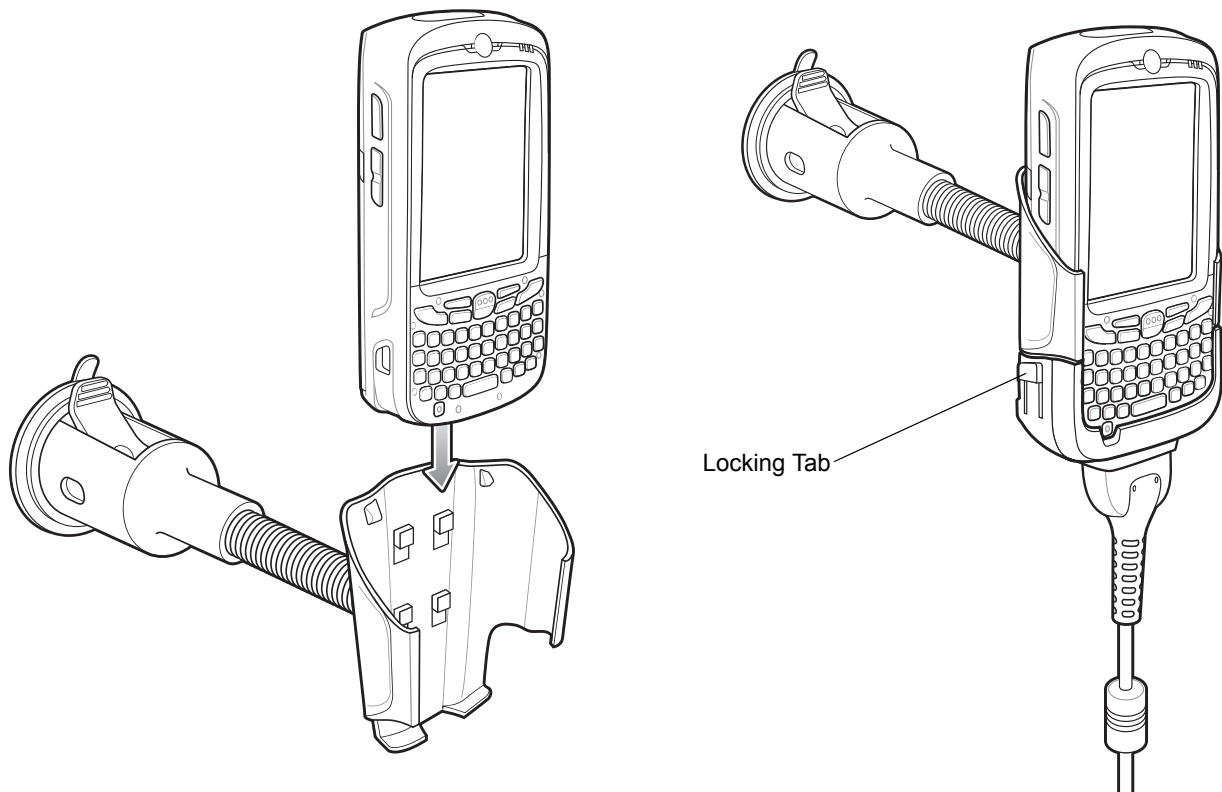

Figure 5-14 *Insert MC55 into Vehicle Holder*

5. Connect the auto charger cable to the MC55 and slide the two locking tabs up to secure the cable cup to the MC55.
6. Connect the other end to the cigarette lighter socket.
The LED indicator on the right side of the touch screen lights up orange during charging.

Flat Surface Installation

1. Remove the plastic sheet on the bottom of the mounting disc.
2. Place the disc, sticky side down, on a clean flat surface.

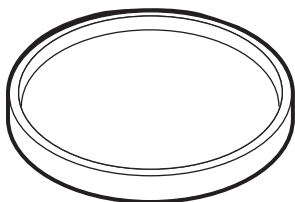

Figure 5-15 *Mounting Disc*

3. Fix the suction cup mount to the disc with the suction lever facing up.
4. Flip the lever down to create a vacuum between the suction cup and the disc.
5. Make sure that the suction bond is strong enough before proceeding to the next step.
6. Slide the MC55 into the cradle.

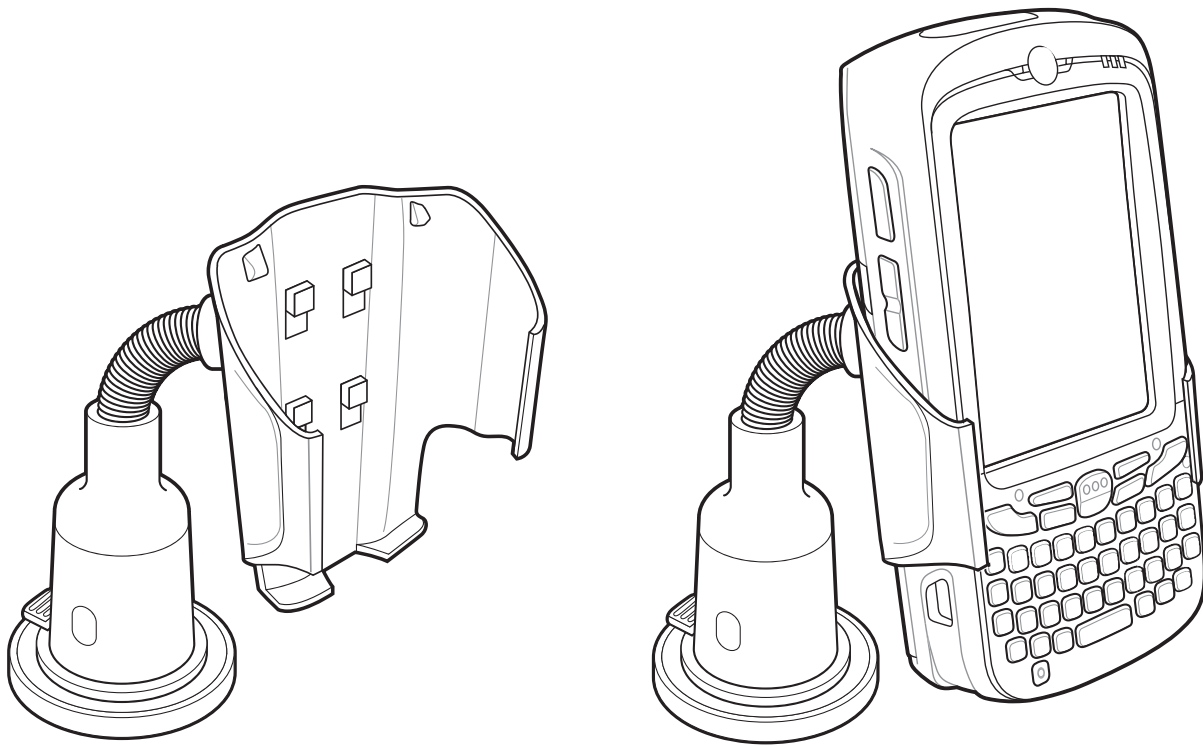

Figure 5-16 *Vehicle Holder Mounted on Flat Surface*

7. Connect the auto charger cable to the MC55 and slide the two locking tabs up to secure the cable cup to the MC55.
8. Connect the other end to the cigarette lighter socket.
The LED indicator on the right side of the touch screen lights up orange during charging.

Trigger Handle

The TRG5500 Trigger Handle adds a gun-style handle with a scanning trigger to the MC55. It increases comfort when using the MC55 in scan-intensive applications for extended periods of time.

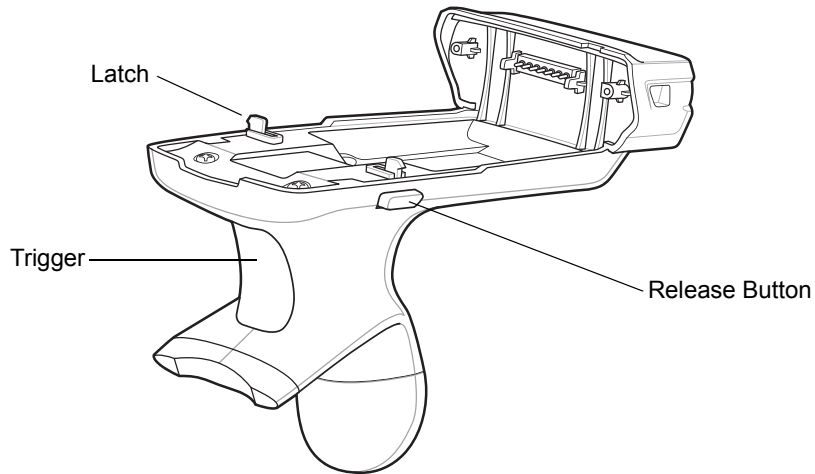

Figure 5-17 *Trigger Handle Features*

Inserting the MC55 into the Trigger Handle

Slide the MC55 into the Trigger Handle until it locks in place. The latches secure the MC55 to the Trigger Handle.

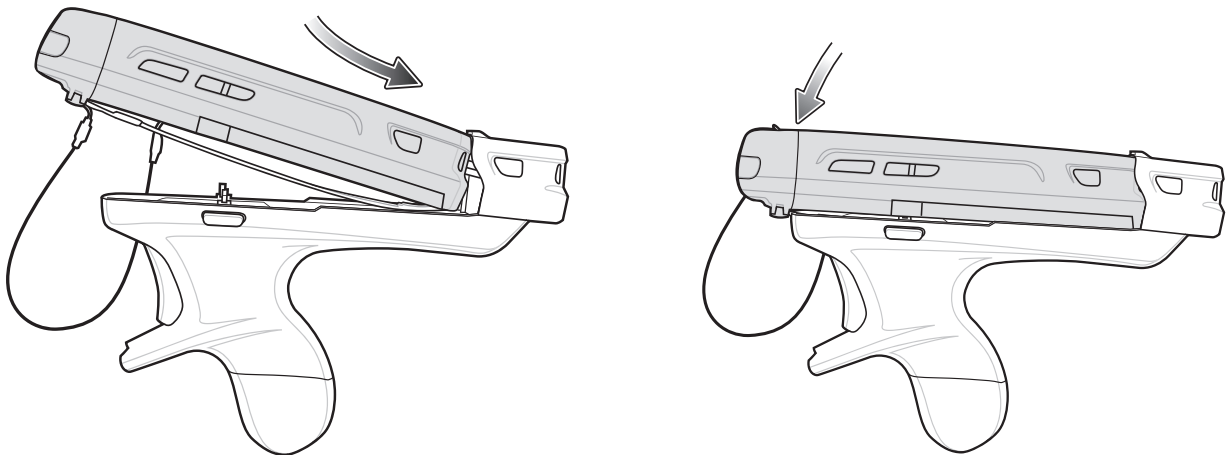

Figure 5-18 *Installing the MC55*

Removing the MC55

To remove the MC55, press the release buttons and pull the MC55 forward.

Scanning

To scan bar codes:

✓ **NOTE** A scanning application must be installed prior to scanning a bar code.

1. Start the MC55's scanning application.
2. Aim the MC55 at the bar code.
3. Press the trigger on the handle. The Scan/Decode LED lights and a beep sounds to indicate a successful decode.

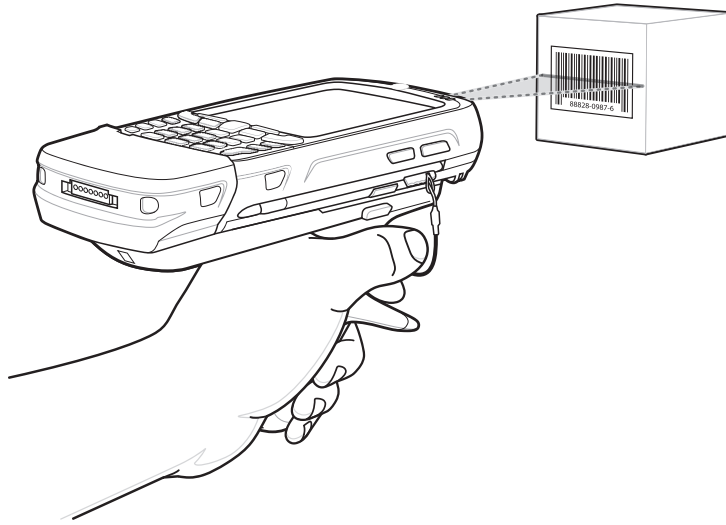

Figure 5-19 Scanning with the Trigger Handle

CHAPTER 6 MAINTENANCE & TROUBLESHOOTING

Introduction

This chapter includes instructions on cleaning and storing the MC55, and provides troubleshooting solutions for potential problems during MC55 operation.

Maintaining the MC55

For trouble-free service, observe the following tips when using the MC55:

- Do not scratch the screen of the MC55. When working with the MC55, use the supplied stylus or plastic-tipped pens intended for use with a touch-sensitive screen. Never use an actual pen or pencil or other sharp object on the surface of the MC55 screen.

Zebra recommends using a screen protector, p/n KT-67525-01R.

- The touch-sensitive screen of the MC55 is glass. Do not drop the MC55 or subject it to strong impact.
- Protect the MC55 from temperature extremes. Do not leave it on the dashboard of a car on a hot day, and keep it away from heat sources.
- Do not store or use the MC55 in any location that is dusty, damp, or wet.
- Use a soft lens cloth to clean the MC55. If the surface of the MC55 screen becomes soiled, clean it with a soft cloth moistened with a diluted window-cleaning solution.
- Periodically replace the rechargeable battery to ensure maximum battery life and product performance. Battery life depends on individual usage patterns.

- A screen protector is applied to the MC55. Zebra recommends using this to minimize wear and tear. Screen protectors enhance the usability and durability of touch screen displays. Benefits include:
 - Protection from scratches and gouges
 - Durable writing and touch surface with tactile feel
 - Abrasion and chemical resistance
 - Glare reduction
 - Keeping the device's screen looking new
 - Quick and easy installation.

Removing the Screen Protector

A screen protector is applied to the MC55. Zebra recommends using this to minimize wear and tear. Screen protectors enhance the usability and durability of touch screen displays.

To remove the screen protector, lift the corner using a thin plastic card, such as a credit card, then carefully lift it off the display.

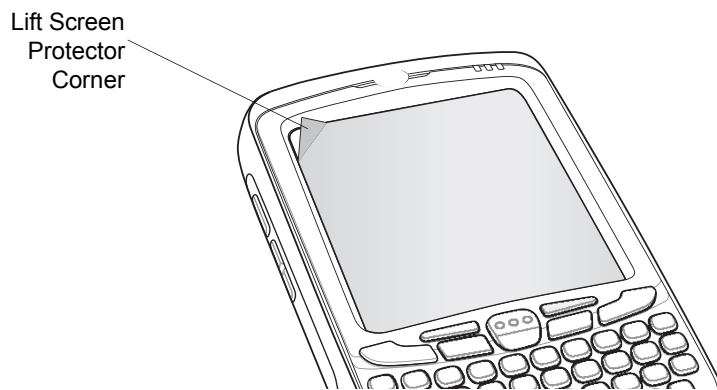

Figure 6-1 *Removing the Screen Protector*



CAUTION Do not use a sharp object to remove the protector. Doing so can damage the display.



NOTE Not using a screen protector can affect warranty coverage. To purchase replacement protectors, contact your local account manager or Zebra. These include screen protector installation instructions. Part number: KT-67525-01R Screen Protector 3/pk.

Battery Safety Guidelines

- The area in which the units are charged should be clear of debris and combustible materials or chemicals. Particular care should be taken where the device is charged in a non commercial environment.
- Follow battery usage, storage, and charging guidelines found in the user's guide.
- Improper battery use may result in a fire, explosion, or other hazard.

- To charge the mobile device battery, the battery and charger temperatures must be between +32 °F and +104 °F (0 °C and +40 °C)
- Do not use incompatible batteries and chargers. Use of an incompatible battery or charger may present a risk of fire, explosion, leakage, or other hazard. If you have any questions about the compatibility of a battery or a charger, contact Zebra support.
- For devices that utilize a USB port as a charging source, the device shall only be connected to products that bear the USB-IF logo or have completed the USB-IF compliance program.
- To enable authentication of an approved battery, as required by IEEE1725 clause 10.2.1, all batteries will carry a Zebra hologram. Do not fit any battery without checking it has the Zebra authentication hologram.
- Do not disassemble or open, crush, bend or deform, puncture, or shred.
- Severe impact from dropping any battery-operated device on a hard surface could cause the battery to overheat.
- Do not short circuit a battery or allow metallic or conductive objects to contact the battery terminals.
- Do not modify or remanufacture, attempt to insert foreign objects into the battery, immerse or expose to water or other liquids, or expose to fire, explosion, or other hazard.
- Do not leave or store the equipment in or near areas that might get very hot, such as in a parked vehicle or near a radiator or other heat source. Do not place battery into a microwave oven or dryer.
- Battery usage by children should be supervised.
- Please follow local regulations to properly dispose of used re-chargeable batteries.
- Do not dispose of batteries in fire.
- In the event of a battery leak, do not allow the liquid to come in contact with the skin or eyes. If contact has been made, wash the affected area with large amounts of water and seek medical advice.
- If you suspect damage to your equipment or battery, contact Zebra support to arrange for inspection.

Cleaning



CAUTION Always wear eye protection.

Read warning label on compressed air and alcohol product before using.

If you have to use any other solution for medical reasons please contact Zebra for more information.



WARNING! Avoid exposing this product to contact with hot oil or other flammable liquids. If such exposure occurs, unplug the device and clean the product immediately in accordance with these guidelines.

Approved Cleanser Active Ingredients

100% of the active ingredients in any cleaner must consist of one or some combination of the following: isopropyl alcohol, bleach/sodium hypochlorite, hydrogen peroxide or mild dish soap.

Harmful Ingredients

The following chemicals are known to damage the plastics on the MC55 and should not come in contact with the device: ammonia solutions, compounds of amines or ammonia; acetone; ketones; ethers; aromatic and

chlorinated hydrocarbons; aqueous or alcoholic alkaline solutions; ethanolamine; toluene; trichloroethylene; benzene; carbolic acid and TB-lysoform.

Cleaning Instructions

Do not apply liquid directly to the MC55. Dampen a soft cloth or use pre-moistened wipes. Do not wrap the device in the cloth or wipe, but gently wipe the unit. Be careful not to let liquid pool around the display window or other places. Allow the unit to air dry before use.

Special Cleaning Notes

Many vinyl gloves contain phthalate additives, which are often not recommended for medical use and are known to be harmful to the housing of the MC55. The MC55 should not be handled while wearing vinyl gloves containing phthalates, or before hands are washed to remove contaminant residue after gloves are removed. If products containing any of the harmful ingredients listed above are used prior to handling the MC55, such as hand sanitizer that contain ethanolamine, hands must be completely dry before handling the MC55 to prevent damage to the plastics.

Materials Required

- Alcohol wipes
- Lens tissue
- Cotton tipped applicators
- Isopropyl alcohol
- Can of compressed air with a tube.

Cleaning the MC55

Housing

Using the alcohol wipes, wipe the housing including keys and in-between keys.

Display

The display can be wiped down with the alcohol wipes, but care should be taken not to allow any pooling of liquid around the edges of the display. Immediately dry the display with a soft, non-abrasive cloth to prevent streaking.

Scanner Exit Window

Wipe the scanner exit window periodically with a lens tissue or other material suitable for cleaning optical material such as eyeglasses.

Connector

1. Remove the main battery from mobile computer. See [Replacing the Battery on page 1-8](#).
2. Dip the cotton portion of the cotton tipped applicator in isopropyl alcohol.
3. Rub the cotton portion of the cotton tipped applicator back-and-forth across the connector on the bottom of the MC55. Do not leave any cotton residue on the connector.
4. Repeat at least three times.

5. Use the cotton tipped applicator dipped in alcohol to remove any grease and dirt near the connector area.
6. Use a dry cotton tipped applicator and repeat steps 4 through 6.



CAUTION Do not point nozzle at yourself and others, ensure the nozzle or tube is away from your face.

7. Spray compressed air on the connector area by pointing the tube/nozzle about ½ inch away from the surface.
8. Inspect the area for any grease or dirt, repeat if required.

Cleaning Cradle Connectors

To clean the connectors on a cradle:

1. Remove the DC power cable from the cradle.
2. Dip the cotton portion of the cotton tipped applicator in isopropyl alcohol.
3. Rub the cotton portion of the cotton tipped applicator along the pins of the connector. Slowly move the applicator back-and-forth from one side of the connector to the other. Do not let any cotton residue on the connector.
4. All sides of the connector should also be rubbed with the cotton tipped applicator.



CAUTION Do not point nozzle at yourself and others, ensure the nozzle or tube is away from your face.

5. Spray compressed air in the connector area by pointing the tube/nozzle about ½ inch away from the surface.
6. Ensure that there is no lint left by the cotton tipped applicator, remove lint if found.
7. If grease and other dirt can be found on other areas of the cradle, use lint free cloth and alcohol to remove.
8. Allow at least 10 to 30 minutes (depending on ambient temperature and humidity) for the alcohol to air dry before applying power to cradle.

If the temperature is low and humidity is high, longer drying time is required. Warm temperature and dry humidity requires less drying time.

Cleaning Frequency

The cleaning frequency is up to the customer's discretion due to the varied environments in which the mobile devices are used. They may be cleaned as frequently as required. However when used in dirty environments it may be advisable to periodically clean the scanner exit window to ensure optimum scanning performance.

Troubleshooting

MC55

Table 6-1 Troubleshooting the MC55

Problem	Cause	Solution
When pressing the power button the MC55 does not turn on.	Battery not charged.	Charge or replace the battery in the MC55.
	Battery not installed properly.	Install the battery properly. See Installing the Battery on page 1-5 .
	System crash.	Perform a warm boot. If the MC55 still does not turn on, perform a cold boot. See Resetting the MC55 on page 2-19 .
When pressing the power button the MC55 does not turn on but two LEDs blink.	Battery charge is at a level where data is maintained but battery should be re-charged.	Charge or replace the battery in the MC55.
Rechargeable battery did not charge.	Battery failed.	Replace battery. If the MC55 still does not operate, perform a warm boot, then a cold boot. See Resetting the MC55 on page 2-19 .
	MC55 removed from cradle while battery was charging.	Insert MC55 in cradle. The 3600 mAh battery fully charges in less than six hours.
	Extreme battery temperature.	Battery does not charge if ambient temperature is below 0°C (32°F) or above 40°C (104°F).
Cannot see characters on display.	MC55 not powered on.	Press the Power button.
During data communication, no data transmitted, or transmitted data was incomplete.	MC55 removed from cradle or disconnected from host computer during communication.	Replace the MC55 in the cradle, or reattach the communication cable and re-transmit.
	Incorrect cable configuration.	See the system administrator.
	Communication software was incorrectly installed or configured.	Perform setup. Refer to the <i>MC55 Integrator Guide</i> for details.
No sound.	Volume setting is low or turned off.	Adjust the volume.

Table 6-1 Troubleshooting the MC55 (Continued)



Problem	Cause	Solution
MC55 shuts off.	MC55 is inactive.	The MC55 turns off after a period of inactivity. If the MC55 is running on battery power, set this period from 1 to 5 minutes, in one-minute intervals. If the MC55 is running on external power, set this period to 1, 2, 5, 10, 15, or 30 minutes. Check the Power window by selecting  > Settings > System > Power . Select Advanced and change the setting for a longer delay before the automatic shutoff feature activates.
	Battery is depleted.	Replace the battery.
	Battery is not inserted properly.	Insert the battery properly. See Installing the Battery on page 1-5 .
Tapping the window buttons or icons does not activate the corresponding feature.	Screen is not calibrated correctly.	Re-calibrate the screen. Press Blue key - Backspace key or tap  > Settings > System > Screen > Align Screen button.
	The system is not responding.	Warm boot the system. See Resetting the MC55 on page 2-19 .
A message appears stating that the MC55 memory is full.	Too many files stored on the MC55.	Delete unused memos and records. If necessary, save these records on the host computer (or use an SD card for additional memory).
	Too many applications installed on the MC55.	Remove user-installed applications on the MC55 to recover memory. Select  > Settings > System Remove Programs . Select the unused program and tap Remove .
The Charging/Battery Status LED flashes with the Power button is pressed and the MC55 does not turn on.	The MC55's battery is low.	Recharge the battery.

Table 6-1 *Troubleshooting the MC55 (Continued)*

Problem	Cause	Solution
The MC55 does not decode with reading bar code.	Scanning application is not loaded.	Load a scanning application on the MC55. See your system administrator.
	Unreadable bar code.	Ensure the symbol is not defaced.
	Distance between exit window and bar code is incorrect.	Place the MC55 within proper scanning range.
	MC55 is not programmed for the bar code.	Program the MC55 to accept the type of bar code being scanned. Refer to the EMDK or Control Panel application.
	MC55 is not programmed to generate a beep.	If the MC55 does not beep on a good decode, set the application to generate a beep on good decode.
	Battery is low.	If the scanner stops emitting a laser beam upon a trigger press, check the battery level. When the battery is low, the scanner shuts off before the MC55 low battery condition notification. Note: If the scanner is still not reading symbols, contact the distributor or Zebra.

Bluetooth Connection

Table 6-2 *Troubleshooting Bluetooth Connection*

Problem	Cause	Solution
MC55 cannot find any Bluetooth devices nearby.	Too far from other Bluetooth devices.	Move closer to the other Bluetooth device(s), within a range of 10 meters.
	The Bluetooth device(s) nearby are not turned on.	Turn on the Bluetooth device(s) to find.
	The Bluetooth device(s) are not in discoverable mode.	Set the Bluetooth device(s) to discoverable mode. If needed, refer to the device's user documentation for help.
When trying to connect a Bluetooth phone and MC55, the phone thinks a previously paired MC55 is used.	The phone remembers the name and address of the MC55 it last paired with via the Bluetooth radio.	Manually delete the pairing device and name from the phone. Refer to the phone's user documentation for instructions.

Single-slot USB Cradle

Table 6-3 Troubleshooting the Single-slot USB Cradle

Symptom	Possible Cause	Action
LEDs do not light when MC55 or spare battery is inserted.	Cradle is not receiving power.	Ensure the power cable is connected securely to both the cradle and to AC power.
	MC55 is not seated firmly in the cradle.	Remove and re-insert the MC55 into the cradle, ensuring it is firmly seated.
	Spare battery is not seated firmly in the cradle.	Remove and re-insert the spare battery into the charging slot, ensuring it is firmly seated.
MC55 battery is not charging.	MC55 was removed from cradle or cradle was unplugged from AC power too soon.	Ensure cradle is receiving power. Ensure MC55 is seated correctly. Confirm main battery is charging under  > Settings > System > Power . The 2400 mAh battery fully charges in less than four hours and the 3600 mAh battery fully charges in less than six hours.
	Battery is faulty.	Verify that other batteries charge properly. If so, replace the faulty battery.
	The MC55 is not fully seated in the cradle.	Remove and re-insert the MC55 into the cradle, ensuring it is firmly seated.
	Extreme battery temperature.	Battery does not charge if ambient temperature is below 0°C (32°F) or above 40°C (104°F).
Spare battery is not charging.	Battery not fully seated in charging slot.	Remove and re-insert the spare battery in the cradle, ensuring it is firmly seated.
	Battery inserted incorrectly.	Re-insert the battery so the charging contacts on the battery align with the contacts on the cradle.
	Battery is faulty.	Verify that other batteries charge properly. If so, replace the faulty battery.
During data communication, no data transmits, or transmitted data was incomplete.	MC55 removed from cradle during communications.	Replace MC55 in cradle and retransmit.
	Communication software is not installed or configured properly.	Perform setup as described in the <i>MC55 Integrator Guide</i> .

Four-slot Ethernet Cradle

Table 6-4 Troubleshooting the Four-slot Ethernet Cradle



Symptom	Cause	Solution
Attempt by the MC55 to ActiveSync failed.	MC55 removed from the cradle while the LED was blinking green.	Wait one minute and reinsert the MC55 in the cradle. This allows the cradle to attempt another synchronization.
	Using an outdated version of ActiveSync.	Visit http://www.microsoft.com for the latest ActiveSync software.
	ActiveSync on the host computer has not yet closed the previous ActiveSync session.	Wait one minute and reinsert the MC55 in the cradle. This allows the cradle to attempt another synchronization.
	Incorrect cable configuration.	Ensure the correct cable (Ethernet) is used with the cradle.
	Communication software improperly configured.	Perform setup as described in the <i>MC55 Integrator Guide</i> .
	MC55 ActiveSync disabled or not configured to accept network connection.	On the MC55, tap  > ActiveSync > Tools > Options > Options button. Then, uncheck the Enable PC sync using this connection: check box.
	Host ActiveSync disabled or not configured to accept network connection.	On the host computer, check File > Connection Settings > Allow network (Ethernet) Server Connection with this desktop computer .
During communication, no data transmits, or transmitted data was incomplete.	MC55 removed from cradle during communications.	Replace MC55 in cradle and retransmit.
	MC55 has no active connection.	An icon is visible in the status bar if a connection is currently active.

Table 6-4 Troubleshooting the Four-slot Ethernet Cradle (Continued)

Symptom	Cause	Solution
Battery is not charging.	MC55 removed from the cradle too soon.	Replace the MC55 in the cradle. The 2400 mAh battery fully charges in less than four hours and the 3600 mAh battery fully charges in less than six hours. Tap  > Settings > System > Power to view battery status.
	Battery is faulty.	Verify that other batteries charge properly. If so, replace the faulty battery.
	MC55 is not inserted correctly in the cradle.	Remove the MC55 and reinsert it correctly. Verify charging is active. Tap  > Settings > System > Power to view battery status.
	Ambient temperature of the cradle is too warm.	Move the cradle to an area where the ambient temperature is between 0°C (32°F) and 35°C (95°F).

Vehicle Cradle

Table 6-5 Troubleshooting the Vehicle Cradle

Symptom	Possible Cause	Action
MC55 battery charging LED does not light up.	Cradle is not receiving power.	Ensure the power input cable is securely connected to the cradle's power port.
MC55 battery is not recharging.	MC55 was removed from the cradle too soon.	Replace the MC55 in the cradle. The 2400 mAh battery fully charges in four hours and the 3600 mAh battery fully charges in less than six hours.
	Battery is faulty.	Replace the battery.
	MC55 is not placed correctly in the cradle.	Remove the MC55 from the cradle, and re-insert correctly. If the battery still does not charge, contact customer support. The MC55 battery charging LED slowly blinks amber when the MC55 is correctly inserted and charging.
	Ambient temperature of the cradle is too warm.	Move to an area where the ambient temperature is between 0°C and 35°C.

Four-slot Battery Charger

Table 6-6 *Troubleshooting The Four-slot Battery Charger*

Symptom	Possible Cause	Action
Battery not charging.	Battery was removed from the charger or charger was unplugged from AC power too soon.	Re-insert the battery in the charger or re-connect the charger's power supply. The 3600 mAh battery fully charges in less than six hours.
	Battery is faulty.	Verify that other batteries charge properly. If so, replace the faulty battery.
	Battery contacts not connected to charger.	Verify that the battery is seated in the battery well correctly with the contacts facing down.

Cables

Table 6-7 *Troubleshooting the Cables*

Symptom	Possible Cause	Action
MC55 battery is not charging.	MC55 was disconnected from AC power too soon.	Connect the power cable correctly. Confirm main battery is charging under  > Settings > System > Power . The 2400 mAh battery fully charges in less than four hours and the 3600 mAh battery fully charges in less than six hours.
	Battery is faulty.	Verify that other batteries charge properly. If so, replace the faulty battery.
	The MC55 is not fully attached to power.	Detach and re-attach the power cable to the MC55, ensuring it is firmly connected.
During data communication, no data transmits, or transmitted data was incomplete.	Cable was disconnected from MC55 during communications.	Re-attach the cable and retransmit.
	Incorrect cable configuration.	See the system administrator.
	Communication software is not installed or configured properly.	Perform setup as described in the <i>MC55 Integrator Guide</i> .

Magnetic Stripe Reader

Table 6-8 *Troubleshooting the Magnetic Stripe Reader*

Symptom	Possible Cause	Action
MSR cannot read card.	MSR removed from MC55 during card swipe.	Reattach MSR to MC55 and reswipe the card.
	Faulty magnetic stripe on card.	See the system administrator.
	MSR application is not installed or configured properly.	Ensure the MSR application is installed on the MC55. Ensure the MSR application is configured correctly.
MC55 battery is not charging.	MC55 was removed from MSR or MSR was unplugged from AC power too soon.	Ensure MSR is receiving power. Ensure MC55 is attached correctly. Confirm main battery is charging under  > Settings > System > Power . The 2400 mAh battery fully charges in less than four hours and the 3600 mAh battery fully charges in less than six hours.
	Battery is faulty.	Verify that other batteries charge properly. If so, replace the faulty battery.
	The MC55 is not fully attached to the MSR.	Detach and re-attach the MSR to the MC55, ensuring it is firmly connected.
During data communication, no data transmits, or transmitted data was incomplete.	MC55 detached from MSR during communications.	Reattach MC55 to MSR and retransmit.
	Incorrect cable configuration.	See the system administrator.
	Communication software is not installed or configured properly.	Perform setup as described in the <i>MC55 Integrator Guide</i> .

Trigger Handle

Table 6-9 *Trigger Handle*

Problem	Cause	Solution
Scan line does not appear when trigger is pressed.	MC55 is not attached properly to the Trigger Handle and is not making contact with the connector.	Remove the MC55 from the Trigger Handle and reinsert.
	MC55 does not contain a scanning application.	Load a scanning application on the MC55. Refer to the <i>MC55A0/N0 Integrator Guide</i> .
	Scanning application is not active.	Start the scanning application.

Table 6-9 *Trigger Handle (Continued)*

Problem	Cause	Solution
MC55 battery does not charge when Trigger Handle is placed in a cradle.	Trigger Handle is not properly seated in the cradle.	Remove the Trigger Handle from the cradle and reinsert.
	Power is not available to the cradle.	Ensure that power connections to the cradle are connected properly.
Cannot print to printer.	Printer cable not connected properly.	Ensure cable is connected properly to the printer and Trigger Handle.
MC55 does not wake from suspend mode when trigger is pressed.	The trigger only wakes the MC55 from the suspend mode if a scanning application is active.	Press a key on the MC55 to wake from the suspend mode.

APPENDIX A TECHNICAL SPECIFICATIONS

MC55 Technical Specifications

The following tables summarize the MC55's intended operating environment and technical hardware specifications.

MC55

Table A-1 MC55 Technical Specifications

Item	Description
Physical Characteristics	
Dimensions	(2400 mAh battery): Height: 14.7 cm (5.78 in.) Width: 7.7 cm (3.03 in.) Depth: 2.7 cm (1.06 in.) (3600 mAh battery): Height: 14.7 cm (5.78 in.) Width: 7.7 cm (3.03 in.) Depth: 2.8 cm (1.10 in.)
Weight	315 g (11.1 oz.) with 2400 mAh battery 338 g (11.9 oz.) with 3600 mAh battery
Display	Pentile 3.5" VGA with backlight, TFT-LCD, 65k colors, 480 W x 640 H, 650+ Nits
Touch Panel	Glass analog resistive touch
Backlight	LED backlight
Battery	Rechargeable Lithium Ion 3.7V, 2400 or 3600 mAh Smart battery
Backup Battery	NiMH battery (rechargeable) 18 mAh 2.4 V (not user accessible).
Expansion Slot	User accessible microSD slot. Up to 32 GB.

Table A-1 MC55 Technical Specifications (Continued)

Item	Description
Network Connections	Full-speed USB, host or client, Bluetooth and WiFi. USB host mode available with appropriate cables only.
Notification	LED and audible alert
Keypad Options	26-key numeric; 44-key QWERTY, 44-key AZERTY, 44-key QWERTZ; PIM (available on the MC55N0 in a future release)
Audio	Speaker, microphone, receiver (for handset mode use), and Bluetooth audio headsets.
Performance Characteristics	
CPU	Marvell PXA 320 processor at 806 MHz
Operating System	Microsoft® Windows Mobile™ 6.5.3 Classic
Memory	256 MB RAM/1 GB Flash
Interface/Communications	USB 1.1 Full-speed
Output Power	USB: 5 VDC @ 500 mA max.
User Environment	
Operating Temperature	-10°C to 50°C (14°F to 122°F)
Storage Temperature	-40°C to 70°C (-40°F to 158°F)
Charging Temperature	32°F to 104°F / 0° C to 40° C
Humidity	95% non-condensing
Drop Specification	Multiple 1.8 m (6 ft.) drops per MIL-STD 810G specifications.
Tumble	1000 0.5 m (1.6 ft.) tumbles (2000 drops) per IEC tumble specifications
Electrostatic Discharge (ESD)	+/-15kVdc air discharge, +/-8kVdc direct discharge, +/-8kVdc indirect discharge
Sealing	IP64 per IEC sealing specifications
Wireless LAN Data and Voice Communications	
Wireless Local Area Network (WLAN) radio	MC55A0: Tri-mode IEEE® 802.11a/b/g MC55N0: Quad-mode IEEE® 802.11a/b/g/n
Data Rates Supported	1, 2, 5.5, 6, 9, 11, 12, 18, 24, 36, 48, and 54 Mbps
Operating Channels	Chan 8 - 165 (5040 - 5825 MHz), Chan 1 - 13 (2412 - 2472 MHz), Chan 14 (2484 MHz) Japan only; actual operating channels/frequencies depend on regulatory rules and certification agency.

Table A-1 MC55 Technical Specifications (Continued)

Item	Description
Security	<p>Security Modes: Legacy, WPA and WPA2</p> <p>Encryption: WEP (40 or 128 bit), TKIP and AES</p> <p>Authentication: TLS, TTLS (MS-CHAP), TTLS (MS-CHAP v2), TTLS (CHAP), TTLS (MD5), TTLS (PAP), PEAP-TLS, PEAP (MS-CHAP v2), PEAP (EAP-GTC), EAP-FAST-TLS, EAP-FAST (MS-CHAP v2), EAP-FAST (EAP-GTC) and LEAP</p> <p>Certifications: CCXv4 and FIPS 140-2</p> <p>Note: CCXv4 certified and FIPS 140-2 certified will be supported on the MC55N0 on a future release.</p>
Spreading Technique	Direct Sequence Spread Spectrum (DSSS) and Orthogonal Frequency Division Multiplexing (OFDM)
Antenna	Internal
Voice Communication	<p>Note: Currently supported on the MC55A0. It will be supported on MC55N0 in a future update.</p> <p>Voice-over-IP ready (with P2P, PBX, PTT clients), Wi-Fi™-certified, IEEE 802.11 a/b/g direct sequence wireless LAN, Wi-Fi Multimedia™ (WMM), Zebra Voice Quality Manager (VQM)</p>
Wireless PAN Data and Voice Communications	
Bluetooth	Class II, v 2.1 EDR; on-board antenna. Supports StoneStreet One Bluetooth stack and Microsoft Bluetooth stack.
Data Capture Specifications	
Options	1D laser scanner 2D imager 1D laser scanner and color camera 2D imager and color camera
Linear 1D Scanner (SE960) Specifications	
Optical Resolution	0.005 in. minimum element width
Roll	+/- 35° from vertical
Pitch Angle	+/- 65° from normal
Skew Tolerance	+/- 40° from normal
Ambient Light	Sunlight: 10,000 ft. candles (107640 Lux) Artificial Light: 450 ft. candles (4,844 Lux)
Shock	2,000 +/- 5% G
Scan Rate	104 (+/- 12) scans/sec (bidirectional)
Scan Angle	47° (typical)
Laser Power	1.7 mW nominal

Table A-1 MC55 Technical Specifications (Continued)

Item	Description
2D Imager Engine (SE4500-SR) Specifications	
Field of View	Horizontal - 39.6° Vertical - 25.7°
Optical Resolution	752 H x 480 V pixels (gray scale)
Roll	360°
Pitch Angle	+/- 60° from normal
Skew Tolerance	+/- 60° from normal
Ambient Light	9,000 ft. candles (96,900 Lux)
Shock	2,000 +/- 5% G
Aiming Element (VLD)	655 nm +/- 10 nm
Illumination Element (LED)	625 nm +/- 5 nm LEDs (2x)
2D Imager Engine (SE4500-HD) Specifications (MC55A0 only)	
Field of View	Horizontal - 38.4° Vertical - 24.9°
Optical Resolution	752 H x 480 V pixels (gray scale)
Roll	360°
Pitch Angle	+/- 60° from normal
Skew Tolerance	+/- 60° from normal
Ambient Light	9,000 ft. candles (96,900 Lux)
Shock	2,000 +/- 5% G
Aiming Element (VLD)	655 nm +/- 10 nm
Illumination Element (LED)	625 nm +/- 5 nm LEDs (2x)
2D Imager Engine (SE4500-DL) Specifications	
Field of View	Horizontal - 39.2° Vertical - 25.4°
Optical Resolution	752 H x 480 V pixels (gray scale)
Roll	360°
Pitch Angle	+/- 60° from normal
Skew Tolerance	+/- 60° from normal
Ambient Light	9,000 ft. candles (96,900 Lux)
Shock	2,000 +/- 5% G
Aiming Element (VLD)	655 nm +/- 10 nm

Table A-1 MC55 Technical Specifications (Continued)

Item	Description
Illumination Element (LED)	625 nm +/- 5 nm LEDs (2x)
Camera Specifications	
Resolution	3 Mega pixel with flash and auto focus.

Table A-2 Data Capture Options

Item	Description
Laser Decode Capability	Code 39 Codabar Interleaved 2 of 5 MSI UPC/EAN supplementals Webcode GS1 DataBar Truncated GS1 DataBar Expanded GS1 DataBar Stacked Omni
Imaging Decode Capability	Code 128 Code 93 Code 11 Discrete 2 of 5 EAN-8 EAN-13 UPCA UPCE Coupon Code Trioptic 39 GS1 DataBar GS1 DataBar Limited GS1 DataBar Stacked GS1 DataBar Expanded Stacked
Camera Decode Capability	Code 39 Codabar Discrete 2 of 5 EAN-13 UPC/EAN supplementals Webcode Composite C Macro PDF-417 Data Matrix US Planet Canadian 4-state Chinese 2 of 5 microQR GS1 DataBar Truncated GS1 DataBar Expanded GS1 DataBar Stacked Omni
	Code 128 Code 93 Code 11 Interleaved 2 of 5 EAN-8 UPCA UPCE Coupon Code Trioptic 39 Composite AB PDF-417 QR Code US Postnet Australian 4-state Dutch Kix Japanese 4-state Aztec GS1 DataBar GS1 DataBar Limited GS1 DataBar Stacked GS1 DataBar Expanded Stacked

MC55 Accessory Specifications

Single-slot USB Cradle

Table A-3 *Single-slot USB Cradle Technical Specifications*

Feature	Description
Dimensions	Height: 7.1 cm (2.80 in.) Width: 11.0 cm (4.33 in.) Depth: 15.0 cm (5.91 in.)
Weight	210 g (7.41 oz)
Input Voltage	12 VDC
Power Consumption	30 watts
Interface	USB
Operating Temperature	0°C to 50°C (32°F to 122°F)
Storage Temperature	-40°C to 70°C (-40°F to 158°F)
Charging Temperature	0°C to 40°C (32°F to 104°F)
Humidity	5% to 95% non-condensing
Drop	76.2 cm (30.0 in.) drops to vinyl tiled concrete at room temperature
Electrostatic Discharge (ESD)	+/- 15 kV air +/- 8 kV contact

Single-slot Ethernet/Modem/USB Cradle

Table A-4 *Single-slot Ethernet/Modem/USB Cradle Technical Specifications*

Feature	Description
Dimensions	Height: 7.1 cm (2.80 in.) Width: 11.0 cm (4.33 in.) Depth: 15.0 cm (5.91 in.)
Weight	210 g (7.41 oz)
Input Voltage	12 VDC
Power Consumption	30 watts
Interface	USB
Operating Temperature	0°C to 50°C (32°F to 122°F)
Storage Temperature	-40°C to 70°C (-40°F to 158°F)
Charging Temperature	0°C to 40°C (32°F to 104°F)

Table A-4 *Single-slot Ethernet/Modem/USB Cradle Technical Specifications (Continued)*

Feature	Description
Humidity	5% to 95% non-condensing
Drop	76.2 cm (30.0 in.) drops to vinyl tiled concrete at room temperature
Electrostatic Discharge (ESD)	+/- 15 kV air +/- 8 kV contact

Four-slot Battery Charger

Table A-5 *Four-slot Battery Charger Technical Specifications*

Feature	Description
Dimensions	Height: 4.7 cm (1.85 in.) Width: 15.5 cm (6.10 in.) Depth: 21.0 cm (8.27 in.)
Weight	384 g (13.55 oz)
Input Voltage	12 VDC
Power Consumption	30 watts
Operating Temperature	0°C to 40°C (32°F to 104°F)
Storage Temperature	-40°C to 70°C (-40°F to 158°F)
Charging Temperature	0°C to 40°C (32°F to 104°F)
Humidity	5% to 95% non-condensing
Drop	76.2 cm (30.0 in.) drops to vinyl tiled concrete at room temperature
Electrostatic Discharge (ESD)	+/- 15 kV air +/- 8 kV contact

Four-slot Charge Only Cradle

Table A-6 *Four-slot Charge Only Cradle Technical Specifications*

Feature	Description
Dimensions	Height: 13.7 cm (5.39 in.) Width: 46.8 cm (18.43 in.) Depth: 9.9 cm (3.90 in.)
Weight	1115 g (39.33 oz)
Input Voltage	12 VDC
Power Consumption	100 watts
Operating Temperature	0°C to 50°C (32°F to 122°F)

Table A-6 *Four-slot Charge Only Cradle Technical Specifications (Continued)*

Feature	Description
Storage Temperature	-40°C to 70°C (-40°F to 158°F)
Charging Temperature	0°C to 40°C (32°F to 104°F)
Humidity	5% to 95% non-condensing
Drop	76.2 cm (30.0 in.) drops to vinyl tiled concrete at room temperature
Electrostatic Discharge (ESD)	+/- 15 kV air +/- 8 kV contact

Four-slot Ethernet Cradle

Table A-7 *Four-slot Ethernet Cradle Technical Specifications*

Feature	Description
Dimensions	Height: 13.7 cm (5.39 in.) Width: 46.8 cm (18.43 in.) Depth: 9.9 cm (3.90 in.)
Weight	1115 g (39.33 oz)
Power	12 VDC
Operating Temperature	0°C to 50°C (32°F to 122°F)
Storage Temperature	-40°C to 70°C (-40°F to 158°F)
Charging Temperature	0°C to 40°C (32°F to 104°F)
Humidity	5% to 95% non-condensing
Drop	76.2 cm (30.0 in.) drops to vinyl tiled concrete at room temperature
Electrostatic Discharge (ESD)	+/- 15 kV air +/- 8 kV contact

Magstripe Reader

Table A-8 *Magstripe Reader (MSR) Technical Specifications*

Feature	Description
Dimensions	8.4 cm x 9.4 cm (3.3 inches x 3.7 inches)
Weight	79.4 g (2.8 oz.)
Interface	Serial with baud rate up to 19,200
Format	ANSI, ISO, AAMVA, CA DMV, user-configurable generic format
Swipe Speed	5 to 50 in. (127 to 1270 mm) /sec, bi-directional
Decoders	Generic, Raw Data
Mode	Buffered, unbuffered
Track Reading Capabilities	Tracks 1 and 3: 210 bpi Track 2: 75 and 210 bpi, autodetect
Operating Temperature	32° to 122° F (-10° to 50° C)
Storage Temperature	-40° to 158° F (-40° to 70° C)
Humidity	5% to 95% non-condensing
Drop	4 ft. (1.22 m) drops to concrete
Electrostatic Discharge (ESD)	+/- 15 kV air +/- 8 kV contact

Vehicle Cradle

Table A-9 *Vehicle Cradle Technical Specifications*

Feature	Description
Dimensions	Height: 10.4 cm (4.09 in.) Width: 11.1 cm (4.37 in.) Depth: 6.9 cm (2.72 in.)
Weight	240 g (8.47 oz)
Power	9 - 32 VDC
Operating Temperature	-20°C to 50°C (-4°F to 122°F)
Storage Temperature	-40°C to 70°C (-40°F to 158°F)
Charging Temperature	0°C to 40°C (32°C to 104°F)
Humidity	10% to 95% non-condensing
Drop	76.2 cm (30.0 in.) drops to vinyl tiled concrete at room temperature
Electrostatic Discharge (ESD)	+/- 15 kV air +/- 8 kV contact

Cables

Table A-10 *USB Charging Cable Technical Specifications*

Feature	Description
Length	161.9 cm (63.74 in.)
Input Voltage	5.4 VDC
Operating Temperature	-10°C to 50°C (14°F to 122°F)
Storage Temperature	-40°C to 70°C (-40°F to 158°F)
Humidity	10% to 95% non-condensing
Electrostatic Discharge (ESD)	+/- 15 kV air +/- 8 kV contact

Table A-11 *Charge Only Cable Technical Specifications*

Feature	Description
Length	28.0 cm (11.00 in.)
Input Voltage	5.4 VDC
Operating Temperature	-10°C to 50°C (14°F to 122°F)
Storage Temperature	-40°C to 70°C (-40°F to 158°F)
Humidity	10% to 95% non-condensing
Electrostatic Discharge (ESD)	+/- 15 kV air +/- 8 kV contact

Table A-12 *Auto Charge Cable Technical Specifications*

Feature	Description
Length	169.0 cm (66.54 in.)
Input Voltage	12 - 24 VDC
Operating Temperature	-10°C to 50°C (14°F to 122°F)
Storage Temperature	-40°C to 70°C (-40°F to 158°F)
Humidity	10% to 95% non-condensing
Electrostatic Discharge (ESD)	+/- 15 kV air +/- 8 kV contact

Table A-13 *DEX Cable Technical Specifications*

Feature	Description
Length	111.76 cm (44.0 in.)
Operating Temperature	-10°C to 50°C (14°F to 122°F)
Storage Temperature	-40°C to 70°C (-40°F to 158°F)
Humidity	10% to 95% non-condensing
Electrostatic Discharge (ESD)	+/- 15 kV air +/- 8 kV contact

APPENDIX B KEYPADS

The MC55 offers three types of keypad configurations: Numeric, alpha-numeric and PIM (available on the MC55N0 in a future release).

Numeric Keypad Configuration

The numeric keypad contains application keys, scroll keys, and function keys. The keypad is color-coded to indicate the alternate function key (blue) values. Note that an application can change keypad functions so the MC55's keypad may not function exactly as described. See [Table B-1](#) for key and button descriptions and [Table B-2 on page B-4](#) for the keypad's special functions.

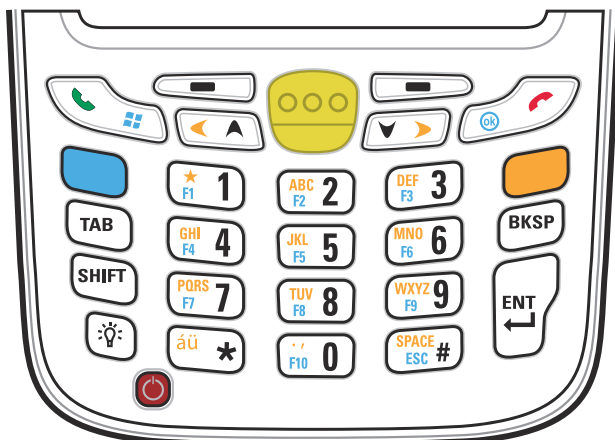

Figure B-1 MC55 Numeric Keypad

Table B-1 MC55 Numeric Keypad Descriptions









Key	Description
<p>Blue Key</p> 	<p>Use this key to launch applications or access items (shown on the keypad in blue). Press the Blue key once to activate this mode, followed by another key. A single press illuminates the key and displays the following icon at the bottom of the screen, until a second key is pressed: </p>
<p>Orange Key</p> 	<p>Use this key to access the secondary layer of characters and actions (shown on the keypad in orange). Press the Orange key once to lock the keypad into Alpha state. A single press illuminates the key and displays the following icon at the bottom of the screen: </p> <p>Press the Orange key a second time to return to the normal state.</p> <p>Press the Orange key, then the Shift key to add a temporary shift (that applies only to the next key pressed) to the orange lock state. This displays the following icon at the bottom of the screen: </p>
<p>Talk/Start Menu</p> 	<p>Use this key in conjunction with the Blue key to instantly display the Start menu from any application without tapping the screen. This function is user programmable.</p> <p>To use a key as an application key (APP key) on the keyboard, create and install a new keyboard remap table. However, to remap the green phone key as APP keys through the registry, create an XML provisioning file that includes the following entry:</p> <pre data-bbox="472 1098 1300 1182"><characteristic type="HKLM\Hardware\DeviceMap\KYBD"> <parm name="GreenKeyOverride" value="xx" datatype="integer" /> [where xx is the new APP key code]</pre> <p>Provision the file to the MC55 to send an APP key code, instead of the original key code, upon pressing the green phone key. Refer to the <i>MC55A0/MC55N0 Integrator Guide</i> for information on creating XML provisioning files.</p>
<p>Scan (yellow)</p> 	<p>Activates the scanner/imager in a scan enabled application.</p>
<p>End/OK</p> 	<p>Use this key in conjunction with the Blue key as an OK or close button. This function is user programmable.</p> <p>To use a key as an application key (APP key) on the keyboard, create and install a new keyboard remap table. However, to remap the red phone keys as APP keys through the registry, create an XML provisioning file that includes the following entry:</p> <pre data-bbox="472 1728 1276 1812"><characteristic type="HKLM\Hardware\DeviceMap\KYBD"> <parm name="RedKeyOverride" value="yy" datatype="integer" /> [where yy is the new APP key code]</pre> <p>Provision the file to the MC55 to send an APP key code, instead of the original key code, upon pressing the red phone key. Refer to the <i>MC55A0/MC55N0 Integrator Guide</i> for information on creating XML provisioning files.</p>

Table B-1 MC55 Numeric Keypad Descriptions (Continued)





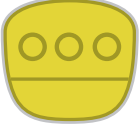





Key	Description
Scroll Up and Left 	Moves up one item. Moves left one item when pressed with the Orange key.
Scroll Down and Right 	Moves down one item. Moves right one item when pressed with the Orange key.
Soft Keys 	Accesses the command or menu above it on the screen.
Star 	Produces an asterisk in default state. Press and release the orange key, then press the Star key to create special characters. See Special Character Key on page B-15 for more information.
Alphanumeric 	In default state, produces the numeric value on the key. In Alpha state, produces the lower case alphabetic characters on the key. Each key press produces the next alphabetic character in sequence. For example, press and release the Orange key and then press the '4' key once to produce the letter 'g'; press and release the Orange key and then press the '4' key three times to produce the letter 'i'. Press the SHIFT key in Alpha state to produce the upper case alphabetic characters on the key. For example, press and release the Orange key, press and release the SHIFT key, and then press the '4' key once to produce the letter 'G'; press and release the Orange key, press and release the SHIFT key and then press the '4' key three times to produce the letter 'I'.
Backspace 	Produces a backspace.
SHIFT 	Press and release the SHIFT key to activate the keypad alternate SHIFT functions. A single press displays the following icon at the bottom of the screen, until a second key is pressed:  Press the Orange key, then the Shift key to add a temporary shift (that applies only to the next key pressed) to the orange lock state. This displays the following icon at the bottom of the screen: 
Enter 	Executes a selected item or function.

Table B-2 Numeric Keypad Input Modes

Key	Numeric Mode			Orange Key (Alpha Lowercase Mode)				Orange + Shift Keys (Alpha Uppercase Mode)			
		Blue+ Key	SHIFT + Key	1st Press	2nd Press	3rd Press	4th Press	1st Press	2nd Press	3rd Press	4th Press
1	1	F1	!	*	*	*	*	*	*	*	*
2	2	F2	@	a	b	c		A	B	C	
3	3	F3	#	d	e	f		D	E	F	
4	4	F4	\$	g	h	i		G	H	I	
5	5	F5	%	j	k	l		J	K	L	
6	6	F6	^	m	n	o		M	N	O	
7	7	F7	&	p	q	r	s	P	Q	R	S
8	8	F8	*	t	u	v		T	U	V	
9	9	F9	(w	x	y	z	W	X	Y	Z
0	0	F10)	.	,			>	<		
Up	Up	Up	Hilight Up	Left				Left			
Down	Down	Down	Hilight Down	Right				Right			
Enter	Action	Action	Action	Action				Action			

Note: An application can change the key functions. The keypad may not function exactly as described.

Alpha-numeric Keypad Configurations

The three types of alpha-numeric keypads (QWERTY, AZERTY and QWERTZ) produce the 26-character alphabet (A-Z, both lowercase and uppercase), numbers (0-9), and assorted characters. The keypad is color-coded to indicate which modifier key to press to produce a particular character or action. The keypad default is alphabetic, producing lowercase letters. See [Table B-3](#) for key and button descriptions and [Table B-4 on page B-8](#) for the keypad's special functions. AZERTY keypad is used on configurations installed with the French operating system. QWERTZ keypad is used on configurations installed with the German operating system.



Figure B-2 QWERTY Keypad Configuration



Figure B-3 AZERTY Keypad Configuration



Figure B-4 QWERTZ Keypad Configuration

Table B-3 Alpha-numeric Keypad Descriptions







Key	Action
<p>Blue Key</p> 	<p>Press and release the Blue key once to activate this mode temporarily, followed by another key. This displays the following icon at the bottom of the screen, until a second key is pressed: </p> <p>Press and release the Blue key twice to lock this mode. This displays the following icon at the bottom of the screen: </p> <p>Press and release the Blue key a third time to unlock.</p>
<p>Orange Key</p> 	<p>Accesses the secondary layer of characters and actions (shown on the keypad in orange).</p> <p>Press and release the Orange key once to activate this mode temporarily, followed by another key. This displays the following icon at the bottom of the screen, until a second key is pressed: </p> <p>Press and release the Orange key twice to lock this mode. This displays the following icon at the bottom of the screen: </p> <p>Press and release the Orange key a third time to unlock.</p>
<p>Talk/Start Menu</p> 	<p>Use this key in conjunction with the Blue key to instantly display the <i>Start</i> menu from any application without tapping the screen. This function is user programmable.</p> <p>To use a key as an application key (APP key) on the keyboard, create and install a new keyboard remap table. However, to remap the green phone key as APP keys through the registry, create an XML provisioning file that includes the following entry:</p> <pre data-bbox="505 1732 1333 1818"> <characteristic type="HKLM\Hardware\DeviceMap\KYBD"> <parm name="GreenKeyOverride" value="xx" datatype="integer" /> [where xx is the new APP key code] </pre> <p>Provision the file to the MC55 to send an APP key code, instead of the original key code, upon pressing the green phone key. Refer to the <i>MC55A0/MC55N0 Integrator Guide</i> for information on creating XML provisioning files.</p>

Table B-3 Alpha-numeric Keypad Descriptions (Continued)







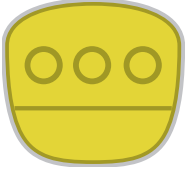

Key	Action
Scan (yellow) 	Activates the scanner/imager in a scan enabled application.
End/OK 	Use this key in conjunction with the Blue key as an OK or close button. This function is user programmable. To use a key as an application key (APP key) on the keyboard, create and install a new keyboard remap table. However, to remap the green phone key as APP keys through the registry, create an XML provisioning file that includes the following entry: <pre><characteristic type="HKLM\Hardware\DeviceMap\KYBD"> <parm name="RedKeyOverride" value="yy" datatype="integer" /> [where yy is the new APP key code]</pre> Provision the file to the MC55 to send an APP key code, instead of the original key code, upon pressing the red phone key. Refer to the <i>MC55A0/MC55N0 Integrator Guide</i> for information on creating XML provisioning files.
Scroll Up and Left 	Moves up one item. Moves left one item when pressed with the Orange key.
Scroll Down and Right 	Moves down one item. Moves right one item when pressed with the Orange key.
Soft Keys 	Accesses the command or menu above it on the screen.
Shift 	Changes the state of the alpha characters from lowercase to uppercase. <ul style="list-style-type: none"> Press the Shift key to activate this mode temporarily, followed by another key. This displays the following icon at the bottom of the screen, until a second key is pressed:  Press the Shift key twice to lock this mode. This displays the following icon at the bottom of the screen:  Press the Shift key a third time to unlock.
Backlight 	Turns the display backlight on and off.

Table B-3 Alpha-numeric Keypad Descriptions (Continued)





Key	Action
Backspace 	Produces a backspace.
Enter 	Executes a selected item or function.
Star 	Produces an asterisk.
au 	Creates special characters.

Table B-4 QWERTY Keypad Input Modes

Key	Normal	Shift + Key	Orange + Key	Blue + Key
Q	q	Q	*	q
W	w	W	1	w
E	e	E	2	e
R	r	R	3	r
T	t	T	+	t
Y	y	Y	-	y
U	u	U	-	u
I	i	I	=	i
O	o	O	"	o
P	p	P	áü	p
A	a	A	#	a
S	s	S	4	s
D	d	D	5	d
F	f	F	6	f
G	g	G	(g
H	h	H)	h

Note: An application can change the key functions. The keypad may not function exactly as described.

Table B-4 QWERTY Keypad Input Modes (Continued)

Key	Normal	Shift + Key	Orange + Key	Blue + Key
J	j	J	/	j
K	k	K	:	k
L	l	L	'	l
Backspace	Backspace	Backspace	Backspace	Backspace
Shift	Shift	Shift-Lock	Shift	Shift
Z	z	Z	7	z
X	x	X	8	x
C	c	C	9	c
V	v	V	%	v
B	b	B	&	b
N	n	N	!	n
M	m	M	?	m
,	,	<	@	,
ENTER	Enter	Enter	Enter	Enter
0	0)	0	0
TAB	Tab	Tab	Back tab	Tab
SPACE	Space	Space	Space	Space
Backlight	Backlight	Backlight	Backlight	Backlight
. (Period)	.	>	.	.

Note: An application can change the key functions. The keypad may not function exactly as described.

Table B-5 AZERTY Keypad Input Modes

Key	Normal	Shift + Key	Orange + Key	Blue + Key
A	a	A	*	a
Z	z	Z	1	z
E	e	E	2	e
R	r	R	3	r
T	t	T	+	t
Y	y	Y	_	y

Note: An application can change the key functions. The keypad may not function exactly as described.

Table B-5 AZERTY Keypad Input Modes (Continued)

Key	Normal	Shift + Key	Orange + Key	Blue + Key
U	u	U	-	u
I	i	I	=	i
O	o	O	“	o
P	p	P	áü	p
Q	q	Q	#	q
S	s	S	4	s
D	d	D	5	d
F	f	F	6	f
G	g	G	(g
H	h	H)	h
J	j	J	/	j
K	k	K	:	k
L	l	L	‘	l
Backspace	Backspace	Backspace	Backspace	Backspace
Shift	Shift	Shift-Lock	Shift	Shift
W	w	W	7	w
X	x	X	8	x
C	c	C	9	c
V	v	V	%	v
B	b	B	&	b
N	n	N	!	n
M	m	M	?	m
,	,	<	@	
Enter	Enter	Enter	Enter	Enter
0	0)	0	0
TAB	Tab	Tab	Back tab	Tab
SPACE	Space	Space	Space	Space
Backlight	Backlight	Backlight	Backlight	Backlight
. (Period)	.	>	.	.

Note: An application can change the key functions. The keypad may not function exactly as described.

Table B-6 QWERTZ Keypad Input Modes

Key	Normal	Shift + Key	Orange + Key	Blue + Key
Q	q	Q	*	q
W	w	W	1	w
E	e	E	2	e
R	r	R	3	r
T	t	T	+	t
Z	z	Z	-	z
U	u	U	-	u
I	i	I	=	i
O	o	O	"	o
P	p	P	áü	p
A	a	A	#	a
S	s	S	4	s
D	d	D	5	d
F	f	F	6	f
G	g	G	(g
H	h	H)	h
J	j	J	/	j
K	k	K	:	k
L	l	L	'	l
Backspace	Backspace			
Shift	Shift			
Y	y	Y	7	y
X	x	X	8	x
C	c	C	9	c
V	v	V	%	v
B	b	B	&	b
N	n	N	!	n
M	m	M	?	m
,	,	<	@	,

Note: An application can change the key functions. The keypad may not function exactly as described.

Table B-6 QWERTZ Keypad Input Modes (Continued)

Key	Normal	Shift + Key	Orange + Key	Blue + Key
ENTER	Enter	ENTER	ENTER	Enter
0	0)	0	0
TAB	Tab	Tab	Back tab	Tab
SPACE	Space	Space	Space	Space
Backlight	Backlight	Backlight	Backlight	Backlight
. (Period)	.	>	.	.

Note: An application can change the key functions. The keypad may not function exactly as described.

PIM Keypad Configuration

✓ **NOTE** Available on the MC55N0 in a future release

The PIM keypad contains application keys and scroll keys. Note that an application can change keypad functions so the MC55's keypad may not function exactly as described. See [Table B-1](#) for key and button descriptions and [Table B-2 on page B-4](#) for the keypad's special functions.

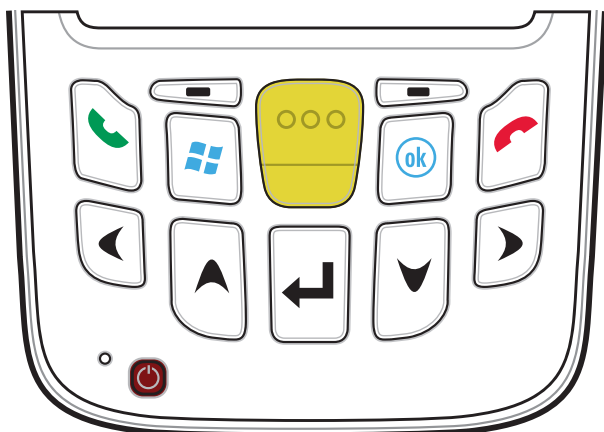

Figure B-5 MC55 PIM Keypad

Table B-7 MC55 PIM Keypad Descriptions









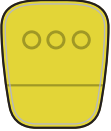

Key	Description
Talk (Green Phone) 	<p>This key is user programmable.</p> <p>To use a key as an application key (APP key) on the keyboard, create and install a new keyboard remap table. However, to remap the green phone key as APP keys through the registry, create an XML provisioning file that includes the following entry:</p> <pre><characteristic type="HKLM\Hardware\DeviceMap\KYBD"> <parm name="GreenKeyOverride" value="xx" datatype="integer" /> [where xx is the new APP key code]</pre> <p>Provision the file to the MC55 to send an APP key code, instead of the original key code, upon pressing the green phone key. Refer to the <i>MC55A0/MC55N0 Integrator Guide</i> for information on creating XML provisioning files.</p>
End (Red Phone) 	<p>This key is user programmable.</p> <p>To use a key as an application key (APP key) on the keyboard, create and install a new keyboard remap table. However, to remap the green phone key as APP keys through the registry, create an XML provisioning file that includes the following entry:</p> <pre><characteristic type="HKLM\Hardware\DeviceMap\KYBD"> <parm name="RedKeyOverride" value="yy" datatype="integer" /> [where yy is the new APP key code]</pre> <p>Provision the file to the MC55 to send an APP key code, instead of the original key code, upon pressing the red phone key. Refer to the <i>MC55A0/MC55N0 Integrator Guide</i> for information on creating XML provisioning files.</p>
Scan (yellow) 	Activates the scanner/imager in a scan enabled application.
Scroll Up 	Moves up one item.
Scroll Down 	Moves up down item.
Scroll Left 	Moves left one item.
Scroll Right 	Moves right one item.

Table B-7 MC55 PIM Keypad Descriptions (Continued)

Key	Description
Soft Keys 	Accesses the command or menu above it on the screen.
Enter 	Executes a selected item or function.
OK 	Use this key as an OK or close button.

Special Character Key

✓ **NOTE** Special characters are only available on the alpha-numeric keypad configurations.

To add special characters using the MC55 áü key, type the related character first, then press the Orange twice followed by the áü (P) key. Continue pressing the áü key until the special character displays. To modify an existing character, move the cursor to the right of the character then press the Orange key twice and then press the áü key until the special character replaces the original character. [Table B-8](#) lists the special characters you can generate.

Table B-8 Special Characters

Key	Special Characters	Key	Special Characters
a	à á â ã ä å æ	A	À Á Â Ã Ä Å Æ
c	ç ć ċ ©	C	Ç Ć Ć ©
d	ð	D	Ð
e	è é ê ë ě	E	È É Ê Ë Ě
i	ì í î ï	I	Ì Í Î Ï
l	ł	L	Ł
n	ñ	N	Ñ
o	ò ó ô õ ö ø œ	O	Ò Ó Ô Õ Ö Ø Œ
p	þ	P	Þ
r	®	R	®
s	ş š ß	S	Ş Š ß
t	ţ	T	Ț
u	ù ú û ü	U	Ù Ú Û Ü

Table B-8 *Special Characters (Continued)*

Key	Special Characters		Key	Special Characters
y	ÿ		Y	Ÿ
z	ž ž		Z	Ž Ž
\$	€ £ ¥		/	\
"	' « ' »		([{ < «
)] } > »		+	± & - _
!	¡ ? ¿		.	¡ , ;
*	#		@	~ %
%	^		,	¡ , ;
#	*		&	- _ + ±
_	+ ± & -		'	« » "
?	¿ ! ¡		:	¡ , ;
-	_ + ± &			

APPENDIX C VOICE QUALITY MANAGER

Introduction

The Voice Quality Manager (VQM) is a software package that resides on the MC55. VQM enables a set of features for Voice over WiFi (VoWiFi) calls. The VQM user interface is designed to be intuitive and easy to use, so complex tasks such as enabling the Acoustic Echo Canceller (AEC) while a call is in progress are done with very little or no user intervention.

Features

The VQM software:

- Improves the voice transmission quality without using additional battery power.
- Turns on the AEC for VoWiFi calls automatically, without user intervention.
- Prioritizes the outgoing audio IP packets.
- Provides user-selectable audio modes (speakerphone and handset) with a single tap of the VQM icon. A VQM icon in the title bar of the device indicates the audio mode currently in use.
- NDIS 5.1 compliant.

Enabling VQM

To enable VQM:

1. Tap  > **File Explorer**.
2. Navigate to the **Windows** folder.
3. Locate the file **VQMAudioNotify**.
4. Tap the filename to enable VQM.

Audio Modes

The MC55 can be in any one of the seven different audio modes. The mode is visually indicated by the VQM icon on the status bar.

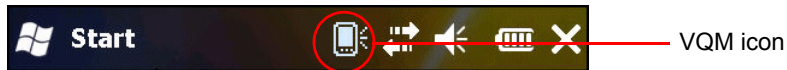







Figure C-1 VQM Icon in Status Bar

The VQM icon indicates that the device is in speakerphone mode without Acoustic Echo Cancellation (indicated by the gray VQM icon). The audio modes and their corresponding VQM Status bar icons are:

Table C-1 VQM Icons

Icon	Description
	Speakerphone with Acoustic Echo Cancellation.
	Speakerphone without Acoustic Echo Cancellation.
	Handset with Acoustic Echo Cancellation (device is in handset mode only while on a call).
	Bluetooth headset while on a call (Acoustic Echo Cancellation is not enabled for Bluetooth headsets). White icon.
	Bluetooth headset while not on a call. Gray icon.

Changing Audio Modes

Depending upon the audio mode being used, the mode can be changed by tapping the VQM icon in the status bar. The audio mode can only be changed only while the user is on a call.

The table below lists the current audio mode and the subsequent audio mode after tapping the VQM icon.

Table C-2 Changing Audio Modes

Audio Mode before Tapping VQM Icon	Audio Mode after Tapping VQM Icon
Speakerphone	Handset
Handset	Speakerphone
Bluetooth headset	Speakerphone

When using a Bluetooth headset with BTE Explorer, enable the headset profile and ensure that the device is connectable. Pressing the headset button pairs the headset back to the MC75A. A second click of the headset button sends audio to the Bluetooth headset.

If the MC75A and the Bluetooth headset are un-paired, there is no way to go back to the Bluetooth headset using the VQM icon. The only way to reconnect the Bluetooth headset to the device is by using the BTEplorer application.

If the user taps the VQM icon when a wired headset is connected to the MC75A, the audio mode does not change.

The audio continues to get routed to the wired headset.

If the user taps the VQM icon while not on a call there is not change to the audio mode.

To view the VQM versions numbers tap  > **File Manager**. Navigate to the Windows folder and search for VQMAudioNotify.exe file.

A dialog box displays listing the versions numbers.

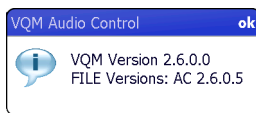

Figure C-2 VQM Audio Control Dialog Box

Voice Packet Prioritization

IP soft phones transmit voice packets in the same manner as any other application that sends data over the network. On a network with different types of traffic, voice packets are given the same priority as any other traffic, and therefore may be subject to delays.

WiFi Multi-media (WMM) is a solution to this problem. WMM is a specification that supports prioritizing traffic, and “higher-priority” packets can be given preferential treatment.

To make use of WMM, the devices that generate traffic must mark their packets as high or normal priority in a field in the IP packet called Differentiated Services Code-Point (DSCP). The wireless infrastructure, which must be configured to support WMM, gives a higher priority to packets that have been marked as high priority through DSCP marking by the devices that generate traffic.

VQM detects if there is an ongoing Voice over WiFi (VoWiFi) call, and if so, marks outgoing voice packets (Only outgoing voice packets can be marked. The incoming voice packets have already been through the network, so it makes no sense to mark them.) as high-priority using DSCP. This enables WMM-compatible wireless infrastructure to treat the voice packets preferentially. This results in fewer delays for voice packets, which in turn improves the call quality.

Acoustic Echo Cancellation

Acoustic Echo occurs during a voice call when the audio from the earpiece enters the microphone of the same device. This results in the person at the other end hearing back a delayed version of his/her own voice (“Echo”). Needless to say, “Echo” is not desirable, and needs to be suppressed. This is the functionality performed by the Acoustic Echo Canceller (AEC). There are two approaches to suppressing the Echo:

- Turn the Acoustic Echo Canceller (AEC) on permanently. This approach is not very efficient because the device consumes more power when the AEC is on.
- Turn the Acoustic Echo Canceller (AEC) on only when there is an ongoing call.

VQM follows the second of the two approaches mentioned above.

VQM automatically turns on the Acoustic Echo Canceller (AEC) when the mobile device is in a VoWiFi call. When the call is terminated, VQM turns the AEC off. Note that the AEC is turned on for speakerphone and

handset modes and does not get turned on for wired headset and Bluetooth headset modes. The AEC is not required for wired headset because the audio volume is quite low (because of the proximity of the earpiece to the ear), and therefore it is very unlikely for the audio from the earpiece to go in to the mouthpiece. Bluetooth headsets typically have an Echo Canceller built in. Turning the AEC on only while on a call saves battery power, compared to leaving the AEC turned on permanently.

The AEC is not turned on for Cellular calls because the WWAN phone application has a built-in echo canceller.

Limitations

- There is no VPN support in VQM.
- Only the Avaya softphone is supported.

Disabling VQM

To disable VQM perform a warm boot.

GLOSSARY

A

API. (Application Programming Interface) An interface by means of which one software component communicates with or controls another. Usually used to refer to services provided by one software component to another, usually via software interrupts or function calls

AZERTY. A standard keyboard commonly used on French keyboards. “AZERTY” refers to the arrangement of keys on the top row of keys.

AKU. (Adaptation Kit Update) Updates to the Windows Mobile operating system.

AFH. Adaptive Frequency Hopping

ActiveSync. ActiveSync is a data synchronization program developed by Microsoft for use with Windows Mobile operating systems.

B

Bar Code. A pattern of variable-width bars and spaces which represents numeric or alphanumeric data in machine-readable form. The general format of a bar code symbol consists of a leading margin, start character, data or message character, check character (if any), stop character, and trailing margin. Within this framework, each recognizable symbology uses its own unique format. See **Symbology**.

Bit. Binary digit. One bit is the basic unit of binary information. Generally, eight consecutive bits compose one byte of data. The pattern of 0 and 1 values within the byte determines its meaning.

Bits per Second (bps). Bits transmitted or received.

Bluetooth. A wireless protocol utilizing short-range communications technology facilitating data transmission over short distances.

boot or boot-up. The process a computer goes through when it starts. During boot-up, the computer can run self-diagnostic tests and configure hardware and software.

bps. See **Bits Per Second**.

Byte. On an addressable boundary, eight adjacent binary digits (0 and 1) combined in a pattern to represent a specific character or numeric value. Bits are numbered from the right, 0 through 7, with bit 0 the low-order bit. One byte in memory is used to store one ASCII character.

C

CDRH. Center for Devices and Radiological Health. A federal agency responsible for regulating laser product safety. This agency specifies various laser operation classes based on power output during operation.

CDRH Class 1. This is the lowest power CDRH laser classification. This class is considered intrinsically safe, even if all laser output were directed into the eye's pupil. There are no special operating procedures for this class.

CDRH Class 2. No additional software mechanisms are needed to conform to this limit. Laser operation in this class poses no danger for unintentional direct human exposure.

Character. A pattern of bars and spaces which either directly represents data or indicates a control function, such as a number, letter, punctuation mark, or communications control contained in a message.

Codabar. A discrete self-checking code with a character set consisting of digits 0 to 9 and six additional characters: (“-”, “\$”, “.”, “/”, “,” and “+”).

Code 128. A high density symbology which allows the controller to encode all 128 ASCII characters without adding extra symbol elements.

Code 3 of 9 (Code 39). A versatile and widely used alphanumeric bar code symbology with a set of 43 character types, including all uppercase letters, numerals from 0 to 9 and 7 special characters (“-”, “.”, “/”, “+”, “%”, “\$” and space). The code name is derived from the fact that 3 of 9 elements representing a character are wide, while the remaining 6 are narrow.

Code 93. An industrial symbology compatible with Code 39 but offering a full character ASCII set and a higher coding density than Code 39.

Cold Boot. A cold boot restarts the mobile computer and erases all user stored records and entries.

COM port. Communication port; ports are identified by number, e.g., COM1, COM2.

Cradle. A cradle is used for charging the terminal battery and for communicating with a host computer, and provides a storage place for the terminal when not in use.

D

DCP. See **Device Configuration Package**.

Decode. To recognize a bar code symbology (e.g., UPC/EAN) and then analyze the content of the specific bar code scanned.

Decode Algorithm. A decoding scheme that converts pulse widths into data representation of the letters or numbers encoded within a bar code symbol.

Decryption. Decryption is the decoding and unscrambling of received encrypted data. Also see, **Encryption** and **Key**.

Depth of Field. The range between minimum and maximum distances at which a scanner can read a symbol with a certain minimum element width.

Device Configuration Package. The Symbol Device Configuration Package provides the Product Reference Guide (PRG), flash partitions, Terminal Configuration Manager (TCM) and the associated TCM scripts. With this package hex images that represent flash partitions can be created and downloaded to the mobile computer.

Discrete 2 of 5. A binary bar code symbology representing each character by a group of five bars, two of which are wide. The location of wide bars in the group determines which character is encoded; spaces are insignificant. Only numeric characters (0 to 9) and START/STOP characters may be encoded.

E

EAN. European Article Number. This European/International version of the UPC provides its own coding format and symbology standards. Element dimensions are specified metrically. EAN is used primarily in retail.

EMDK. Enterprise Mobility Developer's Kit.

ESD. Electro-Static Discharge

F

File Transfer Protocol (FTP). A TCP/IP application protocol governing file transfer via network or telephone lines. See **TCP/IP**.

Flash Memory. Flash memory is nonvolatile, semi-permanent storage that can be electronically erased in the circuit and reprogrammed.

FHSS (Frequency Hopping Spread Spectrum). A method of transmitting radio signals by rapidly switching a carrier among many frequency channels, using a pseudorandom sequence known to both transmitter and receiver.

H

Hard Reset. See **Cold Boot**.

Hz. Hertz; A unit of frequency equal to one cycle per second.

Host Computer. A computer that serves other terminals in a network, providing such services as computation, database access, supervisory programs and network control.

I

IEC. International Electrotechnical Commission. This international agency regulates laser safety by specifying various laser operation classes based on power output during operation.

IEC (825) Class 1. This is the lowest power IEC laser classification. Conformity is ensured through a software restriction of 120 seconds of laser operation within any 1000 second window and an automatic laser shutdown if the scanner's oscillating mirror fails.

IEEE Address. See **MAC Address**.

Input/Output Ports. I/O ports are primarily dedicated to passing information into or out of the terminal's memory. MC55 mobile computers include USB ports.

Interleaved 2 of 5. A binary bar code symbology representing character pairs in groups of five bars and five interleaved spaces. Interleaving provides for greater information density. The location of wide elements (bar/spaces) within each group determines which characters are encoded. This continuous code type uses no intercharacter spaces. Only numeric (0 to 9) and START/STOP characters may be encoded.

Internet Protocol Address. See **IP**.

I/O Ports. The connection between two devices, defined by common physical characteristics, signal characteristics, and signal meanings. Types of interfaces include RS-232 and USB.

IP. Internet Protocol. The IP part of the TCP/IP communications protocol. IP implements the network layer (layer 3) of the protocol, which contains a network address and is used to route a message to a different network or subnetwork. IP accepts "packets" from the layer 4 transport protocol (TCP or UDP), adds its own header to it and delivers a "datagram" to the layer 2 data link protocol. It may also break the packet into fragments to support the maximum transmission unit (MTU) of the network.

IP Address. (Internet Protocol address) The address of a computer attached to an IP network. Every client and server station must have a unique IP address. A 32-bit address used by a computer on a IP network. Client workstations have either a permanent address or one that is dynamically assigned to them each session. IP addresses are written as four sets of numbers separated by periods; for example, 204.171.64.2.

IPX/SPX. Internet Package Exchange/Sequential Packet Exchange. A communications protocol for Novell. IPX is Novell's Layer 3 protocol, similar to XNS and IP, and used in NetWare networks. SPX is Novell's version of the Xerox SPP protocol.

ISM. Industry Scientific and Medical

K

Key. A key is the specific code used by the algorithm to encrypt or decrypt the data. Also see, **Encryption** and **Decrypting**.

L

LASER. Light Amplification by Stimulated Emission of Radiation. The laser is an intense light source. Light from a laser is all the same frequency, unlike the output of an incandescent bulb. Laser light is typically coherent and has a high energy density.

laser scanner. A type of bar code reader that uses a beam of laser light.

LCD. See **Liquid Crystal Display**.

LED Indicator. A semiconductor diode (LED - Light Emitting Diode) used as an indicator, often in digital displays. The semiconductor uses applied voltage to produce light of a certain frequency determined by the semiconductor's particular chemical composition.

Light Emitting Diode. See **LED**.

Liquid Crystal Display (LCD). A display that uses liquid crystal sealed between two glass plates. The crystals are excited by precise electrical charges, causing them to reflect light outside according to their bias. They use little electricity and react relatively quickly. They require external light to reflect their information to the user.

M

MC. Mobile Computer.

MDN. Mobile Directory Number. The directory listing telephone number that is dialed (generally using POTS) to reach a mobile unit. The MDN is usually associated with a MIN in a cellular telephone -- in the US and Canada, the MDN and MIN are the same value for voice cellular users. International roaming considerations often result in the MDN being different from the MIN.

MIN. Mobile Identification Number. The unique account number associated with a cellular device. It is broadcast by the cellular device when accessing the cellular system.

Mobile Computer. In this text, *mobile computer* refers to the MC55. It can be set up to run as a stand-alone device, or it can be set up to communicate with a network, using wireless radio technology.

N

Nominal. The exact (or ideal) intended value for a specified parameter. Tolerances are specified as positive and negative deviations from this value.

NVM. Non-Volatile Memory.

O

Open System Authentication. Open System authentication is a null authentication algorithm.

P

PAN . Personal Area Network. Using Bluetooth wireless technology, PANs enable devices to communicate wirelessly. Generally, a wireless PAN consists of a dynamic group of less than 255 devices that communicate within about a 33-foot range. Only devices within this limited area typically participate in the network.

PING. (Packet Internet Groper) An Internet utility used to determine whether a particular IP address is online. It is used to test and debug a network by sending out a packet and waiting for a response.

Q

QWERTY. A standard keyboard commonly used on European keyboards. "QWERTY" refers to the arrangement of keys on the top row of keys.

QWERTZ. A standard keyboard commonly used on German keyboards. "QWERTZ" refers to the arrangement of keys on the top row of keys.

R

RAM. Random Access Memory. Data in RAM can be accessed in random order, and quickly written and read.

RF. Radio Frequency.

ROM. Read-Only Memory. Data stored in ROM cannot be changed or removed.

Router. A device that connects networks and supports the required protocols for packet filtering. Routers are typically used to extend the range of cabling and to organize the topology of a network into subnets. See **Subnet**.

S

Scanner. An electronic device used to scan bar code symbols and produce a digitized pattern that corresponds to the bars and spaces of the symbol. Its three main components are: 1) Light source (laser or photoelectric cell) - illuminates a bar code.; 2) Photodetector - registers the difference in reflected light (more light reflected from spaces); 3) Signal conditioning circuit - transforms optical detector output into a digitized bar pattern.

SDK. Software Development Kit

Shared Key. Shared Key authentication is an algorithm where both the AP and the MU share an authentication key.

SID. System Identification code. An identifier issued by the FCC for each market. It is also broadcast by the cellular carriers to allow cellular devices to distinguish between the home and roaming service.

Soft Reset. See **Warm Boot**.

Space. The lighter element of a bar code formed by the background between bars.

Specular Reflection. The mirror-like direct reflection of light from a surface, which can cause difficulty decoding a bar code.

Start/Stop Character. A pattern of bars and spaces that provides the scanner with start and stop reading instructions and scanning direction. The start and stop characters are normally to the left and right margins of a horizontal code.

Subnet. A subset of nodes on a network that are serviced by the same router. See **Router**.

Subnet Mask. A 32-bit number used to separate the network and host sections of an IP address. A custom subnet mask subdivides an IP network into smaller subsections. The mask is a binary pattern that is matched up with the IP address to turn part of the host ID address field into a field for subnets. Default is often 255.255.255.0.

Substrate. A foundation material on which a substance or image is placed.

Symbol. A scannable unit that encodes data within the conventions of a certain symbology, usually including start/stop characters, quiet zones, data characters and check characters.

Symbol Aspect Ratio. The ratio of symbol height to symbol width.

Symbol Height. The distance between the outside edges of the quiet zones of the first row and the last row.

Symbol Length. Length of symbol measured from the beginning of the quiet zone (margin) adjacent to the start character to the end of the quiet zone (margin) adjacent to a stop character.

Symbology. The structural rules and conventions for representing data within a particular bar code type (e.g. UPC/EAN, Code 39, PDF417, etc.).

T

TCP/IP. (Transmission Control Protocol/Internet Protocol) A communications protocol used to interconnect dissimilar systems. This standard is the protocol of the Internet and has become the global standard for communications. TCP provides transport functions, which ensures that the total amount of bytes sent is received correctly at the other end. UDP is an alternate transport that does not guarantee delivery. It is widely used for real-time voice and video transmissions where erroneous packets are not retransmitted. IP provides the routing mechanism. TCP/IP is a routable protocol, which means that all messages contain not only the address of the destination station, but the address of a destination network. This allows TCP/IP messages to be sent to multiple networks within an organization or around the world, hence its use in the worldwide Internet. Every client and server in a TCP/IP network requires an IP address, which is either permanently assigned or dynamically assigned at startup.

Telnet. A terminal emulation protocol commonly used on the Internet and TCP/IP-based networks. It allows a user at a terminal or computer to log onto a remote device and run a program.

Terminal. See **Mobile Computer**.

Terminal Emulation. A "terminal emulation" emulates a character-based mainframe session on a remote non-mainframe terminal, including all display features, commands and function keys. The VC5000 Series supports Terminal Emulations in 3270, 5250 and VT220.

TFTP. (Trivial File Transfer Protocol) A version of the TCP/IP FTP (File Transfer Protocol) protocol that has no directory or password capability. It is the protocol used for upgrading firmware, downloading software and remote booting of diskless devices.

Tolerance. Allowable deviation from the nominal bar or space width.

Transmission Control Protocol/Internet Protocol. See **TCP/IP**.

Trivial File Transfer Protocol. See **TFTP**.

U

UDP. User Datagram Protocol. A protocol within the IP protocol suite that is used in place of TCP when a reliable delivery is not required. For example, UDP is used for real-time audio and video traffic where lost packets are simply ignored, because there is no time to retransmit. If UDP is used and a reliable delivery is required, packet sequence checking and error notification must be written into the applications.

UPC. Universal Product Code. A relatively complex numeric symbology. Each character consists of two bars and two spaces, each of which is any of four widths. The standard symbology for retail food packages in the United States.

V

Visible Laser Diode (VLD). A solid state device which produces visible laser light.

W

Warm Boot. A warm boot restarts the mobile computer by closing all running programs. All data that is not saved to flash memory is lost.

INDEX

Numerics

- 1-D bar codes 3-1
- 2-D bar codes 3-1

A

accessories

- auto charge cable 5-1
 - cables 5-13
 - charge only cable 5-1
 - communication/charge cables
 - battery charging 5-13
 - LED indicators 5-14
 - EMDK 5-2
 - fabric holster 5-2
 - four-slot charge only cradle 5-1, 5-8
 - four-slot Ethernet cradle 5-9
 - four-slot spare battery charger 5-1, 5-12
 - holster 5-2
 - microSD 1-3, 1-4
 - screen protector 5-2
 - single-slot USB cradle 5-3
 - spare battery 5-2
 - specifications A-6
 - spring loaded stylus 5-2
 - stylus 5-2
 - USB charging cable 5-1
 - USB cradle 5-1
 - vehicle cradle 5-10
 - vehicle holder 5-1
 - wall mounting kit, cradle 5-2
- Acoustic Echo Cancellation C-2
- action button 2-21
- ActiveSync 2-8
- adaptive frequency hopping 4-1
- AFH 4-1

- AirBEAM 2-8
- alpha-numeric keypad B-5
 - key descriptions B-6
- auto charge cable 5-1, 5-13
- AZERTY B-5

B

- bar codes
 - one dimensional 3-1
 - two dimensional 3-1
- battery
 - charging 1-6, 5-3, 5-8, 5-9, 5-10, 5-12
 - check status 1-7
 - installing 1-5
 - removing 1-8
- battery chargers
 - communication/charge cables 5-13
 - LED indicators 5-14
 - four-slot 5-12
- battery charging 1-6
 - communication/charge cables 5-13
 - using four-slot charge only cradle 5-8
 - using four-slot Ethernet cradle 5-9
 - using four-slot spare battery charger 5-12
 - using single-slot USB cradle 5-3
 - using vehicle cradle 5-10
- battery icon 2-5, 2-15
- Bluetooth 4-1
 - adaptive frequency hopping 4-1
 - bonding 4-30
 - deleting bonded device 4-31
 - security 4-2
 - turning off 4-5, 4-14
 - turning on 4-5, 4-14
- bluetooth
 - communicating icon 2-4

- disabled icon 2-4
- discovering devices 4-6, 4-15
- enabled icon 2-4
- turning on and off 4-5, 4-14
- bonding
 - Bluetooth 4-30
- boot
 - cold 2-19, 2-20, 4-4
 - warm 2-19, 2-20, 4-4
- bullets xv
- buttons
 - action 2-21
 - function 2-21
 - power 2-20, 2-21
 - scan 2-21
 - up and down 2-21

C

- cables 5-13
 - auto charge cable 5-1
 - connecting 5-13
- calculator 2-8
- calendar 2-7
- calibrating the screen 1-7
- charge only cable 5-1, 5-13
- charge only cradle 5-1
- charging
 - spare batteries 1-7, 5-4, 5-12
 - using four-slot charge only cradle 5-8
 - using four-slot Ethernet cradle 5-9
 - using four-slot spare battery charger 5-12
 - using single-slot USB cradle 5-3
 - using vehicle cradle 5-10
- charging indicators 2-19, 5-14
 - four-slot charge only cradle 5-8
 - four-slot Ethernet cradle 5-9
 - four-slot spare battery charger 5-12
 - single-slot USB cradle 5-4
 - vehicle cradle 5-11
- charging temperature 1-7, 5-4
- cleaning 6-1
- clock & alarms 2-9
- cold boot 2-19, 2-20, 4-4
- command bar
 - icons 2-4, 2-6
- communication 5-13
- communication/charge cables 5-13
 - battery charging 5-13
 - LED indicators 5-14
- configuration xii
- Contacts 2-7
- contacts 2-7
- conventions

- notational xiv
- cradles
 - four-slot charge only 5-1, 5-8
 - four-slot charge only cradle 5-8
 - four-slot Ethernet 5-9
 - four-slot spare battery charger 5-12
 - single-slot USB 5-3
 - vehicle 5-10

D

- data capture xii
- digital camera 3-1
- dot aiming 3-4
- imager operational modes
 - decode mode 3-2
 - image capture mode 3-2
 - pick list mode 3-2
- imaging 3-1
- linear scanning 3-1
- one dimensional bar codes 3-1
- scan angle 3-2
- scan button 2-21
- scan range 3-2
- scanning 3-3, 3-5
 - two dimensional bar codes 3-1
- deleting Bluetooth bond 4-31
- display xii

E

- enterprise mobility developer kit 5-2
- ESD 1-3, 1-4
- Ethernet cradle 5-9

F

- fabric holster 5-2
- file explorer 2-8
- four-slot charge only cradle 5-8
 - charging 5-8
 - charging indicators 5-8
- four-slot Ethernet cradle 5-9
 - charging 5-9
 - charging indicators 5-9
- four-slot spare battery charger 5-1, 5-12
 - charging 5-12
 - charging indicators 5-12
 - setup 5-12
- function buttons 2-21

H

- handset C-2

hard reset 2-19, 2-20, 4-4
holster 5-2

I

icons
battery 2-5, 2-15
bluetooth communicating 2-4
bluetooth disabled 2-4
bluetooth enabled 2-4
status 2-5
task tray 2-4, 2-6
wireless applications 2-4
wireless status 2-4

imager. See data capture, imaging
imager. See data capture, imaging, imagersample
imaging 3-1, 3-2
information, service xv
installing battery 1-5
Internet Explorer Mobile 2-7
internet sharing 2-8

K

key descriptions
alpha-numeric keypad B-6
numeric keypad B-2, B-14

keypads xii
input modes B-4, B-8, B-9, B-11
key descriptions B-2, B-6, B-14
numeric B-1, B-13
QWERTY B-5
special character key B-15
types B-1

L

LEDs 2-19
battery status 2-19
charging 2-19, 5-4, 5-8, 5-9, 5-11, 5-12, 5-14
scan and decode 2-19, 3-3, 3-4, 3-5

lithium-ion battery 1-2

M

main battery
charging 1-3, 1-6
installing 1-3

maintenance 6-1

Media Player 2-7

memory xii

messaging 2-7

microSD card 1-3, 1-4

MSP Agent 2-9

N

navigation bar
icons 2-5

notational conventions xiv

notes 2-7

numeric keypad B-1, B-13
input modes B-4
key descriptions B-2, B-14

O

operating environment A-1
operating system xii

P

passwords 2-14

pictures 2-7

power button 2-20, 2-21

Q

QWERTY keypad
input modes B-8, B-9, B-11

QWERTZ keypad B-5

R

radios xii

rapid deployment 2-9

removing main battery 1-8

reset 2-19
hard 2-19, 2-20, 4-4
soft 2-19, 2-20, 4-4

resume 4-4

rigid holster 5-2

S

scan button 2-21

scanning
button 2-21
imaging 3-1

screen
calibration 1-7

screen protector 5-2

SDK
See EMDK 5-2

security
Bluetooth 4-2

service information xv

settings
about 2-10

buttons	2-10
certificates	2-10
connections	2-10
customer feedback	2-10
encryption	2-10
error reporting	2-10
keylight	2-10
lock	2-9
memory	2-11
owner information	2-10
power	2-11
regional settings	2-11
remove programs	2-11
screen	2-11
sounds & notifications	2-9
system info	2-11
USB to PC	2-10
Wi-Fi	2-10
wireless manager	2-10
single-slot USB cradle	5-3
charging	5-3
charging indicators	5-4
soft reset	2-19, 2-20, 4-4
spare battery	
2400 mAh	5-2
3600 mAh	5-2
charging	1-7, 5-4, 5-12
spare battery charger	
charging	5-12
charging indicators	5-12
setup	5-12
special character key	B-15
spring loaded stylus	5-2
starting the EDA	1-3, 1-7
status icon	2-5
battery	2-5, 2-15
strap	1-2
stylus	1-2, 2-21, 5-2
suspend	1-8, 2-21, 4-4
synchronize with PC	
using Bluetooth	4-11

T

task tray icons	2-4
tasks	2-8
technical specifications	A-1
accessories	A-6
temperature	A-2
charging	1-7, 5-4
troubleshooting	6-6

U

unpacking	1-2
up and down button	2-21
USB charge cable	5-13
USB charging cable	5-1
USB client charge cable	5-13
USB cradle	5-1
using stylus	2-21

V

vehicle cradle	5-10
charging indicators	5-11
vehicle holder	5-1
videos	2-7
Voice Quality Manager	C-1
VQM	C-1
disabling	C-4
enabling	C-1

W

wakeup conditions	2-20
waking EDA	2-20
wall mounting kit, cradle	5-2
warm boot	2-19, 2-20, 4-4
Windows Live	2-7
Windows Live Messenger	2-7
wireless manager	2-10
wireless status	2-4
WLAN 802.11a/b/g/n	xii
WPAN Bluetooth	xii



Zebra Technologies Corporation
Lincolnshire, IL U.S.A
<http://www.zebra.com>

Zebra and the stylized Zebra head are trademarks of ZIH Corp., registered in many jurisdictions worldwide. All other trademarks are the property of their respective owners.
©2015 ZIH Corp and/or its affiliates. All rights reserved.

