

TRUCK STORAGE EQUIPMENT

weather guard[®]

UNMATCHED SECURITY & DURABILITY



WHAT DO THE MOST ADMIRABLE TRADESMEN AND CONTRACTORS HAVE IN COMMON?

WEATHER GUARD® TRUCK EQUIPMENT

You know the ones. Just like you, they understand that being at the top goes beyond skill and talent. It's about projecting competence every step of the way. It starts with buying the best possible truck. From there, it's all about dressing it up with the stylish, organized security of WEATHER GUARD® Truck Boxes, Ladder Racks, Cab Protectors and In-Bed Storage Solutions. WEATHER GUARD® Truck Equipment. *SECURING YOUR REPUTATION®* every day.



WEATHER GUARD® EXCLUSIVES

Who's working hard? You, of course. But so are we. That's why we're able to offer these exclusive features that make WEATHER GUARD® truck boxes easier to use, more secure and even better looking. The best choice in work truck storage? We've made it an open-and-shut case.

- **EXTREME PROTECTION® Lock** tamper-resistant retracting lock helps protect against break-ins
- **90° cover opening** for easy access
- **Crimp-free/drill-free install** mounting brackets
- **12v pass-through** provides easy, weatherproof power cord access
- **Heavy-duty gas springs** assist for smooth opening
- **Automotive-style rotary latch** features smooth "one-touch" opening
- **Latch linkage protection** helps eliminate damage from shifting loads
- **Powder coat finish** years of dependability
- **Full weather seal** protects against the elements
- **Limited Lifetime Warranty** for peace of mind

ALUMINUM Looks great and withstands weather with a durable CLEAR or BLACK ARMOR TUF® POWDER COAT FINISH

STEEL Resists dents and rust with BLACK or WHITE ARMOR TUF® POWDER COAT FINISH



TABLE OF CONTENTS

WEATHER GUARD® EXCLUSIVES	3
PROFESSIONAL TRUCK BOXES	4
Saddle Boxes	6
Cross Boxes	8
Pork Chop Boxes	9
All-Purpose Chests	10
Lo-Side Boxes	12
Hi-Side Boxes	14
Super-Side Boxes	16
Truck Box Accessories	17
E-LINE® SADDLE BOXES	18
Gear Up™ Truck Fit Guide	20
UNDERBED BOXES	22
Steel Underbed Boxes	24
Aluminum Underbed Boxes	26
IN-BED STORAGE SOLUTIONS	28
PACK RAT® Drawer Units	30
PACK RAT® Drawer Units/ BED RAT® Sliding Platform	31
Transfer Tanks/Accessories	32
BED-MOUNTED SOLUTIONS	34
ATR® - Aluminum Truck Rack	36
Service Body Ladder Racks	38
Steel Ladder Rack	39
WEEKENDER® Ladder Rack	40
FAST RACK® System	41
PROTECT-A-RAIL® Cab Protectors/ Mounting Accessories	42
CONFIGURATIONS GUIDE	44
REPLACEMENT PARTS	47



INDUSTRY LEADING TRUCK BOXES

Rolling up with WEATHER GUARD® Professional Truck Boxes in your vehicle commands instant respect. You're a serious professional and you want the world to know it. Fortunately, we offer many ways for you to express your credibility. Your choices will depend on how you work and how much free space you need in your truck bed. WEATHER GUARD® Professional Truck Boxes cover all the bases, from the classic, rugged Saddle Box to the Cross Box, Pork Chop Box and space-saving Lo-Side and Hi-Side Boxes, WEATHER GUARD® Professional Truck Equipment means business.



Saddle Boxes



PAGE 6

Cross Boxes

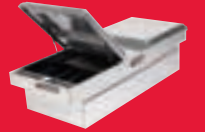

PAGE 8

Pork Chop Boxes



PAGE 9

All Purpose Chests



PAGE 10

Lo-Side Boxes



PAGE 12

Hi-Side Boxes



PAGE 14

Truck Box Accessories



PAGE 17

E-LINE® Saddle Boxes



PAGE 18

WEATHER GUARD® TRUCK EQUIPMENT. SECURING YOUR REPUTATION®

SADDLE BOXES



WEATHER GUARD® IS THE PRO STANDARD OF SADDLE BOXES

Like you, WEATHER GUARD® Saddle Boxes keep getting better and better. Now with more options and features than ever. Like industry-leading security with our exclusive tamper-resistant EXTREME PROTECTION® Lock. WEATHER GUARD® Saddle Boxes are the most popular truck storage option due to ease of installation, maximum bed clearance, and of course legendary durability. Constructed of either steel or aluminum diamond plate and finished with an ARMOR TUF® Powder Coat in clear, white or black that lasts for years and looks great.

NEW!

FULL-SIZE STANDARD 11.3 CUBIC FEET



ALUMINUM

- 127-0-02
- 127-5-02
- Ship Weight: 86 Lbs.

STEEL

- 126-3-02
- 126-5-02
- Ship Weight: 133 Lbs.

FULL-SIZE EXTRA WIDE 15.3 CUBIC FEET



ALUMINUM

- 117-0-02
- 117-5-02
- Ship Weight: 105 Lbs.

STEEL

- 116-3-02
- 116-5-02
- Ship Weight: 160 Lbs.

SADDLE BOX KEY FEATURES

- 1 **EXTREME PROTECTION® Lock** tamper-resistant retracting lock helps protect against break-ins
- 2 **90° Cover opening** for easy access
- 3 **Automotive-style rotary latch** features smooth “one-touch” opening
- 4 **Level storage** secures 48” level
- 5 **Full weather seal** protects against the elements
- 6 **Powder coat finish** years of dependability
- 7 **Limited Lifetime Warranty** for peace of mind

FLAGSHIP SADDLE BOX ENHANCED FEATURES

Along with the standard features, we have enhanced our flagship saddle box models with several NEW features.

- 8 **NEW Convenient attachment points** secures materials and tools in pickup bed
- 9 **NEW “Easy-Find” organization** removable parts bin, metal tray

Aluminum Diamond plate with Clear ARMOR TUF® Powder Coat



Aluminum Diamond plate with Black ARMOR TUF® Powder Coat



Steel with Brite White ARMOR TUF® Powder Coat



Steel with Black ARMOR TUF® Powder Coat



COMPACT STANDARD 6.4 CUBIC FEET

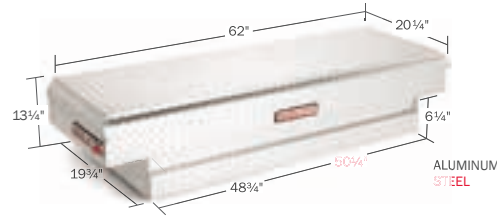

ALUMINUM

- 154-0-01
- 154-5-01

Ship Weight: 68 Lbs.

STEEL

- 156-3-01

Ship Weight: 100 Lbs.

NOTE: This product has different dimensions for ALUMINUM and STEEL.

COMPACT LOW-PROFILE 8.7 CUBIC FEET



ALUMINUM

- 131-0-01
- 131-5-01

Ship Weight: 76 Lbs.

COMPACT DEEP 8.9 CUBIC FEET



ALUMINUM

- 137-0-01
- 137-5-01

Ship Weight: 79 Lbs.

STEEL

- 136-3-01

Ship Weight: 115 Lbs.

FULL-SIZE LOW-PROFILE 8.8 CUBIC FEET

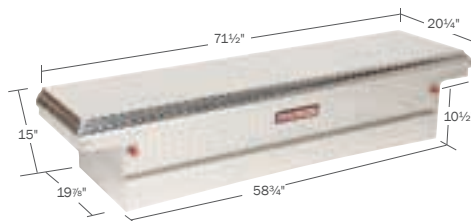

ALUMINUM

- 121-0-01
- 121-5-01

Ship Weight: 80 Lbs.

STEEL

- 120-3-01
- 120-5-01

Ship Weight: 122 Lbs.

FULL-SIZE EXTRA DEEP 15.1 CUBIC FEET



ALUMINUM

- 123-0-01
- 123-5-01

Ship Weight: 94 Lbs.

STEEL

- 128-3-01

Ship Weight: 148 Lbs.

CROSS BOXES



CROSS BOX KEY FEATURES

- 1** **EXTREME PROTECTION® Lock**
tamper-resistant retracting lock helps protect against break-ins
- 2** **Two independent covers**
access from either side of truck
- 3** **Automotive-style rotary latch**
features smooth "one-touch" opening
- 4** **Full weather seal**
protects against the elements
- 5** **Powder coat finish**
years of dependability
- 6** **Limited Lifetime Warranty**
for peace of mind

QUICK ACCESS FROM EITHER SIDE OF THE TRUCK BED

WEATHER GUARD® Cross Boxes allow access from either side of the truck with two independent covers. A productivity-aiding plus is an automotive-style latch that allows you to pop each cover open with one hand. These rugged, versatile boxes are available in steel with a Brite White or Black ARMOR TUF® Powder Coat, or in aluminum diamond plate (Clear or Black) and a full weather seal keeps out the elements. Cross Boxes can be used in combination with Lo-Side or Super-Lo Boxes for even more storage.

FULL-SIZE STANDARD

11.3 CUBIC FEET



ALUMINUM

- 124-0-01
- 124-5-01

Ship Weight: 78 Lbs.

STEEL

- 125-3-01
- 125-5-01

Ship Weight: 122 Lbs.

FULL-SIZE EXTRA WIDE

15.3 CUBIC FEET

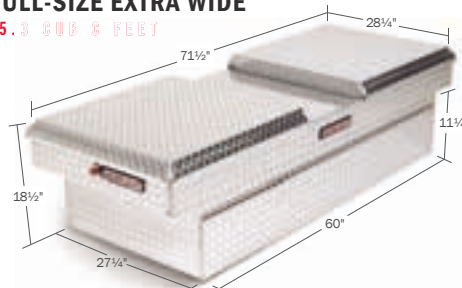

ALUMINUM

- 114-0-01
- 114-5-01

Ship Weight: 92 Lbs.

STEEL

- 115-3-01

Ship Weight: 150 Lbs.

PORK CHOP BOXES

PORK CHOP BOX KEY FEATURES

- 1** **EXTREME PROTECTION® Lock**
tamper-resistant retracting lock helps protect against break-ins
- 2** **90° Cover opening** for easy access
- 3** **Full weather seal**
protects against the elements
- 4** **Powder coat finish**
years of dependability
- 5** **Limited Lifetime Warranty**
for peace of mind



DRIVER/PASSENGER-SIDE STANDARD 2.1 CUBIC FEET

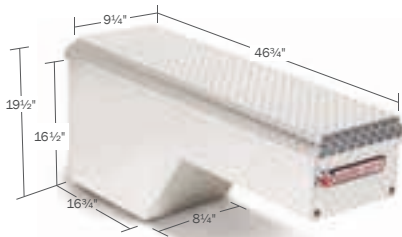

ALUMINUM

- 170-0-01 (driver)
- 171-0-01 (passenger)

- 170-5-01 (driver)
- 171-5-01 (passenger)

Ship Weight: 36 Lbs.

STEEL

- 160-3-01 (driver)
- 161-3-01 (passenger)

Ship Weight: 53 Lbs.

DRIVER/PASSENGER-SIDE WIDE 3.4 CUBIC FEET

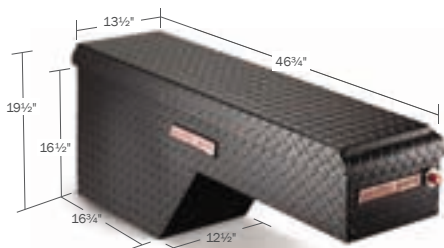

ALUMINUM

- 172-0-01 (driver)
- 173-0-01 (passenger)

- 172-5-01 (driver)
- 173-5-01 (passenger)

Ship Weight: 42 Lbs.

STEEL

- 162-3-01 (driver)
- 163-3-01 (passenger)

Ship Weight: 66 Lbs.

MAKING USE OF SPACE AROUND THE WHEEL WELLS

WEATHER GUARD® has figured out a way to make use of otherwise unutilized truck bed space above and behind the wheel wells with these uniquely shaped boxes. They establish a great location for storing small parts and hand tools to which you often need quick, easy access. They're constructed of either steel—protected with a Brite White ARMOR TUF® Powder Coat finish—or aluminum diamond plate (Clear or Black). Pork Chop Boxes leave plenty of room in the truck bed for hauling around your weekend toys.

ALL PURPOSE CHESTS



A LOW-RIDER WORK HORSE

Maximize your visibility. All-Purpose Chests sit below the bedrail, accommodating tonneau covers and lids. An angled body design allows the chest to fit in fifth-wheel trailer configurations. The cover opens to 90° for maximum access using a unique offset hinge design that still allows installation flush against the truck cab. For durability, they're built of steel and finished with Brite White or Black ARMOR TUF® Powder Coat, or diamond plate aluminum (Clear or Black).

COMPACT

6.0 CUBIC FEET



ALUMINUM

644-0-01

644-5-01

Ship Weight: 37 Lbs.

STEEL

645-3-01

Ship Weight: 67 Lbs.

FULL/COMPACT

10.0 CUBIC FEET

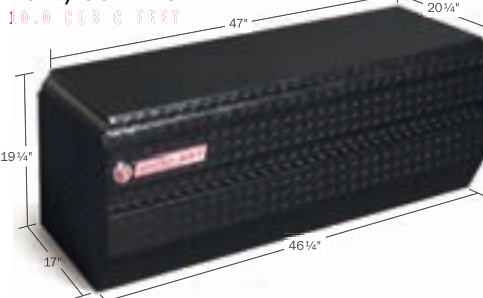

ALUMINUM

674-0-01

674-5-01

Ship Weight: 43 Lbs.

STEEL

675-3-01

Ship Weight: 80 Lbs.

ALL PURPOSE CHESTS KEY FEATURES

- 1 **EXTREME PROTECTION® Lock** tamper-resistant retracting lock helps protect against break-ins
- 2 **90° Cover opening** for easy access
- 3 **Automotive-style rotary latch** features smooth "one-touch" opening
- 4 **Unique offset hinges** allows chest to lie flat against truck
- 5 **Full weather seal** protects against the elements
- 6 **Limited Lifetime Warranty** for peace of mind

FULL/COMPACT 12.0 CUBIC FEET



ALUMINUM

- 654-0-01
 - 654-5-01
- Ship Weight: 52 Lbs.

STEEL

- 655-3-01
- Ship Weight: 94 Lbs.

FULL-SIZE STANDARD 13.1 CUBIC FEET



ALUMINUM

- 664-0-01
 - 664-5-01
- Ship Weight: 57 Lbs.

STEEL

- 665-3-01
 - 665-5-01
- Ship Weight: 112 Lbs.

Aluminum Diamond plate with
Clear ARMOR TUF® Powder Coat



Aluminum Diamond plate with
Black ARMOR TUF® Powder Coat



Steel with Brite White
ARMOR TUF® Powder Coat



Steel with Black
ARMOR TUF® Powder Coat



FULL-SIZE EXTRA WIDE 18.6 CUBIC FEET



ALUMINUM

- 684-0-01
 - 684-5-01
- Ship Weight: 71 Lbs.

STEEL

- 685-3-01
- Ship Weight: 134 Lbs.

LO-SIDE BOXES

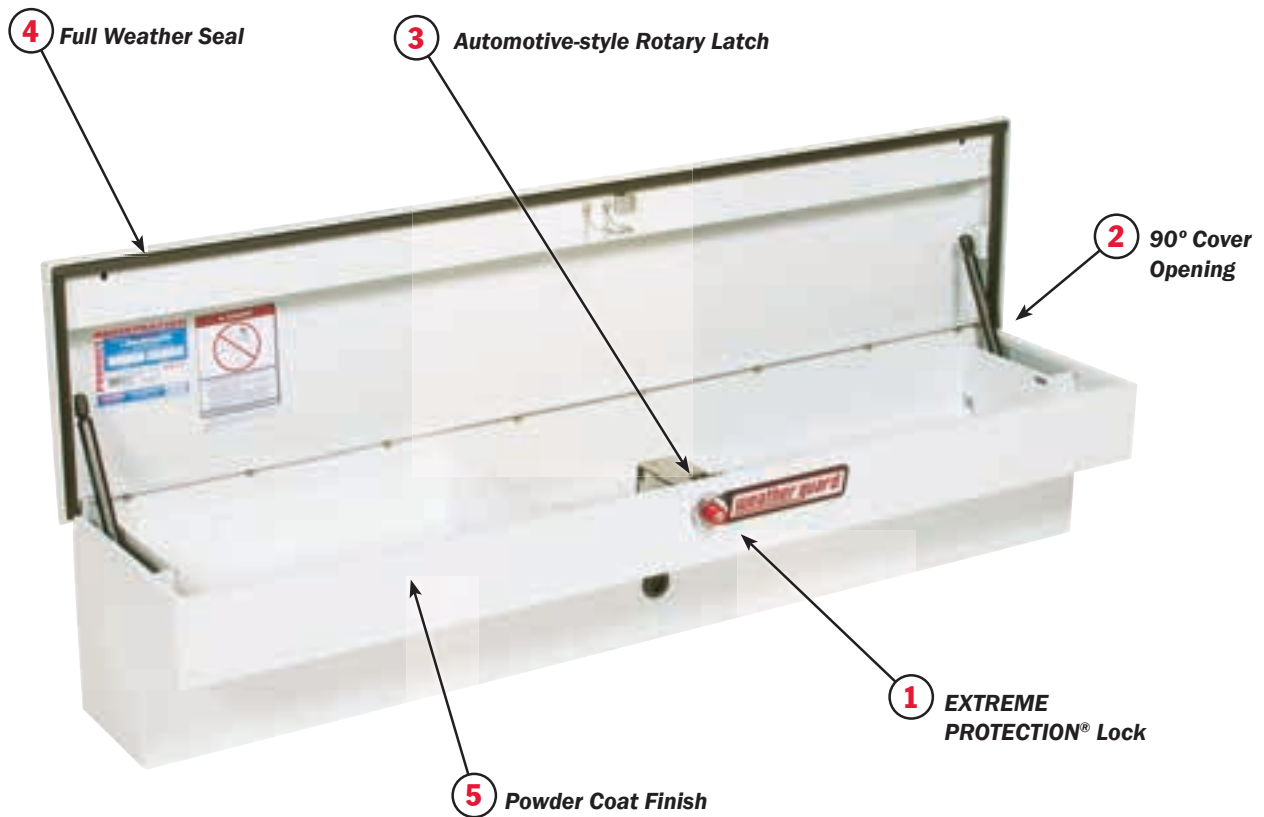

QUICK ACCESS FROM THE BEDRAILS

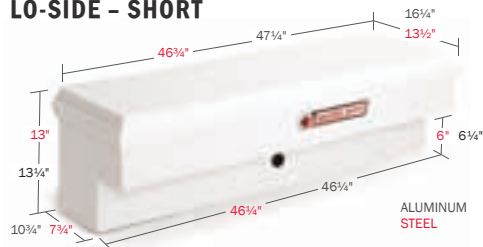

WEATHER GUARD® Lo-Side Boxes mount over the bedrails of your truck and keep critical tools and parts at your fingertips. Their easy installation utilizes mounting brackets that do not require drilling into the rails. The design and location on the truck bed aren't the only attributes that keep you productive—you can get inside with just one hand using an automotive-style latch. The durable Lo-Side is available in steel, and protected by an ARMOR TUF® Powder Coat finish in either Brite White or Black, or diamond plate aluminum (Clear or Black). The Lo-Side from WEATHER GUARD® can also be used separately or in combination with Cross Boxes or Saddle Boxes.

LO-SIDE - SHORT



NOTE: This product has different dimensions for ALUMINUM and STEEL.

ALUMINUM 3.4 CUBIC FEET

-  184-0-01
 -  184-5-01
- Ship Weight: 46 Lbs.

STEEL 3.2 CUBIC FEET

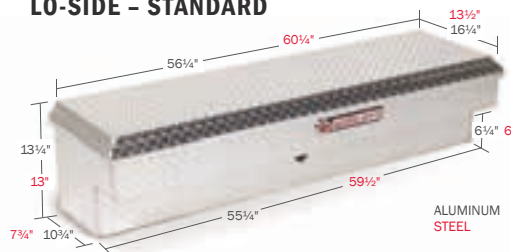

-  185-3-01
- Ship Weight: 63 Lbs.

LO-SIDE - STANDARD



NOTE: This product has different dimensions for ALUMINUM and STEEL.

ALUMINUM 4.1 CUBIC FEET

-  174-0-01
 -  174-5-01
- Ship Weight: 53 Lbs.

STEEL 4.5 CUBIC FEET

-  175-3-01
- Ship Weight: 81 Lbs.

LO-SIDE BOXES KEY FEATURES

- 1** **EXTREME PROTECTION® Lock** tamper-resistant retracting lock helps protect against break-ins
- 2** **90° Cover opening** for easy access
- 3** **Automotive-style rotary latch** features smooth “one-touch” opening
- 4** **Full weather seal** protects against the elements
- 5** **Powder coat finish** years of dependability
- 6** **Limited Lifetime Warranty** for peace of mind

Aluminum Diamond plate with Clear ARMOR TUF® Powder Coat



Aluminum Diamond plate with Black ARMOR TUF® Powder Coat



Steel with Brite White ARMOR TUF® Powder Coat



Steel with Black ARMOR TUF® Powder Coat

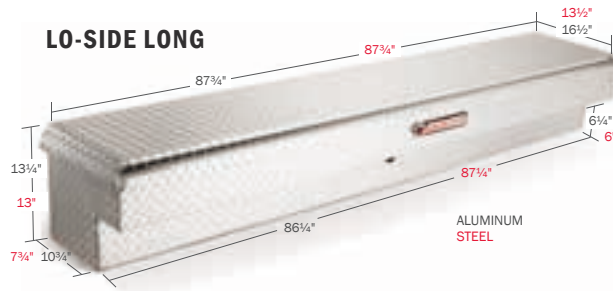

NOTE: This product has different dimensions for ALUMINUM and STEEL.

ALUMINUM 6.4 CUBIC FEET

- 164-0-01
- 164-5-01

Ship Weight: 74 Lbs.

STEEL 6.2 CUBIC FEET

- 165-3-01

Ship Weight: 108 Lbs.

LOW-PROFILE SIDE - SHORT 3.2 CUBIC FEET

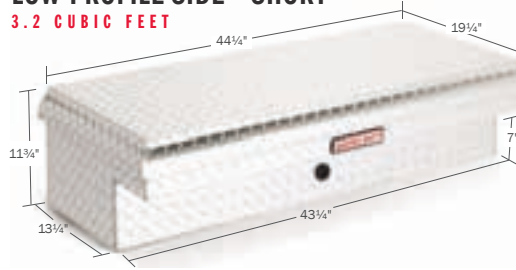

ALUMINUM

- 180-0-01 (driver)
 - 181-0-01 (passenger)
- Ship Weight: 41 Lbs.

ALUMINUM

- 180-5-01 (driver)
 - 181-5-01 (passenger)
- Ship Weight: 41 Lbs.

LOW-PROFILE SIDE - STANDARD 4.3 CUBIC FEET



ALUMINUM

- 178-0-01 (driver)
 - 179-0-01 (passenger)
- Ship Weight: 46 Lbs.

ALUMINUM

- 178-5-01 (driver)
 - 179-5-01 (passenger)
- Ship Weight: 46 Lbs.

SUPER-LO - SHORT 4.5 CUBIC FEET



STEEL

- 186-3-01

Ship Weight: 72 Lbs.

SUPER-LO - STANDARD 6.5 CUBIC FEET



STEEL

- 176-3-01
- 176-5-01

Ship Weight: 94 Lbs.

SUPER-LO - LONG 9.2 CUBIC FEET

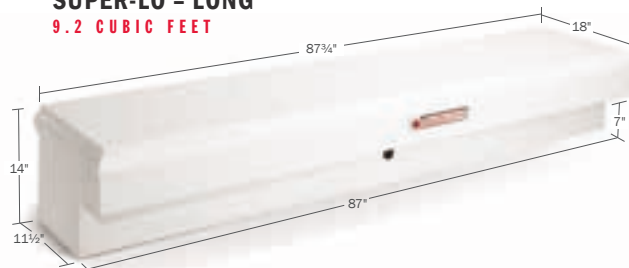

STEEL

- 166-3-01

Ship Weight: 128 Lbs.

HI-SIDE BOXES

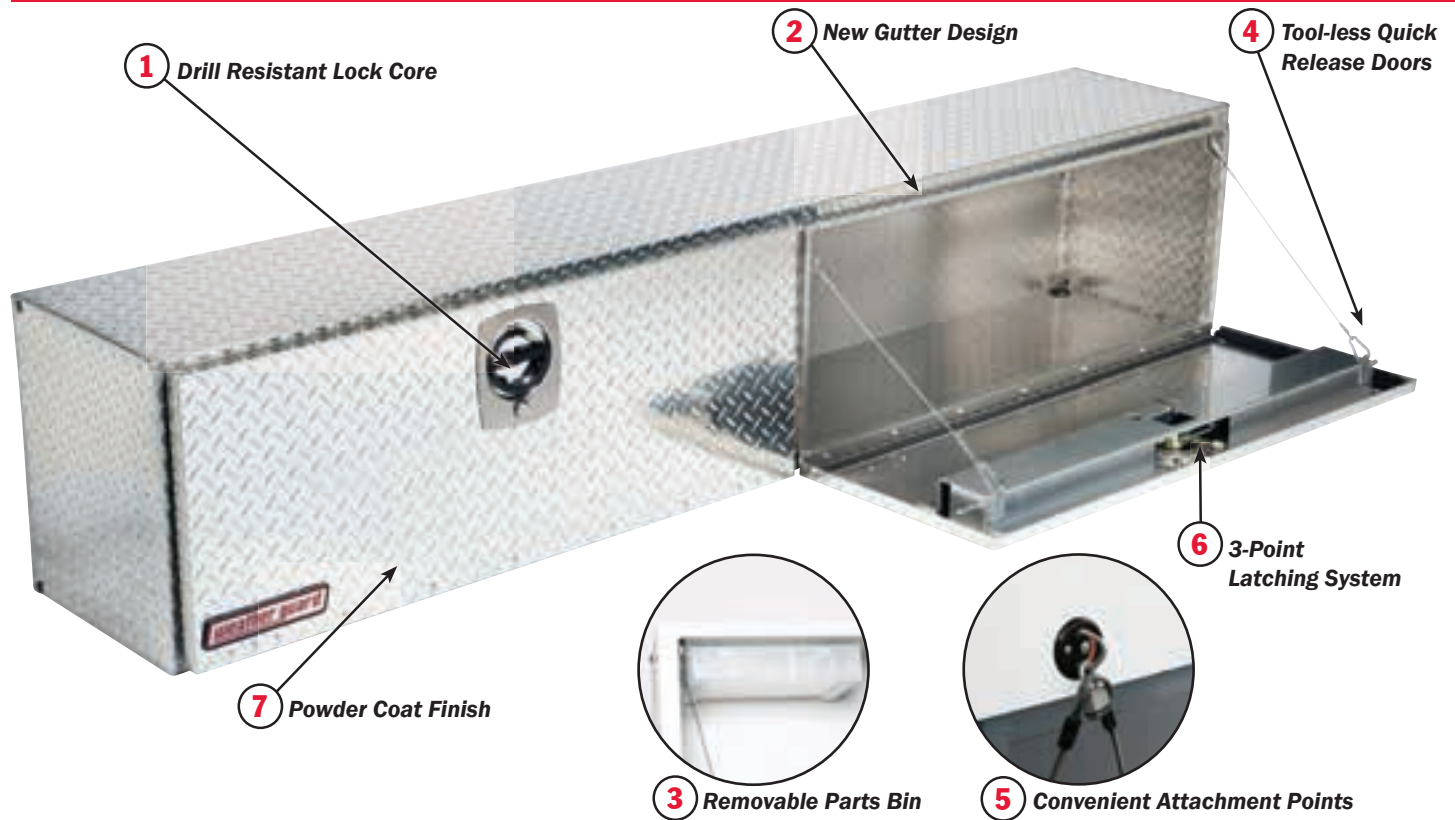

ADDING STORAGE WHILE PRESERVING BED SPACE

Even the best can get better. That's why we keep pushing our engineers to top themselves. And so they have. Now our class-leading WEATHER GUARD® Hi-Side Truck Boxes deliver even greater protection. From the elements. From vandalism. New WEATHER GUARD® Hi-Sides are built to outlast the competition, just like you—hard-working construction pros. Skilled tradespeople. Field service and municipal workers who need quick access to valuable tools, equipment and parts while keeping the truck bed open for supplies. You never stop. Neither do we.

NEW!

HI-SIDE

5.6 CUBIC FEET



ALUMINUM

346-0-02

346-5-02

Ship Weight: 45 Lbs.

STEEL

246-3-02

Ship Weight: 76 Lbs.

Door Opening Measures:
12 3/4" H x 42" W

HI-SIDE

7.9 CUBIC FEET



ALUMINUM

364-0-02

364-5-02

Ship Weight: 60 Lbs.

STEEL

264-3-02

Ship Weight: 101 Lbs.

Door Opening Measures:
12 3/4" H x 29" W

HI-SIDE BOXES KEY FEATURES

- 1 **NEW Drill resistant lock core**
helps protect against break-ins
- 2 **NEW Gutter design**
channels rain and snow off box to keep contents dry
- 3 **NEW Removable parts bin**
keeps small items organized
- 4 **NEW Tool-less quick release doors**
adjust from 90° to 180° with QuickClips, no tools required
- 5 **NEW Convenient attachment point**
secures materials and tools in pickup bed
- 6 **3-Point latching system**
helps protect against theft and weather
- 7 **Powder coat finish**
years of dependability
- 8 **Limited Lifetime Warranty**
for peace of mind

RECOMMENDED ACCESSORIES

Adjustable Shelf Accessory (pg. 17)



Parts Cabinet Accessory (pg. 17)



HI-SIDE
8.9 CUBIC FEET



ALUMINUM

- 372-0-02
- 372-5-02

Ship Weight: 64 Lbs.

Door Opening Measures:
12 3/4"H x 33"W

HI-SIDE
8.9 CUBIC FEET



STEEL

- 272-3-02

Ship Weight: 109 Lbs.

Door Opening Measures:
12 3/4"H x 33"W

HI-SIDE
11.1 CUBIC FEET



ALUMINUM

- 390-0-02
- 390-5-02

Ship Weight: 74 Lbs.

Door Opening Measures:
12 3/4"H x 42"W

HI-SIDE
11.1 CUBIC FEET



STEEL

- 290-3-02

Ship Weight: 129 Lbs.

Door Opening Measures:
12 3/4"H x 42"W

HI-SIDE
11.8 CUBIC FEET



ALUMINUM

- 396-0-02
- 396-5-02

Ship Weight: 79 Lbs.

Door Opening Measures:
12 3/4"H x 45"W

HI-SIDE
11.8 CUBIC FEET



STEEL

- 296-3-02

Ship Weight: 136 Lbs.

Door Opening Measures:
12 3/4"H x 45"W

SUPER-SIDE BOXES

SUPER-SIZE YOUR STORAGE

Super-Side versions of the WEATHER GUARD® Hi-Side are available—whether you choose the steel or diamond plate aluminum version—with all of the same features that the Hi-Sides offer. A Super-Side version of the steel Hi-Side is available, providing an extra 2 inches of height and 3 inches of depth. A Jumbo Super-Side version of the steel Hi-Side is also available, with 6 more inches of width and 6 more inches of height for a whopping 21.4 cubic feet capacity. An extra-large Super-Side version of the aluminum Hi-Side is available, too, with an extra 2 inches of height and 3 inches of depth.

SUPER-SIDE 7.7 CUBIC FEET



ALUMINUM

-  347-0-02
-  347-5-02

Ship Weight: 50 Lbs.

STEEL

-  247-3-02

Ship Weight: 86 Lbs.

Door Opening Measures:
14 3/4" H x 42" W

SUPER-SIDE 10.8 CUBIC FEET



ALUMINUM

-  365-0-02
-  365-5-02

Ship Weight: 65 Lbs.

STEEL

-  265-3-02

Ship Weight: 114 Lbs.

Door Opening Measures:
14 3/4" H x 29" W

SUPER-SIDE 15.2 CUBIC FEET



ALUMINUM

-  391-0-02
-  391-5-02

Ship Weight: 83 Lbs.

STEEL

-  291-3-02

Ship Weight: 147 Lbs.

Door Opening Measures:
14 3/4" H x 42" W

JUMBO SUPER-SIDE 21.4 CUBIC FEET



STEEL

-  297-3-02

Ship Weight: 174 Lbs.

Door Opening Measures:
20 3/4" H x 45" W

TRUCK BOX ACCESSORIES

KEEP YOUR TOOLS AND EQUIPMENT ORGANIZED AND EASY TO ACCESS

ACCESSORY TOOL BOX

610 - Plastic Tool Box
Ship Weight: 3 Lbs.

New WEATHER GUARD® Plastic Tool Box fits into E-LINE® Saddle Boxes

FITS: 143-X-01



ACCESSORY PARTS BIN FOR SADDLE BOXES

618 - Accessory Parts Bin
Ship Weight: 2 Lbs.

New WEATHER GUARD® Parts Bin fits into enhanced (-02) Saddle Boxes.

FITS: 116-X-02, 117-X-02, 126-X-02 and 127-X-02



ACCESSORY TRAY FOR LO-SIDE & SUPER-LO BOXES

911 - Tray
Ship Weight: 9 Lbs.

913-3 - Dividers (3 per package)
Ship Weight: 3 Lbs.



STEEL DIVIDER TRAY

613-3 - 19¼"L x 14"W
Ship Weight: 14 Lbs.

FITS: 124, 124-5, 125-3, 125-5, 126-3, 126-5, 127, 127-5, 134, 134-5, 135-3, 136-3, 137, 137-5, 153, 153-5, 154, 154-5, 155-3, 156-3, 156-5, 654, 654-5, 655-3, 664, 664-5, 665-3, 665-5, 674, 674-5, 675-3



STEEL DIVIDER TRAY

614-3 - 26½"L x 14⅞"W
Ship Weight: 14 Lbs.

FITS: 114, 114-5, 115-3, 116-3, 116-5, 117, 117-5, 157-3, 158-3, 159, 159-5, 684, 684-5, 685-3



STEEL DIVIDER TRAY

615 - 19¼"L x 14"W
Ship Weight: 14 Lbs.

FITS: 121-0-01, 121-5-01, 123-0-01, 123-5-01, 124-0-01, 124-5-01, 125-3-01, 126-3-02, 126-5-02, 127-0-02, 127-5-02, 128-3-01, 128-5-01, 131-0-01, 131-5-01, 136-3-01, 136-5-01, 137-0-01, 137-5-01, 147-0-01, 147-5-01, 154-0-01, 154-5-01, 156-3-01, 156-5-01, 654-0-01, 654-5-01, 655-3-01, 664-0-01, 664-5-01, 665-3-01, 665-5-01, 674-0-01, 674-5-01, 675-3-01



STEEL DIVIDER TRAY

617 - 26½"L x 14"W
Ship Weight: 14 Lbs.

FITS: 114-0-01, 114-5-01, 115-3-01, 116-3-02, 116-5-02, 117-0-02, 117-5-02, 684-0-01, 684-0-01, 685-3-01



STEEL TOTE TRAY

619-3 - 18½"L x 9"W x 3"H
Ship Weight: 8 Lbs.

FITS: 126-3, 126-5, 127, 127-5, 136-3, 154, 154-5, 156-3, 156-5



STEEL TOTE TRAY

620-3 - 25½"L x 9"W x 3"H
Ship Weight: 14 Lbs.

FITS: 116-3, 116-5, 117, 117-5, 158-3



TRAYS

200-3 - 41½"L x 9½"W
Ship Weight: 17 Lbs.

202-3 - 24"L x 9½"W
Ship Weight: 12 Lbs.

16-gauge steel with adjustable dividers; bolts to back wall of cabinet.



Shown in Hi-Side Box

PARTS CABINET

201-3 - 32½"L x 11¾"H
Ship Weight: 28 Lbs.

All steel cabinets feature removable partitions; bolts through bottom of box. Not intended for use with 264-3 and 272-3.



Shown in Hi-Side Box

WATCHMAN® IV SINGLE-PADLOCK LOCK SYSTEM

9036-3
Ship Weight: 93 Lbs.

FOR INSIDE USE ONLY!
Use in conjunction with a pickup cap or other type of enclosure and bolt it to the truck bed.



E-LINE[®] SADDLE BOX

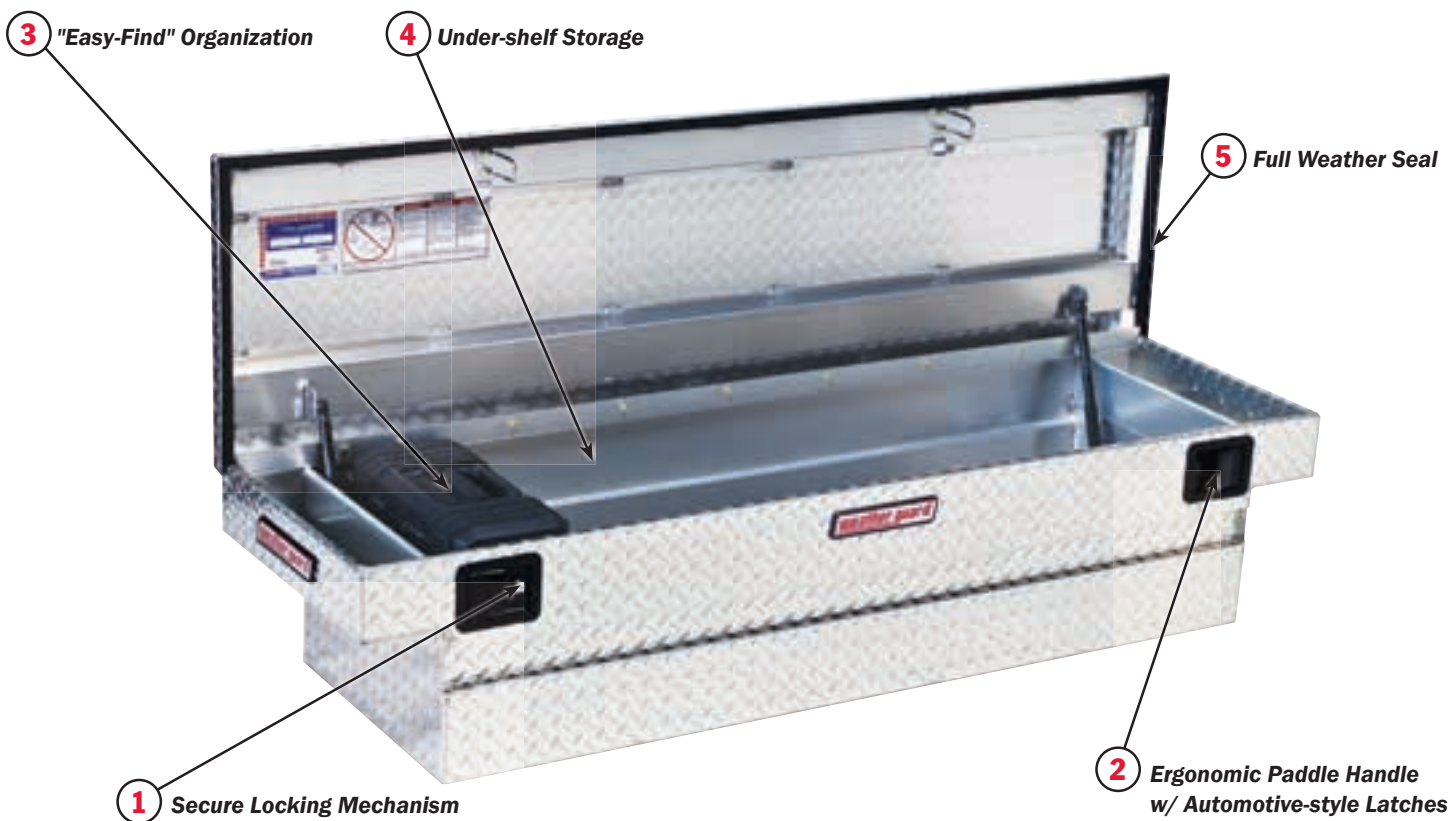

INDUSTRY-LEADING FEATURES FOR SMALL CONTRACTORS AND REMODELERS

Now contractors of any size can step up to the quality and image of WEATHER GUARD[®] with the new E-LINE[®] Saddle Box. Extraordinary value from the experts in truck storage, E-LINE[®] features a secure locking system, ergonomic paddle handle, a convenient toolbox with removable tray. Durability is assured with heavy-duty aluminum diamond plate construction, and Clear or Black ARMOR TUF[®] Powder Coat finish. Rest assured that E-LINE[®] is backed by a Limited 10-Year Warranty!

E-LINE SADDLE BOX
10.4 CUBIC FEET



ALUMINUM

143-0-01

143-5-01

Ship Weight: 75 Lbs.

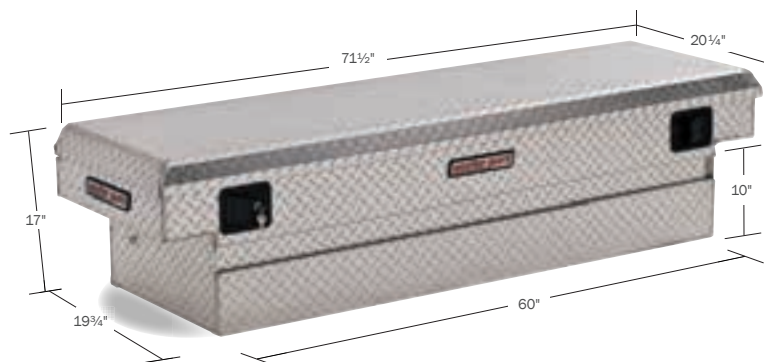

E-LINE® SADDLE BOX KEY FEATURES

- 1 Secure locking mechanism**
helps protect against break-ins
- 2 Ergonomic paddle handle with automotive style latches**
allows for smooth "one-touch" opening
- 3 "Easy-Find" organization**
includes removable toolbox, lift-out tray
- 4 Under-shelf storage**
maximizes box organization
- 5 Full weather seal**
protects against the elements
- 6 Limited 10-Year Warranty**
quality assured

Aluminum Diamond plate with
Clear ARMOR TUF® Powder Coat



Aluminum Diamond plate with
Black ARMOR TUF® Powder Coat



Secure Paddle Handle



90° Cover Opening



"Easy Find" Organization



E-LINE® Saddle Box
in black (143-5-01)

GEAR UP™ TRUCK FIT GUIDE

Aluminum Boxes available in Clear or Black ARMOR TUF® Powder Coat.

Steel Boxes available in Brite White ARMOR TUF® Powder Coat (select models also available in Black).

Coating Choice Options: **X=0**(Clear) or **X=3**(Brite White) or **X=5**(Black)

			ALUMINUM		STEEL		5' FLEETSIDE		6' FLEETSIDE		5½' FLEETSIDE		6' FLEETSIDE		8' FLEETSIDE		5' BED		6½' BED		6' BED		8' BED		6' STYLESIDE		7' STYLESIDE		
			CHEVROLET COLORADO	CHEVROLET SILVERADO	DODGE DAKOTA	DODGE RAM	FORD RANGER																						
FULL-SIZE EXTRA WIDE		116-X-02																											
		117-X-02																											
FULL-SIZE EXTRA DEEP		128-X-01																											
		123-X-01																											
FULL-SIZE STANDARD		126-X-02																											
		127-X-02																											
FULL-SIZE LOW-PROFILE		120-X-01																											
		121-X-01																											
E-LINE® SERIES		143-X-01																											
COMPACT - DEEP		136-3-01																											
		137-X-01																											
COMPACT - STANDARD		156-X-01																											
		154-X-01																											
COMPACT - LOW-PROFILE		130-X-01																											
		131-X-01																											

FULL-SIZE EXTRA WIDE		115-3-01																											
		114-X-01																											
FULL-SIZE STANDARD		125-X-01																											
		124-X-01																											

COMPACT		645-X-01																											
		644-X-01																											
FULL/COMPACT		655-3-01																											
		654-X-01																											
FULL-SIZE STANDARD		665-X-01																											
		664-X-01																											
FULL/COMPACT		675-3-01																											
		674-X-01																											
FULL-SIZE EXTRA WIDE		685-3-01																											
		684-X-01																											

NOTE: THIS GUIDE APPLIES TO 2005 AND NEWER MODEL YEAR VEHICLES.
 YOU SHOULD MEASURE YOUR VEHICLE TO MAKE SURE
 YOUR WEATHER GUARD® TRUCK BOX WILL FIT.

FORD F150				FORD F250		GMC CANYON		GMC SIERRA			TOYOTA TACOMA		TOYOTA TUNDRA		NISSAN FRONTIER		NISSAN TITAN	
5½' STYLE	6' STYLE	6½' FLARE	8' STYLE	6½' STYLE	8' STYLE	5' FLEET	6' FLEET	5½' FLEET	6' FLEET	8' FLEET	5' BED	6' BED	6' BED	8' BED	4½' BED	6' BED	5½' BED	6½' BED
•	•		•	•	•				•	•				•			•	•
•	•		•	•	•				•	•				•			•	•
			•		•				•	•				•				•
			•		•				•	•				•				•
•	•		•	•	•				•	•			•	•			•	•
•	•		•	•	•				•	•			•	•			•	•
	•		•	•	•			•	•	•			•	•			•	•
	•		•	•	•			•	•	•			•	•			•	•
•	•		•	•	•				•	•			•	•			•	•
						•	•				•	•			•	•		
						•	•				•	•			•	•		
						•	•				•	•			•	•		
						•	•				•	•			•	•		
						•	•				•	•			•	•		
						•	•				•	•			•	•		
•	•	•	•	•	•	•	•	•	•	•			•	•	•	•	•	•
•	•	•	•	•	•	•	•	•	•	•			•	•	•	•	•	•
			•	•	•				•	•				•				•
			•	•	•				•	•				•				•
			•	•	•				•	•				•				•
•	•	•	•	•	•			•	•	•			•	•			•	•
•	•	•	•	•	•			•	•	•			•	•			•	•
			•	•	•				•	•				•				•
			•	•	•				•	•				•				•



UNDERBED BOXES

WEATHER GUARD® Underbed Boxes are designed to take whatever you and the elements dish out. These rugged storage boxes keep larger heavy items and tools accessible when you need them, and safely out-of-sight when you don't. Designed for heavy-duty trucks and semis, WEATHER GUARD® Underbed Boxes are available in a range of sizes from mini to jumbo, steel and aluminum, and backed by a Limited Lifetime Warranty.



Steel Underbed Boxes



PAGE 24

Aluminum Underbed Boxes



PAGE 26

STEEL UNDERBED BOXES



WIDE SELECTION OF SIZES FOR YOUR NEEDS

WEATHER GUARD® Steel Underbed Boxes come in three size groupings: compact, standard and jumbo. A Brite White or Black ARMOR TUF® Powder Coat enhances the durability of these boxes' heavy-gauge steel. Steel Underbed Boxes are supplied with an aluminum door and hinge for superior resistance from rust and corrosion.

COMPACT UNDERBED



2.3 CUBIC FEET

- 525-3-02
- 525-5-02

Ship Weight: 45 Lbs.

Door Opening Measures:
10½"H x 22½"W

NEW!

STEEL UNDERBED BOX KEY FEATURES

- 1 Gutter design & weather stripping**
easy and positive door closure that protects against the elements
- 2 3-point latching system**
for optimum security and weather resistance
- 3 Stainless Steel D Handle**
for easy and positive door closure, and added protection against break-ins
- 4 Tool-less quick release drop down door**
full and easy access, adjusts from 90° to 180°
- 5 Powder coat finish**
years of dependability
- 6 Limited Lifetime Warranty**
for peace of mind

STANDARD UNDERBED



4.5 CUBIC FEET

- 524-3-02
- 524-5-02
(24½"L x 18¼"W x 18½"H)
Ship Weight: 60 Lbs.
Door Opening Measures:
14½"H x 22½"W

5.6 CUBIC FEET

- 530-3-02
- 530-5-02
(30½"L x 18¼"W x 18½"H)
Ship Weight: 70 Lbs.
Door Opening Measures:
14½"H x 28½"W

6.7 CUBIC FEET

- 536-3-02
- 536-5-02 (shown)
Ship Weight: 82 Lbs.
Door Opening Measures:
14½"H x 34¾"W

9.1 CUBIC FEET

- 548-3-02
- 548-5-02
(48½"L x 18¼"W x 18½"H)
Ship Weight: 100 Lbs.
Door Opening Measures:
14½"H x 46¼"W

11.2 CUBIC FEET

- 560-3-02
- 560-5-02
(60½"L x 18¼"W x 18½"H)
Ship Weight: 135 Lbs.
Door Opening Measures:
14½"H x 58¼"W

JUMBO UNDERBED



12.1 CUBIC FEET

- 538-3-02 (shown)
- 538-5-02
(36½"L x 24¼"W x 24½"H)
Ship Weight: 111 Lbs.
Door Opening Measures:
20½"H x 34¼"W

16.2 CUBIC FEET

- 550-3-02
- 550-5-02
(48½"L x 24¼"W x 24½"H)
Ship Weight: 145 Lbs.
Door Opening Measures:
20½"H x 46¼"W

20.2 CUBIC FEET

- 562-5-02
(60½"L x 24¼"W x 24½"H)
Ship Weight: 181 Lbs.
Door Opening Measures:
20½"H x 58¼"W

ALUMINUM UNDERBED BOXES

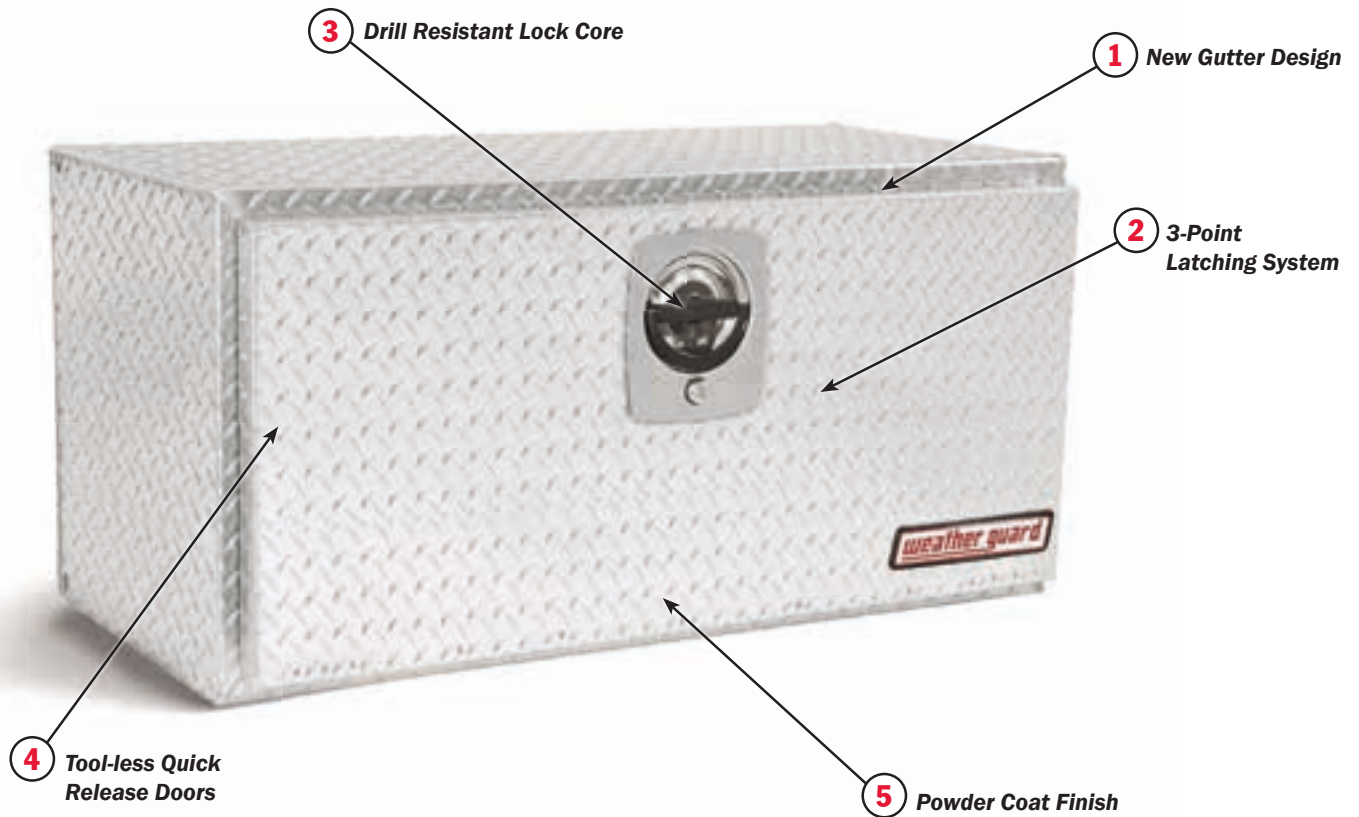

UNITS PROVIDE DURABILITY AT LIGHTER WEIGHT

WEATHER GUARD® Aluminum Underbed Boxes are available in compact, standard and jumbo versions to meet your specific needs. Clear or Black ARMOR TUF® Powder Coat finishes extend the ruggedness of the diamond plate aluminum.



**TOOL-LESS QUICK RELEASE
DROP DOWN DOOR**



WEATHER STRIPPING
protects contents from the weather.



STAINLESS STEEL D HANDLE
With Drill-resistant Lock Core

NEW!

ALUMINUM UNDERBED BOX KEY FEATURES

- 1 Gutter design & weather stripping**
easy and positive door closure that protects against the elements
- 2 3-point latching system**
for optimum security and weather resistance
- 3 Stainless Steel D Handle**
for easy and positive door closure, and added protection against break-ins
- 4 Tool-less quick release drop down door**
full and easy access, adjusts from 90° to 180°
- 5 Powder coat finish**
years of dependability
- 6 Limited Lifetime Warranty**
for peace of mind

COMPACT UNDERBED

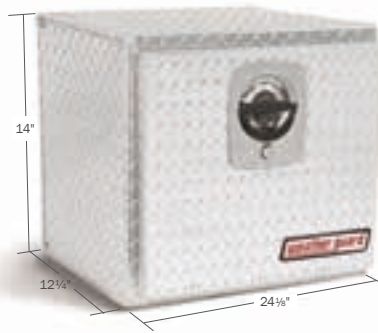

2.4 CUBIC FEET

622-0-02

622-5-02

Ship Weight: 24 Lbs.

Door Opening Measures:
9 1/4"H x 19 1/4"W

STANDARD UNDERBED

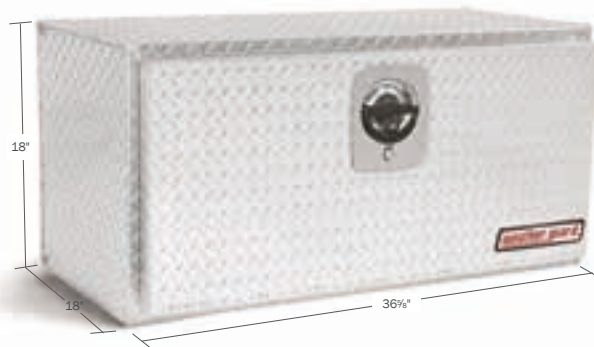

6.5 CUBIC FEET

636-0-02 (shown)

636-5-02
(36 5/8"L x 18"W x 18"H)

Ship Weight: 47 Lbs.

Door Opening Measures:
13 1/2"H x 31 1/4"W

8.6 CUBIC FEET

648-0-02
(48 5/8"L x 18"W x 18"H)

Ship Weight: 62 Lbs.

Door Opening Measures:
13 1/2"H x 43 1/4"W

11.2 CUBIC FEET

660-0-02

660-5-02
(60 5/8"L x 18"W x 18"H)

Ship Weight: 76 Lbs.

Door Opening Measures:
13 1/2"H x 55 1/4"W

4.3 CUBIC FEET

627-0-02
(24 1/8"L x 18 1/4"W x 18"H)

Ship Weight: 35 Lbs.

Door Opening Measures:
13 1/2"H x 19 1/4"W

5.4 CUBIC FEET

631-0-02

631-5-02
(30 1/8"L x 18"W x 18"H)

Ship Weight: 42 Lbs.

Door Opening Measures:
13 1/2"H x 25 1/4"W

JUMBO UNDERBED



16 CUBIC FEET

650-0-02
(48 5/8"L x 24"W x 24"H)

Ship Weight: 81 Lbs.

Door Opening Measures:
19 1/2"H x 43 1/4"W

20 CUBIC FEET

662-0-02 (shown)
(60 5/8"L x 24"W x 24"H)

Ship Weight: 100 Lbs.

Door Opening Measures:
19 1/2"H x 55 1/4"W

12.2 CUBIC FEET

638-0-02
(36 5/8"L x 24"W x 24"H)

Ship Weight: 65 Lbs.

Door Opening Measures:
19 1/2"H x 31 1/4"W



IN-BED STORAGE

What separates the average hard workers from the top dogs? Those who stand out address challenges with creative solutions. Same goes for WEATHER GUARD® In-Bed Storage. These smartly designed, durable components serve specific needs across a wide spectrum of trades and types of businesses. Whether you need a convenient fueling source for diesel-powered equipment or bed-mounted storage, you can depend on WEATHER GUARD® Truck Equipment for best-in-breed, specialized add-ons.



PACK RAT® Drawer Units

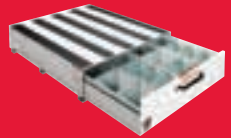

PAGE 30

BED RAT® Sliding Platform



PAGE 31

Transfer Tanks/Accessories



PAGE 32

PACK RAT® DRAWER UNITS

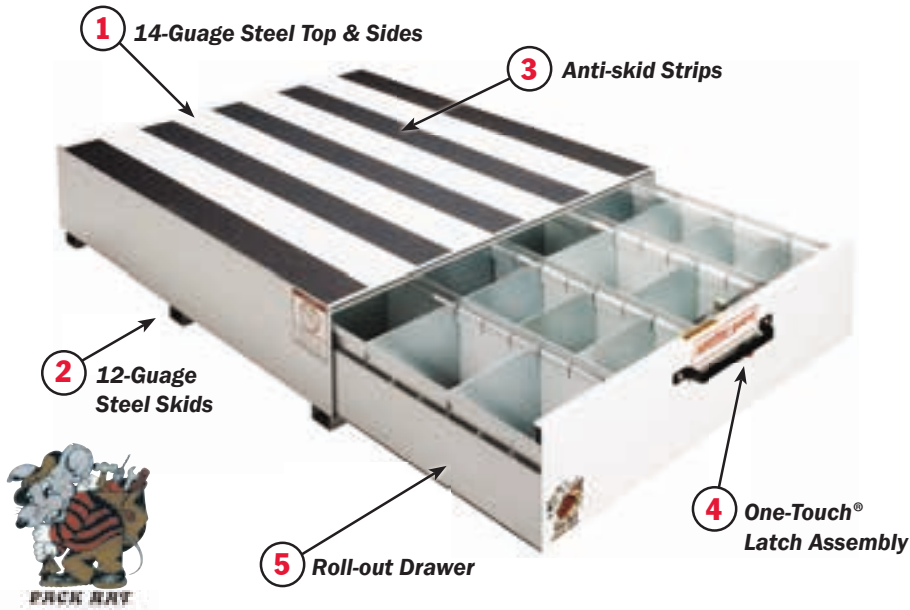

PACK RAT® DRAWER UNIT KEY FEATURES

- 1 **14-Gauge steel top and sides** allows 750 lb load rating
- 2 **12-Gauge steel skids** extra strength
- 3 **Anti-skid strips** provide traction for workboots
- 4 **One-Touch® latch assembly** easy, one-hand operation
- 5 **Roll-out drawer** easy access and organization
- 6 **Limited Lifetime Warranty** unparalleled quality

HEAVY-DUTY STORAGE KEEPS BED SPACE OPEN AND YOU ORGANIZED

The Heavy-Duty PACK RAT® drawer units can be mounted inside the rear of the vehicle and give you easy access to large tools and supplies while leaving floor space open. These rugged units are constructed of 14-gauge steel on the top and sides, giving you a 750 pound load rating and placing them among the sturdiest items in the back of your truck.

STANDARD DRAWER UNIT

305-3

1 compartment, 6 dividers.

Each Compartment: 5"H x 9¼"W x 45"L

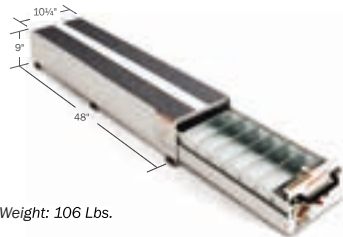

Ship Weight: 106 Lbs.

STANDARD DRAWER UNIT

306-3

2 compartments, 12 dividers.

Each Compartment: 5"H x 9¼"W x 45"L

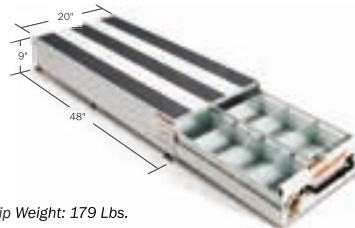

Ship Weight: 179 Lbs.

STANDARD DRAWER UNIT

307-3

3 compartments, 18 dividers.

Each Drawer Compartment: 5"H x 9¼"W x 45"L

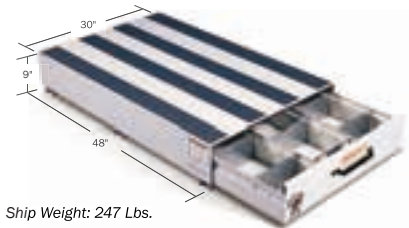

Ship Weight: 247 Lbs.

STANDARD DRAWER UNIT

308-3 (white) \ 308-5 (black)

4 compartments, 24 dividers.

Each Drawer Compartment: 5"H x 9¼"W x 45"L

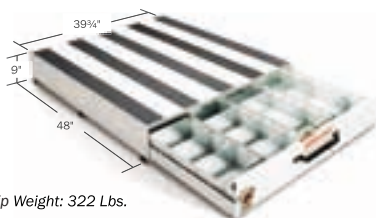

Ship Weight: 322 Lbs.

STANDARD DRAWER UNIT

335-3

1 compartment, 6 dividers.

Each Drawer Compartment: 8½"H x 9¼"W x 45"L

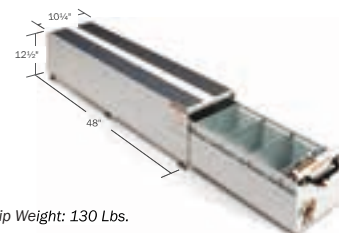

Ship Weight: 130 Lbs.

STANDARD DRAWER UNIT

336-3

2 compartments, 12 dividers.

Each Drawer Compartment: 8½"H x 9¼"W x 45"L

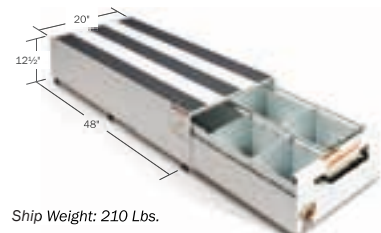

Ship Weight: 210 Lbs.

STANDARD DRAWER UNIT

337-3

3 compartments, 18 dividers.

Each Compartment: 8½"H x 9¾"W x 45"L

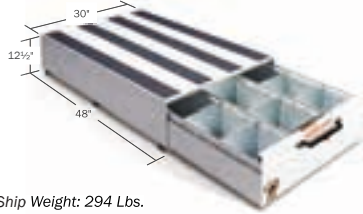

Ship Weight: 294 Lbs.

STANDARD DRAWER UNIT

338-3 (white) \ 338-5 (black)

4 compartments, 24 dividers.

Each Compartment: 8½"H x 9¾"W x 45"L

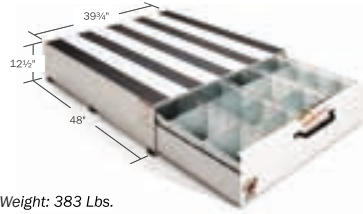

Ship Weight: 383 Lbs.

EXTRA-WIDE COMPARTMENT

304-3

2 compartments, 6 dividers.

Small Compartment: 5"H x 9¾"W x 45"L
Large Compartment: 5"H x 19½"W x 45"L

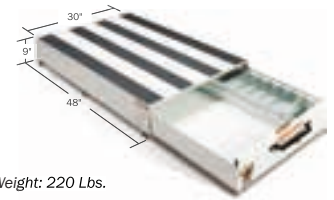

Ship Weight: 220 Lbs.

EXTRA-WIDE COMPARTMENT

334-3

2 compartments, 6 dividers.

Small Compartment: 8½"H x 9¾"W x 45"L
Large Compartment: 8½"H x 19½"W x 21"L

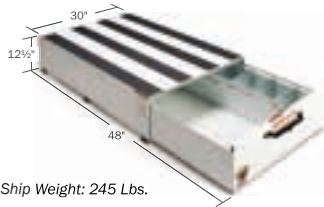

Ship Weight: 245 Lbs.

SHORT DRAWER UNIT

301-3

3 compartments, 12 dividers.

Each Compartment: 8½"H x 9¾"W x 21"L

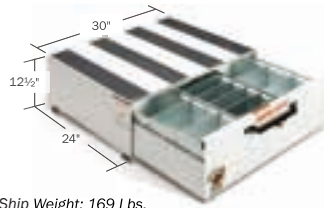

Ship Weight: 169 Lbs.

SHORT DRAWER UNIT

303-3

4 compartments, 12 dividers.

Each Compartment: 8½"H x 9¾"W x 21"L

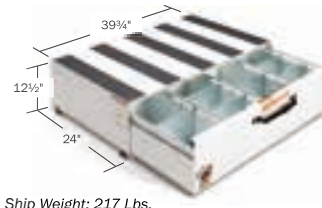

Ship Weight: 217 Lbs.

SHORT DRAWER UNIT

312-3

3 compartments, 12 dividers.

Each Compartment: 5"H x 9¾"W x 21"L

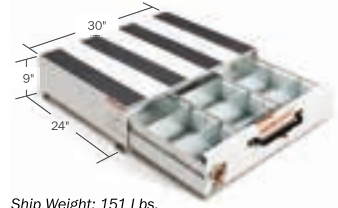

Ship Weight: 151 Lbs.

BED RAT® SLIDING PLATFORM

BED RAT® KEY FEATURES

- 1 Heavy-duty rollers** support maximum loads
- 2 Heavy-duty platform** supports 750 lbs.
- 3 Platform extends 70%** easy access, large work area
- 4 Side and back pack panels** keep items from rolling off
- 5 Limited Lifetime Warranty** unparalleled quality

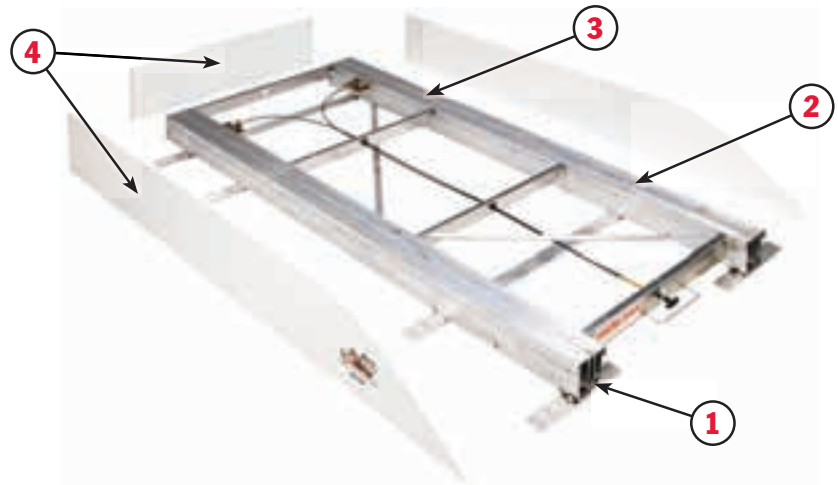

GAIN IN EXTRA WORK SPACE FROM THE BED Grabbing tools or parts as you need them during the course of a project is always easier when they're elevated. The BED RAT® Sliding Platform from WEATHER GUARD® works with PACK RAT® Drawer Unit allowing you to pull items toward you from the cargo area, either from the side or rear of the vehicle, creating an additional work space.

BED RAT® SLIDING PLATFORM

3200

68"L x 44¾"W x 4¾"H

FITS: Chevy full-size short-bed and short-bed sport side. Chevy Colorado, Dodge Dakota, 6½-foot bed, Dodge full-size short-bed, Ford Ranger, 6-foot bed, Ford short-bed and flare side and Toyota Tundra, short bed.

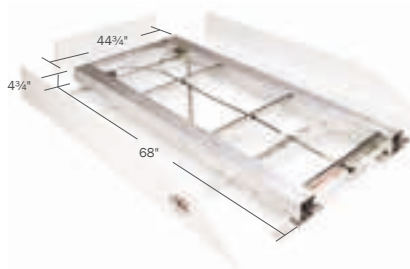

Ship Weight: 123 Lbs.

BED RAT® SLIDING PLATFORM

3400

90"L x 44¾"W x 4¾"H

FITS: Chevy, Dodge, Toyota and Ford full-size pickups.

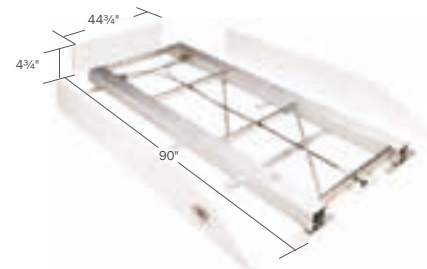

Ship Weight: 155 Lbs.

TRANSFER TANKS

1 Vented Filter Cap



2 Interior Baffle Design

FOR TRANSPORTING DIESEL FUEL

WEATHER GUARD® Transfer tanks offer a safer mode of transporting diesel fuel to your jobsite and beyond. L-shaped tanks are designed to be used with Cross Boxes and Saddle Boxes only; rectangular tanks are designed for full-size pickup trucks. Ranging in capacity from 50-110 gallons, WEATHER GUARD® Transfer Tanks feature full arc-welded, heavy 14 gauge steel construction for long-lasting durability. The interior baffle design reduces fuel movement and provides extra tank reinforcement. The lockable vented filler cap prevents excessive pressure built-up and the threaded filler neck accepts standard 2" threaded pipe. Installation is easy using the heavy-duty lifting loops and secure plate-steel flange bed mounting points. All tanks are protected with Brite White ARMOR TUF® Powder Coat Finish for years of durability, and backed by a Limited Lifetime Warranty.

STEEL TRANSFER TANK 50 GAL. CAPACITY

350-3-01

For compact pickups. May be used in combination with WEATHER GUARD® Cross and Saddle Boxes.

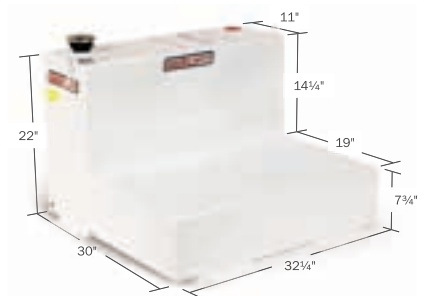

Ship Weight: 131 Lbs.

TRANSFER TANK KEY FEATURES

- 1 Vented filler cap**
prevents excessive
pressure build-up
- 2 Interior baffle design**
reduces fuel movement
- 3 Limited Lifetime Warranty**
for peace of mind

STEEL TRANSFER TANK 75 GAL. CAPACITY

352-3-01

For full-size short-bed pickups, Dodge Dakota and Toyota Tundra. May be used in combination with WEATHER GUARD® Cross and Saddle Boxes.



Ship Weight: 164 Lbs.

STEEL TRANSFER TANK 90 GAL. CAPACITY

354-3-01

For full-size pickups. May be used in combination with WEATHER GUARD® Cross and Saddle Boxes.



Ship Weight: 185 Lbs.

STEEL TRANSFER TANK 100 GAL. CAPACITY

358-3-01

For full-size pickups.



Ship Weight: 152 Lbs.

STEEL TRANSFER TANK 110 GAL. CAPACITY

360-3-01

For full-size pickups. May be used in combination with WEATHER GUARD® Cross and Saddle Boxes.



Ship Weight: 219 Lbs.



BED-MOUNTED SOLUTIONS

WEATHER GUARD® Bed-Mounted Solutions make your job easier and safer — no matter what it is. Our wide range of bed-mounted components for both pickups and service-body trucks is designed for durability, stability, versatility and ease of installation. Ladder racks. Service body racks. Cab protectors. Even a conduit carrier. With most available in either steel or aluminum and a variety of finishes, they look good and work hard. Just like you.



ATR® Aluminum Truck Rack



PAGE 36

Service Body Ladder Racks



PAGE 38

Steel Ladder Rack



FAST RACK® System



PAGE 40

WEEKENDER® Ladder Rack



PAGE 41

PROTECT-A-RAIL®



PAGE 42

Cab Protectors/Screens



PAGE 43

WEATHER GUARD® TRUCK EQUIPMENT. SECURING YOUR REPUTATION®

ATR[®] ALUMINUM TRUCK RACK

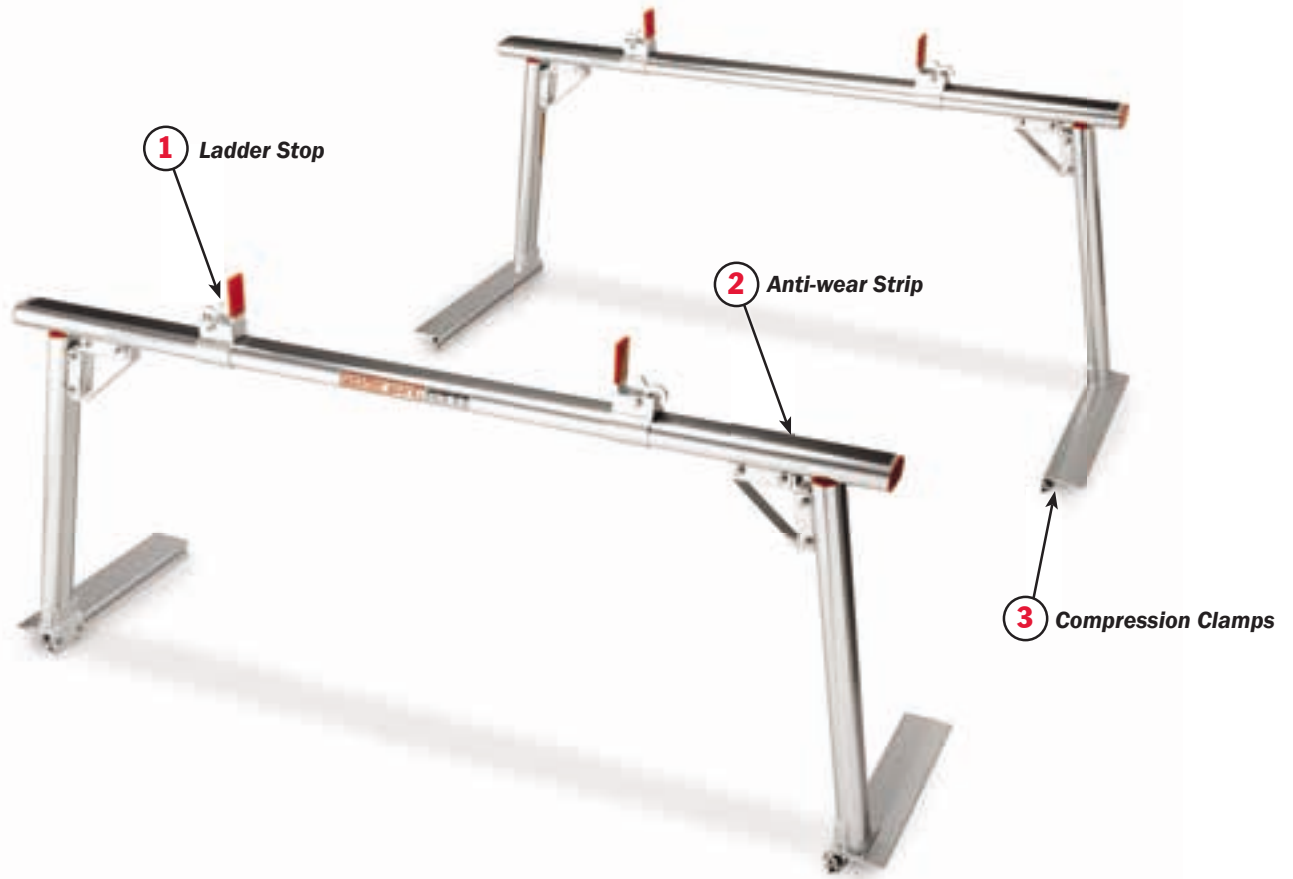

SECURE TRANSIT AND STORAGE

There are a couple of aspects of security above the truck bed. You need to keep your ladders and equipment secure both in transit and in storage. The WEATHER GUARD[®] ATR (Aluminum Truck Rack) comes in versions that fit either compact or full-size pickups and are constructed with several design extras sure to provide years of secure transit and storage, no matter what your specific needs are.

FOR FULL-SIZE PICKUPS

LOAD CAPACITY 800 LBS

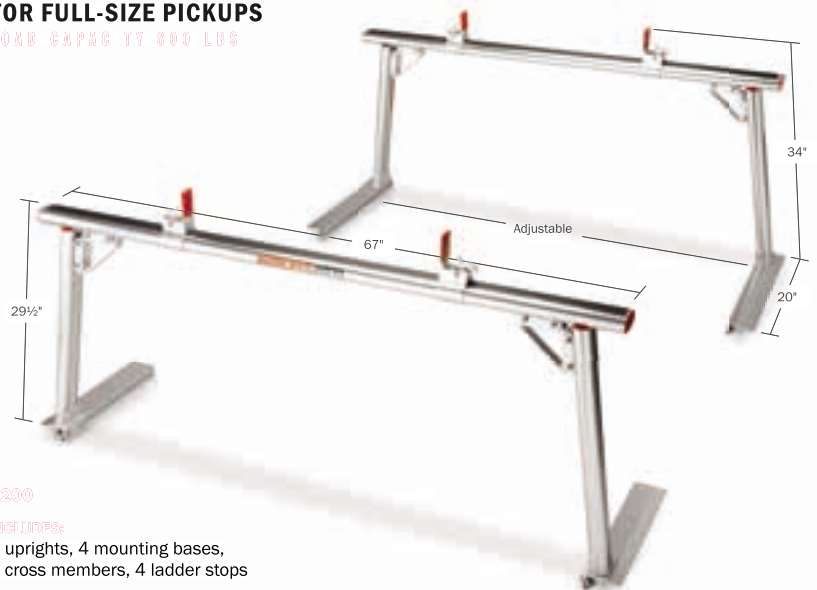

1200

INCLUDES:

4 uprights, 4 mounting bases,
2 cross members, 4 ladder stops

Ship Weight: 68 Lbs.

ATR® ALUMINUM TRUCK RACK KEY FEATURES

- 1 Ladder stop**
easy to adjust, secures ladder/materials
- 2 Anti-wear strip**
protects ladders and materials
- 3 Compression clamps**
easily secures rack to top of truck bed
- 4 Triple-wall reinforcement**
rigidity, durability
- 5 Limited Lifetime Warranty**
for peace of mind

FOR COMPACT PICKUPS

LOAD CAPACITY 500 LBS

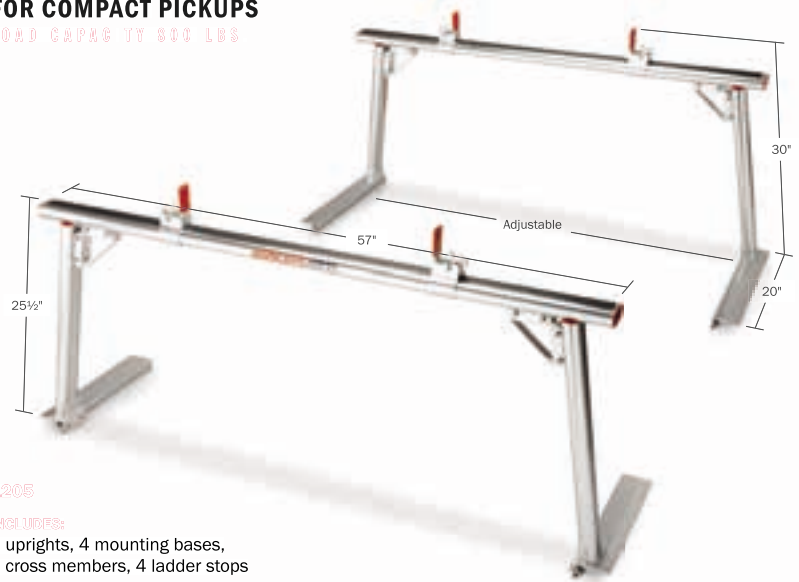

1208

FITS:

4 uprights, 4 mounting bases,
2 cross members, 4 ladder stops

Ship Weight: 61 Lbs.

ACCESSORY SIDE RAILS

1211

For full-size pickups with 6.5'
beds and all compact pickups.

INCLUDES:

2 side rails
1 front cross member

Ship Weight: 46 Lbs.

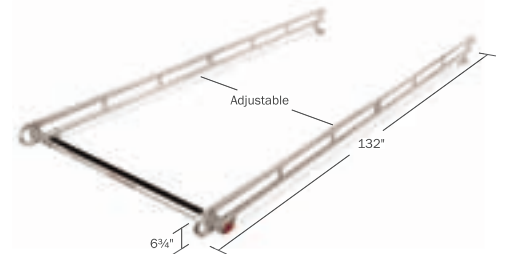

ACCESSORY SIDE RAILS

1210

For full-size pickups
with 8' beds.

INCLUDES:

2 side rails
1 front cross member

Ship Weight: 52 Lbs.

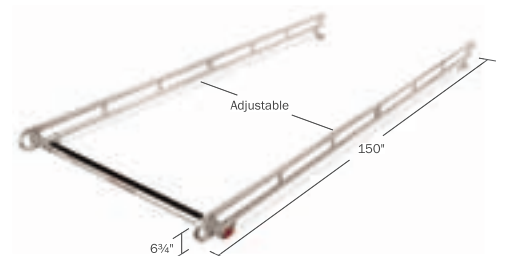

ACCESSORY CROSS MEMBER

1215

FITS: 1210 and 1211
Accessory Side Rails only.

Ship Weight: 12 Lbs.

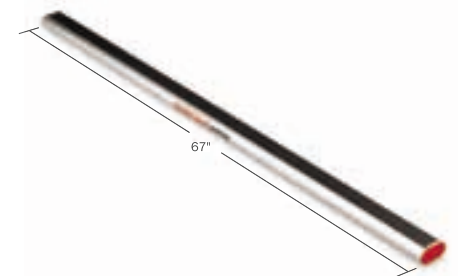

ACCESSORY QUICK RELEASE

1218

Allows quick removal of rear
cross member (2 each.)

FITS: 1210 and 1211
Accessory Side Rails only.

Ship Weight: 2 Lbs.



STEEL SERVICE BODY RACK

STEEL SERVICE BODY RACK

LOAD CAPACITY 1000 LBS.

1225

For full-size steel service bodies.

INCLUDES: legs, side rails and cross members.

Ship Weight: 233 Lbs.

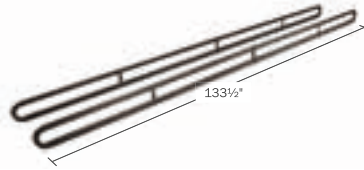

KEY FEATURES

- 1 WEATHER GUARD® Truck Equipment offers the same quality and durability on our Steel Service Body Rack as on our other field-proven racks.

NOTE: Do not mount on aluminum, plastic, fiberglass or top-opening service body trucks: Mount only on steel service bodies.



ALUMINUM SERVICE BODY RACK

ALUMINUM SERVICE BODY RACK

LOAD CAPACITY 200 LBS.

1425-3

For full-size and compact service body trucks on both driver and passenger sides.

Front post adjusts 21^{3/16}"-35^{3/16}"

Rear post is stationary at 21^{3/16}" (shown left)

Front post adjusts 16"-30"

Rear post is stationary at 16^{1/4}" (shown right)

Ship Weight: 22 Lbs.

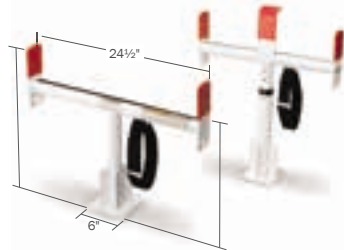

KEY FEATURES

- 1 The WEATHER GUARD® Aluminum Service Body Rack is designed to make loading or unloading a ladder a "one-person" job.
- 2 Front post adjusts in height and swivels to allow for easy positioning of ladder during removal or placement
- 3 Both posts have a wide mounting

NOTE: Do not mount on an aluminum plastic or fiberglass service body. Mount on steel service body only.



STEEL LADDER RACK

KEY FEATURES

- 1 Load capacity rating is 1,000 lbs. Capacity is increased to 1,500 lbs. when using the Accessory Screen on page 43.
- 2 Legs are made of formed 1" x 2", 14-gauge steel wall tubing. The side rails are 1" x 1½", 11-gauge wall tubing. Cross members are made of formed 7- and 12-gauge steel.
- 3 Includes 4 legs, 3 cross members and 2 side rails.
- 4 Ford Super Cab Super Duty, GM, Dodge and Ford F-150 extended cab require separate purchase of Model 1247 Airfoil on page 43.



ADJUSTABLE LEG SOCKET allows easy positioning of the leg for proper fit to truck bed.



REMOVABLE PIN on rear cross member allows you to quickly take off the rear cross member for loading large materials.



CLAMP DESIGN of bracket of front (and accessory) cross member allows you to put them where the load dictates.



TIE-DOWN BRACKET can be bolted wherever you wish.



FOR COMPACT PICKUPS LOAD CAPACITY 1,000 LBS.



FOR FULL-SIZE PICKUPS LOAD CAPACITY 1,000 LBS.



FOR COMPACT PICKUPS - SHORT BED

1345

For short-bed compact pickups.

INCLUDES: legs, side rails and cross members.

Ship Weight: 155 Lbs.

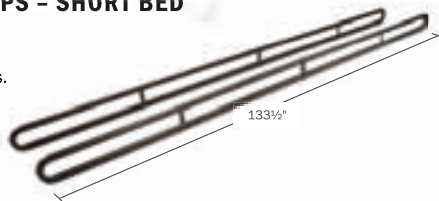

FOR FULL-SIZE PICKUPS - SHORT BED

1245

For short-bed full-size pickups and Toyota Tundra.

INCLUDES: legs, side rails and cross members.

Ship Weight: 159 Lbs.

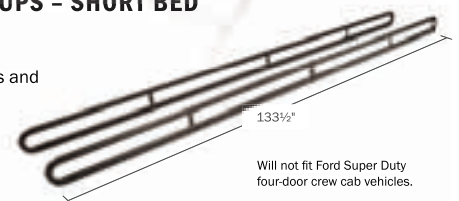

Will not fit Ford Super Duty four-door crew cab vehicles.

FOR COMPACT PICKUPS - LONG BED

1375

For long-bed compact pickups.

INCLUDES: legs, side rails and cross members.

Ship Weight: 167 Lbs.

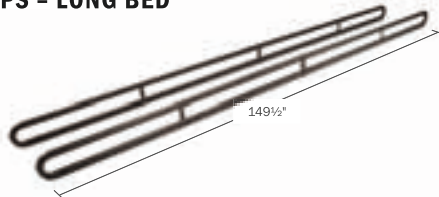

FOR FULL-SIZE PICKUPS - LONG BED

1275

For long-bed compact pickups.

INCLUDES: legs, side rails and cross members.

Ship Weight: 171 Lbs.

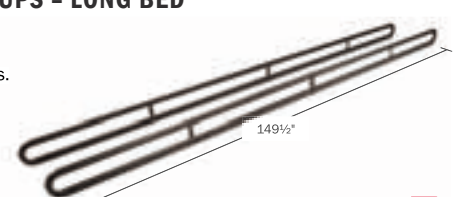

Will not fit Ford Super Duty four-door crew cab vehicles.

WEEKENDER® LADDER RACK



KEY FEATURES

- 1 Easy on, easy off for that occasional need to carry a ladder or long material.
- 2 Uprights should be removed when not in use.
- 3 Adjustable, tubular steel pockets bolt into the side of the truck bed. A set-screw holds the upright in place.
- 4 Load bar is adjustable to accommodate the varied widths of ladders.
- 5 Constructed of 1½" x 1½", 14-gauge wall steel tubing.
- 6 Joints are fully arc-welded.
- 7 Mounting bracket allows WEEKENDER® Ladder Rack to be installed on driver side or curb side of truck.

ANGULAR

LOAD CAPACITY 250 LBS.

1475

For '95 and newer pickups, Chevy, Dodge, Ford and Toyota Tundra.

Ship Weight: 52 Lbs.



HORIZONTAL

LOAD CAPACITY 250 LBS.

1450

For '95 and newer pickups, Chevy, Dodge, Ford and Toyota Tundra.

Ship Weight: 56 Lbs.



FAST RACK® SYSTEM

KEY FEATURES

- 1 Works great with bedliners because it mounts on the bed rails.
- 2 Assembles and installs in approximately one hour.
- 3 Consists of two welded leg, rail and base assemblies, one for the driver side and one for the passenger side. The front piece of each rail is bolted to the welded assembly for each side.
- 4 Constructed of 7-gauge steel bottom rails that add strength to the bed rails on a pickup.
- 5 Requires separate purchase of cross member kit. Cross member kits are specific for Chevy, Dodge, Ford and Ford Super-Duty full-size pickups.
- 6 Contoured legs for greater stability.

FAST RACK LOAD CAPACITY 1000 LBS.

1280

For full-size 8' bed domestic pickups. (shown with typical Cross Member Kit installed.)

Ship Weight: 175 Lbs.



FOR GMC/CHEVROLET VEHICLES

1281

Cross Member Kit for '95 to current GM full size 8' bed pickups (excluding 3500 HD).

INCLUDES: front, middle and rear.

Ship Weight: 34 Lbs.



FOR FORD STANDARD DUTY VEHICLES

1283

Cross Member Kit for '97 and newer Ford full-size 8' bed pickups.

INCLUDES: front, middle and rear.

Ship Weight: 33 Lbs.



FOR DODGE VEHICLES

1282 – Cross Member Kit for all '94 to '01 and '02 Model 2500 and 3500 Dodge full size 8' bed pickups.

1287 – Cross Member Kit for '02 Model 1500 and all '03 and newer Dodge full-size pickups.

BOTH INCLUDE: front, middle and rear.

Ship Weight: 34 Lbs.



FOR FORD SUPER DUTY VEHICLES

1284

Cross Member Kit for '99 and newer Super Duty Ford 8' bed pickups.

INCLUDES: front, middle and rear.

Ship Weight: 34 Lbs.

Will not fit Ford Super Duty four-door crew cab vehicles.



ACCESSORY CAB SCREEN

1285

Cab Screen clamps to leg of rack with no drilling required.

Ship Weight: 34 Lbs.

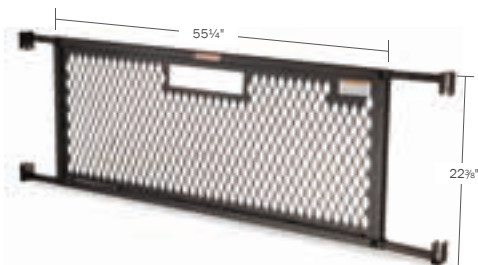

ACCESSORY CROSS MEMBER

1060-5

Accessory cross member makes it easier to haul shorter and more flexible materials or shorter ladders on your ladder rack.

Ship Weight: 10 Lbs.

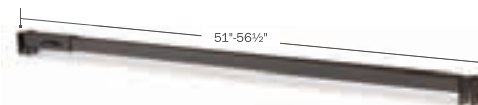

PROTECT-A-RAIL® CAB PROTECTORS/ACCESSORIES

FOR COMPACT PICKUPS

1910-3-01 (white)
1910-5-01 (black)

Steel Screen cab protector mounts to the bed of a mini pickup. Installation hardware provided.

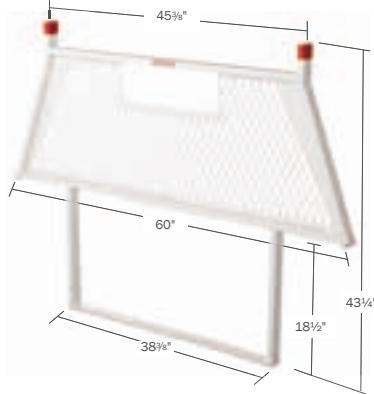

Ship Weight: 42 Lbs.

FOR FULL-SIZE PICKUPS

1905-0-02

Aluminum frame cab protector. Features a lightweight extruded aluminum frame with 14-gauge steel louvers. (Requires separate purchase of Installation Kit.)

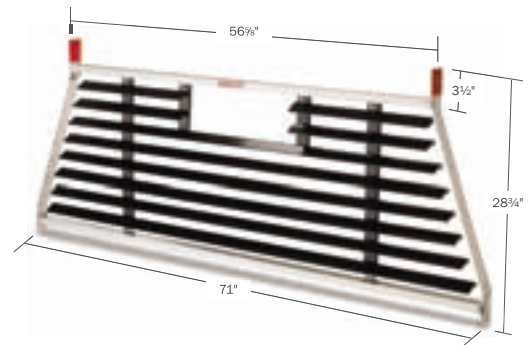

Ship Weight: 33 Lbs.

FOR FULL-SIZE PICKUPS

1907-0-02

Aluminum frame cab protector. Features a lightweight extruded aluminum frame. (Requires separate purchase of Installation Kit.)

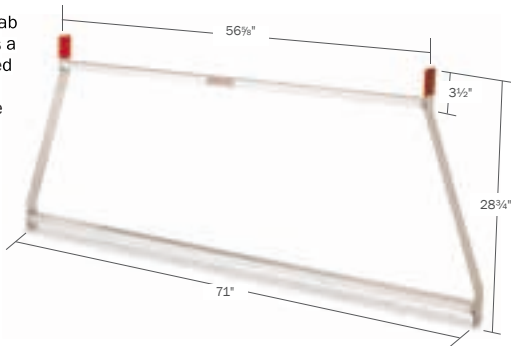

Ship Weight: 19 Lbs.

FOR FULL-SIZE PICKUPS

1904-3-02 (white)
1904-5-02 (black)

Steel louvered cab protector. Features a steel frame and 14-gauge steel louvers. (Requires separate purchase of Installation Kit.)

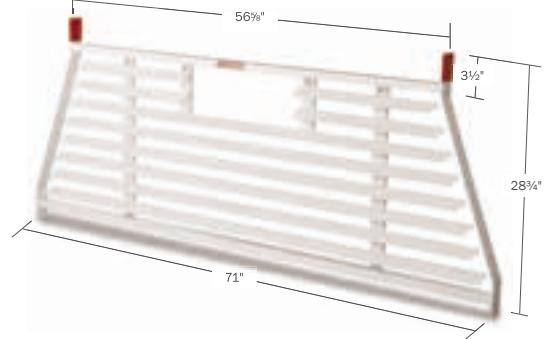

Ship Weight: 46 Lbs.

FOR FULL-SIZE PICKUPS

1906-3-02 (white)
1906-5-02 (black)

Punched steel screen cab protector. (Requires separate purchase of Installation Kit.)

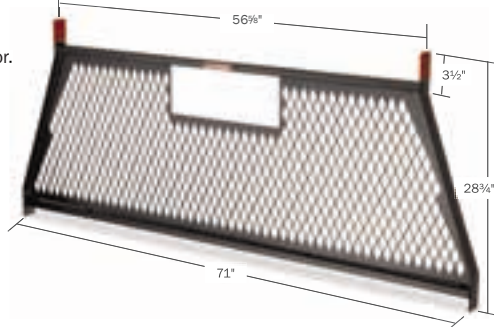

Ship Weight: 33 Lbs.

FOR FULL-SIZE PICKUPS

1908

Heavy-duty cab protector. (Requires separate purchase of Installation Kit.)

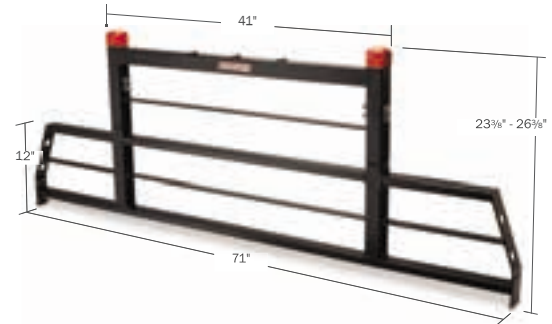

Ship Weight: 46 Lbs.

NEW!

Improved Fit on Full-Size Pickups

ACCESSORIES FOR MOUNTING WARNING LIGHTS & LADDERS FOR 1908

1917
Ladder mount extension.
Ship Weight: 5 Lbs.



1918
7½" round base.
Ship Weight: 2 Lbs.



1920
9½" x 17" rectangular base.
Ship Weight: 6 Lbs.



1919
7½" side mount round base.
Ship Weight: 3 Lbs.



INSTALLATION KITS

All full-size PROTECT-A-RAIL® Cab Protector models require separate purchase of Installation Kit. Each kit is designed to custom fit your vehicle.

CHEVROLET **1916-3, 1916-5**
'99 and newer Silverado Ship Weight: 14 Lbs.
1914-3, 1914-5
'00 and older CK Ship Weight: 13 Lbs.

Will not fit GM & Chevy 3500 HD.

DODGE **1912-3-01, 1912-5-01**
'94 and newer Ship Weight: 13 Lbs.

FORD **1913-3, 1913-5**
'97 and newer Ford F-150, 2007 and newer Toyota Tundra Ship Weight: 15 Lbs.

1915-3-01, 1915-5-01
'99 and newer Super Duty F-250/F-350 '96 and older F-150/F-250/F-350 Ship Weight: 14 Lbs.



Mounting Bracket

ACCESSORY CAB SCREEN FOR FULL-SIZE PICKUPS

1259
Fits both the 1245 and 1275 series racks. Not available for Dodge Dakota.

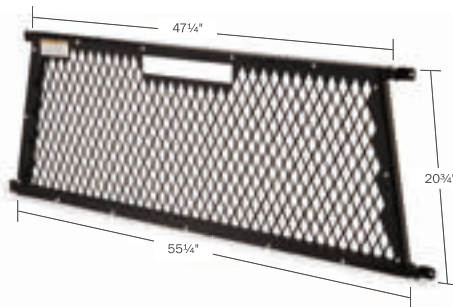

Ship Weight: 35 Lbs.

AIRFOIL

FOR USE WITH MODEL 1245 & 1275



1246
Separate purchase of Airfoil required for Ford Super Cab Super Duty Vehicles.

Ship Weight: 5 Lbs.



1247
Separate purchase of Airfoil required for GM, Dodge and Ford F-150 Extended Cab Vehicles.

Ship Weight: 7 Lbs.

ACCESSORY CROSS MEMBER

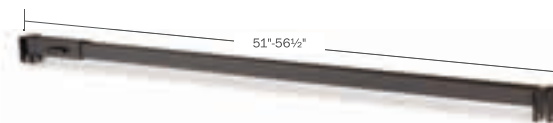

1060-5
Fits the 1245, 1275, 1345 & 1375 series racks. Accessory cross member makes it easier to haul shorter and more flexible materials or shorter ladders on your ladder rack.

Ship Weight: 10 Lbs.

MAKE-YOUR-OWN CONDUIT CARRIER

239
PVC not included. Separately purchase a section of standard 6" PVC (9ASTM D2665) plastic drain pipe. Coordinate the length of the PVC with the length of conduit you'll be carrying.



Ship Weight: 4 Lbs.

ALUMINUM CONDUIT CARRIER

Keep your conduit safe, secure and clean with our lightweight and durable Conduit Carrier.

237
Conduit Carrier
Ship Weight: 40 Lbs.

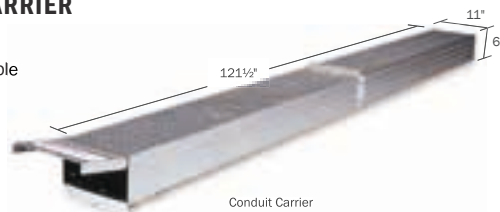

Conduit Carrier

238
6" Extension
Ship Weight: 4 Lbs.



6" Extension

CONFIGURATIONS GUIDE

TUNDRA COMPLETE UPFIT

LO-SIDE BOXES

(2) 174-0-01 (page 12)

ATR®

1200 (page 36), 1210 Rails (page 37)

PACK RAT®

338-3 (page 31)

SADDLE BOX

127-0-02 (page 6)



LOW-PROFILE UPFIT

LOW-PROFILE SADDLE BOX

121-0-01 (page 7)

LOW-PROFILE SIDE BOXES

180-0-01, 181-0-01 (page 13)





SMALL CONTRACTOR/ REMODELER UPFIT

E-LINE® SADDLE BOX

143-0-01 (page 18)



TRANSFER TANK UPFIT

PROTECT-A-RAIL®

1908 (page 42)

TRANSFER TANK

354-3-01 (page 33)

SADDLE BOX

126-3-02 (page 6)



FORD F150 COMPLETE UPFIT

HI-SIDE BOXES

(2) 390-0-02 (page 15)

HEAVY-DUTY STEEL LADDER RACK

1275 (page 39)

PACK RAT®

338-3 (page 36)

CONFIGURATIONS GUIDE

ALUMINUM HI-SIDE BOX UPFIT

HEAVY-DUTY LADDER RACK

1275 (page 39)

HI-SIDE BOXES

(2) 390-0-01 (page 15)



WEEKENDER® UPFIT

WEEKENDER® LADDER RACK

1475 (page 40)

SADDLE BOX

127-0-02 (page 6)



COMPACT TRUCK UPFIT

LO-SIDE BOXES

(2) 174-0-01 (page 12)

PROTECT-A-RAIL®

1910-3-01 (page 42)



REPLACEMENT PARTS

LOCKS

7838-2PK – EXTREME PROTECTION® Retrofit Lock Kit

Dual Locks fit current and retro fit older Cross, Saddle, Lo-Side, Pork Chop Boxes

7748-1PK – EXTREME PROTECTION® Replacement Lock Kit

Single Lock for Current Cross, Saddle, Lo-Side, Pork chop & All-Purpose Chests



7081-1PK – Paddle-Handle Latch & Lock Kit

FITS: Older Hi-Sides, current aluminum Underbeds, older steel Underbeds

7106-1PK – Striker Plate Kit

FITS: Three generations Cross, Saddle, Lo-Side, Pork Chop, All-Purpose Chests



CABLES

7069-2PK – 14" Cables

FITS: All standard-size steel and aluminum Hi-Sides

7071-2PK – 16" Cables

FITS: All steel & Aluminum Super-Side Boxes except 297-3 Jumbo Super-Side. Any 18" high Underbeds, current aluminum and old-style steel



PAINT

886-1CN – White Aerosol Touch-up paint

For touchup on all WEATHER GUARD® White Products

887-1CN – Black Aerosol Touch-up paint

For touchup on all WEATHER GUARD® Black Products



BLIND FASTENERS

7998-20PK – ¼" Blind Fasteners (20)

Rigid fastening on sheet metal, fiberglass and plastic

999-20PK – ⅜" Blind Fasteners (20)

Rigid fastening on sheet metal, fiberglass and plastic

7998-10PK – ¼" Blind Fasteners (10)

Rigid fastening on sheet metal, fiberglass and plastic

999-10PK – ⅜" Blind Fasteners (10)

Rigid fastening on sheet metal, fiberglass and plastic



FILL CAP

355-1PK – Fill Cap

FITS: Transfer Tanks



GAS SPRINGS 2PK



7009-2PK

FITS: 121-X-01, 123-X-01, 123, 123-X, 127-X-01, 127, 127-X, R-127, 131-X-01, 137-X-01, 137, 137-X, 147-X-01, 154-X-01, 6212-5.

7249-2PK

FITS: 117-X-01, 117, 117-X, R-117, 126-X-01, 126-X, R-126, 128-X-01, 128-X.

7917-2PK

FITS: 114-X-01, 114, 114-X, 114-B, 124-X-01, 124, 124-X, 124-B, 134, 134-X, 134-B, 153, 153-X, 153-B, 159, 159-X, 159-B, 191, 193.

900-2PK

FITS: 125-X-01, 125-X, R-125, R-125-B, 135-X, R-135, 155-X, R-155.

7095-2PK

FITS: 160-X-01, 161-X-01, 164-X-01, 165-X-01, 166-X-01, 170-X-01, 170, 170-X, 171-X-01, 171, 171-X, 172-X-01, 172, 172-X, 173-X-01, 173, 173-X, 174-X-01, 175-X-01, 184-X-01, 185-X-01, 186-X-01, 644-X-01, 645-X-01, 654-X-01, 654, 654-X, 654-B, 655-X-01, 664-X-01, 664-X, 664, 664-B, 674-X-01, 674-X, 674, 674-B, 675-X-01.

7096-2PK

FITS: 162-X-01, 163-X-01, 166-X-01, 665-X-01, 665-X, 665, 665-B.

7248-2PK

FITS: 116-3, 116-5, R-116.

7250-2PK

FITS: 136-X-01, 136-X, R-136, 156-X-01, 156-X, R-156.

7250-2PK

FITS: 116-X-01, 158-X, R-158.

7252-2PK

FITS: 154, 154-X, R-154.

7900-2PK

FITS: 115-X-01, 115-X, R-115, 157-X, R-157.

7902-2PK

FITS: 165-X-01, 176-X-01, 655, 655-X, 675, 675-X, 684-X-01, 684, 684-X.

7904-2PK

FITS: 685-X-01, 685-X.

918-2PK

FITS: 162-X, 162, 163-X, 163.

932-2PK

FITS: 165-X, 186-X, 630, 630-X.

932-2PK

FITS: 160-X, 160, 161-X, 161, 164, 164-X, R-164, R-164-B, 175-X, 185-X, 624, 624-X.

7010-2PK

FITS: 174, 174-X, R-174, R-174-B, 184, R-184, R-184-B.

7011-2PK

FITS: 176-X.

7901-2PK

FITS: 166-X.

921-4PK – Ball Studs 4-Pack

Fits all KNAACK® & WEATHER GUARD® Gas Springs



*Model Number Color Coating:
X = 0 (Clear), 3 (White), 5 (Black)