

PowerFlex 525 Configuration with Permanent Magnet Motors

Catalog Numbers 25B



Topic	Page
Overview	3
PM Motor Identification	3
Open Loop PM Motor Setup	4
Closed Loop iPM Motor Setup	15
Additional Tuning Options	19
Additional Information	30



Important User Information

Read this document and the documents listed in the additional resources section about installation, configuration, and operation of this equipment before you install, configure, operate, or maintain this product. Users are required to familiarize themselves with installation and wiring instructions in addition to requirements of all applicable codes, laws, and standards.

Activities including installation, adjustments, putting into service, use, assembly, disassembly, and maintenance are required to be carried out by suitably trained personnel in accordance with applicable code of practice.

If this equipment is used in a manner not specified by the manufacturer, the protection provided by the equipment may be impaired.

In no event will Rockwell Automation, Inc. be responsible or liable for indirect or consequential damages resulting from the use or application of this equipment.

The examples and diagrams in this manual are included solely for illustrative purposes. Because of the many variables and requirements associated with any particular installation, Rockwell Automation, Inc. cannot assume responsibility or liability for actual use based on the examples and diagrams.

No patent liability is assumed by Rockwell Automation, Inc. with respect to use of information, circuits, equipment, or software described in this manual.

Reproduction of the contents of this manual, in whole or in part, without written permission of Rockwell Automation, Inc., is prohibited.

Throughout this manual, when necessary, we use notes to make you aware of safety considerations.



WARNING: Identifies information about practices or circumstances that can cause an explosion in a hazardous environment, which may lead to personal injury or death, property damage, or economic loss.



ATTENTION: Identifies information about practices or circumstances that can lead to personal injury or death, property damage, or economic loss. Attentions help you identify a hazard, avoid a hazard, and recognize the consequence.

IMPORTANT Identifies information that is critical for successful application and understanding of the product.

Labels may also be on or inside the equipment to provide specific precautions.



SHOCK HAZARD: Labels may be on or inside the equipment, for example, a drive or motor, to alert people that dangerous voltage may be present.



BURN HAZARD: Labels may be on or inside the equipment, for example, a drive or motor, to alert people that surfaces may reach dangerous temperatures.



ARC FLASH HAZARD: Labels may be on or inside the equipment, for example, a motor control center, to alert people to potential Arc Flash. Arc Flash will cause severe injury or death. Wear proper Personal Protective Equipment (PPE). Follow ALL Regulatory requirements for safe work practices and for Personal Protective Equipment (PPE).

Overview

Version 5 of the PowerFlex® firmware adds support for permanent magnet (PM) motor control to the PowerFlex 525. The PowerFlex 523 does not support PM motor control. Three types of PM motor control modes are supported:

1. Open loop sPM (surface permanent magnet)
2. Open loop iPM (interior permanent magnet)
3. Closed loop iPM with encoder feedback.

IMPORTANT sPM closed loop **is not** supported.

Publication 520-UM001 is the main source of information for the permanent magnet motor control methods of the PowerFlex 525, including setup and configuration. This document supplements the flowcharts that are provided in 520-UM001 and provides set up suggestions that are based on tests completed by Tech Support and Commercial Engineering with several motor setups.

PM Motor Identification

There are three types of Permanent Magnet Motors (PM Motors) that are available. This document focuses on Interior-Mounted Permanent Magnet (iPM) and Surface-Mounted Permanent Magnet (sPM) motors. The Line Start Synchronous Permanent Magnet motor is not covered in this document.

iPM Motors

Lq inductance and Ld Inductance values are listed on the nameplate or the motor data sheet of iPM motors. This information can be used to identify iPM motors when the motor type is not indicated on the nameplate. [Figure 1](#) is a Marathon Symax Motor nameplate, an iPM that has both values listed on the nameplate.

Figure 1 - Marathon Symax iPM Nameplate

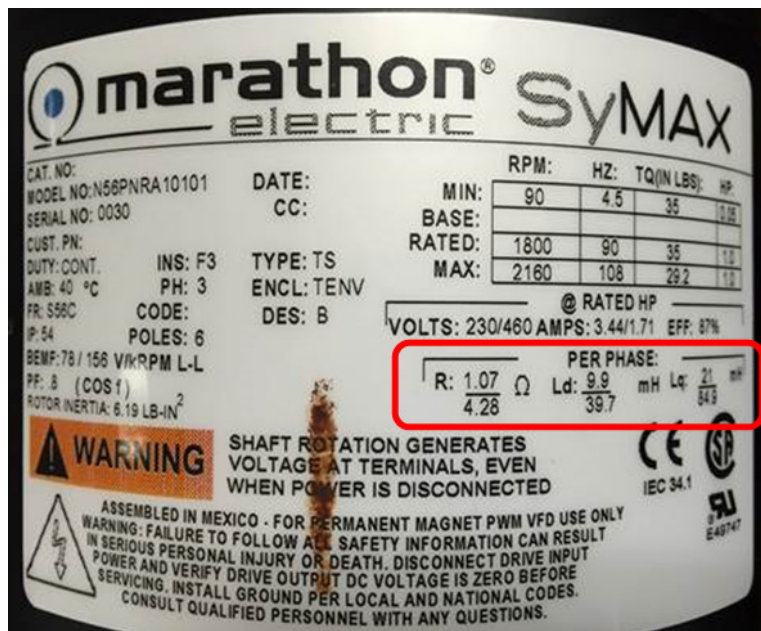

sPM Motors

sPM motors do not have Ld or Lq listed on the nameplate or data sheet. They usually have the resistance and inductance listed as single items. Ke or Counter EMF (CEMF) of the motor is usually listed in V/1000RPM. The PowerFlex 525 uses the CEMF data as RMS. The MPL motor nameplate image in [Figure 2](#) has 0-Pk listed for the Ke value.

Figure 2 - Allen-Bradley® sPM Nameplate

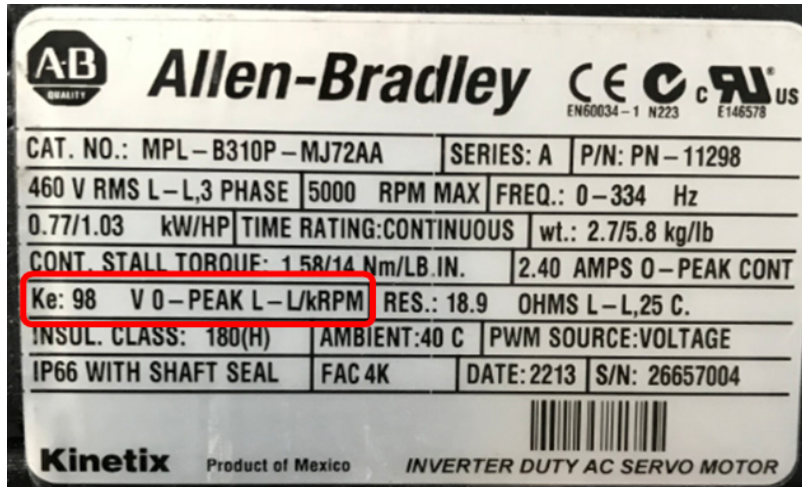

Open Loop PM Motor Setup

The following section steps through the flowchart for open loop control for both the iPM (Interior Permanent Magnet) and sPM (Surface-Mounted Permanent Magnet) motors. The original flowchart is in Appendix J of the PowerFlex 520-Series Adjustable Frequency AC Drive User Manual (520-UM001). Additional information and context about parameter configurations are provided to help have a successful PM motor startup. Refer to [Figure 3](#) for the complete flowchart.

Step 1: Reset to Defaults

Reset the drive to load defaults if the drive has been programmed for other functions. If the drive has just been taken out of the box, this step is not necessary.

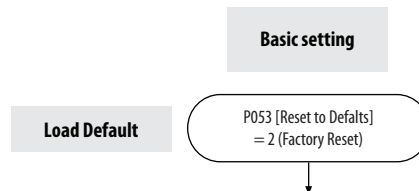

P053 [Reset To Defaults]



Stop drive before changing this parameter.

Resets all parameters to their factory default values. After a Reset command, the value of this parameter returns to zero.

Options	0 "Ready/Idle" (Default)	
	1 "Param Reset"	Does not reset custom groups, parameter P030 [Language], and communication parameters.
	2 "Factory Reset"	Restore drive to factory condition.
	3 "Power Reset"	Resets only power parameters. Can be used when you swap power modules.
	4 "Module Reset" ^{(1) (2)}	Power cycle of the drive, NO parameters are reset.

(1) Setting is available in PowerFlex 525 FRN 5.xxx and later.

(2) Setting is available in PowerFlex 523 FRN 3.xxx and later.

Step 2: Configure the Control Mode Selection

PM Motor Control was added to the PowerFlex 525 in v5.xx of the firmware. The control mode selection of "4" is used for the PM motor control. The PM algorithm is basically a VHz type algorithm with alignment, stability, and efficiency gain controls to improve permanent magnet response and performance.

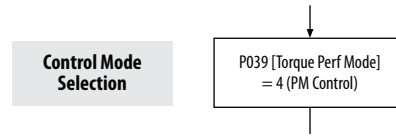

P039 [Torque Perf Mode]

 Stop drive before changing this parameter.

Selects the motor control mode. The PowerFlex 523 and PowerFlex 525 drives can perform with the following motor control modes.

Options	0 "V/Hz"
	1 "SVC" (Default)
	2 "Economize"
	3 "Vector"
	4 "PM Control" ^{(1) (2)} When P039 [Torque Perf Mode] is set to 4 and A535 [Motor Fdbk Type] is set to 0, 1, 2, or 3, the drive is in open loop PM motor control mode. When P039 [Torque Perf Mode] is set to 4 and A535 [Motor Fdbk Type] is set to 4 or 5, the drive is in closed loop PM motor control mode.

(1) Setting is specific to PowerFlex 525 drives only.

(2) Setting is available in PowerFlex 525 FRN 5.xxx and later.

Step 3: Enter Motor Nameplate Information

Motor data entry is critical for successful startup and proper operation. Enter the motor data that is seen in the following flowchart section:

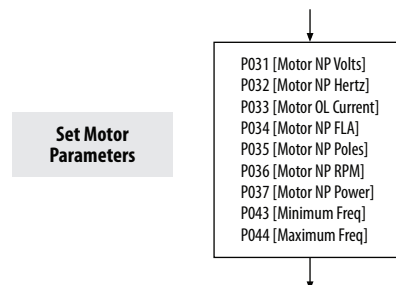

P031: Motor Nameplate Volts

Motor Voltage is used in the motor equivalent circuit tests and calculations during the Autotune process. We recommend that you have the drive input voltage match the motor voltage rating.

$$460\text{V Drive Input} = 460\text{V Motor}$$

We recommend that the drive input voltage is **not greater** than the motor voltage rating.

$$460\text{V Drive Input} = 230\text{V Motor}$$

Motor dielectric strength for a 230V motor may not be able to handle the voltage potentials from a 460V drive.

P031 [Motor NP Volts]

 Stop drive before changing this parameter.

Sets the motor nameplate rated volts.

Values	Default:	Drive Rated Volts
	Min/Max:	10V (for 230V Drives), 20V (for 460V Drives), 25V (for 600V Drives)/Drive Rated Volts
	Display	1V

P032: Motor Nameplate Hertz

Motor frequency and motor poles determine the synchronous speed of the motor. PM motors are synchronous motors. If the Motor Nameplate Hz is not printed on the nameplate of the motor, it can be calculated using the following equation:

$$n_s = \frac{120 * f}{p} \text{ where } f = \text{frequency}; p = \text{poles}$$

P032 [Motor NP Hertz]

 Stop drive before changing this parameter.

Sets the motor nameplate rated Frequency.

Values	Default:	60 Hz
	Min/Max:	15/500 Hz
	Display	1 Hz

P033: Motor Overload Current

Set the motor overload current based on the motor manufacturer data sheet.

P033 [Motor OL Current]

Sets the motor nameplate overload current. Used to determine motor overload conditions and can be set from 0.1 A to 200% of drive rated current.

IMPORTANT: The drive faults on an F007 "Motor Overload" if the value of this parameter is exceeded. This fault is based on class 10 motor overload protection according to NEC article 430, and motor over-temperature protection according to NEC article 430.126 (A) (2), UL 508C File 29572.

Values	Default:	Drive Rated amps
	Min/Max:	0.0/(Drive Rated amps x 2)
	Display	0.1 A

P034: Motor Nameplate FLA

Motor FLA is based on motor nameplate setting.

P031 [Motor NP Volts]

Sets the motor nameplate FLA. Used to assist the Autotune routine and motor control.

Values	Default:	Based on Drive Rating
	Min/Max:	0.1/(Drive Rated amps x 2)
	Display	0.1 A

P035: Motor Nameplate Poles

Enter the motor poles from the nameplate. If the poles are listed in pairs, double the number to enter. If nothing is listed, contact the motor manufacturer. The motor poles are critical data for running the motor and are used in the tuning calculations.

P035 [Motor NP Poles]

Sets the number of poles in the motor.

Values	Default:	4
	Min/Max:	2/40
	Display	1

P036: Motor Nameplate RPM

Remember for PM motors, Motor Nameplate RPM is the synchronous speed because there is no slip. This parameter works alongside P035 [Motor NP Poles] and P032 [Motor NP Hertz] for the proper synchronous speed.

P036 [Motor NP RPM]

 Stop drive before changing this parameter.

Sets the rated nameplate rpm of the motor. Used to calculate the rated slip of the motor. To reduce the slip frequency, set this parameter closer to the motor synchronous speed.

Values	Default:	1750 rpm
	Min/Max:	0/24000 rpm
	Display	1 rpm

P037: Motor Nameplate Power

Motor nameplate power is in kW. It is critical that motor nameplate power is entered correctly as it is used in tuning calculations.

P037 [Motor NP Power]

 PowerFlex 525 only.

Sets the motor nameplate power. Used in PM regulator.

Values	Default:	Drive Rated Power
	Min/Max:	0.0/Drive Rated Power
	Display	0.01 kW

P041 & P042: Acceleration Time 1 and Deceleration Time 1

Amount of time it takes the drive to increase the speed of the motor from 0 Hz to P044 [Maximum Freq]. Amount of time it takes the drive to decrease the speed of the motor from P044 [Maximum Freq] to 0 Hz.

P041 [Accel Time 1]

Sets the time for the drive to accelerate from 0 Hz to P044 [Maximum Freq].
Accel Rate = [Maximum Freq]/[Accel Time x]

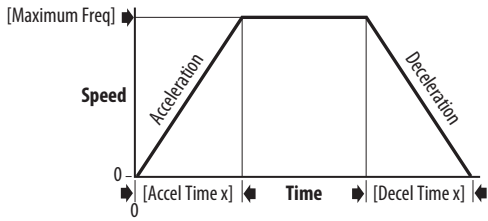

Values	Default:	10.00 s
	Min/Max:	0.00/600.00 s
	Display	0.01 s

P042 [Decel Time 1]

Sets the time for the drive to decelerate from P044 [Maximum Freq] to 0 Hz.
Accel Rate = [Maximum Freq]/[Decel Time x]

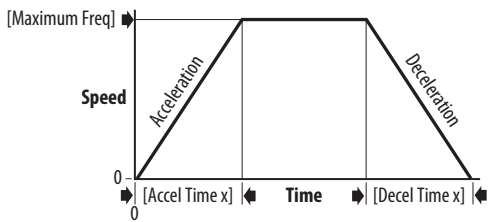

Values	Default:	10.00 s
	Min/Max:	0.00/600.00 s
	Display	0.01 s

P043: Minimum Frequency

If the frequency is set to greater than zero, then this frequency is the minimum frequency to which the drive ramps after a start command.

P043 [Minimum Freq]

 Stop drive before changing this parameter.

Sets the lowest frequency that the drive outputs.

Values	Default:	0.00 Hz
	Min/Max:	0.00/500.00 Hz
	Display	0.01 Hz

P044: Maximum Frequency

Maximum frequency is defaulted to 60 Hz. For most PM motors, the maximum frequency has to be changed. Improper current draw and speed regulation occurs if maximum frequency is not set to the proper motor requirements. During the rotate autotune, it requires the motor to run to the frequency in P032 [Motor NP Hertz]. If P044 [Maximum Freq] is not set above P032 [Motor NP Hertz], the autotune fails.

P044 [Maximum Freq]

 Stop drive before changing this parameter.

Sets the highest frequency that the drive outputs.

IMPORTANT: This value must be greater than the value set in P043 [Minimum Freq].

Values	Default:	60.00 Hz
	Min/Max:	0.00/500.00 Hz
	Display	0.01 Hz

Step 4: A440 [PWM Frequency]

The PWM carrier frequency is defaulted to 4 kHz. Most motor manufacturers have a recommended drive PWM frequency setting to configure for proper operation. The lower the PWM carrier frequency, the lower the stress on the power module of the drive. The higher the PWM carrier frequency, increased stresses are observed on the drive IGBTs based on load current requirements.

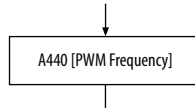

Parameter A440 [PWM Frequency] can typically be left at the default 4 kHz, but check with the motor manufacturer to confirm. Most sPM motors recommend 8 kHz PWM carrier frequency and iPM motors usually recommend 6 kHz PWM carrier frequency.

A440 [PWM Freq]

Sets the carrier frequency for the PWM output waveform. The following chart provides derating guidelines that are based on the PWM frequency setting.

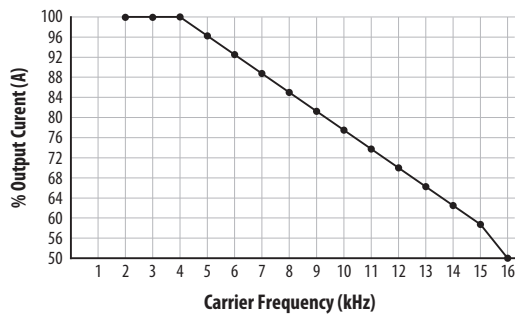

Note: If Vector mode (open loop) is selected and 16 kHz is selected, the drive forcibly reduces the carrier frequency to 8 kHz.

IMPORTANT: Ignoring derating guidelines can cause reduced drive performance. The drive automatically reduces the PWM carrier frequency at low output speeds, unless prevented from doing so by A540 [Var PWM Disable].

Values	Default:	4.00 kHz
	Min/Max:	2.0/16.0 kHz
	Display	0.01k Hz

Step 5: Set Motor Feedback Type

Motor feedback type is configured using A516 [Motor Fdbk Type]. The default value of "0" represents no feedback or open loop control. For open loop sPM and iPM control, the default value can remain.

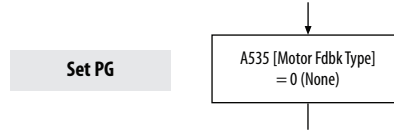

A535 [Motor Fdbk Type]

Stop drive before changing this parameter.

Selects the encoder type.⁽¹⁾



ATTENTION: The loss of analog input, encoder, or other feedback can cause unintended speed or motion. Take appropriate precautions to guard against possible unintended speed or motion.

	Allowable Control Modes (See P039 [Torque Perf Mode])	Hardware Inputs
Options		
0 "None" (Default)	V/Hz, SVC, Economize, Vector, PM Control	-
1 "Pulse Train"	V/Hz, SVC, Economize, PM Control	[DigIn TermBlk 05] for PowerFlex 523 [DigIn TermBlk 07] for PowerFlex 525
2 "Single Chan" ⁽²⁾	V/Hz, SVC, Economize, PM Control	
3 "Single Check" ⁽²⁾	V/Hz, SVC, Economize, PM Control	Optional incremental encoder card (catalog number 25-ENC-1)
4 "Quadrature" ⁽²⁾	V/Hz, SVC, Economize, Vector, PM Control	
5 "Quad Check" ⁽²⁾	V/Hz, SVC, Economize, Vector, PM Control	

(1) Parameter is also available in PowerFlex 523 FRN 3.xxx and later.

(2) Setting is specific to PowerFlex 525 drives only.

Step 6: Perform an Autotune

Set P040 [Autotune] to "2" to perform a rotate tune. The motor must be unloaded to perform a rotate tune test properly.

P040 [Autotune]

Related Parameters: P034, P039, A496, A497

Stop drive before changing this parameter.

Enables a static (not spinning) or dynamic (motor spinning) autotune to set the motor parameters automatically. Set the parameter value to a one or two, then issue a valid "Start" command to begin the routine. After the routine is complete, the parameter resets to a zero. A failure (such as if a motor is not connected) results in an Autotune Fault.

It is recommended to perform a full rotate tune when using VVC mode.

IMPORTANT: All motor parameters in the Basic Program group must be set before running the routine. If a start command is not given (or a stop command is given) within 30 s, the parameter automatically returns to a zero and an Autotune Fault occurs.



ATTENTION: Rotation of the motor in an undesired direction can occur during this procedure. To guard against possible injury and/or equipment damage, we recommended that you disconnect the motor from the load before proceeding.

Options	0 "Ready/Idle" (Default)	
	1 "Static Tune"	A temporary command that initiates a non-rotational motor stator resistance test for the best possible automatic setting of A496 [IR Voltage Drop]. A start command is required following initiation of this setting. The parameter returns to 0 "Ready/Idle" following the test, at which time another start transition is required to operate the drive in normal mode. Used when motor cannot be uncoupled from the load.
	2 "Rotate Tune"	A temporary command that initiates a "Static Tune" followed by a rotational test for the best possible automatic setting of A497 [Flux Current Ref]. A start command is required following initiation of this setting. The parameter returns to 0 "Ready/Idle" following the test, at which time another start transition is required to operate the drive in normal mode. Important: Used when motor is uncoupled from the load. Results may not be valid if a load is coupled to the motor during this procedure.

The rotate autotune procedure measures and configures the following parameters:

A501 [PM IR Voltage]

(PF 525) PowerFlex 525 only.

(With FRN 5.xxx and later.)

Voltage across the stator resistance of the PM motor at the rated motor current displayed in line-to-line rms value.

Values	Default:	11.50V
	Min/Max:	0.00/655.35V
	Display:	0.01V

A502 [PM IXd Voltage]

(PF 525) PowerFlex 525 only.

(With FRN 5.xxx and later.)

Voltage across the d-axis stator inductance of the PM motor at the rated motor current and the rated motor frequency that is displayed in line-to-line rms value.

Values	Default:	17.91V
	Min/Max:	0.00/655.35V
	Display:	0.01V

A503 [PM IXq Voltage]⁽¹⁾

(PF 525) PowerFlex 525 only.

(With FRN 5.xxx and later.)

Voltage across the q-axis stator inductance of the PM motor at the rated motor current and the rated motor frequency that is displayed in line-to-line rms value.

Values	Default:	53.21V
	Min/Max:	0.00/655.35V
	Display:	0.01V

(1) For sPM motors, there is no reluctance torque so $A502 \approx A503$. For iPM motors, there is reluctance torque so $A502$ does not equal $A503$.

A504 [PM BEMF Voltage]⁽¹⁾

(PF 525) PowerFlex 525 only.

(With FRN 5.xxx and later.)

Back electromotive force (EMF) voltage.

Values	Default:	1640.0 Drive Rated Volts
	Min/Max:	0.0/6000.0 Drive Rated Volts
	Display:	0.1V

(1) For this test, the drive spins the motor to the maximum motor frequency as configured in P032 [Motor NP Hertz]. Remember, P044 [Maximum Freq] must be greater than or equal to P032 [Motor NP Hertz] for this test to complete properly.

Step 7 (Optional): Reverse Startup Experienced

After performing an autotune on an open loop PM motor, a momentary "reverse startup" can occur. Configuration of the A516, A517, A518, and A519 may need to be done to help ensure a reverse startup is not experienced. A516 is the selection of the commutation angle detection method to be used. The default value is "0 - Align".

A516 [PM Initial Sel]

(PF 525) PowerFlex 525 only.

(With FRN 5.xxx and later.)

PM initial angle detect.

Options	0	"Align" (Default)
	1	"HFI" High Frequency Injection to detect initial angle.
	2	"Six Pulse"

A516 Set to "0 - Align" or "2 - Six Pulse"

Both 'Align' and 'Six Pulse' commutation angle detection methods take advantage of A517 [PM DC Inject Cur] and A518 [PM Align Time]. These parameters can be adjusted during setup if there are issues with the reverse startup of the motor after doing an autotune.

A517 [PM DC Inject Cur]

PF 525 PowerFlex 525 only.

(With FRN 5.xxx and later.)

Maximum DC current in amps applied to the motor to reset the rotor position of a PM motor.

Values	Default:	30%
	Min/Max:	0/300%
	Display:	1%

A518 [PM Align Time]

PF 525 PowerFlex 525 only.

(With FRN 5.xxx and later.)

Magnetic pole reorientation time.

Values	Default:	0.7 s
	Min/Max:	0.0/60.0 s
	Display:	0.1 s

A516 Set to "2 - HFI"

High Frequency Injection (HFI), is a method to detect the commutation angle leverages, A519 [PM HFI NS Cur], to configure the percentage of frequency amplitude to inject into the motor to detect the N/S orientation of the magnet.

A519 [PM HFI NS Cur]

PF 525 PowerFlex 525 only.

(With FRN 5.xxx and later.)

High Frequency Injection (HFI) North South Current to detect N/S Magnet.

Values	Default:	100%
	Min/Max:	0/300%
	Display:	1%

Steps to Help Prevent a Reverse Startup

1. Set A516 [PM Initial Sel] = "1 - HFI"
2. Increase the value of A519 [PM HFI NS Cur] by 10%
3. Perform a run test at a set reference speed. Check if the motor reverses
 - a. If the motor rotates, repeat Steps 2...3
 - b. If A519 [PM HFI NS Cur] has reached its maximum value of 200%:
 - i. Reset the value to the default = 100%
 - ii. Set A516 [PM Initial Sel] = "2 - Six Pulses"
 - iii. Repeat Step 3
4. Perform a test run at a reference speed and check if the motor reverses.
5. If the motor reverses, repeat steps 2 and 3.

6. If A519 [PM HFI NS Cur] has reached its maximum value again and a reverse motor startup still occurs, the motor setup has failed.

A start command and speed reference help generate good PM performance.

Step 8: Load Motor and Start Moving

Setup of Open Loop control should be complete. If additional tuning is required, continue to [Open Loop Additional Tuning](#) in the [Additional Tuning Options](#) section.

Figure 3 - Open Loop PM Startup Procedure

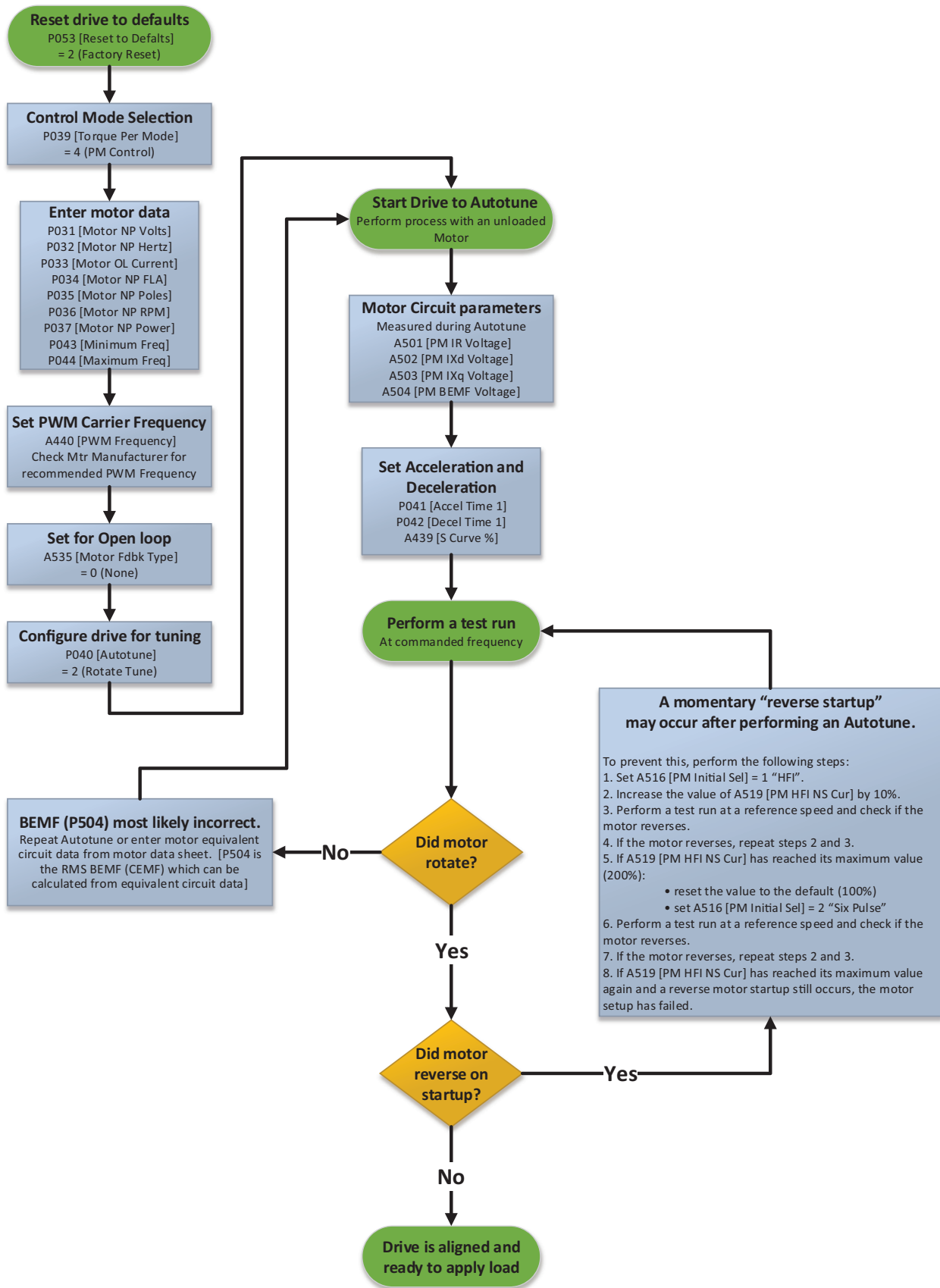

Closed Loop iPM Motor Setup

The PowerFlex 525 supports closed loop control on iPM motors only. Most of the steps to configure the drive to support this control mode, are the same as the open loop setup. The difference is the change that is made to the feedback option. If there are issues after completing an autotune, there are fixes that can be tried. Refer to [Figure 4](#) for the complete flowchart.

Step 1: Complete Open Loop Steps 1...4

Steps 1... 4 in the open loop control are the same steps that we want to take for the closed loop control option.

1. Reset PowerFlex 525 to factory defaults
2. Configure Motor Control Mode P039 [Torque Perf Mode] = “4 - PM Control”
3. Enter Motor Nameplate Information
 - a. P031 [Motor NP Volts]
 - b. P032 [Motor NP Hertz]
 - c. P033 [Motor OL Current]
 - d. P034 [Motor NP FLA]
 - e. P035 [Motor NP Poles]
 - f. P036 [Motor NP RPM]
 - g. P037 [Motor NP Power]
 - h. P041 [Acceleration Time 1] & P042 [Deceleration Time 1]
 - i. P043 [Minimum Freq]
 - j. P044 [Maximum Freq] (*Remember that $P044 \geq P032$)
4. Configure the PWM carrier Frequency A440

Step 2: Set Motor Feedback Type

For closed loop control, the motor feedback option must be configured to the type of feedback that is being using with the motor setup. The encoder options to configure to A535 [Motor Fdbk Type] are:

- 4 - Quadrature
- 5 - Quad Check

A535 [Motor Fdbk Type]

Related Parameters: P039, A537

 Stop drive before changing this parameter.
Selects the encoder type.⁽¹⁾

ATTENTION: The loss of analog input, encoder, or other feedback can cause unintended speed or motion. Take appropriate precautions to guard against possible unintended speed or motion.

		Allowable Control Modes (See P039 [Torque Perf Mode])	Hardware Inputs
Options	0 "None" (Default)	V/Hz, SVC, Economize, Vector, PM Control	–
	1 "Pulse Train"	V/Hz, SVC, Economize, PM Control	[DigIn TermBlk 05] for PowerFlex 523 [DigIn TermBlk 07] for PowerFlex 525
	2 "Single Chan" ⁽²⁾	V/Hz, SVC, Economize, PM Control	
	3 "Single Check" ⁽²⁾	V/Hz, SVC, Economize, PM Control	
	4 "Quadrature" ⁽²⁾	V/Hz, SVC, Economize, Vector, PM Control	Optional incremental encoder card (catalog number 25-ENC-1)
	5 "Quad Check" ⁽²⁾	V/Hz, SVC, Economize, Vector, PM Control	

(1) Parameter is also available in PowerFlex 523 FRN 3.xxx and later.

(2) Setting is specific to PowerFlex 525 drives only.

Step 3: Perform an Autotune

Run the drive with P040 [Autotune] = "2 - Rotate Tune" configured to complete the autotune process. This process measures and configures the following:

- A501 [PM IR Voltage]
- A502 [PM IXd Voltage]
- A503 [PM IXq Voltage]
- A504 [PM BEMF Voltage]

Step 4: Alignment Configuration

The final step before the motor can be attached to the load, and the application can start, is to configure the alignment options of the PowerFlex 525. A516, A517, and A518 must be configured to help ensure proper operation. A516 is the selection of the commutation angle detection method to be used. The default value is "0 - Align". Leave A516 at the default value.

A516 [PM Initial Sel]
 PowerFlex 525 only.

(With FRN 5.xxx and later.)

PM initial angle detect.

Options	0 "Align" (Default)	
	1 "HFI"	High Frequency Injection to detect initial angle.
	2 "Six Pulse"	

A516 Set to "0 - Align"

The 'Align' commutation angle detection method takes advantage of A517 [PM DC Inject Cur] and A518 [PM Align Time]. These parameters are changed from the default value for closed loop iPM motor control.

A517 [PM DC Inject Cur]

(PF 525) PowerFlex 525 only.

(With FRN 5.xxx and later.)

Maximum DC current in amps applied to the motor to reset the rotor position of a PM motor.

Values	Default:	30%
	Min/Max:	0/300%
	Display:	1%

A518 [PM Align Time]

(PF 525) PowerFlex 525 only.

(With FRN 5.xxx and later.)

Magnetic pole reorientation time.

Values	Default:	0.7 s
	Min/Max:	0.0/60.0 s
	Display:	0.1 s

Step 5: Current Bandwidth Configuration

The current bandwidth configuration of the PowerFlex 525 must also be changed from the default value.

A580 [Current Loop BW]

(PF 525) PowerFlex 525 only.

(With FRN 5.xxx and later.)

Current loop bandwidth (0 = Automatically calculate the control gain of current loop).

Values	Default:	0 Hz
	Min/Max:	0/65535 Hz
	Display:	1 Hz

Step 6: Drive Aligned Correctly

If the PowerFlex 525 closed loop control of the iPM motor aligns successfully, then the system is ready for the load to be applied.

F12 or F13 Occurs on a Start

If a 'hardware overcurrent' (F12) or a 'ground fault' (F13) occurs on a start, then a power cycle to the drive must occur and more refinement of the alignment configuration must be completed. Follow these steps:

1. Power cycle the drive after experiencing a F12 or F13
2. Set A535 [Motor Fdbk Type] = 0, press enter. Change A535 = 4, press enter
3. Set A517 [PM DC Inject Cur] = 110%
4. Set A518 [PM Align Time] = 6.0 s

Confirm that the motor aligns correctly.

Step 7: Load Motor and Start Moving

Setup of Closed Loop control should be complete. If additional tuning is required, continue to the [Closed Loop Additional Tuning](#) in the [Additional Tuning Options](#) section.

Figure 4 - Closed Loop Startup Flowchart

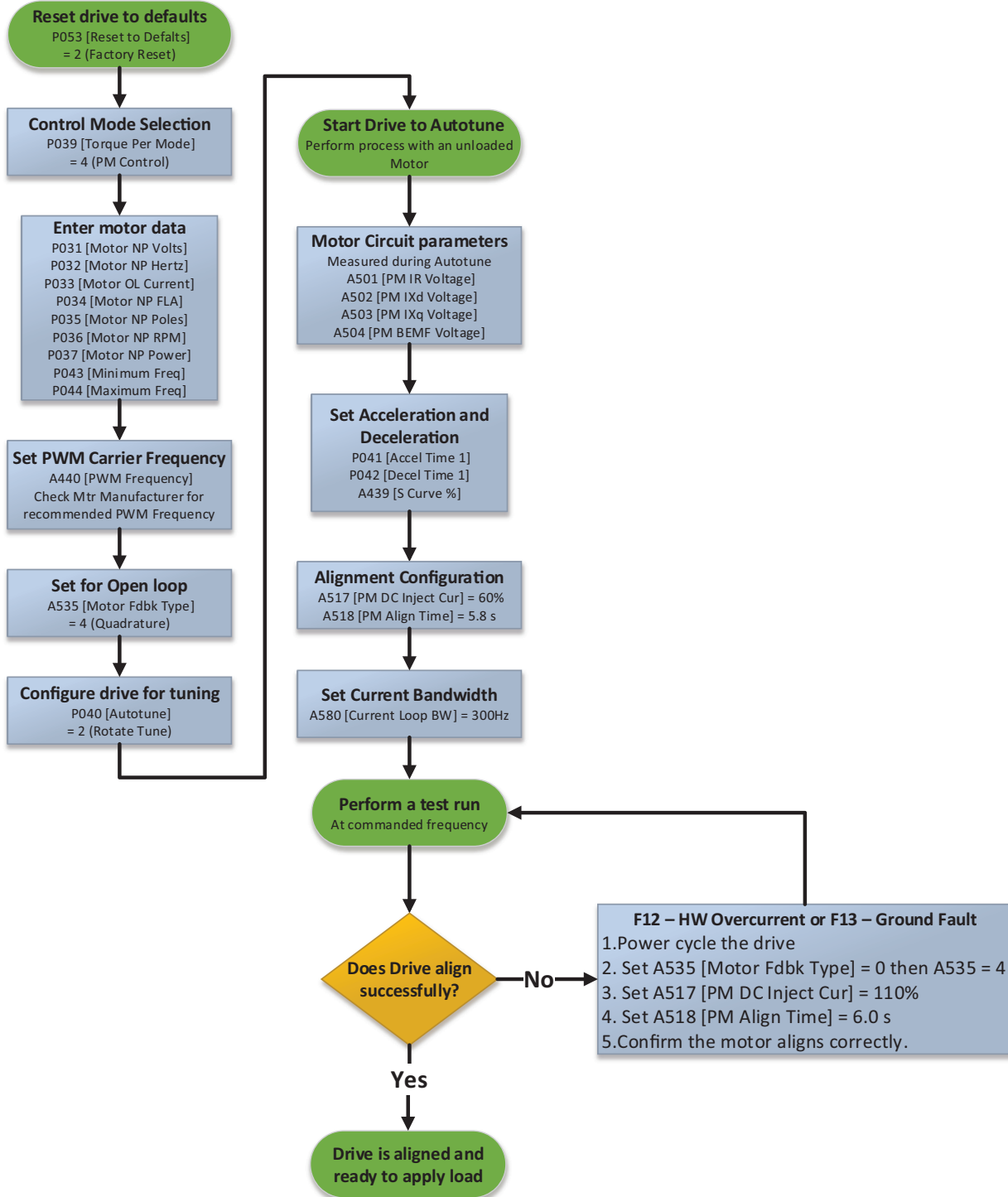

Additional Tuning Options

The following sections provide additional tuning information for the PowerFlex 525 after completing either the open loop control or closed loop setup from the previous sections.

General Tuning Changes

The following tuning changes can be applied to either an open loop or closed loop permanent magnet system.

DC Bus Overvoltage Faults

If the PowerFlex 525 is experiencing DC Bus overvoltage faults due to rapid changes in the load, or rapid deceleration rates, then complete changes to A520 [PM Bus Reg Kd].

- A520 [PM Bus Reg Kd] = ↑ (increase by 10% and try again)

A520 [PM Bus Reg Kd]

(PF 525) PowerFlex 525 only.

(With FRN 5.xxx and later.)

Derivative gain for bus regulator.

Values	Default:	2
	Min/Max:	0/500
	Display:	1

Open Loop Additional Tuning

The PowerFlex 525 PM open loop control provides several different methods to modify the control loops that are being used to power the sPM or iPM motor in open loop. The following control blocks can be modified to improve operation:

- V/Hz Curve (green)
- Efficiency Control (blue)
- Stabilization Control (orange)

[Figure 5](#) shows the PM open loop control diagram. The blocks that are listed earlier that can be modified are highlighted.

Figure 5 - PM Open Loop Control Diagram

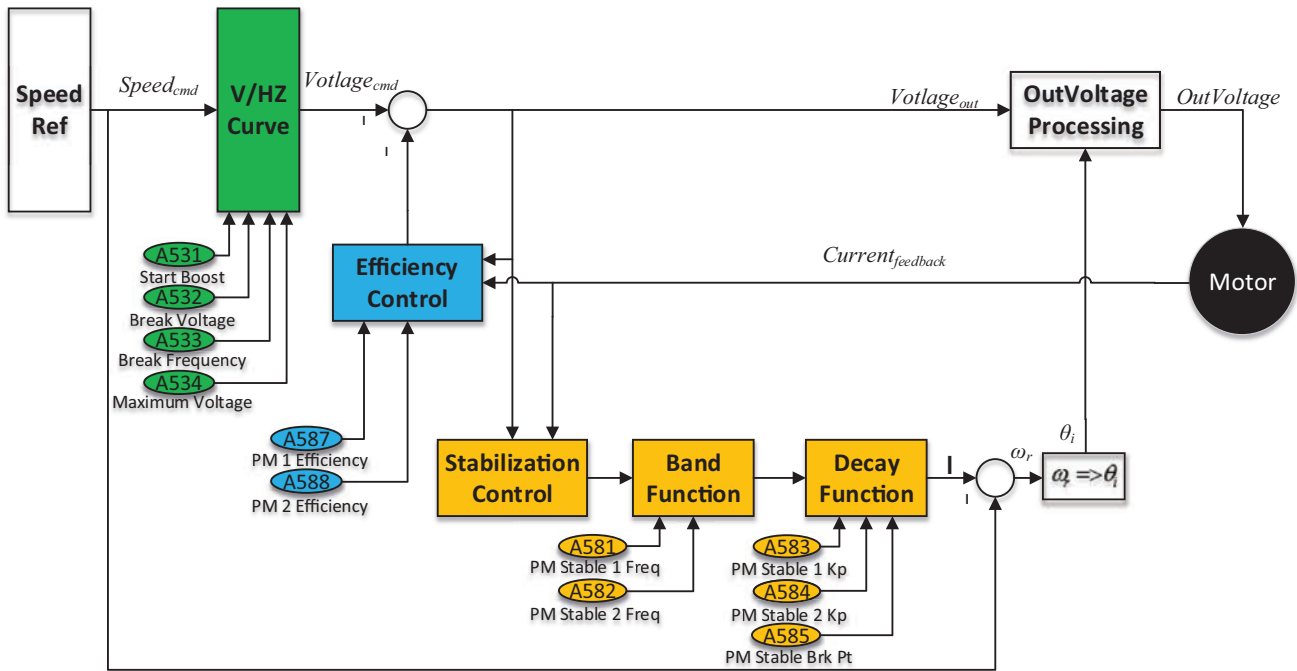

V/Hz Curve Adjustments

The open loop control for the PowerFlex 525 takes advantage of a V/Hz curve to determine what output voltage to produce. If the motor startup is not successful, or the system must be tuned more to perform the application correctly, adjustments can be made to the V/Hz curve to adjust starting torque, or reduce the chance of the drive running into current limit at low speeds.

The custom V/Hz curve has the following parameters that can be adjusted to change the voltage output of the drive:

A531 [Start Boost]

Related Parameters: P031, P032, P039, A530

Sets the boost voltage (% of P031 [Motor NP Volts]) and redefines the V/Hz curve when A530 [Boost Select] = 0 "Custom V/Hz" and P039 [Torque Perf Mode] = 0 "V/Hz".

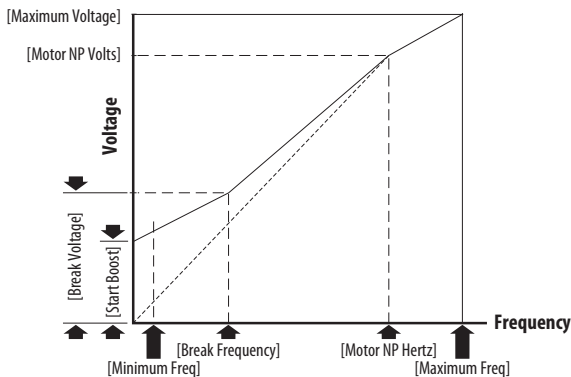

Values	Default:	2.5%
	Min/Max:	0.0/25.0%
	Display:	0.1%

A532 [Break Voltage]

Related Parameters: P031, P032, P039, A530, A533

Sets the voltage (in percent of [Base Frequency]) at the A533 [Break Frequency] if A530 [Boost Select] is set to 0 "Custom V/Hz".

Values	Default:	25.0%
	Min/Max:	0.0/100.0%
	Display:	0.1%

A533 [Break Frequency]

Related Parameters: P031, P032, P039, A530, A532

Sets the frequency where A532 [Break Voltage] is applied if A530 [Boost Select] is set to 0 "Custom V/Hz".

Values	Default:	15.0 Hz
	Min/Max:	0.0/500.0 Hz
	Display:	0.1 Hz

The "Start Boost" and "Break Voltage" are a percentage of the A504 [PM BEMF Voltage] that is calculated during the autotune process. The "Break Frequency" parameter determines at what frequency setting the "Break Voltage" occurs. Adjusting these parameters changes the starting voltage that is applied to the motor to change the starting torque available.

A504 [PM BEMF Voltage]

PF 525 PowerFlex 525 only.

(With FRN 5.xxx and later.)

Back electromotive force (EMF) voltage.

Values	Default:	1640.0 Drive Rated Volts
	Min/Max:	0.0/6000.0 Drive Rated Volts
	Display:	0.1V

Lack of Starting Torque

If the system is experiencing a lack of starting torque, do the following:

- Increase A531 [Start Boost]
- Increase A532 [Break Voltage]

Current Limit at Low Speeds

If the system is experiencing current limit conditions while running at low speeds, do the following:

- Decrease A531 [Start Boost]
- Decrease A532 [Break Voltage]

V/Hz Adjustment Summary

[Figure 6](#) is a basic flowchart for adjusting the V/Hz curve.

Figure 6 - Open Loop PM Motor V/Hz Tuning Procedures

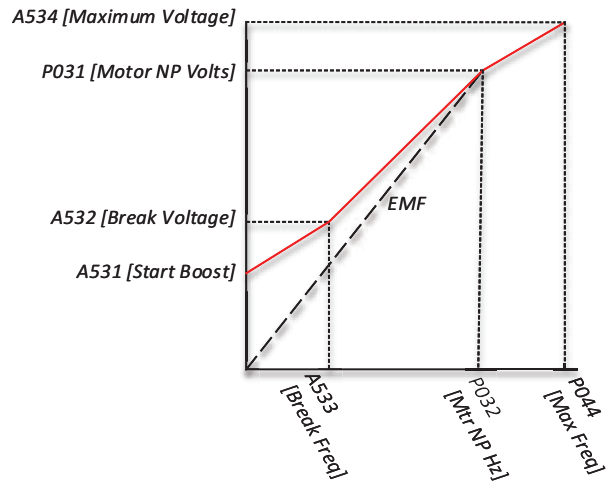
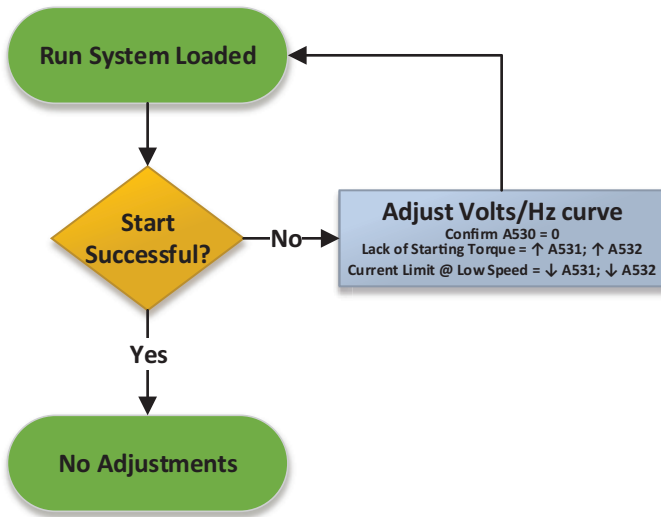

Efficiency Control

Efficiency of the drive and motor can be tuned to get the optimal system performance. A587 [PM 1 Efficiency] and A588 [PM 2 Efficiency] parameters can be increased or decreased depending on the needs to the system. The following is a list of effects to the system whether you increase or decrease A587 and A588.

Drive output voltage is the sum of voltage of V/F curve and voltage of efficiency control. A587 and A588 are the gain of efficiency control.

A587 is the gain of positive efficiency control voltage when motor is loaded. Higher gain increases the output voltage when the motor is loaded.

A588 is the gain of negative efficiency control voltage when motor is not loaded. Zero value disables it and therefore results in higher voltage, which means more available torque.

A587 [PM 1 Efficiency] - increase this parameter to improve the efficiency of a motor at higher loading. Keep in mind that:

- Increasing too much reduces the load capability of the drive motor combination
- Decreasing A587 [PM 1 Efficiency] increases current drawn by the motor and reduces overall efficiency

A587 [PM 1 Efficiency]

[PF 525] PowerFlex 525 only.

(With FRN 5.xxx and later.)

Reduce full load current.

Values	Default:	120%
	Min/Max:	0/2000%
	Display:	1%

A588 [PM 2 Efficiency] - increasing this parameter reduces the current drawn at light loading. Keep in mind that:

- Too large an increase can cause motor stability issues
- Too large a decrease can cause the motor to draw excessive current at light loading

A588 [PM 2 Efficiency]

 PowerFlex 525 only.

(With FRN 5.xxx and later.)

Reduce no load current.

Values	Default:	500%
	Min/Max:	0/2000%
	Display:	1%

A586 [PM Stepload Kp]

 PowerFlex 525 only.

(With FRN 5.xxx and later.)

The gain to maintain robustness under step load in low speed region.

Values	Default:	0%
	Min/Max:	0/1000%
	Display:	1%

A589 [PM Algor Sel]

Related Parameters: A550

 Stop drive before changing this parameter.

 PowerFlex 525 only.

(With FRN 5.xxx and later.)

Selects the algorithm to use with your motor. Check with the manufacturer of your motor to determine whether it is an iPM or sPM motor.

Options	0 "Algorithm 1" (Default)	Suggested for most motors.
	1 "Algorithm 2"	Enable an embedded algorithm to reduce oscillation in output waveform (use with sPM motor only, do not enable for iPM motor).

Stabilization Control

Some motors do not operate well with the default stabilization loop curve. There are several parameters that can be used to fine-tune the stabilization control loop to achieve optimal operation. The parameters that control the stabilization loop are as follows:

A581 [PM Stable 1 Freq]

 PowerFlex 525 only.

(With FRN 5.xxx and later.)

The start frequency for stabilization loop (P032 [Motor NP Hertz] x A581 [PM Stable 1 Freq]).

Values	Default:	0%
	Min/Max:	0/100%
	Display:	1%

A582 [PM Stable 2 Freq]

 PowerFlex 525 only.

(With FRN 5.xxx and later.)

Stabilization function returns to normal output after this frequency (P032 [Motor NP Hertz] x A582 [PM Stable 2 Freq]).

Values	Default:	45%
	Min/Max:	0/100%
	Display:	1%

A583 [PM Stable 1 Kp]

(PF 525) PowerFlex 525 only.

(With FRN 5.xxx and later.)

Percentage of the gain for stabilization loop. The gain is set in A584 [PM Stable 2 Kp].

Values	Default:	40%
	Min/Max:	0/100%
	Display:	1%

A584 [PM Stable 2 Kp]

(PF 525) PowerFlex 525 only.

(With FRN 5.xxx and later.)

The gain for stabilization loop.

Values	Default:	250%
	Min/Max:	0/2000%
	Display:	1%

A585 [PM Stable Brk Pt]

(PF 525) PowerFlex 525 only.

(With FRN 5.xxx and later.)

Percentage of rated power P037 [Motor NP Power] for the gain of (A584 [PM Stable 2 Kp] x A583 [PM Stable 1 Kp]).

Values	Default:	40%
	Min/Max:	0/100%
	Display:	1%

If the system is experiencing any of the following conditions, follow the recommendations that are listed:

If “F64 - Drive overload” faults occur, or the motor oscillates during or after acceleration/deceleration.

- Increase A584 [PM Stable 2 Kp]

Need to increase the loop load step response.

- Decrease A584 [PM Stable 2 Kp]
- It is possible to cause oscillations in speed if A584 is set too low
- *Note: Increase A584 in increments of 100%

Example Stabilization Changes

The graphs in [Figure 7](#), [Figure 8](#), [Figure 9](#), and [Figure 10](#) provide examples of systems with varying values set for A584 [PM Stable 2 Kp]. In this example, a 125% load step change was applied, while the graphs show the speed recovery response time of the system. The “Δ time” in the legend of each graph is the time between the lowest speed after the load change until the motor recovers to commanded speed.

Figure 7 - A584 [PM Stable 2 Kp] = Default Value of 250%

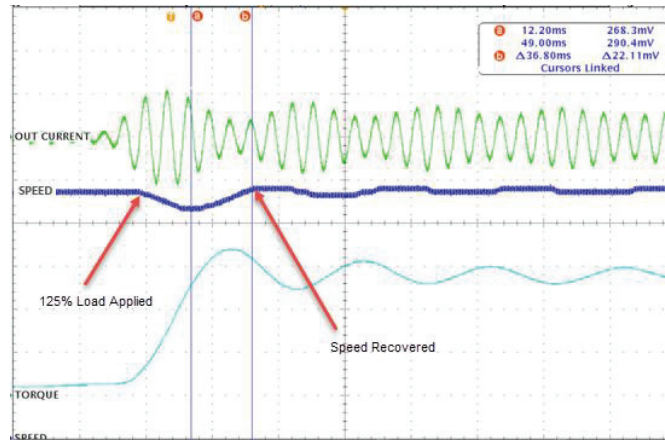

Figure 8 - A584 [PM Stable 2 Kp] = 100%

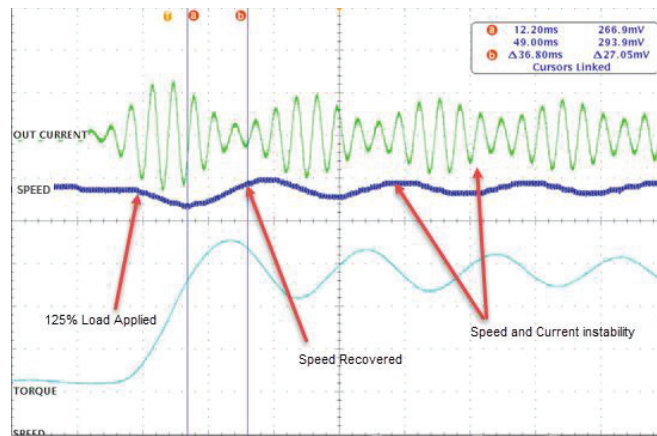

Figure 9 - A584 [PM Stable 2 Kp] = 500%

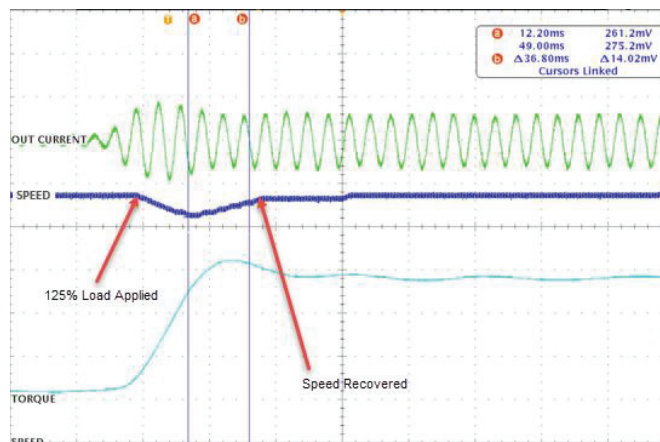
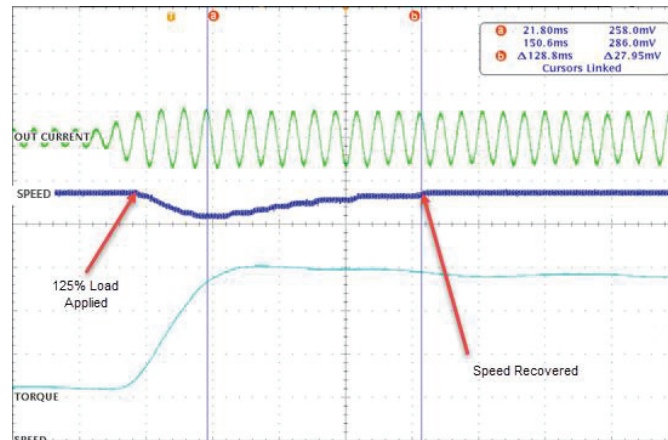

Figure 10 - A584 [PM Stable 2 Kp] = 970%

Closed Loop Additional Tuning

The PowerFlex 525 PM closed loop control provides several different methods to modify the control loops that are being used to power the iPM motor in closed loop. The following control blocks can be modified to improve operation:

- Speed Loop PI Regulator (green)
- Current Loop PI Regulator (blue)
- PM Control Configuration (not pictured)

The blocks listed earlier that can be modified are highlighted in [Figure 11](#).

Figure 11 - PM Closed Loop Control Diagram

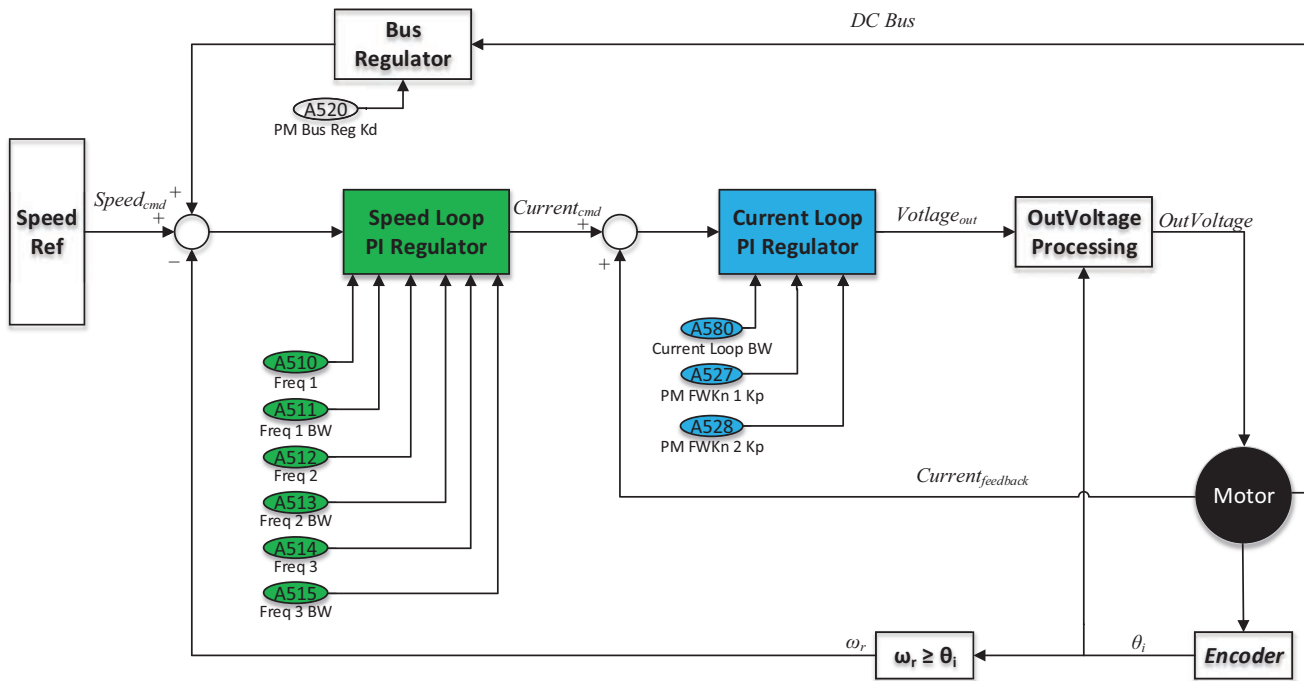

Closed Loop Velocity Stabilization

Speed loop tuning is accomplished by adjusting the vector control mode frequencies and the speed control loop bandwidths. There are three bands that can be adjusted for tuning using the following parameters:

A510 [Freq 1]
A512 [Freq 2]
A514 [Freq 3]

[PF 525] PowerFlex 525 only.

Sets the "Vector" control mode frequency.

Values	Default:
Freq 1:	8.33%
Freq 2:	15.00%
Freq 3:	20.00%
Min/Max:	0.00/200.00%
Display:	0.01%

A511 [Freq 1 BW]
A513 [Freq 2 BW]
A515 [Freq 3 BW]

[PF 525] PowerFlex 525 only.

Speed control loop bandwidth for "Vector" control mode.

Values	Default:
	10 Hz
Min/Max:	0/40 Hz
Display:	1 Hz

By default, the frequency settings are with a 10 Hz bandwidth. The bandwidth changes linearly between frequencies selected. These are the default frequencies:

- A510 [Freq 1] = 0...8.33 Hz
- A512 [Freq 2] = 8.33...15 Hz
- A514 [Freq 3] = 15...20 Hz
- Above 20 Hz

Application Scenario Changes

What to change from the default depends on the system configuration and application needs. The following scenarios describe what to do if the system is experiencing one of the issues.

- If the response is too slow, increase **A51x [Freq # BW]**
- If the speed is unstable, decrease **A51x [Freq # BW]**

Example System

In this example the motor is rated at 60 Hz and the frequencies and bandwidths are configured as follows:

- | | |
|------------------------------|--------------------------------|
| A510 Hz (default) | A511 [Freq 1 BW] = 10Hz |
| A512 [Freq 2] = 10 Hz | A513 [Freq 2 BW] = 10Hz |
| A514 [Freq 3] = 15 Hz | A513 [Freq 3 BW] = 5Hz |

Figure 12 - Closed Loop PM - Speed Loop Example

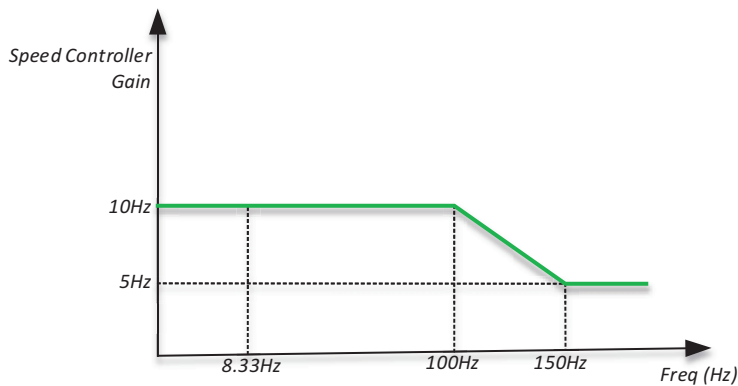

Closed Loop Current Stabilization

In addition to the changes that were made to the Speed Loop PI Regulator, changes can be made to the Current Loop PI regulator to improve stability and performance of the system.

The Current Loop PI regulator leverages the following parameters to make changes and tune the system accordingly:

A580 [Current Loop BW]

(PF 525) PowerFlex 525 only.

(With FRN 5.xxx and later.)

Current loop bandwidth (0 = Automatically calculate the control gain of current loop).

Values	Default:	0 Hz
	Min/Max:	0/65535 Hz
	Display:	1 Hz

A527 [PM FWKn 1 Kp]

(PF 525) PowerFlex 525 only.

(With FRN 5.xxx and later.)

The gain to achieve good performance in field weakening region.

Values	Default:	250%
	Min/Max:	0/2000%
	Display:	1%

A528 [PM FWKn 2 Kp]

(PF 525) PowerFlex 525 only.

(With FRN 5.xxx and later.)

The gain to achieve robustness under step load in weakening region.

Values	Default:	100%
	Min/Max:	100/8000%
	Display:	1%

A580 [Current Loop Bandwidth]

The current loop bandwidth parameter A580 is only used when the PowerFlex 525 is in closed loop iPM control. The current loop bandwidth can affect the stability and response of a system.

- If stabilization was not successful changing the Speed Loop PI regulator with A510 - A515, then decrease A580 [Current Loop BW] by increments of 50 Hz until the instability in the system has been removed.
- If response to load or speed changes must increase, increase A580 [Current Loop BW].

A527 [PM FWKn 1 Kp] & A528 [PM FWKn 2 Kp]

The PM FWKn 1 Kp and 2 Kp are performance parameters that can be adjusted to change the system performance at base speed to maximum speed range. This is considered the field weakening range for the motor. These are only used for closed loop iPM motor control.

PM Control Configuration

Parameter A529 [PM Control Cfg] determines what control features are being used on a closed loop iPM motor system.

A529 [PM Control Cfg]

(PF 525) PowerFlex 525 only.

(With FRN 5.xxx and later.)

Control configuration for Feed Forward Decouple (FFD), Maximum Torque Per Amp (MTPA), and Load Disturbance Observer (LDOB).

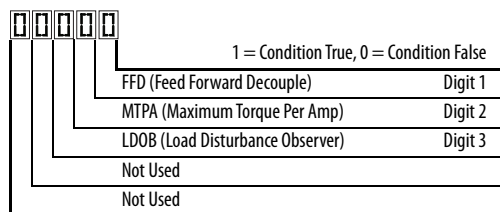

Values	Default:	00111
	Min/Max:	00000/00111
	Display:	00000

Following are the various control configurations and what they provide to a closed loop iPM motor control system:

- Feed Forward Decouple (FFD)
 - To get better response from current loop on a closed loop control, a feed forward decouple compensation is enabled
- Maximum Torque Per Ampere (MTPA)
 - iPM motors have $L_q \neq L_d$ inductance differences (saliency effect). This characteristic creates reluctance torque that sPM motors do not. To produce the best efficiency, MTPA is on to control reluctance.

- Load Disturbance Observer (LDOB)
 - Enable LDOB to increase the response of the speed loop with rapid load changes

Additional Information

Commutation Offset

To control any sPM or IPM motor properly, the commutation angle must be known. If the commutation angle is not correct, the motor draws much higher current and produces lower torque. This is the reason that you cannot run a PM motor with in just V/Hz or Sensorless vector modes. If you start a drive in V/Hz mode and the voltage angle is not correct one of two things may occur, either the motor jumps forward or reverses to align with the output voltage, or the motor does not move at all because the voltage angle is so far from the correct commutation angle.

Commutation Offset Angle Measurement

Commutation offset in the PowerFlex 525 is measured to calculate the proper magnet position in relation to the stator.

The commutation test is accomplished as shown in [Figure 13](#) as A516 = "Align".

Figure 13 - Commutation Offset Angle Measurement

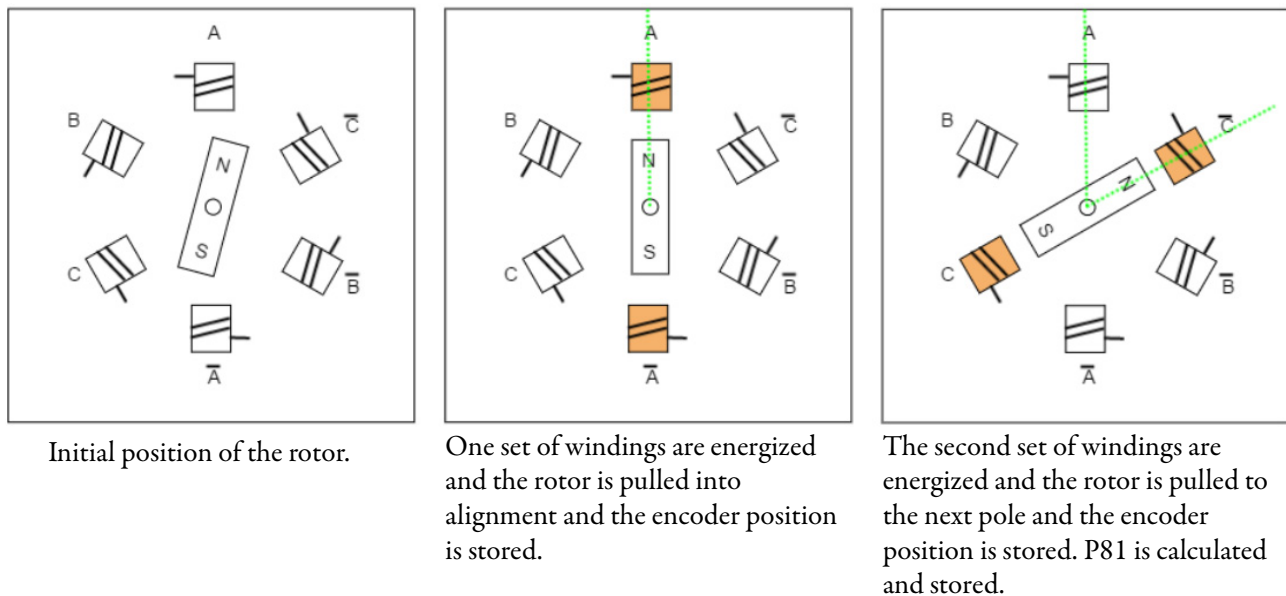

With an incremental encoder, the commutation angle in the PowerFlex 525 is measured once on the first start after power-up. The system must allow the movement of the motor to align the poles and the commutation test current must be set high enough to accomplish the task. If the encoder is ever replaced or uncoupled, the commutation test must be run again to align the feedback with the motor.

Without motor feedback, the PowerFlex 525 uses a static test is run by pulsing each IGBT independently, A516 = "Six Pulse" the current waveform from all six IGBT firings is analyzed and the commutation angle is estimated. Or by High Frequency injection, A516 = "HFI", to calculate the rotor position. In open loop, the commutation offset is done on each start of the motor.

Rockwell Automation Support

Use the following resources to access support information.

Technical Support Center	Knowledgebase Articles, How-to Videos, FAQs, Chat, User Forums, and Product Notification Updates.	www.rockwellautomation.com/knowledgebase
Local Technical Support Phone Numbers	Locate the phone number for your country.	www.rockwellautomation.com/global/support/get-support-now.page
Direct Dial Codes	Find the Direct Dial Code for your product. Use the code to route your call directly to a technical support engineer.	www.rockwellautomation.com/global/support/direct-dial.page
Literature Library	Installation Instructions, Manuals, Brochures, and Technical Data.	www.rockwellautomation.com/literature
Product Compatibility and Download Center (PCDC)	Get help determining how products interact, check features and capabilities, and find associated firmware.	www.rockwellautomation.com/global/support/pcdc.page

Documentation Feedback

Your comments will help us serve your documentation needs better. If you have any suggestions on how to improve this document, complete the How Are We Doing? form at http://literature.rockwellautomation.com/idc/groups/literature/documents/du/ra-du002_-en-e.pdf.

Rockwell Automation Support

For technical support, visit <http://www.rockwellautomation.com/support/overview.page>.

Rockwell Automation maintains current product environmental information on its website at <http://www.rockwellautomation.com/rockwellautomation/about-us/sustainability-ethics/product-environmental-compliance.page>.

Allen-Bradley, LISTEN. THINK. SOLVE., PowerFlex, Rockwell Automation, and Rockwell Software are trademarks of Rockwell Automation, Inc. Trademarks not belonging to Rockwell Automation are property of their respective companies.

Rockwell Otomasyon Ticaret A.Ş., Kar Plaza İş Merkezi E Blok Kat:6 34752 İçerenköy, İstanbul, Tel: +90 (216) 5698400

www.rockwellautomation.com

Power, Control and Information Solutions Headquarters

Americas: Rockwell Automation, 1201 South Second Street, Milwaukee, WI 53204-2496 USA, Tel: (1) 414.382.2000, Fax: (1) 414.382.4444
Europe/Middle East/Africa: Rockwell Automation NV, Pegasus Park, De Kleetlaan 12a, 1831 Diegem, Belgium, Tel: (32) 2 663 0600, Fax: (32) 2 663 0640
Asia Pacific: Rockwell Automation, Level 14, Core F, Cyberport 3, 100 Cyberport Road, Hong Kong, Tel: (852) 2887 4788, Fax: (852) 2508 1846