

THE MAGAZINE OF MODERN DIGITAL ELECTRONICS

COMPUTER DESIGN

JUNE 1967



NEGATIVE RADIX
METRIC

ES DAVIS PRES
NATIONAL TELG OFFICE 96133
1149 WEBER ST 07083
UNION 04
NJ 07083



In-depth software...

**...at your fingertips
for the finest 24-bit
I/C computer buy
...DDP-124**

Every μ -COMP DDP-124 includes 253 field-proven software programs, FORTRAN IV compiler with Boolean capabilities, compatible symbolic assembler . . . and more. That's a lot of 24-bit software strength at your fingertips to help solve your programming problems.

Hardware? DDP-124 features I/C μ -PAC logic modules for high reliability, high performance, high speed at low cost . . . and its specs make it an ideal computer for flight simulation, message switching, physics research, radar tracking, data acquisition, scientific computation, missile tracking, impact prediction.

Interested in the finest 24-bit I/C computer? Write today for new DDP-124 brochures with complete software listing. Honeywell, Computer Control Division, Old Connecticut Path, Framingham, Massachusetts 01701.

Honeywell

 **COMPUTER CONTROL**
DIVISION

CIRCLE NO. 1 ON INQUIRY CARD

Did you ever reach the point where you'd like to stuff something down a salesman's throat? We were in that situation, once. We bought a highly touted heat-writing strip chart recorder. Although it worked well in the "spec" sheets, it failed miserably in our lab. We had to design our own heat-writing system to get the quality we demanded. It performed so well, we've put it on the market. We wouldn't have done so if it didn't come up to BLH Electronics standards.

The heart of the system is the BLH THERMOTIP™ STYLUS with its signal-regulated automatic heat control. You set the heat control and the system automatically adjusts to changes in signal without manual readjustments. Great for one-of-a-kind transients that must be caught. Great for multichannel applications where several different signals (with individual variation characteristics) must be handled.

Yes, BLH Electronics Recorders have a variety of signal-matching plug-in preamplifiers. They fit ALL BLH Systems . . . 2, 4, 6 and 8 channels . . . portable, console or low-boy configurations.

But the proof is in the "putting": putting traces of your signals on chart paper in your

laboratory. If a BLH High Speed Strip Chart Recorder doesn't surpass the others, instead of you stuffing Jack, let Jack stuff you . . . with a steak at your favorite restaurant. Could anything be fairer than that?

To arrange for a demonstration in your plant, or for information on this new THERMOTIP Stylus Recorder, call BLH Electronics or your nearest BLH Representative. BLH Electronics, Inc. a Subsidiary of Baldwin-Lima-Hamilton Corporation, Waltham, Mass. Plants in Waltham, Mass., Pasadena, Calif., and Darmstadt, West Germany.

BLH ELECTRONICS, INC.

A subsidiary of Baldwin • Lima • Hamilton Corporation



STRAIN GAGES • TEMPERATURE SENSORS • LOAD CELLS • PRESSURE CELLS • TORQUE PICKUPS • RECORDERS • INSTRUMENTATION • INTEGRATED SYSTEMS

**How would you like
to stuff ten feet
of Chart Paper
down Jack Joyce's throat?**

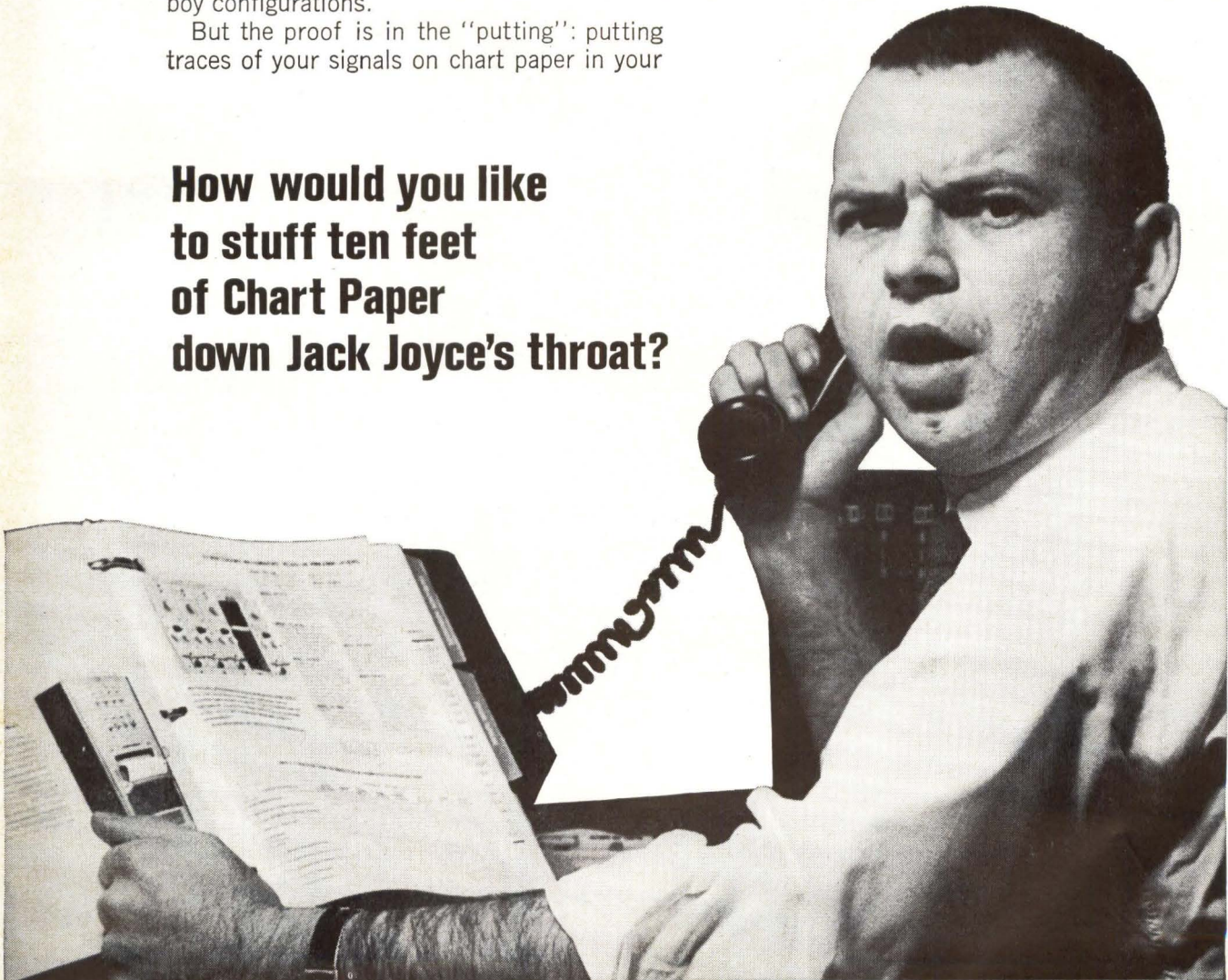

CIRCLE NO. 2 ON INQUIRY CARD

Low cost
(only \$195.00)

Small size
(3" x 4" x 4")

High reliability
(fewer parts)

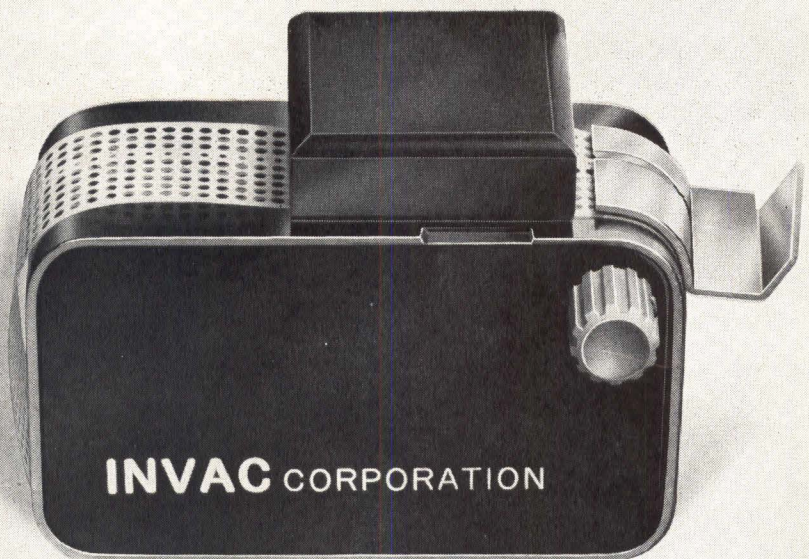

Breakthrough

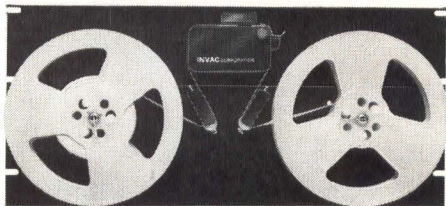

"Ball Sensing" Tape Reader

A sensing design breakthrough by Invac means Tape Readers are now available for only \$195.00 (less standard discounts) with smaller size and inherent high reliability as extra bonuses. The Model R-360 utilizes a unique "reading" method, "Ball Sensing", and accommodates 5, 6, 7 or 8 channel tapes (paper, mylar and aluminized mylar) at speeds up to 60 characters per second.

Invac's new Tape Reader is completely self contained . . . no motors or clutches used, direct logic level outputs . . . no amplifiers required. The tape transport mechanism is positive-indexing, solenoid-actuated, and operates asynchronously from 12, 26 or 48 volt D.C. sources. The Model 360 is available as a separate component, mounted on a 19" panel, or with a panel-mounted tape handler.

Write for the Model R-360 Technical Bulletin

IT'S INVAC FOR ADVANCED PERIPHERAL EQUIPMENT



CORPORATION

26 Fox Road, Waltham, Mass. 02154 Tel. (617) 899-2380

CIRCLE NO. 3 ON INQUIRY CARD

Publisher
ROBERT BROTHERSTON

Editor
S. HENRY SACKS

Associate Editor
WM. A. GANNON

Editorial Advisory Board

DAN M. BOWERS
Chief Editorial Advisor
HAROLD H. SEWARD
JOSEPH D. SABO
EDWARD M. COPPS, JR.
DANIEL J. LICKLY

Contributing Editors

RICHARD AHRONS
T. PAUL BOTHWELL
DAN M. BOWERS
J. REESE BROWN, JR.
A. S. BUCHMAN
WILLIAM B. HUGLE
WALTER A. LEVY
H. S. MILLER
RICHARD PETTERSEN
DAVID L. SANSBURY

Washington Editor

HAROLD V. SEMLING, JR.

Art Director

JAMES FLORA

Production Manager

THERESA SACKS

Ass't. Prod. Mgr.

RUTH MARTIN

Tech. Illus.

BERNARD GREENSIDE

Editorial Ass'ts.

JERILYN PRIMIANO
LOIS LIBBY

Adv. Prod.

BERNARD GREENSIDE

Circ. Mgr.

ALMA BROTHERSTON

Vice Pres.-Sales

LINDSAY H. CALDWELL

Editorial & Executive Offices
Prof. Bldg., Baker Ave.,
W. Concord, Mass. 01781
Tel. 369-6660

Computer Design is published monthly. Copyright 1967 by Computer Design Publishing Corporation. Accepted as controlled circulation publication at Post Office at Boston, Massachusetts. No material may be reprinted without permission. Postmaster: CHANGE OF ADDRESS — FORM 3579 to be sent to Computer Design, Circulation Dept., P. O. Box A, Winchester, Mass. 01890. Subscription rate to nonqualified subscribers is \$15.00 per year; \$1.50 per issue. Subscription rate to all foreign subscribers is \$25.00 per year; \$2.50 per copy.



Circulation
over 32,000

COMPUTER DESIGN

THE MAGAZINE OF MODERN DIGITAL ELECTRONICS

FEATURES

42 BROADBAND LIGHT MODULATORS FOR FUTURE OPTICAL COMMUNICATIONS SYSTEMS

Experimental units modulate both pulsed and continuous laser light.

44 DESIGNING COMBINATORIAL AND SEQUENTIAL ADAPTIVE LOGIC NETWORKS

This article describes a technique for synthesizing combinatorial and sequential adaptive logic networks by partitioning the logic into two sub-networks. A specific illustration is given.

50 ELECTRON BEAM RECORDING

New technique converts computer data 25 times faster than conventional printers.

52 SMALL-SCALE, LARGE-SCALE INTEGRATION

Twenty-four IC chips in a single ceramic package.

**56 NEGATIVE RADIX ARITHMETIC
Part 2 — NEGATIVE RADIX REPRESENTATION**

Continuing this series introduced in last month's issue, Part 2 explains the terminology, conventions, and properties of negative radix number systems.

DEPARTMENTS

16 LETTERS TO EDITOR

18 CD COMMENTARY

22 CD READERS' FORUM

26 DC OUTPUT

28 CD REFRESHER SERIES

36 INDUSTRY NEWS

66 NEW PRODUCTS

- Circuit Components • Circuit Packaging • Input-Output Equipment
- Console Equipment • Power Supplies • Memories • Test Equipment
- Systems • Circuit Modules

84 LITERATURE

88 ADVERTISERS' INDEX

Reader subscription cards opposite Page 1
Reader inquiry cards opposite Page 88

A COMPUTER IS ONLY AS RELIABLE AS ITS WEAKEST LINK

A six per cent increase in tape transport-to-computer availability ratio can mean the difference between completing a computer's assigned workload or running a second shift. Couple this increased availability with improved data reliability, and you have an excellent case for the replacement of those IBM 729 leased transports with their "identical twins", the Midwestern Instruments 4700 series.

This increased reliability is coupled with a savings of 40% to 60% in cost. That's no exaggeration; a glance at the chart (or a call to our Customer Service Department) will verify this cost differential.

Every Midwestern Instruments 4700 series unit uses the IBM diagnostics for preventive maintenance and runs the same programs as the corresponding IBM 729 transport. In appearance and design, they're identical. But not in performance characteristics. The 4700 provides a computer-availability ratio consistently higher than 98%; tape loads in 20 seconds (and stays loaded); set-up time is decreased; and last, but certainly not least, the 4700 runs programs with greater data reliability.

If you're using IBM 729 leased transports now, write or call for your copy of "THE CASE OF THE SUPERLATIVE TWIN" and get the full story on Midwestern Instruments 4700 series replacement units.

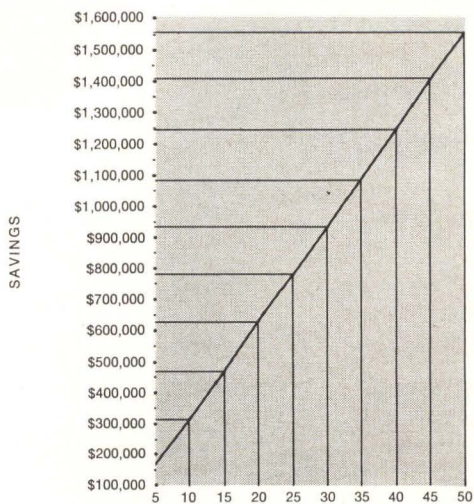

IBM TAPE TRANSPORTS TO BE REPLACED

4700



MIDWESTERN INSTRUMENTS / TELEX

6422 E. 41st STREET • TULSA, OKLAHOMA 74135
PHONE (918) 627-1111 • TWX (918) 627-6030 • TELEX 049-589

MIDWESTERN INSTRUMENTS, INC.

A SUBSIDIARY OF THE TELEX CORPORATION

CIRCLE NO. 4 ON INQUIRY CARD

RCA ESTABLISHES NEW DIVISION TO SERVE THE COMPUTER AND DATA PROCESSING INDUSTRY

They're geared for big things at Needham, Mass., headquarters for RCA's new Memory Products Division. Recently elevated to full Division status in RCA Electronic Components and Devices, the Needham activity has been implemented with a major expansion program at home and abroad—in engineering, manufacturing, and quality control—to meet your expanding requirements for high quality memory products.

RCA HAS 100% IN-HOUSE CAPABILITY FOR CORES, PLANES AND STACKS

- 100% in-house core manufacture gives RCA *full control* over electrical characteristics of planes and stacks
- for commercial, military and aerospace
- 2½D, 3D and linear select
- as fast as 250 nanoseconds
- from small to large capacity arrays
- from standard temperature designs to RCA-developed Lithium wide temperature designs
- from commercial to ruggedized military construction
- high density stacks, non-destructive read out devices, printed circuit and molded plastic frames, and other custom features

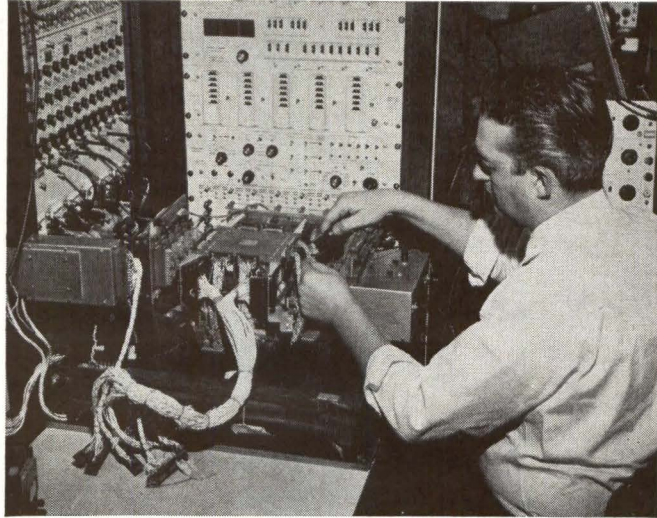

RCA tests *every* plane and stack under simulated operating conditions with dynamic testers and custom interface equipment to assure ultra-reliable memory products.

FAST, FLEXIBLE INTEGRATED CIRCUIT MEMORY SYSTEMS MEET WIDE RANGE OF COMPUTER AND DATA PROCESSOR NEEDS

RCA 1- μ S MEMORY SYSTEM is a coincident-current, integrated-circuit system with 400 nanosecond access time...capacity available to 32,768 words x 36 bits. Front-panel accessibility for easy maintenance...panels slide out and open like a book. Optional features include self-tester.

From wide-temperature cores to complete state-of-the-art memory systems, RCA's total capability in research, development and manufacturing can answer your memory design problems as well as your volume production requirements. See your nearest RCA Field Representative today. Or call 617-444-7200, RCA Electronic Components and Devices, Memory Products Division, 150 "A" Street, Needham Heights, Mass. 02194. For specific technical bulletins, write RCA Commercial Engineering, Section FZB-6, Harrison, N. J. 07029.

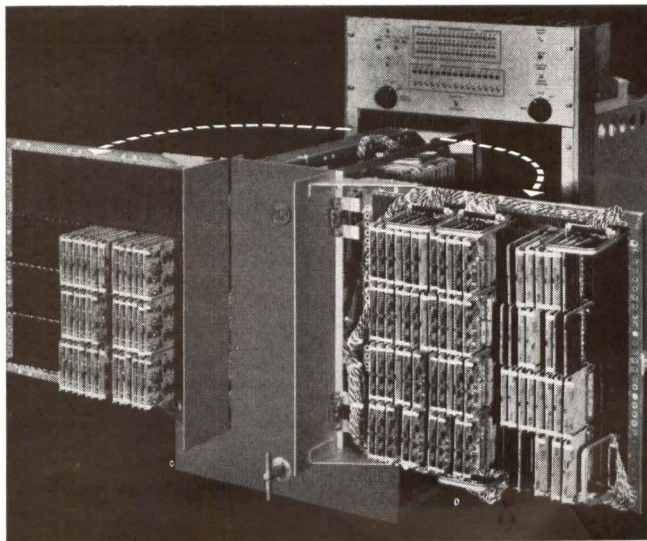

RCA Electronic Components and Devices

THE MOST TRUSTED NAME IN ELECTRONICS

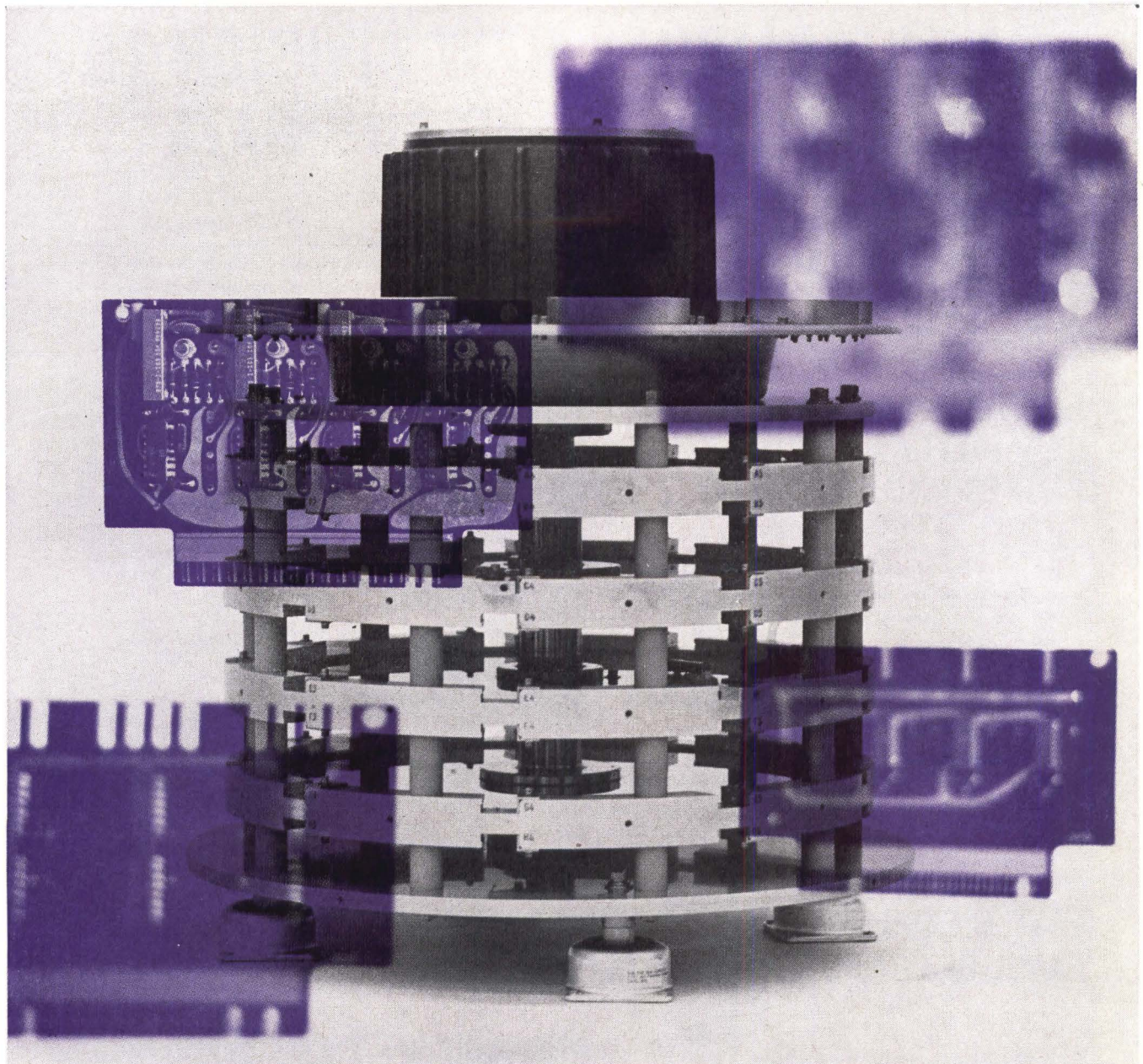

DISC MEMORIES...? INTEGRATED CIRCUITS...? 10 MEGABITS...?



Magne-Head Integrated Circuit Disc Memories with memory capacities from 100K bits to 10 Megabits are available with data transfer rates up to 2 Megacycles. The system interface is +5v. Power Nand DTL. The Magne-Head Integrated Circuit Disc Memory system offers modular growth from 100,000 to 10,000,000 bits. For information on any or all of our high-performance Magnetic Memory Components, write or call today. Write for: free TYPICAL DISC SPECIFICATION BULLETIN.

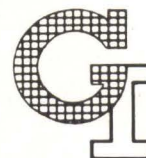

MAGNE-HEAD a division of General Instrument Corp.

13040 South Cerise Avenue / Hawthorne, California 90250 / 213 679-3377 / 772-2351 / TWX 910-325-6203

CIRCLE NO. 6 ON INQUIRY CARD

A NEW CONCEPT IN AUTOMATED DRAFTING —

ON-LINE, TIME-SHARING WITH YOUR COMPUTER,
USING THE GERBER SERIES 500 INTERFACE.



YOUR COMPUTER

COMPUTER
OUTPUT

**SERIES 500
INTERFACE**



THE GERBER SERIES 500 INTERFACE OFFERS A SUBSTANTIAL COST SAVING BY UTILIZING YOUR PRESENT COMPUTER TO DRIVE GERBER GRAPHICAL DISPLAY SYSTEMS AND ACCESSORIES FEATURING THE PROVEN ACCURACY AND RELIABILITY INHERENT IN GERBER EQUIPMENT.

THE GERBER SERIES 500 INTERFACE OPERATES ON-LINE, ON A TIME-SHARING BASIS TO FORM A COMPLETE AUTOMATIC GRAPHIC DISPLAY SYSTEM WHEN MATED WITH ANY OF THE GERBER TABLES AND ACCESSORIES.

TO
ANY
GERBER
DRAFTING
MACHINE



MODEL 75 TABLE — LARGE AREA LOFTING AIRCRAFT AND AUTOMOBILE DESIGN, ACCURACY $\pm 0.005''$ UP TO 24'.

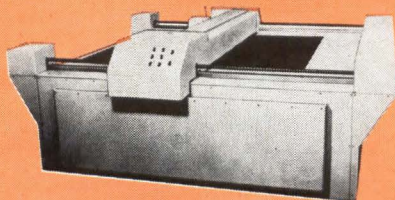

MODEL 32 TABLE — PRECISION LAYOUT FEATURING OPTICAL EXPOSURE OUTPUT FOR PHOTOGRAPHIC PRODUCTION OF PRINTED AND INTEGRATED CIRCUIT ARTWORK. ACCURACY BETTER THAN 0.001''.



THE GERBER SCIENTIFIC INSTRUMENT CO.

HARTFORD, CONNECTICUT

TEL. (203) 644-1551

We'll stop at nothing to help you select the right memory system

... we'll even lend you one (with or without the applications engineer) for a free trial

We can help if you have no experience with core memories, but are designing industrial control systems that must handle and store data. To see how they can profit by the use of a low cost core memory, give us a call. We'll send an applications engineer around with the system best suited to your needs. He'll help you get it on line for evaluation.

We can help if you're familiar with core memories, but don't see how a standard off-the-shelf design could satisfy your requirements. Send us your block diagram. We'll study it and send you back a complete blueprint showing you how a general purpose core memory can be used as a versatile data-manipulating system capable of many

more logic functions than storage. (We may even be able to eliminate some redundant functions required by less versatile storage techniques.)

We can help even if you're already using core storage, but aren't convinced that a mass produced memory can provide many of the control, access and operating mode functions formerly associated (usually one at a time) with custom design. Drop us a line. We'll lend you a small system for a 10-day free trial. See for yourself what it

can do. If at the end of the trial period you can't bear to part with it, we'll work something out.

Our point—to prove that our line of catalog standards is broad enough to satisfy most data storage requirements and that we'll do almost anything to help you apply them to your system. Our FX-12 and FX-14 Series Systems are available in some 200 types. Sizes range from 128 words x 8 bits to 4K x 32, with cycle times from 4 to 8 microseconds. Prices start at \$1,190. If you'd like to check details and specifications before we talk, write for Bulletins M6612 and M6614.

Ferrocube 
Systems Division Englewood, Colorado



FERROXCUBE CORPORATION
Systems Division
5455 S. Valentia Way
Englewood, Colorado
303-771-2000

Boston
617-899-3110

Chicago
312-261-7880

Dallas
214-255-0441

Los Angeles
213-837-1484

Minneapolis
612-888-4681

New York Area
201-964-1844

Phoenix
602-265-1792

Philadelphia
215-927-6262

CIRCLE NO. 8 ON INQUIRY CARD

Who makes a **complete line** of **electronic packaging hardware**?...**Scanbe does!**

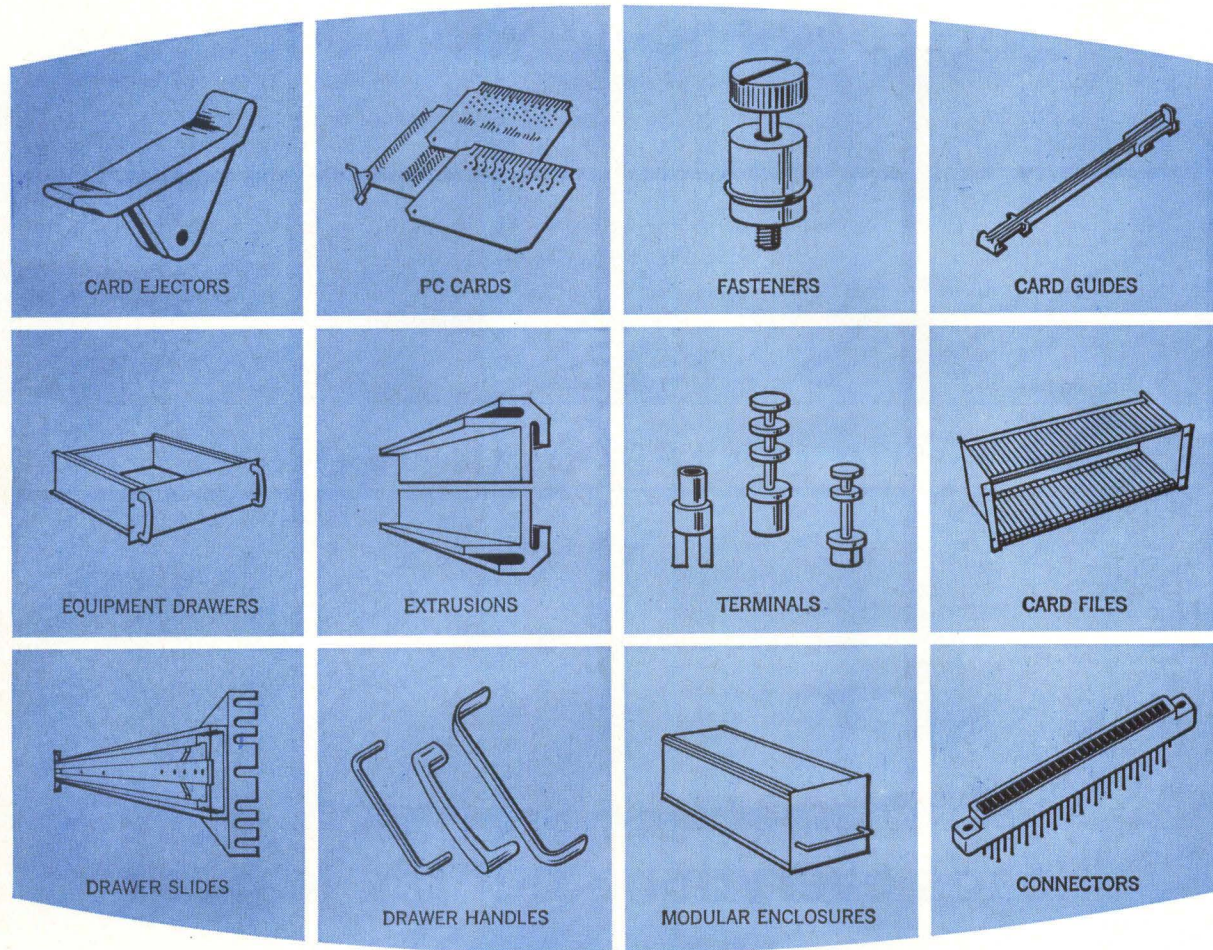

Exclusive from Scanbe

- SINGLE SOURCE SERVICE ■ COMPLETE AND WIDEST SELECTION OF HARDWARE ■ OFF-THE-SHELF AVAILABILITY
- EXPERIENCED DESIGN ASSISTANCE ■ PRECISION MANUFACTURING ■ RIGID QUALITY CONTROL

Save money and time without sacrificing performance—contact Scanbe, *the specialist in electronic packaging hardware*. Write for Scanbe's new *electronic packaging hardware guide*.

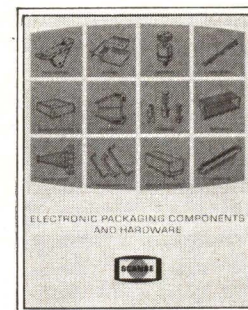

SCANBE MANUFACTURING CORP.

1161 Monterey Pass Road • Monterey Park, California 91754 • Tel. (213) 264-2300 TWX (213) 266-8853

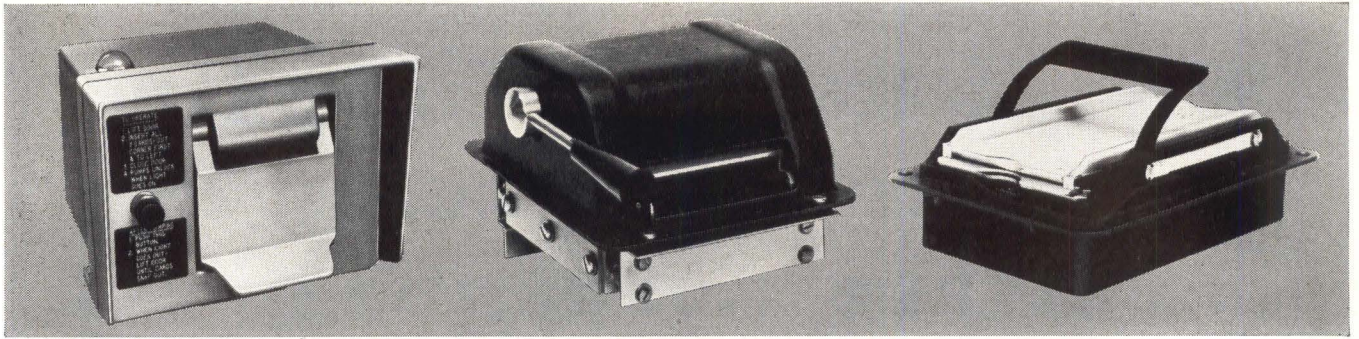

Are we handing you a line?

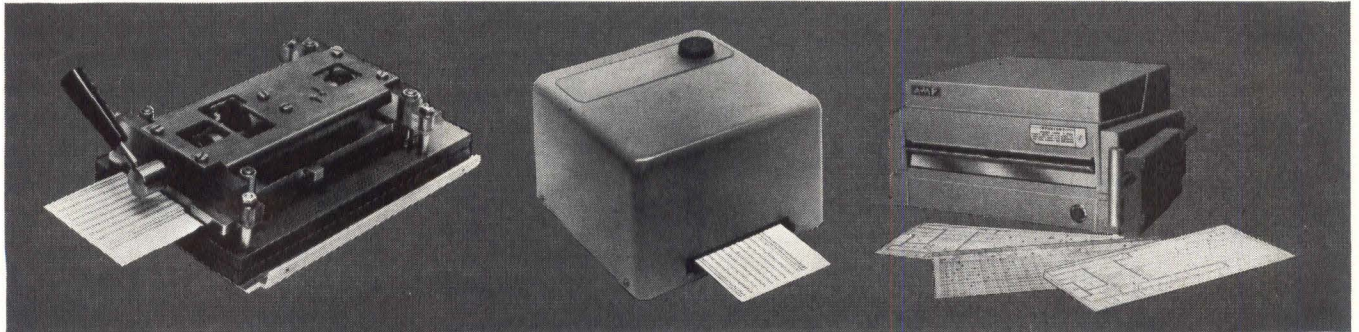

Yes. The biggest in the world ...

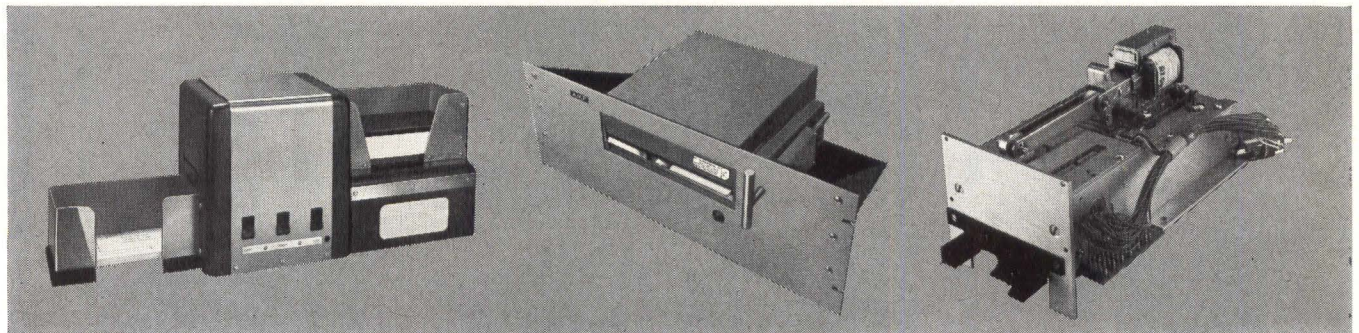

Reads everything but tea leaves.

**For—Digital—Analog—Instrumentation & Testing
—Industrial Control—Batching, Conveyor, Stack-
ing, Molding, etc.—Aerospace—Military—Civil
Service Applications.**

Our line includes models for all size cards and can meet any price objective—O. E. M. or commercial. We match card readers to existing circuits and systems for every application and environment from office to plant to field. If none of our many models can do your job, we'll modify one so it

will. And still produce it in volume. And deliver it and service it anywhere in the world.

AMP Incorporated, worldwide leader in electrical interconnection and packaging, now offers the world's widest line of card readers for E. D. P. With many different models, from simple badge readers to sophisticated reader/imprinters, AMP stands ready to supply you with card reader products in volume—backed up by traditionally superior construction and engineering.

Put your ideas into action with the help of AMP Engineering...Worldwide

AMP
INCORPORATED
Harrisburg, Pennsylvania

CIRCLE NO. 10 ON INQUIRY CARD

DATA COMMUNICATIONS

equipment for on-line,
real-time processing

calling all stations

If your home office in Chicago wanted to send data to the San Francisco, Seattle, Dallas, and Detroit branches, it would be very time consuming and costly to contact each city individually. However, if you send your message by Teletype machine, you could contact all these cities simultaneously.

In fact, with Teletype Model 35 equipment, you not only can call all these cities at once, but individually or in selected groups in any desired sequence. This unique capability of Teletype equipment is due to a compact assembly called the STUNT BOX.

AUTOMATIC GENIUS

The stunt box is an automatic switching device capable of performing any electrically controlled nonprinting function. It can activate paper tape punches, tape readers, computers, and other remote equipment. It can make one machine record on paper tape, another on business forms, and still have another machine "listen" but not record.

However, the most common application of the stunt box in data communications and processing is as a sequential selector for directing data to one or more locations.

SELECTIVE CALLING OPERATION

Each station in a network of Teletype sets has an identification code consisting of three characters and re-

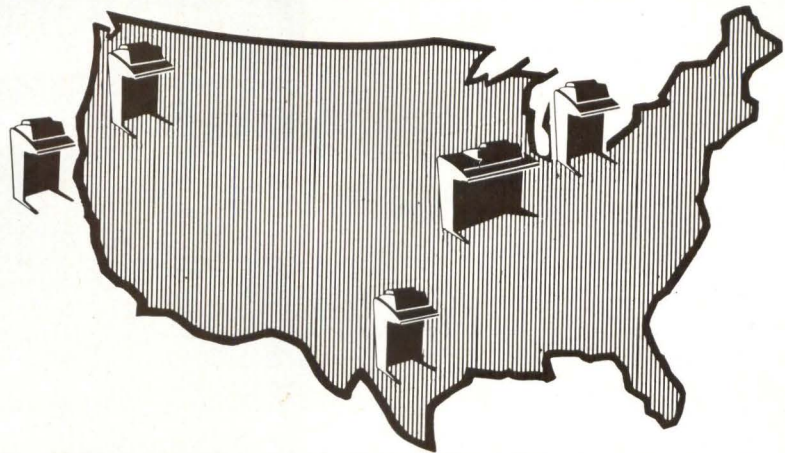

ferred to as a Call Directing Code (CDC). Your Teletype machine in Chicago would thus transmit the proper Call Directing Codes to the Teletype sets in San Francisco, Seattle, Dallas, and Detroit.

When each Teletype machine receives its CDC, selected stunt box function mechanisms move the suppression code bar to the spacing side. This unblocks the type box clutch of the typing unit. All sets are now in the SELECT PRINT condition ready to receive your message.

At this point, an End of Address Code is automatically transmitted. This causes the Teletype sets in your network that have not been called to shift to the NON-SELECT position. This is necessary in order to prevent any "uncalled" machines from receiving the message should their CDC be transmitted within the message text.

After your message has been sent, an End of Message Code is transmitted by the stunt box. This turns off the local sending set and all remote receiving sets.

VERSATILE EQUIPMENT

The stunt box in the Model 35 sets is just one of the many features that make Teletype data communications equipment the most versatile, reliable, and least costly means of collecting, integrating, and distributing data.

For more information about the uses of Teletype equipment, send for our brochure, "HOW TELETYPE EQUIPMENT MOVES DATA FOR YOUR BUSINESS OR INDUSTRY." Teletype Corporation, Dept. 71F, 5555 Touhy Avenue, Skokie, Illinois 60076.

machines that make data move



CIRCLE NO. 11 ON INQUIRY CARD

THIS LITTLE THREAD...

HELPS OUR AIR-SPACED COAX DO BIG THINGS FOR IBM

Our coax can do the same for you! A spiral of flame-retardant polyethylene thread air-spaces the center conductor of Brand-Rex Turbo® 209A Coaxial Cable. The result: a tough, miniature coax, with excellent electricals for high-speed transmission, at moderate cost. □ We first developed the Turbo 209A for use in the IBM Computer/360, but you may find this space-saving performer

useful in a variety of data processing and communications applications. □ It is available as single cable, cemented ribbon cable (illustrated), or conventional round multiconductor cable. □ Substantially lower in price than standard 95 ohm High Temperature types, it also offers lower attenuation; higher velocity of propagation. A spiral drain wire under the shield simplifies termination.

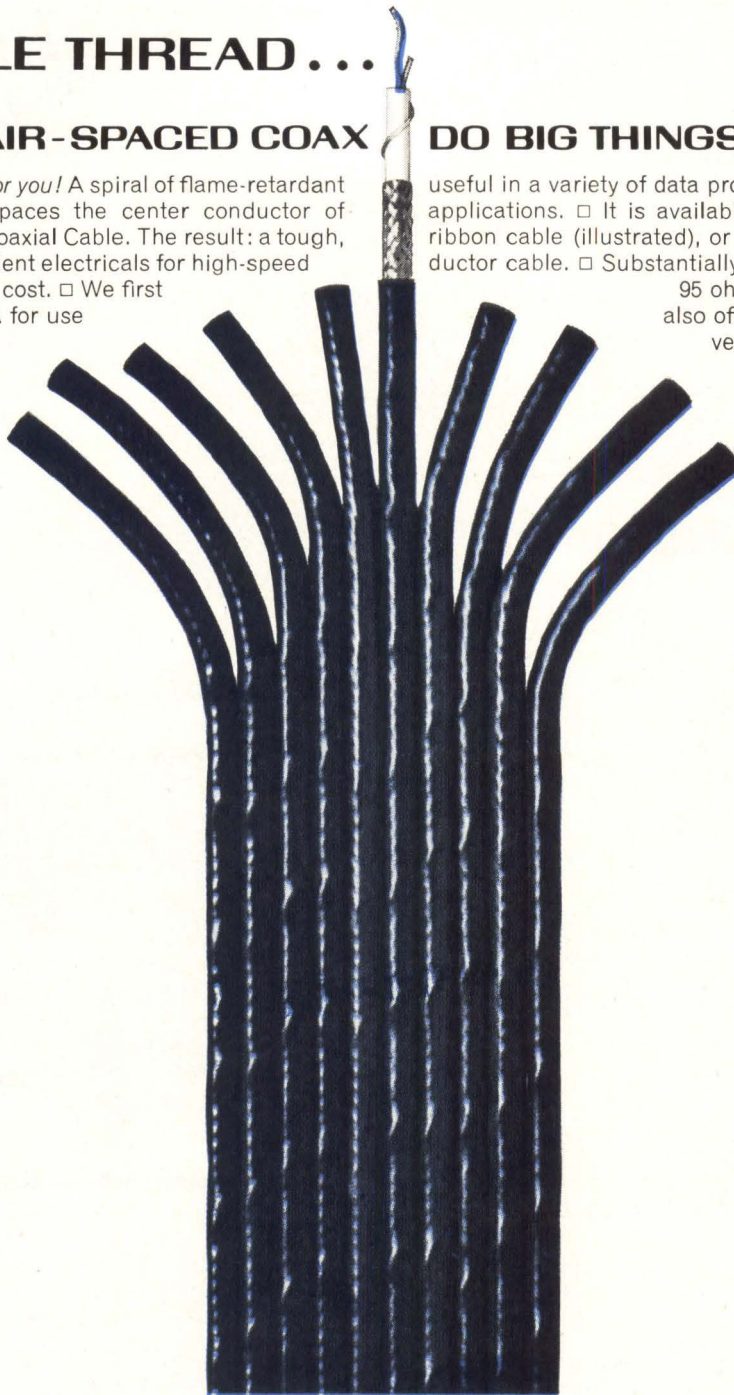

Check the specs. Sound good? Write for full information.

Brand-Rex Turbo 209A Coax U.L. Approvals. Style 1354 (single), Styles 2384, 2385, 2386, 2387, 2388 (cable).

Nominal voltage: 600 volts rms.

Nominal impedance: 95 ohms, +6 -4.

Nominal capacitance: 13.5 pf/ft.

Max. attenuation: 14 db/100 ft at 400 Mc.

Velocity of propagation: 80%.

Inner conductor: #29 AWG silver-coated Turballoy C.

Cable core: Air-spaced, flame-retardant polyethylene. 0.072/0.078" O.D.

Drain wire: #29 AWG silver-coated Turballoy C spirally applied for flexibility and fatigue resistance.

Shield: #38 AWG tinned copper braid, providing 90% min coverage.

Jacket: High-density vinyl, 0.112" nom. O.D.; 0.122" max O.D. at drain wire points.

AMERICAN ENKA CORPORATION

BRAND-REX DIVISION

Willimantic, Connecticut 06226

Phone: (203) 423-7771



CIRCLE NO. 12 ON INQUIRY CARD

DATA COMMUNICATIONS

equipment for on-line,
real-time processing

traveling fast with a host of characters

Modern data communications and processing systems require high-speed operations to be most effective. However, they must also be versatile to meet speed and code level requirements of various data equipment. The Teletype DRPE high-speed paper tape punch meets this very need.

The DRPE is an asynchronous, electromechanical, parallel-wire punching unit. It is capable of receiving and punching characters in paper tape at any speed up to 240 characters per second (2400 words per minute)—without any internal changes or readjustments. In addition, the DRPE can perforate most 5, 6, 7, or 8-level codes in 11/16, 7/8, or 1 inch wide tape.

VERSATILE DATA USES

The DRPE can be used as the receiving terminal in high-speed tape-to-tape equipment or as a high-speed output device for computers and other business machines. The punched tape produced by the DRPE can be relayed by Teletype high-speed or standard-speed paper tape readers.

The circuitry of the DRPE converts low-level signals to controlled power signals that are capable of operating the punch magnets at the required high speeds.

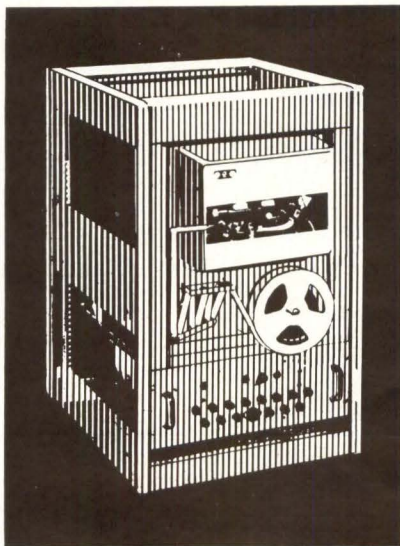

DRPE WITH ELECTRONICS AND TAPE HANDLING GEAR IN 19 INCH RELAY RACK

OPERATION OF THE DRPE

Basically, the DRPE punch consists of cantilevered armatures attracted to magnets—one for each code level and the feed hole. Here's how it operates...

When a character code combination is received, appropriate armatures, linked to corresponding punch pins, perforate the tape when they are released from their magnets by a no-current interval. Immediately the current is reapplied to the magnets so that they return the armatures to their home position, ready to punch the next character.

Since the DRPE's mechanism is not in motion while the unit is on-line waiting for a signal, longer life is assured.

AVAILABLE AS SELF-CONTAINED OR PACKAGE UNIT

The DRPE punch mechanism, driving electronics, and tape handling facilities are available individually or packaged together in a relay rack or floor model cabinet. Either 50 or 60 cycles per second units are available.

More information on the DRPE punch is contained in our 8-page brochure, "TELETYPE DRPE HIGH-SPEED PAPER TAPE PUNCH." To obtain a copy, contact: Teletype Corporation, Dept. 71F, 5555 Touhy Avenue, Skokie, Illinois 60076.

machines that make data move



CIRCLE NO. 13 ON INQUIRY CARD



The publishers of
COMPUTER DESIGN
 are pleased to announce
 the release of the 1967-68
 issue of
COMPUTER INDUSTRY ANNUAL

All **COMPUTER DESIGN** readers on the controlled circulation list as of the January, 1967 issue will receive the **ANNUAL**.

ORDER YOUR UPDATING SUPPLEMENTS NOW!

To keep pace with the accelerated growth of the industry between yearly issues of **COMPUTER INDUSTRY ANNUAL**, quarterly updating supplements will be available at a nominal cost.

The supplements will include new product listings, new manufacturers listings, additions to the Equipment Characteristics Review section, newly released sales and earnings data, and other timely information on computer products, services, and suppliers.

Supplements will be issued in July, October and January for a total cost of \$4.75, payable with your order. Make checks payable to **COMPUTER INDUSTRY ANNUAL**.

*prepaid
 orders
 only*

**Since number
 of copies
 printed will
 be limited
 to pre-paid
 orders**

*Send
 Coupon
 Now—*

**COMPUTER INDUSTRY ANNUAL
 PROF. BLDG. — BAKER AVE.
 WEST CONCORD, MASS. 01781**

GENTLEMEN:

Enclosed is my check for \$4.75 for the three 1967-68 updating supplements to **Computer Industry Annual**. Please mail supplements to:

NAME _____ TITLE _____

COMPANY _____

ADDRESS _____

CITY _____ STATE _____ ZIP _____

DATA COMMUNICATIONS

equipment for on-line,
real-time processing

no time for errors

Transmitting data at high speeds through large switching systems is a major factor in the effectiveness of sophisticated data systems. However, without some automatic method for detecting and correcting errors fast, an entire real-time operation could be in jeopardy.

TELESPEED EQUIPMENT IS THE ANSWER

Telespeed 1200 EDC paper tape equipment is designed specifically to automatically detect and correct errors. It operates at 120 characters per second (1200 words per minute), or less when required. It can utilize any 5, 6, 7 or 8-level code including the officially approved United States of America Standard Code for Information Interchange (USASCII).

Operation of the Telespeed 1200 EDC equipment is based on the transmission of redundant information. The sending set transmits data in blocks of 80 characters without the need for special tape format.

Two redundant check characters are generated by a separate tape-reading head on the sending set, and by a photoelectric reader on the receiving set. The two sets of characters are

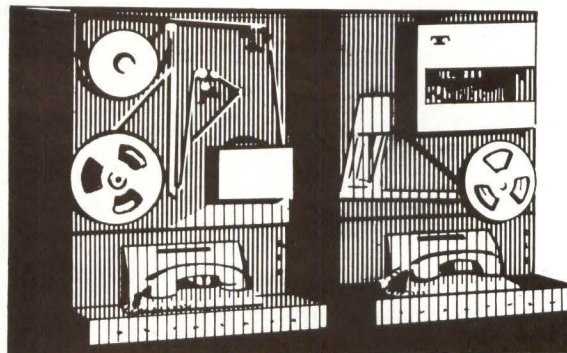

TELESPEED 1200
EDC EQUIPMENT

compared by the receiving terminal, and transmission continues if the characters agree.

CORRECTING AN ERROR

When the Telespeed 1200 EDC receiving set detects an error, the tape containing the block in which the error occurred is pulled back and retransmitted. The receiving set also

pulls back the erroneous tape block and overpunches all code levels prior to receiving the retransmitted block.

The fact that the two sets of check characters are generated from reading both the original tape and the output tape adds another benefit to the Telespeed 1200 EDC equipment. It not only detects any transmission errors, but also checks the accuracy of the terminal equipment.

For further information on Teletype error detection and correction equipment, send for free literature. Contact: Teletype Corporation, Dept. 71F, 5555 Touhy Avenue, Skokie, Illinois 60076.

machines that make data move



CIRCLE NO. 14 ON INQUIRY CARD

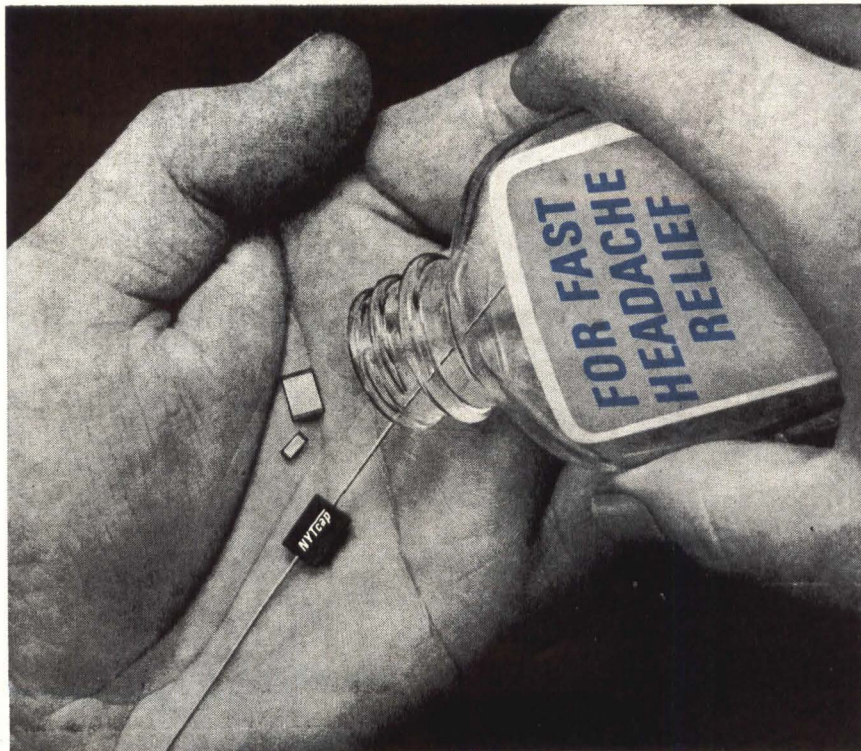

Cure for circuitry headaches

Solve your critical circuitry problems with two extraordinary new miniaturized ceramic capacitors — the product of Nytronics research and development in the continuing pursuit of excellence.

New NYT-CHIP, an ultra-stable chip capacitor, has such advantages as superior packaging flexibility and mounting versatility, particularly for outboard mounting on integrated, thick and thin film circuitry. Dimensions, with tinned terminals, 0.170" x 0.065" x 0.070", with capacitance range of 4.7 pf through 220 pf, and 0.280" x 0.195" x 0.070" for 270 pf to 4700 pf.

NYT-CAP, an ultra high stability ceramic capacitor series is packaged in a miniature molded epoxy tubular package 0.1" diameter by 0.250" in length, with capacitance range of 4.7 pf to 220 pf. The remainder of series in miniature, molded epoxy case 0.350" long by 0.250" wide by 0.1", with a range of 270 pf to 4700 pf.

Both NYT-CHIP and NYT-CAP have a temperature coefficient that does not exceed ± 40 ppm/ $^{\circ}$ C over temperature range of -55° C to $\pm 125^{\circ}$ C, and working voltages of 200 D.C.

As a pioneer in the concept of standardization, Nytronics maintains large volume inventories of these two products, as well as of many other standardized high quality components: inductors, delay lines, and resistors. Write for complete engineering data.



...for Precision Electronic Components

550 Springfield Ave., Berkeley Heights, N. J. 07922 ■ (201) 464-9300 ■ TWX: 710-984-7977

CIRCLE NO. 15 ON INQUIRY CARD

Letters to Editor

LOGIC MINIMIZATION

To the Editor:

Concerning Mr. Levine's article in the March issue of Computer Design, I feel obligated to point out that in spite of a multitude of "methods," minimization is still at least as much an art as a science. The NAND circuit realization below has the same

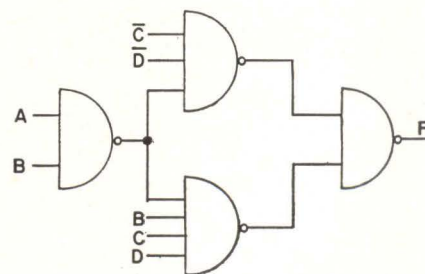
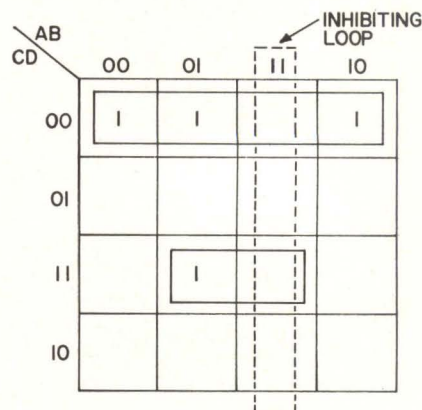

number of inputs, the same number of logic levels, and one less gate than Mr. Levine's "minimum."

Very truly yours,

Robert B. Lackey,
Assoc. Prof. E.E.,
Ohio State University,
Columbus, Ohio 43210

**We started
developing our skills in
computer bus bars
before computers
were invented**

...or bus bars.

We started, in fact, way back when electricity was coming of age, bringing with it increasingly critical requirements for insulation.

Responding to those needs, we became insulation system specialists . . . ideally equipped when the computer age dawned to pioneer the concept of voltage distribu-

tion by laminar bus assembly.

Today, Rogers MEKTRON® Laminar Bus Assemblies are used by every major computer manufacturer.

If you want Mektron data for your files . . . or want help on bus assembly design, call or write today. We promise an appropriate and prompt response.

ROGERS CORPORATION ROGERS, CONNECTICUT 06263



Other Mektron products include: flat, flexible cable, circuitry and connective hardware; molded circuits; Mektherm heater circuits.

CIRCLE NO. 16 ON INQUIRY CARD

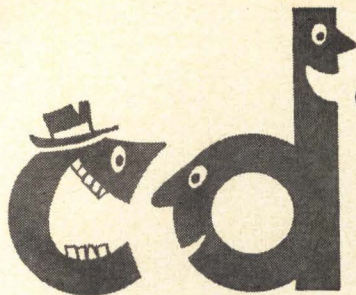

commentary

Comments and opinions on topics of current interest to digital design engineering personnel. A monthly column organized and prepared under the direction of **T. PAUL BOTHWELL, Contributing Editor.**

THE CASE AGAINST STATISTICAL LOGIC DESIGN TECHNIQUES

David S. St. Lawrence

The usual rallying cry for the proponents of statistical logic design techniques goes something like this: "statistical design techniques permit a more realistic evaluation of system operation than do worst-case design techniques." This is usually accompanied by a dissertation on the desirability of avoiding worst-case design methods in calculating signal delays through a logic network because of the extremely low probability that all of the elements in a logic chain would exhibit worst-case delays. The argument then skips nimbly over the abyss of component specification, barely mentions relative design effort, and concentrates on the appeal of applying a formalized statistical method to logic design.

The statistical design technique treats the delay through an n stage logic chain as the sum of n random variables. The probability distribution of the sum of n random variables becomes more peaked as n increases, indicating clearly the decreasing probability of this sum approaching the sum of the worst-case delays. In addition, the probability distribution of the sum of n random variables will be normal for larger values of n regardless of the individual probability distributions, thereby simplifying the task of computation.

However, let us examine what is involved in the application of statistical techniques to the design of a digital system logic network. The logic network under consideration might be a data transfer path for a 30-bit word and consist of at least 30 independent logic chains of nine gates in length. A con-

sistent performance specification would require that all 30 outputs of this logic network be stable within some interval, following a change to the input of the logic network.

Even if not explicitly stated, the confidence level of such a minor network specification must be 99.5% or better if the total system is to be mass-produced economically and reliably. This requirement springs from the fact that it becomes prohibitively expensive if more than a small percentage of completed systems suffer from what is essentially a basic design defect. Considering that the total system might have ten or more such logic networks contributing to the system confidence level, it is not at all unreasonable that each network specification be required to have a 0.995 probability of successful operation. For the example under consideration, there are thirty independent logic chains of nine gates each, and the individual logic chain delay must be computed for a 0.9998 probability of satisfactory operation ($0.9998^{30} = 0.995$). Even with this requirement, the logic delay so computed can be 30% less than the worst-case delay through nine gates. Thus, the statistical approach to logic design can show a possibility of significant improvement in the system performance, and it requires only the specification of the logic element delay distributions.

The case against the application of statistical techniques to logic design is based almost entirely upon economic considerations. Logic element performance can indeed be specified adequately for statistical design purposes and sampling procedures can be set up to insure the continuing delivery of satisfactory devices. Design techniques can be elaborated to make use of this increased information but all of this acts to increase the cost of the basic logic element. Since a statistical design technique merely reduces the number of logic elements required for a given level of performance, the increased cost of suitably specified devices acts to negate any advantage for the statistical design approach. The vendor, planning for a long production run with

The author of this month's CD Commentary, David S. St. Lawrence, is a senior design engineer at Honeywell's Computer Control Division. He is responsible for central processor logic design and development.

Contemporary Electronics is one of the largest producers of computer pulse transformers in the U.S.

SO?

So, maybe you're missing a bet if you haven't checked Contemporary Electronics for *quality, service* and *price*.

Contemporary Electronics *specializes* in pulse transformers. It's not a sideline, but a principal part of our business. Well over 100,000 pulse transformers are produced each month in 75 different designs.

Advantages? Here are some.

Technical Capability. Contemporary Electronics engineering staff knows computers and can design any special product for any application.

High Quality. Most transformers have special high quality design features. All pulse transformers are 100% inspected as many as three times before shipment. QC system meets MIL-Q-9858, and has been approved for use on the Apollo program.

Fast Sample Service. Samples, small production lots and specials are normally shipped 24 to 72 hours after receipt of request.

Interested in what can be done in terms of performance, size, delivery, or MIL-specs? Get to us—we've got lots more to tell.

WRITE, OR CALL COLLECT AND WE'LL HAVE THE FULL STORY TO YOU WITHIN 48 HOURS

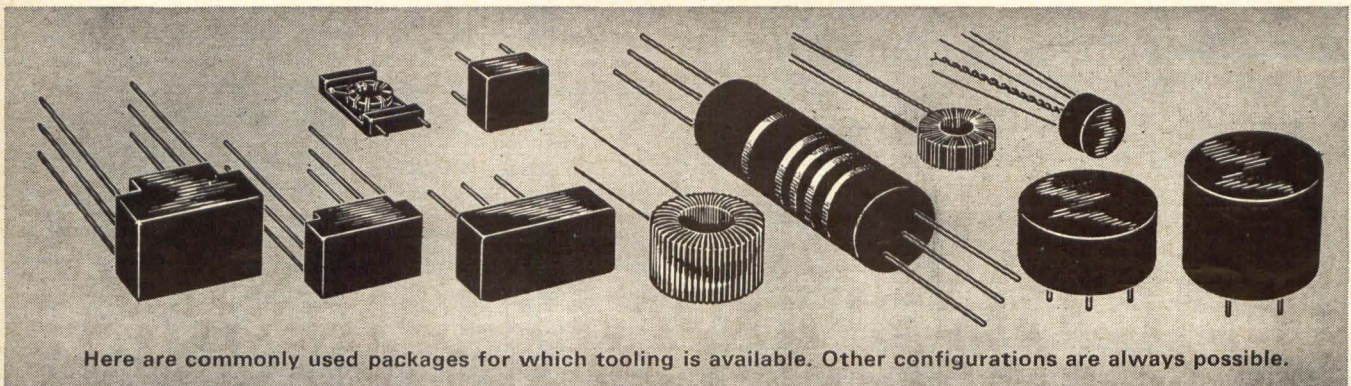

Here are commonly used packages for which tooling is available. Other configurations are always possible.

 **CONTEMPORARY
ELECTRONICS**

4838 West 35th Street, Minneapolis, Minnesota 55416

612/920-6444

EXTRA SERVICE TO THE DATA PROCESSING INDUSTRY

CIRCLE NO. 17 ON INQUIRY CARD

Rack-Mounted BIT 480 COMPUTERS

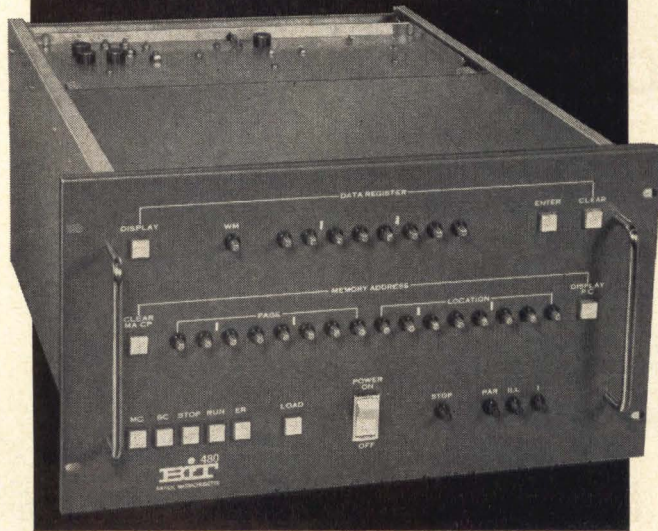

4K 8 μ s MEMORY
WITH ASR 33 Teletype® **\$8,660***
WITH High Speed Data Channel (24 microsecond add) MODEL 480

4K 2 μ s MEMORY
WITH ASR 33 Teletype® **\$10,360***
WITH High Speed Data Channel (6 microsecond add) MODEL 480-F

BIT COMPUTERS FEATURE:

- INTEGRATED CIRCUITS
- BINARY AND DECIMAL ARITHMETIC
- VARIABLE WORD LENGTH

It takes only a SINGLE instruction to add:

346.72	or	0101100111011101
-82.75		10101101
263.97		0101101010001010

ADD TIME = 3n memory cycles, where
n = no. of byte pairs

You **don't** have to worry about multiple precision programming or decimal points with this machine, and you need not have equal length operands.

Write or call for additional information.

*Ask about OEM discounts, too

BIT

Business Information Technology, Inc.

3 Erie Drive, Natick, Mass. 01760 • 617-235-6842

© Product of Teletype Corp., Skokie, Ill.

CIRCLE NO. 18 ON INQUIRY CARD

normal process evolution, will charge more because of his reduced yield. The inspection of purchased material will be more elaborate and expensive than the far simpler one-sided tests used for checking conformance to existing specifications. Management will have a difficult time accepting the element cost-differential due to the increased specifications.

There is little possibility of circumventing this specification problem by in-house testing of devices purchased to a general specification because those attributes of the device that are being relied upon are not under control. For example, a shift in the mean delay can occur without a significant change in the reject rate if the manufacturer has negotiated sufficiently wide guard bands in the purchase specification.

Thus, the designer contemplating statistical design techniques must balance the desirability of using fewer elements for equivalent system performance against the increased cost of adequately specified devices. The alternate choice of using worst-case design techniques with the identical devices that are less expensive because of reduced specification requirements may be a more attractive solution. ■

GOVERNMENT REPORTS ★★

JOSS TIME-SHARED COMPUTER SYSTEM

Developed by the RAND Corporation, the Joss Time-Shared Computer System provides for the solution of numerical problems via an easily learned language at remote typewriter consoles. Intended primarily as a tool for the solution of numerical problems, JOSS provides ease of use, rapid solution time, and simultaneous service to users at reasonable price. The software includes the JOSS language interpreter, a monitor for user scheduling and resource allocation, and I/O routines for the hardware devices. Service is currently available to nearly 500 users through 34 consoles, of which six are remote, operating over private or dataphone lines.

Order from Clearinghouse, U.S. Dept. of Commerce, Springfield, Va. 22151. Order No.: AD-644339. Price: \$3.00 (microfiche 65 cents).

SOVIET COMPUTER TECHNOLOGY

Articles of Soviet developments in computer technology have been compiled and abstracted by the Aerospace Technology Division of the Library of Congress. The seventh in a continuing series, the compilation includes 69 abstracts in the categories of components, design, applications, and associated systems. Specific items describe a semiconductor-controlled memory unit with increased speed of operation, tape cores, a magnetic parametron-type null circuit, scanning device utilizing a fiber-optical converter, and various devices and converters. A bibliography is included. . . . ORDER AD-643 854 — COMPUTER TECHNOLOGY, price \$3.00 (microfiche 65 cents). . . . B. Doncov, Aerospace Technology Division, Library of Congress (ATD Report 66-120), Sept. 1966, 84 pages.

Order from Clearinghouse, U.S. Dept. of Commerce, Springfield, Va. 22151. Order No.: AD-643 854. Price: \$3.00 (microfiche 65 cents).

if your military stack doesn't have this trademark, it's a modified commercial design

And you're taking an unnecessary chance if you use it in a severe environment. Our exclusive design, the SEMSTAK™ militarized stack, is the only one on the market specifically designed for military environments. A proprietary contact design eliminates riser wires between planes and cuts solder terminations by half. The stack is metal, providing excellent heat dissipation and a nominal thermal gradient of only 2°C. No plastic or printed circuit cards are used within the stack.

And we successfully tested it at 30g's vibration at 2000 cycles per second. This is three times more than the requirements of MIL-T-5422E, the current test specification for airborne electronic equipment.

We just printed a handsome new brochure on this compact design. Write or call us and we'll be happy to send you one. Ask for Litpak 3D.

electronic memories

12621 Chadron Avenue, Hawthorne, California
Telephone (213) 772-5201



What do you think?



This department is devoted to a continuous interchange of ideas, comments, and opinions on significant problems facing the industry. What do you think about the impact of a computer-automated world and the engineer/scientist's role in it? What do you think about engineering unions — professional societies — industry conferences? Or any significant facet of your professional life. **COMPUTER DESIGN** will print your views here. Write to: CD Readers' Forum, Computer Design, Baker Ave., West Concord, Mass. 01781.

CD READERS' FORUM

LOGIC SYMBOLS STANDARDS

Editor's Note: *In the CD Readers' Forum (January issue), we pointed out that "the basic and apparently irreconcilable matter of the right triangle versus the circle appears to prevent a compromise between the Y32.14 and 806B standards."*

This month's correspondents represent Sandia Corporation, a military contractor who has chosen Y32.14, and they offer a suggestion for resolving the "basic and apparently irreconcilable matter."

TO CD READERS' FORUM:

At Sandia Corporation, we explored the same situation you portrayed so vividly in your Readers' Forum and tried to pick the eventual winner. We based our final selection mostly on two opinions, one historical — the other technical. The historically-based opinion relates to the fact that many military standards have been dropped in favor of commercial or ASA standards. Historically, MIL-806-B was an offshoot of an ASA task force on logic, to meet an immediate need. The technical opinion is that fixed potential logic is less powerful and less widely accept-

able than mixed logic will be. As a result, we selected the one set of the options available in the ASA which would be as close as possible to MIL-806-B in case we had selected a loser. The result was Sandia Logic Diagram Standard, D10252.

We chose to omit the optional use of the filled right triangle in order to minimize the reproduction processing difficulties and to permit a simple "rule of thumb" substitution if translation from or to positive potential logic MIL-806-B is required. The rule is to substitute an open circle for the right triangle wherever it appears or vice versa. The portions of the standard pertinent to this rule are presented below. This restriction to one of the many options of ASA Y32.14 will also allow direct reading of Bell Labs Standard SD-Schematic Dwg. Stds.-Appendix A (essentially Positive Logic ASA) and the NASA Standard MFSFC-STD.-353 by anyone familiar with this single rule of equivalence. Thus, anyone could use either 806B or ASA Y32.14 (the above described option only) and be able to read and interpret electrical logic, mathematical logic, circuit functions, and troubleshooting voltage levels by equating the open triangle and circle to the same place on a logic diagram.

We consider there is a real advantage to the use of the ASA over MIL-806-B in the realm of precise definitions. Careful scrutiny of the ASA definition of the electrical inverter indicates a distinction must be made between electric potential and (logic) truth. Such a distinction is contrary to fixed potential logic and was difficult to accept at first. After using the ASA, however, we find that it makes much more sense to permit the above distinction than to perform a logic inversion at the input or the output of every gate. The result of the distinction is called mixed logic. With such a system every symbol on the diagram conveys meaningful information to both the logic designer and the field maintenance, service, and troubleshooting staff. By keeping electrical condition information separate from the logic equations until they must be reconciled, the interpretation of logic diagrams is simplified. The troubleshooter can interpret each symbol separately to find out which item is failing to act electrically the way the symbol says it should. The logic designer can document exactly what he had in mind by showing the OR shapes for gates where his logic

Continued on page 25

**DRUMS
•
MODULES
•
SYSTEMS**

*A Page from the Vermont Research
MEMORY FACT BOOK*

Fact:

\$9,950 Drum Memory System Makes Small Computers Think Big

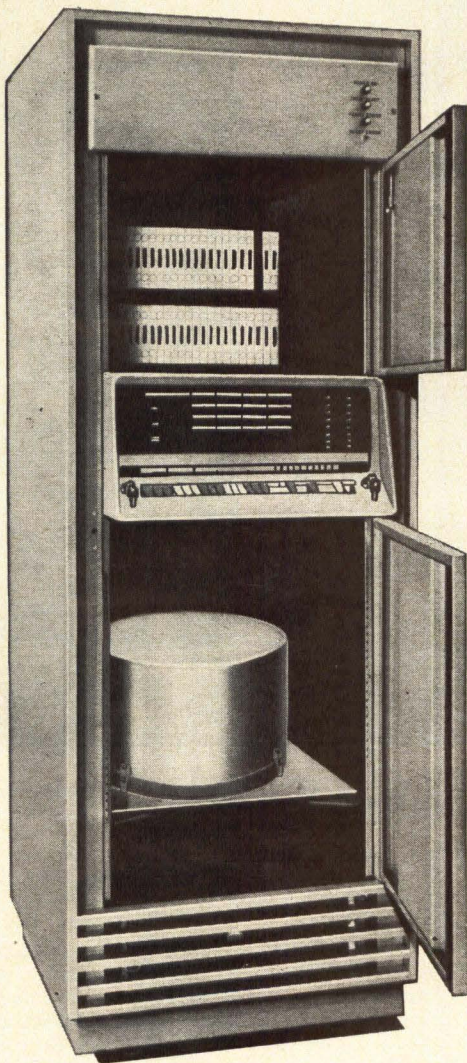

The versatile new PDP-8/S Digital Computer costs about \$10,000, complete with 4,096-word core memory. By investing \$9,950 more, any PDP-8/S (or PDP-8) user can make his computer think on a 32-times bigger scale. How? By plugging in a VRC 1104-8/S Drum Memory System . . . thus adding 131,072 additional words of data base or program storage . . . and enabling drum-stored programs to be called out as sub-routines, page by page or in up to 7-page groups at any point in your program.

VRC offers other similar systems, complete with drum routines, based on the same compact, high-performance memory drum, to boost capacity, program input speed and versatility of *any* digital computer with 12, 16 or 18 bit words. And all these VRC systems feature plug-in design that enables simple interface by the computer user.

What will be the impact of this new VRC memory development on computer applications? We don't know for sure. But it will certainly encourage thousands of small computer users, and would-be users, to think big. How about you?

*Computers are known
by their MEMORIES*

... so is

Vermont Research
CORPORATION

Box 20a

Precision Park • North Springfield • Vermont

CIRCLE NO. 20 ON INQUIRY CARD

Cinch
Creative
Problem
Solving

to produce a precision contact connector

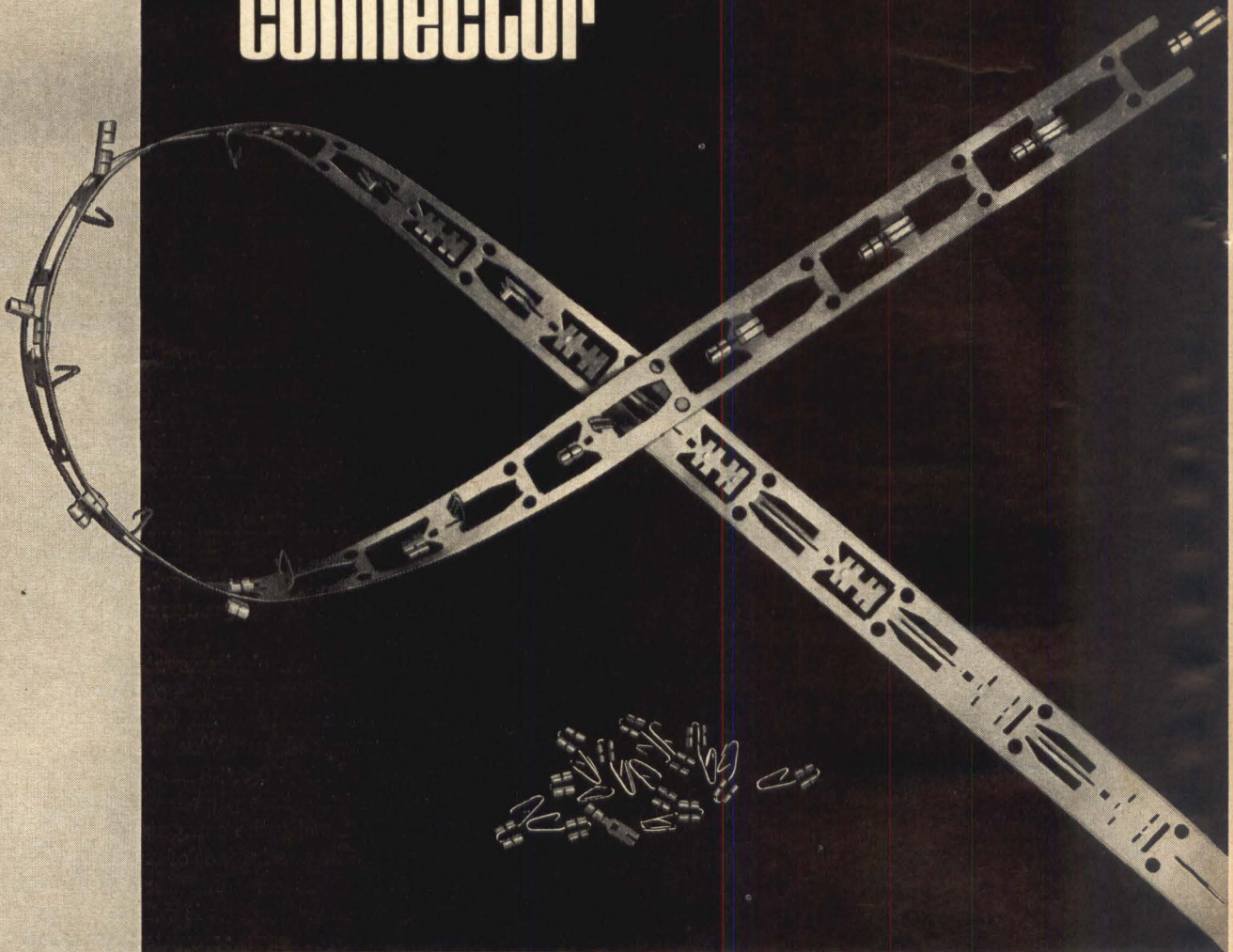

design an 18 station progressive die

This unusual, highly complex contact design provides the necessary balance between contact pressure and insertion force required by a unique PC edge connector application. Its complexity made economical production doubtful . . . then Cinch tool design engineers tackled the problem.

RESULT: An 18 station, high speed progressive die that holds contact tolerance to ± 0.003 " through eleven bends in four directions. Individual sections of the die can be adjusted or replaced without removing the die from the press—thus assuring maintenance of tolerances as the die wears.

The die produces over 4,500 contacts per hour from special controlled grain structure metal stock.

Here is another demonstration of the extra dimension in Cinch's engineering and developmental skills. Beyond the ability to design fine products, we offer in-depth production engineering capabilities, including tool, die, mold and equipment design and fabrication.

MEMBER

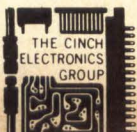

CINCH
DIVISION OF UNITED-CARR

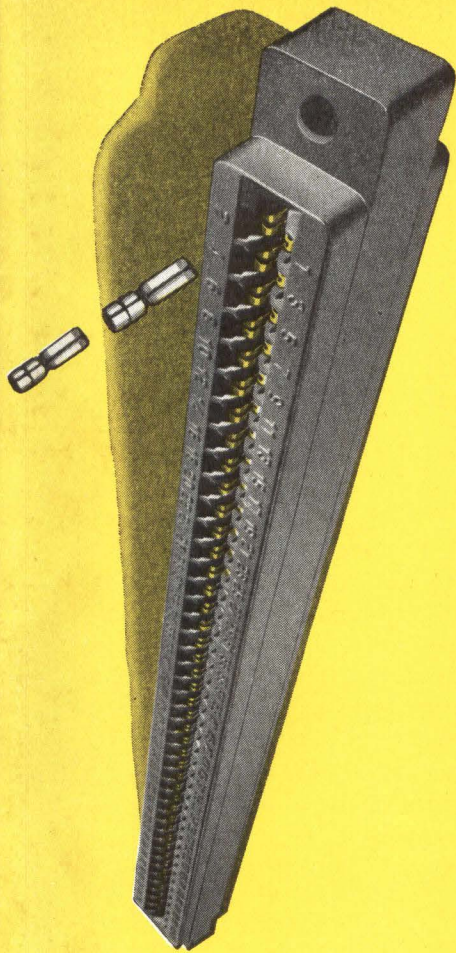

equations contained + symbols and AND shapes for gates where the equations contained • symbols and selecting the inverter symbol or the amplifier symbol depending on whether polarity correction or gain was primarily intended.

Your final paragraph states that a compromise between the standards is apparently irreconcilable because of the matter of right triangle vs. circle. As we have presented above, there is a compromise for one set of options of ASA and a restriction to positive potential logic in MIL-806-B. These marks are not equivalent to the symbol and associated level, but they are translatable.

Please count us among those who recognize the need for a universally accepted standard. Also count us among those who strongly advocate thoughtful consideration of the set of options we have selected from those available in the ASA as a technically and economically attractive candidate for such a standard.

Robert W. Roberts, Div. Supervisor,
and
L. J. O'Connell, Staff Member,
Sandia Corp.,
Albuquerque, New Mexico.

SANDIA LOGIC DIAGRAM STANDARD D10252 EXTRACTS

1. INTRODUCTION

This standard provides mixed logic and assignment of open right triangle for less positive voltage as logical 1 and absence of filled right triangle for more positive voltage as logical 1.

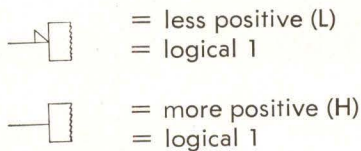

We observe that the combination of the logic negation symbol \bigcirc and the level indicator \triangle (L), $\bigcirc\triangle$, is equal to \blacktriangle (H). Therefore, the following two logic diagrams are equivalent:

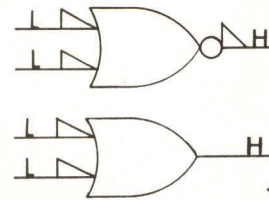

Note the absence of Filled right triangle per convention above.

2. LOGIC NEGATION

The output of a logic negation operation takes on the 1 state if and only if the input does not take on the 1 state.

a. Symbol — a small circle, \bigcirc , drawn at the point where a signal line joins a logic symbol indicates a logic negation.

b. Detailed Logic Diagram — it should be noted that logic negation, in a detailed logic diagram, may be indicated by the relationship between types of level indicators on opposite ends of a line.

c. Deletion of Symbol — note that whenever a small circle appears adjacent to a level indicator, the circle may be deleted provided the level indicator is replaced by its opposite kind. Conversely, whenever a level indicator appears without adjacent small circle, it may be replaced by its opposite kind and adjacent small circle. Since they are equivalent representations, interchanging such symbols and indicators does not disturb the relationship between logic function symbols. For example, the following logic diagrams are equivalent.

SANDIA BASIC POSITIVE LOGIC

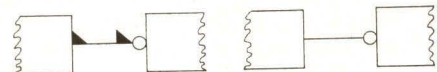

SANDIA DETAILED MIXED LOGIC

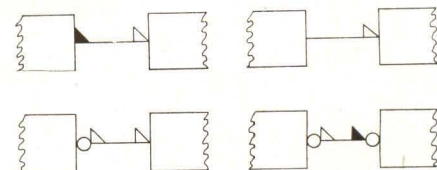

CD Readers' Forum welcomes comments from our readers on the above technique developed by Sandia.

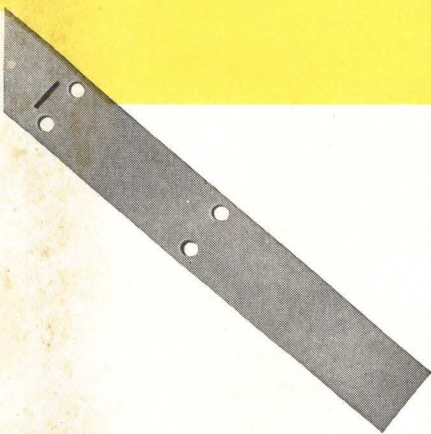

Our skills and services are available to you. For Cinch creative problem solving assistance contact Cinch Manufacturing Company, 1501 Morse Avenue, Elk Grove Village, Illinois 60007.



"It is well-known that the electronic computer industry at the present time is, and for many years, has been, out of balance in competitive structure," Representative Emanuel Celler, Chairman of the House Judiciary Committee recently told a Washington meeting of the Antitrust Law Section of the American Bar Association. Rep. Celler was discussing an investigation the House Antitrust Subcommittee, which he also heads, was conducting of the computer industry. Moreover, he said, "the significance of computers to innovation in our modern interrelated society can not be overstated. Antitrust enforcement officials must keep abreast of these emerging technologies if future markets are to remain accessible to all operators that have the means and are eligible to participate."

Rep. Cornelius E. Gallagher (D. N.J.) has asked the Defense Department and the General Accounting Office to reconsider the decision to assign social security numbers to incoming and present military personnel until a considerable amount of re-thinking had gone into the possibility that this information would be used to violate the privacy of the individual. Gallagher, who is Chairman of the House Invasion of Privacy Subcommittee, pointed out that "the computerization of this information would be a step in the wrong direction — the direction of the establishment of a dossier bank within the government. The information accumulated under an individual's social security number is immense, and at least partially beyond the review of and the challenging by the individual. Such things as induction tests and their result would be indelibly attached to the personal history of every American inducted into the Armed Services."

Public Law 89-306, the Brooks Bill, assigned to the National Bureau of Standards a comprehensive responsibility for establishing standards to govern the widespread use of data processing systems by the Federal Government. A Research Associate Program directed towards the development of standards proposal has been undertaken by Stanley F. Buckland under the sponsorship of Control Data Corp. In this program,

a natural adjunct to the work of the NBS Center for Computer Sciences and Technology, Buckland is developing both qualitative and quantitative information on the value of standards to EDP users, and is surveying user, manufacturer, and data transmission requirements for compatibility in data interchange. The possible impact of standards on capital operating costs of Federal EDP installations is also being studied.

IBM has been selected by the Air Force to provide EDP equipment (System 360 30/40) for a Base Level Automation Standardization Program which will provide a modern computer capability at base level throughout the Air Force. The IBM system will permit standardization and centralization of computer programming, processing techniques, and systems design. Installation of what has been estimated to be between 100 to 150 computers will be completed by 1970. No cost figures were given for the job, but it is estimated by trade sources to cost about \$100 million.

Recent Government Contracts

URS CORP., Burlingame, Cal., has been issued a \$1,154,741 modification to a previously awarded contract for development of an automatic data processing system dealing with software for the Seventh Army. Work will be done in Germany. The Engineer R&D Labs, Fort Belvoir, Va., is awarding the contract.

RCA, Burlington, Mass., has received \$1,000,000 for work on an airborne data automation system. The Electronic Systems Division (Air Force Systems Command), L. G. Hanscom Field, Mass., is the contracting agency.

DATA PRODUCTS CORP., Culver City, Cal., has received a \$1,342,948 fixed-price incentive contract for high-speed line printers for ship computer systems. The Naval Ship Systems Command is the contracting agency.

IBM, Gaithersburg, Md., has been awarded a \$17,216,536 contract for four additional computer systems to automate and modernize the nation's air traffic control system by the Federal Aviation Administration. The systems will be installed in four of FAA's air route traffic control centers.

Introducing

the DATA 620-I new systems computer

The DATA/620-I integrated circuit computer is the newest member of the DATA/620 family of system computers. DATA/620-I fills the gap between general purpose and special purpose computers. It belongs in a system, and solves problems previously considered too difficult or expensive for computer solution.

Designed for faster problem solution the DATA/620-I has a bigger instruction set, integrated circuit reliability, is smaller, has one-half the components, and costs less than any computer in its class.

DATA/620-I comes complete with software, field-proven and refined on the DATA/620.

Extremely compact, the DATA/620-I requires only 10" of 19" rack space. It's available with memory modules from 1024 to 32,768 words of 16 or 18 bits, and with a selection of control, arithmetic and I/O facilities, including D.M.I.'s unique Micro-Exec.

Price: \$13,900 with 4096 words of 16 bit memory, including ASR 33 teletype.

We are very proud of our new DATA/620-I, and would like to tell you more in a fact filled brochure. Please write for one.

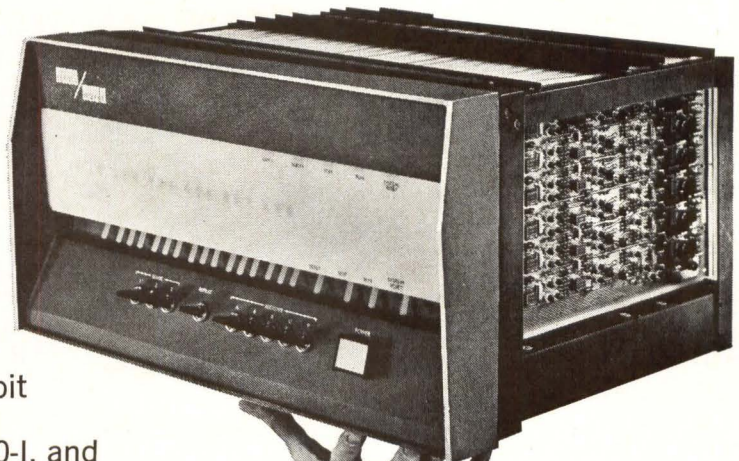

DATA MACHINES

1590 Monrovia Avenue, Newport Beach, California

TeI. (714) 646-9371 TWX (910) 596-1358

Division of DECISION Control, Inc.

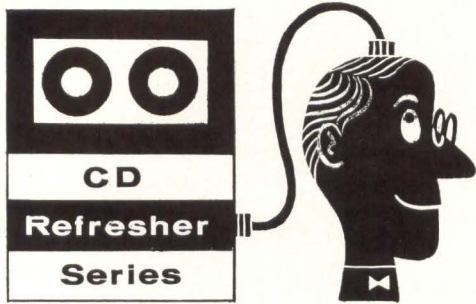

MATHEMATICS REVISITED:

Selected Topics In Probability And Statistics

Dan M. Bowers, Contributing Editor

Part 11 - TESTS of HYPOTHESES and RANDOMNESS

Last month we investigated sampling, a useful application of statistics which allows us, by examining only a relatively few bits of the data, to obtain information about a large population of data. This month we shall discuss another useful application: testing of hypotheses — which is a method by which we can minimize the chance of error by evaluating the risks inherent in a prospective decision.

The hypothesis which we desire to test may be one of the following kind:

- Selling through sales representatives is more effective than selling with direct salesmen.
- Transistors purchased from manufacturer X have a longer life than those purchased from manufacturer Y.
- Most UFO sightings have not been satisfactorily explained.
- Trout in the Yellow Breeches Creek are larger than those in Kettle Creek.

Based on the results of testing the hypothesis under consideration, we plan to take some action or make a decision, and we desire to know the risks involved. If the above hypotheses were true, we might plan to take the following actions:

- Change from direct salesmen to reps.
- Specify manufacturer X as the primary source for transistors.
- Initiate a research effort to determine whether UFO's are of extra-terrestrial origin.
- Fish only in the Yellow Breeches Creek.

Any time a decision is made, there is the possibility that it is wrong. For example, if we are presently selling with direct salesmen, we are continually making either the decision to stay direct, or change to reps. If we stay direct, but it would have been better to change to reps, we have made an error; and if we change to reps but it would have been better to stay direct, we have again erred. These two kinds of errors are known in statistics as alpha-type and beta-type errors:

- Alpha-type error: we reject a hypothesis which should be accepted.

- Beta-type error: we accept a hypothesis which should be rejected. Obviously, we define what is an alpha-error and what is a beta-error by the way in which we state the hypothesis.

As an example of this decision-making process, let us consider the transistor life problem. Assume that we are presently purchasing transistors from manufacturer Y, and that our long-run experience (1000 samples) is that the mean life of these transistors is 10,000 hours, with a standard deviation of 1000 hours. Our QC department has tested 100 transistors from manufacturer X, and has established that these devices have a mean life of 10,250 hours with a standard deviation of 1200 hours. Engineering management desires to know whether, on the basis of these facts, manufacturer X should become our supplier, replacing manufacturer Y. Statistically speaking, we want to know whether the apparent longer life of X is **statistically significant**, or whether it can **reasonably be attributed to chance**. We may state our hypothesis as: "There is no statistically significant difference between the two means." Therefore if the hypothesis is true, we shall continue to purchase transistors from Y, and if it is false, we shall change to X as a supplier; our alpha and beta errors have thus been defined.

The sampling theorems which we presented last month are modified to fit this situation, and we have:

- Theorem: **standard error of the difference of two means** — if two large random samples of size n_1 and n_2 have means m_{s1} and m_{s2} , and are taken from populations with means m_1 and m_2 and standard deviations σ_1 and σ_2 , then the theoretical sampling distribution of $m_{s1} - m_{s2}$ can be approximated closely with a Gaussian curve with mean $m_1 - m_2$ and standard deviation:

$$\sqrt{\frac{\sigma_1^2}{n_1} + \frac{\sigma_2^2}{n_2}}$$

which is known as the standard error of the difference of two means.

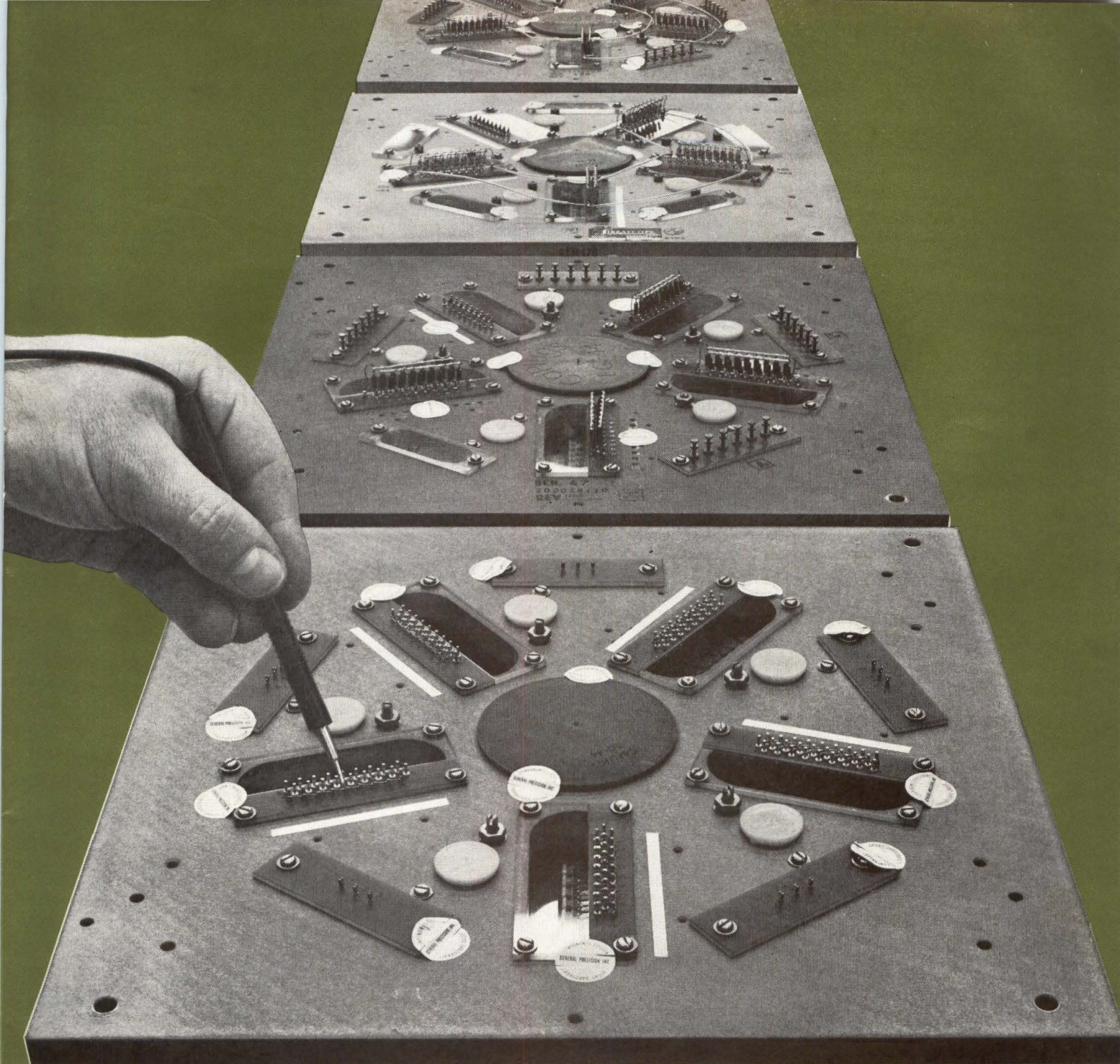

Fairchild has these fond memories of Librascope

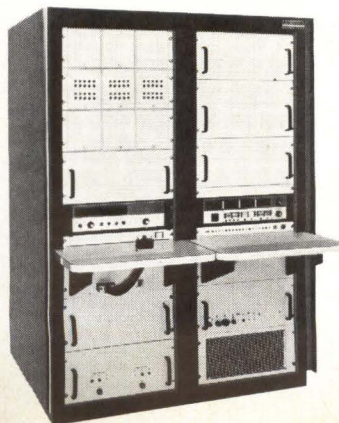

Unlimited programmed testing with flexible test sequencing is one reason why. That's the advanced state-of-the-art job called for by the programming unit of Fairchild's new Series 4000M Automatic Integrated Circuit Testing System. Librascope's Series L100 Disc Memory got the call. Each stores 900 test programs—grouped in sequences of 25—and runs up to 60 per second. The same testing line accepts a variety of devices for high-speed processing. A simple keyboard programs the disc—no accessory hardware needed. And an entire sequence is reprogrammed in minutes. Proven reliability (over 600 L100 units in use) stems from conservative, no-compromise design. Yet the L100 is probably the lowest-cost disc memory on the market.

Thanks for the memory order, Fairchild—reputations are made of this. For the brochure detailing the longest line of discs in memory, write: General Precision, Inc., Librascope Group, Components Division, 808 Western Avenue, Glendale, California 91201.

GP **GENERAL
PRECISION** **INC.**
LIBRASCOPE GROUP

As we did last month, we shall substitute the standard deviations of the samples for the unknown, σ_1 and σ_2 , and therefore we have for the theoretical sampling distribution of $m_{s1} - m_{s2}$:

$$m = m_1 - m_2$$

$$\sigma = \sqrt{\frac{\sigma_{s1}^2}{n_1} + \frac{\sigma_{s2}^2}{n_2}}$$

From our statement of the transistor problem:

$$\begin{array}{ll} m_{sy} = 10,000 & m_{sx} = 10,250 \\ \sigma_{sy} = 1,000 & \sigma_{sx} = 1,200 \\ n_y = 1,000 & n_x = 100 \end{array}$$

and the hypothesis is: $m_x = m_y$.

In accordance with the theorem, then, we construct the normal curve shown in Fig. 1 for the theoretical sampling distribution of $m_{sy} - m_{sx}$, with $m = 0$ in accordance with our hypothesis, that $m_1 = m_2$ and:

$$\sigma = \sqrt{\frac{\sigma_{sy}^2}{n_y} + \frac{\sigma_{sx}^2}{n_x}} = \sqrt{\frac{(1000)^2}{1000} + \frac{(1200)^2}{100}} = 120.$$

The actual observed value of $m_{sy} - m_{sx}$ is 250 hours, or 2.08σ from the mean. From the chart in Part 6 (November 1966), we find that the area under the Gaussian curve between this and the mean is 0.481, and therefore the probability of occurrence of this deviation is $2(0.500 - 0.481) = 0.038$ (the shaded area in Fig. 1), i.e., the probability that the hypothesis $m_x = m_y$ is true is about 0.04.

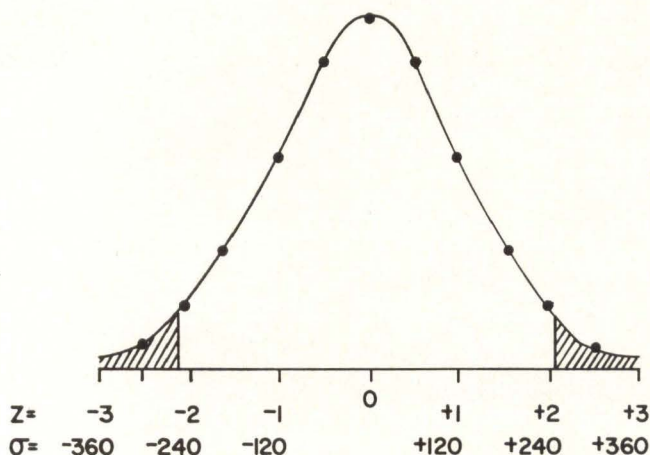

Fig. 1: Theoretical Sampling Distribution of $m_{sy} - m_{sx}$.

We conclude therefore, that the probability that brand X transistors have a longer life than brand Y transistors is 0.96, and that we would be well advised to change to brand X (providing, of course, that life-time is the ruling criterion).

Tests For Randomness

In the opening sentence of this series of articles, we specified the three cornerstones of probability

and statistics: "randomness," "independent trials," and "in the long run." Although we have discussed these frequently during the series, the reader may still be left with the nagging doubt that, despite careful procedures, he may somehow end up with a non-random sample or a non-random experiment. There are several methods of determining, from sampled data alone, whether or not the sample is random, and we shall discuss three of these as the last topic in this series of articles.

The first of the three relates to the method of testing of hypotheses described above. Although several variations are possible, for illustrative purposes we might consider the method of taking two (or, by extension, more) samples from the same population. We can then test by the above method to see if the difference between the means of these two (or more) samples is statistically significant: if so, then at least one of the samples is probably not a random sample.

A second method which has been used is to determine whether the data in question is a good fit to an expected (e.g., Gaussian or binomial) curve. This requires a large quantity of data; for example, if a binary digit stream were being tested for randomness, we would calculate the following probabilities of occurrence for various bit patterns:

bit pattern	P	Occurrences per 10^3 bits
0	0.500	500
1	0.500	500
00	0.250	250
01	0.250	250
10	0.250	250
11	0.250	250
000	0.125	125
.	.	.
.	.	.
.	.	.
.	.	.
.	.	.
111	0.125	125
0000	0.063	63
.	.	.
.	.	.
.	.	.
.	.	.
1111	0.063	63
.	.	.
.	.	.
.	.	.

The entire bit stream would then be analyzed, the number of occurrences of each bit pattern counted, and the results compared with the calculated occurrences to determine "goodness of fit."

The third — and most interesting — test for randomness is known as the theory of **runs**. It is particularly well adapted to binary problems such as that discussed above under the curve-fitting test; however, to illustrate both its binary and general utility, we shall use it to test the randomness of

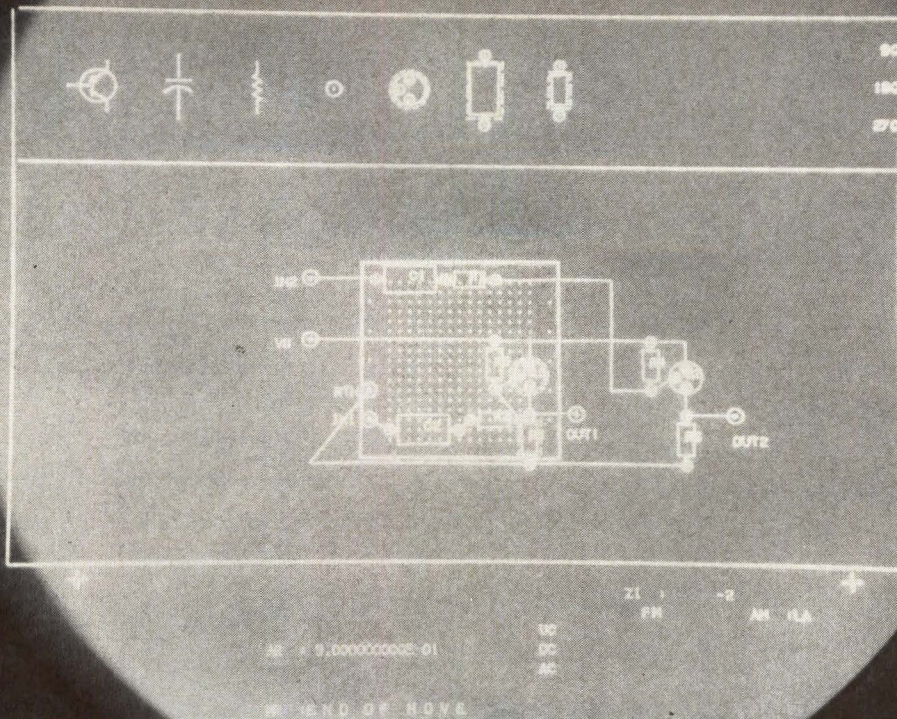

Readouts clear up problems.

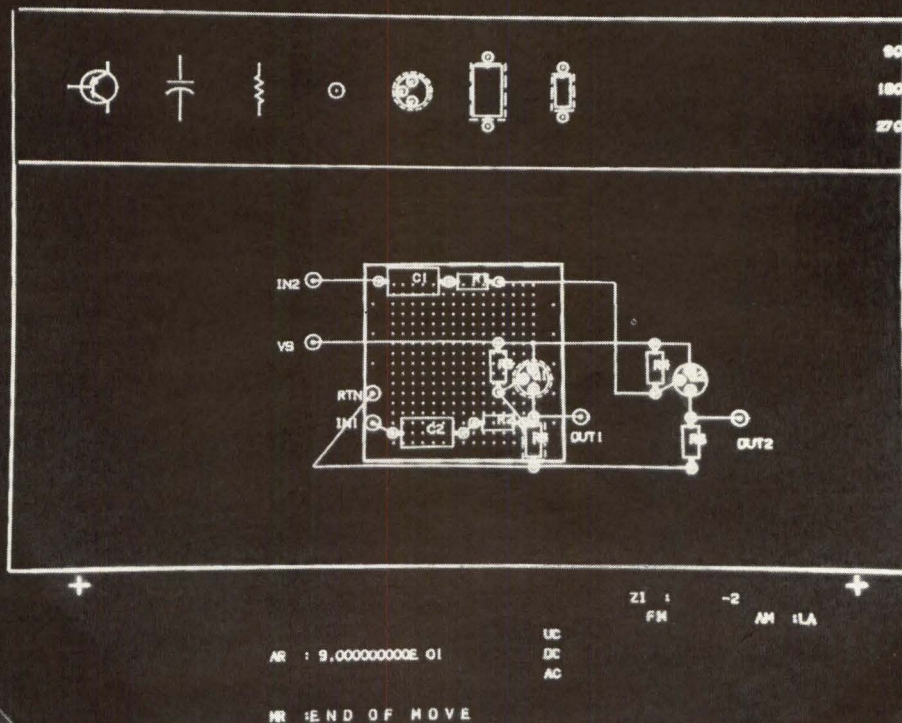

Polaroid circular polarizers clear up readouts.

It's never a problem to read readouts if they're equipped with Polaroid circular polarizers. Our polarizers improve readability from every angle by increasing contrast. In daylight. Or even in brightly lighted rooms.

But now you don't have to take our word for it. Send for our new brochure, and we'll include 3 samples of our circular polarizers (amber, neutral, and green). They'll help you see very clearly why many major display and

instrument manufacturers are now using Polaroid circular polarizers.

Write Polaroid Corporation, Polarizer Sales, Department 59, Cambridge, Massachusetts 02139.
Polaroid Circular Polarizers.

FOR LONG LIFE

ALSiMAG[®] MAGNETIC TAPE GUIDES

- Permit high tape speed.
- Protect the tape, prevent chafing of edges.
- Are harder (9 on Mohs' scale, Rockwell 45 N is 78), smoother, more wear resistant than ANY metal.
- Surface finish is 6 microinches CLA or better on flat and curved areas.
- ALSiMag magnetic tape guides are homogeneous.
- Radii can be blended absolutely into flat surfaces without sacrifice of finish.
- Flatness can be held to 1 light band (.0000116 in.).
- Flat surfaces can be held parallel within .000050 in.
- Specified dimensions can be precisely controlled.

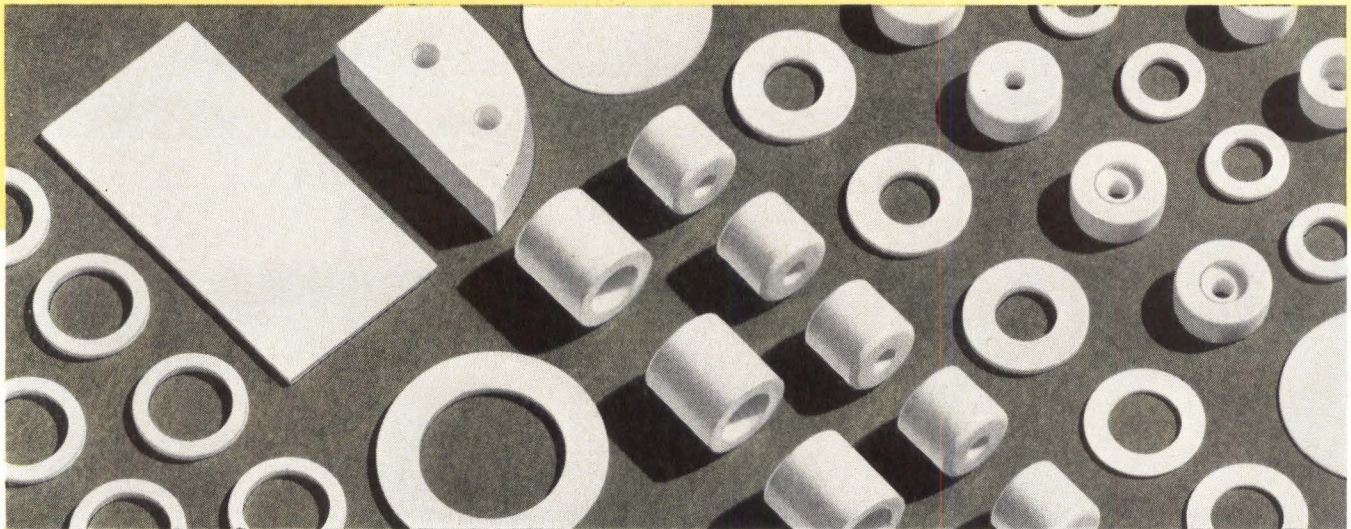

PHYSICAL SPECIFICATIONS

ALSiMag 614 Tape Guides are 96% alumina. The material is impervious and has a specific gravity of 3.70, a density in pounds per cubic inch of .134. Its safe temperature at continuous heat is 2822° F. It is 9 on Mohs' scale with a Rockwell N hardness of 78. Its strength in pounds per square inch: tensile 25,000; compressive 375,000; flexural 48,000. Its resistance to impact is 7.0 inch-pounds.

SERVICE RECORD

Magnetic guides made of this very hard, fine grained ceramic have a service record normally measured in years. This guide safeguards the

tape, permits high speeds because of the very low coefficient of friction of the extremely hard surface.

FINISH

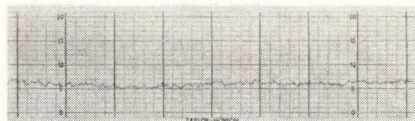

Talysurf of production run. Working surface finish smoother than 6 microinches CLA or better can be established by mutual agreement at commensurate cost. The blend of radii into flat areas maintains the same surface smoothness.

The material is very fine grained. The surface is polished. There is no skin, plating or coating to wear through. The action of the tape helps to maintain the polish. ALSiMag Tape Guides

under heavy use for more than two years show no visible sign of wear and no instance of chafing or tearing the magnetic tape.

OTHER MATERIALS

ALSiMag 614, a dense 96% alumina ceramic has an unequalled service record on magnetic tape. ALSiMag 753, a dense 99½% alumina is available for certain special purpose guide uses. Our technical people will be glad to make suggestions.

PROTOTYPES

Prototypes to your blueprint are available at reasonable cost to facilitate comparative tests.

CODE IDENT. NO. 70371

PHONE 615 265-3411, CHATTANOOGA, TENN. 37405

American Lava Corporation **3M**
A SUBSIDIARY OF COMPANY

SALES ENGINEERS: NEW ENGLAND: W. J. Geary, 72 Blueberry Drive, East Greenwich, Rhode Island, 401/884-8122 • NORTHEAST: J. S. Gosnell, 205 Walnut Street, Livingston, New Jersey, 201/992-1260 • SOUTHEAST: James W. Crisp, 27 Forestdale Drive, Taylors, South Carolina, 803/244-0063 • CANADA: Ian M. Haldane & Co., Ltd., Post Office Box 54, London, Ontario • ALL OTHER AREAS INCLUDING INTERNATIONAL: J. B. Shacklett, J. E. Hicks, or W. H. Cooper, American Lava Corp., Chattanooga, Tenn., 615/265-3411.

66th
YEAR
OF
CERAMIC
LEADERSHIP

the 36 mutual fund prices used last month to illustrate sampling theory:

32.69	6.27	8.77	6.85
14.67	32.69	16.74	8.14
7.52	18.85	30.49	18.33
7.25	10.24	14.67	7.25
6.58	9.80	11.61	14.09
21.62	8.88	10.29	7.54
23.79	4.78	1.72	4.46
8.79	13.84	18.14	11.30
6.91	11.54	18.98	13.67

We begin by finding the median of the sample, which is \$10.29 $\frac{1}{2}$. We then replace each item in the sample by either the letter H or the letter L, depending upon whether the item had a value higher or lower than the median:

H H L L L H H L L L L H H L H H H L L H H L L H L L L H H

Note that we have created a binary sequence of digits out of the sample of dollar values, and that therefore the procedure from this point applies equally well to determining the randomness of, for example, a coin (heads or tails), a roulette wheel (odd or even, red or black), or consumer preference between two brands (A or B).

The theory of runs is a method of testing the randomness of a binary sample, based on the order in which the items occur in the sample. Taking the string of H's and L's above, we define a "run" as a contiguous sequence of identical letters, and count the total number of runs:

HH	LL	HH	LLL	HH	LLLL	HH	L	
1	2	3	4	5	6	7	8	
HHHH	LL	HH	LL	H	L	H	LL	HH
9	10	11	12	13	14	15	16	17

The theory of runs postulates that too many runs in a sample indicates a cyclic pattern (e.g., HLHLHLHL), and that too few runs indicates a trend (e.g., HHHHLHLLHLLLL); the tests of hypothesis can be used to establish the presence of cycles or trends once the theory of runs has indicated that they may exist.

The basis of the theory is to judge whether the observed number of runs differs significantly from the number to be expected in a random selection, and we shall accept on faith the statement that the theoretical sampling distribution of the total number of runs in a binary sequence can be closely approximated by a Gaussian curve with the following parameters:

$$m = \frac{2n_1 n_2}{n_1 + n_2} + 1$$

$$\sigma = \sqrt{\frac{2n_1 n_2 (2n_1 n_2 - n_1 - n_2)}{(n_1 + n_2)^2 (n_1 + n_2 - 1)}}$$

where n_1 and n_2 are the number of items of each of the two binary values. In our sample, we had $n_1 = 18 = n_2$; therefore:

$$m = \frac{2 \times 18^2}{36} + 1 = 19$$

$$\sigma = \sqrt{\frac{2 \times 18^2 (2 \times 18^2 - 36)}{36^2 \times 35}} = 2.96$$

OFF-THE-SHELF

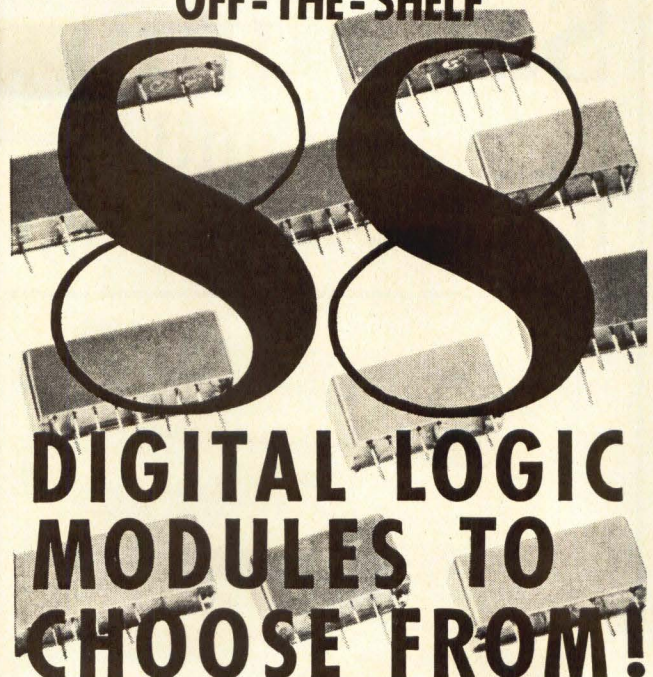

DIGITAL LOGIC MODULES TO CHOOSE FROM!

And we have more than 188 other types designed and quickly available

It's the most comprehensive line of digital logic modules available anywhere. Greatest versatility is found in EMC's complete families of rugged potted germanium and silicon modules, operating over an ambient temperature range of -55°C to $+125^{\circ}\text{C}$. Quality and reliability is demonstrated by a proven $4\frac{1}{2}$ million hours MTBF. You'll find lowest cost, too. For example, 100 KHz S-R flip-flop module, \$3.95 each in quantities of 100. "Off-the-shelf" families include 250 KHz, 2 MHz Germanium, 2 MHz Silicon, and 100 KHz.

A variety of EMC power supplies are available for use with the standard EMC logic modules. Commonly used special function boards are available from stock in 250 KHz, 2 MHz and 100 KHz versions. Other accessory equipment includes universal mounting boards, mounting racks and extender cards.

CUSTOM APPLICATION. To provide the flexibility which is often lacking in "off-the-shelf" products, EMC has adopted a policy which should appeal to the system and logic designer. In addition to offering standard families of circuit modules, EMC also offers a line of basic techniques at various frequency ranges and the ability to alter inputs, outputs and other parameters to better satisfy a specific need. Your circuit can be packaged with the same 2 to 3 week delivery as for standard modules. Interesting? Then write for EMC's catalog.

ELECTRONIC **EMC**
MODULES COMPONENTS
CORPORATION DIVISION

P.O. BOX 141 TIMONIUM, MARYLAND 21093

TWX-301-0723 301-666-3300

CIRCLE NO. 25 ON INQUIRY CARD

Save time in testing and trouble-shooting

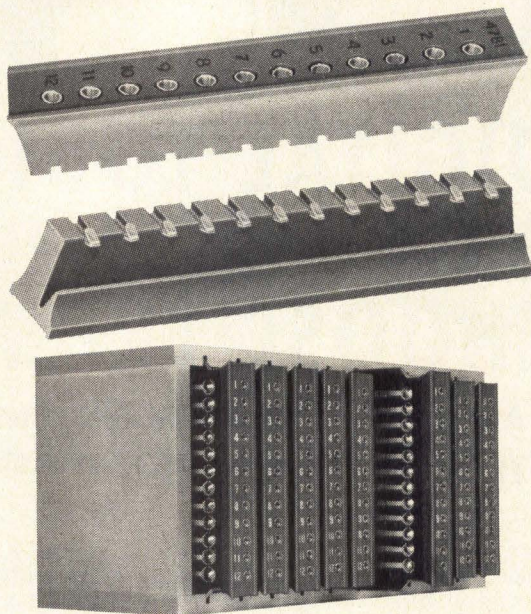

New, convenient test point strip also serves as PC board handle

This unique component offers ready access to desired portions of the circuit without the use of jumper cables. Rapid mounting is accomplished by manual positioning, and the unit is secured permanently in the wave solder operation.

Low-loss polyamide body provides insulation resistance greater than 200 megohms after MIL-T-5422B humidity test. Individual test points rated 5 amperes maximum current capacity. Operating voltage 1500 volts RMS at sea level, 350 volts RMS at 50,000 feet. Contact resistance under 2 milliohms. Capacitance between two adjacent jacks less than 1 pf at 1 MHz.

Write today for more information on this and other E. F. Johnson quality electronic components.



E. F. JOHNSON COMPANY

6618 Tenth Ave. S.W., Waseca, Minn. 56093

Providing nearly a half-century of communications leadership

CIRCLE NO. 26 ON INQUIRY CARD

The total number of runs in our sample was 17, or 0.675 σ from the mean of 19, giving a probability of occurrence of slightly over 0.500, and indicating that we do have a truly random sample.

Tables of Random Numbers

There exist tables of random numbers, for which random digits have been generated by digital computers or other machines, which can be used in the selection of random samples and in other random operations. The sampling of 36 mutual fund prices from the list of 188, which we have just shown to be random, was selected from such a table using the following procedure. The book of random numbers was opened to an arbitrary ("random") page, and the first three random digits thereon were used to select a page number, the next two digits to designate a column on the selected page, and the following two digits to designate a row on the selected page. The designated row and column on the selected page was then used as the starting point, from which the succeeding 108 random digits were extracted in thirty-six groups of three digits each; each of these 36 three-digit numbers was then reduced modulo-188 to obtain a number between 1 and 188.

EPILOGUE

In introducing the **CD Refresher Series** in April 1966, we stated that our purpose was to present basic analytical techniques, of use to the design engineers and management personnel whom we serve in a form useful both as a review and as a primer. We have devoted the first eleven articles in this series to communicating a basic understanding of the usefulness of probability and statistics, which is not a difficult subject when reduced to a relatively simple form and stripped of its mystique, jargon, and mathematical rigor. To avoid becoming bogged down in rigorous mathematical developments and pages of integrals, we have frequently used borrowed results and intuitive arguments, and we hope that this applications-oriented approach will stimulate the reader to utilize probability and statistics as tools in the pursuit of his profession — or in the pursuit of riches through gambling, to which we have also devoted considerable space because games of chance are excellent illustrations of the subject.

The CD Refresher Series will observe a summer vacation from cerebral endeavors (to the inexpressible relief of our production staff, who are tasked with keeping each integral sign, greek letter, and sub-subscript in its rightful place), and will begin discussion of a new technical subject, with the same concern for usefulness over rigor, in the fall. We shall soon make the "Selected Topics in Probability and Statistics" series available in booklet form.

The Peripheral People announce the availability of CRAM 5 (a 580 million bit, 90 to 150 ms retrieval Card Random Access Memory)

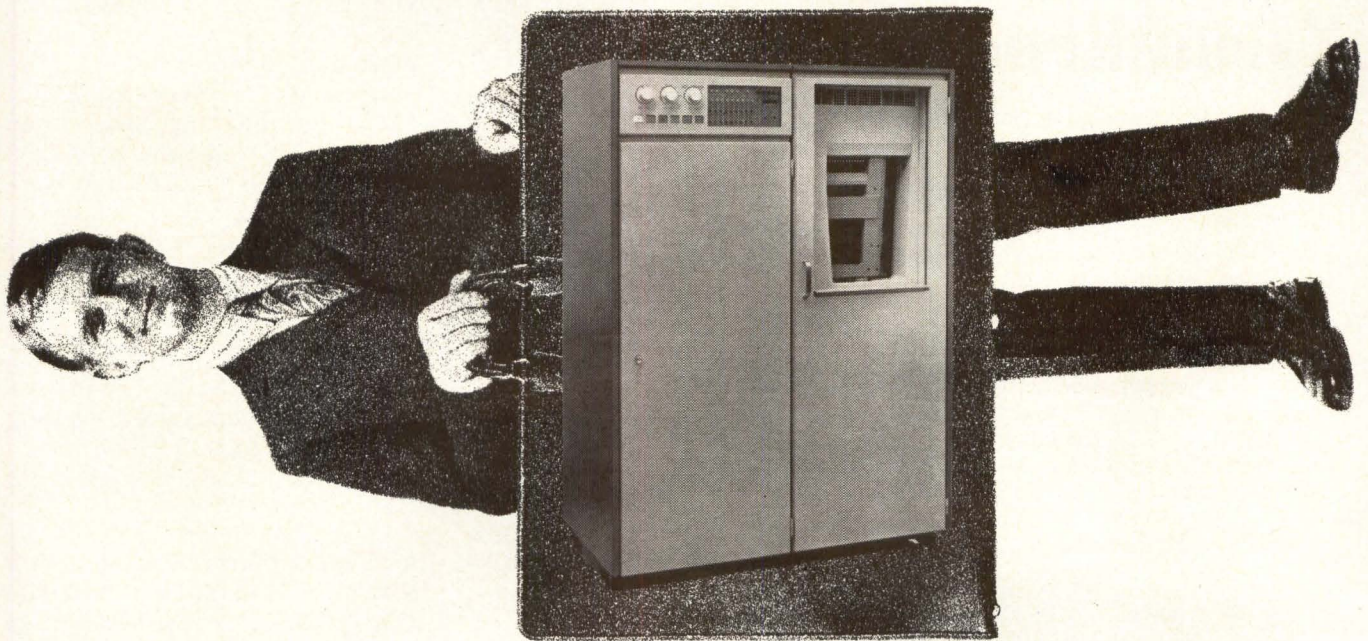

They all laughed when we sat down and developed CRAM. Now we announce our third generation, available for OEM sales. Our competitors are still trying to solve the problems of their first born.

Now, instead of 112 million bits, you can store more than five times as many and find your data 1/10th of a second faster.

With a single controller, you can hook up 16 of the new CRAM 5 units to accommodate over nine billion bits. And don't forget, you can change a cartridge in 30 seconds. We have lots of electro-mechanical experience so you know we know how to make it work. And keep on working. Quickly. Accurately. Inexpensively. Reliably. Well.

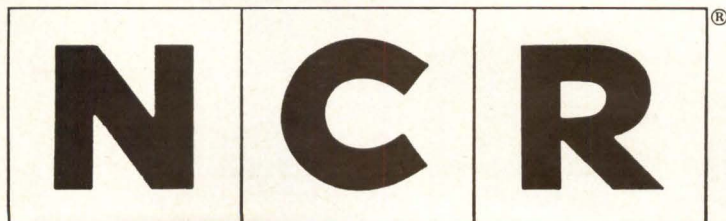

**THE
Peripheral
PEOPLE**



Card Readers, Tape Punches, Tape
Readers, Printers, MICR Readers,
CRAM (Card Random Access Memory)

THE NATIONAL CASH REGISTER COMPANY • INDUSTRIAL PRODUCTS DIVISION • DAYTON, OHIO 45409

FOR DEPENDABLE
NUMERICAL
DISPLAY...



High-speed, integrated-circuit counter/display units providing high performance at low cost are available from Transitron's Special Products Division. Utilizing high-visibility, in-line neon display tubes, modules are available for side or end viewing. Both continuous and latching display types can be ordered, with options of 8- or 4-line output, 8421 or 2421. Complete decades (counter and display) or separate decoder/display units are available as standard products. Most standard models are presently in stock, ready for immediate shipment.

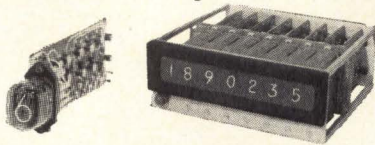

Custom displays cost less than you think

Special decades and display modules, designed to meet the requirements of a specific system, can be produced at surprisingly low cost... for fast delivery. Try us.

IC Counter Modules

Individual, IC counters (without display) are also available. Line includes 25MHz decade counters, 25MHz decade dividers, and 5MHz bi-directional counters.

Send for complete data on this new numerical display series.

Transitron
ELECTRONIC CORPORATION
WAKEFIELD, MASSACHUSETTS 01880

CIRCLE NO. 27 ON INQUIRY CARD

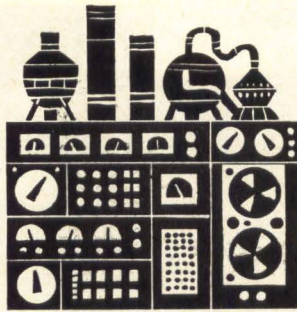

INDUSTRY NEWS

THE FIRST PRACTICAL PROCESS FOR BUILDING SUPERCONDUCTIVE COMPUTER MEMORIES THAT MAY STORE UP TO A BILLION BITS OF DATA AND OPERATE SEVERAL TIMES FASTER THAN PRESENT WIDELY USED MASS-INFORMATION STORAGE UNITS was announced recently by the Radio Corporation of America. Dr. James Hillier, Vice President, RCA Laboratories, called the achievement a major advance in information storage technology. He said that it represents the culmination of 11 years of intensive research to harness superconductivity for use in practical high-capacity memory systems. Dr. Hillier said RCA scientists already have constructed a unit that stores 14,120 bits of information in arrays of microscopic "loop cells" made of superconductive materials deposited in thin films on glass slides. The experimental unit can recall the stored information at a rate of nearly half a million bits per second, he said. Both the new technology and the experimental memory resulted from a program partially sponsored by the Air Force Systems Command, Wright-Patterson Air Force Base, Dayton, Ohio, and led by John Carrona, head of Cryoelectric Devices Laboratory at RCA's David Sarnoff Research Center, Princeton, N. J. The technical effort was directed by Robert Gange, of the RCA Laboratories technical staff.

According to Mr. Carrona,

the problem in applying superconductivity to computer memories was to devise a loop structure that could be fabricated uniformly by the thousands and could be made to carry a tiny current whose energy could be sensed or removed at will. "This has been accomplished through development of a cell consisting of thin layers of lead, tin, and insulating material deposited in large arrays on a glass slide," he said. "Our experimental memory is made up of four such slides stacked one atop the other and interconnected along their edges."

A DEVELOPMENT PROGRAM FOR A NEW TYPE OF MAGNETIC RECORDING TAPE is being conducted by the Du Pont Company. The tape employs a unique magnetic material, chromium dioxide, rather than conventional iron oxide. The patented compound was developed in the course of a Du Pont research program in the general field of magnetism. Among the advantages of the new tape are its greater magnetic strength and fidelity in high frequency instrumentation and video recording, and its increased reliability and information storage capacity in computer use. Du Pont is planning to produce development quantities of the tape in a manufacturing facility recently completed at the company's Newport, Del., site.

Circle No. 28 on Inquiry Card →

First come first served.

You can have all the SDS T Series integrated circuit modules you want now. We're in full production.

All T Series active elements are integrated circuits and guarantee reliable operation at clock rates to 10 mc. Each circuit output drives 14 unit loads, even after generous allowances for wiring capacitance.

Outputs switch 60 ma (4 times more than standard IC's). Noise rejection is at least 1.5 volts at the 0 and 4-volt logic levels.

SDS Natural Logic gives you AND and OR as well as NAND and NOR —

Each card uniquely keyed for proper installation.

Test points.

Ground plane laminated through middle of entire glass-epoxy board.

Load resistors separate from IC's for heat isolation.

Discrete diode-resistor inputs for gating flexibility, high noise rejection.

Four pins reserved for ground lines.

Four integrated-circuit buffer amplifiers in each hermetically sealed TO-5 can.

52 ribbon connectors (26 each side) for easy access to all circuits.

All components clearly identified.

Individual power line filters.

Actual size 4¼ x 4¾.

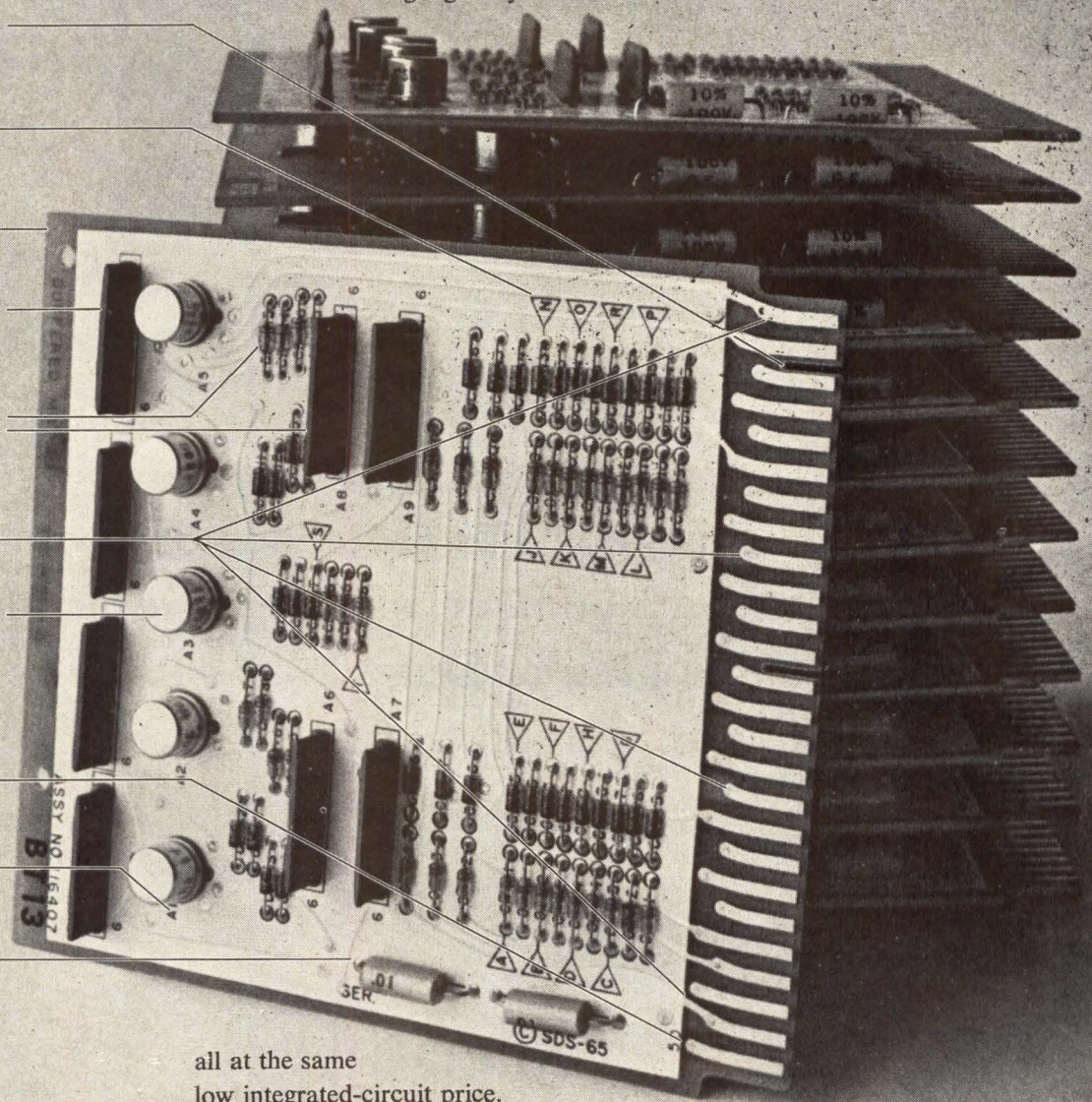

all at the same low integrated-circuit price.

We designed these modules for our new Sigma computers, but we also intend to become the largest manufacturer of logic modules for system designers.

We don't want to give away any of our Sigma secrets. But we'll sell them pretty cheap.

SDS
Scientific Data Systems,
Santa Monica, California

The Predictables.

**Some computer
manufacturers
stockpile diodes.**

**The others order
from ITT.**

ITT ships any size order, any day you say.
Any part number, silicon or germanium,
double plug or DO-7. Make us prove it.
RFQ: The Predictables.

diodes **ITT**

ITT SEMICONDUCTORS IS A DIVISION OF INTERNATIONAL TELEPHONE AND TELEGRAPH CORPORATION
FACTORIES IN WEST PALM BEACH, FLORIDA; PALO ALTO, CALIFORNIA; LAWRENCE, MASSACHUSETTS; HARLOW AND FOOTSCRAY, ENGLAND; FREIBURG AND NURENBERG, GERMANY

ITT FIELD SALES OFFICES

ARIZONA

Phoenix (602) 264-2778

CALIFORNIA

Burlingame (415) 692-2777

El Segundo (213) 772-1437

COLORADO

R. G. Bowen Company, Inc.

Denver (303) 722-4641

FLORIDA

J. F. Griffin & Company

North Palm Beach (305) 848-4617

J. F. Griffin & Company

Sanford (305) 645-3790

ILLINOIS

Chicago (312) 282-4777

MARYLAND

Towson (301) 828-4616

MASSACHUSETTS

Wakefield (617) 245-8350

MINNESOTA

Minneapolis (612) 920-2943

E. C. Electronics

Minneapolis (612) 869-1144

NEW YORK

James Semple Associates

Rochester (716) 342-1413

NEW JERSEY

Clifton (201) 284-2770

South Orange (201) 763-5010

PENNSYLVANIA

Bala Cynwyd (215) 667-4596

OHIO

Electro Com

Cleveland (216) 886-2404

Electro Com

Dayton (513) 278-4797

TEXAS

Dallas (214) 369-3882

UTAH

R. G. Bowen Company, Inc.

Salt Lake City (801) 364-4632

WASHINGTON

Seattle (206) 282-9150

CANADA

Atkinson & Vail Ltd.

Pierrefonds, Quebec (514) 626-6511

Atkinson & Vail Ltd.

Willowdale, Ont. (416) 225-7494

diodes **ITT**

CIRCLE NO. 29 ON INQUIRY CARD

INDUSTRY NEWS

A PATENT FOR AN INVENTION WHICH HELPED PAVE THE WAY TO FASTER, MORE EFFICIENT DATA PROCESSING SYSTEMS AND WHICH HAS BEEN WIDELY USED THROUGHOUT THE COMPUTER INDUSTRY was issued to IBM Corp. The invention provided an automatic interruption to the processor to signal that a data transfer originally requested by the processor was ready to occur. The execution of the program is delayed or interrupted for a minimum length of time, permitting maximum use of the computer components. The unique interrupt feature of this data processing machine is used in most present-day computers. Incorporated in U.S. Patent number 3,319,230 for which a patent application was originally filed in 1956, the invention is entitled "Data Processing Machine Including Program Interrupt." The invention has a simultaneous overlapping feature which permits a computer program to continue operating after requesting input/output (I/O) information. These I/O data are retrieved independently of the program after the request is initiated. Prior systems either required the computer program to issue instructions at appropriately-timed intervals to transfer data from or to memory, or to wait after selecting an I/O device until data transmission was complete. Principles of the invention are used in IBM System/360 and in almost all other data processing systems. It resulted from the work of Dr. Morton M. Astrhan, Bennett Housman, Hrand L. Kurkjian, and Bernard L. Sarahan while they were working on an early computer system for IBM.

A FOUR-WAY EXPANSION OF THE LOW-COST IBM 1130 COMPUTING SYSTEM WAS ANNOUNCED BY IBM. Users whose data processing needs grow, but who do not require the computing power of an IBM System/360, can now use the 1130 to meet those needs in both technical and commercial areas. C.B. Rogers, Jr., vice president-marketing of IBM's Data Processing Division, said, "The 1130, originally developed as a small scientific computer, has now been improved in four major areas to help users tailor it to their individual needs." Expansions of the 1130 include:

- Five times the disc storage; four time the magnetic core memory size;
- An additional processing speed almost 40 per cent faster than previously available;
- More and faster peripheral equipment, including an optical mark reader;
- An improved commercial programming package.

Other peripheral include high-speed printers, card and paper tape readers and punches, and a plotter that represents data in graphic form. Printing speeds of 600 lines per minute and card reading speeds of 1,000 cards per minute are now available. The minimum IBM 1130 computing system rents for \$716 a month and sells for \$30,975. Ranges for disc-oriented systems are monthly rentals of about \$950 to \$5,800 and purchase prices of about \$45,000 to \$270,000, depending on core storage size and types of peripherals. Deliveries of 1130's with newly-announced features are scheduled to start in January 1968. The system will continue to be manufactured at IBM facilities in San Jose, Cal.

MILITARY MEMORIES

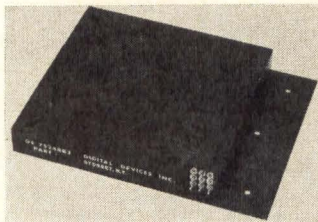

The DDI Model 443E-1000 military delay line memory system uses a high performance magnetostrictive delay line to provide a reliable memory qualified for operation during missile launch, or other severe military environments.

Unit is available with a wide range of interface circuits to permit ready system usage.

Specifications:

Storage Capacity:	to 2000 bits
Bit Rate:	to 1 MHz
Recording Mode:	Bipolar
Recirculation Period:	to 3300 usec.
Interface:	TTL, RTL, DTL, or discrete
Power:	+ 12v, 110 ma - 12v, 110 ma + V_{ee} , 50 ma
Dimensions:	Height 3/4" Width 5" Length 7"
Weight:	1 1/4 lbs.
Packaging:	Hermetically sealed delay lines. Enclosed recirculation electronics
Mounting:	Through holes or threaded inserts.
Operating Environment:	
Temperature	-25° C to +75° C
Vibration	20 G RMS, 50 to 2000 cps
Shock	50 G, 3 planes

Other MIL spec memories are available including units fully qualified to MIL E-5400, MIL E-16400, and MIL-STD-202. Total storage and other specifications can be easily modified to accommodate customer requirements.

Digital Devices Inc. offers a complete line of delay lines, associated electronics and related systems and subsystems. Write, wire or phone for the name of your nearest DDI representative and let him show you how you can store more information with greater reliability and at less cost.

**DIGITAL
DEVICES INC.**

200 Michael Dr., Syosset, L.I., N.Y., 11791
Phone: (516) 921-2400. TWX: (510) 221-2187

CIRCLE NO. 30 ON INQUIRY CARD

INDUSTRY NEWS

TWENTY COUNTRY BANKS NESTLED THROUGHOUT NORTHWESTERN OHIO AND SOUTHWESTERN MICHIGAN ARE PROVING THAT THE COOPERATIVE USE OF MODERN DATA COMMUNICATIONS AND DATA PROCESSING IS GIVING THEM THE EDGE NEEDED TO COMPETE WITH THE BIGGER INSTITUTIONS. Tied to a computer center in Fremont, Ohio, by a teletypewriter network, the banks have been able to broaden their services to customers while simultaneously cutting their costs of doing business. The center is identified as Financial Computer Services, Inc., which was established originally by six of the present banks. It is one of the first of its type in the nation, and is designed to permit on-line, real-time operation in the future. Today, data transmitted to the center is digested by two computers in the processing of over 70,000 checking, 55,000 savings, and 7,000 installment loan accounts of member banks. And, according to James E. Stoner, executive vice president, the center is also processing bank general ledgers, safe deposit box rental billings, Christmas clubs, shareholder records and dividend checks, certificates of deposit, and bank payrolls. Modern teletypewriters provide the communications link to transmit a variety of bank "file maintenance" information from new accounts to name and address changes. The network also finds application in providing ready, fast communications not only between member banks but also with others throughout the country. This is particularly important within the Federal Reserve System, Stoner states. Over half of the twenty banks on the

teletypewriter network transmit via Bell System Teletypewriter Exchange Service (TWX), with the remaining firms transmitting over private leased lines. The basic communications device is the Teletype Model 33 ASR (automatic send-receive) set. This machine features a send-receive page printer, a paper tape punch, and a paper tape reader which can be used in various combinations. It operates at 100 words per minute (10 characters per second) and utilizes a code compatible with the United States of America Standard Code for Information Interchange (USASCII). Financial Computer Services pays all teletypewriter costs, including charges for the machine on bank premises.

AN ELECTRONIC BALLPOINT PEN WHICH TRANSLATES GRAPHIC MATERIAL TO COMPUTER LANGUAGE AS IT WRITES AND TRANSMITS DATA SIMULTANEOUSLY TO COMPUTERS FOR STORAGE OR ANALYSIS was introduced recently by Sylvania Electric Products Inc. Known as the Sylvania Data Tablet, the system converts written symbols to digital and analog signals for transmittal to computers or over telephone lines for display at remote locations. The writing area is a conductive surface on which electric waves travel in "x" (horizontal) and "y" (vertical) directions. As the pen passes over the writing surface it records its position by measuring the phase of these "x" and "y" signals at a rate of 200 per second. In addition to "x" and "y" measurements, the Sylvania Data Tablet has a third axis capability. Varying the height of the pen above the tablet can assign electronically an increased number of characteristics to graphic elements.

Looking for a better high speed commercial tape reader . . . ?

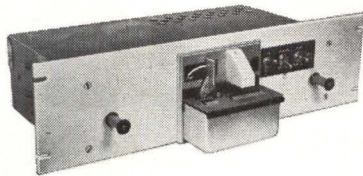

here's a 1000 char/sec. tape reader at better than competitive prices

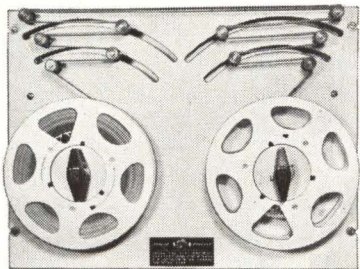

...and a spooler that rewinds at 2000 char/sec.

The 4002 Tape Reader has a free run speed of 1000 char/sec and will stop before the next character at this speed. It is available in a rack mounted or desk top version.

The 4003 Tape Spooler stores 1000 feet of Paper Tape and is suitable for 19" rack mounting to RETMA standards.

The units can be purchased separately or as a combination. For information on logic, speed and other options wire, write, or phone.

FERRANTI-PACKARD ELECTRIC LIMITED



ELECTRONICS DIVISION

Industry Street
Toronto 15, Ontario, Canada
Area Code 416 762-3661

6606

CIRCLE NO. 31 ON INQUIRY CARD

FORMATION OF THE INTERNATIONAL SOCIETY OF HYBRID MICROELECTRONICS, a professional society devoted to the furtherance of the state of the art in hybrid film microelectronics, was announced recently in Mountain View, California by the Ad Hoc Committee for Thick Films. Acting as spokesmen for the committee, George Anderson of Fairchild Semiconductor and George Doyle of Union Carbide explained that the First Technical Thick Film Symposium, held by the committee in Palo Alto, California in February, was a great success and has stimulated interest in formation of a permanent organization to provide an open forum on Hybrid Film Microelectronics. Mr. Doyle stated that interest has not been limited to so-called thick films alone, but that substantial interest in vacuum deposited thin film has also been evident. Since both techniques are used for microelectronics and perform similar functions, it is necessary for engineers and scientists to know something of both disciplines in making a technical and economic selection for their application. The Society will concentrate on, and encourage, a free interchange of ideas, problems and technology covering film microelectronics. It will include those areas related to materials, processes, control, adjustment, attachment to, and protection of the film microcircuit from the point of view of design and manufacture. In addition, it will encourage interest in developing new circuit and systems philosophies which optimize designs for the characteristics inherent in film and hybrid microelectronics. For further information, contact Mr. George Doyle, Union Carbide Electronics, 365 Middlefield Road, Mountain View, Cal.

from

VERNITRON

The Quality Name in Precision Components

- ★ SHAFT ENCODERS
- ★ LOGIC DEVICES

NEW!

Synchro/DIGITAL
Digital/SYNCHRO
Digital/RESOLVER

**From the expanding range of
ADVANCED-DESIGN
DIGITAL DEVICES**

Value-engineered to insure the reliability of your equipment

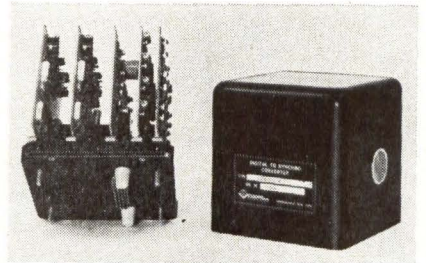

THE NEW VERNITRON Model VDS-101-5 Digital-To-Synchro Converter

Solid State . . . Conversion Speed less than 25 microseconds, with a System Resolution of 1 part in 2,048. Plug-In Modules. Accepts parallel 11 bit binary inputs . . . standard accuracy is 1 Bit, higher if needed. Permits expansion of Input Data and Logic Levels. Drives standard 11.8 v., 400 hz synchros. Also available to drive 90 v., 60 hz or 400 hz synchros.

Let VERNITRON'S DIGITAL PRODUCTS DIVISION know your Parameters! Phone or write today for full information.

THE QUALITY NAME IN DIGITAL DEVICES



DIGITAL PRODUCTS DIVISION
80 Central Ave., Farmingdale, L.I., N.Y. 11735
(516) 694-5002 TWX: 510-224-6890
TORRANCE DIVISION AND WESTERN REGIONAL SALES:
1780 South Crenshaw Blvd., Torrance, Calif.
(213) FA 8-2504 TWX: 910-349-6250

ENCODERS, SOLID STATE CONVERTERS, SYNCHRO-TO-DIGITAL, DIGITAL-TO-SYNCHRO, AND DIGITAL-TO-RESOLVER CONVERTERS

CIRCLE NO. 32 ON INQUIRY CARD

BROADBAND LIGHT MODULATORS FOR FUTURE OPTICAL COMMUNICATIONS SYSTEMS

Light modulators developed at Bell Telephone Laboratories now makes it possible to impress broadband communications signals onto laser beams using modulating powers of less than one watt. Most earlier modulators required too much power or had insufficient bandwidth to be practical.

In one device, pulses of visible light passing through a lithium tantalate crystal are modulated for digital transmission when an electric field is pulsed rapidly through the crystal. In another, near-infrared light waves traveling through a gallium-doped crystal of yttrium-iron garnet (YIG) are continuously modulated when the direction of the crystal's internal magnetic field is varied. In a third device, varying a reverse bias to a gallium phosphide diode modulates visible or near-infrared light traveling along the plane of the diode p-n junction.

The three devices are the most efficient modulators of infrared and visible light to be demonstrated thus far. All three can modulate both pulsed and continuous laser light.

The lithium tantalate electro-optic modulator — developed by R. T. Denton, T. S. Kinsel, F. S. Chen, and A. A. Ballman — has been used in an experimental system for high-speed transmission of pulse code modulation (PCM) signals. In PCM systems, information (television, voice, and data signals) is translated into a coded sequence of electrical

pulses (bits), which are then transmitted at very high rates (in this case, 224 million bits per second).

The electro-optic modulator uses this coded sequence of high-speed electrical pulses to modulate an equally fast, uncoded train of light pulses from a helium-neon laser. A thin rod of lithium tantalate crystal, measuring only 0.4 x 0.01 x 0.01 inch, acts as a high-speed optical gate. In effect, the crystal either blocks or passes each pulse, producing a coded sequence of optical pulses.

Because the optical pulses are of considerably shorter duration than the PCM pulse repetition period, several high-speed PCM signals converted to optical pulses can be multiplexed or combined on a single laser beam. The width of the pulses from the helium-neon laser allows four pulses to be inserted during each PCM pulse repetition period, so the maximum potential speed of this optical PCM system is 896 megabits (million bits) per second. This bit-rate, corresponding to a bandwidth of about 1600 megahertz, can be achieved by using four modulators to time-multiplex signals from four PCM terminals. Future experimental systems using a solid state laser with narrower pulse widths will have a potential speed of 5000 megabits per second.

The lithium tantalate modulator requires only 10 milliwatts input power to a transistor pulse amplifier,

which supplies the drive voltage for the crystal (30 volts across 5.5 picofarad capacitance to produce 100 per cent modulation). Lithium tantalate requires only 1/20 the power required by KDP (potassium dihydrogen phosphate), the most common electro-optic material used in the past.

The infrared modulator, invented by R. C. LeCraw, consists of a thin rod of gallium-doped YIG crystal with a small coil wound around it. It operates on the principle of Faraday rotation. Light passing through the crystal is continuously modulated by varying a current or signal in the coil. The strength of this signal determines the amount of modulation at any time.

When operated at room temperature with a modulating power of less than 1/10 of a watt, this modulator exhibits a bandwidth of 200 megahertz and 40 per cent modulation. (A bandwidth of 200 megahertz is sufficient to transmit about 50,000 telephone calls or 30 television programs.) LeCraw's modulator has a bandwidth of 400 megahertz when operated at 1/3 of a watt; its maximum potential bandwidth has not yet been determined.

The gallium phosphide modulator — developed by A. Ashkin, M. Gershenzon, D. F. Nelson, and F. K. Reinhart — consists of a semiconductor p-n junction, together with a suitable mounting and input and output lenses. The p-n junction is made

in the form of a narrow strip. The laser light is confined within the plane of the p-n junction by discontinuities in the index of refraction along both sides of the junction. This light is modulated by varying a reverse bias voltage to the junction. Light of wavelengths ranging from 0.55 micron to several microns can be modulated with gallium phosphide diodes.

This type of modulator has exhibited phase modulation corresponding to over 80 per cent intensity modulation of visible light (0.63 micron wavelength) when excited with 1.5 milliwatts of power per megahertz of modulation bandwidth. The diode used to demonstrate this capability was 0.06 inch long, and the modulation required 24 volts (peak-to-peak) across the capacitive (6.7 picofarad) junction. This test of modulation efficiency was made at 51.1 megahertz, but modulation can be achieved in this diode at all frequencies up to 7000 megahertz. Optical losses were less than 3 db.

Many other light modulating materials are being studied at Bell Laboratories. For example, work done by I. P. Kaminow, E. G. Spencer, R. T. Denton, and E. H. Turner has shown that barium titanate and lithium niobate exhibit modulating efficiencies that are comparable to those of the materials mentioned above. Many modulating materials are being investigated because each material modulates most efficiently at its own characteristic frequency. The ability to modulate efficiently several laser frequencies is an obvious advantage for the designers of optical communications systems of the future. The operating frequency or frequencies of these future systems will be established when the system designers choose — from the lasers, modulators, transmission paths, demodulators, and detectors then available — those elements that are the most economical and technically sound. END

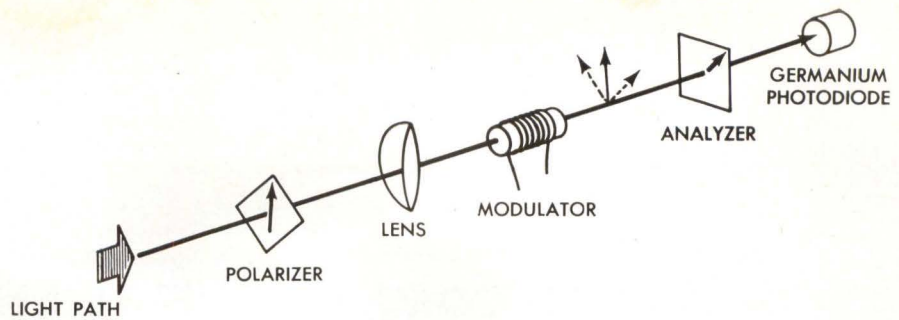

The modulator of near-infrared laser light is a thin, rod-shaped crystal of gallium-doped yttrium iron garnet. Polarized infrared light is focused by the lens and enters the modulating crystal. The magnetic field within the modulator changes as the signal in the surrounding coil varies. The plane of polarization of the light fluctuates in response to the changing magnetic field. An analyzer, which is simply another polarizer rotated clockwise 45 degrees, translates the fluctuating plane of polarization into an amplitude modulated light wave. This light wave is detected by a high-speed germanium photodiode, which demodulates the signal impressed on the light beam.

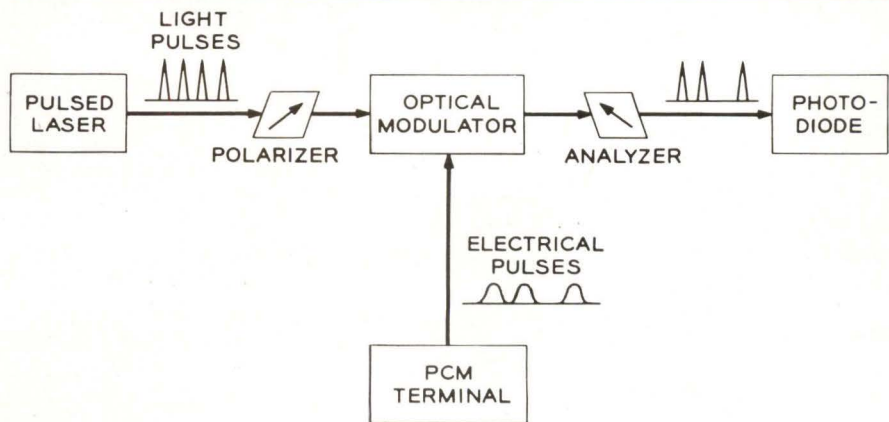

This diagram illustrates how light waves are modulated with gallium phosphide diodes. With a reverse bias applied to the diode, an incoming light wave is polarized and focused on the diode p-n junction region. The two polarization components of the light wave then travel at different velocities along the plane of the p-n junction and emerge from the junction out of phase with each other. The change in velocity imparts a phase modulation to each polarization component of light. To achieve amplitude modulation, the phase-modulated components of light are passed through an output polarizer.

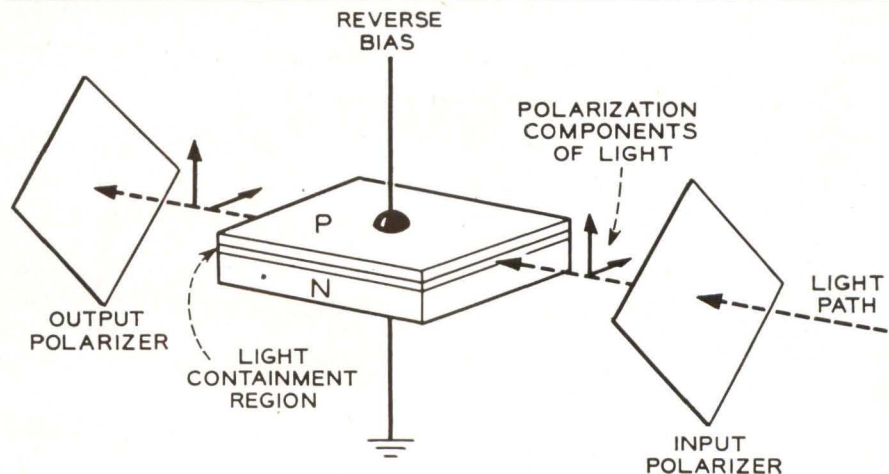

A lithium tantalate modulator uses high-speed electrical pulses from a pulse code modulation (PCM) terminal to modulate an equally fast stream of visible light pulses. After passing through a polarizer, the light pulses enter the lithium tantalate crystal, which acts as a high-speed gate. Two electrodes are plated on opposite rectangular faces of the crystal. When the PCM terminal sends an electrical pulse (a ONE) to these electrodes, it causes the plane of polarization of the light pulse, then passing through the crystal, to shift 90 degrees. This change allows the light pulse to pass through the analyzer and to be detected by the photodiode. If no electrical pulse (a ZERO) is sent from the PCM terminal, the light pulse passing through the crystal is blocked when it reaches the analyzer and does not register at the photodiode.

DESIGNING COMBINATORIAL AND SEQUENTIAL ADAPTIVE LOGIC NETWORKS

R. J. BARBETTA,

IBM, Components Division,
East Fishkill Facility,
Hopewell Junction, N. Y.

Synthesis of combinatorial and sequential adaptive logic networks described in this article, uses a technique which partitions the logic into two sub-networks. The first sub-network contains the logic necessary to perform the functions to which the network adapts; the second sub-network is a sequential logic network which controls the adaptive process, and employs binary encoding to minimize the number of memory cells needed. A specific implementation of a memory cell is given to illustrate the application of the technique to network examples.

In the past decade, much theory has been added to the analysis and synthesis of both combinatorial and sequential logic circuitry. The problems of analyzing and synthesizing sequential circuits can be greatly simplified by stating them in terms of combinatorial circuitry and then applying known theoretical approaches. Recently, extensive interest has been shown in adaptive logic circuitry; circuits that possess the ability to "learn" a logical function. Since an adaptive network eventually learns to produce a given logical function or a given sequence of logical functions, it eventually results in either a combinatorial or a sequential circuit; the "learning" process is analogous to the design of the circuit. During the learning process, the network takes the form of a set of sequentially-changing combinatorial circuits, with the performed logical functions varying as the output function is learned.

It would seem reasonable that an adaptive logic network could be synthesized by breaking the network into combinatorial and sequential sub-networks. This done, each sub-network might be designed independently and then the two be put together to form the overall adaptive network. Using this approach, the separation of the network must be made with intent to achieve circuit minimality and simplicity of design of each sub-network. This article presents a method for organizing the sub-networks efficiently. The method allows existing theoretical approaches to be used in the design of both segments of the problem. A sequential memory cell is illustrated which makes the design of either a combinatorial or a sequential adaptive logic network only slightly more difficult than the design of the equivalent non-adaptive circuit.

The Adaptive Technique

An adaptive logic network must consist of both memory elements and combinatorial logic elements; the memory elements are essential to the learning process which the network must perform, and the logic elements are nec-

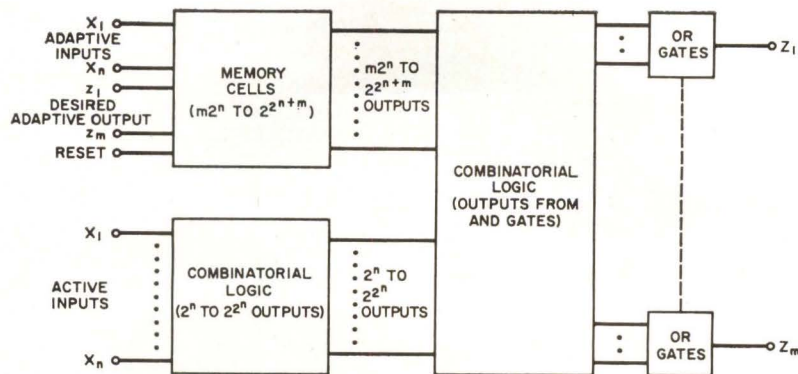

Fig. 1. Generalized multi-output combinatorial adaptive logic network.

essary in analyzing the inputs on the network in relation to the response desired from the network during the learning process. Once this process is complete the logic elements are necessary to produce the learned output from a given input. Since the adaptive network consists of both memory and combinatorial logic elements, it is a network which is in part sequential and in part combinatorial.

The organization of the sequential and combinatorial sub-networks within the adaptive network plays an important part in minimality and simplicity of design which may be achieved. Minimality problems in relatively few input variables become unwieldy even for solution by computer programs if the adaptive network is poorly organized. This is especially true of networks which require every input combination to be considered and/or will produce all possible output functions, and therefore provide no logical redundancy.

Since 2^{2^n} different functions can be created from n input variables, the amount of memory necessary to remember each of these functions becomes prohibitive in any economical design. By coding the 2^{2^n} functions, 2^n memory elements can be used to remember them, thus minimizing the sequential portion of the network. This is equivalent to remembering (or learning) the 2^{2^n} functions represented by the 2^n elements of the n -variable Karnaugh map. If 2^n memory elements are used in the network, the primary inputs (which shall be referred to as x_1, x_2, \dots, x_n) must be decoded into the 2^n minterms which can be formed from n variables. Once these functions are formed, the ANDing of the minterms with the associated memory element output (which represents the presence of the minterm in the function the network is trying to learn) will provide an output equivalent to one element of the Karnaugh map, and when all the AND outputs are ORed together, the entire function is formed. The general form of such a network is shown in Fig. 1. The combinatorial logic necessary to generate each of the minterms of interest may be designed using existing minimization techniques.

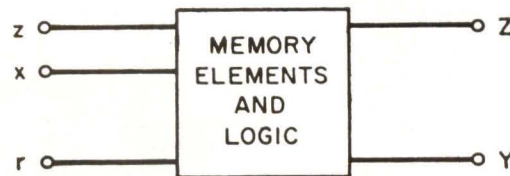

Fig. 2. A typical memory cell.

The Memory Cell

Since each memory cell represents an element of a Karnaugh map, both the input variables which define that element of the map and the desired output from the circuit which is being synthesized must be present on the input to the memory cell. The output from the cell represents the presence of the minterm in the function the network is trying to learn. Therefore, a sequential network must be synthesized which gives an output when a given function of $x_1 \dots x_n$ and a given desired output z are both present; once "set," the network must continue to give this output for the same given input function of $x_1 \dots x_n$.

Fig. 2 shows a typical memory cell with x as the input representing a function of $x_1 \dots x_n$, z representing the input which signals a desired output, and r representing clearing or resetting the memory cell. The cell will be "set" when x and z occur simultaneously. It will be "reset" when r occurs. An output Z will be produced from the cell whenever x occurs following the "setting" of the cell (and also upon initial setting of the cell). Straightforward application of sequential circuit theory¹ to the cell description above, and proper choice of the "don't cares" in the matrices result in the "set dominant" circuit implementation shown in Fig. 3. This circuit, if studied carefully, clearly portrays the action of a typical adaptive memory cell.

Initially, the latch portion of the cell is "reset." The cell will be "set" only if x and z are present at the same time, and the combinatorial circuitry on the "set" of the

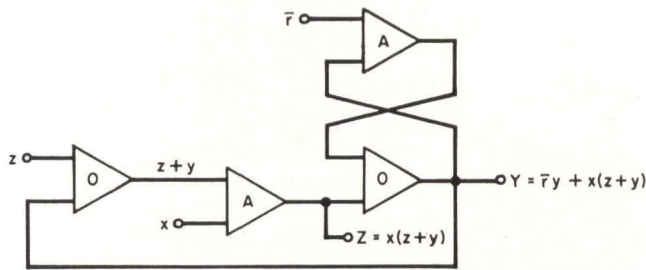

Fig. 3. A set-dominant circuit implementation.

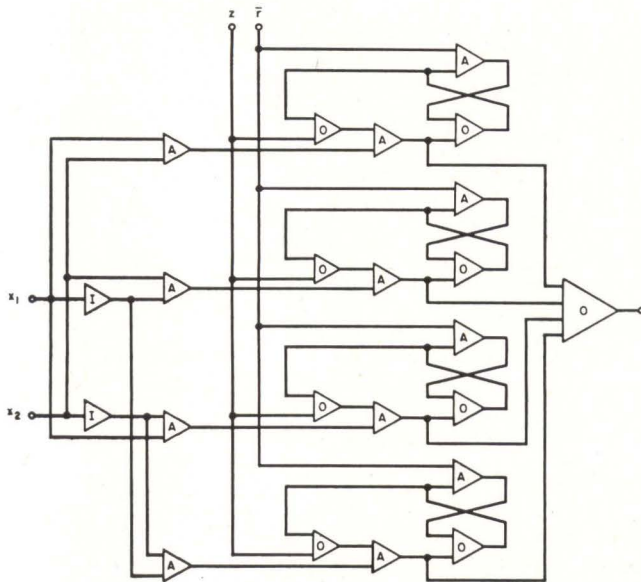

Fig. 4. Two-input adaptive combinatorial network.

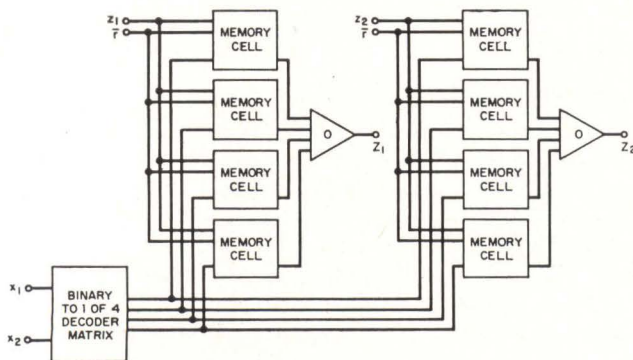

Fig. 5. Two-input, two-output adaptive combinatorial network.

latch serves the dual purpose of initially allowing the latch to be "set" and subsequently providing the desired output of the cell.

Combinatorial Adaptive Network

The input x to the typical memory cell is in no way restricted and may be any decoded Boolean minterm. Therefore, if a memory cell is provided for each of the 2^n input minterms of $x_1 \dots x_n$, the network is capable of learning any of the possible 2^{2^n} functions of n variables. To implement a functionally-complete combinatorial adaptive network, it is both necessary and sufficient to have available all the minterms of the functions of n variables. A combinatorial circuit, to produce these minterms, would consist of at least 2^n AND gates, since a unique output for each minterm must be available.

Using the 2^n outputs of the combinatorial AND gates as inputs to the 2^n memory cells and ORing the outputs of all the memory cells together completes the network design. The output appears at the output of the final OR circuit. The logic for a two-input network is shown in Fig. 4.

Combinatorial networks with multiple outputs are designed using an extension of the method described in the previous section. For a network with n inputs and m outputs, any one of the 2^{2^n} functions of the input variables may produce any of the m output functions. (For each output function to be unique m must be less than or equal to 2^{2^n} .) Since each minterm must have a cell for every possible desired output, the total number of memory cells needed for a coded implementation of the input functions is:

$$N_T = (2^n) (m)$$

To produce the adaptive output, all cells having a particular z_k ($1 \leq k \leq m$) as an input have their outputs ORed together. The multiple output problem is, in essence, the solution of m single output combinatorial problems. Fig. 5 shows a two-output adaptive network.

Sequential Adaptive Networks

The design of sequential networks is analogous to that of combinatorial networks, once they are separated into combinatorial and sequential portions. For simplicity, it is assumed that the inputs x_1 to x_n are independent with only one input ever present at a time, and that each stable state of the resulting sequential network is represented by one memory cell, and that only one cell at a time is ever set. (This is the form of networks designed using flow table logic.^{2,3}) Although these restrictions are not necessary for the application of the following technique, they greatly simplify the organization of the network and the illustration of the approach, just as a minterm implementation did in the combinatorial case. The inputs to the adaptive memory cells of a sequential network are functions of the primary input variables (as they were in the combinatorial case) and also of the present and next desired secondary state of the network. The sequential network must learn a particular sequence of minterms; there are n primary input variables and s secondary states, and from any state s_k the network may

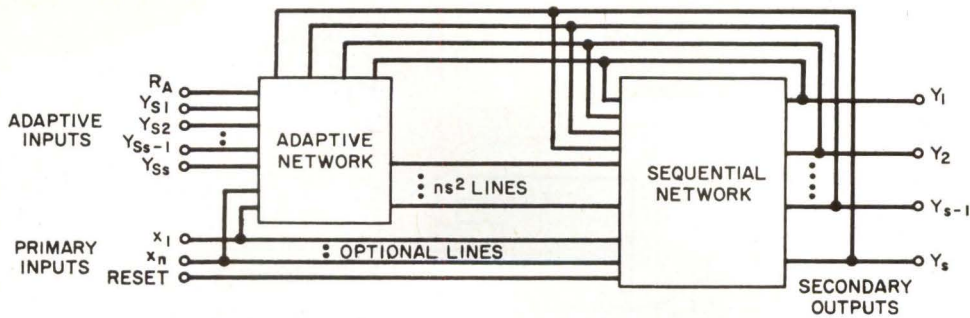

Fig. 6. Generalized n input adaptive sequential circuit.

go to $s-1$ secondary states. Therefore, the number of adaptive memory cells needed to provide the "sets" for the sequential network is:

$$N_s = ns(s - k) = ns^2 - ns$$

Since a unique memory cell is set for each stable state, the previous stable state must be reset; for n inputs and s stable states, the number of possible "resets" is:

$$N_R = ns$$

Therefore, the total number of adaptive memory cells needed to implement the sets and resets for the sequential network is:

$$N_T = N_s + N_R = (ns^2 - ns) + ns = ns^2$$

Fig. 6 shows a general block diagram of an adaptive sequential network. The sequential network block is a set of s memory cells, each of which is set by any one of $s-1$ lines from the adaptive network and reset by any one of n lines from the adaptive network. A typical memory cell, as shown in Fig. 7, has a reset line and is set by the primary input x_n and the present stable state y_s and the next desired stable state Y_k . The resets for the sequential block are obtained by setting an adaptive cell, which represents a primary input occurring simultaneously with a desired next stable state. Therefore, once the network has adapted itself, the resets are functions of only the primary inputs.

The set lines, however, are functions of both the primary inputs and the present stable states. Using ns AND gates to produce all possible combinations of the n x 's and s y 's produces one input to the adaptive cells, which produce the sets for the sequential network. The second input needed is the next desired stable state (represented by Y). The outputs of these cells go to the sets of the sequential network.

Restrictions And Alternatives

The design approach described in this article was not meant to be restrictive, and may be modified and expanded to handle most adaptive synthesis problems. However, we have imposed several restrictions, and they and the alternatives to them should be discussed.

- The learning process for the networks described in this article was a sequential minterm by minterm process. Up to 2^n inputs are necessary to complete this learning process, depending on the particular function being synthesized. This learning process is serial rather than

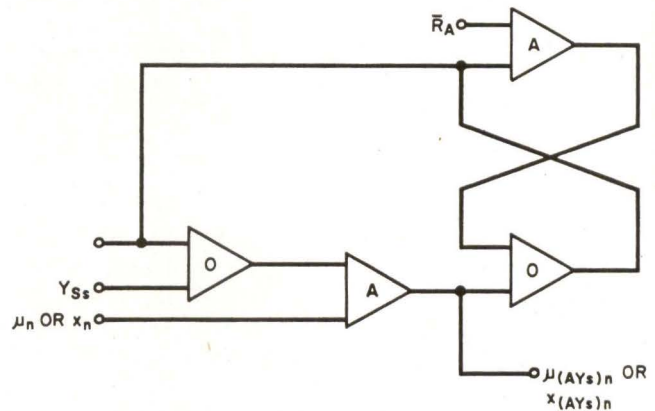

Fig. 7. Adaptive memory cell for sequential network.

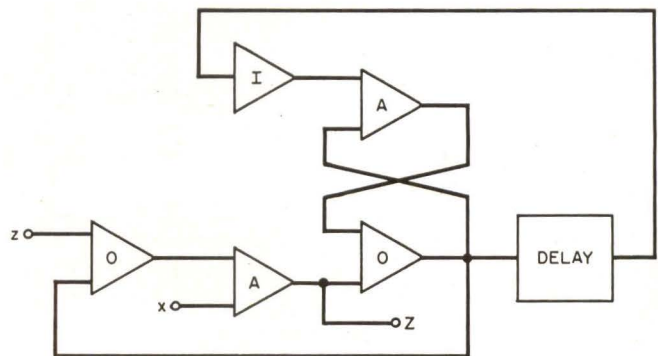

Fig. 8. Single shot type memory cell.

parallel, and in some applications this would seriously limit the usefulness of the network. However, a parallel decoding network may be employed to generate all minterms of a given function simultaneously, thus allowing the learning process to take place with parallel minterm inputs.

- The design procedure assumes that a minimum of memory cells (2^n cells) are used in the design. In some applications it may be desirable to use more cells (up

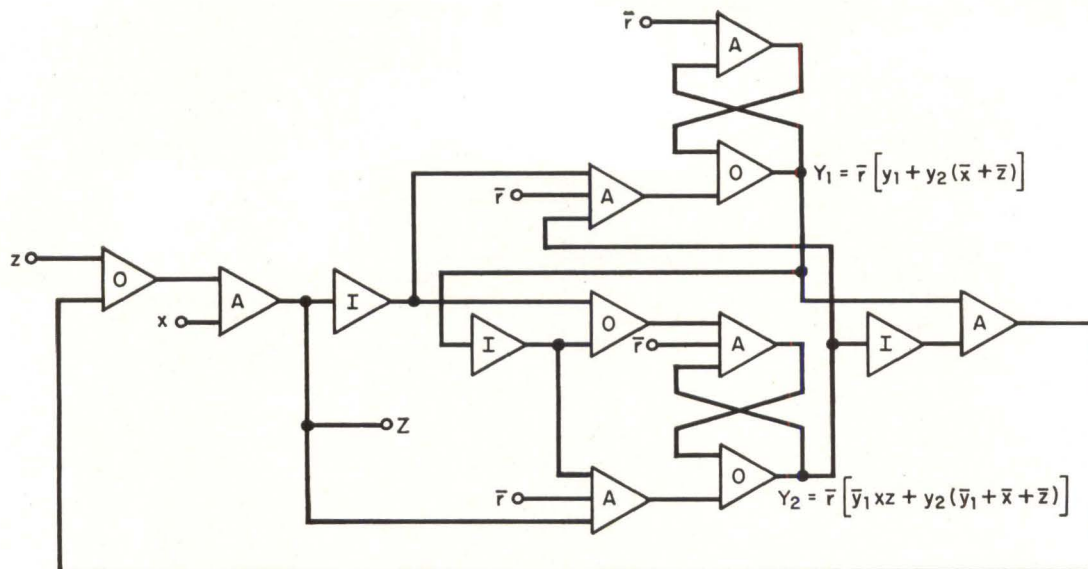

Fig. 9. Counter type memory cell.

to 2^{2^n}). However, the use of only 2^n memory cells is not a true restriction since the input to a memory cell may be any Boolean function. If all 2^{2^n} functions of n variables are available and if 2^{2^n} memory cells are used, the design is reduced to the trivial process of attaching one memory cell to each of the function lines and using the cell outputs as the appropriate learned function output.

- A specific memory cell was designed and used for the applications described in this article. The limitation of the design to a memory cell with fixed properties may be undesirable in certain applications. However, any memory cell with equivalent input-output characteristics may be used. For example, the "single-shot" type cell shown in Fig. 8 learns a function for a fixed period of time and then forgets it. A counter type cell (shown in Fig. 9) has a greater memory capacity than either cell so far described, since it learns a function only after it has been shown the function a given number of times (in Fig. 9, two). Since the design of the memory cell is independent of the adaptive network synthesis, various memory cells may be employed within one adaptive network, to allow certain minterms or functions to be learned more quickly than others.

Comments And Observations

It should be observed that the memory cells presented in this article provide a valid partial output while the network is learning its output function, provide a valid partial output for repeated settings of the same minterm function, and can accumulate additional minterm settings even after the circuit has been producing a useful output.

Knowledge of the characteristics of a particular problem may allow simplifications and reductions in the circuitry provided. If it is known that certain minterms will never appear in any of the output functions of the adaptive network, then the memory cells associated with

these minterms may be omitted. If it is known that certain minterms will never appear in the input to the adaptive network, then standard minimization techniques may be employed in implementing the input combinatorial logic. It should, however, be noted that the most generally-useful adaptive network will have no redundancy (that is, it will allow all possible inputs and provide all possible outputs), and, therefore, many designs will be straightforward application of the approach presented.

Because of the learning properties of the networks described in this paper, several interesting applications may be cited:

- A digital synchronization circuit, which under control of the incoming data, allows the synchronization pattern to be varied;
- A correlation circuit for seeking a relation between two logical functions in a network;
- A dynamic logic gate which changes its output function on the basis of incoming signals to the point of resetting all previously-set memory cells and/or inhibiting further setting of memory cells;
- An adaptive pattern recognizer (which has been implemented by Clapper⁴).

END

REFERENCES

1. S. H. Caldwell, "Switching Circuits and Logical Design," John Wiley & Sons, Inc., New York, 1958.
2. P. R. Low and G. A. Maley, "Flow Table Logic," IBM Technical Report TR 00.752, Poughkeepsie, New York.
3. E. J. Skiko and P. R. Low, "Flow Table Logic Applied to Variable Pattern Recognition," IBM Technical Report TR 00.760, Poughkeepsie, New York.
4. G. L. Clapper, "An Adaptive Pattern Recognizer," IBM Technical Report TR 01.808, General Products Division, Endicott, New York, June 19, 1964.

read a little



Pay a Little. The price is as small as the product. It's a miniature rear projection readout, and it costs as little as \$14.00. The new IEE Series 345 Readout requires very little space, but it offers the readability and versatility available only with rear projection readouts. And the price is comparable to other types of readouts with limited messages and cluttered displays.

The Series 345 operates on the rear projection principle. A lamp in the rear of the unit illuminates one of the 11 film messages, and projects it to the front viewing screen. A single plane display on the non-glare screen, so you get no distortion or confusion. It is very versatile, since anything that can be put on film can be displayed on the screen. You can display a variety of messages or colors.

The Series 345 has a front plug-in feature. It can be quickly inserted into the housing. It can be just as easily removed to insert a new readout with a different display, or to replace a lamp.

 *Series 345 Readout:* $\frac{1}{2}$ " wide x $\frac{3}{4}$ " high. Six digits will fit in a 3" wide panel space. Depth, $2\frac{1}{2}$ ". Character height, $\frac{3}{8}$ ". Weight, $\frac{3}{4}$ oz. Six available colors, including white, amber, yellow, blue, red or green. Straight decimal input. Vertical and horizontal viewing angle 175° with V-1 viewing screen, or 160° with standard screen.



"I double-E," the world's largest manufacturer of rear projection readouts.
Industrial Electronic Engineers, Inc., 7720 Lebona Ave., Van Nuys, California

CIRCLE NO. 33 ON INQUIRY CARD

ELECTRON BEAM RECORDING

**New Technique Converts Computer Data
25 Times Faster Than Conventional Printers**

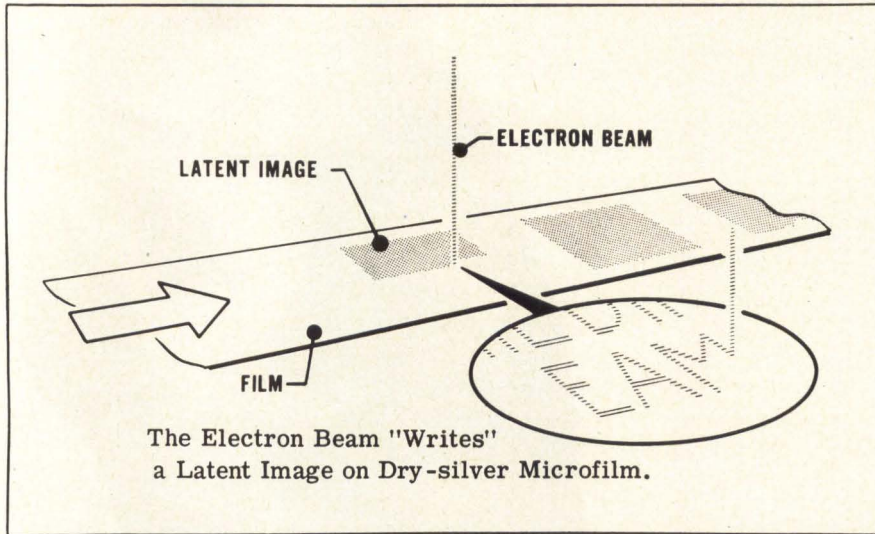

Electron beam "writes" a latent image on dry-silver microfilm in new unit developed by 3M Co. which converts computer generated information into human readable language at speeds of 60,000 characters per second or 30,000 lines per minute. Since the film is developed by heat, it is ready for instant viewing on microfilm reader-printers without the need for a darkroom, chemicals, or other conventional photographic processing equipment.

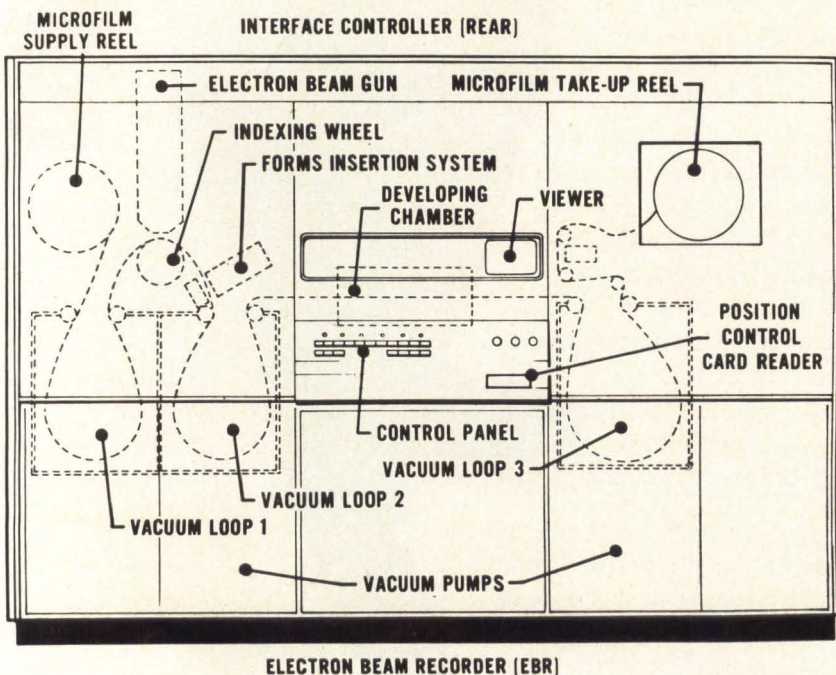

Details of 3M's new electron beam recorder showing path of dry-silver film from left, proceeding under electron gun where latent images are "written" on the film. Footage is then passed through chamber where film is developed by heat. Viewer permits visual check of film while processing occurs.

By firing electron beams onto a new type of microfilm, an electron beam recorder, developed by 3M Co., will convert computer-generated information into human readable language. Signals from a computer are fired through an electron gun and are written in standard or enlarged symbols at speeds of 60,000 characters per second or 30,000 lines per minute on a dry-silver microfilm. Since the film is developed by heat, it is ready for instant viewing without the need for a darkroom, chemicals, or other conventional photographic processing equipment.

"With this recorder, we are converting machine language into human readable language electronically at fantastic speeds," said Dr. Marshall R. Hatfield, technical director of the 3M Co., Microfilm Products Division. "This system is the result of five years research effort in our laboratories with electron beams, how they can be controlled, and how to image directly with them. The results of our searches indicate the beams have few limitations. We have found they can be squeezed to the size of a micron or 25,000 dots or lines per inch.

"Electronic advances in the computer industry during the past 15 years have been significant," Dr. Hatfield said. "In fact, the speed with which computers handle calculations is so fast that they have outpaced the speed and flexibility of electronics with the latest graphics technology. By combining our research in electron beams with our dry-silver technology, we believe we have developed a system to overcome this problem and will enable computer users to realize the full potential of their equipment.

"In addition," Dr. Hatfield added, "we have designed the system to be compatible with future computers as well as hardware which is available today. The use of microfilm also will enable users to realize considerable cost savings."

A typical electron beam recording system consists of a computer magnetic tape unit, the electron beam recorder itself, a microfilm duplicator, and microfilm viewers or printers at point-of-use locations. Digital information is transferred from the tape unit to the electron beam recorder. In one operation, the electron beam recorder converts the digital language on computer-generated tape into microfilm images.

The electron beam recorder is a self-contained unit which includes control interfacing electronics, a film transport system, an electron beam gun, an automatic random optical forms insertion system, a film developing unit, and a viewer for inspecting the microfilm images. Film is processed within the recorder which keeps pace with the magnetic tape unit supplying the digital information. No buffer is required.

The output of the electron beam recorder is positive-appearing frames of 16mm microfilm in roll form. Output rate is eight frames per second. The film is ready for instant viewing, copying, or duplicating into any of the standard formats.

Dry-silver is a new photographic type emulsion which can be processed and fixed almost instantly with heat and offers resolutions ranging up to 1500 line pairs per millimeter. It is supplied for the system in 12½ inch reels containing 2,400 feet of film with a capacity of 45,000 images.

The film is developed in a chamber in which hot air is passed over the microfilm. Electronic-optical controls insure development with consistent quality. A viewer allows the operator to inspect the microfilm frames at random while they are being processed for proper forms insertion, image format, and similar qualities.

The forms insertion feature of the recorder permits the printing of catalogs, maintenance manuals, and similar publications which include a combination of alphanumeric and graphic information. Sales price for the basic unit is \$80,000. The unit may be rented for \$3,000 per month, which includes a maintenance agreement. A number of optional features will be available and range in purchase price from \$1,200 to \$15,000. For more information:

Circle No. 106 on Inquiry Card

ZERO T.C. **S/N**
SERIAL MEMORY **20,000 BITS**
TORSIONAL DELAY
UNITY GAIN **BI-POLAR**
BULK & BUFFER
VIDEO **ZiZo**

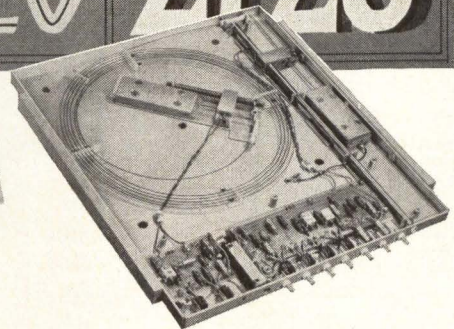

In a word, LFE for glass and magnetostrictive delay lines for digital applications

These are just a sampling of the performance features of LFE's glass and magnetostrictive delay lines. We can supply you with standard delay lines or serial memories with the capacity, bit rate, mode, delay and other parameters you need . . . or, you can specify custom delay lines, with or without associated electronics, to meet your special design requirements.

For the complete story write for technical data.

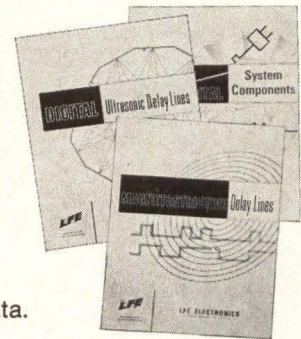

ELECTRONICS DIVISION

Laboratory For Electronics, Inc.
WALTHAM, MASSACHUSETTS 02154
Tel: 617-894-6600 • TWX: 710-324-0681

CIRCLE NO. 34 ON INQUIRY CARD

SMALL-SCALE, LARGE-SCALE INTEGRATION

Twenty-Four IC Chips In a Single Ceramic Package

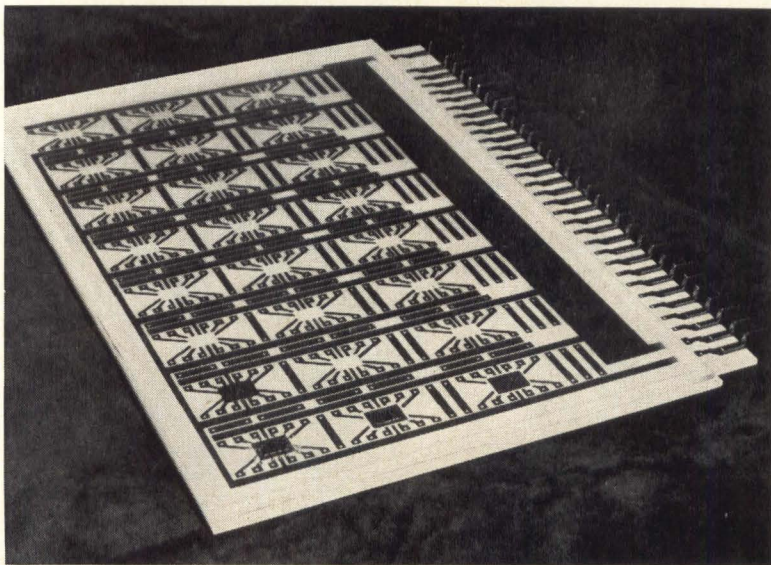

The Westinghouse interim approach to LSI is like a miniature printed circuit board that neatly carries 24 tiny encased circuit chips (only four in place in this photo, two right-side up and two flipped over). But unlike a printed circuit board, this package is made of ceramic and acts as a protective container for it hermetically seals the chips against the environment by means of a ceramic lid (that isn't shown but would cover top making contact with ridge that is barely visible around the edge).

Terming it an interim approach to large-scale integration (LSI), the Molecular Electronics Division of Westinghouse has put 24 individual integrated-circuit chips into a single ceramic package, about the size of a businessman's calling card. This package not only seals the chips against the environment but carries all the complex wiring needed to connect the chips into a working subsystem.

There are 64 electrical connections coming out of the new package and they are all purposely brought out along one of the long edges. This makes it possible to plug the packages on-edge into larger printed-circuit "motherboards." For the user, this is said to represent a large saving in assembly labor. Only 50 of these LSI packages might be needed for a fair-sized computer and they could all fit onto a roughly one-foot square motherboard. Then one dip of the motherboard into a solder bath would form all the LSI package-to-motherboard electrical circuit connections and the lion's share of the assembly task would be over.

Plugging in the complete LSI packages would be child's play compared to the present tedious soldering or welding of the individual leads of the integrated circuits. For the 50 LSI package example, there would be $50 \times 24 = 1,200$ individual integrated circuit packages. Each of these integrated circuits would prob-

ably have 14 leads so the total number of joints that the user would have to make without LSI would be $1,200 \times 14 = 16,800$. A mistake in any one of these joints might ruin the whole circuit. The user can obtain the LSI packages complete and tested from Westinghouse.

The multi-chip package uses an alumina ceramic substrate as its main structural member. The 24 integrated circuit chips are fastened to one side and as many layers of metal circuit patterns built up on the other side as are necessary to interconnect the 24 chips into a complete, self-contained working subsystem. Westinghouse is able to use several methods to attach the circuit leads to the chips. It can put the chips face up on the substrate and use conventional wire bonding connection methods, or it can flip the chips face down on the substrate and use either solder dot or beam lead connections. Westinghouse says it will start with the familiar wire bonding attachments and then progressively phase into the new solder dot and beam lead methods as it is proved that these newer methods can be reliably accomplished in regular production.

The metal interconnection patterns on the opposite side from the chips are applied either by evaporative deposition techniques (thin-film processes) or silk-screened and fired on thick metallic films. The metal films would be separated by fired-on

ceramic layers. Naturally, says Westinghouse, the interconnection patterns would be varied for different applications and could be customized to suit the system needs of particular customers.

Connections from the chip side to the wiring side are made by plated-through holes going through the ceramic substrate. These plated-through holes are also the means for achieving wiring crossovers and there are a number of short circuit runs on the chip side of the substrate for just this purpose.

The chips are protected by either one large ceramic lid that hermetically seals them all or by smaller lids that cover the chips individually. The advantage of the individual lid for each chip approach is that the individual chips can be replaced after the package is finished — a feature that should appeal to industrial users who like inexpensively repairable systems.

All-in-all, the package might be considered a ceramic version of a multiple-layer printed circuit board, such as the types that are now being used to carry complex assemblies of integrated circuits. However, the ceramic LSI package is said to be more rugged and compact than an equivalent circuit board.

For more information:

Circle No. 102 on Inquiry Card

The first real real-time monitor for a 24-bit computer.

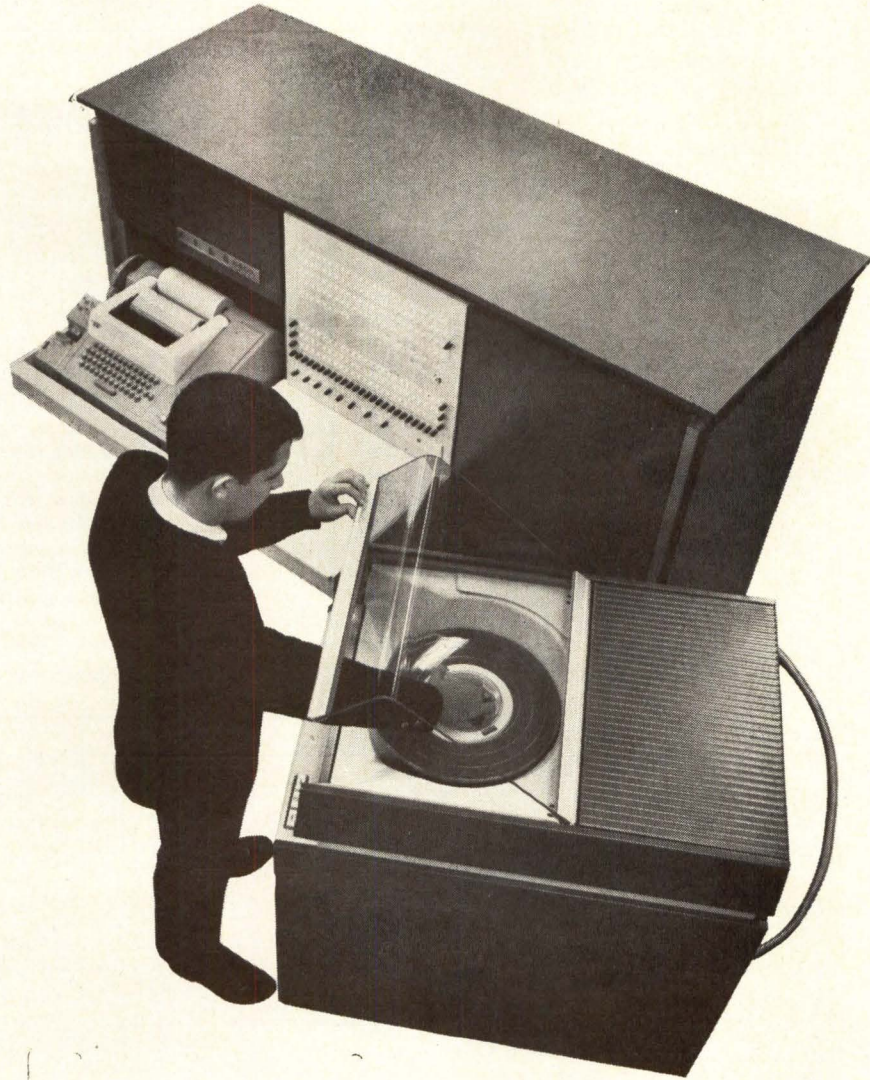

Only our SEL-840A general-purpose parallel computer has it. A unique monitor permits time-sharing execution, including batch processing of background programs, task scheduling of foreground programs and on-line debugging.

Twenty percent less expensive and with twice the throughput (572K words/sec.) of its nearest competitor, the SEL-840A is also the only 24-bit real-time computer with an independent, concurrent floating-point arithmetic unit. Delivery: 60 days. Price: \$54,500.

For further information, write for BULLETIN 9056A, or contact Systems Engineering Laboratories, Inc., 6901 West Sunrise Blvd., Fort Lauderdale, Fla. 33310. Area Code 305-587-2900. Offices also in Washington, D.C.; Los Angeles, California; Boston, Massachusetts; San Francisco, California; Cleveland, Ohio; Houston, Texas; Huntsville, Alabama; and Orlando, Florida.

Systems Engineering Laboratories

CIRCLE NO. 35 ON INQUIRY CARD

EXPERIMENTAL SUPERCONDUCTING LOGIC ELEMENT SWITCHES FASTER THAN A CRYOTRON

R & D Report

Described in the current Proceedings of the IEEE by Juri Matisoo, of IBM's Research Division, a new superconducting device differs from a cryotron in that it is never in the normal state. It switches in less than 800 picoseconds (the limit of resolution of Matisoo's measurements). Switching is probably much faster than this. More important, calculations indicate that, after switching, it can transfer current from one path to another in 80 to 200 picoseconds, depending on the materials used. Processes inherent in switching a cryotron between the normal and superconducting states had limited its switching speed to 20 or 30 nanoseconds under reasonable operating conditions. The new device avoids this limitation since it remains superconducting at all times.

The new superconducting element takes advantage of the fact that two different types of electron tunneling can occur through a thin insulating barrier separating two superconducting metals. In one form of tunneling, single electrons pass through the barrier with a voltage drop corresponding to the energy required to break up the electron pairs characteristic of superconductivity. This type of tunneling has been known for some time.

A second type of tunneling was predicted theoretically by B. D. Josephson, of Cambridge University, in 1962, and was observed shortly thereafter. In Josephson tunneling, paired electrons flow through an ultra-thin insulating barrier with no voltage drop, just as if the insulator itself were a superconductor. Josephson tunneling is extremely sensitive to a magnetic field in the plane of the insulator.

The switching device described by Matisoo consists of two metal films separated by an oxide layer 10 to 30 Angstroms thick. Above the metal films, and insulated from them, is a control film through which a current can be passed to generate a magnetic field in the plane of the device. The device works as follows. A current of up to about 30 milliamps will flow

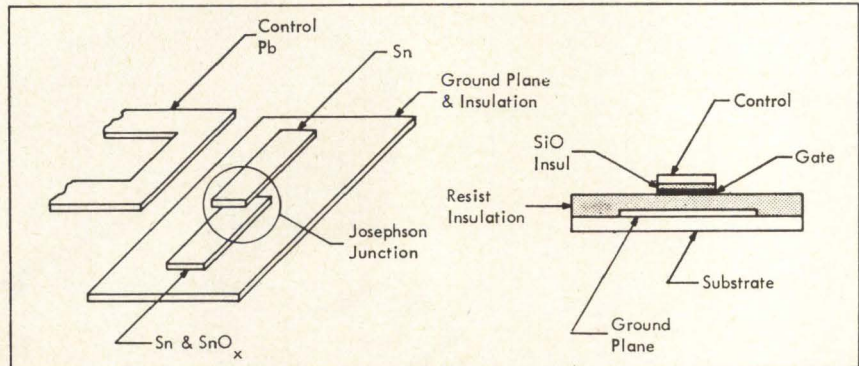

The new superconducting logic element, reported by IBM, takes advantage of the two types of electron tunneling that can occur through an ultra-thin insulating layer separating two superconductors. The junction is fabricated by depositing a film of metal allowing a thin oxide layer to form on it, then depositing a second film of metal on top of the oxide. Above the junction is another metal film through which a current can be passed to generate a magnetic field in the plane of the junction. When this control film is pulsed, its magnetic field quenches the paired-electron (Josephson) tunneling through the junction. The junction then switches to single-electron tunneling in which a voltage appears across the junction. This voltage tends to drive the current into another path if one is available.

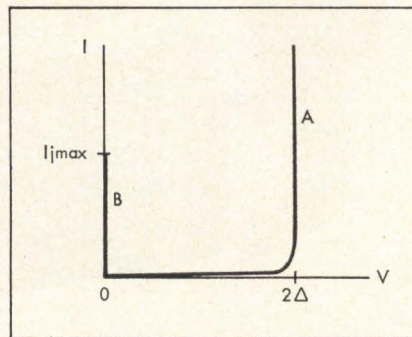

The current-voltage characteristics of the two types of tunneling that can occur through a thin-insulating barrier between two superconductors is shown here. Curve A is for single-electron tunneling. No current flows until the voltage provides enough energy to raise electrons to an excited state corresponding to breaking up the pairs of electrons characteristic of the superconducting state. In contrast, curve B shows Josephson tunneling in which paired electrons tunnel through the insulator with no voltage drop. The insulator thus behaves as a superconductor itself.

across the insulator by Josephson tunneling with no voltage drop. If a

magnetic field of about one-half gauss is then generated by a current in the control line, the Josephson tunneling is quenched. But a single-electron tunneling process is available at a voltage corresponding to the energy required to break apart the electron pairs (about 1 mv for Sn-Sn junctions, 2.5 mv for Pb-Pb). If the current is held constant, the device switches to this mode.

If a second path is available to the current, such as another device in parallel with the first, the voltage across the first device will drive the current into the alternate path. This is a unique characteristic of the device; after switching, the current does not decay by an L/R time constant, but rather is driven into a new path by a voltage which is very nearly constant during the entire current transfer period. The effect is exactly the same as if a battery had been inserted in place of the first device. The time required for current transfer is calculated to be 200 picoseconds for Sn-Sn junctions which have a single electron tunneling voltage of 1 mv, and 80 picoseconds for Pb-Pb with 2.5 mv. END

The new, small DECdisk provides 32K words extra memory for the PDP-8 for \$6,000. Additional 32K DECdisk units cost \$3,000 each. Since a basic \$18,000 PDP-8 computer has 4096 words in core, with four DECdisk units, that could give you a high speed computer with 135,168 12 bit words for \$33,000!

DECdisk is compatible with the \$10,000 PDP-8/S, too. Adding four DECdisk units gives you a slightly slower computer with 135,168 12 bit words.

More memory for less cost than any other computer.

At last count, more than 700 PDP-8 computers have been sold to scientists and equipment manufacturers. The PDP-8 is, by far, the most successful and proven on-line, real time,

small computer in the world. And that was before DECdisk.

DECdisk was developed, like all DIGITAL peripherals, to customize a basically inexpensive computer to special applications. Yours. DECTape was developed the same way. The unique 3½" reels of magnetic tape not only provide low cost storage, but permit you to carry your program library in your pocket. And displays — did you know that DIGITAL was the first computer manufacturer to put a CRT on a computer?

Computer manufacturers who worry about what the customer needs, worry a great deal about peripherals. DIGITAL has one of the largest lines of peripherals in the industry. Write, and we'll send you a free "Small Computer Handbook" and tell you all about our peripherals.

New, low cost, small computer disk. Thanks for the memory, PDP-8.



DIGITAL EQUIPMENT CORPORATION, Maynard, Massachusetts 01754. Telephone: (617) 897-8821 • Cambridge, Mass. • New Haven • Washington, D.C. • Parsippany, N.J. • Rochester, N.Y. • Philadelphia • Huntsville • Pittsburgh • Chicago • Denver • Ann Arbor • Houston • Los Angeles • Palo Alto • Seattle • Carleton Place and Toronto, Ont. • Reading, England • Paris, France • Munich and Cologne, Germany • Sydney and West Perth, Australia • Modules distributed also through Allied Radio

digital
MODULES • COMPUTERS



In last month's issue, Part 1 introduced the notion of using a negative number as a radix, and illustrated the representation of numbers and the arithmetic using a base of -10 . The rules of arithmetic in this system were explained by means of a special decimal system in which the negative numerals $-1, -2, -3, \dots, -9$, were used for odd positions (positions in which the radix exponent is odd), and the normal numerals were used in even positions. We also speculated on how the properties of negative-radix scales of notation might be exploited in computer systems.

Here in Part 2, we shall concentrate on the number representation aspects of negative radix notation. It was mentioned in the first article that the operational aspects were of much greater importance than the representational, however, the representational aspects are the first which strike the individual when considering the possible advantages of negative radix notation. (In fact, a common reaction is that one bit per word will be saved, since the sign bit is eliminated. This is not true, of course, since N positions of any two-symbol number system will permit 2^N different combinations of the two symbols. If $N = 12$, 4096 different combinations exist, and these combinations may be defined to be the integers from 0 to 4095; they may be defined to be the negative and positive integers from -2047 to $+2047$, with two representations for zero; they may be defined to represent fractions.) We will examine certain conventions as they apply specifically to negative radix notation, present descriptions and properties of systems for representing integers and fractions, and examine various number systems in which the numerals are represented by negative binary codes.

Terminology & Conventions

Any negative radix could be used to illustrate a discussion on the representation of numbers using negative radix notation. However, following the example set in the first article, negative decimal will be the system upon which most of the emphasis will be placed. This emphasis results from our objective of achieving familiarity with the notation and the arithmetic, which is best done through development of manual, rather than machine, algorithms. In negative decimal, all of the normal decimal symbols, rules, tables, and conventions apply except that the sign of a carry is changed; negative binary is a sort of special case, and generalities may be more easily illustrated in a system having more than two numerals.

We will be speaking extensively of negative and positive numbers with negative and positive radices. This could lead to awkward terminology, such as speaking of a negative number in negative decimal as a "negative negative decimal" number, and it is essential to coin some names for these negative radix systems. We shall use the following:

- 2 Negabinary
- 3 Negaternary
- 4 Negaquaternary
- 8 Negoctal (Negoctal)
- 10 Negadenary (Negadecimal)
- 16 Negahexadenary (Negahexadecimal).

The names binary, octal, decimal, etc., will continue to refer to $+2, +8, +10$ base systems. The words **negaradix** and **posiradix** will be used to refer to numbers of either polarity expressed in negative radix systems and positive radix systems, respectively.

PART 2

Negative Radix Representation

Editor's Note: Last month's issue introduced the concept of negative radix number systems and put forth the advantages of designing digital systems based on a negative radix system. Here, in part 2, the terminology, conventions, and properties of negative radix systems are described and illustrated.

The words "digit," "numeral," "number," and "quantity" have overlaps of common and technical meaning. In order to make meanings immediately clear, **digit** will be used to indicate one of a set of n symbols comprising a **number** whose radix is r . **Numeral** will be used to indicate one of a set of $|r|$ symbols used in a scale of notation whose radix is r . The words **quantity** or **amount** will frequently be used in the place of "number" to reduce the confusion which arises when "number" is used for two different meanings in the same paragraph.

REPRESENTATION OF INTEGERS

Referring to the polynomial which defines positional notation (see Part 1, last month), the most significant non-zero digit in an n digit integer was defined as a_{n-1} , the coefficient of the term $a_{n-1}r^{n-1}$. Assuming all $a > 0$ and $r < -1$, this term will be negative for even n and positive for odd n . Since the magnitude of this term must be greater than the sum of the magnitudes of all the lower order terms, it can be said that a **negative radix number having an even number of digits is negative, and one having an odd number of digits is positive.**

The counting exercise of the first article suggested that the distribution of negative and positive numbers for a given quantity of digit positions might not be symmetrical, and this is indeed the case. Let us consider negadecimal integers. For one digit position, we have ten possible representations: zero, and the numerals 1 through 9, that is, zero and nine positive numbers. The lower limit in this set is zero; the upper limit nine. For two positions, we have one hundred representations; the

ten formed by one digit, and ninety more, which are the negative numbers 19 (-1) through 90 (-90). The upper limit is still nine; the lower limit is now -90 . Table 1 shows the upper and lower limits in decimal for each of the given quantities of positions. Negadecimal representations are identical, with the signs dropped. The pattern of alternating zeroes and nines for the upper and lower limits is easily explained by reference to the polynomial. Because even positions (even powers 0, 2, 4, etc.) have positive values and odd positions (odd powers 1, 3, 5, etc.) have negative values, a number having 9's in even positions and zeroes in odd positions has the maximum value for the word size. Similarly, when the 9's are in the odd positions and zeroes in the even, the number has the minimum value for the word size.

Analogous numbers may be formed for any negative radix system having the numerals 0, 1, . . . , $|r| - 1$. If

NOW AVAILABLE

A Negadecimal Add/Subtract Module

For demonstration or experimentation —
Complete with input/output and power supply;
negadecimal in-negadecimal out.

Modular by digit —

Buy only as many digits as you desire.

For more information:
Circle No. 103 on Inquiry Card

negative radix arithmetic

continued

$|r|$ is represented by R , then the upper and lower limits for a number having n positions are as follows:

n is even

$$A_{UL} = (R-1)r^{n-2} + (R-1)r^{n-4} + \dots + (R-1)$$

$$= \frac{R^n - 1}{R + 1}$$

$$A_{LL} = (R-1)r^{n-1} + (R-1)r^{n-3} + \dots + (R-1)r$$

$$= -\frac{R(R^n - 1)}{R + 1}$$

n is odd

$$A_{UL} = (R-1)r^{n-1} + (R-1)r^{n-3} + \dots + (R-1)$$

$$= \frac{R^{n+1} - 1}{R + 1}$$

$$A_{LL} = (R-1)r^{n-2} + (R-1)r^{n-4} + \dots + (R-1)r$$

$$= -\frac{R(R^{n-1} - 1)}{R + 1}$$

A decrease in a coefficient from $(R-1)$ will decrease the magnitude of A , and an increase from zero in the coefficient of a missing term will also decrease the magnitude. If these expressions for the limits are applied to negabinary, we will have limit values as shown in Table 2. The numbers in Tables 1 and 2 that start with zero correspond to the series that start with $(R-1)r^{n-2}$, in which the r^{n-1} term has a zero coefficient. The distribution of the four-digit negabinary integers is illustrated in Table 3.

REPRESENTATION OF FRACTIONS

Fractional values may also be represented to any desired degree of precision by a descending power series. To find the limiting values of the limits of the range of values which may be represented, the infinite series comprising the non-zero terms are summed, as follows:

$$A_{UL} = (R-1)r^{-2} + (R-1)r^{-4} + (R-1)r^{-6} + \dots$$

$$= \frac{1}{R+1}$$

$$A_{LL} = (R-1)r^{-1} + (R-1)r^{-3} + (R-1)r^{-5} + \dots$$

$$= -\frac{R}{R+1}$$

n	Lower Limit	Upper Limit
1	0	+9
2	-90	+09
3	-090	+909
4	-9,090	+0,909
5	-09,090	+90,909
6	-909,090	+090,909

As in normal notation, the range of numbers which can be represented is independent of the number of digits, and depends only on the radix. The number of digits affects only the precision with which numbers within the range can be represented. For negadecimal, the resulting range (expressed in normal decimal) is:

$$+\frac{1}{11} > A > -\frac{10}{11}$$

and for negabinary it is:

$$+\frac{1}{3} > A > -\frac{2}{3}$$

The proper fractions which lie outside of these ranges are represented by numbers with digits to the left of the radix point. If unity is added to the positive limit, and subtracted from the negative limit, the corresponding number ranges clearly include all proper fractions of both polarities:

$$\text{negadecimal: } +\frac{12}{11} > A > -\frac{21}{11}$$

$$\text{negabinary: } +\frac{4}{3} > A > -\frac{5}{3}$$

The two strings of alternating zeroes and nines (or zeroes and ones for negabinary) may be regarded as special number forms. For radix r and numerals zero to $R-1$, the alternating digits are zero and $R-1$. If we add to these two special number forms, a third one comprising a string of digits $R-1$ to the right of the radix point, and a fourth comprising a string of zeroes, and then add and subtract unity to each of these four special forms, we will have a total of twelve repeating proper and improper radix fractions. Table 4 is a table of the resulting representations for negabinary, in which the representations have been arranged in decreasing order of value.

The limiting values for these radix fractions, presented in Column 1 of Table 4, cannot be represented by a finite number of terms; they represent the sums of infinite geometric progressions. The difference between each of these limiting values and the sum of the first m fractional terms of the geometric progression are given in Columns 3 and 4. These increments are given as fractions of Δa , which is $1/(R+1)$ of the weight of the least significant digit, r^{-m} . For negabinary, therefore, $\Delta a = 1/3(-2)^m$. The first fractional terms of each geometric progression are represented by the repeating radix fractions given in Column 2. If we truncate the repeating radix fractions to four positions to the right

n	NEGABINARY NUMBERS		DECIMAL VALUES	
	Lower	Upper	Lower	Upper
1	0	1	0	+1
2	10	01	-2	+1
3	010	101	-2	+5
4	1 010	0 101	-10	+5
5	01 010	10 101	-10	+21
6	101 010	010 101	-42	+21
7	0 101 010	1 010 101	-42	+85
8	10 101 010	01 010 101	-170	+85

of the radix point, then the increments $-\Delta a$, 0 , Δa , and $2\Delta a$ (in Column 3, for even m) will have values, respectively, of $-1/48$, 0 , $+1/48$, and $+1/24$. These increments may be added to the decimal-limiting values to obtain the true decimal value of the repeating negabinary fraction truncated to four places. Examples are:

$$\begin{aligned} 0.0101 &= +1/3 - \Delta a = +1/3 - 1/48 = +5/16 \\ 0.1111 &= -1/3 + \Delta a = -1/3 + 1/48 = -5/16 \\ 00.1010 &= -2/3 + \Delta a = -2/3 + 1/24 = -5/8 \\ 11.0101 &= -2/3 - \Delta a = -2/3 - 1/48 = -11/16 \end{aligned}$$

An interesting and important property revealed by Table 4 and the last two examples is the fact that the upper and lower limits in each box have limiting values identical to those in the adjoining boxes, are complements on $R-1$ in radix fraction form, and have a difference of r^{-m} in truncated form. An attempt to generate a number whose less significant portion has a value in the neighborhood of a limiting value could result in either one of two correct negative radix representations. This fact is of extreme importance in negative radix division operations, as will be seen in a later article. For example, the result of dividing 0.0010 ($-1/8$) by 0.0111 ($+3/16$) is the representation for $-2/3$, which lies between $-5/8$ and $-11/16$. If this division in negabinary is carried to only four places, then either of two quotients could correctly be obtained: 0.1010 or 11.0101 .

Table 4 also illustrates the form of combined integral and fractional parts required to represent the full range of fractions. The analogous table for negadecimal is readily worked out.

OTHER NEGARADIX SYSTEMS

If the digits of a number expressed in negabinary are grouped in pairs, triplets, or higher quantity groups, the result can be considered to be the same number expressed in a higher radix, with the numerals represented by the possible bit configurations. In positive octal notation, for example, the 3-bit binary groups ranging from 000 to 111 represent the digits 0 through 7. If this same procedure is followed for 2-bit, 3-bit, and 4-bit negabinary groups, we have the sets of coded numerals as shown in Table 5.

The radices of the systems shown in Table 5 would be

Negabinary Number	DECIMAL EQUIVALENT															
	Negative								Positive							
	10	9	8	7	6	5	4	3	2	1	0	1	2	3	4	5
0	-	-	-	-	-	-	-	-	-	X	-	-	-	-	-	
1	-	-	-	-	-	-	-	-	-	-	X	-	-	-	-	
11	-	-	-	-	-	-	-	-	X	-	-	-	-	-	-	
100	-	-	-	-	-	-	-	-	-	X	-	-	-	-	-	
101	-	-	-	-	-	-	-	-	-	-	-	-	X	-	-	
110	-	-	-	-	-	-	-	-	-	-	-	X	-	-	-	
111	-	-	-	-	-	-	-	-	-	-	-	-	X	-	-	
1000	-	-	X	-	-	-	-	-	-	-	-	-	-	-	-	
1001	-	-	-	X	-	-	-	-	-	-	-	-	-	-	-	
1010	X	-	-	-	-	-	-	-	-	-	-	-	-	-	-	
1011	-	X	-	-	-	-	-	-	-	-	-	-	-	-	-	
1100	-	-	-	-	X	-	-	-	-	-	-	-	-	-	-	
1101	-	-	-	-	-	X	-	-	-	-	-	-	-	-	-	
1110	-	-	-	-	-	-	X	-	-	-	-	-	-	-	-	
1111	-	-	-	-	-	-	-	X	-	-	-	-	-	-	-	

$(-2)^2$, $(-2)^3$, and $(-2)^4$ respectively, or quarternary, negoctal, and hexadecimal. However, as we have learned to expect in negaradix systems, these systems do not have the normal range of numerals progressing up from zero, but include numerals with negative values. The basis for this is quickly demonstrated for negoctal by reference to the polynomial, with its terms grouped into triplets. Each triplet will have the form:

$$\dots + [a_{3i+2} (-2)^{3i+2} + a_{3i+1} (-2)^{3i+1} + a_{3i} (-2)^{3i}] + \dots$$

This group may be rearranged to:

$$\dots + [a_{3i+2} (-2)^2 + a_{3i+1} (-2) + a_{3i}] (-2)^{3i} + \dots$$

or:

$$\dots + (4a_{3i+2} - 2a_{3i+1} + a_{3i}) (-8)^i + \dots$$

In this form, the terms in the parentheses comprise the general expression for the values of the eight numerals of a negoctal system. By assigning all of the possible combinations of values (of 0 and 1) to the a 's, we have the lower set of eight codes and decimal values of Table 5.

When the grouping comprises an even number of terms, the power of (-2) taken outside of the brackets is even, hence the radix is positive. We then have a positive-radix system whose numerals are symbolized by negabinary codes and have appropriate values, both negative and positive.

Although such codes for radices which are integral powers of (-2) are quite natural, other sets of numerals can be used and the radices need not be confined to integral powers of -2 . Some of these, including decimal, are discussed below.

The Cobinary System

This introduction of the concept of numerals of negative value (called "signed digits") leads to the possibility of a system whose radix is -2 and whose numerals have

Special Number Forms	Repeating Radix Fraction	Increments to obtain true limits for m digits $\Delta a = 1/3 (-2)^m$	
		Even m	Odd m
+4/3	1.0101...	$-\Delta a$	$2\Delta a$
+1	1.0000...	0	0
+2/3	1.1111...	Δa	Δa
+1/3	1.1010...	$2\Delta a$	$-\Delta a$
+1/3	0.0101...	$-\Delta a$	$2\Delta a$
0	0.0000...	0	0
-1/3	00.1111...	Δa	Δa
-2/3	00.1010...	$2\Delta a$	$-\Delta a$
-2/3	11.0101...	$-\Delta a$	$2\Delta a$
-1	11.0000...	0	0
-4/3	11.1111...	Δa	Δa
-5/3	11.1010...	$2\Delta a$	$-\Delta a$

negative radix arithmetic

continued

the values 0 and -1. (Since the numeral -1 will be frequently used, it will be convenient to establish a separate symbol for it, and the letter *N* will be used.) The system of radix -2 using symbols (0, *N*) could be called a second negabinary system, simply because of its radix, but will be more convenient to give it a separate name, since the two sets of digits (0,1) and (0, *N*) are the only practicable non-redundant numeral sets. It will be called cobinary — which is short for complementary binary — since both the radix and the non-zero digit are complemented relative to binary. Table 6 is an expansion of Table 5 to include cobinary.

Although negabinary and cobinary appear to be merely complementary ways of representing numbers, a fundamental difference appears in the multiplication operation. The range for proper radix fractions in negabinary is:

$$+\frac{1}{3} > A_{\text{neg}} > -\frac{2}{3}$$

Because identical number configurations in negabinary and cobinary have opposite polarities, the limits of the range for proper fractions have opposite signs, and for cobinary the range is:

$$+\frac{2}{3} > A_{\text{cob}} > -\frac{1}{3}$$

If we multiply two proper fractions, then the lower and upper limits of the product for negabinary are:

$$\left\{ AB \right\}_{LL} = \left(\frac{1}{3} \right) \left(-\frac{2}{3} \right) = -\frac{2}{9}$$

$$\left\{ AB \right\}_{UL} = \left(-\frac{2}{3} \right) \left(-\frac{2}{3} \right) = +\frac{4}{9}$$

and for cobinary they are:

$$\left\{ AB \right\}_{LL} = \left(+\frac{2}{3} \right) \left(-\frac{1}{3} \right) = -\frac{2}{9}$$

$$\left\{ AB \right\}_{UL} = \left(+\frac{2}{3} \right) \left(+\frac{2}{3} \right) = +\frac{4}{9}$$

Thus, the limiting values for a product of two proper radix fractions are the same for negabinary and for cobinary.

The fundamental difference comes in when these product limits are compared with those for a proper radix fraction. For both negabinary and cobinary it is seen that lower product limit, $-\frac{2}{9}$, lies within the lower proper fraction limit, which is $-\frac{2}{3}$ for negabinary and $-\frac{1}{3}$ for cobinary. However, only for cobinary does the upper product limit of $+\frac{4}{9}$ lie within the upper proper fraction limit, which is $+\frac{1}{3}$ for negabinary and $+\frac{2}{3}$ for cobinary. This implies that **overflow in multiplication is possible in negabinary, but not in cobinary.**

Conversion between negabinary and cobinary is readily accomplished. One method is to write down the representation for the number of opposite polarity and exchange 1's and *N*'s, which is equivalent to subtracting the number from zero, and then changing the polarity (or vice versa). (Note that in negative radix arithmetic, subtraction from zero is not a trivial operation.) For example:

$$\begin{array}{r} 0000000 \\ -1101011 \\ \hline 0111001 \\ NNN00N \end{array} \qquad \begin{array}{r} 00 \\ -(+23) \\ \hline -23 \\ +23 \end{array}$$

TABLE 5

Bit Groupings to Form Higher-Radix Systems

Negabinary Code	Decimal Value
1 0 1 0	-10
1 0 1 1	-9
1 0 0 0	-8
1 0 0 1	-7
1 1 1 0	-6
1 1 1 1	-5
1 1 0 0	-4
1 1 0 1	-3
0 0 1 0	-2
0 0 1 1	-1
0 0 0 0	0
0 0 0 1	+1
0 1 1 0	+2
0 1 1 1	+3
0 1 0 0	+4
0 1 0 1	+5

Hexadecimal: 1 1 1 1, 1 1 0 0, 1 1 0 1

Quarternary: 0 0 1 0, 0 0 1 1, 0 0 0 0, 0 0 0 1

Negoctal: 0 1 1 1, 0 1 0 0, 0 1 0 1

TABLE 6

Decimal Equivalents of Negabinary and Cobinary

Negabinary	Decimal	Cobinary
1010	-10	NNNNO
1011	-9	NNOON
1000	-8	NNOOO
1001	-7	NNONN
1110	-6	NNONO
1111	-5	NNON
1100	-4	NNO
1101	-3	NNN
10	-2	NNO
11	-1	N
0	0	O
1	+1	NN
110	+2	NO
111	+3	NNON
100	+4	NNOO
101	+5	NNNN
11010	+6	NNNO
11011	+7	NOON
11000	+8	NOOO
11001	+9	NONN
11110	+10	NOOO

If we made only digital IC's, what would we try to sell you?

If we made only linear IC's, what would we try to sell you?

If we made only hybrid IC's, what would we try to sell you?

If we made only MOS LSI, what would we try to sell you?

If we made only transistors, what would we try to sell you?

But since we make **all these, what will we try to sell you?**

Only what you need.

We make an excellent source for all your present- and future-systems requirements. We offer you economy, unbiased service, and the finest products available today. For a copy of our new product reference guide, write to 2920 San Ysidro Way, Santa Clara, Calif. 95051.

CIRCLE NO. 37 ON INQUIRY CARD



PHILCO-FORD CORPORATION
Microelectronics Division
Santa Clara, California • 95051

negative radix continued arithmetic

A Symmetrical Ternary System

A symmetrical ternary (base +3) system using numerals N , 0, and 1 has certain advantages. These include an average truncation error of zero, simple arithmetic, elimination of polarity symbols, and the theoretical high storage efficiency of base 3 data. These three symbols could also be used for base -3 (although the utility of this is questionable), base $+2$ (which has been discussed) and base -2 (where it has advantages in division, because the quotient may be generated in any scale of notation).

Although representation in a system using redundant digits is not unique, there is a special case of representing base ± 2 numbers uniquely with the symmetrical ternary numerals. In base -2 systems, this unique representation is obtained by proceeding from the radix point, and replacing digit pairs 11 with $0N$ or NN with 01 . The result is a representation which contains a minimum number of 1's and N 's, and which may be useful for minimizing time for such operations as multiplication and division.

Comparison of the procedures for obtaining such a representation for normal base $+2$ and -2 systems will show the latter to be much simpler, because no carry or borrow is propagated. In the $+2$ system, the digit pair 11 is equivalent to the triplet $10N$, so that it is replaced by $0N$, with the "1" carried into the next higher position. For example, converting $+10111$ ($+23$) to the symmetrical (base $+2$) notation,

$$\begin{array}{rcl}
 +00011 & = & +0010N \\
 +00100 & = & +00100 \\
 +00111 & = & +0100N \\
 +10000 & = & +10000 \\
 +10111 & = & +1100N \\
 & = & +10N00N
 \end{array}$$

For negabinary and cobinary 1101011 ($+23$) and $NNN00N$ ($+23$), respectively, the conversions are made easily: $N0100N$ and $N0100N$. Naturally, they are identical. There are clear implications of advantages over binary for high speed multiplication and division.

Use of this notation offers a method of conversion between binary and negabinary (or cobinary). For conversion to base -2 , convert the normal binary form to the symmetrical form. Then change all non-zero digits in **odd** positions to the opposite polarity — that is, 1's to N 's and N 's to 1's. The result is the base -2 symmetrical form for the number. Then change $0N$ to 11 for negabinary, or 01 to NN for cobinary. Reverse the process for conversion the other way.

Examples:

- Convert $+1011101$ from binary to symmetrical binary

$$\begin{array}{rcl}
 +0001101 & = & 10N01 \\
 +1010000 & = & +101 \\
 +1011101 & = & +1100N01 \\
 & = & +10N00N01 \text{ Sym. Binary}
 \end{array}$$

- Convert $10N00N01$ from symmetrical binary to negabinary and cobinary

$10N00N01$	Symmetrical Binary
$N0100N01$	Symmetrical Negative Binary
110101101	Negabinary
$NNN00NN$	Cobinary

Negabinary-Coded Decimal

A symmetrical set of eleven numerals ranging from -5 to $+5$ was first suggested by Shannon in 1950 (see Bibliography) as having possible application to simplification of computer arithmetic. As can be seen from Tables 5 and 6, these values can be neatly bracketed by four-bit codes in either negabinary or cobinary. The easy complementation of digits is lost; however the need is eliminated because the primary object of such complementation is to perform subtraction by adding the complement, and this practice is not necessary in negative radix arithmetic. Hence, even though the primary radix is positive ($+10$), the secondary radix can be negative (-2) and the resulting system (negabinary-coded-decimal) has many of the advantages of negative radix notation.

Many other decimal codes, both ten-numeral sets and redundant sets are, of course, possible. An almost symmetrical set of sixteen decimal numerals having values corresponding to four bits may be obtained by biasing the zero by -2 (cobinary $+2$), so that the zero is represented by 0010 (cobinary $00N0$). A biased code confuses the addition algorithm somewhat, because 0100 (cobinary $0N00$) has to be added to each digit of the sum to compensate. In subtraction, the bias is automatically wiped out.

It is interesting that the normal, 0-9, set of ten-decimal numerals can be represented by an unbiased cobinary code of four bits. A more useful set might be one which includes at least one negative digit, say N , followed by the normal 0, 1, ..., 7, and 8, which would also permit decimal representation and arithmetic without separate polarity symbols.

Codes for Residue Number Systems

A more interesting set of possible codes is presented by residue notation, also called modular or mixed radix notation. In this type of number system, each digit position has its own radix, rather than a different power of one radix, and the numerals for each such radix comprise the set of residues for that radix. Radices must be relatively prime, and a set of numbers may be uniquely represented ranging from 0 to the product of all radices, less one. For example, in a two-digit number system using radices 3 and 2, a total of six different representations is possible, e.g., the numbers 0, $+1$, $+2$, $+3$, $+4$, and $+5$. To find the representation for each of these, we divide it by the radices, 3 and 2, and obtain the residues, or remainders. Thus, 4 is represented by the digit pair (1,0) since the residue of 4 modulo 3 is 1, and the residue of 4 modulo 2 is 0. Table 7 gives the entire set of digit pairs, or "numbers," for the decimal numbers 0-5 in a radix (3,2) residue number system. If radices 5, 3, and 2 were used, then there would be a total of $5 \times 3 \times 2 = 30$ representations; larger sets of representations

why MTOS monolithic shift registers are superior to any previously available...

MEM #	STATIC	DYNAMIC	FREQUENCY		NUMBER OF BITS	INPUT		OUTPUT		NUMBER OF CLOCKS	NUMBER OF POWER SUPPLIES
			LOW	HIGH		PARALLEL	SERIAL	PARALLEL	SERIAL		
3005 SP	X		DC	1.0MHz	5		X	X		2	2
3005 PP	X		DC	1.0MHz	5	X		X		2	2
3008 PS	X		DC	1.0MHz	8	X			X	2	2
3012 SP	X		DC	100kHz	12		X	X		1	1
3016-2	X		DC	1.0MHz	32 (16, 16)		X		X	2	2
3016-2D		X	10 kHz	3.0MHz	32 (16, 16)		X		X	2	1*
3020	X		DC	1.0MHz	20		X		X	2	2
3021	X		DC	500kHz	21 (1, 4, 16)		X		X	1	1
3021 B	X		DC	250kHz	21 (1, 4, 16)		X		X	1	1
3050		X	10 kHz	500kHz	50 (25, 25)		X		X	2	1*
3064		X	10 kHz	5.0MHz	64		X		X	4	NONE

*required for output circuit only

they're LSI

And only General Instrument devices incorporate the exclusive MTOS[†] process which provides Large Scale Integration (without the need for high-cost discretionary wiring) in the only broad line of shift registers available anywhere.

[†]Metal-Thick-Oxide-Silicon

and LSI means...

lower cost: Low initial device cost plus elimination of most printed circuit boards, assembly labor and external wiring.

higher reliability: External connections are minimized, eliminating a major failure mechanism in electronic systems.

highest packaging density ever.

No matter what your design requirements, chances are you'll find the shift register you need in General Instrument's broad line, at authorized GI distributors now. If you don't, contact us. Our line is being broadened regularly. Write for complete data and Application Notes, "MTOS Shift Registers."

GENERAL INSTRUMENT CORPORATION
600 WEST JOHN STREET, HICKSVILLE, L. I., NEW YORK
CIRCLE NO. 38 ON INQUIRY CARD



negative radix arithmetic

continued

can be obtained by using more and larger radices.

The advantage of such a system is primarily that carry propagation is eliminated. Thus, in the radix (3,2) residue system of Table 7, the sum of two numbers is formed by adding residues (digits) **without** carries, as illustrated in the following example:

Residue	Binary	Decimal
2,0	+10	+2
0,1	+11	+3
<hr/> 2,1	<hr/> +101	<hr/> +5

No carry was involved in the above example. In adding +2 to +2 however, we have:

Residue	Binary	Decimal
2,0	+10	+2
2,0	+10	+2
<hr/> 1,0	<hr/> +100	<hr/> +4

The arithmetic is explained by recalling that summing each column involves **residue** arithmetic; that is, $2 \bmod 3 + 2 \bmod 3$ is $4 \bmod 3$, which is congruent to $1 \bmod 3$. No carry is involved.

In past attempts to adapt residue number systems to computers, the numeral sets for each radix were generally expressed in a binary code, including normal binary representation for the positive integers. Thus, the arithmetic for each digit (radix) position still involved normal binary arithmetic, with provision for carry. However, the carry chain was limited to the length of the binary equivalent of the largest radix. At present, the utility of residue notation for computer design is rather limited. Major problems exist in sign detection, detection of overflow, division, and scaling, and while algorithms for these operations have been developed, they are not generally practicable. It is possible that some of these problems are traceable to the difficulties of the coding of numerals, rather than to residue notation. This may be particularly true of sign detection, which is in turn an operation critical to division. If so, the use of a negative binary code may provide better solutions. Some possibilities are therefore discussed here.

Since the radices must be relatively prime (or else unique representation would be lost), only one radix can be even. The use of all odd radices introduces the fascinating possibility of using a set of residues for each (odd) radix comprising a symmetrical set of negative and positive numerals ranging from $-(R-1)/2$ to $+(R-1)/2$, where R is the absolute value of the radix. These could be encoded in negabinary or cobinary. A total of P representations is thus possible, which could represent the set of numbers from $-(P-1)/2$ to $+(P-1)/2$, where P is the product of all the radices.

An example of such a system, using radices 7 and 3, is given in Table 8. The complement of a number is

obtained by complementing each digit, and addition, subtraction, and multiplication of either negative or positive numbers can thus be accomplished without need for special provision for negative representation or polarity manipulation.

TABLE 7

Radix (3,2) Residue Number System

Decimal Number	Binary Number	Residues		Radix (3,2) Residue Number
		Mod 3	Mod 2	
+0	+0	0	0	0,0
+1	+1	1	1	1,1
+2	+10	2	0	2,0
+3	+11	0	1	0,1
+4	+100	1	0	1,0
+5	+101	2	1	2,1

TABLE 8

Symmetrical Negabinary Residue Number System of Radix (7,3)

Decimal Number	Residues 7	Modulo 3	Negabinary Coded Residue Number
-10	-3	-1	1101,11
-9	-2	0	0010,00
-8	-1	+1	0011,01
-7	0	-1	0000,11
-6	+1	0	0001,00
-5	+2	+1	0110,01
-4	+3	-1	0111,11
-3	-3	0	1101,00
-2	-2	+1	0010,01
-1	-1	-1	0011,11
0	0	0	0000,00
+1	+1	+1	0001,01
+2	+2	-1	0110,11
+3	+3	0	0111,00
+4	-3	+1	1101,01
+5	-2	-1	0010,11
+6	-1	0	0011,00
+7	0	+1	0000,01
+8	+1	-1	0001,11
+9	+2	0	0110,00
+10	+3	+1	0111,01

TABLE 9

Negabinary Residue System With Unused Codes

Decimal Number	Residues 7	Modulo 3	Negabinary Coded Residue Number
-10	+4	-1	100,11
-9	-2	0	010,00
-8	-1	+1	011,01
-7	0	-1	000,11
-6	+1	0	001,00
-5	+2	+1	110,01
-4	+3	-1	111,11
-3	+4	0	100,00
-2	-2	+1	010,01
-1	-1	-1	011,11
0	0	0	000,00
+1	+1	+1	001,01
+2	+2	-1	110,11
+3	+3	0	111,00
+4	+4	+1	100,01
+5	-2	-1	010,11
+6	-1	0	011,00
+7	0	+1	000,01
+8	+1	-1	001,11
+9	+2	0	010,00
+10	+3	+1	111,01

A second possibility is illustrated by Table 9, in which radices are selected equal to $2^k - 1$ for various values of k such that the radices are relatively prime. This system is highly efficient in storage requirements. For each radix, a negative binary code is used comprising k bits, and all but one of the possible bit combinations are used to represent the numerals. In Table 9, for example, radices 7 and 3 were used, corresponding to values of k of 3 and 2. The unused codes are 101 and 10, each being the maximum magnitude combination for 3 and 2 bit numbers, and having decimal values of +5 and -2. This system also has the advantage that overflow can be used to indicate that an addition or subtraction has resulted in an out-of-range residue, so that the radix can be added or subtracted to yield a residue of not more than k bits. The single illegitimate k -bit code is easily detected, and its one's complement substituted to provide the correct residue. For example, the sum of -5 and +10 requires addition of the residue pairs (110, 01) and (111, 01), the sum of which is (101, 110). The code 101 is not legitimate and its complement 010 is substituted; the code 110 has a positive overflow, and the radix is subtracted. The final answer (010, 11), is the residue pair for +5.

Summary And Look-Ahead

Many other codes could doubtless be invented for particular kinds of representation and arithmetic. Since negative numbers are a practical necessity in any number system to be used for performing arithmetic, negabinary or cobinary coding offers a simple solution in those cases where use of negative numerals is acceptable or advantageous.

Next month we shall develop the normal arithmetic operations of addition and subtraction, in negative radix systems. Future articles will discuss multiplication, division, and the conversion between positive and negative radix systems. The above reference to "normal" arithmetic operations implies the existence of new arithmetic operations; this is indeed the case, and a later article will introduce the new concept of "complementary arithmetic operations."

BIBLIOGRAPHY

- C. E. Shannon, "A Symmetrical Notation for Numbers," *American Mathematical Monthly*, Vol. 57, pp. 90-93, 1950.
- G. W. Patterson, "Algebraic Foundations of Number-Representation Systems," "Final Report, Volume II, Theory of Switching Circuits," University of Pennsylvania, Moore School of Electrical Engineering, Philadelphia, Pa., Contract No. DA-36-039 SC-72344, Signal Corps Project No. 102A, September 1958.
- Harrey L. Garner, "Number Systems and Arithmetic," *Advances in Computers*, edited by F. L. Alt and M. Rubino, Vol. 6, pp. 131-194, Academic Press, New York, 1965.
- G. F. Songster, "Some Representation Systems for the Real Numbers," University of Pennsylvania, Moore School of E.E. Ph.D. Dissertation, 1962.

NOW AVAILABLE

A Negadecimal Add/Subtract Module

For demonstration or experimentation —
Complete with input/output and power supply;
negadecimal in-negadecimal out.

Modular by digit —
Buy only as many digits as you desire.

For more information:
Circle No. 103 on Inquiry Card

Series 90E miniature lighted pushbutton switch. Makes small work of big control jobs.

The MSC 90E Tellite® Word Indicating Switch-Lite is ideal for equipment where panel space is at a premium. But small size is only part of the story. Check the features below. Then add options such as drip-proof seals to block moisture or dust. And integral holding coils for electrical interlock functions. Consider the smart, distinctive styling. It all adds up to high reliability plus versatility in control . . . in a minimum of panel space. Specify the Series 90E. It's your best answer for high density packaging. Not just because of its small size . . . but because of its big performance features!

SEND FOR CATALOG 2008 TODAY!

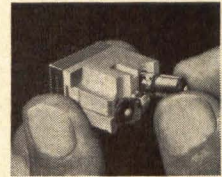

RELAMP WITHOUT TOOLS!

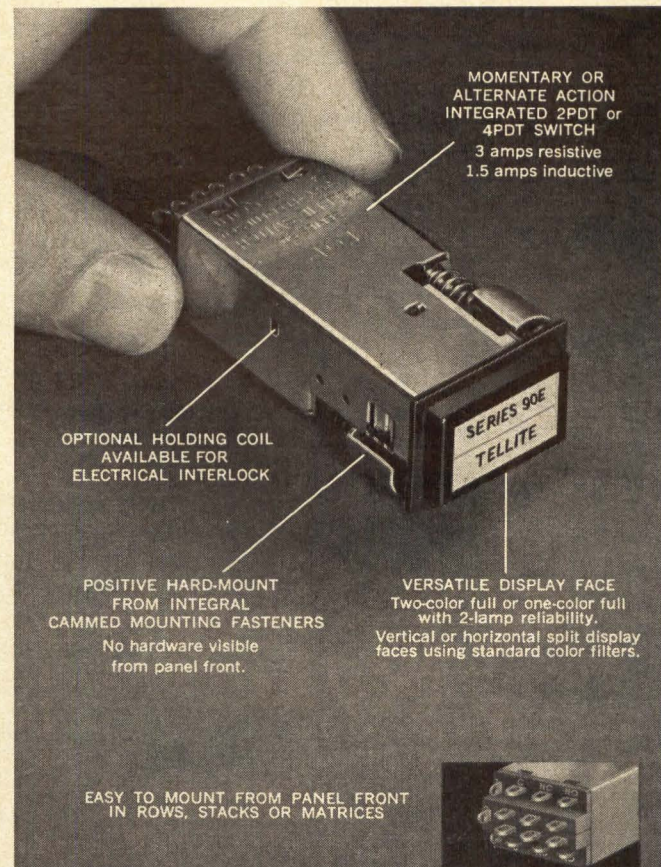

MOMENTARY OR ALTERNATE ACTION INTEGRATED 2PDT or 4PDT SWITCH
3 amps resistive
1.5 amps inductive

OPTIONAL HOLDING COIL AVAILABLE FOR ELECTRICAL INTERLOCK

POSITIVE HARD-MOUNT FROM INTEGRAL CAMMED MOUNTING FASTENERS
No hardware visible from panel front.

VERSATILE DISPLAY FACE
Two-color full or one-color full with 2-lamp reliability.
Vertical or horizontal split display faces using standard color filters.

EASY TO MOUNT FROM PANEL FRONT IN ROWS, STACKS OR MATRICES



EASY TO WIRE
All terminals at rear for easy access.

Master Specialties Company



25 YEARS IN INFORMATION DISPLAY AND CONTROL DEVICES

MSC Master Specialties Company, 1640 Monrovia, Costa Mesa, Calif. 92627 • Telephone (714) 642-2427 • TELEX 6-78433
Offices in Principal Cities.

Also available thru AVNET ELECTRONICS

WESTBURY, LONG ISLAND, NEW YORK • (516) 333-5800

CIRCLE NO. 46 ON INQUIRY CARD



NEW PRODUCTS

DATA DISPLAYS

Illuminated digital data displays are readable at 500 feet. Each digit consists of a lamp matrix or a segmented seven-bar type readout. Each display consists of several digits and a power supply module. Input signals may be decimal or BCD. A latching circuit to hold the display after the input signal has been removed is optional. Alphanumeric characters as well as several digit configurations and sizes are available ranging from 1 to 20 inches high, depending on the lamp matrix employed. A keyboard to operate this display manually from a remote location is also available. PPM, Inc., Cleveland, Ohio.

Circle No. 264 on Inquiry Card

ULTRAMINIATURE CONNECTOR

New series of ultraminiature rectangular plug-and-receptacle connectors was designed for use in high density packages. The special molded-in right angle contacts of this connector series permit its use in tight spaces where connector wiring cannot be made to straight contacts. A typical connector in this series is the model UMI-29MLTU which has 29 turret contacts in three rows. The pins are 0.030 inch in diameter. Test voltage between contacts is 900 VAC at sea level. Contact current rating is 3 amperes. The body of the connector is diallyl phthalate. U. S. Components, Incorporated, Bronx, N. Y.

Circle No. 204 on Inquiry Card

**Up to 48
COLUMNS
40 LINES
PER SEC.**

SHEPARD 848

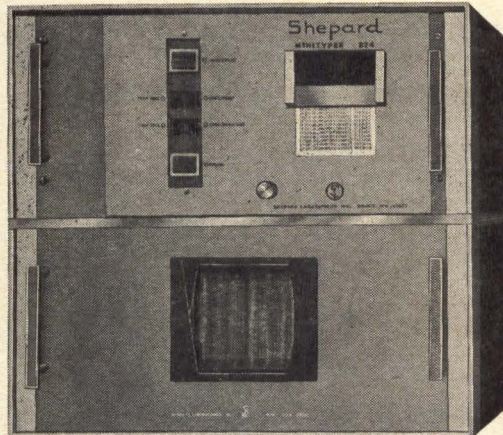

HIGH-SPEED PRINTERS

Rack or Table Mounted
Size 1 to 24 columns 8¾ H x 19 W x 22 D
25 to 48 columns 2 drawers 8¾ x 19 x 22 each
Codes — BCD — ASC11 — Baudot or your choice
Data Rates — up to 600,000 char. per sec.
Speed — numerics only — 40 lines per sec.
Alpha-numeric 20 lines per second.

Shepard ^{TM.} **LABORATORIES, INC.** / 480 Morris Avenue
 Summit, N. J. 07901
 Tel.: (201) 273-5255

4

CIRCLE NO. 39 ON INQUIRY CARD

SYSTEM-ORIENTED COMPUTER

A low-cost digital computer was designed to perform many system and automation tasks previously considered too difficult or expensive for computer solution. Called the DATA/620 I, it can be easily interfaced with special-purpose system components through its unique party line input/output system. The DATA/620 I is also functionally adaptable to the characteristics of the system or process through its Micro-Exec facility, a proprietary hardware technique for micro-step sequencing which permits subroutine processing at nanosecond speeds. The DATA/620 I features hardware registers for arithmetic and addressing speed, over 100 machine commands, six addressing modes, and over 100 register change commands. It occupies 10½" of a 19" x 24" relay rack, weighs less than 100 lbs., and requires 350 watts. The processor is supplied with memories operating at 1.8 μsec cycle time and ranging from 1,024 to 32,768 words of 16 or 18 bits. The DATA/620 I is fully equipped with field-proven software. The software is modular in design and includes the current languages, such as FORTRAN, Assembler, Aid, etc. A typical system including 4K memories and a Teletype costs less than \$15,000. Data Machines, Incorporated, Newport Beach, Cal.

Circle No. 290 on Inquiry Card

DIODE MATRICES

Three new monolithic diode matrices include a 5 x 5 matrix, a 5 x 8 matrix, a 6 x 8 matrix. The devices were expressly designed for standard decoding, addressing, and steering applications, both in military and industrial equipment applications. According to the company, the IC's can be patterned after the packages are hermetically sealed, enabling the company to market a low-priced device custom-tailored to the user's specific requirement. The three types are currently available in standard TO-84 flat packs. Radiation, Inc., Melbourne, Florida.

Circle No. 255 on Inquiry Card

STEPPING DRUM PROGRAMMERS

A broad range of stepping drum programmers includes models with from 16 to 93 output switches operating through 30, 60, or 100 steps. The stepping drum programmer is a pulse-actuated, motor-driven switching device which automatically sequences operations according to a preset program. The program pattern is established by inserting switch-actuating plugs in the drum. Each step occurs only in response to a deliberate pulse signal, supplied by an external source, such as a remote sensor switch, counter, or some other device indicating the end of the preceding step. This is called endpoint program control. The drum programmer can serve as an inexpensive, easily programmed binary logic device. Standard stepping motor provides maximum continuous stepping speed of 2 steps per sec. Tenor Company, Milwaukee, Wis.

Circle No. 263 on Inquiry Card

ULTRASONIC LEAD BONDER

A new ultrasonic lead bonder for use in the production of semiconductor devices was developed for a major manufacturer of semiconductor devices and has been tested and proved in operation over a long period of time. It is highly simplified in operation to minimize personnel training time and margin of error. It has handled, in one application, as many as 600 flat packages per day with 14 leads of two bonds each. The bonder has an automatic bonding cycle and features two separate channels for post-bonding and chip-bonding. A key to the success of the device is a 20-watt ultrasonic generator and transducer with a temperature-compensated feed-back network for operational stability. It incorporates a unique cam-locking device for superior reproducibility and elimination of costly maintenance. Hugle Ind., Sunnyvale, Cal.

Circle No. 209 on Inquiry Card

SYNCHRO-TO-DIGITAL CONVERTERS

Solid-state synchro-to-digital converters offer high-speed multiplex capabilities. Single speed accuracy can be provided to 15 binary bits (0.01 degrees of arc), with resolutions of 16 binary bits. A single unit can accommodate from 1 to 32 multiplexed synchro and/or resolver units. These inputs may be either single speed or multi-speed. Synchro rotational speeds to 360 degrees per second can be accommodated. Digital outputs may be selected at random or can be provided sequentially upon command. The basic measuring element of the system is a set of high precision tapped toroidal transformers. Synchro measurements are made directly on an ac basis rather than on a dc basis thus eliminating the necessity for precision demodulators and filters. Astrosystems Inc., New Hyde Park, N. Y.

Circle No. 207 on Inquiry Card

OP-AMPS ANONYMOUS

THINK WHAT IT DOES TO YOUR SYSTEM

New scientific discoveries can help you break the amplifier module habit. Get blessed relief from high analog subsystem costs. Avoid the embarrassment of being caught with your old-fashioned subsystems down.

Learn how amazing new methods help anyone achieve Total Monolithic Integration. Join OAA and discover Fairchild's all-new linear integrated circuit product line.

For free 24" x 31 1/2" poster and complete data kit, contact:

OP-AMPS ANONYMOUS

Fairchild Semiconductor, P. O. Box 1058,
Mountain View, California 94040

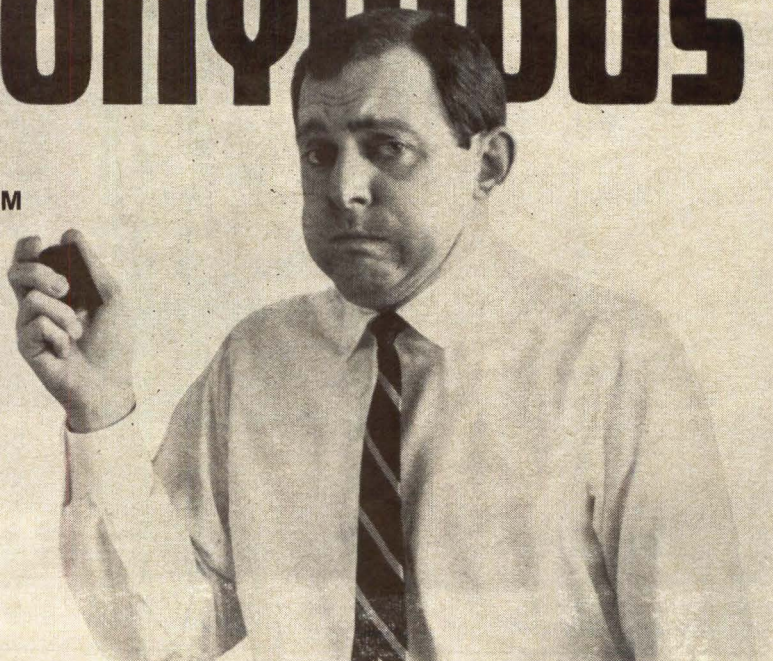

CIRCLE NO. 40 ON INQUIRY CARD

NEW PRODUCTS

SHIELDED RIBBON CABLES

Ribbon cables utilizing several new fabrication techniques are presently available for situations which require shielded constructions to be constantly flexed. The high degree of flex-life of this cable is said to result from special shielding techniques and the use of TFE Teflon as the insulation material. The shield employed is Awg 38 round wires helically wrapped around individual conductors or groups. Recent tests have shown this type of shield to attenuate unwanted radiated signals better than braided shields. In one installation, the cables have completed over 5,000,000 flexures without any signs of deterioration. W. L. Gore & Associates, Inc., Newark, Delaware.

Circle No. 256 on Inquiry Card

16-BIT COMPUTER

A new 16-bit integrated circuit digital computer, designated the 703, carries a basic price tag of \$15,000. According to T. J. Smith, manager of data processing equipment at Raytheon Computer, the 703 will give the systems designer more power, versatility, and adaptability to changing requirements than is available with combinations of core buffers and special purpose logic. Mr. Smith says, "customers can afford to integrate this low-cost machine into a wide variety of product systems for resale." Twenty-two orders have already been received for 703's for use in applications including radar data processing, aircraft and helicopter checkout, and seismic data processing. The 703 is being applied to manufacturing test, engine test, signal processing, and other applications. The 703 features a 16-bit word length, 71 hardware instructions, direct and indexed ad-

ressing, byte addressing and manipulation, and memory expansion to 32K words. Memory cycle time is 2 microseconds. Options include direct memory access channels, real-time clock, hardware multiply/divide, and additional interrupt lines. Raytheon's exclusive multiverter family (multiplexer, sample and hold, and a/d converter) can be connected to the 703 by standard coupler to form data acquisition or logging systems. Software for the 703 will include an assembler as well as executive, utility, and diagnostic routines. Particular emphasis is being placed on diagnostics to assist OEM customers in providing high reliability systems with minimum maintenance expense. The \$15,000 basic 703 includes a central processor with a register display and entry control panel, 4K words of core memory, a priority interrupt system, and an ASR 33 teleprinter. Raytheon Computer, Santa Ana, Cal.

Circle No. 289 on Inquiry Card

DIGITEC®

single range dc MILLIVOLTMETER

**0.1%
full
scale
accuracy**

6 standard
single range
models:

Model 401, 100 MV
Model 402, 200 MV
Model 404, 400 MV
Model 451, 10 MV
Model 452, 20 MV
Model 454, 40 MV

From \$375

Stocking Representatives
Throughout the World



Model 401 (shown)

- 100.0 MV
- 2% Calibrated over range
- 0.05% Full scale linearity
- AC Rejection 50DB @ 60 Hz
- Options Available include BCD Output
Auto Polarity
Retransmitting Pot
- Delivery: stock to 6 wks.

DIGITEC

by UNITED SYSTEMS CORPORATION

918 Woodley Road

Dayton, Ohio 45403

CIRCLE NO. 41 ON INQUIRY CARD

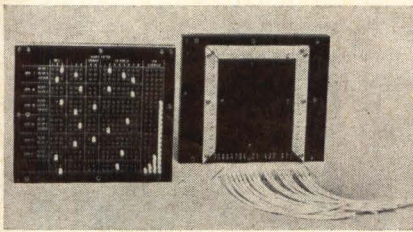

MATRIX PROGRAM BOARDS

Newly-developed X-Y matrix program boards are capable of handling high frequency signals. Typical capacitance through the unit is 4 uuf; crosstalk pickup is 40-60 db down. A cordless video patching panel contains 16 inputs and 17 outputs. Input-output connections are made by inserting pins at the appropriate crosspoints. These units may be supplied with mating coaxial connectors for terminating shielded cables. Co-Ord Switch, Div. of LVC Inds., Corona, N. Y.

Circle No. 221 on Inquiry Card

CRYSTAL OSCILLATOR

A crystal oscillator was designed for DTL and TTL logic circuitry. Rise and fall time is less than 15 nano-seconds. Fan-out is 5 and input voltage is $5 \pm 10\%$. Frequency ranges from KHz to 1 MHz. Stability over the range of -55°C to 125°C is $\pm 0.025\%$. Size is $1'' \times 1'' \times 0.375''$ Hill Electronics, Inc., Mechanicsburg, Pa.

Circle No. 238 on Inquiry Card

ELECTROLUMINESCENT DIODE

Claimed to be the first reproducible silicon carbide electroluminescent diode, the new device has applications for recording data on film, computer components, and in high temperature electronic components. The diode emits a needle-thin beam of cold yellow light with an efficiency of about 10^{-5} or one photon of light emitted for every 100,000 electrons passing through the diode. It measures $0.030 \times 0.030 \times 0.015''$. Norton Co., Worcester, Mass.

Circle No. 272 on Inquiry Card

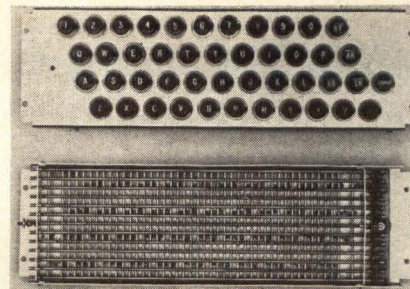

SUB-ASSEMBLY KEYBOARD

An unusual word length of 12 bits is provided by means of a unique mechanical x-y matrix. This sub-assembly keyboard provides high reliability and long life by reducing switch contacts by as much as 15 to 1. Interface problems are eliminated by bounce-free action of the switch contact output. Keys have snap action, light touch feel, and short stroke. The module can generate either Morse, 3 BCD's, ASCII, IBM, EBCDIC, CCIT, or any cipher required on order. It is $\frac{7}{8}''$ deep, $3\frac{1}{4}''$ wide, $11''$ long including mounting. Price is \$150, Computronics Engineering, Los Angeles, Cal.

Circle No. 253 on Inquiry Card

OP-AMPS ANONYMOUS

"...THIS OVERWHELMING DESIRE
TO TAKE ONE LITTLE ONE..."

Resist that urge! Break the amplifier module habit (every dollar saved in analog subsystem manufacture and test is worth \$7.32 in sales).

Do as thousands of successful men have done. Use Fairchild's all-new linear integrated circuit product line to achieve Total Monolithic Integration.

For helpful data kit, including instructional brochure and free $24'' \times 31\frac{1}{2}''$ poster, contact:

OP-AMPS ANONYMOUS

Fairchild Semiconductor, P. O. Box 1058,
Mountain View, California 94040

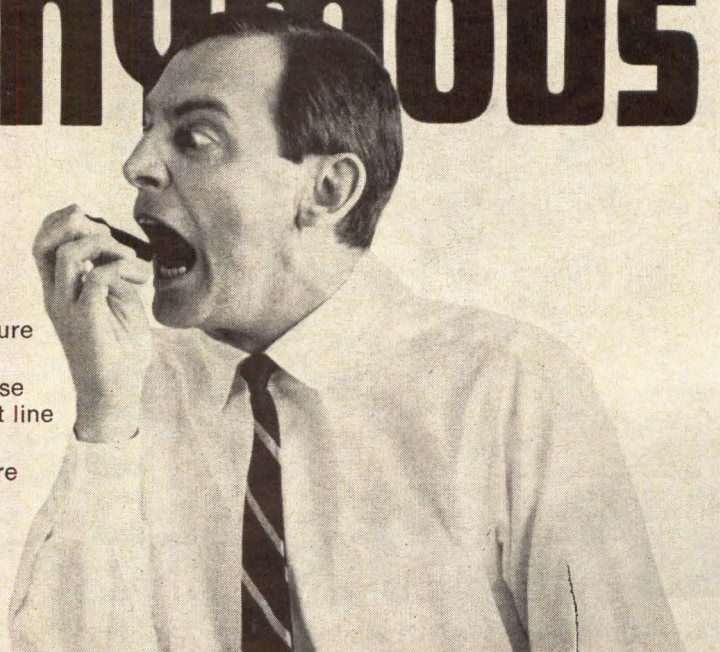

CIRCLE NO. 42 ON INQUIRY CARD

New Thermocouple Reference for Computerized Data Acquisition Systems

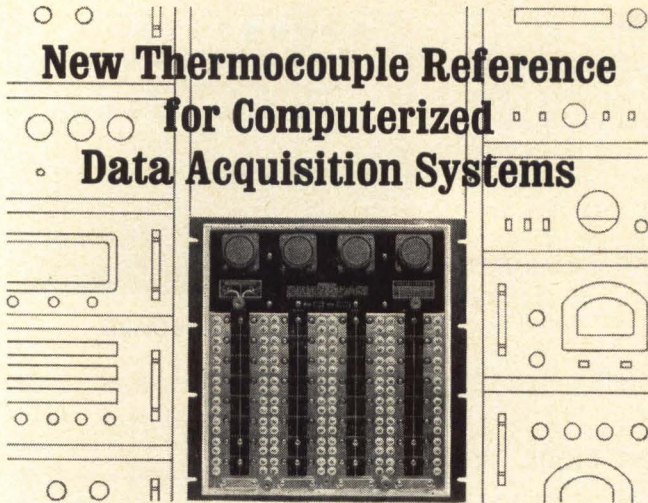

Kaye engineers have revolutionized thermocouple references used with computerized data acquisition systems with the Model UTR Floating Temperature Reference System.

- Universal — accepts any type of thermocouple material interchangeably.
- Highly Accurate — $\pm 0.1^\circ\text{F}$.
- Inexpensive — costs less than other references of same capacity.
- Fail-Safe — it has no "working" parts.



State-of-the-Art Reference Systems — Our Only Endeavor
JOSEPH KAYE & COMPANY, INC.
 737 CONCORD AVENUE • CAMBRIDGE, MASS. 02138
 TELEPHONE: (617) 868-7880

CIRCLE NO. 43 ON INQUIRY CARD

Standard Wakefield Packages Customized:

- Confined Airflow Series
- Open Airflow Series
- Liquid Cooled Plates

Special Coolers or Assemblies

- engineered cooling packages
- special fabrications
- unique hole/fin patterns
- special extrusions

Write for
CATALOG NO. 17 . . .
 24 pages of technical data.

make or buy?

A great solution . . .
**SEMICONDUCTOR
 COOLING PACKAGES**
 by Wakefield

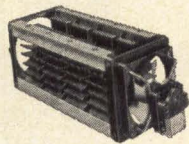

Open Airflow FCA-1100 Package
 with customized mounting holes.



Machined aluminum base with
 staked-in fins for cooling.

**WAKEFIELD
 ENGINEERING, INC.**

WAKEFIELD, MASS. 01880 ■ (617) 245-5900 • TWX 617-245-9213
 CIRCLE NO. 44 ON INQUIRY CARD

NEW PRODUCTS

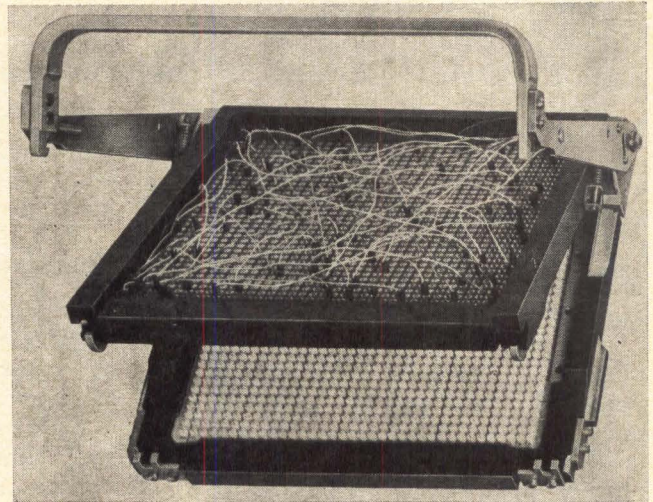

PATCH PANEL ASSEMBLY

Designed for use in programming computers and digital systems, a new patch panel assembly permits 1064 simultaneous connections. It can be interconnected into a system with patchcords or can be wired permanently. The patch panel features a levered-activated anodized aluminum frame with a positive locking feature. The top patchboard is made of epoxy glass with 0.040" cage type high reliability jacks for positive contact. One or more top boards can be supplied for a variety of programs. The bottom board is made from anodized aluminum with Teflon pressmount type 0.040" plug connectors with clamp or soldered tails. The Teflon plugs can be replaced without removing the board from its frame or mounting. Patchboards are marked into grids of 25 contacts and are numbered and lettered for ease of wiring identification. Cambridge Thermionic Corp., Cambridge, Mass.

Circle No. 242 on Inquiry Card

DUAL IN-LINE RECEPTACLE

New receptacle is a universal mounting device for all dual-in-line packages with 14 round or blade leads. Compact insulator design permits high packaging density (side-by-side mounting on 0.500" centers, in-line mounting on 0.800" centers). Wire-wrap contacts are of the double-leaf type and are made of spring-temper phosphor bronze with a gold flash over a nickel underplate. Insulator is a wood-flour filled phenolic (per MIL-M-14F, Type CFG) molding. Mounting is by interference fit between contacts and PC holes (no soldering needed with plated-through holes), or riveting. Closed-entry contact holes with chamfered edges prevent contact damage and facilitate DIP insertion. Elco Corp., Willow Grove, Pa.

Circle No. 232 on Inquiry Card

SQUARE WAVE GENERATOR

Solid-state square wave generator is said to produce square waves of exceptionally clean shape over a wide frequency range, from 1Hz to 10 MHz. Square-wave rise and fall times are less than 5 nanoseconds, overshoot, preshoot, and ringing are less than 5%, there is no sag, and jitter is less than 0.2% of waveform period at any repetition rate. The generator supplies 5-volt pulses into a 50-ohm load (10 V open-circuited). A second output, matched for 600 ohms, supplies 30 V peak into 600 ohms or 60 V open-circuited (risetime at this output is 70 ns across 600 ohms). Both output waveforms are dc-coupled negative-going but differ in time phase by 180°. A third output supplies 2-volt trigger pulses into 50 ohms, either positive or negative as selected by a switch, coincident with the leading edge of the 50-ohm square wave. These pulses are useful for synchronizing an oscilloscope and they also make generator useful as a controllable-rate trigger source. Hewlett-Packard, Palo Alto, Cal.

Circle No. 216 on Inquiry Card

DIGITAL OSCILLOSCOPE SYSTEM

An oscilloscope and a digital unit comprise a new high-speed digital oscilloscope system that provides digital readout of measurements that are displayed in analog form on the CRT. The system has flexible measurement capabilities and features up to 50 measurements per second, easy external programming, BCD data outputs, and solid-state circuitry with extensive use of integrated circuits. The digital unit can make a wide variety of repetitive pulse measurements on the signals displayed on the oscilloscope. The digital presentation can designate voltage measurements, time-difference measurements between similar pulses, and time-difference measurements between percentages or voltages of pulse amplitudes. All of its measurement functions can be programmed by means of ground closures or logic levels. The programming is achieved with 104 program lines using negative logic with true being ground or less than 2 V and false being open or greater than 6 V. Suitable programming devices include card readers, block readers, computers, etc. Tektronix, Inc., Beaverton, Oregon.

Circle No. 211 on Inquiry Card

TRIM POTENTIOMETER

A new 1/2 watt trimmer potentiometer costs less than \$1.00 each in quantities of 1,000. Designated as the 2300 Series, this new commercial grade trimmer is directly interchangeable with other 1-inch commercial models. New construction method is said to create excellent setting stability, allowing reliable use for balancing printed circuits. Other design features include ultrasonically-welded lid for protection against dust and dirt, shockproof insulated nylon-head lead screw, an exclusive wiper arm that provides positive settings (idles at either end to prevent over-travel damage), gold-plated collector bar and printed circuit pins, and precision-molded case made for use with production soldering processes. Resistance range is 10 ohms to 50K ohms with a standard tolerance of $\pm 10\%$. Power rating is 0.5 watt at room temperature to 0 watt at 85C with an operating temperature range of -55C to 85C. Dimensions are 1 inch long by 0.36 inch high by 0.28 inch wide. Dale Electronics, Columbus, Nebraska.

Circle No. 203 on Inquiry Card

Join today.
Get your
free poster.

OP-AMPS ANONYMOUS

OUR PLEDGE:
To keep a clean
system and a pure
profit through
Total Monolithic
Integration.

JOIN NOW.
OUR COUNSELOR IN YOUR AREA IS: Your nearby Fairchild Semiconductor distributor or sales office

A simple inquiry makes you a member of Op-Amps Anonymous. You get a free 24" x 31 1/2" poster plus a complete Linear Integrated Circuits Data Kit (data sheets on all Fairchild Linear Integrated Circuits, specs on new circuits, circuit designs, cost-performance comparisons and information on how to simultaneously cut costs and upgrade analog systems). Hurry, while the supply lasts.

OP-AMPS ANONYMOUS

Fairchild Semiconductor,
P.O. Box 1058,
Mountain View, Calif. 94040

CIRCLE NO. 45 ON INQUIRY CARD

NEW PRODUCTS

SYSTEMS POWER SUPPLIES

New systems power supplies offer a packaging technique that allows them to be mounted on any of three mounting surfaces. The new series is available in 88 different voltage-current combinations. Up to 485 watts of power from the modules will fit into a standard 19" rack. There are four package sizes, providing 6 watts in the smallest size. The others are 18 watts, 48 watts, and 120 watts. A wide variety of rack mount adapters is also available to allow the systems designer to use the smallest possible rack for his power requirements. The modules, designated the SC series, are self-cooled. No external heat sinking is required. Remote sensing and remote voltage adjustment capabilities are standard. Line and load regulation combined is $\pm 0.05\%$ or 2mv, whichever is greater. Response time is 20 usec. and ripple is 1 mv, rms. Consolidated Avionics, Westbury, L.I., N.Y.

Circle No. 246 on Inquiry Card

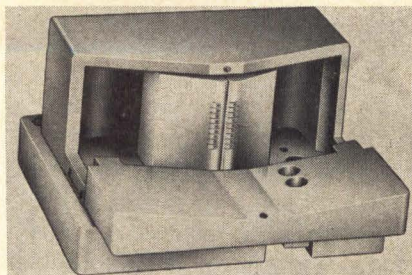

TAPE HEADS

Seven and nine channel read/write digital tape heads are said to be distinguished by extremely high temperature stability, encapsulated above 250 degrees Fahrenheit. These digital heads have glass deposited read and write gaps. Combination ferrite and hi-nickel shields included on covered models. Tape cleaner is included or provision is made for installation holes on tape drive equipment. Magnetic Heads, Inc., Minneapolis, Minn.

Circle No. 257 on Inquiry Card

FET OPERATIONAL AMPLIFIER

New FET input amplifier offers a common mode rejection ratio in excess of 10,000, over a temperature range of -55 to 85°C . The amplifier, Model D-15, has an input impedance, in both differential and common mode, greater than 10^{11} ohms. Its typical frequency for full output is 35KHz (either input). Frequency for unity gain is 2.5MHz and voltage gain (into a 10K load) is 25,000. Salient stability specifications include offset current of 10pA and voltage drift of $5\mu\text{V}/^{\circ}\text{C}$. Data Device Corp., Hicksville, N.Y.

Circle No. 258 on Inquiry Card

PC CARD TESTER

An automatic card tester for printed circuit cards is adaptable to operate with a wide range of central control and evaluating subsystems. The use of plugboards provides a combination of readily-changed connections to accommodate many types of cards, including discrete and integrated circuits. The tester operates with two types of control; digital computer or programmer/comparator. For computer control, a perforated tape reader and typewriter are included as peripheral equipment. For programmer/comparator control, a manual programming panel is provided instead of the typewriter. A symbolic language has been devised and is used for the source program. An assembly program (SCATRAN) is in turn translated into a sequence of instruction blocks. These instruction blocks then produce an eight-level program tape which is used by the programmer-controller or the computer. The station utilizes a plugboard switching-scheme tied in with the interface connectors into which the modules to be tested are inserted. When a test is to be changed, the plugboard interconnections can be changed easily to meet the new connection requirements. The plugboards are indexed with a wired-in code number corresponding to the card with which each is to be used. General Dynamics, Electronics Division, Rochester, N. Y.

Circle No. 228 on Inquiry Card

SCAN CONVERTERS

Three new double-ended scan converter storage tubes are electrical input-electrical output tubes designed for service in which stored information written in one particular scanning mode is read out with either a different scanning mode or the same mode scanned at a different rate. A feature of the tubes is the shielding between the writing and reading sections, which eliminates write-read crosstalk at the signal output electrode. Type H-1161, a $2\frac{5}{8}$ -inch diameter tube, features two flooding guns, connected externally for parallel operation, by means of which immediate erasure can be performed, or the decay rate of stored information can be controlled. Resolution is 800 TV lines at 50 per cent modulation by orthogonal reading. Type H-1203, with 4-inch diameter, and Type H-1213, with a 3-inch diameter, are designed as versatile tubes which permit erasure of selected portions, or of the entire storage target area performed as a time-shared operation with either the writing or reading gun. It is also possible to control the information decay rate by applying suitable pulses simultaneously to the read-gun cathode, control grid, and prefocus electrode during sweep retrace intervals. Resolutions are 2000 lines for the H-1203 and 1600 lines for the H-1213, both at 50 per cent modulation by orthogonal reading. Hughes Vacuum Tube Products, Oceanside, Cal.

Circle No. 251 on Inquiry Card

BCD ENCODER

Shaft encoder with its associated logic card provides non-ambiguous BCD 8421 output. The encoder counts from $+000.0^{\circ}$ to $+179.9^{\circ}$ then, -179.9° to -000.0° . The electronic card consists of dual-in-line integrated circuit logic modules. Output voltage levels are 5 volts and operating power is 5 volts at 150 mamps. Units are available with 100, 200, or 400 count resolution — internal select electronics — full count range 0-359.99, 0-99999, and 0 ± 179.99 . Vernitron Corp., Encoder Div., Farmingdale, L.I., N.Y.

Circle No. 235 on Inquiry Card

THE COMPLETE FAMILY OF MICRO LOGIC PRODUCTS.

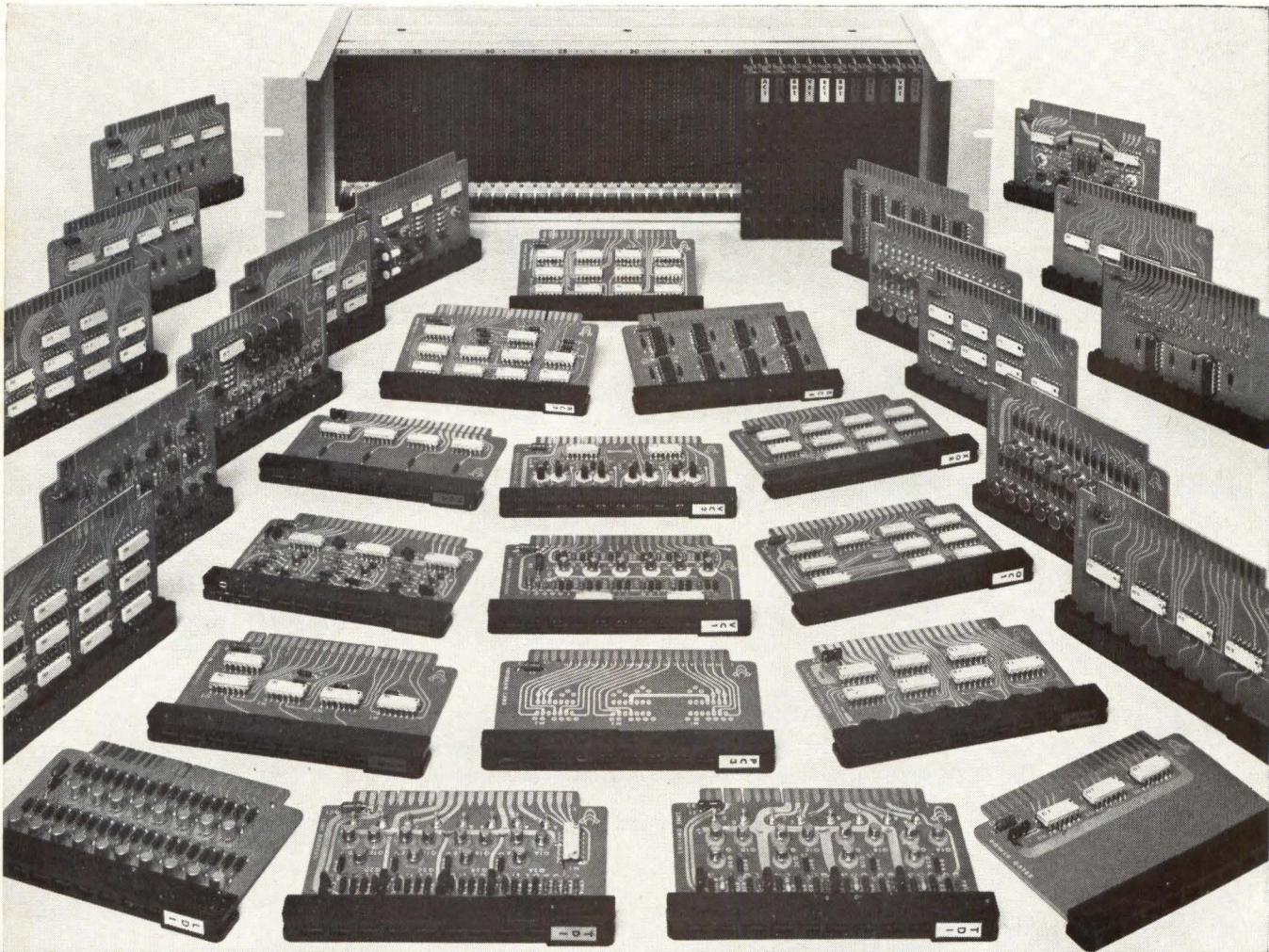

THE COMPLETE FAMILY. That's what Control Logic offers. The complete family of logical and system packaging components including the widest choice of DTL and TTL logic . . . with speed capability of DC to 30 MC!

THE COMPLETE FAMILY.



Control Logic's TTL 5 MC and 20 MC Series C products have set industry standards in packaging design and functional logical components. They are the best for high speed system design!

THE COMPLETE FAMILY.



Control Logic's DTL Series C 110 for DC to 1 MC operation offers exceptional economy plus logical features of collector OR and input expansion while maintaining complete compatibility with all Series C cards!

THE COMPLETE FAMILY.



Control Logic's Series C Analog cards are "building block" components for A/D and D/A conversion. They can be integrated with Series C card types for analog interfacing in system design, or as discrete AD or DA "instrument" assemblies!

THE COMPLETE FAMILY. Control Logic's complete family is also a *first* family. Control Logic was *first* with TTL . . . *first* with test point handles . . . *first* with 20 MC logic . . . *first* with the blue card . . . *first* with plug-in IC packages . . . *first* with ceramic IC packages . . . *first* with a highly flexible modular packaging approach . . . *first* with a . . . but need we go on? Check Control Logic's complete family of system components and services yourself. Once you do, you'll agree it's the best available!

Call or write today for descriptive literature.

 **CONTROL LOGIC, INC.**
subsidiary of Schaevitz Engineering

3 STRATHMORE RD., NATICK, MASSACHUSETTS 01760
TEL: 617 655-1170 or 617 235-1865

CIRCLE NO. 47 ON INQUIRY CARD

SPECIAL or STOCK BLOWERS

Call Ripley!

Designing, development and production of precise air-moving units to fit your performance requirements and your budget. Stocked units available from 4 to 145 CFM for immediate delivery. For fast action, call Sales Dept., (203) 346-6678.

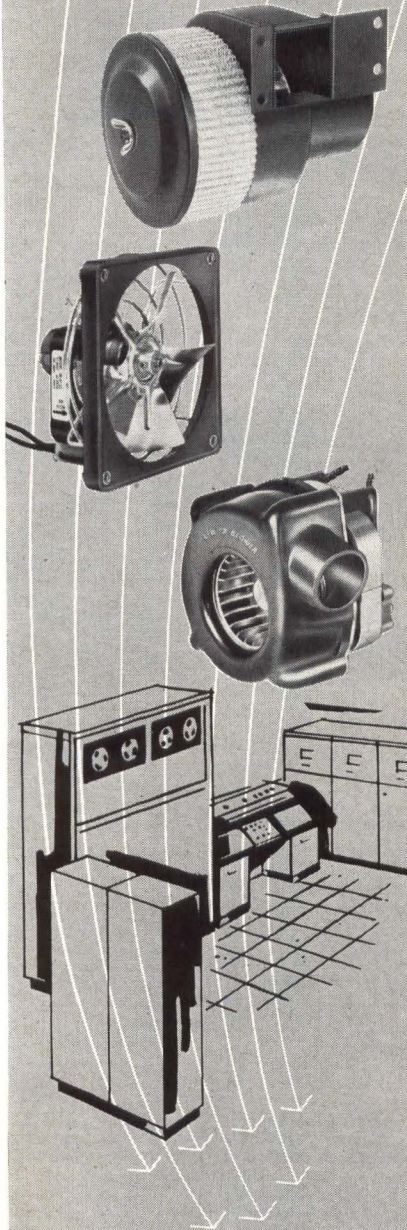

RIPLY
COMPANY, INC.
MIDDLETOWN, CONNECTICUT

CIRCLE NO. 48 ON INQUIRY CARD

NEW PRODUCTS

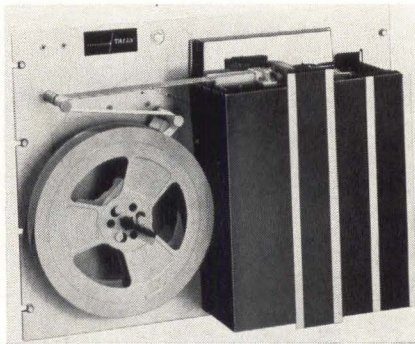

TAPE PERFORATOR

A new high speed paper tape perforator features integral tape handling on a space-saving rack mounted panel. The new model, designated the P-150A, operates asynchronously up to 150 characters per second. Error control options allow the motion of each punch pin to be mechanically sensed as the character is being punched. Odd or even parity can be checked. If an error has occurred, the tape advance pulse can be inhibited and the erroneous character overpunched with a delete code. Standard units have unidirectional tape advance with remote tape backup at a modest extra cost. Tally Corp., Seattle, Wash.

Circle No. 262 on Inquiry Card

DIGITAL DECODER ASSEMBLIES

New digital assemblies include binary-to-octal, BCD-to-decimal, 2421-to-decimal, 5421-to-decimal, excess 3-to-decimal, and binary-to-hexadecimal decoders. The binary-to-octal decoder card provides conversion from a 3-bit to an 8-bit octal equivalent and is available with options for either a single decoder, a dual decoder, or a decoder with drivers. The binary-to-hexadecimal decoder assembly provides conversion from a 4-bit binary code to a 16-bit alphanumeric equivalent. The other assemblies all provide conversions from a 4-bit binary code to a 10-bit decimal equivalent and can be ordered with options for either a single or dual decoder. Cambridge Thermionic Corp., Cambridge, Mass.

Circle No. 268 on Inquiry Card

another
breakthrough
from
**FRANKLIN
ELECTRONICS**

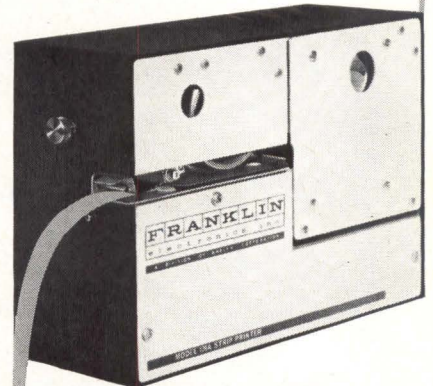

the Model 120A STRIP PRINTER

- Full alpha-numeric font of 64 characters and numerals.
- 1200 characters per minute.
- Serial entry.
- Impact printing with inked roller option.
- 8 $\frac{1}{8}$ " D x 3" W x 6 $\frac{1}{4}$ " H.
- Less than 5 lbs.
- Front paper exit.
- Less than \$300 w/o electronics, \$500 with.
- Franklin reliability!

SEND FOR
ENG. DATA 3010

FRANKLIN
electronics, inc.

East Fourth St. • Bridgeport, Pa. 19405
A Division of the Anelex Corporation

CIRCLE NO. 49 ON INQUIRY CARD
COMPUTER DESIGN/JUNE 1967

RECORDING STORAGE TUBE

A miniature recording storage tube is capable of simultaneously reading and writing. The CY1519 is a dual-gun storage tube which may be regarded as an electronic input-electronic output storage device which combines high output signal with high resolution. The tube has a nominal length of 16½ inches and a maximum bulb diameter of 1.5 inches. Resolution is typically 850 TV lines per diameter. The chief application is scan conversion to television-type presentation of the outputs of such airborne sensors as sonar, infrared, and radar. This system yields a bright display with high resolution and adjustable gradual erasing. Stored signals can be held for a long period, read several thousand times, or erased in a fraction of a second. The storage capabilities permit additional coherence of target information despite high noise levels. The tube achieves a wide range of gray shades, fast writing speeds, and selective erasure of stored information. Erasing operations can be carried out by either the reading or the writing gun. Raytheon Co., Industrial Components Operation, Quincy, Mass.

Circle No. 226 on Inquiry Card

INCREMENTAL PLOTTERS

First of a new family of incremental plotters operating at the rate of 800 steps per second is said to feature high speed and accuracy, with a resolution up to 0.0025 inches. According to the manufacturer, this increase in incremental performance will extend the use of digital plotting for applications previously requiring high-precision drafting systems. All models in the new incremental family make use of an exclusive engineering concept that allows the generation of multiple plotting commands from a minimum of digital input. Over an average run of plotting applications, the logic design is said to save from 50% to 90% of computer write-time. By shrinking plotter command lists, the same principle also serves to reduce the amount of input media used. The plotter is designed to operate on-line with computer, multiplexed to a time-sharing system, or off-line with magnetic tape input. Benson-Lehner Corp., Van Nuys, Cal.

Circle No. 224 on Inquiry Card

FLEXIBLE CIRCUITS

Principal characteristics of a new flexible flat cable and printed wiring circuit is a flat conductor of 0.003" average thickness. Conductors will be etched from a foil (forming a planar pattern) or rolled and laminated using either polyimide, Teflon, polyester, or polyvinyl chloride insulation. Finished cables are thin, flexible, and may be furnished, shielded or in harness assemblies. They are said to offer increased reliability, consistent electrical characteristics, and extreme ease of handling Cerro Corp., Old Saybrook, Conn.

Circle No. 201 on Inquiry Card

µVL same MicroVersaLOGIC

µVL same performance

µVL same reliability

µVL from Decision Control

µVL now costs . . .

33% less!*

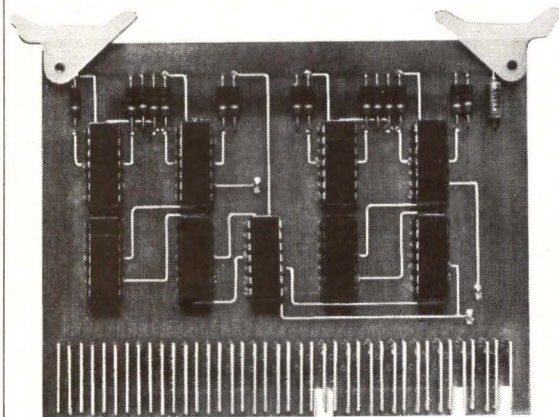

We've reduced MicroVersaLOGIC prices sharply, thanks to lower microcircuit prices.

Get the same reliable performance—same proven DTL circuits—5 v. logic levels—plenty of output drive—single power supply—complete mounting hardware available.

If you're building a digital system, build it with MicroVersaLOGIC and really save time and money. We'll show you how—in our uVL applications brochure. Send for it today.

**average module price reduction*



DECISION CONTROL, INC.

1590 Monrovia Avenue, Newport Beach, California
Tel. (714) 646-9371 • TWX (714) 642-1364

CIRCLE NO. 50 ON INQUIRY CARD

When You Need A Low Cost Indicator... Use The

"PEANUT LITE!"

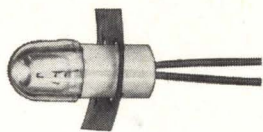

Incandescent lamp potted in base with macrodome filter (available in colors) and spring retaining clip.

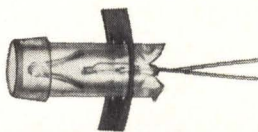

Neon lamp in base with short cylindrical filter (available in colors) and spring retaining clip.

LAMPS SHOWN ACTUAL SIZE

This versatile indicator lamp offers not only low initial cost but low installation cost as well. It is available in both T-2 neon or T-1- $\frac{3}{4}$ incandescent lamp styles and in a wide range of voltages from 2.7V to 28V.

Easily mounted by means of a unique friction clip, these lamps require only a simple drilled hole in the panel. The incandescent lamps are potted in a high temperature polycarbonate shell—the neon lamps are simply slipped into a butyrate shell where they are held in place by a molded shoulder.

When it becomes necessary to trim costs on indicator panels, investigate the "Peanut Lite." Write for Product Bulletin 102A for the complete story—or write for incandescent or neon sample on your letterhead.

CHICAGO MINIATURE  LAMP WORKS

4433 Ravenswood Ave., Chicago, Illinois 60640

CIRCLE NO. 51 ON INQUIRY CARD

NEW PRODUCTS

CRT DISPLAY CONVERTER

Two new CRT display converters enable a recorder to provide a large, precisely scaled plot of a CRT display. It is an interface device which fits between any oscilloscope and X-Y or strip chart recorder. The first new device, called the PM 1001-02, enables the instrument to operate properly with curve tracers. New circuitry senses the absence of a sampling pulse which causes the pen-lift relay to energize and the retrace circuit to cycle. This becomes necessary with the curves of certain transistors because the CRT trace terminates before it has progressed to the right edge of the graticule. It senses the end of the CRT trace, lifts the recorder pen, and initiates retrace. An additional control on the new converter allows an operator to set the recorder vertical start point even though the CRT trace starts after the first vertical graticule line. The second unit, for recording waveforms at very low repetition rates, is the PM 1005. It is able to record oscilloscope waveforms at repetition rates as low as one every 10 seconds. Pacific Measurements, Palo Alto, Cal.

Circle No. 222 on Inquiry Card

DATA ACQUISITION

New line of stored-program data acquisition systems samples a large number of analog and digital inputs, performs A/D conversion, formats the system data for computer compatibility, and records data on magnetic tape. The system is available in three models, each offering varying degrees of data manipulating facility. Model 100 includes the essential commands which provide control over sampling sequence and tape block length. Model 200 includes an expanded command list which allows a more sophisticated approach to data acquisition. Model 300 is provided with a general-purpose computer interface which allows on-line processing of the data collected. Key to the flexibility of the data acquisition system is a high speed core memory providing storage as a data buffer as well as for program steps, one hundred of which can be stored. Program steps, consisting of input channel identifiers and control functions, are entered into the memory via a ten-key keyboard as decimal digits. A standard system includes a sixteen channel multiplexer, expandable to one hundred channels, an A/D converter, a 4000 word 8-bit core memory and a digital tape transport. Each of these units are selectable to be compatible with user requirements. Conversion rates as high as 100,000 conversions per second are obtainable. Information Control Corp., El Segundo, Cal.

Circle No. 231 on Inquiry Card

Hewlett-Packard Stresses Reliability

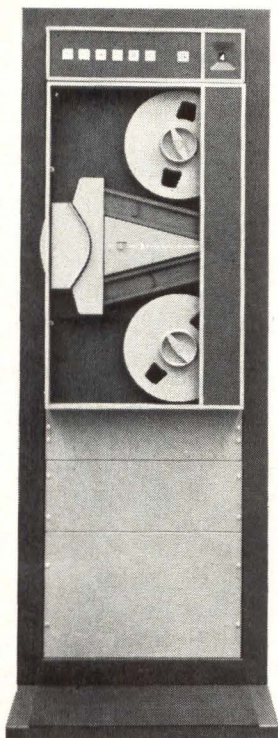

2020 Series

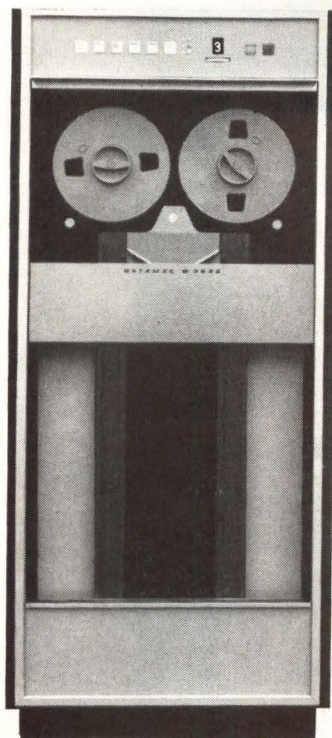

3030 Series

Ask any of these people who use Hewlett-Packard tape units in their digital systems



1. **Digitronics Corporation**
System 600 Dial-o-verter
2. **Electro-Mechanical Research**
EMR 6050 Computer System
3. **Scientific Control Corporation**
SCC-650 Computer System
4. **Stromberg-Carlson Data Products Div.**
S-C 4400 System
5. **Photon, Inc.**
713 Textmaster Phototypesetter
6. **Gerber Scientific Instrument Co.**
Series 2000 Control

Perhaps you, too, have a program that would profit from **low cost / high reliability** in computer tape handling. Check with the company that stresses service to its customers. Write us at 690 Middlefield Road, Mountain View, California 94040. Better yet, call your nearby Hewlett-Packard sales office.

HEWLETT  **PACKARD**

Servo is Digital to Synchro



And Servo's digital-to-synchro converters are fast. In fact, Servo's patented resistor ladder technique enables conversion speeds of 25 microseconds. Result, you save valuable computer time because of fast scan rates on multi-channel operation; multiplex operation is also available.

Only Servo's converters have variable offset angle control and built-in converter self test—giving you zero setting between channel-to-channel set-up on multi-channel systems.

Servo's digital-to-synchro converter

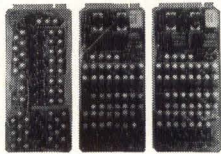

boards offer you an electrical output accuracy of ± 0.5 degrees at 250 ma output current. Data input is 11 bit Binary angular data in parallel format.

Look to Servo—your answer to accurate, high speed converters . . . in applications for: • simulation and training systems • digitally controlled servo systems • mechanical position data transmission • radar antenna and navigation controls • remote operation of controls and indicators.

For additional information, write or phone the Servodynamics Division.

servo corporation of america

Servo

servodynamics division
111 new south road
hicksville, new york 11802
516-938-9700

CIRCLE NO. 53 ON INQUIRY CARD

NEW PRODUCTS

GLASS FIBER OPTICS

Said to be the industry's first continuous length flexible fiber optics made of glass, non-coherent fiber optic bundles, jacketed in polyvinylchloride (PVC), are available in single lengths up to 10,000 feet. The glass fibers can be twisted and flexed without degradation of light transmission. Initial selling price is 10 cents per foot in quantities of 50,000 feet. As volume increases, the company expects the price to fall to five cents or less per foot, depending on quantity and specifications. The jacketed fibers can easily be cut, terminated, end finished, and installed to light source and output devices. They are particularly useful in applications where multiple light sources can be replaced by a single source or where direct light might be impractical. Uses include transmission of remote light or optical data, medical instrumentation, electronic data processors, inspection systems, and high-speed printing systems. A 10-foot length of flexible glass fibers with polished ends will transmit 40 per cent of input light. Corning Glass Works, Corning, N. Y.

Circle No. 243 on Inquiry Card

SYSTEMS POWER SUPPLY

A systems power supply produces five voltages from +20 to -20 VDC at currents from 1 to 7 amperes. Typical of systems supplies designed for data processing equipment, the Model 11578 incorporates features which can be adapted to specific system requirements. The supply accepts inputs of 100 to 250 VAC at 47 to 63 Hz, and incorporates four series regulators and one shunt regulator. Additional features include 1% envelope regulation, margin-checking, turn-on and turn-off sequencing, and remote sensing. Also provided are automatic current limiting, interlocks, and high pulse load capabilities. Advanced Development Corp., Gardena, Cal.

Circle No. 249 on Inquiry Card

AXIAL FAN

Miniature axial fan is of all-metal construction and is said to incorporate an exclusive and proved broached dual-sleeve bearing system which assures longer and more reliable operation. It offers lubrication-free life expectancy in excess of 20,000 operational hours, continuous duty at 55°C. Designed specifically for industrial and commercial applications, the Model 4500 exhibits a low noise figure of less than 37.5db SIL (Speech Interference Level) which is of primary concern in computer and office machine applications. Pamotor, Inc., San Francisco, Cal.

Circle No. 200 on Inquiry Card

RESISTOR NETWORKS

Precision matched thick-film resistor networks are offered in values from 100 ohms to 100K. The networks are glassivated and "fired" on a common alumina substrate to assure stability and temperature tracking. Temperature tracking of a ratio of 25ppm/°C from -55°C to +125°C is standard. The networks show less than 0.05% change in absolute resistor value after 1000 hours load life. Price of the thick-film resistor networks depends upon number of bits and package configuration. Microtek-Electronics, Inc., Cambridge, Mass.

Circle No. 265 on Inquiry Card

DELAY-LINE MEMORIES

New delay line memories are capable of storing up to 20,000 bits in a single magnetostrictive delay line. Input and output characteristics are designed to be completely compatible with system requirements. Newly-designed modules employ integrated circuitry in and out, with a special low voltage series using a single power supply of +4½ or +5 volts. Model MM offers up to 5000 bits (bipolar, 1 MHz bit rate) or 10,000 bits (NRz, 2 MHz bit rate) and will perform over a wide temperature range. Delay Devices Corp., Watertown, Mass.

Circle No. 291 on Inquiry Card

IN-LINE DISPLAYS

We also make panel displays, CRT displays, readouts, switches and indicators.

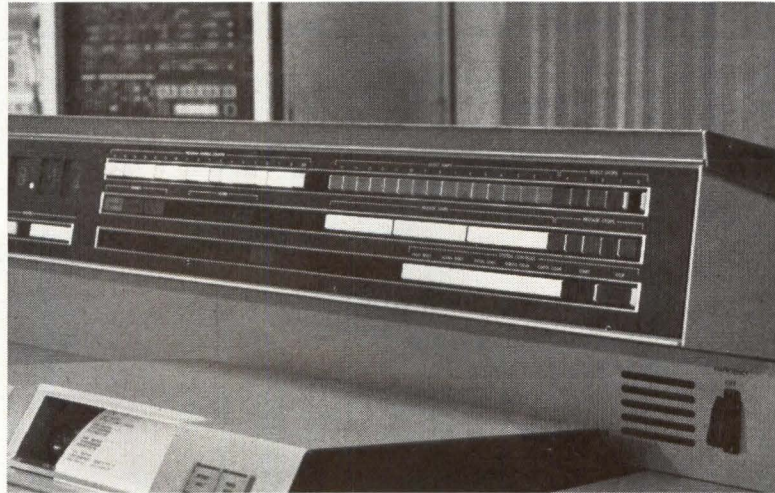

DATA-LINE DISPLAY BRINGS A TOTALLY NEW MEANING TO THE WORD VERSATILITY!

■ Combine basic switch, indicator and message display functions in this new, in-line modular package. Handsome! And a practical approach to display, compatible with today's demand for human engineered, high density packaging. Permits intermixing of message display, neon or incandescent indicators, switch-indicators or switch functions on .700" centers in frame lengths up to four feet—and functions may be arranged in any sequence! Mechanically and electrically, DATA-LINE Display is as versatile as your needs. Makes a lot of dollar sense, too.

Price of DATA-LINE Display's switch indicator function compares favorably with other multi-pole lighted push button switches. Its appearance and design flexibility is unexcelled!



For complete information, contact your local TEC-Rep, or write direct.



INFORMATION DISPLAY
AND CONTROL DEVICES

TRANSISTOR ELECTRONICS CORPORATION

Box 6191 • Minneapolis, Minnesota 55424 • Phone (612) 941-1100

CIRCLE NO. 54 ON INQUIRY CARD

HYBRIDIZATION . . . the fine art of converting your discrete component circuit to a microcircuit.

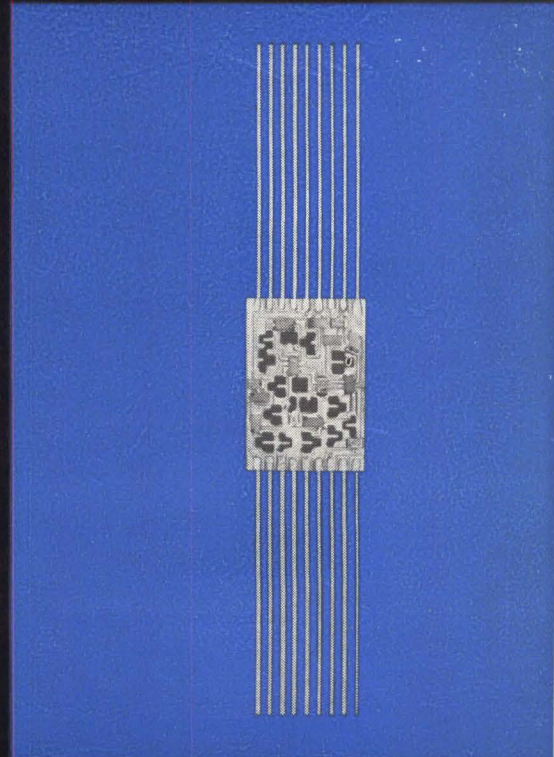
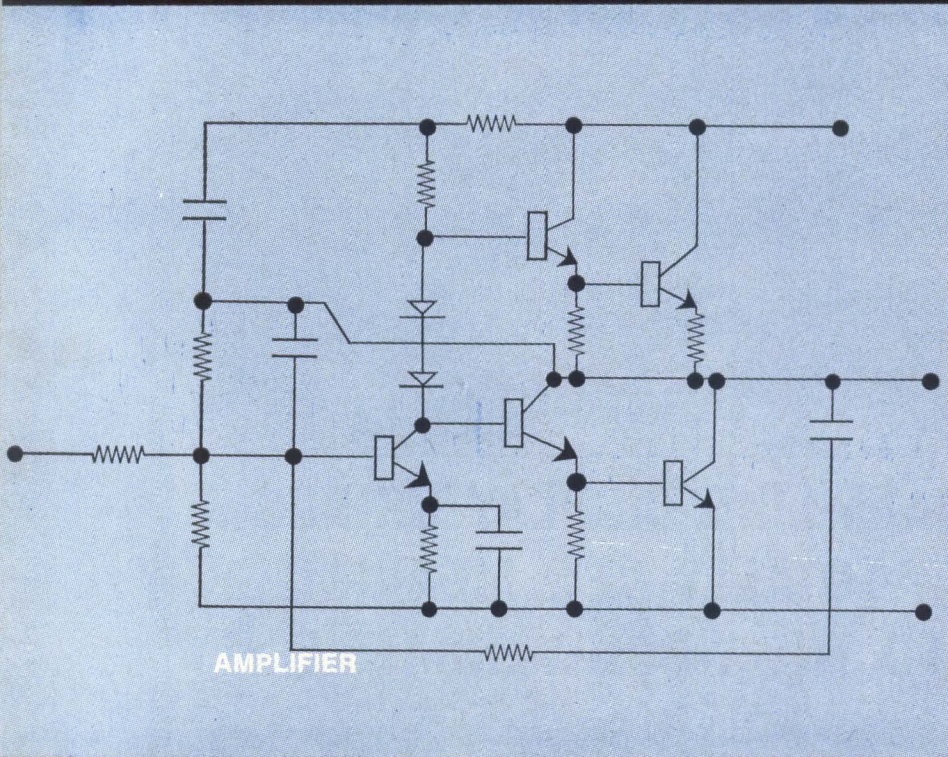

Volume microcircuit production of your analog or digital circuit is accomplished at Mepco by HYBRIDIZATION. The ability to manufacture precision passive film components is complemented by a wide variety of semiconductor attachment techniques. These capabilities provide the required flexibility to microminiaturize your circuit at the lowest possible cost. Consider these exceptional performance characteristics.

- Matched semiconductor parameters
- Ratio match of resistance values to .1%
- Power dissipation — 10 watts per sq. inch
- Temperature coefficient tracking of ± 20 ppm maximum

Write or call today for complete details.
Mepco, Inc., Columbia Road, Morristown, N.J. 07960
(201) 539-2000 TWX: 710-986-7437
O.E.M. Sales Offices from Coast to Coast



A Heritage of Reliability

Resistors . . . Potentiometers . . . Microcircuits . . . Capacitors

CIRCLE NO. 55 ON INQUIRY CARD

NEW PRODUCTS

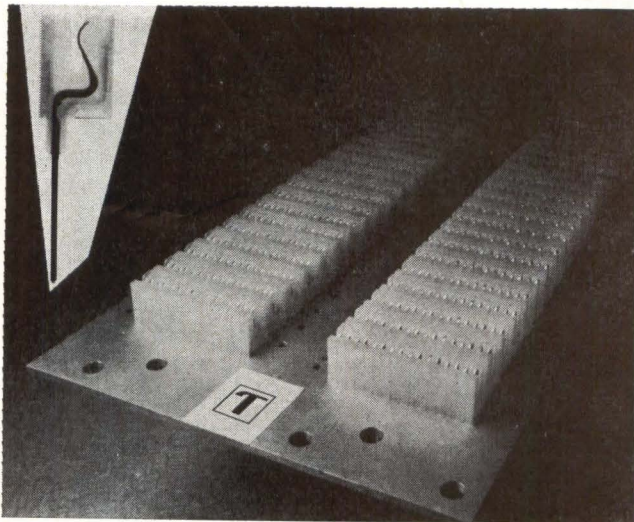

CONNECTOR PLATE ARRAYS

Large scale aluminum plate connector arrays are capable of accepting all current manual and automatic machine wiring methods. Back panel wiring terminals are precisely indexed, available in square or rectangular geometries, and identified by alphanumeric stamping or silk screening. Circuit card contacts range from leaf, fork, and male posts through special spring cage types. Contact insulators are molded in various colors and materials with modular single, double and cluster configurations. Transatron Electronic Corp., Wakefield, Mass.

Circle No. 240 on Inquiry Card

BINARY CODE SWITCH

Compact switching matrix for memory, programming, data, voice, and broadband switching applications offers 2,040 switching contacts in 670 cubic inches. Switch includes ten modules, each with 17 multiple positions having 12 make contacts per position. Maximum power voltage is 56V, minimum 44V. The Ericsson Corp., New York, N. Y.

Circle No. 284 on Inquiry Card

SELF-DECODED ENCODER

A size 11, 13-bit, self-decoded encoder with natural binary output requires no external decoding or drive electronics. The new encoder offers a true, natural binary, unambiguous output. A second unit, supplies as an output both the natural binary number and its complement, available to those who need an encoder with self-checking ability. Encoder Div., Litton Industries, Chatsworth, Cal.

Circle No. 212 on Inquiry Card

New from Diehl



The shaft of this induction motor measures 51" from end to end... and no wobble

Diehl precision induction motors are just that . . . whether your needs are for a special design or for a more conventional *catalog* item. The 2 hp induction motor pictured above has a 51 inch double ended shaft, machined after assembly to hold shaft run-out within 0.001 inches of the total indicated reading. This concentricity is mandatory because the motor drives shaft-mounted memory discs which must align perfectly with pick-up recording heads in a new computer. Thousands of such special motors have been designed and manufactured by Diehl to fill the specific needs of military and industrial customers.

If your requirements are for more conventional designs, ask about our full line of Diehl precision induction motors, all designed and manufactured with experience gained in over 78 years of motor production.

Among the many features which distinguish the standard line of Diehl induction motors are: *motor housings and end bells* of high strength aluminum alloys; *stainless steel shafts*; *dynamically balanced rotors* with spring-loaded bearings, providing quieter operation and longer life; and *double shielded ball bearings*. As with all Diehl motors, a wide selection of voltages, frequencies, types of insulation available, lubrication, etc., can be made to meet your requirements.

For further information on Diehl Division's special motor capability, just send in the coupon below.

SINGER INDUSTRIAL CONTROLS

The Singer Company
Diehl Division
Finderne Avenue
Somerville, New Jersey 08876 — (201) 725-2200

D-128

Please send me a free copy of the new Diehl Synchronous and Induction Motor brochure.

Please send details about other Diehl special motors.

Name _____

Company _____

Address _____

City _____

State _____ Zip _____

CIRCLE NO. 56 ON INQUIRY CARD

A NEW LITTON CORE MEMORY SYSTEM

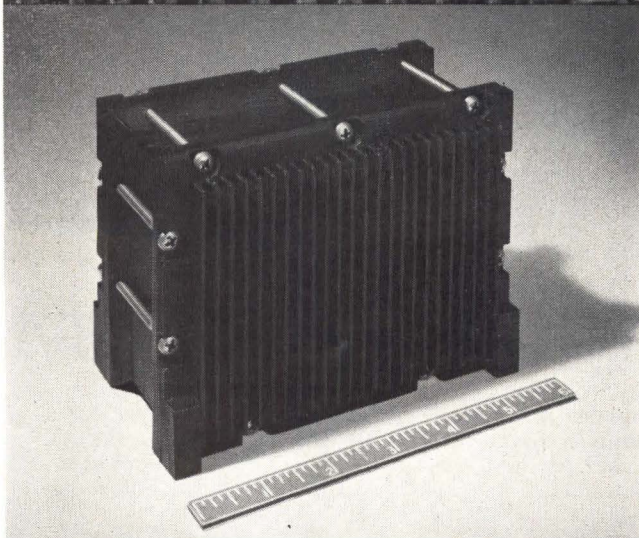

DUCOR

DUCOR, LITTON'S DUAL MEMORY SYSTEM SIMULTANEOUSLY COMBINES FIXED-WIRED NDRO STORAGE WITH ALTERABLE DRO STORAGE—IN THE SAME CORES—USING COMMON ELECTRONICS!

- A TYPICAL DUCOR SYSTEM FOR 1024×6 BIT NDRO PLUS 1024×6 BIT DRO IS 98 CUBIC INCHES AND 4.4 POUNDS
- DUCOR HAS BEEN CHOSEN FOR A MAJOR AIRBORNE MISSILE LAUNCH SYSTEM
- LITTON'S CORE MEMORY SYSTEMS MEET OR EXCEED MIL E-5400 PERFORMANCE SPECS!

For information on DUCOR and other advanced military memories, please contact the Manager of Applications Engineering; wire 910-494-2091, phone 213-887-2162 or write —

GUIDANCE & CONTROL SYSTEMS
A DIVISION OF LITTON INDUSTRIES

5500 CANOGA AVENUE, WOODLAND HILLS, CALIFORNIA 91364

CIRCLE NO. 57 ON INQUIRY CARD



NEW PRODUCTS

SHAFT ENCODER

Based on a simple patent-applied-for mechanical-optical principle, a high code-count shaft encoder is priced at under \$400, complete with self-contained solid-state electronics. Specially sealed against hostile environments, the 3½-pound package measures less than 3½" x 5" x 6". Count capacity is 32,768 (2^{15}) in reflected binary (gray) code, delivered after internal amplification to a sealed terminal connector. Other codes, requiring external solid-state translation, are available. Input shaft motion results in 2048 counts per revolution, monitoring accurately up to 10,000 counts per second. Rotation adds or subtracts, depending on direction, repeating the code sequence after 16 full turns. The unit features two uniquely interacting code discs each geared to the input shaft. Ambiguity is said to be permanently eliminated, without electronics. The single, instantly-replaceable incandescent lamp is rated 5,000/10,000 hours and is monitored for output by a clear track on the fast code disc. Consolidated Controls Corp., Bethel, Conn.

Circle No. 227 on Inquiry Card

MULTIPLE VOLTAGE POWER

Specifically designed for systems use, new rack-mounted power supplies allow users to select up to four independent dc output voltages in the same chassis. Offered in the 3½-inch and 5¼-inch rack panels, these supplies feature output voltages to 60 vdc, output current up to 25 amps, voltage regulation better than ± 0.1 percent, ripple less than 5 mv, ± 5 percent voltage adjustment, independent floating outputs for positive or negative polarity, and input and output protection. Eastern Dynamics, Inc., Bloomfield, Conn.

Circle No. 244 on Inquiry Card

DATA RECORDING SYSTEM

Third generation data collection, transmission, and computer input device replaces punched cards and punched paper tape. Direct recording from IBM Selectric I/O on ¼" magnetic tape in continuous loop cartridges provides the media for computer input, data transmission, and automatic typing. Variable length cartridge and variable densities provide for virtually unlimited cartridge capacity. Standard cartridge capacity is 190K. Transmission speeds are put to 300 CPS using standard Dataphone sets. Marksmen, Inc., Kansas City, Mo.

Circle No. 234 on Inquiry Card

IC SOCKETS

New sockets were developed for aging, production, breadboarding, and life or sampling test of dual-in-line IC packages. The new sockets accommodate all packages in common use with 14 or 16 leads on 0.100" centers. Round, rectangular, and octagonal leads, trimmed as short as 0.100", are accepted. Large chamfered entrances permit fast, easy insertion of devices. Quick-removal slot facilitates rapid withdrawal, and ejection slot is available for semi-automatic device removal. Designed for chassis mounting or dip soldering to PC boards, units are available with or without mounting flanges and with tubular or tab type terminals. Overall socket dimensions include 1/4" above board and 1/2" wide by 3/4" long. Barnes Development Co., Lansdowne, Pa.

Circle No. 205 on Inquiry Card

COUNTERMODULES

Versatile single-wheel counter modules feature electric reset, readout, and transfer. New models in this series consist of a BCD counter and a unit equipped with an acknowledgment switching function. The BCD model offers four-line — 1,2,4,8 — readout. The "acknowledgment" decade utilizes a switching function to verify the account registration at a remote location. This model is also available as a subtractive version. A completely new pushbutton switch is also offered with either decimal or BCD output. This 10-position switch can be used as a separate component or in combination with a decade to provide a predetermining function. They are said to be ideal for a variety of predetermining controls in automatic systems such as data processing equipment, peripheral computer equipment, and machine tool numerical controls. The counters are easily stacked to form a compact, multi-digit control package in a variety of configurations. Improved Delrin materials are used for the figure wheel, drive gear, drive pawl and arm, no-back pawl, and preset button. Veeder-Root, Hartford, Conn.

Circle No. 208 on Inquiry Card

not so unusual...

No, it's not unusual to see thin, flat, flexible aci Signaflo systems in computers, business machines, communication equipment and control systems! Not so long ago packaging engineers discovered that problems lead to solutions at aci. Conventional bulky cabling is being replaced. And, in every case there are good reasons why . . . increased performance levels, lower costs or both. No wonder aci Signaflo wiring systems are not so unusual.

aci
SIGNAFLO
WIRING
SYSTEMS

very unusual...

aci has shown a capacity to respond with practical solutions. This, plus a constant search for advanced wiring techniques has led to some very unusual developments at aci.

- a. Unparalleled uniformity is obtained for Signaflo transmission line systems with controlled characteristics such as impedance, cross-talk, propagation velocity and capacitance.
- b. "Micro-Pitch" Signaflo wiring systems are uniquely presenting imaginative and creative solutions to memory plane and integrated circuit interconnection.

"Acknowledged leader in flat cable systems."



aci DIVISION OF KENT CORPORATION
206 Industrial Center, Princeton, N. J. 08540
Telephone 609-924-3800 TWX. 609-921-2077

CIRCLE NO. 58 ON INQUIRY CARD



Point to point wiring is a thing of the past! aci "Spread-Pitch" Signaflo wiring system matches hardware dimensions for p.c. board computer interconnection circuitry.

254 conductors

Micro-module high density wiring with aci "Micro-Pitch" Signaflo wiring system with conductors on .015" centers and a cumulative error within .002"!

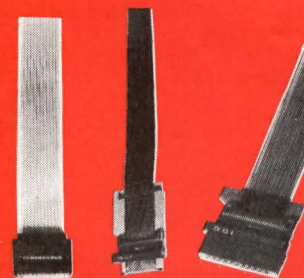

100 ohm
with
2 grounds

55 ohm

106 ohm

aci Signaflo systems for signal transmission line wiring, shielded or unshielded, are replacing coax and twisted pairs.

Send in your resume
and wait, wait,

wait.

No need to. Phone us in the morning;
have information that night.

You will be called by one of our Managers, who will discuss your goals and how they can be fulfilled at Control Data Corporation.

Government Systems Division, in suburban Minneapolis, has grown into new market areas, creating opportunities in the areas of:

SYSTEMS ENGINEERING

Responsibilities in ASW and Ship Systems programs. Must be able to convey military requirements and problems to systems engineers for EDP solution.

SYSTEMS PROGRAMMING

Opportunity to work with command-control problems and new program techniques, including multiprocessor concepts, executive and monitor programs, and man-machine interface.

ENGINEERING WRITING

Prepare operation and maintenance manuals for complex military computer systems.

CIRCUIT DESIGN

Specify, design, and finalize circuits for military computer systems. Conduct trade-off studies for optimization of subsystems and total systems with both integrated circuits and discrete components.

If you have a degree, one to four years of related experience, and a professional interest, don't wait.

Call us today.

Where success creates opportunity

CONTROL DATA
CORPORATION

GOVERNMENT SYSTEMS DIVISION

3101 East 80th Street
Minneapolis, Minnesota 55440
Tel.: (612) 888-5555; Ext. 4800

An equal opportunity employer

LITERATURE

Information Retrieval

The BOLD (bibliographic On-Line Display) system for automated document storage and retrieval is described in a new brochure. The BOLD user, located at a station equipped with teletypewriter and CRT display, communicates with the computer, using a language approximating everyday English, to receive data from a stored document collection. The brochure lists the features of BOLD which include a browse capability patterned after features found in conventional libraries, a search capability using coordinate index terms that the machine helps the user to specify, and instant display of document numbers, titles, authors, and abstracts. System Development Corp., Santa Monica, Cal.

Circle No. 307 on Inquiry Card

Circuit Design Program

CIRC, an SDS-developed computer program to assist in circuit design engineering, is described in a 5-page bulletin. CIRC is said to reduce circuit breadboarding and testing time by permitting engineers to simulate, evaluate, and modify their designs on an SDS 900 Series computer. It permits computer analysis of circuits containing 50 or more nodes and provides nonlinear models that accurately simulate semiconductor components. Circuit equations are written automatically. In addition to providing a general description of the program, the bulletin takes the reader through a detailed, step-by-step solution to a typical problem in circuit analysis. Scientific Data Systems, Santa Monica, Cal.

Circle No. 301 on Inquiry Card

INFORMATION SYSTEMS SCIENTISTS AND ENGINEERS

Bendix Research Laboratories has excellent career opportunities for B.S., M.S., and Ph.D. graduates with 2 to 15 years experience in one or more of the following key areas:

- **ARTIFICIAL INTELLIGENCE**, pattern recognition, trainable systems, adaptive logic.
- **COHERENT OPTICAL PROCESSING**, holography, spatial filtering, optical correlation, electro-optical systems.
- **DIGITAL AND ANALOG COMPUTERS**, systems analysis, logic and circuit design, real-time computer control.
- **AUTOMATIC CONTROLS**, information theory, control theory, circuit and servo analysis, correlation techniques.
- **COMPUTER PROGRAMMING**, mathematical analysis, scientific computing.

Assignments involve research and development in automatic extraction of information from photographic records, image processing and analysis, adaptive and trainable control systems, digital and hybrid computing techniques, and advanced real-time computer control applications.

Located in progressive suburban Detroit. Call collect or send resume to Research Laboratories, The Bendix Corporation, Southfield, Michigan (313) 353-3500.

Bendix Research
Laboratories

An equal opportunity employer

CIRCLE NO. 900 ON INQUIRY CARD



MELPAR

to
Step up

Where Performance
Comes
FIRST

**A LEADER IN
COMPUTER AND DATA
HANDLING SYSTEMS**

MELPAR, now celebrating more than 22 years in Space and Defense brings new life to creative pioneering by continually expanding in new areas of R & D and further developing our broad capabilities.

Melpar's Engineering Division has immediate openings for qualified personnel in the following areas:

- **Project Engineers**
Video Signal Processing
- **Senior EE's and EE's**
Computer Programming and Analysis
HF, VHF, and Microwave Receivers and Antennas
Communications—Microwave Components Design
Digital Circuit and Systems Design
Flight Simulation — Human Factors
- **Senior Programmers and Analysts**
Real Time and Control Applications
Math Modeling
Business Applications - Teleprocessing
- **Senior ME's and ME's**
Electronic Packaging
Heat Transfer and Stress Analysis
- **Field Service Engineers**
Flight Simulators
Airborne Radar Countermeasures

Write in confidence, to:

Professional Placement

WABCO
MELPAR INC

A Subsidiary of Westinghouse Air Brake
Company

7761 ARLINGTON BOULEVARD
FALLS CHURCH, VA. 22046
(Suburb of Washington, D. C.)

An equal opportunity employer M/F

CIRCLE NO. 901 ON INQUIRY CARD

Transistors and IC's

An 18-page catalog describes more than 500 types of silicon transistors and integrated circuits. Among the more than 400 silicon transistors listed are new epoxy-molded 25 cents types, JAN-approved types, NPN and PNP small signal units, differential amplifiers, PNP avalanche transistors, radiation-resistant devices, medium power switches, and integrated choppers. The new catalog also lists flip-flops, registers, gates, buffers, adders, counter adders, and inverters in a line of RTL integrated circuits. Milliwatt RTL integrated circuits, including flip-flops, expanders, adders, buffers, and gates are also described. National Semiconductor Corp., Danbury, Conn.

Circle No. 321 on Inquiry Card

Fluid Logic

A new publication of interest to persons working in the technology of fluidics is published quarterly in newsletter form. Called "Fluidic Forum" it serves as a medium of exchange for ideas, opinions, and experiences between users of fluidic systems. The bulletin will feature reader's reports and schematic drawings on significant fluidic applications. Featured in the first issue is a definition of what a fluid power system is and how such a system can duplicate, and in many instances, improve upon electronic, electromechanical and mechanical operations. A review of basic fluidic terminology is also included. Corning Glass Works, Corning, N. Y.

Circle No. 311 on Inquiry Card

Multilayer Printed Circuits

An 8-page technical bulletin on multilayer printed circuits details the entire manufacturing process, and also offers long life and environmental test results to demonstrate the high reliability of the boards. Multilayer boards with plated-through holes are described as having evolved into the ideal interconnecting system for integrated circuits. Photocircuits Corp., Glen Cove, N.Y.

Circle No. 303 on Inquiry Card

*If you had your choice,
what part or kind of a*

computer systems design

*would you really
like to tackle?*

**At UNIVAC, we like to
match your interests
with our work.**

Take our tiny 1824. Or the king-size 667. Each has special jobs to do. Each is a large scale system project. Yet there are differences which appealed to the teams that made them. And those are only two of the top priority challenges that UNIVAC systems people have tackled and whipped lately.

Your opportunity now is to join a Univac team and help design our new computers and their systems. It's a big job with an even bigger future. We have people with know-how—who also know that no matter how good a computer system is, there is room for improvement.

We have a wide range of specific opportunities open in areas that may exactly match your interests. Take your pick from:

- **Aerospace Systems Design & Analysis**
- **Advanced Development & Electrical Engineering in Memory and Data Technology**
- **Scientific Programming/Analysis**
- **I/O Systems Development**
- **Computer Graphics and Display**

Opportunities are open to engineers with BS or MS degrees and 2-5 years experience.

**Write today and make an
appointment with tomorrow**

Write
R. K. PATTERSON
Employment Manager, Dept. 116
UNIVAC
DIVISION OF SPERRY RAND CORP.
FEDERAL SYSTEMS DIVISION
2750 WEST SEVENTH BLVD.
ST. PAUL, MINNESOTA 55116
An equal opportunity employer M/F



The Aerospace Corporation performs systems engineering and provides technical direction for the U.S. Government on military space and missile programs.

COMPUTER SYSTEM ARCHITECT Assist in providing technical direction for studies determining the proper computer architectures required to satisfy a broad range of weapon functions. Relate software structure to computer organization and assimilate the effects of batch fabrication techniques on computer organization. Perform individual research in computer organization theory and practice.

RADIATION HARDENING SCIENTIST Perform general studies on selected guidance computer hardening problems. Should have a good foundation in circuit design, computer organization, and desire to learn fundamentals of interaction of nuclear radiation with circuit components. Will provide contractor technical direction in these areas. Perform individual research in related topics.

COMPUTER TECHNOLOGIST Perform technology surveys to define future computer requirements. Will provide technical direction in support of advanced weapon systems. Typical assignments will include definition of evaluation procedures for computer prototypes, preparation of computer and acceptance test specifications, and monitoring testing activities. Should have a strong background in the design aspects of computers and their application to real-time computational problems and be motivated to have a general understanding of software development problems.

COMPUTER SYSTEMS PROGRAMMER Assignment will include working on the integration of remote consoles into complex machine configurations. Design and implementation of information, manipulation techniques. Hardware to be used is IBM/360 Model 40/65 with wide variety of on-line storage and I/O devices including tape, disk, drum, data cell, plotter, and CTR consoles. Prefer three or more years of experience on operating systems and diagnostic programming.

If you have an advanced degree and a minimum of five years experience, contact The Aerospace Corporation, an equal opportunity employer. Write
T. E. Newburg
P.O. Box 249
San Bernardino, Calif.



THE AEROSPACE CORPORATION



SALES OFFICES

BOSTON

Lindsay H. Caldwell
Professional Bldg.
Baker Ave.
W. Concord, Mass.
phone: (617) 369-6660

NEW YORK

Robert J. Bandini
18 East 41st St.
Room 1501
New York, N.Y. 10017
phone: (212) 685-5854

CHICAGO

Brent Salmon
410 N. Michigan Avenue
Chicago 11, Illinois
phone: (312) 467-6240

DETROIT

James Stem
424 Book Bldg.
Detroit 26, Michigan
phone: (313) WO 1-0278

LOS ANGELES

David Barton
672 So. Lafayette Park Pl.
Los Angeles 57, California
phone: (213) 382-1121

SAN FRANCISCO

David Barton
672 So. Lafayette Park Pl.
Los Angeles 57, California
phone: (213) 382-1121

FT. LAUDERDALE

Dan Wiper
2801 E. Oakland Park Blvd.
Ft. Lauderdale, Fla. 33308
phone: (305) 563-1376

careers in micro- electronics/ computer technology

Why base your career on just one interview?

EUROPEAN and NATIONWIDE CHOICE

N. Y., N. J., NEW ENGLAND, WASHINGTON, D.C., PHILA., MINNESOTA, TEXAS, HUNTSVILLE, FLA., ARIZONA, CALIFORNIA AND OTHERS

Contact us if you have some experience or interest in any of the following:

- Newest Memory Dvmt.**—Cryogenics, Thin Films/Magnetics, Multi-perature Cores, Delay Lines, Disk Files
- Micro-Electronics Design/Dvmt.**—Devices, Circuitry, Components, Systems
- Solid State Circuitry**—State of the Art Technique Dvmt., New Uses for Available Modules
- Logic and Digital Design**
- Semi-Conductor Engineering**
- Solid State Materials Technology**

Unusually interesting Senior Staff and Managerial Positions Available to \$22,000

Newest Computer Systems Development/Logic Design & Circuitry

All expenses are assumed by our client companies

Write in confidence, including present salary, acceptable locations or call (Collect) Mr. Nellissen. (Area Code 212) Plaza 9-1720

a&n

ALBERT NELLISSEN, INC.

Leading Consultants to Management
in the Computer Field

510 MADISON AVENUE, N.Y., N.Y. 10022

CIRCLE NO. 902 ON INQUIRY CARD

COMPUTER DESIGN/JUNE 1967

**LOOKING FOR
GROWTH?**

**INVESTIGATE
3C NOW!**

Net sales have increased an average of 50% each year over the past 10 years; personnel has grown from less than 200 people to 1700 in the same period.

3C offers, to its customers, a total digital capability; to our professional engineers we offer a dramatic, dynamic growth potential. Continued market acceptance of our new DDP-516, DDP-416, and DDP-124 computers, I/C logic modules and core memory systems has created key opportunities for professional design engineers with experience in integrated circuits, high speed switching circuits and A/D-D/A circuitry to work on our next generation of digital equipment.

If you want growth, in a challenging atmosphere, call or wire collect, Mr. Martin Dorfman (617) 235-6220, or send your current resume to Honeywell, COMPUTER CONTROL DIVISION, Old Connecticut Path, Framingham, Massachusetts 01701.

Honeywell

 **COMPUTER CONTROL
DIVISION**

To explore professional opportunities in other Honeywell locations, coast to coast, send your application in confidence to Mr. Fred G. Laing, Honeywell, Minneapolis 55408. An Equal Opportunity Employer

Let's Talk...

BLUE CHIP

In a non-defense industry, The Foxboro Company has chalked up another successful year, breaking new records and creating an all-time high. The increased demand for our advanced computer-controlled systems, worldwide, has resulted in an aggressive expansion program thereby creating unlimited opportunity for the professional who is particular and not complacent. The positions listed below represent only a few of the many NOW available in our fast-growing commercial technology of COMPUTER CONTROL PROCESSES.

SYSTEMS ENGINEERS

BS or MS engineering. Minimum 3 years experience including project engineering, programming, instrumentation, application of digital computer equipment, system start-up, and customer negotiation. Ability to define system specification, design checkout, etc. Technical decisions on application requirements, manpower capabilities, time and cost. Principal technical responsibility for customer projects.

SENIOR SYSTEMS ANALYSTS

Computer process control. Advanced ME or ChE degree preferred. Must have 5-10 years experience in chemical, refinery or power plant computer automation. Simulation and process modeling experience desirable.

PROGRAMMERS

Engineering or Scientific Degree desired with systems programming ability. At least 2 years solid programming. Mathematic analysis and process control experience plus knowledge of assemblers and compilers is desirable to handle industrial process control problems.

DIGITAL PROJECT ENGINEERS

BSEE with training in computer technology. At least two years experience in computer applications, with knowledge of logic design, programming, and proven ability in project engineering. Responsible for equipment specification and design on customer projects.

SERVICE ENGINEERS

Minimum 2 years technical schooling in electronics plus general purpose digital computer system-check-out installation and on site maintenance. Ability to trouble shoot digital portion of systems main frame as well as peripheral equipment. Minimum 3 months training at our facility prior to field assignment.

LET'S TALK . . . If you think you would like to join us and grow with our new facility, forward your resume in confidence to:

J. G. WILLETT

Supervisor, Technical Recruiting

**THE FOXBORO COMPANY
DIGITAL SYSTEMS DIVISION**

Dept. 6CD Neponset Avenue
Foxboro, Massachusetts 02035

FOXBORO®

"Specialists in Process and Energy Control"

An Equal Opportunity Employer

CIRCLE NO. 903 ON INQUIRY CARD

ADVERTISERS' INDEX

ACI	83
Div. of Kent Corp.	83
AEROSPACE CORP.	86
ALBERT, NELLISSEN, INC.	86
AMERICAN LAVA CORP.	32
AMP, INC.	10
BENDIX CORP.	
Research Laboratories Div.	84
BLH ELECTRONICS, INC.	1
BRAND-REX	
Div. American Enka Corp.	12
BUSINESS INFORMATION TECHNOLOGY, INC.	20
CHICAGO MINIATURE LAMP WORKS	76
CINCH MFG. CO.	24, 25
COMPUTER TEST CORP.	Cover 3
CONTEMPORARY ELECTRONICS	19
CONTROL DATA CORP.	84
CONTROL LOGIC, INC.	73
DATA MACHINES, INC.	27
DECISION CONTROL, INC.	75
DIGITAL DEVICES	40
DIGITAL EQUIPMENT CORP.	55
ELECTRONIC MEMORIES, INC.	21
ELECTRONIC MODULES CORP.	33
FAIRCHILD SEMICONDUCTOR	67, 69, 71
FERRANTI-PACKARD ELECTRIC, LTD.	41
FERROXCUBE CORP.	8
FOXBORO CO.	88
FRANKLIN ELECTRONICS, INC.	74
GENERAL INSTRUMENT CORP.	63
GENERAL PRECISION INC.	
Librascope group	29
GERBER SCIENTIFIC INSTRUMENT CO.	7
HEWLETT-PACKARD	
HONEYWELL	
Computer Control Div.	Cover 2, 87
INDUSTRIAL ELECTRONIC ENGINEERS, INC.	49
INVAC CORP.	2
ITT SEMICONDUCTORS	38, 39
E. F. JOHNSON CO.	34
JOSEPH KAYE & CO., INC.	70
LABORATORIES FOR ELECTRONICS, INC.	
LITTON INDUSTRIES	
Guidance & Control Systems Div.	82
MAGNE-HEAD	
Div. of General Instrument Corp.	6
MASTER SPECIALTIES CO.	65
MELPAR INC.	85
MEPCO, INC.	80
MIDWESTERN INSTRUMENTS	4
NATIONAL CASH REGISTER CO.	35
NYTRONICS, INC.	16
PHILCO-FORD CORP.	
Microelectronics Div.	61
POLAROID CORP.	31
RCA CORP.	
Electronic Components & Devices	5
RIPLEY CO., INC.	74
ROGERS CORP.	17
SCANBE MFG. CORP.	9
SCIENTIFIC DATA SYSTEMS, INC.	37
SERVO CORP. OF AMERICA	78
SHEPARD LABORATORIES, INC.	66
SINGER CO.	
Diehl Div.	81
SYSTEMS ENGINEERING LABORATORIES	53
TALLY CORP.	Cover 4
TELETYPE CORP.	11, 13, 15
TRANSISTOR ELECTRONICS CORP.	79
TRANSITRON ELECTRONIC CORP.	36
UNITED SYSTEMS CORP.	68
UNIVAC	
Federal Systems Div.	85
VERMONT RESEARCH CORP.	23
VERNITRON CORP.	41
WAKEFIELD ENGINEERING, INC.	70

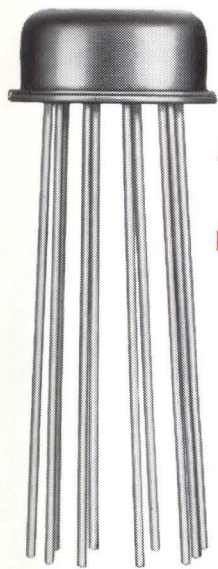

**now you can test
24 parameters of a
10-pin microcircuit
in 2 minutes flat...**

with this new semi-automatic IC analyzer

**MICA
150**

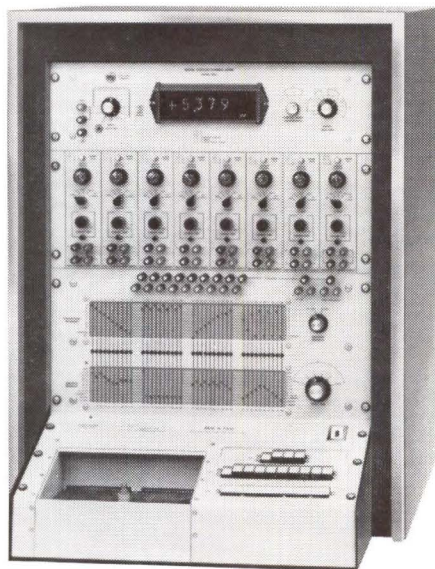

Now even a non-technical operator can speed through comprehensive DC tests on all types of IC packages with from 2 to 40 pins. Test conditions are easily set up on the programming switches of MICA-150 and pushbutton sequencing of the test from pin-to-pin of a device is simple and fast with test results indicated by direct digital readout. On a typical 10-pin, 5-input gate circuit, as many as 24 parameters of the device can be checked within two minutes without changing a single crossbar switch.

For additional information on applications of MICA-150 for DC or high frequency testing, contact W. Leo McBlain, (609) 424-2400

COMPUTER TEST CORPORATION

CHERRY HILL, NEW JERSEY



CIRCLE NO. 59 ON INQUIRY CARD

New Tally 500 series photoelectric tape readers work up to 1000 characters per second.

That's not unique.

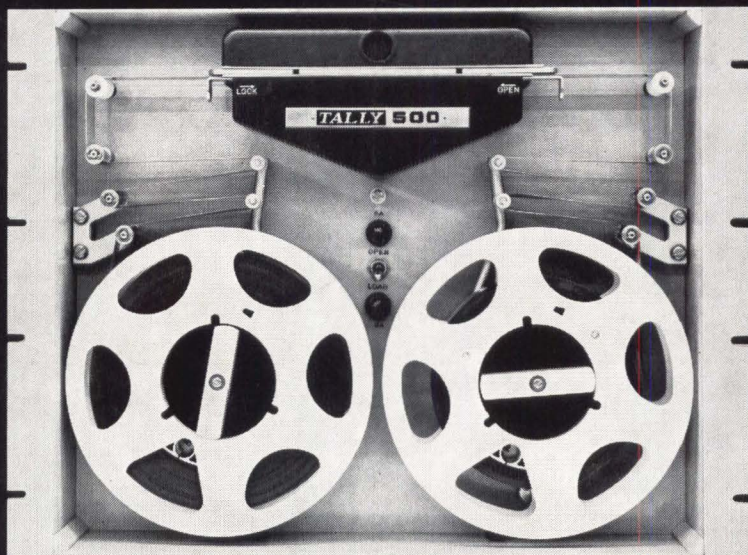

**But working without pinch rollers,
friction brakes, clutches, or solenoids — that is!**

There's no point in Number 1 introducing just another "me too" product. Just to give you an idea of how good the new line is, in a recent life test, one photoelectric reader ran for 15,000 hours at maximum speed without a failure. You can see why we say these new readers represent genuine "state of the art" achievement. Adding them to the Tally line rounds out the broadest line of perforated tape equipment on the market today.

The 500R, 500RF, and 500T.

These three readers operate at up to 200 characters per second asynchronously (stop on character), up to 500 char/sec in the synchronous or free running mode (stop before next character), and 1000 char/sec in the wind/search mode. All feature printed motor direct capstan drive, and bi-directional reading and winding. The Model 500R (recess mounted) and the Model 500RF (flush mounted) are reader and spooler com-

binations, while the Model 500T comes without the reel servo system. For tape handling only, two spoolers using printed circuit motors and proportional reel servo are offered, one with 8 inch reels, the other with 10½ inch reels.

MIL-SPEC reader, Model 500RM and "ruggedized" reader, Model 500RF/10

Fully militarized, the Model 500RM is the first high speed reader that meets all applicable military specifications without exception. Featuring the same basic design as other Series 500 photoelectric readers, this unit will work in environments of -40°F to +145°F, in humidities of 100%, and take more than 15 g's shock. Pertinent RFI specs are met. MTBF is 5,000 hours. Expected life is 10,000 hours minimum.

Where severe environmental conditions are not encountered, the Model 500 RF/10 will perform with the same accuracy and life for about half the cost. Reading speeds for both readers are

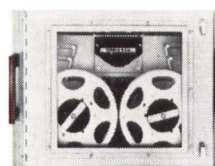

Model 500 RM

150 char/sec asynchronously, 500 char/sec synchronously, and 1000 char/sec wind/search.

Full disclosure.

For all the facts, call your full service Tally sales engineer (see EEM), or write Ken Crawford, Tally Corporation, 1310 Mercer Street, Seattle, Washington 98109. In the U.K. and Europe, address Tally Europe, Ltd., Radnor House, 1272 London Road, London, S.W. 16, England.

