

# REUSABLE COMPATIBLE SpO<sub>2</sub> SENSORS FOR ALL BRANDS



GIMA code	OEM - Brand	N	Sensor type	Cable length	Connector type	Compatibility	Extension cable - 2.4 m
35220*	BCI	5	Pediatric finger	0.9 m		BCI: 3401, 3304, 3303, 3302, 3301, 3300; Spacelabs Burdick: PRO <sub>2</sub> ; Draeger: Oxipac 2000/2500	35300
35221		1	Adult finger	0.9 m			-
35222		1	Adult finger	3.0 m			-
35225	CSI (Criticare)	6	Neonatal Y-type	3.0 m		Alaris (IVAC): VitalCheck 4400; Criticare: 503DX, 503 Spot, 504DX/P, 504DX, 506 series (except 506LN3), 507ELC2, 8100 Poet Plus, Poet (602-3A), Scholar, Scholar III	-
35226		1	Adult finger	0.9 m			-
35227		1	Adult finger	3.0 m			-
35230*	Datascope	1	Adult finger	0.9 m		Accusat, Accutorr 3/4 SAT, Accutorr Plus, Passport (Database SpO <sub>2</sub> )	35301
35231		1	Adult finger	3.0 m			-
35232*	Datex-Ohmeda	1	Adult finger	0.9 m		Datex-Ohmeda: AS/3, CS/3, CH/S, CH/2S, CH-RS, SAF-F, CG/2S, Cardiacap I, Cardiacap II, Cardiacap 5, Capnomac Ultima, Light Monitor, M-Estpr, Oscar II, OSP-200, Satellite Trans, Satllile, Trans Plus, System 5, ULTS00	35302
35233		5	Pediatric finger	3.0 m			-
35234		1	Adult finger	3.0 m			-
35235		3	Adult Y-type ear sensor	3.0 m			-
35238	GE Datex-Ohmeda	1	Adult finger	3.0 m		GE (Datex-Ohmeda): S/5, 14 Modular Monitors with Eseries modules, Corometrics® 259 with TruSignal Ohmeda Technology	-
35239		2	Adult finger	4.0 m			-
35240		3	Adult soft-finger	3.0 m			-
35241		1	Adult Y-type ear	3.0 m			-
35243		1	Adult finger	3.0 m		Ohmeda TruSat Ohmeda TruSat TD	-
35245	GE	1	Adult finger	3.0 m		GE: Dash 2000/3000/4000 with Nellcor option, Dash 3000/4000/5000 with Ohmeda option, Solar 8000/8000M, i/9500 with Tram Module 451/451N/851/851N, CardioLab®/Mac-Lab® with Tram Module 451/451N Corometrics® 120/2120 series, Eagle 1000/3000/4000 Responder 3000 with Nellcor option	-
35247*	GE TruSignal	1	Adult finger	0.9 m		TruSignal sensors and interconnect cables are backwards compatible with Datex, ohmeda and GE SpO <sub>2</sub> technologies.	35303
35250	Goldway	1	Adult finger	3.0 m		Goldway: UT4000 A / 4000 A pro / 4000B, UT6000 C	-
35252	Mindray	1	Adult finger	3.0 m		PM-600, PM-5000, PM-6000, PM-7000, PM-8000, PM-9000, MEC-1000 (Nellcor based) PM-50	-
35255**	Nellcor	6	Neonatal Y-type	0.9 m		Artema: Diascope, Datascope: (Mindray): Accutorr Plus, Expert, Passport, PM-50; Drager: Cicero, Narkomed, Vitalert 1000, GE Medical: Corometrics 118, 120, 129, 188, 510, 556, Critikon 9710, 9720, Plus, Compact, Dinamap Select, MPS, Oxyshuttle, Pro 300/400, Eagle Series, Dash Series, Hellige Eagle, 1000, 3000, Eagle SMK, SMU, SMV, SOLAR Series, TRAM Modular x50SL Series; Invivo Research: MI2 (Nellcor SpO <sub>2</sub> ), Millennia 4500 Plus 2, Invivo/MDE Escort 100 OPT11A Escort 300A, Escort II OPT30, Prism (Nellcor SpO <sub>2</sub> ); Ivy Biomedical: 405A, 4050, 405P, 405T, Vital-Guard 450 CN, Mennen: Horizon XL (Nellcor SpO <sub>2</sub> ), MR 1300 Mercury 1200; Nellcor: N100 (req. preamp cable), N180, N200 (req. preamp cable), N-20, NPB-75, NPB-290, NPB-295, N-390, N-395, N-3000, N6000; Nihon Kohden: BSM-1102 Life Scope EC, BSM2304 iPro (Life Scope i), BSM-4102, 4112 Procyon LT (Life Scope P), BSM-4104, 4114 Procyon (Life Scope P), BSM-9510 Life Scope M (Nellcor SpO <sub>2</sub> ), OGS2000 PocketCare (Nellcor SpO <sub>2</sub> ); Pace Tech Vitalmax 800 Series (cara negra Nellcor SpO <sub>2</sub> ): Philips 78352C, 78354C, 78834C, M1020A, M1025B, M1205A, M1350B, M1 722A/B, M1732A/B, M2475B, M2601A, M3000A	35304
35256**		5	Pediatric finger	0.9 m			35304
35257**		4	Adult/neonatal wrap	0.9 m			35304
35258**		1	Adult finger	0.9 m			35304
35259**		1	Adult finger	3.0 m			35304
35260**		2	Adult soft-finger	0.9 m			35304
35261**	3	Adult Y-type ear	3.0 m	35304			
35262**	Nellcor Oxitech	1	Adult finger	0.9 m		Nellcor Oximax: N-550, N-560, N-595, N-600 and Patient monitors with Oximax module	35305
35263**		2	Adult soft finger	0.9 m			-
35265**		4	Adult/neonatal wrap	0.9 m			
35264	Nihon-Kohden	1	Adult finger	3.0 m		Nihon Kohden: BSM-4101, 4103 4111, 4113 Life scope P BSM-5105, 5135 Life scope A BSM-2351, 2353 Life scope L BSM-2301, 2303 Life scope I, Life scope S	-
35266**	Nonin	1	Adult finger	0.9 m		NONIN: 8500, 8600, 8700, 8800/9840 NONIN: 2500, 9600, 9700	-
35268	Novamatrix	6	Neonatal Y-type	3.0 m		Novamatrix: 505, 510, 511, 515B/C, 520, 7000, 7100; Oxypleth	-
35269		1	Adult finger	3.0 m			-
35272	Ohmeda	1	Adult finger	3.0 m		Datex-Ohmeda: 3740, 3710, 4700 OxiCap, 520RGM, Biox 3760, Ohmeda 3700, 3770, 3775, Rascal II, GE Medical System: 7000 series, Corometrics 511, TRAM A.R., Tram Modular x00SL Series, Mennen: Horizon XL800 (Ohmeda SpO <sub>2</sub> )	-
35275	Philips	6	Neonatal Y-type	1.6 m		Philips: M3, M4, MP20, MP30, MP40, MP50, MP70, MP80, VM4, VM6, VM8	-
35276		4	Adult/neonatal wrap	1.6 m			-
35277		1	Adult finger	1.6 m			-
35278		1	Adult finger	3.0 m			-
35279		2	Adult soft-finger	1.6 m			-
35280		2	Adult soft-finger	3.0 m			-
35281	3	Adult Y-type ear	3.0 m	-			
35283		2	Adult soft-finger	3.0 m		Philips: 1205, M1205A, 78352C, 78834C, 78354C, M1020A, M1025A, M1025B, M1350B, M1772A/B, M1732A/B, M2475B	-
35285	Siemens/Drager	1	Adult finger	1.6 m		Siemens/Drager: SC6002XL, 7000, SC8000, SC9000XL	-
35286		2	Adult soft-finger	1.6 m			-
35287		3	Adult Y-type ear	1.6 m			-

\*These SpO<sub>2</sub> sensors need extension cable for connection to device.

\*\* Available extension cable.

All products are supplied with manual in GB, FR, IT, ES.

# CAPNOGRAPH AND OXIMETER

## 33698 CAPNOGRAPH AND OXIMETER PC-900B

This innovative and handheld capnograph and oximeter is ideal for monitoring the most severe conditions of patients. It provides reliable SpO<sub>2</sub> and pulse rate measurements thanks to its unique MoveOxy™ technology specially conceived for SpO<sub>2</sub>. It offers an accurate monitoring even in weak pulse signals condition and reliable monitoring in movement. Display of graphical trends and plethysmographic waveform.

- 3.5" TFT display showing EtCO<sub>2</sub>, RR and SpO<sub>2</sub>, PR
- lung pressure and temperature compensation (BTPS compensation)

- for intubated or non-intubated patients
- graphic trend storage up to 24 hours
- USB cable to transfer data on PC
- wireless module to connect to Bluetooth printer

Internal languages: GB, IT, ES, NL  
Water filter, sampling line and airway adapter must be changed anytime you use it.

- 34351 ADULT SpO<sub>2</sub> RUBBER PROBE - reusable
- 34345 ADULT SpO<sub>2</sub> CLIP PROBE - reusable - spare
- 34347 PEDIATRIC SpO<sub>2</sub> PROBE - reusable
- 34349 NEONATAL SpO<sub>2</sub> Y PROBE - reusable
- 33699 WATER FILTER
- 33700 SAMPLING LINE
- 33701 AIRWAY ADAPTER
- 34172 NASAL CANNULAS



CE 0123

FDA 510(K)



PC software for data review and analysis  
Software (GB only) can be freely downloaded



Wireless connection  
Bluetooth printer



### STANDARD ACCESSORIES

- 2 water filters
- 2 sampling lines
- 2 airway adaptors
- SpO<sub>2</sub> probe
- USB data cable
- Nasal CO<sub>2</sub> sampling cannula
- Silicone protective case
- Carrying bag
- Support base
- Manual GB, IT



### TECHNICAL SPECIFICATIONS

<b>EtCO<sub>2</sub></b>	0-150 mmHg (0-20 kPa, or 0-20% (V/V))	<b>SpO<sub>2</sub></b>	0-100%
<b>EtCO<sub>2</sub>/CO<sub>2</sub> range:</b>	±2 mmHg when 0-40 mmHg	<b>Oximetry saturation range:</b>	±2% when 70-100%, ±3% when 50-69%
<b>Accuracy:</b>	±5% (reading) when > 41-70 mmHg	<b>Accuracy:</b>	±2% when 70-100%, ±3% when 50-69%
	±8% (reading) when > 71-100 mmHg	<b>Trend length:</b>	24 hours
	±10% (reading) when > 101-150 mmHg	<b>Pulse rate</b>	
<b>Update:</b>	Every breath, 10, 20 or 30 sec selectable	<b>Range:</b>	30-250 bpm
<b>Trend length:</b>	24 hours	<b>Accuracy:</b>	±2 bpm or ±2% (reading) when 30-250 bpm
<b>Respiration rate</b>		<b>Trend length:</b>	24 hours
<b>Range:</b>	3-150 breaths/min	<b>Power supply</b>	
<b>Accuracy:</b>	±1% (reading) or ±1 times/min whichever is greater	<b>AC input consumption:</b>	100-250 V, 50-60 Hz, 5 W
<b>Trend length:</b>	24 hours	<b>Battery:</b>	Built-in rechargeable lithium battery - 3.6 V, 3000 mAh
<b>Flux:</b>	50-250 cc/min selectable	<b>Working time:</b>	10 hours
		<b>Dimension - Weight</b>	70x160x40 mm - 600 g

# OXY-200 DESKTOP PULSE OXIMETER

Continuous working time: more than 1 hour

Audible and visible alarm for over-limit and low battery.  
Upper and lower alarm limit can be set.



- 35101
- Screen brightness, volume and display mode can be adjusted
- 320x240 TFT screen and LCD
- Menu operation easy to use

## 35101 OXY-200 DESKTOP PULSE OXIMETER with monitor and battery

Portable oximeter displays SpO<sub>2</sub>, PR, bar graph, PI, pulse waveform and battery power. Multiuser data storage and review. Stored data can be uploaded to PC in real time. Finger adult probe, battery and software for PC download are included.

- 35102 LITHIUM RECHARGEABLE BATTERY - spare
- 35105 SpO<sub>2</sub> FINGER-PROBE - adult or child over 15 kg - spare
- 35106 PEDIATRIC PROBE 3-15 kg - reusable
- 35107 NEONATAL PROBE <3 kg - reusable - needs 35108
- 35109 ADULT NEONATAL PROBE\* - disposable - needs 35108
- 35108 EXTENSION CABLE necessary for 35107, 35109

### TECHNICAL SPECIFICATIONS

Power supply: 100-240 V, 50/60 Hz rechargeable lithium battery	Resolution: 1%
SpO <sub>2</sub> measuring range: 0-100% ±2% (between 70-100%)	Resolution: 1 bpm
Pulse rate: 30-250 bpm ±2 bpm or ±2% (select larger)	Resolution: 0.1%
PI measuring range: 0-20% ±1% (between 1%-20%)	User manual (GB, IT)
Size: 269x222x79 mm - Weight: 1 kg	

\*Suitable for adult over 40 kg (finger) or neonate less than 3 kg (foot)

# ETCO<sub>2</sub> + SPO<sub>2</sub>

Size: 170x88x44 mm

## PORTABLE OXI-CAPNOGRAPHY MONITOR

- 33702 OXY CAPNOGR. HUMAN
- 33703 OXY CAPNOGR. VET

Portable multifunctional Capnography monitor providing SpO<sub>2</sub>, Pulse, EtCO<sub>2</sub>, Respiration with accuracy and reliable performance. Light and large LCD display providing graphical SpO<sub>2</sub>, EtCO<sub>2</sub> and Trend function all in one design. Through optional software link to PC via USB. Filter replacement after 8 hours of use. Supplied with adult sensor, AC adapter, sampling tube, airway adapter, filter cartridge, carrying bag, 4 AA rechargeable batteries.

- 33705 FILTER - box of 10
- 33706 SAMPLING TUBE 1.2 m - box of 20
- 33708 VET PROBE - spare

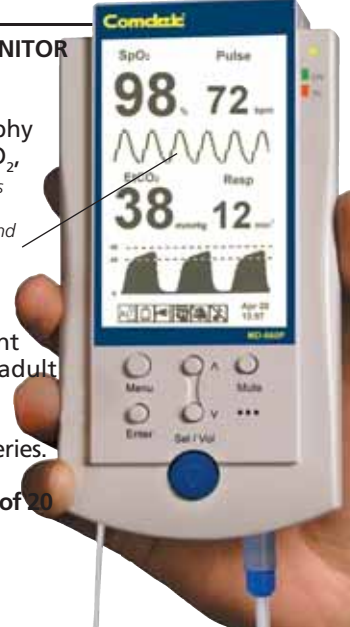

### TECHNICAL SPECIFICATIONS

SpO <sub>2</sub> Saturation:	0% to 100%	Accuracy	±2% between 80% to 100%
Pulse Rate:	30 bpm to 250 bpm		±1% of full scale
		<b>Average</b>	4 breaths of EtCO <sub>2</sub>
EtCO <sub>2</sub> :	0 mmHg to 100 mmHg		8 breaths of respiration rate
Respiration rate	0 l/min to 99 l/min		
Memory: 72 hours			
Output interface: USB			
<b>Default Alarm Settings:</b>			
SpO <sub>2</sub> upper limit: 100%		SpO <sub>2</sub> lower limit: 50%	
Pulse rate upper limit: 250 bpm		Pulse rate lower limit: 30 bpm	
EtCO <sub>2</sub> upper limit: 100 mmHg		EtCO <sub>2</sub> lower limit: 0 mmHg	
Resp upper limit: 99 l/min		Resp lower limit: 0 l/min	
Power 4 AA rechargeable batteries 6 volts or AC/DC adapter			

# OXY-50 HANDHELD PULSE OXIMETER



CE 0476  
FDA K090671

Plethysmogram waveform

• **35100 OXY-50 PULSE OXIMETER - with software**  
Pocket fingertip pulse oximeter with colour display for both routine check and continuous monitoring use.

Main features:

- display: 1.8" colour OLED
- resolution: 160x128
- alarm sound, pulse tone
- power supply: DC3V, <100MA
- record: data can be recorded up to 24 hours
- alarm: adjustable high and low limits
- PC software for transferring real time data

GIMA code	ACCESSORIES OXY-50
35105	Adult probe >15 kg - reusable - spare
35106	Pediatric probe 3-15 kg - reusable
35107	Neonatal probe < 3 kg - reusable
35109	Adult neonatal probe* - disposable - 70 cm cable
35108	Extension cable necessary for 35107, 35109 - 2 m

\*Suitable for adult over 40 kg (finger) or neonate less than 3 kg (foot)

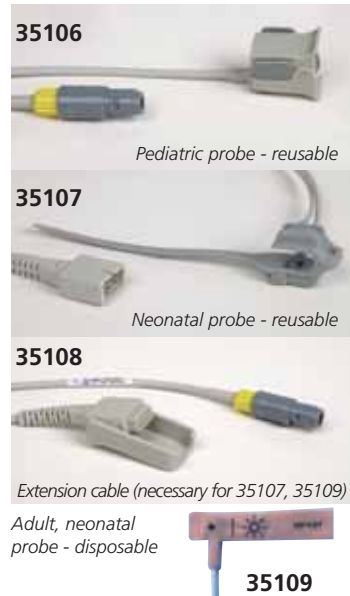

Supplied with one adult probe, 2 AA batteries, USB cable, PC software (GB, IT, PL) and user manual (GB, FR, IT, ES)



## TECHNICAL SPECIFICATIONS

Display mode (OLED display)

Pulse oxygen saturation (SpO<sub>2</sub>): 2 digits  
Pulse rate (PR): 3 digits  
Pulse intensity: bar-graph

Pulse rate

Measuring range: 25 ~ 250bpm  
Resolution: 1 bpm  
Accuracy: ±2bpm or ±2%

SpO<sub>2</sub>

Measuring range: 0 ~ 100%, (resolution 1%)  
Accuracy: 70 ~ 100%: ±2%  
Average value: Calculate the average value every 4 measure value  
Deviation between average value and true value does not exceed 1%

Average pulse rate:

Moving calculate the average pulse rate every 4 cardio-beat's cycle. Deviation between average value and true value does not exceed 1%

Pulse intensity Range:

Continuous bar-graph display, the higher display indicates the stronger pulse

Battery:

Oxymeter probe: dry battery (2AA)  
wavelength: 660 - 880nm  
Dimension: 110(L)x60(W)x23(H) mm  
Weight: about 180g (with dry battery 2AA)  
Safe type: BF Type

35109

# OXY-100 HAND-HELD PULSE OXIMETER

## • 34342 OXY-100 PULSE OXIMETER

Compact pulse oximeter for hospital and rescue applications to monitor SpO<sub>2</sub> pulse rate, and perfusion index (PI). SpO<sub>2</sub> can be displayed in numbers with bar-graph of pulse as well as full display of plethysmogram.

Includes adult SpO<sub>2</sub> sensor and extension cable.

Features:

- high accuracy and repeatability
- visual and audible alarm, with adjustable limits
- 384-hours data storage and review (with 1/2/4/8 sec.)

- automatic power-off  
Manual: GB, FR, IT, ES, PT.

## • 34344 SOFTWARE

This software allows to download and store all measurements on a PC through USB port.

- 34345 ADULT SpO<sub>2</sub> CLIP PROBE - reusable - spare
  - 34351 ADULT SpO<sub>2</sub> RUBBER PROBE - reusable
  - 34347 PEDIATRIC SpO<sub>2</sub> PROBE - reusable
  - 34348 EXTENSION CABLE - spare for 34345-34347-34349-34351 - 1 m
  - 34349 NEONATAL SpO<sub>2</sub> Y-TYPE PROBE - reusable
- All probes with cable 0.9 m

3 ways switchable display to show: numbers, number and waveform, waveform

Battery status display

## TECHNICAL SPECIFICATIONS

Oxygen saturation range: 35% to 100%  
Pulse rate range: 30 bpm to 240 bpm  
Perfusion index (PI) range: 0.2% to 20%  
Display: oxygen saturation, pulse rate, pulse strength, low battery indicator, perfusion index  
SpO<sub>2</sub> accuracy: not greater than 3% for SpO<sub>2</sub> range from 70% to 100%  
Accuracy defined as root-mean-square value of derivation according to ISO 9919  
Pulse accuracy: ± 2% of full scale  
Range alarm setting: SpO<sub>2</sub> upper limit: 95%  
SpO<sub>2</sub> lower limit: 85%  
pulse rate upper limit 100 - 240 bpm  
pulse rate lower limit 30 - 60 bpm  
Power requirements: 3 alkaline AA size batteries 4.5 V  
continuous working time >30 hours  
Dimensions: 145x74x29 mm - Weight: 210 g  
Warranty: 1 year



Output for USB

High resolution LCD display, backlight to display SpO<sub>2</sub>, PR, Pulse Bar, Pi, and Plethysmogram



34342



Portable and lightweight

CE 0476



# MINDRAY PM-60 PULSE OXIMETER



Size: 55x120x30 mm  
Weight 300 g with battery

- **35060 MINDRAY PM-60 PULSE OXIMETER**  
PM-60 is a miniature, lightweight device capable of **spot-check and continuous monitoring of SpO<sub>2</sub> and pulse rate.**
- Spot Check Mode**
  - auto-standby and power off during the idle status
  - auto-increase the patients IDs
  - non-alarm setting for "sensor off" occasion
- 1-99 IDs for maximum 4,000 sets of measurements
- Continuous monitoring mode**
  - regular alarm handling
  - enable to input patient ID manually
  - view SpO<sub>2</sub> waveform for maximum 96 hours trend
- Other features**
  - suitable for adult and pediatric patients
  - high resolution 2.4" colour LCD display
  - adjustable visual and audible alarms
  - real-time data transfer by infrared technology
  - choose between Lithium-ion or AA alkaline batteries (for up to 36 hours continuous working) depending on your run-time needs
  - protective cover perfect for portable monitoring needs
- Supplied with adult reusable sensor
- **35062 PROTECTIVE COVER - light blue**
- **35063 DATA MANAGEMENT KIT**
- **35064 BATTERY CHARGING KIT (EU)**
- Li-ion battery + charge stand + power cable**
- **35065 PEDIATRIC REUSABLE SENSOR**

35060  
+  
35062



TECHNICAL SPECIFICATIONS	
<b>Performance specifications</b>	
Display:	2.4" colour TFT Resolution: 320x240
Multi displays:	selectable: standard or waveform screen
Trace:	1 plethysmogram waveform
Indicator:	alarm indicator light, power indicator light, pulse tone, alarm sound, button tones
Interface:	dual-purpose socket for connecting SpO <sub>2</sub> sensor and communication cable
IR interface:	infrared link allows downloading realtime patient data to computer
DC power interface:	Charger stand for Li-ion battery
DC power requirements:	input voltage 5V DC Power 1.2A
Battery:	Li-ion battery 24 hours continuous working 3xAA batteries 36 hours continuous working
Trend memory:	Monitoring mode: Resolution: 2s Maximum time: 96 h
	Spot-check mode: Review of up to 4,000 data Measure up to 99 patients
Alarm:	user adjustable high and low limits 3-level audible and visual alarm
SpO <sub>2</sub> Measurement range:	0~100% ±2% (70~100%)
Resolution:	1% Alarm range: 50~100%
Refreshing rate:	1 s
Averaging time:	7 s (sensitivity set HIGH) 9 s (sensitivity set MED) 11 s (sensitivity set LOW)
Pulse rate Range:	18~300 bpm (±3 bpm non-motion) (±5 bpm motion)
Resolution:	1 bpm Alarm range: 18~300 bpm
Refreshing rate:	1 s
Averaging time:	same as SpO <sub>2</sub>
Type of protection:	Class II with internal electric power supply
Degree of protection:	BF (defibrillation proof)
Protection against ingress of liquid:	IPX 2

# COMDEK HOSPITAL PULSE OXIMETERS

- **34290 MD-600 PULSE OXIMETER with alarms**
  - **34291 MD-630 PLUS PULSE OXIMETER with alarms, printer and USB**
- Light-weight pulse oximeters with high accuracy and reliable performances:
- adjustable SpO<sub>2</sub> and pulse alarm settings
  - quick assessment of oxygen saturation and pulse rate
  - with SpO<sub>2</sub> and pulse rate display
- Pulse oximeter with printer and USB (34291 only)**  
Built-in thermal printer allows immediate data printing.  
36 hours memory (with interval of 6 seconds) or 24 hours (with interval of 4 seconds) with possibility to recall up to 100 records (print out the last records up to 240 seconds).  
Tone function and adjustable volume.
- **34295 THERMAL PAPER - for code 34291**
  - **33704 PC-SMART LINK SOFTWARE - for code 34291**
  - **34292 ADULT FINGER SENSOR over 40 kg - reusable**
  - **34294 CHILD TOE SENSOR 3-15 kg - reusable - need 34299**
  - **34299 EXTENSION CABLE for 34294**

34290



Weight: 240 g

### STANDARD ACCESSORIES (codes 34290-34291)

- 1 AC/DC Adaptor
- 1 SpO<sub>2</sub> standard adult sensor
- 4 AA Batteries - alkaline
- 1 User manual (GB, IT, FR, ES)
- 1 Carrying bag

USB Output port for PC data download

SpO<sub>2</sub> Time Pulse



With 24 hours memory

CE 0434

TECHNICAL SPECIFICATIONS (codes 34290-34291)	
Oxygen saturation range:	0% to 100% ± 2% between 80% to 100%; ± 3% between 65% to 79%
Pulse rate range:	30 bpm to 250 bpm ± 1% of full scale
Display:	oxygen saturation, pulse rate, pulse search indicator, low battery indicator
Range alarm setting:	SpO <sub>2</sub> upper limit: 100%, lower limit: 50%; pulse rate upper limit 250 bpm, lower limit 30 bpm
Power requirements:	DC 6 volts by 4 alkaline AA size batteries AC adaptor output DC 6 Volts, 600 mA
Dimensions - weight:	172x90x36 mm (34290) - 170x88x44 mm (34291) - 240 g - 300 g (34291) - without battery

# OXY 110 PULSE-OXIMETER FOR NEONATES, CHILDREN AND ADULTS

- **34341 OXY 110 PULSE OXIMETER**
- large 3.5 inch auto rotation TFT display for SpO<sub>2</sub>, PI, Plethysmogram, PR and temperature
  - patented MoveOxy™ SpO<sub>2</sub> technology with artifact removal and anti-motion performance
  - various choice of SpO<sub>2</sub> probes for adult, pediatric and neonate
  - in-built lithium battery up to **20 hours continuous monitoring**
  - adjustable alarm limit, pitch tone level, key tone and brightness
  - up to 1,000 hours SpO<sub>2</sub> data storage
  - upgradeable to **infrared ear temperature**
- Supplied with adult probe, charging base, USB cable.
- **34345 ADULT SpO<sub>2</sub> CLIP PROBE - reusable - cable 0.9 m - spare**
  - **34351 ADULT SpO<sub>2</sub> RUBBER PROBE - reusable - cable 0.9 m**
  - **34347 PEDIATRIC SpO<sub>2</sub> PROBE - reusable - cable 0.9 m**
  - **34349 NEONATAL SpO<sub>2</sub> Y-TYPE PROBE - reusable - cable 0.9 m**
  - **35170 EAR INFRARED THERMOMETER**
  - **35171 EAR PROBE COVER for 35170 - box of 500**
  - **34344 SOFTWARE for download and store**

34341

TECHNICAL SPECIFICATIONS	
Technique:	dual wavelength LED
Oxygen saturation range:	35 to 100% ±3%
Pulse rate range:	30 to 250 bpm ±2%
Perfusion index (PI) range:	0.2 to 20%
Display:	3.5" TFT display
Data storage:	up to 1,000 hours
Measuring mode:	continuous or spot check
Power supply:	lithium battery
Charging:	charging stand or USB cable
Dimension:	158x73x25 mm
Weight:	240 g
Data upload:	USB cable or wireless

34341

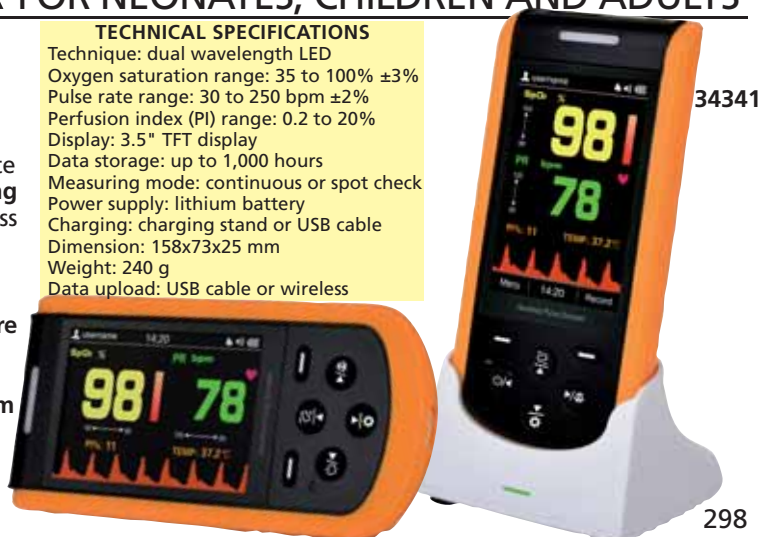

## OXY-5 AND OXY-6 PROFESSIONAL OXIMETERS



34282

BACKLIT DISPLAY



34285

OLED COLOUR DISPLAY



34285

- 34282 OXY-5 FINGERTIP OXIMETER
  - 34265 OXY-5 PEDIATRIC FINGERTIP OXIMETER
  - 34285 OXY-6 COLOUR FINGERTIP OXIMETER
- To monitor pulse oxygen saturation and pulse rate through patient's finger (10-22 mm finger thickness for 34282, 34285 - 8-16 mm finger thickness for 34265) in medical and hospital environments.

Main features:

- SpO<sub>2</sub> and pulse rate measurement
- bargraph of pulse rate
- perfusion index display. P.I. is a numerical value that indicates the blood perfusion condition at the sensor site. It is a relative value that varies from patient to patient and from measuring site
- high accuracy and repeatability: products are manufactured by GIMA (in P.R.C. facilities) under strong quality controls guaranteed by Italian notified body (CE 0476 CERMET)
- accuracy from the first reading in few seconds thanks to a unique noise rejection capability feature
- extra stability against motion during measurement (finger bending, Parkinson's disease, hand movement, button pressing)

- audible and visible alarms
- automatic power on and power off when finger is out
- low voltage alarm display
- 8 or 9 language manual (GB, FR, IT, ES, DE GR, PT, PL\*, Arabic)
- 50 hours working time with full batteries (30 hours for oxy-6)
- supplied in plastic case with batteries and pouch
- 4 direction adjustable display (Oxy-6 only)

• 35076 CORDURA BAG with belt loop - blue <sup>\*34265, 34282 only</sup>

TECHNICAL SPECIFICATIONS			
	RANGE	ACCURACY	RESOLUTION
Pulse rate:	30-240 bpm	± 2 bpm (2%)	1bpm
SpO <sub>2</sub> :	35%-99%	± 2% (75-99%) ± 3% (50-75%)	1%
Perfusion Index:	0-20%	± 0.1% (0,2-2%) ± 0.2% (2-10%)	0.1%
Alarm:	SpO <sub>2</sub> : low limit 90% Pulse rate: low: < 50 bpm - high > 120 bpm		
Power:	1.5V (AAA size) alkaline battery x 2		
Norms:	IEC 60601-1-2 Class II		
LCD Display:	oxygen saturation, pulse rate, low battery indicator		
Size - weight:	6.6x3.6x3.3 cm - 60 g including batteries		
Italian manufacturer (made in P.R.C.)			

## OXY-3 OXIMETER



35090

DUAL COLOUR OLED DISPLAY

CE 2179  
FDA

- 35090 OXY-3 OXIMETER - blister
- Easy to use pocket device, measures oxygen level and pulse rate.

Main features:

- simple operation, small & lightweight design, portable
- display SpO<sub>2</sub>, SpO<sub>2</sub> waveform, PR, Pulse bar
- low power consumption
- 2 AAA alkaline batteries included
- low battery indication, auto power off
- accommodates widest range of finger sizes from pediatric to adult
- soft silicone padding, strong slip
- resistant clip, non-invasive, no pricking
- 4 direction display
- user manual in GB, IT, ES, FR
- 35075 SILICONE COVER - light blue
- 35076 CORDURA BAG with belt loop - blue

Supplied in blister with batteries and lanyard.

35090



35075 + 35090

## OXY-4 COLOUR OXIMETER



35091

35092

DUAL COLOUR OLED DISPLAY

CE 0123

- 35091 OXY-4 OXIMETER - blue
  - 35092 OXY-4 OXIMETER - orange
  - 35093 OXY-4 OXIMETER - other colour (minimum 100 pieces)
- Select colour with order

Fingertip pulse oxymeter to monitor pulse oxygen saturation, pulse rate, and perfusion index.

- it is light, small in size and easy to take
- accurately measures SpO<sub>2</sub> value and pulse rate value
- dual-color display of SpO<sub>2</sub>, PR, PI, Plethysmogram and pulse bar
- measuring range, SpO<sub>2</sub> 35 - 99%, Pulse rate 30 - 240 bpm
- innovative 4 directions display
- automatic power On/Off
- more than 30 hours continuous working with 2AAA alkaline batteries
- audible and visible alarm function
- battery voltage indication, low battery voltage alarm
- prevention against water ingress, drop resistant
- manual in 8 languages: GB, FR, IT, DE, ES, PT, GR, PL
- 35076 CORDURA BAG with belt loop - blue

## NONIN GO2 OXIMETER



Back light display  
2400 tests performed with one AAA battery (21 hours continued use)



CE 0123

Lead (PB) free and latex free

- 35079 NONIN GO2 - 9570 - IT, FR, DE, NL
  - 35080 NONIN GO2 - 9570 - GB, FR, ES, PT
- GO2 are manufactured to the same technical specifications and technology used in

NONIN professional oximeters, but are dedicated to consumers for people suffering from shortness of breath, fatigue or limited activities.

- highly resistant: it is tested to resist 25 times to fall down from 1 meter, to liquids and to continuative use
  - patient oriented display
  - finger size range from pediatrics to adult
  - easy to read perfusion indicator
  - suitable for low perfusion patient
- Other manuals for download: GR, PL, DK, NO, SE, FI.

### TECHNICAL SPECIFICATIONS

Saturation range: 0-100% ±2 digit (70-100%)  
Pulse rate range: 18-321 bpm ±3 digit (20-250 bpm)

## NONIN ONYX® VANTAGE 9590



Large Bright LED Display SpO<sub>2</sub> and pulse rate can be read from any angle, day or night



The original all-in one digital fingertip pulse oximeter™  
Lead (PB) free and latex free



CE 0123

### • 35085 NONIN ONYX® VANTAGE 9590 PULSE OXIMETER

The Onyx is the only finger pulse oximeter with scientifically proven accuracy in motion and low perfusion, and it is tested for use on fingers, thumbs, or toes.

- **Accurate** - Scientifically proven performance in the widest range of patient populations and settings
  - **Durable** - Protects against dropping and water spills; allows for thousands of uses in the most demanding environments and exceed IP32 water ingress testing
  - **Efficient** - Up to 6000 spot checks or 36 hours of continual operation on two AAA batteries
  - **Safe** - Built in the USA with lead-free and latex-free construction
  - **Versatile** - One unit works on the widest range of patients from pediatric to larger adult patients. Accommodates a wide range of digit thicknesses from 8 mm to 25.4 mm
  - **Warranted** - Industry-leading 4-year warranty
  - **Cost Effective** - Proven accuracy, quality and durability make the Onyx Vantage a smart purchase for the long term
- Supplied with multilanguage CD-rom manual: GB, FR, IT, DE, ES, PT, GR, NL, PL, NO, FI, DK, SE.

### TECHNICAL SPECIFICATIONS

Pulse rate range: 18-321 bpm ±3 digit (20-250 bpm)  
SpO<sub>2</sub> range: 0-100% ±2 digit (70-100%)  
Low perfusion SpO<sub>2</sub>: 70-100% ±2 digit  
Low perfusion pulse rate: 40-240 bpm ±3 digit

## OXY-PED

4 direction OLED colour display



PEDIATRIC

Visual and audible alarms

- 34266 OXY-PED PEDIATRIC OXIMETER  
Similar to OXY-6 but suitable for pediatric use. Input shaped to fit children's fingers thickness 8-16 mm. It is supplied with two rechargeable batteries and USB battery recharger. All other specifications are like OXY-6 model.
- 34270 RECHARGEABLE BATTERY - spare



### TECHNICAL SPECIFICATIONS

	RANGE	ACCURACY	RESOLUTION
Pulse rate:	30-240 bpm	± 2 bpm (2%)	1bpm
SpO <sub>2</sub> :	35%-99%	± 2% (75-99%) ± 3% (50-75%)	1%
Perfusion index:	0-20%	± 0.1% (0.2-2%) ± 0.2% (2-10%)	0.1%
Alarm:	SpO <sub>2</sub> : low limit 90% Pulse rate: low: < 50 bpm - high > 120 bpm		
Power:	3.6V rechargeable batteries		
Norms:	IEC 60601-1-2 Class II		

## OXY-10 OXIMETER - WIRELESS



OLED COLOUR DISPLAY

wireless

### • 35095 OXY-10 FINGERTIP MULTIFUNCTION OXIMETER

Professional oximeter to monitor pulse oxygen saturation and pulse rate through patient's finger (adult, child, neonate).

- wireless Bluetooth technology for transmission to PC Windows (XP and Seven) and Android (need APP). Software for data management
- external pediatric SpO<sub>2</sub> probes available in 4 sizes for pediatric and neonatal use
- large true colour OLED display
- SpO<sub>2</sub>, PR, Pulse bar, P.I. and plethysmogram
- accuracy from the first reading in a few seconds
- extra stability against motion during measurement
- audible and visible alarms with high and low alarm limits adjustable by user

CE 0476

- patient oriented display with automatic change of 4 directions
- 9 languages manual (GB, FR, IT, DE, ES, GR, PT, PL, Arabic)
- Communication protocols on request
- Supplied in nylon bag with batteries
- 35096 PEDIATRIC CLIP PROBE - reusable
- 35097 PEDIATRIC RUBBER PROBE - reusable
- 35094 NEONATAL PROBE KIT - reusable probe + 20 disposable wraps
- 35099 NEONATAL Y-PROBE - reusable

### TECHNICAL SPECIFICATIONS

	RANGE	ACCURACY
Pulse rate:	30-240 bpm	± 2 bpm or 2%
SpO <sub>2</sub> :	70%-100%	± 3%
Perfusion index (PI):	0.2-20%	
Alarm:	SpO <sub>2</sub> : 85-99%	
	Pulse rate: high 100-240 bpm low 30-60 bpm	
Power:	2xLR03 (AAA) Alkaline batteries 3.0 VDC	
Size:	60x33x30 mm	Weight: 35 g

### EXTERNAL PEDIATRIC - NEONATAL PROBES

Neonatal reusable probe with disposable wrap



35099

Neonatal reusable probe



35096

Pediatric clip reusable probe



35097

Pediatric rubber reusable probe

External pediatric SpO<sub>2</sub> probe with 1 m cable

35096

## IPAD CU-SP1 INTELLIGENT PUBLIC ACCESS DEFIBRILLATOR

CU-SP1 is the last generation of intelligent public access defibrillators with innovative features:

**- Auto volume adjustment**

It detects the ambient noise and automatically adjusts the volume of its prompts to make them audible over the background noise.

**- Smart pads - intelligent storage**

The pre-connected "Smart" electrode pads are stored in an easy access compartment on the underside of the unit. This ensures that the iPad SP1 is always ready to be used in the shortest time possible. In addition, the visual frontal indicator shows if the connected pads are within their life expectancy. The indicator will change when the pads have only 3 months life left before their expiry date giving you time to arrange for replacements. It will change again when the expiry date is reached.

**- CPR detection**

CPR ensures that the casualty has the best chances of survival. The CU-SP1 detects if CPR is being performed with appropriate prompts, if not it encourages the responder to perform it.

**- Easy communication with CU-EX1 software**

Installing CU-EX1 software onto a computer allows you to see and analyze the usage history of the unit. Information such as time of "power on", the casualty's heart rhythm and shocks delivered are all clearly presented.

The iPad CU-SP1 can store up to 5 events with up to 3 hours of ECG analysis on an SD memory card.

**- 16 languages available**

(to be indicated with order)

Selectable software languages: US, GB, FR, IT, ES, DE, PT, NL, PL, SE, DK, NO, CZ, GR, AE, KR, IL. On request LT.

Supplied with adult SAVE PADS, carrying bag, disposable lithium battery pack, paper manual (GB, IT) and CD manual in above languages excluding PL and GR.



Automatic defibrillator without shock button

35339



35340

### TECHNICAL SPECIFICATIONS

<b>Defibrillator</b>	
Operating mode:	Semi-automatic
Waveform:	e-cube biphasic (Truncated exponential type)
Energy:	150J fixed Adult: nominal 150J at 50 ohm load Infant/child: nominal 50 joules at 50 ohm
Charge control:	controlled by automated patient analysis system
Charging time:	within 10 seconds since voice instruction "an electric shock is needed"
Sealing:	waterjet proof IPX5 per IEC60529 (IP55) dust protected IP5X per IEC60529
<b>User interface</b>	
User support:	detailed voice prompts and flashing indicators
CPR guidance:	voice prompts for how to perform CPR for adult and child
Controls:	on/off button, "i" button, shock button (only 35340)
Indicator:	LCD display (Device status, Battery status, Pads status)
Sensing:	pads expiry date, Pads connection status
CPR Monitoring	
Automatic Volume adjustment	
<b>Data recording and transmission</b>	
IrDA port:	wireless transmission of event data to PC, SD Card
Internal Memory (Nand-flash):	ECG, Event
Storage capacity:	multi recording 5 events / Max 3 hours
Data review PC Programme:	CU-EX1
<b>Patient analysis system</b>	
Patient Analysis:	Shockable Rhythms - Ventricular Fibrillation, Tachycardia
Sensitivity/Specificity	Meets AAMI DF80 Guideline
<b>Disposable high capacity battery</b>	
Standard	Type: DC 12 Volt 4.2 Ah, Lithium manganese dioxide Capacity: Minimum 200 shocks (150J)

GIMA code	IPAD CU-SP1 AED DEFIBRILLATOR
35340	iPad CU-SP1 defibrillator - semiautomatic
35339	iPad CU-SP1 defibrillator - automatic
ACCESSORIES FOR CU-SP1	
35342	Trainer Defi Pads - kit of 2
35343	Trainer - 16 selectable software languages
35344	Adult PADS - kit of 2 pcs - disposable
35345	Pediatric PADS - kit of 2 pcs - disposable
35346	Disposable lithium battery LiMnO <sub>2</sub> high capacity 4.2 Ah
33423	Wall cabinet with sound alarm
35349	SD card+ software for event recording download

## METAL CABINETS FOR DEFIBRILLATORS - INDOOR OR OUTDOOR

### METAL CABINETS FOR DEFIBRILLATORS - INDOOR USE

- 35330 METAL CABINET - INDOOR USE - white
- 35331 METAL CABINET WITH ALARM - INDOOR USE - white  
Door with opening at 180° with transparent acrylic window. Suitable for wall mounting or use with pole. Horn alarm at 100 dB (only 35331)
- 35333 POLE for cabinet - white

### METAL CABINETS FOR DEFIBRILLATORS - OUTDOOR USE

- 35334 METAL CABINET - OUTDOOR USE - yellow  
Water tight welding on the sides, water and dust proof gaskets. Made in carbon steel, thickness 15/10. Adjustable internal shelf. Door with transparent acrylic window.
- 35335 METAL CABINET WITH THERMO REGULATION SYSTEM AND ALARM - OUTDOOR USE - yellow  
Same as 35334, with antitheft magnetic sensor that activates a 100 dB siren in case of non authorized withdrawal. 9V alkaline battery for alarm. Low charger indicator. Power 230V for thermoregulation. Suitable for wall mounting or use with pole.
- 35337 POLE for cabinet - yellow

### INDOOR USE



External size: 42.5x16xh 42.5 cm  
Internal size: 40x13xh 40 cm

### OUTDOOR USE



External size: 43x21xh 48 cm  
Internal size: 42x20xh 45 cm

IP 44 PROTECTION

# iPAD CU-SP2 AED MODE DEFIBRILLATOR



**• 35341 IPAD CU-SP2 DEFIBRILLATOR - AED MODE**  
 CU-SP2 is the last generation of intelligent public access defibrillators with innovative features:

- **Auto volume adjustment**  
 It detects the ambient noise and automatically adjusts the volume of its prompts to make them audible over the background noise.
- **Smart pads - intelligent storage**  
 The pre-connected "Smart" electrode pads are stored in an easy access compartment on the underside of the unit ensuring use in the shortest possible time. In addition, the visual frontal indicator shows if the connected pads are within their life expectancy. The indicator will change when the pads have only 3 months life left before their expiry date giving you time to arrange for replacements. It will change again when the expiry date is reached.
- **CPR detection**  
 CPR is vital to ensure that the casualty has the best chances of survival. iPAD CU-SP2 detects if CPR is being performed with appropriate prompts, if not it encourages the responder to perform it.
- **Easy communication with CU-EX1 software**  
 It allows to see and analyze information such as time of "power on", the casualty's heart rhythm and shocks delivered. It saves 3 events on the internal memory (up to 17 hours per event).
- **Wireless ECG transmission device (CU-EM1) - optional**  
 In monitor mode, iPAD CU-SP2 uses Bluetooth to receive ECG data from CU-EM1 and displays it on the LCD screen.
- **Printer - optional**  
 iPAD CU-SP2 supports connection to an external Bluetooth printer.
- **16 languages available**  
 Selectable software languages: GB, FR, IT, ES, DE, PT, NL, SE, PL, FI, DK, NO, CZ, GR, UA, KR.  
 Supplied with adult SAVE PADS, carrying bag, disposable Li-ion battery pack, paper manual (GB, IT) and CD manual in above languages excluding PL and GR. Warranty 5 years.

TECHNICAL SPECIFICATIONS	
<b>Defibrillator</b>	
Operating mode:	Semi-automatic
Waveform:	e-cube biphasic (Truncated exponential type)
Energy:	AED mode: 150/200J fixed or 150-150-200J energy escalating Manual mode: 2-200J, R-Sync
Charging time:	within 10 seconds
Charging time after CPR finished:	at least 6 seconds
Sealing:	waterjet proof IPX5 per IEC60529 (IP55) dust protected IP5X per IEC60529
<b>User interface</b>	
User support:	detailed voice and text prompts
CPR guidance:	voice prompts for how to perform CPR for adult and child
Controls:	on/off button, "i" button, shock button, soft keys
Indicator:	graphic LCD display (status, user's guide, ECG, heart rate, .....
Sensing:	pads expiry date, pads connection status
CPR Monitoring, ECG Monitoring, Automatic Volume adjustment	
<b>Data recording and transmission</b>	
IrDA port:	wireless transmission of event data to PC, SD Card
Internal Memory (Nand-flash):	ECG, Event
Storage capacity:	multi recording 3 events / Max 17 hours for each event
Bluetooth:	communication with the printer
Data review PC Programme:	CU-EX1
<b>Patient analysis system</b>	
Patient Analysis:	Shockable Rhythms (Ventricular Fibrillation, Tachycardia)
Sensitivity/Specificity	meets AAMI DF80 Guideline
<b>Battery</b>	
Rechargeable battery Type:	DC 11.1 Volt 1.9 Ah, Li-ion rechargeable
Capacity:	Minimum 60 shocks or 3 hours of operation
Standard Type:	DC 12 Volt 4.2 Ah, Lithium manganese dioxide
Capacity:	Minimum 200 shocks (150J)

ACCESSORIES FOR CU-SP2	
<b>35344</b>	Adult PADS - kit of 2 pcs - disposable
<b>35345</b>	Pediatric PADS - kit of 2 pcs - disposable
<b>35346</b>	Disposable Lithium battery LiMnO <sub>2</sub> high capacity 4.2 Ah - spare
<b>35347</b>	Rechargeable 12 V, 1.9 Ah Li-ion battery - optional
<b>35348</b>	Battery charge dock + battery charger for 35347
<b>35349</b>	SD card+ software for event recording download
<b>35350</b>	Wireless ECG for CU-SP2
<b>35351</b>	Wireless printer for CU-SP2

## COMPATIBLE DEFIBRILLATOR ECG THERMAL PAPER - DIFFERENT BRANDS

GIMA code	MANUFACTURER AND MODEL	Type	Width mm	Length m	Sheet	Marker	Grid*	Min. order	GIMA code	MANUFACTURER AND MODEL	Type	Width mm	Length m	Sheet	Marker	Grid*	Min. order
33100	CORPLUS Corplus 3	roll	106	20	-	no	or/red	10	33102	PHILIPS Defibrillator MRX	roll	75	25	-	no	or/red	10
32968	MINDRAY Beneheart D3, D6	roll	50	20	-	no	or/red	20	33103	Heartstart XL	roll	50	30	-	no	or/red	20
33103	HEWLETT PACKARD 40457C/D, Codemaster 100, XL	roll	50	30	-	no	or/red	20	33032	PHYSIO CONTROL Life Pack 8-9-10	roll	50	23	-	no	or/red	20
33029	NIHON KOHDEN Def. TEC 5521, 5531, BSM 2300, 3000	pack	50	100	200	no	or/red	25	33033	Life Pack 11-12-15	roll	107	25	-	no	or/red	10
32988	Tech-8300	roll	50	30	-	no	or/red	20	32983	SCHILLER Defigard 6002	pack	80	70	300	yes	or/red	20
									33106	ZOLL Defi/1400 (P/N 8000-0300)	pack	90	90	200	yes	or/red	20

\*or/red: grid could be orange or red colour



\*If used during 5 years battery should be replaced

# i-PAD NF 1200 PUBLIC ACCESS DEFIBRILLATOR

Semi-automatic external defibrillator designed for minimally trained individuals. It provides simple and direct voice prompts and indications for a straightforward rescue operation. Lightweight and battery powered for maximum portability. Designed to treat Ventricular Fibrillation (VF) and Fast Ventricular Tachycardia: the most common causes of sudden cardiac arrest (SCA). In SCA, the heart of the victim suddenly stops pumping. The only effective treatment for VF is the application of a defibrillating shock. It may be used on children 1-8 years old (less than 25 kg) with pediatric reduced energy pads, over with adult pads. Supplied with a set of adult pads, lithium battery (200 Shocks or 10 hours operating time), manual. According to ERC Guidelines 2010.

**TRAINER:** simulates all the functions of i-PAD, with 8 rescue scenarios.

Voice version and manual	i-PAD DEFIBRILLATOR AND TRAINER					
	Spanish	French	Portuguese	Italian	English	Other languages*
<b>DEFIBRILLATOR</b>	<b>33408</b>	<b>33409</b>	<b>33413</b>	<b>33414</b>	<b>33416</b>	<b>33417</b>
<b>TRAINER</b>	-	-	-	<b>33424</b>	<b>33405</b>	<b>33406</b>

\*Voice languages: DE, DK, KR, JP, NL, SE, with same language manual, updated to ERC guidelines 2010  
\*Voice languages: CZ, GR, HU, IL, IR, NO, TR, with English manual, updated to ERC guidelines 2005

GIMA code	Original accessories for I-PAD
<b>33418</b>	Lithium battery pack for i-PAD and i-PAD trainer (for 200 Shocks)
<b>33441</b>	Disposable pads - kit of 2 pcs
<b>33443</b>	Disposable pediatric pads - kit of 2 pcs
<b>33422</b>	Carrying bag
<b>33423</b>	Wall cabinet with alarm sound
<b>33403</b>	IrDa connector for data communication + software for event recording download with key file



**SPECIALLY DESIGNED FOR PUBLIC USAGE**



### TECHNICAL SPECIFICATIONS

Operating mode:	Semi-automatic	Charge time from "Shock advised":	< 10 seconds, typical
Waveform:	e-cube biphasic (Truncated exponential type); impedance compensated	Voice instruction:	Voice messages guide through use of defibrillator
Energy:	200J fixed	Controls:	Shock Button, i-Button, On/Off Button
Shock energy accuracy:	Adult: nominal 200J into a 50 ohm load	Indicators:	7 LEDs (different colours), i-Button
Shock to shock cycle time:	Infant/child: nominal 50 joules into a 50 ohm load	Patient isolation:	Type BF, defibrillation protected
Protocol:	Within ±3% (200J into 50 Ω)	Battery:	12 Volt DC, 4.2 Ah, lithium manganese dioxide, disposable long-life primary cell
Charge control:	Voice prompts and indicators guide through protocol	Battery capacity:	Min. 200 Shocks or 4 hours of operating time
	Automatic by Software (Arrhythmia Detection System and Charging Control)	Data recording:	Data Stored: First 40 minutes of ECG and the entire incident's events and analysis decision
		Size - Weight:	220x260x70 mm - 2.2 kg (4.84 lbs) with battery pack

# RESCUE SAM AED DEFIBRILLATORS - SEMI OR FULL AUTOMATIC

5 YEARS WARRANTY MADE IN ITALY

Rescue Sam with carrying bag 33421

33425 + 33421

Semi automatic



Full automatic



Semi or full automatic external defibrillators designed for public use by minimally trained people. They provide easy and simple indications for rescue operations. Designed to treat Ventricular Fibrillation (VF) and Fast Ventricular Tachycardia (VT). Supplied with lithium battery, set of adult pads and manual. According to AHA/ERC Guidelines 2010. Made in Italy.

RESCUE SAM DEFIBRILLATOR - Semi automatic				
English	Italian	French	Spanish	Other languages*
<b>33425</b>	<b>33426</b>	<b>33427</b>	<b>33430</b>	<b>33559</b>
<small>Other languages available in 20 days: DE, PL, RU (manual and voice), PT, CZ, FI, GR, LT, NL, RO, TR, KR, TH (voice with English manual)</small>				
RESCUE SAM DEFIBRILLATOR - Full automatic				
<b>33165</b>	-	<b>33167</b>	-	-
<small>German available on request in 20 days</small>				
TRAINER FOR SEMI-AUTOMATIC RESCUE SAM				
<b>33170</b>	<b>33171</b>	-	-	<b>33174</b>
<small>Trainer: other languages available in 20 days: ES, FR, PL (voice only)</small>				
ACCESSORIES FOR RESCUE SAM DEFIBRILLATORS				
<b>33558</b>	USB PC interface			
<b>33419</b>	Lithium battery pack			
<b>33458</b>	Disposable pediatric pads (kit of 2)			
<b>33451</b>	Disposable adult pads (kit of 2)			
<b>33420</b>	Disposable adult pads (kit of 2) and cable			
<b>33421</b>	Carrying bag			



**TRAINER AED RESCUE SAM PRO**  
Designed to effectively train emergency responders to the use of RESCUE SAM, thanks to simple, clear, spoken and visual instructions. 5 pre-programmed scenarios selected directly by the remote control. Totally safe real shock simulation. Supplied with remote control, training pads, battery charger.

33170  
303

# COMPATIBLE PADS FOR OVER 90% OF DEFIBRILLATORS ON THE MARKET



## ADULT COMPATIBLE PADS - disposable

A range of compatible pads BSI certified for patients >8 years (25 kg) for most defibrillators on the market. Excellent adherence and adequate gel thickness. Includes a couple of pads, cable and connector. Maximum shelf life 30 months from production date. Latex free.

Compliance to regulations: Directive 93/42/EEC and amendments. Class IIb medical device. ANSI/AAMI: DF-80; IEC/EN: 60601-1, 60601-2-4; ISO: 10993-1. Made in Italy.

GIMA code	BRAND	MODEL	GIMA code	BRAND	MODEL
33576	Agilent-Philips	- Heartstream/HeartStart XL M4735A - Heartstream/HeartStart XLT M3500B - HeartStart XL 861290 - HeartStart 4000 M5500B (all with Philips cable M3508A)	33587	Mindray	- Beneheart D3 - Beneheart D6
33577	Agilent Hewlett-Packard	- Codemaster 100-XE-XL-XL+ - Heartstream XL, XLT, XL+ with cable M3507A	33579	MRL	Life - Lifequest
33579	Artema Innomed	- Cardio Aid 100 - 200 - 200B - 360B - XL - XL+	33579	Nihon Kohden	Cardiolife TEC 2202 - 2203 - 5500 - 7531 - 7600 - 7700 - 8251 all with cable JC-755V, TEC 8300 with cable JC855V
33579	Artema S&W	- Cardio Aid LS - MC - MC+	33587	Osatu Bexen	- Reanibex 200 - 300 - 500 - 700 - 800
33587	Cardioline	- Elife 700	33576	Philips Laerdal Medical	- Heartstream Fore Runner I AED models E, S, EM - Heartstart FR1 AED 940010XX - 940020XX - 940030XX - Heartstart FR2 AED M3841A - M3861A - Heartstart FR2+ AED, with ECG module M3840A, M3860A - Codemaster M1722A/B, M1723A/B, M1724A, M2475B (with Philips cable M3507A and pad adapter 05-200) - Heartstart MRx M3535A (with Philips cable M3508A)
33448	Cmos Drake	- Futura	33588	Schiller	- Fred Easy - Fred Easy 2G - Defigard DG4000 - DG5000 - DG6002
33448	CU Medical System	- i-PAD NF1200	33586	Schiller	- Defigard DG1002 - DG3002 - DG2000 EDOS
33578	Defibtech	- DDU 100 Lifeline AED - DDU 120 Lifeline Auto AED	33592	Schiller	- Fred easy port - Argus PRO Lifecare - Argus PRO Lifecare 2 - Cardiovit AT 101 Easy
33579	Drager	- Cardiolog 2000	33579	S&W	- Cardio Aid LS - MC - MC+
33586	Esaote	- MDF SAED - MDF II	33579	Welch-Allyn	- AED 10 - AED20 - PIC30 - PIC40 - PIC50
33579	Innomed	- CardioAid 200B - 200 - 100 - 360B - XL+ - XL	33589	Zoll Medical Corp	- Zoll PD 1200 - 1400 - 1600 - 1700 - 2000 - M series - E series - R series
33577	Laerdal Medical	- HeartStart 4000			
33589	M&B	- AED 7000			
33587	Medtronic-Physiocontrol	- Lifepak 9 connector Quick-Combo - Lifepak 10 - 12 - 15 - 20 - 500 AED pink or grey socket - 1000 AED			
33609	Metrax Primedic	- Heartsave AED - AED-M - 6 - 6S since S.N. 739xxxxxxx - Defimonitor XD			

Connectors to defibrillator of compatible pads

Multilanguage envelope: English, Italian, French, German, Spanish, Portuguese, Greek, Dutch, Russian, Swedish

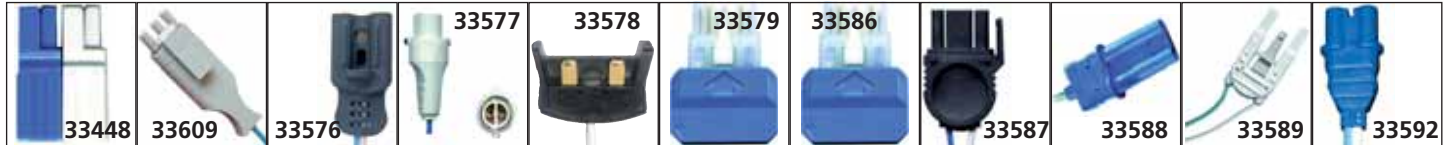

# PEDIATRIC COMPATIBLE PADS WITH ENERGY REDUCTION SYSTEM

## PEDIATRIC COMPATIBLE PADS - disposable

These pads have an energy reduction system: defibrillator output of 150J (33606) or 200J (33603) is reduced to 50J. International RCP guidelines state 8 years as limit age for

pediatric treatment, corresponding to about 25 kg according to standard growth curves. Compliance to regulation as above adult compatible pads. Latex free. Made in Italy.

GIMA code	BRAND - MODEL	GIMA code	BRAND - MODEL
33603	Medtronic-Physiocontrol - Lifepak 500 AED pink socket - Lifepak 1000 AED - Lifepak CR plus AED - Lifepak Express AED	33603	Philips Laerdal Medical - Heartstart FR2 AED M3841A & M3861A - Heartstart FR2 AED, with ECG module 3840A, M3861A

# ORIGINAL CU, PRIMEDIC AND PROGETTI PADS

GIMA code	BRAND - MODEL	GIMA code	BRAND - MODEL
PEDIATRIC PADS		ADULT PADS	
33569	CU Medical System CU-ER1, CU-ER2, CU-ER3	33565	CU Medical System CU-ER1, CU-ER2, CU-ER3
33443	iPad NF 1200	33441	iPad NF 1200
35345	CU-SP1, CU-SP2	35344	CU-SP1, CU-SP2
35390	Metrax-Primedic HeartSave Pad, AED, AED-M, 6, 6S since S.N. 739xxxxxxx	35392	Metrax-Primedic HeartSave Pad, AED, AED-M, 6, 6S since S.N. 739xxxxxxx
33458	Progetti Rescue Sam, Rescue 230, Rescue Life 5.7" and 7"	33388	Progetti HeartSave Pad, AED, AED-M, 6, 6S up to S.N. 738xxxxxxx
		35380	Defimonitor XD1, XD3, XD10, XD30, XD100, XD300, XD110, XD330
		33451	Progetti Rescue Sam, Rescue 230, Rescue Life 5.7 "and 7"

# PRIMEDIC™ EXTERNAL DEFIBRILLATORS - AED

PRIMEDIC HeartSave product range is easy to operate and offers fast operation. Clear voice prompts guide first aiders through the rescue procedure.

## Current controlled defibrillation - CCD

CCD Biphasic technology delivers peak-free current defibrillation on the patient's heart muscle through its individualized, gentle, effective and current-controlled defibrillation pulse. Featuring an escalating defibrillation strategy, HeartSave is impedance compensated and capable of a maximum energy of 360J.

## Effective workflow

HeartSave is designed to help first aiders delivering the most effective life support. Through its advanced workflow, HeartSave supports the rescuer in minimizing the perishock pause as well as no-flow fraction.

## Pediatric mode

At a touch of a button the Paediatric Mode can be promptly selected. No need of dedicated paediatric electrodes and extreme ease of use result in optimized costs of maintenance and prompt operation.

## Fast

It turns on automatically as soon as the cover has been opened and rhythm analysis starts immediately as the pre-connected electrodes are attached to the patient. All accessories (razor, breathing mask, scissors and gloves) are included.

## Status display

Active status display provides comprehensive information on the device's operating status and battery status (daily and monthly self-tests).

## HEARTSAVE PAD and HEARTSAVE AED

Automatic external defibrillator with 3 years life (PAD) or 6 years life (AED) in standby mode with non rechargeable lithium battery.

The HeartSave AED has 4 selectable languages.

## HEARTSAVE AED-M

Same features as HeartSave AED, plus large LCD display for ECG waveform, HR, shockable rhythm counts and other relevant information. AED-M is supplied with non rechargeable lithium battery

## HEARTSAVE 6

For professional and non professional users. In addition to the AED-M features, HeartSave 6 offers both AED and MANUAL mode, 6 leads ECG, alarms and SYNC for Cardioversion.



PRIMEDIC™  
Saves Life. Everywhere.

High resolution LCD monitor gives important information for resuscitation



HEART SAVE EXTERNAL DEFIBRILLATORS		Voice version and manual			
	<b>WITH LITHIUM BATTERY</b> <b>140 DISCHARGES AT 360J</b> <b>3 YEARS STANDBY</b>	Italian	English	French	Other languages**
	HeartSave PAD	33393	33395	33398	33402

\*\* We can provide following languages (voice + manual): ES, PT, GR, DK, FI, CZ, PL, DE, SE BG, RU, TR, AE, IR, BR, HU, TH, JP, RO, SI, IL. Only voice: MK, HR, FI, NL, LT, IS, IL, KT, TR, IR, BR, JP. Only manual NO.

	<b>WITH LITHIUM BATTERY</b> <b>200 DISCHARGES AT 360J</b> <b>6 YEARS STANDBY</b>	English Spanish Greek Portuguese	Italian French German Polish	Other languages***
	HeartSave AED HeartSave AED-M	33391 33396	33392 33397	33394 33399

	<b>WITH AKUPAK LITE RECHARGEABLE BATTERY AND CLIP CHARGER</b>	English Italian Spanish French	English Spanish Greek Portuguese	Italian French German Polish	Other languages***
	HeartSave AED-M HeartSave 6	33440 -	- 33452	- 33453	33446 33456

\*\*\*We can provide following languages (voice + manual): BG, CZ, DK, FI, HR, HU, MK, NL, NO, RO, RU, SE, SI, TR, AE, CN, IR, TH. Please specify with order. Available in 40/60 days.

SAVEPADS	GB, IT, FR, ES	Other languages
Self-adhesive electrode, cable, razor and gloves - shelf life 3 years		
SavePads mini for 1-8 years max 25 kg	35390	35391
SavePads preconnect for over 8 years, 25 kg Since S. N. 739xxxxxxx	35392	35393
SavePads for over 8 years 25 kg Only for 33384/5 and AED sold before April 2014 up to S.N. 738xxxxxxx	33388	33386

ACCESSORIES - SPARES		
Lithium BATTERY - not rechargeable life 6 years for AED and AED-M	33387	33387
AkuPak Lite Rechargeable battery****	33400	33400
PowerPak Battery charger for code 33400	33407	33407
Flashcard ERC guidelines update (2010 to 2015)****	33401	33401

\*\*\*\*For defibrillators sold up to December 2010 - Specify serial number with order \*\*\*\*\*For AED-M and HeartSave

STANDARD ACCESSORIES		
Lithium battery, 3 years stand-by (140 shocks @360J), (PAD only)		
Lithium battery, 6 years stand-by (200 shocks @360J), (AED, AED-M)		
AkuPak Lite, rechargeable battery with clip charger, (AED-M, H56)		
ECG cable 3 leads (HeartSave 6 only)		
SavePads		
Data and voice recording		Manual

\*AED-M is available with lithium battery or with Akupak Lite rechargeable battery. Select code for requested model

	TECHNICAL SPECIFICATIONS				PAD	AED	AED-M	H56
	PAD	AED	AED-M	H56				
<b>Defibrillation</b>								
Semi-automatic mode	•	•	•	•				
Manual mode								
Wave: biphasic, current controlled pulse	•	•	•	•				
Energy 50-360J	•	•	•	•				
Charging time: < 12 sec @ 360J	•	•	•	•				
Operating modes: asynchronous	•	•	•	•				
Paediatric mode	•	•	•	•				
<b>ECG</b>								
Lead: II								
I, II, III, aVR, aVF, aVL								
Patient's impedance range: 23-200 Ohm	•	•	•	•				
Heart rate: 30-300 per min	•	•	•	•				
<b>VF:VT Detection</b>								
VF/VT Detection	•	•	•	•				
Analysis time 7-12 sec	•	•	•	•				
Asystole threshold <0.2mV	•	•	•	•				
Artefact-Pacemaker detection	•	•	•	•				
<b>Electrodes</b>								
Non polarized electrodes, cable length 2 m	•	•	•	•				
<b>LCD Monitor</b>								
95x72 mm (diagonal 4.7"/120 mm)								
320x240 (pixel size 0.36x0.36 mm)								
Storage battery status display								
Speed 25 mm/s								
Heart rate, number of defibrillation, number of VF/VT, total resuscitation time								
<b>Data backup</b>								
Removable memory	•	•	•	•				
Voice recording	•	•	•	•				
<b>Power supply</b>								
Lithium battery 3 years life or 140 discharges at 360J	•	•	•	•				
Lithium battery 6 years life or 200 discharges at 200J - 15 hours monitoring		•	•	•				
AkuPak Lite with rechargeable battery								
100-240 V, 50/60 Hz - 150 discharges at 200J - 5 hours monitoring								
<b>Status display</b>								
Defibrillator and battery status visualization	•	•	•	•				

# PRIMEDIC™ DefiMonitor XD - PROFESSIONAL DEFIBRILLATORS

## DEFIMONITOR XD

The sophisticated high performance instrument with multifunctional features.

It combines a compact product design, proved and tested in practice with the highest possible degree of safety and user friendly handling.

Range of 8 manual (XD1, XD3, XD10, XD30) or manual + AED (XD100, XD300, XD110, XD330) defibrillators with or without SpO<sub>2</sub> and external pacer.

Supplied with adult/pediatric paddles, disposable adult Save Pads, connect cable, ECG cable, power cable, 1 tube gel, 1 paper roll.

Standard software: GB, FR, DE, IT, ES, KT, PT, RO, TR, CN.

Manual: GB, IT (on request DE, ES, PT, RU, UA).

Other softwares available on request: CZ, FI, HU, NL, NO, PL, RU, SE, DK, GR, LT, JU, AE, BR, CN, IR, JP, TH, US.



Size: 33x29x16 cm

EN 1789

MADE IN GERMANY

GIMA code	DefiMonitors XD
35370	DefiMonitor XD1 manual
35371	DefiMonitor XD3 manual + SpO <sub>2</sub>
35372	DefiMonitor XD10 manual + pacer
35373	DefiMonitor XD30 manual + SpO <sub>2</sub> + pacer
35374	DefiMonitor XD100 manual + AED
35375	DefiMonitor XD300 manual + AED + SpO <sub>2</sub>
35376	DefiMonitor XD110 manual + AED + pacer
35377	DefiMonitor XD330 manual + AED + SpO <sub>2</sub> + pacer

GIMA code	Accessories for DefiMonitors XD
35380	SAVE PADS Connect GB, FR, IT, ES (require cable 35384)
35383	SAVE PADS Connect other languages (require cable 35384)
35384	Connect cable for SAVE PADS Connect 35380/3 - spare
33400	AKuPak LITE rechargeable battery
35386	Charge base for 33400 for DefiMonitor XD
35387	Paper roll 58 mm x25 m - box of 10
35388	DefiMonitor carrying bag with shoulder strap

### TECHNICAL SPECIFICATIONS

	XD1	XD3	XD10	XD30	XD100	XD300	XD110	XD330		XD1	XD3	XD10	XD30	XD100	XD300	XD110	XD330	
<b>Defibrillation</b>									<b>TFT LCD blue-mode monitor</b>									
Wave: biphasic, current controlled impulse	•	•	•	•	•	•	•	•	115x86 mm (diagonal 5.7"/144 mm)	•	•	•	•	•	•	•	•	
Energy (automatic mode) 140-360 J	•	•	•	•	•	•	•	•	320x240 pixels	•	•	•	•	•	•	•	•	
Manual energy stages:									<b>Electrodes</b>									
5J, 10J, 20J, 30J, 50J, 100J, 200J, 300J, 360J	•	•	•	•	•	•	•	•	Adhesive electrodes, 3 years shelf life	•	•	•	•	•	•	•	•	
Charging time: < 6 sec at 200 J	•	•	•	•	•	•	•	•	Cable length 3.5 m Save pads connect	•	•	•	•	•	•	•	•	
Cardio version: manual activation, QRS marker	•	•	•	•	•	•	•	•	<b>Data backup</b>									
<b>ECG</b>									Removable memory 2 GB	•	•	•	•	•	•	•	•	
Derivation: Eindhoven I, II, III	•	•	•	•	•	•	•	•	Data/Voice recording up to 35 h	•	•	•	•	•	•	•	•	
Goldberger, aVR, aVF, aVL	•	•	•	•	•	•	•	•	<b>Power supply</b>									
Patient's resistance: 23-200 Ohm	•	•	•	•	•	•	•	•	Voltage 90-264 V, 50/60 Hz	•	•	•	•	•	•	•	•	
Heart rate: 30-300 per min	•	•	•	•	•	•	•	•	<b>Rechargeable Lithium-ion battery (LiFePO<sub>4</sub>):</b>									
<b>VF: recogniton</b>									Capacity 2.5 Ah Voltage: 13.2 Vdc	•	•	•	•	•	•	•	•	
VF recogniton	•	•	•	•	•	•	•	•	Discharges 160-200 J	•	•	•	•	•	•	•	•	
Analysis time 7-12 sec	•	•	•	•	•	•	•	•	Monitoring 5.30 h Charging time: 3.2 h	•	•	•	•	•	•	•	•	
VF threshold 200 µV	•	•	•	•	•	•	•	•	<b>Resuscitation guidelines</b>									
Asystole threshold < 200 µV	•	•	•	•	•	•	•	•	AHA/ERC	•	•	•	•	•	•	•	•	
Artefact, Pacemaker detection	•	•	•	•	•	•	•	•	<b>Standards</b>									
<b>Pulse Oximeter</b>									IEC60601-1-1:1988+A1:1991+A2:1995	•	•	•	•	•	•	•	•	
Nellcor Oximax	•	•	•	•	•	•	•	•	(Electrical Safety of Med. Electrical Devices)	•	•	•	•	•	•	•	•	
<b>Pacer</b>									IEC60601-1-2:2001 (Electromagnetic compatibility)	•	•	•	•	•	•	•	•	
Trans thoracic heart pacemaker	•	•	•	•	•	•	•	•	IEC60601-1-4:1996+A1:1999	•	•	•	•	•	•	•	•	
Modes: fix, demand, overdrive	•	•	•	•	•	•	•	•	(Programmable electrical medical systems)	•	•	•	•	•	•	•	•	
<b>Thermal printer</b>									IEC60601-2-4:2002 (Defibrillators)	•	•	•	•	•	•	•	•	
Resolution: 200 dpi	•	•	•	•	•	•	•	•	EN1789:2003 (Ambulance standard)	•	•	•	•	•	•	•	•	
Advance: 25 mm/s, 50 mm/s	•	•	•	•	•	•	•	•	Protection class IP33	•	•	•	•	•	•	•	•	

# DEFI-B BATTERY DEFIBRILLATOR - MADE IN GERMANY



33380

*In emergency situation the well structured and logical operator guidance may save a life*

*Suitable for adult and children (reference norms ERC 2005 use of joule depending on kg).*

*Compact and handy: PRIMEDIC DEFI-B is easily transportable and immediately ready to use everywhere*



## • 33380 DEFI-B DEFIBRILLATOR - 220 V

The mobile security: PRIMEDIC DEFI-B is a state-of-the-art accumulator-driven defibrillator. It was designed in accordance with strict requirements of emergency medical science. Fully developed and reliable technique, world-wide in use since years. PRIMEDIC DEFI-B is

a battery supplied version and has proved successful in daily use in ambulances, with cardio sport groups and in hospitals. The convincing advantages: PRIMEDIC DEFI-B is immediately ready for application and is not depending on the main power supply due to large accumulator capacity. After switching on, the defibrillator carry out an internal self-test. In order to ensure a functional optimal handling, the user is supported by clear instructions and pictograms. A shock-resistant plastic casing protects the device, especially under rough conditions.

### • 33381 SPARE BATTERY

#### TECHNICAL SPECIFICATIONS

Mode: Asynchronous, external defibrillator  
 Energy step: 20, 50, 100, 160, 250, 360 Joule  
 Discharges: 45 shocks at 360 Joule, (10 reserve after signal "battery low")  
 Charging time: 2 sec up to 100 Joule, 4.5 sec up to 360 Joule  
 Paddles for children integrated  
 Accumulator: 14.4 V / 1.4 Ah  
 Charging time: 3.5 hours  
 Safety: Internal discharge of energy after 15 sec. Internal self-testing and fault recognition  
 Protection class II, type BF  
 Mains voltage: 200-240 V 50/60 Hz  
 Dimensions: 40x48x12 cm (W x D x H)



Weight: 8.5 kg

# RESCUE 230 BIPHASIC MANUAL DEFIBRILLATOR

## RESCUE 230 BIPHASIC MANUAL DEFIBRILLATOR

A range of 2 professional models with advanced features:

- BTE (Biphasic Truncated Exponential) discharge type
- impedance compensated energy delivery
- energy selection from 2 to 230 joule directly from the front panel
- charge time 5 sec for 230 joule with fully charged battery
- 100 shocks of 230 j with fully charged batteries
- charge/discharge control from the paddles
- ECG 'R' wave synchro mode or async mode
- large (5.7") high resolution backlight LCD display (320x240 dots)
- ECG through the paddles or through patient cable
- adjustable HR and SpO<sub>2</sub> alarms limits

- 33447 RESCUE 230 BIPHASIC DEFIBRILLATOR
- 33457 RESCUE 230 BIPHASIC DEFIBRILLATOR WITH PACEMAKER

(rectangular pulse, pulse duration 22 msec, pulse max amplitude 150 V, stimulation frequency 30 to 150 BPM)

- 33458 DISPOSABLE PADDLES - box of 2 - pediatric
- 33451 DISPOSABLE PADDLES - box of 2 - adult
- 33449 CABLE/ADAPTOR FOR DISPOSABLE PADDLES
- 33439 SpO<sub>2</sub> PROBE
- 33250 THERMAL PAPER



Battery charging car plug on request

33447



Adult and pediatric standard pads



Optional paddles for monitoring

33451

### TECHNICAL SPECIFICATIONS

#### Display:

- large (5.7") high resolution backlight LCD display (320x240 dots)
- ECG through the discharge paddles (1 trace) or through 4 leads patient cable (6 traces): I, II, III, aVR, aVL, aVF
- Automatic change over when plugging the patient cable
- Filters: 50/60 Hz, base line, low pass
- heart rate indicator

#### Printer:

- auto printing mode
- integrated thermal printer for ECG traces and events documentation hardcopy
- paper speed 5, 10, 25 mm/sec (paper width 58 mm)

#### Safety:

- two hands safety shock release
- ECG input insulation CF class
- internal discharge after 30 sec of standby after charge

Power supply: internal Ni-Cd high capacity batteries (charging time 95%: 2 hours)  
universal mains adaptor charger 110/220 VAC, 50/60 Hz

Dimensions: 34x26x13 cm Weight: 5.5 kg Made in Italy

### STANDARD ACCESSORIES

- |                                      |                            |
|--------------------------------------|----------------------------|
| Internal Ni-Cd high capacity battery | Printer                    |
| Carrying case                        | 1 paper roll               |
| Patient cable 4 leads                | 2 reusable paddles         |
| Manual GB, IT, on request ES, TR     | Mains adaptor charger      |
|                                      | Disposable paddle* +cable* |

\*Only for 33457

# AMBU® TRAINING MANIKINS

- 34044 AMBU® MAN COMPRESSION

A basic instruction and training manikin for the practice of external chest compression that meets recommendations of AHA (American Heart Association) and ERC (European Resuscitation Council). With the size of a normal adult torso, provides a lifelike representation of human anatomy. **Indicator for correct compression** The manikin includes an indicator bar that shows the correct compression depth, changing colour from red to green.

**Compact and portable Easy AED training**

Due to the closed shaped torso, defibrillation pads can be placed and AED training can be performed realistically. Weight: 2.0 kg Size: 45x37x25 cm Max compression depth: 7.5 cm Manual in: GB, FR, IT, ES, DE, PT, GR, HU, DK, PL, NO, SE, SI, CZ, TR, JP, CN.



34044

- 34047 AMBU® MAN BASIC

Cost efficient and reliable training manikin designed to fulfill all requirements for the BLS algorithm training. The closed shaped torso with its anatomical correct landmarks allows trainees to learn and train the use of Automatic External Defibrillators (AED) and the placement of pads. It allows an optimal training of chest compression in combination with realistic ventilation. The unique hygienic system prevents cross contamination. It allows a realistic ventilation resistance and expiration through mouth and nose. The correct compression depth and required ventilation volume can be monitored by the feedback indicator on the manikin. **Ventilation as in real life**

The trainees will feel the realistic airway resistance and the chest will start rising when the head is correctly tilted and air blown into the manikin. Weight: 6.0 kg. Size: 70x37 cm Max ventilation: 1,200 ml Max compression depth: 7.5 cm Manual in: GB, FR, IT, ES, DE, PT, HU, DK, NL, PL, CZ, TR.

- 34039 HEAD BAG - box of 100 pcs



34047

- 34042 AMBU® AIRWAY MAN I *Adjustable stiffness of the chest*
- 34049 AMBU® AIRWAY MAN W with CPR

Adult-sized training manikins that provide an optimal lifelike representation of the human anatomy. **Mechanical instrument** gives you instant feedback on ventilation volume, stomach inflation, chest compression depth in mm and wrong hand position. **PC connection** (34049 only) of Ambu CPR Software Kit, Ambu CPR Printer or USB Interface. **Make intubation possible** with ET tube, Guedel, Laryngeal Mask and combi-tube. Ambu Airway man includes torso with hooks for arms, computer interface with CPR software kit (34049 only), supplied in track suit jacket and training mat. CPR software kit selectable languages: GB, FR, IT, ES, DE, PT, PL, DK, HU, NL, RU, JP.

• 34043 COMPLETE SET: ARMS, LEGS, TROUSERS AND BAG



Jaw thrust possible



34042

Size: 80x35 cm Weight: 13 kg



# RESCUE LIFE MANUAL AND SEMIAUTOMATIC DEFIBRILLATORS

Bright, high contrast, wide-angle TFT LCD colour display 5.7" to view simultaneously up to 3 ECG channels

**Ergonomic design.** Impact proof, compact and lightweight. Comfortable and washable carrying bag keeps all accessories at hand and protects Rescue

**RESCUE 7 ONLY:**  
- 7" TFT COLOUR DISPLAY  
- AUTOMATIC SELF TEST

**MADE IN ITALY**

**AVAILABLE WITH:**

- SpO<sub>2</sub>
  - NIBP
  - PACEMAKER
- YOU MAY ORDER UNIT WITH 1 TO 3 OF ABOVE PARAMETERS

**Fast connection.**

User can choose between ergonomic reusable paddles for manual defibrillator or disposable pads for AED defibrillation.

Both types are equipped with a single fast lock connection for reliable rescue operations



Large TFT LCD colour display 7"



Adult and pediatric reusable paddles

## RESCUE LIFE BIPHASIC DEFIBRILLATORS 5.7" and 7"

Rescue Life is an external defibrillator with monitor. It is designed to be used by out-of-hospital and hospital users. Lightweight, transport facility, attractive line, ergonomic shape, studied in every details. It is a complete acute cardiac care response system designed for Basic Life Support (BLS) and Advanced Life Support (ALS) patient management protocols. The IPX4 standard permits the operation under adverse climatic situations. Rescue Life is totally MADE IN ITALY.

### SpO<sub>2</sub> and pacemaker

Range includes models with pacemaker and SpO<sub>2</sub>. ECG module for monitoring (not for diagnosis) includes up to 12 derivations standard 5 leads patient cable (for I, II, III, aVL, aVR, aVF) or optional 10 leads patient cable (for 12 derivations).

### NIBP

The NIBP option is focused on advantage A+ module of SunTech Medical that provides the highest NIBP performance during movements. Suitable for adult, pediatric and neonatal.

### High contrast TFT LCD colour display 5.7" or 7" (Rescue Life 7)

Bright, high contrast, wide-angle colour display for simultaneous view of up to 3 ECG channels

### Data management

The memory is based on a flash disk of 4 GB for 300 recorded hours for all AED models

### Asynchronous and synchronous

- in *asynchronous* defibrillation, Rescue is advised on patients with the following symptoms: unconsciousness, absence of normal breathing and lack of detectable pulse.

- in *synchronous* defibrillation, Rescue Life is advised on patients with ECG's reporting Atrial Fibrillation.

### 3 operation modes: manual, AED, Advisory

- in *manual mode* RESCUE LIFE is intended for use by doctors and trained individuals. Only 3 steps: energy selection from 1 to 230J, energy charge and shock.

- in *AED mode*, RESCUE LIFE is intended for use by personnel authorized by a physician or medical director. The voice prompts and display messages are assisting the operator during CPR operations, charging automatically to 150J when a shock-able ECG rhythm is detected.

- in *advisory Mode*, the system alerts when the shock is necessary leaving the energy level and charging choice to the operator.

### Initialising and system test at switching on of the device (Rescue Life 7 only)

Auto test and fault recognition (Rescue Life 7 only).

### Clinical test

Available on our web site.

### STANDARD ACCESSORIES

- Internal Ni-Mh battery (Rescue 5.7")
- Internal Li-Ion battery (Rescue 7")
- 2 adult and pediatric reusable paddles
- Manual: GB, IT
- Printer
- 1 paper roll
- 2 disposable pads (AED only)
- Main adaptor charger
- Patient cables 5 leads

English	Italian	Other languages	RESCUE LIFE 5.7" DEFIBRILLATORS
33590	33537	33538*	Rescue life defibrillator
33597	33540	33541*	Rescue life defibrillator with SpO <sub>2</sub>
33591	33543	33544*	Rescue life AED defibrillator with pacemaker
33598	33545	33546*	Rescue life AED defibrillator with SpO <sub>2</sub>
33547	33548	33549*	Rescue life AED defib. SpO <sub>2</sub> +NIBP+Pacemaker
		33539**	Rescue life AED defib. other configuration

\*On request we can offer Rescue Life and Rescue Life AED in Spanish and French

\*\*On request we can offer Rescue Life and Rescue Life AED with SpO<sub>2</sub>+NIBP, SpO<sub>2</sub>+Pacemaker (available in GB, FR, IT, ES)

English	Italian	RESCUE LIFE 7" DEFIBRILLATORS
33182	33183	Rescue Life 7 defibrillator
33185	33186	Rescue Life 7 AED
33188	33189	Rescue Life 7 AED defib. other configurations*

\*On request we can offer Rescue Life 7 with SpO<sub>2</sub> NIBP or Pacemaker.

You can choose 1 to 3 of above parameters. \*Available on request manual in FR and ES.

GIMA code	RESCUE LIFE ACCESSORIES
33448	Disposable paddles - box of 2 - adult - compatible
33451	Disposable paddles - box of 2 - adult - original
33458	Disposable paddles - box of 2 - pediatric - original
33593	Cable for disposable paddles
33594	ECG cable 10 leads
33595	Rescue Life bag
33250	Thermal paper
33596	12V car light adapter - inverter

### TECHNICAL SPECIFICATIONS

**Display:**  
- high contrast TFT colour LCD 5.7" (320x240 pixel) or LCD 7" (800x480 dots)  
- ECG through the discharge paddles (1 trace) or through 5, 10 leads patient cable for 3, 6, or 12 traces and SpO<sub>2</sub> value  
Automatic change over when plugging the patient cable  
- filters: 50/60 Hz, base line, EMG  
- heart rate indicator  
**ECG monitoring**  
- bandwidth: 0.5 to 120 Hz (-3db) with filters off  
- speed: 5, 10, 25, 50 mm/sec.  
- gain: 2.5, 5, 10, 20, 40 mm/mV with patient cable; auto with paddles  
- HR digital readout on the display 20 to 300 bpm (± 2%)  
- alarm: settable HR, min 20 bpm, max 250 bpm  
**Pulse oxymetry (SpO<sub>2</sub>) 33540-1-5-6-7-8-9, 33597-8 only**  
- oxygen saturation range: 0 to 100%  
- pulse rate range: 30 - 250 pulses per minute  
- accuracy SpO<sub>2</sub>: 70-100% ± 2 digits for adults using the finger clip sensor  
- SpO<sub>2</sub> Alarms adjustable (min. 50%)  
**Non-invasive pacemaker (33543-4, 33591, 33547-8-9)**  
- rectangular wave  
- operating mode: fixed on demand  
- pulse rate: 0 to 180 ppm adjustable in steps of 5 ppm  
- impulse duration: 22 ms  
- pulse Current: 0 to 180 mA adjustable in steps of 5 mA

- amplitude: MAX 150 V  
**NIBP (33547-8-9 only)**  
- technique: oscillometric  
- accuracy: meets ANSI/AAMI SP10-2002, EN 1060-4  
- patient application: adult/pediatric/neonatal  
- range mmHg adult pediatric neonatal  
systolic 40-260 40-160 40-130  
MAP 26-220 26-133 26-110  
diastolic 20-200 20-120 20-100  
**Printer:**  
- manual, automatic (10" pre and post recording)  
- integrated thermal printer for ECG traces and events documentation including HR/SpO<sub>2</sub> values  
- paper speed: 5, 10, 25, 50 mm/sec.  
- paper width: 58 mm  
**Safety:**  
- two hand safety shock release  
- ECG input insulation CF class  
- internal discharge after 30 sec. of standby after charge  
**Power supply:**  
internal Ni-Mh battery (Rescue Life 5.7")  
internal Li-Ion battery (Rescue Life 7")  
(charging time 95%: 2 hours)  
AC 100-240 VAC, 50/60 Hz  
Memory: internal flash 4 GB up to 300 hours of ECG data, events and usage review  
**General:**  
Dimensions: 36x24x34 cm  
Weight: 5.5 kg with battery

# DTS-3000 SMART PNEUMATIC TOURNIQUET SYSTEM



33138



33138 + 33139



### STANDARD ACCESSORIES

- No pinch single cuff 61x9 cm - red - arm L or thigh S
- No pinch single cuff 80x9 cm - blue - thigh - M
- No pinch single cone cuff 90x12 cm - blue - thigh - L
- No pinch double cuff 57x10 cm - blue - arm - M
- No pinch double cuff 80x15 cm - red - thigh - M
- Air hose
- Power cord
- LOP sensor
- User manual (GB, IT)

### TECHNICAL SPECIFICATIONS

- Max pressure: 800 mmHg
- Voltage: Ac 100-240 V - 50/60 Hz
- Power consumption: 50 W
- Time range: 5-180 min.
- Compressor dimension - weight: 170x210x260 mm - 3 kg

- 33138 DTS-3000 PNEUMATIC TOURNIQUET - 2 channels for 2 double cuffs or 2 single cuffs with 5 no pinch cuffs
- DTS-3000 provides stable operation, easy setup and effective alarm system for safe surgery in an operation room.

### System features

- 2 channels (4 ports for 2 double cuffs or single cuffs)
- easy settings by touch key operation
- graphic LCD screen: easy checking and cleaning
- operation recording (date, time, pressure)
- LOP (Limb Occlusion Pressure) sensor to check limb occlusion pressure and set automatically the optimized pressure
- self test of pressure and system check
- self air pressure sensor calibration
- safety alarm system (cuff, pressure, battery, time)
- built-in battery (max life time: 12-72 hours)

### Full autoclavable no pinch cuffs included

- no pinching, no damage to the skin
- lower pressure compared to normal cuff (about 50 mmHg lower)
- no leaking (main reason for lower pressure)

### • 33139 TROLLEY

Standard	No pinch	CUFFS for DTS-2000 and DTS-3000	Size	
			Arm	Thigh
-	33141	Single cuff 61x9 cm - red	L	S
-	33142	Single cuff 80x9 cm - blue		M
33160	-	Single cone cuff 70x10 cm		
33161	33144	Single cone cuff 90x12 cm - blue		L
-	33145	Double cuff 57x10 cm - blue	M	
-	33146	Double cuff 80x15 cm - red		M

No pinch arm



Standard arm



### INTENDED USE OF TOURNIQUET SYSTEM

- To be used by qualified medical professionals to temporarily occlude blood flow in patient's extremities during surgical procedures. Tourniquet has been found useful in producing bloodless operation field in surgical procedures involving the extremities including:
- reduction of certain fractures
  - Kirschner wire removal
  - tumor and cyst excision
  - subcutaneous fasciotomy
  - nerve injuries
  - bone grafts
  - total wrist joint replacements
  - replacement of joints in the fingers
  - knee joint replacements
  - amputations
  - replantations
  - tendon repair

## RIESTER INFUSION CUFFS

- 32684 RIESTER METPAK® INFUSION CUFF - 500 cc - latex free
  - 32685 RIESTER METPAK® INFUSION CUFF - 1,000 cc - latex free
  - 32683 RIESTER METPAK® INFUSION CUFF - 3,000 cc - latex free
- Pressure cuff for infusion with high quality chrome-plated gauge Ø 49 mm up to 300 mmHg. Made in Germany.



32684



Sturdy blue cotton cuff washable at 60°

## ECONOMIC INFUSION CUFF



32680

- 32680 INFUSION CUFF - 500 cc
- Infusion cuff similar to above. Latex bladder and bulb. Made in Asia.

## PNEUMATIC TOURNIQUET

- 33150 RIESTER PNEUMATIC TOURNIQUET with adult arm and thigh cuff - latex free bladder
  - 33151 CHILD CUFF 38x8 cm - latex free bladder
  - 33148 ADULT CUFF 57x9 cm - latex free bladder - spare
  - 33149 THIGH CUFF 96x13 cm - latex free bladder - spare
- Reliable pneumatic tourniquet used during amputations to restrict blood circulation in the limbs. A robust and accurate manometer provide exact measurements and a long service life.
- sturdy metal pump to produce pressure
  - air in the cuff can escape by opening the release valve
  - chromium-plated metal manometer with easy-to-read aluminium scale up to 700 mmHg. Supplied with 2 cuffs (upper arm 57x9 cm and thigh 96x13 cm) with latex-free bladders.



33150

# VOLUMETRIC INFUSION PUMP

## • 35200 INFUSION PUMP IP-7700

This pump using peristaltic method is a cutting-edge pump realizing high flow precision with compatibility with I.V. set of various brands through ultrasonic bubble detection. IP-7700 provides simple and easy setup process with its numerical silicon keypad. FND and color LCD provides complete information and user gets the information at one glance. Most infusion condition such as K.V.O. rate, purge rate and bolus can be setup as operating application. Supplied with battery.

### Main features

- **Light and compact design:** light as 3.5 kg, compact design, and easy to use.
- **Standard compatibility with 4 brands of IV SET:** TERUMO (TS PA 200L), BD (A122), KOREAN VACCINE (1 and 2), ARIES. Each pump can be calibrated for up to 9 different IV set.
- **Flexible flow setting and easy operation method:** Flow-setting range of 1~1000 ml/h, 0.1~999.9 ml/h is available for wide range settings and numerical keypad is easy to use for setting flow-volume.
- **Full program dosage feature (option):** it can calculate the right flow rate for a patient and inject promptly.
- **Easy recognition of alarm:** it notifies errors and emergencies with LED light and buzzer, simultaneous visual and audio alarm system.
- **Notifying remaining battery:** battery LED is attached to notify charged battery showing remaining battery and when to recharge.
- **Keep Vein Open feature:** when reached preset value, it converts to low flow speed of 3ml/h (when IV set is 15, 19, 20 drops/ml) or 1ml/h (when IV set is 60 drops/ml) automatically to prevent flow route clog due to blood coagulation.
- **Ultrasonic air bubble detector**
- **Suitable also for VET use**
- **35202 DROP SENSOR - for more accurate dropping control (suggested for ICU and new born)**
- **35211 DOSAGE AND PROFILE PROGRAM need Serial Number** • **35203 Ni-Cd BATTERY - spare**
- **26073 I.V. SET ARIES - box of 150 (6 bags of 25)** • **35204 ADAPTER 110 V - 60 Hz - for 35200**

**CALIBRATION TO ANY IV SET BRAND**  
Please send 5 samples of your pump use IV set.  
Delivery in 40 days

Colour LCD

IV clamp included

English and Italian manual

Automatic setup system (flow rate, time, delivery volume)

CE 0120

Numerical silicone key pads

### TECHNICAL SPECIFICATIONS

**Flow volume setting range**  
1~1000 ml/h (1 ml infusion interval)  
0.1~999.9 ml/h (0.1 ml infusion interval)  
**Flow volume error margin** ±5%  
**Infusion limit volume range**  
1~9999 ml  
**Total estimated volume range**  
1~9999 ml  
**K.V.O rate (Keep Vein Open)**  
1 ml/h ~ 10 ml/h adjustable  
**Pump method** Peristaltic method  
**Size (WxDxH)** 100x190x250 mm  
**Weight** 3.5 kg (battery included)

**Rapid flow volume (Purge)**  
1-1000 ml/h adjustable  
**Bolus** 1~1000 ml/h adjustable  
**Alarm features**  
Air in line, occlusion, flow error (free flow), door open, K.V.O. (Infusion completion), standby, low battery, alarm, device malfunction (CPU error), empty container (with optional drop sensor)  
**Special features**  
Keypad lock, retain memory, remaining time, alarm repeat, open system, K.V.O., purge, bolus, occ. level, history call-back.

**Power**  
AC 230V, 50/60Hz and DC9.6V inner source adapter DC 12 / 24V - 2A Switchable at 110V / 60Hz - with adapter 35204  
**Maximum power consumption** 40VA  
**Electric protection levels**  
Class II B, inner source device, CF type  
**Waterproof level** IPX2  
**Battery type** Ni-Mh rechargeable  
**Battery using time**  
4 hrs (when infusing 125 ml/h)  
**Battery recharging time** Minimum 6 hours.  
**Battery life** approx 6 months

# AUTO SYRINGE PUMP

## • 35205 SYRINGE PUMP SP-8800

SP-8800 provides easy syringe installing through one-touch method by slider hook, simple and easy setup process with its numerical silicon keypad. Color LCD displays infusion information dramatically shortcut key manages easy approach for frequent functions. K.V.O. rate, purge rate, bolus and anti bolus can be setup as operating application. Supplied with battery.

### Flexible flow volume setting.

**Full program dosage feature (optional):** it automatically calculates flow rate by patient's weight, injection's mass and melting.

**Keep Vein Open (K. V. O.) feature:** When reached to the preset value, it converts to low flow speed of 0.1 ml/h automatically to prevent flow route clog due to blood coagulation.

**Standard compatibility with 5 major brands of syringes\*:** Setting feature enables you to choose from following syringe brands: BD (Precise), TERUMO, RAYS, PENTAFERTE, KOVA. Each pump can be calibrated for up to 9 different syringes. Alarm and notification feature: It notifies errors and emergencies with LED light and buzzer. Simultaneous visual and audio alarm. Occlusion error range setting: You can set the pressure level of occlusion stage to High, Medium and Low by patient's age condition. Suitable also for VET use.

- **35210 Ni-MH BATTERY- spare** • **35204 ADAPTER 110 V - 60 Hz - for 35205**
- **35211 DOSAGE AND PROFILE PROGRAM need Serial Number**
- **23857 BD SYRINGES 50 ml LL - box of 60 - BD 300865**

**CALIBRATION TO ANY SYRINGE BRAND**  
Please send 5 samples of your syringe.  
Delivery in 60 days

IV clamp included

Colour display

CE 0120

English and Italian manual

Automatic set-up system (flow rate, time, delivery volume)

Easy and quick installation of syringe, just in five seconds

### TECHNICAL SPECIFICATIONS

**Flow volume setting range**  
Syringe 10ml: 0.1-300 ml/h  
Syringe 20ml: 0.1-400 ml/h  
Syringe 30ml: 0.1-500 ml/h  
Syringe 50ml: 0.1-1,200 ml/h  
**Flow volume error margin** ±3%  
**Infusion limit volume range**  
0.1~999.9ml (0.1 ml infusion interval)  
**Total estimated volume range**  
0.1~999.9ml (0.1ml infusion interval)  
**K.V.O rate (Vein maintaing function)**  
1-10 ml/h adjustable  
**Size (WxDxH)** 220x130x108 mm  
**Weight** 2 kg (battery included)

**Rapid flow volume (Purge)**  
0.1~1200 ml/h adjustable  
**Bolus:** adjustable 0.1~1200 ml/h  
0.1~1000 ml  
**Alarm features**  
Occlusion, K.V.O. (infusion completion), standby, near empty, low battery, device malfunction (CPU error), clamp/handle lever/slider disengaged, syringe disengaged.  
**Special features**  
Keypad lock, shortcut key, retain memory, remaining time, alarm repeat, open system, K.V.O., purge, bolus, anti bolus, occ. level, history call-back.

**Power**  
AC 230V, 50/60Hz and DC9.6V inner source adapter DC 12 / 24V - 2A Switchable at 110V / 60Hz - with adapter 35204  
**Maximum power consumption** 45VA  
**Electric protection levels**  
Class II B, inner source device, CF type  
**Waterproof level** IPX2  
**Battery type** Ni-MH rechargeable  
**Battery using time** 2 hours  
**Battery recharging time** Minimum 6 hrs.  
**Battery life** about 6 months.



\* We can calibrate our pumps for other syringe brands, please provide minimum 5 samples. Availability in 60 days.



## PLASTER COVER FOOTWEAR

GIMA code	PLASTER COVER EU SIZE
28630	N 36
28631	N 37
28632	N 38
28633	N 39
28634	N 40
28635	N 41
28636	N 42
28637	N 43
28638	N 44
28639	N 45
28640	N 46
28641	N 47/48



Upper made of biocompatible synthetic materials mold resistant and breathable

Non-slip rubber sole

Cover plaster footwear to be worn over plaster or similar rigid bandage.

It can be worn immediately after application of the plaster because breathable.

The sizes are the same as for standard shoes, with appropriately increased fit.

The shape is symmetrical, then the same cover can be used indifferently on the right or left foot. Washable at 30°.

## ORTHOPEDIC SUPPORTS

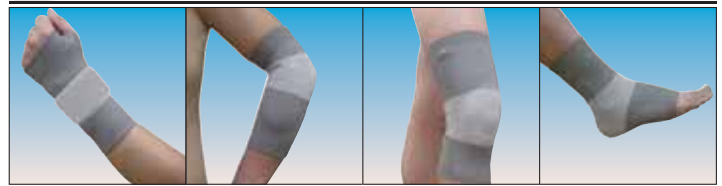

Wrist support    Elbow support    Knee support    Ankle support

Elastic knitting supports to fit body contour. Gel pad inside to release pressure for nerves, muscle, joints and improve stabilization. Hand washable.

Size	WRIST		ELBOW	KNEE	ANKLE	
	Left	Right			Left	Right
S	28731	28741	28751	28761	28771	28781
circumference	15-16 cm		21-23 cm	28-31 cm	19-21 cm	
M	28732	28742	28752	28762	28772	28782
circumference	16-17 cm		23-25 cm	31-34 cm	21-23 cm	
L	28733	28743	28753	28763	28773	28783
circumference	17-18 cm		25-27 cm	34-37 cm	23-25 cm	
XL	28734	28744	28754	28764	28774	28784
circumference	18-19 cm		27-29 cm	37-40 cm	25-27 cm	

## ARM SLINGS



Suitable for supporting a sprained or broken arm during recuperation. The shoulder strap is adjustable to allow a correct positioning of the arm. Stitched from cotton fabric requiring normal laundry care. Fits any arm. Available in 3 sizes.

GIMA code	POUCH ARM SLINGS
28624	Arm sling - small
28625	Arm sling - medium
28626	Arm sling - large

## UNIVERSAL ARM SLINGS



• 28623 UNIVERSAL ARM SLING  
Universal arm sling with adjustable strap and loop contact closure. Fits left and right. Made in comfortable polypropylene material in navy colour. Machine washable.

## SOFT AND RIGID COLLARS

### SOFT CERVICAL COLLARS

This collar is made of soft expanded polyurethane lined with an anti - allergic 100% cotton fabric. Velcro fixing on the back. Available in 3 sizes.

### RIGID CERVICAL COLLARS

Made of polyethylene, with comfortable resting support in vinyl leather and height adjustable. Velcro straps on the back. Available in 3 sizes.

Soft

Rigid



## UNIVERSAL COLLARS



### UNIVERSAL CERVICAL COLLARS

Collars made of foam coated PVC.

Washable, non toxic, with velcro straps.

X-Ray translucent.

Available in 3 sizes or in a set of 3 in a bag.

GIMA code	SOFT AND RIGID NECK COLLARS X-Ray Translucent	CE
34600	Rigid cervical collar 32-40 cm (neck circumference)	
34601	Rigid cervical collar 41-46 cm (neck circumference)	
34602	Rigid cervical collar 47-52 cm (neck circumference)	
34610	Soft cervical collar 43x8 cm - small (h 7 cm)	
34612	Soft cervical collar 46x8 cm - medium (h 8.5 cm)	
34614	Soft cervical collar 49x10 cm - large (h 10.5 cm)	

GIMA code	NECK COLLARS	A	B	C
34050	Set of 3 collars in a bag			
34051	Cervical collar - small	513 mm	87 mm	112 mm
34052	Cervical collar - medium	560 mm	95 mm	123 mm
34053	Cervical collar - large	623 mm	101 mm	132 mm
34054	Bag for 3 collars - blue			

## AMBU® REDI-ACE™



Ambu® REDI-ACE™ Mini is adjustable in 6 sizes

34638



Ambu® REDI-ACE™ Adult is adjustable in 8 sizes

34639

### AMBU® REDI-ACE™ COLLARS

Unique adjustable disposable collar available in 2 versions adult and pediatric for immobilizing of cervical column. With 8 sizes of Ambu® REDI-ACE™ and 6 sizes of Ambu® REDI-ACE™ Mini the majority of patients can be treated. Easy to use, it has an automatic flip up chin and two locking buttons. It can be placed on the patient using only 3 steps; sizing - locking - placement. Made from radiotranslucent material. Packaged completely flat. Latex free.

GIMA code	ADJUSTABLE NECK COLLARS
34638	Ambu® REDI-ACE™ paed.-yellow
34639	Ambu® REDI-ACE™ adult-blue

## AMBU® PERFIT™



Ambu® Mini Perfit™ ACE® is adjustable in 12 sizes

34640



Ambu® Perfit™ ACE® is adjustable in 16 settings from neckless (size 3) to tall (size 6)

34641

### AMBU® PERFIT™ ACE® COLLARS

The Ambu® Perfit™ ACE® extrication collar is a one-piece rigid cervical spine immobilization device, available in 2 versions, adult and pediatric, both adjustable in different sizes/positions. Adult has 16 adjustments, covering neckless, short, regular and tall. Paediatric has 12 adjustments, covering infant, child, small adult. Radiotranslucent CT and MRI compatible it comes with a ventilated, posterior shell for fluid drainage. Made in polyethylene. Flat storage. Latex free.

GIMA code	ADJUSTABLE NECK COLLARS
34640	Ambu® Perfit™ paediatric-yellow
34641	Ambu® Perfit™ adult-white

## PERFIT™ MILITARY

Designed to assist with the maintenance of neutral alignment, prevention of lateral sway and anterior-posterior flexion and extension of the cervical spine during transport.



Ambu® Perfit™ ACE® Militar extrication collar is adjustable in 16 settings

34642

Flat storage



### AMBU® PERFIT™ ACE® MILITARY

Ambu® Perfit™ ACE® is also available in a military version that incorporates a camouflage colour scheme of olive drab body and charcoal black foam and label. The features and specifications are identical to Ambu® Perfit™ ACE®:

- 16 sizes in one collar
- flat storage
- radiotranslucent CT and MRI compatible
- Latex free.

GIMA code	ADJUSTABLE NECK COLLARS
34642	Ambu® Perfit™ Military

## FIRST AID CERVICAL COLLARS



34622



### ONE PIECE AND TWO PIECES FIRST AID COLLAR

Made in polyethylene with washable internal part made in EVA (kind of rubber) fixed to structure by plastic rivets. With a tracheal hole, removable chin support and velcro fastener. X-ray translucent. Available in 6 sizes differentiated by safety closure colour or in a set of 6 in a bag.

GIMA code	ONE PIECE FIRST AID NECK COLLARS
34620	Infant 44-48 cm - pink
34621	Pediatric 45-48 cm - light blue
34622	Stout (bull-neck) 56-60 cm - yellow
34623	Adult small 56-62 cm - blue
34624	Adult medium 56-64 cm - orange
34625	Adult large - tall 56-66 cm - green
34626	Set of 6 collars in a bag
34627	Bag for 6 collars - green

GIMA code	TWO PIECES FIRST AID NECK COLLARS
34630	Infant 2-6 years 35-99 cm - pink
34631	Pediatric 6-12 years 40- 46 cm - light blue
34632	Stout (bull neck) 48-52 cm - yellow
34633	Adult small 50-54 cm- blue
34634	Adult medium 54-58 cm - orange
34635	Adult large - tall 56-60 cm - green
34636	Set of 6 collars in a bag
34627	Bag for 6 collars - green

## AIR CUSHION SPLINTS



• **34106 FIRST AID AIR CUSHION SPLINTS - set of 4 pieces**  
 Indispensable instrument for first aid in case of accidents, cutting and crushing injuries. Prevent surface bleeding without stopping the circulation and secure painless transportation of the injured part. The bandage is a transparent cover of PVC easy to clean and reusable, resistant against water and shifting weather conditions. X-rays can penetrate and medical diagnosis can be made without removing the bandage. The long tube (14.5 cm) with the valve make the inflation of the bandage easy, even by the injured part himself.

**Set of 4 different pieces:** full leg, foot/ankle, full arm, hand/wrist splints in a 4 compartment bag, with inflating pump.

**ALUMINIUM SPLINTS soft lining**  
 With curved edges to avoid harming yourselves. Aluminium thickness 1.2 mm. Made in Italy.

- 34120 SPLINTS - size 13x500 mm
- 34121 SPLINTS - size 19x500 mm
- 34122 SPLINTS - size 24x500 mm



## BOSTON SPLINTS



### • 34123 BOSTON SPLINTS

Adaptable light-weight splints, x-ray translucent, coated with a non-toxic material which can be easily washed and disinfected. Size cm 92x11. Made in Italy.

## FINGER SPLINTS

**FINGER** Set of 8 finger splints in different size (from 5 to 6.5 cm length, from 4.5 to 7.8 cm width circumference). Available in clear and skin tone colours. Made in polypropylene. With holes for air circulation and cooling.

- 34113 FINGER SPLINT KIT - clear - kit of 8
- 34115 FINGER SPLINT KIT - skin - kit of 8

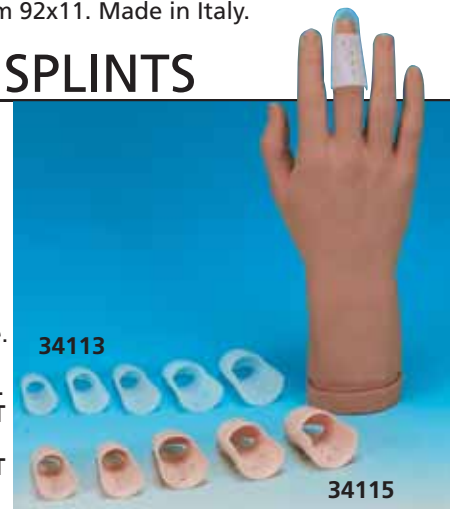

## GIMASPLINTS IN 5 SIZES: LEG, ARM, FOREARM, WRIST AND ELBOW



**GIMASPLINTS** these supports immobilize your limbs in an efficient and practical way. Each splint can be shaped to fit the patient's personal need. It ensures a high degree of rigid support: thanks to inner part made of neoprene lined with 100% laminated, absorbent-proof nylon assembled to a rigid metal splint. A velcro band allows a quick fixing. Available in 5 sizes or in a bag set of 5 pieces.

GIMA code	GIMASPLINTS
34680	Splint for leg - 57 cm
34681	Splint for arm - 60 cm
34682	Splint for forearm - 39 cm
34683	Splint for wrist - 33 cm
34684	Splint for elbow/ankle - 54 cm
34685	Set of 5 splints in a blue bag
34054	Bag for 5 splints - blue



## VACUUM SPLINT KIT

### • 34689 VACUUM SPLINT KIT

The set includes vacuum splints for arm (70x50 cm), leg (100x70 cm) forearm (50x30 cm) and a nylon bag. Produced with high quality materials these splints allow perfect immobilization of the lower and upper limbs by removing the air inside.

Equipped with an outside valve, to avoid troubles to the patient, and three velcro straps.

Made in vinyl covered nylon, x-ray translucent.

- 34093 ALUMINIUM PUMP - for vacuum splints and mattress
- 34084 ALUMINIUM MINI PUMP



## VACUUM MATTRESS

### • 34089 MAT PLUS VACUUM MATTRESS

PVC, X-ray translucent mattress provided with 4 immobilization straps and 12 transport holes. Suitable for any kind of emergency situation. Size: 210x90 cm. Weight: 11.2 kg. Loading capacity: 150 kg. Supplied with nylon bag size 86x43x17 cm, pump not included.



34089



Nylon carrying bag included with all vacuum mattresses



34093

### • 34093 ALUMINIUM PUMP for vacuum mattress

Capacity: 0.75 l  
Supplied with hose and fitting. Rotating handle.

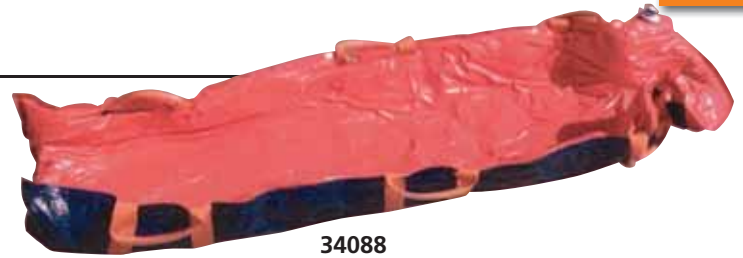

34088

### • 34088 MAT VACUUM MATTRESS

PVC, X-ray translucent mattress with 6 transport handles, perfectly fits the patient body. Sturdy material and careful manufacture make it suitable for Civil Defence, Fire Brigades, Industry and First-aid on the mountains. Size: 200x75 cm. Weight: 8.8 kg. Loading capacity: 150 kg. Supplied with nylon bag size 70x43x15 cm, pump not included.



34091

### • 34091 MAT ORANGE VACUUM MATTRESS

X-ray translucent, comfortable vacuum mattress with 8 transport handles and 4 immobilization straps. Size: 210x90 cm. Weight: 9 kg. Loading capacity: 150 kg. Supplied with nylon bag size 86x43x15 cm, pump not included.

## SEMIRIGID SPLINT KIT

### • 34119 SEMIRIGID SPLINT KIT

Kit of 3 splints (arm, wrist, leg) in nylon carrying bag. All splints are made of polyester + PVC, with lightweight stays providing high strength support. Adjustable velcro for easy use.



34119

## EXTRICATION KITS



34028

34027

Provide horizontal flexibility and vertical rigidity support

• 34027 SPINAL IMMOBILIZER TYPE A  
• 34028 SPINAL IMMOBILIZER TYPE B  
GIMA presents 2 different shape of spinal immobilizers, both are ideal for the immobilization and setting free of patients from emergency situations. They allow to fix vertically and horizontally the head and spine of the patient to limit any injuries caused by wrong transport. Supplied with different colour buckles and belt for easy use, padded cushion velcro straps and waterproof bag.

## BODY BAGS

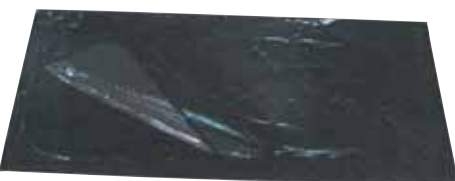

### • 34116 BODY BAG - PVC

Made of PVC (Inner transparent PVC, over black), provided with two long slide fasteners. Colour: black. Size: 210x90 cm. Loading capacity: 150 kg.



### • 34117 BODY BAG - vinyl - blue

Made of vinyl covered nylon conform to standard EN 1865. Provided with a long slide fastener. Size: 210x90 cm. Loading capacity: 150 kg.

## CARRYING COT

Multilanguage manual:  
GB, FR, IT, ES,  
PT, DE

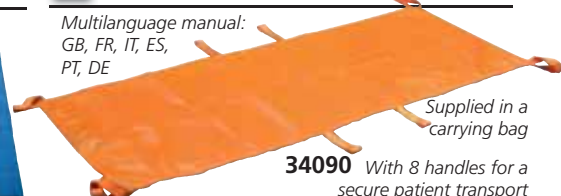

Supplied in a carrying bag

34090 With 8 handles for a secure patient transport

### • 34090 CARRYING COT

Made in polyester, PVC coated. Anti-putridity, bacterial and fungus proof, waterproof, easy to wash and disinfect, X-ray translucent material. Size 185x57 cm. Loading capacity: 150 kg. Certified EN1865-2010 + A1 2015

# GIMA STRETCHERS AND SPINAL BOARDS



• **34101 GIMA STRETCHER 2 - foldable in 2**  
Emergency stretcher is sturdy, but lightweight in construction, with aluminium frame and three solid iron cross-bars for heavy use. Reinforced nylon canvas, fluid repellent and non-tear.



34101

Supplied with carrying bag

• **34107 GIMA STRETCHER 4 - foldable in 4**  
Made of strong alloy and water-tight material. Light weight, easy to carry, foldable in 4. Length foldable in 2 parts, width foldable in 2 parts.



34107

• **34105 STACKABLE STRETCHER**  
Used in small rooms where it is necessary to store a large number of stretchers. PVC does not absorb blood or body fluids. Strong lightweight aluminium construction with vinyl coated polyester



34105

• **34076 BLUE STRETCHER - foldable in 2**  
Light-weight, small sized, easy to carry. High-strength aluminium poles and vinyl coated waterproof nylon canvas.



34076

• **34077 WHEEL STRETCHER - foldable in 2**  
Wheels, outriggers and adjustable backrest. High strength aluminium poles and vinyl coated, waterproof nylon canvas. Light weight, small sized, easy to carry.



34077



34077

• **34083 SPINAL BOARD**  
X-ray translucent, washable, buoyant and impervious to all fluids. Made in linear high density polyethylene with plastic pins. Compatible with all head-immobilization devices and strapping system. CT and MRI transparent. Colour orange.

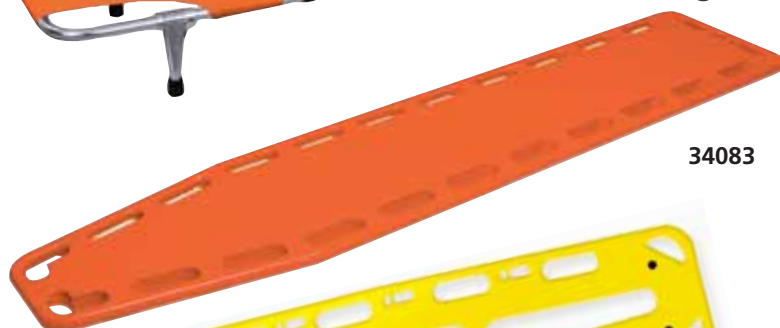

34083

• **34022 B-BAK PIN SPINAL BOARD - yellow**  
PE spinal board with Pin with robust and light structure to ensure high resistance. The 14 handles and their shape offer an easy grip, the low thickness make the application easier. Equipped with 8 plastic pins to allow easy fixing of belts with snap hook.



34022

• **34097 SPINAL BOARD WITH SAFETY GLASS FIBRE PINS - orange**  
Strong and lightweight high density PE spinal board, with two fibre reinforced plastic stays. Provided with glass fibre pins for better fixation of immobilisation belts. Excellent in water rescues. X-ray translucent, except 2 plastic stays.



Glass fibre pins

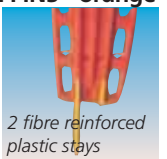

2 fibre reinforced plastic stays

• **34023 BABY GO PEDIATRIC SPINAL BOARD**  
Baby go is a professional board, designed for children, which maintains the spine in neutral position with the ideal alignment for air flow. Board has four different profiles which guarantee the correct position of the child according to his body size.



34097+  
3x34011

• **34024 PEDIATRIC HEAD IMMOBILIZER**  
Ensure optimal immobilization of the head of children perfectly fitting their pronounced occipital prominence.

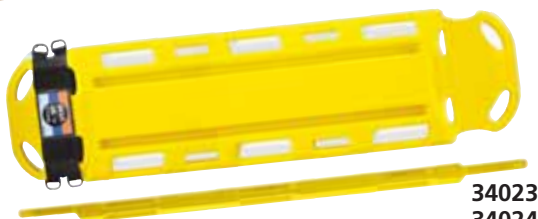

34023+  
34024

• **34025 PEDIATRIC SPIDER STRAP SYSTEM**



34025

The central tape can be used as a tape measure

TECHNICAL SPECIFICATIONS	34101 GIMA 2	34107 GIMA 4	34105 STACKABLE	34076 BLUE	34077 WHEEL	34083 SPINAL	34022 SPINAL WITH PINS	34097 SPINAL WITH PINS	34023 PAED SPINAL
Open size cm:	203x50x14	221x53x16	188x48x18	188x45x7	188x53x21	184x44.5x6.5	184x40.5x4.5	183x46x5	119.5x32x4.5
Folded size cm:	96x50x17	104x19x12	-	94x48x10	92x53x12	-	-	-	-
Weight:	6 kg	5 kg	6 kg	4 kg	8 kg	7.6 kg	6 kg	7 kg	2.2 kg
Load:	120 kg	150 kg	170 kg	150 kg	150 kg	150 kg	180 kg	200 kg	30 kg

## SCOOPIING STRETCHER

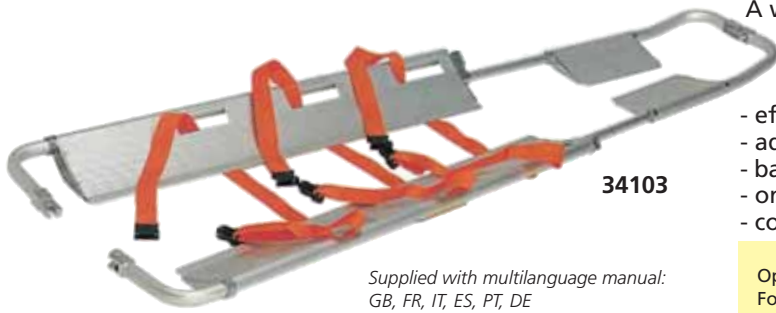

34103

Supplied with multilanguage manual:  
GB, FR, IT, ES, PT, DE

### • 34103 SCOOPIING STRETCHER

- A wonderfully practical scooping stretcher allows to put the stretcher under the patient without moving him/her much. The shape of the stretcher has been designed to immobilize the patient properly during transport.
- effective hooking and unhooking device for stretcher uncoupling
  - adjustable stretcher length with automatic locking device
  - bag with 3 quick unhooking safety belts for patient immobilization
  - once folded can be easily stored inside the ambulance
  - completely built in light and sturdy aluminium

#### TECHNICAL SPECIFICATIONS

Open size cm:	min 171x43	max 212x43
Folded size cm:	120x43	
Weight:	8 kg	
Load:	150 kg	

## HEAD IMMOBILIZERS

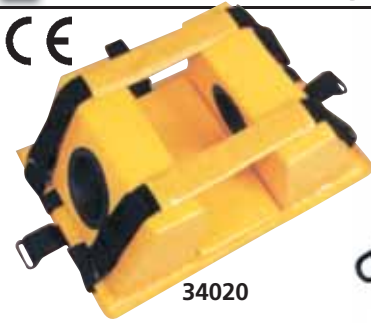

34020



34021



34078

34080

**HEAD IMMOBILIZERS**  
GIMA introduces four models of head immobilizers, different in shape, material and colour. All are composed of two head blocks and two straps to prevent any head movement of the injured person during transport. We can offer "STOP" head immobilizer in yellow, blue, red, green, military green for minimum 50 pieces.



34021



34079

Radiolucent material,  
suitable for x-ray chamber

GIMA code	Type	Colour	Material
34020	FERMO-1	yellow	PE foam covered with PVC
34021	FERMO-2	red	NBR foam dipped with PVC
34080	STOP	orange	High density foam+water repellent coating
34078	STOP	black	High density foam+water repellent coating
34079	CONTOUR	yellow	Moulded polyurethane and PVC

## IMMOBILISATION BELTS FOR STRETCHERS AND SPINAL BOARDS



34010



34011

Adjustable belt



34014

Set of 3 adjustable belts with pouch



34015

Set of 3 belts with pouch



34012



34013

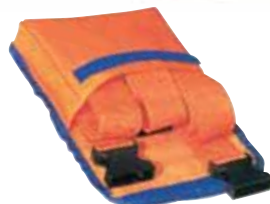

34081



34082

Designed to provide full body immobilization  
183x46x5 cm

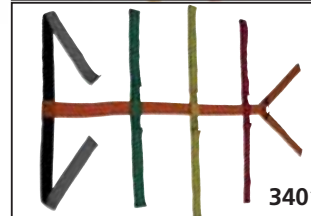

34018

Spider strap adjustable in different sizes for child and adult  
203x51x5 cm

GIMA code	Type	Colour	Size cm	Max load kg	Buckle style	To be used with
34010	Belt-A	red	5x213	60	plastic snap-lock	stretchers + boards
34011	Belt-B - adjust.	black	5x213	60	2 swivel speed clip + plastic snap-lock	spinal boards with pin
34012	Belt-C	red	5x213	200	automatic quick release (unique belt)	stretchers + boards
34013	Belt-D	black	5x213	200	automatic quick release (belt in 2 pcs.)	stretchers + boards
34014	Set 3 belt-B	orange	5x274	60	2 swivel speed clip + plastic snap-lock	spinal boards
34015	Set 3 belt-D	yellow	5x213	200	2 swivel speed clip (belt in 2 pcs.)	stretchers + boards
34081	Set 3 Belts	orange	-	-	quick release plastic hook	stretchers + boards
34082	Ragno/Spider	mix	5x46x183	-	velcro strapping system	spinal boards
34018	Adjustable spider	mix	5x51x203	-	velcro strapping system - adjustable	spinal boards
32794	Nylon bag	red	-	-	-	contains up to 3 belts

## AUTOMATIC LOADING STRETCHER



FDA 3005348775  
 CE  
 SGE

34055

### • 34055 AUTOMATIC LOADING STRETCHER

Automatic stretcher to load and unload patients from emergency vehicles, can be moved by only one person. Specially designed with roll-in system to easily load and unload patients from emergency vehicle without lifting them. Legs fold under cot automatically as stretcher is rolled into the vehicle. Lock-in operating position as cot is removed from vehicle, left-hand and right-hand control levers unlock front and back legs respectively so as to be folded when cot is loaded. Polyethylene covered legs allow cot to roll smoothly in and out of vehicle. Mattress, belts, side rails, IV stand and fixing devices are included.

#### TECHNICAL SPECIFICATIONS

Maximum size (LxWxH):	193x60x88 cm
Minimum size (LxWxH):	193x60x21 cm
Packing size:	195x61x26 cm
Weight:	40 kg
Load:	159 kg



## MULTIPOSITION STRETCHER



FDA 3005348775  
 CE  
 SGE

34056

### • 34056 MULTIPOSITION AUTO STRETCHER

Multifunctional automatic stretcher for ambulance with easily adjustable positioning system, for any emergency situation. The stretcher can bend through 6 different grades, forwards or backwards. The back of the stretcher is fixed by pneumatic springs moving in the range of 0 to 60 degrees, also equipped by front and back fixed supports. It can be locked into place inside ambulance at proper position. Mattress, belts, side rails, I.V. stand and fixing devices are included.



#### TECHNICAL SPECIFICATIONS

Maximum size (LxWxH):	198x53x93 cm
Minimum size (LxWxH):	198x53x34 cm
Packing size:	200x60x35 cm
Load:	159 kg
Net weight, Gross weight:	35 kg, 40 kg
Maximum angle of leaning forwards:	11 degrees
Maximum angle of leaning backwards:	25 degrees
The height scope of touching down (6 grades):	98 cm - 94 cm - 87 cm 77 cm - 60 cm - 34 cm

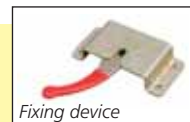

## AUTOMATIC MULTIPosition STRETCHER



FDA 3005348775  
 CE  
 SGE

34072

### • 34072 FULL AUTOMATIC MULTIPosition STRETCHER

Full automatic multiposition stretcher. Easily adjustable to 6 levels for any emergency situation. Back wards and forwards reclining, back and foot rest adjustable to different positions. Can be loaded into ambulance by one operator only and locked at desired position. Structure in high-strength aluminium alloy. Soft foam surface mattress, covered by special seamless welded PVC. Protective block side rust proof and easy to clean. Mattress, belt, side rails, IV stand and fixing device are included.

#### TECHNICAL SPECIFICATIONS

Maximum size (LxWxH):	198x54x93 cm
Minimum size (LxWxH):	198x54x30 cm
Packing size:	218x67x35 cm
Load:	159 kg
Net weight, Gross weight:	39 kg, 45 kg



## WHEELCHAIR STRETCHER



FDA 3005348775  
 CE  
 SGE

34070

### • 34070 WHEELCHAIR STRETCHER

Wheelchair stretcher with varied positions. Lightweight emergency cot quickly convert to any of four chair positions for maneuvering in narrow hallways, elevators and other confined spaces. Stretcher is made in high quality aluminium alloy. Soft foam mattress and protective block side, rust proof and easy to clean. Mattress, belts, side rails, IV stand and fixing device are included.

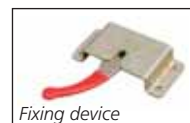

#### TECHNICAL SPECIFICATIONS

Size (LxWxH):	190x57x85 cm
Packing size:	198x60x25 cm
Load:	159 kg
Net weight, Gross weight:	32 kg, 40 kg



## BASKET STRETCHER

- 34094 TWIN SHELL BASKET STRETCHER - orange
- 34098 BASKET STRETCHER - orange

Robust, resistant and flexible, it is ideal for a wide range of rescue operations in mines, at altitude and in water. A revolutionary production technique ensures uniform thickness of the entire length of the stretcher. The shell is in high-density polyethylene and is joined to an aluminium framework for better strength. The handles for transport, integrated in the structure, are placed along the entire perimeter. The grommets for the fixing of the spring catches of the harnessing are in stainless steel. Inside the shell there is a removable mattress, applied with Velcro®, made in closed-cell EPDM, which makes it impermeable to both blood and water. High density polyethylene guarantees shatterproofness and sanitization. It can contain a spine board. Comes with nylon rope along entire perimeter, three 50 mm nylon belts with quick-release buckles, water resistant and closed-cell mattress, footrest in pre-formed polyethylene with position regulator.

### Twin shell basket stretcher

It can be transversally divided in half to improve the storage and transport. To ensure a perfect hold between the two shells, have been inserted four nylon cones and a security system protected by a protuberance placed in the mould itself.

### 34099 LIFTING BRIDLES

Adjustable, can be used for horizontal and vertical patient lifting. Manufactured in durable woven nylon with sound steel attachment hardware and brass locking mechanism.

### 34100 FLOTATION SYSTEM

### 34096 CARRYING BAG for 34094

TECHNICAL SPECIFICATIONS		
	34098	34094
Size (LxWxH):	215x65x19 cm	118/215x64x19 cm
Load capacity:	280 kg	280 kg
Weight:	13.5 kg	17 kg

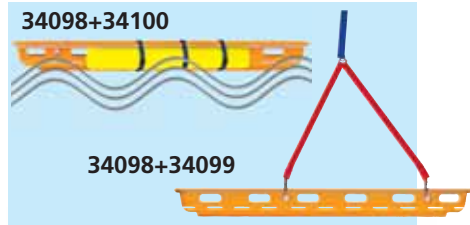

## WHEELCHAIR STRETCHERS

- 34060 WHEELCHAIR STRETCHER - 2 wheels
- 34074 WHEELCHAIR STRETCHER - 4 wheels

Specially designed for confined areas such as narrow hallways or multiple landing stairways; anywhere access is seriously limited. Made in light aluminium with waterproof orange sheet. Two rear stationary wheels Ø 12 cm (34060) or 4 wheels, 2 with brake (34074) two back handles and four front handles, 2 adjustable 30 cm, facilitate transport on most floor types. 2 quick lock safety belts immobilize patient during transport. Locking safety latch maintains chair position during use.

TECHNICAL SPECIFICATIONS		
Folded size:	91x52x19.5 cm	Open size: 91x52x71 cm
Wheelchair size:	- back height: 91 cm - width: 52 cm	- seat height: 48 cm - width: 52 cm
Loading:	150 kg	Weight: 8.5 kg

Foldable down handle

Foldable up handle



34060

Adjustable handle (+30 cm)



34074

## FOLDING STAIR CHAIR AND EVACUATION CHAIR

- 34058 EVACUATION CHAIR - orange/chrome
- 34059 FOLDING CHAIR - black/yellow (orange/chrome on request)
- 34061 SKID EVACUATION CHAIR - with braking slide

Designed and built for emergency patient removal from confined spaces. Folded it can be stored in most ambulances. Manufactured from chromed steel with brakes on the front wheels.

Seat cover made of vinyl coated nylon, easily washable. Folds in one movement, equipped with two quick-release patient restraints.

- 34059 FOLDING CHAIR - black/yellow (orange/chrome on request)

A cost effective choice for moving patients through difficult situations. Four non-slip grip handles make lifting the patient safer and easier. Two large rear wheels provide easy manoeuvring. Tough, black, vinyl coated seat cover easy to clean, resists stain and provides bacteriostatic protection. Supplied with a set of 3 plastic buckle belts. Made in Italy

- 34061 SKID EVACUATION CHAIR - with braking slide

Skid-OK a new ultra compact evacuation chair with innovative aluminium frame and tubular trellis swing fork.

New concept materials and components make the chair lightweight and easy to manoeuvre to offer top performance in any scenario. Reclining armrests to increase patient comfort. The innovative self braking slide system offers the operator total control during the stair descent. Manufactured in welded aluminium with polished finish. Adjustable seat strengthened with Spentex®. Skid-OK is supplied with 2x50 mm polypropylene belts. Made in Italy.

TECHNICAL SPECIFICATIONS			
	34059	34058	34061
	FOLDING	EVACUATION	SKID
Height (open/closed):	92 cm	98/78 cm	154/104 cm
Width:	48 cm	41 cm	52 cm
Depth with retracted handles:	59 cm	-	-
Depth with extended handles:	125 cm	open 80 cm	-
Depth when folded handles:	19 cm	closed 31 cm	-
Weight:	10 kg	12 kg	11 kg
Load:	165 kg	116 kg	150 kg

CE



34059

Pivoting front wheels



34058

Height open/closed 154/104 cm



34059



## SMART OXYGEN CONCENTRATOR

- **34598 SMART OXYGEN CONCENTRATOR 5 l**  
Medical grade, ultra quiet, small oxygen concentrator for home use. Provide high concentration of oxygen through nasal cannula. Work continuously.
- **34599 PAPER FILTER - box of 10**
- **34608 HUMIDIFIER BOTTLE**
- **34167 OXYGEN MASK with tube - pediatric**
- **34166 OXYGEN MASK with tube - adult**
- **34172 OXY GLASSES - nasal cannulas**

TECHNICAL SPECIFICATIONS	
Flow range:	0.5 ~ 5 l/min
Oxygen concentration:	95.5-87 %
Output pressure:	40 ~ 70 kPa
Input power:	400 W
Operation noise level:	≤ 48 dB (front) - ≤52 dB (whole unit)
Size - weight:	39x24xh 50 cm - 16 kg
Operating voltage:	230 V - 50 Hz (110 V - 60 Hz on request)

Supplied with filter and nebulizer set

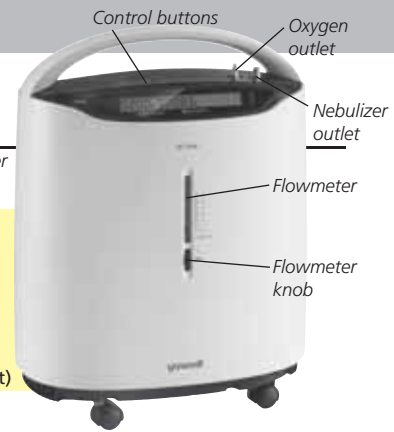

## OXYGEN CONCENTRATORS 3 AND 5 LITRES

- **34604 OXYGEN CONCENTRATOR 3 l**
- **34605 OXYGEN CONCENTRATOR 5 l - with nebulizing function**  
Bionic and streamlined fashion design, which won the national outlook top award-Red Star Award. Low noise achieved by using advanced round airway and multi-level noise decreasing design. Large LCD screen for clearer figures. Cumulative time metering and timing off function. Fault self-detection system.

- Four alarm functions:
- power failure alarm
  - low oxygen concentration alarm
  - pressure cycle failure alarm
  - compressor failure alarm

### Nebulizing function (only 34605)

Oxygen concentrator (with nebulizer function) uses the combination of oxygen uptake and atomization function to offer clean and safe air. It assists in atomized treatment while maintaining the same oxygen concentration.

- **34607 PAPER FILTER - box of 10 (5 internal + 5 external)**
- **34608 HUMIDIFIER BOTTLE**
- **34172 OXY GLASSES - nasal cannulas**
- **34166 OXYGEN MASK with tube - adult**
- **34167 OXYGEN MASK with tube - pediatric**

CE 0123

**yuwell**  
Top manufacturer  
over 200,000 pcs/years



Supplied with filter, nasal oxygen cannula, nebulizer set (34605 only) and manual (GB, IT)

TECHNICAL SPECIFICATIONS		34604	34605
Flow range:		0.5 ~ 3 l/min	0.5 ~ 5 l/min
Oxygen concentration:		93% ± 3%	95.5% ~ 87%
Output pressure:		20 ~ 50 kPa	40 ~ 70 kPa
Operation noise level:		≤ 50 dB (A)	≤ 53 dB (A)
Input power:		320VA	400VA
Net/gross weight:		25/27 kg	
Packing size:		62x37xh 71 cm	
Operating voltage:		230 V - 50 Hz (on request 110 V - 60 Hz)	

## OXYGEN CONCENTRATOR 3 AND 5 L DELUXE

- **34616 OXYGEN CONCENTRATOR 3 l DELUXE**
- **34617 OXYGEN CONCENTRATOR 5 l DELUXE**  
Top of the range oxygen concentrator with innovative design and superior features:
- backlit LCD screen with adjustable brightness
- built-in oximeter for monitoring SpO<sub>2</sub> in real time
- oil free pump: the heart of concentrator adopt compressor with German technology for 30,000 hours service life and 5 years warranty
- high intake position, cleaner air
- remote control function
- 4 alarm system (low oxygen concentrator alarm, power outage alarm, pressure cycle failure alarm, compressor failure alarm), self detection of fault
- 4 safety protections
- **34618 PAPER FILTER - box of 10**
- **34619 HUMIDIFIER BOTTLE**
- **34166 OXYGEN MASK with tube - adult**
- **34167 OXYGEN MASK with tube - pediatric**
- **34172 OXY GLASSES - nasal cannulas**

Manual: GB, IT.

**yuwell**

Backlit LCD screen with adjustable light

CE 0123

Nebulizer function

Built-in oximeter for real time detection

Supplied with filter, nasal oxygen cannula, nebulizer set, remote control and manual (GB, IT)

Remote control

Compact and lightweight only 17.5 kg



TECHNICAL SPECIFICATIONS		34616	34617
Flow range:		0.5 ~ 3 l/min	1 ~ 5 l/min
Oxygen concentration:		93% ± 3 %	87-95.5 %
Operation noise level:		≤ 46 dB(A)	≤ 49.5-52 dB(A)
Output pressure:		20 ~ 50 kPa	40 ~ 70 kPa
Input power:		320VA	400VA
Size - Packing size:		50x21xh 64 cm - 56x32xh 71.5 cm	
Operating voltage:		230 V - 50 Hz (110 V - 60 Hz on request)	



# OXYGEN CYLINDERS: 0.5, 2, 3, 5 AND 7 LITRES



**CYLINDERS FOR OXYGEN THERAPY (empty)**  
Steel cylinders for therapeutic oxygen at 200 bar pressure, with valve and safety lock. These cylinders are ideal for home and hospital therapeutic use, particularly in case of desultory oxygen supply. Supplied in a sturdy plastic bag (5 and 7 l) or soft bag (2 and 3 l) with cover. Oxygen cylinders are provided with a pressure reducer with two-stage release valve (0-15 l/min) and high pressure manometer to indicate oxygen quantity in the cylinder (Code 34510/34511) and face mask (excluding 34500/34520).

GIMA code		OXYGEN CYLINDERS WITH INTEGRATED PRESSURE REDUCER				
UNI	NF	Litres	Flow	Size	Weight kg	
34500	34520*	0.5	fixed 6 l	Ø 60x400mm	2.75	-
34502	34522*	2	0/15 l	Ø110x410mm	4.5	with soft bag + cover
34503	34523*	3	0/15 l	Ø110x530mm	5.5	with soft bag + cover
34505	34525*	5	0/15 l	Ø140x550mm	9	with plastic bag + cover
34507	34527*	7	0/15 l	Ø140x680mm	11	with plastic bag + cover

**PRESSURE REDUCER with valve** 9 steps for flow adjustment

Pressure reducer with valve and index flowmeter adjustable 0-12 l/min, suitable for cylinders 1 to 3 litres (code 34510/34530) and 5 to 7 litres (34511/34531). It includes two stages, release valve and high pressure manometer.

Thread cylinder connection: E25/E17 conical refill thread connection

UNI 21.7 x 1/14" or NF Ø 22.91 x 1.514

Apparatus to be connected to a cylinder without valve.



Oxygen therapy masks are produced with non toxic material, complete with adjustable elastic clip for nose and connecting tube



UNI	NF	PRESSURE REDUCERS WITH VALVE - spare
34510	34530*	Integrated pressure reducer with valve for 2/3 litres
34511	34531*	Integrated pressure reducer with valve for 5/7 litres

UNI	NF	PRESSURE REDUCERS WITH VALVE - spare
34539		Cover protection for cylinders 2/3/5/7 litres

GIMA code		OXYGEN THERAPY MASKS
34166		Oxygen therapy mask - adult - with tube
34167		Oxygen therapy mask - paediatric - with tube
34168		HI-Oxygen therapy mask - adult - with tube
34169		HI-Oxygen therapy mask - paediatric - with tube
34276		Disposable oxy tube - 2m - female - female
34172		Oxy glasses - nasal cannulas

\*Products not in stock, available in 15 days

# GENERAL PURPOSE CYLINDERS 5 AND 10 l AND PRESSURE REDUCERS



**GENERAL PURPOSE CYLINDERS (empty)**

Supplied with valve. Ideal for anaesthesia apparatus, can be used with pressure reducer code 34540-34541 or other standards (NF, DIN, BRITISH STD or PIN INDEX).

GIMA code					OXYGEN CYLINDER WITH VALVE AND ACCESSORIES
UNI	NF	DIN	BULL NOSE BRITISH STD	PIN INDEX	
34545	34555*	34565*	34575*	34585*	Oxygen Cylinder 5 l with valve
34548	34558*	34568*	34578*	34588*	Oxygen Cylinder 10 l with valve
34540	34550*	34560*	34570*	34580*	Pressure reducer
34541	34551*	34561*	34571*	34581*	Pressure reducer with flowmeter and humidifier
34590	34590	34590	34590	34590	Humidifier autoclavable at 121°C

\*Products not in stock, available in 15 days

**PRESSURE REDUCER (34540, 34550, 34560, 34570, 34580)**

Same as code 34541, with adjustable flow 0-15 l/min in 9 steps (1/1.5/2/3/4/6/9/12/15), LP\* port, without flowmeter and humidifier.

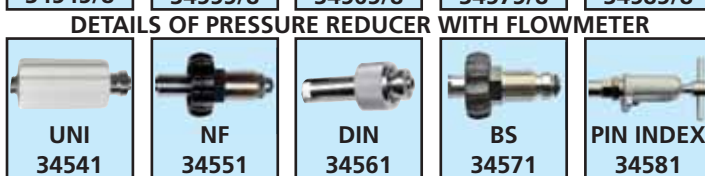
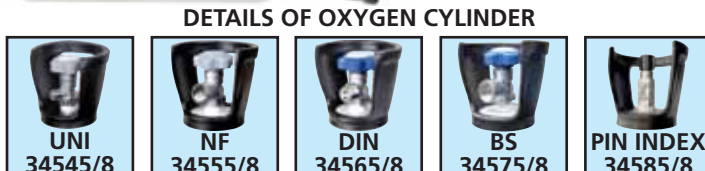

**PRESSURE REDUCER - WITH FLOWMETER AND HUMIDIFIER (34541, 34551, 34561, 34571, 34581)**

Pressure reducer with release valve and H.P. manometer with adjustable ball flowmeter 0-15 l/min and autoclavable humidifier apparatus to be connected with cylinder valve.



- 34590 AUTOCLAVABLE HUMIDIFIER
- 34177 TROLLEY FOR OXYGEN CYLINDER - 5 l - 7 l
- 34178 TROLLEY FOR OXYGEN CYLINDER - 10 l

\*Low pressure port (for ventilators,...)



## AMBU® MARK IV RESUSCITATORS



- 34200 AMBU® MARK IV RESUSCITATOR - adult**  
 Designed in accordance with the original double wall principle, the new 100% latex-free Ambu bags are more robust and provide users with exceptional visual and tactile lung condition feedback during manual resuscitation, making operation safer and more secure. Built-in pressure limitation prevents compression if there is any resistance in the patient's airways. Suitable for adults and children over 15 kg (3 years). Supplied with face mask N°5 and single shutter valve. Autoclavable at 134°C. Maximum volume 1300 ml.
- 34204 AMBU® MARK IV RESUSCITATOR - baby**  
 Same as 34200, but suitable for neonates, infants and children up to 20 kg (approx 4-5 years). Supplied with face mask N°0A, oxygen reservoir tube 250 mm and pressure limiting valve 4.0 kPa (40 cm H<sub>2</sub>O). Maximum volume 300 ml.
- 34217 AMBU MARK® IV RESUSCITATOR - adult with kit bag**  
 Same as code 34200, supplied with helicoidal mouth-wedge, tongue holding forceps, 3 Guedel airways (small, medium and large) and oxygen tube, all fitted in a resistant nylon bag.



- 34242 RESUSCITATOR BAG - infant**  
 Supplied with facemask N° 2 - volume 400 cc

CE

34242



**TRANSPARENT SILICONE AMBU FACE MASKS - Latex-free**  
 The silicone face masks are self-inflating and the cuff pressure can be regulated for an easy and efficient seal. They are comfortable to grip and feature a thumb rest so rescuers can achieve a tight seal. Visual checks of bleeding, vomitus and spontaneous breathing can be made through the transparent dome. Autoclavable at 134°C

GIMA code	AMBU TRANSPARENT LATEX-FREE FACE MASKS AND RESERVOIR
34210	Ambu Baby N° 0A - newborns/prematures - blue
34205	Ambu Baby N° 0 - newborns/children - blue
34206	Ambu N° 2 - boys - blue
34207	Ambu N° 3/4 - adults/small - blue
34208	Ambu N° 5 - adults - blue
34209	Ambu N° 6 - adults/large - blue
34215	Reservoir bag 1500 ml - adult



34217

## GIMA RESUSCITATORS - DOUBLE CHAMBER, WITH QUALITY MASK

**GIMA RESUSCITATOR BAG - with double chamber**  
 Highly professional resuscitator bag with an antistatic autoclavable and self expanding rubber internal bag and with extra soft external bag.  
 Available in 2 models: adult and infant.  
 All models are equipped with connections in accordance with EN 1281-1 directives for peep valve, intubation fitting, oxygen reservoir, oxygen intake and face masks.  
 Radiotransparent and latex free  
 All equipped with removable and autoclavable valve.  
 Made in Italy.

- 34240 RESUSCITATOR BAG - adult**  
 Supplied with facemask N° 4 - volume 1900 cc
- 34241 RESUSCITATOR BAG - with kit bag**  
 Same as 34240 supplied with helicoidal mouth-wedge, tongue holding forceps, 3 Guedel airways (small, medium and large) and oxygen tube, all fitted in a resistant nylon bag.

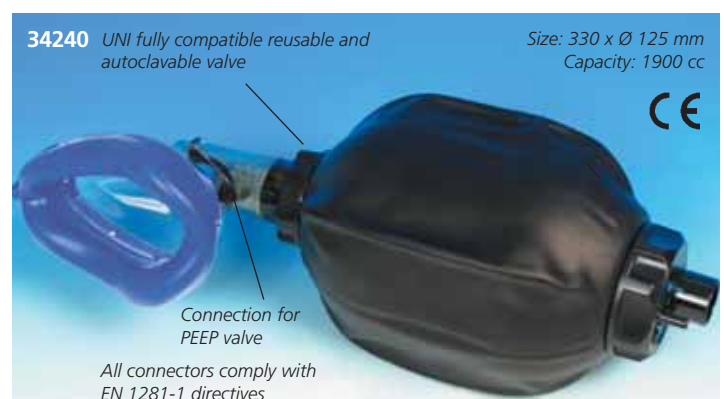

34240 UNI fully compatible reusable and autoclavable valve  
 Size: 330 x Ø 125 mm  
 Capacity: 1900 cc  
 CE  
 Connection for PEEP valve  
 All connectors comply with EN 1281-1 directives



34241

CE

## GIMA RESUSCITATORS WITH DOUBLE STAGE VALVE



**34231**  
Resuscitator with kit bag and facemask N° 4

### GIMA RESUSCITATOR BAGS

The line offers 3 models of different size: adults, children, infants and an adult kit. All models are supplied with pressure relief valve and equipped with connector under EN 1281-1 directive for: peep valve, intubation fitting, reservoir, oxygen intake, face mask. Each resuscitator can be completely disassembled for cleaning and sterilization. Made in Italy. Autoclavable at 121°C max 20 times.

- **34230 RESUSCITATOR BAG - with mask N°4 - adult**  
With a special double stage valve at 54 m/bar. Volume 1800 cc.
- **34233 RESUSCITATOR BAG - with mask N°3 child**  
With a special double stage valve at 54 m/bar. Volume 800 cc.
- **34232 RESUSCITATOR BAG - with mask N°2 - infant/newborn**  
With a special double stage valve at 54 m/bar. Volume 400 cc.
- **34231 RESUSCITATOR BAG - adult with kit bag**  
Same characteristic as code 34230. It is supplied with helicoidal mouth-wedge, tongue holding forceps, 3 Guedel airways (small, medium and large) oxygen tube, in a nylon bag.
- **34271 NYLON BAG - 18.5x15xh 30 cm - spare**

Double side overpressure valve at 54 m/bar avoids inconvenients in case of a regurgitation due to the presence of food in the stomach of the patient

Size 330 x Ø120 mm  
Capacity = 1,800 cc



34232 Pediatric resuscitator with child facemask N° 2



**34230**

## SILICONE TRANSPARENT AUTOCLAVABLE RESUSCITATORS

### SILICONE RESUSCITATORS - latex free

Transparent resuscitators made of silicone and polysulfone fully autoclavable at 134°C.

- **34244 SILICONE RESUSCITATOR KIT - adult**  
Supplied with silicone face mask N° 4, 60 cm H<sub>2</sub>O pop-off valve, oxygen tube 2 metres, autoclavable reservoir valve and 2500 ml reservoir bag. Volume: 1,600 ml.
  - **34245 SILICONE RESUSCITATOR - adult**  
Supplied with silicone face mask N° 4. Volume: 1600 ml.
  - **34246 SILICONE RESUSCITATOR - child**  
Supplied with silicone face mask N° 3 and 40 cm H<sub>2</sub>O pop-off valve. Volume: 500 ml.
  - **34247 SILICONE RESUSCITATOR - infant**  
Supplied with silicone face mask N° 1 and 40 cm H<sub>2</sub>O pop-off valve. Volume: 280 ml.
- All silicone resuscitator have multilanguage manual: GB, FR, IT, ES, PT



**34245**

CE 0476

All resuscitators are LATEX FREE



CE 0476

**34244**



CE 0476

**34246**



CE 0476

**34247**

- **34243 SILICONE RESUSCITATOR BAG KIT - adult**  
Supplied with silicone face mask N° 4, 60 cm H<sub>2</sub>O pop-off valve, oxygen tube 2 metres, autoclavable reservoir valve and 2,500 ml reservoir bag (volume: 1,600 ml), helicoidal mouth wedge (34273), tongue holding forceps, 10 Guedel airways (34439) with Cubo emergency bag (27163).



**34243**

## AMBU® SPUR II RESUSCITATOR - THE NEXT GENERATION

### AMBU SPUR II RESUSCITATOR - single patient

Ambu SPUR II provides users with exceptional tactile and visual feedback during resuscitation. The bag is highly responsive, with minimal mechanical resistance. Furthermore the characteristic design provides optimum stroke volume with perfect recoil. Range includes infant, pediatric, and adult sizes. All Ambu SPUR II resuscitators come in individual, resealable plastic carrying bags, complete with mask, reservoir bag (34235, 34236 only) oxygen tube and pressure limiting valve 4.0 kPa H<sub>2</sub>O (34236/7 only). The bags are color-coded for fast identification of infant, pediatric, and adult sizes.

- 34235 AMBU SPUR II ADULT - with face mask n° 5 and reservoir bag
- 34236 AMBU SPUR II PEDIATRIC - with face mask n°1 and reservoir bag
- 34237 AMBU SPUR II INFANT - with face mask n° 0

	TECHNICAL SPECIFICATIONS		
	34235	34236	34237
Suitable for	adult > 30 kg	baby 10 to 30 kg	infant < 10 kg
Stroke volume	1 hand	800 ml	450 ml
	2 hand	1,000 ml	150 ml
Resuscitator volume	1,475 ml	635 ml	220 ml
Size (Length x diameter)	295x127 mm	234x99 mm	168x71 mm
Bag reservoir volume	2600 ml	1500 ml	-

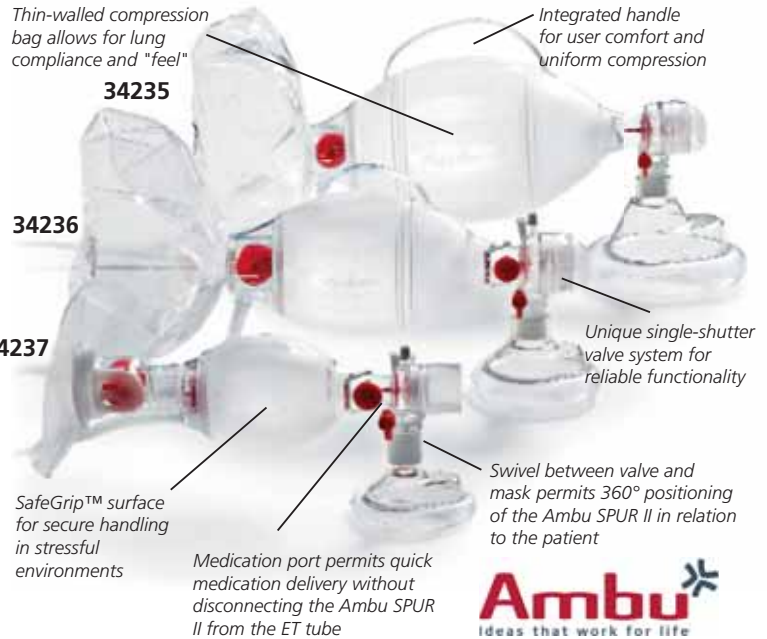

## RESUSCITATOR BAGS SINGLE-USE, SINGLE PATIENT - LATEX FREE

### PVC RESUSCITATORS - SINGLE PATIENT USE

Disposable resuscitator bags with disposable mask, no return membrane valve and connection for PEEP valve.

PVC disposable, transparent mask shaped to allow a perfect adhesion to the patient's face. Latex free.

- 34277 PVC RESUSCITATOR - adult  
Supplied with single use mask N° 5. Volume: 1,600 ml



- 34248 PVC RESUSCITATOR - child  
Supplied with single use mask N° 3 and 40 cm H<sub>2</sub>O pop-off valve. Volume: 500 ml

- 34249 PVC RESUSCITATOR - infant  
Supplied with single use mask N° 1 and 40 cm H<sub>2</sub>O Pop-off valve - Volume: 280 ml

- 34239 PVC RESUSCITATOR KIT - adult  
Same as code 34277. Supplied with oxygen reservoir 2,500 ml, tongue holding forceps and oxygen tube in a nylon bag.



## GUEDEL AIRWAYS

### STERILE AND NON STERILE GUEDEL AIRWAYS

Guedel airways in 9 sizes with smooth surface and round tip for improved patient comfort.

Made in polyethylene (PE). Latex free.

GIMA code	GUEDEL AIRWAYS - STERILE FLEXIBLE, TRANSPARENT, INDIVIDUALLY PACKED GUEDEL AIRWAYS	Minimum order
34431●	Guedel airway 40 mm - pink - newborn - 000	box of 10
34432●	Guedel airway 50 mm - blue - newborn - 00	box of 10
34433●	Guedel airway 60 mm - black - child - 0	box of 10
34434▲	Guedel airway 70 mm - white - boy - 1	box of 10
34435▲	Guedel airway 80 mm - green - adult/small - 2	box of 10
34436●	Guedel airway 90 mm - yellow - adult/small - 3	box of 10
34437●	Guedel airway 100 mm - red - adult/medium - 4	box of 10
34438●	Guedel airway 110 mm - orange - adult/large - 5	box of 10
34383	Guedel airway 120 mm - purple - adult/x-large	box of 10
34439	Mixed Guedel airways pack of 1 pcs. of ● marked and 2 pcs of ▲ marked airways for a total of 10 pcs.	



GIMA code	GUEDEL AIRWAYS - NON STERILE FLEXIBLE, TRANSPARENT,	Minimum order
57751	Guedel airway 40 mm - pink - newborn - 000	box of 50
57752	Guedel airway 50 mm - blue - newborn - 00	box of 50
57753	Guedel airway 60 mm - black - child - 0	box of 50
57754	Guedel airway 70 mm - white - boy - 1	box of 50
57755	Guedel airway 80 mm - green - adult/small - 2	box of 50
57756	Guedel airway 90 mm - yellow - adult/small - 3	box of 50
57757	Guedel airway 100 mm - red - adult/medium - 4	box of 50
57758	Guedel airway 110 mm - orange - adult/large - 5	box of 50

# SILICONE AUTOCLAVABLE AND SINGLE USE FACEMASKS

**GIMA AUTOCLAVABLE FACE MASKS**  
Made in silicone and polycarbonate (sizes 3, 4, and 5) or all in silicone (sizes 0, 1 and 2). Completely transparent, allowing a total visibility. They can be used with any resuscitator and lung ventilator.

**AUTOCLAVABLE UP TO 40 TIMES**



GIMA code	SILICONE FACE MASKS LATEX FREE
34220	Facemask N° 0 - infant small
34221	Facemask N° 1 - infant large
34222	Facemask N° 2 - child small
34223	Facemask N° 3 - child large
34224	Facemask N° 4 - adults small
34225	Facemask N° 5 - adults large

**GIMA PLUS AUTOCLAVABLE FACE MASKS - ANAESTHESIA MASKS**  
Blue silicone inflating cuff and unbreakable transparent polysulfone hood. They can be used with any resuscitator or lung ventilator. Available in 5 sizes. Latex free.

**AUTOCLAVABLE UP TO 120 TIMES**



GIMA code	GIMA PLUS FACE MASKS LATEX FREE
34252	Face mask N°2 - child small
34253	Face mask N°3 - child large
34254	Face mask N°4 - adult small
34255	Face mask N°5 - adult large
34250	Face mask N°6 - adult extra large

**HIGH QUALITY**

**INFLATABLE AIR CUSHION FACE MASKS - ANAESTHESIA MASKS**  
Quality disposable single patient face masks provided of connector for air inflation and hook. Available in 7 sizes.

**CE 0434 SINGLE PATIENT**

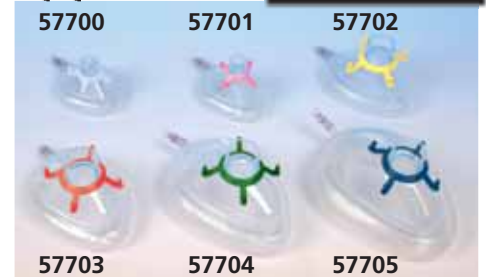

GIMA code	GIMA SINGLE PATIENT FACE MASKS LATEX FREE
57700	Facemask N° 0 - newborn - white
57701	Facemask N° 1 - infant - pink
57702	Facemask N° 2 - child - yellow
57703	Facemask N° 3 - child large - red
57704	Facemask N° 4 - adult - green
57705	Facemask N° 5 - adult large - blue
57706	Facemask N° 6 - adult extra large

# OXYGEN RESERVOIRS, VALVES AND ACCESSORIES

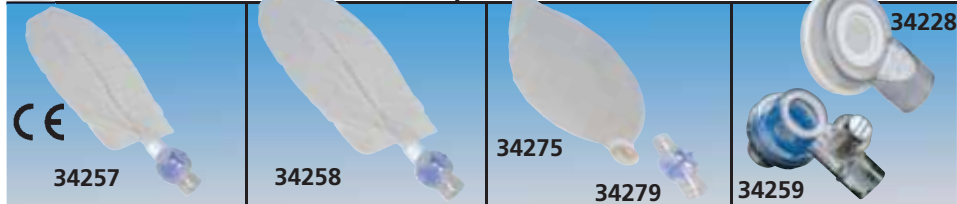

GIMA code	OXYGEN RESERVOIR - OXYGEN TUBE	To be used with GIMA codes
34275	SINGLE USE OXYGEN RESERVOIR - 2,500 ml - without valve	34244 - 34245 - 34277 - 34200 (need valve 34279), AMBU, LAERDAL 34275
34279	RESERVOIR VALVE - autoclavable	34246 - 34247 - 34248 - 34249
34257	SINGLE USE OXYGEN RESERVOIR - 1,000 ml - with valve	34244 - 34245 - 34277
34258	SINGLE USE OXYGEN RESERVOIR - 2,500 ml - with valve	All resuscitators
34276	OXYGEN TUBE - 2 m	34244 - 34245 - 34277
34259	NON-REBREATHING VALVE with 60 cm H <sub>2</sub> O Pop-off - autoclav.	34244-5 - 34277 (need 34228)
34227	PEEP VALVE - 30 mm (5-20 cm H <sub>2</sub> O) autoclavable at 121°C/248°F	34230 - 34240 - 34200
34228	PEEP VALVE ADAPTOR - int. Ø 22 mm, ext. Ø 30 mm	34227 - 34248 - 34249
34256	REAR VALVE (intake valve)	34244 - 34245 - 34246 - 34247

# ULTRA FACE MASKS

**ULTRA ANAESTHESIA - FACE MASKS**  
Disposable single patient face masks. Anti-slip design and anatomical shape for a precise fit. Excellent visibility, soft and comfortable seal. Provided with hook. Medical grade non-PVC, phthalate free.



GIMA code	ULTRA SINGLE PATIENT FACE MASKS LATEX FREE - box of 50	Suitable for kg
57711	Facemask N° 1 - infant - pink	2-10
57712	Facemask N° 2 - child - yellow	10-25
57713	Facemask N° 3 - adult S - green	25-60
57714	Facemask N° 4 - adult M - red	60-110
57715	Facemask N° 5 - adult L - blue	>110

# MOUTH OPENERS AND TONGUE HOLDING



- 34272 HELICOIDAL MOUTH OPENER PINOCCHIO
- 34273 TEETH SCREW DRIVER
- 34274 TONGUE HOLDING FORCEPS

# NYLON BAG

• 34271 NYLON BAG  
Suitable for all resuscitators

# STERILE CUFFED AND UNCUFFED ENDOTRACHEAL TUBES

GIMA code	UNCUFFED ENDOTRACHEAL TUBES - STERILE	Minimum order	GIMA code	CUFFED ENDOTRACHEAL TUBES - STERILE	Minimum order
34385	Uncuffed Endotracheal tube Ø 3 mm - 16.5 cm	box of 10	34387	Cuffed Endotracheal tube Ø 3.5 mm - 18.5 cm	box of 10
34386	Uncuffed Endotracheal tube Ø 4 mm - 21 cm	box of 10	34388	Cuffed Endotracheal tube Ø 5 mm - 24.5 cm	box of 10
			34389	Cuffed Endotracheal tube Ø 6 mm - 28.5 cm	box of 10
			34390	Cuffed Endotracheal tube Ø 6.5 mm - 29.5 cm	box of 10
			34391	Cuffed Endotracheal tube Ø 7 mm - 31 cm	box of 10
			34392	Cuffed Endotracheal tube Ø 7.5 mm - 31.5 cm	box of 10
			34393	Cuffed Endotracheal tube Ø 8 mm - 33 cm	box of 10
			34394	Cuffed Endotracheal tube Ø 8.5 mm - 33 cm	box of 10
			34395	Cuffed Endotracheal tube Ø 9 mm - 33 cm	box of 10
			34396	Cuffed Endotracheal tube Ø 10 mm - 33 cm	box of 10

Ø: Internal diameter

# LARYNGEAL MASKS FOR SAFE AND EASY INTUBATION

## SILICONE REUSABLE LARYNGEAL AIRWAY MASK

1. Optimal anatomical design ensure convenient and safe insertion. Universal 15 mm connector (ISO).
2. See-through flexible airway tube, clear guideline for easy insertion.
3. Tiny protruding bumps minimize the vomiting substance flowing from exophagus and into the lung.
4. Seamless cuff formation offers maximum comfort.
5. Strengthened oval tip prevents possible bending during insertion.
6. Thin walled pilot balloon facilitates the sensing of the inflation tube.

GIMA code	Size	Patient range	Weight range	Cuff volume (ml. of air)
34424	1.5	infant	5-10 kg	7 ml
34425	2	infant	10-20 kg	10 ml
34426	2.5	child	20-30 kg	14 ml
34427	3	boy	30-50 kg	20 ml
34428	4	adult	50-70 kg	30 ml
34429	5	adult	>70 kg	40 ml



Each laryngeal airway mask is individually serialized for identification and traceability purposes

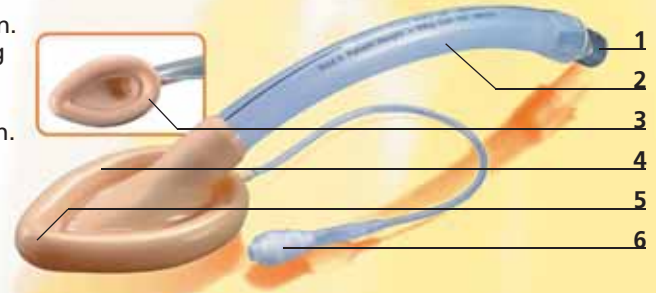

**AUTOCLAVABLE UP TO 40 TIMES**

# AMBU® AURAONCE™ DISPOSABLE LARYNGEAL MASK

## AMBU® AURAONCE™ DISPOSABLE LARYNGEAL MASKS

AuraOnce has a special curve that carefully replicates natural human anatomy. Molded directly into the tube, the unique shape makes correct insertion easy without abrading the upper airway. AuraOnce's curve also ensures that the patient's head remains in a natural supine position when the mask is in use without extra stress on the upper jaw. Moreover, Auraonce is specially designed to give the airway tube the flexibility needed to adapt to individual anatomical variances and wide range of head positions. AuraOnce has a D-shaped airway tube to give a firm and ergonomic grip during insertion. In short, positioning is fast and accurate, with least possible internal pressure.

- Packaged sterile and ready for use
- Colour coded pouch with directions for use
- Available in 5 sizes fitting a wide range of patients.



Cuff and airway tube moulded as single unit with built-in, anatomically correct curve

The airway tube is flexible at the cuff and rigid at the connector for easy, atraumatic insertion and removal

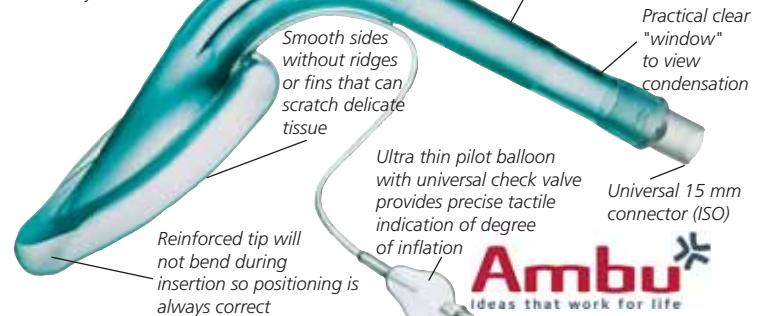

GIMA code	AMBU® AURAONCE™	Patient weight	Maximum cuff inflation volume
34406	Laryngeal Mask N 2 - pink	10-20 kg	10 ml
34407	Laryngeal Mask N 2.5 - pink	20-30 kg	14 ml
34408	Laryngeal Mask N 3 - green	30-50 kg	20 ml
34409	Laryngeal Mask N 4 - yellow	50-70kg	30 ml
34410	Laryngeal Mask N 5 - blue	70-100 kg	40 ml

# AMBU® AURA-i™ LARYNGEAL MASK VENTILATION & INTUBATION

## AMBU® AURA-i™ DISPOSABLE LARYNGEAL MASKS

Ambu® Aura-i™ is a disposable laryngeal mask designed for everyday use. Pre-formed to follow the anatomy of the human airway, the soft rounded curves of the Aura-i ensures fast and easy placement and guarantees long-term performance. Aura-i is the preferred everyday routine device for establishing an airway where an ET-tube is deemed unnecessary. At the same time it holds a place on the difficult airway cart. In case of a "Cannot Intubate - Cannot mask Ventilate" (CI-CV) situation, where the purpose is to intubate the patient, Aura-i can be used as conduit for direct endotracheal intubation assisted by a flexible scope.

The airway tube is designed to allow easy passage of an appropriately sized ET-tube. The recommended ET-tube size is indicated on the connector block of the mask. Aura-i comes in a complete range of 5 sizes, suitable for pediatrics and adults.

- packaged sterile and ready for use
- colour coded pouch with directions for use
- available in 5 sizes fitting a wide range of patients.

Direct endotracheal intubation using a flexible scope and standard ET-tubes



Built-in, anatomically correct curve for fast and easy insertion

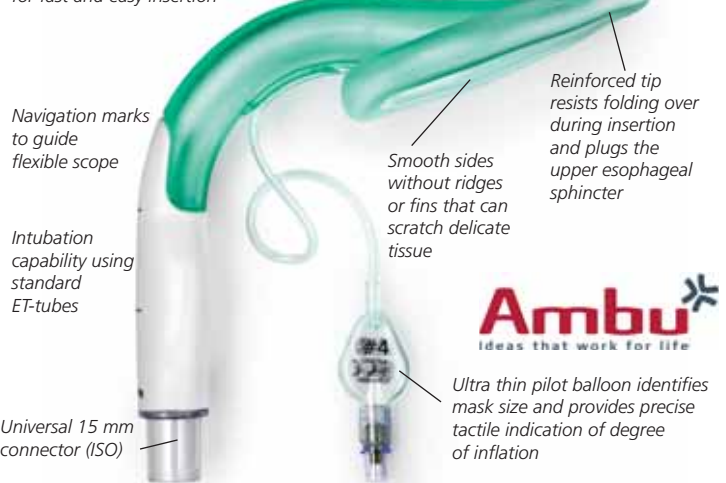

GIMA code	AMBU® AURA-i™	Patient weight	Maximum cuff inflation volume	Mask ET-Tubes
34593	Laryngeal Mask N 2 - pink	10-20 kg	10 ml	5.0
34594	Laryngeal Mask N 2.5 - violet	20-30 kg	14 ml	5.5
34595	Laryngeal Mask N 3 - green	30-50 kg	20 ml	6.5
34596	Laryngeal Mask N 4 - orange	50-70kg	30 ml	7.5
34597	Laryngeal Mask N 5 - blue	70-100 kg	40 ml	8.0

# STANDARD LARYNGOSCOPE BLADES AND SETS - 2.5 V

## McINTOSH BLADES

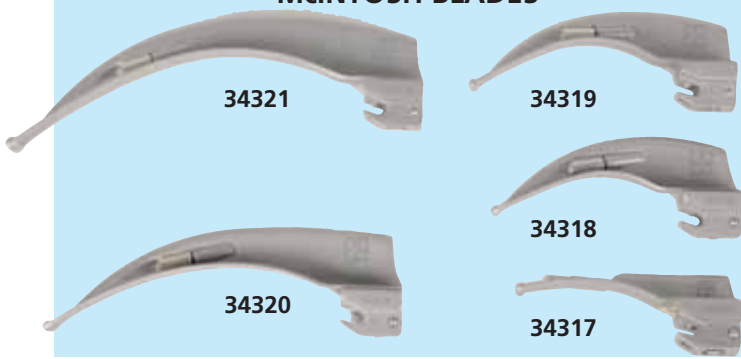

## MILLER BLADES

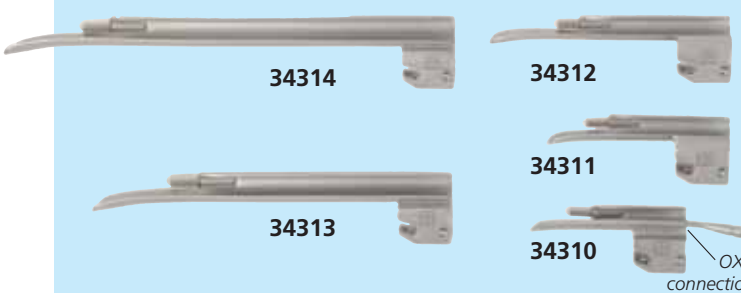

Great features of the unique GIMA blades and handles

- standard 2.5 V vacuum bulb
- light ergonomic, satin finish handle to reduce glare
- Stainless Steel contacts guarantee long working life
- easy sterilization ETO or steam
- full range of Mc Intosh & Miller blades, latex free
- ISO 7376 fittings allow use of blades with existing handles
- set is packaged in an anti-shock case and in cardboard box
- 2.5 V handles work with both alkaline batteries or rechargeable batteries
- good light transmission of 3,500 LUX with 2.5 V handles
- autoclavable up to 134° for 5 minutes (approx. 2,000 times)
- non magnetic blades and handles

GIMA code	STANDARD BLADES	Overall Length mm	Distal Width mm
34310	Blade N° 00 MILLER OXY - premature	65	12.5
34311	Blade N° 0 MILLER - premature/newborn	78	11.5
34312	Blade N° 1 MILLER - babies	102	11.5
34313	Blade N° 2 MILLER - adults	155	16.5
34314	Blade N° 3 MILLER - adults/large	195	16.5
34317	Blade N° 0 Mc INTOSH - newborn	80	13
34318	Blade N° 1 Mc INTOSH - babies	92	14
34319	Blade N° 2 Mc INTOSH - infants	100	14
34320	Blade N° 3 Mc INTOSH - adults	130	18
34321	Blade N° 4 Mc INTOSH - adults/large	155	18

### GIMA code STANDARD RECHARGEABLE SETS (HANDLE+BLADES)

34301	Pediatric set	2 blades MILLER 0-1
34307	Pediatric set	3 blades MILLER 00-0-1
34305	Pediatric set	3 blades MILLER 0-1, Mc INTOSH 0
34306	Doctor set	3 blades MILLER 1, 2, 3
34302	Adult set	3 blades Mc INTOSH 2-3-4
34303	Adult set	4 blades Mc INTOSH 1-2-3-4

### GIMA code BULBS, BATTERIES AND RECHARGEABLE HANDLES

34352	Small rechargeable handle - pediatric (2xAA) - 2.5 V
34354	Large rechargeable handle - adult (2XC) - 2.5 V
34466	Pediatric rechargeable Li-ion battery 2.5 V AA
34467	Adult rechargeable Li-ion battery 2.5 V "C"
<i>Charging time 2.5 hours (34466), 5 hours (34467)</i>	
31542	Charging station (including pediatric adaptor, wall support, UK, US and EU plug) 100-240 V
34324	Small Bulbs for MAC N°0 and MILLER N°00,0,1
34325	Large Bulbs for MAC N°1,2,3,4 and MILLER N°2,3
<i>compatible with Kawe and Riester</i>	



# DISPOSABLE F.O. LARYNGOSCOPE BLADES MILLER AND MC INTOSH

## SINGLE-PATIENT USE LARYNGOSCOPE F.O. BLADES

Choice of 5 different blades: Mc Intosh N° 2, 3, 4 and Miller N° 0,1. All blades are tested for tensile strength. Individually packed, non sterile.

**COMPATIBILITY WITH ALL "GREEN" F.O. SYSTEMS**

GIMA code	DISPOSABLE BLADES NON STERILE	Overall Length mm	Distal Width mm
34481	Metal handle		
34364	Plastic handle		
34365	N° 0 Miller - infant	90	22
34366	N° 1 Miller - child	100	23.3
34375	N° 2 Mc Intosh - adult small	115	34.4
34376	N° 3 Mc Intosh - adult	132	40.6
34377	N° 4 Mc Intosh - adult large	155	58.7
34359	Bulb for old plastic handle sold up to may 2016		
34358	Bulb for new plastic handle sold since june 2016		

## DISPOSABLE BLADES



- 34381 EMERGENCY PACK: plastic handle +3 disposable blades Mc Intosh N° 2,3,4
- 34382 NYLON BAG - empty
- 34384 EMERGENCY CASE: plastic handle+6 disposable blades Miller 0,1,2 and Mc Intosh 2,3,4.





# GIMA GREEN F.O. XENON/HALOGEN AND LED LARYNGOSCOPES



## GIMA GREEN LARYNGOSCOPES

- maximum light transmission thanks to durable and high quality fibres
- specially designed blades for easy intubation
- matt finished to reduce glare
- autoclavable up to 134°C for 5 minutes. Blades autoclavable up to 2,000 times
- compatible to plasma sterilization
- all blades are compatible to BS EN ISO 7376 Green standard handles
- all blades are made from Austenitic Stainless steel thereby making them rust proof
- long life blades. GIMA offers 3 years Warranty
  - a large selection of power sources to use: 'AA' and 'C' type batteries or 2.5 V and 3.5 V rechargeable batteries
  - 2.5 V handles can be used with standard or rechargeable batteries
  - handles are available with 2.5 V and 3.5 V Xenon/Halogen and LED bulbs
  - all blades and handles are non magnetic

### Mc INTOSH BLADES

### MILLER BLADES

### MAXLITE

### HALOGEN/XENON BATTERY HANDLE

### LED BATTERY HANDLE

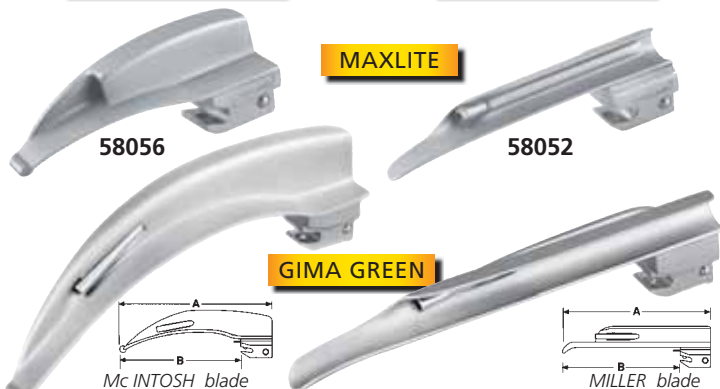

### Xenon/Halogen and LED handles 2.5 V and 3.5 V

- closed battery compartment prevent liquid penetrating inside the battery
- handles are supplied with lamp. Battery not included
- solid metal handle of chromium plated metal

### Gima Green and Maxlite: Miller and Mc-Intosh blades

- Gima Green 4.0 mm Ø F.O. bundle with more than 5,500 individual fibre strands
- Miller Maxlite 3.0 mm Ø bundle with more than 5,000 individual fibre strands
- McIntosh Maxlite 4.5 mm Ø bundle with more than 6,500 individual fibre strands

### High quality fibres ensuring excellent light transmission Gima Green and Miller

- Maxlite: 7,000 lux with 2.5 V Xenon/Halogen lamp, 12,500 lux with 3.5 V Xenon/Halogen lamp, 18,000 lux with 2.5 LED lamp, 30,000 lux with 3.5 V LED lamp
- McIntosh Maxlite: 8,000/14,000/20,000/40,000 lux

GIMA code	"GIMA MAXLITE" FIBRE OPTIC BLADES	A	B
58051	MILLER N° 0 blade - Newborn	80	55
58052	MILLER N° 1 blade - Infant	100	75
58056	Mc INTOSH N° 0 blade - Newborn	82	57
58057	Mc INTOSH N° 1 blade - Infant	93	68
58058	Mc INTOSH N° 2 blade - Child	115	90
58059	Mc INTOSH N° 3 blade - Adult	135	110
58060	Mc INTOSH N° 4 blade - Adult large	155	130
58061	Mc INTOSH N° 5 blade - Adult x-large	176	151

GIMA code	"GIMA GREEN" FIBRE OPTIC BLADES*	A	B
34460	MILLER N° 00 OXY blade - Premature	65	40
34461	MILLER N° 0 blade - Newborn	78	53
34462	MILLER N° 1 blade - Infant	102	77
34463	MILLER N° 2 blade - Child	155	130
34464	MILLER N° 3 blade - Adult	195	170
34469	Mc INTOSH N° 0 blade - Newborn	80	55
34470	Mc INTOSH N° 1 blade - Infant	92	67
34471	Mc INTOSH N° 2 blade - Child	100	75
34472	Mc INTOSH N° 3 blade - Adult	130	105
34473	Mc INTOSH N° 4 blade - Adult large	155	130
34474	Mc INTOSH N° 5 blade - Adult x-large	175	150

\*equipped with detachable fibre optic light guide

### F.O. LIGHT GUIDE FOR GIMA GREEN BLADES

- 34483 F.O. Light guide for "GIMA Green" N°3
- 34484 F.O. Light guide for "GIMA Green" N°4
- 34486 F.O. Light guide for "GIMA Green" other - specify code

• 31542 GIMA GREEN CHARGING STATION - 100/200 V - 50/60 Hz  
It can charge either 2.5 V / 3.5 V NiCa, NimH or Li-ion rechargeable batteries independently of their status of charge. Unit is designed to prevent over charging of batteries. Simultaneously charging of pediatric and adult handle.



Charging station includes pediatric adaptor, wall support, UK, US and EU plug

### GIMA GREEN RECHARGEABLE BATTERY HANDLES

GIMA code	F.O. XENON/HALOGEN BATTERY HANDLES - 2.5 V
34480	Pediatric rechargeable metal handle (2xAA) - 2.5 V
34481	Adult rechargeable metal handle (2xC) - 2.5 V
34466	Pediatric rechargeable Li-ion battery 2.5 V 1,000 mAh
34467	Adult rechargeable Li-ion battery 2.5 V 2,200 mAh
34485	Halogen bulb 2.5 V (minimum order 6 pcs)
"GIMA GREEN" RECHARGEABLE HANDLES AND BATTERIES 3.5 V - OLD up to lot 8 (ped handle) up to lot 7 (adult handle)	
34487	Pediatric rechargeable metal handle (3.5 V) - old
34488	Adult rechargeable metal handle (3.5 V) - old
34489	Pediatric rechargeable NiCa battery 3.5 V/700 mAh for 34487
34490	Adult rechargeable NiCa battery 3.5 V/1,300 mAh for 34488
34491	Halogen Bulb 3.5 V

### F.O. XENON/HALOGEN BATTERY HANDLE 3.5 V

34456	Pediatric rechargeable metal handle (3.5 V)
34457	Adult rechargeable metal handle (3.5 V)
31540	Pediatric rechargeable Li-ion battery** 3.5 V for 34456
31541	Adult rechargeable Li-ion battery** 3.5 V for 34457, 34482
**for handles sold after may 2013	
34491	Halogen Bulb 3.5 V

### F.O. LED BATTERY HANDLES 2.5 V AND 3.5 V

34476	Pediatric LED rechargeable handle 2.5 V
34477	Adult LED rechargeable handle 2.5 V
34482	Adult rechargeable metal handle - LED light 3.5 V

### COMPATIBILITY HANDLE - BATTERY - BULB

GIMA code	Handle		V	Battery			Bulb
	Xenon	LED		Standard 2xAA	Rechargeable 2xC	Li-ion*	
34480	Ped.	-	2.5	yes	no	34466	34485
34481	Adult	-	2.5	no	yes	34467	34485
34456	Ped.	-	3.5	no	no	31540	34491
34457	Adult	-	3.5	no	no	31541	34491
34476	-	Ped.	2.5	yes	no	34466	-
34477	-	Adult	2.5	no	yes	34467	-
34482	-	Adult	3.5	no	no	31541	-

\*Li-ion batteries have twice the capacity of an equivalent size NimH batteries.

# GIMA GREEN F.O. XENON/HALOGEN, LED LARYNGOSCOPE SETS



## GIMA F.O. XENON/HALOGEN AND LED SETS

- Mc Intosh or Miller blades
- F.O. laryngoscopes provide cool bright illumination
- Gima Green F.O. blades with detachable fibre or Maxlite F.O. blades with integrated fibre
- Xenon/Halogen or LED F.O. rechargeable battery handle
- 2.5 V or 3.5 V rechargeable battery handle (battery not included). 2.5 V rechargeable battery handle can be used with standard or rechargeable batteries. Rechargeable battery handles should be used with charging station 31542 (not included).
- non magnetic blades and handles

### LARYNGOSCOPE SET WITH F.O. BLADES

GIMA code	GIMA GREEN F.O. XENON/HALOGEN SET - 2.5 V	
34451	Pediatric set	2 blades Miller 0-1
34454	Pediatric set	3 blades Miller 0-1, Mc Intosh 0
34452	Adult set	3 blades Mc Intosh 2-3-4
34453	Adult set	4 blades Mc Intosh 1-2-3-4
34455	Doctor set	3 blades Miller 1-2-3
34485	Halogen bulb 2.5 V (minimum order 6 pcs)	
34450	Empty box without sponge	
GIMA code	GIMA GREEN F.O. LED SET - 2.5 V OR 3.5 V	
34327	Adult set	3 blades Mc Intosh 2-3-4 - 2.5 V
34328	Adult set	4 blades Mc Intosh 1-2-3-4 - 2.5 V
34329	Adult set	3 blades Mc Intosh 2-3-4 - 3.5 V
34330	Adult set	4 blades Mc Intosh 1-2-3-4 - 3.5 V

## MAXLITE F.O. BLADE WITH INTEGRATED FIBRE

Built with an integrated F.O. bundle with no cavities to trap dirt or body fluids, this allowing the blade to be easily cleaned and decontaminated.



GIMA GREEN F.O. BLADE

### TECHNICAL SPECIFICATIONS - BLADES AND BULBS

	Gima Green F.O. blade	Maxlite F.O. Mc Intosh blade
Fibre light carrier:	detachable	integrated
F.O. bundle Ø:	4.0 mm	4.5 mm
Individual fibre strands:	> 5,500	> 6,500
Light transmission with 2.5 V (Xenon):	7,000 lux	8,000 lux
Light transmission with 2.5 V (LED):	18,000 lux	20,000 lux
Light transmission with 3.5 V (Xenon):	12,500 lux	14,000 lux
Light transmission with 3.5 V (LED):	30,000 lux	40,000 lux
Autoclavable at 134 °C:	2,000 times	2,000 times
LED bulb life:	50,000 hours	50,000 hours

### LARYNGO SET WITH F.O. BLADES - INTEGRATED FIBRE

GIMA code	MAXLITE F.O. XENON/HALOGEN SET - 2.5 V	
34332	Pediatric set	3 blades Miller 00-0-1
34333	Adult set	3 blades Mc Intosh 1-2-3
34334	Adult set	4 blades Mc Intosh 1-2-3-4
34485	Halogen bulb 2.5 V (minimum order 6 pcs)	
GIMA code	MAXLITE F.O. LED SET - 2.5 V or 3.5 V	
34336	Pediatric set	3 blades Miller 00-0-1 - 2.5 V
34335	Adult set	3 blades Mc Intosh 2-3-4 - 2.5 V
34337	Adult set	4 blades Mc Intosh 1-2-3-4 - 2.5 V
34338	Adult set	4 blades Mc Intosh 1-2-3-4 - 3.5 V
GIMA code	BATTERIES for GIMA GREEN and MAXLITE	
34466	Pediatric rechargeable Li-ion battery 2.5 V 1,000 mAh	
34467	Adult rechargeable Li-ion battery 2.5 V 2,200 mAh	
31541	Adult rechargeable Li-ion battery 3.5 V*	

\*Packed and shipped at half charged state

# FLEXTIP F.O. XENON/HALOGEN AND LED SETS FOR DIFFICULT INTUBATIONS

## F.O. SET FOR DIFFICULT INTUBATION

Deluxe boxed set including one F.O. rechargeable handle, one or two F.O. Mc Intosh blades N° 3 or N° 3 and 4, for difficult intubations and bulb. The movable blade tip facilitates lifting of the epiglottis and enables a perfect visibility of the intubation process even in case of difficult anatomical conditions. A better visibility and a lower lever force reduce the risk of injury of the larynx and the teeth. Autoclavable at 134° C.

- stainless steel construction, matt finish
- can be used with all Green Spec Handles
- compatible with ISO 7376 Green Standards
- channel provides improved viewing area
- 4.0 mm fibre bundles (GimaGreen) or 4.5 mm fibre bundle (Maxlite) for maximum light output
- 2x"C" batteries or rechargeable batteries



GIMA code	FLEXTIP F.O. SET - 2.5 V	
34492	GIMA GREEN FLEXI F.O. SET 1 blade Mc Intosh 3	
34495	GIMA GREEN FLEXI F.O. SET 2 blades Mc Intosh 3-4	
34498	MAXLITE F.O. LED FLEXI SET 2 blades Mc Intosh 3-4 with integrated fibre	

GIMA code	ACCESSORIES AND SPARES	
34493	FLEXI F.O. BLADE N° 3 Mc Intosh (130x105 mm)	
34494	FLEXI F.O. BLADE N° 4 Mc Intosh (155x130 mm)	
34485	Bulb 2.5 V - spare	
34467	Adult rechargeable Li-ion battery 2.5 V	
31542	Charging station 100-240 V - see page 327	

# HEINE CLASSIC+® F.O. XHL OR LED<sup>HQ</sup> LARYNGOSCOPES

## HEINE CLASSIC+® F.O. XHL OR LED<sup>HQ</sup> LARYNGOSCOPES

The "Classic+" range of F.O. blades with HEINE HiLite® Fibre bundle with over 6,500 individual micro-fibres offer improved light transmission and longer life. Together with the innovative HEINE LED<sup>HQ</sup> light in the handle or the traditional XHL Xenon Halogen Bulb, the exclusive HEINE HiLite® Fibre Optic bundle with up to 4.3 mm of Ø offers 3X or 40% brighter light as with other conventional halogen bulbs.

**5 years warranty** 5-years guarantee or 4,000 standard autoclave cycles of 134°C/5 min. with more than 1,000 lux on all blades with HEINE HiLite® fibre bundle.

**Long lasting bulbs** HEINE XHL® Xenon Halogen bulbs incorporate the latest Xenon Halogen Technology to give you up to 40% more light! HEINE XHL Xenon Halogen 3.5 V bulbs last up to twice as long as 2.5 V bulbs and give up to three times the light of conventional 2.5 V Halogen laryngoscope bulbs. HEINE LED<sup>HQ</sup> handles offer even three times the light intensity of the 3.5V Xenon Halogen bulbs for an outstanding and constant bright illumination.

**Long lasting 3.5 V rechargeable batteries** HEINE 3.5 V systems (LED<sup>HQ</sup> or XHL) use a long-lasting 3.5 V lithium rechargeable battery which avoids the need to replace non-rechargeable batteries at frequent intervals. HEINE F.O. laryngoscope blades and handles are compatible with the ISO 7376 (green standard).

For fast charge in 2 hours

Size: 14x6x6.6 cm



34374

• **34374 NT 4 CHARGER UNIT FOR 2 HANDLES - X-002.99.494**

Two independent charging compartments:

- fast charge capability: 2 hours for Li-ion handle
- automatic charging
- charger indicator



GIMA code	HEINE code	HEINE FIBRE OPTIC BLADES	Overall length	Distal length
34411	F-000.22.119	MILLER 00	76 mm	9.5 mm
34412	F-000.22.120	MILLER 0	80 mm	10.5 mm
34413	F-000.22.121	MILLER 1	100 mm	11.5 mm
34414	F-000.22.122	MILLER 2	152 mm	13 mm
34415	F-000.22.110	PAED 0	82 mm	12 mm
34416	F-000.22.111	PAED 1	95 mm	13 mm
34417	F-000.22.100	MAC 0	82 mm	9 mm
34418	F-000.22.101	MAC 1	93 mm	11 mm
34419	F-000.22.102	MAC 2	115 mm	13 mm
34420	F-000.22.103	MAC 3	135 mm	15 mm
34421	F-000.22.104	MAC 4	155 mm	15 mm
34422	F-000.22.105	MAC 5	176 mm	15 mm
34423	F-000.22.313	MAC 3 - Flex Tip+	115 mm	13.2 mm
34368	F-000.22.314	MAC 4 - Flex Tip+	137 mm	13.2 mm

**HEINE STANDARD LARYNGOSCOPE HANDLES AND ACCESSORIES**

34430	F-001.22.800	Slim F.O. handle 2.5 V - paediatric
34400	F-001.22.812	Short F.O. handle 2.5 V - paediatric and obese
34401	F-001.22.860	Standard F.O. handle 2.5 V
34405	F-008.22.860	Standard F.O. handle 2.5 V LED
31769	X-001.88.035	Spare bulb 2.5 V for 34400, 34401, 34430
31768	X-002.88.044	Spare bulb 3.5 V for 34369

**HEINE RECHARGEABLE LARYNGOSCOPE HANDLES AND BATTERIES**

34371	F-008.22.804	Paediatric LED handle 2.5 V Li-ion rechargeable*
34372	F-007.22.894	Standard F.O. handle 3.5 V Li-ion - rechargeable*
34373	F-008.22.894	Standard LED handle 3.5 V Li-ion - rechargeable*
34378	X-007.99.104	Re-chargeable 2.5 V battery paediatric for 34371
34448	X-007.99.383	Re-chargeable 3.5 V battery for 34372-3, 34402, 34367

**HEINE CLASSIC+® FIBRE OPTIC LARYNGOSCOPE SETS\*\* with 2.5V handle**

34403	F-119.10.860	3 blades set with paed 1, mac 2, mac 3, XHL handle
34404	F-120.10.860	4 blades set with paed 1, mac 2, mac 3, mac 4, XHL handle
34446	F-120.18.860	4 blades set with paed 1, mac 2, mac 3, mac 4, LED HQ handle
<b>with 3.5V rechargeable handle</b>		
34367	F-119.94.865	3 blades set with paed 1, mac 2, mac 3, LED HQ rechargeable handle

\*\*Set includes spare bulb and F.O. handle 2.5 V (34401) or F.O. LED handle 2.5 V

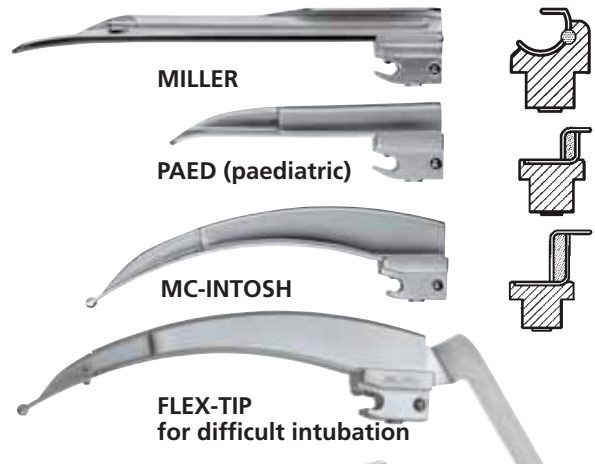

**STANDARD HANDLE 3.5V LED Li-ion®**

Rechargeable 3.5V F.O. LED handle with charge status display in bottom cap. State of charge is indicated for 10 seconds after switching on or after removing from the charger. Two hours charging time with NT4 charger, up to 13 hours ON time.

**LED HANDLE:**  
- 5,000 Kelvin  
- 12,000 LUX at 40 mm  
- 50,000 hours bulb life

Handle with charge status display

**LED HQ**  
LED NOW IN HEINE QUALITY.



# AMBU® KING VISION® VIDEO LARYNGOSCOPE

## • 58101 KING VISION® VIDEO LARYNGOSCOPE SET

The King Vision® video laryngoscope is especially designed to visualize, in the most reliable way, the airways for routine and difficult intubations.

The reusable display is lightweight, water resistant, non-glare, smudge-proof, packaged in a protective foam case and is battery operated.

The blades are disposable and are individually packaged, eliminating cross contamination risks. It can be used continuously about 80 minutes, making it highly portable.

Video output compatible with external monitor and recording devices.

**Two blade types:** a standard blade that requires the use of a stylet to direct the ET tube and a channeled blade where you can guide the ET tube with the blade.

Made in the U.S.A.

- 58104 STANDARD VISION BLADE - size 3 - spare
- 58105 CHANNELED VISION BLADE - size 3 - spare

### STANDARD ACCESSORIES

- Vision display
- 3 channeled vision blades - size 3
- 1 standard vision blade - size 3
- AAA batteries
- Case



Full colour TFT LCD display anti-reflective

Protective gasket

Ergonomic design. Integrated blade/handle design for complete control

Channeled and standard disposable blades for guided or standard insertions

Guiding channel for easy ETT placement and removal

New optics and light in every blade

58101

New anti-fog lens in every blade

# USB F.O. LARYNGOSCOPE HANDLE

## • 34468 USB F.O. LARYNGOSCOPE HANDLE

Universal USB handle for green fibre optic blades. This handle is a charging unit including lithium-ion rechargeable battery and USB port for easy recharging without charging station.

Features:

- glass bead blasted, matt chromium plated surface for a high quality optic
- no surface structure, lateral grooves for hygienic use and secure grip in the hand
- metallic lamp case
- quick and easy removal of bulb
- autoclavable up to 134° (without batteries)
- handle in accordance with ISO 7376 (green standard)

Made in Germany.



USB port

IN ACCORDANCE WITH ISO 7376 FOR ALL GREEN F.O. BLADES



34468



Handle supplied in a rigid case with 3 adapters (US, GB, EU)

# F.O. LARYNGOSCOPE BLADES AND BATTERY HANDLES SINGLE PATIENT STERILE

## SINGLE PATIENT USE F.O. LARYNGOSCOPE BLADES

Choice of 6 blades Miller 0.1 and McIntosh 1, 2, 3, 4 for everyday hospital use. Compatible to ISO 7376 Green System. Light conductor made from material with excellent light transmission: 4,000 lux with 2.5 V Xenon handle and 10,000 lux with LED handle. Need F.O. handle.

A high impact resistant plastic block coupled with metal spatula provides great strength to the whole blade comparable to all metal reusable blades

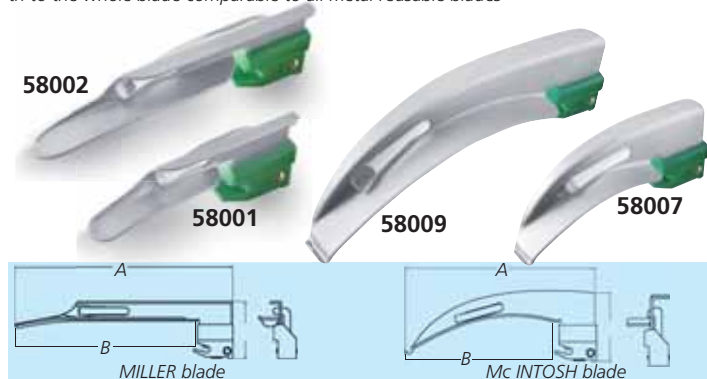

GIMA code	SINGLE PATIENT F.O. BLADES	A	B
58001	MILLER N° 0 blade - Newborn	78	54
58002	MILLER N° 1 blade - Infant	105	80
58006	Mc INTOSH N° 1 blade - Infant	90	66
58007	Mc INTOSH N° 2 blade - Child	100	76
58008	Mc INTOSH N° 3 blade - Adult	130	106
58009	Mc INTOSH N° 4 blade - Adult large	155	131

## SINGLE PATIENT USE BATTERY HANDLES

- lightweight, suitable for everyday hospital use
- single patient use, prevent cross infection
- compatible to ISO 7376 Green System
- perfect solution to cleaning problems confronting EMS field
- Ready To Use (RTU) handles are supplied with preloaded batteries, thus eliminating the hassle of loading batteries
- the 'C' type handles are identified with yellow colour bottom cap, supplied without batteries
- suitable also for reusable blades
- made in ABS



58012

58014

58015

GIMA code	SINGLE PATIENT USE F.O. LED BATTERY HANDLES 2.5 V
58012	Battery handle "C" type - adult
58014	Battery handle "RTU" (ready to use) - pediatric
58015	Battery handle "RTU" (ready to use) - adult

**EMERGENCY KITS COMPLETE WITH STANDARD EMERGENCY DEVICES**



34173

**SMART BAGS - medium - blue**

- 27152 SMART BAG - medium empty - 55x35xh 32 cm
- 34173 "GIMA 3" EMERGENCY BAG - filled - without cylinder



34174

**SMART BAGS - large - red**

- 27153 SMART BAG - large empty - 65x35xh 35 cm
- 34174 "GIMA 7" EMERGENCY BAG - filled



34163

**LOGIC 2 RUCKSACKS - red**

- 27171 LOGIC 2 RUCKSACK - empty - 40x25xh 47 cm
- 34162 "GIMA 8" EMERGENCY RUCKSACK - filled
- 34163 "GIMA 9" EMERGENCY RUCKSACK - filled
- 34164 "GIMA 10" EMERGENCY RUCKSACK - filled - without cylinder
- 34175 "GIMA 11" EMERGENCY RUCKSACK - filled

**LOGIC 2 RUCKSACKS PVC COATED - red**

- 27172 LOGIC 2 RUCKSACK PVC COATED - empty - 40x25xh 47 cm
- 34165 "GIMA 12" EMERGENCY RUCKSACK PVC COATED - filled - same as "GIMA 9", without cylinder

27172



**EMERGENCY ALUMINIUM CASE**

- 34159 ALUMINIUM CASE - empty - 40x35x10 cm
- 34161 "GIMA 2" EMERGENCY CASE - filled

34161

Aluminium emergency case



34156

**EMERGENCY BAGS - red**

- 27165 EMERGENCY BAG - empty - 35x45x21 cm
- 34155 "GIMA 6" EMERGENCY BAG - filled - without cylinder
- 34156 "GIMA 4" EMERGENCY BAG - filled
- 34157 "GIMA 5" EMERGENCY BAG - filled

**EMERGENCY BAGS PVC COATED - blue**

- 27167 EMERGENCY BAG PVC COATED - empty - 35x45xh 21 cm
- 34154 "GIMA 13" EMERGENCY BAG PVC COATED - filled - same as "GIMA 4", without cylinder

27167



34176

**IP67 CERTIFIED DURABLE CASE - waterproof and dustproof**

- 27222 LARGE DURABLE CASE - empty - 55x43xh 21 cm
- 34176 "GIMA 1" EMERGENCY DURABLE CASE - filled

## EMERGENCY KITS - BAGS, RUCKSACKS, CASES

KIT CONTENTS	Size cm	34155	34156	34157	34154	34173	34174	34161	34176	34162	34163	34164	34175	34165
		GIMA 6 bag	GIMA 4 bag	GIMA 5 bag	GIMA 13 bag	GIMA 3 bag	GIMA 7 bag	GIMA 2 al case	GIMA 1 pl case	GIMA 8 rucksack	GIMA 9 rucksack	GIMA 10 rucksack	GIMA 11 rucksack	GIMA 12 rucksack
<b>Container (bag, rucksack or case)</b>														
Smart bag - medium - blue 600D polyester (27152)	55x35xh 32					•								
Smart bag - large - red 600D polyester (27153)	65x35xh35						•							
Emergency bag - red 600D polyester (27165)	35x45xh 21	•	•	•										
Emergency bag - blue 600D polyester PVC coated (27167)	35x45xh 21				•									
Logic 2 rucksack - red 600D polyester (27171)	40x25xh 47								•		•		•	
Logic 2 rucksack - red 600D polyester PVC coated (27172)	40x25xh 47													•
Durable case - orange (27222)	55x43xh 21								•					
Aluminium case (34159)	40x35xh 10							•						
<b>Products included in kits</b>														
Emergency cover (34085)		•	•	•	•	•	•	•	•	•	•	•	•	•
Universal scissors - 15 cm (34128)		•	•	•	•	•	•	•	•	•	•	•	•	•
Facemask n. 2 - child/small (34222)		•	•	•	•	•	•	•	•	•	•	•	•	•
Silicone resuscitator bag with mask n 4 - adult (34245)		•	•	•	•	•	•	•	•	•	•	•	•	•
Teeth screw driver (34273)		•	•	•	•	•	•	•	•	•	•	•	•	•
Tongue holding forceps (34274)		•	•	•	•	•	•	•	•	•	•	•	•	•
Oxygen tube - 120 cm (34276)		•	•	•	•	•	•	•	•	•	•	•	•	•
Mixed Guedel airways - box of 10 (34439)		•	•	•	•	•	•	•	•	•	•	•	•	•
Oxygen therapy mask - adult (34166)			•	•		•	•	•	•	•	•	•	•	•
0.5 l oxygen cylinder (empty) with reducer UNI std (34500)			•	•				•	•	•	•	•	•	•
Yton nurse stethoscope (32514)		•	•	•	•									
Jotarp dual head stethoscope - black (32580)					•	•	•	•	•	•	•	•	•	•
Yton sphygmomanometer (32720)		•	•		•									
London sphygmomanometer (32725)				•		•	•	•	•	•	•	•	•	•
Welch Allyn DURASHOCK sphygmomanometer (32700)														•
Emergency pack - 3 F.O. single-use blades+plastic handle (34381)		•	•		•					•				
Laryngoscope set 3 Mc-Intosh blades 2-3-4 (34302)				•		•	•		•		•	•		•
"Gima green" F.O. laryngoscope set 4 Mc-Intosh blades 1-2-3-4 (34453)														•
Hand suction unit (28180)		•				•	•					•		
Res-q-vac hand suction unit (28124)				•					•			•		•
Delta pen light (25629)				•		•	•		•			•	•	•
Fast tourniquet - green (25728)				•		•	•		•			•	•	•
Magill forceps - 20 cm (34002)				•		•	•		•			•	•	•
Gima digital thermometer °C (25560)				•		•	•		•			•	•	•
Disinfectant wipes - tube 100 wipes (36625)				•		•	•		•			•	•	•
Emocontrol elastic bandage (34782)				•		•	•		•			•	•	•
Gauze bandage 3.5 m x 7 cm - box of 10 (34841)				•		•	•		•			•	•	•
Sterile adhesive dressing 10 x 10 cm - box of 6 (34851)				•		•	•		•			•	•	•
Oxy-4 fingertip oximeter (35092)						•	•		•			•	•	•
Instant ice - bag 3 pcs. (34111)						•	•		•			•	•	•
Burn dressing - 10x10 cm (34871)								•	•			•	•	•
3 E3 padded pouches with window red (27188), blue (27189), green (27191)								•	•			•	•	•
2 E4 pouches with window red (27192), yellow (27194)								•	•			•	•	•

## INTUBATION BAG WITH EMERGENCY ACCESSORIES

- 27133 INTUBATION BAG - empty
  - 34152 INTUBATION KIT - complete
  - 34153 INTUBATION KIT F.O. - complete
- Compact nylon bag suitable for various uses:  
2 internal zip pockets, 9 elastic retainers for instruments, made in water-resistant anti-scratch 600D polyester, blue colour.  
Size: 32x22.5xh 7.5 cm.

STANDARD ACCESSORIES	34152	34153
Mc Intosh Laryngoscope	3	3 F.O.
s/s blades N 1, 2, 3		
Laryngoscope metal handle	1	1
Magill forceps	1	2
Tongue holding forceps	1	1
Guedel cannula	3	5
Mouth opener	1	1
Scissors cm 14.5	1	1
Endotracheal tubes	-	4



## MEDICATION FIRST AID BAG

- 27132 MEDICATION FIRST AID BAG - empty - 31x22x11 cm
  - 34149 MEDICATION FIRST AID BAG - filled
- First aid bag provided with 2 internal transparent pockets, one external pocket, internal division with 2 zip on both sides, handle and carrying belt.

### STANDARD ACCESSORIES

- London palm sphygmomanometer (32725)
- Yton single head stethoscope (32514)
- Delta Led pen light (25629)
- Fast tourniquet (25728)
- Digital thermometer (25560)
- Sterile adhesive dressing 10x10 cm - box of 6 (34851)
- Liester bandage scissors - 15 cm (34129)
- CPR mask (34218)
- Disinfectant wipes
- 3M Steri strips (34915 - 34916 - 34917 - 34918)
- Emergency cover (34085)



## GIMA RESUSCITATION KITS

- 34181 SPEED 1 RESUSCITATION KIT - UNI cylinder
- 34182 SPEED 2 RESUSCITATION KIT - NF cylinder
- 34183 SPEED 3 RESUSCITATION KIT - without cylinder
- 34180 SPEED EMPTY CASE - with sponge
- 34222 FACEMASK N° 2 - child small



First aid kits for reanimation, very useful for medical and dental rooms, sport clubs, factories, ambulances... Case made of anti-shock plastic. Size: 43 x 37 x 11 cm.

STANDARD ACCESSORIES	SPEED 1	SPEED 2	SPEED 3
Silicone resuscitation bag - autoclavable	•	•	•
Silicone Face mask n° 4	•	•	•
Oxygen cylinder 0.5 l (empty). UNI standard	•	•	•
Oxygen cylinder 0.5 l (empty). NF standard	•	•	•
High pressure manometer	•	•	•
Guedel airways (small + medium + large)	•	•	•
Helicoidal mouthwedge + Tongue holding forceps	•	•	•
Atoxing tubing for connection to oxygen cylinder	•	•	•
Plastic case	•	•	•

AVAILABLE WITH OR WITHOUT CYLINDER



34181

## SPLINTER REMOVAL KIT

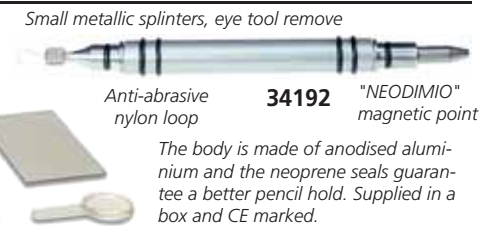

34190

34192

### • 34190 SPLINTER REMOVAL KIT

Includes everything to remove splinters and for first aid medications. In a polypropylene box size 235x190x43 mm:

- 1 Eye wash solution 100 ml with an eye glass
- 1 magnifying glass, 2 sterile gauze pads 18x40 cm
- 1 Professional removal pencil, 1 mirror.
- 1 stainless steel tweezers 11.5 cm

### • 34192 PROFESSIONAL REMOVAL PENCIL

Small metallic splinters eye tool remover. On one side a magnetic point to remove any metallic splinter avoiding any risk for the eye. On the other side an antiabrasive nylon loop for non metallic splinters.

## EYE WASH SYSTEMS

### • 34889 DROP - eye wash station

Thermo-formed wall kit with all necessary items for an efficient first emergency eye wash:

- 2 sterile saline solutions of 500 ml
- 2 integrated eye cups and one mirror.

### • 34888 EYE WASH SOLUTION 500 ml

- sterile - spare



34889

## FIRST AID FAMILY CASE



Size: 235x190x43 mm

34136

### • 34136 FAMILY FIRST AID CASE

Small first aid case suitable for use anywhere and anytime: (at home or office, in the car or boat...). Made in Italy

### • 34450 EMPTY CASE

#### STANDARD ACCESSORIES

- |  |                                   |
|--|-----------------------------------|
| 2 sterile gauze pads 18x40 cm          | 3 antiseptic wipes                |
| 1 pair of scissors. 1 plastic tweezers | 1 adhesive dressing 10 x 6 cm     |
| 1 sterile bandage 60x40 cm             | 1 gauze bandage 5 cm              |
| 1 cotton wool pack 5 g                 | 1 adhesive plaster roll 2 cm x 1m |
| 1 pack of 10 adhesive plasters         | 1 pair of protection gloves       |
| 1 tissue pack 10 pcs                   | Guidance Leaflet 6 languages      |

## MEDICAL SPORT BAG



### • 34135 MEDICAL SPORT BAG

Special kit designed for first aid in sporting clubs (tennis clubs, swimming pools, gymnasium,....).

Soft nylon bag has 2 side pockets and zip closure.

Size: 470x240x190 mm  
Weight: 6.5 kg

#### STANDARD ACCESSORIES

- |   |   |
|---|---|
| 1 isothermic blanket Gold/Silver 160x210 cm | 1 pack of 20 adhesive plasters 2x7 cm   |
| 1 Disinfectant liquid 250 ml                | 8 adhesive plasters 10x6 cm             |
| 2 adhesive plasters 5 m x 2,5 cm            | 1 sterile TNT bandage 60x40 cm          |
| 2 pairs of sterile gloves                   | 1 sterile TNT bandage 60x80 cm          |
| 2 VENTO mouth to mouth resuscitators        | 6 sterile TNT pads 10x10 cm             |
| 6 sterile gauze pads 18x40 cm               | 5 instant ice packs                     |
| 2 instant ice sprays 150 ml                 | 1 hydrogen peroxide solution            |
| 3 triangular TNT bandages 96x96x136 cm      | 1 elastic net bandage                   |
| 3 Elastic bandages 6 cm                     | 1 haemostatic lacet                     |
| 3 Elastic bandages 8 cm                     | 1 sterile tweezers                      |
| 1 cotton wool pack                          | 5 ammonia towelettes                    |
| 1 pair of LISTER scissors 14,5 cm           | 1 sterile saline solution bottle 250 ml |
| 2 compressive pad bandages 80x100 mm        | 1 gel hands disinfectant 100 ml         |
| 2 compressive pad bandages 100x120 mm       | guidance leaflet 5 languages            |

## FIRST AID CASE AND BAG



34184

### • 34184 SMALL KIT - plastic case

Size: 290x215x90 mm - 1.4 kg  
See content of kit at page 334

### • 34188 REFILL PACK for 34184-34185-34194

### • 34186 EMPTY PLASTIC CASE

290x215x90 mm

### • 34185 MIZAR BAG - nylon

Size: 250x180x90 mm

Same contents as 34184 see page 334

34185



Advised for offices or workshops of 2 people  
Meets Italian law 388-Art. 2

# FIRST AID PLASTIC CASES AND METAL CABINETS



34196



34197

- 34196 MEDIUM KIT - plastic case Size: 275x240x123 mm - 2 kg
- 34197 MEDIUM KIT - metal cabinet Size: 370x300x140 mm - 3.8 kg
- 34187 REFILL PACK for code 34196-97
- 34141 EMPTY METAL CABINET 370x300x140 mm



34198



34195



34199

- 34195 LARGE KIT - plastic case 1 Size: 460x345x135 mm - 6.2 kg
- 34198 LARGE KIT - plastic case 2 Size: 395x270x135 mm - 6.2 kg
- 34199 LARGE KIT - metal cabinet Size: 460x300x140 mm - 7.5 kg
- 34189 REFILL PACK for code 34195-34198-34199 without sphygmomanometer
- 34191 EMPTY PLASTIC CASE 1 460x345x135 mm
- 34138 EMPTY PLASTIC CASE 2 395x270x135 mm



- 34143 METAL CABINET  
Supplied with 3 internal metal shelves, removable bottle floor support, 2 small shelves on the door, lock and key.  
Size 402x582x202 mm - 12.9 kg
- 34145 EMPTY METAL CABINET 402x582x202 mm

STANDARD CASES / CABINETS CONTENT	34194 34184-5	34196 34197	34195 34198-9	34143	34151	SPARES see page
Bags liquid soap		3		3		348
Bags antiseptic wipes		3		3		349
Bottle antiseptic solution 125 ml	1	1				-
Bottle antiseptic solution 250 ml				1		349
Bottle antiseptic solution 500 ml			2	3	2	-
Oxygenated water bottle				1		349
Ammonia bag		2		2		-
Pair protective gloves, sterile	2	2	5	5	5	19
Box of 10 assorted plasters	1	1	2		2	345
Box of 100 assorted plasters Plastosan				1		345
Box of 100 assorted 7x2 cm Plastosan				1		345
Adhesive plaster roll 2,5 cm x 5 m	1	1	2	2	2	343
Elastic bandage with clip 4,5 cm x 7 m				1		339
Pack of 8 assorted gauze bandages				1		339
Gauze bandage 10 cm x 3,5 m	1	1				339
Tubular net gauze			1	1	1	336
Pack of sterile compress 10 x 10 cm	3	3	10	10	10	341
Pack of sterile compress 18 x 40 cm	1	3	2	6	2	341
Pack of cotton wool	1	1	1	3	1	342
Mask with face shield			1	1	1	16
Pair of scissors cm 14,5	1	1	1	1	1	335
Sterile forceps	1	1	2	2	2	38
Haemostatic lacet	1	1	3	3	3	56
Sphygmomanometer + Stethoscope			1	1	1	229-250
Sterile blanket 40x60 cm		1	2	2	2	-
Pack of instant ice, single use	1	1	2	2	2	347
Digital thermometer			1	1	1	78
Trash bag	1	1	2	5	2	-
First aid multilanguage booklet	1	1	1	1	1	-
Guidance leaflet	1	1	1	1	1	-
Irrigating solution 250 ml	1	1				349
Irrigating solution 500 ml			3	3	3	-
Triangular blanket 96x96x136 cm		1		4		-
Isothermic blanket gold/silver 160x210 cm				1		347
Sterile burn gel sachet 3.5 g				3		347
Compressive Emocontrol bandage				1		339
Pinocchio helicoidal open mouth Vento				1		324
Autoclavable resuscitator with facemask N° 4					1	322
Oxygen bottle 0.5 l empty - UNI standard					1	320
Guedel airways					3	323
Atoxic tube for oxygen					1	324
Mouth opener					1	324

- 34151 GIMA 3 - FIRST AID CASE + OXYGEN CYLINDER  
Advised for up to 50 people Size: 32x44.5x15 cm  
Meets Italian law D.M. 388 (15.7.03) art. 1 + emergency kit.  
Emergency kit includes:  
- autoclavable resuscitation with security valve, and silicone mask n. 4.  
- oxygen bottle 0.5 l (empty) with reductor and oxygen distributor - UNI standard.  
- 3 guedel airways, atoxic tube for connection to oxygen, mouth opener and wall support.
- 34148 GIMA 3 - EMPTY PLASTIC CASE



34151

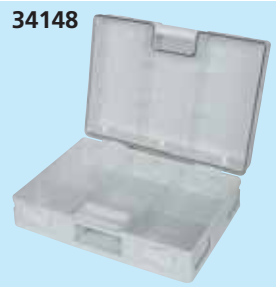

34148



## MASK FOR MOUTH-TO-MOUTH REANIMATION



**Ambu**  
Ideas that work for life

• **34216 LIFEKEY MASK**  
Pocket mask for mouth-to-mouth reanimation. Its special one-direction valve allows oxygen to flow straight to the patient and minimizes risks of cross-contamination. Single-use, non-sterile, made in atoxic transparent material, easy to use and carry. Suitable for adults and children.



**GIMA**

• **34218 CPR MASK - pocket resuscitator**  
The CPR pocket mask is a non-invasive, latex free mask with an integral non-rebreathing valve and efficient filter to prevent direct mouth contact with the patient's face when providing mouth-to-mouth resuscitation. It can be used on adult, child and infant. Supplied in a compact plastic box with a corrugated tube for an easier use.

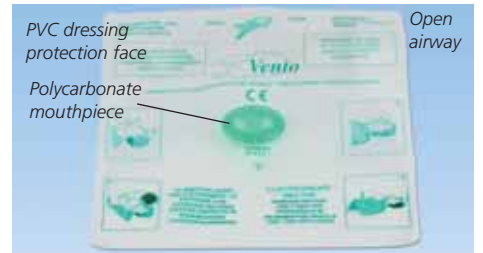

• **34211 VENTO AIRWAYS - Poly-bag**  
• **34213 VENTO AIRWAYS - Key-holder box**  
Disposable mouth to mouth airway with a one way polycarbonate valve and non-toxic pvc protective foil to avoid any direct contact between patient and rescuer. Available in 2 versions: in poly-bag or key-holder box. Instructions in GB, IT, FR, DE.

## EMERGENCY



• **34127 EMERGENCY SCISSORS**  
23.5x10.8 cm  
Autoclavable Stainless steel AISI 420. Made in Italy.

## LISTER BANDAGE S/S SCISSORS

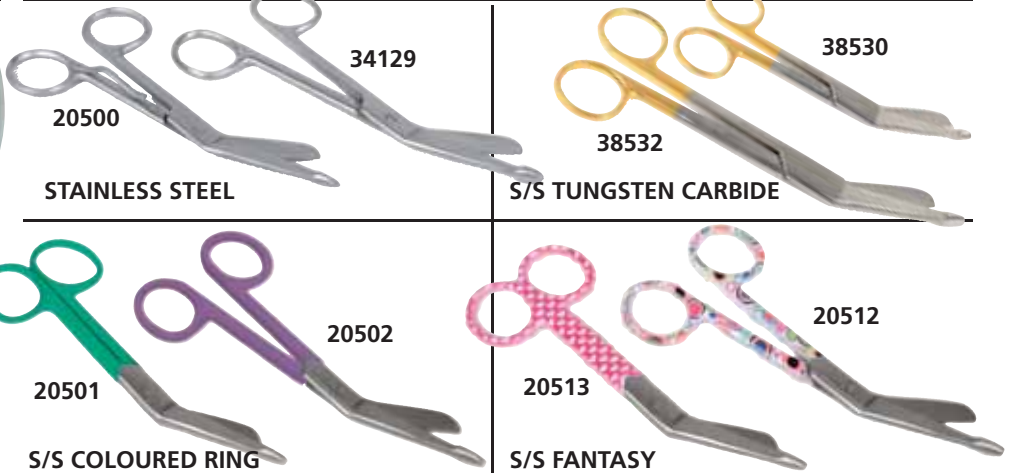

LISTER BANDAGE SCISSORS			
GIMA code	STAINLESS STEEL	GIMA code	FANTASY - COLOURED RING
34125	Lister - 11 cm	20501	Lister - Green ring - 14 cm
34129	Lister - 15 cm	20502	Lister - Lilac ring - 14 cm
34130	Lister - 18 cm	20509	Lister - Foot print - 14 cm
20500	Lister with belt clip - 14 cm	20511	Lister - Leopard - 14 cm
38530	Lister tungsten carbide - 14 cm	20512	Lister - Bubble - 14 cm
38532	Lister tungsten carbide - 18 cm	20513	Lister - Hearts - 14 cm

## STAINLESS STEEL UTILITY AND BANDAGES SCISSORS



All purpose, first aid scissors, easily cut bandages, leather and plaster casts. Autoclavable at 136°C

UTILITY SCISSORS			
12 cm - 4.7"	16.5 cm - 6.5"	19 cm - 7.5"	Colour
20560	20570	20580	Black
-	20571	20581	Blue
-	20572	20582	Red
-	20573	20583	Purple
-	20574	20584	Pink
20590	Steel chain for scissors and forceps		



## LEUKOTAPE® K NEUROMUSCULAR TAPE



### NEUROMUSCULAR TAPE

Elastic adhesive tape for neuromuscular taping. 100% cotton fabric coated with a strong acrylic adhesive mass. Water resistant. Latex-free. Multilanguage GB, FR, IT, ES, DE, PT, NL.



GIMA code	BSN code	LEUKOTAPE® K NEUROMUSCULAR TAPE
59010	72978-11	LEUKOTAPE® K 5 m x 5 cm - skin
59011	72978-16	LEUKOTAPE® K 5 m x 5 cm - red
59012	72978-21	LEUKOTAPE® K 5 m x 5 cm - blue
59013	72978-23	LEUKOTAPE® K 5 m x 5 cm - black
59014	72978-24	LEUKOTAPE® K 5 m x 5 cm - light blue
59015	72978-25	LEUKOTAPE® K 5 m x 5 cm - pink

## KINTAPE KINESIOLOGY TAPES

High quality Kinesiology tape conforms to all areas of the body. Provides firm support and compression. Ideal for treatment of muscular symptoms, stimulus to blood circulation and lymph and fascia diversion. Reduce pain improving athletic performance. Easy to tear and unwinds to the core. Individually packed in a plastic bag and cardboard box. - soft hypoallergenic cotton cloth, elasticity up to 160%

- 70% water proof (level 3) and sweat proof  
- supersticky: up to 7 days, over 10 days for kinesiology PRO  
**Kinesiology PRO:** supersoft and quick drying

GIMA code	KINESIOLOGY STANDARD TAPES - thickness 0.48 mm	Minimum order
34745	Kinesiology tape 5 m x 5 cm - black	box of 1
34746	Kinesiology tape 5 m x 5 cm - ceil blue	box of 1
34747	Kinesiology tape 5 m x 5 cm - red	box of 1
34749	Kinesiology tape 5 m x 5 cm - green	box of 1
34750	Kinesiology tape 5 m x 5 cm - pink	box of 1
34751	Kinesiology tape 5 m x 5 cm - skin	box of 1
34752	Kinesiology tapes 5 m x 5 cm - mix colours	box of 6
KINESIOLOGY PRO TAPES - thickness 0.32 mm		
34757	Kinesiology PRO tapes 5 m x 5 cm - skin	box of 1

Mixed colours box includes 6 rolls in different colours: ceil blue, red, pink, green, black, beige



Multilanguage box and instructions (GB, FR, IT, ES)

Made of 97% cotton, 3% spandex

34752

## FABRIC SPORT TAPES



34755

34754



Made in Italy

GIMA code	WHITE ZINC OXIDE FABRIC TAPE NON ELASTIC ADHESIVE BANDAGE	Minimum order
34753	Tape 14 m x 2.5 cm - for finger	box of 48
34754	Tape 14 m x 3.8 cm - for wrist	box of 30
34755	Tape 14 m x 5 cm - for ankle	box of 24

## ELASTICATED TUBULAR NET

Elastic tubular net for the application of gauze and medication. Versatile, suitable for all parts of the body. The special structure of the material allows a stretching which holds without compressing. Made in Italy.



GIMA code	Range	Length under tension: 25 m		
34701	1		4	
34702	2			
34703	3	1		7 <small>small</small>
34704	4			
34705	5		5	8 <small>medium</small>
34706	6			
34707	7	2		
34708	8		6	
34709	9			

## STRAPPAL® SPORT TAPE

### STRAPPAL® SPORT TAPE

Inelastic adhesive bandage (tape) indicated in traumatology to limit the joint movements.

High quality fabric made of inelastic viscose fibres coated with a strong adhesive mass. Hand tearable. Latex free.

Multilanguage GB, FR, IT, ES, DE, PT, NL.



GIMA code	BSN code	STRAPPAL® SPORT TAPE	Minimum order
59051	71490-00	STRAPPAL® 10 m x 4 cm	box of 24
59052	71493-00	STRAPPAL® 10 m x 5 cm	box of 18



## COMPRILAN® COMPRESSIVE BANDAGES



**COMPRILAN® COMPRESSIVE BANDAGES**  
Short stretch compression bandage (90%) for phlebological and lymphological application. 100% cotton fabric (flesh colour). Stretched length 5 m. Washable and sterilizable. Latex-free.

GIMA code	BSN code	COMPRILAN® COMPRESSIVE BANDAGES	Minimum order
59150	01026-00	COMPRILAN® 5 m x 6 cm	box of 1
59151	01027-00	COMPRILAN® 5 m x 8 cm	box of 1
59152	01028-00	COMPRILAN® 5 m x 10 cm	box of 1
59153	01029-00	COMPRILAN® 5 m x 12 cm	box of 1

## ELASTIC COMPRESSION BANDAGES - LIGHT TO STRONG COMPRESSION



**PREVIBIELASTICA**  
- medical prescription bandage  
- ideal for bandaging when support and strong, constant compression is required  
- used in the treatment of varicose veins and post-operative patients  
- its ability to stretch in any direction makes it ideal for bandaging joints.



**PREVIFORTE**  
- medical prescription bandage  
- compression bandage for phlebitis treatment  
- support bandage with strong, constant compression, ideal for varicose veins, for the prevention and cure of sport and work injuries. Suitable for distortions, light fractures and sprains.



**PREVINOVA**  
- universal compression bandage  
- protects and supports all types of medication  
- to fix medications, support light fractures, distortions, sprains, sport and work injuries with medium compression.

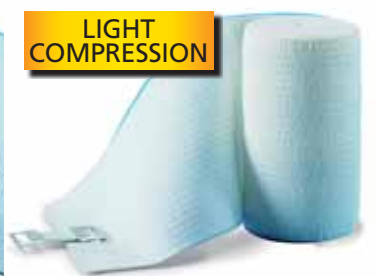

**PREVIMEDICAL**  
- universal compression bandage  
- protects and supports all types of medication  
- to fix medications, for support and relief in case of contusions and haematomas with medium-light compression.

GIMA code	ELASTIC COMPRESSION BANDAGES individually packed, with clip		Minimum order
<b>PREVIBIELASTICA - strong compression</b>			
34644	PreviBielastica	7 m x 8 cm	box of 10
34645	PreviBielastica	7 m x 10 cm	box of 10
<b>PREVIFORTE - strong compression</b>			
34647	PreviForte	7 m x 8 cm	box of 10
34648	PreviForte	7 m x 10 cm	box of 10
<b>PREVINOVA - medium compression</b>			
34650	PreviNova	4.5 m x 6 cm	box of 10
34651	PreviNova	4.5 m x 8 cm	box of 10
34652	PreviNova	4.5 m x 10 cm	box of 10
<b>PREVIMEDICAL - medium light compression</b>			
34654	PreviMedical	5 m x 8 cm	box of 10
34655	PreviMedical	5 m x 10 cm	box of 10

TECHNICAL SPECIFICATIONS				
	PREVIBIELASTICA	PREVIFORTE	PREVINOVA	PREVIMEDICAL
Composition:	Cotton 70%	92%	69%	60%
	polyamide 19%	-	25%	33%
	polyurethane 11%	8%	6%	7%
Extensibility	longitudinal 160%	170%	250%	160%
	transversal 80%	-	-	-

## CO-PLUS® BANDAGES



**CO-PLUS® BANDAGES**  
Flexible cohesive bandage. Sticks only to itself, not on skin. Indications: support and compression in traumatology and phlebology. Longer than competitors (6.3 m stretched instead of 4.5 m). Multilingual box: GB, FR, IT, ES, DE, NL.



GIMA code	BSN code	CO-PLUS® BANDAGES	Minimum order
59182	72100-09	CO-PLUS® 6.3 m x 7.5 cm - skin	box of 1
59183	72100-04	CO-PLUS® 6.3 m x 10 cm - skin	box of 1
59186	72102-03	CO-PLUS® 6.3 m x 7.5 cm - mix colours*	box of 24
59187	72102-02	CO-PLUS® 6.3 m x 10 cm - mix colours*	box of 18

\*Mix of bandages in 6 colours (blue, light blue, red, violet, neon green, neon pink)

## 3M COBAN™ ELASTIC WRAP



Self-adherent cohesive elastic wrap

GIMA code	3M code	3M COBAN™ SELF ADHERENT COHESIVE ELASTIC WRAP - LATEX	Minimum order
34923	1583	COBAN™ 7.5 cm x 2 to 4.57 m	box of 24
34924	1584	COBAN™ 10 cm x 2 to 4.57 m	box of 18

## ELASTOMULL® HAFT COHESIVE BANDAGES



Multilanguage box:  
GB, FR, IT, ES, DE,  
PT, NL, SE

### ELASTOMULL® COHESIVE BANDAGES

Elastic retention bandage. It provides wound care splint retention and light support. Comfortable non woven fabric (cotton, viscose and polyamide) coated with synthetic latex. Stretched length 4 m.



GIMA code	BSN code	ELASTOMULL® HAFT COHESIVE BANDAGES	Minimum order
59211	45471-00	Elastomull® Haft 4 m x 6 cm	box of 10
59212	45472-00	Elastomull® Haft 4 m x 8 cm	box of 10
59213	45473-00	Elastomull® Haft 4 m x 10 cm	box of 10
59214	45474-00	Elastomull® Haft 4 m x 12 cm	box of 10
59218	45477-00	Elastomull® Haft 20 m x 8 cm	box of 1
59219	45478-00	Elastomull® Haft 20 m x 10 cm	box of 1

## ELASTIC COHESIVE BANDAGES

- to fix dressings.
- ideal for supporting light joint fractures.
- this bandage does not require clips because perfectly adherent.

### TECHNICAL SPECIFICATIONS

Composition: 42% cotton, 29% viscose,  
29% polyamide, latex or latex free  
Width: 6 - 8 - 10 - 12 cm  
Length: stretched length 4 m  
Extensibility: approx. 50%



GIMA code	ELASTIC COHESIVE BANDAGE	Minimum order
34657	Cohesive bandage 4 m x 6 cm	box of 10
34658	Cohesive bandage 4 m x 8 cm	box of 10
34659	Cohesive bandage 4 m x 10 cm	box of 10
34660	Cohesive bandage 4 m x 12 cm	box of 10
34661	Cohesive bandage 20 m x 6 cm	box of 1
34662	Cohesive bandage 20 m x 8 cm	box of 1
34663	Cohesive bandage 20 m x 10 cm	box of 1
GIMA code	ELASTIC COHESIVE BANDAGE - LATEX FREE	Minimum order
59201	Cohesive bandage 4 m x 8 cm	box of 10
59202	Cohesive bandage 4 m x 10 cm	box of 10
59206	Cohesive bandage 20 m x 8 cm	box of 1
59207	Cohesive bandage 20 m x 10 cm	box of 1

## COHESIVE BANDAGES

### ELASTIC COHESIVE BANDAGES

Cohesive bandage with instantaneous and lasting fixation.

It adheres only to itself and not to the skin, hair or clothing.

Doesn't slip, is air-permeable, with stretchability of approx 115%.

Comfortable, well tolerated by skin, it adapts perfectly to part to be treated.

Versatile to use, easy to apply, permits free movement. Made in Italy.



GIMA code	COHESIVE BANDAGE	Minimum order
34710	Cohesive bandage size 4 m x 6 cm	box of 72 pcs
34711	Cohesive bandage size 4 m x 8 cm	box of 72 pcs
34712	Cohesive bandage size 4 m x 10 cm	box of 36 pcs
34713	Cohesive bandage size 4 m x 12 cm	box of 36 pcs

## ELASTIC COLOUR COHESIVE BANDAGES - EXTENSIBILITY 90%

Cohesive bandages through microfine latex dots

- for fixing dressings
- ideal for supporting joint treating light fractures
- this bandage does not require clips because it remains well-attached to itself.

### TECHNICAL SPECIFICATIONS

Composition: 42% cotton, 29% viscose,  
28% polyamide, 1% elastan and latex  
Width: 6 - 8 - 10 cm Length: stretched length 4 m  
Extensibility: approx. 90%

### COHESIVE COLOUR BANDAGE

Size	Green	Blue	Red	Yellow	Colours*	Minimum order
4 m x 6 cm	-	34665	34666	-	34668	box of 10
4 m x 8 cm	34669	34670	34671	34672	34673	box of 10
4 m x 10 cm	34674	34675	34676	-	34678	box of 10

\*Mix 2 bandages x 5 colours (red, green, blue, yellow, white)



Cohesive through microfine latex dots

## PREVITNT COHESIVE NON WOVEN ELASTIC BANDAGES

### PREVITNT NON WOVEN ELASTIC BANDAGES

For fixing dressings.

Ideal for supporting joints, treating light fractures.

This bandage does not require clips because it remains well-attached to itself.

Particularly suitable for use on joints, for sports and veterinary use.

Composition: 85% polypropylene - 15% spandex and latex.

Extensibility: approx 100%.

### COHESIVE COLOUR NON WOVEN BANDAGE

Size	Blue	Red	Colours*	Minimum order
4.5 m x 7.5 cm	34734	34735	34736	box of 10
4.5 m x 10 cm	34738	34739	34740	box of 10

\*Mix 2 bandages x 5 colours (red, green, blue, yellow, skin)



## TENSOPLAST® ELASTIC ADHESIVE BANDAGES



**TENSOPLAST® BANDAGES**  
Elastic adhesive bandage. High quality elastic fabric, soft edges and porous adhesive mass. Yellow center line. It provides strong support and compression in traumatology and phlebological disease. Stretched length 4.5 m. Multilanguage box: GB, FR, IT, ES, DE, PT, GR, NL, SE.



GIMA code	BSN code	TENSOPLAST® BANDAGES
59250	71545-00	TENSOPLAST® 4.5 m x 5 cm
59251	71546-00	TENSOPLAST® 4.5 m x 7.5 cm
59252	71547-00	TENSOPLAST® 4.5 m x 10 cm

## GAUZE BANDAGES

For fixing dressing and for absorption of exudates. 100% cotton wool. Latex free. Made in Europe.



GIMA code	Threads	GAUZE BANDAGES - DISPOSABLE	Minimum order
34840	20	Gauze bandage 3.5 m x 5 cm	box of 12
34841	20	Gauze bandage 3.5 m x 7 cm	box of 10
34842	20	Gauze bandage 3.5 m x 10 cm	box of 6
34844	20	Gauze bandage 5 m x 5 cm	box of 100
34846	20	Gauze bandage 5 m x 7 cm	box of 100
34847	20	Gauze bandage 5 m x 10 cm	box of 100

## FIXATION ELASTIC BANDAGES

For fixing dressing, for support and light compression. Its characteristic crepe like touch enables the bandage to remain well-attached to itself. Well-tolerated by the skin, it ensures a high level of breathing. Washable at 60°C. Made of 99% cotton - 1% lycra. Made in Europe.



GIMA code	PREVICREPE S FIXATION ELASTICATED BANDAGES - 75 g <sup>2</sup>	Minimum order
34725	Previcrepe bandage 4 m x 5 cm	box of 10
34726	Previcrepe bandage 4 m x 7 cm	box of 10
34727	Previcrepe bandage 4 m x 10 cm	box of 10
34728	Previcrepe bandage 4 m x 15 cm	box of 10

## ELASTICATED BANDAGES

Elasticated **non adhesive** bandages for containment, individually cellophane wrapped, in a box. Non adhesive bandages are made of 65% cotton and 35% polyamide fibre. Provided with clasp. Made in Italy.



GIMA code	ELASTICATED BANDAGES	Minimum order
34720	Bandage size 4.5 m x 5 cm	box of 20 pcs
34721	Bandage size 4.5 m x 7 cm	box of 20 pcs
34722	Bandage size 4.5 m x 10 cm	box of 20 pcs

## ELASTICATED ADHESIVE BANDAGES

Elasticated **adhesive** bandages for containment, individually cellophane wrapped, in a box. Adhesive bandages are made of 99.7% cotton and 0.3% polyamide. Made in Switzerland.



GIMA code	ELASTICATED ADHESIVE BANDAGES
34730	Adhesive bandage size 4.5 m x 6 cm
34731	Adhesive bandage size 4.5 m x 8 cm
34732	Adhesive bandage size 4.5 m x 10 cm

## HYPOR-PLAST

**Extensible adhesive bandage**  
White extensible non-woven 100% polyester bandage roll. Extremely breathable and conformable. Hypoallergenic, reliable skin friendly acrylic adhesive.

**Indications:** suitable to fix dressings and other medical devices.

GIMA code	EXTENSIBLE ADHESIVE BANDAGE
34863	roll m 10 x 5 cm
34864	roll m 10 x 10 cm
34865	roll m 10 x 15 cm



## EMOCONTROL

• **34782 EMOCONTROL**  
Emocontrol is an easy, quick and effective elastic bandage for injuries and small haemorrhages. Length 4.5 m, width 10 cm with a 10x10 cm pad and 2 clips. English and Italian instructions. Made in Italy.



## ZINC-OINTMENT BANDAGE



- 34715 ZINC-OINTMENT ELASTIC BANDAGE 5 m x 10 cm
  - 34717 ZINC-OINTMENT ELASTIC BANDAGE 10 m x 10 cm
- Homogeneously soaked in zinc ointment ready for use and stretchable (in length).  
Each band is packed in sealed aluminium foil bag and cardboard box.  
Made in Italy.

### TEXTILE COMPOSITION

Viscose 71% - Polyamide 29% - Soaked with zinc oxide, gelatine, glycerin, propyl-hydroxybenzoate, methyl-hydroxybenzoate, water. Elasticity: 60% (±10%)

## PREVIZINC A and E

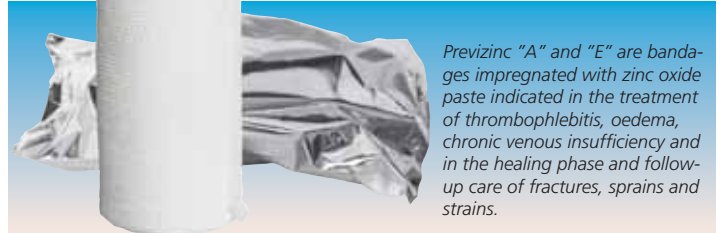

Previzinc "A" and "E" are bandages impregnated with zinc oxide paste indicated in the treatment of thrombophlebitis, oedema, chronic venous insufficiency and in the healing phase and follow-up care of fractures, sprains and strains.

GIMA code	PREVIZINC "A" INELASTIC BANDAGES	Minimum order
34714	Previzinc "A" 6 m x 8 cm	box of 10
34716	Previzinc "A" 5 m x 10 cm	box of 10
PREVIZINC "E" ELASTIC BANDAGES		
34718	Previzinc "E" 6 m x 8 cm	box of 10
34719	Previzinc "E" 5 m x 10 cm	box of 10

### TEXTILE COMPOSITION

Previzinc A: 100% cotton zinc oxide paste  
Previzinc E: 54% polyamide, 46% viscose zinc oxide paste

## PLATRIX® HIGH QUALITY PLASTER OF PARIS BANDAGES



**PLATRIX® PLASTER OF PARIS**  
High quality plaster of Paris bandages. Economic thanks to the high strength and the minimal plaster loss.  
Multilanguage box: GB, FR, IT, ES, DE, NL.

GIMA code	BSN code	PLATRIX® PLASTER OF PARIS	Minimum order
34686	71996 - 05	Platrix® 2 m x 15 cm	box of 40
34688	71996 - 14	Platrix® 3 m x 20 cm	box of 20
34691	71996 - 28	Platrix® 4 m x 20 cm	box of 20

## P.O.P. (PLASTER OF PARIS) BANDAGES

### PLASTER OF PARIS BANDAGES

Absorbent 100% cotton gauze 170 threads/cm<sup>2</sup> complying with British Pharmacopoeia requirements.

GIMA code	CELLONIT - PLASTER OF PARIS BANDAGE	Minimum order
34692	P.O.P. Bandage 2 m x 10 cm	box of 100
34693	P.O.P. Bandage 2 m x 15 cm	box of 50
34694	P.O.P. Bandage 2 m x 20 cm	box of 50
34695	P.O.P. Bandage 2.7 m x 10 cm	box of 80
34696	P.O.P. Bandage 2.7 m x 15 cm	box of 40
34697	P.O.P. Bandage 2.7 m x 20 cm	box of 40

Individually packed in a plastic bag and cardboard box



## OSCILLATING PLASTER SAW



59100

**SCHREIBER** INSTRUMENTE  
Made in Germany

- 59100 SG - 600 PLASTER SAW
- 59101 SAW BLADE Ø 50 mm
- 59102 SAW BLADE Ø 65 mm

German made professional plaster saw, ideal for cutting plasters and synthetic bandages. Adjustable oscillating speed.

### STANDARD ACCESSORIES

Saw blade Ø 50 mm  
Saw blade Ø 65 mm  
One pair of wrenches  
Locking screw  
Fixation ring  
User manual: GB, IT, ES  
(DE on request)

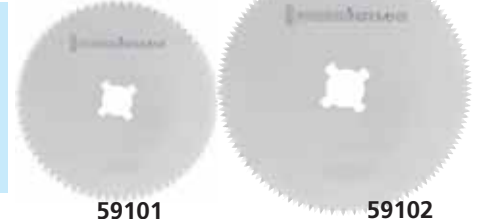

59101

59102

### TECHNICAL SPECIFICATIONS

Voltage:	220-240 V, 50-60 Hz
Power:	250 W
Strokes:	12,000 - 21,000 oscillations/min
Length without cord:	340 mm
Weight with/without cable:	1.3/1.7 Kg
Noise:	68-82 dB
Cord length:	4.5 m
IP code:	IP2X

## COTTON GAUZE SWABS



CE 0373

34772      34790-1-2

GIMA code	Plies	Threads	GAUZES - NON STERILE	Minimum order
34770	16	20	Cotton gauze swab 5x5 cm	pack of 100
34771	16	20	Cotton gauze swab 7.5x7.5 cm	pack of 100
34772	16	20	Cotton gauze swab 10x10 cm	pack of 100
34773	12	20	Cotton gauze swab 10x20 cm	pack of 150
34790		20	Cotton gauze pad 10x10 cm - 1 kg	1 pack
34791		20	Cotton gauze pad 20x20 cm - 1 kg	1 pack
34792		20	Cotton gauze pad 30x30 cm - 1 kg	1 pack

## GAUZE SWABS: COTTON, NON-WOVEN

Gauze swabs pure cotton, 20 threads, yarn 40/40, folded and hemmed without X-ray thread, non-sterile.  
 Non woven swabs, 30% polyester, 70% viscose 30 g/m<sup>2</sup> folded and hemmed without X-ray thread.  
 Carton of 10 packs of 100.



Cotton	Plies	Non Woven	Plies	GAUZE SWABS NON STERILE	Minimum order
35005	16	35010	4	Size 5x5 cm	box of 1,000 (10 packs of 100)
35006	12	35011	4	Size 7.5x7.5 cm	box of 1,000 (10 packs of 100)
35007	16	35012	4	Size 10x10 cm	box of 1,000 (10 packs of 100)

## COTTON GAUZE SWABS - STERILE



CE 0476

34762      34761      34760

34764      34763

GIMA code	Threads	COTTON GAUZE SWABS - STERILE Made in Italy	Minimum order
34760	12/8	Size 10x10 cm	carton of 150 bags of 25 pcs
34761	12/8	Size 15x15 cm	carton of 100 bags of 25 pcs
34762	12/8	Size 20x20 cm	carton of 100 bags of 25 pcs
34763	12/8	Size 18x40 cm	carton of 50 box of 12 pcs
34764	12/8	Size 36x40 cm	carton of 50 box of 12 pcs

## NON WOVEN GAUZE SWABS - STERILE



CE 0476

35025      35028      35029

GIMA code	NON WOVEN GAUZE SWABS - STERILE Made in Italy	Minimum order
35025	Size 10x10 cm	carton of 100 bags of 25 pcs
35028	Size 18x40 cm	carton of 30 box of 12 pcs
35029	Size 36x40 cm	carton of 30 box of 12 pcs

## COTTON GAUZE SWABS - STERILE



100% cotton gauze, 17 threads / 59 cm<sup>2</sup>, according to European Pharmacopoeia and EN 14079. Each dispenser contains sterile packs of 5 gauze swabs.

CE 0373

35035      35037      35039      35038

GIMA code	Plies	Threads	GAUZE SWABS - STERILE	Minimum order
35035	12	17	5x5 cm	dispenser of 350 (70 packs of 5 swabs)
35036	12	17	5x5 cm - X-ray	dispenser of 350 (70 packs of 5 swabs)
35037	12	17	7.5x7.5 cm	dispenser of 250 (50 packs of 5 swabs)
35038	12	17	7.5x7.5 cm - X-ray	dispenser of 250 (50 packs of 5 swabs)
35039	12	17	10x10 cm	dispenser of 150 (30 packs of 5 swabs)
35040	12	17	10x10 cm - X-ray	dispenser of 150 (30 packs of 5 swabs)

## COTTON GAUZE BALLS - STERILE



CE 0373 100% cotton gauze, 20 threads / 59 cm<sup>2</sup> according to European Pharmacopoeia and EN 14079. Each dispenser contains sterile packs of 5 gauze balls.

Pack of 5

GIMA code	Threads	GAUZE BALLS - STERILE	Minimum order
35045	20	Gauze balls Ø 30 mm	dispenser of 250 (50 pack of 5)
35046	20	Gauze balls Ø 40 mm	dispenser of 200 (40 pack of 5)
35047	20	Gauze balls Ø 50 mm	dispenser of 300 (60 pack of 5)

## COTTON GAUZE BALLS



34780      34781

GIMA code	COTTON GAUZE BALLS	Minimum order
34780	Cotton gauze balls Ø 30 mm	100 pcs. (1 bag of 100)
34781	Cotton gauze balls Ø 50 mm	100 pcs. (1 bag of 100)

## COTTON GAUZE BALLS

Pure hydrophilic cotton gauze balls 20 threads, yarn 40/40, without X-ray thread, non sterile package. Carton of 10 bags of 100 balls.



35017      35016      35015

Cotton	Non Woven	GAUZE ROUND BALLS	Open size	Minimum order
35015	35020	Gauze ball Ø 15 mm	11x11 cm	1,000 pcs (10 bags of 100)
35016	35021	Gauze ball Ø 25 mm	12x15 cm	1,000 pcs (10 bags of 100)
35017	35022	Gauze ball Ø 50 mm	30x40 cm	1,000 pcs (10 bags of 100)

## GAUZE LAPAROTOMIC SPONGE

100% cotton gauze according to the European Pharmacopoeia and EN 14079, non sterile. X-ray detectable apx 60% Barium Sulphate.



GIMA code	Plies	Threads	LAPAROTOMIC SPONGE GAUZE	Minimum order
34775	4	17	Size 20x20 cm	box of 100
34776	4	17	Size 30x30 cm	box of 100
34777	4	17	Size 40x40 cm	box of 100
34778	4	17	Size 50x50 cm	box of 100

## DENTAL COTTON ROLLS

• 35000 COTTON ROLLS 1x3.8 cm  
100% cotton interior, soft, pliable, non-linting, non-irritating, highly absorbent up to 6 times their weight. Will not adhere to mucous membranes, maintains shape better when wet, non sterile. Minimum order: carton of 10 boxes of 1,000 pcs.



35000



## 100% COTTON WOOL



GIMA code	COTTON WOOL
34837	Cotton wool 100 g - box of 50 packs
34832	Cotton wool 250 g - box of 20 packs
34838	Cotton wool 1000 g - box of 10 packs

## STERILE ABSORBENT PADS



Multilanguage box:  
GB, FR, IT, ES,  
PT, DE, NL, SE

Ideal for situations where a great capacity of absorption is needed, such as bleedings and chronic wounds. Made of cellulose pulp, white and blue polypropilene and tissue paper.

GIMA code	STERILE ABSORBENT PADS	Minimum order
59402	10x10 cm	box of 60
59403	10x20 cm	box of 30
59404	20x20 cm	box of 30
59405	20x40 cm	box of 25

## 100% COTTON GAUZE ROLLS



### GAUZE ROLLS

100% cotton gauze rolls with 20 threads sq cm according to European Pharmacopoeia and EN 14079. X-Ray detectable thread (approx. 60% barium sulphat) 80 cm width, folded 8 to 10 cm ply. Multilanguage box: GB, FR, IT, ES, PT, DE, NL, SE.

GIMA code	Extended width	Folded width	Plies	Threads sq cm
59410	80 cm x 1 m	10 cm x 1 m	8	20
59411	80 cm x 2 m	10 cm x 2 m	8	20
59412	80 cm x 10 m	10 cm x 10 m	8	20

## 100% COTTON RIBBON GAUZE



- Latex and PVC free  
- Absorption of fluids inside cavities  
- Wound care during surgery

Multilanguage box:  
GB, FR, IT, ES,  
PT, DE, NL, SE

GIMA code	GIMA code	100% COTTON RIBBON GAUZE weight 33 g/sq. m 22 threads/sq. m	Minimum order
-	X-Ray*		
59420	59430	5 m x 1.25 cm	box of 24
59421	59431	5 m x 2.5 cm	box of 12
59422	59432	5 m x 5 cm	box of 12
59423	59433	5 m x 7.5 cm	box of 8
59424	59434	5 m x 10 cm	box of 6
59440	-	5 m x 1.25 cm - sterile	box of 60
59441	-	5 m x 2.5 cm - sterile	box of 30
59442	-	5 m x 5 cm - sterile	box of 26

\*X-Ray: approx. 60% barium sulphat contents

## 3M RESTON™ FOAM PAD

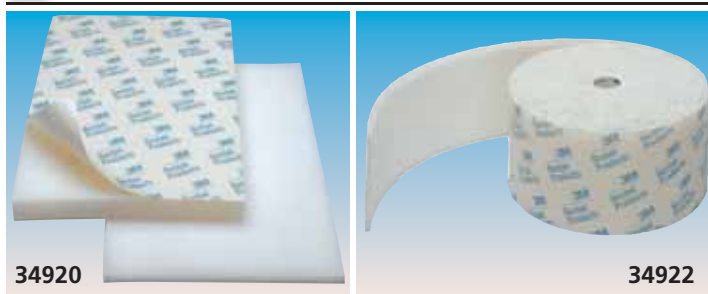

Self-adhering open cell foam designed to protect skin from splints, casts and prostheses. Not intended to be used as a pressure reducing device. It can also be used as a padding for beds and chairs. Can be cut, layered and shaped.



GIMA code	3M code	3M RESTON™ FOAM PAD	Minimum order
34920	1560	RESTON™ 30x20x1.1 cm	box of 10
34921	1561	RESTON™ 30x20x2.5 cm	box of 5
34922	1563	RESTON™ ROLL 10cmx5mx4mm	1 roll



## ADHESIVE DRESSING



GIMA code	STERILE - NON WOVEN ADHESIVE WOUND DRESSING HYPOALLERGENIC	Minimum order
34860	Sterile adhesive dressing 5x7 cm	box of 100 pcs
34861	Sterile adhesive dressing 8x10 cm	box of 50 pcs
34862	Sterile adhesive dressing 8x15 cm	box of 50 pcs

## STERILE ADHESIVE DRESSINGS



- **34848 OCULAR ADHESIVE DRESSING**  
Sterile, extremely absorbent ocular dressing on hypoallergenic permeable adhesive backing. Suitable for a safe and comfortable eye medication. Size 6.5x9.5 cm - box of 10 pcs
- **34845 STERILE ADHESIVE DEVICE for cannula fixation**  
Size 8x5.8 cm - box of 50 pcs

## ADHESIVE DRESSINGS



GIMA code	STERILE HYPOALLERGENIC ADHESIVE DRESSING WITH CENTRAL NON-WOUND-STICKING ABSORBANT PAD	Minimum order
34850	Sterile adh. dressing 7.2x5 cm	box of 8 pcs
34851	Sterile adh. dressing 10x10 cm	box of 6 pcs
34852	Sterile adh. dressing 10x15 cm	box of 4 pcs
34853	Sterile adh. dressing 10x8 cm	box of 50 pcs
34854	Sterile adh. dressing 10x15 cm	box of 50 pcs
GIMA code	HYPOALLERGENIC EXTENSIBLE NON WOVEN ADHESIVE DRESSING TO BE CUT, WITH HIGHLY ABSORBENT CENTRAL WOUND PAD	Minimum order
34855	Size 1 m x 6 cm	1 roll
34856	Size 5 m x 6 cm Recommended for sensitive skin	1 roll

## BWT ADHESIVE DRESSING



GIMA code	STERILE HYPOALLERGENIC ADHESIVE DRESSING WITH CENTRAL NON-WOUND-STICKING ABSORBANT PAD
34857	Sterile adh. BWT dressing 8x6 cm - box of 50 pcs
34858	Sterile adh. BWT dressing 10x10 cm - box of 50 pcs
34859	Sterile adh. BWT dressing 10x15 cm - box of 50 pcs

## SILK PLASTER ROLL

- **34787 SILK PLASTER ROLL 10 m x 2.5 cm - box of 12**
  - **34788 SILK PLASTER ROLL 10 m x 5 cm - box of 6**
- Silk surgical tape, white colour.

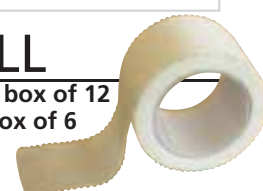

## PLASTER ROLLS



Each roll is supplied with a plastic roll cover except code 34798

PLASTER ROLLS - MADE IN ITALY			
Skintone fabric	Hypoallergenic Non woven	Size	Minimum order
34803	34804	5 m x 2.5 cm	box of 12 rolls
-	34798	9.14 m x 2.5 cm	box of 12 rolls
34806	34807	5 m x 5 cm	box of 6 rolls
34799	Shop Display: for showing up to 88 boxes (32 x 25 xh 63 mm)		

## NON WOVEN PAPER TAPE ROLL



GIMA code	NON WOVEN PAPER TAPE ROLL HYPOALLERGENIC ADHESIVE	Minimum order
34795	Tape roll h 25 mm x 5 m	box of 12 pcs
34796	Tape roll h 25 mm x 9.14 m	box of 12 pcs
34797	Tape roll h 50 mm x 9.14 m	box of 6 pcs

## 3M TAPES: MICROPORE™, MEDIPORE™, DURAPORE™, TRANSPORE™



34904

A latex-free, hypoallergenic paper tape that is gentle to the skin and doesn't leave adhesive upon removal. Highly breathable and economical. Can be used on wet skin.



GIMA code	3M code	3M MICROPORE™ PAPER TAPES	Minimum order
34904	1530-0	MICROPORE™ - h 12.5 mm x 9.14 m	box of 24 rolls
34905	1530-1	MICROPORE™ - h 25 mm x 9.14 m	box of 12 rolls
34906	1530-2	MICROPORE™ - h 51 mm x 9.14 m	box of 6 rolls
34907	1530-3	MICROPORE™ - h 76 mm x 9.14 m	box of 4 rolls



A silk tape with a latex-free, hypoallergenic adhesive that offers high strength and adhesion to skin.

34925



GIMA code	3M code	3M DURAPORE™ SILK TAPES	Minimum order
34925	1538-1	DURAPORE™ - h 25 mm x 9.14 m	box of 12 rolls
34926	1538-2	DURAPORE™ - h 51 mm x 9.14 m	box of 6 rolls



34937

Latex-free, hypoallergenic soft cloth tape. Gentle, breathable and easy-tear. Excellent cross and diagonal stretch to accommodate swelling and body movements

Available also with unique non-adherent pad.

GIMA code	3M code	3M MEDIPORE™ SOFT CLOTH TAPES and 3M MEDIPORE™ + PAD	Minimum order
34930	2991-1	MEDIPORE™ - h 50 mm x 10 m	box of 1 roll
34931	2991-2	MEDIPORE™ - h 100 mm x 10 m	box of 1 roll
34932	2991-3	MEDIPORE™ - h 150 mm x 10 m	box of 1 roll
34933	2991-4	MEDIPORE™ - h 200 mm x 10 m	box of 1 roll
34936	3562E	MEDIPORE™ + PAD - 5x7 cm	box of 25 pcs
34937	3566E	MEDIPORE™ + PAD - 10x10 cm	box of 25 pcs
34938	3569E	MEDIPORE™ + PAD - 10x15 cm	box of 25 pcs
34939	3570E	MEDIPORE™ + PAD - 10x20 cm	box of 25 pcs



Latex-free, hypoallergenic, transparent and perforated plastic tape that offers strong adhesion. Elastic and water-resistant.

34942

GIMA code	3M code	3M TRANSPORE™ PLASTIC TAPES	Minimum order
34941	1527-1	TRANSPORE™ - h 25 mm x 9.14 m	box of 12 rolls
34942	1527-2	TRANSPORE™ - h 51 mm x 9.14 m	box of 6 rolls

## BSN TAPES: LEUKOPOR®, LEUKOPLAST®, HYPAFIX®



The gentle tape for highly sensitive skin. For the fixation of dressings of all types and sizes. Non woven fabric and skin friendly adhesive mass.

GIMA code	BSN code	LEUKOPOR®	Minimum order
59501	02454-00	LEUKOPOR® 25 mm x 9.2 m	box of 12 rolls
59502	02455-00	LEUKOPOR® 50 mm x 9.2 m	box of 6 rolls



Highly adhesive tape for normal skin indicated when a strong adhesion is needed. Viscose fabric coated with traditional adhesive mass (natural rubber).

GIMA code	BSN code	LEUKOPLAST®	Minimum order
59504	01532-00	LEUKOPLAST® 25 mm x 5 m	box of 12 rolls
59505	01534-00	LEUKOPLAST® 50 mm x 5 m	box of 6 rolls



Non woven dressing retention sheet for the retention of dressings especially on highly contoured and frequently moved parts of the body. Conformable non woven fabric coated with a polyacrylic adhesive mass



Pad not included

GIMA code	BSN code	HYPAFIX®	Minimum order
59510	71443-01	HYPAFIX® 50 mm x 10 m	box of 1
59511	71443-02	HYPAFIX® 100 mm x 10 m	box of 1
59512	71443-03	HYPAFIX® 150 mm x 10 m	box of 1
59513	71443-04	HYPAFIX® 200 mm x 10 m	box of 1

## 3M STERI-STRIP™ - SKIN CLOSURE STRIPS

Adhesive skin closures made of non-woven backing coated with a pressure-sensitive hypoallergenic adhesive. Sterile, breathable and comfortable to wear.



34912



34912

STERI-STRIP™

### ELASTIC STERI-STRIP™

Stretches with body movement or edema. Mostly suited for special applications (e.g. joints) or plastic surgery. Skin tone.



GIMA code	3M code	3M REINFORCED STERI-STRIP™ - sterile - skin closure	Minimum order
34909	R1540	STERI-STRIP™ - 3x75 mm	50 bags of 5 strips
34910	R1541	STERI-STRIP™ - 6x75 mm	50 bags of 3 strips
34908	R1542	STERI-STRIP™ - 6x38 mm	50 bags of 6 strips
34911	R1546	STERI-STRIP™ - 6x100 mm	50 bags of 10 strips
34913	R1549	STERI-STRIP™ - 12x50 mm	50 bags of 6 strips
34912	R1547	STERI-STRIP™ - 12x100 mm	50 bags of 6 strips
34914	R1548	STERI-STRIP™ - 25x125 mm	25 bags of 4 strips

GIMA code	3M code	3M ELASTIC STERI-STRIP™ - sterile	Minimum order
34987	E4540	STERI-STRIP™ - 3x75 mm	50 bags of 5 strips
34988	E4541	STERI-STRIP™ - 6x75 mm	50 bags of 3 strips
34989	E4542	STERI-STRIP™ - 6x38 mm	50 bags of 6 strips
34990	E4546	STERI-STRIP™ - 6x100 mm	50 bags of 10 strips
34991	E4549	STERI-STRIP™ - 12x50 mm	50 bags of 6 strips
34992	E4547	STERI-STRIP™ - 12x100 mm	50 bags of 6 strips
34993	E4548	STERI-STRIP™ - 25x125 mm	25 bags of 4 strips

## SUTURE STRIPS

• 34997 STERILE SUTURE STRIPS - box of 8  
Sterile adhesive strips for cut and wound suture. Cut to measure. Dermatologically tested. It contains 5 small strips (3x75 mm) and 3 medium strips (6.4x80 mm). Multilanguage box: GB, FR, IT, ES, DE.



34997

## SOOTHING PATCH

• 34830 PREVIDOL SOOTHING PATCH  
9x14 cm - pouch of 5  
Previdol is a Medical Device patch adjuvant in the treatment of pains in the joints and the muscular-skeletal system. It acts on the affected part, keeping the skin protected and helping to give relief in presence of pain. To improve the cutaneous tolerability of the patch, some plant extracts like Arnica Montana, Devil's Claw and Boswellia were inserted, as well as some essential oils of Mint and Menthol to give a pleasant fragrance. Box: GB, IT.



## 3M SKIN CARE SOLUTIONS - CAVILON™

A complete range of barrier products to protect the skin from body fluids and friction. Cavilon™ products create on the skin a highly breathable, long lasting transparent coating to prevent maceration and trauma. Alcohol-free, hypoallergenic and non irritating, can be used on broken skin and under any tapes and dressing.

GIMA code	3M code	3M CAVILON™	Minimum order
34974	3346E	Cavilon™ no sting barrier film - spray 28 ml	box of 12
34973	3346P	Cavilon™ no sting barrier film - spray 28 ml	box of 1
34975	3392G	Cavilon™ durable barrier cream 92 g	1 dispenser
34976	9274	Cavilon™ continence care wipes	12 boxes of 8

3M CAVILON™ NO STING BARRIER FILM  
Up to 72 hours of protection for peri-wound and peri-ostomy skin.



3M CAVILON™ DURABLE BARRIER CREAM  
Zinc-oxide free barrier cream for continence care. Apply twice a day.

3M CAVILON™ CONTINENCE CARE WIPES  
«All in 1» wipes for cleansing, moisturizing and protecting the skin.



34974

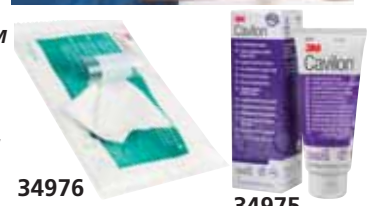

34976

34975

## ADHESIVE PLASTERS AND SPRAY - PLASTER DISPENSER



34817

34814

34809

34823

GIMA code	HYPOALLERGENIC ADHESIVE PLASTERS	Minimum order
34809	Water resistant - 19x72 mm	2,000 (100 boxes of 20)
34814	Water resistant - 4 mixed sizes	2,000 (100 boxes of 20)
34817	Sensitive skin - 5 mixed sizes	3,200 (80 boxes of 40)
34823	Spray plaster - bottle of 30 ml	box of 12



34828

Made in Italy

34826

Size 230x120x38 mm

• 34826 PLASTER DISPENSER - with 2 refills (one each type)  
• 34827 REFILL 42 TEXTILE PLASTERS 19x72 mm - box of 6  
• 34828 REFILL 38 TEXTILE PLASTERS 25x72 mm - box of 6  
Dispenser for adhesive plasters ready for use. It allows operator to extract plaster with one hand and apply directly on the wound. Transparent cover protects plaster and shows residual quantities. Lockable and with fixing wall kit included.

## 3M TEGADERM™ DRESSINGS



### TEGADERM™

Transparent, sterile waterproof dressing. Highly breathable. Frame style for easy application also available in non-sterile roll.

### TEGADERM™ + PAD

Transparent, sterile waterproof dressing. Highly breathable. Frame style for easy application. With a non-adherent absorbent PAD. Ideal for surgical wounds.



GIMA code	3M code	3M TEGADERM™ FILM	Minimum order
34900	1624W	TEGADERM™ - 6x7 cm - sterile	box of 100 pcs.
34901	1626W	TEGADERM™ - 10x12 cm - sterile	box of 50 pcs.
34902	1627	TEGADERM™ - 10x25 cm - sterile	box of 20 pcs.
34903	1628	TEGADERM™ - 15x20 cm - sterile	box of 10 pcs.
34899	16004	TEGADERM™ - 10 cmx10 cm non sterile	1 roll

GIMA code	3M code	3M TEGADERM™ PAD	Minimum order
34895	3582	TEGADERM™ + PAD 5x7.2 cm - sterile	box of 50 pcs.
34896	3586	TEGADERM™ + PAD 9x10 cm - sterile	box of 25 pcs.
34897	3589	TEGADERM™ + PAD 9x15 cm - sterile	box of 25 pcs.
34898	3591	TEGADERM™ + PAD 9x25 cm - sterile	box of 25 pcs.

## 3M VASCULAR ACCESS SOLUTIONS - TEGADERM™ IV

A complete range of sterile, waterproof, highly-breathable transparent film dressings to protect IV sites from water, virus and bacteria. With antifriction backing and reinforced non-woven borders for longer wearing time and minimized catheter dislodgement risk.



### TEGADERM™ IV

A cost-effective solution for peripheral and central vascular lines with strong hold and gentle removal.

### TEGADERM™ IV ADVANCED

A reinforced, 100% waterproof, advanced solution for better securement and longer wearing time.

GIMA code	3M code	3M TEGADERM™ IV - STERILE	Minimum order
34945	1633	7x8.5 cm - for peripheral lines	box of 100
34946	1635	8.5x10.5 cm - for central lines	box of 50

GIMA code	3M code	3M TEGADERM™ IV ADVANCED - STERILE	Minimum order
34947	1683	6.5x7 cm for peripheral lines	box of 100
34948	1685	8.5x11.5 cm for central lines	box of 50

## 3M SOLUTIONS FOR CHRONIC WOUNDS

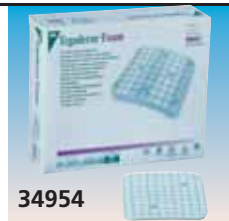

### TEGADERM™ HYDROCOLLOID

Sterile hydrocolloid dressing for low to moderate draining wounds. Also available in sacral shape with highly breathable waterproof border.

### TEGADERM™ HIGH PERFORMANCE FOAM

Sterile, multi-layer foam dressing that combines high absorbency with high breathability to reduce the risk of wound maceration. Well suited for changing levels of exudate to maintain moisture balance for optimal wound healing. Highly breathable and waterproof, also available in heel/elbow shape with adhesive border and simplified application system

GIMA code	3M code	3M TEGADERM™ HYDROCOLLOID	Minimum order
34968	90002	HYDROCOLLOID™ 10x10 cm square	box of 5
34969	90007	HYDROCOLLOID™ 16x17 cm sacral	box of 6

GIMA code	3M code	3M TEGADERM™ FOAM - non adhesive or adhesive dressing	Minimum order
34954	90601	TEGADERM™ FOAM - 10x10 cm	box of 10
34955	90604	TEGADERM™ FOAM - 9x9 cm for tracheostomy	box of 10
34957	90619	TEGADERM™ FOAM ADHESIVE for heel and elbow - 14x14 cm	box of 5



### TEGADERM™ ALGINATE

High integrity, gel forming alginate dressing for moderate to heavily exuding wounds. Compact and comfortable.

### TEGADERM™ ALGINATE AG

Antimicrobial, highly absorbent wound dressing with calcium alginate, carboxymethyl cellulose and ionic silver complex. To prevent and treat wound infections.



### TEGADERM™ HYDROGEL

Preservative-free hydrogel wound filler, easy to apply. Formulated to help provide a moist wound healing environment. Single use tube.



GIMA code	3M code	3M TEGADERM™ ALGINATE and ALGINATE AG	Minimum order
34964	90112	TEGADERM™ ALGINATE - 10x10 cm	box of 10
34965	90312	TEGADERM™ ALGINATE AG - 10x10 cm	box of 10

GIMA code	3M code	3M TEGADERM™ HYDROGEL	Minimum order
34972	91110	TEGADERM™ HYDROGEL 15 g	box of 10

## BURNFREE® - BURN CARE PRODUCTS



A complete range of burn care products with superior benefits:

- dissipates heat on contact
- cools the burn site, relieves pain, calms the burn victim, helps stop the burn process
- covers the burn, helps to prevent contamination
- accommodates swelling or the need to flex joints thanks to elastic texture

### Sterile burn and wounds dressings

Made of a soft open-cell, non-adherent, inert foam, saturated with Burnfree® gel, does not leave residues imbedded in the wound.

### Pain relieving gel

Ideal for all minor burns (including sunburns), cuts and abrasions, available in bottle or single use dose 3.5 g. Without lidocaine, which makes it suitable for children.

GIMA code	BURNFREE® PRODUCTS
34869	Burn Dressing - 5x5 cm - box of 120 pcs
34870	Burn Dressing - 5x15 cm - box of 10 pcs
34871	Burn Dressing - 10x10 cm - box of 10 pcs
34872	Burn Dressing - 20x20 cm - box of 5 pcs
34873	Burn Dressing - 30x30 cm - box of 20 pcs
34875	Pain Relieving Gel - bottle 120 ml
34883	Pain Relieving Gel - 3.5 g sachets - box of 20 pcs
34882	Pain Relieving Gel - 3.5 g sachets - box of 1,000 pcs
34878	Burn Kit (2 sterile dressing 5x15 cm and 2 10x10 cm, 1 gel bottle 120 ml, 20 gel sachets 3.5g and 2 rollers gauzes)

## HYPOTHERMIC BLANKET

### • 34086 HYPOTHERMIC BLANKET

Reflects and retains over 80% of radiated body heat to keep a person warm and protected even at subzero temperature. Waterproof, reusable, wind proof, lightweight.



Size  
200x150 cm

Made of polypropylene Fralom fibre coupled to a metallized polyethylene fibre.

Blanket colour may change in the time

## ISOTHERMIC COVER

### • 34085 EMERGENCY COVER

Suitable for protection against cold and heat. Silver side in keeps the warmth of the body, gold side out reflects sunbeams.



Size: 160x210 cm.  
Weight: 67 g

Radio transparent

## INSTANT ICE: SPRAY OR BAG IN TNT OR PE



34110

34111

34112

## BURNFREE® - FIRE BLANKET

Bags with strap for easy transport (34880-1 only)

34879

Supplied with bag



34880

34881

### BURNFREE FIRE/TRAUMA BLANKETS

Provides physical protection from heat, fire and smoke. Cools and soothes burn area. Fire resistant, are a protective shield for a person trapped by fire.

GIMA code	Blanket Size	Weight
34879	91x76 cm	2.3 kg
34880	183x152 cm	6.9 kg - 15 lbs
34881	244x152 cm	10.9 kg

## FIRE RETARDANT BLANKET

### • 34087 FIRE RETARDANT BLANKET

Made in glass fibre. Can be used to extinguish small fires. Size: 150x180 cm



34087

- 34110 INSTANT ICE - TNT 14x18 cm bag (non woven fabric)
  - 34111 INSTANT ICE - PE 14x18 cm bag (polyethylene)
- minimum order: pack of 25 bags.

Icy-pack "instant ice" is recommended for cryotherapy. Excellent in case of traumas to soothe the pain and to prevent haematomas, swellings, etc.

### Easy and quick to use anywhere and anytime.

Press the bag to break the inner bubble and shake to mix contents. The blend you obtain drops temperature of the pack down. Activates at -6°C, reaches 0°C in 30 minutes (at environment temperature of 20 °C).

### • 34112 SPRAY INSTANT ICE - bottle 400 ml

Ecological, useful for small bruises, haematomas or trauma, in first aid or sport applications. Spray on the injured area at 20 cm distance. (see the reference temperature chart). Content: Ammonium nitrate + water.