

Sapphire™

User Manual

Multi-Therapy & Epidural Infusion Pumps

REF 15025-048-0097 | Rev15Ver01 / 08.2021



For use with
Sapphire Infusion Pump Software r15

Important Notice

The Sapphire Infusion Pump User Manual is delivered subject to the conditions and restrictions listed in this section. Clinicians, qualified hospital staff, and home users should read the entire User Manual prior to operating the Sapphire pump in order to fully understand the functionality and operating procedures of the pump and its accessories.

- Healthcare professionals should not disclose to the patient the pump's security codes, Lock levels, or any other information that may allow the patient access to all programming and operating functions.
- Improper programming may cause injury to the patient.
- Home users of the Sapphire pump should be instructed by a certified home healthcare provider or clinician on the proper use of this pump.

Prescription Notice

Federal United States law restricts this device for sale by or on the order of a physician only {21 CFR 801.109(b) (1)}.

The Sapphire pump is for use at the direction of, or under the supervision of, licensed physicians and/or licensed healthcare professionals who are trained in the use of the pump and in the administration of blood, medication and parenteral nutrition. The instructions for use presented in this manual should in no way supersede established medical protocol concerning patient care.

Copyright, Trademark and Patent Information

© 2021, Eitan Medical Ltd. All right reserved.

Sapphire and Eitan Medical are trademarks of Eitan Medical Ltd.

The design, pumping mechanism and other features of the Sapphire pump are protected under one or more US and Foreign Patents.

Disclaimer

The information in this manual has been carefully examined and is believed to be reliable. No responsibility is assumed for any inadvertent inaccuracies. Eitan Medical Ltd. reserves the right to make changes to any of its products in order to improve reliability, design and performance. The instructions presented in this manual should in no way supersede established medical protocol concerning patient care. The text and drawings herein are for the purposes of illustration and reference only; the specifications on which they are based are subject to change without notice.

Warning

Use only Eitan Medical Ltd. supplied administration sets and accessories with the Sapphire pump. Use of administration sets other than Eitan Medical Ltd. supplied sets may impair the operation of the pump and the accuracy and flow rate of the infusion, and may generate hazardous fluid pressures which may activate occlusion alarms at unpredictable pressures.

Alternatively, administration sets from different manufacturers that are regulatory cleared and labeled for use with the Sapphire infusion system, can be used as well. The list of regulatory cleared sets needs to be obtained from the official manufacturer's publication such as manufacturer's website, catalog or any other formally published document.

Using anything other than administration sets regulatory cleared and labeled for use with Sapphire infusion system, may result in operation that is not within the constraints and parameters of the device.



The use of Administration sets manufactured by ICU Medical is approved for sale through March, 2023.

Eitan Medical Ltd. warranty on this device will be null and void and Eitan Medical Ltd. will assume no responsibility for incidents which may occur if the product is not used in accordance with product labeling. Refer to [Warnings and Safety Precautions](#) on page 22 for a complete list of warnings and cautions.

Technical Assistance

For technical questions, troubleshooting assistance and reporting of unexpected events, please contact your local agent/distributor, and refer to page 290. You may also contact Eitan Medical Ltd. support via email to the following address:

support@eitanmedical.com

Serious Incident Reporting

Any serious incident that has occurred in relation to the device should be reported to complaints@eitangroupmedical.com and the local competent authority.

Contents

1. INTRODUCTION10

Product Overview and Indications	10
Clinical Benefits.....	11
Dedicated Delivery Mode Configurations.....	11
Features	12
Terms and Abbreviations.....	14
Document Conventions	16
Safety and Compliance Information.....	16
Symbols and Labeling	17
Compliance and Classification	20
Biocompatibility	21
Sterilization	21
Degree of Protection Against Ingress of Water and Dust.....	21
Warnings and Safety Precautions.....	22
General Warnings and Precautions	22
Proper Use of the Pump	26

2. COMPONENTS, ACCESSORIES, AND ADMINISTRATION SETS.....32

Unpacking the Pump.....	32
Hardware and Software Components	33
Touch Screen	34
Using Pump Accessories	36
Mini Cradle	36
PCA Lockboxes	40
PCA Lockbox 250mL.....	44
PCA/PCEA/PIEB Bolus Handle	48
Power Supply.....	49

Integrated Power Supply.....	49
External Battery Pack.....	51
Multi-Pump Mounting System	58
Administration Sets.....	63

3. FUNDAMENTAL CONCEPTS AND OPERATIONS66

Working with the Main Display	66
Using the Keypad.....	66
Overview of Toolbar Function Keys.....	68
Overview of Icons.....	69
Selecting Delivery Mode.....	72
Enabling Special Features.....	74
Setting KVO rate	78

4. GETTING STARTED.....80

Typical Workflow	80
Turning the Pump On.....	82
Turning the Pump Off.....	82
Connecting the Infusion Container to the Administration Set.....	83
Opening the Safety Door.....	84
Inserting the Administration Cassette	85
Removing the Administration Cassette	87
Automatic Priming Using the Pump.....	88
Priming Manually.....	90

5. USING THE DELIVERY MODES92

Continuous Mode	92
Infusion Parameters: Continuous Mode	95
Starting a Continuous Infusion	95
Continuous Mode: Mid-infusion Actions.....	107
Multi-step Mode.....	121
Infusion Parameters: Multi-step Mode.....	122

Starting a Multi-step Infusion	122
Multi-step Mode: Mid-infusion Actions	128
Total Parenteral Nutrition (TPN) Mode	130
Infusion Parameters: TPN Mode	131
Starting a TPN Infusion	132
Intermittent Mode	137
Infusion Parameters: Intermittent Mode.....	138
Starting an Intermittent Infusion	138
Intermittent Mode: Mid-infusion Actions	145
Patient Controlled Analgesia (PCA) Mode	147
Infusion Parameters: PCA Mode	148
Starting a PCA Infusion	149
PCA Mode: Mid-infusion Actions.....	155
Epidural Mode	158
Patient Controlled Epidural Analgesia (PCEA) Mode	159
Epidural Intermittent Mode	170

6. BASIC INFUSION OPERATIONS..... 186

Starting New Infusions: Shortcuts.....	186
Repeating Last Infusion.....	186
Using a PreSet Program	188
Resuming Infusions After Pump Shutdown	189
Mid-infusion Actions	190
Pausing Infusions	190
Aborting Infusions	191
Locking the Screen	192
Activating Patient Lockout.....	193
Ending Infusion	193

7. OPTIONS MENU: CONFIGURING, VIEWING AND TESTING.....196

Main Options: Overview	196
Setting Delivery Mode	197
Managing Configuration Settings	198
Managing Alarm Settings.....	198
Configuring Audio Settings	201
Configuring General Settings	202
Defining Regional Parameters	206
Testing System Function.....	208
View Menu	209
Using Special Mode Options	217
PCA Options Menu.....	217
Epidural Mode Options Menu.....	218

8. USING ADVANCED FEATURES220

Managing Authorization Levels.....	220
Setting Authorization Lock Levels	222
Password Re-entry	223
Creating and Editing PreSet Programs	224
Using the Set Delay Feature.....	227
Using the New Patient Feature	231
Monitoring the Accumulated Volume Infused (Shift's Total)	232
Viewing Accumulated VI.....	232
Clearing Accumulated VI.....	233

9. DRUG LIBRARY.....234

Overview	234
Clinical Care Area (CCA)	235
Changing a CCA	235
Programming a New Infusion with the Drug Library	239
Drug Name	239

Drugs List	239
Drug Profiles	240
Soft Limit.....	241
Update a New Drug Library Version	242

10. ALARMS AND TROUBLESHOOTING 244

Alarms Overview.....	244
Level 1 Alarms	245
Level 2 Alarms	246
Level 3 Alarms	247
Messages	249
Troubleshooting.....	251

11. MAINTENANCE AND STORAGE..... 256

Cleaning and Disinfecting the Pump	256
Cleaning and Disinfection Procedure	258
Reprocessing the pump when used by a single patient multiple times	260
Cleaning Electric Connectors of Sapphire Accessories	261
Preventive Maintenance	262
Routine Inspection and Maintenance Tasks	262
Alarm Testing	263
Certification.....	264
Battery Care Information	265
Battery Classification	265
Battery Safety Information	266
Charging the Battery	267
Battery Maintenance	268
Transport and Storage	268

12. TECHNICAL SPECIFICATIONS	270
Pump Accuracy	270
Start-up and Trumpet Graphs	272
Pump Specifications	276
Average Bolus Volume After Occlusion	277
Environmental Specifications	278
Operating Conditions.....	278
Environmental Conditions for Transport and Storage	279
Electromagnetic Compatibility Statement	281
Electromagnetic Emission	281
Electromagnetic Immunity	282
13. LIMITED WARRANTY	288

Chapter 1: Introduction

The following sections describe the functions and features of the Sapphire Infusion Pump, and provide a summary of safety and regulatory information:

Product Overview and Indications	10
Terms and Abbreviations	14
Document Conventions	16
Safety and Compliance Information	16
Warnings and Safety Precautions	22

Product Overview and Indications

The Sapphire Infusion Pump is intended for controlled delivery through intravascular, subcutaneous, intra-arterial and epidural routes. The pump is designed to deliver saline, Total Parenteral Nutrition (TPN), lipids, IV medication, epidural medication, blood and blood products.

The Sapphire Infusion Pump includes the following infusion modes for all intended uses: Continuous, Intermittent, TPN, PCA, Multi-step, and Epidural.

The pump is intended to be used by both licensed health care professionals in a clinical environment, and home users in an ambulatory environment and in pre-hospital medical air and ground transportation.

The dedicated Eitan Medical Sapphire administration sets for the Sapphire Infusion Pump are intended for single-patient use and single-use only.

This user manual supports the use of Sapphire software version r15. Verify that the software version that appears on the Sapphire turn-on screen is r15. The version number can be viewed from **View system** as well (for more information, refer to [View Menu](#) on page 209).

Clinical Benefits

The pump offers significant advantages over manual administration of fluids, including the ability to deliver fluids in very small volumes, and the ability to deliver fluids at precisely programmed rates or automated intervals, thus increasing patient safety.

These and other pump features result in the following benefits:

- Consistent medication flow rates within a stated accuracy range
- Reduction of medication treatment errors
- Simplification of treatment profiles (delivery modes)

Dedicated Delivery Mode Configurations

To promote safety and convenience of use in different environments, the Sapphire Infusion Pump can be preconfigured to support only certain delivery modes. The different types of configurations available on various pump types, are described in the following table.

Pump Type	Delivery Modes Supported
Multi-therapy	1 or more of the following: <ul style="list-style-type: none">• Continuous• Intermittent• TPN• PCA• Multi-step• Epidural
Epidural	<ul style="list-style-type: none">• PCEA• Intermittent Epidural

Each delivery mode is assigned a unique color that appears on the Indicators Bar, helping users to easily differentiate between the different modes ([Figure 3.1](#) on page 73).

Features

The features of the Sapphire Infusion Pump are designed to simplify treatment and ensure patient safety.

Treatment-Related Features

- **Single platform device:** The delivery mode of the pump can be changed, according to the required type of infusion.
- **Priming alternatives:** Both manual priming (by gravity) and automatic priming (using the pump) are available.
- **Quick infusion titration (in most delivery modes):** Modification options allow updating of infusion parameters without stopping the infusion.
- **Delayed Infusion:** Allows users to program an infusion in advance, and set it to Standby for an unlimited time period, or to set it for a defined Delayed Period.
- **Repeat Last Infusion:** Automatically saves the parameters of the last infusion, and allows a quick-start infusion using these parameters.
- **Resume Infusion After Pump Shut Down:** Allows resuming an infusion after the pump has been shut down from a running or paused infusion.
- **PreSet Programs:** Allows saving the infusion parameters of commonly used protocols, and allows a quick-start infusion using these parameters.
- **Piggyback (Continuous delivery mode only):** Provides the ability to add a Secondary line to a running continuous infusion, without re-entering infusion parameters for the Primary line.
- **Flexible programming features (excluding TPN mode):**
 - Infusions can be programmed in a variety of dose rate units, including the following, per different time units: mL, mg, mcg, units, mUnits, Million Units, gram, nanogram, mmol, mEq.
 - Infusion rate can be programmed as a weight based infusion (patient weight can range from 0.1- 500 Kg).
 - PIEB – epidural infusion can support the combination of programmed intermittent doses with patient controlled boluses.

Safety-Related Features

- **Lock Screen:** Avoids inadvertently activating screen functions by locking the screen when the infusion is running.
- **Patient Lockout:** Prevents unauthorized tampering with the pump by locking pump functions. Password entry is required to reactivate the screen. This option can be configured to automatically activate once an infusion begins.
- **Authorization lock level:** Allows access to only those pump functions for which the user has authorization. Authorization levels (Low, Medium, High, Technician) are password-controlled.
- **Range parameter safety check:** Prevents entering infusion parameters that are outside of a precalculated safety range. The permitted ranges vary according to the parameters already entered by the user, or by the limits defined in the Drug Library, if one is installed on the pump.
- **Easy alarm troubleshooting:** Alarm screens display specific instructions about how to manage the alarm or resolve the problem.
- **Drug Library:** Enables safer practice according to clinical care area. Programming is done with drug specific name, profile, hard limits and recommended (soft) limits.

Terms and Abbreviations

The following table defines common terms and abbreviations used in this manual.

Term/Abbreviation	Meaning
AFFV	Anti-Free-Flow-Valve
AC/DC	Alternating Current / Direct Current
Accum.	Accumulated
CCA	Clinical Care Area
DFU	Directions for Use
EBP	External Battery Pack
ECG	Electrocardiogram
Eitan Medical Sapphire administration set	Sapphire administration set
EMC	Electromagnetic compatibility
EMI	Electromagnetic interference
Epi. Int	Epidural Intermittent
h	Hour
Kg	Kilograms
KVO	Keep Vein Open
mcg	Micrograms
mEq	Milliequivalents
min	Minutes
mg	Milligrams
mL	Milliliters
mmol	Millimoles
Mounting System	Sapphire Multi-Pump Mounting System
MRI	Magnetic Resonance Imaging
mUnits	Milliunits

Term/Abbreviation	Meaning
M Units	Million Units
nanog	Nanograms
Occ.	Occlusion
PAV	Pressure Activated Valve
PC	Personal Computer
PCA	Patient Controlled Analgesia
PCEA	Patient Controlled Epidural Analgesia
PIEB	Programmed Intermittent Epidural Bolus
Prim.	Primary
Sec.	Secondary
TPN	Total Parenteral Nutrition
VI	Volume Infused
VTBI	Volume To Be Infused
Eitan Medical	Eitan Medical Ltd.
Sapphire pump	Eitan Medical Sapphire infusion pump family

Document Conventions

The following messages in this manual prompt readers to pay special attention to specific points:



Warnings indicate precautions and instructions which, if not followed, may result in personal injury.



Cautions indicate instructions which, if not followed, may result in damage to the equipment or to the quality of treatment.



Notes provide additional information to help obtain optimal equipment performance.

The parameters ranges described in this manual reflect their factory default settings. These ranges may be configured by an authorized technician.







Safety and Compliance Information







The following section presents important labeling, safety and compliance information:

- [Symbols and Labeling](#) on page 17
- [Compliance and Classification](#) on page 20
- [Biocompatibility](#) on page 21
- [Sterilization](#) on page 21
- [Degree of Protection Against Ingress of Water and Dust](#) on page 21

Symbols and Labeling

The following table describes the labels and symbols that appear on the Sapphire pumps and their components, and identifies their locations on the equipment.

Symbol	Description	Location
	Serial number.	Back of the pump casing and on the back of the mini cradle.
	Catalog Number.	Back of the pump casing, on the back of the mini cradle, EBP, PCA Lockboxes 100, 250 and 500mL, and Mounting System.
	Batch code.	Inside casing of the mini cradle, EBP, PCA Lockboxes 100, 250 and 500mL, and Mounting System.
	Caution: Consult accompanying documents for safety instructions (service to be performed by qualified technician; consult Service Manual before removing cover).	Back of the pump casing cover, EBP, on the back of the mini cradle, and Mounting System.
	Storage temperature range.	Shipping package.
	Storage humidity range.	Shipping package.
	Storage atmospheric pressure range.	Shipping package.

Symbol	Description	Location
	Consult instructions for use.	EBP, on the back of the mini cradle, and PCA Lockbox 500mL.
	Follow instructions for use.	Back of the pump casing, PCA Lockbox 250mL, and Mounting System.
	The C and US indicators adjacent to the CSA mark signify that the product has been evaluated to the applicable CSA and UL standards, for use in Canada and the United States.	Back of the pump casing and Mounting System.
	Date of manufacture (year).	Back of the pump casing.
	Name of manufacturer.	Back of the pump casing, on the back of the mini cradle, EBP, PCA Lockboxes 100, 250 and 500mL, and Mounting System.
	Identify defibrillation proof and degree of protection against electric shock. Equipment Type BF Applied Part.	Back of the pump casing.
	Input: 100-240 V; 50-60 Hz; Max. 120 VA Output: 10V DC; Max. 4.7 A.	Mounting System.
IP24	Dust and splash proof.	Back of the pump casing.
IPX1	Waterproof rating.	Mounting System.

Symbol	Description	Location
IPX2	Waterproof rating.	EBP.
Rx Only	US federal law restricts this device to prescription only.	Back of the pump casing, on the back of the mini cradle, PCA Lockboxes 100, 250, and 500mL.
	<p>Waste Electrical and Electronic Equipment (WEEE) Disposal.</p> <p>This symbol indicates that used batteries and electronic equipment must not be disposed of as unsorted municipal waste, and must be collected separately. Contact an authorized representative for information concerning the decommissioning of your equipment.</p>	Back of the pump casing cover, EBP, and on the back of the mini cradle.
ALARM	Alarm — LED, when lit, indicates an alarm situation in the operation of the pump. Refer to Hardware and Software Components on page 33.	Front casing of the pump, below the red LED.
CHARGE	Charge — LED, when lit, indicates that the battery is charging. Refer to Hardware and Software Components on page 33.	Front casing of the pump, below the yellow LED.
RUN	Run — LED, when lit, indicates that the pump is infusing. Refer to Hardware and Software Components on page 33.	Front casing of the pump, below the green LED.
STOP	Stop — Allows you to temporarily stop the infusion.	Front casing of the pump, below the touch screen.
On/Off	On/Off — Turns pump On and Off.	Front casing of the pump, below the touch screen.

Compliance and Classification

This manual has been written in conjunction with the requirements in the International Standard, IEC 60601-2-24 for Medical Electrical Equipment - Part 2-24: Particular Requirements for Safety of Infusion Pumps and Controllers. Data presented in the Technical Specification section reflect specific test conditions defined in this standard. Other external factors, such as varying back pressure, temperature, head height, set usage, fluid restrictions, solution viscosity, or combinations of these factors may result in deviations from the performance data presented.

- IEC 60601-1, UL 60601-1 and CAN/CSA C22.2 601.1-M90 medical electrical equipment, which classifies the Sapphire pump as:
 - Class II
 - Type BF
 - Continuous operation
 - IP24 dust and splash proof
 - Not suitable for use in the presence of flammable anesthetic mixture with air or with oxygen or nitrous oxide
- IEC 60601-1-2: Electromagnetic compatibility.
- IEC 60601-2-24: Infusion pumps and controllers, which classifies the Sapphire pump as a Type 4 pump (continuous infusion flow, combined with bolus delivery).
- IEC 60601-1-11: Requirements for medical electrical equipment and medical electrical systems used in the home healthcare environment.
- IEC 60601-1-8: Requirements for alarm systems in medical electrical equipment and medical electrical systems.
- IEC 60601-1-12 - Requirements for medical electrical equipment and medical electrical systems intended for use in the emergency medical services environment.
- Defibrillator compliance statement: Equipment Type BF Applied Part.

Biocompatibility

All materials in components of the administration sets that are in the fluid pathway have been tested for biocompatibility, and are in compliance with applicable international standards ISO 10993-1 for biocompatibility.

Sterilization

Administration sets that are manufactured by Eitan Medical for the Sapphire pump, are sterilized with ethylene oxide (EO), according to the sterilization requirements of ISO 11135.

Degree of Protection Against Ingress of Water and Dust

The Sapphire pump meets the IP24 splash/dust standard according to IEC 60601-1-11. Protects from water which is sprayed at 10 L/min at a pressure of 80-100 kN/m² for 5 minutes at all angles, and protects from touch by objects greater than 12 millimeters such as fingers.

Warnings and Safety Precautions

The following sections contain important safety information.

All warnings and safety precautions should be read carefully before operating the Sapphire pump:

- [General Warnings and Precautions](#) on page 22
- [Proper Use of the Pump](#) on page 26

Safety information specific to particular pump functions appears in the relevant sections of this manual.

General Warnings and Precautions

To ensure safety and proper operation, read the User Manual and any instructions accompanying disposables or accessories before operating this device. In addition, adhere to the following safety guidelines:



Avoid placing the administration set or power cord on the floor, or any other location where it can accidentally be damaged or provide a risk of strangulation, particularly due to excessive length.

- To avoid damage to the pump and its accessories, keep the equipment away from unattended children and pets.
- Do not clean, disinfect or sterilize any part of the pump by autoclaving, or with ethylene oxide gas. Doing so may damage the pump and void the warranty. Only external parts of the pump should be disinfected.



If the pump is dropped or appears to be damaged, it should be taken out of service and inspected by Eitan Medical Ltd. trained, qualified personnel only.

- All service procedures, including certification, calibration, part replacement and modification of equipment, should be carried out only by a qualified service technician. Detailed instructions are available in the service manual.
- Do not operate the pump with the safety door open.

Waste Disposal

Take care to dispose of the packaging, the administration sets, the battery, and any other electronic components in accordance with applicable environmental laws (such as the WEEE Directive for Waste Electrical and Electronic Equipment). Contact your local authority to determine the proper method of disposal.



Waste Disposal Safety Precautions

- Keep used plastic infusion containers, packaging and tubing out of the reach of children.
- Administration sets should be disposed of in a proper manner, considering the nature of residual fluid that may be contained within, in accordance with hospital disposal practices.
- Do not dispose of the battery in or near fire.

Explosion Hazard

The equipment is not suitable for use in the presence of flammable anesthetic mixture with air or with oxygen or nitrous oxide.

Electric Shock Hazards

To promote safety, always adhere to the warnings listed below.



Electrical Safety Precautions

- Access to any internal part of the Sapphire pump and the performance of any service procedures should be carried out only by a qualified service technician, fully trained in the operation of the infusion pump.
- Disconnect the power supply before servicing.
- Disconnect the battery prior to opening the pump casing. Voltage present on internal components may cause severe shock or death on contact.
- Connect AC power to the pump only via a dedicated Sapphire power supply.
- Do not touch the pump to cradle (P2C) connection in the back on the pump.

Electromagnetic Compatibility

The Sapphire pump is designed to conform with electromagnetic compatibility (EMC) standard IEC 60601-1-2 and to operate accurately in conjunction with other medical equipment which also meets the requirements of this standard. To avoid electromagnetic interference that may affect the operation of the pump, do not operate the pump near sources of strong electric and magnetic interference (EMI), such as MRI, CT, diathermy (deep heat treatment), electromagnetic security systems (e.g., metal detectors), and large electric motors. Portable and mobile RF communications equipment, such as RF emitters, cellular telephones, 2-way radios, Bluetooth™ devices, microwave ovens in close proximity to this device may affect wireless communications with the Infusion pump and/or the operation of the Infusion pump.



Some of these EMI sources (mostly RF emitters) may not be visible and the device can potentially be exposed to fields from these EMI sources without the user's awareness.

Special precautions need to be exercised regarding EMC. These include:

- Maintaining a minimum separation distance of 2 ½ ft (¾ m) between the Infusion pump system and portable/mobile RF communications equipment.
- Manage the electromagnetic environment to permit the device to perform as intended without disturbing other equipment.
- Separate the device from all other electronic equipment. If the device must be used near other electrical equipment, monitor the equipment to ensure there is no electromagnetic interference.
- Devices should not be used adjacent to or stacked with other equipment. If the device must be used adjacent to or stacked with other equipment, monitor the device to verify normal operation.
- If you identify or suspect external RF sources or other equipment are influencing device operation (from known or unknown source), try to (as applicable) increase the distance between the pump and the EMI source, re-orient the device, relocate the device, connect the device to different outlet or decrease emitting device output power (to 30 dBm).

- Contact the biomedical engineering department for additional information in the service manual concerning operating devices near RF sources.

The EMC limits, as defined by IEC 60601-1-2/EN 60601-1-2, are designed to provide reasonable protection against harmful interference in a typical medical installation. The equipment generates uses and can radiate radio frequency energy, and if not installed and used in accordance with the instructions, may cause harmful interference to other devices in the vicinity. However, there is no guarantee that interference will not occur in a particular installation. If this equipment does cause harmful interference with other devices, which can be determined by turning the equipment Off and On, the user is encouraged to try to correct the interference by one or more of the following measures:

- Reorient or relocate the receiving device.
- Increase the distance separating between the equipment parts.
- Connect the equipment to an outlet on a circuit different from that to which the other device(s) is connected.
- Consult the manufacturer or field service technician for help.



Electromagnetic Safety Precautions

- Do not expose the pump to therapeutic levels of ionizing radiation, as permanent damage to the pump electronic circuitry may occur. Remove the pump from the patient during therapeutic radiation sessions.
- Do not use the pump in the vicinity of magnetic resonance imaging (MRI) equipment, as magnetic fields may adversely affect the operation of the pump. Remove the pump from the patient during MRI procedures, and keep it at a safe distance from magnetic energy.

Proper Use of the Pump

Although the Sapphire pump has been designed and manufactured to exacting specifications, it is not intended to replace trained personnel in the monitoring of infusions.



Home users must be trained by their medical provider before using the Sapphire pump.



Clinicians are advised to verify the proper route of delivery, and the patency of the infusion site.

When using the pump, periodic patient monitoring must be performed to ensure that the infusion is proceeding as expected. The pump is capable of developing positive fluid pressures to overcome widely varying resistances to flow, such as resistance imposed by small-gauge catheters, ports, filters, or intra-arterial infusions. Although the pump is designed to stop fluid flow when an alarm occurs, it is neither designed nor intended to detect infiltrations or extravasations, and such conditions will not trigger an alarm.



When using the pump, use only Eitan Medical approved accessory equipment.



If auditory and/or visual signals do not perform according to settings, or if the hard keys do not perform as expected, do not use the pump, and contact an authorized technician.



Environmental Safety Precautions

- The pump has not been evaluated for use within magnetic resonance imaging (MRI) environments, or with other medical equipment that emits radiation for diagnostic or therapeutic purposes.
- The Sapphire pump has not been evaluated for compatibility with Extracorporeal Membrane Oxygenation (ECMO) systems.

- Use only Sapphire dedicated accessories and cables. The use of accessories and cables other than those specified in this manual, with the exception of cables sold by Eitan Medical Ltd. as replacement parts for internal components, may result in increased emissions or decreased immunity of the pump.

Administration Sets

Before using administration sets, always read and follow the instructions in the User Manual, and the instructions accompanying the administration set and source container. Carefully follow any label copy instructions for loading, removing, and reloading the set, as well as the recommended set change interval.



Use Sapphire standard administration sets listed in Eitan Medical's approved list of products: <https://eitanmedical.com>.

Alternatively, administration sets from different manufacturers that are regulatory cleared and labeled for use with the Sapphire infusion system, can be used as well. The list of regulatory cleared sets needs to be obtained from the official manufacturer's publication such as manufacturer's website, catalog or any other formally published document.

Using anything other than administration sets regulatory cleared and labeled for use with Sapphire infusion system, may result in operation that is not within the constraints and parameters of the device. Severe injury or death may result from using sets other than those indicated in Eitan Medical's approved list of products. For more information refer to [Administration Sets](#) on page 63.

Note: The use of Administration sets manufactured by ICU Medical is approved for sale through March, 2023.

For infection control purposes, consider the set change interval recommended by the local Centers for Disease Control and Prevention (CDC), your facility guidelines, and the instructions provided with the administration set.



Administration Sets: Safety Precautions

- Do not use a damaged administration set or damaged set components or packaging. Always refer to the instructions for use that are included.
- Sapphire administration sets are for **single patient use only**, and should not be sterilized or cleaned for re-use.
- **Do not connect the administration set to the patient while priming.**
- Do not use force when connecting the administration set to the patient.
- Always use the clamps on the administration set to occlude the administration set prior to removing the Sapphire administration cassette from the pump.
- Do not apply pressure or pressurized air to any outlet or tubing connected to the pump. Pressure may destroy sensitive elements.
- Do not pull or stretch the tubing in any section of the administration set when the pump is in use, nor apply pressure to the infusion container.



The minimum pull force applied on the administration set which is capable of disengaging the administration set from the pump is 2.855 Kg.

- The administration set and container should be replaced as needed to avoid fluid contamination problems.
- The administration set must be replaced according to the hospital policy of infection control and treatment protocol. Sapphire sets allow accurate delivery up to 96 hours. If you program rate, dose or bolus combinations which exceed a 96-hour schedule, make sure that you replace the administration set on time.

Basic Infusion Safety Information

To obtain maximum accuracy of the pump when used in a hospital or clinical environment, verify that the infusion container is positioned at a height of 50 cm above the pump. There is no restriction on the location of the infusion container in relation to the patient's heart.

Alarm conditions automatically stop the infusion and require immediate attention before the infusion can be restarted.

When clamping the administration set, ensure that the clamp is at least 20 cm (8 in) away from the pump, when possible.

Note that if the dose rate is beyond the pump resolution of 0.1 mL/h increments, the pump will increase or decrease the rate by up to 0.05 mL/h. This flow rate (in mL/h) is presented on the running screen during infusion.



Administering Infusions: General Safety Precautions

- **Occlusion Pressure Alarm Settings:**
 - High pressure settings may affect the time for occlusion detection. Make sure that the occlusion pressure is set according to the clinical use case.
 - When using sets with a Pressure Activated Valve (PAV), detection may be offset by 0.3 BAR (4.35 PSI or 225 mmHg). (This offset is called PAV cracking pressure.)
- **Volume To Be Infused:** Do not enter a volume to be infused greater than the amount of fluid available in the container.
- **Air Detection:**
 - Air detection is an important safety feature of the Sapphire pump. If the air detection is disabled (OFF), **use a set with an air-eliminating filter to prevent injury to the patient due to an air embolus.**
 - Air detection serves as a safety component. Disabling the air detection hinders the pump's ability to alert on hazardous situations.
 - Always ensure that the administration set is primed before starting an infusion.
 - The air detector working range when delivering fatty acids, is 2%-20% lipids.

- **Secondary Infusions:** When using the Piggyback infusion feature, verify that:
 - The medication/solution in the Secondary infusion container is compatible with the medication/solution in the Primary infusion container.
 - The Secondary administration set is connected to the appropriate injection site on the primary administration set (above the administration cassette).
 - Interruption of the Primary infusion is clinically appropriate for the duration of the Piggyback infusion.
 - The Secondary source container is positioned at least 8 inches (20 cm) higher than the Primary source fluid level.
 - The drip chamber on the set should be used to verify that the correct line is delivering and the other line is idle.
 - The clamp of the Secondary set is closed when Piggyback infusions are not running.
- Do not infuse non-epidural drugs in the Epidural Delivery mode.
- Epidural drugs must be infused in the Epidural Delivery mode.

PCA, PCEA, and Epidural Intermittent Delivery Mode

When using the Clinician Bolus and Patient Demand Bolus functions, special safety precautions need to be followed.



Do not use the Remote Bolus Cord to pick up or carry the cradle or pump. Using the cord in this manner may damage the pump or cord.

To avoid damaging the connector or cord, do not use any excessive force or instruments to remove the Remote Bolus Cord from the cradle.

In addition, adhere to all the warnings listed below.



PCA, PCEA, and Epidural Intermittent Delivery: Safety Warnings

- Do not place the Remote Bolus Cord where the button might accidentally be pushed. Accidentally pushing the button may deliver an inadvertent demand bolus.

- When using the Clinician Bolus function, pay close attention to the current treatment parameters, as well as to the amount of additional dosage being administered.
- Do not allow the patient to access the Clinician Bolus function. Do not reveal the Clinician code to the patient.
- The demand bolus option should be used only by the patient. Administration of a demand bolus by anyone other than the patient (especially if the patient is sleeping or sedated) incurs the risk of potentially fatal overdose.

Epidural Delivery Mode

Epidural administration of anesthetics is limited to short term infusion (not to exceed 96 hours) with indwelling catheters specifically identified for short term anesthetic epidural drug delivery.



Epidural Delivery: Safety Warnings

- Epidural administration of drugs other than those indicated for epidural use could result in serious injury to the patient.
- To prevent infusion of drugs not indicated for epidural use, do not use administration sets with injection ports during epidural delivery.
- Do not infuse non-epidural drugs in the Epidural Delivery mode.
- Epidural drugs must be infused in the Epidural Delivery mode.

Chapter 2: Components, Accessories, and Administration Sets

The following sections present a high level overview of the Sapphire pump components and accessories:

Unpacking the Pump	32
Hardware and Software Components	33
Using Pump Accessories	36

Unpacking the Pump

When unpacking the Sapphire pump, inspect each item to ensure that it is undamaged. The following items should be included:

- Sapphire pump (with Li-Ion Battery enclosed)
- AC/DC power adaptor for pump
- User Manual
- Mini cradle, with key (to lock) and pin (to allow open/close without the key)
- Other optional items:
 - Demand bolus handle
 - Splitter for mini cradle
 - Communication cable
 - PCA Lockbox 100mL
 - PCA Lockbox 250mL
 - PCA Lockbox 500mL
 - Infusion Pouch 500 mL
 - Home Large Backpack (5 liter)
 - Travel Case
 - External Battery Pack
 - Mounting System
 - Integrated Power Supply for Mini cradle

Hardware and Software Components

The pump includes both hardware (control unit) and software (touch screen) components. Hardware components are shown in the figure below. The parts of the control unit are listed and described in the table following the figure.

Figure 2.1. Hardware Components



Number	Component	Description/Notes
1	Safety door	Covers and protects the administration set and pumping mechanism.
2	Speaker	Delivers auditory alarm sounds.
3	Status LEDs	Colored indicators providing a summary of the pump current status: <ul style="list-style-type: none"> • Red: An alarm is occurring. • Yellow (blinking): The battery is charging. • Yellow (steady on): The pump is connected to main power, and the battery is fully charged. • Green: The pump is running.
4	On/Off button	Enables the user to turn the pump On and Off.
5	Stop button	Enables the user to temporarily stop an infusion.

Number	Component	Description/Notes
6	Power socket	Enables you to charge the battery using the power adaptor, connect a communication cable or a bolus handle.
N/A	Battery compartment	Houses the battery. (Located on the back of the pump.)

Touch Screen

The touch screen is used to configure and operate the pump. The main areas of the screen are listed and described in the table following the figure.

Figure 2.2. Touch Screen Areas

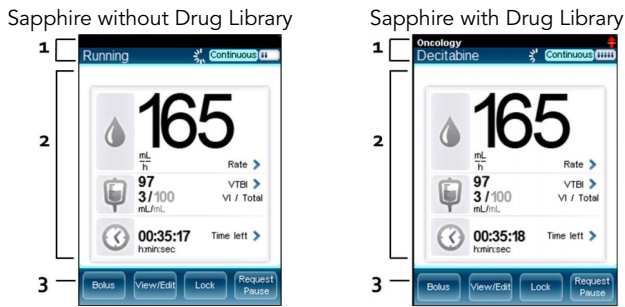

Number	Component	Description/Notes
1	Indicators Bar	<p>Displays the following essential status information:</p> <ul style="list-style-type: none"> • CCA name (appears above Screen title, across all screens when Drug Library is loaded). • Soft Limit icon (appears above Battery status icon, when Drug Library is loaded and current infusion exceeds soft limit range). • External battery icon (appears above the delivery mode header, when an EBP is connected to the pump). • Screen title (Start Up, Running, Paused, drug name, etc.). • Drug concentration (appears when applicable, under screen title). • Running icon (appears while an infusion is running). • Delivery mode (Continuous, Multi-step, etc.). • Battery status icon.
2	Main Display	<p>Displays infusion parameters and other pump settings, and serves as a work area in which most programming and configuration takes place.</p>
3	Toolbar	<p>Contains function keys that enable you to perform common operations, such as confirming settings, pausing infusions, locking the screen, etc.</p>

Using Pump Accessories

This section explains how to set up the following pump accessories:

Mini Cradle	36
PCA Lockboxes	40
PCA/PCEA/PIEB Bolus Handle	48
Power Supply	49
External Battery Pack	51
Multi-Pump Mounting System	58
Administration Sets	63

Mini Cradle

The small, easy to use bedside mini cradle offers flexible positioning of the pump at any angle or height. Components of the mini cradle are listed and described in the table following the figure. Eitan Medical's Mini Cradles are provided in one of the following configurations:

- With an optional connection splitter at the base ([Figure 2.3, #3](#)).
- With an optional Integrated Power Supply (IPS) at the base ([Figure 2.4, #1](#)). The IPS is an AC to DC power supply that is assembled to the Mini Cradle and is used to charge the pump battery.
- Without the optional connection splitter or the optional IPS at the base.

Identify your Mini Cradle configuration by turning the Mini Cradle bottom side up; Mini Cradles with a connection splitter will have two ports, as seen in [Figure 2.3 #3](#). These are used for the RS-232 communication cable and power supply. Mini Cradles with IPS will have power cord connector covered by a power cord retainer, as seen in [Figure 2.4, #2](#). This is used for Sapphire AC power cord.

Figure 2.3. Mini cradle

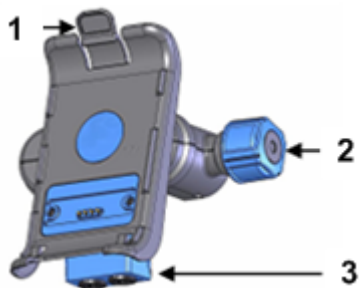

Number	Component Name	Description/Notes
1	Pump hook	Located on the pump holder. Press the hook to release the pump from the mini cradle.
2	Mini cradle knob	Located on the base of the mini cradle. Twist the knob to connect or release the mini cradle from an IV pole. To unlock the knob, use the supplied key or pin.
3	Connection splitter (optional)	Located on the base of the mini cradle. Used for the RS-232 communication cable (optional) and power-supply connections.

Figure 2.4. Mini-Cradle with Integrated Power Supply

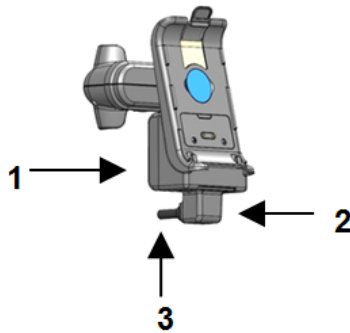

Number	Component	Description/Notes
1	Integrated Power Supply (optional)	Located on the base of the mini cradle. Used for power-supply connection.
2	Cord retainer	Located at the bottom of the integrated power supply. It holds the AC power cord in the IPS power socket.
3	AC Power Cord	Medical Grade AC Power Cord that connected the IPS to the wall socket.

To operate the pump from an IV pole set, attach the pump to the mini cradle. This enables easy access to the screen without the risk of changing the settings through accidental contact. In the mini cradle, you can also charge the pump.



Make sure the cradle is securely attached to the IV pole before attaching the pump.

The following steps explain the workflow of attaching the mini cradle to the IV pole, attaching and releasing the pump, and releasing the mini cradle from the pole:

1. Attach the mini cradle to the IV pole by tightening the mini cradle knob on the right side (Figure 2.3, #2).

To unlock the knob, make sure that the supplied key or pin is placed inside it.



To attach several pumps to the IV pole, rotate the mini cradle to a horizontal position:

Pull the pump holder and the base of the mini cradle away from each other, and rotate to the desired position.

2. To attach the pump to the mini cradle, insert the pump onto the bottom hooks of the mini cradle (Figure 2.5, #1), and then click it into the top hook (Figure 2.5, #2). Ensure that the pump is seated on both hooks.
3. To release the pump, press the pump hook located on the top of the pump holder (Figure 2.5, #2).
4. To open and release the mini cradle, rotate the knob.

Figure 2.5. Mini cradle Hooks

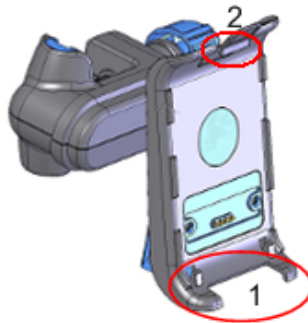

PCA Lockboxes

PCA Lockboxes are designed to secure the IV bag, primarily for treatments involving narcotics or opioids, without interrupting the treatment workflow.

PCA Lockbox 500mL

This Lockbox can accommodate IV bags of up to 500 mL.

Figure 2.6. PCA Lockbox 500mL and Mini cradle



The following steps explain the workflow of using the PCA Lockbox 500mL:

1. Using the mini cradle knob, attach the mini cradle to the IV pole ([Figure 2.3](#) on page 37).
2. To open the Lockbox, swing the blue handle to the left ([Figure 2.7, #2](#)).

Figure 2.7. PCA Lockbox 500mL: Workflow

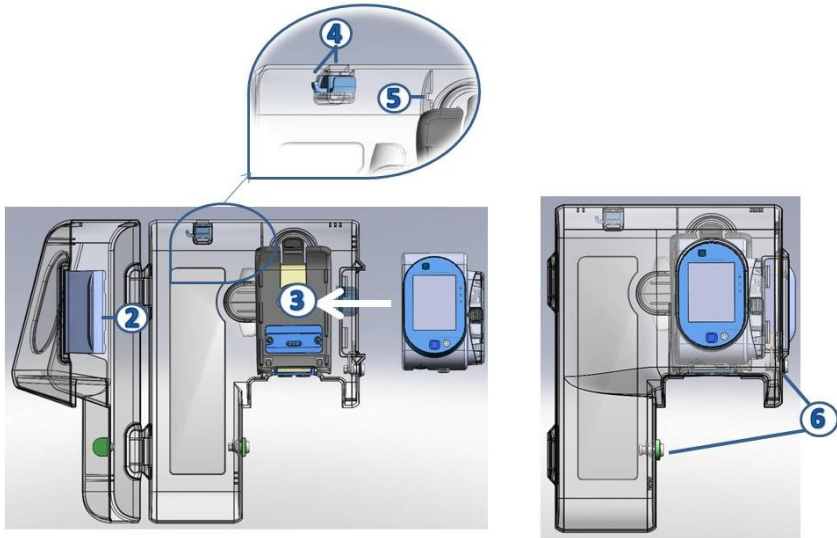

3. Attach the pump to the mini cradle (Figure 2.7, #3).
4. Hang the IV bag with the medication (Figure 2.7, #4) inside the PCA Lockbox.
5. Clamp the administration set, spike the bag, and attach the administration set to the pump.
6. Place the administration set through the hole on top of the pump (Figure 2.7, #5). Verify that there are no kinks in the administration set, so the infusion can run smoothly.
7. Unclamp the administration set. Then, close both locks of the Lockbox and lock it, using the supplied key (Figure 2.7, #6).

PCA Lockbox 100mL

This Lockbox can accommodate IV bags of up to 100 mL.

Figure 2.8. PCA Lockbox 100mL

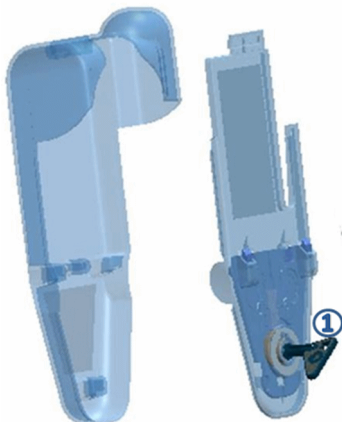

The following steps explain the workflow of using the PCA Lockbox 100mL:

1. Using the key supplied with the Lockbox (Figure 2.8, #1), open the box and remove the plastic cover.
2. Close the clamps on the administration set, and spike the bag.
3. Block the administration set using the AFFV (for more information about the AFFV, refer to: [Priming Manually](#) on page 90), and then open the clamps.
4. Insert the container into the box, and wrap the tube around the inner walls of the box, in order to allow free flow and prevent kinks. Then, set the tube through the exit channel (Figure 2.9, #2).

Figure 2.9. Lockbox 100mL: Workflow

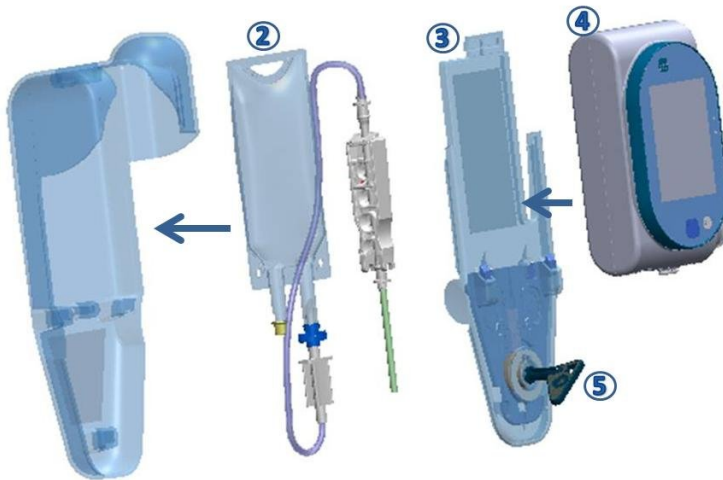

5. Connect the administration set to the pump.
6. Close the box by sliding back the plastic cover (Figure 2.9, #3).
7. Place the pump on the plastic cover (Figure 2.9, #4), and secure it by locking the box with the supplied key (Figure 2.9, #5).

PCA Lockbox 250mL

This Lockbox can accommodate IV bags of up to 250 mL.



- The Lockbox is used in an upright position only; it may be attached to an IV pole, carried by the carry handle, or carried by the shoulder strap.
 - Do not use sets with drip chamber or burette with the Lockbox.
 - Use the Lockbox with bags up to 250 mL IV that are smaller than 7 cm depth, 10 cm width and 24 cm height.
-



Before setup, it is recommended to clamp the administration set and spike the IV bag. Priming may be completed manually at this point, or with the pump after set is inserted to the pump.

The following steps explain the workflow for using the PCA Lockbox 250mL:

1. Attach the Lockbox to the mini cradle by inserting the pump compartment back side of the Lockbox onto the bottom hooks of the mini cradle (Figure 2.10A), and then click it into the top hook (Figure 2.10B). Make sure the Lockbox is secured to the mini cradle.

Figure 2.10. Attaching the Lockbox to the Mini Cradle

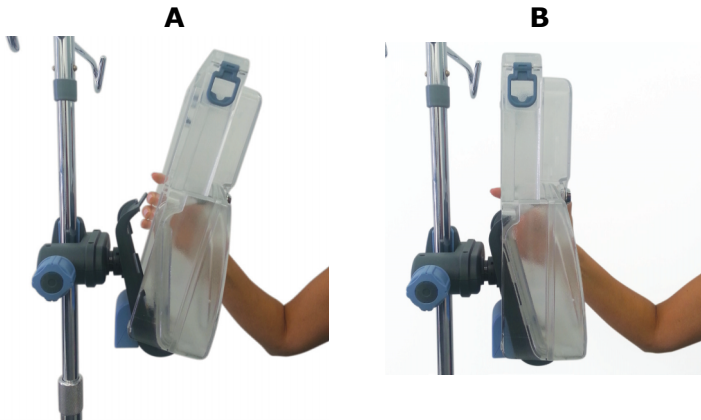

2. Unlock the Lockbox, and open the door.



To lock and unlock the Lockbox the key must be first pressed inwards before turned.

3. Insert the pump onto the bottom hooks of the Lockbox, and then click it into the top hook.
4. Make sure the organizer is aligned with the inner Lockbox wall (Figure 2.11, #1); Hang the spiked IV bag on the hook inside the Lockbox (Figure 2.11, #2).

Figure 2.11. Placing the IV Bag and Set Inside the Lockbox

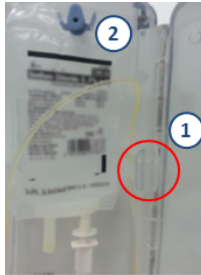

5. Attach the administration cassette to the pump.
6. Insert the set tubing between the IV bag and the pump into the organizer (Figure 2.11, #1).



Make sure this segment of the set does not contain any additional components.
Verify there are no kinks in the administration set.

7. Unclamp the administration set.
8. Close the Lockbox door and lock it using the supplied key. Note not to close the Lockbox door on the set itself.
9. Make sure the Lockbox is locked before removing the key.



Locking the Lockbox with attached mini cradle, locks in the mini cradle as well as the medication. To lock the Lockbox to the IV pole, the mini cradle must be locked to the IV pole.

Removing the Lockbox from the IV pole:

1. Unlock the Lockbox using the supplied key. Then, open the door.
2. To release the Lockbox, press the top hook of the mini cradle. Secure the pump by holding it in the Lockbox while releasing the Lockbox from the mini cradle.
3. Lock the Lockbox using the supplied key.

Figure 2.12. Shoulder Strap



The Lockbox can be carried using the carry handle or the optional shoulder strap (Figure 2.12). The shoulder strap can be used with a pouch for storing the power supply when it is not plugged in.



Do not grab the Lockbox by the handle when attached to an IV pole.



Therapy Identification – to identify the therapy the Lockbox is used for, stick one of the supplied colored stickers to the upper inner side of the Lockbox door. The available sticker colors include: white, blue, red, yellow and green.

PCA/PCEA/PIEB Bolus Handle

The remote bolus handle enables patients to deliver boluses on demand (under clinician's programmed limits). The bolus is requested by pressing the button on the handle, eliminating the need for patient interaction with the function keys on the pump.

When pressing the bolus handle, an auditory signal will be generated. This option can be configured on the pump. For more information refer to [Configuring Audio Settings](#) on page 201.

Figure 2.13. Bolus Handle



Connect the bolus handle by attaching it to the socket at the bottom of the pump. Make sure that the white arrows on the cable connector are facing up (arrows on the bolus cable towards the arrow on the pump).,



When using a mini cradle, the blue-buttoned bolus handle must be connected directly to the pump.

When using a gray-buttoned bolus handle, it may be connected to any port; but the communication cable should not be connected simultaneously.

If a blue-buttoned bolus handle is switched to a gray-buttoned bolus handle the treatment must be re-started.

Power Supply

The pump power supply is used to charge the battery. Specifications of the power supply include:

- **Input voltage:** 100-240 VAC
- **Output voltage:** 10 VDC



To prevent entanglement, always secure the cable cord properly.



Always detach the Sapphire pump from the EBP, before connecting it to the power supply.

> To charge the battery:

1. Plug the Sapphire power supply cord into the main power supply source.
2. With the white arrows or red dot facing up, slide the power cord into the Sapphire pump power socket or into the splitter connector without rotating the connector.
3. On the front of the pump, verify that the Charge LED status indicator is On (blinking yellow light).

For more information regarding charging the battery, refer to [Charging the Battery](#) on page 267.

> To disconnect the power supply from the pump:

Gently press on both sides of the power supply connector, and pull it straight out of the Sapphire pump power socket without rotating the connector.

Integrated Power Supply

The Integrated Power Supply (IPS) is a power supply that is assembled into the Mini Cradle to supply power to the pump. Specifications of the power supply include:

- Input voltage: 100-240 VAC

- Output voltage: 10 VDC

> **To connect the AC Power Cord to the IPS:**

1. Connect the Sapphire AC Power Cord to the IPS.
2. Connect the Cord Retainer to the IPS, using a Philips head screwdriver.



The cord retainer is an integral part of the IPS, and must be connected prior to initial use.

> **To charge the battery:**

1. Plug the Sapphire AC Power Cord into the main power supply source.
2. On the back of the IPS, verify that the Power LED status indicator is On (blue light).
3. Mount the pump into the mini cradle.
4. On the front of the pump, verify that the Charge LED status indicator is On (blinking yellow light).

> **To disconnect the AC Power Cord from the IPS:**

1. Unplug the Sapphire AC Power Cord from the main power supply source.
2. Disconnect the Cord Retainer from the IPS, using a Philips head screwdriver.
3. Remove the Sapphire AC Power Cord from the IPS.

External Battery Pack

The EBP extends the pump's operation time with no need for additional charging.



Warning EBP:

- Do not use the EBP if it is difficult to insert AA batteries or to attach it to the pump.
- Do not use the EBP if the black O-Ring is missing or not attached all around the AA batteries compartment lid.
- When using the strap to hang the EBP with the pump, make sure that the pump is safely secured to the EBP.
- Hang the EBP with the pump only on an IV pole, so that there is no risk of the pump falling.



General Safety Precautions:

- Begin using the EBP before the pump shuts down due to battery depletion.
- When using the EBP with the pump, do not connect the power supply to the pump.



AA Battery Safety Guidelines:

- AA Batteries with signs of rust, bad odor, overheating, and/or other irregularities should not be used in the EBP.
- Avoid any contact of the AA batteries with water.
- Use only valid (none-expired) AA batteries in the EBP.



It is recommended to use in the EBP fresh AA alkaline batteries manufactured by the brands listed below:

- Energizer
 - Duracell
-

General information

- The duration of operation time provided by the EBP, varies according to the pump's Internal Battery power status, infusion rate, backlight settings and AA batteries power status. Operation time of the pump with the EBP is presented in the following table:

Pump Settings	Operation time duration (with fresh AA batteries of the specified brands)
<ul style="list-style-type: none">• Infusion rate of 125 mL/h• Backlight set to Off• Internal Battery depleted	15-20 hours

 It is recommended to turn the pump's backlight Off in order to extend its operation time. For details about configuring the backlight, refer to [Backlight](#) on page 203.

Getting Ready to Use the EBP

The EBP requires six 1.5 V AA batteries (not included in package).

Figure 2.14. The EBP Components



Number	Component
1	Small hooks
2	Large hook
3	Latch
4	Suspension hooks
5	EBP LED

Inserting AA Batteries into the EBP

> To insert AA batteries into the EBP:

1. Make sure that the pump is detached from the EBP.
2. Open the AA batteries compartment lid, by pushing the latch up (Figure 2.14, #3).

Figure 2.15. Opening EBP Lid



3. Place the batteries in their slots by pressing the flat end (negative pole) of each battery to the flat metal plates (marked with "-"), and then fix the other end (positive pole) in place (marked with "+").
4. After all six batteries are in place, insert the protrusion at the bottom of the lid (Figure 2.16, #A1) to its slot in the EBP, and press the latch (Figure 2.14, #3) downwards until it clicks.

Figure 2.16. Closing EBP Lid



To avoid damaging the product, open and close the batteries compartment lid only as instructed. Avoid using excessive force, as it may crack the plastic or damage the metal parts.

Strapping the EBP

If the pump needs to be hung, thread the strap supplied with the EBP through the suspension hooks (Figure 2.14, #4).

> To strap the EBP:



Thread the strap before attaching the Pump to the EBP.

1. Place the EBP with the cover facing down.
2. Thread both ends of the strap through the bottom notch of the suspension hooks (Figure 2.14, #4). Make sure that both buckles (Figure 2.17, #A1) of the strap are facing up.
3. Bend both ends of the strap to form a loop, and thread each end through the top notch of the suspension hooks (Figure 2.14, #4).
4. Thread each end through the buckle and stretch to adjust the length.
5. Attach the pump to the EBP, and hang on an IV pole (Figure 2.17, #C2). For attaching instructions, refer to the next section.

Figure 2.17. Attaching EBP Straps

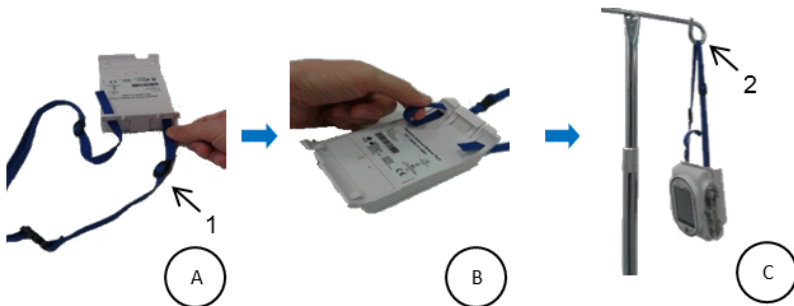

Attaching the Pump to the EBP

> To attach the pump to the EBP:

1. Insert the bottom of the pump onto the two small hooks (Figure 2.14, #1) at the bottom of the EBP, and then push it to click into the large hook (Figure 2.14, #2) at the top of the EBP.
If the power supply is connected to the pump, disconnect it before attaching the EBP.
2. Check for all the indications of proper connection to the EBP:
 - a. The pump turns On.
 - b. The external battery icon appears.
 - c. The LED at the bottom of the EBP (Figure 2.14, #5) turns On.



If the LED at the bottom of the EBP doesn't light, blinks or turns off, replace the AA batteries in the EBP with new fresh AA batteries.

Detaching the Pump from the EBP

Detach the EBP when treatment ends, AA batteries are depleted or stable power supply becomes available. Detach the pump from the EBP before turning the pump Off.

> To detach the pump from the EBP:

1. Hold the pump firmly when detaching it from the EBP.
2. Detach the pump from the EBP by gently pulling the large hook (Figure 2.14, #2), until the pump is released from grip. Make sure not to pull the suspension hooks (Figure 2.14, #4), because this prevents the detachment of the pump from the EBP.
3. Check for all the indications of proper detachment:
 - a. An attention screen, indicating that the pump is operating on Internal Battery, appears.
 - b. Press **OK** to continue working with the pump.
 - c. The external battery icon disappears.
 - d. The EBP LED turns Off.



AA batteries may deplete when pump is turned off and still attached to the EBP.



If stable power supply is available, make sure to detach the Pump from the EBP before connecting the pump to a power supply.

EBP storage



It is recommended to remove the AA batteries from the EBP when not in use.

Cleaning the EBP



Clean only exterior surfaces of the EBP.

Multi-Pump Mounting System

The Mounting System is designed to facilitate the use of multiple pumps while saving valuable bed-side space and providing power consolidation. The Mounting System is designed to accommodate three mini cradles, and charge three pumps via a single power outlet, all attached to an IV pole via a single clamp. The Mounting System can also accommodate the use of a single PCA Lockbox 250mL when mounted on the right-hand mini cradle among the three.



It is recommended to use mini cradles with a splitter in order to facilitate attachment and detachment of pumps.



- Verify that the mini cradles are securely attached to the Mounting System, and that the Mounting System is securely attached to the IV pole before attaching the pumps.
 - Do not transport the Mounting System while mounted on an IV pole. Detach and carry using the handle.
 - Verify that the IV pole is not moving, tilting or wavering when mounted with a Mounting System.
 - Before using the Mounting System, make sure that the Mounting System power supply and all cords are completely dry.
 - To avoid risk of electric shock the mounting system power supply must be connected to a power outlet with protective earth.
 - Always connect the AC input cord to the Mounting System power supply, before connecting it to a power outlet.
 - Make sure that the AC input cord is fully inserted into the Mounting System power supply socket and into the power outlet.
 - Always disconnect the AC input cord from the power outlet before disconnecting it from the Mounting System power supply.
-



- Use only Sapphire dedicated AC input cord and power supply with the Mounting System.
 - To avoid entanglement of lines and cords, do not mount more than 4 Mounting Systems on a single IV pole.
-



It is recommended to use additional IV bag hooks (not supplied by Eitan Medical) when mounting more than two Mounting System on a single IV pole.

Setup Instructions



It is recommended to first attach the Mounting System to the IV pole before attaching the mini cradles to the Mounting System

> To attach the Mounting System to an IV Pole:

1. Loosen the clamp knob by rotating it counter-clockwise.
2. Firmly hold the Mounting System and place the clamp on an IV pole with the carry handle facing upwards.
3. Tighten the clamp knob by rotating it clockwise (Figure 2.18).

Figure 2.18. Mounting System on IV Pole

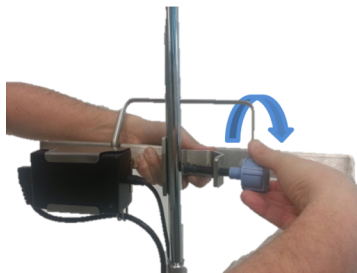



To prevent detaching from the IV pole, the Mounting System can be locked to the pole by removing the knob cap or knob key from the clamp knob.

> **To attach a mini cradle to the Mounting System:**

1. Rotate the mini cradle to a vertical position with the mini cradle knob pointing downward and the top hook pointing upward.

Figure 2.19. Attaching Mini Cradle to Mounting System

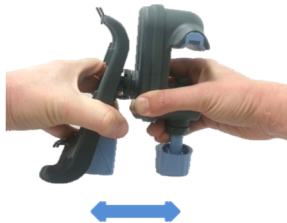

Place the mini cradles according to the markings on the Mounting System, between the designated lines (Figure 2.21).

2. Loosen the mini cradle knob to maximum extent by rotating it.
3. Tilt the mini cradle and place the open vice on the top of the Mounting System (Figure 2.20 Item A). Align the cradle and tighten the knob by rotating it (Figure 2.20 Item B).

Figure 2.20. Placing Mini Cradle on Mounting System

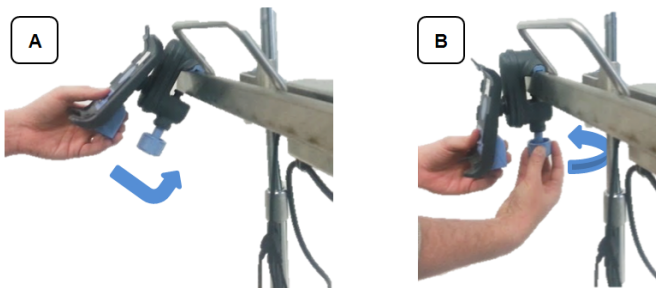

4. Plug a DC output connector to the mini cradle splitter.
5. Fasten the DC output cables to the clips located on the bottom of the Mounting System.
6. Plug the AC input cord to the power outlet. Verify that the Mounting System power supply LED is ON.

Figure 2.21. Fully Assembled Mounting System



> **To transport the Mounting System, detach it from the IV pole:**

1. Unplug the AC input cord from the power outlet.
2. Firmly hold the Mounting System and rotate the clamp knob counter-clockwise, until the Mounting System is loose.
3. To carry the Mounting System always use the dedicated carry handle.



Always contact a certified technician in cases of Mounting System electrical and mechanical malfunctions.
When removing the Mounting System from the IV pole, avoid applying pressure on the power cable, connectors or cradles.

Administration Sets

The Sapphire pump should be used with a Sapphire dedicated administration set, which includes the Sapphire administration cassette. Alternatively, administration sets from different manufacturers that are regulatory cleared and labeled for use with the Sapphire infusion system, can be used as well. The list of regulatory cleared sets needs to be obtained from the official manufacturer's publication such as manufacturer's website, catalog or any other formally published document.



The use of Administration sets manufactured by ICU Medical is approved for sale through March, 2023.

This cassette includes a normally closed valve (three-state Anti-Free-Flow Valve) that provides automatic anti-free-flow protection. Opening the valve allows manual priming as well as transition of infusion to gravity induced.

Figure 2.22. Sapphire Administration Cassette and AFFV

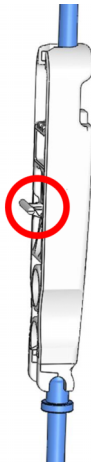

Only administration sets that include a roller clamp and do not include pressure activated valves (PAV) can be used by gravity. For more information, refer to the Directions for Use of each set.

For more information about priming the administration set and inserting it into the pump, refer to [Priming Manually](#) on page 90 and [Inserting the Administration Cassette](#) on page 85.

Sapphire Approved Administration Sets

The Eitan Medical Ltd. approved list of administration sets to be used with the Sapphire pump is listed in the Eitan Medical Official Website at <https://eitanmedical.com/>.



Use Eitan standard administration sets listed in Eitan's approved list of products: <https://eitanmedical.com/>

Alternatively, administration sets from different manufacturers that are regulatory cleared and labeled for use with the Sapphire infusion system, can be used as well. The list of regulatory cleared sets needs to be obtained from the official manufacturer's publication such as manufacturer's website, catalog or any other formally published document. Using anything other than administration sets regulatory cleared and labeled for use with Sapphire infusion system, may result in operation that is not within the constraints and parameters of the device.

Note: The use of Administration sets manufactured by ICU Medical is approved for sale through March, 2023.



All filters used in Sapphire approved administration sets are air eliminating filters.

Other products available from Eitan Medical Ltd. are listed in the Eitan Medical Official Product List, at <https://eitanmedical.com/>

This page is left intentionally blank

Chapter 3: Fundamental Concepts and Operations

The following sections explain the structure and function of the Main Display and the toolbar, provide an overview of the delivery modes, and describe special features that can be enabled and disabled, according to user requirements:

Working with the Main Display	66
Selecting Delivery Mode	72
Enabling Special Features	74

Working with the Main Display

The Main Display is a touch screen that serves as a work area for programming infusion parameters, and choosing from lists of possible selections. While an infusion is running, selected infusion parameters and other relevant information (such as time left until completion of the infusion) appear on the Main Display.

The following sections describe how to use the keypads, and provide an overview of the main function keys and icons that appear on the Main Display.

Using the Keypad

Numeric keypad

The keypad is used for entering digits, to specify parameters for volumes, rates and times, and typing drug names when searching the Drug Library. As you press the relevant digits, they are displayed in the frame at the top of the Main Display, replacing the name of the parameter. Pressing **Clr**, at the lower left corner of the keypad, clears all entered digits and lets you re-enter the value.



The acceptable range of a given parameter is displayed in the upper right corner of the Main Display. When you enter a value that is outside of a permitted range, the range values stay red, and the **OK** function key is disabled. The values of a range are dynamic, and change according to other parameters that have already been programmed.

When entering time, the pump allows you to enter minutes up to the value of **59**. Infusion time of over 59 minutes must be expressed in hours and minutes. For example, 90 minutes must be entered as **1:30** (h:min).

Alphanumeric keypad

In some instances, for example, defining a new PreSet program, or entering a drug name, the keypad displays letters and symbols in addition to numbers.

The Alphanumeric keypad displays uppercase letters with numbers, and lowercase letters with symbols. Uppercase letters and numbers are the default state. Switch the default keypad from uppercase and numbers to lowercase and symbols by pressing the 'abc sym' key on the toolbar and back to default by pressing 'ABC 123' key.

Overview of Toolbar Function Keys

The function keys are located in the toolbar, and enable user actions. The function keys that appear vary according to the screen or program that is currently selected.

Function keys enabling basic actions are described in the following table.

Name of Key	Action	Notes
OK	Confirms a selection or an entered parameter	If the selection involves parameters that are out of the permitted range, the OK key is disabled.
Prime	Initiates priming	Appears in the Attention screen, after the Prime function has been selected.
Mute/Unmute	Silences/unsilences the speaker	Appears when any alarm is triggered. The speaker unmutes automatically after 2 minutes.
Back	Displays the previous screen	
Exit	Returns to either the Start Up screen, or to the screen displaying current infusion parameters	In situations when the Back key and the Exit key will take users to the same screen, only the Exit key is displayed.



The following function keys are available from the Running screen:







Name of Key	Action	Notes
Lock	Locks the screen or the pump	For more information, refer to Locking the Screen on page 192 and Activating Patient Lockout on page 193.
Press to Unlock screen	Unlocks the screen	
Press to Unlock Patient	Unlocks the pump	Unlocking the screen requires a password.



Name of Key	Action	Notes
Request Pause/ Pause Bolus	Pauses an infusion or a bolus	For more information, refer to Pausing Infusions on page 190.
Request Continue/ Continue Bolus	Resumes a paused infusion or a bolus	
View/Edit	Displays a list of infusion parameters to be viewed or edited	
Bolus	Delivers a bolus during continuous, PCA and PCEA modes	

Overview of Icons

Icons that frequently appear on the Indicators Bar and the Main Display are described in the following table. In addition, some alarms appear with their own icons.

Icon	Meaning	Notes
>	Indicates that the parameter immediately adjacent to the icon can be viewed and updated directly from the Main Display.	To initiate the update, touch the box in which the icon appears.
	Rate of the infusion.	
	Volume to be infused.	

Icon	Meaning	Notes
	Time remaining until the end of the infusion.	
	Indicates that an infusion is currently running.	
	Indicates status of battery charge.	For more information, refer to Battery Care Information on page 265.
	Indicates that the current infusion is above the upper soft limit range in at least one parameter.	For more information, refer to Soft Limit on page 241.
	Indicates that the current infusion is below the lower soft limit range in at least one parameter.	For more information, refer to Soft Limit on page 241.
	Indicates that the current infusion is exceeding both upper and lower soft limit ranges.	When more than one parameter is limited by the Drug Library – one of the parameters is programmed above the upper soft limit, and another parameter is programmed below the lower soft limit. For more information, refer to Soft Limit on page 241.
	Indicates that the EBP is connected to the pump.	For more information, refer to External Battery Pack on page 51.

Icon	Meaning	Notes
	Updating data.	May appear when transitioning between lines.
	Pump connected to PC.	Indicates that the pump is connected to the PC.
	Air detection is disabled (OFF)	<p>No Air in Line alarm is triggered when the pump air detection is disabled (OFF). A technician authorization code is required to enable or disable air detection (this can only be set manually on the pump and not by the DLE).</p> <p>If air detection is disabled (OFF), use a set with an air-eliminating filter to prevent injury. Always ensure that the administration set is primed before starting an infusion.</p>

Selecting Delivery Mode

The Sapphire pump is a multi-platform device that has the ability to operate in several different delivery modes.



The delivery modes availability can be set by a technician

Possible delivery modes include:

Mode	Description/Notes
Continuous	Delivers an infusion at a constant, programmed rate. This mode includes the option to add a Secondary (Piggyback) line.
Intermittent	Delivers infusions at intermittent programmed intervals.
TPN (Total Parenteral Nutrition)	Delivers an infusion at a constant rate, with optional tapering at the beginning and end of the infusion.
PCA (Patient Controlled Analgesia)	Delivers PCA boluses, either alone or in addition to a basal programmed rate.
Multi-step	Delivers the infusion in a set of 1 and up to 25 steps.
Epidural	PCEA (Patient Controlled Epidural Analgesia): Delivers epidural boluses, either alone or in addition to a basal programmed rate. Intermittent Epidural: Delivers epidural infusions at intermittent pre-set intervals, with the option to add PCEA (refer to PIEB under Epidural Mode Options Menu on page 218).



The Epidural (PCEA and Epidural Intermittent) modes do not deliver IV infusions. They deliver epidural infusions, using a special catheter and all the required clinical procedures.

Each delivery mode features its own unique options. The current mode is displayed at the right side of the Indicators Bar on some of the screens. On screens that are not mode related, such as **Delivery mode** selections screen below, the name "Sapphire" is displayed instead.

Figure 3.1. Indicators Bar: Delivery Mode



Changing the delivery mode is done using the Options menu. An authorization code of High is required to modify the delivery mode. For more information about how to change the delivery mode, refer to [Setting Delivery Mode](#) on page 197.

Enabling Special Features

Depending on the needs of a specific clinical care area or institution, the Sapphire pump can be enabled to perform special functions. An authorization code is required to enable/disable these functions.



Local configuration made after the Drug Library is loaded, will be valid until the user selects a CCA or turns the pump Off. When Resuming an infusion after pump shutdown, local configurations will remain until the end of the current infusion. For more information about Drug Library, refer to [Chapter 9: Drug Library](#) on page 234. When no Drug Library is loaded, all local changes made to any configuration will remain valid until reconfigured or until the pump is set to factory defaults.

The following features can be enabled/disabled by users who have an authorization code of High:

Feature	Delivery Mode(s)	Description/Notes
Allow delayed start	All	Enables users to start an infusion at a later time. The user may either define a specific delay period or set the pump to Standby. For more information, refer to Using the Set Delay Feature on page 227.
Allow PreProgram	All	Allows users to start an infusion using predefined infusion parameters. When this option is enabled, the PreSet Programs button appears on the pump Start Up screen. For more information, refer to Creating and Editing PreSet Programs on page 224.

Feature	Delivery Mode(s)	Description/Notes
Repeat last infusion	All	Allows the users to start infusions using the same infusion parameters for the same patient. When this option is enabled, the Repeat Last Infusion button appears on the pump Start Up screen. For more information, refer to Repeating Last Infusion on page 186.
Limit Period	PCA Epidural (PCEA and Epidural Intermittent)	Specifies the time period to which the dose limit type is applied (during the selected time, the delivered boluses will be limited by either maximum number, or by maximum volume).
Prime Reminder	All	Enables a reminder for the user to prime the administration set before starting an infusion. For more information, refer to Automatic Priming Using the Pump on page 88
Allow loading dose	PCA PCEA (Epidural)	Enables starting a PCA or PCEA infusion with a programmed initial clinician dose (bolus). For more information about enabling the feature, refer to PCA Options Menu on page 217 or Epidural Mode Options Menu on page 218.
Password request	Epidural (PCEA and Epidural Intermittent)	A safety feature that requires password entry to make changes to important parameters. For more information about enabling the feature, refer to Epidural Mode Options Menu on page 218.
Advanced Bolus	Continuous	Allows users to program a bolus by entering rate, amount and time. For more information, refer to Administering a Bolus on page 108.

Feature	Delivery Mode(s)	Description/Notes
Bolus Reminder	PCA Epidural (PCEA and Epidural intermittent)	Enables a reminder for the user to connect the bolus handle before starting a PCA, or PCEA or PIEB infusion that includes patient boluses. The reminder (i) instructs to connect the bolus handle directly to the pump (ii) Checks functionality – bolus press is recognized by the pump. For more information, refer to Bolus Reminder on page 204.
Auto P. Lockout	All	A safety feature that enables automatic locking of the screen. A password is required to unlock the screen in order to make changes to the infusion parameters or to start a new infusion. Activated first during a running infusion, and automatically re-activated throughout the infusion. For more information about enabling the feature, refer to Configuring General Settings on page 202. For more information about using the feature, refer to Activating Patient Lockout on page 193.
Screen Saver	All	Provides a distant view of the main parameters during a running infusion. Activated 30 seconds after the infusion starts.

A Technician authorization code is required to enable/disable the following additional features:

Feature	Delivery Mode(s)	Description/Notes
Delivery modes	All	Determines the available delivery modes. Each mode can be turned Off separately.
New Patient	All	Allows users to associate an infusion with a patient, and reset the Accumulated VI (accumulated volume infused).

Feature	Delivery Mode(s)	Description/Notes
Set Secondary (Piggyback)	Continuous	Allows users to program a Secondary infusion. For more information about programming a Secondary infusion, refer to Adding a Secondary Line on page 113.
Allow Bolus	Continuous	Allows users to program a bolus during a Continuous infusion. When this feature is enabled, the Bolus button appears in the toolbar during the running infusion. For more information about administering a bolus, refer to Administering a Bolus on page 108.
Bolus Rate	Continuous	Specifies the rate of delivery of a fast dose, for rapid volume infusion.
Sec. Bolus Rate	Continuous	Specifies the rate of delivery of a fast dose for a Secondary (Piggyback) infusion.
Occ. Auto-restart	All	Enables the pump to automatically restart an infusion, up to 5 times an hour, if a downstream occlusion was detected and cleared within 40 seconds.
Calculate Concentration	All Excluding TPN	Determines if the user enters final concentration or Drug Amount and Diluent Volume.
mL/h Only	All Excluding TPN	Allows users to use units other than mL/h. If this option is enabled, programming will automatically default to mL/h. This feature is available in the absence of a Drug Library on the pump.
Med. Titration	All	Allows users with medium authorization level to change rate during a running infusion.
Air Detection	All Excluding Epidural	Determines whether the pump air detection is disabled (OFF) or enabled (ON) during infusion. This feature should be used when meeting the clinical practice and guidelines, and coupled with an alternative method of eliminating air. When air detection is disabled (OFF), the user is prompted to use the set with an air-eliminating filter.

Setting KVO rate

Allows users to set the default rate of fluid that is delivered when the infusion program is completed. The permitted range for the KVO rate parameter is 0-20 mL/h (for all delivery modes).

This page is left intentionally blank

Chapter 4: Getting Started

The following sections explain the sequence of actions necessary to prepare the pump and the administration set for an infusion:

Typical Workflow	80
Connecting the Infusion Container to the Administration Set	83
Opening the Safety Door	84
Inserting the Administration Cassette	85
Automatic Priming Using the Pump	88

Typical Workflow

The recommended workflow for preparing the pump and administration set for an infusion comprises the following steps:

1. Turn the pump On.
2. Connect the infusion container to the administration set.
3. Open the safety door.
4. Insert the cassette.
5. Prime the administration set using the pump.*
6. Connect the administration set to the patient. When using an administration set with a filter, place the filter under the patient's IV infusion site.

* It is recommended to prime the administration set using the pump. It is possible to prime the administration set manually. For more information, refer to [Priming Manually](#) on page 90.

The workflow sequence is illustrated in the following figure:

Figure 4.1. Recommended Workflow

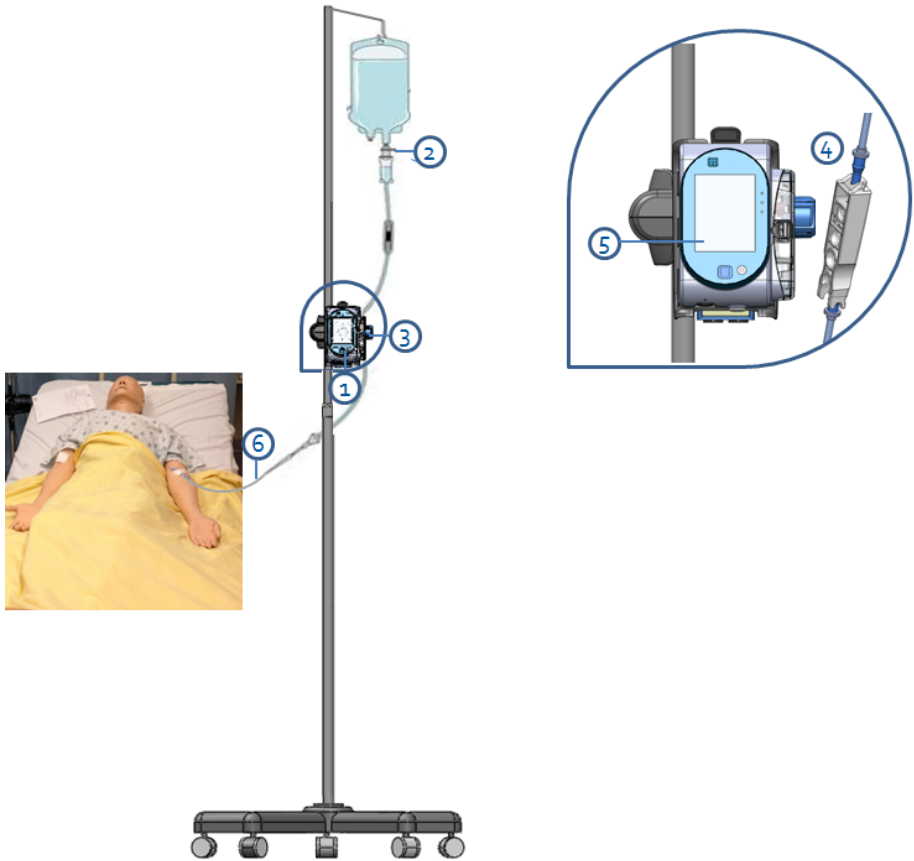

Turning the Pump On

The pump is turned On by pressing the **On/Off** hard key, at the lower right corner of the pump.

When a Drug Library is loaded, a message is displayed asking to accept or change the current CCA. For more information about CCA, refer to [Clinical Care Area \(CCA\)](#) on page 235.



While the pump turns On, a system check is performed. If you do not hear a sound from the speaker, or if items on the screen do not display properly, do not use the pump.



If a message regarding resuming previous infusion appears upon turning the pump On, refer to [Resuming Infusions After Pump Shutdown](#) on page 189.

Turning the Pump Off

Pressing the **On/Off** hard key for 5 consecutive seconds turns the pump Off. Alternatively, press the **On/Off** hard key, and then, from the Attention screen, press **Off**.

For more information about turning the pump Off during an infusion, refer to [Aborting Infusions](#) on page 191.

The pump enables resuming an infusion after pump shut down. For more information, refer to [Resuming Infusions After Pump Shutdown](#) on page 189.

Connecting the Infusion Container to the Administration Set

This section explains how to connect the infusion container to the administration set.



Before setting up the infusion, verify that the container, administration set and administration set package are undamaged.

> To connect the container to the administration set:

1. Open the sterilized administration set package.
2. Close the clamps and the AFFV to block the administration set. Make sure that the clamp is located at least 20 cm (8 in) from the pump, when possible.
3. Spike the administration set into the container.



Verify that the arrow on the administration cassette is pointing toward the same direction of the fluid flow (down).



Connecting the Infusion Container: Safety Precautions

- Make sure there is no leakage from the container, and that the spike is firmly attached to the container.
- Verify that the set components are positioned correctly. The arrows on the administration cassette and the filter must point toward the direction of the flow (from the container to the patient).
- When using a filter, maintain the filter level below the vascular access site.

Opening the Safety Door

Opening the safety door involves pressing it down while simultaneously pulling the safety door open.

> To open the safety door:

1. Using your thumb, press the door outwards.



2. While maintaining pressure, swing the safety door outwards.



Inserting the Administration Cassette

Sapphire

Inserting the administration cassette into the pump involves positioning the cassette in the proper direction, and ensuring that all portions of the cassette including the flange, are secured inside the administration cassette's housing. In [Figure 4.2](#), the flange is represented by #2, and the saddle is represented by #1.

Figure 4.2. Administration Cassette

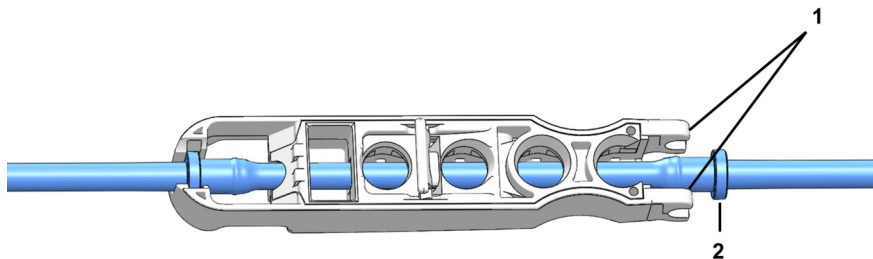

It is recommended to make sure that the pump is turned On, and to verify that all clamps on the administration set are closed before inserting the administration cassette.

> To insert the Eitan Medical administration cassette:

1. Open the safety door ([Opening the Safety Door](#) on page 84). Then, insert the administration cassette at an angle, by placing the saddle ([Figure 4.3](#), #1) on the round metal anchor (#2) in the cassette's housing. Make sure that the arrow on the cassette (#3) is pointing toward the bottom of the pump, and the bottom flange is inside the cassette housing.

Figure 4.3. Insertion of Cassette

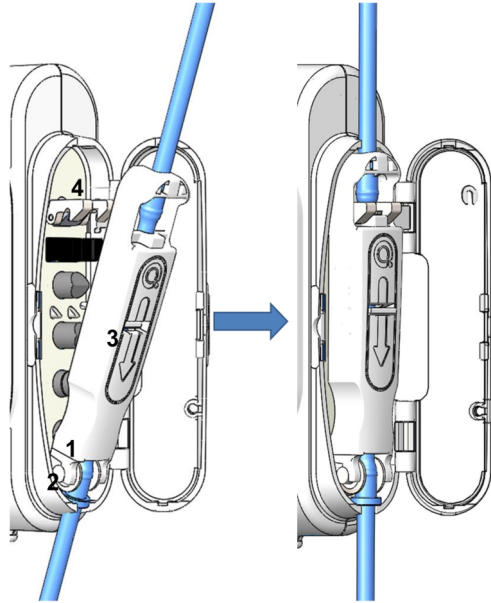

2. Clip the upper end of the administration cassette into the metal lock (Figure 4.3, #4).
3. Close the safety door over the administration cassette. Ensure that the safety door clicks upon closure.

Removing the Administration Cassette

When the infusion is complete, close the clamps, disconnect the administration set from the patient, and disconnect the administration cassette.

In case of emergency, you can stop pump operation by opening the safety door, closing the clamps, removing the administration cassette from the pump and disconnecting the administration set from the patient.

The following procedure describes how to remove the cassette from the pump.



Although the AFFV offers automatic free flow protection, a small amount of fluid (up to 0.09 mL) may be expelled when the administration cassette is detached. In order to ensure full protection, disconnect the patient from the administration set before detaching the cassette from the pump.

> To remove the Sapphire administration cassette:

1. Close all clamps on the administration set.
2. Disconnect the patient from the administration set.
3. Open the safety door ([Opening the Safety Door](#) on page 84).
4. Loosen the cassette by raising the metal lock that secures it to the pump (#4 in [Figure 4.3](#)).
5. Pull out the cassette, and close the safety door.

Automatic Priming Using the Pump

Before commencing infusion setup, the administration set needs to be primed. Priming expels all the air from the administration set, and fills it with the infusion liquid. A fully primed administration set is a set filled with infusion liquid (from which all the air was removed).



It is recommended to prime the administration set using the pump.

Priming with the pump can be initiated from the following screens:

- Start Up
- Start
- Paused (infusion or bolus)
- Air in Line Alarm

Before using the pump for priming, ensure that:

- The administration set clamp is open.
- The safety door is closed.

The Sapphire administration cassette is properly connected to the pump.



Before priming, verify that the administration set is disconnected from the patient.



When the Prime Reminder is enabled and the set has not yet been primed using the pump, a Prime Reminder will be displayed, enabling the user to press **Prime** in order to start priming or to press **Start** in order to proceed with the infusion (refer to [Configuring General Settings](#), page 203).

To prime the administration using the pump

1. Position the pump in an upright position using one of the following methods:
 - Attach the pump to the cradle base.
 - Attach the pump to an IV pole using the mini cradle.
2. From the toolbar of the Start Up, Start, Air in Line Alarm, or Paused screen, press **Prime**.
3. **Verify that the administration set is disconnected from the patient.** Then, from the Attention screen, press **Prime**. Priming begins.

While the pump is priming, a progress circle appears on the screen, with a time countdown displayed. The default priming time is 2 minutes.

When using administration sets that contain less than 20 mL, shorter priming times can be set. For more information, refer to [Set prime volume](#) on page 203.



During priming with the pump, the Air in line alarm is disabled. When priming, check that all clamps are opened and that there is no occlusion. Ensure that liquid, not air, enters the administration set during priming.

The pump automatically indicates when priming is finished.

If priming is completed before the default priming time has elapsed, automatic priming can be discontinued.

> **To discontinue priming:**

1. From the toolbar, press **Finish Prime**. Alternatively, at the bottom of the pump, press the **Stop** hard key.
2. From the toolbar, press **OK**

Priming Manually

The Sapphire administration set can also be used as a gravity set, and the Anti-Free-Flow Valve (AFFV) can be used manually.

Before commencing infusion setup, the administration set needs to be primed. Priming expels all the air from the administration set, and fills it with the infusion liquid. A fully primed set is a set filled with infusion liquid (from which all the air was removed).



The following procedure explains how to prime the administration set manually, using gravity. However, it is recommended to prime the administration set using the pump. For more information, refer to [Automatic Priming Using the Pump](#) on page 88.



A set with a Pressure Activated Valve (PAV) can not be primed manually. For more information, refer to the Direction for Use for each set.

> To prime the administration set manually:

1. Open all the clamps on the administration set.
2. To allow free flow, open the AFFV by pushing it in and down, towards the center of the Sapphire administration cassette (#1 in [Figure 4.4](#)).
3. Fill the entire administration set with fluid, so that the fluid displaces all air in the administration set.



When priming a set with a filter; the filter must remain lower than the patient line.

4. To block free flow, close the AFFV by pushing it up and away from the center of the cassette (#2 in [Figure 4.4](#)).

Figure 4.4. Opening and Closing the AFFV

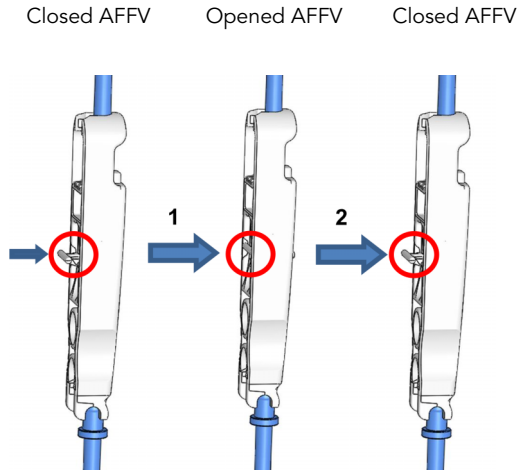

Although the AFFV offers automatic free flow protection, a small amount of fluid (up to 0.12 mL) may be expelled when the administration cassette is attached. In order to ensure full protection, insert the administration cassette to the pump housing before connecting the set to the patient.



To use as a gravity set, fix the AFFV in an open position as described in step 2 in [To prime the administration set manually](#) on page 90. Only administration sets that include a roller clamp and do not include pressure activated valves (PAV) can be used by gravity. For more information, refer to the Administration set's DFU.

Chapter 5: Using the Delivery Modes

The following sections explain how to operate the pump in the different delivery modes. After setting up the pump and the infusion, always check the battery status to ensure it is sufficient for the desired infusion program.

Continuous Mode	92
Multi-step Mode	121
Total Parenteral Nutrition (TPN) Mode	130
Intermittent Mode	137
Patient Controlled Analgesia (PCA) Mode	147
Epidural Mode	158

Continuous Mode

The following sections will be reviewed:

Infusion Parameters: Continuous Mode	95
Starting a Continuous Infusion	95
Continuous Mode: Mid-infusion Actions	107

In this mode, the pump infuses fluid at a constant, programmed rate.

Figure 5.1. Continuous Flow Profile

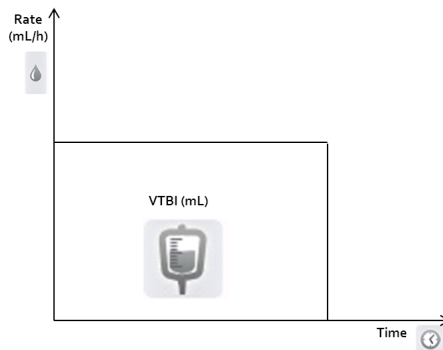

The Sapphire pump can also be configured to support Secondary (Piggyback) infusions. The Secondary option is used when two medications are administered from two different bags; The user may either alternate between the bags or administer them sequentially.



To use the Secondary option, the option must be enabled (requires Technician authorization code).

Figure 5.2. Secondary Infusion Setup

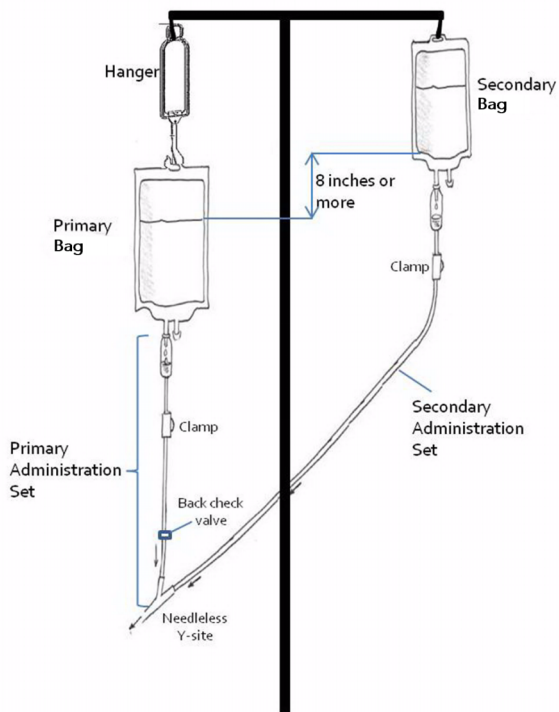

When the Secondary option is enabled, you can set Secondary infusion parameters:

- Immediately after programming the Primary infusion ([Starting a Continuous Infusion Using the Secondary Function](#) on page 101).
OR
- While a Primary infusion is already running ([Adding a Secondary Line](#) on page 113).



Piggyback Option: Safety Precautions

When working with Secondary infusions, adhere to the following instructions and guidelines:

- Use only Sapphire administration sets designed for Piggyback infusions. (For more information, refer to [Sapphire Approved Administration Sets](#) on page 64.)
- Hang the Secondary solution container at least 8 inches above the Primary solution fluid level.
- Use the drip chamber on the set to verify that the correct line is delivering and the other line is idle.
- After the Secondary infusion is complete, clamp the Secondary administration set.

Infusion Parameters: Continuous Mode

The following infusion parameters are relevant for a Continuous infusion. When programming the infusion, it is necessary to specify two of the parameters. The third parameter is then automatically calculated by the pump.

Parameter	Description/Notes
Rate	The speed at which the fluid is infused. Rate values can range from 0.1 to 999 mL/h. Note: When selecting units that are not from the mL/h family, the word Rate is replaced with Dose Rate .
VTBI	The total amount of fluid to be infused. VTBI values can range from 0.1 to 9999 mL. The remaining VTBI is displayed on the screen as the infusion progresses.
Time	The period of time over which the fluid is infused. The range for the Time value varies according to the VTBI and Rate. The upper limit of the Time value is 99 hours and 59 minutes.

Starting a Continuous Infusion

The following procedure explains how to program the pump to start a new Continuous infusion.



If relevant, you may skip programming by using the Repeat Last Infusion or PreSet programs procedures to begin the infusion. For more information, refer to [Starting New Infusions: Shortcuts](#) on page 186.

> To begin a new Continuous infusion without Drug Library:

1. From the Indicators Bar, verify that the pump is in Continuous mode.



For more information about changing delivery modes, refer to [Selecting Delivery Mode](#) on page 72.

2. From the Start Up screen, select **New Infusion**.
3. If a warning that the air detection is disabled (OFF) appears, ensure that a set with an air-eliminating filter is used, and press **OK**.
4. If the Dosing method screen appears, select the appropriate option:
 - **mL**: Continue to Step 8.
 - **Dose calculation**: Continue to Step 5.Weight based units are available for both Dosing methods
Otherwise, continue to Step 11.
5. From the Concentration units screen, select the appropriate drug units.



To display additional concentration units press **Next**.

6. According to the pump configuration one of the following screens will appear:
 - **Concentration**: From the Concentration screen, using the keypad, enter the Concentration → **OK**; then, continue to Step 8.
 - **Drug amount**: Using the keypad, enter the Drug Amount → **OK**. Then, using the keypad, enter the Diluent Volume → **OK**; then, continue to Step 7.
7. From the Attention screen, confirm the concentration and press **OK**.
If the selected drug unit is Million Units, continue to Step 10.
8. If the Patient Weight screen appears, specify whether the infusion is weight based:
 - **Yes**: Continue to Step 9.
 - **No**: Continue to Step 10.
9. From the Patient Weight screen, using the keypad, enter the Patient Weight → **OK**.
10. From the Dose Rate units screen, select the appropriate dose rate units.
11. From the Edit screen, program 2 of the following 3 parameters, by selecting the relevant rows:
 - **Rate**: Using the keypad, enter the value → **OK**.
 - **VTBI**: Using the keypad, enter the value → **OK**.

- **Time:** Using the keypad, enter the value → **OK**.

The third (unprogrammed) parameter is then automatically calculated by the pump and displayed in the relevant box.



If the calculated rate is beyond the pump resolution (0.1 mL/h increments), the pump decreases the rate by 0.1 mL/h during the infusion to achieve accurate delivery of the volume in the specified time. The rate reduction is always 0.1 mL/h, and is presented on the Running screen (when selecting dose calculation, the equivalent change to 0.1 mL/h applies).

12. Review the parameters displayed on the Confirm screen.



Verify that the parameters reflect the correct treatment according to the prescription.

Then, press **OK**.



If the pump is configured to support Secondary infusions, Secondary infusion parameters can be programmed at this point. For detailed instructions, go to Step 3 on page 101 ([To begin a new Continuous infusion using the Secondary option without Drug Library](#)).

13. Make sure that the clamps on the administration set are open; then, press **Start**.

The Running screen is displayed, and the infusion begins.

Throughout the infusion, the following information is displayed on the screen:

- **Drug Name:** The name of the selected drug. Displayed on the indicators bar, when working with a Drug Library.
- **Drug Concentration:** Drug concentration as entered by the user (Final concentration or Drug Amount / Diluent Volume). Displayed when applicable.

- **Rate:** Current infusion rate. For all dose units other than mL/h, the calculated rate will be displayed in mL/h, both in the View system menu and in the Running screen.
- **VTBI:** Total volume left to be infused during the current infusion. As the infusion progresses, this value decreases.
- **VI / Total:** Total volume delivered in the current infusion (including KVO if applied during a delayed start period) / the VTBI value programmed. As the infusion progresses, the VI increases, and the Total remains constant.
- **Time left:** Time remaining until the end of the current infusion.



To view all programmed parameters of the current infusion, including the rate in mL/h, from the Running screen, press **View/Edit** → **View system** → **Infusion values**.

> To begin a new Continuous infusion with a Drug Library:

1. From the Indicators Bar, verify that the pump is in Continuous mode.



For more information about changing delivery modes, refer to [Selecting Delivery Mode](#) on page 72

2. From the Start Up screen, select **New Infusion**.
3. If a warning that the air detection is disabled (OFF) appears, ensure that a set with an air-eliminating filter is used, and press **OK**.
4. From the Drug Name screen:
 - Using the keypad, enter the drug name; then, press **Find** and proceed to Step 5.



The **Find** key can be used to display all available drugs without entering any characters (letters, numbers or symbols), or filter drug names according to the characters entered.

- When the required drug is not found in the Drug Library, press **Choose General** key on the toolbar:



'Choose General' will bypass specific drug limits, and the infusion will be programmed without Drug Library limits.

From the Attention screen, confirm choosing General, and press **OK**. Proceed to Step 4 on page 96 (To begin a new Continuous infusion without Drug Library) and continue programming from there.

5. From the Drug List screen, select the row of the relevant drug.



To display additional drugs press **Next**.

6. If a list of available drug profiles appears, select the appropriate drug profile and proceed according to the step directed to:
 - **No concentration:** proceed to Step 8 on page 96 (To begin a new Continuous infusion without Drug Library), and continue programming from there.
 - **Diluent only** (e.g., 10 mL): proceed to Step 8 on page 96 (To begin a new Continuous infusion without Drug Library), and continue programming from there.
 - **Partial concentration:** the Drug Amount or Diluent Volume is missing. The screen of the missing value will appear:
 - From the Drug Amount screen, using the keypad, enter the Drug Amount → **OK**.
 - From the Diluent Volume screen, using the keypad, enter the Diluent Volume → **OK**.
- From the Attention screen, confirm the concentration and press **OK**. Proceed to Step 8 on page 96 (To begin a new Continuous infusion without Drug Library), and continue programming from there.

- **Full concentration:**

Proceed to Step 8 on page 96 (To begin a new Continuous infusion without Drug Library), and continue programming from there.

If a list of available drug profiles does not appear, continue to Step 11 on page 96 (To begin a new Continuous infusion without Drug Library), and continue programming from there.

For more information about the Drug Library, refer to [Chapter 9: Drug Library](#) on page 234.

Starting a Continuous Infusion Using the Secondary Function

The following procedure explains how to program a Continuous infusion using both Primary and Secondary lines.

> To begin a new Continuous infusion using the Secondary option without Drug Library:

1. Verify that the pump is in Continuous mode, and then enter parameters for the Primary infusion (Step 2 on page 96 through Step 11 on page 96 in [To begin a new Continuous infusion without Drug Library](#)).



If the calculated rate is beyond the pump resolution (0.1 mL/h increments), the pump decreases the rate by 0.1 mL/h during the infusion, in order to achieve accurate delivery of the volume in the specified time. The rate reduction is always of 0.1 mL/h and is presented on the running screen (when selecting dose calculation, the equivalent change to 0.1 mL/h applies).

2. Review the parameters displayed on the Confirm screen.



Verify that the parameters reflect the correct treatment according to the prescription.

Then, press **OK**.

3. From the Start screen, select **Set Secondary**.
4. If the Dosing method screen appears, select the appropriate option:

- **mL:** Continue to Step 8.
- **Dose calculation:** Continue to Step 5.

Weight based units are available for both Dosing methods.

Otherwise, continue to Step 11.

5. From the Concentration units screen, select the appropriate drug units.



To display additional concentration units press **Next**.

6. According to pump configuration one of the following screens will appear:
 - **Concentration:** From the Concentration screen, using the keypad, enter the Concentration → **OK**. Then, continue to Step 8.
 - **Drug amount:** Using the keypad, enter the Drug Amount → **OK**. Then, using the keypad, enter the Diluent Volume → **OK**. Then, continue to Step 7.
7. From the Attention screen, confirm the Concentration and press **OK**.
If the selected drug unit is Million Units, continue to Step 10.
8. If the Patient Weight screen appears, specify whether the infusion is weight based:
 - **Yes:** Continue to Step 9.
 - **No:** Continue to Step 10.
9. From the Patient Weight screen:
If the patient weight was entered during the primary line programming, continue to Step 10.
If the patient weight was not entered during the primary line programming, using the keypad, enter the Patient Weight → **OK**.
10. From the **Dose Rate units** screen, select the appropriate dose rate units.
11. Program 2 of the following 3 parameters, by selecting the relevant boxes:
 - **Rate (Secondary):** Using the keypad, enter the value → **OK**.
 - **VTBI (Secondary):** Using the keypad, enter the value → **OK**.
 - **Time (Secondary):** Using the keypad, enter the value → **OK**.The third (unprogrammed) parameter is then automatically calculated by the pump and displayed in the relevant box.
12. Review the parameters displayed on the Confirm screen.



Verify that the parameters reflect the correct treatment according to the prescription.

Then, press **OK**.

13. From the Start screen, select one of the following:
 - **Start secondary:** The Attention screen appears. After verifying that the clamps on the Secondary administration set are open, press **OK**. The Secondary screen appears, and the Secondary infusion begins. When the Secondary infusion is complete, the pump automatically continues with the Primary infusion.
 - **Start primary:** The Attention screen appears. After closing the clamp on the Secondary administration set, make sure that the clamps on the primary administration set are open; then, press **OK**. The Primary screen appears, and the Primary infusion begins.

Throughout the infusion, the Indicators Bar displays information regarding the current infusion (Primary, Secondary or the name of the drug infused). After the secondary infusion is completed, the pump automatically switches to the primary line, and beeps to notify the user. The following information is displayed on the Primary/Secondary screen:

- **Drug Name:** The name of the selected drug. Displayed on the indicators bar, when working with a Drug Library.
- **Drug Concentration:** Drug concentration as entered by the user (Final concentration or Drug Amount / Diluent Volume). Displayed when applicable.
- **Rate:** Current infusion rate. For all dose units other than mL/h, the calculated rate will be displayed in mL/h, both in the View system menu and in the Running screen.
- **VTBI:** Total volume left (in the current infusion) to be infused. As the infusion progresses, this value decreases.
- **VI / Total:** Total volume that has been infused during the current infusion (including KVO if applied during a delayed start period) / the VTBI value programmed. As the infusion progresses, the VI increases, and the Total remains constant.

- **Time left:** Time remaining until the end of the current infusion.



You can switch between the two infusions at any time. For more information, refer to [Switching between Primary and Secondary Infusions](#) on page 117.



To view all programmed parameters of the current infusion, including the rate in mL/h, from the Running screen, press **View/Edit** → **View system** → **Infusion values**.
For all dose units other than mL/h, the calculated rate will be displayed in mL/h, both in the View system menu and in the Running screen.

> To begin a new Continuous infusion using the Secondary option with a Drug Library:

1. Verify that the pump is in Continuous mode, and then enter parameters for the Primary infusion (To begin a new Continuous infusion with a Drug Library Step 2 on page 98 to Step 6 on page 99).



If the calculated rate is beyond the pump resolution (0.1 mL/h increments), the pump decreases the rate by 0.1mL/h during the infusion in order to achieve accurate delivery of the volume in the specified time. the rate reduction is always of 0.1mL/h and presented on the running screen (when selecting dose calculation, the equivalent change to 0.1mL/h applies).

2. Review the parameters displayed on the Confirm screen.



Verify that the parameters reflect the correct treatment according to the prescription.

Then, press **OK**.

3. From the Start screen, select **Set Secondary**.
4. From the Drug Name screen:

- Using the keypad, enter the drug name, then press **Find** and proceed to Step 5.



The **Find** key can be used to display all available drugs without entering any characters (letters, numbers or symbols), or filter drug names according to the characters entered.

-
- When the required drug is not found in the Drug Library, press **Choose General** key on the toolbar:



'Choose General' will bypass specific drug limits, and the infusion will be programmed without Drug Library limits.

From the Attention screen, confirm choosing General and press **OK**. Proceed to Step 4 on page 101 (To begin a new Continuous infusion using the Secondary option without Drug Library) and continue programming from there.

5. From the Drug List screen, select the row of the relevant drug.



To display additional drugs press **Next**.

6. If a list of available drug profiles appears, select the appropriate drug profile and proceed according to the step directed to:
 - **No concentration:** proceed to Step 8 on page 102 (To begin a new Continuous infusion using the Secondary option without Drug Library), and continue programming from there.
 - **Diluent only** (e.g., 10 mL): proceed to Step 8 on page 102 (To begin a new Continuous infusion using the Secondary option without Drug Library), and continue programming from there.
 - **Partial concentration:** the Drug Amount or Diluent Volume is missing. The screen of the missing value will appear:
 - From the Drug Amount screen, using the keypad, enter the Drug Amount → **OK**.
 - From the Diluent Volume screen, using the keypad, enter the Diluent Volume → **OK**.

From the Attention screen, confirm the concentration and press **OK**.

Proceed to Step 8 on page 102 ([To begin a new Continuous infusion using the Secondary option without Drug Library](#)), and continue programming from there.

- **Full concentration:**

Proceed to Step 8 on page 102 ([To begin a new Continuous infusion using the Secondary option without Drug Library](#)), and continue programming from there.

If a list of available drug profiles does not appear, continue to Step 11 on page 102 ([To begin a new Continuous infusion using the Secondary option without Drug Library](#)), and continue programming from there.

For more information about the Drug Library, refer to [Chapter 9: Drug Library](#) on page 234.

Continuous Mode: Mid-infusion Actions

The following actions can be performed during Continuous infusions:

Updating Infusion Parameters	107
Administering a Bolus	108
Adding a Secondary Line	113
Switching between Primary and Secondary Infusions	117
Replacing the Current Secondary Line	118
Pausing Infusions	190
Aborting Infusions	191
Locking the Screen	192
Activating Patient Lockout	193

Updating Infusion Parameters

Infusion parameters can be modified by using the **View/Edit** function key. In addition, you can modify the rate, VTBI, and time left directly from the Running, Primary or Secondary screen.

> To update current parameters directly from the screen:

1. On the Main Display, select the relevant parameter (**Rate**, **VTBI** or **Time left**).
2. Using the keypad, enter the new value of the parameter → **OK**.
3. To confirm and save changes, press **OK**.
To return to the original infusion screen without saving changes, press **Back**.

> To update parameters using the View/Edit function key:

1. From the toolbar, press **View/Edit**.
2. Select the box of the parameter to be updated.
3. Using the keypad, enter the new value of the parameter → **OK**.
4. To update other parameters, repeat Steps 2-3.

In addition to parameter changes, the following actions are also available:

- **Clear Accum. VI:** Resets the total volume infused via all infusions associated with the current patient to 0 mL. For more information, refer to [Clearing Accumulated VI](#) on page 233.
 - **View system:** Displays various system and pump parameters. (Refer to [View Menu](#) on page 209.)
 - **Edit Primary/Secondary Line:** Allows you to update infusion parameters of the infusion that is not currently running. The pump will prompt you to pause the infusion while updating these parameters.
5. To confirm and save changes, press **OK**.
To return to the original infusion screen without saving changes, press **Back**. Then, from the Attention screen, press **OK**.

Administering a Bolus

The Bolus feature enables administration of a fast dose, when rapid volume infusion in the Continuous mode is necessary.



Bolus delivery allows infusion at high rates. Only certified medical personnel should use this feature.

> To deliver a bolus:

1. From the toolbar of the Running, Primary or Secondary screen, press **Bolus**.



For the **Bolus** button to appear on a Continuous running infusion, the pump needs to be configured to the Allow Bolus setting. The Allow Bolus setting can be modified by Technicians only. For more information, refer to the Service Manual. If a Drug Library is installed on the pump, the Bolus button will appear only if the option was enabled for a specific drug, or an entire CCA.

2. If the Patient Weight screen appears, using the keypad, enter the Patient Weight → **OK**.

3. According to configuration, one of the following screens will appear:
- **Edit:**
 - **Amnt (Bolus):** Using the keypad, enter the Bolus Amount → **OK** (the acceptable range varies, according to the current VTBI).



Trying to enter one of the unavailable (grayed out) boxes, triggers a message requesting to enter the Bolus amount first.

Enter one of the following parameters, by selecting the relevant box:

- **Rate (Bolus):** Using the keypad, enter the Bolus Rate → **OK**.
- **Time (Bolus):** Using the keypad, enter the Bolus Time → **OK**.

The third (unprogrammed) parameter is then automatically calculated by the pump and displayed in the relevant box.

Continue to Step 4.

- **Bolus Amount:** Using the keypad, enter the Bolus Amount → **OK** (the acceptable range varies according to the current VTBI). Then, continue to Step 5.



When trying to exit programming before its completion, a message is displayed stating that the data entered has not been saved.



Bolus units used may differ from the units used by the infusion, due to their pre-configuration in the Drug Library.



When the bolus is programmed by amount only, the default bolus rate is 125 mL/h. This default can be modified using a Technician authorization code.

When the infusion rate is higher than 125 mL/h, the bolus rate will be 1 mL/h faster than the infusion rate.

During a bolus, some of the parameters can be updated from the Bolus delivery screen. For more information, refer to [Updating Bolus Infusion Parameters](#) on page 111.

4. Review the parameters displayed on the Confirm screen.



Verify that the parameters reflect the correct treatment according to the prescription.

Then, press **OK**.

5. To start the bolus, from the Attention screen, press **OK**.
The Bolus delivery screen is displayed, and the bolus begins.

Throughout the bolus, the following information is displayed on the screen:

- **Drug Name:** The name of the selected drug. Displayed on the indicators bar, when working with a Drug Library.
- **Drug Concentration:** Drug concentration as entered by the user (Final concentration or Drug Amount / Diluent Volume). Displayed when applicable.
- **Bolus Rate:** Current infusion rate.
- **Bolus VTBI:** Total bolus amount left to be infused. As the bolus progresses, this value decreases.
- **Bolus VI / Total:** Total bolus amount that has been infused during the current infusion / the total bolus amount programmed. As the infusion progresses, the Bolus VI increases, and the Total remains constant.
- **Time left:** Time remaining until the end of the bolus.

When the bolus is complete, a message appears on the Main Display.

Mid-bolus Actions

The following actions can be performed during bolus delivery:

Updating Bolus Infusion Parameters	111
Pausing a Bolus	111
Aborting a Bolus	112

Updating Bolus Infusion Parameters

Bolus infusion parameters are updated directly from the Bolus delivery screen.

> To update parameters from the Bolus delivery screen:

1. On the Main Display, select the relevant frame (Bolus Rate, Bolus VTBI or Time Left).



The Time Left parameter is not configurable, when the bolus was programmed by amount only.

2. Using the keypad, enter the new Rate, VTBI or Time left → **OK**.
3. From the Attention screen, press **OK**.
Updated parameters are displayed.

Pausing a Bolus

When necessary, you can temporarily stop the bolus.

> To pause a bolus:

- From the toolbar of the bolus delivery screen, press **Pause Bolus**. Then, from the Attention screen, press **OK**.
Alternatively, press the **Stop** hard key.
All volume delivery stops.

> To resume a paused bolus:

1. From the toolbar of the bolus delivery screen, press **Continue Bolus**.
2. From the Attention screen, press **OK**.

Aborting a Bolus

The following procedures involve pausing and then permanently quitting the bolus, with the option to quit the entire infusion.

> To abort a bolus and quit all infusions:

1. Press the **Stop** hard key. Alternatively, press the **Pause Bolus**, then press **OK**. The bolus is paused.
2. From the toolbar, press **Quit Bolus**.
3. From the toolbar of the Paused screen, press **Quit**.
4. From the Attention screen, press **Quit infusion**.



Resuming infusion after quitting will not be possible.

> To abort a bolus and continue the infusion (Secondary option not in use):

1. Press the **Stop** hard key. Alternatively, press the **Pause Bolus**, then press **OK**. The bolus is paused.
2. From the toolbar, press **Quit Bolus**.
3. From the toolbar of the Paused screen, press **Request Continue**.
4. From the Attention screen, press **OK**.

> To abort a bolus and continue the infusion (Secondary option in use):

1. Press the **Stop** hard key. Alternatively, press the **Pause Bolus**, then press **OK**. The bolus is paused.
2. From the toolbar, press **Quit Bolus**.
3. From the toolbar of the Paused screen, press **Switch or Continue**.
4. From the Start screen, press **Primary** or **Secondary**.
5. From the Attention screen, press **OK**.

Adding a Secondary Line

The following procedure explains how to add a Secondary line while a Primary infusion is already running.



If you have already programmed the Secondary infusion, and want to start it, refer to [Switching between Primary and Secondary Infusions](#) on page 117.



Before programming a Secondary infusion, verify that the administration set you are using is appropriate for Secondary (Piggyback) infusions. For more information, refer to [Sapphire Approved Administration Sets](#) on page 64.

> To add a Secondary line while a Primary line is running, without Drug Library:

1. From the toolbar, press **View/Edit**.
2. Select **Add Sec. Line**.
3. If the Dosing method screen appears, select the appropriate option:
 - **mL:** Continue to Step 7.
 - **Dose calculation:** Continue to Step 4.

Weight based units are available for both Dosing methods.

Otherwise, continue to Step 10.

4. From the Concentration units screen, select the appropriate drug units.



To display additional concentration units press **Next**.

5. According to pump configuration one of the following screens will appear:
 - **Concentration:** From the Concentration screen, using the keypad, enter the Concentration → **OK**. Then, continue to Step 7.
 - **Drug amount:** Using the keypad, enter the Drug Amount → **OK**. Then, using the keypad, enter the Diluent Volume → **OK**. Then, continue to Step 6.
6. From the Attention screen, confirm the concentration and press **OK**.
If the selected drug unit is Million Units, continue to Step 9.

7. If the Patient Weight screen appears, specify whether the infusion is weight based:
 - **Yes:** Continue to Step 8.
 - **No:** Continue to Step 9.
8. From the Patient Weight screen:

If the patient weight was entered during the primary line programming, continue to Step 9.

If the patient weight was not entered during the primary line programming, using the keypad, enter the Patient Weight → **OK**.
9. From the Dose Rate units screen, select the appropriate dose rate units.
10. Program 2 of the following 3 parameters, by selecting the relevant boxes:
 - **Rate (Secondary):** Using the keypad, enter the value → **OK**.
 - **VTBI (Secondary):** Using the keypad, enter the value → **OK**.
 - **Time (Secondary):** Using the keypad, enter the value → **OK**.

The third (unprogrammed) parameter is then automatically calculated by the pump and displayed in the relevant box.



If the calculated rate is beyond the pump resolution (0.1 mL/h increments), the pump decreases the rate by 0.1mL/h during the infusion in order to achieve accurate delivery of the volume in the specified time. the rate reduction is always of 0.1mL/h and presented on the running screen (when selecting dose calculation, the equivalent change to 0.1mL/h applies).

-
11. Review the parameters displayed on the Confirm screen.



Verify that the parameters reflect the correct treatment according to the prescription.

Then, press **OK**.

12. From the Start screen, select one of the following:

- **Start secondary:** The Attention screen appears. After verifying that the clamps on the Secondary administration set are open, press **OK**. The Secondary screen appears, and the Secondary infusion begins. When the Secondary infusion is complete, the pump automatically continues with the Primary infusion.
- **Continue primary:** The Primary screen appears, and the Primary infusion begins.
For more information about switching from one infusion to the other, refer to [Switching between Primary and Secondary Infusions](#) on page 117.

> **To add a Secondary line while a Primary line is running, with a Drug Library:**

1. From the toolbar, press **View/Edit**.
2. Select **Add Sec. Line**.
3. From the Drug Name screen:
 - Using the keypad, enter the drug name, then press **Find** and proceed to Step 4.



The **Find** key can be used to display all available drugs when not entering any characters (letters, numbers or symbols), or filter drug names according to the characters entered.

- When the required drug is not found in the Drug Library, press the **Choose General** key on the toolbar:



'Choose General' will bypass specific drug limits, and the infusion will be programmed without Drug Library limits.

From the Attention screen, confirm choosing General and press **OK**.

Proceed to Step 3 on page 113 ([To add a Secondary line while a Primary line is running, without Drug Library](#)), and continue programming from there.

4. From the Drug List screen, select the row of the relevant drug.



To display additional drugs press **Next**.

5. If a list of available drug profiles appears, select the appropriate drug profile and proceed according to the step directed to:
 - **No concentration:** proceed to Step 7 on page 114 (To add a Secondary line while a Primary line is running, without Drug Library), and continue programming from there.
 - **Diluent only** (e.g., 10 mL): proceed to Step 7 on page 114 (To add a Secondary line while a Primary line is running, without Drug Library), and continue programming from there.
 - **Partial concentration:** the Drug Amount or Diluent Volume is missing. The screen of the missing value will appear:
 - From the Drug Amount screen, using the keypad, enter the Drug Amount → **OK**.
 - From the Diluent Volume screen, using the keypad, enter the Diluent Volume → **OK**.

From the Attention screen, confirm the concentration and press **OK**.

Proceed to Step 7 on page 114 (To add a Secondary line while a Primary line is running, without Drug Library), and continue programming from there.

- **Full concentration:**

Proceed to Step 7 on page 114 (To add a Secondary line while a Primary line is running, without Drug Library), and continue programming from there.

If a list of available drug profiles does not appear, continue to Step 7 on page 114 (To add a Secondary line while a Primary line is running, without Drug Library), and continue programming from there.

For more information about the Drug Library, refer to [Chapter 9: Drug Library](#) on page 234.

Switching between Primary and Secondary Infusions

Switching between infusions involves pausing the infusion that is currently running, and then starting or continuing the other infusion.

> To switch from the Primary to the Secondary infusion:

1. Pause the Primary infusion:
From the toolbar of the Primary screen, press **Request Pause**. Then, from the Attention screen, press **OK**.
Alternatively, press the **Stop** hard key.
2. From the toolbar of the Primary screen, select **Switch or Continue**.
3. From the Start screen, select **Start secondary**.
The Attention screen appears. After verifying that the clamps on the Secondary administration set are open, press **OK**. The Secondary screen appears, and the Secondary infusion begins.

> To switch from the Secondary to the Primary infusion:

1. Pause the Secondary infusion:
From the toolbar of the Secondary screen, press **Request Pause**. Then, from the Attention screen, press **OK**.
Alternatively, press the **Stop** hard key.
2. From the toolbar of the Secondary screen, select **Switch or Continue**.
3. From the Start screen, select **Continue primary (or Start primary)**.
The Attention screen appears. After verifying that the clamps on the Secondary administration set are closed, and that the clamps on the primary set are open, press **OK**. The Primary screen appears, and the Primary infusion begins.

Replacing the Current Secondary Line

During a running secondary infusion, the secondary line can be replaced by using one of the following methods:

Deleting the Current Secondary Line and Moving to the Primary Infusion	118
Replacing the Current Secondary Line with a New Secondary Line	119

Deleting the Current Secondary Line and Moving to the Primary Infusion

The following procedure explains how to delete the running secondary line and move to the primary infusion.

> To delete the secondary line and move to the primary infusion:

1. Pause the Secondary infusion:
From the toolbar of the Secondary screen, press **Request Pause**. Then, from the Attention screen, press **OK**.
Alternatively, press the **Stop** hard key.
2. From the toolbar of the paused screen, press **View/Edit**.
3. On the View/Edit screen, select **Delete/Replace Sec. Line**.
4. On the Delete/Replace screen, select **Delete and move to primary**.
5. The Attention screen appears. After verifying that the clamps on the Secondary administration set are closed, and that the clamps on the primary set are open, press **OK**. This will delete the current programmed secondary line.
The paused Primary screen appears.
6. From the toolbar of the paused Primary screen, select **Request Continue**.
Then, from the Attention screen, press **OK**.



If you want to program a new Secondary line, refer to [Adding a Secondary Line](#) on page 113.

Replacing the Current Secondary Line with a New Secondary Line

The following procedure explains how to replace the current secondary line with a different secondary infusion.



Before programming a Secondary infusion, verify that the administration set you are using is appropriate for Secondary (Piggyback) infusions. For more information, refer to [Sapphire Approved Administration Sets](#) on page 64.

> To replace the running secondary line with a different secondary line without Drug Library:

1. Pause the Secondary infusion:
From the toolbar of the Secondary screen, press **Request Pause**. Then, from the Attention screen, press **OK**.
Alternatively, press the **Stop** hard key.
2. From the toolbar of the paused screen, press **View/Edit**.
3. On the View/Edit screen, select **Delete/Replace Sec. Line**.
4. On the Delete/Replace screen, select **Replace secondary**.
5. From the Attention screen press **OK** to delete the current secondary line and to program a different secondary infusion.
6. Proceed to Step 3 on page 113 (To add a Secondary line while a Primary line is running, without Drug Library).

> **To replace the running secondary line with a different secondary line with Drug Library:**

1. Pause the Secondary infusion:
From the toolbar of the Secondary screen, press **Request Pause**. Then, from the Attention screen, press **OK**.
Alternatively, press the **Stop** hard key.
2. From the toolbar of the paused screen, press **View/Edit**.
3. On the View/Edit screen, select **Delete/Replace Sec. Line**.
4. On the Delete/Replace screen, select **Replace secondary**.
5. From the Attention screen press **OK** to delete the current secondary line and to program a different secondary infusion.
6. Proceed to Step 3 on page 115 (To add a Secondary line while a Primary line is running, with a Drug Library).

Multi-step Mode

The following sections will be reviewed:

Infusion Parameters: Multi-step Mode	122
Starting a Multi-step Infusion	122
Multi-step Mode: Mid-infusion Actions	128

This mode allows the pump to deliver a series of up to 25 consecutive infusion Steps from the same infusion container. Each Step is delivered as a Continuous infusion, at its own pre-programmed parameters. Although the infusion rates of each Step can differ, the rate within a single Step does not vary (constant, continuous infusion).

Figure 5.3. Multi-step Flow Profile

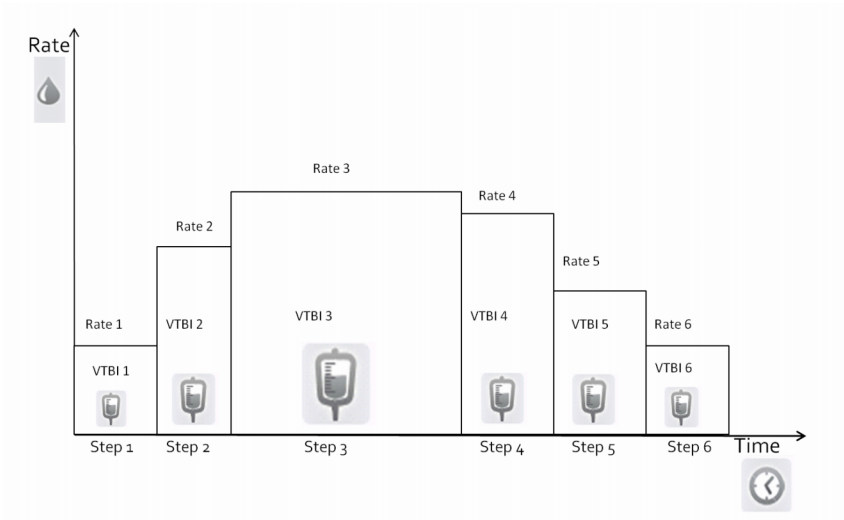

Infusion Parameters: Multi-step Mode

When programming a Multi-step infusion, the number of Steps must be specified. Infusion parameters relevant to each Step are listed in the following table. During programming, it is necessary to specify two of the three parameters. The remaining parameter is then automatically calculated by the pump.

Parameter	Description/Notes
Rate	The speed at which the fluid is infused. Rate values can range from 0.1 to 999 mL/h. Note: When selecting units that are not from the mL/h family, the word Rate is replaced with Dose Rate .
VTBI	The total amount of fluid to be infused. The remaining VTBI is displayed on the screen as the infusion progresses. VTBI values can range from 0.1 to 9999 mL.
Time	The period of time over which the fluid is infused. The acceptable range for time values vary according to the VTBI. The maximum Step time is 24 hours.

Starting a Multi-step Infusion

The following procedure explains how to program the pump to start a new Multi-step infusion.



If relevant, you may skip programming by using the Repeat Last Infusion or PreSet programs procedures to begin the infusion. For more information, refer to [Starting New Infusions: Shortcuts](#) on page 186.

> To begin a new Multi-step infusion without Drug Library:

1. From the Indicators Bar, verify that the pump is in Multi-step mode.



For more information about changing delivery modes, refer to [Selecting Delivery Mode](#) on page 72.

2. From the Start Up screen, select **New Infusion**.

3. If a warning that the air detection is disabled (OFF) appears, ensure that a set with an air-eliminating filter is used, and press **OK**.
4. If the Dosing method screen appears, select the appropriate option:
 - **mL:** Continue to Step 8.
 - **Dose calculation:** Continue to Step 5.Weight based units are available for both Dosing methods.
Otherwise, continue to Step 11.
5. From the Concentration units screen, select the appropriate drug units.



To display additional concentration units press **Next**.

6. According to pump configuration one of the following screens will appear:
 - **Concentration:** From the Concentration screen, using the keypad, enter the Concentration → **OK**. Then, continue to Step 8.
 - **Drug amount:** Using the keypad, enter the Drug Amount → **OK**. Then, using the keypad, enter the Diluent Volume → **OK**. Then, continue to Step 7.
7. From the Attention screen, confirm the concentration and press **OK**.
If the selected drug unit is Million Units, continue to Step 10.
8. If the Patient Weight screen appears, specify whether the infusion is weight based:
 - **Yes:** Continue to Step 9.
 - **No:** Continue to Step 10.
9. From the Patient Weight screen, using the keypad, enter the Patient Weight → **OK**.
10. From the Dose Rate units screen, select the appropriate dose rate units.
11. Using the keypad, enter the number of Steps required for the infusion, and then press **OK**.
12. For the first Step, program 2 of the following 3 parameters, by selecting the relevant boxes (the digit refers to the number of the Step):
 - **Rate 1:** Using the keypad, enter the value → **OK**.

- **VTBI 1:** Using the keypad, enter the value → **OK**.
- **Time 1:** Using the keypad, enter the value → **OK**.

The unprogrammed parameter is then automatically calculated by the pump, and displayed in the relevant box.

13. After reviewing the infusion parameters for the current Step (as displayed on the Indicators Bar), press **OK** to proceed and program the next Step.
14. To program parameters for the remaining Steps of the infusion, repeat Step 12 through Step 13 of this procedure.

After the final Step is programmed, the Confirm screen appears, displaying the following parameters:

- **Total VTBI:** Amount of fluid to be delivered during the entire infusion.
- **Total time:** Time period of the entire infusion.
- **Number of steps:** Number of Steps making up the total infusion.
- **Review Steps details:** Selecting this option displays the parameters of all programmed Steps, screen by screen (with each step displayed in its own screen).

15. Review the parameters displayed on the Confirm screen.



Verify that the parameters reflect the correct treatment according to the prescription.

Then, press **OK**.

16. Make sure that the clamps on the administration set are open; then, press **Start**.
The Running screen is displayed, and the infusion begins.

Throughout the infusion, the current Step number is displayed on the Indicators Bar (e.g., Running 1/6) and next to parameter on main display (Rate 1, VTBI 1 and Time 1). The transition between steps is accompanied by a beep. In addition, the following information appears on the screen:

- **Drug Name:** The name of the selected drug. Displayed on the indicators bar, instead of the step number, when working with a Drug Library.

- **Drug Concentration:** Drug concentration as entered by the user (Final concentration or Drug Amount / Diluent Volume). Displayed when applicable.
- **Rate:** Current infusion rate. For all dose units other than mL/h, the calculated rate will be displayed in mL/h, both in the View System menu and in the Running screen.
- **VTBI:** Total volume left to be infused during the current Step.
- **VI / Total:** Total volume delivered in the current infusion (including KVO if applied during a delayed start period) / the total VTBI (for the entire infusion). As the infusion progresses, the VI increases, and the Total remains constant.
- **Time left:** Time remaining until the end of the entire infusion.
- **Step Time:** Time remaining until the end of the current Step.



To view all programmed parameters of the current infusion, including the rate in mL/h, from the Running screen, press **View/Edit** → **View system** → **Infusion values**.
For more information, refer to [Viewing System Parameters](#) on page 210.

> **To begin a new Multi-step infusion with a Drug Library:**

1. From the Indicators Bar, verify that the pump is in Multi-step delivery mode.



For more information about changing delivery modes, refer to [Selecting Delivery Mode](#) on page 72.

2. From the Start Up screen, select **New Infusion**.
3. If a warning that the air detection is disabled (OFF) appears, ensure that a set with an air-eliminating filter is used, and press **OK**.

- From the Drug Name screen:
 - Using the keypad, enter the drug name, then press **Find** and proceed to Step 5.



The **Find** key can be used to display all available drugs when not entering any characters (letters, numbers or symbols), or filter drug names according to the characters entered.

- When the required drug is not found in the Drug Library, press **Choose General** key on the toolbar:



'Choose General' will bypass specific drug limits, and the infusion will be programmed without Drug Library limits.

From the Attention screen, confirm Choosing General, and press **OK**. Proceed to Step 4 on page 123 (To begin a new Multi-step infusion without Drug Library), and continue programming from there.

- From the Drug List screen, select the row of the relevant drug.



To display additional drugs press **Next**.

- If a list of available drug profiles appears, select the appropriate drug profile and proceed according to the step directed to:
 - No concentration:** proceed to Step 8 on page 123 (To begin a new Multi-step infusion without Drug Library), and continue programming from there.
 - Diluent only** (e.g., 10 mL): proceed to Step 8 on page 123 (To begin a new Multi-step infusion without Drug Library), and continue programming from there.
 - Partial concentration:** the Drug Amount or Diluent Volume is missing. The screen for the missing value will appear:
 - From the Drug Amount screen, using the keypad, enter the Drug Amount → **OK**.
 - From the Diluent Volume screen, using the keypad, enter the Diluent Volume → **OK**.

From the Attention screen, confirm the concentration and press **OK**.

Proceed to Step 8 on page 123 ([To begin a new Multi-step infusion without Drug Library](#)), and continue programming from there.

- **Full concentration:**

Proceed to Step 8 on page 123 ([To begin a new Multi-step infusion without Drug Library](#)), and continue programming from there.

If a list of available drug profiles does not appear, continue to Step 8 on page 123 ([To begin a new Multi-step infusion without Drug Library](#)), and continue programming from there.

For more information about the Drug Library, refer to [Chapter 9: Drug Library](#) on page 234.

Multi-step Mode: Mid-infusion Actions

The following actions can be performed during Multi-step infusions:

Updating Step Parameters	128
Pausing Infusions	190
Aborting Infusions	191
Locking the Screen	192
Activating Patient Lockout	193

Updating Step Parameters

Infusion parameters for the current Step can be modified directly from the Running screen. In addition, infusion parameters for the current Step and the following Step can be updated by using the **View/Edit** function key.



Parameters for only the current Step and the Step immediately following it can be modified.



If the step being updated ends before the change is made or confirmed, the change will not be made and an Attention screen will appear.

> To update current Step parameters from the Running screen:

1. Select the frame of the parameter that you want to update (Rate, VTBI or Step Time).
2. Using the keypad, enter the new rate, VTBI (during the Step), or time remaining until the end of the Step → **OK**.
3. To confirm and save changes, press **OK**.
To return to the original infusion screen without saving changes, press **Back**.

> **To update parameters of the current or next Step using the View/Edit function key:**

1. From the toolbar, press **View/Edit**.
2. Select the box of the relevant parameter.
3. Using the keypad, enter the new value of the parameter → **OK**.
4. To update other parameters, repeat Steps 2-3.

In addition to parameter changes, the following actions are also available:

- **Clear Accum. VI:** Resets the total volume infused via all infusions associated with the current patient to 0 mL. For more information, refer to [Clearing Accumulated VI](#) on page 233.
 - **Next step:** Allows you to update infusion parameters of the Step following the current Step. (This box appears only if there is a Step following the current Step.)
 - **View system:** Displays various system and pump parameters.
5. To confirm and save changes, press **OK**.

To return to the Running screen without saving changes, press **Back**.
Then, from the Attention screen, press **OK**.

Total Parenteral Nutrition (TPN) Mode

The following sections will be reviewed:

Infusion Parameters: TPN Mode	131
Starting a TPN Infusion	132
TPN Mode: Mid-infusion Actions	134

Total Parenteral Nutrition, also known as Parenteral Nutrition or hyperalimentation, is used for patients who are unable to obtain adequate nutrients by oral or enteral routes. TPN solutions supply basic nutrients, including fluids, proteins, carbohydrates, electrolytes, fatty acids, vitamins, minerals, and trace elements directly to the patient's blood stream, bypassing the GI tract.

The TPN delivery mode permits high volume delivery of solutions, with optional tapering (ramping). When tapering is used, delivery rate is gradually increased/decreased (tapered-up/tapered-down) at the beginning and end of the infusion profile.

Figure 5.4. TPN Flow Profile

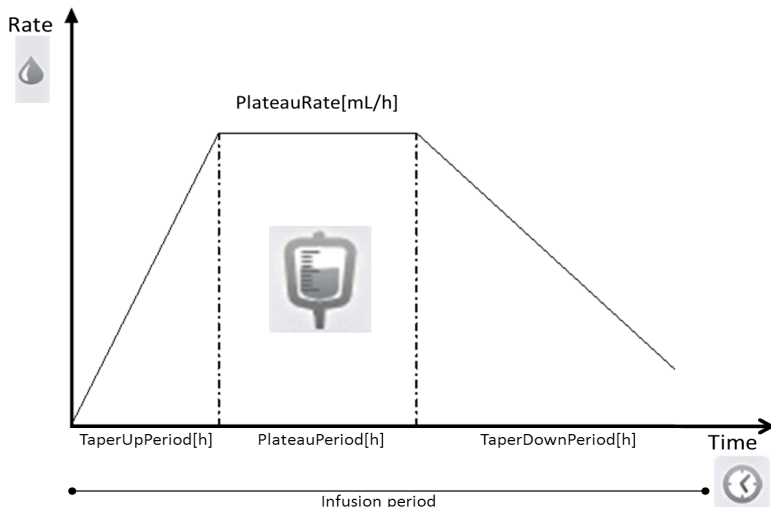

When not using tapers, the TPN infusion starts and ends at the Plateau Rate. In such cases, the Continuous delivery mode can be applied and is recommended.

Infusion Parameters: TPN Mode

The infusion parameters that need to be set for a TPN infusion are listed in the following table. Based on the values that are programmed, the pump automatically calculates the rate (and the gradual increase and decrease) necessary to deliver the infusion.

Parameter	Description/Notes
VTBI	The total amount of fluid to be infused. VTBI values can range from 0.1 to 9999 mL (with a tolerance of 0.2 mL). The remaining VTBI is displayed on the screen as the infusion progresses. The pump calculates the Plateau Rate based on the VTBI, the infusion period, and the taper values.
Taper Up	The length of time over which the rate increases to the Plateau Rate. The Taper Up and Down period can be set to 0 minutes, or range from 10 minutes to 3 hours, for each Taper.
Taper Down	The length of time over which the rate decreases to the KVO rate (from the Plateau Rate). The Taper Up and Down period can be set to 0 minutes, or range from 10 minutes to 3 hours, for each Taper.
Infusion Period	The total time duration for delivering the VTBI (including tapers and plateau period). The maximum Infusion Period is 96 hours. The minimum Infusion Period is determined by the sum of the taper periods plus 10 minutes (minimal Infusion Period between tapers).



TPN Mode: Safety Guidelines

When working in TPN mode, adhere to the following safety precautions and procedures:

- Use only parenteral feeding solutions prescribed by the responsible doctor, registered dietician, nurse or other licensed medical practitioner.
- Check that the correct dosage has been programmed. While a TPN infusion is running or paused, infusion parameters cannot be changed.

- Prior to administration, verify the identity of the patient by using at least two identifiers, as well as the parenteral nutrition container label.
- The Air in Line detector working range when delivering fatty acids is 2%-20% lipids.

Starting a TPN Infusion

The following procedure explains how to program the pump to start a new TPN infusion.



If relevant, you may skip programming by using the Repeat Last Infusion or PreSet programs procedures to begin the infusion. For more information, refer to [Starting New Infusions: Shortcuts](#) on page 186.

> To begin a new TPN infusion:

1. From the Indicators Bar, verify that the pump is in TPN mode.



For more information about changing delivery modes, refer to [Selecting Delivery Mode](#) on page 72.

2. From the **Start Up** screen, select **New Infusion**.
3. If a warning that the air detection is disabled (OFF) appears, ensure that a set with an air-eliminating filter is used, and press **OK**.
4. Using the keypad, enter the **VTBI** value → **OK**.
5. Specify whether you want to use tapers: Select **Yes** or **No**.
If you select **No**, proceed to Step 7.
6. Specify tapers:
 - a. On the Taper Up screen, use the keypad to enter the Taper Up time → **OK**. The Taper Up time can be set to 0.
 - b. On the Taper Down screen, use the keypad to enter the Taper Down time → **OK**. The Taper Down time can be set to 0.

7. Using the keypad, enter the infusion period → **OK**.
8. Review the parameters displayed on the Confirm screen.



Verify that the parameters reflect the correct treatment according to the prescription.

Then, press **OK**.

9. To begin the infusion, make sure that the clamps on the administration set are open; then, press **Start**. The infusion begins.

Throughout the infusion, the following information appears on the Main Display:

- **Rate:** Current infusion rate. For all dose units other than mL/h, the calculated rate will be displayed in mL/h, both in the View system menu and in the Running screen.
- **VTBI:** Total volume left to be infused. As the infusion progresses, this value decreases.
- **VI / Total:** Total volume delivered in the current infusion(including KVO if applied during a delayed start period) / the total VTBI value programmed. As the infusion progresses, the VI increases, and the Total remains constant.
- **Time left:** Time remaining until the end of the infusion.



All the parameters of the current infusion can be viewed from **View system** → **Infusion Values**.

TPN Mode: Mid-infusion Actions

The following actions can be performed during TPN infusions:

Pausing Infusions	134
Immediate Taper Down	136
Aborting Infusions	191
Locking the Screen	192
Activating Patient Lockout	193

In TPN mode, infusion parameters cannot be updated using the **View/Edit** function key. To modify the parameters, you need to quit the infusion, and reprogram a new infusion.

The **View/Edit** function key can be used to perform the following actions only:

- **Clear Accum. VI:** Resets the total volume infused for all infusions associated with a patient to 0 mL.
- **View system:** Displays various system and pump parameters. (Refer to [View Menu](#) on page 209.)

Pausing Infusions

The Pause function allows you to temporarily stop an infusion. Infusions can be paused using either the **Request Pause** function key, or, in an emergency, the **Stop** hard key. A message stating that the infusion is paused appears 30 seconds after pausing the infusion (audible and visual).



Pressing the **Stop** hard key stops the infusion immediately, bypassing the need for confirmation of the Pause action. In an emergency, it is recommended to pause the infusion using the **Stop** hard key. In routine situations, using the **Request Pause** function key is recommended.



During the plateau rate of a TPN infusion, the **Request Pause** function key is replaced with the **Taper down** key. Pausing the infusion remains available using the Taper down key (for more information, refer to [Immediate Taper Down](#) on page 136).

> **To pause an infusion during the plateau rate using the Taper Down function key:**

1. From the toolbar, press **Taper Down**.



If the pump is set to a Low authorization level, with no Taper Down period programmed, the **Request Pause** key will be available, without the option to **Taper Down**.

2. From the Pause Options screen, select **Pause Infusion**; then, press **OK**.
3. The infusion is paused.



If you do not press **OK** within 30 seconds, the infusion is not paused, and the Running screen reappears.

> **To pause an infusion during taper using the Request Pause function key:**

1. From the toolbar, press **Request Pause**.
2. From the toolbar of the Attention screen, press **OK**.
3. The infusion is paused.

If the pump is set to the Low authorization level, with no Taper Down period programmed, the Request Pause key will be available, without the option to Taper down.



If you do not press **OK** within 30 seconds, the infusion is not paused, and the Running screen reappears.

> **To resume a paused infusion:**

1. From the toolbar, press **Request Continue**.
2. From the toolbar of the Attention screen, press **OK**.

Immediate Taper Down

Immediate Taper Down can be used to end the infusion prematurely, utilizing taper down, to slow the infusion rate gradually before stopping. The option is available during the infusion's plateau period, provided there are more than 10 minutes before the infusion is complete. The taper down period is set to the time programmed originally for the infusion, and it can be modified when the pump is set to a Medium or higher authorization level.

Immediate Taper Down is available only in the following conditions:

- The pump is running.
- The pump is delivering at the plateau rate.
- The time left for the infusion is greater than 10 minutes.
- The pump is set to Medium or higher authorization level, in case no Taper period is programmed.

> To immediately Taper Down an infusion:

1. From the toolbar, press **Taper Down**.
2. From the Taper Down screen select **Immediate Taper Down**.



If the pump is set to Low authorization level, the user will be prompted to acknowledge the preprogrammed Taper Down time value (skip step 3) without the ability to change it.



When using the immediate Taper option, the original values programmed for the infusion will be presented in the Infusion Values menu.

3. From the Immediate Taper Down screen, accept the preprogrammed time settings, or enter the Taper Down time using the keypad → **OK**.



Entering 00:00 hh:mm to Taper Down time frame will stop the infusion without tapering.

4. From the Attention screen, press **OK** to begin the Taper Down.
The Taper Down running screen appears.

Intermittent Mode

The following sections will be reviewed:

- Infusion Parameters: Intermittent Mode 138
- Starting an Intermittent Infusion 138
- Intermittent Mode: Mid-infusion Actions 145

This mode enables you to program a dose time and volume infusion to be repeated at regular intervals or cycles. The Dose Interval is the time frequency at which the dose is delivered. A KVO rate can be programmed to run between intermittent dose.

Figure 5.5. Intermittent Flow Profile

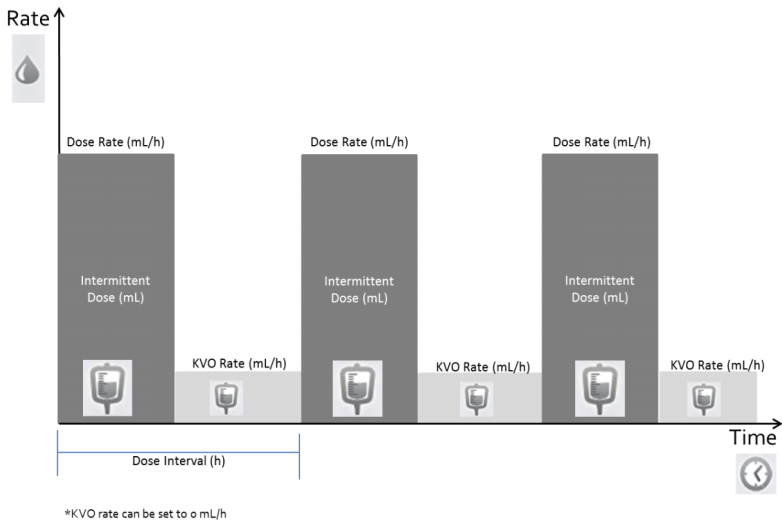

Infusion Parameters: Intermittent Mode

The following infusion parameters need to be set for an Intermittent infusion:

Parameter	Description/Notes
VTBI	The total amount of fluid to be infused. The remaining VTBI is displayed on the screen as the infusion progresses. VTBI values can range from 0.1 to 9999 mL.
Intermittent Dose	The amount of each Intermittent Dose. Values can range from 0.1 to 999 mL.
Dose Time	The period of time over which the intermittent dose is delivered. Values can range from 00:01 to 96:00 hh:mm.
Dose Interval	The frequency of intermittent dose delivery (Intermittent Dose + KVO). Intermittent doses can be given as frequently as 5 minutes apart. Therefore, the minimum programmable Dose Interval is the Dose time plus 5 minutes. This rule applies even when the KVO rate is set to 0.
KVO (Keep Vein Open)	The rate of fluids delivered between doses, to prevent clotting in the infusion cannula. The KVO rate can be set from 0 to 20 mL/h.

Starting an Intermittent Infusion

The following procedure explains how to program the pump to start a new Intermittent infusion.



If relevant, you may skip programming by using the Repeat Last Infusion or PreSet programs procedures to begin the infusion. For more information, refer to [Starting New Infusions: Shortcuts](#) on page 186.

> **To begin a new Intermittent infusion without Drug Library:**

1. From the Indicators Bar, verify that the pump is in Intermittent mode.



For more information about changing delivery modes, refer to [Selecting Delivery Mode](#) on page 72.

2. From the **Start Up** screen, select **New Infusion**.
3. If a warning that the air detection is disabled (OFF) appears, ensure that a set with an air-eliminating filter is used, and press **OK**.
4. If **Dosing method** screen appears, select the appropriate option:
 - **mL:** Continue to Step 8.
 - **Dose calculation:** Continue to Step 5.Weight based units are available for both Dosing methods
Otherwise, continue to Step 11.
5. From the **Concentration units** screen, select the appropriate drug units.



To display additional concentration units press **Next**.

6. According to pump configuration one of the following screens will appear:
 - **Concentration:** From concentration screen, using the keypad, enter the **Concentration** → **OK**. Then, continue to Step 8.
 - **Drug amount:** Using the keypad, enter the **Drug Amount** → **OK**. Then, using the keypad, enter the **Diluent Volume** → **OK**. Then, continue to Step 7.
7. From the Attention screen, confirm the concentration and press **OK**.
If the selected drug unit is Million Units, continue to Step 10.
8. If the **Patient Weight** screen appears, specify whether the infusion is weight based:
 - **Yes:** Continue to Step 9.
 - **No:** Continue to Step 10.

9. From the **Patient Weight** screen, using the keypad, enter the patient weight → **OK**.
10. From the **Dose Rate units** screen, select the appropriate dose rate units.
11. Using the keypad, enter the **VTBI** value → **OK**.
12. Using the keypad, enter the **Intermittent Dose** → **OK**.
13. Using the keypad, enter the **Dose Time** → **OK**.
14. Using the keypad, enter the **Dose Interval** → **OK**.
15. Using the keypad, enter the **KVO** rate → **OK**.
The KVO rate may be set to zero.
16. Review the parameters displayed on the Confirm screen.



Verify that the parameters reflect the correct treatment according to the prescription.

Then, press **OK**.

17. To begin the infusion, make sure that the clamps on the administration set are open; then, press **Start**.
The Intermittent Dose screen is displayed, and the infusion begins with the first dose.

Throughout the infusion, the infusion phase (Intermittent Dose or KVO) is displayed on the Indicators Bar. In addition, the following information appears on the screen:

- **Drug Name:** The name of the selected drug. Displayed on the indicators bar, when working with a Drug Library.
- **Drug Concentration:** Drug concentration as entered by the user (Final concentration or Drug Amount / Diluent Volume). Displayed when applicable.
- **Rate:** Current infusion rate. For all dose units other than mL/h, the calculated rate will be displayed in mL/h, both in the View system menu and in the Running screen.
- **VTBI:** Total volume left to be infused. As the infusion progresses, this value decreases.

- **VI / Total:** Total volume delivered in the current infusion (including KVO if applied during a delayed start period) / the total VTBI value programmed. As the infusion progresses, the VI increases, and the Total remains constant.
- **Time to Dose:** Time remaining before the next dose starts (until the end of the current interval; Dose time left + KVO time).
 - **Pause During Dose**
When the infusion is paused during Dose, the time to the next Intermittent Dose (Time to Dose) is paused and not displayed.

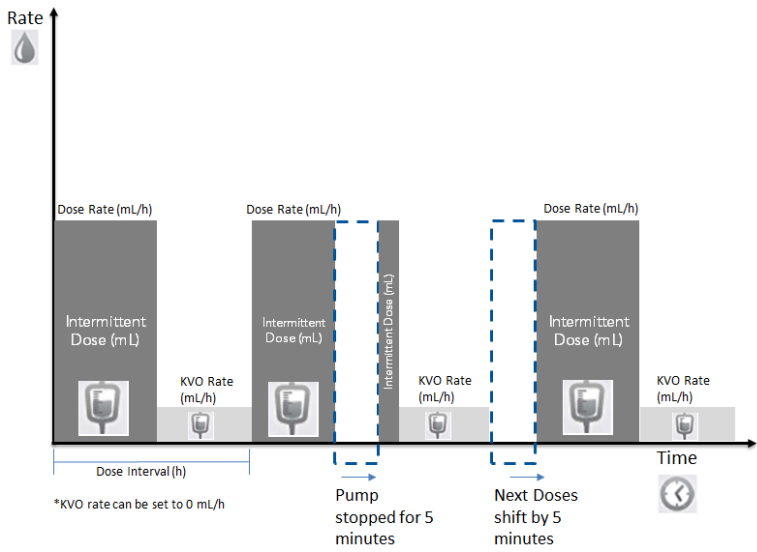

- **Pause During KVO**

The pump can be switched off or paused between intermittent doses without impacting the dose schedule. The time to dose will be displayed, and the pump will also alert when dose schedule is due and infusion not started, reminding when to resume the infusion.

When the infusion is paused during KVO, the time to the next Intermittent Dose (Time to Dose) is displayed, and continues to count.

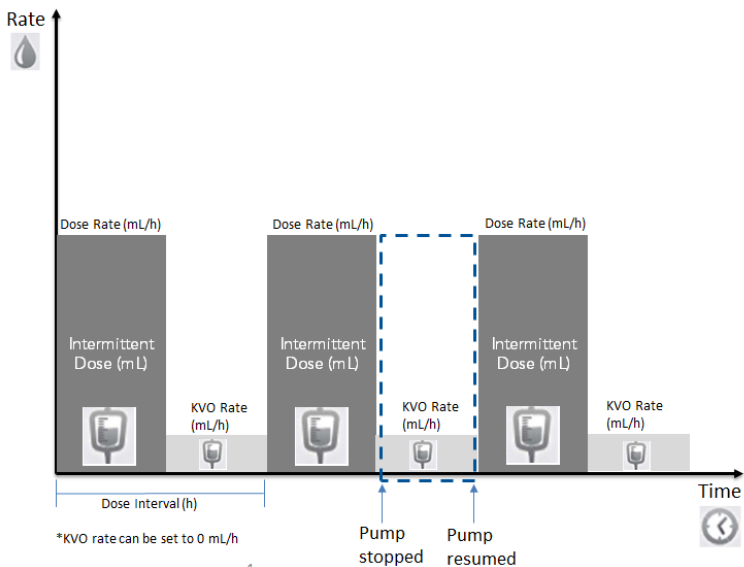

- **Time left:** Time remaining until the end of the entire infusion.



To view all programmed parameters of the current infusion, including the rate in mL/h, from the Running screen, press **View/Edit** → **View system** → **Infusion values**.

For more information, refer to [Viewing System Parameters](#) on page 210.

> **To begin a new Intermittent infusion with a Drug Library:**

1. From the Indicators Bar, verify that the pump is in Intermittent mode.



For more information about changing delivery modes, refer to [Selecting Delivery Mode](#) on page 72.

2. From the **Start Up** screen, select **New Infusion**.
3. If a warning that the air detection is disabled (OFF) appears, ensure that a set with an air-eliminating filter is used, and press **OK**.
4. From the **Drug Name** screen:
 - Using the keypad, enter the drug name, then press **Find** and proceed to Step 5.



The **Find** key can be used to display all available drugs when not entering any characters (letters, numbers or symbols) or filter drug names according to the characters entered.

- When the required drug is not found in the Drug Library, press **Choose General** key on the toolbar:



'Choose General' will bypass specific drug limits, and the infusion will be programmed without Drug Library limits.

From the Attention screen, confirm Choosing General and press **OK**.

Proceed to Step 4 on page 139 ([To begin a new Intermittent infusion without Drug Library](#)), and continue programming from there.

5. From the **Drug List** screen, select the row of the relevant drug.



To display additional drugs press **Next**.

6. If a list of available drug profiles appears, select the Appropriate drug profile and proceed according to the step directed to:
- **No concentration:** proceed to Step 8 on page 139 (To begin a new Intermittent infusion without Drug Library), and continue programming from there.
 - **Diluent only** (e.g. 10 mL): proceed to Step 8 on page 139 (To begin a new Intermittent infusion without Drug Library), and continue programming from there.
 - **Partial concentration:** the Drug Amount or Diluent Volume is missing. A screen for the missing value will appear:
 - From the **Drug Amount** screen, using the keypad, enter the Drug Amount → **OK**.
 - From the **Diluent Volume** screen, using the keypad, enter the Diluent Volume → **OK**.From the Attention screen, confirm the concentration and press **OK**.

Proceed to Step 8 on page 139 (To begin a new Intermittent infusion without Drug Library), and continue programming from there.

- **Full concentration:**
Proceed to Step 8 on page 139 (To begin a new Intermittent infusion without Drug Library), and continue programming from there.

If a list of available drug profiles does not appear, continue to Step 8 on page 139 (To begin a new Intermittent infusion without Drug Library), and continue programming from there.

For more information about the Drug Library, refer to [Chapter 9: Drug Library](#) on page 234.

Intermittent Mode: Mid-infusion Actions

The following actions can be performed during Intermittent infusions:

Updating Infusion Parameters	145
Pausing Infusions	190
Aborting Infusions	191
Locking the Screen	192
Activating Patient Lockout	193

Updating Infusion Parameters

Infusion parameters can be modified by using the **View/Edit** function key. In addition, the VTBI for the current phase (Intermittent Dose or KVO) can be modified directly from the Main Display.

> To update parameters of the current phase from the Main Display:

1. On the Main Display, select the **VTBI** relevant frame.
2. Using the keypad, enter the new VTBI → **OK**.
3. Review the parameter displayed on the Attention screen → **OK**.
To return to the original infusion screen without saving changes, press **Back**. Then, from the VTBI screen, press **Back**

> To update parameters using the View/Edit function key:

1. From the toolbar, press **View/Edit**.
2. Select the box of the parameter to be modified.
3. Using the keypad, enter the new value of the parameter → **OK**.



When changing Intermittent Dose or Dose Time, you will be prompted to enter the Dose interval.

4. To update additional parameters, repeat Steps 2-3.
In addition to parameter changes, the following actions are also available:
 - **Clear Accum. VI:** Resets the total volume infused for all infusions associated with a patient to 0 mL.
 - **View system:** Displays various system and pump parameters. (Refer to [View Menu](#) on page 209.)
5. To confirm and save changes, press **OK**.
To return to the original infusion screen without saving changes, press **Back**. Then, from the Attention screen, press **OK**.

Patient Controlled Analgesia (PCA) Mode

The following sections will be reviewed:

- Infusion Parameters: PCA Mode 148
- Starting a PCA Infusion 149
- PCA Mode: Mid-infusion Actions 155

The Patient Controlled Analgesia (PCA) mode allows the pump to deliver medication at a continuous rate (optional) and limited boluses activated by the patient (via screen key or bolus handle). Additional boluses can be provided by a clinician, using the appropriate authorization code.



For more information about the bolus handle, refer to [PCA/PCEA/PIEB Bolus Handle](#) on page 48.

Figure 5.6. PCA Flow Profile

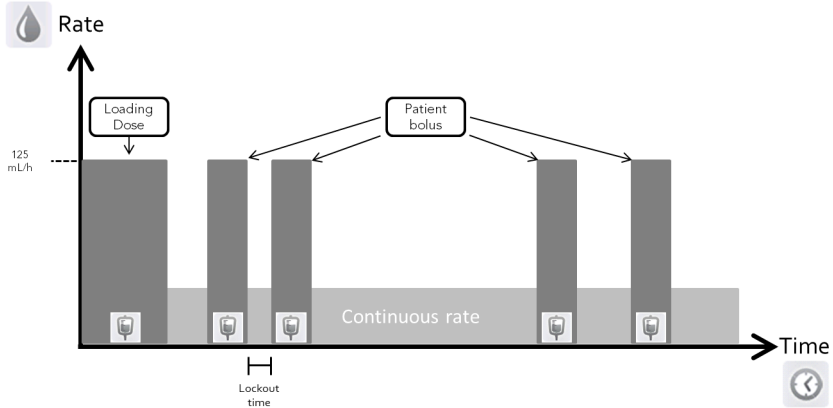

Infusion Parameters: PCA Mode

The following infusion parameters need to be set for a PCA infusion:

Parameter	Description/Notes
Continuous Rate	The rate of the basal infusion. Continuous Rate values can range from 0.1 to 99.9 mL/h, or be equal to zero (Bolus Only infusion).
VTBI	The total amount of fluid to be infused. The remaining VTBI is displayed on the screen as the infusion progresses. VTBI values can range from 0.1 to 9999 mL.
Demand Bolus	The amount of fluid infused in a single bolus. Demand bolus values can range from 0.1 to 30 mL, or be equal to zero (Continuous Only infusion).
Bolus Lockout	The minimum time that must pass between the end of one bolus to the start of the next bolus. After a bolus delivery ends, the next bolus becomes available following the lockout time.
Dose Limit	The option to choose if patient boluses are limited by number or by volume. When choosing No Limits, the patient boluses are set to the maximum allowed volume, according to the other parameters defined for the infusion, including lockout time and demand bolus.

Parameter	Description/Notes
Boluses per 1h (or 4hrs) OR Total dose per 1h (or 4 hrs)	<p>The maximum number of boluses OR the maximum dose that can be delivered during a 1 hour (or 4 hours) period. (A user with high authorization codes can set the 1 hour or 4 hours parameters). The Total dose limit takes into account medication delivered via:</p> <p>Continuous rate Yes Demand Bolus Yes Loading Dose Yes Clinician bolus Yes</p> <p>All doses, including boluses given by clinician, are taken into account.</p> <p>When the Total dose limit is reached, the patient is locked out from activating additional boluses.</p>
Loading Dose	<p>An optional feature that begins the infusion with a clinician bolus. Loading dose values range from 0.1 to 30 mL.</p> <p>To use this feature, it must be enabled. For more information, refer to PCA Options Menu on page 217.</p>

Starting a PCA Infusion

The following procedure explains how to program the pump to start a new PCA infusion.



If relevant, you may skip programming by using the Repeat Last Infusion or PreSet programs procedures to begin the infusion. For more information, refer to [Starting New Infusions: Shortcuts](#) on page 186.

> To begin a new PCA infusion without Drug Library:

1. From the Indicators Bar, verify that the pump is in PCA mode.



For more information about changing delivery modes, refer to [Selecting Delivery Mode](#) on page 72.

2. From the Start Up screen, select **New Infusion**.

3. If a warning that the air detection is disabled (OFF) appears, ensure that a set with an air-eliminating filter is used, and press **OK**.
4. If the Dosing method screen appears, select the appropriate option:
 - **mL:** Continue to Step 8.
 - **Dose calculation:** Continue to Step 5.Weight based units are available for both Dosing methods.
Otherwise, continue to Step 11.
5. From the Concentration units screen, select the appropriate drug units.



To display additional concentration units press **Next**.

6. According to pump configuration one of the following screens will appear:
 - **Concentration:** From concentration screen, using the keypad, enter the Concentration → **OK**. Then, continue to Step 8.
 - **Drug amount:** Using the keypad, enter the Drug Amount → **OK**. Then, using the keypad, enter the Diluent Volume → **OK**. Then, continue to Step 7.
7. From the Attention screen, confirm the concentration and press **OK**.
If the selected drug unit is Million Units, continue to Step 10.
8. If the Patient Weight screen appears, specify whether the infusion is weight based:
 - **Yes:** Continue to Step 9.
 - **No:** Continue to Step 10.
9. From the Patient Weight screen, using the keypad, enter the patient weight → **OK**
10. From the Dose Rate units screen, select the appropriate dose rate units.
11. Using the keypad, enter the VTBI value → **OK**.
12. Using the keypad, enter the Continuous Rate value → **OK**.
The Continuous Rate can be set to zero.
13. Using the keypad, enter the value for the Demand Bolus → **OK**.
14. Using the keypad, enter the value for the Bolus Lockout → **OK**.

15. From the Dose Limit Type screen, specify whether the boluses available for the patient should be limited:
 - **Yes:** Continue to Step 16.
 - **No:** Continue to Step 17.



Choosing **No** on the Dose limit screen will set patient boluses to the maximum allowed, according to the other parameters defined for the infusion, including Lockout Time and Demand Bolus.

16. From the Dose Limit Type screen, select the type of limit to apply for the infusion, and proceed to the directed step:
 - **Number of Boluses:** Using the keypad, enter the maximum number of boluses that will be available for the patient within a one or four-hour period →**OK**. Continue to Step 17.
 - **Total Dose:** Using the keypad, enter the maximum amount of medication that may be delivered within a one or four-hour period →**OK**. Continue to Step 17.
17. If Add Loading Dose screen appears, specify whether to program a loading dose:
 - **Yes:** Using the keypad, enter the value for the Loading Dose → **OK**.
 - **No:** Proceed to Step 18.Otherwise, continue to Step 18.
18. Review the parameters displayed on the Confirm screen.



Verify that the parameters reflect the correct treatment according to the prescription.

Then, press **OK**.

19. To begin the infusion, make sure that the clamps on the administration set are open; then, press **Start**.
The Running screen appears, and the infusion begins.

Throughout the infusion, the infusion phase (Loading Dose, Running, Bolus Delivery, or Clinician Bolus) is displayed on the Indicators Bar.

In addition, the following information appears on the screen:

- **Drug Name:** The name of the selected drug. Displayed on the indicators bar, when working with a Drug Library.
- **Drug Concentration:** Drug concentration as entered by the user (Final concentration or Drug Amount / Diluent Volume). Displayed when applicable.
- **Rate:** Current infusion rate. For all dose units other than mL/h, the calculated rate will be displayed in mL/h; both in the View system menu and in the Running screen.
- **VTBI:** Total volume left to be infused. As the infusion progresses, this value decreases.
- **VI / Total:** Total volume delivered in the current infusion (including KVO if applied during a delayed start period) / the total VTBI value programmed. As the infusion progresses, the VI increases, and the Total remains constant.
- **Lockout time:** Time remaining until the next bolus is available. After the lockout time elapses, this parameter changes to Bolus available (when a bolus is being given – loading dose, clinician bolus or patient bolus – this parameter does not appear).
- **Time left:** The maximum time remaining until the end of the entire infusion. If boluses are given, this time will be shortened.



To view all programmed parameters of the current infusion, including the rate in mL/h, from the Running screen, press **View/Edit** → **View system** → **Infusion values**.

For more information, refer to [Viewing System Parameters](#) on page 210.

> **To begin a new PCA infusion with a Drug Library:**

1. From the Indicators Bar, verify that the pump is in PCA mode.



For more information about changing delivery modes, refer to [Selecting Delivery Mode](#) on page 72.

2. From the **Start Up** screen, select **New Infusion**.
3. If a warning that the air detection is disabled (OFF) appears, ensure that a set with an air-eliminating filter is used, and press **OK**.
4. From the **Drug Name** screen:
 - Using the keypad, enter the drug name, then press **Find** and proceed to Step 5.



The **Find** key can be used to display all available drugs without entering any characters (letters, numbers or symbols) or filter drug names according to the characters entered.

- When the required drug is not found in the Drug Library, press **Choose General** key on the toolbar:



'Choose General' will bypass drug specific limits, the infusion will be programmed outside of the safe Drug Library environment.

From the Attention screen, confirm Choosing General and press **OK**. Proceed to Step 4 on page 150 ([To begin a new PCA infusion without Drug Library](#)), and continue programming from there.

5. From the **Drug List** screen, select the row of the relevant drug.



To display additional drugs press **Next**.

6. If a list of available drug profiles appears, select the appropriate drug profile and proceed according to the step directed to:
- **No concentration:** proceed to Step 8 on page 150 (To begin a new PCA infusion without Drug Library), and continue programming from there.
 - **Diluent only** (e.g. 10 mL): proceed to Step 8 on page 150 (To begin a new PCA infusion without Drug Library), and continue programming from there.
 - **Partial concentration:** the Drug Amount or Diluent Volume is missing. A screen for the missing value will appear:
 - From the **Drug Amount** screen, using the keypad, enter the Drug Amount → **OK**.
 - From the **Diluent Volume** screen, using the keypad, enter the Diluent Volume → **OK**.

From the Attention screen, confirm the concentration and press **OK**.

Proceed to Step 8 on page 150 (To begin a new PCA infusion without Drug Library), and continue programming from there.

- **Full concentration:**

Proceed to Step 8 on page 150 (To begin a new PCA infusion without Drug Library), and continue programming from there.

If a list of available drug profiles does not appear, continue to Step 8 on page 150 (To begin a new PCA infusion without Drug Library), and continue programming from there.

For more information about the Drug Library, refer to [Chapter 9: Drug Library](#) on page 234.

PCA Mode: Mid-infusion Actions

The following actions can be performed during PCA infusions:

Updating Infusion Parameters	155
Administering a Clinician Bolus	157
Pausing Infusions	190
Aborting Infusions	191
Locking the Screen	192
Activating Patient Lockout	193
Viewing Delivery History	215

Updating Infusion Parameters

In PCA mode, the infusion must be paused before parameters can be updated. After the infusion is paused, infusion parameters can be modified by using the **View/Edit** function key. In addition, the Continuous Rate and VTBI for the current infusion phase can be updated directly from the Main Display. (During a bolus delivery, no parameter can be changed.)

> To update parameters for the current phase (Basal/Bolus) from the Main Display:

1. Pause the infusion ([Pausing Infusions](#) on page 190).
2. On the Main Display, select the relevant frame (**Continuous Rate** or **VTBI**).
3. Using the keypad, enter the new Continuous Rate or VTBI → **OK**.
4. To confirm and save changes, press **OK**.
To return to the Paused screen without saving changes, press **Back**. From the Continuous Rate or VTBI screen, press **Back**. Then, from the Attention screen, press **OK**.

> To update parameters using the View/Edit function key:

1. Pause the infusion ([Pausing Infusions](#) on page 190).
2. From the toolbar, press **View/Edit**.
3. Select the box of the parameter to be modified.

- Using the keypad, enter the new value of the parameter → **OK**.



When modifying demand bolus limitations (volume or lockout time), the pump will prompt the user to confirm or adjust the other bolus limitations.

- To update additional parameters, repeat Steps 3-4.

In addition to parameter changes, the following functions are also available:

- **Clear Accum. VI:** Resets the total volume infused for all infusions associated with a patient to 0 mL.
- **View system:** Displays various system and pump parameters. (Refer to [View Menu](#) on page 209.)
- **Delivery history:** Displays a summary of bolus delivery events. For more information, refer to [Viewing Delivery History](#) on page 215.

- To confirm and save changes, press **OK**.

To return to the Paused screen without saving changes, press **Back**.

Then, from the Attention screen, press **OK**.

Administering a Clinician Bolus

A bolus of any amount (within the predefined safe range) can be delivered by clinicians who have a High authorization level. A clinician bolus can be given only while the infusion is running. The lockout time is reset after delivering a clinician bolus.

> To administer a clinician bolus:

1. From the toolbar of the Running screen, press **View/Edit**.
2. Select **Clinician bolus**.
3. Using the keypad, enter the appropriate password → **OK**.
4. On the Clinician bolus screen, using the keypad, enter the bolus amount → **OK**.
5. To start the bolus, from the Attention screen, press **OK**.
The Clinician bolus screen appears, and the bolus begins.



The default clinician bolus infusion rate is 125 mL/h. This default can be modified using a Technician authorization code.

Epidural Mode

This mode enables the pump to deliver epidural infusions. Epidural administration is limited to short term infusions (up to 96 hours), using indwelling catheters specifically identified for epidural drug delivery.

In Epidural delivery mode, the pump can operate in either of the following sub-modes:

- **PCEA (Patient Controlled Epidural Analgesia):** Delivers epidural boluses, either alone or in addition to a basal preset rate. Alternatively, only a basal infusion (without boluses) can be programmed.
- **Intermittent Epidural:** Delivers epidural infusions at intermittent programmed intervals. The Epidural Intermittent mode also enables the addition of PCEA, in order to allow patient boluses throughout the infusion (PIEB).

The features of the Epidural mode are designed to accommodate the special requirements of an epidural infusion, such as lower VTBI, lower infusion rate, and higher backpressure. In Epidural intermittent mode and in PCEA mode, bolus rate can be configured to 125 mL/h or 200 mL/h before starting infusion (for more information, refer to [Epidural Mode Options Menu](#) on page 218).



Epidural Mode: Safety Precautions

When working with epidural infusions, adhere to the following safety procedures, guidelines and reminders:

- Before programming, always verify that the pump is in Epidural delivery mode.
- To prevent infusion of drugs not intended/labeled for epidural use, do not use administration sets with injection ports during epidural delivery.
- Use only yellow-marked administration sets for epidural infusions.
- Epidural administration of drugs other than those intended/labeled for epidural use could result in serious injury to the patient.
- Do not infuse non-epidural drugs in Epidural Delivery mode.
- Epidural drugs must be infused in Epidural Delivery mode.

Patient Controlled Epidural Analgesia (PCEA) Mode

The following sections will be reviewed:

- Infusion Parameters: PCEA Mode 160
- Starting a PCEA Infusion 162
- PCEA Mode: Mid-infusion Actions 167

The PCEA mode allows the pump to deliver medication at a continuous rate (optional) and limited boluses activated by the patient (via screen key or bolus handle). Additional boluses can be provided by a clinician, using the appropriate authorization code.



For more information about the bolus handle, refer to [PCA/PCEA/PIEB Bolus Handle](#) on page 48.

Figure 5.7. PCEA Flow Profile

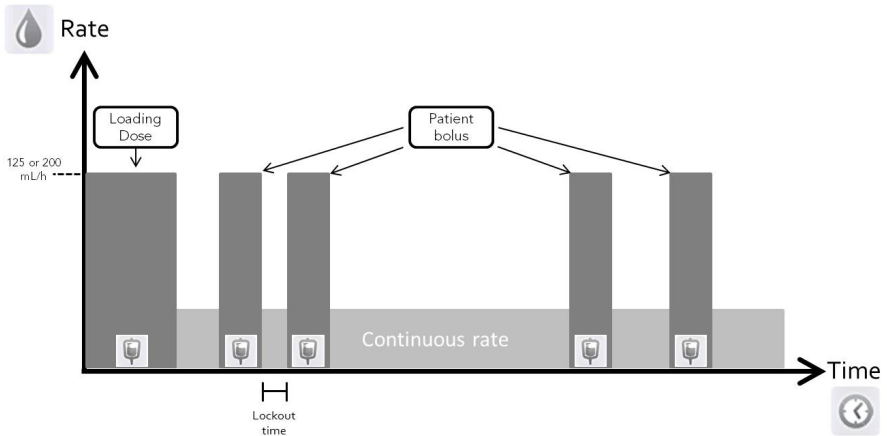

Infusion Parameters: PCEA Mode

The following infusion parameters need to be set for a PCEA infusion:

Parameter	Description/Notes
Continuous Rate	The speed at which the fluid is infused. Continuous Rate values can range from 0.1 to 25 mL/h, or be equal to zero (Bolus Only infusion).
VTBI	The total amount of fluid to be infused. The remaining VTBI is displayed on the screen as the infusion progresses. VTBI values can range from 0.1 to 9999 mL.
Demand Bolus	The amount of fluid infused in a single bolus. Demand bolus values can range from 0.1 to 30 mL, or be equal to zero (Continuous Only infusion).
Bolus Lockout	The minimum time that must pass between the end of one bolus to the start of the next patient bolus. After a bolus delivery ends, the next patient bolus becomes available following the lockout time.
Dose Limit	The option to choose if patient boluses are limited by number or volume. When choosing No Limits, the patient boluses are set to the maximum allowed volume, according to the other parameters defined for the infusion, including Lockout Time and Demand Bolus.

Parameter	Description/Notes
Boluses per 1 h (or 4 hrs) OR Total dose per 1 h (or 4 hrs)	<p>The maximum number of boluses OR the maximum dose that can be delivered during a 1 hour (or 4 hours) period. (A user with high authorization codes can set the 1 hour or 4 hours parameters). The Total dose limit takes into account medication delivered via:</p> <p>Continuous rate Yes Demand Bolus Yes</p> <p>Boluses given by a clinician, are not taken into account for the Total dose limit:</p> <p>Loading Dose No Clinician bolus No</p> <p>When the Total dose limit is reached, the patient is locked out from activating additional boluses.</p>
Loading Dose	<p>An optional feature that begins the infusion with a clinician bolus. Loading dose values range from 0.1 to 30 mL.</p> <p>To use this feature, it must be enabled. For more information, refer to Epidural Mode Options Menu on page 218.</p>



The bolus rate applies to all boluses delivered during the infusion, and is configured before programming starts. It can be set to 125 mL/h or 200 mL/h (for more information, refer to [Epidural Mode Options Menu](#) on page 218).

Starting a PCEA Infusion

The following procedure explains how to program the pump to start a new PCEA infusion.



If relevant, you may skip programming by using the Repeat Last Infusion or PreSet programs procedures to begin the infusion. For more information, refer to [Starting New Infusions: Shortcuts](#) on page 186.

> To begin a new PCEA infusion without Drug Library:

1. From the Indicators Bar, verify that the pump is in Epidural mode.



For more information about changing delivery modes, refer to [Selecting Delivery Mode](#) on page 72.

2. From the Start Up screen, select **New Infusion**.
3. If **Dosing method** screen appears, select the appropriate option:

- **mL:** Continue to Step 7.
- **Dose calculation:** Continue to Step 4.

Weight based units are available for both Dosing methods.

Otherwise, continue to Step 10.

4. From the **Concentration units** screen, select the appropriate drug units.



To display additional concentration units press **Next**.

5. According to pump configuration one of the following screens will appear:
 - **Concentration:** From concentration screen, using the keypad, enter the **Concentration** → **OK**. Then, continue to Step 7.
 - **Drug amount:** Using the keypad, enter the **Drug Amount** → **OK**. Then, using the keypad, enter the **Diluent Volume** → **OK**. Then, continue to Step 6.

6. From the Attention screen, confirm the concentration and press **OK**.
If the selected drug unit is Million Units, continue to Step 9.
7. If the **Patient Weight** screen appears, specify whether the infusion is weight based:
 - **Yes:** Continue to Step 8.
 - **No:** Continue to Step 9.
8. If the **Patient Weight** screen appears, using the keypad, enter the patient weight → **OK**.
9. From the **Dose Rate units** screen, select the appropriate dose rate units.
10. Using the keypad, enter the **VTBI** value → **OK**.
11. Using the keypad, enter the **Continuous Rate** value → **OK**.
The Continuous Rate can be set to zero.
12. Using the keypad, enter the value for the Demand Bolus → **OK**.
13. Using the keypad, enter the value for the Bolus Lockout → **OK**.
14. From the Dose Limit Type screen, specify whether the infusion is according to dose limits:
 - **Yes:** Continue to Step 15.
 - **No:** Continue to Step 16.



Choosing **No** on the Dose limit screen will set patient boluses to the maximum allowed, according to the other parameters defined for the infusion, including Lockout Time and Demand Bolus.

15. From the Dose Limit Type screen, select the appropriate Dose Limit type, and proceed to the directed step:
 - **Number of Boluses:** Using the keypad, enter the maximum number of boluses that will be available for the patient within a one or four-hour period → **OK**. Continue to Step 16.

- **Total Dose:** Using the keypad, enter the maximum amount of medication that may be delivered within a one or four-hour period → **OK**. Continue to Step 16.
16. If **Add Loading Dose** screen appears, specify whether to program a loading dose:
- **Yes:** Using the keypad, enter the value for the Loading Dose → **OK**.
 - **No:** Proceed to Step 17.
- Otherwise, continue to Step 17.
17. Review the parameters displayed on the Confirm screen.



Verify that the parameters reflect the correct treatment according to the prescription.

Then, press **OK**.

18. To begin the infusion, make sure that the clamps on the administration set are open, then, press **Start**.
The Running screen appears, and the infusion begins.

Throughout the infusion, the current infusion phase (Loading Dose, Running, Bolus Delivery or Clinician Bolus) is displayed on the Indicators Bar.

In addition, the following information appears on the screen:

- **Drug Name:** The name of the selected drug. Displayed on the indicators bar, when working with a Drug Library.
- **Drug Concentration:** Drug concentration as entered by the user (Final concentration or Drug Amount / Diluent Volume). Displayed when applicable.
- **Rate:** Current infusion rate. For all dose units other than mL/h, the calculated rate will be displayed in mL/h, both in the View System menu and in the Running screen.
- **VTBI:** Total volume left to be infused. As the infusion progresses, this value decreases.
- **VI / Total:** Total volume that has been infused during the current infusion (including KVO if applied during a delayed start period) / the total VTBI value programmed. As the infusion progresses, the VI increases, and the Total remains constant.

- **Lockout time:** Time remaining until the next bolus is available. After the lockout time elapses, this parameter changes to **Bolus available**.



When a bolus is being given (loading dose, clinician bolus or patient bolus), this parameter does not appear.

- **Time left:** The maximum time remaining until the end of the entire infusion. If boluses are given, this time will be shortened.



To view all programmed parameters of the current infusion, including the rate in mL/h, from the Running screen, press **View/Edit** → **View system** → **Infusion values**.
For more information, refer to [Viewing System Parameters](#) on page 210.

> **To begin a new PCEA infusion with a Drug Library:**

1. From the Indicators Bar, verify that the pump is in Epidural mode.



For more information about changing delivery modes, refer to [Selecting Delivery Mode](#) on page 72.

2. From the **Start Up** screen, select **New Infusion**.
3. From the **Drug Name** screen:
 - Using the keypad, enter the drug name, then press **Find** and proceed to Step 4.



The **Find** key can be used to display all available drugs without entering any characters (letters, numbers or symbols) or filter drug names according to the characters entered.

- When the required drug is not found in the Drug Library, press **Choose General** key on the toolbar:



'Choose General' will bypass specific drug limits, and the infusion will be programmed without Drug Library limits.

From the Attention screen, confirm Choosing General and press **OK**.

Proceed to Step 3 on page 162 (To begin a new PCEA infusion without Drug Library), and continue programming from there.

4. From the **Drug List** screen, select the row of the relevant drug.



To display additional drugs press **Next**.

5. If a list of available drug profiles appears, select the appropriate drug profile and proceed according to the step directed to:
 - **No concentration:** proceed to Step 7 on page 163 (To begin a new PCEA infusion without Drug Library), and continue programming from there.
 - **Diluent only** (e.g. 10 mL): proceed to Step 7 on page 163 (To begin a new PCEA infusion without Drug Library), and continue programming from there.
 - **Partial concentration:** the Drug Amount or Diluent Volume is missing. A screen for the missing value will appear:
 - From the **Drug Amount** screen, using the keypad, enter the Drug Amount → **OK**.
 - From the **Diluent Volume** screen, using the keypad, enter the Diluent Volume → **OK**.From the Attention screen, confirm the concentration and press **OK**.
Proceed to Step 7 on page 163 (To begin a new PCEA infusion without Drug Library), and continue programming from there
 - **Full concentration:**
Proceed to Step 7 on page 163 (To begin a new PCEA infusion without Drug Library), and continue programming from there.

If a list of available drug profiles does not appear, continue to Step 7 on page 163 (To begin a new PCEA infusion without Drug Library), and continue programming from there.

For more information about the Drug Library, refer to Chapter 9: Drug Library on page 234.

PCEA Mode: Mid-infusion Actions

The following actions can be performed during PCEA infusions:

Updating Infusion Parameters	167
Administering a Clinician Bolus	184
Pausing Infusions	190
Aborting Infusions	191
Locking the Screen	192
Activating Patient Lockout	193
Viewing Delivery History	215

Updating Infusion Parameters

In PCEA mode, the infusion must be paused before any parameter can be updated. Once the infusion is paused, infusion parameters can be modified by using the **View/Edit** function key. In addition, the continuous rate and VTBI for the current infusion phase can be modified directly from the Main Display. (During a bolus delivery, no parameters can be changed.)

> To update parameters for the current phase (Basal/Bolus) from the Main Display:

1. Pause the infusion (Pausing Infusions on page 190).
2. On the Main Display, select the relevant frame (**Continuous Rate** or **VTBI**).
3. Using the keypad, enter the new Continuous Rate or VTBI → **OK**.
4. To confirm and save changes, press **OK**.
To return to the Paused screen without saving changes, press **Back**. From the Continuous Rate of VTBI screen, press **Back**. Then, from the Attention screen, press **OK**.

> **To update parameters using the View/Edit function key:**

1. Pause the infusion ([Pausing Infusions](#) on page 190).
2. From the toolbar, press **View/Edit**.
3. Select the box of the parameter to be modified.
4. Using the keypad, enter the new value of the parameter → **OK**.



When modifying demand bolus limitations (volume or lockout time), the pump will prompt you to confirm or adjust the other bolus limitations.

5. To update additional parameters, repeat Steps 3-4.
In addition to parameter changes, the following functions are also available:
 - **Clear Accum. VI:** Resets the total volume infused for all infusions associated with a patient to 0 mL.
 - **View system:** Displays various system and pump parameters. (Refer to [View Menu](#) on page 209.)
 - **Delivery history:** Displays a summary of medication delivery events. For more information, refer to [Viewing Delivery History](#) on page 215.
6. To confirm and save changes, press **OK**.
To return to the Paused screen without saving changes, press **Back**.
Then, from the Attention screen, press **OK**.

Administering a Clinician Bolus

A bolus of any amount (within the predefined safe range) can be delivered by clinicians who have High authorization level. A clinician bolus can be given only while the infusion is running. The lockout time is reset after delivering a clinician bolus.

> To administer a clinician bolus:

1. From the toolbar of the Running screen, press **View/Edit**.
2. Select **Clinician bolus**.
3. Using the keypad, enter the appropriate password → **OK**.
4. Using the keypad, enter the bolus amount → **OK**.
5. To start the bolus, from the Attention screen, press **OK**.

The Clinician bolus screen appears, and the bolus begins.



The rate of all boluses during PCEA is defined prior to programming the infusion. It can be set to 125 mL/h or 200 mL/h (for more information, refer to [Epidural Mode Options Menu](#) on page 218)

Epidural Intermittent Mode

The following sections will be reviewed:

Infusion Parameters: Epidural Intermittent Mode	172
Starting an Epidural Intermittent Infusion	174
Epidural Intermittent Mode: Mid-infusion Actions	182

This mode enables you to program epidural doses (boluses) that are given at a rate of 125 mL/h or 200 mL/h, and are repeated at regular intervals or cycles. The dose interval is the frequency at which the intermittent dose is delivered. A continuous rate can be programmed to run between intermittent doses.

Figure 5.8. Epidural Intermittent Flow Profile

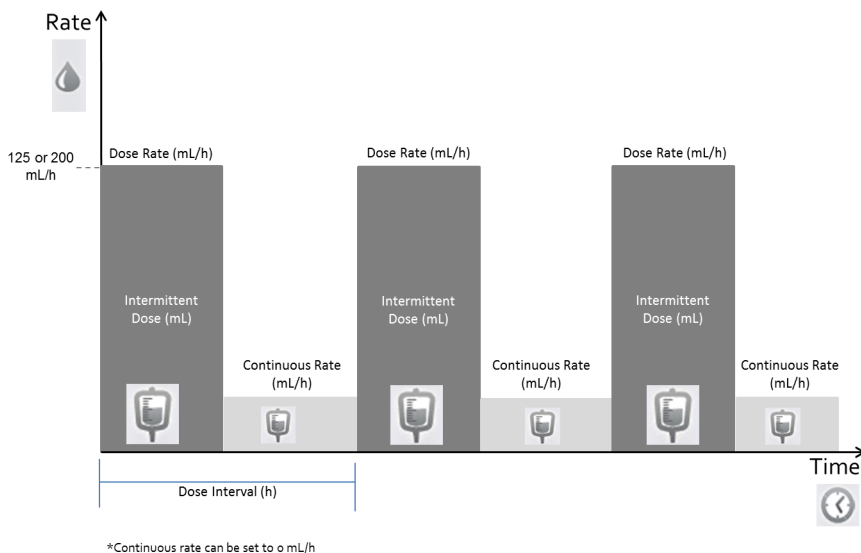

The Sapphire pump can also be configured to support PIEB (Programmed Intermittent Epidural Boluses). When enabled, the option to add PCEA is available on the Start screen. Note that in any case, an Epidural Intermittent infusion will start with an intermittent dose.

The patient will be able to activate a Patient Bolus between intermittent doses, except during the Lockout Time period immediately after an intermittent dose, or any other bolus. If the time remaining from the Patient Bolus to the next scheduled intermittent dose is shorter than the Lockout Time, the next intermittent dose will be delayed to accommodate the Lockout Time.

Unlike the Patient Bolus, the clinician will be able to administer a Clinician Bolus within the Lockout Time immediately after the intermittent dose.

Figure 5.9. Epidural Intermittent with PCEA Flow Profile

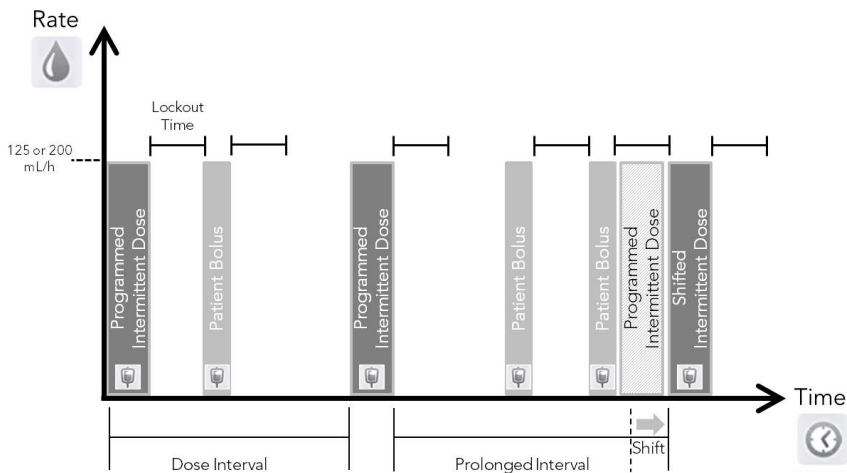

To use the PIEB option, the option must be enabled (requires high authorization code). Refer to [Epidural Mode Options Menu](#) on page 218.



For more information about the bolus handle, refer to [PCA/PCEA/PIEB Bolus Handle](#) on page 48.

When the PIEB option is enabled, you can set PCEA infusion parameters immediately after programming the Epidural Intermittent infusion ([Starting a PIEB Infusion](#) on page 179).

Infusion Parameters: Epidural Intermittent Mode

The following infusion parameters need to be set for an Epidural Intermittent infusion:

Parameter	Description/Notes
VTBI	The total amount of fluid to be infused. The remaining VTBI is displayed on the screen as the infusion progresses. VTBI values can range from 0.1 to 9999 mL.
Intermittent Dose	The amount of each intermittent dose. Values can range from 0.1 to 30 mL.
Dose Interval	The frequency of intermittent dose delivery (Intermittent Dose + Continuous Rate). Intermittent doses can be given as frequently as 5 minutes apart. Therefore, the minimum programmable Dose Interval is the Intermittent Dose time plus 5 minutes. This rule applies even when the continuous rate is set to 0.
Continuous Rate	The rate of fluids delivered between doses, to prevent clotting in the epidural catheter. The Continuous Rate can be set from 0 to 25 mL/h (the range varies according to the Intermittent Dose volume and the Dose Interval entered).
Demand Bolus*	The amount of fluid infused in a single bolus. Demand Bolus values can range from 0.1 to 30 mL.
Bolus Lockout*	The minimum time that must pass between the end of one Demand Bolus to the start of the next Demand Bolus. After a bolus delivery ends, the next Demand Bolus becomes available following the lockout time.

Parameter	Description/Notes
Boluses per 1 h (or 4 hrs) OR Total dose per 1 h (or 4 hrs)*	<p>The maximum number of boluses OR the maximum dose that can be delivered during a 1 hour (or 4 hours) period. (A user with high authorization codes can set the 1 hour or 4 hours parameters). The Total dose limit takes into account medication delivered via:</p> <p>Continuous rate Yes Intermittent dose Yes Demand Bolus Yes</p> <p>Boluses given by a clinician, are not taken into account for the Total dose limit:</p> <p>Clinician bolus No</p> <p>When the Total dose limit is reached, the patient is locked out from activating additional boluses.</p>

* Applicable only when programming Epidural Intermittent with PCEA.



The bolus rate applies to all boluses delivered during the infusion. The bolus rate can be configured to 125mL/ or 200mL/h before programming the infusion (for more information, refer to [Epidural Mode Options Menu](#) on page 218).

Starting an Epidural Intermittent Infusion

The following procedure explains how to program the pump to start a new Epidural Intermittent infusion.



If relevant, you may skip programming by using the Repeat Last Infusion or PreSet programs procedures to begin the infusion. For more information, refer to [Starting New Infusions: Shortcuts](#) on page 186.

> To begin a new Epidural Intermittent infusion without Drug Library:

1. From the Indicators Bar, verify that the pump is in Epidural mode.



For more information about changing delivery modes, refer to [Selecting Delivery Mode](#) on page 72.

2. From the Start Up screen, select **New Infusion**.
3. If **Dosing method** screen appears, select the appropriate option:

- **mL:** Continue to Step 7.
- **Dose calculation:** Continue to Step 4.

Weight based units are available for both Dosing methods.

Otherwise, continue to Step 10.

4. From the **Concentration units** screen, select the appropriate drug units.



To display additional concentration units press **Next**.

5. According to pump configuration one of the following screens will appear:
 - **Concentration:** From concentration screen, using the keypad, enter the Concentration → **OK**. Then, continue to Step 7.
 - **Drug amount:** Using the keypad, enter the Drug Amount → **OK**. Then, using the keypad, enter the Diluent Volume → **OK**. Then, continue to Step 6.
6. From the Attention screen, confirm the concentration and press **OK**.
If the selected drug unit is Million Units, continue to Step 9.

7. If the Patient Weight screen appears, specify whether the infusion is weight based:
 - **Yes:** Continue to Step 8.
 - **No:** Continue to Step 9.
8. From the Patient Weight screen, using the keypad, enter the patient weight → **OK**.
9. From the Dose Rate units screen, select the appropriate dose rate units.
10. Using the keypad, enter the VTBI value → **OK**.
11. Using the keypad, enter the Intermittent Dose → **OK**.
12. Using the keypad, enter the Dose Interval → **OK**.
13. Using the keypad, enter the Continuous rate → **OK**.
The Continuous rate may be set to zero.
14. Review the parameters displayed on the Confirm screen.



Verify that the parameters reflect the correct treatment according to the prescription.

Then, press **OK**.



If the pump is configured to support PIEB option, PCEA infusion parameters can be programmed at this point. For detailed instructions, go to [To begin a new PIEB Infusion without Drug Library](#) (Step 3 on page 179).

15. To begin the infusion, make sure that the clamps on the administration set are open, and press **Start**.
The Intermittent Dose screen is displayed, and the infusion begins with the first dose.

Throughout the infusion, the infusion phase (Intermittent Dose or Continuous Rate) is displayed on the Indicators Bar. In addition, the following information appears on the screen:

- **Drug Name:** The name of the selected drug. Displayed on the indicators bar, when working with a Drug Library.
- **Drug Concentration:** Drug concentration as entered by the user (Final concentration or Drug Amount / Diluent Volume). Displayed when applicable.
- **Rate:** Current infusion rate. For all dose units other than mL/h, the calculated rate will be displayed in mL/h, both in the View System menu, and in the Running screen.
- **VTBI:** Total volume left to be infused. As the infusion progresses, this value decreases.
- **VI / Total:** Total volume delivered in the current infusion (including KVO if applied during a delayed start period) / the total VTBI value programmed. As the infusion progresses, the VI increases, and the Total remains constant.
- **Time Left:** Time remaining until the end of the current infusion. This parameter remains constant throughout the Standby period.
- **Time to Dose:** Time remaining until the beginning of the next Intermittent Dose. .



When the infusion is paused (Intermittent Dose or Continuous Rate), the time to next Intermittent Dose is paused and not displayed.



To view all programmed parameters of the current infusion, including the rate in mL/h, from the Running screen, press **View/Edit** → **View system** → **Infusion values**.

> **To begin a new Epidural Intermittent infusion with a Drug Library:**

1. From the Indicators Bar, verify that the pump is in Epidural mode.



For more information about changing delivery modes, refer to [Selecting Delivery Mode](#) on page 72.

2. From the **Start Up** screen, select **New Infusion**.
3. From the **Drug Name** screen,
 - Using the keypad, enter the drug name, then press **Find** and proceed to Step 4.



The **Find** key can be used to display all available drugs without entering any characters (letters, numbers or symbols) or filter drug names according to the characters entered.

- When the required drug is not found in the Drug Library, press **Choose General** key on the toolbar:



'Choose General' will bypass specific drug limits, and the infusion will be programmed without Drug Library limits.

From the Attention screen, confirm Choosing General and press **OK**.

Proceed to Step 3 on page 174 ([To begin a new Epidural Intermittent infusion without Drug Library](#)), and continue programming from there.

4. From the **Drug List** screen, select the row of the relevant drug.



To display additional drugs press **Next**.

5. If a list of available drug profiles appears, select the appropriate drug profile and proceed according to the step directed to:

- **No concentration:** proceed to Step 7 on page 175 ([To begin a new Epidural Intermittent infusion without Drug Library](#)), and continue programming from there.
- **Diluent only** (e.g. 10 mL): proceed to Step 7 on page 175 ([To begin a new Epidural Intermittent infusion without Drug Library](#)), and continue programming from there.
- **Partial concentration:** the Drug Amount or Diluent Volume is missing. A screen for the missing value will appear:
 - From the **Drug Amount** screen, using the keypad, enter the Drug Amount → **OK**.
 - From the **Diluent Volume** screen, using the keypad, enter the Diluent Volume → **OK**.

From the Attention screen, confirm the concentration and press **OK**.

Proceed to Step 7 on page 175 ([To begin a new Epidural Intermittent infusion without Drug Library](#)), and continue programming from there.

- **Full concentration:**

Proceed to Step 7 on page 175 ([To begin a new Epidural Intermittent infusion without Drug Library](#)), and continue programming from there.

If a list of available drug profiles does not appear, continue to Step 10 on page 175 ([To begin a new Epidural Intermittent infusion without Drug Library](#)), and continue programming from there.

For more information about the Drug Library, refer to [Chapter 9: Drug Library on page 234](#).

Starting a PIEB Infusion

The following procedure explains how to program an Epidural Intermittent with PCEA.

> To begin a new PIEB Infusion without Drug Library:

1. Verify that the pump is in Epidural Intermittent mode, and then program the Epidural Intermittent infusion (Step 2 on page 174 through Step 13 on page 175 in [To begin a new Epidural Intermittent infusion without Drug Library](#)).
2. Review the parameters displayed on the Confirm screen.
Then, press **OK**.
3. From the Start screen, select **Add PCEA**.
4. Using the keypad, enter the value for the Demand Bolus → **OK**.
5. Using the keypad, enter the value for the Bolus Lockout → **OK**.
6. From the Dose Limit Type screen, specify whether or not the patient boluses should be limited:
 - **Yes:** Continue to Step 7.
 - **No:** Continue to Step 8.



Choosing **No** on the Dose limit screen will set patient boluses to the maximum allowed, according to the other parameters defined for the infusion, including Lockout Time and Demand Bolus.

7. From the Dose Limit Type screen, select the appropriate Dose Limit type, and proceed to the directed step:
 - **Number of Boluses:** Using the keypad, enter the maximum number of boluses that will be available for the patient within a one or four-hour period → **OK**. Continue to Step 8.
 - **Total Dose:** Using the keypad, enter the maximum amount of medication that may be delivered within a one or four-hour period → **OK**. Continue to Step 8.
8. Review the parameters displayed on the Confirm screen.
Then, press **OK**.



Verify that the parameters reflect the correct treatment according to the prescription.

9. To begin the infusion, make sure that the clamps on the administration set are open, and press **Start**.

The Running screen appears, and the infusion begins.

Throughout the infusion, the infusion phase (Intermittent dose, continuous rate or bolus) is displayed on the Indicators Bar. In addition, the following information appears on the Main Display:

- **Drug Name:** The name of the selected drug. Displayed on the indicators bar, when working with a Drug Library.
- **Drug Concentration:** Drug concentration as entered by the user (Final concentration or Drug Amount / Diluent Volume). Displayed when applicable.
- **Rate:** Current infusion rate. For all dose units other than mL/h, the calculated rate will be displayed in mL/h, both in the View system menu and in the Running screen.
- **VTBI:** Total volume left to be infused. As the infusion progresses, this value decreases.
- **VI / Total:** Total volume delivered in the current infusion (including KVO if applied during a delayed start period) / the total VTBI value programmed. As the infusion progresses, the VI increases, and the Total remains constant.
- **Lockout time:** Time remaining until the next bolus is available. After the lockout time elapses, this parameter changes to Bolus available.
- **Time to Dose:** Time remaining before the next dose starts (until the end of the interval time: Dose Time left + Continuous Rate time).



When the infusion is paused (Intermittent Dose or Continuous Rate), the time to the next Intermittent Dose is paused and not displayed.



To view all programmed parameters of the current infusion, including the rate in mL/h, from the Running screen, press **View/Edit** → **View system** → **Infusion values**.

> **To begin a new PIEB Infusion with a Drug Library:**

1. Verify that the pump is in Epidural Intermittent mode, and then program the Epidural Intermittent infusion (Step 2 on page 177 through Step 5 on page 177 in [To begin a new Epidural Intermittent infusion with a Drug Library](#)).
2. Review the parameters displayed on the Confirm screen.



Verify that the parameters reflect the correct treatment according to the prescription.

Then, press **OK**.

3. From the Start screen, select **Add PCEA**.

Proceed to Step 4 on page 179 ([To begin a new PIEB Infusion without Drug Library](#)), and continue programming from there.

For more information about the Drug Library, refer to [Chapter 9: Drug Library](#) on page 234.

Epidural Intermittent Mode: Mid-infusion Actions

The following actions can be performed during Epidural Intermittent infusions:

Updating Infusion Parameters	182
Administering a Clinician Bolus	184
Pausing Infusions	190
Aborting Infusions	191
Locking the Screen	192
Activating Patient Lockout	193
Viewing Delivery History	215

Updating Infusion Parameters

In the Epidural Intermittent mode, the infusion must be paused before any parameter can be updated. Once the infusion is paused, any infusion parameter can be modified, by using the **View/Edit** function key. In addition, the rate (Continuous Rate or Dose Rate) and VTBI for the Intermittent Dose phase can be modified directly from the Main Display (during a bolus delivery, no parameter can be changed).

> **To update parameters for the current phase (intermittent dose/Continuous rate) the Main Display:**

1. Pause the infusion (Pausing Infusions on page 190).
2. On the Main Display, select the relevant frame (Dose rate, Continuous rate or VTBI).
3. Using the keypad, enter the new Dose rate, Continuous rate or VTBI → **OK**.
4. To confirm and save changes, press **OK**.

To return to the Paused screen without saving changes, press **Back**. From the Dose rate, Continuous rate or VTBI screen, press **Back**. Then, from the Attention screen, press **OK**.

> **To update parameters using the View/Edit function key:**

1. Pause the infusion (Pausing Infusions on page 190).
2. From the toolbar, press **View/Edit**.

3. Select the box of the parameter to be modified.
4. Using the keypad, enter the new value of the parameter → **OK**.



When changing the Intermittent Dose or Dose Rate, you will be prompted to confirm or adjust the dose interval.



When modifying demand bolus limitations (volume or lockout) the pump will prompt you to confirm or adjust the other bolus limitations.

5. To update additional parameters, repeat Step 3 through Step 4.
In addition to parameter changes, the following functions are also available:
 - **Clear Accum. VI:** Resets the total volume infused for all infusions associated with a patient to 0 mL.
 - **View system:** Displays various system and pump parameters. (Refer to [View Menu](#) on page 209.)
 - **Delivery History:** Displays a summary of medication delivery events. For more information, refer to [Viewing Delivery History](#) on page 215. Applies only when Epidural Intermittent with PCEA infusion was programmed.
6. To confirm and save changes, press **OK**.
To return to the Paused screen without saving changes, press **Back**. Then, from the Attention screen, press **OK**.

Administering a Clinician Bolus

A bolus of any amount (within the predefined range) can be delivered by clinicians who have a High authorization level code. A clinician bolus can be given only while the infusion is running. The lockout time is reset after delivering a clinician bolus.

Clinician bolus is applicable only when programming Epidural Intermittent with PCEA.

> To administer a clinician bolus:

1. From the toolbar of the Running screen, press **View/Edit**.
2. Select **Clinician bolus**.
3. Using the keypad, enter the appropriate password → **OK**.
4. Using the keypad, enter the bolus amount → **OK**.
5. To start the bolus, from the Attention screen, press **OK**.

The Clinician bolus screen appears, and the bolus begins.



The RATE of the Clinician Bolus, as all other boluses in PCEA mode, is defined prior to programming the infusion. It can be set to 125 mL/h or 200 mL/h (for more information, refer to [Epidural Mode Options Menu](#) on page 218).

This page is left intentionally blank

Chapter 6: Basic Infusion Operations

The following sections explain procedures and actions that are commonly performed in all delivery modes to start and manage infusions:

Starting New Infusions: Shortcuts	186
Resuming Infusions After Pump Shutdown	189
Mid-infusion Actions	190

Starting New Infusions: Shortcuts

The following shortcut operations allow you to begin an infusion without the need to enter required parameters:

Repeating Last Infusion	186
Using a PreSet Program	188

Repeating Last Infusion

Repeat Last Infusion is a quick method to continue the infusion with a new IV bag, after the first one has been emptied or discontinued (the same infusion parameters used for the same patient). The pump automatically saves all the parameters programmed, excluding secondary line, for the last infusion performed in that delivery mode. If a parameter is updated while an infusion is running, the updated parameter is saved. The Last Infusion settings are saved even if the last infusion was not completed or the pump has been turned Off.



When using the Repeat Last Infusion option, the **Delivery History**, **Accumulated VI** parameters and the remaining **Lockout Time** are not cleared; instead they continue counting from the previous infusion. For more information about Accumulated VI, and Delivery History, refer to [Using the New Patient Feature](#) on page 231.



Information about Secondary (Piggyback) infusions is not saved. This option is not relevant to Secondary infusions.



Repeat Last Infusion is not available (grayed out) when the pump settings differ from those used for the previous infusion. These include: CCA, regional settings, and PCA/PCEA infusion type.



Repeat Last Infusion does not include a loading dose, even if one was programmed for the original infusion. If required, a clinician bolus can be given when the infusion starts. For more information refer to [Administering a Clinician Bolus](#) on page 157.

To repeat the last infusion

1. From the Start Up screen, select **Repeat Last Infusion**.
2. If a warning that the air detection is disabled (OFF) appears, ensure that a set with an air-eliminating filter is used, and press **OK**.
3. Review the parameters displayed on the Confirm screen.



Verify that the parameters reflect the correct treatment according to the prescription.

Then, press **OK**.

4. To begin the infusion, make sure that the clamps on the administration set are open, and press **Start**.

The Running screen appears, and the infusion begins.

Using a PreSet Program

The PreSet Programs function allows you to select an infusion with predefined parameters. Each delivery mode can support up to 10 PreSet programs. PreSet programs are available only in the delivery mode in which they were saved.



For the PreSet Programs option to appear on the Start Up screen, the PreSet programs need to be enabled on the pump. For more information, refer to [Configuring General Settings](#) on page 202.

> To start an infusion using the PreSet Programs function:

1. From the Start Up screen, select **PreSet Programs**.



If no PreSet program was saved in the current delivery mode, a blank screen appears.
For more information about adding or modifying a program, refer to [Creating and Editing PreSet Programs](#) on page 224.

2. If a warning that the air detection is disabled (OFF) appears, ensure that a set with an air-eliminating filter is used, and press **OK**.
3. Select the row of the desired program.



To display additional programs, press **Next**.

4. Review the parameters that are displayed.



Verify that the parameters reflect the correct treatment according to the prescription.

Then, press **OK**.

5. To begin the infusion, make sure that the clamps on the administration set are open, and press **Start**.

The Running screen appears, and the infusion begins.

Resuming Infusions After Pump Shutdown

When the pump is turned Off during an active infusion (running or paused), the option to resume the previous infusion will be displayed after the pump is turned On. This option is applicable for all delivery modes, excluding TPN:

> To resume the infusion:

1. On the Attention screen, press **OK**.
2. If a warning that the air detection is disabled (OFF) appears, ensure that a set with an air-eliminating filter is used, and press **OK**.
3. The Paused infusion screen appears,
Press **Request continue** to resume the infusion.
4. On the Attention screen, press **OK** to confirm.
The running screen appears.



The option to resume will not be available if the pump was shut down due to a critical alarm, or if the infusion was quit.



When a Drug Library is loaded, Resume Infusion after pump shutdown will keep local configurations changes until the end of the treatment.

> To abort the previous infusion:

- On the Attention screen, press **Exit**. The Start Up screen appears.



When a Drug Library is loaded on the pump, the Clinical Care Area screen appears. The user can either accept or change the current CCA. For more information, refer to [Clinical Care Area \(CCA\)](#) on page 235.

Mid-infusion Actions

The following sections describe procedures that are commonly performed during an infusion:

Pausing Infusions	190
Aborting Infusions	191
Locking the Screen	192
Activating Patient Lockout	193

Pausing Infusions

The Pause function allows you to temporarily stop an infusion. Infusions can be paused using either the **Request Pause** function key, or, in an emergency, the **Stop** hard key. A message stating that the infusion has been paused appears 30 seconds after pausing the infusion (audible and visual).



Pressing the **Stop** hard key stops the infusion immediately, bypassing the need for confirmation of the Pause action. In an emergency, it is recommended to pause the infusion using the **Stop** hard key. In routine situations, using the **Request Pause** function key is recommended.



Turning the pump Off after pausing the infusion allows the user to resume this infusion after turning the pump back on.

> To pause an infusion using the Stop hard key:

- At the bottom of the pump, press **Stop**. The infusion is paused.



When the Patient Lockout or Lock Screen features are activated, it is necessary to confirm pausing from the Attention screen, by pressing **OK**.

> **To pause an infusion using the Request Pause function key:**

1. From the toolbar, press **Request Pause**.
2. From the toolbar of the Attention screen, press **OK**.
3. The infusion is paused.



If you do not press **OK** within 30 seconds, the infusion is not paused, and the Running screen reappears.

> **To resume a paused infusion:**

1. From the toolbar, press **Request Continue**.
2. From the toolbar of the Attention screen, press **OK**.

Aborting Infusions

Aborting an infusion is performed using one of the following methods:

- **Pausing and then quitting the infusion:** Returns the pump to the Start Up screen. Resuming the infusion after quitting is impossible.
- **Turning off the pump:** Turns the pump Off mid-infusion, using the **On/Off** hard key.

When the pump is turned Off mid-infusion, the infusion parameters are saved. When the pump is turned back On, the user is prompted to indicate whether or not to continue the stopped infusion.



In an emergency situation, it is recommended to press and hold the **ON/OFF** hard key for 5 consecutive seconds. This turns the pump Off, bypassing the need to confirm the action.

> **To pause and then quit an infusion:**

1. At the bottom of the pump, press the **Stop** hard key.
2. From the toolbar, press **Quit**.

3. From the toolbar of the Attention screen, press **Quit Infusion**.



Resuming infusion after quitting will not be possible.



When a Drug Library is loaded on the pump, the Clinical Care Area screen appears. The user can either accept or change the current CCA. For more information, refer to [Clinical Care Area \(CCA\)](#) on page 235.

> To turn Off the pump:

1. At the bottom of the pump, press the **ON/OFF** hard key.
2. From the toolbar, press **Off**.

Pressing and holding the **ON/OFF** hard key for 5 consecutive seconds turns the pump Off (bypassing the need for confirmation).



In case of emergency, when Patient Lockout or Lock Screen is activated ([Activating Patient Lockout](#) on page 193), the user must press and hold **ON/OFF** for 5 seconds to turn the pump Off, or unlock the pump before turning it Off.

Locking the Screen

Locking the display screen prevents inadvertent and unintentional changes to settings, by disabling the functionality of the touch screen. For safety, it is recommended to lock the screen while an infusion is running.

> To lock the screen:

1. From the toolbar of the Running screen, press **Lock**.
2. On the Lock options screen, select **Lock Screen**.

The > icons on the Main Display and the toolbar function keys disappear. Only the **Press to Unlock Screen** function key appears on the toolbar.

> **To unlock the screen:**

1. From the toolbar, press **Press to Unlock Screen**.
2. From the toolbar of the Attention screen, press **OK**.

Activating Patient Lockout

The Patient Lockout feature prevents unauthorized personnel from modifying pump and infusion settings. In this state, only limited features are available. A password is required to unlock the pump.



During Patient Lockout or screen lock, the **Request Pause** function key is not available. Pause the infusion by pressing the **Stop** hard key. (Refer to [To pause an infusion using the Stop hard key](#) on page 190.)

To turn the pump Off, press and hold the **ON/OFF** hard key for 5 consecutive seconds.

> **To activate Patient Lockout:**

1. From the toolbar of the Running screen, press **Lock**.
2. On the Lock options screen, select **Patient lockout**.

> **To release Patient Lockout:**

1. From the toolbar, press **Press to Unlock Patient**.
2. Using the keypad, enter the relevant password and press **OK**.

Ending Infusion

When the infusion is complete (entire programmed VTBI delivered), the pump automatically activates the KVO (the default or the infusion rate, the lower of the two) and displays the infusion summary:

- VI - volume infused (VI for the current completed infusion. If the Accumulated VI has been cleared during this infusion, VI presents the volume infused from that time on).

- Rate – the rate at which the infusion was delivered
- Total time – the total time of the infusion



The default KVO can be set by an authorized technician.



When the remaining VTBI is 0.1 mL or less, the time left displayed on the screen may deviate up to a few minutes from the actual time remaining.

> **To proceed with the KVO and view the KVO screen:**

- From the toolbar of the Message screen, press **OK**.

> **To discontinue the KVO:**

1. From the toolbar of the Message screen, press **OK**.
2. From the toolbar of the KVO screen, press **Quit**.



When a Drug Library is loaded and CCA was changed during the previous running infusion, an Attention screen appears, asking to confirm the new CCA. For more information, refer to [Clinical Care Area \(CCA\)](#) on page 235.

This page is left intentionally blank

Chapter 7: Options Menu: Configuring, Viewing and Testing

The following sections describe configuring settings, testing elements, and viewing system data using the Options menu:

Main Options: Overview	196
Setting Delivery Mode	197
Managing Configuration Settings	198
Using Special Mode Options	217

Main Options: Overview

The Options screen provides access to configurable pump settings, testing modes, and system data. The screen is displayed by pressing the **Options** function key, on the toolbar of the Start Up screen.

The Options screen allows access to all configurations and settings of the Sapphire pump (as opposed to settings relevant to a specific infusion). The screen also provides access to testing components and viewing pump (as opposed to infusion) parameters (e.g., System parameters, Event logs, and Delivery History).



The Options function key is not available during an infusion. Some of the configuration and information accessed from the Options menu is also accessible during infusion via the View/Edit menu.

Setting Delivery Mode

The Sapphire pump is a multi-platform device that has the ability to operate in several different modes. Each delivery mode features its own unique options. The current mode is displayed at the right side of the Indicators Bar.

Setting the delivery mode is done using the Options menu. An authorization code of High or Technician is required to modify the delivery mode.



When you change the delivery mode, the pump reverts to the default values for the newly selected mode.

> To change the delivery mode:

1. From the toolbar, press **Options**.
2. From the Options screen, select **Delivery mode**.
3. Using the keypad, enter the required password, and then press **OK**.
4. Select the relevant delivery mode.



To access the PCEA or Intermittent Epidural delivery modes, select **Epidural**. Then select the relevant Epidural delivery mode.

The Start Up screen of the selected mode appears.

Managing Configuration Settings

The following sections describe how to view and update pump configuration settings:

Managing Alarm Settings	198
Configuring Audio Settings	201
Configuring General Settings	202
Defining Regional Parameters	206
Testing System Function	208
View Menu	209



When a drug library is loaded to the pump, local configurations made on the pump remain valid until the user selects a CCA or turns the pump Off. For more information refer to [Chapter 9: Drug Library](#) on page 234.

Managing Alarm Settings

The Alarms menu allows you to view and modify alarm-related options. Only users with authorization levels of High or Technician have access to this menu.

> To access the Alarms menu:

- From the toolbar of the Start Up screen, select **Options**. Then, select **Pump configuration** → **Alarms**.

Option	Descriptions/Notes	To Modify Parameter (from the Alarms screen)
Occlusion units	The format of occlusion units (BAR, PSI or mmHg).	Select Occlusion units . Then, select BAR, PSI or mmHg .

Option	Descriptions/Notes	To Modify Parameter (from the Alarms screen)
Occlusion pressure	The minimum downstream pressure that triggers an Occlusion alarm. Acceptable ranges are 5.8 to 17.4 PSI, 0.4 to 1.2 BAR or 300 to 900 mmHg. An alarm sounds when the downstream pressure reaches the set value \pm the sensor sensitivity level.	Select Occlusion pressure . Then, using the keypad, enter the desired value \rightarrow OK .
Pump unattended	The number of consecutive minutes of no interaction with the pump after which a Pump Unattended alarm is triggered. Options are 2, 5 or 10 minutes. Note: A Pump Unattended alarm is not triggered when the pump is in Delayed start or Standby.	Select Pump unattended . Then, select 2 min, 5 min or 10 min .
Infusion near end	The number of minutes before completion of an infusion at which an Infusion Near End alarm is generated.	Select Infusion near end . Then, select 1 min, 3 min, 5 min, 10 min or Off .

Option	Descriptions/Notes	To Modify Parameter (from the Alarms screen)
Alarm volume	<p>Sets the speaker volume for the auditory alarm signal. Options are Maximum or Minimum.</p> <p>When the option is set to Minimum, messages are provided with a visual signal only. Alarm levels 1, 2 and 3, and the 'Infusion Complete' message are provided with a visual signal and the lowest auditory signal permitted, according to IEC 60601-1-8.</p> <p>Maximum alarm volume is 70 dB. Minimum alarm volume is 56 dB.</p> <p>Note: Auditory alarm signal sound levels, which are less than ambient levels, can impede operator recognition of alarm conditions.</p> <p>For more information about messages and alarms, refer to Chapter 10: Alarms and Troubleshooting on page 244.</p>	<p>Select Alarm volume. Then, select Maximum or Minimum.</p>



An Occlusion Auto-restart option exists and is available for configuration by authorized technicians only. This option allows the pump to restart the infusion automatically provided the occlusion was cleared.

If the occlusion is not cleared within 40 seconds, or the user chooses to exit the process, the downstream occlusion alarm is activated (appears within a few seconds). An Occlusion Auto-restart can occur up to 5 times in one hour.

Configuring Audio Settings

The Audio settings menu allows you to view and modify audio-related pump settings. Only users with authorization levels of High or Technician have access to this menu.

> To access the Audio settings menu:

- From the toolbar of the Start Up screen, select **Options**. Then, select **Pump configuration** → **Audio settings**.

Option	Descriptions/Notes	To Modify Parameter (from the General settings screen)
Keys volume	Sets the speaker volume for the auditory signal generated when users select functions and press keys on the pump.	Select Keys volume . Then, select Low, High or Off .
Alarm volume	Sets the speaker volume for the auditory alarm signal. Options are Maximum or Minimum. When the option is set to Minimum, messages are provided with a visual signal only. Alarm levels 1, 2 and 3, and the 'Infusion Complete' message are provided with a visual signal and the lowest auditory signal permitted, according to IEC 60601-1-8. Maximum alarm volume is 70 dB. Minimum alarm volume is 56 dB. Note: Auditory alarm signal sound levels, which are less than ambient levels, can impede operator recognition of alarm conditions. For more information about messages and alarms, refer to Chapter 10: Alarms and Troubleshooting on page 244.	Select Alarm volume . Then, select Maximum or Minimum .

Option	Descriptions/Notes	To Modify Parameter (from the General settings screen)
Bolus Handle	Sets the Bolus auditory signal, generated when the bolus handle is pressed. When the option is set to Always On, an auditory signal is generated each time the bolus handle is pressed. When set to When Bolusing, an auditory signal is generated, when the bolus handle is pressed and bolus is available.	Select Bolus Handle . Then, select Always On or When Bolusing .

Configuring General Settings

The General settings menu allows you to view basic pump settings, and modify them according to clinical requirements. Only users with authorization levels of High or Technician have access to this menu.

> To access the General settings menu:

- From the toolbar of the Start Up screen, select **Options**. Then, select **Pump configuration** → **General settings**.

Option	Descriptions/Notes	To Modify Parameter (from the General settings screen)
Current CCA	Used to select the CCA to which the pump should be set. Appears only when Drug Library is loaded. For more information, refer to Clinical Care Area (CCA) on page 235.	Select Current CCA . Choose the appropriate CCA; then, from the Attention screen press OK .
Start Up config.	Set the configuration of the Start Up screen. For more information, refer to Start Up Configuration Menu on page 206.	Refer to Start Up Configuration Menu on page 206.

Option	Descriptions/Notes	To Modify Parameter (from the General settings screen)
Authorization level	Sets the authorization lock level of the pump. For more information, refer to Managing Authorization Levels on page 220.	Select Authorization level . Then, enter a password and select Low , Medium , High or Tech .
Allow delayed start	Enables users to start an infusion at a later time. The user may either define a specific delay period, or set the pump to Standby. For more information, refer to Using the Set Delay Feature on page 227.	Select the Allow delayed start row, to toggle the option between On and Off .
Set prime volume	The amount of fluid used to prime the administration set when automatic priming is performed. The acceptable range is 2 to 25 mL.	Select Set prime volume . Then, using the keypad, enter the desired value → OK .
Backlight	Allows the user to set the degree of screen brightness for a running infusion. Backlight can also be modified during a running infusion. The Off and Partial options of this feature save power and promote longer battery life.	Select Backlight . Then, select On , Off or Partial .
Prime Reminder	Enables a reminder for the user to prime the administration set before starting an infusion. For more information, refer to Automatic Priming Using the Pump on page 88.	Select the Prime Reminder row, to toggle the option between On and Off .

Option	Descriptions/Notes	To Modify Parameter (from the General settings screen)
Advanced Bolus	<p>Allows users to program a bolus by entering rate, amount and time. When this option is disabled, the bolus is programmed by amount only, and the rate is the default bolus rate. The option is available only when Allow Bolus is enabled (by a Technician authorization code). Applicable only for the Continuous delivery mode.</p> <p>For more information, refer to Administering a Bolus on page 108.</p>	<p>Select the Advanced Bolus row, to toggle the option between On and Off.</p>
Bolus Reminder	<p>Enables a reminder for the user to connect the bolus handle before starting a PCA, PCEA or PIEB infusion that includes patient boluses. The reminder:</p> <ul style="list-style-type: none"> • Instructs to connect the bolus handle directly to the pump. • Checks functionality – bolus press is recognized by the pump. 	<p>Select the Bolus Reminder row, to toggle the option between On and Off.</p>
Auto P. lockout	<p>Enables/disables Patient Lockout, a safety feature that requires password entry to make any parameter changes. When the option is enabled, Patient Lockout is activated automatically as the infusion begins (Activating Patient Lockout on page 193).</p>	<p>Select the Auto P. Lockout row, to toggle the option between On and Off.</p>

Option	Descriptions/Notes	To Modify Parameter (from the General settings screen)
Screen Saver	<p>Enables/disables a far-view display of the main infusion parameters during a running infusion. These include drug information, delivery mode (color indication), infusion rate, and the phase (dose, continuous rate etc.). The screen saver appears 30 seconds after the infusion program has started, and the pump has not been touched.</p> <p>The screen saver will not appear in the following cases: Delayed start, end of infusion KVO, or during a Bolus delivery. The screen saver will disappear in the following cases:</p> <ul style="list-style-type: none"> • Alarm – screen will revert to the alarm screen • Touching the screen – screen will revert to the Running screen • Infusion is paused – screen will revert to the Paused screen. 	<p>Select the Screen Saver row, to toggle the option between On and Off.</p>

Start Up Configuration Menu

> **To access the Start Up Configuration menu:** From the toolbar of the Start Up screen, select **Options**. Then, select **Pump configuration** → **General settings** → **Start Up Config**

Option	Descriptions/Notes	To Modify Parameter (from the General settings screen)
Repeat last infusion	Allows the user to start infusions, using the same infusion parameters for the same patient. When the option is enabled, the Repeat Last Infusion button appears on the pump Start screen. For more information, refer to Repeating Last Infusion on page 186.	Select the Repeat Last Infusion row, to toggle the option between On and Off .
PreProgram	Allows the user to start an infusion using predefined infusion parameters. When the option is enabled, the PreSet Programs button appears on the pump Start Up screen. For more information, refer to Creating and Editing PreSet Programs on page 224.	Select the PreProgram row, to toggle the option between On and Off .

Defining Regional Parameters

The Regional menu controls date, time, language and US format settings. Only users with authorization levels of High or Technician have access to this menu.

> **To access the Regional menu:**

- From the toolbar of the Start Up screen, select **Options**. Then, select **Pump configuration** → **Regional**.

The following procedures explain how to configure settings from the Regional menu.

> **To set the date:**

1. Select the **Date** frame.
2. Using the keyboard, enter values (2 digits each) for the day, month, and year. (When US format is set, the order is month, day, and year.)
3. To confirm the new settings, press **OK**.

> **To set the time:**

1. Select the **Time** frame.
2. Using the keyboard, enter values (2 digits each) for the hour and the minute.
3. If necessary, switch the time units from AM to PM or vice versa, by pressing the **AM/PM** function key. (This step is relevant only when U.S. format is set.)
4. To confirm the new settings, press **OK**.

> **To set the language:**

1. Select the **Language** frame.
2. Select the desired language.



In some pumps, only the default language is listed.

3. To confirm the new settings, press **OK**.

> **To set the US format:**

1. Select the **US format** frame.
2. Toggle the settings between **On** and **Off**
3. To confirm the new settings, press **OK**.



The date will appear in month/day/year format and time will appear 12 hour format (am/pm) when this setting is toggled On.

Testing System Function

The Test system menu allows you to test basic system functionalities. Only users with authorization levels of High or Technician have access to this menu.

> To access the Test system menu:

- From the toolbar of the Start Up screen, select **Options**. Then, select **Pump configuration** → **Test system**.

Option	Descriptions/Notes
Speaker high	<ul style="list-style-type: none">• On: High volume auditory signal sounds.• Off: No auditory signal.
Speaker low	<ul style="list-style-type: none">• On: Low volume auditory signal sounds.• Off: No auditory signal.
Alarm LED	<ul style="list-style-type: none">• On: The red (Alarm) LED is lit.• Off: The red (Alarm) LED is not lit.
Charge LED	<ul style="list-style-type: none">• On: The yellow (Charge) LED is lit.• Off: The yellow (Charge) LED is not lit.
Running LED	<ul style="list-style-type: none">• On: The green (Run) LED is lit.• Off: The green (Run) LED is not lit.
Door sensor	<ul style="list-style-type: none">• Closed: The safety door is closed.• Opened: The safety door is open.
Bolus handle	<ul style="list-style-type: none">• Released: The handle is not pressed.• Pressed: The handle is pressed.

View Menu

The View menu provides access to current pump settings and lists of events that are audited by the system. The main categories are:

Category	Description/Notes
View system	Provides a view of the current system settings, and allows updating selected settings. For more information, refer to Viewing System Parameters on page 210.
Event log	Provides a view of the events recorded by the system; such as authorization level change, programming infusion parameters, activated alarms etc. For more information, refer to Viewing the Event Log on page 213.
Delivery history (PCA, PCEA and Epidural Intermittent delivery modes only)	Provides a view of the boluses and the total amount of medication delivered during a PCA, PCEA or PIEB infusion. The delivery history is associated with a patient. For more information, refer to Viewing Delivery History on page 215.

> To access the View menu from the Start Up screen:

1. From the toolbar of the Start Up screen, select **Options**.
2. On the Options screen, select **View**.

> To access the View system screen from the Running screen:

1. From the toolbar of the Running screen, select **View/Edit**.
2. From the toolbar of the View/Edit screen, select **View system**.

Viewing System Parameters

The View system screen allows you to view current system settings and infusion parameters, and update selected settings. You can navigate through the pages of settings, by pressing the **Next** and the **Back** function keys.

The following settings appear in all delivery modes:

Setting	Description/Notes
Infusion Values	Displays all the programmed parameters of the current infusion, including rate in mL/h. Applicable only on an active infusion, or during Standby. Pressing > displays the parameters.
Alarm volume	The volume of the auditory alarm signal (Maximum or Minimum). The setting can be modified by pressing >, and then selecting a setting.
Occlusion	The level of downstream pressure that triggers an occlusion alarm. For more information, refer to Managing Alarm Settings on page 198. The setting can be modified by pressing >, entering a value using the keypad, and then pressing OK .
Authorization	Current authorization lock level. For more information, refer to Managing Authorization Levels on page 220. The setting can be modified by pressing >, selecting a setting, and then pressing OK . Password entry is required to change the authorization.
Current CCA	The current CCA, as pre-selected by the user, and used for the current infusion. Appears only when Drug Library is loaded. For more information, refer to Clinical Care Area (CCA) on page 235.
Next CCA	The next CCA appears only when the Drug Library is loaded, and the user changed the CCA during an infusion. Note: The next CCA will apply only after the infusion has ended. Applicable only during an active infusion, or during Standby. For more information refer to Clinical Care Area (CCA) on page 235.

Setting	Description/Notes
Backlight	Current backlight settings. For more information refer to Configuring General Settings on page 202. The setting can be modified by pressing >; then selecting On , Partial or Off .
Accumulated VI	The cumulative volume infused (mL). The Accumulated VI can be cleared by pressing >. For more information, refer to Monitoring the Accumulated Volume Infused (Shift's Total) on page 232.
Accum. Prim. VI	The cumulative volume infused (mL) via the primary infusions. Appears in the View System menu only in the Continuous Delivery mode. For more information, refer to Monitoring the Accumulated Volume Infused (Shift's Total) on page 232.
Accum. Sec. VI	The cumulative volume infused (mL) via the secondary infusions. Appears in the View System menu only in the Continuous Delivery mode. For more information, refer to Monitoring the Accumulated Volume Infused (Shift's Total) on page 232.
VI cleared date	The date and time in which the Accumulated VI was last cleared.
VI cleared time	For more information, refer to Monitoring the Accumulated Volume Infused (Shift's Total) on page 232.
Delivery mode	Current delivery mode.
Single Air detector	These settings are associated with the amount of air that triggers an Air in Line alarm, when the air detection is enabled (ON).
Accumulated Air detector	These settings can be modified by Technicians only. For more information, refer to the Service Manual.
Accumulated Threshold	Note: While a non-epidural infusion is running at a rate of 4 mL/h or lower, the Single air detector switches automatically to On.
Air detection	This setting indicates that air detection is has been disabled (OFF) – it is displayed instead of the single and accumulated air settings mentioned above.
Date	Current date and time. For more information, refer to Defining Regional Parameters on page 206.
Time	
Software version	The software version loaded on the pump.

Setting	Description/Notes
Drug Library name	The Drug Library name appears only if the pump is loaded with a Drug Library. For more information about the Drug Library, refer to Chapter 9: Drug Library on page 234.
Drug Library published date	The Drug Library published date appears only if the pump is loaded with a Drug Library. For more information about the Drug Library, refer to Chapter 9: Drug Library on page 234.
Serial number	Serial number of the pump.
Next Certification	Date that the pump is due for the next Certification. For more information refer to the Service Manual.
Prime Volume	The total amount of volume expelled during priming throughout the treatment. The volume includes the priming volume expelled before treatment started, and any volume primed during the infusion. The Priming volume does not include VI, and does not deducted from the VTBI.
Battery status	The approximate percentage of current battery charge. Possible values are 100%, 75%, 50%, 25% , and Low Batt.
KVO	The default KVO rate set for the current delivery mode. The parameter is not relevant to Intermittent or Epidural Intermittent mode (in which the KVO is equal to the KVO/continuous rate programmed for the infusion).

Setting	Description/Notes
Bolus rate	<p>The default bolus rate set for the current delivery mode. The parameter is not relevant to the Intermittent, TPN or Multi-step modes. In continuous mode, when the Advanced Bolus option is set to On, the bolus Amount, Rate and Time can be programmed by the user, and the bolus rate will not be displayed on the View System menu.</p> <p>Default bolus rate can be modified by Technicians only. For more information, refer to the Service Manual.</p>
Secondary bolus rate	<p>The default secondary bolus rate. This parameter is relevant only for the Continuous Delivery mode. When the Advanced Bolus option is set to On, the bolus Amount, Rate and Time can be programmed by the user, and the secondary bolus rate will not be displayed on the View System menu.</p> <p>Default bolus rate can be modified by Technicians only. For more information, refer to the Service Manual.</p>

Viewing the Event Log

The Event log screen allows you to view a record of all events audited by the system. You can view a list of all events or only the events that occurred on a specific day.

> To view events that occurred on a specific day:

1. From the Options menu, select **View**.
2. On the View screen, select **Event log**.
3. On the Event log screen, select **By date**.
4. Using the keypad, enter values for the day (2 digits), the month (2 digits), and the year (2 digits). (When U.S. format is set, the order is month, day, and year.)



To navigate directly to a component of the date (e.g., day), press the component.

5. On the toolbar, press **OK**.

A list of events is displayed.



If no events occurred on the selected day, a blank screen is displayed.

> **To view all events:**

1. From the Options menu, select **View**.
2. On the View screen, select **Event log**.
3. On the Event log screen, select **All events**.

A list of events is displayed.

The Event log is sorted according to time, with the most recent event listed first. Each event is assigned a specific code. (For example, the code for the Pump Unattended alarm is 18.) The code appears in the Event log next to the time of the event.

When the row of an event is selected, the Event details frame displays the complete timestamp of the event (date and exact time), and a brief description of the event. When the pump is turned Off, or a power failure occurs, the pump shut-down is registered as an event (with a time stamp), and the event log is saved. When the number of events in the Event Log exceeds the maximum capacity, the earlier half of the event log will be cleared, in order to allow logging of new events.

Viewing Delivery History

This screen, which appears only in the PCA, PCEA and PIEB delivery modes, provides a summary of the total amount of medication delivered throughout the treatment, including all bolus-related events.



To access the Delivery History during PCA, PCEA, or PIEB infusion: From the tool bar select **View/Edit**; then, select **Edit PCEA → Delivery history**. When the pump is locked, the Delivery History can be accessed from the toolbar without unlocking the pump.

Delivery history information includes:

Name of Value	Description/Notes
Total Dose given	The total amount of drug delivered to the patient during a treatment through Boluses, Loading dose, Continuous rate, KVO if applied and Intermittent doses. When using Repeat Last Infusion, this value accumulates from the previous infusion/s.
Bolus History Period	The number of hours over which the displayed boluses occurred. The default history period is 1 hour, and it can be set from 1 hour up to the number of hours that the infusion has been running. The setting can be modified by pressing > , entering a value using the keypad, and then pressing OK .

Name of Value	Description/Notes
Patient bolus given/attempts	Total number of patient boluses delivered to the patient/ number of times that the patient requested a bolus (by pushing the button on the Bolus Handle, or by pressing the Bolus function key).
Patient Bolus given	Total amount of infusion (in mL, mg, mcg, mUnits, million Units, gram, nanogram, mmol, or mEq) given via demand boluses.
Clinician Bolus given	Total amount of infusion (in mL, mg, mcg, mUnits, million Units, gram, nanogram, mmol, or mEq) given via boluses administered by clinicians, including loading dose.
Total Bolus given	Total amount of infusion given to the patient via boluses (loading dose, clinician, patient) or intermittent doses (PIEB).
Intermittent Doses given	Total amount of intermittent doses (in mL, mg, mcg, mUnits, million Units, gram, nanogram, mmol, or mEq). Appears only when Epidural Intermittent with PCEA is programmed.
Intermittent doses Given/ Total	Total number of Intermittent doses actually given/number of Intermittent doses programmed to be administered. Appears only when Epidural Intermittent with PCEA is programmed.



When using the **Repeat Last Infusion** option (for the same patient), the Delivery History, the accumulated VI, and the lockout time are not cleared, they continue counting from the previous infusion.

Using Special Mode Options

The following sections describe options that are available only in PCA and Epidural delivery modes:

PCA Options Menu	217
Epidural Mode Options Menu	218

PCA Options Menu

The PCA options screen is accessed from the main Options menu, when the pump is in PCA delivery mode. It enables you to view and update the following parameters:

Parameter	Description/Notes
Bolus rate	The rate at which a bolus (Patient bolus, Clinician bolus and Loading dose) is delivered. The bolus rate can be set from 1 and up to 600 mL/h; the default is 125 mL/h.
Allow loading dose	Enables the user to program a loading dose (starting the infusion with a clinician bolus). Select the row to toggle the option between On and Off .
Infusion type	Defines the PCA infusion type that is available for the user: <ul style="list-style-type: none">• Continuous only – includes only a continuous rate without boluses (if enabled, a loading dose can be programmed)• Bolus only – includes only patient boluses and no continuous rate (clinician and loading dose can be given)• Continuous with Bolus – allows the user to program both continuous and patient boluses (either one of which is optional)
Limit Period	Specifies the time period to which the dose limit type is applied (during the selected time, the delivered boluses will be limited by either maximum number, or by maximum volume).

> To change the bolus rate from the PCA options screen::

1. Select the Bolus rate row.
2. Using the keypad, enter the value for the new bolus rate → **OK**.

3. To save the change in the system, press **OK**.

Epidural Mode Options Menu

The PCEA options and Epi Int options screens are accessed by pressing the **Options** function key when the pump is in PCEA or Epidural Intermittent delivery modes, respectively. These screens enable you to view and update the following parameters:

Parameter	Description/Notes
Bolus rate (PCEA mode only)	The rate at which a bolus (Patient bolus, Clinician bolus and Loading dose) is delivered. Options are 125 or 200 mL/h; the default rate is 125 mL/h.
Password request	Enables a safety feature that requires a high authorization level password entry for programming and editing actions.
Allow loading dose (PCEA mode only)	Enables the user to program a loading dose (starting the infusion with a clinician bolus). Select the row to toggle the option between On and Off .
Infusion type (PCEA mode only)	Defines the PCEA infusion type that is available for the user: <ul style="list-style-type: none">• Continuous only – includes only a continuous rate without boluses (if enabled, a loading dose can be programmed)• Bolus only – includes only patient boluses and no continuous rate (clinician and loading dose can be given)• Continuous with Bolus – allows the user to program both continuous and patient boluses (either one of which is optional)
Dose rate (Epi. Int mode only)	The rate at which an Intermittent dose is delivered. Options are 125 or 200 mL/h; the default rate is 125 mL/h.
Limit Period	Specifies the time period to which the dose limit type is applied (during the selected time, the delivered boluses are limited by either maximum number, or by maximum volume).
PIEB (Epi. Int mode only)	Enables the user to program a PIEB infusion.

This page is left intentionally blank

Chapter 8: Using Advanced Features

This chapter explains how to work with less frequently used pump features. The following options are generally reserved for more advanced pump users:

Managing Authorization Levels	220
Password Re-entry	223
Creating and Editing PreSet Programs	224
Using the Set Delay Feature	227
Using the New Patient Feature	231

Managing Authorization Levels

To help ensure patient safety, the Sapphire pump can be set to one of four authorization levels. Authorization levels control access to the programming options available in the pump. Each level allows users to access a different set of pump actions and programming options.

Authorization levels are modular. Therefore, users with a given authorization level can access actions available to their level, plus all actions available to users with lower authorization levels. The levels are:

- **Low:** All programming options are disabled, and no settings can be changed.
- **Medium:** Basic programming options, such as using shortcuts to start infusions, are enabled.
- **High:** All tasks and configuration settings are enabled, except for options limited to technician use.
- **Technician:** All settings are enabled. This level is restricted to technicians and developers only.



Passwords are defined by technician or loaded with the Drug Library.

Specific actions allowed in each of the authorization levels are listed in the following table.

Authorization Level	Allowed Actions
Low	<ul style="list-style-type: none"> Stop the pump, and then continue the infusion Power the pump On and Off Administer patient bolus Use the View menu Activate immediate taper-down during TPN infusion, using the taper-down period defined by the clinician
Medium	<ul style="list-style-type: none"> Stop the pump, and then continue the infusion Start infusions using the PreSet Programs feature Start infusions using the Repeat Last Infusion feature Priming with the pump Edit Rate during running infusion (the option must be enabled prior to the infusion by an authorized Technician) View bolus rate (PCA options) Activate immediate taper-down during TPN infusion, and set the time for it Use the Set Delay feature
High	<ul style="list-style-type: none"> Start infusions using the New Infusion feature View/Edit parameters Use the Pump Configuration menu Create/Edit PreSet programs (requires a unique password) Use of all PCA, PCEA and PIEB options Changing delivery mode (requires password re-entry) Clinician bolus
Technician	All

When the pump is turned Off, the authorization lock level setting is saved. Therefore, the lock level set most recently is maintained when the pump is turned back On.



If the pump is turned Off in Technician mode, the pump turns back On in a High authorization level.

The current authorization lock level can be viewed via the Options menu. When an infusion is running, the lock level can be accessed via the Running screen.

> **To view the current authorization lock level from the Options menu:**

- From the Options menu, select **View** → **View system**.
The Authorization parameter is displayed.

> **To view the current authorization lock level via the Running screen:**

1. From the toolbar of the Running screen, press **View/Edit**.
2. From the View/Edit screen, select **View system**.
The Authorization parameter is displayed.

Setting Authorization Lock Levels

Users with an authorization level of High can reset the authorization lock level of the pump.

> **To change authorization level from a lock level of High:**

1. From the Options menu, select **Pump configuration** → **General settings**.
2. Select **Authorization level**. Then, using the keypad, enter the High level password → **OK**.



Because only High and Tech authorization levels can change the authorization level on the pump, a high or technician password is required to access this setting. Entering a Medium or Low level password generates an error message.

The authorization level matching the entered password, as well as all levels below it, are listed on the Main Display.

3. Select the authorization level at which you want to lock the pump. Then, from the Attention screen, press **OK**.
4. To exit the Options menu, press **OK**.

> **To change authorization level from a lock level of Medium or Low:**

1. From the Options menu, select **Pump configuration**.
2. On the Password screen, using the keypad, enter the High level authorization password. Then, from the toolbar, press **OK**.
3. To exit the Options menu, press **Exit**.



Do not disclose the passwords of authorization levels Medium, High or Technician to patients, home users or any other unauthorized user.

Password Re-entry

The Sapphire pump is designed to prevent inadvertent parameter changes, or actions other than those permitted by the currently set authorization level. As a safety measure, the pump will prompt the user to re-enter the High level password before performing the following actions:

- Changing delivery modes
- Changing authorization levels



Entering a High level authorization password allows access to these actions, even if the pump is set at a Medium or Low authorization lockout level.

A password entry is also required to unlock the screen when the Auto Patient Lockout feature is enabled. The authorization level of the password entered sets the authorization lockout level of the pump.

Creating and Editing PreSet Programs

The PreSet Programs feature allows users to start infusions using predefined infusion parameters, thus eliminating the need for programming. Each delivery mode can support its own set (of up to 10) predefined infusion programs. Only the infusion programs set for the currently selected delivery mode are displayed (a preset program is available for use and edit only when the pump is set to the delivery mode in which the program was saved).



For the PreSet Programs function to appear in the Start Up screen, the pump needs to be configured to the PreProgram setting. For more information, refer to [Start Up Configuration Menu](#) on page 206.

The following procedures explain how to create, edit and delete preset programs.



Creating and Editing preset programs can be done only by High and Technician authorization levels, and in addition require a unique password.

A PreSet program will be available for creating, using and editing only when the program settings are consistent with the current pump settings, and drug availability in the current CCA (for example, when creating a PCA PreSet program while the pump is set to Continuous + Bolus infusion type, this program can be used only when the pump is configured to Continuous + Bolus and not when the pump is configured to Continuous only or Bolus only).



Exception: a PreSet program created with Drug amount and Diluent volume, will be available for creating, using and editing, regardless of Calculate concentration setting.

> To create a new preset program:

1. From the Indicators Bar, verify that the pump is in the desired delivery mode.
2. From the Start Up screen, select **PreSet Programs**.
3. From the toolbar, press **Create New**.
4. Using the keypad, enter the appropriate password; then, press **OK**.

5. Using the keypad, enter a relevant name for the new program.
 - To enter the second character that appears on a key, press the key twice. (Press 3 times to enter the third character, etc.)
 - To enter a space, press the **0** (zero) key once.
 - To clear the most recently entered character, press the backspace key (left arrow key at the lower right corner of the keypad).
 - To clear all entered characters, press **Clr**.
 After entering the name, press **OK**.
6. Set the relevant infusion parameters. Refer to the following table for more information about setting parameters in each mode.

Delivery Mode	Refer to:
Continuous	Starting a Continuous Infusion on page 95
Intermittent	Starting an Intermittent Infusion on page 138
TPN	Starting a TPN Infusion on page 132
Multi-step	Starting a Multi-step Infusion on page 122
PCA	Starting a PCA Infusion on page 149
Epidural	Starting a PCEA Infusion on page 162 or Starting an Epidural Intermittent Infusion on page 174



The PIEB option is not available when creating and editing a PreSet program.

7. Review the parameters displayed on the screen.



Verify that the parameters reflect the correct treatment according to the prescription.

Then, press **OK**. The program is saved.

8. To return to the PreSet programs screen, press **OK**.

> **To edit a preset program:**

1. From the Indicators Bar, verify that the pump is in the desired delivery mode.
2. From the Start Up screen, select **PreSet Programs**.
3. From the toolbar of the PreSet Programs screen, press **Edit**.
4. Using the keypad, enter the appropriate password; then, press **OK**.
5. From the list, select the program that you want to update.
6. Select the box of the parameter that you want to change. Using the keypad, enter the new parameter, and then press **OK**.



If relevant, the pump will prompt you to confirm or update other parameters that may need to be modified, based on the change made. The name of the program, drug name, drug concentration and patient weight cannot be modified.

7. Repeat Step 6 , until all relevant parameters are updated as required.
8. Review the parameters displayed on the screen.



Verify that the parameters reflect the correct treatment according to the prescription.

Then, press **OK**. The program is saved.

> **To delete a preset program:**

1. From the Indicators Bar, verify that the pump is in the desired delivery mode.
2. From the Start Up screen, select **PreSet Programs**.
3. From the toolbar of the PreSet Programs screen, press **Edit**.
4. Using the keypad, enter the appropriate password; then, press **OK**.
5. From the list, select the program that you want to delete.
6. From the toolbar, press **Delete**.
7. From the toolbar of the Attention screen, press **OK**.
The program is deleted.

Using the Set Delay Feature

The Set Delay feature allows users to program an infusion in advance. When the option is enabled, the Set Delay option appears on the Start screen. The users can then choose to set the infusion to Standby for an unlimited time period, or to set the infusion for a defined Delayed Period, after which one of the following occurs:

- If the KVO was used during the delay period, the pump starts the infusion automatically.
- If the KVO was not used during the delay period, the alarm for the clinician sounds to start the infusion.



For the Set Delay option to appear on the Start screen, the pump needs to be configured with the **Allow delayed start** setting enabled. For more information, refer to [Configuring General Settings](#) on page 202.

> To program an infusion using the Standby option:

1. Set the relevant infusion parameters. Refer to the following table for more information about setting parameters in each mode.

Delivery Mode	Refer to:
Continuous	Starting a Continuous Infusion on page 95
Intermittent	Starting an Intermittent Infusion on page 138
TPN	Starting a TPN Infusion on page 132
Multi-step	Starting a Multi-step Infusion on page 122
PCA	Starting a PCA Infusion on page 149
Epidural	Starting a PCEA Infusion on page 162 or Starting an Epidural Intermittent Infusion on page 174

2. From the Start screen, select **Set Delay**.
3. From the Delayed Start screen, select **Standby**.
4. The Standby screen is displayed.

Throughout the Standby period, the following information appears on the screen:

- **Drug Name:** The name of the selected drug. Displayed on the indicators bar, when working with a Drug Library.
- **Concentration:** Drug concentration as entered by the user (Final concentration or Drug Amount / Diluent Volume). Displayed when applicable.
- **Rate:** Programmed infusion rate. For all dose units other than mL/h, the calculated rate will be displayed in mL/h, both in the View system menu and in the Running screen.
- **VTBI:** Total volume left to be infused. This parameter remains constant throughout the Standby period.
- **VI / Total:** Total volume that has been infused in the current infusion / the VTBI value programmed. These parameters remain constant throughout the Standby period.
- **Time left:** Time remaining until the end of the current infusion. This parameter remains constant throughout the Standby period.



During Standby, Pump unattended alarm will not be active.



To view all of the current infusion programmed parameters, from the Standby screen, press **View/Edit** → **View system** → **Infusion Values**.



When in Standby, the pump can be turned Off without losing the infusion parameters. To resume infusion, refer to [Resuming Infusions After Pump Shutdown](#) on page 189.



To abort Standby and the infusion, from the toolbar, press **End Standby**; then, from the Confirm screen, press **Exit**. The Start Up screen will appear.

> **To start an infusion from the Standby state:**

1. Press **End Standby**.
2. Review the parameters displayed on the Confirm screen.



Verify that the parameters reflect the correct treatment according to the prescription.

Then, press **OK**.

3. Make sure that the clamps on the administration set are open; then, press **Start**. The Running screen is displayed, and the infusion begins.

> **To program an infusion using the Delay Period option:**

1. Set the relevant infusion parameters. Refer to the following table for more information about setting parameters in each mode.

Delivery Mode	Refer to:
Continuous	Starting a Continuous Infusion on page 95
Intermittent	Starting an Intermittent Infusion on page 138
TPN	Starting a TPN Infusion on page 132
Multi-step	Starting a Multi-step Infusion on page 122
PCA	Starting a PCA Infusion on page 149
Epidural	Starting a PCEA Infusion on page 162 or Starting an Epidural Intermittent Infusion on page 174

2. From the Start screen, select **Set Delay**.
3. From the Delayed Start screen, select **Delay Period**.
4. Using the keypad, enter the desired delay period (h:min); then, press **OK**.

5. Specify whether or not to run the infusion in a KVO, during the delay period:



If KVO rate is pre-configured to 0 mL/h for the delivery mode, from the Start screen, select **Start with Delay**. (Refer to **Do not use KVO:** below)

- **Use KVO:**

Press **Yes** → **Start with Delay**. The infusion begins with a KVO rate. When the delay period is over, the programmed infusion begins immediately.



Pressing **Start** during the delay period begins the infusion immediately (overriding the delay period).

- **Do not use KVO:**

Press **No** → **Start with Delay**.

On the Delayed Start screen, the words No KVO appear in the Rate frame, and a time countdown for the delay period is displayed in the Time frame.



To override the delay period, from the toolbar, press **Skip delay**. Then, from the Start screen, press **Start**.

When the delay period is over, an alarm sounds.

6. To begin the infusion, verify that the clamps on the administration set are open, and press **OK**; then, press **Start**.



When a KVO rate is not used during the delay period, the infusion does not begin automatically when the delay period is over. You need to begin the infusion manually, by pressing **Start**.

Using the New Patient Feature

The Sapphire pump allows you to associate infusions to a specific patient. When the New Patient feature is enabled, and either a New Infusion or a PreSet program is selected, the pump will prompt you to indicate whether the infusion to be programmed is for a new patient or not. When selecting Repeat Last Infusion the New Patient screen will not appear, and the pump will indicate that the infusion to be repeated will be used for the last patient selected.



The New Patient feature can be enabled/disabled by technicians only.

When a new patient is selected, entries associated with the patient can be tracked in the Event Log ([Viewing the Event Log](#) on page 213). In addition, when Repeat Last Infusion is used, the pump calculates the accumulated volume infused (**Accumulated VI**) for all infusions associated with the patient and the **Delivery History**. When a new patient is selected, the Accumulated VI and Delivery History values are automatically cleared (for more information, refer to [Monitoring the Accumulated Volume Infused \(Shift's Total\)](#) on page 232).

The current accumulated Delivery history can be viewed via the Options menu. When an infusion is running, the Delivery History can be accessed via the View/Edit soft key in the toolbar (for more information, refer to the [Viewing Delivery History](#) on page 215).

> To select a New Patient:

1. From the Start Up screen, select **New Infusion** or **PreSet Programs**.
2. On the New Patient screen, select **Yes**.

Monitoring the Accumulated Volume Infused (Shift's Total)

The Sapphire pump calculates the Accumulated Volume Infused (Accumulated VI) for all infusions associated with a specific patient.

The accumulated VI includes the volume infused to a specific patient via infusions (including primary, secondary etc.), Boluses and KVO (if applied during delayed Start or post infusion). This allows the clinical staff to monitor the total volume infused to a specific patient. The Accumulated VI can be cleared during infusion or before starting another infusion (for more information, refer to [Clearing Accumulated VI](#) on page 233).

The date and time in which the Accumulated VI was cleared is also captured.

The Sapphire pump also provides the volume infused in the current running infusion (VI), including KVO if applied, during a delayed start period. This VI is presented on the running screen as well as in the message given at the end of the infusion. Clearing the Accumulated VI automatically clears the VI.

Viewing Accumulated VI

The Accumulated VI value can be viewed before programming an infusion via the Options menu, or during a running infusion via the View/Edit and View System menus.

> To view the current Accumulated VI value from the Options menu:

1. From the **Options** menu, select **View** → **View system**.
2. From the toolbar of the View system screen, press **Next** until the Accumulated VI parameter is displayed.

> To view the current Accumulated VI value during infusion via the View/Edit menu:

1. From the toolbar of the Running screen, press **View/Edit**.

The Accumulated VI value is presented in the Clear Accum. VI box.

> To view the current Accumulated VI value during infusion via the View System menu:

1. From the toolbar of the Running screen, press **View/Edit**.
2. From the View/Edit screen, select **View system**.

3. From the toolbar of the View system screen, press **Next** until the Accumulated VI parameter is displayed.



In addition to the Accumulated VI value, when using the Continuous delivery mode, the View System screen also presents the Accumulated Volume Infused via the primary line (Accum. Prim. VI) and the Accumulated Volume Infused via the secondary line (Accu. Sec. VI). The View system function captures the date and time in which the accumulated VI was last cleared.

Clearing Accumulated VI

The Accumulated VI value is cleared in the following cases:

- The pump clears the Accumulated VI automatically
 - If the New Patient feature is disabled – Each time a New Infusion or a PreSet Programs is confirmed (**Note:** Repeating the last infusion won't clear the Accumulated VI).
 - If the New Patient feature is enabled – Each time a new patient is identified (**Note:** Repeat Last Infusion is intended for the same patient; this means that a new patient can't be identified when using the Repeat Last Infusion shortcut).
- The user clears the Accumulated VI
 - During infusion via the View/Edit screen. This will reset the total volume infused for all infusions associated with a specific patient to 0 mL.



The date and time in which the accumulated VI was cleared is captured and can be viewed in the View System menu.

> To clear the Accumulated VI value during infusion:

1. From the toolbar of the Running screen, press **View/Edit**.
2. From the View/Edit screen, press **Clear Accum. VI**.
3. From the Clear Accum. VI screen, press **Yes** to clear the Accumulated VI.

Chapter 9: Drug Library

The following sections explain about the Drug Library unique features, and describe how to operate the pump in the different delivery modes using the Drug Library:

Overview	234
Clinical Care Area (CCA)	235
Programming a New Infusion with the Drug Library	239
Soft Limit	241
Update a New Drug Library Version	242

Overview

The Drug Library contains information about customized groups of drugs and Clinical Care Areas (CCA) that were approved and saved by qualified and authorized local hospital personnel, using the Eitan Medical Drug Library Editor.

The Drug Library is identified by a Drug Library name and publish date, both displayed on the View system menu. The Drug Library name is also displayed on the Sapphire when the pump turns On.

The Drug Library functions as an error-reduction tool, thus enabling safer practice.

The Drug Library displays for each drug its available concentrations and allowed range (hard limits) of various infusion parameters, such as continuous rate and bolus amount. In addition, it contains the recommended range (soft limits) of these infusion parameters.

The information about customized groups of drugs may be specific to a CCA, or may apply to an entire institution.

The limits set in the Drug Library create a guiding range, thus reducing infusion errors. The pump alerts users when the programmed values exceed the recommended range (soft limits), and prohibits programming of values that exceed the allowed range (hard limits).

The complete detailed information about the Drug Library is available in the Drug Library Editor Software. For more information refer to Drug Library Editor user manual.

Clinical Care Area (CCA)

The Drug Library accommodates of up to 40 CCAs, and up to 8,500 unique drug profiles. Each CCA can accommodate up to 1000 drug profiles, and each unique drug profile can be assigned to more than one CCA, i.e. up to a total of 40,000 medications. The CCA unique configuration is set by the Drug Library. Local configuration made when a Drug Library is loaded remains valid until the user selects a CCA or turns the pump Off.



CCA settings do not include TPN specific settings; TPN hard limits and KVO can be set locally by a technician only.



When Resuming an infusion after pump shutdown, local configurations will remain until the end of the current infusion.

Changing a CCA

CCA selection is available in the following cases:

- When the pump is turned On
- When the pump is idle, from the General Settings menu
- During a running infusion (the selected CCA will apply after the infusion has completed)

The name of the selected CCA is displayed on the Indicators Bar above the screen title.

Selecting a CCA when pump is turned On

When a Drug Library is loaded, a message is displayed, asking to accept or change the current CCA.

> To accept or change a CCA:

1. Turn the pump On.
2. From the Clinical Care Area screen select whether to **Accept** or **Change** the current clinical care area:

- To accept the current CCA, press **Accept**.
The Start Up screen appears.
 - To change the current CCA, press **Change**.
 - From the Choose CCA screen, select the relevant CCA.
-



To display additional CCAs press **Next**.

- a. From the Attention screen, press **OK**.
-



In case the current delivery mode is unavailable in the selected CCA, the pump will prompt the user to change the delivery mode.

The Start Up screen appears.



CCA selection should be selected according to local facility procedures.



If a message regarding resuming previous infusion appears upon turning the pump On, refer to [Resuming Infusions After Pump Shutdown](#) on page 189.

Selecting a CCA from the General Settings

> To change the current CCA:

1. From the toolbar of the Start Up screen, press **Options**; then, select **Pump configuration** → **General Settings**.
 2. Select the **Current CCA** row.
 3. From the Choose CCA screen, press the row of the relevant CCA.
-



To display additional CCAs press **Next**.

4. To confirm the selected CCA, press **OK**.

The Start Up screen appears.



Selecting a CCA should be conducted according to local facility procedures.



The Repeat Last Infusion option will be unavailable (grayed out) after the CCA is changed.

Changing a CCA during a running infusion



When changing the CCA during a running infusion, the CCA will change only after the infusion has completed. The selected CCA name will appear in the indicators bar, two arrows on either side.

> To change a CCA during a running infusion:

1. From the Running screen press **View/Edit**.
2. From the View/Edit screen, select **View system**.
3. Select the **Current CCA** row.
4. From the Choose CCA screen, select the row of the relevant CCA.



To display additional CCAs press **Next**.

5. From the Attention screen, confirm the selected CCA, and press **OK**.

The View/Edit screen is displayed.



To view or change the Next CCA:

- From the View/Edit screen, press **View System**.
- Press **Next CCA**.
- Select CCA from list.
Note: To display additional CCAs press **Next**.
- From the Attention screen, press **OK**.



The Repeat Last Infusion option will be unavailable (grayed out) after the CCA is changed.

-
6. To return to the running infusion, press **OK**.

Programming a New Infusion with the Drug Library

When the Sapphire pump is loaded with a Drug Library, the programming flow includes additional related steps: Drug name entry, Drug list and Drug profile. Following the drug profile selection, the user is required to enter the infusion parameters according to the delivery mode.

Drug Name

After starting a **New Infusion**, the pump displays the Drug name screen. From the Drug name screen, using the keypad, the user enters the drug name then presses **Find***.



Drug name search is not sensitive to uppercase or lowercase letters.

When the required drug is not found in the Drug Library, the user can program an infusion without a defined drug by using the **Choose General** key on the toolbar.



'Choose General' will bypass the specific drug profile limits, and the infusion will be programmed under the CCA limitations only.

Drugs List

The filtered drugs are displayed in the Drugs List screen.

The Drugs List screen displays only drugs that are available in the current CCA and delivery mode. When there are more than 4 available drugs, use the **Next** key to display additional drugs.

* The **Find** key can be used to display all available drugs when no characters have been entered (letters, numbers or symbols), or to filter drug names according to the characters entered. The number of matching drugs found is displayed at the top right corner of the main display.

Drug Profiles

The pump displays the available profiles for the selected drug. The drug profile includes concentration and defines hard limits and soft limits. Each available drug is defined by the CCA and the delivery mode to which it was assigned; a drug profile may be available in more than one delivery mode.

Each drug profile is defined by one of the following types:

1. **No concentration:** The drug concentration or diluent volume are not needed. Available drug units are: mL/h, mL/min, mL/kg/h and mL/kg/min.
2. **Diluent only:** Solutions where medication amount is not required (e.g., 100 mL). Available drug units are: mL/h, mL/min, mL/kg/h and mL/kg/min.
3. **Partial concentration:**
 - **Without Drug Amount** Only Diluent Volume is defined. The user will be asked to enter Drug Amount (e.g., __ mg/100 mL).
 - **Without Diluent Volume** Only the Drug Amount is defined. The user will be asked to enter Diluent Volume (e.g., 10 mg/__ mL).
4. **Full concentration:** Both Drug Amount and Diluent Volume are defined.

For more information about programming a new infusion with Drug Library, according to the chosen delivery mode, refer to:

To begin a new Continuous infusion with a Drug Library on page 98

To begin a new Multi-step infusion with a Drug Library on page 125

To begin a new Intermittent infusion with a Drug Library on page 143

To begin a new PCA infusion with a Drug Library on page 153

To begin a new PCEA infusion with a Drug Library on page 165

To begin a new Epidural Intermittent infusion with a Drug Library on page 177

Soft Limit

The limits set in the Drug Library create a guiding range, thus reducing infusion errors. When programming values that exceed the recommended range (soft limits), an Attention screen is displayed, showing the applicable soft limit icon, with the details of the exceeded parameter. The user can either:

- Acknowledge the message and continue with the entered value.
- Go back and enter a new value instead of the entered value.

Figure 9.1. Soft Limit Icon

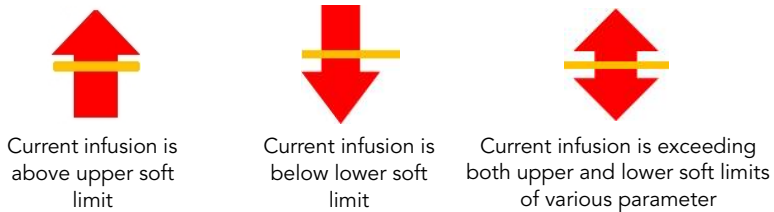

> To acknowledge the message and continue with the entered value:

From the Attention screen, press **OK** and continue programming.



When a soft limit has been exceeded, an applicable Soft Limits icon will be shown on the Sapphire pump indicators bar during infusion.

> To enter a new value instead of the entered value:

From the Attention screen, press **Back**.

Then, using the keypad, enter a new value and press **OK**.



Soft limits Attention screen and icon are applicable only when soft limits are defined in the Drug Library.

Update a New Drug Library Version

Following a Drug Library update, when the pump is turned On, the user is prompted to specify whether or not to update the Drug Library with the new available version.



Updating Drug Library should be conducted according to local facility procedures.

Updating a new Drug Library version may take a few minutes, during which the pump is inactive.

> To update a new Drug Library version:

From the Update screen, press **Yes**. The pump will start updating the Drug Library. At the end of the process the pump will restart and the user will be prompted to specify the CCA;

- If the last active CCA is available in the new Drug Library, the Clinical Care Area screen will appear. Press **Accept** and the Start Up screen will appear.
- If the last active CCA is not available in the new Drug Library, the Choose CCA screen will appear.
 - a. Select the relevant CCA.
 - b. To confirm the changed CCA, press **OK**.

The Start Up screen will appear.



If the user chooses not to update the Drug Library upon pump turn on, the Update screen will be prompted the next time the pump is turned on.

This page is left intentionally blank

Chapter 10: Alarms and Troubleshooting

The following sections describe the different types of alarms and messages that can be generated by the pump, and explain how to troubleshoot common programming issues:

Alarms Overview	244
Level 1 Alarms	245
Level 2 Alarms	246
Level 3 Alarms	247
Messages	249
Troubleshooting	251

Alarms Overview

The Sapphire pump generates four different types of alarms. The alarm types are categorized according to their effect on the infusion. In all alarm types, instructions about how to proceed (and, if relevant, to solve the problem) are displayed on the touch screen.

Alarm Type	Effect on Infusion
Level 1	Pump shuts down.
Level 2	Infusion stops and cannot be reactivated.
Level 3	Infusion stops, but may be reactivated.
Message	Infusion is not interrupted.

When Level 1, 2, and 3 alarms occur, the red Alarm LED stays On continuously, and an auditory alarm sounds continuously. These alarms require immediate attention.

The following sections provide details about each alarm type. In the lists of alarms, messages and alarms related to battery issues are shaded. Alarms related to battery problems can be prevented by adhering to the recommended guidelines for battery care ([Battery Care Information](#) on page 265).

Level 1 Alarms

This type of alarm is the highest severity alarm category. If the pump is running when the alarm occurs, the infusion stops immediately, and the pump automatically shuts down within 3 minutes. The infusion cannot be restarted or continued.

The following soft keys are available during a Level 1 alarm:

- **Mute:** Silences the auditory alarm.
- **Shutdown:** Turns Off the pump immediately.

When a Battery Depleted alarm occurs, connect the pump to an AC power supply. A pump with an Internal Error alarm needs to be evaluated by an authorized service technician.

Alarm Title	Screen Header	Displayed Text
Battery Depleted	Battery	Pump will automatically shut down in 3 minutes. Please connect pump to power.
Internal Error	Error	Pump will automatically shut down in 3 minutes. Please send the pump for service.

Level 2 Alarms

This alarm type is a high severity category. If the pump is running when a Level 2 alarm occurs, the infusion automatically stops.

The pump can be reactivated by a technician (using a technician authorization code) to retrieve infusion data and/or manage a battery problem. Pumps with Level 2 alarms need to be sent for servicing. Screen instructions are directed to technicians only.

To silence the audio signal of an alarm, press the **Mute** soft key. This silences the alarm sound for 2 minutes. If the issue has not been cleared after 2 minutes, the alarm sound will be resumed.

The following soft keys are available during a Level 2 alarm:

- **Mute:** Silences the auditory alarm for 2 minutes.
- **Unmute:** Returns the auditory alarm.
- **OK:** Displays the Paused screen. This soft key is enabled after **Mute** is pressed.

Alarm Title	Displayed Text
Mechanism Error	A pump fault has occurred. Please enter technician code to proceed.
Pump Fault	A pump fault has occurred. Please enter technician code to proceed.
Battery Reminder	End of battery life. Please contact authorized technician to replace battery.

Level 3 Alarms

This alarm type is a medium severity category that requires immediate attention. If the alarm occurs during an infusion, the infusion automatically stops. However, you may continue the infusion after the problem has been resolved. Instructions for resolution of the problem are displayed on the touch screen.

To silence the audio signal of an alarm, press the **Mute** soft key. This silences the alarm sound for 2 minutes. If the issue has not been cleared after 2 minutes, the alarm sound will be resumed.



Resolving these alarms will lead to the Paused Infusion screen. If the alarm occurs while programming a mid-infusion action, the programming process needs to be re-initiate.

Figure 10.1. Sample Level 3 Alarm Screen

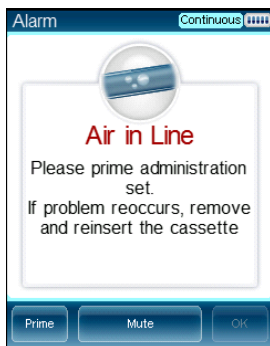

The following soft keys are available during a Level 3 alarm:

- **Mute:** Silences the auditory alarm for 2 minutes.
- **Unmute:** Returns the auditory alarm.
- **OK:** Displays the Paused screen. The infusion may then be resumed after the problem is resolved. This soft key is enabled after **Mute** is pressed.

- **Prime:** Enables automatic priming. This key appears only during an Air in Line alarm.

Alarm Title	Displayed Text
Air in Line	<p>Accumulated air in line is over the limit. Please prime administration set. If problem reoccurs, remove and reinsert the cassette.</p> <p>Please prime administration set. If problem reoccurs, remove and reinsert the cassette.</p> <p>Possible excessive environmental light. Please reduce exposure and check if priming is required.</p>
Potential Air in Line	Press OK to resolve.
Cassette Misplaced	<p>The administration cassette is not loaded or misplaced. Please reload the cassette.</p> <p>Reinsert cassette. Verify both flanges inside safety door. If problem persists contact technician.</p> <p>Remove the administration cassette, verify cassette chamber is clean, and correctly reinsert it. If alarm reoccurs please contact authorized technician.</p>
Check for Occlusion	Please verify clamps are open and set is not occluded.
Downstream Occlusion	To clear occlusions verify: 1. Clamps are open; 2. Administration cassette is properly positioned; 3. Line is not kinked; 4. No occlusion at the output connection. If all occlusions were cleared press OK to continue.
Pump Stopped	Please quit and restart the infusion.
Flow Error	Verify that the administration cassette is correctly positioned and battery is sufficiently charged. If alarm reoccurs contact authorized technician.
Occlusion	To clear occlusions verify: 1. Clamps are open; 2. Administration cassette is properly positioned; 3. Line is not kinked; 4. No occlusion at the output connection. If all occlusions were cleared press OK to continue.
Upstream Occlusion	To clear occlusions verify: 1. Clamps are open; 2. Administration cassette is properly positioned; 3. Line is not kinked; 4. No occlusion at the output connection. If all occlusions were cleared press OK to continue.

Alarm Title	Displayed Text
Insufficient Battery	Low battery voltage for current rate. Please connect pump to power supply.

Messages

A Message indicates a condition of medium severity that you should attend to as soon as possible. When a Message occurs, an auditory alarm sounds, and the condition that triggered the message (and recommended actions, if relevant) is displayed on the touch screen.

To silence the audio sound of a message, press the **Mute** soft key. This silences the message sound for 2 minutes. If the issue has not been cleared after 2 minutes, the alarm sound will be resumed.

Figure 10.2. Sample Message Screen

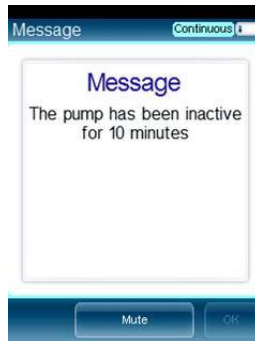

If a message is displayed during infusion, the infusion continues, and the system continues to operate. The following soft keys are available:

- **Mute:** Silences the auditory alarm for 2 minutes.

- **Unmute:** Returns the auditory alarm.
- **OK:** Confirms the message, and returns the display to the previous screen. If the infusion is complete, the pump returns to the Start Up screen. This soft key is enabled after **Mute** is pressed.

If the alarm volume is configured to minimum in the Alarms menu, the OK soft key will always be enabled.

Screen Header	Displayed Text
Low Battery	30 minutes left to battery depletion. Connect pump to power supply.
Message	Battery life will expire in 2 days. Please contact authorized technician. The battery could not be fully charged - please check power supply. Door open. Check administration cassette position and close the safety door. Infusion complete. Infusion near end. The pump has been inactive for <xx> minutes. System temperature is out of range. If the alarm reoccurs please contact authorized technician. Please Wait. Possible Downstream Occlusion. The pump is attempting to restart; press exit to cancel.

Troubleshooting

The following table lists some common programming issues, and explains how to solve them.

Problem	Probable Cause	Solution
Programming cannot be completed. The OK function key is disabled, and the parameter range is in red font.	The parameter entered is outside of the safety range calculated by the pump.	Verify the prescription, and obtain a new one if necessary. Enter infusion parameters within the permitted ranges.
The Set Delay option does not appear on the Start screen.	The option is not enabled.	Enable the Allow delayed start setting (Configuring General Settings on page 202). High Authorization level is required.
The PreSet Programs option does not appear on the Start Up screen in any mode.	The option is not enabled.	Enable the PreProgram setting (Start Up Configuration Menu on page 206). High Authorization level is required.
The Repeat last infusion option does not appear on the Start Up screen in any mode.	The option is not enabled.	Enable Repeat Last infusion setting (Start Up Configuration Menu on page 206). High Authorization level is required.
Loading dose cannot be programmed in PCA or PCEA mode.	The option is not enabled.	Enable the Allow loading dose setting (PCA Options Menu on page 217 or Epidural Mode Options Menu on page 218). Authorization level of High is required.
Pump becomes locked whenever an infusion starts.	The Auto Patient Lockout feature is enabled.	Disable the Auto P. Lockout option (Configuring General Settings , page 204). High Authorization level is required.

Problem	Probable Cause	Solution
A password needs to be entered to change any parameter in Epidural mode.	The Password Request feature is enabled.	Disable the Password request setting (Epidural Mode Options Menu on page 218). Authorization level of High is required.
Grey-buttoned bolus handle is not responding.	The gray-buttoned bolus handle has become disconnected from the pump, or the grey-buttoned bolus handle is connected to the mini cradle together with a communication cable.	<ul style="list-style-type: none"> ● Reconnect the bolus handle to the pump. ● Disconnect the communication cable from the mini cradle.
Blue-buttoned bolus handle is not responding.	The handle has become disconnected from the pump, or the blue-buttoned bolus handle is being used, and is connected to the mini cradle instead of to the pump.	Reconnect the bolus handle to the pump.
The Bolus button does not appear in the toolbar during a Continuous infusion.	The Allow Bolus feature is not enabled.	<ul style="list-style-type: none"> ● Enable the Allow Bolus setting. Technician Authorization level is required. For more information refer to the Service Manual. ● The drug profile in the Drug Library was not configured to support a bolus.
Communication error while pressing the bolus handle button.	The Bolus handle button was pressed during pump start up.	Disconnect the bolus handle from the pump, turn the pump off, and reconnect the bolus handle after turning the pump On.

Problem	Probable Cause	Solution
Pump is not charging.	<ul style="list-style-type: none"> • The power supply has become disconnected from the mini cradle. • The power supply was connected to the pump during pump turn-off. • The power supply is not working. 	<ul style="list-style-type: none"> • Verify the power supply is connected to the mini cradle splitter. • Disconnect and reconnect the power supply to the pump. • If the power supply is not functioning properly, replace it.
Recurring Air in Line alarms.	Treatment is near end, or the air detection settings are too sensitive.	Close clamps, remove administration cassette from pump and prime (flush) the set manually. If the issue is not resolved, replace the administration set. If the issue is still not resolved, have a technician review and adjust the air detection settings.
Recurring Occlusion alarms.	The occlusion issue has not been properly resolved.	<ul style="list-style-type: none"> • Close clamps, remove administration cassette from pump, disconnect patient and prime (flush) the set manually. • Replace the administration set. • Change the infusion site.
Occlusion alarm is triggered immediately after the infusion or bolus starts, or rate is increased.	The backpressure caused by the catheter used for the treatment, at the programmed rate, is too high.	Reduce the backpressure by either replacing the catheter or by decreasing the infusion rate.

Problem	Probable Cause	Solution
Screen saver does not appear.	<ul style="list-style-type: none"> • Screen saver option was not enabled. • Pump is not in an applicable state. 	<ul style="list-style-type: none"> • Enable the Screen Saver option (refer to Configuring General Settings on page 202) • The screen saver will not appear if the pump is in one of the following states: Paused, Delayed Infusion, end of treatment KVO, during alarm, when screen is touched, when key is pressed, or during a Bolus delivery
The pump pauses when programming a secondary.	The pump is not connected to an AC outlet, and currently the battery power is insufficient to support both the primary line rate and the secondary line programming.	Connect the pump to an AC outlet, and select to continue the primary or start the secondary.
Fast depletion of AA batteries.	Power Supply is connected to the Pump, and not to electricity, while EBP is attached to the pump.	Disconnect power supply from the Pump.
Pump doesn't turn on when attached to the EBP.	Internal battery is below the required voltage level for the pump to turn on.	<ul style="list-style-type: none"> • If stable power supply is available, connect the power supply to the pump. • Contact an authorized technician to replace the internal battery.

Problem	Probable Cause	Solution
<p>Pump does not show indications of connection when attached to the EBP.</p>	<ul style="list-style-type: none"> • EBP was not properly attached. • AA batteries were misplaced in compartment. • AA batteries are depleted. 	<ul style="list-style-type: none"> • Detach the EBP and re-attach it exactly as instructed. • Detach the EBP, make sure the AA batteries inserted properly and re-attach it exactly as instructed. • Detach the EBP and replace the AA batteries with fresh AA batteries and re-attach it exactly as instructed.

Chapter 11: Maintenance and Storage

The following sections describe the proper cleaning, preventive maintenance, and storage procedures for the pump and the battery:

Cleaning and Disinfecting the Pump	256
Cleaning Electric Connectors of Sapphire Accessories	261
Preventive Maintenance	262
Battery Care Information	265
Transport and Storage	268

Cleaning and Disinfecting the Pump

Between use on different patients, the Sapphire pump and all of its components need to be first cleaned, and then disinfected, per hospital/medical provider protocol for multiple patient use.

Cleaning and disinfecting the pump involves wiping it with Dispatch® (Caltech) ready-to-use towels.



For cleaning, one minute waiting time.
For disinfecting, 15-minute waiting time.

Additional Cleaning and Disinfection Agents:

- Virex® II 256
- Virox® AHP 5 RTU, Diversey
- Klor De™ (Chlorine tablets)
- 70% Isopropyl alcohol



Cleaning and Disinfection: Safety Precautions

Before and during cleaning, adhere to the following safety guidelines and recommendations:

- Only people who are trained in the maintenance of this type of medical device should clean the infusion pump
- Before cleaning/disinfecting the pump, verify that:
 - The pump is disconnected from the patient.
 - The pump is disconnected from all connections, sets, and accessories.
 - The pump is turned Off.
- While cleaning/disinfecting the pump, do not allow fluid to enter the pump housing, speaker holes or battery chamber.
- Do not steam autoclave, ethylene oxide sterilize or immerse any part of the pump in fluid.
- Do not use spray or aerosol cleaners.
- Dispose of all cleaning/disinfectant materials per laws and regulations for infectious waste disposal.
- Do not clean or disinfect the pump using liquid household Bleach.



Before using materials other than the products listed above for cleaning and disinfecting the Sapphire Infusion pump, make sure that they are listed in Eitan Medical's official approved list of materials (published at <https://eitanmedical.com>).



The pump must be completely dried out before connecting it to a power supply.

Cleaning and Disinfection Procedure

Cleaning/Disinfecting Solution	Manufacturer
Dispatch® (Caltech) ready-to-use towels	Caltech
Virex® II 256	Diversey
Klor De™ (Chlorine tablets)	Concept
70% Isopropyl alcohol	Generic (any brand containing 70% Isopropyl alcohol diluted in water)
Virox® AHP 5 RTU	Diversey

Cleaning Procedure

The following procedure explains how to clean the pump using the approved agents (listed above):

> To clean the pump:

1. Turn the pump Off and unplug the power cord from the Sapphire pump power socket.
2. Use the appropriate dilution ratio per the manufacturer's instructions.
3. When the solution is ready, apply the solution on a cloth or sponge, then squeeze so it won't drip.
4. Wipe the exterior planes areas in back and forth motions, vertically and horizontally (mainly on the pump housing).
5. The wiping should be applied with normal force, few times on the same locations (at least twice) verifying complete coverage of the areas to be cleaned.
6. Guidelines for cleaning specific pump components are listed in the table below.
7. After the cleaning process is completed, the pump should be dried out for 10 minutes.

8. Wipe the pump with a clean dry cloth.



The pump must be completely dried out before connecting it to a power supply.

Disinfecting Procedure

The following procedure explains how to disinfect the pump using the approved agents (listed in [Cleaning and Disinfection Procedure](#) on page 258):

> To disinfect the pump:

1. Perform steps 1-6 specified in the cleaning process above.
2. Replace the cloth or sponge with a new one and repeat steps 3-5 (specified in the cleaning process above) two more times (a total of 3 cycles).
3. After the disinfection process is completed, the pump should be dried out for 15 minutes.
4. Wipe the pump with a clean dry cloth.



The pump must be completely dried out before connecting it to a power supply.

Guidelines for cleaning/disinfecting specific pump components

Guidelines for cleaning/disinfecting specific pump components are listed in the following table:

Component	Cleaning Recommendations
LCD Screen	Wipe thoroughly with a squeezed sponge. Avoid scratching the LCD panel. Ensure that no fluid enters the speaker holes at the top of the panel.

Component	Cleaning Recommendations
<p>Sensor Fingers</p> <ul style="list-style-type: none"> ● Internal White Panel ● Bubble Detector (on the internal white panel) ● Anchor (on the internal white panel) ● Locking tooth (on the internal white panel) ● P to C connector, Power communication connector 	<p>Clean the finger tip of the sensor using only a damp cloth or sponge.</p> <p>This part should be kept free from foreign materials and dirt. If necessary, use foam swab moistened with the detergent solution to clean the connector, particularly around the 4 fingers roots by applying normal finger force, assuring that the swab reaches all areas, at least twice.</p> <p>Note: Swabbing should be applied in vertical or horizontal movement, where possible, while less accessible areas should be swabbed in a circular motion (at least 3 bi-directional rotations clockwise-counterclockwise).</p>

Reprocessing the pump when used by a single patient multiple times

When the Sapphire pump is used by a single patient for multiple times, the pump and all of its components need to be cleaned first, and then disinfected using 70% Isopropyl alcohol.

The user is required to clean and disinfect the pump in the following conditions (the earlier of the three):

- Every time there is visibly soiled.
- Once a week.
- After storage at the patient's home; even if not used.

Cleaning and disinfection instructions are identical to [Cleaning and Disinfection Procedure](#) on page 258.

Cleaning Electric Connectors of Sapphire Accessories

Cleaning the electrical connectors of all accessories is restricted to the use of 70% Isopropyl alcohol (IPA) ONLY.

1. Place the accessory on a clean and stable surface.
2. Apply IPA 70% lightly to a cloth or sponge.
3. Squeeze the cloth / sponge before cleaning, so that it would not drip on the accessory to be cleaned.
4. Swab in a rotational manner for at least 3 bi-directional rotations (clockwise-counterclockwise)*.

Figure 11.1. Cleaning Electric Connectors



5. Take caution and avoid dripping the reagent into the pins or pores of the electrical connector.
6. Allow the IPA to air dry for at least 3 minutes before connecting to power.

* Be careful not to apply excessive pressure on the connector during swabbing

Preventive Maintenance

The following sections describe:

Routine Inspection and Maintenance Tasks	262
Alarm Testing	263
Certification	264

Routine Inspection and Maintenance Tasks

The following sections provide guidelines about inspecting and caring for the pump before and after use.



Take care not to drop the pump. If the pump is dropped or appears to be damaged, cracked or dented, return it to your local representative for inspection.



Preliminary Inspection

Before using the Sapphire pump and its accessories, check the pump for signs of any mechanical damage.



Do not use the pump if you identify anything which may indicate impaired functioning of the system. In such a case, contact the facility biomedical engineer or a Eitan Medical approved service technician.

Post-use Procedures

The following equipment checks should be performed following each use of the pump, and as required:

Pump Component	Action
Pump housing	Check for cracks and dents.
Power cord	Verify that the power cord is undamaged. Check the entire length of the cord, and the plug.

Alarm Testing

It is recommended to perform manual testing of the following alarms at least once a year. Alarm testing can be conducted as part of the yearly certification.

For the Sapphire Epidural pump manual alarm testing, refer to the testing protocols available for authorized technicians (for more information refer to the service manual).



Before testing the alarms, make sure to disconnect the set from the patient.

Name of Test	Procedure
Air in Line Alarm	<p>Connect a new Sapphire administration set to the pump without connecting it to the infusion container. Start an infusion at a rate of 100 mL/h. An Air in Line alarm should occur.</p> <p>Note: To test the Air in Line alarm, ensure that air detection is enabled (ON) in the Technician options. If air detection has been disabled (OFF), the icon is displayed, and a warning message stating that air detection has been disabled (OFF) appears when programming an infusion. The Air in Line alarm will not be triggered.</p>
Occlusion Alarm	<p>Start an infusion at a rate of 600 mL/h over 5 minutes. While the pump is running, close the upstream clamp. An Upstream Occlusion alarm should occur.</p> <p>Test the Downstream Occlusion alarm by repeating the above test, but closing the clamp or pinching the tubing downstream while the pump is running.</p>

If an alarm is not generated, contact your local representative or authorized technician.



The operator should stand 1 meter from the pump, and verify that he/she can hear and see the alarm.



For more information about the Air in Line and Occlusion alarms, refer to [Level 3 Alarms](#) on page 247.

Certification

To ensure proper fluid delivery, the pump should be checked by an authorized service provider at least once a year, to perform yearly certification. For more information on yearly maintenance procedures to be performed by technicians or certified service providers, refer to the Sapphire Infusion Pump Service Manual.

Battery Care Information

The Sapphire pump can operate on battery power, enabling operation of the pump during an electrical power failure, during patient transport or during ambulatory care. When working on battery power (disconnected from main power supply) the battery charge level icon, at the upper right corner of the indicators bar, indicates the remaining battery capacity. Check the status of the battery charge level icon regularly:

Number of Bars in Icon	Approximate Remaining Battery Capacity
5	100%
4	75%
3	50%
2	25%
1	Low



You can also check the status of the battery using the **Options** menu. For more information, refer to [Viewing System Parameters](#) on page 210.

Battery operation time is dependent upon the condition of the battery, which varies according to temperature conditions, battery age, frequency of charging, and conditions of storage and use.

An alarm is triggered when there are 30 minutes left until battery depletion. This time may depend on the delivery rate, the frequency of pressing keys, and whether the backlight is On. When the Battery Depletion alarm sounds or following long periods of storage, connect the pump to the power supply.

Notification messages begin appearing on the Main Display of the pump 2 weeks before battery life expiration. When the battery life expires, the pump allows you to finish the current infusion and then turns Off. Make sure to test the batteries at least once a year, and replace the batteries every 2 years or every 500 charging cycles.

Battery Classification

The UL 1642 Standard for Lithium batteries classifies the Lithium-Ion battery used in the Sapphire pump as follows:

- Secondary battery (rechargeable)
- Technician replaceable

Battery Safety Information

When working with the battery, adhere to the safety precautions and recommendations listed below.



Battery Safety Guidelines

- Ensure that only Sapphire rechargeable Lithium Ion (Li-Ion) battery is used.
- In case of rust, bad odor, overheating, and/or other irregularities when using the battery pack for the first time, return it to your local representative.
- Avoid any contact with water. Do not immerse the battery pack in water.
- Do not open the battery casing.
- Store batteries in a closed carton.
- Short term storage temperature should be below 35°C (95°F).

Long Term Battery Storage

When you store batteries for extended periods of time, ensure the following conditions:

- Well-ventilated facility, free of a corrosive gas atmosphere
- Low humidity environment
- Storage temperature should be between -20°C (-4°F) to +35°C (+95°F). The recommended temperature is 23° ±3°C (73° ±5°F).



Storage at low temperatures may affect initial battery performance.
Storage at high temperatures may degrade battery performance.

Charging the Battery

Before initial use of the Sapphire pump, the battery must be charged for at least 6 hours. The battery must also be charged if it has been disconnected from the pump unit for more than 6 months. While the pump is in storage, recharge the battery at least every 12 months.

The pump can operate while it is being charged.



When using the pump while connected to the power supply, ensure that the pump is attached securely to the power supply, the mini cradle is attached securely to an IV pole, and the power cord is secure, to prevent entanglements that might cause strangulation.

To preserve battery life, connect the pump to the main power supply using the power supply whenever possible.



While connected to a power supply and charging, the Charge (yellow) LED blinks, and stops blinking when the battery is fully charged.

If the pump is turned Off, the company logo appears on the screen while the pump is charging.



Before charging the battery, ensure that the device is completely dry. Failure to do so may compromise patient safety.

> To charge the battery:

1. Plug the Sapphire dedicated power supply cord into the main power supply.
2. With the white arrows facing up, plug the power cord into the Sapphire pump power socket or into the splitter connector.
3. On the front of the pump, verify that the Charge LED status indicator is On (blinking yellow light).

Battery Maintenance

To promote maximum battery life, the following procedures should be performed at regular intervals.

Frequency	Action
Following each use of the pump	Check the status of battery charge, and recharge as necessary.
Every 2 years or every 500 charging cycles	Replace batteries.

Transport and Storage

The pump should always be transported in a protective case internally padded with cushioning material. It is best to use the original packaging. During handling and transport, protect the pump and the case from water, excessive humidity, and heat sources.

To safeguard the pump against prolonged exposure to dust and moisture, the pump must be stored in a clean and dry environment. It is recommended that the pump remain plugged in during storage, in order to maintain the battery at full charge. If the pump is disconnected from the power supply, or is in storage without being connected to power for several months, check the battery level, and recharge the battery before using the pump ([Charging the Battery](#) on page 267).

For any storage period, make sure that the Sapphire administration cassette is disconnected from the pump, and that the safety door over the pump mechanism is closed. Specific recommendations for long term storage conditions are listed in the following table.

Condition	Parameters
Temperature	-40°C (-40°F) to +70°C (+158°F)
Relative humidity	15% RH to 95% RH
Atmospheric pressure	50 kPa to 106 kPa (500 hPa to 1060 hPa)

This page is left intentionally blank

Chapter 12: Technical Specifications

The following sections present technical specifications for the pump and its components:

Pump Accuracy	270
Pump Specifications	276
Average Bolus Volume After Occlusion	277
Environmental Specifications	278
Electromagnetic Compatibility Statement	281

Pump Accuracy

The following graphs and curves were derived from the pump accuracy testing procedures described in the IEC60601-2-24 standard. Testing was performed under normal conditions (specified in IEC60601-2-24 standard) at room temperature (25°C, 72°F).

Normal conditions to ensure optimal accuracy of $\pm 2.5\%$:

- Fluid level should be 50 cm above the pump
- No back pressure due to catheter size or difference in height of pump and infusion site
- Room temperature (25°C)
- Barometric pressure of sea level altitude (101kPa)
- IV medication with water like fluid characteristics

Infusion under high backpressure conditions (for example, when using catheters, or other restricting administration set components) may cause the accuracy of the pump flow delivery to deviate from the accuracy stated for normal conditions.

The pump is designed to accommodate the delivery of infusions under backpressure conditions with an expected deviation in accuracy of +5% to -5% (**Note:** In high backpressure conditions, such as with a 26G PICC line infusing at 100mL/h, additional under delivery may occur).

In the Sapphire pump, as in all infusion systems external factors may cause fluctuations in rate accuracy. Conditions that can cause flow fluctuations include:

- Position of the infusion container height (any deviation from 50 cm above the pump)
- Fluid characteristics that deviate from water-like characteristics, such as density, viscosity and homogeneity
- Positive and negative pressure, including back pressure
- Environmental temperature above or below 25°C and barometric pressure above or below 101kPa

For example:

- A change of ± 25 cm in the fluid level above the pump may result in deviation in accuracy of $\pm 1\%$
- Using sets with PAV may result in deviation in accuracy of -6%



When using accessories where the container height deviates from 50 cm above the pump, there may be deviations in pump accuracy (e.g., PCA Lockboxes, Large Backpack and EBP).

Start-up and Trumpet Graphs

The start-up graphs represent startup flow versus operating time for the first two hours from the start of the infusion. They exhibit the stability of delivery due to mechanical compliance and provide a visual representation of uniformity. Start-up graphs were performed according to the IEC 60601-2-24 standard.

In the Sapphire pump, as in all infusion systems, the action of the pumping mechanism and variations or external factors may cause fluctuations in rate accuracy. Conditions that can cause flow fluctuations include:

- Position of the infusion container
- Fluid density
- Positive and negative pressure
- Environmental temperature
- Operation of the pump beyond the recommended operating limits

Trumpet curves are named for their characteristic /shape, and are developed in accordance with IEC 60601-2-24. They display the percent flow rate deviation from the programmed rate over time. The horizontal axis represents the observation time intervals.

Over long observation windows, short-term fluctuation has little effect on accuracy, as represented by the flat part of the curve. As the observation window is reduced, short-term fluctuations have a greater effect, as represented by the "mouth" of the trumpet.

Figure 12.1. Delivery Startup Graph, First 2 Hours of Test Period, 1 mL/h

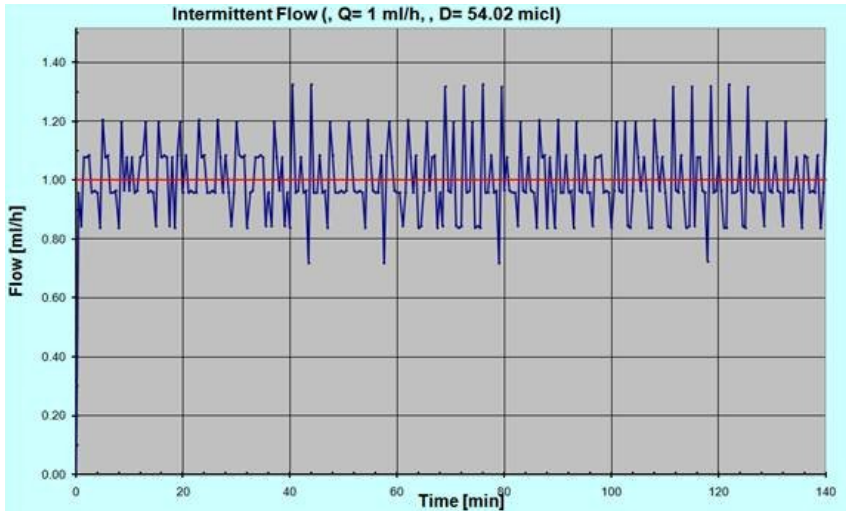

Figure 12.2. Trumpet Graph, Second Hour of Delivery, 1 mL/h

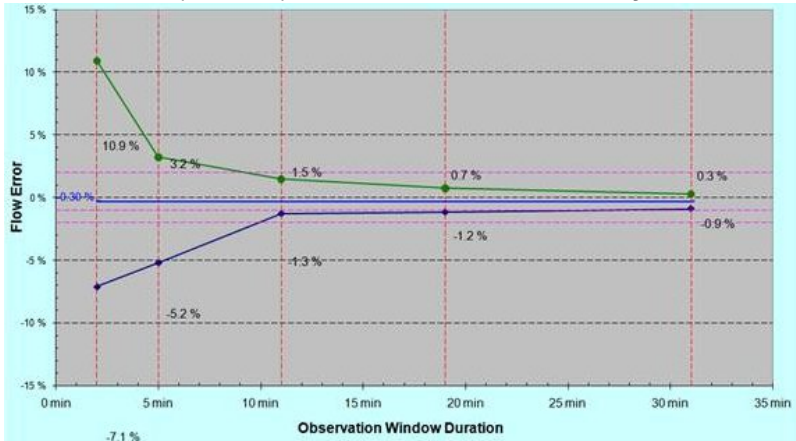

Figure 12.3. Trumpet Graph, 24th (Last) Hour of Delivery, 1 mL/h

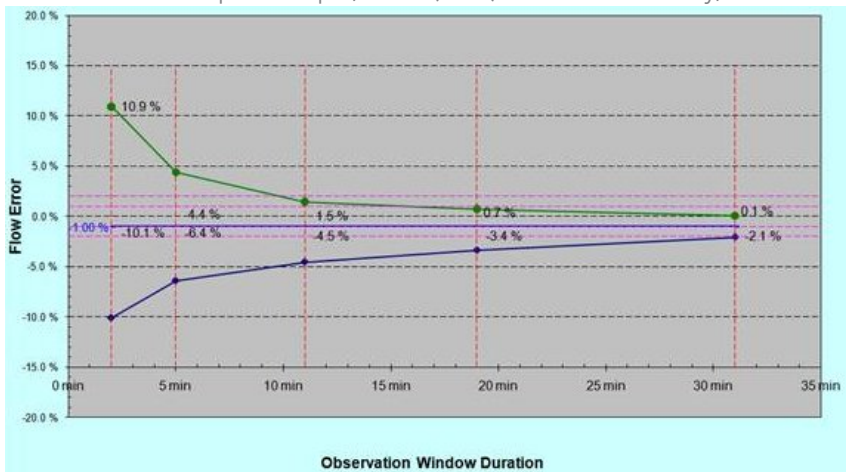

Figure 12.4. Delivery Startup Graph, First 2 Hours of Test Period, 25 mL/h

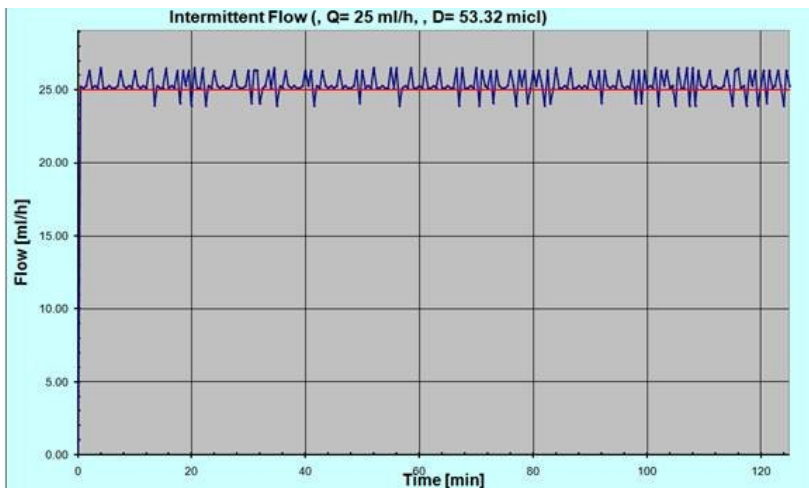

Figure 12.5. Trumpet Graph, Second Hour of Delivery, 25 mL/h

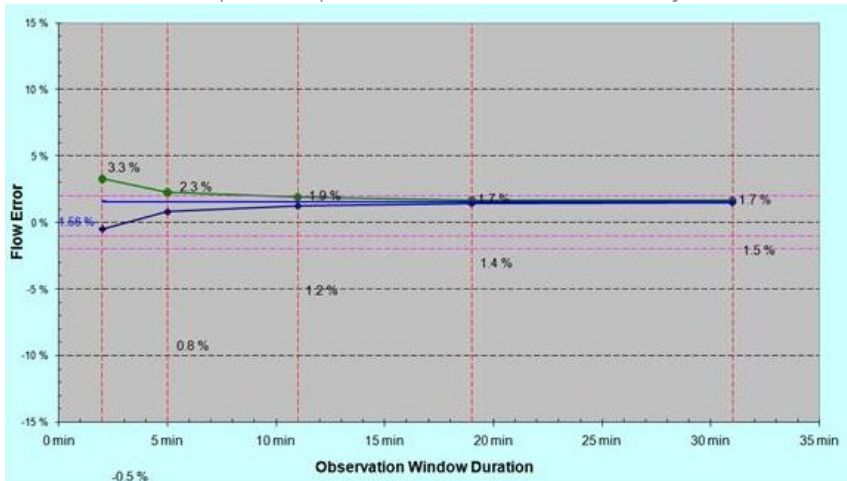
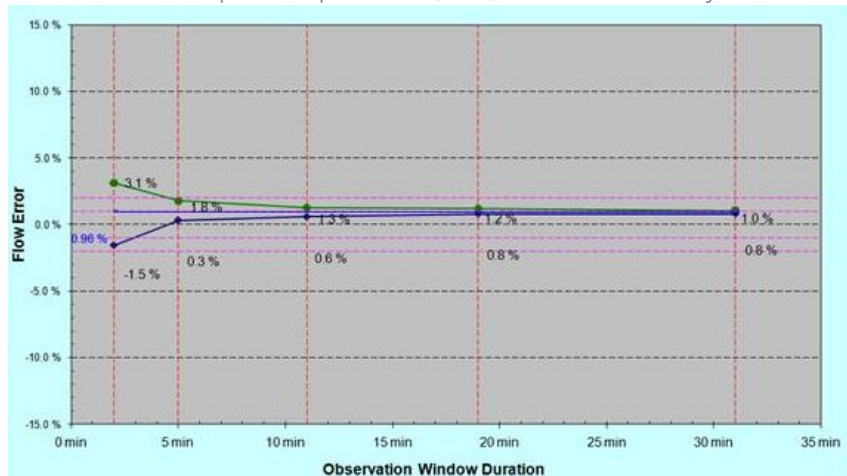

Figure 12.6. Trumpet Graph, 24th (Last) Hour of Delivery, 25 mL/h



Pump Specifications

The following table lists and describes pump specifications.

Parameter	Description
Dimensions	143 x 96 x 49 mm (5.63 x 3.78 x 1.93 in.) (H x W x D)
Weight (excluding batteries)	418 g (14.7 oz.)
Pumping mechanism	Single channel volumetric, with integral pressure sensor
Infusion delivery modes	Continuous (with and without a Secondary line), PCA, Intermittent, Multi-step, TPN, Epidural (PCEA, Epidural Intermittent)
KVO rate	Up to 20 mL/h in increments of 0.1 mL/h
Accuracy	±2.5% (Subject to external conditions such as tubing, pressure, container position relative to the pump, barometric pressure, humidity and temperature)
Defibrillation proof - recovery time	Max 1 sec
Flow rate	0.1 - 99.9 mL/h in increments of 0.1 mL/h 100 - 999 mL/h in increments of 1 mL/h
Volume (VTBI)	0.1 - 9999 mL in increments of 0.1 mL
Infusion device	Volumetric, peristaltic
External power supply	100 - 240V 50-60 Hz, 0.6A
Battery	<ul style="list-style-type: none"> • Rechargeable Li-Ion battery 7.4V, 1960 mA/h • 24 hrs @ 125 mL/h (with a fully charged battery, and backlight Off) • Recharge time: up to 6 hrs (when pump is not in operation)
Adaptor	AC Adaptor 10 VDC/2.0A
Fuse rating	T1.6A, 250V
Downstream occlusion	Up to 17.4 PSI (1.2 bar or 900 mmHg)
Operating temperature	+5° (41°F) to 40°C (104°F)

Parameter	Description
Alarms	Refer to full list of alarms in Chapter 10: Alarms and Troubleshooting on page 244.
Prime	Manual or automatic priming (600 mL/h, or from air in line alarm 900 mL/h)
Sensors	<ul style="list-style-type: none"> • Air in line sensor: Detects both single and accumulated bubbles sized 0.02-0.5 mL. The desired size range of each option can be selected by the technician. • Upstream/Downstream occlusion sensor • Door open sensor • Temperature sensor

Average Bolus Volume After Occlusion

The following table presents the average time to a downstream occlusion alarm, and the bolus volume after occlusion, at a rate of 25 mL/h.

Parameter	Pressure	
	0.4 bar	1.2 bar
Average bolus volume following downstream occlusion	0.135 mL	0.75 mL*
Average time to downstream occlusion alarm	38 sec	3 min

* Under single fault condition

The following table presents the average time to a downstream occlusion alarm at a rate of 0.1 mL/h.

Parameter	Pressure	
	0.4 bar	1.2 bar
Average time to downstream occlusion alarm	2:30 hours	12:30 hours



In case of an occlusion (upstream or downstream), clear the occlusion by disconnecting the set from the patient and priming the administration set. When priming manually, close clamps and disconnect the patient from the administration set prior to detaching the administration cassette from the pump.

Environmental Specifications

The pump should be operated within the temperature and humidity ranges specified below. To avoid damage to the pump or battery, do not store the pump or the administration set outside these temperature and humidity ranges. Do not store the pump for prolonged periods with the battery installed.

Operating Conditions

Adhere to the following operating conditions:

Condition	Details/Range
Operating mode	Long term infusion usage
Humidity	15% to 95% 15% to 90% at transient state
Temperature	+5°C (41°F) to 40°C (104°F) -20°C (-4°F) to +50°C (122°F) at transient state
Atmospheric pressure	70 kpa to 106 kpa

Environmental Conditions for Transport and Storage

When transporting or storing the pump, adhere to the following conditions:

Condition	Details/Range
Atmospheric pressure	50 kPa to 106 kPa (500 hPa to 1060 hPa)
Relative humidity	15% to 95%
Temperature	-40°C to +70°C (-40°F to 158°F)



Do not disassemble the portion of the Sapphire pump that houses the pump mechanism and the electronics. This should be done by authorized personnel only; Eitan Medical Ltd. will not be obligated to provide technical service in such a case.

When storing batteries separately from the pump, maintain the following storage temperature ranges:

Type of Storage	Temperature Range
Short term	<40°C (<95°F)
Long term	-20°C (-4°F) to +35°C (+95°F) Recommended: 23° ±3°C (73° ±5°F)



Storage at low temperatures may affect initial battery performance.
Storage at high temperatures may degrade battery performance.

The following list provides guidelines about environmental conditions and situations to be avoided when working with or storing the pump:

- Avoid locations where there is inadequate ventilation.
- Avoid locations where sudden impact or vibration may occur.

- Avoid damp locations, or locations where moisture level may increase considerably.
- Avoid locations with large temperature fluctuations.
- Avoid locations exposed to direct sunlight.
- Avoid locations near an electrical heating apparatus.
- Avoid locations exposed to chemicals or explosive gases.

Electromagnetic Compatibility Statement

The following sections provide information about testing of and recommendations for:

Electromagnetic Emission	281
Electromagnetic Immunity	282
Recommended Separation Distances from Mobile RF Communication Equipment	285

Electromagnetic Emission

The pump is intended for use in the electromagnetic environment specified below. The customer or the user of the pump should ensure that it is used in such an environment.

Emission Test	Compliance	Electromagnetic Environment Guidance
RF emission CISPR 11	Group 1	The pump uses RF energy for its internal function only. Therefore, RF emissions are very low and are not likely to cause any interference with nearby electronic equipment.
RF emission CISPR 11	Class B	The pump is suitable for use in all establishments, including domestic establishments and those directly connected to the public low-voltage power supply network that supplies buildings used for domestic purposes.
Harmonic emissions IEC 610003-3-2	Class B	
Voltage fluctuations / flicker emissions IEC 61000-3-3	Complies	

Electromagnetic Immunity

The pump is intended for use in the electromagnetic environment specified below. The customer or the user of the pump should ensure that it is used in such an environment.

Immunity Test	IEC 60601 Test Level	Compliance Level	Electromagnetic Environment Guidance
Electrostatic discharge (ESD) IEC 61000-4-2	±6 kV contact ±8 kV air	±8 kV contact ±15 kV air*	Floors should be wood, concrete or ceramic tile. If floors are covered with synthetic material, the relative humidity should be at least 30%.
Electrical fast transient/burst IEC 61000-4-4	±2 kV for power supply lines ±1 kV for input/output lines	±2 kV for power supply lines ±1 kV for input/output lines	Mains power quality should be that of a typical commercial or hospital environment.
Surge IEC 61000-4-5	±1 kV differential mode	±1 kV at 110 & 230 VAC	Mains power quality should be that of a typical commercial or hospital environment.
Voltage dips, short interruptions and voltage variations on power supply input lines IEC 61000-4-11	<5% UT (>95% dip in UT) for 0.5 cycles 40% UT (60% dip in UT) for 5 cycles 70% UT (30% dip in UT) for 25 cycles <5% UT (>95% dip in UT) for 5 s	<5% UT (>95% dip in UT) for 0.5 cycles 40% UT (60% dip in UT) for 5 cycles 70% UT (30% dip in UT) for 25 cycles <5% UT (>95% dip in UT) for 5 s	Mains power quality should be that of a typical commercial or hospital environment. If the user of the pump requires continued operation during power mains interruptions, it is recommended that the pump be powered from an uninterruptible power supply or a battery.

Immunity Test	IEC 60601 Test Level	Compliance Level	Electromagnetic Environment Guidance
Power frequency (50/60 Hz) magnetic field IEC 61000-4-8	3 A/m	3 A/m	Power frequency magnetic fields should be at levels characteristic of a typical location in a typical commercial or hospital environment.

* The pump was tested to the EMC requirements of **IEC 60601-1-2/EN 60601-1-2 (fourth edition)** and **IEC 60601-2-24 (second edition)**.

Electromagnetic Immunity for Life-supporting Equipment and Systems

The pump is intended for use in the electromagnetic environment specified below. The customer or the user of the pump should ensure that it is used in such an environment. Portable and mobile RF communications equipment should be used no closer to any part of the pump, including cables, than the recommended separation distance calculated from the equation applicable to the frequency of the transmitter. Field strengths from fixed RF transmitters, as determined by an electromagnetic site survey, should be less than the compliance level in each frequency range.



Interference may occur in the vicinity of equipment marked with the symbol.

Immunity Test	IEC 60601 Test Level	Compliance Level	Electromagnetic Environment Guidance*
Conducted RF IEC 61000-4-6	3 Vrms 150 kHz to 80 MHz 10 Vrms 150 kHz to 80 MHz	3 Vrms 3 Vrms †	Recommended separation distance (RSD) $d = 1.2\sqrt{p}$ RSD $d = 4\sqrt{p}$

Immunity Test	IEC 60601 Test Level	Compliance Level	Electromagnetic Environment Guidance *
Radiated RF IEC 61000-4-3	3 V/m 80 MHz to 2,5 GHz	10 V/m 80 MHz – 2.5 GHz 80% AM, 2 Hz 80 MHz – 2.5 GHz 80% AM, 1 KHz	<p>where p is the maximum output power rating of the transmitter in watts (W) according to the transmitter manufacturer, and d is the recommended separation distance in meters (m).</p> <p>Recommended separation distances:</p> <ul style="list-style-type: none"> 80 MHz to 800 MHz: $d = 4\sqrt{p}$ 800 MHz to 2.5 GHz: $d = 7.7\sqrt{p}$ <p>At 80 MHz and 800 MHz, the higher frequency range applies.</p>

* These guidelines may not apply in all situations. Electromagnetic propagation is affected by absorption and reflection from structures, objects and people.

† The pump was tested to the EMC requirements of **IEC 60601-1-2/EN 60601-1-2 (fourth edition)** and **IEC 60601-2-24 (second edition)**.

Notes

- The ISM (industrial, scientific and medical) bands between 150 kHz and 80 MHz are 6,765 MHz to 6,795 MHz; 13,553 MHz to 13,567 MHz; 26,957 MHz to 27,283 MHz; and 40,66 MHz to 40,70 MHz.
- The compliance levels in the ISM frequency bands between 150 kHz and 80 MHz and in the frequency range 80 MHz to 2.5 GHz are intended to decrease the likelihood that mobile/portable communications equipment could cause interference if it is inadvertently brought into patient areas. For this reason, an additional factor of 10/3 is used in calculating the recommended separation distance for transmitters in these frequency ranges.

3. Field strengths from fixed transmitters, such as base stations for radio (cellular/cordless) telephones and land mobile radios, amateur radio, AM and FM radio broadcast and TV broadcast cannot be predicted theoretically with accuracy. To assess the electromagnetic environment due to fixed RF transmitters, an electromagnetic site survey should be considered. If the measured field strength in the location in which the Sapphire pump is used exceeds the applicable RF compliance level above, the pump should be observed to verify normal operation. If abnormal performance is observed, additional measures may be necessary, such as re-orienting or relocating the pump.
4. Over the frequency range 150 kHz to 80 MHz, field strengths should be less than 3 V/m.

Recommended Separation Distances from Mobile RF Communication Equipment

The pump is intended for use in an electromagnetic environment in which radiated RF disturbances are controlled. The customer/pump user can help prevent electromagnetic interference by maintaining a minimum distance between portable and mobile RF communications equipment (transmitters) and the pump, according to the maximum output power of the communications equipment.

The following table provides recommended separation distances between portable and mobile RF communication equipment and the pump (for life-supporting equipment and systems).

For transmitters rated at a maximum output power not listed in the table, the recommended separation distance d in meters (m) can be determined using the equation applicable to the frequency of the transmitter, where p is the maximum output power rating of the transmitter in watts (W) according to the transmitter manufacturer.

Rated Maximum Output Power of Transmitter (W)	Separation Distance According to Frequency of Transmitter (m)			
	150 kHz to 80 MHz outside ISM bands	150 kHz to 80 MHz in ISM bands	80 MHz to 800 MHz	800 MHz to 2.5 GHz
	$d = 1.2\sqrt{p}$	$d = 4\sqrt{p}$	$d = 1.2\sqrt{p}$	$d = 2.3\sqrt{p}$
0.01	0.12	0.40	0.12	0.23
0.1	0.38	1.3	0.38	0.72
1	1.2	4.00	1.2	2.3
10	3.8	13	3.8	7.27
100	12	4.00	12	23

Notes

1. These guidelines may not apply in all situations. Electromagnetic propagation is affected by absorption and reflection from structures, objects and people.
2. At 80 MHz and 800 MHz, the separation distance for the higher frequency range applies.
3. The ISM (industrial, scientific and medical) bands between 150 kHz and 80 MHz are 6,765 MHz to 6,795 MHz; 13,553 MHz to 13,567 MHz; 26,957 MHz to 27,283 MHz; and 40,66 MHz to 40,70 MHz.
4. An additional factor of 10/3 is used in calculating the recommended separation distance for transmitters in the ISM frequency bands between 150 kHz and 80 MHz and in the frequency range 80 MHz to 2.5 GHz. This decreases the likelihood that mobile/portable communications equipment could cause interference if it is inadvertently brought into patient areas.

This page is left intentionally blank

Chapter 13: Limited Warranty

Eitan Medical Ltd. (the "Manufacturer") warrants to the buyer who purchased the Sapphire directly from the manufacturer (Initial Buyer) that the Sapphire Infusion Pump ("Sapphire"), not including accessories, shall be free from defects in materials and workmanship under normal use, if used in accordance with this User Manual, for a period of two years from the actual date of sale to the Initial Buyer. THERE ARE NO OTHER WARRANTIES.

This warranty does not cover normal wear and tear and maintenance items, (such as the Yearly Certification Kit), and specifically excludes batteries, administration sets, extension sets or any other accessory items or equipment used with the Sapphire. Subject to the conditions of and upon compliance with this Limited Warranty, the Manufacturer will repair or replace at its option without charge (except for a nominal charge for postage and handling) any defective Sapphire provided a claim is made during such two years period.

The following conditions, procedures, and limitations apply to the Manufacturer's obligation under this warranty:

A. Parties Covered by this Warranty: This Warranty extends only to the Initial Buyer of the Sapphire.

Warranty Performance Procedure: Notice of the claimed defect must be made by Initial Buyer in writing to the Manufacturer as follows:

Eitan Medical Ltd., 29 Yad Haruzim St., P.O. Box 8639, Netanya, 4250529, Israel. Initial Buyer should send mail to support@eitanmedical.com or contact the account manager.

Notice to the Manufacturer must include date of purchase, serial number, and a description of the claimed defect in sufficient detail to allow the Manufacturer to determine and facilitate any repairs which may be necessary. AUTHORIZATION MUST BE OBTAINED PRIOR TO RETURNING THE SAPPHIRE. If authorized, the Sapphire must be properly and carefully cleaned, packaged and returned to the Manufacturer. Any loss or damage during shipment is at the risk of the sender.

B. Conditions of Warranty: The warranty is void if the Sapphire has been

1) repaired by someone other than the Manufacturer or its authorized agent
2) altered so its stability or reliability is affected 3) misused or 4) damaged by negligence or accident. Misuse includes, but is not limited to, use not in compliance with the User Manual or use with non-approved accessories. Removal or damage to the Sapphire's serial number will invalidate this warranty.

C. Limitations and Exclusions: Repair or replacement of the Sapphire or any component part therefore is the EXCLUSIVE remedy offered by Manufacturer. The following exclusions, disclaimers, and limitations shall apply:

1. No agent, representative, or employee of the Manufacturer has authority to bind the Manufacturer to any representation or warranty, expressed or implied.

2. THERE IS NO WARRANTY OF MERCHANTABILITY OR FITNESS OR USE OF THE SAPPHIRE FOR ANY PARTICULAR PURPOSE.

3. The Sapphire can only be used under the instruction of trained medical personnel whose skill and judgment determine the suitability of the Sapphire for any particular medical treatment.

4. All recommendations, information, and descriptive literature supplied by the Manufacturer are believed to be accurate and reliable, but do not constitute warranties. The Manufacturer disclaims responsibility for the suitability of the Sapphire for any particular medical treatment or for any medical complications resulting from the use of the Sapphire. The Manufacturer shall not be responsible for any incidental damage or consequential damages to property, loss of profits, or loss of use caused by any defect or malfunction of the Sapphire.

Service Information

While under Eitan Medical warranty, the Sapphire pump must not be opened by unauthorized personnel.

Use only an authorized Eitan Medical service provider for service and repair. In the event that your pump needs to be returned for service, contact your local representative, or obtain a Return Authorization by filling an inquire form through the Eitan Medical website. The pump must be packed in a suitable container that will provide adequate protection during shipment. To ensure prompt return, a Eitan Medical authorized service representative must be notified before shipping any pump for repair. When calling for service, please be prepared to provide the serial number of the pump and software version details. A brief written description of the problem should be attached to the pump when it is returned for service.

Eitan Medical Ltd. will not be responsible for unauthorized returns or for pumps damaged in shipment due to improper packing. The Sapphire pump service life is 7 years from the date of manufacture.

Technical Support Contacts

For technical assistance, contact your local representative, or contact Eitan Medical by filling an inquire form through the Eitan Medical website <https://eitanmedical.com/>.

This page is left intentionally blank



REF 15025-048-0097 | Rev15Ver01 / 08.2021



 Eitan Medical Ltd.
29 Yad Haruzim St.
P.O. Box 8639
Netanya 4250529, ISRAEL

www.eitanmedical.com

Product of israel

