

Impressioning Compendium



ExpertiseTM

A guideline for
excellent impressions
in theory and practice

In collaboration with
Prof. Dr. med. dent. Bernd Wöstmann
Prof. John M. Powers, Ph.D.

3M ESPE

Espertise™

A guideline for
excellent impressions
in theory and practice

guideline

Preface

As the worldwide market leader in impressioning, 3M ESPE aspires to be the partner of choice for precision impressions in practice and teaching establishments. Our goal is to leverage our expertise in innovative materials, technology, and manufacturing to provide our customers with the highest performing impressioning systems and workflow on the market. We have received a resounding, positive response to the first and second editions of “Precision Impressions – A Guideline for Theory and Practice” from dentists around the world. This confirms the importance of our process-oriented approach and demonstrates our commitment to continually deliver customer-valued solutions.

Over the past nine years, thousands of dentists and their teams have been working with our handbook. In addition, many universities and training centres utilise the guidelines for precision impression taking as a benchmark. Many of the dentists especially value the clear and concise step-wise procedures, as well as the supportive function for vocational training and further education in practice. This third edition puts even stronger focus on the procedure of impression taking since this is the most important step for ultimately producing high-quality aesthetic restorations. The improvements achieved through material science and dental procedures, as well as important changes in the workflow, prompted us to update almost all the chapters.

3M ESPE feels very much indebted to Prof. Dr. med. dent. Wöstmann, one of the authors of the first and second editions, for his competent, clinical and process-oriented view. Chapters 1, 2, 4 and 6–11 very much benefit from his outstanding clinical expertise. 3M ESPE wishes also to thank Dr. Powers who in chapter 3 links the chemistry of impressioning materials to their clinically relevant properties in an intelligible and user-friendly way.

3M ESPE complements their work with our long standing expertise in impression material mixing technology in chapter 5.

We hope that you find the changes made to the latest edition will help you to further improve the quality of your impressions and the restorations you produce in practice or training.

Dr. Alfred Viehbeck
3M ESPE Global Technical Director
St. Paul, MN, USA and Seefeld, Germany
May 2008



Biographical sketch

Bernd Wöstmann, Prof. Dr. med. dent.

Dr. Wöstmann graduated from the University of Münster, Germany in 1985. From 1986 to 1992 he was assistant doctor and from 1993 to 1995 assistant medical director of the Department of Prosthodontics of the Westphalian Wilhelms-University, Münster, Germany. In 1995 he was appointed assistant professor and in 1998 professor at the Justus-Liebig-University in Giessen, Germany, where he is currently holding a lifetime professorship for Clinical Dental Materials Sciences and Gerodontology. His main areas of interest are dental elastomers and related aspects of material science, especially impression taking in dentistry. He is also working in gerodontology and implantology. Dr. Wöstmann is a member of several scientific organisations including the IADR and also several DIN-ISO working groups. He is currently President-elect of the European College of Gerodontology (ECG) and second vice president of the Head Association of the German Geriatric Scientific Societies (DVGG). Dr. Wöstmann is the author of more than 200 scientific articles, abstracts, books, and chapters. He serves on the editorial boards of many dental journals and has given more than 400 scientific and professional presentations and lectures. Dr. Wöstmann has been awarded the Friedrich-Hartmut-Dost Award in 1999 for excellent education in dentistry and co-authored several presentations that have been awarded by the German Prosthodontic Society (DGZPW), the German Geriatric Society (DGG) and the Austrian Geriatric Society.



Prof. Dr. med. dent. Bernd Wöstmann
Department of Prosthodontics – Dental Clinic
Justus-Liebig-University Giessen
Schlangenzahl 14
35392 Giessen
Germany
Phone: +49641 99-46143/-46150
Fax: +49641 99-46139
E-mail: Bernd.Woestmann@dentist.med.
uni-giessen.de

John M. Powers, Ph.D.

Dr. Powers graduated from the University of Michigan with a B.S. in chemistry in 1967 and a Ph.D. in dental materials and mechanical engineering in 1972. He is senior vice president of Dental Consultants, Inc., and editor of The Dental Advisor, a dental newsletter. He is also Professor of Oral Biomaterials, Department of Restorative Dentistry and Biomaterials, and Senior Scientist of the Houston Biomaterials Research Center at the University of Texas Dental Branch at Houston. He is also a member of the faculty of Graduate School of Biomedical Sciences and Adjunct Professor at the University of Michigan School of Dentistry, University of Regensburg and the Ludwig-Maximilians-University Munich. He is active in the applied and basic research of bonding to dental substrates, colour and optical properties of aesthetic materials, and physical and mechanical properties of dental cements, composites and other restorative materials. Dr. Powers is currently the Councilor of the DMG/IADR and Chair of ANSI/ADA Working Groups on waxes and cements. Dr. Powers is the author of more than 875 scientific articles, abstracts, books, and chapters. He is co-author of the textbook, Dental Materials – Properties and Manipulation, and co-editor of Craig's Restorative Dental Materials. He serves on the editorial boards of many dental journals. He has given numerous scientific and professional presentations in the United States, Europe, Asia, Mexico and South America.



Dental Consultants, Inc.
(THE DENTAL ADVISOR)
3110 W. Liberty
Ann Arbor, MI 48103
Phone: 734-665-2020 (x113)
Fax: 734-665-1648
E-mail: jpowers@dentaladvisor.com
www.dentaladvisor.com

A guideline for excellent impressions in theory and practice

Preface	2
Biographical sketch	3
1. Clinical importance of the precision impression	6
1.1. Introduction	6
1.2. Reasons for discrepancy between laboratory results and precision in clinical situations	8
1.3. Improvement of results by standardisation	8
1.4. Standardisation in the daily routine – dental practice and dental laboratory	9
2. Clinical parameters influencing impression taking	10
2.1. Periodontal status and oral hygiene	10
2.2. Waiting period between preparation and impression	10
2.3. Preparation of the operative field	11
2.4. Anaesthesia	12
2.5. Choice of tray and specific impression techniques	12
2.6. Removal of the impression from the mouth	13
3. Properties of today's impression materials	14
3.1. History of precision impressions	14
3.2. Addition curing precision impression materials	15
3.3. Condensation curing elastomers	18
3.4. Impression materials for preliminary impressions	19
3.5. Material incompatibilities and impression disposal	20
3.6. Overview of material types and consistencies according to ISO 4823:2000	21
4. Impression trays	22
4.1. Choice of tray	22
4.2. Stock trays for full arch impressions	22
4.3. Stock trays with optimised fit	24
4.4. Custom trays	24
4.5. Dual-arch trays	26
4.6. Tray adhesive	26
5. Mixing of impression materials	27
5.1. Hand-mixing of impression materials	27
5.2. Hand dispenser system	29
5.3. Automatic mixing system	30
6. Impression techniques	33
6.1. 1-step impression techniques	33
6.2. 2-step impression techniques	34
6.3. Taking the impression	36
7. Indications	38
7.1. Orthodontic splints	38
7.2. Veneers	38
7.3. Adhesive bridges	39
7.4. Inlays and partial crowns	39
7.5. Single crowns	40
7.6. Bridges	40
7.7. Combination dentures	41
7.8. Implants	42
7.9. Summary indications and techniques	43
8. Disinfection	44
9. Storage of the impression and transport to the dental lab	45
10. Fabrication of the stone model	46
10.1. Standardisation of the model fabrication	46
10.2. Model systems	46
10.3. Timing of the model fabrication	47
11. Conclusion	48
12. Impression taking in the clinical workflow – Overview	49
13. Literature	50
14. Glossary	53
15. Overview 3M ESPE impression materials	54

1. Clinical importance of the precision impression

(B. Wöstmann)

1.1. Introduction

Restorations which fit exactly and can be inserted without any further corrections are high on the list of every dentist. Exact fitting restorations do not only facilitate more efficient and faster working, they also aid periodontal prophylaxis. Furthermore, today's aesthetically superior restorations do require exact fitting. A full ceramic crown surrounded by chronic gingivitis with its characteristic discolouration caused by a widely protruding crown margin is totally unacceptable.

The impression is an important step in the procedure of obtaining a perfect restoration. It is the aim of the impression to produce a dimensionally stable "negative" which can serve as the cast mould for a model. Due to the fact that indirect restorations are classically produced in the dental laboratory, it is inevitable that an optimal precise fit of the laboratory-made appliance is only given if the model exactly matches the original situation. Despite rapid technical progress in the field of CAD/CAM systems, the impression remains immensely important to prosthetic dentistry. At least in the near future, the impression will continue its vital role transporting information from the dentist to the dental lab. Most CAD/CAM systems available today start from the model and, thus, also require primarily an impression. Despite many efforts, the conventional impression process has not yet been replaced by more modern reproduction procedures – such as "photographic" impression with the help of an intra-oral scan, e.g. with the CEREC (Sirona Dental Systems). However, 3D-imaging procedures will increasingly be used (e.g. 3M ESPE Lava™ Chairside Oral Scanner C.O.S.) in the future. These innovations are quite promising. However, especially for deep subgingival areas and areas difficult to access, the conventional impression remains a necessary and indispensable procedure step in dental treatment.

Current trends in digital impressioning

Over the last 100 years, elastomeric impression materials were continuously developed and optimized for improved precision, patient comfort and ease of use.

Modern materials are robust, precise, fast, hydrophilic, and can be automatically mixed – but still the patient needs to keep a filled impression tray in the mouth for some very long minutes, and external factors, e.g. temperature, can impact the final result.

Thus, digital approaches were made to circumvent these problems. The first optical impressioning system was marketed in the 1980s as part of the CEREC system (Sirona Dental Systems).

The Lava™ Chairside Oral Scanner C.O.S. (3M ESPE) uses 3D-in-Motion Technology. This technique, in contrast to known "point and click" systems, captures continuous 3D video images and displays these images in real time on a touch screen monitor.

These digital impressions will be sent to the dental lab where a technician will digitally cut and mark the margin. Models for the lab technician will be made with digital precision using stereolithography. While model fabrication still is a necessary work step, it might become less important in the future. 3M ESPE already manufactures Lava™ Zirconia copings with CAD/CAM technology. In the future these copings could be milled based on a digital impression.

Marginal accuracy: what is necessary and what is possible?

Due to numerous material-related aspects, an identical replication of the original situation is not possible with the materials and methods used in today's dentistry. In fact, impressioning is a constant tightrope walk between lumina that either came out too small or too large, and thus, between oversized or undersized model abutments. The equivalent is in the lumen of a crown, which is either too large or too small. Crowns that are too large have intolerable marginal gaps and if too small, crowns do not reach the preparation margin.

The biological tolerance for marginal discrepancies is almost unknown, although both the correlation between marginal accuracy and periodontal damage^{1,2}, and the appearance of secondary caries in the case of inaccurate fit³ has been proven.

The margin of a restoration is the critical point, since inadequate restoration margins can hardly be corrected afterwards. Occlusal interferences as well as inaccurate fit around the approximal contacts can be corrected much easier – independent of whether these are classical metal restorations or CAD/CAM-produced zirconium oxide frameworks. Thus, the reproduction of the preparation margin in an impression is a necessary requirement in order to achieve good marginal quality. In vitro, the marginal precision of a dental restoration is approx. 50 µm on average⁴⁻⁶. However, this level of precision can rarely be met clinically. This divergence applies mainly to restorations with subgingival or paragingival margin areas. If the crown margin is completely supragingival, it is possible to obtain accuracies which are quite comparable with the results from lab tests. This has been impressively proven in several studies⁷⁻¹².

What are the reasons for the considerable discrepancy between the technical possibilities of the respective materials and the clinical results? These mainly relate to the clinical factors encountered during the treatment of the patient. Otherwise, similar results as in lab tests would be achieved. Thus, factors related to clinical procedure have a significant influence on the fitting accuracy and will be described in the next chapter.

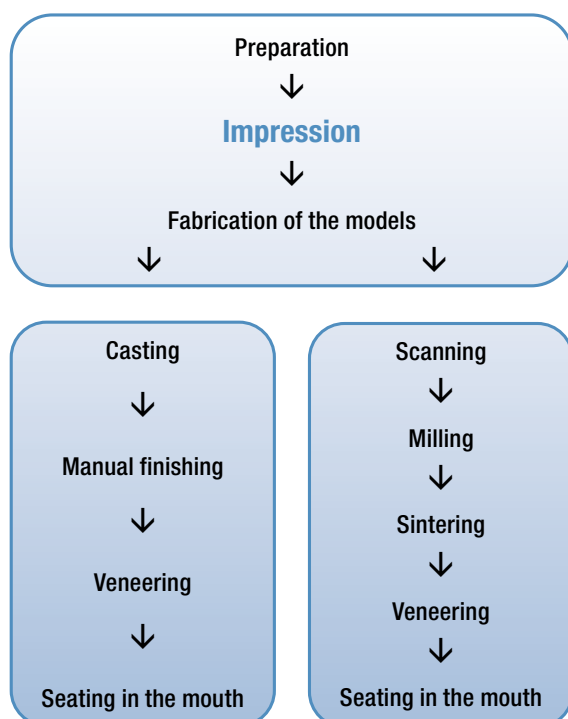

Fig. 1: Today's typical workflow for metal restorations (left) and for CAD/CAM-manufactured restorations in the lab (right).

1.2. Reasons for discrepancy between laboratory results and precision in clinical situations

The preparation of a fixed dental restoration with the help of precision impression materials requires several treatment and laboratory steps independent of whether a conventional or CAD/CAM technique is chosen.

The same sources of potential error apply to all fixed restorations. We will use the example of a crown for explanation.

The lumen of a crown has to be a little bit larger than the original abutment so that the restoration can be cemented, so it is desirable to achieve a slight enlargement of the crown lumen in the course of the workflow from impression to crown. However, due to material-related reasons (like shrinkage of cast gypsum or impression material) this is not possible.

Usually, the known dimensional errors of the impression are compensated by the experienced dental lab by applying spacers or changing the setting expansion of the embedding material to achieve well-fitting restorations.

1.3. Improvement of results by standardisation

To achieve reproducible results with regard to accurately fitting, fixed restorations one must standardise the process from the preparation of the tooth to the seating of the final restoration¹³. Fig. 2 shows – in a simplified manner – that the dimension of the abutment, as it is reproduced in the impression, approximately corresponds to a normal distribution (Gaussian distribution). Its width depends on the consistency or rather the inconsistency of the initial conditions like impression technique, tray choice, temperature, etc. In daily practice it is scarcely possible to evaluate the actual dimension of the reproduced abutment in the impression, since such discrepancies are rarely obvious to the naked eye.

The subsequent work steps in the lab (fabrication of the model, carving, embedding, casting) in principle follow the same scheme. The difference is that the position of the curve maximum no longer corresponds to the original tooth but to the position delivered in the impression (e.g. positions a, b or c, Fig. 2).

At this point the problem is clear: with each further work step the spreading of the results becomes larger. It can never become smaller (Fig. 2 red curve below).

Thus, it is a widespread fallacy that the deviations resulting from insufficient standardisation “level out” on their own²².

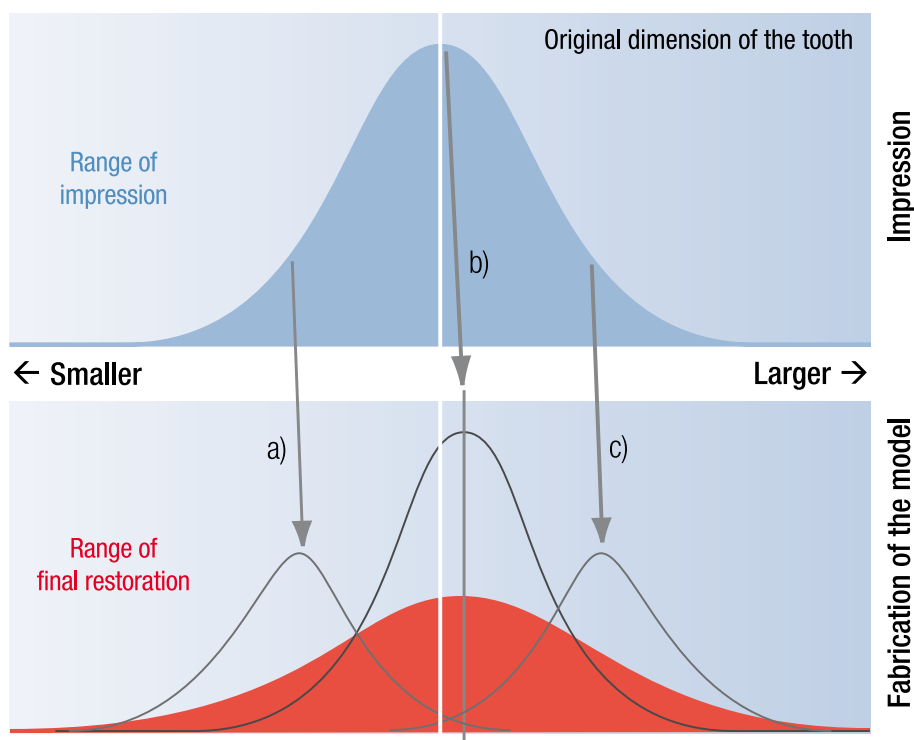

Fig. 2: Schematic of the spreading of results along a multi-step workflow.

The statistical spread of results can be reduced by standardised procedures, good communication between technician and dentist, the use of modern, high-quality impression materials (with constant and reproducible properties in all production batches) and correct and reproducible handling of these materials, especially through automatic mixing¹⁴.

1.4. Standardisation in the daily routine – dental practice and dental laboratory

In daily clinical practice, the statistical spread can be reduced especially by standardising processes. This starts with the planning of the treatment and ends with the shipment conditions used to send the impression to the lab.

Furthermore, it is essential to co-ordinate the work steps in the dental practice and the lab. It is very important for the dental lab to know the general conditions of the impression to compensate the system-related errors by suitable measures. In principle, the procedures in practice and lab would require a process management as known from industrial fabrication and an intensive **communication** between dentist and dental technician. Only if he/she knows which impression technique and material were used, can the dental technician effectively co-ordinate the material chain and finally produce an accurately fitting restoration.

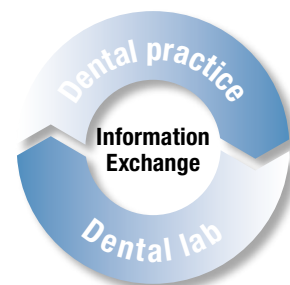

2. Clinical parameters influencing impression taking

(B. Wöstmann)

Systematic standardisation can reduce the number of retakes and corrections. Additionally, the final success of an impression is strongly influenced by the clinical situation and is individual for each patient.

2.1. Periodontal status and oral hygiene

The periodontal and **oral hygiene** status of the patient significantly influence the result of an impression, since inflamed periodontium around a diseased tooth shows increased bleeding tendency. As periodontal disease and **sulcus bleeding** are inextricably connected to the oral hygiene behaviour of the patient, it is very important to achieve good oral hygiene circumstances before the prosthetic therapy, especially with regard to the impression. The worse the individual hygiene circumstances, the more failures must be expected. Thus, the vicious circle as displayed in Fig. 3 is inevitable^{70,71}.

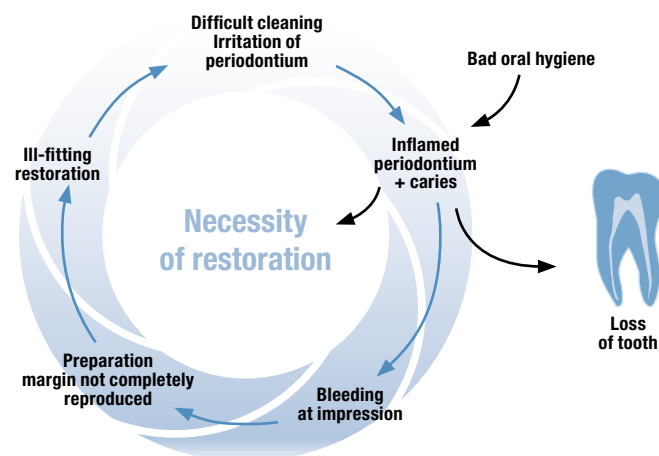

Fig. 3: Insufficient periodontal circumstances and possible after-effects.

2.2. Waiting period between preparation and impression

The waiting period between preparation and impression is an extremely important parameter for the success of the impression and has been widely disregarded to date. In particular, whenever an injury to the marginal **periodontium** has occurred during preparation, the periodontium should be allowed to heal completely before the impression is taken (about one week, if it is not possible to effectively dry the sulcus). This greatly reduces the risk of failure for the impression^{15,16}. The greatest inaccuracy can be expected when the impression is taken on the day following the tooth preparation. Positioning of the cord inevitably causes trauma to the granulation tissue which has formed, involving bleeding which is generally difficult to arrest²⁵.

Less failures can be expected – even with fully supragingival preparations – when the impression does not immediately follow preparation^{15,16}.

2.3. Preparation of the operative field

Retraction

An essential requirement for a successful impression is the accurate reproduction of the prepared teeth. Only then can the preparation margin be defined unequivocally on the stone model. You can only reproduce what is accessible. With supragingivally located preparations keeping the area to be impressed dry and accessible is usually quite easy^{8;17}. However, if a tooth is crowned to preserve it, it is often deeply destroyed and the preparation margin is fully or at least partly subgingival. If the tooth should serve as a bridge abutment it is the question of sufficient retention of the bridge which forces a paragingival or subgingival preparation.

If the preparation margin is not accessible it can either become supragingival by surgical treatment and/or – preferably – the sulcus can temporarily be extended with a retraction material.

Haemostatic properties of the retraction material are not required when healthy periodontal conditions have been achieved with good oral hygiene and subsequent tissue management. However, sometimes it is necessary to work with pre-impregnated retraction cords despite the use of local anaesthetic containing a **vasoconstrictor** (warning: cardio-vascular risk patients). Pre-impregnated retraction cords or added retraction liquids – especially based on metal salts – can interact with impression materials and prevent their setting process^{18;19}.

The aim of a retraction is to clearly display the preparation while causing the least trauma possible to the tissue. Mainly, **single and double cord retraction techniques** are used depending on the impression site. In the double cord technique, at first a thin cord is placed on the bottom of the sulcus, a thicker cord on top of it takes care of the actual **tissue displacement**. In both retraction techniques the cord placed last is removed shortly before the impression is taken.

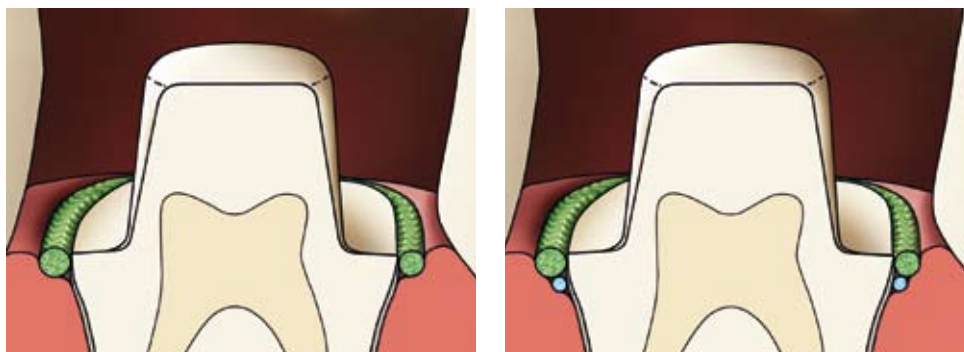

Fig. 4: One cord technique (left), two cord technique (right) for retraction.

An already open sulcus can be dried efficiently by using pastes, e.g. Expassyl™ (Pierre Roland)⁷².

For single teeth the use of retraction sleeves (e.g. Peridenta) to open the sulcus is an alternative to retraction cords.

! You can only reproduce what is accessible.

! Testing the compatibility of impression materials and retraction agents is easy: A retraction cord is soaked with the astringent to be tested, slightly dabbed and coated with the light-bodied impression material which is selected to be used later. As a control use another cord soaked with saliva or salt solution. After setting of the impression material the cords must stick tightly and it should not be possible to remove them from the impression material. If they can be removed easily and if there is even some unset impression material on the cords, the materials are NOT compatible.



Fig. 5: Retraction cord in situ.



Fig. 6: Drying of the sulcus with retraction paste.

Cleaning the prepared tooth

Before the impression can be made, agents that might have been used for cleaning or disinfecting the cavity (e.g. [hydrogen peroxide](#)) must be thoroughly rinsed off from the preparation with water spray. Residues of these materials can prevent complete setting of the impression material. VPS (A-silicone) and polyether materials, for example, can react with remaining hydrogen peroxide, VPS may generate foam and thus prevent an accurate reproduction of the preparation margin. Also, unset residues of [methacrylate composites](#) can interrupt the setting process and, thus, have to be removed carefully with alcohol and then with water (see “[Material incompatibilities](#)”, [chapter 3.5.](#)). Subsequently, the tooth is dried with a gentle air stream.

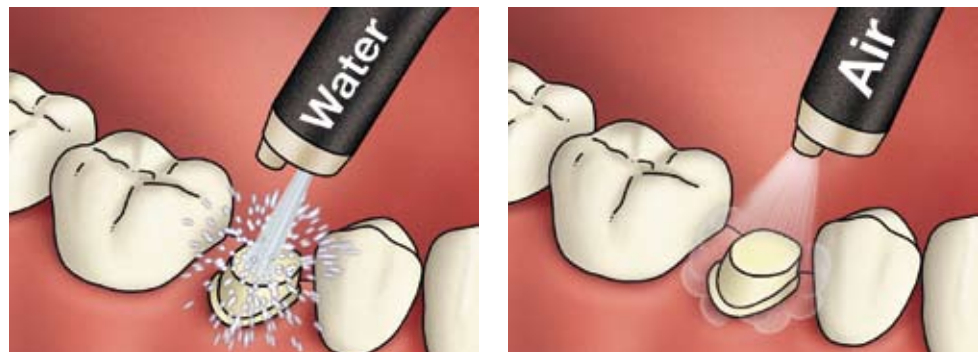

Fig. 7: Thorough rinsing and drying of the tooth using water spray and air.

2.4. Anaesthesia

Impressions which are taken under local anaesthesia are often more successful than those taken without^{15,16}. Without [anaesthesia](#) it is almost inevitable that the patient has to endure pain during the impression procedure; especially during the positioning of the retraction cords and the drying of the prepared abutments. The reaction of the patient to pain often leads to inappropriately placed retraction cords or insufficiently dried teeth. If this happens, the result is a relatively bad impression. Furthermore, most anaesthetics contain vasoconstrictors which cause anaemic conditions around the anaesthetised area, counteract sulcus bleeding and, thus, favour a positive impressing result.

2.5. Choice of tray and specific impression techniques

Both the selection of the proper impression tray for the specific indication and technique as well as the choice of the impression technique appropriate for the indication have significant influence on the final success. That is why we have dedicated them a full chapter each ([chapters 4 and 6](#)).

2.6. Removal of the impression from the mouth

Even with a seemingly uncomplicated task such as the removal of the impression from the mouth, some basics have to be observed to avoid **permanent deformation** of the impression material. Since the **tooth axes** on both sides are not parallel but either converge (lower jaw) or diverge (upper jaw), the preferred removal technique especially when using full arch trays depends on the localisation and number of prepared teeth. Permanent deformation of the impression at the prepared tooth can only be avoided if the impression is removed exactly in the direction of the tooth axis *of the prepared tooth*. With preparations in the lower jaw posterior area this can be achieved best if the impression is loosened at the side of the prepared teeth so that it rotates around a support in the contra-lateral vestibulum (Fig. 8). Impressions of prepared teeth in the upper arch posterior area, however, are preferably first loosened at the opposite side (Fig. 8). In the case of front teeth the primary loosening of the impression should be dorsally on both sides. If this not observed, the impression material can be compressed considerably, which results in deformation of the material. If an impression with preparations on both sides of the jaw has to be taken, deformation of the impression material around the preparations is inevitable. In such situations carefully choose the impression tray and take care that the tray is large enough around the undercut areas (see “Impression trays”, chapter 4).

 Remove along axis of prepared tooth.

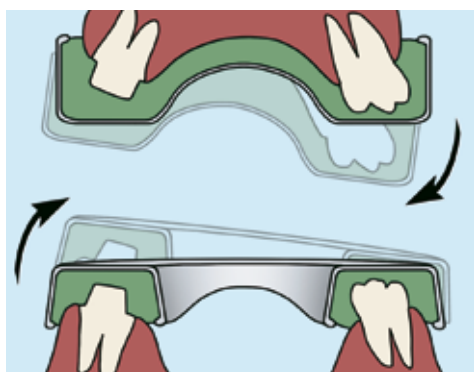

Fig. 8: Optimum removal of impression tray: for upper jaw loosen tray on opposing side, for lower jaw, loosen tray on prep side.

Especially for high precision impressions a vacuum between the teeth and impression material develops during material setting which complicates the removal of the tray. In order to disrupt this vacuum, open the tight seal by mobilising the oral mucosa with an in-rotating movement of the forefinger at a suitable place. Additional application of compressed air can be helpful (see Fig. 9).

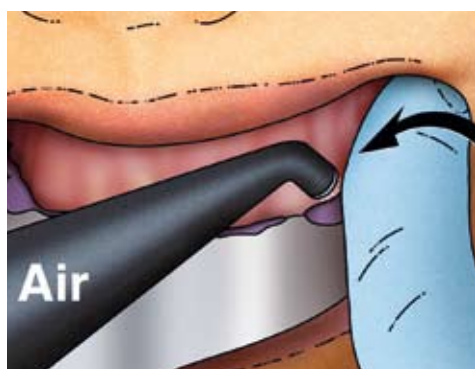

Fig. 9: Use of finger and air stream to loosen impression.

3. Properties of today's impression materials

(J. M. Powers)

3.1. History of precision impressions

The introduction of reversible hydrocolloids in the mid-1930s heralded a new age in the impression sector. For the first time the impression of undercuts became possible. With the appearance of polysulfides at the beginning of the 1950s, an elastomeric impression material was used in dentistry for the first time. Around 55 years ago the world of dentistry saw the introduction of a category of materials – the C-type silicones (condensation-cured) – which, like another condensation-cured class of materials, the polysulfides, were not originally intended for oral applications.

The great disadvantage of these products still remains: shrinkage intrinsic to the system – be it due to the evaporation of water with the hydrocolloids or of low-molecular side-products in the case of the condensation cured elastomers^{20,21}.

In 1965, 3M ESPE polyethers were introduced to the market (Fig. 11). Polyether is a hydrophilic impression material cured by cationic ring-opening polymerization, which is far superior to the hydrocolloids and C-type materials. It has high mechanical properties, good elastic recovery and is subject to virtually no shrinkage. The main advantages include hydrophilicity, unique flow and setting behaviour. Since the impression material is in close contact with wet soft and hard tissue, hydrophilicity is one major feature of a modern precision impression material. **Hydrophilicity** is defined as an affinity for water (Fig. 10).

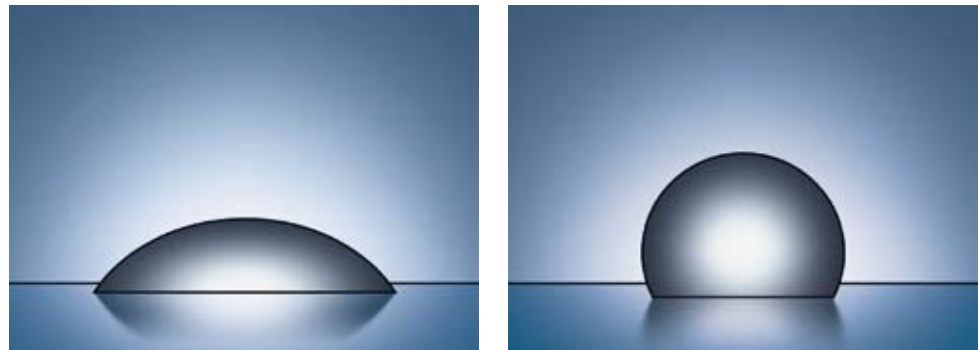

Fig. 10: On hydrophilic material water can spread easily (left) whereas its contact surface is minimised to hydrophobic material (right).

Ten years later, silicones in their enhanced form, the **addition-cured silicones (vinyl polysiloxanes)** were introduced as impression materials. However, they are hydrophobic by their molecular chemistry (**hydrophobic** = repels or does not absorb water, the opposite of hydrophilic). It has been possible to reduce the level of **hydrophobicity** by the addition of soap-like molecules (**surfactants**). These increase the hydrophilicity of the material, especially in the set stage^{22–24}. Set vinyl polysiloxanes have very high dimensional stability over time and temperature, even in a moist environment. They are known for their superior elastic recovery. Some of the most recent materials like Imprint™ 3/Express™ 2 VPS Impression Materials (3M ESPE) have been improved with regard to the clinical problem of tearing.

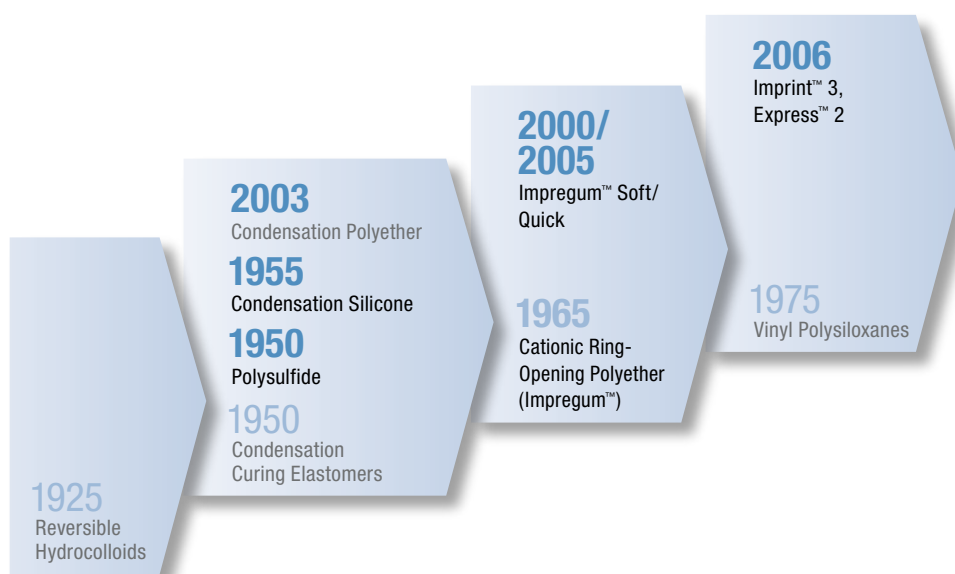

Fig. 11: History of precision impression materials.

With the launch of 3M ESPE Impregum™ Soft/DuoSoft™ Polyether Impression Materials, new polyether-based impression materials became available, combining all the positive characteristics of polyether with simpler handling both chairside and in the laboratory.

The most recently introduced fast-setting Impregum Soft/DuoSoft Quick Polyether Impression Material which is recommended for one to two units offers more patient comfort and saves chairtime.

3.2. Addition curing precision impression materials

Vinyl polysiloxanes (VPS, addition silicones, A-silicones)

Vinyl polysiloxane exploits the principle of “addition reaction curing”. As opposed to condensation curing materials that experience shrinkage as a result of evaporation of by-products, vinyl polysiloxane remains dimensionally stable.

With vinyl polysiloxane, different pre-polymeric silicon-functionalised hydrocarbon chains (hydrogen siloxane, vinyl siloxane) and a platinum catalyst are involved in the reaction. The addition of hydrogen siloxane (-O-Si-H) to vinyl siloxane (CH₂=CH-Si-O) is called a **hydrosylation reaction**.

As a result of this reaction the vinyl polysiloxane is formed at the platinum catalyst^{23;25;26}.

The **platinum catalyst** is a platinum compound which, starting from H₂PtCl₆, is adjusted through reduction and serves as a molecular “docking station” for the two reacting partners, which leave the platinum compound once they are linked to each other (see Fig. 12).

Vinyl polysiloxane impression materials are hydrophobic by their chemical nature – they are more or less apolar hydrocarbon chains – and can be made hydrophilic using suitable molecules. However, these are always extrinsic molecules; a true **intrinsic hydrophilicity**, as in the case of the polar polyether molecules, cannot be established for these molecules. Some degree of hydrophilicity can be achieved after a certain period of time by the use of surfactants. **Surfactants** contain a hydrophobic part, which ensures miscibility in the formulation and a hydrophilic part which is responsible for improved wetting.

To convert the liquid siloxane parent compounds into a paste, inorganic fillers are added. The thixotropic properties of the vinyl polysiloxane can be controlled using appropriate fillers. The colours of the materials are adjusted through the addition of dyes and pigments.

Popular brands:

- Imprint™ 3 VPS Impression Material (3M ESPE)
- Express™ 2 VPS Impression Material (3M ESPE)
- Aquasil™ Ultra (Dentsply Caulk)
- Affinis™ (Coltene/Whaledent)
- Honigum™ (DMG)

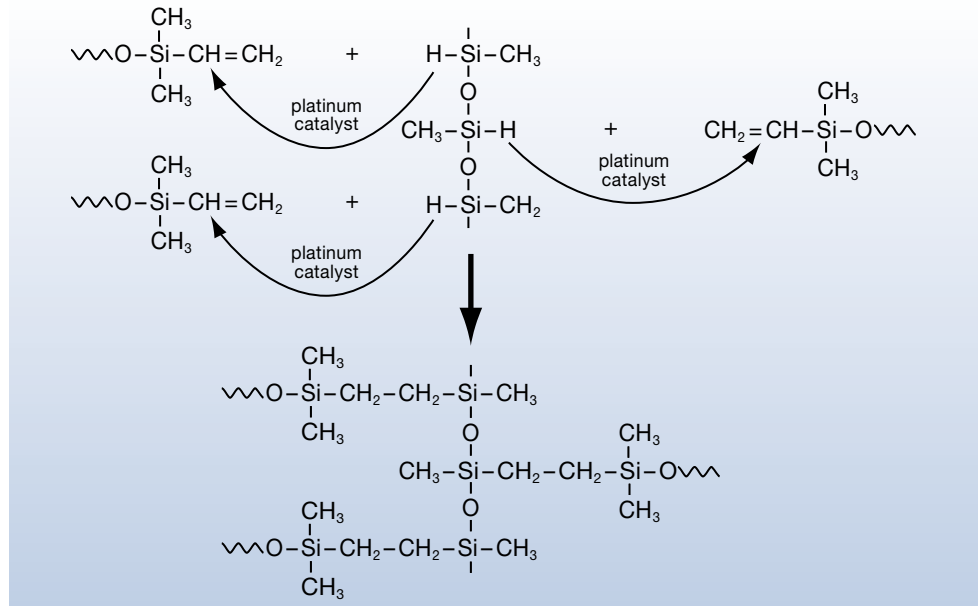

Fig. 12: Polymerisation mechanism for vinyl polysiloxane.

Recent vinyl polysiloxanes, such as 3M ESPE Imprint™ 3/Express™ 2 VPS Impression Material contain tailor-made cross linkers. The materials are designed for high **tensile strength**, resulting in high tear-resistance and high **elastic recovery**.

A-silicones have almost no limits with regard to disinfection and are compatible with most model materials²⁷.

Polyethers cured via ring-opening polymerisation

The polyether contained in the base paste, which is already a longer chain polyether (**macromonomer**), is a tailor-made copolymer of ethylene oxide and butylene oxide units (Fig. 13). The ends of the macromolecular chain are converted into reactive rings, which form into the cross-linked final product (Figs. 13, 14) under the influence of the cationic initiator of the catalyst paste.

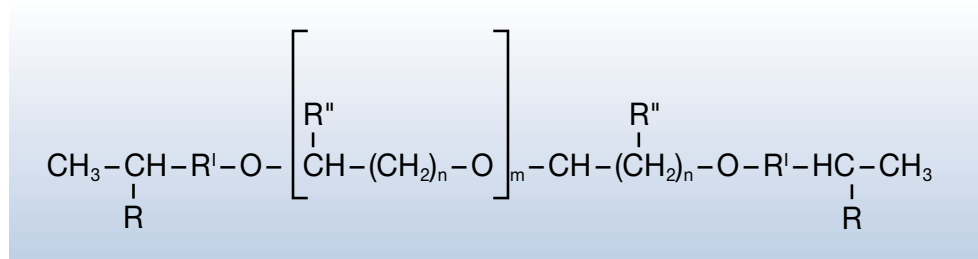

Fig. 13: Polyether macromonomer – the chains are terminated by the highly reactive ring groups (marked with an R).

The reactive ring of the polyether copolymer (basic polyether molecule) is opened by a cationic starter (Fig. 14) and can then, as a cation itself, attack and open other rings, creating a snowball effect. Whenever a ring is opened, the opening cationic starter remains attached to the former ring, thus lengthening the chain²³. This unique setting mechanism causes “**snap set**” behaviour, which refers to the rapid transition from the working to the setting stage²⁸ (Fig. 15).

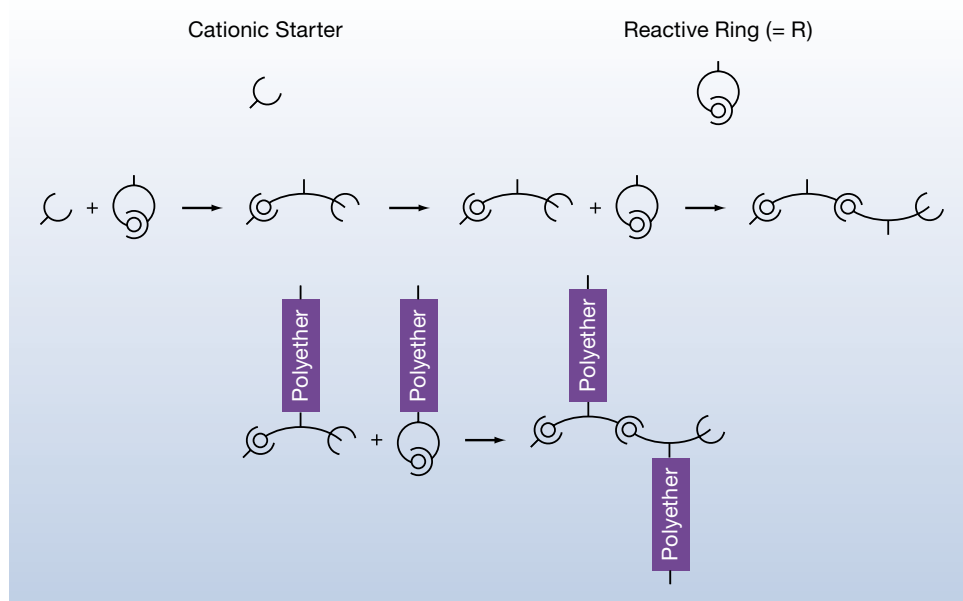

Fig. 14: Polymerisation process during setting of polyether.

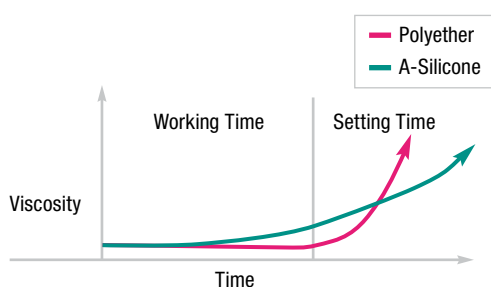

Fig. 15: Snap-set behaviour of 3M ESPE Polyether Impression Materials.

Source: 3M ESPE

The actual polyether **macromonomer** (Fig. 13) consists of a long chain of alternating oxygen atoms and alkyl groups ($O-[CH_2]_n$). The high level of hydrophilicity of the polyether itself is due to the large number of oxygen molecules in the long chain and the large polarity difference between oxygen and carbon (or hydrogen). In other words, upon contact with moisture the hydrophilic characteristics will immediately become evident.

Next to addition-cured silicones, polyether materials are the most important products in the sector of high-precision impression materials. The natural hydrophilicity of polyethers – due to their unique molecular structure, formulation and chemical setting reaction – is well-suited for a permanently moist environment such as the mouth. This characteristic is particularly useful when taking impressions of gingival areas or in the sulcus, such as subgingival preparations²⁹.

Thanks to its hydrophilic macromonomers, polyether offers precise flow behaviour, which also explains the strong initial adhesion of the polyether impression upon removal. Triglycerides are responsible for these special flow characteristics, which ensure optimal wetting of the preparation surface after syringing around the preparations. Inorganic fillers produce the high rigidity of the impression and contribute to dimensional stability following removal of the set polyether material.

Given the identical chemical basis, all three consistencies of 3M ESPE polyether impression materials can be freely combined with each other, e.g. for taking edentulous impressions. A chemical bond after curing is guaranteed.



Popular brands:

- Impregum™ Polyether Impression Material (3M ESPE)
- Permadyne™ Polyether Impression Material (3M ESPE)

3.3. Condensation curing elastomers

Polysulfides (Thiokols)

Cross-linking of polysulfides is brought about by a polycondensation reaction in which water is the reaction product. Some polysulfides may be categorised as toxic substances, primarily due to the heavy metal (esp. lead) oxides contained in the reactor paste³⁰.

Compared to polyethers and silicones, polysulfides do not have a good elastic recovery. After the clinically recognisable hardening the crosslinking continues. During this ongoing curing reaction the elasticity and elastic recovery increase considerably. Therefore, polysulfide impressions should be left for at least another 5 minutes in the mouth – beyond the clinically recognisable setting³¹. Today, polysulfides do not play an important role in the market^{23,25}, but are still in use for some indications³².

Condensation silicones

The base component of the condensation silicone category consists of oleaginous polydimethyl siloxane with hydroxyl-terminated groups and fillers such as diatomite, TiO₂ and ZnO. The base component contains tetrafunctional alkoxy silanes which, in the presence of a catalyst such as dibutyl tin dilaurate or zinc octoate, will react with the hydroxyl groups, splitting off a condensate (usually alcohol) and cause cross-linking. After curing, subsequent and inevitable evaporation of the alcohol results in shrinkage of the material.

A further problem commonly encountered is the difficulty of obtaining the correct proportions of the individual components when hand-mixing condensation silicone impression materials. With the standard dispensing of C-type silicones, a deviation of +/- 25 percent from the set point can be expected. This may cause the working and setting time of the material to vary, thus indirectly affecting the quality of the impression²³⁻²⁵.

C-silicones are compatible with most model materials. However, allergic reactions to the catalyst paste have been reported. Therefore, skin contact during mixing should be avoided.

Condensation polyethers

There is only one condensation polyether impression material on the market today. Its base component contains a polypropylene glycol that is functionalised with alkoxy silane end groups. Cross-linking is achieved by the transformation of alkoxy silane end groups while ethanol is released. The catalyst component contains acid and water that are needed for the curing reaction³³.

Reversible hydrocolloids

The main constituent of hydrocolloids is water, which sets together with agar-agar, a long-chain galactose polysaccharide. This produces a gelatinous mass that is solid at room temperature. If the mass is heated, a sol-gel transition occurs, and the material becomes liquid. As this process is reversible, the material solidifies again after cooling. Both solidification and liquefaction temperatures depend on, among other factors, the purity of the agar and the addition of other substances. Talcum, lime and borax are added to hydrocolloids, affecting their flowability.

When properly handled, hydrocolloids offer a high level of accuracy. This is comparable to, although not surpassed by, other elastomeric impression materials. On the other hand, the handling when taking a hydrocolloid impression is sometimes cumbersome. Wider use is additionally discouraged

 Popular brands:

- Permalastic™ (SDS/Kerr)

 Popular brands:

- Optosil/Xantopren (Heraeus Kulzer)
- Speedex (Coltène Whaledent)

 Popular brands:

- P2® Impression Polyether (Heraeus Kulzer)

 Popular brands:

- AccuLoid™
- Identic™ (Dux Dental)

by limited shelf life and insufficient tear-resistance. As a result, the use of hydrocolloids has dwindled to a small number of users over the years, and agar impression materials are by no means as important as they used to be before the introduction of polyether and vinyl polysiloxane^{23,25}. Hydrocolloid impressions need to be cast immediately (within 20 minutes).

3.4. Impression materials for preliminary impressions

For the fabrication of a prosthetic restoration a model of the opposing arch is necessary, as there is no other way to ensure a correct occlusion. It is important therefore that materials used for preliminary impressions are discussed:

Alginates – irreversible hydrocolloids

Alginates are irreversible elastic impression materials. The basic substance of alginates is alginic acid, a polyglycoside of D-mannuronic and L-gulonic acid which itself is not soluble in water. Usual alginate powders contain, besides fillers, sodium or potassium alginate, calcium sulphate as a reagent and sodium or potassium phosphate as a retarder. Alginates are usually mixed by hand. With the available mixing devices – depending on the type of device – the material properties can only be slightly improved.

Alginate impressions should be cast within 15–30 minutes, since during further storage the impression inevitably shrinks due to syneresis and evaporation of water from the alginate gel. Additionally, alginate impressions cannot be stored, show a low tear-resistance²² and the elastic recovery after deformation is not as good as with precision impression materials³⁴. The use of such an impression for the preparation of temporary restorations is limited since it cannot be stored over a prolonged period of time.

Although the handling of alginates as well as their material properties are altogether not very efficient, their low tear-resistance offers advantages in some situations, i.e. when taking an impression of a periodontally affected tooth or over fixed orthodontic appliances which cannot be reproduced with tear-resistant materials since the impression could not be removed from the mouth.

Alginate replacement materials

To avoid the described disadvantages of alginates, so-called **alginate replacement** materials (e.g. Position™ Penta™ VPS Alginate Replacement, 3M ESPE) were developed. Since they are processed with automatic mixing systems (e.g. Pentamix™ 3 Automatic Mixing Unit, 3M ESPE, see chapter 5.3.), mixing and processing errors can almost be excluded.

Alginate replacement materials are cost-effective VPS materials which, as other VPS materials, have a high dimensional stability.

When used with prefabricated single-use impression trays (Position™ Tray, 3M ESPE) (see chapter 4), alginate replacement materials quickly and efficiently provide preliminary impressions.



Popular brands:

- Palgat™ Plus / Quick Alginate Impression Material (3M ESPE)



Popular brands:

- Position™ VPS Alginate Replacement (3M ESPE)
- AlgiNot (Kerr)



Warning:

Incompatibilities may arise during

- Retraction (→ 2.9.)
- Tray customisation (→ 4.2.)
- Putty wash technique (→ 6.1.)
- After core build-up or fabrication of temporaries

Especially for the fabrication of [temporary restorations](#), the use of alginate replacement materials in combination with such trays offers several advantages: their smooth silicone surface facilitates the trimming of temporary restorations considerably; due to the unlimited shelf life of the impression, temporaries can be renewed later without problems. No further impressions have to be made. The preparation of the tray (adhesive, customisation etc.) as well as its cleaning and sterilisation is not necessary.

3.5. Material incompatibilities and impression disposal

General incompatibilities

[Metal salts](#) which are contained in many astringents used for haemostasis can inhibit the setting of impression materials. The result is – at least partly – an insufficient setting of the material especially in the critical sulcus region ([see also chapter 2.3.](#)).

Generally, *only* materials of the *same* material class should be used together ([see e.g. chapter 4.2.1. Customisation of stock trays or chapter 6.1. 1-step impression techniques](#)). All 3M ESPE polyethers (cationic ring-opening polymerisation, [chapter 3.2.](#)) can be combined with each other, yet, not with other material classes.

If a [methacrylate composite material](#) has been used for abutment completion or core build-up, or a temporary restoration of methacrylates or composites was produced before the impression, the resulting [smear layer](#) has to be removed with alcohol and cotton pellet, otherwise the impression material will not set at the contact areas. Grinding and polishing is not enough in this case.

Therefore, the impression area should always be thoroughly cleaned and dried before the impression is taken ([chapter 2.3.](#)).

When working with hand-mix VPS putty materials it has to be observed that the contents of the gloves can negatively influence the setting behaviour of the impression materials ([chapter 5.1.](#)).

Disposal

Impression materials can be disposed of in the household waste, special local regulations might apply. With regard to waste prevention the materials filled in foil bags and used in automatic mixing devices are especially environmentally friendly, since they can be exactly dosed and only little packaging waste is generated.

3.6. Overview of material types and consistencies according to ISO 4823:2000

Type 0 Putty consistency

Alternative terminology:

Kneadable material / putty

Use (technique):

Tray material (1-step, 2-step)



Type 1 Heavy-bodied consistency

Alternative terminology:

Heavy-body / tray

Use (technique):

Tray material (1-step, 2-step)



Type 2 Medium-bodied consistency

Alternative terminology:

Medium body, medium viscosity, regular body

Use (technique):

Tray/syringe material (1-step, monophasic)

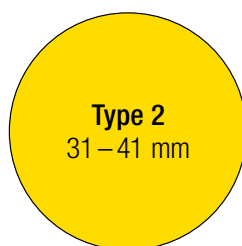

Type 3 Light-bodied consistency

Alternative terminology:

Light body / wash / light viscosity

Use (technique):

Syringe material (1-step, 2-step)

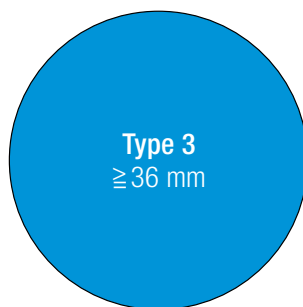

Fig. 16: Material types and consistencies according to ISO 4823:2000.

Materials are classified according to the disc diameter they achieve in the ISO test 4823:2000; 9.2. The larger the disc, the thinner the material, i.e. the lower the consistency of the impression material.

4. Impression trays

(B. Wöstmann)

4.1. Choice of tray

Unless you take an impression of an edentulous situation, you normally have to cope with **undercuts**. These undercuts are either in the natural shape of the unprepared teeth or result from the opposing inclination of the tooth axes. Most of the time even the alveolar ridge shows undercuts. In all cases the impression is inevitably compressed during removal from the mouth. Elastomeric impression materials can be deformed both elastically – which is reversible – and plastically, irreversibly. So care must be taken not to compress the materials so much that they undergo plastic deformation. Material compression can be controlled by sufficient space between teeth and impression tray wall. A rule of thumb is to compress VPS and polyether materials by *no more than 1/3* of their original length or thickness. For tray selection that means that around undercuts, the distance of the tooth to the tray wall needs to be at least *twice* the depth of the undercut (Fig. 17).

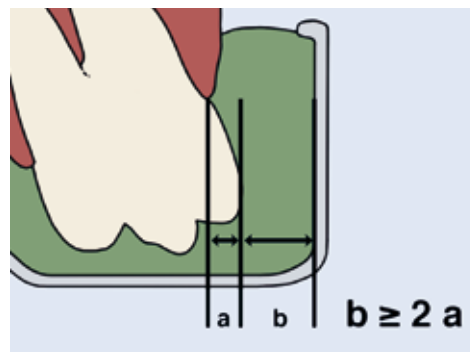

Fig. 17: Silicones and polyethers require twice the undercut depth as a distance to the tray wall (3-fold depth of the undercut from tooth to tray in total).

4.2. Stock trays for full arch impressions

Metal stock trays which completely cover the tooth row distally should be the preferred choice. If this is not possible a dorsal dam can be produced individually (see chapter 4.2. “Customisation of stock trays”). For polyethers the use of non-perforated trays is recommended. VPS putty materials can be applied in perforated trays since the perforation increases the retention of the materials in the tray.

Using putty materials in a simple plastic tray (stock tray or custom-made tray) can cause problems as the tray may be deformed when inserting the impression. The impression material then sets in this position and is uncontrollably deformed after mouth removal due to the elastic recovery of the tray. If a custom tray or a plastic stock tray is used, heavy- or regular-bodied consistencies should be chosen for the impression (see also Fig. 16, chapter 3.6.).

Customisation of stock trays

If there is no adequately fitting impression tray available, it is possible to customise a stock tray. Customisation can be done with a composite tray material, shellac or a putty impression material. Especially if the tray has to be prolonged, a stable composite tray material is preferable. In general, the damming material used needs to be compatible with the impression material. If, e.g. an addition-cured silicone (VPS) is used for impressing, C-silicones should not be used for damming, since the catalyst of the C-silicones inhibits the setting reaction of the VPS material.

Dorsal damming (Fig. 18a–d) helps the dentist to find an exact, reproducible position of the impression tray in the distal area and increases the patient's comfort since it prevents the impression material from flowing down the throat.

Occlusal stops (Fig. 18c, d) avoid the contact of the tray and the occlusal surface, especially during pressureless impressions (e.g. with polyethers) or when using low-viscous materials. Occlusal stops are mainly applied with composite tray material in the incisal area and/or molar area at places distant from the preparation.

Additionally, the application of a support in the palate area, for example with a VPS putty material is possible (Fig. 18c, d). This is customised to the patient i.e. by quick insertion and removal of the tray with a fast setting putty material.

The optimised fit of customised trays reduces the appearance of **flow defects** (see also chapter 6.1.).

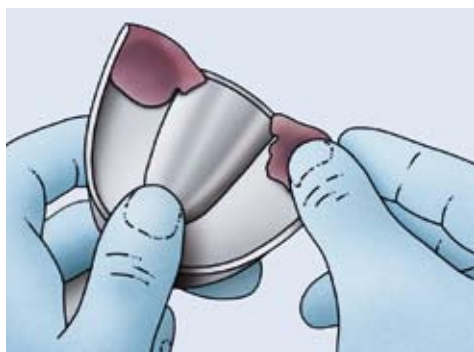

Fig. 18a: Application of dorsal stops.

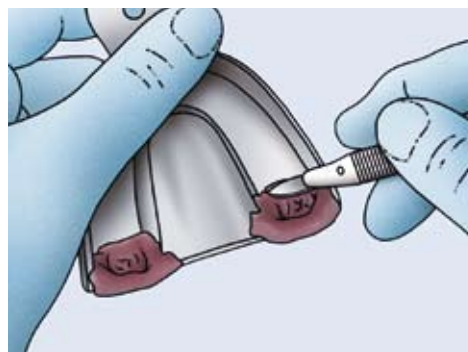

Fig. 18b: Try-in and reduction with scalpel if necessary.

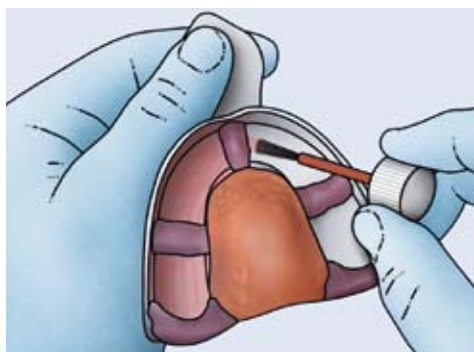

Fig. 18c: Palate (putty material, customised to the patient) and occlusal stops added, application of the tray adhesive followed by drying for at least 5 minutes.

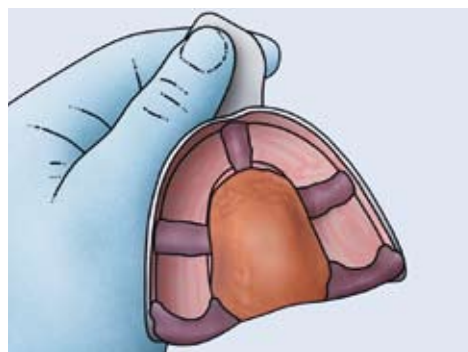

Fig. 18d: Example for a customised tray with palate and occlusal stops, dorsal damming and applied adhesive.

4.3. Stock trays with optimised fit

While choosing a tray for impressions of the upper jaw is usually quite easy, you might encounter problems with a fully-toothed lower jaw. Most lower jaw serial trays available in the dental market are either wide enough but then dorsally too short or, if they are long enough, they are too wide^{35,36}. Thus, the use of impression trays which have been especially developed for the impression of fully-toothed lower jaws is advantageous*.

For preliminary impressions Position™ Trays (3M ESPE) can be used alternatively (Fig. 19). As this tray set was developed from an analysis of jaw shapes of over 1,500 test subjects in Europe and the U.S., it is usually possible to find a matching tray³⁵. The tray is coated with a retentive fabric which ensures adhesion of the impression material to the tray and it makes a tray adhesive redundant.



Fig. 19: Position™ Tray (3M ESPE).

For precision impressions, autoclavable carbon fibre trays** can be used as an alternative to metal stock trays. These trays are almost as stable as steel trays.

4.4. Custom trays

Requirements

A custom tray is intended to create optimum flow to the teeth and an evenly thick layer of the impression material in all areas of the impression. Thus, the absolute value of the inevitable dimensional change of the impression remains low^{37,38}.

This ideal can only be realised if the area of which the impression should be taken is free of undercuts. If there are undercuts their threefold depth needs to be blocked out on the gypsum model before the tray is made. This avoids excessive compression of the impression material³⁹ and facilitates easy removal from the mouth – analogous to the stock tray.

The main indication for custom trays is the edentulous or partially toothed jaw. Also for special impression situations (e.g. above-average small or large jaws, exceptional abutment positions, implants) the fabrication of a custom tray is necessary.

Custom trays require careful fabrication. Today mainly light-cured tray materials are used, since they are sufficiently rigid and dimensionally stable^{42,43}.

Thermoplastic materials (e.g. shellac) are highly deformable and, thus, only conditionally suitable for the fabrication of custom-made trays^{40,41}. Autopolymerising materials are subject to both prolonged polymerisation shrinkage and tend to expand due to water sorption.

* Aesculap, Tuttlingen, Germany

** Clan BV, Eindhoven, Netherlands

Fabrication

For the fabrication of a custom tray a study model is needed. Draw the prospective tray margins onto the model (Fig. 20a). Then, the undercuts are blocked out sufficiently (see chapter 4.1). It can be useful to analyse the depth of the undercuts with a measurement device. Subsequently, the teeth are covered with wax plates up to the later tray margins (2 stacked wax plates → resulting layer thickness approx. 2.5–3 mm (Fig. 20b)). If no modern light-curing but traditional autopolymerising resins are used (“cold polymer”), the wax should be covered with a thin tin or aluminium foil to protect it from the polymerisation heat. After that, the soft plastic plate is adapted to the model (Fig. 20c). Take care that the plate is not thinned out by stretching it too strongly, which would result in a reduced stiffness of the tray. Then, the tray material is cured. To improve its stability it is recommended to adapt another plastic plate (double thickness → 8-fold flexural strength). Finally a tray handle can be attached by polymerisation, if desired. Before using the tray, the inside should be roughened to improve the effect of the tray adhesive⁴⁴.



Fig. 20a: Marking of prospective tray margins.



Fig. 20b: Covering of teeth with wax plates. The wax layer thickness defines the space available for the impression material later on.

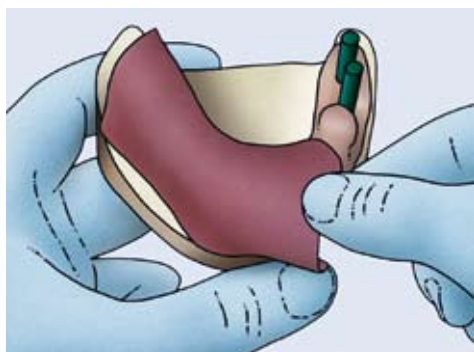

Fig. 20c: Adaptation of resin plates here with spacers for an open tray implant impression.

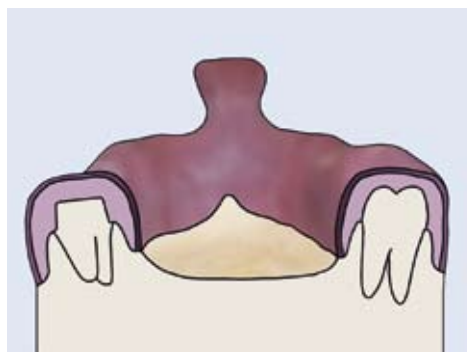

Fig. 20d: Cross-section of well fitting custom tray with optimised impression material layer thickness.



Fig. 20e: Custom tray for an open implant impression, with occlusal stops.

TM Popular brands:
 • Triple Tray®
 (Premier Dental)

4.5. Dual-arch trays

Especially for single-tooth restorations, the time needed for the actual precision impression of the prepared tooth, an additional impression of the opposing jaw and the bite registration is in a very unfavourable relation to the remaining time required for the treatment.

In order to work more efficiently in this situation, **dual-arch impression** trays are offered. The specialty of this impression technique is that a (partial) impression of the toothed upper and lower jaws as well as a bite registration are taken simultaneously. To do so, the impression support/tray is designed in such a way that the patient can close the jaw in almost maximum intercuspitation while the impression is taken. The impression tray is mostly U-shaped. In between the arms, there is usually a fine metal or plastic net which separates the tooth rows of the upper and lower arch during impressing (Fig. 21). If the patient bites, the loop of the “U” lies distal of the terminal teeth.

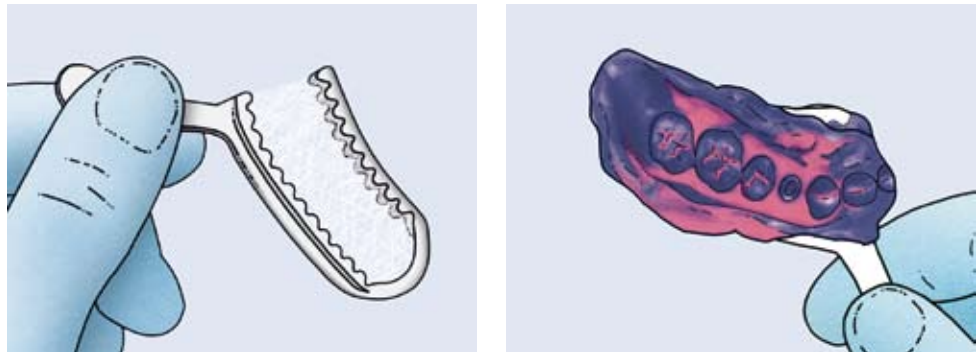

Fig. 21: Dual-arch tray (posterior).

These trays only allow for 1-step impression techniques with tray materials having sufficient flowability (see chapter 6.1.). Since correct occlusal relations have to be ensured, the impression of more than one prepared tooth or of terminal teeth should be avoided with dual-arch trays. In order to give the impression sufficient stability for the production of the stone model, it is important to use an impression material which has a high shore hardness after setting⁴⁵. With correct indication and use, impressions in dual-arch trays produce accuracies which do not differ or only slightly differ from that achieved with conventional impression trays under comparable conditions⁴⁶.

! Sufficient drying time simplifies cleaning the tray later.

4.6. Tray adhesive

The use of a **tray adhesive** improves the reliable adhesion of the impression material to the impression tray and, thus, is an essential factor for the standardisation of the good impression result. All impression trays should be coated with a thin layer of a suitable adhesive before use. The used adhesive has to match the respective impression material type to ensure adhesion. For the same reason the drying time recommended by the manufacturer should be observed.

When using 3M ESPE Position™ Trays no adhesive is necessary, since the retention fabric procures adhesion to the impression material.

5. Mixing of impression materials (3M ESPE)

The importance of a **standardised workflow** has been discussed in chapters 1.3. and 1.4. Modern impression materials are high-tech products with a sophisticated chemistry which are produced by the manufacturer within tight tolerance limits.

All impression materials have to be mixed from at least two components (usually named base and catalyst paste) before use. Only a homogeneous, void-free mixing with a correct mixing ratio of the components allows a perfect precision impression which exploits all qualities of modern impression materials.

The majority of impressions worldwide are still performed with hand-mixed materials, although automixed systems based on hand dispensers with dual-barrel cartridges have been available since 1983 (Express™, 3M ESPE) and **automatic mixing systems** for foil bags since 1993 (Pentamix™ Automatic Mixing Unit, 3M ESPE).

Meanwhile all common impression consistencies, including the especially high-viscous putty material can be mixed automatically, homogeneously and void-free, using the Pentamix™ System.

Today's most common mixing procedures are:

5.1. Hand-mixing of impression materials

For paste type materials (type 1–3), dispense equal length strands of base and catalyst paste next to each other on a mixing pad (Fig. 22a). If using a polyether (e.g. from 3M ESPE), dispensing too much or too little of the catalyst will have no effect on the working time, but will impair the quality of the impression. The working time of polyether can be prolonged for up to one minute with **Polyether Retarder** for complex cases. This is an extremely useful property especially for functional impressions.

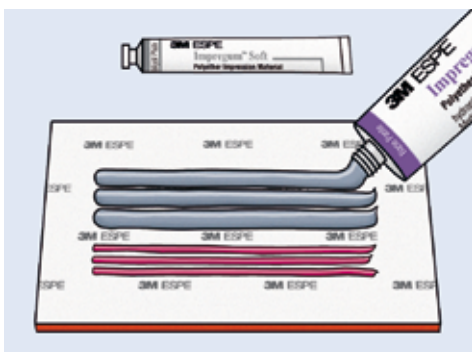

Fig. 22a: Dispensing of correct ratio of base and catalyst pastes.

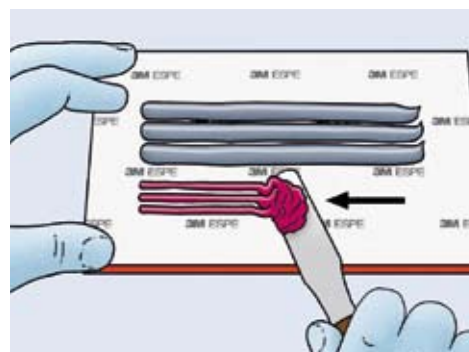

Fig. 22b: Hand-mixing of polyether impression material.

Use a spatula to mix the strands of paste to form a homogeneous mass until even colour results (Fig. 22b). Repeated spreading over the mixing pad and then picking up with the spatula will produce a homogeneous mixture. The mixing process should not take longer than 45 seconds (Fig. 22c–e). Under no circumstances should the pastes be mixed using stirring movements.

Available 3M ESPE products:

- Impregum™ F Polyether Impression Material
- Permadyne™ Polyether Impression Material
- Ramitec™ Polyether Bite Registration Material

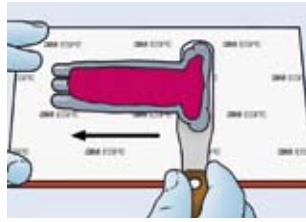

Fig. 22c–e: Hand-mixing of polyether impression material.

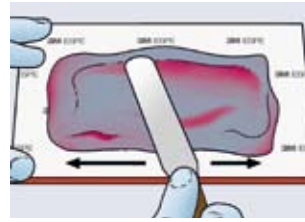

Fig. 22d

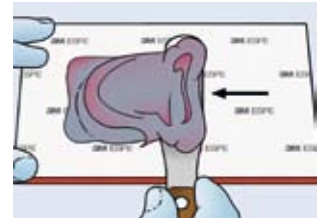

Fig. 22e

For type 2 or 3 materials use a filling device (red) to facilitate filling of the syringe (Fig. 22f–h). Due to increased viscosity, the polyether pastes cannot be squeezed from the tube at temperatures below 16° C/61° F. When returned to room temperature they become workable again with no loss of quality.



Fig. 22f: Filling of hand-mixed impression material into syringe for intra-oral application.



Fig. 22g

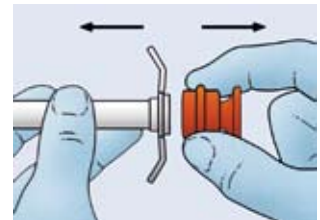

Fig. 22h

TM Available 3M ESPE products:

- Express™ STD Putty
- Express™ 2 Putty Soft VPS Impression Material
- Express™ 2 Putty Quick VPS Impression Material

For mixing of putty materials, measure equal volumes of putty base and catalyst using the colour-coded putty spoons. Mix the base and catalyst with the fingertips until a homogeneous colour is achieved. The mixing process should not take longer than 30 seconds.

The putty materials should not be mixed with latex gloves, since components of the latex rubber can interfere with the polymerisation reaction of the impression material. If possible use gloves made of other materials, e.g. nitrile.

5.2. Hand dispenser system

Automix systems with hand dispensers and dual-barrel cartridges have been used since 1983 (Express™, 3M ESPE). These systems have been developed continuously and today are the standard for light-bodied syringing materials. Even many monophasic materials or tray materials for the 1-step technique are offered in this application (e.g. 3M ESPE Garant™ System). Such systems usually consist of a 50 ml double-barrel cartridge filled with base and catalyst paste, the corresponding mixing tips, application tips and hand dispensers.

The mixing principle is a repeated separation and blending of paste strands in the so-called **static mixing** tips. With an increased number of strand separations (number of mixing elements) in the mixing tip, the quality of the mix increases, but also the extrusion force.

This undesired effect can be overcome by enlarging the diameter of the mixing tip. However, the higher the consistency of the materials to be mixed the more difficult it is to combine on the one hand acceptable **extrusion forces** and simultaneously good mixing quality with an acceptable amount of waste material in the mixer on the other hand. Thus, these systems have an upper consistency limit with respect to tray materials and are unsuitable for putty materials.

For 3M ESPE impression materials, use the Garant™ Dispenser 1:1/2:1. In order to ensure optimal mixing, it is highly important to use the correct colour-coded mixing tips and intra-oral tips for each material (Fig. 23).

Insert the cartridge with the impression material into the dispenser. Before applying the tip, check that the two cartridge openings are not clogged, and bleed the cartridge until the base and catalyst paste are evenly extruded.

Attach the Garant™ Mixing Tip, and if necessary, the intra-oral tip for syringing.

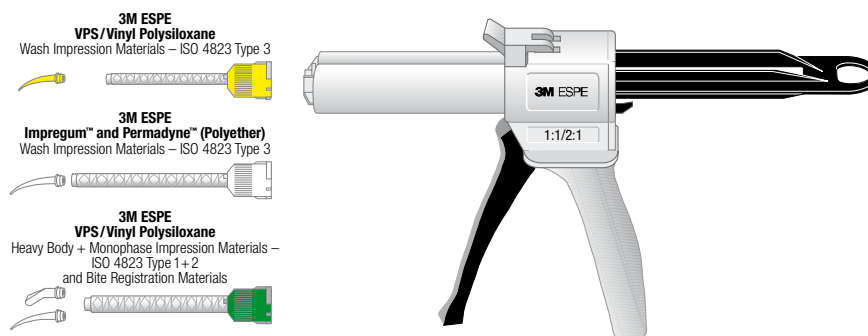

Fig. 23: 3M ESPE Garant™ Dispenser, Mixing Tip and Intra-oral Tip.

Make sure that base paste and catalyst paste are mixed completely and are extruded in uniform colour. Alternatively the 3M ESPE Penta™ Elastomer Syringe can be filled directly from the mixing tip, which might give an easier handling while syringing.

The used mixing tip should be kept on the material cartridge as a seal.

5.3. Automatic mixing system

Exact dispensing and thorough, homogeneous mixing of the materials are fundamental requirements for successful precision impressions. That's why 3M ESPE developed the fully-automatic **Pentamix™ Automatic Mixing Unit** which entered full-scale production at the end of 1993.

The name Pentamix is derived from the Greek word for five (penta), reflecting the mix ratio of base paste to catalyst paste, namely 5:1. Meanwhile in its third generation, this system has helped to standardise clinical workflows, eliminating the strain and uncertainty of hand-mixed materials for many practices. The Pentamix™ 3 Automatic Mixing Unit delivers a completely homogeneous and void-free mix for highly accurate impressions and perfectly fitting restorations.

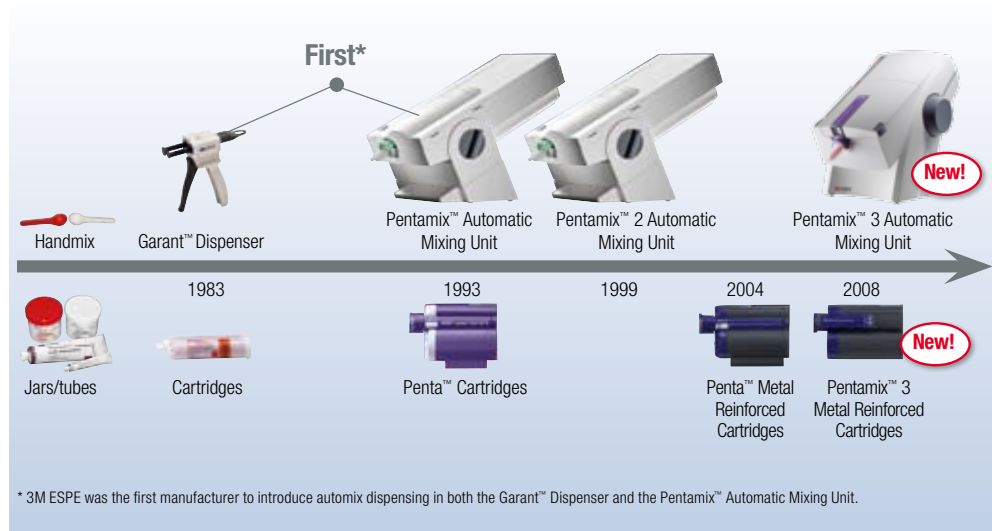

Fig. 24: Important milestones

Direct filling of trays and syringes from the automatic mixing unit is hygienic, and overall, less time is spent cleaning and disinfecting guns and cartridges. The risk of cross-contamination is reduced.

Clinical timing with the Pentamix mixing unit is reliable and reproducible. Two main advantages of machine mixing become clearer the faster the paste can be extruded:

- Shorter tray filling time leaves more working time for the actual impression.
- Shorter tray filling time gives more time to the assistant for chairside help.

Mixing principle

The Pentamix™ System is based on **dynamic mixing**, i.e. the mixing spiral in the mixing tip is driven by a separate motor via a shaft. The rotation of the mixing spiral in conjunction with the extrusion generates a turbulent flow within the material which results in complete mixing. In comparison to static mixing systems or hand-mixing the quality of mix is much more homogeneous^{68,69}.

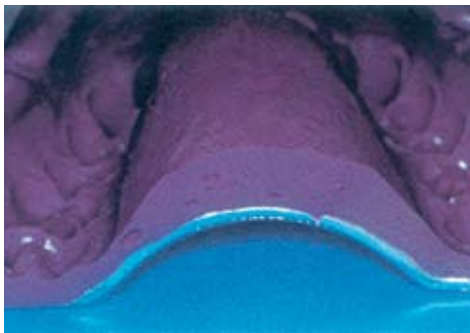

Fig. 25: Example of an impression taken with hand-mixed impression material. If such voids occur in the area of the occlusal surface or the prepared abutment teeth, the result may be inaccuracies which jeopardise the success of the work.

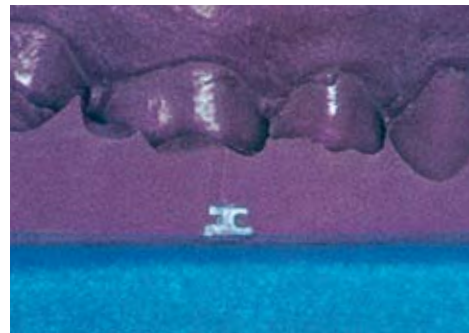

Fig. 26: Example of an impression with Pentamix™ mixing: absolutely void-free, homogeneous impression.

Another advantage of the dynamic mixing principle is that it also allows highly viscous materials such as type 0 putties to be mixed automatically.

Pentamix™ System and components

The core of the Pentamix system is the Pentamix™ Automatic Mixing Unit, which permits more relaxed and cost-effective work.

Over time, system components were improved to enhance the robustness and reliability of the system.

Penta™ Mixing Tips – Red

The Penta Mixing Tip enables an efficient mixing process by optimised inner geometry which significantly reduces the flow resistance.

PentaMatic™ AutoOpen System Foil Bags

The Penta foil bags require no separate activation and are colour-coded.

A Penta™ Authentication Label ensures genuine 3M ESPE quality.

Penta™ Cartridges

Penta cartridges are reinforced with steel inner tubes and are less sensitive to fatigue than the original plastic cartridges.



Fig. 27: Superior mixing quality of Express™ 2 Penta™ Putty with the Pentamix™ Mixing Unit (left) compared with a putty mixed by hand (right, Express™ STD Putty).



Fig 28: Pentamix™ 3 Automatic Mixing Unit.



Fig. 29: Penta™ Mixing Tips Red.



Fig. 30: Penta™ Foilbags with Penta™ Authentication Label.

Mixing with the Pentamix™ System

Insert the Penta™ Foil Bag into the corresponding Penta™ Cartridge (Fig. 32a).

Place the cartridge into the Pentamix System (Fig. 32b) and attach a red Penta mixing tip.

Push and hold the start button. When starting a new pair of foil bags, it might take 10–15 seconds for both foil bags to open automatically. Extrude a little material until its colour is consistent (Fig. 32c).

Dispense the material into the tray and the Penta elastomere syringe (Fig. 32d, e).

Leave the used mixing tip attached to the foil bags for tight sealing. Always store filled cartridges horizontally or with the mixing tip pointing down (Fig. 32f).



Fig. 31: Steel-reinforced Penta™ Cartridges with new colour coding.

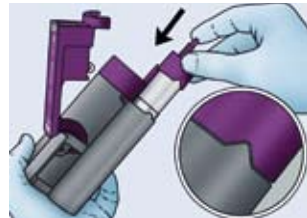

Fig. 32a: Insertion of Penta™ Foil Bags into matching, unlocked Penta™ Cartridge.

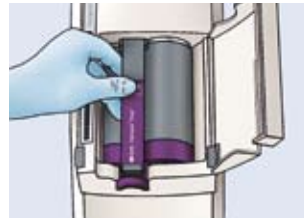

Fig. 32b: Insertion of cartridge into the unit parallel to the unit opening.



Fig. 32c: Material extrusion until mix is homogeneous.

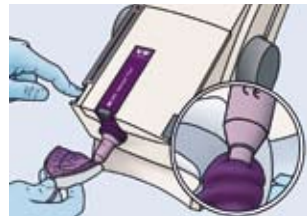

Fig. 32d: Direct filling of impression tray.

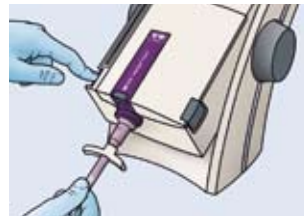

Fig. 32e: Direct filling of syringe.

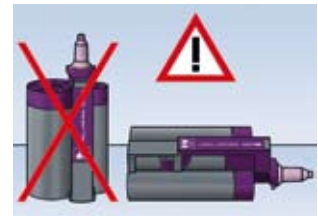

Fig. 32f: Correct storage of cartridges with partially used foil bags.

All available 3M ESPE impression materials for automatic mixing and dispensing with the Pentamix™ System are listed in a separate overview. This overview comprises materials covering all indications and techniques for precision impressions, including putty type consistencies, occlusal registration and alginate replacement materials.

6. Impression techniques

(B. Wöstmann)

6.1. 1-step impression techniques

1-step putty/wash, sandwich, single-stage two-phase, 1-step heavy body/light body technique

In the **1-step putty/wash technique** a putty or putty “soft” material is used as a tray material in combination with a light-bodied material (type 3 or 2, [see chapter 3.6.](#)). If the prepared tooth is syringed with the light-bodied material, the term 1-step putty/wash technique is used as opposed to the **sandwich technique** where the light-bodied material is applied as a second layer (“sandwich”) on the putty tray material⁴⁷.

The 1-step technique allows very good reproduction of epi- and supragingival areas which are state of the art in today’s aesthetic, minimally invasive approach to dentistry. The reproduction of areas deep in the sulcus can be difficult since often only low insertion pressure can be applied to push the material into the sulcus and, thus, impress subgingival areas of the tooth^{9,48}. Sometimes **flow defects, pulls and drags** around the undercuts of the impressed tooth are visible. They always run parallel to the insertion direction of the tray. These flow defects can appear if the tray material slides over an edge during insertion and then the impression material is not able to completely fill the undercut lying behind. This can be avoided – for instance – by applying sufficient pressure using the 2-step impression technique. Alternatively the problem can be solved by using a tray which is better suited for the anatomical shape of the jaw or a customised tray ([see chapters 4.2. – 4.4.](#)). Another alternative is the use of a light body material with very good flow properties.



Fig. 33: Pulls or drags in the impression appear if the tray material slides over a protruding shape and fails to fill the undercut lying behind. The pulls/drags always run parallel to the insertion direction.

Heavy body/light body technique

The **heavy body/wash (or heavy body/light body) technique** is – like the sandwich or putty/wash technique – a single-stage, two-phase impression technique. As opposed to the two techniques described previously, in this technique a high-viscous material (heavy-bodied, type 1, [see chapter 3.6.](#)) and not a kneadable material (putty, type 0, [see chapter 3.6.](#)) is used. Sometimes also a medium consistency (type 2, [see chapter 3.6.](#)) is used as a tray material. The use of a custom or customised tray or another tray with optimised fit is advantageous to support the material flow into small gaps and to avoid flow defects.

With all two-phase impression techniques only materials of the same material class can be combined since the impression material would not set otherwise.

! In general, inserting the impression tray very slowly (take 5 seconds time) helps to reduce flow defects.

Monophase technique

In the **monophase technique**, a type 2 (see chapter 3.6.) material consistency is used as a tray material and for syringing the abutments. Since stock trays usually create less pressure upon insertion, the monophase technique is best suited for use with a customised tray or another tray with optimised fit and an impression material with excellent flow properties. With custom trays and an automatically mixed polyether or VPS material extremely precise impressions can be achieved^{25,49}.

Hydrocolloid impression

A hydrocolloid impression is also a 1-step impression procedure. Instead of silicones or polyethers a reversible thermoplastic hydrocolloid is used. The hydrocolloid technique achieves results which are comparable to VPS and polyether materials with regard to accuracy. However, it is not that easy to exactly reproduce subgingival areas^{50,51}. This impression technique in particular shows the importance of a highly standardised workflow in the dental practice for good and reproducible results. If, for example, the material is only a little too cold, it cannot be applied. A slightly too warm material, however, can be perceived by the patient as rather uncomfortable or even cause burns, which also affects the quality of the impression.

6.2. 2-step impression techniques

2-step putty/wash technique

In the **2-step putty/wash technique** with silicones a first impression taken after preparation is “corrected” with a more flowable material. The initial impression is taken with a serial tray and a putty (type 0, see chapter 3.6.) or heavy body (type 1, see chapter 3.6.) consistency. Then careful removal of all undercuts and interproximal septa is essential for the success of the impression. If undercuts are not removed, displacement of the first impression material will occur through the pressure of the flowable material during the second impression step and, thus, errors in the impression are inevitable.

! Carving of 2-step impressions:

- Do not cut at the prepared surfaces.
- Carving instrument should be sharp, otherwise impression material might tear off partly, e.g. around the gingival septa, which would reproduce later in the wash material at a random position. Furthermore, the putty material could detach from the tray unnoticed and cause deformation.

Fig. 34 shows a carved first impression. All interfering areas have been cut with a scalpel to enable easy re-insertion. Also channels are carved in order to allow excess wash material to be displaced. Otherwise deformations will occur which result in ill-fitting restorations, e.g. too tight crowns. The impression has to be cleaned with plenty of water (or alcohol) and air to remove excessive or detached debris. During this procedure, saliva has to be removed completely from the impression which then must be dried thoroughly, otherwise the adhesion of the wash material to the first material can be interrupted.



Fig. 34: Properly carved initial impression (Express™ 2 Penta™ Putty) for the 2-step putty/wash technique. Since the impression is carved for the use of Express™ 2 Ultra-Light Body which forms very thin layers, the impression was not carved extensively.

Even if the impression has been carefully carved the teeth are reproduced slightly too small due to the distortion of the tray material, which cannot be completely avoided due to the materials' inherent flexibility⁵²⁻⁵⁴. This can be compensated for by the dental technician, e.g. by applying an additional layer of spacer.

Alternatively, the initial impression can be taken before the preparation of the teeth. In this case there will be a large gap at the prepared tooth in the second impression, so that there is no congestion of the second material. If that impression is carved carefully, displacement effects can be avoided almost completely.

Another alternative is the so-called **foil technique** (e.g. Plicafol). Here, a highly elastic, approximately 0.2 mm thick plastic foil is put over the tray filled with putty material and then the initial impression is taken (Fig. 35). The necessary carving of the impression can thus be considerably reduced, however, somewhat more light-bodied material is spent.

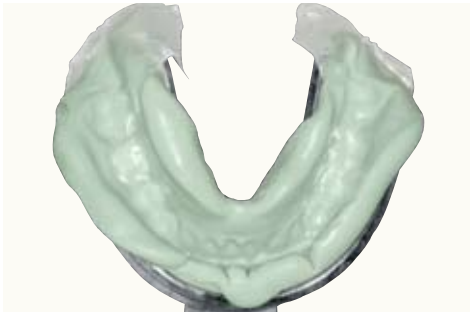

Fig. 35: Initial impression (Express™ 2 Penta™ Putty) using the foil technique.

The 2-step impression technique slows down the procedure in the dental surgery since the impression is carried out in two steps. Errors which often occur with the 1-step impression due to non-timely supply and setting of the tray material on the one hand, and syringe material on the other hand, can be minimised. The disadvantage of the 2-step impression technique is that it is more time-consuming than 1-step impression procedures.

The 2-step impression technique is not recommended with 3M ESPE polyether materials.

6.3. Taking the impression

Syringing the preparation

Immediately before syringing the teeth, retraction cords are removed and the teeth are lightly dried with air. If **retraction solutions** have been used, the sulcus should be carefully rinsed and dried to avoid setting problems. When using the two-cord technique, rinse carefully before taking the impression and take care that the cord remaining in the sulcus does not contain any more retraction agents.

The tip of the application syringe with the impression material is placed in the sulcus. Then, starting in the sulcus, the preparation is syringed without interruption with plenty of material. The abutment is used as a guiding support. The syringe tip should always remain within the material to avoid air inclusions and, thus, possible voids in the impression (Fig. 36).

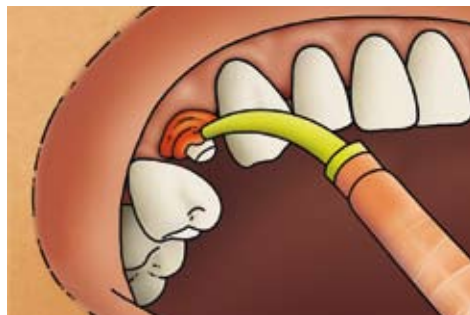

Fig. 36: Syringing of the prepared tooth.

Insertion of the impression tray

When inserting the filled tray into the mouth, at first only one end of the tray is inserted (Fig. 37a). Then, the other cheek is pulled back and the tray is completely inserted (Fig. 37b) and positioned into the mouth with a rotating movement without getting into contact with the arch from which the impression has to be taken.

! Tray insertion: avoid contact of teeth and tray, e.g. use occlusal stops (see chapter 4.2.) if necessary and choose tray size carefully (see chapter 4.1.).

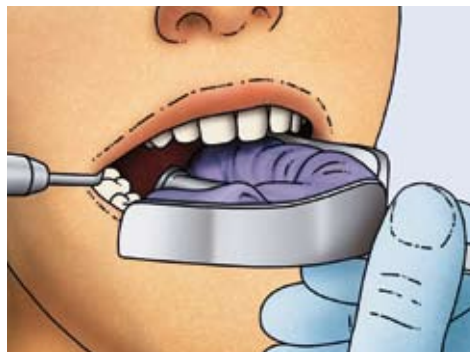

Fig. 37a: Pulling back the opposite cheek and inserting the tray at side...



Fig. 37b: ... with a rotating movement.

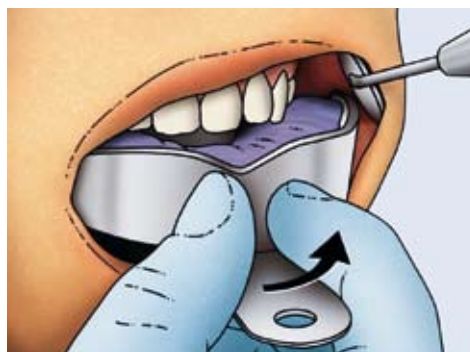

Fig. 37c: If necessary at the end of tray insertion, the cheek can also be pulled back with mirrors on the other side.

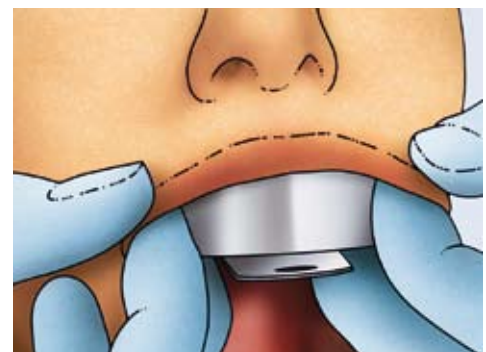

Fig. 37d: Adaptation of the lip to the tray margin to reproduce the area of the gingivobuccal fold correctly.

If necessary, the cheek can also be pulled back with mirrors as shown (Fig. 37c). Slowly, the tray is adapted in the direction of the preparation and held in the same position without pressure by the same person until the material is set.

Setting process of the impression material

When taking an impression of the upper jaw you can easily find support on the chin or cheek bone of the patient (Fig. 38). This prevents **blurring** of the impression and the movements of the patient can be followed. With impressions of the lower jaw it is recommended to support the tray on the mandibula. Also, the patients should close their mouth as much as possible to avoid deformation of the mandibula and, thus, errors in the impression.

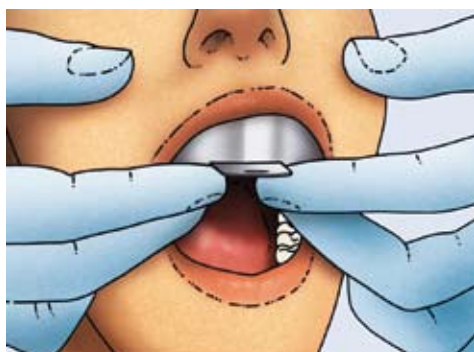

Fig. 38: Extra-oral finger support on the zygomatic bone and intra-orally on both sides on the distal sections of the impression tray.

Please note that the working time stated in the manufacturers' instructions for use (according to ISO 4823) mostly relate to room temperature. Some manufacturers (e.g. 3M ESPE) additionally list a clinically relevant working time (e.g. at mouth temperature), as due to the higher temperatures inside the mouth of the patient the material used for syringing the prepared teeth sets faster. In an optimised workflow, syringing the teeth and filling the tray should be coordinated so that both procedures are finished simultaneously.

7. Indications

(B. Wöstmann)

Impressions of unprepared tooth structure e.g. for a study model or the fabrication of an orthodontic splint is not subject to as many considerations as a true precision impression for a laboratory-made restoration.

7.1. Orthodontic splints

An impression for the fabrication of clear **aligners** (e.g. Invisalign®) has to reproduce the tooth arch completely and precisely. The impression tray should be chosen large enough and be filled well to completely capture the terminal molars. Since no subgingival details have to be reproduced, a 1-step impression technique like the sandwich technique with a heavy-bodied tray material (not type 0) is the most efficient variant in this case.



Fig. 39: 1-step heavy body/light body impression for aligner fabrication using Imprint™ 3 Heavy Body (3M ESPE) and Imprint™ 3 Regular Body VPS Impression Material (3M ESPE).

The impression of prepared tooth structure requires a differentiated, indication-dependent procedure. The choice of a suitable impression technique and impression material for a special indication has an essential influence on the quality of the final restoration. Depending on the clinical situation the different impression techniques have advantages and disadvantages.

7.2. Veneers

The fabrication of veneers requires utmost precision of the impression otherwise a visible cement gap could affect the final aesthetic result. Usually the preparation margin is located supragingivally, deeply subgingival preparations should occur very rarely. In these cases, single-step impression techniques are preferred.

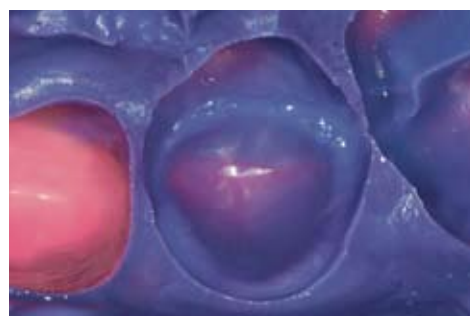

Fig. 40: Impression for a porcelain veneer with Permadyne™ Polyether Impression Material (3M ESPE). (Courtesy of Dr. Zafiriadis, Zurich, Switzerland)

7.3. Adhesive bridges

Usually, preparation margins for adhesive bridges are supragingival and visible, so the impression should be uncomplicated from that aspect. In order to achieve optimum fit, it is recommended to take the impression using the monophasic technique. However, the 1-step heavy body/light body or sandwich technique can also be used if the tray component is not too viscous (e.g. use Impregum™ Penta™ H DuoSoft™ Polyether Impression Material, 3M ESPE).

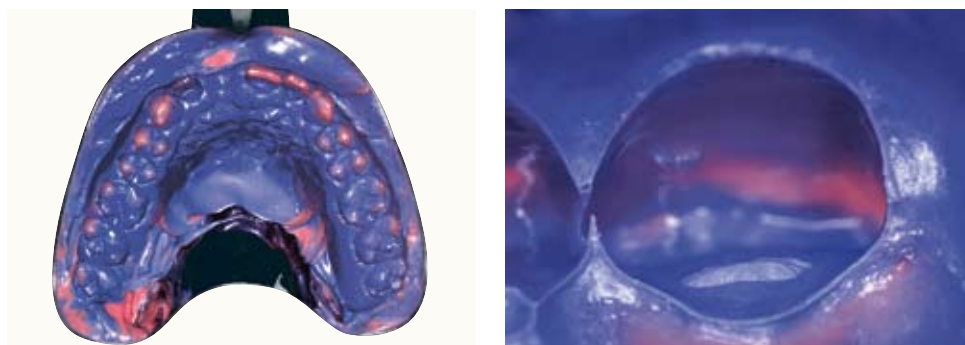

Fig. 41: 1-step heavy body/light body impression for an adhesive bridge using Permadyne™ Polyether Impression Material (3M ESPE).

7.4. Inlays and partial crowns

Partial crown preparations and inlay cavities are the most difficult to reproduce since they mostly have a complicated geometrical shape. Therefore, 1-step impression techniques with an addition-cured silicone or 3M ESPE Polyether Impression Material should be preferred. Especially for single restorations the dual-arch impression technique is an efficient and fast alternative. Due to its imminent displacement effects the 2-step putty/wash technique is only recommended with limitations. Careful carving is time-consuming and often impossible when undercuts are directly located at the prepared tooth.

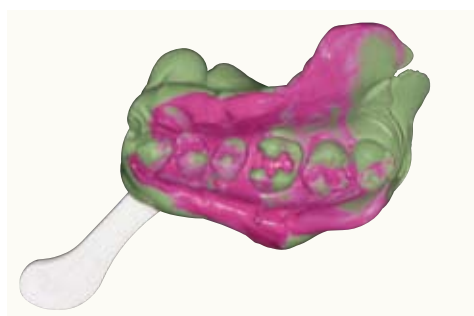

Fig. 42: 1-step heavy body/light body impression for an inlay restoration using Express™ 2 Penta™ H Quick and Express™ 2 Light Body Standard Quick VPS Impression Material (3M ESPE).

7.5. Single crowns

For taking an impression of a prepared crown abutment especially with deep subgingival preparation margins, the 2-step putty/wash technique is suitable. The pressure during the second impression reliably pushes the light-bodied impression material into the sulcus. When using 1-step impression techniques, flow defects can happen more often, especially with a putty/wash impression in a stock tray. This can be avoided by using the 1-step impression technique with a heavy-bodied or monophasic material for the tray instead of a putty material. The use of a tray with optimised fit (e.g. Border-Lock®) or a custom tray is also recommended. Alternatively, the dual-arch impression technique could be used if applied carefully.

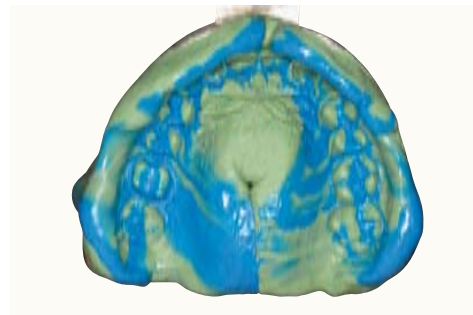

Fig. 43: 1-step heavy body/light body impression for a single crown restoration using Express™ 2 Penta™ H Quick and Express™ 2 Light Body Flow Quick VPS Impression Material (3M ESPE).

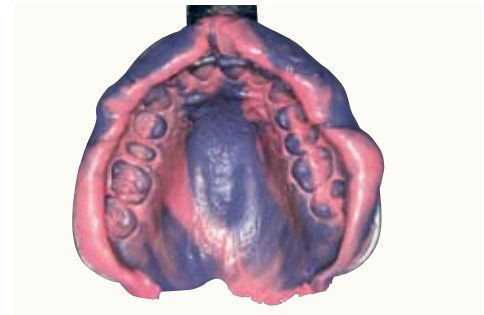

Fig. 44: 1-step heavy body/light body impression for a single crown restoration using Impregum™ Penta™ H DuoSoft™ Quick (3M ESPE) and Impregum™ L DuoSoft™ Quick Polyether Impression Material (3M ESPE).

7.6. Bridges

From an impression perspective there is hardly any difference between the abutments for a bridge and a single crown. The more abutment teeth and the deeper the preparation margins, the more difficult it is to use a single-step impression technique. Choose either the 2-step putty/wash or a 1-step impression technique (monophasic or heavy body/light body technique), preferably in combination with a custom or customised tray. For small bridges (3-unit) the dual-arch impression technique can be an alternative; for larger units this technique is not suitable.



Fig. 45: 2-step putty/wash impression for a 3-unit bridge using Express™ 2 Penta™ Putty and Express™ 2 Ultra-Light Body VPS Impression Material (3M ESPE).

7.7. Combination dentures

For the fabrication of combination dentures, two different impression problems have to be solved. On the one hand, abutment teeth have to be reproduced and, on the other hand, mucogingival areas and their relation to the teeth have to be reproduced. For the reproduction of the abutment teeth the same guidelines apply as for the impression of crowns and bridges. After fabrication and seating of the primary copings, the impression is carried out with a custom-made tray. Here, the use of polyether materials is advantageous, since they favour safe fixation of the primary copings in the total impression due to their high adhesion. Secondly, functional marginal adaptation is possible since the patient can make functional movements during the setting phase of the impression material, and, thus, the mobile areas of the mucosa can be reproduced in their maximum extension.

(If a polyether is used for the **functional impression** of a toothless jaw, it can be advantageous to use the Polyether Retarder to prolong and adjust the working time optimally to the clinical requirements). Alternatively, the secondary frame can be fabricated on the primarily produced study model if it contains all the necessary information.



Fig. 46: Monophase impression with fixed primary copings using Impregum™ Penta™ Polyether Impression Material (3M ESPE).
(Courtesy of Dr. P. Chlum, Saalburg, Germany)

7.8. Implants

When taking an impression for implant supported dentures additional aspects need to be considered.

Since implant systems work with prefabricated precision parts, it is no longer necessary to exactly reproduce the implant surface and margin as needed with a preparation on the natural tooth. However, implants are osseointegrated and compared to natural teeth do not have the slightest mobility. Thus, it is crucial to capture the exact three-dimensional implant positions and their relation to each other, as well as to ensure the flawless transmission of that information to the cast⁵⁵⁻⁵⁷. As opposed to implants, a conventional bridge can still be placed in situ if the distance of the abutments on the model slightly deviates from the actual position of the teeth, since the periodontium enables the single tooth to move about 30–50 µm.

The impression conditions for implants differ fundamentally depending on the clinical situation, the chosen implant type and the corresponding transfer technique for the implant position (see table 1 for overview).

Transfer technique for implant position	Impression technique		Impression material
	Tray	Technique	
Individually ground core build up	Closed	All impression techniques	Polyether <i>or</i> VPS
Transfer caps which remain in the impression (abutment level)	Closed	1-step impression technique in customised <i>or</i> stock tray	Polyether
Screwed-in impression posts which remain in the impression (implant level)	Open	1-step impression technique in open customised <i>or</i> custom tray	Polyether
Screwed-in impression posts which will be repositioned* in the impression (implant level)	Open	1-step impression technique in open custom tray	VPS

* Repositioning generally is less exact⁵⁸ and thus not recommended.

Table 1: Choice of impression technique and material depending on transfer technique and implant system.



Fig. 47: Open custom tray.

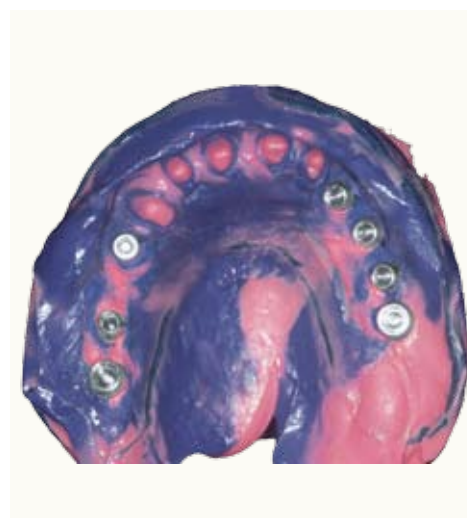

Fig. 48: 1-step heavy body/light body impression for implant-supported restorations and multiple crowns with Permadyne™ Polyether Impression Material (3M ESPE). (Courtesy of Dr. S. Gracis, Milan, Italy)

7.9. Summary indications and techniques

Indication	Preparation margin		Impression technique	Impression tray	Recommended available 3M ESPE impression materials
	Iso or supragingival	subgingival			
Impressions without preparation (splints etc.)	-	-	Monophase	Stock tray <i>or</i> Position tray	Impregum™ Penta™ Soft (Quick) Position™ Penta™ (preliminary)
			1-step	Stock tray	Express™ 2 Penta™ H (Quick) <i>and</i> Express™ 2 Light Body <i>Standard</i> (Quick)
Inlay, veneer, adhesive bridge	x	-	Monophase	Customised <i>or</i> custom tray	Impregum™ Penta™ Soft
			1-step	Stock <i>or</i> customised tray	Express™ 2 Penta™ H (Quick) <i>and</i> Express™ 2 Light Body <i>Standard</i> (Quick)
Onlay, partial crown	x	x	Monophase	Customised <i>or</i> custom tray	Impregum™ Penta™ Soft
			1-step	Stock <i>or</i> customised tray	Express™ 2 Penta™ H (Quick) <i>and</i> Express™ 2 Light Body <i>Standard</i> (Quick)
Crown	x	(x)	1-step	Customised <i>or</i> custom tray	Express™ 2 Penta™ H (Quick) <i>and</i> Express™ 2 Light Body <i>Standard</i> (Quick) <i>or</i> Impregum™ Penta™ DuoSoft™
			2-step	Stock <i>or</i> customised tray	Express™ 2 Penta™ Putty <i>and</i> Express™ 2 Regular Body
Bridge	x	x	1-step	Customised <i>or</i> custom tray	Express™ 2 Penta™ H (Quick) <i>and</i> Express™ 2 Light Body <i>Standard</i> (Quick) <i>or</i> Impregum™ Penta™ DuoSoft™
			2-step	Stock <i>or</i> customised tray	Express™ 2 Penta™ Putty <i>and</i> Express™ 2 Regular Body
Combination denture	x	x	Primary impression 1-step	Customised <i>or</i> custom tray	Express™ 2 Penta™ H (Quick) <i>and</i> Express™ 2 Light Body <i>Standard</i> (Quick) <i>or</i> Impregum™ Penta™ Soft DuoSoft™
			Secondary/fixation impression single-stage/partly functional	Custom tray	Impregum™, Permadyne™ (with optional use of Polyether Retarder)

Table 2: Impression techniques for different clinical situations.

8. Disinfection

(B. Wöstmann)

Popular brands:

- Impresept™ (3M ESPE)



Fig. 49: Immerse the impression trays completely. Action time 10 minutes (Impresept™, 3M ESPE).



Fig. 50: Let the impression drain in the basket after the immersion time and rinse with water. Exchange solution after one week.

Infection control is one of the most essential tasks in the dental practice. Impressions are major carriers of bacteria and viruses since they are contaminated with saliva and often with blood. Disinfection ensures the interruption of the infection chain between dental practice and laboratory and protects the dental technician. So each impression should be disinfected routinely before forwarding it to the dental lab to prevent contamination.

Impressions should be disinfected as soon as they are removed from the mouth. Each delay can cause an increase in the number of microorganisms. Each impression should be carefully rinsed under running water *before* disinfection, otherwise the bacteria and viruses which should be destroyed can be protected by saliva or blood proteins and the disinfection solution cannot reliably destroy the germs in the stated immersion time.

Disinfection aims at reducing the number of germs by at least a factor of 10^5 . Thus, in most cases spray disinfection is not enough as complete surface wetting cannot be ensured. Complete immersion in disinfectant guarantees sufficient disinfection⁵⁹. The immersion bath should be in a sealable container to avoid evaporation of the disinfection agent and, thus, enrichment in the air.

Only use disinfectants which have been especially developed and released for impression materials (e.g. based on aldehyde or peracetic acid: alcohol as disinfectant is not sufficient for some germs). Make sure that the disinfectant is compatible with the impression material as well as with the stone used for model fabrication^{60,61}. Disinfection solutions based on alcohol (instead of water) as a solvent may cause swelling of the impressions and, thus, ill-fitting restorations.

Water-based impression materials like alginates and hydrocolloids are prone to swelling and should therefore remain in the disinfection bath for as short a time as possible. Polyether, polysulfides and silicones, especially addition-cured materials are less sensitive. Impresept™ Immersion Disinfectant (3M ESPE) has a short immersion time and is suitable for all materials. After disinfection the impression should be rinsed again under running water and dried.

Furthermore, please follow the recommendations of the respective associations for hygiene and occupational health and safety as well as the manufacturers' instructions⁶².



Fig. 51: Impression material specimens contaminated with human saliva carry a multitude of potentially pathogenic microorganisms despite thorough rinsing with water.



Fig. 52: Impresept™ Immersion Disinfectant (3M ESPE) effectively kills microorganisms. After incubation on blood agar no colony-forming units can be detected.

9. Storage of the impression and transport to the dental lab

(B. Wöstmann)

On the way from the practice to the dental lab the impression is best carried in a container, securely fixed in foam. Inappropriate transport and storage conditions can lead to further changes in dimension⁶³, e.g. by overheating or absorption or release of moisture.

Alginates and hydrocolloids should be cast immediately (usually in the dental practice). If transport is inevitable, the impression should be stored in hygrophor or alternatively in a resealable plastic bag together with a moist (not wet) paper towel. C-silicone or polysulfide impressions should be cast as soon as possible as well, since they are not dimensionally stable.

Polyether impressions must be sent separately from alginate impressions and should be transported and stored dry, cold and protected from direct sunlight. Under these conditions they can be kept for up to two weeks.

VPS materials have the most favourable material properties for storage. However, they should also be kept and transported dry and not above room temperature. In any case please follow the manufacturers' instructions for use.

10. Fabrication of the stone model (B. Wöstmann)



Fig: 53: Sectioned stone model.

Impressions and models are closely connected. Basically, the successfully fabricated model is the completion of the treatment step “impression”.

10.1. Standardisation of the model fabrication

Especially when using VPS materials, the thermal contraction of the material when cooling down from mouth to room temperature should not be underestimated, since the extent of this contraction is comparably high⁶⁴. Heating the impression to mouth temperature before pouring, however, is not useful since this process is never reproducible and, thus, cannot be standardised. For consequent standardisation of the process it is much more beneficial to compensate for the dimensional error with targeted dental technical methods. The dental technician adjusts processes in response to impression material, tray and information received from the dentist (e.g. use of spacer, embedding mass, gypsum expansion, control of the milling machine, etc.) and carries out casting of the impression under constant conditions (room temperature, water temperature etc.).

Resin-based model materials, (e.g. **epoxy resins**) are used less frequently. Some of these materials are not directly compatible with 3M ESPE polyether impression materials and can only be used with a separator which completely seals the surface.

Silverplating of 3M ESPE polyether impressions in the galvanisation bath is possible, but copper plating is not possible for chemical reasons.

10.2. Model systems

The **sectioned model** is still one of the most used model systems. In order to work on the model a removal of the stone tissue is usually necessary around the preparation margin. However, these gypsum parts, often regarded as superfluous, reproduce the soft tissues. In most cases they facilitate a correct shaping of the crown, since it has to correctly fit to the prepared tooth as well as harmonise with the periodontal tissue. If necessary, a removable tissue (gingiva mask) has to be prepared.

Alternatively, model systems with prefabricated bases or base moulds can be used.

The problem with these systems is, however, that the gypsum arches expand during setting and, thus, are put under stress being fixed to the stable base. These stresses are released after removal from the base plate, which might lead to difficulties in correctly repositioning the tooth arch later. The teeth have to be pinned, then sectioned into small segments each of which can be repositioned exactly. Still, highly precise models can be fabricated if this technique is skilfully used^{65–67}.

Model systems with a finely detailed base plate should be avoided since complete repositioning in vertical dimension is sometimes difficult or impossible.

10.3. Timing of the model fabrication

Cast

Before pouring the master cast the impression should be trimmed. The excess impression material which does not contain any information for the fabrication of the master cast is removed. Since each impression is deformed upon mouth removal, the impression material needs time for elastic recovery before model fabrication. Usually, the minimum time required varies between 30 minutes to 2 hours. All 3M ESPE polyethers can be cast after 30 minutes.

The manufacturers' instructions must always be followed. Especially with VPS impressions, voids in the stone model may be a result of casting too early – reflecting a continuing polymerisation reaction during which hydrogen gas is released.

Furthermore, the cast should be removed from the mould only after the time stated by the manufacturer. Careful removal of the arch is essential. If necessary, it can be carefully loosened at the margin with a knife (this is comparable to breaking the vacuum when loosening an impression in the patient's mouth, [see chapter 2.6.](#)) then remove the impression in a flowing movement towards the front teeth.

If impression materials with a high final hardness are used, the impression tray can be removed first, if possible. Then, the flexible impression material can be pulled off the cast much easier. Alternatively, the tray (e.g. of a 3M ESPE polyether impression) can be warmed, e.g. on the radiator – but not in a hot water bath. Do not exceed a maximum temperature of 40–45° C. If the impression needs to be cast a second time, it must be given time to recover from deformation upon removal of the first cast.

Base

The model base should be of a type IV or V stone or a special base stone with a low expansion coefficient to keep expansion and, thus, errors as low as possible. Such special base stones have a lower hardness than type IV stone, but have the same or better (i.e. less) expansion behaviour. The usual type III stone is obsolete. It leads to considerable dimensional changes of the model. The highly expanding stone even further expands the finished tooth arch fixed to it.

The model base is ideally immediately prepared after removal of the cast arch or up to 24 hours later. If the model base is prepared immediately the tooth arch is not sectioned immediately, since base and arch undergo the same expansion behaviour.

After fabrication and final setting of the model base, the tooth arch has to be trimmed off the base. Otherwise the arch is under stress which might cause cracks and tears.

Hardened stone is hygroscopic. It takes up moisture from the air and should be stored dry to avoid surface and dimensional changes.



Fig: 54: Courtesy of J.H. Bellmann, MDT, Rastede, Germany.

11. Conclusion

(B. Wöstmann)

What further developments can be expected in the area of impressioning? High-tech procedures connected to optical impressioning will be improved more and more. This, however, does not solve the basic clinical problems. All available impression methods allow only for the reproduction of accessible areas, irrespective of the use of an elastomeric impression material or a scanner as reproduction media.

Accessible, visible areas can be reproduced without many problems, and the subsequent work and material flow is sufficiently exact to achieve good restorations.

Basically, today's impression materials and methods deliver excellent results. In order to take advantage of their full capabilities it is essential to respect the **clinical** and **process-relevant** parameters discussed in this document. They are often underestimated but are the key to achieving results corresponding to the high levels of material science behind today's impression materials.

Following a structured procedure during impressioning in conjunction with good communication and cooperation with the dental technician (and, of course, avoiding consequently clinical sources of error) you can produce restorations which fulfill the highest biological as well as aesthetic requirements.

12. Impression taking in the clinical workflow – Overview

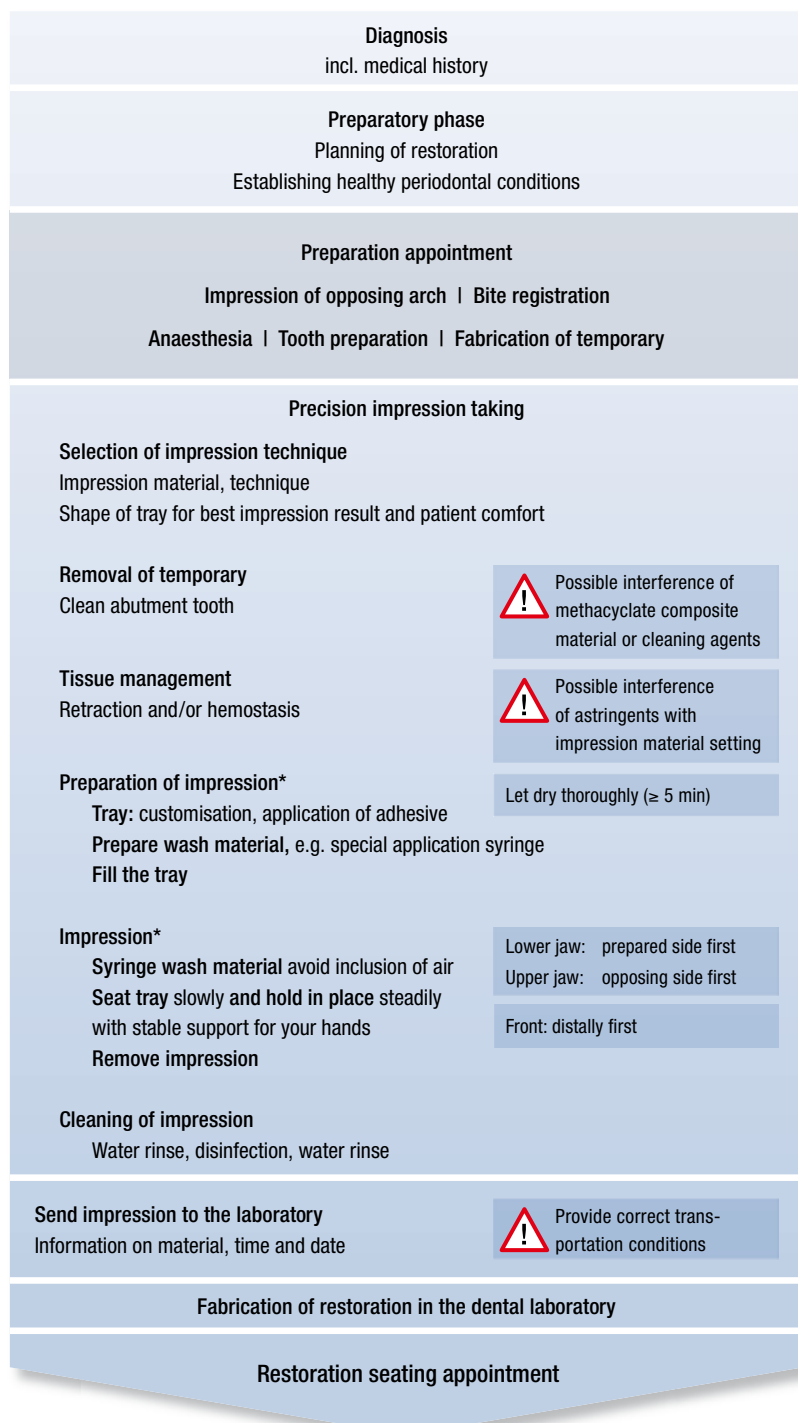

*needs to be performed once for tray material and once for wash material only if 2-step technique is applied

Fig. 55: Treatment procedure for (subgingival) crown and bridge impressions.

If a tooth is restored with a supragingival or minimally invasive restoration such as an inlay, abutment preparation and precision impression usually take place during the same appointment. In these cases the temporary restoration is fabricated after impression taking.

13. Literature

References

1. Knoernschild KL, Campbell SD. Periodontal tissue responses after insertion of artificial crowns and fixed partial dentures. *J Prosthet Dent* 2000;84:492-498.
2. Müller N, Pröschel P. Kronenrand und parodontale Reaktion Ergebnisse einer histopathologischen Studie an 368 Sektionspräparaten. *Dtsch Zahnärztl Z* 1994;49:30-36.
3. Turner CH. A retrospective study of the fit of jacket crowns placed around gold posts and cores, and the associated gingival health. *J Oral Rehabil* 1982;9:427-434.
4. Tjan AH, Li T, Logan GI, Baum L. Marginal accuracy of complete crowns made from alternative casting alloys. *J Prosthet Dent* 1991;66:157-164.
5. Tinschert J, Natt G, Mautsch W, Spiekermann H, Anusavice KJ. Marginal fit of alumina- and zirconia-based fixed partial dentures produced by a CAD/CAM system. *Oper Dent* 2001;26:367-374.
6. Gelbard S, Aoskar Y, Zalkind M, Stern N. Effect of impression materials and techniques on the marginal fit of metal castings. *J Prosthet Dent* 1994;71:1-6.
7. Wöstmann B, Kraft A, Ferger P. Accuracy of impressions attainable in vivo. *J Dent Res* 1998;77:798.
8. Kern M, Schaller HG, Strub JR. Marginal Fit of Restorations Before and After Cementation. *Int J Prosthodont* 1993;6:585-591.
9. Wöstmann B, Blösser T, Gouentenoudis M, Balkenhol M, Ferger P. Influence of margin design on the fit of high-precious alloy restorations in patients. *J Dent* 2005;33:611-618.
10. Diedrich P, Erpenstein H. Rasterelektronenmikroskopische Randspaltanalyse von in vivo eingegliederten Stufenkronen und Inlays. *Schweiz Monatsschr Zahnmed* 1985;95:575-586.
11. Wolf BH, Walter MH, Boening KW, Schmidt AE. Margin quality of titanium and high-gold inlays and onlays – a clinical study. *Dent Mater* 1998;14:370-374.
12. Boening KW, Wolf BH, Schmidt AE, Kastner K, Walter MH. Clinical fit of Procera AllCeram crowns. *J Prosthet Dent* 2000;84:419-424.
13. Meiners H. Prophylaxe und Werkstoffkunde. *Zahnärztl Welt* 1985;94:792-798.
14. Pospiech P, Wildenhain M. Zur Frage der Mischbarkeit von Polyetherabformstoffen – ein Vergleich zwischen Hand und dynamischer Mischung. *Dental Spiegel* 1998.
15. Wöstmann B. Clinical parameters of impression techniques in dentistry. *Z Stomatol* 93, 531-532. 1996.
16. Wöstmann B. Klinische Bestimmungsvariablen bei der Abformung präparierter Zähne. *Z Stomatol* 1996;93:51-57.
17. Kern M, Schaller HG, Strub JR. Randschluß von Konuskronen vor und nach der Zementierung. *Quintess Zahnärztl Lit* 1994;45:37-48.
18. Kimoto K, Tanaka K, Toyoda M, Ochiai KT. Indirect latex glove contamination and its inhibitory effect on vinyl polysiloxane polymerization. *J Prosthet Dent* 2005;93:433-438.
19. Rodrigues Filho LE, Muench A, Francci C, Luebke AK, Traina AA. The influence of handling on the elasticity of addition silicone putties. *Pesqui Odontol Bras* 2003;17:254-260.
20. Clancy JM, Scandrett FR, Ettinger RL. Long-term dimensional stability of three current elastomers. *J Oral Rehabil* 1983;10:325-333.
21. Lin CC, Donegan SJ, Dhuru VB. Accuracy of impression materials for complete-arch fixed partial dentures. *J Prosthet Dent* 1988;59:288-291.
22. Meiners H, Lehmann KM. *Klinische Materialkunde für Zahnärzte*. München – Wien: Carl Hanser, 1998.
23. Anusavice KJ. *Phillips' Science of Dental Materials*. 11 ed. Philadelphia: W.B. Saunders, 2003.
24. Eichner K, Kappert HF. *Zahnärztliche Werkstoffe und ihre Verarbeitung*. 6 ed. Heidelberg: Hüthig, 1996.
25. Wöstmann B. *Zum gegenwärtigen Stand der Abformung in der Zahnheilkunde*. Berlin: Quintessenz, 1998.
26. Wöstmann B. Accuracy of impressions obtained with the Pentamix automixing system. *J Dent Res* 1997;76:139.
27. Gerrow JD, Schneider RL. A comparison of the compatibility of elastomeric impression materials, type IV dental stones, and liquid media. *J Prosthet Dent* 1987;57:292-298.
28. Powers JM, Sakaguchi RL. *Impression materials. Craig's restorative dental materials*. Elsevier Mosby, 2006:294-95.
29. Hembree JH, Jr., Andrews JT. Accuracy of a polyether impression material. *Ark Dent J* 1976;47:10-11.
30. Spranley TJ, Gettleman L, Zimmerman KL. Acute tissue irritation of polysulfide rubber impression materials. *J Dent Res* 1983;62:548-551.
31. Nayyar A, Tomlins CD, Fairhurst CW, Okabe T. Comparison of some properties of polyether and polysulfide materials. *J Prosthet Dent* 1979;42:163-167.
32. Petrie CS, Walker MP, Williams K. A survey of U.S. prosthodontists and dental schools on the current materials and methods for final impressions for complete denture prosthodontics. *J Prosthodont* 2005;14:253-262.

33. Kanehira M, Finger WJ, Endo T. Volatilization of components from and water absorption of polyether impressions. *J Dent* 2006;34:134-138.
34. Kandelman D, Meyer JM, Lamontagne P, Nally JN. Etudes comparative de 3 hydrocoillides irreversibles. *Schweiz Monatsschr Zahnheilkd* 1978;88:134-152.
35. Wöstmann B, Lammert U, FP. Analysis of fit of stock trays for dentate jaws. *J Dent Res* 2002;81:A-60.
36. Wöstmann B. Entwicklung neuer Abformlöffel für vollbezahnte Unterkiefer. *Dent Magazin* 1991;62-66.
37. Bomberg TJ, Hatch RA, Hoffmann WJ. Impression material thickness in stock and custom trays. *J Prosthet Dent* 1985;54:170-173.
38. Wirz J. Materialien für individuelle Abformlöffel. *Dtsch Zahnärztl Z* 1982;92:207-211.
39. Marxkors R. Abformung bezahnter Kiefer mit individuellen Löffeln. *Zahnärztl Welt* 1978;87:682-684.
40. Thongthammachat S, Moore BK, Barco MT, Hovijitra S, Brown DT, Andres CJ. Dimensional accuracy of dental casts: influence of tray material, impression material, and time. *J Prosthodont* 2002;11:98-108.
41. Wirz J, Schmidli F. Individuelle Abformlöffel. *Schweiz Monatsschr Zahnmed* 1987;97:1417-142.
42. Millstein P, Maya A, Segura C. Determining the accuracy of stock and custom tray impression/casts. *J Oral Rehabil* 1998;25:645-648.
43. Martinez LJ, von Fraunhofer JA. The effects of custom tray material on the accuracy of master casts. *J Prosthodont* 1998;7:106-110.
44. Abdullah MA, Talic YF. The effect of custom tray material type and fabrication technique on tensile bond strength of impression material adhesive systems. *J Oral Rehabil* 2003;30:312-317.
45. Ceyhan JA, Johnson GH, Lepe X. The effect of tray selection, viscosity of impression material, and sequence of pour on the accuracy of dies made from dual-arch impressions. *J Prosthet Dent* 2003;90:143-149.
46. Ceyhan JA, Johnson GH, Lepe X, Phillips KM. A clinical study comparing the three-dimensional accuracy of a working die generated from two dual-arch trays and a complete-arch custom tray. *J Prosthet Dent* 2003;90:228-234.
47. Wirz J, Jäger K, Schmidli F. *Abformungen in der zahnärztlichen Praxis*. Stuttgart: Gustav Fischer, 1993.
48. Kraft A, Wöstmann B, Ferger P. Marginal fit of crowns resulting from different impression materials and techniques. *J Dent Res* 2001;80:245.
49. Wöstmann B, Höing M, Ferger P. Vergleich von hand- und maschinengemischten Abformmassen (Pentamix-System). *Dtsch Zahnärztl Z* 1998;53:753-756.
50. Nichols C, Woelfel JB. Improving reversible hydrocolloid impressions of subgingival areas. *J Prosthet Dent* 1987;57:11-14.
51. De Mourgues F, Llory H. Déflexion et régénération gingivale après électrotpmie. *Rev mens suisse Odontostomat* 1979;89:1271-127.
52. Omar R, Abdullah MA, Sherfudhin H. Influence on dimensional accuracy of volume of wash material introduced into pre-spaced putty/wash impressions. *Eur J Prosthodont Restor Dent* 2003;11:149-155.
53. Lehmann KM, Hartmann F. Untersuchungen zur Genauigkeit von Doppelabformungen. *Quintessenz* 33, 985 – 987.
54. Lehmann KM, Zacke W. Untersuchungen zur okklusalen Schichtdicke des Korrekturmateri als bei der Korrekturabformung. *Dtsch Zahnärztl Z* 1983;38:220-222.
55. Lorenzoni M, Pertl C, Penkner K, Polansky R, Sedaj B, Wegscheider WA. Comparison of the transfer precision of three different impression materials in combination with transfer caps for the Frialit-2 system. *J Oral Rehabil* 2000;27:629-638.
56. Kohavi D. A combined impression technique for a partial implant-supported fixed-detachable restoration. *Quintessence Int* 1997;28:177-181.
57. Giordano R. Issues in handling impression materials. *Gen Dent* 2000;48:646-648.
58. Wöstmann B, Hassfurth U, Balkenhol M, Ferger P. Influence of Impression Technique and Material on the Transfer Accuracy of the Implant Position onto the Working Cast. *J Dent Res* 2003;82:3060.
59. Borneff M, Behneke N, Hartmetz G, Siebert G. Praxisnahe Untersuchung zur Desinfektion von Abformmaterialien auf der Basis eines standardisierten Modellversuches. *Dtsch Zahnärztl Z* 1983;38:234-237.
60. Hutchings ML, Vandewalle KS, Schwartz RS, Charlton DG. Immersion disinfection of irreversible hydrocolloid impressions in pH-adjusted sodium hypochlorite. Part 2: Effect on gypsum casts. *Int J Prosthodont* 1996;9:223-229.
61. Abdelaziz KM, Combe EC, Hodges JS. The effect of disinfectants on the properties of dental gypsum, part 2: surface properties. *J Prosthodont* 2002;11:234-240.

62. Jagger DC, Vowles RW, McNally L, Davis F, O'Sullivan DJ. **The effect of a range of disinfectants on the dimensional accuracy and stability of some impression materials.** Eur J Prosthodont Restor Dent 2007;15:23-28.
63. Wirz J. **Klinische Material- und Werkstoffkunde.** Berlin: Quintessenz, 1993.
64. Brown D. **An Update on Elastomeric Impression Materials.** Br Dent J 1981;150:35-40.
65. Aramouni P, Millstein P. **A comparison of the accuracy of two removable die systems with intact working casts.** Int J Prosthodont 1993;6:533-539.
66. Lehmann KM, Wengeler U. **Untersuchungen zur Genauigkeit verschiedener zahntechnischer Modellsysteme.** Dent Labor 1985;33:613-617.
67. Reiber T, Dertinger K. **Zur Präzision von Präparationsmodellen nach der Sägeschnittmethode.** Zahnärztl Prax 1988;39:257-263.
68. Gramann J. and Hartung M.: AADR 2006 Orlando, Abstract No 1297; „**Mixing quality of static and dynamic mixers for impression materials**“ http://iadr.confex.com/iadr/2006Orld/techprogram/abstract_74418.htm.
69. P. Pospiech, M. Wildenhain. **Zur Frage der Anmischung von Polyetherabformstoffen – Ein Vergleich zwischen Hand- und dynamischer Mischung.** Dental Spiegel 5/98.
70. Müller N, Pröschel P. **Kronenrand und parodontale Reaktion.** Dtsch Zahnärztl Z 1994; 49:30-36.
71. Padbury Jr A, Eber R, Wang H-L. **Interactions between the gingiva and the margin of restorations.** J Clin Periodontol 2003; 30: 379–385.
72. Wöstmann B, Haderlein D, Balkenhol M, Ferger P. **Influence of Different Retraction Techniques on the Sulcus Exudate Flow.** J Dent Res 2004;83: A-4087.

14. Glossary

A		M	
Abutment level	42	Macromonomer	16, 17
Addition-cured silicones (vinyl polysiloxanes)	14, 17, 23, 44	Medium body	21
Addition silicones	15	Metal salts	11, 20
Alginate	19, 46	Methacrylate composite	12, 20
Alginate replacement	19	Monophase technique	34
Aligners	38	O	
Anaesthesia	12	Occlusal stops	23, 36
A-silicones	12, 15	Oral hygiene	10, 11
Automatic mixing systems	9, 19, 20, 27	P	
B		Pentamix™ Automatic Mixing Unit	27, 30, 31, 32
Blurring	37	Periodontium	10, 42, 46
C		Permanent deformation	13
Communication	9	Platinum catalyst	15
Condensation polyether	15, 18	Polyether Retarder	27, 41
D		Polysulfides	18
Dorsal damming	23	Pulls	33
Double cord retraction technique	11	Putty	20, 21, 22, 23, 27, 28, 33, 34
Drags	33	R	
Dual-arch impression	26, 39, 40	Retraction solutions/liquid	11, 36
Dynamic mixing	31	Reversible hydrocolloids	14, 15, 18
E		S	
Elastic recovery	14, 16, 18, 19, 22, 47	Sandwich technique	33
Epoxy resins	46	Sectioned model	46
Extrusion forces	29	Setting process	11, 12, 37
F		Single cord retraction technique	11
Flow defects	23, 33, 40	Smear layer	20
Foil technique	35	Snap set	16, 17
Functional impression	27, 41	Standardised workflow	9, 27, 34
G		Static mixing	29, 31
Garant™	29	Sulcus bleeding	10, 12
H		Surfactants	14, 15
Haemostatic	11	Syringing	17, 29, 36
Heavy body	21, 33, 34	T	
Heavy body/wash (or heavy body/light body) technique	33	Temporary restorations	19, 20, 49
Hydrogen peroxide	12	Tensile strength	16
Hydrophilicity	14, 15, 17	Tissue displacement	11
Hydrophobic	14, 15	Tooth axes	13, 22
Hydrophobicity	14	Tray adhesive	24, 25, 26
Hydroxylation reaction	15	U	
I		Undercuts	22, 25, 33, 34
Implant level	42	V	
Infection control	44	Vasoconstrictor	11, 12
Insertion	33, 36	VPS	12, 15, 16, 20
Intrinsic hydrophilicity	15	1-step putty/wash technique	
Irreversible hydrocolloids	19	33	
L		2-step putty/wash technique	
Latex	28	34	
Light body	21, 33		

15. Overview 3M ESPE impression materials



Impregum™ Penta™ Soft/Quick

Polyether Impression Material

Excellent fit due to first-class precision.

Benefits

- **Precise and void-free impressions** through outstanding initial hydrophilicity in moist environments
- **First-rate detail reproduction** thanks to excellent flow properties
- **Constant flow behaviour throughout working period and less distortions** by unique “snap-set” behaviour
- **Quick material cuts working and setting times** by at least 33 %
- **Fresh minty flavour and easier removability** of “Soft” materials

Indications

- Crown and bridge impressions
- Inlay and onlay impressions
- Functional impressions
- Implant impressions



Express™ 2

VPS Impression Material

Outstanding balance of clinically relevant properties for uncompromising impression accuracy.

Benefits

- **Extraordinarily well balanced properties** compared to other leading VPS products
- **Great detail reproduction** through superior hydrophilicity and flow behaviour
- **Distortion-free removal from the mouth** due to excellent toughness
- **Reduced chance of costly remakes** due to almost 100% recovery from deformation
- **Faster setting of wash materials without reduced working time** through thermally active putty technology



Indications

- Crown and bridge impressions
- Inlay and onlay impressions

Position™ Penta™ / Quick

VPS Alginate Replacement

Less prep time. More working time. A stress-free alginate replacement.

Benefits

- **Precise impressions** through higher accuracy
- **Fast working and setting times** at room temperature
- **Less distortions** thanks to elastic recovery
- **Easy and thorough disinfection** because material can be completely submersed in disinfectant solution
- **Long-term storage ability** due to high dimensional stability
- **Suitable for multiple pouring** plus no need of immediate casting

Indications

- Preliminary impressions
- Impressions for bleaching trays and mouthguards
- Provisional crown and bridge impressions
- Study model impressions
- Opposing dentition impressions
- Impressions for orthodontic models



You + 3M ESPE =
New ideas for dentistry

3M ESPE

3M ESPE AG
ESPE Platz
82229 Seefeld · Germany
E-Mail: info3mespe@mmm.com
Internet: www.3mespe.com

EUR 49.00 Recommended price.

3M, ESPE, DuoSoft, Express, Garant, Impregum, Impresept, Imprint, Lava, Palgat, Penta, PentaMatic, Pentamix, Permadyne, Position and Ramitec are trademarks of 3M or 3M ESPE AG.

Acculoid, Affinis, Alginot, Aquasil, Boder-Lock, CEREC, Expasyl, Hongum, Identec, Invisalign, Optosil, P2, Peridenta, Permalastic, Plicafol, Speedex, Triple Tray and Xantopren are not trademarks of 3M or 3M ESPE AG.

© 3M 2008. All rights reserved.

70200956095/01 (5.2008)