

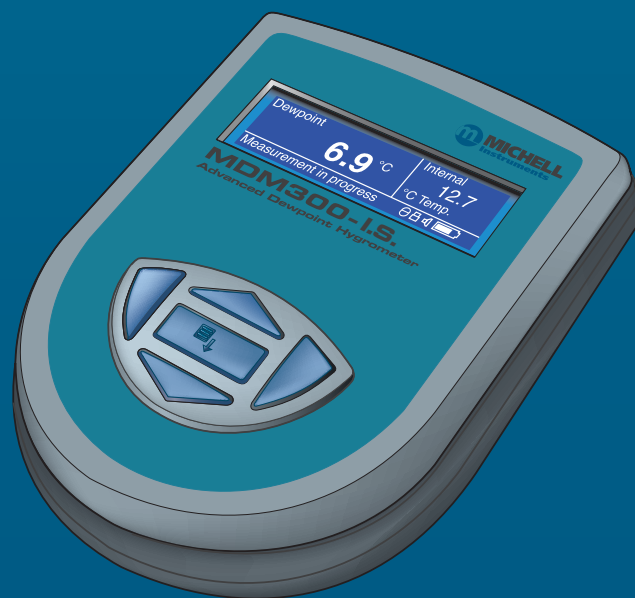

MDM300 I.S. Advanced Dew-Point Hygrometer User's Manual



97213 Issue 5
October 2017

Please fill out the form(s) below for each instrument that has been purchased.

Use this information when contacting Michell Instruments for service purposes.

Hygrometer	
Code	
Serial Number	
Invoice Date	
Location of Instrument	
Tag No	

Hygrometer	
Code	
Serial Number	
Invoice Date	
Location of Instrument	
Tag No	

Hygrometer	
Code	
Serial Number	
Invoice Date	
Location of Instrument	
Tag No	



MDM300 I.S.
Advanced Dew-Point Hygrometer
(for use in hazardous areas)

For Michell Instruments' contact information please go to
www.michell.com

© 2017 Michell Instruments

This document is the property of Michell Instruments Ltd. and may not be copied or otherwise reproduced, communicated in any way to third parties, nor stored in any Data Processing System without the express written authorization of Michell Instruments Ltd.

Contents

Safety	vii
Electrical Safety	vii
Pressure Safety	vii
Toxic Materials	vii
Repair and Maintenance	vii
Calibration	vii
Safety Conformity	vii
Abbreviations	viii
Warnings	viii
1 INTRODUCTION	1
1.1 Controls and Indicators	3
1.2 Function Keys	5
1.2.1 Enter Key	5
1.2.2 Up (▲) and Down (▼) Keys	5
1.2.3 Right (►) Key	5
1.2.4 Left (◄) / Escape Key	5
1.3 Instrument Display	6
1.3.1 Display Units	7
1.3.2 Status Display Indications	8
2 INSTALLATION	9
2.1 Safety	9
2.2 Unpacking the Instrument	9
2.3 MDM300 I.S. Accessories	10
2.4 Operational Requirements	12
2.4.1 Environmental Requirements – MDM300 I.S. Instrument	12
2.4.2 Charger Electrical Requirements	12
2.5 Instrument Gas Connections	12
2.5.1 Gas Inlet /Outlet Fittings	13
2.6 Connect External Sensors	14
2.6.1 Set up External Sensor Interface	15
2.6.2 Entering User Pressure	15
2.7 Battery Charging	16
3 OPERATION	18
3.1 Preparation for Operation	18
3.2 Instrument Start-Up	19
3.3 Overall Menu Structure and Operation	20
3.3.1 SET-UP Menu	20
3.3.2 Chart Page	20
3.4 SET-UP Menu Parameters	22
3.4.1 SETTINGS	22
3.4.2 LOGGING	23
3.4.3 BLUETOOTH	24
3.4.3.1 Bluetooth Pairing Procedure	25
3.4.4 EXTERNAL (Sensor Interface)	26
3.4.5 CLOCK	27
3.4.6 HMI	28
3.4.7 INFO	29
3.4.8 CHART Page	29
3.4.9 LOG FILES Page	30
3.4.10 LOGS Page	30
3.4.11 CALIBRATION	31
3.5 Default Parameters	32

3.6	Guide to Measurement and Sampling	33
3.6.1	Measuring at Atmospheric or System Pressure	34
3.6.2	Measurement Guide	35
3.6.3	Conditional Sensor Purge.....	37
3.7	Battery Management	37
3.7.1	Battery Troubleshooting.....	37
4	GOOD MEASUREMENT PRACTICE	38
4.1	Sampling Hints.....	39
5	APPLICATION SOFTWARE	42
6	CALIBRATION.....	43
6.1	Traceability	43
6.2	Calibration Method	44
6.3	Calibration Correction Method	45
7	SHIPPING	46

Appendices

Appendix A	Technical Specifications.....	48
A.1	Dimensions	49
Appendix B	Datalog Status Display	51
Appendix C	Hazardous Area Certification	54
C.1	Product Standards	54
C.2	Product Certification	54
C.3	Global Certificates/Approvals	54
C.4	Input Terminal Parameters	54
C.5	Special Conditions of Use	55
C.6	Maintenance and Installation	55
Appendix D	FCC Declaration.....	57
Appendix E	Quality, Recycling & Warranty Information.....	59
Appendix F	Return Document & Decontamination Declaration.....	61

Figures

Figure 1	MDM300 I.S. Advanced Dew-Point Hygrometer.....	2
Figure 2	User Connections, Controls and Indicators.....	3
Figure 3	Instrument Display	6
Figure 4	Packing Method.....	9
Figure 5	Gas Port Adaptors	10
Figure 6	Accessories.....	11
Figure 7	Bonded Seal Fitting	13
Figure 8	Gas Coupling Examples for Atmospheric Pressure Measurement.....	13
Figure 9	MDM300 I.S. Remote Sensor Interface.....	14
Figure 10	External Sensor Connection.....	14
Figure 11	Typical External Dew-Point Display.....	15
Figure 12	Battery Charger Connection	16
Figure 13	Start-Up Sequence	19
Figure 14	Menu Structure	21
Figure 15	SETTINGS Page.....	22
Figure 16	LOGGING Page.....	23
Figure 17	BLUETOOTH Page	24
Figure 18	Typical Bluetooth Pairing Sequence.....	25
Figure 19	EXTERNAL SET-UP Page.....	26
Figure 20	CLOCK Page.....	27
Figure 21	HMI Page.....	28
Figure 22	INFO Page	29
Figure 23	CHART Page.....	29
Figure 24	LOG FILES Page	30
Figure 25	LOGS Page.....	30
Figure 26	CALIBRATION Page	31
Figure 27	Easi-Fit Sample Kit MDM300 Panel-Mount Sampling System	33
Figure 28	Large and Small Orifice Fitting.....	34
Figure 29	Typical Application Software Screen	42
Figure 30	Typical 7-point Calibration Certificate	43
Figure 31	Calibration Menu Page	45
Figure 34	Instrument Packing Details.....	46
Figure 35	Dimensions - MDM300 I.S.	49
Figure 36	Current Datalog File Display	51
Figure 37	MDM300 I.S. Status Register.....	51
Figure 38	MDM300 I.S. Status Register (Hex 28).....	51

Tables

Table 1	Controls and Indicators.....	4
Table 2	Instrument Display Descriptions	6
Table 3	Adaptor Fittings.....	12
Table 4	SETTINGS Parameters	22
Table 5	LOGGING Parameters	23
Table 6	BLUETOOTH Parameters	24
Table 7	EXTERNAL Sensor Parameters.....	26
Table 8	CLOCK Parameters	27
Table 9	HMI Parameters	28
Table 10	MDM300 I.S. Default Parameters	32
Table 11	MDM300 I.S. Measurement Procedures	35
Table 12	Example Of Calibration Run Readings.....	44
Table 13	Status Register Flags	52

Safety

The manufacturer has designed this equipment to be safe when operated using the procedures detailed in this manual. The user must not use this equipment for any other purpose than that stated. Do not apply values greater than the maximum value stated.

This manual contains operating and safety instructions, which must be followed to ensure the safe operation and to maintain the equipment in a safe condition. The safety instructions are either warnings or cautions issued to protect the user and the equipment from injury or damage. Use competent personnel using good engineering practice for all procedures in this manual.

Electrical Safety

The instrument is designed to be completely safe when used with options and accessories supplied by the manufacturer for use with the instrument. The instrument is powered by an internally mounted rechargeable battery - this battery should never be allowed to fully discharge. The input power supply voltage limits for the battery charger supplied with the instrument are 100 to 240 V AC, 50/60 Hz.

NOTE: No other battery charger unit, other than that supplied with the instrument should be used.

NOTE: Do not allow the battery to fully discharge.

Pressure Safety

DO NOT permit pressures greater than the safe working pressure to be applied to the instrument. The specified safe working pressure (SWP), for this instrument is 350 barg (5076 psig).

Toxic Materials

The use of hazardous materials in the construction of this instrument has been minimized. During normal operation it is not possible for the user to come into contact with any hazardous substance which might be employed in the construction of the instrument. Care should, however, be exercised during maintenance and the disposal of certain parts.

Repair and Maintenance

The instrument must be maintained either by the manufacturer or an accredited service agent. Refer to www.michell.com for details of Michell Instruments' worldwide offices contact information.

Calibration

The recommended calibration interval for the MDM300 I.S. is 12 months. The instrument should be returned to the manufacturer, Michell Instruments Ltd., or one of their accredited service agents for re-calibration.

Safety Conformity

This product meets the essential protection requirements of the relevant EU directives. Further details of applied standards may be found in Appendix F.

Abbreviations

The following abbreviations are used in this manual:

AC	alternating current
atm	pressure unit (atmosphere)
barg	pressure unit (=100 kP or 0.987 atm) gauge
bara	bar absolute
°C	degrees Celsius
°F	degrees Fahrenheit
K	Kelvin (absolute temperature)
COM	common
DC	direct current
ft	foot (feet)
Hz	Hertz
kg	kilogram(s)
lb	pound
l/min	liters per minute
m	meter(s)
mA	milliampere
Mb	megabytes
max	maximum
min	minute(s)
mm	millimeter(s)
MPa	megapascal
No.	number
PIN	personal identification number
ppm _v	parts per million (by volume)
ppm _w	parts per million (by weight)
psig	pounds per square inch
scfh	standard cubic feet per hour
SWP	safe working pressure
sec	second(s)
V	volts

Warnings

The following general warning listed below is applicable to this instrument. It is repeated in the text in the appropriate locations.



Where this hazard warning symbol appears in the following sections it is used to indicate areas where potentially hazardous operations need to be carried out.

1 INTRODUCTION

The MDM300 I.S. Advanced Dew-Point Hygrometer is a portable instrument designed for on-line measurement of moisture content in non-corrosive gases in hazardous areas, over an operational range of -100 to +20°C (-148 to +68°F).

The instrument is independently assessed and certificated as being intrinsically safe and fully compatible with safe operation within defined Zone 0 hazardous areas.

The instrument is contained within a steel fiber-loaded high-impact polyamide 6 case, sealed to IP66 / NEMA4 standard and is powered by an internally mounted Nickel Metal Hydride (NiMH) battery, designed to typically provide 24 hours continuous use between charges. Continuous battery charge status indication is provided. Additional battery status information is provided by a battery indicator icon, in addition to a warning beep and Shutdown Mode.

The MDM300 I.S. is fitted with an internally mounted ceramic sensor, which is enhanced for a quicker response to dew points as dry as -75°Cdp (-103°Fdp).

The MDM300 I.S. can also be used to read the dew-point signal from a Michell Instruments' Easidew I.S. transmitter. To do this, the MDM300 I.S. Remote Sensor Interface is used to connect to the Easidew I.S. transmitter.

No other sensor can be connected to the MDM300 I.S.

A graphical display presents the dew-point data in large format characters and simultaneously provides a primary display of real time dew-point readings and a secondary display, in smaller characters, for the external sensor input. If no external input is programmed, gas temperature (measured by the internal sensor) is displayed by default.

A fully programmable, real-time, datalogging facility is provided which has an internal memory capacity of 8Mb, capable of storing up to 10,000 logs per file (typically giving a maximum of 64 log files).

A Bluetooth, wireless, communication system is provided, giving access to a dedicated, PC based, MDM300 I.S. Software Application Package which provides the facility for handling the logged data files and uploading and downloading instrument parameters.

A user-friendly operator interface provides easy access to all levels of the instrument's functionality.

An easy-to-follow calibration routine is built into the instrument's software.

Two versions of the instrument are available, an MDM300 (standard) version and an MDM300 I.S. (intrinsically safe) version.

This manual covers the MDM300 I.S. version only.

For information about the MDM300 contact your local Michell Instruments' representative (contact information at www.michell.com).



Figure 1 *MDM300 I.S. Advanced Dew-Point Hygrometer*

(for use in hazardous areas)

1.1 Controls and Indicators

The controls and indicators associated with the MDM300 I.S. instrument are located on the front panel of the instrument.

Connections to the MDM300 I.S. dew-point hygrometer, comprising the gas ports, battery charger input connector and input connector for the external sensor are all made to the top panel.

Figure 2 shows the layout of these controls and Table 1 describes their respective operational functions.

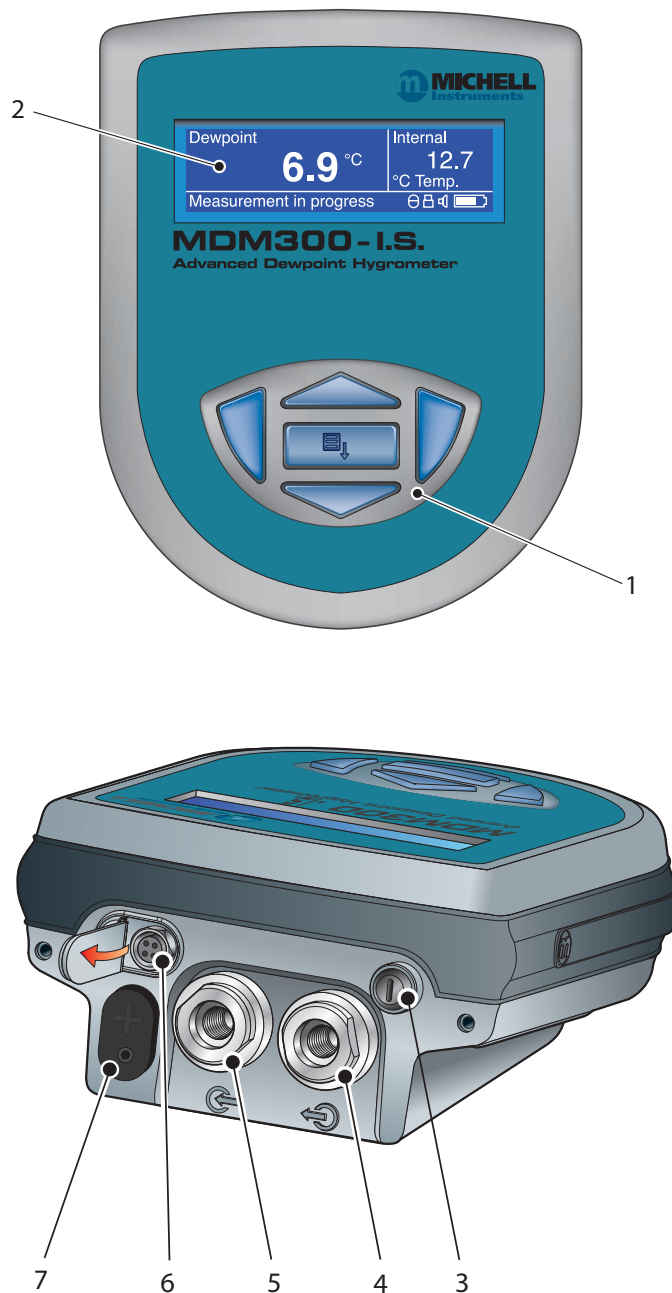

Figure 2 User Connections, Controls and Indicators



Item	Panel	Description
1	Front	Function keys. Refer to Section 1.2 for the details of these keys.
2	Front	Instrument display, partitioned to show 3 main panels: The primary display shows internal sensor parameters. The secondary display indicates the external sensor parameter. The status display area shows icons representing battery charge state, initialization in progress, data logging in progress, keyboard lock status and keyboard beep status.
3	Top	Instrument ON/OFF switch. NOTE: The instrument does not need be switched ON in order to charge the internal NiMH battery.
4	Top	Gas Output port. Refer to Section 2.5.
5	Top	Gas Input port. Refer to Section 2.5.
6	Top	Analog input connector for external sensor. By default, this signal is displayed in the secondary display area but may be configured to be displayed as the primary display. If no external input is selected, the internal sensor temperature is shown, on the secondary display, by default (refer to Section 3.4.6). NOTE: The hinged rubber protection cover should be kept closed when the connector is not in use.
7	Top	Socket for connection of battery charger (located behind secured cover).  Connection to the battery charger should always be made in a safe area - never in a hazardous area environment The secured cover should be kept screwed on when the connector is not in use.  ONLY USE THE CHARGER PROVIDED  Never allow the battery to fully discharge

Table 1 Controls and Indicators

1.2 Function Keys

The function keys, located on the front panel, are used to select operations from the menus and to select and enter parameter variables within those menu levels.

The function key described is shaded darker and the operation of the keys is as follows:

1.2.1 Enter Key

The **Enter** key is used within the menus to highlight and select options and to accept entered values.

Operation of this key from the Main Display causes the Passcode entry page (for entry to the SET-UP Menu) to be displayed.

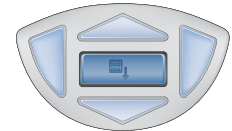

1.2.2 Up (▲) and Down (▼) Keys

Within the SET-UP Menu and sub-menus these ▲ and ▼ keys are used to scroll down and highlight options.

Within sub-menu levels requiring the entry of alpha numeric values, these keys are used to change the values. Pressing the key once increases or decreases the selected field by one step. Pressing and holding the key will cause the selected field to be continuously increased or decreased until the key is released.

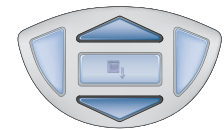

1.2.3 Right (▶) Key

Within sub-menu levels requiring the entry of alpha numeric values, this ▶ key is used to shift the insertion point right in the file name entry field.

From the Main Display, pressing this ▶ key moves to the Chart Page.

From the Chart Page, pressing this ▶ key moves to the Logging Pages.

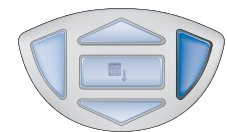

1.2.4 Left (◀) / Escape Key

Within sub-menu levels requiring the entry of alpha numeric values, this ◀ key is used to shift the insertion point left in the file name entry field. As the insertion point is shifted to the left, the entry at the former position is deleted.

Within any menu or sub-menu level, pressing this ◀ key escapes to the previous menu above the current level.



1.3 Instrument Display

The graphics display and the associated function keypad (*Figure 2*), form the operator interface of the equipment. *Figure 3* shows all the elements of a typical display page after the instrument's initialization period has completed.

Table 2 details the elements of the display:

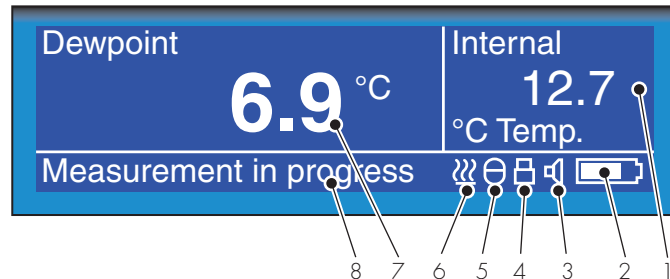

Figure 3 Instrument Display

Item	Description
1	Secondary display Shows reading from external sensor, if configured; or internal temperature if external sensor is not configured (refer to Section 3.4.6).
2	Battery charge indicator icon Flashes when the battery needs charging. A warning beep sounds when the battery charge level is critical - followed immediately by Shutdown Mode. NOTE: The icon becomes animated when the charger is connected.
3	Keyboard beep indicator Indicates that the keyboard beep is switched on.
4	Keyboard lock indicator Indicates that the keyboard is locked.
5	Datalog status indicator Indicates that logging is enabled and running.
6	Sensor initializing indicator Indicates that the initialization process is in progress and that the sensor heating is on. The presence of this symbol is accompanied by Initializing internal sensor status message.
7	Primary display During normal operation, the internal sensor readings are shown in the primary display. If the external sensor has been configured then this reading can be shown in this display (refer to Section 3.4.6).
8	Status message display area Displays status and error messages.

Table 2 Instrument Display Descriptions

1.3.1 Display Units

The instrument can display the measured reading in the following units:

Absolute Humidity

- lb/MMscf
- g/m³
- g/m³ NG

Moisture Content

- ppmV NG
- ppmV
- ppmW (AIR, USER, H₂, SF₆, CO₂ or N₂)

Dew Point

- °C
- °F
- K

Relative Humidity (%)

Mixing Ratio

- g/kg (AIR, USER, H₂, SF₆, CO₂ or N₂)

To toggle between displayed units, press either the ▲ or ▼ key.

1.3.2 Status Display Indications

'Initializing Internal Sensor'

This is displayed immediately after the instrument has been powered up, and indicates that the sensor is being heated up to accelerate equilibrium with the moisture in the sample gas. This has the effect of drying the sensor out, and results in the 'undershoot' seen in the first stage of the measurement process.

'Measurement in Progress'

This is displayed after the sensor initialization has finished, and indicates that the sensor is running through the following initial measurement procedure:

1. Undershooting the dew-point
2. Making a first estimate
3. Running a QRA (Quick Response Algorithm), if necessary

Once the message has disappeared, this indicates that the instrument has finished its accelerated approach to the actual dew point. Depending on the conditions, it may continue to respond for a number of minutes more, before settling on (or tracking) the actual measured dew point.

Other Status Display Indications

Internal sensor error	Dew-point reading out of range ($> +30 / < -120^{\circ}\text{C}$)
Internal thermistor error	Sensor internal temperature reading out of range ($> +100 / < -40^{\circ}\text{C}$) or Thermistor fault
External sensor error	External Sensor Input out of range ($< 4 \text{ mA} / > 20 \text{ mA}$)
Battery low	Battery level low - recharge as soon as possible
Battery low - recharge now	Battery level critical - recharge immediately
Log finished	Log file has reached the maximum of 10,000 logs and logging has been stopped
Internal sensor not found	Could not detect internal sensor on power up
Default CONFIG file used	Config. file missing, new file created and default settings used

2 INSTALLATION

2.1 Safety



It is essential that the installation of the electrical and gas supplies to this instrument be undertaken by qualified personnel.

2.2 Unpacking the Instrument

The MDM300 I.S. instrument is packed into a standard box and the method of unpacking is shown below:

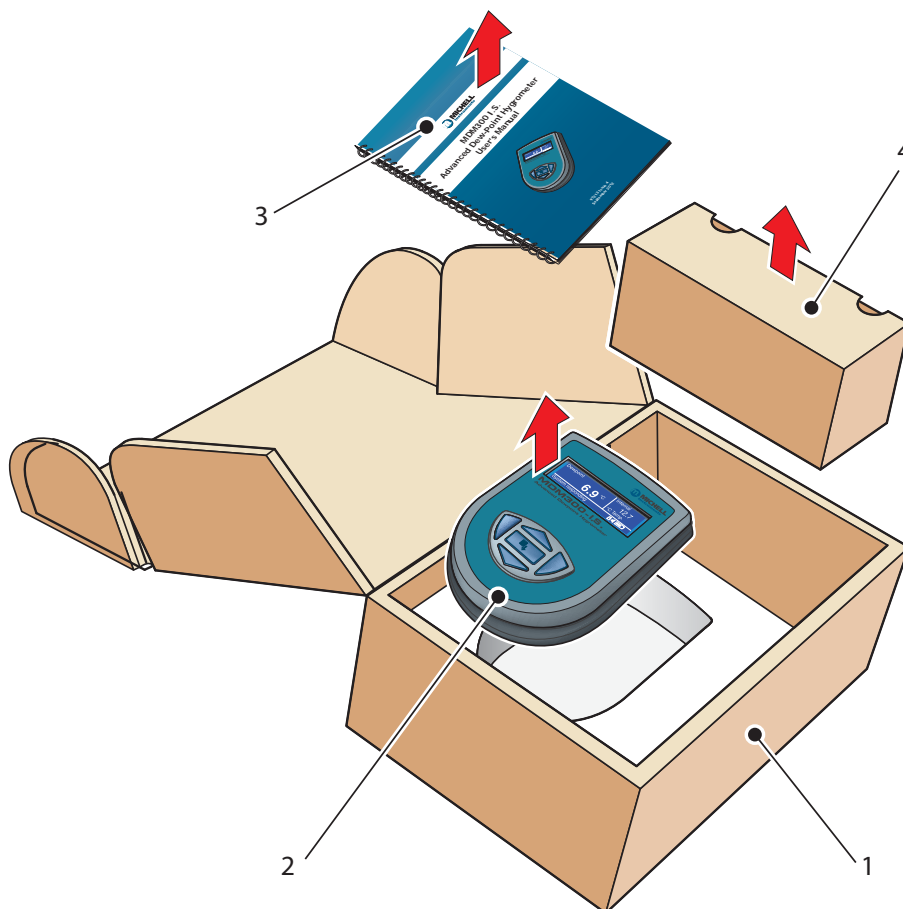

Figure 4 *Packing Method*

1. Open the box (1) and unpack carefully.
2. Remove the MDM300 I.S. (2), the user's manual (3) and the accessories box (4).
3. Save all the packing materials for the purpose of returning the instrument for re-calibration or any warranty claims.
4. If the optional carry bag has been ordered it will be located underneath the foam insert, in a cardboard box.

2.3 MDM300 I.S. Accessories

The accessories for the MDM300 I.S. are shown in *Figure 6*. Items 1 to 7 are supplied as standard and item 8 is optional. Please check that all the standard components are present after unpacking. Report any shortages immediately.

1. Calibration certificate
2. User's manual
3. Charger unit
4. Country specific mains lead
5. Gas Input/Output port adaptors
(three provided - two fitted to the instrument - see *Figure 5*)
6. Application Software CD
7. Quick-start card
8. Carrying case - made from anti-static materials suitable for use in hazardous areas (optional)

Three gas port adaptors are provided, two with a large bore orifice and one with a small bore orifice. Depending upon configuration, this permits the instrument to be run at either system pressure or atmospheric pressure and facilitates the connection of external flow monitoring and control.

NOTE: On delivery the two large orifice adaptors are fitted into the instrument's gas ports (1 and 2) as shown in *Figure 5*. One small orifice adaptor is provided as a loose spare in the accessory pack (see Section 2.5).

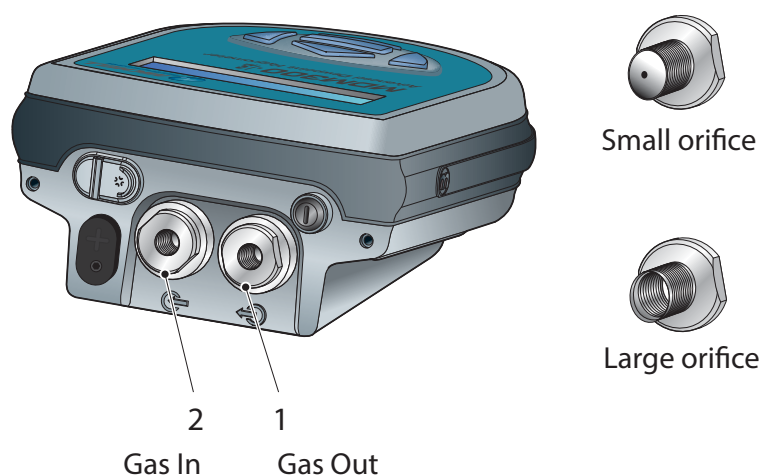

Figure 5 Gas Port Adaptors



Figure 6 Accessories

2.4 Operational Requirements

Operational requirements are as follows:

Sample gas flow rate: 0.2 to 0.5 NI/min (0.5 to 1 scfh)
 Operating pressure: 0 to 350 barg (0 to 5076 psig)

2.4.1 Environmental Requirements – MDM300 I.S. Instrument

Operating temperature range: -20 to +50°C (-4 to +122°F)
 Humidity: 0 to 100% RH (non-condensing)
 Altitude: Up to 2000m (6562 ft)

2.4.2 Charger Electrical Requirements

Charger supply voltage: 100 to 240 V AC (+10%, -15%)
 50/60 Hz (±5%), 8 VA

2.5 Instrument Gas Connections



POSSIBLE INJURY! The tubing, valves and other apparatus attached to this instrument must be adequate for the maximum pressure which will be applied, otherwise physical injury to the operator or bystander is possible.

Sample gas connections are made via the Gas In (2) and Gas Out (1) ports located on the rear of the instrument as shown in *Figure 5*.

The MDM300 I.S. is supplied with a large bore orifice fitting installed into the Gas In and Gas Out ports. These fittings have an 1/8" NPT female thread to allow the user to connect other components of their choice.

Atmospheric pressure or system pressure dew point can be measured depending on the configuration of the adaptor fittings as shown in Table 3.

For gas pressures outside the range 2.5 to 10 barg, the instrument requires external flow control components, as shown in *Figure 8*.

Dew point at	Gas Inlet port fitting	Gas Outlet port fitting	Sample gas pressure
Atmospheric	Small bore orifice	Large bore orifice	2.5 to 10 barg (36 to 145 psig)
System	Large bore orifice	Small bore orifice	2.5 to 10 barg (36 to 145 psig)
Either (using other flow control components)	Large bore orifice	Large bore orifice	0 to 350 barg (0 to 5076 psig)

Table 3 Adaptor Fittings

2.5.1 Gas Inlet /Outlet Fittings



HIGH PRESSURE! High pressure gases are potentially hazardous. Energy stored in these gases can be released suddenly and with extreme force. High pressure systems should be assembled and operated only by people who have been trained in proper safety practices.

Before making a measurement, the gas fittings should be attached to the instrument as shown in Table 3.

1. Fit the required orifice fittings with supplied bonded seals. Ensure bonded seals are correctly seated in recessed grooves.

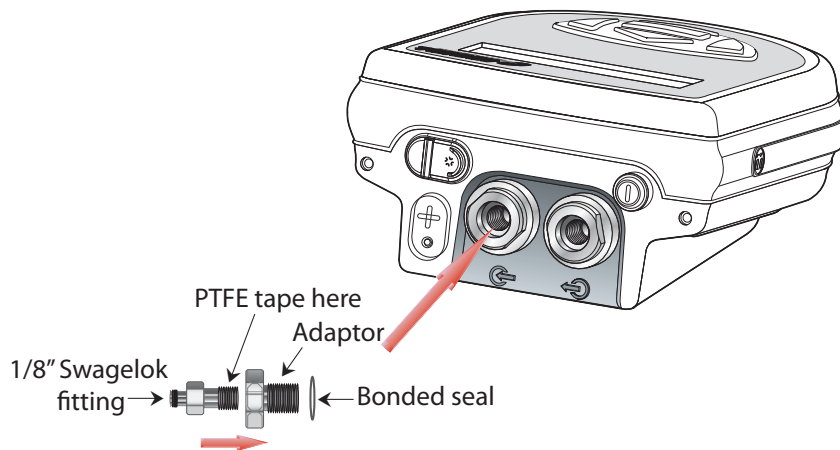

Figure 7 *Bonded Seal Fitting*

2. Fit any other adaptors that might be required.
3. If the small bore orifice fitting is not being utilized then one of the optional application kits could be fitted (as shown below).

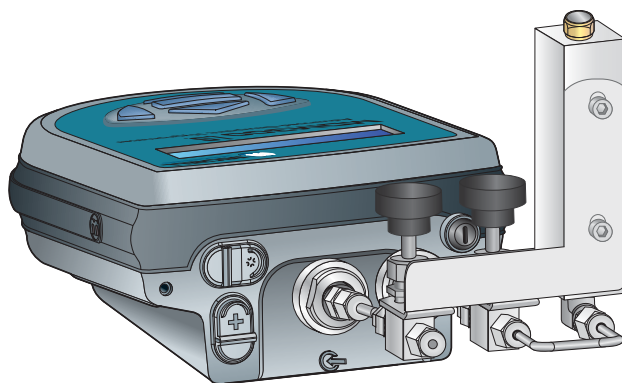

Figure 8 *Gas Coupling Examples for Atmospheric Pressure Measurement*

NOTE: The application kit shown above (excluding the orifice fittings) is not supplied as standard, but is part of a range of kits which can be ordered from Michell Instruments, on request.

NOTE: The bonded seals used for the MDM300 I.S. are Dowty part number 400-228-4490-74 (from Michell Instruments, part number MDM300-DS).

2.6 Connect External Sensors

The MDM300 I.S. can be configured for connection to a Michell Instruments' Easidew I.S. transmitter (ATEX Baseefa 06ATEX0330X, IECEx BAS06.0090X), via the MDM300 I.S. Remote Sensor Interface, when the Easidew I.S. transmitter is installed within a hazardous area.

The MDM300 I.S. Remote Sensor Interface is a passive device. The combined terminal parameters of the MDM300 I.S. and of the barrier used with the Easidew I.S. system must not exceed the input terminal parameters of the Easidew I.S. as specified in the System Drawing (System Certificate No. Baseefa 07Y0027).

To view any of these certificates go to: <http://www.michell.com>



Figure 9 MDM300 I.S. Remote Sensor Interface

Refer to Appendix C (Hazardous Area Certification) for the MDM300 I.S. terminal parameters.

Figure 10 shows the connection of the MDM300 I.S. Remote Sensor Interface to the MDM300 I.S. and the Easidew I.S. transmitter.

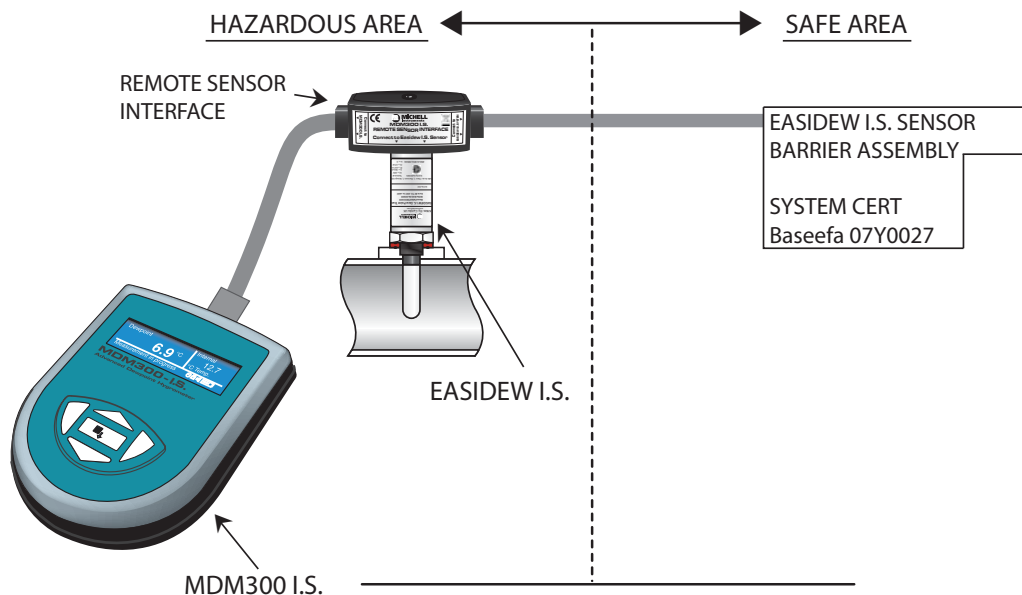

Figure 10 External Sensor Connection

2.6.1 Set up External Sensor Interface

After connecting the Easidew I.S. transmitter, the following parameters must be defined:

Switch on the instrument and set the required **DP/TEMP** units to either °C, °F or K from the SETTINGS Menu (refer to Section 3.4.1). Set up the required pressure units.

Using the **EXTERNAL** option from the SET-UP Menu, set up the instrument for an external Easidew input as follows (refer to Section 3.4.4):

EXTERNAL TYPE	Select EASIDEW
EXTERNAL ZERO	-100°C (DP Temp represented by 4 mA input - can be reset)
EXTERNAL SPAN	20°C (DP Temp represented by 20 mA input - can be reset)
USER PRESSURE	Refer to Section 2.6.2. NOTE: Pressure compensation does not affect the reading of the external sensor.

After completion of the above settings, return to the Main Display. The instrument will now display dew point from the external sensor in the secondary display area and the selected units. (Refer to Section 3.4.6 for more information.)

An example is shown below:

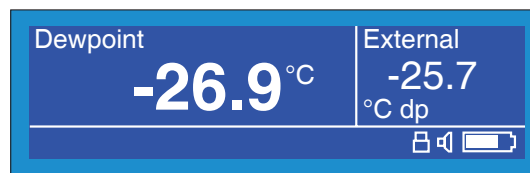

Figure 11 Typical External Dew-Point Display

2.6.2 Entering User Pressure

The MDM300 I.S. can be programmed with a pressure to be used in the calculation of atmospheric equivalent or pressure dew point, moisture content or absolute humidity. **NOTE: Care should be taken to ensure that the entered pressure is correct as it may have a considerable effect on the measurement.**

Using the **EXTERNAL** option in the SET-UP Menu, set a user pressure as follows.

1. Scroll to **USER PRESSURE**.
2. Use the ▲ and ▼ keys to select either **ATM** (for atmospheric pressure) or the required pressure.

NOTE: The pressure units are selected in the Settings Menu.

2.7 Battery Charging



WARNING: The battery charger must **NOT** be connected within the hazardous area.
The battery charger socket cover **MUST** be closed when the product is in use within a hazardous area.

The MDM300 I.S. is powered from an internally mounted, rechargeable Nickel Metal Hydride (NiMH) battery. Typically, depending upon the instrument settings, the battery will provide approximately 24 hours of continuous operation when fully charged.

A graphical display of battery charge state is provided and an audible warning is given as the battery approaches full discharge.

Loosen the securing screw and swing aside the sealing cover (2). Insert the battery charger connector (1) into the charger connector as shown in *Figure 12*.

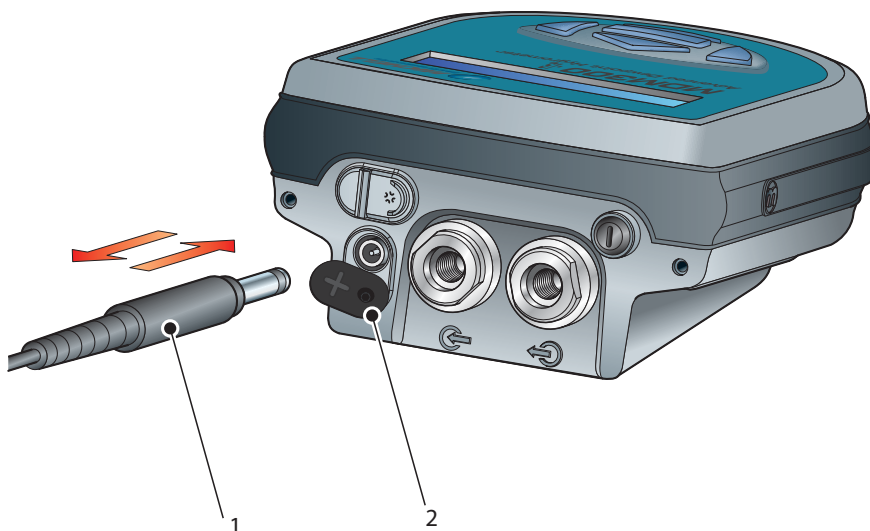

Figure 12 *Battery Charger Connection*

Connect an AC power supply, 100 to 240 V AC, 50/60 Hz, to the battery charger unit.

NOTE: The MDM300 I.S. instrument does not need to be switched on in order to charge the battery.

The battery charger supplied is a 'Smart' charger.



WARNING: DO NOT use any other charger than that supplied with this product.

The use of any charger other than that supplied for use will invalidate the product warranty.

The smart charger goes through three charging stages:

- pre-charge
- fast-charge
- trickle charge

If the battery has been damaged then the charger will not begin the fast-charge stage. Please contact Michell Instruments' service department for advice.

Once the charger has finished the fast-charge stage it can be safely disconnected. Switch off the AC power supply, remove the charger unit and close the instrument's charge connector protection cover.

A complete charge cycle will take 2 to 4 hours for a fully discharged battery.

The table below shows the different charging stages and durations.

Stage / Charger	FW 7219 Type (Older)	Cell-con (Newer)	Duration
Pre-charge	Flashes Orange	Orange	Up to 5 minutes
Rapid-charge	Flashes Green (Fast)	Red	2 to 4 hours
Trickle-charge	Flashes Green (Slow)	Green, flashes Orange	Indefinite - Cell-con One hour - FW
Charging complete	Green	Green	N/A

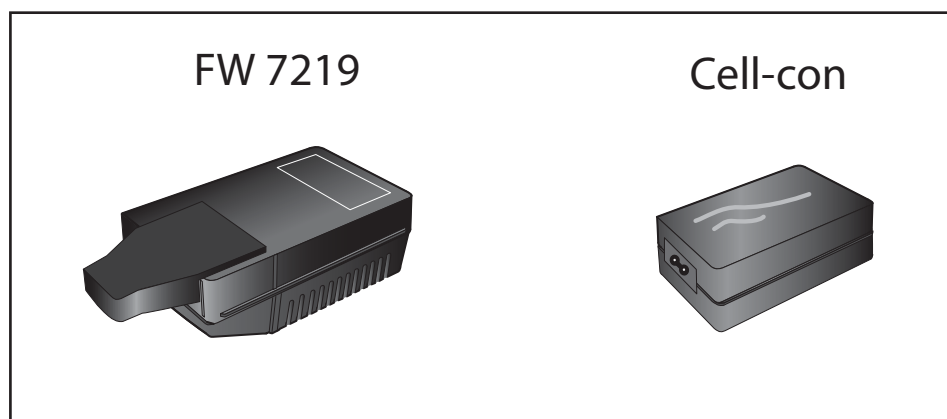

3 OPERATION



High pressure gases are potentially dangerous.

POSSIBLE INJURY! The tubing, valves and other apparatus attached to this instrument must be adequate for the maximum pressure which will be applied, otherwise physical injury to the operator or bystander is possible.

3.1 Preparation for Operation

The MDM300 I.S. has a user-friendly system of operation. Before operation it is recommended that the user becomes familiar with Section 1 of this manual in which the equipment controls and indicators, and the elements of the display are described.

Prior to making a measurement, the instrument must have been connected to a sample gas stream, see Section 2.5.

It is recommended that the battery is charged before conducting any tests (refer to Section 3.7).

The instrument will have been set up with a number of factory default parameters. These default parameters are shown in Table 10, together with a reference to the relevant part of this manual which details the method of changing these default values.

3.2 Instrument Start-Up

At switch on, the instrument goes through an initialization process of between 4 and 7 minutes, depending on the sensor and sample gas characteristics. During this time the internal sensor is heated to a maximum of +60°C (+140°F). The heating process increases the mobility of water molecules and accelerates equilibrium with the passing sample gas.

During this period the sample gas flow purges the system. After this period, the sensor will be dried to below the dew point of the gas to be measured. The heating is then switched off and the display becomes dynamic. *Figure 13* shows a typical start-up sequence.

At switch-on, the System Initializing Page is displayed for several minutes during which the page will show a countdown of the remaining initialization time. **NOTE: The initialization stage is skipped if the initial dew point is detected to be within 2°C of the dew point when the instrument was switched off.**

During this period, gas will be flowing through the sensor and can be externally regulated to meet the instrument's flow requirements, and the real time sensor temperature is indicated in the secondary display area. The initializing icon (item 6 in *Figure 3*) is displayed in the status area and the keyboard is locked out until the initialization period has expired.

It is possible to terminate the initialization process before the initialization period has timed out by pressing the ▲ and ▼ keys simultaneously. This action aborts the instrument's response enhancement system and allows the operator to make an immediate measurement if the measured dew point is wetter than -20°Cdp (-4°Fdp).

While the initialization process is in progress, the backlight time-out is inhibited and, if any external sensor has been configured and connected to the instrument, display of the external sensor reading is also inhibited.

After the end of the initialization period, the display reverts to Measurement Mode displaying dew point (in the currently selected unit) in the primary display area, and any external sensor reading in the secondary display area. By default, the internal temperature is displayed in the secondary display area if no external sensor is configured.

If an external sensor has been selected but has either not been connected or is giving an over-range indication, a flashing **External Sensor Error** message (alternating with a **Measurement in progress** message) will be displayed.

While the Quick Response Algorithm is in operation a **Measurement in progress** message is displayed. After this, depending on the sample conditions, the instrument may continue to respond to the final dew-point for a number of minutes. This is further explained in Section 3.6.

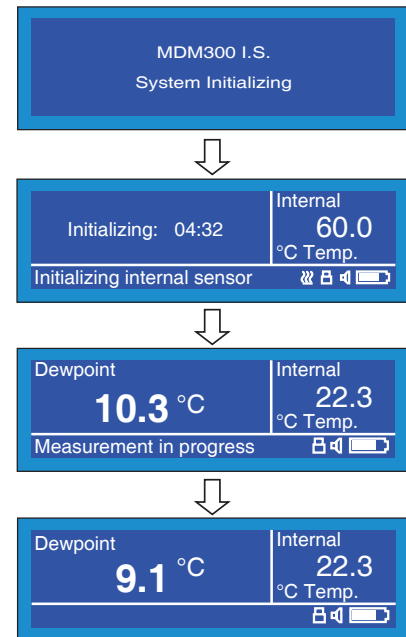

Figure 13 Start-Up Sequence

3.3 Overall Menu Structure and Operation

3.3.1 SET-UP Menu

All instrument settings are made from the SET-UP Menu which is accessible from the Main Display by pressing the **Enter** key.

On the first occasion after switch-on the Passcode Entry page will be displayed. Enter the passcode **7316** as follows:

- With the first digit of the passcode highlighted, enter the first digit (**7**) using the **▲** and **▼** keys.
- Press the **Enter** key to accept this entry and move to the next digit position.
- Repeat this procedure until all the passcode digits have been entered. On successful entry of the last digit, the SET-UP Menu will be displayed.

NOTE: If the passcode is incorrectly entered, the passcode page remains displayed showing the entries that have been made. To accept any digit as correct and to move to the next digit position, press the **Enter** key. Change the incorrect entry, using the **▲** or **▼** keys, and when the correct passcode has been entered, the SET-UP Menu will be displayed.

Within this SET-UP Menu, eight options are available: **SETTINGS, LOGGING, BLUETOOTH, EXTERNAL, CLOCK, HMI, CALIBRATION** and **INFO**. For more detailed information on these options refer to Section 3.4.

These options are selected by means of the **▲** and **▼** keys. Pressing the **Enter** key then provides access to a sub-menu which permits the variables associated with that option to be edited, as follows:

- Press the **▲** and **▼** keys to highlight the required field.
- Press the **Enter** key to select the field.
- Press the **▲** and **▼** keys to edit the parameter value associated with that field.
- Press the **Enter** key to enter the new value.

Quit the sub-menu by pressing the **◀** key and return to the SET-UP Menu. From the SET-UP Menu either select another sub-menu with the **▼** key or press the **◀** key to return to the Main Display.

3.3.2 Chart Page

The Chart Page is reached from the Main Display, by pressing the **▶** key. The chart interval is set up under the **SETTINGS** Menu. For more information on the Chart Page refer to Section 3.4.8.

Pressing the **▶** key when the chart is displayed will show either the Log Files (if Logging is **not** selected), or the current data Logs Page (if Logging is selected). If Logging is not selected press the **Enter** key for a shortcut to the **LOGGING** Menu.

Where more than one page of data is available, the **▲** and **▼** keys are used to scroll up or down.

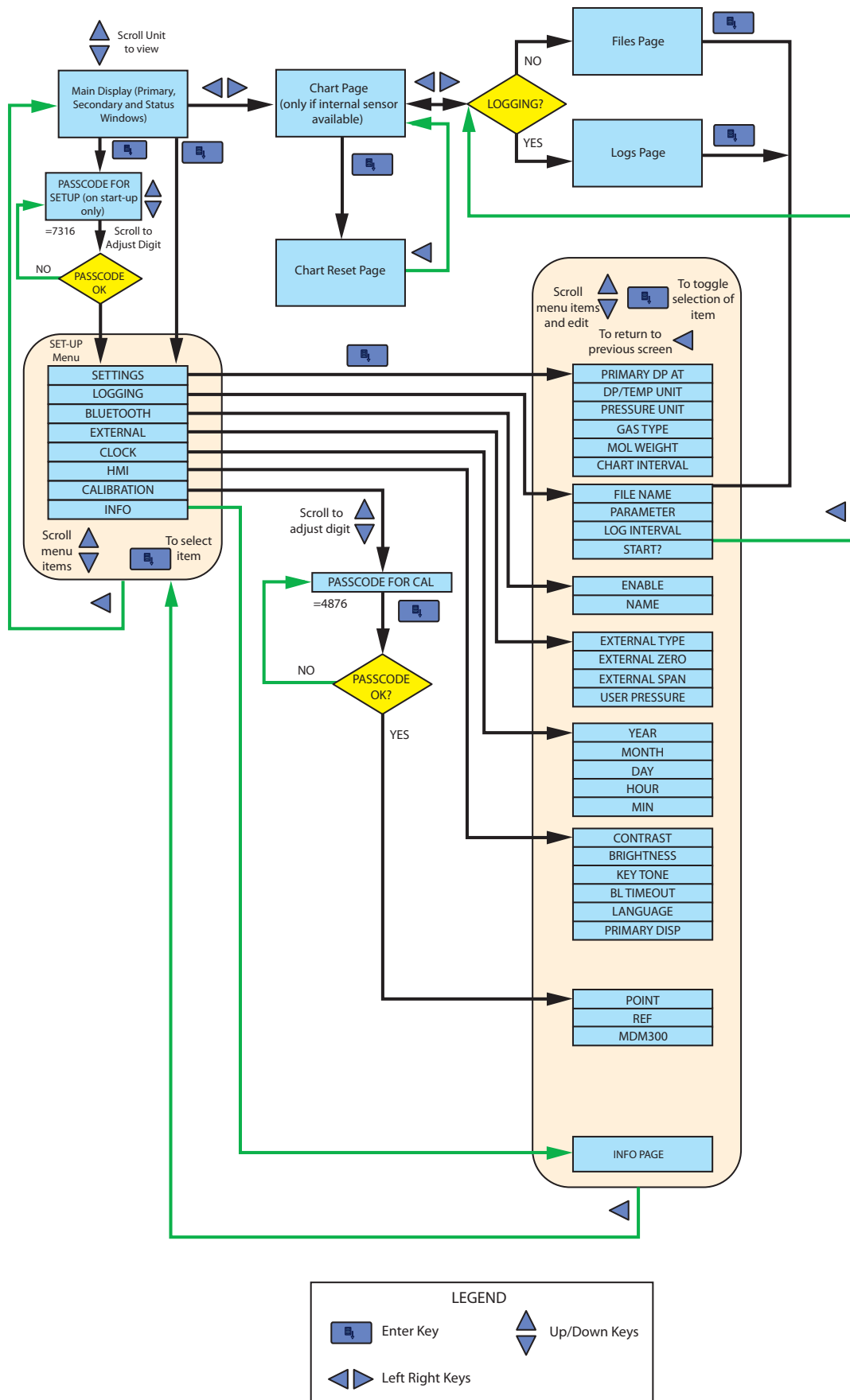

Figure 14 Menu Structure

3.4 SET-UP Menu Parameters

Follow the instructions in Section 3.3.1 to select the required parameters.

3.4.1 SETTINGS

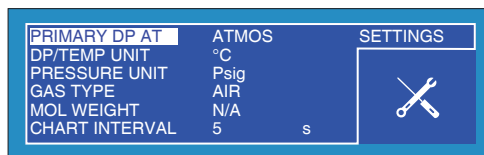

Figure 15 *SETTINGS* Page

Parameter	Description
PRIMARY DP AT	Indicates if the primary display sensor is at atmospheric or system pressure. Available Input: ATMOS or PRESS (Atmospheric or Pressure)
DP/TEMP UNIT	Sets system temperature units. Available Input: °C , K , °F
PRESSURE UNIT	Sets system pressure units. Available Input: psig , MPa , psia , bara , KPa , barg ,
GAS TYPE	Defines the sample gas type. NOTE: The MOL WEIGHT field automatically reads N/A for all gases other than USER . For any other type of sample gas, the molecular weight of the gas must be defined in the MOL WEIGHT field. Available Input: Air , USER , H2 , SF6 , CO2 , N2
MOL WEIGHT	Sets molecular weight of user-defined sample gas, default value 1. Available Input: Range 1 to 99
CHART INTERVAL	Sets chart time interval, default value 5. Available Input: Range 1 to 60 seconds

Table 4 *SETTINGS* Parameters

3.4.2 LOGGING

Logging can be set up either from the SETTINGS Menu or from the Chart Page (see Section 3.4.8). Both methods of entry lead to the same LOGGING SET-UP menu as shown below:



Figure 16 LOGGING Page

Parameter	Description
FILE NAME	Defines datalog file name. Field width up to eight alphanumeric characters. NOTE: ◀ key deletes characters NOTE: If a file name is not entered, a logging cycle cannot be started. Available Input: 0 - 9, A - Z (keying up and down will change the numbers to letters or vice-versa)
PARAMETER	Sets parameter to be logged. This need not necessarily be the same as that displayed on the Main Display. NOTE: Only one parameter may be logged at one time Available Input: DEWP, GM3, GKG, RH, PPMW, PPMV, CALC DP, GM3(NG), LBMMSCF, PPMV(NG)
LOG INTERVAL	Sets log interval in 5 sec increments. Available Input: Range 5 to 600 seconds
START ?	Starts the log cycle after logging parameters are set-up. NOTE: If a file name is not entered, a logging cycle cannot be started. Once logging has started, log file parameter fields are locked out and cannot be changed. Available Input: STOPPED, STARTED

Table 5 LOGGING Parameters

NOTE: If a duplicate file name has been entered an error message will be shown when attempting to start logging.

A maximum of 64 log files can be stored in the instrument memory before it is necessary to download or remove them. The START ? option will not be available if this limit is exceeded.

Cycling power will stop the logging.

The size of any one log file is limited to 60kb. If the unit is left logging, and the file size exceeds 60kb, then the log file will finish automatically. To ensure that the log file you initiate collects all the data from your test, an

appropriate sample time should be chosen. The table below can be used as a rough guide:

Sample time (sec)	Logging duration
5	3 hours
10	6 hours
30	18 hours
60	36 hours
100	60 hours
200	120 hours
400	240 hours
600	360 hours

3.4.3 BLUETOOTH

Bluetooth mode is used, in conjunction with a dedicated MDM300 I.S. application software package, for the purpose of uploading datalog files to a PC using a wireless connection. Within the PC the dedicated Michell application software package is used to upload the files to the PC's desktop, from where they can be loaded into other programs, e.g. Microsoft Excel, for further examination and processing.

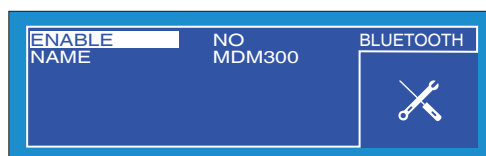

Figure 17 BLUETOOTH Page

Parameter	Description
ENABLE	Turns the Bluetooth facility on or off. When Bluetooth is turned ON - a status message *in Bluetooth mode* will be displayed. No other menu options can be selected at this time and this page remains until the Bluetooth mode is cancelled by pressing the ▲ key. Available Input: ON or OFF
NAME	Before enabling Bluetooth (above) set up a Bluetooth name (address) for the instrument. Maximum eight alphanumeric characters. Default name set is MDM300. Available Input: 0 - 9, A - Z (keying up and down will change the numbers to letters or vice-versa)

Table 6 BLUETOOTH Parameters

3.4.3.1 Bluetooth Pairing Procedure

When the instrument is in Bluetooth mode, a pairing procedure needs to be carried out in order for the PC system to recognize the instrument. This procedure only needs to be carried out once for each instrument. A typical pairing procedure is outlined in *Figure 18*. The procedure is as follows:

1. From the PC's Bluetooth menu, search for devices in range. This yields the instrument named, i.e. MDM300.
2. Double click the instrument icon and enter the instrument's pairing passcode (**7316**) for all MDM300 I.S. instruments. **NOTE: Each digit will be shown only briefly as it is entered and then hidden.**
3. When all digits have been entered click **Next**.
4. With the serial link established, click **Configure**. **NOTE: The name of the COM port allocated, i.e. COM7, will need to be entered when starting the Michell application software.**

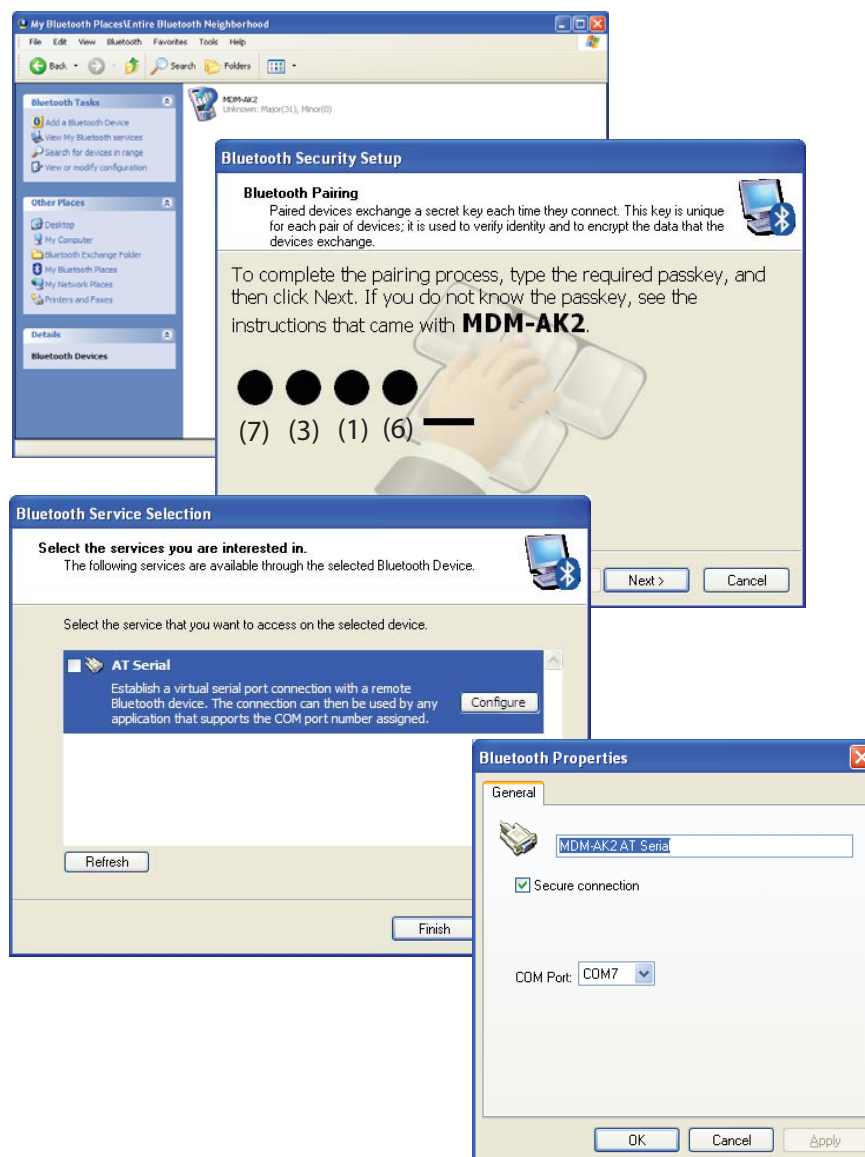

Figure 18 Typical Bluetooth Pairing Sequence

3.4.4 EXTERNAL (Sensor Interface)



The MDM300 I.S. is designed to be connected **ONLY** to a Michell Instruments' remotely mounted Easidew I.S. or Easidew PRO I.S. transmitter. Connection to any other type of sensor could impair safety.

The Easidew I.S. or Easidew PRO I.S. must be connected retaining the associated I.S. barriers and using a Michell Remote Sensor Interface module. See Section 2.6.

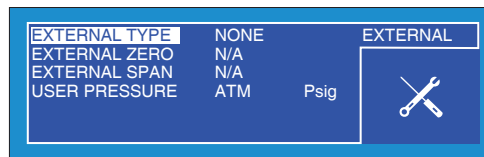

Figure 19 EXTERNAL SET-UP Page

Parameter	Description
EXTERNAL TYPE	Defines use of Easidew I.S. transmitter. NOTE: The ZERO and SPAN limits are automatically added for this transmitter. Available Input: NONE, EASIDEW
EXTERNAL ZERO	Defines external zero (lower limit). The ZERO default limit is pre-programmed but can be redefined. Available Input: Range: -120 to +30°C
EXTERNAL SPAN	Defines external span (upper limit). The SPAN default limit is pre-programmed but can be redefined. Available Input: Range: -120 to +30°C
USER PRESSURE	Used in the calculation of dew point at pressure, moisture content and absolute humidity. If a user pressure is not selected then the MDM300 I.S. assumes atmospheric pressure. (Refer to Section 2.6.2.) NOTE: Pressure compensation does not affect the reading of the external sensor. Available Input: Range ATM, 0 to 300 barg (or equivalent in other units).

Table 7 EXTERNAL Sensor Parameters

3.4.5 CLOCK

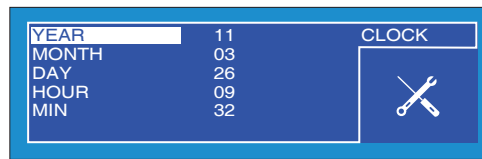

Figure 20 CLOCK Page

Parameter	Description
YEAR	Current year Available Input: Range: 00 to 99
MONTH	Current month Available Input: Range: 01 to 12
DAY	Current day Available Input: Range: 01 to 31
HOUR	Current hour Available Input: Range: 00 to 23
MIN	Current minute Available Input: Range: 00 to 59

Table 8 CLOCK Parameters

3.4.6 HMI

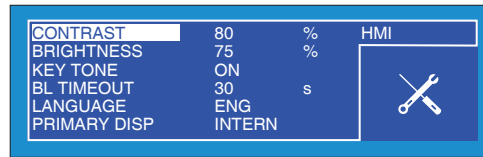

Figure 21 HMI Page

Parameter	Description
CONTRAST	Sets the contrast on the screen. Available Input: Range: 0 to 100% in 5% increments
BRIGHTNESS	Sets the brightness of the screen. Available Input: Range: 0 to 100% in 5% increments
KEY TONE	Turns the key tone on or off. Available Input: ON, OFF
BL TIME-OUT	Backlight control. Available Input: OFF, 15 to 60 sec in 15 sec increments
LANGUAGE	Sets the language required. Available Input: ENG, DEU, ESP, FRA, ITA, POR
PRIMARY DISP	Sets the display option. NOTE: This option is only accessible if an external sensor has been configured - see below. Available Input: INTERN, EXTERN

Table 9 HMI Parameters

If no external input is selected, the internal sensor temperature is shown, on the secondary display, by default.

When an Easidew I.S. transmitter has been configured, the primary and secondary displays can be interchanged to show the external sensor reading as the main display and the internal sensor reading as the secondary display.

With an Easidew I.S. transmitter connected, the ability to display the output of the external device as the main (large character) display can be particularly advantageous for a number of applications such as:

- Remote monitoring
- Calibration checks on an existing installation
- High pressure measurements

3.4.7 INFO

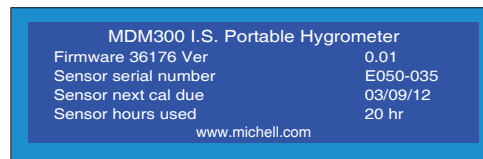

Figure 22 INFO Page

This page contains system information and no changes can be made.

Information available:

- Firmware number and version
- Sensor serial number
- Date of sensor calibration next due
- Hours that the sensor has been used

3.4.8 CHART Page

At any time while the Main Display is indicating internal sensor parameters, a graphical display of the output can be obtained by pressing the ► key from the Main Display.

The chart can be reset at any time by pressing the **Enter** key. Reset the chart by pressing the ► key or return to the chart, without resetting, by pressing the ◀ key.

A typical chart plot is shown below:

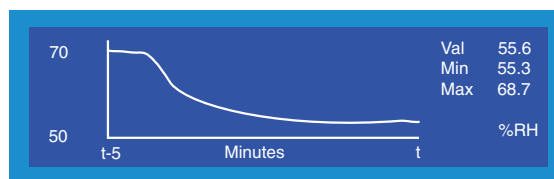

Figure 23 CHART Page

The X-axis (time) has a default range of 5 minutes and the graph is incremented (drawn) at the interval set up under the SETTINGS Menu (see Section 3.4.1). The Y-axis shows the measured value, with respect to time.

The current, maximum and minimum values of the displayed parameter are shown to the right of the graph and the unit of the selected parameter is displayed below.

3.4.9 LOG FILES Page

If the instrument is **not** logging, pressing the ► key, while the chart is displayed, will show the FILES Page. This page provides a list of all the previously saved log files, together with an indication of the available memory capacity (see *Figure 24*). To scroll through the list, use the ▲ and ▼ keys as required.



Figure 24 LOG FILES Page

The content of the datalog files cannot be examined but, by enabling the instrument's Bluetooth mode, (see Section 3.4.3), the MDM300 I.S. application software may be used to upload the datalog files to a PC.

In the FILES Page a shortcut to the LOGGING Set-Up Menu is provided by pressing the **Enter** key. Refer to Section 3.4.2 for logging set-up details.

3.4.10 LOGS Page

If the instrument **is** logging, pressing the ► key, while the chart is displayed, will show the LOGS Page. The page shows the current log file.

In the LOGS Page a shortcut to the LOGGING Set-Up Menu is provided by pressing the **Enter** key. Refer to Section 3.4.2 for logging set-up details.

The ▲ and ▼ keys are both active while the log file is being displayed. To view log points taken earlier in the logging cycle, press the ▲ key. To continuously scroll back, keep the ▲ key pressed down.

Similarly, to move forward in the list press the ▼ key, once for a single step, or press and hold to continuously scroll forward.

#	INT	EXT	ST	File	CR030911
106	26.8	100.0	0028	INT	RH
107	26.2	-90.0	0028	EXT.	EXT_DP
108	25.9	-80.0	0028	INTVAL	05 Sec
109	25.8	-70.0	0028	D#	110903
110	25.5	-60.0	0028	T#	123606

Figure 25 LOGS Page

The display shows:

#	Indicates a log number for each set of log points
INT	Value of primary display parameter
EXT	Value of secondary display parameter
ST	Status column which reports the status of the instrument at each log point in hexadecimal code. The status codes are explained in Appendix B.

- **FILE** File name
- **INT** Primary display parameter being logged
- **EXT** Secondary display parameter being logged
- **INTVAL** Logging interval
- **D#** Current date in YYMMDD format
- **T#** Current time in HHMMSS format

NOTE: The chart and datalogging are independent functions; therefore the parameter displayed on the chart may not necessarily reflect what is being logged.

3.4.11 CALIBRATION



WARNING: These procedures require the use of specialized test equipment and calibration adjustments should only be carried out by qualified personnel.

POINT	REF	MDM300	CALIBRATION
-100	-100.0	-100.0	
-90	-90.0	-90.0	
-80	-80.0	-80.0	
-70	-70.0	-70.0	
-60	-60.0	-60.0	

Figure 26 CALIBRATION Page

Entry to the CALIBRATION Menu is protected by a passcode (4876). The passcode is entered in a similar manner to that described in Section 3.3.1.

This page gives access to the internal sensor's calibration look-up table and provides the facility to select and change any single point, or number of points.

The values in both the REF (reference dew-point) and MDM300 I.S. (reading at the corresponding REF level input) columns can be edited.

Section 6 details the use of the calibration routines.

3.5 Default Parameters

Parameter	Default Value	Associated Section Reference
SETTINGS		
PRIMARY DP AT	ATMOS	Section 3.4.1, <i>Figure 15</i>
DP/TEMP UNIT	°C	
PRESS UNIT	psig	
GAS TYPE	AIR	
MOL WEIGHT	N/A	
CHART INTERVAL	5 sec	
LOGGING		
FILE NAME	-	Section 3.4.2, <i>Figure 16</i>
PARAMETER	DEWP	
LOG INTERVAL	5 sec	
START?	STOPPED	
BLUETOOTH		
ENABLE	NO	Section 3.4.3, <i>Figure 17</i>
NAME	MDM300 I.S.	
EXTERNAL		
EXTERNAL TYPE	NONE	Section 3.4.4, <i>Figure 19</i>
EXTERNAL ZERO	N/A	
EXTERNAL SPAN	N/A	
CLOCK		
	Current UK time & date	Section 3.4.5, <i>Figure 20</i>
HMI		
CONTRAST	80%	Section 3.4.6, <i>Figure 21</i>
BRIGHTNESS	40%	
KEYTONE	OFF	
BL TIME-OUT	OFF	
LANGUAGE	ENG	
PRIMARY DISP	INTERN	
CALIBRATION & INFO		
	Default values not applicable	Section 3.4.11 & Section 6

Table 10 MDM300 I.S. Default Parameters

3.6 Guide to Measurement and Sampling

Operating the MDM300 I.S. is very straightforward, but sampling conditions can vary greatly from one application to another. To get the best possible response speed, the appropriate procedure should be followed.



HIGH PRESSURE! High pressure gases are potentially hazardous. Energy stored in these gases can be released suddenly and with extreme force. High pressure systems should be assembled and operated only by people who have been trained in proper safety practices.



POSSIBLE INJURY! The tubing, valves and other apparatus attached to this instrument must be adequate for the maximum pressure which will be applied, otherwise physical injury to the operator or bystander is possible.

For the most basic measurement it is recommended to have a flow meter (0 to 1 l/min), and at least one metering valve.

A number of sampling kits are available from Michell Instruments:

- The Easi-fit sample kit is a low cost sampling system consisting of 2 metering valves and a flow meter which is suitable for many applications.
- The MDM300 panel-mount sampling system offers a complete package for conditioning of a sample, prior to measurement with an MDM300. It is contained within an optional flight case which allows for easy transport of everything required to make the measurements. The anti-static construction of the case makes it suitable for use in hazardous areas.

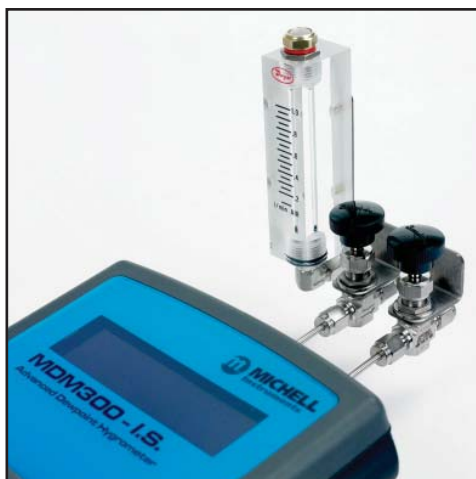

Figure 27 *Easi-Fit Sample Kit*



MDM300 Panel-Mount Sampling System

Specialized kits are available for the measurement of atmospheric pressure samples, compressed air, medical gas and SF₆. Contact a Michell Instruments' representative for more information.



It is highly recommended that a filter is installed upstream of the MDM300. Refer to the Sample Conditioning section of the Sampling Hints found in Section 4.1.

3.6.1 Measuring at Atmospheric or System Pressure

Without a metering valve

The large and small orifice fittings can be used to restrict flow at pressures up to 10 barg (145 psig).

To measure at atmospheric pressure, fit the small orifice fitting to the inlet of the instrument. Fit a large orifice fitting to the outlet of the instrument.

To measure at system pressure, fit the small orifice fitting to the outlet of the instrument. Fit a large orifice fitting to the inlet of the instrument.



Figure 28 Large and Small Orifice Fitting

With one metering valve

Ensure that large orifice fittings are fitted to both the inlet and the outlet of the instrument.

To measure at atmospheric pressure the metering valve used to control the sample flow should be fitted to the inlet of the instrument.

To measure at system pressure the metering valve used to control the sample flow should be fitted to the outlet of the instrument.

With two metering valves

Ensure that large orifice fittings are fitted to both the inlet and the outlet of the instrument.

To measure at atmospheric pressure the metering valve on the instrument outlet should be fully open. The metering valve on the inlet should be used to control the sample flow.

To measure at system pressure the metering valve on the instrument inlet should be fully open. The metering valve on the outlet should be used to control the sample flow.

3.6.2 Measurement Guide

1. Follow procedure A and note the result.
2. Turn the instrument off.
3. If you wish to measure at sample pressure then use the Michell Humidity Calculator (http://www.michell.com/uk/downloads/humidity_calculator.msi) to convert this result back to the equivalent at your sample pressure.
4. Using this converted result, and the table below, find the appropriate procedure to measure your sample.

Dew Point	Measure at Sample Pressure > 2.5 barg	Measure at Atmospheric Pressure
>-40°C	Procedure B	Procedure A
<-40°C	Procedure C	Procedure A

Table 11 MDM300 I.S. Measurement Procedures

A Standard Purge (Atmospheric Measurement)

1. Connect the MDM300 I.S. to the sample gas stream.
2. Adjust the flow rate, **using the inlet flow** control valve, to between 0.2 & 0.5 NI/min (0.5 & 1 scfh). The outlet flow control valve should be fully open.
3. Turn the instrument on - the initialization period begins automatically. The page will show a countdown of the remaining initialization time. The status display will read '**Initializing internal sensor**'.
4. After Initialization, the instrument will begin Measurement mode. During the first few minutes of Measurement mode, the displayed moisture value will drop rapidly below the actual moisture value, before returning to a stable reading. The instrument display will show an initial measured value, and the status display will show '**Measurement in progress**'.
5. Once '**Measurement in progress**' has disappeared, the instrument is close to the final dew point. Depending on the conditions, it may continue to respond for a number of minutes before tracking the measured dew point.

B Standard Purge (Pressure Measurement)

1. Connect the MDM300 I.S. to the sample gas stream.
2. Adjust the flow rate, using the **outlet flow control valve**, to between 0.2 & 0.5 NI/min (0.5 & 1 scfh). The inlet flow control valve should be fully open.
3. Turn the instrument on - the initialization period begins automatically. The page will show a countdown of the remaining initialization time. The status display will read '**Initializing internal sensor**'.
4. After Initialization, the instrument will begin Measurement mode. During the first few minutes of Measurement mode, the displayed moisture value will drop rapidly below the actual moisture value, before returning to a stable reading. The instrument display will show an initial measured value, and the status display will show '**Measurement in progress**'.
5. Once '**Measurement in progress**' has disappeared, the instrument is close to the final dew point. Depending on the conditions, it may continue to respond for a number of minutes before tracking the measured dew point.

C Enhanced Purge

1. Connect the MDM300 I.S. to the sample gas stream.
2. Adjust the flow rate, using the **inlet flow control valve**, to between 0.2 & 0.5 NI/min (0.5 & 1 scfh). The outlet flow control valve should be fully open.
3. Turn the instrument on - the initialization period begins automatically. The page will show a countdown of the remaining initialization time. The status display will read '**Initializing internal sensor**'.
4. Once 2-3 minutes of the initialization period have elapsed, close the outlet flow control valve and fully open the inlet flow control valve. Then adjust the flow rate using the outlet flow control valve to between 0.2 & 0.5 NI/min (0.5 & 1 scfh).
5. After Initialization, the instrument will begin Measurement mode. During the first few minutes of Measurement mode, the displayed moisture value will drop rapidly below the actual moisture value, before returning to a stable reading. The instrument display will show an initial measured value, and the status display will show '**Measurement in progress**'.
6. Once '**Measurement in progress**' has disappeared, the instrument is close to the final dew point. Depending on the conditions, it may continue to respond for a number of minutes before tracking the measured dew point.

3.6.3 Conditional Sensor Purge

In order to ensure consistently fast measurement response speeds after power Off/On, the sensor will not be automatically purged when the measured dew point is deemed to be sufficiently close to the previously measured dew point.

3.7 Battery Management

The battery will typically provide 24 hours of continuous operation from full charge. When the battery approaches discharge, the instrument will display the warning message '**Battery low – recharge now**'.

Following this, the instrument will enter a Shutdown Mode, accompanied by an audible beep. This mode will disable the operation of the keypad and display backlight, preventing further usage of the unit. Upon connecting the instrument to the battery charger it will exit Shutdown Mode within 30 seconds.

When Shutdown Mode occurs, connect the instrument to the battery charger as soon as possible to prevent complete discharge. Complete discharge may occur if the unit is not connected to a battery charger within a 24 hour period - see below.



WARNING: If complete discharge does occur, then difficulties may be encountered when attempting to recharge the battery.

If this problem is experienced, refer below for a possible solution.

3.7.1 Battery Troubleshooting

Problem: Instrument battery is flat and will not charge.

(NOTE: OLDER FW 7219 MODEL BATTERY CHARGER ONLY).

Cause: If the instrument has been left in a completely discharged state for several days then it is possible that the FW 7219 charger will not recharge the battery.

Solution: The instrument will need to be connected to a 6 V (500 mA max) power supply – via its normal charging port – for a maximum of 15 seconds before switching to the FW 7219 charger, which should now behave normally.



DO NOT leave this 6 V power supply connected to the instrument for any longer than the recommended 15 seconds or the battery may be damaged.

NOTE: Michell Instruments will replace the older FW 7219 charger with the new Cell Con model free of charge. The Cell Con will re-charge batteries which have completely discharged.

4 GOOD MEASUREMENT PRACTICE

The MDM300 I.S. is designed to operate in a flowing gas stream with flow rates between 0.2 and 0.5 NI/min (0.5 and 1 scfh). Flow regulation is provided with the MDM300 I.S. instrument between 2.5 and 10 barg. Outside of this, the sample flow must be regulated outside the unit.

For all applications, the sample gas is taken into the instrument via the Gas In port (2) *Figure 5* located on the top of the instrument, from where it passes through the internal sensor and out via the Gas Out port (1) *Figure 5*. Gas flow rate (if monitored) is normally measured externally, on the output side of the instrument.

There are a number of options for sample conditioning including a purpose built sampling system and a variety of application kits. The flow rate can be regulated on the inlet or outlet depending on whether the intention is to measure at atmospheric or sample pressure. Up to 10 barg, this can be achieved by use of the orifice fittings supplied with the instrument. Section 2.5.1 and *Figure 8* show a typical arrangement for measuring non-hazardous gas at atmospheric or elevated pressure.

In applications where the sample gas has a very high flow rate it is advisable to use an instrument by-pass arrangement to provide the minimal flow rates which the sensor requires. Excessive flow restriction can cause back-pressure across the sensor, leading to a discrepancy between the readings recorded and those expected.

Note: Dew-point is dramatically affected by changes in pressure - in order to ensure the best performance from the instrument it is essential to adequately regulate the sample pressure.

Ideally, a good quality pressure regulator should be used in conjunction with a fine adjustment needle valve. Using a needle valve exclusively is acceptable, but only if the sample pressure downstream of the nearest regulator is not susceptible to pressure fluctuations greater than ± 250 millibar.

Measurement of Dew Points Drier than -70°Cdp

The MDM300 I.S. Sampling System is optimized for fast response. Therefore, when measuring very dry dew points, certain steps need to be taken to ensure that the best accuracy is achieved:

Make sure that all tubing and fittings used are made from stainless steel.

This should reduce the possibility of any moisture being trapped upstream of the sensor prolonging the dry-down process, or permeating into the sample line through unsuitable tubing - such as PTFE.

Due to the significantly lower levels of moisture present at dew points of this level, the response times of the sensor will be significantly increased. The table below offers an approximate guide to the times taken for the instrument to stabilize at a given dew point (from a starting point of 10°Cdp ambient):

Target Dew Point ($^{\circ}\text{C}$)	T100 response time from ambient (hours)
-80	12
-90	48
-100	96

4.1 Sampling Hints

Measurement of moisture content is a complex subject, but does not need to be difficult. This section aims to explain the common mistakes made in measurement situations, the causes of the problem, and how to avoid them. Mistakes and bad practices can cause the measurement to vary from the expectation; therefore a good sampling technique is crucial for accurate and reliable results.

Transpiration and Sampling Materials

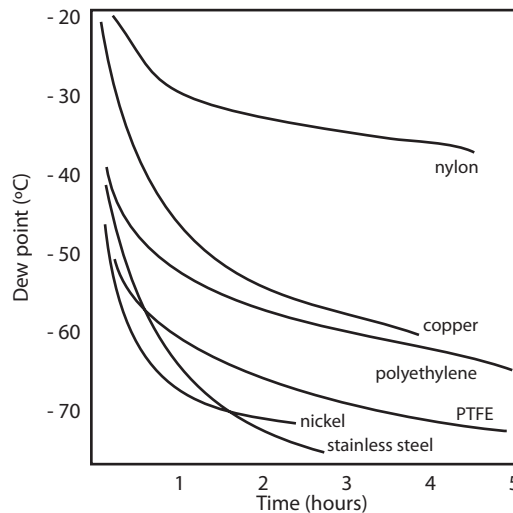

All materials are permeable to water vapor, as the water molecule is extremely small compared to the structure of solids, even when compared to the crystalline structure of metals. The graph to the right shows the dew point inside tubing of different materials when purged with very dry gas, where the exterior of the tubing is in the ambient environment.

Many materials contain moisture as part of their structure, particularly organic materials (natural or synthetic), salts (or anything which contains them) and anything which has small pores. It is important to ensure that the materials used are suitable for the application.

If the partial water vapor pressure exerted on the outside of a compressed air line is higher than on the inside, the atmospheric water vapor will naturally push through the porous medium causing water to migrate into the pressurized air line. This effect is called transpiration.

Adsorption and Desorption

Adsorption is the adhesion of atoms, ions, or molecules from a gas, liquid, or dissolved solid to the surface of a material, creating a film. The rate of adsorption is increased at higher pressures and lower temperatures.

Desorption is the release of a substance from or through the surface of a material. In constant environmental conditions, an adsorbed substance will remain on a surface almost indefinitely. However, as the temperature rises, so does the likelihood of desorption occurring.

In practical terms, as the temperature of the environment fluctuates, water molecules are adsorbed and desorbed from the internal surfaces of the sample tubing, causing small fluctuations in the measured dew point.

Sample Tubing Length

The sample point should always be as close to the critical measurement point as possible, in order to obtain a truly representative measurement. The length of the sample line to the sensor or instrument should be as short as possible. Interconnection points and valves trap moisture, so using the simplest sampling arrangement possible will reduce the time it takes for the sample system to dry out when purged with dry gas.

Over a long tubing run, water will inevitably migrate into any line, and the effects of adsorption and desorption will become more apparent. It is clear from the graph shown above that the best materials to resist transpiration are stainless steel and PTFE.

Trapped Moisture

Dead volumes (areas which are not in a direct flow path) in sample lines, hold onto water molecules which are slowly released into the passing gas; this results in increased purge and response times, and wetter than expected readings. Hygroscopic materials in filters, valves (e.g. rubber from pressure regulators) or any other parts of the system can also trap moisture.

Sample Conditioning

Sample conditioning is often necessary to avoid exposure of sensitive measuring components to liquids and other contaminants which may cause damage or affect the accuracy over time, depending on the measurement technology.

Particulate filters are used for removing dirt, rust, scale and any other solids that may be in a sample stream. For protection against liquids, a coalescing filter should be used. The membrane filter is a more expensive but highly effective alternative to a coalescing filter. It provides protection from liquid droplets, and can even stop flow to the analyzer completely when a large slug of liquid is encountered.

Condensation and Leaks

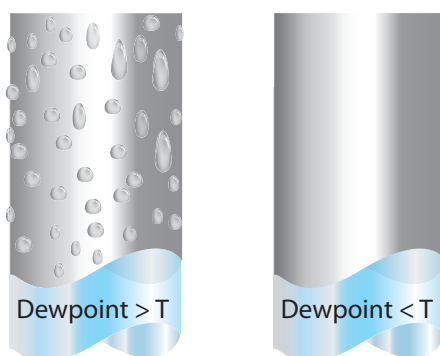

Maintaining the temperature of the sample system tubing above the dew point of the sample is vital to prevent condensation. Any condensation invalidates the sampling process as it changes the water vapor content of the gas being measured. Condensed liquid can alter the humidity elsewhere by dripping or running to other locations where it may re-evaporate.

The integrity of all connections is also an important consideration, especially when sampling low dew points at an elevated pressure. If a small leak occurs in a high pressure line, gas will leak out but vortices at the leak point and a negative vapor pressure differential will also allow water vapor to contaminate the flow.

Flow Rates

Theoretically flow rate has no direct effect on the measured moisture content, but in practice it can have unanticipated effects on response speed and accuracy. The optimal flow rate varies depending on the measurement technology, and can always be found in the instrument or sensor manual.

An inadequate flow rate can:

- Accentuate adsorption and desorption effects on the gas passing through the sampling system.
- Allow pockets of wet gas to remain undisturbed in a complex sampling system, which will then gradually be released into the sample flow.
- Increase the chance of contamination from back diffusion: ambient air that is wetter than the sample can flow from the exhaust back into the system. A longer exhaust (sometimes called a pigtail) can also help alleviate this problem.
- Slow the response of the sensor to changes in moisture content.

An excessively high flow rate can:

- Introduce back pressure, causing slower response times and unpredictable effects on equipment such as humidity generators.
- Result in a reduction in heating capabilities of the sensor tile during the initialization period. This is most apparent with gases that have a high thermal conductivity such as hydrogen and helium.



POSSIBLE INJURY! The tubing, valves and other apparatus attached to this instrument must be adequate for the maximum pressure which will be applied, otherwise physical injury to the operator or bystander is possible.



Before disconnecting the MDM300 I.S. from the gas line it is essential to vent the system to atmospheric pressure, otherwise severe injury could result.

5 APPLICATION SOFTWARE

Application software for the MDM300 I.S. is supplied on a CD.

The latest version of this application software is also available for download from the Michell website – <http://www.michell.com/uk/support/sware-downloads.htm>.

To install on a PC: place the CD in the CD drive and follow the instructions in the application set-up wizard. If the CD does not auto-run, double-click the application set-up file on the CD. The following authorization code will be required during the installation process: **MDM-300-7392**

Once the software has been installed and run, the MDM300 I.S. can be linked to the PC by activating the Bluetooth on the MDM300 I.S. and then connecting with the application software (see Section 3.4.3 for details).

The application software allows modification of all the instrument parameters from the connected PC. The settings currently stored on the MDM300 I.S. can be downloaded to the PC by clicking the '**Download from MDM300**' button, and can then be changed and stored by clicking the '**Upload to MDM300**' button.

The software gives access to all logging files stored on the instrument's internal memory. These can be downloaded to a specific location by right clicking, and selecting '**download**'.

A context sensitive help file provides further details on the use of the application software.

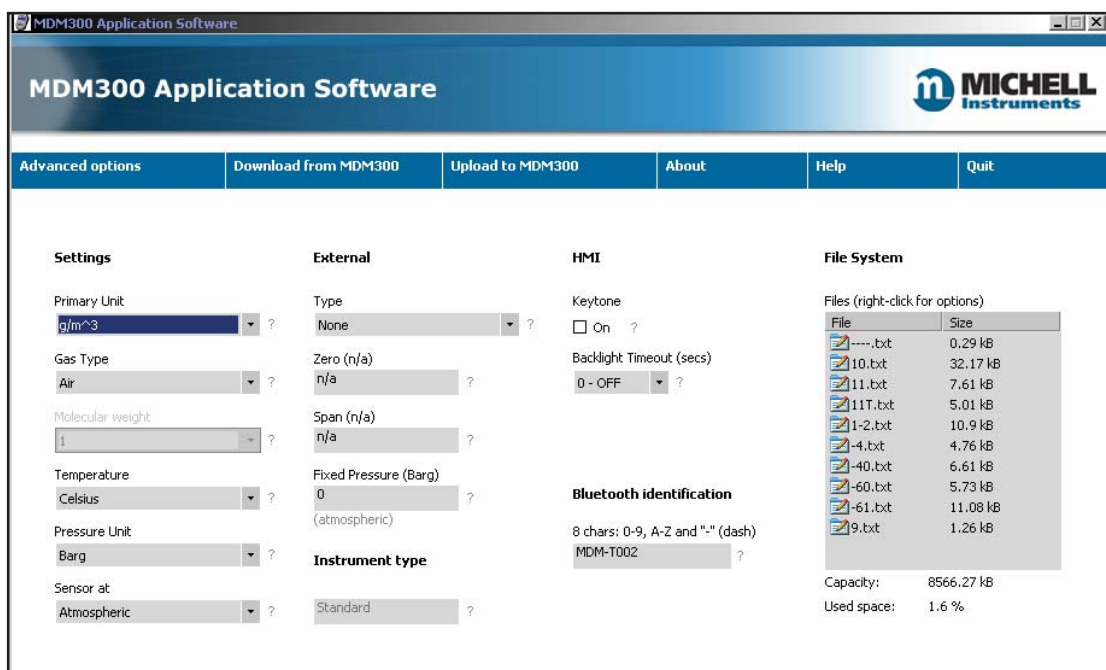

Figure 29 Typical Application Software Screen

6 CALIBRATION

6.1 Traceability

The calibration of this instrument is traceable to national standards. For this reason the instrument should only be calibrated in an accredited, e.g. UKAS or NIST (U.S.) standards laboratory.

If these facilities do not exist it is recommended that the instrument be returned to the manufacturer, Michell Instruments Ltd., or one of the approved agents.

A calibration certificate bearing a seven point calibration is issued with each instrument.

Figure 30 shows a typical seven point calibration certificate.

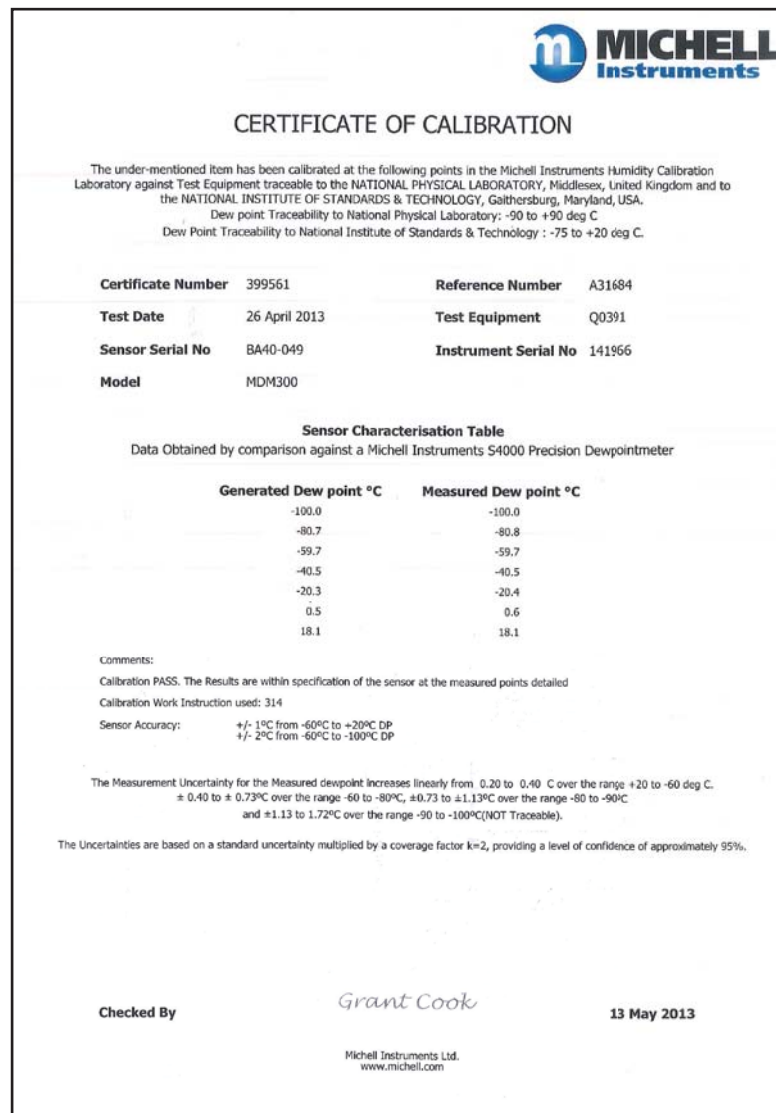

Figure 30 Typical 7-point Calibration Certificate

6.2 Calibration Method



WARNING:
 These procedures require the use of specialized test equipment and calibration adjustments should only be carried out by qualified personnel. If not correctly carried out, the instrument's calibration can be lost.

The calibration procedure for the instrument is as follows:

1. Switch on the instrument. Wait for the initialization period to complete and allow sufficient time for it to stabilize.
2. Ensure the instrument is set up with sample gas as **AIR** and operating pressure as **ATMOS**.
3. Ensure that the temperature units are set up as °C and the primary display is reading **Dew point**.
4. Ensure that all sample tubing and connectors are made from stainless steel and are of suitable quality.
5. Connect the MDM300 I.S. to a dew-point generator and establish a gas flow through the instrument.
6. Apply a dew point of -100°C and allow the instrument's reading to stabilize for a minimum of 96 hours (including dry down).
7. Record the applied **REF** dew point and the corresponding MDM300 I.S. display reading.
8. Repeat steps 6 and 7 at all the required dew-point values over the operating range of the instrument, as shown in Table 12, allowing the stabilization times shown before recording consecutive readings.

A set of results similar to that shown below could be generated over the calibration range of the instrument.

DP REF °C	Stabilize Time (Hours)	MDM300 I.S. Rdg °C	DP REF °C	Stabilize Time (Hours)	MDM300 I.S. Rdg °C
-100	96	-99.8	-30	1	-30.1
-80	12	-79.7	-20	1	-19.9
-70	8	-70	-10	1	-10
-60	4	-59.8	0	1	0.1
-50	2	-49.8	10	1	10
-40	1	-39.9	20	1	20

Table 12 Example Of Calibration Run Readings

6.3 Calibration Correction Method

NOTE: Any logging procedure currently in operation must be cancelled before the calibration procedures can be entered.

To enter the CALIBRATION Menu page, highlight **CALIBRATION** from the SET-UP Menu by using the ▲ or ▼ keys and press the **Enter** key.

Entry to the CALIBRATION Menu is protected by a passcode (**4876**).

Once the passcode has been successfully entered, the following page will be shown.

POINT	REF	MDM300	CALIBRATION
-100	-100.0	-100.0	
-90	-90.0	-90.0	
-80	-80.0	-80.0	
-70	-70.0	-70.0	
-60	-60.0	-60.0	

Figure 31 Calibration Menu Page

The MDM300 I.S. Calibration look-up table is divided into three columns.

The values in the first column **POINT** represent the thirteen nominal calibration points, spread at 10°C intervals over the instruments operating range of -100 to +20°C (-148 to +68°F). These points cannot be edited.

The second column **REF** represents the value of the reference dew-point standard applied at that particular point.

The third column **MDM300** represents the reading that the MDM300 I.S. was showing at the corresponding **REF** level input.

The values in both the **REF** and **MDM300** I.S. columns can be edited by means of the ▲ and ▼ keys. The ► and ◀ keys provide the means of switching between corresponding table columns.

After changes have been made press the **Enter** key to reach the Exit page. No changes are implemented until the ► key is pressed at the Exit page.

To exit without implementing any changes, press the **Enter** key to reach the Exit page. Press the ◀ key, from the Exit page, to return to the SET-UP Menu.

7 SHIPPING

For shipping purposes the instrument should be packed into its original carton which will provide the recommended degree of protection during transit.

To prepare the instrument for shipping, proceed as follows:

1. Switch the instrument off and remove any connections to the Gas In and Gas Out ports and any external sensors connected to it.
2. If fitted, remove the instrument from its carrying case.
3. Pack the instrument in its original carton (1) as shown below.

NOTE: It is not necessary to return any accessories unless they require repair/replacement. Any returned accessories can be packed in the box (4).

4. Create a packing list detailing all equipment contained in the box, place it inside the box and seal the box.



Before disconnecting the MDM300 I.S. from the gas line it is essential to vent the system to atmospheric pressure, otherwise severe injury could result.

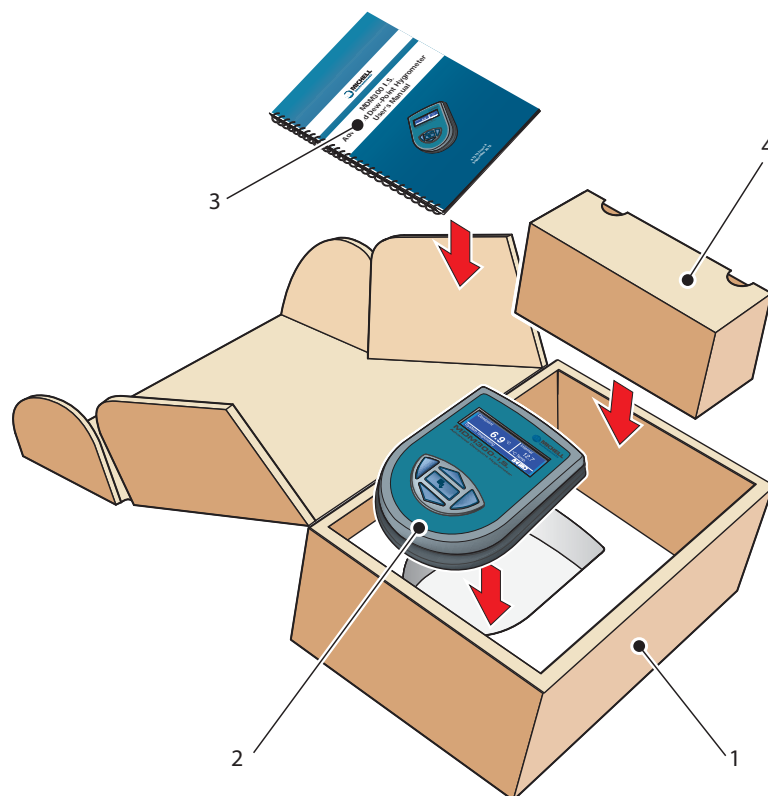

Figure 34 Instrument Packing Details

Appendix A

Technical Specifications

Appendix A Technical Specifications

Performance	
Measurement Technology	Michell Ceramic Sensor
Accuracy	±1°C from -60 to +20°Cdp (-76 to +68°Fdp) ±2°C from -100 to -60°Cdp (-148 to -76°Fdp) ±0.2°C (0.3°F) temperature
Calibrated Measurement Range	For Spot Checks -70 to +20°Cdp (-95 to +68°Fdp) For Online Analysis -100 to -70°Cdp (-148 to -95°Fdp)
Uncalibrated Readings From	+20 to +30°Cdp (+68 to +86°Fdp)
Measurement Units	°C, °F, K dew point & gas temperature % RH, ppm _v , g/m ³ ppm _w & g/kg (for air, N ₂ , H ₂ , CO ₂ , SF ₆ , user-defined mw) ppm _v , lb/mmscf & g/m ³ for natural gas
Pressure Units	psig, barg, KPa, bara, psia, MPa
Resolution (display)	0.1 for all dew-point derived units & auto ranging where appropriate
Resolution (measurement)	Better than 0.1°Cdp (0.2°Fdp)
Typical Response Speed	T95 in ≤30 minutes to -60°Cdp (-76°Fdp)
Sample Gas Flow	0.2 to 0.5 NI/min (0.5 to 1 scfh)
Electrical Specifications	
Auxiliary Inputs	Connection to Michell Easidew I.S. or Easidew PRO I.S. via Remote Sensor Interface
Battery	4.8 V internally mounted Nickel Metal Hydride (NiMH) battery
Battery Operating Life	Up to 24 hours of typical usage between charges
Battery Charger	Intelligent charger, NOT certified for hazardous area use Charger supply voltage: 100 to 240 V AC, 50/60 Hz, 8 VA
Operating Conditions	
Operating Pressure	0 to 35 MPa (0 to 350 barg / 0 to 5076 psig)
Operating Environment	Outdoors 0 to +100% RH (non-condensing)
Operating Temperature	-20 to +50°C (-4 to +122°F)
Storage / Transport Temperature	-40 to +70°C (-40 to +158°F)
Altitude	Up to 2000m (6562ft)
Mechanical Specifications	
Display	Blue LCD graphical display
Enclosure Type	Steel fiber-loaded high-impact polyamide 6
IP/NEMA Rating	IP66/NEMA 4
Gas Connections	1/8" NPT female (other options available)
Gas Wetted Materials	AISI 316L stainless steel, PTFE Seal, Borosilicate glass, ceramic
Outline Dimensions	218 x 170 x 90mm (8.6 x 6.7 x 3.5ft) (d x w x h)
Weight	1.5kg (3.3lbs)

Data Logging	Capacity: 8Mb Log interval: 5 to 60 sec Maximum log file size: 60kb
Communications	(Wireless) Bluetooth™ range up to 5m (16ft) (Version 2.0)
Languages	English, German, Spanish, French, Italian, Portuguese
Hazardous Area Certification	
Certification Codes	ATEX II 1G Ex ia IIC T4 Ga (-20°C to +50°C) IECEX Ex ia IIC T4 Ga (-20°C to +50°C) INMETRO Ex ia IIC T4 Ga (-20°C to +50°C) TC TR Ex 0Ex ia IIC T4 Ga FM Class I, Division 1, Groups A B C D, T4 CSA Class I, Division 1, Groups A B C D, T4

A.1 Dimensions

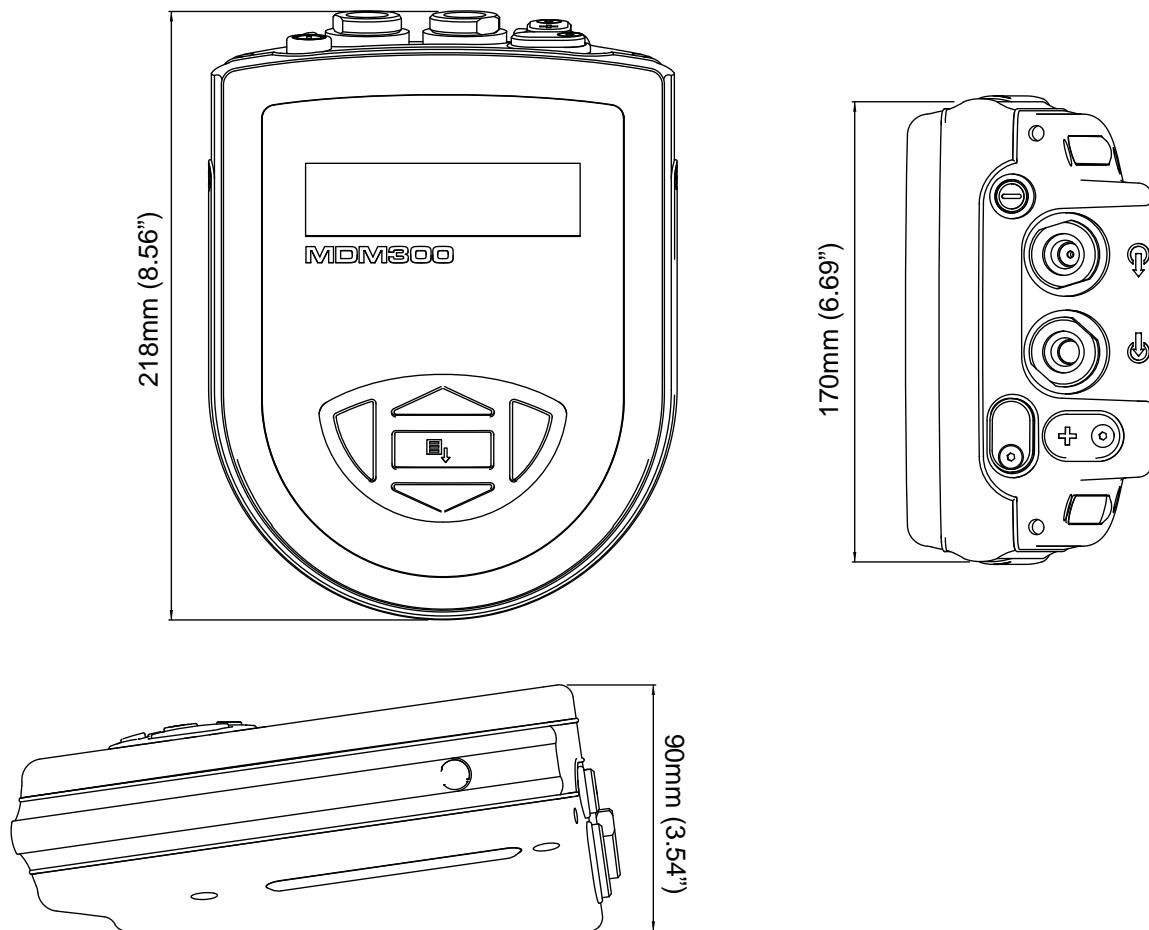

Figure 35 Dimensions - MDM300 I.S.

Appendix B

Datalog Status Display

Appendix B Datalog Status Display

When the status of the current log file is displayed, see *Figure 33*, the **ST** column in the current log file display represents the instrument's status at the time that each log point is recorded.

#	INT	EXT	ST	File	CR270309
106	26.8	100.0	0028	INT	RH
107	26.2	-90.0	0028	EXT.	EXT_DP
108	25.9	-80.0	0028	INTVAL	05 Sec
109	25.8	-70.0	0028	D#	090327
110	25.5	-60.0	0028	T#	123606

Figure 36 Current Datalog File Display

This column shows a hexadecimal representation of the instrument's 16-bit status register shown below in *Figure 36*. Bit 1 is the least significant bit. The four most significant bits 13 to 16 are for Michell Instruments' service use and so the first character in any MDM300 I.S. ST display will always read 0.

Status register bit position															
16	15	14	13	12	11	10	9	8	7	6	5	4	3	2	1
N/A	N/A	N/A	N/A	0/1	0/1	0/1	0/1	0/1	0/1	0/1	0/1	0/1	0/1	0/1	N/A

Figure 37 MDM300 I.S. Status Register

For the example given for each of the log plots shown in *Figure 35* (Hex 0028), the output pattern of the status register will be as shown in *Figure 37*.

Status register bit position															
16	15	14	13	12	11	10	9	8	7	6	5	4	3	2	1
N/A	N/A	N/A	N/A	0	0	0	0	0	0	1	0	1	0	0	N/A

Figure 38 MDM300 I.S. Status Register (Hex 28)

Each of the error bits set high (1) represents a specific status or error condition. In this example, bits 4 and 6 are set high indicating that two (status) conditions exist.

Table 13 shows the status flags associated with each bit of the status register. If a status flag is set high then the associated condition exists. If it is set low, then that condition does not exist.

Status Register bit in Hex	Message	Details
0x0002 = BIT 2	Internal sensor error	Dew-point reading out of range (> +30 / < -120°C)
0x0004 = BIT 3	Internal thermistor error	Sensor internal temperature reading out of range (> +100 / < -40°C) or Thermistor fault
0x0008 = BIT 4	External sensor error	External Sensor Input out of range (< 4 mA / > 20 mA)
0x0010 = BIT 5	Battery low	Battery level low - recharge as soon as possible
0x0020 = BIT 6	Measurement in progress	Internal dew point not stable
0x0040 = BIT 7		Internal dew point changing <0.2°Cdp over a 3 minute interval
0x0080 = BIT 8	Log finished	Log file has reached the maximum of 10,000 logs and logging has been stopped
0x0100 = BIT 9	Internal sensor not found	Could not detect internal sensor on power up
0x0200 = BIT 10	Default CONFIG file used	Config. file missing, new file created and default settings used
0x0800 = BIT 12	Initializing Internal Sensor	Indicates system in purging phase

Table 13 Status Register Flags

For the example given in *Figure 35*, from Table 13, Hex 28 translates, reading from right to left, as bit 4 set '**External sensor error**' and bit 6 set '**Measurement in progress**'. Therefore, at the time that these log points were taken, the external sensor was out of range and the internal dew point was not stable.

Appendix C

Hazardous Area Certification

Appendix C Hazardous Area Certification

The MDM300 I.S is certified compliant to the ATEX Directive (2014/34/EU) and IECEx for use within Zone 0 Hazardous Area, and has been assessed so by Baseefa Ltd (Notified Body 1180).

The MDM300 I.S is certified compliant to North American Standards (USA and Canada) for use within Class I, Division 1, Groups A, B, C & D Hazardous Locations and has been assessed so by CSA and FM.

C.1 Product Standards

This product conforms to the Standards:

EN60079-0:2009	IEC60079-11:2006
EN60079-26:2007	IEC60079-0:2007-10
EN60079-11:2007	IEC60079-26:2006
CAN/CSA-C22.2 No.0-M10	FM CLASS 3600:1998
CAN/CSA-C22.2 No. 157-92(R2012)	FM CLASS 3610:2010
CAN/CSA-C22.2 No.142-M1987(R2009)	FM CLASS 3810:2005
ANSI/IEC 60529:2004	

C.2 Product Certification

This product is attributed with the product certification codes:

ATEX & IECEx
II 1 G Ex ia IIC T4 Ga (-20°C to +50°C)

North American
IS - Class I, Division 1, Groups A, B, C, D, T4

C.3 Global Certificates/Approvals

ATEX	BASEEFA09ATEX0149
IECEX	IECEX BAS09.0063
FM	3036712
CSA	2318983
TC TR Ex	RU C-GB. ГБ05.B.00229
INMETRO	NCC14.03165

These certificates can be viewed or downloaded from our website at:
<http://www.michell.com>

C.4 Input Terminal Parameters

External Sensor Socket		Charging Socket	
U_i	= 28 V	U_m	= 18V
I_i	= 93 mA		
P_i	= 650 mW		
PO	= 0		
C_i	= 0		
L_i	= 0		

C.5 Special Conditions of Use

None

C.6 Maintenance and Installation

The MDM300 I.S. must only be installed by suitably qualified personnel and in accordance with the instructions provided and the terms of the applicable product certificates.

Maintenance and servicing of the product must only be carried out by suitably trained personnel or returned to an approved Michell Instruments' Service Center.

Appendix D

FCC Declaration

Appendix D FCC Declaration

MDM300 I.S. Advanced Dewpoint Hygrometer.

This Device complies with FCC Rules Part 15 Subpart B Unintentional Radiators Class B digital devices. Operation is subject to the following conditions:

- 1) This device may not cause harmful interference
- 2) This device must accept any interference received, including interference that may cause undesired operation.

Note: This product has been tested and found to comply with the limits of Class B digital devices, pursuant to Part 15 of the FCC rules. This product generates, uses and can radiate radio frequency energy and, if not installed and used in accordance with the instructions, may cause harmful interference to radio communications. However, there is no guarantee that interference will not in a particular installation. If this product does cause harmful interference to radio reception, which may be determined by turning the product on & off, the user is encouraged to try to correct the interference by one or more of the following measures:

- Reorient or relocate the receiving antenna,
- Increase the separation between the product and receiver,
- Connect the equipment into an outlet on a circuit different from that to which the receiver is connected
- Consult the dealer or an experienced radio/TV technician for help.

This product must be operated as per the operating instructions provided.

Do not make any alterations or modifications to the product. Any unauthorised alterations or modifications made to this product may require you to stop operating the product.

Canadian Radio Interference Regulations.

This Class B digital product complies with Canadian ICES-003, CISPR 22 :1997.

Règlement canadien sur les interférences radio.

Ce produit numérique de classe B est conforme à la norme NMB-003, CISPR 22: 1997.

Signed for, and on behalf of,
Michell Instruments Ltd.

A handwritten signature in black ink, appearing to read 'Andrew M.V. Stokes'.

Andrew M.V. Stokes, Technical Director

Issue date: 05/2011

Appendix E

Quality, Recycling & Warranty Information

Appendix E Quality, Recycling & Warranty Information

Michell Instruments is dedicated to complying to all relevant legislation and directives. Full information can be found on our website at:

www.michell.com/compliance

This page contains information on the following directives:

- ATEX Directive
- Calibration Facilities
- Conflict Minerals
- FCC Statement
- Manufacturing Quality
- Modern Slavery Statement
- Pressure Equipment Directive
- REACH
- RoHS2
- WEEE2
- Recycling Policy
- Warranty and Returns

This information is also available in PDF format.

Appendix F

Return Document & Decontamination Declaration

Appendix F Return Document & Decontamination Declaration

Decontamination Certificate

IMPORTANT NOTE: Please complete this form prior to this instrument, or any components, leaving your site and being returned to us, or, where applicable, prior to any work being carried out by a Michell engineer at your site.

Instrument			Serial Number	
Warranty Repair?	YES	NO	Original PO #	
Company Name			Contact Name	
Address				
Telephone #			E-mail address	
Reason for Return /Description of Fault:				
Has this equipment been exposed (internally or externally) to any of the following? Please circle (YES/NO) as applicable and provide details below				
Biohazards			YES	NO
Biological agents			YES	NO
Hazardous chemicals			YES	NO
Radioactive substances			YES	NO
Other hazards			YES	NO
Please provide details of any hazardous materials used with this equipment as indicated above (use continuation sheet if necessary)				
Your method of cleaning/decontamination				
Has the equipment been cleaned and decontaminated?			YES	NOT NECESSARY
Michell Instruments will not accept instruments that have been exposed to toxins, radio-activity or bio-hazardous materials. For most applications involving solvents, acidic, basic, flammable or toxic gases a simple purge with dry gas (dew point <-30°C) over 24 hours should be sufficient to decontaminate the unit prior to return. Work will not be carried out on any unit that does not have a completed decontamination declaration.				
Decontamination Declaration				
I declare that the information above is true and complete to the best of my knowledge, and it is safe for Michell personnel to service or repair the returned instrument.				
Name (Print)			Position	
Signature			Date	



NOTES:

EU Declaration of Conformity.



Manufacturer: Michell Instruments Limited
Address: 48 Lancaster Way Business Park
Ely, Cambridgeshire
CB6 3NW. UK.

Equipment Type: **MDM300 I.S. Advanced Dewpoint Hygrometer**



2014/34/EU ATEX Directive

Provisions of the Directive fulfilled by the Equipment:

Group II Category 1G Ex ia IIC T4 Ga (-20°C to +50°C)

Notified Body for EC-Type Examination and Production (QAN):

Baseefa, Buxton. UK. Notified Body No. 1180

EC-Type Examination Certificate:

Baseefa09ATEX0149

Standards used:

EN60079-26:2007

EN 60079-0:2009

On 7th October 2016 this standard will cease to have harmonised status. **EN60079-0:2012/A11:2013** has now superseded. A technical review of this standard against the old standard showed that the equipment remains in conformance with all relevant clauses and that the State of the Art is maintained. The Essential Health & Safety Requirements of the Directive is still maintained with no changes necessary for the safe and reliable functioning and operation of the product with respect to the risks of explosion).

EN60079-11:2007

(By August 2014 this standard is expected to have ceased to have harmonised status. **EN60079-11:2012** and has now also been Harmonised. A technical review of this new standard against the old standard showed that the equipment remains in conformance with all relevant clauses and that the State of the Art is maintained. The Essential Health & Safety Requirements of the Directive is still maintained with no changes necessary for the safe and reliable functioning and operation of the product with respect to the risks of explosion).

IECEx Certification:

Certificate of Conformity No.

IECEx BAS 09.0063

Marking.

Ex ia IIC T4 Ga (-20°C to +50°C)

Standards used:

**IEC60079-0:2007-10 IEC60079-11:2006
IEC60079-26:2006**

Type of Protection.

Intrinsic Safety

Other Directives Is in conformity with the following Standard(s) or Normative Document(s):

2014/30/EU EMC Directive

EN61326-1:2006 *Electrical equipment for measurement, control and laboratory use - EMC requirements. Class B (emissions) and Industrial Locations (immunity).*

2011/65/EU Restriction of Hazardous Substances Directive (RoHS2) (effective date 17th July 2017)

RoHS2 EU Directive 2011/65/EU (Article 3, [24]) states, "industrial monitoring and control instruments means monitoring and control instruments designed exclusively for industrial or professional use".

(mandatory compliance effective date 22nd July 2017).

2014/53/EU (RED) Radio Equipment Directive (effective from 13 June 2016).

Article 3.1a

As part of EN61010-1:2010

Article 3.1b

EN 301 489-1 V1.9.2 (2012), EN 301 489-17: V2.2.1 (2012) Electromagnetic Compatibility and radio spectrum Matters (ERM); Electro Magnetic Compatibility (EMC) standard for radio equipment and services; Part 17: Specific conditions for wideband data HiperLAN equipment

Article 3.2

EN 300 328 V1.9.1 (2015), Radio Equipment and Systems (RES); Wideband transmission systems; Technical characteristics and test conditions for data transmission equipment operating in the 2,4 GHz ISM band and using spread spectrum modulation techniques. Part 2: Harmonized EN covering essential requirements under article 3 (2) of the R&TTE directive.

EN60529

Degrees of Protection Provided by Enclosures. Ingress Rating equivalent to IP66

On behalf of the above named company, I declare that, on the date the equipment accompanied by this declaration is placed on the market, the equipment conforms with all technical and regulatory requirements of the above listed directives.

Andrew M.V. Stokes, Technical Director.
December 2016

EUD MDM300IS Issue 09



<http://www.michell.com>