

TX312

High Data Rate GOES Transmitter

The TX312 transmitter provides communications, via GOES satellites, from a Data Collection Platform (DCP) to a receiving station. Data transmission rates of 100, 300, and 1200 bps are supported. Because clock accuracy is critically important for GOES satellite telemetry, the TX312 includes a robust, TCXO-based real-time clock and a GPS receiver.

Benefits/Features

The TX312 provides the following advantages over its predecessor, the SAT HDR GOES:

- Up to 28 days of operation between GPS fixes
- Every unit tested by Campbell Scientific in an environmental chamber to ensure the unit operates within specifications
- Additional LEDs that indicate transmitter's operation
- Easier to use Windows-based software for configuring the non-volatile setups



◀ The TX312 GOES transmitter offers a convenient tele-communications option for DCPs.



The TX312 also retains the following benefits/features that were provided by the SAT HDR GOES:

- Complies with the High Data Rate (HDR) specifications
- Automatic GPS correction of clock and oscillator
- Diagnostics and status information that can be sampled by the datalogger and transmitted as part of the data stream
- Independent self-timed and random data buffers
- Available on GSA (GSA MAS Contract Number GS-07F-9255S)
- Readily added or retrofitted to existing Campbell Scientific GOES systems without changing data-logger program
- NESDIS certified (on February 15, 2005)

◀ Our GOES transmitters are used for stream stage, water quality, and rainfall applications. In this photograph, the GPS antenna is mounted in the center of the CM202 crossarm via a 7623 3/4" threaded pipe and the CM210 bracket.

LEDs/Ports

Front Panel

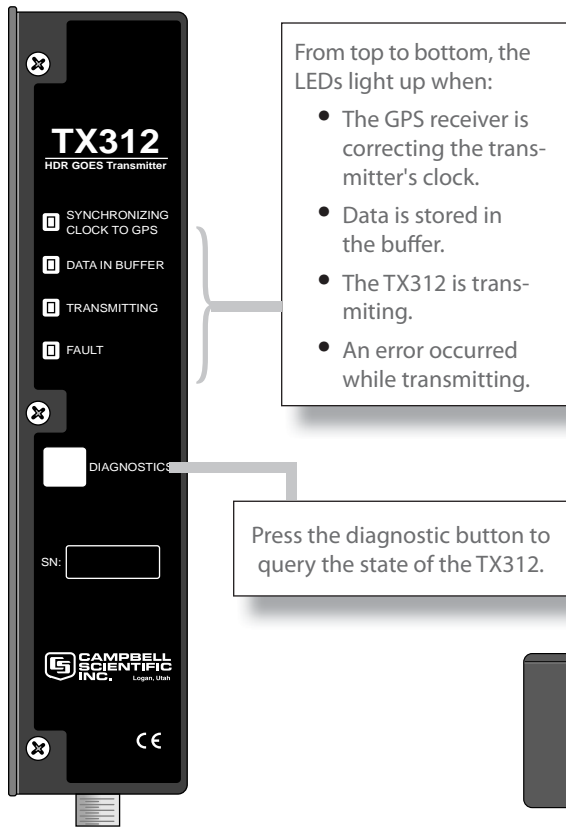

From top to bottom, the LEDs light up when:

- The GPS receiver is correcting the transmitter's clock.
- Data is stored in the buffer.
- The TX312 is transmitting.
- An error occurred while transmitting.

Press the diagnostic button to query the state of the TX312.

Bottom Panel

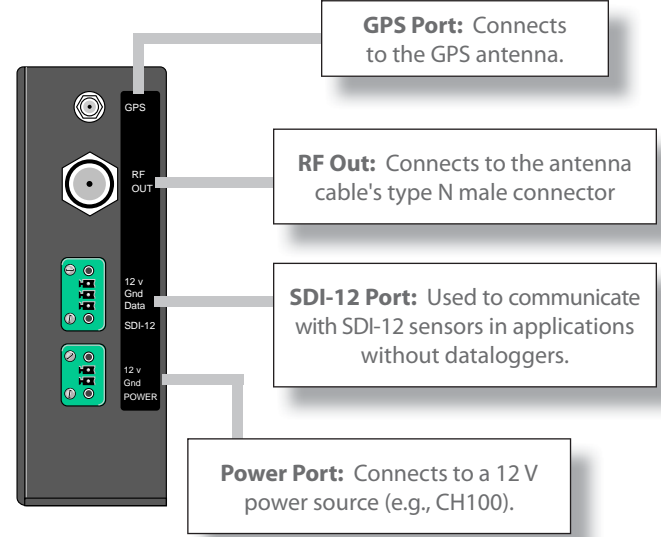

GPS Port: Connects to the GPS antenna.

RF Out: Connects to the antenna cable's type N male connector

SDI-12 Port: Used to communicate with SDI-12 sensors in applications without dataloggers.

Power Port: Connects to a 12 V power source (e.g., CH100).

Top Panel

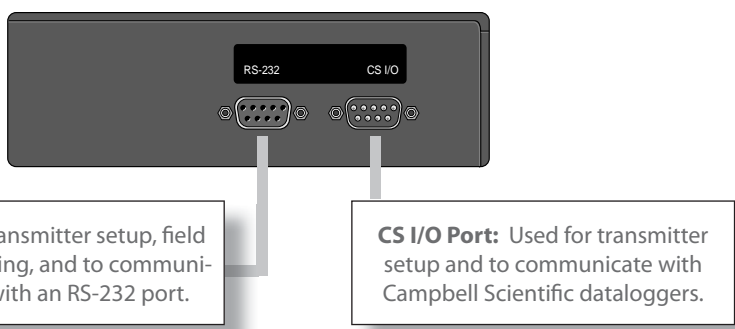

RS-232 Port: Used for transmitter setup, field diagnostics, troubleshooting, and to communicate with dataloggers with an RS-232 port.

CS I/O Port: Used for transmitter setup and to communicate with Campbell Scientific dataloggers.

Specifications

Operating Voltage:	+10.8 to +16 Vdc	RS-232 Port	
Supply Current (@ 12 Vdc)		Signal Levels:	RS232C
Idle:	5 mA	Connector:	DB9F
Transmission:	2.6 A	Command Protocols:	ASCII Command Protocol, Binary Command Protocol (see notes)
Transmission Data Rates:	100, 300, and 1200 bps	SDI-12 Port (see notes)	
CS I/O Port (see notes)		Signal Levels:	TTL
Signal Levels:	TTL	Connector:	3 terminal Phoenix plug
Connector:	DB9M	Protocol:	SDI-12 Recorder - version 1.3
Interface Protocol:	Campbell Scientific Synchronous Device Communication (SDC)	Channel Bandwidth	
Command Protocol:	Binary Command Protocol (see notes)	100 bps Transmission Rate:	1.5 kHz
		300 bps Transmission Rate:	1.5 kHz
		1200 bps Transmission Rate:	3.0 kHz

Notes:

- (1) ASCII command protocol is described in "G5 ASCII Command Protocol (Doc # 700-G5-CMND-ASCII)".
- (2) Binary packet protocol is described in "G5 Binary Command Protocol (Doc # 700-G5-CMND-BIN)".
- (3) The CS I/O port is multiplexed with the SDI-12 port and can not be used if the SDI-12 port is in use.
- (4) The SDI-12 port is multiplexed with the CS I/O port and can not be used if the CS I/O port is in use.

Specifications (continued)

Output Power:	Complies with NESDIS DCPRS Certification Standards, Section 4.
For 1200 bps:	Has a nominal EIRP of 51 dBm and a maximum EIRP of 53 dBm, assuming appropriate antenna.
For 100/300 bps:	Has a nominal EIRP of 48 dBm and a maximum EIRP of 50 dBm, assuming appropriate antenna.
Example output power:	11.2 W @ 1200 bps transmission rate
Timekeeping	
Setting Accuracy:	±100 µs synchronised to GPS
Drift:	±10 msec/day over -40° to 60°C
GPS Schedule:	1 fix at power up, 1 fix per day afterwards
Transmission Continuation without GPS Fix:	28 days
Frequency Range:	401.7 MHz to 402.1 MHz
Frequency Stability	
Initial Accuracy:	±20 Hz disciplined to GPS
GPS Schedule:	1 fix at power up, 1 fix per day afterwards
Short Term Drift:	±0.04 Hz/seconds
Aging:	±0.1 PPM/year
Vcc + Temperature:	±0.1 PPM
Temperature Range	
Operating:	-40° to 60°C
Storage:	-55° to 70°C
25316 Transmit Antenna	
Gain:	11 dBi
Type:	Right hand circular polarization Yagi
Connector:	Type N female
Wind Load:	~100 knots
17992 GPS Antenna:	
	3.3 V active, <20 mA, jam resistant
Gain:	30 dBi
Connector:	TNC
Weight:	2.1 lbs (0.95 kg)
Dimensions	
Height:	6.38-in. (16.2 cm)
Length:	9.0-in. (22.86 cm)
Width:	2.0-in. (5.08 cm)

GOES, NESDIS, and Transmit Windows

The TX312 transmitter sends data via Geostationary Operational Environmental Satellites (GOES). GOES satellites have orbits that coincide with the Earth's rotation, allowing each satellite to remain above a specific region. The GOES system is administered by the National Environmental Satellite Data Information Service (NESDIS). NESDIS assigns addresses, uplink channels, and self-timed/random transmit time windows. Self-timed windows allow data transmission only during a predetermined time frame. Random windows are for applications of a critical nature (e.g., flood reporting) and allow transmission immediately after a threshold has been exceeded.

GOES System Authorization Procedure

U.S. Federal, State, or local government agencies or users sponsored by one of those agencies may use GOES. Potential GOES users must receive formal permission from NESDIS.

The following four steps are required:

1. The user contacts NESDIS at the following address and submits a formal request to transmit data via GOES. Non-U.S. or private users must also submit a written statement indicating that their sponsor requires all or part of the transmitted data. NESDIS will fax or mail the user a form to complete and submit for approval.

DCS Coordinator, NOAA/NESDIS
Federal Office Building
Suitland, Maryland
Phone: (301) 457-5681
Web: <http://dcs.noaa.gov/contact.htm>
2. Following approval, NESDIS sends a Memorandum of Agreement (MOA). The MOA must be signed and returned to NESDIS.
3. After the MOA is approved, NESDIS will issue a channel assignment and an ID address code.
4. NESDIS must be contacted to coordinate a "start-up" date.

Notes:

- (1) See <http://noaasis.noaa.gov/DCS/> for more information about the authorization procedure.
- (2) For applications outside GOES coverage area or users who don't qualify for using the GOES system, transmitters that support METEOSAT, Argos, and INMARSAT-C are available; contact Campbell Scientific for more information.
- (3) Information on analyzing your system's power requirements is provided in Campbell Scientific's Power Supply product literature. For a more thorough explanation, request the Power Supplies Application Note 5-F. The product brochure and application note can be downloaded from our website: www.campbellsci.com

Data Collection Platform (DCP)

Equipment

- TX312 GOES satellite transmitter (includes an SC12 cable)
- 17992 GPS antenna and the 18017-L cable. The GPS antenna mounts to the end of a crossarm via the 7623 ¾" threaded pipe and a 1049 NU-RAIL fitting or CM220 Mount.
- Datalogger (CR295, CR800, CR850, CR1000, CR3000, CR5000). Several retired dataloggers are also compatible; the CR10 requires a special PROM (#14150).
- 25316 11-dBi Right-Hand Circular Polarized (RHCP) Yagi antenna with mounting hardware.
- COAXNTN-L RG8 antenna cable
- ENC16/18 16" x 18" enclosure. Order the 19332 and 19336 Antenna Cable/Bulkhead accessories to have Campbell Scientific punch a special bulkhead hole in the enclosure and install 17" cables for the Yagi and GPS antennas.
- Power supply consisting of Campbell Scientific's BP12 12-Ahr or BP24 24-Ahr battery pack, CH100 regulator, and SP10 10-W or SP20 20-W solar panel.
- 16981 Surge Suppressor Kit (optional)

Retrieving Data from the Ground Receiving Station

Choose one of the following methods:

- Phone modem with MNP level 4 error correction (most Hayes-compatible modems contain this error-checking protocol; check the operator's manual for your modem) and user-supplied communication software (e.g., Procomm Plus, Crosstalk).
- Internet (see NESDIS for requirements)
- Domsat/LRGS
- DRGS (Direct Readout Ground Station)
- Telnet

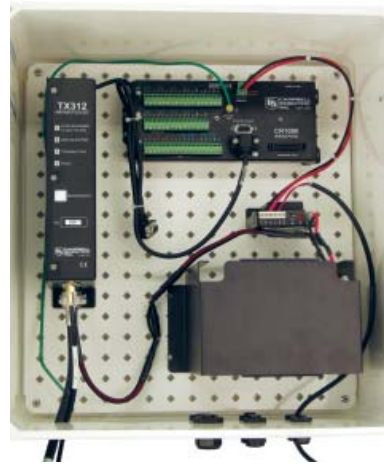

◀ This ENC16/18 enclosure houses the TX312 transmitter, a CR1000 datalogger, and a BP12 battery.

Typical System

DCP equipment: sensors and an environmental enclosure that houses the TX312 GOES transmitter, datalogger, and power supply

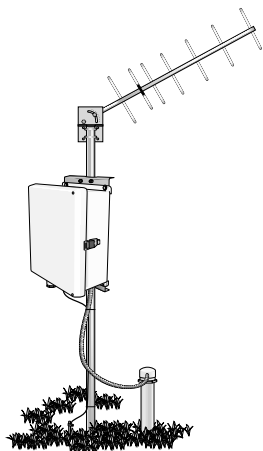

Data Collection Platform (DCP)

GOES Satellite

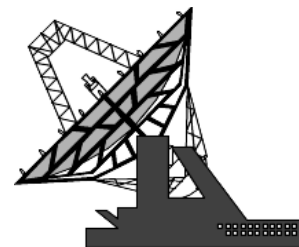
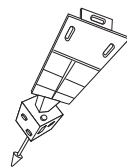

Ground Receiving Station

