

TAOTRONICS

Questions or Concerns?
support@taotronics.com

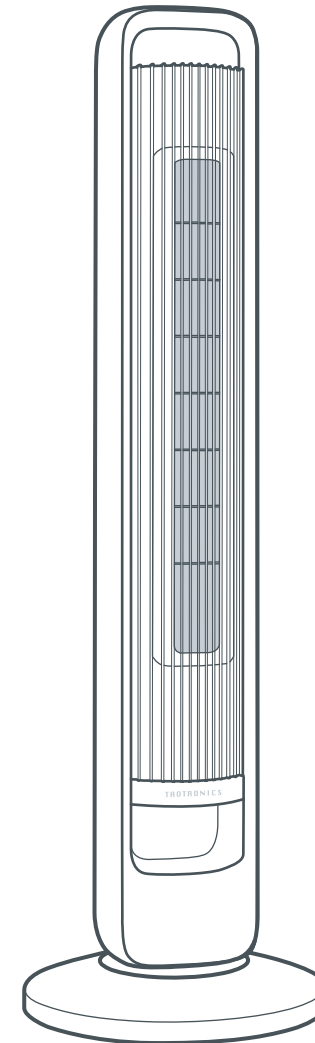

TAOTRONICS
TOWER FAN



User Manual

THANK YOU

FOR BEING OUR CUSTOMER



Your purchase is truly appreciated!
We hope you are over-the-moon with our product!

CONTENTS

IMPORTANT SAFETY INSTRUCTIONS	02
ASSEMBLING YOUR TOWER FAN	05
USING YOUR TOWER FAN	08
CLEANING AND MAINTENANCE	14
TROUBLESHOOTING	16

01

IMPORTANT SAFETY INSTRUCTIONS

Summon A Cool
Breeze Into Your
Space



DANGER

BEFORE USING THIS APPLIANCE READ ALL INSTRUCTIONS AND CAUTIONARY MARKINGS IN YOUR USER MANUAL AND ON THE APPLIANCE

READ AND SAVE THESE INSTRUCTIONS



DO NOT touch or hold the mains plug with wet hands.

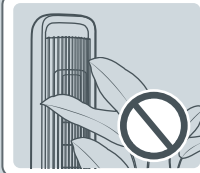

DO NOT block or cover air flow to or from the fan while in operation.

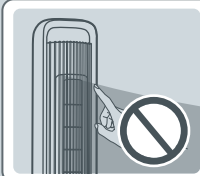

DO NOT insert fingers or objects through the grille while in operation.

INTENDED USE

- This appliance is not intended for use by people (including children) with reduced physical, sensory or mental capabilities, or lack of experience and knowledge, unless they have been given supervision or instruction concerning the use of the appliance by person responsible for their safety.
- Close supervision is necessary when any appliance is used by or near children. Children should be supervised to ensure that they do not play with the appliance. Cleaning and user maintenance shall not be done by children unless they are older than 8 and supervised.
- Use the appliance only for intended household purposes as described in this User Manual. Any other use is not recommended that may cause fire, electric shock, or injury to people.

ELECTRICITY SAFETY

- This appliance must be provided with correct voltage via a professionally installed power socket. Make sure the voltage indicated on the label of the appliance is the same as your local supply.
- **IMPORTANT** - This appliance has a polarized plug (one blade is wider than the other). To reduce the risk of electric shock, this plug is intended to fit in a polarized outlet only one way. If the plug does not fit fully in the outlet, reverse the plug. If it still does not fit, contact a qualified electrician. Do not attempt to rig this safety feature.
- This product employs overload protection (fuse). A blown fuse indicates an overload or short-circuit situation. If the fuse blows, unplug the product from the outlet. Replace the fuse as per the user servicing instructions (follow product marking for proper fuse rating) and check the product. If the replacement fuse blows, a short-circuit may be present and the product should be discarded or returned to an authorized service facility for examination and/or repair.
- **WARNING:** To Reduce The Risk Of Fire Or Electric Shock, Do Not Use This Fan With Any Solid-State Speed Control Device.

- Include instructions pertaining to a risk of fire, electric shock, or injury to persons, for cleaning and user-maintenance, such as lubrication;
- Do not operate any fan with a damaged cord or plug. Discard fan or return to an authorized service facility for examination and/or repair.
- Do not run cord under carpeting. Do not cover cord with throw rugs, runners, or similar coverings. Do not route cord under furniture or appliances. Arrange cord away from traffic area and where it will not be tripped over.

RELATED TO USE

- DO NOT use this fan to ventilate areas where flammable liquids or vapors are used, stored or are present.
- DO NOT attempt to disassemble, repair, modify or replace any part any part of your product.
- Always make sure to place the fan on a flat, level surface before operation.
- Always unplug the appliance before cleaning, making any repairs or servicing, or whenever not in use.
- It is normal that there is noise during operation. If too loud, please set the fan to lower speed.

FOR HOUSEHOLD USE ONLY



Regular Check

HAVE YOUR TOWER FAN CHECKED REGULARLY FOR ANY SIGN OF MALFUNCTION!

Check if plug, cord or appliance is damaged

Stop using, check FAQ and contact TaoTronics Support Team.

SPECIFICATIONS

Model	TT-TF003
Input	120V~ 60Hz
Rated Power	20W

02

ASSEMBLING YOUR TOWER FAN

Summon A Cool Breeze Into Your Space

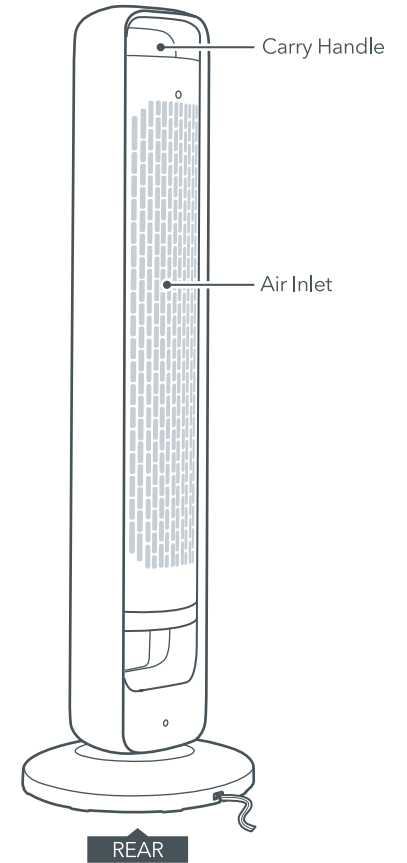
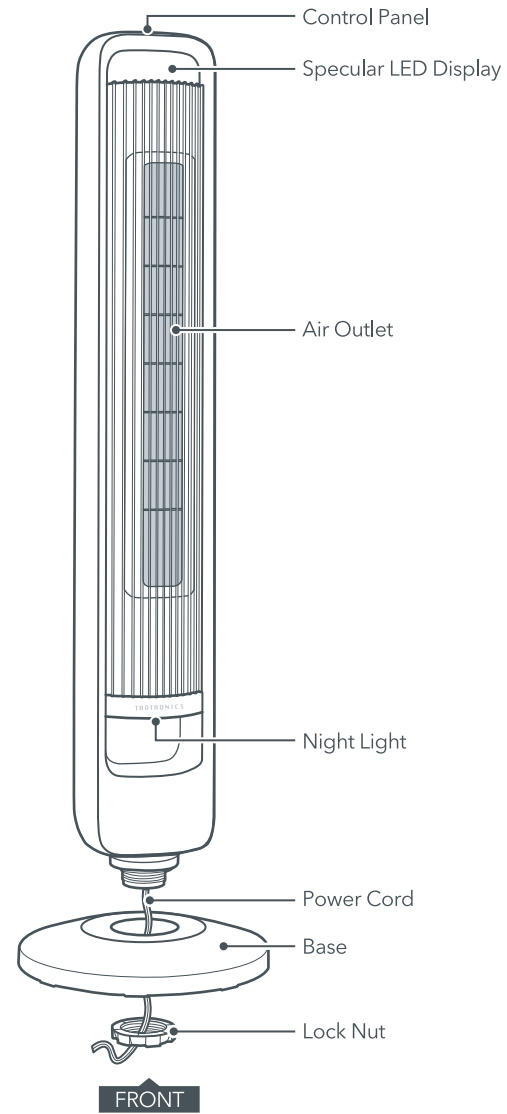

Tool-free Assembly

1.

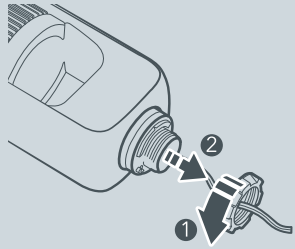

Loosen the lock nut on the fan, anticlockwise as shown on the nut.

2.

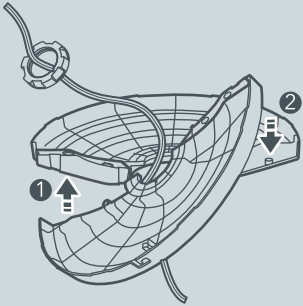

Stagger the front and rear bases at an angle, align them with the holes and snap them together tightly.

3.

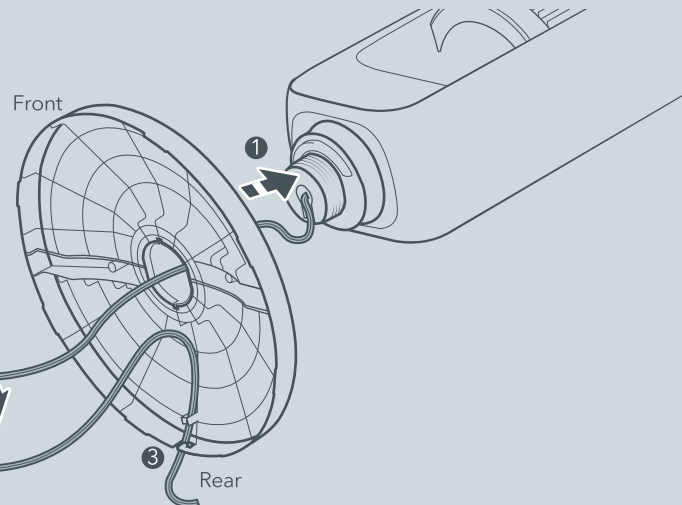

- 1 Put the base on the main body (make sure the base slot towards the rear side).
- 2 Fasten the nut clockwise as shown on the nut
- 3 Buckle the power cord into the holes of the base slot, for making sure the base is upright on the level ground.

03

USING YOUR TOWER FAN

Summon A Cool Breeze Into Your Space

Control Panel



LED Display



Remote Control

For added convenience, the same control buttons can be found on the remote control.

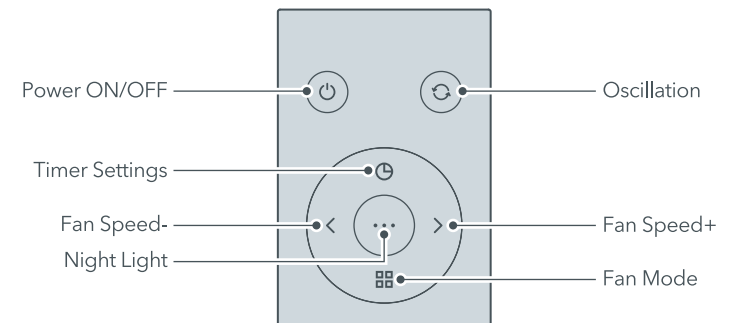

Fan Modes

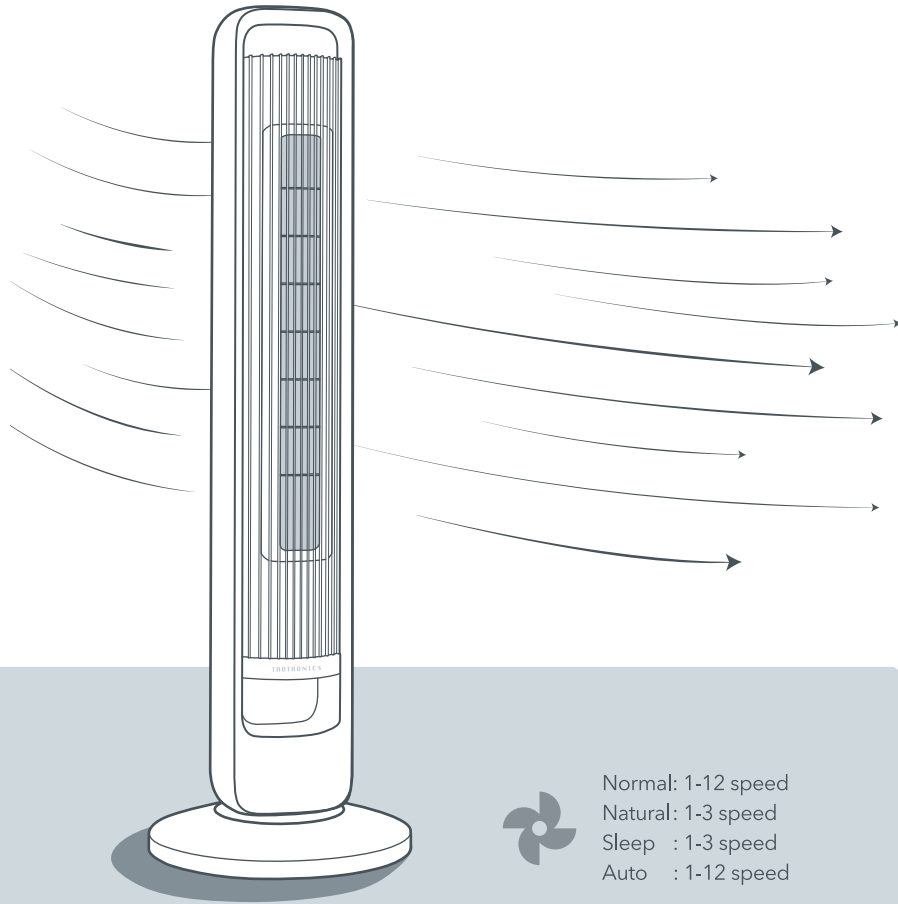

Normal mode

Runs with selected constant speed.

Sleep mode

Fan speed reduces by 2 levels every 30 min. Any operation is mute by default.

Natural mode

Fan speed changes cyclically for mimic natural wind.

Auto mode

Fan speed changes as ambient temperature varies.

Additional Features



Memory Function

- The fan is designed with power off memory function (except timer setting).
- The memory of each mode is non-interacting and it will always remember the last settings.



Auto Display OFF

- If no operation is done within 1 minute when powered on, the display will turn off automatically.
- To turn the display back on, press any button to wake it up.



Always On Display

- Hold the Night Light Button for 2s, Auto Display OFF disabled and display will be always on. Hold for 2s again to enable Auto Display OFF function.

User Servicing Instructions



This Tower Fan features a fused safety plug which is designed to cut off electric current to the fan if an electrical fault occurs. If your fan loses power and you suspect that the fuse on your fan has blown,

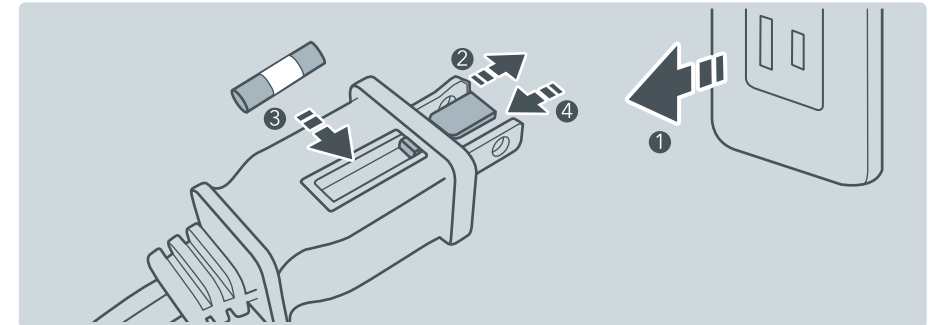

- 1 Grasp plug and remove from the receptacle or other outlet device. DO NOT unplug by pulling on cord.
- 2 Open fuse cover. Slide open fuse access cover on top of attachment plug towards blades.
- 3 Remove fuse carefully. Insert the tip of your tool into fuse slot (close with the terminal), then prize the fuse gradually and slowly, but not overexert. If you feel tight, you can try it at several times and prize the fuse little by little. When one side of the fuse has been prized, then you can get the fuse out entirely. Risk of fire. Replace fuse only with 2.5 Amp, 125 Volt fuse.
- 4 Close fuse cover. Slide closed the fuse access cover on top of attachment plug. Risk of fire. DO NOT replace attachment plug. Contains a safety device (fuse) that should not be removed. Discard product if the attachment plug is damaged.

Replacement of Batteries



- Replace with new batteries of the same type when replacement is required.
- When not using the remote control for a long time, please take out the batteries.
- DO NOT attempt to dismantle the batteries.
- DO NOT dispose the batteries in fire, batteries may explode or leak.
- DO NOT use rechargeable batteries.

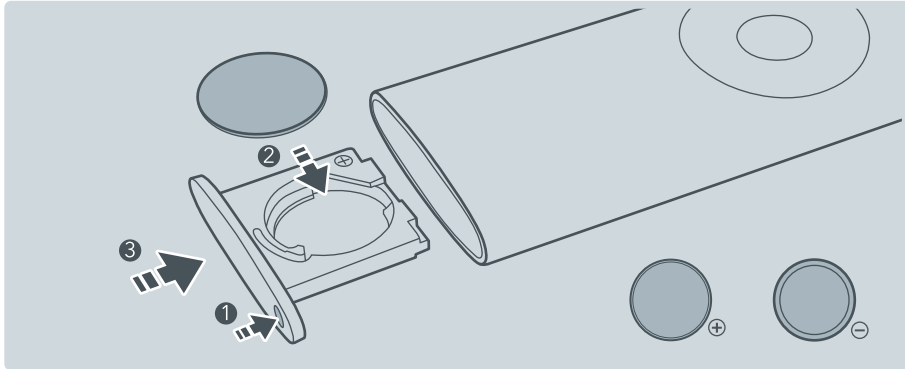

- 1 Press the locking button to pop up the battery holder.
- 2 Replace the battery with the same type (CR2025, 3V), making sure the (+) side facing up.
- 3 Push in the holder until securely locked into place.



WARNING:

Do not ingest battery, Chemical Burn Hazard. This product contains a coin / button cell battery. If the coin / button cell battery is swallowed, it can cause severe internal burns in just 2 hours and can lead to death. Keep new and used batteries away from children. If the battery compartment does not close securely, stop using the product and keep it away from children. If you think batteries might have been swallowed or placed inside any part of the body, seek immediate medical attention. The batteries contain materials, which are hazardous to the environment; they must be removed from the appliance before it is scrapped and that they are disposed of safely.

04

CLEANING AND MAINTENANCE

Summon A Cool
Breeze Into Your
Space

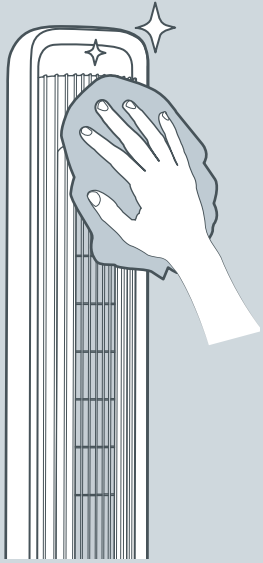

Only a soft cloth can be used for cleaning the outer surfaces.



To remove dust between the grills, a pipe cleaner, flexible dust wand, vacuum cleaner or compressed air are acceptable.



- Always make sure the tower fan is turned off and unplugged before cleaning.
- DO NOT stick any foreign objects or your fingers inside of the unit.
- Never immerse in water or allow water to drip into the motor housing.
- DO NOT clean with abrasive chemicals or flammable cleaning agents.



For storage, you may leave the tower fan covered to protect it from dust. Store it in a cool, dry location and wrap the cord around the cord wrap on the unit so that it will not be tripped over or damaged.

05

TROUBLE-SHOOTING

Summon A Cool
Breeze Into Your
Space

Why there is noise

Why the wind power is not strong enough

Why the remote control is not working

Why the oscillation is not steady

It is normal that there is noise during high speed, lower the speed and check again.

- Move the fan closer.
- Ensure air inlet and outlet are unobstructed, and no obstacles before the fan.
- Make sure the fan is connected to a powered electrical outlet.
- Check that the remote control is powered and move the obstacles between the fan and the remote.
- Operate the remote control near or in front of the tower fan.

Check that the base is firmly assembled and the fan is on a level ground.

The troubleshooting guide addresses the most common problems. If problems persist, feel free to contact the Customer Support at

support@taotronics.com 

WARRANTY AND SERVICE

Thanks for choosing TaoTronics Tower Fan.

This product is covered with TaoTronics product and labor warranty for 12 months from the date of its original purchase.

The warranty will not apply in cases of:

- Accident, misuse, or repairs performed by unauthorized personnel.
- Any unit that has been tampered with or used for commercial purpose.
- Normal wear and tear of wearable parts.
- Use of force, damage caused by external influences.
- Damage caused by non-observance of the User Manual, e.g. connection to an unsuitable mains supply or non-compliance with the instructions.
- Partially or completely dismantled appliances.
- Defects caused by or resulting from damages from shipping or from repairs, service, or alteration to the product or any of its parts that have been performed by a repair person not authorized by TaoTronics.

We can only provide after sales service for products that are sold by TaoTronics or TaoTronics authorized retailers and distributors. If you have purchased your unit from a different place, please contact your seller for return and warranty issues.

※ **Please have your invoice and order ID ready before contacting Customer Support.**

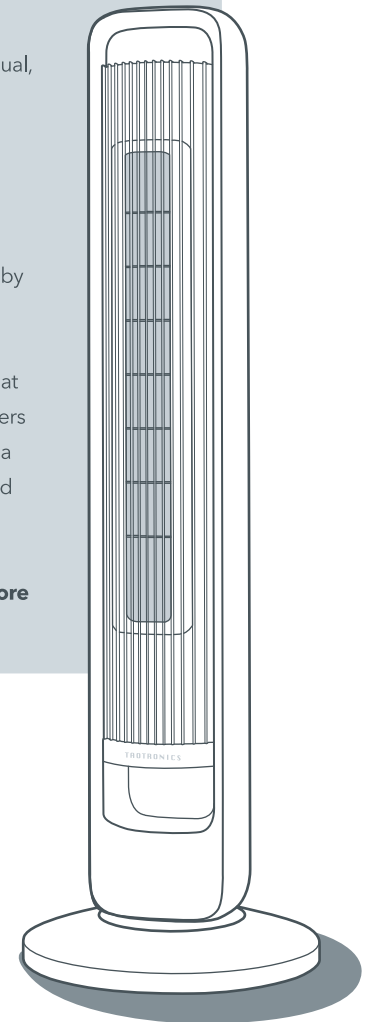

Model: TT-TF003



support@taotronics.com



www.taotronics.com



Manufacturer: Shenzhen NearbyExpress Technology Development Co.,Ltd.
Address: Floor 7, Building E, Galaxy World Phase II, Shenzhen, China



LISTED
E219869

Made In China