



Technical Note

TN_166

FTDI Example IC PCB Footprints

Version 1.2

Issue Date: 2019-06-14

This Technical Note shows examples of FTDI IC PCB footprints which can be used as a guide for creating your own IC PCB footprints.

Use of FTDI devices in life support and/or safety applications is entirely at the user's risk, and the user agrees to defend, indemnify and hold FTDI harmless from any and all damages, claims, suits or expense resulting from such use.

Future Technology Devices International Limited (FTDI)

Unit 1, 2 Seaward Place, Glasgow G41 1HH, United Kingdom

Tel.: +44 (0) 141 429 2777 Fax: + 44 (0) 141 429 2758

Web Site: <http://ftdichip.com>

Copyright © Future Technology Devices International Limited

Table of Contents

1	Introduction	5
1.1	Scope	5
2	All Scaled Footprints.....	6
2.1	DFN Packages.....	6
2.2	QFP Packages.....	6
2.3	QFN Packages.....	6
2.4	SSOP Packages.....	6
3	Packages by Product	7
3.1	DFN Packages.....	7
3.2	QFP Packages.....	7
3.3	QFN Packages.....	7
3.4	SSOP Packages.....	7
4	10-pin DFN	8
4.1	Scaled Footprint	8
4.2	Annotated Footprint	8
5	12-pin DFN	9
5.1	Scaled Footprint	9
5.2	Annotated Footprint	9
6	16-pin QFN (4mm x 4mm).....	10
6.1	Scaled Footprint	10
6.2	Annotated Footprint	10
7	16-pin SSOP	11
7.1	Scaled Footprint	11
7.2	Annotated Footprint	11
8	20-pin QFN	12
8.1	Scaled Footprint	12
8.2	Annotated Footprint	12

9	20-pin SSOP	13
9.1	Scaled Footprint	13
9.2	Annotated Footprint	13
10	24-pin QFN	14
10.1	Scaled Footprint.....	14
10.2	Annotated Footprint.....	14
11	24-pin SSOP	15
11.1	Scaled Footprint.....	15
11.2	Annotated Footprint.....	15
12	28-pin QFN	16
12.1	Scaled Footprint.....	16
12.2	Annotated Footprint.....	16
13	28-pin SSOP	17
13.1	Scaled Footprint.....	17
13.2	Annotated Footprint.....	17
14	28-pin TSSOP	18
14.1	Scaled Footprint.....	18
14.2	Annotated Footprint.....	18
15	28-pin WQFN	19
15.1	Scaled Footprint.....	19
15.2	Annotated Footprint.....	19
16	32-pin LQFP.....	20
16.1	Scaled Footprint.....	20
16.2	Annotated Footprint.....	20
17	32-pin VQFN/QFN (5mm x 5mm)	21
17.1	Scaled Footprint.....	21
17.2	Annotated Footprint.....	21
18	32-pin QFN (7mm x 7mm).....	22

18.1	Scaled Footprint.....	22
18.2	Annotated Footprint.....	22
19	48-pin LQFP.....	23
19.1	Scaled Footprint.....	23
19.2	Annotated Footprint.....	23
20	48-pin QFN (8mm x 8mm).....	24
20.1	Scaled Footprint.....	24
20.2	Annotated Footprint.....	24
21	56-pin QFN (7mm x 7mm).....	25
21.1	Scaled Footprint.....	25
21.2	Annotated Footprint.....	25
22	56-pin VQFN (8mm x 8mm)	26
22.1	Scaled Footprint.....	26
22.2	Annotated Footprint.....	26
23	64-pin LQFP.....	27
23.1	Scaled Footprint.....	27
23.2	Annotated Footprint.....	27
24	64-pin TQFP	28
24.1	Scaled Footprint.....	28
24.2	Annotated Footprint.....	28
25	64-pin QFN (9mm x 9mm).....	29
25.1	Scaled Footprint.....	29
25.2	Annotated Footprint.....	29
	25.2.1 Additional Information	30
26	76-pin QFN	31
26.1	Scaled Footprint.....	31
26.2	Annotated Footprint.....	31
27	Contact Information	32

Appendix A – References	33
Document References	33
Acronyms and Abbreviations.....	33
Appendix B – List of Tables & Figures	34
List of Tables.....	34
List of Figures	34
Appendix C – Revision History	36

1 Introduction

This Technical Note shows examples of FTDI IC PCB footprints which can be used as a guide for creating your own PCB footprints.

The IC footprints in this document are sourced from various FTDI hardware such as development and application [modules](#) and demo hardware, using the most common and cost effective package types.

The IC footprints in this document provide:

- A 1:1 scaled IC footprint
- An annotated IC footprint showing some key measurements

All dimensions shown are in millimeters (mm).

Additionally, a range of USB Interface IC solutions from FTDI Chip available through [AltiumLive](#).

To view Altium files, you need either the full version of 'Altium Designer', or 'Altium Viewer' which can be downloaded for free from [Altium's](#) web site.

<http://www.ftdichip.com/Support/Documents/PCBData.htm>

Note that all IC footprints may not be available through [AltiumLive](#). Please contact FTDI in this case.

1.1 Scope

These IC PCB footprints can be used as a guide to create your own IC PCB footprints with particular PCB design tools other than Altium.

Please refer to the IC datasheet for full IC package parameters.

Note: No guarantees can be provided in this document. These can be used as a guide only.

Note: FTDI [Cables](#) and [Modules](#) are recommended for product test and development prior to custom hardware development.

2 All Scaled Footprints

This section shows all packages scaled to 1:1 size to show the exact package size which can help when selecting a package to use in your design.

Note that not all packages are available for all products. See Section 3 'Packages by Product' in this document, the product datasheet, or check the IC webpage:

<http://www.ftdichip.com/Products/ICs.htm>

2.1 DFN Packages

Figure 2.1 shown in pin count order from left to right:

DFN-10, DFN-12.



Figure 2.1 DFN Packages

2.2 QFP Packages

Figure 2.2 shown in pin count order from left to right:

LQFP-32, LQFP-48, LQFP-64, TQFP-64.

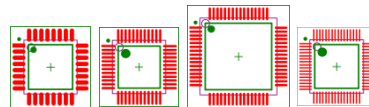

Figure 2.2 QFP Packages

2.3 QFN Packages

Figure 2.3 shown in pin count order from left to right:

QFN-16 (4x4), QFN-20, QFN-24, QFN-28, WQFN-28, QFN-32 (5x5), QFN-32 (7x7), QFN-48 (8x8), QFN-56 (7x7), VQFN-56 (8x8), QFN-64 (9x9), QFN-76.

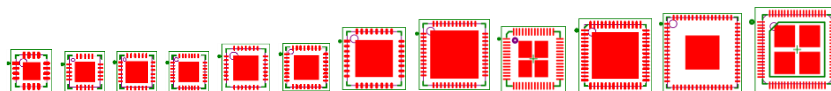

Figure 2.3 QFN Packages

2.4 SSOP Packages

Figure 2.4 shown in pin count order from left to right:

SSOP-16, SSOP-20, SSOP-24, SSOP-28, TSSOP-28.

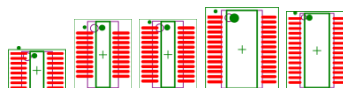

Figure 2.4 SSOP Packages

3 Packages by Product

Package availability for FTDI products is shown in this section.

3.1 DFN Packages

Package	Part Numbers
DFN-10	FT200XD
DFN-12	FT234XD

Table 3.1 DFN Packages

3.2 QFP Packages

Package	Part Numbers
LQFP-32	FT232BL, FT245BL, FT311D-32L1C, FT312D-32L1C, VNC2-32L1B
LQFP-48	FT232HL, FT2232D, VNC1L-1A, VNC2--48L1B
LQFP-64	FT2232HL, FT4232HL, FT313HL
TQFP-64	FT313HP

Table 3.2 QFP Packages

3.3 QFN Packages

Package	Part Numbers
QFN-16 (4x4)	FT201XQ, FT220XQ, FT230XQ
QFN-20	FT221XQ, FT231XQ
QFN-24	FT240XQ
QFN-28	FT120Q
WQFN-28	FT260Q
QFN-32 (5x5)	FT232RQ, FT245RQ, FT4222HQ
QFN-32 (7x7)	FT311D-32Q1C, FT312D-32Q1C, VNC2-32Q1B
QFN-48 (8x8)	FT232HQ, VNC2-48Q1B
QFN-56 (7x7)	FT600Q
VQFN-56 (8x8)	FT2232H-56Q, FT4232H-56Q
QFN-64 (9x9)	FT2232HQ, FT4232HQ, FT313HQ
QFN-76	FT601Q, FT602Q

Table 3.3 QFN Packages

3.4 SSOP Packages

Package	Part Numbers
SSOP-16	FT201XS, FT220XS, FT230XS
SSOP-20	FT221XS, FT231XS
SSOP-24	FT240XS
SSOP-28	FT232RL, FT245RL
TSSOP-28	FT120T, FT260S

Table 3.4 SSOP Packages

4 10-pin DFN

The 10-pin DFN is used on the following product:

- [FT200XD](#)

This package is nominally 3.00mm x 3.00mm. The solder pads are on a 0.50mm pitch.

Please see the IC Package Parameters in the IC datasheet for full information.

4.1 Scaled Footprint

This 1:1 scaled footprint is the exact size when viewed or printed at 100%.



Figure 4.1 10-pin DFN Scaled Footprint

4.2 Annotated Footprint

The annotated footprint shows key measurements.

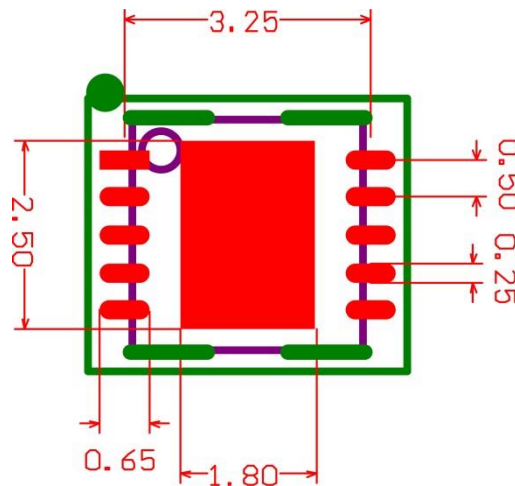

Figure 4.2 10-pin DFN Annotated Footprint

Note: Red = top layer copper, other colors are mechanical layers.

Note: Connect exposed center pad to GND. Do not place tracks on the top layer of the PCB in this area.

5 12-pin DFN

The 12-pin DFN is used on the following product:

- [FT234XD](#)

This package is nominally 3.00mm x 3.00mm. The solder pads are on a 0.45mm pitch.

Please see the IC Package Parameters in the IC datasheet for full information.

5.1 Scaled Footprint

This 1:1 scaled footprint is the exact size when viewed or printed at 100%.



Figure 5.1 12-pin DFN Scaled Footprint

5.2 Annotated Footprint

The annotated footprint shows key measurements.

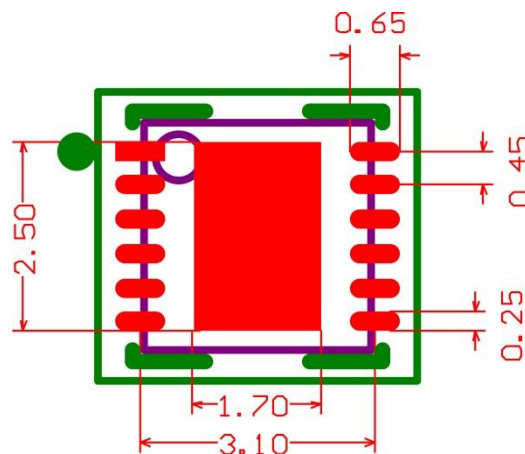

Figure 5.2 12-pin DFN Annotated Footprint

Note: Red = top layer copper, other colors are mechanical layers.

Note: Connect exposed center pad to GND. Do not place tracks on the top layer of the PCB in this area.

6 16-pin QFN (4mm x 4mm)

The 16-pin QFN (4mm x 4mm) is used on the following products:

- [FT201XQ](#)
- [FT220XQ](#)
- [FT230XQ](#)

This package is nominally 4.00mm x 4.00mm. The solder pads are on a 0.65mm pitch.

Please see the IC Package Parameters in the IC datasheet for full information.

6.1 Scaled Footprint

This 1:1 scaled footprint is the exact size when viewed or printed at 100%.



Figure 6.1 16-pin QFN (4mm x 4mm) Scaled Footprint

6.2 Annotated Footprint

The annotated footprint shows key measurements.

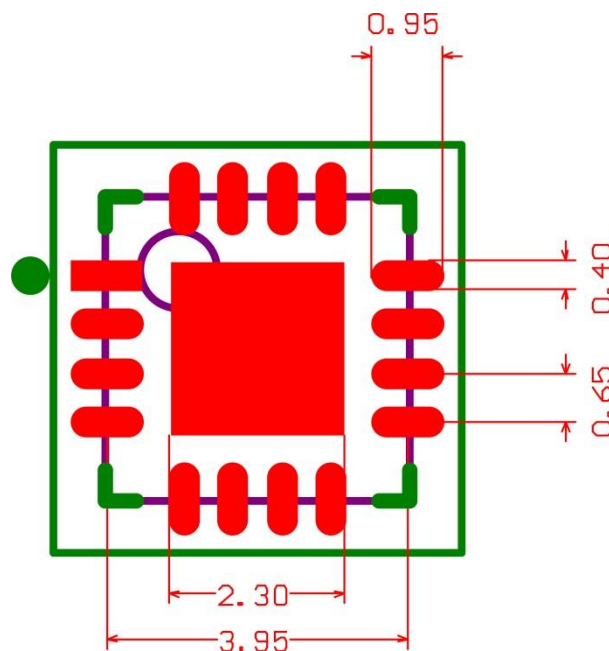

Figure 6.2 16-pin QFN (4mm x 4mm) Annotated Footprint

Note: Red = top layer copper, other colors are mechanical layers.

Note: Connect exposed center pad to GND. Do not place tracks on the top layer of the PCB in this area.

7 16-pin SSOP

The 16-pin SSOP is used on the following products:

- [FT201XS](#)
- [FT220XS](#)
- [FT230XS](#)

This package is nominally 4.90mm x 3.91mm body (4.90mm x 5.99mm including pins). The solder pads are on a 0.635mm pitch.

Please see the IC Package Parameters in the IC datasheet for full information.

7.1 Scaled Footprint

This 1:1 scaled footprint is the exact size when viewed or printed at 100%.



Figure 7.1 16-pin SSOP Scaled Footprint

7.2 Annotated Footprint

The annotated footprint shows key measurements.

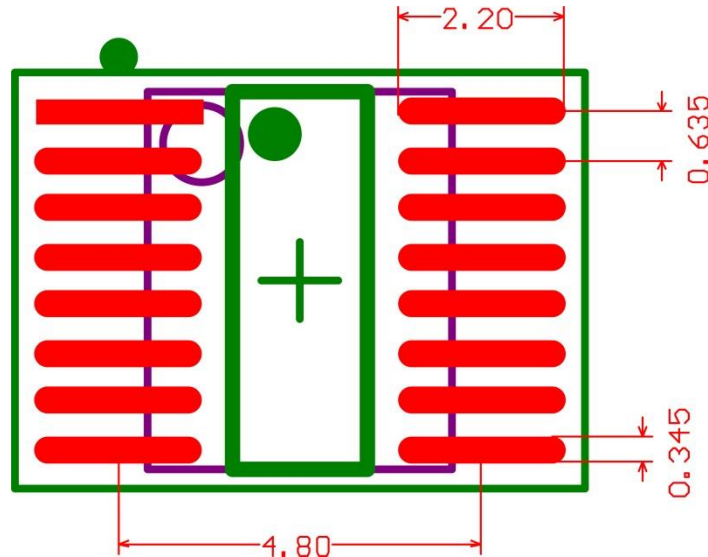

Figure 7.2 16-pin SSOP Annotated Footprint

Note: Red = top layer copper, other colors are mechanical layers.

8 20-pin QFN

The 20-pin QFN is used on the following products:

- [FT221XQ](#)
- [FT231XQ](#)

This package is nominally 4.00mm x 4.00mm. The solder pads are on a 0.50mm pitch.

Please see the IC Package Parameters in the IC datasheet for full information.

8.1 Scaled Footprint

This 1:1 scaled footprint is the exact size when viewed or printed at 100%.



Figure 8.1 20-pin QFN Scaled Footprint

8.2 Annotated Footprint

The annotated footprint shows key measurements.

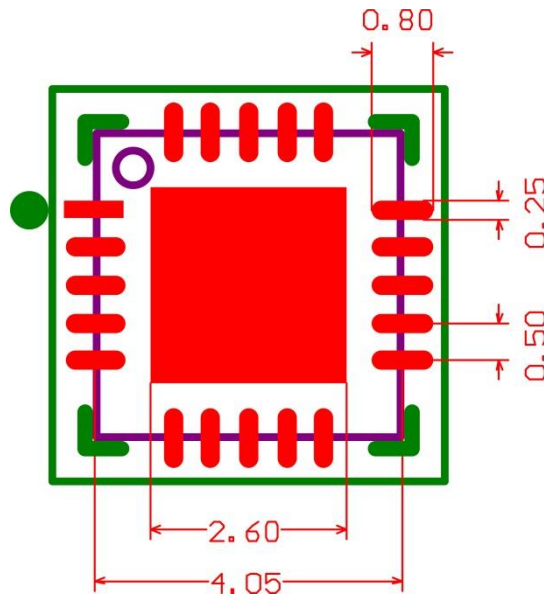

Figure 8.2 20-pin QFN Annotated Footprint

Note: Red = top layer copper, other colors are mechanical layers.

Note: Connect exposed center pad to GND. Do not place tracks on the top layer of the PCB in this area.

9 20-pin SSOP

The 20-pin SSOP is used on the following products:

- [FT221XS](#)
- [FT231XS](#)

This package is nominally 8.66mm x 3.91mm body (8.66mm x 5.99mm including pins). The solder pads are on a 0.635mm pitch.

Please see the IC Package Parameters in the IC datasheet for full information.

9.1 Scaled Footprint

This 1:1 scaled footprint is the exact size when viewed or printed at 100%.



Figure 9.1 20-pin SSOP Scaled Footprint

9.2 Annotated Footprint

The annotated footprint shows key measurements.

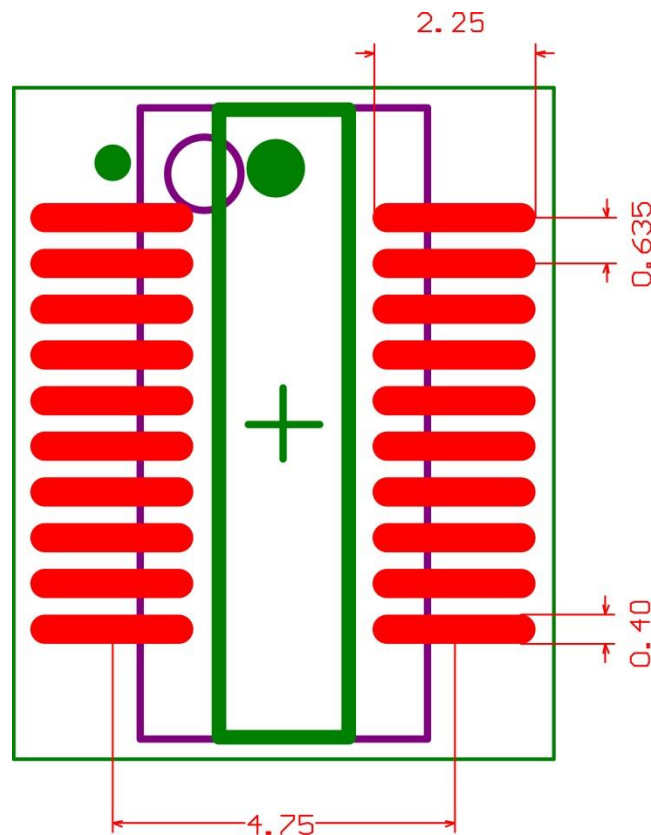

Figure 9.2 20-pin SSOP Annotated Footprint

Note: Red = top layer copper, other colors are mechanical layers.

10 24-pin QFN

The 24-pin QFN is used on the following product:

- [FT240XQ](#)

This package is nominally 4.00mm x 4.00mm. The solder pads are on a 0.50mm pitch.

Please see the IC Package Parameters in the IC datasheet for full information.

10.1 Scaled Footprint

This 1:1 scaled footprint is the exact size when viewed or printed at 100%.



Figure 10.1 24-pin QFN Scaled Footprint

10.2 Annotated Footprint

The annotated footprint shows key measurements.

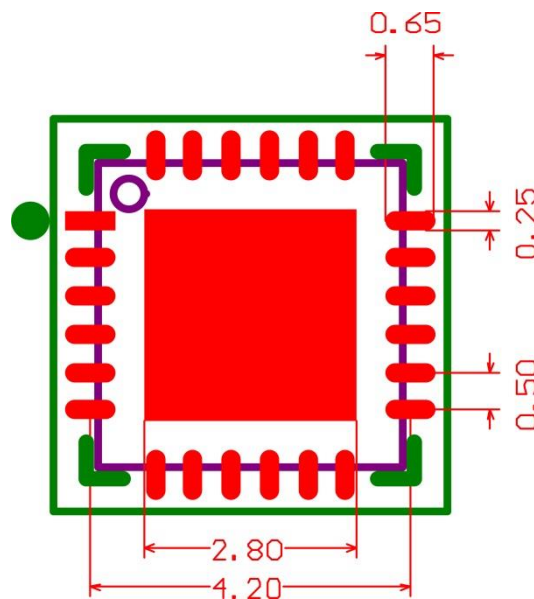

Figure 10.2 24-pin QFN Annotated Footprint

Note: Red = top layer copper, other colors are mechanical layers.

Note: Connect exposed center pad to GND. Do not place tracks on the top layer of the PCB in this area.

11 24-pin SSOP

The 24-pin SSOP is used on the following products:

- [FT240XS](#)

This package is nominally 8.66mm x 3.91 mm body (8.66mm x 5.99mm including pins). The solder pads are on a 0.635mm pitch.

Please see the IC Package Parameters in the IC datasheet for full information.

11.1 Scaled Footprint

This 1:1 scaled footprint is the exact size when viewed or printed at 100%.



Figure 11.1 24-pin SSOP Scaled Footprint

11.2 Annotated Footprint

The annotated footprint shows key measurements.

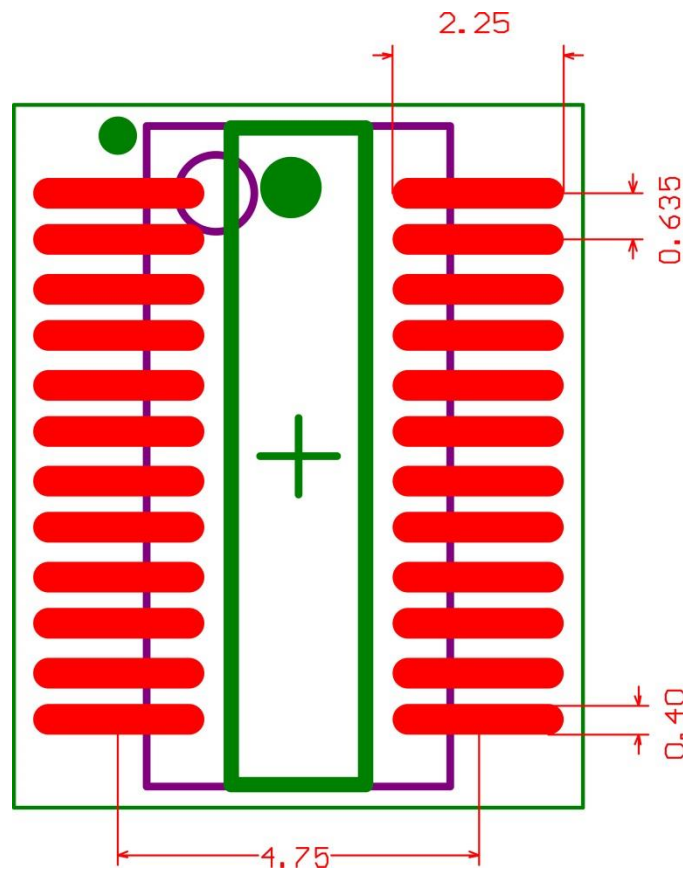

Figure 11.2 24-pin SSOP Annotated Footprint

Note: Red = top layer copper, other colors are mechanical layers.

12 28-pin QFN

The 28-pin QFN is used on the following products:

- [FT120Q](#)

This package is nominally 4.00mm x 4.00mm. The solder pads are on a 0.40mm pitch.

Please see the IC Package Parameters in the IC datasheet for full information.

12.1 Scaled Footprint

This 1:1 scaled footprint is the exact size when viewed or printed at 100%.



Figure 12.1 28-pin QFN Scaled Footprint

12.2 Annotated Footprint

The annotated footprint shows key measurements.

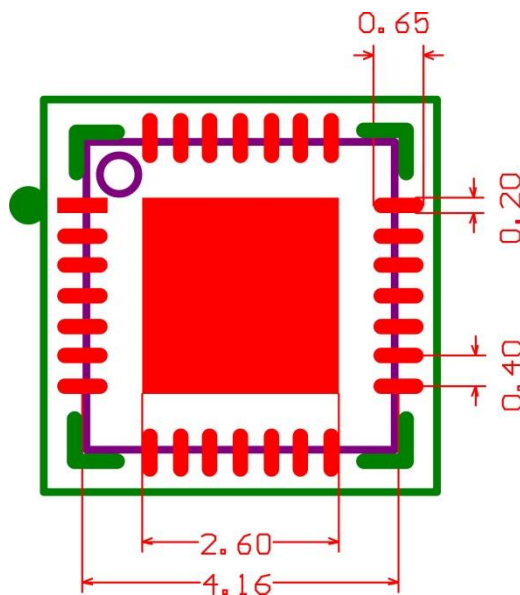

Figure 12.2 28-pin QFN Annotated Footprint

Note: Red = top layer copper, other colors are mechanical layers.

Note: Connect exposed center pad to GND. Do not place tracks on the top layer of the PCB in this area.

13 28-pin SSOP

The 28-pin SSOP is used on the following products:

- [FT232RL](#)
- [FT245RL](#)

This package is nominally 5.30mm x 10.20mm body (7.80mm x 10.20mm including pins). The solder pads are on a 0.65mm pitch.

Please see the IC Package Parameters in the IC datasheet for full information.

13.1 Scaled Footprint

This 1:1 scaled footprint is the exact size when viewed or printed at 100%.



Figure 13.1 28-pin SSOP Scaled Footprint

13.2 Annotated Footprint

The annotated footprint shows key measurements.

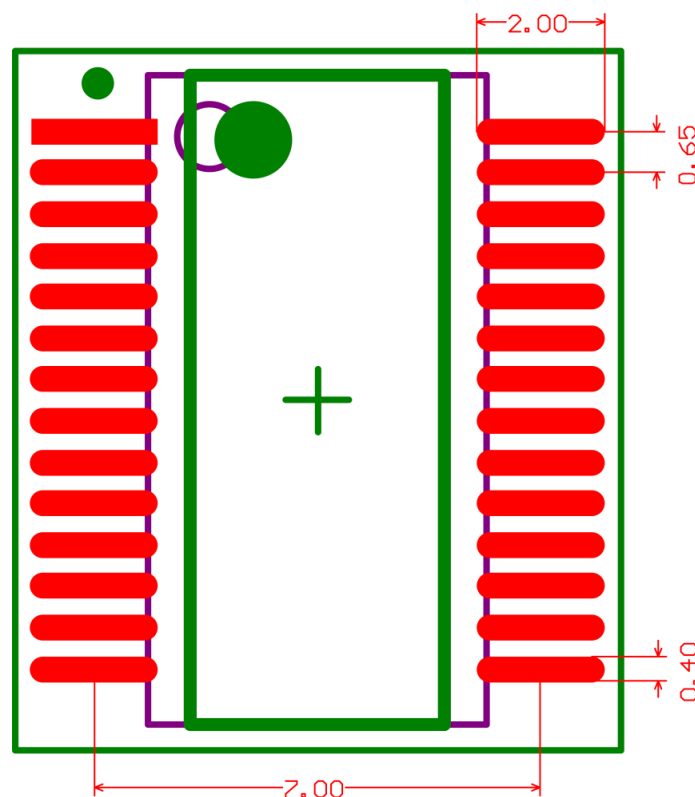

Figure 13.2 28-pin SSOP Annotated Footprint

Note: Red = top layer copper, other colors are mechanical layers

14 28-pin TSSOP

The 28-pin TSSOP is used on the following products:

- [FT120T](#)
- [FT260S](#)

This package is nominally 9.7mm x 4.4mm body (9.7mm x 6.4mm including pins). The solder pads are on a 0.65mm pitch.

Please see the IC Package Parameters in the IC datasheet for full information.

14.1 Scaled Footprint

This 1:1 scaled footprint is the exact size when viewed or printed at 100%.



Figure 14.1 28-pin TSSOP Scaled Footprint

14.2 Annotated Footprint

The annotated footprint shows key measurements.

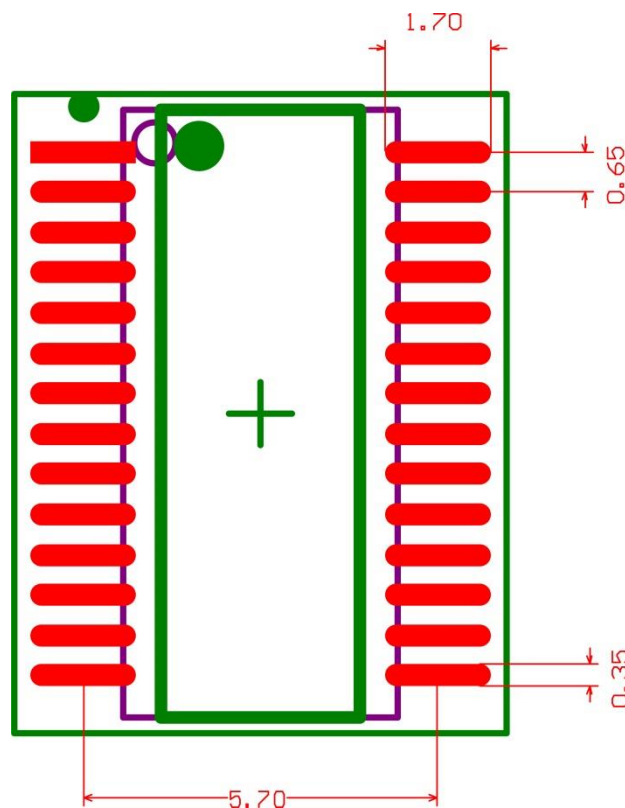

Figure 14.2 28-pin TSSOP Annotated Footprint

Note: Red = top layer copper, other colors are mechanical layers.

15 28-pin WQFN

The 28-pin WQFN is used on the following product:

- [FT260Q](#)

This package is nominally 5.00mm x 5.00mm. The solder pads are on a 0.50mm pitch.

Please see the IC Package Parameters in the IC datasheet for full information.

15.1 Scaled Footprint

This 1:1 scaled footprint is the exact size when viewed or printed at 100%.



Figure 15.1 28-pin WQFN Scaled Footprint

15.2 Annotated Footprint

The annotated footprint shows key measurements.

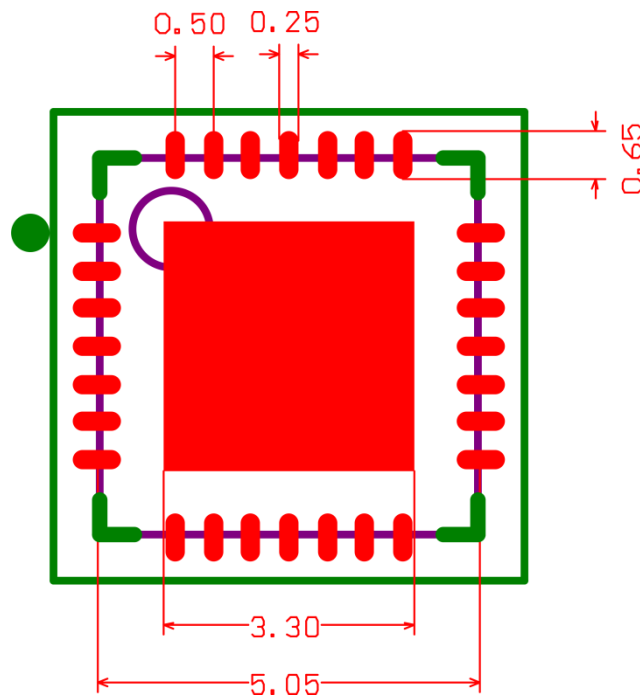

Figure 15.2 28-pin WQFN Annotated Footprint

Note: Red = top layer copper, other colors are mechanical layers.

Note: Connect exposed center pad to GND. Do not place tracks on the top layer of the PCB in this area.

16 32-pin LQFP

The 32-pin LQFP is used on the following products:

- [VNC2-32L1B](#)
- [FT311D-32L1C](#)
- [FT312D-32L1C](#)
- [FT232BL](#)
- [FT245BL](#)

This package is nominally 9.00mm x 9.00mm. The solder pads are on a 0.80mm pitch.

Please see the IC Package Parameters in the IC datasheet for full information.

16.1 Scaled Footprint

This 1:1 scaled footprint is the exact size when viewed or printed at 100%.



Figure 16.1 32-pin LQFP Scaled Footprint

16.2 Annotated Footprint

The annotated footprint shows key measurements.

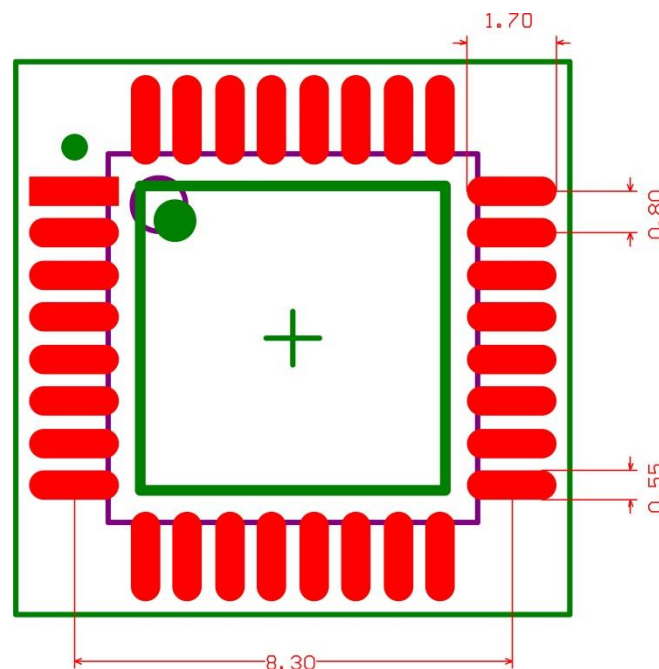

Figure 16.2 32-pin LQFP Annotated Footprint

Note: Red = top layer copper, other colors are mechanical layers.

17 32-pin VQFN/QFN (5mm x 5mm)

The 32-pin VQFN/QFN (5mm x 5mm) is used on the following products:

- [FT232RQ](#)
- [FT245RQ](#)
- [FT4222HQ](#)

This package is nominally 5.00mm x 5.00mm. The solder pads are on a 0.50mm pitch.

Please see the IC Package Parameters in the IC datasheet for full information.

17.1 Scaled Footprint

This 1:1 scaled footprint is the exact size when viewed or printed at 100%.



Figure 17.1 32-pin VQFN/QFN (5mm x 5mm) Scaled Footprint

17.2 Annotated Footprint

The annotated footprint shows key measurements.

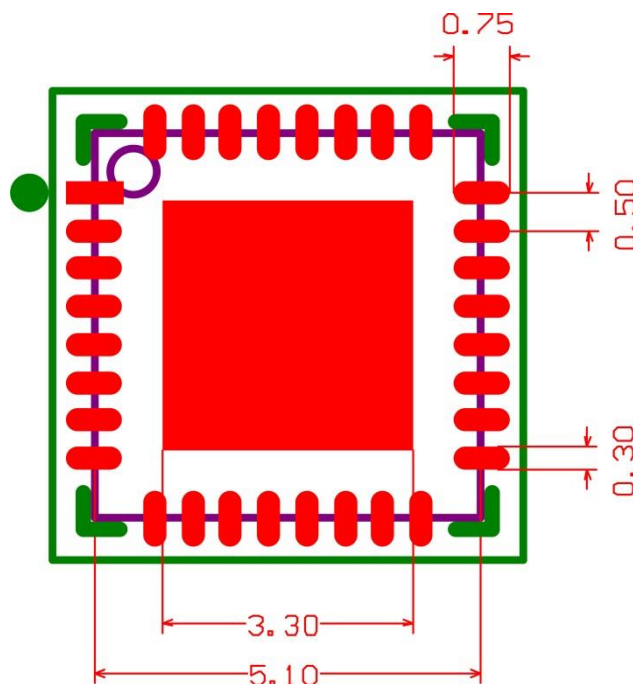

Figure 17.2 32-pin VQFN/QFN (5mm x 5mm) Annotated Footprint

Note: Red = top layer copper, other colors are mechanical layers.

Note: Connect exposed center pad to GND. Do not place tracks on the top layer of the PCB in this area.

18 32-pin QFN (7mm x 7mm)

The 32-pin QFN (7mm x 7mm) is used on the following products:

- [VNC2-32Q1B](#)
- [FT311D-32Q1C](#)
- [FT312D-32Q1C](#)

This package is nominally 7.00mm x 7.00mm. The solder pads are on a 0.65mm pitch.

Please see the IC Package Parameters in the IC datasheet for full information.

18.1 Scaled Footprint

This 1:1 scaled footprint is the exact size when viewed or printed at 100%.



Figure 18.1 32-pin QFN (7mm x 7mm) Scaled Footprint

18.2 Annotated Footprint

The annotated footprint shows key measurements.

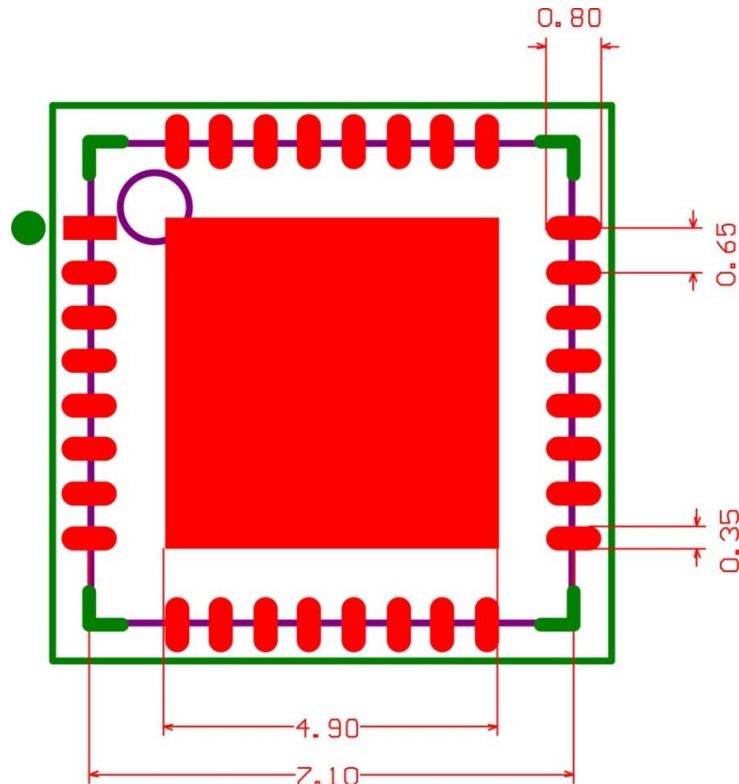

Figure 18.2 32-pin QFN (7mm x 7mm) Annotated Footprint

Note: Red = top layer copper, other colors are mechanical layers.

Note: Connect exposed center pad to GND. Do not place tracks on the top layer of the PCB in this area.

19 48-pin LQFP

The 48-pin LQFP is used on the following products:

- [FT232HL](#)
- [FT2232D](#)
- [VNC1L-1A](#)
- [VNC2-48Q1B](#)

This package is nominally 9.00mm x 9.00mm. The solder pads are on a 0.50mm pitch.

Please see the IC Package Parameters in the IC datasheet for full information.

19.1 Scaled Footprint

This 1:1 scaled footprint is the exact size when viewed or printed at 100%.



Figure 19.1 48-pin LQFP Scaled Footprint

19.2 Annotated Footprint

The annotated footprint shows key measurements.

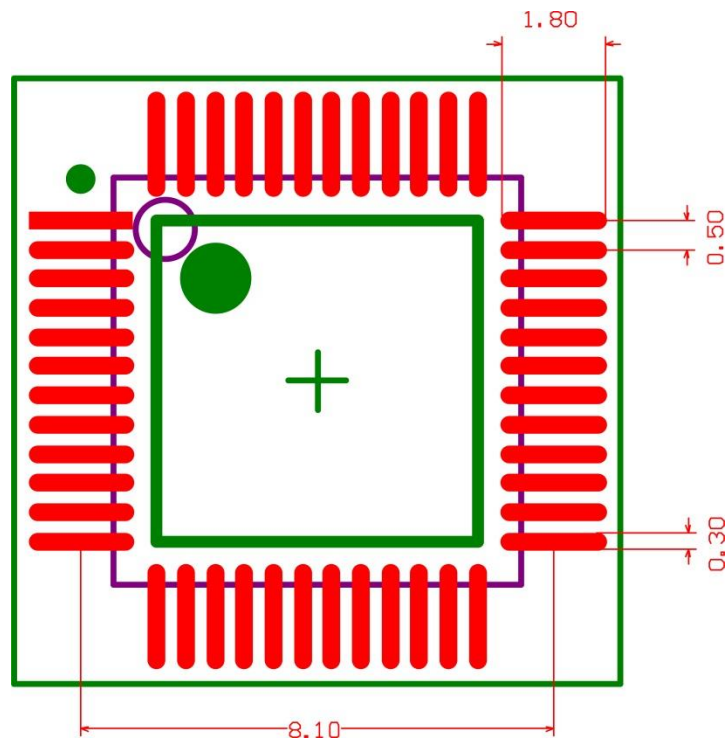

Figure 19.2 48-pin LQFP Annotated Footprint

Note: Red = top layer copper, other colors are mechanical layers.

20 48-pin QFN (8mm x 8mm)

The 48-pin QFN (8mm x 8mm) is used on the following products:

- [VNC2-48Q1B](#)
- [FT232HQ](#)

This package is nominally 8.00mm x 8.00mm. The solder pads are on a 0.50mm pitch.

Please see the IC Package Parameters in the IC datasheet for full information.

20.1 Scaled Footprint

This 1:1 scaled footprint is the exact size when viewed or printed at 100%.



Figure 20.1 48-pin QFN (8mm x 8mm) Scaled Footprint

20.2 Annotated Footprint

The annotated footprint shows key measurements.

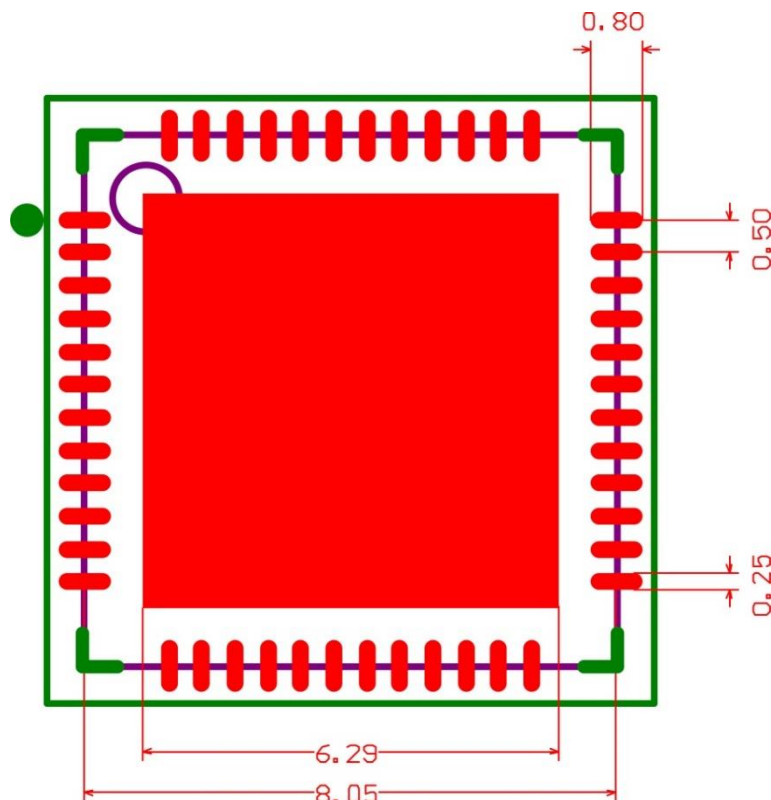

Figure 20.2 48-pin QFN (8mm x 8mm) Annotated Footprint

Note: Red = top layer copper, other colors are mechanical layers.

Note: Connect exposed center pad to GND. Do not place tracks on the top layer of the PCB in this area.

21 56-pin QFN (7mm x 7mm)

The 56-pin QFN (7mm x 7mm) is used on the following product:

- [FT600Q](#)

This package is nominally 7.00mm x 7.00mm. The solder pads are on a 0.40mm pitch.

Please see the IC Package Parameters in the IC datasheet for full information.

21.1 Scaled Footprint

This 1:1 scaled footprint is the exact size when viewed or printed at 100%.



Figure 21.1 56-pin QFN (7mm x 7mm) Scaled Footprint

21.2 Annotated Footprint

The annotated footprint shows key measurements.

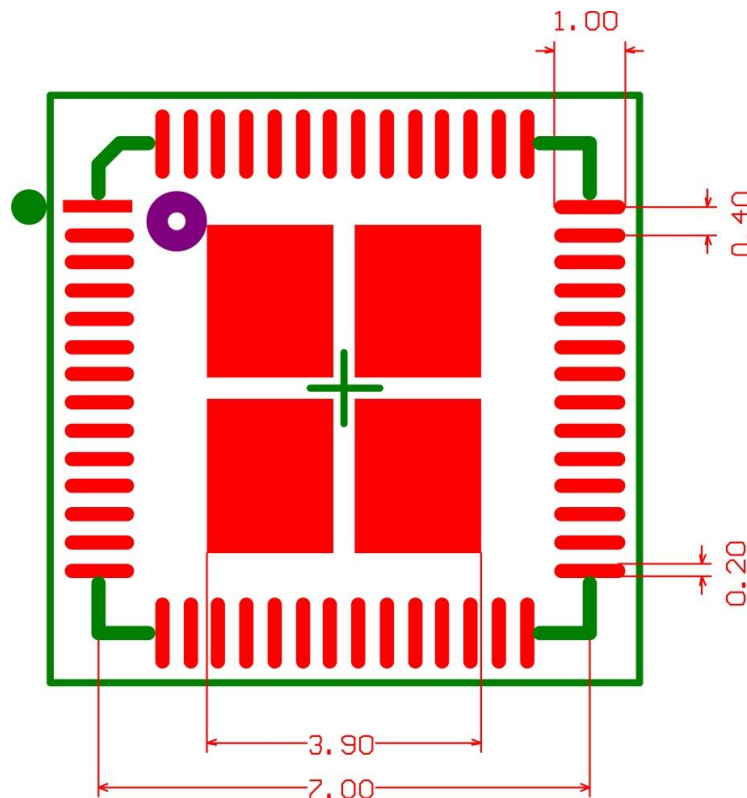

Figure 21.2 56-pin QFN (7mm x 7mm) Annotated Footprint

Note: Red = top layer copper, other colors are mechanical layers.

Note: Connect exposed center pad to GND. Do not place tracks on the top layer of the PCB in this area. Cross-hatching designs used for less solder paste and less heat up rate required.

22 56-pin VQFN (8mm x 8mm)

The 56-pin VQFN (8mm x 8mm) is used on the following products:

- [FT2232H-56Q](#)
- [FT4232H-56Q](#)

This package is nominally 8.00mm x 8.00mm. The solder pads are on a 0.50mm pitch.

Please see the IC Package Parameters in the IC datasheet for full information.

22.1 Scaled Footprint

This 1:1 scaled footprint is the exact size when viewed or printed at 100%.



Figure 22.1 56-pin VQFN (8mm x 8mm) Scaled Footprint

22.2 Annotated Footprint

The annotated footprint shows key measurements.

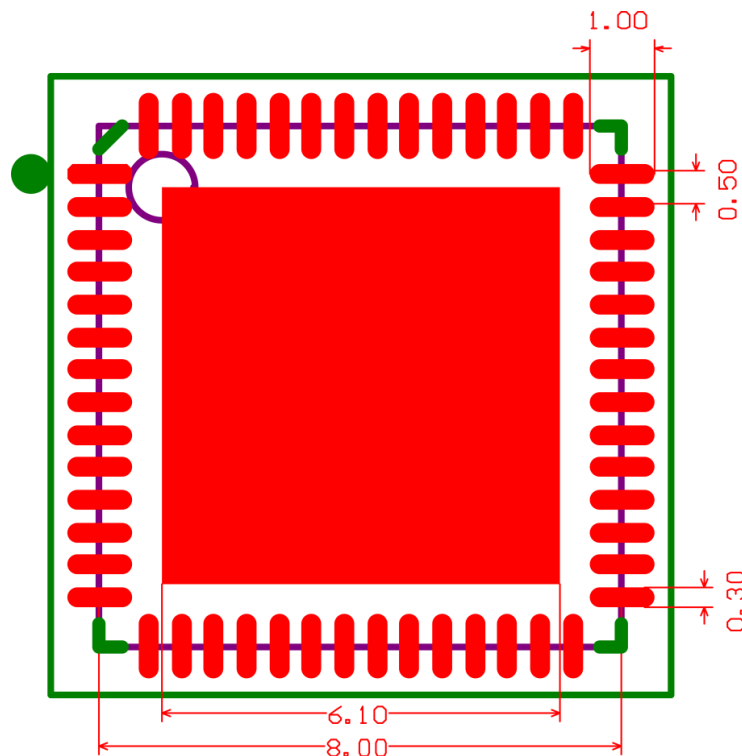

Figure 22.2 56-pin VQFN (8mm x 8mm) Annotated Footprint

Note: Red = top layer copper, other colors are mechanical layers.

Note: Connect exposed center pad to GND. Do not place tracks on the top layer of the PCB in this area.

23 64-pin LQFP

The 64-pin LQFP is used on the following products:

- [FT313HL](#)
- [FT2232HL](#)
- [FT4232HL](#)

This package is nominally 12.00mm x 12.00mm. The solder pads are on a 0.50mm pitch.

Please see the IC Package Parameters in the IC datasheet for full information.

23.1 Scaled Footprint

This 1:1 scaled footprint is the exact size when viewed or printed at 100%.

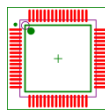

Figure 23.1 64-pin LQFP Scaled Footprint

23.2 Annotated Footprint

The annotated footprint shows key measurements.

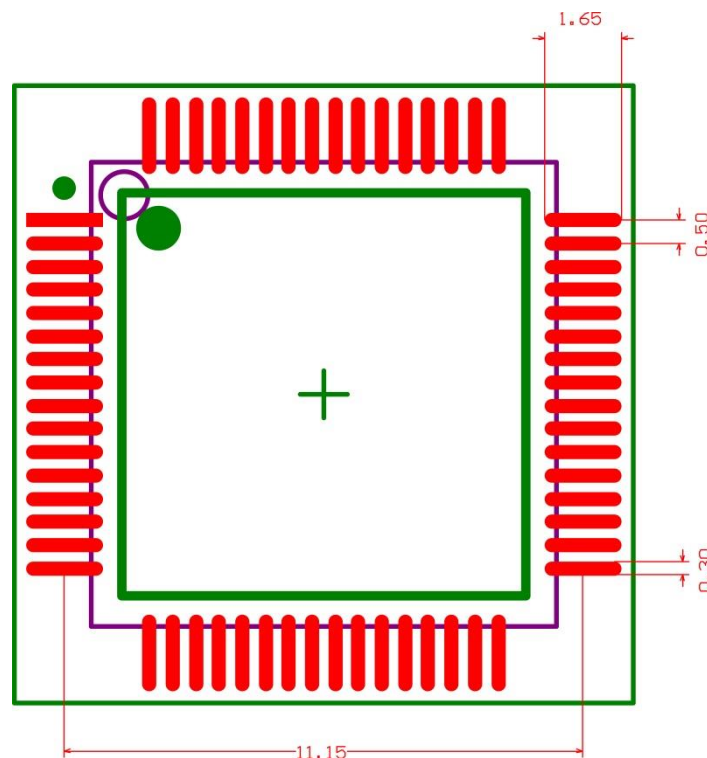

Figure 23.2 64-pin LQFP Annotated Footprint

Note: Red = top layer copper, other colors are mechanical layers.

24 64-pin TQFP

The 64-pin TQFP is used on the following products:

- [FT313HP](#)

This package is nominally 9.00mm x 9.00mm. The solder pads are on a 0.40mm pitch.

Please see the IC Package Parameters in the IC datasheet for full information.

24.1 Scaled Footprint

This 1:1 scaled footprint is the exact size when viewed or printed at 100%.



Figure 24.1 64-pin TQFP Scaled Footprint

24.2 Annotated Footprint

The annotated footprint shows key measurements.

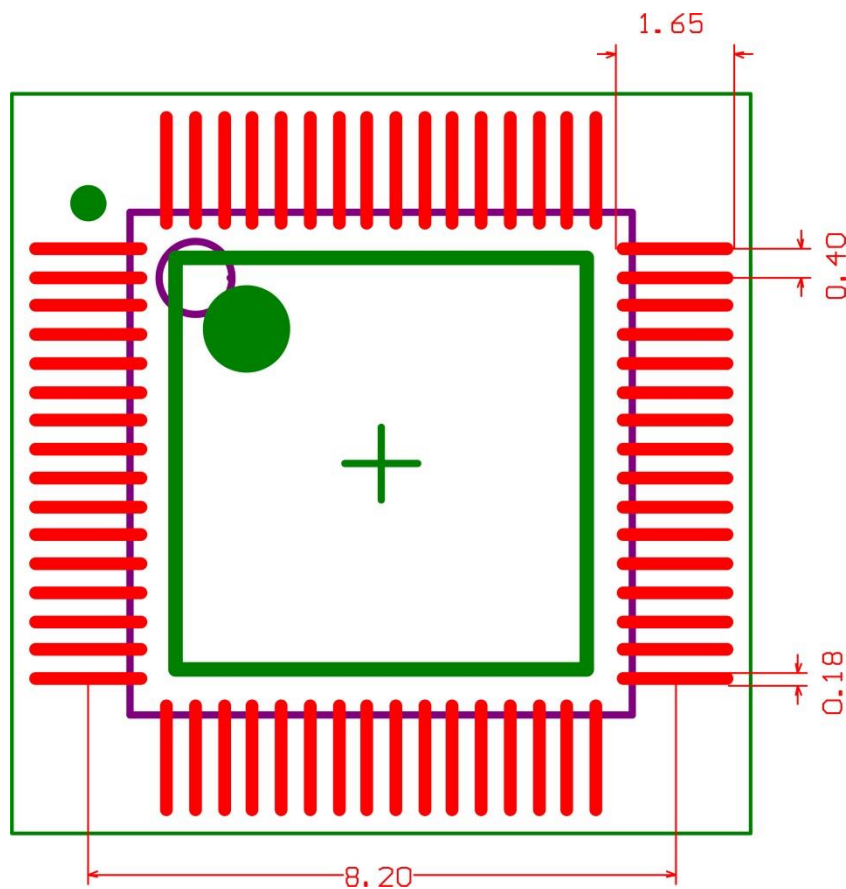

Figure 24.2 64-pin TQFP Annotated Footprint

Note: Red = top layer copper, other colors are mechanical layers.

25 64-pin QFN (9mm x 9mm)

The 64-pin QFN (9mm x 9mm) is used on the following products:

- [FT313HQ](#)
- [FT2232HQ](#)
- [FT4232HQ](#)

This package is nominally 9.00mm x 9.00mm. The solder pads are on a 0.50mm pitch.

Please see the IC Package Parameters in the IC datasheet for full information.

25.1 Scaled Footprint

This 1:1 scaled footprint is the exact size when viewed or printed at 100%.



Figure 25.1 64-pin QFN (9mm x 9mm) Scaled Footprint

25.2 Annotated Footprint

The annotated footprint shows key measurements.

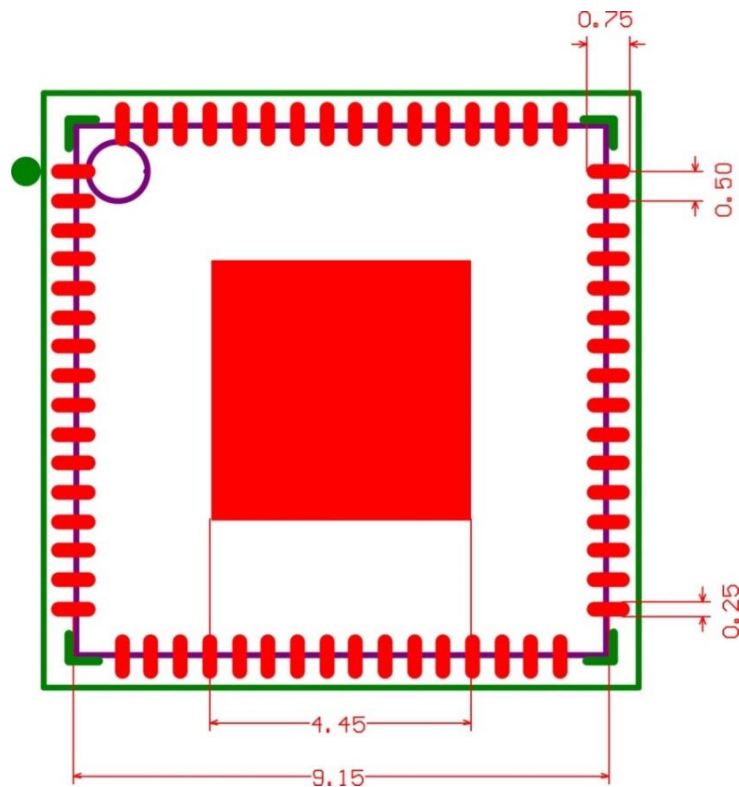

Figure 25.2 64-pin QFN (9mm x 9mm) Annotated Footprint

Note: Red = top layer copper, other colors are mechanical layers.

Note: Connect exposed center pad to GND. Do not place tracks on the top layer of the PCB in this area.

25.2.1 Additional Information

This package is unique to all the other packages where there is extra strain relief between the exposed pad in the center and the IC pins at the edge of the IC.

The exposed strain relief is connected to the pins so it is very important to ensure that the center exposed pad is not larger than specified, otherwise it could short all the signals together rendering the device and PCB useless.

The exposed strain relief should not be connected to the PCB in any way and this area should be marked as keep out. Only the pins at the edge of the package and the center exposed pad should be connected to the PCB.

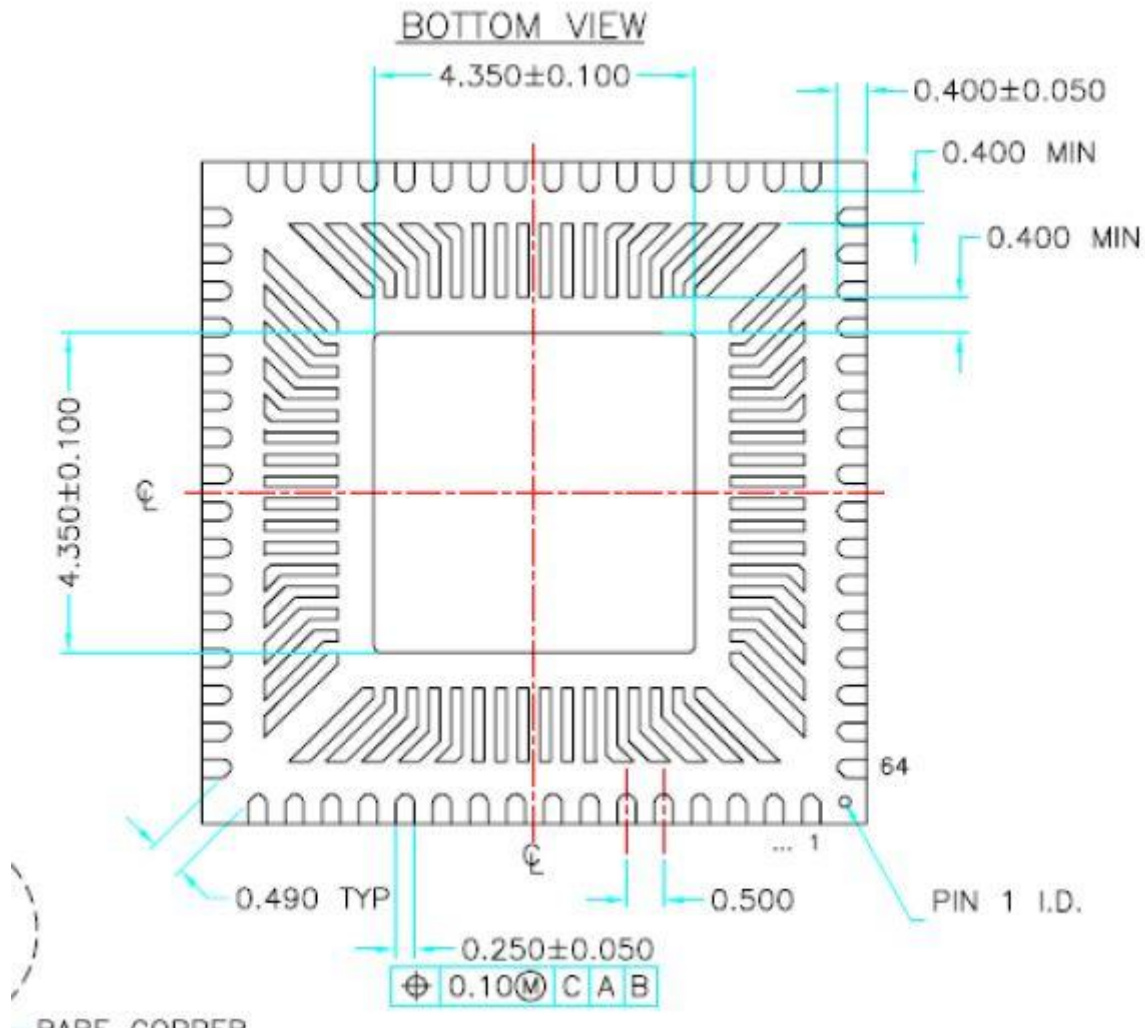

Figure 25.3 64-pin QFN (9mm x 9mm) Bottom View

26 76-pin QFN

The 76-pin QFN is used on the following products:

- [FT601Q](#)
- [FT602Q](#)

This package is nominally 9.00mm x 9.00mm. The solder pads are on a 0.40mm pitch.

Please see the IC Package Parameters in the IC datasheet for full information.

26.1 Scaled Footprint

This 1:1 scaled footprint is the exact size when viewed or printed at 100%.



Figure 26.1 76-pin QFN Scaled Footprint

26.2 Annotated Footprint

The annotated footprint shows key measurements.

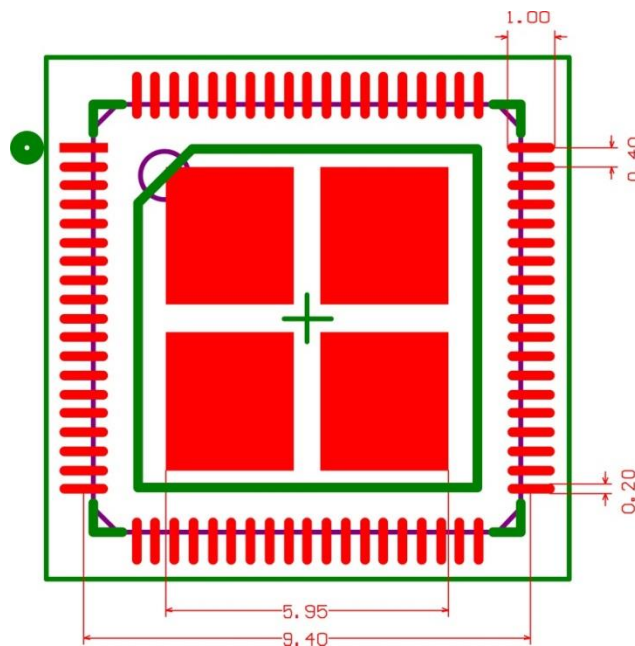

Figure 26.2 76-pin QFN Annotated Footprint

Note: Red = top layer copper, other colors are mechanical layers.

Note: Connect exposed center pad to GND. Do not place tracks on the top layer of the PCB in this area. Cross-hatching design used for less solders paste and less heat up rate required.

27 Contact Information

Head Office – Glasgow, UK

Future Technology Devices International Limited
Unit 1, 2 Seaward Place, Centurion Business Park
Glasgow G41 1HH
United Kingdom
Tel: +44 (0) 141 429 2777
Fax: +44 (0) 141 429 2758

E-mail (Sales) sales1@ftdichip.com
E-mail (Support) support1@ftdichip.com
E-mail (General Enquiries) admin1@ftdichip.com

Branch Office – Tigard, Oregon, USA

Future Technology Devices International Limited
(USA)
7130 SW Fir Loop
Tigard, OR 97223-8160
USA
Tel: +1 (503) 547 0988
Fax: +1 (503) 547 0987

E-Mail (Sales) us.sales@ftdichip.com
E-Mail (Support) us.support@ftdichip.com
E-Mail (General Enquiries) us.admin@ftdichip.com

Branch Office – Taipei, Taiwan

Future Technology Devices International Limited
(Taiwan)
2F, No. 516, Sec. 1, NeiHu Road
Taipei 114
Taiwan, R.O.C.
Tel: +886 (0) 2 8797 1330
Fax: +886 (0) 2 8751 9737

E-mail (Sales) tw.sales1@ftdichip.com
E-mail (Support) tw.support1@ftdichip.com
E-mail (General Enquiries) tw.admin1@ftdichip.com

Branch Office – Shanghai, China

Future Technology Devices International Limited
(China)
Room 1103, No. 666 West Huaihai Road,
Shanghai, 200052
China
Tel: +86 21 62351596
Fax: +86 21 62351595

E-mail (Sales) cn.sales@ftdichip.com
E-mail (Support) cn.support@ftdichip.com
E-mail (General Enquiries) cn.admin@ftdichip.com

Web Site

<http://ftdichip.com>

Distributor and Sales Representatives

Please visit the [Sales Network](#) page of the [FTDI Web site](#) for the contact details of our distributor(s) and sales representative(s) in your country.

System and equipment manufacturers and designers are responsible to ensure that their systems, and any Future Technology Devices International Ltd (FTDI) devices incorporated in their systems, meet all applicable safety, regulatory and system-level performance requirements. All application-related information in this document (including application descriptions, suggested FTDI devices and other materials) is provided for reference only. While FTDI has taken care to assure it is accurate, this information is subject to customer confirmation, and FTDI disclaims all liability for system designs and for any applications assistance provided by FTDI. Use of FTDI devices in life support and/or safety applications is entirely at the user's risk, and the user agrees to defend, indemnify and hold harmless FTDI from any and all damages, claims, suits or expense resulting from such use. This document is subject to change without notice. No freedom to use patents or other intellectual property rights is implied by the publication of this document. Neither the whole nor any part of the information contained in, or the product described in this document, may be adapted or reproduced in any material or electronic form without the prior written consent of the copyright holder. Future Technology Devices International Ltd, Unit 1, 2 Seaward Place, Centurion Business Park, Glasgow G41 1HH, United Kingdom. Scotland Registered Company Number: SC136640

Appendix A – References

Document References

<http://www.ftdichip.com/Support/Documents/PCBData.htm>

<http://www.ftdichip.com/Products/ICs.htm>

[Altium](#)

Acronyms and Abbreviations

Terms	Description
DFN	Dual-Flat No-Leads Package
IC	Integrated Circuit
LQFP	Low Profile Quad Flat Package
PCB	Printed Circuit Board
QFN	Quad Flat No-Leads Package
SSOP	Shrink Small-Outline Package
TSSOP	Thin-Shrink Small Outline Package
VQFN / WQFN	Very Thin Quad Flat No-Lead Package

Appendix B – List of Tables & Figures

List of Tables

Table 3.1 DFN Packages.....	7
Table 3.2 QFP Packages	7
Table 3.3 QFN Packages	7
Table 3.4 SSOP Packages.....	7

List of Figures

Figure 2.1 DFN Packages	6
Figure 2.2 QFP Packages.....	6
Figure 2.3 QFN Packages	6
Figure 2.4 SSOP Packages.....	6
Figure 4.1 10-pin DFN Scaled Footprint.....	8
Figure 4.2 10-pin DFN Annotated Footprint	8
Figure 5.1 12-pin DFN Scaled Footprint.....	9
Figure 5.2 12-pin DFN Annotated Footprint	9
Figure 6.1 16-pin QFN (4mm x 4mm) Scaled Footprint	10
Figure 6.2 16-pin QFN (4mm x 4mm) Annotated Footprint.....	10
Figure 7.1 16-pin SSOP Scaled Footprint.....	11
Figure 7.2 16-pin SSOP Annotated Footprint.....	11
Figure 8.1 20-pin QFN Scaled Footprint.....	12
Figure 8.2 20-pin QFN Annotated Footprint	12
Figure 9.1 20-pin SSOP Scaled Footprint.....	13
Figure 9.2 20-pin SSOP Annotated Footprint.....	13
Figure 10.1 24-pin QFN Scaled Footprint.....	14
Figure 10.2 24-pin QFN Annotated Footprint.....	14
Figure 11.1 24-pin SSOP Scaled Footprint.....	15
Figure 11.2 24-pin SSOP Annotated Footprint.....	15
Figure 12.1 28-pin QFN Scaled Footprint.....	16
Figure 12.2 28-pin QFN Annotated Footprint.....	16
Figure 13.1 28-pin SSOP Scaled Footprint.....	17
Figure 13.2 28-pin SSOP Annotated Footprint.....	17
Figure 14.1 28-pin TSSOP Scaled Footprint	18
Figure 14.2 28-pin TSSOP Annotated Footprint	18
Figure 15.1 28-pin WQFN Scaled Footprint	19
Figure 15.2 28-pin WQFN Annotated Footprint.....	19

Figure 16.1 32-pin LQFP Scaled Footprint.....	20
Figure 16.2 32-pin LQFP Annotated Footprint	20
Figure 17.1 32-pin VQFN/QFN (5mm x 5mm) Scaled Footprint	21
Figure 17.2 32-pin VQFN/QFN (5mm x 5mm) Annotated Footprint	21
Figure 18.1 32-pin QFN (7mm x 7mm) Scaled Footprint	22
Figure 18.2 32-pin QFN (7mm x 7mm) Annotated Footprint	22
Figure 19.1 48-pin LQFP Scaled Footprint.....	23
Figure 19.2 48-pin LQFP Annotated Footprint	23
Figure 20.1 48-pin QFN (8mm x 8mm) Scaled Footprint	24
Figure 20.2 48-pin QFN (8mm x 8mm) Annotated Footprint	24
Figure 21.1 56-pin QFN (7mm x 7mm) Scaled Footprint	25
Figure 21.2 56-pin QFN (7mm x 7mm) Annotated Footprint	25
Figure 22.1 56-pin VQFN (8mm x 8mm) Scaled Footprint	26
Figure 22.2 56-pin VQFN (8mm x 8mm) Annotated Footprint	26
Figure 23.1 64-pin LQFP Scaled Footprint.....	27
Figure 23.2 64-pin LQFP Annotated Footprint	27
Figure 24.1 64-pin TQFP Scaled Footprint	28
Figure 24.2 64-pin TQFP Annotated Footprint	28
Figure 25.1 64-pin QFN (9mm x 9mm) Scaled Footprint	29
Figure 25.2 64-pin QFN (9mm x 9mm) Annotated Footprint	29
Figure 25.3 64-pin QFN (9mm x 9mm) Bottom View	30
Figure 26.1 76-pin QFN Scaled Footprint.....	31
Figure 26.2 76-pin QFN Annotated Footprint.....	31

Appendix C – Revision History

Document Title: TN_166 FTDI Example IC PCB Footprints
 Document Reference No.: FT_001321
 Clearance No.: FTDI# 501
 Product Page: <http://www.ftdichip.com/FTPProducts.htm>
 Document Feedback: [Send Feedback](#)

Revision	Changes	Date
1.0	Initial Release	2016-04-27
1.1	Updated Release	2017-05-16
1.2	Removed discontinued parts (VNC2-64, FT121, FT122, FT51A) Removed Bridgetek parts as they are now covered in a separate document. Added FT602. Edited FT2232H-56Q and FT4232H-56Q part numbers. Added new footprints for SSOP28 (FT232RL, FT245RL), 56-pin VQFN (FT2232H-56Q, FT4232H-56Q)	2019-06-14