

Serving your industry with quality fluid conveying products

QUICK DISCONNECT COUPLINGS



Construction



Forestry



Public Safety



Utility



Marine and Defense



Oil and Gas



Transportation



Steel



Machine Tool

Section	Pages	Section	Pages	Section	Pages
Hose	15-67	Swivel Joints	229-244	Quick Disconnect Couplings	268-345
Fittings	68-180	Flexmaster Joints	245-260	Access., Equipment & Assembly Instructions	346-393
Adapters and Tube Fittings	181-228	FLOCS®	261-267	Technical Data	394-433

QUICK DISCONNECT COUPLINGS

Description	Page	Description	Page	Description	Page
Air Couplings		FD56 Series –		Special Application	
FD40 Series – Interchange	284	DryBreak – Steel	300	FD14 Series –	
FD41 Series – Interchange	286	5600 Series –		Drain Coupling	290
FD43 Series – Interchange	288	General Purpose	324	FD15 Series –	
Fluid Transfer and Hydraulic		FD86 Series –		Oil Sampling Valve	292
FD35 Series –		DryBreak, High Impulse	336	FD69 Series –	
Arc Latch™, High Pressure	294	FD89 Series		High Pressure/Water Blast	329
FD42 Series –		Flush Face Coupling	339	FD90 Series –	
Interchange	297	Fluid Transfer and Refrigerant		Diagnostic	342
FD45 Series –		5400 Series –		FF10000-02 – Diagnostic Kit	342
DryBreak, Steel	300	Low Air Inclusion,		Configuration Index	273
FD45 Series –		Low Fluid Loss	320	Coupling Construction	276
Interchange – Steel	302	Hydraulic Farm		Coupling Selection Chart	280
FD45 Series –		FD70 Series –		Coupling Selection Chart	280
Interchange – Brass	305	Male Tip – Deere	335	Fluid Compatibility Chart	282
FD45 Series –		FD71 Series –		How to Order	274
Interchange – Stainless Steel	308	Push to Connect – ISO	331	Part Number Index	270
FD48 Series –		FD72 Series –		Industry Application Symbols	272
Interchange	312	Push to Connect –		Safety Information	275
FD49 Series –		Connect Under Pressure	333		
HTMA Interchange	314	FD76 Series –			
5100 Series –		Male Tip – ISO	335		
Threaded, Low Spill	317				



This page is part of a complete catalog which contains technical and safety data that must be reviewed when selecting a product.

[RETURN TO CONTENTS PAGE](#)



Part numbers listed below are base part numbers that exclude size designation, for complete part number refer to page and line referenced.

Part Number	Page	Line	Part Number	Page	Line	Part Number	Page	Line
150-22	319	40-44	560078	327	1-7	FD45-1045	304	17-22
487	322	40-45	565006	326	33-34	FD45-1046	304	9-14
5100	317		565007	326	25-26	FD45-1047	303	33-38
5100	319	1-8	565014	328	17-19	FD45-1052	310	1-5
5100-22	319	45	565015	328	9-11	FD45-1053	309	33-37
5100-S2	318	1-8	FD14	290		FD45-1056	310	17-21
5100-S4	318	9-16	FD14-1001	291		FD45-1059	310	9-13
5100-S5	318	17-24	FD14-1002	291		FD45-1061	303	25-30
5100-S7	319	32-37	FD14-1004	291		FD45-1062	309	25-29
5100-S9	319	32-37	FD14-1204	291		FD45-1063	303	17-22
5101	318	33-40	FD14-1206	291		FD45-1064	303	1-6
5110	319	17-24	FD15	292		FD45-1065	303	9-14
5110-S5	318	25-32	FD15-1000	293	1-2	FD45-1070	303	9-14
5111	319	9-16	FD15-1002	293	9	FD45-1071	303	1-6
5400	320		FD15-1025	293	25	FD45-1072	303	17-22
5400-17	323	5	FD15-1026	293	17	FD45-1075	309	17-21
5400-53	323	8	FD35	294		FD45-1076	309	9-13
5400-54	323	7	FD35-1000	295	17	FD45-1078	309	1-5
5400-S2	321	1-4	FD35-1001	295	9	FD45-1086	306	1-7
5400-S5	321	9-12	FD35-1002	295	1	FD45-1090	306	17-23
5400-S6	322	18-21	FD35-1006	296	1	FD45-1091	306	9-15
5400-S8	322	18-21	FD35-1007	295	33	FD45-1092	306	1-7
5400-S16	323	10	FD35-1008	295	25	FD45-1100	306	17-23
5400-S19	323	12	FD35-1042	296	30	FD45-1101	306	9-15
5400-S20	323	4	FD35-1043	296	9	FD45-1120	309	17-21
5401	322	9-15	FD35-1044	296	17	FD45-1121	309	1-5
5401-S14	322	1-7	FD40	284		FD45-1122	309	9-13
5401-S17	321	41-47	FD40-1000	285	1-5	FD45-1142	309	33-37
5410	321	33-39	FD40-1001	285	9-12	FD45-1143	310	1-5
5410-S14	321	25-31	FD40-1013	285	17-21	FD45-1153	306	1-7
5410-S17	321	17-23	FD40-1013	289	22-26	FD45-1156	306	9-15
5600	324		FD40-1014	285	25-32	FD45-1157	306	17-23
5600	325	17-23	FD40-1014	289	29-36	FD45-1172	303	33-38
5601	325	9-15	FD41	286		FD45-1173	304	1-6
5602	301	1-3	FD41-1000	287	1-2	FD45-1174	307	1-7
5602	325	1-7	FD41-1013	287	9	FD45-1175	306	25-31
5603	328	42	FD41-1014	287	17	FD45-1176	306	33-39
5603	332	33	FD42	297		FD45-1177	307	1-7
5603	334	33	FD42-1000	298	17	FD45-1178	306	33-39
5606	327	17-23	FD42-1001	298	9	FD45-1179	307	1-7
5608	327	9-15	FD42-1002	298	1	FD45-1180	306	33-39
5610	301	13-15	FD42-1006	298	41	FD45-1194	310	1-5
5610	327	1-7	FD42-1008	298	33	FD45-1195	309	33-37
5642	325	17-23	FD42-1010	298	25	FD45-1197	310	17-21
5643	325	9-15	FD43	288		FD45-1199	307	18-22
5644	325	1-7	FD43-1001	289	1-7	FD45-1201	307	10-14
5650	326	33-34	FD43-1011	289	8-14	FD45-1203	307	18-22
5651	326	25-26	FD43-1031	289	15-16	FD45-1206	304	1-6
5657	328	32-36	FD45 DryBreak	300		FD45-1207	303	33-38
5657	332	18	FD45 Steel	302		FD45-1209	310	17-21
5657	334	19	FD45 Brass	305		FD45-1211	307	18-22
5659	328	37-41	FD45 Stainless Steel	308		FD45-1228	304	17-22
5659	332	25	FD45-1000	303	17-22	FD45-1229	304	17-22
5659	334	25	FD45-1001	309	17-21	FD45-1267	311	9
5667	328	17-19	FD45-1002	301	25-28	FD45-1270	311	1
5668	328	9-11	FD45-1002	303	1-6	FD45-1399	306	31
5690	328	1-7	FD45-1003	303	9-14	FD45-1400	306	31
5691	327	33-39	FD45-1004	309	1-5	FD45-4001	301	6-8
22008	323	6	FD45-1005	309	9-13	FD48	312	
22546	322	27-33	FD45-1040	304	34-39	FD48-1000	313	17
22546	322	35-38	FD45-1040	307	34-39	FD48-1001	313	9
22546	322	40-45	FD45-1040	310	34-38	FD48-1002	313	1
22546	323	3, 11, 13	FD45-1041	304	41-46	FD48-1042	299	9
202208	322	35-38	FD45-1041	307	41-46	FD48-1042	313	26
202208	323	2, 14	FD45-1041	310	39-43	FD49	314	
202220	322	27-33	FD45-1044	304	1-6	FD49-1001	315	25-26



Part numbers listed below are base part numbers that exclude size designation, for complete part number refer to page and line referenced.

Part Number	Page	Line	Part Number	Page	Line	Part Number	Page	Line
FD49-1002	315	1-2	FD76	335		FF056	310	26-30
FD49-1004	315	9-10	FD76-1002	332	1	FF082	325	42-46
FD49-1005	315	33	FD76-1002	334		FF082	326	42-46
FD49-1014	316	1-2	FD76-1002	335	9	FF082	327	42-46
FD49-1042	316	20	FD76-1010	335	17	FF082	328	26-30
FD49-1057	315	17-18	FD86	336		FF092	325	42-46
FD49-1088	316	28	FD86-1001	338	9-10	FF092	326	42-46
FD49-1200	316	9-10	FD86-1002	338	1-2	FF092	327	42-46
FD51-1264	318	1-8	FD86-1004	338	17-18	FF092	328	26-30
FD51-1265	318	1-8	FD86-1006	337	17-18	FF093	325	42-46
FD51-1266	318	17-24	FD86-1008	337	1-2	FF093	326	42-46
FD51-1267	318	25-32	FD86-1010	337	9-10	FF093	327	42-46
FD51-1268	318	17-24	FD86-1016	338	2-3	FF093	328	26-30
FD51-1269	318	25-32	FD86-1018	338	2-3	FF095	318	41-46
FD51-1270	318	33-40	FD86-1035	338	10-11	FF095	319	25-30
FD51-1271	319	9-16	FD86-1039	338	9-10	FF097	318	41-46
FD51-1272	318	33-40	FD86-1040	338	1-2	FF097	319	25-30
FD51-1273	319	9-16	FD86-1041	338	17-18	FF098	318	41-46
FD56 DryBreak	300		FD86-1042	337	17-18	FF098	318	25-30
FD56-1009	327	17-23	FD86-1043	337	1-2	FF1607	299	1
FD56-1012	327	9-15	FD86-1044	337	9-10	FF10000	342	
FD56-1037	325	25-31	FD86-1049	338	9-10	FF10166	330	26
FD56-1062	325	1-7	FD86-1050	338	1-2	FF10173	296	26
FD56-1064	325	9-15	FD86-1051	338	17-18	FF10174	296	27
FD56-1065	325	17-23	FD86-1052	337	17-18	FF10175	296	28
FD56-1070	326	25-26	FD86-1053	337	1-2	FF10593	338	30-31
FD56-1071	326	33-34	FD86-1054	337	9-10	FF10594	338	30-31
FD56-1072	327	1-7	FD89	339		FF10595	338	30-31
FD56-1074	327	9-15	FD89-1001	340	11-20	FF10596	338	27-28
FD56-1075	327	17-23	FD89-1002	340	1-10	FF10597	338	27-28
FD56-1081	328	9-11	FD89-1006	340	31-40	FF10598	338	27-28
FD56-1082	328	17-19	FD89-1007	340	21-30			
FD56-1123	326	17-23	FD89-1008	341	20-27			
FD56-1125	326	9-15	FD89-1009	341	1-7, 10-11			
FD56-1196	326	17-23	FD90	342				
FD56-1201	326	17-23	FD90-1004	343	9-12			
FD56-1204	325	33-39	FD90-1012	343	17-18			
FD56-1205	326	1-7	FD90-1021	343	32-33			
FD56-1207	325	33-39	FD90-1034	343	1-2			
FD56-1208	326	1-7	FD90-1035	343	1-2			
FD56-1209	327	33-39	FD90-1040	343	32-33, 41			
FD56-1210	328	1-7	FD90-1041	343	41			
FD56-1221	327	25-31	FD90-1044	343	9-12			
FD56-1225	325	33-39	FD90-1045	343	17-18			
FD56-1226	326	1-7	FD90-1046	343	25			
FD56-1233	327	33-39	FD90-1047	343	25			
FD56-1234	328	1-7	FD90-1061	344	9			
FD56-4001	301	31-34	FD90-1090	344	17			
FD56-4101	301	19-21	FD90-1206	344	1			
FD69	329		FF013	303	42-47			
FD69-1000	330	18-21	FF013	304	26-31			
FD69-1001	330	10-11	FF014	303	42-47			
FD69-1002	330	2-3	FF014	304	26-31			
FD69-1010	330	23	FF015	303	42-47			
FD69-1011	330	14	FF015	304	26-31			
FD69-1012	330	6	FF016	306	42-48			
FD69-1026	330	10-11	FF016	307	26-32			
FD69-1027	330	18-21	FF017	306	42-48			
FD69-1028	330	10-11	FF017	307	26-32			
FD69-1029	330	18-21	FF018	306	42-48			
FD70	335		FF018	307	26-32			
FD70-1010	335	1	FF054	309	42-46			
FD71	331		FF054	310	26-30			
FD71-1001	332	9	FF055	309	42-46			
FD72	333		FF055	310	26-30			
FD72-1001	334	9	FF056	309	42-46			



Industry Application Symbols

Industry symbols are provided for each coupling indicating where it is typically used. But remember, a coupling can be used in any industry, provided it meets the established application requirements.

Agriculture

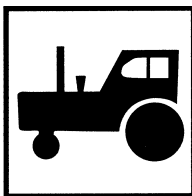

FD14, FD42, FD48, 5400, 5600, FD70, FD71, FD72, FD76, FD89, FD90

Electronic Cooling

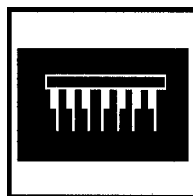

FD45 (stainless), FD45 (brass), 5100, 5400

Marine and Defense

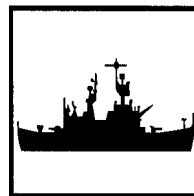

FD14, FD15, FD35, FD45 (stainless), FD45 (brass), 5100, 5400, 5600, FD69, FD86, FD90

Pharmaceutical/Medical

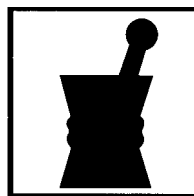

FD15, FD45 (brass), FD45 (stainless), FD89, 5400

Chemical Processing

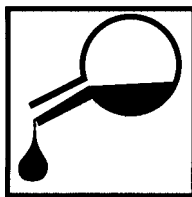

FD45, FD49, FD89, 5100, 5400

Food & Beverage

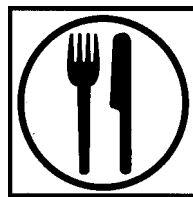

FD15, FD45 (stainless)

Industrial Plants

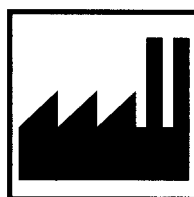

FD14, FD35, FD40, FD41, FD43, FD45 (steel), FD45 (brass), FD45 (stainless), FD48, FD49, 5100, 5600, FD69, FD86, FD89, FD90

Construction



FD14, FD15, FD35, FD40, FD41, FD42, FD43, FD45 (steel), FD48, FD49, 5100, 5400, 5600, FD69, FD86, FD89, FD90

Forestry

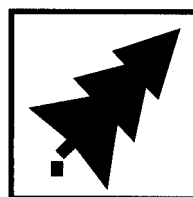

FD14, FD15, 5600, FD86, FD89

Transportation

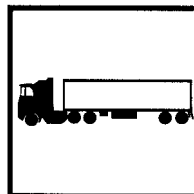

FD14, FD15, FD42, FD45 (steel), FD45 (brass), 5100, 5400, 5600, FD90

Oil and Gas

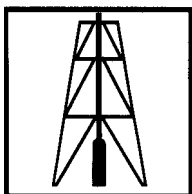

FD15, FD35, FD45 (stainless), FD45 (brass), 5100, 5600, FD86, FD89, FD90

Maintenance & Repair Operations



FD14, FD40, FD41, FD43, FD45 (steel), FD45 (brass), FD49, 5100, 5600, FD69, FD89, FD90

Utility

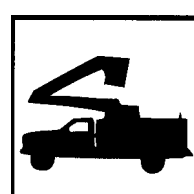

FD14, FD15, FD35, FD45 (steel), FD49, 5100, 5600, FD86, FD89, FD90



AIR COUPLINGS

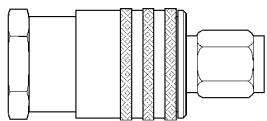

FD40 Series – page 284
MIL-C-4109 Interchange—
Automatic Sleeve

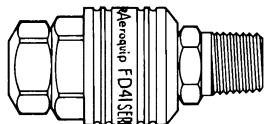

FD41 Series – page 286
ARO-210 Interchange

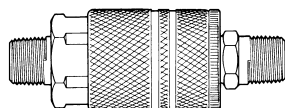

FD43 Series – page 288
MIL-C-4109 Interchange—
Manual Sleeve

HYDRAULIC—FARM

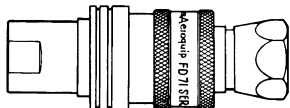

FD71 Series – page 331
Push to Connect
ISO Interchange

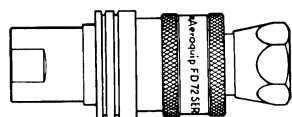

FD72 Series – page 333
Push to Connect
Connect Under Pressure—Male
ISO Interchange

Male Tips

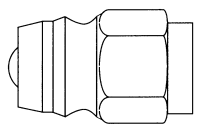

FD70 Series – page 335
Deere Interchange

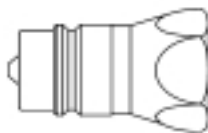

FD76 Series – page 335
ISO Standard

FLUID TRANSFER and HYDRAULIC

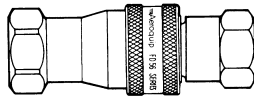

5600 Series – page 324
General Purpose Industrial Interchange
ISO 7241/1 Series A

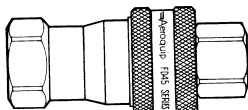

FD45 Series
Steel...page 302
Brass...page 305
Stainless Steel...page 308
Industrial Interchange
ISO 7241/1 Series B

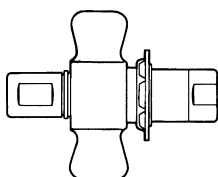

5100 Series – page 317
Thread Together—Low Spill

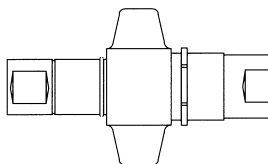

FD86 Series – page 336
5000 psi High Impulse—DryBreak



FD49 Series – page 314
Flush Face—No Spill
HTMA Interchange

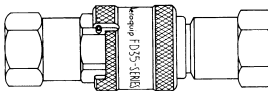

FD35 Series – page 294
High Pressure—“Arc Latch”™

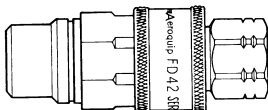

FD42 Series – page 297
Pioneer 4000-2 Interchange

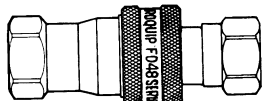

FD48 Series – page 312
Bruning SM-250 Interchange

FLUID TRANSFER and HYDRAULIC

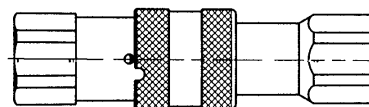

FD89 Series – page 339
ISO 16028 Interchange

FLUID TRANSFER and REFRIGERANT

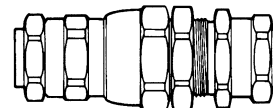

5400 Series – page 320
Low Spill—Low Air Inclusion

SPECIAL APPLICATION

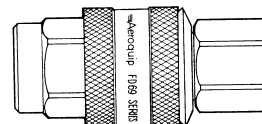

FD69 Series – page 329
Water Blast “Arc Latch”™

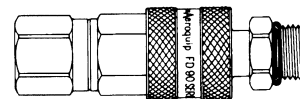

FD90 Series – page 342
Diagnostic SAE J1502 Interchange

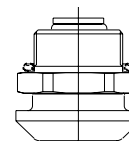

FD14 Series – page 290
Drain Coupling

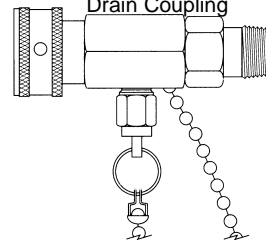

FD15 Series – page 292
Oil Sampling Valve

DRYBREAK



FD56 and FD45 DryBreak – page 300
ISO 7241



How to Order

Aeroquip quick disconnect couplings can generally be ordered as a complete assembly or as separate halves. Couplings ordered by complete assembly part numbers will be supplied by halves. For special packaging, contact Eaton Aeroquip. (The FD14, FD40, FD41, FD43, FD86 and FD90 series are ordered by halves only.)

Standard coupling part numbers are described below:

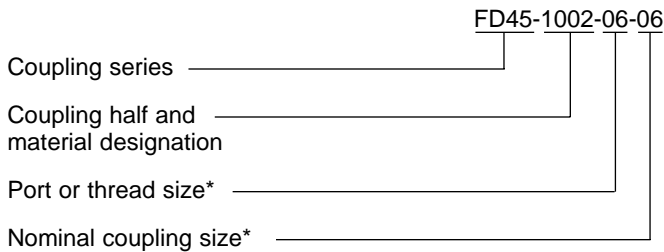
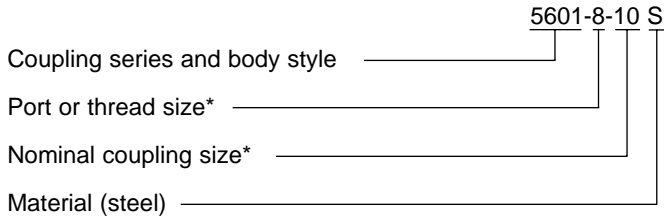

*Size designations are represented in 16ths of an inch, i.e., 06 = 3/16 or 3/8 inch

Dimensions

Dimensions in this catalog are for reference only. Actual dimensions may vary from those shown.

Coupling Identification

Generally, the coupling series or complete part number will be stenciled on the coupling body.

Caution:

The user should observe carefully the precautions listed in this catalog. These include selection of seals and body materials for fluid compatibility and recommendations on the selection of quick disconnect couplings. In addition, care should be taken not to exceed the maximum operating pressures listed for each coupling size and type shown in the physical characteristics table for each coupling. Because of possible variations in machining tolerances, quality control, inspection and quality assurance, Aeroquip coupling halves should not be used with coupling halves supplied by other manufacturers except where such use is approved for a particular coupling as noted in this catalog.

For Technical Assistance Contact:

Eaton Aeroquip
 Industrial Division
 3000 Strayer Road, P.O. Box 631
 Maumee, Ohio 43537-0631
 419/867-2600; Fax: 419/867-2629
 www.aeroquip.com



Construction



Transportation



Forestry



Safety Information for Aeroquip Coupling and Swivel Products

1.0 General Instructions

1.1 Scope. The scope of this safety bulletin is to warn against improper selection, use, installation, etc. of Aeroquip coupling/swivel products.

1.2 Distribution. A copy of this safety bulletin should be distributed to all individuals responsible for using and/or selecting Aeroquip coupling/swivel products.

1.3 Fail-Safe. Design all systems and equipment for fail-safe operation such that failure of any component does not result in personal injury and/or property damage.

1.4 User Responsibility. It is the sole responsibility of the user to select and determine that the Aeroquip product is compatible with the end use application. The user is responsible for reading and following this safety bulletin as well as any instructions or literature on the Aeroquip product being used. The user must provide necessary product warnings for Aeroquip couplings/swivel products, used with systems or equipment, to the operators of the systems or equipment.

1.5 Usage with other Manufacturers' Products. When using Aeroquip coupling/swivel products with other manufacturers' adapters, hoses, etc., do not exceed the lowest pressure rating of any of the components being used or rupture may result.

2.0 Selection of Aeroquip Couplings/Swivels.

2.1 Pressure. Ensure that the maximum operating pressure of the system or equipment does not exceed the rated operating pressure of the Aeroquip coupling/swivel product or rupture may result.

2.2 Fluid compatibility. Verify that all components (seals, metals, etc.) are compatible with the fluid being conveyed. Failure to do so may result in high speed fluid discharge and/or leakage of fluids which may be flammable, toxic, at extreme temperatures, or otherwise harmful.

2.3 Temperature. Ensure that the maximum operating temperature of the system or equipment does not exceed the rated operating temperature of the Aeroquip coupling/swivel product (including seals) or rupture may result.

2.4 Coupling/Swivel Size. Use properly sized couplings/swivels such that there is not a large pressure drop across them thus avoiding system damage due to excessive heat generation or failure of internal components.

2.5 Sleeve Lock. Use sleeve locks or threaded couplings where there is the possibility of accidental disconnection. Failure to utilize sleeve locks or threaded couplings in these applications may result in hose whip, expelled components, high speed fluid discharge, system damage, or leakage of fluids which may be flammable, toxic, at extreme temperatures, or otherwise harmful.

2.6 Connect or Disconnect Under Pressure. If connection and/or disconnection of couplings under pressure is a requirement, only use couplings designed for connection/disconnection under pressure. Failure to utilize this type of coupling in that application may result in hose whip, expelled components, high speed fluid discharge, and/or system damage. Be certain not to confuse the rated operating pressure with the rated connect/disconnect under pressure.

2.7 Environment. Ensure that Aeroquip couplings/swivels are compatible with the surrounding environment. The surrounding environment may be heat, salt water, moisture, chemicals, and the like. Failure to protect against an adverse environment may cause system damage, premature failure, and/or leakage of fluids which may be flammable, toxic, at extreme temperatures, or otherwise harmful.

2.8 External Loads. Avoid any external loads such as side loads, tensile loads, vibration, etc. Failure to do so may result in accidental disconnection, premature failure, system damage, and/or leakage of fluids which may be flammable, toxic, at extreme temperatures, or otherwise harmful.

2.9 Welding & Brazing. Extreme heating of plated products above +450°F (+232°C) such as welding, brazing, baking, etc., where the plating is burned off, may result in the release of deadly gases.

3.0 Installation of Aeroquip Coupling & Swivel Products.

3.1 Inspection of Product. Prior to installation, ensure that the Aeroquip product meets all of the requirements of the system and/or equipment it is to be used on. Ensure you have the correct part number, function test the coupling by connecting it with a mating half, and function test the swivel by rotating the sleeve. The function test should result in smooth, non-binding operation or premature failure may result.

3.2 Cleanliness. Use end caps and plugs to reduce the risk of system contamination or damage to critical sealing surfaces. Failure to do so may result in leakage of fluids which may be flammable, toxic, at extreme temperatures, or otherwise harmful. Caps and plugs are not a secondary seal unless explicitly noted.

3.3 Location. Place Aeroquip couplings and swivels in a safe location such as not to expose the user to personal injury (slippage, tripping, falling, etc.) during installation, connection, disconnection and maintenance.

4.0 Product Maintenance. A maintenance schedule should be put in place to ensure that Aeroquip couplings and swivels are functioning properly.

4.1 Inspection. Visually inspect to ensure that there is NO leakage, cracked components, corrosion build-up, contamination build-up, wear, etc. If any abnormality is encountered, the coupling or swivel should be replaced immediately.

* Specifications and dimensions on this catalogue are subject to change without notice.

SAFETY PRECAUTIONS: Read the instruction manual carefully and thoroughly before using the product, and then use it correctly.



Quick Disconnect Couplings

Quick disconnect couplings are connecting devices which permit easy, immediate connection and separation of fluid lines. When installed in a fluid system, quick disconnect couplings save time by eliminating system bleeding, recharging and purging of air whenever an accessory is being replaced. Dependability is assured because the coupling valves automatically open and close and because the possibility of air, dirt, and moisture being trapped in the system is minimized.

Aeroquip quick disconnect couplings may be used in systems to help align components and the swivel feature helps prevent twisting of hose assemblies. However, they are not intended to be used as swivel joints in applications subjected to constant rotation. Aeroquip swivel joints should be used in these applications. See pages 229-244.

Selection of Quick Disconnect Couplings

See selection chart on pages 280 and 281.

The following questions should be answered before selecting or specifying a quick disconnect coupling.

1. What are the functional requirements of the coupling?
2. To what pressures will the coupling be subjected?
3. What are the flow requirements of the coupling?
4. What is the maximum acceptable pressure drop at specified flow rate?
5. Is the coupling to be connected or disconnected under pressure? How much pressure? Which half?
6. What metals are compatible with the fluid in the system?
7. What seals are compatible with the system's fluid?
8. Are minimum air inclusion or fluid loss upon connection and disconnection critical to the proper operation of the system?
9. What threads and end configurations are necessary?
10. Is bulkhead flange or frame mounting necessary?
11. Should the coupling be interchangeable with other couplings presently in use?

I. Types of Valves

Double Poppet Valves – Most Common

FD14, FD35, FD42, FD45, FD48, 5600, FD71, FD72, FD76

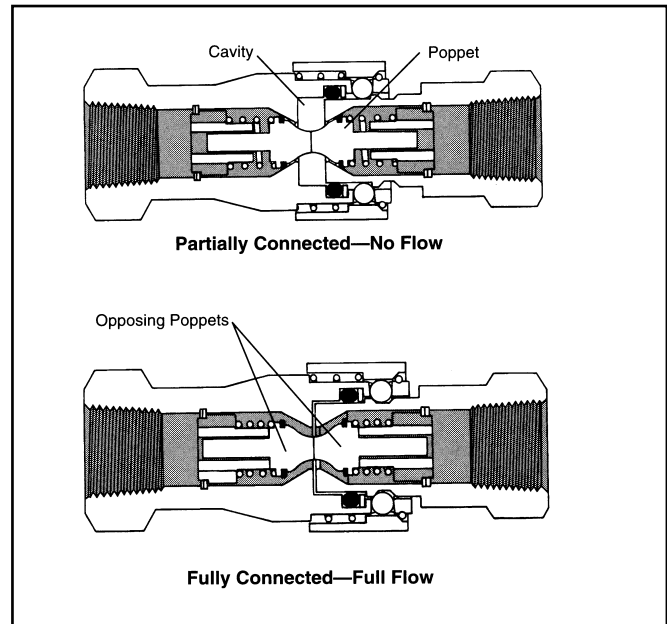

- Spring loaded poppet valves in each half immediately self-seal both halves upon disconnection.
- Cavity between halves allows some air inclusion when connecting and some fluid loss upon disconnection.
- Durable and economical.

Stem Valve and Sleeve – Poppet FD45 DryBreak and FD56 DryBreak

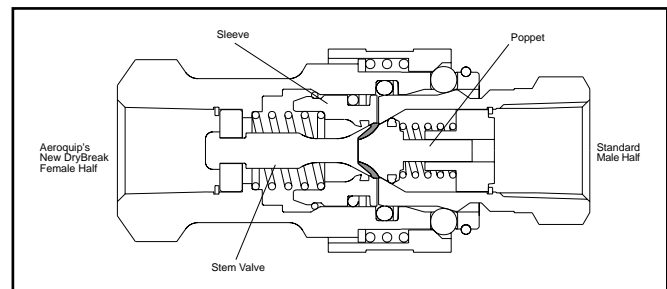

- Patented valving for low air inclusion and fluid loss.
- Allows mating to any standard ISO 7241 poppet style male half.
- Spring loaded sleeve in the female half seals against stem valve and body.
- Poppet valve in opposing half self seals.
- No cavity between halves to cause spillage or air inclusion.



Valved – One Side
FD40, FD41, FD43, FD45, 5600

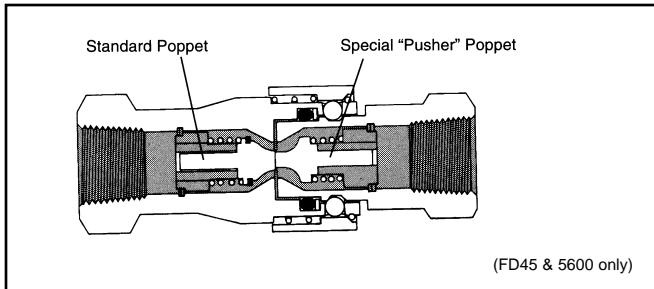

- Immediate self-sealing in valved half only.
- Either male or female half can be valved.
- Full flow in non-valved half upon disconnection.

NOTE: A "Pusher" poppet is needed in non-valved half to open poppet in valved half except for FD40, FD41 and FD43.

No Valves
FD45, 5600, FD69

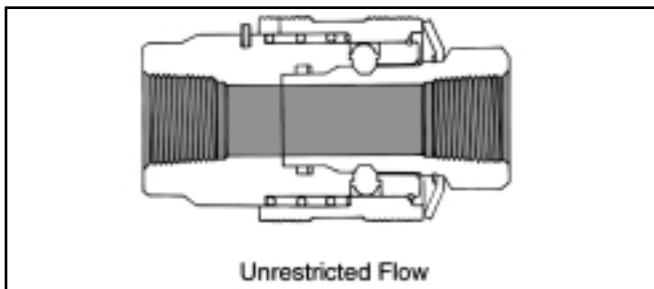

- Full flow when connected and disconnected.
- Minimum pressure drop.
- Maximum flow.

Tubular Valve and Sleeve – Poppet
FD49, 5100, 5400, FD86, FD89, FD90

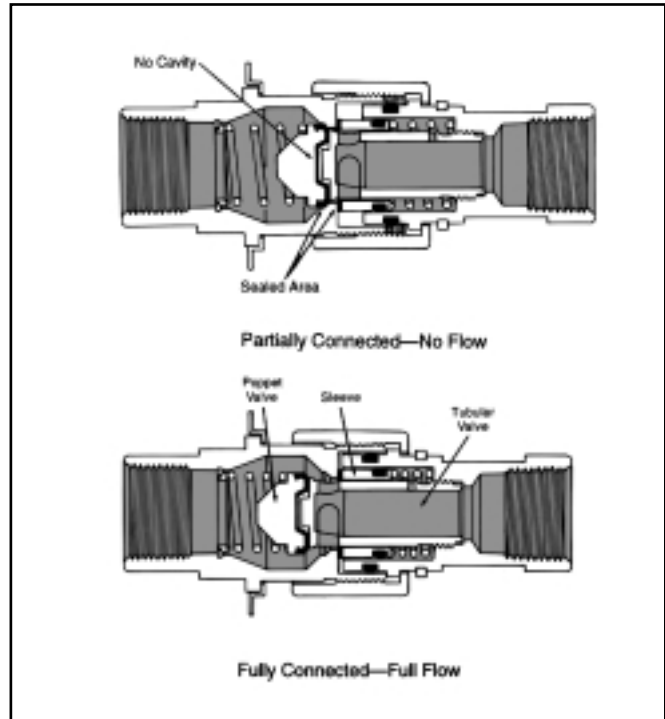

- Precision valving for low air inclusion and fluid loss.
- Spring loaded sleeve provides access to tubular valve ports.
- Poppet valve in opposing half self seals.
- No cavity between halves to cause spillage or air inclusion.

Ball Bearing Valve
FD70

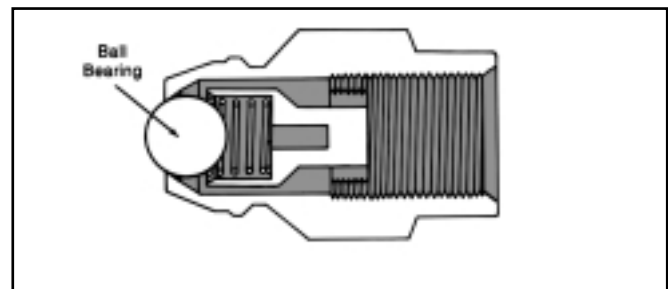

- Spring loaded ball bearing.
- Durable and economical.
- Not recommended for vacuum.
- Metal-to-metal seal.



II. Types of Latches

Threaded Connections 5100, 5400, FD86

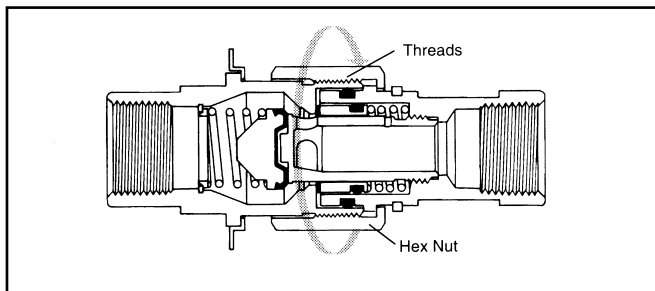

- Uses mechanical advantage of threads to connect or disconnect under pressure.
- Greater holding power under impulsing and vibration.
- Union nuts may be wing or hex type.

Ball Latch Connections FD14, FD40, FD42, FD43, FD45, FD48, FD49, 5600 (FD56), FD71, FD72, FD89, FD90

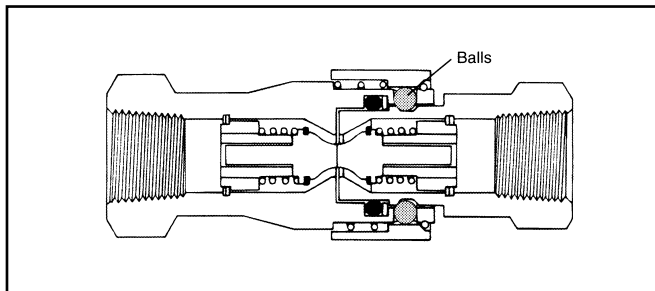

- Series of balls on female half, lock into recess on male half.
- Allows for 360° swiveling (not intended for constant swiveling).
- Quick and easy to connect and disconnect.
- Can be used as an emergency breakaway when female sleeve is frame mounted.
- Most popular and economical latching design.

“Arc Latch™” Connections FD35, FD69

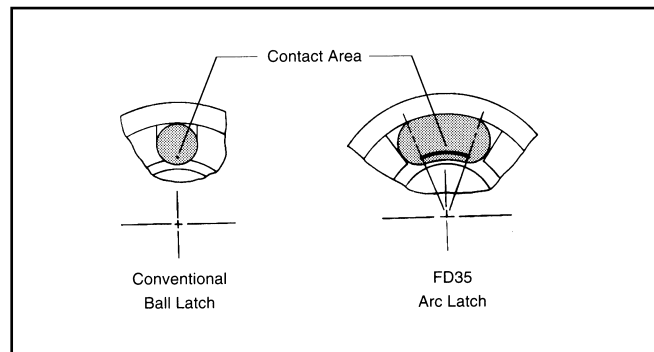

- Exclusive Aeroquip design.
- Series of arcs in female half, lock into recess on male half (same as ball latch).
- Greater surface contact area gives tremendous holding strength.
- For high pressure applications.

Bar/Pin Latch Connections FD41

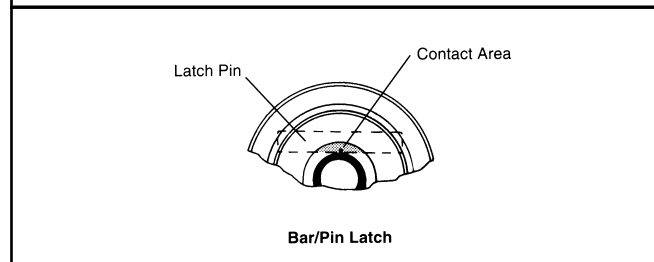
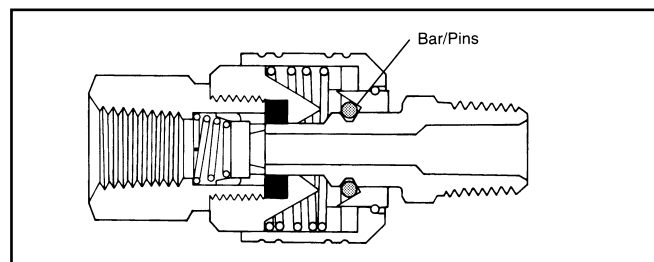

- Two bar/pins in female half lock into recess on male half.
- Allows for 360° swiveling (not intended for constant swiveling).
- Design allows for push to connect operation.
- Typically used for low pressure applications.



Latching Methods—(How To) Push-to-Connect

FD14, FD40, FD41, FD49, FD89, FD90,
(FD71, FD72 when female half is frame mounted)

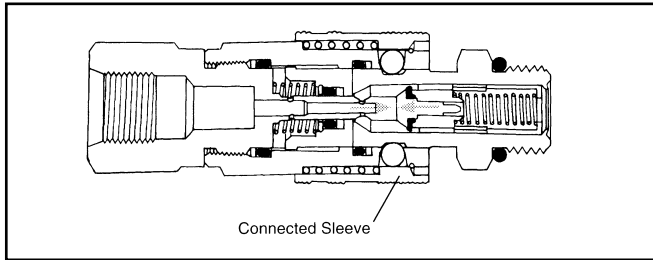

To Connect

- Relieve system pressure.
- Insert and push male half into female half.
- Release sleeve on female half will connect automatically.
- Only one hand is required.
- FD71, FD72, only—to obtain push-to-connect female half must be frame mounted. (Ref. 5603 breakaway frame.) Female half end port must be connected to a 12" minimum length of flexible hose for full female body motion.

To Disconnect

- Relieve system pressure.
- Manually retract release sleeve on female half and remove male half.
- FD71, FD72 only—female half must be frame mounted and will automatically disconnect when male half is pulled out. This requires a slightly higher force to disconnect.

Retract (Sleeve) To-Connect

FD35, FD42, FD43, FD45, FD48, 5600 (FD56), FD69

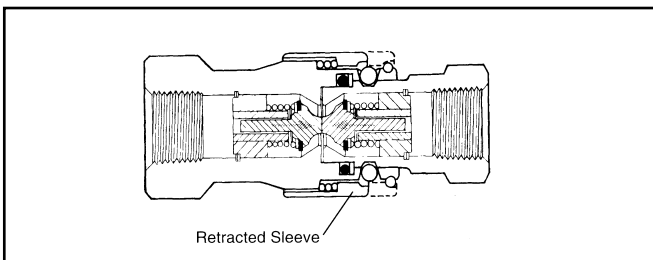

To Connect

- Relieve system pressure.
- Pull back and hold release sleeve on female half.
- Insert male half.
- Let go of release sleeve on female half.

To Disconnect

- Relieve system pressure.
- Pull back and hold release sleeve on female half.
- Remove male half.
- Let go of release sleeve on female half.

Thread-to-Connect

5100, 5400, FD86

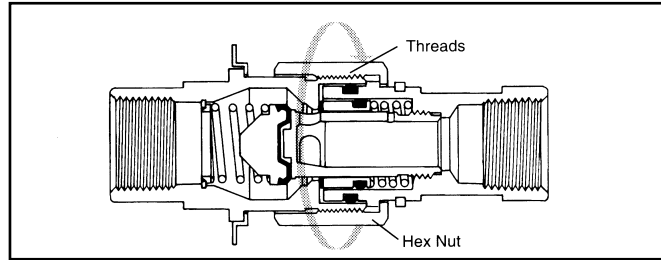

- Prevent male from rotating.
- Insert male into union nut on female body assembly.
- Rotate union nut clockwise.
 - With hand if wing nut type.
 - With wrench if hex nut type.
- Tighten as follows.

5100 Series

- Tighten until halves bottom out and connection indicator groove is no longer visible.

FD86 Series

- Tighten until halves bottom out and connection indicator O-Ring is no longer visible.

5400 Series

- Recommended torque values for S2 half to S5 half are listed below.

Dash Size	Torque – ft. lbs.
–4	10–12
–8	35–37
–12	45–47
–16	65–67

COUPLING SELECTION CHART



WARNING: The information provided in the chart below is provided to assist the customer in the selection of appropriate components. The final selection must take into account fluid type, ambient temperature, concentration of agent, nature of exposure to fluid (intermittent or continuous.) A fluid compatibility chart has been provided on page 282 with additional information in the product description. The failure to evaluate these factors may result in the selection of a connector which may fail under operating conditions with the potential for serious personal injury and property damage.

Where dash sizes appear in the chart below, the coupling is available only in those sizes.

The check marks (✓) in the chart below indicate product is normally available in either final assembly and/or component form. Contact Eaton Aeroquip for availability of products without a check mark.

Function	Nominal Coupling Size (inches)	Dash Size	FD14 Pg. 290	FD15 Pg. 292	FD35 Pg. 294	FD40 Pg. 284	FD41 Pg. 286	FD42 Pg. 297	FD43 Pg. 288	FD45					FD48 Pg. 312
										DryBreak Steel Pg. 300	Steel Pg. 302	Brass Pg. 305	SS Pg. 308		
	1/8	-2									4500	1000			
	1/4	-4		50/300		300	300	3000	300	4000	5000	1000	3000	3000	
	3/8	-6	50		10000	300			300	4000	4000	1000	1500		
	1/2	-8				300			300						
	1/2	-8-10								4000	4000	1000	1500		
	3/4	-12								4000	4000	1000	1500		
	1	-16									4000	1000	1250		
	1 1/4	-20										1000			
	1 1/2	-24													
	2	-32													
Vacuum (in./Hg.)			28	28	28	28	28	28		28/15	28	28	28	28	
Choice of Seals (other seal compounds available upon request)	Buna-N		✓	✓		✓	✓	✓		✓	✓	✓	✓	✓	
	Neoprene								✓						
	EPR									✓	✓	✓	✓		
	Viton*		✓		✓					✓	✓	✓	✓		
Valve Options	No-spill valving			N/A						✓					
	Double valve		✓	N/A	✓			✓		✓	✓	✓	✓	✓	
	Valved male only			N/A							✓	✓	✓		
	Valved female only			N/A		✓	✓		✓		✓	✓	✓		
	Straight thru - no valves			N/A							✓	✓	✓		
Basic Material	Steel		✓	✓	✓	✓	✓	✓	✓	✓	✓			✓	
	Brass											✓			
	Stainless Steel												✓		
	Aluminum														
	Polypropylene														
Latch Style	"Arc latch" TM				✓										
	Ball latch		✓			✓		✓	✓	✓	✓	✓	✓	✓	
	Bar Pin latch						✓								
	Threaded														
End Connections	Female pipe		✓		✓	✓	✓	✓	✓	✓	✓	✓	✓	✓	
	Male pipe		✓	✓		✓	✓		✓						
	Fem. st. thd. O-ring				✓			✓							
	Male st. thd. O-ring		✓	✓											
	SAE 37° (JIC) male														
	Metric male O-ring		✓												
	Braze														
	Hose barb								✓						
Mounting Method	Bulkhead							✓							
	Flange														
	Frame														
Connect Under Pressure					✓	✓		✓							
Caps/Plugs		✓		✓			✓		✓	✓	✓	✓	✓		
Full Field Service				✓						✓	✓	✓			
Push to Connect (Automatic Sleeve)		✓			✓	✓									
Interchangeable with Other Brands				✓	✓	✓	✓	✓	✓	✓	✓	✓	✓		

*Viton is a DuPont trademark.



Function	Nominal Coupling Size (inches)	Dash Size	FD49 Pg. 314	5100 Pg. 317	5400 Pg. 320	5600		FD69 Pg. 329	FD71 Pg. 331	FD72 Pg. 333	FD86 Pg. 336	FD89 Pg. 339	FD90 Pg. 342	
						DryBreak Pg. 300	Standard Pg. 324							
Maximum Operating Pressure (psi connected)	1/8	-2												
	1/4	-4		3000*	3000*		5000					4350	7000	
	3/8	-6	3000	3000*		4000	4000					4350		
	1/2	-8		3000*	1750*			10000				3625		
	1/2	-8-10				4000	4000		3000	3000				
	3/4	-12		3000*	700*	4000	4000					3625		
	1	-16		3000*	700*		4000				5000	3625		
	1 1/4	-20			2750*						5000	3625		
	1 1/2	-24			2500*							2900		
Vacuum (in./Hg.)	2	-32										2900		
Choice of Seals (other seal compounds available upon request)	Buna-N		✓	✓		✓	✓	✓	✓	✓	✓	✓	✓	
	Neoprene				✓									
	EPR			✓		✓	✓	✓			✓		✓	
	Viton [†]			✓		✓	✓	✓			✓		✓	
Valve Options	No spill valving		✓	✓	✓	✓					✓	✓	✓	
	Double valve		✓	✓	✓	✓	✓		✓	✓	✓	✓	✓	
	Valved male only						✓							
	Valved female only						✓							
	Straight thru – no valves						✓	✓						
Basic Material	Steel		✓		✓	✓	✓	✓	✓	✓	✓	✓	✓	
	Brass			✓										
	Stainless Steel							✓						
	Aluminum													
	Polypropylene													
Latch Style	"Arc latch" [™]							✓						
	Ball latch		✓			✓	✓		✓	✓		✓	✓	
	Bar Pin latch													
	Threaded			✓	✓						✓			
End Connections	Female pipe		✓	✓		✓	✓	✓	✓	✓	✓	✓	✓	
	Male pipe												✓	
	Fem. st. thd. O-ring		✓			✓	✓				✓		✓	
	Male st. thd. O-ring		✓										✓	
	SAE 37° (JIC) male				✓								✓	
	Metric male O-ring												✓	
	Braze				✓									
Hose barb														
Mounting Method	Bulkhead			✓					✓	✓			✓	
	Flange			✓							✓			
	Frame					✓	✓		✓	✓				
Connect Under Pressure		500	500	✓		-8 -10				✓	750		500	
Caps/Plugs		✓	✓	✓	✓	✓			✓	✓	✓	✓	✓	
Full Field Service			✓	✓		✓	✓				✓			
Push to Connect (Automatic Sleeve)		✓							✓	✓		✓	✓	
Interchangeable with Other Brands		✓	✓	✓	✓	✓	✓		✓	✓		✓	✓	

*Not recommended for continuous hydraulic impulse applications at maximum operating pressure.
[†]Viton is a DuPont trademark.



WARNING: Final responsibility for determining compatibility rests with the user.

FLUID COMPATIBILITY

This chart indicates the suitability of various elastomers and metals for use with fluids to be conveyed. It is intended for use with Aeroquip couplings and should not be used to determine compatibility for other products.

HOW TO USE THE CHART

- 1. Both the elastomer and the metal must be considered when determining suitability of a combination for a coupling.
2. Locate the fluid to be conveyed and determine the suitability of the elastomeric and metal components according to the resistance ratings shown for each.
3. Dimensional and operation specifications for each coupling can be found on the catalog pages.
4. Information on seal options for couplings, and how to specify them, are shown in the respective sections of this catalog.
5. Be sure to check the table below for maximum operating temperature range of the elastomer for desired temperature.
6. For further details on the products shown in this catalog, and their applications, contact Eaton Aeroquip Inc., Industrial Division, Maumee, Ohio, 419-867-2600.
7. Coupling component materials may differ from body material. Refer to specific catalog pages.

RESISTANCE RATING KEY

E=Excellent - Fluid has little or no effect.
G=Good - Fluid has minor to moderate effect.
C=Conditional - Service conditions should be described to Eaton Aeroquip for determination of suitability for application.
U=UNSATISFACTORY

The differences between ratings "E" and "G" are relative. Both indicate satisfactory service. Where there is a choice, the materials rated "E" may be expected to give better or longer service than those rated "G".

SEAL ELASTOMER DATA

Table with 3 columns: Seal Elastomer, Application Specification, Max. Operating Temperature Range. Rows include Buna-N, Neoprene, EPB (Ethylene Propylene Rubber), and Viton.

NOTE: This chart does not apply to bonded seals used in the 5100 and FD86 Series Couplings. Consult Eaton Aeroquip for special applications.

Compatibility chart for seal elastomers: Buna-N, Neoprene, EPB/EPDM, Viton*, Steel, Brass, Cres, Aluminum, Monel. Lists various fluids and their compatibility ratings.

Main compatibility chart listing fluid types and their compatibility ratings with various seal materials (Buna-N, Neoprene, EPB/EPDM, Viton*) and metal components (Steel, Brass, Cres, Aluminum, Monel).

This chart is intended for reference use only. The information in this chart pertains strictly to material compatibility and is not intended to be used as an application guide. See page 272 for application information. For applications not included on these pages, please contact Eaton Aeroquip Inc. *Viton is a DuPont trademark.



E = EXCELLENT G = GOOD C = CONDITIONAL U = UNSATISFACTORY	Buna-N	Neoprene	EPR/EPDM	Viton*	Steel	Brass	Cres	Aluminum	Monel
	SEALS				METAL				
FLUID	SEALS				METAL				
Ethylene Dichloride	U	U	U	G	G	C	G	G	G
Ethylene Glycol	U	U	U	G	G	C	G	G	G
Ferric Chloride	F	F	F	F	F	F	F	F	F
Ferric Nitrate	F	F	F	F	F	F	F	F	F
Ferric Sulfate	F	F	F	F	F	F	F	F	F
Formaldehyde	C	C	C	C	F	F	F	F	F
Formic Acid	C	C	C	C	F	F	F	F	F
Fuel Oil	C	C	C	C	F	F	F	F	F
Furfural	C	C	C	C	F	F	F	F	F
Gallic Acid	F	F	F	F	F	F	F	F	F
Gasoline	F	F	F	F	F	F	F	F	F
Gasohol	F	F	F	F	F	F	F	F	F
Glycerine/Glycerol	F	F	F	F	F	F	F	F	F
Green Sulfate Liquor	G	G	G	G	F	F	F	F	F
Helium	U	U	U	U	U	U	U	U	U
Heptane	U	U	U	U	U	U	U	U	U
Hexaldehyde	U	U	U	U	U	U	U	U	U
Hexane	U	U	U	U	U	U	U	U	U
Hydraulic Oils	F	F	F	F	F	F	F	F	F
Straight Petroleum	F	F	F	F	F	F	F	F	F
Water Petroleum Emulsion	F	F	F	F	F	F	F	F	F
Water Glycol	F	F	F	F	F	F	F	F	F
Straight Phosphate Ester	F	F	F	F	F	F	F	F	F
Phos. Ester/ Petroleum Blend	U	U	U	C	F	F	F	F	F
Ester Blend	F	U	U	F	F	F	F	F	F
Silicone Oils	F	U	U	F	F	F	F	F	F
Hydrobromic Acid	U	U	U	F	F	F	F	F	F
Hydrochloric Acid	U	U	U	F	F	F	F	F	F
Hydrocyanic Acid	C	C	C	C	F	F	F	F	F
Hydrofluoric Acid	U	U	U	C	F	F	F	F	F
Hydrofluorosilic Acid	G	G	G	F	F	F	F	F	F
Hydrogen	F	F	F	F	F	F	F	F	F
Hydrogen Peroxide	U	U	U	F	F	F	F	F	F
Hydrogen Sulfide, Dry	U	U	U	F	F	F	F	F	F
Isocyanate	U	U	U	U	F	F	F	F	F
Iso Octane	U	U	U	U	F	F	F	F	F
Isopropyl Acetate	U	U	U	U	F	F	F	F	F
Isopropyl Alcohol	G	G	G	U	G	G	G	G	G
Isopropyl Ether	G	G	G	U	G	G	G	G	G
JP-4, JP-5	U	U	U	U	F	F	F	F	F
Kerosene	U	U	U	U	F	F	F	F	F
Lacquer/Lacquer Solvents	U	U	U	U	F	F	F	F	F
Lime Sulfur	U	U	U	U	F	F	F	F	F
Linseed Oil	E	G	U	E	E	E	E	E	E
LPG	E	G	U	E	E	E	E	E	E
Lubricating Oils	F	F	F	F	F	F	F	F	F
Magnesium Chloride	F	F	F	F	F	C	G	G	G
Magnesium Hydroxide	G	G	G	F	F	F	F	F	F
Magnesium Sulfate	G	G	G	F	F	F	F	F	F
Maleic Acid	U	U	U	U	F	F	F	F	F
Maleic Anhydride	U	U	U	U	F	F	F	F	F
Malic Acid	G	G	G	G	F	F	F	F	F
Mercuric Chloride	U	U	U	U	F	F	F	F	F
Mercury	F	F	F	F	F	F	F	F	F
Methanol	G	G	G	U	G	G	G	G	G
Methyl Bromide	G	G	G	U	G	G	G	G	G
Methyl Chloride	U	U	U	U	F	F	F	F	F
Methyl Butyl Ketone	U	U	U	U	F	F	F	F	F
Methyl Ethyl Ketone	U	U	U	U	F	F	F	F	F
Methylene Chloride	U	U	U	U	F	F	F	F	F
Methyl Isobutyl Ketone	U	U	U	U	F	F	F	F	F
Methyl Isopropyl Ketone	U	U	U	U	F	F	F	F	F
Methyl Salicylate	U	U	U	U	F	F	F	F	F
MIL-L-2104	F	F	F	F	F	F	F	F	F
MIL-D-5606	F	F	F	F	F	F	F	F	F
MIL-H-6083	F	F	F	F	F	F	F	F	F
MIL-L-7808	G	G	G	F	F	F	F	F	F
MIL-L-23699	G	G	G	F	F	F	F	F	F
MIL-H-46170	G	G	G	F	F	F	F	F	F
MIL-H-83282	F	F	F	F	F	F	F	F	F
Mineral Oils	F	F	F	F	F	F	F	F	F
Naphtha	U	U	U	U	F	F	F	F	F
Naphthalene	U	U	U	U	F	F	F	F	F
Naphthenic Acid	C	C	C	C	F	F	F	F	F
Natural Gas	F	F	F	F	F	F	F	F	F
Nickel Acetate	C	C	C	C	F	F	F	F	F
Nickel Chloride	E	E	E	E	F	F	F	F	F
Nickel Sulfate	E	E	E	E	F	F	F	F	F
Nitric Acid, to 10%	U	U	U	U	F	F	F	F	F
Nitric Acid, over 10%	U	U	U	U	F	F	F	F	F
Nitrobenzene	U	U	U	U	F	F	F	F	F
Nitrogen	F	F	F	F	F	F	F	F	F
Octyl Alcohol	F	F	F	F	F	F	F	F	F

This chart is intended for reference use only. The information in this chart pertains strictly to material compatibility and is not intended to be used as an application guide. See page 272 for application information. For applications not included on these pages, please contact Eaton Aeroquip Inc.
*Viton is a DuPont trademark.

E = EXCELLENT G = GOOD C = CONDITIONAL U = UNSATISFACTORY	Buna-N	Neoprene	EPR/EPDM	Viton*	Steel	Brass	Cres	Aluminum	Monel
	SEALS				METAL				
FLUID	SEALS				METAL				
Oleic Acid	U	U	U	G	C	F	G	C	U
Oleum (Fuming Sulfuric Acid)	U	U	U	C	C	C	C	C	C
Oleum (Mineral Spirits)	F	F	F	F	F	F	F	F	F
Ortho-Dichlorobenzene	U	U	U	U	F	F	F	F	F
Oxalic Acid	C	C	C	C	F	F	F	F	F
Oxygen	F	F	F	F	F	F	F	F	F
Palmitic Acid	F	F	F	F	F	F	F	F	F
Para-Dichlorobenzene	U	U	U	U	F	F	F	F	F
Pentane	U	U	U	U	F	F	F	F	F
Perchloroethylene	U	U	U	U	F	F	F	F	F
Phenol (Carbolic Acid)	U	U	U	U	F	F	F	F	F
Phosphoric Acid	U	U	U	U	F	F	F	F	F
Phosphorous Trichloride	U	U	U	U	F	F	F	F	F
Potassium Acetate	G	G	G	F	F	F	F	F	F
Potassium Chloride	F	F	F	F	F	F	F	F	F
Potassium Cyanide	F	F	F	F	F	F	F	F	F
Potassium Dichromate	F	F	F	F	F	F	F	F	F
Potassium Hydroxide, to 10%	G	G	F	U	G	G	G	U	F
Potassium Hydroxide, over 10%	C	C	E	U	G	G	G	U	F
Potassium Nitrate	F	F	F	F	F	F	F	F	F
Potassium Sulfate	F	F	F	F	F	F	F	F	F
Propane	U	U	U	U	F	F	F	F	F
Propyl Acetate	U	U	U	U	F	F	F	F	F
Propyl Alcohol	U	U	U	U	F	F	F	F	F
Propylene	U	U	U	U	F	F	F	F	F
Refrigerant R-12	U	U	U	U	F	F	F	F	F
Refrigerant R-13	G	G	G	G	F	F	F	F	F
Refrigerant R-22	U	U	U	U	F	F	F	F	F
Refrigerant R-134a	U	U	U	U	F	F	F	F	F
Sewage	U	U	U	U	F	F	F	F	F
Soap (Water Solutions)	F	F	F	F	F	F	F	F	F
Sodium Acetate	G	G	G	F	F	F	F	F	F
Sodium Bicarbonate	F	F	F	F	F	F	F	F	F
Sodium Borate	F	F	F	F	F	F	F	F	F
Sodium Carbonate	F	F	F	F	F	F	F	F	F
Sodium Chloride	F	F	F	F	F	F	F	F	F
Sodium Cyanide	U	U	U	U	F	F	F	F	F
Sodium Hydroxide, to 10%	U	G	F	F	C	G	C	U	C
Sodium Hydroxide, over 10%	U	U	G	E	C	C	C	U	C
Sodium Hypochlorite	C	C	F	C	U	U	U	U	G
Sodium Metaphosphate	F	F	F	F	F	F	F	F	F
Sodium Nitrate	G	G	G	F	F	F	F	F	F
Sodium Perborate	G	G	G	F	F	F	F	F	F
Sodium Peroxide	G	G	G	F	F	F	F	F	F
Sodium Phosphates	F	F	F	F	F	F	F	F	F
Sodium Silicate	F	F	F	F	F	F	F	F	F
Sodium Sulfate	F	F	F	F	F	F	F	F	F
Sodium Sulfide	F	F	F	F	F	F	F	F	F
Sodium Thiosulfate	G	G	G	U	C	C	C	U	C
Soy Bean Oil	F	F	F	F	F	F	F	F	F
Stannic Chloride	F	F	F	F	F	F	F	F	F
Steam (up to 300°F)	U	U	U	U	F	F	F	F	F
Stearic Acid	G	G	G	G	F	F	F	F	F
Stoddard Solvent	U	U	U	U	F	F	F	F	F
Styrene	U	U	U	U	F	F	F	F	F
Sulfur	U	U	U	U	F	F	F	F	F
Sulfur Chloride	U	U	U	U	F	F	F	F	F
Sulfur Dioxide	U	U	U	U	F	F	F	F	F
Sulfur Trioxide	U	U	U	U	F	F	F	F	F
Sulfuric Acid, over 10%	U	U	U	U	F	F	F	F	F
Sulfurous Acid	U	U	U	U	F	F	F	F	F
Tannic Acid	F	F	F	F	F	F	F	F	F
Tar (Bituminous)	G	G	G	G	F	F	F	F	F
Tartaric Acid	G	G	G	G	F	F	F	F	F
Tertiary Butyl Alcohol	U	U	U	U	F	F	F	F	F
Titanium Tetrachloride	U	U	U	U	F	F	F	F	F
Toluene (Toluol)	U	U	U	U	F	F	F	F	F
Trichlorethylene	U	U	U	U	F	F	F	F	F
Tricresyl Phosphate	U	U	U	U	F	F	F	F	F
Triethanolamine	U	U	U	U	F	F	F	F	F
Tung Oil	G	G	G	G	F	F	F	F	F
Turpentine	U	U	U	U	F	F	F	F	F
Varnish	U	U	U	U	F	F	F	F	F
Vinyl Chloride	U	U	U	U	F	F	F	F	F
Water (to +150°F)	U	U	U	U	F	F	F	F	F
Water (+151°F to +200°F)	U	U	U	U	F	F	F	F	F
Water (+201°F to +250°F)	U	U	U	U	F	F	F	F	F
Xylene	U	U	U	U	F	F	F	F	F
Zinc Chloride	F	F	F	F	F	F	F	F	F
Zinc Sulfate	F	F	F	F	F	F	F	F	F



FD40 Series/MIL-C-4109 Industrial Interchange – Air

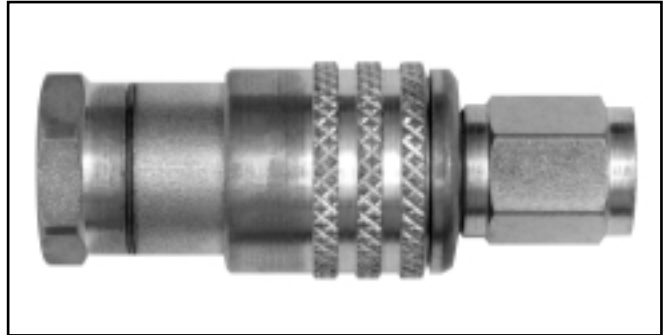
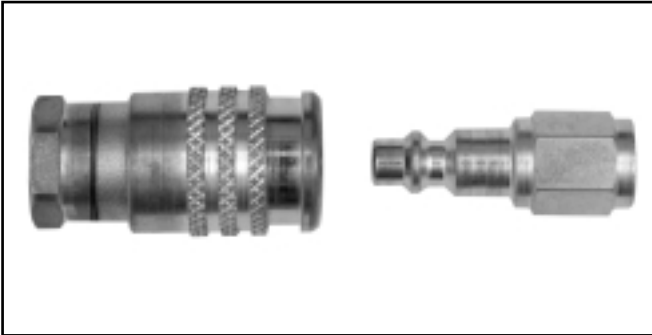

The FD40 Series offers a one-hand push-to-connect latch ideal for compressed air service. The female half features self-sealing poppet valves, preventing air loss while disconnected. Male half uses straight through design.

- Automatic sleeve for one-hand push-to-connect operation.
- Protective collar to prevent accidental snagging and disconnection.
- Meet dimensional requirements of MIL-C-4109 for industrial interchangeability.
- Swivels 360°, eliminating hose kinking.
- Ball latching mechanism.
- Standard seal material – Buna-N.
- Standard body material – Zinc plated steel.

Flow Data

Pressure Drop Versus Flow Graph

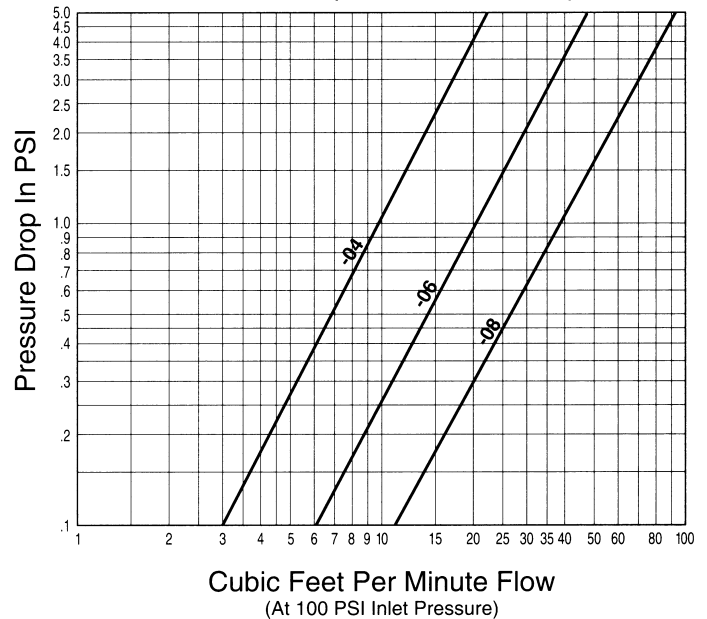

Physical Characteristics

Coupling Size	Maximum Operating Pressure (psi)	Minimum Burst Pressure (psi)		Vacuum (in./Hg.) Connected Only
		Female Half Only	Connected	
-04	300	3000	8000	28
-06	300	3000	8000	28
-08	300	2000	8000	28

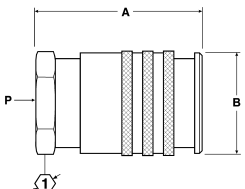
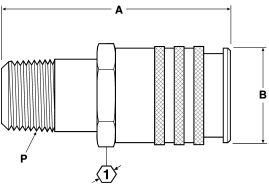
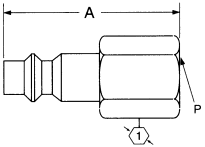
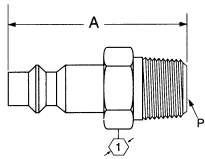

FD40 Series	Coupling Size	Thread Size(P)	Dimensional Data			Part Number Buna-N	Line Ref.
			A	B	ϕ		
Female Half Female Pipe/Valved 	-04	1/4-18	1.88	1.00	.81	FD40-1000-04-04	1
	-04	3/8-18	2.56	1.00	.94	FD40-1000-06-04	2
	-06	1/4-18	2.63	1.16	.94	FD40-1000-04-06	3
	-06	3/8-18	2.13	1.16	.94	FD40-1000-06-06	4
	-08	1/2-14	2.38	1.28	1.06	FD40-1000-08-08	5
							6
							7
							8
Female Half Male Pipe/Valved 	-04	1/4-18	2.63	1.00	.81	FD40-1001-04-04	9
	-04	3/8-18	2.63	1.00	.81	FD40-1001-06-04	10
	-06	3/8-18	2.88	1.16	.94	FD40-1001-06-06	11
	-08	1/2-14	3.50	1.28	.88	FD40-1001-08-08	12
							13
							14
							15
							16
Male Half Female Pipe/Non-Valved 	-04	1/8-27	1.21		.56	FD40-1013-02-04	17
	-04	1/4-18	1.62		.62	FD40-1013-04-04	18
	-04	3/8-18	1.80		.88	FD40-1013-06-04	19
	-06	3/8-18	1.90		.88	FD40-1013-06-06	20
	-08	1/2-14	2.40		1.12	FD40-1013-08-08	21
							22
							23
							24
Male Half Male Pipe/Non-Valved 	-04	1/8-27	1.50		.50	FD40-1014-02-04	25
	-04	1/4-18	1.75		.56	FD40-1014-04-04	26
	-04	3/8-18	1.75		.69	FD40-1014-06-04	27
	-06	1/4-18	1.88		.62	FD40-1014-04-06	28
	-06	3/8-18	1.88		.69	FD40-1014-06-06	29
	-06	1/2-14	2.13		.88	FD40-1014-08-06	30
	-08	3/8-18	2.18		.69	FD40-1014-06-08	31
	-08	1/2-14	2.44		.88	FD40-1014-08-08	32



FD41 Series/ARO 210 Interchange – Air

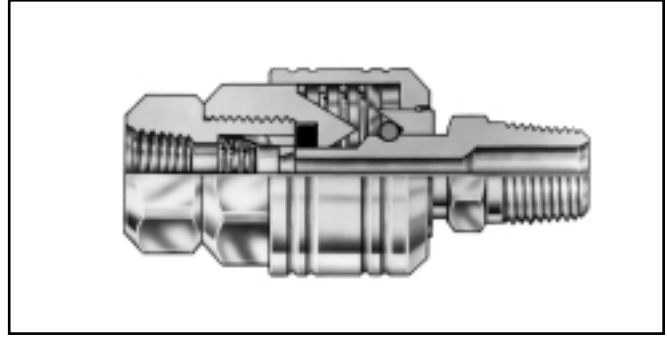
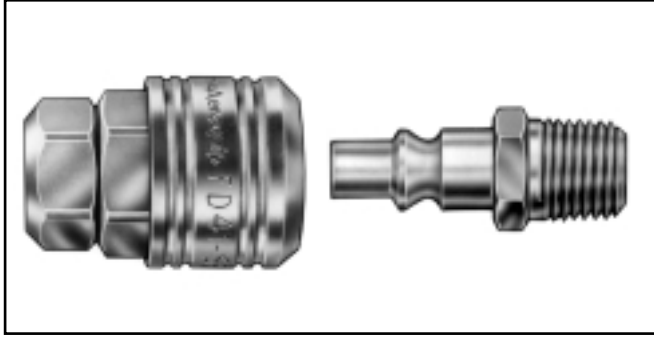

The FD41 interchanges with the ARO 210 Series for compressed air service, with a self-sealing female half and straight through male half.

- Designed to interchange with ARO 210 Series.
- Automatic sleeve for one hand push-to-connect operation.
- Swivels 360°, eliminating hose kinking.
- Designed to assure high flow with low pressure drop for peak tool performance.
- Standard seal material – Buna-N.
- Standard body material – Zinc plated steel.

Flow Data

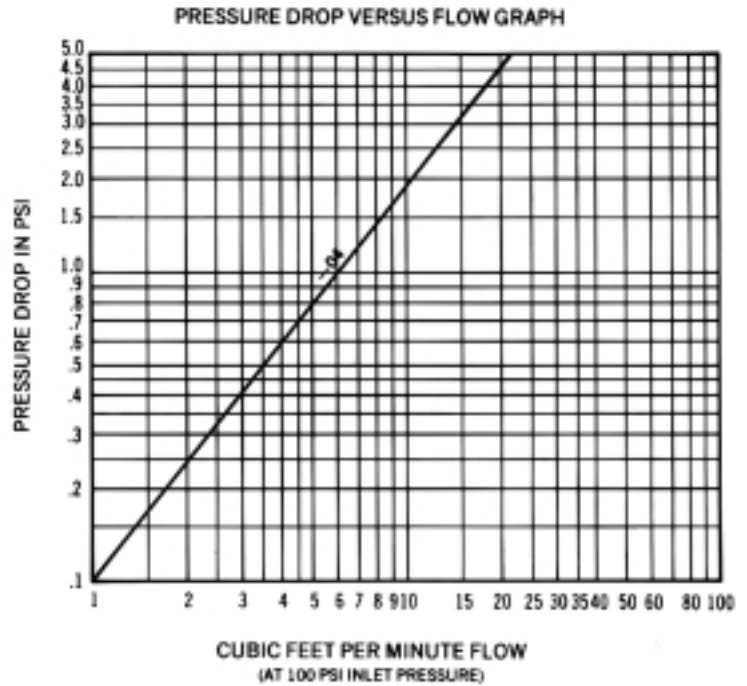

Physical Characteristics

Coupling Size	Maximum Operating Pressure (psi)	Minimum Burst Pressure (psi)		Vacuum (in./Hg.) Connected Only
		Female Half Only	Connected	
-04	300	3000	8000	28

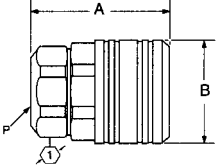
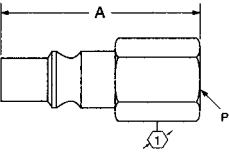
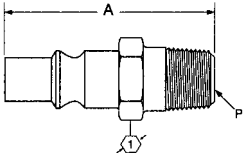

FD41 Series	Coupling Size	Thread Size (P)	Dimensional Data			Part Number Buna-N	Line Ref.
			A	B	\sqrt{D}		
Female Half Female Pipe/Valved 	-04	1/8-27	2.15	1.12	.62	FD41-1000-02-04	1
	-04	1/4-18	1.62	1.12	.81	FD41-1000-04-04	2
							3
							4
							5
							6
							7
							8
Male Half Female Pipe/Non-Valved 	-04	1/4-18	1.51	-	.62	FD41-1013-04-04	9
							10
							11
							12
							13
							14
							15
							16
Male Half Male Pipe/Non-Valved 	-04	1/4-18	1.61	-	.56	FD41-1014-04-04	17
							18
							19
							20
							21
							22
							23
							24



FD43 Series/Industrial Interchange—Air

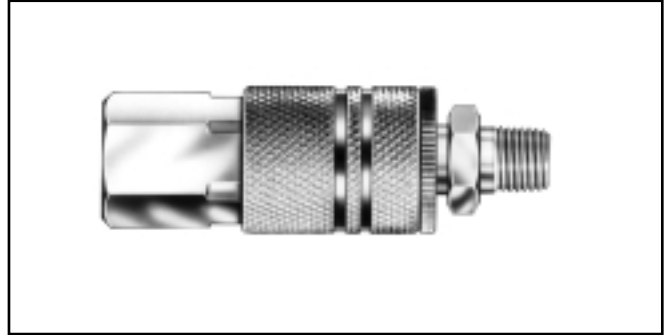
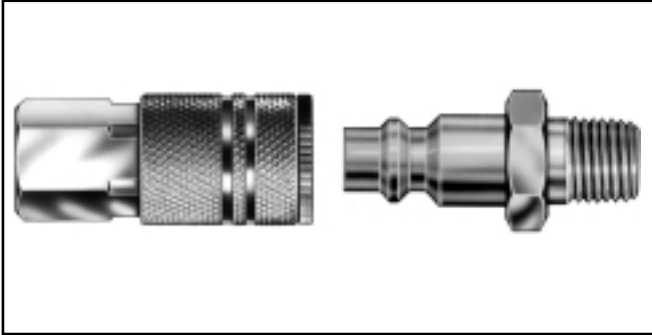

The FD43 Series is a manual retract-type ball latch industrial interchange coupling. Ideal for compressed air service, the FD43 uses FD40 male tips.

- Meets dimensional requirements of MIL-C-4109 specifications for industrial interchangeability.
- Protective collar to prevent accidental snagging and disconnection.
- Manual retract latch design allows quick and easy connection of hose lines.
- Swivels 360°, eliminating hose kinking.
- Standard seal material – Neoprene.
- Standard body material – Zinc plated steel.

Flow Data

**FD43 SERIES
PRESSURE DROP VERSUS FLOW GRAPH**

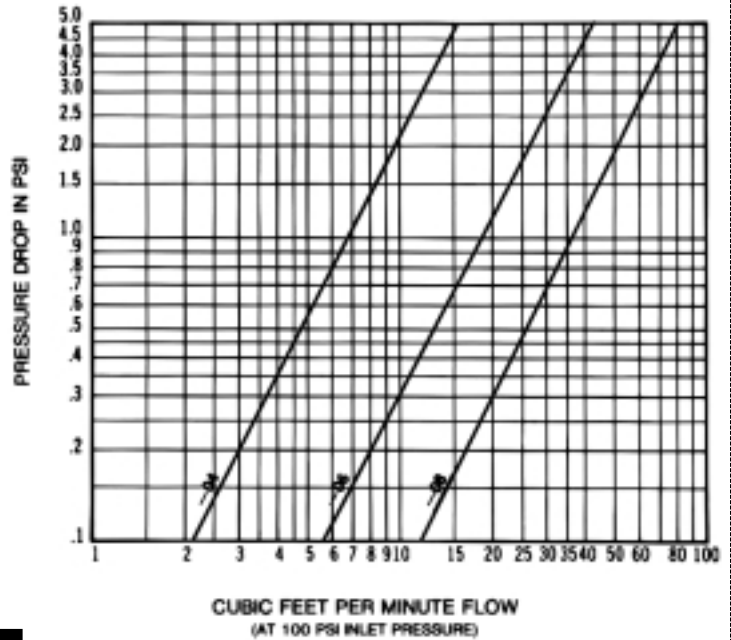

Physical Characteristics

Coupling Dash Size	Maximum Operating Pressure (psi)	Minimum Burst Pressure (psi)		Vacuum (in./Hg.) Connected Only
		Female Half Only	Connected	
-04	300	3000	8000	Not Rated
-06	300	3000	8000	Not Rated
-08	300	2000	8000	Not Rated



FD43 Series	Coupling Size	Thread Size(P)	Hose I.D.	Dimensional Data			Part Number Neoprene	Line Ref.
				A	B			
Female Half Female Pipe/Valved 	-04	1/8-27		1.88	.88	.75	FD43-1001-02-04	1
	-04	1/4-18		2.09	.88	.75	FD43-1001-04-04	2
	-04	3/8-18		2.16	.88	.81	FD43-1001-06-04	3
	-06	1/4-18		2.38	1.06	.88	FD43-1001-04-06	4
	-06	3/8-18		2.38	1.06	.88	FD43-1001-06-06	5
	-06	1/2-14		2.53	1.06	1.00	FD43-1001-08-06	6
	-08	1/2-14		3.06	1.19	1.00	FD43-1001-08-08	7
Female Half Male Pipe/Valved 	-04	1/8-27		2.19	.88	.75	FD43-1011-02-04	8
	-04	1/4-18		2.28	.88	.75	FD43-1011-04-04	9
	-04	3/8-18		2.34	.88	.75	FD43-1011-06-04	10
	-06	1/4-18		2.41	1.06	.88	FD43-1011-04-06	11
	-06	3/8-18		2.44	1.06	.88	FD43-1011-06-06	12
	-06	1/2-14		2.56	1.06	.88	FD43-1011-08-06	13
Female Half SOCKETLESS™ Hose Barb/Valved 	-04		1/4	2.78	.88	.75	FD43-1031-04-04	15
	-04		3/8	2.78	.88	.75	FD43-1031-06-04	16
								17
								18
								19
								20
Male Half Female Pipe/Non-Valved 	-04	1/8-27		1.21		.56	FD40-1013-02-04	22
	-04	1/4-18		1.62		.62	FD40-1013-04-04	23
	-04	3/8-18		1.80		.88	FD40-1013-06-04	24
	-06	3/8-18		1.90		.88	FD40-1013-06-06	25
	-08	1/2-14		2.40		1.12	FD40-1013-08-08	26
								27
Male Half Male Pipe/Non-Valved 	-04	1/8-27		1.50		.50	FD40-1014-02-04	29
	-04	1/4-18		1.75		.56	FD40-1014-04-04	30
	-04	3/8-18		1.75		.69	FD40-1014-06-04	31
	-06	1/4-18		1.88		.62	FD40-1014-04-06	32
	-06	3/8-18		1.88		.69	FD40-1014-06-06	33
	-06	1/2-14		2.13		.88	FD40-1014-08-06	34
	-08	3/8-18		2.18		.69	FD40-1014-06-08	35
	-08	1/2-14		2.44		.88	FD40-1014-08-08	36



FD14 Series/Drain Coupling

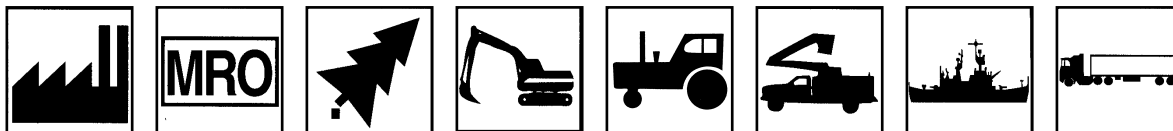

Male Half with Rubber Molded Cap



Female Half

The FD14 Drain coupling is designed to serve as a drain port for use with systems such as the Aeroquip FLOCS® (Fast Lube Oil Change System) as well as providing a purging port for use during prefill operations.

- Low-Profile, with multiple sealing mechanisms
 - O-ring – primary seal
 - Metal-to-metal – Secondary Seal
 - Rubber protective cap - Secondary Seal
- Push-To-Connect female half for easy one-hand operation
- Broad range of standard thread styles for Male Half
 - Utilizes a Copper-Crush gasket to seat against the port face.
- Standard male half seal material - Viton*
- Standard female half seal material - Buna-N
- Standard body material - Zinc plated steel with zinc die-cast valve
- Rubber molded cap
 - Standard material - Buna-N

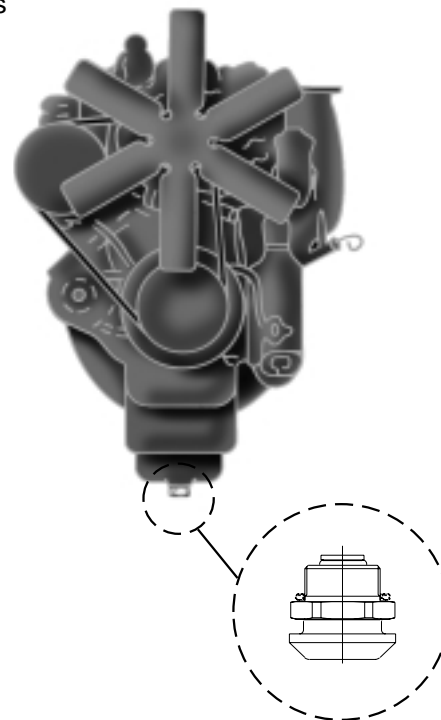

Physical Characteristics

Coupling Size	Maximum Operating Pressure (psi)	Minimum Burst Pressure (psi)	Vacuum (in./Hg.)	Rated Flow (gpm)
-06	50	200	28	3

*Viton is a DuPont trademark.



Aeroquip FD14 Drain Coupling

Providing direct access for fast oil changes.

The FLOCS® Direct Access Conversion Kit uses the Aeroquip-developed FD14 Drain Coupling as an alternative to the standard remote hose kit. This coupling design permits easy, one-hand connection and disconnection of the evacuation unit's hose.

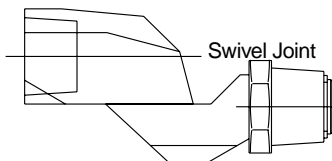
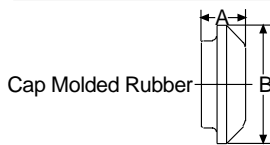
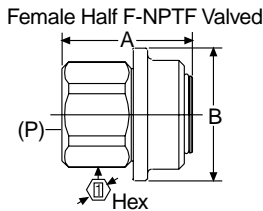
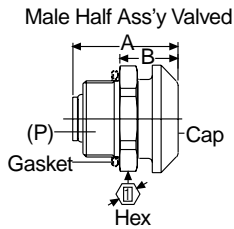

Coupling Size	Thread Size (P)	A	B		Ass'y Torque (Ft.-Lbs.)	Assembly (Includes Gasket & Cap)	Gasket (Copper-Crush)	Cap (Buna-N)
-06	1/2 - 20 UNF - 2A	1.33	.56	15/16	20-24*	FD14-1002-01-06	FD14-1206-01	FD14-1204-06
-06	M18 x 1.5 6g	1.33	.56	1 1/4	20-40*	FD14-1002-02-06	FD14-1206-04	FD14-1204-06
-06	M14 x 1.25 6g	1.33	.56	15/16	20-24*	FD14-1002-03-06	FD14-1206-02	FD14-1204-06
-06	1 1/4 - 18 UNEF - 2A	1.37	.56	1 1/2	30-60*	FD14-1002-05-06	FD14-1206-11	FD14-1204-06
-06	1 - 18 UNS - 2A	1.37	.56	1 1/4	30-60*	FD14-1002-06-06	FD14-1206-07	FD14-1204-06
-06	7/8 - 18 UNS - 2A	1.37	.56	1 1/4	30-60*	FD14-1002-07-06	FD14-1206-06	FD14-1204-06
-06	5/8 - 18 UNF - 2A	1.33	.56	15/16	20-40*	FD14-1002-08-06	FD14-1206-03	FD14-1204-06
-06	3/4 - 16 UNF - 2A	1.37	.56	1 1/4	30-50*	FD14-1002-09-06	FD14-1206-04	FD14-1204-06
-06	7/8 - 14 UNF - 2A	1.37	.56	1 1/4	30-60*	FD14-1002-10-06	FD14-1206-06	FD14-1204-06
-06	M24 x 2 6g	1.37	.56	1 1/4	30-60*	FD14-1002-11-06	FD14-1206-07	FD14-1204-06
-06	9/16 - 18 UNF - 2A	1.33	.56	15/16	20-40*	FD14-1002-12-06	FD14-1206-02	FD14-1204-06
-06	1 1/8 - 12 UNF - 2A	1.37	.56	1 1/2	30-60*	FD14-1002-14-06	FD14-1206-09	FD14-1204-06
-06	M20 x 1.5 6g	1.37	.56	1 1/4	30-60*	FD14-1002-16-06	FD14-1206-05	FD14-1204-06
-06	M25 x 1.5 6g	1.37	.56	1 1/4	30-60*	FD14-1002-17-06	FD14-1206-07	FD14-1204-06
-06	M22 x 1.5 6g	1.37	.56	1 1/4	30-60*	FD14-1002-18-06	FD14-1206-06	FD14-1204-06
-06	M24 x 1.5 6g	1.37	.56	1 1/4	30-60*	FD14-1002-19-06	FD14-1206-07	FD14-1204-06
-06	1 1/16 - 12 UN - 2A	1.37	.56	1 1/2	30-60*	FD14-1002-20-06	FD14-1206-08	FD14-1204-06
-06	M30 x 1.5 6g	1.37	.56	1 1/2	30-60*	FD14-1002-21-06	FD14-1206-10	FD14-1204-06
-06	1/2 - 14 UNS - 2A	1.33	.56	15/16	20-24*	FD14-1002-22-06	FD14-1206-01	FD14-1204-06
-06	M12 x 1.5 6g	1.33	.56	15/16	20-24*	FD14-1002-23-06	FD14-1206-01	FD14-1204-06
-06	M14 x 1.5 6g	1.33	.56	15/16	20-24*	FD14-1002-24-06	FD14-1206-02	FD14-1204-06
-06	M12 x 1.75 6g	1.33	.56	15/16	20-24*	FD14-1002-25-06	FD14-1206-01	FD14-1204-06
-06	3/4 - 14 Dryseal NPTF	1.52	.56	1 1/4		FD14-1002-26-06	None Needed	FD14-1204-06

* CAUTION: Failure to meet minimum assembly torque could result in fluid leakage.

Coupling Size	Thread Size (P)	A	B		Assembly
-06	3/4 - 14 Dryseal NPTF	1.83	1.81	1 5/16	FD14-1001-12-06

Coupling Size	A	B	Cap (Buna-N)
-06	0.519	1.400	FD14-1204-06

Coupling Size	Thread Size (P)	Assembly
-06	3/4 - 14 Dryseal NPTF	FD14-1004-12-12

FLOCS System Components & Accessories



- FLOCS Oil Thief Sampling System

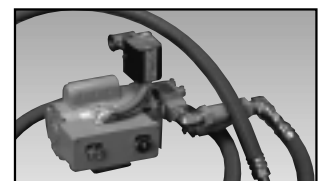

- FLOCS 15 Direct Access Oil Evacuation Unit (Electric)

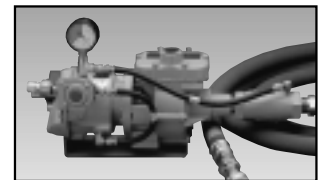

- FLOCS 30A Air Powered Oil Evacuation Unit



FD15 Series/Oil Sampling Valve

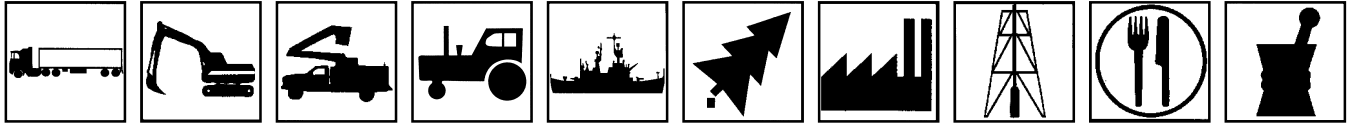

0-50 psi

Part Number	Inlet Ports
FD15-1026-04	1/4" NPTF
FD15-1025-04	7/16"-20 Male ORB

As required in MIL-V-81940/2-1 this valve's flow rate is between 100 and 1500 milliliters per minute at pressures from 0-50 psi. (MIL-V-81940/2-1 applies only to pressures from 50-300 psi.)



50-300 psi

Part Number	Inlet Ports
FD15-1000-02	1/8" NPTF
FD15-1000-04*	1/4" NPTF
FD15-1002-04	7/16"-20 Male ORB

*The 1/4" NPTF version is qualified to MIL-V-81940/2-1 and its performance is representative of the other inlet port configurations listed above.
QPL-81940-9 6-5-89

FD15 Oil Sampling Valve: In-line sampling of system fluids is made without system shutdown, usually in less than one minute, and without fluid contamination.

Application: Engine oil, lubricating oil, transmission fluid and hydraulic fluids in mobile construction equipment, military vehicles, trucks and stationary equipment.

For best results, Aeroquip FD15 Oil Sampling Valves should be installed in dynamic fluid lines in low pressure and return lines. If only one sampling point can be chosen, it should be in the return line, upstream of any return line filter. This will insure a representative sample of all components in the fluid system for their present condition.

Operation: Remove metal dustcover on discharge port. Discharge approximately 200 ml of oil to flush valve by turning knurled knob 1/4 turn to the right. Dispose of this sample in the appropriate manner. Locate clean oil sample bottle under discharge port.

(Sample bottles are usually supplied by the oil analysis lab.) Turn knurled knob 1/4 turn to the right until bottle is filled to the desired level. The knob can be backed off to throttle the rate of flow. When bottle is filled let go of the knurled knob, the valve will close automatically. Replace metal dustcover wrench tight.

Construction: Corrosion resistant plated steel with brass internal components and Viton® seals.

Operating Temperature Range: -65°F to +275°F (-53°C to +135°C)

Minimum Burst Pressure: 1200 psi

Minimum Particle Restriction: 500 microns

Maximum Torque to Operate: 10 in. lbs.

Note: This valve is not intended for aerospace applications.

*Viton is a trademark of DuPont.



FD15 Series	Coupling Size	Thread Size (P)	Dimensional Data						Part Number Viton*	Line Ref.
			A	B	C	①	②	③		
<p>Male Pipe Thread 50-300 psi</p>	-	1/8-27	2.42	1.00	1.30	.69	.38	-	FD15-1000-02	1
	-	1/4-18	2.56	1.00	1.30	.69	.38	-	FD15-1000-04	2
										3
										4
										5
										6
										7
										8
<p>Male SAE O-Ring Thread 50-300 psi</p>	-	7/16-20	2.79	1.00	1.30	.69	.38	.56	FD15-1002-04	9
										10
										11
										12
										13
										14
										15
										16
<p>Male Pipe Thread 0-50 psi</p>	-	1/4-18	2.56	1.00	1.30	.69	.38	-	FD15-1026-04	17
										18
										19
										20
										21
										22
										23
										24
<p>Male SAE O-Ring Thread 0-50 psi</p>	-	7/16-20	2.79	1.00	1.30	.69	.38	.56	FD15-1025-04	25
										26
										27
										28
										29
										30
										31
										32

*Viton is a DuPont trademark.



FD35 Series/Arc Latch™ for 10,000 psi High Pressure Applications

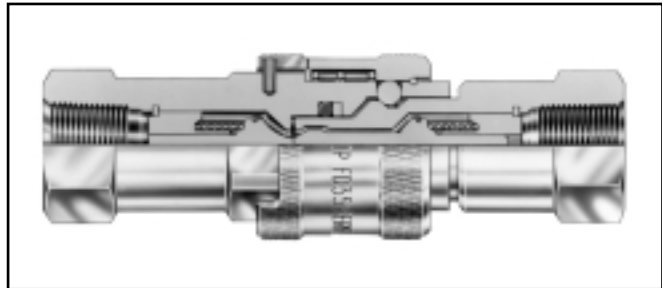
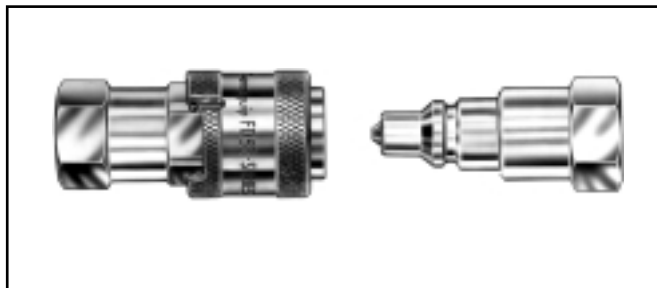
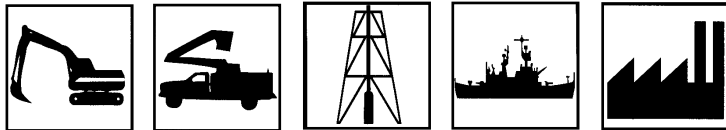

The FD35 Series Arc Latch™ design has a greater surface contact area for long surface life in rugged high pressure applications. The maximum operating pressure is 10,000 psi.

- Safety sleeve lock prevents accidental disconnection.
- Heavy duty back-up ring prevents O-ring extrusion.
- Heat treated and plated steel for greater wear and corrosion resistance.
- Self-sealing poppet valves provide excellent high and low pressure sealing.
- Standard seal material – Viton*.
- Standard body material – Zinc plated steel.

Flow Data

Pressure Drop Versus Flow Graph

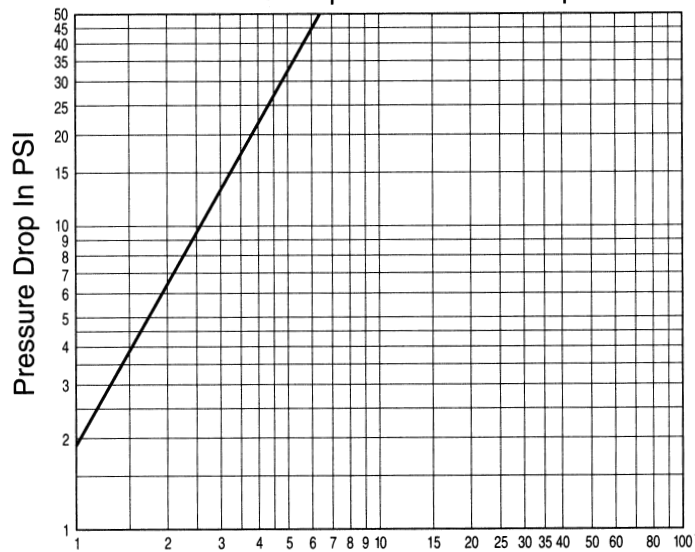

Gallons Per Minute Flow
(Test Fluid MIL-H-5606 Hydraulic Oil At 100° F.)

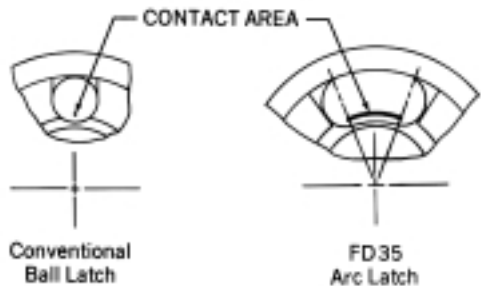

Physical Characteristics						
Coupling Size	Maximum Operating Pressure (psi)	Minimum Burst Pressure (psi)	Vacuum (in./Hg.)	Rated Flow (gpm)	Air Inclusion (cc. max.)	Fluid Loss (cc. max.)
-06	10,000	40,000	28	2	0.50	0.50



*Viton is a DuPont trademark.

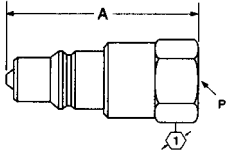
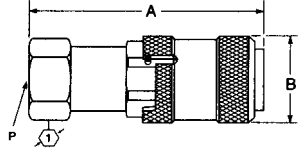
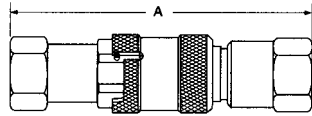
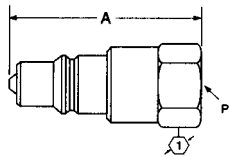
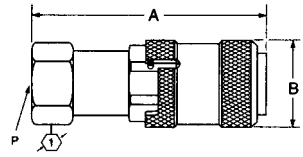

FD35 Series	Coupling Size	Thread Size (P)	Dimensional Data			Part Number Viton*	Line Ref.	
			A	B	ϕ			
Male Half Female Pipe/Valved 	-06	3/8-18	2.05		0.94	FD35-1002-06-06	1	
								2
								3
								4
								5
								6
								7
								8
Female Half Female Pipe/Valved 	-06	3/8-18	2.56	1.27	0.94	FD35-1001-06-06	9	
								10
								11
								12
								13
								14
								15
								16
Complete Coupling Female Pipe/Valved 	-06	3/8-18	3.53			FD35-1000-06-06	17	
								18
								19
								20
								21
								22
								23
								24
Male Half Female SAE O-Ring/Valved 	-06	9/16-18	2.05		0.94	FD35-1008-06-06	25	
								26
								27
								28
								29
								30
								31
								32
Female Half Female SAE O-Ring/Valved 	-06	9/16-18	2.56	1.27	0.94	FD35-1007-06-06	33	
								34
								35
								36
								37
								38
								39
								40

*Viton is a DuPont trademark.

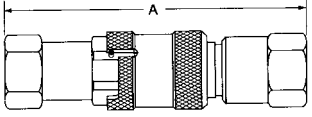
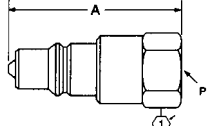
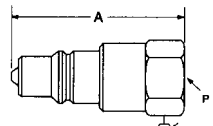

FD35 Series	Coupling Size	Thread Size(P)	Dimensional Data			Part Number Viton*	Line Ref.
			A	B	ϕ		
Complete Coupling Female SAE O-Ring/Valved 	-06	9/16-18	3.53			FD35-1006-06-06	1
							2
							3
							4
							5
							6
							7
							8
Male Half Female Pipe/45 psi Bleed Valve  Incorporates a special relief valve set at 45 psi, preventing disconnected pressure build-up.	-06	3/8-18	2.05		0.94	FD35-1043-06-06	9
							10
							11
							12
							13
							14
							15
							16
Male Half Female SAE O-Ring/ 45 psi Bleed Valve  Incorporates a special relief valve set at 45 psi, preventing disconnected pressure build-up.	-06	9/16-18	2.12		0.94	FD35-1044-06-06	17
							18
							19
							20
							21
							22
							23
							24
Repair Kits							25
	-06	Male Valving				FF10173-06	26
	-06	Female Valving				FF10174-06	27
	-06	Female Locking Arc Latch				FF10175-06	28
Accessories							29
Dust Cover 	-06	Fits Male and Female Halves				FD35-1042-06	30
							31
							32
							33
							34
							35
							36
							37

*Viton is a DuPont trademark.



FD42 Series/Pioneer 4000 Interchange

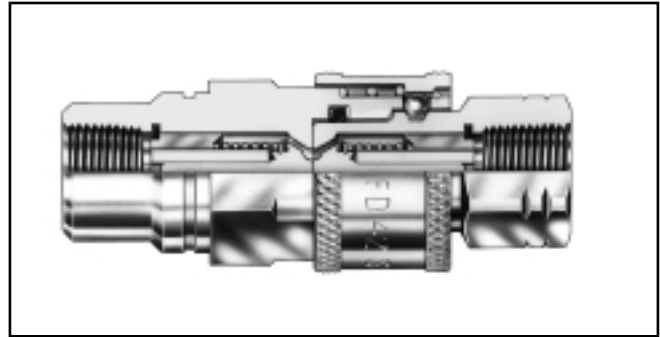
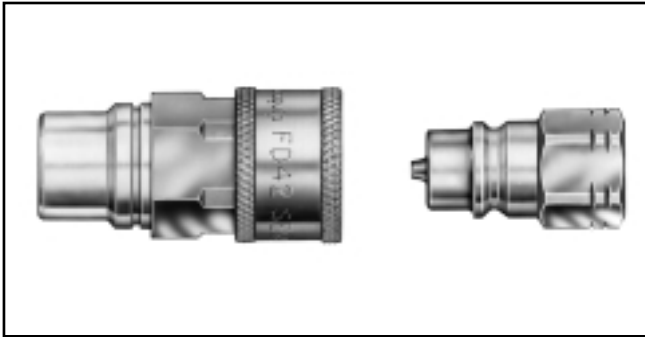

The FD42 Series coupling is designed as a Pioneer 4000 interchange to accommodate high surge flows typically found in snow plow applications. The maximum operating pressure is 3,000 psi.

- PTFE back up ring in female half improves impulse life.
- Self-sealing poppet valve design provides excellent high and low pressure sealing.
- *PUSH-PULL™* ball latch design allows quick and easy connection and disconnection of hose lines.
- Interchanges with Pioneer 4000-2 and Safeway S20-A.
- Retaining groove on female half for bulkhead mounting.
- Male half can be bulkhead mounted with optional adapter.
- Standard seal material – Buna-N.
- Standard body material – Zinc plated steel with zinc poppet guides.

Flow Data

Pressure Drop Versus Flow Graph

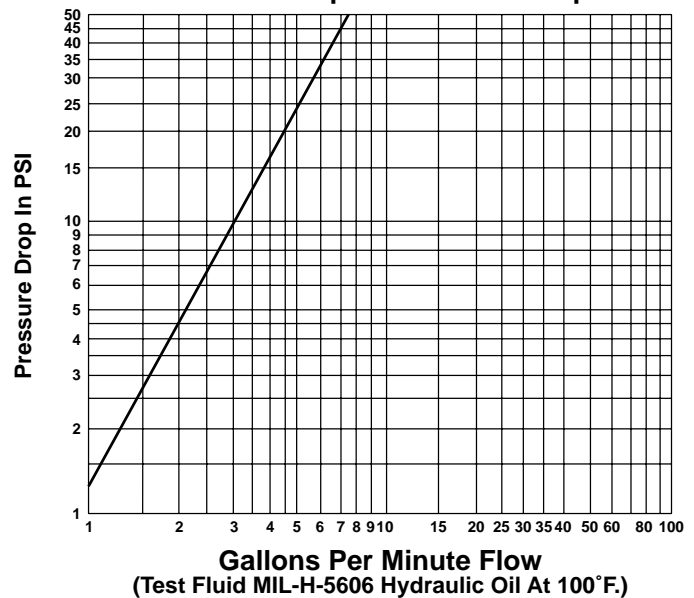

Physical Characteristics

Coupling Size	Maximum Operating Pressure (psi)	Minimum Burst Pressure (psi)	Vacuum (in./Hg.)	Rated Flow (gpm)	Air Inclusion (cc. max.)	Fluid Loss (cc. max.)
-04	3000	12,000	28	3	.62	.80



FD42 Series	Coupling Size	Thread Size (P)	Dimensional Data						Part Number Buna-N	Line Ref.
			A	B	C	D	E			
Male Half Female Pipe/Valved 	-04	1/4-18	1.34					.75	FD42-1002-04-04	1
										2
										3
										4
										5
										6
										7
										8
Female Half Female Pipe/Valved 	-04	1/4-18	2.04	1.06	.87	.05	.10	.88	FD42-1001-04-04	9
										10
										11
										12
										13
										14
										15
										16
Complete Coupling Female Pipe/Valved 	-04	1/4-18	2.68						FD42-1000-04-04	17
										18
										19
										20
										21
										22
										23
										24
Male Half Female SAE O-Ring/Valved 	-04	9/16-18	1.63					.81	FD42-1010-06-04	25
										26
										27
										28
										29
										30
										31
										32
Female Half Female SAE O-Ring/Valved 	-04	9/16-18	2.13	1.06	.87	.05	.10	.88	FD42-1008-06-04	33
										34
										35
										36
										37
										38
										39
										40
Complete Coupling Female SAE O-Ring/Valved 	-04	9/16-18	2.97						FD42-1006-06-04	41
										42
										43
										44
										45
										46
										47



FD42 Accessories	Coupling Size	Thread Size (P)	Dimensional Data						Part Number Buna-N	Line Ref.
			A	B	C	D	E			
Bulkhead Adapter 	-04	1/4-18	1.39	.87	.08			.88	FF1607-0404S	1
										2
										3
										4
										5
										6
										7
										8
Dust Cap/Plug (Fits Both Halves) 	-04								FD48-1042-04	9
										10
										11
										12
										13
										14
										15
										16



DryBreak

ISO INTERCHANGE

The Aeroquip DryBreak Difference

DryBreak/Industrial Interchange Coupling

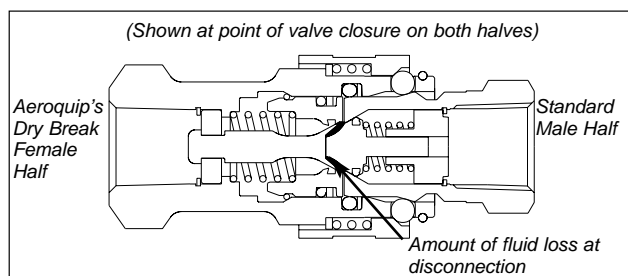

Industry Standard Opposed Poppet Style

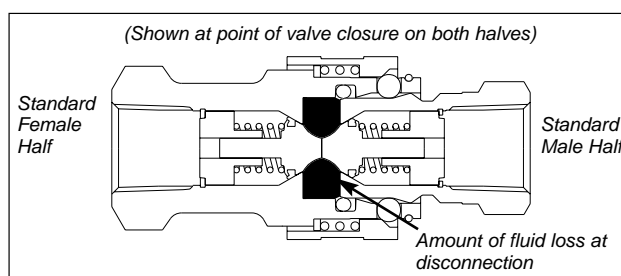

DryBreak Valves

DryBreak Valve for the 5600 Series

- Mates with all standard poppet valved style ISO 7241/1 Series A male halves.
- Economical Patented concave stem valve in the female coupling half that provides disconnecting fluid loss rates comparable with more expensive flush faced coupling styles.
- Standard Seal Materials – Buna-N, Viton*, and EPR available on request.
- Standard body material – Zinc plated steel.

DryBreak Valve for the FD45 Series

- Mates with all standard poppet valved style ISO 7241/1 Series B male halves.
- Economical Patented concave stem valve in the female coupling half that provides disconnecting fluid loss rates comparable with more expensive flush faced coupling styles.
- Standard Seal Materials – Buna-N, Viton*, and EPR available on request.
- Standard body material – Zinc plated steel.

Physical Characteristics

Coupling Size	Maximum Operating Pressure (psi)	Minimum Burst Pressure (psi)	Vacuum (in./Hg.)	Rated Flow (gpm)	Air Inclusion (cc. max.)	Fluid Loss (cc. max)
-06	4,000	12,000	28	6	.36	.05
-10	4,000	12,000	28	12	1.14	.08
-12	4,000	12,000	15	28	1.19	.23

Physical Characteristics

Coupling Size	Maximum Operating Pressure (psi)	Minimum Burst Pressure (psi)	Vacuum (in./Hg.)	Rated Flow (gpm)	Air Inclusion (cc. max.)	Fluid Loss (cc. max)
-04	4,000	15,000	28	3	.25	.02
-06	4,000	12,000	28	6	.89	.05
-10	4,000	12,000	28	12	1.12	.08
-12	4,000	12,000	15	28	2.53	.23

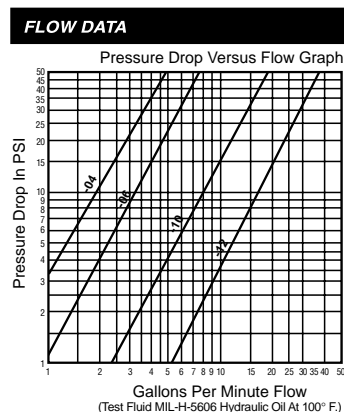
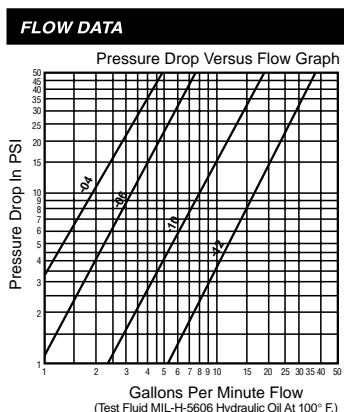

*Viton is a DuPont trademark.

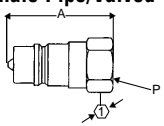
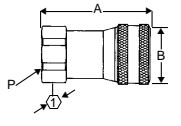
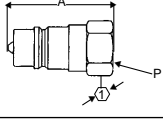
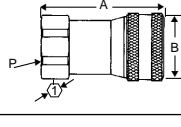
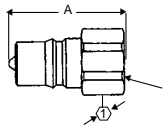
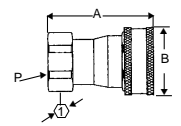

	Coupling Size	Thread Size (P)	Dimensional Data			Buna-N	Line Ref.
			A	B	①		
5600 SERIES							
Standard Male Half Female Pipe/Valved 	-06	3/8-18	1.40		.88	5602-6-6S	1
	-10	1/2-14	1.89		1.06	5602-8-10S	2
	-12	3/4-14	2.28		1.38	5602-12-12S1	3
							4
							5
Female Half Female Pipe/DryBreak Valving ISO-7241-A 	-06	3/8-18	2.23	1.23	1.00	FD56-4001-06-06	6
	-10	1/2-14	2.70	1.50	1.19	FD56-4001-08-10	7
	-12	3/4-14	3.29	1.81	1.50	FD56-4001-12-12	8
							9
							10
							11
							12
							13
							14
							15
Standard Male Half Female SAE O-Ring/Valved 	-06	9/16-18	1.50		.88	5610-6-6S	13
	-10	3/4-16	2.03		1.06	5610-8-10S	14
	-12	1 1/16-12	2.55		1.38	5610-12-12S	15
							16
							17
Female Half Female SAE O-Ring/DryBreak Valving 	-06	9/16-18	2.23	1.23	1.00	FD56-4101-06-06	19
	-10	3/4-16	2.70	1.50	1.19	FD56-4101-08-10	20
	-12	1 1/16-12	3.33	1.81	1.50	FD56-4101-12-12	21
							22
							23
							24
							25
FD45 SERIES							
Standard Male Half Female Pipe/Valved 	-04	1/4-18	1.53		.75	FD45-1002-04-04	25
	-06	3/8-18	1.69		.88	FD45-1002-06-06	26
	-10	1/2-14	1.96		1.06	FD45-1002-08-10	27
	-12	3/4-14	2.41		1.31	FD45-1002-12-12	28
							29
Female Half Female Pipe/DryBreak Valving ISO-7241-B 	-04	1/4-18	2.35	1.10	.81	FD45-4001-04-04	31
	-06	3/8-18	2.65	1.36	1.06	FD45-4001-06-06	32
	-10	1/2-14	3.02	1.67	1.31	FD45-4001-08-10	33
	-12	3/4-14	3.44	2.04	1.62	FD45-4001-12-12	34
							35
							36
							37
							38



FD45 Series/Industrial Interchange Series B ... (Steel)

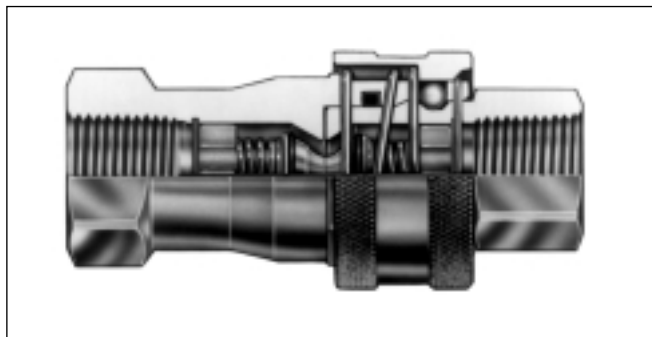
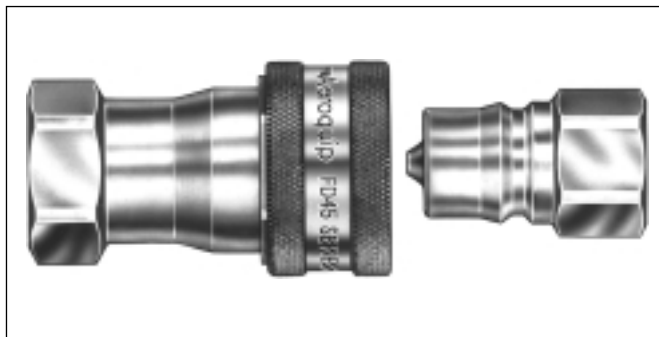
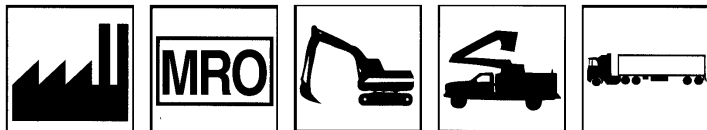

The FD45 Series steel is an industrial interchange popular in North America. Features rugged ball latch mechanism with automatic self-sealing poppet valves.

- Industrial interchange coupling conforming dimensionally to ISO standard 7241/1 Series B.
- *PUSH-PULL*[™] ball latch design allows quick and easy connection and disconnection of hose lines.
- Self-sealing poppet valve design provides excellent high and low pressure sealing.
- Standard seal material – Buna-N, EPR and Viton.*
- Standard body material – Zinc plated steel. (Brass poppet guide in -02 size.)

Flow Data

Pressure Drop Versus Flow Graph

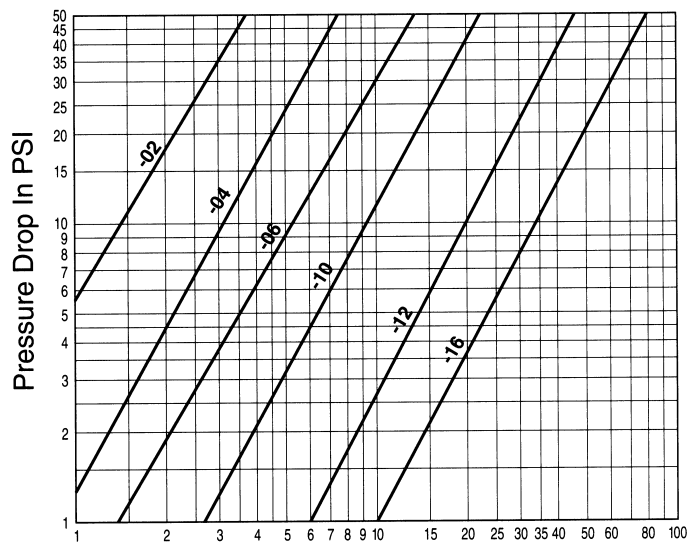

Gallons Per Minute Flow
(Test Fluid MIL-H-5606 Hydraulic Oil At 100° F.)

Physical Characteristics

Coupling Size	Maximum Operating Pressure (psi)	Minimum Burst Pressure (psi)	Vacuum (in./Hg.)	Rated Flow (gpm)	Air Inclusion (cc. max.)	Fluid Loss (cc. max.)
-02	4,500	13,500	28	1	.50	.50
-04	5,000	15,000	28	3	.50	.50
-06	4,000	12,000	28	6	2.5	1.3
-10	4,000	12,000	28	12	4.0	2.8
-12	4,000	12,000	28	28	11.0	8.2
-16	4,000	12,000	28	50	18.0	16.0

*Viton is a DuPont trademark.





FD45 Steel	Coupling Size	Thread Size (P)	Dimensional Data			Part Number			Line Ref.
			A	B		Buna-N	Viton*	EPR	
Male Half Female Pipe/Valved 	-02	1/8-27	1.28		.56	FD45-1002-02-02	FD45-1071-02-02	FD45-1064-02-02	1
	-04	1/4-18	1.50		.75	FD45-1002-04-04	FD45-1071-04-04	FD45-1064-04-04	2
	-06	3/8-18	1.66		.88	FD45-1002-06-06	FD45-1071-06-06	FD45-1064-06-06	3
	-10	1/2-14	1.93		1.06	FD45-1002-08-10	FD45-1071-08-10	FD45-1064-08-10	4
	-12	3/4-14	2.26		1.31	FD45-1002-12-12	FD45-1071-12-12	FD45-1064-12-12	5
	-16	1-11 1/2	2.72		1.62	FD45-1002-16-16	FD45-1071-16-16	FD45-1064-16-16	6
									7
									8
Female Half Female Pipe/Valved 	-02	1/8-27	1.81	.96	.75	FD45-1003-02-02	FD45-1070-02-02	FD45-1065-02-02	9
	-04	1/4-18	2.22	1.13	.81	FD45-1003-04-04	FD45-1070-04-04	FD45-1065-04-04	10
	-06	3/8-18	2.45	1.38	1.06	FD45-1003-06-06	FD45-1070-06-06	FD45-1065-06-06	11
	-10	1/2-14	2.86	1.69	1.31	FD45-1003-08-10	FD45-1070-08-10	FD45-1065-08-10	12
	-12	3/4-14	3.40	2.06	1.62	FD45-1003-12-12	FD45-1070-12-12	FD45-1065-12-12	13
	-16	1-11 1/2	4.02	2.44	2.00	FD45-1003-16-16	FD45-1070-16-16	FD45-1065-16-16	14
									15
									16
Complete Coupling Female Pipe/Valved 	-02	1/8-27	2.31			FD45-1000-02-02	FD45-1072-02-02	FD45-1063-02-02	17
	-04	1/4-18	2.74			FD45-1000-04-04	FD45-1072-04-04	FD45-1063-04-04	18
	-06	3/8-18	3.04			FD45-1000-06-06	FD45-1072-06-06	FD45-1063-06-06	19
	-10	1/2-14	3.54			FD45-1000-08-10	FD45-1072-08-10	FD45-1063-08-10	20
	-12	3/4-14	4.02			FD45-1000-12-12	FD45-1072-12-12	FD45-1063-12-12	21
	-16	1-11 1/2	4.88			FD45-1000-16-16	FD45-1072-16-16	FD45-1063-16-16	22
									23
									24
Male Half Female Pipe/Non-Valved <p>Will not operate with valved coupling halves. No valve actuator.</p>	-02	1/8-27	1.20		.56	FD45-1061-02-02	FD45-1061-02-02	FD45-1061-02-02	25
	-04	1/4-18	1.37		.75	FD45-1061-04-04	FD45-1061-04-04	FD45-1061-04-04	26
	-06	3/8-18	1.50		.88	FD45-1061-06-06	FD45-1061-06-06	FD45-1061-06-06	27
	-10	1/2-14	1.76		1.06	FD45-1061-08-10	FD45-1061-08-10	FD45-1061-08-10	28
	-12	3/4-14	2.00		1.31	FD45-1061-12-12	FD45-1061-12-12	FD45-1061-12-12	29
	-16	1-11 1/2	2.43		1.62	FD45-1061-16-16	FD45-1061-16-16	FD45-1061-16-16	30
									31
									32
Female Half Female Pipe/Non-Valved <p>Will not operate with valved coupling halves. No valve actuator.</p>	-02	1/8-27	1.81	.96	.75	FD45-1047-02-02	FD45-1172-02-02	FD45-1207-02-02	33
	-04	1/4-18	2.22	1.13	.81	FD45-1047-04-04	FD45-1172-04-04	FD45-1207-04-04	34
	-06	3/8-18	2.45	1.38	1.06	FD45-1047-06-06	FD45-1172-06-06	FD45-1207-06-06	35
	-10	1/2-14	2.86	1.69	1.31	FD45-1047-08-10	FD45-1172-08-10	FD45-1207-08-10	36
	-12	3/4-14	3.40	2.06	1.62	FD45-1047-12-12	FD45-1172-12-12	FD45-1207-12-12	37
	-16	1-11 1/2	4.02	2.44	2.00	FD45-1047-16-16	FD45-1172-16-16	FD45-1207-16-16	38
									39
									40
Repair Kit									
Each kit will repair one male or female half.									
	-02					FF013-02†	FF014-02†	FF015-02†	42
	-04					FF013-04	FF014-04	FF015-04	43
	-06					FF013-06	FF014-06	FF015-06	44
	-10					FF013-10	FF014-10	FF015-10	45
	-12					FF013-12	FF014-12	FF015-12	46
	-16					FF013-16	FF014-16	FF015-16	47
									48
									49

†The -02 coupling size valving is not repairable. This size repair kit contains an interface seal and back-up ring.

*Viton is a DuPont trademark.

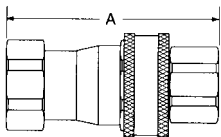
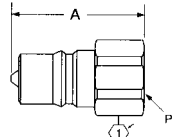
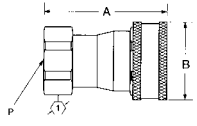

FD45 Steel	Coupling Size	Thread Size (P)	Dimensional Data			Part Number			Line Ref.	
			A	B	ϕ	Buna-N	Viton*	EPR		
Complete Coupling Female Pipe/Non-Valved 	-02	1/8-27	2.31			FD45-1044-02-02	FD45-1173-02-02	FD45-1206-02-02	1	
	-04	1/4-18	2.74			FD45-1044-04-04	FD45-1173-04-04	FD45-1206-04-04	2	
	-06	3/8-18	3.04			FD45-1044-06-06	FD45-1173-06-06	FD45-1206-06-06	3	
	-10	1/2-14	3.54			FD45-1044-08-10	FD45-1173-08-10	FD45-1206-08-10	4	
	-12	3/4-14	4.02			FD45-1044-12-12	FD45-1173-12-12	FD45-1206-12-12	5	
	-16	1-11 1/2	4.88			FD45-1044-16-16	FD45-1173-16-16	FD45-1206-16-16	6	
									7	
								8		
Male Half Female Pipe/Pusher Style Valving  <p>Incorporates a pusher device to open mating valved coupling halves.</p>	-02	1/8-27	1.28		.56	FD45-1046-02-02	FD45-1046-02-02	FD45-1046-02-02	9	
	-04	1/4-18	1.50		.75	FD45-1046-04-04	FD45-1046-04-04	FD45-1046-04-04	10	
	-06	3/8-18	1.66		.88	FD45-1046-06-06	FD45-1046-06-06	FD45-1046-06-06	11	
	-10	1/2-14	1.93		1.06	FD45-1046-08-10	FD45-1046-08-10	FD45-1046-08-10	12	
	-12	3/4-14	2.26		1.31	FD45-1046-12-12	FD45-1046-12-12	FD45-1046-12-12	13	
	-16	1-11 1/2	2.72		1.62	FD45-1046-16-16	FD45-1046-16-16	FD45-1046-16-16	14	
									15	
								16		
Female Half Female Pipe/Pusher Style Valving  <p>Incorporates a pusher device to open mating valved coupling halves.</p>	-02	1/8-27	1.81	.96	.75	FD45-1045-02-02	FD45-1228-02-02	FD45-1229-02-02	17	
	-04	1/4-18	2.22	1.13	.81	FD45-1045-04-04	FD45-1228-04-04	FD45-1229-04-04	18	
	-06	3/8-18	2.45	1.38	1.06	FD45-1045-06-06	FD45-1228-06-06	FD45-1229-06-06	19	
	-10	1/2-14	2.86	1.69	1.31	FD45-1045-08-10	FD45-1228-08-10	FD45-1229-08-10	20	
	-12	3/4-14	3.40	2.06	1.62	FD45-1045-12-12	FD45-1228-12-12	FD45-1229-12-12	21	
	-16	1-11 1/2	4.02	2.44	2.00	FD45-1045-16-16	FD45-1228-16-16	FD45-1229-16-16	22	
									23	
								24		
Repair Kit Each kit will repair one male or female half. †The -02 coupling size valving is not repairable. This size repair kit contains an interface seal and back-up ring.	-02					FF013-02†	FF014-02†	FF015-02†	25	
	-04					FF013-04	FF014-04	FF015-04	26	
	-06					FF013-06	FF014-06	FF015-06	27	
	-10					FF013-10	FF014-10	FF015-10	28	
	-12					FF013-12	FF014-12	FF015-12	29	
	-16					FF013-16	FF014-16	FF015-16	30	
									31	
								32		
Accessories									33	
	Dust Cap 	-02						FD45-1040-02		34
		-04						FD45-1040-04		35
		-06						FD45-1040-06		36
		-10						FD45-1040-10		37
		-12						FD45-1040-12		38
		-16						FD45-1040-16		39
									40	
Dust Plug 	-02						FD45-1041-02		41	
	-04						FD45-1041-04		42	
	-06						FD45-1041-06		43	
	-10						FD45-1041-10		44	
	-12						FD45-1041-12		45	
	-16						FD45-1041-16		46	
									47	

*Viton is a DuPont trademark.



FD45 Series/Industrial Interchange Series B . . . (Brass)

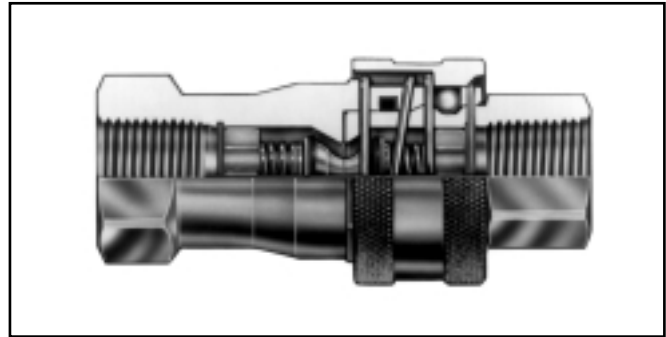
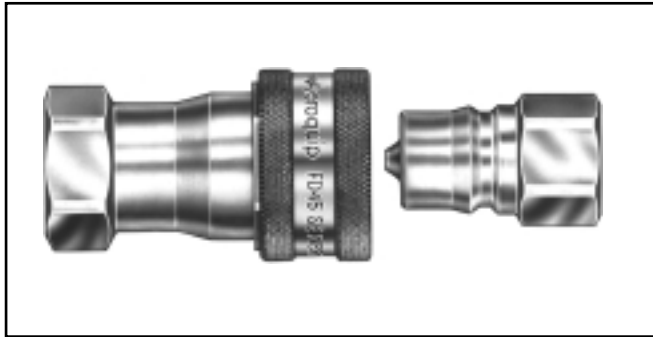
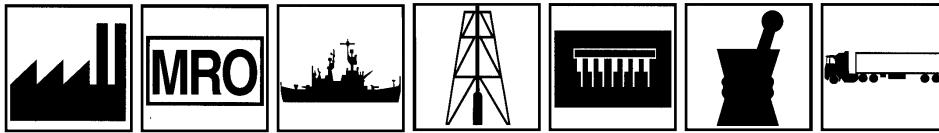

The FD45 Series brass industrial interchange coupling offers corrosion resistance where steel couplings are unacceptable. This general purpose coupling uses a *PUSH-PULL™* latch mechanism.

- Dual interface O-Rings in the female half provide redundant sealing while connected.
- Brass construction with stainless steel springs for greater corrosion resistance and fluid compatibility.
- Industrial interchange coupling conforming dimensionally to ISO standard 7241/1 Series B.
- *PUSH-PULL™* ball latch design allows quick and easy connection and disconnection of hose lines.
- Self-sealing poppet valves provide excellent high and low pressure sealing.
- Standard seal material – Buna-N, EPR and Viton*.
- Standard body material – Brass with stainless steel springs and balls.

Flow Data

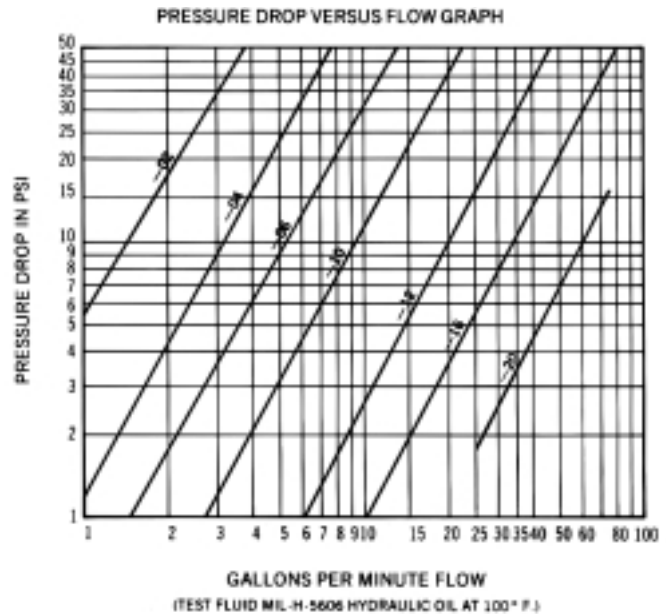

Physical Characteristics

Coupling Size	Maximum Operating Pressure (psi)	Minimum Burst Pressure		Vacuum (in./Hg.)	Rated Flow (gpm)	Air Inclusion (cc. max.)	Fluid Loss (cc. max)
		Connected (psi)	Disconnected (psi)				
-02	1,000	11,000	12,000	28	1	.50	.50
-04	1,000	18,000	14,000	28	3	.50	.50
-06	1,000	12,000	9,000	28	6	2.5	1.3
-10	1,000	12,000	6,500	28	12	4.0	2.8
-12	1,000	10,000	10,000	28	28	11.0	8.2
-16	1,000	8,500	11,000	28	50	18.0	16.0
-20	1,000	6,000	6,000	28	75	30.0	45.0

*Viton is a DuPont trademark.



FD45 Brass	Coupling Size	Thread Size (P)	Dimensional Data			Part Number			Line Ref.
			A	B	ϕ	Buna-N	Viton*	EPR	
Male Half Female Pipe/Valved 	-02	1/8-27	1.28		.56	FD45-1086-02-02	FD45-1092-02-02	FD45-1153-02-02	1
	-04	1/4-18	1.50		.69	FD45-1086-04-04	FD45-1092-04-04	FD45-1153-04-04	2
	-06	3/8-18	1.66		.88	FD45-1086-06-06	FD45-1092-06-06	FD45-1153-06-06	3
	-10	1/2-14	1.93		1.06	FD45-1086-08-10	FD45-1092-08-10	FD45-1153-08-10	4
	-12	3/4-14	2.26		1.31	FD45-1086-12-12	FD45-1092-12-12	FD45-1153-12-12	5
	-16	1-11 1/2	2.72		1.62	FD45-1086-16-16	FD45-1092-16-16	FD45-1153-16-16	6
	-20	1 1/4-11 1/2	4.25		2.38	FD45-1086-20-20	FD45-1092-20-20	FD45-1153-20-20	7
	Art is not representative of -20 size.								
Female Half Female Pipe/Valved 	-02	1/8-27	1.81	.96	.75	FD45-1101-02-02	FD45-1091-02-02	FD45-1156-02-02	9
	-04	1/4-18	2.22	1.13	.81	FD45-1101-04-04	FD45-1091-04-04	FD45-1156-04-04	10
	-06	3/8-18	2.45	1.38	1.06	FD45-1101-06-06	FD45-1091-06-06	FD45-1156-06-06	11
	-10	1/2-14	2.86	1.69	1.31	FD45-1101-08-10	FD45-1091-08-10	FD45-1156-08-10	12
	-12	3/4-14	3.40	2.01	1.62	FD45-1101-12-12	FD45-1091-12-12	FD45-1156-12-12	13
	-16	1-11 1/2	4.02	2.38	1.94	FD45-1101-16-16	FD45-1091-16-16	FD45-1156-16-16	14
	-20	1 1/4-11 1/2	4.49	2.62	2.38	FD45-1101-20-20	FD45-1091-20-20	FD45-1156-20-20	15
	Art is not representative of -20 size.								
Complete Coupling Female Pipe/Valved 	-02	1/8-27	2.31			FD45-1100-02-02	FD45-1090-02-02	FD45-1157-02-02	17
	-04	1/4-18	2.74			FD45-1100-04-04	FD45-1090-04-04	FD45-1157-04-04	18
	-06	3/8-18	3.04			FD45-1100-06-06	FD45-1090-06-06	FD45-1157-06-06	19
	-10	1/2-14	3.54			FD45-1100-08-10	FD45-1090-08-10	FD45-1157-08-10	20
	-12	3/4-14	4.02			FD45-1100-12-12	FD45-1090-12-12	FD45-1157-12-12	21
	-16	1-11 1/2	4.88			FD45-1100-16-16	FD45-1090-16-16	FD45-1157-16-16	22
	-20	1 1/4-11 1/2	6.80			FD45-1100-20-20	FD45-1090-20-20	FD45-1157-20-20	23
	Art is not representative of -20 size.								
Male Half Female Pipe/Non-Valved <p>Will not operate with valved coupling halves. No valve actuator.</p>	-02	1/8-27	1.20		.56	FD45-1175-02-02	FD45-1175-02-02	FD45-1175-02-02	25
	-04	1/4-18	1.37		.69	FD45-1175-04-04	FD45-1175-04-04	FD45-1175-04-04	26
	-06	3/8-18	1.50		.88	FD45-1175-06-06	FD45-1175-06-06	FD45-1175-06-06	27
	-10	1/2-14	1.76		1.06	FD45-1175-08-10	FD45-1175-08-10	FD45-1175-08-10	28
	-12	3/4-14	2.00		1.31	FD45-1175-12-12	FD45-1175-12-12	FD45-1175-12-12	29
	-16	1-11 1/2	2.43		1.62	FD45-1175-16-16	FD45-1175-16-16	FD45-1175-16-16	30
	-20	1 1/4-11 1/2	4.25		2.38	FD45-1175-20-20	FD45-1399-20-20	FD45-1400-20-20	31
	Art is not representative of -20 size.								
Female Half Female Pipe/Non-Valved <p>Will not operate with valved coupling halves. No valve actuator.</p>	-02	1/8-27	1.81	.96	.75	FD45-1176-02-02	FD45-1180-02-02	FD45-1178-02-02	33
	-04	1/4-18	2.22	1.13	.81	FD45-1176-04-04	FD45-1180-04-04	FD45-1178-04-04	34
	-06	3/8-18	2.45	1.38	1.06	FD45-1176-06-06	FD45-1180-06-06	FD45-1178-06-06	35
	-10	1/2-14	2.86	1.69	1.31	FD45-1176-08-10	FD45-1180-08-10	FD45-1178-08-10	36
	-12	3/4-14	3.40	2.01	1.62	FD45-1176-12-12	FD45-1180-12-12	FD45-1178-12-12	37
	-16	1-11 1/2	4.02	2.38	1.94	FD45-1176-16-16	FD45-1180-16-16	FD45-1178-16-16	38
	-20	1 1/4-11 1/2	4.49	2.62	2.38	FD45-1176-20-20	FD45-1180-20-20	FD45-1178-20-20	39
	Art is not representative of -20 size.								
Repair Kit Each kit will repair one male or female half.									41
	-02					FF016-02†	FF017-02†	FF018-02†	42
	-04					FF016-04	FF017-04	FF018-04	43
	-06					FF016-06	FF017-06	FF018-06	44
	-10					FF016-10	FF017-10	FF018-10	45
	-12					FF016-12	FF017-12	FF018-12	46
	-16					FF016-16	FF017-16	FF018-16	47
-20					FF016-20	FF017-20	FF018-20	48	

*Viton is a DuPont trademark.

†The -02 coupling size valving is not repairable. This size repair kit contains an interface seal and back-up ring.



FD45 Brass	Coupling Size	Thread Size (P)	Dimensional Data			Part Number			Line Ref.
			A	B		Buna-N	Viton*	EPR	
Complete Coupling Female Pipe/Non-Valved 	-02	1/8-27	2.31			FD45-1174-02-02	FD45-1179-02-02	FD45-1177-02-02	1
	-04	1/4-18	2.74			FD45-1174-04-04	FD45-1179-04-04	FD45-1177-04-04	2
	-06	3/8-18	3.04			FD45-1174-06-06	FD45-1179-06-06	FD45-1177-06-06	3
	-10	1/2-14	3.54			FD45-1174-08-10	FD45-1179-08-10	FD45-1177-08-10	4
	-12	3/4-14	4.02			FD45-1174-12-12	FD45-1179-12-12	FD45-1177-12-12	5
	-16	1-11 1/2	4.88			FD45-1174-16-16	FD45-1179-16-16	FD45-1177-16-16	6
	-20	1 1/4-11 1/2	6.80			FD45-1174-20-20	FD45-1179-20-20	FD45-1177-20-20	7
	Art is not representative of -20 size.								
Male Half Female Pipe/Pusher Style Valving Incorporates a pusher device to open mating valved coupling halves.	-04	1/4-18	1.50		.75	FD45-1201-04-04	FD45-1201-04-04	FD45-1201-04-04	10
	-06	3/8-18	1.66		.88	FD45-1201-06-06	FD45-1201-06-06	FD45-1201-06-06	11
	-10	1/2-14	1.93		1.06	FD45-1201-08-10	FD45-1201-08-10	FD45-1201-08-10	12
	-12	3/4-14	2.26		1.31	FD45-1201-12-12	FD45-1201-12-12	FD45-1201-12-12	13
	-16	1-11 1/2	2.72		1.62	FD45-1201-16-16	FD45-1201-16-16	FD45-1201-16-16	14
									15
									16
									17
Female Half Female Pipe/Pusher Style Valving Incorporates a pusher device to open mating valved coupling halves.	-04	1/4-18	2.22	1.13	.88	FD45-1203-04-04	FD45-1199-04-04	FD45-1211-04-04	18
	-06	3/8-18	2.45	1.38	1.06	FD45-1203-06-06	FD45-1199-06-06	FD45-1211-06-06	19
	-10	1/2-14	2.86	1.69	1.31	FD45-1203-08-10	FD45-1199-08-10	FD45-1211-08-10	20
	-12	3/4-14	3.40	2.01	1.62	FD45-1203-12-12	FD45-1199-12-12	FD45-1211-12-12	21
	-16	1-11 1/2	4.02	2.38	1.94	FD45-1203-16-16	FD45-1199-16-16	FD45-1211-16-16	22
									23
								24	
Repair Kit Each kit will repair one male or female half. †The -02 coupling size valving is not repairable. This size repair kit contains an interface seal and back-up ring.	-02					FF016-02†	FF017-02†	FF018-02†	25
	-04					FF016-04	FF017-04	FF018-04	26
	-06					FF016-06	FF017-06	FF018-06	27
	-10					FF016-10	FF017-10	FF018-10	28
	-12					FF016-12	FF017-12	FF018-12	29
	-16					FF016-16	FF017-16	FF018-16	30
	-20					FF016-20	FF017-20	FF018-20	31
								32	
Accessories Dust Cap 	-02						FD45-1040-02		33
	-04						FD45-1040-04		34
	-06						FD45-1040-06		35
	-10						FD45-1040-10		36
	-12						FD45-1040-12		37
	-16						FD45-1040-16		38
									39
									40
Dust Plug 	-02						FD45-1041-02		41
	-04						FD45-1041-04		42
	-06						FD45-1041-06		43
	-10						FD45-1041-10		44
	-12						FD45-1041-12		45
	-16						FD45-1041-16		46
								47	

*Viton is a DuPont trademark.



FD45 Series/Industrial Interchange Series B . . . (Stainless Steel)

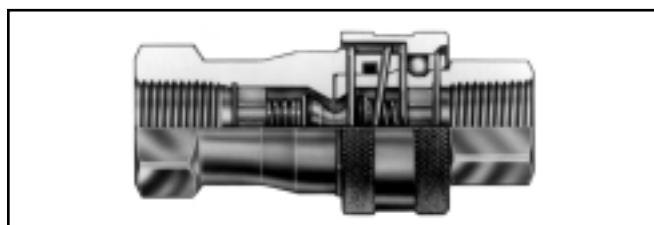
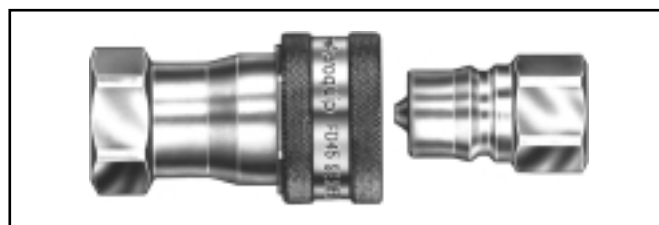
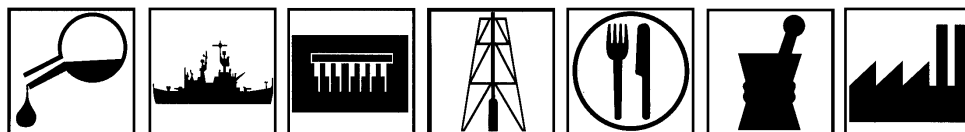

The FD45 stainless steel is a general purpose industrial interchange coupling available valved or non-valved. Offered in 303/304 grades of stainless steel for excellent corrosion resistance in rugged applications.

- Industrial interchange coupling conforming dimensionally to ISO standard 7241/1 Series B.
- Stainless steel construction for greater corrosion resistance and fluid compatibility.
- *PUSH-PULL*TM ball latch design allows quick and easy connection and disconnection of hose lines.
- Self-sealing poppet valves provide excellent high and low pressure sealing.
- Standard seal material – Buna-N, EPR and Viton*.
- Standard body material – Stainless Steel.

Flow Data

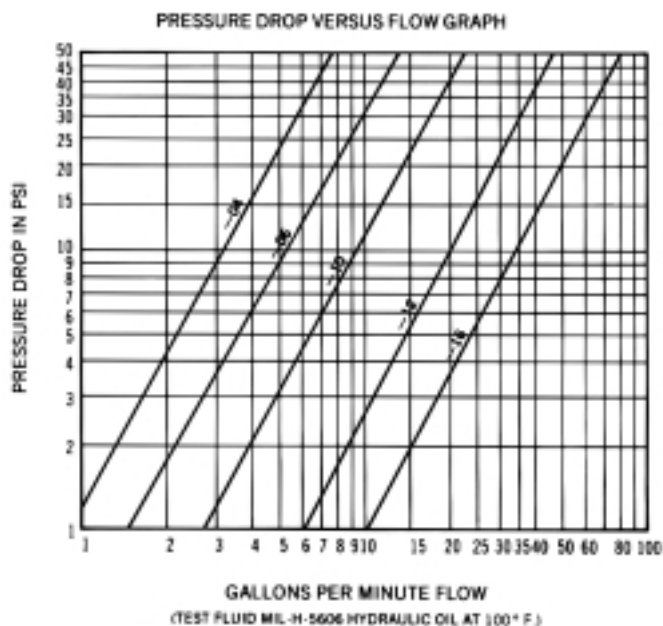

Physical Characteristics

Coupling Size	Maximum Operating Pressure		Minimum Burst Pressure (psi)	Vacuum (in./Hg.)	Rated Flow (gpm)	Air Inclusion (cc. max.)	Fluid Loss (cc. max)
	Hydraulic (psi)	Static (psi)					
-04	3,000	3,000	12,000	28	3	.50	.50
-06	1,500	1,750	12,000	28	6	2.5	1.3
-10	1,500	1,750	12,000	28	12	4.0	2.8
-12	1,500	1,750	12,000	28	28	11.0	8.2
-16	1,250	1,500	12,000	28	50	18.0	16.0

*Viton is a DuPont trademark.

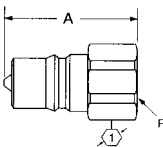
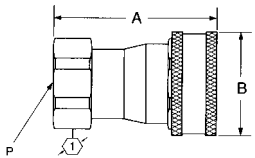
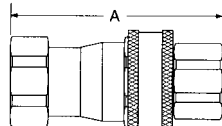
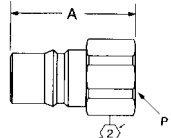
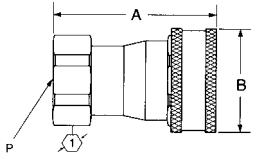

FD45 Stainless Steel	Coupling Size	Thread Size (P)	Dimensional Data			Part Number			Line Ref.
			A	B	ϕ	Buna-N	Viton*	EPR	
Male Half Female Pipe/Valved 	-04	1/4-18	1.46		.69	FD45-1004-04-04	FD45-1078-04-04	FD45-1121-04-04	1
	-06	3/8-18	1.66		.88	FD45-1004-06-06	FD45-1078-06-06	FD45-1121-06-06	2
	-10	1/2-14	1.89		1.06	FD45-1004-08-10	FD45-1078-08-10	FD45-1121-08-10	3
	-12	3/4-14	2.26		1.31	FD45-1004-12-12	FD45-1078-12-12	FD45-1121-12-12	4
	-16	1-11 1/2	2.72		1.62	FD45-1004-16-16	FD45-1078-16-16	FD45-1121-16-16	5
Female Half Female Pipe/Valved 	-04	1/4-18	2.22	1.13	.81	FD45-1005-04-04	FD45-1076-04-04	FD45-1122-04-04	9
	-06	3/8-18	2.45	1.38	1.06	FD45-1005-06-06	FD45-1076-06-06	FD45-1122-06-06	10
	-10	1/2-14	2.86	1.69	1.31	FD45-1005-08-10	FD45-1076-08-10	FD45-1122-08-10	11
	-12	3/4-14	3.40	2.01	1.62	FD45-1005-12-12	FD45-1076-12-12	FD45-1122-12-12	12
	-16	1-11 1/2	4.02	2.38	2.00	FD45-1005-16-16	FD45-1076-16-16	FD45-1122-16-16	13
Complete Coupling Female Pipe/Valved 	-04	1/4-18	2.70			FD45-1001-04-04	FD45-1075-04-04	FD45-1120-04-04	17
	-06	3/8-18	3.04			FD45-1001-06-06	FD45-1075-06-06	FD45-1120-06-06	18
	-10	1/2-14	3.50			FD45-1001-08-10	FD45-1075-08-10	FD45-1120-08-10	19
	-12	3/4-14	4.02			FD45-1001-12-12	FD45-1075-12-12	FD45-1120-12-12	20
	-16	1-11 1/2	4.88			FD45-1001-16-16	FD45-1075-16-16	FD45-1120-16-16	21
Male Half Female Pipe/Non-Valved  <p>Will not operate with valved coupling halves. No valve actuator.</p>	-04	1/4-18	1.33		.69	FD45-1062-04-04	FD45-1062-04-04	FD45-1062-04-04	25
	-06	3/8-18	1.50		.88	FD45-1062-06-06	FD45-1062-06-06	FD45-1062-06-06	26
	-10	1/2-14	1.72		1.06	FD45-1062-08-10	FD45-1062-08-10	FD45-1062-08-10	27
	-12	3/4-14	2.00		1.31	FD45-1062-12-12	FD45-1062-12-12	FD45-1062-12-12	28
	-16	1-11 1/2	2.43		1.62	FD45-1062-16-16	FD45-1062-16-16	FD45-1062-16-16	29
Female Half Female Pipe/Non-Valved  <p>Will not operate with valved coupling halves. No valve actuator.</p>	-04	1/4-18	2.22	1.13	.81	FD45-1053-04-04	FD45-1195-04-04	FD45-1142-04-04	33
	-06	3/8-18	2.45	1.38	1.06	FD45-1053-06-06	FD45-1195-06-06	FD45-1142-06-06	34
	-10	1/2-14	2.86	1.69	1.31	FD45-1053-08-10	FD45-1195-08-10	FD45-1142-08-10	35
	-12	3/4-14	3.40	2.01	1.62	FD45-1053-12-12	FD45-1195-12-12	FD45-1142-12-12	36
	-16	1-11 1/2	4.02	2.38	2.00	FD45-1053-16-16	FD45-1195-16-16	FD45-1142-16-16	37
Repair Kit Each kit will repair one male or female half.	-04					FF054-04	FF055-04	FF056-04	42
	-06					FF054-06	FF055-06	FF056-06	43
	-10					FF054-10	FF055-10	FF056-10	44
	-12					FF054-12	FF055-12	FF056-12	45
	-16					FF054-16	FF055-16	FF056-16	46
									48

*Viton is a DuPont trademark.



FD45 Stainless Steel	Coupling Size	Thread Size(P)	Dimensional Data			Part Number			Line Ref.
			A	B		Buna-N	Viton*	EPR	
Complete Coupling Female Pipe/Non-Valved 	-04	1/4-18	2.70			FD45-1052-04-04	FD45-1194-04-04	FD45-1143-04-04	1
	-06	3/8-18	3.04			FD45-1052-06-06	FD45-1194-06-06	FD45-1143-06-06	2
	-10	1/2-14	3.50			FD45-1052-08-10	FD45-1194-08-10	FD45-1143-08-10	3
	-12	3/4-14	4.02			FD45-1052-12-12	FD45-1194-12-12	FD45-1143-12-12	4
	-16	1-11 1/2	4.88			FD45-1052-16-16	FD45-1194-16-16	FD45-1143-16-16	5
									6
									7
									8
Male Half Female Pipe/Pusher Style Valving <p>Incorporates a pusher device to open mating coupling halves</p>	-04	1/4-18	1.46		.69	FD45-1059-04-04	FD45-1059-04-04	FD45-1059-04-04	9
	-06	3/8-18	1.66		.88	FD45-1059-06-06	FD45-1059-06-06	FD45-1059-06-06	10
	-10	1/2-14	1.89		1.06	FD45-1059-08-10	FD45-1059-08-10	FD45-1059-08-10	11
	-12	3/4-14	2.26		1.31	FD45-1059-12-12	FD45-1059-12-12	FD45-1059-12-12	12
	-16	1-11 1/2	2.72		1.62	FD45-1059-16-16	FD45-1059-16-16	FD45-1059-16-16	13
									14
									15
									16
Female Half Female Pipe/Pusher Style Valving <p>Incorporates a pusher device to open mating coupling halves</p>	-04	1/4-18	2.22	1.13	.81	FD45-1056-04-04	FD45-1197-04-04	FD45-1209-04-04	17
	-06	3/8-18	2.45	1.38	1.06	FD45-1056-06-06	FD45-1197-06-06	FD45-1209-06-06	18
	-10	1/2-14	2.86	1.69	1.31	FD45-1056-08-10	FD45-1197-08-10	FD45-1209-08-10	19
	-12	3/4-14	3.40	2.01	1.62	FD45-1056-12-12	FD45-1197-12-12	FD45-1209-12-12	20
	-16	1-11 1/2	4.02	2.38	2.00	FD45-1056-16-16	FD45-1197-16-16	FD45-1209-16-16	21
									22
									23
									24
Repair Kit									
Each kit will repair one male or female half.	-04					FF054-04	FF055-04	FF056-04	25
	-06					FF054-06	FF055-06	FF056-06	26
	-10					FF054-10	FF055-10	FF056-10	27
	-12					FF054-12	FF055-12	FF056-12	28
	-16					FF054-16	FF055-16	FF056-16	29
									30
									31
								32	
Accessories									
Dust Cap 	-04						FD45-1040-04		33
	-06						FD45-1040-06		34
	-10						FD45-1040-10		35
	-12						FD45-1040-12		36
	-16						FD45-1040-16		37
Dust Plug 	-04						FD45-1041-04		38
	-06						FD45-1041-06		39
	-10						FD45-1041-10		40
	-12						FD45-1041-12		41
	-16						FD45-1041-16		42
									43

*Viton is a DuPont trademark.

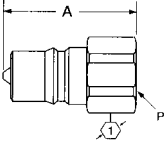
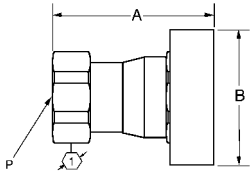

FD45 Stainless Steel	Coupling Size	Thread Size (P)	Dimensional Data			Part Number			Line Ref.
			A	B	ϕ	Buna-N	Viton*	EPR	
†Fryer Coupling/Male Half Female Pipe/Valved 	-10	1/2-14	1.92		1.06		FD45-1270-08-10		1
									2
									3
									4
									5
									6
									7
									8
									9
†Fryer Coupling/Female Half Female Pipe/Valved Silicone Collar on Ball Release Sleeve 	-10	1/2-14	2.86	2.38	1.31		FD45-1267-08-10		10
									11
									12
									13
									14
									15
									16
									16

†Special internal Viton* seal material approved for use by the National Sanitation Foundation. The fryer coupling uses a silicone collar aiding disconnection with hot fluid applications.

Connecting and disconnecting lines between deep fat fryers and oil recycling units has been made cleaner, safer and quicker with Aeroquip's FD45 "Fryer" coupling.

Aeroquip's FD45 "Fryer" coupling is made of stainless steel with Viton* seal material. It has a silicone rubber collar on the sleeve of the female half to provide insulation from high oil temperatures and an excellent gripping surface during connection and disconnection. The coupling has been approved for use by the National Sanitation Foundation.

*Viton is a DuPont trademark.



FD48 Series/Parker Bruning—SM Interchange

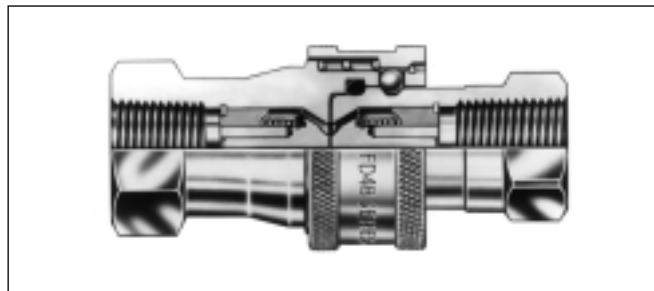
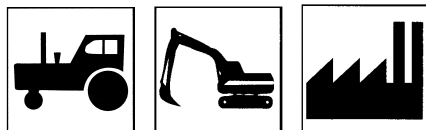

The FD48 Series coupling is designed to interchange with Parker Bruning SM-250 couplings.

- Self-sealing poppet valves provide excellent high and low pressure sealing.
- *PUSH-PULL*™ ball latch design allows quick and easy connection and disconnection of fluid lines.
- Heat-treated and plated steel for wear and corrosion resistance.
- 3,000 psi operating pressure.
- Standard seal material – Buna-N.
- Standard seal material – Zinc plated steel with zinc poppet guides.

Flow Data

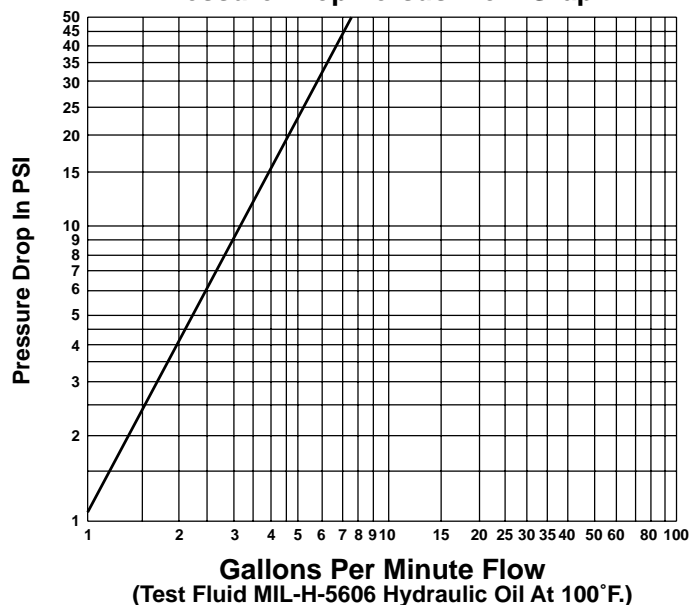

Pressure Drop Versus Flow Graph



Physical Characteristics

Coupling Size	Maximum Operating Pressure (psi)	Minimum Burst Pressure (psi)	Vacuum (in./Hg.)	Rated Flow (gpm)	Air Inclusion (cc. max.)	Fluid Loss (cc. max.)
-04	3,000	12,000	28	3	0.50	1.10

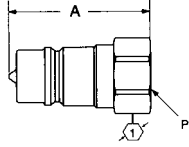
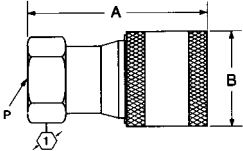
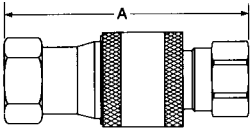

FD48 Series	Coupling Size	Thread Size (P)	Dimensional Data			Part Number Buna-N	Line Ref.
			A	B	ϕ		
Male Half Female Pipe/Valved 	-04	1/4-18	1.45		.75	FD48-1002-04-04	1
							2
							3
							4
							5
							6
							7
							8
Female Half Female Pipe/Valved 	-04	1/4-18	2.01	1.06	.81	FD48-1001-04-04	9
							10
							11
							12
							13
							14
							15
							16
Complete Coupling Female Pipe/Valved 	-04	1/4-18	2.69			FD48-1000-04-04	17
							18
							19
							20
							21
							22
							23
							24
Accessories							25
Dust Cap/Plug (Fits both male and female halves) 	-04					FD48-1042-04	26
							27
							28
							29
							30
							31
							32



FD49 Series/HTMA Flush Face, Hydraulic Tool

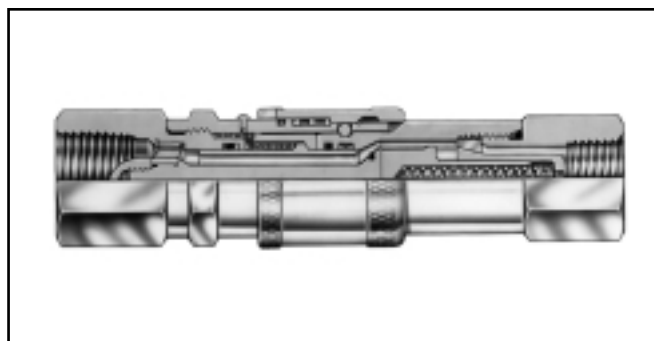

The FD49 Series meets NFPA standard T3.20.15, which was developed in conjunction with HTMA (Hydraulic Tool Manufacturer's Association).

- Twin-Guard™ sealing system prevents weepage and allows connection and disconnection against pressure up to 500 psi.
- Dual flush face valving for minimal fluid loss and air inclusion.
- Tubular valve and sleeve construction for high fluid flow with low pressure drop.
- Push-to-connect latching for one hand operation.
- Standard seal material – Teflon channel seal and Buna-N O-Ring backup.
- Standard body material – Zinc plated steel.



Our patented Twin-Guard™ seal system consists of channel and Buna-N O-Ring seals. The channel seal prevents blowout during connection and disconnection under pressure to 500 psi. The Buna-N O-Ring seal is a secondary seal eliminating fluid weepage.

*Patent Number 5123446

Physical Characteristics

Coupling Size	Maximum Operating Pressure (psi)	Minimum Burst Pressure (psi)	Vacuum (in./Hg.)	Rated Flow (gpm)	Air Inclusion (cc. max.)	Fluid Loss (cc. max.)
-06	3,000	9,000	28	10	.01	.02

Flow Data

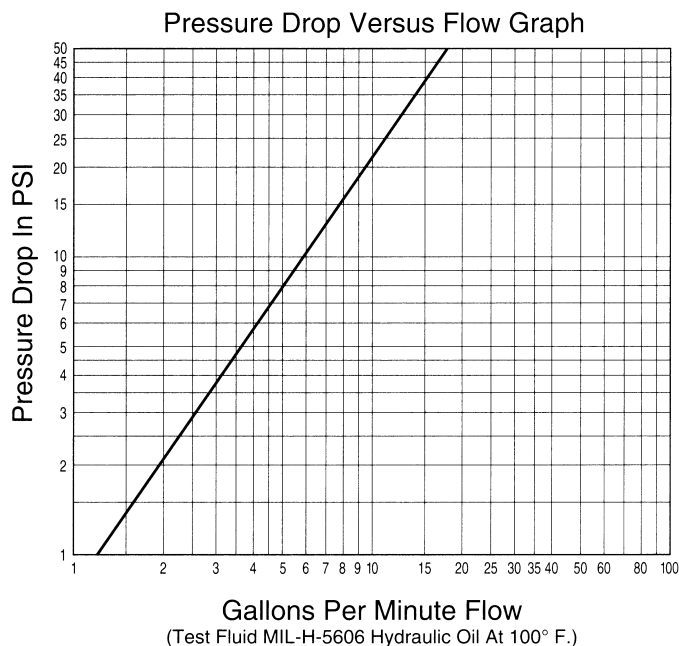

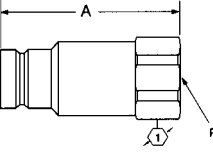
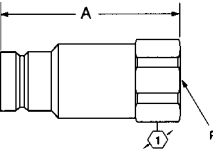
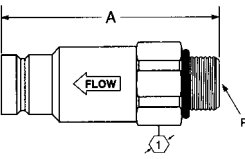
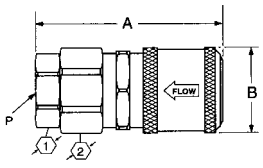
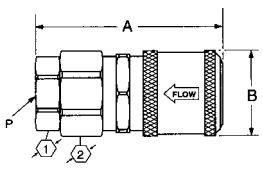

FD49 Series	Coupling Size	Thread Size (P)	Dimensional Data				Part Number Buna-N	Line Ref.
			A	B	①	②		
Male Half Female Pipe/Valved 	-06	3/8-18	2.62		1.00		FD49-1002-06-06	1
	-06	1/2-14	2.75		1.06		FD49-1002-08-06	2
								3
								4
								5
								6
								7
								8
Male Half Female SAE O-Ring/Valved 	-06	9/16-18	2.79		1.06		FD49-1004-06-06	9
	-06	3/4-16	2.75		1.00		FD49-1004-08-06	10
								11
								12
								13
								14
								15
								16
Male Half Male SAE O-Ring/Valved 	-06	9/16-18	2.99		1.00		FD49-1057-06-06	17
	-06	3/4-16	2.99		1.00		FD49-1057-08-06	18
								19
								20
								21
								22
								23
								24
Female Half Female Pipe/Valved 	-06	3/8-18	2.74	1.20	1.00	1.06	FD49-1001-06-06	25
	-06	1/2-14	2.85	1.20		1.06	FD49-1001-08-06	26
								27
								28
								29
								30
								31
								32
Female Half Female SAE O-Ring/Valved 	-06	3/4-16	2.82	1.20		1.06	FD49-1005-08-06	33
								34
								35
								36
								37
								38
								39
								40



FD49 Series	Coupling Size	Thread Size (P)	Dimensional Data				Part Number Buna-N	Line Ref.
			A	B	①	②		
Female Half Male SAE O-Ring/Valved 	-06	3/16-18	3.22	1.20	1.00	1.06	FD49-1014-06-06	1
	-06	3/4-16	3.28	1.20	1.00	1.06	FD49-1014-08-06	2
								3
								4
								5
								6
								7
								8
Female Half/Heavy Duty Sleeve Female Pipe/Valved 	-06	3/8-18	2.74	1.40	1.00	1.06	FD49-1200-06-06	9
	-06	1/2-14	2.85	1.40		1.06	FD49-1200-08-06	10
								11
								12
								13
								14
								15
								16
Accessories								17
Dust Cover For Standard Coupling 								18
								19
	-06						FD49-1042-06	20
								21
								22
								23
								24
								25
Dust Cover For Heavy Duty Coupling 								26
								27
	-06						FD49-1088-06	28
								29
								30
								31
								32
								33
							34	
							35	



5100 Series/Low Spill—Connect Under Pressure

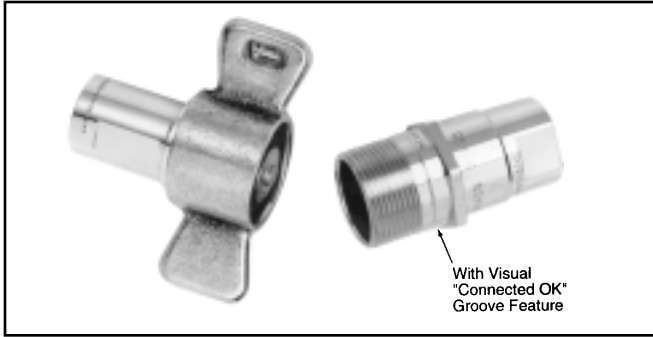

The 5100 Series brass coupling with steel tubular valve offers minimum air inclusion and fluid loss. Thread together latch provides connect under pressure capability and vibration resistance. It is not rated for continuous hydraulic impulse applications. (See FD86 on page 336.)

- Tubular valve construction for virtually no fluid loss during disconnection, reduces environmental and worker safety hazards.
- Low air inclusion during connection maintains system performance.
- Available with wing or hex nut configurations.
- Connect against pressure capability allows connecting of halves even when pressurized up to 500 psi.
- Steel flange available for accessible bulkhead mounting.
- Standard seal material – Buna-N, Viton* and EPR available upon request.
- Standard body material – Brass with steel valving components, hex and wing nuts.

Flow Data

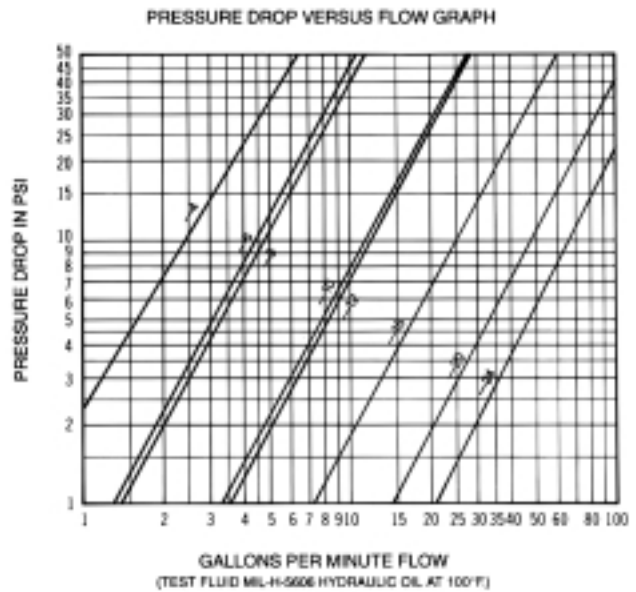

Physical Characteristics

Coupling Dash Size	Coupling Interface Size	Maximum Operating Pressure† (psi connected)	Maximum Operating Pressure (psi disconnected)		Vacuum (in./Hg.)	Rated Flow (gpm)	Air Inclusion (cc max.)	Fluid Loss (cc max.)
			Male Half S2 and S4	Female Half S5				
-4	-4	3000	3000	3000	28	4	.03	.01
-6	-8	3000	3000	3000	28	7	.05	.06
-8	-8	3000	3000	3000	28	7	.05	.10
-10	-12	3000	3000	3000	28	18	.14	.10
-12	-12	3000	3000	3000	28	18	.34	.26
-16	-16	3000	3000	3000	28	40	.50	.35
-20	-20	2750	2500	2750	28	75	.68	.70
-24	-24	2500	2500	2000	28	100	.60	.94

†Minimum burst pressure is equal to three times the maximum operating pressure. Not recommended for continuous hydraulic impulse applications at maximum operating pressures.

*Viton is a DuPont trademark.



For component part number breakdown and service instructions, request bulletin JB41.



QUICK DISCONNECT COUPLINGS

5100 Series	Coupling Size	Thread Size (P)	Dimensional Data				Part Number			Line Ref.
			A	B	①	②	Buna-N	Viton*	EPR	
Male Half/Less Flange Female Pipe 	-4	1/8-27	1.88	.90	.69		5100-S2-4B	FD51-1264-04	FD51-1265-04	1
	-6	1/4-18	2.58	1.07	.94		5100-S2-6B	FD51-1264-06	FD51-1265-06	2
	-8	3/8-18	2.58	1.07	.94		5100-S2-8B	FD51-1264-08	FD51-1265-08	3
	-10	1/2-14	3.11	1.38	1.19		5100-S2-10B	FD51-1264-10	FD51-1265-10	4
	-12	3/4-14	3.11	1.38	1.19		5100-S2-12B	FD51-1264-12	FD51-1265-12	5
	-16	1-11 1/2	3.55	1.76	1.56		5100-S2-16B	FD51-1264-16	FD51-1265-16	6
	-20	1 1/4-11 1/2	3.71	2.10	1.88		5100-S2-20B	FD51-1264-20	FD51-1265-20	7
	-24	1 1/2-11 1/2	4.12	2.48	2.19		5100-S2-24B	FD51-1264-24	FD51-1265-24	8
Male Half/With Flange Female Pipe 	-4	1/8-27	1.88	.90	.94		5100-S4-4B			9
	-6	1/4-18	2.58	1.07	1.12		5100-S4-6B			10
	-8	3/8-18	2.58	1.07	1.12		5100-S4-8B			11
	-10	1/2-14	3.11	1.38	1.62		5100-S4-10B			12
	-12	3/4-14	3.11	1.38	1.62		5100-S4-12B			13
	-16	1-11 1/2	3.55	1.76	1.88		5100-S4-16B			14
	-20	1 1/4-11 1/2	3.71	2.10	2.12		5100-S4-20B			15
	-24	1 1/2-11 1/2	4.12	2.48	2.50		5100-S4-24B			16
Female Half/Wing Nut Female Pipe 	-4	1/8-27	1.97	3.03	.56		5100-S5-4B	FD51-1266-04	FD51-1268-04	17
	-6	1/4-18	2.37	3.44	.76		5100-S5-6B	FD51-1266-06	FD51-1268-06	18
	-8	3/8-18	2.37	3.44	.76		5100-S5-8B	FD51-1266-08	FD51-1268-08	19
	-10	1/2-14	3.09	4.06	1.16		5100-S5-10B	FD51-1266-10	FD51-1268-10	20
	-12	3/4-14	3.09	4.06	1.16		5100-S5-12B	FD51-1266-12	FD51-1268-12	21
	-16	1-11 1/2	3.67	4.38	1.44		5100-S5-16B	FD51-1266-16	FD51-1268-16	22
	-20	1 1/4-11 1/2	3.98	5.19	1.78		5100-S5-20B	FD51-1266-20	FD51-1268-20	23
	-24	1 1/2-11 1/2	4.02	5.31	2.00		5100-S5-24B	FD51-1266-24	FD51-1268-24	24
Female Half/Hex Nut Female Pipe 	-4	1/8-27	2.10	1.32	.56	1.19	5110-S5-4B	FD51-1267-04	FD51-1269-04	25
	-6	1/4-18	2.40	1.53	.76	1.38	5110-S5-6B	FD51-1267-06	FD51-1269-06	26
	-8	3/8-18	2.40	1.53	.76	1.38	5110-S5-8B	FD51-1267-08	FD51-1269-08	27
	-10	1/2-14	3.07	1.98	1.16	1.75	5110-S5-10B	FD51-1267-10	FD51-1269-10	28
	-12	3/4-14	3.07	1.98	1.16	1.75	5110-S5-12B	FD51-1267-12	FD51-1269-12	29
	-16	1-11 1/2	3.68	2.41	1.44	2.12	5110-S5-16B	FD51-1267-16	FD51-1269-16	30
	-20	1 1/4-11 1/2	4.00	2.81	1.78	2.50	5110-S5-20B	FD51-1267-20	FD51-1269-20	31
	-24	1 1/2-11 1/2	4.10	3.10	2.00	2.75	5110-S5-24B	FD51-1267-24	FD51-1269-24	32
Complete Coupling Less Flange/With Wing Nut/ Female Pipe 	-4	1/8-27	3.20				5101-4B	FD51-1270-04	FD51-1272-04	33
	-6	1/4-18	4.11				5101-6B	FD51-1270-06	FD51-1272-06	34
	-8	3/8-18	4.11				5101-8B	FD51-1270-08	FD51-1272-08	35
	-10	1/2-14	5.21				5101-10B	FD51-1270-10	FD51-1272-10	36
	-12	3/4-14	5.21				5101-12B	FD51-1270-12	FD51-1272-12	37
	-16	1-11 1/2	5.98				5101-16B	FD51-1270-16	FD51-1272-16	38
	-20	1 1/4-11 1/2	6.31				5101-20B	FD51-1270-20	FD51-1272-20	39
	-24	1 1/2-11 1/2	6.52				5101-24B	FD51-1270-24	FD51-1272-24	40
Repair Kit Each kit will repair male and female halves.	-4						FF098-04	FF095-04	FF097-04	41
	-6, -8						FF098-08	FF095-08	FF097-08	42
	-10, -12						FF098-12	FF095-12	FF097-12	43
	-16						FF098-16	FF095-16	FF097-16	44
	-20						FF098-20	FF095-20	FF097-20	45
	-24						FF098-24	FF095-24	FF097-24	46

*Viton is a DuPont trademark.

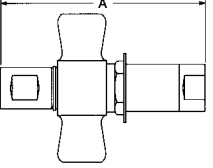
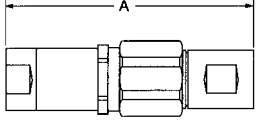
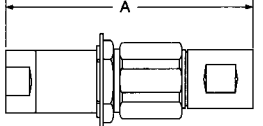

For component part number breakdown and service instructions, request bulletin JB41.

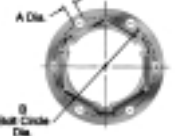
5100 Series	Coupling Size	Thread Size (P)	Dimensional Data				Part Number			Line Ref.	
			A	B	①	②	Buna-N	Viton**	EPR		
Complete Coupling With Flange/With Wing Nut/ Female Pipe 	-4	1/8-27	3.24				5100-4B			1	
	-6	1/4-18	4.11				5100-6B			2	
	-8	3/8-18	4.11				5100-8B			3	
	-10	1/2-14	5.21				5100-10B			4	
	-12	3/4-14	5.21				5100-12B			5	
	-16	1-11 1/2	5.99				5100-16B			6	
	-20	1 1/4-11 1/2	6.33				5100-20B			7	
	-24	1 1/2-11 1/2	6.54				5100-24B			8	
Complete Coupling Less Flange/With Hex Nut/ Female Pipe 	-4	1/8-27	3.20				5111-4B	FD51-1271-04	FD51-1273-04	9	
	-6	1/4-18	4.11				5111-6B	FD51-1271-06	FD51-1273-06	10	
	-8	3/8-18	4.11				5111-8B	FD51-1271-08	FD51-1273-08	11	
	-10	1/2-14	5.21				5111-10B	FD51-1271-10	FD51-1273-10	12	
	-12	3/4-14	5.21				5111-12B	FD51-1271-12	FD51-1273-12	13	
	-16	1-11 1/2	5.98				5111-16B	FD51-1271-16	FD51-1273-16	14	
	-20	1 1/4-11 1/2	6.31				5111-20B	FD51-1271-20	FD51-1273-20	15	
	-24	1 1/2-11 1/2	6.52				5111-24B	FD51-1271-24	FD51-1273-24	16	
Complete Coupling With Flange/With Hex Nut/ Female Pipe 	-4	1/8-27	3.20				5110-4B			17	
	-6	1/4-18	4.11				5110-6B			18	
	-8	3/8-18	4.11				5110-8B			19	
	-10	1/2-14	5.21				5110-10B			20	
	-12	3/4-14	5.21				5110-12B			21	
	-16	1-11 1/2	5.98				5110-16B			22	
	-20	1 1/4-11 1/2	6.31				5110-20B			23	
	-24	1 1/2-11 1/2	6.52				5110-24B			24	
Repair Kit Each kit will repair male and female halves.	-4						FF098-04	FF095-04	FF097-04	25	
	-6, -8						FF098-08	FF095-08	FF097-08	26	
	-10, -12						FF098-12	FF095-12	FF097-12	27	
	-16						FF098-16	FF095-16	FF097-16	28	
	-20						FF098-20	FF095-20	FF097-20	29	
	-24						FF098-24	FF095-24	FF097-24	30	
Accessories	Dust Cap with Chain*						Dust Cap with Chain	Dust Plug with Chain	6 Bolt Flange	31	
			-4				5100-S7-5	5100-S9-5		32	
			-6, -8					5100-S7-8	5100-S9-8		33
			-10, -12					5100-S7-12	5100-S9-12		34
			-16					5100-S7-16	5100-S9-16		35
			-20					5100-S7-20	5100-S9-20		36
			-24					5100-S7-24	5100-S9-24		37
										38	
										39	
	6 Bolt Flange† 	-4		.201	1.44				150-22-5		40
-6, -8			.201	1.69				150-22-8		41	
-10, -12			.201	2.12				150-22-12		42	
-16			.201	2.38				150-22-16		43	
-20			.201	2.62				150-22-20		44	
-24			.201	3.25				5100-22-24S		45	

†6 Bolt Flange-holes equally spaced. (See "A" for bolt hole diameter, and "B" for bolt circle diameter).
 *To order caps and plugs without chain, order cap by part number 5100-32-(size) and plug by part number 5100-41-(size).
 **Viton is a DuPont trademark.



5400 Series/Low Air Inclusion Refrigerant

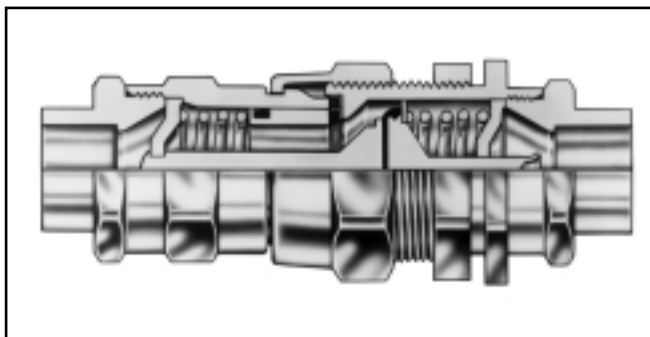
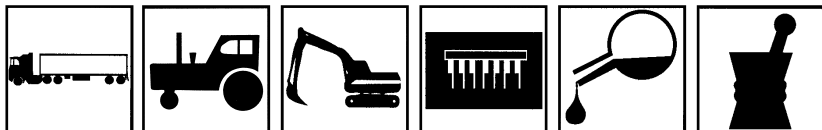

The 5400 Series is designed for air conditioning, refrigerant, gaseous and fluid transfer applications.

- Brazed or threaded end connections for versatility of installation on tubing or hose.
- Tubular valve construction for low fluid loss and air inclusion.
- Thread together design allows connection and disconnection against pressure.
- Lock washer and jam nut standard for optional bulkhead mounting.
- Standard seal material – Neoprene.
- Standard adapter material – Steel or Brass.
- Standard body material – Zinc plated steel.
- Safety sleeve lock available, contact Eaton Aeroquip for details.

Flow Data

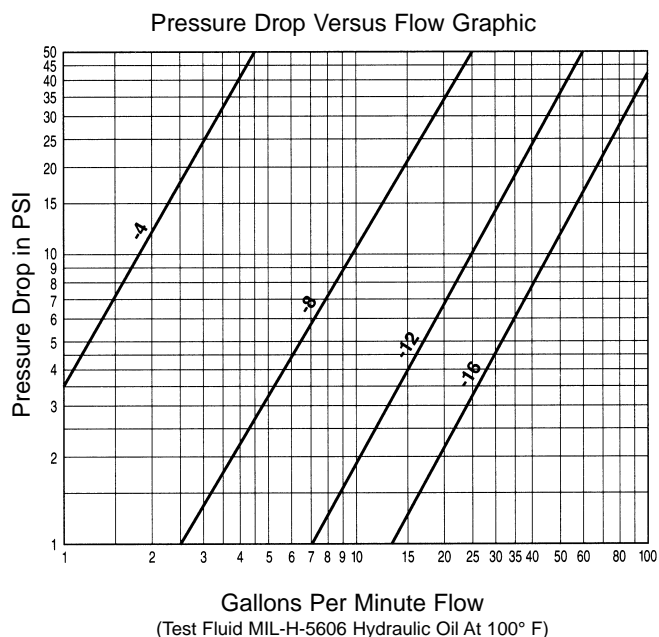



Physical Characteristics

Coupling Dash Size	Maximum Operating Pressure (psi connected)	Minimum Burst Pressure (psi connected)	Maximum Operating Pressure (psi disconnected)		Vacuum (in./Hg.)	Rated Flow (gpm)	Air Inclusion (cc max.)	Fluid Loss (cc max.)
			Male Half	Female Half				
-4	3000	9000	2500	500	28	2	.10	.05
-8	1750	5200	1750	400	28	14	.10	.10
-12	700	2100	800	400	28	35	.30	.10
-16	700	2100	700	300	28	75	.50	.20



5400 Series	Coupling Size	Thread Size (P)	Tube O.D. Size	Dimensional Data					Part Number Neoprene	Line Ref.
				A	B	①	②	③		
Male Half No Adapter 	-4			1.08	.83	.75			5400-S2-4	1
	-8			1.37	1.25	1.13			5400-S2-8	2
	-12			1.74	1.83	1.63			5400-S2-12	3
	-16			1.83	2.10	1.88			5400-S2-16	4
										5
										6
										7
										8
Female Half No adapter 	-4			1.13	.83	.63	.75		5400-S5-4	9
	-8			1.63	1.31	1.00	1.19		5400-S5-8	10
	-12			2.15	1.80	1.38	1.63		5400-S5-12	11
	-16			2.37	2.24	1.75	2.00		5400-S5-16	12
										13
										14
										15
										16
Male Half SAE 37° (JIC) 	-4	7/16-20		1.88	.83	.75		.63	5410-S17-4-4	17
	-4	9/16-18		1.89	.83	.75		.63	5410-S17-6-4	18
	-8	9/16-18		2.18	1.25	1.13		1.00	5410-S17-6-8	19
	-8	3/4-16		2.28	1.25	1.13		1.00	5410-S17-8-8	20
	-12	7/8-14		2.75	1.83	1.63		1.38	5410-S17-10-12	21
	-12	1 1/16-12		2.86	1.83	1.63		1.38	5410-S17-12-12	22
	-16	1 5/16-12		2.99	2.10	1.88		1.75	5410-S17-16-16	23
										24
Female Half SAE 37° (JIC) 	-4	7/16-20		1.93	.83	.63	.75	.63	5410-S14-4-4	25
	-4	9/16-18		1.94	.83	.63	.75	.63	5410-S14-6-4	26
	-8	9/16-18		2.43	1.31	1.00	1.19	1.00	5410-S14-6-8	27
	-8	3/4-16		2.53	1.31	1.00	1.19	1.00	5410-S14-8-8	28
	-12	7/8-14		3.16	1.80	1.38	1.63	1.38	5410-S14-10-12	29
	-12	1 1/16-12		3.27	1.80	1.38	1.63	1.38	5410-S14-12-12	30
	-16	1 5/16-12		3.53	2.24	1.75	2.00	1.75	5410-S14-16-16	31
										32
Complete Coupling SAE 37° (JIC) 	-4	7/16-20		3.54					5410-4-4	33
	-4	9/16-18		3.56					5410-6-4	34
	-8	9/16-18		4.23					5410-6-8	35
	-8	3/4-16		4.44					5410-8-8	36
	-12	7/8-14		5.33					5410-10-12	37
	-12	1 1/16-12		5.54					5410-12-12	38
	-16	1 5/16-12		5.89					5410-16-16	39
										40
Male Half Brazing Adapter 	-4		1/4	1.52	.83	.75		.63	5401-S17-4-4	41
	-4		3/8	1.52	.83	.75		.63	5401-S17-6-4	42
	-8		3/8	1.75	1.31	1.13		1.00	5401-S17-6-8	43
	-8		1/2	1.75	1.31	1.13		1.00	5401-S17-8-8	44
	-12		5/8	2.47	1.80	1.63		1.38	5401-S17-10-12	45
	-12		3/4	2.47	1.80	1.63		1.38	5401-S17-12-12	46
	-16		1	2.80	2.24	1.88		1.75	5401-S17-16-16	47
										48

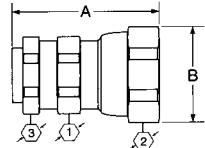
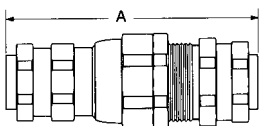

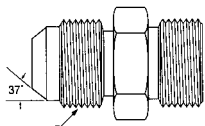
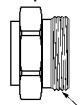
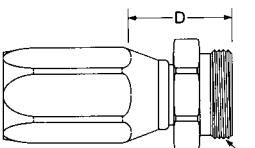
5400 Series	Coupling Size	Thread Size (P)	Tube O.D. Size	Dimensional Data					Part Number Neoprene	Line Ref.
				A	B	①	②	③		
Female Half Braze Tubing Adapter 	-4		1/4	1.57	.83	.63	.75	.63	5401-S14-4-4	1
	-4		3/8	1.57	.83	.63	.75	.63	5401-S14-6-4	2
	-8		3/8	2.00	1.31	1.00	1.19	1.00	5401-S14-6-8	3
	-8		1/2	2.00	1.31	1.00	1.19	1.00	5401-S14-8-8	4
	-12		5/8	2.88	1.80	1.38	1.63	1.38	5401-S14-10-12	5
	-12		3/4	2.88	1.80	1.38	1.63	1.38	5401-S14-12-12	6
	-16		1	3.34	2.24	1.75	2.00	1.75	5401-S14-16-16	7
										8
Complete Coupling Braze Tubing Adapter 	-4		1/4	2.82					5401-4-4	9
	-4		3/8	2.82					5401-6-4	10
	-8		3/8	3.37					5401-6-8	11
	-8		1/2	3.37					5401-8-8	12
	-12		5/8	4.76					5401-10-12	13
	-12		3/4	4.76					5401-12-12	14
	-16		1	5.52					5401-16-16	15
										16
Accessories Dust Cap Dust Plug 				Dust Cap with Gasket			Dust Plug with Gasket		17	
	-4			5400-S6-4			5400-S8-4		18	
	-8			5400-S6-8			5400-S8-8		19	
	-12			5400-S6-12			5400-S8-12		20	
	-16			5400-S6-16			5400-S8-16		21	
									22	
									23	
								24		
								25		
Adapter SAE 37° (JIC)  O-Ring Required				O-Ring		Brass		Steel	26	
	-4	7/16-20	1/4	22546-12		202220-4-4B		202220-4-4S	27	
	-4	9/16-18	3/8	22546-12		202220-6-4B		202220-6-4S	28	
	-8	9/16-18	3/8	22546-17		202220-6-8B		202220-6-8S	29	
	-8	3/4-16	1/2	22546-17		202220-8-8B		202220-8-8S	30	
	-12	7/8-14	5/8	22546-23		202220-10-12B		202220-10-12S	31	
	-12	1 1/16-12	3/4	22546-23		202220-12-12B		202220-12-12S	32	
	-16	1 5/16-12	1	22546-28		202220-16-16B		202220-16-16S	33	
Adapter-Braze  O-Ring Required					Brass			34		
	-4	1/2-20	1/4	22546-12		202208-4-4B			35	
	-8	7/8-20	1/2	22546-17		202208-8-8B			36	
	-12	1 1/4-18	5/8	22546-23		202208-10-12B			37	
	-16	1 19/32-20	7/8	22546-28		202208-14-16B			38	
Hose Fitting SAE 100R5†  O-Ring Required			Hose Size	D					39	
	-4	1/2-20	-4	.92	22546-12		487-4-4S		40	
	-4	1/2-20	-6	.96	22546-12		487-4-6S		41	
	-8	7/8-20	-6	.96	22546-17		487-8-6S		42	
	-8	7/8-20	-8	1.06	22546-17		487-8-8S		43	
	-12	1 1/4-18	-10	1.07	22546-23		487-12-10S		44	
	-16	1 19/32-20	-16	1.01	22546-28		487-16-16S		45	

†Additional dash styles available.



Assembly Instructions/Component Part Numbers

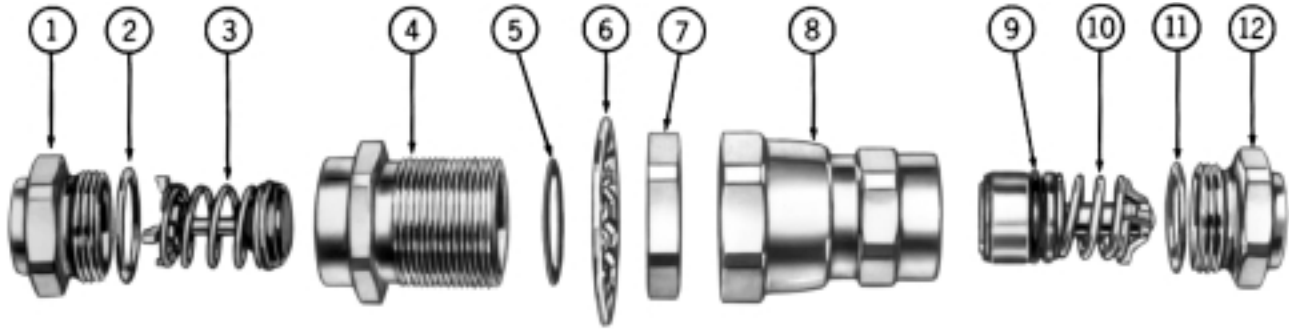

Typical Male Coupling Half (S2)

Typical Female Coupling Half (S5)

Assembly Instructions

Steps:

- After tubing or hose has been connected to adapters ① and ⑫, install O-Rings ② and ⑪† on adapters. Be sure O-Rings are not twisted.
- Oil O-Rings ② and ⑪ liberally with system fluid to prevent them from scuffing and tearing when coupling body is threaded on adapter.
- S2 Half—Lubricate poppet face with system fluid. Insert poppet valve assembly ③ into body ④. Tighten body ④ on adapter ①. After body and adapter make metal-to-metal contact, tighten by rotating body ④ 1/8" with respect to adapter ① or torque per table value.
S5 Half—Oil O-Ring ⑨† liberally with system fluid. Insert valve and sleeve assembly ⑩ into body ⑧. Tighten body ⑧ on adapter ⑫. After body and adapter make metal-to-metal contact, tighten by rotating body ⑧ 1/8" with respect to adapter ⑫ or torque per table value.
- Coupling Connection—Lubricate gasket seal ⑤ on 5400-S2 half with system fluid. Thread union nut ⑦ on 5400-S2 half. Tighten union nut to torque values shown in Table. Be sure S2 and S5 bodies do not rotate during connection.

Bulkhead Mounting—S2 Half

Install lock washer ⑥ on S2 half. Insert S2 half through bulkhead, and tighten jam nut ⑦ so that lock washer teeth are fully compressed.

NOTE: Lock washer ⑥ must be between hex of S2 half and bulkhead.

Maximum Bulkhead Thickness

Coupling Size	Lock Washer Installed	Lock Washer Not Used
-4	.206	.256
-8	.136	.203
-12	.232	.292
-16	.101	.161

Torque Values

Recommended torque values in ft. lbs., are listed below.

Dash Size	Adapter to Body		S2 Half to S5 Half
	Braze Type or Aluminum	Non-braze Type Steel or Brass	
-4	6-8	12-15	10-12
-8	15-20	35-45	35-37
-12	35-40	45-55	45-47
-16	50-60	55-65	65-67

†IMPORTANT: Generous lubrication is required for all gaskets and O-Rings. Use refrigeration oil only when used in refrigerant system.

Component Part Numbers

Item No.	Dash Size →	-4	-8	-12	-16	Line Ref.
	O.D. Tube Size →	1/4" - 3/8"	1/4" - 5/8"	5/8" - 7/8"	7/8" - 1 3/8"	
	Typical Male Half					1
1	Tubing Adapter	202208-*4	202208-*8	202208-*12	202208-*16	2
2	O-Ring	22546-12	22546-17	22546-23	22546-28	3
3	Poppet Valve Assembly	5400-S20-4	5400-S20-8	5400-S20-12	5400-S20-16	4
4	Body	5400-17-4	5400-17-8	5400-17-12	5400-17-16	5
5	Gasket Seal	22008-4	22008-8	22008-12	22008-16	6
6	Lock Washer	5400-54-4S	5400-54-8S	5400-54-12S	5400-54-16S	7
7	Jam Nut	5400-53-4S	5400-53-8S	5400-53-12S	5400-53-16S	8
	Typical Female Half					9
8	Union Nut and Body Assembly	5400-S16-4	5400-S16-8	5400-S16-12	5400-S16-16	10
9	O-Ring	22546-10	22546-112	22546-116	22546-214	11
10	Valve and Sleeve Assembly	5400-S19-4	5400-S19-8	5400-S19-12	5400-S19-16	12
11	O-Ring	22546-12	22546-17	22546-23	22546-28	13
12	Tubing Adapter	202208-*4	202208-*8	202208-*12	202208-*16	14

*Specify O.D. Tubing size of adapter required in 16th of an inch. Example: -4 coupling with 3/8" O.D. tubing is 5/16 or -6. Part number is then 202208-6-4.



5600 Series/Industrial Interchange (Series A)

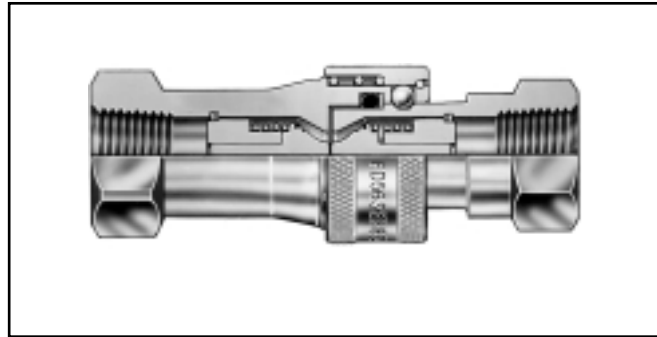
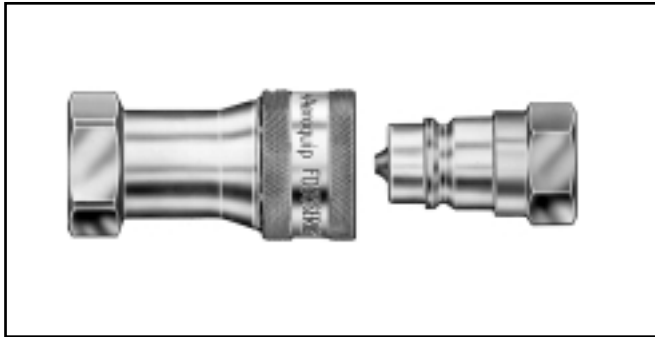

The 5600 Series general purpose coupling features a *PUSH-PULL™* latch and poppet valving in a low profile design. It is a favorite in North America and abroad.

- *PUSH-PULL™* ball latch design allows quick and easy connection and disconnection of fluid lines.
- Self-sealing poppet valve provides excellent high and low pressure sealing.
- Conforms dimensionally to ISO standard 7241/1 Series A.
- Streamlined valving provides minimum pressure drop.
- Standard seal materials – Buna-N, EPR and Viton*.
- Standard body material – Zinc plated steel with Zinc poppet guides. (Brass poppet guide in -04 size.)
- Safety sleeve lock available. Contact Eaton Aeroquip for details.

Physical Characteristics

Coupling Size	Maximum Operating Pressure (psi)	Minimum Burst Pressure (psi)	Vacuum (in./Hg.)	Rated Flow (gpm)	Air Inclusion (cc. max.)	Fluid Loss (cc. max.)
-04	5,000	15,000	28	1	.50	.50
-06	4,000	12,000	28	6	1.5	1.3
-10	4,000	12,000	28	12	2.8	2.8
-12	4,000	12,000	28	28	10.0	8.2
-16	4,000	12,000	28	50	14.2	14.2

*Viton is a DuPont trademark.

Flow Data

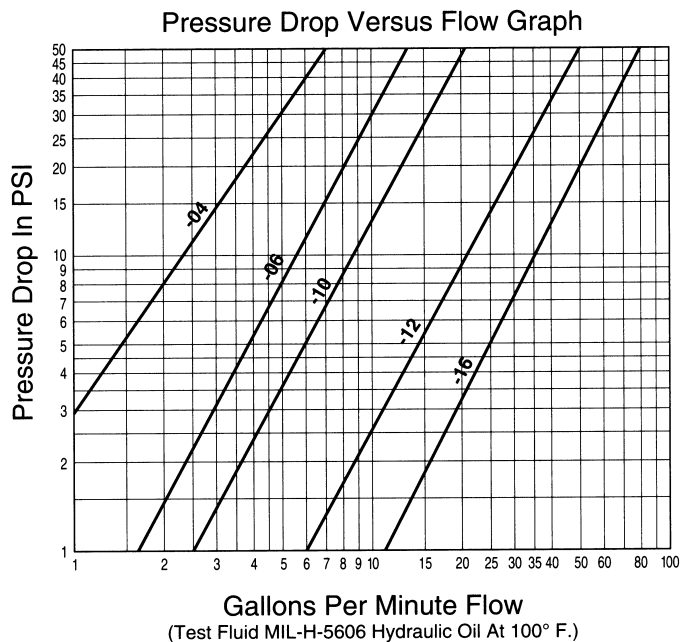

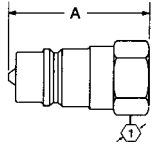
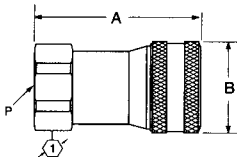
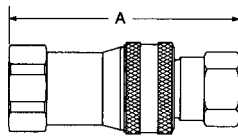
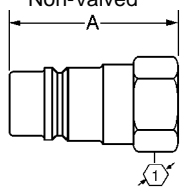
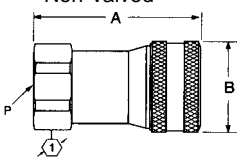

5600 Series	Coupling Size	Thread Size (P)	Dimensional Data			Part Number			Line Ref.
			A	B	ϕ	Buna-N	Viton*	EPR	
Male Half Female Pipe/Valved 	-04	1/8-27	1.17		.56	5602-2-4S	FD56-1062-02-04	5644-2-4S	1
	-04	1/4-18	1.24		.75	5602-4-4S	FD56-1062-04-04	5644-4-4S	2
	-06	3/8-18	1.40		.88	5602-6-6S	FD56-1062-06-06	5644-6-6S	3
	-10	1/2-14	1.89		1.06	5602-8-10S	FD56-1062-08-10	5644-8-10S	4
	-10	3/4-14	2.03		1.38	5602-12-10S	FD56-1062-12-10	5644-12-10S	5
	-12	3/4-14	2.28		1.38	5602-12-12S	FD56-1062-12-12	5644-12-12S	6
	-16	1-11 1/2	2.77		1.62	5602-16-16S	FD56-1062-16-16	5644-16-16S	7
									8
Female Half Female Pipe/Valved 	-04	1/8-27	1.81	1.08	.88	5601-2-4S	FD56-1064-02-04	5643-2-4S	9
	-04	1/4-18	1.81	1.08	.88	5601-4-4S	FD56-1064-04-04	5643-4-4S	10
	-06	3/8-18	2.15	1.23	1.00	5601-6-6S	FD56-1064-06-06	5643-6-6S	11
	-10	1/2-14	2.61	1.50	1.19	5601-8-10S	FD56-1064-08-10	5643-8-10S	12
	-10	3/4-14	2.61	1.50	1.31	5601-12-10S	FD56-1064-12-10	5643-12-10S	13
	-12	3/4-14	3.25	1.81	1.50	5601-12-12S	FD56-1064-12-12	5643-12-12S	14
	-16	1-11 1/2	3.82	2.10	1.69	5601-16-16S	FD56-1064-16-16	5643-16-16S	15
									16
Complete Coupling Female Pipe/Valved 	-04	1/8-27	2.42			5600-2-4S	FD56-1065-02-04	5642-2-4S	17
	-04	1/4-18	2.49			5600-4-4S	FD56-1065-04-04	5642-4-4S	18
	-06	3/8-18	2.80			5600-6-6S	FD56-1065-06-06	5642-6-6S	19
	-10	1/2-14	3.78			5600-8-10S	FD56-1065-08-10	5642-8-10S	20
	-10	3/4-14	4.06			5600-12-10S	FD56-1065-12-10	5642-12-10S	21
	-12	3/4-14	4.46			5600-12-12S	FD56-1065-12-12	5642-12-12S	22
	-16	1-11 1/2	5.54			5600-16-16S	FD56-1065-16-16	5642-16-16S	23
									24
Male Half/Female Pipe Non-Valved  <p>Will not operate with valved coupling halves. No valve actuator.</p>	-04	1/8-27	1.17		.56	FD56-1037-02-04	FD56-1037-02-04	FD56-1037-02-04	25
	-04	1/4-18	1.24		.75	FD56-1037-04-04	FD56-1037-04-04	FD56-1037-04-04	26
	-06	3/8-18	1.40		.88	FD56-1037-06-06	FD56-1037-06-06	FD56-1037-06-06	27
	-10	1/2-14	1.89		1.06	FD56-1037-08-10	FD56-1037-08-10	FD56-1037-08-10	28
	-10	3/4-14	2.03		1.38	FD56-1037-12-10	FD56-1037-12-10	FD56-1037-12-10	29
	-12	3/4-14	2.28		1.38	FD56-1037-12-12	FD56-1037-12-12	FD56-1037-12-12	30
	-16	1-11 1/2	2.77		1.62	FD56-1037-16-16	FD56-1037-16-16	FD56-1037-16-16	31
									32
Female Half/Female Pipe Non-Valved  <p>Will not operate with valved coupling halves. No valve actuator.</p>	-04	1/8-27	1.81	1.08	.88	FD56-1225-02-04	FD56-1207-02-04	FD56-1204-02-04	33
	-04	1/4-18	1.81	1.08	.88	FD56-1225-04-04	FD56-1207-04-04	FD56-1204-04-04	34
	-06	3/8-18	2.15	1.23	1.00	FD56-1225-06-06	FD56-1207-06-06	FD56-1204-06-06	35
	-10	1/2-14	2.61	1.50	1.19	FD56-1225-08-10	FD56-1207-08-10	FD56-1204-08-10	36
	-10	3/4-14	2.61	1.50	1.31	FD56-1225-12-10	FD56-1207-12-10	FD56-1204-12-10	37
	-12	3/4-14	3.25	1.81	1.50	FD56-1225-12-12	FD56-1207-12-12	FD56-1204-12-12	38
	-16	1-11 1/2	3.82	2.10	1.69	FD56-1225-16-16	FD56-1207-16-16	FD56-1204-16-16	39
									40
Repair Kit									
Each kit will repair one male or female half. †This size repair kit contains an interface seal and back-up ring.	-04					FF082-04†	FF092-04†	FF093-04†	42
	-06					FF082-06	FF092-06	FF093-06	43
	-10					FF082-10	FF092-10	FF093-10	44
	-12					FF082-12	FF092-12	FF093-12	45
	-16					FF082-16	FF092-16	FF093-16	46

*Viton is a DuPont trademark.



5600 Series	Coupling Size	Thread Size (P)	Dimensional Data			Part Number			Line Ref.
			A	B		Buna-N	Viton*	EPR	
Complete Coupling/Non-Valved Female Pipe 	-04	1/8-27	2.42			FD56-1226-02-04	FD56-1208-02-04	FD56-1205-02-04	1
	-04	1/4-18	2.49			FD56-1226-04-04	FD56-1208-04-04	FD56-1205-04-04	2
	-06	3/8-18	2.80			FD56-1226-06-06	FD56-1208-06-06	FD56-1205-06-06	3
	-10	1/2-14	3.78			FD56-1226-08-10	FD56-1208-08-10	FD56-1205-08-10	4
	-10	3/4-14	4.06			FD56-1226-12-10	FD56-1208-12-10	FD56-1205-12-10	5
	-12	3/4-14	4.46			FD56-1226-12-12	FD56-1208-12-12	FD56-1205-12-12	6
	-16	1-11 1/2	5.54			FD56-1226-16-16	FD56-1208-16-16	FD56-1205-16-16	7
									8
Male Half/Female Pipe Pusher Style Valving Incorporates a pusher device to open mating valved coupling halves.	-04	1/8-27	1.17	.56		FD56-1125-02-04	FD56-1125-02-04	FD56-1125-02-04	9
	-04	1/4-18	1.24	.75		FD56-1125-04-04	FD56-1125-04-04	FD56-1125-04-04	10
	-06	3/8-18	1.40	.88		FD56-1125-06-06	FD56-1125-06-06	FD56-1125-06-06	11
	-10	1/2-14	1.89	1.06		FD56-1125-08-10	FD56-1125-08-10	FD56-1125-08-10	12
	-10	3/4-14	2.03	1.38		FD56-1125-12-10	FD56-1125-12-10	FD56-1125-12-10	13
	-12	3/4-14	2.28	1.38		FD56-1125-12-12	FD56-1125-12-12	FD56-1125-12-12	14
	-16	1-11 1/2	2.77	1.62		FD56-1125-16-16	FD56-1125-16-16	FD56-1125-16-16	15
									16
Female Half/Female Pipe Pusher Style Valving Incorporates a pusher device to open mating valved coupling halves.	-04	1/8-27	1.81	1.08	.88	FD56-1123-02-04	FD56-1201-02-04	FD56-1196-02-04	17
	-04	1/4-18	1.81	1.08	.88	FD56-1123-04-04	FD56-1201-04-04	FD56-1196-04-04	18
	-06	3/8-18	2.15	1.23	1.00	FD56-1123-06-06	FD56-1201-06-06	FD56-1196-06-06	19
	-10	1/2-14	2.61	1.50	1.19	FD56-1123-08-10	FD56-1201-08-10	FD56-1196-08-10	20
	-10	3/4-14	2.61	1.50	1.31	FD56-1123-12-10	FD56-1201-12-10	FD56-1196-12-10	21
	-12	3/4-14	3.25	1.81	1.50	FD56-1123-12-12	FD56-1201-12-12	FD56-1196-12-12	22
	-16	1-11 1/2	3.82	2.10	1.69	FD56-1123-16-16	FD56-1201-16-16	FD56-1196-16-16	23
									24
Female Half/Female Pipe Connect Under Pressure Style 	-10	1/2-14	2.88	1.52	1.06	5651-8-10S	FD56-1070-08-10	565007-8-10S	25
	-10	3/4-14	3.30	1.22	1.25	5651-12-10S	FD56-1070-12-10	565007-12-10S	26
									27
									28
									29
									30
									31
									32
Complete Coupling/Female Pipe Connect Under Pressure Style 	-10	1/2-14	3.89			5650-8-10S	FD56-1071-08-10	565006-8-10S	33
	-10	3/4-14	4.45			5650-12-10S	FD56-1071-12-10	565006-12-10S	34
									35
									36
									37
									38
									39
									40
Repair Kit									
Each kit will repair one male or female half.									
	-04					FF082-04†	FF092-04†	FF093-04†	42
	-06					FF082-06	FF092-06	FF093-06	43
	-10					FF082-10	FF092-10	FF093-10	44
	-12					FF082-12	FF092-12	FF093-12	45
	-16					FF082-16	FF092-16	FF093-16	46

*Viton is a DuPont trademark.

† This size repair kit contains an interface seal and back-up ring.

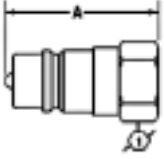
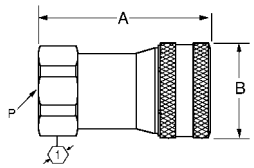
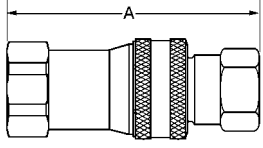
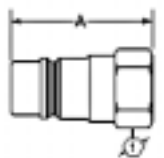
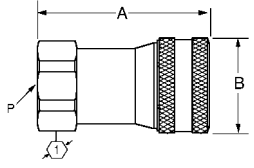

5600 Series	Coupling Size	Thread Size (P)	Dimensional Data			Part Number			Line Ref.
			A	B		Buna-N	Viton*	EPR	
Male Half Female SAE O-Ring/Valved 	-04	7/16-20	1.28		.62	5610-4-4S	FD56-1072-04-04	560078-4-4S	1
	-06	9/16-18	1.50		.88	5610-6-6S	FD56-1072-06-06	560078-6-6S	2
	-10	3/4-16	2.03		1.06	5610-8-10S	FD56-1072-08-10	560078-8-10S	3
	-10	7/8-14	2.08		1.12	5610-10-10S	FD56-1072-10-10	560078-10-10S	4
	-10	1 1/16-12	2.26		1.38	5610-12-10S	FD56-1072-12-10	560078-12-10S	5
	-12	1 1/16-12	2.55		1.38	5610-12-12S	FD56-1072-12-12	560078-12-12S	6
	-16	1 5/16-12	3.10		1.62	5610-16-16S	FD56-1072-16-16	560078-16-16S	7
									8
Female Half Female SAE O-Ring/Valved 	-04	7/16-20	1.81	1.08	.88	5608-4-4S	FD56-1074-04-04	FD56-1012-04-04	9
	-06	9/16-18	2.11	1.27	1.00	5608-6-6S	FD56-1074-06-06	FD56-1012-06-06	10
	-10	3/4-16	2.76	1.52	1.19	5608-8-10S	FD56-1074-08-10	FD56-1012-08-10	11
	-10	7/8-14	2.81	1.52	1.19	5608-10-10S	FD56-1074-10-10	FD56-1012-10-10	12
	-10	1 1/16-12	3.00	1.52	1.31	5608-12-10S	FD56-1074-12-10	FD56-1012-12-10	13
	-12	1 1/16-12	3.25	1.84	1.50	5608-12-12S	FD56-1074-12-12	FD56-1012-12-12	14
	-16	1 5/16-12	3.83	2.15	1.88	5608-16-16S	FD56-1074-16-16	FD56-1012-16-16	15
									16
Complete Coupling Female SAE O-Ring/Valved 	-04	7/16-20	2.53			5606-4-4S	FD56-1075-04-04	FD56-1009-04-04	17
	-06	9/16-18	2.84			5606-6-6S	FD56-1075-06-06	FD56-1009-06-06	18
	-10	3/4-16	3.78			5606-8-10S	FD56-1075-08-10	FD56-1009-08-10	19
	-10	7/8-14	3.88			5606-10-10S	FD56-1075-10-10	FD56-1009-10-10	20
	-10	1 1/16-12	4.24			5606-12-10S	FD56-1075-12-10	FD56-1009-12-10	21
	-12	1 1/16-12	4.46			5606-12-12S	FD56-1075-12-12	FD56-1009-12-12	22
	-16	1 5/16-12	5.54			5606-16-16S	FD56-1075-16-16	FD56-1009-16-16	23
									24
Male Half Female SAE O-Ring/Non-Valved  <p>Will not operate with valved coupling halves. No valve actuator.</p>	-04	7/16-20	1.21	.72	.62	FD56-1221-04-04	FD56-1221-04-04	FD56-1221-04-04	25
	-06	9/16-18	1.42	.73	.88	FD56-1221-06-06	FD56-1221-06-06	FD56-1221-06-06	26
	-10	3/4-16	1.89	1.02	1.06	FD56-1221-08-10	FD56-1221-08-10	FD56-1221-08-10	27
	-10	7/8-14	1.94	1.07	1.12	FD56-1221-10-10	FD56-1221-10-10	FD56-1221-10-10	28
	-10	1 1/16-12	2.12	1.24	1.38	FD56-1221-12-10	FD56-1221-12-10	FD56-1221-12-10	29
	-12	1 1/16-12	2.28	1.21	1.38	FD56-1221-12-12	FD56-1221-12-12	FD56-1221-12-12	30
	-16	1 5/16-12	2.77	1.45	1.62	FD56-1221-16-16	FD56-1221-16-16	FD56-1221-16-16	31
									32
Female Half Female SAE O-Ring/Non-Valved  <p>Will not operate with valved coupling halves. No valve actuator.</p>	-04	7/16-20	1.81	1.08	.88	5691-4-4S	FD56-1233-04-04	FD56-1209-04-04	33
	-06	9/16-18	2.11	1.27	1.06	5691-6-6S	FD56-1233-06-06	FD56-1209-06-06	34
	-10	3/4-16	2.76	1.52	1.25	5691-8-10S	FD56-1233-08-10	FD56-1209-08-10	35
	-10	7/8-14	2.81	1.52	1.25	5691-10-10S	FD56-1233-10-10	FD56-1209-10-10	36
	-10	1 1/16-12	3.00	1.52	1.38	5691-12-10S	FD56-1233-12-10	FD56-1209-12-10	37
	-12	1 1/16-12	3.25	1.84	1.50	5691-12-12S	FD56-1233-12-12	FD56-1209-12-12	38
	-16	1 5/16-12	4.09	2.15	1.88	5691-16-16S	FD56-1233-16-16	FD56-1209-16-16	39
									40
Repair Kit									41
Each kit will repair one male or female half.									
	-04					FF082-04†	FF092-04†	FF093-04†	42
	-06					FF082-06	FF092-06	FF093-06	43
	-10					FF082-10	FF092-10	FF093-10	44
	-12					FF082-12	FF092-12	FF093-12	45
	-16					FF082-16	FF092-16	FF093-16	46

*Viton is a DuPont trademark.



5600 Series	Coupling Size	Thread Size (P)	Dimensional Data			Part Number			Line Ref.	
			A	B		Buna-N	Viton*	EPR		
Complete Coupling Female SAE O-Ring/Non-Valved Will not operate with valved coupling halves.	-04	7/16-20	2.53			5690-4-4S	FD56-1234-04-04	FD56-1210-04-04	1	
	-06	9/16-18	2.84			5690-6-6S	FD56-1234-06-06	FD56-1210-06-06	2	
	-10	3/4-16	3.78			5690-8-10	FD56-1234-08-10	FD56-1210-08-10	3	
	-10	7/8-14	3.88			5690-10-10S	FD56-1234-10-10	FD56-1210-10-10	4	
	-10	1 1/16-12	4.24			5690-12-10S	FD56-1234-12-10	FD56-1210-12-10	5	
	-12	1 1/16-12	4.46			5690-12-12S	FD56-1234-12-12	FD56-1210-12-12	6	
	-16	1 5/16-12	5.54			5690-16-16S	FD56-1234-16-16	FD56-1210-16-16	7	
									8	
Female Half/Female SAE O-Ring Connect Under Pressure 	-10	3/4-16	2.88	1.52	1.06	5668-8-10S	FD56-1081-8-10	565015-8-10S	9	
	-10	7/8-14	3.19	1.52	1.12	5668-10-10S	FD56-1081-10-10	565015-10-10S	10	
	-10	1 1/16-12	3.38	1.52	1.38	5668-12-10S	FD56-1081-12-10	565015-12-10S	11	
										12
										13
										14
Complete Coupling/Female SAE O-Ring Connect Under Pressure 	-10	3/4-16	3.88			5667-8-10S	FD56-1082-8-10	565014-8-10S	17	
	-10	7/8-14	4.25			5667-10-10S	FD56-1082-10-10	565014-10-10S	18	
	-10	1 1/16-12	4.62			5667-12-10S	FD56-1082-12-10	565014-12-10S	19	
										20
										21
										22
										23
										24
Repair Kit Each kit will repair one male or female half. †This size repair kit contains an interface seal and back-up ring.	-04					FF082-04†	FF092-04†	FF093-04†	26	
	-06					FF082-06	FF092-06	FF093-06	27	
	-10					FF082-10	FF092-10	FF093-10	28	
	-12					FF082-12	FF092-12	FF093-12	29	
	-16					FF082-16	FF092-16	FF093-16	30	
										31
Accessories Dust Cap 	-04						5657-4		32	
	-06						5657-6		33	
	-10						5657-10		34	
	-12						5657-12		35	
	-16						5657-16		36	
Dust Plug 	-4						5659-4		37	
	-6						5659-6		38	
	-10						5659-10		39	
	-12						5659-12		40	
	-16						5659-16		41	
Break Away Frame 	-10						5603		42	
									43	
									44	
									45	
									46	

*Viton is a DuPont trademark.



FD69 Series/Arc Latch™—High Pressure Water Blast (10,000 psi)

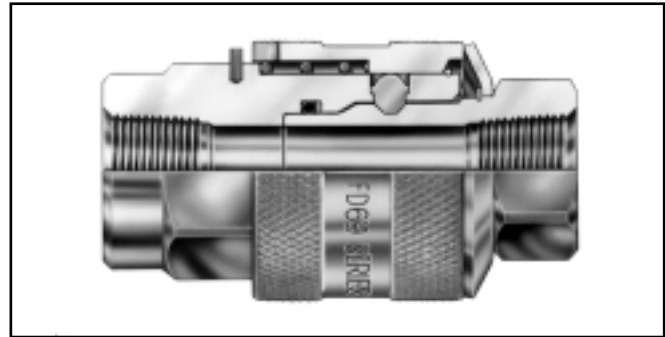
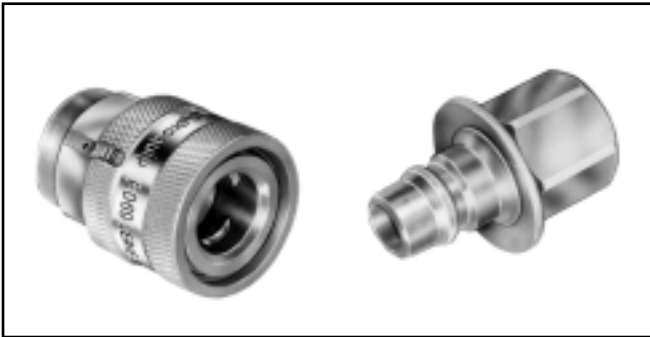
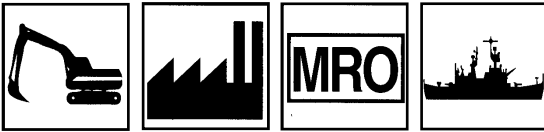

The FD69 Series “Arc Latch™” design has a greater surface contact area for long service life in rugged high-pressure and water blast applications. The maximum operating pressure is 10,000 psi with 40,000 psi minimum burst pressure.

- Safety sleeve lock guards against accidental disconnection.
- Smooth bore “straight through” design for high flow.
- Heavy duty back-up ring to prevent O-Ring extrusion.
- Available in plated steel and stainless steel for added corrosion resistance.
- Standard seal material – Buna-N.
- Standard body material – Zinc plated steel, Stainless steel.

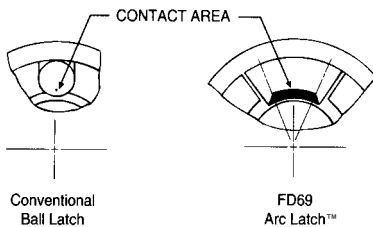

Flow Data

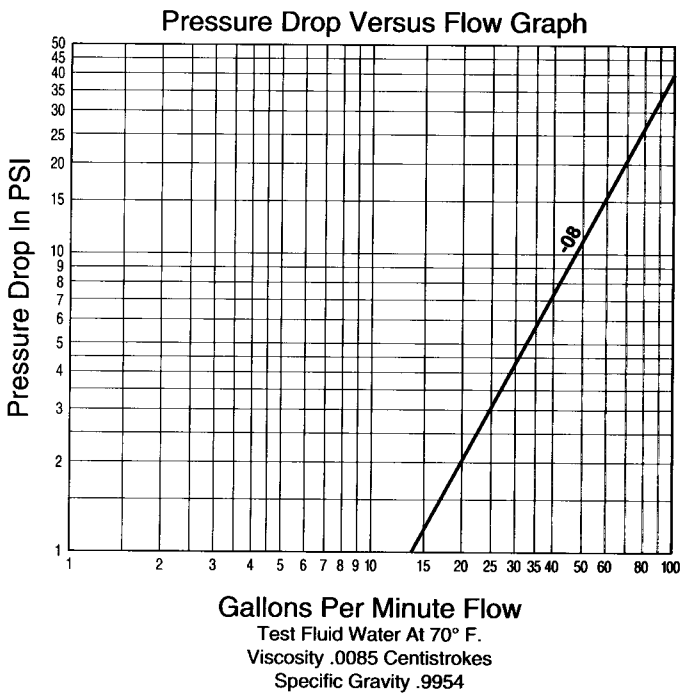

Physical Characteristics

Coupling Dash Size	Maximum Operating Pressure (psi)	Minimum Burst Pressure (psi)	Vacuum (in./Hg.)	Rated Flow (gpm)	Air Inclusion (cc. max.)	Fluid Loss (cc. max)
-08	10,000	40,000	28	45	—	—



FD69 Series	Coupling Size	Thread Size (P)	Thread Size (P _i)	Dimensional Data			Part Number			Line Ref.
				A	B		Buna-N	Viton*	EPR	
Male Half/Female Pipe 	Steel									1
	-08	3/8-18		1.85	1.64	1.00	FD69-1002-06-08	FD69-1002-06-08	FD69-1002-06-08	2
	-08	1/2-14		2.34	1.64	1.12	FD69-1002-08-08	FD69-1002-08-08	FD69-1002-08-08	3
										4
	Stainless Steel									5
	-08	1/2-14		2.34	1.64	1.12	FD69-1012-08-08	FD69-1012-08-08	FD69-1012-08-08	6
										7
										8
Female Half/Female Pipe 	Steel									9
	-08	3/8-18		2.13	1.62	1.25	FD69-1001-06-08	FD69-1026-06-08	FD69-1028-06-08	10
	-08	1/2-14		2.13	1.62	1.25	FD69-1001-08-08	FD69-1026-08-08	FD69-1028-08-08	11
										12
	Stainless Steel									13
	-08	1/2-14		2.13	1.62	1.25	FD69-1011-08-08			14
										15
										16
Complete Coupling Female Pipe 	Steel									17
	-08	1/2-14	1/2-14	3.43			FD69-1000-080808	FD69-1027-080808	FD69-1029-080808	18
	-08	1/2-14	3/8-18	3.43			FD69-1000-080806	FD69-1027-080806	FD69-1029-080806	19
	-08	3/8-18	1/2-14	2.94			FD69-1000-060808	FD69-1027-060808	FD69-1029-060808	20
	-08	3/8-18	3/8-18	2.94			FD69-1000-060806	FD69-1027-060806	FD69-1029-060806	21
	Stainless Steel									22
	-08	1/2-14	1/2-14	3.43			FD69-1010-080808			23
										24
Repair Kit	Female Interface Seal Kit									25
	-08						FF10166			26

*Viton is a DuPont trademark.



FD71 Series/Push-to-Connect Farm

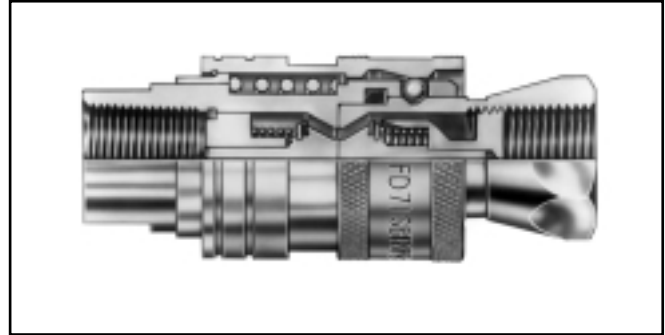
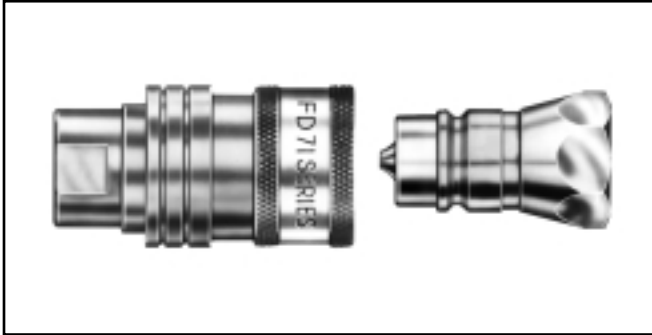
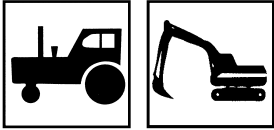

The FD71 Series coupling is designed to interchange with male tips made to ISO 5675 specifications. It features one hand push-to-connect latching. The maximum operating pressure is 3,000 psi.

- Self-sealing poppet valve construction provides reliable leak-free service.
- Push-to-connect for one-hand operation when sleeve is mounted.
- Retaining ring groove on female half for bulkhead and break-away frame mounting.
- Standard seal material – Buna-N.
- Standard body material – Zinc plated steel with Zinc poppet guide.

Flow Data

Pressure Drop versus Flow Graph

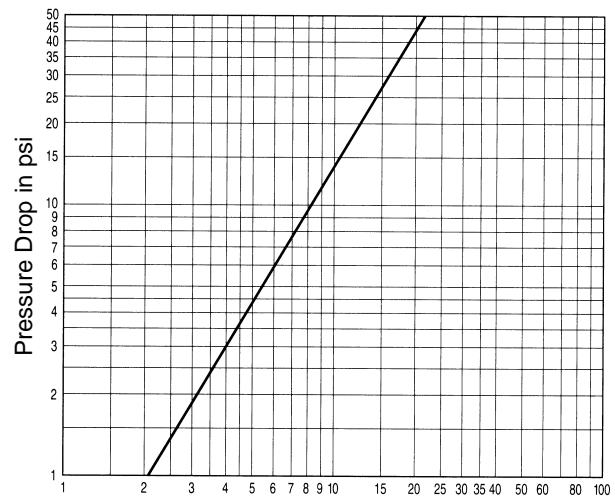

Gallons per Minute Flow
(Test Fluid MIL-H-5606 Hydraulic Oil at 100°F)

Physical Characteristics

Coupling Size	Maximum Operating Pressure (psi)	Minimum Burst Pressure (psi)	Vacuum (in./Hg.)	Rated Flow (gpm)	Air Inclusion (cc. max.)	Fluid Loss (cc. max.)
-10	3,000	12,000	28	16	2.8	2.8



FD71 Series	Coupling Size	Thread Size (P)	Dimensional Data						Part Number	Line Ref.
			A	B	C	D	E			
Male Half Female Pipe/Valved 	-10	1/2-14	2.05					1.06	FD76-1002-08-10	1
										2
										3
										4
										5
										6
										7
										8
Female Half Female Pipe/Valved 	-10	1/2-14	2.74	1.52	1.50	1.41	.20	1.00	FD71-1001-08-10	9
										10
										11
										12
										13
										14
										15
										16
Accessories										17
Dust Cap 	-10								5657-10	18
										19
										20
										21
										22
										23
										24
Dust Plug 	-10								5659-10	25
										26
										27
										28
										29
										30
										31
										32
Break Away Frame 	-10								5603	33
										34
										35
										36
										37
										38
										39
										40



FD72 Series/Connect Under Pressure—Farm

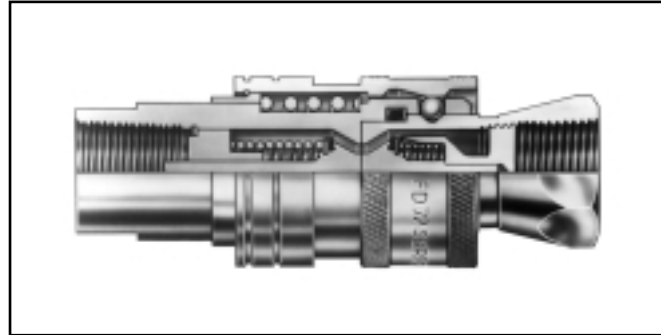

The FD72 Series coupling incorporates special valving allowing connection to a male half under pressure (FD76 Series male). The maximum operating pressure is 3,000 psi.

- Over travel, self-sealing poppet valve construction for connecting to a pressurized male tip. Requires that the tractor control valve be actuated to open the flow path and to equalize the pressure.
- Push-to-connect for one-hand operation when sleeve is mounted.
- Interchanges with ISO 5675 male tips.
- Retaining ring groove on female half for bulkhead and breakaway frame mounting.
- Standard seal material – Buna-N.
- Standard body material – Zinc plated steel with zinc poppet guide.

Physical Characteristics

Coupling Size	Maximum Operating Pressure (psi)	Minimum Burst Pressure (psi)	Vacuum (in. Hg.)	Rated Flow (gpm)	Air Inclusion (cc. max.)	Fluid Loss (cc. max.)
-10	3,000	12,000	28	16	2.8	2.8

Flow Data

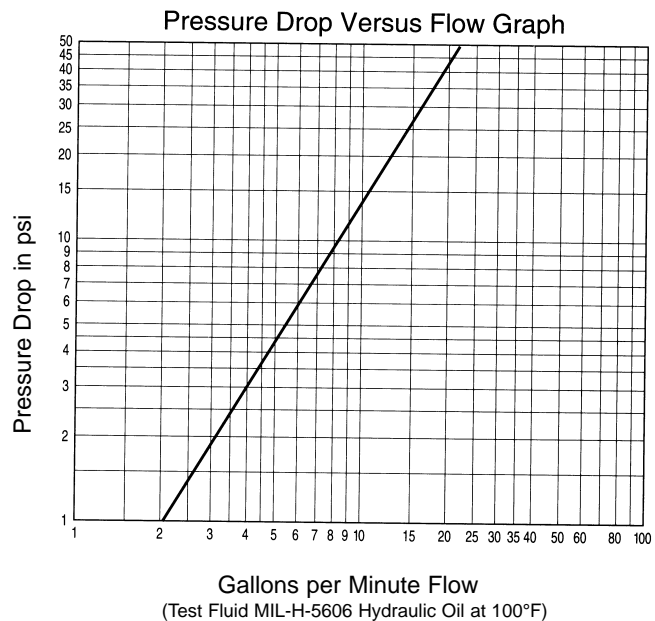



FD72 Series	Coupling Size	Thread Size (P)	Dimensional Data						Part Number	Line Ref.
			A	B	C	D	E			
Male Half Female Pipe/Valved 	-10	1/2-14	2.05					1.06	FD76-1002-08-10	1
										2
										3
										4
										5
										6
										7
										8
Female Half Female Pipe/Valved 	-10	1/2-14	3.17	1.52	1.50	1.41	.20	1.00	FD72-1001-08-10	9
										10
										11
										13
										14
										15
										16
										17
										18
Accessories										
Dust Cap 	-10								5657-10	19
										20
										21
										22
										23
										24
Dust Plug 	-10								5659-10	25
										26
										27
										28
										29
										30
										31
										32
Break Away Frame 	-10								5603	33
										34
										35
										36
										37
										38
										39
									40	



FD70 & FD76 Series/Male Tip—Farm

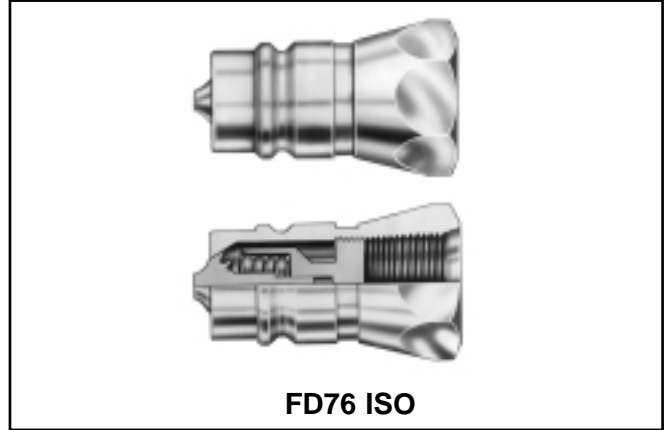
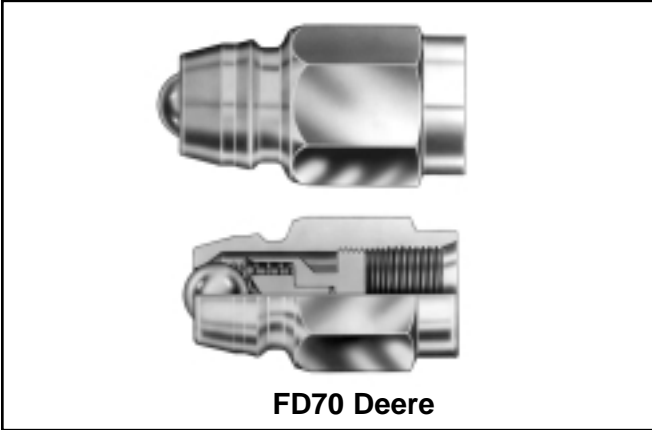

● Designed to connect with female couplings on most older style John Deere farm equipment.

● Interchanges with ISO 5675 used on most farm tractors found throughout North America and abroad.

FD70 & FD76 Series	Coupling Size	Thread Size (P)	Dimensional Data			Part Number Buna-N	Line Ref.
			A	B			
Deere Male Half Female SAE O-Ring/Ball Valve 	-10	3/4-16	1.96		1.00	FD70-1010-08-10	1
							2
							3
							4
							5
							6
							7
							8
ISO Male Half Female Pipe/Poppet Valve 	-10	1/2-14	2.05		1.06	FD76-1002-08-10	9
							10
							11
							12
							13
							14
							15
							16
ISO Male Half Female SAE O-Ring/Poppet Valve 	-10	3/4-16	2.05		1.00	FD76-1010-08-10	17
							18
							19
							20
							21
							22
							23
							24



FD86 Series/5,000 PSI DryBreak—High Impulse

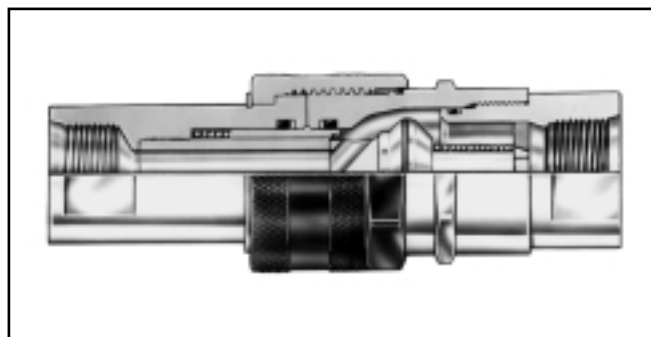
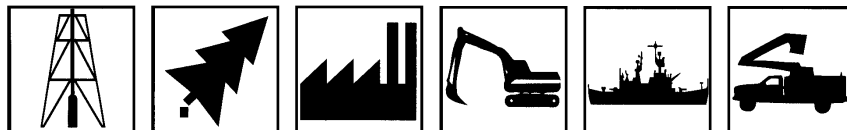

The FD86 Series is a thread together steel coupling offering dry break and high impulse technology and capabilities. The maximum operating pressure is 5,000 psi.

- Tubular valve and sleeve construction for low fluid loss and air inclusion.
- Thread together design using wing or hex nut allows connection and disconnection against pressures up to 750 psi.
- PTFE back-up rings along with secondary metal-to-metal sealing contact provides high impulse capability up to 5,000 psi operating pressure.
- Acme threads prevent galling and provide ease of connection.
- Metal-to-metal sealing withstands +2,000°F for ten minutes with no fluid loss (requirement in California for oil field blow-out preventers).
- Steel flange available for bulkhead mounting.
- Standard seal material – Buna-N.
- Standard body material – Zinc plated steel.

Flow Data

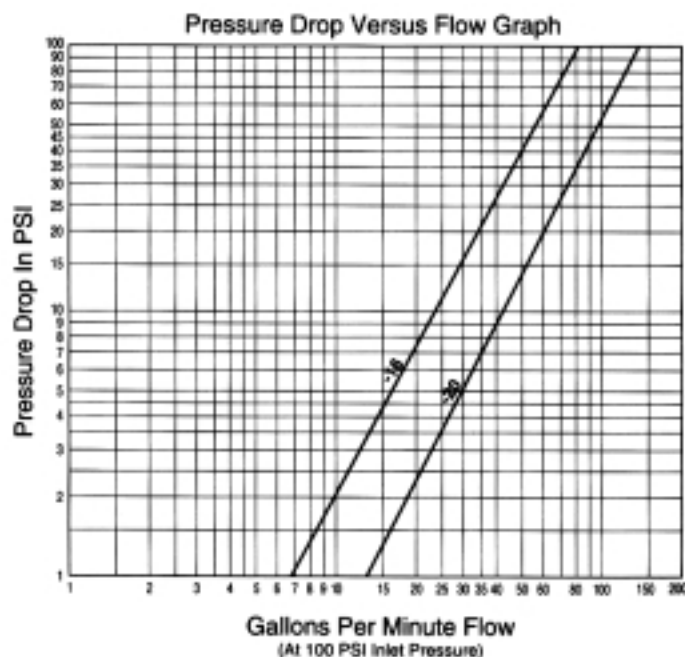

Physical Characteristics

Coupling Size	Maximum Operating Pressure (psi)	Minimum Burst Pressure (psi)	Vacuum (in./Hg.)	Rated Flow (gpm)	Air Inclusion (cc. max.)	Fluid Loss (cc. max.)
-16	5,000	15,000	28	50	2.90	.72
-20	5,000	15,000	28	75	4.61	1.0



FD86 Series	Coupling Size	Thread Size (P)	Dimensional Data			Part Number			Line Ref.
			A	B		Buna-N	Viton*	EPR	
Male Half Female SAE O-Ring 	-16	1 ⁵ / ₁₆ -12	4.03	2.11	1.75	FD86-1008-16-16	FD86-1043-16-16	FD86-1053-16-16	1
	-20	1 ⁵ / ₈ -12	4.16	2.48	2.25	FD86-1008-20-20	FD86-1043-20-20	FD86-1053-20-20	2
									3
									4
									5
									6
									7
									8
Female Half Female SAE O-Ring/With Wing Nut 	-16	1 ⁵ / ₁₆ -12	4.62	4.50	1.62	FD86-1010-16-16	FD86-1044-16-16	FD86-1054-16-16	9
	-20	1 ⁵ / ₈ -12	5.22	5.25	2.00	FD86-1010-20-20	FD86-1044-20-20	FD86-1054-20-20	10
									11
									12
									13
									14
									15
									16
Female Half Female SAE O-Ring/With Hex Nut 	-16	1 ⁵ / ₁₆ -12	4.62	2.81	1.62	FD86-1006-16-16	FD86-1042-16-16	FD86-1052-16-16	17
	-20	1 ⁵ / ₈ -12	5.22	3.40	2.00	FD86-1006-20-20	FD86-1042-20-20	FD86-1052-20-20	18
									19
									20
									21
									22
									23
									24

*Viton is a DuPont trademark.

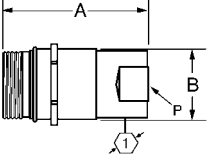
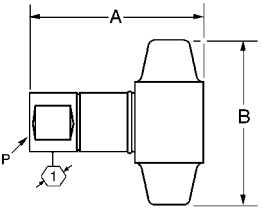
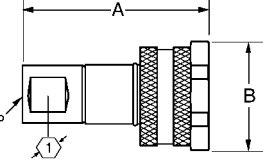

FD86 Series	Coupling Size	Thread Size(P)	Dimensional Data			Part Number			Line Ref.
			A	B	ϕ	Buna-N	Viton*	EPR	
Male Half Female NPTF 	-16	1-11 $\frac{1}{2}$	4.40	2.11	1.75	FD86-1002-16-16	FD86-1040-16-16	FD86-1050-16-16	1
	-20	1 $\frac{1}{4}$ -11 $\frac{1}{2}$	4.43	2.48	2.25	FD86-1002-20-20	FD86-1040-20-20	FD86-1050-20-20	2
									3
									4
									5
									6
									7
									8
Female Half Female NPTF/With Wing Nut 	-16	1-11 $\frac{1}{2}$	4.98	4.50	1.62	FD86-1001-16-16	FD86-1039-16-16	FD86-1049-16-16	9
	-20	1 $\frac{1}{4}$ -11 $\frac{1}{2}$	5.62	5.25	2.00	FD86-1001-20-20	FD86-1039-20-20	FD86-1049-20-20	10
									11
									12
									13
									14
									15
									16
Female Half Female NPTF/With Hex Nut 	-16	1-11 $\frac{1}{2}$	4.98	2.81	1.62	FD86-1004-16-16	FD86-1041-16-16	FD86-1051-16-16	17
	-20	1 $\frac{1}{4}$ -11 $\frac{1}{2}$	5.62	3.40	2.00	FD86-1004-20-20	FD86-1041-20-20	FD86-1051-20-20	18
									19
									20
									21
									22
									23
									24
Repair Kit	Male Half								26
	-16					FF10596-16	FF10597-16	FF10598-16	27
	-20					FF10596-20	FF10597-20	FF10598-20	28
	Female Half								29
	-16					FF10593-16	FF10594-16	FF10595-16	30
-20					FF10593-20	FF10594-20	FF10595-20	31	

*Viton is a DuPont trademark.

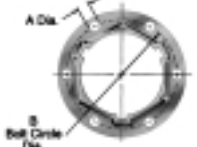
FD86 Series	Coupling Dash Size	Dimensional Size		Part Number			Line Ref.	
		A	B	Dust Cap with Chain	Dust Plug with Chain	6 Bolt Flange Assembly		
Dust Cap With Chain Dust Plug With Chain 	-16			FD86-1018-16	FD86-1016-16		1	
	-20			FD86-1018-20	FD86-1016-20		2	
								3
								4
								5
								6
								7
								8
6 Bolt Flange Assembly ¹ 	-16	.19	2.98			FD86-1035-16	10	
	-20	.19	3.50			FD86-1035-20	11	
								12
								13
								14
								15
								16

¹6 Bolt Flange-holes equally spaced. (See "A" for bolt hole diameter, and "B" for bolt circle diameter.)

This page is part of a complete catalog which contains technical and safety data that must be reviewed when selecting a product.



FD89 Series/ISO 16028 Interchange

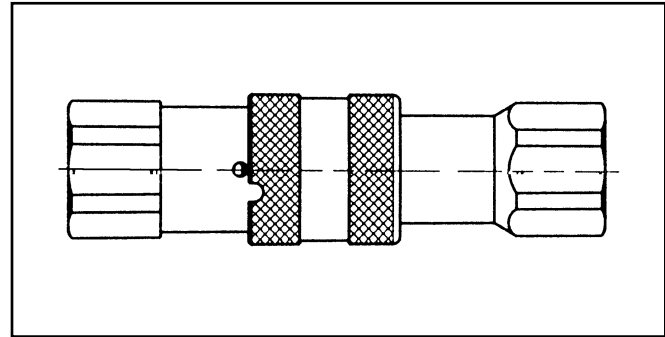
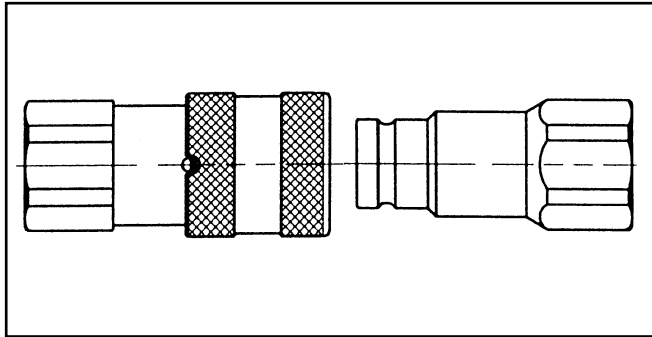

Aeroquip's FD89 Series is specifically designed for those applications where quick and easy connections and no-spill performance are essential. Ideal for use where global interchangeability with other manufacturers is important. The FD89 Series is available in sizes from 1/4" through 2" to best meet your specific size requirements.

- Globally accepted interface which meets dimensional requirements of ISO 16028 (1/4"-1").
- Quick and easy Push-to-Connect latching.
- Safety sleeve lock guards against accidental disconnections.
- The globally accepted interface meets HTMA requirements.
- Dual flush face valves result in minimal fluid loss, air inclusion, and easy cleaning.

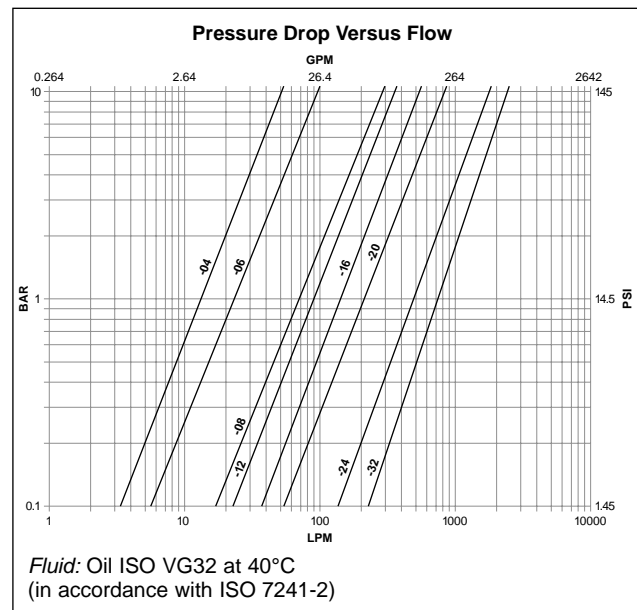

Physical Characteristics

Coupling Size	Maximum Operating Pressure Connected	Maximum Operating Pressure Male Half	Maximum Operating Pressure Female Half	Minimum Burst Pressure Connected	Minimum Burst Pressure Half Male	Minimum Burst Pressure Female Half	Rated Flow	Fluid Loss	Air Inclusion	Force To Connect (No Pressure)
-04	4,350	4,350	1,740	17,400	17,400	6,960	3.2	0.006	0.005	40.2
-06	4,350	4,350	1,740	17,400	17,400	6,960	6.1	0.012	0.280	38.9
-08	3,625	3,625	1,450	14,500	14,500	5,800	11.9	0.020	0.040	40.7
-12	3,625	3,190	1,450	14,500	12,760	5,800	19.5	0.026	0.270	43.8
-16	3,625	2,900	1,450	14,500	11,600	5,800	26.4	0.032	0.040	50.4
-20	3,625	2,900	1,450	14,500	11,600	5,800	49.9	0.010	0.140	68.3
-24	2,900	2,320	1,160	11,600	9,280	4,640	76.1	0.050	0.980	96.0
-32	2,900	2,320	1,160	11,600	9,280	4,640	100.0	NA	NA	110.0



FD89 Series	Coupling Size	Thread Size(P)	Dimensional Data			Part Number			Line Ref.
			A	B		Buna-N	Viton*	EPR	
Male Half Female Pipe/Valved 	-04	1/4-18	1.89		0.87	FD89-1002-04-04			1
	-06	3/8-18	2.36		0.94	FD89-1002-06-06			2
	-06	1/2-14	2.46		1.06	FD89-1002-08-06			3
	-08	1/2-14	2.68		1.26	FD89-1002-08-08			4
	-08	3/4-14	2.78		1.42	FD89-1002-12-08			5
	-12	3/4-14	2.78		1.42	FD89-1002-12-12			6
	-16	1-11 1/2	3.24		1.73	FD89-1002-16-16			7
	-20	1 1/4-11 1/2	3.54		2.17	FD89-1002-20-20			8
	-24	1 1/2-11 1/2	4.37		2.56	FD89-1002-24-24			9
	-32	2-11 1/2	4.87		2.95	FD89-1002-32-32			10
Female Half Female Pipe/Valved 	-04	1/4-18	1.89	1.10	0.87	FD89-1001-04-04			11
	-06	3/8-18	2.53	1.26	1.06	FD89-1001-06-06			12
	-06	1/2-14	2.72	1.26	1.06	FD89-1001-08-06			13
	-08	1/2-14	2.91	1.50	1.26	FD89-1001-08-08			14
	-08	3/4-14	3.18	1.50	1.42	FD89-1001-12-08			15
	-12	3/4-14	3.09	1.65	1.42	FD89-1001-12-12			16
	-16	1-11 1/2	3.67	1.89	1.73	FD89-1001-16-16			17
	-20	1 1/4-11 1/2	4.17	2.17	2.17	FD89-1001-20-20			18
	-24	1 1/2-11 1/2	5.21	3.15	2.56	FD89-1001-24-24			19
	-32	2-11 1/2	6.17	3.94	3.15	FD89-1001-32-32			20
Male Half Female BSP/Valved 	-04	G 1/4	1.89		0.87	FD89-1007-04-04			21
	-06	G 3/8	2.36		0.94	FD89-1007-06-06			22
	-06	G 1/2	2.46		1.06	FD89-1007-08-06			23
	-08	G 1/2	2.68		1.26	FD89-1007-08-08			24
	-08	G 3/4	2.78		1.42	FD89-1007-12-08			25
	-12	G 3/4	2.78		1.42	FD89-1007-12-12			26
	-16	G 1	3.24		1.73	FD89-1007-16-16			27
	-20	G 1 1/4	3.54		2.17	FD89-1007-20-20			28
	-24	G 1 1/2	4.37		2.56	FD89-1007-24-24			29
	-32	G 2	4.87		2.95	FD89-1007-32-32			30
Male Half Female BSP/Valved 	-04	G 1/4	1.89	1.10	0.87	FD89-1006-04-04			31
	-06	G 3/8	2.53	1.26	1.06	FD89-1006-06-06			32
	-06	G 1/2	2.72	1.26	1.06	FD89-1006-08-06			33
	-08	G 1/2	2.91	1.50	1.26	FD89-1006-08-08			34
	-08	G 3/4	3.18	1.50	1.42	FD89-1006-12-08			35
	-12	G 3/4	3.09	1.65	1.42	FD89-1006-12-12			36
	-16	G 1	3.67	1.89	1.73	FD89-1006-16-16			37
	-20	G 1 1/4	4.17	2.17	2.17	FD89-1006-20-20			38
	-24	G 1 1/2	5.21	3.15	2.56	FD89-1006-24-24			39
	-32	G 2	6.17	3.94	3.15	FD89-1006-32-32			40

*Viton is a DuPont trademark.

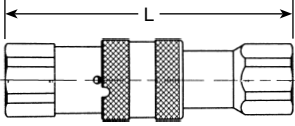

FD89 Series	Coupling Size	Connected Length (L) (NPT & BSP)	Line Ref.
Connected Dimensions 	-04	3.37	1
	-06-06	4.29	2
	-08-06	4.59	3
	-08-08	4.92	4
	-12-08	5.30	5
	-12	5.20	6
	-16	6.06	7
	-20	6.81	8
	-24	8.46	9
	-32	9.51	10

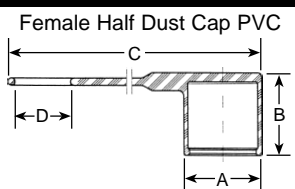
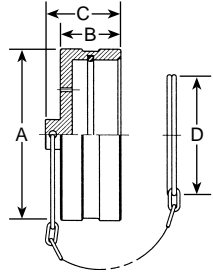
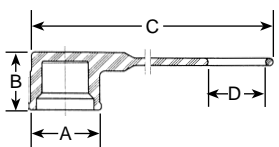
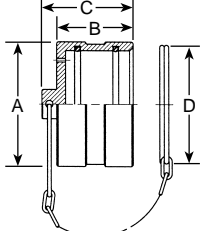
FD89 Series	Coupling Size	A	B	C	D	Part Number	Line Ref.	
Accessories Female Half Dust Cap PVC 	-04	1.26	1.50	9.41	0.79	FD89-1009-04	1	
	-06	1.42	1.69	9.72	0.98	FD89-1009-06	2	
	-08-08	1.65	1.81	10.10	0.98	FD89-1009-08-08	3	
	-12-08	1.65	1.81	10.20	1.18	FD89-1009-12-08	4	
	-12	1.81	1.97	10.43	1.18	FD89-1009-12	5	
	-16	2.05	2.44	12.50	1.38	FD89-1009-16	6	
	-20	2.36	2.68	13.20	1.77	FD89-1009-20	7	
							8	
							9	
Female Half Dust Cap Aluminum 	-24	3.74	1.57	1.97	2.30	FD89-1009-24	10	
	-32	4.53	1.57	1.97	2.95	FD89-1009-32	11	
								12
								13
								14
								15
								16
								17
								18
								19
	Male Half Dust Cap PVC 	-04	1.10	0.91	9.06	0.79	FD89-1008-04	20
-06-06		1.26	1.10	9.17	0.79	FD89-1008-06-06	21	
-08-06		1.26	1.10	9.25	0.98	FD89-1008-08-06	22	
-08-08		1.50	1.22	9.76	0.98	FD89-1008-08-08	23	
-12-08		1.50	1.22	9.76	1.18	FD89-1008-12-08	24	
-12		1.65	1.10	10.10	1.18	FD89-1008-12	25	
-16		1.89	1.38	12.20	1.38	FD89-1008-16	26	
-20		2.17	1.52	12.80	1.77	FD89-1008-20	27	
								28
								29
Male Half Dust Cap Aluminum 	-24	2.76	1.57	1.97	2.30	FD89-1008-24	30	
	-32	3.35	2.05	2.44	2.95	FD89-1008-32	31	
								32
								33
								34
								35
								36
								37
								38



FD90 Series/SAE J1502 Interchange

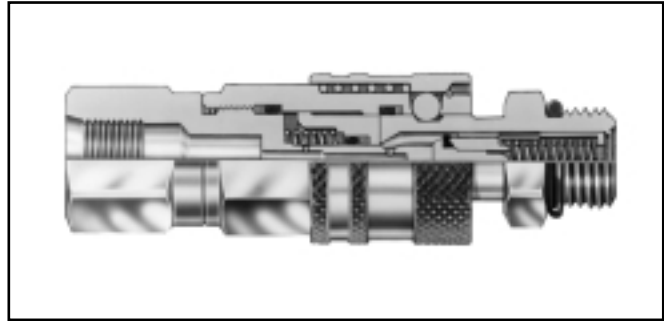
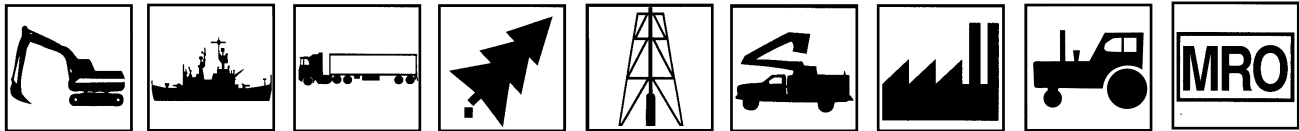

The FD90 Series diagnostic coupling is designed to connect and disconnect pressure gauges to hydraulic systems, eliminating the need for permanent gauges. The maximum operating pressure is 7,000 psi.

- Automatic sleeve for one hand push-to-connect operation.
- Flush face valving provides minimal fluid loss and low air inclusion.
- Self-sealing valve design allows connection and disconnection at 500 psi.
- Broad range of end configurations for system accessibility.
- Standard seal material – Buna-N.
- Standard body material – Zinc plated steel.

Diagnostic Kit* – FF10000-02





**Contact Eaton Aeroquip for additional information.*

Physical Characteristics

Coupling Size	Maximum Operating Pressure (psi)	Minimum Burst Pressure (psi)	Vacuum (in./Hg.)	Rated Flow (gpm)	Air Inclusion (cc. max.)	Fluid Loss (cc. max.)
-04	7,000	28,000	28	.50	0.02	0.10

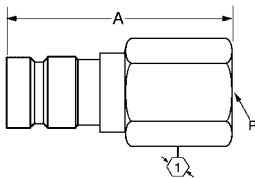
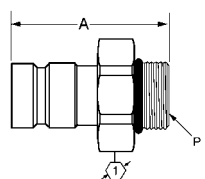
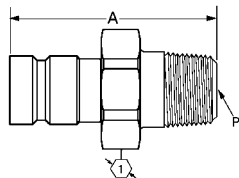
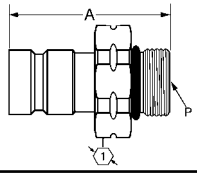
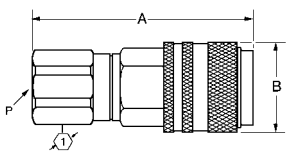

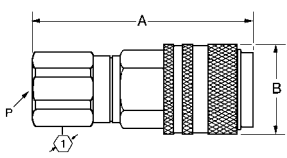
FD90 Series	Coupling Size	Thread Size (P)	Dimensional Data			Part Number Buna-N	Part Number with Dust Cap Buna-N	Line Ref.
			A	B	ϕ			
Male Half Female Pipe/Valved 	-04	1/8-27	1.70		.62	FD90-1034-02-04	FD90-1035-02-04	1
	-04	1/4-18	1.90		.75	FD90-1034-04-04	FD90-1035-04-04	2
								3
								4
								5
								6
								7
								8
Male Half Male SAE O-Ring/Valved 	-04	3/8-24	1.52		.62	FD90-1044-03-04	FD90-1004-03-04	9
	-04	7/16-20	1.58		.62	FD90-1044-04-04	FD90-1004-04-04	10
	-04	1/2-20	1.32		.62	FD90-1044-05-04	FD90-1004-05-04	11
	-04	9/16-18	1.32		.69	FD90-1044-06-04	FD90-1004-06-04	12
								13
								14
								15
								16
Male Half Male Pipe/Valved 	-04	1/8-27	1.60		.62	FD90-1012-02-04	FD90-1045-02-04	17
	-04	1/4-18	1.49		.69	FD90-1012-04-04	FD90-1045-04-04	18
								19
								20
								21
								22
								23
								24
Male Half Metric Male O-Ring/Valved 	-04	M14x1.5	1.38		.75	FD90-1046-06-04	FD90-1047-06-04	25
								26
								27
								28
								29
								30
								31
Female Half Female Pipe/Valved 	-04	1/8-27	1.95	1.00	.75	FD90-1021-02-04	Dust Cap for Male Halves FD90-1040-04 	32
	-04	1/4-18	2.25	1.00	.75	FD90-1021-04-04		33
								34
								35
								36
								37
								38
								39
Female Half Female SAE O-Ring/Valved 	-04	7/16-20	2.20	1.00	.75	FD90-1041-04-04		41
								42
								43
								44
								45
								46
								47
								48

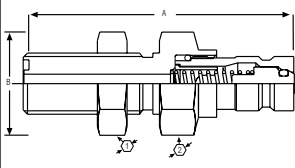
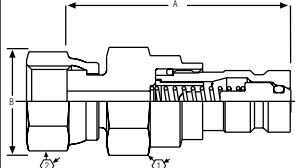
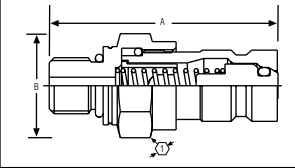

FD90 Series	Coupling Size	Thread Size (P)	Dimensional Data				Part Number Buna-N	Part Number with Dust Cap Buna-N	Line Ref.
			A	B	①	②			
Male Half Male ORS Bulkhead, Valved 	-04	9/16-18	2.46	.94	.81	.81	FD90-1206-04-04		1
									2
									3
									4
									5
									6
									7
									8
Male Half, Female ORS Swivel Valved 	-04	9/16-18	1.79	.87	.75	.69	FD90-1061-04-04		9
									10
									11
									12
									13
									14
									15
									16
Male Half Male Metric O-Ring ISO6149-2 Valved 	-04	M10x1	1.58	.72	.62		FD90-1090-10-04		17
									18
									19
									20
									21
									22
									23
									24



A Brief History of “Dry Break” Couplings



Quick Disconnect Couplings were first introduced with an opposed poppet-type valve. This economical valve type reduces spillage drastically, yet it remains measurable in whole cc's.*



As the number of applications for couplings grew, so did the demand for reduced spillage. Aeroquip responded with the patented tubular valve design which became standard in critical industrial and aerospace applications. Typically, fluid loss is measured in fractions of cc's per disconnection.



State-of-the-art valving was introduced with flush-face style couplings that provide fluid loss rates that are nearly unmeasurable. These couplings also provide one-hand push-to-connect and connect under limited pressure features, but require complete changeover from poppet-style couplings.



Aeroquip now introduces patented DryBreak female coupling halves that mate with any ISO poppet-style male coupling half. This upgrade ensures virtually no-spill performance without the necessity of changing out any of the male halves.



*cc = cubic centimeters (28.4 cc = 1 oz.)