



MASTER FADER™

REFERENCE GUIDE



MACKIE.
SOUND LIKE YOU MEAN IT®

www.mackie.com

Table of Contents

Table of Contents	2
--------------------------------	----------

Chapter 1 : Welcome.....	9
---------------------------------	----------

Chapter 2 : Wireless Setup.....	10
--	-----------

Introduction.....	10
Wireless Setup on DL16S • DL32S.....	10
Wireless Setup on DL806 • DL1608 • DL32R	11
Wi-Fi Router	11
Network Connectivity.....	11
Connecting iOS Devices	12
Connecting Android Devices	14
Router Settings.....	16

Chapter 3 : Mackie Master Fader Software	17
---	-----------

Introduction.....	17
Downloading and Installing the Master Fader App on iOS Devices	17
Updating the Master Fader App on iOS Devices.....	19
Downloading and Installing the Master Fader App on Android Devices	19
Updating the Master Fader App on Android Devices	20
Updating the Firmware.....	21
Lingo	22
Tapping, Dragging, Flicking, Swiping and Pinching.....	22
Three Main Views.....	23
Overview	23
Mixer View	25
Channel View	26
Grow & Glow, Current Parameter Display and The Swipe Zone.....	28

Chapter 4 : Level Setting Procedure.....	31
---	-----------

Introduction.....	31
Level Setting Procedure – DL806 • DL1608.....	31
Level Setting Procedure – DL16S • DL32S • DL32R.....	33

Chapter 5 : Mixer View : Channel Strips 35

Introduction.....	35
The Swipe Zone.....	35
Input Routing.....	36
EQ Curve	36
Gain Reduction Meters.....	36
Pan / Balance.....	37
Mute	37
Channel Faders and Input Meters	38
Selected Mix Indicators	38
Solo	39
Channel ID Button	40
QuickAssign.....	42
Linking Input Channels.....	43
Presets	44
Copy-and-Paste	44
Return 1–4 [DL32R]	46
iPad / Playback [DL806 • DL1608]	47
FX Return Channel Strips	49
Subgroups	50
VCAs	51

Chapter 6 : Mixer View : Subgroups and VCAs 52

Introduction.....	52
Subgroups	52
VCAs	53

Chapter 7 : Mixer View : Master Fader / Selector Strip 56

Introduction.....	56
Selector Strip.....	57
Mute Groups	57
Mix Selector.....	63
View Groups	65
Masters Selector	69
Output Routing View	70
Parametric EQ / Graphic EQ.....	70
Output Gain Reduction Meter	70
Balance	71
Mute	71
Aux/FX Send Configuration Menu	71
Master Fader and Output Meters.....	74
Solo	74
Master ID Button.....	75
QuickAssign.....	78
Linking Auxes.....	79
Presets	79
Copy-and-Paste	80

Chapter 8 : Mixer View : The Matrix [DL32R] 83

Introduction..... 83
Matrix Uses 83
Configuring The Matrix..... 85

Chapter 9 : Channel View : Input Routing View 89

Introduction..... 89
Source Selection 90
Assignments (for the current channel) 92
Aux Send Assignments (for the current channel) 93

Chapter 10 : Channel View : EQ 94

Introduction..... 94
EQ On / Off 95
Modern / Vintage..... 95
Presets 95
RTA / Spectrograph..... 96
Modern EQ Introduction..... 98
Modern EQ Swipe Zone..... 98
Modern EQ Gain, Frequency and Q [Bandwidth] 98
 Low Shelving – Band 1..... 99
 Low-Mid Peaking – Band 2 99
 High-Mid Peaking – Band 3 100
 High Shelving – Band 4..... 100
Modern EQ Shelf / Bell 101
Modern EQ HPF On / Off and Frequency..... 102
Modern EQ at a Glance 103
Vintage EQ Introduction..... 104
Vintage EQ Swipe Zone..... 104
Vintage EQ HPF Frequency Buttons..... 105
Vintage EQ Gain and Frequency..... 105
Vintage EQ at a Glance 106

Chapter 11 : Channel View : Gate and Compression 107

Introduction..... 107
Gate On / Off..... 108
Modern / Vintage..... 108
Presets 108
Compressor On / Off 109
Modern / Vintage..... 109
Presets 109
Modern Gate and Compressor Introduction 110
Modern Gate and Compressor Swipe Zone 110
Modern Gate Display and Settings 111
Modern Gate Meters..... 111
Modern Compressor Display and Settings..... 111
Soft Knee / Hard Knee Compression 112
Modern Compressor Meters..... 112
Modern Gate at a Glance..... 112
Modern Compressor at a Glance 112

Vintage Gate and Compressor Introduction 113
Vintage Gate and Compressor Swipe Zone 113
Vintage Gate Settings 114
Vintage Compressor Settings 114
Vintage Gate / Compressor VU Meters 114
Vintage Gate at a Glance 114
Vintage Compressor at a Glance 114

Chapter 12 : Channel View : Output Routing Views 116

Introduction 116
Main L/R 116
Subgroups 118
VCA's 119
Matrix [DL32R] 120

Chapter 13 : Channel View : Output Parametric EQ 121

Introduction 121
EQ On / Off 122
Modern / Vintage 122
Presets 122
RTA / Spectrograph 123
Modern PEQ Introduction 125
Modern PEQ Swipe Zone 125
Modern PEQ Gain, Frequency and Q [Bandwidth] 125
 Low Shelving – Band 1 126
 Low-Mid Peaking – Band 2 126
 High-Mid Peaking – Band 3 127
 High Shelving – Band 4 127
Modern PEQ Shelf / Bell 128
Modern PEQ HPF On / Off, Frequency and Selectable Slope 129
Modern PEQ LPF On / Off, Frequency and Selectable Slope 130
Modern PEQ at a Glance 131
Vintage PEQ Introduction 132
Vintage PEQ Swipe Zone 132
Vintage PEQ HPF Frequency Buttons 132
Vintage PEQ Gain and Frequency 133
Vintage PEQ at a Glance 133

Chapter 14 : Channel View : Output Graphic EQ 134

Introduction 134
The Swipe Zone 134
Graphic EQ On / Off 134
Presets 135
RTA / Spectrograph 135
31-Band EQ 138
2X 138
Draw 138
Graphic EQ at a Glance 139

Chapter 15 : Channel View : Output Compressor / Limiter / Delay 140

Introduction..... 140
Output Compressor / Limiter On / Off 141
Modern / Vintage..... 141
Presets 141
Modern Output Compressor / Limiter Introduction 142
Modern Output Compressor / Limiter Swipe Zone 142
Modern Output Compressor / Limiter Display and Settings..... 142
Soft Knee / Hard Knee Compression 143
Modern Output Compressor / Limiter Meters..... 143
Vintage Output Compressor / Limiter Introduction 144
Vintage Output Compressor / Limiter Swipe Zone 144
Vintage Output Compressor / Limiter Display and Settings..... 145
Vintage Output Compressor / Limiter VU Meter 145
Output Alignment Delay 146

Chapter 16 : Channel View : Presets 147

Introduction..... 147
Factory Presets vs User Presets 147
Channel Presets vs DSP Presets..... 151

Chapter 17 : Mixer View : Navigation Bar 156

Introduction..... 156
Overview 156
Mixer View 156
Channel View 157
Current Parameter Display 157

FX 158
FX View 159
Reverb Type 164
Reverb Sliders..... 165
Delay Type 166
Delay Sliders 167
Modulation Type 168
Modulation Sliders..... 169

Tools, Part I 173
Devices 174
Controllers 186

Tools, Part II 187
Settings..... 187
Access Limits..... 190
Help..... 195

I/O Patch 196
Introduction 196
I/O Patch on DL16S, DL32S and DL32R..... 196
I/O Patch at a Glance 207
I/O Patch on DL806 and DL1608 208

Recording / Playback	210
Introduction	210
Recording and Playback via DL32R	210
Recording and Playback via DL806 • DL1608	225
Quick Access Panel	231
Clear Solo	231
FX Controls	232
Monitor	232
Talkback	232
Shows	233
Shows	223
Snapshots	237
Channel Safes	239
Current Show vs Offline Shows	241
Random Notes and Other Musings	244

Chapter 18 : Importing and Exporting **245**

Introduction	245
Exporting	245
Importing	247

Chapter 19 : Mackie Master Fader for Phones **249**

Introduction	249
Downloading, Installing and Updating the Master Fader App for Phones	249
Using the Master Fader App for Phones	249
Input Channel Strip	250
Pan	250
Mute	251
Gain Reduction Meters	251
Channel Faders and Input Meters	252
Selected Mix Indicators	252
Channel ID Button	253
Master Fader / Selector Strip	255
Selector Strip	256
Mix Selector	256
View Groups	257
Master Channel Strip	258
Balance	258
Mute	258
Output Gain Reduction Meter	258
Master Fader and Output Meters	258
Master ID Button	259
Linking Auxes	261
Tools	262
Devices	262
Access Limits	263
Mute Groups	264
Shows	264
Master Fader for iPhone and iPod touch Wrap-Up	265

Chapter 20 : Mackie Master Fader for PC and Mac266

Introduction.....266
Downloading and Installing the Master Fader App for PC266
Downloading and Installing the Master Fader App for Mac.....270

Appendices271

Appendix A : Service Information.....271

Appendix B : Android and iOS Optimizations.....273

Appendix C : Technical Information.....286
 Specifications.....286
 DL806 • DL1608 Block Diagram.....287
 DL16S • DL32S Block Diagram.....288
 DL32R Block Diagram.....290

Appendix D : Force Update / Network Reset Instructions292

Appendix E : Release Notes294

Appendix F : Glossary Of Terms349
Warranty Statement356
GPL Statement.....356
3rd Party Firmware Statement.....356
Open Source Code357
PureLayout Statement and Notice.....358
Fin359

Chapter 1 : Welcome

Introduction

Hello everyone! This is the Master Fader Reference Guide...we hope you like it!

Instead of one massive document containing detailed information about the hardware and software, we have divided them into separate manuals. Simply decide if you need assistance with the hardware or software and dive on in. The water here is warm and crystal clear.

Master Fader V5.1

The following pages describe the software side of things. The hardware should remain relatively unchanged throughout the life of your product. The software, though, is another story. The Master Fader app is always being updated...even right now this very minute! This means frequent updates to this Reference Guide, firmware and more. With each major release comes an updated Reference Guide.

This version of the Reference Guide is written and designed for Master Fader V5.0, V5.0.1, V5.1 and V5.1.1 and the corresponding mixer firmware installed by this app. With so many frequent changes, some screenshots may look slightly different than what you see within these pages and there could be some functional differences, as well.



Versions 5.0, 5.0.1, 5.1 and 5.1.1 will be released in order. Do not fret if a feature listed in this document is not available. It will be shortly. Our goal is to make Master Fader the best possible app before releasing it to the public. All of these features (and more) will be available shortly if not now. Thank you for your patience and understanding. It is much appreciated!

So there you have it. Again, we hope you like it. If you have any questions or comments about this Reference Guide (or other Mackie documentation), please don't hesitate to contact us:

- 1-800-898-3211 (Monday through Friday, normal business hours, Pacific Time)
- www.mackie.com/support-contact

About This Guide

This guide is designed to be accessible, with subsections as complete as practical to minimize having to electronically leaf back and forth looking for the whole story. The entire guide does not need to be read to figure out how to use this console. However, a certain amount of familiarity with analog mixing consoles, their features, and commonly used signal processing (compressors, limiters, gates, EQs, etc.) is assumed.

As the saying goes, "a picture tells a 1000 words". With that thought in mind, we added quite a few illustrations, screenshots and other images throughout to accompany the text.



This icon marks information that is critically important or unique! For your own good, read and remember them because there is pop quiz built in to the Master Fader app. To confirm your knowledge of these features, the app will not function until all answers are correct. Ok, maybe that's not entirely accurate (or even somewhat accurate), but it IS a good idea to pay special attention to these areas in the Reference Guide marked with the "VERY IMPORTANT" hand icon.



There's an illustration of a microscope, so, of course, you're going to get more detailed information when you see this little guy. There are explanations of features and practical tips listed here.



It's a good idea to pay attention to text displayed next to a note icon, as this icon draws attention to certain features and functions relating to the usage of Master Fader.

Chapter 2 : Wireless Setup

Introduction

Do you want wireless control of your mixer? Of course you do! Let's dig in and get the router set up, as this is quite an important feature of the DL Series mixers. Up to 20 devices may be connected to the network and control the mixer simultaneously.

Wireless Setup on DL16S • DL32S

The DL16S and DL32S both feature built-in Wi-Fi for wireless control via Master Fader from iOS and/or Android. By default, your mixer will use the built-in Wi-Fi (Access Point mode). There are no changes necessary; it is ok to leave all settings as-is. Gently remove the antenna from its "clasp" and rotate it 90° **CLOCKWISE** so it points straight up. On your device running Master Fader, go into the Wi-Fi settings and look for the default SSID (Mackie DL16S or Mackie DL32S). Connect and enter the default password (MixWithMackie). You should be good to go!

Wi-Fi SETTINGS: <ul style="list-style-type: none">• Default Wi-Fi Name - Mackie DL32S or Mackie DL16S• Default Wi-Fi Password - MixWithMackie• For security, we recommend changing your Wi-Fi password in the Master Fader app.	NEED TO RESTORE DEFAULT Wi-Fi SETTINGS? <ul style="list-style-type: none">• Power up the unit and wait 30 seconds.• Press and hold the recessed reset button for 5 seconds. (Found between the front panel Power and Wi-Fi LEDs)• The Wi-Fi name/password will revert to the defaults listed to the left.
--	--

If not using the built-in Wi-Fi, there are two other options that may be configured with Master Fader.

In External Router mode, you can connect your mixer to an external router using a cable plugged into the mixer's Ethernet port.

Another option is using Wi-Fi Client mode to connect wirelessly to an existing Wi-Fi access point. In this mode, a router is not physically connected to your mixer. Instead, the venue runs a dedicated (and protected) Wi-Fi access point for their internal use. If using this mode, there are a few steps necessary to get dialed in.

More details about setting up your mixer in External Router mode or Wi-Fi-Client mode may be found on pages 179-183. In addition to reviewing those pages, we also recommend reading the rest of this chapter for setup instructions (if using an external router).



Utilizing the built-in Wi-Fi will satisfy most users. Only those with very specific Wi-Fi requirements (extra-wide range demands, integration with existing network, etc.) would need to use the External Router or Wi-Fi Client modes.



Do NOT connect an external router when using Access Point mode. This can create an unstable network causing some devices to stop operating properly. When configuring for External Router, change the settings with Master Fader, then connect the external router.



Only one networking mode may be selected: (1) Access Point, (2) External Router OR (3) Wi-Fi Client.

Wireless Setup on DL806 • DL1608 • DL32R

These three mixers require an external router in order for you to control your mixer wirelessly. Please continue on...

Wi-Fi Router

For wireless control, all that's necessary is to connect the mixer to a Wi-Fi router. While it is possible to utilize an existing wireless network, a dedicated Wi-Fi router will give you complete control, resulting in the best possible performance.

If you don't already have a Wi-Fi router, nearly any Wi-Fi router found at a reputable office supply store (or other similar business) will work. When selecting a new router (or checking out your current router) please make sure it has ALL of the following features:

(1) CAT5 Connection — Make sure the Wi-Fi router connects via CAT5 Ethernet cable, not USB. Most routers allow the use of either a straight-wired cable or crossover cable, but if you have a choice, a straight-wired CAT5 Ethernet cable is the way to go to ensure smooth operation with any router.

(2) DHCP — The router needs to be able to assign an IP address to a device [the DL32R, for example] connected to the Ethernet port. In most cases, the router will handle this task. However, there are some routers that can't complete this simple assignment and should not be used. Routers with a single Ethernet port often will not work well with the DL mixer for this reason.



You may choose to configure the mixer to use a fixed IP address, if needed. More information may be found in the devices section, pages 174-186.

(3) 802.11n / 5GHz — Believe it or not, those numbers are not just a bunch of mumbo jumbo. Those numbers reflect a Wi-Fi mode [802.11n] and band [5GHz] that we prefer and strongly suggest. Wi-Fi mode 802.11g and band 2.4GHz also work, but all the cool kids are using 802.11n and 5GHz. This is often packaged as "Dual Band".

(4) Brand — We are not in the business of suggesting what Wi-Fi router to go with, but choosing one with an instantly recognizable, quality, trustworthy name doesn't hurt. Some examples we've heard of:

- Apple
- Belkin
- D-Link
- Linksys
- NETGEAR

Ok, you twisted our arm. For small, portable setups, we like to use the Apple Airport Express. When we demand the best performance and Wi-Fi range, we prefer the Apple Airport Extreme. Having said that, there are a lot of routers from multiple manufacturers that work. These are just the ones that we've used and they've worked flawlessly.

Network Connectivity

Now it's time to connect to the network. Here are the steps to get some connectivity. Connectivity before creativity!

(1) CAT5 Connection — Plug one end of the CAT5 Ethernet cable into the network connector on the mixer and the other end into a LAN port on the router, NOT a WAN port. Read that sentence again.

(2) Power to the Router — The router needs to be powered up first before anything else. Plug it in and flip the power switch to the "on" position. <--ok, that might have been a cruel trick. Wireless routers often power up when plugged in with no power switch to flip.

(3) The Waiting — Give the router a little time to boot up and do its thing. We know, we know, the waiting is the hardest part. Somehow I don't think Tom Petty was singing about wireless router boot up times. This shouldn't take more than 10-30 seconds.

(4) Power to the Mixer — Go ahead and power up the mixer.

Connecting iOS devices

At this point in time, we're ready to dial in the settings of the device. Start by turning the device on (if it's not already).



You should have to follow these instructions only once for each device connected to the router. After that they should connect automatically.

Tap "Settings" on the device.

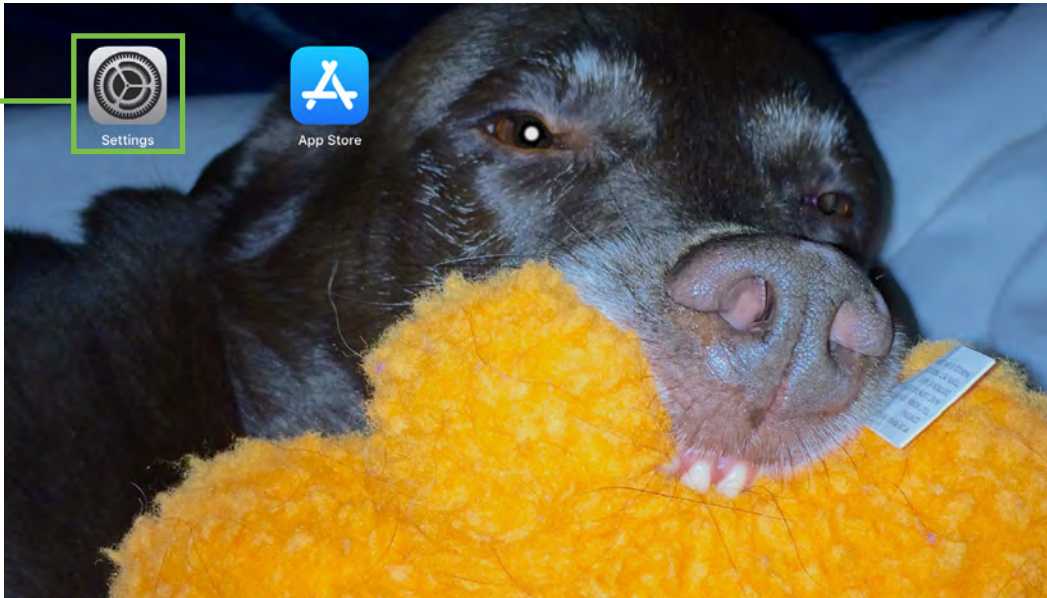

Settings lands you here. Select Wi-Fi by touching it. Notice that Wi-Fi is "Off" at this point, but we're going to fix that.

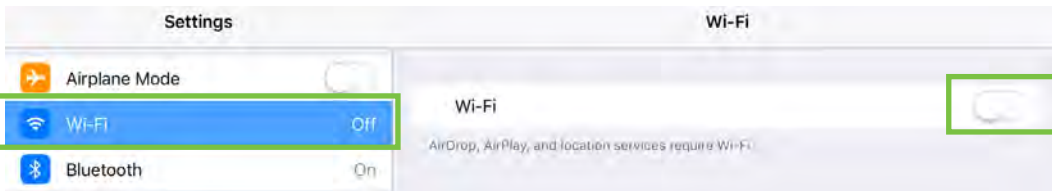

Drag the Wi-Fi on/off slider right to the on position.

Check out the view below. The device is searching for (and setting up the connection to) the router.

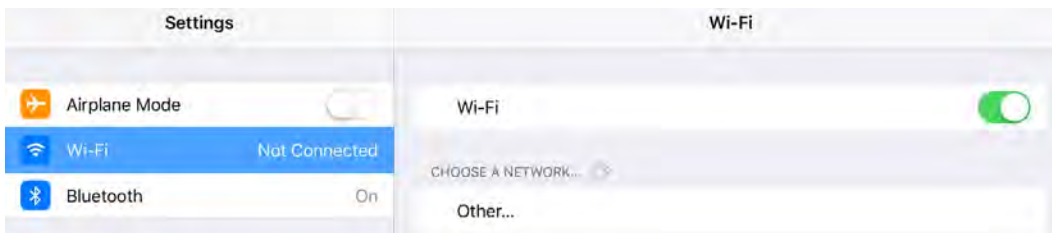

It should be noted here that (by default) many routers will NOT be password protected. In the occurrence that yours has a pre-configured password from the factory, you should be able to locate it on the bottom of the wireless router and type it in the space provided on the device.



If using the internal Wi-Fi router of the DL16S or DL32S, the password is MixWithMackie. More information may be found on pages 179-180.

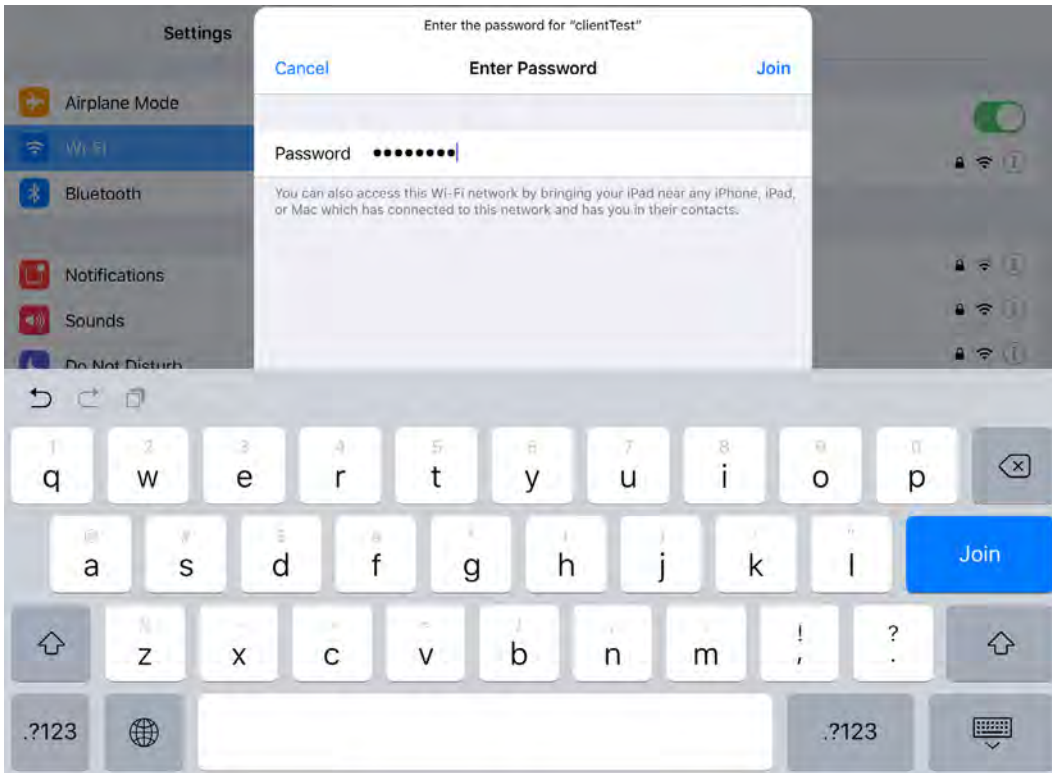

Check it out...you're good to go! With your assistance, the device found the router and dialed in the Wi-Fi connection!

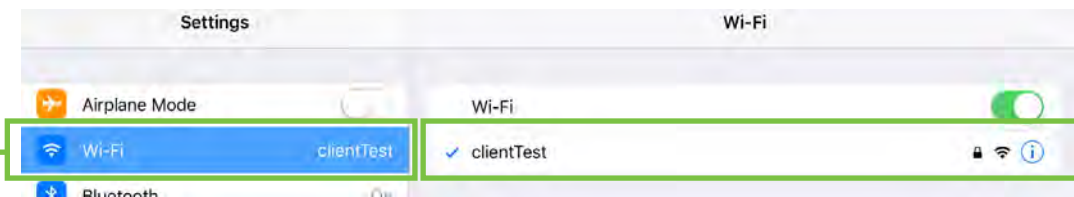

Now go back and launch the Master Fader app. It's that easy!

Connecting Android devices

At this point in time, we're ready to dial in the settings of the device. Start by turning the device on (if it's not already).



You should have to follow these instructions only once for each device connected to the router. After that they should connect automatically.

Tap "Settings" on the device.

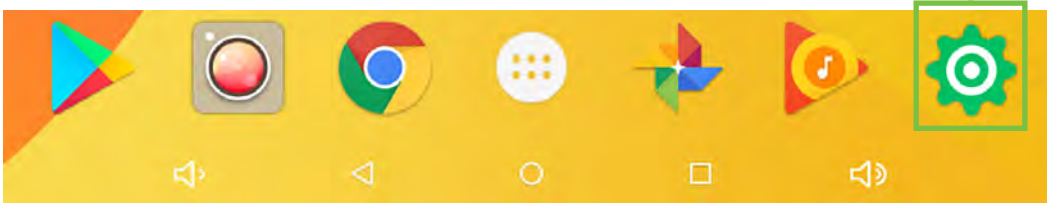

Settings lands you here. Select Wi-Fi by touching it. Notice that Wi-Fi is "Disabled" at this point, but we're going to fix that.

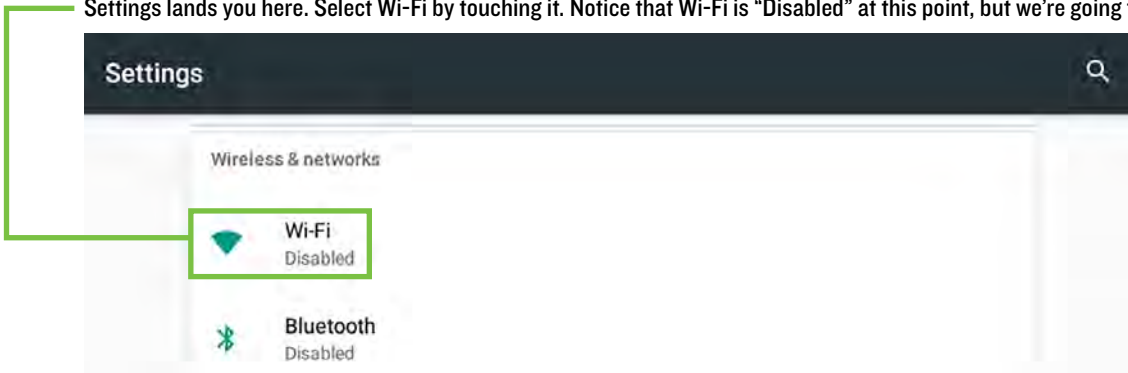

Drag the Wi-Fi on/off slider right to the on position.



Check out the view below. The device is searching for (and setting up the connection to) the router.



It should be noted here that (by default) many routers will NOT be password protected. In the occurrence that yours has a pre-configured password from the factory, you should be able to locate it on the bottom of the wireless router and type it in the space provided on the device.



If using the internal Wi-Fi router of the DL16S or DL32S, the password is MixWithMackie. More information may be found on pages 179-180.

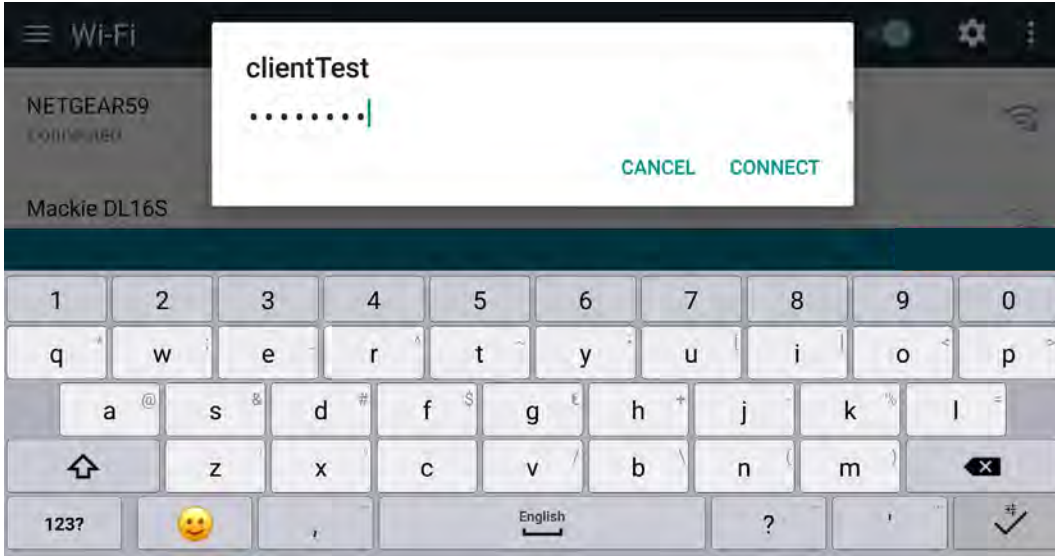

Check it out...you're good to go! With your assistance, the device found the router and dialed in the Wi-Fi connection!



Now go back and launch the Master Fader app. It's that easy!

Router Settings

Default router settings are typically fine, but most Wi-Fi routers may be customized to ensure high performance and a secure network. We'll outline some common router settings to adjust, but since each brand is different, refer to its manual to learn how to adjust these settings.

(1) SSID — SSID stands for Service Set Identification. Create a name for the Wi-Fi network here.

(2) Security — You will need to select a security mode and password. We suggest using WPA [Wi-Fi Protected Access] for security purposes and a password that is easy for you to recall, but difficult for others to hack.



This prevents strangers from joining your network and controlling the mixer, so pick a good password!

(3) Band — No, we're not here to talk about your favorite rock band. Rather, we are here to choose the Wi-Fi band. If you are in Wi-Fi mode 802.11n, you might be requested to choose a Wi-Fi band. Here, we prefer and strongly suggest 5GHz. However, 2.4GHz also works.

(4) Enable Auto Channel Selection¹ — Look for a setting named "Auto Channel Selection" (or similar) and enable it. The Wi-Fi channel with the least interference will be selected automatically.

This should set you up nicely with no issues at all, so feel free to exit out of settings at this point. If you desire more information, refer to the Troubleshooting section on page 266.

¹ Enable Auto Channel Selection is an advanced option that is usually automatically enabled. If you see it, ensure that it is enabled.

Chapter 3 : Mackie Master Fader Software

Introduction

The DL16S, DL32S, DL32R , DL806 or DL1608 is the digital mixer, and one or more devices controls it. All DSP processing and routing takes place in the mixer itself, while the Master Fader app is where you control the mix.

Downloading and Installing the Master Fader App on iOS Devices

The easiest and fastest way to download and install the Master Fader app is directly from the device. You've downloaded apps before and it's the same method to download this one, as well. Here's how:

With a good internet connection, turn on the iOS device and open up the App Store.

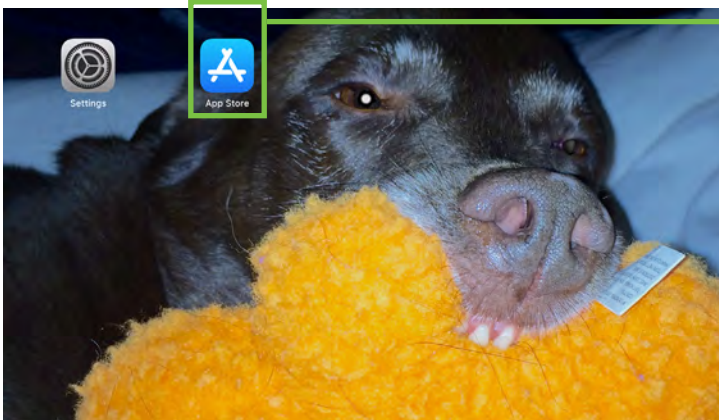

Type "Master Fader" in the search box followed by tapping the blue "Search" key.

Now tap the download icon button.

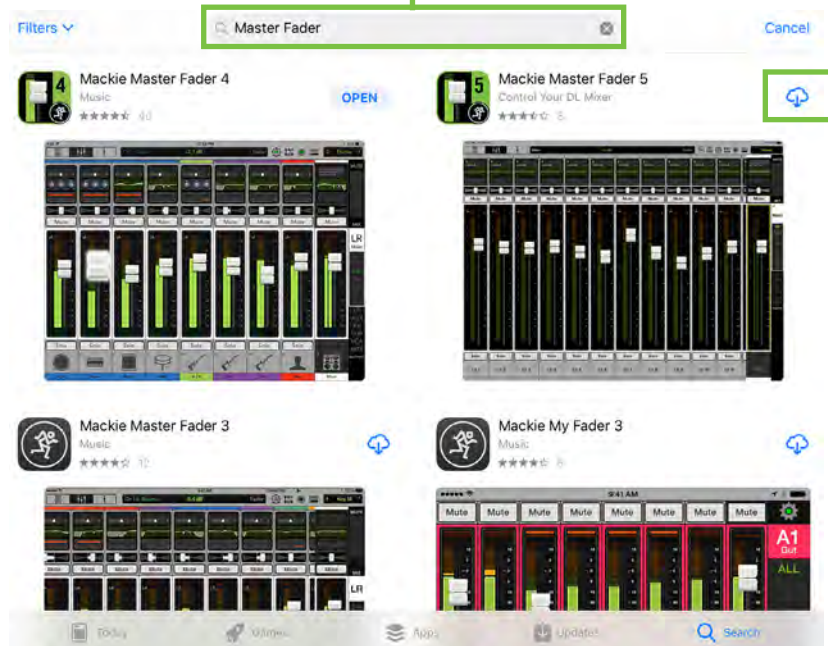

The download icon button turns into a circle, indicating that Master Fader is downloading.

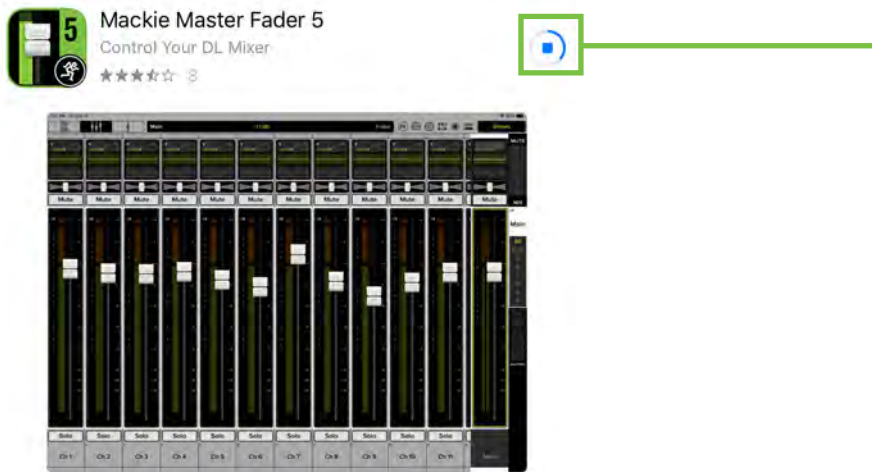

After downloading, the Master Fader app is ready for use. From here, there are two ways to open the Master Fader app.

First, simply tap the OPEN button to open the app...

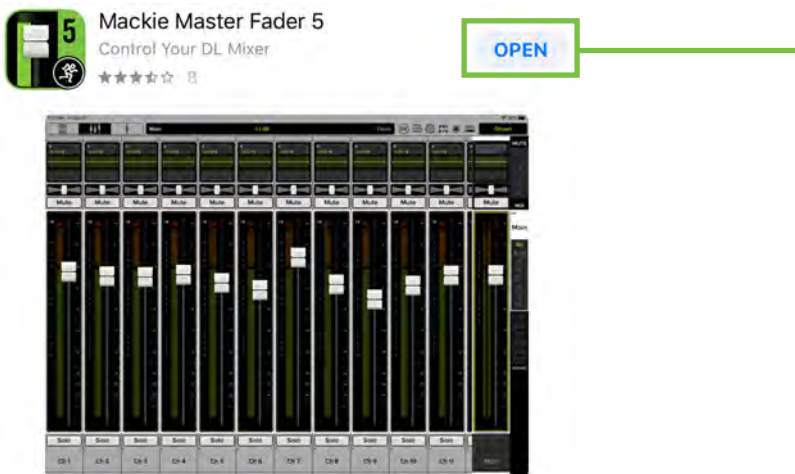

...or second, exit out of the App Store back to the home screen. Tap the Master Fader app!

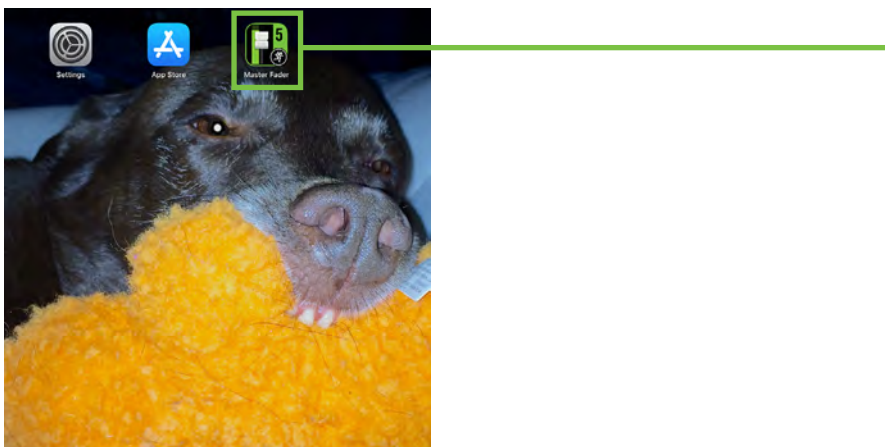

Updating the Master Fader App on iOS Devices

It is possible that the Master Fader app has already been downloaded and installed. In this case, you're probably good to go. However, it is a good idea to go to the App Store to check for updates. You will want the latest and greatest version for the absolute best in functionality and versatility.

Once in the App Store, tap the Update button located near the bottom-right of the iOS device.

The first screenshot below shows an iOS device with all apps up to date. The second screenshot below displays six apps that need updating (which may or may not include the Master Fader app). Tapping the Update button here will display the icon, name and description of changes of each app needing an update. If you see Master Fader listed, tap the blue UPDATE button on the far right. Or better yet, tap the blue Update All button in the upper-right corner of the screen. The updates will commence. Don't do anything until the downloads have completed.

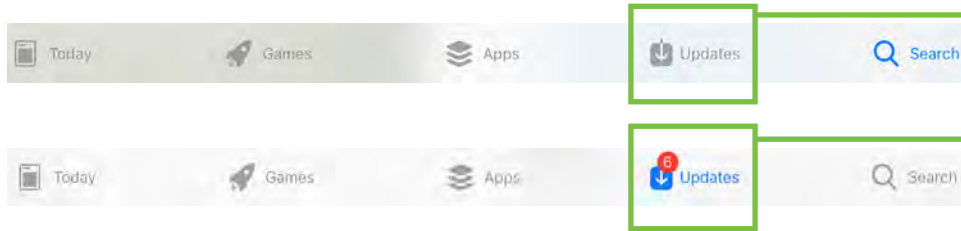

Downloading and Installing the Master Fader App on Android Devices

The easiest and fastest way to download and install the Master Fader app is directly from the device. You've downloaded apps before and it's the same method to download this one, as well. Here's how:

With a good internet connection, turn on the Android device and open up the Play Store.



Type "master fader 5" in the search box followed by tapping the Master Fader 5 app.

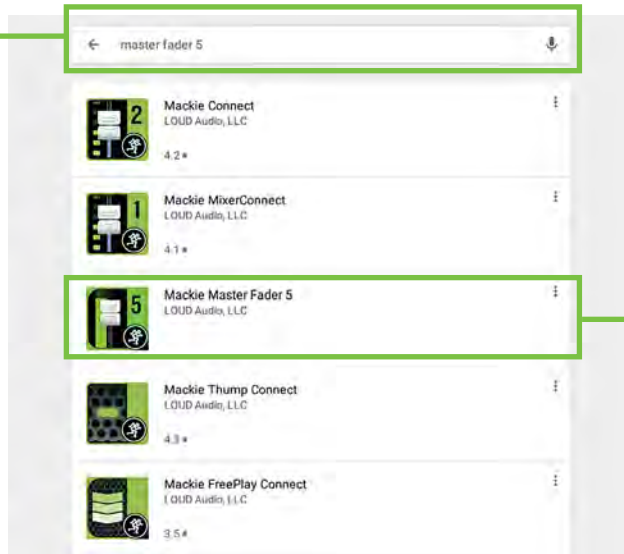

Now tap the install button.



After tapping the install button, an install percentage bar appears, indicating that Master Fader is downloading.



After downloading, the Master Fader app is ready for use. From here, there are two ways to open the Master Fader app.

First, simply tap the OPEN button to open the app...



...or second, exit out of the Play Store back to the home screen. Tap the Master Fader app!



Updating the Master Fader App on Android Devices

It is possible that the Master Fader app has already been downloaded and installed. In this case, you're probably good to go. However, it is a good idea to go to the Play Store to check for updates. You will want the latest and greatest version for the absolute best in functionality and versatility.

Once in the Play Store, tap the three horizontal lines located in the upper-left corner of the Android device; this icon is sometimes referred to as a 'hamburger'. From here, tap 'My apps & games'.

The first (left) screenshot below shows an Android device with all apps up to date. The second (right) screenshot below displays multiple apps that need updating (which may or may not include the Master Fader app). There is an update button displayed to the far right of each icon and name of each app needing an update. If you see Master Fader listed, tap the green UPDATE button on the far right. Or better yet, tap the green Update All button in the upper-right corner of the screen. The updates will commence. Don't do anything until the downloads have completed.

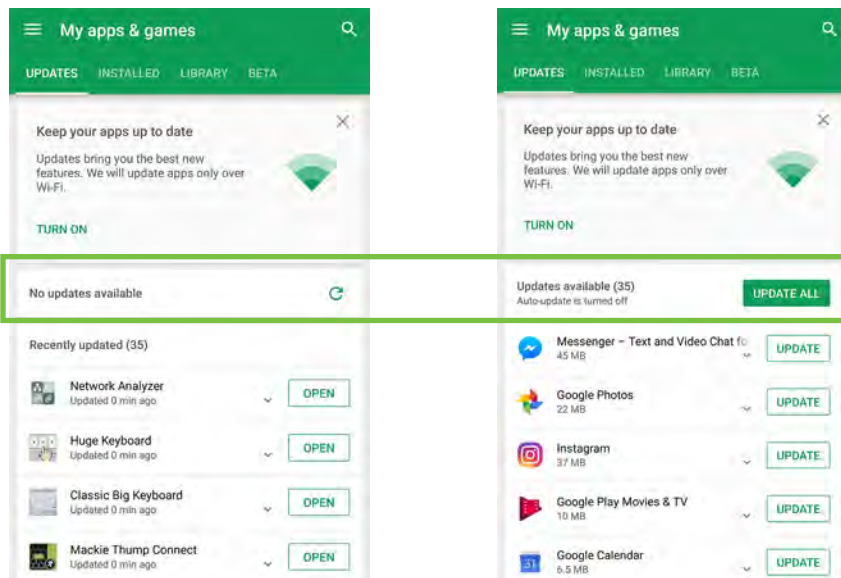

Updating the Firmware



Master Fader App Needs an Update

The Master Fader app automatically compares the app and firmware versions each time the app connects to the mixer. In order to operate properly, the firmware and app versions must match. If the Master Fader app is older than the firmware version in the mixer, you will be prompted to update the app. Tap the 'Download Master Fader' button on the popup and update as described on the previous page.

If the firmware version in the mixer is older than the Master Fader app, you will be prompted to update the firmware. The latest firmware is built into the Master Fader app, so there is nothing additional to download. Just follow the on-screen prompts. Be sure you have up to 15 minutes to spare, as the firmware update sometimes takes that long.

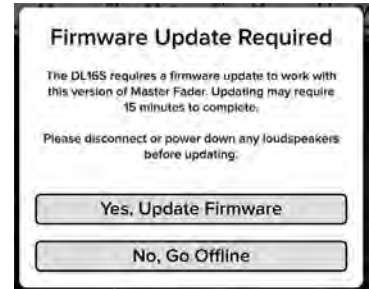

Mixer Firmware Needs an Update

Once you've made the decision to update the firmware, an image similar to what is shown below will appear on the device.



The warning "Please do NOT exit the Master Fader app, power cycle the mixer, or otherwise interrupt the upgrade" means exactly what it states. Allow the mixer and Master Fader to update the firmware.



The firmware upgrade may occur wired [DL806 or DL1608 only] or wirelessly. Choose one or the other and go with it; do NOT change from one to the other halfway through the upgrade.



Do you see the button centered at the bottom of the screen that reads "Abort"? Yeah, you're going to want to go ahead and leave that alone. There should be no reason to abort the firmware upgrade. Frankly, I'm not even sure why it's there if we don't want anyone to touch it. Leave it off, right? Alas, I digress...



If using a Static IP address for your DL Series Mixer, an update may fail to begin properly. Similarly, a force update will fail in the same way. The first thing to do is check the Wi-Fi settings to ensure that it didn't hop onto a different wireless network. Forgetting other networks helps alleviate the problem of Wi-Fi hopping. If that is not the problem, you will need to temporarily configure the DL hardware to use Dynamic [DHCP] IP addressing.

DL16S • DL32S — This can be accomplished by temporarily changing back to Access Point mode and using the internal Wi-Fi for the update. When the update is complete, change the DL hardware back to static IP and connect it back to the main network.

DL806 • DL1608 • DL32R — This can be accomplished by changing to Dynamic IP, disconnecting the hardware from the main network, then configuring a temporary Wi-Fi network with a router directly connected to the DL hardware with no other network connections. When the update is complete, change the DL hardware back to static IP and connect it back to the main network.

Lingo

Before diving into the features and functions of the Master Fader app, let's take a few minutes to get acquainted with the wording that will be used throughout this Reference Guide. Doing so will minimize confusion and increase productivity, a great combination!

Tapping, Dragging, Flicking, Swiping, and Pinching

You already have a smart device, be it an Android or iOS phone or tablet. Master Fader also works with PC and Mac computers. Options, baby! Getting around the Master Fader app is similar to getting around the device and many of the other apps you currently utilize. Let's go over the functions you will be using:

Gesture	Action	Examples
Tap	To press or touch a control or item (analogous to a single mouse click)	Adjust tools, mute, polarity, ID buttons, etc.
Drag	To press down and slowly drag the feature to the desired spot (that is, move side-to-side and up and down)	Adjust faders, pans, channel view sliders, etc. and to view a different set of channels
Flick	A very fast drag	View a different set of channels
Swipe	To make a sweeping motion with your finger side-to-side or up and down	Navigate between channel views; refer to The Swipe Zone on page 29
Pinch	Use two fingers to pinch open [zoom in] or close [zoom out]	Adjust EQ Q

There are a multitude of things to tap: mute, solo and other buttons scattered throughout the channel view [EQ, gate and compressor, and many more]. In fact, you have already tapped a few things: the App Store icon, the download button, etc. The Master Fader app works in similar fashion. In most cases, it is tap to engage, tap again to disengage.

Some things may be double-tapped to reset to their default settings. For example, pans will be centered, EQ will be set to 0 dB gain, etc.

Dragging is how to adjust faders, pans, EQ, gate, compressor and FX settings, graphic EQ and the mix selector to name just a few. Keep a finger on the device and drag the selected item to the desired destination. You will become a master dragger of the master fader in no time!

Flicking is similar to dragging, but "faster". In fact, flicking could be compared to a slap shot in hockey. Flicking will be used mostly to view a different set of channels or in a mixer view swipe zone when a "slower" drag just isn't fast enough. We get it. You have places to go, people to see, shows to mix. Flick away.

Swiping will become second nature, as this is how to switch between channel views. Swiping may be compared to the aforementioned flick, but instead of being like a slap shot in hockey, a swipe is more like sweeping. That's an easy way to remember it: swiping = sweeping! There is a whole page dedicated to swiping, appropriately titled "The Swipe Zone". Read all about it on page 29.

Pinching is the only function you probably will not use a whole lot. The only things that get pinched are the EQ balls to adjust their Q and a loaf to get rid of waste and relieve tension.

Three Main Views



Throughout this Reference Guide we will be talking quite a bit about views. The good thing, though, is that there are only three main views in the Master Fader app: overview, mixer view and channel view. The following is just a general outline of what may be accomplished in each view. Soon enough we will go through each of these in detail.

Let's take a quick peek at what each one looks like and what each represents.
This is important so focus!

Overview

The overview displays all important functions of all input and output channels at one time in one place. Once a show is set up, this is the place to be. If any issues arise, you can easily spot it here in the overview, head to the affected channel with just a tap and fix it immediately. Fader changes, enabling / disabling a solo, mute and/or mute group may occur within the overview, as well.

The overview is divided into four main rows:

- Master Outputs
- Matrix + Groups
- Inputs 1
- Inputs 2

The following are displayed on every channel of every row:

- Mute
- Meter (except VCAs)
- Gain Reduction Meter (except VCAs)
- Fader
- Solo
- Mix Select Color
- Channel Name
- Channel Color



Overview

Mixer View

The mixer view is exactly what it sounds like; it's a view of the mixer! The key mixing controls of every input and output for the mixers exist here. All channel strips (plus the FX, sub outs, VCAs, returns [DL16S, DL32S, DL32R] and iPad [DL1608 / DL806 channel strips] are present along with a thumbnail view of each channel's input routing view, EQ curve, gain reduction meters, pan slider, mute, fader level, input meters, selected mix color, solo and channel name, image and color.

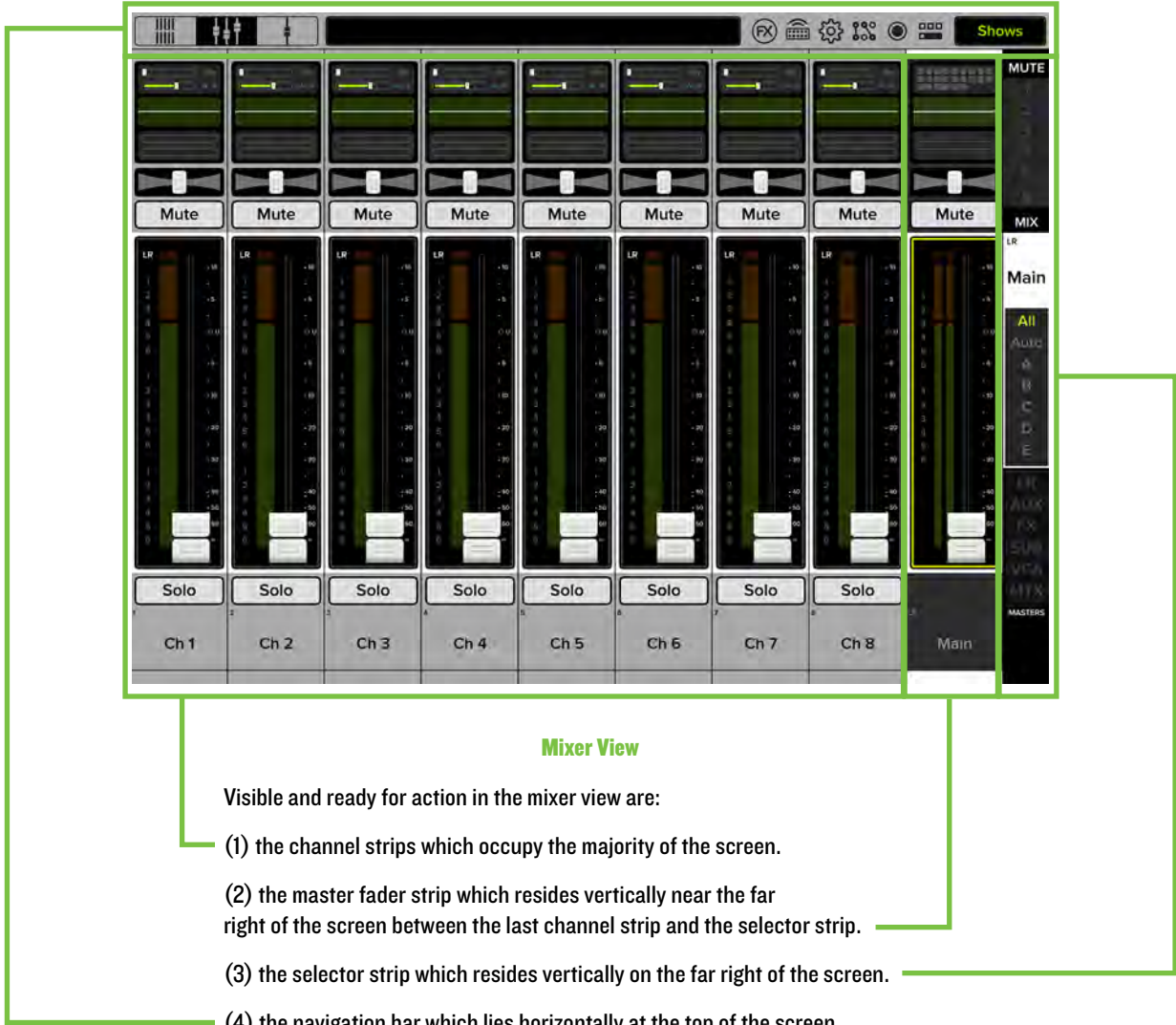

There is an easy way to determine which view you're in. Look in the upper-left corner of the device. There are three buttons. In order from left to right, they are overview, mixer view and channel view. The button of the selected view is dark gray while the other two views' buttons remain light gray.



This is just an overview of the mixer view. There is a plethora of information in chapter 17 (pages 156-244) which deals with all things navigation bar. Head there for additional information.

So the mixer view is where you adjust the key mixing controls for all channels at once. If you would like to adjust the individual channel processing, you need to go to the channel view. The channel view button is the right button near the top-left of the navigation bar. Tap it!

Channel View

The channel view handles all DSP-related activities. It is in the channel view where all plug-in processing is adjusted on individual channel inputs and outputs. This includes each channel's source and routing, channel EQ, channel gate and compression, FX, output routing and channel assignment, graphic and parametric EQ and output compression and delay.

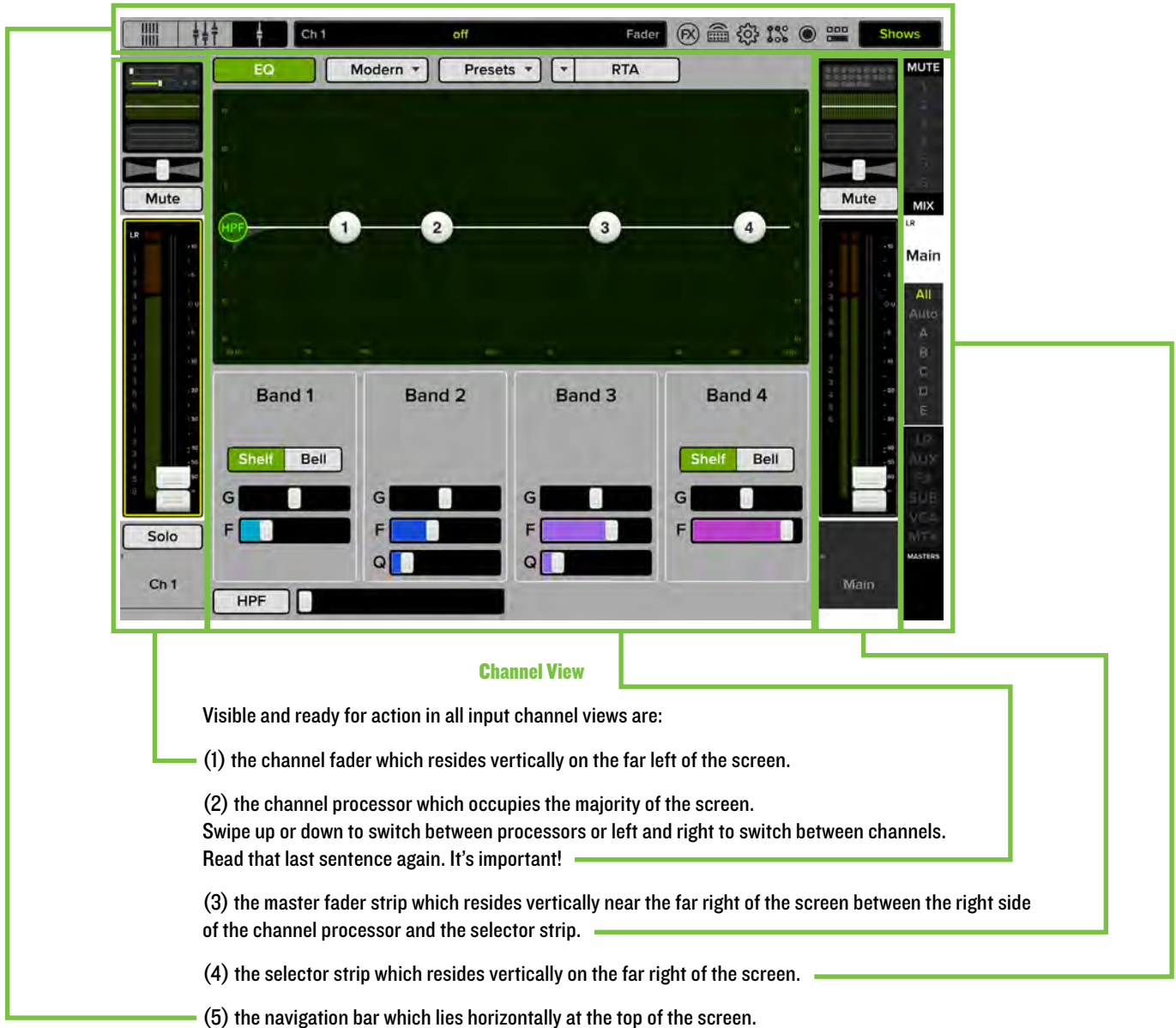

Channel View

Visible and ready for action in all input channel views are:

- (1) the channel fader which resides vertically on the far left of the screen.
- (2) the channel processor which occupies the majority of the screen.
Swipe up or down to switch between processors or left and right to switch between channels.
Read that last sentence again. It's important!
- (3) the master fader strip which resides vertically near the far right of the screen between the right side of the channel processor and the selector strip.
- (4) the selector strip which resides vertically on the far right of the screen.
- (5) the navigation bar which lies horizontally at the top of the screen.

Speaking of the navigation bar...

NOTE There is an easy way to determine which view you're in. Look in the upper-left corner of the device. There are three buttons. In order from left to right, they are overview, mixer view and channel view. The button of the selected view is dark gray while the other two views' buttons remain light gray.

NOTE This is just an overview of the channel view. There is a plethora of information in chapter 17 (pages 156-244) which deals with all things navigation bar. Head there for additional information.

In addition to these three main views, there are a variety of buttons that trigger a popover, giving additional controls to adjust. Many of these come from the upper-right side of the navigation bar; when a button is tapped, a popover is revealed and awaiting your adjustments. Tapping the button again closes the popover, revealing the previous view underneath.

Below left is an example of the mixer view changing to the tools view popover, while the screenshots below right show a channel view changing to the shows popover. Notice the difference in the upper-right side of the navigation bar, too. The selected button will illuminate, indicating which popover is now displayed.

Mixer View to Tools View

Channel View to Shows View

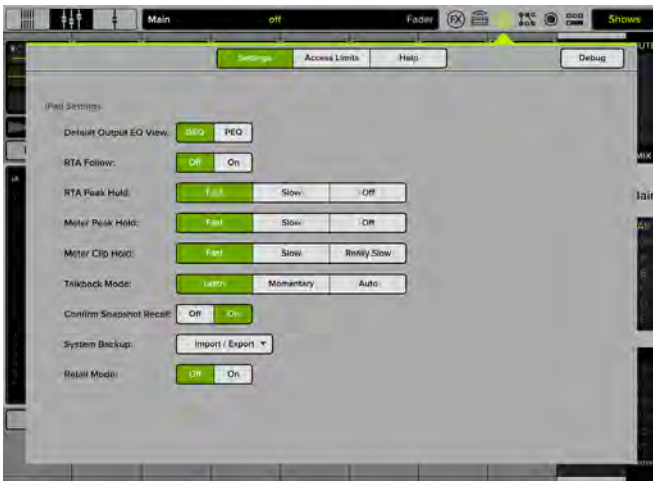
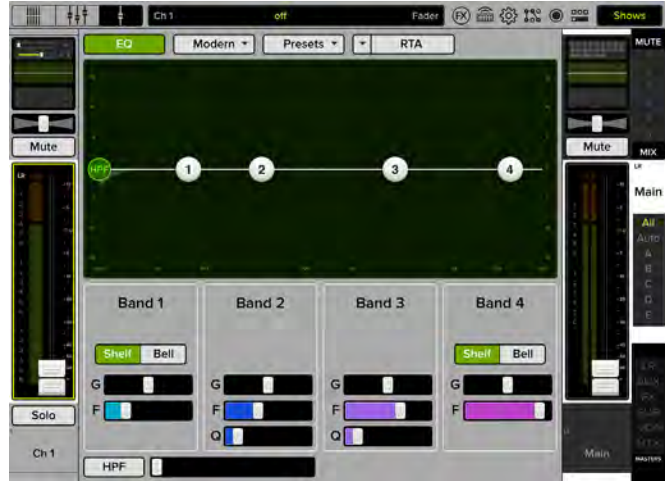

Now that you know the basics of the views, there are just a few more things to cover before we look at every single screen and control in thoroughly exhaustive detail.

Grow & Glow, Current Parameter Display and The Swipe Zone

The following are key paradigms built into the Master Fader app to help simplify your mixing world. These exist on all screens and are important concepts to understand.



Pan Grow & Glow

Grow & Glow — When making changes to the mix, certain controls “Grow & Glow” to indicate that they are being adjusted. This builds your confidence in that the controls you are adjusting are under your power, including faders, EQ balls, gate and compressor balls, graphic EQ sliders and more. There are multiple examples of the “Grow & Glow” feature displayed on this page.

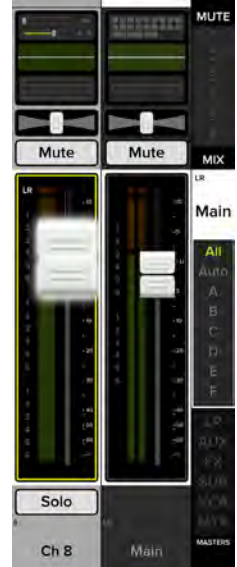

Fader Grow & Glow

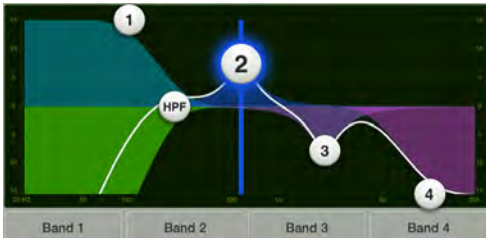

Band 2 Grow & Glow [EQ]

(Also of note here is the vertical line; it helps indicate the band's current frequency).



Attack Slider Grow & Glow [Compressor]

Current Parameter Display — The current parameter display is conveniently located dead-center on the navigation bar at the top of whatever view is open. It constantly updates to display the channel and the value of the current parameter being adjusted. However, this is not just a point of reference. Tap the current parameter display and the device's keyboard appears. Here you may enter the exact value you would like for that parameter. Sometimes multiple parameters may be changed. For example, both the gain and frequency may be updated on each EQ band, as seen below.

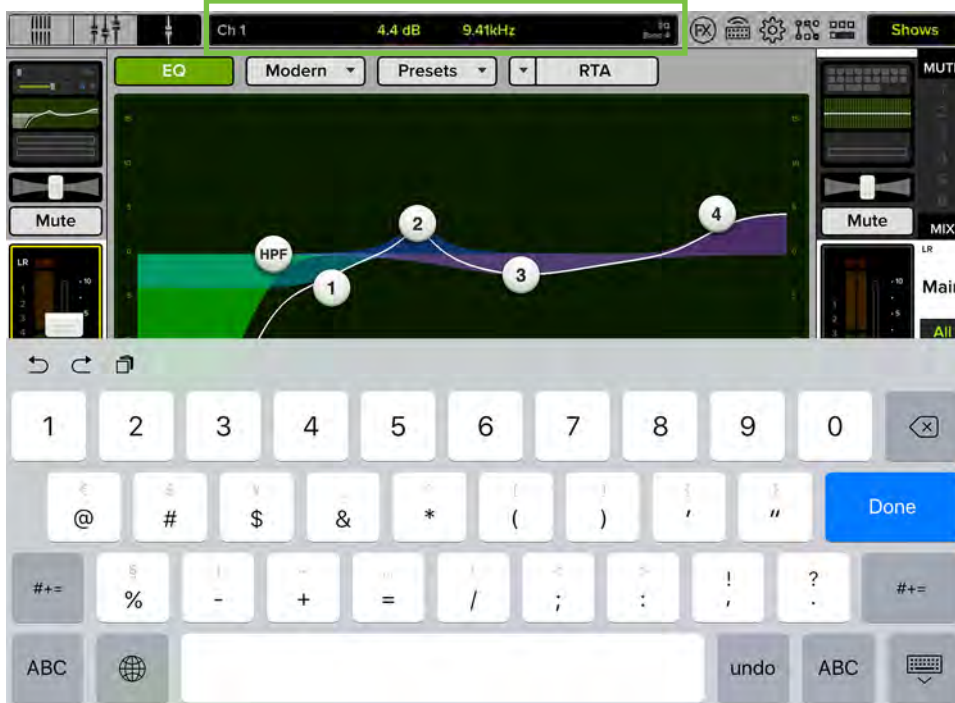

The Swipe Zone — Swiping, dragging and flicking are the keys to navigating the Master Fader app and the swipe zone exists in nearly every single view. While in the mixer view, the swipe zone exists everywhere...yes, everywhere! Swipe left or right to display any of the input channels, FX channels, sub channels, VCA group channels, return channels [DL16S, DL32S, DL32R] and iPad channel [DL806, DL1608].

Mixer View Swipe Zone



In a channel view, the swipe zone exists anywhere on the gray background. On input channels, swipe up and down to switch between the input routing views, EQ and gate and compressor and left and right to stay on the same view, but switch between input channels. Swipe up and down on the output channels to switch between output routing views, graphic EQ, parametric EQ, and the output compressor / limiter.

Channel View Swipe Zone

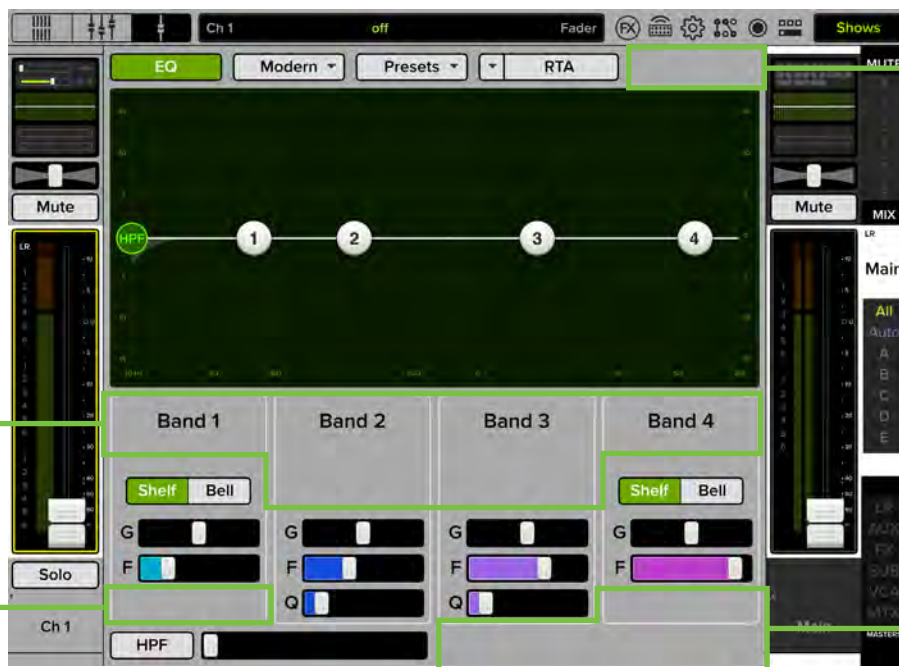

Screen Flow — The screen flow shown below – say that ten times fast! – displays what is described on the previous page and provides an overview of all the different views on the Master Fader app. We'll cover the swipe zone for each view in detail, but wanted you to have an overview of what you can expect from the coming pages.

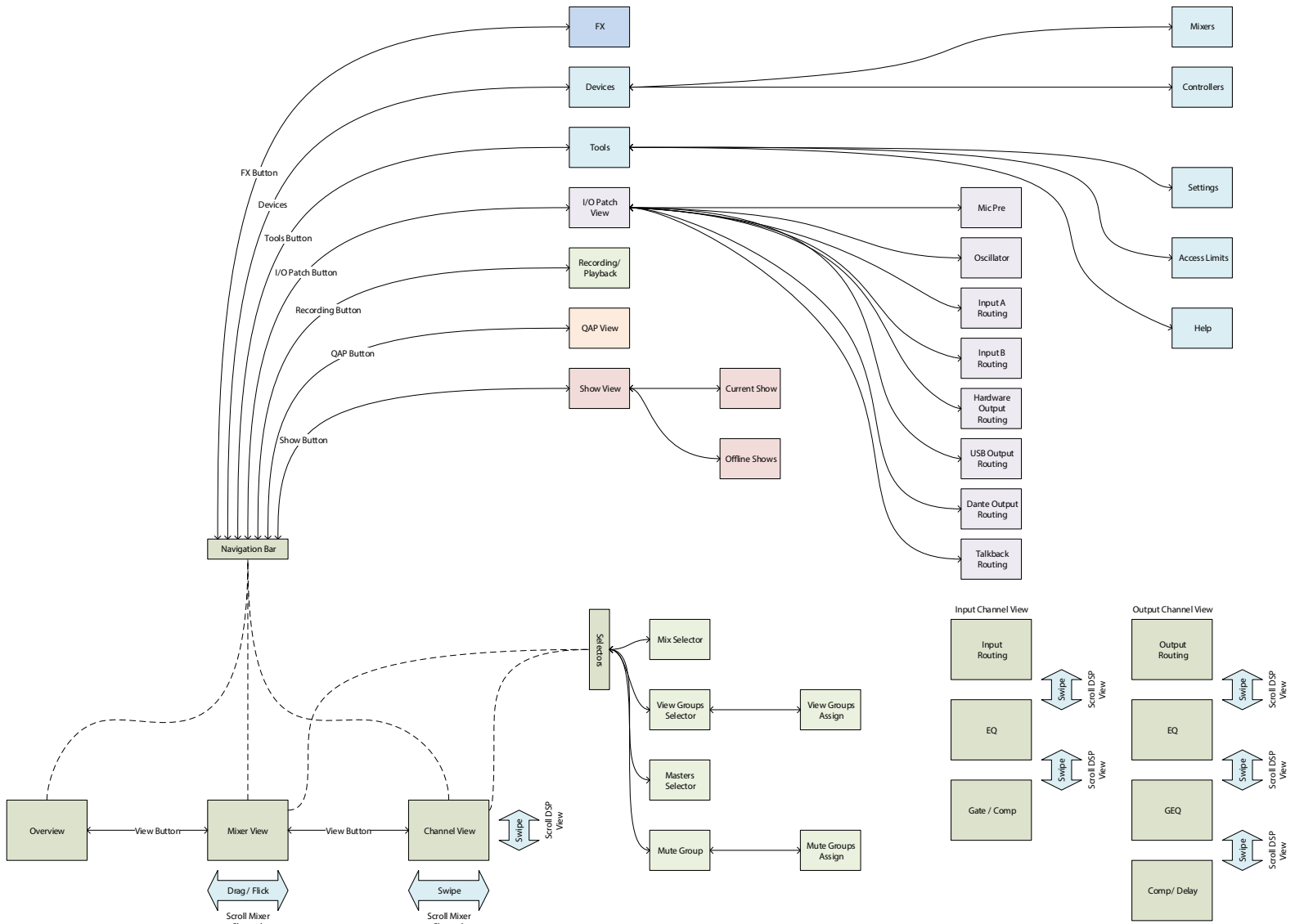

Master Fader app Screen Flow

Chapter 4 : Level Setting Procedure

Introduction

Before we go into great detail about all of the features of Master Fader, let's get some audio. The key to that is setting levels. Setting levels on the DL16S, DL32S and DL32R vary slightly from setting levels on a DL806 and DL1608, but of course we'll show both...come along, won't you?!

Level Setting Procedure – DL806 • DL1608

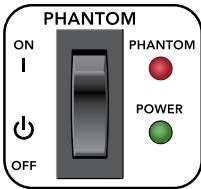

(1) Phantom Power — Every DL806 and DL1608 has a global phantom power switch (located on the rear panel of the mixer) that affects all mic channels' XLR jacks simultaneously. If any connected mics require an extra 48V of power, engage the phantom power switch. The accompanying phantom power LED will illuminate red, indicating that phantom power has been engaged.



(2) Let There Be Rock — Use your voice, play the instrument, or play the line-level source at the same volume as it would be during normal use...and keep it going!

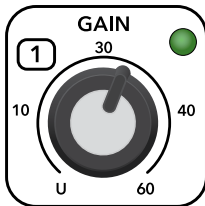

Step 3



Step 4

(3) Raising Gain and Watching Meters — Turn the gain knob clockwise until the input meters bounce between green and yellow, the colors of our beloved hometown Seattle Supersonics [RIP]. The accompanying LED will illuminate green (to indicate signal).

This same LED may illuminate red (to indicate clipping). Clipping creates undesirable distortion and should be avoided at all costs. If this LED illuminates red frequently, turn the gain down.

(4) The Raising of the Fader, Part I — Raise the channel fader to 0 dB.

(5) Rinse and Repeat — Repeat steps 2-4 for each channel with signal.

(6) Less Than Zero — The gain knob should be completely counter-clockwise and channel fader all the way down for each channel not in use.

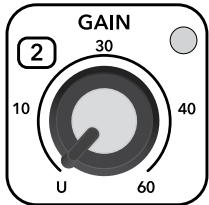

Step 6



Step 7

(7) The Raising of the Fader, Part II — Slowly raise the master fader to the desired amount. You should now see output meters and hear signal through the speakers. Hopefully it's music to your ears...otherwise it's going to be a long night.

Headphones

Here is how to get the same sound to a pair of cans...and by cans we mean headphones. Pervert.

(1) First Things First — Follow the level setting procedure starting on the previous page.

(2) Hearing Aid — We like your ears and are quite sure that you do, too. Make sure the phones knob is fully counter-clockwise before continuing.

(3) Cover Thy Ears — Release yourself from the outside world by putting on the headphones.

(4) As the Knob Turns — Turn the phones knob clockwise until you hear music through the cans.



Step 2



Step 4



(5) The Obligatory Warning — The headphone amp is loud and could cause permanent hearing damage. Even intermediate levels may be painfully loud with some headphones. **BE CAREFUL!** Always turn the phones knob all the way down before connecting headphones, soloing a channel or doing anything new that may affect the headphone volume. Then turn it up slowly as you listen carefully.

Level Setting Procedure – DL16S • DL32S • DL32R

(1) Phantom Power — If any connected mics require an extra 48V of power, engage the phantom power. Each DL16S, DL32S and DL32R has individual 48v phantom power buttons on all mic inputs, controlled via Master Fader. Phantom power for each channel may be selected by:

(1) tapping that channel's input routing view.

(2) tapping the 48v button.

Notice that the 48v button illuminates red, indicating that phantom power has been engaged.

Furthermore, notice that the 48v text on each channel's input routing view is red when phantom power is engaged and gray when disengaged.

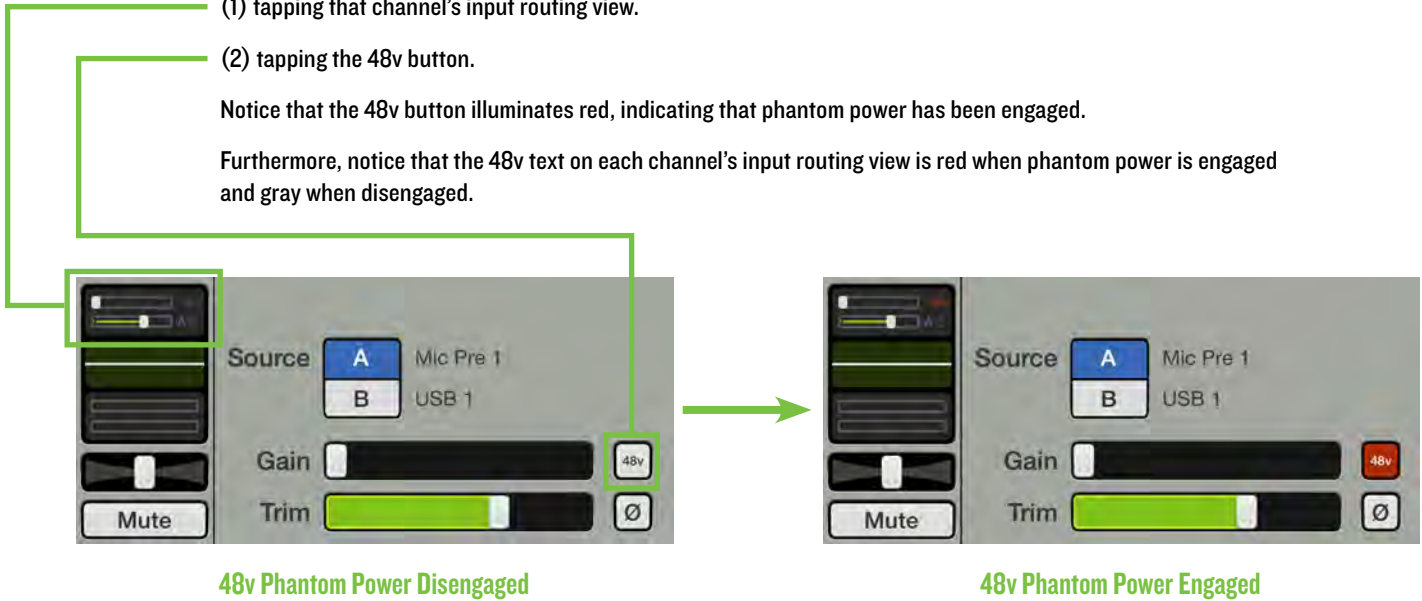

(2) Let There Be Rock — Use your voice, play the instrument, or play the line-level source at the same volume as it would be during normal use...and keep it going!

(3) Raising Gain and Watching Meters — Now we'll want to raise the gain until the input meters bounce between green and yellow, the colors of our beloved hometown Seattle Supersonics [RIP]...but how? You might have noticed a gain slider conveniently located to the left of the phantom power button. Yup, that's your gain, one for each input channel. Simply drag the channel's gain slider from left to right while watching the bouncing meters, making sure it doesn't get too hot.

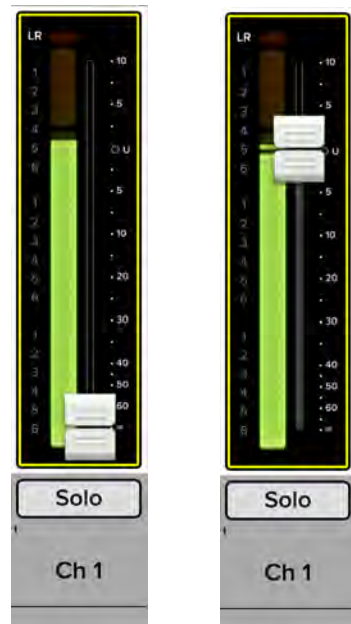
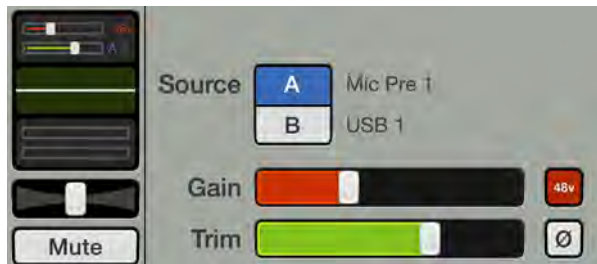

Step 3

Step 4

(4) The Raising of the Fader, Part I — Raise the channel fader to 0 dB.

(5) Rinse and Repeat — Repeat steps 2-4 for each channel with signal.

(6) Less Than Zero — The gain should be completely off and channel fader all the way down for each channel not in use.



(7) The Raising of the Fader, Part II — Slowly raise the master fader to the desired amount. You should now see output meters and hear signal through the speakers. Hopefully it's music to your ears...otherwise it's going to be a long night.



Step 6



Step 7

Headphones

Here is how to get the same sound to a pair of cans...and by cans we mean headphones. Pervert.

(1) First Things First — Follow the level setting procedure starting on the previous page.

(2) Hearing Aid — We like your ears and are quite sure that you do, too. Make sure the phones knob is fully counter-clockwise before continuing.

(3) Cover Thy Ears — Release yourself from the outside world by putting on the headphones.

(4) As the Knob Turns — Turn the phones knob clockwise until you hear music through the cans.



Step 2



Step 3



Step 4



(5) The Obligatory Warning — The headphone amp is loud and could cause permanent hearing damage. Even intermediate levels may be painfully loud with some headphones. **BE CAREFUL!** Always turn the phones knob all the way down before connecting headphones, soloing a channel or doing anything new that may affect the headphone volume. Then turn it up slowly as you listen carefully.

Chapter 5 : Mixer View : Channel Strips

Introduction

The mixer view contains input channel faders, FX channel faders, sub group faders, VCA group faders, return faders [DL16S, DL32S, DL32R only] and an iPad channel fader [DL806, DL1608 only]. Most channel strips look and function exactly like the others.

These faders may be seen in both the mixer view and channel view. In the mixer view, all faders are readily available, while in the channel view it is the current channel's fader strip that is displayed along with whatever digital signal processing is taking place for that channel.

The mixer view displays input channels, as well as the navigation bar and master fader.

Take a look at the image below. It is the first visual you will see when booting up the Master Fader app for the first time.

The Swipe Zone

Here in the mixer view, drag or flick left or right anywhere in the background of the outlined area to view the remaining channel strips. So, yeah, basically anywhere you want!



Let's look at one of the input channels first, discussing each of its features top to bottom. We will then take a look at the remaining channels and go over how and why they're different than the input channels.

Input Routing



At the top of each channel strip is a thumbnail view of key input routing parameters for each channel.

The screenshots to the left display the default settings of the digital trim...0.0 dB for those counting. In addition to digital trim, the DL16S, DL32S and DL32R also display the currently selected source [A or B], and if that source is a mic pre, the corresponding mic pre gain and 48v setting.

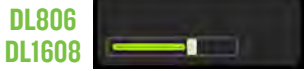

Tapping a channel's input routing button will change from the mixer view to that channel's input routing channel view.

There is quite a bit to learn about the input routing view. Check it out in chapter 9 starting on page 89.

EQ Curve

Next is a thumbnail of the current EQ and HPF processing that's applied to each channel (whether the EQ and/or HPF is currently engaged or not).

As seen below, there are five possible scenarios regarding the EQ curve depending on whether the EQ and/or HPF are enabled. Each one may look unique, but it is the same exact EQ in each of the five different scenarios.



MODERN EQ OFF
HPF OFF



MODERN EQ ON
HPF OFF



MODERN EQ OFF
HPF ON



MODERN EQ ON
HPF ON



VINTAGE EQ ON/OFF
HPF ON/OFF

Tapping a channel's EQ curve will change from the mixer view to that channel's EQ channel view.

To learn more about EQ and HPF, check out chapter 10 starting on page 94.

Gain Reduction Meters



The gain reduction meters display the input channel gain reduction from the gate [top] and compressor [bottom]. These illuminate from right to left and are 20 dB when fully lit.

Tapping a channel's gain reduction meter button will change from the mixer view to that channel's gain reduction meter channel view.

To learn more about dynamics, check out chapter 11 starting on page 107.

Pan / Balance



LR Pan

Pan allows you to adjust how much of the channel is sent to the left versus the right outputs. Touch and drag a channel's pan slider left or right to make adjustments. Touched pans will "grow & glow" to indicate that they are being adjusted. The pan may be centered by double-tapping the pan slider.

The pan control employs a design called "Constant Loudness." If a channel is panned hard left (or right) and then panned to the center, the signal is attenuated 3 dB to maintain the same apparent loudness. Otherwise, the sound would appear much louder when panned center.



LR Balance

The pan slider becomes a balance slider on linked channels, now acting as a stereo balance. It allows you to adjust how much of the left or right output signals are heard. Touch and drag the sliders left or right to make adjustments. Center it to hear the output equally from the left and right sides. The balance may be centered by double-tapping the balance slider. How to link channels is discussed on page 43.

For a linked aux, the user may de-select Use LR Pan to control the aux pans and main mix pans independently for each channel. An example of this is displayed below.

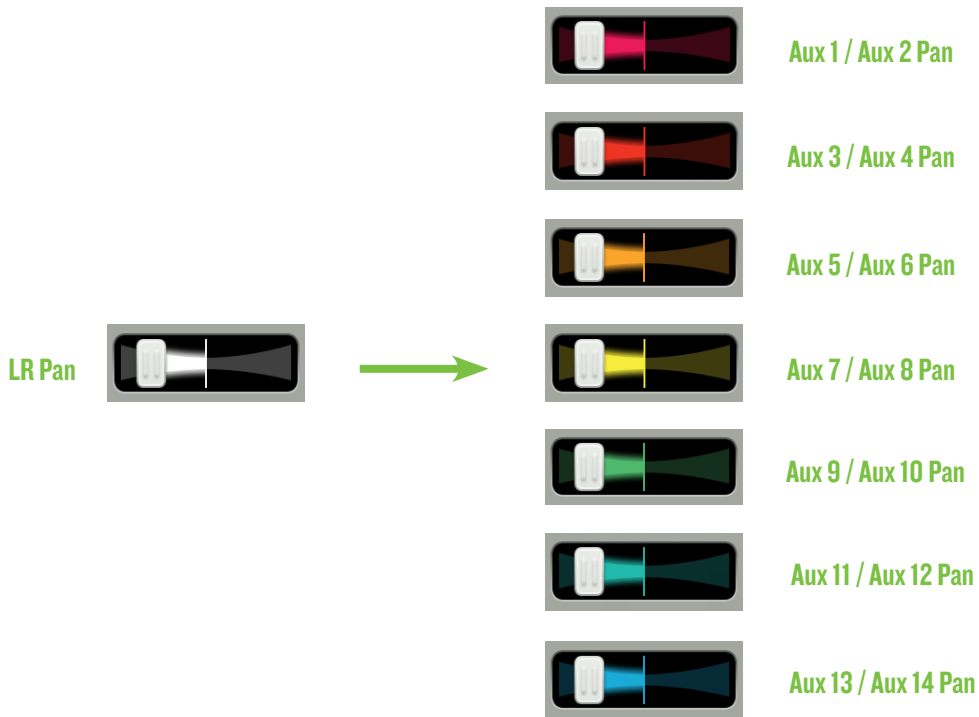

More information about Use LR Pan may be found on page 73.

Mute



Mute buttons do just what they sound like they do. They mute – turn off – the signal on the channel(s).



Mute buttons illuminate red when engaged and are gray when disengaged.



Muting a channel mutes it all on all outputs, not just the output that is currently shown...unless the user de-selects Use LR Mute for a particular aux/FX send, in which case aux mutes (or FX mutes) and main mix mutes may be controlled independently for each channel. More information about Use LR Mute may be found on page 72.



Inputs muted by mute groups or VCAs will illuminate oxblood red. More information about mute groups may be found on pages 57-62.

Channel Faders and Input Meters

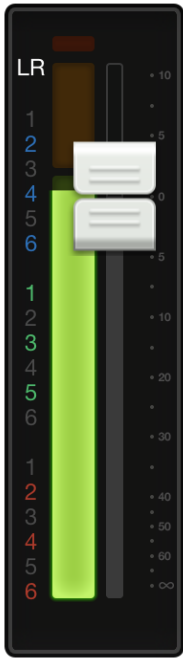

Mono

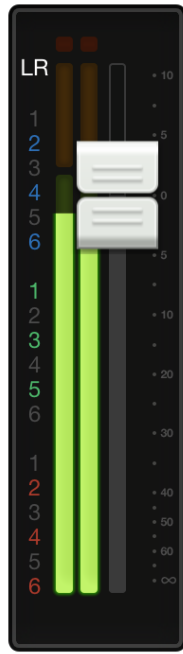

Stereo

The touch sensitive faders adjust the level of each channel going to the selected output. Adjustments are made by touching and dragging channel faders up and down. Touched channel faders will “grow & glow” to indicate that they are being adjusted. The fader level ranges from $-\infty$ to +10 dB as indicated by the scale on the right.

The input meters display the input signal level to the channel before all channel processing. Changes made to the EQ, mute and fader do not affect these meters. This meter should remain green with the occasional bump into the yellow zone. Turn down the gain if the input meter remains consistently yellow. If the input is too high [overloading], a clip indicator at the top of the meter will illuminate red. If clipping occurs, reduce the gain.

Unlinked channels display mono meters, while linked channels display stereo meters. How to link channels is discussed on page 43.

- Red [clipping] = -3 dBFS
- Green to yellow = -12 dBFS
- Green [bottom] = -60 dBFS

The color of the currently selected output will surround the channel strips [L/R default is white].

To the left of the input meters is a column of numbers. In order from top to bottom, these indicate the channel's routing assignments for subgroups, VCAs and mute groups. As seen to the left, these numbers illuminate when channels are assigned to these groups.

Selected Mix Indicators

Surrounding each fader and input meter is the selected mix indicator. This varies by color for clear indication of which mix is currently selected.

The mix type will be discussed in greater detail in the master fader section, starting on page 56.



There is no way you would ever see the image as shown below. It is just a point of reference. As mentioned above, each selected output has a different color for clear indication of which output type is currently selected. This is especially useful in the mixer view.

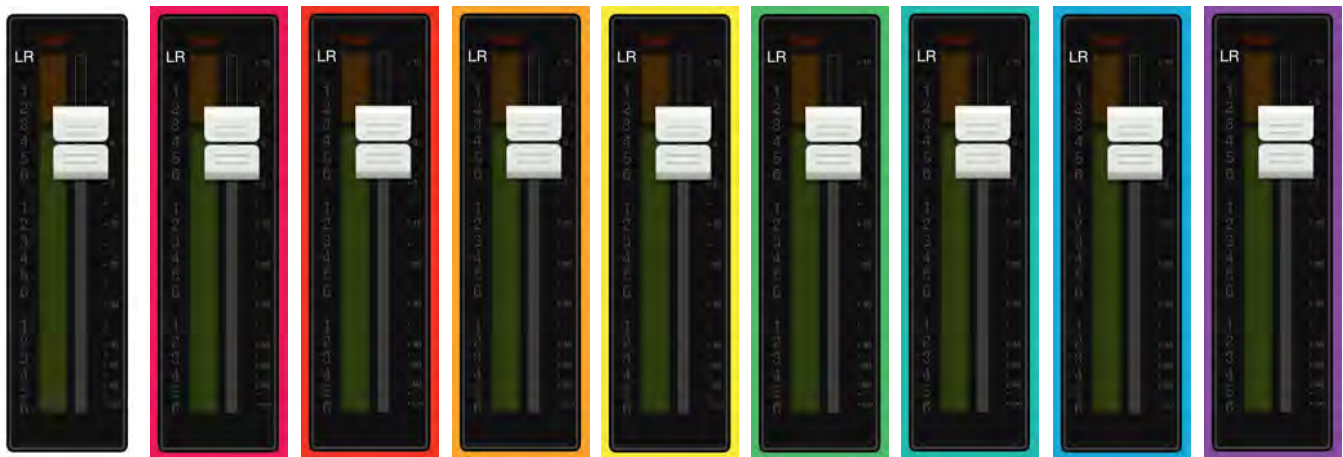

LR

AUX 1/2

AUX 3/4

AUX 5/6

AUX 7/8

AUX 9/10

AUX 11/12

AUX 13/14

FX

All we did was change the selected output from main LR to aux 1. Notice below how each channel's input meter is surrounded by the color of the selected output. In the left image, the faders control the levels going to the LR mix, while the faders on the right image control the levels going to the aux 1 mix.

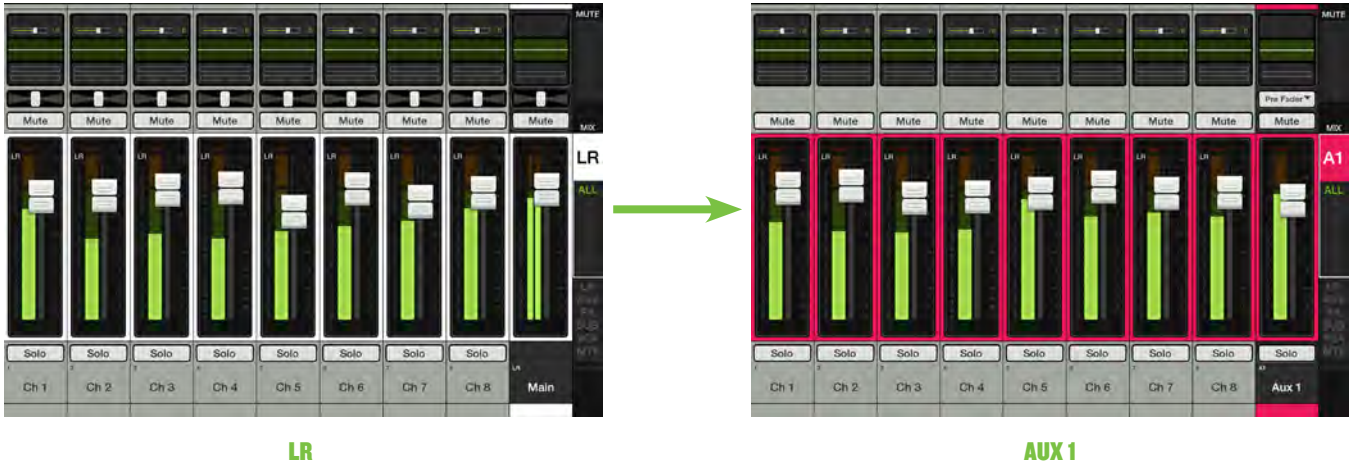

Solo

Solo offers the opportunity to audition channel(s) in the monitor bus/headphones discretely, even if they are muted. Whenever a channel's solo button is engaged, only the soloed channel(s) may be heard in the monitor bus. By default, the monitor bus is patched to the monitor and phones outputs on the DL32R, but this may be changed. By default, the monitor bus is patched to the phones output on the DL16S, DL32S, DL806 and DL1608.



Solo buttons illuminate orange when engaged and are gray when disengaged. Inputs soloed by VCAs, however, will illuminate a darker yellow-ish orange.

BY DEFAULT, input channel solo buttons are PFL which stands for pre-fader listen. Therefore, the level of the channel fader DOES NOT affect the level heard in the monitor bus.

BUT... solo location may be changed to AFL (which stands for after-fader listen (and the level of the channel fader DOES affect the level heard in the monitor bus)) or PFL for inputs and AFL for outputs. Solo Location is available by going to Tools > Settings > Solo Location. Simply tap the button of the selection you desire. It will illuminate green while the other choices remain gray as seen below.



NOTE Solo Location cannot be set while in Offline mode. A device needs to be connected (whether wired or wirelessly).

Solo is also post-DSP, so if a soloed channel's EQ, compressor or gate is engaged, the processed settings will be heard. But, solo is unaffected by the position of the mute button.

By default, if no channels are soloed, you will hear the main LR output in the monitor bus [i.e. Headphone and Monitor outputs]. This is because the Tools > Settings > LR to Monitors setting is set to ON.



If the LR to Monitors setting is set to OFF, you will only hear channels that have been soloed in the Headphone and Monitor outputs. When no channels are soloed, no audio is sent to the monitor bus.

NOTE When any input solo is engaged, not only will that solo button be engaged, but a solo indicator will also appear on the navigation bar above the quick access panel, see below. Because this is always shown (and could be considered distracting), we've named it the "rude solo" button. Tap the channel solo button again to disengage or tap the quick access panel to show the clear solo button allowing you to clear ALL solos with a single tap.



Channel ID Button

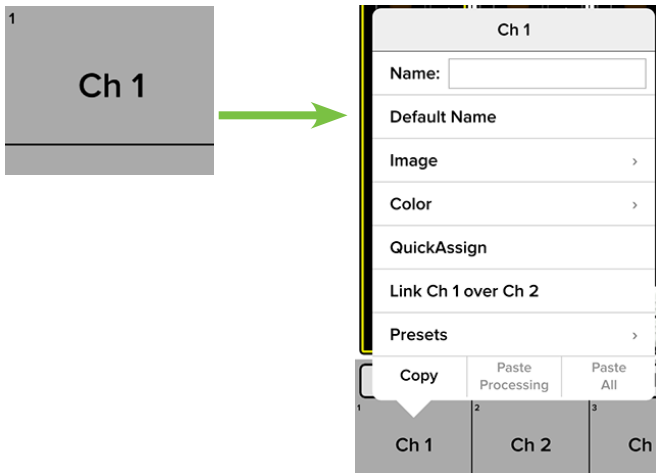

Each channel ID button name, image, color and preset is user-editable. Additionally, users may also QuickAssign the aforementioned, link two adjoining channels together into a single channel strip and/or copy the channel's characteristics in order to paste them to other input channels. To get started, tap the button at the very bottom of the channel strip to reveal a popover.

Let's start with the name. Tap in the name box to bring up the blinking cursor and keyboard (as seen in the image below). Type in the name you want for that channel followed by tapping the blue "Done" button. If the name is too long to fit, the button scrolls, displaying the entire name.

It goes without saying that tapping "Default Name" changes that channel's name back to its default name. True story.

Before moving on with the rest of the Channel ID, let's look at another exciting feature regarding channel naming.



On the left and right side of Name: are "previous" and "next" arrows². This makes it easier to edit the names of multiple channels in a row without having to re-tap each channel's ID button just to name it.

An open gray box with only the channel's name works, but let's spice it up with an image. Show images are kept in sync which means that all connected devices will display the new image once it's been added, whether or not it was already on that device. There are several ways to choose an image. From the channel popover, tap "Image" to reveal a new popover as seen to the right. You will be presented with five choices:

Camera — If you're familiar with how the camera on your device works – and who doesn't these days? Selfie, anyone? – Well, you're in luck...this one works the exact same way!

Photo Library — Here you may select from all the photos that currently reside on your device or computer.

Icon — Or select from a multitude of built-in icons at your disposal.



² Ok perhaps there isn't a "previous" arrow shown in this example, but that's because we're naming channel 1. There is no "previous" channel!

Show Images — This allows you to select the channel image from photos that are currently in use on the current show. The list will display all images currently in use. Tap the photo you would like to use from this list.



A maximum of 64 images may be used per show. However, if the same image is used on multiple channels, it only counts as one image (if the image has been selected from show images and not multiple times from the photo library). Icons do not count toward the 64. More information about the file system [shows, snapshots, etc.] begins on page 233.

Clear Image — Believe it or not, tapping here will clear the image for that channel. This removes the image from the channel and, if it isn't used elsewhere, from the Current Show and the Show Images list.



If you're ok with it, we'll go with the kick drum icon. Cool? Great! Tap the kick drum icon in the upper-left corner to select it.

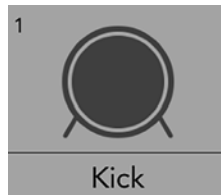

As seen in all of these images, a small number resides in the upper-left corner regardless of name and/or image. This number represents each channel and it cannot be changed or removed. Trust us, it's for the best, as it is for easy identification.

But wait, there's more! A few weeks ago I played a show. One of the songs features 12 goats on the choruses, each with its own mic. I was thinking, "there's got to be a 'colorful' way to distinguish between channels, right?" Well, I brought the idea up to the bigwigs, and the rest, as they say, is history.

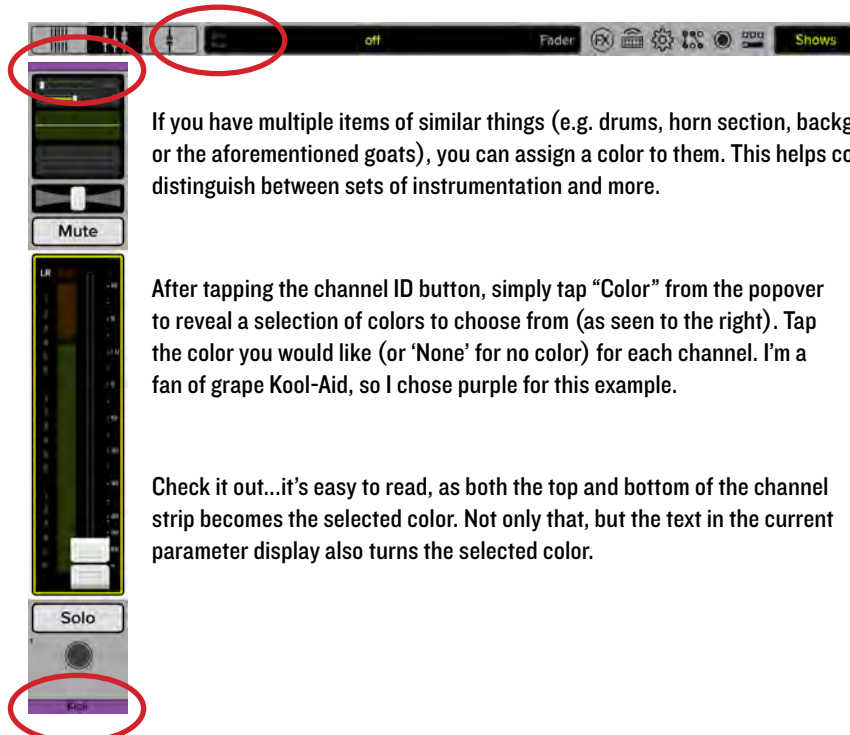

If you have multiple items of similar things (e.g. drums, horn section, background vocals or the aforementioned goats), you can assign a color to them. This helps color coordinate, distinguish between sets of instrumentation and more.

After tapping the channel ID button, simply tap "Color" from the popover to reveal a selection of colors to choose from (as seen to the right). Tap the color you would like (or 'None' for no color) for each channel. I'm a fan of grape Kool-Aid, so I chose purple for this example.

Check it out...it's easy to read, as both the top and bottom of the channel strip becomes the selected color. Not only that, but the text in the current parameter display also turns the selected color.



QuickAssign

Wait, so I have to tap the Channel ID button multiple times? Once for the name, once for the image and again to assign a color? Then I have to repeat that process all over again for each additional channel? Au contraire mon frère!

Sandwiched between “Color” and “Link Ch X over Ch X” is an option to “QuickAssign”. Tap it to reveal something similar to what may be seen below.



QuickAssign allows you to, wait for it.....

.....quickly assign these same characteristics – names, icons, colors and show images – via drag-and-drop! Then repeat as needed for subsequent channels. Makes sense, right? As seen in the image above, the “Kick” name is being dragged-and-dropped onto the Ch. 1 input. You can see that the same method is used to add a kick drum icon (below left) and color (below right) to the same channel. Much easier and faster than tapping the Channel ID button each time for each channel.



QuickAssign – Icons



QuickAssign – Colors

Additionally, any show images stored on the device may be quickly retrieved and assigned to channel inputs via the same drag-and-drop method displayed above.

Once completed assigning a name, icon, color and/or show image to a channel, you may close QuickAssign by tapping the “Close” button located in the upper-right corner of the QuickAssign popover.



Even with QuickAssign open, you are still able to scroll through channels, making fast assignments to multiple channels. No need to open QuickAssign on each separate channel! Simply swipe left or right in the mixer view to access other channels.

Linking Input Channels

As mentioned previously, two adjoining mono input channels may be linked together into a single stereo channel strip. This is ideal for stereo input sources such as keyboards, submixer outputs, vocal processors and more. When linked, the level control, EQ, gate/compressor, etc. are adjusted with a single set of controls!

Linking channels is easy. After tapping a Channel ID button, you will see an option to “Link Ch X over Ch X”. Tap it! A popover will be displayed asking you to confirm. A visual difference between unlinked and linked channels is displayed below. Follow the same steps outlined above to unlink channels.

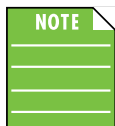

Odd-numbered channels will link to the next (even-numbered) channel [e.g. 1-2, 3-4, etc], while even-numbered channels will link to the previous (odd-numbered) channel [e.g. 10-9, 12-11, etc].



The new linked channel will take on all of the attributes [EQ settings, gate and compressor settings, FX, etc.] of the tapped Channel ID button. In other words, if you link channel 1 over 2, the resulting stereo channel will take on all of the settings of channel 1. However, if you link channel 2 over channel 1, the resulting stereo channel will take on all of the settings of channel 2.



Mic pre gain, 48V, source and digital trim are not linked and remain independent. This is useful in multiple situations. Stereo overhead mics on a drum set require different gain levels to adjust for crash versus ride, for one example. Or perhaps two mics are in front of a guitar cabinet, one condenser and one dynamic. Here you would be able to enable 48v on one, leaving it off for the other, even though the channel is linked. Perhaps a visual will help. See below for examples of unlinked input routing (below left), left linked input routing (below middle) and right linked input routing (below right).



Unlinked Input Routing



Linked Input Routing (Left)



Linked Input Routing (Right)

Presets

Presets save parameters and may be recalled as needed. The mixer comes with a library of factory presets.

There are also user presets. These may be created for each preset type. The number of user presets available is limited only by the available space on the device.

An entire chapter is dedicated to presets. This includes detailed instructions and multiple screenshots every step of the way. Please check it out on pages 147-155.

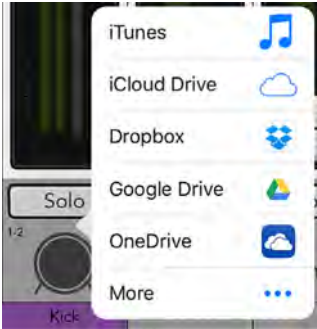

Import / Export — Master Fader affords you the opportunity to import and export input channel presets. An entire chapter is dedicated to importing and exporting files. This includes detailed instructions and multiple screenshots every step of the way. Please check it out on pages 245-248.

Copy-and-Paste

It's the 21st century and seemingly everyone has been using copy-and-paste for a multitude of things...and you can with Master Fader, as well. Here you're able to copy the settings of one input channel and paste those same settings onto another input channel.

If each channel is different, though, why on earth would you want to copy-and-paste the same settings from one channel to another one? There are a multitude of reasons, actually! For one example, perhaps the mixer needs to be reorganized. Copy-and-paste is a fast, easy way to move channels around...infinitely faster and easier than starting from a zeroed out board!

For another example, perhaps there are multiple channels with similar inputs. A five piece rock band might have a twin guitar attack. Same thing goes for a band with a multiple piece horn section. Copy-and-paste the settings from one channel to the next and tweak to your liking. It's a great starting point!

In the end, it really all just boils down to flexibility. We assume that copy-and-paste will see the highest use in the output section, copying settings from one output to another output and/or copying settings of a mix from one output to another output. But since we're still on the Channel Strips chapter, you'll have to review the output version of copy-and-paste in Chapter 7 : Mixer View : Master Fader / Selector Strip.

Input channel copy-and-paste is easy. The example below demonstrates the aforementioned rock band with two guitars. Set up the first channel as you would like; here we loaded the “electric guitar” preset which set all DSP settings for a typical electric guitar setup on to channel 10.

Step 1 (Copy) : Tap the channel ID button. At the bottom of the popover is copy-and-paste. Tap the Copy button.

Step 2 (Paste) : Tap a different channel ID button. At the bottom of the popover is copy-and-paste. Tap the Paste Processing button.

The “pasted” channel will take on most of the attributes [name, icon, color, EQ settings, gate and compressor settings] of the “copied” channel.

But there are a few characteristics that are not pasted and remain independent. This includes mic pre gain, 48V, source, digital trim, pan and fader level and any assignments / routing. This is useful in multiple situations. A typical setup might have one guitar panned hard left and the other panned hard right. Or perhaps if they’re using different amps (which is highly likely), then gain, trim and fader levels would differ. See the Step 3A screenshot below.

If you prefer to have ALL characteristics copied to another channel, tap the Paste All button. See the Step 3B screenshot below.

Step 3 (Results) : As you can see below, channel 11 is nearly identical (step 3A below) or exact (step 3B below) to that of channel 10.



Return 1-4 [DL16S • DL32S • DL32R]

Below is a look at the return 1-4 channel strips. The return channels control the level and DSP from the USB drives. These operate slightly differently than the channel strips; let's find out how.

To get here, flick or drag left anywhere in the mixer view swipe zone until the return channels appear. The differences between the input channel strips and return channel strips are noted below. Channel 32 was left in the image on purpose to easily see the side-by-side difference between an input channel strip and the return channel strips.



48V / Gain — By default, 48V and gain on the return channels is absent from the input routing view for these two channels. However, the source and trim will still be displayed and input routing may still be accessed in order to update channel and aux send assignments.



48V and gain WILL be visible on the return channels' input routing view IF a mic pre is sent to the returns via the I/O patch. More about I/O patching on pages 196-209.

No High-Pass / Low-Pass Filters — There are no high-pass or low-pass filters on the return channels, so they will be absent in the EQ view for these channels.

One Gain Reduction Meter — Compressors are available on the return channels, but not gates, so a single gain reduction meter will be displayed instead of two.

Stereo Meters — Because the the return channels are stereo linked by default, the meters are shown in stereo, not mono.



The default setting are dual stereo return channels [return 1-2 and return 3-4]. However, these may be unlinked to make up to four separate mono return channels. This is ideal for isolating click tracks and backing tracks, for example. In this example, the drummer would receive the click track and backing tracks, while the rest of the band and audience would hear only the backing tracks.

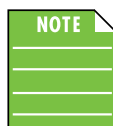

The DL32R has dual stereo return channels while the DL16S and DL32S each has a single stereo return channel.

Unlinking the return channels is easy. After tapping the return Channel ID button, you will see an option to “Unlink Return x and Return x”. Tap it! A popover will be displayed asking you to confirm. Follow the same steps outlined above to link the return channels.



More information about the return channels may be found in the recording and playback section, pages 210-224.

iPad / Playback [DL806 and DL1608]

Now let's take a look at the iPad channel strip since it operates slightly different than the input channel strips. To get here, flick or drag left anywhere in the mixer view swipe zone until the iPad channel appears. The differences between the input channel strips and iPad channel strip are noted below. Channel 16 was left in the image on purpose to easily see the side-by-side difference. The only differences between the iPad channel and input channels is that the iPad channel does not have a HPF or gate and it defaults as a stereo channel (but may be unlinked to make two separate mono iPad channels). Otherwise, they are totally the same. Take a look below:

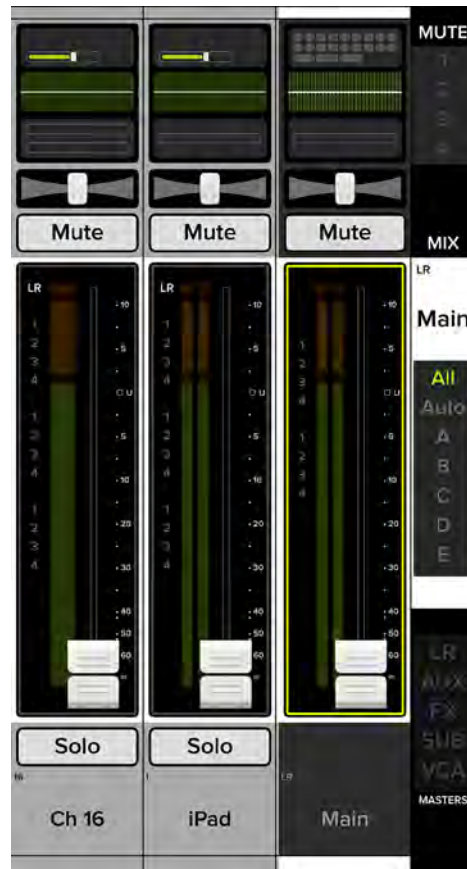

No High-Pass Filter — There is no high-pass filter on the iPad channel, so it will be absent in the EQ view for this channel.

One Gain Reduction Meter — A compressor is available on the iPad channel, but not a gate, so a single gain reduction meter will be displayed instead of two.

Stereo Meters — Since the iPad channel is stereo linked by default, the meters are shown in stereo, not mono. Also of note is the absence of a clipping LED. This is because the digital input from an iPad doesn't clip.



The default setting is a single stereo iPad channel. However, it may be unlinked to make two separate mono iPad channels. This is ideal for isolating click tracks and backing tracks, for example. In this example, the drummer would receive the click track and backing tracks, while the rest of the band and audience would hear only the backing tracks.

Unlinking the iPad channel is easy. After tapping the iPad Channel ID button, you will see an option to “Unlink iPad 1 and iPad 2”. Tap it! A popover will be displayed asking you to confirm. Follow the same steps outlined above to link the iPad channel.

The iPad channel controls the level and EQ from the iPad music library (or any other audio app on the iPad that supports background audio playback). It's easy, just follow these instructions:

(1) — Make sure that the iPad is attached to the mixer for playback, as it will not work in Wi-Fi mode.

(2) — Open the audio app of your choice on the iPad by tapping its icon; this could be the music app, your favorite multitrack DAW, Spotify and more.

(3) — Tap the play button to begin playback (if it's not already playing).

Notice that the volume slider IS available.
This is because the iPad is NOT yet attached to the mixer.

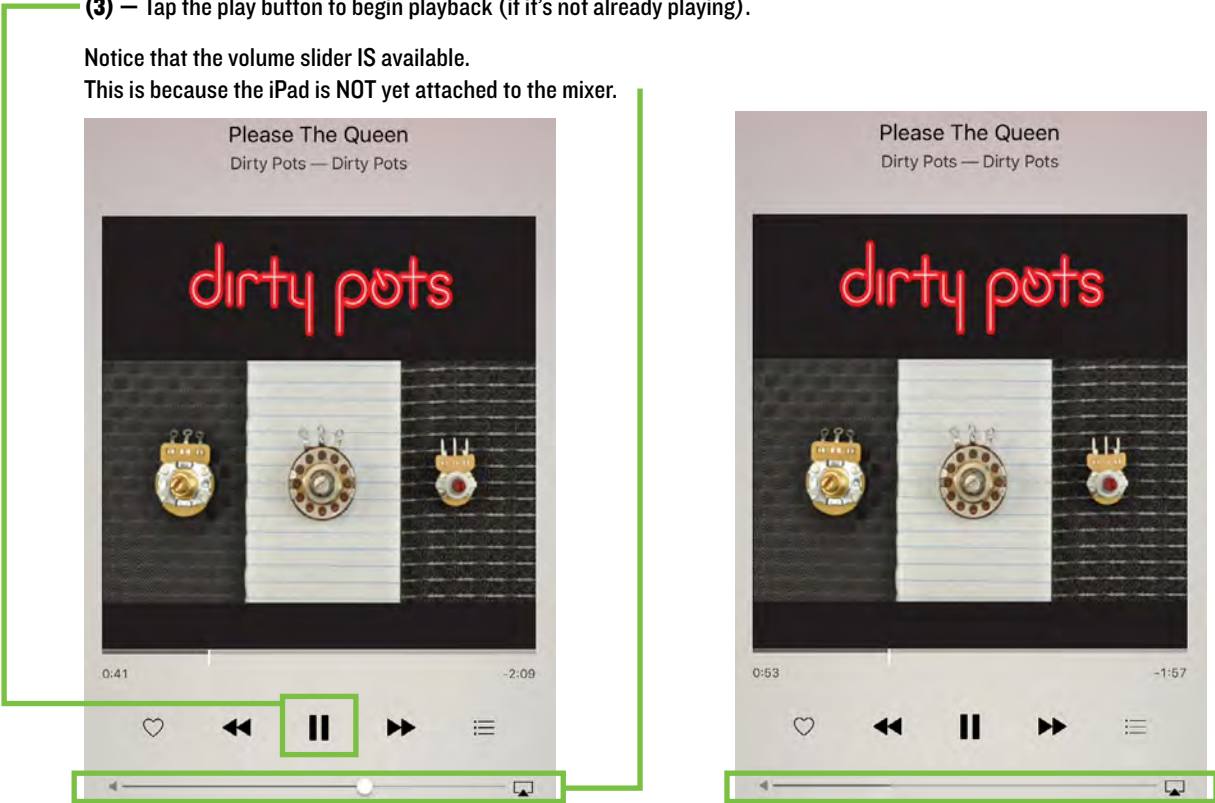

Once attached, the volume slider disappears.

The volume is now changed with the Master Fader app.

(4) — Press the home button on the iPad to exit the app.

(5) — Tap the Master Fader app to relaunch the program and control the source in the mix.

Everything will be just as you left it. This is where you control the volume and EQ.

Heed our advice and raise the iPad channel fader slowly. Most mastered music coming off the iPad is loud.

As the fader rises, so should the music in your speakers and headphones.

FX Return Channel Strips

Now let's take a look at the FX Return channel strips since they operate slightly different than the input channel strips. To get here, flick or drag left anywhere in the mixer view swipe zone until the FX Return channels appear. The differences between the input channel strips and FX Return channel strips are noted below. Channel 16 was left in the image on purpose to easily see the side-by-side difference.

These FX Return Channel Strips differ from the FX Send Master Channels in the mix selector (see pages 63-64) and masters bank (see page 69). The FX source selection occurs within the FX processors tab located on the navigation bar between the current parameter display and devices tab (see pages 158-169).



No Digital Trim — There is no digital trim on FX channels, so it will be absent from the input routing view on these channels. However, input routing may still be accessed in order to update channel and aux send assignments.

No High-Pass Filter — There is no high-pass filter on FX channels, so it will be absent in the EQ view on these channels.

FX Button — There are no dynamics on FX channels, so the gain reduction meters are not shown. Instead, the gain reduction meters are replaced with the name of the effect. Tapping the effect name takes you to the controls for that effect.

Balance Slider — The pan slider becomes a balance slider on these channels, now acting as a stereo balance. It allows you to adjust how much of the left or right output signals are heard. Touch and drag the sliders left or right to make adjustments. Center it to hear the output equally from the left and right sides. The balance may be centered by double-tapping the balance slider.

Stereo Meters — Because the FX channels are stereo returns, the meters are shown in stereo, not mono.



The DL806 and DL1608 have two FX channels each, while the DL16S, DL32S and DL32R all have four FX channels each.

To learn more about FX, check out chapter 17, pages 158-169.

Subgroups

Subgroup channel strips are similar (in a way) to input channel strips, but also quite different at the same time, so let's take a look. To get here, flick or drag left anywhere in the mixer view swipe zone until the subgroup channels appear. The differences between the input channel strips and subgroup channel strips are noted below.

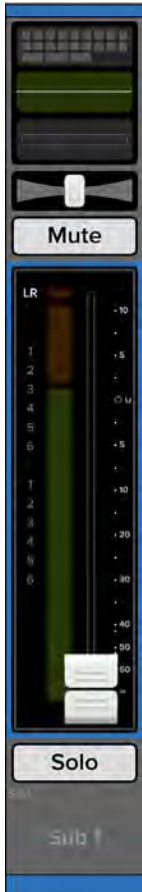

No Source Select — There is no digital trim on subgroups, so it will be absent from the routing view for these channel strips. However, routing may still be accessed in order to assign channels to subgroups and route them to the main L/R, VCAs, mute groups and view groups.

No High-Pass / Low-Pass Filters — There are no high-pass or low-pass filters on subgroup channels, so they will be absent in the EQ view for these channels.

One Gain Reduction Meter — Compressors are available on subgroups, but not gates, so a single gain reduction meter will be displayed instead of two.

The default configuration is mono subgroups. However, they may be linked for stereo operation. Linking subgroups is easy. After tapping the subgroup's Channel ID button, you will see an option to "Link Sub x over Sub x". Tap it! A popover will be displayed asking you to confirm. Follow the same steps outlined above to unlink subgroups.



The DL806 and DL1608 have four subgroups each, while the DL16S, DL32S and DL32R all have six subgroups each.

To learn more about subgroups, check out chapter 6 starting on page 52.

VCA's

VCA channel strips are in a category all by themselves. To get here, flick or drag left anywhere in the mixer view swipe zone until the VCA channel strips appear. The differences between the input channel strips and VCA channel strips are noted below.



No Source Select — There is no digital trim on VCAs, so it will be absent from the routing view for these channel strips. However, routing may still be accessed in order to assign channels to VCAs and route them to view groups.

No EQ — VCA channels do not have EQ, so there is no EQ button.

No Dynamics — VCA channels do not have compressors or gates, so there is no dynamics button.

No Pan Slider — VCA channels do not have pan sliders.

No Channel Assignments — VCA channels do not have channel assignment indicators.

No Meters — VCA channels do not have meters.



The DL806 and DL1608 have four VCAs each, while the DL16S, DL32S and DL32R all have six VCAs each.

To learn more about VCAs, check out chapter 6 starting on page 52.

Chapter 6 : Mixer View : Subgroups and VCAs

Introduction

The previous chapter was an in-depth look at channel faders with a super-duper sneaky-peeky quick look at subgroups and VCA groups. There we wanted to display the similarities and differences between these channels, but you know what? There's more to them than just the why and how they look and act similarly (or differently) than the input channels. They deserve their own chapter...and here you are! Let's take a deeper look at subgroups and VCAs.

Subgroups and VCAs may be used as master faders for a group of channels on their way to the main mix. Let's say you have a drum kit hogging up seven channels and want to fade them out at a different rate than the other channels. You do not want to try that with seven hands or seven fingers. That's difficult at best...instead, just assign channels to a subgroup or VCA! They sound like the same thing, though; what are the differences between a subgroup and a VCA? How do you decide which to use and when?

Subgroups

The main difference between subgroups and VCAs is that subgroups have basic output DSP and VCAs do not. This includes 4-band EQ (no HPF or LPF) and compression. So you should choose to use a subgroup when you need to provide processing to a group of channels. The most commonly used example of this is for drums. Route all the drums to a stereo linked subgroup and apply compression to the entire drum set together. Then you can send that compressed signal to the mains for the audience to hear.

Another common use is for backing vocals where you might want to EQ them all the same. Instead of doing the same thing on each channel, simply send them all to a subgroup and EQ them there.

Each subgroup fader controls the level of the signals sent to the main L/R, to the matrix, and/or to any physical output via patching. All channels that are assigned to subgroups, not muted, and not turned fully down will appear here. The subgroup signal is off when its fader is fully down and fully up provides 10 dB additional gain.

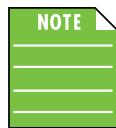

The DL16S, DL32S and DL32R have six subgroups each, while the DL806 and DL1608 have four subgroups each.

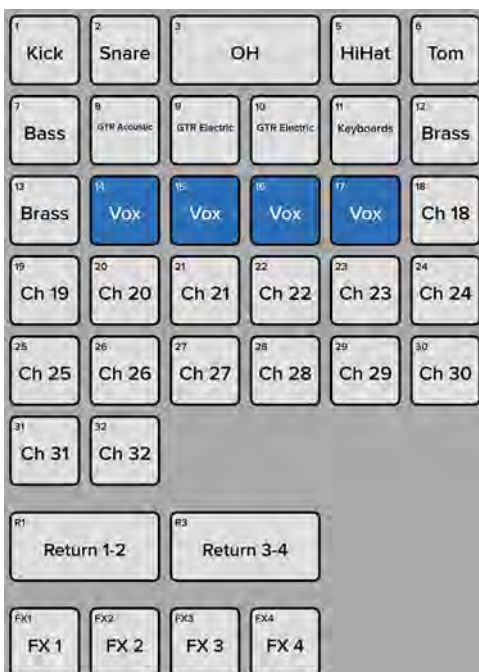

To route signals to a subgroup, tap a subgroup's routing button followed by tapping the button of every channel that should be a member of that subgroup. Assigned buttons will illuminate, while unassigned channels will remain gray. It is permissible for any channel to be a member of multiple subgroups. In this example, we're sending channels 14-17 [lead and background vocals] to subgroup 1.

We are able to set up each input channel the way we want – levels, DSP, routing, etc. – send them all to subgroup 1 and change the level and DSP of a single channel [subgroup 1] instead of having to update all four channels separately. Dude!

There is an entire chapter dedicated to output routing on pages 116-120.

It's also possible to assign a channel to a subgroup outside of using the subgroup's routing button. Simply tap the channel's routing button followed by tapping the button for each subgroup desired. Repeat this for each channel as necessary.

There is an entire chapter dedicated to input routing on pages 89-93.

An overview of the subgroups may be accessed via the overview screen as described on pages 23-24. Here it is possible to see the settings of all subgroups simultaneously and head straight to the subgroup needing updates simply by tapping that subgroup channel.

A subgroup's ID button – naming, image, color, linking and presets – works exactly like that of a channel's ID button. Refer to pages 40-45 for more information on these features.



VCA's

While subgroups have processing, VCA's do not. In fact, no audio actually passes through a VCA. VCA stands for voltage control amplifier and the key word there is control. VCA's remotely control the faders of all channels assigned to them, adding or removing gain to the channels based on the VCA master position. Because DL Series mixers follow the model of analog consoles, groups for submixing are often not needed since VCA's may be used instead.

One reason to make a group assignment might be to apply signal processing to a group of inputs as a whole. Here you would use a subgroup. Another might be to easily control a lot of channels from a single fader. Here you would use a VCA. Simply put, if DSP is not necessary for a group of channel inputs, VCA's are the way to go.

VCA's allow creation of fader groups controlled by a master VCA fader. These control any number of input or output channel faders. In addition, VCA's allow muting and soloing of VCA groups (muting and/or soloing all channels assigned to it).

So you'll create a VCA for drums, bass and guitars, as well as one for instruments that contains all the channels assigned to drums, bass and guitars. Use the first 3 VCA's to mix the members of the band and the last to control the level of all instruments together relative to the vocals.

Ultimately, you'll end up with a set of VCA masters that represents your groups of channels and you can mix on those faders, only needing to return to the channels to make relative changes to channels within the groups.

Another benefit is that with VCA's the post-fader sends are also controlled by the channel VCA. So when you adjust the vocal channel from a VCA, the FX levels remain consistent.

Finally, outputs can be assigned to VCAs, as well. So you could have a VCA for all the outputs in an install allowing you to control all the speakers in the venue from a single fader while allowing each to still have separate processing.



The DL16S, DL32S and DL32R have six VCA masters each, while the DL806 and DL1608 have four VCA masters each.

To create a VCA, tap a VCA's routing button followed by tapping the button of every channel that should be a member of that VCA. Assigned buttons will illuminate, while unassigned channels will remain gray. It is permissible for any channel to be a member of multiple VCAs. In this example, we're sending channels 1-6 [drum set] to VCA 1.

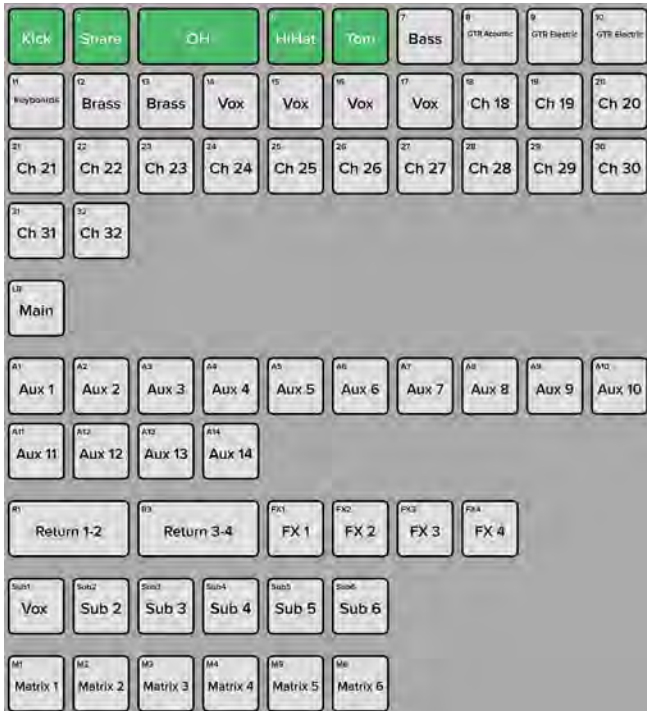

There is an entire chapter dedicated to output routing on pages 116-120.

It's also possible to assign a channel to a VCA outside of using the VCA's routing button. Simply tap the channel's routing button followed by tapping the button for each VCA desired. Repeat this for each channel as necessary.

There is an entire chapter dedicated to input routing on pages 89-93.

An overview of the VCAs may be accessed via the overview screen as described on pages 23-24. Here it is possible to see the settings of all VCAs simultaneously and head straight to the VCA needing updates simply by tapping that VCA channel.



VCA channels simply act as control faders with no regard to mono or stereo. Therefore, they may not be linked (or unlinked, for that matter).

We know you're here to mix, not do math, but this is easy. As stated earlier, any channel may belong to more than one VCA group. The actual gain value for a channel assigned to one or more VCA Groups is the algebraic sum of its own fader and all of the VCA master faders of the VCA groups to which it belongs.

Example 1: Channel 5 belongs to VCA Groups 2, 4, and 5. All of the masters are set to 0 dB and the channel is set to 0 dB. Channel 5's VCA gain value is 0 dB.

Example 2: Channel 5 again. All of the VCA masters (2, 4, and 5) are set to -3 dB and the channel is set to 0 dB. Channel 5's VCA gain value is -9 dB.

Example 3: Channel 5 again. VCA masters 2 and 4 are set to -5 dB, VCA master 5 is set to -∞ (off). Channel 5's VCA gain value is -∞ (off) because -∞ (off) is larger than any of the other settings, so it forces the channel's VCA to -∞ (off).

It's a good idea to know the math and science behind how VCAs control the channels assigned to them. Whether you've mastered VCA gain value or not, we make your life significantly easier by adding semi-transparent "ghost faders" that display the actual level of the fader, including all VCA adjustments. Additionally, if a VCA is muted or soloed, the assigned channels' button(s) will illuminate to show that they are remotely muted (darker red) and/or soloed (darker yellow-ish orange).



Is that it? Nope, glad you asked! This same information will also be displayed on the Overview for easy reference of – and fast accessibility to – the entire mixer and all assignments.



A VCA's ID button – naming, image, color and presets – works exactly like that of a channel's ID button. Refer to pages 40-45 for more information on these features.



Chapter 7 : Mixer View : Master Fader / Selector Strip

Introduction

The master fader and selector strip are arguably the most important tools of the mixer. So much so, in fact, that they are always displayed in both the mixer view and channel view. As seen in the image below, the master fader has six different views based on what type of output is selected (via the mix selector).

The selector strip has one of the most important roles (and we just showed an image with six different outputs selected), so we'll start there. After that, we will head back to the top of the master fader and work our way down.

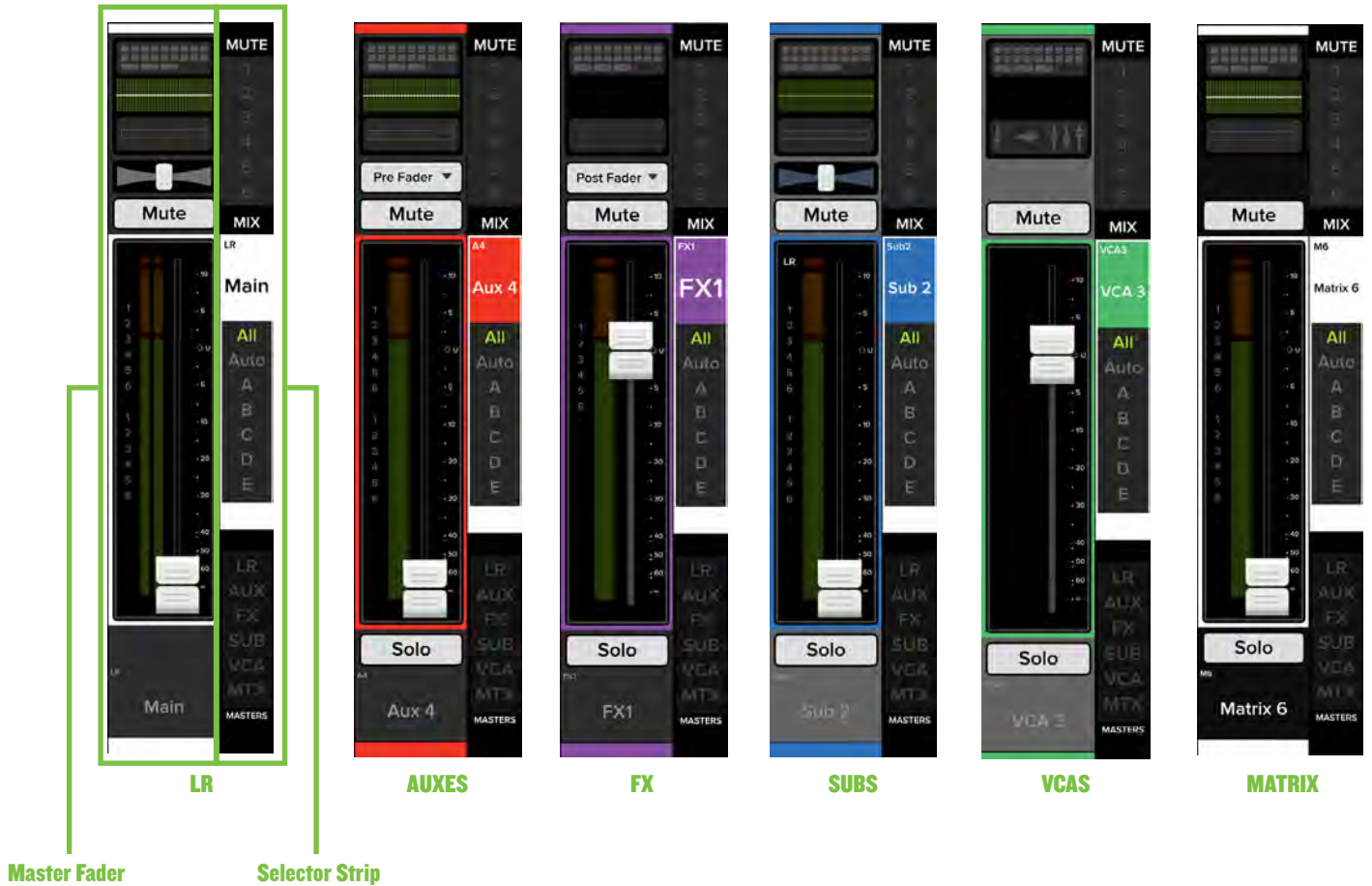

Selector Strip

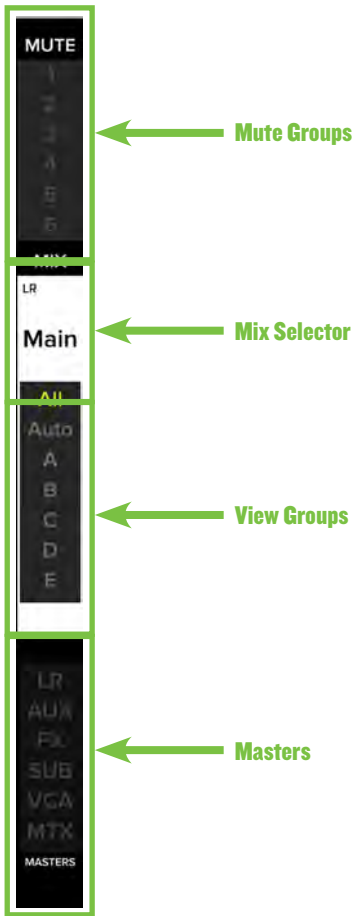

Top to bottom, the selector strip breaks down to four separate selectors:

- Mute Groups
- Mix Selector
- View Groups
- Masters

Together, these four selectors are the main interface controlling what inputs and outputs you see and hear.

Let's take a look at them in order. First up...mute groups!

Mute Groups – Mute groups allow you to quickly mute (and unmute) multiple channels and/or outputs. There are a multitude of possibilities in which to assign and enable mute groups: productions featuring a rotating cast of musicians, theater productions, a house of worship and more. It is also great for muting all inputs during song breaks or in-between sets.

The DL16S, DL32S and DL32R have six mute groups each, while the DL806 and DL1608 have four mute groups each.

Let's take a closer look at a couple of examples.

Example One: A cover band plays four sets in one night. Eight of the tunes feature slide guitar, a horn section and background singers. One option is for the band to play all eight songs in a row, then mute the channels once completed...but that isn't very diverse, is it? Rather, the band would prefer to pepper the songs in throughout the night for variety. Simply assign those channels to a mute group and keep that mute group master engaged until the songs featuring slide guitar, a horn section and background singers are played. Here's how:



Mute Groups Selected

Step 1 — Open the mute group selector: Assigning channels to mute groups starts in the selector strip, so you'll need to head here first. Tap anywhere in the mute groups selector, as outlined in the image above left. Doing so displays a popover similar to what's seen above right. Mute groups (including the default, "None") illuminate when selected.

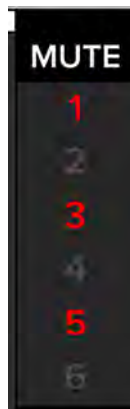

Mute Groups Enabled

As one might expect, if Multi-Select is enabled [as indicated with a ✓], multiple mute groups may be selected. As such, if Multi-Select is disabled [as indicated with no ✓], only a single mute group may be selected.

I'm an odd bird, so we'll go with the odd numbers for the mute groups. Tap mute group numbers 1, 3 and 5 to see them illuminate. [Simply tapping a mute group again unassigns the mute group].

Tapping anywhere in the mixer view or channel view will close the mute group popover. Now take a look at the mute groups on the selector strip; mute groups 1, 3 and 5 are illuminated in oxblood red.

This is great, save for one thing...nothing's been assigned to these mute groups! Lucky for us, near the bottom of the mute group selector is an option to assign mute groups...that's what we want! Open the mute group selector again by tapping anywhere in the mute group selector.

Step 2 — Tap the “Assign” button: The assignment panel slides into view when the assign button is tapped. As seen below, doing so opens up a world of mute group possibilities!



Step 3 — Name the mute group: Each mute group may be given a personal name; it’s much easier to recall a mute group that you named versus just “mute group x”. In this example, the synth, horn section and background vocals are to be added to this mute group. Here the band plays on all songs except song 9...the ballad, of course.

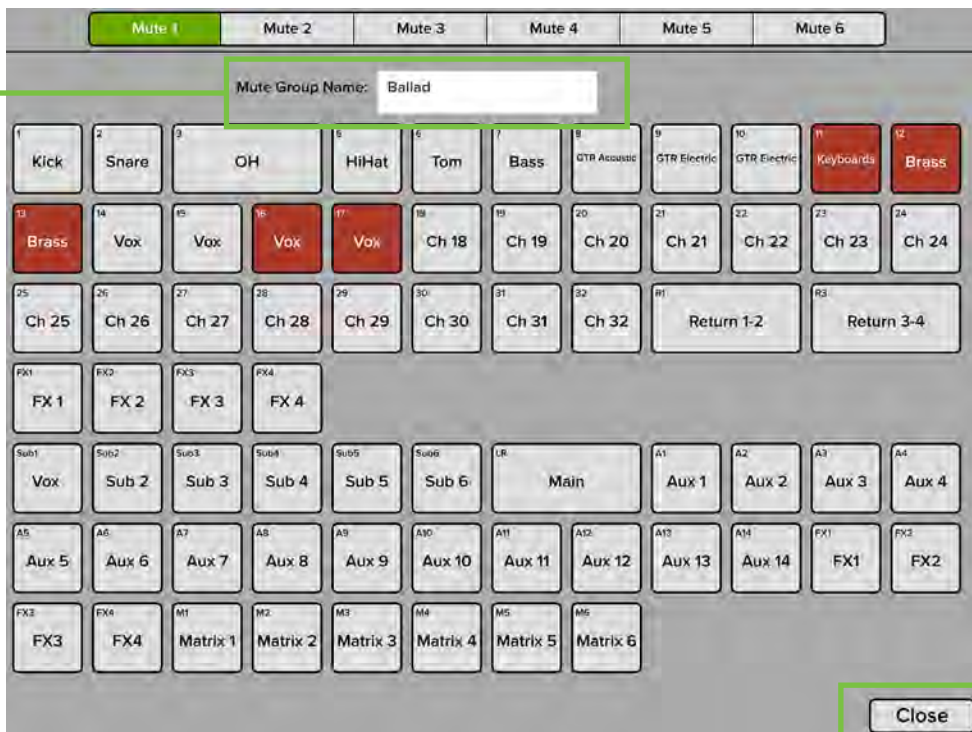

Step 4 — Tap the channels to assign: Tap the channels you wish to assign to a mute group. In this case, tap channels 11-13 and 16-17. Notice in the screenshot above that each assigned channel button turns oxblood red when selected. Coincidentally, the band’s name is Oxblood Red and they put on a great show!

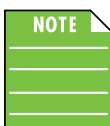

You may also notice in the image above that the button of linked channels (channel input 3-4, Return 1-2, Return 3-4, Main L/R) is twice the size of unlinked channels.

Step 5 — Tap the “Close” button: Close the assignment panel by tapping the close button.

The mixer view should now look something like the image below.



There are a few things to notice in the image:

- (1) You should notice that each assigned channel's mute button (channels 11-13 and 16-17) turns oxblood red, indicating that they are muted by the mute group.
- (2) You should notice that the inputs that have been assigned to mute groups (again, channels 11-13 and 16-17) will also display the mute group number (also in oxblood red) on its channel strip to the left of the meter.
- (3) You should notice that the text of the mute group 1 master (Ballad) on the selector strip turns oxblood red when enabled.



The mute group number will still illuminate to the left of the meters even if the mute group is unassigned. This just makes you aware which inputs and outputs are assigned to which mute groups. Check the status of mute groups on the selector strip

Excellent work! You assigned the channels to mute group 1 and enabled mute group 1 master (thereby muting channels 11-13 and 16-17).

When you're ready to unmute the channels, simply re-open the mute group masters on the selector strip and tap the mute group 1 master button. It will no longer illuminate and each of the mute buttons on channels 11-13 and 16-17 turn gray, indicating that the channels are no longer muted (see images below). Do this each time the synth, horn section and background singers are and are not needed. This is much easier than muting and unmuting all channels every time!



Step 6 — Do what you just did...all over again! Follow steps 1-5 to assign inputs and outputs to additional mute groups.

Using this same example, let's say there are a couple of tunes that feature only acoustic guitar and vocals. You should follow the same steps, except:

- (1) be sure to assign them to a different mute group first since mute group 1 is already in use – Remember, I'm an "odd bird", so mute group 3 is next – and...
- (2) select all channels except channel 8 (Acoustic) and channel 14 (M Vox).

Other than that, the process remains the same!

Mute groups are also great for muting all inputs during song breaks or as a break switch in between sets. In fact, this is similar to the iconic break switch found on many classic consoles...but with these mixers, you can actually set up the break switch how you want. See the next page to find out how.

A classic break switch is muting all inputs and outputs, except the returns channels [DL16S, DL32S, DL32R] or iPad channel [DL806, DL1608] and LR, as seen below.

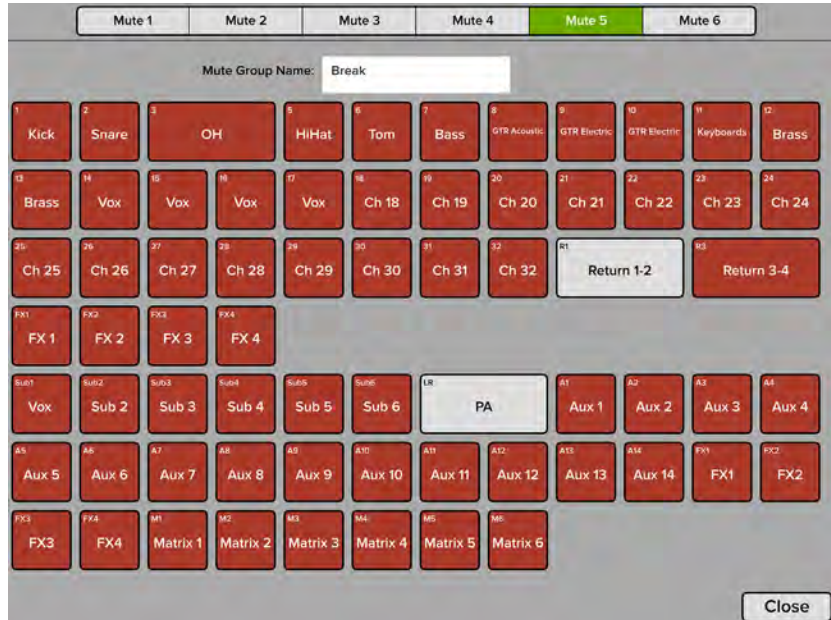

When the mute group 5 button – the aptly named “Break” – is engaged everything will be muted except for the house music over the PA. Just unmute group 5 when the next band’s gear has been set up and they’re ready to rock!



It is still possible to mute channels, even if mute groups are engaged. Not only that, but the color differs, so you know which muted channels belong to a mute group [oxblood red] or just a regular 'ol mute [red]. See below.





Multiple mute groups may be enabled simultaneously. This would be particularly helpful in a larger production featuring a rotating ensemble of musicians on stage. You could also use mute groups for scenes in a theater production, a variety of services in a House of Worship and more. The possibilities are endless!

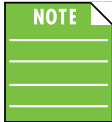

Snapshots will save your mute group assignments, but not the mute group master enables! In other words, you can enable/disable the mute group masters regardless of how they were stored as a snapshot. If you need additional (different) mute groups in the same show, save the mute group assignments as snapshots and recall when needed!

These are great ways to assign multiple inputs and outputs to mute groups, but it's also possible to assign a single input or output to a mute group at a time. Check out how to do this in 'Chapter 9 : Channel View : Input Routing View' on pages 89-93 and 'Chapter 12 : Channel View : Output Routing View' on pages 116-120.

Mix Selector – The mixer view shows a fader for each channel. Initially, this fader controls the level to the LR mix. But how do you control the level going to the aux sends? Or how about the aux master level? What about the sub groups and VCAs? Simple. Use the mix selector to switch between mixes.

The currently selected mix is illuminated, but changing the selected output is easy. Simply tap the output selector to reveal a popover displaying all outputs. Tap the desired output and voilà...the master fader now controls a different output. Additionally, you could tap the output selector – and with your finger still on the mix selector – drag until the desired output is highlighted, then release to select. See the images below for an example of changing outputs from LR to aux 4.

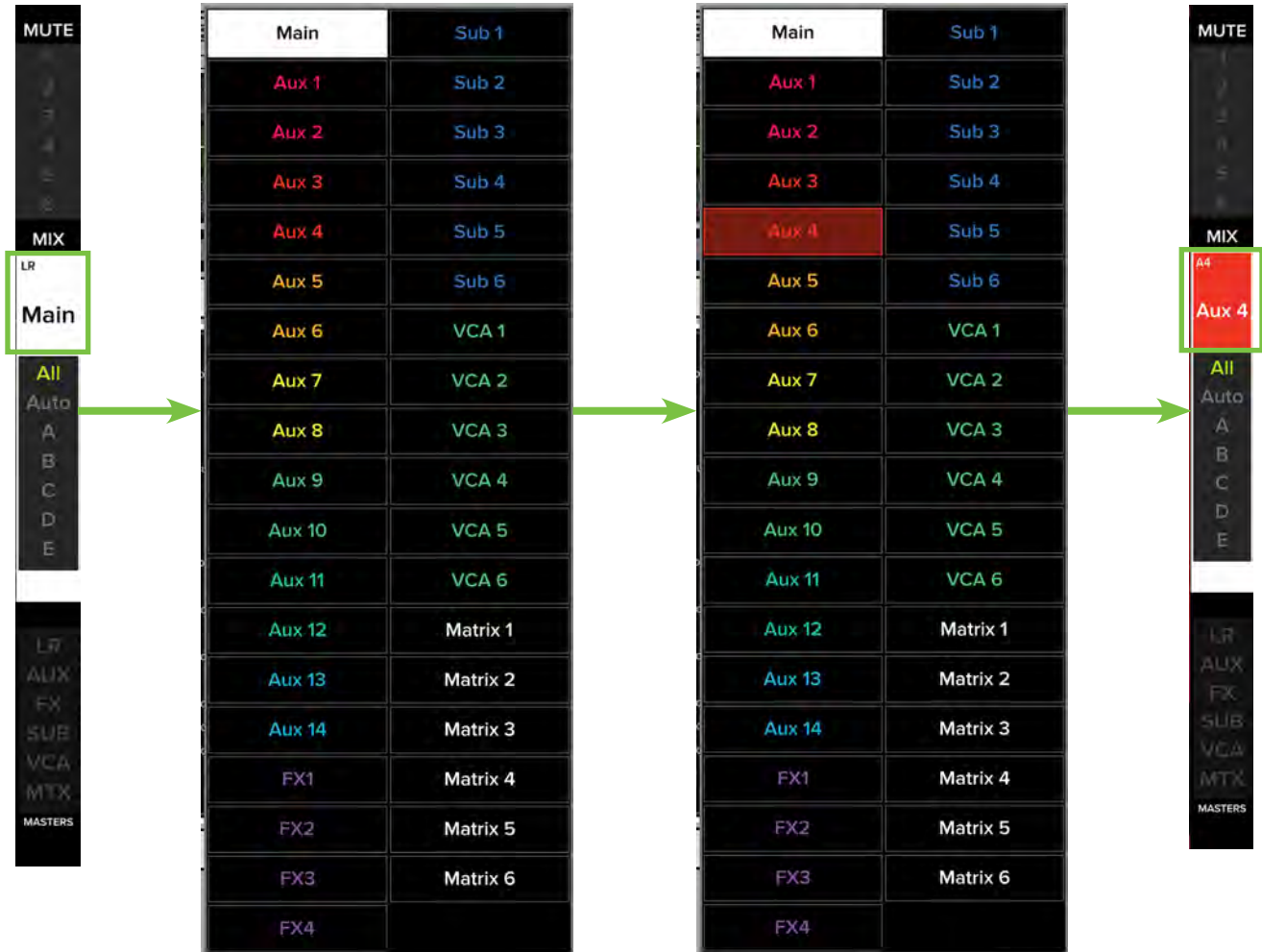

Once a different mix has been selected, the color surrounding the channel faders will change to show the newly selected output. Similarly, the master fader will display the newly selected mix. In this case, LR to A4.

Here, the mixer view acts like a window where you may view and change one output's mix at a time. No matter which output is currently selected, the others are still there, as they were.

The thin illuminated strip surrounding the master fader meter also helps indicate which mix type is currently selected. Additionally, a horizontal strip of the same color is located at the top and bottom of the master fader; the color varies and is dependent on the selected output. This is the same indicator that is also on display surrounding each input meter. Also note how the selected output is displayed in nice, big text and surrounded by a box of the same color as the selected output.



See below for the various colors that represent each selected mix, but know that there is no way you would ever see the image as shown below, as only one mix may be selected at any given time. The image is just a point of reference.

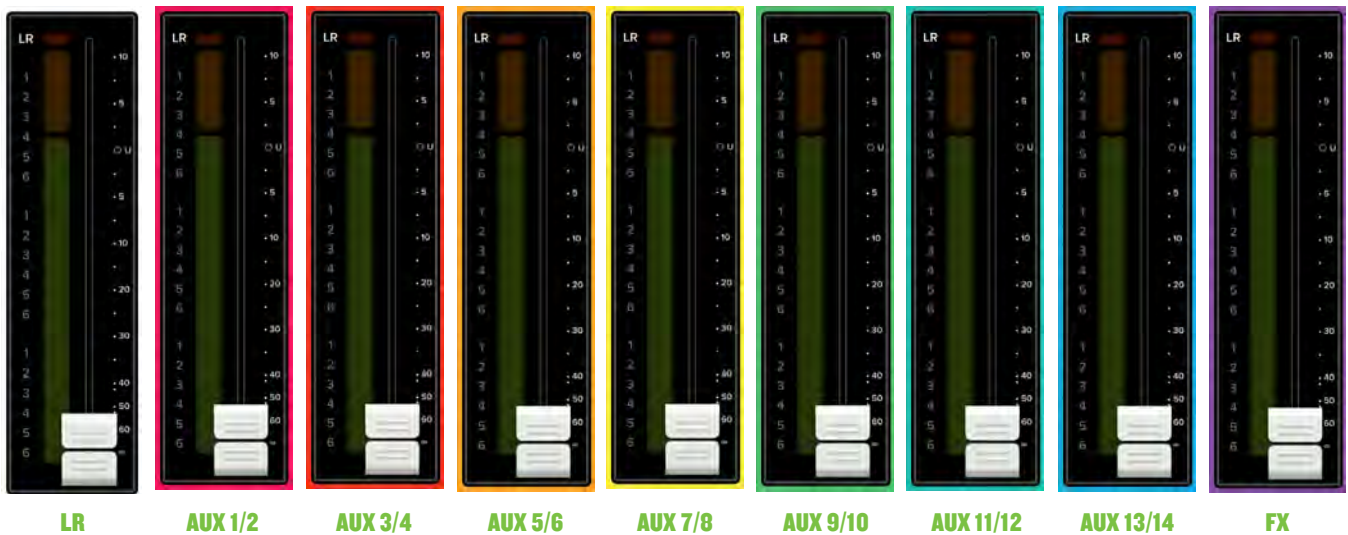

In the images below, all we did was change the selected output from LR to A1. Notice how each channel's input meter is surrounded by the color of the selected output.



View Groups – View groups allow you to see only the channels that you want to view, hiding the rest. This improves organization and allows for faster navigation.

The DL16S, DL32S and DL32R have six view groups each, while the DL806 and DL1608 have four view groups each.



Channels not assigned to any view group(s) can still produce sound.

Let's take a look at a couple of examples.

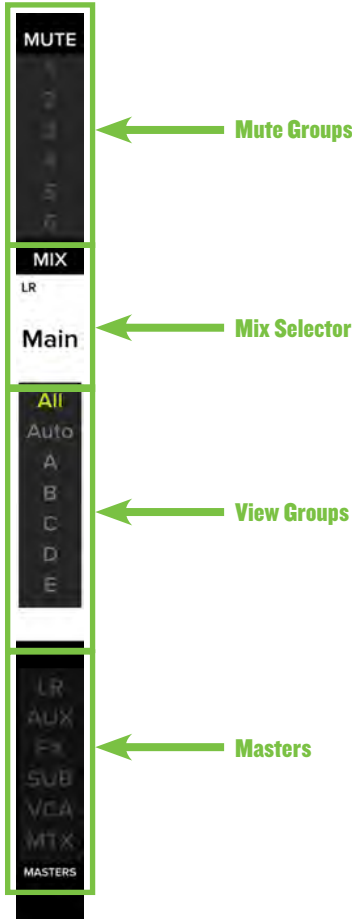

Example One: A singer-songwriter is playing at the local coffee shop. In all likelihood, 3-4 inputs are probably the maximum amount of channels needed. Wouldn't it be great to hide the unused channels, showing only the channels in use? The answer is a resounding "YES, of course it would!" Plus, the FX returns would be in view with the selected channel strips...no more swiping back and forth! Simply assign those channels to a view group and engage that view group button. Here's how:

Step 1 – Open the view group selector: Assigning channels to view groups starts in the selector strip, so you'll need to head here first. Tap anywhere in the view groups selector, as outlined in the image to the left. Doing so displays a popover similar to what's seen below left. View groups (including the default, "All") illuminate when selected.

As one might expect, if Multi-Select is enabled [as indicated with a ✓], multiple view groups may be selected. As such, if Multi-Select is disabled [as indicated with no ✓], only a single view group may be selected.

I like to spell things out whenever possible – especially if it happens to be my favorite card in the deck – so we'll go with every other letter for the view groups. Tap view group letters A, C and E to see them illuminate. [Simply tapping a view group again unassigns the view group].

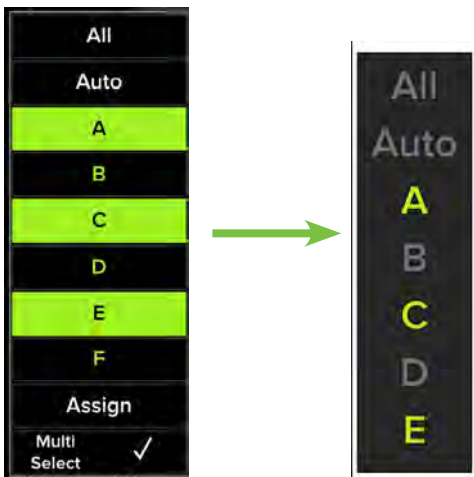

Tapping anywhere in the mixer view or channel view will close the view group popover. Now take a look at the view groups on the selector strip; view groups A, C and E are illuminated in green.

This is great, save for one thing...nothing's been assigned to these view groups! In fact, you may have noticed that the mixer view is just a blank, black screen... none more black. Lucky for us, near the bottom of the view group selector is an option to assign view groups...that's what we want! Open the view group selector again by tapping anywhere in the view group selector.

View Groups Selected

View Groups Enabled

Step 2 — Tap the “Assign” button: The assignment panel slides into view when the assign button is tapped. As seen below, doing so opens up a world of view group possibilities!



Step 3 — Name the view group: Each view group may be given a personal name; it’s much easier to recall a view group that you named versus just “view group x”. In this example, it’s simply a singer-songwriter show at a local coffee shop. We named it as such.



Step 4 — Tap the channels to assign: Tap the channels you wish to assign to a view group. In this case, tap channels 1 (Yairi acoustic guitar) and 2 (female vocals). FX and backing tracks will only enhance the performance, so tap the FX 1-4 buttons and return 1-2 channel buttons, as well. Notice in the screenshot above that each assigned channel button turns green when selected.



You may notice in the image above that the button of linked channels (Return 1-2, Return 3-4) is twice the size of unlinked channels.

Step 5 — Tap the “Close” button: Close the assignment panel by tapping the close button.

The mixer view should now look something like the image below.



There are a couple of things to notice in the image:

- (1) You should notice that each channel assigned to view group A (channels 1 and 2, return 1-2 and FX 1-4) are the only visible channels. All others have now “disappeared.”
- (2) You should notice that the text of the view group A master (Coffee Shop) on the selector strip turns green when enabled.

If the view group “ALL” is illuminated, then you are currently viewing all channels (even if channels have been assigned to view groups). Any time you wish to view all channels again, tap the “ALL” button from the view groups masters on the selector strip.

Excellent work! You assigned channels 1, 2, the FX and return 1-2 channels to view group A and engaged view group A (thereby hiding all other channels). Notice that only channels 1, 2, return 1-2, FX 1-4 and the master fader channels are present... the channels you assigned to view!

When you're ready to view all of the channels, simply re-open the view group masters on the selector strip and tap the "ALL" button. The view group letters will no longer illuminate and the entire mixer is now at your disposal!

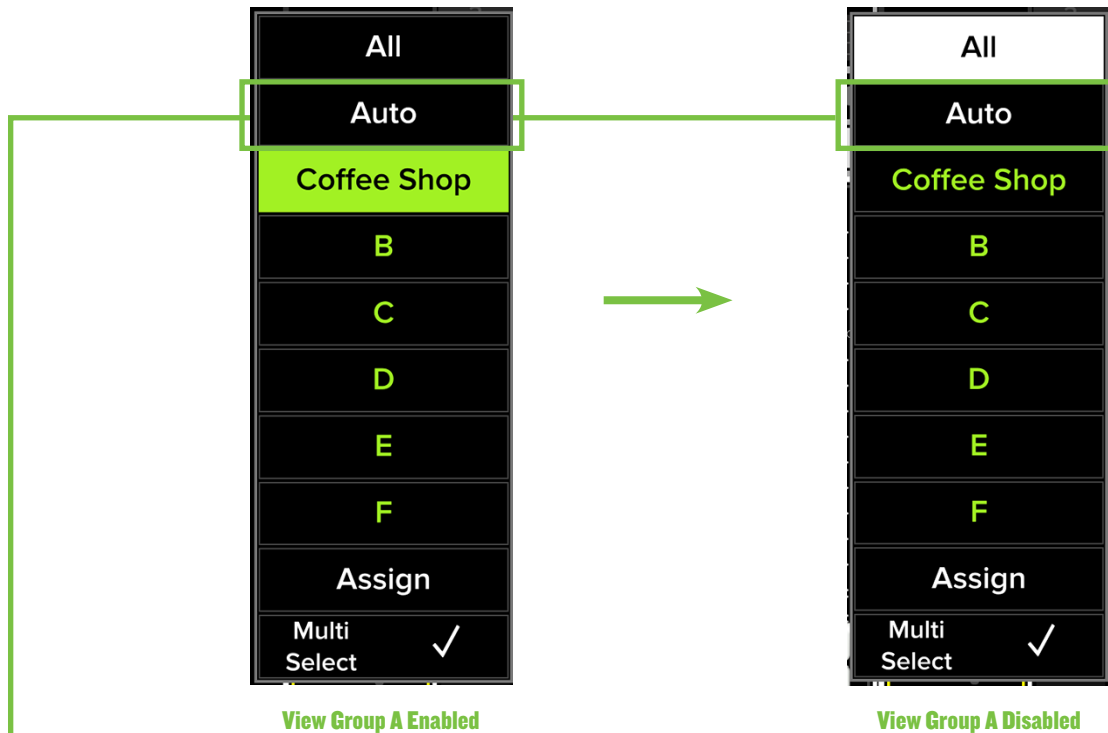

Step 6 — Do what you just did...all over again! Follow steps 1-5 to assign inputs and outputs to additional view groups.

AUTO – Ok, let's roll back to the top of the view groups list. Just below the All button is the Auto button. Simply put, tapping the auto view button will showcase all faders that are up and hide all faders that are down.

One last example. Now, let's say there's an all-acoustic hootenanny taking place at the monthly hoedown. After the singer-songwriter's session is completed, the next band up could add mandolin and banjo to the mix. Assign those channels to a different view group following the same steps.



Snapshots will save your view group assignments, but not the view group master enables! In other words, you will need to engage/disengage the view group masters regardless of how they were stored as a snapshot. If you need additional (different) view groups in the same show, save the view group assignments as snapshots and recall when needed!



Each user may decide what view group they want enabled for their device. This is extremely helpful for a band on stage wanting to view only the channel(s) they're using. The channels assigned to each view group are shared, but each user decides which view they want enabled, including "ALL".

These are great ways to assign multiple inputs and outputs to view groups, but it's also possible to assign a single input or output to a view group at a time. Check out how to do this in 'Chapter 9 : Channel View : Input Routing View' on pages 89-93 and 'Chapter 12 : Channel View : Output Routing View' on pages 116-120.

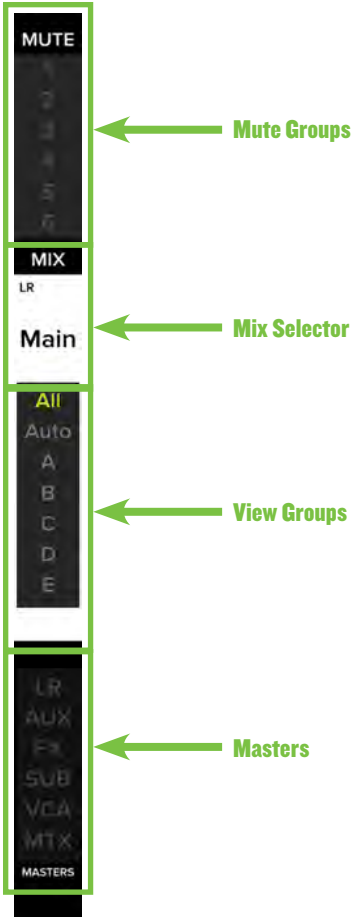

Masters Selector – At the bottom of the selector strip is the masters section. This allows you to look at all (or some) of the master faders and control them simultaneously. This is ideal for improved organization and faster navigating.

Step 1 – Open the masters selector: A single tap in the masters selector area will immediately replace all input channels with all output channels, similar to what may be seen below. Left to right they are: main L/R, auxes, FX, subgroups, VCAs and matrix.



That is the default view, but you can set it up to your liking. Tap the masters selector area again to open it up, as seen to the left. The selected masters (including the default, “All”) illuminate when selected.

As one might expect, if Multi-Select is enabled [as indicated with a ✓], multiple masters may be selected. As such, if Multi-Select is disabled [as indicated with no ✓], only a single master may be selected.

For the masters, just tap the masters you want readily available, hiding the rest. In the example to the right, we selected L/R, subgroups and VCAs. They illuminate, letting you know that they have been selected. [Simply tapping a master again unassigns the master.]

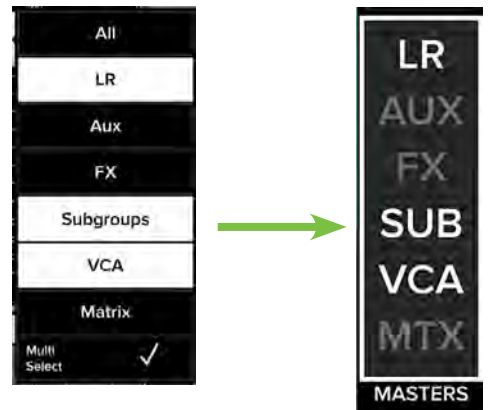

Masters Selected

Masters Enabled

Tapping anywhere in the mixer view or channel view will close the masters popover. Now take a look at the masters on the selector strip above-right; masters L/R, subgroups and VCAs are illuminated white.

That pretty much wraps up the selector section of the master fader. As a reminder, there is another way to assign inputs and outputs to mute groups and view groups. If interested, please refer to 'Chapter 9 : Channel View : Input Routing View' on pages 89-93 and 'Chapter 12 : Channel View : Output Routing View' on pages 116-120.

Now we're headed to the top of the master fader itself, starting with a quick look at the output routing view.

Output Routing View

The output routing view is the place to engage / disengage channel, output and group assignments for each output. This includes the subgroups, VCAs, matrix and, of course, the main L/R. Please refer to 'Chapter 12 : Channel View : Output Routing View' on pages 116-120 for more information.

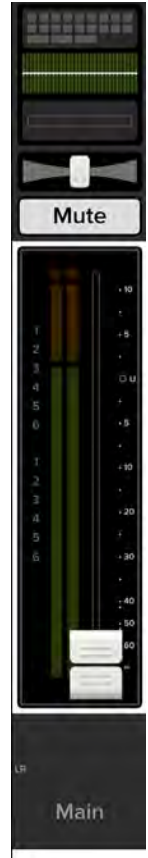

Parametric EQ / Graphic EQ

The master fader EQ displays the current graphic EQ and parametric EQ settings. The graphic EQ display illuminates green when engaged and is gray when disengaged.

Tapping the master fader's graphic / parametric EQ display will change the outlook from the mixer view to the channel view for the currently selected output. The graphic / parametric EQ is available with all selected outputs, except the FX and VCA outputs.

As seen below, there are several scenarios regarding the GEQ / PEQ curve depending on whether the GEQ, PEQ, HPF and/or LPF are enabled. Each one may look unique, but it is the same exact EQ in each of the scenarios. The EQ curve will illuminate green when engaged and is gray when disengaged.



Note that not every combination is displayed below. In addition to whether the GEQ, PEQ, HPF and/or LPF is enabled or not, the HPF and LPF each have four possible slopes to select. There is an insane amount of possible combinations!

To learn more about GEQ, PEQ, HPF and LPF check out chapters 13-14 starting on page 121.

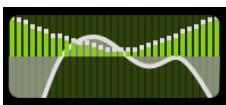

**GEQ ON
MODERN PEQ ON
HPF ON, LPF ON**

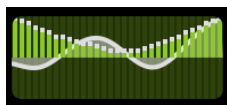

**GEQ ON
MODERN PEQ ON
HPF OFF, LPF OFF**

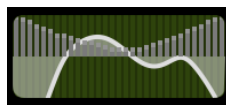

**GEQ OFF
MODERN PEQ ON
HPF ON, LPF ON**

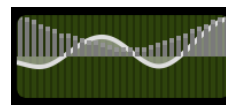

**GEQ OFF
MODERN PEQ ON
HPF OFF, LPF OFF**

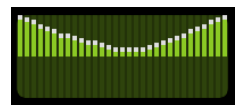

**GEQ ON
VINTAGE PEQ ON
HPF ON/OFF, LPF ON/OFF**

Output Gain Reduction Meter

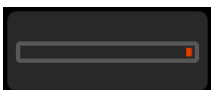

Like channel faders, the output gain reduction meter shows the amount of gain reduction applied to the output by the compressor / limiter. Output channels do not contain gates. What's more, simply tap the output gain reduction meter in the mixer view for quick access to the compressor / limiter view. Anyone else think of KITT from Knight Rider when looking at the gain reduction meter?

To learn more about the output compressor / limiter, check out chapter 15 starting on page 140.

Balance



When LR is the selected output, the balance slider controls how much of the output signal is sent to the left versus the right outputs. Touch and drag the slider left or right to make adjustments. Tapping the master fader's balance slider twice will center it.

Mute



The master fader mute button works exactly like a channel mute, except it mutes the output. Use it as a break switch to mute monitors (or even the main PA) when the band takes a break, for example. The mute button is available when any output is selected.



The mute button illuminates red when engaged and is gray when disengaged.

The user may de-select Use LR Mute for a particular aux/FX send to control the aux mutes (or FX mutes) and main mix mutes independently for each channel. More information about Use LR Mute may be found on page 72.

Outputs muted via group mutes will illuminate oxblood red. More information about mute groups may be found on pages 57-62.

Aux/FX Send Configuration Menu

When the selected output is anything other than LR or subs, the balance control is replaced with a button displaying settings for that aux or FX send. Here is where the source for each aux and FX send may be configured as Pre DSP, Pre Fader or Post Fader. Simply tap the button to display the configuration menu.

Now tap which setting you prefer:

Pre DSP — Pre DSP is ideal when using the auxes for monitor mixes and you want compression and other effects in the main mix, but not the monitors. Pre DSP is available in all auxes, but not the FX.

Pre Fader — Like Pre DSP, Pre Fader is also ideal when using the auxes for monitor mixes, but unlike Pre DSP, Pre Fader adds gate, compression and EQ to both the main mix and the monitors. The level is not affected by the setting of the associated channel fader. Pre Fader is available in all outputs, including FX. Pre Fader is the default setting for the aux sends.

Post Fader — Post Fader is for external and internal FX; the Post Fader level is affected by the channel DSP and the setting of the associated channel fader. Sends connected this way are also useful for recording sends. Post Fader is available in all outputs, including FX. Post Fader is the default setting for the FX sends.

There are two other output options to choose from, Use LR Mute and Use LR Pan. Let's take a look at each.

Use LR Mute – When Use LR Mute is enabled [indicated with a ✓], the aux sends share the same mutes as the LR main mix.

When Use LR Mute is disabled [indicated with no ✓], users can control aux mutes and main mix mutes independently for each channel.

To see the difference, de-select Use LR Mute by tapping it. A pop-over will ask you to confirm the change. The channel mute buttons will now show "Aux Mute" indicating that you may now mute channels on the selected aux without affecting the channel's mute on any other output, including the LR mute.

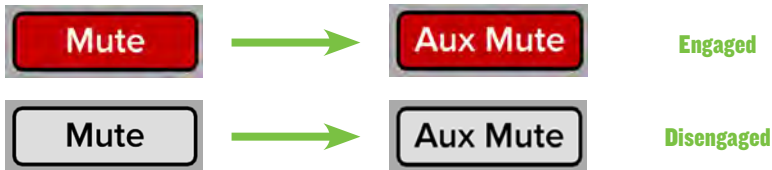

Why use aux mutes instead of LR mutes? When you need to control aux mutes and main mix mutes independently for each channel and aux send. For example, FOH will use the auxes to communicate with the band without the the audience hearing the conversation coming through the main mix. They should be enjoying a frosty beverage while the house music pumps through the main PA. Or perhaps the band members are mixing their own monitors...they have control over their own mute!

NOTE Use LR Mute is the default setting for all aux and FX outputs.

NOTE When first disabled, the aux mutes take on the same settings as the LR mutes, so no audible change is heard.

NOTE Use LR mute is automatic when post fader is selected. This is why the setting is grayed out.

Use LR Pan [Stereo Auxes only] — When Use LR Pan is enabled [indicated with a ✓], the aux pans share the same pans as the LR main mix.

When Use LR Pan is disabled [indicated with no ✓], users can control aux pans and main mix pans independently for each channel.

To see the difference, first move the channel 1 pan far left on the LR output. Now select an aux and link the corresponding auxes together (as described near the end of this chapter, page 79). The color of the channel pans will be white, indicating that the selected stereo aux is now using the LR pans. De-select Use LR Pan by tapping it. A pop-over will ask you to confirm the change. Now you will see the aux pans matching the selected aux color indicating that these are independent of the LR pans.

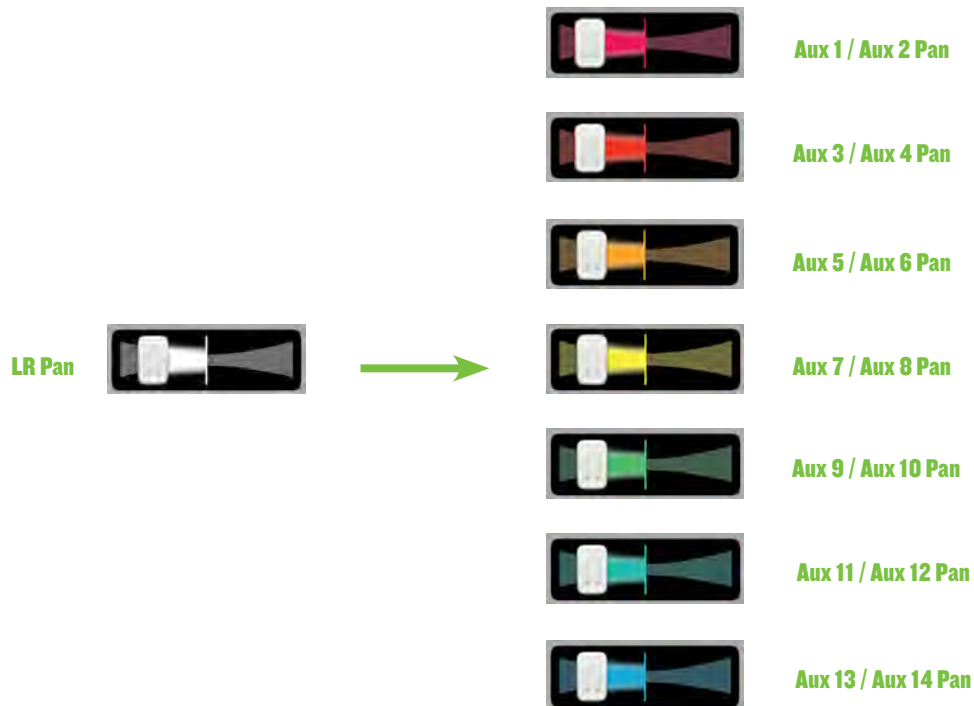

Why use aux pans? A performer may request a personal pan for their in-ear monitors that differs from the LR pan. The aux pan gives the performer exactly what they want without affecting the LR mix.



Use LR Pan is the default setting for all aux and FX outputs.



When first disabled, the aux pans take on the same settings as the LR pans, so no audible change is heard.



As just mentioned, being able to choose pan selection is only available when auxes are linked. That is described in detail near the end of this chapter (on page 79).

Master Fader and Output Meters

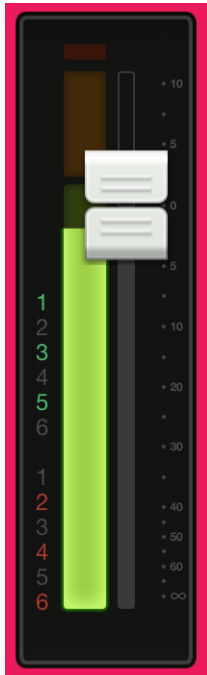

Mono

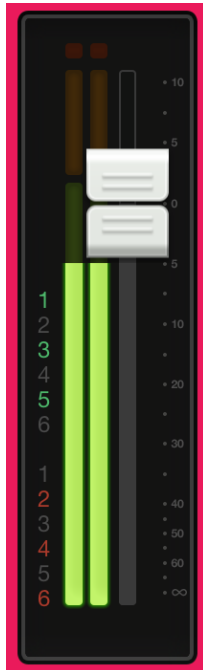

Stereo

As discussed, the master fader adjusts the output level of the LR, the aux masters, the FX sends, the sub outs, VCAs and matrices depending on which output is selected. While one fader controls the output level of each output, each output is independent of the others. Once the selected output has been chosen, touch and drag the master fader up and down to make adjustments.

The output meter displays the output signal level. The output meter is presented in mono or stereo depending on the selected output. It is stereo for LR and linked auxes and FX sends. Subgroups, VCAs, unlinked auxes and FX sends are presented in mono. How to link auxes and FX sends is discussed on page 79.

Speaking of FX, if reverb or delay is selected, the fader controls the master send into the corresponding FX processor.

This meter should remain green with the occasional bump into the yellow zone. The output meters are post-fader, so if there is too much yellow (or any red clipping), lower the master fader until it's gone and check the input channels, as well.

Red [clipping] = -3 dBFS
 Green to yellow = -12 dBFS
 Green [bottom] = -60 dBFS

The color of the currently selected output will surround the channel strips [L/R default is white].

To the left of the output meters is a column of numbers. In order from top to bottom, these indicate the channel's routing assignments for VCAs and mute groups. As seen above, these numbers illuminate when outputs are routed there.

Solo



If the selected output is anything other than LR, a solo button appears just underneath the master fader's meters. Soloing offers the opportunity to audition the selected output and make any necessary level adjustments to the inputs.

The solo button illuminates orange when engaged and is gray when disengaged.



BY DEFAULT, the output solo is AFL, so the fader level will affect the signal you hear in the headphones.

BUT...solo location may be changed to PFL (which stands for pre-fader listen (and the level of the channel fader DOES NOT affect the level heard in the monitor bus)) or PFL for inputs and AFL for outputs. Solo Location is available by going to Tools > Settings > Solo Location. Simply tap the button of the selection you desire. It will illuminate green while the other choices remain gray as seen below.



NOTE Solo Location cannot be set while in Offline mode.
 An iPad needs to be connected (whether wired or wirelessly).

NOTE When any output solo is engaged, not only will that solo button be engaged, but a solo indicator will also appear on the navigation bar above the quick access panel, see right. Because this is always shown (and could be considered distracting), we've named it the "rude solo" button. Tap the solo button again to disengage or tap the quick access panel to show the clear solo button allowing you to clear ALL solos with a single tap.



Master ID Button

The master fader's name and image is similar to that of a channel strip's name and image.

Like the channel faders, the master fader's name, image, color and preset is also user-editable. Additionally, users may also QuickAssign the aforementioned, link two adjoining auxes or sub outputs together and/or copy the output's characteristics (and/or mix) in order to paste them to other outputs. Simply tap the button at the bottom of the master fader to reveal a popover.

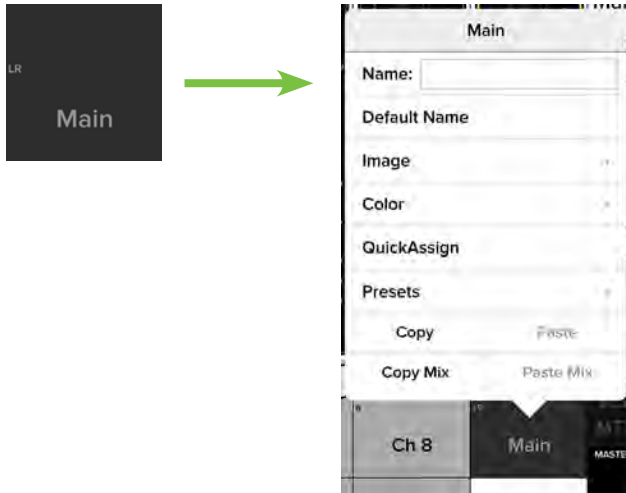

Let's start with the name. Tap in the name box to bring up the blinking cursor and keyboard (as seen in the image below). Simply type in the name you want followed by tapping the blue 'Done' button. Note the text change from "Main" to "FOH".

If the name is too long to fit, the button scrolls, displaying the entire name.

For familiarity, this is the same keyboard that is used for messaging or emailing from the device.

It goes without saying that tapping "Default Name" changes the master fader's name back to its default name.

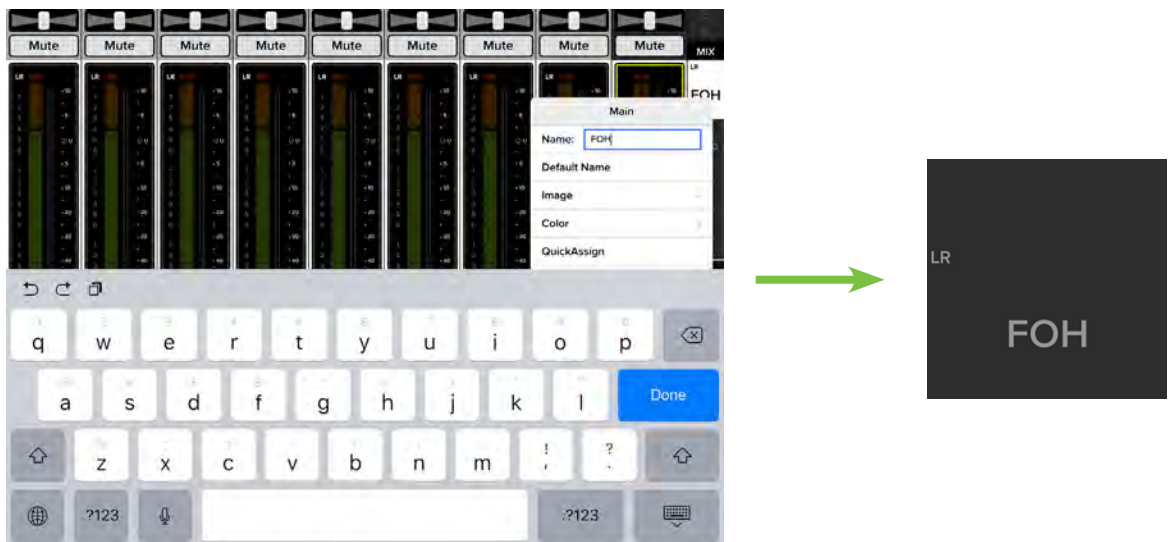

As seen in all of these images, a small name resides in the upper-left corner of the master ID button regardless of the name and/or image. This system name represents each output and it cannot be changed or removed. Trust us, it's for the best, as it is for easy identification of each output, even after you rename it something goofy.

An open gray box with only the master fader's name works, but let's spice it up with an image. Show images are kept in sync which means that all connected devices will display the new image once its been added, whether or not it was already on that device. There are several ways to choose an image. From the popover, tap "Image" to reveal a new popover as seen below. You will be presented with five choices:

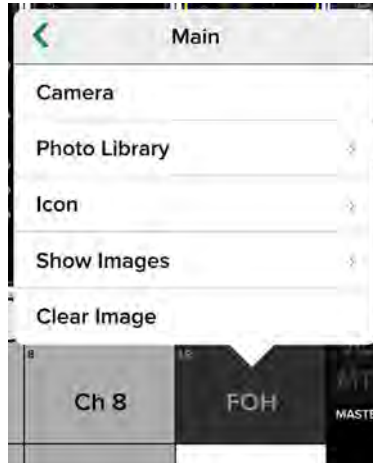

Camera — If you're familiar with how the camera on the device works, then you're in luck...this one works the exact same way!

Photo Library — Here you may select from all the photos that currently reside on your device.

Icon — Or select from a multitude of built-in icons at your disposal.

Show Images — This allows you to select the master fader image from photos that are currently in use on the current show. The list will display all images currently in use. Tap the photo you would like to use from this list.



A maximum of 64 images may be used per show. However, If the same image is used on multiple channels, it only counts as one image (if the image has been selected from show images and not multiple times from the photo library). Icons do not count toward the 64. More information about the file system [shows, snapshots, etc.] begins on page 233.

Clear Image — Believe it or not, tapping here will clear the image for that channel. This removes the image from the channel and, if it isn't used elsewhere, from the Current Show and the Show Images list.

If you're ok with it, we'll go with the rockin' FOH icon. Cool? Great! Tap the FOH icon towards the lower-right corner to select it.

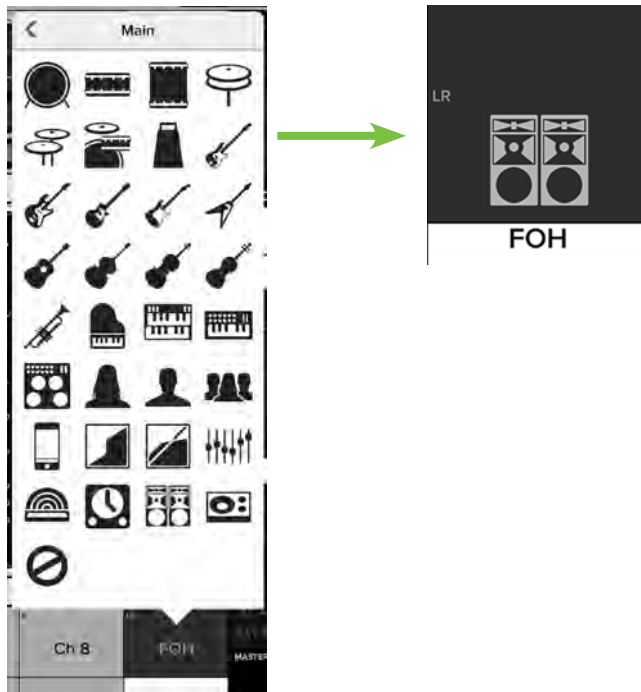

Main Fader -0.0 dB

Shows

If you have multiple items of similar things (e.g. drums, horn section, background vocals, etc.), you can assign a color to them. This helps color coordinate, distinguish between sets of instrumentation and more.

After tapping the master ID button, simply tap "Color" from the popover to reveal a selection of colors to choose from (as seen to the left). Tap the color you would like (or 'None' for no color) for the selected output. I'm a fan of grape Kool-Aid, but I already chose purple for the mic'd goats on the channel strips. Instead, let's go with... **BLUE!**

Check it out...it's easy to read, as both the top and bottom of the output strip becomes the selected color. Not only that, but the text in the current parameter display also turns the selected color.

QuickAssign

Wait, so I have to tap the Master ID button multiple times? Once for the name, once for the image and again to assign a color? Then I have to repeat that process all over again for each additional output? Au contraire mon frère!

Sandwiched between “Color” and “Link Ch X over Ch X” is an option to “QuickAssign”. Tap it to reveal something similar to what may be seen below.

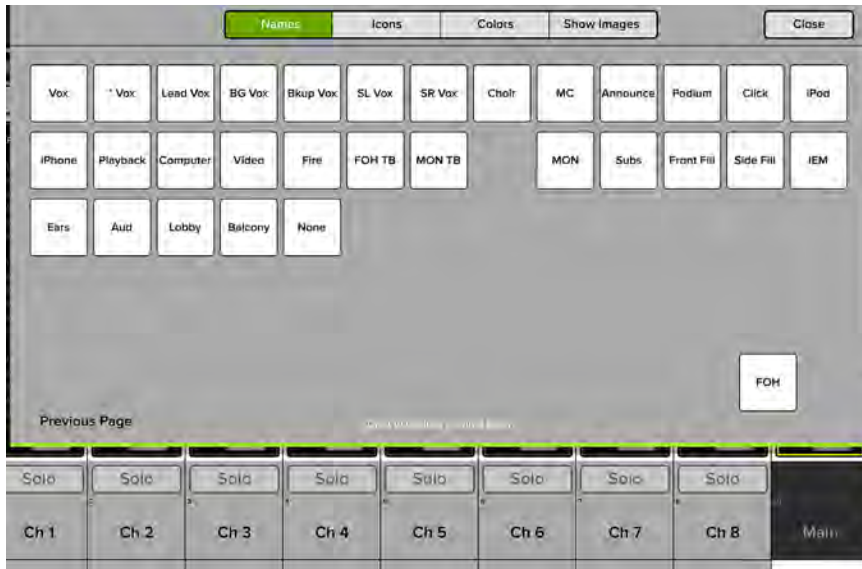

QuickAssign - Names

QuickAssign allows you to, wait for it.....

.....quickly assign these same characteristics – names, icons, colors and show images – via drag-and-drop! Then repeat as needed for subsequent outputs. Makes sense, right? As seen in the image above, the “FOH” name is being dragged-and-dropped onto the main output. You can see that the same method is used to add a PA icon (below left) and color (below right) to the same output. Much easier and faster than tapping the Master ID button each time for each output.



QuickAssign - Icons



QuickAssign - Colors

Additionally, any show images stored on the device may be quickly retrieved and assigned to outputs via the same drag-and-drop method displayed above.

Once completed assigning a name, icon, color and/or show image to an output, you may close QuickAssign by tapping the “Close” button located in the upper-right corner of the QuickAssign popover.

Linking Auxes

As mentioned previously, two separate mono auxes, sub outputs and matrix outputs may be linked together into a single stereo aux and/or sub. This is ideal for using in-ear monitors or other stereo output destinations such as broadcast feeds, recording devices and more. When linked, the level control, graphic EQ, parametric EQ and output compressor/limiter are adjusted with a single set of controls!

Linking these outputs is easy. First you need to select the output you want to link (as described at the beginning of this chapter). Now tap the output's Master ID button; you will see an option to "Link Output X over Output Y". Tap it! A popover will be displayed asking you to confirm. A visual of these steps is displayed below. Follow the same steps outlined above to unlink outputs.

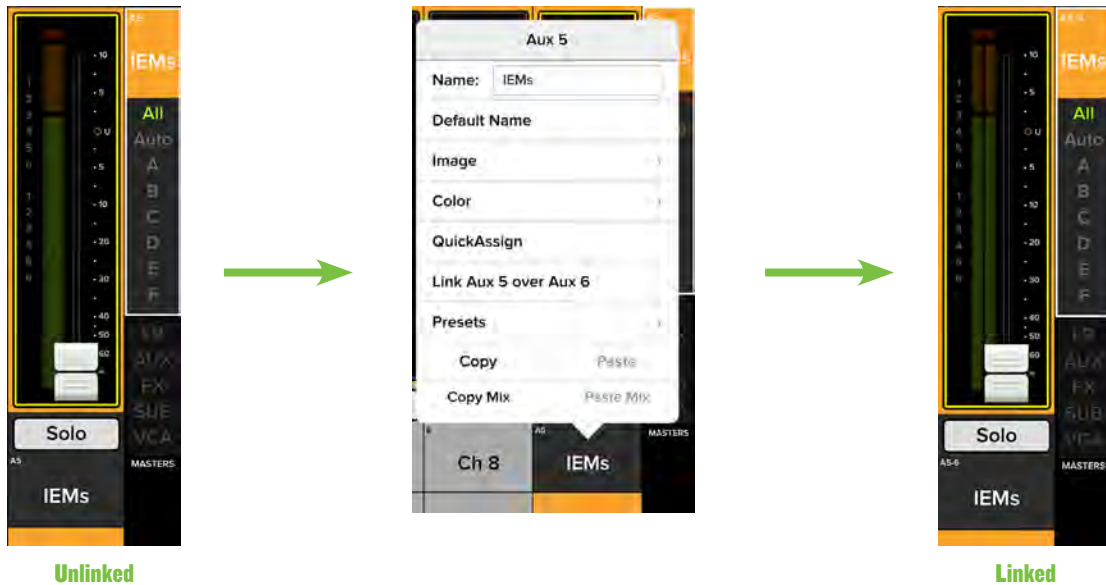

Odd-numbered outputs will link to the next (even-numbered) output [1-2, 3-4, 5-6, etc.], while even-numbered outputs will link to the previous (odd-numbered) output [6-5, 4-3, 2-1, etc.].



The linked over output will take on all of the attributes [graphic EQ settings, output compressor/limiter settings, aux send output routing, etc.] of the tapped Master ID (aux) button. In other words, if you link output 1 over output 2, the resulting stereo output will take on all of the settings of output 1. However, if you link output 2 over output 1, the resulting stereo output will take on all of the settings of output 2.



With linked auxes, users have the ability to choose whether to use aux pans or the LR pan. Make your choice in the aux/FX send configuration menu. More information may be found on pages 71-73.

Presets

Presets save parameters and may be recalled as needed. The mixer comes with a library of factory presets.

There are also user presets. These may be created for each preset type. The number of user presets available is limited only by the available space on the device.

An entire chapter is dedicated to presets. This includes detailed instructions and multiple screenshots every step of the way. Please check it out on pages 147-155.

Import / Export — Master Fader affords you the opportunity to import and export output channel presets. An entire chapter is dedicated to importing and exporting files. This includes detailed instructions and multiple screenshots every step of the way. Please check it out on pages 245-248.

Copy-and-Paste

Copy-and-Paste Output Settings

It's the 21st century and seemingly everyone has been using copy-and-paste for a multitude of things... and you can with Master Fader, as well. Here you're able to copy the settings of one output and paste those same settings onto another output.

If each output is different, though, why on earth would you want to copy-and-paste the same settings from one output to another one? There are a multitude of reasons, actually! For one example, perhaps the mixer needs to be reorganized. Copy-and-paste is a fast, easy way to move outputs around...indefinitely faster and easier than starting from a zeroed out board!

For another example, perhaps there are multiple outputs with similar settings. Like this: a lot of professional bands use in-ear monitors for live performances. You could copy-and-paste the in-ear monitor settings from one aux to another aux and tweak to your liking. It's a great starting point!

In the end, it really all just boils down to flexibility. We assume that copy-and-paste will see the highest use here in the output section, but copying settings from one input to another input is also possible. But since we're still on the Master Fader / Selector Strip chapter, you'll have to review the input version of copy-and-paste in Chapter 5 : Mixer View : Channel Strips.

Output copy-and-paste is easy. The example below demonstrates the aforementioned band who use in-ears instead of wedges for monitoring. Using the selector strip, select aux 1 and set it up as you would like; here we set all DSP settings for an in-ear setup on to aux 1.

Step 1 (Copy) : Tap the aux 1 master ID button. At the bottom of the popover is copy-and-paste. Tap the Copy – NOT Copy Mix – button.

Step 2 (Paste) : Use the selector strip to select aux 2. Tap the aux 2 master ID button. At the bottom of the popover is copy-and-paste. Tap the Paste – NOT Paste Mix – button.

The "pasted" output will take on most of the attributes [name, icon, color, EQ settings, gate and compressor settings, etc.] of the "copied" output.

But there are a few characteristics that are not pasted and remain independent. This includes pan and fader level, aux / FX send configuration and any assignments / routing. This is useful in multiple situations. Everyone in the band is different and will have different needs. Levels will certainly differ and aux sends could be configured, assigned and routed differently.

Screenshot #2 (Copy Mix) : As before, tap the FOH (Main LR) master ID button to bring up the popover. Tap the Copy Mix button.

Screenshot #3 (Paste Mix) : Use the selector strip to select another output; aux 8 in this example. Tap the aux 8 master ID button. Tap the Paste Mix button.

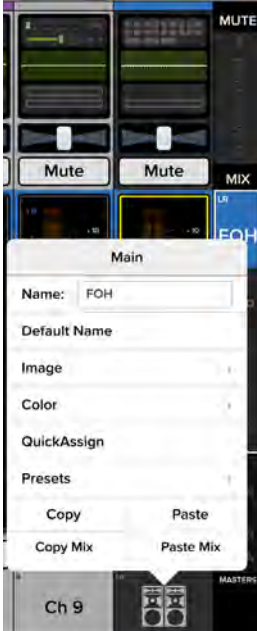

Screenshot #2



Screenshot #3

Screenshot #4 (Results) : As you can see below, the levels of aux 8 are identical to that of FOH (Main LR).



Screenshot #4

So...what does this mean? Simply put, if you already have multiple channels dialed in and the FOH sounds great, setting up monitors for the band is a cinch. Copy-and-paste **the mix** from one output to another output. It's a great starting point rather than starting out from scratch...right?!

Chapter 8 : Mixer View : The Matrix [DL32R]

Introduction

So I was told that I would be able to write about *The Matrix*. What? Really?! I love *The Matrix*! Well, the first two, at least. Of the three movies, the original *Matrix* is the best, with *The Matrix Reloaded* being pretty good and *The Matrix Revolutions* quite forgettable.

When we talk about the matrix and the DL32R, though, it's a totally different beast. It has nothing to do with *The Matrix* trilogy... and just like that, there goes my dream of writing movie reviews.

Before we get started, there's a bit of text ahead. We know...this is some heady stuff, but it is cool to use and easy to set up. Don't fret, as examples and images are coming!

A mixer matrix allows separate mixes to be created, each from a combination of output signals on the console.

The DL32R has a matrix with six outputs (M1 – M6) and each matrix output is comprised of a combination of 22 outputs (left output, right output, 14 aux sends and six sub groups). The hippest of hip engineers might even say it's a 22x6 matrix. Be aware that some unhip engineers might say the same thing.

Each input to the matrix has a level, mute and meter.

Two matrix outputs may be linked for stereo operation, but each input to a matrix is mono no matter the stereo state of the matrix. When matrix outputs are stereo linked, matrix inputs will have a pan control.

Each matrix has output processing comparable to any aux send or the main L/R, each with its own parametric EQ (with high-pass and low-pass filtering), graphic EQ and compressor/limiter with delay... and all prior to the output connector. Additionally, each matrix may be controlled by any number of available VCAs and/or mute groups (via output routing).

Matrix Uses

There's already a main L/R and up to 14 available auxes. So why use a matrix instead of one of these other choices? Simply put, the levels and DSP for each input channel is already set up for the main L/R and auxes, so why duplicate your work to send similar signals to different destinations? A matrix essentially takes what's already dialed in on other outputs (be it the main L/R and/or auxes) and allows you to combine them as needed for other uses. For example...



Theatre Production : Theatres are an excellent source that begs for matrix use. Envision your favorite theatre. Perhaps it's only used for musicals and other theatre productions, or maybe they house the occasional band, too. Either way, the DL32R can handle both FOH and monitors, as previously discussed.

However, many – all? – theatres have a lobby and bathrooms; a matrix mix can easily provide sound to these locations without much effort. Not only that, but lobbies and bathrooms clearly have different acoustics than what's delivered from the main L/R. Simply set the levels and DSP (from each matrix) to its particular location. For example, a bathroom has natural low end and heavy reverb, so set the EQ and FX differently than it is for the main L/R.

Continuing on with the theme of theatres, many of them also have a backstage where cast members await their turns in the spotlight, change outfits, converse, eat, drink and be merry and more. A speaker system may be set up there for the cast to get their cues. Just send a matrix output there, as well.

Last, but not least...green rooms. Perhaps the theatre has a green room (or two) where the rock stars and their posse can congregate. The band doesn't want to miss their cue to hit the stage – or maybe they want to listen to the opening bands while getting prepared for their own. Regardless of reason, matrix mixes may be sent to the green room(s).

House of Worship : A matrix may be used for creating mixes for lobbies and cry rooms in a house of worship. Use two of the matrix outputs to drive the lobby and cry rooms, created from the L/R mixes. Another matrix output may be used to drive the speech system covering the choir.

Concert / Club FOH : Like a theatre, venues that host concerts might have a lobby and definitely have bathrooms. Hopefully they won't have cry rooms, though. In fact, if they do exist, we haven't seen it. Something else to consider here, though, are the front fills.

PAs are typically set up to reach the majority of the venue, but there's a triangle-shaped group of folks near the front of the stage that the sound from the PA will miss. Front fills are the answer here. A matrix mix should be sent here because it's basically the same sound you desire out of the PA, but at a much lower volume (and perhaps dialed with slightly different DSP settings).

Matrix Usage Wrap-Up :

In all of these examples, the benefit of output matrix mixes is multiple zone coverage with unique processing, levels and alignment delay on each output. This helps (audibly) align balconies, lobbies and more. Read more about (audio) alignment delay on page 146.

Here's another tip for those of you still reading: using any of the previous examples, matrix outputs may be used to make a board recording of the show. Why do this if you can record multiple (separate) tracks, take it back to the studio and set it up for later mixdown using your favorite DAW [pages 210-224]? Well, if you've been around bands as much as I have, you know that they'll want to hear the results immediately... as in on their way home or on to the next town for the next gig. A simple L/R matrix mix will work just fine for a personal "board recording."

Bonus tip for anyone STILL reading: When playing craps I always place the 4s and 10s and press a unit every time my numbers hit. Units!

Configuring The Matrix

You have waited long enough...time for some step-by-step directions and screenshots of what we're talking about!

- **Step 1** — Matrix outputs are assigned via the I/O patch.



There is a plethora of information about the I/O patch on pages 196-209, but the idea here is that matrix outputs are assigned via the output tabs on the I/O patch. If you need to review that section first, we'll wait.

In this example, aux sends 1-8 are assigned to XLR outputs 1-8, the main L/R is assigned to XLR outputs 13-14 and matrix 1-4 are assigned to the remaining XLR outputs [9-12]. Set up the main L/R and aux sends as you normally would. We're here to set the matrix up!

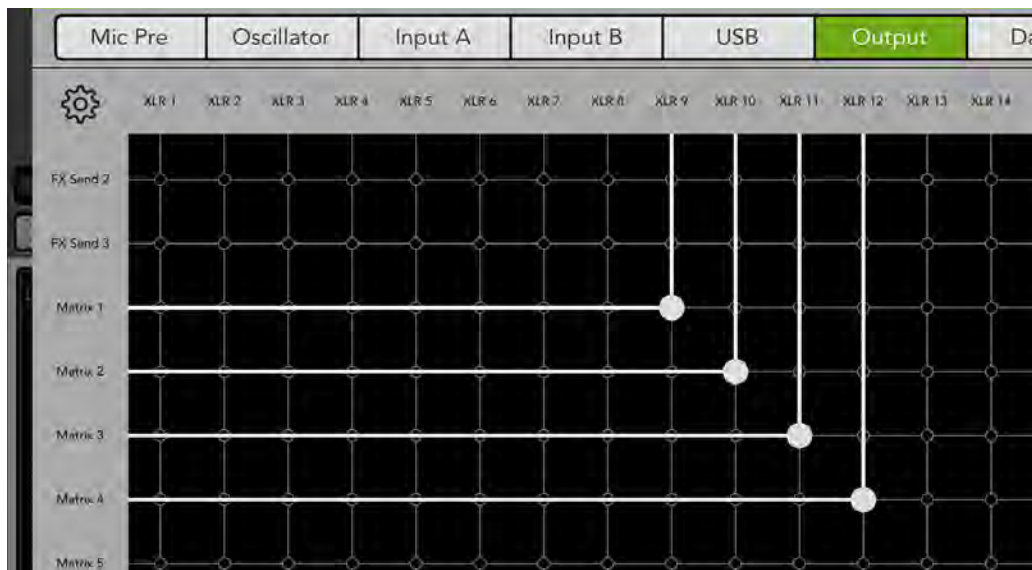

There IS one additional thing we can set up while the I/O patch is still open: talkback. Tap the talkback tab and swipe left. Assign talkback to matrix 1-4.

With talkback set up, the house manager can now make an announcement for the audience to return to their seats for the next portion of the show. This announcement will be sent to matrix 1 (lobby), matrix 2 (mezzanine), matrix 3 (bathrooms) and matrix 4 (backstage), but not in the main L/R (auditorium).



We're off to a fantastic start! Now we'll need to set up names, levels, DSP, etc. for each matrix.

- **Step 2** — Return to the mixer view and select “Matrix 1” from the master fader’s output selector. Left to right, the mixer view will now show subgroups 1-6, left output, right output and aux sends 1-14.



- **Step 3** — As discussed a couple of pages back, the processing and capabilities of the matrix outputs are almost identical to the main L/R and aux sends. Since we already discussed setting these up, set up each matrix similarly, but this time for the lobby, mezzanine, bathrooms and backstage. Be sure to update the name, icon and color for each matrix output.

- **Step 4** — Now let’s get signal to the lobby. View the matrix 1 [lobby] mix by choosing it via the mix selector. You should see signal coming in from the main L/R. Raise the left and right faders (remembering that each input to a matrix is mono). Now set the level of the matrix 1 fader to your liking. In this example, a common way to explain the routing would be “matrix 1 send from main L/R”. Repeat matrix 2-4 sending each the desired mix of output signals.



All matrix outputs may be viewed simultaneously by touching the masters selector located at the bottom right of Master Fader.

In the image below, we selected matrix only for what masters to view. Notice here that names, icons, colors, PEQ and GEQ have been set up...but most importantly, the lobby, mezzanine, bathrooms and backstage are all receiving signal as indicated by the cheerfully bouncing meters.

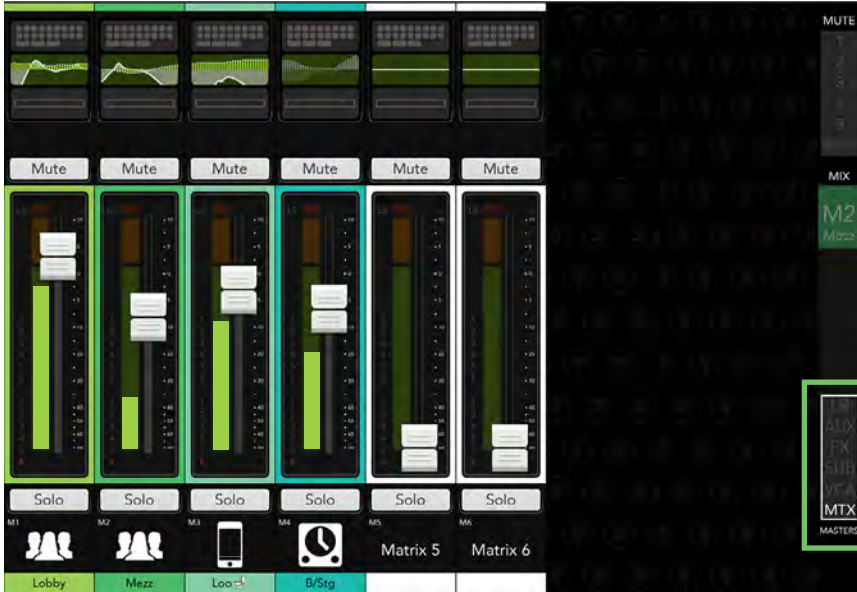

- **Step 5** — Remember when we set up talkback to the matrix outputs back in step 1? Tap the quick access panel, tap the talkback button and make your very important announcements (making sure the talkback level is set appropriately).

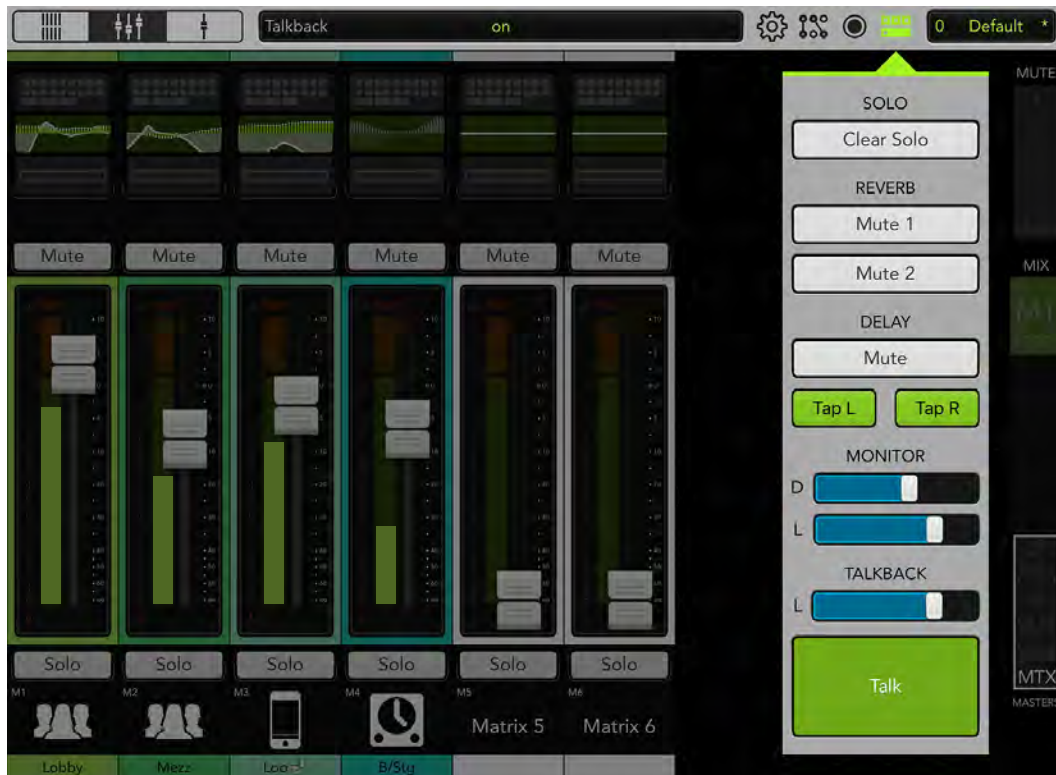

- **Step 6** — Everyone is back in their seats enjoying the second act, so all you need to do at this point is return to the overview. All channels are in view simultaneously, so chill here unless you see some spiking meters or hear something that doesn't sound quite right to you. You can head straight to the problem immediately and make the necessary adjustments or make adjustments right there on the overview. Congrats!

There are plenty of other situations where the matrix may come in handy. For example, envision a band playing at an intimate venue. There may not be much of a need to mic anything other than kick and vocals. The rest of the kit, bass and guitars are loud enough on their own; they don't need to be added to the PA.

Having said that, there could be a need for the sound of those instruments to be delivered elsewhere. Maybe the PA is too loud for someone with sensitive ears. They could enjoy a crisp, clean representation of the show in the lobby. Another matrix could be set up in the green room so the headlining band can listen to the support act while stretching and warming up backstage.

In scenarios like these, it might be best to assign these channels to subgroups and unassign them from the main L/R. The subs may be specifically set up to send to the matrix. Simply raise the subgroup faders followed by raising the matrix faders to the desired levels. This might be explained as "matrix 5 and 6 sends from subgroups 5 and 6".

The Matrix... if you haven't seen the movie yet, do yourself a favor and check it out. The DL32R matrix. If you haven't set one up yet, do yourself a favor and line it up!

Chapter 9 : Channel View : Input Routing View

Introduction

The input routing view is the place to adjust all assignments and sends for each channel in a convenient location.

The input routing view is divided into three sections:

- **Source Selection**
- **Assignments (for the current channel)**
- **Aux and FX Send Assignments (for the current channel)**

Let's check all three out, shall we? With nothing assigned, the default view will look something like the image shown below.

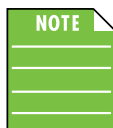

- The input routing view on a DL16S, DL32S, DL32R, DL806 and DL1608 look similar except for the following:
- (1) Trim and polarity only; no source selection, gain or 48v on the DL806 and DL1608.
 - (2) Four subgroups, VCAs, mute and view groups (versus six of each on the DL16S, DL32S and DL32R).
 - (3) Four auxes [DL806], six auxes [DL16S and DL1608] and eight auxes [DL32S] (versus 14 on the DL32R).
 - (4) Two FX sliders (versus four on the DL16S, DL32S and DL32R).

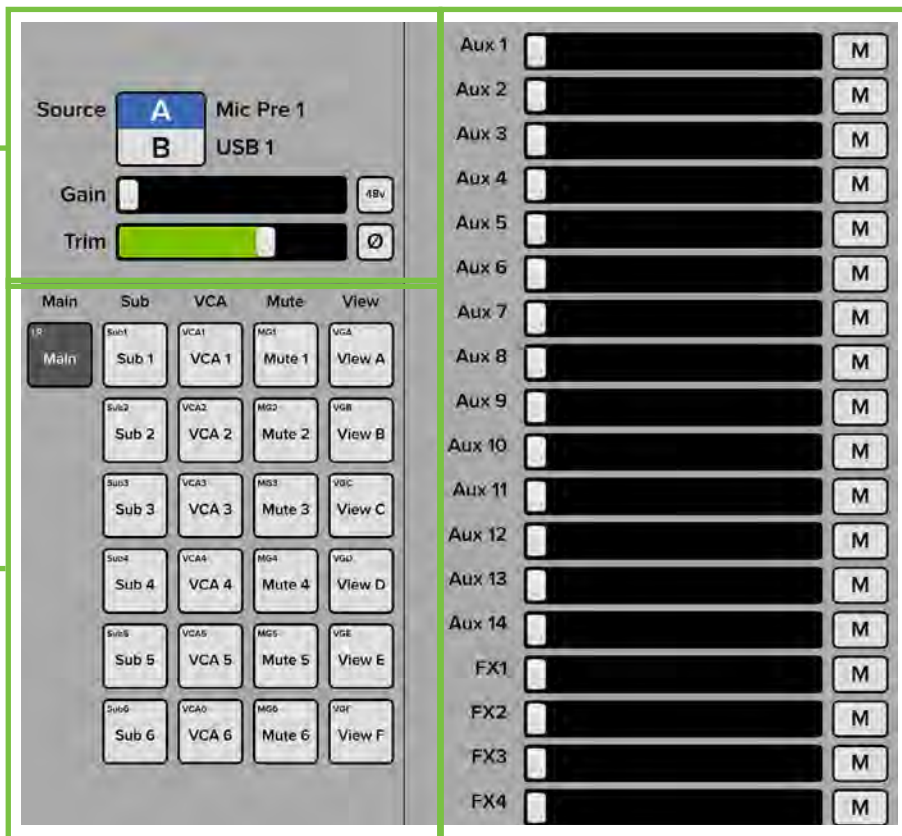

Source Selection

On the top left of the current channel's input routing view are the source selection, digital trim slider and polarity button. As seen below left, if a mic pre is the currently selected input for the current channel, a mic pre gain slider and 48v button also appear.



DL16S • DL32S • DL32R – Mic Pre

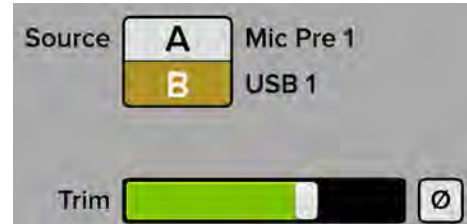

DL16S • DL32S • DL32R – USB

If a source without a mic pre is selected – USB 1 (above right, for example) – the gain and 48v controls are hidden.

Dedicated A and B channel inputs allow for fast switching between two sources for each channel. The most common use for this is for virtual sound check, switching between the mic pres and USB returns to monitor the recorded signal back through the channel. However, the flexibility allows a variety of other professional uses. For example, the user might set up a spare mic for the lead vocalist and switch to it with just a button tap if the primary wireless mic were to go down.



As stated on the previous page, if using a DL1608 or DL806, only trim and polarity will be displayed.



DL806 • DL1608

- **Mic Pre [DL16S • DL32S • DL32R]** – By default, each mic pre is aligned with its channel input. In other words, mic pre 1 is assigned to channel 1, mic pre 2 is assigned to channel 2 and so on and so forth.

BUT...it's those first two words that say everything: "By default". Mic pre assignments may be changed via the I/O patchbay. Read more about the I/O patchbay on pages 196-209.

- **USB [DL16S • DL32S • DL32R]** – By default, each USB is aligned with its mic pre. In other words, USB 1 is assigned to mic pre 1, USB 2 is assigned to mic pre 2 and so on and so forth.

BUT...it's those first two words that say everything: "By default". USB assignments may be changed via the I/O patchbay. Read more about the I/O patchbay on pages 196-209.

- **Gain [DL16S • DL32S • DL32R]** – Gain adjusts the input sensitivity of the mic and mic/line inputs. This allows signals from the outside world to be adjusted to run through each channel at optimal internal operating levels. Setting the preamp gain correctly with the gain control is an essential step in establishing good signal-to-noise ratio and sufficient headroom for the mix because its setting determines the overall noise performance in that channel of the mixer.

If a balanced mic or line-level signal is connected to any channel, there is 0 dB of gain with the slider fully left, ramping up to 60 dB of gain all the way to the right.

If a 1/4" line-level signal is connected, there is 20 dB of attenuation with the slider fully left and 40 dB of gain fully right, with unity gain "U" at 10:00.

This 20 dB of attenuation can be very handy when inserting a hot signal from a line-level source. Without this "virtual pad," there is more chance of channel clipping.

Because the gain here is digital, it is recallable.



Gain is raised and lowered via the gain knobs on the DL1608 and DL806 mixers. These are analog controls, and are therefore NOT recallable.

See the chapter on the level setting procedure, starting on page 31, for information on setting gain.

- **Trim** – Trim is a digital level control at the top of the channel's processing. It affects all input sources to the channel whether analog or digital. It ranges from -40 dB to +20 dB with a default of 0 dB. It's used for adding level to a channel before any of the channel processing.



So what is the difference between gain and trim? When would you use gain and when would you use trim? In short, gain is analog, while trim is digital (right after the A/D conversion but before everything else). So if the source is analog, you would use gain. If the source is digital, you would use trim since it doesn't have gain. In most cases, you will adjust (analog) gain, not (digital) trim.

Trim is also useful on the DL1608 and DL806 that don't have a digitally controlled gain. If you want to lower a channel level, you can adjust the channel's trim (assuming it isn't clipping). Trim does not help curb clipping or distortion.

- **48v [DL16S • DL32S • DL32R]** – The DL16S, DL32S and DL32R have separate phantom power for each of the channel inputs. Tap the 48v button if the microphone connected to this channel requires phantom power. (Always check the color of the button before connecting microphones. The button will illuminate red when phantom power is engaged and is gray when disengaged.).



Not only will the 48v button itself illuminate, but "48v" will also illuminate on the input routing button at the top of each channel strip.



Mic pre gain and 48V phantom power for all channels may also be adjusted (in one convenient location!) via the mic pre tab in the I/O Patch. See page 196 for more information.

Most modern professional condenser mics require 48v phantom power which lets the mixer send low-current DC voltage to the mic's electronics through the same wires that carry audio. (Semi-pro condenser mics often have batteries to accomplish the same thing.) "Phantom" owes its name to an ability to be "unseen" by dynamic mics [Shure SM57 / SM58, for example], which do not need external power and are not affected by it, anyway.



Never plug single-ended (unbalanced) or ribbon microphones into the mic input jacks when phantom power is on. Do not plug instrument outputs into the mic XLR input jacks with phantom power on unless you know for certain that it is safe to do. When phantom power is engaged, be sure that the master fader is down when connecting microphones to the mic inputs to prevent pops from getting through the PA.



It is not a good idea to enable the phantom power unless it is actually needed. Line-level sources may be particularly unhappy when they are subjected to 48v phantom powering. Many musical instrument amps and keyboards with "direct outputs" fit this description.



It takes approximately 15 seconds for the phantom power to shut off completely. Do not add or remove any inputs until phantom power is completely off or mics could be ruined.

Because the phantom power here is digital, it is recallable.



48v phantom power is engaged via the phantom power switch on the DL1608 and DL806 mixers. It is a global switch affecting all channel inputs simultaneously. It is an analog control, and is therefore NOT recallable.

- **Polarity Invert** – The polarity invert button [Ø] allows for individual channel activation of 180° polarity inversion; it is available on all input channels and the return channels [DL16S, DL32S and DL32R]. Press the polarity invert button to turn polarity invert on or off. It will illuminate yellow when engaged and is gray when disengaged.

Assignments (for the current channel)

Below the source selection are the assignments for the current channel. Channels may be assigned and unassigned to the following simply by tapping the displayed assignment buttons. These buttons display the custom name and color of the group (with the default of both displayed below). All outputs and groups that are unassigned will remain light gray. [See below left].

- **Main L/R (Main)**
- **Subgroups (Sub X)**
- **VCAs (VCA X)**
- **Mute Groups (Mute X)**
- **View Groups (View X)**

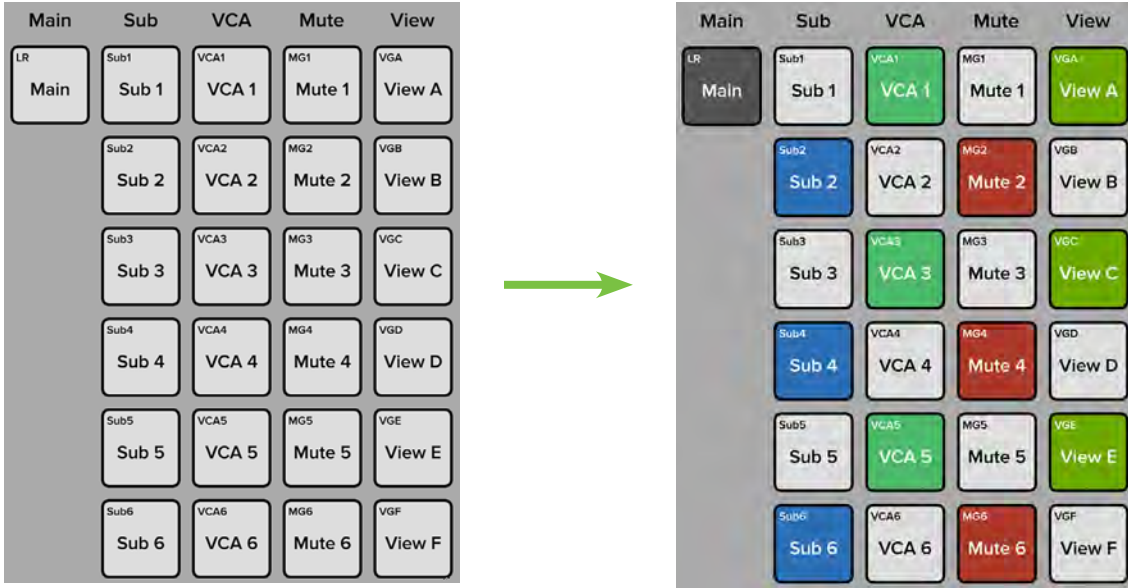

The DL16S, DL32S and DL32R have six subgroups, VCAs, mute groups and view groups each while the DL806 and DL1608 have four of each.

Simply put, where do you want the current channel routed? The default is to route each channel to the main L/R only, so the button is dark gray, as indicated in the above right image. Simply tap the button if you do not want the current channel routed to the main L/R. The button will turn light gray as seen in the image above left.

Let's take a quick look at what each of the choices are:

- **Subgroups** – Subgroups and VCAs are typically used as master faders for a group of channels on their way to the main mix. The major difference being that basic output DSP may be added to subgroups.
- **VCAs** – Subgroups and VCAs are typically used as master faders for a group of channels on their way to the main mix. The major difference being that basic output DSP may be added to subgroups.
- **Mute Groups** – Mute groups allow you to quickly mute (and unmute) multiple channels and/or outputs.
- **View Groups** – View groups allow you to see only the channels that you want to view, hiding the rest.

Setting current channel assignments via the input routing view is great for a couple of channels, but what if there are a massive amount of channels that need to be routed to certain groups? In that case, it would probably be better to utilize the output routing view (for the main L/R, subgroups and VCAs, pages 116-120) and selector strip (for mute groups and view groups, pages 57-62, 65-68). Within these pages are several examples of each. Additional information about subgroups and VCAs may also be found on pages 52-53. Simply put, channel assignments via the input routing view is a great tool for a few select channels, not a plethora of them!

Aux Send Assignments (for the current channel)

On the right hand side are the aux send assignments for the current channel. Here you're able to adjust each aux level independently with the slider displaying the color of the aux send master. Additionally, text of what each assignment represents is listed to the left of each slider. As seen below right, linked aux sends [aux 7-8, aux 9-10] will display a stereo pan.

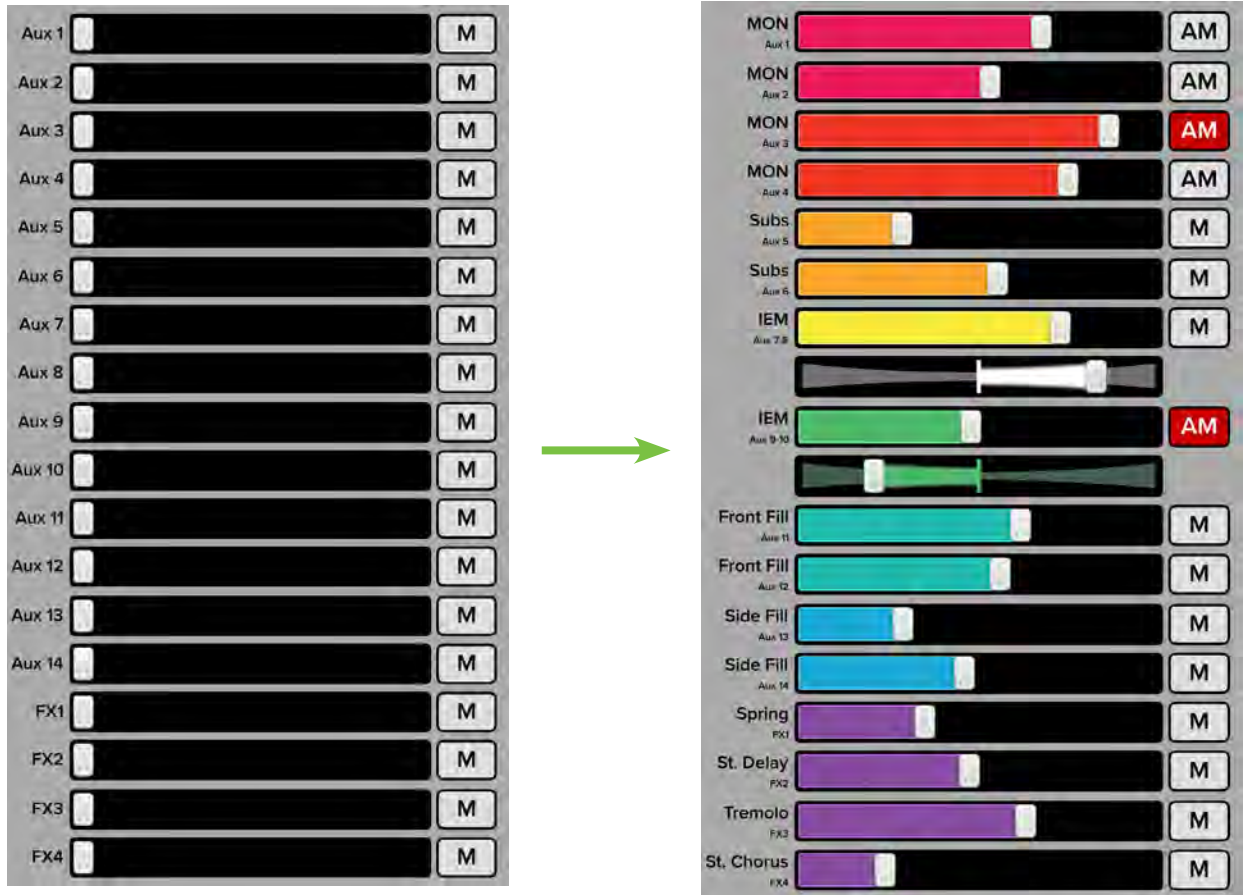

The mute for each aux send (linked or unlinked) will be the channel mute by default – and will mute all aux sends simultaneously when engaged – but will switch to an independent aux mute just for that aux IF “Use LR Mute” has been disabled for the aux send master. See auxes 1-4, and aux 9/10 above right for an example of auxes with “Use LR Mute” disabled [with aux 3 and aux 9/10 mutes engaged].



Similarly, the pan for each aux send will be the LR pan by default [aux 7/8 above right], but will switch to an independent pan just for that aux IF “Use LR Pan” has been disabled for the aux send master [aux 9/10 above right].

Chapter 10 : Channel View : EQ

Introduction

The equalizer area accesses all EQ-related parameters such as EQ for the selected channel (including gain, frequency and Q) and a high-pass filter (HPF). The input channels, FX and iPad channels all have up to 4-band EQ with high shelving, high-mid peaking, low-mid peaking and low shelving. Shelving means that the circuitry boosts or cuts all frequencies past the specified frequency. Peaking means that certain frequencies form a “hill” around the center frequency. All channel inputs also have an RTA / spectrograph which allows you to see what you hear so you may easily locate and eliminate feedback and other anomalies, while seeing the EQ changes in real time.



You can really upset things with too much EQ. Each EQ band has a lot of boost and cut because that is needed on occasion. But if the EQ is maxed on every channel, the mix turns to mush. Equalize subtly, using cut as well as boost. If you find yourself repeatedly using a lot of boost or cut, consider altering the sound source such as placing a mic differently, trying a different kind of mic, a different vocalist, changing the strings, gargling, or all of the above.

There are actually two different types of EQ to choose from on each channel: clean, surgical modern EQ and classic sounding vintage EQ. That's right, you can mix and match to heart's content! We will dissect both the modern and vintage EQs separately, but let's begin by taking a peek at what features apply to both. Modern EQ is discussed further on pages 98-103, while more information about the vintage EQ may be found on pages 104-106.

EQ On / Off

The EQ button – near the upper-left corner of the screen – allows for true bypass of the EQ circuitry to ensure that there is no coloration of the signal if the EQ is not needed. When this button is disengaged, the EQ controls have no effect on the signal. You may use this button to make an A/B comparison between the EQ'd signal and the signal without EQ. Press this button to turn EQ on or off. It will illuminate green when engaged and is gray when disengaged.

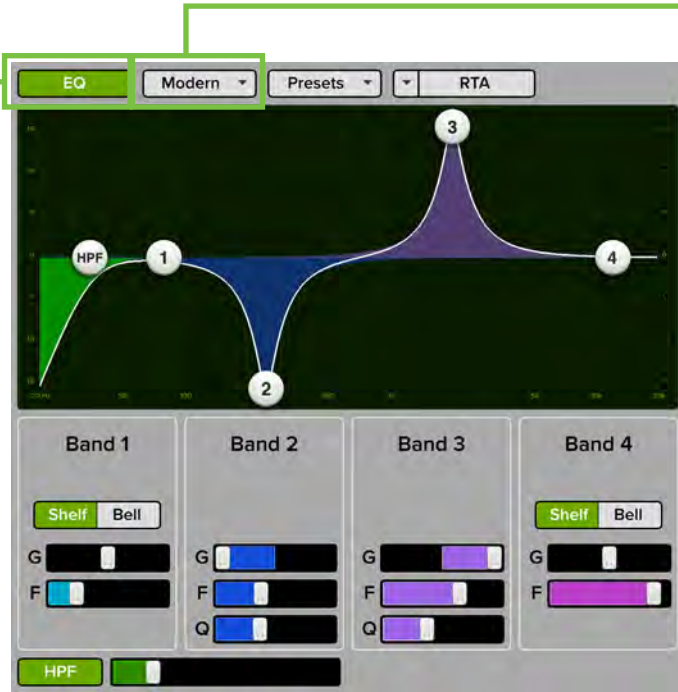

Modern EQ



Vintage EQ

Modern / Vintage

The modern/vintage button is located directly to the right of the EQ button. It displays the EQ type currently in use, with “Modern” as the default EQ. Tap this button to reveal the two EQ types, then tap the EQ you would like for the selected channel. The image will change to reflect the EQ type chosen.



You can switch between EQ types while audio passes and the settings will match as closely as possible, but the sound will change.

Presets

Presets save parameters and may be recalled as needed. The mixer comes with a library of factory presets.

There are also user presets. These may be created for each preset type. The number of user presets available is limited only by the available space on the device.

An entire chapter is dedicated to presets. This includes detailed instructions and multiple screenshots every step of the way. Please check it out on pages 147-155.

Import / Export — Master Fader affords you the opportunity to import and export EQ presets. An entire chapter is dedicated to importing and exporting files. This includes detailed instructions and multiple screenshots every step of the way. Please check it out on pages 245-248.

RTA / Spectrograph

Directly to the right of presets is another button and pulldown menu. Here you're able to choose between using an RTA or a spectrograph. Make your selection and then press the button to turn it on or off. The button will illuminate green when engaged and is gray when disengaged.

RTA stands for "Real-Time Analyzer" and it measures and displays the sound of the corresponding output – amplitude versus frequency components of a continuous signal – via DSP.

A spectrograph, on the other hand, provides a 3-dimensional view of the outgoing signal: energy versus frequency versus time. It may be thought of as a record of multiple RTA spectrums taken over time, with color representing amplitude. When spectrograph is chosen, two vertically adjustable sliders appear on the left hand side of the EQ graph. These adjust the maximum [red] and minimum [blue] signal level shown in the spectrograph, ranging between 0 dBFS [top] and -60 dBFS [bottom].

An RTA / spectrograph allow you to see what you hear so you may easily locate and eliminate feedback and other anomalies, while seeing the EQ changes in real time.

Many audio signals are highly dynamic: music, speech and even environmental noise contain significant changes in spectral content as a function of time. With a digital mixer, musicians and sound engineers can save time setting up at shows by recalling previous settings. The RTA / spectrograph fits right in with that, literally displaying frequencies, shortening the time it takes to tune the main loudspeakers or stage monitors during setup in a new room.

A screenshot of an RTA in action may be seen below. Some notes regarding this particular example:

- There are 31 bands on all DL Series RTAs.
- At the top of each RTA band is a single, solid horizontal line. This line indicates the peak hold of that band and will remain there until a new peak is reached.
- Notice the RTA drops underneath EQ bands 1 and 2 that reflect the change in the PEQ. This indicates that the PEQ adjustment was seen by the RTA and should be audible in the acoustic environment, as well.

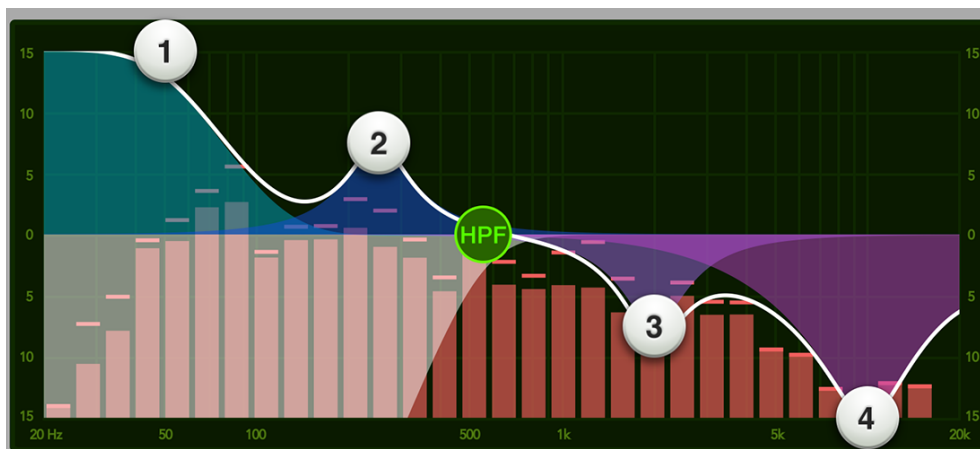

A screenshot of a spectrograph in action may be seen below. Some notes regarding this particular example:

- Each DL Series mixer features a spectrograph that provides visual feedback about the acoustic environment.
- The spectrograph may be overlaid on all input and output PEQs and GEQs, allowing you to see real time EQ adjustments.
- The spectrograph represents audio signal strength – amplitude – by color and color intensity at a specific frequency. Darker colors such as blue or light blue will generally represent an audio signal with a lower strength – lower amplitude – while brighter more intense colors such as yellow and red represent a higher strength – higher amplitude – audio signal.
- Here, the maximum signal level [red slider] is set at -12 dBFS and the minimum signal level [blue slider] is set at -50 dBFS. These settings may be adjusted to determine the maximum and minimum signal level that will be visualized by the spectrograph.
- Band 2 has a -10 db cut at 240 Hz which may be seen on the spectrograph as a narrow light blue line, indicating that the level has been cut at 240 Hz.
- Band 3 has a $+10$ db boost at 2.5 kHz which may be seen on the spectrograph as a narrow red and yellow line, indicating that the level has been boosted at 2.5 kHz.

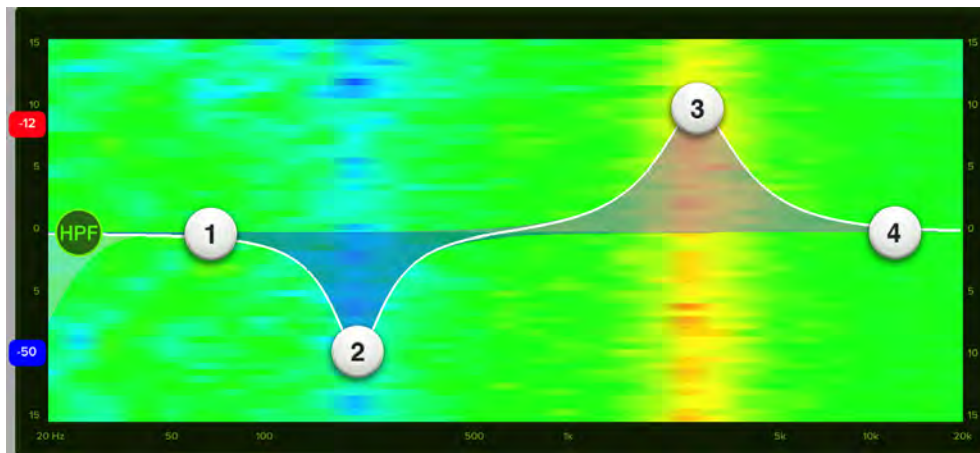

The RTA / spectrograph is available on all channel inputs and outputs. There is only one instance of the RTA implemented in the mixer. Therefore, only one channel can show the RTA or spectrograph at a time regardless of how many devices are connected.

By default, once the RTA or Spectrograph is enabled, it will automatically change to show the signal for the currently selected input channel or output mix. This is because the RTA Follow switch is in the ON position: Tools > Settings > RTA Follow > On



This works as expected if using a single device. However, you will (most likely) want to disable RTA Follow on devices that are added to the mix. With this setting off, it won't "steal" the RTA from the primary device as different outputs are selected on the other devices. It may sound a bit confusing at first, but helps if you remember that the RTA is being calculated in the mixer DSP, not the Master Fader software. To learn more about RTA Follow, see page 188.

NOTE The RTA / Spectrograph is only available when modern EQ is selected.

Modern EQ Introduction

As mentioned previously, the modern EQ is designed for clean, surgical processing; it's great for dialing in a nice, tight sound. As such, each of the four bands have adjustable gain and frequency, while bands 2 and 3 also have adjustable Q (bandwidth). [Bands 1 and 4 also have adjustable Q (bandwidth) when in 'Bell' mode]. Bands 1 and 4 may be independently switched to shelving bands using the switches located between the EQ graph and band sliders. The shelves have adjustable gain and frequency, which is the -3 dB point from the shelf. Now for a detailed – let's say “surgical” – look at the modern EQ.

Modern EQ Swipe Zone

Here in the Modern EQ view, swipe anywhere in the gray areas outlined below. Swiping up displays that channel's gate and compressor view. Swiping down displays that channel's input routing view. And swiping left and right changes channels.

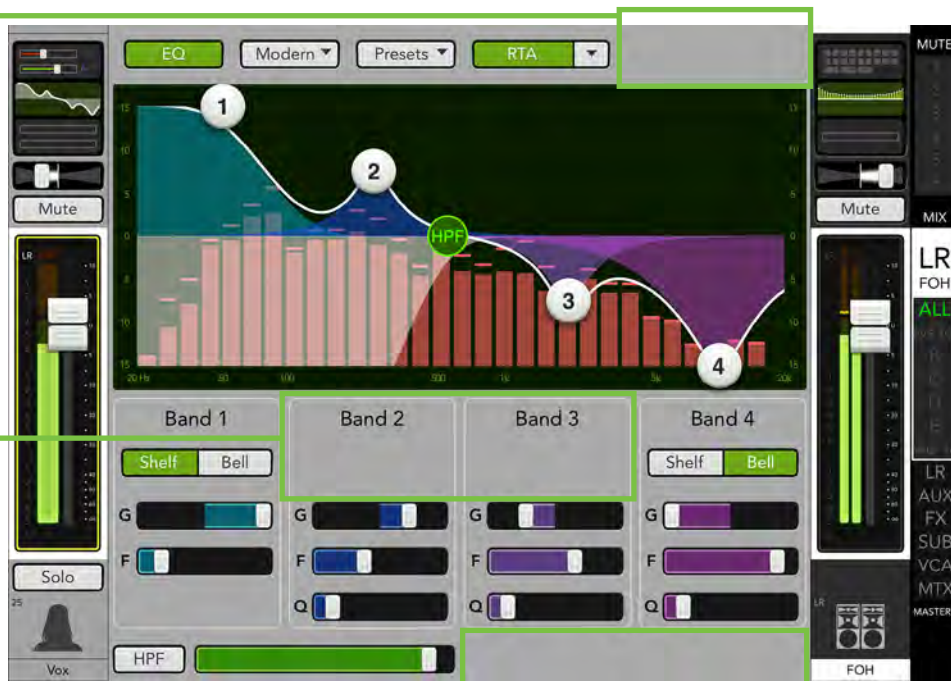

Modern EQ Gain, Frequency and Q [Bandwidth]

The gain and frequency may be changed by moving any of the four numbered balls (representing each band) until the desired sound has been achieved. Moving a ball vertically changes the gain by up to ±15 dB. Moving a ball horizontally changes the frequency, ranging from 20 Hz to 20 kHz. There is a Shelf / Bell option for bands 1 and 4 and it is described in detail on page 101. Q [bandwidth] is changed by pinching the ball. Double-tap an EQ ball to reset its gain to zero.

Low Shelving – Band 1

The low EQ provides up to 15 dB of boost or cut from 20 Hz to 20 kHz. This frequency represents the punch in bass drums, bass guitar, fat synth patches, and some really serious male singers who eat raw beef for breakfast.

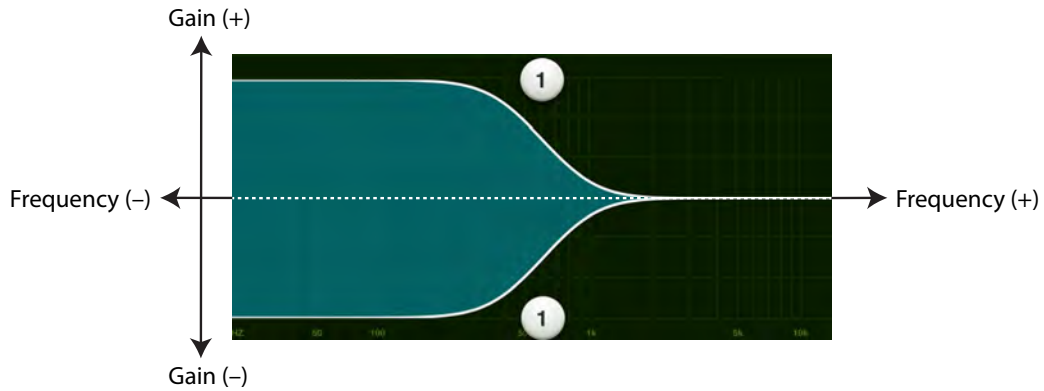

Low-Mid Peaking – Band 2

The low-mid EQ provides up to 15 dB of boost or cut from 20 Hz to 20 kHz. Frequencies affected typically include the male vocal range as well as the fundamentals and harmonics of many lower-timbred instruments.

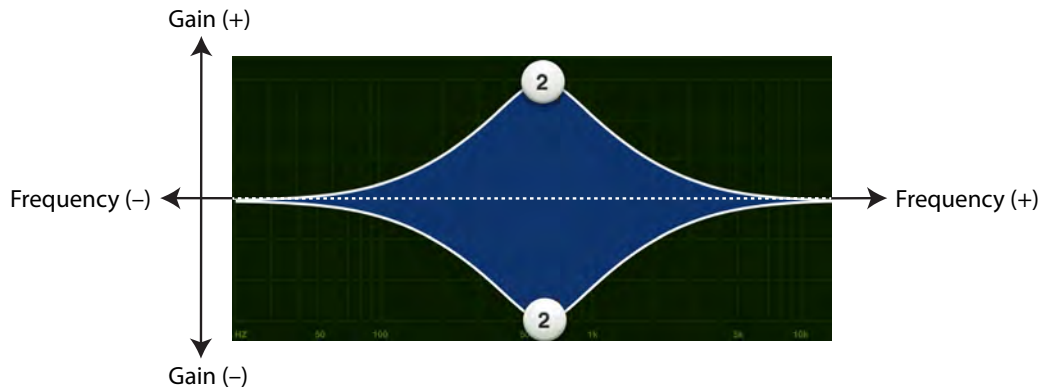

High-Mid Peaking – Band 3

The high-mid EQ provides up to 15 dB of boost or cut from 20 Hz to 20 kHz. Midrange EQ is often thought of as the most dynamic because the frequencies that define any particular sound are almost always found within this range. For example, the female vocal range as well as the fundamentals and harmonics of many higher-timbred instruments.

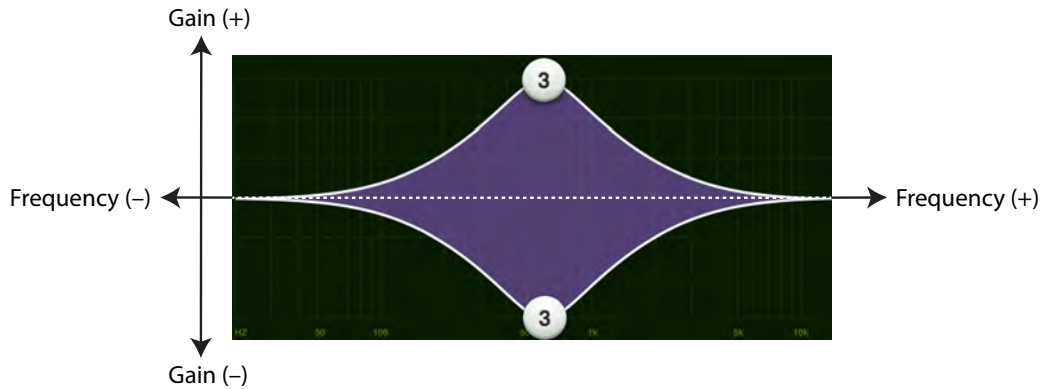

High Shelving – Band 4

The high EQ provides up to 15 dB of boost or cut from 20 Hz to 20 kHz. Use it to add sizzle to cymbals, an overall sense of transparency, or an edge to keyboards, vocals, guitar and bacon frying. Turn it down a little to reduce sibilance or harsh treble.

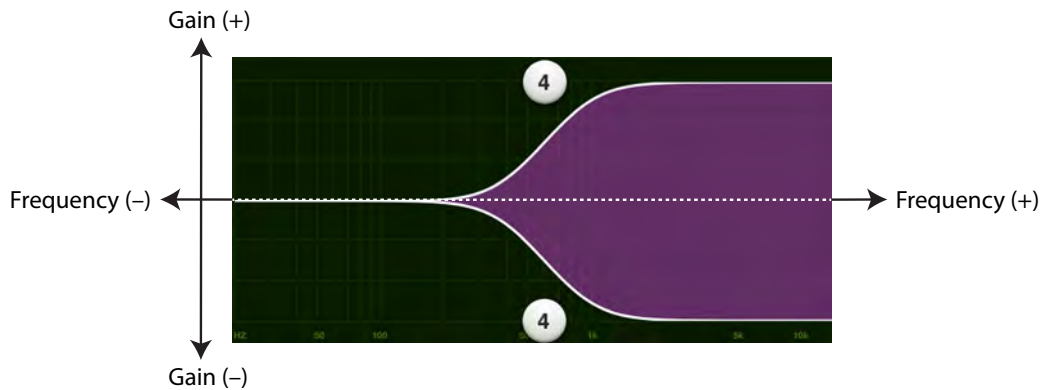

Although the Q control does adjust the bandwidth of a filter, the Q value itself is dimensionless; it has no unit of measurement. Some equalizers use the fractional bandwidth of the filter, measured in octaves, to express this parameter. The two parameters are inversely related; a high Q value corresponds to a small fractional bandwidth. The following table lists some equivalent Q and fractional bandwidth values.

Q	BW (oct)	Q	BW (oct)
0.7	2	2.871	1/2
1.414	1	4.318	1/3
2.145	2/3	15	1/10

Modern EQ Shelf / Bell

A Shelf / Bell option is available on bands 1 and 4. Simply tap which setting you prefer. The chosen setting will illuminate green when engaged, while the other option will be grayed out.

When engaged, the EQ becomes a shelving filter rather than a parametric filter. Shelf boosts frequencies from the cut-off point upwards. A gentle roll-off may be assumed with shelf. The Q control becomes inactive when shelf is engaged.

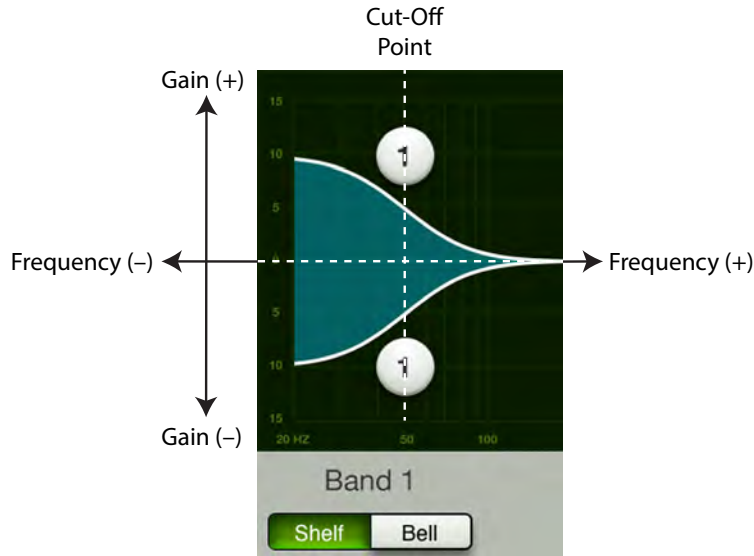

Shelf EQ

Bell boosts frequencies near the cut-off point then slowly decreases until it reaches a gain of zero. When engaged, the EQ becomes a parametric filter rather than a shelving filter. The Q control becomes active when bell is engaged. In fact, a smaller Q value results in a wider curve, while a larger Q value results in a narrower curve where frequencies may be zoomed in on more precisely. A smaller Q is generally intended for more musical purposes, while a larger Q is generally used when decreasing problem frequencies.

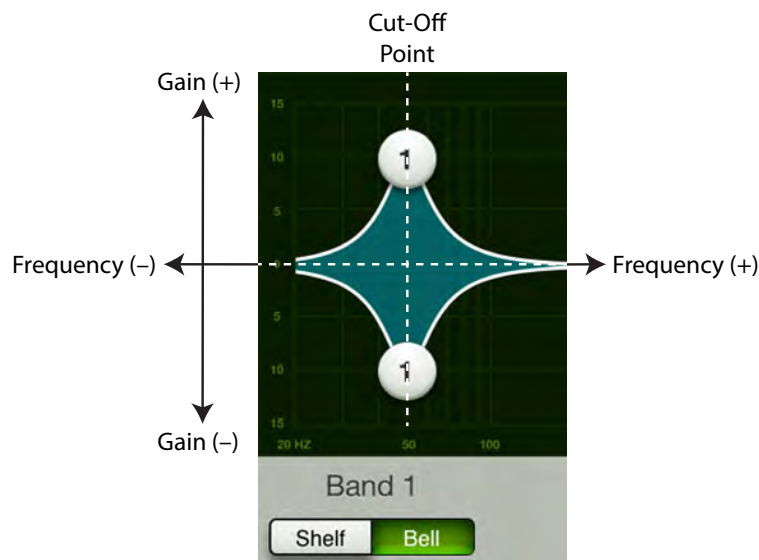

Bell EQ

Modern EQ HPF On / Off and Frequency

High-pass filters are utilized to cut out low frequencies. The high-pass filter control adjusts the cut-off frequency for the filter. Frequencies below the cut-off frequency are attenuated at a rate of 12 dB/octave. The slope for the HPF is adjustable by sliding the HPF ball or HPF slider left and right. Simply tap the HPF button – near the lower-left corner of the screen – to engage the high-pass filter. It will illuminate green when engaged and is gray when disengaged.

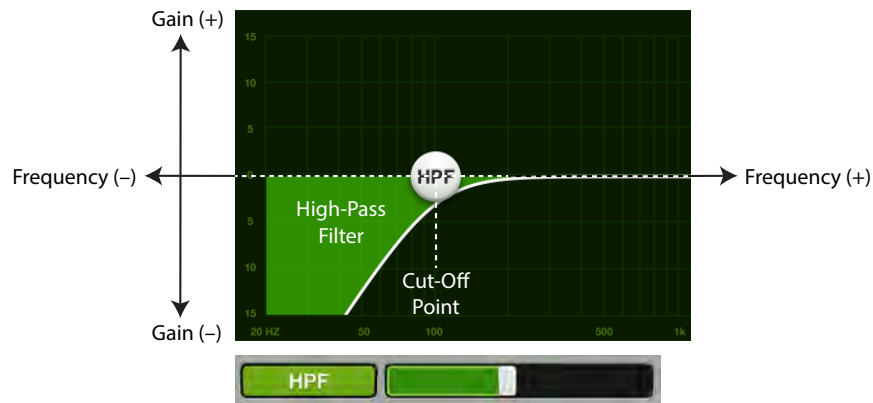

High-Pass Filter (Engaged)

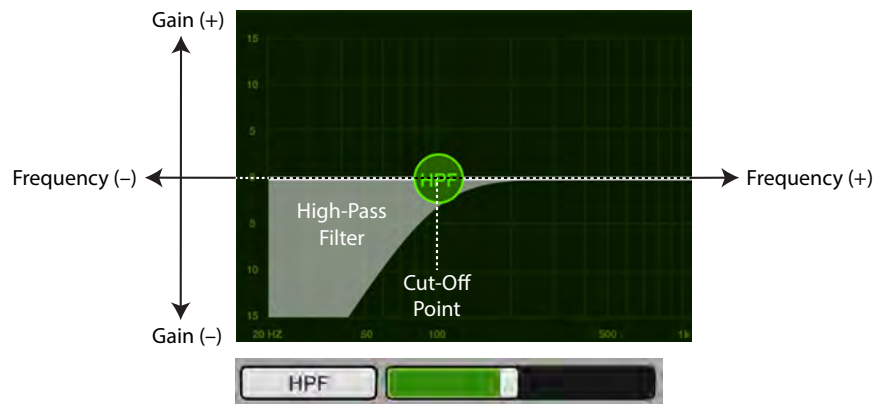

High-Pass Filter (Disengaged)

Modern EQ at a Glance

Parameter	Low Value Limit	High Value Limit	Default
Polarity Invert	Off	On	Off
HPF Enable	Off	On	On
HPF Frequency	20 Hz	700 Hz	100 Hz
HPF Slope	-	-	18 dB/octave
EQ Enable	Off	On	On
High Band Type	Parametric	Shelf	Shelf
Low Band Type	Parametric	Shelf	Shelf
High Gain	-15 dB	+15 dB	0 dB
High Freq	20 Hz	20 kHz	12 kHz
High Q / Shelf Slope	0.5	16	2
High Mid Gain	-15 dB	+15 dB	0 dB
High Mid Freq	20 Hz	20 kHz	2 kHz
High Mid Q	0.5	16	2
Low Mid Gain	-15 dB	+15 dB	0 dB
Low Mid Freq	20 Hz	20 kHz	250 Hz
Low Mid Q	0.5	16	2
Low Gain	-15 dB	+15 dB	0 dB
Low Freq	20 Hz	20 kHz	80 Hz
Low Q / Shelf Slope	0.5	16	2

Vintage EQ Introduction

Many of our audio engineer friends and other pro audio gear heads yearn for the ease of use and sound of yesteryear. That's right, the vintage EQ was created with you in mind...but every user will love using it! It meticulously recreates the feel and sound of EQ of classic consoles. The vintage EQ captures the unique interactions between the shelving bands and the gain and frequency-dependent Q structure of the parametric band to deliver the clarity and sheen of classic EQ designs. The vintage EQ is great for shaping the tone of bass, guitars and other instruments. The screenshot below displays the default vintage EQ settings. Let's take a look at each of the selections starting on the left with the HPF and working our way right to the high EQ.

Vintage EQ Swipe Zone

Here in the Vintage EQ view, swipe anywhere in the dark gray areas outlined below. Swiping up displays that channel's gate and compressor view. Swiping down displays that channel's input routing view. And swiping left and right changes channels.



Vintage EQ HPF Frequency Buttons

High-pass filters are utilized to cut out low frequencies. The high-pass filter control adjusts the cut-off frequency for the filter. Frequencies below the cut-off frequency are attenuated at a rate of 18 dB/octave. The slope of the HPF is engaged by tapping any frequency button other than “Off”. The current selection will illuminate green.

Vintage EQ Gain and Frequency

The gain for each EQ band may be changed by dragging up [increases gain] and down [decreases gain] over the knob until the desired gain has been achieved. The gain may be changed by approximately ± 15 dB...it's vintage, so nothing is exact! Double-tap a gain knob to reset its gain to 0 dB. Each EQ band here has a vertical row of frequency buttons located underneath its gain knob. Simply tap the frequency button you desire for each band. The frequency ranges from 35 Hz to 15 kHz. The gain (but not the frequency) may also be manually entered via the current parameter display.

Low

The low EQ provides approximately 15 dB of boost or cut from 35 Hz to 330 Hz. This frequency represents the punch in bass drums, bass guitar, fat synth patches, and some really serious male singers who eat raw beef for breakfast.

Mid

The mid EQ provides approximately 15 dB of boost or cut from 360 Hz to 7.2 kHz. Frequencies affected typically include guitar, piano and the fundamentals and harmonics of many instruments.

Wide / Narrow

Below the mid EQ vertical frequency strip is a wide / narrow button. Generally speaking, wide is used for broad tone-shaping while narrow is more precise. Select what you would prefer the mid frequency Q [bandwidth] to sound like.

High

The high EQ provides approximately 15 dB of boost or cut from 3.3 kHz to 15 kHz. Use it to add sizzle to cymbals, an overall sense of transparency, or an edge to keyboards, vocals, guitar and bacon frying. Select a lower frequency to reduce sibilance or harsh treble.

Vintage EQ at a Glance

Parameter	Low Value Limit	High Value Limit	Default
Polarity Invert	Off	On	Off
HPF Enable	Off	On	On
HPF Frequency	Off • 50 Hz • 80 Hz • 160 Hz • 300 Hz		80 Hz
HPF Slope	Off	300 Hz	18 dB/octave
EQ Enable	Off	On	On
High Shelf Gain	-15 dB	+15 dB	0 dB
High Shelf Freq	3.3 kHz • 4.7 kHz • 6.8 kHz • 10 kHz • 15 kHz		10 kHz
Mid Gain	-15 dB	+15 dB	0 dB
Mid Freq	360 Hz • 700 Hz • 1.6 kHz • 3.2 kHz • 4.8 kHz • 7.2 kHz		360 Hz
Mid Q	Wide	Narrow	Narrow
Low Shelf Gain	-15 dB	+15 dB	0 dB
Low Shelf Freq	35 Hz • 60 Hz • 110 Hz • 220 Hz • 330 Hz		60 Hz

Chapter 11 : Channel View : Gate and Compression

Introduction

Gates are typically used to reduce leakage from open microphones. Signals below the threshold level are muted, while signals above the threshold get to pass through. The range control changes the rule slightly. Signals below the threshold are attenuated by the amount of the range setting, while signals above the threshold get to pass through.

The operation of the gate is further modified by the attack, hold, and release controls. In order to open the gate, the input signal must exceed the threshold for at least the duration of the attack time. This is useful for helping the gate discriminate between something that is short duration and long duration, such as hi-hat leakage into one of the tom-tom mics.

Once the gate has opened, the hold time begins. The hold timer resets any time the input signal crosses the threshold again, as long as it remains above the threshold for longer than the attack setting. After the hold time passes, the gain falls at a rate determined by the release setting. The range control allows the gate to remain partly open, even if the input is below the threshold.

Compressors are used to reduce or limit transient peaks in a signal. If the signal is too hot, turn it down, otherwise leave it alone. As the input level to the compressor increases, the output level increases linearly until the threshold point is reached. After that point, the output level no longer increases linearly. Instead, it increases at a reduced rate determined by the ratio setting.

The attack and release controls affect the rate of the gain change; attack affects the rate of the onset of gain reduction and release affects the recovery rate once the transient has passed.

For stereo linked channels, the gain reduction is applied equally to both the left and right side.

There are actually two different types of gates and compressors to choose from on each channel: clean, surgical modern dynamics and classic sounding vintage dynamics. That's right, you can mix and match to heart's content! We will dissect both the modern and vintage dynamics separately, but let's begin by taking a peek at what features apply to both. Modern gates and compressors are discussed further on pages 110-112, while more information about the vintage gates and compressors may be found on pages 113-115.

Gate On / Off

Press the Gate button to turn the gate on or off. It will illuminate green when engaged and is gray when disengaged. Notice the input and output meters below, as well. There is mono metering for inputs and outputs on unlinked channels and stereo metering for inputs and outputs on linked channels.

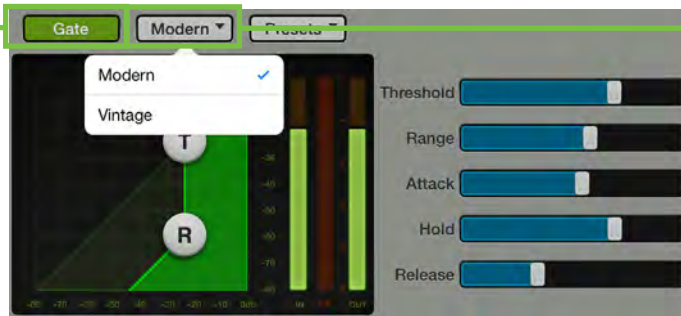

GATE ON / MONO METERS



GATE OFF / STEREO METERS

Modern / Vintage

The modern/vintage button is located directly to the right of the gate on/off button. It displays the gate type currently in use, with "Modern" as the default gate. Tap this button to reveal the two gate types, then tap the gate you would like for the selected channel. The controls will change to reflect the gate type chosen.



You can switch between gate and compressor types while audio passes and the settings will match as closely as possible, but the sound will change.

Presets

Presets save parameters and may be recalled as needed. The mixer comes with a library of factory presets.

There are also user presets. These may be created for each preset type. The number of user presets available is limited only by the available space on the device.

An entire chapter is dedicated to presets. This includes detailed instructions and multiple screenshots every step of the way. Please check it out on pages 147-155.

Import / Export — Master Fader affords you the opportunity to import and export gate presets. An entire chapter is dedicated to importing and exporting files. This includes detailed instructions and multiple screenshots every step of the way. Please check it out on pages 245-248.

Compressor On / Off

Press the Comp button to turn the compressor on or off. It will illuminate green when engaged and is gray when disengaged. Notice the input and output meters below, as well. There is mono metering for inputs and outputs on unlinked channels and stereo metering for inputs and outputs on linked channels.

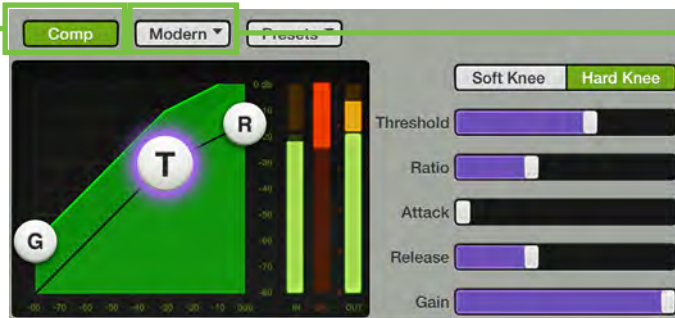

COMPRESSOR ON / MONO METERS

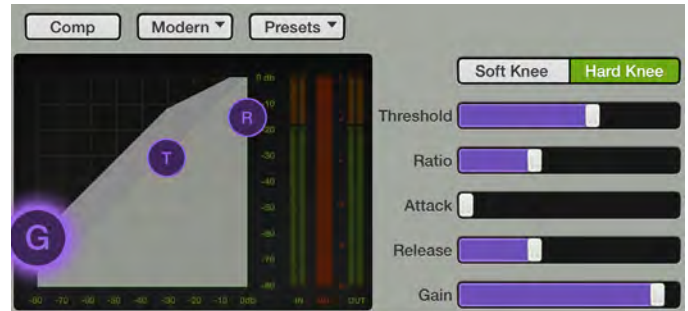

COMPRESSOR OFF / STEREO METERS

Modern / Vintage

The modern/vintage button is located directly to the right of the comp on/off button. It displays the compressor type currently in use, with "Modern" as the default compressor. Tap this button to reveal the two compressor types, then tap the compressor you would like for the selected channel. The image will change to reflect the compressor type chosen.

Presets

Presets save parameters and may be recalled as needed. The mixer comes with a library of factory presets. Several factory presets will be displayed at one time. Just scroll up to view the other factory presets, if available.

There are also user presets. These may be created for each preset type. The number of user presets available is limited only by the available space on the device.

An entire chapter is dedicated to presets. This includes detailed instructions and multiple screenshots every step of the way. Please check it out on pages 147-155.

Import / Export — Master Fader affords you the opportunity to import and export compressor presets. An entire chapter is dedicated to importing and exporting files. This includes detailed instructions and multiple screenshots every step of the way. Please check it out on pages 245-248.

Modern Gate and Compressor Introduction

As mentioned previously, modern dynamics were designed for clean, surgical processing; they're great for dialing in a nice, tight sound. As such, the range, attack, release and ratio features may be fine-tuned when modern dynamics are utilized. Now for a detailed (let's say "surgical") look at modern dynamics.

Modern Gate and Compressor Swipe Zone

Here in the modern gate and compression view, swipe anywhere in the gray areas outlined below. Swiping up displays that channel's input routing view. Swiping down displays that channel's EQ view. And swiping left and right changes channels.



Modern Gate Display and Settings

The gate for each channel may be adjusted by moving the threshold and range balls or moving any of the five sliders left and right. Additionally, exact settings may be entered into the current parameter display. The gate may be adjusted whether the gate is on or off. The iPad and return channels only have a compressor, not a gate.

Threshold — Threshold determines the level at which the gate acts on the incoming signal. The range of the threshold setting varies from -80 dBFS to 0 dBFS.

Range — Range determines how far the gain drops once the signal is below threshold. Setting the range control to something in the 10-20 dB range allows some amount of signal leakage when the gate is closed, which may make its action more subtle (less abrupt) and therefore less noticeable. The range of the gated signal varies from 0 dB to 60 dB.

Attack — Attack determines how quickly the gate opens once the signal is above threshold. Short attack times allow triggering on short transients, while longer attack times cause these transients to be ignored. The range of the attack time varies from 0 ms to 300 ms.

Hold — Hold sets a fixed time that the gate remains open once the signal drops below the threshold setting. During the hold time, the gain is held constant, whereas during the release time, the gain is falling at the release rate. The range of the hold time varies from 0 seconds to 5 seconds.

Release — Release determines how long it takes for the gain to fall to the setting of the range control once the signal falls below threshold and the hold time elapses. The range of the release speed varies from 50 ms to 3 seconds.

Modern Gate Meters

These three meters show the input level, amount of gain reduction and output level. The input and output meters range from -80 dBFS to 0 dBFS. The reduction meter of the gate ranges from 0 to 20 dB. Mono metering is displayed for inputs and outputs on unlinked channels and stereo metering is displayed for inputs and outputs on linked channels.

Modern Compressor Display and Settings

The compressor for each channel may be adjusted by moving the gain, threshold and ratio balls or moving any of the five sliders left and right. Additionally, exact settings may be entered into the current parameter display. The compressor may be adjusted whether the compressor is on or off. The iPad and return channels only have a compressor, not a gate.

Threshold — Threshold sets the threshold of the compressor in dB below 0 dBFS. The range of the threshold setting varies from -80 dBFS to 0 dBFS.

Ratio — Ratio sets the amount of gain reduction applied as the signal exceeds the threshold level. The range of the ratio of the compressor varies from 1:1 to inf:1.

Attack — Attack determines how quickly the compressor reacts once the signal is above threshold. Short attack times allow compressing on short transients, while longer attack times cause these transients to be ignored. The range of the attack time varies from 0 ms to 300 ms.

Release — Release determines how long it takes for the compressor to end gain reduction once the signal drops back below the threshold. The range of the release speed varies from 50 ms to 3 seconds.

Gain — Gain adds make-up gain to the output of the compressor. This is useful to make the apparent volume of the signal the same with the compressor in and out of the signal chain. The range of the make-up gain varies from 0 dB to 20 dB.

Soft Knee / Hard Knee Compression

This switch sets the shape of the gain reduction curve at the threshold level. When set to hard, the gain reduction curve changes abruptly at the threshold level. When set to soft, the gain reduction curve changes gently as it transitions to the final ratio amount.

Modern Compressor Meters

These three meters show the input level, amount of gain reduction and output level. The input and output meters range from -80 dBFS to 0 dBFS. The reduction meter of the compressor ranges from 0 to 20 dB. Mono metering is displayed for inputs and outputs on unlinked channels and stereo metering is displayed for inputs and outputs on linked channels.

Modern Gate at a Glance

Parameter	Low Value	High Value	Default
Gate Enable	Off	On	On
Threshold	-80 dBFS	0 dBFS	-80 dBFS
Attack	0 ms	300 ms	0.1 ms
Release	50 ms	3 s	250 ms
Range	0 dB	60 dB	60 dB
Hold	0 ms	5 s	0 ms

Modern Compressor at a Glance

Parameter	Low Value	High Value	Default
Comp Enable	Off	On	On
Threshold	-80 dBFS	0 dBFS	0 dBFS
Ratio	$1 : 1$	$INF : 1$	$2 : 1$
Gain	0 dB	20 dB	0 dB
Attack	0 ms	300 ms	0.1 ms
Release	50 ms	3 s	250 ms
Knee	Soft	Hard	Soft

Vintage Gate and Compressor Introduction

Many of our audio engineer friends and other pro audio gear heads yearn for the ease of use and sound of yesteryear. That's right, the vintage gate and compressor were created with you in mind...but every user will love using it! It meticulously recreates the feel and sound of gates and compressors of classic consoles. The vintage gate and compressor provide a lightning-fast attack, non-linear attack/release and program dependent release making them great for drums, slap bass and other transient sources. The screenshot below displays the default vintage dynamic settings.

Vintage Gate and Compressor Swipe Zone

Here in the Vintage Gate and Compression view, swipe anywhere in the dark gray areas outlined below. Swiping up displays that channel's input routing view. Swiping down displays that channel's EQ view. And swiping left and right changes channels. See page 110 for the Swipe Zone of the Modern Gate and Compression view.



Vintage Gate Settings

Each channel's threshold and hold levels may be changed by dragging up [increases level] and down [decreases level] over their respective knobs until the desired level has been achieved. To the right are two horizontal rows of buttons for the attack and release. Simply tap the button you desire for the attack and release time. The current selection will illuminate green. The threshold and hold settings (but not the attack and release settings) may also be manually entered via the current parameter display. The range is fixed. The gate may be adjusted whether it is on or off. The iPad and return channels only have a compressor, not a gate.

Threshold — Threshold determines the level at which the gate acts on the incoming signal. The range of the threshold setting varies from -80 dBFS to 0 dBFS.

Hold — Hold sets a fixed time that the gate remains open once the signal drops below the threshold setting. During the hold time, the gain is held constant, whereas during the release time, the gain is falling at the release rate. The range of the hold time varies from 0 seconds to 5 seconds.

Attack — Attack determines how quickly the gate opens once the signal is above threshold. Short attack times allow triggering on short transients, while longer attack times cause these transients to be ignored. Choose between a fast, medium or slow attack time.

Release — Release determines how long it takes for the gain to fall to the setting of the range control once the signal falls below threshold and the hold time elapses. Choose between a fast, medium or slow release time.

Vintage Compressor Settings

Each channel's threshold and gain levels may be changed by dragging up [increases level] and down [decreases level] over their respective knobs until the desired level has been achieved. To the right are three horizontal rows of buttons for the attack, release and ratio. Simply tap the button you desire for the attack, release and ratio. The current selection will illuminate green. The threshold and gain settings (but not the attack, release and ratio settings) may also be manually entered via the current parameter display. The compressor may be adjusted whether it is on or off. The iPad and return channels only have a compressor, not a gate.

Threshold — Threshold sets the threshold of the compressor in dB below 0 dBFS. The range of the threshold setting varies from -80 dBFS to 0 dBFS.

Gain — Gain adds make-up gain to the output of the compressor. This is useful to make the apparent volume of the signal the same with the compressor in and out of the signal chain. The range of the make-up gain varies from 0 dB to 20 dB.

Attack — Attack determines how quickly the compressor reacts once the signal is above threshold. Short attack times allow compressing on short transients, while longer attack times cause these transients to be ignored. Choose between a fast, medium or slow attack time.

Release — Release determines how long it takes for the compressor to end gain reduction once the signal drops back below the threshold. Choose between a fast, medium or slow release time.

Ratio — Ratio sets the amount of gain reduction applied as the signal exceeds the threshold level. Choose between 2:1, 4:1, 8:1, 12:1 and 20:1.

Vintage Gate / Compressor VU Meters

To complete the classic look of the vintage dynamics, the gate and compressor are outfitted with VU meters. What's more, underneath each VU meter is a set of buttons to select between displaying the input level, amount of gain reduction or output level. The input and output meters range from -20 dBu to 0 dBu. The reduction meter of the gate and compressor ranges from 0 to 20 dB. Mono metering is displayed for inputs and outputs on unlinked channels and stereo metering is displayed for inputs and outputs on linked channels.

Vintage Gate at a Glance

Parameter	Low Value	High Value	Default
Gate Enable	Off	On	On
Threshold	-80 dBFS	0 dBFS	-80 dBFS
Attack	0.025 ms [Fast] • 12.5 ms [Med] • 75 ms [Slow]		Fast
Release	50 ms [Fast] • 500 ms [Med] • 3 s [Slow]		Fast
Range	-	-	90 dB
Hold	0 ms	5000 ms	0 ms

Vintage Compressor at a Glance

Parameter	Low Value	High Value	Default
Comp Enable	Off	On	On
Threshold	-80 dBFS	0 dBFS	0 dBFS
Ratio	2:1 • 4:1 • 8:1 • 12:1 • 20:1		2 : 1
Gain	0 dB	20 dB	0 dB
Attack	Fast • Medium • Slow		Fast
Release	Fast • Medium • Slow		Fast
Knee	-	-	Soft

Chapter 12 : Channel View : Output Routing Views

Introduction

The output routing view is the place to engage / disengage channel, output and group assignments for each output. This includes the subgroups, VCAs, matrix and, of course, the main L/R.

A few notes about the output routing views before diving in...

- Unlike the input routing view, the output routing view is different for each type.
- Unlike the input routing view, there is no source selection. Rather, it's divided into two – or one in the case of the matrix – main sections.
- Like the input routing view, the output routing view is located in a convenient location as it, too, is the thumbnail at the top of each output channel strip.
- For all except VCA, the view provides a place to assign the output to VCAs and mute groups.
- For main L/R, subgroups and VCAs, it also adds the ability to assign channels to the group.
- The output routing view that appears is dependent on which output's group (or matrix) is selected. In other words, if you tap the channel 4 VCA output routing view, you will be making changes to VCA 4. Simply swiping left and right will leave the output routing view open, but will change the channel. The current input or output channel will be displayed in the current parameter display, as well as on the channel strip to the left of the routing view.

Let's check out all four, shall we?

Main L/R

The main L/R is really the brains of the operation. Even if utilizing subgroups, VCAs and matrices, they still need to get routed to the main L/R to be heard. Ok, ok, it could be routed to a monitor via an aux send, but the main L/R is important nonetheless. The default view will look something like the image shown below.



Main L/R

Notice that all channel assignments are engaged (dark gray) and VCA and mute groups disengaged (light gray). This is the standard setup, but this is YOUR mixer and you get to choose what gets assigned and what doesn't.



The main L/R output routing view on a DL16S, DL32S, DL806 and DL1608 look similar except for the following:

- (1) 16 input channels [DL16S and DL1608] and 8 input channels [DL806] (versus 32 on the DL32S and DL32R).
- (2) One linked iPad channel (versus one linked return channel on the DL16S and DL32S and two on the DL32R).
- (3) Two FX (versus four on the DL16S, DL32S and DL32R).
- (4) Four subgroups (versus six on the DL16S, DL32S and DL32R).
- (5) Four VCAs and mute groups (versus six of each on the DL16S, DL32S and DL32R).

Ok, let's start with the channel assignments. What is the reasoning behind unassigning a channel from the main L/R? Why would you not want a channel routed to the main L/R? Well, one reason could be that a series of channels are routed to a subgroup. Instead of messing around with a bunch of channel strips routed to the main L/R, you could simply route that single (subgroup) channel to the main L/R instead.

Another example could be a click track that's sent to the drummer's in-ears monitors. How awful would it be if the audience could hear the click track through the main PA, too? I'd say pretty awful is putting it lightly. More like atrocious!

Simply unassign channels that you don't want routed to the main L/R by tapping them. Assigned channels illuminate dark gray while unassigned channels are light gray.

So what about the VCAs and mute groups? What do they have to do with the main L/R output routing?

Well, you may want to assign the L/R fader to a VCA along with some other output faders (e.g. all aux sends and matrix masters). Then you can use a single VCA to lower the level of all of your outputs at once.

In the case of mute groups, one might want to assign the main L/R to a mute group as part of a "break switch" during band changeovers as discussed more in depth on pages 57-62.

Subgroups

The subgroups output routing view is a great way to assign multiple channels to a subgroup. If only one or two channels need to be assigned, then the input routing view (pages 89-93) may be the way to go. The subgroups output routing default view will look something like the image shown below.

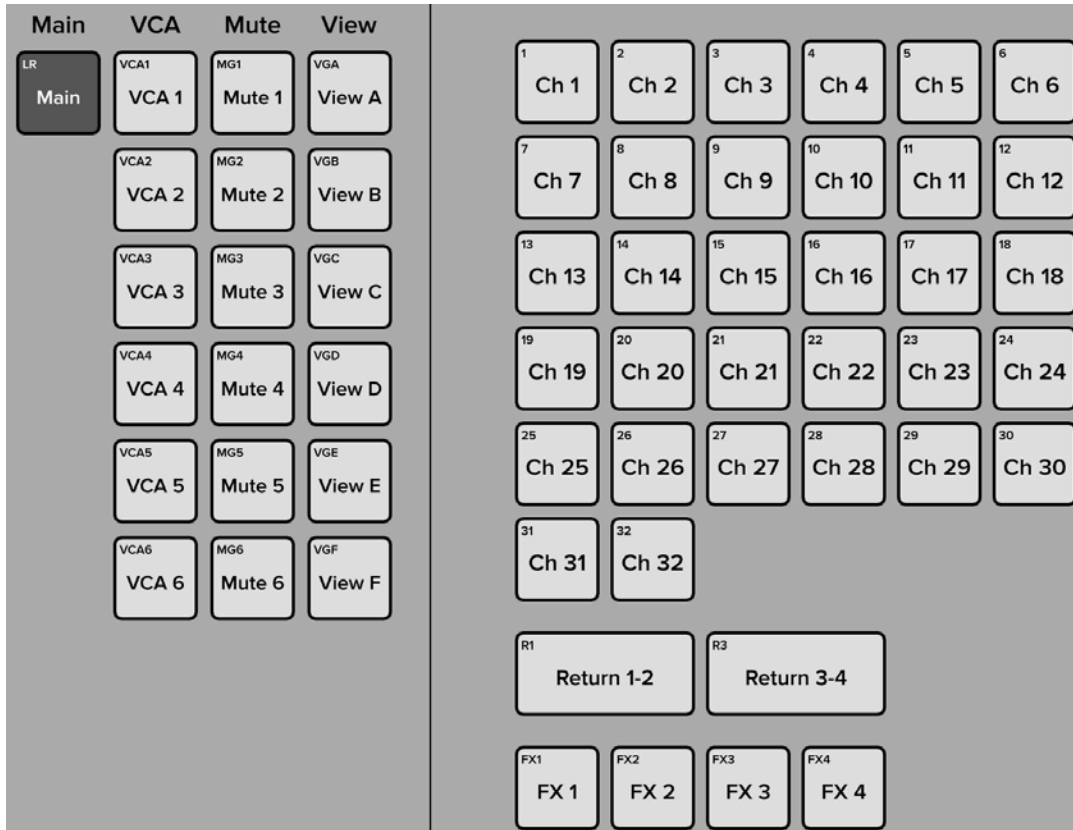

Subgroups

Notice that only the main L/R is engaged (dark gray) and everything else is disengaged (light gray). This is the standard setup, but this is YOUR mixer and you get to choose what gets assigned and what doesn't.

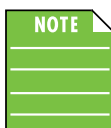

- The subgroups routing view on a DL16S, DL32S, DL806 and DL1608 look similar except for the following:
- (1) 16 input channels [DL16S and DL1608] and 8 input channels [DL806] (versus 32 on the DL32S and DL32R).
 - (2) One linked iPad channel (versus one linked return channel on the DL16S and DL32S and two on the DL32R).
 - (3) Two FX (versus four on the DL16S, DL32S and DL32R).
 - (4) Four VCAs, mute groups and view groups (versus six of each on the DL16S, DL32S and DL32R).

Ok, let's start with the channel assignments. Channels may be assigned to subgroups via each channel's input routing view, but that could be time consuming if there are multiple channels per subgroup. Instead, you could just tap a subgroup's output routing view (as seen above) and assign multiple channels simultaneously. How cool is that?!

Simply assign channels that you want routed to a subgroup by tapping them. Assigned channels illuminate blue by default, unless the default color is changed. Unassigned channels remain light gray.

The left side allows you to route the subgroup to the main L/R and assign it to VCAs, mute and view groups.

VCA's

The VCA's output routing view is a great way to assign multiple channels to a VCA. If only one or two channels need to be assigned, then the input routing view (pages 89-93) may be the way to go. The VCA's output routing default view will look something like the image shown below.

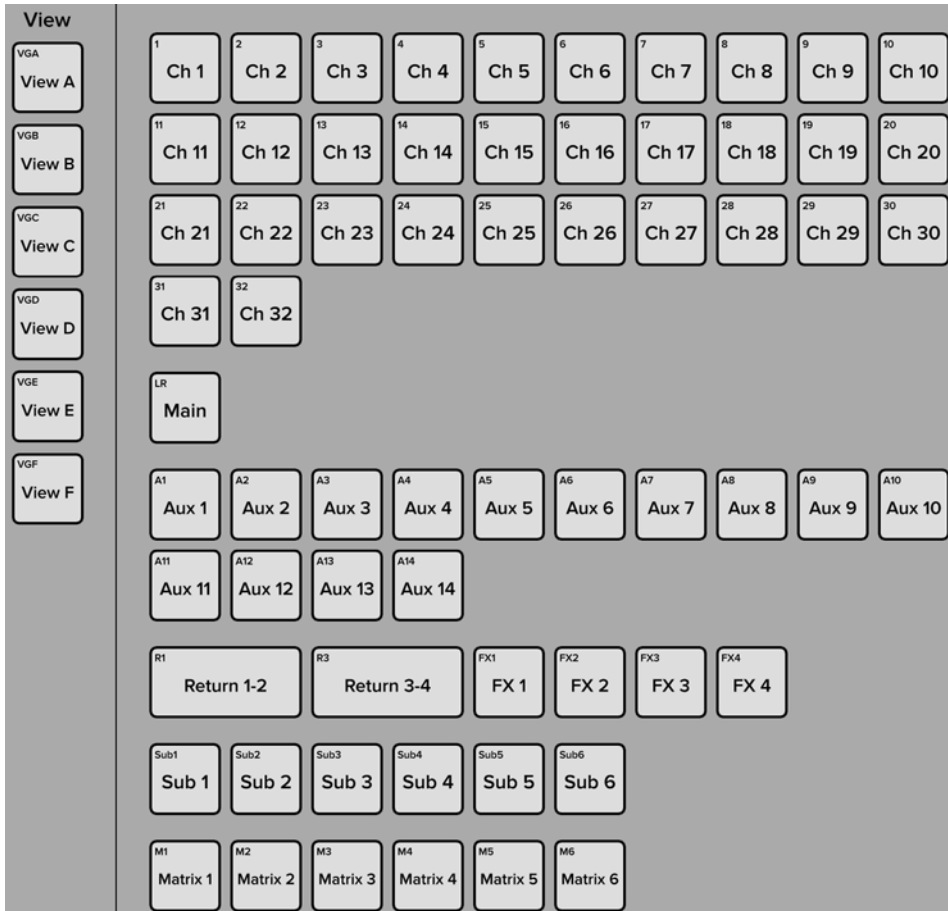

VCA's

Notice that everything is disengaged (light gray). This is the standard setup, but this is YOUR mixer and you get to choose what gets assigned and what doesn't.



The VCA's routing view on a DL16S, DL32S, DL806 and DL1608 look similar except for the following:

- (1) 16 input channels [DL16S and DL1608] and 8 input channels [DL806] (versus 32 on the DL32S and DL32R).
- (2) One linked iPad channel (versus one linked return channel on the DL16S and DL32S and two on the DL32R).
- (3) Two FX (versus four on the DL16S, DL32S and DL32R).
- (4) Four subgroups (versus six on the DL16S, DL32S and DL32R).
- (5) Four view groups (versus six of each on the DL16S, DL32S and DL32R).

Ok, let's start with the channel assignments. Channels may be assigned to VCA's via each channel's input routing view, but that could be time consuming if there are multiple channels per VCA. Instead, you could just tap a VCA's output routing view and assign multiple channels simultaneously. How cool is that?!

Simply assign channels that you want routed to a VCA by tapping them. Assigned channels illuminate green by default, unless the default color is changed. Unassigned channels remain light gray.

The left side allows you to assign the VCA to view groups.

Matrix [DL32R]

The matrix output routing tab is quite sparse. The only controls shown allow you to assign the matrix to VCAs and mute groups.



Matrix

Notice that everything is disengaged (light gray). This is the standard setup, but this is YOUR mixer and you get to choose what gets assigned and what doesn't.

Chapter 13 : Channel View : Output Parametric EQ

Introduction

The parametric equalizer is a great tool for dialing in the response for the room or to squelch feedback from monitors. The LR, auxes and matrices have up to 4-band EQ with high shelving, high-mid peaking, low-mid peaking and low shelving and a high-pass filter (HPF) and low-pass filter (LPF), both with selectable slopes. These outputs also have an RTA / spectrograph which allows you to see what you hear so you may easily locate and eliminate feedback and other anomalies, while seeing the EQ changes in real time.



The sub outs also have 4-band EQ, but they do not have a high-pass filter (HPF) or low-pass filter (LPF).



You can really upset things with too much EQ. Each EQ band has a lot of boost and cut because that is needed on occasion. But if the EQ is maxed on every channel, the mix turns to mush. Equalize subtly, using cut, as well as boost. If you find yourself repeatedly using a lot of boost or cut, consider altering the sound source, such as placing a mic differently, trying a different kind of mic, a different vocalist, changing the strings, gargling, or all of the above.

There are actually two different types of parametric EQ to choose from on each output: clean, surgical modern PEQ and classic sounding vintage PEQ. That's right, you can mix and match to heart's content! We will dissect both the modern and vintage PEQs separately, but let's begin by taking a peek at what features apply to both. Modern PEQ is discussed further on pages 125-131, while more information about the vintage PEQ may be found on pages 132-133.

Arrival is easy. Simply tap the graphic/parametric EQ curve at the top of the master fader channel from the mixer view or from any input channel view.

What's more, you don't have to decide between utilizing PEQ or GEQ...use one or the other or both simultaneously! This extra flexibility allows you to take advantage of each output EQ's strengths by choosing the right tool for the job. For example, if you prefer to fight feedback with the graphic EQ, you may continue to do so while also utilizing the parametric EQ for general tone shaping. Or perhaps you would rather use the parametric EQ to fight feedback and use the graphic EQ to tune the room? The parametric EQ looks and works similarly to that of the channel input EQ with just a couple of minor differences.



The default output EQ view may be changed in Tools > Settings > Default Output EQ View for even faster access. [See page 188 for more information].

EQ On / Off

The EQ on/off button – near the upper-left corner of the screen – allows for true bypass of the parametric EQ circuitry to ensure that there is no coloration of the signal if the parametric EQ is not needed. When this button is disengaged, the parametric EQ controls have no effect on the signal. You may use this button to make an A/B comparison between the EQ'd signal and the signal without parametric EQ. Press the EQ button to turn parametric EQ on or off. It will illuminate green when engaged and is gray when disengaged.

NOTE The HPF and LPF operate independently of the 4-band EQ. In other words, the EQ on/off button only affects the 4-band EQ. It will not turn the HPF or LPF on and off. This gives you more options and flexibility with the output parametric EQ.

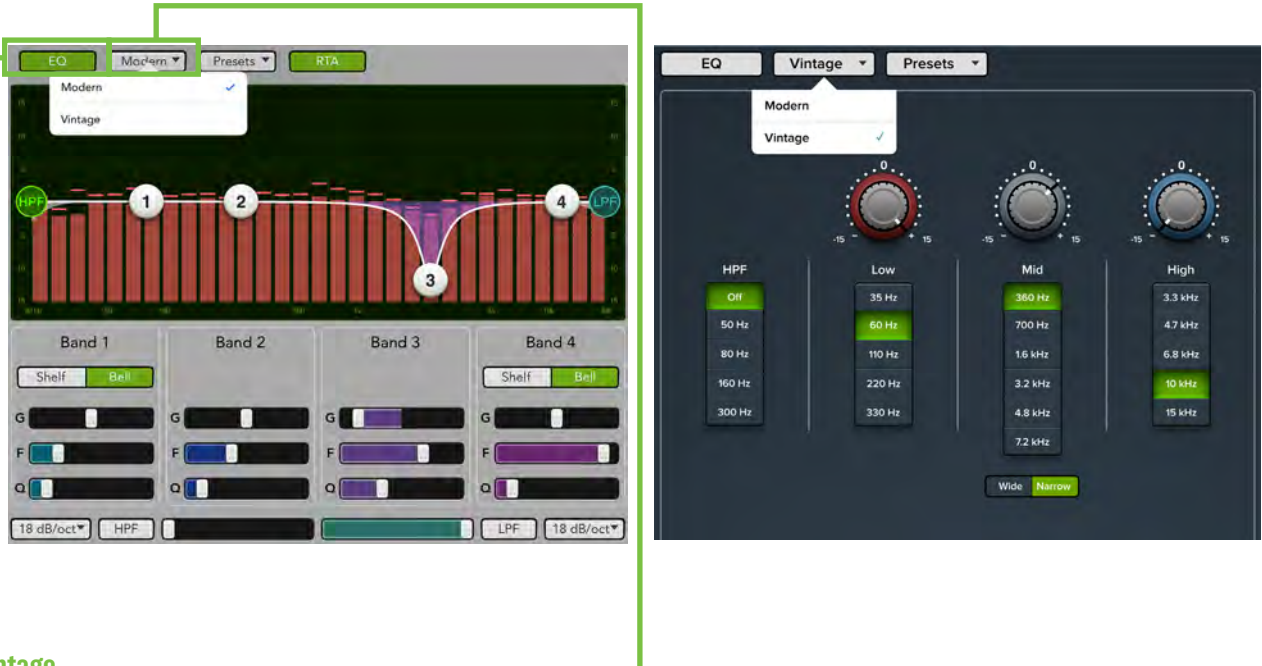

Modern / Vintage

The modern/vintage button is located directly to the right of the EQ on/off button. It displays the parametric EQ type currently in use, with “Modern” as the default EQ. Tap this button to reveal the two PEQ types, then tap the PEQ you would like for the selected channel. The image will change to reflect the PEQ type chosen.

NOTE You can switch between parametric EQ types while audio passes and the settings will match as closely as possible, but the sound will change.

Presets

Presets save parameters and may be recalled as needed. The mixer comes with a library of factory presets.

There are also user presets. These may be created for each preset type. The number of user presets available is limited only by the available space on the device.

An entire chapter is dedicated to presets. This includes detailed instructions and multiple screenshots every step of the way. Please check it out on pages 147-155.

Import / Export — Master Fader affords you the opportunity to import and export output parametric EQ presets. An entire chapter is dedicated to importing and exporting files. This includes detailed instructions and multiple screenshots every step of the way. Please check it out on pages 245-248.

RTA / Spectrograph

Directly to the right of presets is another button and pulldown menu. Here you're able to choose between using an RTA or a spectrograph. Make your selection and then press the button to turn it on or off. The button will illuminate green when engaged and is gray when disengaged.

RTA stands for "Real-Time Analyzer" and it measures and displays the sound of the corresponding output – amplitude versus frequency components of a continuous signal – via DSP.

A spectrograph, on the other hand, provides a 3-dimensional view of the outgoing signal: energy versus frequency versus time. It may be thought of as a record of multiple RTA spectrums taken over time, with color representing amplitude. When spectrograph is chosen, two vertically adjustable sliders appear on the left hand side of the EQ graph. These adjust the maximum [red] and minimum [blue] signal level shown in the spectrograph, ranging between 0 dBFS [top] and -60 dBFS [bottom].

An RTA / spectrograph allow you to see what you hear so you may easily locate and eliminate feedback and other anomalies, while seeing the EQ changes in real time.

Many audio signals are highly dynamic: music, speech and even environmental noise contain significant changes in spectral content as a function of time. With a digital mixer, musicians and sound engineers can save time setting up at shows by recalling previous settings. The RTA / spectrograph fits right in with that, literally displaying frequencies, shortening the time it takes to tune the main loudspeakers or stage monitors during setup in a new room.

With a digital mixer, musicians and sound engineers can save time setting up at shows by recalling previous settings. The RTA / spectrograph fits right in with that, literally displaying frequencies, shortening the time it takes to tune the main loudspeakers or stage monitors during setup in a new room.

NOTE The RTA is especially useful on a DL16S, DL32S and DL32R when used in conjunction with the built-in oscillator (page 197).

A screenshot of an RTA in action may be seen below. Some notes regarding this particular example:

- There are 31 bands on all DL Series RTAs.
- At the top of each RTA band is a single, solid horizontal line. This line indicates the peak hold of that band and will remain there until a new peak is reached.
- The EQ is flat, but the highs and lows are cut with both the HPF and LPF buttons engaged.
- Notice the RTA drops underneath EQ bands 1 and 4 that reflect the change in the PEQ. This indicates that the PEQ adjustment was seen by the RTA and should be audible in the acoustic environment, as well.

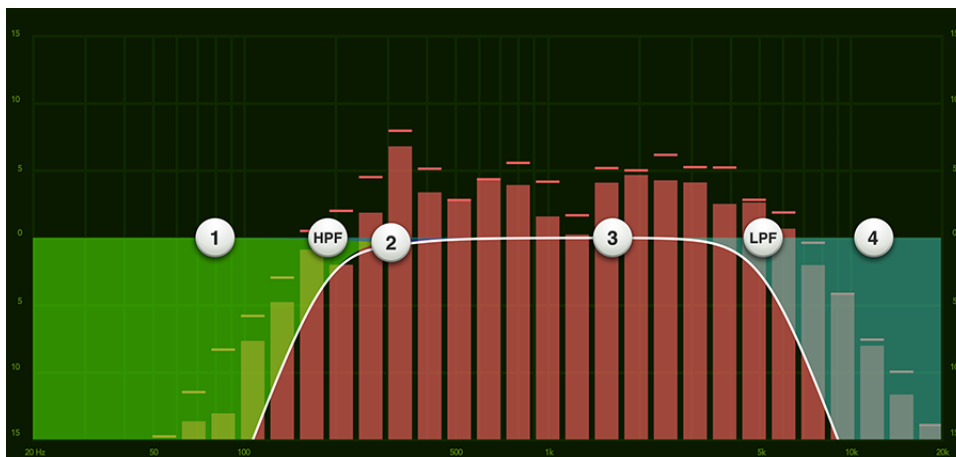

A screenshot of a spectrograph in action may be seen below. Some notes regarding this particular example:

- Each DL Series mixer features a spectrograph that provides visual feedback about the acoustic environment.
- The spectrograph may be overlaid on all input and output PEQs and GEQs, allowing you to see real-time EQ adjustments.
- The spectrograph represents audio signal strength – amplitude – by color and color intensity at a specific frequency. Darker colors such as blue or light blue will generally represent an audio signal with a lower strength – lower amplitude – while brighter more intense colors such as yellow and red represent a higher strength – higher amplitude – audio signal.
- Here, the maximum signal level [red slider] is set at -12 dBFS and the minimum signal level [blue slider] is set at -46 dBFS. These settings may be adjusted to determine the maximum and minimum signal level that will be visualized by the spectrograph.
- Band 2 has a -10 dB cut at 240 Hz which may be seen on the spectrograph as a narrow light blue line, indicating that the level has been cut at 240 Hz.
- Band 3 has a $+13$ dB boost at 2.5 kHz which may be seen on the spectrograph as a narrow red and yellow line, indicating that the level has been boosted at 2.5 kHz.

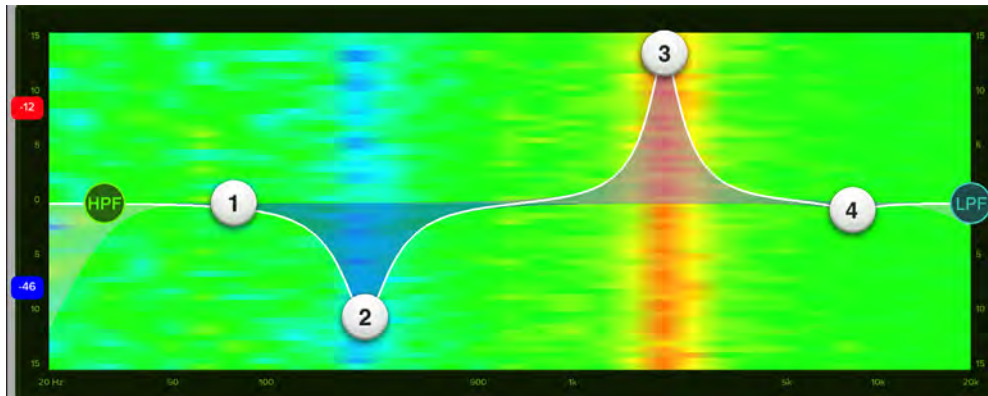

The RTA / spectrograph is available on all channel inputs and outputs. There is only one instance of the RTA implemented in the mixer. Therefore, only one channel can show the RTA or spectrograph at a time regardless of how many devices are connected.

By default, once the RTA or Spectrograph is enabled, it will automatically change to show the signal for the currently selected input channel or output mix. This is because the RTA Follow switch is in the ON position: Tools > Settings > RTA Follow > On



This works as expected if using a single device. However, you will (most likely) want to disable RTA Follow on devices that are added to the mix. With this setting off, it won't "steal" the RTA from the primary device as different outputs are selected on the other devices. It may sound a bit confusing at first, but helps if you remember that the RTA is being calculated in the mixer DSP, not the Master Fader software. To learn more about RTA Follow, see page 188.

NOTE The RTA / Spectrograph is only available when modern EQ is selected.

Modern PEQ Introduction

As mentioned previously, the modern EQ is designed for clean, surgical processing; it's great for dialing in a nice, tight sound. As such, each of the four bands has adjustable gain and frequency, while bands 2 and 3 also have adjustable Q (bandwidth). [Bands 1 and 4 also have adjustable Q (bandwidth) when in 'Bell' mode]. Bands 1 and 4 may be independently switched to shelving bands using the switches located between the EQ graph and band sliders. The shelves have adjustable gain and frequency, which is the -3 dB point from the shelf. Now for a detailed (let's say "surgical") look at the modern EQ.

Modern PEQ Swipe Zone

Here in the parametric EQ view, swipe anywhere in the gray area outlined below. Swiping up displays the graphic EQ. Swiping down displays the output routing view. Swiping left and right does nothing.

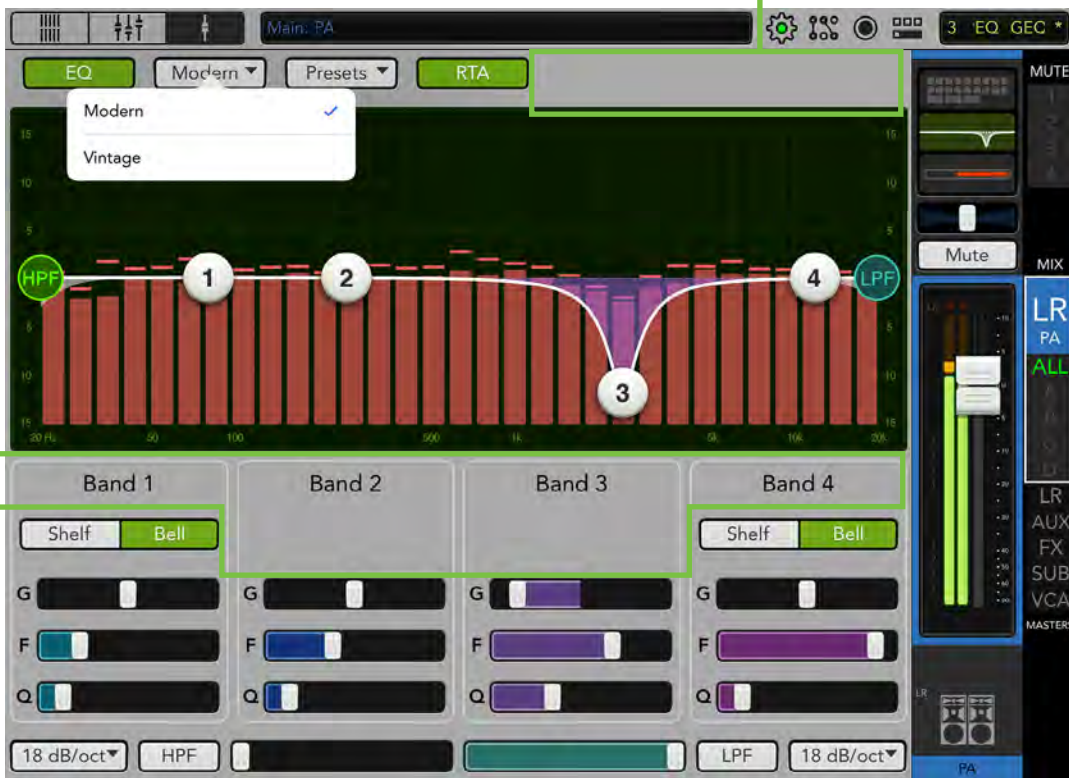

Modern PEQ Gain, Frequency and Q [Bandwidth]

The gain and frequency may be changed by moving any of the four numbered balls (representing each band) until the desired sound has been achieved. Moving a ball vertically changes the gain by up to ± 15 dB. Moving a ball horizontally changes the frequency, ranging from 20 Hz to 20 kHz. There is a Shelf / Bell option for bands 1 and 4 and it is described in detail on page 128. Q [bandwidth] is changed by pinching the ball. Narrow Q is great for fighting feedback. Double-tap an EQ ball to reset its gain to zero.

Low Shelving – Band 1

The low EQ provides up to 15 dB of boost or cut from 20 Hz to 20 kHz. This frequency represents the punch in bass drums, bass guitar, fat synth patches, and some really serious male singers who eat raw beef for breakfast.

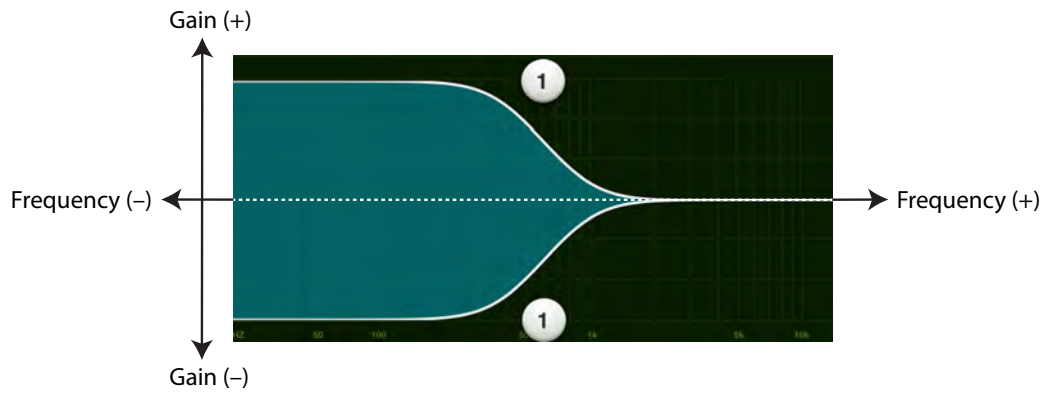

Low-Mid Peaking – Band 2

The low-mid EQ provides up to 15 dB of boost or cut from 20 Hz to 20 kHz. Frequencies affected typically include the male vocal range as well as the fundamentals and harmonics of many lower-timbred instruments.

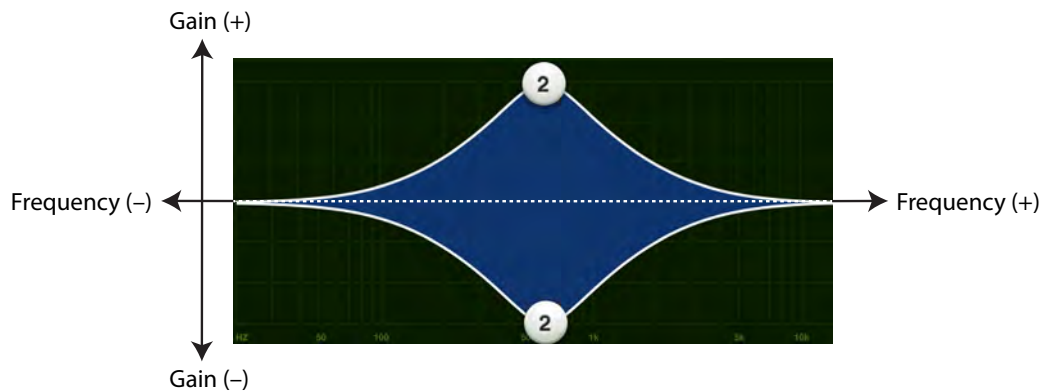

High-Mid Peaking – Band 3

The high-mid EQ provides up to 15 dB of boost or cut from 20 Hz to 20 kHz. Midrange EQ is often thought of as the most dynamic because the frequencies that define any particular sound are almost always found within this range. For example, the female vocal range as well as the fundamentals and harmonics of many higher-timbred instruments.

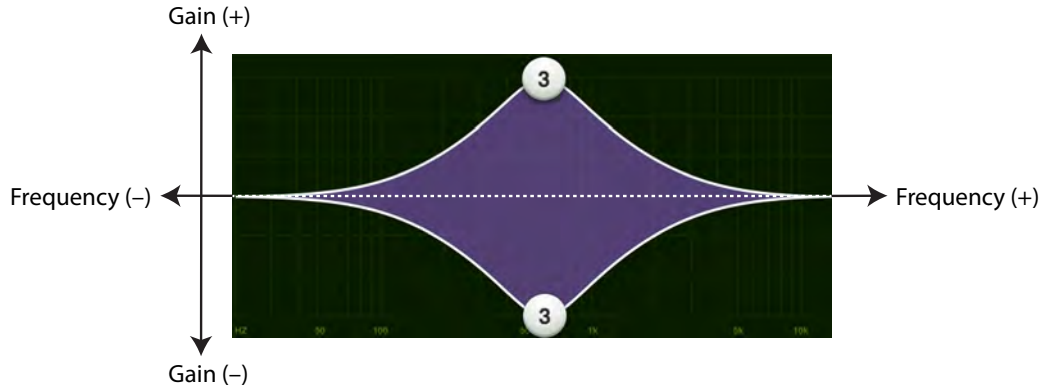

High Shelving – Band 4

The high EQ provides up to 15 dB of boost or cut from 20 Hz to 20 kHz. Use it to add sizzle to cymbals, an overall sense of transparency, or an edge to keyboards, vocals, guitar and bacon frying. Turn it down a little to reduce sibilance or harsh treble.

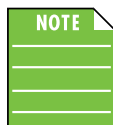
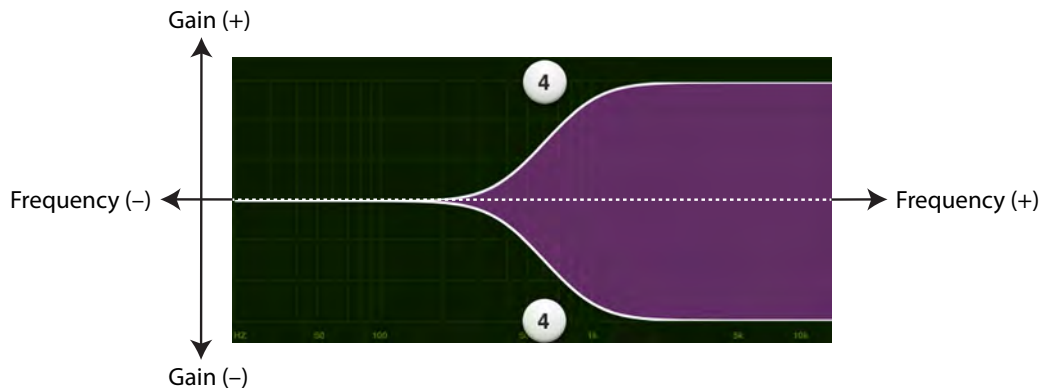

Although the Q control does adjust the bandwidth of a filter, the Q value itself is dimensionless; it has no unit of measurement. Some equalizers use the fractional bandwidth of the filter, measured in octaves, to express this parameter. The two parameters are inversely related; a high Q value corresponds to a small fractional bandwidth. The following table lists some equivalent Q and fractional bandwidth values.

Q	BW (oct)	Q	BW (oct)
0.7	2	2.871	1/2
1.414	1	4.318	1/3
2.145	2/3	15	1/10

Modern PEQ Shelf / Bell

A Shelf / Bell option is available on bands 1 and 4. Simply tap which setting you prefer. The chosen setting will illuminate green when engaged, while the other option will be grayed out.

When engaged, the EQ becomes a shelving filter rather than a parametric filter. Shelf boosts frequencies from the cut-off point upwards. A gentle roll-off may be assumed with shelf. The Q control becomes inactive when shelf is engaged.

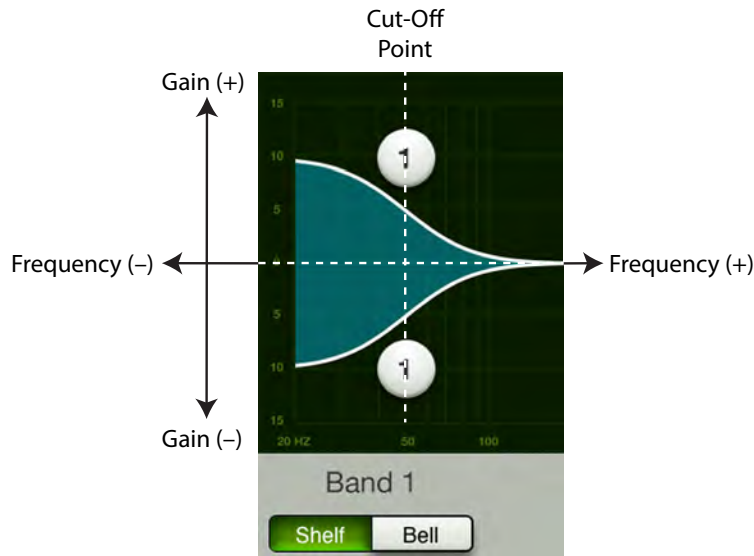

Shelf EQ

Bell boosts frequencies near the cut-off point then slowly decreases until it reaches a gain of zero. When engaged, the EQ becomes a parametric filter rather than a shelving filter. The Q control becomes active when bell is engaged. In fact, a smaller Q value results in a wider curve, while a larger Q value results in a narrower curve where frequencies may be zoomed in on more precisely. A smaller Q is generally intended for more musical purposes, while a larger Q is generally used when decreasing problem frequencies.

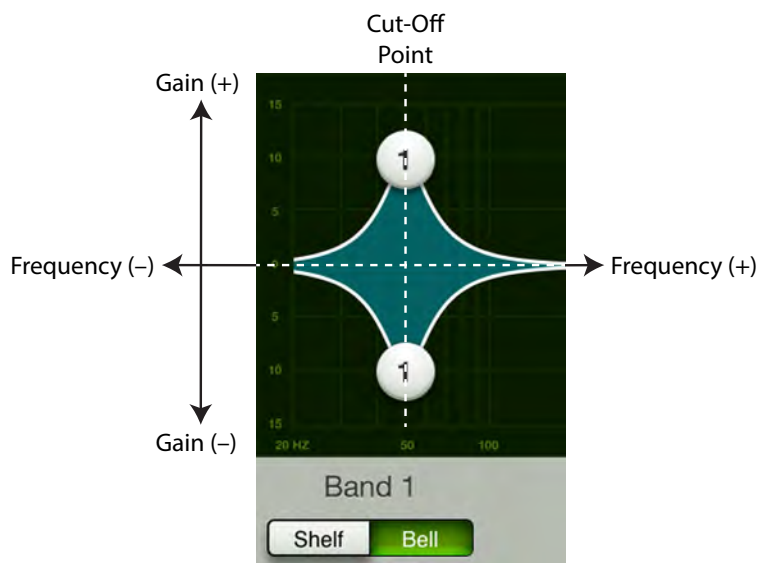

Bell EQ

Modern PEQ HPF On / Off, Frequency and Selectable Slope

High-pass filters are utilized to cut out low frequencies. For example, remove the low-frequency content from stage monitors. This helps the monitors cut through better for a clearer, crisper sound. Additionally, they are louder since fewer lows are being pushed through. The high-pass filter control adjusts the cut-off frequency for the filter. Frequencies below the cut-off frequency are attenuated at a rate of 12 dB/octave (default). The slope for the HPF is adjustable by sliding the HPF ball or HPF slider left and right. Simply tap the HPF button – near the lower-left corner of the screen – to engage the high-pass filter. It will illuminate green when engaged and is gray when disengaged. The slope for the HPF is adjustable by tapping the slope button and selecting the slope desired from the menu [6, 12, 18 and 24 dB/octave], allowing you to choose between a gentle slope or a steep one.

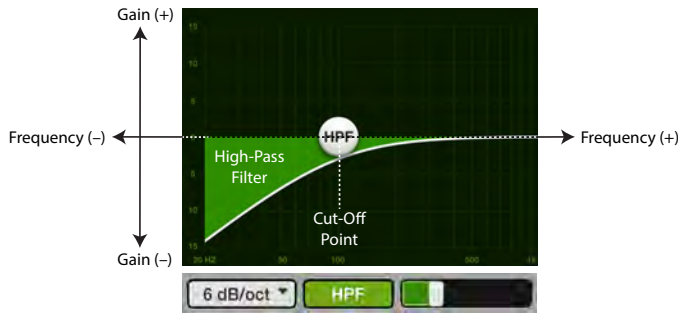

HPF ON at a 6 dB/oct slope

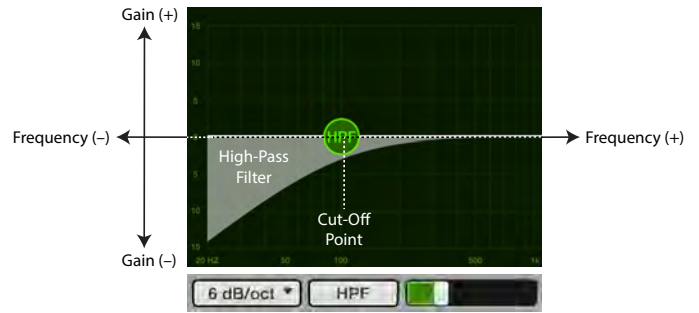

HPF OFF at a 6 dB/oct slope

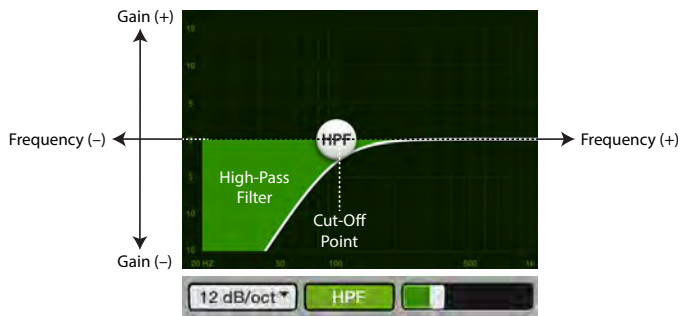

HPF ON at a 12 dB/oct slope

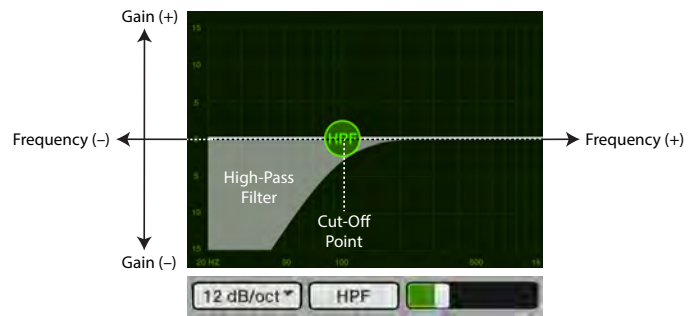

HPF OFF at a 12 dB/oct slope

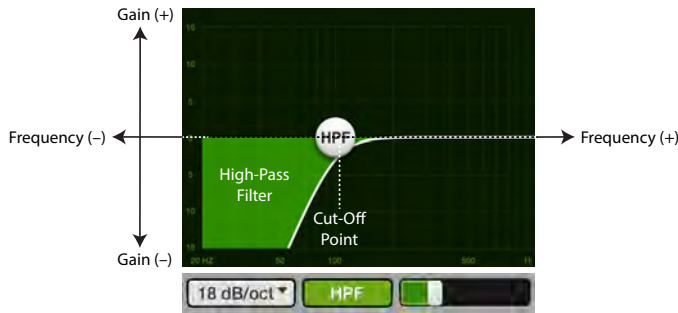

HPF ON at a 18 dB/oct slope

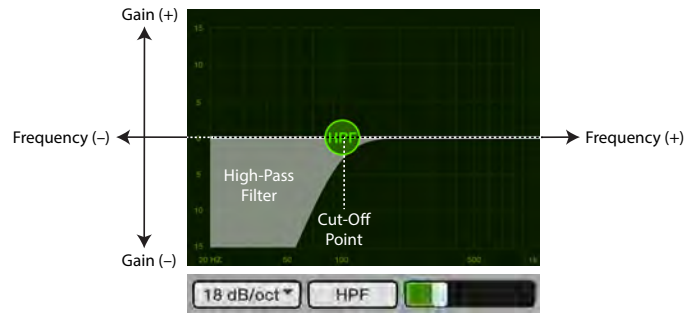

HPF OFF at a 18 dB/oct slope

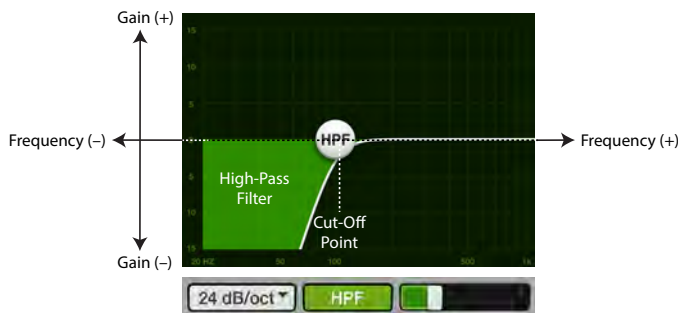

HPF ON at a 24 dB/oct slope

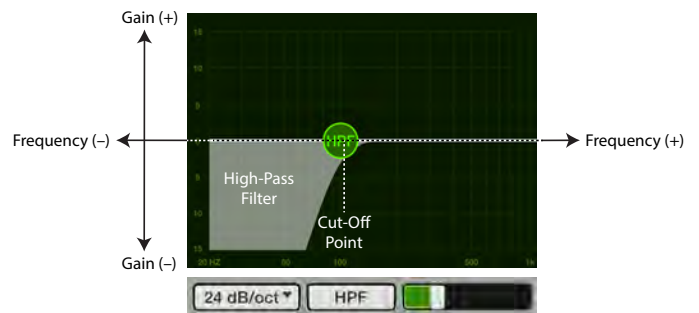

HPF OFF at a 24 dB/oct slope

Modern PEQ LPF On / Off, Frequency and Selectable Slope

Low-pass filters are utilized to cut out high frequencies. For example, remove the high-frequency content from subwoofer feeds. Why send subwoofers material they are not designed to reproduce? The low-pass filter control adjusts the cut-off frequency for the filter. Frequencies above the cut-off frequency are attenuated at a rate of 12 dB/octave (default). The slope for the LPF is adjustable by sliding the LPF ball or LPF slider left and right. Simply tap the LPF button – near the lower-right corner of the screen – to engage the low-pass filter. It will illuminate green when engaged and is gray when disengaged. The slope for the LPF is adjustable by tapping the slope button and selecting the slope desired from the menu [6, 12, 18 and 24 dB/octave], allowing you to choose between a gentle slope or a steep one.

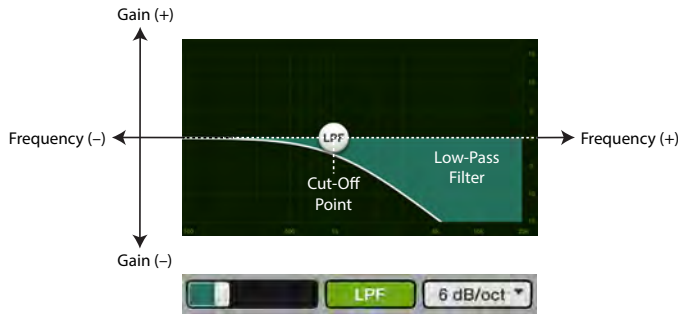

LPF ON at a 6 dB/oct slope

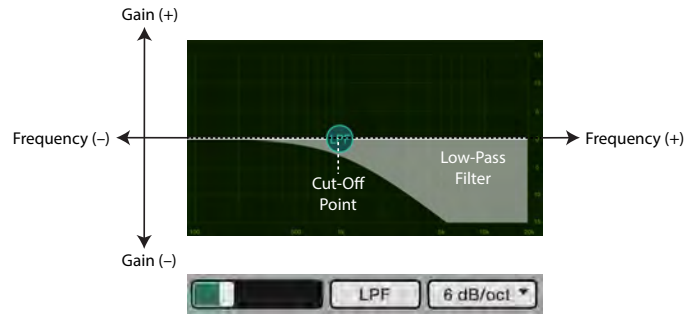

LPF OFF at a 6 dB/oct slope

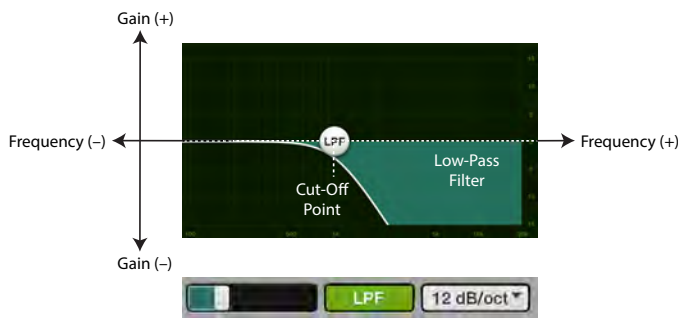

LPF ON at a 12 dB/oct slope

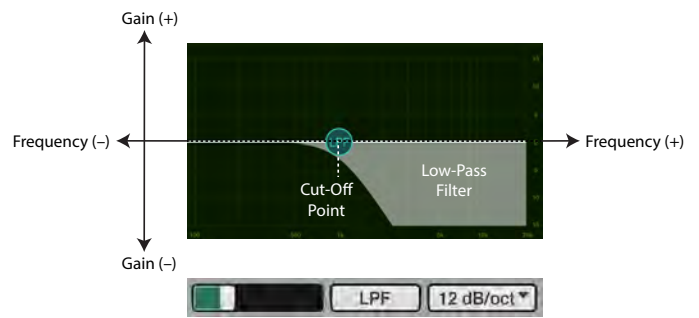

LPF OFF at a 12 dB/oct slope

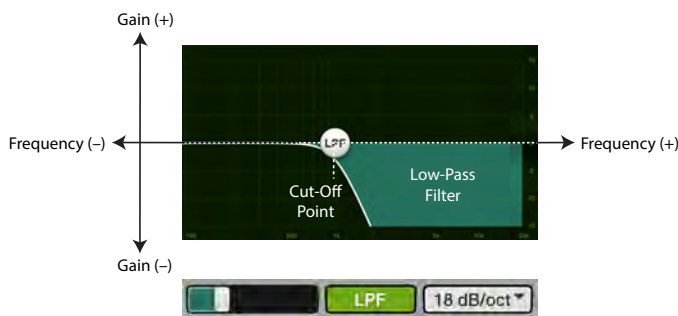

LPF ON at a 18 dB/oct slope

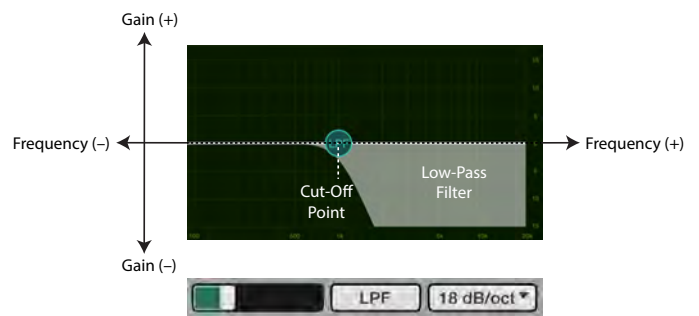

LPF OFF at a 18 dB/oct slope

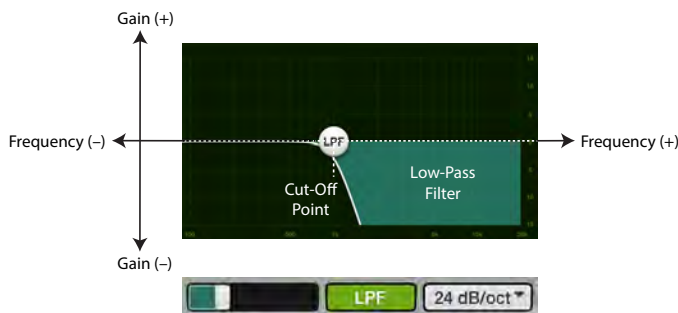

LPF ON at a 24 dB/oct slope

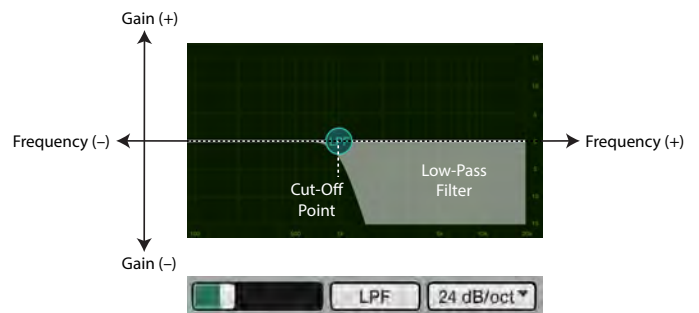

LPF OFF at a 24 dB/oct slope

Modern PEQ at a Glance

Parameter	Low Value Limit	High Value Limit	Default
HPF Enable	Off	On	Off
HPF Frequency	20 Hz	20 kHz	20 Hz
HPF Slope	Off • 6 dB/oct • 12 dB/oct • 18 dB/oct • 24 dB/oct		18 dB/octave
EQ Enable	Off	On	On
High Band Type	Parametric	Shelf	Bell
Low Band Type	Parametric	Shelf	Bell
High Gain	-15 dB	+15 dB	0 dB
High Freq	20 Hz	20 kHz	12 kHz
High Q / Shelf Slope	0.5	16	2
High Mid Gain	-15 dB	+15 dB	0 dB
High Mid Freq	20 Hz	20 kHz	2 kHz
High Mid Q	0.5	16	2
Low Mid Gain	-15 dB	+15 dB	0 dB
Low Mid Freq	20 Hz	20 kHz	250 Hz
Low Mid Q	0.5	16	2
Low Gain	-15 dB	+15 dB	0 dB
Low Freq	20 Hz	20 kHz	80 Hz
Low Q / Shelf Slope	0.5	16	2
LPF Enable	Off	On	Off
LPF Frequency	20 Hz	20 kHz	20 kHz
LPF Slope	Off • 6 dB/oct • 12 dB/oct • 18 dB/oct • 24 dB/oct		18 dB/octave

Vintage PEQ Introduction

Many of our audio engineer friends and other pro audio gear heads yearn for the ease of use and sound of yesteryear. That's right, the vintage EQ was created with you in mind...but every user will love using it! It meticulously recreates the feel and sound of EQ of classic consoles. The vintage EQ captures the unique interactions between the shelving bands and the gain and frequency-dependent Q structure of the parametric band to deliver the clarity and sheen of classic EQ designs. The vintage EQ is great for shaping the general tone of the output while the graphic EQ fights off feedback. The screenshot below displays the default vintage EQ settings. Let's take a look at each of the selections starting on the left with the HPF and working our way right to the high EQ.

Vintage PEQ Swipe Zone

Here in the vintage parametric EQ view, swipe anywhere in the gray area outlined below. Swiping up displays the graphic EQ. Swiping down displays the output routing view. Swiping left and right does nothing.



Vintage PEQ HPF Frequency Buttons

High-pass filters are utilized to cut out low frequencies. The high-pass filter control adjusts the cut-off frequency for the filter. Frequencies below the cut-off frequency are attenuated at a rate of 18 dB/octave. The slope of the HPF is engaged by tapping any frequency button other than "Off". The current selection will illuminate green.

Vintage PEQ Gain and Frequency

The gain for each EQ band may be changed by dragging up [increases gain] and down [decreases gain] over the knob until the desired gain has been achieved. The gain may be changed by approximately ± 15 dB...it's vintage, so nothing is exact! Double-tap a gain knob to reset its gain to zero. Each EQ band here has a vertical row of frequency buttons located underneath its gain knob. Simply tap the frequency button you desire for each band. The frequency ranges from 35 Hz to 15 kHz. The gain (but not the frequency) may also be manually entered via the current parameter display.

Low

The low EQ provides approximately 15 dB of boost or cut from 35 Hz to 330 Hz. This frequency represents the punch in bass drums, bass guitar, fat synth patches, and some really serious male singers who eat raw beef for breakfast.

Mid

The mid EQ provides approximately 15 dB of boost or cut from 360 Hz to 7.2 kHz. Frequencies affected typically include guitar, piano and the fundamentals and harmonics of many instruments.

Wide / Narrow

Below the mid EQ vertical frequency strip is a wide / narrow button. Generally speaking, wide is used for broad tone-shaping while narrow is more precise. Select what you would prefer the mid frequency Q [bandwidth] to sound like.

High

The high EQ provides approximately 15 dB of boost or cut from 3.3 kHz to 15 kHz. Use it to add sizzle to cymbals, an overall sense of transparency, or an edge to keyboards, vocals, guitar and bacon frying. Select a lower frequency to reduce sibilance or harsh treble.

Vintage PEQ at a Glance

Parameter	Low Value Limit	High Value Limit	Default
HPF Enable	Off	On	On
HPF Frequency	Off • 50 Hz • 80 Hz • 160 Hz • 300 Hz		Off
EQ Enable	Off	On	On
High Shelf Gain	-15 dB	+15 dB	0 dB
High Shelf Freq	3.3 kHz • 4.7 kHz • 6.8 kHz • 10 kHz • 15 kHz		10 kHz
Mid Gain	-15 dB	+15 dB	0 dB
Mid Freq	360 Hz • 700 Hz • 1.6 kHz • 3.2 kHz • 4.8 kHz • 7.2 kHz		360 Hz
Mid Q	Wide	Narrow	Narrow
Low Shelf Gain	-15 dB	+15 dB	0 dB
Low Shelf Freq	35 Hz • 60 Hz • 110 Hz • 220 Hz • 330 Hz		60 Hz

Chapter 14 : Channel View : Output Graphic EQ

Introduction

Graphic EQ is a great tool for really dialing in the response needed for a room or to squelch feedback from monitors. Arrival is easy. Simply tap the graphic/parametric EQ curve at the top of the master fader channel from the mixer view or from any input channel view.

What's more, you don't have to decide between utilizing GEQ or PEQ...use one or the other or both simultaneously! This extra flexibility allows you to take advantage of each output EQ's strengths by choosing the right tool for the job. For example, if you prefer to fight feedback with the graphic EQ, you may continue to do so while also utilizing the parametric EQ for general tone shaping. Or perhaps you would rather use the parametric EQ to fight feedback and use the graphic EQ to tune the room? The graphic EQ looks and works similarly to that of a typical 31-band graphic EQ.



The default output EQ view may be changed in Tools > Settings > Default Output EQ View for even faster access. [See page 188 for more information].

The Swipe Zone

Here in the graphic EQ view, swipe anywhere in the gray area outlined below. Swiping up displays the output compressor / delay view. Swiping down displays the parametric EQ. Swiping left and right does nothing.



Graphic EQ On / Off

The graphic EQ button is located near the upper-left corner of the screen. This allows for true bypass of the graphic EQ circuitry to ensure that there is no coloration of the signal if the graphic EQ is not needed. When this button is disengaged, the graphic EQ controls have no effect on the signal. You may use this button to make an A/B comparison between the EQ'd signal and the signal without graphic EQ. Press the graphic EQ button to turn graphic EQ on or off. It will illuminate green when engaged and is gray when disengaged.

Presets

Presets save parameters and may be recalled as needed. The mixer comes with a library of factory presets.

There are also user presets. These may be created for each preset type. The number of user presets available is limited only by the available space on the device.

An entire chapter is dedicated to presets. This includes detailed instructions and multiple screenshots every step of the way. Please check it out on pages 147-155.

Import / Export — Master Fader affords you the opportunity to import and export graphic EQ presets. An entire chapter is dedicated to importing and exporting files. This includes detailed instructions and multiple screenshots every step of the way. Please check it out on pages 245-248.

RTA / Spectrograph

Directly to the right of presets is another button and pulldown menu. Here you're able to choose between using an RTA or a spectrograph. Make your selection and then press the button to turn it on or off. The button will illuminate green when engaged and is gray when disengaged.

RTA stands for "Real-Time Analyzer" and it measures and displays the sound of the corresponding output – amplitude versus frequency components of a continuous signal – via DSP.

A spectrograph, on the other hand, provides a 3-dimensional view of the outgoing signal: energy versus frequency versus time. It may be thought of as a record of multiple RTA spectrums taken over time, with color representing amplitude. When spectrograph is chosen, two vertically adjustable sliders appear on the left hand side of the EQ graph. These adjust the maximum [red] and minimum [blue] signal level shown in the spectrograph, ranging between 0 dBFS [top] and -60 dBFS [bottom].

An RTA / spectrograph allow you to see what you hear so you may easily locate and eliminate feedback and other anomalies, while seeing the EQ changes in real time.

Many audio signals are highly dynamic: music, speech and even environmental noise contain significant changes in spectral content as a function of time. With a digital mixer, musicians and sound engineers can save time setting up at shows by recalling previous settings. The RTA / spectrograph fits right in with that, literally displaying frequencies, shortening the time it takes to tune the main loudspeakers or stage monitors during setup in a new room. With a digital mixer, musicians and sound engineers can save time setting up at shows by recalling previous settings.



The RTA is especially useful on a DL16S, DL32S and DL32R when used in conjunction with the built-in oscillator (page 197).

A screenshot of an RTA in action may be seen below. Some notes regarding this particular example:

- There are 31 bands on all DL Series RTAs.
- At the top of each RTA band is a single, solid horizontal line. This line indicates the peak hold of that band and will remain there until a new peak is reached.
- The mids are scooped.
- Notice the RTA drop near the scooped mids to reflect the change in the GEQ. This indicates that the GEQ adjustment was seen by the RTA and should be audible in the acoustic environment, as well.

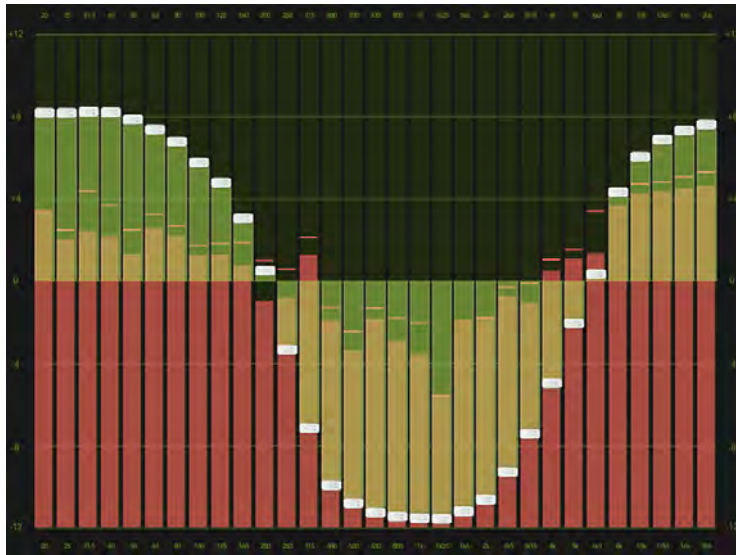

Another screenshot of an RTA in action may be seen below. Some notes regarding this particular example:

- A 1 kHz signal is routed to the channel 1 input via the built-in oscillator (page 197).
- The EQ is completely flat except for the notch at 1 kHz.
- Sending pink or white noise is most common, but you also have the option of simply sending a 100 Hz, 1 kHz or 10 kHz signal...and if that's not enough, there's a variable option where you may set the frequency anywhere from 20 Hz to 20 kHz!

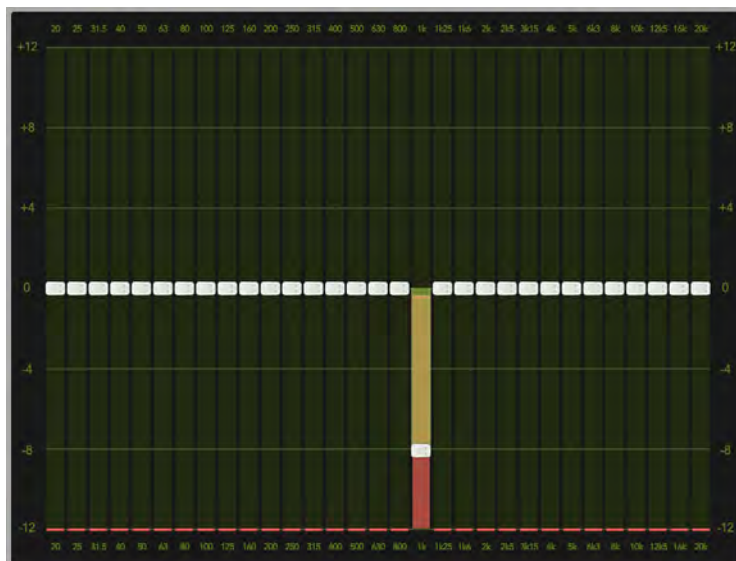

A screenshot of a spectrograph in action may be seen below. Some notes regarding this particular example:

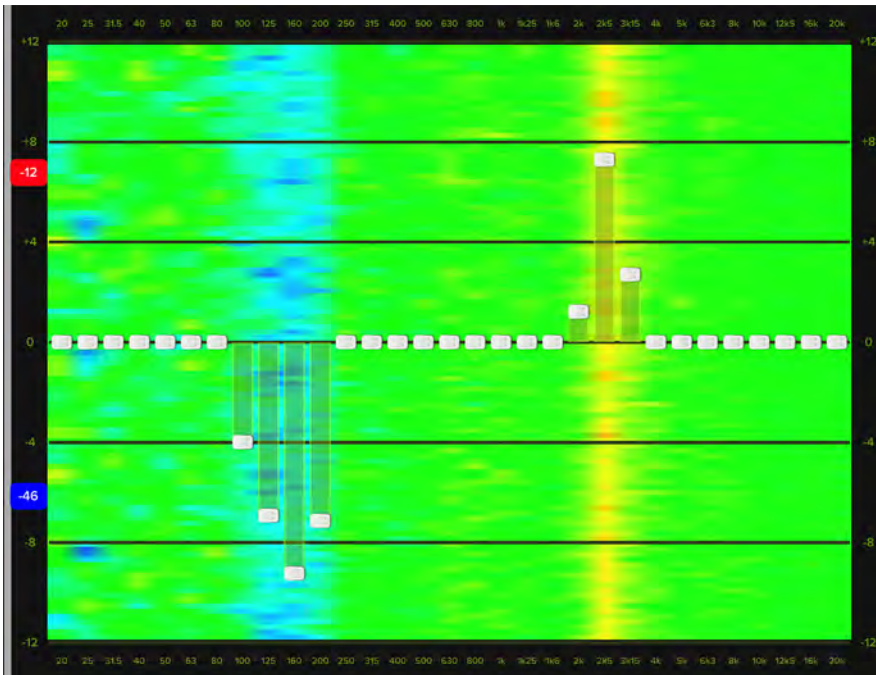

- Each DL Series mixer features a spectrograph that provides visual feedback about the acoustic environment.
- The spectrograph may be overlaid on all input and output PEQs and GEQs, allowing you to see real-time EQ adjustments.
- The spectrograph represents audio signal strength – amplitude – by color and color intensity at a specific frequency. Darker colors such as blue or light blue will generally represent an audio signal with a lower strength – lower amplitude – while brighter more intense colors such as yellow and red represent a higher strength – higher amplitude – audio signal.
- Here, the maximum signal level [red slider] is set at -12 dBFS and the minimum signal level [blue slider] is set at -46 dBFS. These settings may be adjusted to determine the maximum and minimum signal level that will be visualized by the spectrograph.
- There is a -4 dB to -9 dB cut on the 100 Hz, 125 Hz, 160 Hz and 200 Hz sliders which may be seen on the spectrograph as a faint narrow light blue line, indicating that these levels have been cut at these frequencies.
- The boosts on the 2k, 2k5 and 3k15 sliders may be seen on the spectrograph as a narrow red and yellow line, indicating that these levels has been boosted at these frequencies.

The RTA / spectrograph is available on all channel inputs and outputs. There is only one instance of the RTA implemented in the mixer. Therefore, only one channel can show the RTA or spectrograph at a time regardless of how many devices are connected.

By default, once the RTA or Spectrograph is enabled, it will automatically change to show the signal for the currently selected input channel or output mix. This is because the RTA Follow switch is in the ON position: Tools > Settings > RTA Follow > On



This works as expected if using a single device. However, you will (most likely) want to disable RTA Follow on devices that are added to the mix. With this setting off, it won't "steal" the RTA from the primary device as different outputs are selected on the other devices. It may sound a bit confusing at first, but helps if you remember that the RTA is being calculated in the mixer DSP, not the Master Fader software. To learn more about RTA Follow, see page 188.

31-Band EQ

There are 31 graphic EQ sliders ranging from 20 Hz to 20 kHz. Moving a slider vertically changes that frequency's gain by up to ± 12 dB. Drag these sliders up or down until the desired sound has been achieved. Tapping a band's graphic EQ slider twice will zero it.

2X

The 2X button is located near the upper-right corner of the screen, just left of the draw button. This allows you to zoom in on the graphic EQ, perfect for our friends with sausage fingers and/or mixing with a small tablet. Swipe left and right to view and adjust the remaining bands.

Press the 2X button to turn the 2X zoom function on or off. It will illuminate green when engaged (as seen below) and is gray when disengaged (as seen four pages ago). Note that draw (detailed below) is unavailable when in 2X mode (as seen below).

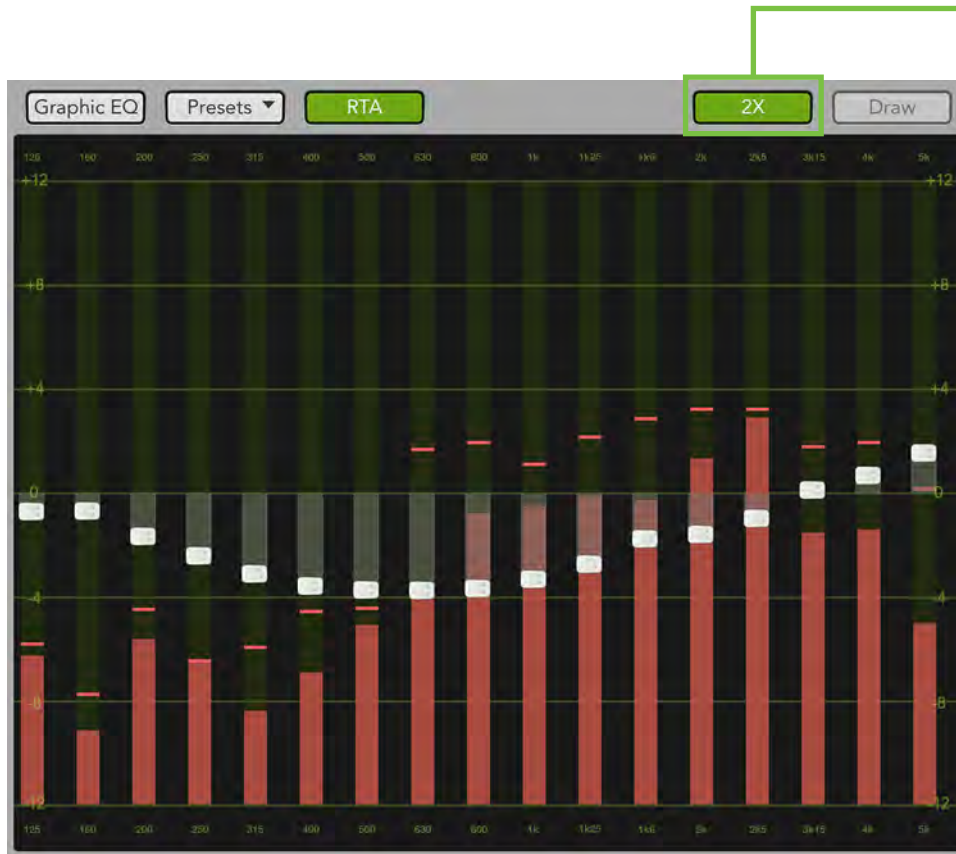

Draw

The draw button is located near the upper-right corner of the screen. This allows you to draw an EQ curve over the display (regardless of where the slider balls currently reside) and the sliders will snap to the corresponding position.

Engage draw to quickly create a basic GEQ outline, then disengage draw to fine-tune any of the 31 bands one-by-one, as needed.

Press the draw button to turn the draw function on or off. It will illuminate green when engaged (as seen four pages ago) and is gray when disengaged. Note that draw is unavailable when in 2X mode (as seen above).

Graphic EQ at a Glance

Parameter	Low Value	High Value	Default
GEQ ENABLE	OFF	ON	OFF
20 Hz Gain	-12 dB	12 dB	0 dB
25 Hz Gain	-12 dB	12 dB	0 dB
31.5 Hz Gain	-12 dB	12 dB	0 dB
40 Hz Gain	-12 dB	12 dB	0 dB
50 Hz Gain	-12 dB	12 dB	0 dB
63 Hz Gain	-12 dB	12 dB	0 dB
80 Hz Gain	-12 dB	12 dB	0 dB
100 Hz Gain	-12 dB	12 dB	0 dB
125 Hz Gain	-12 dB	12 dB	0 dB
160 Hz Gain	-12 dB	12 dB	0 dB
200 Hz Gain	-12 dB	12 dB	0 dB
250 Hz Gain	-12 dB	12 dB	0 dB
315 Hz Gain	-12 dB	12 dB	0 dB
400 Hz Gain	-12 dB	12 dB	0 dB
500 Hz Gain	-12 dB	12 dB	0 dB
630 Hz Gain	-12 dB	12 dB	0 dB
800 Hz Gain	-12 dB	12 dB	0 dB
1 kHz Gain	-12 dB	12 dB	0 dB
1.25 kHz Gain	-12 dB	12 dB	0 dB
1.6 kHz Gain	-12 dB	12 dB	0 dB
2 kHz Gain	-12 dB	12 dB	0 dB
2.5 kHz Gain	-12 dB	12 dB	0 dB
3.15 kHz Gain	-12 dB	12 dB	0 dB
4 kHz Gain	-12 dB	12 dB	0 dB
5 kHz Gain	-12 dB	12 dB	0 dB
6.3 kHz Gain	-12 dB	12 dB	0 dB
8 kHz Gain	-12 dB	12 dB	0 dB
10 kHz Gain	-12 dB	12 dB	0 dB
12.5 kHz Gain	-12 dB	12 dB	0 dB
16 kHz Gain	-12 dB	12 dB	0 dB
20 kHz Gain	-12 dB	12 dB	0 dB
Master	-12 dB	12 dB	0 dB

Chapter 15 : Channel View : Output Compressor / Limiter / Delay

Introduction

The output compressor / limiter looks and functions similar to that of the channel compressor, except the output compressor / limiter affects and alters the sound of everything passing through the selected output.

Compressors are used to reduce or limit transient peaks in a signal. If the signal is too hot, turn it down, otherwise leave it alone. As the input level to the compressor increases, the output level increases linearly until the threshold point is reached. After that point, the output level no longer increases linearly. Instead, it increases at a reduced rate determined by the ratio setting.

With limiters, signals below a specified input level are allowed to pass unaffected while attenuating the peaks of stronger signals that exceed the input levels.

The attack and release controls affect the rate of the gain change; attack affects the rate of the onset of gain reduction and release affects the recovery rate once the transient has passed.

For stereo linked outputs, the gain reduction is applied equally to both the left and right side.

There are actually two different types of output compressor / limiters to choose from on each channel: the clean, surgical modern output compressor / limiter and classic sounding vintage output compressor / limiter. That's right, you can mix and match to heart's content! We will dissect both the modern and vintage output compressor / limiter separately, but let's begin by taking a peek at what features apply to both. The modern output compressor / limiter is discussed further on pages 142-143, while more information about the vintage output compressor / limiter may be found on pages 144-145.

Output Compressor / Limiter On / Off

Press the Comp button to turn the compressor on or off. It will illuminate green when engaged and is gray when disengaged. Notice the input and output meters below, as well. There is mono metering on unlinked auxes and stereo metering on the LR and linked aux outputs.

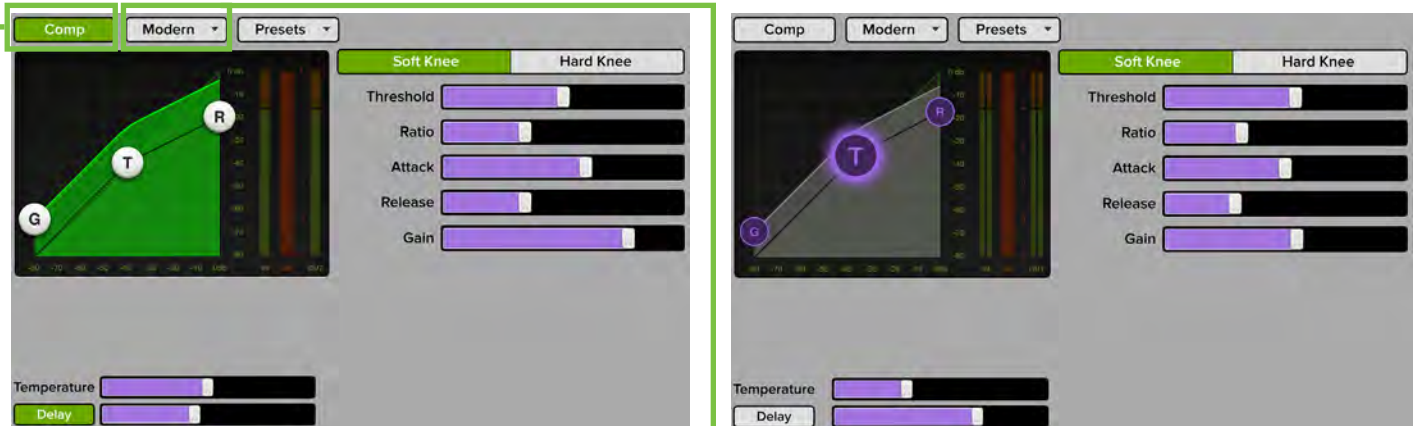

Modern / Vintage

The modern / vintage button is located directly to the right of the comp on / off button. It displays the compressor type currently in use, with “Modern” as the default. Tap this button to reveal the two compressor types, then tap the compressor you would like. The image will change to reflect the compressor type chosen.

Presets

Presets save parameters and may be recalled as needed. The mixer comes with a library of factory presets. There are also user presets. These may be created for each preset type. The number of user presets available is limited only by the available space on the device. An entire chapter is dedicated to presets. This includes detailed instructions and multiple screenshots every step of the way. Please check it out on pages 147-155.

Import / Export — Master Fader affords you the opportunity to import and export output compressor / limiter presets. An entire chapter is dedicated to importing and exporting files. This includes detailed instructions and multiple screenshots every step of the way. Please check it out on pages 245-248.

Modern Output Compressor / Limiter Introduction

As mentioned previously, the modern output compressor / limiter is designed for clean, surgical processing; it's great for dialing in a nice, tight sound. As such, the attack, release and ratio features may be fine-tuned when the modern output compressor / limiter is utilized. Now for a detailed (let's say "surgical") look at the modern output compressor / limiter.

Modern Output Compressor / Limiter Swipe Zone

Here in the output compressor / limiter view, swipe anywhere in the gray areas outlined below. Swiping up displays the parametric EQ. Swiping down displays the output compressor / limiter view. Swiping left and right does nothing. See page 144 for the Swipe Zone of the Vintage Output Compressor / Limiter view.



Modern Output Compressor / Limiter Display and Settings

The output compressor for each selected output may be adjusted by moving the gain, threshold and ratio balls or moving any of the five sliders left and right. Additionally, exact settings may be entered into the current parameter display. The output compressor may be adjusted whether the output compressor is on or off. There is no output compressor for the FX outputs.

Threshold — Threshold sets the threshold of the compressor in dB below 0 dBFS. The range of the threshold setting varies from -80 dBFS to 0 dBFS.

Ratio — Ratio sets the amount of gain reduction applied as the signal exceeds the threshold level. The range of the ratio of the compressor varies from 1:1 to inf:1.

Attack — Attack determines how quickly the compressor reacts once the signal is above threshold. Short attack times allow compressing on short transients, while longer attack times cause these transients to be ignored. The range of the attack time varies from 0.1 ms to 300 ms.

Release — Release determines how long it takes for the compressor to end gain reduction once the signal drops back below the threshold. The range of the release speed varies from 50 ms to 3 seconds.

Gain — Gain adds make-up gain to the output of the compressor. This is useful to make the apparent volume of the signal the same with the compressor in and out of the signal chain. The range of the make-up gain varies from 0 dB to 20 dB.

Soft Knee / Hard Knee Compression

This switch sets the shape of the gain reduction curve at the threshold level. When set to hard, the gain reduction curve changes abruptly at the threshold level. When set to soft, the gain reduction curve changes gently as it transitions to the final ratio amount.

Modern Output Compressor / Limiter Meters

These three meters show the input level, amount of gain reduction and output level. The input and output meters range from -80 dBFS to 0 dBFS. The reduction meter ranges from 0 to 20 dB. Mono metering is displayed for inputs and outputs on unlinked auxes and stereo metering is displayed for inputs and outputs on linked auxes.

Vintage Output Compressor / Limiter Introduction

Many of our audio engineer friends and other pro audio gear heads yearn for the ease of use and sound of yesteryear. That's right, the vintage output compressor / limiter was created with you in mind...but every user will love using it! It meticulously recreates the feel and sound of output compressor / limiters of classic consoles. The vintage output compressor / limiter provides a lightning-fast attack, non-linear attack / release and program dependent release.



Dynamics may be dialed in on each channel, but the output compressor / limiter will change the sound of the entire output. It's best to switch between the modern and vintage output compressor / limiter settings and use the one that sounds best to your ears.

Vintage Output Compressor / Limiter Swipe Zone

Here in the output compressor / limiter view, swipe anywhere in the dark gray areas outlined below. Swiping up displays the output routing. Swiping down displays the Graphic EQ. Swiping left and right does nothing. See page 142 for the Swipe Zone of the Modern Output Compressor / Limiter view.



Vintage Output Compressor / Limiter Display and Settings

Each channel's threshold and gain levels may be changed by dragging up [increases level] and down [decreases level] over their respective knobs until the desired level has been achieved. To the right are three horizontal rows of buttons for the attack, release and ratio. Simply tap the button you desire for the attack, release and ratio. The current selection will illuminate green. The threshold and gain settings (but not the attack, release and ratio settings) may also be manually entered via the current parameter display. The compressor may be adjusted whether the compressor is on or off.

Threshold — Threshold sets the threshold of the compressor in dB below 0 dBFS. The range of the threshold setting varies from -80 dBFS to 0 dBFS.

Gain — Gain adds make-up gain to the output of the compressor. This is useful to make the apparent volume of the signal the same with the compressor in and out of the signal chain. The range of the make-up gain varies from 0 dB to 20 dB.

Attack — Attack determines how quickly the compressor reacts once the signal is above threshold. Short attack times allow compressing on short transients, while longer attack times cause these transients to be ignored. Choose between a fast, medium or slow attack time.

Release — Release determines how long it takes for the compressor to end gain reduction once the signal drops back below the threshold. Choose between a fast, medium or slow release time.

Ratio — Ratio sets the amount of gain reduction applied as the signal exceeds the threshold level. Choose between 2:1, 4:1, 8:1, 12:1 and 20:1.

Vintage Output Compressor / Limiter VU Meter

To complete the classic look, the vintage output compressor / limiter is outfitted with a VU meter. What's more, underneath the VU meter is a set of three buttons to select between displaying the input level, amount of gain reduction or output level. The input and output meters range from -20 dBu to 0 dBu. The reduction meter ranges from 0 to 20 dB. Mono metering is displayed for inputs and outputs on unlinked auxes and stereo metering is displayed for inputs and outputs on linked auxes.

Output Alignment Delay

Located at the bottom of the screen is the output alignment delay. It's used to time-align the sound when there are speakers that are not near each other. If two speakers are playing the same sound (the mains and a loudspeaker in the balcony) that are physically distant from each other, the sound can get muddled since the sound from each loudspeaker is hitting the listener's ears at different times. Additionally, there are sound sources on stage – drums, for example – that are so loud that the audience can hear them even before they reach the loudspeakers. Therefore, most professionals align every speaker on the stage to the drums so all sounds arrive simultaneously.

Here are a few more examples in which the output alignment delay is handy:

Delay Stacks — Sometimes additional speakers are necessary in order to support the main PA. Perhaps it's a club with multiple rooms, or an outdoor concert with a beer garden located up on the lawn, or a cry room in a House of Worship. Applying alignment delay to these delay stacks ensures that the sonic experience is the same throughout the venue.

For setup, the user will set a delay time based on the distance and a given temperature. As the show goes on, the room will heat up from the glow of the amp tubes and growing audience...or the temperature might drop at an outdoor venue after the sun disappears. The engineer may simply adjust the temperature and the delay time adjusts automatically. After all, the temperature is changing, not the (already) fixed distance between the speakers!

Stage Monitors — Band members hear the drum kit itself, as well as the drums coming through the monitors. Delaying the monitors to align these different sources improves intelligibility.

Main PA — Like the band, audience members located close to the stage also hear the stage drums and the monitors. Delaying the main PA back to the drums improves intelligibility for these front row warriors.

Fill Speakers — The main PA stack doesn't always cover all spots of a venue. Architectural features like balconies, alcoves, etc. are often simply not covered, or the sound is undesirable in those areas. The first few rows of an audience is another common place for the main PA to miss. Fill speakers are used to cover these areas and aligning them with the PA is the only way to ensure proper sound throughout the venue.

The delay time ranges from a low of 0.0 ms (m, ft) to a maximum of 341.7 ms (115.8 m, 380.1 ft). The temperature ranges from a low of 0.0 °C (32.0 °F) up to a maximum of 40.0 °C (104.0 °F). These may be adjusted by moving the sliders left and right. Additionally, exact settings may be entered into the current parameter display. The output alignment delay may be adjusted whether the output compressor / limiter is on or off. The output alignment delay is accessible on the main LR and all aux sends. There is no output alignment delay on the FX outputs. Press the Delay button to turn the output alignment delay on or off. It will illuminate green when engaged and is gray when disengaged.



Chapter 16 : Channel View : Presets

Introduction

Presets save parameters on individual input or output channels and on particular DSP blocks such as EQ, dynamics, FX, graphic EQ, etc. For example, a favorite kick drum EQ setting may be saved as a preset and recalled as needed. Presets are not associated with a particular show, snapshot or channel. In other words, a preset may be created while one show is active and recalled again into a different show.

Master Fader comes with a library of factory presets. A maximum number of factory presets will be displayed at one time. Just scroll up to view the other factory presets, if available. There are also user presets. These may be created for each preset type. The number of user presets available is limited only by the available space on the device. Presets are generally set ahead time, not as an event is taking place. Presets are stored on the device, not the mixer.

The following preset types are available:

- Input channel
- Output channel
- Gate
- Compressor
- EQ
- FX
- Output Parametric EQ (user presets only)
- Graphic EQ (user presets only)

The first thing we will do is take a look at factory presets vs user presets. From there, channel presets and DSP presets may be selected [factory] or created [user].

Factory Presets vs User Presets

There are factory presets and user presets on all channel and DSP settings that may be set ahead of time. Feel free to start with a factory preset, manipulate to your liking, then save as a user preset. We will start with what each one looks like and how they work. The next section will discuss the differences between channel presets and DSP presets.

Near the top of each factory preset list is a button labeled "Reset X". This selection will zero out the current selection. For example, imagine how long it might take to reset each of the 31 bands on the graphic EQ to ± 0 dB. The factory default for graphic EQ will do that for you in two easy steps. From the graphic EQ presets page: (1) tap the presets button, then (2) tap reset graphic EQ. Done! Factory presets may only be recalled; they cannot be replaced, renamed or deleted... that's what user presets are for!

In addition to "Reset X", a wide variety of other factory presets are available to choose from. These are graced with an icon and name of said factory preset. Simply tap the preferred preset, recall and yes. This will update the current selection. For example, selecting "Kick" from the list will update the EQ, gate and compressor settings to standard kick settings. It's certainly easier to make updates from a factory preset versus updating parameters from a zeroed out board!

User presets' names and images are user-editable. At the top of the preset list is a button labeled "Store Preset". Tapping this button reveals a keyboard. Simply type in a name you would like to call this preset. This stores the new preset. This is similar to a "Store" button on other consoles.

Recalling a factory preset is easy. Simply tap “Presets” to reveal a popover. The popover displays a list of factory presets to choose from, as well as the opportunity to...

- store the preset,
- reset the channel and/or
- import/export the preset.

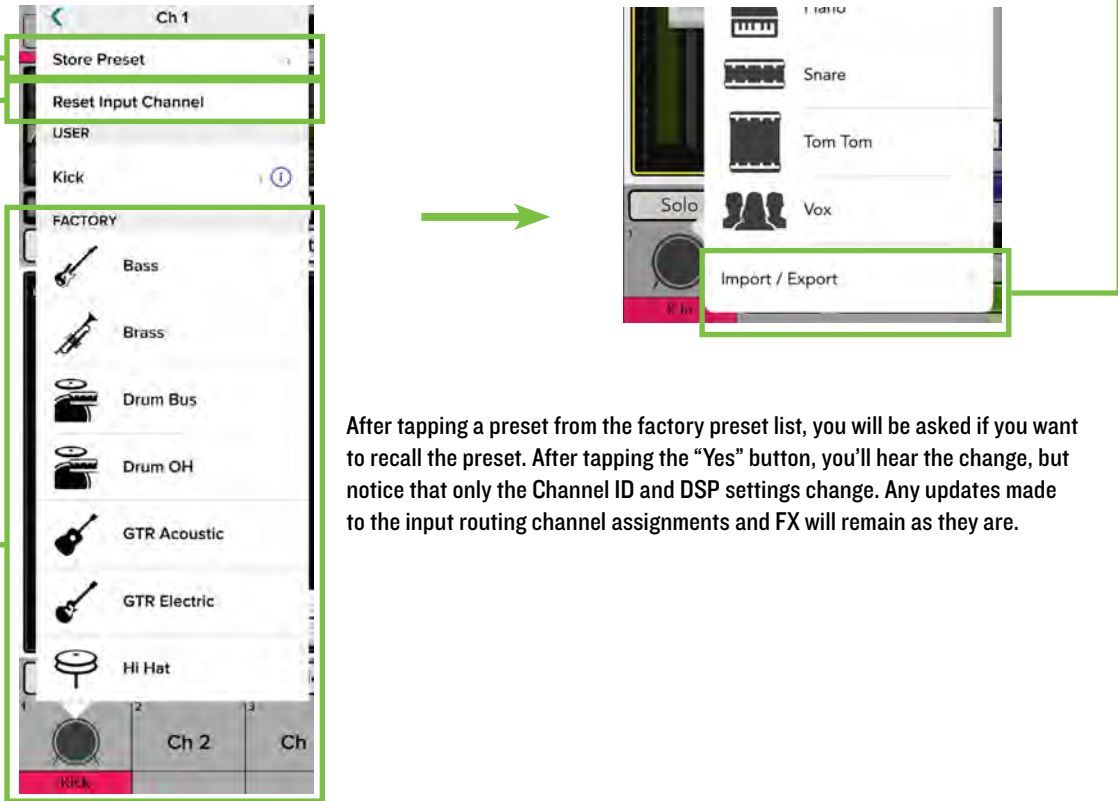

After tapping a preset from the factory preset list, you will be asked if you want to recall the preset. After tapping the “Yes” button, you’ll hear the change, but notice that only the Channel ID and DSP settings change. Any updates made to the input routing channel assignments and FX will remain as they are.

As mentioned above, the other choices here are...:

Store Preset — The store preset button stores the current state of the processing into a new user preset. After tapping “Store Preset” you will be asked to name the preset.



The name of the preset is the name of the preset, not the channel input, master output, etc.

Reset — The reset button resets the selection [input channel, output channel, DSP, etc.] to its default state. After tapping the reset button, a confirmation dialog will appear.

Import / Export — Master Fader affords you the opportunity to import and export presets. An entire chapter is dedicated to importing and exporting files. This includes detailed instructions and multiple screenshots every step of the way. Please check it out on pages 245-248.

Tapping a user preset's blue-circled "i" [information] button will display a popover with the following options:

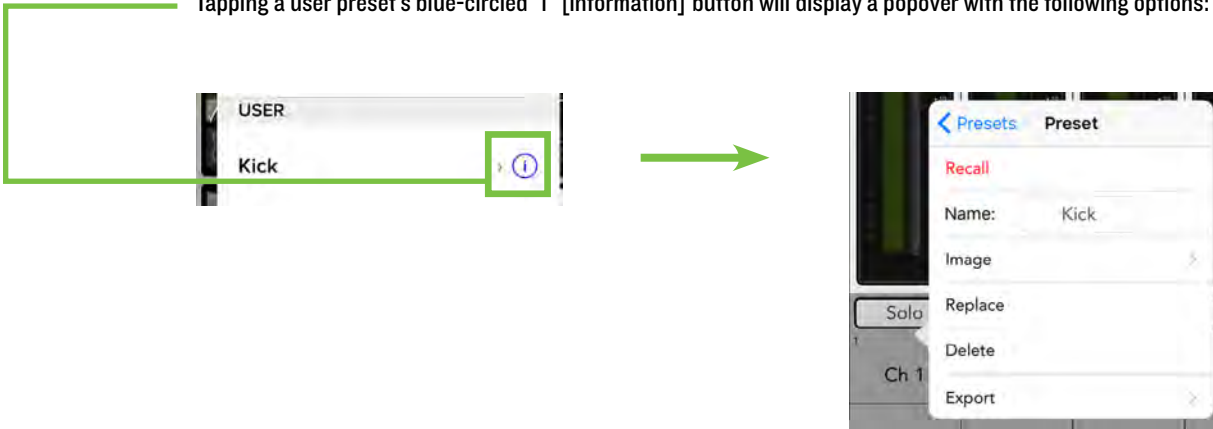

Recall — Pressing the recall button recalls presets. On recall, all appropriate console parameters change to match the stored preset. Recall is the only available option with factory presets. A confirmation dialog will appear.

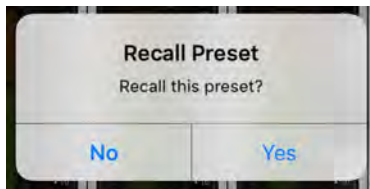

Name — When the name button is pressed, use the onscreen keyboard to name (or rename) the currently selected item. Simply type a name in the box and tap the "return" key when finished. If the name is too long to fit, the button scrolls, displaying the entire name.

For familiarity, this is a similar keyboard that is used for messaging or emailing from your device.

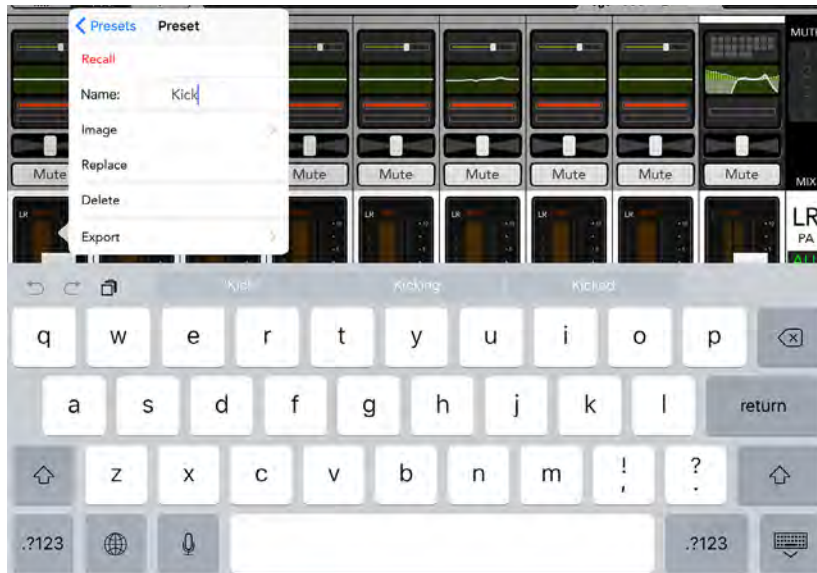

An open gray box with only the preset's name works, but you may choose to spice it up with an image. There are several options in this department. From the preset popover, tap "Image" to reveal a new popover as seen below [Image Source]. You will be presented with four choices:

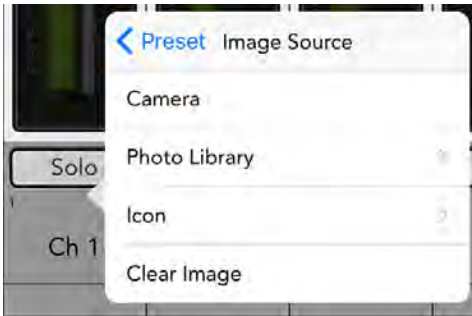

Camera — If you're familiar with how the camera on the device works, then you're in luck...this one works the exact same way!

Photo Library — Here you may select from all the photos that currently reside on your device.

Icon — Or select from a multitude of built-in icons at your disposal.

Clear Image — Believe it or not, tapping here will clear the image for that preset.

Replace — Saves the current settings over the selected preset. A confirmation dialog will appear.

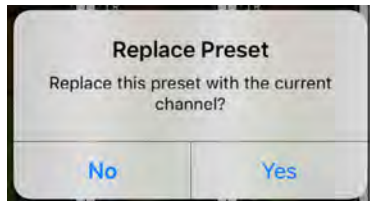

Delete Preset — The delete button deletes the currently selected preset. This is a permanent deletion with no undo, so a confirmation dialog helps prevent accidents.

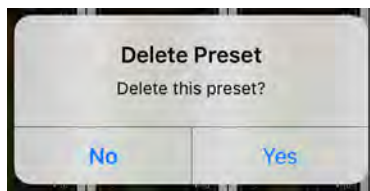

Import / Export — Master Fader affords you the opportunity to import and export presets. An entire chapter is dedicated to importing and exporting files. This includes detailed instructions and multiple screenshots every step of the way. Please check it out on pages 245-248.

Channel Presets vs DSP Presets

There are channel presets and DSP presets. Also, there are factory presets for both or you may create your own user presets for each. So many options! Let's take a look at each:

Input and Output Channel Presets — Channel presets change virtually all controls on the channel. There are both input and output channel presets. Input channel presets do **NOT** change pan, mute, fader, solo, polarity or the linked state. Output channel presets do **NOT** change balance, level, the aux/FX send configuration or the linked state. This allows you to easily audition presets on a channel one after another.

Input channel, output channel and DSP presets can be stored and recalled to linked and unlinked channels. The link parameter is **NOT** stored in the preset.

Channel names and images are stored in the preset if present on the same channel when creating the preset. When recalled – if a name or image is present – it will be updated on the destination channel.

DSP Presets — DSP presets change only a portion of an input or output channel. This includes EQ and HPF, gate, compressor, and graphic EQ. The EQ and dynamics presets also recall the type [modern or vintage]. However, DSP presets do **NOT** change the on / off state. This allows a user to audition presets with the processor on or off, as desired.

Below are two images. The one on the left displays the input channel presets and the one on the right displays the output channel presets. They look identical except for there are no factory presets for the output channels.

From the EQ channel view you are able to set a preset for the channel's EQ. Don't forget to scroll up to access more factory presets, if going that route. EQ presets do **NOT** recall either the HPF on/off or the EQ on/off, but the EQ presets **DO** recall the EQ type [modern or vintage].

INPUT CHANNEL PRESETS

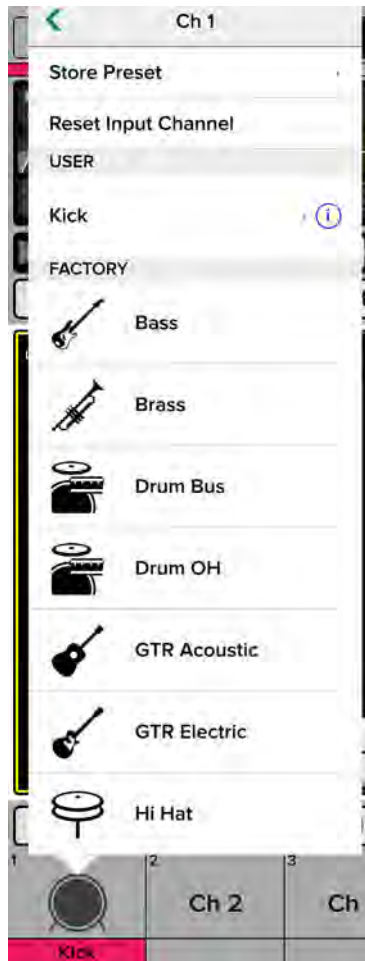

OUTPUT CHANNEL PRESETS



From the gate / compressor channel view you are able to set a preset for the dynamics. Don't forget to scroll up to access more factory presets, if going that route. These presets recall the dynamics type [modern or vintage].



**EQ
PRESETS**



**GATE
PRESETS**

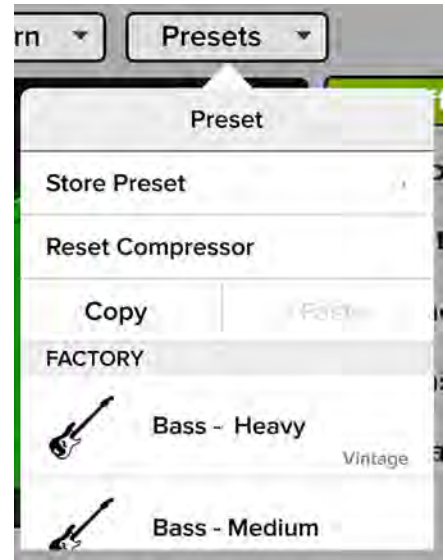

**COMP
PRESETS**

From the FX channel view you are able to set a preset for the FX. Don't forget to scroll up to access more factory presets, if going that route. Note that the FX presets do **NOT** change the send or return level, but these presets recall the FX type. These presets all store and recall the EQ on the FX Return channel. This allows you to change not only the effect, but the EQ shaping the effect.



FX PRESETS

From the parametric and graphic EQ channel views you are able to store, reset and/or import/export a preset for the PEQ or GEQ. Again, there are no factory presets for the output EQ processing.

Also, this is the easy way to reset the parametric and graphics EQ to their default of ± 0 dB. With their respective presets popover displayed, simply (1) tap reset, and (2) tap the yes button. Done!



**PEQ
PRESETS**



**GEQ
PRESETS**

And from the compressor / limiter channel view you are able to set a preset for the compressor / limiter. Don't forget to scroll up to access more factory presets, if going that route. These presets recall the compressor / limiter type [modern or vintage].

**OUTPUT
COMP
PRESETS**

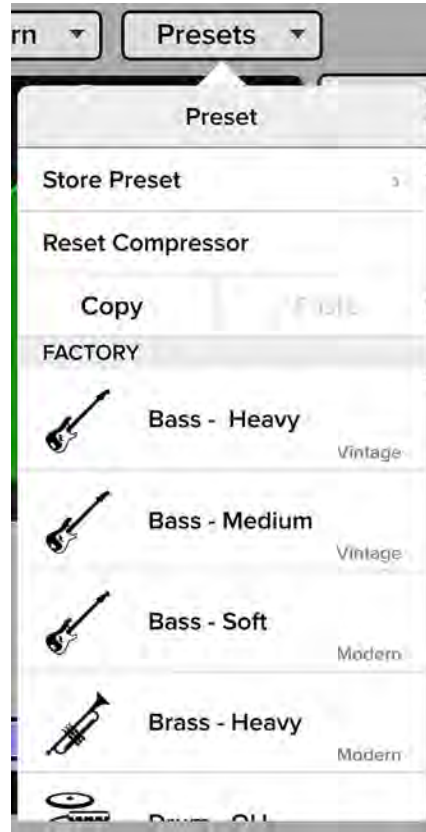

Last but not least, if you need a clean slate to work with, all presets (and shows) may be deleted in a few fell swoops! Simply go to Tools > Settings > System Backup > Import/Export > Reset Shows and Presets³.



Tapping Reset Shows and Presets here will **DELETE** all shows and presets. This is a permanent deletion with no undo, so a confirmation dialog helps prevent accidents.



Shows and presets cannot be reset when connected to a mixer. Select an offline mixer in the devices page first.

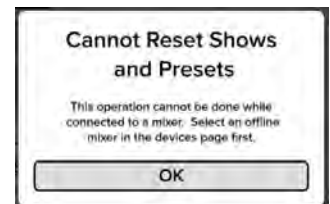

³ Additional information about Tools and Settings starts on the next page!

Chapter 17 : Mixer View : Navigation Bar

Introduction

Just how important is the navigation bar? It's so important that it is always available regardless of what view is currently displayed. Want more? Not only is it always available, but it is right on top in plain sight! Not at the bottom or tucked away in some corner. It's a banner announcing (and awaiting) your choice. Interestingly, though, there are no faders here; EQ, gates and compressors and FX live elsewhere, etc. Think of the navigation bar as the brains behind the operation. We'll work our way left to right, starting with the three views: overview, mixer view and channel view.



We will just recap these three views as they were already discussed in greater detail on pages 23-27.

Overview



When tapped, the overview button turns dark gray to indicate that it has been selected. The mixer view and channel view buttons will remain light gray.

The overview displays all important functions of all input and output channels at one time in one place. Once a show is set up, this is the place to be. If any issues arise, you can easily spot it here in the overview, head to the affected channel and fix it immediately.

The overview is divided into four main rows:

- Master Outputs
- Matrix + Groups
- Inputs 1
- Inputs 2

The following are displayed on every channel of every row:

- Mute
- Meter
- Gain Reduction Meter
- Fader
- Solo
- Mix Select Color
- Channel System Name
- Channel User Name
- Channel Color

A mix selector below each output displays the mix for that output on the input channel faders. Touching any channel takes you right to the channel view to make adjustments.

Mixer View



When tapped, the mixer view button turns dark gray to indicate that it has been selected. The overview and channel view buttons will remain light gray.

The mixer view is exactly what it sounds like; it's a view of the mixer! The key mixing controls of every input and output for the mixers exist here. All channel strips (plus the FX, sub outs, VCA outs, iPad [DL806 and DL1608] and return [DL16S, DL32S and DL32R] channel strips) are present along with a thumbnail view of each channel's input routing view, EQ curve, gain reduction meter, pan slider, mute, fader level, input meters, solo and channel name, image and color.

So the mixer view is where you adjust the key mixing controls for all channels at once. If you would like to adjust the individual channel processing, you need to go to the channel view.

Channel View

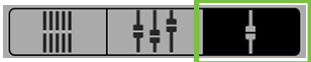

When tapped, the channel view button turns dark gray to indicate that it has been selected. The overview and mixer view buttons will remain light gray.

The channel view handles all DSP-related activities. It is in the channel view where all plug-in processing is adjusted on individual channel inputs and outputs. This includes input channel routing, channel EQ, channel gate and compression, FX, output routing, graphic and parametric EQ and output compression / delay.

Current Parameter Display

Here, the current parameter display shows the current channel system name [Ch 1] – it scrolls if the name is too long to fit, displaying the entire name – followed by the custom user name [Kick], the current parameter value [0.0 dB] and current parameter name [Fader] for just about every control or parameter as it is adjusted.

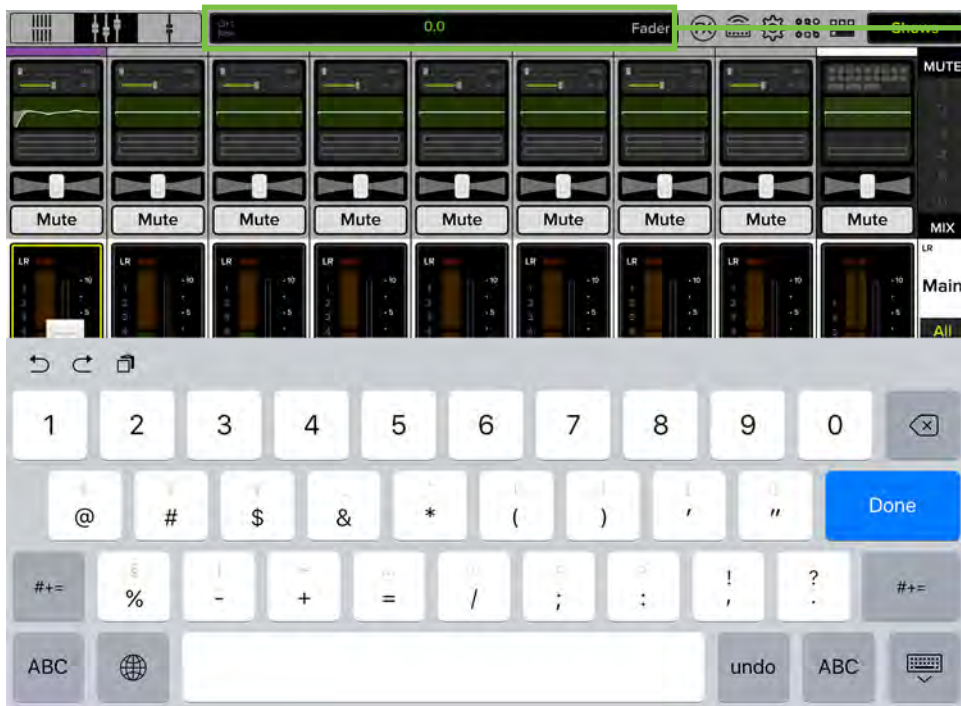

Also, if you want to type in an exact value for a parameter, touch the channel's parameter you would like to update so it appears in the current parameter display. Next, tap the current parameter display and type in the exact value you would like for that channel's parameter followed by tapping the blue "Done" button.

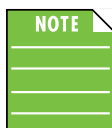

Sometimes multiple parameters may be changed. For example, both the gain and frequency may be updated on each EQ band.



The current parameter value will always be green and the current parameter name will always be gray. However, the color of the current channel system name and custom user name will illuminate in the color you choose for each input and output.

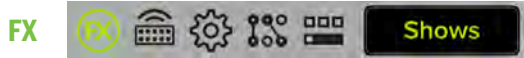

Directly to the right of the current parameter display is the FX button. Tap to open it, revealing a screen that looks somewhat like what is displayed below. The DL16S, DL32S and DL32R each have up to four FX available, while the DL806 and DL1608 have up to two FX available. These FX may be fed from any combination of channels with dedicated FX sends. There are a wide variety of FX types at your disposal on the Master Fader app. The Master Fader app follows standard FX send and return configuration so the learning curve is kept to a minimum.



FX View

From left to right, each effect displays the following:

Effect Type — This displays the currently selected effects types in user-friendly rack-mounted UIs. These selections are global and affect all channels sent to the effects. The effect types are described in more detail in a few pages.

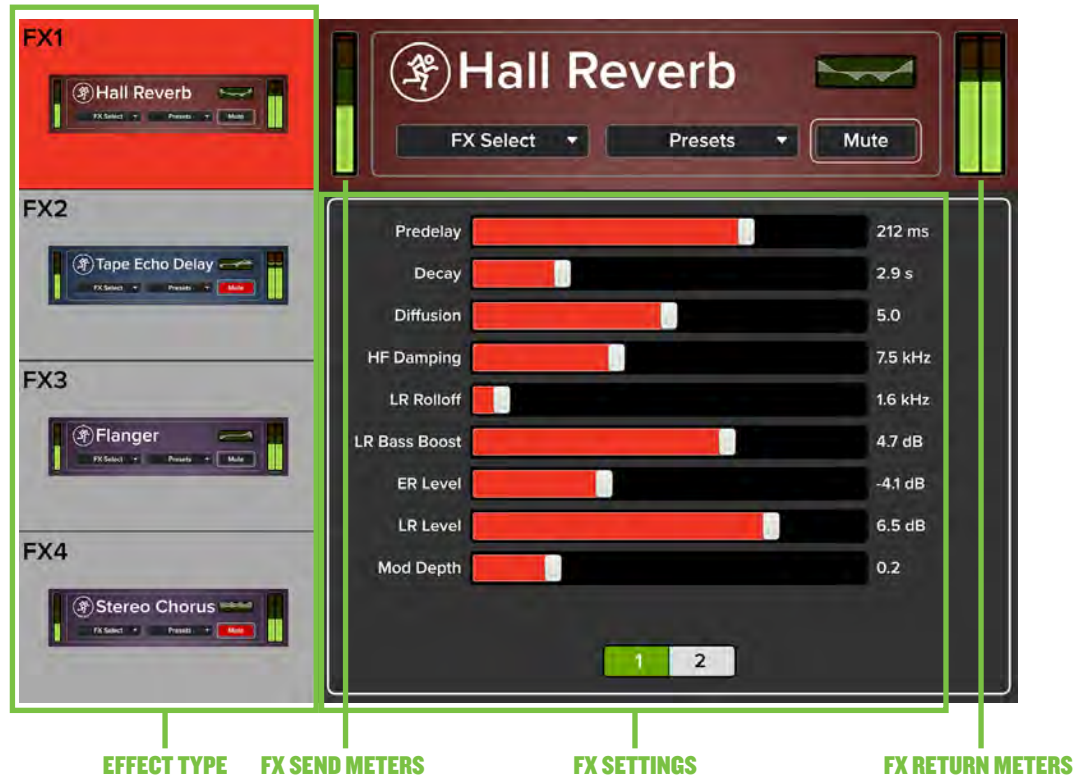

FX Send Meters — There are separate vertical send meters, one for each effect.

The FX send meters display the summed signals from all channel sends post-send master. Put another way, this shows the total signal going into the FX processor regardless of the current channel being adjusted.

FX Select — This pull-down menu allows you to select which reverb, delay and/or modulation effect(s) you desire. There is quite a bit of information here, so this will not be a 'quick look' as mentioned above (except for the screenshot shown below), but rather a full-on in-depth look. Be patient, it's coming...



Presets — Presets save parameters and may be recalled as needed. The mixer comes with a library of factory presets.

Here you can choose between “Show: All” which displays all FX presets or “Show: Current” which displays the FX presets for the currently chosen effect. In the example below right, the hall reverb has one factory preset available: ‘Hall - At the Symphony’. Just tap the button to switch between “Show: All” and “Show: Current”.

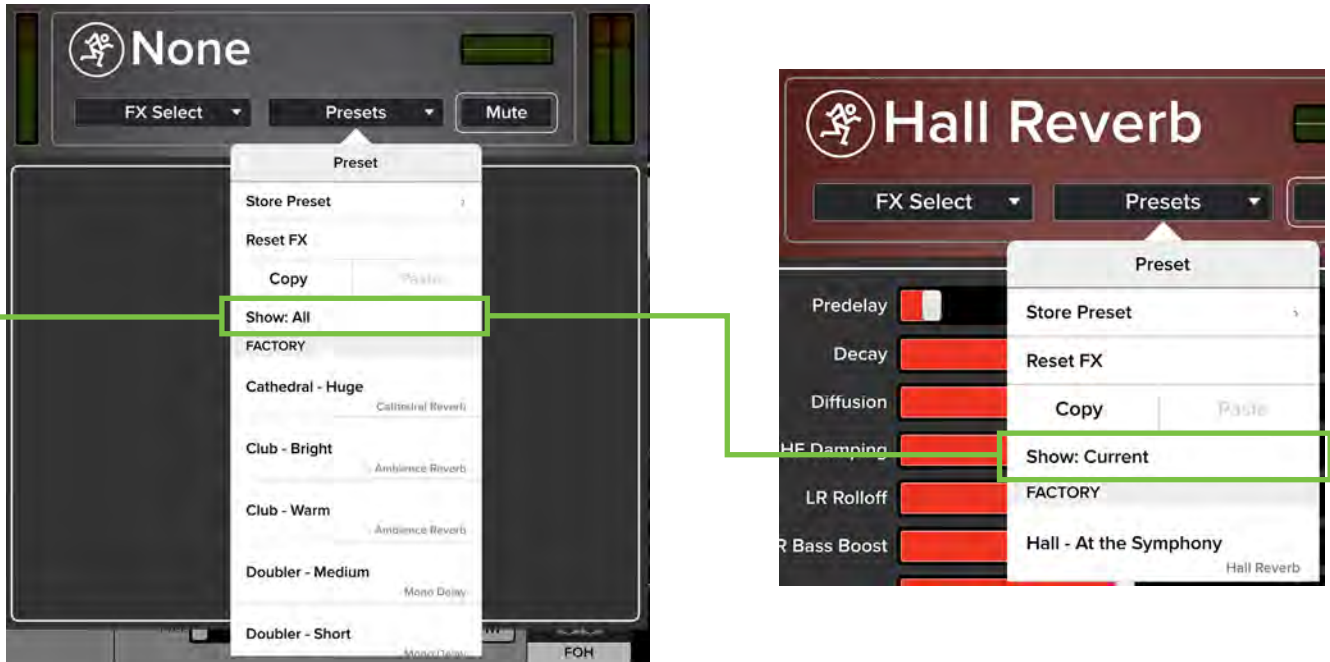

There are also user presets. These may be created for each preset type. The number of user presets available is limited only by the available space on the device.

An entire chapter is dedicated to presets. This includes detailed instructions and multiple screenshots every step of the way. Please check it out on pages 147-155.

Import / Export — Master Fader affords you the opportunity to import and export FX presets. An entire chapter is dedicated to importing and exporting files. This includes detailed instructions and multiple screenshots every step of the way. Please check it out on pages 245-248.

PEQ — Not only is each effect return’s PEQ curve displayed prominently next to the FX name, but it’s also a fast-track to that effect return’s PEQ settings. Tap the PEQ icon which takes you to the PEQ view for that effect return. Make changes as needed.

An entire chapter is dedicated to PEQ. This includes detailed instructions and multiple screenshots every step of the way. Please check it out on pages 121-133.

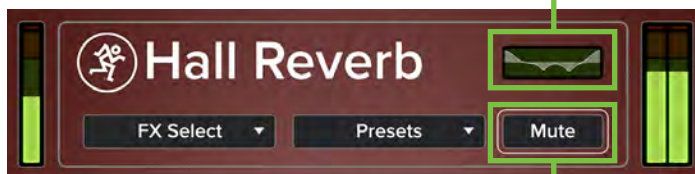

Mute — Tap this button to mute or un-mute the selected effect return to the Main LR. The FX may also be muted directly from the overview.

FX Settings — Each effect has multiple sliders which are used to alter the selected effect. Some even have two pages of sliders; see the screenshot posted above, for example. These sliders change dependent on which effect type is chosen for each channel, are global and affect all channels. The various FX controls for each FX type are described in more detail in a few pages.

FX Return Meters — On the far right of the FX view are separate vertical return meters, one for each effect. These display the return level from the effect to the corresponding FX return.

There are no effects returns to the effects sends (which would be crazy...and it avoids a feedback loop), so when an effect send is the selected output, there are no return faders as seen in the image below.



FX Send and Return Level — We have a good grip on what the FX layout looks like, but how do we change the fader levels for the FX sends and returns? There are four locations, actually: two for the FX sends, one for the FX returns and one for both. Let's take a look...

- **Input Routing View (FX Sends)** — check out the screenshot below. Shown here is the input routing view for channel one, the kick drum. The purple sliders raise (drag right) and lower (drag left) the FX sends on the currently selected channel.



- **FX Send 1-4 Mixer View (FX Sends)** — check out the screenshot to the right. Shown here is the mix selector. Select which FX mix you prefer and raise / lower the fader to the desired level.

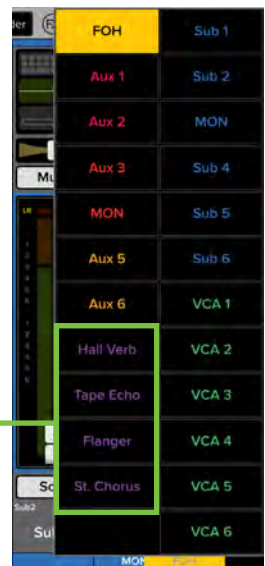

- **Main Mixer View (FX Returns)** — check out the screenshot below. Shown here is the mixer view swiped over until the FX return channels are in view. From here, changes to each FX return may be changed, including fader levels, mutes, solos, pans, PEQ and the output routing view.



- **Overview (FX Sends and Returns)** — check out the screenshot below. Shown here is the overview, a great selection for once the show has started. Input and output fader levels may be changed, channels muted and/or soloed, and direct access to the chosen input / output. As seen below, this also includes the FX sends and FX returns.

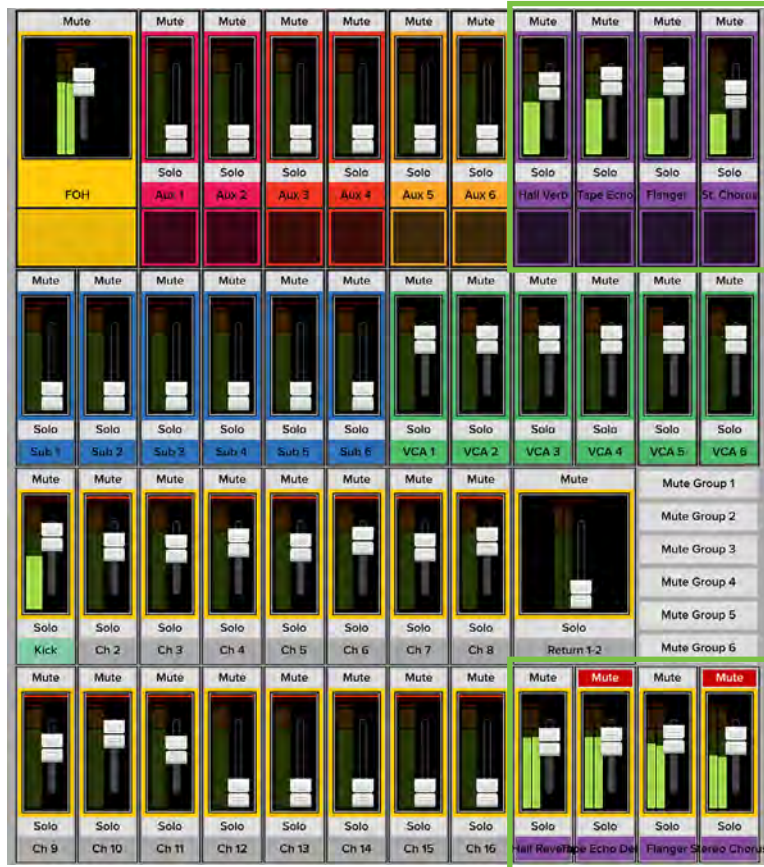

Back to the FX Select pull-down menu starting with the reverbs, then delays and finishing up with the modulation FX...

Reverb Type

Reverb simulates the effect of room variations. The Master Fader app comes with nine reverb types to choose from: plate, ambience, small room, medium room, large room, hall, cathedral, gated reverb and spring. All nine reverbs feature two pages of settings. These may be accessed simply by tapping the '1' and '2' button. Tap and drag sliders left [decrease] and right [increase] to change the settings.

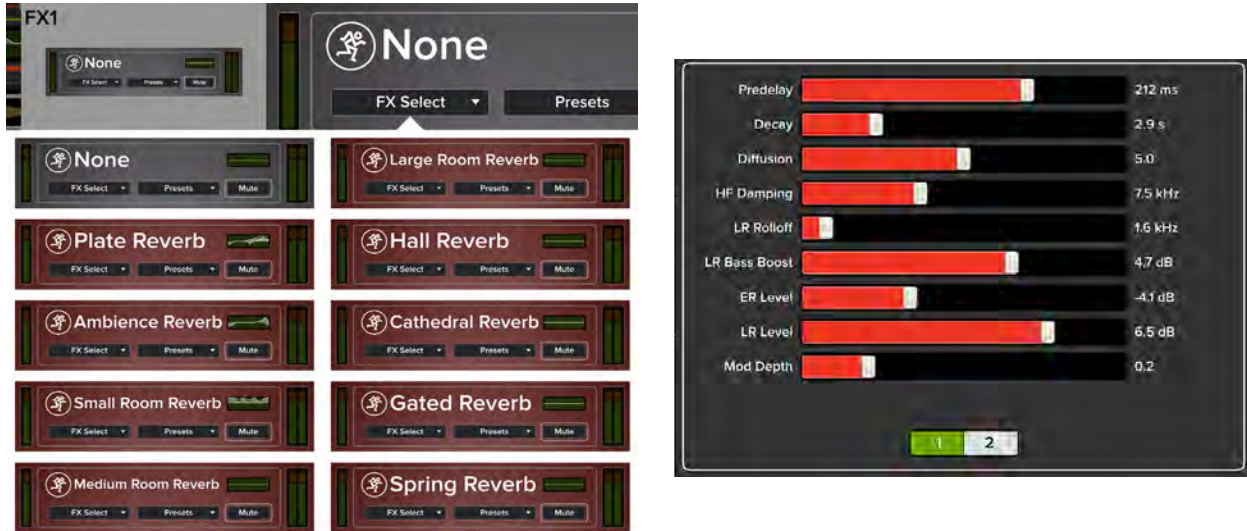

Reverb Type	Description	Examples
Plate	Plate reverbs emulate vintage mechanical reverberation that is generated with a metal plate. Its sound is characterized by lots of early reflections and no pre-delay.	Perfect for thickening percussive instruments, such as a snare drum, or tight vocal arrangements.
Ambience	Ambience is the surrounding sound field. This reverb adds depth and space.	Ambience is good for scoring movie soundtracks and post-rock bands utilizing a lot of depth in their sound.
Small Room	The small room reverb simulates the reverberation (persistence of sound) in a typical small room. Small rooms are typically coined "dead" rooms with little to no reverb.	Some artists record guitars (and/or bass) from a bathroom to get a "punchier" sound out of their amp.
Medium Room	The medium room reverb simulates the reverberation (persistence of sound) in a typical medium room.	A medium room would be good for thickening up a bass sound without it sounding muddy.
Large Room	The large room reverb simulates the reverberation (persistence of sound) in a typical large room. Large rooms are typically coined "live" rooms since they have a lot of reverb.	Sound tends to carry in large rooms with a lot of open space. This works well for a good, boomy kick sound.
Hall	This reverb is characterized by its large, spacious sound, long pre delay and vibrant tone.	Adds life to acoustic instruments and vocals from solos to full-on symphonies and choirs.
Cathedral	This reverb emulates the extremely long tails, dense diffusion and long pre-delays and reflections that would be found in a very large, stone-walled house of worship.	Gives amazing depth to choirs, wind instruments, organs and soft acoustic guitars.
Gated Reverb	Gated reverbs incorporate an age-old trick whereby an extremely dense reverb is processed through a fast gate for an interesting, albeit artificial, sound.	Most often used to fatten snare drums and toms without clutter.
Spring	A spring reverb uses a transducer at one end of a spring and a pickup at the other end to create and capture vibrations in a metal spring. The longer the spring, the longer the decay time of the reverberation.	Spring reverbs are typically used on guitar amplifiers or organs in a rock band format.

Reverb Sliders

The following is a list of sliders available for each selected reverb. Slide left to decrease the selected parameter and slide right to increase the selected parameter.

Pre Delay (All) — When listening to a live performance, direct sounds are reached first, followed by reverberation caused by room reflections. The pre delay is the amount of time between when the direct sounds arrive and when the reflections arrive. The range is 0 ms to 300 ms.

The speed of sound is approximately 340 meters per second (1100 feet per second). This means that in one millisecond, it travels 0.34 meters (1.1 feet). As a rough idea, think of 1 ms as the time it takes for sound to travel one foot.

Decay (All) — This represents the decay time of the reverb. The range will vary depending on the reverb chosen.

LF / HF Damping (All) — Damping decreases the amount of low frequency and high frequency reflections that make up the reverb. The range is 500 Hz [HF] / 20.0 Hz [LF] to 20 kHz.

Parameter	Low Value	High Value	Default
Pre Delay	0.0 ms	300.0 ms	0.0 ms
Decay	0.10 sec – 4.00 sec	1.30 sec – 10.00 sec	—
Diffusion	0.0	10.0	5.0
Damping	500 Hz [HF] 20.0 Hz [LF]	20.00 kHz	20.00 kHz [HF] 20.0 Hz [LF]
ER Level	-12.0 dB	12.0 dB	0.0 dB
ER Rolloff	500 Hz	20.00 kHz	20.00 kHz
LR Level	-12.0 dB	12.0 dB	0.0 dB
LR Rolloff	500 Hz	20.00 kHz	20.00 kHz
LR Bass Boost	-15.0 dB	15.0 dB	0 dB
Mod Rate	0.0 Hz	20.0 Hz	1.0 Hz
Mod Depth	0.0%	50.0%	100.0%
Gate Release	50.0 ms	3000.0 ms	250.0 ms

ER Level (All) — This slider provides up to 12.0 dB of boost or cut of the early reflection and then “aimed” at a specific frequency, from 500 Hz to 20 kHz, via the ER Rolloff slider.

ER Rolloff (All) — This provides an early reflection low-pass filter at the output of the reverb. This allows the level of the audio range to be rolled off above the frequency set by this slider. The range is 500 Hz to 20 kHz.

LR Level (All) — This slider provides up to 12.0 dB of boost or cut of the late reflection – aka reverb tail – and then “aimed” at a specific frequency, from 500 Hz to 20 kHz, via the LR Rolloff slider.

LR Rolloff (All) — This provides a late reflection low-pass filter at the output of the reverb. This allows the level of the audio range to be rolled off above the frequency set by this slider. The range is 500 Hz to 20 kHz.

LR Bass Boost (All) — The late reflection bass boost provides up to 15.0 dB of boost or cut below 300 Hz.

Diffusion (All) — Diffusion this operates on late reflections and controls how the signal gets “smeared out” before going into the main reverb tank. At 0, the reverb has a more “coarse” feel – it’s easy to hear the individual “echoes”. As the diffusion setting increases, the tail continues to get more “dense” and “softer”. Past 9, the attack of the echoes return to being more pronounced, less dense.

Mod Rate and Mod Depth (All) — These control the variation of the timing of the late reflections. By increasing the modulation, the reflection times vary more, making the reverb tail smoother. At the highest settings (max rate, max depth) a slight audible “warbling” (similar to a chorus) may be heard during the tail. The Mod Rate slider adjusts the rate at which the signal varies, ranging from 0.0 Hz to 20.0 Hz. The Mod Depth range is 0.0% to 100.0%

Gate Release (Gated Reverb) — Release is the amount of time it takes for attenuation to happen (i.e. how long it takes the gate to close). The range is 50.0 ms to 3000 ms.

Delay Type

Delay allows adjustment of the effect delay. The Master Fader app comes with five delays to choose from: mono, tape echo, stereo, ping-pong and multi-tap. Tap and drag sliders left [decrease] and right [increase] to change the settings.



Delay Type	Description	Examples
Mono	The mono delay provides an echo effect with a mono delay line.	Mono delay is great for added depth and space. Pink Floyd guitarist David Gilmour is one of the kings of delay.
Tape Echo	Tape Echo provides a single, relatively rapid delay of the original signal, with the added warmth that vintage tape-based echo units provided.	Often used on vocals for a 1950's-era feel, or on guitars for a surf-type tone.
Stereo	The stereo delay is a stereo version of the mono delay, with a left and right input and a left and right output. Each side (left and right) has its own set of controls).	A guitarist with dual outputs (or A/B switcher) can create interesting stereo delays, setting each amp's delay times independent of the other one.
Ping-Pong	The ping pong delay works the same as the stereo delay, with the exception that the feedback is routed to the opposite channel, producing a bouncing sound as the delayed signal bounces from left to right.	Similar to the stereo delay example, but instead of each delay being set independently of the other, this creates a steady ping-pong delay with varying speed.
Multi-Tap	This allows you to create two delays with different lengths.	With added feedback, you can create very interesting effects on a guitar solo.

Delay Sliders

The following is a list of sliders available for each selected delay. Slide left to decrease the delay time and slide right to increase the delay time. Some delays have a 'tap' function in which case you tap the 'tap' button at the rate you would like the delay.

Delay (Mono, Tape Echo) — This slider sets the current delay time in milliseconds, from 10 ms to 1600 ms.

A tap button resides in the upper-left corner of the delay image if you would rather tap the preferred delay tempo.

Delay L (Stereo, Ping-Pong) — This slider sets the left side current delay time in milliseconds, from 10 ms to 1600 ms.

A tap l button resides in the upper-left corner of the delay image if you would rather tap the preferred delay tempo.

Delay R (Stereo, Ping-Pong) — This slider sets the right side current delay time in milliseconds, from 10 ms to 1600 ms.

A tap r button resides in the upper-right corner of the delay image if you would rather tap the preferred delay tempo.

Delay 1 (Multi-Tap) — This slider sets one delay time in milliseconds, from 10 ms to 1600 ms.

A tap 1 button is available at the bottom of the screen if you would rather tap the preferred delay tempo.

Delay 2 (Multi-Tap) — This slider sets a second delay time in milliseconds, from 10 ms to 1600 ms.

A tap 2 button is available at the bottom of the screen if you would rather tap the preferred delay tempo.

Feedback (All) — This controls how much of the delayed signal is routed back to the input of the delay section to create multiple echoes. Each time the signal is fed back, the delayed signal becomes quieter (so the echo won't go on forever unless set at 100%). It ranges from 0% to 100%.

HF Damping (All) — This applies a low-pass filter to the delayed signal and rolls off the higher frequencies. On the Tape Echo, the damping is in the feedback path; as the echoes repeat, they get darker and darker. On all other delays, the damping is on the output. It ranges from 500 Hz to 20 kHz.

Parameter	Low Value	High Value	Default
Delay	10 ms	1.6 s	250 ms
Delay L	10 ms	1.6 s	250 ms
Delay R	10 ms	1.6 s	250 ms
Delay 1	10 ms	1.6 s	250 ms
Delay 2	10 ms	1.6 s	250 ms
Feedback	0%	100%	20%
HF Damping	500 Hz	20 kHz	20 kHz

Modulation Type

Modulation FX – mod for short – allows adjustment of signal strength to alter the tone. The Master Fader app comes with ten mods to choose from: phaser, tremolo, rotary, mono chorus, stereo chorus, flanger, mod delay, sweep filter manual, sweep filter auto and sweep filter LFO. Tap and drag sliders left [decrease] and right [increase] to change the settings.



Mod Type	Description	Examples
Phaser	The phaser uses a series of all pass filters to alter the phase of the signal so that when it adds to the dry signal, you get notches in the output.	Guitarist King Edward uses a phaser all over the early Van Halen albums.
Tremolo	The tremolo effect produces a slight, rapid variation in loudness. i.e. volume modulation [Not to be confused with a guitar's tremolo bar which fluctuates the pitch of the sound, not the volume.]	Green Day – Boulevard of Broken Dreams, Audioslave – Like a Stone and many more.
Rotary	The rotary effect "mirrors" the Doppler effect – aka known as the Leslie in the music world; i.e. a mic'd rotating speaker – thus creating a relatively chorus-type effect.	Many rock bands that implement Hammond Organs have that classic "Leslie" / rotary sound: The Doors, Led Zeppelin, Deep Purple and Emerson, Lake and Palmer come to mind.
Mono / Stereo Chorus	The chorus effect simulates the sound of more than one instrument or voice playing the same passage. When two people play the same part in unison, they are never exactly the same. There are differences in timing and pitch. Chorus is a modulated delay.	The Police – Walking on the Moon, Nirvana – Come As You Are and U2 – I Will Follow to name just a few...
Flanger	The flange effect is a modulated delay with feedback (and shorter delay times than chorus), which creates the characteristic "whooshing" sound often used to describe the flange sound.	Check out Heart's 'Barracuda'!
Mod Delay	Mod delay is just like any of the delay FX, but with modulation added; i.e. like a flanger because it has feedback, but with much longer delay times)	If used with a chorus, the entire signal is modulated and the result is clarity with a wash behind the note.
Sweep Filter (Manual, Auto, LFO)	The sweep filter is essentially a filter that can be swept smoothly between a low and high setting based on a manual control, an LFO, or the level of the signal (auto).	Sweep filters help achieve that "underwater" sound prevalent in many pop, electronic and rap and hip-hop songs.

Modulation Sliders

The following is a list of sliders available for each selected mod type. Slide left to decrease the mod time and slide right to increase the mod time.

Phaser

Rate — This slider sets the rate at which the center frequency of the notch filters sweep up and down the audio spectrum, from 0.02 Hz to 1 Hz.

Depth — This slider sets how far the notch frequencies modulate around the center frequency, from 1 to 10.

Waveform — Different waveform shapes create different phaser effects. Using the slider, select between sine, square, triangle, saw and reverse saw waveforms.

Notch Freq. — This slider sets the center frequency of the notch filters in Hz, from 500 Hz to 2 kHz.

Filter Number — Also known as a 'stage', the filter number sets the number of all pass filters in the series. For each increment of 2, the effect is another added notch. With odd numbers, the audio that passes through will be out of phase (at the high end) with respect to the input. When adding it back to the dry, it has the effect of having a low-pass filter on, as well. So, for a filter number of 7, there will 3 notches and a low-pass, whereas 6 will just have 3 notches. This slider has filter numbers ranging from 2 to 12.

Feedback — The higher the feedback percentage, the sharper the peaks between the notches. It ranges from -100% to 100%.

Width — This button sets the stereo width (i.e. narrow = mono). Choose between narrow (left button) or wide (right button).

Parameter	Low Value	High Value	Default
Rate	0.02 Hz	10 Hz	1.00 Hz
Depth	1	10	10
Waveform	Sine • Square • Triangle • Saw • Reverse Saw		Sine
Notch Freq.	500.0 Hz	2.0 kHz	500.0 Hz
Filter Number	2	12	12
Feedback	-100%	100%	0%
Width	Narrow	Wide	Narrow

Tremolo

Rate — This slider sets the rate at which the volume modulates from 0.02 Hz to 10 Hz.

Depth — This slider sets how much the volume modulates around the center frequency, from 1 to 10.

Waveform — Different waveform shapes create different tremolo effects. Using the slider, select between sine, square, triangle, saw and reverse saw waveforms.

Width — This button sets the modulation width (i.e. stereo spread). Choose between narrow (left button) or wide (right button).

Parameter	Low Value	High Value	Default
Rate	0.02 Hz	10.00 Hz	5.00 Hz
Depth	1	10	7
Waveform	Sine • Square • Triangle • Saw • Reverse Saw		Sine
Width	Narrow	Wide	Narrow

Rotary

Mod Depth — This slider sets the depth of the delay modulation, from 0 ms to 1 ms.

Tremolo Depth — This slider sets the depth of the volume modulation, from 0 to 10.

Acceleration — This button sets the acceleration rate. In other words, how fast the tremolo and modulation speeds change when switching between low speed and high speed. Choose between slug slow (left button) or Ferrari fast (right button).

Rate High — This slider sets the spinning speed in the high setting in Hz, from 0.1 Hz to 10 Hz. Increase this value to add more high-end shimmer.

Rate Low — This slider sets the spinning speed in the low setting in Hz, from 0.1 Hz to 10 Hz. Increase this value to add more low-end throb.

HF Damping — This applies a low-pass filter to the signal and rolls off the higher frequencies, from 500 Hz to 20 kHz.

Speed — This button sets the rotary speed. Choose between low (left button) or high (right button).

Width — This button sets the modulation width (i.e. stereo spread). Choose between narrow (left button) or wide (right button).

Parameter	Low Value	High Value	Default
Mod Depth	0.0 ms	1.0 ms	0.3 ms
Tremolo Depth	0.0	10.0	7.0
Acceleration	Slow	Fast	Slow
Rate High	0.1 Hz	10.0 kHz	6.7 Hz
Rate Low	0.1 Hz	10.0 kHz	1.0 Hz
HF Damping	500 Hz	20.0 kHz	20.0 kHz
Speed	Low	High	Low
Width	Narrow	Wide	Wide

Chorus (Mono and Stereo)

Rate — This slider sets the speed of the delay modulation, from 0.05 Hz to 5 Hz.

Depth — This slider sets the depth of the delay modulation, from 1 to 10.

Delay Time — This slider sets the current delay time in milliseconds, from 0 ms to 50 ms.

Waveform — Different waveform shapes create different phaser effects. This controls the way the delay modulation moves. Using the slider, select between sine, square, triangle, saw and reverse saw waveforms.

Voices — This button sets the number of voices. Choose between one (left button) or two (right button).

HF Damping — This applies a low-pass filter to the signal and rolls off the higher frequencies, from 500 Hz to 20 kHz.

Parameter	Low Value	High Value	Default
Rate	0.05 Hz	5.00 Hz	0.50 Hz
Depth	1	10	5
Delay Time	0.0 ms	50.0 ms	10.0 ms
Waveform	Sine • Square • Triangle • Saw • Reverse Saw		Sine
Voices	One	Two	Two
HF Damping	500.0 Hz	20.0 kHz	20.0 kHz

Flanger

Rate — This slider sets the speed of the delay modulation, from 0.05 Hz to 5 Hz.

Depth — This slider sets the depth of the delay modulation, from 1 to 10.

Delay Time — This slider sets the current delay time in milliseconds, from 0 ms to 10 ms.

Waveform — Different waveform shapes create different flanger effects. This controls the way the delay modulation moves. Using the slider, select between sine, square, triangle, saw and reverse saw waveforms.

Feedback — The higher the feedback percentage, the sharper the peaks between the notches. It ranges from -100% to 100%.

HF Damping — This applies a low-pass filter to the signal and rolls off the higher frequencies, from 500 Hz to 20 kHz.

Width — This button sets the modulation width (i.e. stereo spread). Choose between narrow (left button) or wide (right button).

Parameter	Low Value	High Value	Default
Rate	0.05 Hz	5.00 Hz	0.20 Hz
Depth	1	10	2
Delay Time	0.0 ms	10.0 ms	0.0 ms
Waveform	Sine • Square • Triangle • Saw • Reverse Saw		Sine
Feedback	-100%	100%	69%
HF Damping	500.0 Hz	20.0 kHz	20.0 kHz
Width	Narrow	Wide	Narrow

Mod Delay

Rate — This slider sets the speed of the delay modulation, from 0.05 Hz to 5 Hz.

Depth — This slider sets the depth of the delay modulation, from 1 to 10.

Delay Time — This slider sets the current delay time in milliseconds, from 60 ms to 1.6 ms.

Waveform — Different waveform shapes create different mod delay effects. This controls the way the delay modulation moves. Using the slider, select between sine, square, triangle, saw and reverse saw waveforms.

Feedback — This controls how much of the delayed signal is routed back to the input of the delay section to create multiple echoes. Each time the signal is fed back, the delayed signal becomes quieter (so the echo won't go on forever unless set at 100%). It ranges from 0% to 100%.

HF Damping — This applies a low-pass filter to the delayed signal and rolls off the higher frequencies, from 500 Hz to 20 kHz.

Width — This button sets the modulation width (i.e. stereo spread). Choose between narrow (left button) or wide (right button).

Parameter	Low Value	High Value	Default
Rate	0.05 Hz	5.00 Hz	0.50 Hz
Depth	1	10	1
Delay Time	60.0 ms	1.6 ms	500.0 ms
Waveform	Sine • Square • Triangle • Saw • Reverse Saw		Sine
Feedback	0%	100%	20%
HF Damping	500.0 Hz	20.0 kHz	4.0 kHz
Width	Narrow	Wide	Narrow

Sweep Filter (Manual, Auto and LFO)

Enable — This button enables or disables the sweep filter. Choose between off (left button) or on (right button).

Sweep Type — This is the type of filter that will be used for the sweep filter. Using the slider, select between HPF, LPF, PEQ, bandpass and shelf sweep types.

Upper Freq, Upper Q, Upper Gain — These parameters (along with the type) define the filter shape at its “high” setting.

Lower Freq, Upper Q, Upper Gain — These parameters (along with the type) define the filter shape at its “low” setting.

Auto Upper Gain (Auto) — This filter setting is based on where the input level is in between the upper and lower gain levels in dB. Auto Sweep filter uses the input level to control the position of the filter. This parameter defines the input level at which Sweep filter will be at its “high” settings, from -80 dB to 0 dB. When the input level is at or above this level, the sweep filter will be at its upper settings.

Auto Lower Gain (Auto) — This filter setting is based on where the input level is in between the upper and lower gain levels in dB. This parameter defines the input level at which Sweep filter will be at its “low” settings, from -80 dB to 0 dB. When the input level is at or below this level, the sweep filter will be at its lower settings.

Rate (LFO) — This slider adjusts the speed of the LFO that controls the sweeping, ranging from 0.02 Hz to 10 Hz.

Waveform (LFO) — Different waveform shapes create different sweep filter effects. This controls how the filter sweeps between the upper and lower settings. Using the slider, select between sine, square, triangle, saw and reverse saw waveforms.

Attack — This slider controls how fast the filter will change when it moves, ranging from 0 ms to 1 ms. 0 is slower, 1 is faster.

Position (Manual) — This slider sets the position of the sweep filter, ranging from 0 to 1. The filter will sweep from its low settings when positioned at 0 to its high settings when positioned at 1.

Parameter	Low Value	High Value	Default
Enable	Off	On	On
Sweep Type	HPF • LPF • PEQ • Bandpass • Shelf		Bandpass
Upper Freq.	20.0 Hz	20.0 kHz	2.7 kHz
Lower Freq.	20.0 Hz	20.0 kHz	200.0 Hz
Upper Q	0.5	16.0	4.0
Lower Q	0.5	16.0	1.0
Upper Gain	-15.0 dB	15.0 dB	15.0 dB
Lower Gain	-15.0 dB	15.0 dB	8.0 dB
Auto Upper Gain (Auto)	-80.0 dB	0.0 dB	-21.0 dB
Auto Lower Gain (Auto)	-80.0 dB	0.0 dB	-40.0 dB
Rate (LFO)	0.02 Hz	10.00 Hz	1.00 Hz
Waveform	Sine • Square • Triangle • Saw • Reverse Saw		Sine
Attack	0.0 ms	1.0 ms	1.0 ms
Position	0.0	1.0	0.0

Tools, Part I

Ok, you got us... we skipped over Devices to mention Tools, but there's a reason why, and it's only for but a moment. No need to even tap tools (aka the gear icon) at this point; we're just going to look at it.

The tools button states the current connection status of the Master Fader app. As seen in the images below, it could display one of four statuses:



Offline — The Master Fader app is NOT communicating with a mixer because it has been configured as such. Offline could even be displayed when an iPad is physically connected to a DL806 or DL1608.



Connected — The Master Fader app is connected to the mixer, either wired or wirelessly.



Syncing — The Master Fader app is syncing to the mixer wirelessly. This often happens so fast that you might not even see it!



Disconnected — The Master Fader app is trying to connect wirelessly to the mixer, but is unable to connect.

These will make more sense when we discuss devices, starting on the next page.

When tapped, the tools menu will appear. Additionally, the tools icon illuminates green depending on if it is engaged or disengaged and if a device is connected or offline. See below.

**Tools Engaged,
Device Connected**



**Tools Engaged,
Device Offline**



**Tools Disengaged,
Device Connected**



**Tools Disengaged,
Device Offline**



Devices

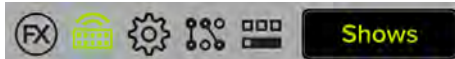

Devices is where you select a mixer to control from the Master Fader app, whether wired or wirelessly. Or you may choose to work offline. This could be to demo the Master Fader app or prepare a mix prior to the next gig. Simply select from the list of discovered DL Mixers to control. The list of available devices to select from is divided into three sections: Offline, Wired and Wireless.

Offline — Select “Work Offline/Demo” to sever all control from a mixer. A device that is offline will not control a mixer, whether physically connected to the mixer or not. In fact, the device need not be anywhere near the mixer. You could be 35,000 feet up in the air traveling to your next gig setting up snapshots, shows and presets. Offline, of course! Offline is also where you test drive the Master Fader app [for free!] before purchasing a DL Series mixer.

Wired [DL806 / DL1608 only]— A wired iPad is using the wired connection to control the mixer. Only one iPad may be wired per mixer. Therefore, only one item will ever be shown in the wired list. If the iPad is not docked with a mixer, the word “Disconnected” will be displayed in the ‘Current Device’ box.

Wireless — The wireless list will display all mixers available for wireless control from the Master Fader app. Choose one mixer to connect to and then control it from the device. A wireless device is connected to the mixer (via Wi-Fi), but not physically docked with the mixer. If it is, the device will change automatically to wired. Up to 20 devices may be connected wirelessly to a single DL mixer.

On first launch of the the Master Fader app, you will need to selected a DL mixer you wish to connect to for control. Anytime the Master Fader app is put in the background and then brought back into the foreground it will attempt to reconnect to the last selected DL mixer. If the last selected DL mixer is not available it will be shown as disconnected. You can then choose to work offline or select another available wired or wireless DL mixer to connect to.

Let’s walk through the various ways to connect a device to a mixer, starting with Offline:

Offline — This is what the devices list displays when you first fire up the Master Fader app (before the device is connected to the mixer and prior to the mixer being connected to the Wi-Fi router). The “Work Offline/Demo” device is selected and its corresponding button illuminates green. This is about as basic as the devices screen gets, so it seems like a great place to start! In this particular case, there is nothing else to choose from. This mode is perfect for configuring a complete show offline or to test drive the Master Fader app before buying the accompanying mixer.

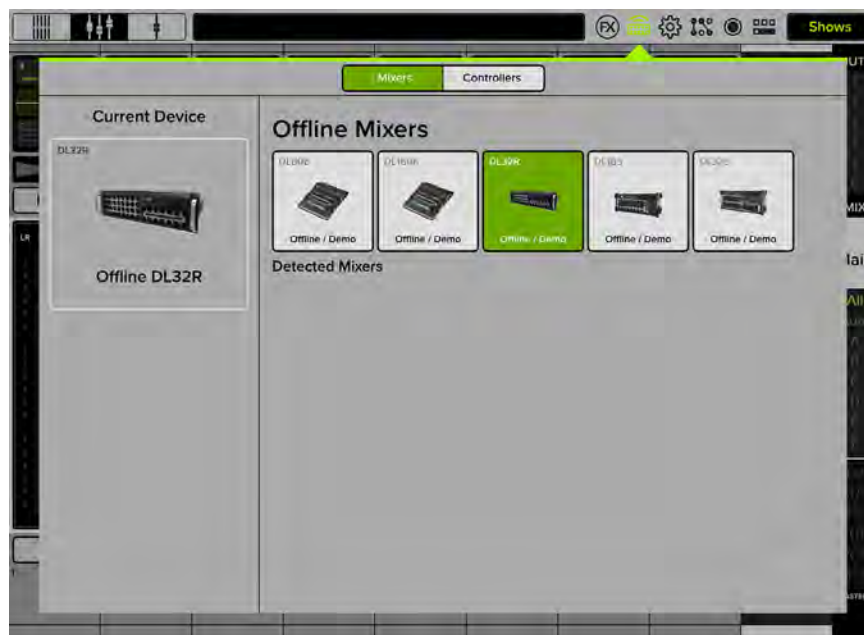

Wired [DL806 • DL1608] — Slide the iPad into the mixer. You will see that the wired device changes to display the name of the DL Series mixer and it is automatically selected.

Switch between the offline and wired device selections and notice that the Master Fader app re-syncs with the console's current state every time you reconnect. The mixer is shown in full color in both devices [offline and wired] indicating that either may be selected.

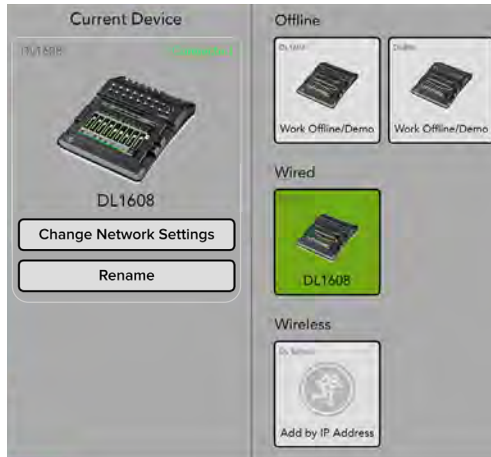

The devices view can show both wired and wireless mixers simultaneously, but if you are using the wired connection you will not be able to select the wireless DL mixer shown until your iPad is removed from the dock. Try to select the wireless DL Series mixer by tapping it. Notice that it just bounces back to the wired device. This is indicated by a grayed out mixer icon in the wireless selection. However, the offline icon is not grayed out, indicating that it is available for selection. You might decide to work offline so your changes don't affect the mix of the gig currently taking place.

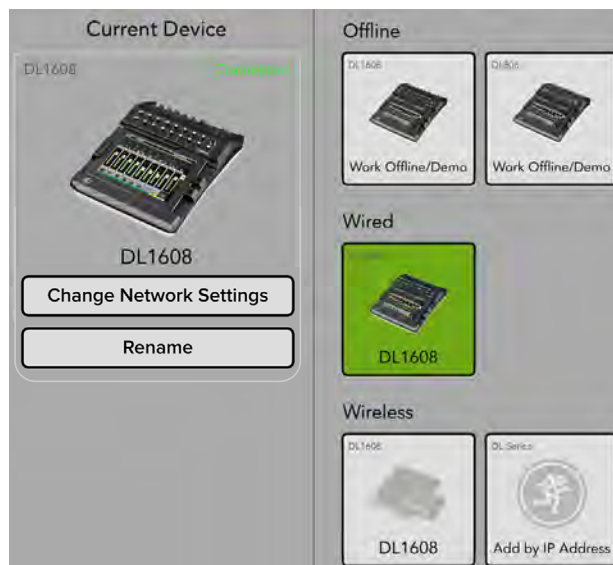

Wireless — Remove the iPad from the mixer dock and select the mixer from the wireless list so it's highlighted. Feel free to wander the venue and mix with this wireless iPad. Because the iPad is wireless, working wired (with a DL806 • DL1608) is not an option until the iPad is docked to the mixer. As such, the wired list isn't even displayed. However, working offline is still available for selection. You might decide to work offline so your changes don't affect the mix of the gig currently taking place.



The **CURRENT** show on the device must match the **CURRENT** show on the mixer. If they do not, you will be asked to select between the two so they are synced. Why would shows not be synced? Well, one example could be that current show (X) was used at a gig. The band and crew then pack up for the next show, but the engineer wants to make some tweaks for the next night's performance. The engineer makes a few changes and stores a new snapshot offline; this show now differs from the **CURRENT** show that is still on the mixer. What will happen when the device is reunited with the mixer once again? The engineer will be asked which one to use: the current show on the mixer [X, tap the DL806 • DL1608 • DL16S • DL32S • DL32R button] or the current show on the device [Y, tap the device button]. In this case, the engineer would choose the device since it contains the latest changes.

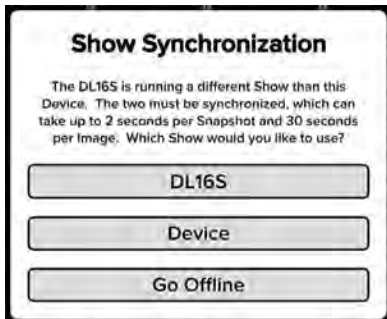

DL806 • DL1608 • DL16S • DL32S • DL32R – tapping the DL806 • DL1608 • DL16S • DL32S • DL32R button here is considered **PULLING** the current show from the mixer and copying it to the device. Note that the previous current show on the device is replaced, but an offline copy of the previous show will remain. It will take about two seconds per snapshot to synchronize the shows.

Device – tapping the Device button here is considered **PUSHING** the current show from the device and copying it to the mixer. It will take about two seconds per snapshot to synchronize the shows. All connected devices will automatically sync with the current show.

Go Offline – tapping the Go Offline button here allows you time to figure things out before deciding which show to use.

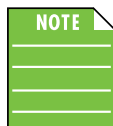

Each device that is offline is unique. In other words, multiple varying snapshots and shows may be created on each device. This is something to be aware of when reconnecting.

Disconnected — Let's try something. Turn the mixer off and see what changes. Notice that the mixer is now listed as "Disconnected". Additionally, a red dot appears inside the tools icon.



So how does disconnected differ from offline? Glad you asked! Disconnected means that you are trying to connect to a mixer wirelessly, but can't at this time. The most likely cause for this in the real world is that you have wandered just out of range of the wireless router. However, it could also be caused by some kids moshing in the pit accidentally unplugging the mixer from its power source. Oops! But the Master Fader app remembers that you were once connected and it is trying to reconnect. We know because the mixer icon is still there and the wireless selection remains highlighted. If you would prefer to stay permanently disconnected (even when the mixer returns to the wireless network) simply select "Work Offline/Demo" from the devices list. If you do this, you will eventually see the mixer disappear from the wireless list. This is because it is not currently available AND you are no longer trying to connect to it.



Be patient. The wireless device will not immediately disappear after it is powered off. This is one of the safety features of the device auto-discovery. It is normal to see devices hang around longer than you might expect.

Obviously, since we are walking around the room mixing wirelessly, there is no wired device available.



Change Network Settings • Rename — When a device is connected to a mixer (either wired or wirelessly), you are able to set up some advanced configuration settings for the mixer. Two buttons are located in the Current Device box: Change Network Settings and Rename.

Let's start with renaming the mixer. Wait, did we just say "renaming the mixer"? Sure enough, we did. Here you are physically changing the name on the device, but it is indeed the mixer you're naming. Why name the mixer anything else other than "DL806", "DL1608", "DL16S", "DL32S" or "DL32R"? Well, you might have two (or more) mixers and want to identify between them on the same wireless network. A maximum of 54 characters may be used when naming the mixer.

As a hardware setting, the name is stored in the mixer, is global to the mixer and therefore affects all connected devices. It is not changed by show or snapshot changes.

Renaming from a wired or wireless device:

- (1) Tap the "Rename" button.
- (2) Type in the name you want to call the mixer followed by tapping the "OK" button.
- (3) It stays connected and receives the new name. Easy!



Step 2



Step 3

Change Network Settings [DL16S • DL32S]:

In addition to renaming the mixer, you are also able to change the network settings. On the DL16S and DL32s, this means selecting between one of the following choices:

- Access Point
- External Router
- Wi-Fi Client

Tapping 'Change Network Settings' reveals the popover displayed below:

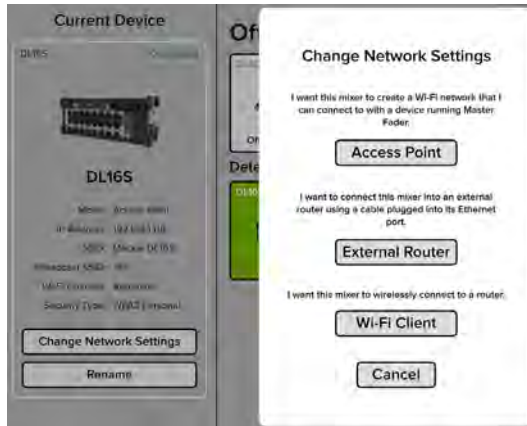

Access Point:

By default, your mixer will use the built-in Wi-Fi (Access Point mode). There are no changes necessary; it is ok to leave all settings as-is. In fact, this was all described in greater detail on page 10. So if this was your choice, you are well ahead of the curve at this point! Tap the 'Access Point' button.

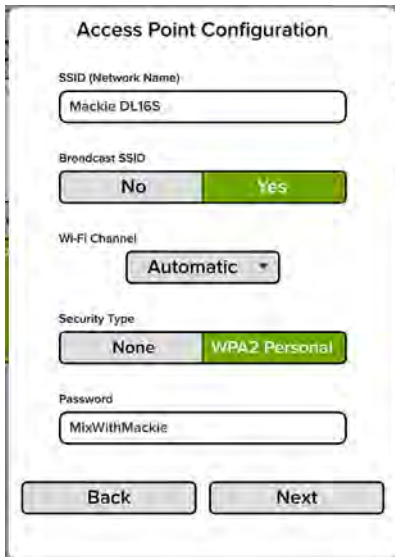

As seen to the left, the first screen that appears is the current access point configuration. Let's look at the choices:

SSID (Network Name) — SSID stands for Service Set Identification. A name has already been created – Mackie DL16S or Mackie DL32S – but you may create a different name for the Wi-Fi network here, if so desired. Simply tap inside the SSID box and type in a new name for the network.

Broadcast SSID — By default, SSIDs are broadcast. For example, when you want to connect to the free Wi-Fi at the local cafe. When searching for Wi-Fi networks, the local cafe network pops up, but other networks within a close proximity are also displayed. Here you are able to "hide" the mixer's network simply by tapping the 'No' button – do not broadcast SSID. If you set Broadcast to "No", you will have to manually enter your Wi-Fi network name in your Android or iOS device's Wi-Fi connection screen.

Wi-Fi Channel — Wi-Fi channels are smaller bands within the frequency band of the router. We suggest leaving this set at 'Automatic' as the Wi-Fi channel with the least interference will be selected automatically. If you run into performance issues and/or other signal interference, we suggest selecting channel 1, 6 or 11. If you want to get really advanced, you can download apps for iOS and Android that let you view the Wi-Fi channel usage in your area. You can then choose

the channel that has the least amount of use giving you the best possible Wi-Fi range and reliability for your particular venue. Remember this usage can change frequently, so if you choose a manual setting, be sure to check regularly to make sure you have selected the optimal channel. Tap the button and select the Wi-Fi channel.

Security Type — There are two security types to choose from here: None and WPA2 Personal. None means that there is no security. In other words, if you're running sound at a show with Master Fader, a concert-goer with Master Fader could hop onto the network and change settings. Yikes! WPA2 Personal protects unauthorized network access by utilizing a set-up password. In this case, 'MixWithMackie' (unless changed). The only time we would remotely suggest setting this to 'None' is during rehearsals.

Password — By default, the password is set to 'MixWithMackie' on both the DL16S and DL32S. That said, you may create a different password, if so desired. We recommend changing the password for security purposes. Simply tap inside the Password box and type it in. If changing, make it a password that is easy for you to recall, but difficult for others to hack. Of course, the password box will disappear if the security type is set to 'None'.

Once you are happy with the settings, tap the 'Next' button to reveal the next screen as seen below. Here you are able to either apply the settings or go back if more changes are necessary.

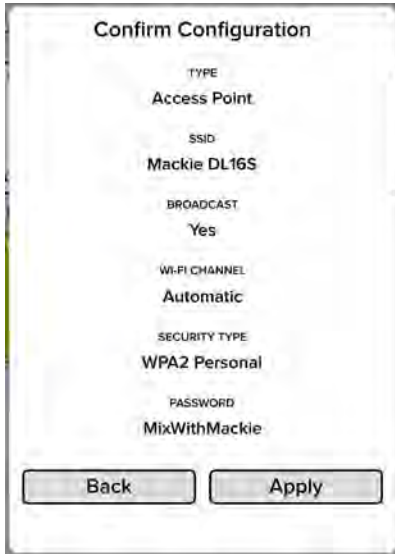

Utilizing the built-in Wi-Fi will satisfy most users. Only those with very specific Wi-Fi requirements (extra-wide range demands, integration with existing network, etc.) would need to use the External Router or Wi-Fi Client modes.



Do NOT connect an external router when using Access Point mode. This can create an unstable network causing some devices to stop operating properly.

If not using the built-in Wi-Fi, there are two other options that may be configured with Master Fader.

External Router:

Some of our friends in the pro audio industry would prefer to use an external router instead of the built-in router. That's ok... we have options for you, too!

This is similar to the DL806, DLI608 and DL32R which all require an external router in order to work. Here, you will need to plug one end of a CAT5 Ethernet cable into the mixer's network connector [Ext. Control] and the other end of the CAT5 Ethernet cable into a LAN port on the router, NOT a WAN port.



When configuring for External Router, first change the settings with Master Fader, then connect the external router.

Let's see how to configure an external router. The first two steps are the easiest: tap the 'Change Network Settings' button followed by tapping the 'External Router' button. Here's what appears:

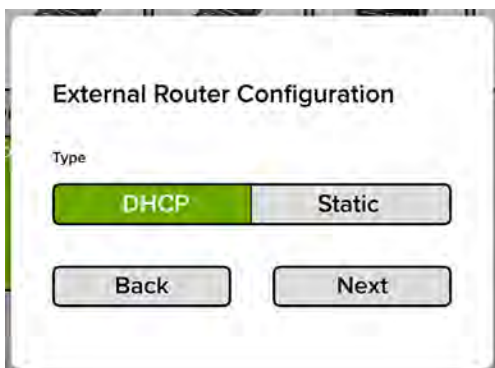

DHCP — DHCP stands for Dynamic Host Configuration Protocol. In short, the external router needs to be able to assign an IP address to a device – i.e. one of the DL mixers – connected to the Ethernet port. This is the most common selection, with the IP address changing (automatically) being assigned automatically by the external Wi-Fi router each time it connects. More information and screenshots on the following page.

Static — A static IP address, on the other hand, has a permanent number assigned to a one of the DL mixers. This is the selection to configure the mixer to use a fixed IP address. Most users shouldn't ever need to choose static, but if you need to, you know it. More information and screenshots on the following page.

In short, the mixer IP address is assigned by the user instead of the Wi-Fi Router via DHCP.

Let's look at DHCP first. Tap the 'Next' button to reveal the following screen.



Because the DHCP IP address is automatically changed, there is nothing to do here except tap the 'Apply' button. And off you go... mix away!

Setting a static IP address involves a few more steps. Before going over the steps, though, let's first discuss why you might want to use a static IP address. Well, if the mixer is used in a complex network, such as a church or other fixed install, it allows the mixer to work better in that environment. This is because the mixer will remain at the same IP address, allowing IT to set up and better monitor the devices.



Since this is only an option, it does not add any extra complexity for users not needing this flexibility. In other words, don't follow these instructions unless utilizing in a fixed install or other similar situation.



If using a Static IP address for your DL Series Mixer, an update may fail to begin properly. Similarly, a force update will fail in the same way. If either of these happen, you will need to temporarily configure the DL hardware to use Dynamic [DHCP] IP addressing.

This can be accomplished by temporarily changing back to Access Point mode and using the internal Wi-Fi for the update. When the update is complete, change the DL hardware back to static IP and connect it back to the main network.

Configuring your system to use a fixed [static] IP address for the mixer involves the following steps:

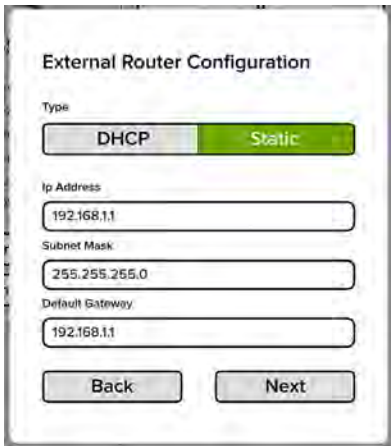

Steps 2-3



Step 4

(1) Before anything else – begin with an iPad or Android tablet connect via Access Mode. An external router should NOT be connected yet!

(2) In Master Fader, go to: Devices > Change Network Settings > External Router > Static.

(3) Type in the IP Address, Subnet Mask and Default Gateway followed by tapping the “Next” button.

(4) Tap the “Apply” button in order for the changes to take place.

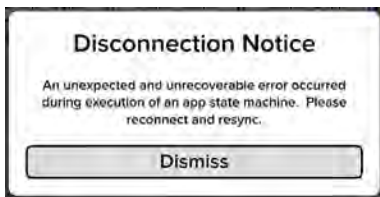

Step 5

(5) The dreaded disconnection notice (as seen to the left) really isn’t so dreadful. No need to worry! Tap “Dismiss”.

(6) Connect the external router now and return to the Devices screen. It should now show that you are connected via external router using static IP.

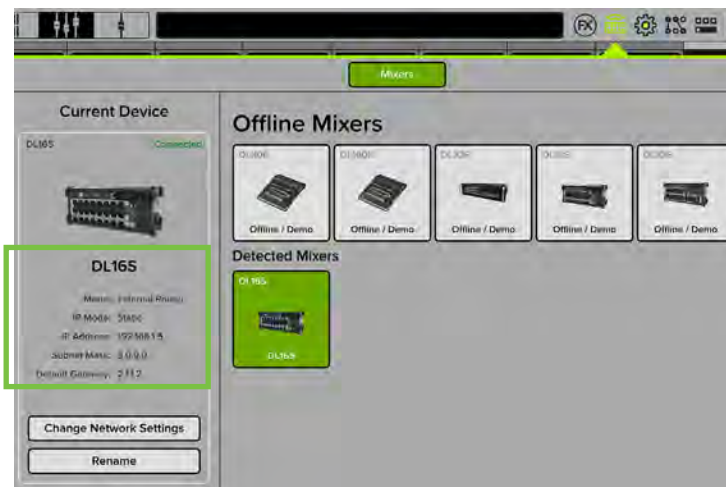

Step 6



Again! When configuring for External Router, change the settings with Master Fader, then connect the external router.

Wi-Fi Client:

The last network setting that may be selected is Wi-Fi Client. We added this feature in for even greater network flexibility. But what is the Wi-Fi Client mode? What does it mean?

In short, Wi-Fi Client mode connects wirelessly to an existing Wi-Fi access point. In this mode, a router is not physically connected to the mixer. Instead, the venue runs a dedicated (and protected) Wi-Fi access point for their internal use. If using this mode, there are a few steps necessary to get dialed in.



As mentioned earlier, utilizing the built-in Wi-Fi will satisfy most users. Only those with very specific Wi-Fi requirements (extra-wide range demands, integration with existing network, etc.) would need to use the External Router or Wi-Fi Client modes.

Configuring your system to connect to a Wi-Fi Network involves the following steps:

- (1) Begin with an iPad or Android tablet connect via Access Mode.
- (2) In Master Fader, go to: Devices > Change Network Settings > Wi-Fi Client.
- (3) Tap the “Automatic” button to reveal a list of detected networks. If you do not see the network you desire, simply tap the “Refresh” button.

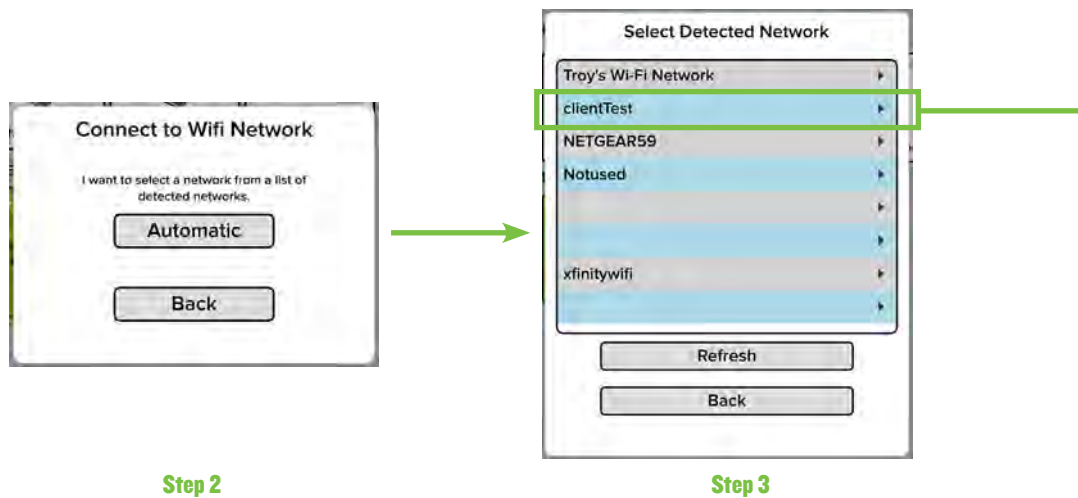

- (4) Tap the detected network you wish to connect to; in this example, we’re selecting our ‘clientTest’ router. As seen below-left, this opens a new window in which you will need to enter the password followed by tapping the “Next” button.



Be very careful when entering the Wi-Fi password for Client mode. If incorrect, you will need to use the network reset button to reset the network to Access Point mode.

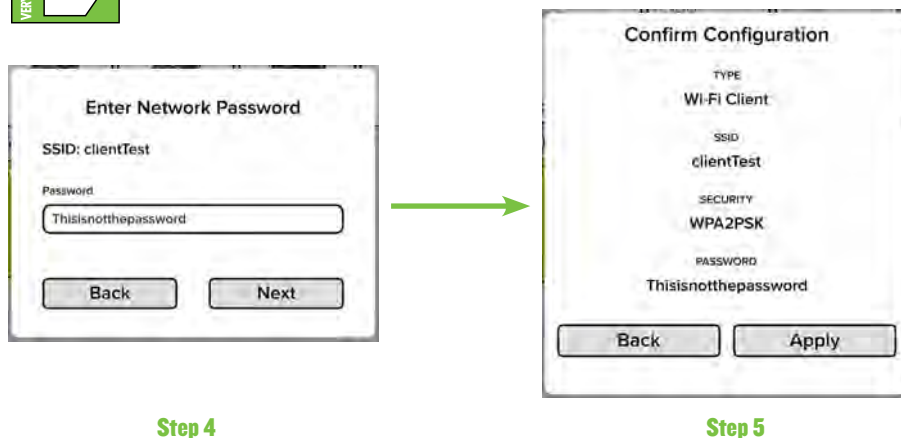

- (5) The next window asks you to confirm the configuration by tapping ‘Apply’... or tap the ‘Back’ button if the selected network and/or password are wrong.

Change Network Settings [DL806 • DL1608 • DL32R]:

As mentioned way, way back in Chapter 2: Wireless Setup (pages 10-16), the DL806, DL1608 and DL32R all require an external router in order to work. In fact, you should be all dialed in and rolling at this point. But what if the mixer will be used in a complex network such as a church or other fixed install? Advanced network settings allow for this so the mixer works better in that environment. Your environment! This is because the mixer will remain at the same IP address, allowing IT to set up and better monitor the devices.



Since this is only an option, it does not add any extra complexity for users not needing this flexibility. In other words, don't follow these instructions unless utilizing in a fixed install or other similar situation.

Let's see how to configure your system to use a fixed IP address. The first two steps are the easiest: tap the 'Change Network Settings' button followed by tapping the 'External Router' button. Here's what appears:



DHCP — DHCP stands for Dynamic Host Configuration Protocol. In short, the external router needs to be able to assign an IP address to a device – i.e. one of the DL mixers – connected to the Ethernet port. This is the most common selection, with the IP address changing (automatically) each time it connects. More information and screenshots on the following page.

Static — A static IP address, on the other hand, has a IP address assigned to a one of the DL mixers. This is the selection to configure the mixer to use a fixed IP address. More information and screenshots on the following page.

In short, the mixer IP address is assigned by the user instead of the Wi-Fi Router via DHCP.

Let's look at DHCP first. Tap the 'OK' button to select DHCP.

Because the DHCP IP address is automatically changed, there is nothing to do here except mix away!

Setting a static IP address involves a few more steps.



If using a Static IP address for your DL Series Mixer, an update may fail to begin properly. Similarly, a force update will fail in the same way. If either of these happen, you will need to temporarily configure the DL hardware to use Dynamic [DHCP] IP addressing.

This can be accomplished by changing to Dynamic IP, disconnecting the hardware from the main network, then configuring a temporary Wi-Fi network with a router directly connected to the DL hardware with no other network connections. When the update is complete, change the DL hardware back to static IP and connect it back to the main network.

Configuring your system to use a fixed [static] IP address for the mixer involves the following steps:



Steps 2-3

(1) Before anything else – turn the mixer OFF and connect the router (if not already connected). It is ok to leave the router ON.

(2) In Master Fader, go to: Devices > Change Network Settings > Static.

(3) Type in the IP Address, Subnet Mask and Default Gateway followed by tapping the “OK” button to apply.

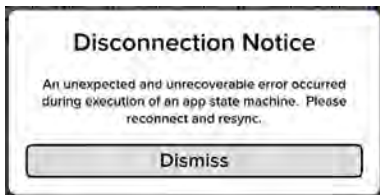

Step 4

(4) The dreaded disconnection notice (as seen to the left) really isn't so dreadful. No need to worry! Tap “Dismiss”.

(5) Turn on the mixer and return to the Devices screen. It should now show that you are connected via external router using static IP.



Step 5

You should now know how to connect your device to offline, wired and wireless mixers. Go ahead and experiment with it, switching between the selections. The more you do it, the more familiar it becomes. Plus, it's software: you can't break it!

If you believe that the device should be connected when wireless, please follow the steps outlined below in order:

- (1) DL1608 / DL806 users: connect the iPad wired just to ensure that the app works.
- (2) Follow the directions again as listed in "Chapter 2: Wireless Setup" (pages 10-16), step-by-step. Did that work?
- (3) You're here, so that didn't work. Now review the devices section which we just detailed (pages 174-186). Are you good to go now?
- (4) Well shoot, let's try something else out. Head over to the Troubleshooting section in Appendix A: Service Information on page 266. That worked, right?
- (5) Darn, we've run out of options. Time to contact our splendid Technical Support Heroes. The contact information is built right into the Master Fader app! Just go to: Tools > Help > Support. Page 195 explains this in greater detail.

Controllers



As seen below, the "Controllers" tab only appears when a DL32R mixer is selected. Controllers offer a wide variety of Follow Mode possibilities.



While the controllers tab is available for anyone to view, the functions only work for users running an Axis system: DC16 and DL32R.



Because controllers is dedicated to DC16, the description, functionality and use case scenarios are all outlined in the **DC16 owner's manual**.

Tools, Part II

The gear icon is where you access the tools view. Think of it as a “settings”-type area.

Tap the tools icon to reveal the following options:

(1) Settings

(2) Access Limits

(3) Help

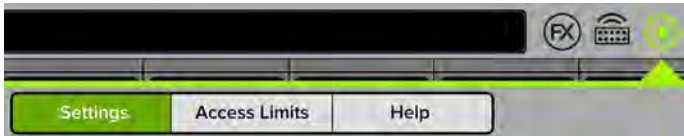

As we go through each of these sections, notice that the current selection illuminates green. When finished, tap the tools button again to return to the previous view, be it the overview, mixer view or channel view.

Settings

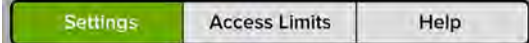

There are two types of settings available:

- (1) Settings that only affect the device. These may be customized differently for each device being used.
- (2) Settings that are transferred to the console and affect every device connected to it. Changing these on one device changes them on all devices.

When the settings tab is first opened, it will look something like what you see below. Let’s discuss each of the settings, what they do and how they benefit you.

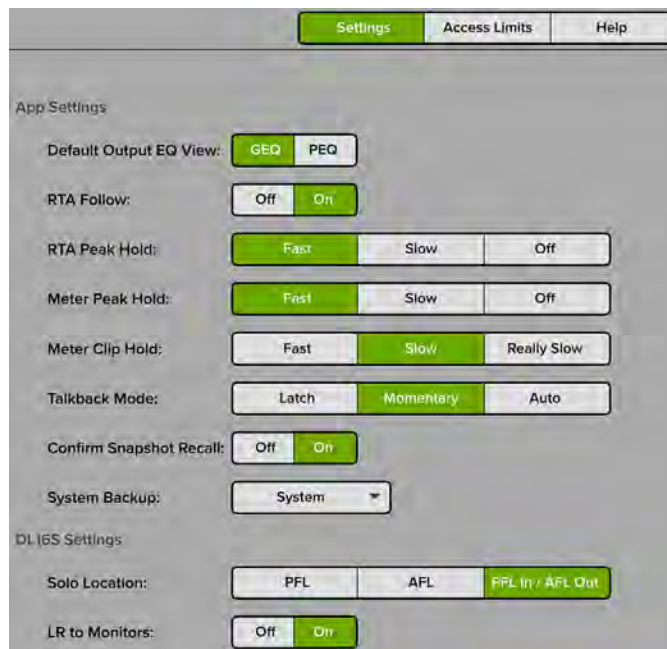

Default Output EQ View — The main LR and each aux send, sub out and matrix feature graphic EQ and parametric EQ. Of course tapping the output EQ takes you to that view, but you get to decide whether the graphic EQ or parametric EQ is the default. The current settings are located underneath ‘Settings’. Simply tap which setting you prefer. The chosen setting will illuminate green when engaged, while the other option will be grayed out. Whichever output EQ view is chosen, you can always swipe in the output view to get to the other.

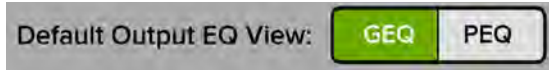

RTA Follow — An RTA / spectrograph is available on all channel inputs and outputs and here you can decide whether it’s automatically enabled or not. Simply tap the “On” button to follow or “Off” so it doesn’t follow. The chosen setting will illuminate green, while the other option will be grayed out.

There is only one instance of the RTA implemented in the mixer. Therefore, only one channel can show the RTA or spectrograph at a time regardless of how many devices are connected.

By default, once the RTA or Spectrograph is enabled, it will automatically change to show the signal for the currently selected input channel or output mix. This is because the RTA Follow switch is in the ON position: Tools > Settings > RTA Follow > On



This works as expected if using a single device. However, you will (most likely) want to disable RTA Follow on devices that are added to the mix. With this setting off, it won’t “steal” the RTA from the primary device as different outputs are selected on the other devices. It may sound a bit confusing at first, but helps if you remember that the RTA is being calculated in the mixer DSP, not the Master Fader software.

Metering Ballistics Options — Here you may determine the metering behavior that you prefer.



- **RTA Peak Hold** — Select if the RTA Peak Hold should be fast, slow or off.
- **Meter Peak Hold** — Select if the Meter Peak Hold should be fast, slow or off.
- **Meter Clip Hold** — Select if the Meter Clip Hold should be fast, slow or really slow.

Talkback Mode — Here you may select which Talkback Mode you prefer: latching, momentary or automatic.



- **Latch** — The talkback button is either on [green] or off [gray] until the talkback button is tapped again.
- **Momentary** — The talkback button is always on [green] when the talkback button is tapped and held. Talkback will be off [gray] when released.
- **Auto** — The talkback button (and functionality) is automatic, depending on if you tap and release [latching] or tap and hold [momentary] the talkback button.

Confirm Snapshot Recall — By default, a confirmation popover appears when recalling a snapshot. If you would prefer to NOT have the confirmation popover appear, you may do so by turning the feature off here.



This is a safety feature that we highly recommend leaving in the ON position unless it is absolutely necessary needed to be off.



Turning this feature off leads to faster snapshot recalls, but it could also lead to unwarranted snapshot recalls if not careful.

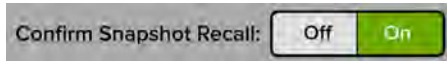

System Backup (Import / Export) — Here is where to reset shows and presets and import and export full system backups. Occasional full system backups are highly suggested.

- **Reset Shows and Presets** — Tapping Reset Shows and Presets here will **DELETE** all shows and presets. This is a permanent deletion with no undo, so a confirmation dialog helps prevent accidents.

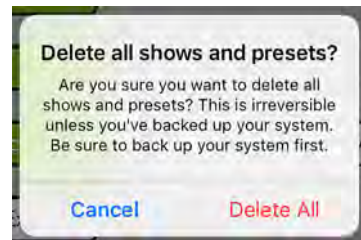

NOTE Shows and presets cannot be reset when connected to a mixer. Select an offline mixer in the devices page first.

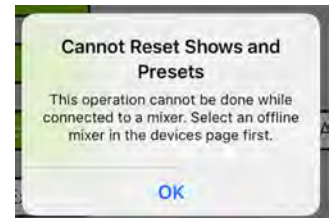

- **Import / Export** — An entire chapter is dedicated to importing and exporting files. This includes detailed instructions and multiple screenshots every step of the way. Please check it out on pages 245-248.

Solo Location — Solo location is a feature that allows you to select if the solo location is PFL, AFL or PFL for inputs and AFL for outputs. Simply tap the button of the selection you desire. It will illuminate green while the other choices remain gray as seen below.



BY DEFAULT, input channel solo buttons are PFL which stands for pre-fader listen. Therefore, the level of the channel fader **DOES NOT** affect the level heard in the monitor bus and headphones.

BUT...solo location may be changed to AFL (which stands for after-fader listen (and the level of the channel fader **DOES** affect the level heard in the monitor bus)) or PFL for inputs and AFL for outputs.



NOTE Solo Location cannot be set while in Offline mode. A device needs to be connected (whether wired or wirelessly).

Solo is also post-DSP, so if a soloed channel's EQ, compressor or gate is engaged, the processed settings will be heard. But, solo is unaffected by the position of the mute button.

LR to Monitors — By default, if no channels are soloed, you will hear the main LR output in the monitor bus [i.e. Headphone and Monitor outputs]. This is because the Tools > Settings > LR to Monitors setting is set to ON.



If the LR to Monitors setting is set to OFF, you will only hear channels that have been soloed in the Headphone and Monitor outputs. When no channels are soloed, no audio is sent to the monitor bus.

Access Limits



This set of buttons allows you to limit access to a variety of controls on each device. This is useful in multiple situations. For example, each member of a band with a device can access and change only the controls you choose. The singer won't be thrilled about it, but we all know that you're the one who really runs the show! This feature works great for FOH and monitor engineers, as well. Each can have their own device, but without the ability to access and ruin each other's already glorious settings.



With no access limits buttons pressed, the device can access all controls. With one or more buttons pressed, the corresponding control will be hidden and cannot be accessed or changed from that device. The function of the limiting buttons is described below.



Access limits are set on each device. No matter what mixer is connected (or even when working offline) the limits will take effect.

- **LR / Auxes** — Pressing any of the output buttons will prevent access to the corresponding output in the mix selector. These are the most common limits, preventing any unwarranted changes to the selected outputs. If either side of a linked aux send is access limited, the stereo aux will be hidden in the mix selector.
- **FX** — Limiting the FX prevents access to the effect sends AND the FX channel view screen. However, the effect returns for any unlimited output may still be adjusted, allowing the total amount of FX for the output to be adjusted. BUT, you will not have the ability to change any of the global FX controls.

- **Subgroups** — Pressing any of the subgroup buttons will prevent access to the corresponding subgroup in the mix selector. If either side of a linked subgroup is access limited, the stereo subgroup will be hidden from the mix selector.
- **VCAs** — Pressing any of the VCA buttons will prevent access to the corresponding VCA in the mix selector. They will be hidden and cannot be selected.
- **Matrix** — Pressing any of the matrix buttons will prevent access to the corresponding matrix in the mix selector. They will be hidden and cannot be selected. If either side of a linked matrix is access limited, the stereo matrix will be hidden from the mix selector.
- **Input DSP** — When engaged, you will not be able to access the input channel views for EQ, gate and compressor. If the FX limit is also engaged, you will not be able to access the input channel view at all and the EQ curve of each channel will be hidden. If input routing is also engaged, you will not be able to access the input routing view at all and the input routing button at the top of each channel will be hidden.
- **Master DSP** — When engaged, you will not be able to access the output channel views for parametric EQ, graphic EQ and compressor / limiter. Additionally, the PEQ/GEQ curve will be hidden. If master routing is also engaged, you will not be able to access the master routing view at all and the master routing button at the top of the master fader will be hidden.
- **Input Routing** — Engaging the input routing button will prevent access to the input routing view for all input channels, return channels [DL16S, DL32S, DL32R], iPad channel [DL806, DL1608], FX channels, subgroup channels and VCA channels. They will be hidden and cannot be selected.
- **Master Routing** — Engaging the master routing button will prevent access to the master routing view for the main L/R, all auxes, all FX, all subgroups, all VCAs and all matrix channels [DL32R]. They will be hidden and cannot be selected.
- **Mic Preamps** — With the mic preamps access limits button engaged, only the state of the mic preamp functions [48v, gain, trim and polarity] cannot be changed. Input routing (and each channel's source selection and assignments) may still be accessed and changed. [Tap the input routing button to limit access to those functions in addition to the mic preamps].
- **Oscillator** — Engaging this button limits access to the Oscillator, removing it as an option.



- **Channel Mute / Channel Solo / Pan / Channel ID** — These buttons will limit access to the corresponding channel controls. Additionally, mute, solo and pan will be hidden and cannot be selected.
- **Presets / Shows** — These buttons will limit access to presets and/or the show screen. Shows will be hidden and presets will be grayed out.
- **Quick Access** — Engaging this button limits access to the quick access panel, hiding it from the navigation bar.
- **Mute Groups / View Groups / Group Assign** — These buttons will limit access to the corresponding group controls, removing them from the mix selector and graying them out elsewhere. That's the short version. Let's take a closer look at these three access limits in detail, starting with group assign.
 - **Group Assign** — Once the user has configured the channels assigned to the mute and view groups, enable the group assign limit to prevent any changes to those assignments. The band will still be able to enable and disable mute masters and view groups, but they won't be able to make changes to the mute and view select group assignments. Slick!
 - **Mute Groups** — Enabling the mute groups limit button will prevent access to the mute group masters. This is useful for when FOH may need to use mute groups for the show, but they don't want the band members accidentally (or purposefully!) enabling a mute group with their device.

- **View Groups** — Enabling the view groups limit button will prevent access to the view group selects. After assigning channels to the various view groups, select the corresponding view group on each band member's device and enable the view groups access limits button so the band members can only view what channels pertain to them. It's foolproof...even for the lead singer! Hard to believe, but it's true.

See pages 57-63, 65-68 for more information about mute groups and view groups.

- **Masters** — Pressing the masters button will prevent access to the masters selector. It will be hidden and cannot be selected.
- **Overview** — Engaging this button limits access [imagine that!] to the overview, hiding the button from the navigation bar.
- **Devices** — Engaging this button limits access to devices.
- **Controllers [DL32R]** — Engaging this button limits access to the controllers, hiding the button from the devices screen.



- **Settings** — Engaging this button limits access to the settings, hiding the button from the tools screen.
- **I/O Patchbay** — Engaging this button limits access to the I/O patchbay button, hiding it from the navigation bar.
- **Record/Play** — Engaging this button limits access to recording and playback, hiding it from the navigation bar.



The following screenshots shows a totally locked down device with access to aux 4 only. There has to be an easier way to set access limits on everything (except Aux 4) than by tapping every button, right? Yup, there sure is! Just above the "LR" button is another gear icon. Tap it to access the All On / All Off buttons. From there, simply tap "All On" then de-select Aux 4 by tapping that button. Same idea applies if you need to de-select all engaged access limits (by tapping "All Off").



Upon return to the mixer view, you can see that only Aux 4 is accessible. Notice on the far right that Aux 4 is the only available output and that the output selector can't even be opened. Other than that, every other control has been hidden. This makes the faders and meters larger and removes unnecessary information from the interface.

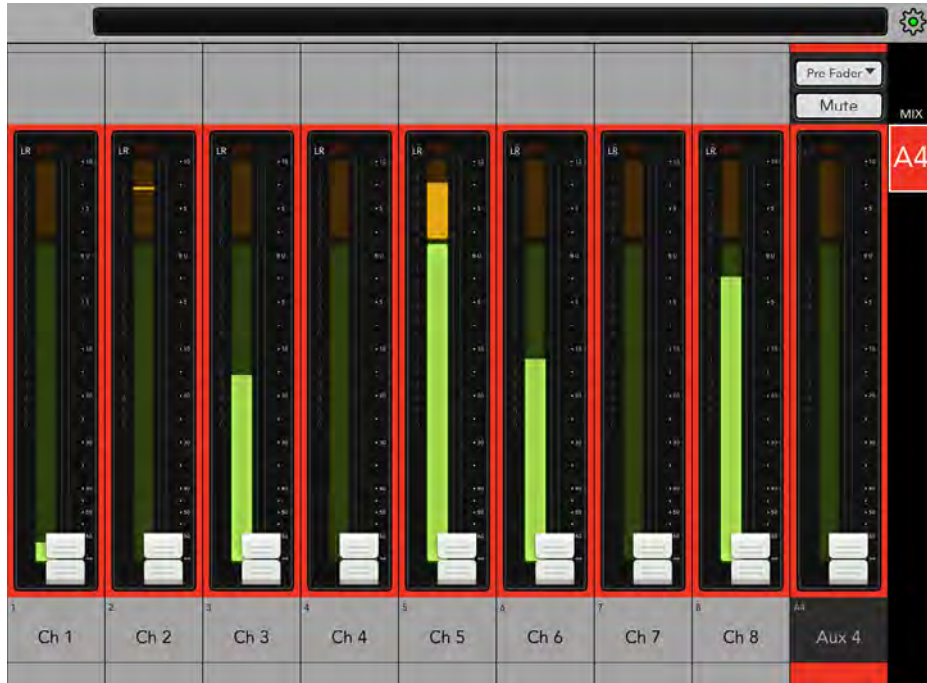

Additionally, a lock switch allows the engineer to limit changes to the access limits controls by setting a four character passcode. Simply configure the access limits as desired and tap the lock switch.



At this time, you will be prompted to enter and confirm a four character passcode.

Enter a Passcode

Choose your passcode.

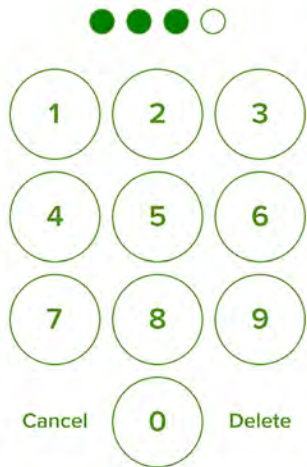

The image shows a passcode entry interface. At the top, there are four green dots, the first three are filled and the fourth is empty. Below this is a numeric keypad with buttons for digits 1 through 9, 0, a 'Cancel' button, and a 'Delete' button.

The access limit controls will now be hidden and/or grayed out, preventing any unwarranted changes.

To adjust them again, tap the lock switch and enter the four character passcode.



Be sure to remember the passcode! If you forget, you will not be able to access these controls ever again! Read that again...no access to the limit controls if you lock it and can't recall the passcode. Ok, ok, you can access them again, but you will need to uninstall and then re-download and install the Master Fader app to reset the app. Unfortunately, this will also delete all stored snapshots, shows and presets, as well as any recordings not yet exported from the app. Yeah, we bet you'll remember that passcode now!

Help

We're with you every step of the way and here's where to go if you need further assistance or simply want to seek additional information. There is plenty enough to go around for everyone and we share nice!

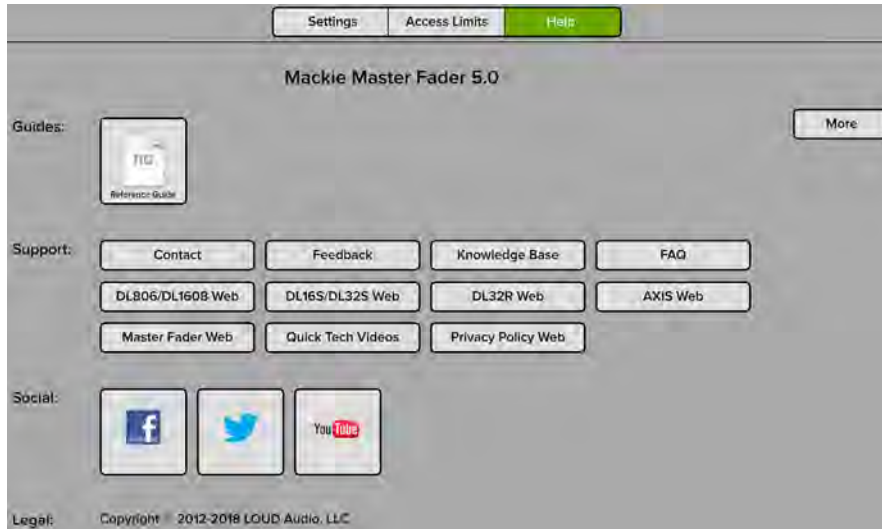

The list below describes all of the goodies as shown in the image above:

The top line displays the Master Fader App version that is currently installed on the device.

More — Tap the more button to reveal detailed version information about the app and firmware of the connected device. For the most part, this information is useless mumbo jumbo. There is no need to go here unless requested by Technical Support.

Guides — Need A LOT of information. Tap the Reference Guide button. If you prefer to view (and/or save) in iBooks, GoodReader, Adobe Reader, etc., just tap the box with the upwards-facing arrow in the upper-right corner of the document.

Printing and emailing the documents from here is also an option.

Support — So you need to talk to someone and your psychiatrist doesn't know the first thing about pro audio? We've got your back! Support provides all the phone numbers, forum and feedback links, direct access to the Mackie Service Portal [Knowledge Base, FAQs], YouTube Quick Tech Videos, and other URLs that you could ever need.

Social — Well, all the kids are doing it and we are, too. If you have a Facebook account you should 'like' us. If you have a Twitter account, you should 'follow' us. And if you like watching awesome videos, check out some of our YouTube videos. Social shows you the way.



I/O Patch



Introduction

Master Fader’s I/O patch allows you to patch audio from physical inputs to input channels and from any signal source to any physical or recording output. To slide open the I/O patch view, just tap the I/O patch button in the upper-right corner of the navigation bar. As seen in the images above and below, it will illuminate green when open. We will go over the I/O patch of the DL16S, DL32S and DL32R first (beginning below) followed by the DL806 and DL1608 (starting on page 208).

I/O patch on DL16S, DL32S and DL32R

The DL16S and DL32S I/O patches have seven tabs each and the DL32R has eight. When first opened, the I/O patch will display the “Mic Pre” tab and the default view will look something like this:



Captain Obvious says, “The mic pre tab is where you adjust the mic pre gains and 48V phantom power in one convenient location.” Don’t you just love it when something is named for what it does?! Not only are mic pre settings made here, but meter levels are also displayed for fast, easy adjustment. Because all mic pres are present in one view, this is extremely useful when the DL32R is used as a digital snake with another console via Dante.

Of course, these same adjustments may also be made by tapping a channel’s input routing button – pages 89-93 – and making modifications there.

Below is a look at the mic pre tab with levels set [channels 1-16], 48V phantom power engaged [channels 9-24] and meters [channels 1-16, 25-32].

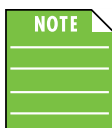

Master Fader will display input meter strips for each mic pre by default. This is because:

(1) All mic pres are patched 1-to-1 to the corresponding channel: Input A = mic pre 1 to ch. 1, mic pre 2 to ch. 2, etc. and...

(2) All mic pre source A switches [mic pre X] are engaged.

If mic pres are routed to different channels and/or different sources are selected, then meters may NOT be displayed. For example, meters will not be shown if mic pre 2 is patched to ch. 1 or input B is selected for ch. 1 with the input B source set to USB 1.

There is much more information about routing via the I/O patch over the next few pages. Additional information about source switches (which is a part of input routing) may be found on page 90.

The next tab over is the Oscillator tab. That’s right, the DL16S, DL32S and DL32R have a built-in oscillator that may be routed to any input or output! This allows you to easily test system components, diagnose routing issues and more. There are multiple options to choose from including pink noise, white noise, 100 Hz, 1 kHz, 10 kHz and a variable setting which allows you to program any frequency ranging from 20 Hz to 20 kHz.

In order for the oscillator to work you will first need to turn it on. Simply tap the ‘On’ button. It will illuminate green when engaged and is gray when disengaged.

The level slider increases [slide right] and decreases [slide left] the oscillator level.



As mentioned (and seen) above, there are multiple types of oscillators available. Simply tap the oscillator you prefer. The button of the chosen type will illuminate green.

When the “Var” (iable) oscillator type is selected (seen below), any frequency ranging from 20 Hz to 20 kHz may be dialed in (either by moving the frequency slider left and right or punching in the preferred range into the current parameter display). Options, baby!

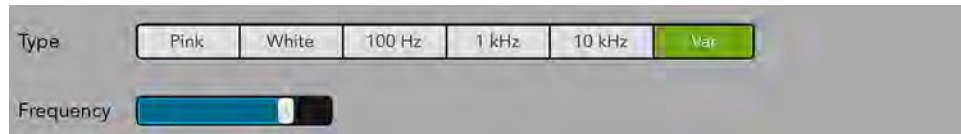

NOTE Notice that the frequency slider is only available [i.e. not grayed out] when the chosen oscillator type is “Var” (iable).

It’s great that you know how to turn the oscillator on and off, change the level and select the type, but how do you configure where the oscillator goes? Glad you asked! The oscillator routing is set in the input and output tabs. Simply tap on the horizontal oscillator line – it’s at the very top, first one listed – where the source and destination meet. The list below displays possible sources and destinations:

- **Input A** – Ch. 1 – 16 [DL16S] or Ch. 1 – 32 [DL32S, DL32R], Return 1 – 2 [DL16S, DL32S] or Return 1 – 4 [DL32R], Talkback
- **Input B** – Ch. 1 – 16 [DL16S] or Ch. 1 – 32 [DL32S, DL32R], Return 1 – 2 [DL16S, DL32S] or Return 1 – 4 [DL32R]
- **USB** – USB 1 – 16 [DL16S] or USB 1 – 32 [DL32S, DL32R]
- **Output** – XLR 1 – 8 [DL16S] or XLR 1 – 10 [DL32S] or XLR 1 – 14 [DL32R], AES 1 – 2 [DL32R], Monitor L/R
- **Dante** – Dante 1 – 32 [DL32R]

Now tap the “Input A” tab. When first opened, the default view will look something like the image below. The horizontal rows are the sources and the vertical columns are the destinations...the goal here is to connect a source to a destination.

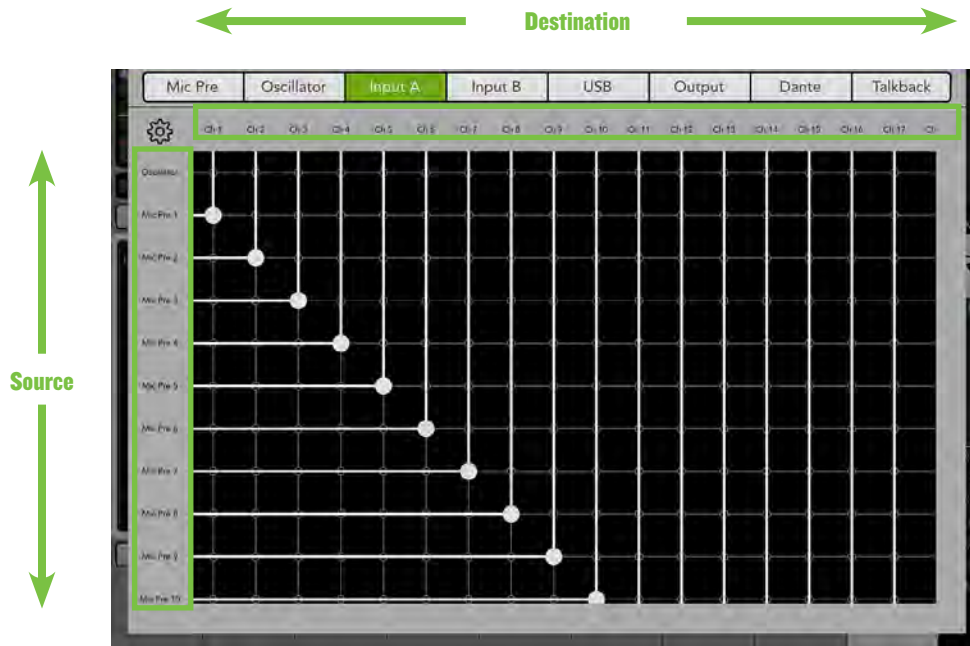

The source and destination may change, but the default patching for each channel input A is mic pres 1-xx routed to channels 1-xx and USB 1-2/4 routed to returns 1-2/4. Additionally, mic pre 16 [DL16S] / 32 [DL32S, DL32R] is routed to talkback. Drag anywhere in the black box to view these other routings.

So how does one change the patching? Well, for starters you have to make sure that both the source and destination are in view. Once visible, just tap the crosshairs where they meet. The horizontal and vertical lines will illuminate, as well as the text. Additionally, the I/O patch ball will grow 'n glow. This is how to select a destination for each source. You may also tap an existing ball to make it disappear and remove a patch.

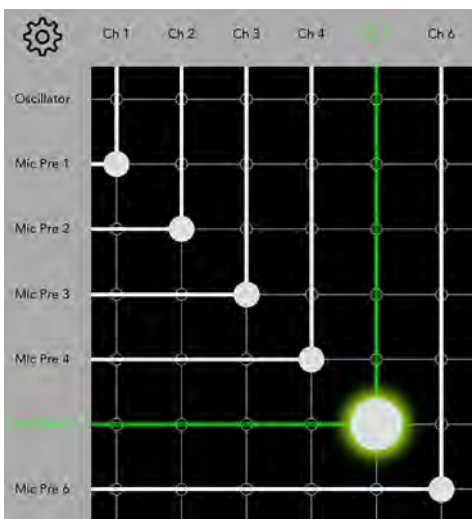

Changes made to the I/O patch are stored in snapshots. This means you can easily change the patching for different snapshots and shows. More information about snapshots and shows may be found on pages 233-244.

Below is a list of the six remaining I/O patch tabs with a quick overview of each. After the quick overview, we'll return with situational examples, including the necessary routing. In the end, though, the possibilities are nearly endless and you'll be a master I/O patcher in no time for whatever your needs may be.

Dedicated A and B channel inputs allow for fast switching between two sources for each channel. The most common use for this is for virtual sound check, switching between the mic pres and USB returns to monitor the recorded signal back through the channel. However, the flexibility allows a variety of other professional uses. For example, the user might set up a spare mic for the lead vocalist and switch to it with just a button tap if the primary wireless mic were to go down.

- **Input A** — Every single channel has two inputs, with this being input A. Here you're able to choose the source. By default, these are the mic preamps. Additionally, this is where to select the talkback input.
- **Input B** — Every single channel has two inputs, with this being input B. Here you're able to choose the source. By default, these are the USB returns.



More information about channel input A and B may be found in the recording / playback section on pages 210-224.

The three output tabs – USB, Output and Dante – allow you to configure which signals go to which outputs. These are all completely independent. In other words, you could choose to use USB for recording and Dante for networked speakers, each with different signals sent to them.

- **USB [Outputs]** — Fully routable USB recording means you're able to record just the direct inputs off the mic pres, or just the output buses of any combination of the two. This is extremely flexible as you could record multiple input channels and main L/R for a reference mix simultaneously, for example.
- **[Hardware] Output** — By having complete output patching, you are able to configure the hardware outputs to suit your needs. For example, if you're running FOH and monitors, you'll want both main L/R and aux sends on the XLR outputs. However, if you're just doing FOH, you might not need as many aux sends, but need more matrix on the XLRs. On the other hand, a dedicated monitor DL mixer could patch all aux sends to XLR outputs without having to waste XLR outputs on the main L/R.

Because the monitor outputs are patchable, if the engineer isn't using in-ear monitors, headphones, or monitor speakers, you can use these 1/4" outputs for something else such as additional aux sends. Similarly, if you want the solo bus on XLR outputs, you're able to patch this, as well.

- **Dante [Outputs] [DL32]** — Here is where to choose which signals are sent to the Dante outputs. This would usually be output channels if connecting to Dante-enabled amps and speakers, but could also be the mic pres if using Dante for recording.

Because the USB and Dante are sourced completely and independently, they may be used for completely different purposes. Most commonly, the USB could be used for recording while the Dante could be used for networking to loudspeakers. With a shared system, they would have to compromise and use the same outputs for both.

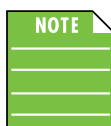

Routing to Dante requires a Dante card (available separately).

The last tab in the row is the talkback tab and it is unique.

- **Talkback** — With talkback, you're able to configure which outputs the talkback is sent to.

In the upper-left corner of the I/O patch view is a tools button. This is available regardless of what tab is open (Mic Pre and Oscillator being the exceptions). Here you're able to reset the patching to default or clear the patching altogether. Tap it to display a popover as seen below right.

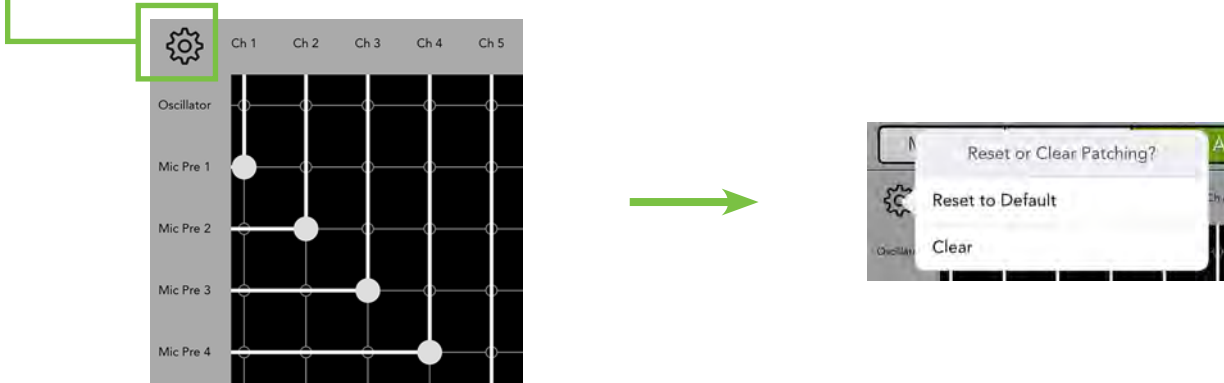

Reset to Default resets (the currently opened tab) to its default state. Clear clears all patchings (of the currently opened tab) and all balls will be removed from the I/O patch. Clearing all routings may be used in more complex setups where it's easier to start from scratch. Once cleared, the source(s) and destination(s) may be tapped into spot for your needs.

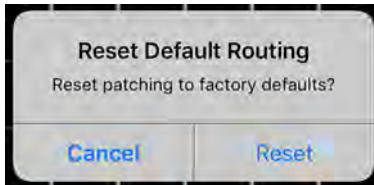

Reset to Default

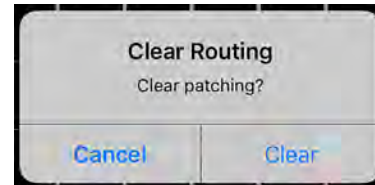

Clear Routing

I/O patching situational examples:

INPUT A/B 1 — Input A and input B have the same sources [Mic pres 1-xx, USB 1-xx, Dante 1-xx] and destinations [Chs 1-xx and Returns 1-x]. Input A is also where to patch the talkback source. Hmmm, Destination Talkback. That might be the name of my next band.

Let's take a look at a few examples why the routing might be changed here. Here's a common one – there's a saying that goes a little something like this: “there are too many cooks in the kitchen.” In a nutshell this means that there are too many people doing one job and end up ruining the final product. The same is true of engineers.

Without saying, you are the best engineer and need to be running the show. But what if there are more engineers at the venue thinking they know how to connect all the hardware and rewire some of the inputs and outputs? One option is to head back to the mixer and wire it back the way you originally set it up. Another option is to open the I/O patch view and reroute the mic pres to the updated channel.

An example – you originally set up mic pres 1-32 to channels 1-32. Nice, easy, concise. Evil engineer then heads to the mixer and switches inputs 1 with 5, 2 with 10, 3 with 15, 4 with 6 and 5 with...that's a trick. 1 and 5 were already swapped. Below is an image of how you would set the I/O patch:

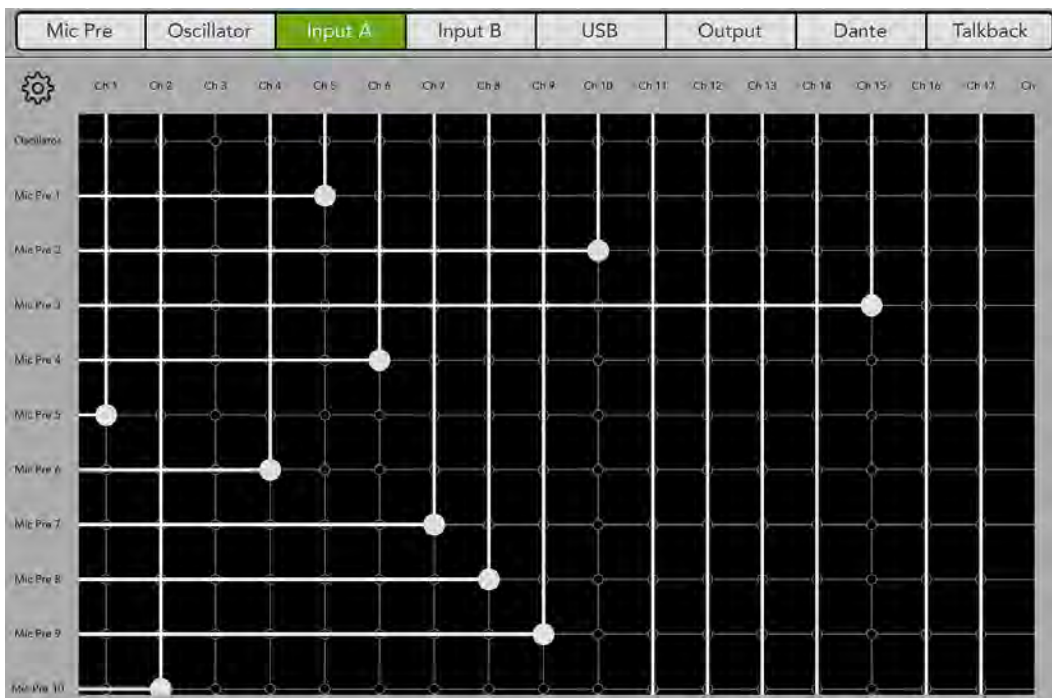

INPUT A/B 2 — Or how about this one...any sports fans in the house? After showering and getting dressed, the coach and star athletes head to the post-game press conference to face the media and discuss the match where the winners gloat about the big victory and the losers cry that the refs blew several calls.

At least a couple of mics are in front of each person at these press conferences. One is the main mic and the second is a backup mic. Simply route input A mic pre 1-5 [source] to channels 1-5 [destination]. These are the main mics. Now tap the input B tab and route mic pre 28-32 [source] to channels 1-5 [destination].

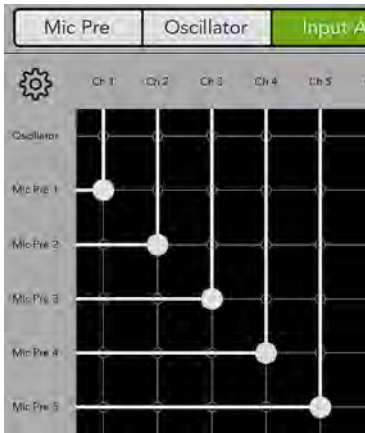

INPUT A: Mic Pre 1-5 to Channels 1-5

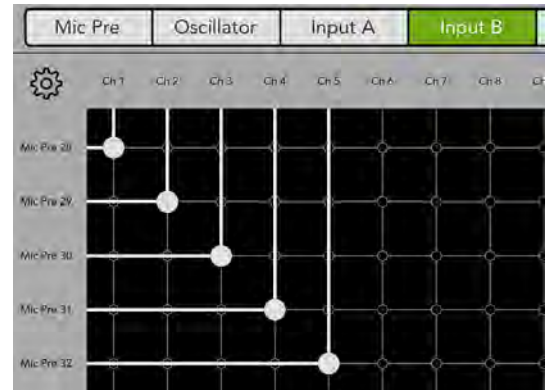

INPUT B: Mic Pre 28-32 to Channels 1-5

So what if the main mic suddenly stops working? Do you pack your bags, go home and start looking for a new job? Perhaps...or you could also tap the input routing button of the channel with the issue and switch the source to input B. Backup mic is now in effect!

More information regarding input routing may be accessed on pages 89-93.



USB 1 — By default, mic pres 1-16/32 [source] are routed to USB 1-16/32 [destination]. This is the most common recording scenario: recording each input directly off the mic pre with no processing. But sometimes you might want to record the main mix instead, or even create a dedicated recording mix.

In the first image shown below, we routed mic pres 1-12 to USB 1-12. The vertical lines coming down from USB 13-16 might look like they are connected to mic pres 13-14, but when swiping up you'll see in the second image that we actually routed the main L/R to USB 13-14 and aux sends 1-2 to USB 15-16. Routing the main L/R to USB 13-14 and aux sends 1-2 to USB 15-16 allows us to make not one, but two – or more if desired! – stereo recordings. These stereo recordings are separate and may have unique settings, levels, DSP and otherwise.



Mic Pre 1-12 to USB 1-12

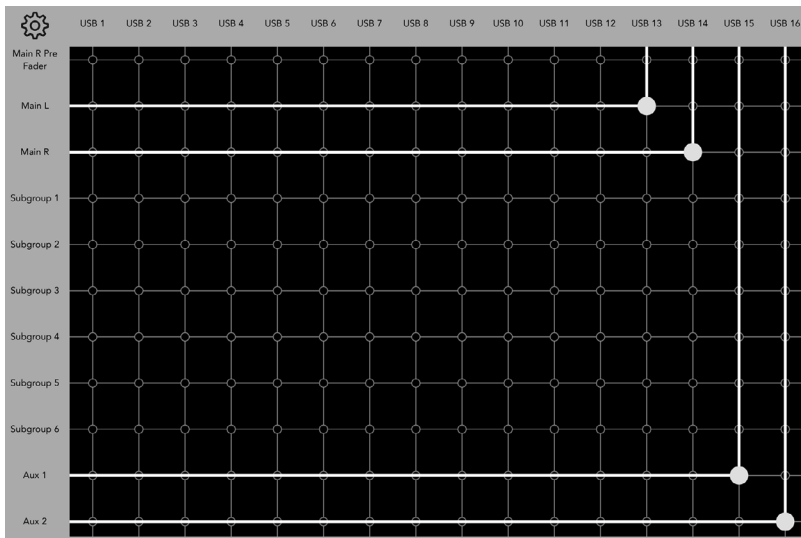

Main L/R to USB 13-14 /
Aux Sends 1-2 to USB 15-16

USB 2 — Another popular example of USB routing would be to route each of the post-DSP inputs to each of the USB outputs. This would be used in a situation similar to a “live” recording at a rehearsal studio where processing is added immediately to the recording. See below.

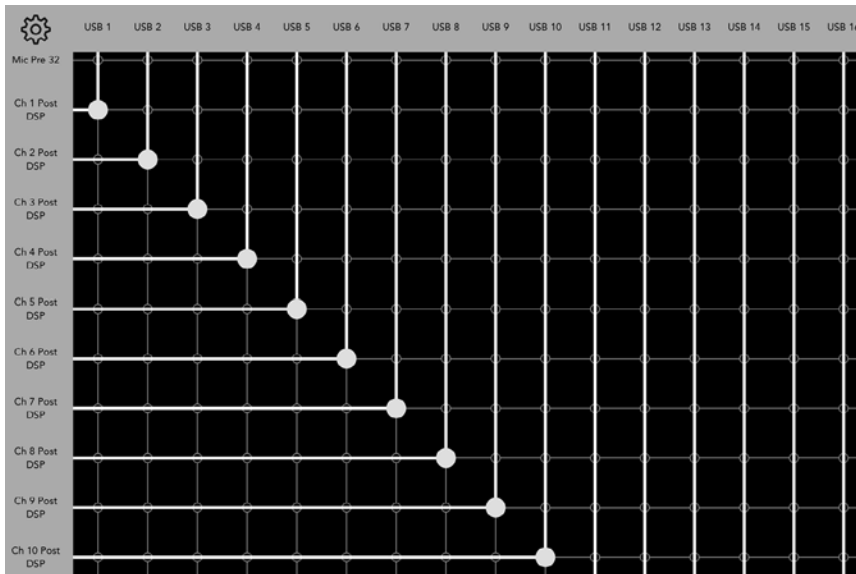

OUTPUT 1 — Perhaps the mixer will be used strictly as a monitor mixer with no need for main L/R. Here you’re able to use all outputs as linked aux sends for a total of seven in-ear and/or 14 wedge monitors.

But how? The output tab defaults to aux sends 1-10 [source] to XLRs 1-10 [destination]. From here, you just need to add aux sends 11-14 to XLRs 11-14 as seen below.



By default, the main L/R will still be sent to AES 1-2 and monitor L/R will still be sent to monitor L/R. These may remain as they are, or you may clear these (or any) balls by tapping them.

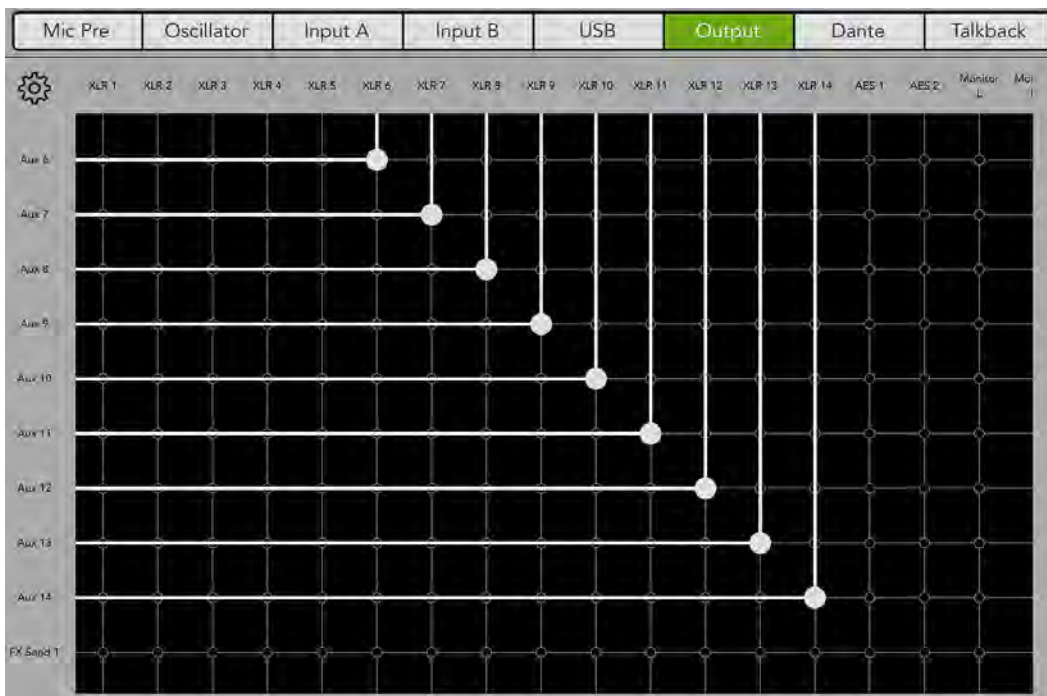

OUTPUT 2 — Another output patching example might be found in a typical theatre setup. Here, the main L/R would be the PA and all six matrix outputs will be dialed in, as well, sending signal to the theatre’s lobby, mezzanine, bathrooms, etc. (all with unique settings).

In a case like this, you might consider setting matrix 1-6 [source] to XLRs 1-6 [destination] and main L/R [source] to XLRs 13-14 [destination]. Before setup, I cleared the output’s I/O patching...and there are still several outputs available for patching!

If you need more information regarding the matrix, please refer to pages 83-88.

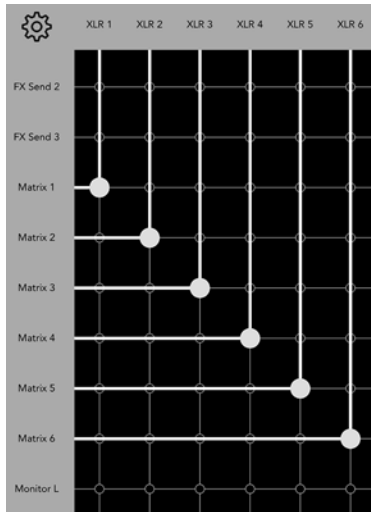

Matrix 1-6 to XLRs 1-6

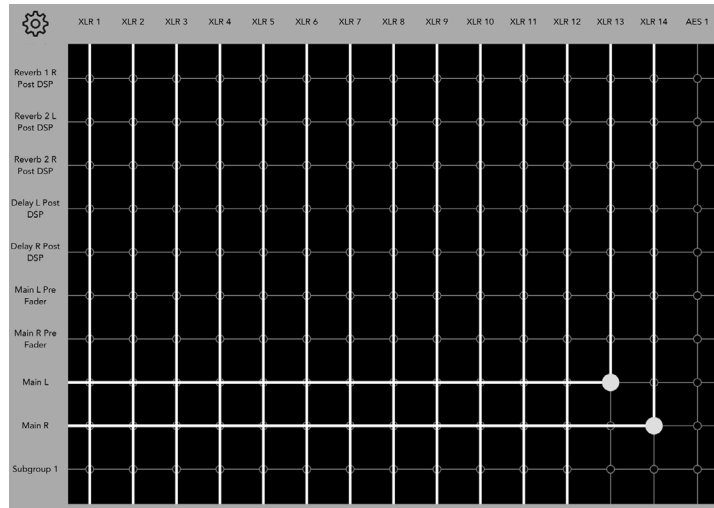

Main L/R to XLRs 13-14

OUTPUT 3 — You didn’t ask for it, but we’re going to give it to you...a third example of output I/O patch routing! Let’s say that a ska band is on tour. Ask anyone who has run sound for ska bands and they’ll probably complain that there are A LOT of people in the band – as in a lot a lot – and all XLR outputs are already accounted for and patched in.

Let’s also say that this ska band is playing a city where a former member now lives. The band invites this former member up on stage to join them on a song or two, but where can they be patched in? Easy! Aux sends 13-14 [source] may be sent to monitor L/R [destination]; that’s right, the 1/4” jacks may be utilized for our guest artist!

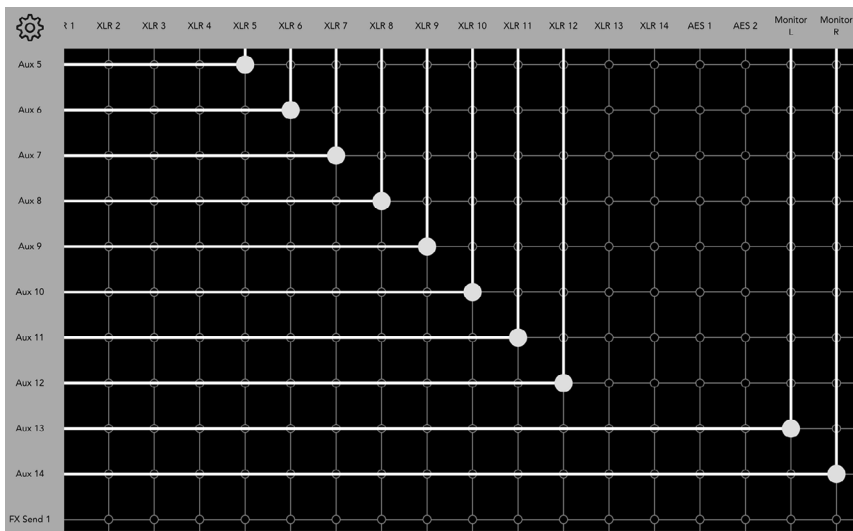

Aux Sends 13-14 to Monitor L/R

DANTE 1 [DL32R] — Dante is useful for recording. For this purpose the Dante output routing is similar to that of the previously discussed USB output and its routing. Simply route, mic pres 1-32 [source] to Dante 1-32 [destination].



Routing to Dante requires a Dante card (available separately).

DANTE 2 [DL32R] — The other common use for Dante is routing signals throughout a venue by connecting to enabled Dante amps and speakers. Here you might patch it a little like this: aux sends 1-14 [source] to Dante 1-14 [destination], matrix 1-6 [source] to Dante 15-20 [destination] and main L/R [source] to Dante 21-22 [destination].

If you need more information regarding the matrix, please refer to pages 83-88.



Routing to Dante requires a Dante card (available separately).

TALKBACK — When the selected tab is talkback, there is only one source...talkback! All you need to do here is select the destination(s). This is where everyone will hang onto every word you mutter.

One might send talkback [source] to the main L/R and matrix [destinations]. Here the house manager might make an announcement that the second half of the play is about to start, that a lost child is looking for their parents or to thank everyone for coming once the show ends.

Talkback may also be sent to aux sends. This is handy when a band is soundchecking. The engineer will tell the drummer, “kick”...”snare”...”toms”...”full kit”, setting levels for each. This way the talkback is only sent to the drummer via an aux send. Then bass, guitars, vocals, etc. levels are checked the same way.

There is more information about talkback (and the quick access panel, in general) on pages 231-232.

I/O Patch at a Glance

The following table shows the available sources for each tab:

Source	Input A	Input B	USB	Output	Dante	Talkback
Oscillator	✓	✓	✓	✓	✓	
Mic Pre 1-32	✓	✓	✓	✓	✓	
USB 1-32	✓	✓	✓	✓	✓	
Dante 1-32	✓	✓	✓	✓	✓	
Channel 1-32, Post-DSP			✓	✓	✓	
Return 1-4, Post-DSP			✓	✓	✓	
FX L/R, Post-DSP			✓	✓	✓	
Main L/R, Pre-Fader			✓	✓	✓	
Main L/R			✓	✓	✓	
Subgroups 1-6			✓	✓	✓	
Aux 1-14			✓	✓	✓	
FX Send 1-3			✓	✓	✓	
Matrix 1-6			✓	✓	✓	
Monitor L/R			✓	✓	✓	
Talkback						✓

The following table shows the available destinations for each tab:

Destination	Input A	Input B	USB	Output	Dante	Talkback
Channel 1-32	✓	✓				
Return 1-4	✓	✓				
Talkback	✓					
XLR 1-14				✓		
AES 1-2				✓		
Monitor L/R				✓		
USB 1-32			✓			
Dante 1-32					✓	
Main						✓
Subgroups 1-6						✓
Aux 1-14						✓
Matrix 1-6						✓

I/O patch on DL806 and DL1608

The I/O patch on the DL806 and DL1608 allow you to choose which signals you wish to record. The horizontal rows are the sources [Main L Pre-Fader and Main R Pre-Fader by default] and the two vertical columns [iPad L and iPad R] are the destinations...the goal here is to connect a source to a destination. If you need more information regarding recording on the DL806 and DL1608, please refer to pages 225-230. When first opened, the I/O patch will look something like this:



DL1608 / DL806 sources:

- Mic Pre 1-8 [DL806] | Mic Pre 1-16 [DL1608]
- Channel 1-8, post-DSP [DL806] | Channel 1-16, post-DSP [DL1608]
- iPad L/R, FX post-DSP
- Main L/R pre-fader
- Main L/R
- Sub 1-4
- Aux 1-4 [DL806] | Aux 1-6 [DL1608]
- FX send 1-2

Scroll down to view the other sources by dragging up anywhere in the black area until you see a pair of balls, one hanging a little lower than the other. [See image above right]. These balls indicate that the iPad L and iPad R are currently set up to record the signals from the main L/R pre-fader (again, by default).

So how does one change the patching? Well, for starters you have to make sure that the source is in view. Once visible, just tap the crosshairs where it meets with the desired destination, be it iPad L or iPad R. The horizontal and vertical lines will illuminate, as well as the text. Additionally, the I/O patch ball will grow 'n glow. This is how to select a destination for each source. You may also tap an existing ball to make it disappear and remove a patch.



Changes made to the I/O patch are stored in snapshots. This means you can easily change the patching for different snapshots and shows. More information about snapshots and shows may be found on pages 233-244.

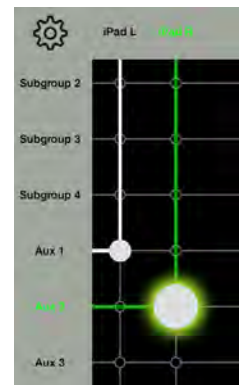

In the upper-left corner of the I/O patch view is a tools button. Tap it to display a popover as seen below.

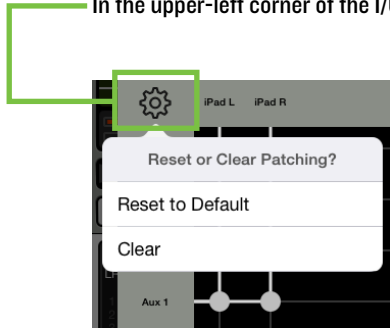

From here you can choose to reset the I/O patch to its default or clear the routing.

Reset to Default resets the iPad L to Main L Pre-Fader and the iPad R to Main R Pre-Fader.

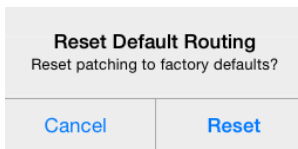

Clear clears all patchings and both balls will be removed from the I/O patch. Simply tap a source to reroute the channel.

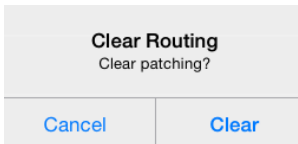

Recording / Playback



Introduction

Not only are these great live mixers with some pretty amazing features, but here you can also record the gig, band rehearsal, house-of-worship service and more! To slide open the recording/playback view, just tap the recording/playback button in the upper-right corner of the navigation bar. As seen in the images above and below, it will illuminate green when open. We will go over recording and playback of the DL32R first (beginning below) followed by the DL806 and DL1608 (starting on page 225).



The USB type B connector allows 16x16 [DL16S] and 32x32 [DL32S] channels of recording and playback to a connected Mac or PC over USB 2.0. Because recording and playback on DL16S and DL32S mixers occurs outside of Master Fader, additional information may be found by reading the DL16S / DL32S Owner's Manual.

Recording and Playback via DL32R

On the rear panel of the DL32R are two USB connectors. The USB type A connector [Drive] allows 32 channel (48 kHz, 24-bit) recording and playback to (and from) a USB hard drive and the USB type B connector [Computer] allows 32x32 channels of recording and playback to a connected Mac or PC over USB 2.0. Either choice allows any combination of channels or outputs to be selected as the record source and playback destination via the I/O patching view. See pages 196-209 for more information about the I/O patch.



A Mac should work automatically with no additional drivers. Windows drivers will require separate installation, but this is included. Simply download it from our website.



USB A and USB B connectors may NOT be used simultaneously. If a hard drive is connected to USB A, it will take priority over anything connected to USB B. For example, if you are recording to a DAW (via computer connected to the USB B port) and connect a hard drive to the USB A port, the hard drive will mount and the DAW recording interrupted. Additionally, the DL32R will no longer show up as an available device until the USB A connection is removed and the USB B connection is disconnected and reconnected again.

The recording and playback view gives complete wireless control over the integrated hard drive recording and playback system. It slides down from the top navigation bar so it is accessible at all times from any view. Initially, it should look a little like something as seen below.

FORMAT



Formatting

We know you're an eager beaver, all psyched to start recording, but let's take care of something very important first: formatting the hard drive. First, get a hard drive; this could be a brand new one or one you've had for awhile as long as it's a USB 2.0 spinning hard drive. Do not use a thumb drive!



Even if the hard drive has already been formatted via different source, we highly suggest formatting via the DL32R. In fact, never mind the "highly suggest." DO IT!

Just follow the steps listed below.



This probably goes without saying, but we're going to say it, anyway. In order for the hard drive to be formatted via DL32R, (1) the hard drive needs to be connected to the DL32R's USB A connector and (2) the device needs to be connected (wirelessly, of course) to the DL32R. Granted, you might have a difficult time trying to format the hard drive if either one – or both – of the above conditions aren't yet met. This is because the format button will be grayed out, as seen in the images below.

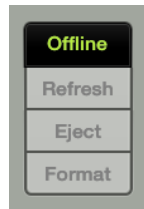

Device Not Connected

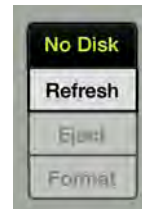

Hard Drive Not Connected

- **Step 1** — With the hard drive and device connected to the DL32R, tap the "Format" button as outlined on the previous page.



This is a permanent deletion with no undo, so a confirmation dialog helps prevent accidents. Formatting will completely erase the hard drive. Back up any files to a computer before formatting!!

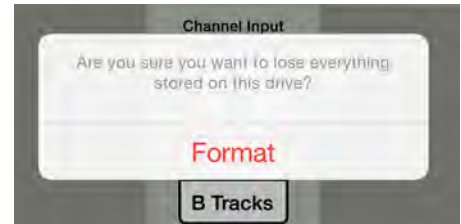

- **Step 2** — Wait until the "Formatting" text changes to "Ready". That's it!

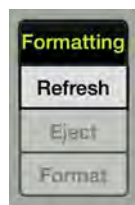

Formatting



Ready

The hard drive has been formatted and we're working with a clean slate...great!



You will want to format a hard drive **via DL32R** any time...:

- (1) ...a brand new (just out-of-box) hard drive is connected to the mixer.
- (2) ...you want to use an existing drive exclusively for recording and playback with a DL32R.

Now we're going to head back and take a look at the DL32R's recording and playback view, discussing all of its features.

The view is split into three sections. From left to right, they are:

- **Stereo music playback**
- **General drive, controls and routing shortcuts**
- **Multichannel recording and playback**



Stereo music playback — The left side of the screen displays controls for stereo music playback. Currently an empty, dark gray box is displayed, but soon a list of all music files on the drive (in the music folder) will be displayed.

As stated, this is STEREO playback, a simple L/R playback. So what's its use? Great question, I'm glad you asked! The following is just a sample of many of the stereo music playback uses.

- **Click tracks** — Click tracks may be routed to the drummer's in-ear monitors.
- **Backing tracks** — Perhaps the stage setup is too small for backup singers and/or keys, or perhaps there is a scheduling conflict. Have backing tracks available for playback during the band's set.
- **Intermission music** — One band is tearing down their equipment and the next band is setting their equipment up. Play some intermission music for the good folks who arrived early to support music.
- **Walk on / off music** — Walk on / off music is typically used at corporate meetings, conferences, weddings, comedy shows and more. Here is where music plays when someone is introduced and/or after giving a speech (e.g. here comes the bride and groom [cue walk on music]).
- **Tuning the room music** — You diligently arrived to the venue before anyone else and want to tune the room via your playlist. Yep, this is it. You might have bands and/or albums you like to tune rooms with, but some of the standards are Steely Dan, Toto and Mark Knopfler / Dire Straits.

- Pink, white, brown, etc. noise — Does your audio equipment need to be calibrated? Have some noise generators set up for playback.
- A-440 sine wave — Possibly the band needs to tune to standard A-440 tuning. A sine wave is the perfect solution. Well, perfect until the band is tuned up. It could get annoying after a few minutes.

As you can see from these suggestions, stereo playback is extremely useful, especially when it's controlled wirelessly.

Now that the hard drive is formatted, it's time to add some files to it for playback. Please follow along.

- **Step 1** — The first step is to remove the hard drive from the DL32R. This can be accomplished one of two ways: (1) Tap the “Eject” button located just above the “Format” button – and if you've been following along, you know exactly where the “Format” button is located – then remove the hard drive. Or (2) turn the DL32R mixer off, wait 2-3 seconds, then remove the hard drive.

- **Step 2** — Connect the hard drive to Mac or PC.

- **Step 3** — If they aren't there already, add two folders to the hard drive, one named “Music” and the second named “Recordings”. Be sure that these are spelled exactly as-is or it won't work! More on this later.

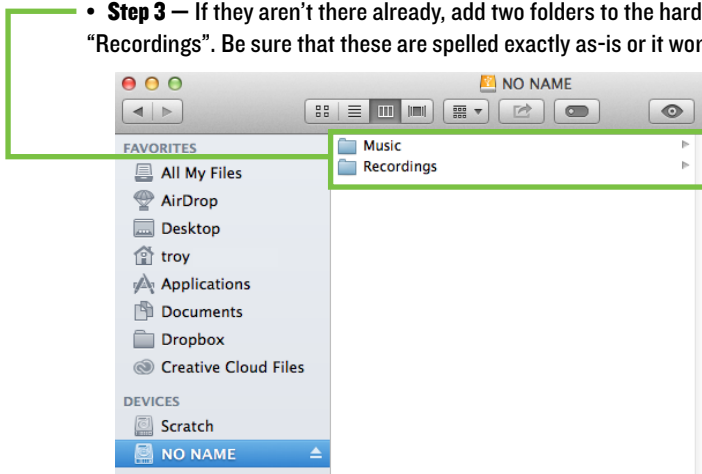

- **Step 4** — On the computer, open the folder containing the mono or stereo 48 kHz .wav files you wish to transfer to the portable hard drive.



Supported files — The .wav file must be 48 kHz in order for playback to work on the DL32R. AAC, MP3, AIFF and 44.1 kHz .wav files will not play. However, there are many audio apps (including iTunes) that will convert the files for you.

I've been working with a band called None More Black, so those are the files I want to transfer. The first image shown below are the two open folders side-by-side. On the left side are my personal None More Black .wav files and on the right side is the portable hard drive's (empty) "Music" folder awaiting the files. The second image is showing the files transferring to the "Music" folder.

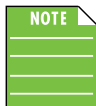
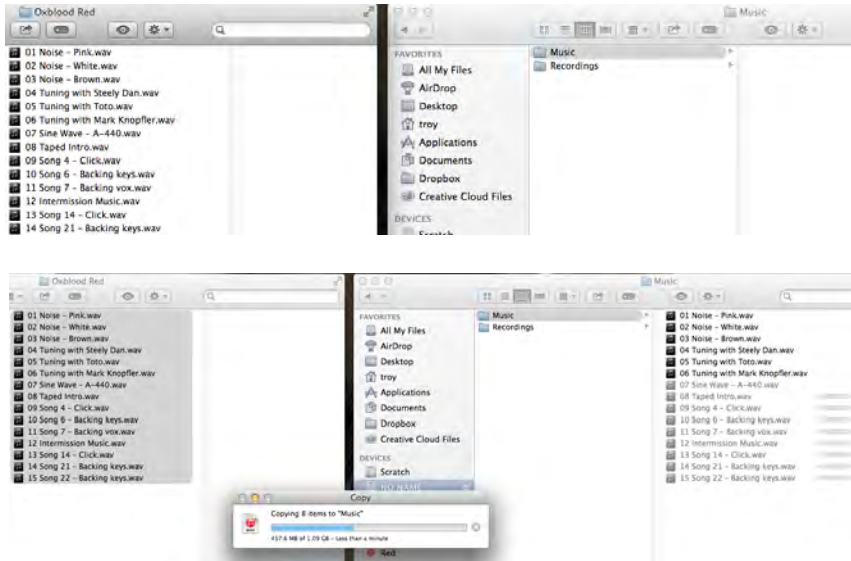

Something to keep in mind is that the .wav files are listed in alphabetical order. If you prefer the files be in the order you'll use them – as I do – simply add a "01" before the first track, "02" before the second track, etc.

- **Step 5** – Eject and remove the portable hard drive from the computer.

- **Step 6** – Connect the portable hard drive back to the DL32R mixer. If the mixer was turned off, you will have to power it up and head back to the recording and playback view. If the mixer was left on, you might need to tap the "Refresh" button. This is located just above the previously tapped "Format" and "Eject" buttons. Either way, the files you transferred from the computer to the hard drive are now prominently displayed in the music playback list (as seen below).

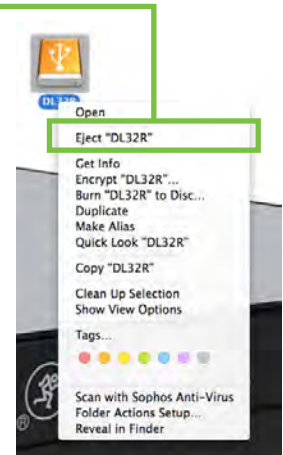

Not only have I successfully added items to my playback list, but they're in the order I will use them, too.

- **Step 7** — Scroll up and down in the playback list in order to view more items.

- **Step 8** — Select the file you want for playback by tapping it.

In this example, we're going to assume that all of our audio equipment is calibrated, we've tuned the room and that the band is all tuned up and ready to rock. Therefore, we selected "Taped Intro", as that's the cue that the band will be hitting the stage shortly.

Notice that the selected file in the file list illuminates dark gray. The file type [stereo], bit depth [16 bits] and sample rate [48 kHz] are listed next to the file name. Additionally, the name and file length appear in the music playback control panel.



If the file is unplayable (e.g., it's 44.1 kHz), the selected file will illuminate red to indicate that it is unplayable after selecting the file from the list. Non-.wav files won't even be displayed in the file list.



In most cases, channel input A will be used when recording the show and channel input B is used for USB playback. Simply tap the channel input B button to hear the music and see the meters. However, this may be changed via the I/O patch, if so desired. More information about channel input A and B may be found on page 224. More information about the I/O patch may be found on pages 196-209.

From here, we're able to play it back using standard transport controls. Left to right, the buttons are:

- Go to the beginning of the track.
- Rewind the track 10 seconds.
- Stop track playback.
- Pause track playback.
- Play track.
- Fast forward the track 10 seconds.
- Go to the end of the track.

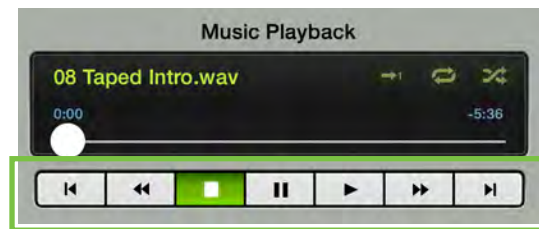

In the upper-right corner of the music playback section is an additional set of controls. Left to right, the buttons are:

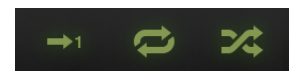

- Play once – When engaged, playing will stop when the current file ends. If disengaged, the next track will load and start playing immediately.



This is usually the button to engage when click tracks and backing tracks will be played.

- Loop – When engaged (with no "1" present), the entire music list is looped. When engaged (with a "1" present), the current track will repeat repeatedly. When disengaged, playback will stop when it reaches the end of the music list.
- Shuffle – When engaged, the playlist is randomly shuffled for a unique playback.

Selected controls will illuminate to indicate that play once, loop and/or shuffle are in effect.

Once the track starts playing, the control panel status changes from “Ready” to “Playing”.

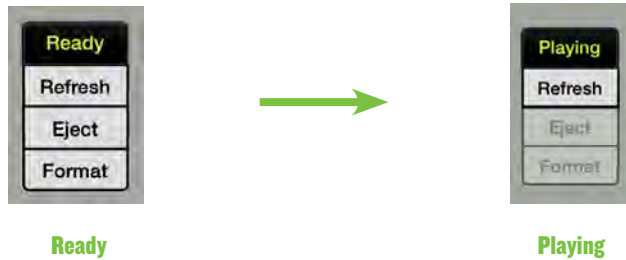

When a multichannel playback is occurring, the music playback controls are grayed out and vice-versa, as only one playback may occur at a time.

Multichannel recording and playback — The right side of the screen displays controls for multichannel recording and playback. When we first booted it up, only an empty, dark gray box was displayed, but this is where a list of all multichannel recordings made on the drive (in the recordings folder) is displayed.

As stated above, this is MULTICHANNEL recording and playback. The following is just a sample of many of the multichannel recording and playback uses.

- Record a live album — The band has been rehearsing for weeks on end for the upcoming festival gig. It's a no brainer that the band and their fans will want a live recording of this very special show. Here you'll be able to record up to 32 separate tracks and mix it at a later date using your favorite DAW.
- Record a stereo mix — We call a stereo mix recording the “instant gratification” recording. This is your basic stereo L/R recording. I've been to several shows where the artist would make the show (that just ended) available to the fans instantaneously. This would be one example of the stereo L/R recording.
- Virtual soundcheck — Whoa, dude, virtual soundcheck? Well, it's not as cool as it sounds, but it could prove to be very useful for the driven engineer. It's similar to the stereo music playback “tuning the room music” mentioned a few pages ago, but here you can play back multiple separate tracks of a previously recorded show or rehearsal to tune the room to the band that will be playing later that night.
- Complex backing tracks — Or perhaps there are complex backing tracks. This could be several backup singers, a horn section or string quartet, for example. Each of the backing tracks here may have different levels, DSP, patching, etc.



If you ever find a band that is comprised of only backup singers, a horn section and string quartet, let me know. I have to hear what that sounds like!

So at this point we should make a recording...



It might be a good idea to get a solid grasp of how multichannel recording and playback works on the DL32R before using it in a real-live scenario.

- **Step 1** — With the hard drive and device connected to the DL32R, name the new recording. Normally, this is where the name of the artist, song or show goes, but since we're just testing to see how it works, we'll call it "Test".

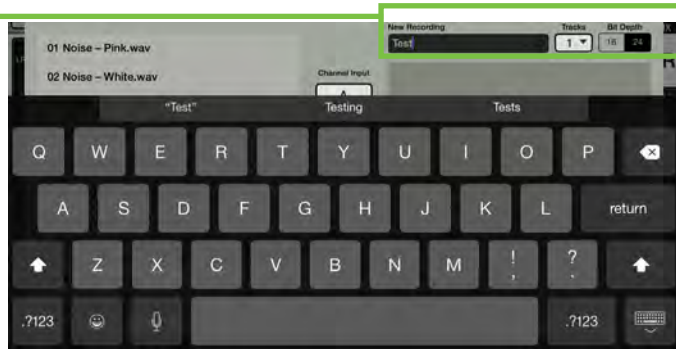

- **Step 2** — Using the pulldown menu, select how many tracks to record, 1-32.



- **Step 3** — Tap what bit depth you prefer for the recording, 16 bits or 24 bits.

From here, we're able to start recording (and play it back later) using standard transport controls. Notice that most buttons are currently grayed out. That's because there are no files available for playback yet. We need to record first. Left to right, the buttons are:

- Go to the beginning of the track.
- Rewind the track 10 seconds.
- Stop track recording / playback.
- Pause track playback.
- Play track.
- Start recording.
- Fast forward the track 10 seconds.
- Go to the end of the track.

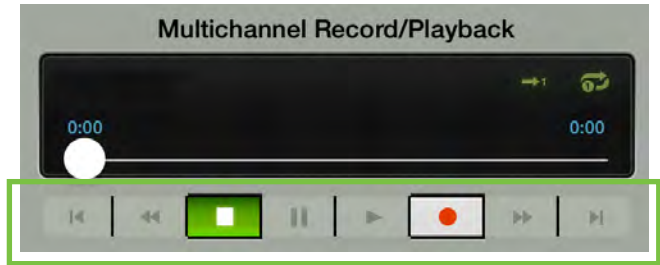

- **Step 4** – Tap the record button and recording will begin immediately.

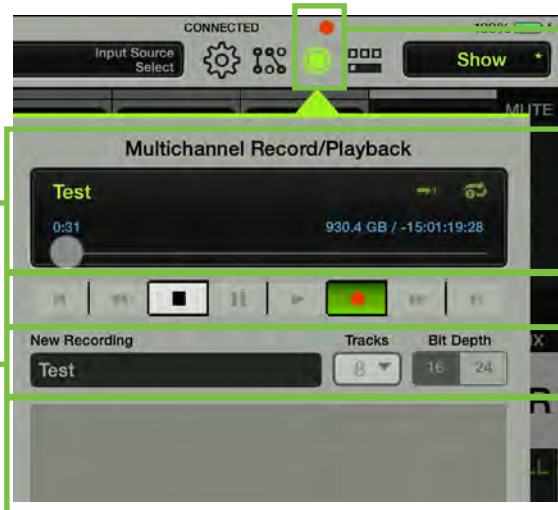

A few things to notice in the image above (top to bottom):

- The international symbol for a recording in progress is a red dot. One will appear above the record/playback button on the navigation bar on all connected devices.
- The name of the recording in progress ["Test"] is displayed in the upper-left corner of the multichannel record/playback screen. Also displayed here are the record time, amount of hard drive space left and amount of record time remaining.
- The record button illuminates green when engaged; it is gray when disengaged.
- The name, number of tracks and bit depth cannot be changed while recording is in progress.
- The name is not listed in the playback list; this is because the recording has not yet finished.

- **Step 5** — Tapping the stop button asks you to confirm your wish to stop the recording. It will continue recording until you tap “Stop”.

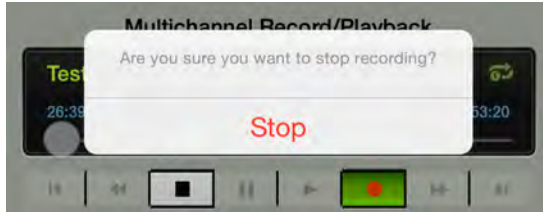

Because the recording is occurring on the DL32R hardware and the connected USB drive, Master Fader supports background recording. This means that you may press the device's home button to leave the app or switch to another app while the DL32R continues to record. So go ahead and check your email or tweet about the show to your heart's content. Recording will continue until you stop it, the power goes out or the hard drive runs out of space.



Speaking of running out of space, recording will automatically stop when there is less than 100MB of free drive space.

- **Step 6** — Once recording is completed, you may notice that the name ["Test"] is now listed in the playback list. The number of tracks used [8 channels], bit depth [16 bits] and sample rate [48 kHz] are listed next to the file name. From here, you may play back the multichannel recording here with controls for common transport as documented on the previous page.



Once a recording has completed, it is (almost) ready for immediate playback. The hard drive needs a short amount of time to gather its senses and do a bit of general cleanup; this is especially true on longer recordings.



Notice that the name of the new recording automatically changed to “Test_2”. This is great for bands doing multiple takes of a single song, for example. It's already set up to simply tap record again and the name will be similar. If you don't like the name, though, feel free to rename it if so desired. Easy!

- **Step 7** — Press the play track button. Do you hear anything? Probably not and here’s why. In most cases, channel input A will be used for recording and channel input B is for playback (assuming nothing’s changed in the I/O patch view). Simply tap the channel input B button in the middle of the recording view to change all the input channels to input B to hear the music and see the meters. However, this may be changed via I/O patch, if so desired. This is how you would make a virtual soundcheck. More information about channel input A and B may be found on page 224. More information about the I/O patch may be found on pages 196-209.

In the upper-right corner of the music playback section is an additional set of controls. Left to right, the buttons are:

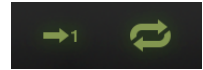

- **Play once** – When engaged, playing will stop when the current file ends. If disengaged, the next multichannel track will load and start playing immediately.
- **Loop** – When engaged, the multichannel current track will repeat repeatedly. When disengaged, playback will stop when it reaches the end of the music list.

Selected controls will illuminate to indicate that play once and/or loop are in effect.

Once the track starts playing, the control panel status changes from “Ready” to “Playing”.

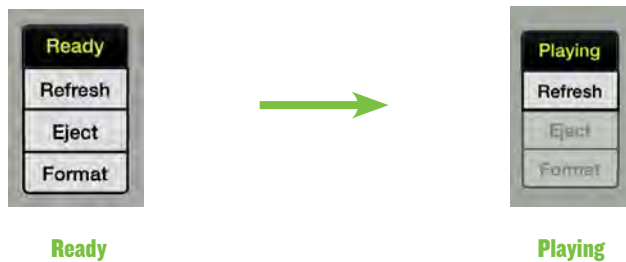

- **Step 8** — Repeat steps 1 to 7 to make more recordings!



When a multichannel playback is occurring, the music playback controls are grayed out and vice-versa, as only one playback may occur at a time.

File Structure

Several pages ago we mentioned that there are two folders on the hard drive, one named “Music” and the second named “Recordings”. The music folder contains all of the stereo L/R .wav files and the recordings folder contains all of the multitrack .wav files.

The main difference, of course, is stereo L/R files [music folder] versus multitrack files [recording folder], but that’s not the only difference. The file structure is slightly different between the two, too...tutu?

The two images below display the music folder and recording folder. Let’s take a look at the music folder [top] first. Notice how all of the .wav files are directly placed in this folder and that there are no subfolders. To reiterate, these are listed alphanumerically.

Music Folder

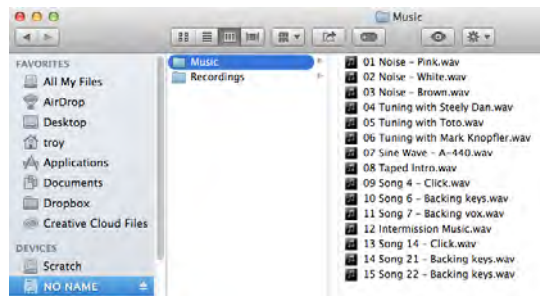

Recording Folder

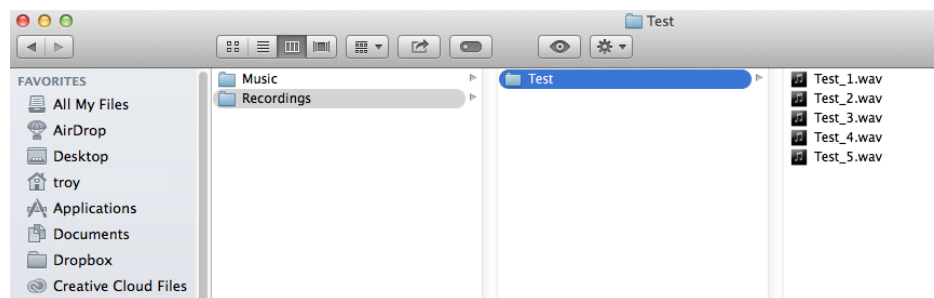

The recordings folder, on the other hand, is nothing but subfolders. Ok, ok, perhaps not in the example shown above. A subfolder is created for each recording. So after performing multiple recordings there would be multiple subfolders, each named with the name you provided. So, each subfolder contains a different recording made up of at least one .wav file. Longer recordings will yield more .wav files but we’ll get to that in a second.

Wasn’t our test recording eight tracks? Why aren’t there eight files? Good questions. The DL32R records to multichannel .wav files that contain between one and 32 channels (or tracks) in a single file. Think of your standard stereo .wav file you use on the music side; it is similar and contains two channels, left and right. Well, these are similar, they just can have more channels. By using multichannel .wav files instead of 32 individual files, one for each track, we are able to get much better performance out of standard off the shelf hard drives, which is why the DL32R doesn’t require you to invest a fortune in super-fast recording hard drives.

So how do you listen to it? Simple. Most major DAWs import it perfectly. Simply import it into your DAW and it will split it into separate tracks. For example, we’ve imported our masterpieces into Pro Tools flawlessly.

If your DAW doesn’t support it, check out [Wave Agent from Sound Devices](http://www.sounddevices.com/support/downloads/wave-agent)⁴ which easily allows you to convert to and from multichannel .wav files.

⁴ <http://www.sounddevices.com/support/downloads/wave-agent>

So we mentioned you might see more than one file in each recording subfolder. In the recordings folder image on the previous page, you see 5. When would that occur? In order to achieve maximum compatibility with DAWs and other pieces of hardware, we must ensure that the .wav files we produce are less than 2 GB. It takes a very long time to get to 2 GB when you are recording a stereo .wav file but what about for a 24 channel wav file? With that many channels all in one file, 2 GB comes after just around 10 minutes of recording. So what happens when you cross that limit? Well, the DL32R is smart and just before that happens, it stops recording one file and instantly (and without any data loss) starts recording another. We call this gapless recording. So in your song's folder, a 50 minute 24 channel recording would end up as 5 separate .wav files.

See the table below for the maximum recording time based upon the number of tracks and bit depth.

Tracks	16 bit	24 bit
1	6 hours	4 hours
2	3 hours	2 hours
3	2 hours	80 minutes
4	90 minutes	60 minutes
5	70 minutes	45 minutes
6	60 minutes	40 minutes
7	50 minutes	35 minutes
8	45 minutes	30 minutes
9	40 minutes	25 minutes
10	35 minutes	20 minutes
11	30 minutes	20 minutes
12	30 minutes	20 minutes
13	25 minutes	19 minutes
14	25 minutes	17 minutes
15	20 minutes	16 minutes
16	20 minutes	15 minutes
17	20 minutes	14 minutes
18	20 minutes	13 minutes
19	19 minutes	13 minutes
20	18 minutes	12 minutes
21	17 minutes	11 minutes
22	16 minutes	11 minutes
23	16 minutes	10 minutes
24	15 minutes	10 minutes
25	14 minutes	9 minutes
26	14 minutes	9 minutes
27	13 minutes	9 minutes
28	13 minutes	8 minutes
29	12 minutes	8 minutes
30	12 minutes	8 minutes
31	12 minutes	8 minutes
32	11 minutes	7 minutes

Now as we said, there is no audio loss and as these files are played back on the DL32R it seamlessly switches from one to the next and if we didn't just tell you this, you might never know this was even happening. It does mean that you need to use Snap or Shuffle for each file when importing into your favorite DAW to get them to butt up together one after the next.

Lastly, what if you want to take your own multichannel files and put them on a hard drive for playback on the DL32R. Easy. Just create the multichannel files in your DAW or use the WaveAgent application mentioned earlier. Now you need to be careful and replicate the same file structure the DL32R uses for recording. In the Recordings folder, add a subfolder named after your song. Then in that subfolder put the multichannel .wav file and give it the same name as the folder followed by “_1”. If there are multiple files that will use gapless playback, name them similarly with “_2”, “_3” and so on. If done correctly, when connected to the DL32R these files should show up in the list just as if you had recorded them with the mixer.



Creating multichannel files from some DAWs will only play back properly with 27 or fewer tracks. If this happens to you, please contact Tech Support for more information.

General drive, controls and routing shortcuts — The center of the recording and playback screen displays general drive status and controls on top and channel input routing shortcuts below.

Drive Status and Controls



Routing Shortcuts

- Drive Status — This displays the current hard drive and/or playback status, including...:
 - o Offline — Master Fader is not connected to a DL32R and is in offline DL32R mode.
 - o No Disk — No disk drive is attached to the DL32R USB Host port.
 - o Scanning — A disk is connected and is being scanned by the DL32R to determine if it can be used for recording and playback.
 - o Ready — A properly-formatted disk is attached to the DL32R and ready for normal operations.
 - o Unknown — A disk is connected, but it either has an unsupported format, such as HPFS, or is completely unformatted. If this is a new disk you wish to use for recording and playback, press the Format button described below.
 - o Formatting — The DL32R is actively formatting the attached drive.
 - o Ejected — A disk is connected, but all drive activity has ceased. Press the Refresh button described below to rescan the attached drive.
 - o Playing — Same as Ready, plus the DL32R is actively playing back from the drive.
 - o Record — Same as Ready, plus the DL32R is actively recording to the drive.
 - o Busy — The DL32R is busy with a process like booting, updating the firmware on the USB board, or other such tasks. This message may appear at other times, when no other message is appropriate.

- Refresh — This refreshes the hard drive and what files are displayed in the stereo music playback and multichannel recording and playback lists. If the displayed lists don't look like you think they should, then try refresh! This also helps if a new drive has been attached.
- Eject — Tap the “Eject” button prior to disconnecting the USB hard drive. Wait 2-3 seconds before removing the hard drive.



While it may seem like nothing is happening at the moment, a lot of under-the-hood things are in constant motion. Therefore, it is imperative that you tap the eject button before physically removing the hard drive.



The hard drive may also be disconnected when the mixer is turned off.

- **Format** — As discussed previously, format will erase the hard drive and format it for recording. Go back to page 211 to review the instructions on formatting a drive.



As a reminder...even if the hard drive has already been formatted via different source, we highly suggest formatting via the DL32R. In fact, never mind the “highly suggest.” **DO IT!**

The channel input shortcut buttons are a quick way to change the channel inputs from A to B for all channels or just those used in the current recording. See below.

- **Channel A / B** — Tapping either the Channel A or Channel B button here changes the source for **ALL** input channels to the selection (being source A or source B). The button does not remain illuminated because the source may be changed for an input channel (or channels) via channel input routing (as discussed on page 36).
- **A Tracks / B Tracks** — Tapping either the A Tracks or B Tracks button here changes the source for the number of tracks in the **CURRENT MULTICHANNEL PLAYBACK FILE** to the selection (being source A or source B). For example, if the currently selected multichannel file has eight tracks, then only these eight channels will change to the source selection. The button does not remain illuminated because the source may be changed for an input channel (or channels) via channel input routing (as discussed on page 36).



I spent hours waiting for an 8-track from the product manager until finally realizing that he was saying “A tracks”, not “8 tracks”, hmmm. 8 tracks will make a comeback, too, right?

Hard Drive Recommendations For High Performance

Some of the following dos and do nots have been mentioned previously, but they are quite important, so we are going to mention them again.

For best performance we recommended the following:

- **DO** dedicate a hard drive for recording and playback.
 - **DO NOT** have any other content on it if possible.
- **DO USE** a USB 2.0 or better spinning hard disk drive OR Pro SSD Drive.
 - **DO NOT USE** a thumb drive (especially if it was freebie). [OK to use for stereo L/R playback, though].
- **DO USE** a bus-powered hard disk drive, if preferred (from 5V up to 1A).
- **DO** have as much free space on the hard disk drive as possible before recording. [Recording cannot begin with less than 100MB of free drive space. Furthermore, recording will automatically stop when there is less than 100MB of free drive space.]
- **DO NOT USE** a USB hub between the hard disk drive and DL32R.

Recording and Playback via DL806 • DL1608

Recording with a DL806 and DL1608 mixer is easy, as it allows you to record the sources selected in the I/O patch onto the iPad. First make sure the iPad is attached to the mixer as recording is unavailable in Wi-Fi mode. Once attached, the record button is no longer greyed out. Note the difference between an iPad that is not attached to the mixer (below left) versus one that is attached (below right). Your chance for a historic recording becomes available when the iPad is attached to the mixer!



Wireless iPad



Wired iPad



Sample Rate and Bit Depth — The next step is to choose the quality of the recording sample rate [44.1 kHz or 48 kHz] and recording bit depth settings [16 bit or 24 bit]. Simply tap which settings you prefer. As seen to the left, these settings cannot be changed while recording is in progress, nor can anything be imported or exported. However, the L/R recording levels may still be changed during recording.

Naming the Recording — The default recording name is “Song Name”. Let that one sink in for a sec.

Again, “Song Name”. Fancy, huh? We hope you think so, too, because there were meetings upon meetings upon meetings to decide on a default recording name. But let’s say for kicks-and-giggles that you would rather name it after one of your songs. You can, it’s true!

Tap in the ‘New Recording’ window to bring up the blinking cursor and keyboard. Simply type in the song name followed by a carriage return. For familiarity, this is the same keyboard that is used for messaging or emailing from the device.

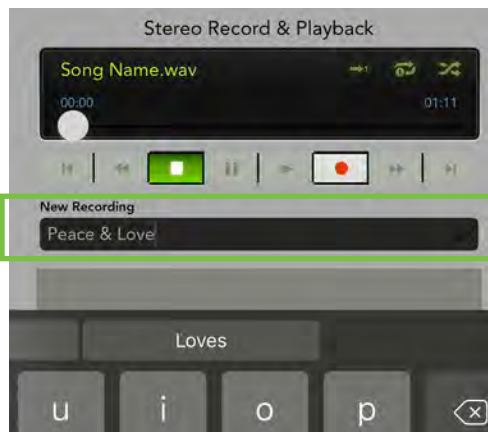

Before recording begins, the iPad needs to access its microphone (if not previously set up). If NOT already set up, tapping the record button will display a popover similar to what's displayed below right. Tap "OK" to allow access and continue on with the recording process.



Setting the iPad to access the microphone may also be set up manually. If you tapped "Don't Allow" here [tsk tsk], you will have to follow the steps detailed on page 272. This is necessary for recording.

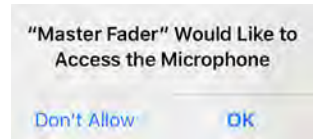

If access to the microphone had previously been set up, then recording will begin immediately. The record button illuminates green when engaged (as seen to the left) and is gray when disengaged. Additionally, the international symbol for a recording in progress is a red dot. The record button on the navigation bar will turn from green to red to indicate recording. A third and final indicator is the "Recording" – in red text, no less! – that lies within the Stereo Record & Playback window.

Pressing the 'Stop' button asks you to confirm your wish to stop the recording.

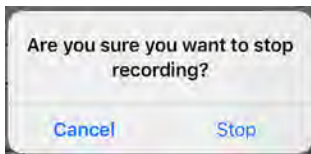

The stereo recording is automatically saved as a .wav file within the application. In addition to the name, this .wav file also includes the date and time the recording started.



Master Fader supports background recording. This means that you may press the iPad's home button to leave the app or switch to another app while Master Fader continues to record. So go ahead and check your email or tweet about the show to your heart's content.



Generally speaking, master fader can be used for recording while other audio apps are used for playback. Because every app is different, testing your desired combination of apps before using them on a mission critical show is strongly suggested! Also, you should NOT record in multiple apps simultaneously; strange things might happen with the recorded files.



Recording is limited to 4 GB and will stop when the limit is reached. See the table below for the maximum recording time based upon the chosen sample rate and bit depth.

Sample Rate	Bit Depth	File Size	Maximum Stereo Recording Time
44.1 kHz	16 bit	4 GB	6 hours, 17 minutes
44.1 kHz	24 bit	4 GB	4 hours, 11 minutes
48 kHz	16 bit	4 GB	5 hours, 47 minutes
48 kHz	24 bit	4 GB	3 hours, 51 minutes

There are multiple options to choose from at this point. For example, you could...

- **Record a new track** — Perhaps you would like to record the same song again? Look at the screenshot below. It has the same song name but with a “_2” added to the end. This is for easy recall of each version of that particular song. Simply start recording a second [“_2”], third [“_3”] or fourth [“_4”] take of the same song the same way you did as the original.

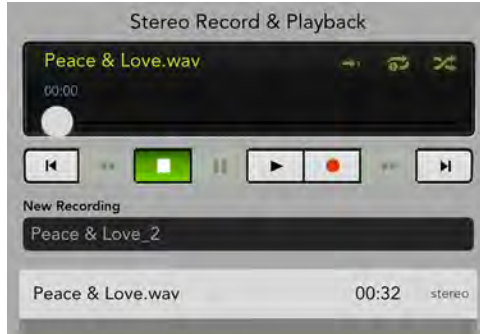

Or perhaps you would like to record a different track from your massive song collection? Follow the instructions as outlined on the previous two pages.

- **Play the track back** — Want to hear what you just did? Play it back using standard transport controls. Left to right, the buttons are:

- Go to the beginning of the track.
- Rewind the track 10 seconds.
- Stop track playback.
- Pause track playback.
- Play track.
- Fast forward the track 10 seconds.
- Go to the end of the track.

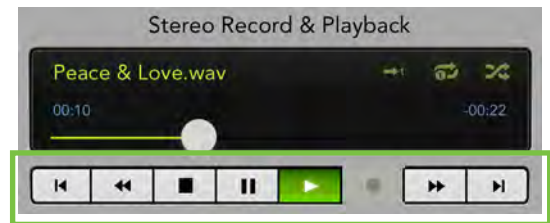

In the upper-right corner of the music playback section is an additional set of controls. Left to right, the buttons are:

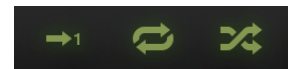

- **Play once** – When engaged, playing will stop when the current file ends. If disengaged, the next track will load and start playing immediately.



This is usually the button to engage when click tracks and backing tracks will be played.

- **Loop** – When engaged (with no “1” present), the entire music list is looped. When engaged (with a “1” present), the current track will repeat repeatedly. When disengaged, playback will stop when it reaches the end of the music list.
- **Shuffle** – When engaged, the playlist is randomly shuffled for a unique playback.

Selected controls will illuminate to indicate that play once, loop and/or shuffle are in effect.

- **Delete the track** — If you would prefer to think this recording never occurred – it happens, we know – it may be discarded. Simply...
 - Tap Edit in the bottom-right corner of Master Fader.
 - This brings up the universal symbol for delete which will appear next to each recorded track.
 - Tap Done in the bottom-right corner if you don't really want to delete the song...

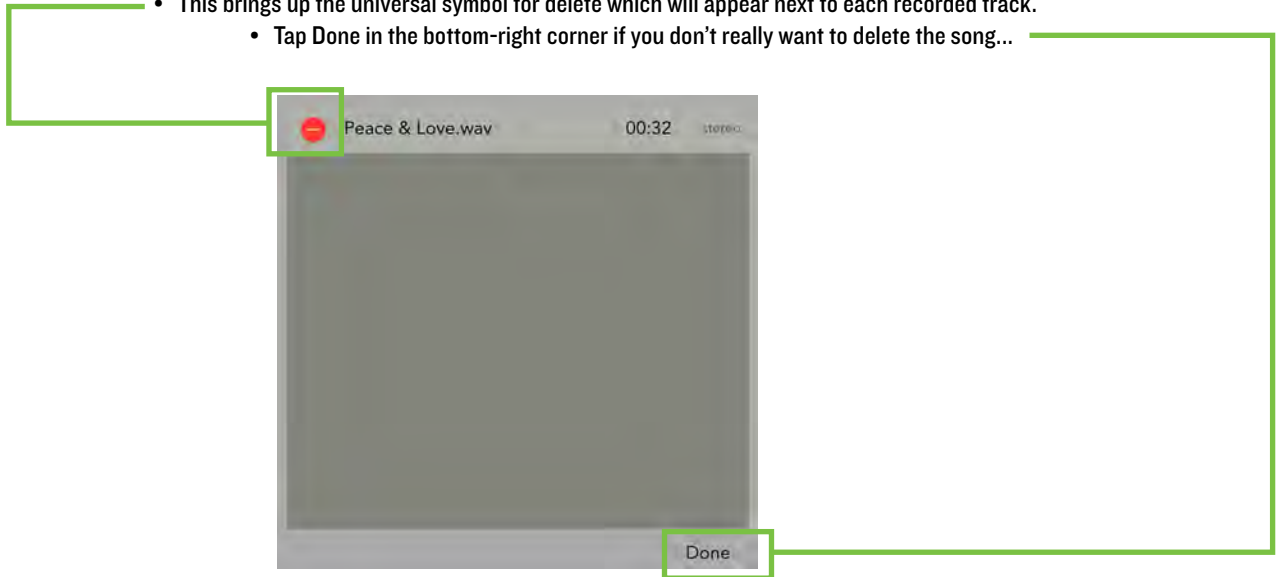

- ...Or tap the aforementioned delete symbol **next to the actual song you want deleted** to begin the deletion process. As seen below left, this will bring up a Delete button. This is a permanent deletion with no undo, so a final confirmation dialog [below right] helps prevent accidents. Around these parts, we're fans of Peace & Love, so we're going to keep this track. Who wants to delete Peace & Love, anyway? No way!



- **Import / Export the track** — Master Fader affords you the opportunity to import and export recorded songs. An entire chapter is dedicated to importing and exporting. This includes detailed instructions and multiple screenshots every step of the way. Please check it out on pages 245-248.

- **Retrieve the track via iTunes** — Use iTunes to retrieve recordings off of the iPad by following the instructions below:

(1) — Connect the iPad to your iTunes account via Mac or PC.

(2) — Select your iPad in the list.

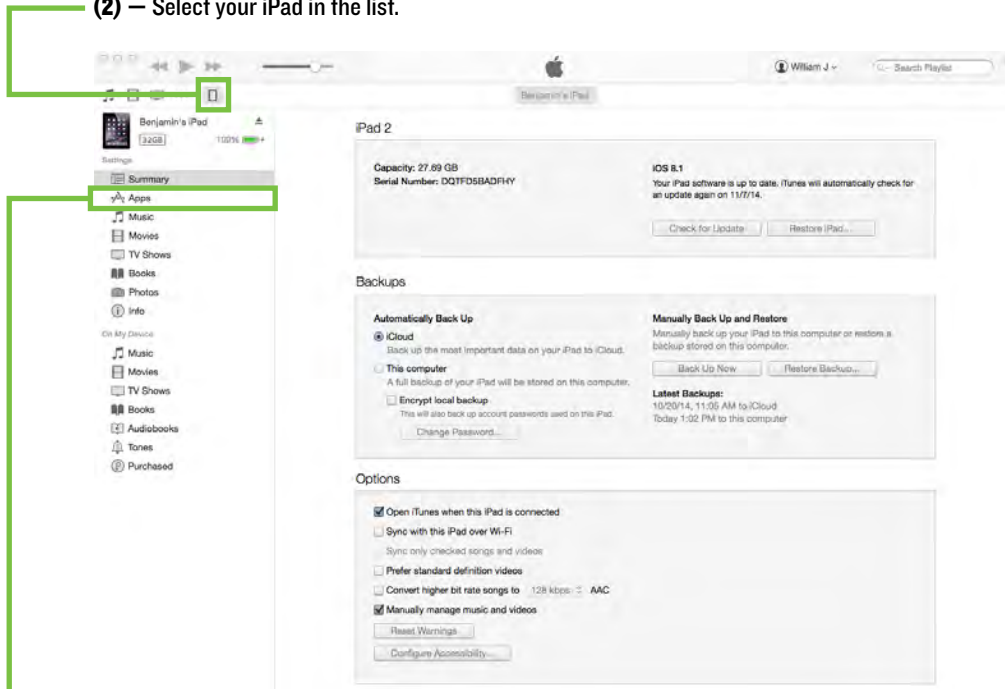

(3) — Go to the apps tab.

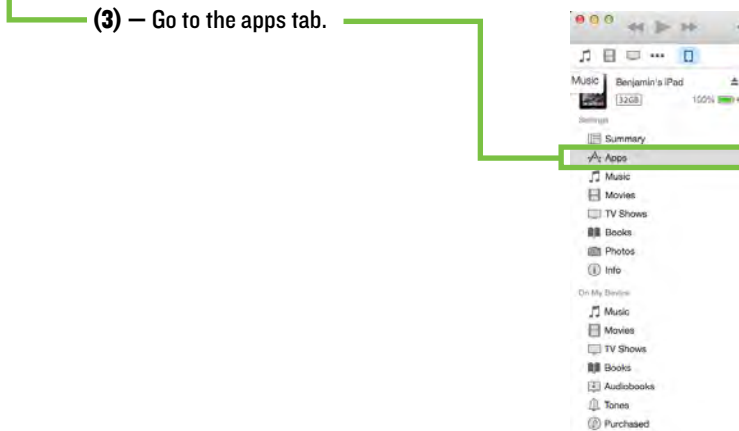

(4) — Scroll down until the Master Fader app appears in the list of apps. Tap it to illuminate the app blue.

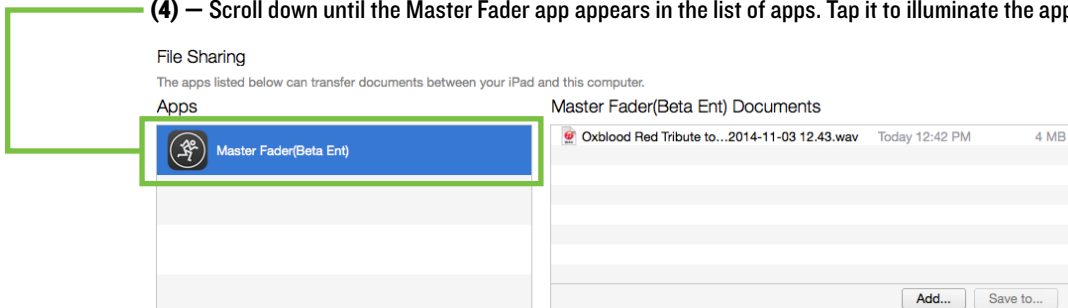

(5) — Tap the desired recording from the list; it will illuminate blue, indicating that it has been selected. Now drag and drop the recording(s) from the list to your hard drive.

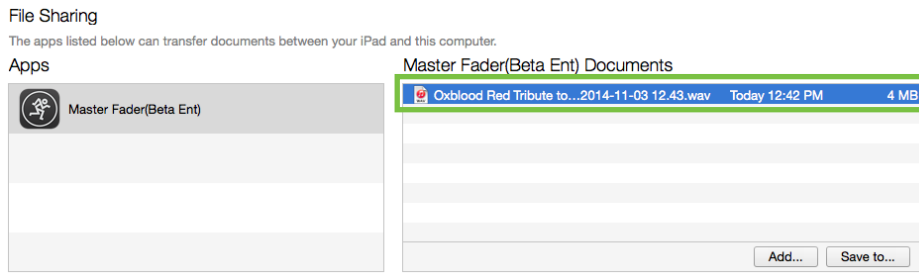

Quick Access Panel



Residing in the upper-right side of the navigation bar between the record/playback and shows buttons is the quick access panel. It allows for fast control over critical functions.



As seen above and to the left, tapping the quick access panel illuminates the button green.

The following is a list of what resides in the quick access panel. We will go through each one in detail, but here now is a super-short overview of each:

- (1) **Clear Solo** [below] — Easily clear all solos.
- (2) **FX Controls** [next page] — Globally mute the FX. Set tap delay.
- (3) **Monitor** [next page] — Aligning the main PA with remote speakers.
- (4) **Talkback** [next page] — An easier way to communicate with the band on stage.

Tap the quick access panel button again to exit out of the quick access panel.

Clear Solo



Let's say the band is just tearing it up, playing the absolute best show of their lives. Right in the middle of their best song, the guitarist just chokes on the memorable, hummable guitar solo. Just tap the 'Clear Solo' button and all will be right in the world again.

Yeah, we wish it were that easy, too. Here is what the clear solo button really does. When any input or output is soloed this button illuminates orange, serving as a reminder that a soloed channel exists somewhere. This is especially useful when an output is soloed and you switch to adjust a different channel on a different output. Tapping this button will clear all solos on all inputs and outputs, including the ones you can't see.



Not only will the quick access panel's Clear Solo button illuminate, but an all-caps SOLO (also orange) will be displayed proudly above the quick access panel button. Yes, in many circles, all-caps is considered bad form because it's "yelling", but we feel it's necessary to let you know that something has been soloed... we're just trying to get your attention!

FX Controls

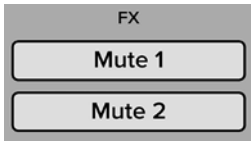

Mute FX— Tapping an FX mute button in the quick access panel is akin to tapping the mute button at the top of the FX channel strip. However, with the quick access panel, you now have easier access to the effects controls regardless of what view is open.

For example, let's say you're adjusting the EQ on channel three. One option is to go back to the mixer view, swipe left until the FX channels are visible, tap the FX's mute buttons, swipe right to head back to channel three and finally tap its EQ curve to continue where you left off.....or simply leave the channel three EQ open, tap the quick access panel, tap the FX's mute button, then continue to adjust the channel three EQ without missing a beat!

DL806 • DL1608

DL16S • DL32S • DL32R

Like the FX channels mute buttons, the quick access effect's mute buttons are also global. Additionally, they illuminate the same red color when engaged and are gray when disengaged.

Tap Delay — Tapping the tap delay button in the quick access panel is akin to tapping the tap delay button in the FX view. However, with the quick access panel, you now have easier access to the tap delay regardless of what view is open.

For example, let's say you're adjusting the gate on channel nine. One option is to swipe up to the FX view, tap the tap delay button to the desired setting, then swipe back down to the comp/gate view to continue where you left off.....or simply leave the channel nine comp/gate view open, tap the quick access panel, tap the tap delay button to the desired setting, then continue to adjust the channel nine gate without missing a beat!

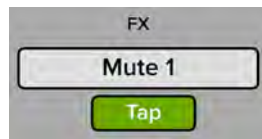

Mono Tap Delay

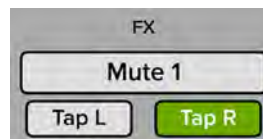

Stereo Tap Delay

Monitor



Monitor — These sliders control the monitor delay (D) and level (L) for the monitor bus. For example, if you are mixing from the back of the venue, you are going to want to align the main PA with the remote level. This is the place.

The delay time ranges from a low of 0.0 ms (m, ft) to a maximum of 337.8 ms (115.8 m, 380.1 ft). The level ranges from a low of off ($-\infty$) up to a maximum of +10 dB. These may be adjusted by moving the sliders left and right. Additionally, exact settings may be entered into the current parameter display.

Talkback

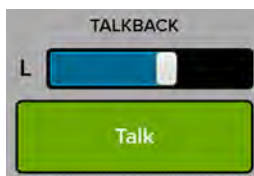

Talkback — DL Series mixers have a talkback level (L) and button. The last input channel is the default for the talkback input. The talkback level slider controls the level of the talkback mic with the gain ranging from $-\infty$ to +10 dB. Talkback may be routed to the main L/R, any subgroup, aux send and/or matrix. Refer to the I/O patch on pages 196-209 for more information.



The talkback button operates via latching, momentary or automatic depending on how you set up the talkback mode in settings. Refer to page 232 for more information.

Shows

Shows

The shows button reveals a popover displaying the current show, snapshots and channel safes. These three things (with the addition of the current state) make up the mixer's file system. Before diving directly into shows, let's do a quick overview of the file system.

DL series mixers save every parameter associated with its operation with the exception of the gain [DL806 and DL1608], power switch and phone knobs. The current state of all parameters is constantly stored so the console powers on in the same state as when it was turned off, just like an analog console.

The file system consists of the following:

- (1) **Current State** — When the mixer is turned on, it wakes in the state that it was in when it was powered off.
- (2) **Shows** [pages 233-236, 241-244] — A show is comprised of multiple snapshots in order. Multiple shows may be created, but only one show is loaded at a time.
- (3) **Snapshots** [pages 237-238] — A snapshot is just that: a “photograph” of the current state of the mixer.
- (4) **Channel Safes** [page 239-240] — Channel safes allow selected channels to be removed from snapshot recall, leaving them unchanged.

Shows

One of the most important facets of the Master Fader is the ability to create shows. A typical concert consists of the headliner and the support act. Since the support act kicks off the show and warms up the crowd, it makes sense to start there. Creating shows is not just for concerts, though. Feel free to set up multiple shows for conferences, church services, theatre productions and more! As mentioned above, a show is comprised of multiple snapshots in order with one show loaded on the mixer at any given time. This is called the Current Show. The amount of shows that may be created is limited only by the available space on the device, with up to 99 snapshots per show. Creating shows is easy and will make your life infinitely better, so let's run through some steps to see how it's done. Please follow along slowly, carefully and step-by-step!

Step 1 — Tap shows button:

The first step is the easiest: tap the shows button in the upper right-hand corner of the device; the image below is similar to what you should see upon your first trip to the show zone. The button will illuminate green, indicating your presence in the shows section. The absence of anything mixer-ey like also indicates the same. The mixer always has a Current Show loaded, so if this is your first visit, you will see an empty Current Show. If so, there is no need to create a new show just yet. Instead, we will create some new snapshots that will make up your first show.

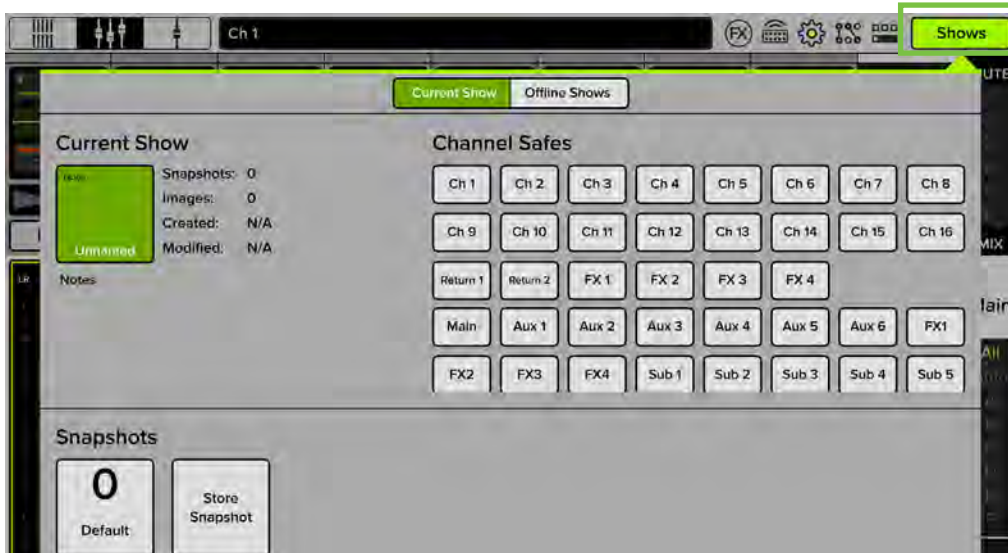

Step 2 — Name the show: Each new show begins as “Unnamed”. However, with multiple shows, trying to find the exact “unnamed” show that you want could prove to be difficult to say the least. So let’s name it. Tap the green “unnamed” button to reveal a popover, as seen below.

Tap inside of the blank “Name:” box to reveal the onscreen keyboard, then name the currently selected show as you so desire. Tap the blue “Done” key when satisfied with the name. If the name is too long to fit, the button scrolls, displaying the entire name.

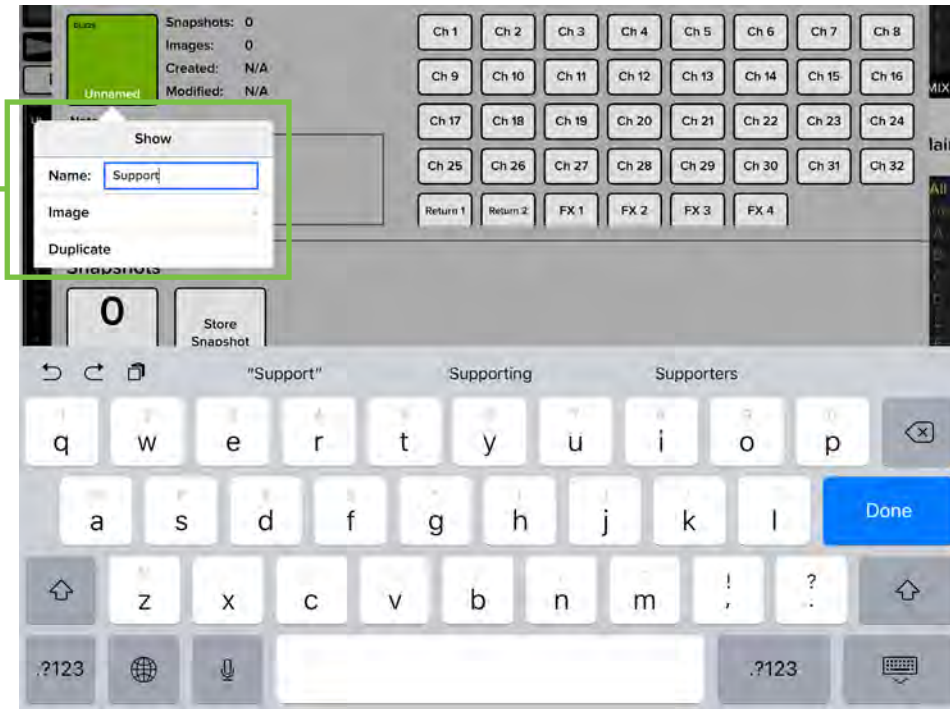

The shows button displays the name of the last recalled snapshot. In this case it is the default “Shows”. If an asterisk * is displayed, this lets you know that the state of the console has changed (whether the shows panel is open or not).



Shows Panel Open

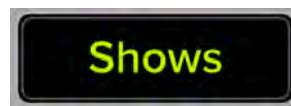

Shows Panel Not Open

Step 3 — Looks are everything: Looks are everything...or so I've heard. Let's say the mixer is on tour where the support act and headliner may change on any given night. It's not far from the realm of possibilities and happens more often than folks might think. Therefore, it might be helpful to not just name the show, but also select an image, so as not to open the wrong show...oops! Tap the show button to reveal the popover again. This time, instead of naming the show, tap "Image" instead to reveal a new popover, as seen below.

You will be presented with four choices:

Camera — If you're familiar with how the camera on your device works, then you're in luck... this one works the exact same way!

Photo Library — Here you may select from all the photos that currently reside on your device.

Icon — Or select from a multitude of built-in icons at your disposal.

Clear Image — Believe it or not, tapping here will clear the image for the show.

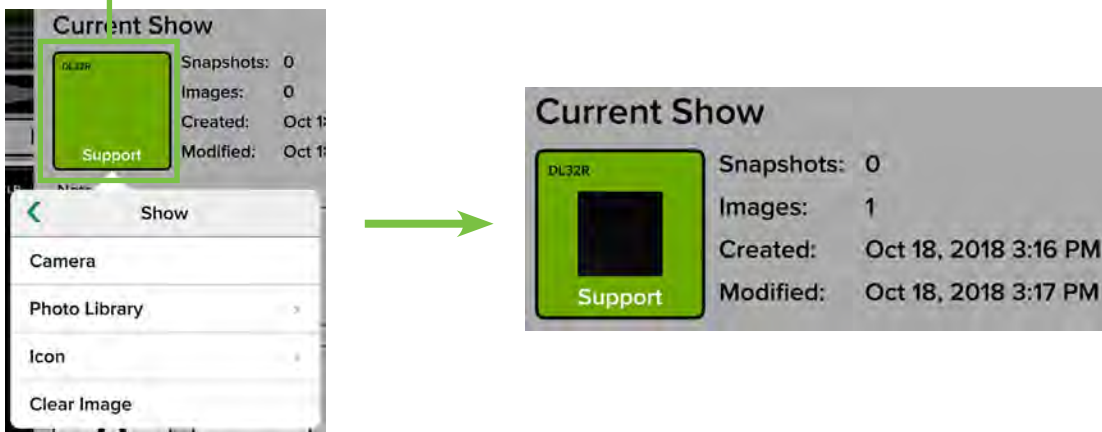

As you can see in the example above, None More Black are the support act tonight, with Another Band in the headlining slot. Here we decided to snag None More Black's album cover from the photo library. Notice that the show now says "Support" instead of "Unnamed". Also, each show is date and time-stamped from when it was created and when it was modified. it will display the number of snapshots and images used in each show, as well.



In the upper-left corner of the current show's button is the name of the mixer – DL32R in this example. This is important to know because you can NOT convert between mixers. Make sure the right mixer is assigned before creating shows.

Step 4 — Add notes: Just below the shows button is an empty space awaiting your witty notes. Tap inside the blank "Notes" box to reveal the onscreen keyboard, then add notes as you see fit. Tap the "return" key when satisfied with the name.

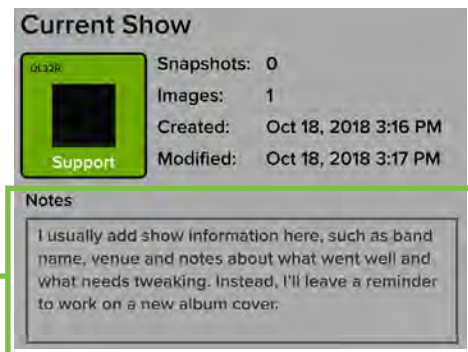

You may have noticed a third choice in the popover when the shows button is tapped – **Duplicate**. Duplicate will create an exact copy of the current show. This is useful in situations where two (or more) shows may be quite similar, with only a few minor changes between them. For example, a band could have a long set list and short set list. After creating the show containing the long set list, duplicate it and delete the snapshots from the show that won't be used when the band plays the songs on the short set list.

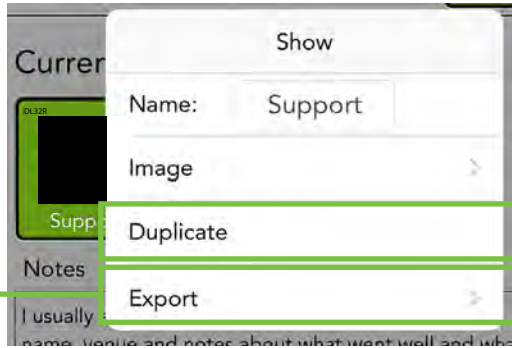

Another scenario is setting shows for multiple venues. Save the first show by naming it as the first venue, duplicate it at the next venue, make the appropriate changes and save it by naming this as the second venue and so on and so forth. When the band makes return visits to each of the venues, the settings are readily available at the tap of a button! Why do the same work multiple times instead of just duplicating the original and then tweaking the copy as needed?

Export – Export is the fourth choice in the popover when the shows button is tapped. Master Fader affords you the opportunity to import and export shows. An entire chapter is dedicated to importing and exporting files. This includes detailed instructions and multiple screenshots every step of the way. Please check it out on pages 245-248.

Snapshots

As mentioned earlier, a snapshot is just that: a “photograph” of the current state of the mixer. So why would you create snapshots? For one example, a band could create snapshots for every song. Or snapshots could be created with and without FX. Snapshots may be created for in-between song banter. Snapshots may be created for each scene in a musical or other theatre performance. Houses of worship may create snapshots containing key changes of each service. The possibilities are unlimited!

The following is a list of features that are stored in a snapshot:

- Input channel settings
- FX channel settings
- Aux channel settings
- Main LR channel settings
- Channel ID
- I/O patch

The following is a list of features that may not be snapshot:

- Solo
- Access Limits
- Board Settings
- Talkback
- Monitor
- Recording / Playback

Ok, that’s what they are, but how do you create them?

Step 5 — Creating snapshots: Creating snapshots is easy. Simply set fader levels, source / trim, DSP (EQ, dynamics, FX, etc.) for each snapshot that you are going to want to recall at a later time.



As user-friendly as creating snapshots may be with Master Fader, if this is your first time creating them, it might be best to start off simple until you get the hang of it. Go ahead and move some faders around, name some channel inputs and load up a couple of images, as well. If feeling brave, set some EQs, gate and compressor levels, too.

Now return to the Shows view by tapping it. At the bottom of the shows view you should see a section labeled “Snapshots”. It may be mostly barren now, but will fill up soon. This area is called the snapshot list. At the beginning of the snapshot list is a button labeled “0 - Default” and at the end of the snapshot list is a button labeled “Store Snapshot”. Tapping the “Store Snapshot” button will store the current state of the console [the faders, EQs, gates and compressors, etc. that you just set] into a new snapshot and move the “Store Snapshot” button to the end of the snapshot list. Doing this is similar to pressing a “Store” button on other consoles.

Repeat this step a couple more times. Go back to the mixer view and channel view to change the mixer settings, and store these snapshots in the shows view as indicated above. At this point, the snapshot list will look somewhat like the image below (depending upon the number of snapshots you took, of course!).



Step 6 – Naming snapshots: You created a bunch of snapshots for your first show, but how do you know what each one represents? By naming them, of course! Touching a snapshot button (other than “0 - Default” or “Store Snapshot”) will display a popover with the following options.



Tap inside of the blank “Name:” box to reveal the onscreen keyboard, then name the currently selected snapshot as you so desire. Tap the blue “Done” key when satisfied with the name. If the name is too long to fit, the button scrolls, displaying the entire name.

Notice that the number remains, even once the snapshot has been named. This helps keep the snapshots in order, regardless of name.

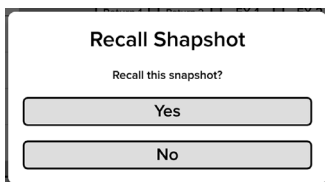
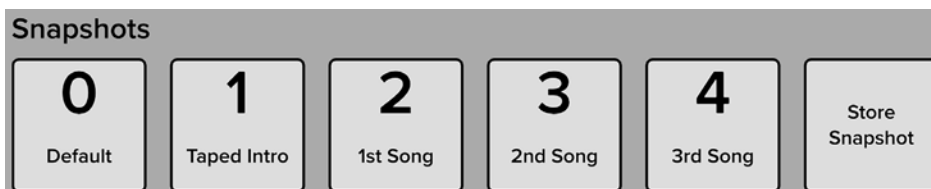

Step 7 – Recalling snapshots: Now that you’ve created and named the snapshots, it’s time to recall them! On recall, all appropriate console parameters change to match the stored snapshot. In our example, recall each of the snapshots, starting with the Taped Intro. Tap the Taped Intro button to reveal the popover as shown above, tap the red Recall button to reveal a confirmation dialog as seen to the left, then tap the Yes button to recall the snapshot. Now go back to the mixer and channel views. The settings you created for the Taped Intro snapshot will be recalled. Do the same thing with each snapshot [1st Song, 2nd Song, 3rd Song, etc.] going back and revisiting the mixer and channel view each time to see the changes – wait for it – recalled!



Recalling snapshot “0 - Default” will set the Master Fader to its default (which – for all intents and purposes – is a zeroed out board). Snapshot “0 - Default” is always listed first and cannot be renamed, replaced or deleted; only recalled.



Input and output channel linking may be stored and recalled in snapshots so that a pair of channels could be linked in one snapshot and unlinked in another.

Channel Safes

In addition to the current show and snapshots, the shows view also houses the channel safe buttons. Engaged selections will be removed from snapshot recall, leaving the corresponding channels or outputs unchanged. These will illuminate green when engaged and are gray when disengaged.

The following are available for channel safes:

- Channel inputs
- Returns [DL16S, DL32S, DL32R]
- iPad [DL806, DL1608]
- FX [Controls reverb send and return]
- Main LR
- Aux sends
- Subgroups
- VCAs
- Matrix [DL32R]

When recalling a snapshot (including snapshot 0 - Default), the Master Fader app will not change any parameters on safe channels. Channel safe settings are global and applied to all snapshots in the show. They are saved and recalled with the show and recalled via power cycle.

Channel safes will still be individually touchable for each channel and output regardless of linked state. Linking or unlinking channels does not change the safe button states. If either channel of a linked pair is marked safe in the shows screen, both will be treated as safe and not affected by the snapshot recall. Similarly, when recalling a snapshot that unlinks the pair of channels, both will be treated as safe and not affected by the recall. So if you get it wrong, no harm no foul; simply mark both as safe or neither of the channels as safe and recall again.

Step 8 — Setting channel safes: Let's give it a shot to understand how this functions a little better. A common scenario for using channel safes is on outputs. This way, the settings on all input channels will recall, but the output settings [assignments, parametric EQ, graphic EQ and output compressor / delay] will not. Select all outputs (as seen in the image below).



DL1608 Channel Safes

Now that we've set channel safes, go ahead and recall the snapshots again [step 7, previous page]. There should now be no changes to the output settings when recalling any of the snapshots (assuming, of course, that you made changes to the outputs when creating the snapshots [step 5, two pages back]).

Step 9 — Remaining snapshot popover choices: You might be wondering what the other snapshot popover choices accomplish. Well, you're in luck, as here they are!

Replace — Saves the current state of the console over the selected snapshot. This is useful in situations where the settings on a snapshot might be close to where you want them, but not quite exactly where you want them. Make your tweaks, then select “replace” to replace the snapshot with the updates for next time. A confirmation dialog will appear.

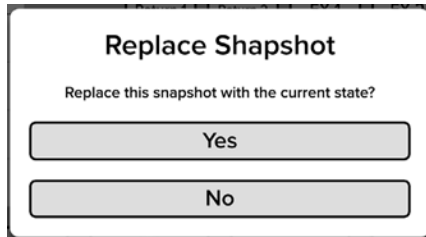

Delete — The delete button deletes the currently selected snapshot. This is a permanent deletion with no undo, so a confirmation dialog helps prevent accidents.

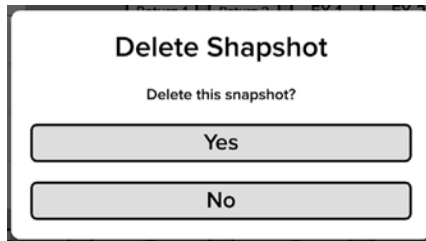

Current Show vs Offline Shows

So you've successfully created your first show...congratulations! Creating additional shows will be a breeze, but let's take a quick peek at how it works. As mentioned earlier, at all times there is a single show loaded on the mixer. We call this the Current Show. Additional offline shows may be created and stored, each with their own set of snapshots.

Here's one way to understand the difference between current shows and offline shows: envision your High School days. The textbook you have with you in the classroom would be considered the current show. Each page [snapshot] is filled with different information, but they are all necessary to make up the textbook [show].

Ok, so the textbook you have in class with you is considered the show and it's comprised of X number of pages with each page considered another snapshot. So what (and where) are offline shows? Easy! The various textbooks you have in your locker would be akin to offline shows. They are available when you need them, but you don't need them at the moment; you only need the textbook [show] for the class you're currently in. And, of course, each textbook [show] in your locker is comprised of many pages [snapshots]. So, in our example, we named the current show "Support" and chose the None More Black album artwork for the image. Additionally, the "Support" show is comprised of snapshots named "Taped Intro", "1st Song", "2nd Song", etc...

Make sense? If so, let's make another show, this time for the headlining band, Another Band!

Step 10 – Creating additional shows: Start by tapping the shows button again. Next, tap "Offline Shows".



Here you can see all shows that have been created (which is why we strongly suggest giving each show a name, image and notes!). What will not be shown here is each show's snapshots. The snapshot list will not be displayed until a show is loaded. The button of the currently loaded show will be green.

At the end of the show list is a gray button labeled “New Show”. Tap this button to create a new show and move the “New Show” button to the end of the show list.

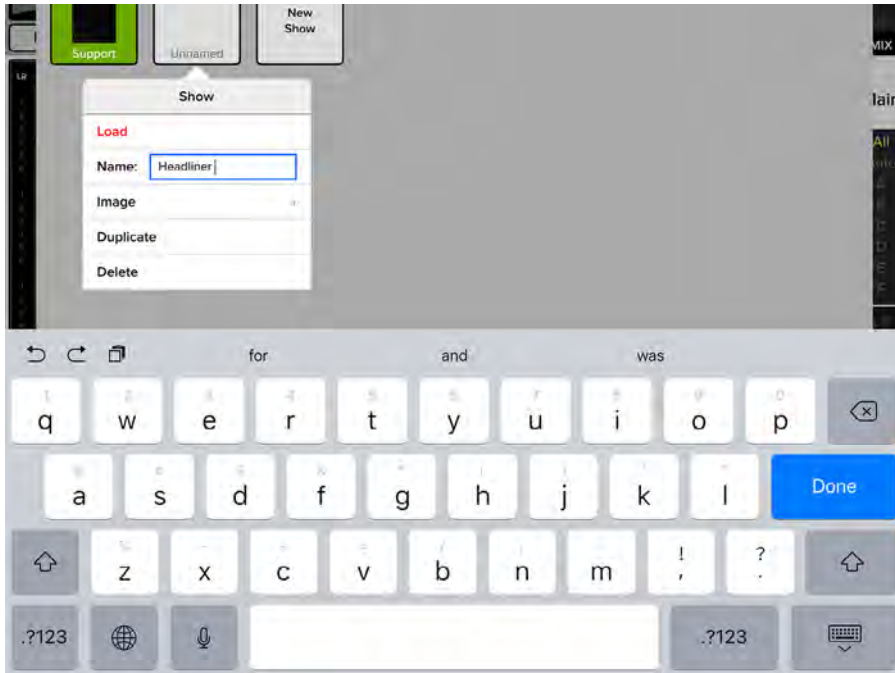

In this example, we named it “Headliner”. Type “Headliner” in the name field followed by tapping the blue “Done” key to see an image similar to what is displayed below.

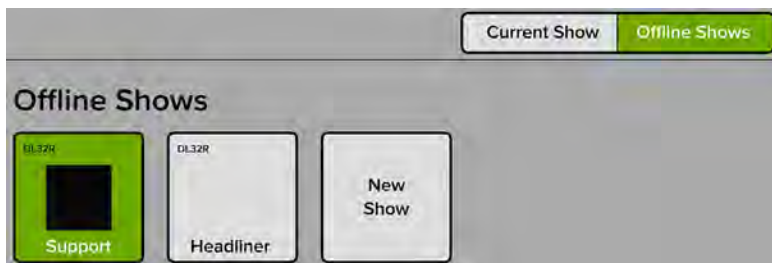

At this point the show has been created, but it is still an Offline Show. It has to be the Current Show in order to view and load snapshots. That’s easy! Just tap the Headliner button to reveal a popover similar to what is displayed at the top of this page. From there tap the red Load button to reveal an image similar to what may be seen below.

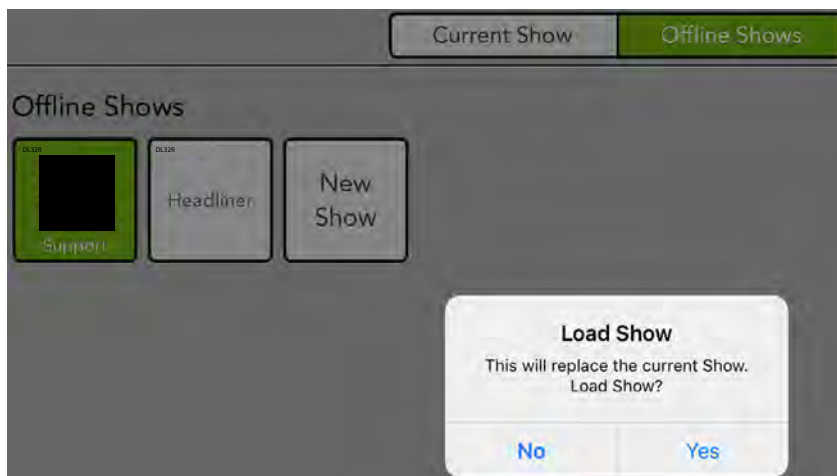

Before tapping the Yes button, let's discuss the load button for a moment...but only for a moment!

Load — Load is an option we did not see in the “Current Shows” section. That's because the current show is the loaded show! Load is only available in the “Offline Shows” section and will load the selected show (including all of the snapshots associated with the show) as the Current Show.

Ok, now tap the Yes button!

After loading, the Current Show will display the Headliner show and all of its snapshots. Now tap the Offline Shows button to see an image similar to what is displayed below. Notice that Support is no longer the green button...Headliner is!

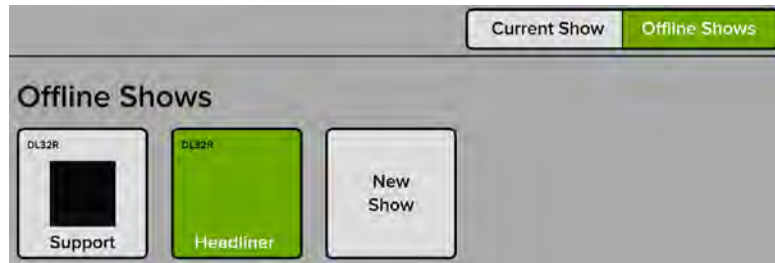

As stated on the Load Show popover, the load time is all dependent on the number of stored snapshots on the show. It can take up to two seconds per snapshot and 30 seconds per image to transfer. The current state of the console is not changed on a show load, audio still passes and you can still adjust all mix controls. However, in reality, you will probably want to wait to recall a snapshot from the new show after loading the show completes.



As a reminder, loading a show will replace the current show on the mixer with the new show.



All connected devices will also load the new show. This will create a copy of it on each device so it may be used offline in the future, if needed.

At this point, a new show has been created and named, but it's time to create some snapshots. Simply follow the same steps as you did for the original show [Support - None More Black].

That's basically it. When tapping an unloaded show [gray button], the only other choices in the popover include Name, Image, Duplicate and Export. All except Delete work exactly like they do for the Current Show. Only Offline Shows may be deleted, not the Current Show. So let's take a gander at Delete.

Delete — As mentioned above, the delete button deletes the currently selected show and all of its snapshots.

This is a permanent deletion with no undo, so a confirmation dialog helps prevent accidents.

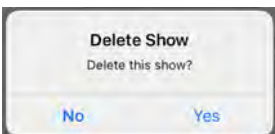

Import / Export — Master Fader affords you the opportunity to import and export offline shows. An entire chapter is dedicated to importing and exporting files. This includes detailed instructions and multiple screenshots every step of the way. Please check it out on pages 245-248.

Random Notes and Other Musings

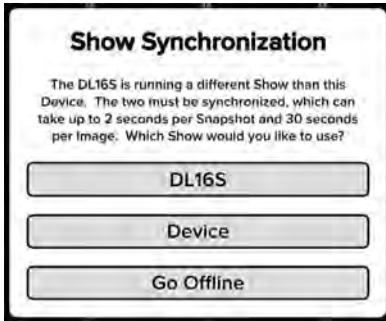

To Push or to Pull, That is the Question — The CURRENT show on the device must match the CURRENT show on the mixer. If they do not, you will be asked to select between the two so they are synced. Why would shows not be synced? Well, one example could be that current show (X) was used at a gig. The band and crew then pack up for the next show, but the engineer wants to make some tweaks for the next night's performance. The engineer makes a few changes and stores a new snapshot offline; this show now differs from the CURRENT show that is still on the mixer. What will happen when the device is reunited with the mixer once again? The engineer will be asked which one to use: the current show on the mixer [X, tap the DL16S-DL32S-DL32R-DL806-DL1608 button] or the current show on the device [Y, tap the device button]. In this case, the engineer would choose the device since it contains the latest changes.

DL16S-DL32S-DL32R-DL806-DL1608 – tapping the DL16S-DL32S-DL32R-DL806-DL1608 button here is considered PULLING the current show from the mixer and copying it to the device. Note that the previous current show on the device is replaced, but an offline copy of the previous show will remain. It will take about two seconds per snapshot to synchronize the shows. All connected devices will automatically sync with the current show.

Device – tapping the device button here is considered PUSHING the current show from the device and copying it to the mixer. It will take about two seconds per snapshot to synchronize the shows. All connected devices will automatically sync with the current show.

Go Offline – tapping the Go Offline button here allows you time to figure things out before deciding which show to use.

You will also receive the Show Synchronization notification the first time you power on the DL Series mixer if you tried out the Master Fader app prior to purchasing the mixer.

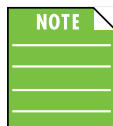

Each device that is offline is unique. In other words, multiple varying snapshots and shows may be created on each device. This is something to be aware of when reconnecting.

64: it's not just a number, kids — A maximum of 64 images may be used per show. However, if the same image is used on multiple IDs/snapshots, it only counts as one image (if the image has been selected from show images and not the photo library). Show images do not count toward the 64, nor do icons.

Chapter 18 : Importing and Exporting

Introduction

Master Fader affords you the opportunity to import and export presets, shows, recordings and even full system backups. That's right, your mixer IS a computer. You're able to export presets, shows, recordings and more and then import them elsewhere...or export to an engineering friend who could use a good preset or a show to bandmates who can then import on their devices, for a couple of examples.

This allows us to create additional presets [available through our website](#). Beyond that, occasional full system backups are highly suggested, as well. That's what we'll do in this example. From Tools > Settings > System Backup, tap the import / export button to reveal a popover similar to what's displayed below.

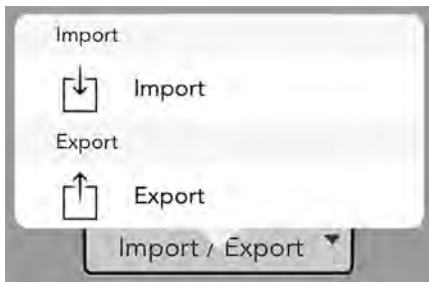

Tapping any of the **EXPORT** options here displays a popover where you can:

- Name the file
- Give it a description
- Choose which items to export [indicated with a ✓ – simply tap to add or remove]

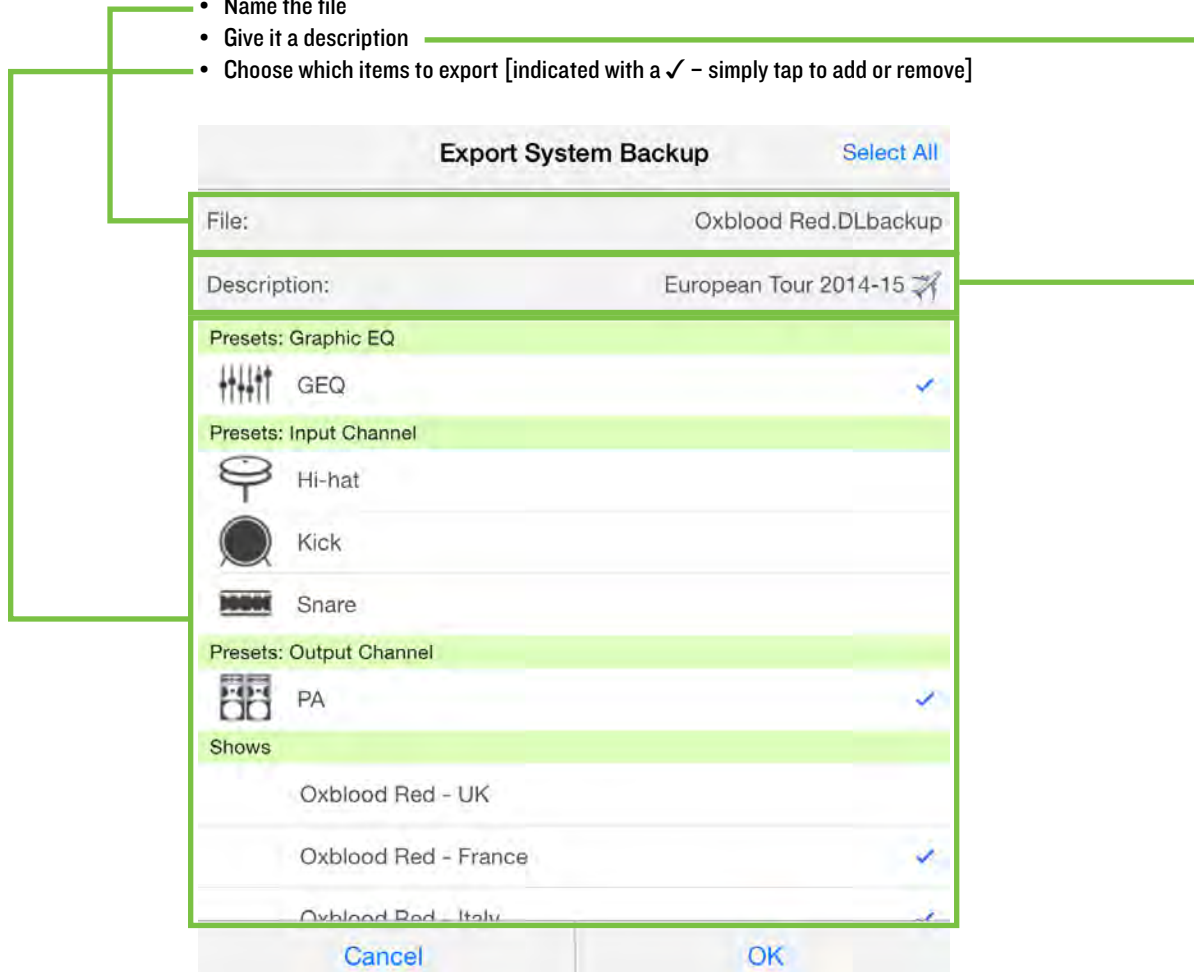

Regardless of the export option chosen, the first view looks similar for all (as seen above).

iTunes — If exporting via iTunes, tapping “OK” here should reveal a confirmation that the export is complete.

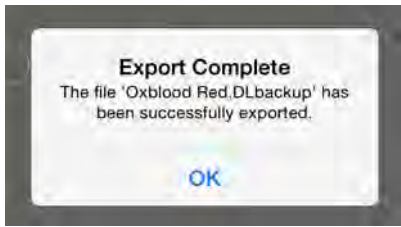

Dropbox — First, a word from our sponsors: A Dropbox account needs to be created before importing or exporting via this method.

If exporting via Dropbox, tapping “OK” here should reveal a confirmation that the export is complete.

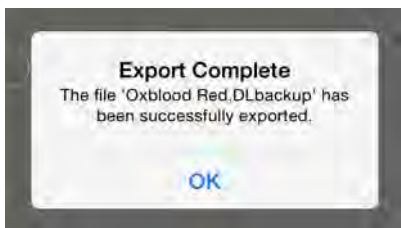

Email — If exporting via Email, tapping “OK” here should reveal a similar email in compose form as seen below left. From here, type in the email address and tap “Send”. Once successful, you should receive confirmation that the export is complete.

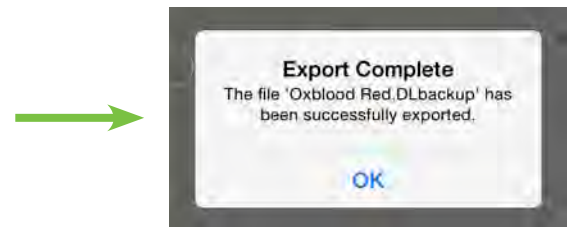
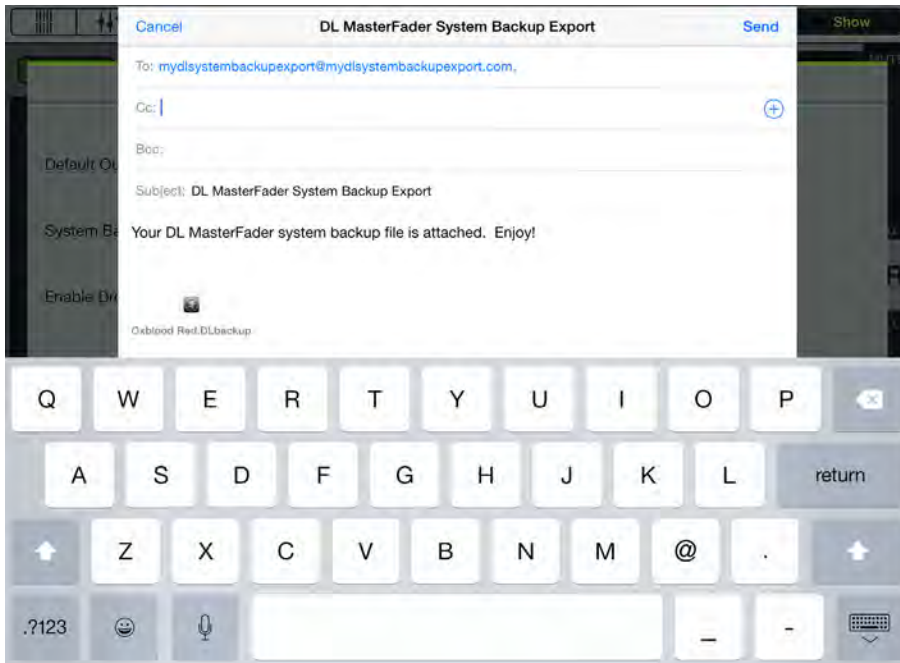

Don't forget to name the files differently, lest you receive a warning like this to the right. Perhaps you want to overwrite the current file, in which case tap “Yes”. Otherwise, tap “No” and rename the file.

Congratulations, you just exported some files. Easy, huh?!

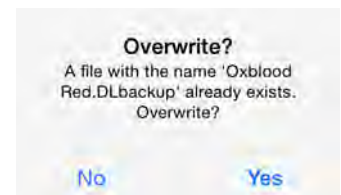

Import — Importing files is an easy process:

- **Step 1** — Tap the “Import / Export” button.
- **Step 2** — Where will you be importing from...? Tap the selection from the list!

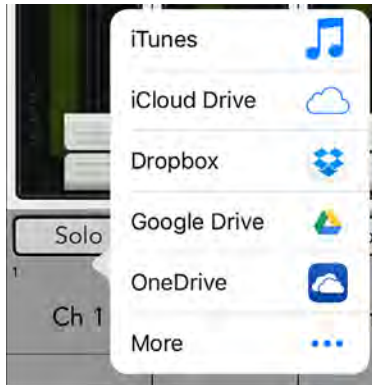

- **Step 3** — Select the file for import by tapping it. You may have to scroll down until the file is visible.

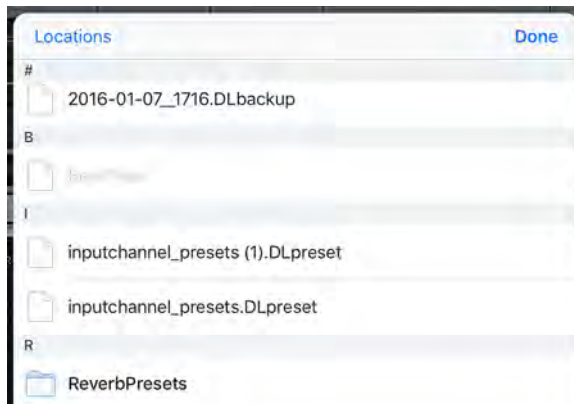

- **Step 4** — Select the presets, shows, etc. you want to restore by tapping them [indicated with a ✓].

If you want to clear all user presets and shows before restoring the backup, move the slider to the right. This will delete all of the existing files so be sure this something you want to do. Tap OK.

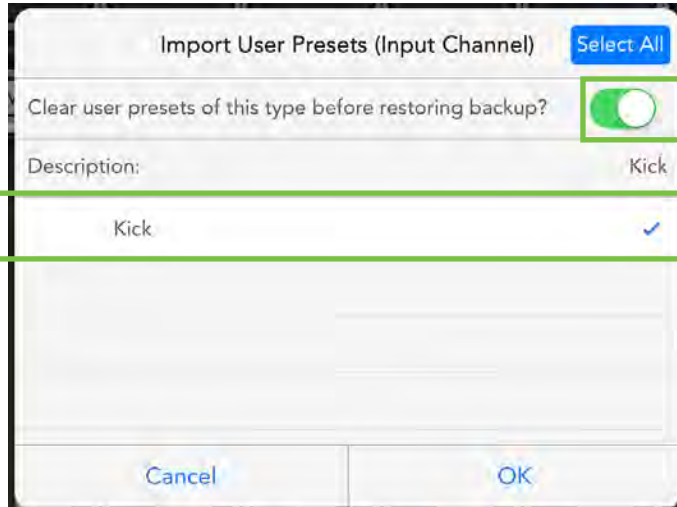

- **Step 5** — A confirmation should be revealed that the import is complete. Tap OK.

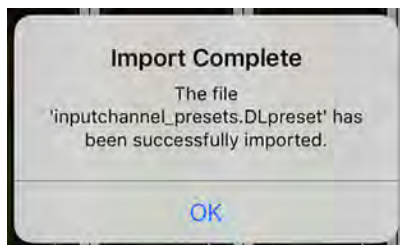

Chapter 19: Mackie Master Fader for Phones

Introduction

Do you want to control the mix via phone? Of course you do! Well, you've come to the right place! At this point, you must be well-versed in – or at least somewhat familiar with – the ins and outs of Master Fader. Master Fader on phones look and work similarly to Master Fader on tablets, but just on a much smaller scale. It's great for easy, fast access to key controls needed during a show.

Master Fader on phones allow control of DL Series mixers via Wi-Fi. Version 5.0 features touch-friendly control over multiple input channels at once and an output selector for quick access to any mix. The addition of channel muting, detailed channel ID and metering and the inclusion of a master fader provide unmatched control. Plus, an access control feature limits users to only control their assigned output, keeping them away from other outputs. This is great for simple on-stage control of monitor mixes.

Also included is the ability to recall any snapshots from the current show on the mixer. This way, bands are able to control the whole mix from the stage. Last, but not least, users have the ability to enable/disable mute groups and select view groups. Mute groups are great for muting all inputs in-between sets (for just one example), while view groups displays only the input channels you want, hiding the others. With Master Fader for phones, DL Series mixer users benefit from the full power of a digital mixer with an easy-to-use application that fits right in their hand.

Downloading, Installing and Updating the Master Fader App for Phones

The steps it takes to download, install and update the Master Fader app for phones are nearly identical to that of the Master Fader app for tablets. Just follow the same steps as outlined in Chapter 3, starting on page 17.

Using the Master Fader App for Phones

Master Fader for phones don't have every single feature of Master Fader for tablets. Rather, it contains the primary features needed while a show is under way. You will still want to use Master Fader for tablet to set up everything before-hand, then use Master Fader for phone to fine-tune levels and load snapshots during the set. There are two views available: mixer view and tools.

Take a look at the mixer view of Master Fader for phones. Starting at the top and working your way down, the first thing you might notice is that the whole top section of Master Fader for tablets is non-existent here; this includes the entire navigation bar, channel EQ curves and GEQ. Also of note are the missing solo buttons.

As with Master Fader for tablets, you're able to drag or flick left and right in order to view the other input channels, return channels [DL16S, DL32S, DL32R], iPad / Playback channel [DL806, DL1608], FX, Subgroups and VCAs.

The tools button is located above the mix selector. Here is where devices, access limits, mute groups, shows (and snapshots) and help may be acquired.



Input Channel Strip

The previous page displayed an image of what the entire mixer view of Master Fader for a phone looks like and we just discussed the differences between Master Fader for tablet versus Master Fader for phone, but let's take a closer look at what was just explained. We'll break down the mixer view before moving onto tools.

The images below show side-by-side comparisons (and differences) between the channel strips (left) and output strips (right).

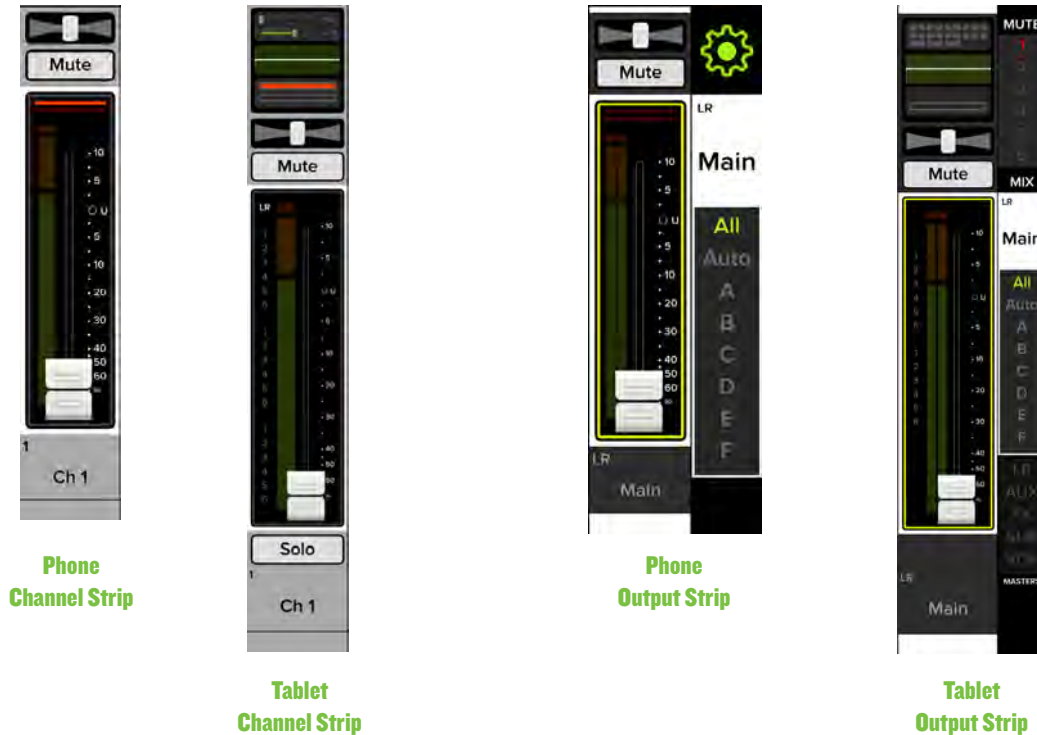

While Master Fader for phones doesn't have every single feature that Master Fader for tablets does, it still offers a wide-selection of tools necessary to run a show. Let's break it down.



LR Pan

Pan – Pan allows you to adjust how much of the channel is sent to the left versus the right outputs. Touch and drag a channel's pan slider left or right to make adjustments. Touched pans will “grow & glow” to indicate that they are being adjusted. The pan may be centered by double-tapping the pan slider.

The pan control employs a design called “Constant Loudness.” If a channel is panned hard left (or right) and then panned to the center, the signal is attenuated 3 dB to maintain the same apparent loudness. Otherwise, the sound would appear much louder when panned center.

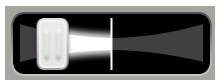

LR Balance

The pan slider becomes a balance slider on linked channels, now acting as a stereo balance. It allows you to adjust how much of the left or right output signals are heard. Touch and drag the sliders left or right to make adjustments. Center it to hear the output equally from the left and right sides. The balance may be centered by double-tapping the balance slider. How to link channels is discussed on page 255.

For a linked aux, the user may de-select Use LR Pan (on the tablet) to control the aux pans and main mix pans independently for each channel. An example of this is displayed below.

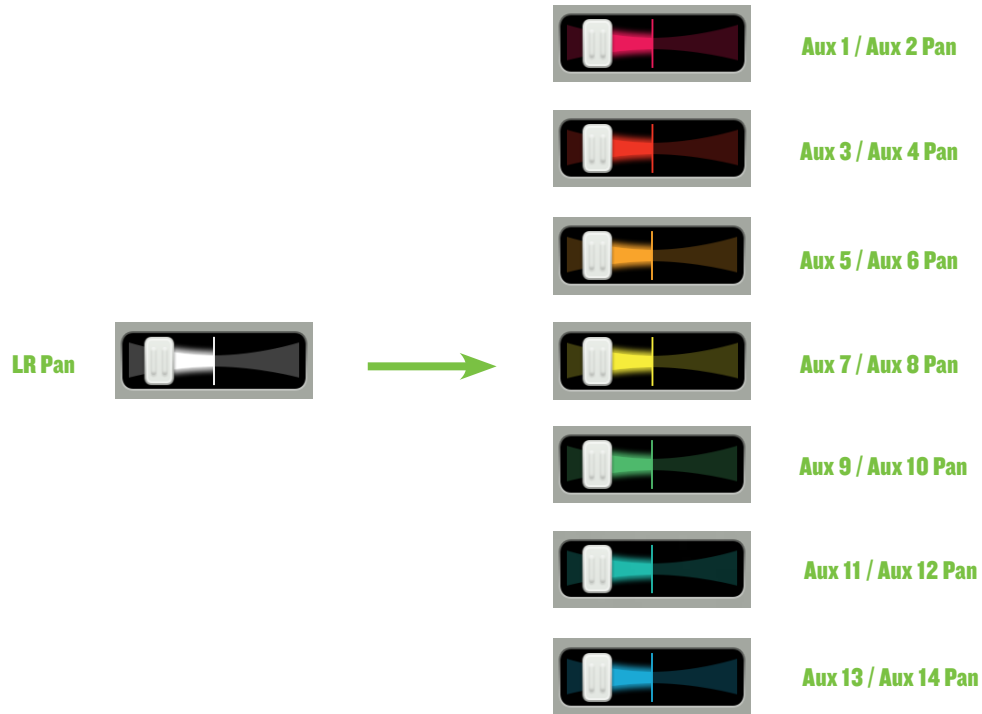

More information about Use LR Pan may be found on page 73.



Mute – Mute buttons do just what they sound like they do. They mute – turn off – the signal on the channel(s).



Mute buttons illuminate red when engaged and are gray when disengaged.

Please note that muting a channel mutes it on all outputs, not just the output that is currently shown...unless the user de-selects Use LR Mute for a particular aux/FX send, in which case aux mutes (or FX mutes) and main mix mutes may be controlled independently for each channel. More information about Use LR Mute may be found on page 72.



Inputs muted by mute groups or VCAs will illuminate oxblood red. More information about mute groups may be found on pages 57-62, 264.



Gain Reduction Meters – The gain reduction meters display the input channel gain reduction from the gate [top] and compressor [bottom]. These illuminate from right to left and indicate 20 dB of gain reduction when fully lit.

To learn more about dynamics, check out chapter 11 starting on page 107.



Mono



Stereo

Channel Faders and Input Meters – The touch sensitive faders adjust the level of each channel going to the selected output. Adjustments are made by touching and dragging channel faders up and down. Touched channel faders will “grow & glow” to indicate that they are being adjusted. The fader level ranges from $-\infty$ to +10 dB as indicated by the scale to the right of the fader.

The input meters display the input signal level to the channel before all channel processing. Changes made to the EQ, mute and fader do not affect these meters.

This meter should remain green with the occasional bump into the yellow zone. Turn down the gain if the input meter remains consistently yellow. If the input is too high [overloading], a clip indicator at the top of the meter will illuminate red. If clipping occurs, reduce the gain.

Unlinked channels display mono meters, while linked channels display stereo meters. How to link channels is discussed on page 255.

- Red [clipping] = -3 dBFS
- Green to yellow = -12 dBFS
- Green [bottom] = -60 dBFS

Selected Mix Indicators – Surrounding each fader and input meter is the selected mix indicator. This varies by color for clear indication of which mix is currently selected.

The output type is discussed in greater detail in the master fader section, starting on page 56.

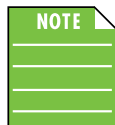

There is no way you would ever see the image as shown below. It is just a point of reference. As mentioned above, each selected output has a different user-selectable color for clear indication of which output type is currently selected. This is especially useful in the mixer view.

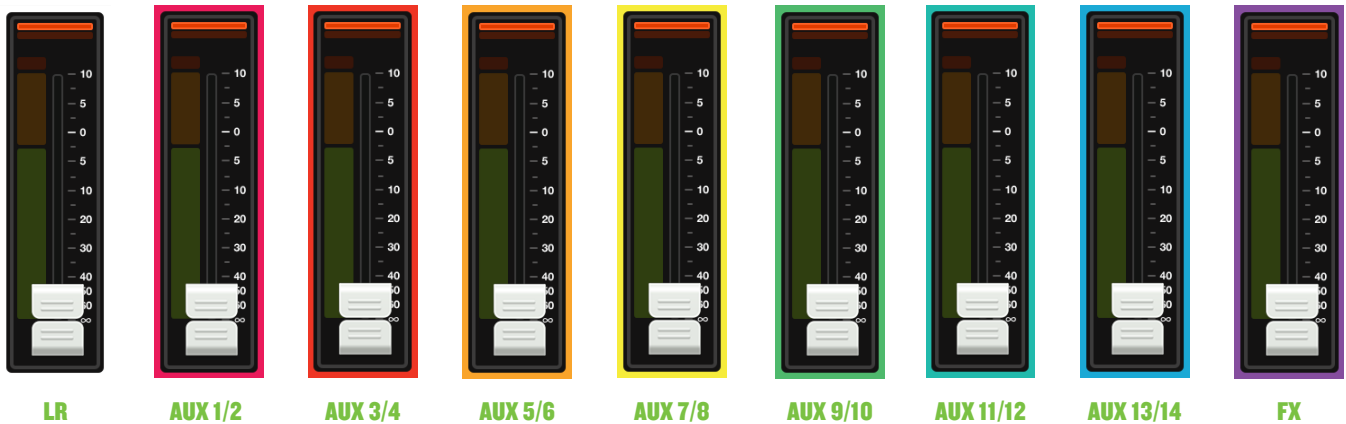

Notice below how each channel's input meter is surrounded by the color of the selected output. In the left image, the faders control the levels going to the LR mix, while the faders on the right image control the levels going to the aux 1 mix. All we did was change the selected output from main LR to aux 1.



LR



AUX 1

Channel ID Button – Each channel ID button name and image is user-editable. Additionally, users may also link two adjoining channels together into a single channel strip. Simply tap the button at the very bottom of the channel strip to reveal a popover that allows editing of the name, image and color and an option to link channels.

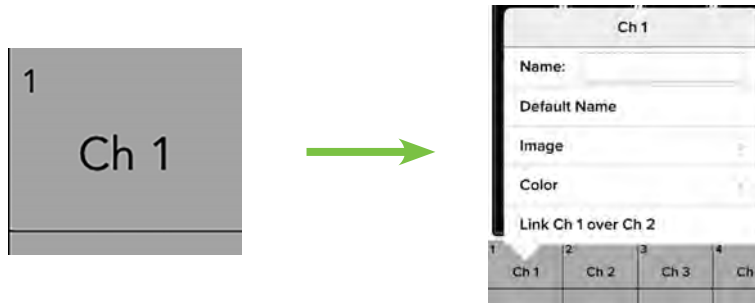

Let's start with the name. Tap in the name box to bring up the blinking cursor and keyboard (as seen in the image below). Simply type in the name you want for that channel followed by tapping the blue 'Done' button. If the name is too long to fit, the button scrolls, displaying the entire name.

For familiarity, this is the same keyboard that is used for messaging or emailing from the phone.

It goes without saying that tapping "Default Name" changes that channel's name back to its default name.



Before moving on with the rest of the Channel ID, let's look at another exciting feature regarding channel naming. On the left and right side of Name: are "previous" and "next" arrows⁵. This makes it easier to edit the names of multiple channels in a row without having to re-tap each channel's ID button just to name it.

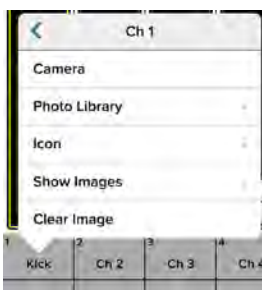

An open gray box with only the channel's name works, but let's spice it up with an image. Show images are kept in sync which means that all connected devices will display the new image once its been added, whether or not it was already on that device. There are several ways to choose an image. From the channel popover, tap "Image" to reveal a new popover as seen to the left [Image Source]. You will be presented with five choices:

Camera – If you're familiar with how the camera on the phone works, then you're in luck...this one works the exact same way!

Photo Library – Here you may select from all the photos that currently reside on your phone.



The first time you try to access the camera and photo library, a popover will appear, prompting you to allow access. Click "OK" to continue.

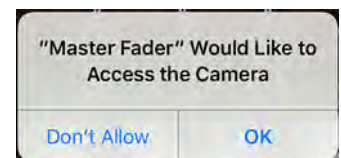

⁵ Ok perhaps there isn't a "previous" arrow shown in this example, but that's because we're naming channel 1. There is no "previous" channel!

Icon — Or select from a multitude of built-in icons at your disposal.



Show Images — This allows you to select the channel image from photos that are currently in use on the current show. The list will display all images currently in use. Tap the photo you would like to use from this list.



A maximum of 64 images may be used per show. However, if the same image is used on multiple channels, it only counts as one image (if the image has been selected from show images and not multiple times from the photo library). Icons do not count toward the 64. More information about the file system [shows, snapshots, etc.] begins on page 233.

Clear Image — Believe it or not, tapping here will clear the image for that channel. This removes the image from the channel and, if it isn't used elsewhere, from the Current Show and the Show Images list.



Since we already named channel 1 the kick drum, we might as well go with the kick drum icon to boot, right? Tap the kick drum icon in the upper-left corner. Channel 1 is set: name and image.

As seen in all of these images, a small number resides in the upper-left corner regardless of name and/or image. This number represents each channel and it cannot be changed or removed. Trust us, it's for the best, as it is for easy identification of each mic pre.

As mentioned previously, two adjoining mono input channels may be linked together into a single stereo channel strip. This is ideal for stereo input sources such as keyboards, submixer outputs, vocal processors and more. When linked, the level control, EQ, gate and compressor are adjusted with a single set of controls!

Linking channels is easy. After tapping a Channel ID button, you will see an option to “Link Ch X over Ch X”. Tap it! A popover will be displayed asking you to confirm. A visual difference between unlinked and linked channels is displayed below. Follow the same steps outlined above to unlink channels.

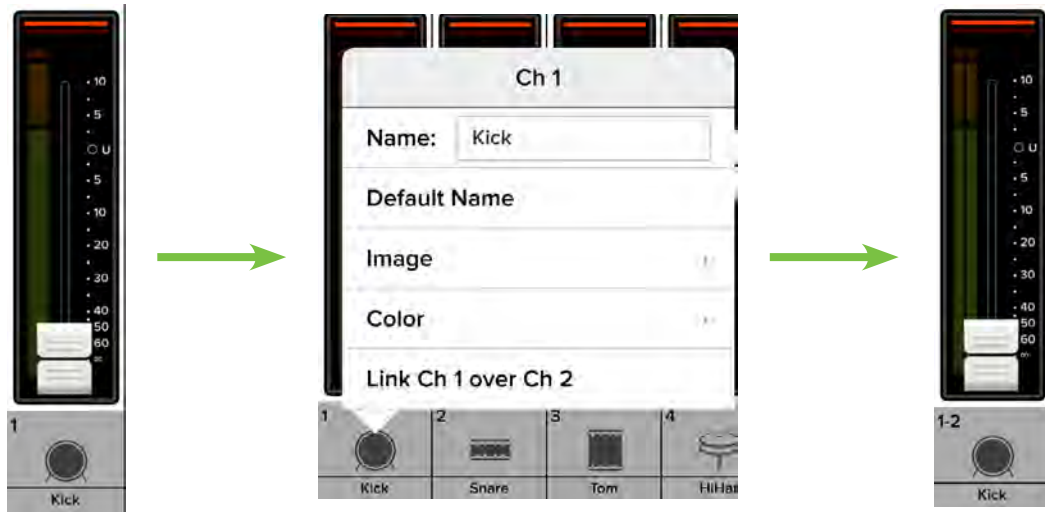

Unlinked

Linked



Odd-numbered channels will link to the next (even-numbered) channel [e.g. 1-2, 3-4, etc], while even-numbered channels will link to the previous (odd-numbered) channel [e.g. 10-9, 12-11, etc].



The linked over channel will take on all of the attributes [EQ settings, gate and compressor settings, delay and reverb settings, etc.] of the tapped Channel ID button. In other words, if you link channel 1 over 2, the resulting stereo channel will take on all of the settings of channel 1. However, if you link channel 2 over channel 1, the resulting stereo channel will take on all of the settings of channel 2.

Master Fader / Selector Strip – The master fader and selector strip are arguably the most important tools of the mixer. As seen in the image below, the master fader has six different views based on what type of output is selected (via the mix selector).

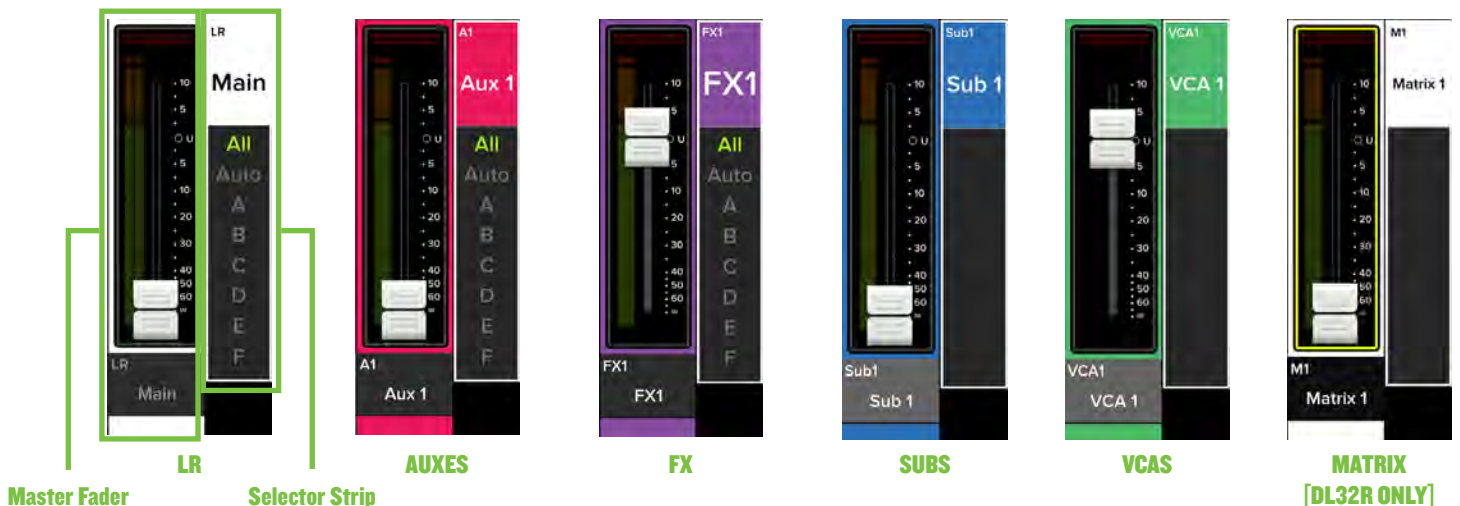

The selector strip has one of the most important roles (and we just showed an image with six different outputs selected), so we'll start there. After that, we will head back to the top of the Master Fader and work our way down.

Selector Strip – Top to bottom, the selector strips breaks down to two separate selectors:

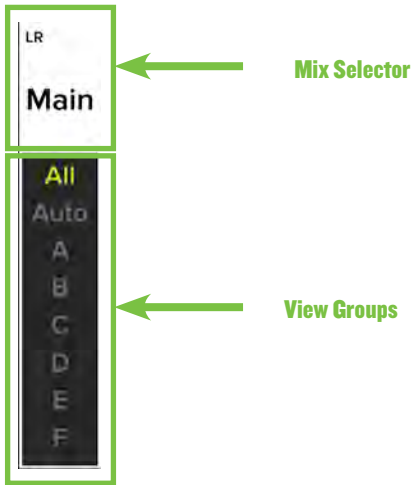

- Mix Selector
- View Groups

The remaining choices – Devices, Access Limits, Mute Groups, Shows and Help – are all located in the Tools section and will be discussed later in the chapter.

Mix Selector – The mixer view shows a fader for each channel. Initially, this fader controls the level to the LR mix. But how do you control the level going to the aux sends? Or how about the aux master level? What about the sub groups and VCAs? Simple. Use the mix selector to switch between mixes.

The currently selected mix is illuminated, but changing the selected output is easy. Simply tap the mix selector to reveal a popover displaying all outputs. Tap the desired output and voilà... the master fader now controls a different output. Additionally, you could tap the mix selector – and with your finger still on the mix selector – drag until the desired output is highlighted, then release to select. See the images below for an example of changing from LR to aux 4.

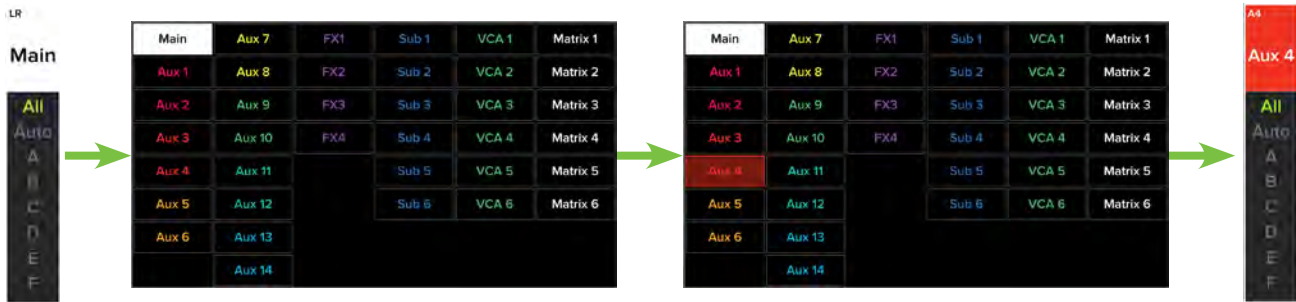

Once a different mix has been selected, the color surrounding the channel faders will change to show the newly selected output. Similarly, the master fader will display the newly selected mix. In this case, LR to A4.

Here, the mixer view acts like a window where you may view and change one output’s mix at a time. No matter which output is currently selected, the others are still there, as they were.

The thin illuminated strip surrounding the master fader meter also helps indicate which mix type is currently selected; the color varies and is dependent on the selected output. This is the same indicator that is also on display surrounding each input meter. Also note how the selected output is displayed in nice, big text and surrounded by a box of the same color as the selected output.



See below for the various colors that represent each selected mix, but know that there is no way you would ever see the image as shown below, as only one mix may be selected at any given time. The image is just a point of reference.

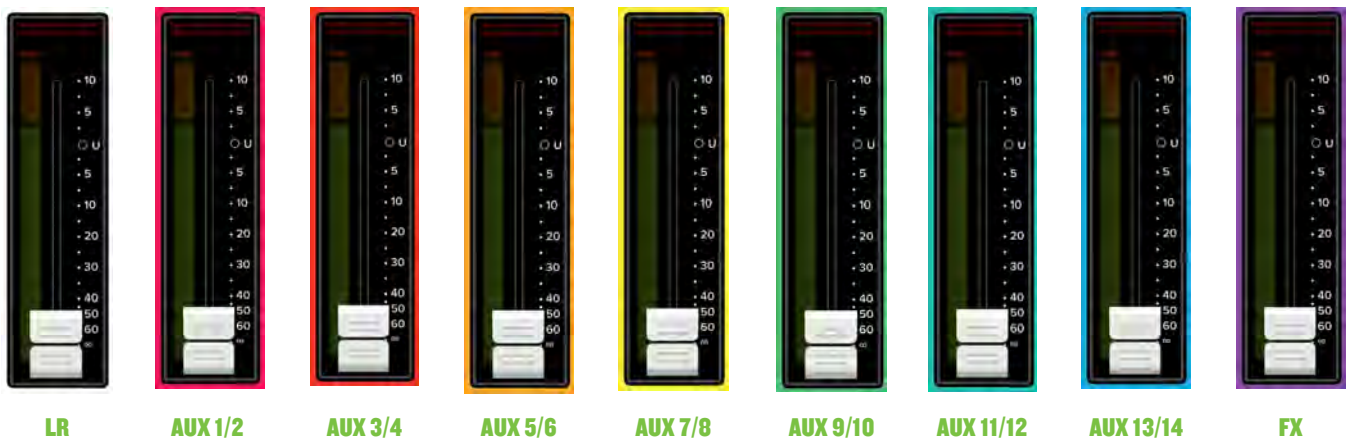

Notice how each channel's input meter is surrounded by the color of the selected output. In the left image, the faders control the levels going to the LR mix, while the faders on the right image control the levels going to the aux 1 mix. As seen in the images below, all we did was change the selected output from main LR to aux 1.

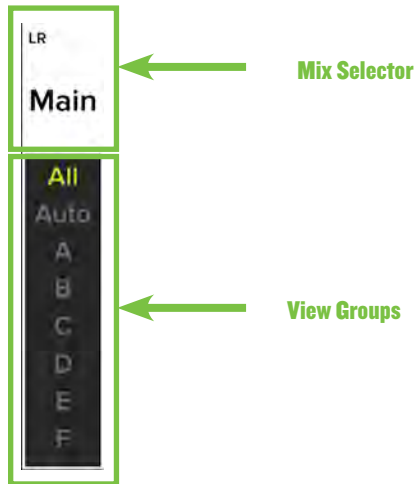

View Groups – Tapping anywhere in the view groups selector accesses the view group select. View groups allow you to see only the channels that you want to view, hiding the rest. This improves organization and allows for faster navigation.



The view group masters may be enabled/disabled via Master Fader for tablet and/or phone. However, channels may only be assigned to view groups via tablet.

Utilizing view groups with Master Fader for phones is the perfect tool for personal monitor mixing. Take the band Slick Willy and the Willettes, for example. Slick Willy is on view group A [Bill] and the Willettes [Phil, Gil, Mel and Will] have been added to view groups B-E. As you can see in the image below-left, we enabled view group select D [Mel] and below-right is an image of the mixer view with view group select D enabled. These view group select buttons were set up with Master Fader for tablets and enabled via Master Fader for phones.

Notice that the channel – Channel 1 – that was added to view group D is the only channel in view.



More information about view groups may be found on pages 65-68.

Now we're headed back to the top of the master fader itself, starting with the balance slider.



Balance – When LR is the selected output, the balance slider controls how much of the output signal is sent to the left versus the right outputs. Touch and drag the slider left or right to make adjustments. Tapping the master fader's balance slider twice will center it.



Mute – The master fader mute button works exactly like a channel mute, except it mutes the output. The mute button is available when any output is selected.



The mute button illuminates red when engaged and is gray when disengaged.

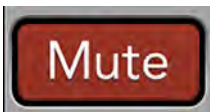

Outputs muted by mute groups will illuminate oxblood red. More information about mute groups may be found on pages 57-62, 264.



Output Gain Reduction Meter – Like channel faders, the output gain reduction meter shows the amount of gain reduction applied to the output by the compressor / limiter. Output channels do not contain gates.

To learn more about the output compressor / limiter, check out chapter 15 starting on page 140.



Mono



Stereo

Master Fader and Output Meters – As discussed, the master fader adjusts the output level of the LR, the aux masters and the FX master sends, depending on which output is selected. While one fader controls the output level of each output, each output is independent of the others. Once the selected output has been chosen, touch and drag the master fader up and down to make adjustments.

The output meter displays the output signal level. The output meter is presented in mono or stereo depending on the selected output. It is stereo for LR and linked auxes and FX sends. Subgroups, VCAs, unlinked auxes and FX sends are presented in mono. How to link auxes and FX sends is discussed on page 261.

Speaking of FX, if an FX is selected, the fader controls the master send into the corresponding FX processor.

This meter should remain green with the occasional bump into the yellow zone. The output meters are post-fader, so if there is too much yellow (or any red clipping), lower the master fader until it's gone and check the input channels, as well.

- Red [clipping] = -3 dBFS
- Green to yellow = -12 dBFS
- Green [bottom] = -60 dBFS

The color of the currently selected output will surround the channel strips [L/R default is white].

Master ID Button – The master fader’s name and image is similar to that of a channel strip’s name and image. Like the channel faders, the master fader’s name and image is also user-editable. Additionally, users may also link two adjoining axes together. Simply tap the button at the bottom of the master fader and a popover to reveal a popover that allows editing of the name, image and color and an option to link axes.



Let’s start with the name. Tap in the name box to bring up the blinking cursor and keyboard. Simply type in the name you want followed by tapping the blue ‘Done’ button.

If the name is too long to fit, the button scrolls, displaying the entire name.

For familiarity, this is the same keyboard that is used for messaging or emailing from the phone.

It goes without saying that tapping “Default Name” changes the master fader’s name back to its default name.



As seen in all of these images, a small name resides in the upper-left corner of the master ID button regardless of the name and/or image. This system name represents each output and it cannot be changed or removed. Trust us, it’s for the best, as it is for easy identification of each output, even after you rename it something goofy.



An open gray box with only the master fader’s name works, but let’s spice it up with an image. Show images are kept in sync which means that all connected devices will display the new image once its been added, whether or not it was already on that device. There are several ways to choose an image. From the popover, tap “Image” to reveal a new popover as seen to the left. You will be presented with five choices:

Camera — If you’re familiar with how the camera on the phone works, then you’re in luck... this one works the exact same way!

Photo Library — Here you may select from all the photos that currently reside on your phone.



The first time you try to access the camera and photo library, a popover will appear, prompting you to allow access. Click “OK” to continue.

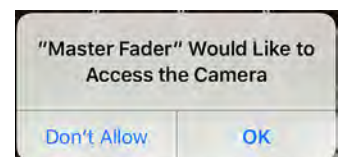

Icon — Or select from a multitude of built-in icons at your disposal.



Show Images — This allows you to select the master fader image from photos that are currently in use on the current show. The list will display all images currently in use. Tap the photo you would like to use from this list.



A maximum of 64 images may be used per show. However, If the same image is used on multiple channels, it only counts as one image (if the image has been selected from show images and not multiple times from the photo library). Icons do not count toward the 64. More information about the file system [shows, snapshots, etc.] begins on page 233.

Clear Image — Believe it or not, tapping here will clear the image for that channel.

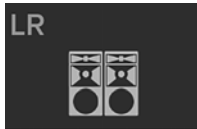

FOH

Since we already named the master fader the PA, we might as well go with the PA icon to boot, right? Tap the PA icon. The master fader is set: name and image.

Linking Auxes – As mentioned previously, two separate mono auxes may be linked together into a single stereo aux. This is ideal for using in-ear monitors or other stereo output destinations such as broadcast feeds, recording devices and more. When linked, the level control, graphic EQ and output compressor/limiter are adjusted with a single set of controls!

Linking auxes is easy. First you need to select the aux you want to link. Now tap the aux’s Master ID button; you will see an option to “Link Aux X over Aux X”. Tap it! A popover will be displayed asking you to confirm. A visual of these steps is displayed below. Follow the same steps outlined above to unlink auxes.

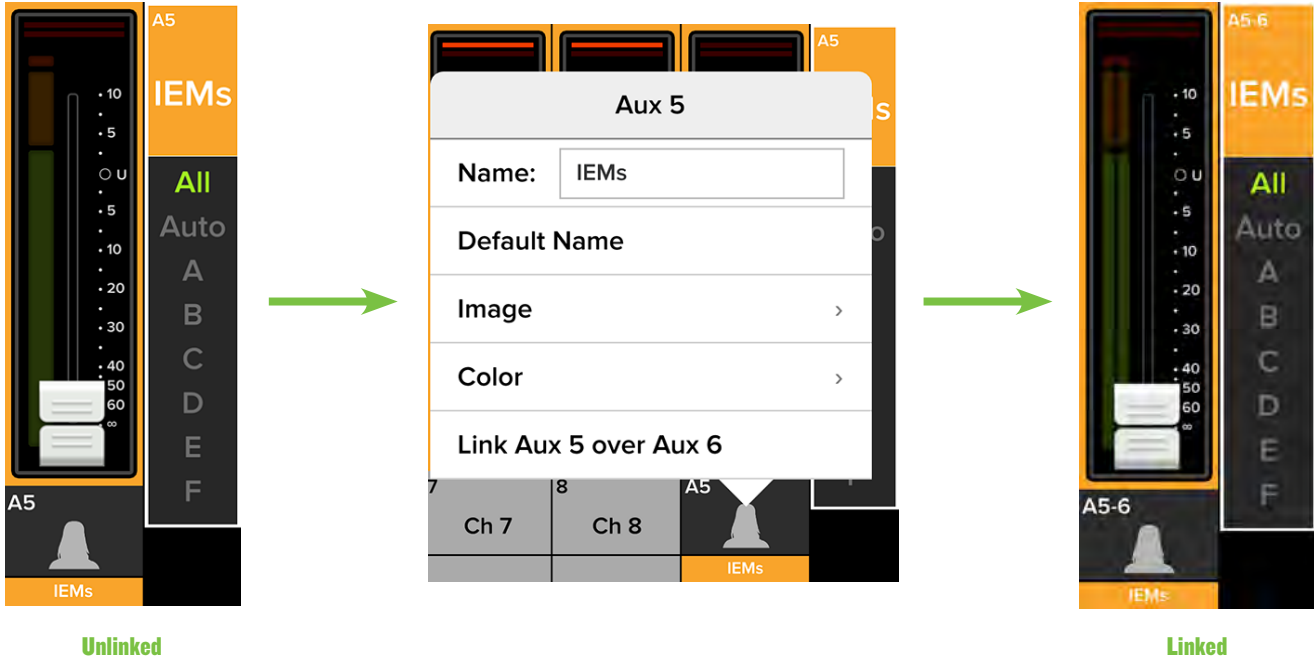

Odd-numbered auxes will link to the next (even-numbered) aux [1-2, 3-4, 5-6], while even-numbered auxes will link to the previous (odd-numbered) aux [6-5, 4-3, 2-1].



The linked over aux will take on all of the attributes [graphic EQ settings, output compressor/limiter settings, aux send output routing, etc.] of the tapped Master ID (aux) button. In other words, if you link aux 1 over 2, the resulting stereo aux will take on all of the settings of aux 1. However, if you link aux 2 over aux 1, the resulting stereo aux will take on all of the settings of aux 2.

Tools

Like Master Fader for tablets, the tools icon in Master Fader for phones displays the current connection status, too. As seen in the images below, it could display one of three statuses:



Offline — Master Fader for the phone is NOT communicating with a mixer because it has been configured as such. Offline mode allows a user to try out the functionality of Master Fader for the phone without a mixer. Unlike with Master Fader for tablets, there is no offline setup with Master Fader for the phones.



Syncing — The Master Fader app is syncing to the mixer wirelessly. This often happens so fast that you might not even see it!



Connected — Master Fader for the phone is connected to the mixer wirelessly.



Disconnected — Master Fader for the phone is trying to connect wirelessly to the mixer, but is unable to connect.



Tap the the gear icon to open up the tools view. Notice that it has a nearly identical layout to that of the tools section of Master Fader for tablets. Master Fader for phones is divided into five sections: devices, access limits, mute groups, show and help.

At the top of the list is mixer view. Tap that when you're ready to return to the mixer view.

Devices – Devices is where you select a mixer to control wirelessly from a phone. Or you may choose to work offline for a variety of reasons. Simply select from a list of all discovered consoles available for control. The list of available devices to select from is divided into two sections: Offline and Detected Mixers (Wireless).



Do not try connecting any phone to the wired dock connection of a DL806 or DL1608; Master Fader for phones only works wirelessly (or offline).

More information about devices may be found on pages 174-186.

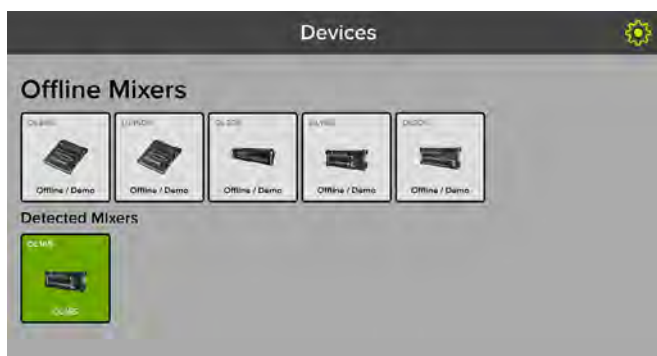

Access Limits – This set of buttons allows you to limit access to a variety of controls on each device. This is useful in multiple situations. For example, each member of a band with a device can access and change only the controls you choose.

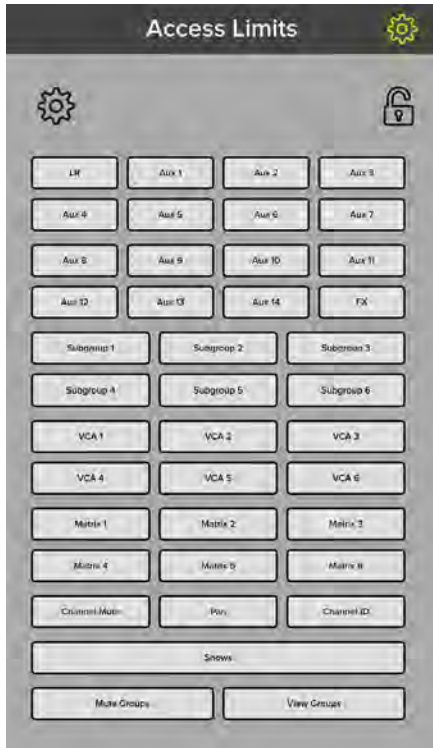

Check out the two images below. On the left side, we set access limits to everything except aux 1. On the right hand side is an image of the mixer view with the above-mentioned access limits in place. Notice that only the Aux 1 functions are accessible. Also, on the far right, Aux 1 is the only available output and the output selector can't even be opened. Other than that, nothing but darkness exists.

More information about settings (and access limits) may be found on pages 187-194.

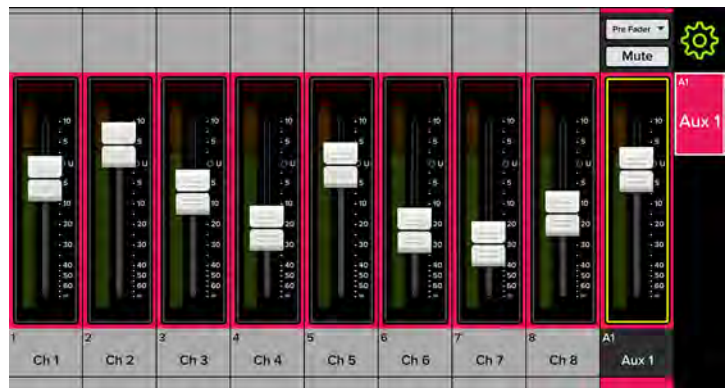
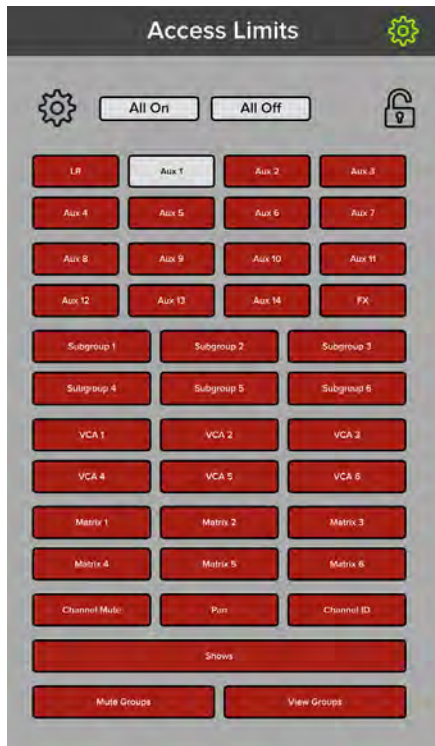

Mute Groups – Tapping the mute groups button accesses the mute group masters. Mute groups allow you to quickly mute (and unmute) multiple channels and/or outputs with a single tap. There are a multitude of possibilities in which to assign and enable mute groups: productions featuring a rotating cast of musicians, theatre productions, a house of worship and more. It is also great for muting all inputs during song breaks or in-between sets.



The mute group masters may be enabled/disabled via Master Fader for tablets or Master Fader for phones. However, channels may only be assigned to mute groups in Master Fader for tablets or computers.

Check out the images below. On the left side, we enabled mute group master 1. On the right side is an image of the mixer view with mute group master 1 enabled. Notice that the channels that were added to mute group 1 are now muted. These mute group buttons were enabled via Master Fader for phones.

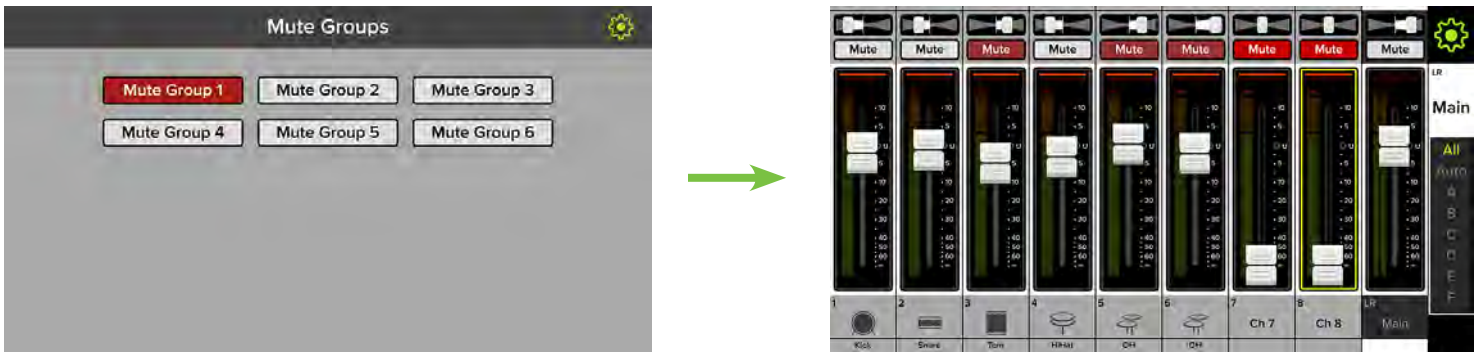

More information about mute groups may be found on pages 57-62.

Shows



Shows from Master Fader for phones works similarly to that of Master Fader for tablets except that you cannot create and save them. Instead, Master Fader for phones pulls the current show from the mixer, allowing you to recall its snapshots.

To do this, the show on the phone must be synced with what's currently loaded on Master Fader for tablets. If not, you will be asked whether to go offline or load the current show so they're synced.

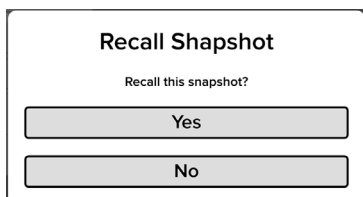
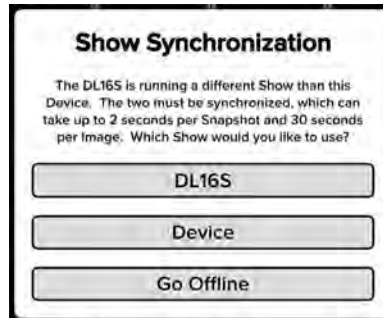

Once the show is loaded, simply tap the snapshot button containing the settings you desire to recall. On recall, all appropriate console parameters change to match the stored snapshot. A Recall Snapshot confirmation dialog will be revealed; tap the Yes button to recall the snapshot.

If trying to load a show when not connected to a mixer, you will kindly be asked to connect to a mixer first, as seen below.

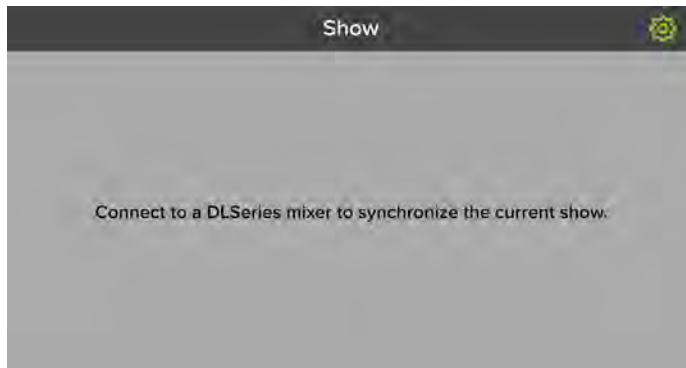

Some things to note between Master Fader for tablets and Master Fader for phones:

- Channel safes may only be viewed on phones. Use a tablet to set channel safes.
- Shows and snapshots are created using Master Fader for tablets, not via Master Fader for phones.
- Only the snapshots of the current show is displayed in Master Fader for phones. Offline shows need to be retrieved via Master Fader for tablets.

There is a lot more information about shows (and the file system in general: shows, snapshots and channel safes) on pages 233-244.

Help – For the most part, the help section is pretty self-explanatory. Basically this is where to go if you need further assistance or simply want to seek additional information. There is plenty enough to go around for everyone and we share nice.

More information about help may be found on page 195. Seems like an oxymoron, doesn't it? For more help about help go here, haha!

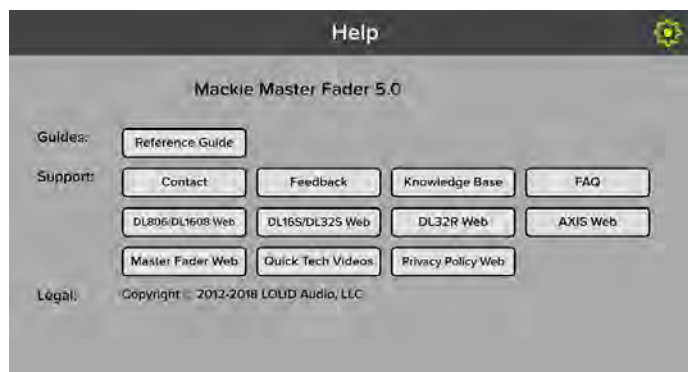

Master Fader for Phones Wrap-Up

As you saw within these last few pages, Master Fader for phones is basically a “Greatest Hits” version of Master Fader for tablets. It gives you just the things needed during a show. They function quite similarly so the learning curve is kept to a minimum. To reiterate, though: if you came straight here, it would behoove you to read and review all the pages mentioned in this chapter so you have a firm grasp on how these features work.

If I told you 20 years ago that you would be mixing a show from a phone in the near future, you would laugh, point fingers and tell your engineer friends about a great joke you heard earlier in the day...and I wouldn't blame you! Now if you'll excuse me, I need to go make a call on my RAZR...

Chapter 20: Mackie Master Fader for PC and Mac

Introduction

The last chapter dealt with using Master Fader, but on a much smaller scale: phones. This chapter, though, deals with the exact opposite: Master Fader for PC and Mac. But like Master Fader for phones, Master Fader for PC and Mac works similarly, but with all of the features already accessible on tablets.

At this point, you must be well-versed in – or at least somewhat familiar with – the ins and outs of Master Fader. If not, we strongly suggest reading and reviewing this Reference Guide whether before or after installing and downloading Master Fader for PC or Mac.

Downloading and Installing the Master Fader App for PC

The steps it takes to download and install the Master Fader app for PC are completely different than that of the Master Fader app for tablets and phones. Instead, please follow the steps outlined below:

- **Step 1** – Start by clicking this [link](https://mackie.com/sites/default/files/Master%20Fader%20v5.1%20Setup.zip). It is a zip file that will be available in your downloads folder. Double-click the zip file to open it.

<https://mackie.com/sites/default/files/Master%20Fader%20v5.1%20Setup.zip>



- **Step 2** – When opened, you will see something similar to the image shown below. Our goal here is to download and install the Master Fader app to your PC, so right-click the 'Master Fader v5.1 Setup' Application and select 'Extract All'.

Name	Type	Compressed size	Password ...	Size	Ratio
 Master Fader V5.1 Release Notes	Adobe Acrobat Document	1,095 KB	No	1,098 KB	1%
 Master Fader v5.1 Setup	Application	154,573 KB	No	155,215 KB	1%

The extraction wizard will come up and guide you through unzipping the download.

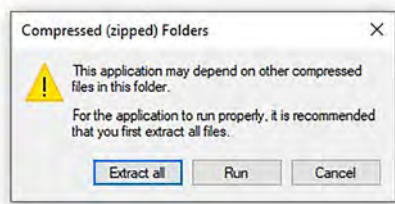

- **Step 3** – Something similar to the following image will appear. Click 'Extract' and wait while the items are copied. Apologies on the white block covering text... that's my last name and you don't get to see it!

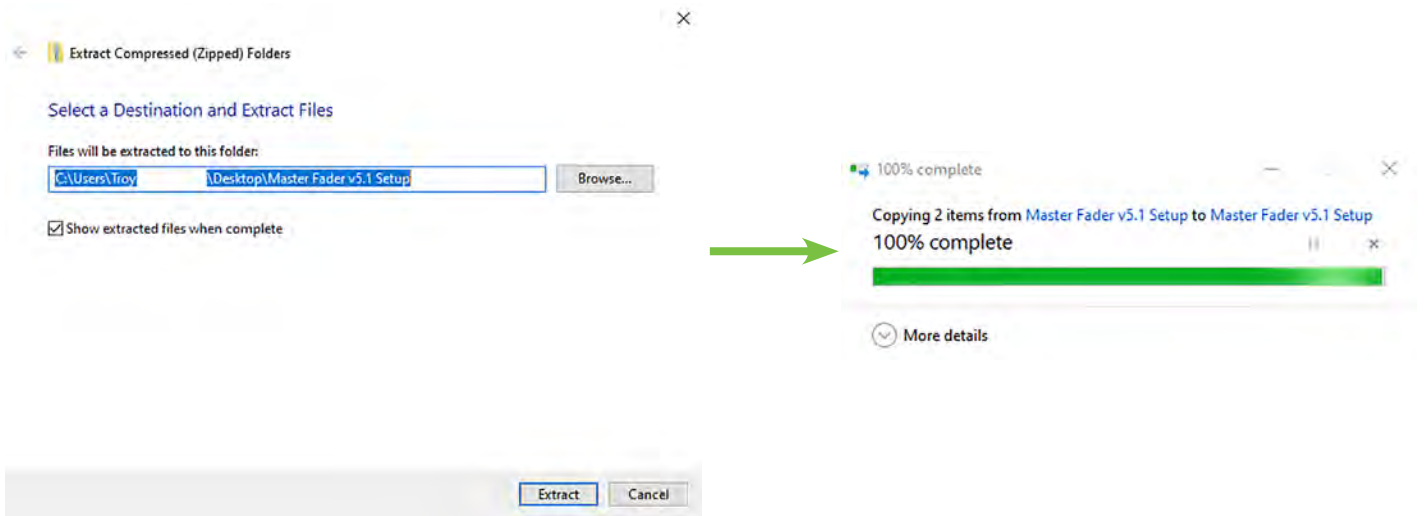

- **Step 4** – Double-click 'Master Fader v5.1 Setup' Application.

Name	Date modified	Type	Size
Master Fader V5.1 Release Notes	1/29/2020 5:31 PM	Adobe Acrobat D...	1,098 KB
Master Fader v5.1 Setup	1/24/2020 7:07 PM	Application	155,215 KB

- **Step 5** – In order to install Mackie Master Fader to PC, check the 'I agree to the license terms and conditions' box followed by clicking 'Install'.



- **Step 6** – You will be asked, “Do you want to allow this app from an unknown publisher to make changes to your device?” Here you will want to click ‘Yes’ to continue on with the process. After clicking ‘Yes’, a progress display bar will be revealed. Leave it be while it does its thing.

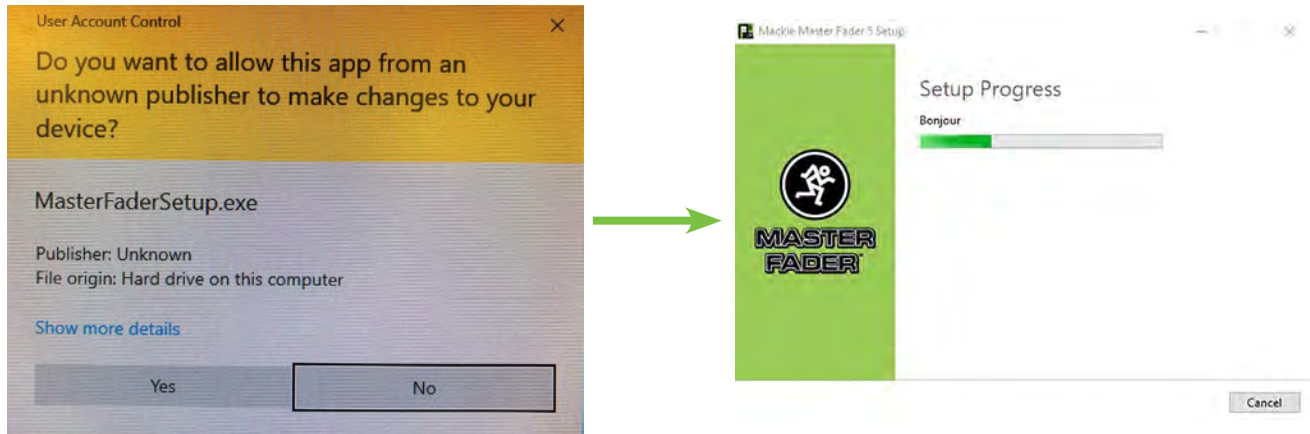

- **Step 7** – The following steps explain how to install Bonjour. Don't fret, we haven't forgotten about Master Fader. This is part of the process... come along by clicking 'Next'!

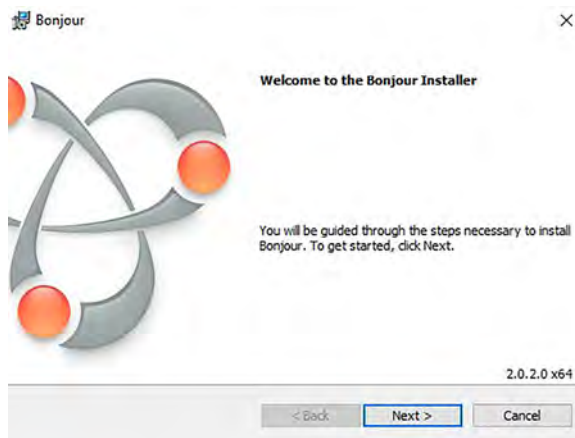

- **Step 8** – With this step you will need to select ‘I accept the terms in the license agreement’ followed by clicking ‘Next’.



- **Step 9** – Now we’re ready to install Bonjour! Do so by clicking ‘Install’. After clicking ‘Install’, a progress display bar will be revealed. Leave it be while it does its thing.

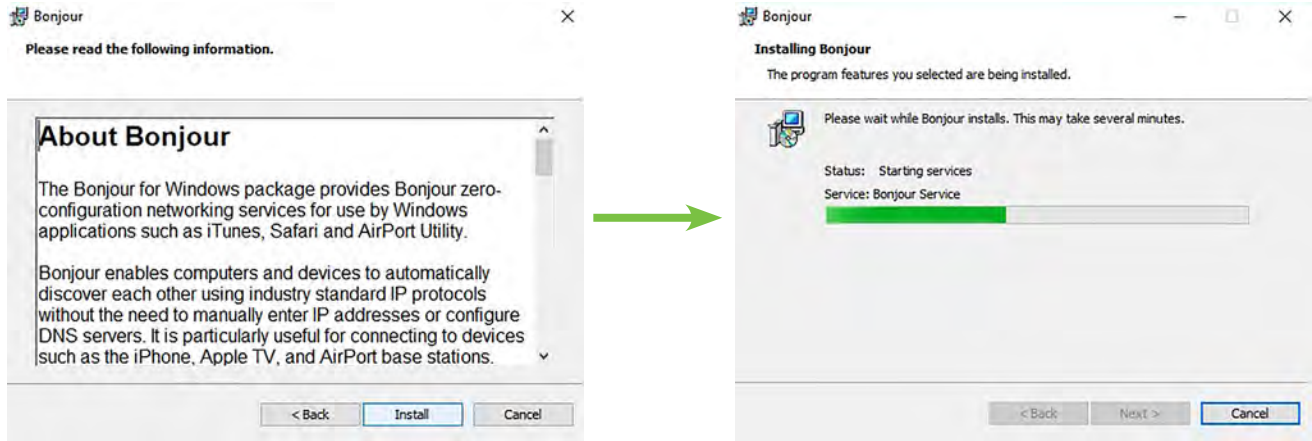

- **Step 10** – We’re on the home stretch! Bonjour has been successfully installed, so click ‘Finish’ to quit the installer.



- **Step 11** – After clicking ‘Finish’, the image seen below will be displayed. The setup was successful! Simply click ‘Close’.

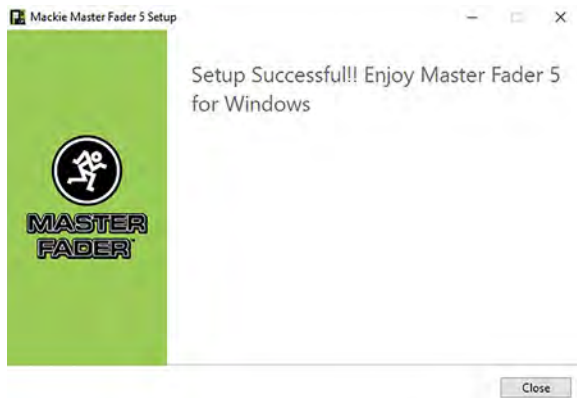

- **Step 12** – Our favorite step... the last one! The Master Fader app has been downloaded and installed on your PC. From here just double-click on the app to open it and begin mixing!

Downloading and Installing the Master Fader App for Mac

The steps it takes to download and install the Master Fader app for Mac are completely different than that of the Master Fader app for tablets and phones. Instead, please follow the steps outlined below:

- **Step 1** – Start by clicking this [link](#). It is a dmg file that will be mounted to your desktop. Double-click the dmg file on the desktop to extract the files.

<https://mackie.com/sites/default/files/Master%20Fader%20v5.1%20Setup.dmg>

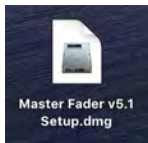

- **Step 2** – When opened, you will see something similar to the image shown below. As indicated by the arrow, you will want to drag Master Fader into the Applications folder.



You *could* double-click to open and run the Master Fader app from here, but it's not installed yet.

At this point you would simply be running it out of the dmg file.



- **Step 3A** – Our favorite step... the last one (sort of)! The Master Fader app has been downloaded and installed on your Mac. From here, double-click on the app from the Applications folder to open it and begin mixing!

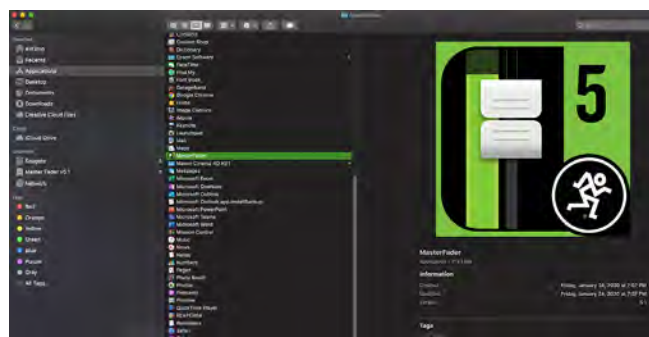

- **Step 3B** – The first time you open Master Fader from the Applications folder, a pop-up will appear asking, "Are you sure you want to open it?" You do, so simply click 'Open'. You will not be prompted in the future.

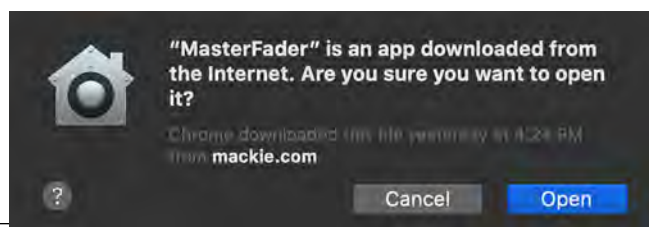

Appendix A : Service Information

Troubleshooting

If you think your Mackie product has a problem, please check out the following troubleshooting tips and do your best to confirm the problem. Visit the Support section of our website (www.mackie.com) to get some ideas or contact our technical support heroes. You may find the answer to the problem without having to send your Mackie product away.

Here are some useful tips that could correct any of the issues outlined below (or possibly any other issue that we haven't yet discovered):

- (1)** — Restart the device. Don't just restart the Master Fader app. Restart the device! Completely power it down, then power it back up.
- (2)** — Restart the mixer. This is especially useful after firmware and software updates where the mixer and device aren't quite on the same page. A simple reboot can sometimes work great wonders.
- (3)** — Restart the external router (if connected). Internet disconnectivity got you down? Unplug and re-plug the router. This may resolve any connection issues.
- (4)** — Level setting procedure. If you are having any sound (or non-sound) issues, try following the level setting procedure as outlined in chapter 4 [pages 31-34] to verify that all of the volume controls in the system are properly adjusted.

There are no user serviceable parts. If none of these tips work, please refer to "Repair" on the next page to find out how to proceed.

No Power

- Our favorite question. Is it plugged in? [On the DL1608 and DL806 make sure that the female end of the line cord is securely seated in the IEC socket of The Power Block and the male end plugged all the way into a live grounded AC outlet. Make sure the locking barrel connector at the end of the cord attached to The Power Block is attached to the power connector on the mixer and securely tightened. An LED on The Power Block will illuminate green to indicate success (whether the mixer is powered on or not)].
- Our second favorite question. Is the rear panel power switch in the ON position? [Side panel power switch on the DL16S and DL32S].
- Are all the lights out in town? If so, contact the local power company to get power restored.

No Sound

- Are all the connections good and sound? Make sure all of the connecting cables work and are securely connected at both ends. Try the same source signal in another channel, set up exactly like the suspect channel.
- Is the signal source powered on? Is it working (and making union scale)?

Noise / Hum

- Are all the connections good and sound? Make sure all of the connecting cables work and are securely connected at both ends. Try the same source signal in another channel, set up exactly like the suspect channel.
- Are you using unbalanced cables? Swap them out with balanced cables to see if that fixes the problem.
- Turn the input gains down one-by-one. If the offending noise disappears, it's either that input or whatever is plugged into it. If you unplug the whatever-is-plugged-into-it and turn the input gain back up and the noise is gone, it's from your whatever.
- Is phantom power required for the microphone?
- Sometimes it helps to plug all the audio equipment into the same AC circuit so they share a common ground. Make it so.
- Has the band been together long?

Connectivity Issues

All DL mixers

- Re-read "Chapter 2: Wireless Setup" [pages 10-16]. This section is very important and reading it cover-to-cover is the best troubleshooting.
- Is your device connected to the correct wireless network? Check the Wi-Fi settings to ensure that it didn't hop onto a different wireless network.
- Did you select the correct mixer from the tools > devices screen?
- Are you running the latest and greatest master fader and firmware? Go to Google Play, App Store or Mackie website to check for an update as described on pages 19-20.
- If using an external router, did you connect the Ethernet cable to the correct port? Be sure to use the LAN port and not the WAN port.
- If using an external router, did you connect and power on the router BEFORE turning on the mixer?
- Leave Master Fader and then return.
- Force quit the Master Fader app.
- Force update the mixer. See pages 287-288 for instructions.
- Try another Ethernet cable.
- Try another Wi-Fi router.

DL16S
and
DL32S
specific

- Questions about Access Point mode and initial connection? See pages 10, 179-180 for instructions.
- Questions about External Router mode? See pages 180-182 for more information.
- Questions about Wi-Fi Client mode? See page 183 for more information.
- Try resetting the network. See page 287 for instructions.

Repair

For warranty service, refer to the warranty information on page 350.

Non-warranty service for Mackie products is available at a factory-authorized service center. To locate the nearest service center, visit www.mackie.com, click "Support" and select "Locate a Service Center." Service for Mackie products living outside the United States can be obtained through local dealers or distributors.

If you do not have access to our website, you can call our Tech Support department at 1-800-898-3211, Monday-Friday during normal business hours, Pacific Time, to explain the problem. Tech Support will tell you where the nearest factory-authorized service center is located in your area.

Appendix B : Android and iOS Optimizations

iOS Optimizations



Below is a list of ways to trick out your iOS device to optimize its use with Master Fader and your mixer. When you have some additional time, use your favorite search engine to search “trick out your iPad” for other ways to optimize your device. Most of the following tips and tricks may be found by going to Settings > General on the device.

iOS Optimization #1: Prevent the device from turning off in the middle of a show.
Go to Settings > Display & Brightness > Auto-Lock.

Simply change the Auto-Lock from its current selection to “Never” (or 15 minutes, at least).

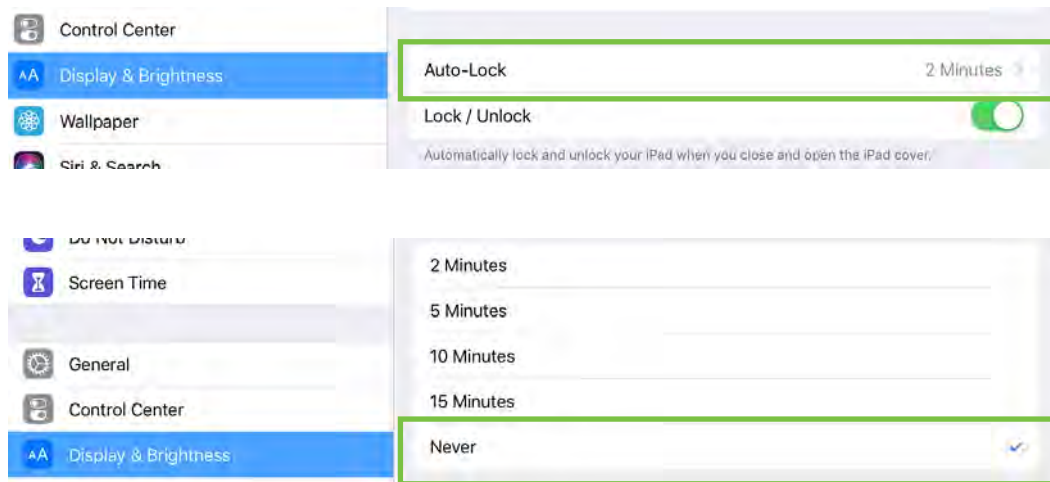

iOS Optimization #2: Allows you to change the level on more than three faders simultaneously.
Go to Settings > General > Multitasking & Dock.

Simply turn Gestures off.

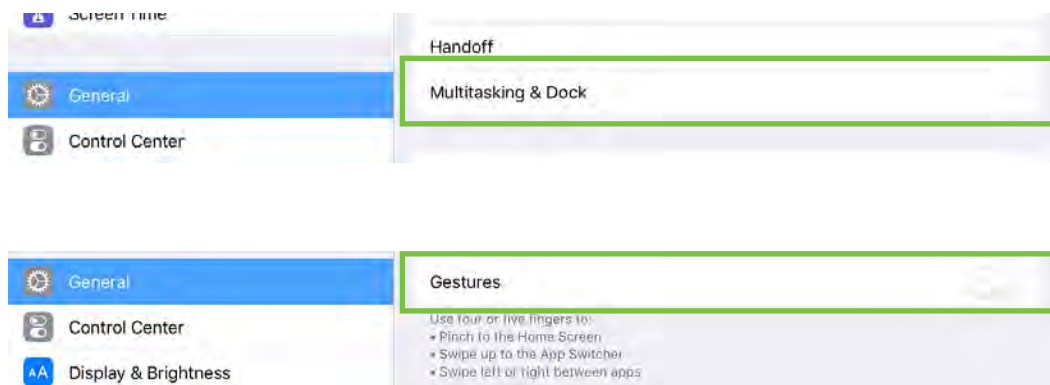

iOS Optimization #3: Allows you to press three faders simultaneously.
Go to Settings > General > Accessibility.

Simply turn Zoom off.

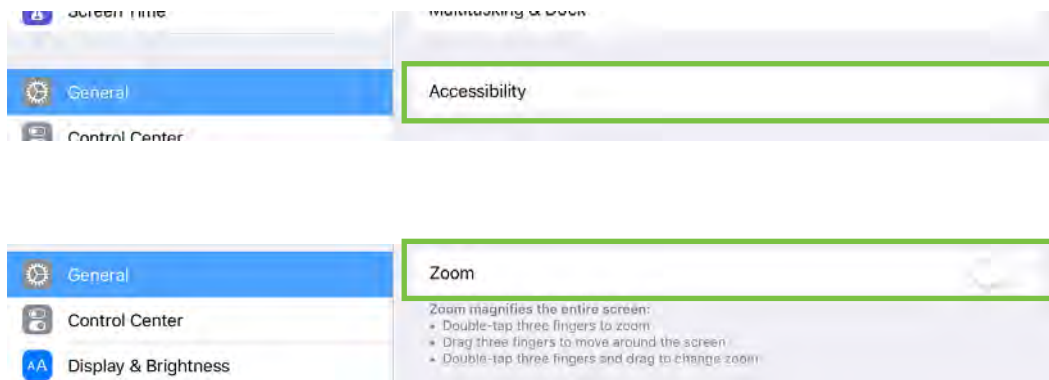

iOS Optimization #4: Disable 3G / 4G Data [TDMA] so the device is Wi-Fi only.

Simply turn Cellular Data off.

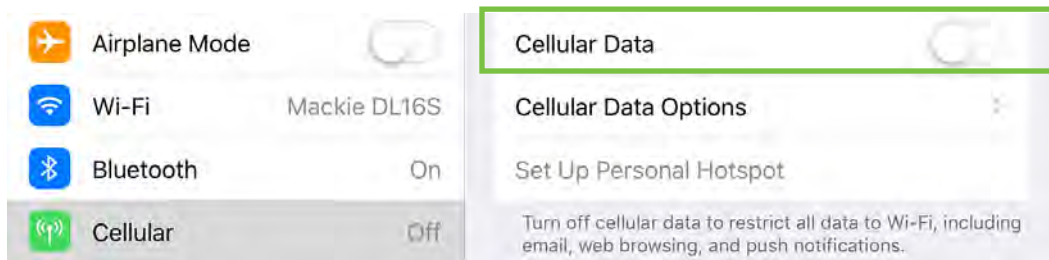

iOS Optimization #5: Turn off Lock Sounds and Keyboard Clicks.

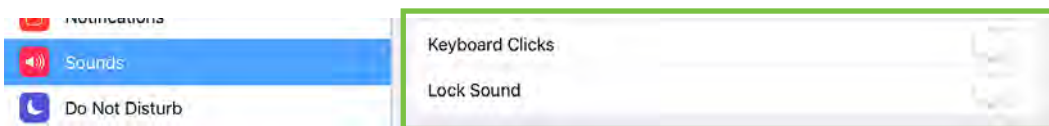

iOS Optimization #6 [if your iPad has a side switch]: Mute sounds, including email alerts, calendar event warnings, alarms and other extraneous noises (except music apps; those will continue to play). There are two methods to optimize your device here. It's just a matter of preference.

Use Side Switch to: Mute

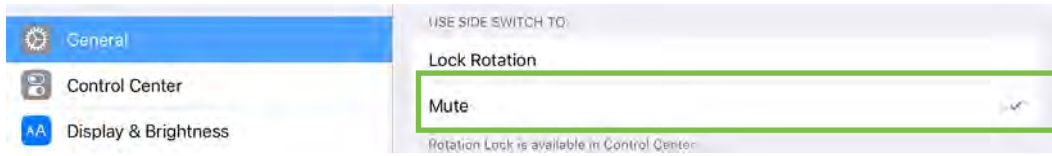

Now flip the side switch on the device (next to the volume up/down switch) so that the orange dot is visible. It indicates that the device is indeed muted (except for the music apps).

OR

Use Side Switch to: Lock Rotation

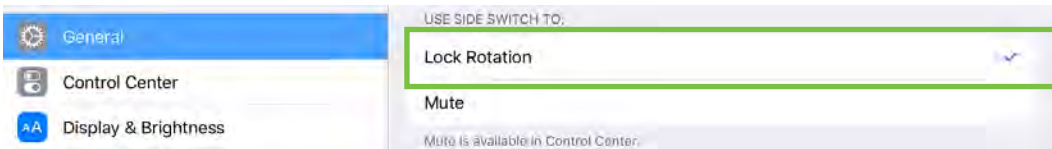

Now open the device's Control Center. Do so by swiping down from the upper-right corner of the screen.

Look for the mute/un-mute button. Mute it.

The icon will be crossed out to indicate that the device is indeed muted (except for the music apps).

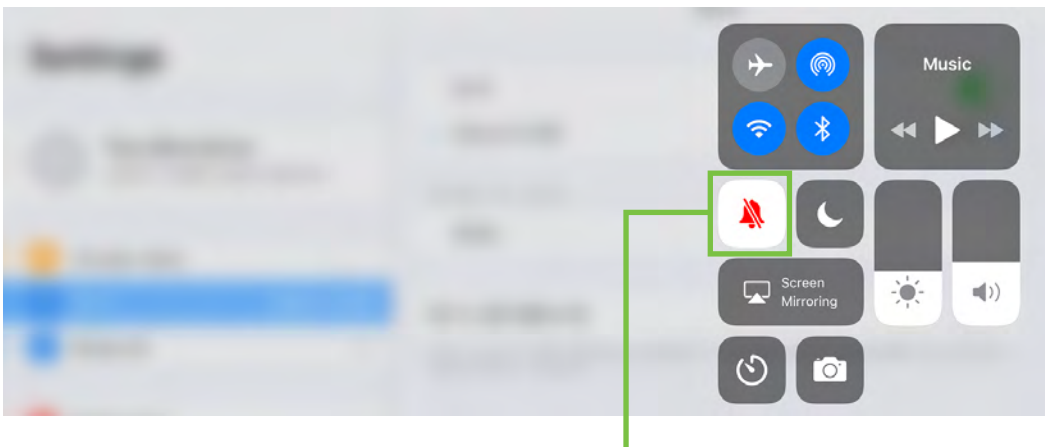

iOS Optimization #7: Master Fader and Auto Updating Apps

By default, apps are updated in the background. This is great for consumer apps like games, etc. However, you use apps like Master Fader professionally and auto-updating your apps can cause problems at the gig if the process is not properly understood.

If Master Fader is automatically updated without you knowing, you could find yourself at a show needing to do an unexpected firmware update. Since this update can take up to 15 minutes, this may cause serious problems delaying setup or the start of your show. Obviously this is not something you want to happen.

To avoid this, we strongly recommend you disable automatic updates for Apps.

Here's how:

Go to Settings > iTunes & App Store.

Simply turn App Updates off.

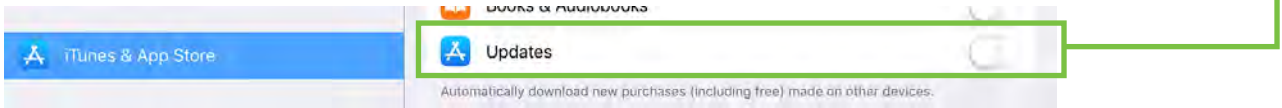

iOS Optimization #8: Turn microphone access on.

A security feature requires apps that record via the microphone or dock connector to first get approval from the user. So the first time you launch Master Fader you will see the following popup.

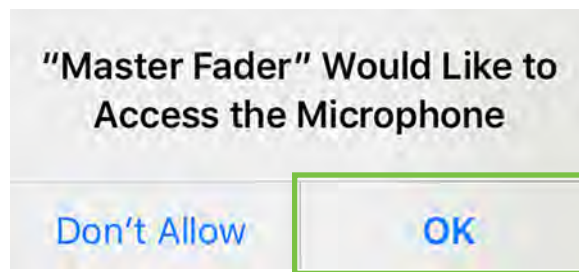

Even though Master Fader does not use the microphone to record, you need to approve this request in order to allow it to record over the dock connector. If you don't allow access, Master Fader will record short, empty audio files.

If you had previously denied access, you can still change this setting later through the Settings app.

Go to Settings > Privacy

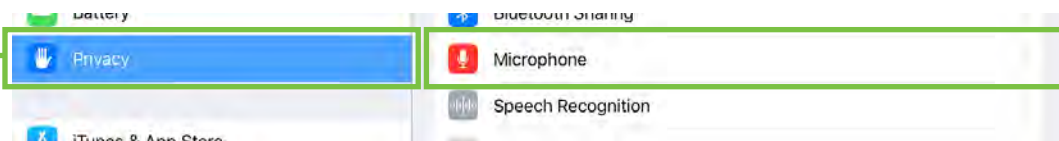

Tap Microphone

Turn Master Fader microphone on.

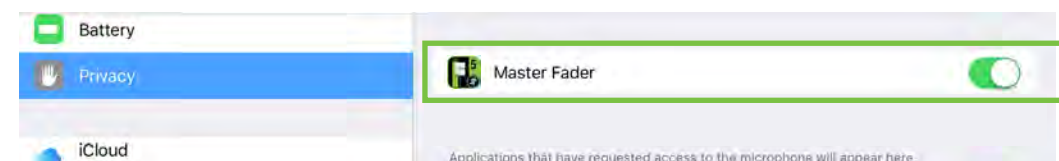

iOS Optimization #9: Turn camera access on.

The first time you try to take a picture using the device's camera, you will see the following popup.

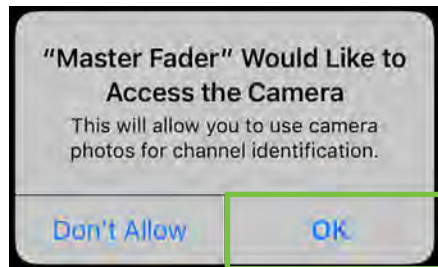

If you had previously denied access, you can still change this setting later through the Settings app.

Go to Settings > Privacy

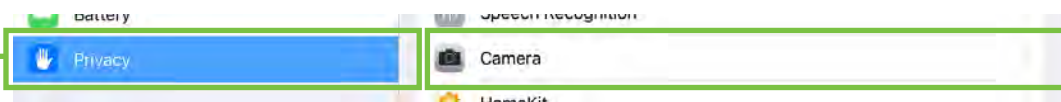

Tap Camera

Turn Master Fader camera on.

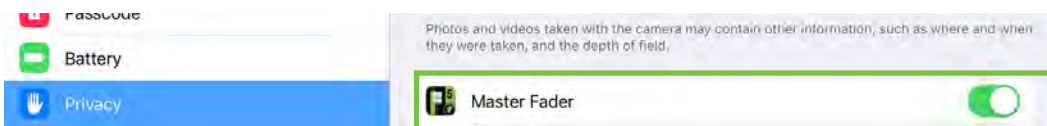

iOS Optimization #10: Scalable UI

More of an update than an optimization, Master Fader may be viewed in landscape and portrait orientation, whether using an iPad and/or iPhone. See below.

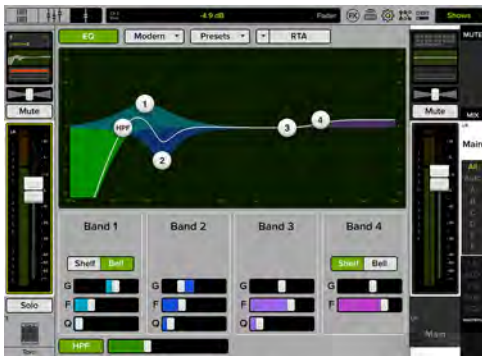

iPad – Landscape

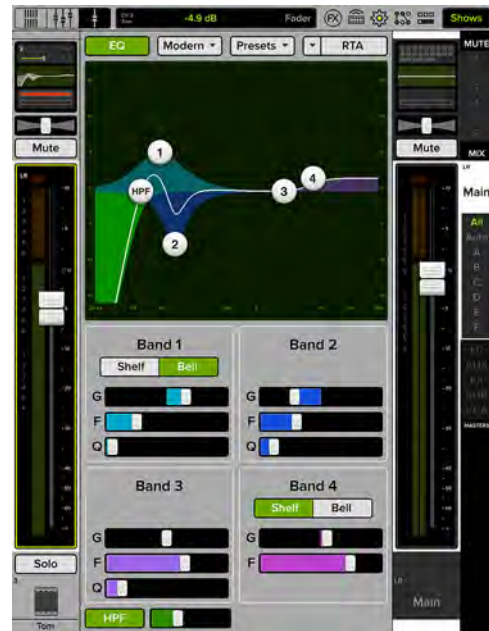

iPad – Portrait



iPhone – Landscape



iPhone – Portrait

Android Optimizations

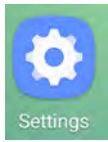

Below is a list of ways to trick out your Android device to optimize its use with Master Fader and your mixer. When you have some additional time, use your favorite search engine to search “trick out your Android” for other ways to optimize your device. Most of the following tips and tricks may be found by going to on the device.

Android Optimization #1 : Prevent the device from turning off in the middle of a show.
Go to Settings > Display > Screen timeout.

Simply change the Screen timeout from its current selection to the longest time available.

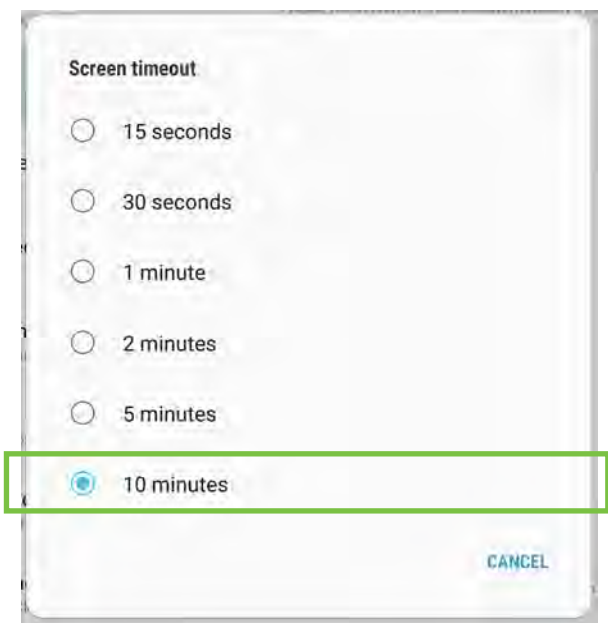

Android Optimization #2 : Allows you to press three faders simultaneously.

Go to Settings > Accessibility > Vision > Magnification gestures.

Simply turn Magnification gestures off.

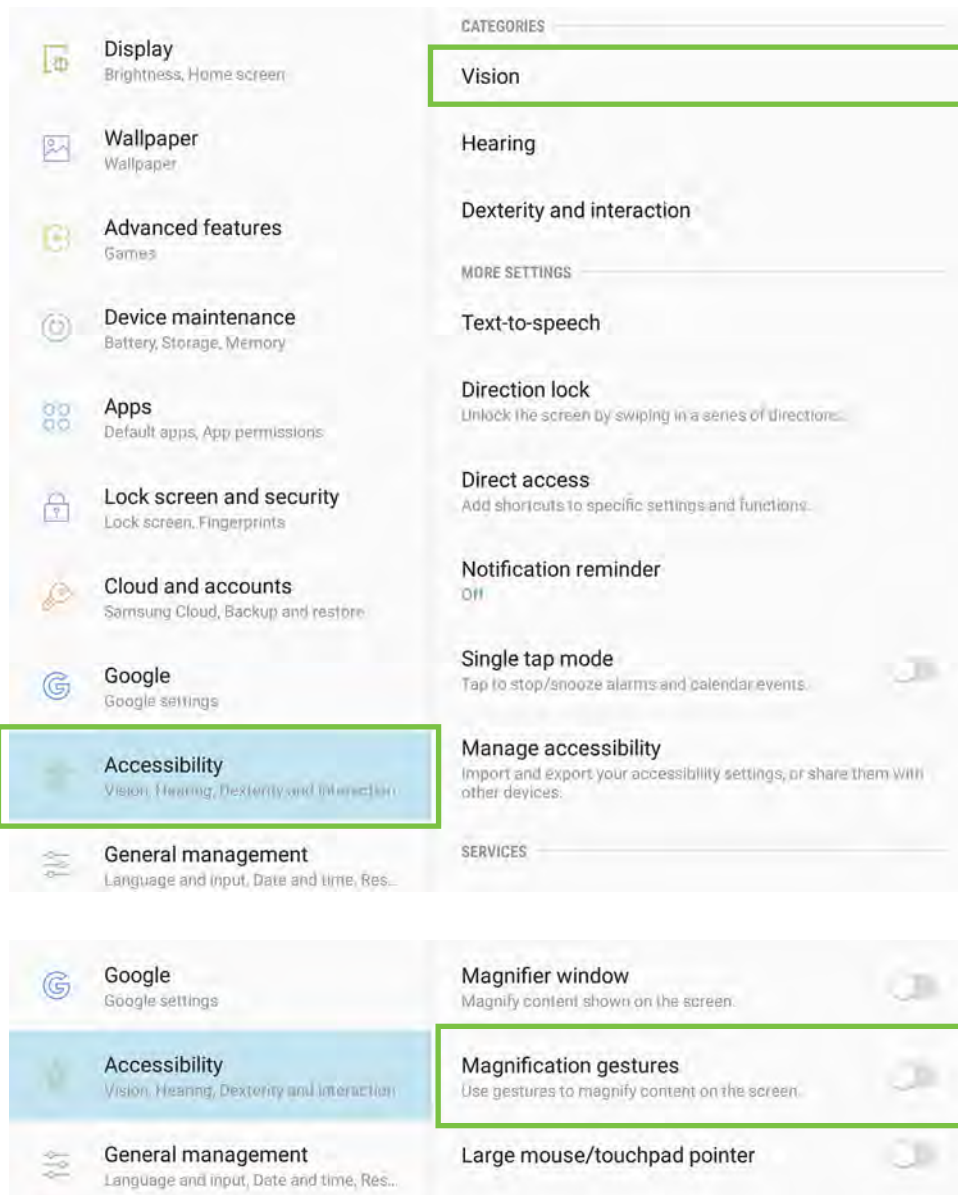

Android Optimization #3: Disable 3G / 4G Data [TDMA] so the device is Wi-Fi only.



Some Android devices will not connect to a DL mixer with Mobile Data turned on.

Simply turn Mobile Data off.

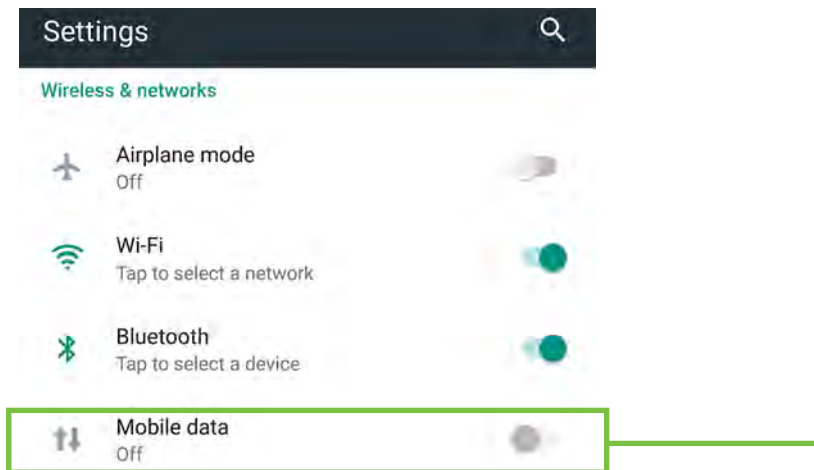

Android Optimization #4: Blocking calls.

To block calls, go to Settings > Networks and put the phone into 'Airplane Mode'.

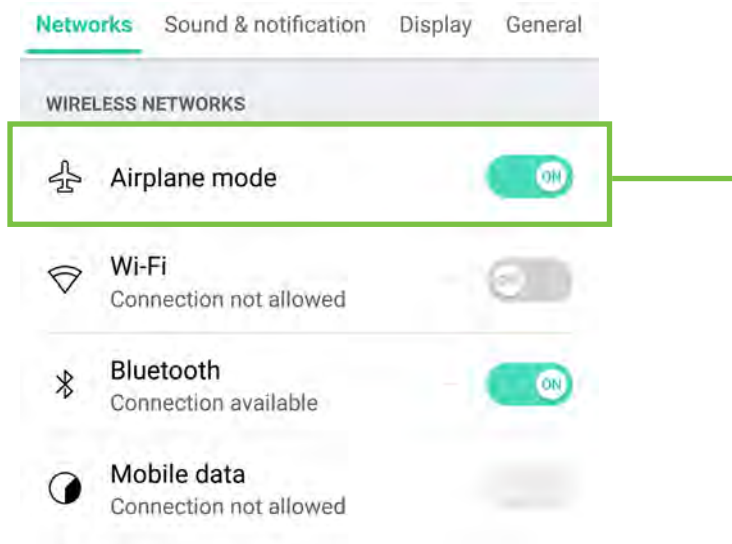

Android Optimization #5: Master Fader and Auto Updating Apps

By default, apps are updated in the background. This is great for consumer apps like games, etc. However, you use apps like Master Fader professionally and auto-updating your apps can cause problems at the gig if the process is not properly understood.

If Master Fader is automatically updated without you knowing, you could find yourself at a show needing to do an unexpected firmware update. Since this update can take up to 15 minutes, this may cause serious problems delaying setup or the start of your show. Obviously this is not something you want to happen.

To avoid this, we strongly recommend you disable automatic updates for Apps.

Here's how:

Tap the Play Store icon to open it.

In the upper-left corner are three horizontal lines, sometimes referred to as a 'hamburger'. Tap it.

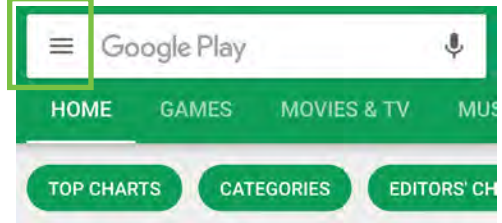
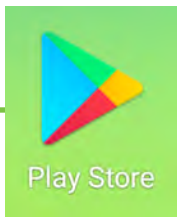

From here you will want to tap 'Settings' followed by 'Auto-update apps'.

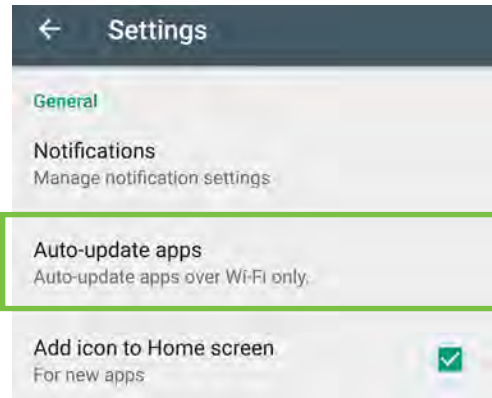
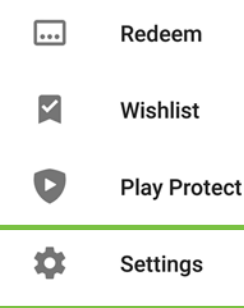

Lastly, simply select "Do not auto-update apps." It will be noted in your settings!

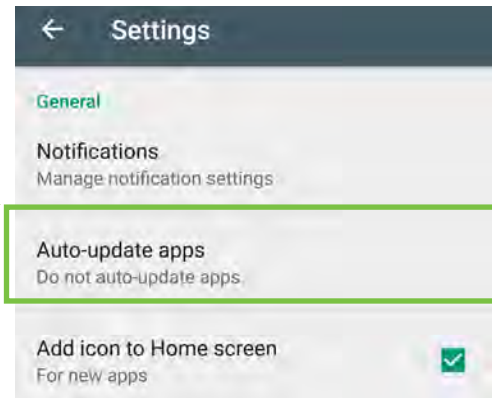
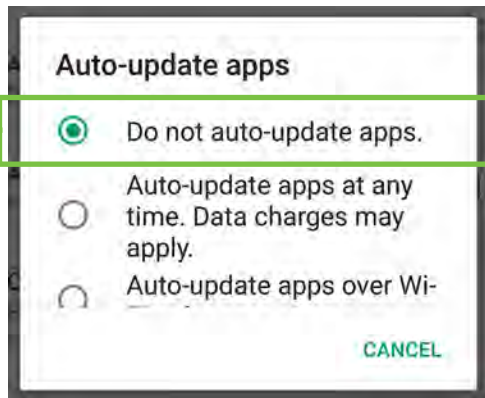

Android Optimization #6: Set the display size to small so Master Fader displays the most features on the screen.



This is especially important for users mixing with smaller Android tablets. If you see the phone UI on the tablet, try changing this setting.

Go to Settings > Display, gestures & buttons

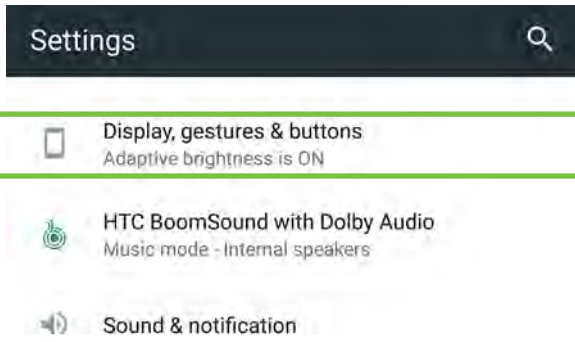

Tap Display Size

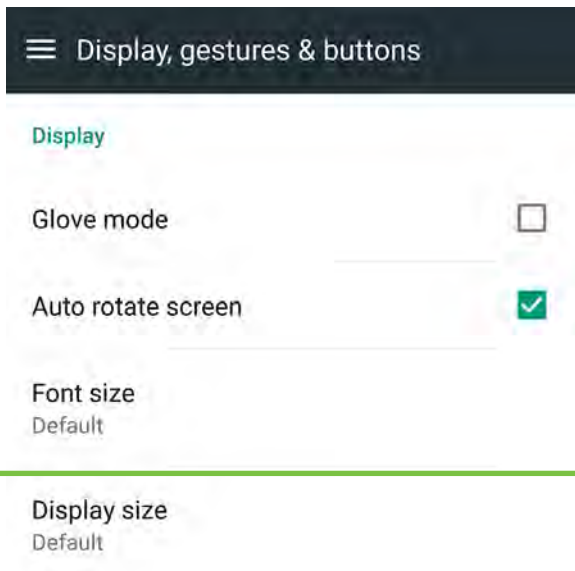

Drag the slider to the left (Small)

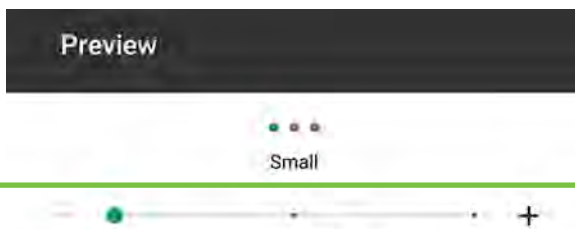

Make the items on your screen smaller or larger. Some apps on your screen may change position.

Android Optimization #7: Scalable UI

More of an update than an optimization, Master Fader may be viewed in landscape and portrait orientation, whether using an Android tablet and/or phone. See below.

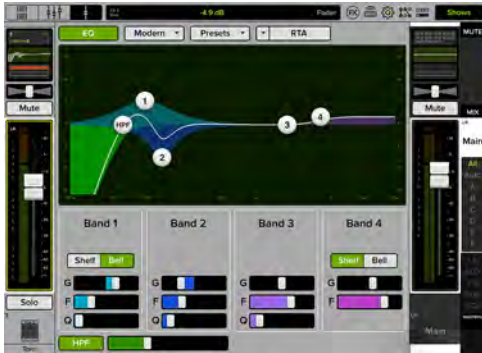

Tablet - Landscape

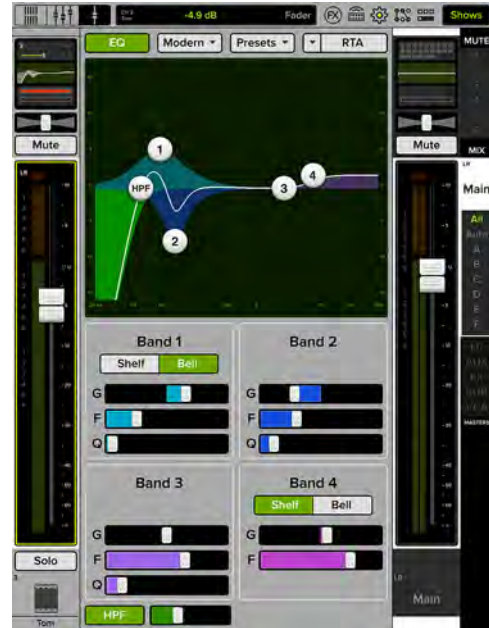

Tablet - Portrait



Phone - Landscape



Phone - Portrait

Appendix C : Technical Information

Specifications

Supported Devices

Android and iOS

System Requirements: • Android: v6.0 or higher required
(requires Google Play Store access to install)

• iOS: v11.0 or higher required

Control Application: Master Fader app for Mac, PC, Android and iOS
For optimal performance and latest feature set,
we suggest using the latest Master Fader app

Simultaneous Control: 20 Devices

About

Reference Guide Version:..... V5.1

Part Number, Rev and Date: SW1080, Rev G, January 2020

©2020 LOUD Audio, LLC. All rights reserved. Apple, iPad and iPhone are trademarks of Apple Inc., registered in the U.S. and other countries. All other marks are Registered Trademarks, or Trademarks, of LOUD Audio, LLC. in the United States and other countries. DL806, DL1608, DL16S, DL32S and DL32R Patent Pending.

"Made for iPad" means that an electronic accessory has been designed to connect specifically to iPad and has been certified by the developer to meet Apple performance standards. Apple is not responsible for the operation of this device or its compliance with safety and regulatory standards. Please note that the use of this accessory with iPad may affect wireless performance.

LOUD Audio, LLC. is always striving to improve our products by incorporating new and improved materials, components, and manufacturing methods. Therefore, we reserve the right to change these specifications at any time without notice.

Please check our website for any updates to this Reference Guide: www.mackie.com.

DL1608 / DL806 Block Diagram

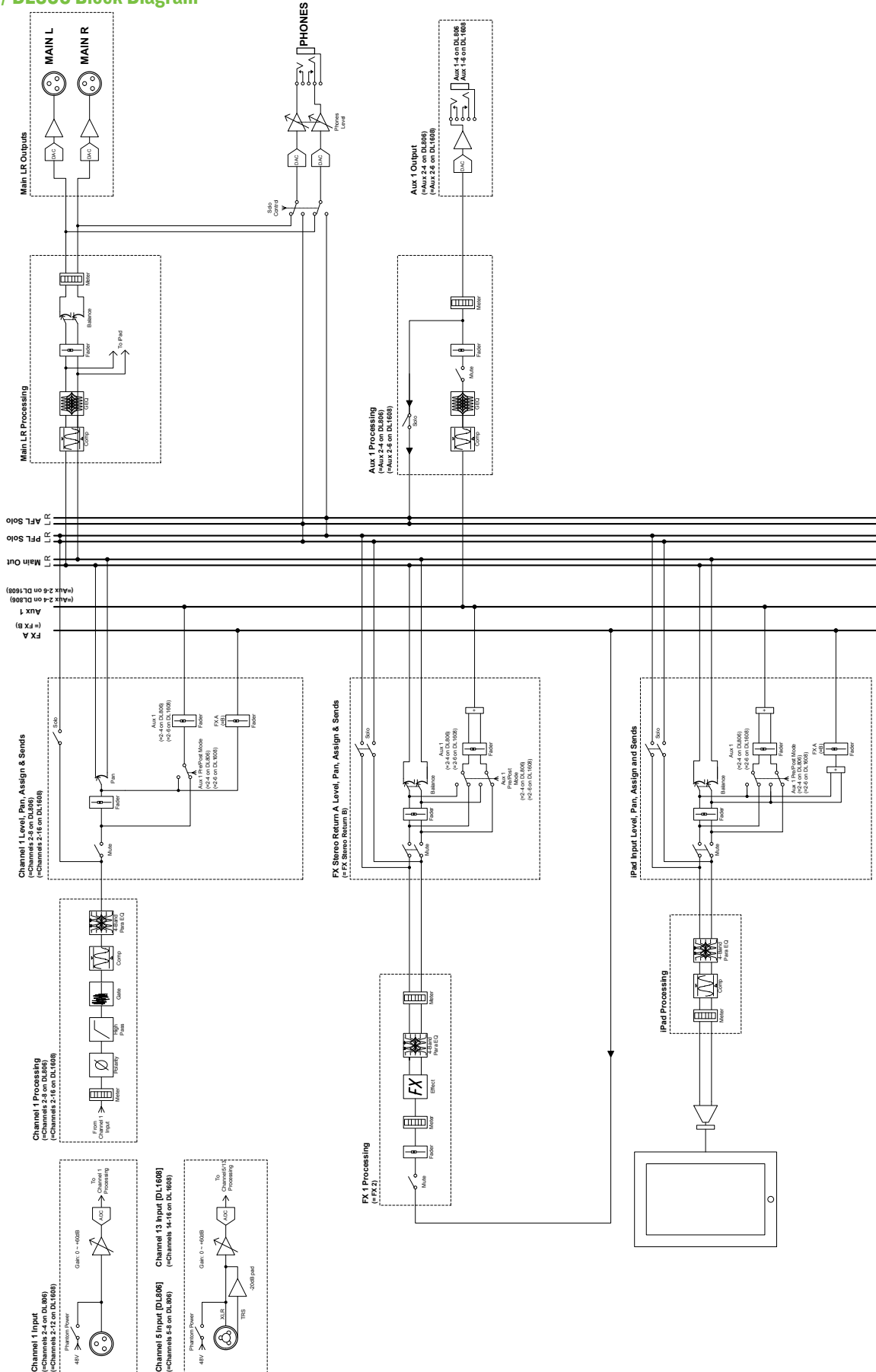

DL16S / DL32S Block Diagram

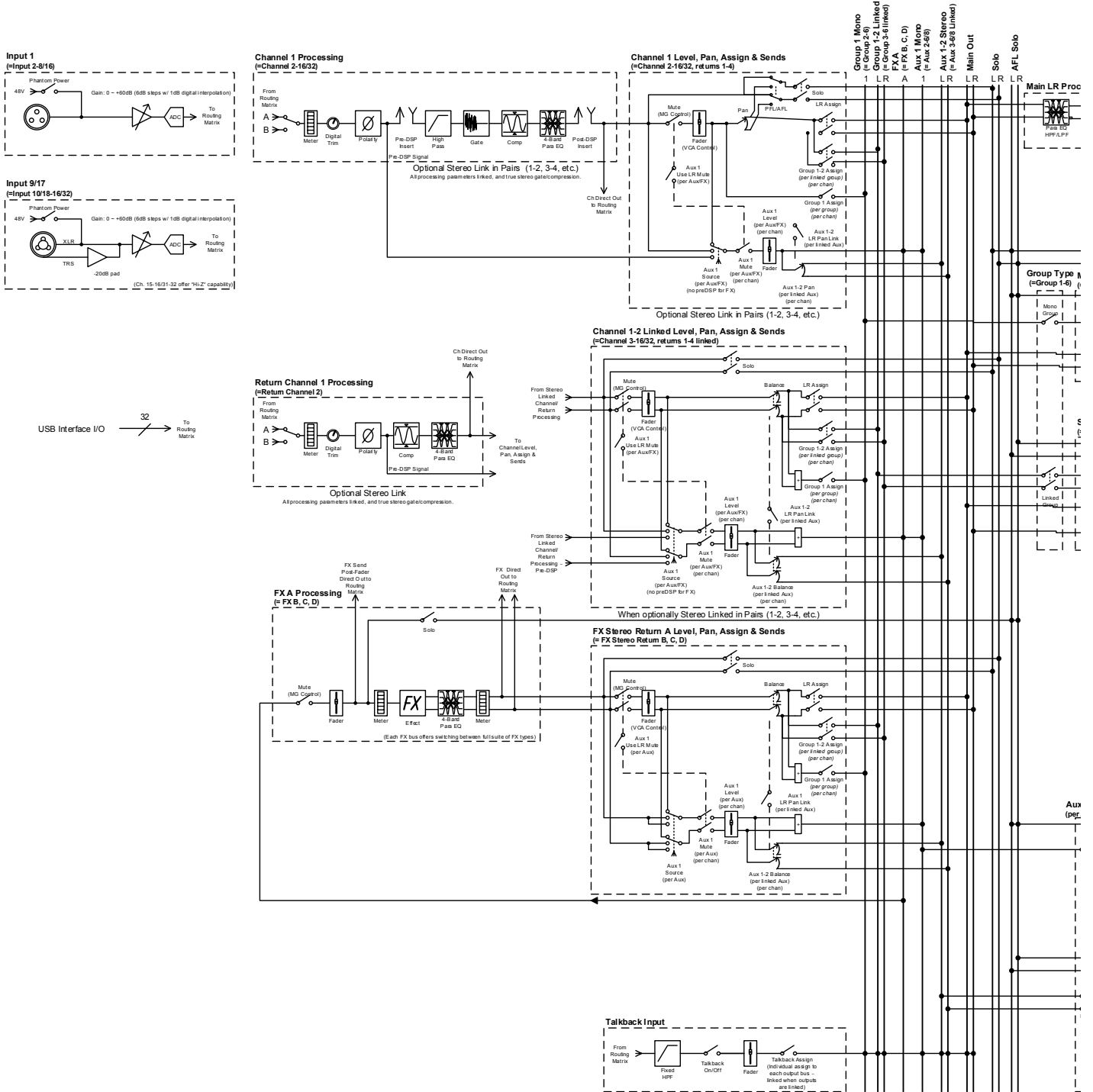

DL16S / DL32S Block Diagram

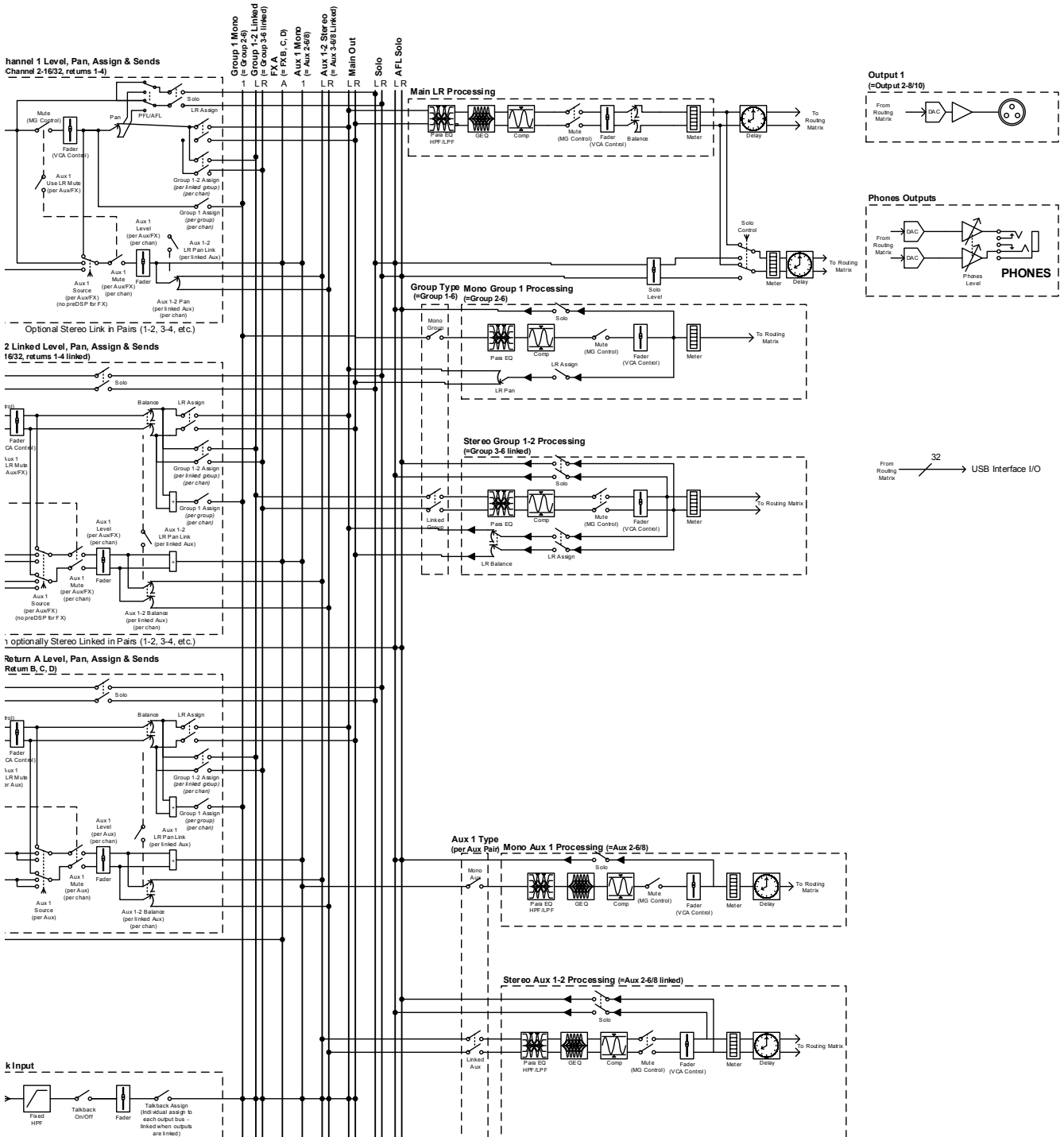

DL32R Block Diagram

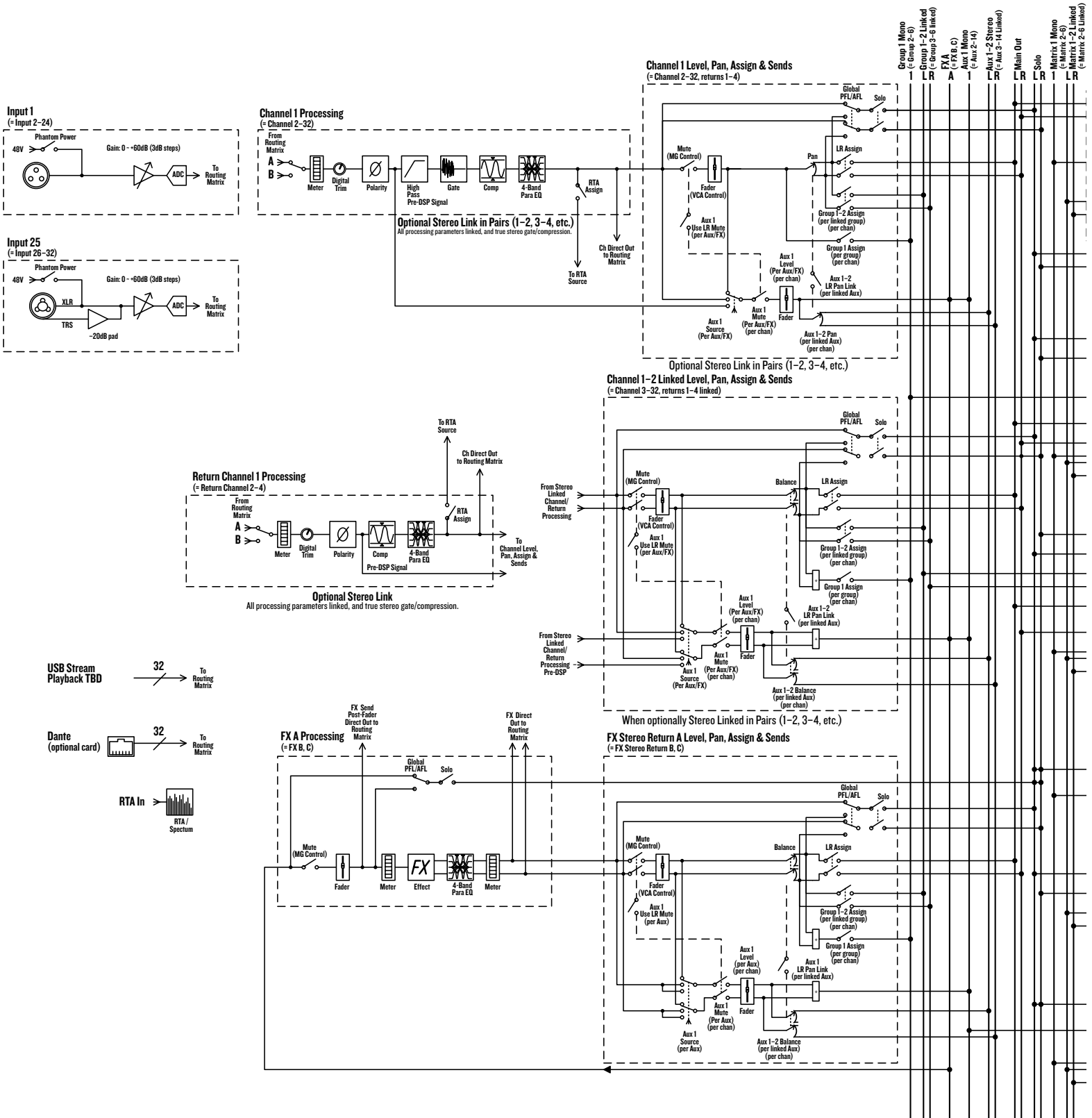

DL32R Block Diagram

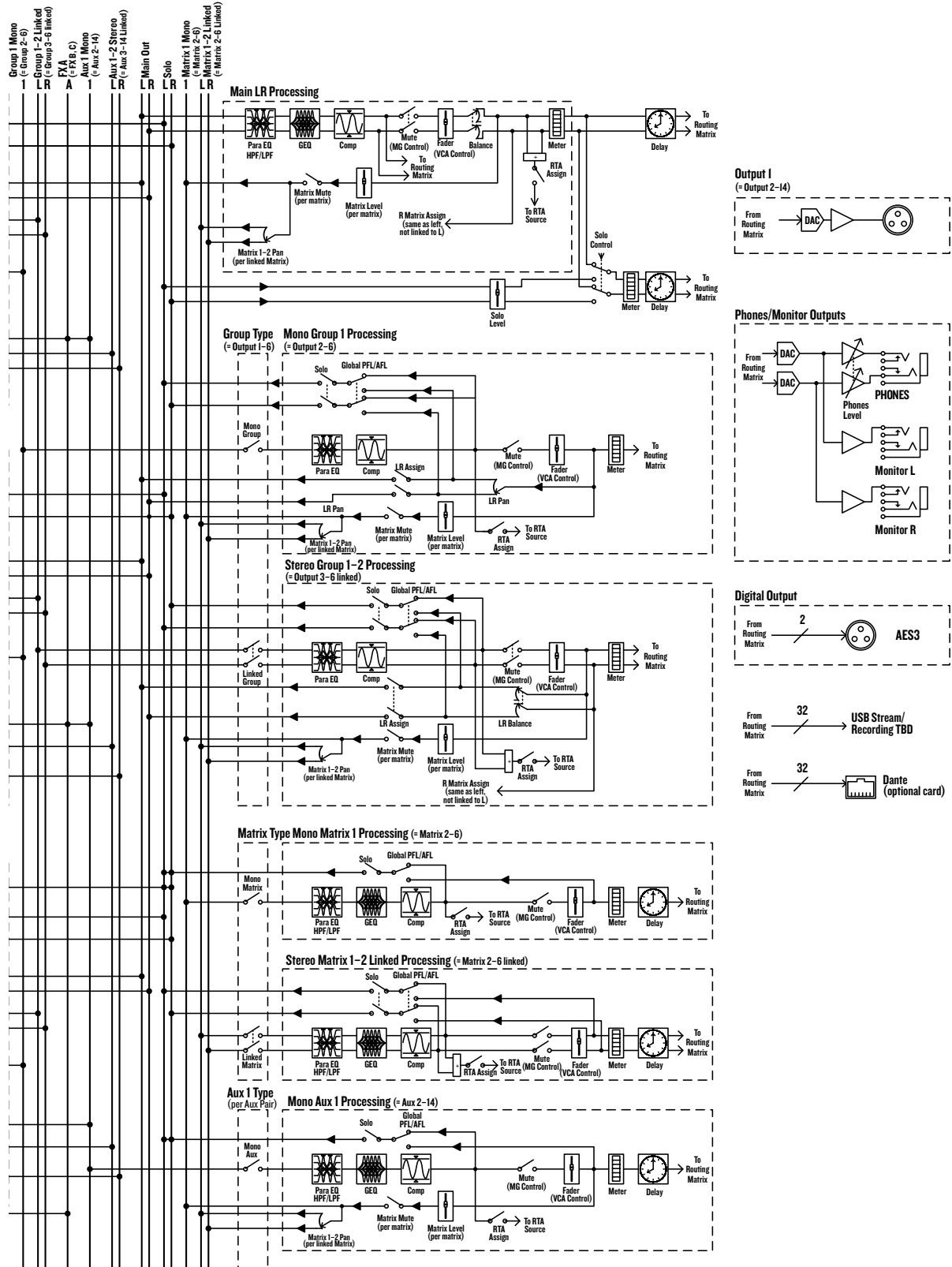

Appendix D : Force Update / Network Reset Instructions

Introduction

In a perfect world, the Force Update button would just sit there without a care in the world, umbrella drink in hand, beach, surf and sun on a daily basis. In all likelihood, this button will live his / her dream out, while the rest of us can only dream of such a life.

DL Series mixers and the Master Fader app do a great job at letting you know when either (or both) the software and firmware need updating, but this button here forces a complete firmware update if the need ever arrives.

Instructions [DL16S • DL32S]

Here's how to force a firmware update:

1. Make sure the device has the latest version of Master Fader and is set to never go to sleep [auto lock set to never].
2. Turn the mixer OFF.
3. Using a bent paperclip, poke the force update button, then power up the mixer with the button depressed.

The button is located on the front panel between the power and Wi-Fi LEDs.

Force Update: The mixer will boot and you will be prompted with an update bubble the next time a tablet or computer with the Master Fader app is turned on.

Network Reset: Press the button for 5 seconds and release to reset the network settings to its default. This is useful if you're not sure of the current configuration, if the mixer isn't being discovered by Master Fader or can't connect. It resets the mixer to access point mode using the default network and password.

Network Reset+: Press and hold the button for 30 seconds, then release. Like Network Reset above, Network Reset+ resets the mixer to access point mode using the default network and password, but it also completely reloads the firmware in the Wi-Fi module (leaving all other firmware intact). Use this if Network Reset doesn't solve the network related problem or if instructed by support.

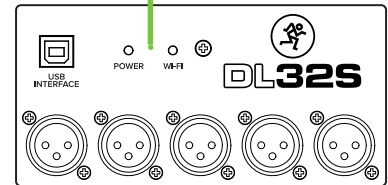

4. Go to Tools > Devices in Master Fader and select the wireless DL mixer which will be listed in update mode.
5. After several seconds, a popup will appear in Master Fader asking you to confirm the update. Press "Yes, update" to approve and the update will continue. This can take up to 15 minutes.
6. After the update, the mixer restarts. Note that after the mixer says it is finished, it actually still has one small update to finish to work properly.
7. Wait about a minute before connecting the device. It should now work properly wired and wireless.

Very Important Notes



Now that you know how to force an update, here's a friendly reminder that you should let the button remain peaceful, calm and tranquil, only forcing a firmware update if instructed by Tech Support. Thank you for listening!



Save any current show to your device before forcing an update or you may lose it. The show and your sanity!



If using a Static IP address for your DL Series Mixer, an update may fail to begin properly. Similarly, a force update will fail in the same way. If either of these happen, you will need to temporarily configure the DL hardware to use Dynamic IP addressing.

This can be accomplished by changing to Dynamic IP, disconnecting the hardware from the main network, then configuring a temporary Wi-Fi network with a router directly connected to the DL hardware with no other network connections. When the update is complete, change the DL hardware back to static IP and connect it back to the main network.

Instructions [DL806 • DL1608 • DL32R]

Here's how to force a firmware update:

1. Make sure the device has the latest version of Master Fader and is set to never go to sleep [auto lock set to never].
2. Turn the mixer OFF.
3. Connect the Wi-Fi router to the mixer and turn the router on.

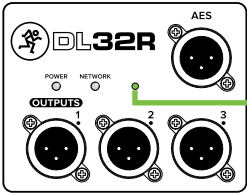

4. Connect the device to the Wi-Fi router.
5. Using a bent paperclip, poke the force update button, then power up the mixer with the button depressed.

- DL32R: The button is on the front panel next to the network LED.
- DL806/1608: The button is on the rear panel between the network and power connectors.

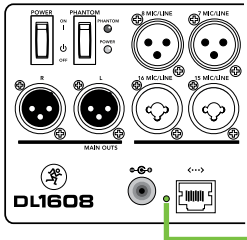

6. Release the force update button after five seconds.
7. Go to Tools > Devices in Master Fader and select the wireless DL mixer which will be listed in update mode.
8. After several seconds, a popup will appear in Master Fader asking you to confirm the update. Press "Yes, update" to approve and the update will continue. This can take up to 15 minutes.
9. After the update, the mixer restarts. Note that after the mixer says it is finished, it actually still has one small update to finish to work properly.

10. Wait about a minute before connecting the device. It should now work properly wired and wireless.

Very Important Notes



Now that you know how to force an update, here's a friendly reminder that you should let the button remain peaceful, calm and tranquil, only forcing a firmware update if instructed by Tech Support. Thank you for listening!



Save any current show to your device before forcing an update or you may lose it. The show and your sanity!



If using a Static IP address for your DL Series Mixer, an update may fail to begin properly. Similarly, a force update will fail in the same way. If either of these happen, you will need to temporarily configure the DL hardware to use Dynamic IP addressing.

This can be accomplished by changing to Dynamic IP, disconnecting the hardware from the main network, then configuring a temporary Wi-Fi network with a router directly connected to the DL hardware with no other network connections. When the update is complete, change the DL hardware back to static IP and connect it back to the main network.

Appendix E : Release Notes

Updating the Master Fader App

New Master Fader app releases may be downloaded and installed directly from the Play Store (Android device) or the App Store (iOS device).

If you don't know the version you are currently using, go to Tools > Help > About on the app. The version is listed near the top of the screen.

Be sure to perform a full System Backup of Master Fader – Tools > Settings – before updating the app. After updating Master Fader, the mixer firmware will also need to be updated. This will happen next time Master Fader is connected to the DL Series mixer. Simply follow the on-screen instructions. Please ensure that there is enough time for both before the next gig!

NOTE: Master Fader requires Android v6.0 or higher, iOS v11.0 or higher, macOS 10.12 or higher and/or Windows 10.

NOTE: By default, apps update automatically on iOS and Android. We strongly recommend that you disable automatic updates for apps. Otherwise you run the risk of a long update occurring right in the middle of a show. Ouch!

Android: Go to the Play Store > Tap the "Hamburger" > Settings > Auto-update apps > Do not auto-update apps.

iOS: Go to Settings > iTunes & App Store, then turn Updates off.

More detailed instructions (with screenshots!) may be found in Appendix B of the Reference Guide.

NOTE: If using a Static IP address for your DL Series Mixer, an update may fail to begin properly. Similarly, a force update will fail in the same way. If either of these happen, you will need to temporarily configure the DL hardware to use Dynamic IP addressing.

This can be accomplished by changing to Dynamic IP, disconnecting the hardware from the main network, then configuring a temporary Wi-Fi network with a router directly connected to the DL hardware with no other network connections. When the update is complete, change the DL hardware back to static IP and connect it back to the main network.

Master Fader V5.1

The following is a list of items that have been added, changed or fixed since Master Fader V5.0.2

1. Enhancements, bug fixes and stability improvements (including, but not limited to):

- Support for the Mackie DL806, DL1608 and DL32R mixers.
- Works with a plethora of Android and iOS devices, as well as Windows and macOS.
- Improvements to the overall performance.
- Improvements to the firmware update progress bar.
- Fixed an issue where the next and previous arrows were unavailable when naming channels.
- A rude solo indicator has been added above the QAP.
- A confirmation prompt appears when recalling presets and resetting channels/processors.
- Fixed an issue where the preset list for the input and output compressor was too small.
- Fixed an issue where the shows button did not display the current snapshot by number.
- Fixed importing and exporting.
- Fixed an issue where sometimes two mixers were shown on the Devices tab when only one should've been.

- Fixed an issue where after renaming a mixer, the devices view showed two detected mixer icons in the list with the same mixer name.
- Fixed an issue where the HPF and LPF engage buttons and slope buttons touched.
- Fixed the spacing between RTA meters.
- Fixed an issue where the maximum (red) slider of the Spectrum Analyzer covered up the +15 dB indicator.
- Fixed an issue where the Help view on phones was not centered.
- Fixed an issue where dragged Quick Assign buttons overlapped the horizontal green line.
- Fixed an issue where the Return button on iPads did not move the cursor to the next line.
- Fixed an issue where the trim slider was off-center in the main mixer view.
- Fixed an issue where pressing 'Done' after naming a channel did not hide the channel menu.
- Fixed an issue where Master Fader failed to reconnect to after changing the SSID [DL32S].
- Fixed an issue where the back button closed Master Fader [Android].
- Fixed an issue where "Copy to Dropbox" was the only option to successfully export using Dropbox [iOS].

Master Fader V5.0.1

The following is a list of items that have been added, changed or fixed since Master Fader V5.0.

1. Enhancements, bug fixes and stability improvements (including, but not limited to):

- Improved updating by adding additional informational pop-ups.
- Fixed issues with some show operations on multiple connected control devices.
- Fixed issue where audio did not return quickly after a power cycle.
- Fixed issue where auto view group did not refresh upon snapshot recall.
- Fixed issue where you were unable to place images or icons on a channel after placing an image on a stored preset.
- Fixed issue where deleting shows did not completely delete the show.
- Fixed issue where a matching offline show was loaded instead of the pushed show.
- Fixed issue when recalling an output channel preset did not correctly recall delay and reset temperature.
- Fixed issue when routing talkback to auxes 7 and 8 on a DL32S would crash.
- Fixed issue where show images order was not correct after image deletion.
- Fixed issue where you could not scroll through show images.

Master Fader V5.0

The following is a list of items that have been added, changed or fixed since Master Fader V4.6.2.

1. Multi-Platform Support

- Master Fader 5.0 works with a plethora of Android and iOS devices. See previous page for system requirements.

2. Support for DL16S and DL32S

- Master Fader 5.0 adds support for the Mackie DL16S and DL32S mixers.

The internal Wi-Fi for these mixers is controlled via the Devices View. Three modes are available: Access Point, External Router and Wi-Fi Client.

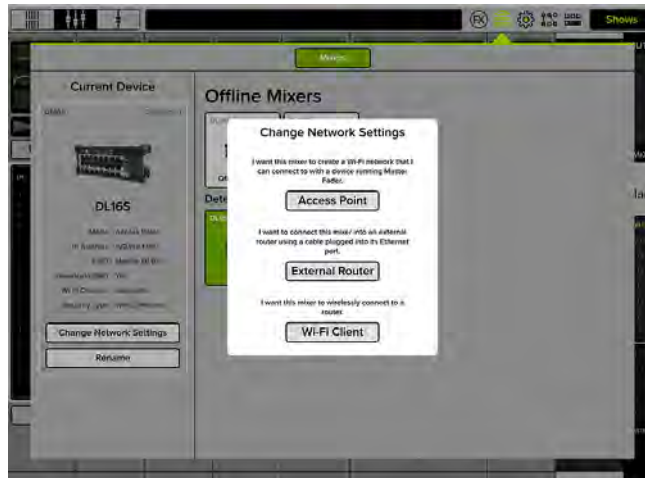

3. FX Overhaul

- New effects have been added to Master Fader V5.0: phaser, tremolo, rotary, mono and stereo chorus, flanger, mod delay and sweep filter manual / auto / LFO.
- All-new rack-inspired FX interface for all DL Series mixers.
- FX are now accessed from a top level menu.



4. Improved Copy-and-Paste

- In addition to channel processing, complete channels (including Aux / Group routing) may be copied-and-pasted.

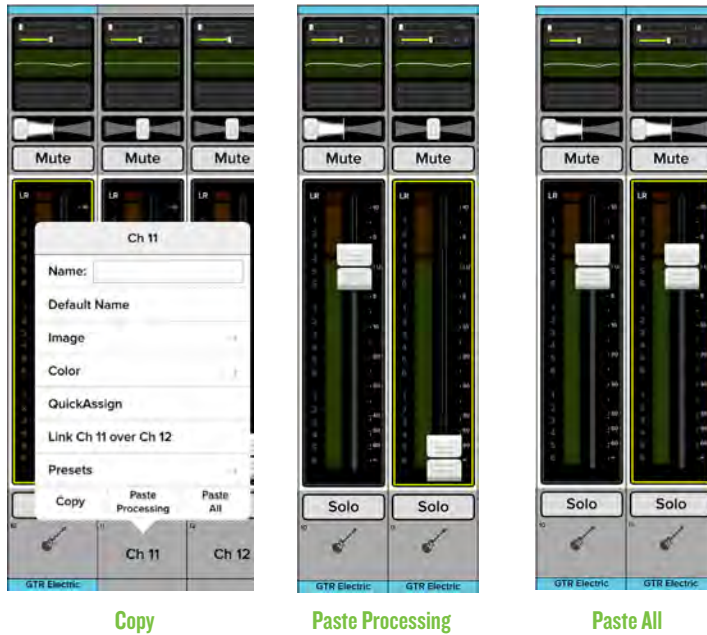

5. Improved Overview

- Fader levels are adjustable and solos, mutes and mute groups may be turned on and off in the overview.



6. Devices

- Devices are now accessed from a top level menu.



The following is a list of features to be added in Future Master Fader 5.x Updates (including, but not limited to):

- Support for the DL806, DL1608, DL32R and DC16
- Support for macOS and Windows
- Support for Import/Export
- Tools menu will be added to the I/O patch
- A confirmation prompt will be implemented when enabling or disabling Use LR Mute, Pre-Fader, Post-Fader, etc.
- A confirmation prompt will be implemented when recalling presets and resetting channels/processors
- An updated Reference Guide will be added
- Split screen operation will be added
- PDF viewing on Android for Help will be added
- Firmware update percentage complete will be added
- Improved portrait view will be added
- Next and previous arrows will be added when naming channels
- A rude solo indicator will be added above the QAP
- Multitouch on EQ, comp / gate and GEQ will be added

The following is a list of known issues to be addressed in Future Master Fader 5.x Updates (including, but not limited to):

- Some Android Tablets show the Phone UI instead of Tablet UI
- When a device is Access Limited, users shouldn't be able to push from an iPad or upgrade firmware
- The Help view on smart phones is not centered
- Some presets do not have the modern / vintage text
- The I/O patch is missing some animations
- The I/O patch is occasionally misaligned
- Dragged QuickAssign buttons overlap the horizontal green line
- After renaming a mixer, devices view shows two detected mixer icons in the list with the same new mixer name
- Vertical lines don't appear when touching PEQ balls
- The Return button on iPads does not move the cursor to the next line
- Users are not taken to the mixer view when recalling a snapshot with Snapshot Recall setting off
- Channel ID popovers get cut off when switching from portrait to landscape mode
- The preset list for input and output compressor is too small
- The Gate Range ball covers the Gate Threshold ball
- Mix Selector popovers appear even when access limits is set to All On
- The maximum (red) slider of the Spectrum Analyzer covers up the +15 dB indicator
- There is no spacing between RTA meters

- Occasionally unable to add channel images or icons after a copy / paste
- Master Fader occasionally creates multiple offline shows on its own
- Switching between I/O tabs resets the view
- The Access Limits All Off button reverts to the Settings page
- The trim slider is off-center in the main mixer view
- The HPF and LPF engage buttons and slope buttons are touching
- Pressing done after naming a channel does not hide the channel menu
- The GEQ slider should be adjustable above and below the grabber
- Touching a channel in the overview doesn't navigate to channel view
- The output selector does not adjust after limiting access to outputs
- Access Limits All On still allows access to LR faders

Master Fader V4.6.2

The following is a list of items that have been added, changed or fixed since Master Fader V4.6.1.

1. Enhancements, bug fixes and stability improvements (including, but not limited to):
 - Improved support for iPad Pro 10.5-inch.
 - Added support for new iPhones.

Master Fader V4.6.1

The following is a list of items that have been added, changed or fixed since Master Fader V4.6.

1. Enhancements, bug fixes and stability improvements (including, but not limited to):
 - Fixed issue with Master Fader where meters might not operate when using Auto View Group.
 - Fixed issue with Master Fader where pressing transport controls in the record view too quickly could cause Master Fader to re-sync or disconnect from DL32R.
 - Fixed issue where Master Fader could crash when initializing the record view, using a docked iPad connection.
 - Fixed issue with Master Fader when using a DL32R where the play icon on the navigation bar wouldn't always show active playback until entering record view.
 - Fixed issue with DC16 where recalling a snapshot from a wired or wireless iPad during a show load, could cause snapshot changes to be lost on the DC16 until recalling the snapshot a second time.
 - Fixed issue with DC16 where show controls could become unresponsive when loading a large show.
 - Fixed issue with DC16 and Master Fader where the DC16 wired iPad connection could disconnect when adjusting parameters from Master Fader when show load is still in progress on the DC16.
 - Fixed issue with DC16 and Master Fader where a wired iPad could occasionally disconnect from the DC16 during a large show load.

Master Fader V4.6

The following is a list of items that have been added, changed or fixed since Master Fader V4.5.3.

1. Enhancements, bug fixes and stability improvements (including, but not limited to):
 - Added DC16/Master Fader Auto View Group – Choose the Auto View group in Master Fader to automatically hide channels with faders all the way down. This will dynamically update as you change mixes showing only channels contributing to the mix. This is especially useful when mixing monitors. The Auto View Group is accessed on the DC16 by holding the ALT button and pressing the top view selector.
 - Added DC16 Flip – Pressing Page UP and Down simultaneously flips the parameters under adjustment with the edit encoders down to the faders. This gives more visual control and is especially useful for editing a GEQ.
 - Added DC16 Shift Modifier Key – Holding Shift and turning encoder adjusts the parameter in a fine increment for precise control
 - Added DC16 Alt+Shift Modifier Key – Holding Shift+Alt simultaneously and turning an encoder resets the parameter to the default value.
 - Added DC16 access even channel controls for linked channels – Hold Alt to adjust the right side parameter for gain, trim, polarity, and 48V for linked channels.
 - Added DC16 link/unlink channels and mixes – Press and hold the Select button to link channels or output mixes. The channel or mix pressed will be the source. Similarly, press and hold the Select button on linked channels or output mixes to unlink them.
 - Added DC16 Per Channel Assign Button Encoder Mode – Hold ALT+___ to access the Assign controls for the selected channel on the edit encoders. This provides access to Main, Subgroup, VCA, Mute Group and View Group assignments.
 - Added DC16 Transport Encoder Mode – Hold ALT + ___ to access the Recording and Playback transport controls for a USB Drive attached to the DL32R. Page 1 provides controls for the Stereo Playback while Page 2 shows the Multichannel Playback and Recording controls.
 - Added DC16 FX Full Control Encoder Mode – Press the FX Per Channel Encoder mode button to see an expanded range of controls for adjusting the effects. The send for the selected channel and the return for the selected mix are both shown, as are all the global controls. Page 1 shows reverb 1, page 2 reverb 2, and page 3 the delay.
 - Added DC16 Vintage Comp/Gate Encoder Mode – Customized controls are now shown for the vintage gate and compressor.
 - Added DC16 Quick Access Buttons – The User button now allows quick access to commonly used controls including main mute, FX mutes, and delay tap tempo.
 - Added DC16 Talkback modes – Setup allows configuration of the operation of the talkback button between momentary, latched and auto operation. Auto is enabled by default.
 - Added DC16 Select Follows Solo and Fader modes – Setup allows configuration of Select follows Solo and/or Fader for both input and output channels. These are enabled by default.
 - Improved DL32R USB drive support and recording/playback reliability on DL32R
 - Improved DC16 Show Load Progress Indication and reliability
 - Improved DC16 Discovery and Connection reliability
 - Improved DC16 Navigation and screen switching performance
 - Improved DC16 Output LPF and HPF Type selection
 - Improved DC16 wired iPad connectivity
 - Improved Other minor DC16 workflow enhancements
 - Fixed issue where Channel Safes did not protect even numbered Aux Sends when unlinked by Snapshot Recall

- Fixed issue with DC16 and Master Fader where changing Mute Group Multi-select would disable all Mute Groups
- Fixed issue with DC16 and Master Fader where changing View Group Multi-select would disable all View Groups
- Other bug fixes

Master Fader V4.5.3

The following is a list of items that have been added, changed or fixed since Master Fader V4.5.2.

1. Enhancements, bug fixes and stability improvements (including, but not limited to):
 - Added high contrast "Sun" mode to DC16 screen brightness options.
 - Improved reliability of DC16 iPad wired connection.
 - Improved connection reliability between DC16 and DL32R when switching slots.
 - Improved connection reliability between DC16 and DL32R after updating.
 - Improved operation of DC16 and DL32R so they now reconnect when switching from link local to DHCP.
 - Improved DC16 Auto Route status messages.
 - Improved resolution of DC16 PEQ Frequency control.
 - Improved performance of DC16 when loading large shows.
 - Improved speed of various DC16 navigation and screen change operations.
 - Improved the text on Master Fader blank following screens.
 - Fixed various issues with Master Fader Follow Mode going to the incorrect blank view.
 - Fixed issue with Master Fader sometimes not re-connecting when returning to foreground from background.
 - Fixed issue with Master Fader where iPad auto lock and re-sync while importing audio caused the import to be interrupted.
 - Fixed issue with Master Fader where Current Parameter display showed the incorrect inputs for some Matrix Sends.
 - Fixed issue with Master Fader where the Overview wouldn't follow the currently selected mix in Follow Mode.
 - Fixed issue with Master Fader where recalling a snapshot turned Follow Mode on.
 - Fixed issue with Master Fader layout of devices view in alternate orientations.
 - Fixed various refresh issues with DC16 selected channel display.
 - Fixed various refresh issues with DC16 when linking / unlinking channels and mixes.
 - Fixed various issues with DC16 fader LEDs not updating when changing mix color.
 - Fixed issue with DC16 I/O Patch routing not preserved after upgrade.
 - Fixed issue with DC16 All Sends view not properly reflecting the linked state of the output.
 - Fixed issue where DC16 per channel sends view was not showing matrix sends when main was selected.
 - Fixed issue with DC16 where Selected Channel SENDS edit didn't update screens for color, link and name changes.
 - Fixed issue where DC16 output selector would reset upon snapshot recall.
 - Fixed issue with DC16 where Vintage PEQ HPF value was with Master Fader.
 - Fixed issue where DC16 would not reset FX send masters when recalling default snapshot.
 - Fixed issue where DC16 master mute and solo would not function on subgroup masters.

- Fixed issue with DC16 screen refresh when changing between certain mixes.
- Fixed issue with DC16 where adding or removing a channel from a subgroup would reset the display to the first 16 channels.
- Fixed issue with DC16 Show display showing wrong current snapshot on power cycle.
- Fixed issue with DC16 where HPF enable / disable wouldn't work in EQ Per Channel View.
- Fixed issue with DC16 where Snapshot Recall button would sometimes not light after a snapshot recall.
- Fixed issues with Master Fader where static IP and Subnet could be set incorrectly leading to the device being undiscoverable.
- Various other stability improvements, fixes and enhancements to DC16 and Master Fader.

Master Fader V4.5.2

The following is a list of items that have been added, changed or fixed since Master Fader V4.5.1.

1. Enhancements, bug fixes and stability improvements (including, but not limited to):
 - Updated Reference Guide with information for V4.5
 - Improved DC16 connection reliability.
 - Improved DC16 slot selection reliability.
 - Improved DC16 wired iPad connection reliability.
 - Improved formatting of Master Fader Spectrum Analyzer on iPad mini.
 - Improved DC16 screen color uses and made them more accurately match Master Fader.
 - Fixed an issue where DC16 could crash while adjusting per channel encoders.
 - Fixed various formatting and refresh issues with DC16 screens.
 - Fixed various issues with DC16 meters briefly flashing.
 - Fixed various issues with DC16 encoder response for stepped parameters.
 - Fixed various issues with Follow Mode where DC16 or Master Fader were not following the correct view.
 - Fixed various issues and improved accuracy of DC16 About view.
 - Fixed an issue where loading channel images could cause DC16 and Master Fader to disconnect.
 - Fixed an issue where DC16 Show display and controls could stop functioning.
 - Fixed an issue where DC16 right main matrix source would flash when mute group 2 is enabled.
 - Fixed an issue where DC16 Reverb and Delay Masters were not showing custom names.
 - Fixed an issue where DC16 was not switching properly between iPad and Analog inputs.
 - Fixed an issue where DC16 couldn't change options for the Vintage EQ HPF, Mid Freq and Mid Q.
 - Fixed an issue where DC16 would get in an unknown state after pressing the MUTE and VIEW control buttons at the same time.
 - Fixed an issue where DC16 briefly displays old channel image when loading new image.
 - Fixed various issues with assigning VCAs and Subgroups when on the DC16 Masters Bank.
 - Various other fixes and enhancements to DC16 and Master Fader.

Master Fader Version 4.5.1

The following is a list of items that have been added, changed or fixed since Master Fader Version 4.5.

1. Enhancements, bug fixes and stability improvements (including, but not limited to):

- Fixed an issue where Master Fader navigation could stop working when using follow mode.
- Fixed an issue where the Master Fader linked / un-linked state was not always reflected in the app when linking or un-linking channels.
- Fixed an issue where Master Fader could have an infinite loop in follow mode.
- Fixed an issue where Master Fader iPad Pro keyboard covered up the static IP input fields.
- Fixed an issue where Master Fader presets menu doesn't stay open.
- Fixed an issue where Master Fader follow mode went to an incorrect blank GEQ view on Main L/R.
- Fixed an issue where Master Fader controllers tab was not shown in iOS10 until the iPad was rotated from landscape to portrait.
- Fixed an issue where moving multiple faders in Master Fader while in follow mode caused Master Fader to resync.
- Fixed an issue where Master Fader wired update of DL806 & DL1608 could fail.
- Fixed an issue where Master Fader could fail to connect to DC16 during OS upgrade.
- Fixed an issue where DC16 delay parameters for FX were showing in Hz and the value bar moved in the wrong direction.
- Fixed an issue where DC16 view group multi-select was not reflected on the mix deck.
- Fixed an issue where DC16 selected channel display didn't refresh the selected channel image when a new image was loaded.
- Fixed an issue where DC16 received the wrong IP from a DL32R if the link local address was previously used.
- Fixed an issue where DC16 did not refresh per channel edit screen parameters on snapshot recall.
- Fixed an issue where DC16 showed LPF on input channels and changed the channel input source when encoder was turned.
- Fixed an issue where DC16 assign mode for even numbered linked subgroups did not work properly.
- Fixed an issue where DC16 ALT + Pan did not adjust delay for the selected output.
- Fixed an issue where DC16 IP address was cut off in setup about.
- Fixed an issue where DC16 pressing view group multi-select or ALL caused faders to move slightly.
- Fixed an issue where DC16 front panel board A froze after an upgrade.
- Fixed an issue where DC16 selected channel display didn't show parameter values for all channel edits.
- Fixed an issue where DC16 new show images were not shown on surface until after power cycle.
- Fixed an issue where DC16 control group selector showed mute group name when 'view' was selected.
- Fixed an issue where DC16 group selector switched to mute group view when it shouldn't.
- Fixed an issue where DC16 channel linking didn't update the selected channel correctly.
- Fixed an issue where DC16 subgroups did not show LR Pan or LR Bal as they should.
- Fixed an issue where the DC16 screen should be blank or show upgrade status during upgrade.
- Fixed an issue where DC16 channel display refresh issue was not showing pan for linked matrices.
- Fixed an issue where DC16 page down arrow was illuminated when selecting an input channel and GEQ.

- Fixed an issue where DC16 was disconnecting and reconnecting to mixer loop.
- Fixed an issue where DC16 banking on DC16 was still active on view groups with less than 16 channels.
- Fixed an issue where DC16 displayed delay L value without decimal.
- Fixed an issue where DC16 displayed the mono delay Tap as “Tap L”.

Master Fader Version 4.5

The following is a list of items that have been added, changed or fixed since Master Fader Version 4.0.

1. Support for Mackie DC16

Master Fader V4.5 adds support for Mackie DC16, including a new 'Controllers' tab and a variety of Follow mode possibilities.



2. All-new, great-sounding reverb

We've spent serious time and development on a completely new set of reverb algorithms that are a true sonic step up for any Master Fader user.

More realistic in every way and offering a whole range of new setting options, your next mix will benefit from the richness and depth of the all-new reverb and expanded control options. With this added level of control, you can build the perfect reverb for your application and save all of those details for easy recall later.

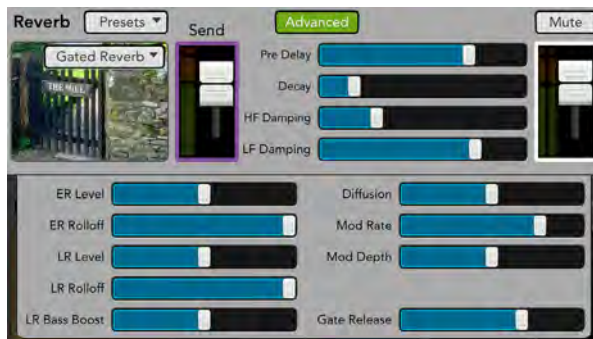

Due to the upgraded reverbs, your snapshots and presets might sound different. We did our best to match the resulting reverb as closely as possible but we recommend you listen to each snapshot and preset and modify the reverb controls as needed.

3. Spectrograph option for RTA

A spectrograph is available on all PEQ | GEQ outputs and subgroups [PEQ only]. A spectrograph provides a 3-dimensional view of the outgoing signal: energy versus frequency versus time.

A spectrograph may be thought of as a record of multiple RTA spectrums taken over time, with color representing amplitude. This allows you to more clearly see what you hear so you may easily locate and eliminate feedback and see the EQ changes in real time.

On the left hand side lies two vertically adjustable sliders that adjust the maximum and minimum signal level shown in the spectrograph. These range between 0 dBFS [top] and -100 dBFS [bottom].

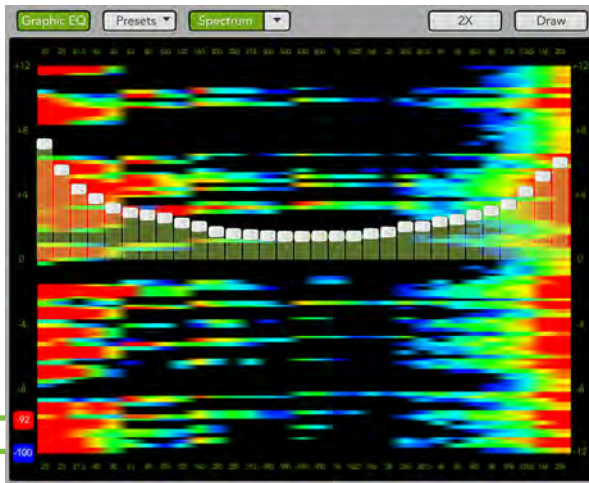

4. RTA and Spectrograph for input channels

An RTA or Spectrograph may now be displayed on input channels.

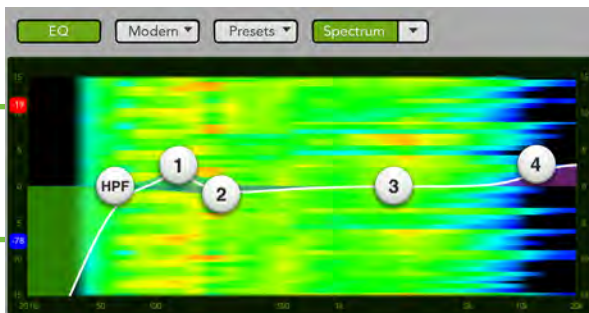
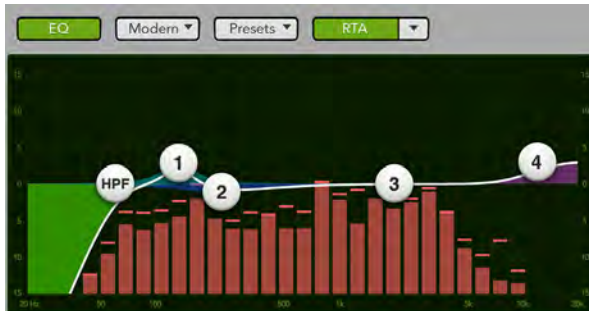

5. New factory presets for all processors

New factory presets are available on all processors, including EQ, dynamics, FX and output compressor. These new presets sound even better and present easier starting points to set up a quick mix.

• EQ Presets

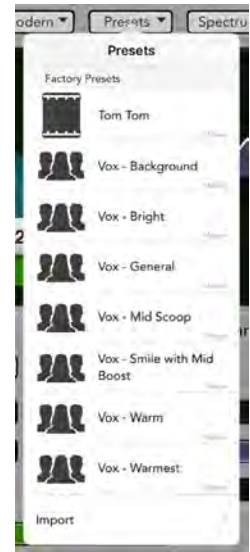
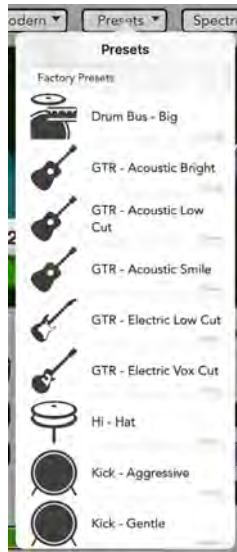
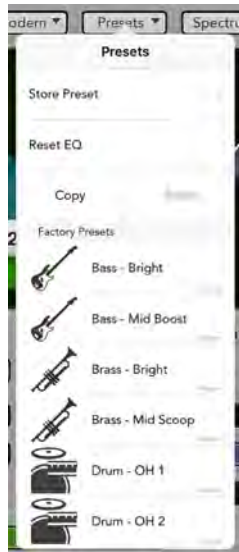

• Gate Presets

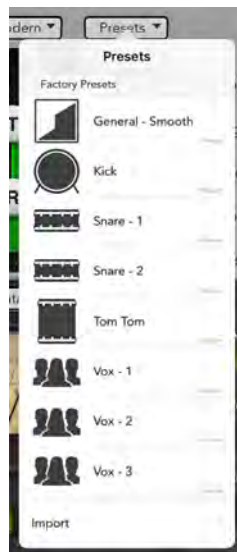

• Compressor Presets

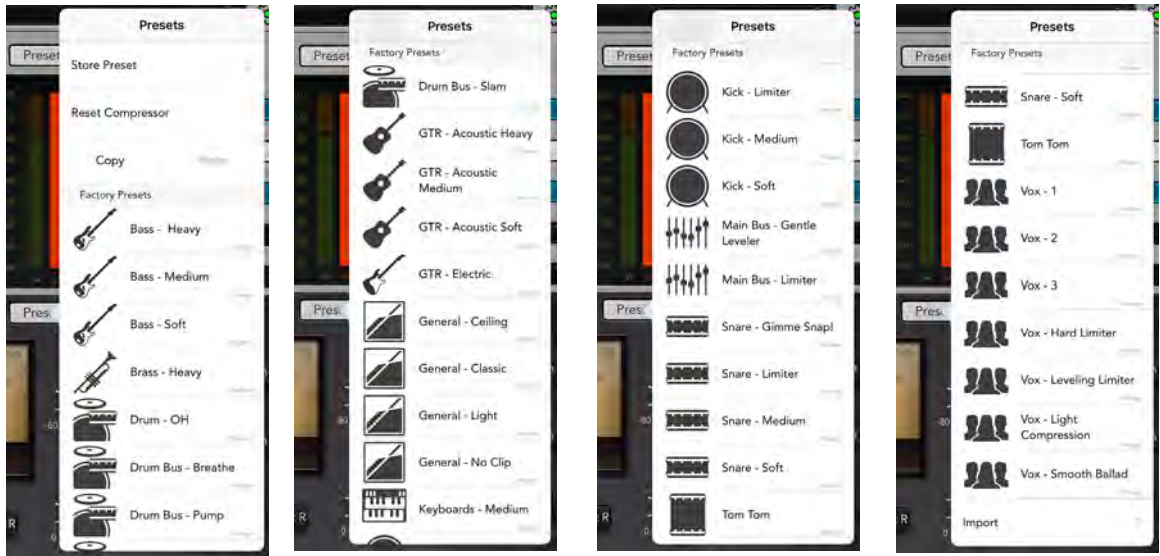

• Reverb Presets



• Delay Presets

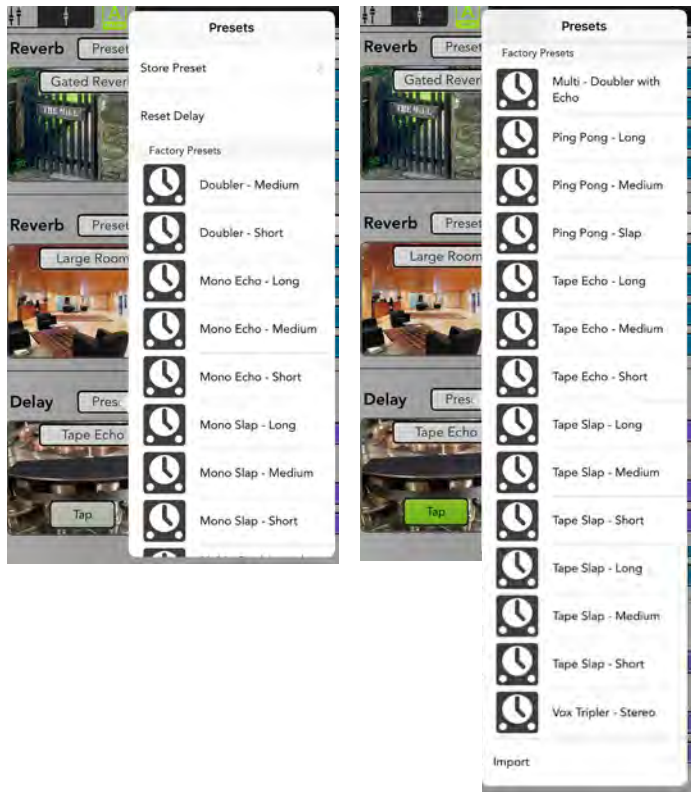

• Output Compressor Presets

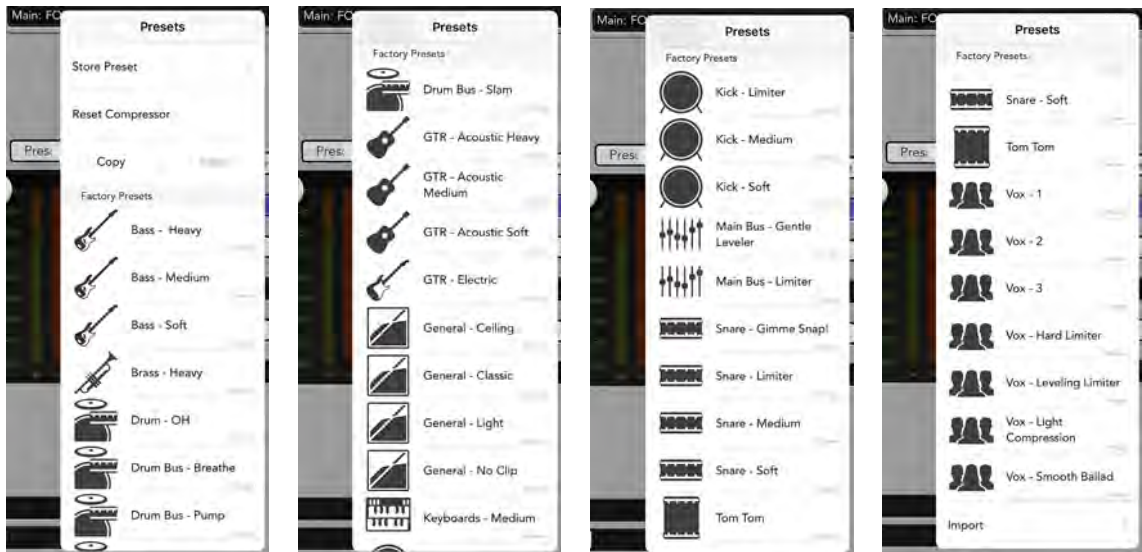

6. New Master Fader Settings

- **Metering Ballistics Options** – There are several new settings that determine the metering behavior.

- **RTA Peak Hold**

Select if the RTA Peak Hold should be fast, slow or off.

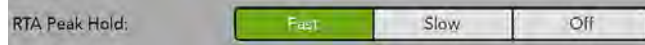

- **Meter Peak Hold**

Select if the Meter Peak Hold should be fast, slow or off.



- **Meter Clip Hold**

Select if the Meter Clip Hold should be fast, slow or really slow.



- **LR to Monitors**

By default, if no channels are soloed, you will hear the main LR output in the monitor bus [i.e. Headphone and Monitor outputs]. This is because the Tools > Settings > LR to Monitors setting is set to ON.



If the LR to Monitors setting is set to OFF, you will only hear channels that have been soloed in the Headphone and Monitor outputs. When no channels are soloed, no audio is sent to the monitor bus.

7. FX Presets now store & recall FX return EQ

The reverb and delay presets used to recall all parameters except EQ. That's changed in V4.5! Now all parameters are recalled – including the associated return EQ – making it easier and faster to dial in the desired sound.

8. Numerous bug fixes and minor enhancements

Master Fader Version 4.0

The following is a list of items that have been added, changed or fixed since Master Fader Version 3.2.

1. RTA on output mixes

RTA is available on all PEQ | GEQ outputs and subgroups, allowing you to see what you hear so you may easily locate and eliminate feedback and see the EQ changes in real time.



2. Oscillator [DL32R]

A built-in oscillator may be routed to any input or output allowing you to test system components, diagnose routing issues and more.

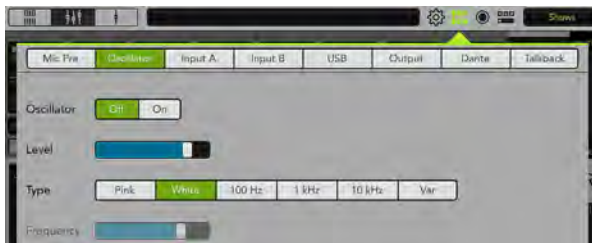

3. QuickAssign for names, icons, colors and show images

Names, icons, colors and show images may now be assigned to channels quickly via drag-and-drop.

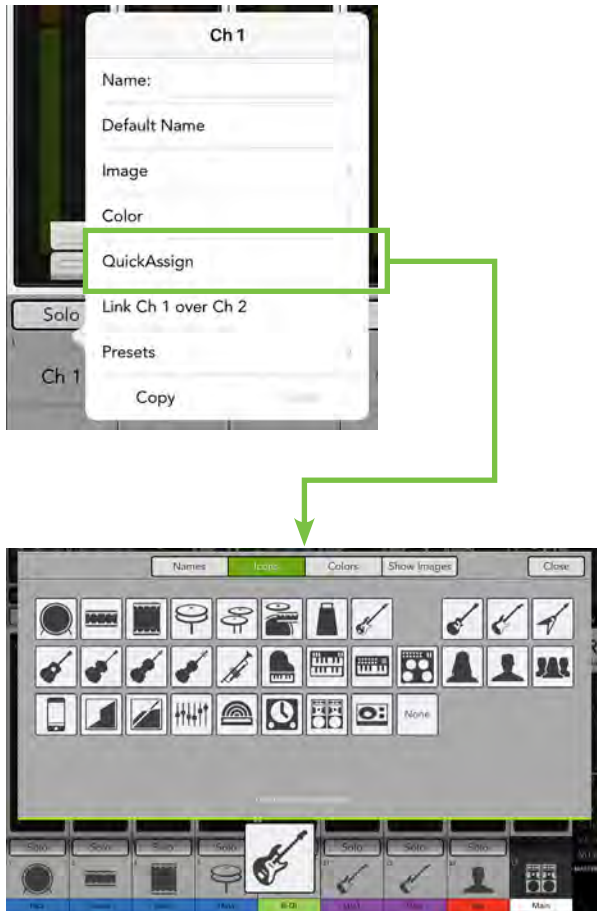

4. Copy - Paste

Channels and mixes may be copied and pasted in Master Fader, including:

- Settings of an input channel to other input channels.

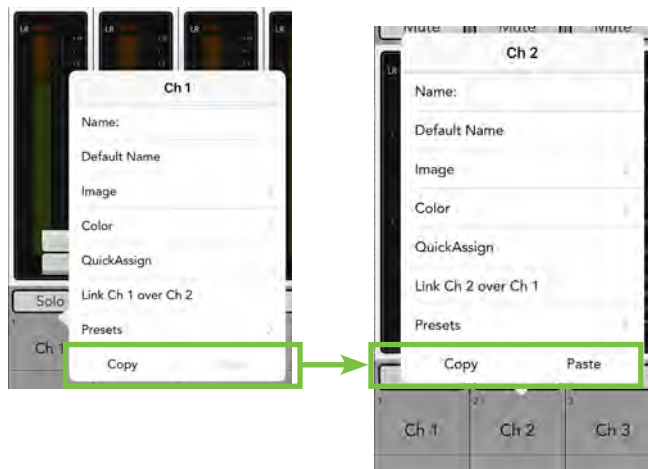

- Settings of an output channel to other output channels.
- Settings of an output mix to other output mixes.

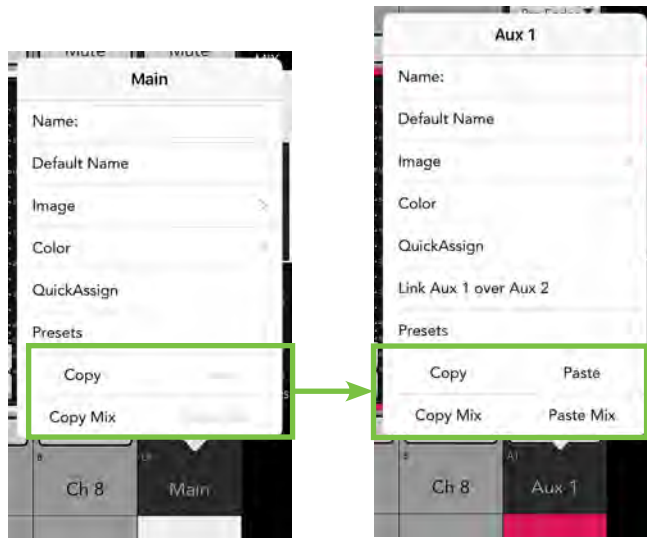

5. Scalable UI

Master Fader may now be viewed in landscape and portrait orientation.

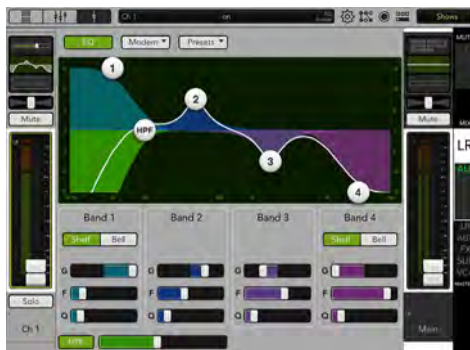

Additionally, Master Fader works as either a primary or secondary app in Split View [with iPad Air 2 or better].



6. Enhanced Access Limiting

Access limiting now hides controls that have been engaged, removing any control that cannot be used.



7. Recording / Playback View [DL806 / DL1608]

Master Fader now displays a detailed view for controlling recording and playback when connected to a DL806 or DL1608 mixer.



Additionally, recordings may now be imported and exported via Dropbox, Google Drive, OneDrive, Audiocopy, Audioshare, etc.

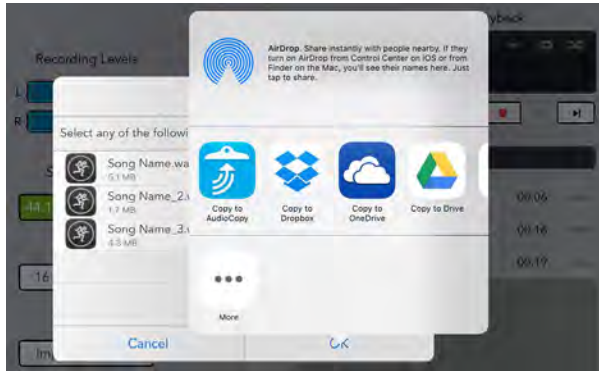

8. Enhanced File Sharing

Shows, presets and system backups may now be imported and exported to many apps including iCloud Drive, Google Drive, OneDrive, etc. using iOS share sheets.

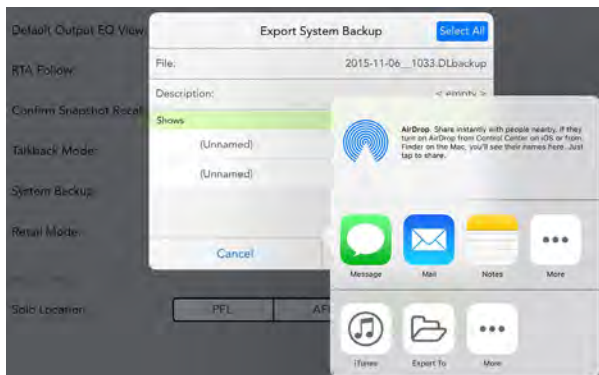
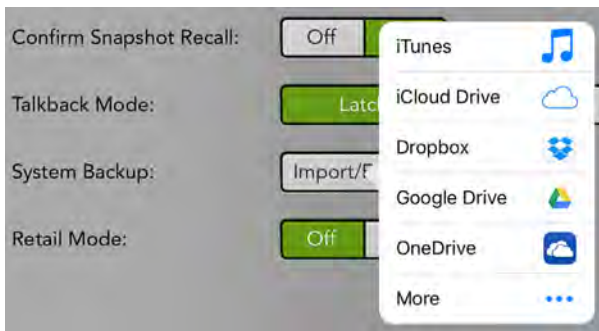

9. Enhanced Devices view

The Devices view has been redesigned to clearly display the selected devices and easily change device specific configuration settings.



10. Enhanced iPhone / iPod touch UI

Pan has been added to the iPhone and iPod touch UI. Like the iPad, the iPhone and iPod touch also display Master Fader in landscape and portrait orientation.



11. New Master Fader Settings

- Talkback Mode [DL32R]



Set the DL32R's talkback mode to your choice:

Latch — The talkback button is either on [green] or off [gray] until the talkback button is tapped again.

Momentary — The talkback button is always ON [green] when the talkback button is tapped and held. Talkback will be OFF [gray] when released.

Auto — The talkback button (and functionality) is automatic, depending on if you tap and release [latching] or tap and hold [momentary] the talkback button.

- RTA Follow

With RTA Follow engaged [ON], the RTA will be displayed on the selected output when switching between outputs.



- Confirm Snapshot Recall

With Confirm Snapshot Recall engaged [ON], a popover appears asking you to confirm the command.

WARNING: Turning this function off leads to faster snapshot recalls, but could also lead to unwarranted snapshot recalls if not careful!

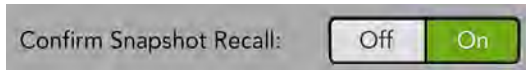

12. New DL Mixer Settings

- Solo Location

Select if the solo location is PFL, AFL or PFL for inputs and AFL for outputs.

13. iPad Pro Support

The iPad Pro displays more faders, bigger controls and allows adjustment with finer resolution.



14. Enhancements, bug fixes and stability improvements (including, but not limited to)...

- Faster channel naming: channel naming now has “next” and “previous” arrows making it easier to edit the names of multiple channels in a row.

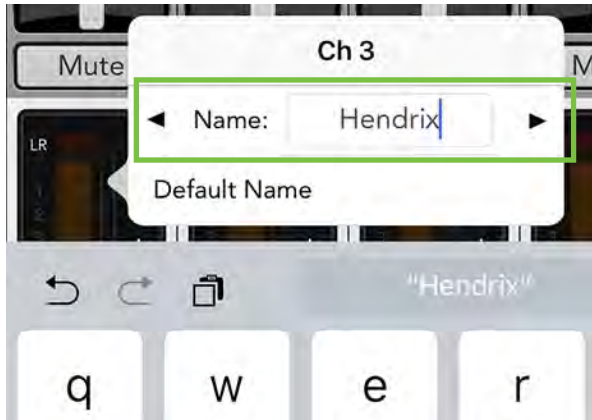

- Custom keyboard for entering values: when editing a numerical parameter value, the keyboard now shows a custom number pad making it easier to enter the value quickly.



- Show VCA Mix Button: a new button on VCA channels gives quick access to the channels contained with the VCA.



- VCA Routing View now shows all channels assigned to the VCA including output mixes.



- Changed font: Master Fader V4.0 uses a new font that is crisper and more modern.

- Channel routing buttons now have an icon making their functionality clear.



- Pan has been added to Access Limits.



- Up to 20 iOS devices may be used simultaneously.

- Several bug fixes and minor enhancements.

Master Fader Version 3.2

The following is a list of items that have been added, changed or fixed since Master Fader Version 3.1.

1. 32x32 Recording and Playback

The DL32R can now record and playback 32x32 channels to and from the external hard drive.

Note: You will NOT be able to downgrade to V3.1 after updating the mixer firmware to V3.2 because of this change to the recording module (but why would you want to?).

2. Mic Pre View

Added new Mic Pre view – IO Patch > Mic Pre – for DL32R allowing adjustment of all 32 mic pre gains and 48V enables at once.



3. Enhanced VCA display

When a channel is assigned to a VCA, a semi-transparent fader cap also shows level changes caused by VCAs on the input channel itself. Additionally, if a VCA is muted or soloed, assigned channels will now show that they are being remotely muted or soloed.



4. Enhanced Retail Mode

Enhanced Retail Mode with integrated demo videos and auto reset to demo show.



5. Enhanced performance of recalling snapshots

6. Reduced overall memory usage improving performance, especially for users with large number of shows or shows with lots of images.

7. Added quick select of All or None for access limits.

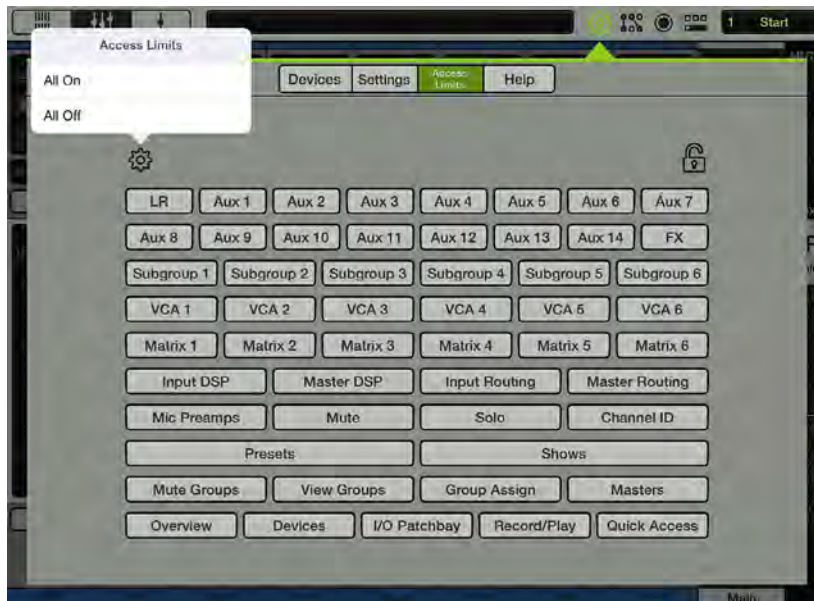

8. Added Reset Shows and Presets Option to Tools > Settings > System Backup Menu



9. Airplay can now be used while also using Master Fader.

10. The DL32R USB drive “Refresh” button is now only available when a drive is in the “Ejected” state.

11. Enhanced Mic Pre Gain sliders to accurately convey step value.

12. Moved user file storage to App Group allowing for future enhancements.

13. Switched to the latest iOS8 SDK and building for 64-bit.

14. Enhancements, bug fixes and stability improvements (including, but not limited to):

- Fixed issue where channel safes did not protect even numbered aux sends after they were unlinked.
- Fixed issue where access limiting the even channel of a linked output didn't limit access to the pair.
- Fixed issue where some flash drives weren't recognized on the DL32R.
- Fixed issue where replacing user presets would make the name and icon disappear.
- Fixed issue where files could be recorded incorrectly on the DL32R if using a name with a space at the beginning or end.
- Fixed a variety of issues with popovers showing slowly and the wrong size.
- Fixed issue where switching between mixer's online and offline states could cause the meters to freeze showing signal when none is present.
- Fixed issue where the Now Playing icon could appear incorrectly.
- Fixed issue where the music play once, loop & shuffle icons would flash after an HDD was ejected on the DL32R.
- Fixed issue with the DL32R where Music and Multitrack file details were not displayed in the tracklist.
- Fixed issue where refreshing/ejecting the DL32R hard drive with multiple iPad connected could disconnect some of them.
- Fixed issue where the DL32R recording view would still show the last file played after the drive is ejected.
- Fixed issue where the DL32R Eject & Format buttons were briefly enabled during playback between playlist songs.
- Fixed issue where the DL32R Loop Once icon briefly appears enabled when it is actually disabled.
- Other bug fixes.

My Fader Version 3.2

My Fader 3.2 requires Mackie Master Fader V3.2. Be sure to perform a full System Backup of Master Fader – Tools > Settings – before updating the app. After updating Master Fader, the mixer firmware will also need to be updated. This will happen next time Master Fader is connected to the DL Series mixer. Please ensure that there is enough time for both before the next gig!

The following is a list of items that have been added, changed or fixed since My Fader Version 3.0.2.

1. Enhanced VCA display:

When a channel is assigned to a VCA, a semi-transparent fader cap also shows level changes caused by VCAs on the input channel itself. Additionally, if a VCA is muted or soloed, assigned channels will now show that they are being remotely muted or soloed.



2. Enhanced performance of recalling snapshots.

3. Reduced overall memory usage improving performance, especially for users with large number of shows or shows with lots of images.

4. Added quick select of All or None for access limits.

5. Switched to the latest iOS8 SDK and building for 64-bit.

6. Enhancements, bug fixes and stability improvements (including, but not limited to):

- Fixed issue where channel safes did not protect even numbered aux sends after they were unlinked.
- Fixed issue where access limiting the even channel of a linked output didn't limit access to the pair.
- Fixed issue where using My Fader on an iPad could show a black bar across the UI.
- Fixed issue where switching between mixer's online and offline states could cause the meters to freeze showing signal when none is present.
- Other bug fixes.

Master Fader Version 3.1

The following is a list of items that have been added, changed or fixed since Master Fader Version 3.0.2.

1. DL Dante Expansion Card Support.

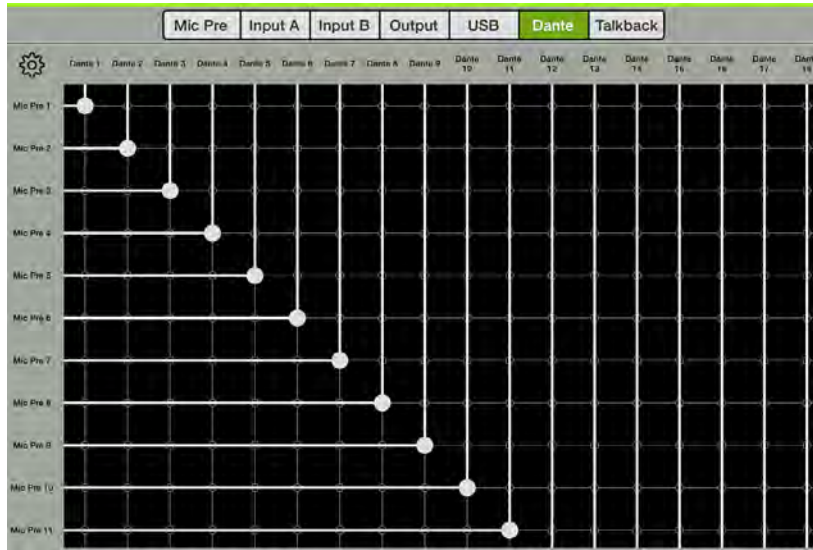

2. Mute Group masters are now actionable from the overview.

3. Access Limit buttons were incorrectly green instead of red.

4. The current parameter readout now shows information when making changes to the IO Patch view.

5. Removed decimal from current parameter readout for Pan and Balance.

6. All radio buttons now activate on release instead of press.

7. Enhancements, bug fixes and stability improvements (including, but not limited to):

- Fixed issue where an update to Master Fader V3 from V2.1.1 and below could fail.
- Fixed crash when Access Limits Input DSP and Input Routing are enabled and then change mixes in the Output Routing Channel View.
- Fixed crash when switching between a DL32R and DL1608 in a very particular way.
- Fixed issue when access limited, Masters was still highlighted in overview when touched.
- Fixed issue where aux pans were not recalled correctly on power cycle.
- Fixed issue where Access Limiting Mutes incorrectly limited Aux Mutes.
- Fixed issue where QAP would not show all FX muted from Mute Group.
- Fixed issue when navigating between Matrix, Overview and Masters view could show incorrect views.
- Fixed issue when navigating between Overview, Subgroup channel, and Mixer view could show incorrect views.
- Fixed issue when navigating between Overview, VCA channel, and Mixer view could show incorrect views.
- Fixed issue where linking and unlinking channels would sometimes not be shown on multiple connected iPads.
- Fixed issue where show note edits were sometimes not shown on multiple connected iPads.
- Fixed issue where output alignment delay wasn't restored upon V2.1.1 to V3.1 update.
- Fixed issue where toggling Access Limits was very slow.

- Fixed issue where switching between devices could cause the view and mute group assignment sources to disappear.
- Fixed issue where faders could disappear from Matrix Mixer View.
- Fixed issue where long channel names could intermittently not scroll in the Matrix and Masters View.
- Fixed issue where Masters View could show no channel strips.
- Fixed issue where the FX Channel View was accessible when FX was Access Limited.
- Fixed issue where channel view meters could stop functioning when switching between view groups.
- Fixed issue where Mute Group assignments that were changed while a Mute Group is enabled wouldn't always update the Overview.
- Fixed issue where linked subgroups would incorrectly show L/R selector in channel routing view.
- Fixed issue where Monitor Delay on QAP only had the ability to manually enter Meter parameter.
- Fixed issue where Access Limited Sub Groups could still be assigned to a VCA.
- Fixed issue where Access Limiting Mutes incorrectly limited Aux Mutes.
- Fixed issue where stereo linked Matrix channel strip would incorrectly appear twice in the Masters View.
- Fixed issue where leaving a Show's Notes field without updating could cause connected iPads to disconnect.
- Fixed issue where with certain Access Limits enabled, selecting a Sub in the Mix Selector would navigate to the wrong view.
- Other bug fixes.

My Fader Version 3.0.2

The following is a list of items that have been added, changed or fixed since My Fader Version 2.1.

1. Enhancements, bug fixes and stability improvements (including, but not limited to):

- Added support for Control with Master Fader 3.0 systems.
- Added support for DL32R.
- Added support for iPhone 6 and iPhone 6 Plus.
- Added support for iOS8.
- All new modern UI.
- Added support for Channel Colors.
- Added support for Output Colors.
- Added Subgroups and VCAs in Mixer View.
- Added separate Gate and Comp Gain Reduction Meters.
- View Group Selector now accessible from mixer view.
- Updated Access Limiting.
- Added a new reference guide pdf.
- Other bug fixes.

Master Fader Version 3.0.2

The following is a list of items that have been added, changed or fixed since Master Fader Version 3.0.1.

1. Enable Retail Mode

Delivers a better experience for dealers using Master Fader for in-store demos.

2. Enhancements, bug fixes and stability improvements (including, but not limited to):

- EQ drawing performance improved, especially on older iPad devices.
- Fixed a bug where Master Fader would crash when recording to a hard drive approaching capacity.
- Fixed a bug where Master Fader would disconnect from a DL32R when storing a snapshot with non-default Talkback Routing.
- Fixed a bug where Master Fader would disconnect from a DL32R when storing a snapshot with non-default AES Routing.
- Fixed a bug where Master Fader would disconnect from a mixer when storing a snapshot with non-default FX Send colors.
- Fixed a bug where View and Mute Group Assignment windows did not populate correctly when switching between DL32R and DL806 / DL1608.
- Changed “Trim” on iPad / Return channels to “Trim L” and “Trim R”.
- Fixed a bug where entering the alignment delay (in feet or ms) was incorrectly interpreted as meters.
- Fixed a bug where the user was unable to access Input Routing or Input DSP on input channel strips when Access Limit > FX enabled.
- Fixed a bug where mix masters were incorrectly affected by the Mute-access limit.
- Fixed a bug where the illuminated QAP mute button said “Mute I” when using a DL1608 / DL806.
- Fixed a bug where the text in the show button was not visible when the show button was touched.
- Fixed a bug where the default created and modified date for shows were “strange” before a snapshot stored.
- Fixed a bug where some text problems appeared when operating the iPad in German or Chinese.
- Other bug fixes.

Master Fader Version 3.0.1

The following is a list of items that have been added, changed or fixed since Master Fader Version 3.0.

1. Enhancements, bug fixes and stability improvements (including, but not limited to):

- Fixed a bug where an iPad would lose sync when a second wireless iPad was out of range.
- Fixed a bug where Master Fader crashed when an incorrectly formatted HDD was attached.
- Fixed a bug where long song names for an HDD recording could cause the DL32R to crash.
- Fixed a crash when you enable Access Limiting on Input DSP and Input Routing and then navigate to Output Routing Channel View.
- Fixed a bug where Access Limits could cause some channels to be incorrectly hidden in Masters View.
- Fixed a bug where Subs and VCAs could not be muted on an aux with “Use LR Mute” disabled.
- Added Sub 6 to the VCA Assignment view.
- Fixed a bug so “None” in the mute group selector is toggle-able when Multi-Select is enabled.
- Fixed a bug where the Master Channel View did not respond to Access Limits.
- Aligned the gated reverb release slider.
- Fixed a Grow and Glow graphics issue on the LPF of the Output PEQ.
- Fixed a bug where scrolling labels were doing “funky” things. And not the good – James Brown – kind of funk, either.
- Fixed a bug where crash logging wasn’t working. You may now be prompted to send information after a crash. Please do so.
- Added a new reference guide pdf.
- Radio buttons now highlight and act on release.
- Improved stereo delay time resolution.
- Improved labels on output patching tabs for the DL32R.
- Other bug fixes.

Master Fader Version 3.0

The following is a list of items that have been added, changed or fixed since Version 2.1.

1. Added online and offline support for the DL32R



2. Upgraded user interface for faster workflow

- More information available at a glance for faster navigation.
- New navigation bar with instant access to overview, mixer and channel view.
- Improved current parameter display that reads more clearly and includes channel color.
- Better access to secondary views.
- Updated channel strips provides more channel information at a glance.



3. Added Overview showing all input and output channels at once for fast, simple navigation

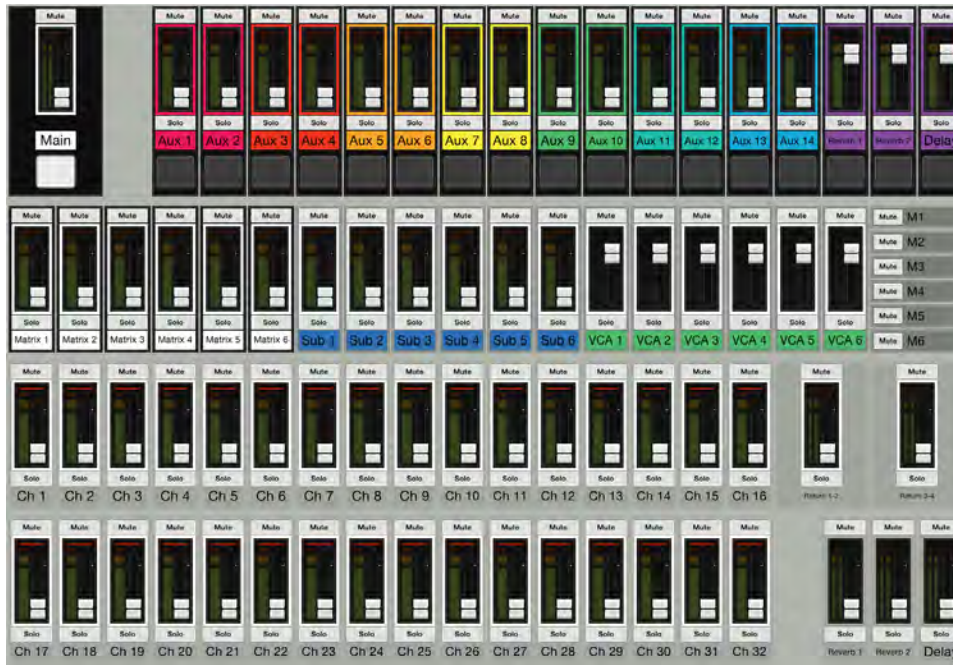

4. Added 4 subgroups (6 in DL32R) with stereo linking and dedicated processing on each subgroup

5. Added 4 VCAs (6 in DL32R) for professional control over groups of channels



Subgroup Channel



VCA Channel

6. Added digital control over Mic Pre Gain and 48V in DL32R

7. Added digital trim on each input, providing additional input gain control when working wirelessly



8. Added Routing view providing complete channel routing in one place for inputs, groups and outputs

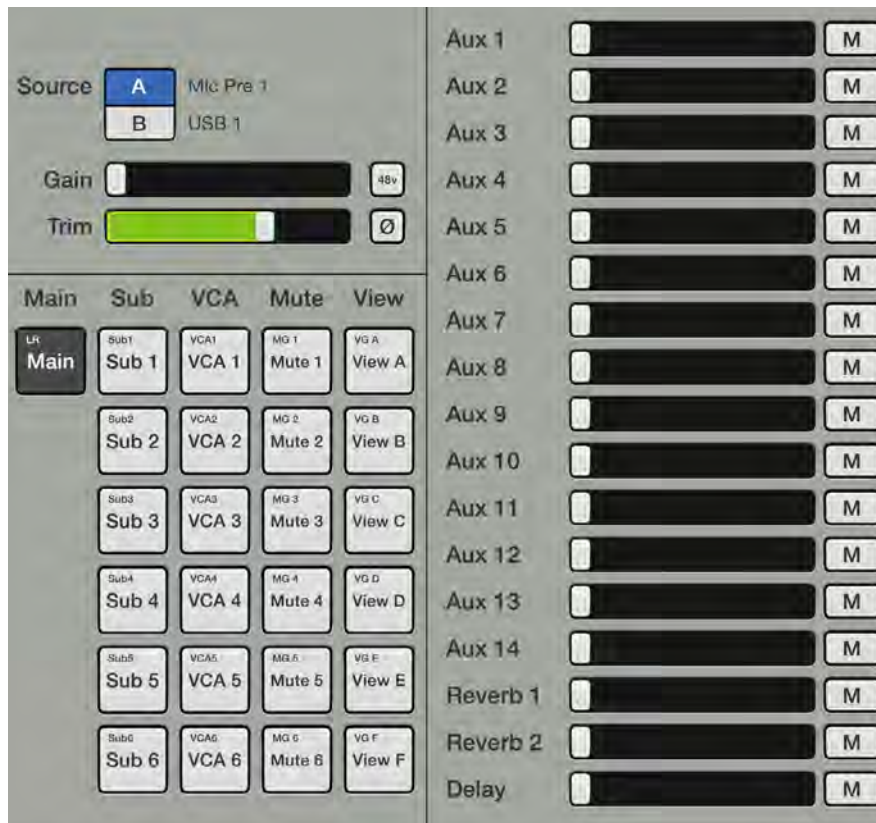

9. Added Custom Channel colors and Mix colors for visually differentiated channels, groups and outputs.



10. Updated Selector area adds mute group and view group controls along with a new Masters selector. Together, these 4 selectors control what inputs and outputs are visible.



11. Updated Shows view allows user to add a comment to each show. Added created/modified dates to each show for improved organization.



12. Added full IO Patching to DL32R.

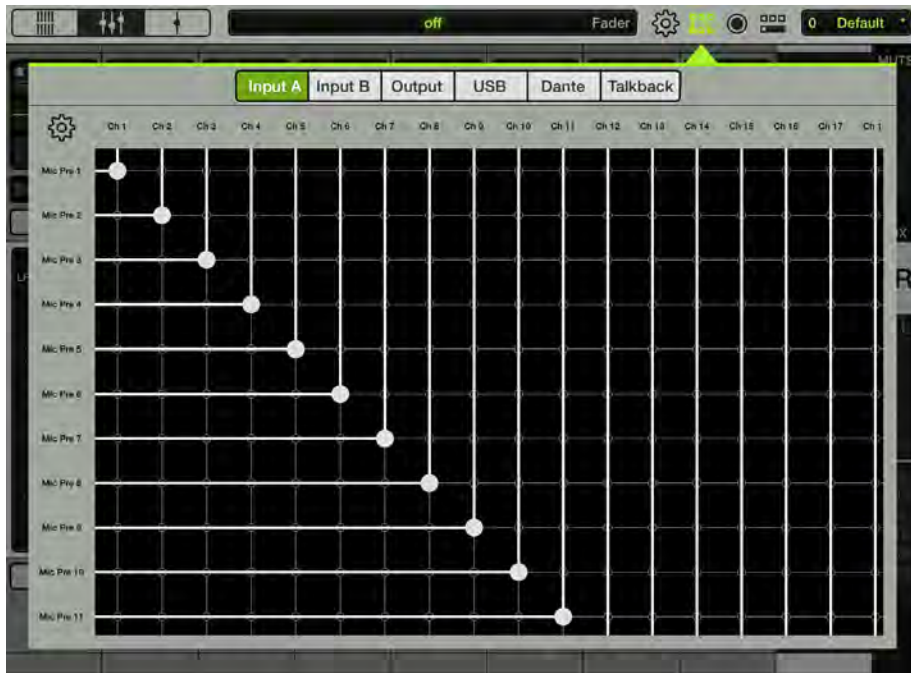

13. Added flexible Record Output patching with record levels to DL1608/DL806.

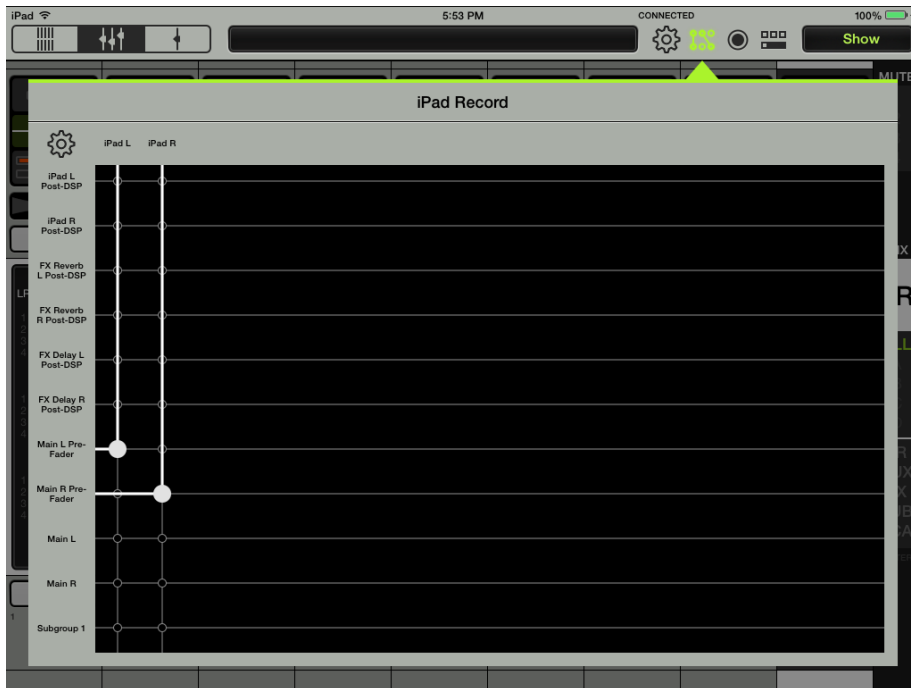

14. Added control of Hard Drive Recording and Playback on DL32R.



15. Added talkback controls (DL32R only) and digital level and delay control for headphone output to QAP.



16. Updated Preset workflow with new location right at the channel.



17. Added ability to export presets, shows and backups via Dropbox or email.

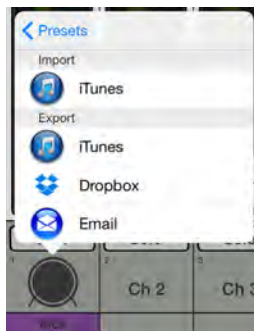

18. Added ability to import presets, shows and backups from 3rd party apps supporting Open In...**19. Bug fixes and stability improvements (including, but not limited to):**

- Fixed a bug where iPad playback could be interrupted by noise or distortion.
- Fixed a bug with how alignment delay is stored in snapshots.
- Fixed a bug where firmware update status could show complete before it really is done.
- Fixed a bug where presets wouldn't store for comp/gate on linked channels.
- Other bug fixes.

Master Fader / My Fader Version 2.1

The following is a list of items that have been added, changed or fixed since Version 2.0.

1. Output Parametric EQ

The parametric equalizer is a great tool for dialing in the sound you're looking for or to squelch feedback from monitors. All output channels (LR, auxs 1-4/6) have up to 4-band EQ with high shelving, high-mid peaking, low-mid peaking and low shelving and a high-pass filter (HPF) and low-pass filter (LPF), both with selectable slopes.

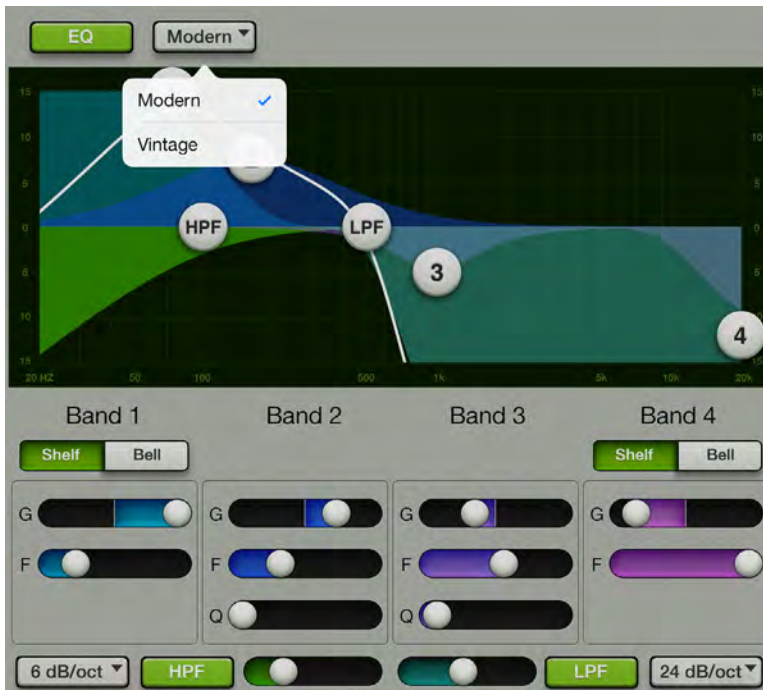

2. Output Alignment Delay

The main LR and all aux sends now feature a 350 ms delay with adjustable delay time, room temperature adjustment and on/off functionality. It is accessible via the output compressor/limiter of each aux send master. It's used to time-align the sound when there are speakers that are not near each other.

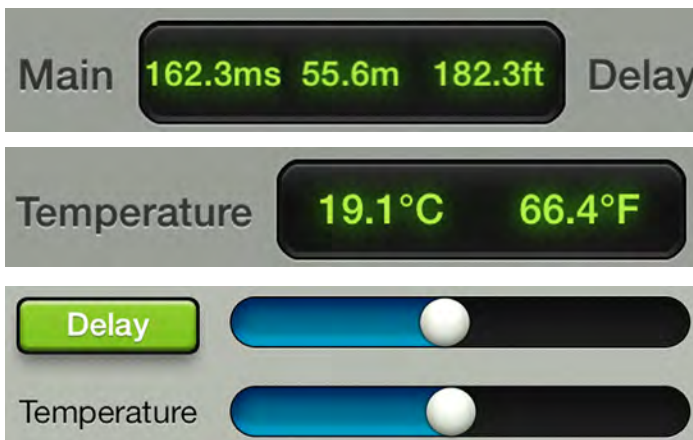

3. Default Output EQ View

You get to decide whether the graphic EQ or parametric EQ is the default output EQ view. Simply go to Tools > Settings > Default Output EQ View and tap which setting you prefer (GEQ or PEQ). The chosen setting will illuminate green when engaged, while the other option will be grayed out. Whichever output EQ view is chosen, you can always swipe in the output view to get to the other.

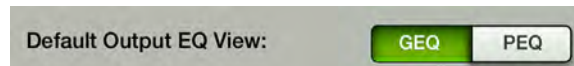

4. Localized Text

Localized text is available in five languages, including English.

- English
- German
- Spanish
- French
- Mandarin (Simplified Chinese)

This is ideal for users who may not have a pro audio background to instantly know and understand these pro audio terms in English. Even if a non-English speaking user is able to read and understand pro audio terms in English, the language of advanced settings, critical warnings, firmware updates and complex show management could be difficult to translate. Non-English speaking users will be able to dig in deeper than ever before by changing their iOS device to their native language.

5. Bug fixes and stability improvements (including, but not limited to):

- Improved accuracy of EQ graphics code.
- Fixed bug where Master Fader could stop registering touches while recording on iOS7.
- Fixed crash bug when attempting to rename the current show under iOS6.
- Fixed crash bug when pulling a show with maximum snapshots and images.
- Fixed bug where the device name could be reset after an upgrade.
- Fixed bugs with preset recall immediately after a channel link.
- Fixed graphics issue with output selector on DL806.
- Fixed bug with Vintage Comp/Gate meter settings not being stored correctly.
- Fixed bug where channel safes weren't working properly offline.
- Fixed bug when updating mixer with multiple iPads connected.
- Fixed bug where access limiting wasn't properly preventing access for linked outputs.
- Fixed bug where access limiting wasn't properly indicating limit state for output compressor.
- Fixed bug where the Podcast button wasn't working properly.
- Performed other minor fixes and stability improvements.

Master Fader / My Fader Version 2.0

The following is a list of items that have been added, changed or fixed since Version 1.4.

1. Input Channel Linking

Two neighboring mono input channels may be linked together into a single stereo channel strip. This is ideal for stereo input sources such as keyboards, submixer outputs, vocal processors and more. When linked, the level control, EQ, gate and compressor are adjusted with a single set of controls.

Additionally, the single stereo iPad channel may be unlinked to make two separate mono iPad channels. This is ideal for click tracks and backing tracks.

Channels may be linked and unlinked in My Fader, too.



2. Aux Send Linking

Two neighboring mono aux sends may be linked together into a single stereo aux. This is ideal for using in-ear monitors or other stereo output destinations such as broadcast feeds, recording devices and more. When linked, the level control, graphic EQ and output compressor/limiter are adjusted with a single set of controls.

Aux sends may be linked and unlinked in My Fader, too.



3. Aux/FX Send Configuration Menu

There are three additions to the aux/FX send configuration menu:

Pre DSP — In addition to Pre Fader and Post Fader, users may now choose Pre DSP as the aux send source. Pre DSP is ideal when using the auxes for monitor mixes and you want EQ, gate and compression in the main mix, but not the monitors. Pre DSP is available on all auxes, but not the FX sends.

Use LR Mute — When Use LR Mute is enabled, the aux sends share the same mutes as the LR main mix. When Use LR Mute is disabled, users can control aux mutes and main mix mutes independently for each channel. Use LR Mute is available on all auxes and FX.

Use LR Pan [Stereo Auxes only] — When Use LR Pan is enabled, the aux pans share the same pans as the LR main mix. When Use LR Pan is disabled, users can control aux pans and main mix pans independently for each channel. Use LR Pan is available on stereo linked auxes, but not on FX.



Additionally, FX sends may now be configured as Pre Fader for more advanced FX needs.

4. Quick Access Panel

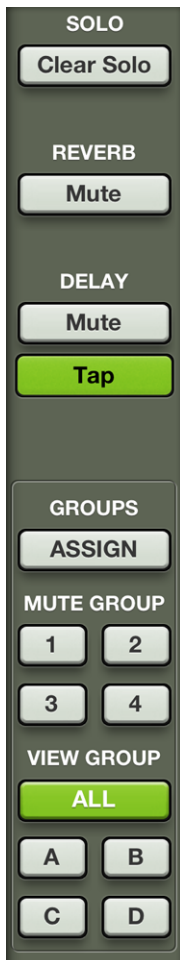

The quick access panel allows for fast control over critical functions, including:

- (1) Clear Solo — Easily clear all solos.
- (2) Effects Controls — Globally mute the reverb and/or delay. Set tap delay tempo.
- (3) Mute Group Control — Set channel assignment and on/off control per mute group master.
- (4) View Group Control — Set channel assignment and view group select.

5. Mute Group Control

Mute groups allow you to quickly mute (and unmute) multiple channels and/or outputs with a single tap. There are a multitude of ways to configure and use mute groups: productions featuring a rotating cast of musicians or theater productions with different scenes. It is also great for muting all inputs during song breaks or in-between sets. You may create and assign as many as four separate mute groups with Master Fader.

The mute group masters may be enabled/disabled via Master Fader or My Fader. However, channels may only be assigned to mute groups in Master Fader.

Master Fader

Mute Group Control

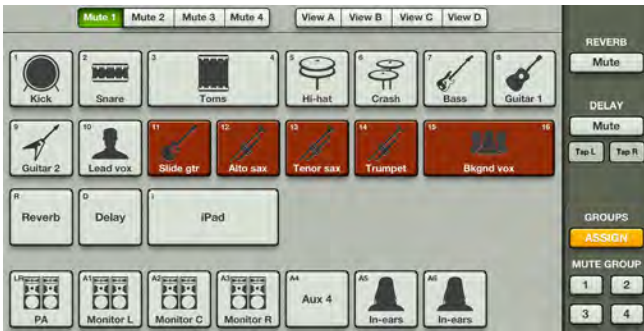

My Fader

Mute Group Control



6. View Group Control

View groups allow you to see only the channels that you want to view, hiding the rest. This improves organization and allows for faster navigation. You may create and assign as many as four separate view groups with Master Fader.

The view group may be selected via Master Fader or My Fader. However, channels may only be assigned to view groups in Master Fader.

Master Fader

View Group Select



My Fader

View Group Select



7. Other changes

- Updated gate and compressor/limiter graphics.

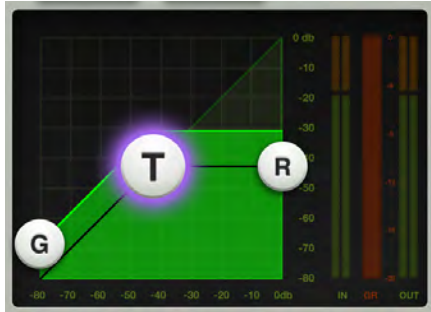

- A mute has been added to the main LR.
- Navigation enhancements
 - **Effects Display** — The EQ curve is replaced with an image of the currently selected reverb and delay effect type. Simply tapping the image will take you straight to that effect's controls.



- **Fast access to dynamics** — Tapping the gain reduction meter takes you straight to the dynamics view.
- **Fast return from channel view** — When in channel view, tapping the small EQ curve at the top of the channel strip returns you back to the mixer view.
- Improved order of items in the snapshot, show and preset popovers making it easier to make the right selection. Recall is now Red!

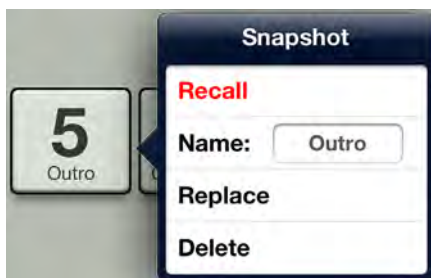

- Improved Aux 1 color to be more easily discerned from LR and Aux 2. Pink!
- Added some color to unlit fader strips making it easier to tell what output is selected
- Added Access Limits for View Groups, Mute Groups and Groups Assign.
- Added Feedback button on Help page leading to UserVoice
- Updated app icons
- iOS7 Support
- Updated Reference Guide
- Updated Quick Start Guide

8. Bug fixes and stability improvements (including, but not limited to):

- Fixed intermittent crash when trying to load channel images simultaneously from two different iOS devices
- Fixed intermittent crash when rapidly changing back and forth between offline DL1608 and Offline DL806
- Fixed bug where the Current Show would display the incorrect number of images it contained.
- Fixed bug where launching Master Fader while docked could halt iPad audio playback
- Fixed bug where HPF could get above the maximum of 700 Hz
- Fixed incorrect frequency labels in GEQ
- Performed other minor fixes and stability improvements.

Master Fader / My Fader Version 1.4

The following is a list of items that have been added, changed or fixed since Version 1.3.

1. Added support for DL806

Master Fader and My Fader now work with both the DL1608 and DL806, including offline operation. Shows, snapshots, presets and access limiting work seamlessly across DL mixers automatically.

2. Show improvements

Many show, snapshot and synchronization enhancements have been added. The show screen now displays "Offline Shows" and the "Current Show" separately. The Current Show is saved to the iPad automatically as changes are made and the last modified date and time are shown. Channel images and icons are now stored in shows, recalled with snapshots and synchronized between devices. Up to 64 channel images may be used in a single show. All images used in the current show are displayed in the Channel > Images > Show Images list. Shows are now recalled in the background (with indication in the navigation bar) so that operation may continue as they load. All connected devices now remain online when shows are loaded.



3. Vintage EQ

After extensive analysis, development and testing, the new vintage EQ delivers the sought-after musical characteristics of your favorite industry-standard processors. For each channel processor, the user may select between the new vintage type for creative tone shaping and the current modern type for surgical control. The vintage EQ captures the unique interactions between the shelving bands and the gain and frequency-dependent Q structure of the parametric band to deliver the clarity and sheen of classic EQ designs. This EQ is great for getting vocals, guitars and other instruments to sit perfectly in a mix. Presets now store and recall DSP type and new vintage factory presets have been added.



4. Vintage gate and compressor

After extensive analysis, development and testing, the new vintage compressor and gate delivers the sought-after musical characteristics of your favorite industry-standard processors. For each channel processor, the user may select between the new vintage type for creative tone shaping and the current modern type for surgical control. The vintage compressor and gate provide a lightning-fast attack, non-linear attack/release and program dependent release making them great for drums and other transient sources. Presets now store and recall DSP type and new vintage factory presets have been added.



5. Other changes:

- Improved meter response.
- Improved taper on gate hold parameter to make it easier to adjust for shorter hold times.
- Added Tools > About > More button with additional software and firmware version information.
- Updated connected device name length to 54 characters long.
- Added new Quick Start Guide.
- Added new Reference Guide.

6. Bug fixes and stability improvements (including, but not limited to):

- Fixed bugs where the mixer button may disappear on the channel view. This was most often seen on the iPad (1st generation).
- Fixed bug where popover lists did not show selection highlight.
- Fixed bug where device discovery could fail when repeatedly selecting the Tools > Devices button.
- Fixed bug where gate meter showed inaccurate value.
- Fixed bug where changing FX type did not show update on multiple connected iPad devices.
- Fixed bug where quickly swiping between channels in channel view could show a black screen.
- Performed other minor fixes and stability improvements.

Master Fader Version 1.3

The following is a list of items that have been added, changed or fixed since Version 1.2.

1. Wireless support for iPad (4th generation) and iPad mini

Master Fader now officially supports wireless operation with iPad (4th generation) and iPad mini.

2. Retina Ready

All graphics have been updated to full retina resolution for use with a retina iPad (3rd or 4th generation).

3. Access Limits

Access Limits have been added to the Tools > Settings screen. This set of buttons allows you to limit access to a variety of controls on each iPad.



When limited, the user cannot access those controls.



A passcode may be set to ensure that no changes will be made.

4. Added 2X Graphic EQ Zoom

A new 2X zoom button has been added to the graphic EQ. This allows you to zoom in on the GEQ, perfect for our friends with sausage fingers and/or mixing with the iPad mini. Swipe left and right to view and adjust the remaining bands. Note that draw is unavailable when in 2X mode.

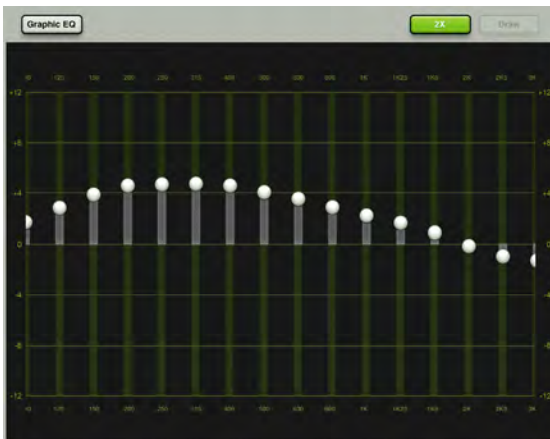

5. Scrolling name

- Channel ID Button
- Master ID Button
- Current Parameter Display
- Snapshot List
- Presets

If the name is too long to fit, the button scrolls, displaying the entire name.

6. Reverb and Delay images

When selecting a new reverb or delay type, an image will be displayed to reflect the chosen effect type.

7. Bug fixes and stability improvements

Master Fader Version 1.2

The following is a list of items that have been added, changed or fixed since Version 1.1.

1. iOS6 Support

Master Fader is now fully tested with iOS6 on the iPad 2 and iPad (3rd generation).

2. Added background recording

Master Fader now supports background recording. This means that you may press the iPad's home button to leave the app or switch to another app while Master Fader continues to record.

Generally speaking, Master Fader can be used for recording while other audio apps are used for playback. Because every app is different, testing your desired combination of apps before using them on a mission critical show is strongly suggested! Also, you should NOT record in multiple apps simultaneously; strange things might happen with the recorded files.

3. Added recorded file sample rate selection 44.1 kHz / 48 kHz

4. Added recorded file bit depth selection 16 bit / 24 bit

You are now able to choose the recording sample rate [44.1 kHz or 48 kHz] and recording bit depth settings [16 bit or 24 bit]. Simply tap which settings you prefer. The chosen settings will illuminate green when engaged, while the other option will be grayed out. Note that these settings cannot be changed while recording is in progress.

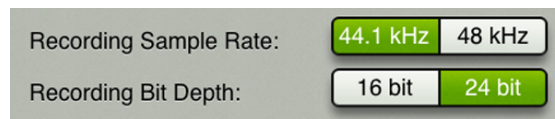

5. Added rude solo and clear solo

When any input or output is soloed, a rude solo button will now appear below the master fader's output selector. This serves as a reminder that a soloed channel exists somewhere. This is especially useful when an output is soloed and you switch to adjust a different channel on a different output. Tapping the rude solo button will clear all solos on all inputs and outputs, including the ones you can't see.

6. Improved wireless discovery and connection reliability

The Master Fader app will now discover DLI608 mixers on a network more quickly and remain connected to them with increased reliability.



7. Improved current parameter display now shows both system and custom channel name

The current parameter display now shows the current channel system name [Ch 1], followed by the custom user name [Kick], the current parameter value [off] and current parameter name [Fader].



8. Improved master channel identification button with added system name display

Regardless of the name and/or image, a small name resides in the upper-left corner of the master ID button. This makes it easier to identify the output even after you change its name.

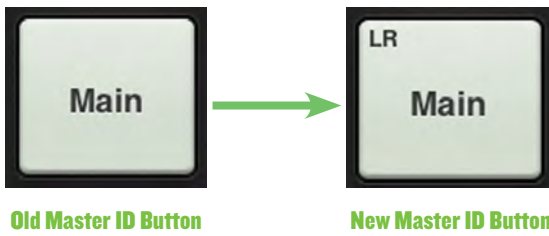

9. Improved output colors of Aux 1 and Rev for easier identification

Two of the selected output colors – Aux 1 and Rev – have been updated for easier identification. All other selected output colors remain the same.

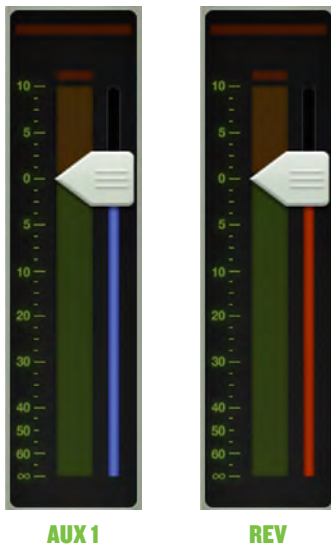

10. Bug fixes and stability improvements

Appendix F : Glossary Of Terms

The glossary contains brief definitions of many of the audio and electronic terms and acronyms used in discussions of sound mixing and recording. If you would like more information, we recommend the following:

The Audio Dictionary — Glenn White
 Tech Terms — Peterson & Oppenheimer
 Handbook For Sound Engineers — Glen Ballou
 Pro Audio Reference — Dennis Bohn
 Sound Reinforcement Handbook — Gary Davis

A/D Converter — Analog-to-digital converter. A device that transforms incoming analog signals into digital form.

AFL — An acronym for After Fade Listen, which is another way of saying post-fader solo function.

Attenuate — To reduce or make quieter.

Aux — Short for auxiliary.

Auxiliary — Long for aux. In sound mixers, supplemental equipment or features that provide additional capabilities to the basic system.

Aux Send — A mixer bus output designed to send a signal to an auxiliary processor or monitor system.

Balanced Input — An input consists of two leads, neither of which is common to the circuit ground. This is a “differential pair”, where the signal consists of the difference in voltage between the two leads. Balanced input circuits can offer excellent rejection of common-mode noise induced into the line.

Balanced Output — In a classic balanced audio circuit, the output is carried on two leads (high or + and low or –) which are isolated from the circuit ground by exactly the same impedance.

A symmetrical balanced output carries the same signal at exactly the same level but of opposite polarity with respect to ground.

A special case of a balanced output carries the signal on only one lead, with the other lead being at zero voltage with respect to ground, but at the same impedance as the signal-carrying lead. This is sometimes called impedance balanced.

Bandwidth — The band of frequencies that pass through a device with a loss of less than 3 dB, expressed in Hertz [Hz] or in musical octaves. Also see Q.

Channel — A functional path in an audio circuit: an input channel, an output channel, the iPad channel, an FX channel and so on.

Channel Strip — An audio channel consisting of a long, vertical strip.

Clipping — A form of severe audio distortion that results from peaks of the audio signal attempting to rise above the capabilities of the amplifier circuit. Seen on an oscilloscope, the audio peaks appear clipped off. To avoid clipping, reduce the system gain in or before the gain stage in which the clipping occurs. Also see headroom.

Compressor — This is a dynamic processor used to smooth out any large transient peaks in an audio signal that might otherwise overload your system or cause distortion. The amplitude threshold and other parameters such as attack time, release time, and tire pressure are adjustable.

Condenser — Another term for the electronic component generally known as a capacitor. In audio, condenser often refers to a type of microphone that uses a capacitor as the sound pickup element. Condenser microphones require electrical power to run internal amplifiers and maintain an electrical charge on the capacitor. They are typically powered by internal batteries or phantom power supplied by the mixer.

Console — Another term for mixer. DLI608 mixer = DLI608 console.

D/A Converter — Digital-to-analog converter. A device that transforms incoming digital signals into analog form.

Glossary Of Terms Continued...

dB — See decibel.

dBu — A unit of measurement of audio signal voltage in an electrical circuit, expressed in decibels referenced to 0.775 VRMS into any impedance. Commonly used to describe signal levels within a modern audio system.

Decibel (dB) — The dB is a ratio of quantities measured in similar terms using a logarithmic scale. Many audio system parameters measure over such a large range of values that the dB is used to simplify the numbers. A ratio of 1000:1 = 60 dB. Since dB is a unitless quantity, it doesn't matter if it's volts or dollars. (Just try asking the chief engineer for a 3 dB raise). When one of the terms in the ratio is an agreed upon standard value, such as 1.23 V, 1 V or 1 mw, the ratio becomes an absolute value. For example, +4 dBu, -10 dBV or 0 dBm.

Delay — Delay “delays” the audio signal for a short period of time. Delay can refer to one short repeat, a series of repeats or the complex interactions of delay used in chorusing or reverb.

Dipping — The opposite of peaking, of course, used in audio to describe the shape of a frequency response curve. A dip in an EQ curve looks like a valley, or a dip. Dipping with an equalizer reduces a range of frequencies. (See guacamole).

Doubling — A delay effect where the original signal is mixed with a medium (20 to 50 ms) delayed copy of itself. When used carefully, this effect can simulate double-tracking [recording a voice or instrument twice].

Dry — Dry means without effects. It is just the signal alone; no reverb, no delay, etc.

DSP — Digital Signal Processing accomplishes the same functions found in analog signal processors, but performs them mathematically in the digital domain, with more precision and accuracy than its analog counterpart. Since DSP is a software-based process, parameters and processing functions are easily changed and updated by revising the Master Fader app.

Dynamic Microphone — The class of microphones that generate electrical signals by the movement of a coil in a magnetic field. Dynamic microphones are rugged, relatively inexpensive, capable of very good performance and do not require external power.

Dynamics Processor — A type of processor that only affects the overall amplitude level of the signal (sometimes as a function of its frequency content), such as a gate, compressor, or limiter.

Dynamic Range — The range between the maximum and minimum sound levels that a sound system can handle. It is usually expressed in decibels as the difference between the level at peak clipping and the level of the noise floor.

Echo — The reflection of sound from a surface such as a wall or floor. Reverberation and echo are terms that are often used interchangeably, but in audio parlance a distinction is usually made: echo is considered to be a distinct, recognizable repetition (or series of repetitions) of a word, note, phrase or sound, whereas reverberation is a diffuse, continuously smooth decay of sound.

EIN — Equivalent Input Noise. A specification that helps measure the “quietness” of a gain stage by deriving the equivalent input noise voltage necessary to obtain a given preamp's output noise. Numerically, it's the output noise at a given gain setting minus the gain. EIN is usually measured at a maximum gain and typically ranges from -125 to -130 dBu.

EQ — Short for equalization.

EQ Curve — A graph of the response of an equalizer, with frequency on the x (horizontal) axis and amplitude (level) on the y (vertical) axis. Equalizer types and effects are often named after the shape of the graphed response curve, such as peak, dip, bell and shelf.

Equalization — Long for EQ. Equalization refers to purposefully changing the frequency response of a circuit, sometimes to correct for previous unequal response (hence the term, equalization), and more often to boost or cut the level at certain frequencies for sound enhancement, to remove extraneous sounds, or to create completely new and different sounds.

A lot of how we refer to equalization has to do with what a graph of the frequency response looks like. A flat response (no EQ) is a straight line; a peak looks like a hill, a dip is a valley, a notch is a really skinny valley, and a shelf looks like a plateau (or shelf). The slope is the grade of the hill on the graph.

Glossary Of Terms Continued...

Fader — Another name for an audio level control.

Filter — A simple equalizer designed to remove certain ranges of frequencies. The high-pass filter attenuates frequencies below its cutoff frequency.

FOH — Front Of House. See house and main (house) speakers. No engineer ever goes to the BOH because there's never enough time to drink beer.

Frequency — The number of times an event repeats itself in a given period of time. Generally, the time period for audio frequencies is one second, and frequency is measured in cycles per second, abbreviated Hz, honoring Dr. Heinrich Hertz (who did not invent the rental car company). One Hz is one cycle per second. One kHz (kilohertz) is 1000 cycles per second.

The audio frequency range is generally considered to be 20 Hz to 20,000 Hz (or 20 kHz). This covers the fundamental pitch and most overtones of musical instruments.

Gain — The measure of how much a circuit amplifies a signal. Gain may be stated as a ratio of input to output voltage, current or power, such as a voltage gain of 4, or a power gain of 1.5, or it may be expressed in decibels, such as a line amplifier with a gain of 10 dB.

Gain Stage — An amplification point in a signal path, either within a system or a single device. Overall system gain is distributed between the various gain stages.

Gate — A dynamics processor that automatically turns off an input signal when it drops below a certain level. This can reduce the overall noise level of your mix by turning off inputs when they are not in use. Threshold, attack time, hold, and release time are some of the adjustable gate parameters.

Graphic EQ — The graphic equalizer uses sliders for its boost / cut controls, with its operating frequencies evenly spaced through the audio spectrum. In a perfect world, a line drawn through the centers of the control shafts would form a graph of the frequency response curve. Or, the positions of the sliders give a graphic representation of boost or cut levels across the frequency spectrum.

Ground — Also called earth. Ground is defined as the point of zero voltage in a circuit or system, the reference point from which all other voltages are measured.

In electrical power systems, ground connections are used for safety purposes, to keep equipment chassis and controls at zero voltage and to provide a safe path for errant currents. This is called a safety ground. Maintaining a good safety ground is essential to preventing electrical shock. Follow manufacturer's suggestions and good electrical practices to ensure a safely grounded system. Never remove or disable the grounding pin on the power cord.

In sensitive electronic equipment, tiny currents and voltages riding on the ground (so it's not truly zero volts) can cause noise in the circuits and hamper operation. Often a ground separate from the power ground is used as the reference point for the electronics, isolating the sensitive electronics from the dirty power ground. This is called a technical ground.

Quality audio equipment is designed to maintain a good technical ground and also operate safely with a good safety ground.

Ground Loop — A ground loop occurs when the technical ground within an audio system is connected to the safety ground at more than one place. This forms a loop around which unwanted current flows, causing noise in the audio system. Never disable the safety ground in an attempt to solve hum problems.

Guacamole — A delicious dip comprised mostly of avocados. Speaking of dips, refer to dipping.

Hertz — The unit of frequency, equal to 1 cycle per second. 1000 Hz equals 1 kHz.

House — In audio-land, the house refers to the systems (and even persons) responsible for the primary sound reinforcement in a given venue. Hence, we have the house mixer or house engineer, the house mix, house mix amps, main house speakers, etc.

Hz — Short for Hertz.

Glossary Of Terms Continued...

Impedance — The A.C. resistance, capacitance, and inductance in an electrical circuit, measured in ohms [Ω]. In audio circuits (and other AC circuits) the impedance in ohms may often be much different from the circuit resistance as measured by a DC ohmmeter.

Maintaining proper circuit impedance relationships is important to avoid distortion and minimize added noise. Mackie input and output impedances are set to work well with the vast majority of audio equipment.

Knee — A knee is a sharp bend in a compressor gain curve, not unlike a sharp bend in your leg.

Level — Another word for signal, voltage, power, strength or volume. Audio signals are sometimes classified according to their level. Commonly used levels are: microphone level (-40 dBu or lower), instrument level (-20 to -10 dBu), and line level (-10 to $+30$ dBu).

Line Level — A signal whose level falls between -10 dBu and $+30$ dBu.

Main (House) Speakers — The main loudspeakers for a sound reinforcement system. These are usually the largest and loudest loudspeakers, positioned facing the audience; the sound is typically delivered from the stage. This is also called the PA.

Mains — Short for main or house speakers in a sound reinforcement system.

Master — Me. I am your master. Obey! The master on the Master Fader app, though, refers to the master fader. It affects the total level of the selected output in which one or more signals are mixed together.

Mic Amp — See Mic Preamp.

Mic Level — The typical level of a signal from a microphone. A mic level signal (usually – but not always – coming from a microphone) is generally lower than -30 dBu. With a very quiet source [a pin dropping?] the signal may be -70 dBu or lower.

Some microphones, notably vintage or vintage-style condenser mics, deliver a higher signal level than this for the same sound pressure level. A “hot” mic output level isn’t necessarily a measure of the microphone’s quality; it’s just an option that the designer(s) chose.

Mic Pre — Short for Mic Preamp.

Mic Preamp — Short for microphone preamplifier. An amplifier whose job is to bring the very low microphone level signal up to line level, or in the case of a mic preamp built into a mixer, the mixer’s internal operating level [approximately 0 dBu].

Mic preamps often have their own volume control, called gain, to properly set the gain for a particular source. Setting the mic preamp gain correctly is an essential step in establishing good signal-to-noise ratio and sufficient headroom. The DL Series mixers are outfitted with Onyx mic preamps.

Mixer — An electronic device used to combine various audio signals into a common output. Different from a blender, which combines various fruits and alcohol into a common libation.

Monaural — Long for mono. Literally, pertaining to or having the use of only one ear.

In the audio field, monaural describes a signal or system which carries audio information on a single channel with the intent of reproducing it from a single source. One microphone is a mono source; many microphones mixed to one channel is a mono mix; a stereo (or – to be picky – a two-channel) mix of many microphones panned left and right is a stereo mix of mono sources.

Monaural listening, and therefore mono compatibility of a stereo mix, is more important than you might realize. Most people hear television audio and clock radios in mono.

Monitor — In sound reinforcement, monitor speakers [or monitor headphones or in-ear monitors] are used by performers to hear themselves. In the video and broadcast world, monitor speakers are often called foldback speakers. In recording, the monitors speakers are those used by the engineer and production staff to listen to the recording as it progresses. In zoology, the monitor lizard is the lizard that observes the production staff as the recording progresses. Keep the lizard out of the mixer.

Glossary Of Terms Continued...

Mono — Short for monaural (and mononucleosis for that matter).

Mute Groups — Mute groups allow you to quickly mute (and unmute) multiple channels and/or outputs with a single tap. There are a multitude of possibilities in which to assign and enable mute groups: productions featuring a rotating cast of musicians, theater productions, a house of worship and more. It is also great for muting all inputs during song breaks or in-between sets. You may create as many as four separate mute groups with Master Fader.

Noise — Whatever you don't want to hear. This could be hum, buzz or hiss; or it could be crosstalk, digital hash, or your neighbor's stereo; or it could be white noise, pink noise or brown noise. It's also how your parents describe your band. After all, it's what they don't want to hear.

Noise Floor — The residual level of noise in any system. In a well-designed mixer (such as the Mackie DL Series mixers), the noise floor will be a quiet hiss, which is the thermal noise generated by electrons bouncing around in resistors and semiconductor junctions. The lower the noise floor and the higher the headroom, the more usable dynamic range a system has.

Nyquist Sampling Theorem — This theorem states that, when an analog signal is converted to a digital signal, it must be sampled at a frequency that is at least twice the highest audio frequency present in the analog signal. If the audio frequency should exceed one-half the sampling frequency, aliasing may result. Thus, if an analog-to-digital converter is sampling at 44.1 kHz, the audio signal should not exceed 22.05 kHz.

PA — Acronym for Public Address. Today, people who work with PA systems like to say they're working in "sound reinforcement". See SR.

Pan — Pan sliders are used to position (or even dynamically move) a monaural sound source in a stereo mixing field by adjusting the source's volume between the left and right channels. Our brains sense stereo position by hearing this difference in loudness when the sound strikes each ear, taking into account time delay, spectrum, ambient reverberation and other cues.

Peaking — The opposite of dipping. A peak is an EQ curve that looks like a hill, or a peak. Peaking with an equalizer amplifies a band of frequencies.

PFL — An acronym for Pre-Fade Listen. Broadcasters call it cueing. Sound folks call it being able to solo a channel with the fader down.

Phantom Power — A system of providing electrical power for condenser microphones (and some electronic pickup devices) from the microphone input jack. The system is called phantom because the power is carried on a standard microphone audio wiring in a way that is "invisible" to ordinary dynamic microphones. The DL Series mixers use a standard +48 volt DC power, switchable on or off.

Generally, phantom power is safe to use with non-condenser microphones, as well, especially dynamic microphones. However, unbalanced microphones, some electronic equipment (such as some wireless microphone receivers) and some ribbon microphones can short out the phantom power and be severely damaged.

Phase — The time relationship between two signals, expressed in degrees around a circle. 0° and 360° represent an in-phase relationship. Both signals change in the same way at the same time. Anything else is out of phase.

180° out-of-phase is a special case which, for a continuous waveform, means that at any given time the two signals have the same amplitude but are opposite in polarity. The two legs of a differential output are 180° out-of-phase. The polarity invert button (found in the EQ view) reverses the signal polarity.

When out-of-phase signals are mixed, there will be some cancellation at certain frequencies, the frequencies and the degree of cancellation being a function of the amount of phase shift and the relative amplitude of the signals. Attention to mic placement and careful listening will allow you to use this effect creatively.

Post Fader — A term used to describe an aux send (or other output) that is connected so that it is affected by the setting of the associated channel fader. Sends connected this way are typically (but not always) used for effects. A post-fader output from a mixer channel is usually post-EQ.

Glossary Of Terms Continued...

Pre DSP — Pre DSP is ideal when using the auxes for monitor mixes and you want compression and other effects in the main mix, but not the monitors. Pre DSP is available in all auxes, but not the FX.

Pre Fader — A term used to describe an aux send (or other output) that is connected so that it is not affected by the setting of the associated channel fader. Sends connected this way are typically (but not always) used for monitors.

Q — A way of stating the bandwidth of a filter or equalizer section. An EQ with a Q of .75 is broad and smooth, while a Q of 10 gives a narrow, pointed response curve. To calculate the value of Q, you must know the center frequency of the EQ section and the frequencies at which the upper and lower skirts fall 3 dB below the level of the center frequency. Q equals the center frequency divided by the difference between the upper and lower 3 dB-down frequencies. A peaking EQ centered at 10 kHz whose -3 dB points are 7.5 kHz and 12.5 kHz has a Q of 2.

Reverberation, Reverb — The sound remaining in a room after the source of sound is stopped. It's what you hear in a large tiled room immediately after you've clapped your hands.

Reverberation and echo are terms that are often used interchangeably, but in audio parlance, a distinction is usually made: reverberation is considered to be a diffuse, continuously smooth decay of sound, whereas echo is one or more distinct, recognizable repetitions of a word, note, phrase or sound which decreases in amplitude with every repeat.

Highly reverberant rooms are called live; rooms with very little reverberation are called dead. A sound source without added reverb is dry; one with reverb added is wet.

RFI — Radio Frequency Interference. High frequency radiation that often results from sparking circuits. This may be manifested in a number of ways in audio systems, but is usually evident as a high-frequency buzz or harsh sound.

RMS — An acronym for root mean square, a conventional way to measure the effective average value of an audio signal or other AC voltage. Most AC voltmeters are calibrated to read RMS volts, though on many meters that calibration is accurate only if the waveform is sinusoidal.

Sampling Frequency — This is the rate at which an analog signal is sampled during the analog-to-digital conversion process. The sampling rate used for CDs is 44.1 kHz, but professional recordings are often sampled at higher sample rates.

Send — A term used to describe the output of a secondary mix of the input signals, typically used for monitors, headphone amp or effects devices. These are the aux sends on the DL Series mixers.

Shelving — A term used to describe the shape of an equalizer's frequency response. A shelving equalizer's response begins to rise (or fall) at some frequency and continues to rise (or fall) until it reaches the shelf frequency, at which point the response curve flattens out and remains flat to the limits of audibility. If you were to graph the response, it would look like a shelf. Or more like a shelf than a hiking boot. See also peaking and dipping.

Signal-to-Noise (S/N) — This is a specification that describes how much noise an audio component has compared to the signal. It is usually expressed in dB below a given output level. The S/N of the DL Series mixers is 92 dB.

Solo — Italian for alone. Solo allows you to listen to individual channels singly or in combination with other soloed signals.

Sound Reinforcement — A system of amplifying acoustic and electronic sounds from a performance or speech so that a large audience can hear clearly. Or, in popular music, so that a (hopefully) large audience can be excited, stunned, or even partially deafened by the tremendous amplification. Sound reinforcement means essentially the same thing as PA [Public Address].

Spaghetti — That mess of wires and cables in the back of your rack and/or console. You really can tame this beast.

SR — An acronym for Sound Reinforcement, which refers to the process (or a system for) amplifying acoustic and electronic sounds from a performance or speech so that a large audience can hear clearly. Or, in popular music, so that a (hopefully) large audience can be excited, stunned, or even partially deafened by the tremendous amplification. Sound reinforcement means essentially the same thing as PA [Public Address].

Stereo — Believe it or not, stereo comes from a Greek word that means solid. We use stereo or stereophony to describe the illusion of a continuous, spacious sound field that is seemingly spread around the listener by two or more related audio signals. In practice, stereo often is taken to simply mean two channels.

Glossary Of Terms Continued...

Tinnitus — The ringing in the ears that often results from prolonged exposure to very loud sound levels.

TRS — Acronym for Tip-Ring-Sleeve, the three parts of a two conductor (plus shield) phone plug. Since the plug or jack can carry two signals and a common ground, TRS connectors are often referred to as stereo or balanced plugs or jacks.

TS — Acronym for Tip-Sleeve, the two parts of a single conductor (plus shield) phone plug. TS connectors are sometimes called mono or unbalanced plugs or jacks. A 1/4" TS phone plug or jack is also called a standard phone plug or jack.

Unbalanced — An electrical circuit in which the two legs of the circuit do not have the identical impedance to ground. Often one leg is also at ground potential. Unbalanced circuit connections require only two conductors (signal "hot" and ground). Unbalanced audio circuitry is less expensive to build, but under certain circumstances is more susceptible to noise pickup.

View Groups — View groups allow you to see only the channels that you want to view, hiding the rest. This improves organization and allows for faster navigation. You may create and assign as many as four separate view groups with Master Fader.

Volume — The sound level in an audio system. Perhaps the only thing that some bands have too much of.

VRMS — Acronym for Volts Root Mean Square. See RMS.

Wet — A signal with added reverberation or other effect like echo, delay or chorusing.

XLR Connector — Three-pin connectors now universally used for balanced microphone connections. Also known as Cannon, as Cannon was the original manufacturer of this type of connector. In sound work, a Cannon connector is taken to mean a Cannon XLR-3 connector or any compatible connector. You can tell who the audio geezers are when they refer to XLR connectors as Cannon connectors.

Z — The electrical symbol for impedance.

Zymurgy — The science of brewing, an important part of Mackie technology and history since we are located less than one mile from the Red Hook brewery. Besides, we need something other than just a plain 'ol "Z" to end the glossary.

Warranty Statement

Please keep your sales receipt in a safe place.

This Limited Product Warranty (“Product Warranty”) is provided by LOUD Audio, LLC. (“LOUD”) and is applicable to products purchased in the United States or Canada through a LOUD-authorized reseller or dealer. The Product Warranty will not extend to anyone other than the original purchaser of the product (hereinafter, “Customer,” “you” or “your”).

For products purchased outside the U.S. or Canada, please visit www.mackie.com/warranty to find contact information for your local distributor, and information on any warranty coverage provided by the distributor in your local market.

LOUD warrants to Customer that the product will be free from defects in materials and workmanship under normal use during the Warranty Period. If the product fails to conform to the warranty then LOUD or its authorized service representative will at its option, either repair or replace any such nonconforming product, provided that Customer gives notice of the noncompliance within the Warranty Period to the Company at: www.mackie.com/support or by calling LOUD technical support at 1.800.898.3211 (toll-free in the U.S. and Canada) during normal business hours Pacific Time, excluding weekends or LOUD holidays. Please retain the original dated sales receipt as evidence of the date of purchase. You will need it to obtain any warranty service.

For full terms and conditions, as well as the specific duration of the Warranty for this product, please visit www.mackie.com/warranty.

The Product Warranty, together with your invoice or receipt, and the terms and conditions located at www.mackie.com/warranty constitutes the entire agreement, and supersedes any and all prior agreements between LOUD and Customer related to the subject matter hereof. No amendment, modification or waiver of any of the provisions of this Product Warranty will be valid unless set forth in a written instrument signed by the party to be bound thereby.

GPL Statement

This Mackie product includes software code developed by third parties, including software code subject to the GNU General Public License (“GPL”) Version 2. Where such specific license terms entitle you to the source code of such software, LOUD Audio, LLC. will provide upon written request via email or traditional paper mail the applicable GPL source code files via CD-ROM for a nominal cost to cover media, shipping and handling charges as allowed under the GPL.

The GPL code used in this product is distributed WITHOUT ANY WARRANTY and is subject to the copyrights of one or more authors. For details, see the GPL code and the terms of the GPL. For a copy of the GPL please write to the Free Software Foundation, Inc., 51 Franklin Street, Fifth Floor, Boston, MA 02110-1301, USA.

Please direct all GPL Source Requests to the following email/address.

Attn: GPL Source Request
LOUD Audio, LLC.
16220 Woodinville-Redmond Rd. N.E.
Woodinville, WA 98072

or

techmail@mackie.com

3rd Party Firmware Statement

This product contains firmware (Archwave.bcd) (related to USB streaming and HDD recording/playback) subject to the following:

Warning: This computer program is protected by copyright law and international treaties. Unauthorized reproduction or distribution of this program, or any portion of it, may result in severe civil and criminal penalties.

Copyright © 1998-2018 Archwave Technologies B.V. All Rights Reserved.

Open Source Code

Master Fader uses the following open source code:

PA Passcode

Copyright (c) 2012, Denis Hennessy (Peer Assembly - <http://peerassembly.com>) All rights reserved.

Redistribution and use in source and binary forms, with or without modification, are permitted provided that the following conditions are met:

- * Redistributions of source code must retain the above copyright notice, this list of conditions and the following disclaimer.
- * Redistributions in binary form must reproduce the above copyright notice, this list of conditions and the following disclaimer in the documentation and/or other materials provided with the distribution.
- * Neither the name of Peer Assembly, Denis Hennessy nor the names of its contributors may be used to endorse or promote products derived from this software without specific prior written permission.

THIS SOFTWARE IS PROVIDED BY THE COPYRIGHT HOLDERS AND CONTRIBUTORS "AS IS" AND ANY EXPRESS OR IMPLIED WARRANTIES, INCLUDING, BUT NOT LIMITED TO, THE IMPLIED WARRANTIES OF MERCHANTABILITY AND FITNESS FOR A PARTICULAR PURPOSE ARE DISCLAIMED. IN NO EVENT SHALL PEER ASSEMBLY OR DENIS HENNESSY BE LIABLE FOR ANY DIRECT, INDIRECT, INCIDENTAL, SPECIAL, EXEMPLARY, OR CONSEQUENTIAL DAMAGES (INCLUDING, BUT NOT LIMITED TO, PROCUREMENT OF SUBSTITUTE GOODS OR SERVICES; LOSS OF USE, DATA, OR PROFITS; OR BUSINESS INTERRUPTION) HOWEVER CAUSED AND ON ANY THEORY OF LIABILITY, WHETHER IN CONTRACT, STRICT LIABILITY, OR TORT (INCLUDING NEGLIGENCE OR OTHERWISE) ARISING IN ANY WAY OUT OF THE USE OF THIS SOFTWARE, EVEN IF ADVISED OF THE POSSIBILITY OF SUCH DAMAGE.

Objective-Zip

Copyright (c) 2009-2012, Flying Dolphin Studio All rights reserved.

Redistribution and use in source and binary forms, with or without modification, are permitted provided that the following conditions are met:

- * Redistributions of source code must retain the above copyright notice, this list of conditions and the following disclaimer.
- * Redistributions in binary form must reproduce the above copyright notice, this list of conditions and the following disclaimer in the documentation and/or other materials provided with the distribution.
- * Neither the name of Flying Dolphin Studio nor the names of its contributors may be used to endorse or promote products derived from this software without specific prior written permission.

THIS SOFTWARE IS PROVIDED BY THE COPYRIGHT HOLDERS AND CONTRIBUTORS "AS IS" AND ANY EXPRESS OR IMPLIED WARRANTIES, INCLUDING, BUT NOT LIMITED TO, THE IMPLIED WARRANTIES OF MERCHANTABILITY AND FITNESS FOR A PARTICULAR PURPOSE ARE DISCLAIMED. IN NO EVENT SHALL THE COPYRIGHT HOLDER OR CONTRIBUTORS BE LIABLE FOR ANY DIRECT, INDIRECT, INCIDENTAL, SPECIAL, EXEMPLARY, OR CONSEQUENTIAL DAMAGES (INCLUDING, BUT NOT LIMITED TO, PROCUREMENT OF SUBSTITUTE GOODS OR SERVICES; LOSS OF USE, DATA, OR PROFITS; OR BUSINESS INTERRUPTION) HOWEVER CAUSED AND ON ANY THEORY OF LIABILITY, WHETHER IN CONTRACT, STRICT LIABILITY, OR TORT (INCLUDING NEGLIGENCE OR OTHERWISE) ARISING IN ANY WAY OUT OF THE USE OF THIS SOFTWARE, EVEN IF ADVISED OF THE POSSIBILITY OF SUCH DAMAGE.

PureLayout Statement and Notice

This code is distributed under the terms and conditions of the MIT license.

Copyright (c) 2014-2015 Tyler Fox

Permission is hereby granted, free of charge, to any person obtaining a copy of this software and associated documentation files (the "Software"), to deal in the Software without restriction, including without limitation the rights to use, copy, modify, merge, publish, distribute, sublicense, and/or sell copies of the Software, and to permit persons to whom the Software is furnished to do so, subject to the following conditions:

The above copyright notice and this permission notice shall be included in all copies or substantial portions of the Software.

THE SOFTWARE IS PROVIDED "AS IS", WITHOUT WARRANTY OF ANY KIND, EXPRESS OR IMPLIED, INCLUDING BUT NOT LIMITED TO THE WARRANTIES OF MERCHANTABILITY, FITNESS FOR A PARTICULAR PURPOSE AND NONINFRINGEMENT. IN NO EVENT SHALL THE AUTHORS OR COPYRIGHT HOLDERS BE LIABLE FOR ANY CLAIM, DAMAGES OR OTHER LIABILITY, WHETHER IN AN ACTION OF CONTRACT, TORT OR OTHERWISE, ARISING FROM, OUT OF OR IN CONNECTION WITH THE SOFTWARE OR THE USE OR OTHER DEALINGS IN THE SOFTWARE.



19820 North Creek Parkway #201, Bothell, WA 98011 • USA
Phone: 425.487.4333 • Toll-free: 800.898.3211
Fax: 425.487.4337 • www.mackie.com

 **MACKIE.**
SOUND LIKE YOU MEAN IT[®]