



Technical Manual

- [Table of Contents](#)
- [Safety Information](#)
- [Introduction](#)
- [Installation and Operation](#)
- [Calibration](#)
- [Maintenance](#)
- [Warnings/Faults](#)
- [Specifications](#)
- [Control Drawings](#)
- [HART® Protocol](#)
- [Warranty](#)
- [Index](#)

Table of Contents

Safety		2.1 Mounting and Location of Sensors	28
Warnings.....	5	2.1.1 Mounting the XNX® Universal Transmitter.....	28
Cautions.....	7	2.2 Wiring the XNX Transmitter.....	30
Notes	7	2.2.1 General Wiring Considerations	30
Information.....	8	2.2.2 Distance Considerations for Installation.....	31
1 Introduction		2.2.3 POD Connections	36
1.1 Product Description	10	2.2.4 4-20mA Output, Common Connections, and Power	
1.1.1 The XNX® Universal Transmitter	10	Settings	37
1.1.2 20 mA/HART® Output	11	2.2.5 Foundation Fieldbus Wiring.....	38
1.1.3 Communications	11	2.2.6 Terminal Block Connections.....	38
1.1.4 Certifications	11	2.2.7 EC Personality Wiring.....	39
1.1.5 Patents.....	12	XNX Electrochemical Sensor Installation.....	40
1.2 Product Overview	12	XNX EC Sensor Remote Mounting Kit.....	41
1.2.1 Enclosure.....	12	2.2.8 mV Personality Wiring.....	43
1.2.2 Cover	13	2.2.9 IR Personality Wiring	46
1.2.3 POD	14	Connecting a Searchpoint Optima Plus or Searchline	
1.3 Options	14	Excel	46
1.3.1 Local HART	14	Connecting Generic mA Devices	47
1.3.2 Relays.....	14	2.3 Options	51
1.3.3 Modbus	15	2.3.1 Local HART Interface.....	51
1.3.4 Foundation Fieldbus	15	2.3.2 Relays.....	53
1.3.5 XNX Accessories.....	15	2.3.3 Modbus	53
1.4 The XNX Front Panel.....	17	2.3.4 Foundation Fieldbus	54
1.4.1 Controls and Navigation	18	2.4 Powering the XNX for the First Time.....	55
1.4.2 The General Status Screen	19	2.4.1 XNX Units Configured for EC, mV, and IR	
1.5 Main Menu.....	22	(except Searchline Excel)	55
1.5.1 XNX Menu Map	23	2.4.2 LCD and LED Test	56
2 Installation and Operation		2.4.3 XNX IR Units Configured for Searchline Excel	56

Table of Contents

2.5 Configuring the XXN Universal Transmitter	57	Transmitter Status	84
Select Language	57	Sensor Data	85
Set Date & Time	58	Sensor Status	85
Set mV Sensor Type	59	Gas Data.....	85
Set mA Sensor Type	60	Range/Alarm Settings.....	85
Range & Alarms.....	67	mA Level Settings.....	86
Latching / Non-Latching.....	69	Fieldbus Settings.....	86
Set Units	70	Relay Data.....	86
mA Levels	70	Event History.....	87
Calibration Interval.....	71		
Accept New Sensor Type	72	3 Calibration	
Beam Block Options	72	3.1 Gas Calibration Menu	90
Path Length	74	3.2 Calibration	90
Unit ID	75	3.2.1 Zero and Span Calibration for XXN EC Sensors, mV	
Relay Options	76	Sensors, and Searchpoint Optima.....	91
Fieldbus Options	77	3.2.2 Calibration Procedure.....	91
Configure Security.....	78	3.2.3 Using the Calibration Cup.....	93
2.6 Verifying the XXN Configuration	79	3.2.4 Zero and Span Calibration of XXN EC Hydrogen	
2.6.1 Test Menu	79	Sulfide (H ₂ S) Sensors.....	94
Inhibit	79	3.2.5 705/705HT Calibrating.....	94
Force mA Output	80	3.2.6 Sensepoint/Sensepoint HT Calibrating.....	94
Force Relays	81	3.2.7 Calibrating the Searchpoint Optima Plus.....	94
Alarm/Fault Simulation	81	3.2.8 Zero and Span Calibration for MPD Sensors	97
2.6.2 Information Menu.....	83	3.2.9 MPD Flammable Sensor Operational Life	98
Alarm/Fault Status	83	3.2.10 XXN EC Sensor Operational Life.....	98
Date & Time.....	83	3.3 Functional Gas Testing (Bump Testing)	99
Transmitter Data.....	83	3.4 Calibrate mA Output	100
		3.5 Align Excel (Searchline Excel)	100
		3.6 Soft Reset	101

Table of Contents

<p>4 Maintenance</p> <p> 4.1 MPD Sensor Cartridge Replacement 104</p> <p> 4.2 XNX® EC Sensor Cartridge Replacement 105</p> <p> 4.2.1 Replacing with the Same Cartridge Type..... 105</p> <p> 4.2.2 Replacing with a Different Cartridge Type..... 106</p> <p>5 Warnings and Faults</p> <p> 5.1 Warning Messages 108</p> <p> 5.2 Fault Messages 113</p> <p> 5.3 Informational Messages 124</p> <p>6 Specifications</p> <p> 6.1 Product Specifications 128</p> <p> 6.2 Sensor Data..... 130</p> <p> 6.2.1 Operating and Storage Conditions for Performance Tested EC Cartridges 130</p> <p> 6.2.2 EC Sensor Performance Data, Factory Mutual Verified (see Section 6.3)..... 131</p> <p> 6.2.3 EC Sensor Performance Data, DEKRA EXAM verified (see Section 6.3)..... 132</p> <p> 6.2.4 Other EC Sensors..... 133</p> <p> 6.2.5 XNX EC Sensor Cross-sensitivity 135</p> <p> 6.2.6 XNX MPD Sensor Performance Data 142</p> <p> 6.2.7 EN60079-29-1 Performance Approved Gases for mV Sensor Types 143</p> <p> 6.2.8 Other Sensor Performance Data 143</p> <p> 6.3 XNX Certifications by Part Number Series 144</p> <p> 6.3.1 Certification Labels 148</p> <p> 6.4 Product Identification 151</p> <p> 6.4.1 XNX Universal Transmitter 151</p>	<p> 6.4.2 XNX EC Replacement Sensors 152</p> <p> 6.4.3 XNX EC Replacement Cells 153</p> <p> 6.4.4 Multi Purpose Detector (MPD)..... 154</p> <p> 6.4.5 XNX Catalytic Bead and IR Replacement Sensor Cartridges 154</p> <p> 6.4.6 Accessories/Spares 155</p> <p>7 Control Drawings</p> <p> 7.1 XNX UL/INMETRO 159</p> <p> 7.2 XNX UL/CSA/FM 162</p> <p> 7.3 Remote Sensor Mount 164</p> <p>Appendix A - HART® Protocol</p> <p> A.1 HART® Interface 168</p> <p> ATEX Conditions for Safe Use of Intrinsically Safe HART Handheld Devices 168</p> <p> A.1.1 HART Sink, Source, and Isolated Wiring..... 169</p> <p> A.1.2 DevComm PC-based HART Interface 172</p> <p> Overview 172</p> <p> Functions 173</p> <p> A.1.3 Handheld Online Menu..... 176</p> <p>Appendix B - Modbus® Protocol</p> <p> B.1 Modbus and the XNX transmitter 183</p> <p> B.2 Modbus Registers 185</p> <p>Appendix C - Warranty</p> <p> Warranty Statement..... 191</p> <p>Index..... 192</p>
---	--

Safety

Read and understand this manual before installing, operating, or maintaining the XNX Transmitter. Pay particular attention to the warnings and cautions below. All of the warnings and cautions shown here are repeated in the appropriate sections of the manual.



Warnings: Identify hazardous or unsafe practices which could result in severe injury or death.

Warnings

- Installation must be in accordance with the recognized standards of the appropriate authority in the country concerned.
 - Access to the interior of the sensor, when carrying out any work, must only be conducted by trained personnel.
 - Before carrying out any work ensure local regulations and site procedures are followed. Appropriate standards must be followed to maintain the overall certification of the sensor.
 - To reduce risk of ignition of hazardous atmospheres, conduit runs must have a seal fitting connected within 18 inches (45 cm) of the enclosure.
 - To reduce the risk of ignition of hazardous atmosphere, disconnect the equipment from the supply circuit before opening the sensor enclosure. Keep assembly tightly closed during operation.
 - Never open the XNX enclosure under power unless the area is known to be non hazardous.
- The sensor must be earthed/grounded for Intrinsic Safety, electrical safety and to limit the effects of radio frequency interference. Earth/ground points are provided inside and outside the unit. EMI note for applications using shielded cable: Cable shield terminations must be made at the cable glands with suitable EMI type glands. Avoid terminating cable shields at the Earth ground lug inside the XNX enclosure. In cases where wiring is in pipe, a shielded cable is not required. The external terminal is only a supplemental bonding connection where local authorities permit or require such a connection.
 - Take care when handling EC sensor cells as they may contain corrosive solutions.
 - Do not tamper or in any way disassemble the sensor cells.
 - Do not expose to temperatures outside the recommended range.
 - Do not expose the sensor to organic solvents or flammable liquids.
 - At the end of their working lives, sensors must be disposed of in an environmentally safe manner, in accordance with local waste management requirements and environmental legislation. Do NOT incinerate sensors as they may emit toxic fumes.
 - High off-scale readings may indicate an explosive concentration of gas.
 - Verify all outputs, including display, after installation, after service events, and periodically to ensure the safety and integrity of the system.
 - Do not use the XNX Universal Transmitter in oxygen-enriched atmospheres. Concentrations displayed will be adversely affected by oxygen depletion.
 - After changing parameters with a handheld device, verify that the parameter settings are correct at the transmitter.
 - The factory-set passcodes must be reset to prevent unauthorized access to the transmitter's menus.

- When the transmitter is equipped with the optional Remote Mount Kit, the remote sensor must be securely mounted in a fixed position. The Remote Sensor kit is not intended to be used as a hand-held sensor.
- Enclosures of remotely mounted sensors contain aluminum. Be careful to avoid ignition hazards due to impact or friction when installed in Zone 1 locations.
- Install the junction box according to local codes and manufacturer's requirements.
- The enclosures of remotely mounted 705HT sensors contain aluminum. Be careful to avoid ignition hazards due to impact or friction when installed in Zone 1 locations.
- Power off the transmitter before changing S3 or S4. Both switches must be set in either Source or Sink prior to applying power.
- Minimum and maximum controller alarm levels should not be set at less than 10% or greater than 90% of the full scale range of the sensor. Limits are 60% LEL or 0.6mg/m³ for agency performance certification.
- When configuring or communicating with the transmitter using the front panel displays, resume monitoring by exiting all menus and returning to the General Status menu manually. No time outs are invoked.
- When selecting a new target gas for units with a Searchpoint Optima Plus, the sensor must be recalibrated.
- XNX Universal Transmitters carrying UL/CSA/FM approvals that are configured for devices measuring %LEL will not allow adjustments to the full scale value. The range is fixed at 100%.
- There is a potential loss of sensitivity during exposure to high concentrations of H₂S. Under these conditions, set the control unit to latch at overrange. In standalone configuration, set alarms to latching. When resetting the overrange or alarm, verify correct operation of the transmitter.
- Keep the passwords in a secure area to prevent unauthorized access to the transmitter. If the passwords are lost, resetting the XNX transmitter will require a service technician.
- When the XNX transmitter is placed in Inhibit Mode, alarms are silenced. This will prevent an actual gas event from being reported. Inhibit Mode must be limited to testing and maintenance only. Exit Inhibit Mode after testing or maintenance activities.
- Honeywell recommends periodic bump tests (every 30 days or in accordance with customer site procedures) to the sensor to insure proper operation and compliance with the functional safety rating of the installation.
- As some test gases are hazardous, exhaust the flow housing outlet to a safe area. Do not use the XNX Universal Transmitter in oxygen-enriched atmospheres. (In oxygen-enriched atmospheres, the electrical safety is not given.)
- Exposure to desensitizing or contaminating substances or concentrations causing operation of any alarm may affect sensor sensitivity. Following such events, it is recommended to verify sensor performance by performing a functional gas test (bump test).
- When servicing or replacing sensors, reduce the risk of ignition of hazardous atmosphere by declassifying the area or disconnecting the equipment from the supply circuit before opening the sensor enclosure. Keep the assembly tightly closed during operation.
- Take appropriate precautions when using toxic, flammable, and pressurized cylinders.
- Delays resulting from transmission errors between sensor and transmitter extend response times T₉₀ by more than one-third. The period until fault indication is 10 seconds.
- The HART interface is subject of this EC-type examination certificate only for the purpose of configuration and maintenance.

- The options “Modbus interface” and “Foundation Fieldbus interface” are not subject of this EC-type examination certificate.
- Long-term exposure (> 20 minutes) to concentrations exceeding the fullscale range of the H2S sensor type 2 can cause it to lose sensitivity. The measured value may decrease even though high levels of toxic gas are still present. If such conditions can occur, set the control unit to latch at overrange. In standalone operation, set alarms to latching. When resetting the overrange or alarm, verify correct operation of the transmitter.

Hazardous Location Installation Requirements (UL/CSA)

- To reduce risk of ignition of hazardous atmospheres, conduit runs must have a pour gland installed within 18 inches (457mm) of enclosure.
- All ¾ inch NPT conduit, stopping plugs and adapters must be installed with 5¼ threads (minimum) engaged to maintain Explosion Proof rating.
- Stopping Plugs supplied (Honeywell Part Number 1226-0258) are approved for use ONLY with the XNX Universal Transmitter.
- For units fitted with the Optional Relay Module: Relay Contact Ratings are 250 VAC 5A, 24 VDC 5A Resistive Loads Only.
- Terminal block screws should be tightened to 4.5 lb/in (max).
- Reference XNX Control Drawing 1226E0402 or 1226E0454 for additional information regarding IS function (Local HART and EC Personality).

Hazardous Location Installation Requirements (ATEX)

- Read and understand this manual prior to installation and use.
- Use only certified M25 cable glands for installation.
- Shielded armored cable is required for CE compliance.

Special Conditions for Safe Use

- The following applies to the HART Barrier intrinsically safe circuits: For installations in which both the Ci and Li of the intrinsically safe apparatus exceeds 1% of the Co and Lo parameters of the associated apparatus (excluding the cable), then 50% of Co and Lo parameters are applicable and shall not be exceeded, i.e. the Ci of the device plus the C of the cable must be less than or equal to 50% of the Co of the associated apparatus, and the Li of the device plus the L of the cable must be less than or equal to 50% of the Lo of the associated apparatus.
- For circuits connected to the EC barrier in which the capacitance and inductance exceed 1% of the permitted values, then the maximum permitted capacitance is limited to 600nF for group IIC and 1uF for group IIIC.
- The connection to the HART circuit shall be rated a minimum of IP 6X.

Cautions



Cautions: Identify hazardous or unsafe practices which could result in damage to property or to the product.

Notes



Notes: Additional useful information.

Information

Honeywell Analytics assumes no responsibility for equipment that is not installed and used following the procedures in the Technical Manual.

The reader of this manual should ensure that the appropriate equipment has been installed. If in doubt, contact Honeywell Analytics.

Every effort has been made to ensure the accuracy of our documents, however, Honeywell Analytics can assume no responsibility for any errors or omissions in its documents or their consequences. Honeywell Analytics greatly appreciates being informed of any errors or omissions that may be found in the contents of any of its documents. For information not covered in this document, or if there is a requirement to send comments/corrections about this document, please contact Honeywell Analytics using the contact details given on the back cover of this document.

Honeywell Analytics reserves the right to change or revise the information supplied in this document without notice and without obligation to notify any person or organization of such revision or change. If information is required that does not appear in this document, contact the local distributor/agent or Honeywell Analytics.

XNX® is a registered trademark of Honeywell International.

HART® is a registered trademark of the HART Communication Foundation.

Modbus® is a registered trademark of Schneider Automation Inc.

FOUNDATION™ is a trademark of Fieldbus Foundation.

1 Introduction

1.1 Product Description

1.1.1 The XNX® Universal Transmitter

The XNX Universal Transmitter is a comprehensive gas detection system designed to operate in hazardous locations¹ and utilize multiple sensor technologies, catalytic bead, electrochemical (EC), or infrared (IR) to detect toxic gases, flammable gases, and oxygen depletion gas hazards. Each technology has a dedicated personality board.

Catalytic bead technology is used with the XNX mV personality board. Catalytic bead sensors respond to a wide variety of combustibles so are typically used for flammable gas detection.

Electrochemical technology is used with the XNX electrochemical board. EC sensors measure toxic gases in low concentrations. The XNX EC sensors employ the patented Reflex™ cell fault diagnosis routine. Reflex™ checks for cell presence, cell dry-out, and cell open or short circuit. Reflex™ is automatically initiated by the transmitter at eight-hour intervals. It is also initiated on power up or sensor exchange. In the event of a cell failing this test, a sensor fault code is displayed. Reflex™ diagnostics occur in the first minutes of the power up sequence.

Infrared technology is used with the XNX IR board. IR sensors optically absorb gases that fall into the infrared spectrum.

For additional information about any of the three sensor types, refer to the applicable data sheet for the supported sensor in Figure 1.

The XNX Universal Transmitter also allows for an optional

¹There are three main types of gas hazards: flammable, toxic, and asphyxiant. A flammable gas hazard is one in which there is a risk of fire and/or explosion (e.g., a situation in which a gas such as methane, butane, or propane is present). A toxic gas hazard is one in which there is a risk of poisoning (e.g., a gas such as carbon monoxide, hydrogen sulfide, or chlorine is present). An asphyxiant hazard would include a risk of suffocation through oxygen deficiency. (Oxygen can be consumed or displaced by another gas.)

communication board. There are three types of boards: relay, Modbus®, or Foundation™ Fieldbus. See [Section 1.1.2 Communications](#) for additional information.

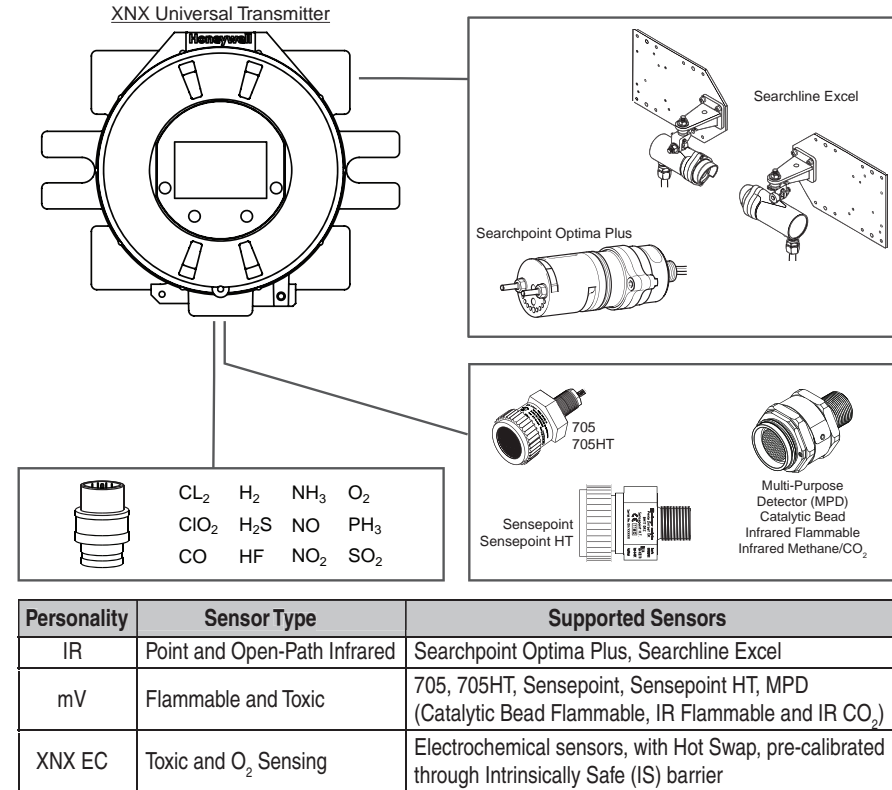

Figure 1. XNX Universal Transmitter and supported sensing technologies

The XNX Universal Transmitter relies on 4-20mA output, refreshed at least every two seconds (once per second is typical), in which the output is proportional to the gas concentration.

1.1.2 20 mA/HART® Output

All XNX Transmitters provide a 20mA Current Loop with HART Digital Communication which can be user configured for Sink, Source (3-Wire) or Isolated (4-Wire) electrical interface based on installation requirements.

The 20mA current loop output provides an analog indication of special states, a proportional output to gas concentration and over range indication per the table below. In the event of a simultaneous alarm and fault, an alarm condition will always override a warning state.

Output	Description*	Notes
1.0 mA	Fault	Special State Indication
2.0 mA	Warm-up Inhibit Bump Test Calibration	
3.0 mA	Warning	
4-20 mA	Gas Concentration	
21 mA	Over Range	

*Alarm conditions always take priority over faults and warnings.

HART Protocol provides digital communications with the XNX from a remote control system for Configuration, Status and Diagnostics. (See Appendix A HART Protocol for additional information)

1.1.3 Communications

The XNX Universal Transmitter is registered with the HART Communication Foundation.



The transmitter uses HART over 4-20mA as the standard communications protocol. Additional optional communication interfaces are available: relay communication, Modbus, or Foundation Fieldbus. Each communication option has a dedicated option board. For additional information, refer to [Section 1.3 Options](#).

1.1.4 Certifications

XNX-UT**_***** Versions are UL classified and CSA listed for installation in Class I, Division 1, Groups A, B, C and D Hazardous Locations. FM Approvals evaluation includes Class I, Zone 1, Groups B, C, D, as well as performance tests for specific sensor/transmitter combinations. CSA/FM certification does not cover daisy-chained XNX combustible gas transmitters, the use of HART, Modbus, or Foundation Fieldbus protocols for combustible gas performance. HART, Modbus, or Foundation Fieldbus protocols can be used only for data collection or record keeping with regards to combustible gas. The EC cartridge² and EC remote mount kit are UL classified to Canadian and US standards.

XNX-AM **_***** versions are certified to comply with the European Community ATEX Directive and the prescribed protection methods for installation in Potentially Explosive Atmospheres.

XNX-BT**_***** and XNX-UT**_***** versions are UL classified and INMETRO approved (TÜV Rheinland) for compliance with both U.S. and Brazilian standards.

See [Section 6.2](#) for additional information on applicable approvals by part number and [Section 6.2.1](#) for marking.

²“Cartridge” and “sensor” are used interchangeably in this document.

1.1.5 Patents

This table shows details about XNX-related patents.

Patents Applicable to the XNX Universal Transmitter		
Patent Number	Description	Application
6,123,818	Reflex patent	Implemented in XNX
6,251,232	Reflex patent	Implemented in XNX
6,351,982	Flammable sensor housing	XNX accepts this sensor
6,395,230	Pellistor	Sensor used in XNX
7,225,661	Gas calibration adapter	Applicable to XNX
7,716,962	Method of gas calibration	Used to calibrate XNX ECC cartridges

1.2 Product Overview

The XNX transmitter is comprised of the main parts shown below.

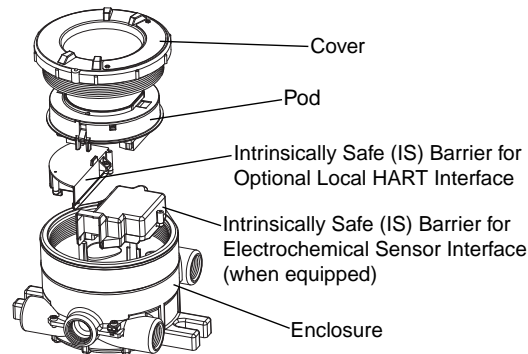

Figure 2. XNX Exploded View

A complete description of XNX accessories can be found in publication 1998-0807 XNX Universal Transmitter Parts List.

1.2.1 Enclosure

Available in either Stainless Steel or Aluminum, with 3/4" NPT (UL/CSA or UL/ INMETRO) or M25 (ATEX/IECEX only) threaded cable/conduit ports, the XNX Universal Transmitter enclosure is explosion-proof and suitable for use in -40°F to +149°F (-40°C to +65°C) operating conditions. A 5-coat marine finishing process provides the highest degree of corrosion protection. For more information on performance specifications, see [Section 6 - Specifications](#).

The XNX enclosure is equipped with five threaded cable/conduit ports providing functional and flexible configurations based on sensor and option choices. See [Figure 5](#) for cable/conduit port assignments and restrictions.

Stopping plugs (HA PN# 1226-0257 or 1226-0258) have been provided to seal unused cable/conduit ports and have been Agency evaluated/approved for use with the XNX enclosure only. The number of stopping plugs varies among available configurations.



Caution: The stopping plugs are for use only with the XNX Transmitter and should not be used with any other device.

Mounting lugs integral to the XNX enclosure allow easy installation on a flat surface or 2"-6" (50-150mm) diameter pipe with the optional Pipe Mount Kit or Ceiling Mount Bracket Kit.

1.2.2 Cover

The transmitter cover is supplied in the identical material specified for the enclosure.

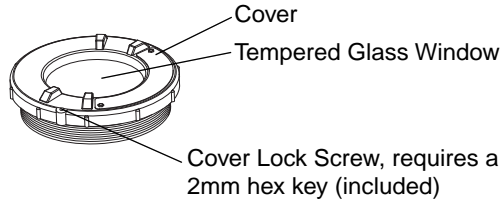

Figure 3. XNX components

A tempered glass window requires the use of the supplied magnetic wand/screwdriver to activate the four user interface switches that are located on the front of the display module. This allows for non-intrusive setup and operation.

A locking screw integrated into the cover provides positive locking that can be removed by using the supplied 2mm hex key³.

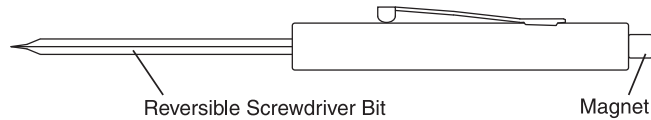
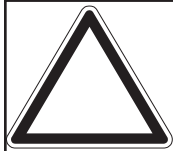
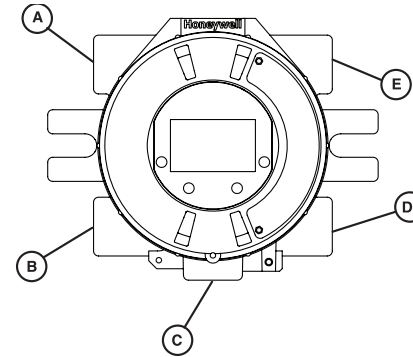

Figure 4. Magnetic Wand/Screwdriver



Note: When attaching the cover or stopping plugs, coat the threads to prevent corrosion.

³See the *XNX Universal Transmitter Parts List* (document 1998-0807) for a description of all of the parts that are shipped with the transmitter.



While relay wiring can use any available cable/conduit port in the XNX enclosure, do not use the same cable/conduit port for both relay reset and relay signal lines to avoid electrical noise.

*Limited access due to IS barrier if equipped with electrochemical cell.

Option	Position
Local HART Option	B
XNX Electrochemical Sensor - Local/Remote	C
MPD, 705 Series, Sensepoint Series	C
Searchpoint Optima Plus	A or E
Searchline Excel	Typically C
Remote Sensor Connection (except EC)	Any remaining
Searchpoint Optima Plus - Remote	Any remaining
Modbus	Any remaining
Relays	Any remaining
Power	Any remaining

Figure 5. XNX Universal Transmitter Cable/Conduit Port Assignments

1.2.3 POD

The POD (Personality, Options, and Display) encloses circuit boards for the personality module, optional interfaces, and display.

The personality module, or circuit board, determines the transmitter behavior based on the sensor type attached to the transmitter (electrochemical cell, catalytic bead sensor, or infrared) and provides the necessary interface. Connection to the attached sensor is made through the sensor connector accessed via a slot in the POD housing.

The optional communication boards vary depending on the option selected when ordered. Only one of the three available interface options (relays, Modbus, or Foundation Fieldbus) can be attached to the XNX transmitter.

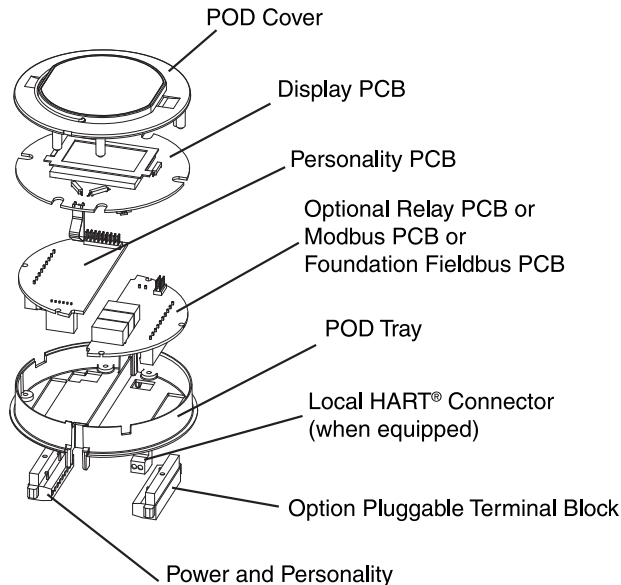

Figure 6. POD, exploded View

1.3 Options

1.3.1 Local HART

Available with any sensor technology or personality, an external access to the HART interface in the XNX transmitter is provided. An intrinsically safe (IS) barrier inside the transmitter gives the user full control using a hand-held interrogator for programming and configuration. The external interface is installed in the lower left cable/conduit port of the transmitter and is intrinsically safe. For more information, see [Appendix A - HART Protocol](#).

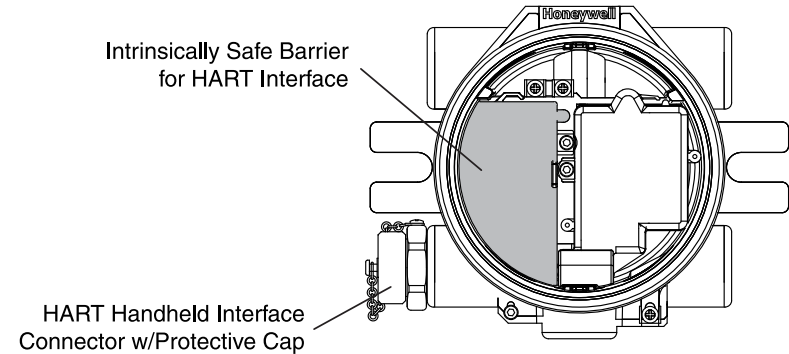

Figure 7. XNX Universal Transmitter with HART Interface IS Barrier

1.3.2 Relays

The relay option (XNX-Relay) provides 3 form “C” (SPDT) normally open/normally closed (NO/NC) contacts for alarm and fault indication. A remote reset input is provided (TB4). Momentarily closing the the circuit between the pins of TB4 performs the same function as the Reset Alarms & Faults command.

The XNX transmitter has three relays: relay 1 is for alarm level 1, relay 2 is for alarm level 2, and relay 3 is for faults and special

states. Two alarm levels can be set, allowing, for example, a level 1 alarm for the immediate area when a certain gas concentration is detected and a plant-wide level 2 alarm when a greater gas concentration is detected.

The maximum refresh rate of the relays is 2 seconds. See [Set Alarm Values](#) for more information.

1.3.3 Modbus

The optional Modbus interface allows the XNX to connect to a bus of devices and transmit data to PLCs or controllers. (For more information, see the Modbus Protocol Manual). Connections to the XNX are made through a pluggable terminal block on the Modbus interface circuit board. Modbus RTU protocol uses ASCII/Hex protocols for communication.



Note: POD options are either relay, Modbus, or Foundation Fieldbus.

1.3.4 Foundation Fieldbus

Foundation Fieldbus is a digital communication system which supports several types of messages. Unlike many traditional systems which require a set of wires for each device, multiple Foundation Fieldbus devices can be connected with a single set of wires. Foundation Fieldbus overcomes some of the disadvantages of proprietary networks by providing a standardized network for connecting systems and devices.

1.3.5 XNX Accessories

Pipe Mount Kit

The Pipe Mount kit (1226A0358) allows the XNX to be mounted to pipe from 2"-6" (50-150mm) in diameter. The kit includes the pipe mount bracket, two carriage bolts, nuts, and lock washers.

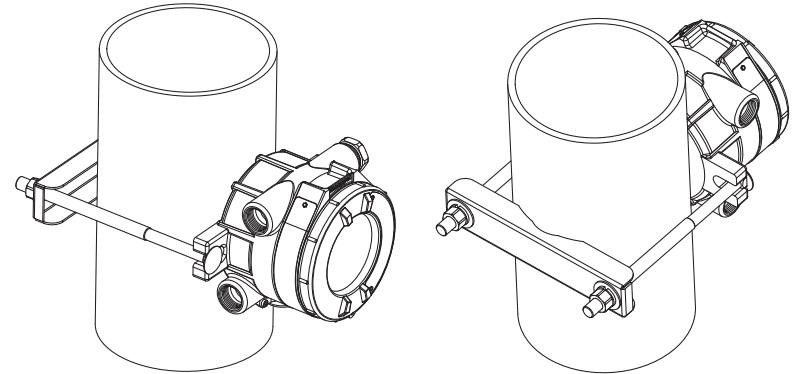
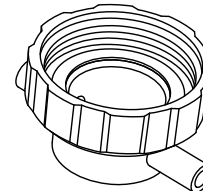

Figure 8. Pipe-mounted XNX Transmitters

Calibration Gas Flow Adapter

The calibration gas flow adapter is used to apply calibration test gas to the sensor. It attaches to the bottom of the sensor and can be fitted without removing the weatherproof cover. See [Section 3 - Calibration](#) for further details on gas calibration.



Sensor	Flow Adapter P/N
XNX EC	S3KCAL
MPD	1226A0411
Sensepoint	02000-A-1645
705	00780-A-0035

Weatherproof Cap

The weatherproof cap protects XNX sensors from harsh weather.

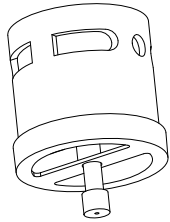

Sensor	Weatherproof Cap P/N
XNX EC	Included
MPD	02000A1640
Sensepoint	02000-A-1640
705	00780-A-2076
MPD-*TCB1	SPXCDWP (included)

Remote Sensor Mounting Kit for XNX EC Sensors

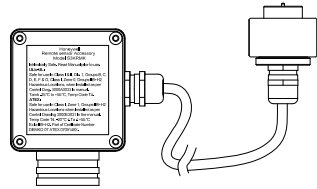

The remote sensor mounting kit (S3KRMK) allows XNX EC sensors to be remotely mounted via an IS cable kit, up to 50 feet (15 meters) from the transmitter. The kit includes 50 feet of shielded cable, cable glands, and remote terminal box. The cable can be cut to the required length then terminated at the remote terminal box.

Collecting Cone

The collecting cone improves detection of lighter-than-air gases such as hydrogen and methane.

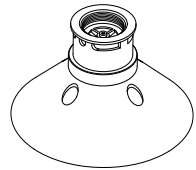

Sensor	Collecting Cone P/N
XNX EC	S3KCC
MPD	02000-A-1642
Sensepoint	02000-A-1642
705	02000-A-1642

Ceiling Mount Bracket Kit

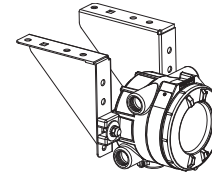

The optional Ceiling Mount Bracket Kit (1226A0355) allows the XNX Transmitter to be mounted to the ceiling. The kit includes two stainless steel ceiling mount brackets, bolts, and nuts.

Remote Gassing Kit

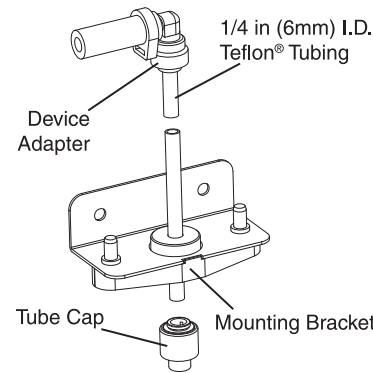

The Remote Gassing Kit (1226A0354) enables gas to be applied remotely for performing functional response checks (bump tests). The kit includes: 50' Teflon® tubing, a mounting bracket, a tube cap, and device adapters in 1/4" and 1/8" (6.3 mm and 3.2 mm) ID to attach to bump test ports on the weatherproof cap of the device.

Duct Mount Kit

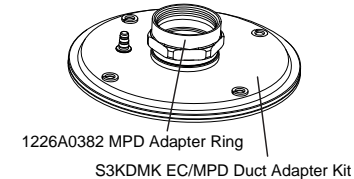

The duct mounting kit (S3KDMK) can be used with the EC sensor to allow detection of O₂, CO, H₂ and H₂S gases in ducts. When combined with the MPD Interface Adapter (1226A0382), the duct mounting kit can accommodate the MPD to detect flammable gases in a duct application. The duct mount kit includes the adapter, gasket and required fasteners. The MPD Interface Adapter includes only the adapter and requires the S3KDMK duct mount kit.

Weather Protector

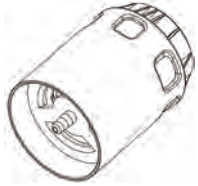

The Extreme Weather Protector (SPXCDWP) is designed to protect the sensor from environmental conditions in outdoor exposure applications.

1.4 The XNX Front Panel

The XNX Transmitter uses magnetic switches to enable non-intrusive operation. To activate a magnetic switch, hold the magnetic end of the screwdriver up to the glass window and slowly swipe the magnet directly over the shaded area.

For best results, hold the screwdriver as illustrated in Figure 9.

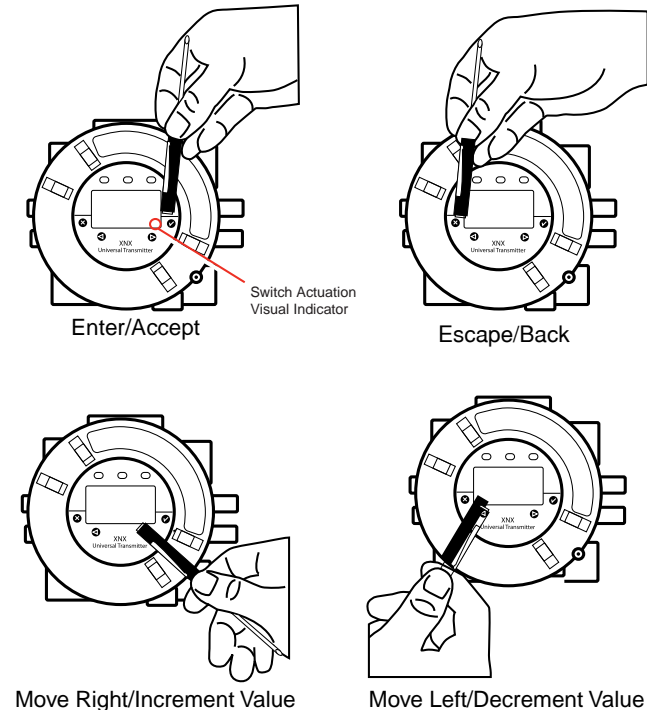

Figure 9. Using the magnetic wand

A decal illustrating the proper method for actuating the magnetic switches is placed on the POD of each transmitter.

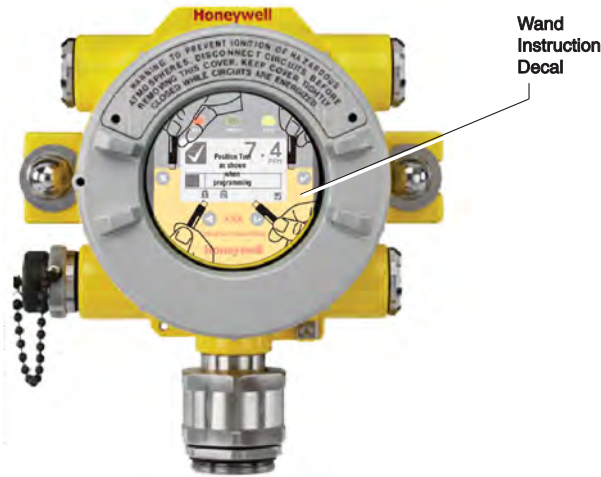

Figure 10. Operation decal

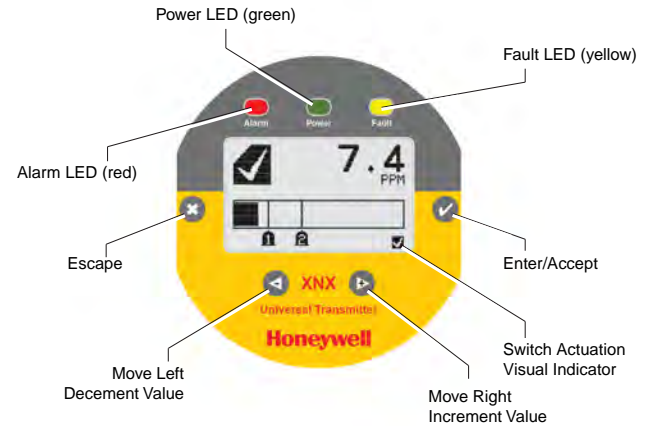

Figure 11. Front panel display of the XNX transmitter

The switch is actuated by the flux lines between the poles of the magnet. This actuation method provides the most consistent response.

A visual indication of the switch actuation will appear in the lower right corner of the XNX display each time the switch is activated.

In some menus where displayed values can be changed, the magnet must be swiped over the switch to cause the numeral on the display to advance through the available values. Use the switch to return to a previous menu or field.

For the purposes of this manual, the instruction to use , , or , means to activate the relevant magnetic switch as described above.

1.4.1 Controls and Navigation

Command	Description
Enter/Accept	The Enter/Accept switch is used to access menus, accept changes and to answer “yes” to system prompts.
Escape/Back	The Escape/Back switch is used to return to previous menus or to answer “no” to system prompts.
Move Left/Decrement Value	The Left/Decrement arrow is used to move through menu options or decrement values when entering text or numbers.
Move Right/Increment Value	The Right/Increment arrow is used to move through menu options or increment values when entering text or numbers.

1.4.2 The General Status Screen

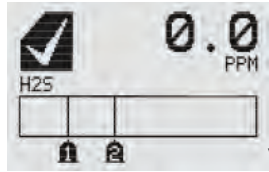

Figure 12. General Status screen⁴

The General Status Screen shows the status of the XNX Transmitter.

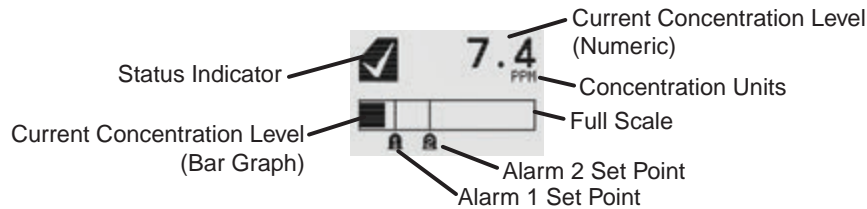

Figure 13. General Status screen, normal operating mode

The Normal Operating Mode icon indicates proper operation. The XNX display also shows the concentration level of the target gas in two ways. In the first, a numeric value is shown in the upper right corner of the display in the units selected (ppm, %LEL, %VOL). The second concentration display is shown in the form of a bar graph representing the current concentration against full scale and in relation to the defined alarm levels. For more information on setting range and alarm levels, see [Section 2.6.2 Range/Alarm Settings](#). See [Section 6.2.2](#), [Section 6.2.3](#), and [Section 6.2.4](#) for negative drift and zero deviation values.

⁴The LCD screen's refresh rates are 500 milliseconds (when the LCD heater is off) and 1 second (when the heater is on).

When a warning is triggered, the warning icon appears and information is displayed on the General Status Screen. The information displayed alternates between screens displaying the gas concentration and the warning code. See [Section 5 - Warnings/Faults](#) for more warning code information.

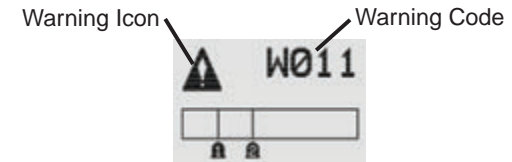

Figure 14. General Status Warning detail

If the Fault icon is displayed, a fault condition has been triggered and the display will alternate between the target gas concentration and the fault code. See [Section 5 - Warnings/Faults](#) for more fault code information.



Figure 15. General Status Fault detail

In the event of multiple warnings or faults, the user can view all messages with the transmitter's [Event History](#) function. When an Alarm icon is displayed, the target gas concentration exceeds one or both preset alarm levels. The General Status Screen displays the gas concentration and the alarm level exceeded.

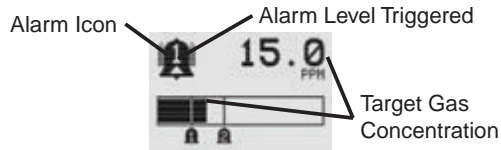

Figure 16. General Status Alarm detail

In an over range condition, the alarm icon will display and the target gas concentration bar graph and alarm setpoints will flash.

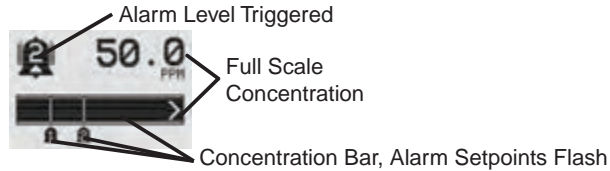

Figure 17. General Status Over Range detail

Negative values are not displayed and do not appear on the 4-20 mA output, but they are indicated by faults or warnings when preset thresholds are exceeded. (See zero deviation in [Section 6.1.1](#))

In addition to the graphic alarm, fault, and warning indicators, the LEDs on the front panel flash in these patterns based on the condition:

Condition	LED ¹		
	Red	Green	Yellow
Alarm 1	Solid		
Alarm 2	Flashing		
Warning			Solid
Fault			Flashing ²
Health		Flashing	

¹The refresh rate of the LEDs is 0.5 second.

²Special states (Warmup, Inhibit) are not indicated by the Fault LED.

1.4.3 Entering the Menu Structure

Swiping the magnet over the magnetic switch or allows the user to reset faults or alarms, display current settings, or make adjustments to the device.



Note: If the Easy Reset option is set to Lock, alarms and faults cannot be reset without logging in or entering a passcode. For more information, see [Section 2.5.1 Configure Security](#).

Swiping the or “escape” magnetic switch activates the Alarm Re-set screen and allows alarms to be silenced and faults to be reset.

The switch resets all alarms and faults and returns to the General Status Screen. Use the switch to return to the General Status Screen without resetting the alarms and faults.



Figure 18. Alarm Reset screen

Two authorization levels control access based upon the security level of the user: Level 1 (routine maintenance) and Level 2 (technician and password administrator). The default passcodes for both levels are “0000” and must be reset after installation to control access (see [Section 2.5.1 Configure Security](#)). In general, access to neither security level restricts the user to viewing the transmitter’s display. If desired, the [Easy Reset from Main Status](#) option allows alarm and fault resets without requiring access to either security level.



Figure 19. Passcode screen

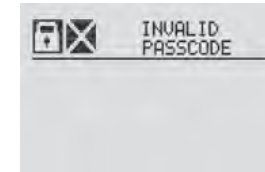

Figure 21. Invalid Passcode screen



Warning: The factory-set passcodes must be reset to prevent unauthorized access to the transmitter's menus.

When the Passcode Screen is displayed, the first passcode digit is highlighted. Use the $\triangleleft \triangleright$ switches to increment or decrement through the values. Once the correct value is displayed for the first digit, \checkmark accepts the value and moves to the next digit or \otimes moves to the previous digit of the passcode.

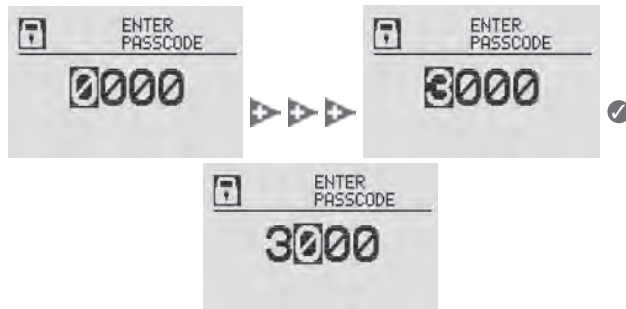

Figure 20. Entering the passcode

Repeat for each of the remaining digits in the passcode. If the passcode is not entered correctly, the Invalid Passcode screen is displayed and the user is returned to the General Status screen.

1.4.4 Displaying Transmitter Information

While in the General Status display, swipe the magnet over the magnetic switch \triangleright to display information about the transmitter. The General Status display will replace the bar graph in the lower portion of the screen with the unit's serial number, the date and time, and the unit's part number.

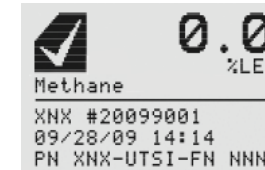

Figure 22. General Status Screen with Unit Information

1.5 Main Menu

Once the proper passcode has been entered, the transmitter displays the Main Menu.

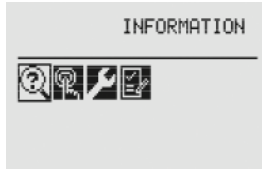





Figure 23. The Main Menu

From the Main Menu, a Level 1 user can:

- display the current settings/configuration
- test the transmitter
- calibrate and bump test the transmitter
- configure the unit for language, date and time

The Main Menu consists of these options:

Menu	Description	See Section...
 Configure	Provides access to settings to configure the transmitter and connected devices	2.5.1
 Test	Provides access to tools and settings to allow simulation of gas events to test the system	2.6.1
 Information	Displays current settings for the XNX transmitter including optional relays and Modbus	2.6.2
 Gas Calibration	Displays the XNX interface to calibrate sensors attached directly to the transmitter	3.1

1.5.1 XNX Menu Map

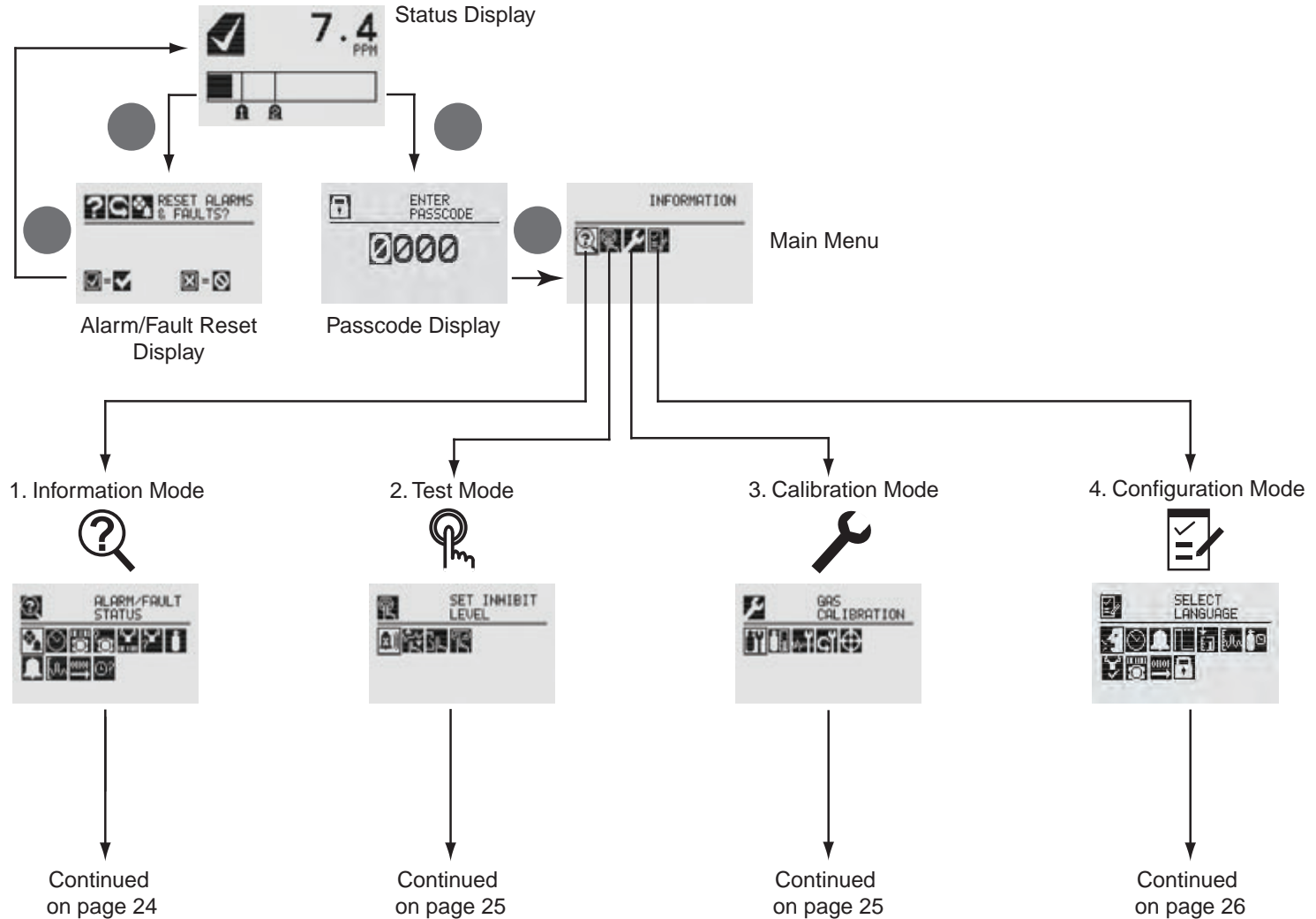



- Information Mode
 - Alarm/Fault Status
 - Alarm/Fault
 - Confirm Alarm/Fault Reset
 - Reset Alarm/Fault
 - Date & Time
 - Transmitter ID, Serial #, Revision
 - Transmitter Data
 - Transmitter Status
 - Transmitter Status
 - Sensor Type, Serial #, Revision
 - Sensor Data
 - Sensor Status
 - Sensor Status
 - Gas Name, ID, Range
 - Gas Data
 - Range Settings, Alarm Settings
 - Range/Alarm Settings
 - mA Level Settings
 - mA Level Settings
 - Relay Settings⁵
 - Relay Settings

Fieldbus Settings⁶

- Fieldbus Settings
- Event History
 - Increment Next/Previous Event
 - Increment Next/Previous Hour
 - Increment Next/Previous Day
 - Increment Next/Previous Alarm
 - Increment Next Previous Fault

⁵ Optional relay only

⁶ Optional Foundation Fieldbus and Modbus only



- Test Mode
 - Inhibit
 - Enable/Disable Inhibit
 - Force mA Output
 - Select Current: 0 to 22 mA
 - Accept
 - Force Relay⁷
 - Select Relay 1
 - Select Relay 2
 - Select Relay 3
 - Accept
 - Alarm/Fault Simulation
 - Alarm 1 Simulation
 - Alarm 2 Simulation
 - Warning Simulation
 - Fault Simulation



- Calibration Mode
 - Gas Calibration
 - Enter Span Gas Concentration (Oxygen)
 - Enter Span Gas Concentration (Not Oxygen)
 - Bump Test
 - mA Output Calibration
 - Adjust 4 mA Output
 - Adjust 20 mA Output
 - Soft Reset⁸
 - Align Excel⁹

⁷ Optional relay only

⁸ Searchpoint Optima and Searchline Excel only

⁹ Searchline Excel only



- Configuration Mode
- Select Language
- Set Date & Time
 - Set Date Format
 - Set Year, Month, Day
 - Set Hours, Minutes, Seconds
- Sensor Type Selection
 - Set mV Sensor Type¹⁰
 - Set mA Sensor Type¹¹
- Gas Selection
 - Changing the Gas or Units Name
 - Gas Selections and Alarm Limits Based on mV Sensor Type
- Range & Alarms
 - Set Range
 - Alarm 1 Type
 - Alarm 1 Setpoint
 - Alarm 1 Latching or Non-latching
 - Alarm 2 Type
 - Alarm 2 Setpoint
 - Alarm 2 Latching or Non-latching
 - Selecting the Numeric Format
- Latching/Non-latching
- Change Meas. Units¹²
- mA Output Levels
 - Change mA for Inhibit

10 Catalytic bead sensor only
 11 Searchpoint Optima and Searchline Excel only
 12 ECC and mV only

- Change mA for Warning
- Change mA for Overrange
- Change mA for Low Signal
- Change mA for Blocked Beam
- Set Calibration Interval
- Accept New Sensor Type¹³
 - Information screen identifying previous sensor and new sensor
 - Screen displays new type and old type
- *|| Set Beam Block¹⁴
 - Select Beam Block Threshold
 - Select Time to Beam Block
 - Select Time to Fault
- *|| Set Path Length¹⁵
 - Set New Path Length
- Configure Unit ID
 - Edit ID
 - Clear ID
 - Default ID
- ⚡ Relay Options¹⁶
 - Select A1
 - Select A2
- Fieldbus Options¹⁷
 - Change Fieldbus Address
 - Change Fieldbus Speed
- Security
 - Reset and LVL1
 - LVL1 Code
 - LVL2 Code

13 Electrochemical and catalytic bead sensors only
 14 Searchline Excel only
 15 Searchline Excel only
 16 Optional relay only
 17 Optional Foundation Fieldbus and Modbus only

2 Installation and Operation

2.1 Mounting and Location of Sensors



Caution: Locate transmitters and sensors in accordance with relevant local and national legislation, standards, and codes of practice.

The placement of sensors should be determined following the advice of experts having specialist knowledge of gas dispersion, experts having knowledge of the process plant system and equipment involved, and safety and engineering personnel. The agreement reached on the location of sensors should be recorded. Consider these factors when locating gas sensors:

- possible damage caused by natural events such as rain or flooding
- ease of access for functional testing and servicing
- how escaping gas may behave due to natural or forced air currents.

2.1.1 Mounting the XNX® Universal Transmitter

The transmitter can be mounted in a number of ways using the integral mounting tabs. The transmitter can be attached to flat wall surfaces or to Unistrut®. With the optional Pipe Mount kit, the unit can be mounted to pipe of diameter 2" to 6" (50 to 150mm). A ceiling mount bracket kit (1226A0358) is also available.



Note: Agency certifications require that EC and mV sensors face down. Optima sensors must be mounted horizontally.

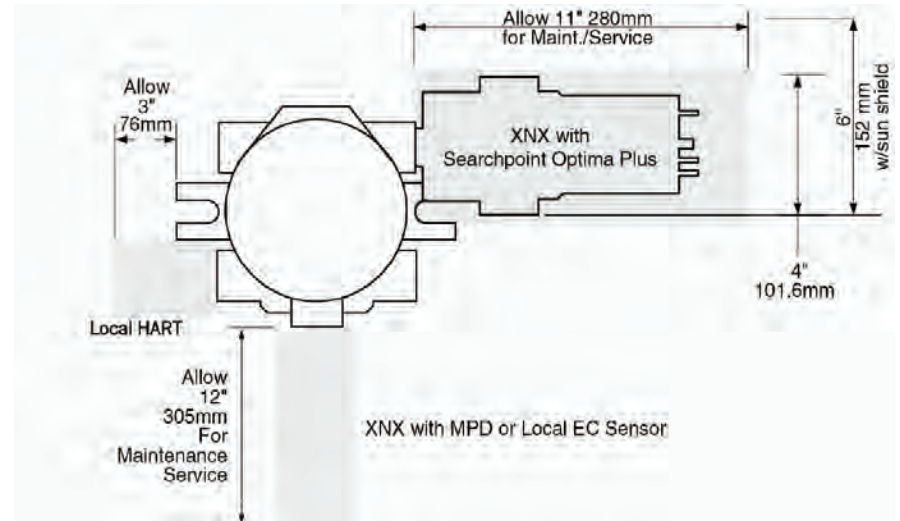
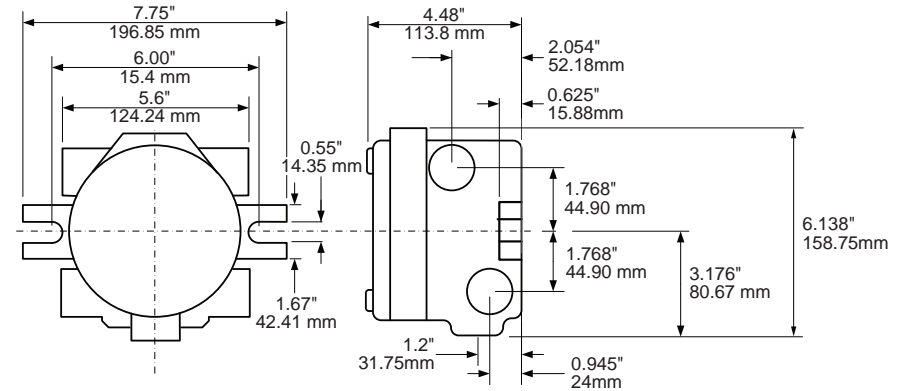

Figure 24. XNX Universal Transmitter mounting dimensions and clearances

XNX Universal Transmitter



Warning: When the transmitter is equipped with the optional Remote Mount Kit, the remote sensor **must** be securely mounted in a fixed position. The Remote Sensor kit is not intended to be used as a hand-held sensor.

The transmitter is configured with five cable/conduit ports built into the housing for wiring and mounting sensors. Figure 25 provides the guidelines to proper installation of the XNX.

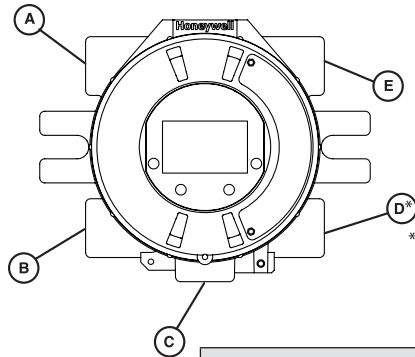

While relay wiring can use any available cable/conduit port in the XNX enclosure, do not use the same cable/conduit port for both relay reset and relay signal lines to avoid electrical noise.

*Limited access due to IS barrier if equipped with electrochemical cell.

Option	Position
Local HART® Option	B
XNX Electrochemical Sensor - Local/Remote	C
MPD, 705 Series, Sensepoint Series	C
Searchpoint Optima Plus	A or E
Searchline Excel	Typically C
Remote Sensor Connection (except EC)	Any remaining
Searchpoint Optima Plus - Remote	Any remaining
Modbus	Any remaining
Relays	Any remaining
Power	Any remaining

Figure 25. XNX Universal Transmitter cable/conduit port assignments

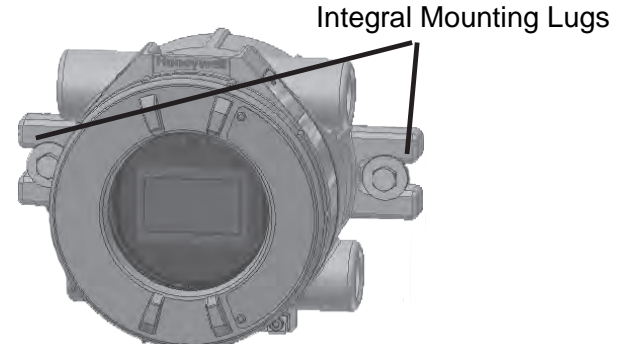

Figure 26. XNX Universal Transmitter mounting lugs

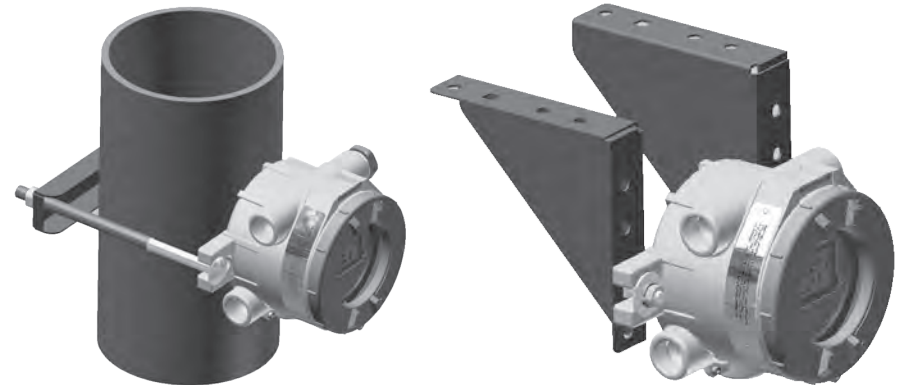

Figure 27. Optional pipe and ceiling mounts

2.2 Wiring the XNX Transmitter

The XNX transmitter is available in sensor technologies, or personality options, which support a variety of sensors and applications. Each of the personalities use dedicated interface boards. Pluggable terminal blocks are used for easy connection and service. The personality boards and optional communication interfaces are enclosed in plastic housings comprising the electronics POD (Personality, Options, and Display). The Personality circuit board determines the XNX behavior based on the sensor type attached to the XNX interface (Figure 35). See Specifications for drift and zero deviation values.

This table illustrates the three XNX transmitter configurations and the sensors each support.







XNX IR Personality		XNX EC Personality
		
Searchline Excel	Searchpoint Optima Plus Local/Remote	XNX EC Sensor
Generic mA Sensors		XNX EC Sensor Remote Mount Kit
XNX mV Personality		
		
705 Local / Remote	MPD Local (cat bead and IR)	Sensepoint Local / Remote
705HT Local / Remote	MPD Remote	Sensepoint PPM Local/Remote
		Sensepoint HT Remote

Figure 28. XNX Transmitter personalities



Caution: Before wiring the transmitter, confirm that the correct personality and communication boards are installed.

2.2.1 General Wiring Considerations

For proper operation of the XNX Universal Transmitter and sensor technologies, consideration of wiring-induced voltage drops, transient electrical noise, and dissimilar earth ground potentials is imperative in the design and installation of the system.

EMI note for applications using shielded cable: Cable shield must provide 90% coverage of the wiring. Cable shield terminations must be made at the cable glands with suitable EMI-type glands. Avoid terminating cable shields at the earth ground lug inside the XNX enclosure.

Loading

When wiring for DC power, 4-20mA signal, remote wiring to sensors must be sized sufficiently to provide adequate voltages for the line length and the loads that will be used.

Isolation

Isolating power and signal carrying conductors is recommended.

Circuit Protection

Supply circuits must provide over current protection. Class 2 power supplies are required for 24 volt DC supply. Consider inrush current in specifying any DC supply. Power supply range

XNX Universal Transmitter

is 16 to 32 VDC for EC and mV versions, 18 to 32 VDC for Searchpoint Optima Plus and Searchline Excel, and 16 to 32 VDC depending on the limitations of the device for the generic 4-20mA input.

Loads

The use of high inrush or inductive loads may affect the performance of the transmitter. For best reliability use resistive loads only.

2.2.2 Distance Considerations for Installation

Providing power to the transmitter is the factor that will determine the maximum distance of the installation. The 4-20 mA output signal will easily handle the distance back to the control equipment.

The primary factors determining distance are the minimum operating voltage of the transmitter and/or sensor; the maximum current draw of the transmitter/sensor, the resistance of the wire used, the power supply voltage, and the current capacity of power supply.

An additional consideration is the type of installation; specifically, how many transmitters/sensors are drawing power from the same power supply and whether these transmitters are using the same pair of wires (“daisy-chain”) or have their own connections.

Types of Installations

There are three basic types of installation: a single transmitter; multiple transmitters connected to a single power source; and multiple transmitters connected in a “daisy-chain” configuration.

Single Transmitter

This is the simplest type of installation. It consists of a single XNX transmitter installation per power source.

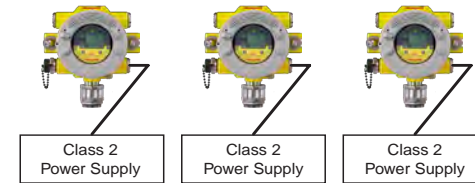

Figure 29. Single Transmitter Installation

Advantages:

- Maximum distance between power source and transmitter
- Smaller power source
- If a power source fails, only one monitoring point fails.

Disadvantage:

- Multiple transmitters require multiple power sources.

Multiple Transmitters Connected to a Single Power Source

This is two or more transmitters sharing a single power source with each transmitter having its own dedicated wiring to the power source.

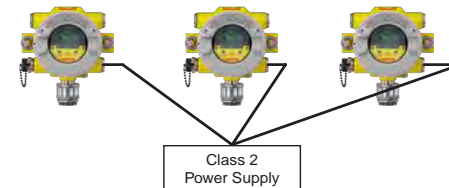

Figure 30. Multiple Transmitters Powered by a Single Power Supply

Advantages:

- Maximum distance between power source and transmitters

- Fewer power sources.

Disadvantages:

- Larger power source will be needed
- If a power source fails, several monitoring points fail.

Multiple Transmitters Connected in a “Daisy-Chain” Configuration

This configuration consists of two or more transmitters installed in a line. The power connections are installed as an extension of the previous transmitter, with the first transmitter being the only one actually wired to the power source.

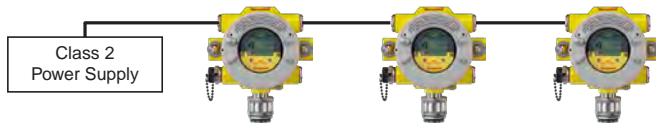

Figure 31. Daisy-chained transmitters from one power supply

Advantages:

- Less wire needed for installation
- Fewer power sources.

Disadvantages:

- Requires a larger power source
- Shorter distance between power source and transmitters.
- If a power source fails, several monitoring points fail.

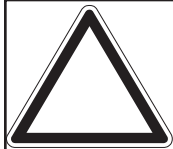

Note: CSA/FM certification does not cover daisy-chained XNX combustible gas transmitters.

Power Source Selection

For each type of installation, selection of power supply is

important. Power supplies are rated by voltage and power. The nominal voltage for all XNX transmitters is 24V with the power required depending on the number of points using the same power supply.

XNX Universal Transmitter Maximum Power Consumption				
Configuration	-40°C to +65°C		-10°C to +65°C	
	HART over 4-20mA (watts)	HART over 4-20mA with Relay, Modbus®, or Foundation™ Fieldbus (watts)	HART over 4-20mA (watts)	HART over 4-20mA with Relay, Modbus, or Foundation Fieldbus (watts)
XNX with toxic sensors	5.1	6.2	3.4	4.5
XNX with catalytic sensors	5.4	6.5	3.7	4.8
XNX with infrared cartridge	5.4	6.5	3.7	4.8
XNX with Searchpoint Optima Plus	8.6	9.7	6.9	8.0
XNX with Searchline Excel	12.1	13.2	10.4	11.5

As a general guideline, the power supply should be capable of providing more power than is required by the installation. A 10 watt power supply is fine for a single XNX mV with catalytic sensor (6.5 watts required, see the following table) but is inadequate for a single XNX IR with Searchpoint Optima Plus (10 watts required).

To determine the wattage required, add the maximum power requirements of all the points that will share the power supply. For example, consider a system with two XNX mV transmitters with catalytic sensors (6.5 watts each) and one XNX IR with

XNX Universal Transmitter

Searchpoint Optima Plus (10 watts). A 25 watt power supply would probably handle this installation, but a 30 watt power supply would be a better choice.

Wire Selection

The type of wire used for connections has an effect on the distance of the installation. This is because some of the voltage is lost in the wire on the way to the transmitter.

Thinner wire (i.e., 18 AWG) will lose more voltage than thicker wire (i.e., 12 AWG). The amount of voltage lost depends on how much power is being drawn through the wire; more power means more loss. If too much voltage is lost in the wiring, there may not be enough at the distant point to allow the transmitter to operate.

Single Transmitter Distances				
Configuration	18 AWG [1.0 mm ²]	16 AWG [1.5 mm ²]	14 AWG [2.0 mm ²]	12 AWG [3.5 mm ²]
XNX mV or EC With Sensor	1140 feet [347 meters]	1810 feet [551 meters]	2890 feet [880 meters]	4620 feet [1408 meters]
XNX IR with Searchpoint Optima Plus	660 feet [201 meters]	1060 feet [323 meters]	1690 feet [515 meters]	2690 feet [820 meters]
XNX IR with Searchline Excel	550 feet [168 meters]	890 feet [270 meters]	1410 feet [430 meters]	2260 feet [690 meters]

Distance Chart for Single Transmitter Distances

For installations that have dedicated wiring between the transmitter and the power supply, use the following chart. These distances assume stranded wire is used. If multiple transmitters are using the same power supply, make sure the power supply wattage rating is high enough to power all transmitters simultaneously.

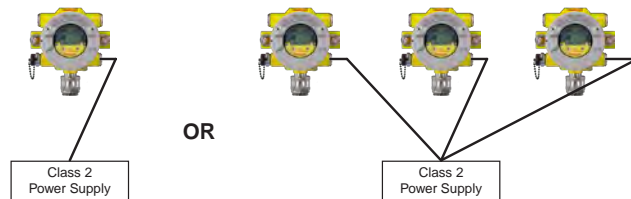

Figure 32. Single transmitter distances

Daisy-Chained Transmitter Distances

It is difficult to calculate distances for this configuration. There are many factors to be considered: distance from control room to first transmitter, distance between transmitters, sensor types, etc. A few scenarios are presented here to provide a base to work from.

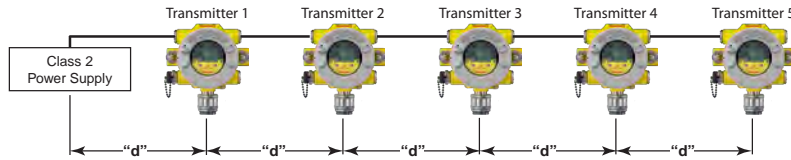

Figure 33. Daisy-chained transmitter distances

1. Several transmitters equally spaced from themselves and the power source.

2 Transmitters - Distance "d"				
Configuration	18 AWG [1.0 mm ²]	16 AWG [1.5 mm ²]	14 AWG [2.0 mm ²]	12 AWG [3.5 mm ²]
XNX mV or EC With Sensor	380 feet [115 meters]	600 feet [183 meters]	960 feet [292 meters]	1540 feet [469 meters]
XNX IR with Searchpoint Optima Plus	220 feet [67 meters]	350 feet [106 meters]	560 feet [170 meters]	900 feet [274 meters]
XNX IR with Searchline Excel	185 feet [56 meters]	295 feet [90 meters]	470 feet [143 meters]	750 feet [229 meters]

3 Transmitters - Distance "d"				
Configuration	18 AWG [1.0 mm ²]	16 AWG [1.5 mm ²]	14 AWG [2.0 mm ²]	12 AWG [3.5 mm ²]
XNX mV or EC With Sensor	190 feet [58 meters]	300 feet [91 meters]	480 feet [146 meters]	770 feet [234 meters]
XNX IR with Searchpoint Optima Plus	110 feet [33 meters]	175 feet [53 meters]	280 feet [85 meters]	450 feet [137 meters]
XNX IR with Searchline Excel	90 feet [27 meters]	145 feet [44 meters]	235 feet [71 meters]	375 feet [114 meters]

4 Transmitters - Distance "d"				
Configuration	18 AWG [1.0 mm ²]	16 AWG [1.5 mm ²]	14 AWG [2.0 mm ²]	12 AWG [3.5 mm ²]
XNX mV or EC With Sensor	110 feet [33 meters]	180 feet [55 meters]	290 feet [88 meters]	460 feet [140 meters]
XNX IR with Searchpoint Optima Plus	65 feet [20 meters]	105 feet [32 meters]	165 feet [50 meters]	270 feet [82 meters]
XNX IR with Searchline Excel	55 feet [17 meters]	85 feet [26 meters]	140 feet [43 meters]	225 feet [68 meters]

5 Transmitters - Distance "d"				
Configuration	18 AWG [1.0 mm ²]	16 AWG [1.5 mm ²]	14 AWG [2.0 mm ²]	12 AWG [3.5 mm ²]
XNX mV or EC With Sensor	75 feet [23 meters]	120 feet [36 meters]	190 feet [58 meters]	300 feet [91 meters]
XNX IR with Searchpoint Optima Plus	45 feet [13 meters]	70 feet [21 meters]	110 feet [33 meters]	180 feet [55 meters]
XNX IR with Searchline Excel	35 feet [11 meters]	55 feet [17 meters]	90 feet [27 meters]	150 feet [46 meters]

2. Several transmitters installed in pairs with each pair equally spaced from the next pair and the power source. These distances assume the paired transmitters are installed within 10 feet [3 meters] of each other.

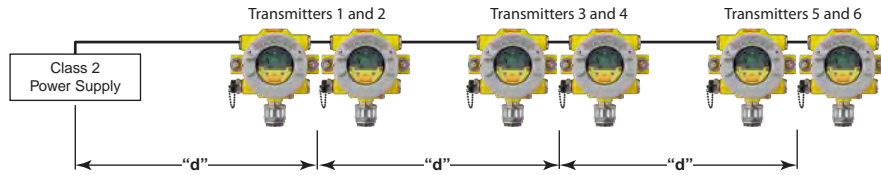

Figure 34. Transmitters in pairs

6 Transmitters - Distance "d"				
Configuration	18 AWG [1.0 mm ²]	16 AWG [1.5 mm ²]	14 AWG [2.0 mm ²]	12 AWG [3.5 mm ²]
XNX mV or EC With Sensor	95 feet [33 meters]	150 feet [45 meters]	240 feet [73 meters]	385 feet [117 meters]
XNX IR with Searchpoint Optima Plus	55 feet [17 meters]	85 feet [26 meters]	140 feet [42 meters]	225 feet [68 meters]
XNX IR with Searchline Excel	45 feet [14 meters]	70 feet [21 meters]	115 feet [35 meters]	185 feet [56 meters]

2 Transmitters - Distance "d"				
Configuration	18 AWG [1.0 mm ²]	16 AWG [1.5 mm ²]	14 AWG [2.0 mm ²]	12 AWG [3.5 mm ²]
XNX mV or EC With Sensor	485 feet [147 meters]	775 feet [235 meters]	1230 feet [292 meters]	1970 feet [600 meters]
XNX IR with Searchpoint Optima Plus	380 feet [115 meters]	600 feet [180 meters]	960 feet [290 meters]	1540 feet [470 meters]
XNX IR with Searchline Excel	280 feet [85 meters]	440 feet [134 meters]	700 feet [213 meters]	1130 feet [344 meters]

4 Transmitters - Distance "d"				
Configuration	18 AWG [1.0 mm ²]	16 AWG [1.5 mm ²]	14 AWG [2.0 mm ²]	12 AWG [3.5 mm ²]
XNX mV or EC With Sensor	190 feet [58 meters]	300 feet [91 meters]	480 feet [146 meters]	770 feet [234 meters]
XNX IR with Searchpoint Optima Plus	110 feet [33 meters]	175 feet [53 meters]	280 feet [85 meters]	450 feet [137 meters]
XNX IR with Searchline Excel	90 feet [27 meters]	145 feet [44 meters]	235 feet [71 meters]	375 feet [114 meters]

Ensure that wiring is adequately protected from mechanical failure in installation. Specific shorted or open circuit conditions of wiring to the MPD ****I**** sensors may result in full scale concentration readings prior to, or preventing the internal diagnostic routines from identifying the external installation fault.

2.2.3 POD Connections

This illustration shows the connections available on each of the terminal blocks for each type of personality board.

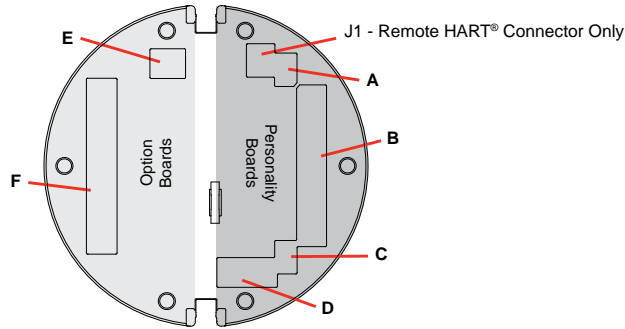

Figure 35. XNX Personality Board Terminal Block Legend

Each of the personalities use a single terminal block for connection with the exception of the IR personality, which requires a second terminal block.

The personality boards also provide a dedicated pair of jumper switches to define output of the transmitter as isolated 4-20mA, Sink 20mA, or Source 20mA as well as a service jumper to allow power to the loop to continue when the transmitter is being serviced. A separate connector is used to activate local HART (see [Section 2.3.1](#)).

Local HART provides an external access to control the transmitter. An intrinsically safe (IS) barrier inside the transmitter allows the user to attach an external hand-held interrogator for programming and configuration. The external interface is intrinsically safe. It is installed in the transmitter's lower left cable/conduit port.

Table A				
Board Type	Function		S1	S2
EC Personality	4-20mA Output	Source	▼	▲
mV Personality		Sink	▲	▼
IR Personality		Isolated	▼	▼

Table B		
Board Type	Connection	Function
EC Personality	TB1	Power, 4-20mA
mV Personality		Power, 4-20mA, Sensor
IR Personality		Power, 4-20mA, IR Power and Signal

Table C				
Board Type	Function		S3	S4
IR Personality	IR 4-20mA Input	Source	▼	▼
		Sink	▲	▲

Table D		
Board Type	Connection	Function
EC Personality	J2	EC IS Barrier
IR Personality	TB2	Com A and B

Table E		
Board Type	Connection	Function
Relay	TB4	Remote Reset Connector
Modbus	SW5	Bus Loop Terminators
Foundation Fieldbus	SW5	Simulation Mode

Table F		
Board Type	Connection	Function
Relay	TB3	Relay Output
Modbus	TB3	Data Connection
Foundation Fieldbus	TB3	Data connection

Note: Open loop faults are not available due to HART, Modbus, and Foundation Fieldbus interfaces where a 4-20 signal cannot be used. In this case, open loop, 0mA must be used as the diagnostic.

The Option circuit boards vary depending upon the option selected when ordered. Only one of the three available interface options (relays, Modbus, or Foundation Fieldbus) can be attached to the XNX transmitter. When installed, connections to the options are made to connectors at the bottom of the POD.

2.2.4 4-20mA Output, Common Connections, and Power Settings

The XNX Universal Transmitter allows the user to configure the 4-20mA output to Sink, Source, or Isolated mode operation via two programming switches on the POD¹. The Switch Configuration table shows the S1 and S2 setting and corresponding output configuration.

Switch Configuration		
Mode	S1	S2
Source	Down	Up
Sink	Up	Down
Isolated	Down	Down

Most controllers in the market will accept source-configured devices. Sink-configured signals are used in older technology controllers, which reduce the need for complete system upgrades. In isolated-signal devices, if the controller fails or the mA signal wires are disconnected or broken, the field device will remain operational. Most controllers in the market will accept isolated configured devices.

Power and 4-20mA connections are made at TB-1 and are identical for the EC, IR, and mV Personality Boards. For user convenience, a second set of +Ve and -Ve power terminals have been provided to eliminate the need for a secondary junction box in multi-node systems when used with the supplied terminal jumpers.

The total load resistance for the 4-20mA output should be kept lower than 500Ω , including the resistance of the properly selected 4-20mA cable and input impedance of the equipment to be connected. The minimum loop impedance is 200 ohms;

¹ The 4-20 mA output state is refreshed at least every two seconds (once per second is typical).

the maximum is 500 ohms. If the 20 mA output is not used, a 500 ohm resistor must be installed.

The XNX Universal Transmitter power consumption is dependent on the sensor and options for the specific configuration. For proper operation, the input voltage must be maintained at 16 to 32 VDC for EC and mV units and 18 to 32 VDC for IR units.

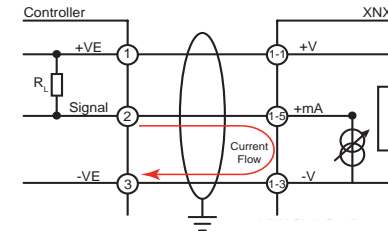

Figure 36. Sink wiring for XNX

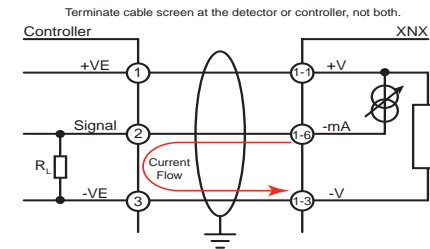

Figure 37. Source wiring for XNX

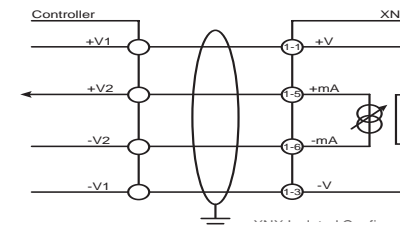

Figure 38. Isolated wiring for XNX

Labels applied to the back of the POD identify each of the connection points.

Note: Pins 2 and 4 of terminal block TB1 have no internal connection on the personality board. When used with the terminal block jumpers, pins 2 and 4 can provide additional 4-20mA connections or supply power for daisy-chained units.

2.2.5 Foundation Fieldbus Wiring

Foundation Fieldbus connections to the XNX transmitter are made through a pluggable terminal block on the Foundation Fieldbus option board, shown in Figure 39. A simulation switch (SW5) is included on the board to enable/disable simulation mode. Terminals 3-1 through 3-4 are provided to facilitate bus wiring; there is no internal connection to other XNX circuitry. Terminal 3-1 is connected internally to 3-2. Similarly, terminal 3-3 is connected internally to 3-4.

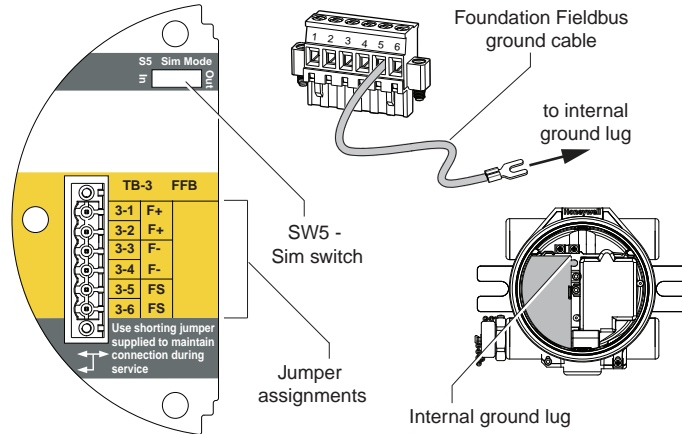

Figure 39. XNX Foundation Fieldbus option board and terminal block

2.2.6 Terminal Block Connections

Connections to the transmitter are made via pluggable terminal blocks secured to the back of the POD. The terminal blocks are keyed and polarized. A color coded label assists in wiring when the block is removed from the POD.

The terminals are suitable for use with 12 to 28 AWG or 0.8 to 2.5mm² wire. Wire insulation must be stripped 5/16" (0.312") or 8mm. Tighten each terminal to a maximum of 4.5 in-lbs (0.51 Nm). Up to four terminal blocks are provided; each having 2, 6, 9, or 10 positions (see the *XNX Quick Start Guide* for additional details).

Two terminal block jumpers are included to provide an electrical connection without connection to the Personality Board. Install the jumpers between pins 1 and 2 and between pins 3 and 4 to support multi-node wiring.

Warning: When the transmitter is equipped with the optional Remote Mount Kit, the remote sensor must be securely mounted in a fixed position. The Remote Sensor kit is not intended to be used as a hand-held sensor.

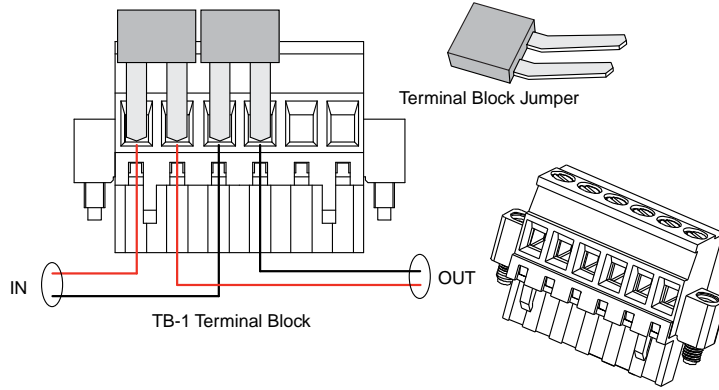

Figure 40. Pluggable Terminal Block and Terminal Block Jumper

2.2.7 EC Personality Wiring



Caution: Do not force the POD into the enclosure. Doing so may result in damage to the wiring or the POD or may alter the switch settings. If resistance is felt, wires may be preventing the POD from being properly positioned.

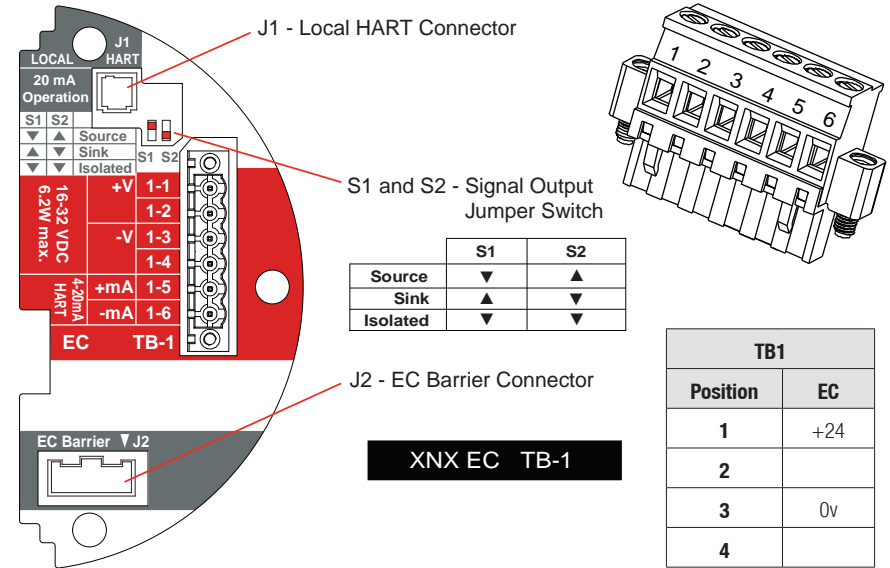

Figure 41. XNX EC Personality Board Terminal Blocks and Jumper Switches and Terminal Block Assignments

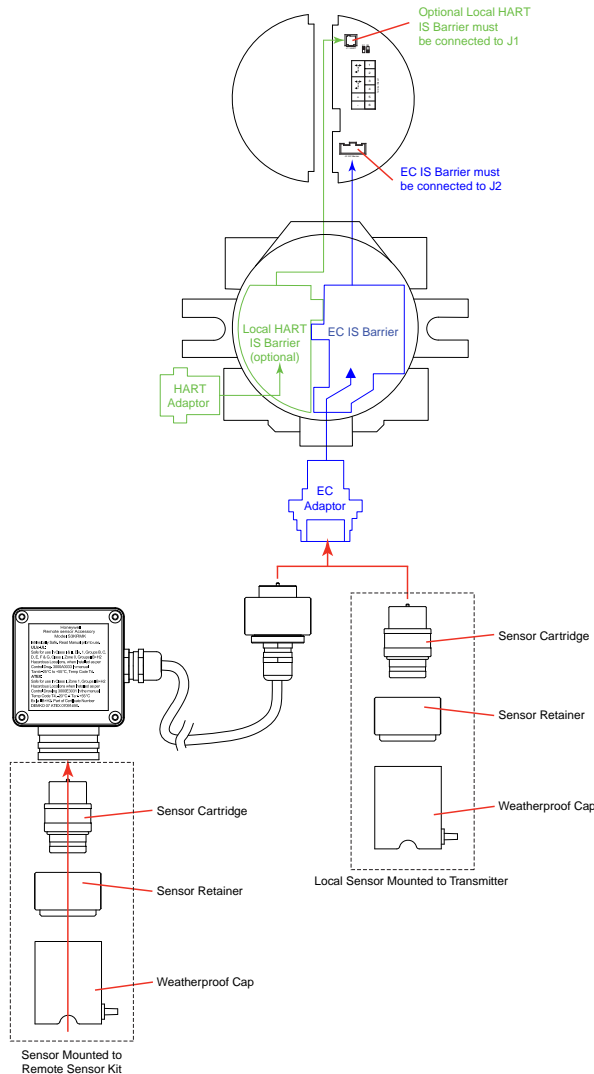

Figure 42. EC Personality Wiring

XNX Electrochemical Sensor Installation

EC Sensor Installation



Caution: A missing oxygen cell will result in 0% V/V O₂ gas concentration, thus triggering alarm events. In this situation, check the connection of the EC cell to the sensor connector board.



Caution: For biased sensors (e.g., nitrogen dioxide) remove the sensor stabilizer from the bottom of the sensor prior to installation.

Using [Figure 42](#) as a guide, follow this procedure:

1. Verify that the label on the new sensor is the correct gas type.
2. Unscrew the weatherproof cover, loosen the retainer locking screw with the supplied hex key, and unscrew the sensor retainer.
3. Plug in the new sensor. Take care to align the sensor pins with the connector.
4. Refit the sensor retainer, tighten the locking screw with the hex key, and refit the weatherproof cover. Countdown time of up to 180 seconds (depending on the sensor type) will be displayed.
5. Acknowledgement of the gas type will be required before proceeding. For more information on setting gas type, see [Section 2.5.1 Gas Selection](#).

6. After the sensor is installed and the gas type is confirmed, the range, alarm levels, and other important settings must be set; see [Section 2.5](#).
7. After the transmitter has been configured, calibrate the sensor following the procedures in [Section 3 - Calibrations](#).

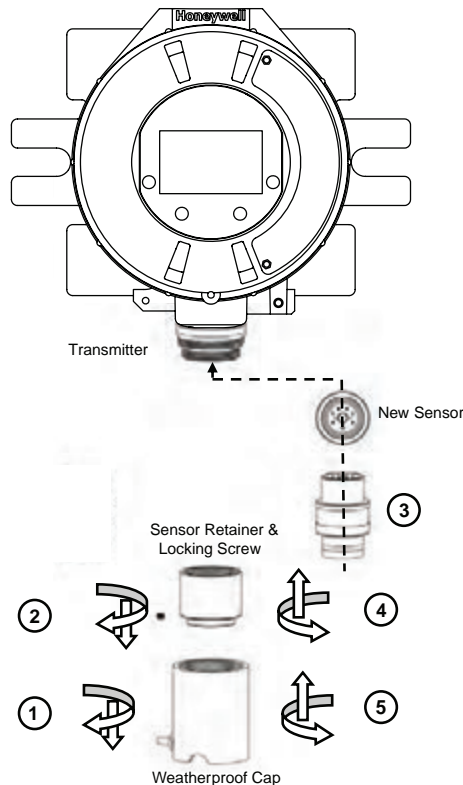

Figure 43. Installing Plug In Sensor



Note: Reference Control Drawing 3000E3157 and 3000E3159 for install requirements on EC cells and remote mounting.

XNX EC Sensor Remote Mounting Kit

The remote sensor mounting kit is used to mount the XNX EC sensor up to 50 feet away from the transmitter. To mount the sensor remotely, follow this procedure:

1. Unscrew the weatherproof cover, loosen the retainer locking screw and unscrew the sensor retainer.
2. Remove the sensor by pulling without twisting.
3. Plug the remote sensor cable connector into the bottom of the transmitter.
4. Route the cable to the location where the remote sensor is to be mounted.
5. Optional: make a loop of cable at the junction box. This will provide some slack for any future re-terminations.
6. If necessary, cut the cable to the required length.



Caution: Take care not to cut the cable too short. Once cut, additional lengths of cable cannot be added as this would invalidate the intrinsically safe certification.



Warning: Enclosures of remotely mounted sensors contain aluminum. Be careful to avoid ignition hazards due to impact or friction when installed in Zone 1 locations.

7. Mount the remote sensor junction box ensuring enough room below to fit the sensor and weatherproof cover. See control drawing 3000E3157 in [Section 7.2](#) for specific mounting information.
8. Attach the cable to the remote terminal box via the gland provided.
9. Make the wiring connections as shown in [Figure 43](#).
10. Fit the Terminal box lid.
11. Plug the sensor into the socket at the bottom of the terminal box.
12. Fit the sensor retainer, tighten the locking screw, and fit the weatherproof cover.
13. Calibrate the sensor following the procedure in [Section 3.2.1](#).

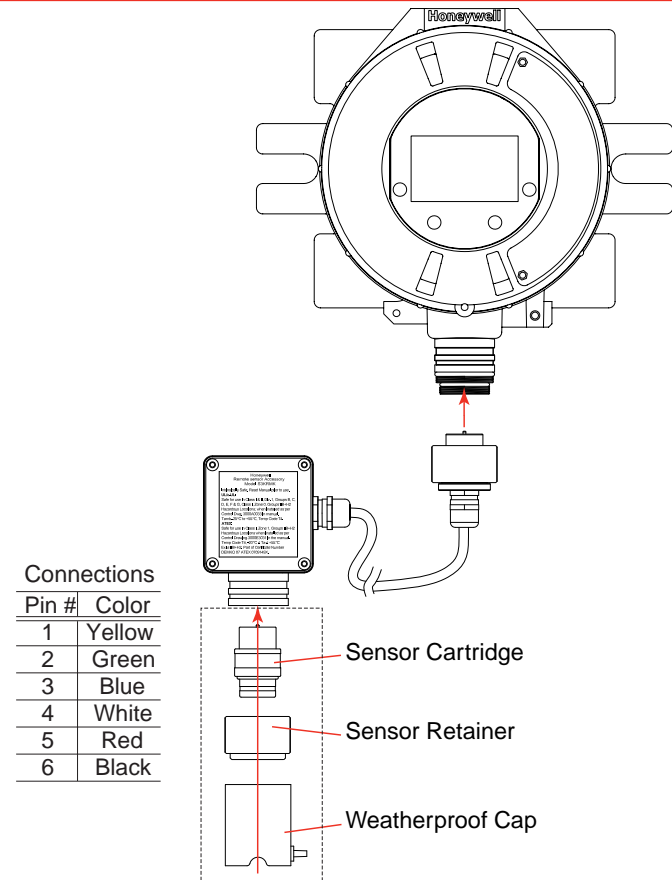

Sensor Mounted to Remote Sensor Kit

Figure 44. Installing Remote Sensor Mounting Kit

2.2.8 mV Personality Wiring

XNX Universal Transmitter with the mV personality Board allows interface to HA's Multi Purpose Detector (MPD) and field proven 705 and Sensepoint devices.



Caution: See [Section 6 - Specifications](#) to ensure that the transmitter and the mV sensor have the appropriate approvals prior to commissioning.



Caution: Verify that the mV sensor being installed has compatible threads (3/4 NPT or M25).

Read [Section 2.2](#) which defines the XNX power and 4-20mA output connections that are common to all personalities.

Connections from the mV Sensor to the XNX are made via a single pluggable terminal block allowing ease of installation and service. Honeywell Analytics recommends that an 8" (203 mm) service length for wiring be maintained. The wire colors for the connections for each sensor type are shown in the following Wire Color from Sensor table.

Verify that wires for 4-20mA outputs are routed away from sources of noise such as relay wires.

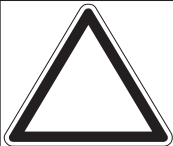

Note: The black and red wires from the MPD are not used with the XNX mV personality board. Ensure that they are properly isolated from live connections. Do NOT cut the wires.



Caution: Do not force the POD into the enclosure. Doing so may result in damage to the wiring or the POD or may alter the switch settings. If resistance is felt, wires may be preventing the POD from being properly positioned.



Caution: Be certain to dress the wires properly to ensure cabling does not contact switches 1-2 on the back of the POD.

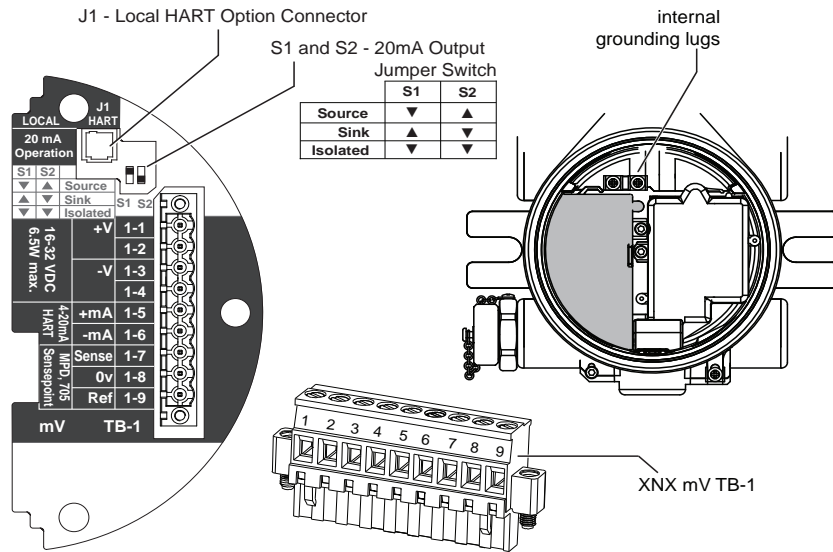

Figure 45. mV personality board terminal blocks and jumper switches.

TB-1	Desc.	Wire Color from Sensor					
		mV Catalytic Bead Sensor			Sensepoint PPM*	mv MPD w/IR Sensor	
		MPD	705 705HT	Sensept Sensept HT		CO ₂	CH ₄
Pins 1-6		See subsections in Section 2.2.4 for pin identification					
7	Sense		Brown		Red		Brown
8	0v		White		Green		White
9	Ref		Blue		Blue		Blue

*Internal earth ground; approximately one inch of the black sheath that contains the Sensepoint PPM's four wires (red, blue, green, silver) must be split to allow the silver grounding wire to reach the internal grounding lugs.

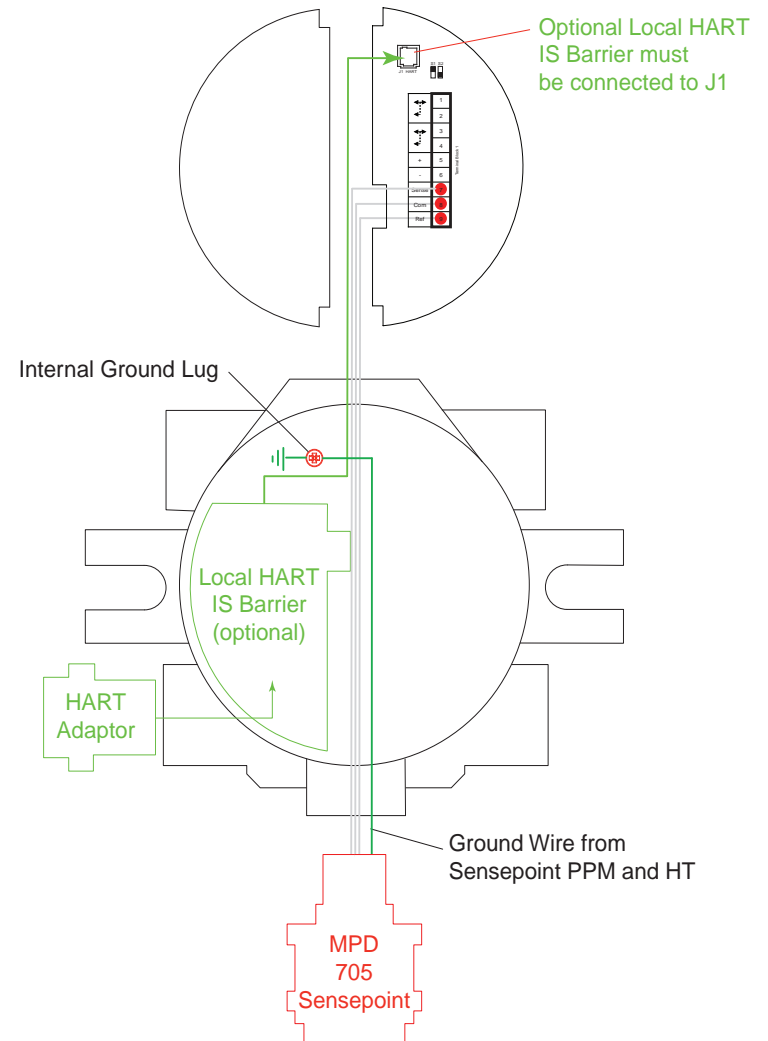

Figure 46. mV Personality Wiring

mV Remote Sensor Mounting

The sensor can be mounted remotely from the transmitter; the installation will vary by installed location, sensor and thread type used. To remotely mount the sensor, follow this procedure:

1. Unscrew the transmitter's weatherproof cover and loosen the retainer locking screw with the supplied hex key.
2. Run conduit from one of the transmitter's available conduit ports to the location of the remote terminal housing.

A terminal housing provides a mounting base for the sensor. The installation wiring enters the terminal housing via conduit.

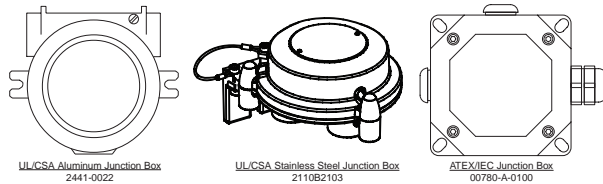

Figure 47. Remote Terminal Housings

The distance between the XNX Transmitter and remote installation must comply with these parameters to insure proper operation. Distances are dependent on sensor types and the wire gauge used.

AWG	Metric Wire Gauge	MPD CB1, 705 Series. Sensepoint Series Sensors	MPD IC1, IV1 & IF1 Sensors
24	0.25 mm ²	12m (47 ft.)	30m (97 ft.)
22		20m (65 ft.)	50m (162 ft.)
20	0.5 mm ²	30m (97 ft.)	80m (260 ft.)
18		50m (162 ft.)	120m (390 ft.)*
16	1.0 mm ²	80m (260 ft.)*	200m (650 ft.)*

* Frequency of Zero calibration may increase due to the changes in wire resistance from changing temperature.

3. Wire the pluggable terminal block as shown in Figure 45 then plug the connector into the back of the mV personality board. In remote mount MPD configurations, the 3 wires connecting the pluggable terminal block and the remote MPD must be routed through the supplied ferrite bead (Honeywell Analytics part no. 0060-1051, supplied in the accessory kit) as shown in Figure 48.

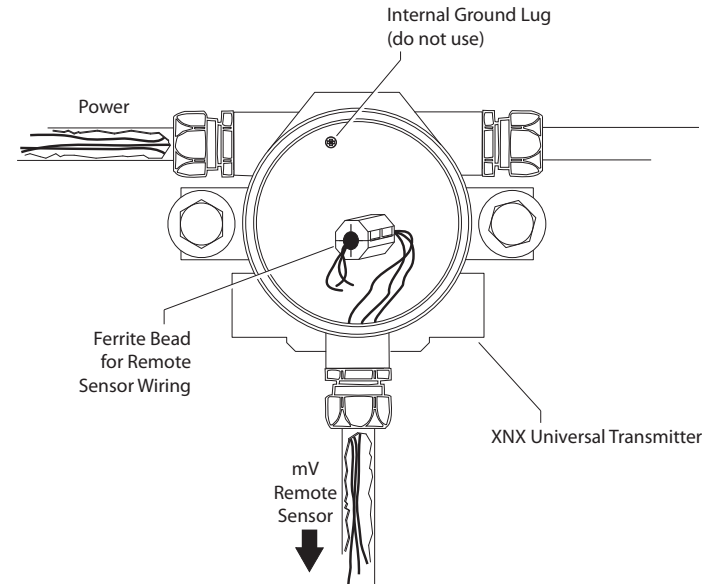

Figure 48. Ferrite bead wiring

4. Mount the remote sensor junction box with sufficient room below to fit the sensor and weatherproof cover.



Warning: Install the junction box according to local codes and manufacturer's requirements.

5. Attach the conduit to the remote terminal box.
6. In the remote junction box, connect the wires from the transmitter to the 3-way terminal block in the terminal box.

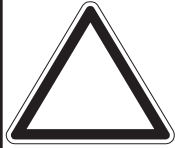

Note: The black and red wires from the MPD are not used with the XNX mV personality board. Ensure that they are properly isolated from live connections. Do NOT cut the wires.



Warning: The enclosures of remotely mounted 705HT sensors contain aluminum. Be careful to avoid ignition hazards due to impact or friction when installed in Zone 1 locations.

All cable port devices and blanking elements shall be certified in type of explosion protection flameproof enclosure “Ex d” or “Ex e”, suitable for the conditions of use and correctly installed.

7. Attach and wire the sensor in the terminal box.
8. Fit the terminal box lid.
9. Fit the sensor.
10. Calibrate the sensor following the procedure in [Section 3.2 - Calibration](#).

2.2.9 IR Personality Wiring

The XNX Universal Transmitter allows local programming and configuration through the local LCD display as well as through the HART protocol. Gas concentrations can be read at the transmitter from Searchpoint Optima Plus or Searchline Excel, via 4-20mA output as well as from the digital communication connection on TB2 that can provide additional diagnostic information. The gas concentration is taken from the digital

communication line as long as it is in agreement with the 4-20 mA output, otherwise the 4-20mA output takes precedence.



Caution: Dress the wires properly so that cabling does not contact switches 1-4 on the back of the POD.

The transmitter provides a 4-20mA output reflecting the input received. It also offers diagnostic information or data via HART or any of the additional communication options offered.

Read [Section 2.2](#) which defines the XNX power and 4-20mA output connections that are common to all personalities.



Warning: Power off the transmitter before changing S3 or S4. Both switches must be set in either Source or Sink prior to applying power.



Caution: Do not force the POD into the enclosure. Doing so may result in damage to the wiring or the POD or may alter the switch settings. If resistance is felt, wires may be preventing the POD from being properly positioned.

Do not adjust switch settings while power is applied to the transmitter; doing so will cause permanent damage.

Connecting a Searchpoint Optima Plus or Searchline Excel

Connections from the Searchpoint Optima Plus or Searchline Excel to the transmitter are made via two pluggable terminal blocks allowing ease of installation and service (see [Figure 49](#)). HA recommends that an 8” service length of wiring be maintained.

In remote mount configurations, the maximum distance between

XNX Universal Transmitter

the XNX Transmitter and Optima Plus or Excel is 100 feet (33 meters) using 0.75 mm² (18 AWG) wire minimum.



Note: A second, black-handled screwdriver is included for use on terminal blocks 2 and 4. This tool is smaller than the magnetic wand and is designed to fit into the terminal connections on TB2 and TB4.

The Searchpoint Optima Plus or Searchline Excel can be supplied in either Sink or Source mode operation and is typically labeled on the white wire exiting the Searchpoint Optima Plus or Searchline Excel. Use the table in [Figure 50](#) to set S3 and S4 to the same output type that appears on the wire tag of the IR device.

For more information see the Searchpoint Optima Plus Operating Instructions (2104M0508) or the Searchline Excel Technical Manual (2104M0506).

Connecting Generic mA Devices

Use the following schematics to set switches S3 and S4 They *must* be set to the same output type (which appears on the wire tag of the mA device).

The IR personality type provides for a generic mA input under sensor type configuration. The transmitter can be used to convert the mA input to be read over HART or optional Modbus or Foundation Fieldbus protocols and set optional relays (if equipped). Additional configuration of gas type and unit ID for reporting is required (see [Gas Selection](#)). For Generic mA devices, input values below 3mA will generate Fault 155.

XNX S3 and S4 must be in the UP position
Set mA Device and XNX to the same output type.

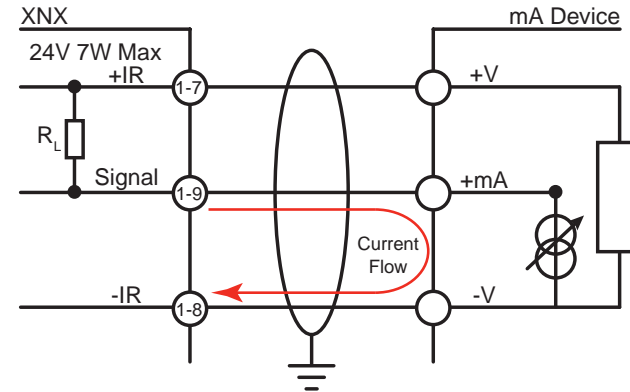

Figure 49. XNX mA input sink configuration

XNX S3 and S4 must be in the DOWN position
Set mA Device and XNX to the same output type.

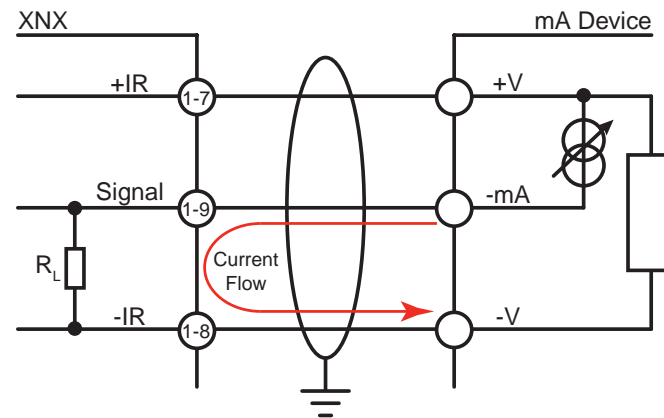

Figure 50. XNX mA input source configuration

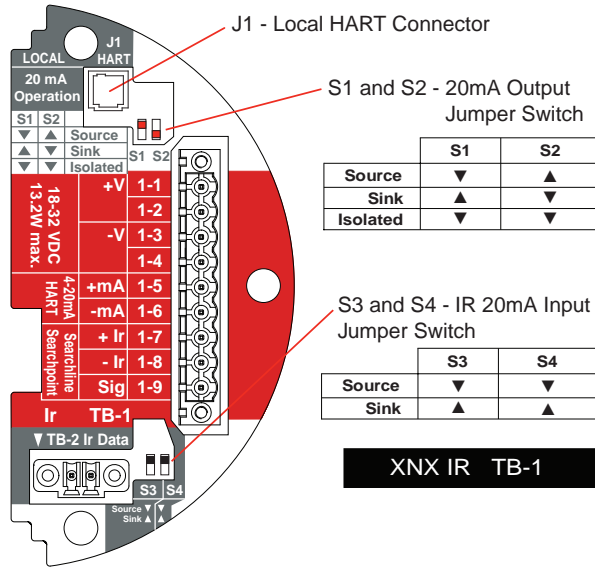
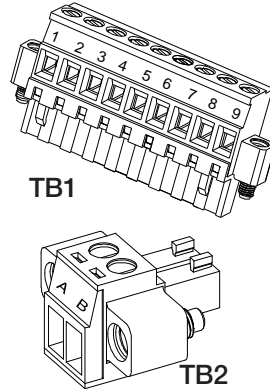

Figure 51. XNX IR Personality Board Terminal Blocks, Jumper Switches and Wiring Guide



TB1		
Terminal No.	Desc.	From Searchpoint Optima Plus Searchline Excel
1	+24v	See Section 2.2.4 Common Connections
2		
3	0 VDC	
4		
5	+20mA	
6	-20mA	
7	+24VDC	Red
8	0VDC	Black
9	Sig - 20mA	White

TB2	
Terminal No.	From Searchpoint Optima Plus Searchline Excel
A	Blue
B	Orange

XNX	
Desc.	From Searchpoint Optima Plus Searchline Excel
Earth	Green/Yellow

Note:

Honeywell Analytics recommends that Excel or Optima and the XNX transmitter be wired to building ground. The system should be grounded at only one point.

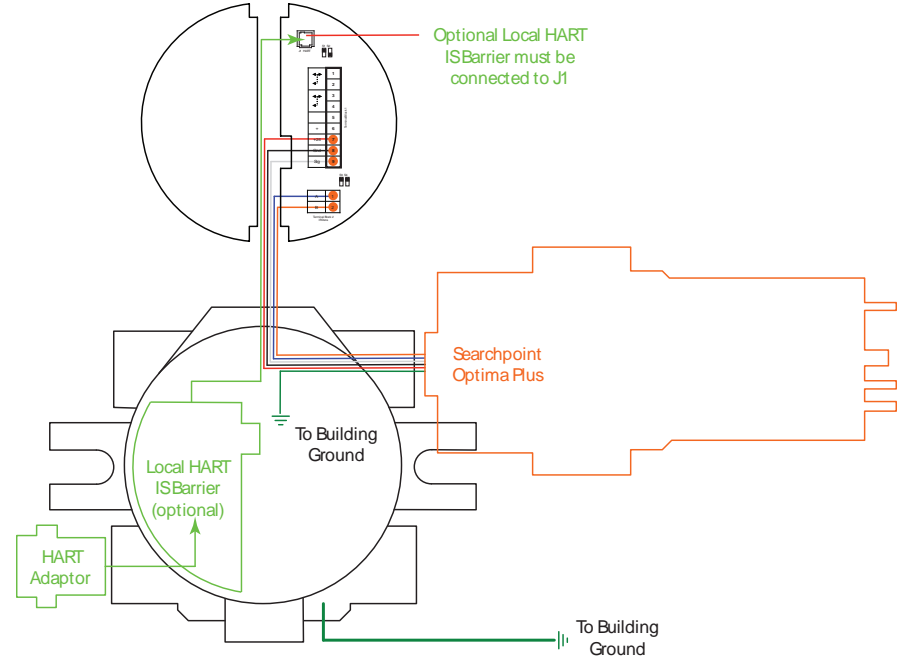

Figure 52. IR Personality Wiring - Searchpoint Optima Plus

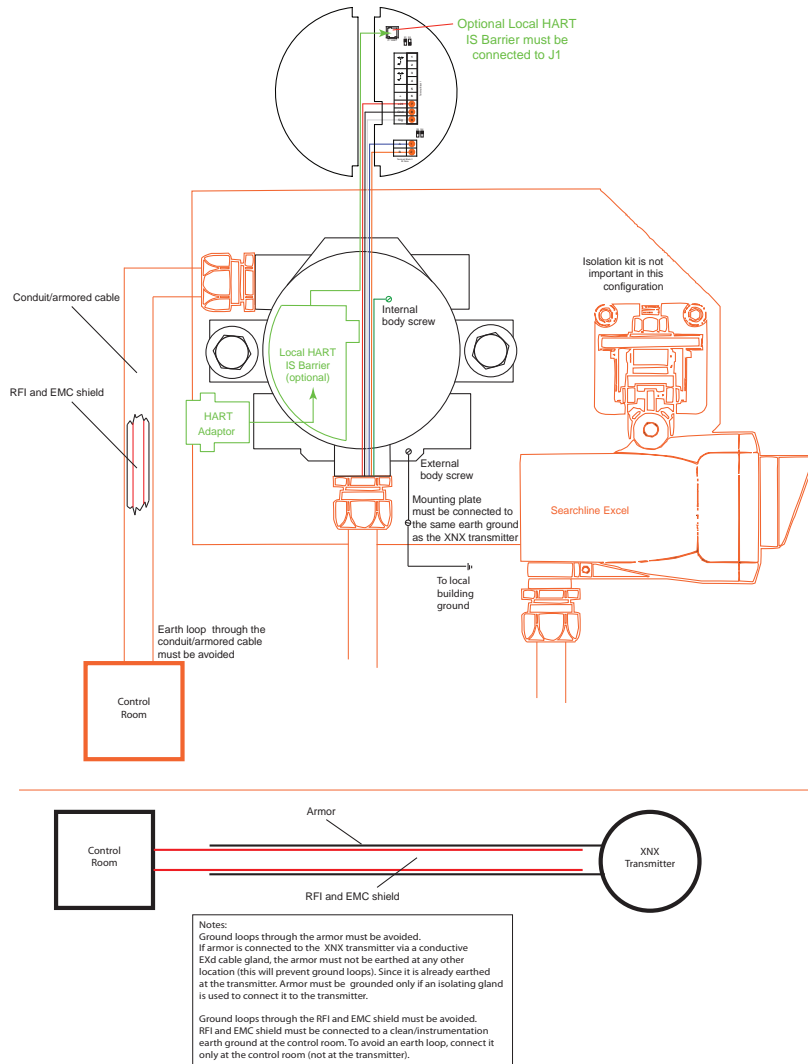

Figure 53. IR Personality Wiring - Searchline Excel

Attaching the Searchpoint Optima Plus to the XNX Universal Transmitter

For M25 entries, insert the seal (P/N 1226-0410) into the proper cable/conduit opening then thread the locknut (P/N 1226-0409) onto the Optima to the end of the threads. Thread the Optima body into the transmitter until the seal compresses and/or the Optima bottoms out. Reverse until the semi-circular pattern of holes on the front of the weather protection are on the bottom (see below). Tighten the locknut to the XNX body.

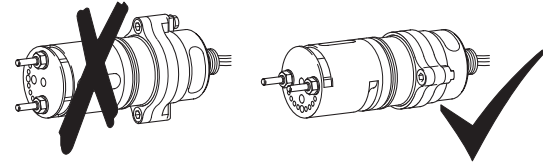



Figure 54. Searchpoint Optima Plus orientation

The 3/4" NPT ports do not require the seal and locknut. The form of the threads provide positive locking and sealing.



Note: When attaching the Searchpoint Optima Plus, coat the threads with an anti-seize compound to prevent corrosion.

Searchline Excel and Searchpoint Optima Plus Remote Installation

Junction Boxes are available for the Searchline Excel and Searchpoint Optima Plus to facilitate remote mounting from the XNX Universal Transmitter. Junction boxes are available for installations requiring UL/CSA or ATEX approvals. Consult

XNX Universal Transmitter

the Searchline Excel Technical Handbook (2104M0506) or Searchpoint Optima Plus Operating Instructions (2104M0508) for specifics on remote installations or contact your Honeywell Analytics representative for more information.

Searchpoint Optima Plus or Searchline Excel Wiring Recommendations

When wiring the XNX transmitter and the Searchpoint Optima Plus or Searchline Excel for remote applications, the general recommendations of the ANSI/TIA/EIA-485-A standard must be adhered to with the following additions:

1. When mounting the Searchline Excel or Searchpoint Optima Plus, run wiring connections between each Excel or Optima and the transmitter in a dedicated separate conduit.
2. Use 18 AWG twisted shielded cable for the RS485 connection between Excel or Optima and the XNX. Make sure that the shield of the cable is grounded to earth and XNX ground on one end **ONLY**.
3. Avoid running wiring near main cables or other high voltage equipment.
4. Do *not* apply 120 ohm terminating resistors. These resistors are not required due to low data rates.
5. Honeywell Analytics recommends that Excel or Optima sensors and the XNX transmitter be wired to building ground. The system should be grounded at one point only.

INSTALLATION TIP:

Always perform a soft reset after connecting the Searchpoint Optima and XNX transmitter for the first time. The soft reset is performed by accessing the transmitter's Calibration Menu.

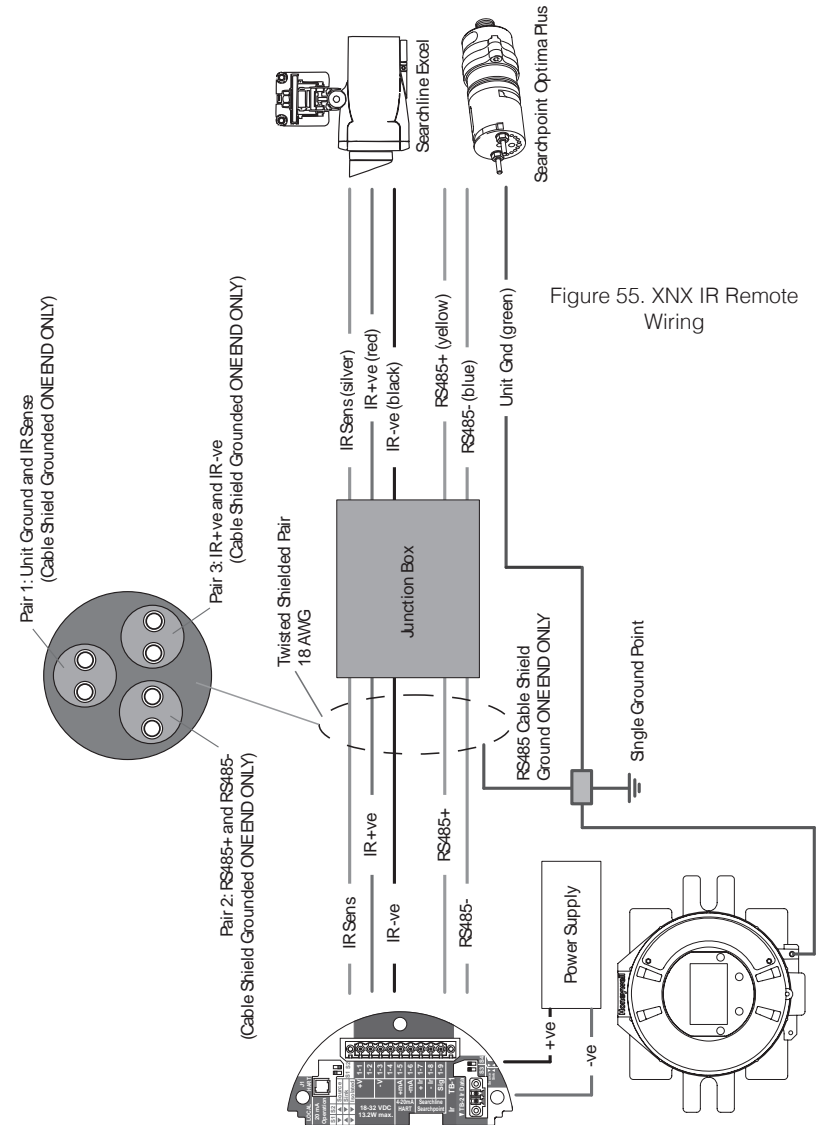

2.3 Options

2.3.1 Local HART Interface

Available with any sensor technology or option, this option provides an external access to the HART interface in the transmitter. An IS barrier inside the transmitter allows the user to attach an external hand-held interrogator for programming and configuration. The external interface is installed in the lower left cable/conduit port of the transmitter and is intrinsically safe (IS).

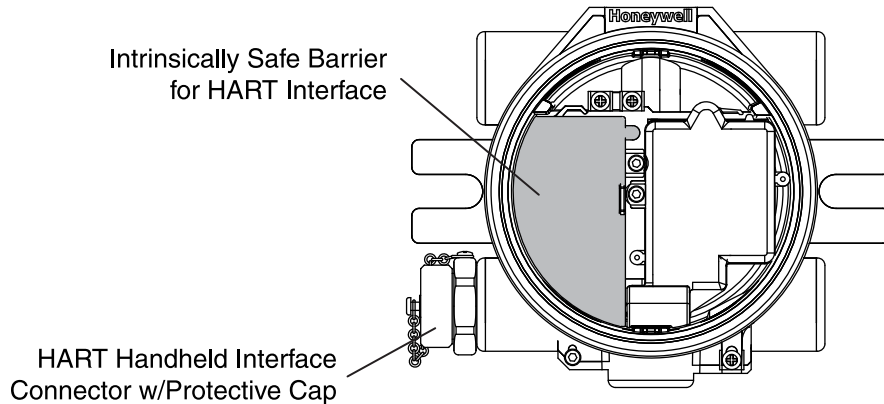

Figure 56. XNX Universal Transmitter with HART Interface IS Barrier installed

The HART protocol is a communication technology used with smart process instrumentation, providing two-way digital communication simultaneously with the 4-20mA analog signaling used by traditional instrumentation equipment. For more detailed information on HART, see the [HART Protocol](http://www.hartcomm.org) and www.hartcomm.org.

Implementation of the HART protocol in the XNX transmitter:

- Meets HART 6.0 physical layer specification
- The physical layer is tested according to HART Physical

Layer Test Procedure, HCF_TEST-2.

- Data transfer rate: 1200 bps.

HART devices can operate in point-to-point or multidrop configurations.



Caution: Device address changes must be performed only by qualified service personnel.

Point-to-Point Mode

In point-to-point mode, the 4–20 mA signal is used to communicate one process variable, while additional process variables, configuration parameters, and other device data are transferred digitally via HART protocol (Figure 57). The 4–20 mA analog signal is not affected by the HART signal.

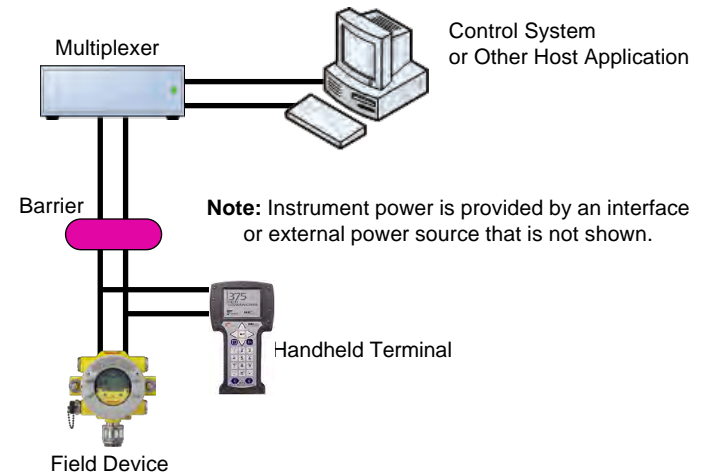
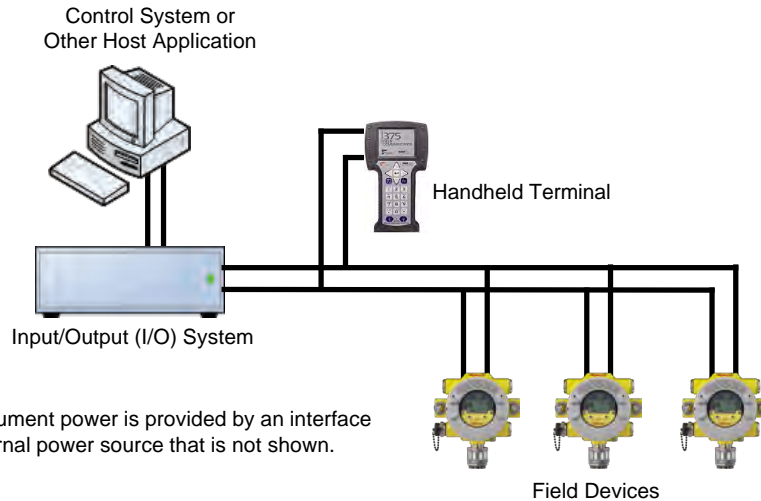

Figure 57. Point-to-Point Mode of Operation

Multidrop Mode

The multidrop mode of operation requires only a single pair of wires and, if applicable, safety barriers and an auxiliary power supply for up to 8 field devices (Figure 58). All process values are transmitted digitally. In multidrop mode, all field device polling addresses are >0, and the current through each device is fixed at a minimum value (typically 4 mA).



Note: Instrument power is provided by an interface or external power source that is not shown.

Figure 58. Multidrop Mode of Operation

Note: Use multidrop connection for supervisory control installations that are widely spaced, such as pipelines, custody transfer stations, and tank farms.

In general, the installation practice for HART devices is the same as conventional 4-20mA instrumentation. Individually shielded twisted pair cable, either in single-pair or multi-pair varieties, is the recommended wiring practice. Unshielded cables may be

used for short distances if ambient noise and cross-talk will not affect communication.

The minimum conductor size is 0.51mm diameter (#24 AWG) for cable runs of less than 5,000 ft (1,524m) and 0.81mm diameter (#20 AWG) for longer distances.

Cable Length

Most installations are well within the 10,000 ft (3,000 m) theoretical limit for HART communication. However, the electrical characteristics of the cable (mostly capacitance) and the combination of connected devices can affect the maximum allowable cable length of a HART network. The table below shows the effect of cable capacitance and the number of network devices on cable length. The table is based on typical installations of HART devices in non-IS environments, i.e. no miscellaneous series impedance.

Detailed information for determining the maximum cable length for any HART network configuration can be found in the HART Physical Layer Specifications.

Cable Capacitance – pf/ft (pf/m)				
Allowable Cable Lengths for 1 mm (18 AWG) Shielded Twisted Pair – feet (meters)				
Number of Network Devices	20 pf/ft (65 pf/m)	30 pf/ft (95 pf/m)	50 pf/ft (160 pf/m)	70 pf/ft (225 pf/m)
1	9,000 ft (2,769 m)	6,500 ft (2,000 m)	4,200 ft (1,292 m)	3,200 ft (985 m)
5	8,000 ft (2,462 m)	5,900 ft (1,815 m)	3,700 ft (1,138 m)	2,900 ft (892 m)
8	7,000 ft (2,154 m)	5,200 ft (1,600 m)	3,300 ft (1,015 m)	2,500 ft (769 m)

2.3.2 Relays

The relay option (XNX-Relay) provides 3 form “C” SPCO contacts for alarm and fault indication. TB4 allows alarms to be reset remotely.



Note: This option is not available when the Modbus or Foundation Fieldbus options are installed.

Wiring for the relays is through an available cable/conduit port to a pluggable terminal block. See [Figure 35](#) for the terminal block legend.



Note: A second, black-handled screwdriver is included for use on terminal blocks 2 and 4. This tool is smaller than the magnetic wand and is designed to fit into the terminal connections on TB4.

The XNX transmitter has three relays: relay 1 is for alarm level 1, relay 2 is for alarm level 2, and relay 3 is for faults and special states. All special states are indicated by the fault relay.

Honeywell Analytics recommends that the fault relay be used in all installations to maintain safe operation. See [Set Alarm Values](#) for more information.

The relay state is refreshed every 2 seconds. The fault relay is normally energized indicating proper operation. In the event of power failure or fault, the C-NO connection will open.

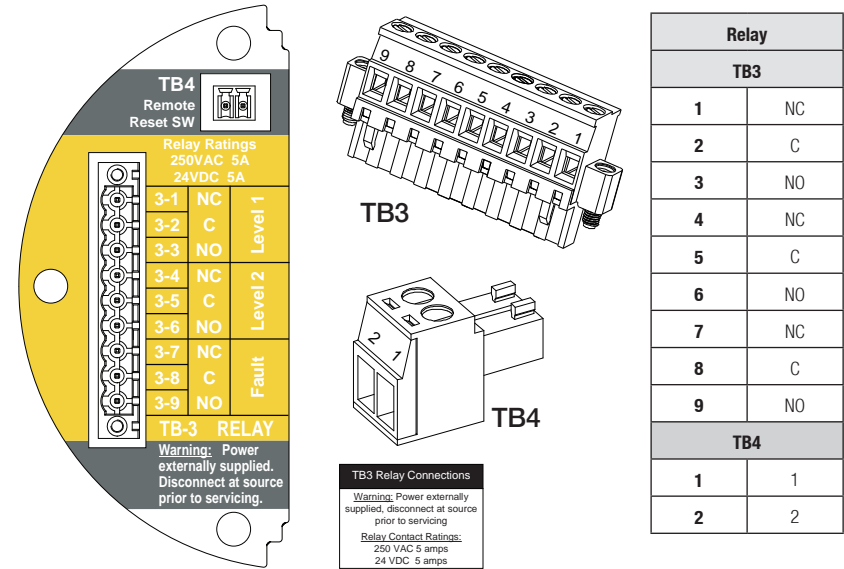

Figure 59. XNX Relay Option Board Terminal Blocks

2.3.3 Modbus

The optional Modbus interface allows all transmitter local user interface (LUI) functions and parameter settings to be transmitted.

Modbus is a master-slaves protocol. Only one master (at a time) is connected to the bus. Up to 247 slave nodes are also connected to the same serial bus. Modbus communication is always initiated by the master. The slave nodes never transmit data without receiving a request from the master node. The slave nodes never communicate with each other. The master node initiates only one Modbus transaction at a time.

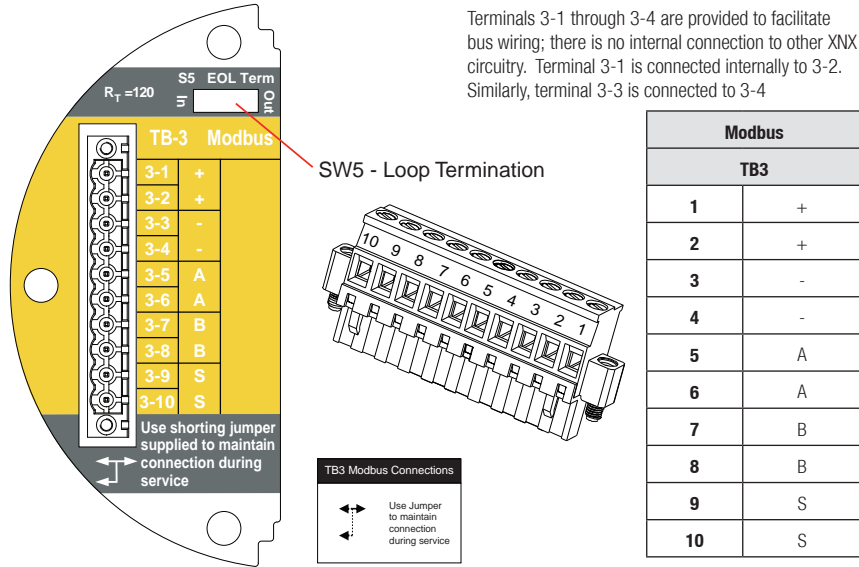

Figure 60. XNX Modbus Option Board Terminal Block / Jumper Switch

Modbus connections to the XNX are made through a pluggable terminal block on the Modbus interface circuit board. Modbus RTU protocol uses ASCII/Hex protocols for communication. See [Figure 35](#) for the terminal block legend. A loop termination point (SW5) is included on the Modbus interface board to provide termination of the Modbus loop.

2.3.4 Foundation Fieldbus

Foundation Fieldbus connections to the XNX transmitter are made through a pluggable terminal block on the Foundation Fieldbus option board, shown in Figure 60. A simulation switch (SW5) is included on the board to enable/disable simulation mode. Terminals 3-1 through 3-4 are provided to facilitate bus wiring; there is no internal connection to other XNX circuitry. Terminal 3-1 is connected internally to 3-2. Similarly, terminal 3-3 is connected internally to 3-4.

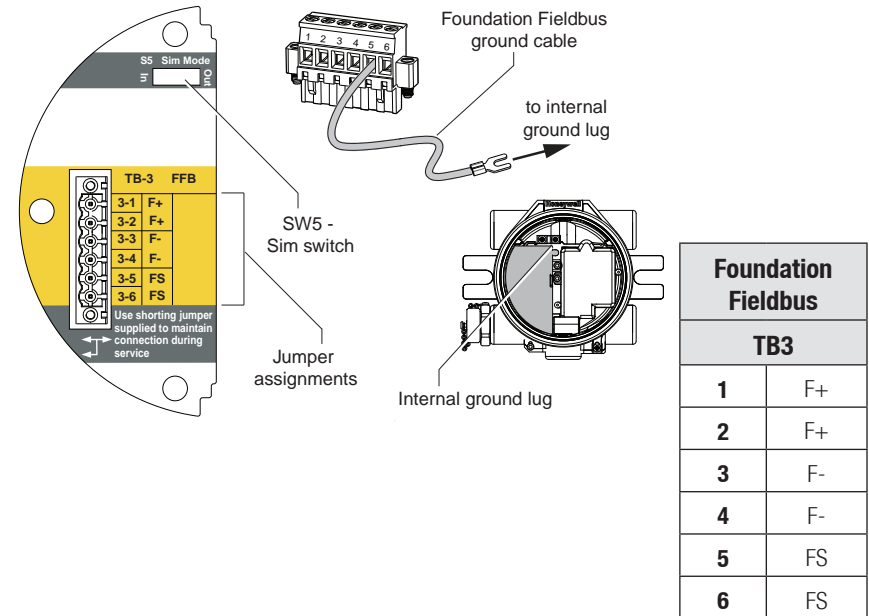

Figure 61. Foundation Fieldbus Option Board, Terminal Block, Jumper Switch

2.4 Powering the XNX for the First Time

2.4.1 XNX Units Configured for EC, mV, and IR (except Searchline Excel)

After mounting, wiring the transmitter, wiring the specific mV or IR sensor or installing the EC cartridge, the installation is visually and electrically tested as described below.



Warning: Minimum and maximum controller alarm levels should not be set at less than 10% or greater than 90% of the full scale range of the sensor. CSA and FM agency limits are 60% LEL or 0.6mg/m³.

1. Verify that the transmitter is wired correctly according to this manual and the associated control equipment manual.
2. If equipped, unscrew the weatherproof cover, loosen the sensor retainer locking screw, and unscrew the retainer.
3. For EC sensors, plug in the sensor cartridge, taking care to align the sensor pins with the connector holes in the PCB.



Caution: For toxic sensors, remove the shorting clip from the bottom of the sensor prior to installation. No shorting clip is provided with O₂ sensors.

4. Refit the sensor retainer, tighten the locking screw and refit the weatherproof cover.

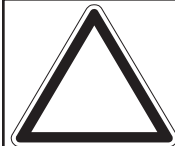

Note: Before replacing the cover on the transmitter housing, coat the threads with anti-seize compound to prevent corrosion buildup.



Note: Inspect the cover O-ring for cracking or any other defects that might compromise the integrity of the seal. If it is damaged, replace with the O-ring supplied in the accessory kit.

5. Apply power to the transmitter. This will in turn provide power to the sensor.
6. During warmup, the XNX transmitter will be forced to 2mA (inhibit mode).
7. The transmitter will enter a boot-up routine displaying the initialization screen. The transmitter loads its operating system, data from the sensor, sensor software version numbers, gas type, the detection range and span calibration gas level, estimated time to next calibration due, and self test result. This will take about 45 seconds.



Figure 62. XNX Initialization and General Status Screens

In the final stages of boot-up, warnings and faults may be observed until the user performs the proper configuration, calibration, and reset activities described in the following sections. See [Section 5](#) for descriptions of warnings and faults.

Once the General Status screen appears, the transmitter and sensor are in normal monitoring mode.



Note: Calibration of sensors attached to the transmitter is mandatory before the sensor can be used for gas monitoring. Refer to [Section 3 - Calibration](#) for the procedure.

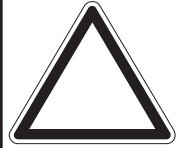

Note: For initial commissioning, refer to EN 60079-29-2.

2.4.2 LCD and LED Test

The LCD and LED test is performed in the initialization after powering on. All LCD pixels and LEDs (red, green, and yellow) are turned on for 1.5 seconds. The LCD then goes blank and the LEDs turn off.

2.4.3 XNX IR Units Configured for Searchline Excel

When powering the transmitter fitted with a Searchline Excel sensor, the following procedure must be followed to assure proper installation.

1. Verify that the transmitter is wired correctly according to this manual and the associated control equipment manual.
2. Apply power to the XNX transmitter. This will in turn provide power to the sensor.
3. The sensor output will be forced to 2mA (default fault/inhibit).
4. The XNX transmitter will enter a boot-up routine, displaying the initialization screen. The transmitter will load its operating system, data from the sensor, sensor software

version numbers, gas type, the detection range and span calibration gas level, estimated time to next calibration due, and self test result. This will take about 45 seconds.



Figure 63. XNX Initialization and General Status Screens

In the final stages of boot-up, warnings and faults may be observed until the user performs the proper configuration, calibration, and reset activities described in the following sections. See [Section 5](#) for descriptions of warnings and faults.

5. When the XNX completes boot-up, perform a soft reset (see [Section 3.6 Soft Reset](#)) on the Excel sensor from the Calibration Menu. When the soft reset is initiated, the RS-485 communication will be temporarily interrupted and faults F120 and/or F161 may be observed. The RS-485 communication will be re-established in a few minutes and the faults will automatically be reset in the Non-Latching mode. F120 and/or F161 must be reset manually in the Latching mode.
6. Set the [Path Length](#) for the application, then align the transmitter and receiver (see [Section 3.5 Align Excel](#)).
7. Once the alignment is complete, a Zero Calibration must be performed on the Excel sensor to complete the commissioning process. (See the Searchline Excel

Technical Manual for calibration information P/N 2104M0506).

- Reset any faults that appear in the transmitter's display. The XNX transmitter and Searchline Excel sensor are now ready to monitor.

2.5 Configuring the XNX Universal Transmitter

The XNX Universal Transmitter can be configured via the front panel by using the menus available in Configure Menu. For information on accessing and navigating the menus, see [Section 1.4.1](#).

2.5.1 Configure Menu

Functions in the Configure Menu and the security levels required to change them are explained in this table.

Symbol	Description	Security Level	Symbol	Description	Security Level
	Select Language	1		Calibration Interval	2
	Set Date & Time	1		Accept New Sensor Type	2
	Set mV Sensor Type	2		Beam Block Options	2
	Set mA Sensor Type	2		Path Length	2
	Gas Selection	2		Unit ID	2
	Range & Alarms	2		Relay Options	2
	Latching/Non-latching	2		Fieldbus Options	2
	Set Units	2		Configure Security	2
	mA Levels	2			



Warning: When configuring or communicating with the transmitter using the front panel displays, resume monitoring by exiting all menus and returning to the General Status menu manually. No time outs are invoked.



Note: With the exception of Inhibit Mode, gas measurement continues in the background allowing users to navigate screens without taking the transmitter offline.

Select Language

Available languages for the XNX transmitter are English, Italian, French, German, Spanish, Russian, Mandarin, and Portuguese.



Figure 64. Select Language Menu

Different screens are used to display each of the eight available languages, one language per screen. Each language screen will appear in three languages: the selected language, Russian, and Mandarin. To select a new display language, use the switches to navigate through the selections. Use to make the selection or to discard the selection and return to the previous menu.



Figure 65. Language Selection Screen

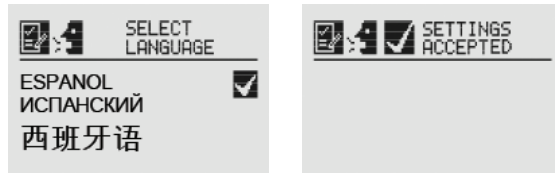

Figure 66. Accept Language Change Screen

🕒 Set Date & Time



Figure 67. Set Date & Time Menu

Select “Set Date and Time” to change the date format and set the current time/date into the XNX.

Set Date Format

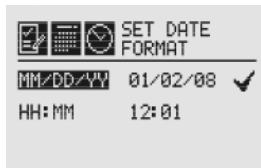

Figure 68. Set Date Format Menu

Use the $\leftarrow \rightarrow$ switches to highlight “MM/DD/YY.” Select \checkmark to set the date format.

Set Date



Figure 69. Set Date Format Screen / Set Date Menu

Use the Set Date selection to set the current date. Use the $\leftarrow \rightarrow$ switches to select the year, month, and day. Select \checkmark to set the desired date.

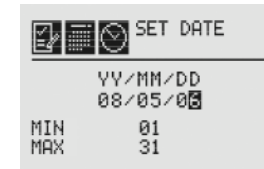

Figure 70. Setting the Date Screen

Use the $\leftarrow \rightarrow$ switches to decrement or increment the values until the desired value appears. Select \checkmark to set the value and move to the next character. Repeat for each character to be changed.

Set Time



Figure 71. Set Time Menu

Use the $\leftarrow \rightarrow$ switches to decrement or increment the values until the desired value appears. Use \checkmark to select the value and move to the next character. Repeat for each character to be changed.



Figure 72. Set Time Screen

Use the switches to navigate to the . Select it to save the changes. If is not selected, no changes will be saved.

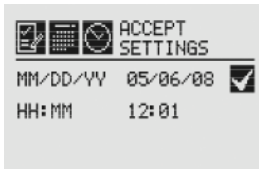

Figure 73. Accept Time-Date Changes

When the new settings have been saved, the “Settings Accepted” screen will be displayed.



Figure 74. Time-Date Settings Accepted

The remainder of this section requires **Level 2** security access.

Set mV Sensor Type

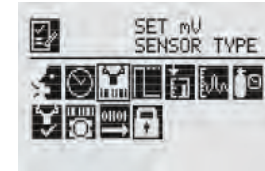

Figure 75. Set mV Sensor Type Screen

Set mV Sensor Type sets the identity of the type of mV sensor attached to the transmitter. The available mV sensor type selections are:

Sensor	Description
MPD-IC1 (5%V)	MPD Carbon Dioxide 5%Vol
MPD-IV1 (5%V)	MPD Methane 5%Vol
MPD-IV1 (100%L)	MPD Methane 100%LEL
MPD-IF1 (100%L)	MPD Flammable 100%LEL
MPD-CB1 (100%L)	MPD Flammable 100%LEL
705-HT (20%L)	705 Flammable 20%LEL (High-Temp)
705-HT (100%L)	705 Flammable 100%LEL (High-Temp)
705-STD (100%L)	705 Flammable 100%LEL
SP-HT (20%L)	Sensepoint Flammable 20%LEL (High-Temp)
SP-HT (100%L)	Sensepoint Flammable 100%LEL (High-Temp)
SP-STD (100%L)	Sensepoint Flammable 100%LEL
SP-PPM (10%L)	Sensepoint Flammable PPM (10%LEL equiv)
SP-PPM	Sensepoint Flammable PPM
SP-HT-NH3	Sensepoint Ammonia 30,000 PPM

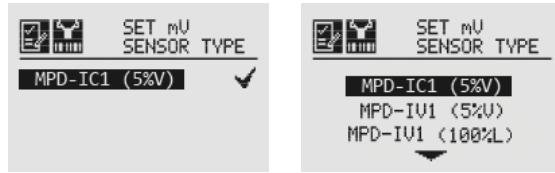

Figure 76. Current configured mV sensor and mV Available Sensor List

The first screen displays the currently configured sensor. Select to navigate to the Sensor Selection screen. To select a new mV sensor, use the switches to scroll through the list. Use to select a sensor or to discard the sensor selection, retaining the previously selected sensor, and return to the previous menu.

Set mA Sensor Type

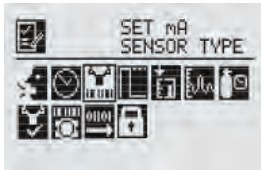

Figure 77. Set mA Sensor Type Screen

Set mA Sensor Type identifies the type of mA sensor attached to the transmitter. The available mA sensor choices are “Excel/ Optima” and “Other mA Sensor.”

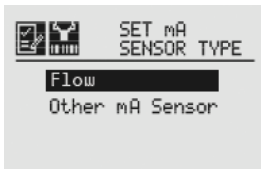
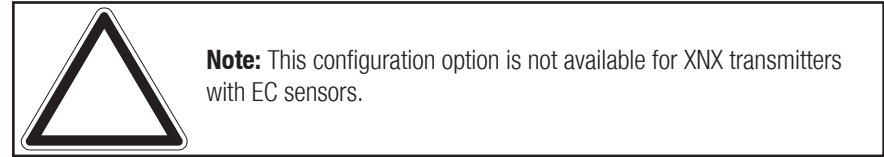

Figure 78. mA Available Sensor List

To select a new mA sensor, use the switches to move through the list. Use to make the selection or to discard the

selection, retain the previously selected sensor, and return to the previous menu.



Gas Selection

Gas Selection sets the target gas for sensors capable of detecting multiple gases. The available gases for each of the capable sensors is determined by the device connected to the XNX transmitter.

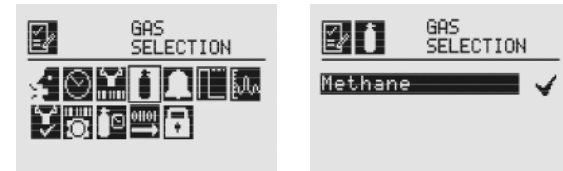

Figure 79. Gas Selection Menu

After selecting Gas Selection, the initial screen displays the current target gas. Select to display the list of available gases for the configured sensor. Use the switches to scroll through the list. A sample of the list is shown in Figure 81.

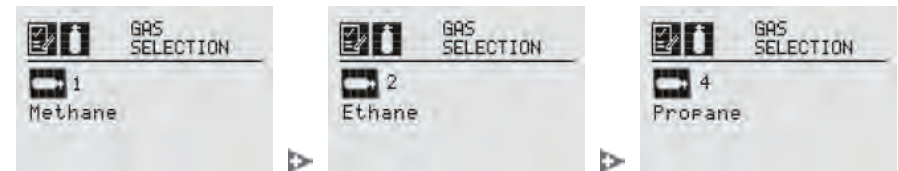

Figure 80. Available Target Gas List

Use to select the new gas or to discard the selection, retain the previously selected gas, and return to the previous menu.

When a new gas is selected, these screens are displayed:



Figure 81. Select New Target Gas

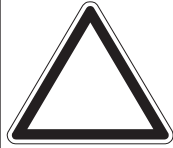

Note: The gas selections available will vary with different types of sensors. Gases listed with a “-2” suffix are compliant with 60079-20-1 LEL levels.



Warning: When selecting a new target gas for units with a Searchpoint Optima Plus, the sensor must be recalibrated.

These are the XNX transmitter’s selectable gases:

- Butane (C₄H₁₀)
- Carbon Dioxide (CO₂)
- Ethanol (C₂H₅OH)
- Ethylene (C₂H₄)
- Hexane (C₆H₁₄)
- Hydrogen (H₂)
- Methane (CH₄)
- Methanol (CH₃OH)
- Propane (C₃H₈)
- Star 1 through Star 8¹



Warning: Do not use the XNX Universal Transmitter in oxygen-enriched atmospheres. Concentrations displayed will be adversely affected by oxygen depletion.

¹In nonane detection applications, if an MPD-CB1 sensor is employed, use star rating 2; with SP-HT sensors, use star rating 4.

Changing the Gas or Units Name

If “Other mA Sensor” has been selected as the sensor type, the existing gas and units can be renamed. From the Gas Selection menu, select to open the Gas Name menu. Select again to open the Gas Name editing display. The first letter of the current selection will be highlighted (Figure 82).



Figure 82. Gas Name Screen / Gas Name editing screen

Use the switches to cycle through the 76 options (26 capital letters, 26 lower case letters, 10 numbers, 13 typographic characters, and a space). When the first character of the new gas name has been reached, select to advance to the second character. Repeat this procedure with each character until the new gas name is displayed. In this example, “mA Sensor” has been changed to “Flow Sensor” (Figure 83). The name can be up to 15 characters long. Select to return to the Gas Name screen. The new name will be displayed in reverse (light characters on a dark background). Select the switch twice to display the Accept Settings screen. Select to accept the new gas name. A “Settings Accepted” screen will be displayed briefly, followed by the Gas Selection menu.

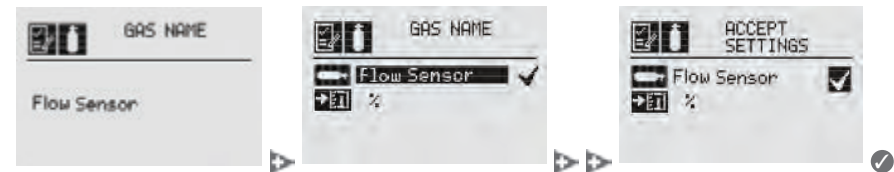

Figure 83. Accepting the New Gas Name

Follow the same procedure to rename the units (“%” in the illustrations). The units name can be up to 5 characters long.

Gas Selections and Alarm Limits Based on mV Sensor Type

The following tables show the transmitter's programmable alarm limits.

Note: -2 Gas Selection %LEL values are per IEC 60079-20-1:2010

	MPD-IC1 (5%V)
	Carbon Dioxide
Lower Alarm Limit (% Vol)	0.5
Upper Alarm Limit (% Vol)	5.0

	MPD-IV1 (5%V/V, 100%LEL)		
	Methane	Methane-1	Methane-2
Lower Alarm Limit	0.5% Vol	10% LEL	10% LEL
Upper Alarm Limit	5.0% Vol	60% LEL	60% LEL
% Volume Reference	n/a	5.0	4.4

	MPD-IF1 (100%LEL)	
	Propane-1	Propane-2
Lower Alarm Limit (% LEL)	10	10
Upper Alarm Limit (% LEL)	60	60
% Volume Reference	2.0	1.7

	MPD-CB1 (100% LEL)																						
	Hydrogen	Methane-1	Methane-2	Methanol	Ethelyne-1	Ethelyne-2	Ethanol-1	Ethanol-2	Propane-1	Propane-2	Butane-1	Butane-2	Hexane-1	Hexane-2	Star 1	Star 2	Star 3	Star 4	Star 5	Star 6	Star 7	Star 8	
Lower Alarm Limit (% LEL)	10	10	10	10	10	10	10	10	10	10	10	10	10	10	20	20	20	10	10	10	10	10	
Upper Alarm Limit (% LEL)	60	60	60	60	60	60	60	60	60	60	60	60	60	60	60	60	60	60	60	60	60	60	60
% Volume Reference	4.0	5.0	4.4	5.5	2.7	2.3	3.3	3.1	2.0	1.7	1.5	1.4	1.2	1.0	n/a	n/a	n/a	n/a	n/a	n/a	n/a	n/a	

	705-STD (100% LEL)																						
	Hydrogen	Methane-1	Methane-2	Methanol	Ethelyne-1	Ethelyne-2	Ethanol-1	Ethanol-2	Propane-1	Propane-2	Butane-1	Butane-2	Hexane-1	Hexane-2	Star 1	Star 2	Star 3	Star 4	Star 5	Star 6	Star 7	Star 8	
Lower Alarm Limit (% LEL)	20	20	20	25	25	30	30	30	25	30	30	30	50	50	50	30	25	20	20	20	15	15	
Upper Alarm Limit (% LEL)	60	60	60	60	60	60	60	60	60	60	60	60	60	60	60	60	60	60	60	60	60	60	60
% Volume Reference	4.0	5.0	4.4	5.5	2.7	2.3	3.3	3.1	2.0	1.7	1.5	1.4	1.2	1.0	n/a	n/a	n/a	n/a	n/a	n/a	n/a	n/a	

	705-HT (100% LEL)																					
	Hydrogen	Methane-1	Methane-2	Methanol	Ethelyne-1	Ethelyne-2	Ethanol-1	Ethanol-2	Propane-1	Propane-2	Butane-1	Butane-2	Hexane-1	Hexane-2	Star 1	Star 2	Star 3	Star 4	Star 5	Star 6	Star 7	Star 8
Lower Alarm Limit (% LEL)	20	15	20	20	20	20	20	20	20	20	20	20	20	20	50	30	25	20	20	20	15	15
Upper Alarm Limit (% LEL)	60	60	60	60	60	60	60	60	60	60	60	60	60	60	60	60	60	60	60	60	60	60
% Volume Reference	4.0	5.0	4.4	5.5	2.7	2.3	3.3	3.1	2.0	1.7	1.5	1.4	1.2	1.0	n/a	n/a	n/a	n/a	n/a	n/a	n/a	n/a

	705-HT (20% LEL), SP-HT (20% LEL)		
	Hydrogen	Methane-1	Methane-2
Lower Alarm Limit (% LEL)	5.0	5.0	5.0
Upper Alarm Limit (% LEL)	20	20	20
% Volume Reference	4.0	5.0	4.4

	SP-STD (100% LEL)																						
	Hydrogen	Methane-1	Methane-2	Methanol	Ethelyne-1	Ethelyne-2	Ethanol-1	Ethanol-2	Propane-1	Propane-2	Butane-1	Butane-2	Hexane-1	Hexane-2	Star 1	Star 2	Star 3	Star 4	Star 5	Star 6	Star 7	Star 8	
Lower Alarm Limit (% LEL)	20	15	20	20	20	20	20	20	20	20	20	20	20	20	50	30	25	20	20	20	15	15	
Upper Alarm Limit (% LEL)	60	60	60	60	60	60	60	60	60	60	60	60	60	60	60	60	60	60	60	60	60	60	60
% Volume Reference	4.0	5.0	4.4	5.5	2.7	2.3	3.3	3.1	2.0	1.7	1.5	1.4	1.2	1.0	n/a	n/a	n/a	n/a	n/a	n/a	n/a	n/a	

	SP-HT (100% LEL)																						
	Hydrogen	Methane-1	Methane-2	Methanol	Ethelyne-1	Ethelyne-2	Ethanol-1	Ethanol-2	Propane-1	Propane-2	Butane-1	Butane-2	Hexane-1	Hexane-2	Star 1	Star 2	Star 3	Star 4	Star 5	Star 6	Star 7	Star 8	
Lower Alarm Limit (% LEL)	10	10	10	10	10	10	10	10	10	10	10	10	10	10	20	20	20	10	10	10	10	10	
Upper Alarm Limit (% LEL)	60	60	60	60	60	60	60	60	60	60	60	60	60	60	60	60	60	60	60	60	60	60	60
% Volume Reference	4.0	5.0	4.4	5.5	2.7	2.3	3.3	3.1	2.0	1.7	1.5	1.4	1.2	1.0	n/a	n/a	n/a	n/a	n/a	n/a	n/a	n/a	

	SP-PPM (10% LEL)		
	Hydrogen	Methane-1	Methane-2
Lower Alarm Limit (% LEL)	2.0	2.0	2.0
Upper Alarm Limit (% LEL)	10	10	10
% Volume Reference	4.0	5.0	4.4

	SP-HT-NH3
	Ammonia
Lower Alarm Limit (% LEL)	3000 ppm
Upper Alarm Limit (% LEL)	30000 ppm
% Volume Reference	n/a

	SP-PPM	
	Hydrogen	Methane
Lower Alarm Limit (% LEL)	1000 ppm	1000 ppm
Upper Alarm Limit (% LEL)	5000 ppm	5000 ppm
% Volume Reference	n/a	n/a

🔔 Range & Alarms



Warning: XNX Universal Transmitters carrying UL/CSA approvals that are configured for devices measuring %LEL will not allow adjustments to the full scale value. The range is fixed at 100%.

The Range & Alarms option applies only to units with certifications other than UL/CSA.

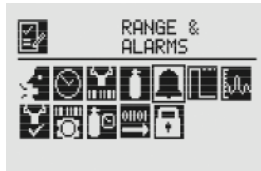

Figure 84. Range & Alarms Menu

Set Range (full-scale)

Range is sensor dependent. The Set Range option allows the full-scale range to be set for the sensor which is attached to the transmitter. The full-scale range is based on the capability of the sensor. The selectable range for EC sensors is defined in the Selectable Range column of the table in [Section 6.3.2](#). The selectable range for catalytic bead sensors is defined in the Selectable Range column of the table in [Section 6.3.5](#).

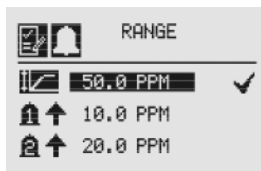

Figure 85. Range Option

When the Range option is highlighted, use the ◀▶ switches to decrement or increment the value. Use ✓ to accept the displayed value and move to the next field. When all fields have been updated, use the ▶ switch to highlight ✓ on the right side of the display. Use ✓ to accept the changes.



Figure 86. Setting the Range Value

When complete, the display will return to the Range Option screen.

Set Alarm Values

Set Alarm Values allows the values for Alarm Direction and Alarm Limits for both Alarm 1 and Alarm 2 to be set.



Caution: Alarm 1 and Alarm 2 values *must* be less than the Upper Limit value.

Use Alarm Direction to establish whether the alarm is to be triggered by rising or falling gas concentrations. Alarms for most target gases are triggered by rising concentration levels but certain gases; e.g., oxygen, can be measured for depletion levels. When the XNX transmitter is configured with mV or OPTIMA sensors and the measurement units are LEL, the alarm level setting is limited to 60%LEL.

If the concentration of the target gas remains above the alarm values for 3 seconds or more, an alarm will be triggered.

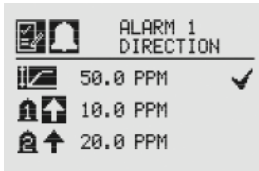

Figure 87. Alarm Direction

The icons next to the bell images indicate whether the alarm has been triggered by rising (↑) or falling (↓) gas concentrations. Use the ◀▶ switches to highlight the appropriate trigger. Use ✓ to make the selection or ✖ to discard it.



Figure 88. Setting Alarm Rising/Falling

The Alarm Limits selection sets the alarm trigger level for both alarms.

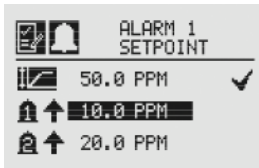

Figure 89. Alarm Limits

Use ◀▶ to set the desired alarm limit and ✓ select it. Repeat for each alarm.

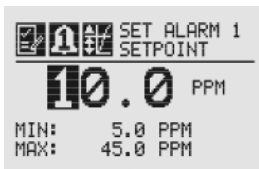

Figure 90. Setting an Alarm Setpoint

When complete, the display will return to the main Range & Alarm screen. When all settings have been made, use ◀▶ to move to the ✓ on the display to Accept Settings.

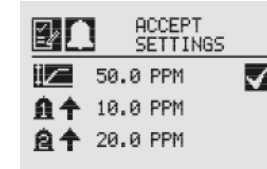

Figure 91. Accept Settings

When the settings have been saved, the following screen will appear on the display.



Figure 92. Settings Accepted Screen

See [Section 6.1 Product Specifications](#) for EC cell information.

Selecting the Numeric Format

If “Other mA Sensor” has been selected as the sensor type, the transmitter’s output can be displayed in one of three numeric formats. From the Ranges & Alarms menu, select the switch to open the Range menu (Figure 93). Select the switch again to display the Range Lower Limit menu. Select the switch twice to open the first Numeric Format menu.

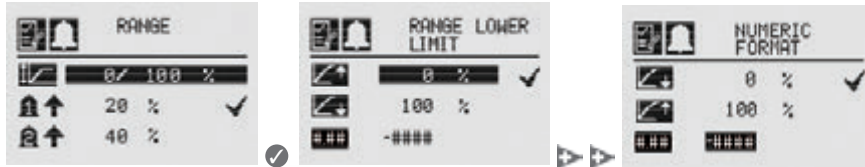

Figure 93. Navigating to the first Numeric Format menu

Select the switch to open the second Numeric Format menu, which displays the formats available for numerical display (see Figure 94).

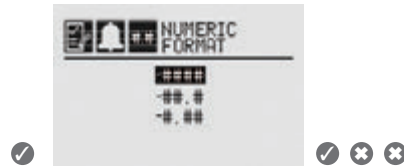

Figure 94. Navigating to the second Numeric Format menu

Select or to cycle through the three options. When the desired format is highlighted, select the switch to make the selection the default display format. Select twice to return to the Ranges & Alarms menu.

Latching / Non-Latching



Warning: There is a potential loss of sensitivity during exposure to high concentrations of H₂S. Under these conditions, set the control unit to latch at overrange. In standalone configuration, set alarms to latching. When resetting the overrange or alarm, verify correct operation of the transmitter.

Latching / Non-Latching is used to control whether Alarms 1 and 2 and faults will latch alarms.



Figure 95. Alarm Latching/Non-Latching Screen



Figure 96. Alarm Latching

Select the or icon beside the alarm limit to display the Alarm Latching/Unlatching screen. Alarm latching determines whether alarms that are triggered are automatically reset when the condition dissipates (latching off) or remain active until an operator resets them manually (latching on). Highlight the desired latching option with the switches. Use to accept it.



Figure 97. Setting Alarm Latching/Unlatching

Use the same procedure to set the desired values for Alarm 2 and Faults. When all settings have been made, use $\leftarrow \rightarrow$ to navigate to the \checkmark on the display. Use \checkmark to accept settings.

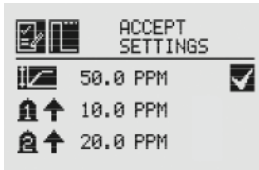
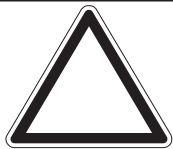

Figure 98. Accept Settings

When the settings have been saved, the following screen is displayed.



Figure 99. Settings Accepted Screen



Note: When non-latching is selected, external alarm latching is recommended.

Set Units

The Set Units menu allows the units of measurement displayed on the XNX main menu to be set. This option also sets the units

transmitted via HART, Modbus, or Foundation Fieldbus sensors attached to the XNX transmitter, reporting concentrations in PPM or %VOL (except oxygen).



Figure 100. Set Units Menu

To change the units, use the $\leftarrow \rightarrow$ switches to highlight the units icon. Use \checkmark to select it. The transmitter's display will change to the Display Unit Selection screen which shows the available choices for the sensor type installed. Use the $\leftarrow \rightarrow$ switches to highlight the desired unit of measurement. Use \checkmark to select it or \otimes to discard the selection.



Figure 101. Display Unit Selection Screen



Caution: When changing units of measure, check alarm level settings for the proper units and change as necessary.

Once the units of measurement have been set, use the $\leftarrow \rightarrow$ switches to navigate to the \checkmark to accept the values.

mA Levels

This option allows the user to select mA output levels for inhibit, fault, and over range. Beam block and low signal apply to

Searchline (see the table in the next column).



Figure 102. mA Levels Menu

Using the $\leftarrow \rightarrow$ switches, move to the mA output to be changed and use \checkmark to select it.



Figure 103. Set mA Levels for Warning

Use the $\leftarrow \rightarrow$ switches to decrement or increment the value until the desired value appears. Use \checkmark to select the value and move to the next setting. Repeat for each setting to be changed.

The default values and available output ranges for Inhibit, Warning, Overrange, Beam Blocked, and Low Signal are shown in the following table. See [Section 5 Warnings/Faults](#) for more information.

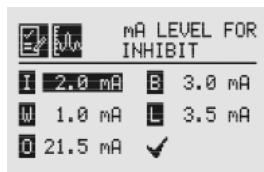

Figure 104. Set mA Levels for Inhibit

Signal	Output (mA)		
	Default	Min	Max
I Inhibit	2.0	1.0	3.5
W Warning	3.0	1.0	3.5
O Overrange	21.0	20	22
B Beam Blocked	1.0	1.0	4.0
L Low Signal	1.0	1.0	4.0

After all changes have been made, use the $\leftarrow \rightarrow$ switches to move to the \checkmark and use \checkmark on the front panel to accept and save the settings. If \checkmark is not selected, none of the changes will be saved.



Figure 105. mA Settings Saved

🔧 Calibration Interval

Calibration Interval allows a desired interval for sensor calibration to be set for sensors attached to the transmitter. The transmitter will generate a warning when the interval is reached.



Figure 106. Calibration Interval Menu

Calibration Interval will not appear when an IR personality board is attached and the mA sensor type is set as 'Other mA Sensor'.

The default calibration values for the "Calibration Required" diagnostic vary based on sensor type. This value can be reprogrammed in accordance with site requirements to ensure the highest level of safety. Correct operation of each sensor should be confirmed using calibration with a certified gas of known concentration before commissioning.

Although the calibration Interval can be set to any value between 0 and 360 days, Honeywell Analytics recommends that the interval for electrochemical and catalytic sensors be set to 180

days (or fewer, in accordance with customer site procedures) to assure the highest level of safety.

Use the switches to highlight the current interval and use to select it.

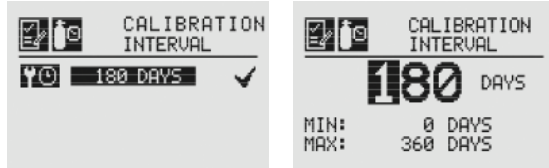

Figure 107. Edit Interval and Setting Interval Value Screens

Use the switches to move to the desired position. Use to select it. Use the switches to decrement or increment the value until the desired value is reached. (The minimum number of days is 0; the maximum number is defined by the sensor type.) Use to select the value and move to the next field. Repeat for each field. When all of the fields have been updated, use the switches to highlight the '✓' on the right side of the display. Use on the front panel to save the settings.



Caution: Setting the Calibration Interval to zero turns off the calibration notification. This can seriously affect sensor performance.

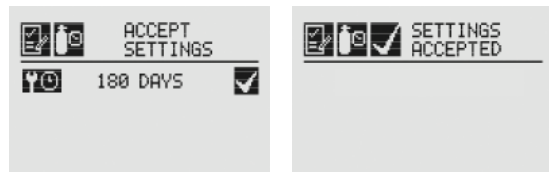

Figure 108. Saving New Interval and New Interval Accepted Screens

Accept New Sensor Type

When replacing EC cells or mV sensors, use Accept New Sensor Type to load default parameters into the XNX transmitter for calibration and sensor life. Accept New Sensor Type is also used when replacing an EC cell with another EC cell for a different target gas. (See [Section 4.2.2](#)).

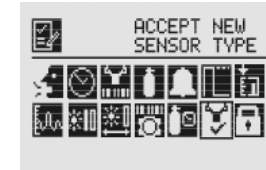

Figure 109. Accept New Sensor Type Menu

When changing the target gas by inserting a new sensor, the transmitter will prompt the user for a confirmation of the change before adjusting to the properties of the new sensor.

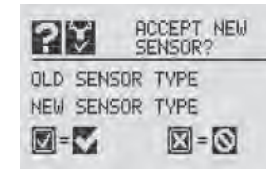

Figure 110. Select New Sensor

In the display of the XNX transmitter, the old sensor type and the new sensor type will be displayed. Use to accept the new sensor or to reject it.

Beam Block Options

The Beam Block Options menu is available only if the XNX transmitter is connected to a Searchline Excel sensor.

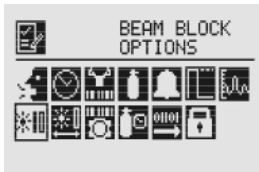

Figure 111. Beam Block Menu

If the infrared beam from the Excel transmitter is blocked or inhibited in such a way that the intensity of the beam drops to a level below the readable threshold set by the receiver, a warning will be generated by the XNX transmitter. The Beam Block Options menu allows the user to define the maximum period of time the infrared beam can be blocked and the percentage of signal loss before generating a warning through the transmitter.

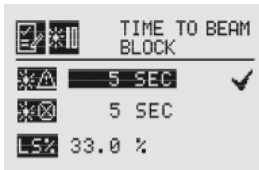

Figure 112. Beam Block Warning Time

Use the ◀▶ switches to move to the desired beam block time option and use ✓ to select it. Use the ◀▶ switches to decrement or increment the value until the desired value appears. Use ✓ to select the value and move to the next setting.

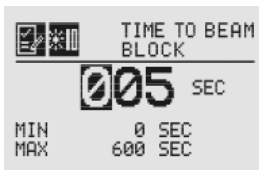

Figure 113. Setting Beam Block Warning Time

When the beam is blocked longer than the value set in Time to Beam Block, a fault is generated by the transmitter.

Set Time to Fault sets the minimum time the beam is blocked before generating a fault.

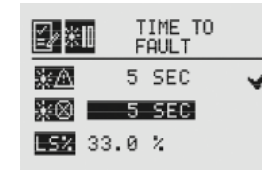

Figure 114. Beam Block Fault Time

Use the ◀▶ switches to move to the desired beam block time option and use ✓ to select it. Use the ◀▶ switches to decrement or increment the value until the desired value appears. Use ✓ to select the value and move to the next setting.

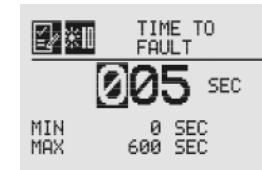

Figure 115. Setting Beam Block Fault Time

When the beam is blocked longer than the value set in Time to Fault, a fault is generated by the transmitter.

Low Signal Percentage sets the minimum percentage value of the beam that is not blocked. When the percentage decreases below the defined percentage, a fault is generated.

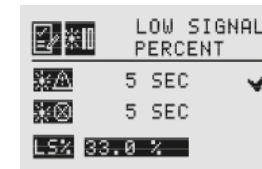

Figure 116. Low Signal Percentage

Use the ◀▶ switches to move to the desired Low Signal Percentage and use ✓ to select it. Use the ◀▶ switches

to decrement or increment the value until the desired value appears. Use to select the value and move to the next setting.

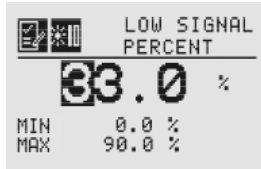

Figure 117. Setting the Low Signal Percentage

Once the values for Beam Block Warning, Beam Block Fault and Low Signal Percentage have been set, use the switch to highlight the '✓' on the right side of the display. Then use to accept the changes to the XNX. If '✓' is not highlighted, none of the changes will be saved.

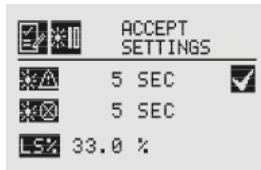

Figure 118. Accept Beam Block Changes



Figure 119. Beam Block Changes Accepted

Path Length

The distance (in meters) between the transmitter and the receiver is set through the Path Length menu. This menu is available only if the transmitter is connected to a Searchline Excel sensor.

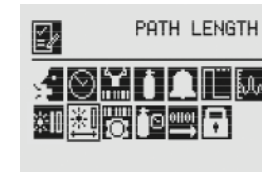

Figure 120. Path Length Menu

Setting the Path Length or distance between the transmitter and receiver of the Excel lets the devices determine the optimum settings for the beam strength for the application.

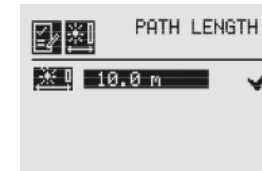

Figure 121. Current Path Length Setting

Use the switches to move to the desired Path Length setting and use to select it. Use the switches to decrement or increment the value until the desired value appears. Use to select the value and move to the next setting.

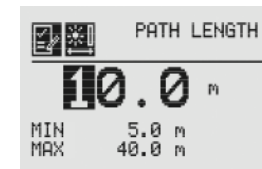

Figure 122. Setting Path Length

Once the values for Path Length have been set, use the switch to highlight the '✓' on the right side of the display. Use the to accept the changes.



Figure 123. Accepting Path Length Changes



Figure 124. Path Length Changes Accepted

Unit ID

The Unit ID option allows a unique unit ID of up to 18 characters to be set for each XNX transmitter. This character string can be broadcast over any of the supported communication options, providing a means to create a unique identification for each XNX transmitter for accurate reporting. Available characters are A-Z, a-z, 0-9 and special characters ? ! * % () : & / , # + -



Figure 125. Unit ID Menu



Note: The XNX Unit ID is not the same as the HART tag in XNX applications using HART protocol.

Edit ID

Each XNX is assigned a default Unit ID from the factory. The Edit ID menu allows the assigned ID to be modified.



Figure 126. Edit Unit ID Screen

From the Edit ID Screen, use the switches and to select Edit ID. The current Unit ID is displayed. When editing an existing ID, the list of available characters begins at the value displayed.



Figure 127. Editing the Unit ID

Use the switch to highlight the first character to be changed. Use the switches to decrement or increment the value until the desired value appears. Use to accept the new value and move to the next character. Repeat for each character to be changed. The Unit ID can be up to 18 characters long.

Clear ID

This option clears the current set Unit ID.



Figure 128. Clear Unit ID and Cleared Unit ID Screens

Set ID to Default

The Set ID to Default option returns the Unit ID to the factory default.

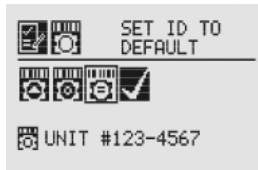

Figure 129. Set ID to Default Screen

Once all changes have been made, Accept Settings must be selected before exiting the Unit ID menu. When all changes are saved, the transmitter will display the Settings Accepted screen.





Figure 130. Accept Settings and Accepted Screens

Relay Options

The Relay Options menu allows the relays for both alarm levels to be configured. This menu is available only if the XNX transmitter is equipped with the optional relays.



Figure 131. Relay Options Screen

XNX relays can be set to Energized or De-energized. The default is De-energized. The two states for each relay are represented by the symbols  for energized and  for de-energized.

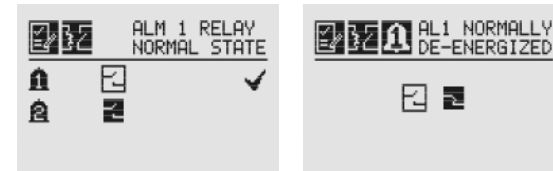

Figure 132. Alarm 1 Relay Current State and Setting New State







Use the   switches to move to the desired alarm and use  to select it. Use the   switches to change the state of the relay. Use  to accept the new state. Once the XNX transmitter has accepted the new information, a Settings Accepted screen appears.



Figure 133. Accept New Alarm Relay Settings and new Settings Accepted

Fieldbus Options

The Fieldbus Options menu allows configuration of the HART address or the optional Modbus fieldbus address and baud rate.



Figure 134. Fieldbus Options Screen

Select the Fieldbus Options icon to activate the HART/Modbus screens to allow selection of the protocols to be configured or changed. If the XNX is configured without HART or Modbus, only the installed options will be visible.



Figure 135. HART Options Screen

The HART menu provides the ability to select the HART mode. From the HART screen, use the $\leftarrow \rightarrow$ switches to highlight the HART option, then select \bullet . This displays the HART address screen where the device address and whether the HART protocol is active in the unit can be set. To set the address, use the $\leftarrow \rightarrow$ switches to highlight the number in the top line (between 0 and 63) and use \bullet to select it. Use the $\leftarrow \rightarrow$ switches to decrement or increment the value until the desired value appears. Use \bullet to select the value and move to the next setting.



Figure 136. HART Address and Address Value Screens

Use the $\leftarrow \rightarrow$ switches to move to the HART option and use \bullet to select it. Use the $\leftarrow \rightarrow$ switches to scroll through the options until the desired option is highlighted. Use \bullet to accept the new state. See [Section 2.3.1](#) and [Appendix A](#) for more information on available HART modes.

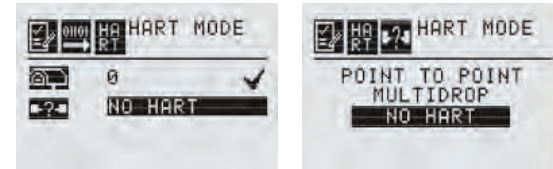

Figure 137. HART Mode Screens

Once the values for the HART address and Mode have been set, use the $\leftarrow \rightarrow$ switches to navigate to the '✓' then select it to save the changes to the XNX.



Figure 138. HART Settings Accepted

When the Modbus option is available, use the $\leftarrow \rightarrow$ switches to move to the Modbus icon and use \bullet to select it. The Modbus option allows the address and communication baud rate to be set.



Figure 139. Modbus Options Screen

From the Set Fieldbus Address screen, select . To set the Fieldbus address, use the switches to move to the desired position and use to select it. Use the switches to decrement or increment the value until the desired value appears. Use to select the value and moves to the next setting.



Figure 140. Set Fieldbus Address and Address Value Screens

The communications baud rate can be set from this screen. Use the switches to highlight the proper baud rate and select .



Figure 141. Set Baud Rate Screens

Once the values for the Fieldbus address have been set, use the switches to navigate to the '✓' then select it to save the changes.



Figure 142. Accept Settings and Fieldbus Address Settings Accepted

Configure Security

Configure Security is used to set or reset the level 1 and level 2 passcodes that control access to the configuration menus of the XNX transmitter.

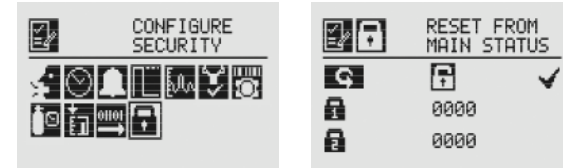

Figure 143. Configure Security Screens

Easy Reset from Main Status

The Easy Reset from Main Status option controls the ability to reset faults, warnings, and alarms from the General Status screen (see [Section 1.4.2](#)).

Use the switches and to select the lock icon . The Lock/Unlock screen will be displayed. Choose 'Lock' to prevent reset without password access. The 'Unlock' choice allows resets without requiring login or a passcode.



Figure 144. Lock/Unlock Screen

Level 1 and Level 2 Passcode

Level 1 and 2 passcode screens give the administrator the ability to assign new passcodes for either or both access levels.

From the Configure Security Screen, use the ◀▶ switches to highlight Passcode 1. Use ⏎ to choose the first digit and the ◀▶ switches to decrement or increment the values. Use ⏎ to accept the new value and move to the next digit. Repeat until all four digits have been selected. Follow the same procedure to change the Level 2 passcode.



Figure 145. Setting Level 1 Passcode

Use the ◀▶ switches to move to “Accept Settings” on the display. Choose ⏎ to save the settings to the transmitter.



Figure 146. Accept Settings and Security Settings Accepted Screens

2.6 Verifying the XNX Configuration

2.6.1 Test Menu

The test menu icons are shown in this table:

Symbol	Description	Symbol	Description
	Inhibit		Force Relay
	Force mA Output		Alarm/Fault Simulation

Warning: Keep the passwords in a secure area to prevent unauthorized access to the transmitter. If the passwords are lost, resetting the XNX transmitter will require a service technician.

Inhibit

Warning: When the XNX transmitter is placed in Inhibit Mode, alarms are silenced. This will prevent an actual gas event from being reported. Inhibit Mode must be limited to testing and maintenance only. Exit Inhibit Mode after testing or maintenance activities.



Figure 147. Inhibit Screen

The Inhibit mode is designed to prevent alarms from being triggered during testing or maintenance.



Figure 148. Inhibit Menu

Use the switches to inhibit alarms by selecting Inhibit On with the . The confirmation screen appears.

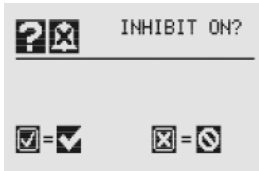

Figure 149. Confirm Inhibit On

Select to place the transmitter alarms into inhibit mode. Select will cancel the choice and leave the alarms in normal operating mode.

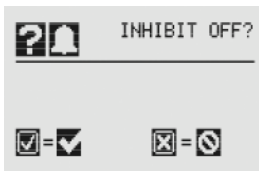

Figure 150. Confirm Inhibit Off

To return from Inhibit mode to the normal monitoring mode, select Inhibit Off with the . A confirmation screen appears.

Select to remove the XNX from Inhibit mode. Select 'X' to cancel the choice and leave the alarms in Inhibit mode.

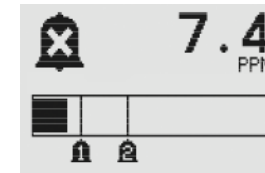



Figure 151. Inhibit Status Screen

When the XNX transmitter is in Inhibit mode, the General Status display will display the inhibit icon .

Force mA Output



Caution: The mA output set in this menu will revert to the normal operating values when exiting the Test Menu. For more information on setting the mA output levels for normal operation, see [mA Levels](#).

Force mA Output allows peripheral devices driven by mA output from the XNX transmitter to be tested. Based on the mA output values set in the mA Levels option (see [mA Levels](#)), the operator chooses the mA level to output to the device.

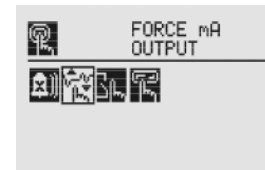

Figure 152. Force mA Output Screen

The New mA Output screen shows the current mA output in the left column. The output can be controlled by changing the value in the column on the right.

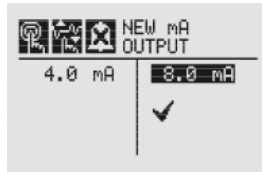

Figure 153. New mA Output Screen

Once the new value is input, use the $\leftarrow \rightarrow$ switches to move to the '✓' and use the \checkmark magnetic switch on the front panel to set the mA output.

Force Relays



Caution: Any relay conditions set in this menu will revert to the normal operating values when exiting the Test Menu. For more information on setting the relay options for normal operation, see [Relay Options](#).

The Force Relay menu allows peripheral devices driven by relays from the transmitter to be tested. Depending on the relay options set in the Relay Options menu (see [Relay Options](#)), the relay will be open or closed.



Figure 154. Force Relays Screen

The Relay State screen shows the current relay configuration in the left column. The output can be controlled by changing the value in the column on the right.

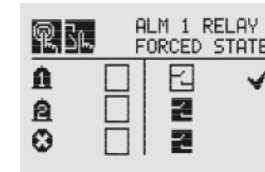

Figure 155. Relay State Screen

Once the new value is input, use the $\leftarrow \rightarrow$ switches to move to the '✓' and use the \checkmark magnetic switch on the front panel to change the condition of the relay.

Alarm/Fault Simulation

Alarm and Fault simulation work in tandem with the previous sections (Force mA Output and Force Relays) to allow thorough testing of the XNX transmitter and the peripheral warning and safety devices attached. Figure 156 shows the menu choices for selecting an alarm or fault simulation.



Figure 156. Alarm/Fault Simulation Screen

Selecting an alarm level to simulate activates a confirmation screen.



Figure 157. Alarm/Fault Simulation Menu

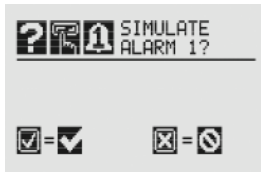

Figure 158. Confirmation

Selecting will simulate the alarm from the transmitter. If the is selected, the simulation will be aborted.

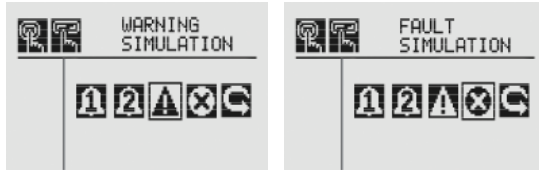

Figure 159. Warning and Fault Simulation Screens

To simulate a Warning or Fault from the transmitter, select the appropriate icon from the menu.

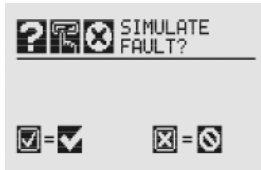

Figure 160. Fault Simulation Confirmation

A confirmation screen will appear. Select to simulate the warning or fault from the transmitter. If the is selected, the simulation will be aborted. Use Alarm/Fault Reset to reset alarms, faults, or warnings generated by the simulation.

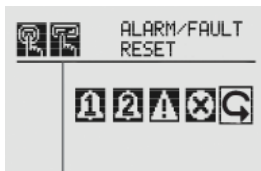

Figure 161. Alarm/Fault Reset Screen

A confirmation screen will appear.



Figure 162. Alarm/Fault Reset Screen

Select to reset the alarms, faults, or warnings generated by the simulation. If the is selected, the simulation continues.



Caution: Relays and LEDs will return to their initial states after simulations are completed unless faults and alarms are set to latching by the user.



Warning: After changing parameters with a handheld device, verify that the parameter settings are correct at the transmitter.

2.6.2 Information Menu

The Information Menu Displays the current status information for these parameters:

Symbol	Description	Symbol	Description
	Show Alarm/Fault Status		Show Gas Data
	Show Date/Time		Show Range/Alarm Settings
	Show Transmitter Data		Show mA Level Settings
	Show Transmitter Status		Show Relay Settings
	Show Sensor Data		Show Fieldbus Settings
	Show Sensor Status		Show Event History

Alarm/Fault Status

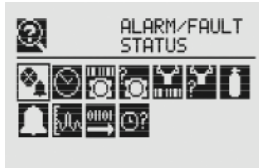

Figure 163. Alarm/Fault Status Screen

Select Alarm/Fault Status to display the Alarm/Fault Status screen allowing faults and alarms to be reset.

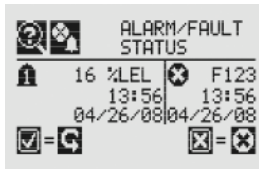

Figure 164. Alarm/Fault Status Screen

The '✓' will be highlighted. Select to reset all faults and alarms

generated by the transmitter then return to the Alarm/Fault Status screen. Select the switch to return to the Alarm/Fault Status screen without resetting faults or alarms.

Date & Time

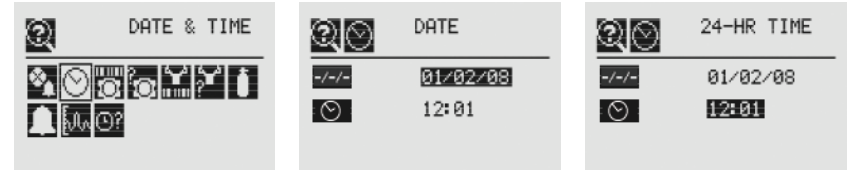

Figure 165. Date/Time Screens

The Date and Time screens display the date and time in the formats currently set on the transmitter. To set the time and date see [Set Date & Time](#).

Transmitter Data

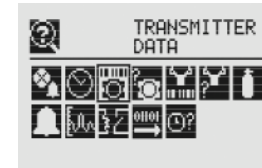

Figure 166. Transmitter Data Screen

Using the switches, the Transmitter Data displays the ID, part number, serial number, and version number of the firmware.

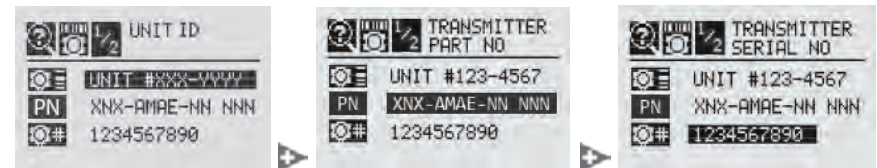

Figure 167. Transmitter ID, Part Number and Serial Number Screens

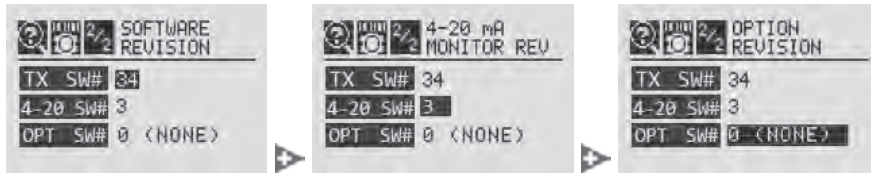

Figure 168. Transmitter Software, 4-20 Monitor and Option Version

Transmitter Data is also used to update the configuration of the XNX when an option board is added or changed. To add the new option, use the switches to navigate to the Option Revision screen, then swipe the magnetic switch on the front panel to display the Accept New Option Screen. The screen will show the current option (if any) and the newly installed option. Use the switches to highlight the option then swipe the magnetic switch on the front panel to accept the change. The transmitter will update the part number of the unit. The new option will then be operational.

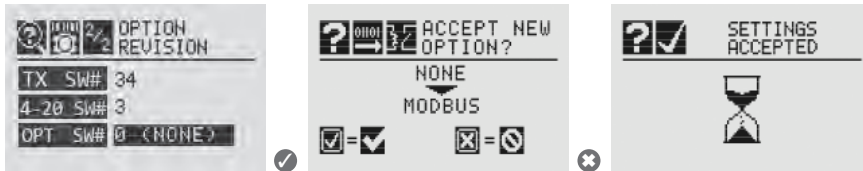

Figure 169. Updating The XNX for Option Boards Added or Changed

Transmitter Status

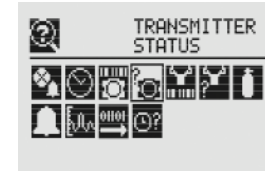

Figure 170. Transmitter Status Screen

Transmitter Status displays information about the XNX unit including temperature, 4-20 mA output value, and supply voltage.



Figure 171. Transmitter Temperature and Supply Voltage Screens

Sensor Data

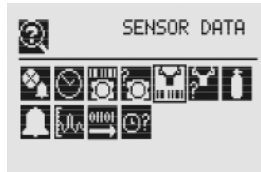

Figure 172. Sensor Data Screen

Sensor Data displays information about the transmitter including sensor type and sensor software revision.



Figure 173. Sensor Type and Software Screens

Sensor Status

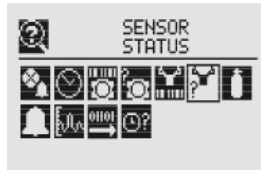

Figure 174. Sensor Status Screen

Sensor Status displays the temperature of the sensor attached to the transmitter. When equipped with an EC or mV sensor, sensor life is also displayed.

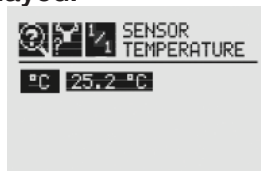

Figure 175. Sensor Temperature Screen

Gas Data

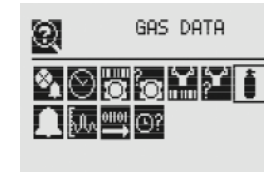

Figure 176. Gas Settings Screen

Gas Data displays the current detectable gas as configured for the attached sensor.



Figure 177. Gas Abbreviation and Full Scale Screens

Range/Alarm Settings



Figure 178. Range/Alarm Settings Screen

Range/Alarm Settings displays the currently configured alarm information.

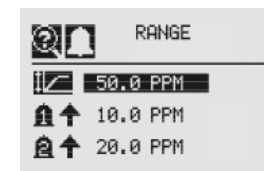

Figure 179. Alarm Display Range Screen

mA Level Settings

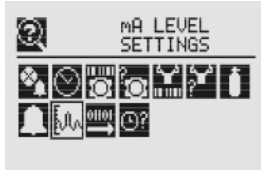

Figure 180. mA Level Settings Screen

mA Level Settings shows the current values for mA output for Inhibit, Warning, and Overrange output.

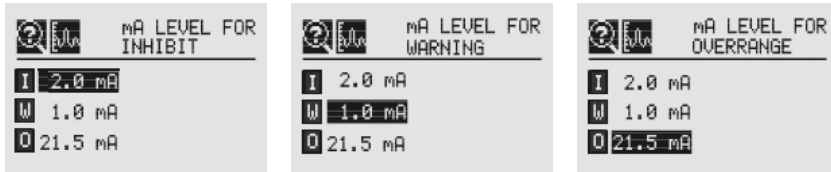

Figure 181. mA Output Inhibit, Warning and Overrange Screens.

Fieldbus Settings

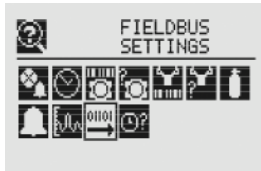

Figure 182. Fieldbus Settings

Fieldbus Settings displays the current configuration of both HART and Modbus. To change the settings see [Fieldbus Options](#). HART displays the current HART address assigned to the transmitter.



Figure 183. HART Configuration Settings

Modbus displays the current address and communication data rate assigned to the transmitter.



Figure 184. Modbus Configuration Display Screen

Relay Data

The Relay Menu is enabled only if the XNX transmitter is equipped with the optional relays.

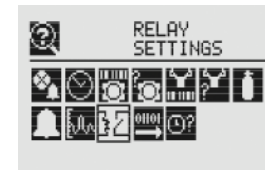

Figure 185. Relay Data Screen



Figure 186. Relay State Screens

Relay Data displays the current setting of the optional relays on the transmitter. To change the relay settings, see [Relay Options](#).

🕒? Event History

The Event History screen lists all events that are activated by the transmitter's settings. Five types of events are recorded: reset messages, alarm messages, warning messages, fault messages, and informational messages. The events are listed in chronological order beginning with the latest.

Events can be displayed through five browsing modes:

- all events in order of occurrence
- all events by hour
- all events by day
- only the alarm events, in order of occurrence
- only the fault events, in order of occurrence

The Event History screen groups events into chronological order (beginning from the unit's installation). Events can also be viewed by hour or by date.

Events listed in *hour* order are grouped without regard to date. For example, all events that have occurred between noon and 1:00 o'clock since the transmitter's installation can be isolated.

To view all events in hour order:

1. Use the magnetic wand to filter the display by hour.
2. Navigate through the displayed times.

To isolate all of the events from a specific *day*:

1. Use the magnetic wand to filter the display by day.
2. Navigate through the displayed days.
3. Filter the list by all events. This will display all events that occurred on that day.

When the transmitter is configured with the Searchline Excel or

Searchpoint Optima, the data reported in the event will be the fault code from the Searchline Excel or Searchpoint Optima. The transmitter records up to 1280 events in a circular buffer. When event 1281 is recorded, the oldest event will be bumped from the list.

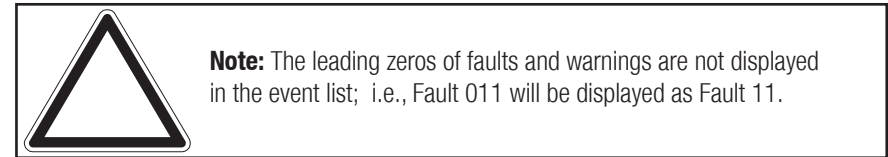

Figure 187. Event History Screen

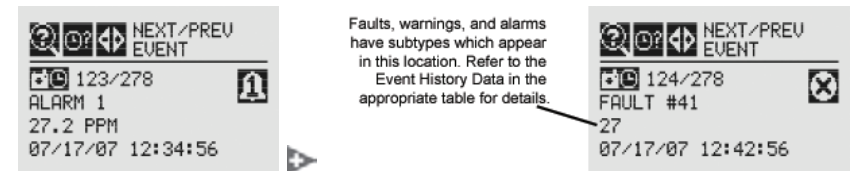

Figure 188. Chronological Event List

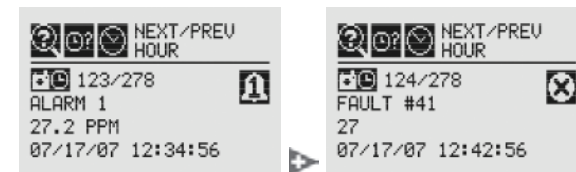

Figure 189. Chronological Event List by Hour

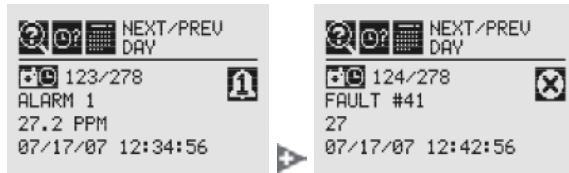

Figure 190. Chronological Event List by Day

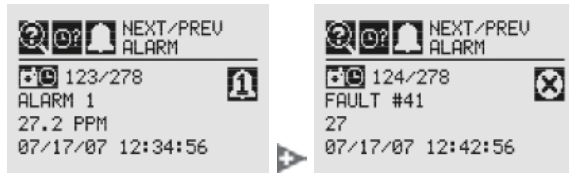

Figure 191. Chronological Alarm List

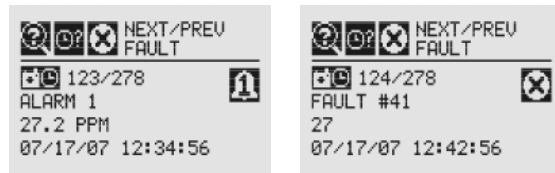

Figure 192. Chronological Fault List

The transmitter is configured with five cable/conduit ports built into the housing for wiring and mounting sensors.

3 Calibration

3.1 Gas Calibration Menu

Each of the sensor technologies supported by the XNX® Universal Transmitter uses unique calibration procedures. The description provided illustrates the XNX interface with the sensor. The description does not replace the procedures found in each sensor’s operating manual.

The Gas Calibration menu is used for Zero and Span calibration as well as functional gas testing (bump test). The Gas Calibration menu is accessed from the Main Menu.

This table shows the Gas Calibration menu icons:

Symbol	Description
	Gas Calibration
	Bump Test
	Calibrate mA Output
	Soft Reset
	Align Excel



Figure 193. Gas Calibration Menu

3.2 Calibration



Warning: Do not use the XNX Universal Transmitter in oxygen-enriched atmospheres. Concentrations displayed will be adversely affected by oxygen depletion.



Caution: The calibration procedure should be performed only by qualified personnel. Take appropriate precautions with cylinders of flammable and toxic gases.

The default calibration values for the “Calibration Required” diagnostic vary based on sensor type. This value can be reprogrammed in accordance with site requirements to ensure the highest level of safety. Correct operation of each sensor should be confirmed before each use by calibration with a certified test gas of known concentration before commissioning. See [Section 6 - Specifications](#) for calibration gas specifications.



Caution: Recalibrate if the temperature of local environment has varied by more than $\pm 15^{\circ}\text{C}$ from the temperature of calibration.



Warning: Honeywell recommends periodic bump tests (every 30 days or in accordance with customer site procedures) to the sensor to insure proper operation and compliance with the functional safety rating of the installation.

3.2.1 Zero and Span Calibration for XNX EC Sensors, mV Sensors, and Searchpoint Optima



Caution: Before initial calibration, allow the sensor to stabilize for 30 minutes after applying power. When in Zero and Span Calibration modes, the current output from the sensor is inhibited (default 2mA) to avoid false alarms.



Caution: For most sticky gases (e.g., HCl, Cl₂) use PTFE tubing with short pieces of rubber tube for the final connection (due to the inflexibility of PTFE). This minimizes adhesion of the gas to the tube surface and allows more accurate measurement.

To calibrate the sensor, use an appropriate span gas cylinder, tubing, magnet, and calibration gas flow housing. Set the flow regulator to 300-375 ml/min for XNX EC sensors or 500 ±200 ml/min for XNX mV sensors. A compressed gas cylinder (20.9%Vol oxygen) should be used to perform the zero calibration if the area where the sensor is located contains any residual amount of the target gas. If no residual gas is present, background air can be used to perform the zero calibration. Contact a Honeywell Analytics representative for details about suitable calibration kits. To calibrate the sensor, follow the procedure in [Section 3.2.2](#).



Note: The oxygen sensor does not require a zeroing procedure. Background air (20.9%Vol oxygen) can be used to span the oxygen sensor in place of a compressed air cylinder (20.9%Vol oxygen). See [Section 6.3.2](#) for other sensors.

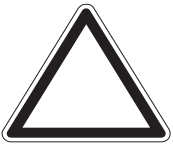

Note: EN performance standards require 10 minutes stabilization time for application of zero and span gas for performance-approved EC, mV, and IR sensors prior to calibration.

3.2.2 Calibration Procedure

This section outlines the steps for calibrating the transmitter's attached sensors.



Note: The Zero Calibration procedure should be performed prior to the Span Calibration procedure.

1. If using a compressed gas cylinder, push the calibration gas flow housing onto the bottom of the sensor and apply the gas.
2. Access the Gas Calibration Menu.



Figure 194. Gas Calibration Menu



Note: The Gas Calibration menu is for both Zero Calibration and Span Calibration.

Zero Calibration



Figure 195. Zero Calibration Screen

As the sensor detects the gas and the concentration increases, the values displayed will reflect the changing concentration. When the concentration values are stable, 3 minutes, select to allow the transmitter to calculate the zero adjustment. Selecting will return to the Gas Calibration menu.



Figure 196. Zero Calibration in Progress

3. If the zero calibration is successful, the transmitter will display the Zero Passed screen.

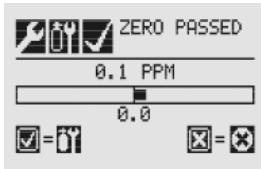

Figure 197. Zero Calibration Passed

Span Calibration

If a Span Calibration is not required, select the to skip the Span Calibration and return to the Calibration menu.

4. When the Zero Calibration is complete, the Span Concentration screen appears. The gas concentration for the Span Gas Calibration can be changed. If the Span Calibration is skipped, the Gas Calibration screen displays.

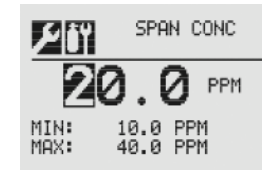

Figure 198. Span Gas Concentration Screen

5. Enter the concentration of the span gas by selecting to choose the first digit. Use the switches to increment or decrement the values. Use to accept the new value and move to the next digit. Continue until all digits have been selected.

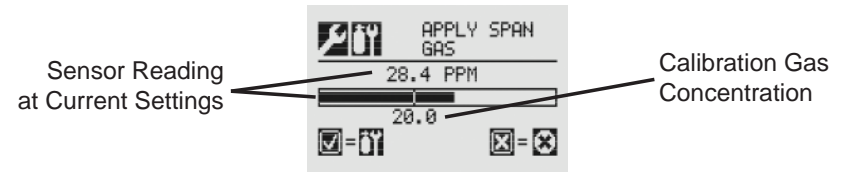

Figure 199. Span Calibration Screen

6. Apply the span gas. As the sensor detects the gas and the concentration increases, the values displayed will reflect the changing concentration. When the concentration values are stable, select to perform the span. The Span Calibration process also determines whether the sensor is within the proper range to accurately detect the target gas.

Selecting will cancel the span calibration and return to the Gas Calibration menu.

7. When the sensor has completed the calibration and the span algorithms have determined that it is within range, the Span Passed screen will appear.

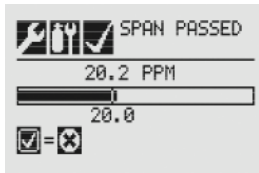

Figure 200. Span Passed Screen

If the calibration is not successful, the Span Failed screen will display. Selecting will return to the Span Concentration screen to begin the span calibration again. Selecting will exit Span Calibration and return to the Gas Calibration Menu.

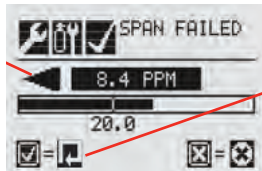

Figure 201. Span Calibration Failed

Once the Zero Gas and Span calibrations are completed successfully, the user will be prompted to:

- exit with inhibit off
- exit with inhibit on, or
- not exit.

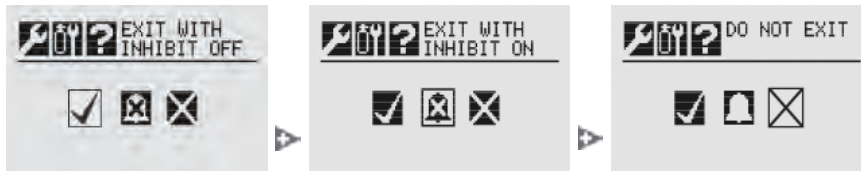

Figure 202. Span Calibration Failed



Warning: When the XNX transmitter is placed in Inhibit Mode, alarms are silenced. This will prevent an actual gas event from being reported. Inhibit Mode must be limited to testing and maintenance only. Exit Inhibit Mode after testing or maintenance activities.

3.2.3 Using the Calibration Cup

Refer to Figure 203 to attach the calibration cup:

1. Snap the calibration cup into the weather protector. The two protrusions on the cup fit into recesses in the weather protector.
2. Attach the hose from the gas cylinder to the calibration cup. Note that the cup's flow is unidirectional. There is an arrow on the bottom showing flow direction
3. Adjust the calibration flow rate¹.

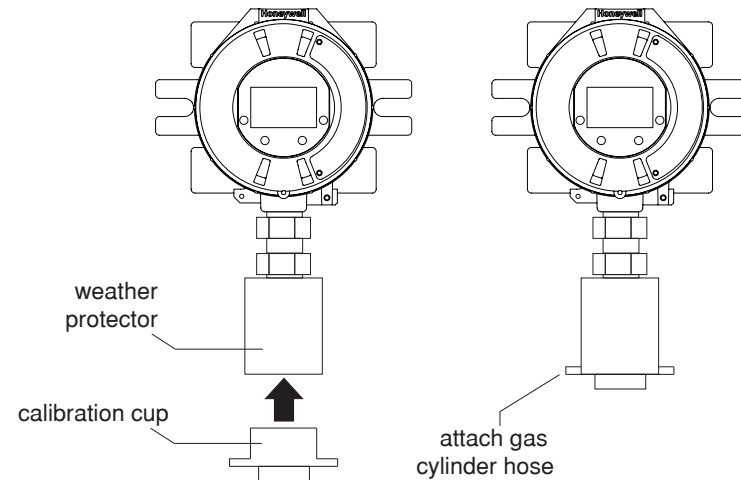

Figure 203. Attaching the Calibration Cup

¹ 300-375 ml/min for XNX EC sensors, 500 ±200 ml/min for XNX mV sensors, unless otherwise directed

3.2.4 Zero and Span Calibration of XNX EC Hydrogen Sulfide (H₂S) Sensors



Caution: Before initial calibration, allow the sensor to stabilize for 30 minutes after applying power. When in zero and span calibration modes, the current output from the sensor is inhibited (default 2mA) to avoid false alarms.



Caution: Recalibrate if the temperature of local environment has varied by more than $\pm 15^{\circ}\text{C}$ from the temperature of calibration.

Hydrogen Sulfide sensors can be affected by extreme humidity changes. A sudden increase in ambient humidity can result in a short-term positive drift in the instrument's reading. A sudden decrease in ambient humidity can result in a short-term negative drift in the instrument's reading. These are most likely to be noticed during calibration with dry or cylinder gas.

When calibrating hydrogen sulfide cartridges, the following should be taken into account while following the procedure in [Section 3.2.2](#).

1. To zero the sensor, use a compressed gas cylinder of 20.9%Vol oxygen (not nitrogen). Do not use background air.

If a span calibration is to be performed, the span calibration gas should be applied to the sensor immediately after the zeroing procedure. Do not allow the sensor to return to ambient air conditions.



Warning: Long-term exposure (> 20 minutes) to concentrations exceeding the full-scale range of the sensor can cause it to lose sensitivity. The output of the sensor may then decrease in value even though high levels of toxic gas are still present. Before re-calibrating the transmitter, verify the absence of gas.

3.2.5 705/705HT Calibrating

For complete calibration and configuration information, see the Type 705 Operating Instructions (P/N: 00705M5002).

3.2.6 Sensepoint/Sensepoint HT Calibrating

For complete calibration and configuration information, see the Sieger Sensepoint Technical Handbook (P/N: 2106M0502).

3.2.7 Calibrating the Searchpoint Optima Plus

Complete calibration and configuration information can be found in the Searchpoint Optima Plus Operating Instructions (P/N:2108M0501). If properly installed and maintained, the Searchpoint Optima Plus sensor will not require routine calibration. This is due to the inherent stability of the IR absorption process and the unit's fully compensated optical configuration.

1. From the Calibration menu, select the Gas Calibration option.

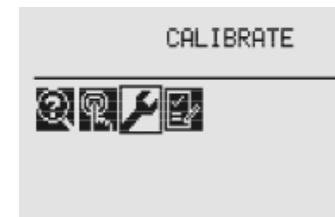

Figure 204. Calibration menu



Figure 205. Gas Calibration menu

2. Perform a zero calibration. When concentration values are stable, select for XNX to calculate the zero adjustment

Sensor Reading
at Current Settings

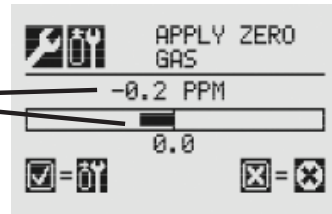

Figure 206. Apply Zero Gas screen

3. Select to return to the Gas Calibration menu. If the zero calibration was successful, the transmitter will display the Zero Passed screen



Figure 207. Zero Calibration screens

4. Begin the span calibration by entering the concentration value of the calibration gas: Select to choose the first digit. Use +/- to increment/decrement values. Select to accept the value and move to the next digit. Use calibration cover P/N 2108B0272 to perform span calibration at a flow regulator of 1 LPM. (If a span calibration is not required, select to return to the calibration menu.)

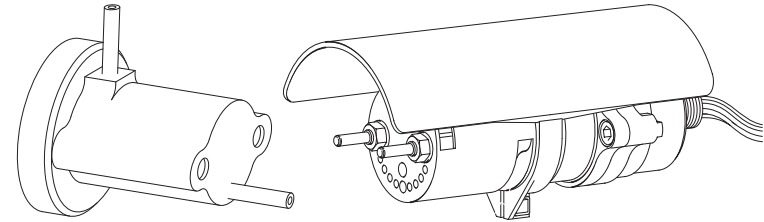

Figure 208. Searchpoint Optima Plus

5. Continue until all three digits have been entered.

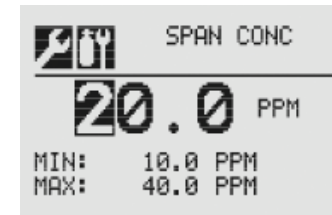

Figure 209. Span Concentration screen

6. Apply the span gas. When concentration values are stable, select to calculate the span adjustment. This process also determines if the sensor is within range to accurately detect the target gas.

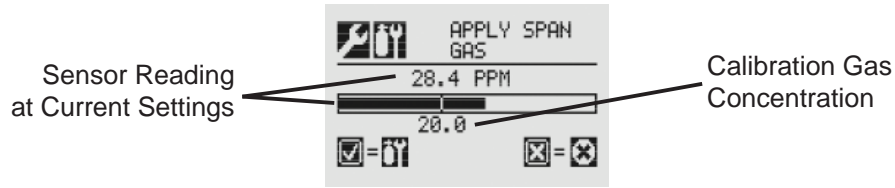

Figure 210. Span adjustment calculation

7. Select to return to the Gas Calibration menu. If the calibration is not successful, the Span Failed screen will be displayed.

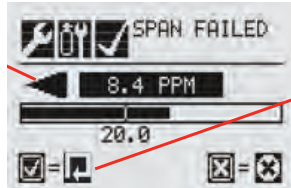

Figure 211. Span Failed screen

Select to return to the Span Concentration screen to repeat the span calibration.

Select to exit Span Calibration and return to main Calibrate screen. If Span Calibration is exited, the previous calibration values will be used. Select to return to the Span Concentration screen.

If the calibration is successful, the Span Passed screen will be displayed.

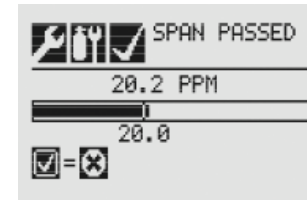

Figure 212. Span Passed screen

8. Exit the Calibration Menu. After the zero and span calibrations have been successfully completed, the user will be prompted to:
 - Exit and turn alarm and fault inhibit off,
 - Exit and leave the transmitter in inhibit mode. or
 - Not exit



Figure 213. Calibration exit options

Warning: When the XNX transmitter is placed in Inhibit Mode, alarms are silenced. This will prevent an actual gas event from being reported. Inhibit Mode must be limited to testing and maintenance only. Exit Inhibit Mode after testing or maintenance activities.

3.2.8 Zero and Span Calibration for MPD Sensors



Caution: Extended or frequent exposure to elevated concentrations of combustible gases may affect sensor sensitivity. Verify sensor performance by frequent calibration.



Caution: Before initial calibration allow the sensor to stabilize for 30 minutes after applying power. When in zero and span calibration modes, the current output from the sensor is inhibited (default 2mA) to avoid false alarms.

The Gas Calibration menu is for both zero and span calibrations. This section describes how to calibrate MPD flammable sensors fitted to the transmitter. The calibration adjustments are made on the transmitters display. Gassing is performed at the sensor, which may be locally or remotely located.

The following equipment is required:

- Flow housing (P/N: 1226A0411)
- Test gas
- Regulator

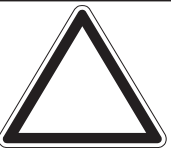

Note: Zero gas and Span gas should be at about the same humidity levels to avoid erroneous cell responses.

1. At the MPD, remove the weatherproof cap, if equipped.
2. Fit the flow housing onto the MPD.

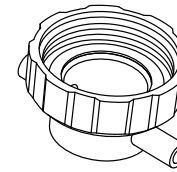

Figure 214. Flow Housing

3. Reverse the cap removal procedure. Figure 215 shows the flow housing accessory fitted to the MPD.

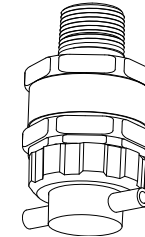

Figure 215. MPD with Flow Housing

4. Connect the flow housing (using either gas pipe) to the regulated cylinder containing a known concentration of the target gas at approximately the sensor alarm point, e.g., 50% LEL methane in air.



Warning: As some test gases are hazardous, exhaust the flow housing outlet to a safe area.

5. Follow the procedure in [Section 3.2.1](#) for both zero and span calibrations.
6. Apply the target gas to the sensor. Pass the gas through the flow housing at a rate of 300-375 ml/min for XNX EC sensors or 500 ±200 ml/min for XNX mV sensors.

Sensors should be calibrated at concentrations representative of those to be measured. It is always recommended that the sensor be calibrated with the target gas it is to detect.



Caution: Responsibility for identifying and recording a sensor calibration made with a different gas rests with the user. Refer to local regulations where appropriate.

Ensure that the sensor and the vicinity around it is clear of all traces of the calibration gas before continuing. This is to avoid triggering spurious alarms.

If calibration fails at any point, discard the cartridge and replace it with a new one (see [Section 4.1](#)).

7. Remove the test equipment, refit the weatherproof cap to the sensor (if previously removed for the test), and return the system to normal operation.

3.2.9 MPD Flammable Sensor Operational Life

The pellistors used in flammable gas sensors can suffer from a loss of sensitivity when in the presence of poisons or inhibitors, e.g., silicones, sulfides, chlorine, lead, or halogenated hydrocarbons. The pellistors are poison resistant to maximize the operational life of the flammable sensor. The typical operating life of the pellistor sensor used in the MPD-CB1 is 60 months.

3.2.10 XNX EC Sensor Operational Life

The typical life of a toxic gas sensor depends on the application, frequency, and amount of gas exposure. Under normal conditions (3 month visual inspection and 6 month test/recalibration) the toxic sensor has an expected life equal to or greater than these lifetimes:

- 12 months for ammonia, hydrogen chloride, and hydrogen fluoride sensors (see further ammonia information below).
- 24 months for chlorine dioxide, oxygen, and other toxic sensors.

See [Section 4 - Maintenance](#) for sensor replacement procedures.



Caution: Oxygen deficient atmospheres (less than 6% V/V) may result in inaccurate readings and performance.

Ammonia electrochemical cells are reliable and suitable for applications where no background concentration of ammonia exists. Under these conditions the cells are expected to operate for 12 to 24 months.

These ammonia cells are of the consumptive type. Their operating life can be adversely affected by continuous or excessive exposure to ammonia, or by prolonged exposure to high temperatures and moisture.

To ensure continued detection availability, bump test the sensors regularly and implement an appropriate cell replacement program.

3.3 Functional Gas Testing (Bump Testing)

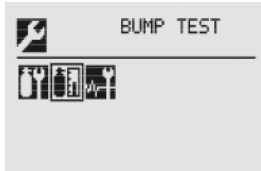

Figure 216. Bump Test Menu



Warning: Exposure to desensitizing or contaminating substances or concentrations causing operation of any alarm may affect sensor sensitivity. Following such events, it is recommended to verify sensor performance by performing a functional gas test (bump test).

It is recommended that the sensor be tested frequently to ensure that the system is operating properly. Different sensor types may require more frequent maintenance, depending on the environmental conditions and the gases present. The weatherproof cover has a spigot for attaching tubing from a gas cylinder. This may be used for a simple functional (bump) test of the sensor. However, environmental conditions may make this unsuitable for some gas types or applications. It is the responsibility of the user to ensure suitability of this method for each application.

1. When bump gas is applied to the sensor, the bump test screen displays the current reading of the sensor and the peak reading that occurred during the bump test.

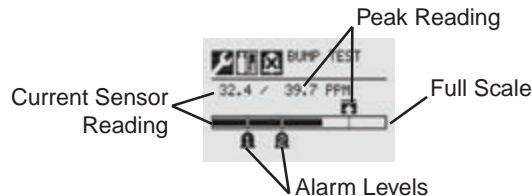

Figure 217. Bump Test Screen

2. If the difference between the reading and the applied gas concentration is outside the acceptable limits for the application, follow the procedures for zeroing and calibrating the sensor (see [Section 3.2.1](#)).
3. If the reading is still inaccurate, replace the sensor (see [Section 4.1](#)).

Once the bump test is completed successfully, the transmitter will exit the calibration procedure. Before returning to the Gas Calibration menu, the user will be prompted to exit and turn alarm and fault inhibit off, exit and leave the transmitter in inhibit mode, or not exit.



Caution: Exiting before the gas level has fallen below the level of Alarm 1 will cause the transmitter to go into alarm.

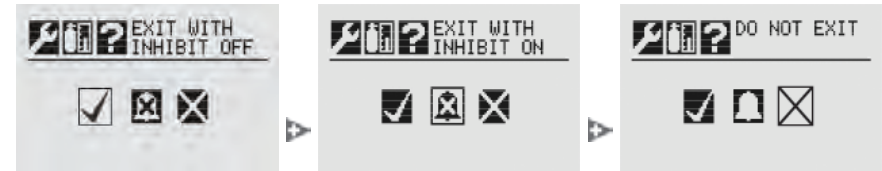

Figure 218. Exiting the calibration procedure

3.4 Calibrate mA Output

Use Calibrate mA Output to adjust the milliamp output to provide the correct output levels at peripheral devices connected to the transmitter.

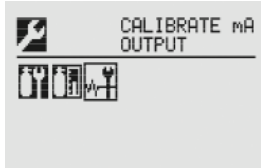

Figure 219. Calibrate mA Output Menu

To adjust the 4mA output, use the switches to increase or decrease the output, then use to accept the new value and move to the 20mA setting or to discard the selection and return to the previous menu.

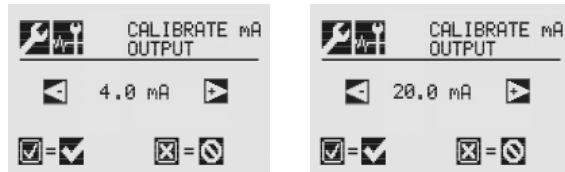

Figure 220. Calibrate mA Output Screens

During installation, an mA meter must be connected in series with the 4-20 mA loop as shown below.

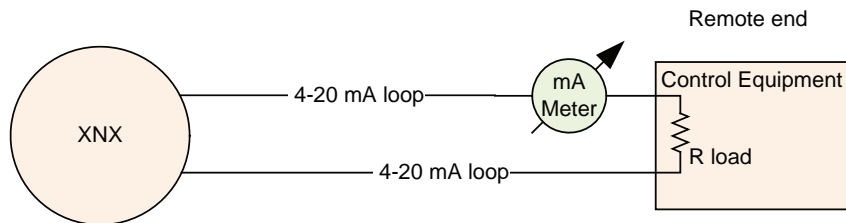

Figure 221. 4-20 mA loop with mA meter



Note: Calibrated mA output is required for proper operation of internal diagnostics.

An F165 fault will be reported if the 4-20 mA calibration fails.

3.5 Align Excel (Searchline Excel)



Figure 222. Align Excel Menu

For detailed information on Aligning the Searchline Excel, see the Searchline Excel Technical Manual (P/N: H-MAN0530-V1).

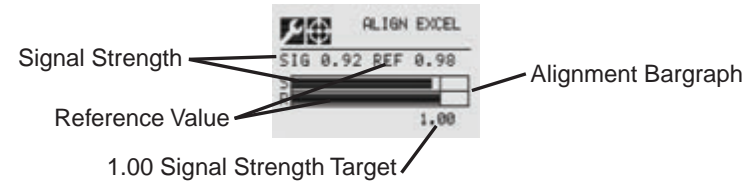

Figure 223. Align Excel Screen

Align the unit using the information found in the Searchline Excel manual. As the alignment is performed, the transmitter display will indicate the signal strength in the form of a bar graph. Align the Excel until the signal strength bar graph reaches or exceeds 1.00 as shown on the display.

3.6 Soft Reset

(Searchline Excel and Searchpoint Optima Plus only)

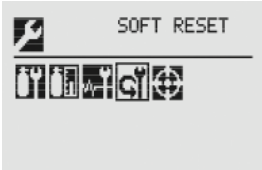

Figure 224. Soft Reset Menu

For transmitters connected to a Searchline Excel or Searchpoint Optima Plus sensor, the Soft Reset sends these infrared devices a signal to restart the sensor.

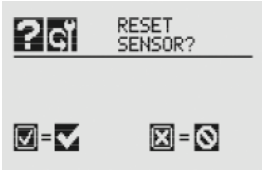

Figure 225. Soft Reset Sensor Screen

4 Maintenance



Warning: When servicing or replacing sensors, reduce the risk of ignition of hazardous atmosphere by declassifying the area or disconnecting the equipment from the supply circuit before opening the sensor enclosure. Keep the assembly tightly closed during operation.



Warning: Take care when handling sensors as they may contain corrosive solutions. Do not tamper or in any way disassemble the sensor cell. Do not expose to temperatures outside the recommended range. Do not expose the sensor to organic solvents or flammable liquids.



Warning: At the end of their working lives, sensors must be disposed of in an environmentally safe manner, in accordance with local waste management requirements and environmental legislation. Sensors should NOT be incinerated as they may emit toxic fumes.



Warning: Verify all outputs, including display, after installation, after service events, and periodically to ensure the safety and integrity of the system.



Caution: The following procedure should be followed carefully and performed only by suitably trained personnel. A fault condition will be signaled by the sensor if it is removed with the unit under power.



Note: If the power-on self-test was skipped during maintenance activities, restart the transmitter.

4.1 MPD Sensor Cartridge Replacement

Using Figure 226 as a guide, follow this procedure:

1. Verify that the label on the new sensor is the correct gas type.
2. Remove power from the transmitter.
3. Unscrew the weatherproof cover (if equipped), loosen the retainer locking screw, and unscrew the sensor retainer.
4. Remove the old sensor by pulling without twisting.
5. Slide the replacement cell into the MPD body taking care to align the tab with the alignment slot, then press the cell firmly to seat it into the body.
6. Refit the sensor retainer, tighten the locking screw and refit the weatherproof cover (if equipped).
7. Recalibrate the sensor following the procedures in [Section 3.2.2](#).

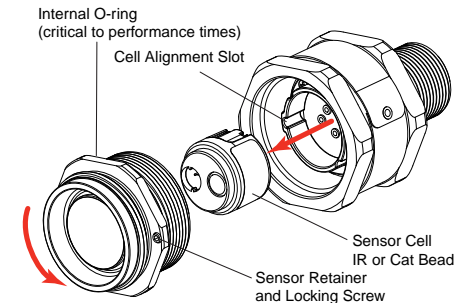

Figure 226. Removing the Plug-in Sensor

4.2 XNX® EC Sensor Cartridge Replacement



Caution: For toxic sensors, remove the shorting clip from the bottom of the sensor prior to installation. No shorting clip is provided with oxygen sensors.

The serviceable sensor allows replacement of the cell inside the sensor. The sensor cell can be replaced with a cell of the same type or changed to detect a different target gas. Both procedures follow.

When replacing oxygen (O₂) sensor cells, the initial warm-up time is between 10 and 15 minutes. This warm-up is required only after sensor cell replacement.

4.2.1 Replacing with the Same Cartridge Type

To replace the cell follow this procedure:

1. Unscrew the weatherproof cover, loosen the sensor retainer locking screw, and unscrew the sensor retainer.
2. Remove the old sensor by pulling without twisting.
3. Unscrew the sensor cap.
4. Remove the old cell by pulling without twisting.
5. Verify that the new cell is the same type as the old one.
6. Plug the new cell into the sensor, taking care to align the sensor pins with the connector holes in the PCB.
7. Refit the sensor retainer, tighten the locking screw, and refit the weatherproof cover.
8. Sensor warm-up will begin and the XNX display will alternate between two screens: “Fault 151” and “WARM.”



Figure 227. Sensor screens during warmup

9. Follow the procedure to accept the new sensor in [Accept New Sensor Type](#).
10. Recalibrate the sensor following the procedures in [Section 3.2.1](#).

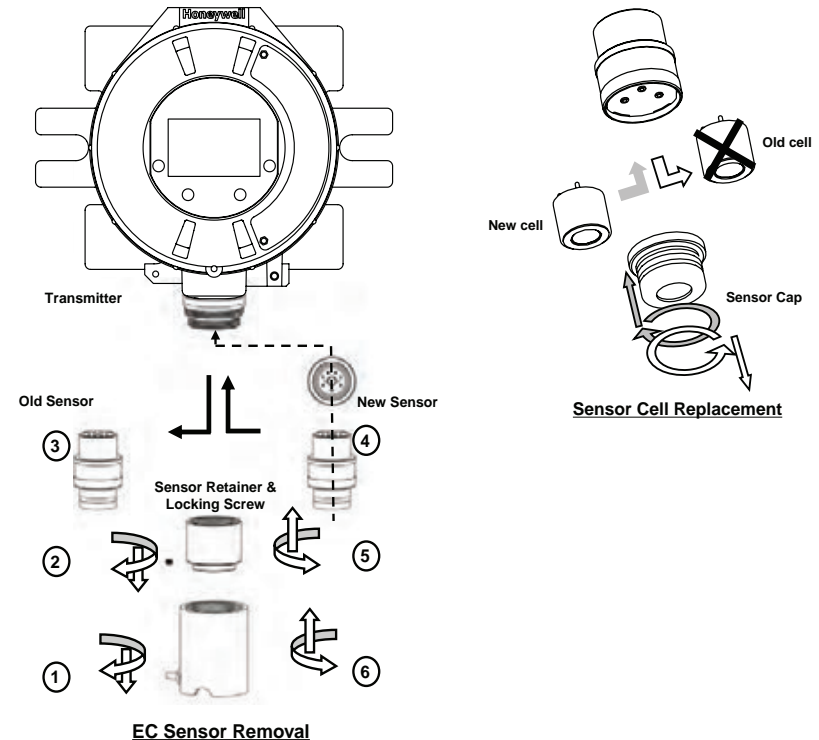

Figure 228. XNX EC Sensor Cell Replacement

4.2.2 Replacing with a Different Cartridge Type

To replace the cell with a cell for a different gas, follow this procedure:

1. Unscrew the weatherproof cover, loosen the sensor retainer locking screw, and unscrew the sensor retainer.
2. Remove the old sensor by pulling without twisting.
3. Unscrew the sensor cap.
4. Remove the old cell by pulling without twisting.
5. Plug the new cell into the sensor, taking care to align the sensor pins with the connector holes in the PCB.
6. Refit the sensor, taking care to align the sensor pins with the connector.
7. Refit the sensor retainer, tighten the locking screw, and refit the weatherproof cover.
8. The transmitter will enter sensor warm-up mode. However, due to the change in sensor cell type, the transmitter will not enter monitor mode until the unit has been reconfigured. The display will show the sensor warm-up screen:

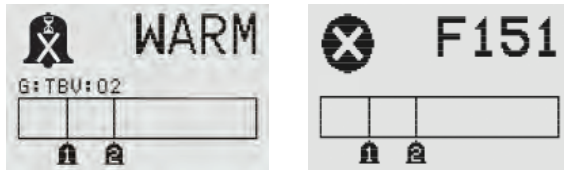

Figure 229. Sensor screens during warmup

Note the message “G:TBV:O2”. “TBV” indicates that the operator must reconfigure the transmitter to recognize the new sensor cell. “O2” will reflect the target gas of the new cell, i.e., H₂S, NO₂, etc. The display will also alternate the warm-up screen with the Fault 151 screen. This indicates that the communication between the transmitter

and the original cell is no longer recognized. This fault condition will clear after the transmitter has been properly reconfigured.

The reconfiguration of the XNX for a new cell/target gas is achieved through [Accept New Sensor Type](#). Recalibrate the sensor following the procedures in [Section 3.2.2](#).

5 Warnings and Faults

5.1 Warning Messages

Warning	Description	Applicable Sensors	Latching / Non-Latching	Frequency of Diagnostic	Event History Data	Action For Resolution
W001	XNX® 24 VDC Supply Bad	All	Non-latching	2 seconds	XNX supply voltage x1000	Check wire of 24V power supply to XNX as well as power supply operation.
W002	XNX Temperature Error	All	Non-latching	2 seconds	XNX temperature (Celsius)	Check location for heat sources. Fit with sunshade or other protection. Change location of XNX. Check temperature in Info->Transmitter Status to ensure temperature is being measured properly.
W003	Simulated Warning/Fault	All	Non-latching	Enabled by user	0	Performing an alarm/fault reset will clear all simulation.
W005	Sensor Temperature Error	Optima	Non-latching	XNX polls sensor every 2 seconds, diagnostic frequency controlled by sensor	Sensor fault or warning code (Note 4)	Check location for heat sources. Fit with sunshade or other protection. Change location of XNX. Check temperature in Info->Sensor Status to ensure temperature is being measured properly.
	Sensor Temperature Error	Excel	Non-latching	XNX polls sensor every 2 seconds, diagnostic frequency controlled by sensor	Sensor fault or warning code (Note 4)	Check location for heat sources. Fit with sunshade or other protection. Change location of XNX. Check temperature in Info->Sensor Status to ensure temperature is being measured properly.
	Sensor Temperature Error	ECC	Non-latching	2 seconds	Sensor temperature (Celsius)	Check location for heat sources. Fit with sunshade or other protection. Change location of XNX. Check temperature in Info->Sensor Status to ensure temperature is being measured properly.
W006	Negative Drift	ECC, mV	Non-latching	2 seconds	Raw gas concentration of sensor	Check sensor location for external interference. Perform zero calibration. If problem persists after zero calibration and no interference exists, replace sensor.
	Negative Drift	Optima, Excel	Non-latching	XNX polls sensor every 2 seconds, diagnostic frequency controlled by sensor	Sensor fault or warning code	Check sensor location for external interference. Perform zero calibration. If problem persists after zero calibration and no interference exists, replace sensor.
W007	Calibration Required	All	Non-latching	2 seconds	Number of days remaining until calibration expires, negative = number of days expired	Time since the last span calibration has exceeded a defined limit. Performing a successful span calibration will clear the condition. The limit is the user-defined calibration interval. W007 can be disabled by setting the calibration interval to 0.

Warning	Description	Applicable Sensors	Latching / Non-Latching	Frequency of Diagnostic	Event History Data	Action For Resolution
W009	Sensor 24 VDC Supply Bad	Optima, Excel	Non-latching	XNX polls sensor every 2 seconds, diagnostic frequency controlled by sensor	Sensor fault or warning code (Note 4)	Check wire of 24V power supply to XNX as well as power supply operation. Also check wiring between XNX and Optima/Excel.
W010	Sensor Path Obscured	Optima	Non-latching	XNX polls sensor every 2 seconds, diagnostic frequency controlled by sensor	Sensor fault or warning code (Note 4)	Check location for external interference. Check sensor for dirty windows.
	Beam Block	Excel	Non-latching	XNX polls sensor every 2 seconds, diagnostic frequency controlled by sensor	Sensor fault or warning code (Note 4)	Check location for external interference or obstructions in the IR path. Check sensor for dirty windows. Check Excel alignment.
W011	Sensor Internal Lamp Issue	Optima	Latching	XNX polls sensor every 2 seconds, diagnostic frequency controlled by sensor	Sensor fault or warning code (Note 4)	Remove and return to Honeywell for repair.
W012	Excessive Float	Optima, Excel	Non-latching	XNX polls sensor every 2 seconds, diagnostic frequency controlled by sensor	Sensor fault or warning code (Note 4)	Check sensor location for external interference, check sensor for operation and re-zero where appropriate.
W013	Sensor Loop Failure, (Sensor is losing/ has lost mA output signal. These are detected by Optima and Excel.	Optima, Excel	Latching	XNX polls sensor every 2 seconds, diagnostic frequency controlled by sensor	Sensor fault or warning code (Note 4)	Check that supply voltage is stable. Check wiring between Optima/ Excel and XNX. Check loop impedance of wiring. Check that switches S3 and S4 are set correctly. If the switch settings need to be changed, power down the transmitter before changing the switch settings. Once the problem has been resolved, a Soft Reset must be performed for the Calibration menu to clear W013.
W014	Sensor Real Time Clock issue	Excel	Non-latching	XNX polls sensor every 2 seconds, diagnostic controlled by sensor	Sensor fault or warning code (Note 4)	Reset "date and time" in Excel, re-cycle Excel power and confirm "date and time." If not retained, remove and return to Honeywell for repair.

Warning	Description	Applicable Sensors	Latching / Non-Latching	Frequency of Diagnostic	Event History Data	Action For Resolution
W015	Sensor Internal Failure	Optima, Excel	Latching and Non-latching	XNX polls sensor every 2 seconds, diagnostic frequency controlled by sensor	Sensor fault or warning code (Note 4)	Remove and return to Honeywell for repair.
	Sensor has an internal software error	Excel	Latching	XNX polls sensor every 2 seconds, diagnostic frequency controlled by sensor	Sensor fault or warning code (Note 4)	Cycle Excel power and confirm "fault cleared." If not, replace sensor.
W016	Sensor Installation Not Complete	Excel	Non-latching	XNX polls sensor every 2 seconds, diagnostic frequency controlled by sensor	Sensor fault or warning code (Note 4)	Check Excel alignment. Perform a zero calibration.
W018	General Diagnostics	Optima, Excel	Non-latching	XNX polls sensor every 2 seconds, diagnostic frequency controlled by sensor	Sensor fault or warning code (Note 4)	Check sensor connections, check sensor operation, fit replacement sensor, replace personality board.
W019	Sensor Internal 5V Power Supply Defect	Excel	Non-latching	XNX polls sensor every 2 seconds, diagnostic frequency controlled by sensor	Sensor fault or warning code (Note 4)	Remove and return to Honeywell for repair.
W020	Forced mA Timeout	All	Latching	1 second	Forced mA	Indicates that a forced mA condition was left on for more than 15 minutes. No action required as mA operation will be returned to normal automatically.
W021	Forced Relay Timeout	All	Latching	1 second	Forced relay status, 1=Alarm1 on, 2=Alarm2 on, 4=Fault on	Indicates that a forced relay condition was left on for more than 15 minutes. No action required as relay operation will be returned to normal automatically.
W022	mV Sensor Calibration Needed	mV	Latching	When user changes sensor type or gas	1=new sensor, 2=changed personality, 3=changed gas	Generated after accepting a new mV sensor or changing the mV sensor type or changing the mV gas selection. This is a warning to user that a span calibration should be performed. If a span calibration is not performed, the default calibration values will be used.

Warning	Description	Applicable Sensors	Latching / Non-Latching	Frequency of Diagnostic	Event History Data	Action For Resolution
W023	Low Optical Sample Signal	Excel	Non-latching	XNX polls sensor every 2 seconds, diagnostic frequency controlled by sensor	Sensor fault or warning code (Note 4)	Check location for external interference or obstructions in the IR path. Check sensor for dirty windows. Check Excel alignment. Check Beam Block Low Signal Percentage setting in the transmitter.
W024	Reflex Failure Warning	ECC	Latching	Dependent on sensor, typically 8 hours; Once fault is detected: every 15 minutes	0	ECC sensor is nearing end of life. Replace sensor.
W025	Safety variable fail warning	All	Latching	2 seconds	Note 3	Contact Honeywell Analytics Service Department.

NOTES

Note 3:

Subtypes	Decimal	Description
Fault 2 Event Bits	1	CRC error in safety critical RAM block
	2	Error reloading safety critical RAM block from EEPROM
	4	Error loading data from Personality board
	8	Excel signal level has been below the low signal level threshold for at least 24 hours
	16	Excel beam blocked
	32	Personality board error code > 0
	64	Option board error code > 0
	128	IR mA input > 1 mA and < 3.4 mA
	256	IR mA input < 1.0 mA
	512	IR forced 10 mA not within +/-1 mA
	1024	gains from PGA don't match local copy
	2048	error reading or writing EEPROM
	4096	ECC reflex failure
	8192	RAM test failure
	16384	Program memory CRC failure
32768	Op code test failure	
Fault 3 Event Bits	1	Interrupt integrity test failure

Note 4:

Optima and Excel fault and warning codes are displayed in the Event History data field.

5.2 Fault Messages

Fault	Description	Applicable Sensors	Latching / Non-Latching	Frequency of Diagnostic	Event History Data	Action For Resolution
F101	Unexpected Sensor Reset	All	Non-latching	ECC & mV: main loop x2; Optima & Excel: 2 seconds	Note 2. Optima or Excel: Sensor fault or warning code (Note 4)	If repeated, check supply voltage, check cable loop impedance, check terminal connections
F103	XNX Temperature Error	All	Non-latching	2 seconds	XNX temperature (Celsius)	Check location for heat sources. Fit with sunshade or other protection. Change the transmitter's location. Check temperature in Info->Transmitter Status to ensure temperature is being measured properly.
F104	XNX 24 VDC Supply Bad	All	Non-latching	2 seconds	XNX supply voltage x1000	Check the wire of the 24V power supply to the transmitter and the power supply operation.
F105	3.3VDC Supply Bad on XNX, personality board, or option board	All	Non-latching	2 seconds	1=XNX, 2=Personality board, 3=Option board	Check Transmitter Status
F106	XNX Real Time Clock Failure	All	Non-latching	2 seconds	Total seconds since Jan 1, 1970	Either clock was incorrectly set or the battery for the clock has failed. Note: the clock will stop running on January 1, 2036.
F107	XNX Internal Failure (RAM, ROM, EEPROM, Opcode)	All	Non-latching except for EEPROM error	At power up and 8 hours	Note 3	Contact Honeywell Analytics' Service Department.
F108	XNX mA Output Loop Failure	All	Latching	2 seconds	mA output error (measured mA - set mA)	Check wiring of mA output from XNX. Check that switches S1 and S2 are set correctly. Note that if F108 is not resolved quickly, an F149 (Internal Communication Failure - mA) will also be generated. When the cause of F108 is resolved, both the F108 and F149 will be cleared.
F109	Simulated Warning/Fault	All	Non-latching	Enabled by user	0	Performing an alarm/fault reset will clear all simulation.
F110	Sensor software mismatch	Optima	Latching	Only checked at power up	Sensor firmware version x10	Contact Honeywell Analytics' Service Department.
F111	Negative Drift	ECC, mV	Non-latching	2 seconds	Raw gas concentration of sensor	Check sensor location for external interference. Perform zero calibration. If problem persists after zero calibration and no interference exists, replace sensor.
	Negative Drift; may indicate a failed IR sensor	Optima, Excel	Non-latching	XNX polls sensor every 2 seconds, diagnostic frequency controlled by sensor	Sensor fault or warning code	Check sensor location for external interference. Perform zero calibration. If problem persists after zero calibration and no interference exists, replace sensor.

Fault	Description	Applicable Sensors	Latching / Non-Latching	Frequency of Diagnostic	Event History Data	Action For Resolution
F112	Sensor 24 VDC Supply Bad	Optima, Excel	Non-latching	XNX polls sensor every 2 seconds, diagnostic frequency controlled by sensor	Sensor fault or warning code (Note 4)	Check the wire of the 24V power supply to the transmitter and the power supply operation. Also check the wiring between the transmitter and the Optima/Excel.
F113	Sensor Internal 5V Power Supply Defect	Excel	Non-latching	XNX polls sensor every 2 seconds, diagnostic frequency controlled by sensor	Sensor fault or warning code (Note 4)	Remove and return to Honeywell for repair.
F114	Sensor Internal Lamp Issue	Optima	Latching	XNX polls sensor every 2 seconds, diagnostic frequency controlled by sensor	Sensor fault or warning code (Note 4)	Remove and return to Honeywell for repair.
F116	Sensor Internal Failure	Optima, Excel	Non-latching	XNX polls sensor every 2 seconds, diagnostic frequency controlled by sensor	Sensor fault or warning code (Note 4)	Remove and return to Honeywell for repair.
F117	Sensor Loop Failure, (Sensor is losing/has lost mA output signal. These are detected by Optima and Excel, F161 is detected by XNX and will usually occur before F117.)	Optima, Excel	Latching	XNX polls sensor every 2 seconds, diagnostic frequency controlled by sensor	Sensor fault or warning code (Note 4)	Check that supply voltage is stable. Check wiring between Optima/Excel and the transmitter. Check loop impedance of wiring. Check that switches S3 and S4 are set correctly. If the switch settings need to be changed, power down the transmitter before changing the switch settings. Once the problem has been resolved, a Soft Reset must be performed for the Calibration menu to clear F117.
F118	Sensor Real Time Clock issue	Excel	Non-latching	XNX polls sensor every 2 seconds, diagnostic controlled by sensor	Sensor fault or warning code (Note 4)	Reset "date and time" in Excel, recycle Excel power, and confirm "date and time. If not retained, remove and return to Honeywell for repair.

Fault	Description	Applicable Sensors	Latching / Non-Latching	Frequency of Diagnostic	Event History Data	Action For Resolution
F119	Cartridge Internal Electrical Failure	ECC, mV	Non-latching	XNX polls sensor every 2 seconds, diagnostic frequency controlled by sensor	Note 5	Check cartridge connections, check sensor operation, fit replacement cartridge, replace personality board.
F120	No Sensor	ECC, mV, Optima, Excel	Non-latching	2 seconds	Note 2	Indicates a loss of communication with the sensor. Check that the sensor type indicated in the part number matches the installed hardware. Check the wiring between ECC sensors or Optima/Excel and the XNX.
F121	Wrong Cartridge, error loading sensor parameters	All	Non-latching	At power up and when cartridge is changed	0	Contact Honeywell Analytics' Service Department.
F122	General Diagnostics	Optima, Excel	Non-latching	XNX polls sensor every 2 seconds, diagnostic frequency controlled by sensor	Sensor fault or warning code (Note 4)	Check sensor connections, check sensor operation, fit replacement sensor, replace personality board.
F123	Sensor Temperature Error	Optima	Non-latching		Sensor fault or warning code (Note 4)	Check location for heat sources. Fit with sunshade or other protection. Change location of the transmitter. Check temperature in Info->Sensor Status to ensure temperature is being measured properly.
	Sensor Temperature Error	Excel	Non-latching	XNX polls sensor every 2 seconds, diagnostic frequency controlled by sensor	Sensor fault or warning code (Note 4)	Check location for heat sources. Fit with sunshade or other protection. Change location of the transmitter. Check temperature in Info->Sensor Status to ensure temperature is being measured properly.
	Sensor Temperature Error	ECC	Non-latching	2 seconds	Sensor temperature (Celsius)	Check location for heat sources. Fit with sunshade or other protection. Change location of XNX. Check temperature in Info->Sensor Status to ensure temperature is being measured properly.
F125	Calibration Required	All	Non-latching	2 seconds	Number of days remaining until calibration expires, negative = number of days expired	Time since the last span calibration has exceeded a defined limit. Performing a successful span calibration will clear the condition. The limit is the maximum calibration interval.

Fault	Description	Applicable Sensors	Latching / Non-Latching	Frequency of Diagnostic	Event History Data	Action For Resolution
F126	Sensor Path Obscured	Optima	Non-latching	XNX polls sensor every 2 seconds, diagnostic frequency controlled by sensor	Sensor fault or warning code (Note 4)	Check location for external interference. Check sensor for dirty windows.
F127	Beam Block	Excel	Non-latching	XNX polls sensor every 2 seconds, diagnostic frequency controlled by sensor	Sensor fault or warning code (Note 4)	Check location for external interference or obstructions in the IR path. Check sensor for dirty windows. Check Excel alignment.
F128	Sensor Installation Not Complete	Excel	Non-latching	XNX polls sensor every 2 seconds, diagnostic frequency controlled by sensor	Sensor fault or warning code (Note 4)	Check Excel alignment. Perform a zero calibration.
F130	Option Communication Failure	All	Non-latching	2 seconds	Option module ID: 0=None, 1=Foundation™ Fieldbus, 2=Modbus®, 3=Relay	Check that installed option matches the option indicated in the XNX part number. If the option has been changed, the new option must be set up in Information->Transmitter Data as described in the manual.
F133	Not used					
F143	Stabilization Timeout	All	Latching	2 seconds	Warm up time (seconds x100)	Cycle power, contact Honeywell Analytics' Service Department if problem persists.
F145	Reflex Failure	ECC	Non-latching	Dependent on sensor, typically 8 hours; Once fault is detected: every 15 minutes	nA/mV	ECC sensor is no longer functioning properly. Replace sensor.
F146	Unknown Sensor Failure	Optima, Excel	Non-latching	2 seconds	Sensor fault or warning code (Note 4)	Contact Honeywell Analytics' Service Department.
F148	Internal option board hardware failure	All	Non-latching	2 seconds	Option board error status (Note 6)	Contact Honeywell Analytics' Service Department.

Fault	Description	Applicable Sensors	Latching / Non-Latching	Frequency of Diagnostic	Event History Data	Action For Resolution
F149	Internal 4-20 mA monitoring circuit communication failure	All	Non-latching	3.366 seconds	0	Contact Honeywell Analytics' Service Department.
F150	mA Output Monitor Communications Watchdog Error	All	Non-latching	138 us	Communication error count	Contact Honeywell Analytics' Service Department.
F151	Sensor Module Type Changed	ECC	Non-latching	2 seconds	Module type: 0=None, 1=ECC, 2=mV, 3=Excel, 4=Optima, 5=Generic mA	For ECC: Perform Accept New Sensor function, if problem persists contact Honeywell Analytics' Service Department. For others, contact Honeywell Analytics' Service Department.
F152	Option Module Configuration Error	All	Latching	Only at powerup or every 125 ms when no option board detected	Option module ID: 0=None, 1=Foundation Fieldbus, 2=Modbus, 3=Relay	Confirm option properly installed, reconfigure unit.
F153	Signal/Data mismatch error on IR personality	Optima, Excel	Non-latching	2 seconds	Digital sensor reading	Check wiring to Optima/Excel. In particular, check the white wire between XnX and Optima/Excel. Note: power must be cycled to reset F153 after correcting the cause.
F154	mA Input Diagnostic Failure	Optima, Excel	Latching	5 minutes after power up and then every 8 hours	Input mA	Contact Honeywell Analytics' Service Department.
F155	Generic mA Sensor Type Error	Generic mA	Non-latching	2 seconds	Input mA	Indicates that mA input from sensor is less than 3 mA. Check wiring between XNX and sensor. Also check the switches S3 and S4 are set correctly. If the switch settings need to be change, power down the XNX before changing the switch settings. If wiring and switches are okay, replace sensor.
F156	mV Current Control Failure	mV	Non-latching	Main loop x16	constant current A/D input mV	Check that correct mV sensor type is selected. Check wiring between XNX and sensor. If sensor type and wiring are okay, replace sensor.
F157	Sensor Drift Fault	ECC, mV	Non-latching	2 seconds	Current baseline	Perform zero calibration. If problem persists, replace sensor.
F158	Sensor/Personality Part Number mismatch	All	Non-latching	"ECC & mV: main loop x2; Optima & Excel: 2 seconds"	Entire personality part #	Check that installed option matches the option indicated in the XNX part number, check wiring to Optima/Excel.

Fault	Description	Appli- cable Sensors	Latching / Non- Latching	Frequency of Diagnostic	Event History Data	Action For Resolution
F159	Option Part Num- ber Mismatch	All	Non-latching	Only at powerup or every 125 ms when no option board detected	Entire option part #	Check that installed option matches the option indicated in the XNX part number, check wiring to Optima/Excel.
F160	Hardware Diagnos- tic Failure	ECC, mV	Non-latching	Main loop x2	Gain1 high byte, Gain2 low byte	Replace defective EC cartridge or mV personality board.
F161	mA Input Indicates Fault	Optima, Excel	Non-latching	1 second	Input mA	Indicates mA input from Optima/Excel is below 1 mA, indicating a fault in the sensor. Any other fault will also trigger this fault, so check for addi- tional faults in event history to determine specific issue. If no other faults indicated, check wiring between Optima/Excel and XNX. Also check that switches S3 and S4 are set correctly.
F162	Error reloading safety critical RAM block	All	Non-latching	2 seconds	Note 3	Contact Honeywell Analytics' Service Department.
F163	Interrupt integrity fault	All	Non-latching	Main loop	Note 3	XNX will reset if more than 600,000 successive errors occur.
F164	mV Sensor failure	mV	Latching	1 second	mV bridge voltage or bridge current that caused fault	Indicates that the sensor was changed or is bad. If the fault will not clear, replace the sensor.

Fault	Description	Applicable Sensors	Latching / Non-Latching	Frequency of Diagnostic	Event History Data	Action For Resolution
F165	mA Calibration failure	all	Latching	2 seconds	DAC: Digital to Analog Converter (4-20 mA output) ADC: Analog to Digital Converter (4-20 mA internal feedback) 0 OK 1 DAC 4 mA point is too low 2 DAC 4 mA point is too high 4 DAC 20 mA point is too low 8 DAC 20 mA point is too high 16 ADC 4 mA point is too low 32 ADC 4 mA point is too high 64 ADC 20 mA point is too low 128 ADC 20 mA point is too high	Indicates that 4-20 mA calibration failed and discarded. Events history parameter indicates which calibration point has failed. If 4-20 mA calibration fails with F165, no changes take place so the 4-20 mA calibration output stays as it was. Check 4-20 mA loop resistance. Repeat 4-20 mA calibration. The fault clears itself after a successful 4-20 mA calibration.

NOTES

Note 2:

Spi Event Bits	
Decimal	Description
1	SPI1 Starting TX
2	SPI1 transmitting
4	falling clock edge, 0 = rising edge
8	SPI1 port open, 0 = closed
16	SPI1 no response
32	SPI1 ECC no response
64	SPI1 missing data
128	Not used
256	SPI3 Starting TX
512	SPI3 transmitting
1024	falling clock edge, 0 = rising edge
2048	SPI3 port open, 0 = closed
4096	Not used
8192	
16384	
32768	SPI2 Starting TX

Note 3:

Subtypes	Decimal	Description
Fault 2 Event Bits	1	CRC error in safety critical RAM block
	2	Error reloading safety critical RAM block from EEPROM
	4	Error loading data from Personality board
	8	Excel signal level has been below the low signal level threshold for at least 24 hours
	16	Excel beam blocked
	32	Personality board error code > 0
	64	Option board error code > 0
	128	IR mA input > 1 mA and < 3.4 mA
	256	IR mA input < 1.0 mA
	512	IR forced 10 mA not within +/-1 mA
	1024	gains from PGA don't match local copy
	2048	error reading or writing EEPROM
	4096	ECC reflex failure
	8192	RAM test failure
16384	Program memory CRC failure	
32768	Op code test failure	
Fault 3 Event Bits	1	Interrupt integrity test failure

Note 4:

Optima and Excel fault and warning codes are displayed in the Event History data field.

Note 5:

Subtypes	Decimal	Description
ECC Fault Subtypes	1	I2C error reading or writing EEPROM
	2	GALPAT RAM test failure
	4	Program memory CRC failure
	8	Opcode test failure
	16	Can't adjust PGA or EEPROM value doesn't match digital pot
	32	Reserved
	64	Reserved
	128	GALPAT RAM test failure in common area
mV Fault Subtypes	1	I2C error reading or writing EEPROM
	2	GALPAT RAM test failure
	4	Program memory CRC failure
	8	Opcode test failure
	16	Can't adjust PGA or EEPROM value doesn't match digital pot
	32	RAM safety variable failure
	64	Interrupts integrity failure
	128	Stack overflow/underflow failure

Note 6:

Relay Option Board Error Status		
	Decimal	Description
Relay Option Board Error Status	1	Didn't receive STX or ETX
	2	Received undefined command
	4	Exceeded maximum data bytes
	8	Write collision or buffer overrun
	16	CRC error in SPI packet
	32	Stack overflow or underflow
	64	Program memory CRC error
	128	Galpat RAM test failure

5.3 Informational Messages

Number	Description	Contents of Data Field
I001	Unused	
I002	Force Relay Mode Started	Bitpattern for relays. (E.G. 7.0 ==All)
I003	Force Relay Mode Ended.	N/A
I004	Force mA Mode Started	Force current. (E.G. 20.0)
I005	Force mA Mode Ended	N/A
I006	Short-Term Inhibit Started	N/A
I007	Short-Term Inhibit Ended	N/A
I008	Long-Term Inhibit Started	N/A
I009	Long-Term Inhibit Ended	N/A
I010	mA Output Recalibrated	N/A
I011	Bump Test Started	N/A
I012	Bump Test Timed Out	N/A
I013	Bump Test Completed Concentration < AI1	Peak concentration observed
I014	Bump Test Completed AI1 < Concentration < AI2	Peak concentration observed
I015	Bump Test Completed. AI2 < Concentration	Peak concentration observed
I016	Zero Calibration Successful	N/A
I017	Zero Calibration Failed	Error code
I018	Calibrate Span Successful 1 of 2	Percent change in span factor from previous
I019	Calibrate Span Successful 2 of 2	Absolute span factor
I020	Calibrate Span Failed	Error code
I021	Calibrate Span Timeout	N/A
I022	Password Changed	1,2 or 3 (access level)
I023	Performing Soft Reset	N/A
I024	Alarms Configured Latching	N/A

Number	Description	Contents of Data Field
I025	Alarms Configured Non-Latching	N/A
I026	Alarm Relays Configured Normally Energized	N/A
I027	Alarm Relays Configured Normally De-Energized.	N/A
I028	Fieldbus Address Changed	New address (e.g. 15)
I029	Fieldbus Speed Changed	New speed (e.g. 19200)
I030	Sensor Type Changed	iCurrentCalGlobalID
I031	Gas Selection Changed	iCurrentCalGlobalID
I032	Time For Beam Block Fault Changed	iBlockFitTime
I033	Time For Fault Detection Changed	iOtherFitTime
I034	Level For Low Signal Fault Changed	fLowSignalLevel
I035	Invalid Path Length Written	fPathLen
I036	Path Length Changed	fPathLen
I037	mA for Inhibit Changed	f_mA_Fit_Step[0]
I038	mA for Warning Changed	f_mA_Fit_Step[1]
I039	mA for Overrange Changed	f_mA_Fit_Step[2]
I040	mA for Fault Changed	f_mA_Fit_Step[3]
I041	mA for Low Signal Changed	f_mA_Fit_Step[4]
I042	mA for Blocked Beam Changed	f_mA_Fit_Step[5]
I043	Concentration for mA Full Scale Changed	fDisplayRange
I044	Instrument Id Changed	N/A
I045	Measuring Units Changed	iMeasurementUnits
I046	Alarm 1 Reconfigured for Increasing Concentrations	N/A
I047	Alarm 1 Reconfigured for Depleting Concentrations	N/A

Number	Description	Contents of Data Field
I048	Alarm 2 Reconfigured for Increasing Concentrations	N/A
I049	Alarm 2 Reconfigured for Depleting Concentrations	N/A
I050	Alarm 1 Value Changed	fAlarmThres[0]
I051	Alarm 2 Value Changed	fAlarmThres[1]
I052	Clock Set	N/A
I053	Date Format Changed	iDateFormat
I054	Sensor Boots	N/A
I055	Unused	
I056	Sensor RTC Adjusted	Error in seconds or +/-999 if large
I057	Fault Set Latching	
I058	Fault Set Non-Latching	
I059	LCD Heater On	
I060	LCD Heater Off	
I061	Personality Power Up	Sensor type
I062	Option Power Up	Option type
I063	Loaded Same Cell	
I064	Loaded Changed Cell	
I065	Loaded Changed Gas	
I066	Option Type Changed	
I067	HART® Address Changed	
I068	HART Mode Changed	

6 Specifications

6.1 Product Specifications

Electrical			
Operating Voltage	EC/mV: 16V to 32V (24V nominal) ** Startup/Normal values ** IR: 18V to 32V (24V nominal) ** Startup/Normal values **		
Power Consumption	Configuration	Max Power	Inrush
	XNX EC	6.2 w	<1A, <10ms@24VDC
	XNX mV	6.5 w	<750mA <2ms@24VDC
	XNX IR (Optima)	9.7w	<1A, <10ms@24VDC
	XNX IR (Excel)	13.2w	<1A, <10ms@24VDC
Termination	Crimp style pluggable with retaining screws, 12-28 AWG (2.5 to 0.5mm ²) with Shorting Jumpers: 14-28 AWG (2.0 to 0.5mm ²) NOTE: To maintain EMC integrity, wiring must be shielded by either an integral shield or run through conduit or pipe. Shield should provide 90% coverage		
20 mA Signal	HART® over 3-wire 4-20mA (sink, source, or isolated) compliant with NAMUR NE43		
Cable Ports	5 – (2 right, 2 left, 1 bottom) Available in ¾" NPT, or M25		
Recommended Cable	See Section 2.2.2 Distance Considerations for Installation .		
Construction			
Material	LM25 Aluminum, (SS316 painted optional)		
Dimensions	159 x 197 x 113.8 mm / 6.138 x 7.75 x 4.48 inches		
Weight	2.27 kg (5 lb) Aluminum 5 kg (11 lb) Stainless		
Mounting			
XNX® Enclosure	Integral Mounting Lugs for Wall- or Optional Pipe-Mount, Optional Wall/Ceiling Bracket		

User Interface	
Standard	Custom Backlit LCD, magnetic wand access
Optional	HART Handheld with IS Port
Environmental - Transmitter Operating	
IP Rating	IP66
Temperature*	-40°C to +65°C / -40°F to +149°F
Humidity	0 to 99% RH non-condensing
*Operating temperatures will be limited by the sensors. See tables 6.2.2, 6.2.3, and 6.2.4 for more information.	
Environmental - Transmitter Storage	
Temperature	-40°C to +65°C / -40°F to +149°F
Humidity	0 to 99% RH non-condensing
Unpowered battery life: (Real Time Clock) 3 years at rated storage temperature	

Hazardous Area Approvals [See Section 6.2 Certifications by Part Number for other approvals (pending)]

XNX-UT**-*****

UL Classified and CSA Listed (see notes below)
 Class I, Div. 1 Groups A, B, C & D Class I, Zone 1 Group IIC
 UL Classified
 Class II, Div. 1 Groups F & G, Class II, Zone 20 & 21
 FM Approvals Listed
 AEx D IIB + H2 T6 -40 °C ≤Tamb ≤65 °C
 AEx D [Ia IIC] IIB + H2 T6 -40 °C ≤Tamb ≤65 °C (XNX UT*E-***** & XNX-UT*-H*****)

XNX-AM**-*****

UL/Demko 09 ATEX 0809943X / IEC Ex UL 09.0010X
 II 2 G Ex d IIC T6 (Tamb -40 °C to +65 °C) IP 66
 II 2 D Ex tb IIIC T85 C Db
 XNX-AM*E-***** & XNX-AM*-H****
 II 2 (1)G Ex d [Ia IIC Ga] IIC T6 (Tamb -40 °C to +65 °C) IP 66
 II 2 (1)D Ex tb [Ia IIIC Da] IIIC T85 Db

XNX-BT**-*****

UL Classified
 Class I, Div. 1 Groups A, B, C & D Class I, Zone 1 Group IIC
 Class II, Div. 1 Groups F & G, Class II, Zone 20 & 21
 INMETRO TUV 12.1018X
 Ex d IIB + H2 T4 Gb IP 66 ≤ -40 °C ta ≤+65 °C
 Ex d [Ia IIC Ga] IIB + H2 T4 Gb IP 66 ≤ -40 °C ta ≤+65 °C (XNX BT*E-***** & XNX-BT*-H*****)
 Ex tb [Ia IIC Da] IIIC T85 Db
 Ex tb IIIC 85° Db
 FM Approvals Listed
 AEx D IIB + H2 T6 -40 °C ≤Tamb ≤65 °C
 AEx D [Ia IIC] IIB + H2 T6 -40 °C ≤Tamb ≤65 °C (XNX BT*E-***** & XNX-BT*-H*****)

NOTES:

1. The temperature class (T6) is limited to T4 when the MPD sensor is attached locally to the transmitter.
2. XNX EC cartridges and Remote Mount Kit have been evaluated by Underwriters Laboratories (UL) to Canadian National Standards.
3. Peer to peer and multi-drop network (daisy chained) HART, Modbus®, and Foundation™ Fieldbus configurations have not been evaluated by CSA to the requirements of CSA 22:2 No. 152 for Combustible Gas Detection and may be used only for diagnostics and data collection.

Performance Approvals

Communication Options

Relays

Type: 3 form “C” SPCO contacts for alarm and fault indication.
 Rating: 250 VAC, 5A/24 VDC, 5A (2 Alarm, 1 Fault)
 A remote reset is provided to silence alarms. (The Foundation Fieldbus, relay, and Modbus options are mutually exclusive.)

Modbus

Modbus/RTU over RS-485 physical layer. Interface isolated; includes switchable 120 Ohm termination resistor.
 Baud rates: 1200 to 38,400; 19,200 default.
 (The Foundation Fieldbus, relay, and Modbus options are mutually exclusive.)

Foundation Fieldbus

H1 Physical Layer.
 31.25 kbit/s Manchester encoded signal.
 AMIS-49200 Fieldbus MAU (media access unit).
 SPC4-2 Fieldbus Controller.
 Do not use Fieldbus communication in hazardous areas.
 The Foundation Fieldbus, Relay, and Modbus options are mutually exclusive.

See [Section 6.2 Certifications by Part Number](#) for other approvals

6.2 Sensor Data

6.2.1 Operating and Storage Conditions for Performance Tested EC Cartridges

Gas		Cartridge P/N	Operating Pressure	Operating Air Speed	Warm-up Time (minimum)	Storage Conditions*			
						Temperature	Pressure	Humidity	Time**
O ₂	Oxygen	XNXXS01SS	80 kPa ~ 120 kPa	0 ~ 6 m/sec	60 sec.	0 to 20°C, 32 to 68°F	80 to 120 KPa	5 to 95% RH	6 months
		XNXXS01FM							
H ₂ S	Hydrogen Sulfide	XNXXSH1SS	80 kPa ~ 120 kPa	0 ~ 6 m/sec	60 sec.	0 to 20°C, 32 to 68°F	70 to 110 KPa	30 to 70% RH	6 months
		XNXXSH1FM							
H ₂ S (High)	Hydrogen Sulfide	XNXXSH2SS	80 kPa ~ 120 kPa	0 ~ 6 m/sec	60 sec.	0 to 20°C, 32 to 68°F	70 to 110 KPa	30 to 70% RH	6 months
CO	Carbon Monoxide	XNXXSC1SS	80 kPa ~ 120 kPa	0 ~ 6 m/sec	60 sec.	0 to 20°C, 32 to 68°F	70 to 110 KPa	30 to 70% RH	6 months
		XNXXSC1FM							

*Store in sealed packages

**Check cartridge certificates

6.2.2 EC Sensor Performance Data, Factory Mutual Verified (see Section 6.3)

Gas		Cartridge P/N	Selectable Full Scale Range (Display and 4-20mA Full Scale)	Default Range	Range Increments	Lower Alarm Limit	Lower Detection Limit	Lower Explosive Limit (% Vol)	Zero Deviation	Selectable Cal Gas Range	Default Cal Point	Response Time (T50) sec	Response Time (T90) sec	Accuracy	Operating Temperature		Operating Humidity	
															Min	Max	Min	Max
O ₂	Oxygen	XNXXS01FM	n/a	23.0% Vol	n/a	5.0%Vol	5% Vol	n/a	n/a	20.9 %Vol (fixed)	20.9 %Vol	T20 <10	<30	<+/-0.5 %Vol	-30°C / -34°F	55°C / 131°F	15% RH	90% RH
H ₂ S	Hydrogen Sulfide	XNXXSH1FM	10.0 to 50.0 ppm	15.0 ppm	0.1 ppm	5.0 ppm	1.5 ppm	n/a	-2.5 ppm	30 to 70% of the selected full scale range	10 ppm	<20	<30	2 ppm or 10% of reading, whichever is greater	-40°C / -40°F	55°C / 131°F	15% RH	90% RH
CO	Carbon Monoxide	XNXXSC1FM ¹	100 to 1000 ppm	300 ppm	100 ppm	30 ppm	15 ppm	na/	-25 ppm		100 ppm	<15	<30		See footnote 1	-40°C / -40°F	55°C / 131°F	15% RH

FOOTNOTES:

1. XNXXSC1FM accuracy over temperature $\leq \pm 10\%$ of reading 20°C/68°F to 55°C/131°F, $\leq \pm 20\%$ of reading 20°C/68°F to -10°C/14°F, $\leq \pm 30\%$ of reading -10°C/14°F to -20°C/-4°F. Recalibration is recommended if the temperature of the local environment has varied by more than -30°C.

NOTES:

- Performance figures are measured by test units calibrated at 50% of full scale, at ambient conditions of 20°C, 50% RH, with the EC weatherproof cover attached
- IP rating of FM Cartridges is IP63.
- Barometric pressure effects on the O₂ sensor: The output from the O₂ sensor has pressure effects of <0.1% change of output per % change in pressure. When the barometric pressure changes by $\pm 20\%$ the output from the O₂ sensor changes $\leq \pm 0.4\%$ Vol. However, the oxygen sensor shows transient behavior when subjected to a rapid change in ambient pressure due to either weather or altitude. For example, a 10KPa instantaneous positive pressure step change may cause an overscale alarm condition for a period of about 12 seconds.
- Operating the XNX EC sensor at extended temperature ranges for a prolonged time period exceeding 12 hours may cause deterioration in the sensor performance and shorten sensor life. Extended temperature range for XNX EC sensors is -40°C to -20°C.
- Response times may increase at lower temperatures.
- FM performance verification is limited to the requirements of the standards identified in Table 6.3 for each cartridge.
- Contact Honeywell Analytics for additional data or details.

6.2.3 EC Sensor Performance Data, DEKRA EXAM verified (see Section 6.3)

Gas		Cartridge P/N	Selectable Full Scale Range (Display and 4-20mA Full Scale)	Default Range	Range Increments	Lower Alarm Limit	Lower Detection Limit	Zero Variation	Selectable Cal Gas Range	Default Cal Point	Response Time (T50) (sec)	T90 Response T10 Recovery Time (sec)	Accuracy ¹	Operating Temperature		Operating Humidity	
														Min	Max	Min	Max
O ₂	Oxygen	XNXXS01SS	n/a	25.0 %Vol	n/a	5.0%Vol	3.5 %Vol	n/a	20.9 %Vol (fixed)	20.9 %Vol	T20 <10	<30	<+/-0.6 %Vol	-30°C / -34°F	55°C /131°F	15% RH	90% RH
H ₂ S	Hydrogen Sulfide	XNXXSH1SS	10.0 to 50.0 ppm	15.0 ppm	0.1ppm	3.0 ppm	1.0 ppm	2.0 ppm	30 to 70% of the selected full scale range	10 ppm	<20	<30	<+/-0.3 ppm	-40°C / -40°F	55°C / 131°F	15% RH	90% RH
H ₂ S (High)	Hydrogen Sulfide	XNXXSH2SS	50 to 500 ppm	100 ppm	10 ppm	5 ppm	1 ppm	2 ppm		50 ppm	<20	<30	<+/-5 ppm	-40°C / -40°F	55°C / 131°F	15% RH	90% RH
CO	Carbon Monoxide	XNXXSC1SS	100 to 500 ppm	300 ppm	100 ppm	15 ppm	5 ppm	10 ppm		100 ppm	<15	<30	<+/-2 ppm	-40°C / -40°F	55°C / 131°F	15% RH	90% RH

FOOTNOTE:

1. Accuracy of reading at default Alarm 1 concentration (typically 10% FS or defined minimum alarm level setting, whichever is greater) when operated at default full scale.

NOTES:

- Sensor drift between LDL and negative drift fault limits (typically > negative zero variation) appear as 0 on the display and outputs of the device.
- Long-term drift: XNXXSC1SS <5%/year, XNXXS01SS <4%/year, XNXXSH1SS and XNXXSH2SS <2%/month.
- Performance figures are measured by test units calibrated at 50% of full scale, at ambient conditions of 20°C, 50% RH, with the EC weatherproof cover attached.
- Operating the XNX EC sensor at extended temperature ranges for a prolonged time period exceeding 12 hours may cause deterioration in sensor performance and shorten sensor life. Extended temperature ranges for XNX EC sensor cartridges are -40°C to -20°C.
- Barometric pressure effects on the O₂ sensor: The output from the O₂ sensor has pressure effects of <0.1% change of output per % change in pressure. When the barometric pressure changes by ±20%, the output from the O₂ sensor changes <±0.4%Vol. However, the oxygen sensor shows transient behavior when subjected to a rapid change in ambient pressure due to either weather or altitude. For example, a 10kPa instantaneous positive pressure step change may cause an overscale alarm condition for a period of about 12 seconds.
- Response times may increase at lower temperatures.
- Contact Honeywell Analytics for any additional data or details.

6.2.4 Other EC Sensors

Gas		Cartridge P/N	Selectable Full Scale Range (Display and 4-20mA Full Scale)	Default Range	Range Increments	Lower Alarm Limit	Lower Detection Limit	Zero Deviation	Selectable Cal Gas Range	Default Cal Point	Response Time (T50) sec	Response Time (T90) sec	Accuracy ¹	Typical Accuracy @ Lowest Alarm Level	Operating Temperature		Operating Humidity	
															Min	Max	Min	Max
HCl	Hydrogen Chloride	XNXXSR1SS	10.0 to 20.0 ppm	10.0 ppm	1.0 ppm	5.0 ppm	0.6 ppm	-1.0 ppm	30 to 70% of the selected full scale range	5.0 ppm	<45 ^{2,3}	<150 ^{2,3}	<+/-1.0 ppm or 20% of applied gas ^{2,3}	<+/-1.0 @ 3 ppm	-20°C/-4°F	40°C/104°F	15% RH	90% RH
H ₂ S (Low)	Hydrogen Sulfide	XNXXSH3SS	n/a	15.0 ppm	n/a	3.0 ppm	1.0 ppm	-2.5 ppm		10 ppm	<20	<40	<+/-0.3 ppm	<+/-0.3 @ 3 ppm	-40°C / -40°F	55°C / 131°F	15% RH	90% RH
SO ₂	Sulfur Dioxide	XNXXSS1SS	5.0 to 20.0 ppm	15.0 ppm	5.0 ppm	2.0 ppm	0.6 ppm	-1.0 ppm		5.0 ppm	<15	<30	<+/-0.3 ppm	<+/-0.3 @ 2 ppm	-40°C / -40°F	55°C / 131°F	15% RH	90% RH
SO ₂ (High)	Sulfur Dioxide	XNXXSS2SS	20.0 to 50.0 ppm	50.0 ppm	10.0 ppm	5.0 ppm	1.5 ppm	-2.5 ppm		25 ppm	<15	<30	<+/-0.6 ppm	<+/-0.6 @ 5 ppm	-40°C / -40°F	55°C / 131°F	15% RH	90% RH
NH ₃	Ammonia	XNXXSA1SS	50 to 200 ppm	200 ppm	50 ppm	20 ppm	6 ppm	-10 ppm		100 ppm	<60	<180	<+/-4 ppm	<+/-4 @ 20 ppm	-20°C / -4°F	40°C / 104°F	15% RH	90% RH
NH ₃ (High)	Ammonia	XNXXSA2SS	200 to 1000 ppm	1,000 ppm	50 ppm	100 ppm	30 ppm	-50 ppm		300 ppm	<60	<180	<+/-20 ppm	<+/-20 @ 100 ppm	-20°C / -4°F	40°C / 104°F	15% RH	90% RH
Cl ₂	Chlorine	XNXXSL2SS	n/a	5.00 ppm	n/a	0.50 ppm	0.15 ppm	-0.25 ppm		2.0 ppm	<20	<60	<+/-0.2 ppm	<+/-0.20 @ 0.50 ppm	-10°C / 14°F	55°C / 131°F	15% RH	90% RH
Cl ₂ (High)	Chlorine	XNXXSL1SS	5.0 to 20.0 ppm	5.0 ppm	5.0 ppm	1.0 ppm	0.6 ppm	-1.0 ppm		2.0 ppm	<20	<30	<+/-0.2 ppm	<+/-0.2 @ 1 ppm	-10°C / 14°F	55°C / 131°F	15% RH	90% RH
ClO ₂	Chlorine Dioxide	XNXXSX1SS	n/a	1.00 ppm	n/a	0.10 ppm	0.03 ppm	-0.05 ppm		0.5 ppm	<30	<120	<+/-30%	<+/-0.03 @ 0.1 ppm	-20°C / -4°F	55°C / 131°F	15% RH	90% RH
NO	Nitrogen Monoxide	XNXXSM1SS	n/a	100 ppm	n/a	10 ppm	3 ppm	-5 ppm		50 ppm	<15	<30	<+/-2 ppm	<+/-2.0 @ 10 ppm	-20°C / -4°F	55°C / 131°F	15% RH	90% RH
NO ₂	Nitrogen Dioxide	XNXXSN1SS	5.0 to 50.0 ppm	10.0 ppm	5.0 ppm	5.0 ppm	1.5 ppm	-2.5 ppm		5 ppm	<15	<30	<+/-0.2 ppm	<+/-0.2 @ 5 ppm	-20°C / -4°F	55°C / 131°F	15% RH	90% RH
H ₂	Hydrogen	XNXXSG1SS	n/a	1,000 ppm	n/a	100 ppm	30 ppm	-50 ppm		500 ppm	<60	<90 ²	<+/-8 ppm	<+/-8 @ 100 ppm	-20°C / -4°F	55°C / 131°F	15% RH	90% RH
H ₂ (High)	Hydrogen	XNXXSG2SS	n/a	10,000 ppm	n/a	1000 ppm	300 ppm	-500 ppm		5000 ppm	<15	<30	<+/-150 ppm	<+/-150 @ 1000 ppm	-20°C / -4°F	55°C / 131°F	15% RH	90% RH
HF	Hydrogen Fluoride	XNXXSF1SS	n/a	12.0 ppm	n/a	1.5 ppm	0.4 ppm	-0.6 ppm		5.0 ppm	120	<240	<+/-0.5 ppm	<+/-0.5 @ 1.5 ppm	-20°C / -4°F	55°C / 131°F	20% RH	75% RH
PH ₃	Phosphine	XNXXSP1SS	n/a	1.20 ppm	n/a	0.15 ppm	0.04 ppm	-0.06 ppm		0.5ppm	<15	<30	<+/- 0.02 ppm	<+/-0.02 @ 0.15 ppm	-20°C / -4°F	40°C / 104°F	10% RH	90% RH

see footnotes and notes on following page

FOOTNOTES (SEE TABLE ON PREVIOUS PAGE):

1. Accuracy of reading at default Alarm 1 concentration (typically 10%FS or defined minimum alarm level setting, whichever greater) when operated at default full scale.
2. System conditioning may be required to achieve stated results. Contact Honeywell Analytics for details.
3. Measured using calibration flow housing at calibration flow rate (300-375 ml/min) with dry gas.

NOTES (SEE TABLE ON PREVIOUS PAGE):

- Data taken at ambient conditions of 20°C, 50% RH.
- Data represents typical values of freshly calibrated sensors without optional accessories attached.
- Performance figures are measured by test units calibrated at 50% of full scale.
- Standard temperature range for XNX EC Sensors is -20°C to +55°C; ATEX, IECEx.
- Extended temperature ranges for the XNX EC Sensors are -40°C to -20°C
- Accuracy between the temperatures of -40°C and -20°C is $\pm 30\%$ at the applied gas concentration.
- Operating the XNX EC Sensors at extended temperature ranges for a prolonged time period exceeding 12 hours may cause deterioration in sensor performance and shorter sensor life.
- Barometric pressure effects on the O₂ sensor: The output from the O₂ sensor has pressure effects of <0.1% change of output per % change in pressure. When the barometric pressure changes by $\pm 20\%$ the output from the O₂ sensor changes $< \pm 0.4\%$ Vol. However, the oxygen sensor shows transient behavior when subjected to a rapid change in ambient pressure due to either weather or altitude. For example, a 10KPa instantaneous positive pressure step change may cause an overscale alarm condition for a period of about 12 seconds.
- Recalibration is recommended if the temperature of local environment has varied by more than $\pm 15^\circ\text{C}$ from the temperature of calibration.
- Response times may increase at lower temperatures.
- Contact Honeywell Analytics for any additional data or details.

6.2.5 XNX EC Sensor Cross-sensitivity

Gas type	Part Number	Gas Type Applied	Concentration	Unit	Reading	Unit
O ₂	XNXXS01SS XNXXS01FM	Carbon Dioxide	5	%vol	0.1	%vol (change O ₂ reading) per %vol CO ₂
HCl	XNXXSR1SS	Carbon monoxide	2000	ppm	0	ppm HCl
		Hydrogen	20000		0	
		Chlorine	5		5.6	
		Nitrogen dioxide	5		0.9	
		Propan-2-ol	500		0	
		Methanol	500		0	
		Hydrogen fluoride	5		6.7	
		Hydrogen sulfide	25		-3.6	
		Sulphur dioxide	50		22.4	
		Arsine	1		0	
		Phosphine	1		-0.14	
		Diborane	1		-1.3	
		H ₂ S (Low Range)	XNXXSH3SS		Ammonia	
Carbon Monoxide	100			<2	ppm H ₂ S	
Carbon Dioxide	5000			0	ppm H ₂ S	
Chlorine	0.5			0	ppm H ₂ S	
Ethylene	100			0	ppm H ₂ S	
Hydrogen	100			0	ppm H ₂ S	
Hydrogen Sulfide	10			10	ppm H ₂ S	
Nitrogen Monoxide	25			0	ppm H ₂ S	
Nitrogen Dioxide	3			0	ppm H ₂ S	
Sulfur Dioxide	2			0	ppm H ₂ S	

Gas type	Part Number	Gas Type Applied	Concentration	Unit	Reading	Unit
H ₂ S	XNXSH1SS XNXSH1FM	Ammonia	50	ppm	0	ppm H ₂ S
		Carbon Monoxide	100		<2	ppm H ₂ S
		Carbon Dioxide	5000		0	ppm H ₂ S
		Chlorine	0.5		0	ppm H ₂ S
		Ethylene	100		0	ppm H ₂ S
		Hydrogen	100		0	ppm H ₂ S
		Hydrogen Sulfide	10		10	ppm H ₂ S
		Nitrogen Monoxide	25		0	ppm H ₂ S
		Nitrogen Dioxide	3		0	ppm H ₂ S
		Sulfur Dioxide	2		0	ppm H ₂ S
H ₂ S (High Range)	XNXSH2SS	Ammonia	50	ppm	0	ppm H ₂ S
		Carbon Monoxide	100		<2	ppm H ₂ S
		Carbon Dioxide	5000		0	ppm H ₂ S
		Chlorine	0.5		0	ppm H ₂ S
		Ethylene	100		0	ppm H ₂ S
		Hydrogen	100		0	ppm H ₂ S
		Hydrogen Sulfide	10		10	ppm H ₂ S
		Nitrogen Monoxide	25		0	ppm H ₂ S
		Nitrogen Dioxide	3		0	ppm H ₂ S
		Sulfur Dioxide	2		0	ppm H ₂ S

Gas type	Part Number	Gas Type Applied	Concentration	Unit	Reading	Unit
CO	XNXXSC1SS XNXXSC1FM	Acetone	1000	ppm	0	ppm CO
		Acetylene	40		80	ppm CO
		Ammonia	100		0	ppm CO
		Carbon Monoxide	100		100	ppm CO
		Chlorine	2		0	ppm CO
		Ethanol	2000		3	ppm CO
		Ethylene	100		85	ppm CO
		Hydrogen	100		20	ppm CO
		Hydrogen Sulfide	25		0	ppm CO
		Iso-Propanol	200		0	ppm CO
		Nitrogen Monoxide	50		8	ppm CO
		Nitrogen Dioxide	800		20	ppm CO
		Sulfur Dioxide	50		0.5	ppm CO
		SO ₂	XNXXSS1SS		Carbon Monoxide	300
Hydrogen Sulfide	15			0	ppm SO ₂	
Nitrogen Monoxide	35			0	ppm SO ₂	
Nitrogen Dioxide	5			~-5	ppm SO ₂	
SO ₂	XNXXSS2SS	Carbon Monoxide	300	ppm	<3	ppm SO ₂
		Hydrogen Sulfide	15		0	ppm SO ₂
		Nitrogen Monoxide	35		0	ppm SO ₂
		Nitrogen Dioxide	5		~-5	ppm SO ₂

Gas type	Part Number	Gas Type Applied	Concentration	Unit	Reading	Unit
NH ₃	XNXXSA1SS	Alcohols	1000	ppm	0	ppm NH ₃
		Carbon Dioxide	5000		0	ppm NH ₃
		Carbon Monoxide	100		0	ppm NH ₃
		Hydrocarbons		% range	0	ppm NH ₃
		Hydrogen	10000	ppm	0	ppm NH ₃
		Hydrogen Sulfide	20		2	ppm NH ₃
NH ₃ (High Range)	XNXXSA2SS	Alcohols	1000	ppm	0	ppm NH ₃
		Carbon Monoxide	100		0	ppm NH ₃
		Chlorine	5		0	ppm NH ₃
		Nitrogen Dioxide	10		0	ppm NH ₃
		Sulfur Dioxide	20		-40	ppm NH ₃
		Hydrogen	3000		0	ppm NH ₃
		Hydrogen Sulfide	20		20	ppm NH ₃
Cl ₂	XNXXSL2SS	Carbon Dioxide	20000	ppm	0	ppm Cl ₂
		Hydrogen Chloride	9		1.25	ppm Cl ₂
		Hydrogen Sulfide	25		-16.3	ppm Cl ₂
		Nitrogen Dioxide	50		1.25 (transient)	ppm Cl ₂
		Sulfur Dioxide	50		9.1	ppm Cl ₂
Cl ₂ (High Range)	XNXXSL1SS	Carbon Dioxide	20000	ppm	0	ppm Cl ₂
		Hydrogen Chloride	9		1.25	ppm Cl ₂
		Hydrogen Sulfide	25		-16.3	ppm Cl ₂
		Nitrogen Dioxide	50		1.25 (transient)	ppm Cl ₂
		Sulfur Dioxide	50		9.1	ppm Cl ₂
ClO ₂	XNXXSX1SS	Refer To Cl ₂	Refer to Cl ₂	Refer to Cl ₂	Refer to Cl ₂	Refer to Cl ₂

Gas type	Part Number	Gas Type Applied	Concentration	Unit	Reading	Unit
NO	XNXSM1SS	Carbon Monoxide	300	ppm	0	ppm NO
		Sulfur Dioxide	5		0	ppm NO
		Nitrogen Dioxide	5		<1.5	ppm NO
		Hydrogen Sulfide	15		~1.5	ppm NO
NO ₂	XNXSN1SS	Carbon Monoxide	300	ppm	0	ppm NO ₂
		Hydrogen Sulfide	15		~ -1.2	ppm NO ₂
		Sulfur Dioxide	5		0	ppm NO ₂
		Nitrogen Monoxide	35		0	ppm NO ₂
		Chlorine	1		~1	ppm NO ₂
H ₂	XNXSG1SS	Carbon Monoxide	300	ppm	≤ 60	ppm H ₂
		Hydrogen Sulfide	15		<3	ppm H ₂
		Sulfur Dioxide	5		0	ppm H ₂
		Nitrogen Monoxide	35		»10	ppm H ₂
		Nitrogen Dioxide	5		0	ppm H ₂
		Chlorine	1		0	ppm H ₂
		Hydrogen Cyanide	10		»3	ppm H ₂
		Hydrogen Chloride	5		0	ppm H ₂
		Ethylene	100		»80	ppm H ₂

Gas type	Part Number	Gas Type Applied	Concentration	Unit	Reading	Unit
H ₂ (High Range)	XNXXSG2SS	Ammonia	100	ppm	0	ppm H ₂
		Arsine	0.2	ppm	0	ppm H ₂
		Carbon Dioxide	1000	ppm	0	ppm H ₂
		Carbon Monoxide	100	ppm	150	ppm H ₂
		Chlorine	1	ppm	0	ppm H ₂
		Ethylene	500	ppm	yes; n/d	ppm H ₂
		Hydrogen Cyanide	20	ppm	0	ppm H ₂
		Hydrogen Sulfide	20	ppm	4	ppm H ₂
		Iso-Propanol	1100	ppm	yes; n/d	ppm H ₂
		Methane	1	%	0	ppm H ₂
		Nitrogen Dioxide	10	ppm	-40	ppm H ₂
		Ozone	0.25	ppm	0	ppm H ₂
		Sulfur Dioxide	5	ppm	0	ppm H ₂
HF	XNXXSF1SS	Carbon Monoxide	2000	ppm	0	ppm HF
		Hydrogen	20000	ppm	0	ppm HF
		Chlorine	5	ppm	5.8	ppm HF
		Nitrogen Dioxide	5	ppm	0.65	ppm HF
		Iso-Propanol	500	ppm	0	ppm HF
		Methanol	500	ppm	0	ppm HF
		Hydrogen Fluoride	5	ppm	7	ppm HF
		Hydrogen Sulfide	25	ppm	-3.6	ppm HF
		Sulfur Dioxide	50	ppm	28.3	ppm HF
		Arsine	1	ppm	0	ppm HF
		Phosphine	1	ppm	-0.14	ppm HF
		Diborane	1	ppm	-1.3	ppm HF

Gas type	Part Number	Gas Type Applied	Concentration	Unit	Reading	Unit
PH ₃	XNXXSP1SS	Carbon Monoxide	2000	ppm	<10	ppm PH ₃
		Hydrogen	5000	ppm	<10	ppm PH ₃
		Chlorine	1	ppm	-70	ppm PH ₃
		Nitrogen Dioxide	8	ppm	-860	ppm PH ₃
		Ethanol	2000	ppm	<10	ppm PH ₃
		Iso-Propanol	1000	ppm	<10	ppm PH ₃
		Hydrogen Chloride	10	ppm	<10	ppm PH ₃
		Hydrogen Fluoride	10	ppm	<10	ppm PH ₃
		Hydrogen Sulfide	0.5	ppm	70	ppm PH ₃
		Ammonia	100	ppm	1050 (transient)	ppm PH ₃
		Sulfur Dioxide	50	ppm	550 (transient)	ppm PH ₃
		Silane	1	ppm	364	ppm PH ₃
		Arsine	1	ppm	680	ppm PH ₃
		Diborane	1	ppm	454	ppm PH ₃
		Germane	1	ppm	454	ppm PH ₃

NOTES:

- The figures of cross-sensitivity are typical values and should not be used as a basis for cross calibration.
- Cross-sensitivities may not be linear and should not be scaled.
- For some cross-interferents breakthrough may occur if gas is applied a longer time period.
- There are many gases and vapors that can poison electrochemical cells. It is difficult to give a complete and exclusive list of all species which will have an effect on the sensors. However, these are some common substances which should be avoided:
- Airborne greases - These may block gas access into the sensors and therefore reduce sensitivity.
- Silicone compounds - These are often found in sprays, aerosols, lubricants, polishes, adhesives, sealants, zebra strip, cleaning agents, and floor waxes. These compounds tend to reduce the sensitivity of the sensors and generally will have a permanent effect.
- Solvents and organic vapors - Many organic vapors will damage the sensors. Some common ones are IPA, toluene, xylene, other benzene derivatives, petrol, and diesel. It is difficult to give a full list of organic vapors, as there are so many of them. Generally, any organic vapor should be avoided.

6.2.6 XNX MPD Sensor Performance Data

Sensor Type	Gas	Typical Response Time (T50) sec	Typical Response Time (T90) sec	Maximum Range	Accuracy (% of full scale or % of applied gas)	Drift Over Time	Operating Humidity	Operating Temperature		Operating Pressure	Operating Air Speed
								Min	Max		
MPD-IC1	Carbon Dioxide	<30	<70	5.00 %Vol	±5%FS or ±15%	< 3%/yr	0-95% RH non-condensing	-20°C / -4°F	+50°C / 122°F	80kPa ~ 110kPa	0 ~ 6m/sec
MPD-IV1	Methane	<15	<30	5.00 %Vol	±5%FS or ±15%	< 3%/yr		-20°C / -4°F	+50°C / 122°F	80kPa ~ 110kPa	0 ~ 6m/sec
MPD-IF1	Propane	<15	<30	100 %LEL	±5%FS or ±15%	< 3%/yr		-20°C / -4°F	+50°C / 122°F	80kPa ~ 110kPa	0 ~ 6m/sec
MPD-CB1	Propane	<15	<30	100 %LEL	±5%FS or ±15%	< 3%/yr		-40°C / -40°F	+65°C / 149°F	80kPa ~ 120kPa	0 ~ 6m/sec
	Methane	<10	<30								
	Hydrogen	<10	<30								
	Butane-2	<15	<40								
	Nonane	<20	<50								

NOTES:

- Response times may vary depending upon molecular weight, size, and structure.
- CSA approved hydrogen sensors are MPDUT-CB1 and 705 STD.
- DEKRA EXAM approved sensors are MPDAM CB1 and SPHT
- Data taken at 20-25°C. Contact Honeywell Analytics for additional data or details.
- Response times may increase at lower temperatures.
- Data represents typical values without optional accessories attached.
- System conditioning may be required to achieve stated results. Contact Honeywell Analytics for details.
- Performance figures are measured using a sample humidity of 50% RH.
- Performance figures are measured between 40 and 60% of full scale.
- Performance figures are measured by test units calibrated at 50% of full scale.
- Use of the weatherproof cap will increase response times.
- FM 6340 performance approval based on MPD-IC1 with SPXCDWP T50<60 T90<150.
- Use of the weatherproof cap will increase response times.
- FM 6340 performance approval based on MPD-IC1 with SPXCDWP T50<60 T90<150.

6.2.7 EN60079-29-1 Performance Approved Gases for mV Sensor Types

Sensor Type	EN60079-29-1 Reference	Verified Gas Selections					
		Hydrogen	Methane-2	Propane-2	Butane-2	Star 2	Star 4
MPD AMCB1	Standard Test Gas		●	●			
	Other Gases	●			●	n-nonane	
SP-HT	Standard Test Gas		●	●			
	Other Gases	●			●		n-nonane
Max Zero Deviation (see note 1)		-7% LEL			-9% LEL	-7% LEL	
LDL (see note 2)		3% LEL			5% LEL	3% LEL	

NOTES:

1. Readings < 0% LEL are not displayed or indicated on the 20 mA output. Values exceeding the zero deviation limit will result in F111 faults.
2. Readings < LDL are shown as 0% on the display and 20 mA output.

6.2.8 Other Sensor Performance Data

Performance data for other supported sensors is available in their respective technical manuals.

6.3 XNX Certifications by Part Number Series

Contact Honeywell Analytics for information about approvals not shown in this section.

XNX Certifications XNX-UT Series

XNX Part Number Series		XNX Transmitter IR Personality			XNX Transmitter mV Personality								XNX Transmitter EC Personality			Options						
		XNX-UTSI-**** XNX-UTAI-****			XNX-UTSV-**** / XNX-UTAV-****								XNX-UTSE-**** / XNX-UTAE-****									
		With Generic 20 mA Input	With Optima Plus	With Searchline Excel	MPD-UTC B1 (Cat Bead)	MPD-UTIV1 (IR Methane)	MPD-UTIF1 (IR Flam)	MPD-UTIC1 (IR CO ₂)	with 705	with Sensepoint	with Sensepoint PPM	with Sensepoint HT	With XNXSO1FM O ₂ Cartridge	With XNXSSH1FM H ₂ S Cartridge	With XNXSC1FM CO Cartridge	SO ₂ , NH ₃ , Cl ₂ , ClO ₂ , NO, NO ₂ , H ₂ PPM HCL, HCN, HF, O ₃ , PH ₃	Modbus	Relays	Local HART	Foundation Fieldbus		
C-UL Classified For Hazardous Locations		UL 1203		T	T	T	T	T	T	T	T	N/A	N/A	N/A	T	T	T	T	T	T	T	
		UL 913-7th Edition		N/A	N/A	N/A	N/A	N/A	N/A	N/A	N/A	N/A	N/A	N/A	N/A	T	T	T	T	N/A	N/A	T
CSA	Hazardous Location	CAN/CSA C22.2 No. 30 M-1986		T	T	T	T	N/A	N/A	T	T	N/A	N/A	N/A	T	T	T	T	T	T	N/A	
		CAN/CSA C22.2 No. 157-92 (Applies to Local HART Option and/or EC Adaptors)		N/A	N/A	N/A	N/A	N/A	N/A	N/A	N/A	N/A	N/A	N/A	T	T	T	T	N/A	N/A	T	N/A
	Performance	CSA C22.2 No. 152		N/A	T	N/A	T	N/A	N/A	N/A	T	N/A	N/A	N/A	N/A	N/A	N/A	T	T	T	T	
FM Listed	US Toxic Performance	Standard referenced in notes 1, 2, 3		N/A	N/A	N/A	N/A	N/A	N/A	3	N/A	N/A	N/A	1	2	3	N/A	T	T	T	T	
	Flammable Performance	FM 6310 / 6320		N/A	T	N/A	T	N/A	N/A	N/A	T	N/A	N/A	N/A	N/A	N/A	N/A	N/A	T	T	T	T
		FM 6325		N/A	N/A	T	N/A	N/A	N/A	N/A	N/A	N/A	N/A	N/A	N/A	N/A	N/A	N/A	T	T	T	T
	Toxic Gas Detector	FM 6340		N/A	N/A	N/A	N/A	N/A	N/A	T	N/A	N/A	N/A	N/A	N/A	N/A	N/A	T	T	T	T	
T = 3/4 NPT threaded Transmitters & Adapters N/A = Not Applicable		1. ANSI/ISA 92.04.01, Part 1 2007 2. ISA 92.0.01, Part 3 1998 3. FM 6340																				

XNX Certifications by XNX-AM Series																							
XNX Part Number Series		XNX Transmitter IR Personality			XNX Transmitter mV Personality								XNX Transmitter EC Personality						Options				
		XNX-AMSI-***** XNX-AMAI-*****			XNX-AMSV-***** / XNX-AMAV-*****								XNX-AMSE-***** / XNX-AMAE-*****										
		With Generic 20 mA Input	With Optima Plus	With Searchline Excel	MPD-AMCB1 (Cat Bead)	MPD-AMV1 (IR Methane)	MPD-AMIF1 (IR Flam)	MPD-AMIC1 (IR CO ₂)	With 705 HT	With Sensepoint	With Sensepoint PPM	With Sensepoint HT	With Oxygen Cartridge	With H ₂ S Low Cartridge	With H ₂ S Med Cartridge	With H ₂ S High Cartridge	With CO Cartridge	SO ₂ , NH ₃ , Cl ₂ , ClO ₂ , NO, NO ₂ , H ₂ PPM HCL, HCN, HF, O ₃ , PH ₃	Modbus	Relays	Local HART	Foundation Fieldbus	
Electromagnetic & Safety; CE Mark EMC Compliance	EU directive 2004/108/EC	M	M	M	M	M	M	M	M	M	M	M	M	M	M	M	M	M	M	M	M		
	EN 50270:2006	B	B	B	B	B	B	B	B	B	B	B	B	B	B	B	B	B	B	B	B		
	EU directive 94/9/EC	M	M	M	M	M	M	M	M	M	M	M	M	M	M	M	M	M	M	M	M		
Hazardous Location --- ATEX/DEMKO IECEx	EN 60079-29-0: 2009	M	M	M	M	M	M	M	N/A	M	M	M	M	M	M	M	M	M	M	M	M		
	EN 60079-29-1: 2007	M	M	M	M	M	M	M	N/A	M	M	M	M	M	M	M	M	M	M	M	M		
	EN 60079-11: 2012	N/A	N/A	N/A	N/A	N/A	N/A	N/A	N/A	N/A	N/A	N/A	M	M	M	M	M	M	N/A	N/A	M	N/A	
	EN 60079-26: 2007	N/A	N/A	N/A	N/A	N/A	N/A	N/A	N/A	N/A	N/A	N/A	M	M	M	M	M	M	N/A	N/A	N/A	N/A	
	IEC 60079-31 1st Ed	M	M	M	M	M	M	M	N/A	N/A	N/A	M	M	M	M	M	M	M	M	M	M	M	
	IEC 60079-0 6th Ed	M	M	M	M	M	M	M	N/A	M	M	M	M	M	M	M	M	M	M	M	M	M	
	IEC 60079-1 6th Ed	M	M	M	M	M	M	M	N/A	M	M	M	M	M	M	M	M	M	M	M	M	M	
	IEC 60079-11 6th Ed	N/A	N/A	N/A	N/A	N/A	N/A	N/A	N/A	N/A	N/A	N/A	M	M	M	M	M	M	M	N/A	N/A	M	M
	IEC 60079-26 2nd Ed	N/A	N/A	N/A	N/A	N/A	N/A	N/A	N/A	N/A	N/A	N/A	M ₁	M ₁	M ₁	M ₁	M ₁	M ₁	M ₁	N/A	N/A	N/A	N/A
EN 60079-31: 2009	M	M	M	M	M	M	M	N/A	N/A	N/A	M	M	M	M	M	M	M	M	M	M	M		

B = Both 3/4 NPT and M25
 M = M25 threaded Transmitters & Adapters
 M₁ = When used with S3KRMK in a Zone 0 location
 N/A = Not Applicable

XNX Certifications XNX-AM Series																					
XNX Part Number Series		XNX Transmitter IR Personality			XNX Transmitter mV Personality								XNX Transmitter EC Personality					Options			
		XNX-AMSI-**** XNX-AMAL-****			XNX-AMSV-**** / XNX-AMAV-****								XNX-AMSE-**** / XNX-AMAE-****								
		With Generic 20 mA Input	With Optima Plus	With Searchline Excel	MPD-AMCB1 (Cat Bead)*	MPD-AMIV1 (IR Methane)	MPD-AMIF1 (IR Flam)	MPD-AMIC1 (IR CO ₂)	With 705 HT	With Sensepoint	With Sensepoint PPM	With Sensepoint HT*	With XNXXS01SS O ₂ Cartridge	With XNXXSH1SS H ₂ S Cartridge	With XNXXSH2SS H ₂ S Cartridge	With XNXXSC1SS CO Cartridge	SO ₂ , NH ₃ , Cl ₂ , ClO ₂ , NO, NO ₂ , H ₂ PPM HCL, HCN, HF, O ₃ , PH ₃	Modbus	Relays	Local HART	Foundation Fieldbus
Performance* EXAM DEKRA GmbH	IEC 60079-29-1:2007*** EN 60079-29-1:2007***	N/A	M	N/A	M	N/A	N/A	N/A	N/A	N/A	N/A	M	N/A	N/A	N/A	N/A	N/A	N/A	M	M	N/A
	EN 45544:1999	N/A	N/A	N/A	N/A	N/A	N/A	N/A	N/A	N/A	N/A	N/A	N/A	M	M	M	N/A	N/A	M	M	N/A
	EN 50104:2010**	N/A	N/A	N/A	N/A	N/A	N/A	N/A	N/A	N/A	N/A	N/A	M	N/A	N/A	N/A	N/A	N/A	M	M	N/A
	EN 50271:2010	N/A	M	N/A	M	N/A	N/A	N/A	N/A	N/A	N/A	M	M	M	M	N/A	N/A	N/A	M	M	N/A
TÜV Rhineland	IEC61508	B	B	B	N/A	N/A	N/A	N/A	B	B	B	B	B	B	B	B	B	N/A	N/A	N/A	N/A
	EN 50402	B	B	B	N/A	N/A	N/A	N/A	B	B	B	B	B	B	B	B	B	N/A	N/A	N/A	N/A

Delays resulting from transmission errors between sensor and transmitter extend response times T90 by more than one-third. The period until fault indication is 10 seconds.

M = M25 threaded Transmitters & Adapters
 B = Both XNX-UT**-**** 3/4"NPT and XNX-AM**-**** transmitters
 N/A = Not Applicable

*Tested components: handheld in point-to-point mode, weatherproof cap (not used for calibration), calibration mask.
 **Tested applications: oxygen deficiency and oxygen enrichment
 *** Tested gases: methane-2, butane-2, propane-2, hydrogen, n-nonane

XNX Certifications - MPD-BT** .***** Part Number Series																		
XNX Part Number Series		XNX Transmitter IR Personality			XNX Transmitter mV Personality						XNX Transmitter EC Personality				Options			
		XNX-BTSL-***** XNX-BTAI-*****			XNX-BTSV-***** XNX-BTAV-*****						XNX-BTSE-***** XNX-BTAE-*****							
		With Generic 20 mA Input	With Optima Plus	With Searchline Excel	MPD-BTCB1 (Cat Bead)	MPD-BTIV1 (IR Methane)	MPD-BTIF1 (IR Flam)	MPD-BTIC1 (IR CO2)	with 705 HT	With XNXSO1FM O ₂ Cartridge	With XNXSH1FM H ₂ S Cartridge	With XNXSC1FM CO Cartridge	SO ₂ , NH ₃ , CL ₂ , ClO ₂ , NO, NO ₂ , H ₂ PPM HCL, HCN, HF, O ₃ , PH ₃	Modbus	Relays	Local HART	FOUNDATION Field Bus	
UL Classified	UL 1203	T	T	T	T	T	T	T	T	T	T	T	T	T	T	T		
	UL 913-7th Edition Applies to Local HART Option)	N/A	N/A	N/A	N/A	N/A	N/A	N/A	N/A	N/A	T	T	T	T	N/A	N/A	T	N/A
INMETRO TÜV Rheinland	ABNT NBR IEC 60079-0:2008	B	B	B	B	B	B	B	B	B	B	B	B	B	B	B	B	
	ABNT NBR IEC 60079-1:2009	B	B	B	B	B	B	B	B	B	B	B	B	B	B	B	B	
	ABNT NBR IEC 60079-11:2013	N/A	N/A	N/A	N/A	N/A	N/A	N/A	N/A	N/A	B	B	B	B	N/A	N/A	T	N/A
	ABNT NBR IEC 60079-26:2008	B	B	B	B	B	B	B	B	B	B	B	B	B	B	B	B	B
	ABNT NBR IEC 60079-31:2014	B	B	B	B	B	B	B	B	B	B	B	B	B	B	B	B	B
	Portar:a INMETRO n°179 de 18/05/2010	B	B	B	B	B	B	B	B	B	B	B	B	B	B	B	B	B
	ABNT NBR IEC 60529:-2009	T	T	T	T	T	T	T	T	T	T	T	T	T	T	T	T	T
FM Listed	Standard referenced in notes 1, 2, 3	N/A	N/A	N/A	N/A	N/A	N/A	3	N/A	1	2	3	N/A	T	T	T	T	
	FM 6310 / 6320	N/A	T	N/A	T	N/A	N/A	N/A	T	N/A	N/A	N/A	N/A	T	T	T	T	
	FM 6325	N/A	N/A	T	N/A	N/A	N/A	N/A	N/A	N/A	N/A	N/A	N/A	T	T	T	T	
	FM 6340	N/A	N/A	N/A	N/A	N/A	N/A	T	N/A	N/A	N/A	N/A	N/A	T	T	T	T	
T = 3/4 NPT threaded Transmitters & Adapters N/A = Not Applicable		1. ANSI/ISA 92.04.01, Part 1 2007 2. ISA 92.0.01, Part 3 1998 3. FM 6340																

Certification Labels

	-WARNING: DO NOT OPEN WHEN EXPLOSIVE GAS ATMOSPHERES ARE PRESENT -READ AND UNDERSTAND MANUAL PRIOR TO INSTALLATION AND OPERATION -ALL THREADED CABLES ENTRIES: M25 ATENÇÃO-NÃO ABRA ONDE UMA ATMOSFERA EXPLOSIVA POSSA ESTAR PRESENTE		MADE IN USA 	11-KB4BO-0120X	XNX-// // // // // SN: // // // // // 32 to 32 VDC Max. Pmax = // // // // W DEMKO 09 ATEX 0809943X // // // // // IECEx UL09,0010X 0539 II 2 G Ex d // // // // // IIC // // // // // Gb (Tamb // // // // °C to // // // // °C) IP66 0539 II 2 D Ex tb // // // // // IIIC T85°C Db IP66 XNX-AM* *- *- * * Contact Ratings: 250 VAC 5A, BVS 10 ATEX G 001X 24 VDC 5A, Resistive Load Only EN60079-29-1 PFG 10 G 002 X	
	Honeywell Analytics, Inc; 405 Barclay Blvd, Lincolnshire, IL 60069 USA					

Figure 230. XNX-AM**-***** Configuration

6.4 Product Identification

6.4.1 XNX Universal Transmitter

The XNX part numbering system contains all of the information necessary to convey the product configuration, including options. Agency, port thread, enclosure material, and sensor personality define the standard unit. Three option fields define optional relay or fieldbus interfaces and factory installed local HART. The sensor and range field is used exclusively by millivolt units to assemble the defined MPD sensor type and corresponding thread to the transmitter. Agency approvals of the MPD sensor are unique by device and part number. Ensure that the approvals of both the transmitter and the MPD sensor meet the requirements of the installation.

Enclosure Options (See Section 6.2 for Agency Approvals)									
Model	Port Thread	Material	Sensor	Interface Option	Local HART	MPD Type Installed			
XNX -	▼	▼	▼	-	▼	▼	▼	▼	▼
AM - A	M25	Painted LM25 Aluminum	E - Electrochem	N - None	N - None	NNN - None			
AM - S	M25	Painted 316 Stainless Steel	I - Infrared	R - Relay	H - Local HART	CB1 - MPD-CB1 (Catalytic Bead %LEL) ¹			
UT - A	3/4 " NPT	Painted LM25 Aluminum	V - Millivolt	M - Modbus		IF1 - MPD-IF1 (IR %LEL Flam) ¹			
UT - S	3/4 " NPT	Painted 316 Stainless Steel		F - Foundation Fieldbus		IV1 - MPD-IV1 (IR CH ₄ 0-5% Vol) ¹			
BT - A	3/4 " NPT	Painted LM25 Aluminum				IC1 - MPD-IC1 (IR CO ₂ 0-5% Vol) ¹			
BT - S	3/4 " NPT	Painted 316 Stainless Steel							

6.4.2 XNX EC Replacement Sensors

XNX ID	Target Gas		Cartridge Part No	Maximum Range	Selectable Range	Increment	Default Range	Cal Gas Range	Cal Gas P/N	Cal Gas Description
1	O ₂	Oxygen	XNXXS01SS	25.0 %Vol	N/A	N/A	25.0 %Vol	20.9 %Vol	N/A	N/A
			XNXXS01FM	23.0% Vol			23.0% Vol			
2	H ₂ S	Hydrogen Sulfide (Low Range)	XNXXSH3SS	15.0 ppm	N/A	N/A	15.0 ppm	5.0 to 10.0 ppm	GFV263	10 ppm H ₂ S
3	H ₂ S	Hydrogen Sulfide	XNXXSH1SS XNXXSH1FM	50.0 ppm	10.0 to 50.0 ppm	0.1 ppm	15.0 ppm	3 to 35 ppm	GFV258	25 ppm H ₂ S
4	H ₂ S	Hydrogen Sulfide (High Range)	XNXXSH2SS	500 ppm	50 to 500 ppm	10 ppm	100 ppm	15 to 350 ppm	GFV421	50 ppm H ₂ S
5	CO	Carbon Monoxide	XNXXSC1SS	1,000 ppm	100 to 500 ppm	100 ppm	300 ppm	30 to 200 ppm	GFV295	100 ppm CO
			XNXXSC1FM		100 to 1,000 ppm					
6	SO ₂	Sulfur Dioxide	XNXXSS1SS	20.0 ppm	5.0 to 20.0 ppm	5.0 ppm	15.0 ppm	2 to 14 ppm	Contact HA	7.5 ppm SO ₂
7	SO ₂	Sulfur Dioxide (High Range)	XNXXSS2SS	50.0 ppm	20.0 to 50.0 ppm	10 ppm	50.0 ppm	6 to 35 ppm	GFV441	25 ppm SO ₂
8	NH ₃	Ammonia	XNXXSA1SS	200 ppm	50 to 200 ppm	50 ppm	200 ppm	150 to 140 ppm	Contact HA	100 ppm NH ₃
9	NH ₃	Ammonia (High Range)	XNXXSA2SS	1000 ppm	200 to 1,000 ppm	50 ppm	1,000 ppm	60 to 700 ppm	Contact HA	300 ppm NH ₃
10	Cl ₂	Chlorine	XNXXSL2SS	5.00 ppm	N/A	N/A	5.00 ppm	2 to 3 ppm	GFV251	2 ppm Cl ₂ in N ₂
11	Cl ₂	Chlorine (High Range)	XNXXSL1SS	20.0 ppm	5.0 to 20.0 ppm	5.0 ppm	5.0 ppm	2 to 14 ppm	GFV251	2 ppm Cl ₂ in N ₂
12	ClO ₂	Chlorine Dioxide	XNXXSX1SS	1.00 ppm	N/A	N/A	1.00 ppm	0.3 to 0.7 ppm	Gas Generator	0.5 ppm
13	NO	Nitrogen Monoxide	XNXXSM1SS	100 ppm	N/A	N/A	100 ppm	30 to 70 ppm	GFV216	50 ppm NO in N ₂
14	NO ₂	Nitrogen Dioxide	XNXXSN1SS	50.0 ppm	5.0 to 50.0 ppm	5.0 ppm	10.0 ppm	2 to 35 ppm	GFV435	5 ppm NO ₂
15	H ₂	Hydrogen	XNXXSG1SS	1000 ppm	N/A	N/A	1,000 ppm	300 to 700 ppm	GFV364	500 ppm H ₂
16	H ₂	Hydrogen (High Range)	XNXXSG2SS	10,000 ppm	N/A	N/A	10,000 ppm	3,000 to 7,000 ppm	Contact HA	5000 ppm H ₂ in N ₂
17	HCl	Hydrogen Chloride	XNXXSR1SS	20.0 ppm	10.0 to 20.0 ppm	1.0 ppm	10.0 ppm	4 to 12 ppm	Contact HA	5 ppm HCl in N ₂
19	HF	Hydrogen Fluoride	XNXXSF1SS	12.0 ppm	N/A	N/A	12.0 ppm	4 to 8 ppm	Contact HA	5 ppm HF in N ₂
21	PH ₃	Phosphine	XNXXSP1SS	1.20 ppm	N/A	N/A	1.20 ppm	0.5 to 0.7 ppm	GFV405	0.5 ppm PH ₃ in N ₂

1 Indicates agency approval and port thread specification

6.4.3 XNX EC Replacement Cells

Replacement Cell P/N	Target Gas		Cartridge Part No
S3K01SS	O ₂	Oxygen	XNXXS01SS XNXXS01FM
S3KH1SS	H ₂ S	Hydrogen Sulfide (Low Range)	XNXXSH3SS
S3KH1SS S3KH1SS	H ₂ S	Hydrogen Sulfide	XNXXSH1SS XNXXSH1FM
S3KH2SS	H ₂ S	Hydrogen Sulfide (High Range)	XNXXSH2SS
S3KC1SS	CO	Carbon Monoxide	XNXXSC1SS XNXXSC1FM
S3KS1SS	SO ₂	Sulfur Dioxide	XNXXSS1SS
S3KS1SS	SO ₂	Sulfur Dioxide (High Range)	XNXXSS2SS
S3KA1SS	NH ₃	Ammonia	XNXXSA1SS
S3KA2SS	NH ₃	Ammonia (High Range)	XNXXSA2SS
S3KL1SS	Cl ₂	Chlorine	XNXXSL2SS
S3KL1SS	Cl ₂	Chlorine (High Range)	XNXXSL1SS
S3KX1SS	ClO ₂	Chlorine Dioxide	XNXXSX1SS
S3KM1SS	NO	Nitrogen Monoxide	XNXXSM1SS
S3KN1SS	NO ₂	Nitrogen Dioxide	XNXXSN1SS
S3KG1SS	H ₂	Hydrogen (Low Range)	XNXXSG1SS
S3KG2SS	H ₂	Hydrogen (High Range)	XNXXSG2SS
S3KR1SS	HCl	Hydrogen Chloride	XNXXSR1SS
S3KY1SS	HCN	Hydrogen Cyanide	XNXXSY1SS
S3KF1SS	HF	Hydrogen Fluoride	XNXXSF1SS
S3KZ1SS	O ₃	Ozone	XNXXSZ1SS
S3KP1SS	PH ₃	Phosphine	XNXXSP1SS

6.4.4 Multi Purpose Detector (MPD)

Similar to the XNX Transmitter, the MPD part numbering system defines the agency approval and thread type. The only material selection is Stainless Steel. Four sensor selections are available. Agency Approvals are specific to the 4 sensor types. Ensure the approval of the specific sensor type meets the requirements of the installation.





MPD	-	Model Type	Port Config	Installed Sensor		Range
		(See Section 6.2 for Agency Approvals)		▼	▼	▼
		AM	M25	CB - Catalytic Bead %LEL		1 - Default
		UT	3/4" NPT	IF - IR %LEL Flammable		2 to 9 - Future
		BT	3/4" NPT	IV - IR Methane 0-5% Vol		
				IC - R Carbon Dioxide 0-5% Vol		



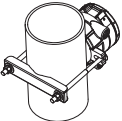
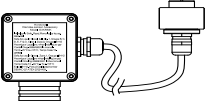
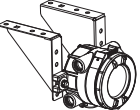

6.4.5 XNX Catalytic Bead and IR Replacement Sensor Cartridges

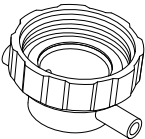
Sensor Type ^{1,2}	Target Gas	Cartridge Part No	Operating Pressure Range (kPa)	Operating Humidity Range (% RH non-condensing)	Air Speed (m/s)	Maximum Range	Selectable Range ³	Increment	Default Range	Cal Gas Range	Cal Gas P/N	Cal Gas Description
MPD-IC1	Carbon Dioxide	1226-0301	80 - 110	see footnote 4	0 - 6	5.00 %Vol	1.00 to 5.00 %Vol	1.00 %Vol	5.00 %Vol	1.50 to 3.5 %Vol	Contact HA	2.5 %VOL CO ₂ in Air
MPD-IV1	Methane	1226-0299	80 - 110	0 - 95	0 - 6	5.00 %Vol	1.00 to 5.00 %Vol	1.00 %Vol	5.00 %Vol	1.50 to 3.5 %Vol	GFV352	2.5 %VOL CH ₄ in Air
	Methane	1226-0299	80 - 110	0 - 95	0 - 6	100 %LEL	1.00 to 5.00 %Vol	1.00 %Vol	5.00 %Vol	1.50 to 3.5 %Vol	GFV352	2.5 %VOL CH ₄ in Air
MPD-IF1	Flammables	1226-0300	80 - 110	0 - 95	0 - 6	100 %LEL	20 to 100 %LEL ³	10 %LEL	100 %LEL	30 to 70 %LEL	GFV406	1 %VOL C ₃ H ₈ in Air
MPD-CB1	Flammables	1226A0359	80 - 120	see footnote 5	0 - 6	100 %LEL	20 to 100 %LEL ³	10 %LEL	100 %LEL	30 to 70 %LEL	GFV352	50 %LEL CH ₄ in Air

- Agency approved hydrogen sensors are MPD-CB1 and 705 STD.
- When ordering replacement MPD sensor cartridges, the replacement cartridge must be the same type as factory configured. Substituting a different cartridge will void agency certification.
- On XNX %LEL units carrying UL/CSA certifications, the range is fixed at 100%LEL and is not adjustable.
- Humidity: 5% to 95% RH non-condensing
- Humidity: 0 to 99% RH non-condensing

6.4.6 Accessories/Spares

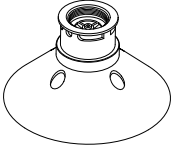
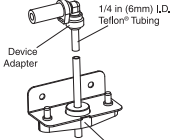
Accessory/Spare		Part Number	Description	
	Pipe Mount Kit	1226A0358	For use on pipes from 2-6 inches (50-150mm) in diameter. Kit includes: Pipe Mount Bracket, (2) Carriage Bolts, Nuts and Lock Washers.	
	Remote EC Sensor Mounting Kit	S3KRMK	The remote sensor mounting kit (S3KRMK) allows the XNX EC sensors to be remotely mounted via an IS cable kit, up to 50 feet (15 meters) from the transmitter. The kit includes 50 feet of shielded cable, cable glands and remote terminal box. The cable can be cut to the required length and terminated at the remote terminal box.	
	Ceiling Mount Bracket Kit	1226A0355	The optional Ceiling Mount Bracket Kit allows the XNX to be mounted to the ceiling. Kit includes: (2) Stainless Steel Ceiling Mount Brackets, bolts and nuts.	
	Duct Mount Kit	S3KDMK	The duct mounting kit (S3KDMK) can be used with the EC sensor to allow detection of O ₂ , CO, H ₂ and H ₂ S gases in ducts.	
	MPD Interface Adapter	1226A0382	When combined with the MPD Interface Adapter (1226A0382), the duct mounting kit can accommodate the MPD to detect flammable gases in a duct application. The duct mount kit includes the adapter, gasket and required fasteners. The MPD Interface Adapter includes only the adapter and requires the S3KDMK duct mount kit.	
	Calibration Gas Flow Adapter	1226A0411	MPD	
		02000-A-1645	Sensepoint HT	
		00780-A-0035	705	
	Calibration Cup	S3KCAL	XNX EC - The calibration cup is used to apply calibration test gas to the sensor. It push fits onto the bottom of the sensor and can be fitted without removing the weatherproof cover.	

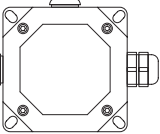
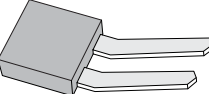
Accessory/Spare		Part Number	Description	
	Weatherproof Cap	Included	XNX EC	The weatherproof cap protects the XNX sensors from harsh weather.
		02000-A-1640	MPD	
		02000-A-1640	Sensepoint	
		02000-A-1635	705	
	Extreme Weather Protector	SPXCDWP	Sensor XNX-EC or MPD; the weather protection is designed to protect the sensor from environmental conditions in outdoor exposure applications.	
	Collecting Cone	S3KCC	XNX EC	The collecting cone improves detection of lighter-than-air gases such as hydrogen and methane.
		02000-A-1642	MPD	
		02000-A-1642	Sensepoint	
		02000-A-1642	705	
	Remote Gassing Kit	1226A0354	<p>The Remote Gassing Kit enables gas to be applied remotely for performing functional response checks.</p> <p>Kit Includes: 50' Teflon® tubing, mounting bracket, tube cap and device adapters in 1/4" and 1/8" ID to attach to bump test ports on the weatherproof cap of your device.</p>	
	Remote MPD Mounting	2441-0022	UL/CSA Aluminum Junction Box	
		00780-A0100	ATEX/IEC Junction Box (3) M20, (1) M25 entries. "Ex e" ATEX IEC Approval	
	Terminal Block/Shorting Jumpers	Contact HA	Terminal block jumpers provide an electrical connection without connection to the Personality Board. Install the jumpers between pins 1 and 2 and between pins 3 and 4 to support multi-node wiring.	

Accessory/Spare	Part Number	Description
	Stopping Plugs	1226-0257 M25 Plug w/protective cap and O-ring. (Certified for use with XNX Universal Transmitter only)
		1226-0258 3/4 NPT w/protective cap. (Certified for use with XNX Universal Transmitter only)
	Replacement Cover O-ring	0235-1266 Replacement O-ring for the XNX front cover
	Pluggable Terminal Blocks	1226A0302 Terminal Block Ass'y 6-Pin XNX EC
		1226A0304 Terminal Block Ass'y 9-Pin XNX mV
		1226A0305 IR Terminal Block Kit Includes: 9-Pin and 2-Pin Terminal Blocks
		1226A0306 Relay Terminal Block Kit Includes: 9-Pin and 2-Pin Terminal Blocks
		1226A0307 Terminal Block Ass'y 10-Pin XNX Modbus
		1226A0303 Terminal Block Ass'y 6-Pin FFB
	Magnetic Wand/Screwdriver	1226-0254 Replacement wand for front panel access
	Ferrite Bead	0060-1051 Bead Ferrite MV XNX
	Foundation Fieldbus Ground Cable	0310-0041 Cable Ground Foundation Fieldbus XNX
	Small Screwdriver	1226-0408 Replacement screwdriver for use on Terminal Block TB2 and TB4 (IR Personality and Relay Option)

Accessory/Spare		Part Number	Description
	Weather Housing	0200-A-1635	For use with Series 2000, SensePoint, and SignalPoint EEC Sensor Products
	Weather Housing	0200-A-1640	For use with Series 2000, SensePoint, and SignalPoint Combustible Sensor Products

7 Control Drawings

7.1 XNX UL/INMETRO

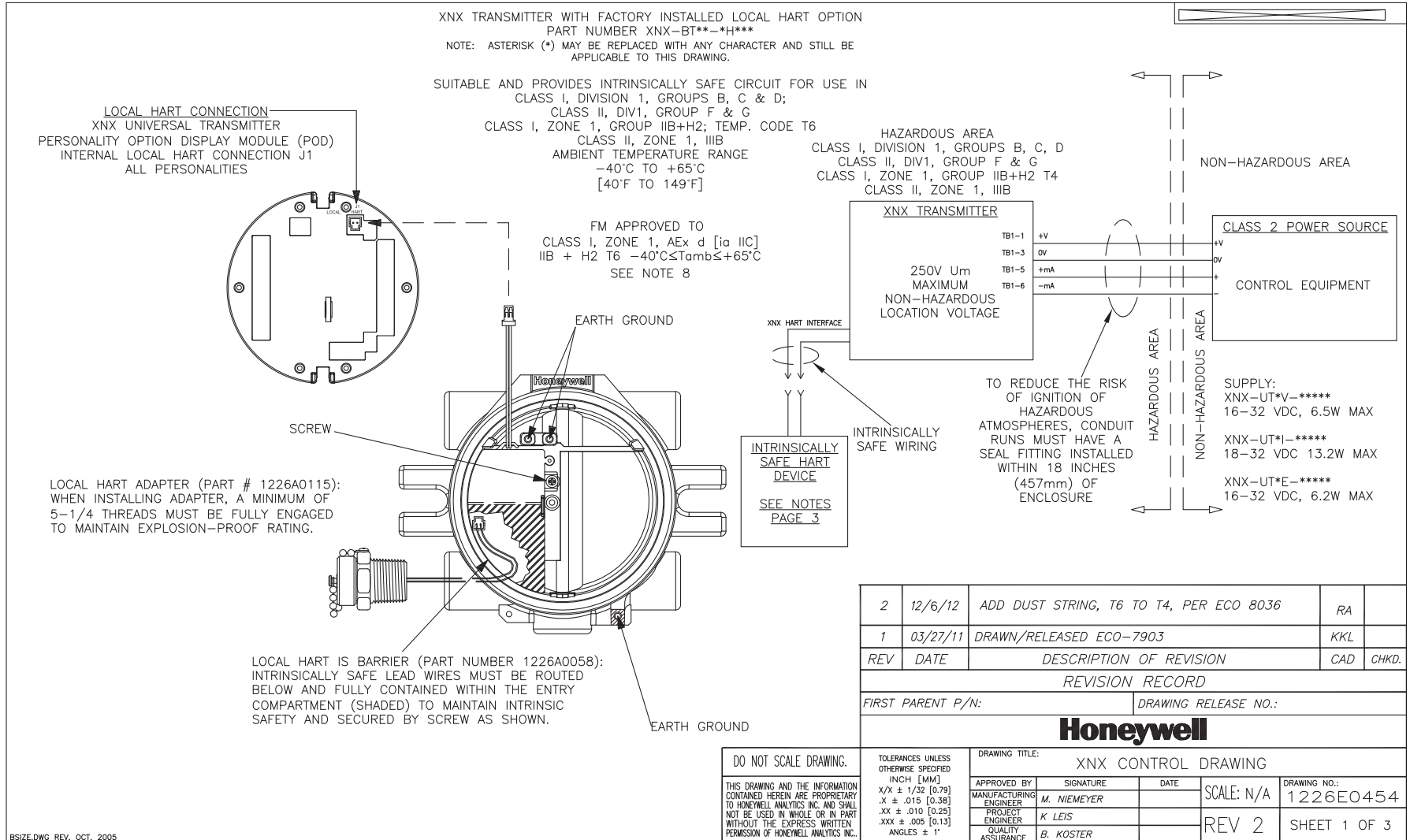

BSIZE.DWG REV. OCT. 2005

EC ADAPTER/IS
BARRIER CONNECTIONS

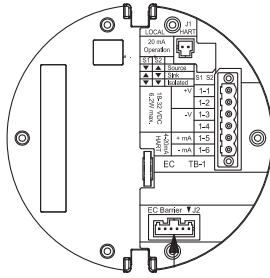

XNX UNIVERSAL TRANSMITTER WITH EC PERSONALITY
PART NUMBER XNX-BT*E-***NNN
NOTE: ASTERISK (*) MAY BE REPLACED WITH ANY CHARACTER AND STILL BE APPLICABLE TO THIS DRAWING.

SUITABLE AND PROVIDES INTRINSICALLY SAFE CIRCUIT FOR USE IN
CLASS I, DIVISION 1, GROUPS B, C & D;
CLASS II, DIV1, GROUP F & G
CLASS I, ZONE 1, GROUP IIB+H2; TEMP. CODE T6
CLASS II, ZONE 1, IIIB
AMBIENT TEMPERATURE RANGE
-40°C TO +65°C
[40°F TO 149°F]

FM APPROVED TO
CLASS I, ZONE 1, AEx d [Ia IIC]
IIB + H2 T6 -40°C ≤ Tamb ≤ +65°C
SEE NOTE 8

HAZARDOUS AREA
CLASS I, DIVISION 1, GROUPS B, C, D
CLASS II, DIV1, GROUP F & G
CLASS I, ZONE 1, GROUP IIB+H2 T4
CLASS II, ZONE 1, IIIB

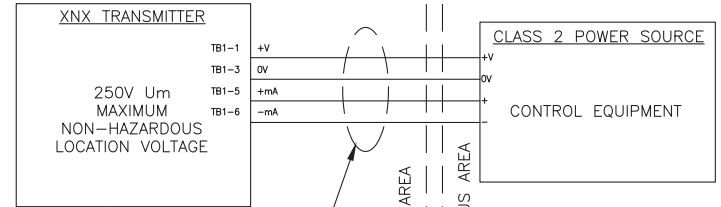

XNX EC
INTERFACE
SEE NOTES
PAGE 3

TO REDUCE THE RISK OF IGNITION OF HAZARDOUS ATMOSPHERES, CONDUIT RUNS MUST HAVE A SEAL FITTING INSTALLED WITHIN 18 INCHES (457mm) OF ENCLOSURE

SUPPLY:
XNX-UT*E-*****
16-32 VDC, 6.2W MAX

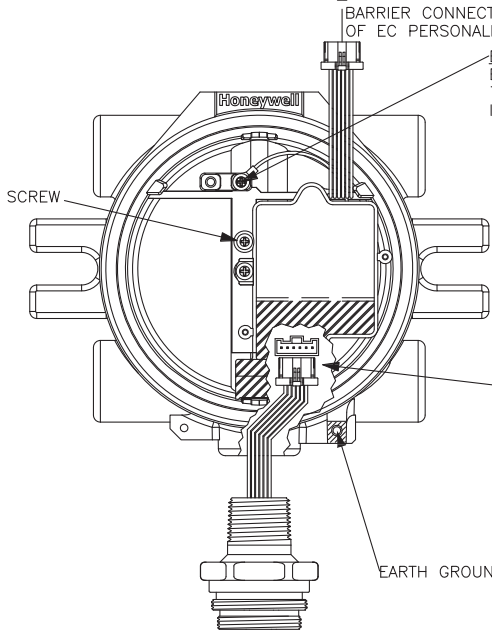

EARTH WIRE (GREEN/YELLOW);
EARTH WIRE MUST BE CONNECTED TO EARTH GROUND TO MAINTAIN INTRINSIC SAFETY.

EC IS BARRIER (PART NUMBER 1226A0057);
INTRINSICALLY SAFE LEAD WIRES MUST BE ROUTED BELOW AND FULLY CONTAINED WITHIN THE ENTRY COMPARTMENT (SHADED) TO MAINTAIN INTRINSIC SAFETY AND SECURED BY SCREW AS SHOWN.

-	--/--/--	SEE SHEET 1/	---	
REV	DATE	DESCRIPTION OF REVISION	CAD	CHKD.

REVISION RECORD

FIRST PARENT P/N: _____ DRAWING RELEASE NO.: _____



DO NOT SCALE DRAWING.		TOLERANCES UNLESS OTHERWISE SPECIFIED INCH [MM] X/X ± 1/32 [0.79] .X ± .015 [0.38] .XX ± .010 [0.25] .XXX ± .005 [0.13] ANGLES ± 1°		DRAWING TITLE: XNX CONTROL DRAWING	
APPROVED BY	SIGNATURE	DATE	SCALE: N/A	DRAWING NO.: 1226E0454	
MANUFACTURING ENGINEER	M. NIEMEYER		REV 2	SHEET 2 OF 3	
PROJECT ENGINEER	K. LEIS				
QUALITY ASSURANCE	B. KOSTER				

XNX TRANSMITTER WITH FACTORY INSTALLED LOCAL HART OPTION

1. ENTITY PARAMETERS OF XNX UNIVERSAL TRANSMITTER LOCAL HART INTERFACE

OUTPUT	INPUT
Uo = 24,15V	Ui = 21,85V
Io = 136mA	Ii = 120mA
Po = 0,82W	PI = 1,0W
Lo = 1,4mH	LI = 0,0mH
Co = 0,122uF	CI = 0,0uF

2. THE LOCAL HART DEVICE CONNECTED MUST BE THIRD PARTY LISTED AS INTRINSICALLY SAFE FOR THE APPLICATION, AND HAVE INTRINSICALLY SAFE ENTITY PARAMETERS CONFORMING WITH TABLE 1 BELOW.

TABLE 1

IS HART DEVICE		XNX HART INTERFACE
INPUT		OUTPUT
V max (or UI)	≥	Voc or Vt (or Uo)
I max (or II)	≥	Isc or It (or Io)
P max, PI	≥	Po
Ci + Ccable	≤	Ca (or Co)
Li + Lcable	≤	La (or Lo)
OUTPUT		INPUT
Voc or Vt (or Uo)	≤	V max (or UI)
Isc or It (or Io)	≤	I max (or II)
Po	≤	P max, PI
Ca (or Co)	≥	Ci + Ccable
La (or Lo)	≥	Li + Lcable

XNX UNIVERSAL TRANSMITTER WITH EC PERSONALITY

1. ENTITY PARAMETERS OF XNX UNIVERSAL TRANSMITTER EC ADAPTER

OUTPUT	INPUT
Voc or Vt (or Uo) = 5,88 V	V max (or UI)
Isc or It (or Io) = 84 mA	I max (or II)
Po = 123 mW	P max, PI
Ca (or Co) = 10uF	Ci + Ccable
La (or Lo) = 1 mH	Li + Lcable

XNX UNIVERSAL TRANSMITTER WITH EC PERSONALITY AND/OR LOCAL HART

- THE OUTPUT CURRENT OF THE LOCAL HART AND EC IS BARRIERS ARE LIMITED BY A RESISTOR SUCH THAT THE OUTPUT VOLTAGE-CURRENT PLOT IS A STRAIGHT LINE DRAWN BETWEEN OPEN-CIRCUIT VOLTAGE AND SHORT-CIRCUIT CURRENT.
- THE ASSOCIATED APPARATUS MAY ALSO BE CONNECTED TO SIMPLE APPARATUS AS DEFINED IN ARTICLE 504.2 AND INSTALLED AND TEMPERATURE CLASSIFIED IN ACCORDANCE WITH ARTICLE 504.10(B) OF THE NATIONAL ELECTRICAL CODE (ANSI/NFPA 70), OR OTHER LOCAL CODES, AS APPLICABLE.
- CAPACITANCE AND INDUCTANCE OF THE FIELD WIRING FROM THE INTRINSICALLY SAFE EQUIPMENT TO THE ASSOCIATED APPARATUS SHALL BE CALCULATED AND MUST BE INCLUDED IN THE SYSTEM CALCULATIONS AS SHOWN IN TABLE 1. CABLE CAPACITANCE, Ccable, PLUS INTRINSICALLY SAFE EQUIPMENT CAPACITANCE, Ci MUST BE LESS THAN THE MARKED CAPACITANCE, Ca (OR Co), SHOWN ON ANY ASSOCIATED APPARATUS USED. THE SAME APPLIES FOR INDUCTANCE (Lcable, Li AND La OR Lo, RESPECTIVELY). WHERE THE CABLE CAPACITANCE AND INDUCTANCE PER FOOT ARE NOT KNOWN, THE FOLLOWING VALUES SHALL BE USED: Ccable = 60 PF/FT., Lcable = 0.2 μH/FT.
- THE ASSOCIATED APPARATUS MUST BE CONNECTED TO A SUITABLE GROUND ELECTRODE PER THE NATIONAL ELECTRICAL CODE (ANSI/NFPA 70), THE CANADIAN ELECTRICAL CODE, OR OTHER LOCAL INSTALLATION CODES, AS APPLICABLE. THE RESISTANCE OF THE GROUND PATH MUST BE LESS THAN 1 OHM.
- INTRINSICALLY SAFE CIRCUITS MUST BE WIRED AND SEPARATED IN ACCORDANCE WITH ARTICLE 504.20 OF THE NATIONAL ELECTRICAL CODE (ANSI/NFPA 70), OR OTHER LOCAL CODES, AS APPLICABLE. REFER TO ARTICLE 504.30(B) OF THE NATIONAL ELECTRICAL CODE (ANSI/NFPA 70) AND INSTRUMENT SOCIETY OF AMERICA RECOMMENDED PRACTICE ISA RP12.6 FOR INSTALLING INTRINSICALLY SAFE EQUIPMENT.
- THIS ASSOCIATED APPARATUS HAS NOT BEEN EVALUATED FOR USE IN COMBINATION WITH ANOTHER ASSOCIATED APPARATUS.
- CONTROL EQUIPMENT MUST NOT USE OR GENERATE MORE THAN 250 V RMS OR DC WITH RESPECT TO EARTH.

-	--/--/--	SEE SHEET 1/	---	
REV	DATE	DESCRIPTION OF REVISION	CAD	CHKD.

REVISION RECORD

FIRST PARENT P/N: DRAWING RELEASE NO.:

Honeywell

DO NOT SCALE DRAWING.	TOLERANCES UNLESS OTHERWISE SPECIFIED INCH [MM] X/X ± 1/32 [0.79] .X ± .015 [0.38] .XX ± .010 [0.25] .XXX ± .005 [0.13] ANGLES ± 1°	DRAWING TITLE: XNX CONTROL DRAWING			
THIS DRAWING AND THE INFORMATION CONTAINED HEREIN ARE PROPRIETARY TO HONEYWELL ANALYTICS INC. AND SHALL NOT BE USED IN WHOLE OR IN PART WITHOUT THE EXPRESS WRITTEN PERMISSION OF HONEYWELL ANALYTICS INC.	APPROVED BY	SIGNATURE	DATE	SCALE: N/A	DRAWING NO.: 1226E0454
	MANUFACTURING ENGINEER	M. NIEMEYER		REV 2	SHEET 3 OF 3
	PROJECT ENGINEER	K. LEIS			
	QUALITY ASSURANCE	B. KOSTER			

XNX UL/CSA/FM

XNX TRANSMITTER WITH FACTORY INSTALLED LOCAL HART OPTION
PART NUMBER XNX-UT**-*H***

NOTE: ASTERISK (*) MAY BE REPLACED WITH ANY CHARACTER AND STILL BE APPLICABLE TO THIS DRAWING.

SUITABLE AND PROVIDES INTRINSICALLY SAFE CIRCUIT FOR USE IN
CLASS I, DIVISION 1, GROUPS A, B, C & D;
CLASS II, DIV1, GROUP F & G
CLASS I, ZONE 1, GROUP IIC; TEMP. CODE T6
CLASS II, ZONE 1, IIB
AMBIENT TEMPERATURE RANGE
-40°C TO +65°C
[-40°F TO 149°F]

HAZARDOUS AREA
CLASS I, DIVISION 1, GROUPS A, B, C, D
CLASS II, DIV1, GROUP F & G
CLASS I, ZONE 1, GROUP IIC T4
CLASS II, ZONE 1, IIB

NON-HAZARDOUS AREA

LOCAL HART CONNECTION
XNX UNIVERSAL TRANSMITTER
PERSONALITY OPTION DISPLAY MODULE (POD)
INTERNAL LOCAL HART CONNECTION J1
ALL PERSONALITIES

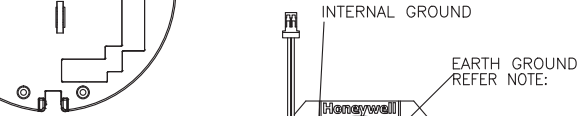
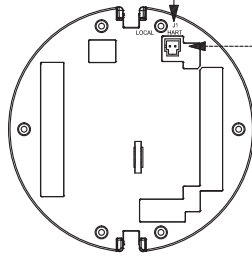

SCREW

LOCAL HART ADAPTER (PART # 1226A0115):
WHEN INSTALLING ADAPTER, A MINIMUM OF
5-1/4 THREADS MUST BE FULLY ENGAGED
TO MAINTAIN EXPLOSION-PROOF RATING.

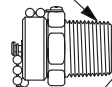

LOCAL HART IS BARRIER (PART NUMBER 1226A0058):
INTRINSICALLY SAFE LEAD WIRES MUST BE ROUTED
BELOW AND FULLY CONTAINED WITHIN THE ENTRY
COMPARTMENT (SHADED) TO MAINTAIN INTRINSIC
SAFETY AND SECURED BY SCREW AS SHOWN.

NOTE:

DEDICATED PROTECTIVE CONDUCTOR TERMINAL (EARTH GROUND)
RESTRICT USE TO PROTECTIVE CONDUCTOR WHENEVER
POSSIBLE. IF IT IS ALSO USED FOR OTHER BONDING
PURPOSES, THE PROTECTIVE CONDUCTOR SHALL BE APPLIED
FIRST AND SECURED INDEPENDENTLY OF OTHER
CONNECTIONS.

THE PROTECTIVE CONDUCTOR SHALL BE CONNECTED IN SUCH
A WAY THAT IT IS UNLIKELY TO BE REMOVED DURING
SERVICING THAT DOES NOT REQUIRE DISCONNECTION OF THE
PROTECTIVE CONDUCTOR.

B51ZE.DWG REV. OCT. 2005

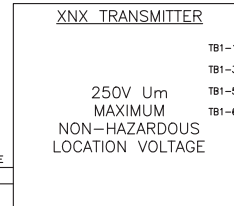

XNX HART INTERFACE

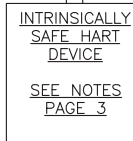

SEE NOTES
PAGE 3

TO REDUCE THE RISK
OF IGNITION OF
HAZARDOUS
ATMOSPHERES, CONDUIT
RUNS MUST HAVE A
SEAL FITTING INSTALLED
WITHIN 18 INCHES
(457mm) OF
ENCLOSURE

HAZARDOUS AREA

NON-HAZARDOUS AREA
SUPPLY:
XNX-UT*V-*****
16-32 VDC, 6.5W MAX
XNX-UT*I-*****
18-32 VDC 13.2W MAX
XNX-UT*E-*****
16-32 VDC, 6.2W MAX

REV	DATE	DESCRIPTION OF REVISION	CAD	CHKD.
5	20/05/15	ADD IIC, DELETE CLASS 2 PS, CHANGE GND SYMBOL	SK	
4	12/6/12	ADD DUST STRING, T4 TO T6, PER ECO 8036	RA	
3	2/12/10	SHTS 1-3: ADDED TEXTS FOR FM/ECO-7754	JAT	
2	03/05/09	REVISED PER AGENCY TO ADD EC & RELEASED/	KKL	
1	02/27/09	ISSUED TO AGENCY/	KKL	
B	02/26/09	REVISED DRAWING PER AGENCY REVIEW/	KKL	
A	02/25/09	DRAWN/	KKL	

REVISION RECORD

FIRST PARENT P/N: DRAWING RELEASE NO.: 226-033

DO NOT SCALE DRAWING.		TOLERANCES UNLESS OTHERWISE SPECIFIED		DRAWING TITLE: XNX CONTROL DRAWING	
THIS DRAWING AND THE INFORMATION CONTAINED HEREIN ARE PROPRIETARY TO HONEYWELL ANALYTICS INC. AND SHALL NOT BE USED IN WHOLE OR IN PART WITHOUT THE EXPRESS WRITTEN PERMISSION OF HONEYWELL ANALYTICS INC.		INCH [MM] 1/8" ± 1/32 [0.79] .X ± .015 [0.38] .XX ± .010 [0.25] .XXX ± .005 [0.13] ANGLES ± 1'		APPROVED BY: M. NIEMEYER, DATE: 3/3/09	
		SIGNATURE: A. RELLA, DATE: 3/3/09		DRAWING NO.: 1226E0402	
		SIGNATURE: B. KOSTER, DATE: 3/3/09		SCALE: N/A	
				REV 5	
				SHEET 1 OF 3	

EC ADAPTER/IS
BARRIER CONNECTIONS

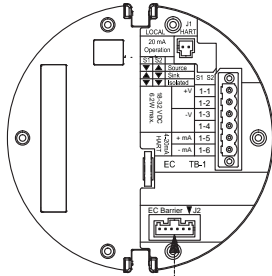

BARRIER CONNECTS TO J2
OF EC PERSONALITY PCB

GROUND WIRE (GREEN/YELLOW):
GROUND WIRE FROM BARRIER MUST BE
CONNECTED TO EARTH GROUND TO MAINTAIN
INTRINSIC SAFETY.
EARTH GROUND
REFER NOTE:

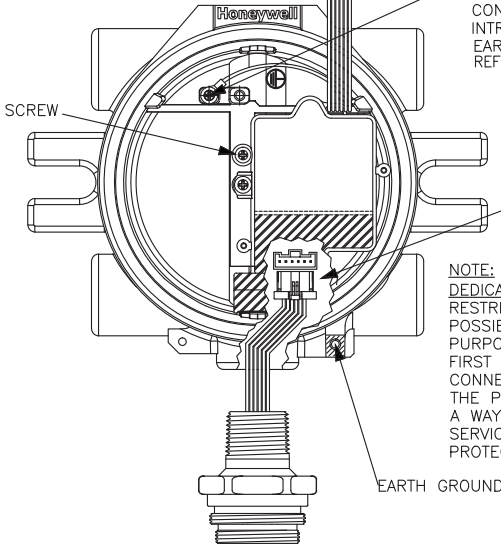

EC IS BARRIER
(PART NUMBER 1226A0057):
INTRINSICALLY SAFE LEAD WIRES MUST BE ROUTED
BELOW AND FULLY CONTAINED WITHIN
THE ENTRY COMPARTMENT (SHADED) TO MAINTAIN
INTRINSIC SAFETY AND SECURED BY SCREW AS SHOWN.

NOTE:
DEDICATED PROTECTIVE CONDUCTOR TERMINAL(EARTH GROUND)
RESTRICT USE TO PROTECTIVE CONDUCTOR(WHENEVER
POSSIBLE. IF IT IS ALSO USED FOR OTHER BONDING
PURPOSES, THE PROTECTIVE CONDUCTOR SHALL BE APPLIED
FIRST AND SECURED INDEPENDENTLY OF OTHER
CONNECTIONS.
THE PROTECTIVE CONDUCTOR SHALL BE CONNECTED IN SUCH
A WAY THAT IT IS UNLIKELY TO BE REMOVED DURING
SERVICING THAT DOES NOT REQUIRE DISCONNECTION OF THE
PROTECTIVE CONDUCTOR.

EC SENSOR ADAPTER

XNX TRANSMITTER WITH FACTORY INSTALLED LOCAL HART OPTION
PART NUMBER XNX-UT**-*H***

NOTE: ASTERISK (*) MAY BE REPLACED WITH ANY CHARACTER AND STILL BE
APPLICABLE TO THIS DRAWING.

SUITABLE AND PROVIDES INTRINSICALLY SAFE CIRCUIT FOR USE IN
CLASS I, DIVISION 1, GROUPS A, B, C & D;
CLASS II, DIV1, GROUP F & G
CLASS I, ZONE 1, GROUP IIC; TEMP. CODE T6
CLASS II, ZONE 1, IIIB
AMBIENT TEMPERATURE RANGE
-40°C TO +65°C
[-40°F TO 149°F]

HAZARDOUS AREA
CLASS I, DIVISION 1, GROUPS A, B, C, D
CLASS II, DIV1, GROUP F & G
CLASS I, ZONE 1, GROUP IIC T4
CLASS II, ZONE 1, IIIB

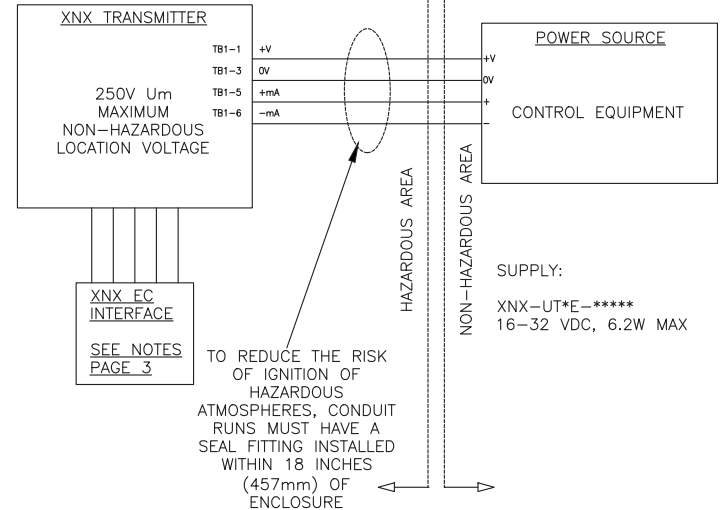

SUPPLY:
XNX-UT*E-****
16-32 VDC, 6.2W MAX

-	--/--/--	SEE SHEET 1/	---	
REV	DATE	DESCRIPTION OF REVISION	CAD	CHKD.

REVISION RECORD

FIRST PARENT P/N:	DRAWING RELEASE NO.:	---
-------------------	----------------------	-----



DO NOT SCALE DRAWING.		TOLERANCES UNLESS OTHERWISE SPECIFIED INCH [MM]		DRAWING TITLE: XNX CONTROL DRAWING	
THIS DRAWING AND THE INFORMATION CONTAINED HEREIN ARE PROPRIETARY TO HONEYWELL ANALYTICS INC. AND SHALL NOT BE USED IN WHOLE OR IN PART WITHOUT THE EXPRESS WRITTEN PERMISSION OF HONEYWELL ANALYTICS INC.		X/X ± 1/32 [0.79]	.X ± .015 [0.38]	.XX ± .010 [0.25]	.XXX ± .005 [0.13]
		APPROVED BY: M. NIEMEYER		SIGNATURE: DATE: 3/3/09	
		PROJECT ENGINEER: A. RELLA		SCALE: N/A	
		QUALITY ASSURANCE: B. KOSTER		DRAWING NO.: 1226E0402	
				REV 5 SHEET 2 OF 3	

XNX TRANSMITTER WITH FACTORY INSTALLED LOCAL HART OPTION

1. ENTITY PARAMETERS OF XNX UNIVERSAL TRANSMITTER LOCAL HART INTERFACE

OUTPUT	INPUT
Uo = 24.15V	Ui = 21.85V
Io = 136mA	Ii = 120mA
Po = 0.82W	Pi = 1.0W
Lo = 1.4mH	Li = 0.0mH
Co = 0.122uF	Ci = 0.0uF

2. THE LOCAL HART DEVICE CONNECTED MUST BE THIRD PARTY LISTED AS INTRINSICALLY SAFE FOR THE APPLICATION, AND HAVE INTRINSICALLY SAFE ENTITY PARAMETERS CONFORMING WITH TABLE 1 BELOW.

TABLE 1

IS HART DEVICE		XNX HART INTERFACE
INPUT		OUTPUT
V max (or Ui)	≥	Voc or Vt (or Uo)
I max (or Ii)	≥	Isc or It (or Io)
P max, Pi	≥	Po
Ci + Ccable	≤	Ca (or Co)
Li + Lcable	≤	La (or Lo)
OUTPUT		INPUT
Voc or Vt (or Uo)	≤	V max (or Ui)
Isc or It (or Io)	≤	I max (or Ii)
Po	≤	P max, Pi
Ca (or Co)	≥	Ci + Ccable
La (or Lo)	≥	Li + Lcable

XNX UNIVERSAL TRANSMITTER WITH EC PERSONALITY

1. ENTITY PARAMETERS OF XNX UNIVERSAL TRANSMITTER EC ADAPTER

OUTPUT	INPUT
Voc or Vt (or Uo) = 5.88 V	V max (or Ui)
Isc or It (or Io) = 84 mA	I max (or Ii)
Po = 123 mW	P max, Pi
Ca (or Co) = 10uF	Ci + Ccable
La (or Lo) = 1 mH	Li + Lcable

XNX UNIVERSAL TRANSMITTER WITH EC PERSONALITY AND/OR LOCAL HART

- THE OUTPUT CURRENT OF THE LOCAL HART AND EC IS BARRIERS ARE LIMITED BY A RESISTOR SUCH THAT THE OUTPUT VOLTAGE-CURRENT PLOT IS A STRAIGHT LINE DRAWN BETWEEN OPEN-CIRCUIT VOLTAGE AND SHORT-CIRCUIT CURRENT.
- THE ASSOCIATED APPARATUS MAY ALSO BE CONNECTED TO SIMPLE APPARATUS AS DEFINED IN ARTICLE 504.2 AND INSTALLED AND TEMPERATURE CLASSIFIED IN ACCORDANCE WITH ARTICLE 504.10(B) OF THE NATIONAL ELECTRICAL CODE (ANSI/NFPA 70), OR OTHER LOCAL CODES, AS APPLICABLE.
- CAPACITANCE AND INDUCTANCE OF THE FIELD WIRING FROM THE INTRINSICALLY SAFE EQUIPMENT TO THE ASSOCIATED APPARATUS SHALL BE CALCULATED AND MUST BE INCLUDED IN THE SYSTEM CALCULATIONS AS SHOWN IN TABLE 1. CABLE CAPACITANCE, Ccable, PLUS INTRINSICALLY SAFE EQUIPMENT CAPACITANCE, Ci MUST BE LESS THAN THE MARKED CAPACITANCE, Ca (OR Co), SHOWN ON ANY ASSOCIATED APPARATUS USED. THE SAME APPLIES FOR INDUCTANCE (Lcable, Li AND La OR Lo, RESPECTIVELY). WHERE THE CABLE CAPACITANCE AND INDUCTANCE PER FOOT ARE NOT KNOWN, THE FOLLOWING VALUES SHALL BE USED: Ccable = 60 PF/FT., Lcable = 0.2 μH/FT.
- THE ASSOCIATED APPARATUS MUST BE CONNECTED TO A SUITABLE GROUND ELECTRODE PER THE NATIONAL ELECTRICAL CODE (ANSI/NFPA 70), THE CANADIAN ELECTRICAL CODE, OR OTHER LOCAL INSTALLATION CODES, AS APPLICABLE. THE RESISTANCE OF THE GROUND PATH MUST BE LESS THAN 1 OHM.
- INTRINSICALLY SAFE CIRCUITS MUST BE WIRED AND SEPARATED IN ACCORDANCE WITH ARTICLE 504.20 OF THE NATIONAL ELECTRICAL CODE (ANSI/NFPA 70), THE CANADIAN ELECTRICAL CODE, OR OTHER LOCAL CODES, AS APPLICABLE. REFER TO ARTICLE 504.30(B) OF THE NATIONAL ELECTRICAL CODE (ANSI/NFPA 70) AND INSTRUMENT SOCIETY OF AMERICA RECOMMENDED PRACTICE ISA RP12.6 FOR INSTALLING INTRINSICALLY SAFE EQUIPMENT.
- THIS ASSOCIATED APPARATUS HAS NOT BEEN EVALUATED FOR USE IN COMBINATION WITH ANOTHER ASSOCIATED APPARATUS.
- CONTROL EQUIPMENT MUST NOT USE OR GENERATE MORE THAN 250 V RMS OR DC WITH RESPECT TO EARTH.
- FOR AEx ia COMPLIANCE, THE ASSOCIATED APPARATUS MUST BE INSTALLED IN ACCORDANCE WITH NFPA 70, ARTICLE 505.

-	--/--/--	SEE SHEET 1/	---	
REV	DATE	DESCRIPTION OF REVISION	CAD	CHKD.
REVISION RECORD				
FIRST PARENT P/N:		DRAWING RELEASE NO.: —		
Honeywell				
XNX CONTROL DRAWING				
DO NOT SCALE DRAWING.				
TOLERANCES UNLESS OTHERWISE SPECIFIED				
INCH [MM]				
X/X ± 1/32 [0.79]				
.X ± .015 [0.38]				
.XX ± .010 [0.25]				
.XXX ± .005 [0.13]				
ANGLES ± 1°				
APPROVED BY		SIGNATURE		DATE
MANUFACTURING ENGINEER		M. NIEMEYER		3/3/09
PROJECT ENGINEER		A. RELLA		3/3/09
QUALITY ASSURANCE		B. KOSTER		3/3/09
SCALE: N/A			DRAWING NO.: 1226E0402	
REV 5			SHEET 3 OF 3	

BSIZE.DWG REV. OCT. 2005

Remote Sensor Mount

3000E3159 sht. 1

Toxic/Oxygen Sensor Cartridge

THIS DOCUMENT HAS BEEN GENERATED USING C.A.D. AND MUST ONLY BE UPDATED BY C.A.D.

Remote Sensor Accessory Honeywell Part Number S3KRMK

Connections:

PIN #	Color
1	Yellow
2	Green
3	Blue
4	White
5	Red
6	Black

Notes:

- Intrinsically Safe Device Entity Parameters
 Entity Parameters for Toxic/Oxygen Sensor Cartridge Only
 $U_{is} = 3.89V$, $I_{is} = 0.124A$, $P_{is} = 183W$, $L_{is} = 0uH$, $C_{is} = 5uf$
 V_{max} , I_{max} , P_{max} , $L_{is} = L_{cable}$, $C_{is} = C_{cable}$
 Entity Parameters for Cartridge and Remote Accessory with Cable
 $U_{is} = 3.89V$, $I_{is} = 0.124A$, $P_{is} = 183W$, $L_{is} = 10uH$, $C_{is} = 5.000uF$
 V_{max} , I_{max} , P_{max} , $L_{is} = L_{cable}$, $C_{is} = C_{cable}$
- Associated apparatus output current must be limited by a resistor such that the output voltage-current plot is a straight line drawn between open-circuit voltage and short-circuit current.

I.S. Equipment	Associated Apparatus
V_{max} (or U_i)	$\geq V_{oc}$ or V_i (or U_o)
I_{max} (or I_i)	$\leq I_{sc}$ or I_t (or I_o)
P_{max} (or P_i)	$\leq P_o$
$C_i + C_{cable}$	$\leq C_a$ (or C_o)
$L_i + L_{cable}$	$\leq L_a$ (or L_o)

- Selected associated apparatus must be third party listed as providing intrinsically safe circuits for the application, and have V_{oc} or V_i not exceeding V_{max} (or U_i not exceeding U_i), I_{sc} or I_t not exceeding I_{max} (or I_o not exceeding I_i), and the P_o of the associated apparatus must be less than or equal to the P_{max} or P_i of the intrinsically safe equipment, as shown in Table above.
- Control equipment must not use or generate more than 250V rms or dc with respect to earth.
- Associated apparatus may be in a Division 2 or Zone 2 location if so approved.
- Associated apparatus must be installed in accordance with its manufacturer's control drawing and Article 504 of the National Electrical Code (ANSI/NFPA 70) for installation in the United States, or Section 18 of the Canadian Electrical Code for installations in Canada.
- When required by the manufacturer's control drawing, the associated apparatus must be connected to a suitable ground electrode per the National Electrical Code (ANSI/NFPA 70), the Canadian Electrical Code, or other local installation codes, as applicable. The resistance of the ground path must be less than 1 ohm.
- Refer to following table for Specific Part Numbers in this listing.
- XNXSC1FM, XNXSH1FM and XNXSO1FM shall be installed in accordance with XNX Control Drawing 1220E0402

Gas Type	Sensor Part No.	Gas Type	Sensor Part No.	Gas Type	Sensor Part No.
H2S(L)	S3K0SH1S8 or XNXSH1S8, XNXSH1FM	O2	S3K0SO1S8 or XNXSO1S8, XNXSO1FM	CO	S3K0SC1S8 or XNXSC1S8, XNXSC1FM
H2S(H)	S3K0SH2S8 or XNXSH2S8	NH3(L)	S3K0SA1S8 or XNXSA1S8	H2(L)	S3K0SG1S8 or XNXSG1S8
H2S(LL)	S3K0SH3S8 or XNXSH3S8	NH3(H)	S3K0SA2S8 or XNXSA2S8	H2(H)	S3K0SG2S8 or XNXSG2S8
HF	S3K0SF1S8 or XNXSF1S8	Cl2(H)	S3K0SL1S8 or XNXSL1S8	HCl	S3K0SH1S8 or XNXSH1S8
NO	S3K0SN1S8 or XNXSN1S8	Cl2(L)	S3K0SL2S8 or XNXSL2S8	HCN	S3K0SY1S8 or XNXSY1S8
SO2(L)	S3K0SO1S8 or XNXSO1S8	ClO2	S3K0SX1S8 or XNXSX1S8	O3	S3K0SZ1S8 or XNXSZ1S8
SO2(H)	S3K0SO2S8 or XNXSO2S8	NO2	S3K0SN1S8 or XNXSN1S8	PH3	S3K0SP1S8 or XNXSP1S8

THIS DRAWING IS CONFIDENTIAL. IT IS THE PROPERTY OF HONEYWELL ANALYTICS LTD AND MUST NOT BE REPRODUCED EITHER WHOLLY OR PARTLY. ALL RIGHTS IN RESPECT OF PATENTS, DESIGNS AND COPYRIGHT ARE RESERVED.

TOLERANCES TO BE AS SPECIFIED BELOW UNLESS OTHERWISE STATED. DIMENSIONS: 2 DP ± 0.10 mm 1 DP ± 0.25 mm NONE ± 0.40 mm ANGULAR $\pm 1/2^\circ$	ALL DIMENSIONS IN MILLIMETRES UNLESS OTHERWISE STATED, AND APPLY AFTER PLATING	FINISH	MATERIAL	SCALE	DRN	BEN	16/NOV/09									
				1/1	TITLE	XNX_ECC_CARTRIDGE										
HOLES: $\phi 0$ to $8 + 0.08 - 0.0$ $\phi 8$ to $14 + 0.0 - 0.0$ $\phi 14$ to $25 + 0.12 - 0.0$	REMOVE ALL BURRS AND SHARP EDGES	SURFACE TEXTURE VALUES ARE IN μm Ro AND TO BS 1134	<table border="1" style="width: 100%; border-collapse: collapse;"> <tr> <td>3</td><td>2</td><td>1</td></tr> <tr> <td>CHANGED NOTES</td><td>CHANGED NOTES</td><td>NEW DRAWING</td></tr> <tr> <td>JEFFREY LEE</td><td>JEFFREY LEE</td><td>J.Y.JUN</td></tr> </table>	3	2	1	CHANGED NOTES	CHANGED NOTES	NEW DRAWING	JEFFREY LEE	JEFFREY LEE	J.Y.JUN	DATE	CONTROL_DRAWING		
				3	2	1										
CHANGED NOTES	CHANGED NOTES	NEW DRAWING														
JEFFREY LEE	JEFFREY LEE	J.Y.JUN														
				3000E3159	SHT. 1 OF 1	A2										

THIS ITEM FORMS PART OF A CERTIFIED PRODUCT. NO MODIFICATION PERMITTED WITHOUT REFERENCE TO CERTIFICATION DEPARTMENT.

Appendix A - HART[®] Protocol

A.1 HART® Interface



The XNX Universal Transmitter is registered with the HART Communication Foundation.

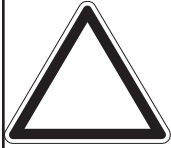

Note: Only qualified service personnel should perform the procedures in this section.

Every XNX® gas sensor can communicate using the HART protocol (defined by the HART Communication Foundation at <http://www.hartcomm.org>). HART is unique among fieldbuses in that the digital signal is superimposed on a traditional 4-20 mA current loop. This provides the reliability of analog signaling with the advanced diagnostic capability of a digital device.

HART devices are usually connected as point-to-point networks. The analog output of the XNX transmitter can also be disabled to facilitate construction of multidrop, all-digital HART networks.

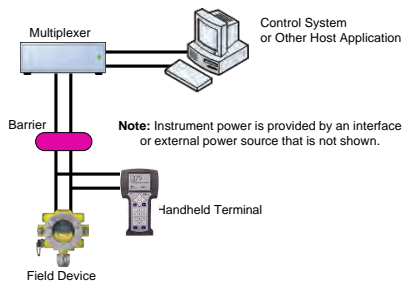

Figure 233. HART Point-to-point Mode

If HART is not needed, the unit can be used as a 4-20 mA transmitter. Since the transmitter is a slave, the internal modem will remain silent if no master signal is present. Additionally the HART signal is at too

high a frequency (1200 Hz) to interfere with analog control equipment. Another novel feature of HART networks is that two masters can be present. The primary master is usually a distributed control system (DCS), programmable logic controller (PLC), or a personal computer (PC). The secondary master can be a handheld terminal. The XNX transmitter has been tested with the handheld Emerson field communicator.

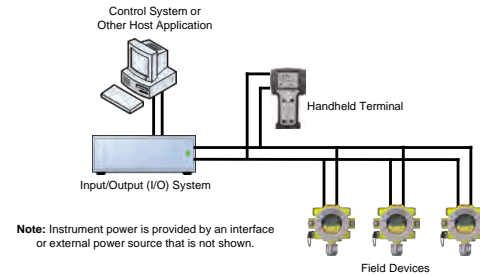

Figure 234. HART Multi-point Mode

The XNX device descriptor (DD) file provides HART users with data on the capabilities and features of the XNX Universal Transmitter. Select HART enabled devices are able to interface with XNX transmitters when connected via HART communication. A copy of the file is included on the Documentation CD. This DD file can be installed on HART-enabled Emerson field communicators using the Emerson Easy Upgrade Utility. The DD files located on the resource CD are compatible with the software integral to the transmitter. Older transmitters using earlier versions of software require previous versions of the DD files. Contact your local Honeywell representative with any questions regarding software compatibility.

During manufacturing, Honeywell configures the 8-digit HART tag to the XNX serial number. This can be used to confirm correct wiring from the transmitter to the control system. If desired, the HART tag can be modified. The fixed XNX serial number can also be read over HART.

For convenience, the transmitter presents the HART signal on two interfaces. The 1200 Hz AC signal is capacitively coupled to the main 20 mA analog output. This may be monitored at the control system

XNX Universal Transmitter

or at any point along the 20 mA loop. Additionally, the optional local HART interface (P/N: XNX-HIF) permits temporary connection of a HART terminal to the transmitter. This local HART port is transformer-coupled to the main 20 mA output. This port is intrinsically safe and polarity insensitive. See [Section 2.3.1](#) for more information.

The internal HART modem functions as a high-impedance current source. Thus transferring the HART signal requires a certain minimum loop resistance between the slave and a low-impedance power supply.

Normally, this resistance is supplied by the control system and so need not be explicitly added. However, special treatment is needed when the 20 mA output is not used and the local HART interface is needed. (An installer might choose to communicate using relays, Modbus®, or Foundation™ Fieldbus instead.) In this case, the supplied 510 ohm resistor must be fitted to create an “artificial” 20 mA loop. The resistor should be connected between TB-1 terminal 1-3 and terminal 1-6. Additionally, S1 and S2 should be placed in “source” configuration. This is shown schematically in [Figure 237](#).

The digital HART interface provides all of the capabilities of the local user interface. The XNX transmitter has been designed to use the portable Emerson field communicator with DevCom2000 software for Microsoft Windows® and Emerson AMS Intelligent Device Manager. Using HART, a service person can display information, test, calibrate, and configure. A map of the HART menus is provided in [Section A.1.3](#).

ATEX Conditions for Safe Use of Intrinsically Safe HART Handheld Devices

For installations in which both the Ci and li of the intrinsically safe apparatus exceeds 1% of the Co and lo parameters of the associated apparatus (excluding the cable), 50% of Co and lo parameters are applicable and shall not be exceeded, i.e., the Ci of the device plus the C of the cable must be less than or equal to 50% of the Co of the associated apparatus, and the li of the device plus the l of the cable must be less than or equal to 50% of the lo of the associated apparatus.

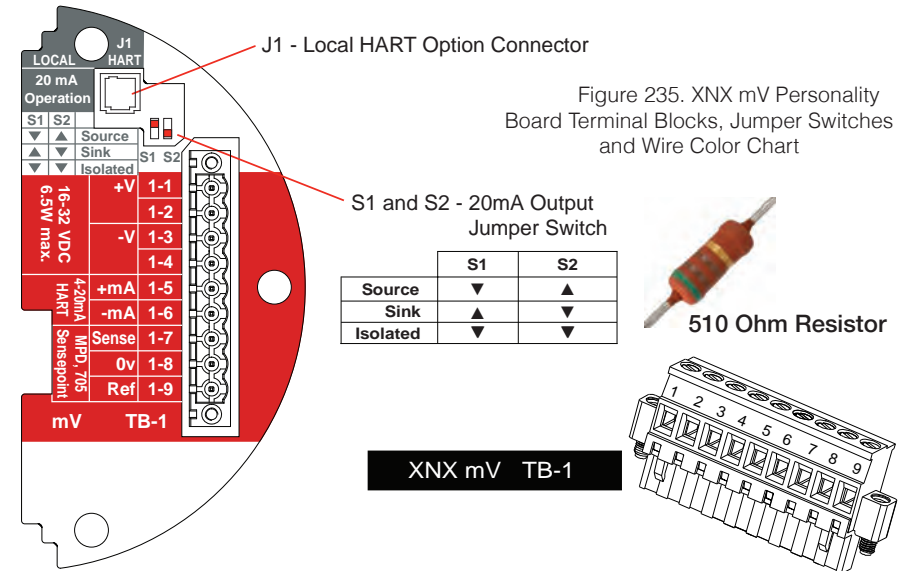

Figure 235. XNX mV Personality Board Terminal Blocks, Jumper Switches and Wire Color Chart

		mV Sensor Type						
		Catalytic Bead				MPD w/IR		
		MPD	705 705HT	S'point S'point HT	S'point PPM	IR 5%		IR Flam
						CO ₂	CH ₄	
TB-1	Desc.	Wire Color from Sensor						
1	24v	See Section 2.2.4 .						
2								
3	Gnd							
4								
5	20mA +							
6	20mA -							
7	Sense	Brown		Red		Brown		
8	0v	White		Green		White		
9	Ref	Blue		Blue		Blue		
		Internal Ground						

XNX Universal Transmitter

A.1.1 HART Sink, Source, and Isolated Wiring

The following figures illustrate the proper HART Multidrop wiring for the XNX.

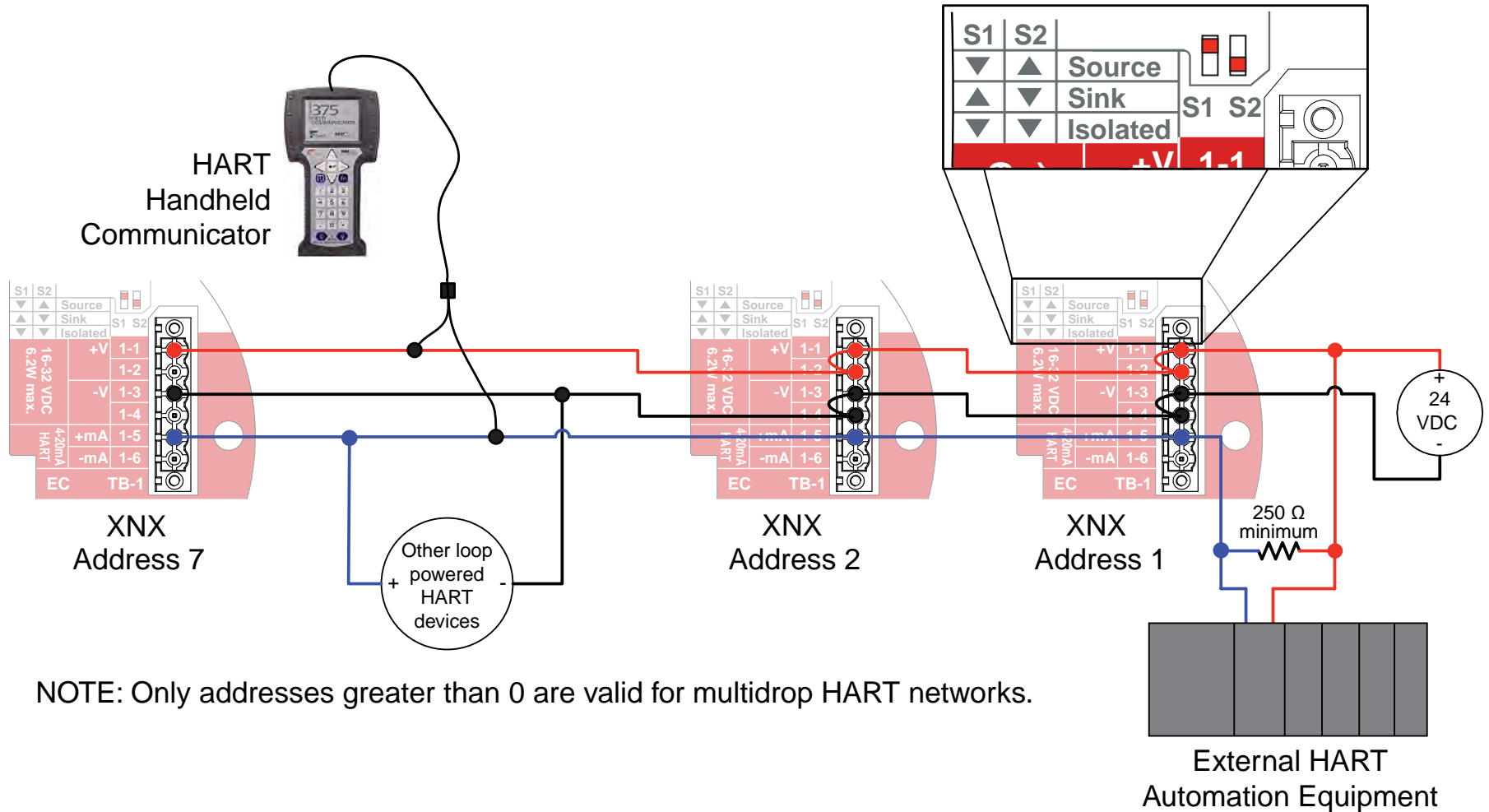

NOTE: Only addresses greater than 0 are valid for multidrop HART networks.

Figure 236. XNX Multidrop HART Network Wiring - XNX Sink

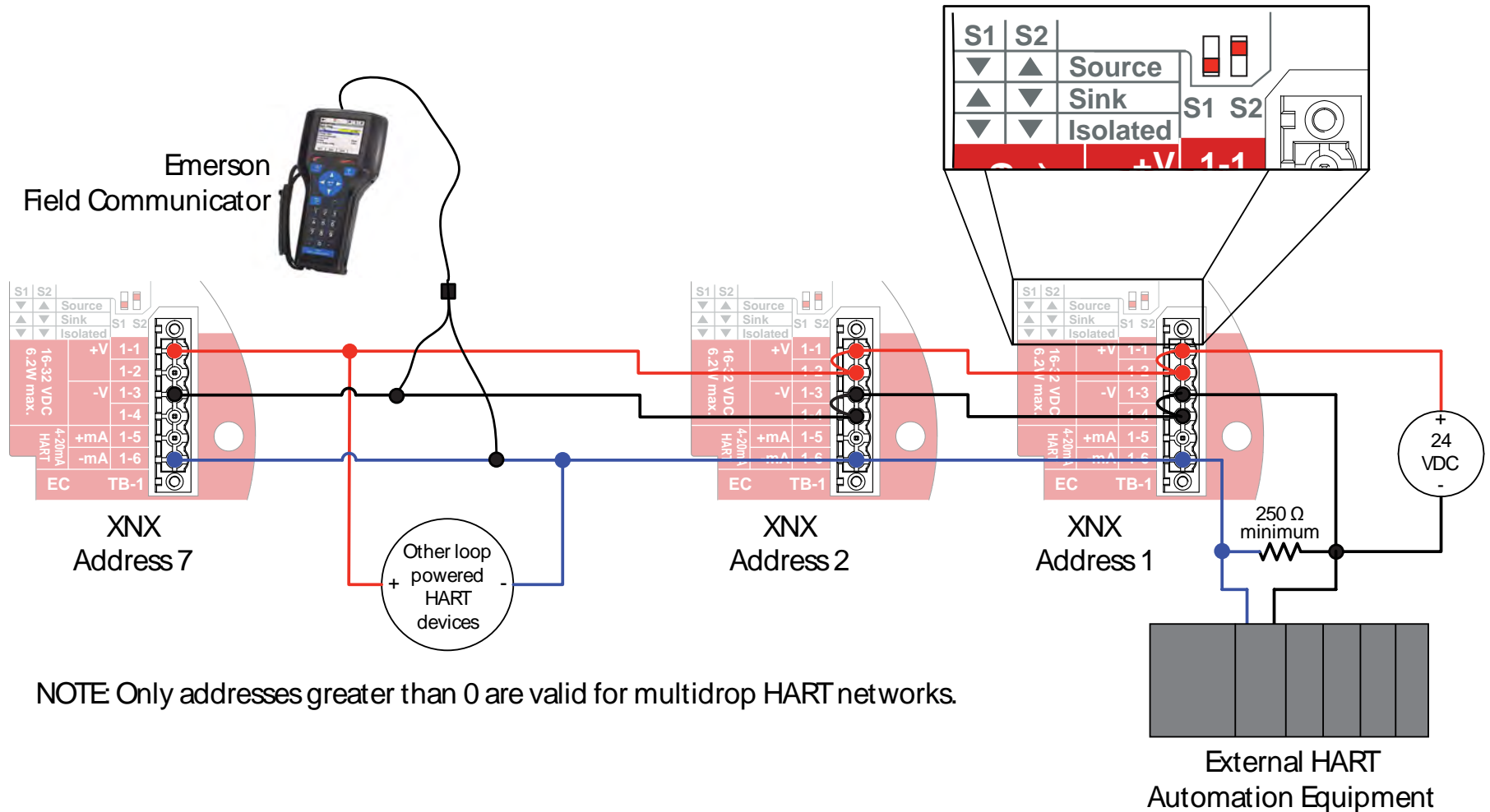

NOTE: Only addresses greater than 0 are valid for multidrop HART networks.

Figure 237. XNX Multidrop HART Network Wiring - XNX Source

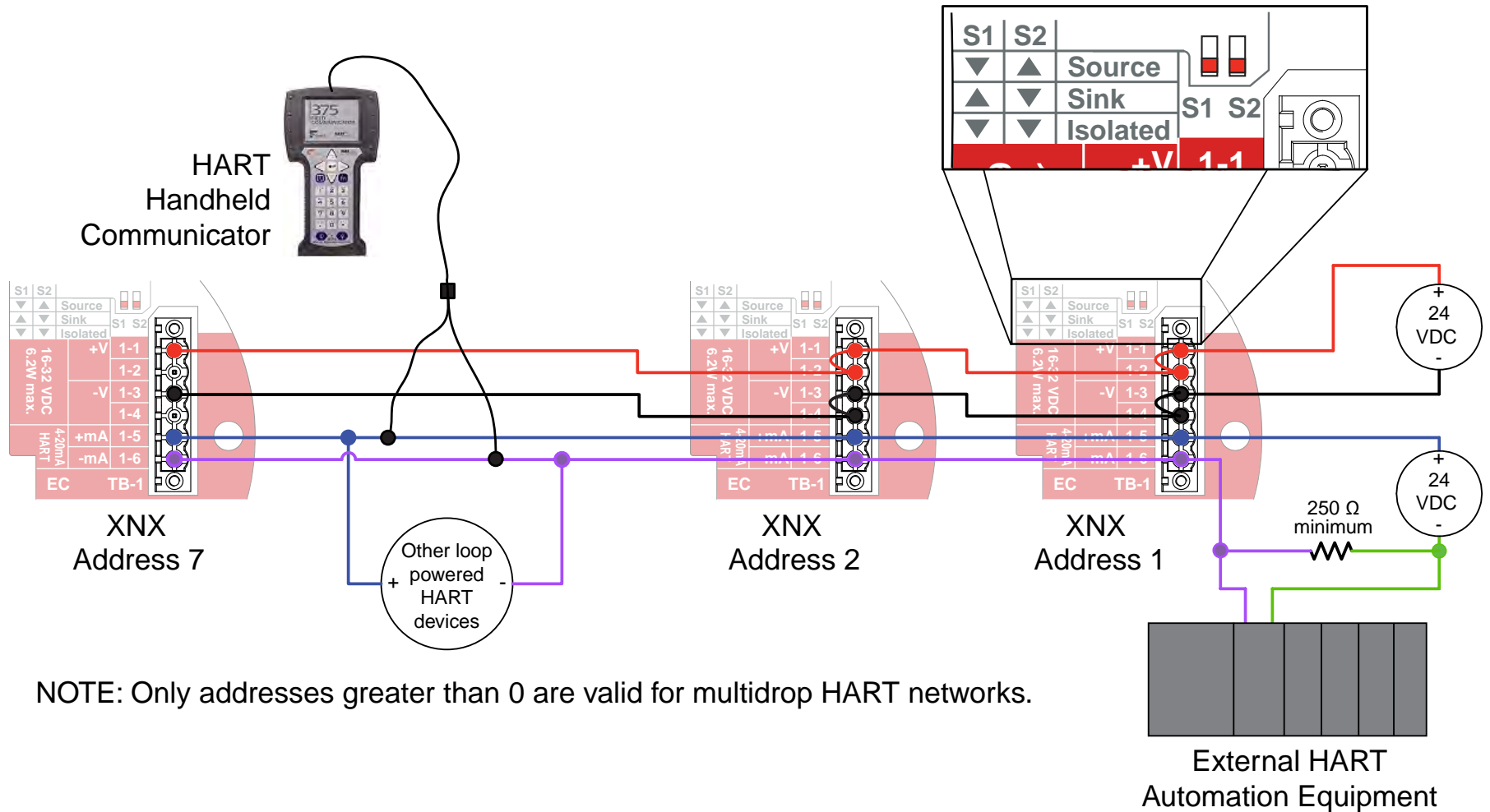

NOTE: Only addresses greater than 0 are valid for multidrop HART networks.

Figure 238. XNX Multidrop HART Network Wiring - Isolated

A.1.2 DevComm PC-based HART Interface

Overview

The XNX-HART interface facilitates remote access to all features of the local user interface including displaying status, testing, calibrating, and configuring. A device descriptor (DD) file is available to adapt standard tools for use with the transmitter.



Warning: After changing parameters with a handheld device, verify that the parameter settings are correct at the transmitter.

The following screens show some of the features of these two interfaces for the XNX transmitter.

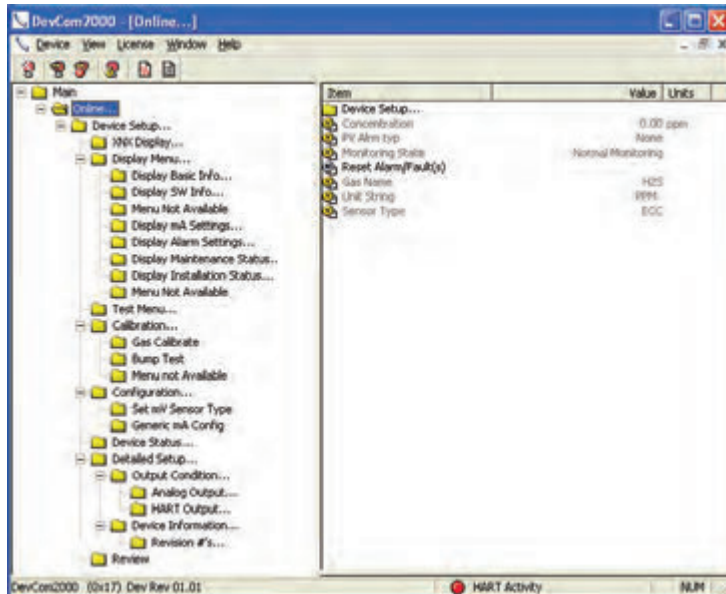

Figure 239. Presentation of XNX Data by DevComm2000



Figure 240. XNX data displayed on an Emerson field communicator

Security level 1 is required to select the display language and to adjust the date and time. All other configuration options require security level 2 access.

Functions in the Configure Menu and the security levels required to change them are explained in this table.

Symbol	Description	Security Level	Symbol	Description	Security Level
	Select Language	1		Calibration Interval	2
	Set Date & Time	1		Accept New Sensor Type	2
	Set mV Sensor Type	2		Beam Block Options	2
	Set mA Sensor Type	2		Path Length	2
	Gas Selection	2		Unit ID	2
	Range & Alarms	2		Relay Options	2
	Latching/Non-latching	2		Fieldbus Options	2
	Set Units	2		Configure Security	2
	mA Levels	2			

Functions

Configuration Summary

All of the HART status information can be extracted from the transmitter as a PDF or text file. This includes voltages, signal strengths, and configuration settings. An example summary, which required only 5 mouse clicks, is shown below.

```
DevCom2000, Rev 7.1, Device Configuration File - C:\Documents and Settings\17501\Workshop\TOWER_V1_11204.txt
Title TOWER_V1
Device ID: 11234
Date (yyyy-mm-dd): 2006-01-14
Time (hh-mm-ss): 01:30:45 PM
Notes:

Label, Value, Units
Conc Unit, ppm
Concentration, 0.00, ppm
Conc Current, 0.000000
AU Unit, mA
Info Max Range, 15.00, ppm
Info Min Range, 15.00, ppm
Sens Min Span, 15.00, %
PV Damp, 0.00, %
Sensor 3PK, 10302
Signal Strength Unit,
Signal Strength, 0.00
Fault/Alarm Number, -mA
Monitoring State, Alarm Monitoring
AlarmFunctLabel, Device Normal
Time Date Stamp, 1408999854, s
Time Date Format, mm/dd/yy hh:mm:ss
Sensor Life, 0, days
Event Counting, Reset Record
History Time Date, 1408997830
History Event Type, INFO
History Event Sub Type, 02
History Parameter, 0.000000
Event Index, 2
Power Supply Voltage, 24014, mVdc
Operating Voltage, 3300, mVdc
Sensor I/F Voltage, 0, mVdc
Sensor Voltage, 0, mVdc
XDC Temp, 32, degC
Sensor Temp, 24, degC
Measure as mg/L, No
Rel Sig Strength, 0.000000, s
Inhibit Analogue, END LONG INHIBIT
Calib Cvd, Select
Alarm Extcl, Select
Alarm Threshold 1, 5.000000, ppm
Alarm Threshold 2, 11.000000, ppm
Sensor Type, ECC
Password, 0
Password 1, 1
Password 2, 1
User, Level 2
Login Level, 0X02 Undefined
Inhibit Current, 2.000000, mA
Warning Current, 3.000000, mA
Overrange Current, 51.000000, mA
Pump, Stop Pump Test
Alarm Config, 0X0C Undefined
Relay State, Deenergize DELAY 1
Automatic Control, End Simulation
XDC ID, P200
Gas Name, H2S
Gas Name, H2S
Unit String, FFM
Sensor Output mA, Yes
Actual Index, 0
Info Index, 0
Access Report, FALSE
Input Range, Normal
Raw Conc, 0.116913
Modbus Addr, 3
```

Figure 241. HART status information

Information Screens

All of the information in the Configuration Summary can be viewed live on various informational displays. For example, alarm settings are shown in Figure 242.

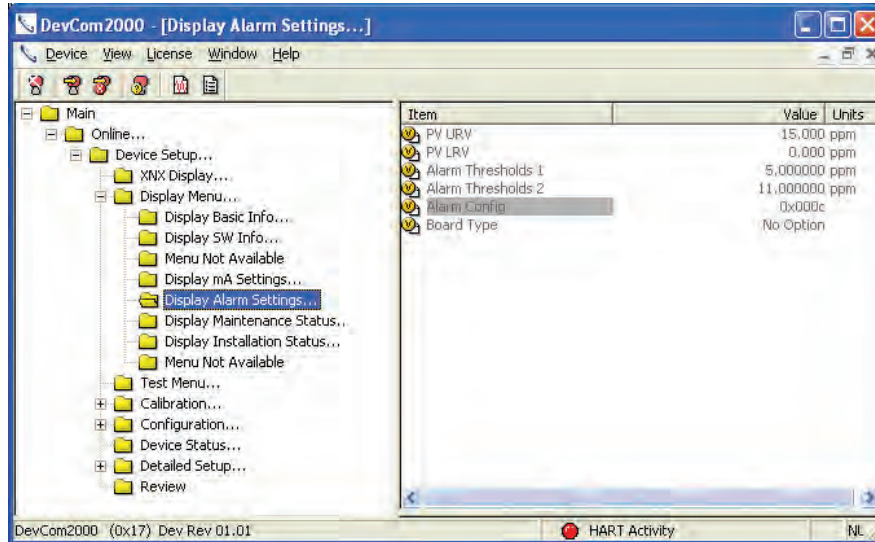

Figure 242. Typical Alarm Settings Display

Event History

The XNX transmitter maintains a record of all significant events. All alarms, all warnings, and all faults are recorded. Additionally, over sixty types of informational events are defined to record important transactions such as recalibrations or configuration changes. One-thousand records are maintained and every event has a timestamp.

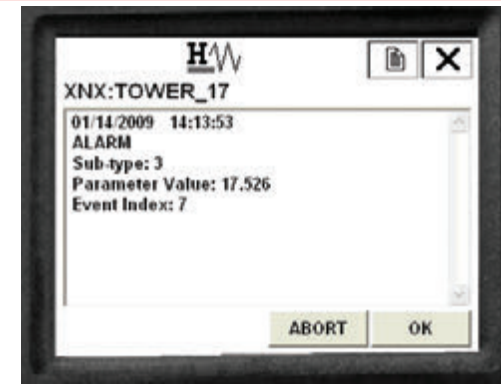

Figure 243. HART Event History Display

Test

The test menu provides methods for inhibiting the output, exercising the analog output, or simulating alarms or faults. These methods simplify common tasks by providing a simple user interface.

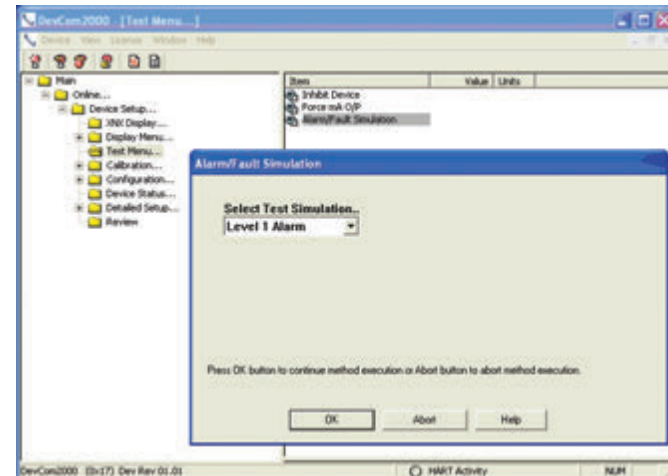

Figure 244. Alarm Simulation

Calibration

The calibration menu permits calibrating zero or span and bump testing. Additionally, when fitted with a Searchline EXCEL sensor, the Calibrate menu displays the optical signal strength for mechanical alignment. The gas calibrate operation is shown below.

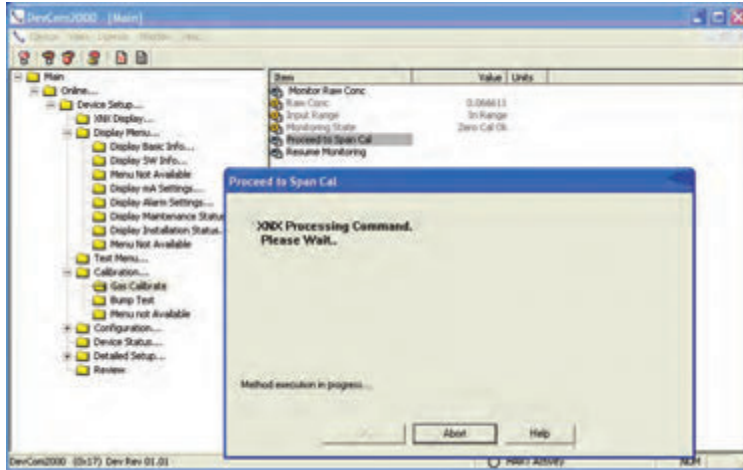

Figure 245. Gas Calibrate Method



Caution: Do not back out of a menu selection while a calibration is in progress.

Configuration

All user settings of the XNX transmitter can be made either at the local user interface or over HART. The configuration menu facilitates convenient setup of alarm levels as shown in [Figure 246](#). Methods are also provided to set time, units, and other parameters.

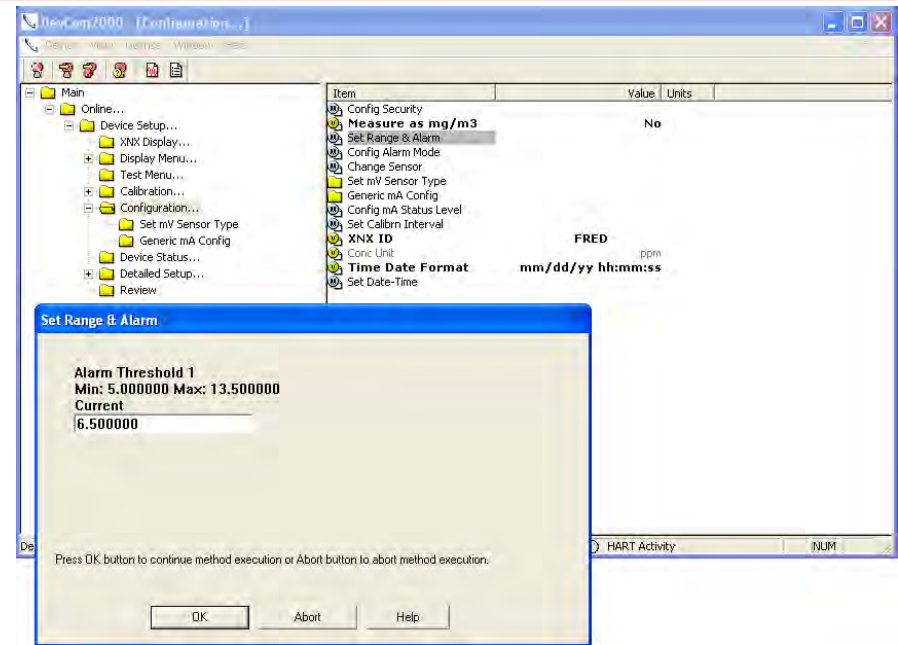

Figure 246. Set Range and Alarm

Conclusion

The XNX HART interface adds value by facilitating remote operation of Honeywell Analytics gas sensors. All functions available locally are also available over HART.

A.1.3 Handheld Online Menu

When HART communication is established with the XNX, the Root menu is displayed:

Main Menu	Key Sub Menus		
Online... 1 Device Setup 2 Concentration 0.00 %LEL 3 PV Alarm Typ 4 Monitoring State Normal Monitoring 5 Reset Alarm Fault(s) None 6 Gas Name Methane 7 Sensor Type Optima	Device Setup... 1 User Login 2 XNX Display... 3 Display Menu... 4 Test Menu... 5 Calibration... 6 Configuration... 7 Device Status... 8 Detailed Setup... 9 Review	Current Login Level: Default Want to change Login Level 1 Logout [Level 0] 2 Login [level1/2/3] 3 Exit	
Online... 1 Device Setup 2 Concentration 0.00 %LEL 3 PV Alarm Typ 4 Monitoring State Normal Monitoring 5 Reset Alarm Fault(s) None 6 Gas Name Methane 7 Sensor Type Optima	Device Setup... 1 User Login 2 XNX Display... 3 Display Menu... 4 Test Menu... 5 Calibration... 6 Configuration... 7 Device Status... 8 Detailed Setup... 9 Review	XNX Display... 1 Concentration 0.00 %LEL 2 PV Alarm Typ None 3 Fault/Warn Number F 4 Monitoring State Normal Monitoring 5 Time Date Format mm/dd/yy hh:mm:ss 6 Time Date Stamp 09/18/08 11:57:57 7 Gas Name Methane LEL	
Online... 1 Device Setup 2 Concentration 0.00 %LEL 3 PV Alarm Typ 4 Monitoring State Normal Monitoring 5 Reset Alarm Fault(s) None 6 Gas Name Methane 7 Sensor Type Optima	Device Setup... 1 User Login 2 XNX Display... 3 Display Menu... 4 Test Menu... 5 Calibration... 6 Configuration... 7 Device Status... 8 Detailed Setup... 9 Review	Display Menu... 1 Reset Alarm Faults 2 Event History 3 Display Basic Info... 4 Display SW Info... 5 Display Optical Performance 6 Display mA Settings 7 Display Alarm Settings 8 Display Maintenance Status 9 Display Installation Status	Display Basic Info... 1 Gas Name Methane LEL 2 XNX ID SOUTH TOWER
XNX HART Basic Menus			

Main Menu		Key Sub Menus					
Online... 1 Device Setup 2 Concentration 0.00 %LEL 3 PV Alarm Typ 4 Monitoring State Normal Monitoring 5 Reset Alarm Fault(s) None 6 Gas Name Methane 7 Sensor Type Optima		Device Setup... 1 User Login 2 XNX Display... 3 Display Menu... 4 Test Menu... 5 Calibration... 6 Configuration... 7 Device Status... 8 Detailed Setup... 9 Review		Display Menu... 1 Reset Alarm Faults 2 Event History 3 Display Basic Info... 4 Display SW Info... 5 Display Optical Performance 6 Display mA Settings 7 Display Alarm Settings 8 Display Maintenance Status 9 Display Installation Status		Display SW Info... 1 Dev id 1081234 2 Fld dev rev 1 3 Sensor S/w Ver 48 4 Sensor s/n 0 5 Gas Name Methane LEL 6 XNX ID SOUTH TOWER	
Online... 1 Device Setup 2 Concentration 0.00 %LEL 3 PV Alarm Typ 4 Monitoring State Normal Monitoring 5 Reset Alarm Fault(s) None 6 Gas Name Methane 7 Sensor Type Optima		Device Setup... 1 User Login 2 XNX Display... 3 Display Menu... 4 Test Menu... 5 Calibration... 6 Configuration... 7 Device Status... 8 Detailed Setup... 9 Review		Display Menu... 1 Reset Alarm Faults 2 Event History 3 Display Basic Info... 4 Display SW Info... 5 Display Optical Performance 6 Display mA Settings 7 Display Alarm Settings 8 Display Maintenance Status 9 Display Installation Status		Display Optical Performance... 1 Signal Strength 0.96 2 Ref Sig Strength 1.12 3 Sam Sig Strength 1.06 4 Baseline 0.92 5 Dynamic Reserve 96 % 6 Window Temp 28 degC	
XNX HART Basic Menus (cont'd)							

Main Menu		Key Sub Menus	
Online... 1 Device Setup 2 Concentration 0.00 %LEL 3 PV Alarm Typ 4 Monitoring State Normal Monitoring 5 Reset Alarm Fault(s) None 6 Gas Name Methane 7 Sensor Type Optima	Device Setup... 1 User Login 2 XNX Display... 3 Display Menu... 4 Test Menu... 5 Calibration... 6 Configuration... 7 Device Status... 8 Detailed Setup... 9 Review	Display Menu... 1 Reset Alarm Faults 2 Event History 3 Display Basic Info... 4 Display SW Info... 5 Display Optical Performance 6 Display mA Settings 7 Display Alarm Settings 8 Display Maintenance Status 9 Display Installation Status	Display mA Settings... 1 Overrange Current 21 mA 2 Warning Current 3 mA 3 Inhibit Current 2 mA
Online... 1 Device Setup 2 Concentration 0.00 %LEL 3 PV Alarm Typ 4 Monitoring State Normal Monitoring 5 Reset Alarm Fault(s) None 6 Gas Name Methane 7 Sensor Type Optima	Device Setup... 1 User Login 2 XNX Display... 3 Display Menu... 4 Test Menu... 5 Calibration... 6 Configuration... 7 Device Status... 8 Detailed Setup... 9 Review	Display Menu... 1 Reset Alarm Faults 2 Event History 3 Display Basic Info... 4 Display SW Info... 5 Display Optical Performance 6 Display mA Settings 7 Display Alarm Settings 8 Display Maintenance Status 9 Display Installation Status	Display Alarm Settings... 1 PV URV 100.000 %LEL 2 PV LRV 0.000 %LEL 2 Alarm Thresholds 1 20 %LEL 3 Alarm Thresholds 2 40 %LEL 4 Alarm Config 0x0C 5 Board Type Modbus/RTU Interf...
Online... 1 Device Setup 2 Concentration 0.00 %LEL 3 PV Alarm Typ 4 Monitoring State Normal Monitoring 5 Reset Alarm Fault(s) None 6 Gas Name Methane 7 Sensor Type Optima	Device Setup... 1 User Login 2 XNX Display... 3 Display Menu... 4 Test Menu... 5 Calibration... 6 Configuration... 7 Device Status... 8 Detailed Setup... 9 Review	Display Menu... 1 Reset Alarm Faults 2 Event History 3 Display Basic Info... 4 Display SW Info... 5 Display Optical Performance 6 Display mA Settings 7 Display Alarm Settings 8 Display Maintenance Status 9 Display Installation Status	Display Maintenance Status.. 1 Sensor Type ECC 2 Sensor Life 0 Hours

XNX HART Basic Menus (cont'd)

Main Menu	Key Sub Menus		
Online... 1 Device Setup 2 Concentration 0.00 %LEL 3 PV Alarm Typ 4 Monitoring State Normal Monitoring 5 Reset Alarm Fault(s) None 6 Gas Name Methane 7 Sensor Type Optima	Device Setup... 1 User Login 2 XNX Display... 3 Display Menu... 4 Test Menu... 5 Calibration... 6 Configuration... 7 Device Status... 8 Detailed Setup... 9 Review	Display Menu... 1 Reset Alarm Faults 2 Event History 3 Display Basic Info... 4 Display SW Info... 5 Display Optical Performance 6 Display mA Settings 7 Display Alarm Settings 8 Display Maintenance Status 9 Display Installation Status	Display Installation Status... 1 Power Supply Volt... 19403 mVolt 2 Operating Voltage 3297 mVolt 3 Sensor I/P Voltage 0 mVolt 4 Sensor Voltage 0 mVolt 5 XNX Temp 33 degC 6 Sensor Temp 41 degC 7 Loop current 4.000 mA
Online... 1 Device Setup 2 Concentration 0.00 %LEL 3 PV Alarm Typ 4 Monitoring State Normal Monitoring 5 Reset Alarm Fault(s) None 6 Gas Name Methane 7 Sensor Type Optima	Device Setup... 1 User Login 2 XNX Display... 3 Display Menu... 4 Test Menu... 5 Calibration... 6 Configuration... 7 Device Status... 8 Detailed Setup... 9 Review	Test Menu... 1 Inhibit Long-term 2 Force mA O/P 3 Alarm/Fault Simulation	
XNX HART Basic Menus (cont'd)			

Main Menu	Key Sub Menus		
Online... 1 Device Setup 2 Concentration 0.00 %LEL 3 PV Alarm Typ 4 Monitoring State Normal Monitoring 5 Reset Alarm Fault(s) None 6 Gas Name Methane 7 Sensor Type Optima	Device Setup... 1 User Login 2 XNX Display... 3 Display Menu... 4 Test Menu... 5 Calibration... 6 Configuration... 7 Device Status... 8 Detailed Setup... 9 Review	Calibration... 1 Gas Calibrn 2 Bump Test 3 Calibrate mA Offset 4 Soft Reset 5 Align Excel	
Online... 1 Device Setup 2 Concentration 0.00 %LEL 3 PV Alarm Typ 4 Monitoring State Normal Monitoring 5 Reset Alarm Fault(s) None 6 Gas Name Methane 7 Sensor Type Optima	Device Setup... 1 User Login 2 XNX Display... 3 Display Menu... 4 Test Menu... 5 Calibration... 6 Configuration... 7 Device Status... 8 Detailed Setup... 9 Review	Configuration... 1 Config Security 2 Measure as mg/m3 3 Set Range & Alarm 4 Config Alarm Mode 5 Fieldbus Option 6 Set mV Sensor Type 7 Gas Selection 8 Config mA Status L... 9 Set Calibrn Interval XNX ID SOUTH TOWER Conc Unit %LEL Time Date Format mm/dd/yy hh:mm:ss Set Date-Time	
XNX HART Basic Menus (cont'd)			

Main Menu	Key Sub Menus		
Online... 1 Device Setup 2 Concentration 0.00 %LEL 3 PV Alm Typ 4 Monitoring State Normal Monitoring 5 Reset Alarm Fault(s) None 6 Gas Name Methane 7 Sensor Type Optima	Device Setup... 1 User Login 2 XNX Display... 3 Display Menu... 4 Test Menu... 5 Calibration... 6 Configuration... 7 Device Status... 8 Detailed Setup... 9 Review	Detailed Setup... 1 Output Condition... 2 Device Information...	
Online... 1 Device Setup 2 Concentration 0.00 %LEL 3 PV Alm Typ 4 Monitoring State Normal Monitoring 5 Reset Alarm Fault(s) None 6 Gas Name Methane 7 Sensor Type Optima	Device Setup... 1 User Login 2 XNX Display... 3 Display Menu... 4 Test Menu... 5 Calibration... 6 Configuration... 7 Device Status... 8 Detailed Setup... 9 Review	Review 1 Manufacturer Honeywell 2 Model XNX 3 Sensor Type Optima 4 PV %LEL 5 Info Min Range 100.00 %LEL 6 Info Max Range 100.00 %LEL 7 PV % Range 0.000 % 8 PV Xfer fnctn Linear 9 PV 4.000 mA PV Alm typ None Tag S. TOWER Long tag Descriptor SOUTH TOWER Message CRACKING TOWER Final asbly num 0 Dev id 1081234 Universal rev 6 Fid dev rev 1 Software rev 38 Poll addr 0 Loop Curnt Mode Enabled Cfg chng count 6 Num req preams 9 Num resp preams 7	
XNX HART Basic Menus (cont'd)			

Appendix B - Modbus[®] Protocol

B.1 Modbus and the XNX transmitter

The XNX[®] gas sensor may be fitted with the optional Modbus[®] interface card (P/N XNX-MB). Authoritative information on the Modbus protocol can be found at www.modbus.org. The XNX supports Modbus/RTU over an RS-485 physical layer. The interface is isolated and includes a switchable 120 Ohm termination resistor. Baud rates from 1200 to 38,400 are supported with 19,200 as the default (8 data bits, even parity, 1 stop bit).

Most of the operations that are possible with the HART[®] and local user interfaces can also be performed using the Modbus interface. This includes test, calibration and configuration operations. This appendix describes only how to monitor XNX status using Modbus.

The zero calibration procedure should be performed prior to the span calibration. The calibration procedure is in Section 3.2.1.

Some of the relevant Modbus holding registers are listed in the following table. In most installations, the XNX transmitter reads only the first five registers (four data). The assignment of the first eight registers (or six data) is identical to the Honeywell Analytics XCD gas sensor.

Building an effective Modbus automatic gas detection system requires checking for faults (using `iFaultWarnNumber` or `iAlmFltLev`) and checking `iMonitoringState` to confirm that the XNX is not inhibited or in calibration. The pseudo code example in Figure 247 suggests computation that should be made in external automation equipment.

See [Section 2.3.4](#) for information on installing the optional Modbus hardware. See [Section 2.5.1](#) for information on setting the Modbus baud rate and address using the local user interface. See [Section A.1.1](#) for information on setting the Modbus parameters using the HART interface.

```
if(
    ((fCurrentConc < TLV) or (iAlmFltLev & 3 == 0))
// low concentration
    and
    ((iFaultWarnNumber < 1000) or (iAlmFltLev & 64 == 0))
// no fault
    and
    ((iMonitoringState == 1) or (iMonitoringState == 7))
// not inhibited
    and
    (
        (Transport layer SW indicates good Comm.)
        or
        (iHeartBeat changes every 5 seconds)
    ) // Modbus link healthy
) Then the area is safe.
```

Figure 247. Modbus Pseudo Code Example

Modbus connections are shown in the following figure.

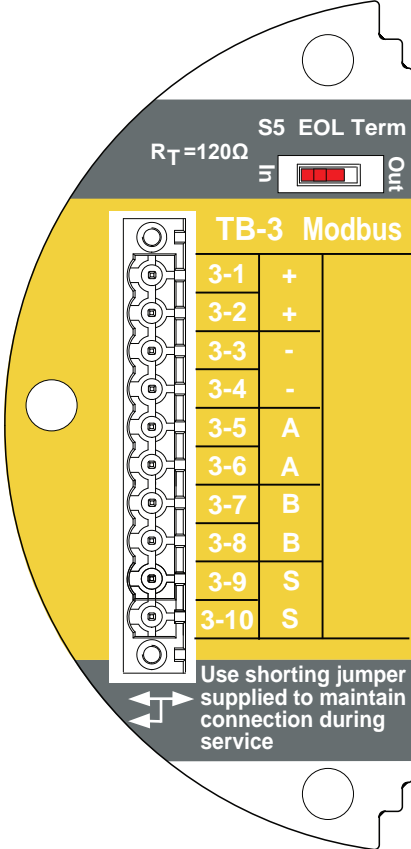

Figure 248. Modbus connections

B.2 Modbus Registers

Modbus Holding Register Address	Datatype	Variable Name	Description
40001	Int16	ID	MSB always 0x24 to facilitate automatic identification. LSB repeat of Modbus address.
40002	Int16	ID	Identical to 40001
40003 to 40004	Float32	fCurrentConc	The reported gas concentration in current measurement units. For example, methane at 50% LEL would be reported as 50.0 here. This concentration is forced to zero during inhibit mode.
40005	int16	iFaultWarnNumber	This is the integer representation of the fault status. If any fault exists this will take a value in the range 1000 to 1999. Otherwise, if any warning exists, this will take a value in the range 1 to 999. Normally, this has the value zero. For example, if the XNX temperature is out of range, this will take the value 1103.
40006	int8	iAlmFltLev	This register contains 4 meaningful bits regarding the presence of alarms or faults. The bit assignments are as follows: Bit 0: AL1 active Bit 1: AL2 active Bit 4: Warning active Bit 6: Fault Active All others: For future expansion

Modbus Holding Register Address	Datatype	Variable Name	Description
40007	uint8	iMonitoringState	<p>This has the following meanings:</p> <ul style="list-style-type: none"> 0 reserved 1 normal monitoring 2 in warm-up 3 long-term inhibit 4 alarm simulation 5 fault simulation 6 Loop current stimulated 7 in warning MFit 8 in Instrument Fit 9 in beam block 10 in bump test 11 short-term inhibit 12 performing zero calibration 13 performing span calibration 14 in pre-zero calibration 15 in pre-span calibration 16 in post-zero calibration, successful 17 in post-span calibration, successful 18 in post-zero calibration, failed 19 in post-span calibration, failed 20 in align Excel mode 21-255 for future expansion
40008	int16	iHeartBeat	<p>This Heartbeat is provided to facilitate detection of communications problems in programming environments where the transport-layer communication error information is unavailable. This increments approximately every 5 seconds.</p> <p>It is the responsibility of the system integrator to notify plant personnel if a Modbus master fails to communicate with the XNX. This register can facilitate this notification.</p>
40009 to 40010	float32	fSensorLifeDays	This indicates the time remaining before the ECC sensor must be calibrated or replaced.

Modbus Holding Register Address	Datatype	Variable Name	Description
40011	int8	iMeasurementUnits	The meaning of this datum is as enumerated below:
			<ul style="list-style-type: none"> 0 Default 1 mg/m3 2 g/m3 3 %vol 4 ppm 5 %LEL 6 UEG 7 Ratio 8 %LEL*M 9 ppm*m 10 EG*m 11 %vol * meter 12 to 255 for future expansion
40012 to 40014	string[5]	strGenericUnits	User-defined 5 character string description for installed generic mA sensor
40015	int8	iWinTemp	If a Searchline Excel is fitted, this is the temperature of the window. Otherwise, this is the temperature of the window.
40016	int8	iTransTemp	Temperature of the XNX in Celcius.
40017	int8	iSensorTemp	Temperature of the sensor (Optima, Excel, ECC, etc)
40018 to 40026	string[18]	strTransmitterID	User-configured transmitter name.
40027 to 40035	string[18]	sDateTime	Format is "mm/dd/yy hh:mm:ss". Month and day inverted if so configured.
40036	int8	iSensorType	The meaning of this datum is as enumerated below
			<ul style="list-style-type: none"> 1 mV Bridge 2 Electrochemical Cell with toxic cartridge 3 Electrochemical Cell with O2 cartridge 4 Optima 5 Excel 7 generic mA input Others for future expansion
40037	float32	f_mA_Out	The current produced by the XNX in milliamperes.

Modbus Holding Register Address	Datatype	Variable Name	Description
40038	int16	iTransVoltage24000	The voltage supplied to the XNX at the nominal 24.0 volt input, in millivolts.
40039	int16	iTransVoltage_3300	The voltage on a nominal 3.3 volt supply in the XNX, in millivolts.
40041	int16	iOptional3300	The voltage on a nominal 3.3 volt supply in the XNX option board, in millivolts.
40042	int16	iPersonality3300	The voltage on a nominal 3.3 volt supply in the XNX personality board, in millivolts.
40043	int16	iPersonality5000	The voltage on a nominal 5.0 volt supply in the XNX personality board, in millivolts.
40044	int16	iSensVoltage24000	The voltage supplied to an Optima or Excel sensor at the nominal 24.0 volt input, in millivolts.
40045	int16	iSensVoltage_5000	The voltage on a nominal 5.0 volt supply in Optima or Excel, in millivolts.
40046 to 40079	Contact HA for details.		
40080 to 40081	int32	iTransSn	Serial number of XNX.
40082 to 40083	int32	iSensSn	Serial number of Optima, Excel, or ECC cartridge.
40084	int8	iSensSwVer	Integer representation of software version in external sensor or mV personality module
40085	int8	iTransSwVer	Software version of XNX.
40086 to 40155	Contact HA for details.		

Appendix C - Warranty

Warranty Statement

All products are designed and manufactured to the latest internationally recognized standards by Honeywell Analytics under a Quality Management System that is certified to ISO 9001.

The XNX® Universal Transmitter is warranted by Honeywell Analytics (herein referred to as ‘HA’) to be free from defects in material or workmanship under normal use and service for:

Device	Warranty Terms
XNX Universal Transmitter (excludes consumables)	36 months from date of shipment to buyer
XNX Electrochemical Sensors (Part Number XNX-XS****)	12 months from date of commissioning by an approved Honeywell Analytics representative or
Multi-Purpose Detector (MPD)	18 months from date of shipment from Honeywell Analytics, whichever is sooner

Service in the field or at the customer’s premises is not covered under these warranty terms. Time and travel expenses for on-site warranty services will be charged at Honeywell Analytics’ normal billing rates. Contact your Honeywell Analytics Service Representative for information on Service Contracts.

Warranty Conditions

1. The Honeywell Analytics (HA) Limited Product Warranty only extends to the sale of new and unused products to the original buyer where purchased from HA or from a HA authorized distributor, dealer or representative. Not covered are: consumable items such as dry-cell batteries, filters and fuses or routine replacement parts due to the normal wear and tear of the product; any product which in HA’s opinion has been altered, neglected, misused or damaged by accident or abnormal conditions of operation, handling, use or severe sensor poisoning; defects attributable to improper installation, repair by an unauthorized person or the use of unauthorized accessories/parts on the product
2. Any claim under the HA Product Warranty must be made within the warranty period and as soon as reasonably possible after a defect is discovered. If a Warranty claim is being sought it is the responsibility of the buyer to obtain a Service Event number (SE#) from HA and if practical return the product clearly marked with the SE# and a full description of the fault.
3. HA, at its sole discretion, may elect to send replacement goods to buyer prior to receipt of the defective goods. Buyer agrees to return defective goods with in 30 days or to pay for the replacement goods.
4. Buyer is responsible for transportation costs from the buyer’s location to HA. HA is responsible for transportation costs from HA’s location to the buyer.
5. If in the case of a fixed installation or when it is not practical to return the

product, the buyer should submit a claim to HA Service Department. A service engineer will attend on site on a day rate basis. Where a valid warranty claim is identified, the faulty product will be repaired or replaced free of charge. A warranty claim will be accepted if all conditions contained within this Warranty are met.

6. When, in the opinion of HA, a warranty claim is valid, HA will repair or replace the defective product free of charge and send it or any replacement back to the buyer. If, in the opinion of HA the warranty claim is not valid, HA will, at the option of the buyer, return the unit unaltered at the buyer’s expense, repair the unit at the then prevailing rates, replace the unit with an appropriate replacement item at the then prevailing price, or discard the unit. HA reserves the right to charge for any attendance by its service engineer at the usual rates in force at the time the claim was received.
7. In no event shall HA’s liability exceed the original purchase price paid by the buyer for the product.

Consumer Claims

If you purchased your HA product as a consumer, the above warranty conditions do not affect your rights under any applicable consumer protection legislation.

Honeywell Analytics reserves the right to change this policy at any time. Contact Honeywell Analytics for current warranty information.

Index

- Symbols**
- 4-20mA output 11, 37, 38
 - 705, calibrating 94
 - 705HT, calibrating 94
- A**
- accessories 156
 - air speed, operating 132
 - alarm/fault simulation 81
 - alarm/fault status 83
 - alarms 67
 - alarm settings 83
 - approvals,
 - hazardous area 129
 - performance 129
- B**
- battery life 128
 - baud rate 184
 - beam block options 72
 - bump test 22, 99, 100
- C**
- cable
 - length 52
 - ports 128
 - recommended 132
 - cal gas range 134, 135, 133
 - Calibration 93–106
 - calibration
 - for MPD sensors 101
 - gas 90
 - gas flow adapter 15, 156
 - interval 71
 - span 90, 91
 - zero 90, 91
 - cal point 130, 131, 133
 - cartridges
 - catalytic bead replacement 155
 - IR replacement 155
 - part numbers 130, 131, 133
 - Cautions 7
 - ceiling mount bracket kit 16, 156
 - cells, replacement 154
 - certifications 11, 12
 - by part number series 145–147
 - chronological list, event,
 - by day 88
 - collecting cone 16, 157
 - Communications 11
 - configuration
 - displaying 22
 - verifying 79
 - configure menu 61
 - construction material 128
 - Control Drawings 159–166
 - remote sensor mount 165
 - controls 18
 - cover 12
 - cross-interferents 141
- D**
- daisy-chain 32
 - date 22, 58, 81
 - dimensions 128
 - duct mount kit 16, 156
- E**
- easy reset 78
 - EC. See *electrochemical sensor*
 - electrochemical sensor 40
 - cartridge, replacing with different type 106
 - cartridge, replacing with same type 105
 - cell 105
 - installation 40
 - operational life 98
 - enclosure
 - aluminum 12
 - stainless steel 12
 - event history 81, 87
- F**
- fieldbus
 - options 77
 - settings 83, 86
 - finish, marine 12
 - flow housing 97
 - force relays 80, 81
 - Foundation Fieldbus 54
 - functional gas test.
 - See *bump test*
- G**
- gas calibration 22, 90
 - gas data 83, 85
 - gases, selectable 61
 - gas name, changing 61
 - general status screen 19, 55
 - greases, airborne 141
- H**
- H₂S sensors, calibrating 94
 - HART®
 - devices 52
 - handheld online menu 1751–179
 - interface 167–169
 - local 14
 - local handheld 51
 - output 11
 - protocol 51, 167–182
 - hex key 13
 - humidity 1284, 130, 131, 133
 - hydrogen sensors 142
- I**
- information 7
 - information menu 83
 - inhibit 79
 - Installation and Operation 27–88
 - installation
 - daisy-chain 31, 32
 - maximum distance 31, 33
 - multiple transmitter 31
 - single transmitter 31
 - types of 31
 - intrinsic safety 5, 14
 - Introduction 9–26
 - IP rating 1284, 130
 - IS. See *intrinsic safety*

J

jumpers 38
jumper switch 54

L

language 22
 selecting 57
latching 69
LCD. See *liquid crystal display*
LDL. See *lower detection limit*
LED. See *light emitting diode*
light emitting diode 18,
 20, 56
 test 56
liquid crystal display 46,
 56
lower detection limit 130,
 131, 133

M

magnetic wand/screw-
 driver 13, 17, 158
main menu 22
Maintenance 103–106
mA devices
 generic, connecting 47

 mA levels 70
 mA
 level settings 83, 86
 output, calibrating 90,
 100
 output, forcing 80
 sensor type 60
 menu map 23
 menu structure 20
 messages
 fault 113–119
 informational 123–124
 warning 1084–1117
 Modbus® 15, 54
 interface card 184
 protocol 183–188
 registers 186–189
 mounting kit, EC sensor
 remote 41
 mounting the enclosure
 128
 MPD. See *multi-purpose detector*
 multi-purpose detector
 155
 flammable sensor 98
 interface adapter 156
 performance 142
 sensor cartridge 104
 multidrop mode 52
 mV
 personality wiring 43
 remote sensor 45

N

navigation 18
non-latching. See *latching*
notes 7
numeric format, selecting
 69

O

off-scale readings 5
operating voltage 128
option board 38, 54
ordering information 152
organic vapors 141
O-ring, front cover 158

P

part numbers 83
parts list 13
passcode screens 79
personality board 36, 38
 IR 48
 mV 42, 44
personality, options, and
 display (POD) 14, 36
personality wiring
 electrochemical 39
 IR 46, 48
pipe mount kit 15, 154
POD. See *personality, op-
 tions, and display*
point-to-point mode 51

power consumption 128
pressure
 barometric 130, 131, 134
 operating 132
product description 10, 12

R

range 67, 130, 131, 133
range/alarm settings 83,
 85
real time clock 128
Reflex cell fault diagnosis
 10
relay
 data 86
 options 14, 53
 settings 83
remote
 sensor mounting kit 16,
 156
 gassing kit 16, 157
 MPD mounting 157
response time 130, 131,
 133

S

Safety 5–8
screwdriver 158
Searchline Excel 50, 56,
 96
 connecting 46

Searchpoint Optima Plus
 50
 connecting 46
 security access level 59
 security, configuring 78
 Sensepoint HT, calibrat-
 ing 94
 sensors 14–26
 cross-sensitivity 135–141
 data 83, 85
 location 28
 mounting 28
 performance 133
 replacement 153
 status 83, 85
 types 59, 72
 serial number 83
 settings, displaying 22
 shorting jumpers 157
 signal 128
 silicone compounds 141
 simulation switch 38, 54
 soft reset 101, 102
 solvents 141
 spares 156
 Specifications 127–158
 stopping plugs 12, 158
 switch configuration 37
 system conditioning 142

- T**
 - temperature 128, 130
 - ranges, extended 134
 - range, standard 134
 - terminal blocks 38, 54
 - connections 38
 - jumpers 157
 - pluggable 158
 - termination 128
 - test menu 79
 - time 22, 58, 83
 - transmitter
 - configuring 57
 - data 83, 84
 - information, displaying 21
 - status 83, 83
 - testing 22
- U**
 - units name, changing 61
 - units, setting 70
 - user interface 128

- W**
 - warm-up time 132
 - Warnings 5
 - Warnings and Faults 107–126
 - warranty 191–192
 - weatherproof cap 16, 157
 - weather protector 17, 157
 - weight 128
 - wiring 30
 - isolated 37
- X**
 - XNX front panel 17
- Z**
 - zero calibration 184

Find out more

www.honeywellanalytics.com

Americas

Honeywell Analytics
405 Barclay Boulevard
Lincolnshire, IL 60069
Tel: +1 847 955 8200
Toll free: +1 800 538 0363
Fax: +1 847 955 8208
detectgas@honeywell.com

Europe, Middle East, and Africa

Life Safety Distribution AG
Javastrasse 2
8604 Hegnau
Switzerland
Tel: +41 (0)1 943 4300
Fax: +41 (0)1 943 4398
Tel: +41 (0)1 943 4300
Fax: +41 (0)1 943 4398
gasdetection@honeywell.com

Technical Services

ha.global.service@honeywell.com

www.honeywell.com

Asia Pacific

#508, Kolon Science Valley (I)
187-10 Guro-Dong, Guro-Gu
Seoul, 152-050
Korea
Tel: +82 (0)2 6909 0307
Fax: +82 (0)2 2025 0328
analytics.ap@honeywell.com

Please Note:

While every effort has been made to ensure accuracy in this publication, no responsibility can be accepted for errors or omissions. Data may change, as well as legislation, and you are strongly advised to obtain copies of the most recently issued regulations, standards and guidelines. This publication is not intended to form the basis of a contract.

Honeywell

1998M0738 Revision 12
June 2015
© 2015 Honeywell Analytics