

Technical Documentation

Microphone Handbook

Vol. 1: Theory

Brüel & Kjær 

WORLD HEADQUARTERS: DK-2850 Nærum • Denmark •
Telephone: +4542800500 • Telex: 37316 bruka dk • Fax: +4542801405 •
e-mail: info@bk.dk • Internet: <http://www.bk.dk>

Microphone Handbook

Volume 1

March 2019

Copyright © 2019, Brüel & Kjær A/S

All rights reserved. No part of this publication may be reproduced or distributed in any form or by any means without prior consent in writing from Brüel & Kjær Sound & Vibration Measurement A/S, Nærum, Denmark.

Preface

This volume provides background information on the Brüel & Kjær microphone product range. It gives an insight into the theory behind the development of microphones and preamplifiers and explains the terminology used to describe these products.

The aim of this volume is to promote a full understanding of measurement microphones and to provide sufficient background information for customers to get the best out of these products. It also gives adequate information for customers to be able to make informed and qualified decisions about the microphone products which are most suitable for their measurement requirements. These products are described in detail in more specific literature, such as Volume 2 of this handbook and in product data sheets.

Chapter 1 gives a brief history of microphone development at Brüel & Kjær and provides an insight into the research and development invested in microphone products. An overview of the production of microphones is also given.

Chapter 2 gives a general introduction to microphone theory and explains the decisions that are made about the design and construction of microphones.

Chapter 3 provides more detailed information about the characteristics of microphones with the aim of allowing an informed view on the specifications applied to microphone products.

Chapter 4 introduces the main characteristics of preamplifiers and explains the categories of information given in Volume 2.

Chapter 5 provides information on the selection criteria commonly used to identify the most suitable microphone for different applications and also the most applicable accessories that should be used.

Chapter 6 discusses the requirement for the calibration of microphones and offers an overview of calibration methods.

Contents

1. Introduction	1 – 1
1.1 Historical Background to Microphone Development at Brüel & Kjær	1 – 2
1.2 Development of Microphone Products.....	1 – 5
1.3 Production of Microphones at Brüel & Kjær	1 – 9
1.4 Product Support	1 – 11
2. Microphone Theory	2 – 1
2.1 Sound Levels and Sound Fields.....	2 – 2
Sound Field Parameters.....	2 – 2
Sound Pressure and Pressure Level.....	2 – 2
Particle Velocity and Particle Velocity Level.....	2 – 3
Sound Intensity and Sound Intensity Level	2 – 3
Pressure-field.....	2 – 4
Free-field.....	2 – 4
Diffuse-field.....	2 – 5
2.2 Measurement Microphone Requirement.....	2 – 5
2.3 Measurement Microphone Design.....	2 – 7
Introduction	2 – 7
Design Description	2 – 7
Material and Process Requirements	2 – 9
Transduction Principles	2 – 11
Diaphragm and Air Stiffness	2 – 15
Static Pressure Equalization	2 – 16
Low Frequency Response and Vent Position	2 – 17
High Frequency Response.....	2 – 20
Microphone Sensitivity	2 – 24
Microphone Modelling by Equivalent Electric Circuits	2 – 25
Acoustic Impedance of Diaphragm System.....	2 – 27
Equivalent Volume of the Diaphragm System	2 – 28
2.4 Combination of Microphone and Preamplifier.....	2 – 31
Microphone Capacitance	2 – 31
Electrical Frequency Response of Microphone and Preamplifier	2 – 32
Inherent Noise of Microphone Systems.....	2 – 35
Distortion	2 – 39
2.5 Microphone Types Dedicated to Different Sound Fields.....	2 – 43
Influence of the Microphone on the Pressure-Field.....	2 – 43

	Pressure Field Microphone and Sensitivity	2 – 45
	Influence of Microphone on the Measured Sound Pressure in a Free-Field	2 – 45
	Free-Field Microphone and Sensitivity	2 – 48
	Influence of the Microphone on the Measured Sound Pressure in a Diffuse Field	2 – 49
	Diffuse Field Microphone and Sensitivity	2 – 50
2.6	Long Term Microphone Stability	2 – 51
2.7	Electrostatic Actuator Calibration	2 – 54
	Introduction	2 – 54
	Electrostatic Actuator	2 – 55
	Electrostatic Calibration Pressure	2 – 55
	Electrostatic Actuator Operation	2 – 57
	Actuator and Pressure-field Responses	2 – 58
	General Note on Actuator Calibration	2 – 58
2.8	Conclusion	2 – 59
3.	Characteristics of Microphones	3 – 1
3.1	Introduction to Characteristics	3 – 2
	The Calibration Chart and Diskette	3 – 2
3.2	Sensitivity	3 – 3
	Open-circuit Sensitivity (S_0)	3 – 3
	Loaded Sensitivity (S_l)	3 – 4
	Correction-factors K and K_0	3 – 5
3.3	Frequency Response	3 – 5
	Introduction and Optimised response	3 – 5
	Low Frequency Response	3 – 6
	High Frequency Response	3 – 7
	Electrostatic Actuator Response	3 – 7
	Free-field Response	3 – 9
	Random Incidence Response	3 – 9
	Pressure-field Response	3 – 9
3.4	Directional Characteristics	3 – 10
3.5	Dynamic Range	3 – 11
	Inherent Noise	3 – 11
	Maximum Sound Pressure Level	3 – 12
3.6	Equivalent Diaphragm Volume	3 – 13
3.7	Calibrator Load Volume	3 – 13
3.8	Capacitance	3 – 13
3.9	Polarisation Voltage	3 – 14
	Externally Polarized Microphones	3 – 14
	Prepolarized Microphones	3 – 15
3.10	Leakage Resistance	3 – 16
3.11	Stability	3 – 17
3.12	Irreversible Changes	3 – 17
	Long-term stability	3 – 17
	Handling	3 – 17
	Short-term Stability	3 – 17

3.13	Reversible Changes	3 – 18
	Effect of Temperature	3 – 18
	Effect of Ambient Pressure	3 – 19
	Effect of Humidity	3 – 21
	Effect of Vibration	3 – 21
	Effect of Magnetic Field	3 – 21
	Electromagnetic Compatibility	3 – 21
4.	Characteristics of Preamplifiers.....	4 – 1
4.1	Introduction to Characteristics of Preamplifiers.....	4 – 2
	Definition of a Microphone Preamplifier.....	4 – 2
	Selection of a Microphone Preamplifier	4 – 2
	Contents of this Chapter	4 – 2
4.2	Frequency Response.....	4 – 2
	Low Frequency Response.....	4 – 2
	High Frequency Response.....	4 – 3
4.3	Dynamic Range	4 – 5
	Upper limit of Dynamic Range	4 – 5
	Maximum Voltage	4 – 6
	Maximum Current.....	4 – 6
	Maximum Slew Rate	4 – 7
	Lower Limit of Dynamic Range.....	4 – 8
4.4	Phase Response	4 – 11
4.5	Effect of Temperature	4 – 11
4.6	Effect of Magnetic Fields	4 – 13
4.7	Electromagnetic Compatibility.....	4 – 13
	The European EMC Directive.....	4 – 13
	The CE label	4 – 13
	EMC Test Facilities at Brüel & Kjær.....	4 – 14
4.8	Monitoring and Calibration Techniques	4 – 15
	Insert Voltage Calibration	4 – 16
	Charge Injection Calibration	4 – 17
	CIC Input Signal Requirements	4 – 19
5.	Selecting a Microphone	5 – 1
5.1	Guidelines on Selecting Microphones	5 – 2
5.2	What to Consider.....	5 – 4
	Frequency Response.....	5 – 4
	Type of Sound Field.....	5 – 4
	Limits of Dynamic Range.....	5 – 4
	Microphone Venting	5 – 5
	Phase Response	5 – 5
	Polarisation.....	5 – 5
	Standards Compliance	5 – 6
	Environment	5 – 7

	Microphone Array Applications.....	5 – 8
5.3	Selecting The Right Accessories.....	5 – 8
	Low Wind Speed, Random Direction.....	5 – 9
	High Wind Speed, Known Direction	5 – 9
	Turbulent Pressure Fluctuations	5 – 10
	Humidity.....	5 – 10
6.	Calibration.....	6 – 1
6.1	Introduction.....	6 – 2
6.2	Calibration of Microphones.....	6 – 4
6.3	Field Calibration	6 – 4
6.4	Laboratory Calibration	6 – 5
	Primary Calibration Laboratories.....	6 – 6
	Accredited Calibration Laboratories	6 – 6
	Calibration at the Brüel & Kjær Factory.....	6 – 7
6.5	Calibration Hierarchy, Traceability and Uncertainty	6 – 8
6.6	Calibration Methods	6 – 9
	Reciprocity Calibration Method.....	6 – 10
	Substitution method.....	6 – 11
	Comparison Method	6 – 11
	Sound Pressure Calibrator Method.....	6 – 12
	Actuator method.....	6 – 12
	Insert Voltage Calibration Method	6 – 13
	Charge Injection Calibration Method	6 – 14

Index

Chapter 1

Introduction

1.1 Historical Background to Microphone Development at Brüel & Kjær

Brüel & Kjær began producing microphones in 1945. By the late 1950s they were established as a leading supplier of measurement microphones, due largely to the inspirational leadership and enthusiasm of Dr. P.V. Brüel in the field of microphone development. In parallel, Brüel & Kjær also conceived, designed and developed complete acoustic measurement systems. Measurement microphones formed an important part of these systems, in combination with instruments such as analysers, recorders and sound level meters.

From this beginning, Brüel & Kjær gained an increasingly good reputation amongst users of microphones, both in the acoustics industry and in the field of academic research. This was achieved as a result of providing a high standard of service and reliable, well built products. The product range was also enhanced by a programme of research and development that ensured continuous improvements in the accuracy and performance of new instruments. Today, this approach continues to deliver innovative measurement instrumentation, including a comprehensive range of measurement microphones in sizes from $\frac{1}{8}$ " to 1". Together these microphones cover all aspects of measurement microphone usage.

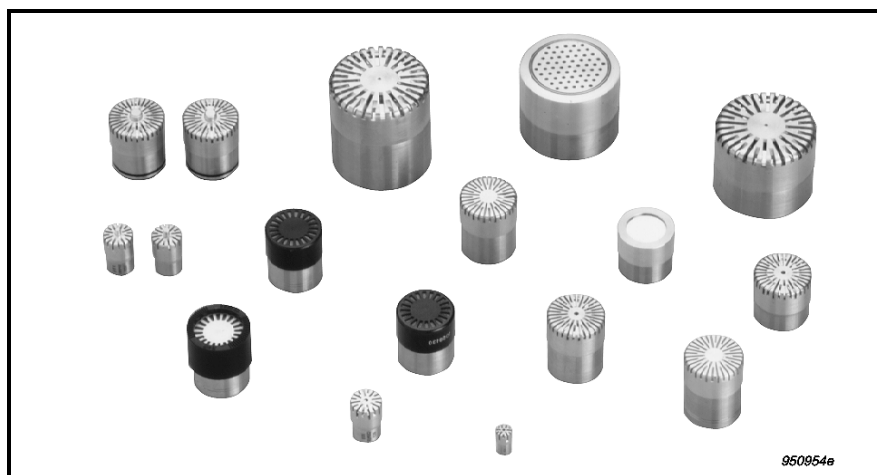

Fig. 1.1 Range of condenser measurement microphones

By the early 1970s, Brüel & Kjær's strong presence in the measurement microphone field had become firmly established with the development of high sensitivity $\frac{1}{2}$ " microphones. These microphones benefited from new techniques allowing less tension in the diaphragm, leading to an increase in sensitivity of approximately 12 dB. During this period Brüel & Kjær also improved techniques to accurately measure and document the performance parameters of their measurement microphones and supplied this information in the form of calibration charts. Microphones could subsequently be relied upon according to certain stated parameters.

Calibration equipment was also made, such as reciprocity equipment for laboratory calibration and the pioneering hand-held pistonphone. This convenient calibration device effectively improved the accuracy of everyday microphone usage by allowing users to check measurement accuracy in the field.

In 1973 Brüel & Kjær consolidated their position as the leading microphone producer by meeting a request from Western Electric to supply 1" microphones to replace their successful but ageing WE 640AA microphone. The Brüel & Kjær solution took the form of the classic Type 4160 microphone. The 4160 together with the 4180 (the 1/2" version) were quickly established as reference microphones for laboratory standard use, due mainly to their stability and accurately documented performance parameters.



Fig.1.2 Microphone Types 4180 1/2" and 4160 1" are used by DPLA as highly stable reference microphones for laboratory calibrations

Further innovations ensued, notably in improvements to electret processes during the 1970s, resulting in the production of stable prepolarised microphones which became standard for use with sound level meters. The 1980s brought further developments, in particular in the field of sound intensity measurement. The mid 1980s also saw the development of specialised types of probe microphone. This microphone made use of a revolutionary and now patented tube system which gives a flat

frequency response and allows for measurements in places where access for standard measurement microphones is difficult.

Improvements have continued into the 1990s with the introduction of highly accurate yet robust microphones (the Falcon Range™) and a microphone unit specially designed for permanent outdoor use. These microphones have proven their ability to perform effectively in harsh measurement environments.

Throughout the history of Brüel & Kjær, a collaborative approach with customers has led to improvements in the design, performance and reliability of measurement microphones. In addition, Brüel & Kjær's response to customer requirements has created several innovations in the related acoustic measurement field, including:

- Sound intensity microphones, phase-matched for accurate, low frequency measurements see Section 2.3.7.
- Sound intensity calibrator, simulating a free-field environment for calibration of sound intensity equipment.
- Charge injection calibration (patented) for verification of complete measurement systems see, Section 4.8.
- Feedback calibration (Multitone calibrator) allowing calibration of microphones, up to 16 kHz.
- New intensity measurement microphones with patented pressure equalisation vent system giving much improved low frequency response.



Fig. 1.3 Sound Intensity probe using a phase-matched pair of microphones

These and other innovations reflect a dedicated and uncompromising approach to the creation of measurement microphones, where reliability, accuracy and quality are the key considerations. This philosophy continues to find ways of meeting the needs of a growing global market through intensive research and development work.

1.2 Development of Microphone Products

Development of microphone products is performed by a dedicated team of engineers. This is something which is not easy to provide given the relatively small and specialist market for precision microphone products. However, at Brüel & Kjær this investment is seen as essential because it allows the design parameters and physical properties of microphones to be based on a solid foundation of knowledge, skills and experience.

As a result of its pioneering nature, development work often enjoys a symbiotic relationship with standards organisations. New product developments contribute new standards to the research and development field, while Brüel & Kjær products benefit from a free-flow of information on the most current and industry-wide requirements for microphones. Improved standards and more advanced Brüel & Kjær products result.

Similarly, this collaborative approach to development includes work with universities and knowledge centres with benefits to both sides. A good example of this approach is the cooperation between Brüel & Kjær and the Technical University of Denmark to set up and run the Danish Primary Laboratory of Acoustics (DPLA).

At Brüel & Kjær the more theoretical aspects of microphone development involve both mathematical modelling and measurement techniques using an anechoic chamber with the most recent technology available. Research and development work also encompasses a number of areas that reflect the different aspects of microphone design and construction, in particular, where highly accurate measurements need to be performed. These include:

- acoustic measurements, such as pressure and free-field reciprocity calibration
- mechanical engineering, for example, when controlling small mechanical tolerances
- electrical engineering, such as frequency analysis and capacitance measurements
- environmental testing, such as measurement of resistance to humidity and temperature tests.

Development skills and knowledge are also applied in research into the optimum choice of materials and to devise effective forms of testing microphones before they go into full production. These tests include resistance to shock, vibration, temperature, humidity and in the case of preamplifiers, resistance to electromagnetic fields is also tested. Bump tests in which the microphone is subjected to repeated knocks



Fig.1.4 Anechoic chamber used for measurement of free-field response

simulate everyday use, while shock tests reproduce the possible effect of impacts received in transport (typically up to the equivalent of 1000 m/s^2). Additionally, microphones are tested for severe impacts by a drop test from a height of one metre onto a wooden block. The tested microphone must show less than 0.1 dB variation in sensitivity after the fall.

As temperature and humidity are both factors which pose the greatest threat to the performance of condenser microphones, pre-production microphones are thoroughly tested for resistance to these influences, typically in temperatures from -20° to $+70^\circ\text{C}$ and in humidity of up to 90% at 40°C . Finally, microphones are also tested for resistance to corrosion, as proven by the most recent range of condenser microphones which have been found to be very robust in harsh measurement environments.

It is these skills, knowledge and experience acquired over more than 50 years of development work, that allows the Brüel & Kjær to handle all the tasks necessary to develop new products, from first specification to final calibration.



Fig 1.5 Microphone undergoing shock tests

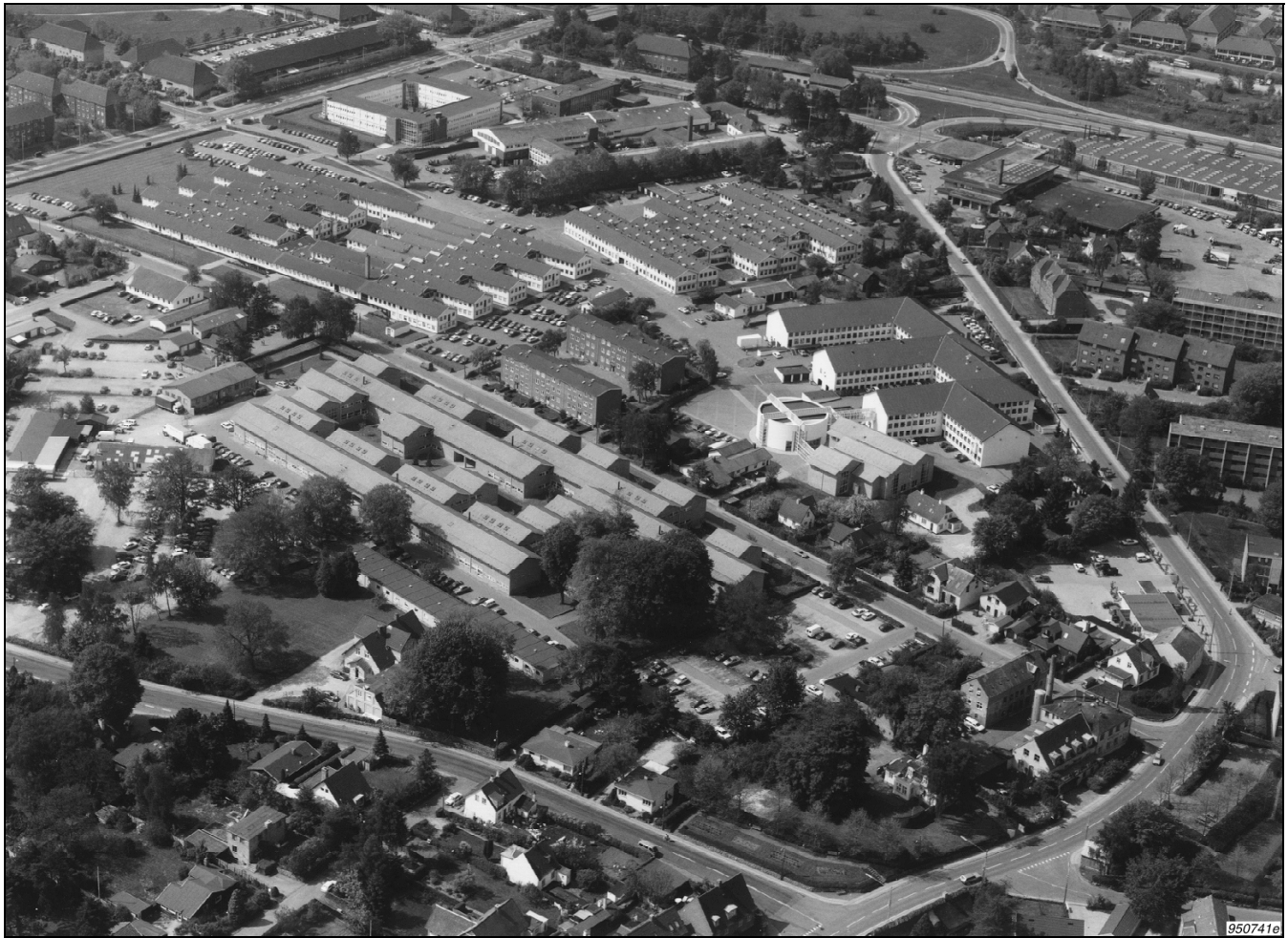

Fig. 1.6 Aerial Photo of the Brüel & Kjær Headquarters, Nærum, Denmark

1.3 Production of Microphones at Brüel & Kjær

Microphones are precision instruments and while the design of a conventional measurement microphone may appear to be quite simple, its production must be very precisely controlled to meet specified tolerances. Such tolerances impose great demands on the materials and construction methods used, yet the products created must be extremely reliable and robust. Many of the closely controlled production processes stem from this requirement. At Brüel & Kjær the emphasis is therefore on quality rather than mass-production. Some examples from the different stages of production illustrate this approach.

Two components which receive a lot of attention during production are the microphone diaphragm and backplate. During production the surfaces of these components are made extremely smooth as a very high electrical field strength must exist across the diaphragm to backplate gap. Any unevenness in the surfaces can lead to arcing. All surfaces must also be thoroughly clean to avoid contamination from dust and dirt that would accentuate the detrimental effect of humidity and in turn the performance of the microphone. A very precise and clean construction environment as well as rigorous quality control are therefore employed. This includes assembly in a clean-room environment where potentially harmful particles of dust in the air are kept to a minimum.



Fig. 1.7 Pre-polarized microphones nearing the end of production

Another critical area of production is the distance between the microphone diaphragm and backplate which must be constructed to very small mechanical tolerances. Typically this is set to 20μ , with a tolerance of 0.5μ . The required distance is monitored and then implemented precisely, once the correct tolerances have been adjusted. Similarly, the tension of the diaphragm is closely monitored and computer controlled.



Fig. 1.8 Diaphragm press in use during production

Forced ageing using temperature and humidity is employed to ensure stability. It does this in two ways. Temperature releases tension inherent in the materials after manufacture. This achieves the required diaphragm tension which will then remain highly stable. High temperature in combination with high humidity also stabilises the polarisation charge applied to pre-polarised microphones. The stability of the microphones is such that Brüel & Kjær can state an accuracy variation from the recorded values of just 0.1 dB over a period of 50 years for a typical $1/2''$ condenser measurement microphone.



Fig. 1.9 Microphone calibration, at the end of production, using an electrostatic actuator

All such measures play an important part in achieving the renowned reliability and accuracy of Brüel & Kjær microphones. This reliability is based on the known performance parameters of the microphone. These parameters are measured at the end of production using highly accurate calibration equipment. The results are recorded on individual calibration charts and data diskettes which are supplied with microphone products.

1.4 Product Support

Brüel & Kjær microphone products are supported by a wealth of information and services. In addition to this handbook, information about microphones is provided in technical journals, product data sheets and application notes. Training in different aspects of acoustics can be provided. Brüel & Kjær also offers a range of accredited calibration services for calibration of microphones and associated equipment.

Chapter 2

Microphone Theory

2.1 Sound Levels and Sound Fields

This chapter provides the background required to understand the properties, specifications and use of condenser measurement microphones. The main subjects are:

- the principle of operation
- the main design parameters
- how the design parameters influence the properties of microphones
- the principle of how microphones interact with different types of sound field
- the need for different microphones that are designed for free-field, pressure-field and diffuse-field measurements
- related subjects including microphone modelling, diaphragm impedance and electrostatic actuator calibration

2.1.1 Sound Field Parameters

Sound pressure has always been the sound field parameter of the greatest interest because sound pressure is what the human ear detects. Measurement microphones have therefore been widely used for analysis and recording of sound pressure. This still applies today, even though modern technology has made it possible for sound intensity and particle velocity measurements to be quite easily and commonly performed.

Sound pressure as well as particle velocity, sound intensity and their respective levels relative to defined references are thus the sound field parameters which are measured and stated in most measurement reports today. The levels are expressed in decibels (dB).

2.1.2 Sound Pressure and Pressure Level

The sound pressure at a certain point is the difference between the instantaneous pressure and the ambient mean pressure. The unit of Sound Pressure (p) is Pascal (Pa) which is equal to Newton per Square Meter (N/m^2). The reference value for Sound Pressure Level (SPL) is twenty micro-Pascal ($20\ \mu\text{Pa}$). The Sound Pressure Level (L_p) is defined by the formula below:

$$L_p = 10 \cdot \log \frac{p^2}{p_{ref}^2} = 20 \cdot \log \frac{p}{p_{ref}} \text{ dB} \quad \text{where } p_{ref} = 20\ \mu\text{Pa}$$

Sound Pressure and Sound Pressure Level generally refer to the Root Mean Square (RMS) value of the pressure. The RMS value is considered if no specific reference is stated. A pressure equal to the reference value is thus equal to zero dB while 1 Pa

equals 94 dB (93.98 dB). The zero dB value corresponds to the threshold of hearing at 1000 Hz for a young person with normal hearing ability. The pressure has no direction and is thus a scalar.

2.1.3 Particle Velocity and Particle Velocity Level

The Air Particle Velocity, or just Particle Velocity (v) is the velocity of a small volume of air (particle). The dimensions of the volume regarded should be very small in comparison with the wave-length. The unit of particle velocity is metres per second (m/s). The particle velocity depends on the sound pressure and on the sound field conditions. Today, the recommended (ISO1683) reference for Particle Velocity Level is one nano-metre per second (1 nm/s or 10^{-9} m/s). However, fifty nano-metres per second (50 nm/s) is also used, as this number was the commonly applied reference in the past. To prevent any misunderstanding, the reference value should therefore be stated together with velocity measurement results. The Particle Velocity Level (L_v) is defined by the formula below:

$$L_v = 10 \cdot \log \frac{v^2}{v_{ref}^2} = 20 \cdot \log \frac{v}{v_{ref}} \text{ dB} \quad \text{where } v_{ref} \text{ is 1 nm/s (alternatively 50 nm/s).}$$

Particle Velocity and Particle Velocity Level generally refer to the Root Mean Square (RMS) value of the velocity. This is considered if no reference is stated specifically. In the propagation direction of a plane progressive sound wave, the velocity level is practically 34 dB above the pressure level when the reference velocity is 1 nm/s, while it is approximately equal to the pressure level, if 50 nm/s is applied. This is valid for normal ambient conditions i.e. for a static pressure of 101.325 kPa, a temperature of 23°C and for 50% Relative Humidity.

2.1.4 Sound Intensity and Sound Intensity Level

Sound Intensity is acoustic power per unit of area. It is the power which flows through a certain area divided by the area. Like the particle velocity, the sound intensity is a function of the direction of the sound wave propagation. The intensity is therefore a vector. The unit of sound intensity is Watts per square-metre (W/m^2). The reference value for sound intensity is one pico-Watt per square-metre (10^{-12}W/m^2). The Sound Intensity Level is specified by the following formula:

$$L_I = 10 \cdot \log \frac{I}{I_{ref}} \text{ dB} \quad \text{where } I_{ref} = 10^{-12} \text{W/m}^2$$

In the propagation direction of a plane progressive sound wave, the sound intensity level is practically equal to the pressure level. This is valid for normal ambient conditions, i.e. for a static pressure of 101.325 kPa, a temperature of 23°C and for 50% Relative Humidity.

2.1.5 Pressure-field

A pressure-field is characterized by a sound pressure which has the same magnitude and phase at any position within the field. Microphone Pressure Sensitivity refers to this type of field.

Pressure fields may be found in enclosures or cavities which are small compared to the wave-length. Such fields occur in couplers applied for testing of earphones or calibration of microphones. They also occur in most types of sound level calibrator and in pistonphones.

The pressure-field conditions of small cylindrical couplers have been carefully analyzed because such couplers are specifically used for primary calibration of microphones by the reciprocity technique. This technique, which can be used to achieve very high calibration accuracy, is applied by most national calibration laboratories.

Microphone calibrations performed in small couplers are pressure-field calibrations, but under certain circumstances they may be applied for microphones which are to be used in other types of field. Pressure-field calibrations are widely applied, as well-defined pressure-fields are rather easily produced.

2.1.6 Free-field

A free sound field, or just a free-field may be created where sound waves can propagate freely i.e. in a continuous medium without any disturbing objects. In this document it is considered that a free-field is made up by a plane wave which propagates in one defined direction. Microphone Free-field Sensitivity refers to this type of field.

Ideal free-fields are difficult, if not impossible, to realise. However, in practice, free-fields which are applicable for instrument verification and calibration may be created either in anechoic rooms, or outdoors away from reflecting surfaces. A small sound source (point source) may create a satisfactory plane wave at the measurement position, provided that it is placed sufficiently far away.

The distance between the source and the measurement site should be at least five to ten times the largest dimension of the source and of the microphone or object which is to be placed in the field.

In practice, sound fields which can be regarded as being free-fields may be found at a distance of approximately one to two metres from a sound source. This is provided that no other sources contribute significantly to the sound pressure and that there are no reflecting surfaces nearby.

2.1.7 Diffuse-field

A diffuse sound field exists at a given location if the field is created by sound waves arriving more or less simultaneously from all directions with equal probability and level.

The diffuse-field or “Random Incidence” sensitivity of a microphone refers to this type of field, even if, in most cases, the sensitivity is calculated from measurements performed under free-field conditions. The calculation method is described in the international standard *Random-incidence and Diffuse-field calibration of Sound Level Meters* IEC 1183.

A diffuse sound field may be created within a room with hard sound reflecting walls and which essentially contains no sound absorbing materials.

Diffuse-field spectra created in such rooms may deviate from that of an ideal field due to resonances in the room and due the sound absorption of the air. In cases where diffuse-fields are to be used for technical purposes, the influence of these effects may be reduced by applying more than one sound source and by mounting reflecting panels which are moved continuously in order to vary the dominating room resonances.

Sound fields with a close resemblance to a diffuse-field may be found in environments such as factories where many simultaneous sound or noise sources exist or in buildings with hard walls, for example, in halls or churches.

2.2 Measurement Microphone Requirement

Today, there are many different areas of application for microphones, including telecommunications, broadcasting, recording of music, consumer electronics and acoustic measurements. For each field and application a certain set of microphone properties is required.

To meet the needs of a specific microphone application, the designer can choose between a number of different acoustic operation and transduction principles. A microphone may either sense the pressure, the pressure gradient or the particle velocity. These may then be converted to electrical signals in several different ways.

Practically all precision measurement microphones are pressure sensing condenser microphones that use a constant electrical charge for conversion of the diaphragm displacement into an analog electrical signal.

Pressure sensing condenser microphones are used because they detect what the human ear detects, namely pressure. Furthermore, they can be realized with the high quality and the predictable performance that is necessary for any type of measurement device.

Even if particle velocity or sound intensity are the parameters to be determined, pressure sensing microphones can be used. Sound intensity and velocity are worked out from pressures measured simultaneously at two points. These are typically spaced 6 to 50 mm from each other, depending on the frequency range of interest. The international standard *Instruments for Measurement of Sound Intensity* IEC1043 defines the requirements for pressure sensing microphones and specifies microphone and system requirements.

As with any other type of measurement, the sound pressure that is to be measured should not be influenced by the microphone applied or, if this is not possible, then it should be influenced in a controlled and known way that makes it possible to correct for the influence.

Measurement microphones influence the sound pressure, especially at higher frequencies, where the wave-length and microphone dimensions are of same order of magnitude. However, the influence, which depends on the type of sound field (pressure-field, free-field or diffuse-field) is thoroughly analysed for condenser measurement microphones. This is done by laboratory measurements and confirmed by calculations which are possible due to the simple cylindrical shapes of the condenser microphone.

The simple diaphragm system and the simple geometry of a condenser microphone ease accurate measurement, calculation and description of the microphone properties under various sound field and environmental conditions. These are very important features of microphones which are to be used for accurate measurements under the many different measurement conditions which may occur.

Corrections for the influence of the microphone on the sound field may be incorporated in the microphone design. Alternatively, it may be made by post-processing of the results.

A list of general measurement microphone requirements is given below:

- good acoustic and electric performance:
 - wide frequency range and flat frequency response
 - wide linear dynamic range, low inherent noise and low distortion
 - low influence on the sound field to be measured
- minor influence from environment:
 - low influence from ambient pressure, temperature and humidity
 - low influence from vibration, magnetic and electromagnetic fields, etc.
 - good mechanical robustness, good bump and shock resistance
 - good chemical resistance, good corrosion resistance
- high stability of sensitivity and frequency response
 - small short term fluctuation (random changes)

- small long term drift (systematic change)
- small high temperature drift (systematic change)
- high suitability for measurement and calculation of properties
 - suitable for calibration using practical and accurate methods
 - simple shapes and easy-to-describe dynamic system parameters
- comprehensive specifications and performance descriptions
 - availability of measured and calculated microphone type data
 - performance documentation by individual calibration chart
 - availability of service for periodic recalibration

The International Electrotechnical Commission (IEC) has worked out two standards which prescribe performance requirements for types of Laboratory Standard and Working Standard microphones respectively. These are IEC 1094-1 (Laboratory Standards) and IEC 1094-4 (Working Standards). The standards are available through national standard organisations.

2.3 Measurement Microphone Design

2.3.1 Introduction

The pressure-sensing microphone (as introduced in the previous section) can be designed for use in different types of sound field i.e. in a Pressure-field, Free-field and Diffuse-field. The influence of the different design parameters is discussed in this section. The classic design of a pressure-sensing measurement microphone is shown in [Fig.2.1](#).

The microphone shown in [Fig.2.1](#) is a $\frac{1}{2}$ " microphone (12.7 mm), but microphones of a similar design exist with housing diameters from $\frac{1}{8}$ " (3.16 mm) to about 1" (25.4 mm). A newer internal design, invented and patented by Brüel & Kjær, is also described. For both designs, the microphone properties, such as sensitivity, frequency response and inherent noise, depend mainly on the diameter and on the dynamic properties of the microphone diaphragm system. The Brüel & Kjær microphone program is composed of a number of microphone types with properties optimised for many different applications.

2.3.2 Design Description

A condenser microphone consists of a metal housing inside which an electrical insulator with a back-plate is mounted behind a delicate and highly tensioned diaphragm, see [Fig.2.2](#), (a). The flat front surface of the back-plate is positioned close to the front open section of the housing. The diaphragm rests across the housing in a way which makes the diaphragm parallel to the backplate. A controlled mechani-

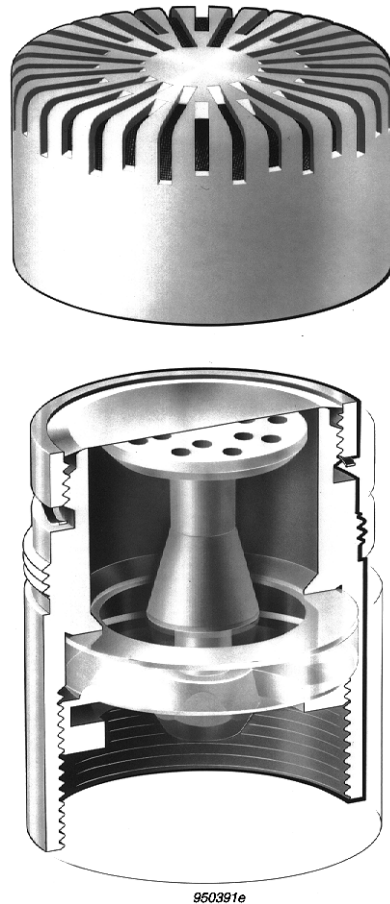

Fig. 2.1 Classic Design of a Condenser Measurement Microphone

cal tension in the foil gives the diaphragm the required mechanical stiffness. The distance between the backplate and the diaphragm is typically $20\ \mu\text{m}$ ($\pm 0.8\ \mu\text{m}$). The nominal distance may vary between microphone types from about 15 to $30\ \mu\text{m}$.

The thickness of the diaphragm may vary from about 1.5 to $8\ \mu\text{m}$ depending on the microphone type. The tolerance is typically less than 10% of the nominal thickness.

The diaphragm and the front of the back-plate form the plates of the active capacitor which generates the output signal of the condenser microphone (see below). This capacitance which is typically between 2 and $60\ \text{pF}$ ($10^{-12}\ \text{F}$), depends mainly on the diameter of the back-plate. The stray capacitance or the passive capacitance between the back-plate and the housing is kept as small as possible, as this makes an undesired load on the active capacitance. The back-plate is connected to the external contact which together with the housing make the concentric output terminals of the microphone. An alternative, microphone design is widely applied by Brüel & Kjær. This patented design employs an integrated backplate and insulator, see [Fig. 2.2](#). In contrast to the first mentioned conventional design of microphone

which is mainly assembled by screwing the parts together, the integrated back-plate and insulator version is assembled by pressing the parts into each other. This design also deviates from the conventional design by applying a backplate consisting of a metal thin-film placed directly on the surface of the insulator.

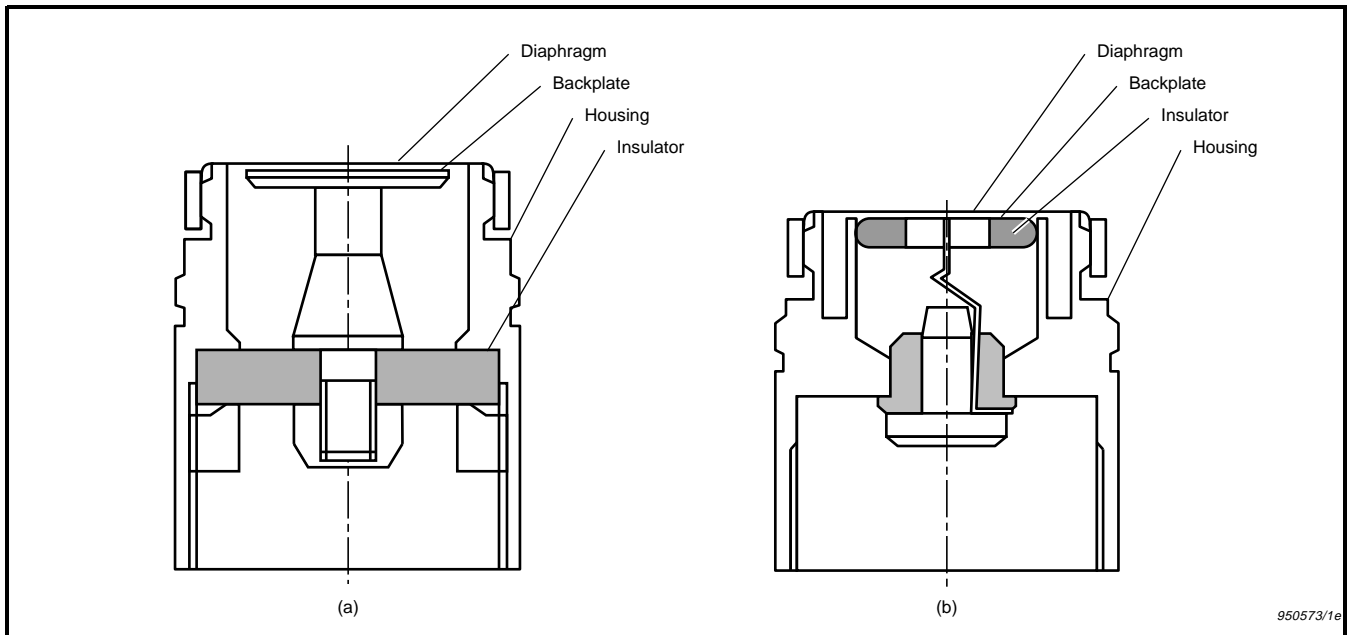

Fig. 2.2 Cross-Sectional view of microphone types. The classic type (left) is assembled by screwing the parts together. The new type (right) is assembled by pressing components together. The design is patented by Brüel & Kjær

In practice, the first mentioned type implies more freedom for the designer to optimise the frequency response, while the second is advantageous during production. The main choice which must be made in respect to the two different design types is one of more narrow frequency response tolerances offered by the conventional design, as opposed to reduced production costs for the alternative design.

2.3.3 Material and Process Requirements

A microphone which is to be used for measurements must be stable over time and its properties should preferably not vary with variations in ambient temperature, pressure and humidity. Therefore, carefully selected, high quality materials must be used, even if they are relatively difficult to machine.

The sensitivity of the microphone is inversely proportional to the diaphragm tension. The tension must therefore be kept stable. Normally it is a requirement that a measurement microphone has a broad frequency range and a high sensitivity. This creates a requirement for light-weight diaphragms with high internal tension and thus a very high loading of the diaphragm material. This is achieved by applying a tension of up to 600 N/mm^2 (which would break most materials) to the diaphragms

made from very fine-grained nickel foil or special stainless steel alloy. These different diaphragm materials are used for the traditional and for the newer Brüel & Kjær microphones, respectively. As a result, only slight and insignificant sagging occurs in the Brüel & Kjær diaphragm foils.

Carefully controlled heat treatments during the manufacturing process also contribute to the high stability of the microphones. For most types of microphone the systematic sensitivity change over time is thus predicted to be less than 1 dB in 500 years at room temperature. For information about the stability characteristics of microphones see also 2.6 and 3.11.

Diaphragm tension should also be unaffected by temperature changes. To ensure this the thermal expansion of the housing and the diaphragm foil should balance each other by being essentially equal. This puts strong ties on the selection of these materials. In particular, Monel (a high Nickel alloy) is the most frequently employed housing material as it matches the diaphragm materials and has a high resistance to corrosion.

The distance between the diaphragm and the back-plate is another critical parameter. In order to keep this distance constant within the operation temperature range, the thermal expansion of the back-plate must match that of the housing. Strong restrictions are thus also related to the choice of back-plate material.

The insulator must also be mechanically stable and its electrical leakage resistance should be as high as $10^{17} \Omega$ at normal ambient conditions. In order to match these requirements, the insulator is normally made of either sapphire, ruby or monocrystalline quartz. All insulators are machined to a high degree of flatness across the two plane surfaces (typically to within $0.5 \mu\text{m}$). All surfaces are also highly polished to achieve the high electrical resistance that characterises Brüel & Kjær microphones. Finally, a thin and invisible layer of silicone is applied to the insulator by a high temperature process. This ensures proper operation in tropical and other hot and humid environments.

Further requirements are imposed on the microphone design and construction by the polarization voltage that is applied across the diaphragm to backplate gap. As the distance across the gap is $20 \mu\text{m}$ and the voltage is typically 200 V, the field strength becomes 10 kV/mm. This exceeds the normally considered break-down field strength for air by a factor of 3 to 4. However, the microphone operates because the distance between electrodes is small enough to prevent the normally occurring electric ion multiplication from reaching a significant level. The ion multiplication that does occur does not escalate and lead to any significant discharge or detectable noise.

Due to the high field strength, the diaphragm and the back-plate must have flat, high quality surfaces which are clean and free from particles. This is necessary to avoid noise due to arcing within the gap. Therefore, special grinding, polishing, cleaning and test procedures are applied to the key components. Assembly is performed in a clean-room environment.

From this brief description of microphone construction, it can be seen that although the design of the condenser microphone may appear to be very simple, the materials that must be used, the mechanical tolerances and the required properties make production of high quality microphones a task which requires significant knowledge and experience.

2.3.4 Transduction Principles

The condenser microphone cartridge converts sound pressure to capacitance variations. These variations in capacitance may be converted to an electrical voltage in two ways. The most simple conversion method makes use of a constant electrical charge, which is either permanently built into the microphone cartridge or applied to it via the preamplifier. Today this method is used for practically all sound measurements.

However, it should be mentioned that the capacitance variations may also be converted to voltage by using high-frequency circuits. High frequency conversion may imply frequency or phase modulation and may use various types of bridge couplings. In principle, such methods may work to very low frequencies (even to DC) and may therefore be used for infra sound measurements. However, in practice the use of the methods is rare due to their complexity, lack of stability and the relatively high inherent noise levels that these methods imply.

Only the constant charge principle will be discussed in the following.

External Polarization Source

The constant charge of the capacitance between the diaphragm and the backplate may be applied, either from an external voltage source as employed for externally polarized microphones or from a permanently charged polymer known as electret, as employed for prepolarized condenser microphones. Today, the newer pre-polarization principle is widely used, especially for microphones used with hand-held instruments, such as sound level meters.

The transduction principle of a condenser microphone using external polarization is illustrated in [Fig.2.3](#). The capacitor of a condenser microphone is formed by two plates: the diaphragm and the back-plate. These plates are polarized by an external voltage source which supplies a charge via a resistor. The resistance of this must be so high that it ensures an essentially constant charge on the microphone, even when its capacitance changes due to the sound pressure on its diaphragm. The charge must be constant, even at the lowest operational frequencies. The value of the resistor is typically in the range 10^9 to $10^{10}\Omega$ or 1 to 10 G Ω . One of the plates (the diaphragm) may be displaced by the sound pressure while the other plate (the back-plate) is stationary. Movements lead to distance and capacitance changes and to a corresponding AC-voltage across the plates. The AC voltage produced is separated from the polarization voltage by a capacitor contained in the preamplifier. The instantaneous value of the output voltage may be derived from the formula below:

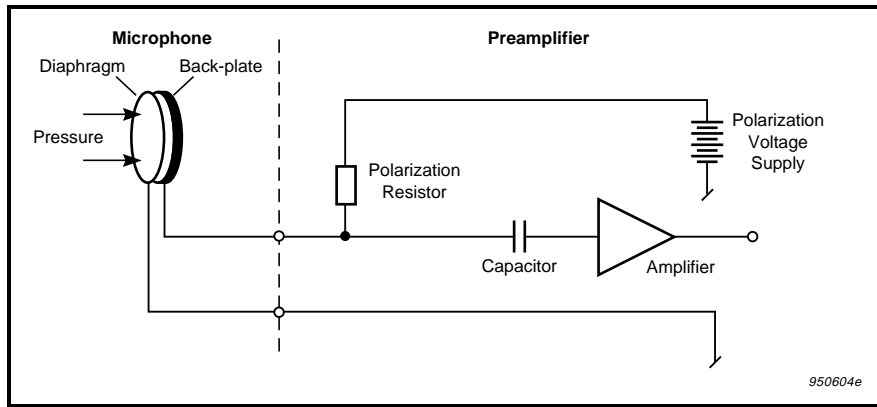

Fig.2.3 Capacitive Transduction Principle. The constant electrical charge used for polarization is supplied from an external source

$$E \cdot C = Q_0 \quad (E_0 + e) \cdot \frac{\epsilon \cdot A}{D_0 + d} = E_0 \cdot \frac{\epsilon \cdot A}{D_0} \quad e = E_0 \cdot \frac{d}{D_0}$$

where:

- A = Area of capacitor plate
- C = Instantaneous capacitance between plates
- D_0 = Distance between plates at rest position
- d = Displacement of moveable plate (diaphragm) from rest position
- E = Instantaneous voltage between plates
- E_0 = Polarization voltage
- e = Voltage change caused by plate displacement
- Q_0 = Constant charge on plate capacitor
- ϵ = Dielectric constant of air

Note that the output voltage of the system is proportional to the displacement of the moveable plate. This is also the case for large displacements. In other words, there is a linear relationship between output voltage and displacement, even if the corresponding capacitance changes are non-linear.

The change in distance is negative for a positive pressure. Therefore, for a positive polarization voltage which is most commonly used, the phase of the output voltage is opposite to that of the sound pressure. A positive pressure creates a negative output voltage and vice versa.

Electret Polarization

Prepolarized microphones contain an electret. The electret consists of a specially selected and stabilised, high temperature polymer material which is applied to the top of the backplate, see Fig.2.4. The electret contains trapped or “frozen” electrical charges which produce the necessary electrical field in the air gap. The frozen charge remains inside the electret and stays stable for thousands of years.

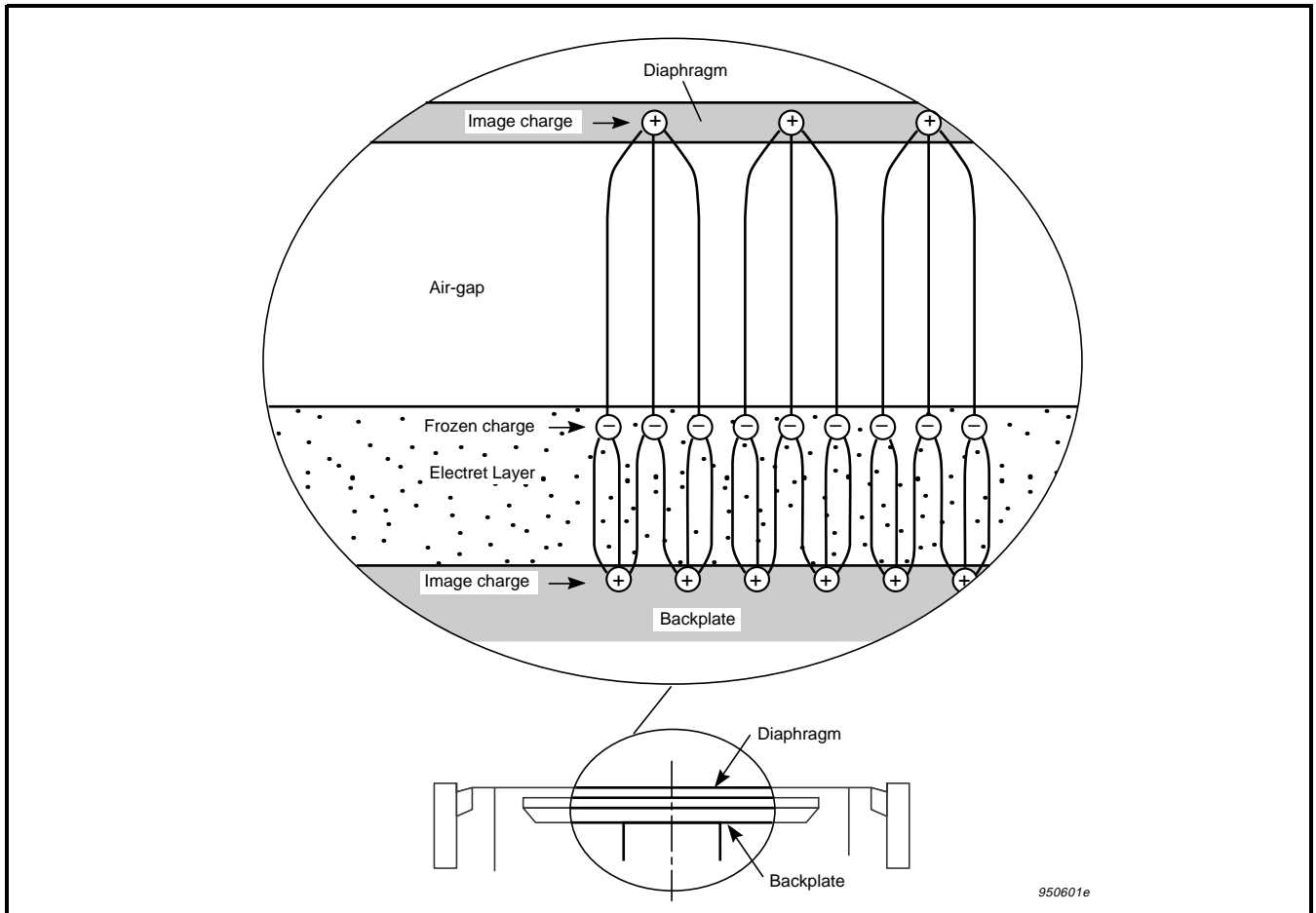

Fig.2.4 Electret polarization. The electret consists of a polymer which contains a permanent or 'frozen' electrical charge. This and an image charge create the necessary field between the diaphragm and the back-plate

The frozen charge is located near to the surface of the polymer which faces the air gap behind the diaphragm. The frozen charge attracts an equally large image charge of opposite polarity which is moveable. A certain fraction of this lies on the conducting part of the backplate, while the other part is on the inner surface of the diaphragm. The relative distribution between the positions is determined by the ratio between the capacitance of the electret and the capacitance of the air gap.

Thus, two electrical fields are produced in the microphone. One across the air gap and one across the electret. These fields must stay essentially constant during the microphone operation which means that any resistance loading on the microphone must be so high that the voltages produced by the microphone do not lead to any significant interchange of charges.

The microphone sensitivity is a function of the field strength in the air gap. This also applies to external polarization, see the formula above. Typically, the field strength and equivalent polarization voltage correspond to those used for microphones with external polarization, namely 200 V. The main microphone specifications do not depend on the polarization principle applied.

There are some minor exceptions. For design reasons, all prepolarized microphones made by Brüel & Kjær have a negative charge applied to the electret (the virtual backplate), while the Brüel & Kjær power supplies apply positive charges for externally polarized microphones. Therefore, the phase responses of these two types of microphone differ by 180 degrees. Positive pressure leads to positive voltage for the prepolarized microphones, while it becomes negative when external polarization is used.

The electret acts as a series capacitor for the active air gap capacitance. This explains why a prepolarized microphone has a capacitance which is typically 20–25 % lower than that of a corresponding microphone with external polarization.

Prepolarized microphones, which are generally more complex than ordinary condenser microphones are mainly intended for use with battery operated and hand-held instruments. Because this type of microphone does not require a polarization voltage it is often selected by instrument designers who can save space and power and make their preamplifiers simpler.

Either of the two types may be selected if it fits with the instruments available. However, the polarization voltage switch (if any) must be set correctly. For normal microphone types it should be set to the specified voltage (in most cases 200 V) and for the prepolarized types to “0 V”. This will place the output terminal of the microphone on ground potential.

Those who make their own preamplifiers and power supplies for Prepolarized Microphones should also be aware of this fact and connect a resistor of 1 to 10 G Ω across the microphone terminals. This will eliminate the possibility of any unwanted charge which might otherwise lead to an erroneous sensitivity.

If a prepolarized microphone is accidentally connected to an external polarization voltage source of +200 V no permanent harm is caused to the microphone. However, while the voltage is applied the sensitivity of the microphone will differ significantly (typically by –10 dB to –40 dB or even more) from its nominal value. In addition, the frequency response relative to the reference frequency might change by typically plus one decibel in the frequency range around half the diaphragm resonance frequency.

To ensure accurate calibrations and measurements after lengthy exposure to an external voltage (+ 200 V), the microphone should be stored with zero volts between its terminals for at least 24 hours. This will minimize the risk of errors due to intermittent charge displacements and shifts in sensitivity which might otherwise be up to a tenth of a decibel

Brüel & Kjær introduced prepolarized measurement microphones in the late seventies and showed by experiments and by extrapolation of measurement results, that such microphones could be made very stable and that they could meet all the requirements set for most applications.

Electret microphones intended for consumer applications were well-known at that time. They used polymer foil diaphragms. The polymer foil served as both a diaphragm and as an electret. Brüel & Kjær found that this solution would not work for a high quality measurement microphone and decided to separate the two functions of the foil in the new Brüel & Kjær design. Thus, the electret was placed on the top of the back-plate. In this way the electret material could then be selected for optimal charge stability, while the highly stable metal diaphragm, used for the existing microphones, could be maintained.

Information about the stability characteristics of Brüel & Kjær Prepolarized Microphones may be found in Section 3.11 of this handbook.

2.3.5 Diaphragm and Air Stiffness

The microphone sensitivity is inversely proportional to the stiffness of the diaphragm system which, therefore, must be carefully controlled. The dominating part of the stiffness is due to the mechanical tension of the diaphragm which is stretched like the skin of a drum. The higher the tension, the higher the stiffness and the lower the microphone sensitivity.

A pressure sensing microphone has an internal air-filled cavity which is generally formed by the housing, the insulator and by the diaphragm. Ideally, there is no sound pressure in this cavity, therefore, an external pressure will displace the diaphragm and produce an electric output signal. However, due to the diaphragm displacement, a minor sound pressure is, in practice, produced in the cavity. This pressure reacts against the external pressure and reduces the diaphragm displacement by typically 10%. This effect may be expressed in term of air-stiffness by stating that this makes 10% of the total stiffness of the diaphragm system.

The cavity stiffness depends partly on cavity volume and partly on static pressure. Therefore, the total stiffness and the sensitivity of the microphone become a function of static pressure. To minimise the influence of static pressure on the sensitivity of the microphone, the stiffness of the cavity must be small compared to that of the diaphragm, as defined by the following formula. A microphone with a low diaphragm stiffness requires a larger cavity volume than one with a high diaphragm stiffness.

$$S(P_s) = S(P_{s,ref}) \cdot \frac{100}{(100 - F) + \frac{P_s}{P_{s,ref}} \cdot F}$$

where:

$S(P_s)$ = microphone sensitivity (a function of static pressure)

P_s = static pressure

$P_{s,ref}$ = the reference static pressure at which 'F' is valid

F = fraction of air stiffness in percent at reference static pressure (ratio between air stiffness and total diaphragm system stiffness)

2.3.6 Static Pressure Equalization

The static pressure may vary within hours or change with the measurement site (height above sea level). The pressure variations may easily be 10^8 to 10^9 times greater than the lowest sound pressures which are to be measured. To eliminate the influence of such pressure variations, the microphone is equipped with a static pressure equalisation vent. The vent, which is a narrow air channel ensures that the static pressure of the internal cavity follows the pressure of the environment. If no vent were present, the static pressure changes might create large and disturbing signals (over-loads of amplifiers) and might significantly displace the diaphragm from its proper working position. This would result in a malfunction or significant sensitivity changes. The tiny vent channel from the internal cavity leads either to the side or to the rear of the microphone which is named accordingly, "side-vented" or "rear-vented", see [Fig.2.5](#). For certain specific applications it is important to select the appropriate type, see [Section 2.3.7](#) and [Chapter 5](#).

The vent has to be very carefully controlled to equalise the static pressure variations without suppressing low frequency components of the acoustic pressure which are to be measured. As the nature of these pressure variations is the same, this may not always be avoided.

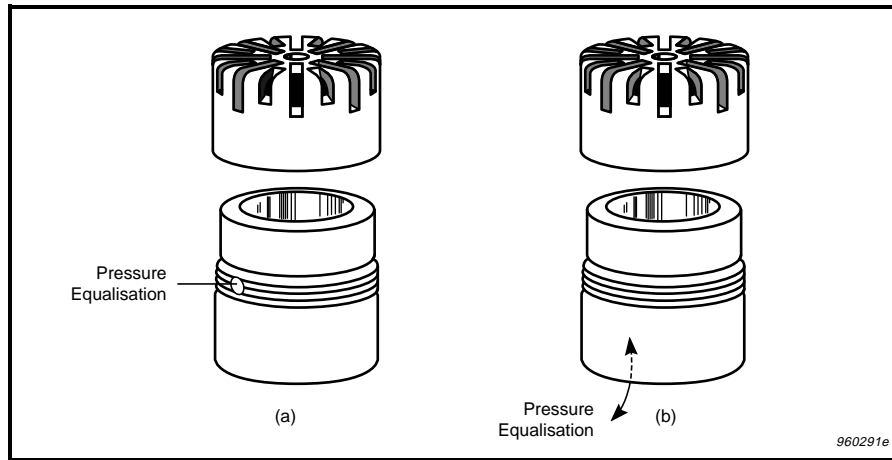

Fig.2.5 Side and Rear Vented Microphones

2.3.7 Low Frequency Response and Vent Position

The time constant of the microphone's pressure equalisation system is typically 0.1s. This is a good practical compromise, as the equalisation is generally fast enough to eliminate any disturbance from changing static pressure. It also gives the microphone a flat magnitude response down to less than 5 Hz, which is sufficient for most applications.

Below 10Hz the frequency response of the microphone is greatly influenced by the pressure equalisation time constant and by the position of the external vent opening. The vent opening might either be exposed to, or be outside the sound field, see Fig.2.6. The response is very different in the two cases.

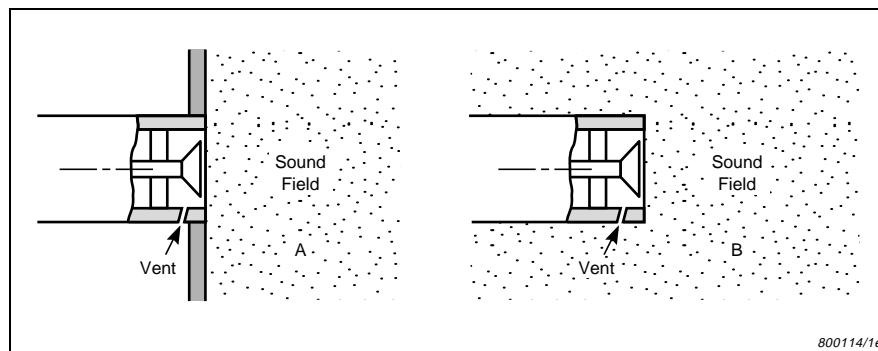

Fig.2.6 Pressure Equalisation Vent positioned inside (B) and outside (A) the sound field. The different situations lead to different microphone responses at low frequencies

Under general field measurement conditions the vent is exposed to the sound field. When this is the case the vent will tend to equalise the sound pressure at low frequencies. This reduces the pressure difference between the front and the rear of the diaphragm and leads to a smaller diaphragm displacement and a lower microphone sensitivity. The lower the frequency the more significant the effect becomes. The sensitivity will continue to fall with frequency. At very low frequencies the slope reaches a maximum of 20 dB per decade, see Fig.2.7, lower curve.

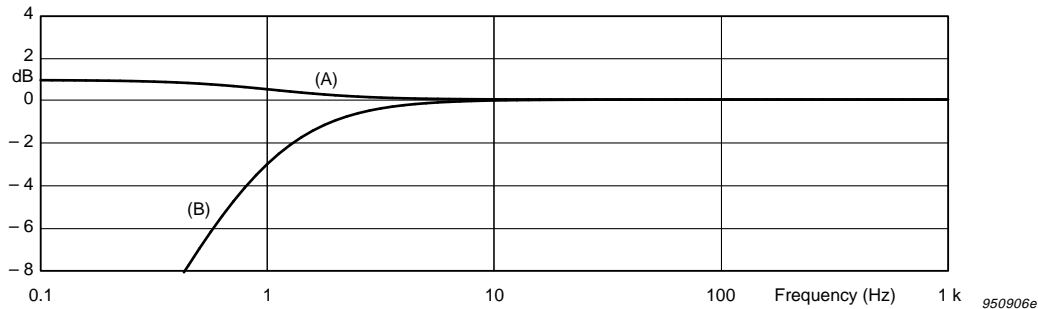
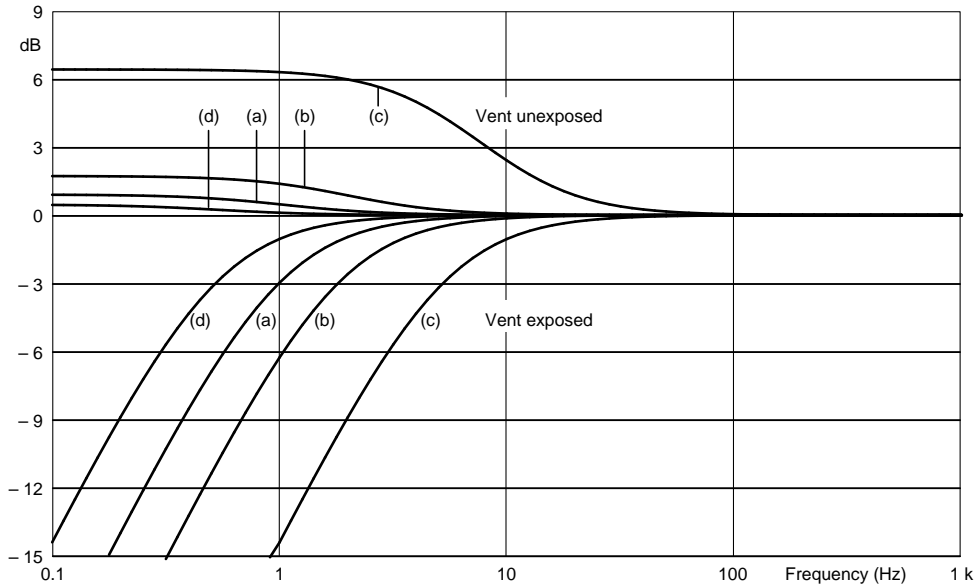

Fig. 2.7 Low frequency response valid for situations where the static pressure equalisation vent is inside (B) and outside (A) the sound field

The frequency at which the response is down by 3 dB is called the Lower Limiting Frequency of the microphone. At Brüel & Kjær, 250 Hz is normally used as the Reference Frequency as this frequency lies well within the flattest and most well-defined part of the frequency response characteristic.

In some measurement circumstances, only the microphone diaphragm is exposed to the sound field. This is often the case when the microphone is used for measurements in small enclosures such as various types of acoustic couplers. When this is the case, the response does not fall with decreasing frequency. In fact, it increases with falling frequency because the fraction of stiffness which is due to the reactive pressure in the internal cavity, becomes smaller as this is equalised through the vent, see Fig.2.7. The low frequency sensitivity increase is smaller for microphones having a low fraction of air-stiffness.

The lower limiting frequency is a function of static pressure, as this determines the compliance of the internal cavity. Generally, this effect can be ignored, but under specific circumstances the response may change significantly. This may be the case in pressurised tanks, diving bells and inside some aircraft. Examples of calculated magnitude and phase responses are given in Fig.2.8 for an ambient pressure of 0.5, 1.0, 2.0 and 10 bar and for a microphone with 10% air stiffness. Note that the calculation of the curves did not account for the heat conduction effect of the cavity walls. The curves are therefore not exact, but still provide a good illustration of the influence of air pressure on the low frequency response.



950908e

Fig.2.8 *The magnitude of the low frequency microphone response is influenced by the ambient pressure. The responses shown are calculated and are all normalized at 250Hz. They are valid for a microphone which has 10% air-stiffness at nominal ambient pressure (101.3kPa): a) 1 bar, b) 2 bar, c) 10 bar, d) 0.5 bar*

The low frequency phase response will also change with the static pressure. Phase response changes may be more severe than magnitude changes, especially in connection with particle velocity and intensity measurements.

Closely phase-matched pairs of microphone are used for such measurements. The microphones of a pair are selected to be essentially equal and to change equally with pressure. Their lower limiting frequencies should be the same. This also applies to the fraction of their air stiffness. [Fig.2.9](#) shows the phase characteristics which correspond to the magnitude responses of [Fig.2.8](#).

For general purpose types of measurement microphone, the lower limiting frequency is between 1 Hz and 2 Hz, but other types with longer time constants are available for measurements at lower frequencies. Microphones with higher cut-off frequencies are also available. They may reduce possible disturbance from infra-sound while doing low level sound measurements in other parts of the frequency range.

The magnitude and phase response curves which are shown on the above graphs are calculated using a model shown in [Section 2.3.10](#).

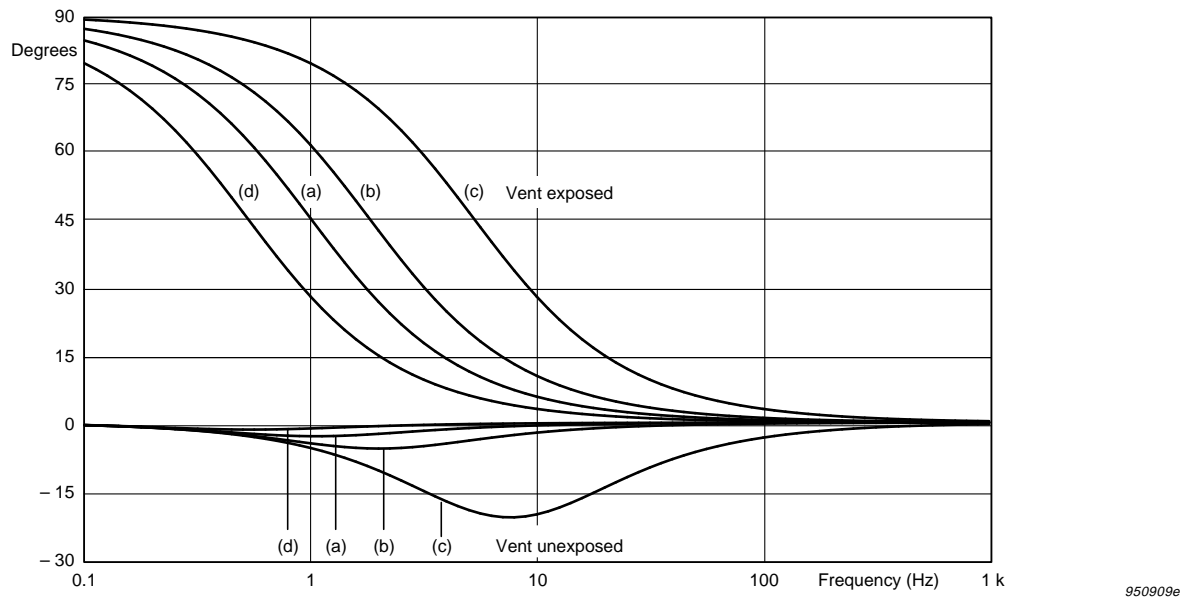

Fig. 2.9 The phase of the low frequency microphone response is influenced by the ambient pressure. The calculated responses shown are valid for a microphone which has 10% air-stiffness at nominal ambient pressure (101.3 kPa): a) 1 bar; b) 2 bar; c) 10 bar; d) 0.5 bar

2.3.8 High Frequency Response

Sound pressure measurements are made at both very low and very high levels of sound pressure, as well as at both very low and very high frequencies. Measurements are also made in different types of sound field, preferably without disturbing the fields.

However, it is not possible to design one single microphone which can fulfil all needs. Several types of microphone must be designed to cover the many different applications.

Some main design parameters are the stiffness and mass of the diaphragm system. These two parameters determine the diaphragm resonance frequency which sets the upper limit of the microphones frequency range. The fact that the microphone sensitivity is also a function of the stiffness, makes the stiffness an especially important design parameter.

The stiffness is mainly due to mechanical tension in the diaphragm which is permanently stretched like the skin on a drum. The mass is partly composed of the diaphragm mass itself and partly by the mass of the air in the narrow slit behind the diaphragm. Even if the physical air mass is low in comparison with the diaphragm mass it is important as the air moves with a much higher velocity than the diaphragm. The energy required to accelerate the air mass is therefore of the same order of magnitude as that required by the diaphragm mass. The effective mass of

the diaphragm system is thus significantly greater than that of the diaphragm itself. Typically, the air-mass makes between 10 and 50% of the total system mass.

As the air mass varies with ambient pressure, it changes the frequency response at high frequencies. A microphone with a large fraction of diaphragm mass should be selected for applications where large pressure variations occur, for example, in diving tanks, as the frequency response of such microphones changes less with ambient pressure than that of other microphones.

Other major design parameters are the diaphragm diameter and the diaphragm damping resistance. For condenser microphones, in contradiction to many other types of transducer, an optimal diaphragm damping may be obtained and maintained over time. Therefore, such types of microphone may be used in the frequency range around and even above the diaphragm resonance frequency.

The damping is caused by the movement of air in the slit between the diaphragm and the back-plate. Diaphragm movements lead to air movements in the slit which cause viscous loss. The damping resistance may be controlled by holes in the back-plate. By changing the number and size of holes and by varying the back-plate's distance to the diaphragm, various degrees of damping may be obtained.

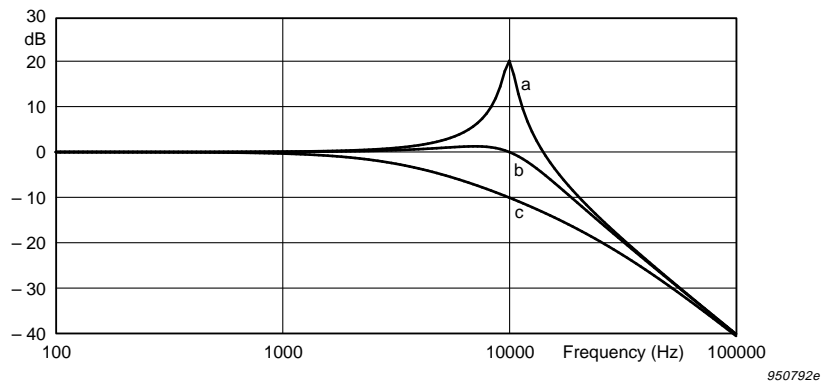

Fig.2.10 Influence of damping on the high frequency microphone response (magnitude). The damping is due to movement of the air in the slit between the diaphragm and back-plate. The damping depends on the microphone design. Examples of a low (a), critical (b) and a high (c) damping are shown

The influence of damping is illustrated by the curves shown in Fig.2.10. In relation to these, the resonance frequency was kept constant at 10 kHz, which is the typical resonance frequency for 1" and for high-sensitivity (50 mV/Pa or -26 dB re 1 V per Pa) 1/2" microphones. The illustrated degrees of damping may all be obtained in practice and they are utilized in microphones designed for different purposes.

The critical damping (b, quality factor = 1) is used for pressure (pressure-field) microphones while the high damping (c, quality factor = 0.316) is used for free-field microphones, see 2.5.3 and 2.5.4. Low damping corresponding to the upper curve* on Fig.2.10 (a, quality factor = 10) is used by Brüel & Kjær for a microphone with extremely low inherent noise. Microphones dedicated to the various types of sound field are discussed later in this chapter.

The influence of the diaphragm diameter on the sensitivity and on the frequency response is illustrated by Fig.2.11. For the calculation of these curves, the diaphragm tension, thickness and quality factor ($Q = 1$) were assumed to be constant. The applied parameters correspond to those of typical one 1", 1/2" and 1/4" microphones. The results show that the flat frequency range is extended upwards when the diaphragm diameter becomes smaller. The upper operation frequency is inversely proportional to the diameter while the sensitivity is proportional to the square of the diameter. Real microphone specifications confirm this.

Microphone types of equal diameter may have a different sensitivity and frequency range. In practice, this is especially the case for 1/2" microphones. The main physical difference between the existing high-sensitivity (50 mV/Pa) and low-sensitivity (12.5 mV/Pa) types is the tension in their diaphragms which the designer may select within certain limits.

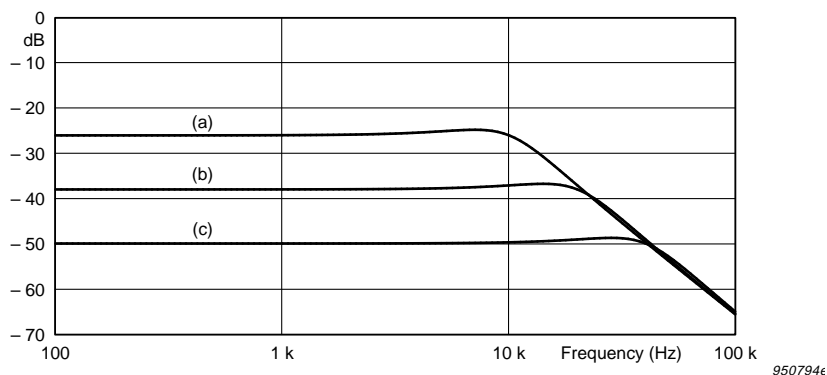

Fig.2.11 Magnitude of frequency responses (pressure). The curves are valid for models of microphone with critical damping and different diaphragm diameters (relative scale: 1 (a), 0.5 (b), 0.25 (c)). The numbers chosen for the calculation approximate the parameters of existing 1", 1/2" and 1/4" microphones

The two upper curves of Fig.2.11 also illustrate typical sensitivities and frequency responses which are obtainable for 1/2" microphones by using different diaphragm

*The peak on the frequency response of the low noise microphone is equalized by an electrical network.

tensions. The phase characteristics which correspond to the above magnitude characteristics are shown in Fig.2.12.

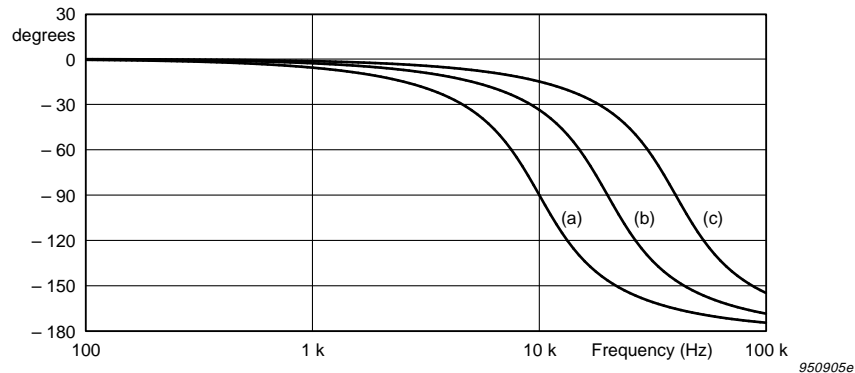

Fig.2.12 Phase of frequency responses (pressure). The curves are valid for models of microphone with critical damping and different diaphragm diameters (relative scale: 1 (a), 0.5 (b), 0.25 (c)). The numbers chosen for the calculation approximate the parameters of existing 1", 1/2" and 1/4" microphones

The above curves were worked out by using a simple mathematical model. The parameters of the model correspond to those valid for a series of 1" 1/2" and 1/4" microphones which make a part of the Brüel & Kjær program. The sensitivities and frequency ranges therefore correspond to those valid for some real microphone types.

The simple models discussed have been chosen to illustrate the influence of the main parameters which determine the microphone response. Other, less important, parameters should be taken into account to relate the models to microphones of the real world. In particular, 1/4" microphones generally cover a wider frequency range than estimated from the simple models. This is because a resonance between the diaphragm mass and the compliance of the air in the slit behind the diaphragm may increase the response at higher frequencies and extend the frequency range of these microphones.

In principle, any microphone could be improved with respect to frequency range if the diaphragm mass could be reduced. A lower mass would increase the resonance frequency and thus also the highest operation frequency. However, this would mean that a thinner diaphragm foil should be used, and that the tension in the diaphragm material itself would be increased accordingly. This might lead to sagging and instability in the diaphragm. Therefore, very strong diaphragm materials are needed when good acoustic performance and good long term stability are required, as is the case for measurement microphones.

The above explanation shows that the microphone size, the sensitivity and the frequency range are tied together and cannot be selected separately. Very often, the user must make a compromise when selecting a microphone. Generally, small microphones work to higher frequencies and create less disturbance in the sound field, but they also have lower sensitivity and higher inherent noise and thus may not be usable at the lowest sound levels of interest.

2.3.9 Microphone Sensitivity

The sensitivity of a measurement microphone may either be expressed in Volts per Pascal (V/Pa) or in decibels referring to one Volt per Pascal (dB re 1 V/Pa). The term “sensitivity”, generally means the sensitivity at the Reference Frequency, which is most often 250 Hz, but in some cases this may be 1000 Hz. The magnitude of the frequency response characteristic represents the ratio between the sensitivity at a given frequency and that of the Reference Frequency. This ratio is generally expressed in dB.

The sensitivity of a microphone depends on the type of sound field. Sensitivity is therefore generally referred to in terms of Free-field, Diffuse-field or Pressure-field sensitivity, see 2.1.5 to 2.1.7 and 2.5. However, at the reference frequency, the sensitivity is essentially equal for all types of sound field.

It should be noted that *pressure-field sensitivity* refers to the pressure at the diaphragm only (by definition). The *free-field sensitivity* and *diffuse-field sensitivity* are defined for pressure applied at both the diaphragm and pressure equalisation vent.

Condenser measurement microphone types generally have a sensitivity between 1mV and 100mV per Pascal. When designing and selecting a microphone for a certain application the expected sound pressure level and microphone output voltage must be taken into account. A microphone with proper sensitivity should be selected. The sensitivity should not be so high that the microphone output signal overloads the preamplifier and it should not be so low that it is exceeded by the inherent noise of the succeeding amplifiers.

In general, the sensitivity may be used for ranking microphones with respect to their ability to measure low and high sound pressure levels. The higher the sensitivity, the lower the sound pressure levels that may be measured and conversely, the lower the sensitivity, the higher the sound pressure levels that may be measured.

The sensitivity is thus not only linked to the applicable frequency range as previously discussed. It is also linked to the dynamic range. The microphone designer must work with this fact and compose a programme of microphone types which meets the needs of the user.

Analysis of microphone system limitations at low levels shows that inherent noise of the microphone itself must also be taken into account. This will be discussed in connection with inherent noise of microphone systems.

2.3.10 Microphone Modelling by Equivalent Electric Circuits

Analysis of electric circuits has been a well-known and widely applied discipline for many years. Today, very effective computer programs have become available for the purpose. This makes the technique very interesting for both microphone designers and for designers of acoustic systems that include microphones.

To use these tools in designing microphones, a model must be made by converting acoustic circuit elements to equivalent electric circuit components and by connecting these in series and parallel corresponding to the acoustic circuit. There are two main analogies, the impedance and the admittance analogies. The impedance analogy is the generally applied analogy for modelling microphone circuits.

An acoustic compliance which corresponds to reciprocal stiffness is converted to an electric capacitance. The acoustic mass corresponds to an electric inductance and acoustic damping is represented by an electric resistance. In such a model, pressure corresponds to voltage, acoustic volume velocity to electric current and acoustic displacement to electrical charge.

Combined acoustic, mechanical and electric constructions, like the condenser microphone, may be modelled by simply connecting the acoustic and electric elements properly under the condition that all elements are given in equivalent units. See the table below.

Acoustic Parameter	Unit	Equivalent Electric Parameter	Unit
Sound Pressure	Pa = N/m ²	Voltage	V
Compliance	m ³ /Pa = m ⁵ /N	Capacitance	F
Stiffness	Pa/m ³ = N/m ⁵	1/Capacitance	F ⁻¹
Mass	kg/m ⁴ = Ns ² /m ⁵	Inductance	H
Acoustic Resistance	Pas/m ³ = Ns/m ⁵	Resistance	Ω
Volume Velocity	m ³ /s	Current	A
Volume Displacement	m ³	Charge	As

Table 2.1 Acoustic and Equivalent Electric Parameters used for modelling of condenser microphones

Microphone designers may use very complex models which take many design details into account and allow calculation of their influence on the response. For users or designers of acoustic systems that include microphones, simpler models are generally sufficient. Models which describe the acoustic diaphragm impedance as a function of frequency are frequently applied for determining the influence of the microphone on the sound pressure of narrow channels or closed cavities, such as couplers used for calibration of microphones or earphones.

The equivalent electric circuit shown in Fig. 2.13 and the indicated component values explained in Table 2.2, form a model of a microphone. The example shown corresponds to a microphone with a diaphragm system resonance of 10 kHz which is critically damped (Quality factor, $Q = 1$) like the diaphragm of a pressure (pressure-field) microphone.

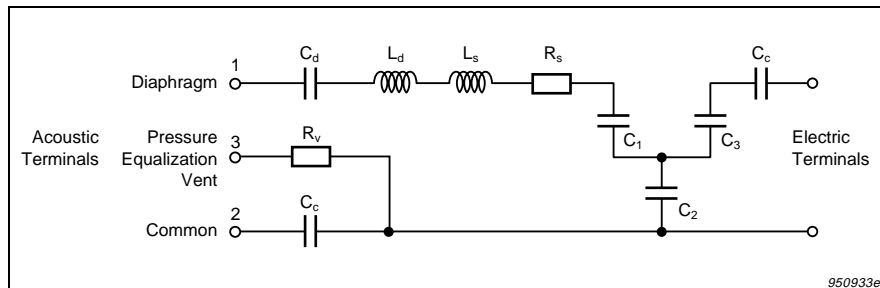

Fig. 2.13 Microphone model. The components of the equivalent electrical circuit represent stiffnesses, masses and damping of the electro-mechanical system. The response of the model depends on the exposure to sound pressure of the static pressure equalization vent (exposed: (3) connected to (1); unexposed: (3) to (2))

Such a model may be used for calculation of the sensitivity and the frequency response (magnitude and phase) which may be found with and without sound pressure at the static pressure equalisation vent. It may also be used to determine the complex acoustic diaphragm impedance as well as the electrical impedance. In addition, the inherent electric noise of the microphone may be calculated as this may be referred to the noise of the resistance elements (also known as Nyquist and Johnson Noise).

This type of model is commonly used for calculation of the response of the microphone, as previously described in this section. The model is also used for describing other microphone properties. This is discussed in the following sections.

Symbol	Model Element	Value	Unit
C_d	Diaphragm Compliance	0.314×10^{-12}	m^5/N
L_d	Diaphragm Mass	600	kg/m^4
L_s	Acoustic Mass of slit behind diaphragm	296	kg/m^4
R_s	Acoustic Resistance of slit behind diaphragm	56.2×10^6	Ns/m^5
C_c	Acoustic Compliance of internal cavity	2.83×10^{-12}	m^5/N
R_v	Acoustic Resistance of pressure equalisation vent	36×10^9	Ns/m^5
C_1	Acoustic Coupling Compliance	5.66×10^{-12}	m^5/N
C_2	Coupling Compliance/Capacitance	-5.66×10^{-12}	m^5/N or F
C_3	Electrical Coupling Capacitance	5.66×10^{-12}	F
C_e	Electrical Capacitance (when diaphragm is blocked)	17×10^{-12}	F

Table 2.2 Values of the microphone model elements which are shown in Fig.2.13. The model corresponds to a microphone (50 mV/Pa) having a critically damped diaphragm with resonance at 10 kHz

2.3.11 Acoustic Impedance of Diaphragm System

In cases where microphones are used in small cavities and narrow channels, it may be necessary to evaluate and correct for the influence of the microphone on the acoustic system.

This is usually done by using a model which is even simpler than that shown above in Fig.2.13. The very simple model shown in Fig.2.14 may only be used if the diaphragm (not the static pressure equalization vent) is exposed to the sound pressure and if the microphone is essentially unloaded on the electrical terminals. Values of the circuit elements which correspond to those of the more complex model are given in Table 2.3. Such values are often stated by microphone manufacturers for the purpose of impedance calculations.

The values of the diaphragm system (ds) elements may be calculated from those given in Section 2.3.10 by using the formulae below:

$$C_{ds} = \frac{C_d \cdot C_c}{C_d + C_c} \quad L_{ds} = L_d + L_s \quad R_{ds} = R_s$$

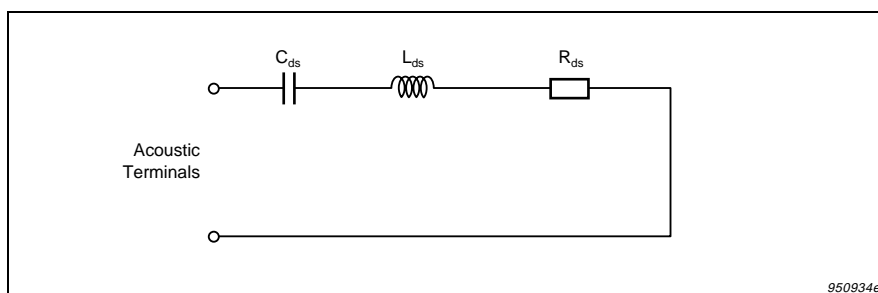

Fig.2.14 Simplified model representing the acoustical impedance of a microphone. Some manufacturers state the model parameters for relevant microphone types

Symbol	Model Element	Value	Unit
C_{ds}	Diaphragm System Compliance	2.83×10^{-13}	m^5/N
L_{ds}	Diaphragm System Mass	896	kg/m^4
R_{ds}	Diaphragm System Resistance	56.2×10^6	Ns/m^5

Table 2.3 Values of the simplified microphone model shown in Fig.2.14. The model represents the acoustic diaphragm impedance of the microphone model shown in Fig.2.13

The diaphragm system impedance (Z_{ds}) may be calculated by using the formula below:

$$Z_{ds} = \frac{1}{j\omega C_{ds}} + j\omega L_{ds} + R_{ds} \quad Ns/m^5$$

2.3.12 Equivalent Volume of the Diaphragm System

The acoustic impedance of a microphone diaphragm may be expressed in terms of equivalent volume. The equivalent volume, which is complex, is a function of frequency. At low frequencies it is essentially real and constant, while it varies with frequency at high frequencies where the imaginary part dominates, see Fig.2.15.

The use of equivalent volume, instead of diaphragm impedance, often makes it more easy to evaluate the influence of a microphone on the sound pressure of small acoustic systems, such as calibration coupler cavities. The equivalent volume of a diaphragm is the volume of air which has the same compliance or impedance as that of the diaphragm.

The acoustic compliance (C_a) of a volume of gas is given by the following formula:

$$C_a = \frac{V}{\gamma \cdot P_s} \quad \text{where}$$

γ = Ratio of specific temperatures of the gas (1.402 for air)
 P_s = Static pressure of the gas in the cavity
 V = Volume of cavity

Accordingly the compliance of a diaphragm system (C_{ds}) is:

$$C_{ds} = \frac{V_e}{\gamma \cdot P_s} \quad \text{where } V_e = \text{Equivalent diaphragm volume}$$

The formula for calculation of equivalent diaphragm volume from diaphragm system impedance is derived from these equations and from the general equation:

$$Z = \frac{1}{j\omega C}$$

The Equivalent Diaphragm System volume is thus:

$$V_e = \frac{\gamma \cdot P_s}{j\omega Z_{ds}} \quad \text{where } Z_{ds} = \text{Diaphragm system impedance}$$

V_e is complex as Z_d is complex.

The equivalent diaphragm volume may be calculated as a function of frequency by using the formula below when the previously mentioned simple C–L–R model, see Section 2.3.11, is considered

$$V_e = \frac{\gamma \cdot P_s}{j\omega[(j\omega C_{ds})^{-1} + j\omega L_{ds} + R_{ds}]}$$

where:

C_{ds} = Diaphragm system compliance

L_{ds} = Diaphragm system mass

R_{ds} = Diaphragm system resistance

Alternatively, the complex equivalent volume may be calculated from another set of parameters as the above equation may be written as:

$$V_e[f] = V_e[If] \cdot \left(1 - \frac{f^2}{f_0^2} + j \frac{f}{f_0} \cdot Q^{-1} \right)^{-1}$$

where:

$V_e(If)$ = Low frequency equivalent diaphragm volume

f_0 = Diaphragm system resonance frequency

Q = Diaphragm system quality factor

The second set of parameters may be calculated from the first set as:

$$V_e[If] = \gamma \cdot P_s \cdot C_{ds} \quad f_0 = (2\pi \sqrt{C_{ds} \cdot L_{ds}})^{-1} \quad Q = \sqrt{\frac{L_{ds}}{C_{ds}} \cdot R_{ds}^{-2}}$$

Both sets of parameters are used in practice. The complex equivalent volume is especially applied in connection with the calibration of Laboratory Standard Microphones and in connection with measurements made on human and artificial ears.

The calculated equivalent diaphragm system volume of the microphone model shown in the previous section, is shown in [Fig. 2.15](#).

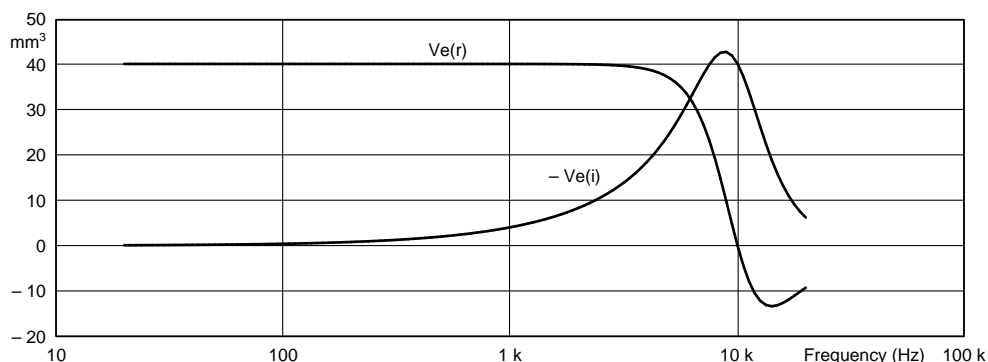

950910e

Fig. 2.15 Real and imaginary part of Equivalent Volume calculated with the values of Table 2.3. Notice that the imaginary part is negative

In practice, the equivalent volume of measurement microphone diaphragms depends on the type of microphone. The total range varies from about a tenth of a cubic millimetre to some hundred cubic millimetres. The diameter of the microphone diaphragm has a great influence on the volume (fourth power). Pressure microphones in a 1" size have typical volumes of 130 to 160 mm³, while corresponding 1/2" microphones have a much smaller volume of approximately 10 mm³. The diaphragm volumes of 1/4" and 1/8" microphones are correspondingly smaller. The equivalent volume is also a function of the diaphragm tension, therefore, the high-sensitivity 1/2" microphones which have lower diaphragm tension have greater equivalent volume, typically 40 mm³.

2.4 Combination of Microphone and Preamplifier

The condenser microphone generates electrical signals. These signals need to be transferred to associated equipment such as an analyzer or recorder which may be placed in some distance from the microphone itself. Because the microphone has a very high electrical impedance it cannot withstand the load made up by the instrument and the cable which is necessary. To minimize the loading and to ensure that even very long cables (perhaps several hundred metres) may be used, specific microphone preamplifiers are employed.

Some microphone system properties are determined by the preamplifier in combination with the microphone. This applies for the electrical frequency response function, especially for the lower limiting frequency and for the dynamic range which is limited by inherent noise and distortion.

2.4.1 Microphone Capacitance

The microphone is an electrical source with an impedance which is determined by its capacitance. The capacitance is mainly made up by the active capacitance between the diaphragm and the backplate and by the stray capacitance of the microphone housing.

However, the microphone capacitance is also influenced by mechanical properties of the diaphragm system. This is especially the case for those microphone types which have the highest sensitivities. At low frequencies, the electro-mechanical coupling adds to the capacitance (by up to 15%) while it subtracts capacitance above the diaphragm resonance (1–2%) where the phase of the diaphragm movements is opposite. Due to the low input capacitance of the preamplifiers used, these rather small capacitance variations are generally ignored.

The capacitance of condenser measurement microphone types is a function of microphone size and it varies from about 3 pF for 1/8" microphones to 70 pF for 1" microphones.

2.4.2 Electrical Frequency Response of Microphone and Preamplifier

To minimize the loading effect on the microphone as described at the start of this section, the microphone is screwed directly on a preamplifier. The preamplifier has a high input impedance which is generally described in terms of input resistance (typically 1 – 100 G Ω) and input capacitance (typically 0.1 – 1 pF). The electrical voltage gain is generally very close to unity, corresponding to “0 dB”.

The preamplifier should preferably withstand loading from even very long cables. The output resistance is therefore low (typically 10 – 100 Ω). As the amplifier output is resistive and the cable loading is capacitive (typically 50 – 100 pF/m) the influence of the loading, if any, will be most significant at the highest frequencies. Due to the low output impedance of the preamplifier, the input resistance and capacitance of most succeeding instruments (1 M Ω and 50 pF) can be ignored.

Modern preamplifiers are able to transfer voltages within a very wide dynamic range, from about 1 μ V to 50 V, i.e. more than 150 dB.

The capacitance of the microphone which makes the electrical source may be regarded as being essentially constant when the microphone is used with a modern preamplifier with a low input capacitance.

The combined electrical circuit of the microphone and the preamplifier is shown in [Fig. 2.16](#). In addition, a set of typical circuit element values valid with a 1/2" microphone is given in the table below.

Circuit Element	Symbol	Typical Value
Open circuit microphone voltage	V_{oc}	1 μ V to 50 V
Microphone Capacitance	C_m	18 pF (1/2" microphone)
Preamplifier Input Capacitance	C_i	0.2 pF
Preamplifier Input Resistance	R_i	10 G Ω
Amplifier Gain	g	0.995
Preamplifier Output Resistance	R_o	30 Ω
Cable Capacitance	C_c	3 nF (corresponding to 30 m)
Output Voltage	v_o	1 μ V to 50 V

Table 2.4 Values of Electrical Circuit Elements of the simplified model, see Fig.2.16 which represents the microphone capacitance, preamplifier and cable of a typical microphone system (1/2"). The model may be used for calculation of the electrical frequency response of a microphone system. Often, only the acoustic response is taken into account, as the electric response is generally flat; see Fig.2.17 and Fig.2.18

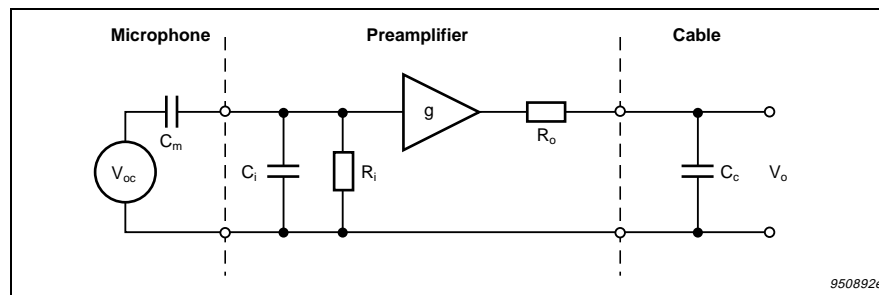

Fig.2.16 Simple model for calculation of the electrical frequency response of a microphone and its preamplifier loaded with a cable. The electrical response should be combined with the acousto-mechanical response of the microphone to obtain the over-all system response

The electrical frequency response of the circuit is given by the formula below:

$$\frac{v_o}{v_{oc}} = \frac{C_m}{C_m + C_i} \cdot \frac{j\omega(C_m + C_i)R_i}{1 + j\omega(C_m + C_i)R_i} \cdot g \cdot \frac{1}{1 + j\omega C_c R_o}$$

$$G = \frac{C_m}{C_m + C_i} \cdot g$$

$$G[dB] = 20 \cdot \log\left(\frac{C_m}{C_m + C_i}\right) + g[dB]$$

The magnitude and phase of a typical electrical frequency response which corresponds to the values given in the table are shown in Fig.2.17 and Fig.2.18 respectively.

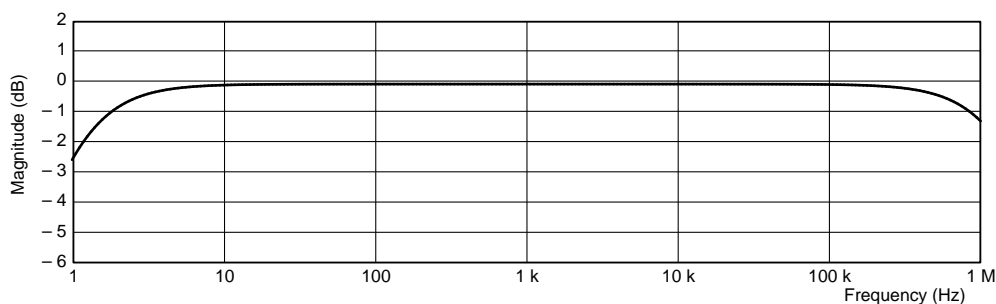

950893e

Fig.2.17 Magnitude of the electrical frequency response calculated with the values of Table 2.4. The response is flat within a wide range including the frequency range where acoustical measurements are most commonly performed

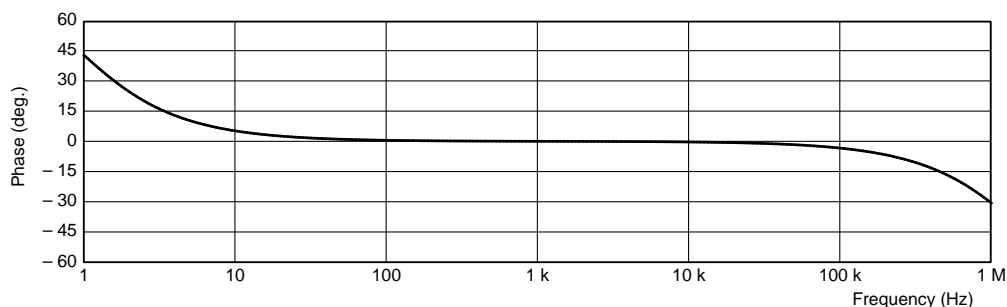

950894e

Fig.2.18 Phase of the electrical frequency response calculated with the values of Table 2.4. The response is flat within a wide range and meets the requirements for most acoustical measurements

The constant magnitude ratio in the mid frequency range is determined by the capacitance ratio (first factor) and by the amplifier gain (g). Their product is named “G” in the Brüel & Kjær calibration literature and on calibration charts. The low frequency roll-off is determined by the input circuit and the high frequency roll-off by the output circuit.

Even if the preamplifier output resistance may be sufficiently low to withstand a certain cable load, the signal may, in extreme cases, be distorted due to insufficient output current. This is especially the case where voltages of high frequencies are transferred via long cables.

Possible problems may be solved by, either selecting a different preamplifier, or by selecting a power supply with a higher current capacity, or both. The output voltage of the microphone may also be lowered. This may be done by selecting a microphone with a lower sensitivity or by lowering the polarization voltage, for example, from 200 V to 28 V, leading to a sensitivity reduction of about 17 dB. The polarization voltage change causes a change in the frequency response depending on the type of microphone. For $\frac{1}{4}$ " and $\frac{1}{8}$ " microphones the change is so small that it can generally be neglected.

The electrical transfer function should be multiplied, or added when expressed in dB, to the frequency response characteristic of the microphone itself. However, in most cases the electrical response is flat within the frequency range of interest. Therefore, it is generally sufficient to account for the gain (G) which is, in most cases, below unity.

The measurement of infra-sound is an exception to this general rule. For this application, proper microphones and preamplifiers must be selected because of the acoustic roll-off of the microphone itself and the combined electrical roll-off of the microphone and preamplifier at low frequencies.

The flat part of the electrical response may be extended at low frequencies by mounting a capacitor in parallel with the microphone. This should be at least a few times larger than the microphone capacitance, but it should not be too large as it also reduces the system sensitivity. The modification corresponds to an increase in the input capacitance (C_i), see the formula stated above.

Note that low frequency adaptors containing a capacitor are available and can be mounted between the microphone and the preamplifier.

2.4.3 Inherent Noise of Microphone Systems

Both condenser microphones and preamplifiers produce noise. In particular, the equivalent noise pressure depends on the size of the microphone. The noise from both microphone and preamplifier adds to the measured signal. However, in most measurement situations the sound pressure produces signals which are so high that the inherent system noise can be ignored. When measurements are to be done at lower levels, the system noise must be estimated and if necessary, taken into account. Typically, the inherent A-weighted noise corresponds to 10 and 40 dB for systems equipped with 1" and $\frac{1}{8}$ " microphones respectively. Special microphone systems with inherent noise as low as 0 dB (A) are also available.

The measured inherent noise level depends on the bandwidth. The broader the measurement bandwidth, the higher the noise level and conversely, the narrower the bandwidth the lower the noise level. Filtering may therefore make it possible to

measure lower signal levels (depending on the type of acoustic signal). By using bandwidths of 1Hz, levels of -35 to -25 dB may be measured in the audible part of the frequency range. According to international sound measurement standards, measurements must be performed with a signal to noise ratio of at least 5 dB. The graph in Fig.2.19 shows how non-correlated system noise adds to the sound pressure level and increases the instrument reading.

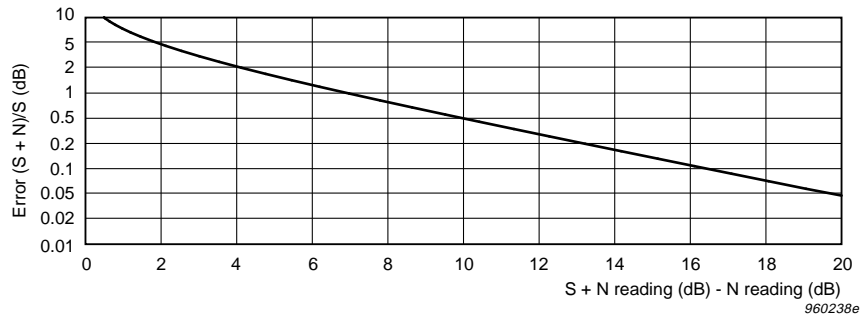

Fig.2.19 Addition of Noise

The noise of a measurement system is composed by microphone noise, preamplifier noise and noise from the succeeding measurement amplifier. The graph, see Fig.2.20, illustrates the contribution of each of these three sources for a typical 1" microphone system. The noise voltages of the preamplifier and the measurement amplifier were converted to equivalent SPL by dividing the noise voltage by the microphone sensitivity. The noise from the measurement amplifier contributes to the system noise at higher frequencies where it is of same order of magnitude as the preamplifier noise. At low frequencies, the preamplifier noise dominates while the microphone noise is dominating from about 200 Hz to 10 kHz.

Microphone Noise

The noise produced by the microphone is basically due to thermal or Brownian movements of the diaphragm and is thus a function of the absolute temperature. In connection with microphone design and selection for specific purposes, noise estimation or analysis may be made in a very practical way by using equivalent circuit models. Acoustic resistances, which produce noise like electrical resistances, make the sources of the microphone while the reactive circuit elements do not produce any noise. There are two sources (resistances) in a microphone, see the equivalent circuit model shown in Fig.2.13. The diaphragm damping resistance and the static pressure equalisation resistance. The noise pressure produced by an acoustic resistance is defined by the formula below.

$$p_n = \sqrt{4 \cdot k \cdot T \cdot R_a \cdot \Delta f}$$

Symbol	Parameter	Unit
ρ_n	Time average of noise pressure	Pa or N/m ²
k	Boltzmanns Constant	Nm/K (1.38×10^{-23})
T	Absolute Temperature	K
R_a	Acoustic Resistance	Pas/m ³ or Ns/m ⁵
Δf	Frequency Bandwidth	s ⁻¹

Table 2.5 Parameters used for calculation of noise pressure produced by an acoustic resistance

The pressure of each of the acoustic resistances may be calculated by using the above formula, but their contribution to the microphone noise depends also on the transfer function from the source location inside the microphone to the output terminals. In practice, only the diaphragm damping noise is significant, as the noise produced by the pressure equalisation vent is lower than that of the preamplifier at any frequency.

The noise spectrum of a microphone looks like its pressure frequency response. This may be realized from the equivalent circuit diagram. As the noise pressure generator of the diaphragm resistance is in series with the diaphragm compliance, mass and resistance, it can be regarded as if it were connected to the acoustic input terminals like any external signal. The flat noise spectrum of the damping resistance will, therefore, lead to an output voltage noise spectrum at the microphone output terminals that is shaped like the pressure response of the microphone.

As most acoustic measurements are made by using filters of constant relative bandwidth, microphone noise data are generally presented for third octave bands, see [Fig. 2.20](#).

Preamplifier Noise

The preamplifier noise may be regarded as a noise composed of two main parts. Namely, a low frequency noise which originates from the input circuit and is a function of the microphone capacitance. This noise voltage is inversely proportional to the frequency and to the transducer capacitance. The other source which is related to the amplifier has a flat voltage spectrum over the entire operation range. Third octave filtering of the preamplifier noise leads to a spectrum which falls by 10 dB/decade at low frequencies and raises by 10 dB/decade at high frequencies, see [Fig. 2.21](#).

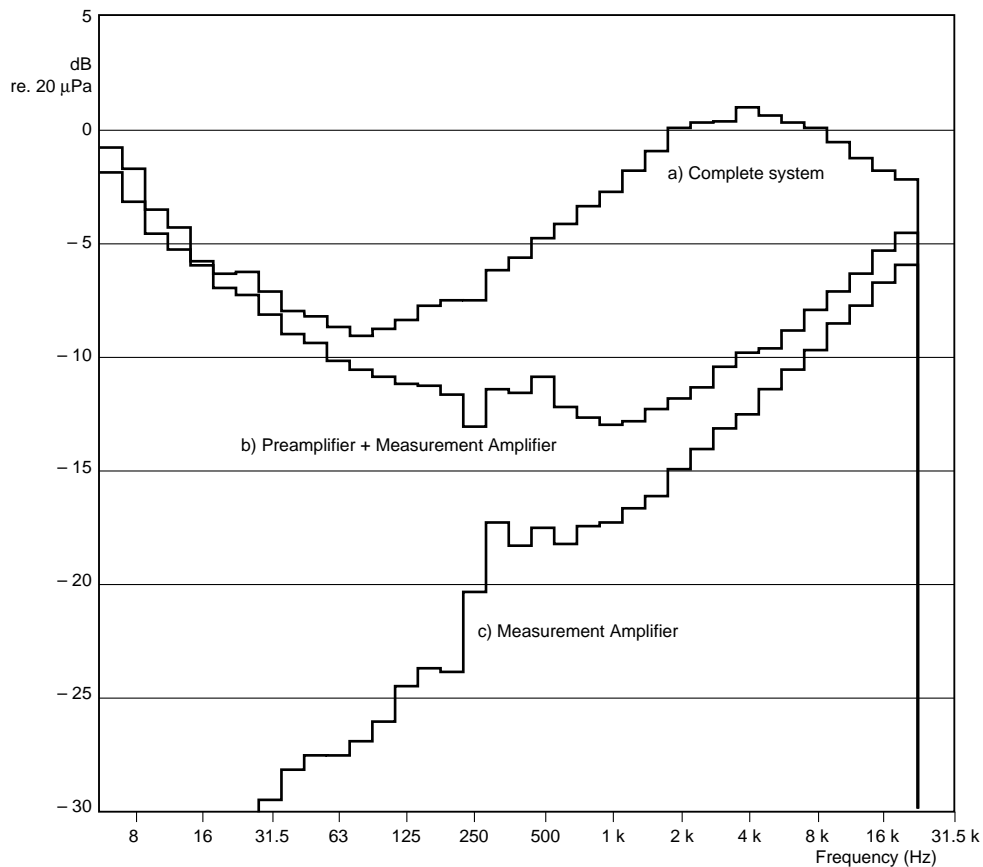

951155/1e

Fig. 2.20 Equivalent levels of inherent noise (1/3 octave bandwidth) produced by the elements of a system equipped with a 1" free-field microphone (50 mV/Pa). The microphone, the preamplifier and the measurement amplifier are all significant noise sources in certain parts of the frequency range

Microphone System Noise

Noise spectra valid for microphone systems equipped with free-field microphones of different sizes are shown in Fig. 2.22. For smaller and less sensitive microphones, in sizes such as 1/4" and 1/8", only the preamplifier noise needs to be taken into account, as this dominates over the microphone noise.

System With Extremely Low Inherent Noise

A specific method of lowering microphone system noise can be applied for the design of a system with extremely low inherent noise. The method is based on the idea of reducing the diaphragm damping resistance as this makes up the main noise source of the microphone. This will lower the noise, but it will also create a peak on the frequency response at the diaphragm resonance frequency. However, this peak may be equalized by an electrical network which can be combined with

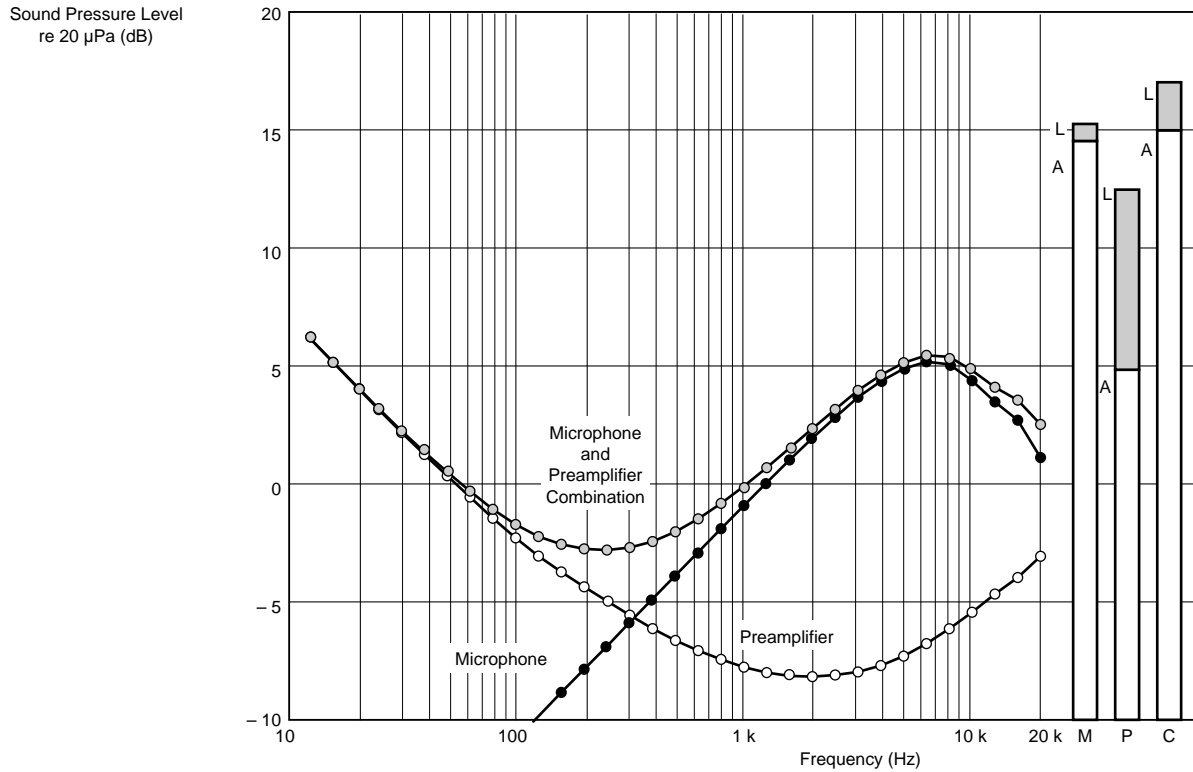
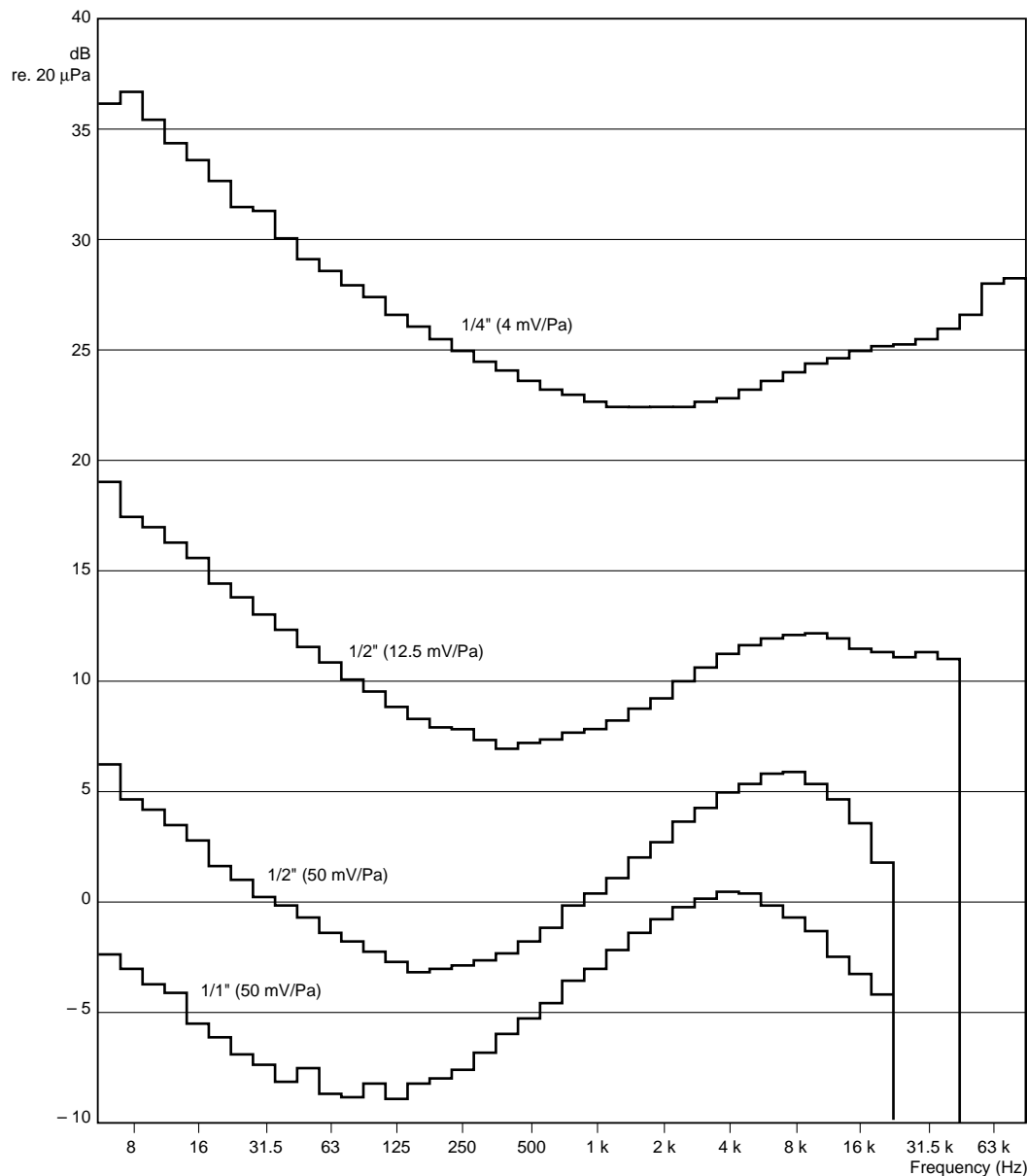

Fig. 2.21 Third Octave Noise Spectra of a system consisting of a free-field microphone ($\frac{1}{2}$ " , 50 mV/Pa) and a high quality preamplifier: The electrical preamplifier noise dominates at low frequencies while Brownian movements of the microphone diaphragm create the most significant noise at high frequencies. The columns to the right show Linear (20 Hz - 20 kHz) (L) and A-weighted (A) noise levels for the microphone (M), preamplifier (P) and combination (C)

the preamplifier. This technique, which requires careful control with the microphone resonance frequency and Q-factor, has led to the development of a system with an equivalent inherent noise level as low as -2 dB(A), see [Fig. 2.23](#).

2.4.4 Distortion

Both the microphone and the preamplifier may distort the output signal. The distortion which is produced by the microphone is the dominating component within the major part of the dynamic range while preamplifier distortion may only be detected close to the clipping limit at the highest operational levels.



950941e

Fig 2.22 Third Octave Noise Spectra of free-field microphone systems. The larger and most sensitive microphones should be used for low level measurements. The microphone noise is most significant in such systems. The preamplifier noise is most significant in systems with small and less sensitive microphones

Microphone Distortion

Microphone distortion (in the frequency range where the diaphragm displacement is stiffness controlled), is caused by passive capacitance in parallel with the active diaphragm capacitance. This passive capacitance is made up by the backplate-hous-

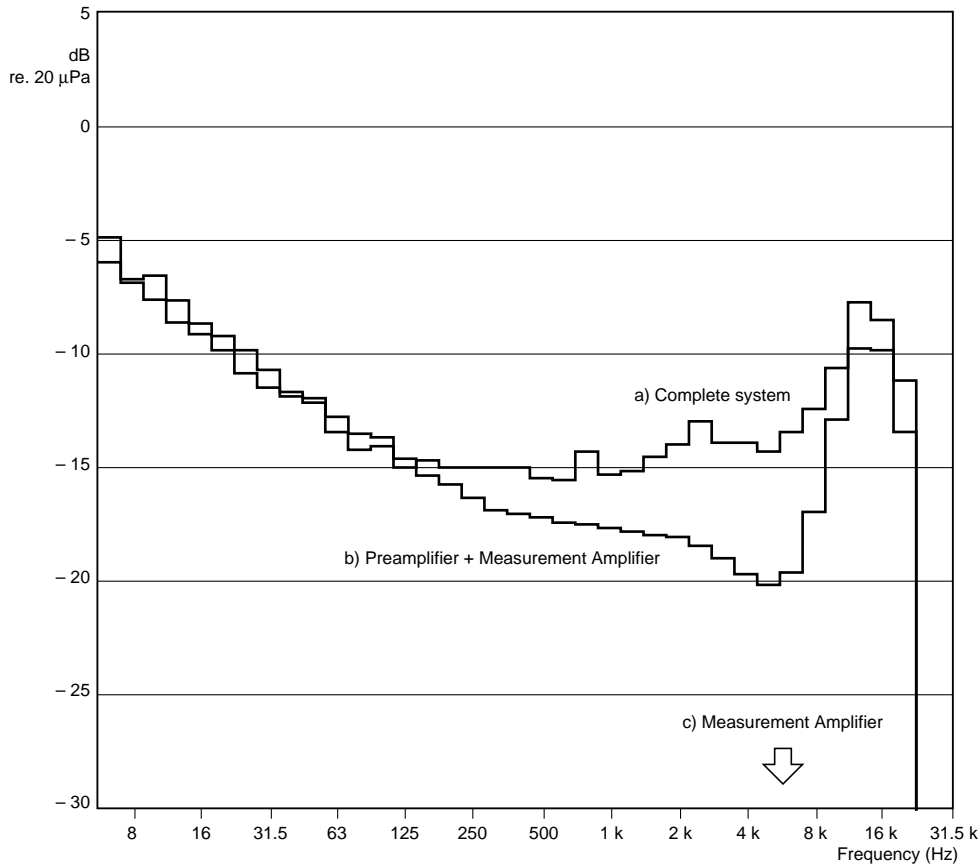

951156e

Fig. 2.23 Equivalent levels of inherent noise (1/3 octave bandwidth) produced by the elements of a low noise system with a special 1" free-field microphone (100 mV/Pa and low diaphragm damping). The microphone and the preamplifier (20 dB gain) which contains a frequency response equalization network, form the main noise sources. The system noise level is -2 dB (A)

ing capacitance, preamplifier input capacitance and to some degree by parts of the diaphragm capacitance which are less active than others. Passive capacitance leads to a dominating second harmonic distortion which increases proportionally with the sound pressure and a less significant third harmonic component which increases by the square of the pressure.

The microphone distortion is practically proportional to the parallel, or stray capacitance. Brüel & Kjær has patented a method for reduction of microphone system distortion which implies the application of negative preamplifier input capacitance for equalization of the passive part of the microphone capacitance.

Microphone distortion is proportional to diaphragm displacement. Therefore, smaller and less sensitive microphones produce less distortion than larger microphones do at the same sound pressure. However, as the parallel capacitance of a small microphone is relatively larger than that of a larger microphone the reduction in

distortion does not fully follow the sensitivity reduction. This can, for example, be seen in the sensitivity and distortion differences between a $1/2''$ and a $1/4''$ microphone. The difference in sensitivity is 22 dB, while the difference in distortion is only 15 dB.

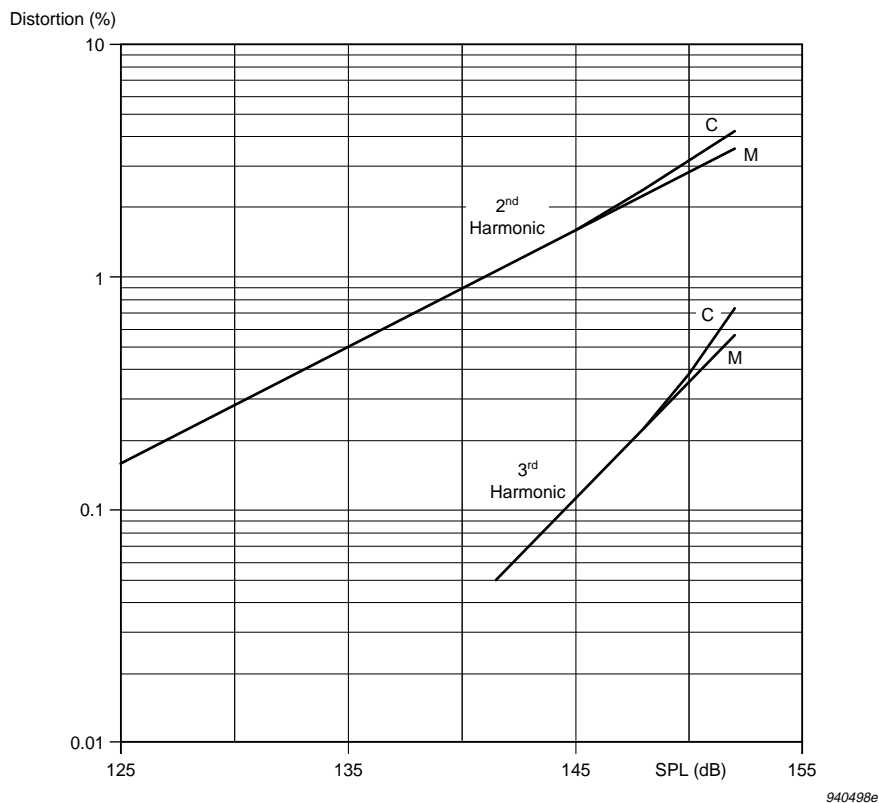

Fig.2.24 Distortion of microphone (M) and of microphone-preamplifier combination (C). The preamplifier distortion which plays the minor role is just noticeable at the highest measurable levels. The distortion is valid for a free-field microphone ($1/2''$, 50 mV/Pa). It is measured at 90 Hz and is representative for that part of the frequency range where the diaphragm displacement is dominantly controlled by stiffness

Preamplifier and Microphone System Distortion

The preamplifier distortion may generally be ignored as this is much lower than the microphone distortion. This is the case at levels up to a few decibels below the upper operation limit where clipping occurs and makes the system unusable, see [Fig.2.24](#). The results shown in the figure are obtained with a Brüel & Kjær High Pressure and Low Frequency Calibrator, Type 4221.

Distortion Due to Large Parallel Capacitors

Most often the preamplifier has only a minor influence on the microphone distortion as it only adds 0.2 to 0.5 pF to its passive parallel capacitance. However, when a large passive capacitor is used for extending the frequency response to lower frequencies this will have great influence on the distortion which may increase by a factor of five or more, see Section [2.4.2](#).

2.5 Microphone Types Dedicated to Different Sound Fields

When a microphone is placed in the sound field which it is to measure, it will influence the field and change the sound pressure. This change needs to be taken into account as it would otherwise lead to a measurement error. Depending on the type of field and on the type of microphone the influence may be so small that it is insignificant. However, it may also amount to several decibels which would be an unacceptable error for most measurements. Microphone types designed for specific applications may correct for the influence under certain circumstances, while in other cases the user must evaluate, and if possible, correct for the influence.

Three different types of sound field are generally considered in connection with acoustic measurements, namely the pressure-field, the free-field and the diffuse-field. The influence of the microphone depends on the type of sound field, on the microphone dimensions and to a minor degree, on its diaphragm impedance.

2.5.1 Influence of the Microphone on the Pressure-Field

A pressure-field generally occurs in a small closed cavity (see Section 2.1.5) which, for example, may make a part of an artificial ear used for the testing of telephones or hearing aids. To measure the sound pressure in such a cavity, the microphone is generally built into the coupler in a way that makes the diaphragm a part of the coupler cavity wall. Because the diaphragm is not as stiff as the wall of the coupler, it deflects due to the sound pressure and loads the cavity acoustically.

The influence of the microphone depends on the size and shape of the coupler and on the microphone diaphragm impedance. Very often, artificial ears are used up to such high frequencies that standing waves occur in the coupler. Depending on the coupler cavity shape, it may be quite complicated to determine the influence of the microphone. It is simpler in cases where the coupler makes a cylindrical cavity with the sound source and a microphone is mounted at each end. In this configuration the coupler acts as an acoustic transmission line which connects the source to the microphone, see [Fig.2.25](#). The transfer function and the microphone influence may then be determined by the general transmission line theory by taking its characteristic impedance, its complex propagation coefficient and its length into account, see [Fig.2.26 \(a\)](#).

At lower frequencies, where standing waves do not occur, the circuit may be further simplified to take only the compliances into account. They represent the reciprocal

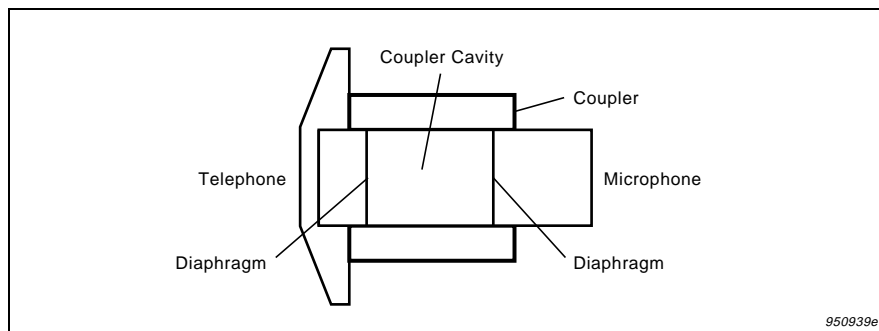

Fig.2.25 Schematic diagram of coupler used for headphone testing

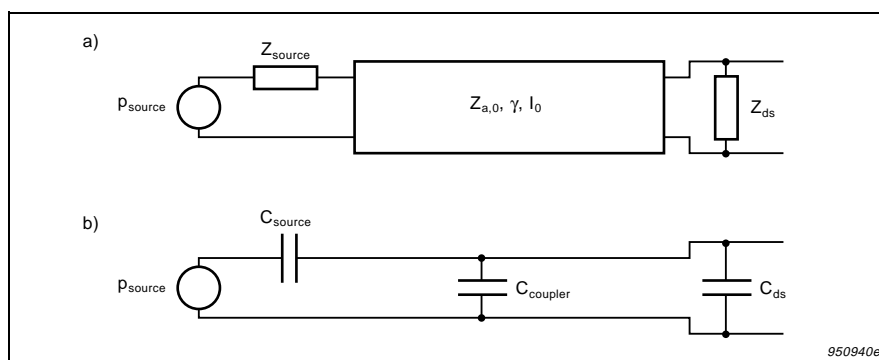

Fig.2.26 Model of headphone coupler using acoustic transmission line (upper circuit) and simplified model (lower circuit). Only the first model should be used at high frequencies. The microphone is represented by its complex impedance (Z_{ds}) and by the low frequency value of its equivalent volume $V_e(lf)$ respectively

stiffnesses of the source, the coupler cavity and the microphone diaphragm, see Fig.2.26 (b). In such cases it is very practical to work with equivalent volumes of the source and the loading microphone.

Most couplers are equipped with a static pressure equalisation vent. The impedance of this should be taken into account if the model is also to be used at the lowest frequencies.

The sound pressure attenuation due to the microphone is given by the following formula:

$$attenuation[dB] = 20 \cdot \log \left(\frac{V_{coupler} + V_{e, source} + V_e[lf]}{V_{coupler} + V_{e, source}} \right)$$

where:

$$\begin{aligned}
 V_{coupler} &= \text{coupler volume} \\
 V_{e,source} &= \text{equivalent volume of source} \\
 V_e [lf] &= \text{equivalent volume of microphone diaphragm system}
 \end{aligned}$$

In practice, 1" microphones are used with larger couplers (3 – 10 cubic centimetres) which may be used for headphone testing while 1/2" microphones are used with smaller couplers of 1 to 3 cubic centimetres, for example, those designed for insert earphone testing.

As the equivalent diaphragm volume of a 1" microphone is typically 0.16 cubic centimetres the microphone will in practice attenuate the sound pressure produced in such a coupler by 0.5 dB to 0.15 dB, depending on its size.

For smaller couplers with 1/2" microphones, the influence is typically smaller. The microphone types may in practice be placed in one of two groups depending on their equivalent volume, which may either be about 0.010 or 0.045 cubic centimetres. Those with a low volume are most frequently applied in couplers. Here their influence is relatively less than that of the larger microphones on the above mentioned coupler sizes.

2.5.2 Pressure Field Microphone and Sensitivity

The frequency response characteristic of a pressure-field microphone is optimised to be as flat as possible when its output voltage is referred to a uniform pressure on the outer surface of its diaphragm.

Ideally, the diaphragm should be as stiff as the walls of the coupler within which it is applied. As this is not possible, its influence may be estimated and taken into account by using equivalent volume or transmission line calculations.

2.5.3 Influence of Microphone on the Measured Sound Pressure in a Free-Field

A free-field exists where a sound wave propagates in a certain direction without being disturbed by any reflecting objects (see Section 2.1.6). However, to measure the sound pressure in a free-field, a microphone must obviously be placed in that field. The microphone will change the sound field as it will diffract and reflect the sound wave, see [Fig.2.27](#). As a result, the pressure acting on the microphone diaphragm will deviate from that of the measurement point in the undisturbed field which was to be measured. The deviation may lead to a measurement error unless a correction is made.

The ratio between the pressure at the diaphragm and that of the undisturbed sound field is a function of the ratio between the microphone diameter and the wavelength. Pressure ratio functions look alike for smaller and larger microphone types, but they are shifted within the frequency range depending on the diameter of the microphone body. This is illustrated in [Fig.2.28](#) which shows the order of mag-

nitude of the pressure ratio valid for sound incidence perpendicular to the front of the microphone (zero degrees) for different sizes of microphone.

For most practical measurements the microphone diaphragm needs to be covered by a protection grid. This grid will also influence the pressure at the diaphragm as it acts as an acoustic resonator. The influence of protection grids is generally very low below 1 kHz, but it increases significantly with frequency. Fig. 2.29 shows a typical contribution of a $\frac{1}{2}$ " protection grid to the pressure increase at the microphone diaphragm (zero degree incidence).

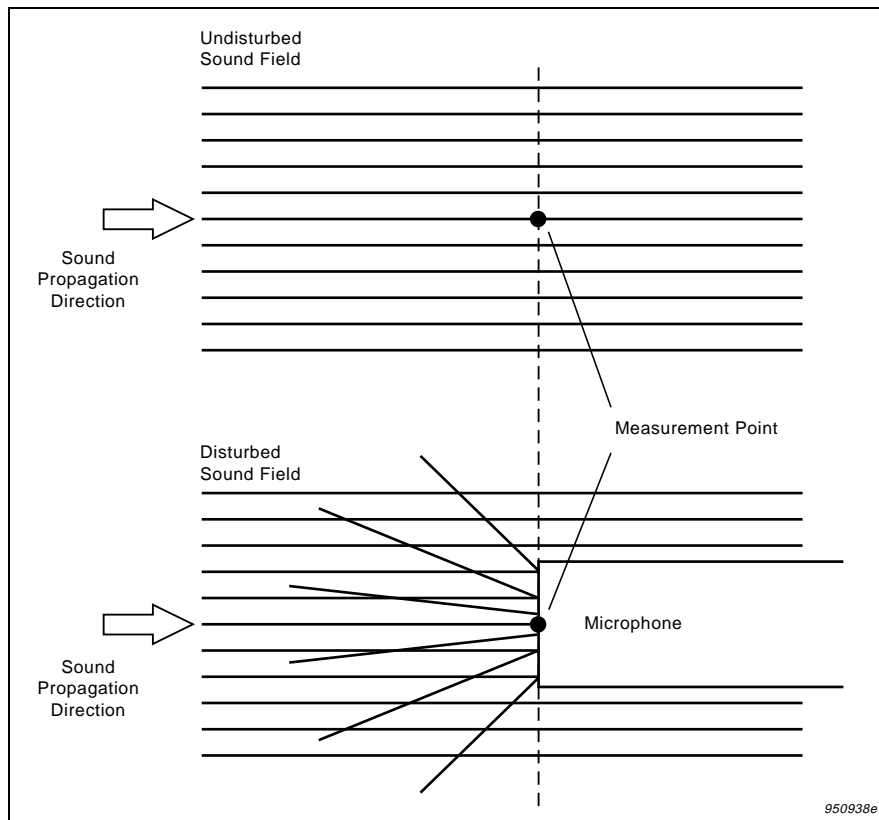

Fig.2.27 Simplified illustration of the disturbance of a plane sound wave caused by a microphone body. The pressure at the position of the diaphragm deviates significantly from that of the undisturbed field at higher frequencies. This effect must be taken into account to avoid large and unacceptable measurement errors

The resulting influence of the body of a $\frac{1}{2}$ " microphone and the protection grid is shown in Fig. 2.30 (upper curve). The influence of the microphone on the pressure of a free-field is so great that it needs to be taken into account to avoid considerable measurement errors.

The influences of both microphone body and protection grid differ with the angle of

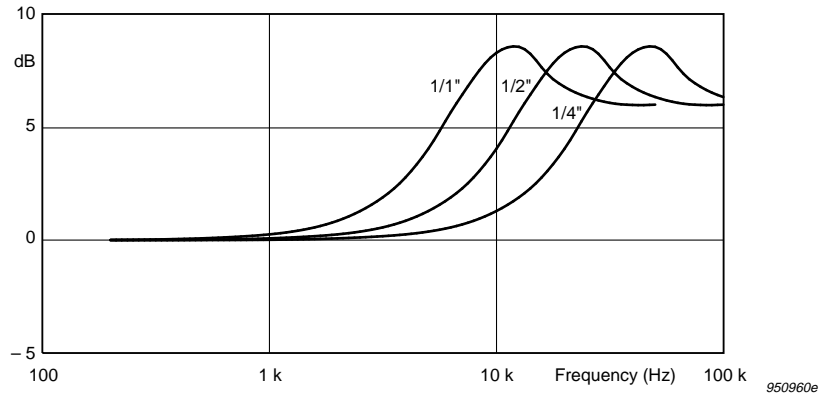

Fig.2.28 Ratio between the pressure at the diaphragm position and the pressure of the undisturbed sound field. The same pressure changes occur for bodies of larger and smaller body diameter, but the frequency range is shifted and is inversely proportional to the diameter of the microphone body

sound incidence on the microphone body. For all Brüel & Kjær microphones the influence is analysed and stated for a number of specific angles of incidence. Therefore, a correction may be made for the above effect, if the angle of sound incidence is known.

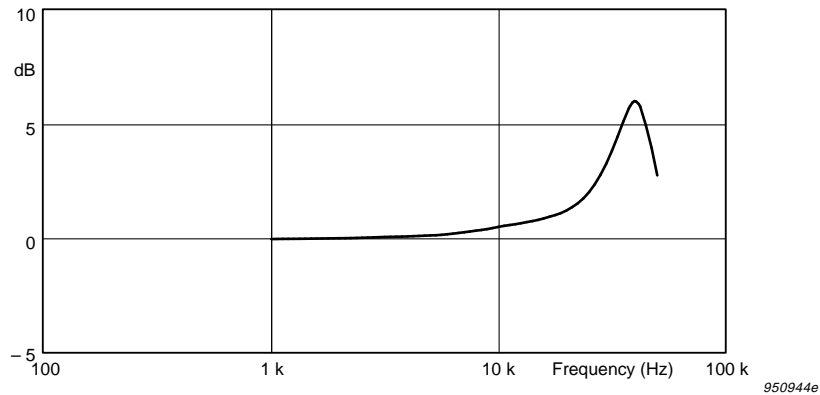

Fig.2.29 Typical influence of protection grid (1/2" microphone) sound incidence perpendicular to the diaphragm. The grid acts as an acoustic resonator

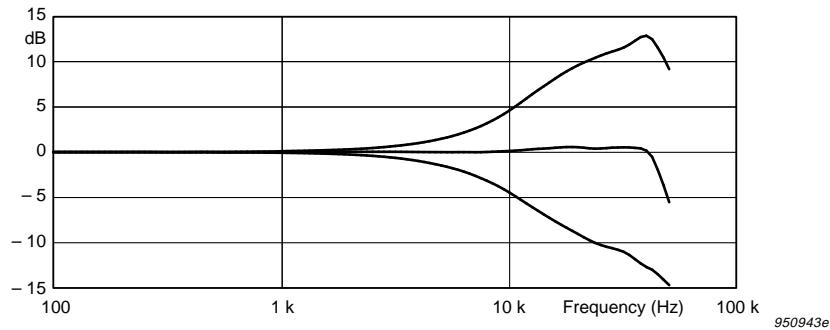

Fig.2.30 Pressure at diaphragm position referred to the pressure of the undisturbed field including influence of protection grid, 0° incidence (upper curve). The free-field response of the microphone (middle curve) is flat as the microphone is designed to have a pressure response (lower curve) which falls with frequency and compensates for the increase of pressure. The curves of the example approximate those valid for a $1/2''$ microphone

2.5.4 Free-Field Microphone and Sensitivity

The correction for the influence of the microphone body on the sound field can be made by post-processing of measured sound spectra, but the compensation might also be built into the microphone itself. This is the case for the so called Free-field microphone types which have a flat free-field frequency response characteristic to sound waves that are perpendicular to the diaphragm (at zero degree incidence).

The compensation is made by introducing a heavy damping of the diaphragm resonance, see the lower curve in Fig.2.10, Section 2.3.8. By proper design, the degree of damping may be chosen to give a decreasing diaphragm system sensitivity with frequency, see Fig.2.30, lower curve which corresponds to the above mentioned increasing sound pressure on the diaphragm, see Fig.2.30, upper curve. This leads to a frequency response characteristic which is essentially flat in a free-field when the output voltage is referred to the sound pressure of the undisturbed free-field. The product (or the sum, when decibels are applied) of the relative pressure increase and the diaphragm system sensitivity is constant over the frequency range, see the middle curve shown in Fig.2.30.

The pressure increase on the diaphragm may be used for extending the frequency range of free-field microphone types at higher frequencies. Therefore, free-field microphones cover wider frequency ranges than equally large and equally sensitive Pressure-field microphone types which have a flat pressure-field response. The extension typically equals one octave.

The ratio between the diaphragm pressure and the undisturbed free-field pressure is generally expressed in decibels. This ratio is essentially the same for all micro-

phones of the same type, as their dimensions are the same, (although the ratio depends slightly on the diaphragm impedance as well). Therefore, it is determined in connection with the development of any new Brüel & Kjær microphone type. The measured number is generally called the free-field correction.

As described above, the free-field correction corresponds to change in sound pressure which is due to the presence of the microphone body in the sound field.

The free-field correction may, therefore, be used for determining the individual free-field response characteristic of a microphone. This is done by adding the correction to the individual pressure response or to the so called, electrostatic actuator response. In practice, this is a great advantage as those responses are less costly to determine. This is especially the case for the actuator response. Most Brüel & Kjær free-field and diffuse-field corrections refer to the electrostatic actuator response.

2.5.5 Influence of the Microphone on the Measured Sound Pressure in a Diffuse Field

The sound pressure of a certain point in a diffuse-field is created by waves which over a certain time impinge to that point from all directions. To measure the pressure, a microphone must be placed in the field. However, the microphone is not equally sensitive to sound waves coming from different directions as the pressure change, due to the presence of the microphone and a possible protection grid, is different for different angles.

[Fig.2.31](#) shows free-field corrections for a 1/2" microphone without protection grid. These were measured for the angles between zero and 180 degrees in steps of 5 degrees.

The above free-field corrections may be used for calculation of the diffuse-field correction; see the bold curve in [Fig.2.31](#).

The diffuse field correction which represents the difference between the diffuse-field and the pressure-field sensitivity may be measured, but this is usually calculated. The international standard 'Random incidence and diffuse-field calibration of sound level meters' IEC 1183 prescribes how this should be done.

The calculation employs a weighted power based summing of the correction values valid for the different angles of incidence. The weighting accounts for the non-equal solid angles of incidence which are represented by the equally stepped angles at which the corrections are measured.

More weight is thus put on the corrections of the angles close to the 90 degrees than on those valid for angles close to zero degrees. IEC 1183 defines the calculation formula and the weighting factors.

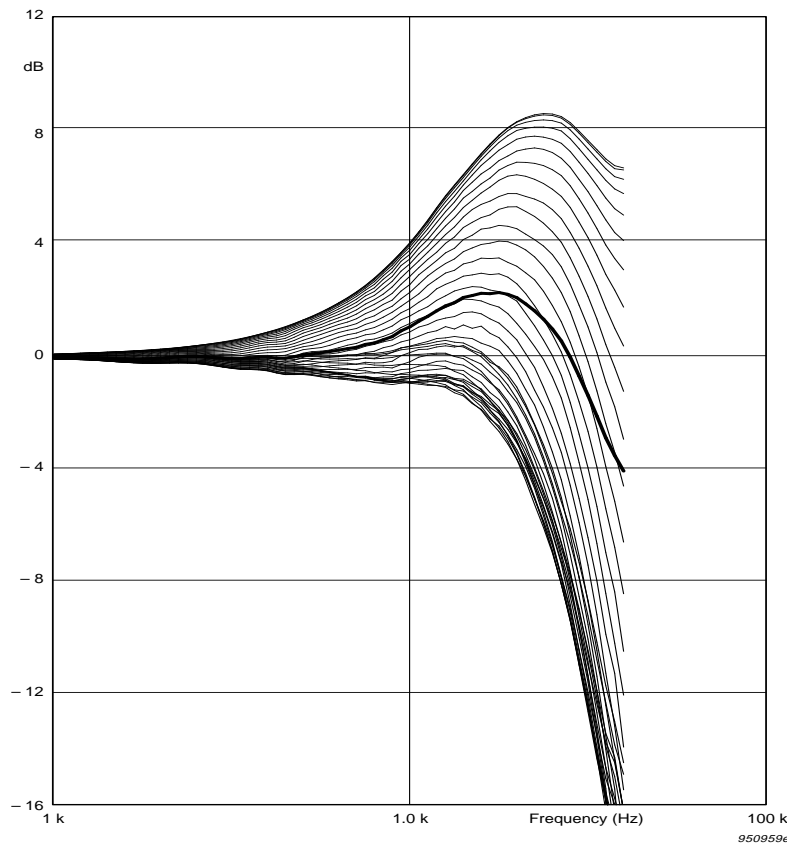

Fig.2.31 Free-field corrections (0° to 180° in 5° steps) valid for a $\frac{1}{2}$ " microphone without protection grid. The diffuse-field correction (bold curve) is calculated according to IEC 1183

As with free-field characteristics, it is very easy to determine the diffuse-field characteristic of a microphone by adding the diffuse-field correction to its individually measured pressure-field response or electrostatic actuator response.

2.5.6 Diffuse Field Microphone and Sensitivity

Dedicated microphones for diffuse-field measurements are rare. A main reason for this is that the diffuse-field correction or the pressure change created by the microphone itself is so small that many pressure-field microphones also have good diffuse-field characteristics.

Diffuse-field characteristics which comply with standards such as ANSI S 1.4 may also be obtained by mounting certain devices on free-field microphones. These devices which at high frequencies increase the pressure at the diaphragm might either replace the protection grids or be mounted on them.

2.6 Long Term Microphone Stability

To obtain valid measurements all the instruments applied must be stable and reliable, including the microphone. However, the microphone may be exposed to harsh environments, outside of the normal environments where the analyser and recording instruments are generally kept. In particular, high temperatures imply a risk of a permanent change in sensitivity.

Depending on the type of microphone there are two parameters which can be expected to change. One is the mechanical tension of the stretched diaphragm and the other, which is only relevant for prepolarised microphones, is the electrical charge of the electret. Both may decay over the time. Carefully controlled artificial or forced ageing procedures are therefore applied during production to stabilise these parameters. The stabilisation is not only relevant for high temperature applications but also in connection with laboratory standard microphones which are calibrated at room temperature to within a hundredth of a decibel. They must therefore be very stable.

A permanent decrease of the diaphragm tension implies an increase of the microphone sensitivity, while a decrease of the electret charge causes a decrease of the sensitivity.

The speed of the relaxation processes which lead to permanent sensitivity changes depends on temperature. At high temperatures the speed at which changes occur is so high that it can be measured. Under normal ambient conditions the speed at which changes occur is very low and is not directly measurable. The stability at room temperature may be estimated from high temperature measurements by extrapolation using an Arrhenius plot. This displays stability as a function the reciprocal Kelvin temperature.

Within a particular type of microphone there may be a great spread between the units. The high temperature stability of some units may be up to ten times better than the estimated and specified value.

Very often the permanent and systematic changes which are to be expected are less than the random changes which may occur due to mechanical shocks and heat transients. This is especially the case for microphones with stainless steel diaphragms (Falcon range microphones) as they are significantly less sensitive to long term heat exposure than the Nickel diaphragms used by other types of microphone.

Minor random changes in sensitivity may occur due to irreversible mutual displacements of the microphone parts. Therefore, microphones which are used as reference standard microphones, for example, for national standards, should always be stored at room temperature.

For an externally polarized microphone, the diaphragm tension may change over time. It will decrease slightly and lead to a small increase in the microphone sensitivity. The rate at which this occurs depends on the temperature and follows the general rule for a material process:

$$t_T = k \times \exp\left(\frac{Q}{RT}\right)$$

where t_T is the time for a certain charge at the absolute temperature T , Q is the process activation energy, R is the universal gas constant and k is a constant. Transformed to logarithmic form this gives:

$$\log t_T = K_1 + K_2 \times \frac{1}{T}$$

where K_1 and K_2 are constants which characterise the material process. The equation shows a linear relationship between $\log t_T$ and $1/T$.

For most Brüel & Kjær microphone types, the long term stability is described by the stability valid at a Reference Temperature (see microphone type specifications) and by a Stability Factor which is a function of temperature. The Stability Factor depends on the type of material and relaxation process.

The Stability Factor is the ratio between the stability at a given temperature and that of the Reference Temperature.

The long term stability is given by the following formula:

$$S_{LongTerm}[T] = S_{LongTerm}[T_{ref}] \cdot F_{stability}[T]$$

where:

$S_{LongTerm}(T)$ = Long Term Stability at the temperature (T)

$S_{LongTerm}(T_{ref})$ = Long Term Stability at the reference temperature (T_{ref})

$F_{stability}(T)$ = Stability Factor (ratio between stability at the temperatures (T and T_{ref}))

The Stability Factors of the Stainless Steel and Nickel diaphragms are shown in Fig. 2.32 and 2.33 respectively.

Two Stability Factors which are valid for the electret used by the Prepolarised Microphones are shown in Fig. 2.34. The factor that is valid for dry air uses 150°C as the Reference Temperature, while that valid for humid air (90% Relative Humidity) uses 50°C as the reference.

The stability at the Reference Temperature should be found in the specification that is valid for the type of microphone.

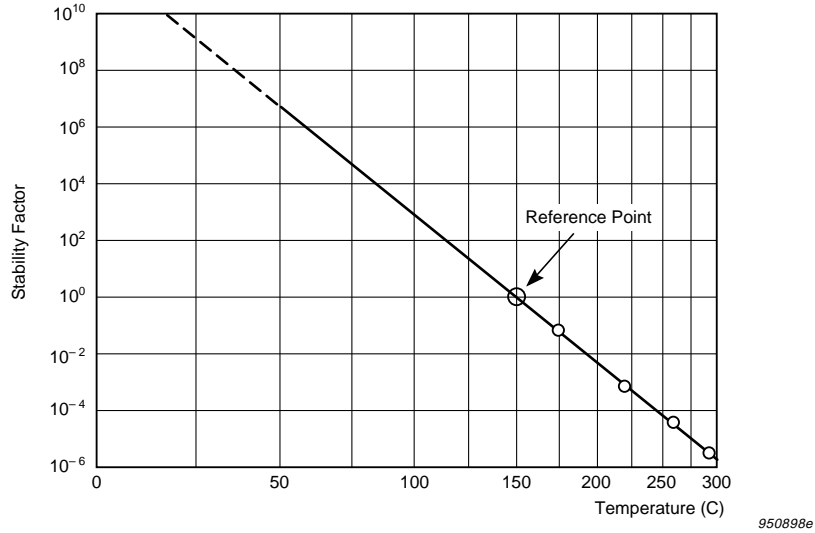

Fig. 2.32 Stability Factor for stainless steel alloy diaphragms (Falcon microphones). To obtain the stability at any temperature multiply the reference stability of 150 °C (see microphone specification) by the stability factor

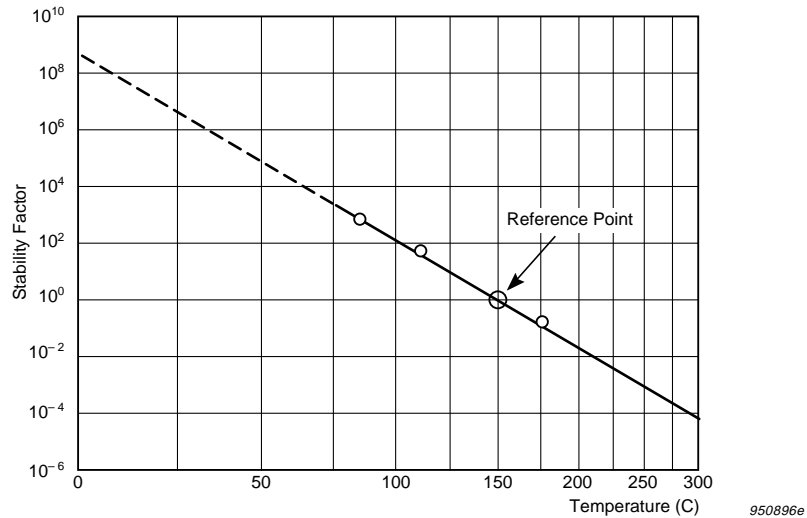

Fig. 2.33 Stability Factor for nickel diaphragms (non-Falcon microphones). To obtain the stability at any temperature multiply the reference stability of 150° C (see microphone specification) by the stability factor

Note, that the above calculation method leads to a rather rough estimates of diaphragm and electret stability and that the stability of most microphone units are actually several times higher than estimated.

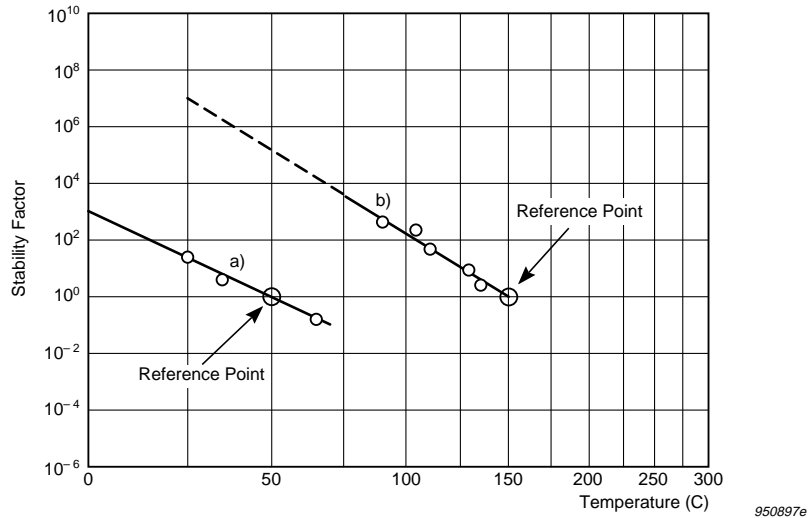

Fig.2.34 Stability Factors as functions of temperature valid for the electrets used by Prepolarized Microphones. Multiply the stability value stated for the reference temperature with the stability factor to estimate the stability at other temperatures. The curve marked a) is valid at 90% relative humidity while b) is valid for dry air

2.7 Electrostatic Actuator Calibration

2.7.1 Introduction

The calibration of microphones using an electrostatic actuator is a widely applied laboratory method for determination of frequency response characteristics of measurement microphones. The actuator produces an electrostatic force which simulates a sound pressure acting on the microphone diaphragm. In comparison with sound based methods, the actuator method has a great advantage. It provides a simpler means to produce a well-defined calibration pressure over a wide frequency range without the special facilities of an acoustics laboratory.

However, the actuator method cannot be used for determination of the microphone sensitivity, as its absolute accuracy is not sufficiently high. Therefore, an actuator frequency response calibration is in most cases combined with an absolute sensitivity calibration at a reference frequency. This may be performed by using a piston-phone, a sound level calibrator or other means.

The actuator simulates a pressure-field or a pressure acting directly on the microphone diaphragm. It cannot simulate a free-field or a diffuse-field. Free-field and diffuse-field corrections must therefore be available if calibrations valid for those types of sound field are required.

The electrostatic force or pressure produced by the actuator is practically independent of environmental factors. This makes the actuator method well suited to environmental testing of microphones which may be performed at various temperatures, pressures and even in gasses other than air.

2.7.2 Electrostatic Actuator

An electrostatic actuator is a stiff and electrically conducting metal plate which forms an electrical capacitor together with the microphone diaphragm. This must be made of metal or of a metal coated material.

The actuator stands on isolating studs on the microphone housing in front of the diaphragm. The distance between the actuator and diaphragm plates is usually between 0.4 and 0.8 mm. The actuator is perforated in order to minimize its influence on the acoustic pressure produced by the diaphragm, when this is displaced by the electrostatic pressure, see Fig.2.35.



Fig.2.35 Electrostatic actuator used with a 1/2" microphone

When an electrical voltage is applied between the parallel actuator and diaphragm plates a uniformly distributed electrostatic force is produced across the diaphragm. The diaphragm reacts on this electrostatic force or pressure as it would react on an equally strong sound pressure.

2.7.3 Electrostatic Calibration Pressure

The equivalent sound pressure produced by an electrostatic actuator may be defined by considering the fact that the stored energy on an electrical capacitor may be expressed either in electrical or in mechanical terms. This leads to the following equation:

$$\frac{E^2 \cdot C}{2} = F \cdot d$$

where:

$$C = \frac{\epsilon \cdot A}{d}$$

E = electrical voltage between the plates

C = electrical capacitance between the plates

F = force between the plates

d = plate distance

ϵ = dielectric constant of the gas between plates (air = 8.85×10^{-12} F/m)

A = plate area

Rearranging the parameters leads to the following equivalent sound pressure acting on the plates:

$$P = \frac{F}{A} = \frac{\epsilon \cdot E^2}{2 \cdot d^2}$$

where: p = electrostatic pressure

When a DC and a sinusoidal AC voltage are applied between the plates, i.e. between the actuator and the microphone diaphragm, the following expression is obtained for the static and dynamic pressure components:

$$p = \frac{\epsilon}{2 \cdot d^2} \cdot (E_0 + e_{peak} \sin \omega t)^2 = \frac{\epsilon}{2 \cdot d^2} \cdot \left(E_0^2 + 2 \cdot E_0 \cdot e_{peak} \sin \omega t + e_{peak}^2 \frac{1 - \cos 2\omega t}{2} \right)$$

$$P_{static} = \frac{\epsilon}{2 \cdot d^2} \cdot (E_0^2 + e_{rms}^2)$$

$$P_{dynamic} = \frac{\epsilon}{2 \cdot d^2} \cdot (2\sqrt{2} \cdot E_0 \cdot e_{rms} \sin \omega t - e_{rms}^2 \cos 2\omega t)$$

where: E_0 = applied DC-voltage
 e_{peak} = peak value of applied AC-voltage
 e_{rms} = rms value of applied AC-voltage ($e_{peak}/\sqrt{2}$)
 P_{static} = produced static pressure
 $P_{dynamic}$ = produced dynamic pressure
 ω = angular frequency
 t = time

The equivalent sound pressure produced by the actuator at the frequency of the applied electric signal may be derived from the above formula. However, it should be taken into account that the area of the actuator, due to its perforation, makes

only a certain fraction of the diaphragm area. The simulated sound pressure is, therefore, reduced accordingly and defined by the following formula:

$$p_{dynamic[rms]} = \frac{\varepsilon \cdot E_0 \cdot e_{rms}}{d^2} \cdot R_{area}$$

where:

R_{area} = ratio between actuator and diaphragm areas (typically, 0.75).

The ratio of the second harmonic component and that of the fundamental frequency becomes:

$$d_{2nd} = \frac{e_{rms}}{2\sqrt{2}E_0} \cdot 100 \%$$

2.7.4 Electrostatic Actuator Operation

An actuator measurement set-up is shown in Fig. 2.36. The required DC-voltage is supplied via a resistor and the AC-voltage is supplied via a capacitor. These component values should be chosen to give a lower cut-off frequency which is 5 to 10 times lower than the lowest calibration frequency. Their impedances should be sufficiently high that the circuit does not create a safety risk for the user.

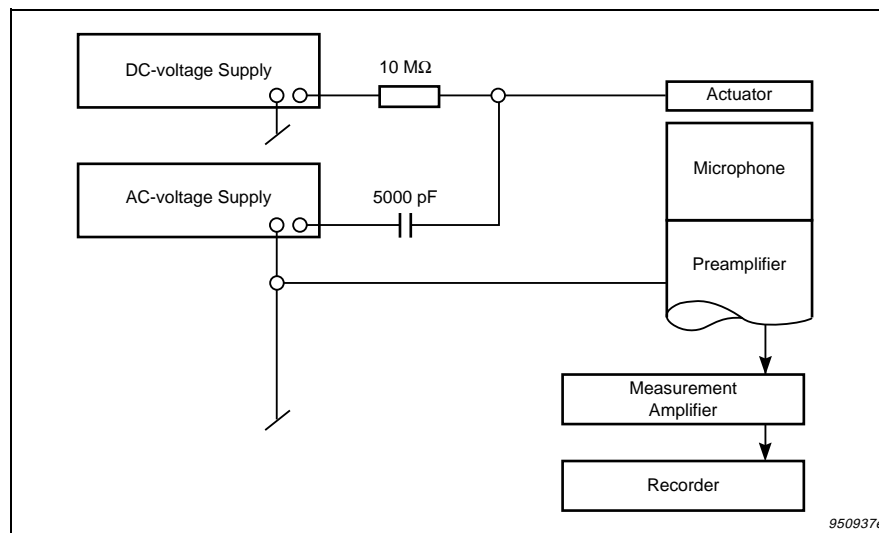

Fig. 2.36 Schematic diagram of measurement set-up for electrostatic actuator calibration

Typical voltages are 800 V DC and 30 V AC (rms). For a distance between the actuator and the diaphragm of 0.4 mm and an actuator-diaphragm area ratio of 0.75, an equivalent sound pressure of one Pascal or 94 dB will be produced. The second harmonic distortion will make 1.3 %.

It is possible to operate the actuator without any DC-voltage. In this case the frequency of the simulated sound pressure will be twice the frequency of the supplied electrical signal, see the formula in 2.7.3 which defines the dynamic pressure. However, this method has two disadvantages: firstly, a much lower sound pressure may lead to an insufficient signal to noise ratio and secondly, the pressure produced depends on the square of the supplied voltage. This may increase the uncertainty of the measurement.

The calibration of a microphone using an electrostatic actuator implies a high AC-voltage on the actuator and often, a very low output voltage from the microphone being calibrated. This creates a risk of making calibration errors due to cross-talk in the measurement set-up. This risk is especially great at high frequencies. The calibration set-up should, therefore, be carefully checked and modified if necessary. The check may be done by either setting the polarization voltages of the microphone or actuator to zero volts. The displayed signal should then fall by 40 dB or more depending on the required calibration accuracy. If this is not the case the cross-talk signal might be reduced by proper selection of instrument ground connections.

2.7.5 Actuator and Pressure-field Responses

In principle, the actuator and the pressure response of a microphone are different. In practice, the difference may be insignificant. It may vary between less than 0.1 dB and about 1 dB depending on the acoustic impedance of the microphone diaphragm system and on the radiation impedance which loads the outside of the diaphragm. The higher the diaphragm impedance the smaller the difference.

For the newer and for some of the older Brüel & Kjær microphone types corrections are available for determination of pressure(-field) responses from measured actuator responses; see examples for 1" and 1/2" microphones in Fig. 2.37. As smaller microphones have higher diaphragm impedances no corrections are necessary.

2.7.6 General Note on Actuator Calibration

Brüel & Kjær give microphone correction values which are to be added to the measured actuator response to obtain the required free-field, diffuse-field and pressure(-field) responses.

Measurement of the actuator frequency characteristic should, generally, be performed with the type of actuator specified with the free-field, diffuse-field and pressure-field corrections as this leads to the highest calibration accuracy.

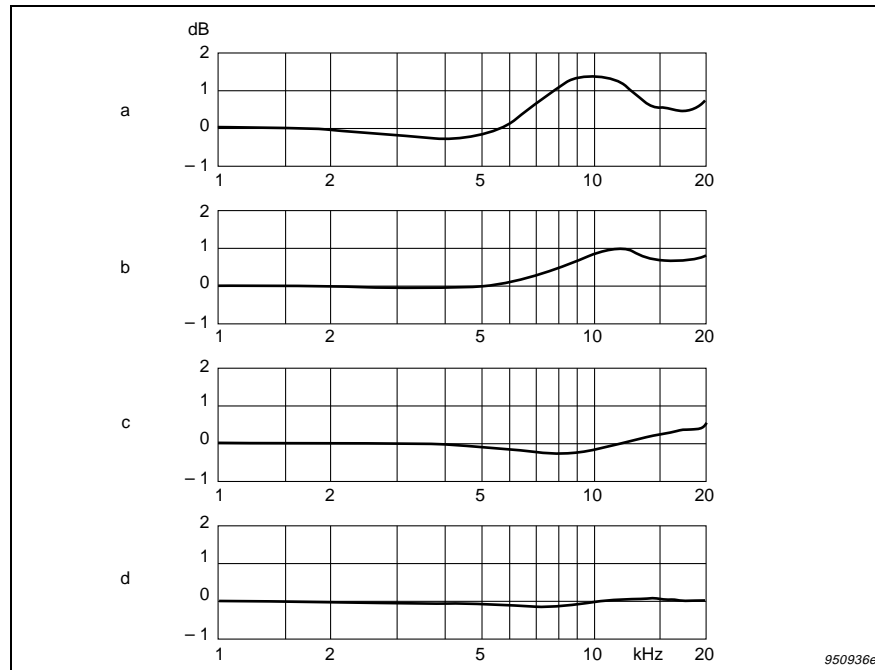

Fig. 2.37 Differences between pressure and actuator responses for four different types of microphone: 1" pressure-field, 50 mV/Pa (a), 1" free-field, 50 mV/Pa (b), 1/2" pressure-field, 12.5 mV/Pa (c) and 1/2" free-field, 12.5 mV/Pa (d)

The reason for this is that the presence of an actuator on the microphone modifies the radiation impedance of the diaphragm. The modification depends on the shape and dimensions of the actuator. As the radiation impedance has an influence on the actuator response, the use of other types of actuator may lead to responses which differ from those valid for the published field corrections.

2.8 Conclusion

This chapter has explained the principles of microphone design and has discussed a number of related subjects. This information is given to promote a general understanding of measurement microphones and in so doing to allow the reader to select and use the correct type of microphone for a specific purpose.

More detailed information on specific types of microphone and microphone products is provided in Volume 2 of this handbook, on individual microphone calibration charts and in product data sheets. Chapter 3 provides further background on the way this data is commonly presented.

Chapter 3

Characteristics of Microphones

3.1 Introduction to Characteristics

The previous chapter of this handbook has described the theory and principles behind measurement microphones. In doing so, the way in which different microphones are designed for different purposes has been explained.

The suitability of a microphone for a particular task is commonly described in terms of a set of characteristics. This chapter describes these characteristics in some detail to give a background to how and why different characteristics are measured. These characteristics are referred to in product-specific literature such as Product Data sheets and Volume 2 of this handbook.

Characteristics are normally described under the following headings:

- The Calibration Chart
- Sensitivity
- Frequency Response
- Directional Characteristics
- Dynamic Range
- Equivalent Volume and Calibrator Load Volume
- Capacitance
- Polarization Voltage
- Leakage Resistance
- Stability
- Effect of Temperature
- Effect of Ambient Pressure
- Effect of Humidity
- Effect of Magnetic Field
- Electromagnetic Compatibility

Similar headings are used in this chapter to provide a reference for the information about specific microphones that is given in product-specific literature.

Information about the characteristics of preamplifiers is not given in this Chapter, but is included in Chapter 4.

3.1.1 The Calibration Chart and Diskette

The calibration chart is an important piece of documentation providing essential information about the performance characteristics of the microphone. A calibration chart is supplied with each microphone delivered by Brüel & Kjær and each calibration chart is individual to that microphone. The calibration chart states both typical

and individual data that applies to the microphone cartridge only, i.e. not a microphone cartridge and preamplifier combination.

The open-circuit sensitivity of the microphone cartridge is an example of an individual and valuable piece of information given on the calibration chart. It allows the user to verify the performance of the cartridge and, together with information on the preamplifier, to calibrate the measurement system.

The microphone calibration diskette provides individual frequency responses for three types of sound field in $1/12$ octave steps. This data can be used to reduce the measurement uncertainty by correcting the measurement data with these responses, by using, for example, a spread-sheet. As this implies, a microphone optimised for one type of sound field can be used in another type of sound field, provided that sufficiently detailed frequency analysis is performed.



Fig. 3.1 Microphone and preamplifier with calibration chart and diskette. The microphone and preamplifier can be stored in the same box

3.2 Sensitivity

3.2.1 Open-circuit Sensitivity (S_0)

The open-circuit sensitivity is defined as the pressure-field sensitivity, valid with an idealised preamplifier which does not load the microphone.

The open-circuit Sensitivity is a microphone specific parameter. The value stated on the microphone Calibration Chart is determined using the Insert Voltage Calibration technique with the configuration described in IEC 1094-1. This standard also describes the mechanical dimensions of both microphone and preamplifier.

The open-circuit sensitivity, which is usually determined at 250 Hz or 1000 Hz, is used for calibration and monitoring of the microphone cartridge. When the entire measurement system must be calibrated, the influence of the preamplifier should be taken into account, see 3.2.2.

3.2.2 Loaded Sensitivity (S_c)

When the microphone cartridge is connected to the preamplifier, its input voltage is attenuated by the preamplifier input capacitance (C_i). This effect is valid over a wide frequency range, therefore, the capacitive loading of the cartridge has no effect on the relative frequency response.

The gain of the microphone and preamplifier combination (G) is also influenced by the gain of the preamplifier itself (g) which is measured by connecting the generator directly to the preamplifier input. The loaded sensitivity, S_c can thus be described using the open-circuit sensitivity, so:

$$S_c = S_o + G[dB]$$

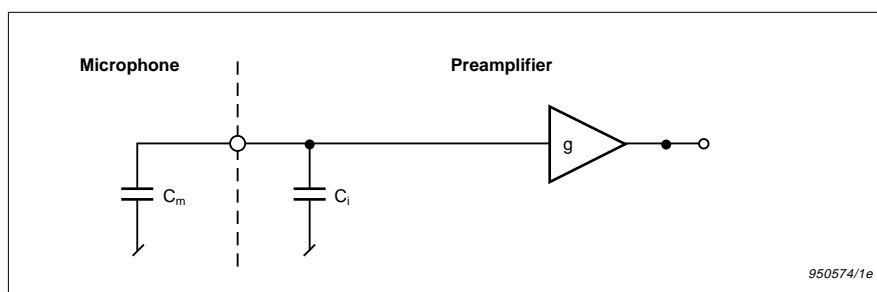

Fig.3.2 Circuit diagram of preamplifier and microphone combination

$$G = 20 \cdot \log \left(\frac{C_m}{C_m + C_i} \cdot g \right) [dB]$$

where:

C_m = polarized microphone capacitance as stated on the microphone calibration chart

C_i = preamplifier input capacitance (as given in the preamplifier specifications)

G = gain of the microphone and preamplifier combination

g = gain of the preamplifier (as given in the preamplifier specifications)

The internal gain, g , of the Brüel & Kjær preamplifiers is typically a little less than unity (for example, $0.997 \approx -0.025$ dB). Typical capacitance values for $1/2''$ microphones and preamplifiers are 20 pF and 0,2 pF respectively. These values yield an overall gain (G) of $(-0,1 \text{ dB}) + (-0,025) = -0,125$ dB.

3.2.3 Correction-factors K and K_o

Some Brüel & Kjær measuring amplifiers and analysers display their input voltage in terms of dB re $1 \mu\text{V}$. This feature can be used for determining the sound level by adding a correction to the displayed value.

The correction is zero dB for a microphone with a sensitivity of $1 \mu\text{V}$ per $20 \mu\text{Pa}$ because $1 \mu\text{V}$ and $20 \mu\text{Pa}$ are the reference values for the levels of the displayed voltage and the sound pressure respectively. This microphone sensitivity equals 50 mV per Pa which corresponds to -26 dB re 1 V per Pascal (microphone sensitivities are specified in dB relative to 1 V/Pa). For microphones with this sensitivity, the instrument will display the sound level directly in dB.

For microphones with other sensitivities, the correction factor (K) defined below should be added to the display reading. The correction factor K is defined as:

$$K = -26 - S_c \text{ or } K = K_o - G \quad [\text{dB}]$$

where K = correction factor

S_c = loaded sensitivity

K_o = open-circuit correction factor

G = gain of the microphone and preamplifier combination

The K_o factor can be found on most Brüel & Kjær microphone calibration charts.

3.3 Frequency Response

3.3.1 Introduction and Optimised response

Individually measured frequency response calibrations are supplied with most Brüel & Kjær microphones. The frequency response of a microphone depends on the type of sound field in which the microphone is used.

In acoustic measurements there are three main types of sound field:

- Free-field
- Pressure-field
- Diffuse-field (equivalent to random incidence response)

The microphone is optimised to have a flat frequency response in one of these sound fields. This response is called the optimised response. The differences between the responses are only evident at higher frequencies. Below 1000 Hz the responses differ by, typically, less than 0.1 dB.

The determination of all responses is based on corrections added to individually measured electrostatic actuator responses above 200 Hz. All measurement microphones have a relatively flat frequency response from 10 Hz to 1000 Hz, independent of the sound field. According to IEC 651 and IEC 1094-4 standards, one frequency in the 200 Hz to 1000 Hz range is selected as the reference frequency, see Fig. 3.3. Brüel & Kjær normally use 250 Hz ($10^{2.4}$ Hz) as the reference frequency. The sensitivity at the reference frequency is used to represent the “overall” sensitivity of the microphone.

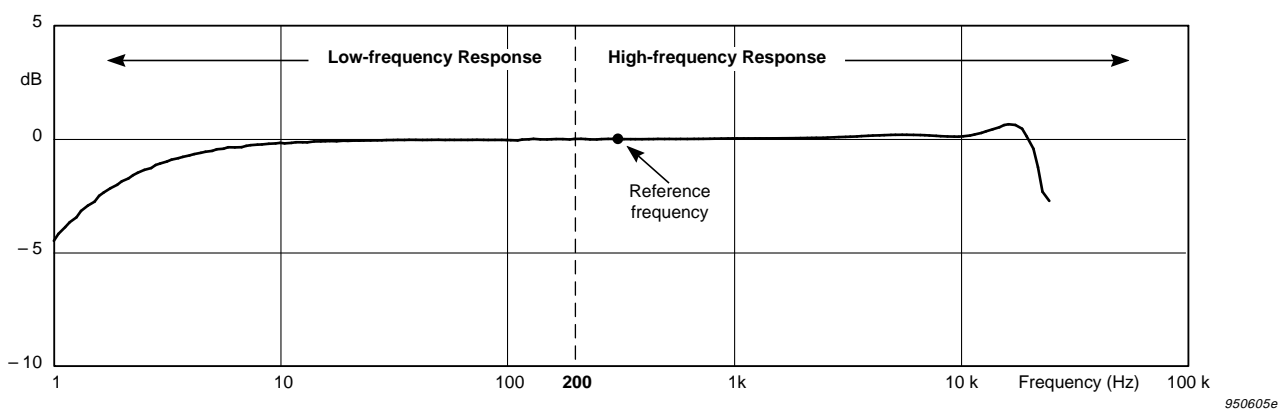

Fig. 3.3 The frequency response curve is composed of an individual high frequency response and a typical low frequency response. The curve is normalised to 0 dB at the reference frequency

For a full discussion about types of microphone designed for different sound fields, see Section 2.5.

3.3.2 Low Frequency Response

In general, the data related to the low frequency response given in the calibration data is typical for the type of microphone cartridge at the reference ambient pressure (101,3 kPa) only.

The -3 dB point on the low frequency response is proportional to the ambient pressure; in practice the influence is insignificant because the lower limiting frequency is below the usual frequency response of interest. Note that the stated low frequency response is valid when the diaphragm and static pressure equalisation vent are exposed to the sound field.

For rear-venting microphones the venting takes place through the preamplifier housing.

In practice, the low frequency response of a measurement system is often determined by other factors, such as the electrical lower limiting frequency of the microphone/preamplifier combination or by a high-pass filter in the conditioning amplifier.

All Brüel & Kjær microphones are tested acoustically to ensure that the lower limiting frequencies are within the production tolerances. This test cannot be performed by an actuator because an actuator does not produce any sound pressure at the vent.

3.3.3 High Frequency Response

To obtain an individual high frequency response, type specific and field dependent corrections are added to the individually measured actuator response for the microphone. These actual corrections are measured during the development of each microphone type.

[Fig. 3.4](#) illustrates how all frequency responses for each of the three sound fields are obtained for the same microphone. This is done by simply adding the type specific correction data to the individually measured actuator response.

3.3.4 Electrostatic Actuator Response

For a description of the electrostatic actuator and its operation, refer to Section 2.7.

Calibration by an electrostatic actuator is a convenient and accurate method for determining individual frequency responses. To a minor degree, the measured response depends on the type of actuator applied. The corrections stated in [Fig. 3.4](#) are valid only for frequency response measurements using the specified type of actuator.

The Electrostatic Actuator Phase Response

The phase response curves shown in Brüel & Kjær literature are normalised to zero degrees at low frequencies. For all Brüel & Kjær externally polarized microphones (positive charge), the phase difference between the voltage and the pressure at low frequencies is -180° . For all Brüel & Kjær prepolarized microphones which use a negative charge, the shift is 0° .

The 90° phase lag relative to the phase at low frequencies determines the resonance frequency of the microphone.

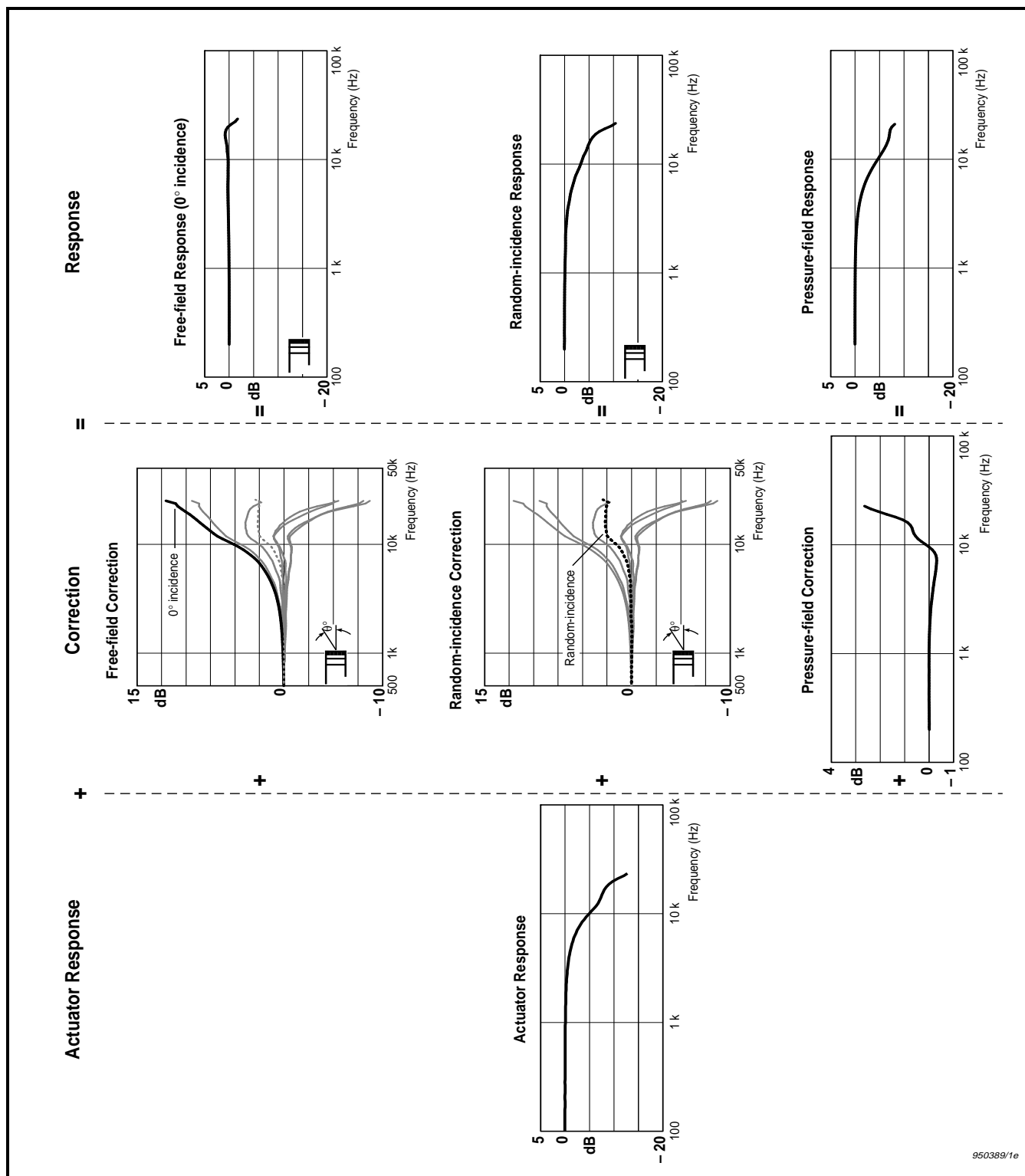

950389/1e

Fig. 3.4 The frequency response curves valid for an individual microphone are obtained on the basis of the individually measured actuator response. The response, valid for different types of sound field, is obtained by adding the corrections, shown in bold, to the actuator response

3.3.5 Free-field Response

For background information on the free-field response of a microphone, refer to Section 2.5.4.

To determine the microphones performance in a free sound field, a correction is added to the actuator response. This correction is denoted as the “Free-field Correction”. This correction must not be confused with corrections used with sound calibrators.

3.3.6 Random Incidence Response

The random-incidence response is the response of a microphone in a diffuse sound field.

A diffuse sound field exists at a given location if the field is created by sound waves arriving more or less simultaneously from all directions with equal probability and level.

A diffuse sound field may be created within a room with hard sound reflecting walls and which essentially contains no sound absorbing materials.

Sound fields with a close resemblance to a diffuse-field may be found in environments such as factories where many simultaneous sound or noise sources exist or in buildings with hard walls, for example, in halls or churches.

The diffuse-field or ‘random incidence’ sensitivity of a microphone refers to this type of field, even if, in most cases, the diffuse-field sensitivity is calculated from measurements performed under free-field conditions. The calculation method is described in the international standard “Random-incidence and Diffuse-field calibration of Sound Level Meters” IEC 1183.

The random-incidence corrections for Falcon-range microphones have been calculated according to IEC 1183-1993 using the free-field corrections from 0° to 360° incidence in 5° steps. For other types of Brüel & Kjær microphone, 30° steps are applied according to IEC 651.

The random-incidence response is determined by adding the random-incidence corrections to the actuator response.

3.3.7 Pressure-field Response

The pressure-field response of a microphone refers to uniformly distributed pressure on the diaphragm.

This response is often regarded as being equal to the actuator response because the difference between them is small compared to the uncertainty related to most meas-

urements. The difference is due to the radiation impedance which loads the diaphragm during the actuator response measurement, see Section 2.7.

The pressure-field response may be determined by adding the pressure-field correction to the individually measured actuator response.

The pressure-field corrections are determined during the intensive analysis that is part of the development of each particular Brüel & Kjær microphone type.

The pressure-field response is measured using the reciprocity method according to the IEC 1094-2 standard. This method is the most accurate calibration method available.

3.4 Directional Characteristics

The directional characteristic is the relative sensitivity variation as a function of angle of incidence. This can be represented graphically by polar plots, see Fig. 3.5 . The same information is, in principle, given in the free-field correction curves. The difference in the representation is that the free-field corrections are given at fixed angles of incidence, while the directional characteristics are given at fixed frequencies.

The directional characteristic is relevant if the microphone is used for free-field measurements.

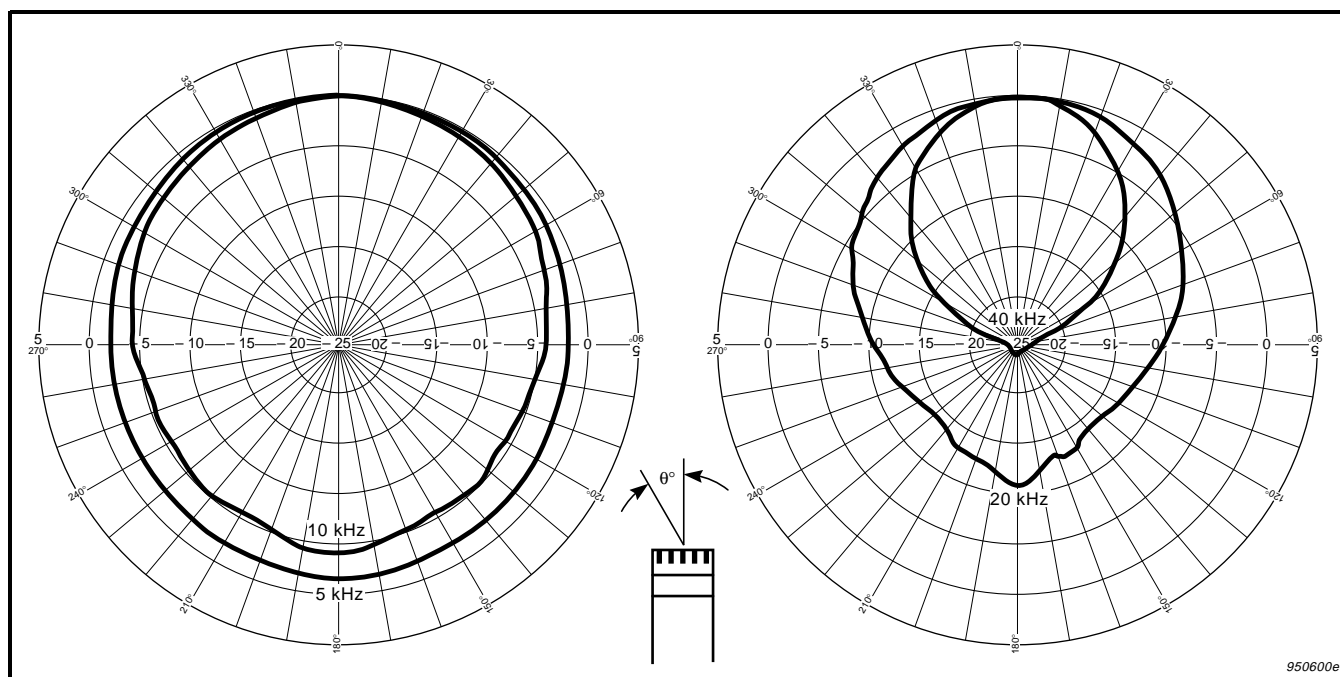

Fig. 3.5 Typical directional characteristics for a $1/2''$ microphone normalised to 0° incidence

The directional characteristics of a 1" microphone will resemble those shown in Fig 3.5 , but at half the frequency. Accordingly, the frequency is multiplied by two or four to represent a 1/4" or 1/8" microphone respectively.

3.5 Dynamic Range

The dynamic range specified for the Brüel & Kjær microphones is limited by:

- the equivalent inherent noise level (dB SPL) which defines the lower limit
- the 3 % distortion level (dB SPL) which defines the upper limit.

3.5.1 Inherent Noise

The inherent noise of the cartridge is determined by the thermal movement of the diaphragm. This is specified either as inherent noise or as cartridge thermal noise, see Section 2.4.3 for a discussion of inherent noise.

Because the microphone cartridge is always used with a preamplifier, the inherent noise of the combination is composed of both microphone and preamplifier noise.

The combined noise level may be calculated by the following formulae:

$$p_n(Mic) = p_{ref} \cdot 10^{\frac{L_n(Mic)}{20}}$$

$$p_n(PA) = \frac{e_n(PA)}{S_c}$$

$$L_n[Combined] = 10 \cdot \log \frac{p_n^2(Mic) + p_n^2(PA)}{p_{ref}^2}$$

where:

$L_n(Mic)$	= cartridge thermal noise level [dB SPL]
$pn(Mic)$	= cartridge thermal noise (Pa)
$pn(PA)$	= equivalent preamplifier noise pressure
$L_n(Combined)$	= combined noise level (dB SPL)
$en(PA)$	= preamplifier noise voltage (V)
P_{ref}	= $p_{ref} = 20 \cdot 10^{-6} Pa$

The noise data ($L_n(\text{Mic})$ and $e_n(\text{PA})$) are given in the respective type specifications. It is important to note that the noise levels must be for the same frequency bandwidths.

3.5.2 Maximum Sound Pressure Level

The dynamic range of condenser microphones is so great that for most practical situations the user will not encounter any limitation due to the maximum permissible sound pressure level.

The maximum output of the microphone is limited by the displacement of the diaphragm. To ensure correct operation, the microphone should not be exposed to sound pressure levels exceeding the stated Maximum Sound Pressure Level (peak).

This corresponds to a peak output voltage of 40 to 50% of the polarization voltage. Above this level, the output becomes heavily distorted (clipping occurs). In addition, an externally polarized microphone will temporarily lose its charge and will need some time to recover. However, even if the maximum sound pressure is exceeded, for example, by up to 10 dB, the microphone will not suffer permanent damage provided it is used with a Brüel & Kjær preamplifier. This is because the preamplifiers are constructed so that the discharge that occurs when the diaphragm touches the backplate does not harm the diaphragm.

The microphone is always used with a preamplifier, therefore the limits for this should also be taken into account. The maximum output voltage from the preamplifier depends on the supply voltage. To utilise the wide dynamic range of the microphone, the preamplifier should be operated at a supply voltage of 100V. Even so, the preamplifier may be the limiting factor.

While the microphone has a distortion proportional to the sound pressure level (3% distortion level is stated), the preamplifier has a very low distortion until a level of a few dB below the clipping point where the distortion suddenly increases. The maximum output peak level from the preamplifier is usually a few volts lower than half the total supply voltage. The actual supply voltages are stated in the product data sheet for the power supply.

Often it is convenient to express the preamplifier maximum output in terms of equivalent peak sound pressure level. The equivalent peak sound pressure can be found from the following equation:

$$SPL_{peak}[max] = 20 \cdot \log \left(\frac{e_{peak}}{S_c \cdot P_{ref}} \right) [dB]$$

where:

SPL_{peak} = equivalent peak sound pressure level of the preamplifier

e_{peak} = Maximum output voltage of the preamplifier (V)

S_c = loaded microphone sensitivity (V/Pa)
 p_{ref} = reference sound pressure ($20 \cdot 10^{-6}$ Pa)

3.6 Equivalent Diaphragm Volume

The equivalent diaphragm volume is that volume of air which has the same compliance as the diaphragm at a static pressure of 101.3 kPa.

Equivalent diaphragm volume is used in connection with coupler calibration of microphones and for evaluating the loading which the microphone presents to small couplers. See Section 2.3.12 for more detailed information.

3.7 Calibrator Load Volume

The calibrator load volume is the sum of the equivalent diaphragm volume and the air volume enclosed by the outer surface of the protection grid and the diaphragm. See the relevant data sheet for typical values.

The calibrator load volume is used to evaluate and correct the loading of microphones when used on calibrators and pistonphones.

3.8 Capacitance

When a condenser microphone is included in an electrical circuit, it may be considered as being a purely capacitive component.

The capacitance is determined by the distance between the diaphragm and the backplate, and by stray capacitance between the backplate and the microphone housing.

The capacitance of the microphone and its variation with frequency is a function of the polarisation voltage, see [Fig. 3.6](#). The stated values of microphone capacitance are valid for nominal polarization voltage at 250 Hz (generally 200 V for externally polarised microphones and 0 V for prepolarized microphones). The capacitance of the microphone can be used for the evaluation of loaded sensitivity (S_c) lower limiting frequency and preamplifier noise.

The stability of the microphone is closely related to its capacitance, i.e. changes in capacitance reveal changes in microphone sensitivity and frequency response. This relationship is exploited in the Brüel & Kjær patented Charge Injection Calibration technique for monitoring the condition of a microphone (see Section 4.8).

A similar capacitance variation with frequency occurs with prepolarized microphones.

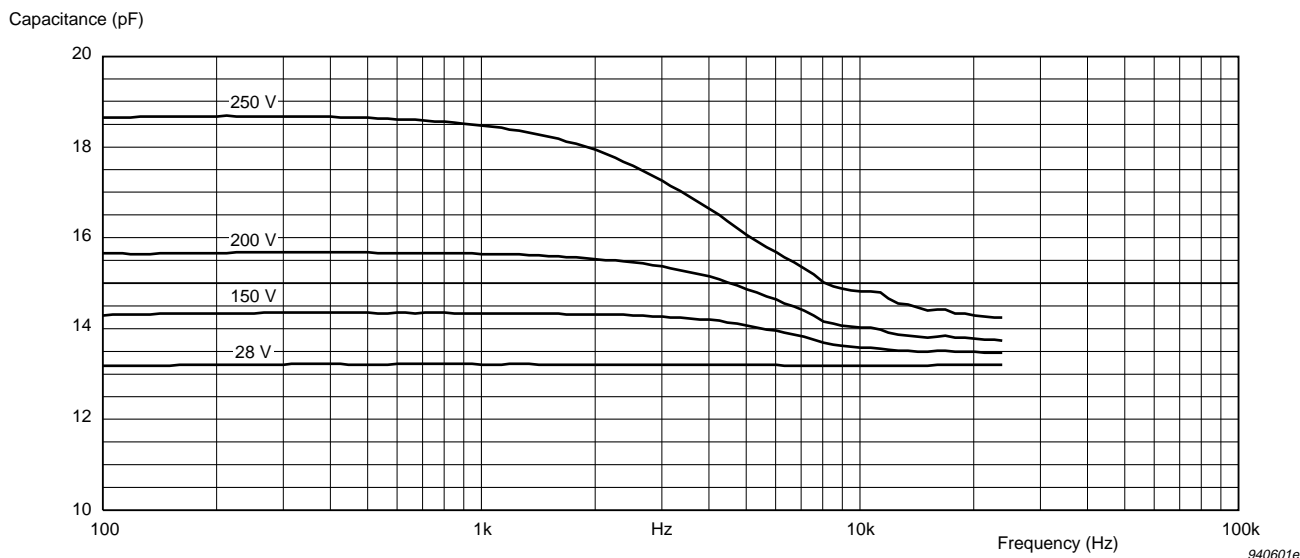

Fig. 3.6 Example of the variation of capacitance with polarization voltage

3.9 Polarisation Voltage

The working principle of the condenser microphone is based on a fixed charge. This charge is established, either with a very stable external polarisation voltage via a large resistor, or by an electret layer deposited on the backplate. The two methods are described below. See also Section 2.3.4 for background theory on the polarization voltage and the transduction principle.

3.9.1 Externally Polarized Microphones

Each type of microphone is designed to operate with a specific polarisation voltage at which the specifications are valid. The microphone should be allowed to charge properly before a measurement is started. In most cases, 30 seconds will be sufficient, but this depends on the microphone capacitance and the polarization resistor of the preamplifier. The polarisation resistor is kept high (typically 10 G Ω) to ensure a large time constant which will not affect the lower limiting frequency of the microphone and preamplifier combination.

The microphone should not be operated at polarisation voltages higher than the nominal value as this may result in excessive leakage or even arcing, both leading to an unstable situation. If the microphone is operated at polarisation voltages lower than the nominal value, the sensitivity and frequency response will change, see the example shown in [Fig. 3.7](#) and [Fig. 3.8](#).

The sensitivity of the cartridge is essentially proportional to the charge, see Fig. 3.8.

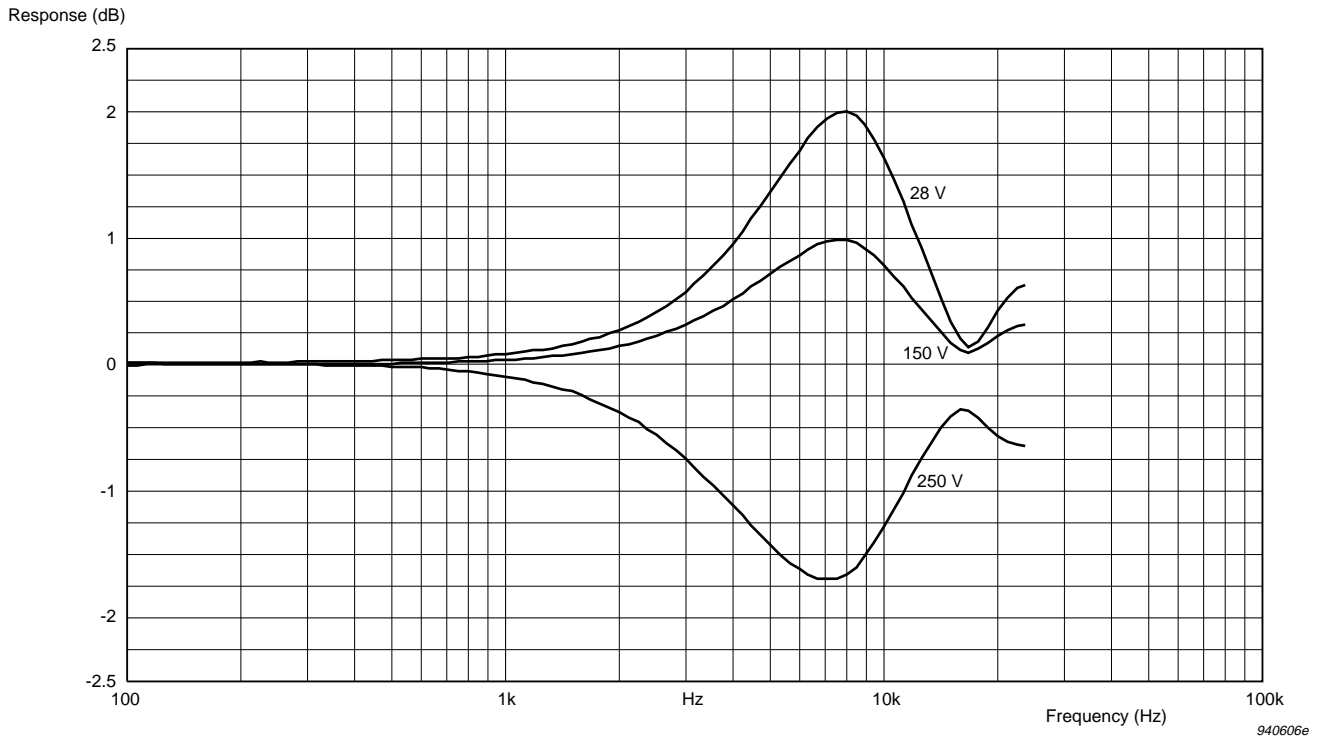

Fig. 3.7 Example of the frequency response dependency with polarisation voltage. The curves are normalised to the nominal value of 200 V. This example is for a $1/2$ " microphone with high sensitivity. The dependency is less for $1/2$ " microphones with lower sensitivity

A reduction in polarization voltage, and hence sensitivity, can be a practical expedient to avoid overloading preamplifiers in situations where there is a combination of high levels, high frequencies and long cables.

Brüel & Kjær instruments supply a positive polarization voltage for externally polarized microphones. This type of microphone therefore produces a negative voltage for a positive pressure.

3.9.2 Prepolarized Microphones

Prepolarized microphones contain a stable charge in the electret layer on the backplate, see Section 2.3.4. All Brüel & Kjær prepolarized microphones are negatively charged. They therefore produce a positive voltage for a positive pressure.

If an external polarisation voltage is accidentally applied to the prepolarized microphone, no permanent harm is done. However, the sensitivity is significantly reduced by 10 dB or more as long as the external polarization is sustained. The resulting

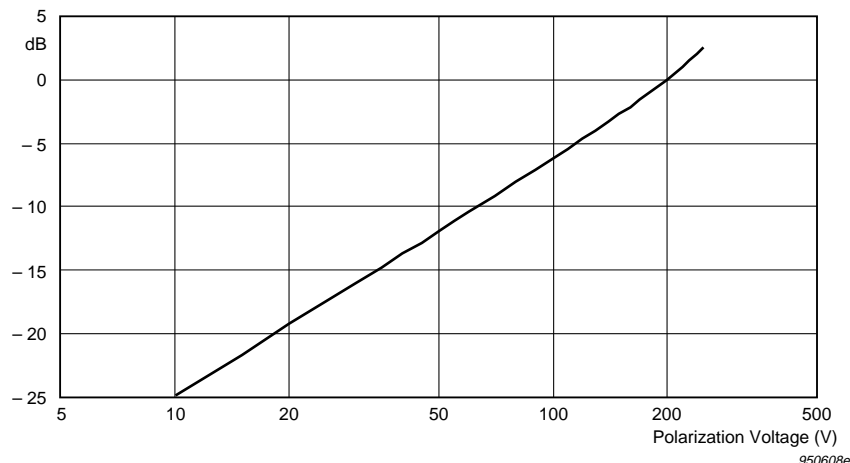

Fig.3.8 Change in sensitivity as a function of polarisation voltage at 250 Hz

polarisation voltage is the sum of the external and internal polarization voltages which are of opposite sign.

3.10 Leakage Resistance

Leakage resistance is the electrical resistance between the centre terminal and the housing of the microphone. For several design reasons, preamplifiers use high resistors for the polarization voltage supply. Therefore to avoid a reduction of the polarization voltage, and so ensure accurate measurements, the leakage resistance of the microphone must be at least a thousand times greater than the polarization voltage resistance of the preamplifier. This requirement must be fulfilled even under severe environmental conditions, for example, in conditions of high humidity and high temperature.

These high values impose stringent demands on design, materials and production of microphones. Brüel & Kjær microphones are tested to these requirements at 90% relative humidity. Note that the surface of the microphone insulator should not be exposed to contamination, for example, from dust and hair, as this may lead to a low leakage resistance.

If microphones, produced to lower leakage resistance requirements, are used with high-quality Brüel & Kjær preamplifiers there will be a risk of instability in sensitivity.

For prepolarized microphones, the leakage resistance is far less critical. It need only be about ten times greater than the resistance of the preamplifier polarization resistance in order not to significantly influence the lower limiting frequency of the microphone and preamplifier combination.

3.11 Stability

The stability of a measurement microphone is a very important feature. It is one of the features that distinguishes measurement microphones from other microphones.

Changes in the parameters of a microphone are dealt with here under “Irreversible Changes” and “Reversible Changes”.

3.12 Irreversible Changes

3.12.1 Long-term stability

The diaphragm of a microphone has a certain, high mechanical tension which will decrease as a function of heat and time. A decrease in tension leads to a permanent change in the sensitivity of a microphone. At normal room temperature this effect is of the order of 1 dB per 1000 years. At elevated temperatures the effect is accelerated, see Section 2.6 for details.

3.12.2 Handling

The mechanical stability of the microphone is determined by its ability to withstand mechanical effects, for example, a force applied to the diaphragm clamping ring or unpredictable mechanical shocks, such as if the microphone is dropped onto a hard surface. Brüel & Kjær microphones are designed and tested to withstand such effects. However, it should be noted that microphones are delicate precision measuring instruments, especially those designed for laboratory use, and should be treated carefully.

Special care should be taken when the grid is removed; avoid touching the diaphragm as it is easily damaged by sharp points or particles. Some microphones have “screwed on” diaphragms and in this case touching the clamping ring may change the diaphragm tension causing subsequent changes in sensitivity and frequency response. In addition, care should also be taken not to stress the diaphragm by having different static pressure on the front and the back side of the diaphragm (normally avoided by having the Pressure Equalisation Vent in the sound field). This may also happen when mounting and dismounting the microphone from a small coupler or cavity. Here the microphone may be subjected to a large vacuum causing heavy loading of the diaphragm. This could cause changes in sensitivity and frequency response.

3.12.3 Short-term Stability

Over the lifetime of a microphone it is very likely that some minor variations in sensitivity will occur due to thermal or mechanical shock. These changes occur due

to settling of the relative positions of the mechanical parts. However these changes will generally not exceed 0.1 dB and are therefore negligible for most applications.

The short term stability of a microphone is very high once the microphone is acclimatised and used in stable ambient environments. Usually the microphone will sustain the sensitivity within 0.01 or 0.02 dB under such stable environments. This is important when the microphone is used as a laboratory reference.

3.13 Reversible Changes

Reversible changes occur as a result of environmental influences. Correction factors are available for the three main influences: temperature, ambient temperature and humidity.

3.13.1 Effect of Temperature

The sensitivity of the microphone is only slightly affected by the ambient temperature. It is usually not necessary to compensate for this influence, unless the microphone is subjected to very high or very low temperatures. After quick changes in temperature the microphone should be allowed to acclimatise for at least 15 minutes at the ambient conditions to ensure correct operation.

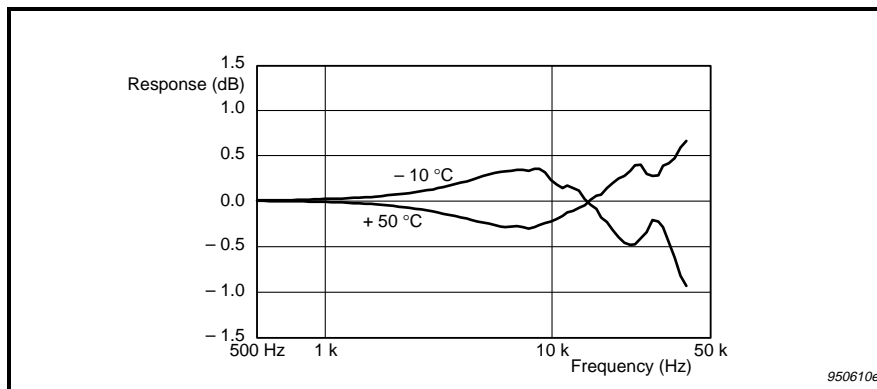

Fig.3.9 Example of reversible changes. Typical variation in 0° – incidence free-field response (normalised at 250 Hz) as a function of temperature, relative to the response at 20°C

Brüel & Kjær specify a temperature coefficient at 250 Hz and graphs of sensitivity variations as function of temperature. These can be used to compensate for the deviation in sensitivity. The deviation is read directly from the graphs. The temperature coefficient depends on the frequency. Fig.3.9 and Fig.3.10 show how changes occur in the frequency characteristics at various temperatures.

The magnitude of the influence on the sensitivity at 250 Hz is typically -0.002 to -0.008 dB/°C. See microphone type data for more details.

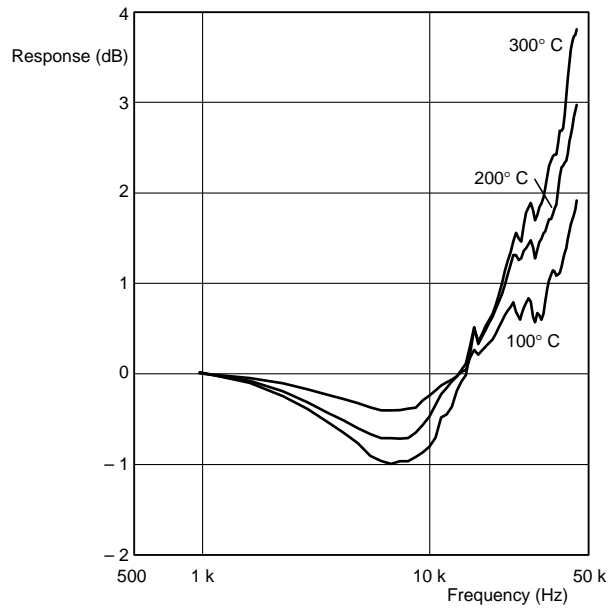

Fig. 3.10 Example of reversible changes. Typical variation in actuator response (normalised at 250 Hz) as a function of temperature, relative to the response at 20°C

3.13.2 Effect of Ambient Pressure

The ambient pressure influences the sensitivity of the microphone. The microphone sensitivity and frequency response stated is in most cases valid at an ambient pressure of 1 atmosphere = 101.325 kPa. The ambient pressure is sometimes referred to as static pressure.

The microphone is designed with a vent to equalise the pressure inside and outside the microphone, so it only detects deviations from the equilibrium, which is the sound we want to measure. The output from the microphone is, however, affected by variations in ambient pressure. This is due to changes in air stiffness and air density which affect the impedance of the cavity behind the diaphragm.

The ambient pressure varies with altitude, and it also varies over time at the same location. With the exception of few locations, these variations do not usually exceed the range 80 to 120 kPa (only ± 20 kPa relative to one atmosphere). Those microphones with the greatest sensitivity to ambient pressure will rarely give rise to a correction of more than 0.4 dB. See microphone type specifications for more details.

Fig. 3.11 shows an example of the variation in sensitivity as a function of ambient pressure at the reference frequency of 250 Hz. The slope of the curve at 101 kPa is specified as the pressure coefficient and is determined by the ratio between the diaphragm stiffness and the stiffness of the air in the internal microphone cavity. The pressure coefficient may be used to add corrections to the sensitivity of the microphone. However, if a sound calibrator is used to calibrate the entire measure-

ment system, the change in sensitivity of the microphone is automatically taken into account.

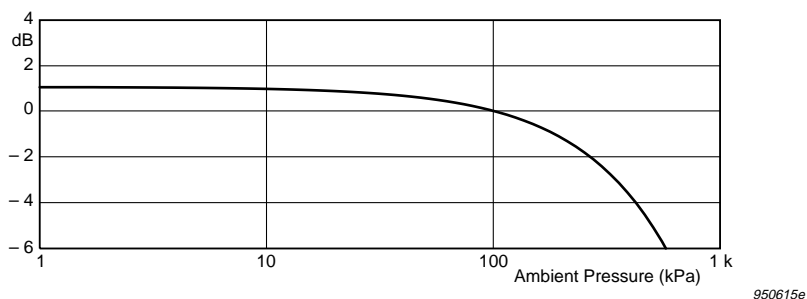

Fig.3.11 Example of the variation in sensitivity as a function of ambient pressure

The graph in Fig.3.12 shows the variation in frequency response due to changes in ambient pressure below one atmosphere. These graphs may be used to make corrections of the frequency response. For small variations in ambient pressure above one atmosphere, the change in frequency response corresponds to that below one atmosphere, but with the opposite sign.

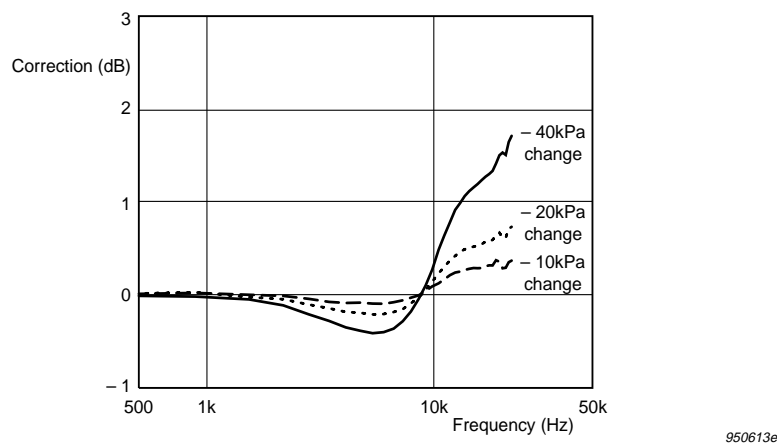

Fig.3.12 Typical variation in frequency response (normalised at 250 Hz) from that at 101 kPa, as a function of change in ambient pressure

3.13.3 Effect of Humidity

Brüel & Kjær microphones have been tested for effects of humidity according to IEC-68-2-3 standard for Basic Environmental Testing Procedures.

In general, humidity has no influence on the sensitivity and frequency response of the microphone. However some microphones have a layer of quartz on the diaphragm which absorbs moisture. This leads to a decrease in tension of the diaphragm and a corresponding increase in microphone sensitivity. The magnitude of this effect is typically 0.4 dB/100% relative humidity. See microphone type specific information for more details.

The situations where one should be aware of humidity problems are where sudden changes in temperature and humidity occur, for example, when going from a warm, humid environment to a cool air-conditioned building. The opposite situation is not so critical because any condensation that may occur will only affect the outside of the instrument.

However, if condensation occurs, it will usually result in some electrical leakage which obviously results in a malfunction of the microphone and preamplifier. The moisture will attenuate the sensitivity of the microphone and as a side effect, increase the inherent noise level, see Section 3.10.

3.13.4 Effect of Vibration

The vibration sensitivity of the microphone (normal to the diaphragm) is well defined as it is determined by the mass of the diaphragm. The vibration sensitivity is much smaller in all other directions. Preamplifiers and electrical adaptors and alike may also contribute to the vibration sensitivity of the measurement channel. The vibration sensitivity usually varies with the vibration direction. The magnitude of this effect is of the order of 65 dB (SPL) for $1/\text{ms}^{-2}$.

3.13.5 Effect of Magnetic Field

The Brüel & Kjær microphones are designed with materials that provide a very low sensitivity to magnetic fields. The latest Falcon RangeTM microphones have significantly lower sensitivity to magnetic fields than earlier microphones.

3.13.6 Electromagnetic Compatibility

A microphone cartridge is a passive and well shielded component. Therefore the electromagnetic compatibility entirely depends on the equipment connected to the cartridge. See Section 4.7, for more information on this subject.

Chapter 4

Characteristics of Preamplifiers

4.1 Introduction to Characteristics of Preamplifiers

4.1.1 Definition of a Microphone Preamplifier

A microphone preamplifier is an impedance converter between a high impedance microphone and its following cable. A low output impedance is necessary to drive long signal cables.

4.1.2 Selection of a Microphone Preamplifier

In principle, microphone preamplifiers have more or less identical electrical characteristics i.e. a gain of unity and a frequency range of a few hertz to more than 200kHz. The most obvious difference between preamplifiers is the diameter, with the most common diameter being $\frac{1}{2}$ ". For acoustical reasons, it is usual to select a preamplifier with the same diameter as the microphone to be used. Brüel & Kjær produce $\frac{1}{2}$ " and $\frac{1}{4}$ " preamplifiers. Adaptors are available to connect these to $\frac{1}{8}$ " or 1" microphones.

Apart from diameter, other important selection parameters include the transmission principle, (for example, current, voltage or digital signals) system verification facilities, phase characteristics, inherent noise and current supply requirements.

4.1.3 Contents of this Chapter

Certain characteristics are commonly referred to in discussion of the performance and design attributes of preamplifiers. This chapter describes these characteristics in some detail. The information is intended to promote both a general understanding of preamplifiers and to support the information given in Volume 2 of this handbook.

4.2 Frequency Response

The frequency response of a microphone preamplifier typically covers a range from a few hertz and up to approximately 200 kHz, which is far greater than the audible range of humans. Within most of this range, the amplifier acts as a buffer with a near perfect flat frequency response. The responses at the extremities of the frequency range are more complex and are described in Section 2.4 and here, in more detail, under separate headings.

4.2.1 Low Frequency Response

Usually the low frequency response of a microphone and preamplifier combination is determined by the static pressure equalisation system of the microphone. There is however, another important factor to be considered. The electrical low frequency

response of the microphone capacitance in combination with the input impedance of the preamplifier.

This electrical response at low frequencies is determined mainly by the highpass filter (R-C circuit), created by the capacitance of the connected microphone (C_m) and the input impedance of the preamplifier (R_i), giving the -3 dB cut-off frequency:

$$f_{-3} = \frac{1}{2\pi \cdot R_i \cdot C_m}$$

The typical electrical low frequency responses are normally shown with capacitances equivalent to common $1/4''$, $1/2''$ and $1''$ microphones (typically 6 pF, 15 pF and 50 pF). While the microphone capacitance is a rather simple and well defined property, the preamplifier input impedance can be more complex.

Normally, the input impedance consists of a resistive impedance of approximately 20 G Ω in combination with small stray capacitances of about 0.2 pF. In conjunction with the microphone, this results in a 1st order highpass filter, as mentioned above, with a minor capacitive attenuation of the microphone signal.

Some preamplifiers use a boot-strapping technique where there is feedback from the output signal to the input of the amplifier. This reduces the alternating voltage across the components, resulting in lower input currents and subsequently in a higher impedance. This technique can be used to achieve a very low cut-off frequency, as well as good phase linearity. Note that with some preamplifiers which use a bootstrapping technique, a gain peaking at frequencies under 20 Hz can occur. In combination with low frequencies and perhaps inaudible signals, this can result in an overload of the system.

[Fig.4.1](#) shows typical electrical low frequency responses for two different types of preamplifier, one with a simple resistive input impedance and one with a complex input impedance obtained by bootstrapping.

Also shown in [Fig.4.1](#) is a solution for lowering the electrical cut-off frequency of the preamplifier. This is done by simply adding stray input capacitance to the preamplifier. Special adaptors may be used to obtain this effect, but this obviously also has the effect of lowering the sensitivity for the system. Such a microphone and preamplifier system is useful for measuring low frequency sound.

4.2.2 High Frequency Response

Normally, the high frequency response of a microphone and preamplifier combination is determined by the acoustical high frequency cut-off of the microphone. However, the electrical high frequency response of the combined preamplifier and cable loading must also be considered.

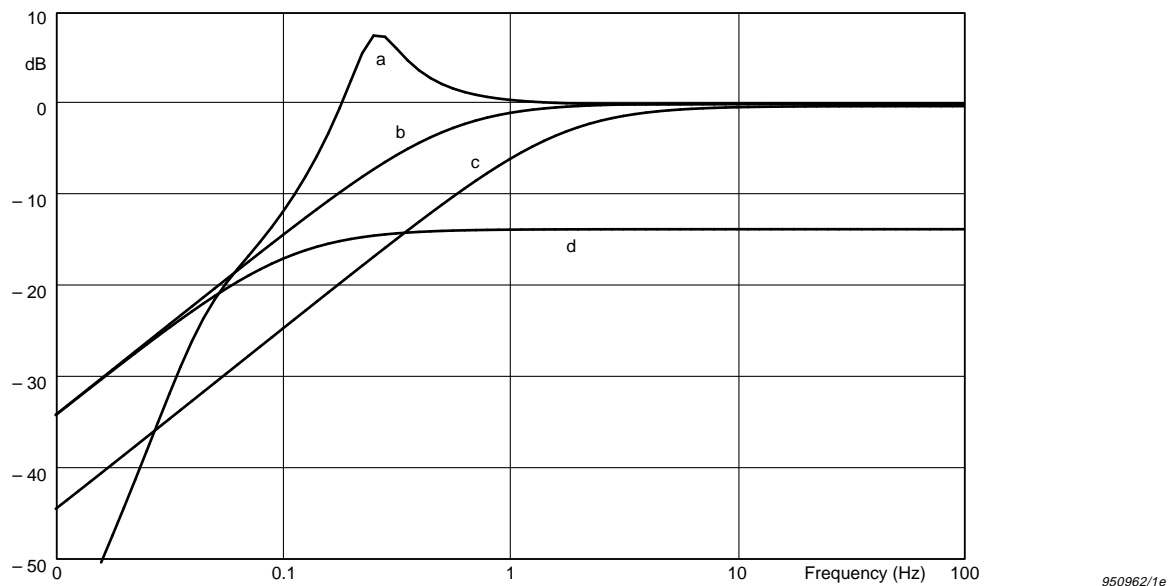

Fig 4.1 Electrical low frequency response of preamplifiers with various microphone and adaptor combinations: a, preamplifier with bootstrapping; b, c and d, preamplifiers with 1st order high pass filter. Microphone capacitance: (a) 6 pF (b) 20 pF, (c) 6 pF (d) 20 pF in combination with a 80 pF stray capacitance adaptor

The electrical high frequency response is determined by different properties of the preamplifier in combination with the capacitive load of the connection cable. These properties are the output impedance, the maximum output current capacity and the maximum output slew rate.

The normally mentioned “Frequency Response” will be considered here as the response obtained when the dynamic properties of the preamplifier are negligible. This response is also known as the “small signal” response. The opposite, “large signal” response will be discussed in Section 4.3: “Dynamic Range”.

The small signal, electrical high frequency response of the preamplifier is determined by the low pass filter created by the output impedance of the preamplifier and the capacitive load of the connection cable.

The output impedance is determined by protection components built into the preamplifier output circuit stage. This protection consists of a current limiting resistor and for some preamplifiers, a filter that protects the preamplifier electronic circuit against high frequency electromagnetic noise picked up by the cable. This filter includes a series inductor, which in combination with the cable capacitance can cause gain peaking in the 100 kHz to 200 kHz frequency range, as illustrated in Fig. 4.2. The advantage of this system is that it enables the preamplifier to be used where radio interference can be expected.

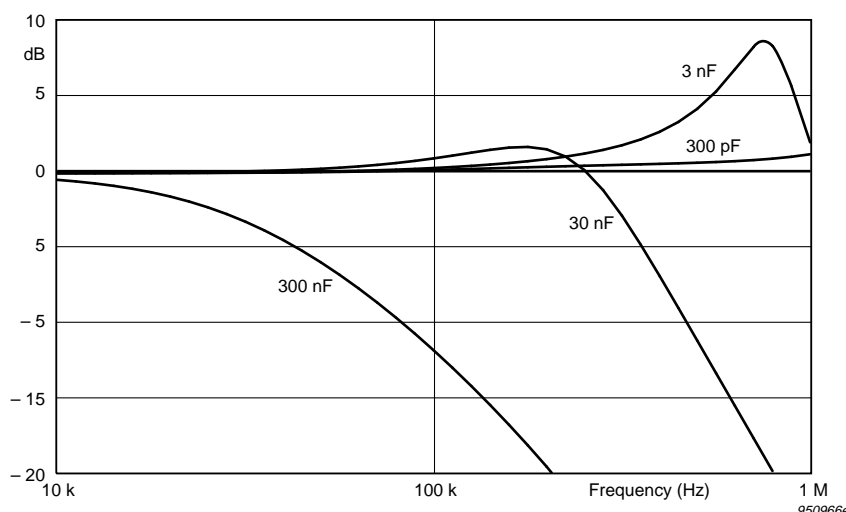

Fig. 4.2 Electrical high frequency responses for small signal of preamplifiers with different cable capacitances. The cable capacitance is typically 100 pF/m

4.3 Dynamic Range

The dynamic range for the microphone and preamplifier combination is also discussed in Section 2.4 and 3.5. This total dynamic range is primarily limited by the preamplifier. This section concentrates on the preamplifier and its associated measurement chain.

The dynamic range of the preamplifier is the ratio between the maximum and the minimum output voltages. The lower limit is defined by the self-generated noise of the amplifier and the upper limit is set by the distortion created at high output levels due to clipping of the signal.

The typical dynamic range of a preamplifier varies from about 1 to 4 μV (A-weighted) to approximately 35 V with maximum preamplifier supply voltage. This gives a dynamic range of up to about 140–150 dB. The location of this range with respect to sound pressure level, is mainly dependent on the sensitivity of the selected microphone. The selection of the microphone depends on the actual measurement requirements, see Chapter 5.

The remainder of this section describes some of the different mechanisms which set the limits at both ends of the dynamic range.

4.3.1 Upper limit of Dynamic Range

The parameters that determine the combined frequency response of the preamplifier and cable also determine the response and behaviour at high signal levels. These

parameters are the maximum output voltage, the current and the slew rate of the signal.

4.3.2 Maximum Voltage

The limitation set by the maximum output voltage is due to a clipping of the signal which occurs when the peak of the output signal reaches a maximum level set by the supply voltage, minus a voltage-drop determined by the preamplifier construction. See the specifications for the relevant preamplifier for details.

Clipping is responsible for the maximum output at lower frequencies. To make the most of the dynamic operation range of the condenser microphones, the supply voltage has to be quite high i.e. 100 – 120 V.

If the input signal exceeds the limits set by the supply voltage, an abrupt generation of harmonic distortion will result

The maximum sound pressure level that can be handled by the microphone preamplifier can be calculated by:

$$SPL_{peak(max)} = 94 + 20 \log \left(\frac{e_{peak}}{S_c \cdot p_o} \right) [dB]$$

where:

SPL_{peak} = peak acoustical sound pressure level in dB re 20 μ Pa (1 Pa = 94 dB)

e_{peak} = peak output voltage of the preamplifier in V

S_c = loaded sensitivity of the microphone in V/Pa

p_o = pressure level for stated microphone sensitivities = 1 Pa.

Note: The peak signal is typically 3 to 10 dB higher than the RMS value (for a pure tone 3 dB, for a noise signal typically 10 dB).

4.3.3 Maximum Current

A second limitation is the maximum output current. This current is normally determined by the design of the output stage in the amplifier, however, the current capacity of the power supply could also be a limiting factor.

The current limitation should be considered when high frequencies, long cables and relatively high signal levels are combined. The relation between the maximum sound pressure level, the frequency and cable load for a given current capability is given by the following formula:

$$SPL_{peak}(max) = 94 + 20\log\left(\frac{i_{peak}}{2\pi \cdot f \cdot C_L \cdot S_c \cdot P_o}\right) [dB]$$

where:

- i_{peak} = maximum current capacity of the preamplifier or (if lower) of the power supply in A.
- C_L = total capacitive load presented by the connection cable in F. Typically 50 to 100 pF/m.
- p_o = pressure level for stated microphone sensitivity = 1 Pa
- f = applied maximum frequency.

4.3.4 Maximum Slew Rate

The third limitation is due to the slew rate which is defined as the rate of change of output voltage (i.e. de/dt). The slew rate limitation is caused by the internal currents and capacities inside the preamplifier. This is typically the limiting factor for the output-voltage and frequency when short cables are used.

The slew rate only requires attention in special situations, for example, where combined very high frequencies and signal levels occur. The limitation is described by:

$$SPL_{peak}(max) = 94 + 20\log\left(\frac{de/dt}{2\pi \cdot f_{max}(S_c \cdot P_o)}\right) [dB]$$

where:

- de/dt = maximum slew rate, V/s
- f_{max} = maximum frequency of interest

The influence of these three limitations (voltage, current and slew rate) are shown in Fig. 4.3. The upper limits are defined here by a distortion level of 3%. Common to all these limitations is the fact that an excess will create a sudden rise in the distortion level. Contrary to this, the microphone exhibits an almost linear relationship between sound pressure level and distortion (see Chapter 3 for details). Therefore, the contribution of the preamplifier to the total distortion can practically be ignored until one of the mentioned limits occur.

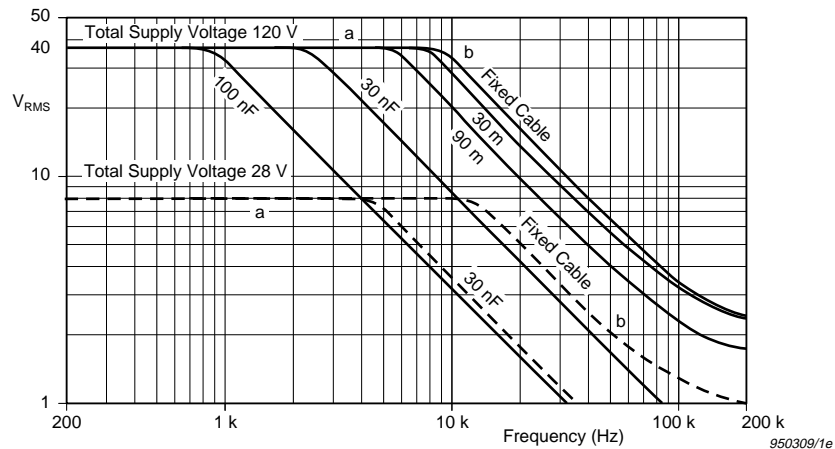

Fig. 4.3 Maximum output voltage vs frequency showing the influence of preamplifier limitations caused by: a) maximum supply voltage, b) slew rate. The curves, for different cable lengths and loads, are all caused by current limitation

4.3.5 Lower Limit of Dynamic Range

The lower limit of the dynamic range of the preamplifier is set by the inherent noise. The noise is primarily generated by two independent sources: resistor noise N_R and transistor noise N_{FET} .

These two noise sources can be considered as being located in the passive and active part of the preamplifiers input circuit respectively, as shown in Fig. 4.4.

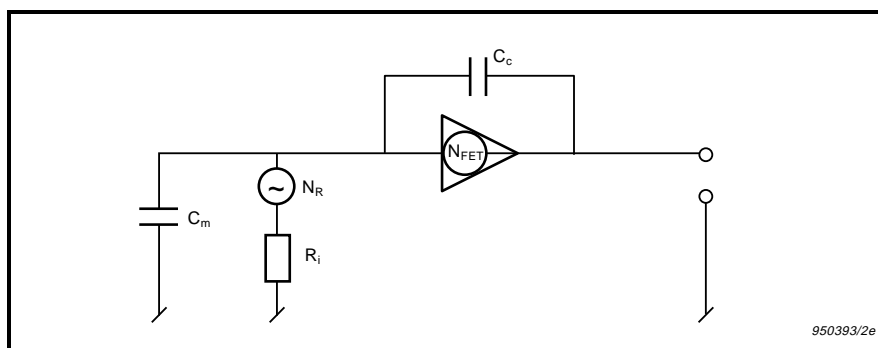
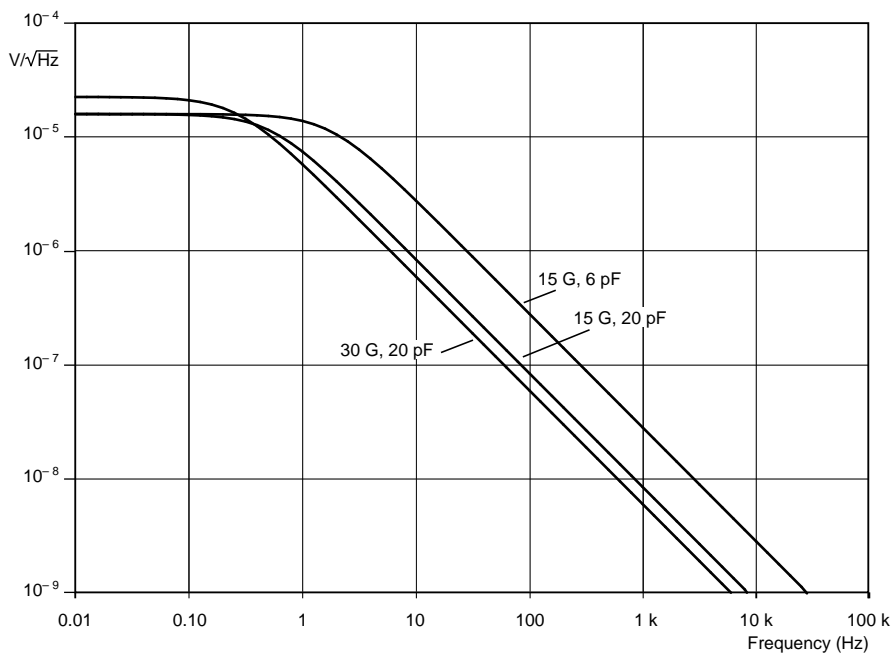

Fig. 4.4 Schematic diagram of preamplifier showing noise sources

The N_R -noise is the thermal noise created by the high value resistors in the input circuit (R_i). Thermal resistor noise is characterised as white noise i.e. the same magnitude for all frequencies and is proportional with both resistance and absolute

temperature. However, in the preamplifier, this resistor noise is shunted by the capacitance of the microphone (C_m). This has the effect of low-pass filtering the noise signal, resulting in a noise spectrum as seen in Fig. 4.5, which shows the noise spectrum for different combinations of capacitance and resistance.



960272e

Fig. 4.5 Noise spectral density $V/\sqrt{\text{Hz}}$, for different combinations of microphone capacitances and input resistances

In the frequency range where the preamplifier is used, this low pass filtering causes a noise decrease when the input resistance increases due to the low pass filtering effect. For this reason, modern preamplifiers are designed with high input resistances.

The input resistance is determined by two resistors; one used to establish the polarisation voltage for the microphone and the other, to set the DC-working point for the preamplifier. Resistors of too high a value can give practical problems, both with respect to DC-stability and with inconvenient long stabilisation times for the complete measuring-system.

The second noise source, the transistor noise N_{FET} is related to the active part of the amplifier input stage, which consists of a Field Effect Transistor (FET). The FET noise has three different origins: channel noise, (creating white noise), material impurities, (creating pink noise) and leakage current, which in combination with the input resistors creates white noise “coloured” by the input impedance. The influence of the leakage current will be mentioned under Section 4.6: Effect of Temperature.

Under normal environmental conditions, only the white noise source is relevant. This white noise source has the same nature as the previously mentioned resistor noise, but here the resistance is typically 1 to 2 kΩ. The microphone capacitance does not have any practical influence on frequency distribution of this noise and, as seen in Fig.4.6, this noise component becomes responsible for the noise from about 1 kHz and above.

Due to coupling capacities (shown in Fig.4.8 as C_d), a fraction of the FET noise is coupled forward to the high impedance input of the preamplifier, resulting in an increase in the noise level. The noise contribution from this mechanism depends on the capacitive attenuator formed by the microphone capacitance C_m and the coupling capacities C_c . This explains why the higher frequency noise also depends on the capacitance of the microphone.

Note that the noise spectra shown in Fig.4.6 as V/\sqrt{Hz} , which is commonly used in electronic engineering, but not in the field of acoustics where a representation as shown in Fig.4.7 is more usual. Here, the total noise is shown for a constant relative bandwidth (third octave) in combination with two different microphone capacitances.

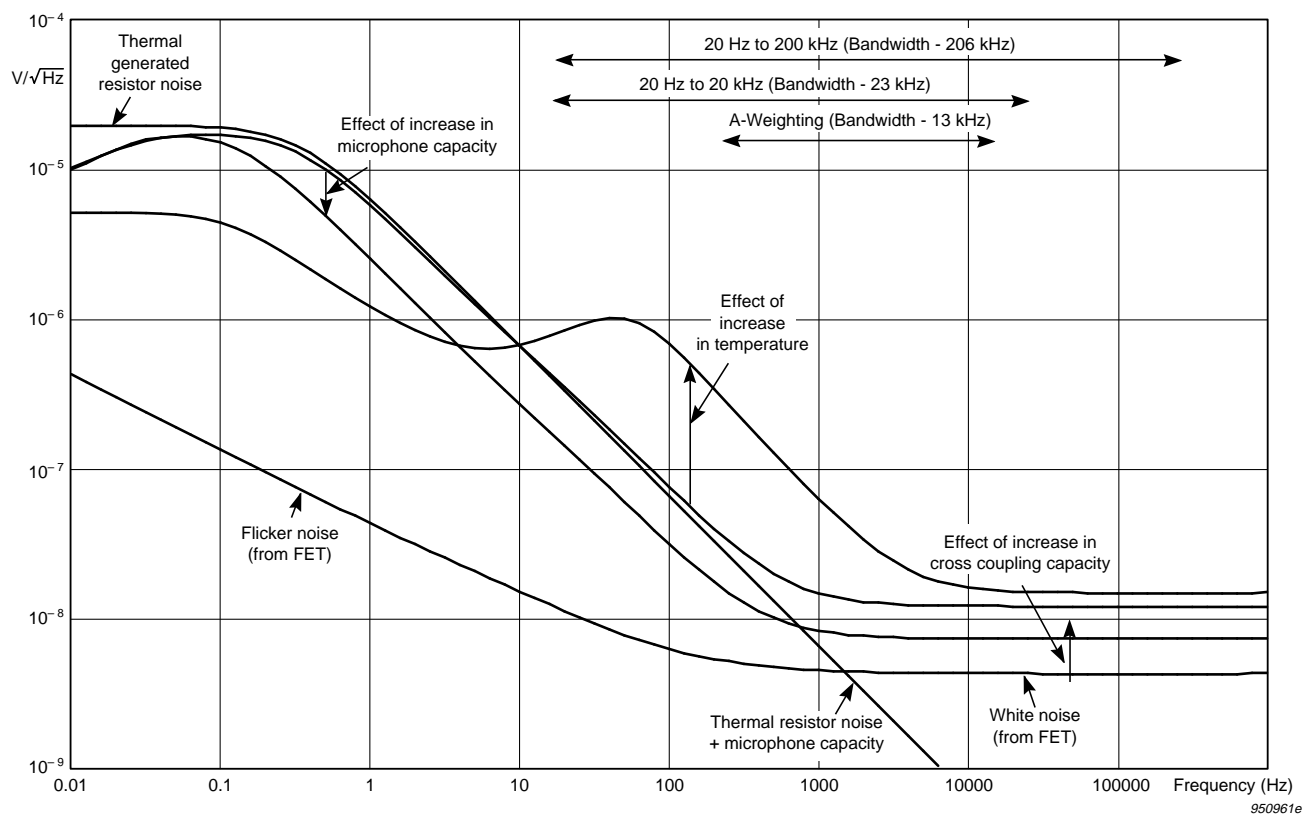

Fig. 4.6 Spectra of noise sources in preamplifiers

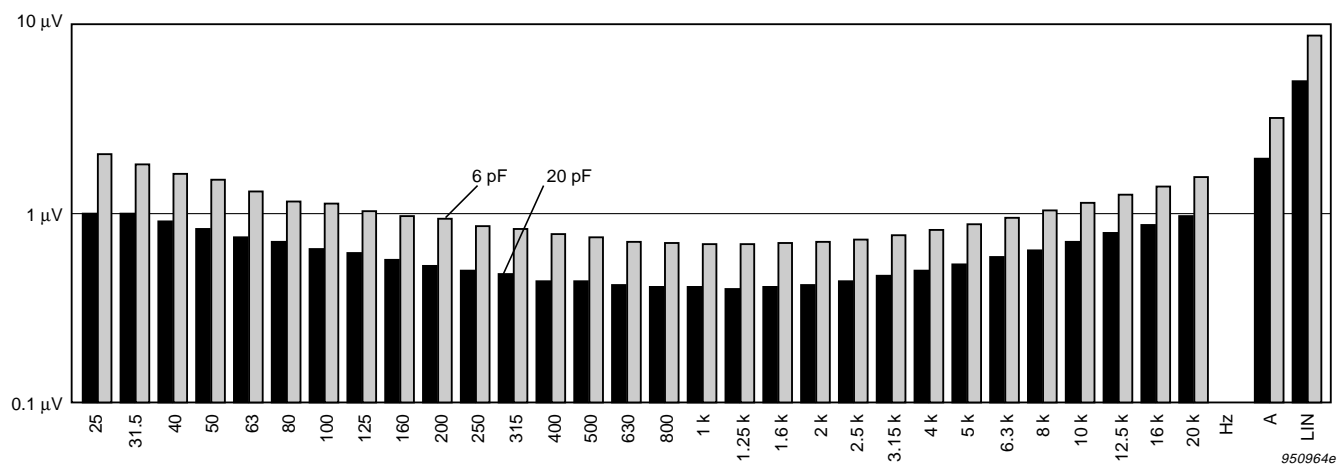

Fig 4.7 Typical third octave noise spectra for preamplifiers noise connected to two different microphones (dummies, 6 pF and 20 pF)

4.4 Phase Response

The phase response is the difference between the phase of the output and the input signals, expressed as a function of the frequency.

All Brüel & Kjær preamplifiers are designed to keep the phase of the output signal essentially equal to the input signal, but for the reasons described in Section 4.2 a phase deviation for low and high frequencies can occur. From about 10 Hz to above 100 kHz, the magnitude response is generally flat, whereas the corresponding phase response is close to zero degrees from typically 100 Hz to 10 kHz, see Fig 4.8.

The low frequency phase response is determined by the microphone capacitance and preamplifier input resistance, while the cable load in combination with the output impedance determines the phase response at the high frequencies.

For some applications, for example, for sound intensity measurements, it is important that the phase differences between a number of measurement channels are very small. It is recommended that specially developed types of preamplifier are used for this kind of measurement. By minimizing the influence of the resistive part of the preamplifier input impedance, it is possible to obtain more closely matched phase responses between a number of channels.

4.5 Effect of Temperature

The specifications of preamplifiers are normally valid within a working temperature range from -20°C to $+60^{\circ}\text{C}$. Some preamplifiers are designed with components and

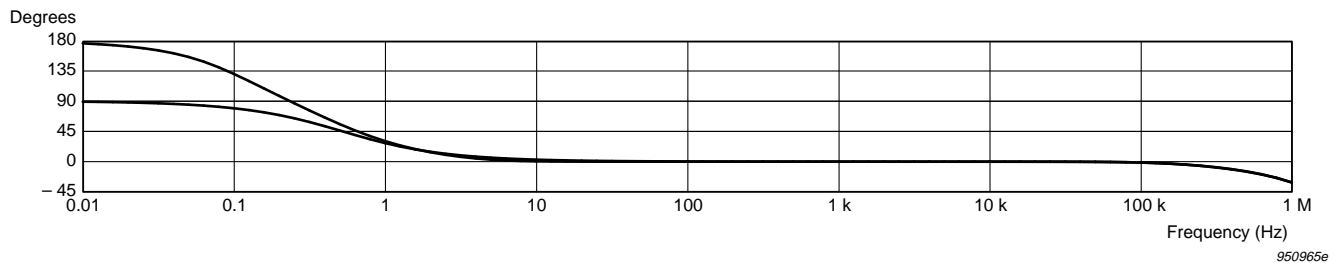

Fig 4.8 Phase responses for two different types of preamplifier. A first order input circuit gives a 90° phase shift at low frequencies, whereas a second order input circuit (bootstrap) gives a 180° phase shift. The latter can be optimised for very low phase shift for frequencies above 10 Hz

materials that allows them to be operated at high temperatures. However, there are always some limitations that should be taken into consideration.

Firstly, at high temperatures, the failure rate of the device increases. At temperatures above 100–125° this increase is dramatic and the preamplifier should only be used at such temperatures for short term measurements.

Another consideration concerns the output power which causes internal heating of the semiconductors. In combination with high external temperature, this heat can destroy the output transistors. The preamplifier can deliver the specified current, but if this is done for a long time at a high temperature, the heat will destroy the preamplifier.

If it is necessary to measure at temperatures which exceed the specified values guaranteed by Brüel & Kjær and if a lower maximum output can be accepted, the preamplifier supply voltage may be reduced to decrease the risk of overheating the circuitry. In such circumstances, the use of a 1/2" preamplifier is recommended as preamplifiers of this size are more efficient at losing heat than 1/4" preamplifiers.

For preamplifiers working at high temperatures, an increase in the noise level is caused by an increase in the bias current in the preamplifiers. This very small bias current of a few pA, produces a noise spectrum equal to the resistor-noise. At normal temperatures this noise is negligible but a temperature rise of 7°C causes a doubling of the noise contributions and so a change from 25°C to 75°C will increase the noise level by approximately 40 dB. That is enough to make it comparable to the resistor-noise. At even higher temperatures, this noise is the most dominant component. This effect of temperature is shown in Fig.4.6 . High temperature noise data are given in Brüel & Kjær type-specific documentation.

4.6 Effect of Magnetic Fields

The design of the preamplifier ensures that the influence of external magnetic fields is negligible. In practice, this means that no influence can be detected within a measurement accuracy of 0.0 dB, when the preamplifier is exposed to a magnetic field of 100 A/m.

4.7 Electromagnetic Compatibility

The electromagnetic compatibility (EMC) of a product which contains electronic components is the ability of the product to function, as intended, without disturbing and without being disturbed by other electronic equipment.

Some electromagnetic disturbances have existed for many years, for example, through electrostatic discharge, lighting transients and mains voltage fluctuations. The recent interest in EMC, however, is due to the huge growth in the use of electronic equipment; from microcomputers operating at radio frequencies to mobile telephones using pulse modulation. Such devices emit electromagnetic noise at radio frequencies which can interfere with equipment that has insufficient immunity. At the same time, electronic circuits are being integrated in all sorts of electrical appliances, from washing machines to burglar alarms, making these products more susceptible and vulnerable to electromagnetic disturbance.

The following sections give a short introduction to EMC requirements, with an emphasis on those aspects relevant to microphone preamplifiers.

4.7.1 The European EMC Directive

Requirements and limits regarding the emission of radio frequencies have existed for many years. Until recently, little attention was paid to the fact that delicate electronic circuits are easily disturbed by strong external signals. In addition to the emission requirements, the European Union EMC directive now makes immunity a mandatory requirement. The directive states that electrical and electronic equipment must be sufficiently immune to disturbances of various kinds. All electrical and electronic devices must comply with the EMC directive in order that they can legally be sold in Europe.

4.7.2 The CE label

The presence of a CE label on a product indicates that it complies with all relevant European Union Directives. The CE label is affixed by the manufacturer (or an authorised European representative) and indicates that product complies with the requirements of the EMC directive and other directives as applicable. Precisely what the relevant requirements are will depend on the product, but for all electronic devices, the requirements include electromagnetic compatibility. Microphone preamplifiers are CE labelled, but devices such as microphones and cables are pas-



Fig 4.9 GTEM (Gigahertz Transversal Electromagnetic) test cell at Brüel & Kjær's EMC test laboratory: measuring radio frequency signals – emission and immunity

sive components and therefore do not need to be CE labelled. They are however, subjected to thorough EMC testing together with their associated equipment, for example, cables are tested with their associated preamplifiers. In many cases, the cables have been specially developed (for example, with braiding patterns) to obtain the specified EMC properties as defined by the manufacturer.

4.7.3 EMC Test Facilities at Brüel & Kjær

In recognition that EMC requirements are now an important part of the development of high quality electronic equipment, Brüel & Kjær have invested in fully equipped EMC test facilities. Certain tests are conducted at external, accredited testing laboratories. Brüel & Kjær products fulfil the toughest generic EMC standards for both emission and immunity. These standards are:

EN 50081-1 Generic emission standard. Residential commercial and light industry

En 50082-2 Generic immunity standard. Industrial environment

Detailed EMC specifications are given in the Product Data sheets for all Brüel & Kjær products.

Cause and Cure of Electromagnetic Introduced Noise.

The reasons for the sensitivity of devices to electromagnetic noise are often quite simple to identify, but the effects can be difficult to avoid.

The connection cable can pick up signals from the electromagnetic field by acting as an antenna while the semiconductors in the electronic circuit act as rectifiers and demodulate the AM signal from the RF-carrier frequency. It is then very difficult to separate this demodulated signal from the measurement signal. The best solution is to prevent the RF-signal reaching the semiconductors. This can be done in different ways. The most common method is a lowpass filtering of the signal going into the electronic circuit.

It is of course, important, that both ends of the cable are connected to devices that are able to avoid demodulation of the RF-noise. This means that connecting a preamplifier with high immunity to an old measuring amplifier that is not constructed to achieve RF-immunity, will not give the expected immunity for the system.

Fig. 4.10 shows the immunity improvement that can be obtained with a preamplifier constructed to fulfil the EMC-requirements, compared to an earlier version. These measurements show the noise signal generated in the preamplifier when it is exposed to an EMC field as described in the EMC standards (a field strength of 3–10 V/m, a modulation of 80% AM and a carrier frequency of 80–1000 MHz).

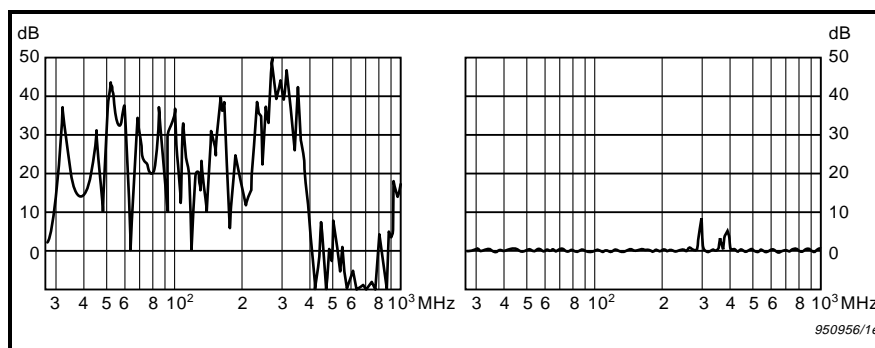

Fig. 4.10 Preamplifier noise when exposed to electromagnetic field, before (left) and after EMC improvements (right). The 0 dB line corresponds to the inherent noise level of the preamplifier. The x-axis corresponds to the carrier frequency (20 MHz to 1 GHz)

4.8 Monitoring and Calibration Techniques

Two different verification techniques are available for Brüel & Kjær preamplifiers. These are either the Insert Voltage Calibration (IVC) facility or the Charge Injection Calibration (CIC) facility. Each has a particular area of application. The principle of both these techniques is shown in Fig. 4.11.

The Insert Voltage Calibration method is primarily intended for use in calibration laboratories for determining the open-circuit sensitivity of condenser microphones. The open-circuit sensitivity is the sensitivity (V/Pa) of the microphone working to an infinitely large electrical impedance, i.e. the same as that of an ideal preamplifier.

The Insert Voltage Calibration technique may also be used to provide a field-check of a measurement system including a preamplifier and cables. However, the method does not account for the mechanical parameters of the microphone cartridge which determine the acoustical properties of the measurement setup. The method is sufficient to verify the electrical part of a measurement system, but it is not satisfactory for verifying the microphone cartridge. To be able to verify the complete system, Brüel & Kjær have developed and patented a technique called Charge Injection Calibration (CIC).

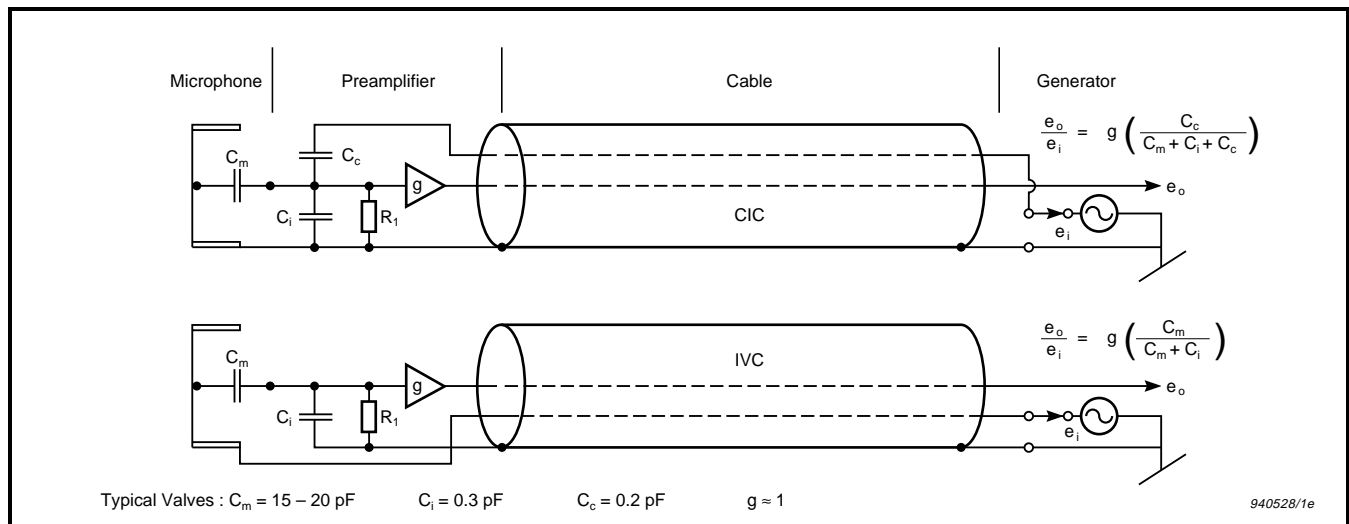

Fig 4.11 Charge Injection Calibration and Insert Voltage Calibration. The formulae are valid for the mid and high frequency range

However, the IVC technique is still the standardised system that should be used for calibration of laboratory microphones.

The Charge Injection Calibration (CIC) technique represents a great improvement for remote testing of a measurement setup compared to the IVC technique. The system is based on a relative measurement of the capacitance of the microphone cartridge, which is a reliable indicator of the microphones condition.

4.8.1 Insert Voltage Calibration

Insert Voltage Calibration is a standardised method of determining the open circuit voltage and open circuit sensitivity of a transducer. Insert Voltage Calibration is a substitution method where the inserted voltage substitutes the open circuit voltage produced by the transducer, see chapter 6 for more details. Insert Voltage Calibra-

tion can be used to monitor a complete acoustic system, but it only checks the function of the preamplifier, cable and the conditioning amplifier. Therefore, Insert Voltage Calibration is not the best choice as it does not give information about the condition of the microphone. As an example, a short-circuited microphone would create a change of about 0.1 dB with an Insert Voltage Calibration system, while it would be hundreds of times greater with the charge injection calibration method described in the following section.

4.8.2 Charge Injection Calibration

The Brüel & Kjær patented Charge Injection Calibration (CIC) technique enables a complete measurement chain to be verified, including the microphone. As the name implies, the method uses frequency independent injection of charge into the microphone and preamplifier input circuit.

The patent includes the measurement method and the practical realisation of a high quality, stable capacitance which is built into the preamplifier.

The main applications are the monitoring of remote microphones and microphone arrays. The principle of operation is shown in Fig. 4.11. The built-in capacitance is very small, typically 0.2 pF. This small capacitor makes an attenuator together with the impedance of the combined microphone and preamplifier input circuit. A voltage supplied at the CIC input will be attenuated, and can be monitored at the preamplifier output. The ratio between the output and input voltages can be used to monitor the stability of the whole measurement system, including the microphone, preamplifier and cables. A simplified formula valid in the mid and high frequency range is given in Fig. 4.11. A more general formula is given here:

$$\frac{e_o}{e_i} = \frac{C_c}{C_c + C_m + C_i} \cdot g \cdot \left(1 + \frac{1}{j\omega R_i (C_m + C_c + C_i)} \right)^{-1}$$

where:

- e_o = output voltage
- e_i = input voltage
- C_c = CIC capacitance
- C_i = input capacitance of preamplifier
- C_m = capacitance of microphone
- R_i = input resistance of preamplifier
- g = preamplifier amplification ≈ 1

As indicated by the formula and as shown in Fig. 4.12, the method can be used to monitor the preamplifier input resistance at low frequencies and the microphone capacitance in the mid and high frequency range.

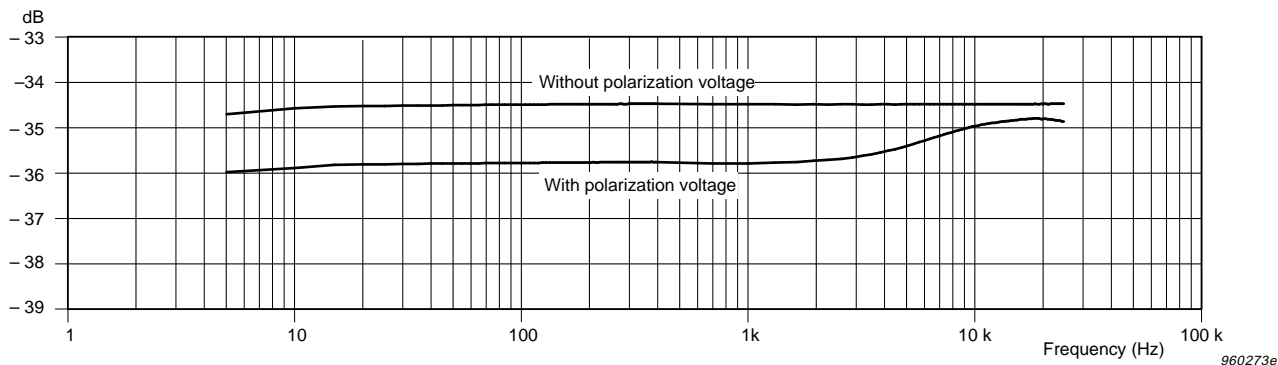

Fig.4.12 Measured ratio e_o/e_i as a function of frequency for a $1/2''$ microphone (50mV/Pa) and preamplifier, with and without polarization voltage

The acoustical equivalent level to the signal introduced through CIC can, for the mid frequency range, be calculated according to:

$$SPL_{CIC} = 94\text{dB} + 20\log\left(\frac{e_i}{S_c \cdot p_o} \cdot \frac{C_c}{C_c + C_m}\right)$$

where:

- S_c = loaded sensitivity for the microphone (e.g. 12.5 mV/Pa)
- p_o = pressure level for stated microphone sensitivity (1 Pa)
- C_m = microphone capacitance (e.g. 15 pF)
- C_c = CIC capacitance (typically 0.2 pF)

The CIC method shows that the microphone capacitance varies with frequency. This phenomenon is explained in Section 3.8.

Use of the CIC System

For acoustical systems, frequent use of a precision acoustical calibrator would be the ideal means of verification. Although this can involve practical and economical disadvantages, for example, difficulty of access, the time involved and disassembly. Used in the right way, the CIC technique has the advantage that it can be used to increase the interval between costly acoustical calibrations. However, an acoustical calibration can never be completely replaced by an electrical test facility.

How to Monitor Using CIC

The procedure is as follows:

1. Install the system and perform an acoustical calibration.
2. Immediately afterwards, measure the ratio between the output and input voltages of each measurement channel.
3. Store the measurement results as reference ratios and the system is ready for use.
4. Verification of the system can now be performed as often as necessary by comparing the present measured ratios with the stored reference ratios.
5. For normal temperature and pressure, variations within 0.2 dB could be expected. Under controlled conditions, for example, in special test cells, a repeatability of better than 0.1 dB can, and should, be obtained.

For results which vary more than expected, the system should be checked with an acoustical calibrator. Frequent initial measurements will create a database valid for the actual set-up on which the threshold for acceptance can be based. As experience and confidence is built up, the interval between acoustical calibrations can be extended.

Note, that some types of microphone have a deliberate variation of capacitance as a function of temperature which will be reflected in the measured ratios.

4.8.3 CIC Input Signal Requirements

Test Level

A test signal close to the allowed maximum limit is recommended in order to obtain a good signal to noise ratio between the attenuated calibration output signal and the signal produced by the acoustical background noise. If available, use filters for the measurement of the test signal to improve the repeatability of the test measurement. This will lead to more stable results.

For a $\frac{1}{2}$ " microphone (15 pF) the attenuation ratio will be in the range of -35 dB to -40 dB. This means that for a test signal of 10 V, an output of 180 mV to 100 mV is obtained. To estimate whether background noise has an influence on the results, it is worth noting that a test signal of 10 V using a microphone with 50 mV/Pa sensitivity corresponds to a sound pressure level of more than 100 dB.

There are no special requirements for the long term stability of the test level, provided that the ratio between the output and input voltage is determined.

Test Frequencies

Even if the system has the possibility to measure over the entire frequency range, it is recommended to limit the amount of data by only using two test frequencies. Use one in the mid frequency range (for example, 1000 Hz) and one at a low frequency, for example, 20 Hz.

The measurement at low frequency has a higher sensitivity to possible problems caused by humidity (leakage), whilst the mid-frequency measurement monitors the stability of the microphone cartridge.

Fault Diagnosis with CIC

Those who do the monitoring of the measurement system do not need to know the reasons for the observed changes in the ratio between the output and the input signals. However, those who perform the maintenance and fault finding may find the following examples of the use of CIC helpful.

The following examples are obtained using a white noise signal as the CIC input.

Normal Working Condition:

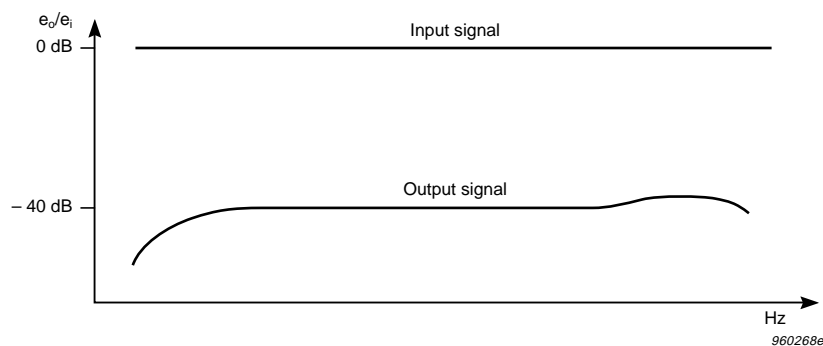

Fig. 4.13 Normal working condition. Notice the attenuation of approximately 40 dB in the mid frequency range. The low frequency roll-off is caused by the preamplifier input resistance

Diaphragm Torn or Missing

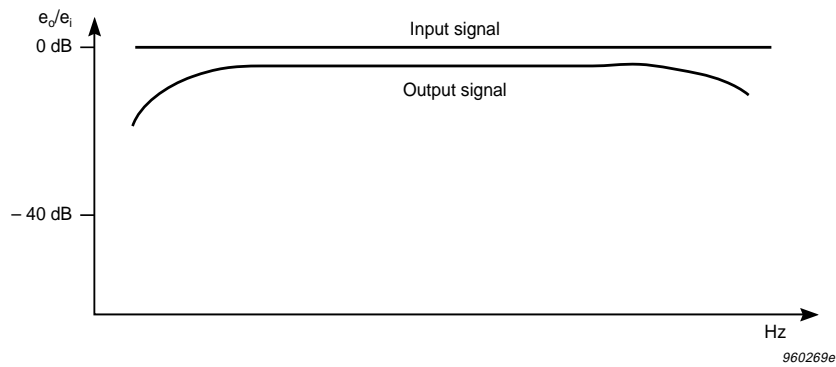

Fig. 4.14 No microphone attached or diaphragm torn or missing. The output level is significantly increased due to reduced microphone capacitance

Microphone Short Circuited

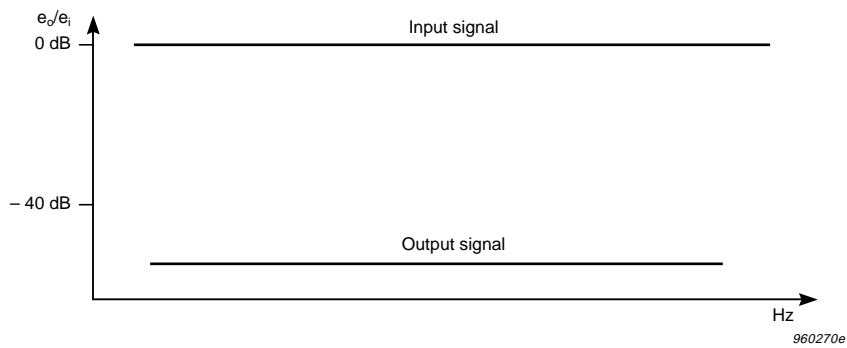

Fig. 4.15 Microphone short circuited. The output level is significantly reduced relative to the normal condition

Disconnected or Broken Cable

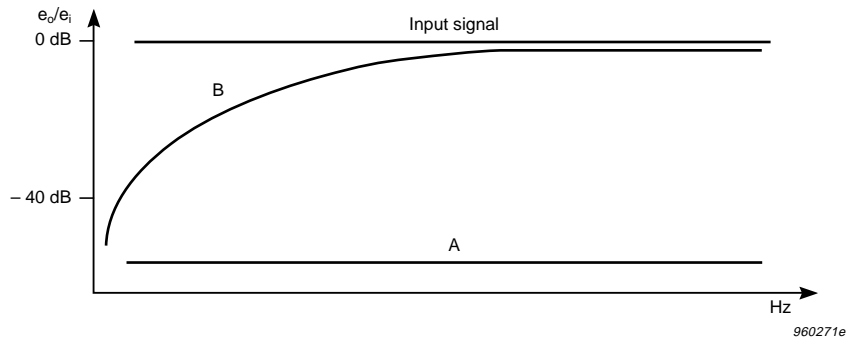

Fig.4.16 Disconnected or broken cable. The output level will change significantly depending on the distance between the conditioning amplifier and the break in the cable. A: cable broken near to power supply. B: cable broken near to the microphone

Chapter 5

Selecting a Microphone

5.1 Guidelines on Selecting Microphones

When selecting a measurement microphone it is important to first understand the measurement requirement and how this imposes demands on the performance of the microphone. This is necessary because, although measurement microphones are precision instruments that are optimised for particular measurement tasks, they still offer a wide operational range.

In fact, such is the versatility of Brüel & Kjær microphones, that the user may be tempted into a “that one will do” philosophy when selecting a microphone, simply because a microphone comes within the required general performance parameters. If, however, the user has a good understanding of the measurement requirement, then it is possible to choose the “optimum” microphone for the measurement task in hand.

For most uses, the type of sound field is the main parameter to consider. This divides the possible choices into roughly two groups of microphones: free-field or pressure-field measurements.

Other factors, such as the measurement environment, the international standards which may need to be adhered to and the type of polarisation charge may also need to be considered. These and other main considerations are discussed in more detail in this chapter.

But first, as a prelude to any specific selection guidelines, it should be stressed that selection considerations cannot be taken in isolation. Many of the parameters are inter-dependent. To illustrate this point, examples of two separate, but inter-linked considerations are given. The first being frequency response, the second being that of dynamic range. Three diagrams illustrate this point.

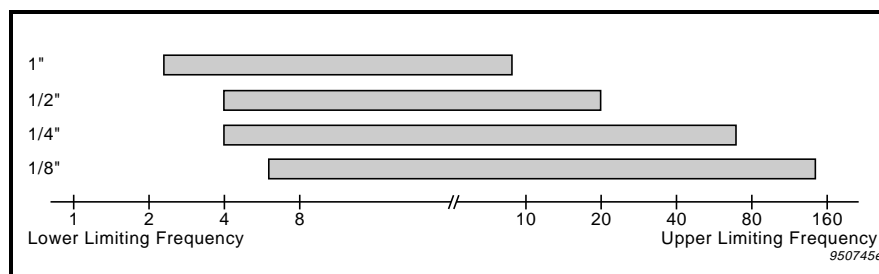

Fig. 5.1 Upper limiting frequency response of 4 typical measurement microphones of different sizes $1/8''$, $1/4''$, $1/2''$ and $1''$

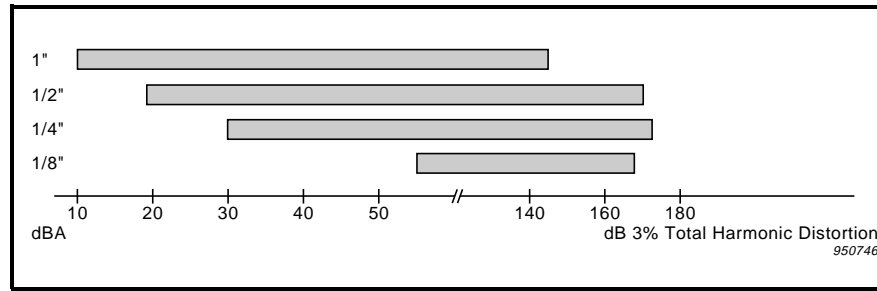

Fig. 5.2 Dynamic range of the same 4 measurement microphones. The lower limit is given in dB(A). The upper limit is given in dB at the level at which 3% total harmonic distortion occurs

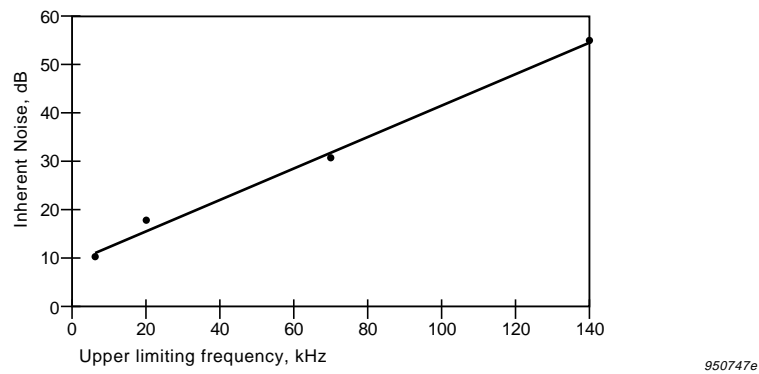

Fig. 5.3 Graph showing relationship between upper limiting frequency range and inherent noise. The 4 dots represent the 4 sizes of microphone in order from 1" (bottom left) to 1/8" (top right)

The above figures show that if, for example, measurements at very high frequencies are required, this will automatically limit the choice of microphone to one with a fairly high, lower limit of dynamic range.

Once the optimum microphone has been selected in terms of primary selection parameters, there will most probably be several other considerations which are relevant to the measurement requirement, for example, the physical robustness of the microphone for the measurement environment. This can be illustrated by comparing two different types of microphone.

A 1/2" microphone for laboratory standard calibration and a 1/2" microphone for general use may appear to have similar performance parameters on paper, but actually have quite different physical characteristics. The mechanical design of the laboratory standard microphone makes it very well suited for pressure reciprocity calibration, but the almost unprotected diaphragm makes this microphone far too fragile for general use.

With this background, the following section gives some of the main considerations when selecting a microphone.

5.2 What to Consider

5.2.1 Frequency Response

Although particular types of microphone are optimised for particular purposes, they still have a wide operational range, as explained by the Frequency Response/Dynamic Range inter-relationship in Section 5.1. Frequency response should therefore be considered in relation to other selection requirements such as the type of sound field.

5.2.2 Type of Sound Field

A good way of narrowing down the choice of microphone is to consider the type of sound field in which measurements are being taken.

For measurements to be made away from reflecting surfaces or in acoustically well damped indoor environments, for example when making outdoor measurements with a sound level meter or indoors in an office offering a lot of natural acoustic damping, a free-field microphone offers the best choice.

Meanwhile, for measurements to be made in small closed couplers or close to hard reflective surfaces, a pressure field microphone is a more appropriate choice. An application which illustrates such usage is where a set of pressure sensing microphones are positioned at different points across an aircraft wing. A complete picture of the pressure variations across the wing surface can then be established.

For measurements in enclosed areas where reverberations are likely, pressure field microphones adapted for random incidence measurements offer the best choice. This is because the random incidence response of a pressure-field microphone is much “flatter” or constant across the frequency range, than that of a free-field response microphone. This is something that can be observed by comparing the random incidence response of a pressure field with that of a free-field microphone using the graphs in Volume 2 of this handbook. See also chapter 2 Section 2.5 for an explanation of how different types of microphone are dedicated to different sound fields.

5.2.3 Limits of Dynamic Range

The lower limit of dynamic range is dictated by the inherent noise of the microphone and preamplifier combination. The upper limit of dynamic range dictated by the maximum sound pressure level (3% total harmonic distortion). Due to the very wide dynamic range of the microphones, it is normally either the lower or the upper limit of dynamic range that is of interest.

An example application for measurement microphones where the lower limit of dynamic range has to be considered is that of the determination of sound power of light armatures for use in office environments. Levels as low as 10–12 dBA may have to be measured.

An example application for measurement microphones where the upper limit of dynamic range has to be considered is that of measurements of exhaust systems on engine test cells. Here, high sound pressure levels (140–150 dB) may be encountered. However, in addition to high sound pressure levels, high temperature may also be encountered. In such a case, it may be necessary to use a probe microphone. However, this type of microphone does not have the highest upper limit of dynamic range. Alternatively, where it is possible to use more conventional, externally polarised microphones, the upper limit of dynamic range of these microphones can be extended slightly by reducing the polarisation voltage to 28 volts.

5.2.4 Microphone Venting

As the microphone is only able to withstand a fairly small static pressure difference between the front and the rear side of the diaphragm, it is important to consider the choice of side or rear vented microphone in relation to measurement situation.

There are basically two different types of static pressure equalisation channels: rear vented, where the microphone is vented through the rear and via the preamplifier and side vented, where the pressure equalisation channel is located on the side of the microphone housing just in front of the thread for the protection grid.

Rear vented microphones have the advantage that they can be used with a dehumidifier. However for certain applications it is necessary to use a side vented type of microphone with its pressure equalisation close to the diaphragm. This is important when the microphone is flush mounted in an air duct where there is typically a large static pressure difference between the inside and the outside of the duct.

5.2.5 Phase Response

Phase response should be considered when choosing microphones for sound intensity measurements and here it is not normally the absolute phase response that is important, but the relative phase response between a pair of microphones. This is because the phase response characteristics have to be closely matched. Special pairs of microphones, with matched phase responses, are available.

5.2.6 Polarisation

There are two different types of microphone construction, one that employs an external voltage supply to polarise the backplate to diaphragm air gap (externally polarised) and one where the polarisation charge is stored in an electret layer on the backplate of the microphone (prepolarized).

Generally there are only small differences between the specifications for externally polarized and prepolarized microphones, but these differences make them suitable for different purposes.

Prepolarized microphones are used for portable sound level meters where their lightweight and lack of a requirement for a polarization voltage supply is an obvious requirement. Prepolarised microphones also offer slightly better performance in very humid environments (see chapter 3 Leakage resistance).

Alternatively, externally polarized microphones are generally more useful for general field and laboratory use and for high temperature measurements. Also, for special measurements, externally polarised microphones offer a broader range to choose from.

5.2.7 Standards Compliance

When selecting a microphone, it is normally a requirement to consider whether the microphone fulfils certain standards, for example, the ANSI S1.12 standard for Laboratory Measurement microphones or the IEC 651 standard for sound level meters (including microphone). As can be gathered from the above example, standards generally relate to the type of application for the microphone. In addition, a further range of levels specified by type numbers exist within a standard, for example the IEC 651 standard for sound level meters has types 0 to 3. Type 0 relates to laboratory reference standard requirements while type 3 is mainly for field applications. Most Brüel & Kjær microphones are type 0 and type 1.

The standards and their associated type levels also specify the performance tolerances to which microphones and associated equipment must conform. This conformance is stated in product literature.

Brüel & Kjær microphones are designed to come within 50 to 70% of the required tolerances depending on the application. In the case of tolerances relating to the use of sound level meters the effect of the sound level meter in the sound field is also taken into account when designing and producing microphones.

Standards Relevant to Measurement Microphones:

Standard	Application	Date
IEC 651	Sound Level Meters	1979
IEC 1094	Measurement Microphones Part 1: Specifications for laboratory stand- ard microphones Part 4: Specifications for Working Standard Microphones	–
ANSI S1.12	Measurement Microphones Type L: Reference Type XL: As is but no outside diam- eter specified Type M: Sound Pressure Magnitude Type H: Small diffraction errors	1967
ANSI S1.4	Sound Level Meters	1983

*Table 5.1 Standards Applicable to Measurement Microphones***5.2.8 Environment**

When selecting a microphone the environment where measurements are to be made should be considered. Some parameters which should be considered are as follows:

- **Robustness**

In a protected laboratory environment all measurement microphones can be used, but more robust general purpose microphones are required for field use.

- **Temperature**

At normal temperatures (-30°C to $+125^{\circ}\text{C}$) all microphones may be used. At high temperatures (up to 300°C) Falcon Range microphones should be used and at very high temperatures, above 300°C , a probe microphone should be employed. The tip of the probe on the probe microphone can withstand up to 700°C .

- **Atmosphere**

In normal air, all microphones may be used, but for measurements where corrosive industrial gasses exist, for example, when making measurements in industrial chimneys, the corrosion resistant Falcon Range™ microphones should be used.

- **Humidity**

In normal humidity, all microphones can be used, but for high humidity, prepolarized microphones offer greater reliability. This is because they are more resistant to the attenuation of the polarization voltage which can occur at high humidity levels.

5.2.9 Microphone Array Applications

When many microphones are to be used, for example, for spatial transformation of sound fields, the size and price per channel are the most important parameters. For this purpose, a specially designed microphone with built-in preamplifier can be used as an integral part of an array.

5.3 Selecting The Right Accessories



Fig.5.4 Range of microphone accessories: windscreens, microphone holder, turbulence screen, windscreen with bird spikes, rain cover and nose cone

For most types of microphones the use of appropriate accessories can effectively extend the application range of the microphone, particularly when making outdoor measurements. Accessories are therefore described here with respect to the two main threats to effective microphone operation: wind, or air turbulence, and humidity.

5.3.1 Low Wind Speed, Random Direction

Outdoor measurements are often disturbed by wind noise. An easy way of reducing the effect of wind noise is to mount a wind screen on the microphone (and preamplifier/Sound Level Meter). The wind screens are made from a porous polyurethane foam. They will attenuate the wind noise by 10 to 12 dB at those wind speeds generally considered acceptable for outdoor testing (0 m/s to 6 m/s).

5.3.2 High Wind Speed, Known Direction

Acoustic measurements in wind tunnels are normally very difficult due to aerodynamically induced noise around the microphone. When the microphone is exposed to high wind speed in a known direction the disturbance can be reduced by using a nose cone. The nose cone replaces the normal protection grid. It has a streamlined shape with a highly polished surface that gives the least possible aerodynamically induced noise.



Fig. 5.5 Nose cones in different sizes to fit $1/8''$, $1/4''$, $1/2''$ and $1''$ microphones

5.3.3 Turbulent Pressure Fluctuations

The turbulence screen is designed to attenuate noise from turbulence when measuring airborne noise in situations where turbulence may occur, such as in ducts and in wind tunnels.

5.3.4 Humidity

The microphone may be protected against humidity in different ways depending on the type and duration of the measurements.

Short Term Protection

Short term protection against humidity when making outdoor measurements in unfavourable weather can be performed by mounting a dehumidifier between the microphone and the preamplifier.

The function of the dehumidifier is to ensure that only dry air reaches the interior cavity of the microphone, thus preventing condensation. This is done by allowing air to pass to the back vent of the microphone through a cavity filled with silica gel. The dehumidifier therefore only works with rear vented microphones.

The dehumidifier is normally used in combination with a wind screen. The assembly should be mounted horizontally in order to let possible water droplets run off the microphone diaphragm.

Long Term Protection

For long term outdoor measurements, a more comprehensive combination of accessories is recommended consisting of a raincover, a windscreen and a dehumidifier. The raincover is designed to be mounted in place of the normal protection grid. As well as offering rain protection, it serves as an electrostatic actuator which can be employed for remote calibration.

A special wind screen, with stainless steel bird spikes, and which allows the use of the rain cover is recommended.

Chapter 6

Calibration

6.1 Introduction

The most important parameter for any measurement device is sensitivity. The sensitivity can be defined as the ratio of the output parameter to the input parameter (the measurand). To determine the sensitivity is to calibrate the measurement device. All the information that follows in this chapter is based on this definition.

For a transducer, sensitivity is measured in terms of units of electrical output (volts, ampere etc) per unit of the physical input parameter (pressure, acceleration, distance etc). In line with this convention, the sensitivity of a microphone is generally given in terms of volts per pascal. Pascal is defined as one Newton per square metre (N/m^2), i.e. a unit of pressure.

These fundamental units provide a fixed reference for the calibration of a measurement device. This reference is essential as it allows measurements, including calibrations, to be compared - measurements which could have been made by different people, in different locations under different conditions. The units must be referred to in a known and agreed way. This is well defined and monitored on an international basis. The accuracy of the calibration must also be known i.e the device and method used to calibrate a microphone must perform the calibration with a known uncertainty.

If these conditions are fulfilled the calibration is called traceable because the calibration can be *reliably* traced back through the measurement chain, ultimately to the fundamental units of measurement. The first or highest link in the measurement chain is normally a device in a primary calibration laboratory, since these establishments usually have the most accurate measurement equipment. Normally the establishment to which a calibration can be traced is stated as a reference for a calibration and as already mentioned, the terms of reference are monitored between calibration establishments. See Section 6.5 for more information on traceability.

It is important to note that traceability is not in itself an indication of high accuracy, but if the uncertainty is known then the calibration can be compared with other valid measurements. Therefore a calibration is not useful, unless the related uncertainty is known.

Other Definitions

Definitions are available which may provide a variation on the above. However they generally have some main principles in common, as seen by the following examples:

The first comes from the ISO publication, *The International Vocabulary of Basic and General Terms in Metrology*:

“Calibration. The set of operations that establish, under specified conditions, the relationship between values of quantities indicated by a measuring instrument or a measuring system, or values represented by a material measure, and the corresponding values realised by standards”.

The important point in this definition is the reference to “corresponding values realised by standards” in the last part of the rather long sentence. This supports the argument that fundamental to calibration is a solid and definable reference. The next definition from the European Space Agency also supports this:

“Calibration. A comparison of two instruments or measuring devices, one of which is a standard of known accuracy traceable to national standards to detect, correlate, report or eliminate by adjustment any discrepancy in accuracy of the instrument or measuring device being compared with the standard.”

This definition uses the word “comparison” to explain how something unknown is referred to (or compared with) something known. However, the reference is clearly defined as a measurement instrument that is ‘high’ in the measurement chain and traceable to national standards.

Why Calibrate?

A calibration is performed:

- To be sure of making correct measurements.
- To prove that measurement methods and equipment are accurate, for example, to prove that a measurement complies with the requirements of national legislation, standards bodies and customers.
- To verify the stability of the measurement equipment, including equipment used to perform calibrations.
- To account for local measurement conditions, for example, variations in ambient pressure and temperature.
- To ensure product quality.
- To build confidence in measurement results.

Summary

- Calibration is to determine the sensitivity of a measurement device.
- The fundamental units of measurement (volt, ampere etc) provide the ultimate reference for measurements, allowing different measurements to be compared.
- The accuracy (or uncertainty) of the calibration must be known. Traceability is necessary, but not sufficient.
- Calibration creates confidence in the measurement result.
- Devices throughout the measurement chain must be reliable and stable within a known uncertainty.

6.2 Calibration of Microphones

This section explains the common terms and methods used in connection with the calibration of measurement microphones.

The calibration can either be performed in the field or in a calibration laboratory. These calibration situations are described here under separate headings.

6.3 Field Calibration

Field calibration is performed at the measurement location using a calibrated reference sound source, such as a pistonphone. This ensures the traceability of absolute sound level measurements. The fact that the measurement is traceable is important if the measurement must be recognized by legal authorities or if compliance with international standards is claimed. See Section 6.5 for a discussion on traceability.

It is advisable to perform a field calibration before and after a measurement, for example, by using a sound level calibrator. This gives confidence in the measurement result by verifying the stability of the entire measurement system. Calibration before and after a measurement is also something which is prescribed by various sound measurement standards to ensure the validity of the measurement.

Even when making a relative measurement, it is still advisable to calibrate to ensure correct operation of the measurement system. This is because calibration is by far the easiest way to check that settings, adjustments and postprocessing analyzers are correct.

Most Sound Level Calibrators are portable, easy-to-use and characterized by the production of a well defined sound pressure at a single frequency, usually in the range of 200 Hz to 1 kHz. Some calibrators are so called Multitone Calibrators which provide a number of pure tones at single frequencies.

When using calibrators that produce a single frequency, the calibration is strictly only valid at this reference frequency. However, microphones are generally manufactured to provide a flat frequency response which means that they will give the same electrical output at all frequencies in the flat frequency range for sound pressures of equal magnitude. Therefore calibration at a single frequency is sufficient in most situations.

See Section 2.3.9 for more on microphone sensitivity and the reference frequency. To perform calibrations across the entire frequency range, a Multitone calibrator may be used to check the performance of the measurement system.



Fig.6.1 Sound Level Calibrator used for field calibration of measurement microphones

In multi-channel microphone systems, or where microphones are difficult to access, an acoustical calibration is sometimes impractical to perform. In these situations a verification method can be used to provide a quick and easy method of checking the function of each measurement channel. All the verification methods have their own advantages and disadvantages. Three common verification methods are:

- The Actuator Method
- The Insert Voltage Calibration Method
- The Charge Injection Calibration Method

See chapter 4 and Section 6.6 for details.

6.4 Laboratory Calibration

Laboratory calibration is a common expression for the type of calibration that cannot be performed in the field. Laboratory calibration is an indoor method, preferably performed in a dedicated and well-controlled environment.

The laboratory calibration methods are normally more accurate than the field calibration methods. This is partly due to the type of equipment used for calibration and partly due to the stable laboratory environments. Calibrations in the field are especially affected by temperature variations, wind and humidity.

While field calibration is usually applied to an entire measurement system, laboratory calibration also covers the calibration of separate devices such as microphones

and calibration devices. Microphone calibrations are usually performed at calibration laboratories on a regular basis. As with field calibration, this provides evidence of stability and ensures traceability.

Standards relating to calibration usually define laboratory recalibration intervals of 1 year, which apply to both the calibrator and the measurement system, for example, sound level meters. In other cases the recalibration interval is determined by the users estimate. It is advisable to start with a 1 year interval, which can then be extended when sufficient evidence of stability is obtained. The mode of use of the device should always be taken into account when determining recalibration intervals; the harsher the mode of use, the more frequent the recalibration should be because of the increased probability of changes in the performance of the device.

Not surprisingly, the most accurate calibration methods are the most difficult and most time consuming and correspondingly the most expensive. Different calibration and test laboratories use different calibration methods. However, for the customer, it is not the method which is so important, but the accuracy (or uncertainty, see Section 6.3) stated by the calibration laboratory, and of course, the price. It is also important for the customer to consider whether traceable calibration, see Section 6.5, is sufficient, or whether an accredited calibration is required.

6.4.1 Primary Calibration Laboratories

Primary laboratories are nationally recognised laboratories which have the responsibility of maintaining, developing and promulgating the highest levels of metrology.

6.4.2 Accredited Calibration Laboratories

Accredited calibration means that the calibration has been performed by an accredited calibration laboratory.

To achieve “accredited status”, the laboratory must be approved by an external accreditation body which also performs an audit on a regular basis. The laboratory must have their quality assurance manual, calibration procedures, uncertainty budgets and technical personnel approved by the accreditation body. This means that accredited laboratories can only offer accredited services which are within the range approved by the accreditation body. Examples of accredited calibration laboratories are: the Danish Primary Laboratory of Acoustics DPLA, (which is jointly run by Brüel & Kjær and the Technical University of Denmark) and the Brüel & Kjær Calibration Laboratory.

6.4.3 Calibration at the Brüel & Kjær Factory

Brüel & Kjær performs thousands of calibrations every year as part of the production of measurement equipment. These are performed under laboratory conditions although they are often referred to as “factory calibrations” because they are an integral part of the production process. All microphones and sound calibrators (including pistonphones) leave the factory in a calibrated state. This is documented on an individual calibration chart stating traceability to DPLA and NIST (National Institute of Standards and Technology, USA).

The methods used for factory calibration of microphones are as follows:

Open-circuit Sensitivity

The open-circuit Sensitivity is determined using a preamplifier with an Insert voltage calibration facility. An unknown microphone is calibrated by the comparison method using a reference standard microphone in a small acoustical coupler. The reference standard microphone is calibrated by DPLA using reciprocity calibration according to IEC 1094.1.

Frequency Response

The frequency response relative to the sensitivity at 250 Hz is measured for each microphone using the actuator method see Section 6.6.5. To obtain other responses, the corresponding correction, for example the free-field correction, is added to the actuator response.

Capacitance of Microphone Cartridge

The capacitance of the microphone cartridge, when mounted on a preamplifier, is measured using the patented Charge Injection Calibration technique. The measurement system is checked regularly with a calibrated reference capacitor.

Lower Limiting Frequency

The Lower Limiting Frequency is measured using a low frequency calibrator which exposes the equalization vent of the microphone to the same sound field as the diaphragm. A reference level is measured at a high frequency and the frequency is then lowered until the output is reduced by 3 dB.

Phase Match (Intensity Microphone Pair)

A special acoustical sound chamber has been designed to ensure exposure of equal sound pressure level, at all frequencies, both at the diaphragm and at the equalization vent of both microphones. The phase match of the microphones is then measured by the comparison method using a dual channel frequency analyser. The phase

response of the microphones are compared at all frequencies in the specified range to ensure compatibility with IEC 1043 requirements.

6.5 Calibration Hierarchy, Traceability and Uncertainty

Calibration hierarchy is a representation of the links between the primary calibration and the succession of intervening calibrations down to the end-user, for example a primary calibration at DPLA, a secondary calibration at a service centre and a tertiary calibration by the end-user.

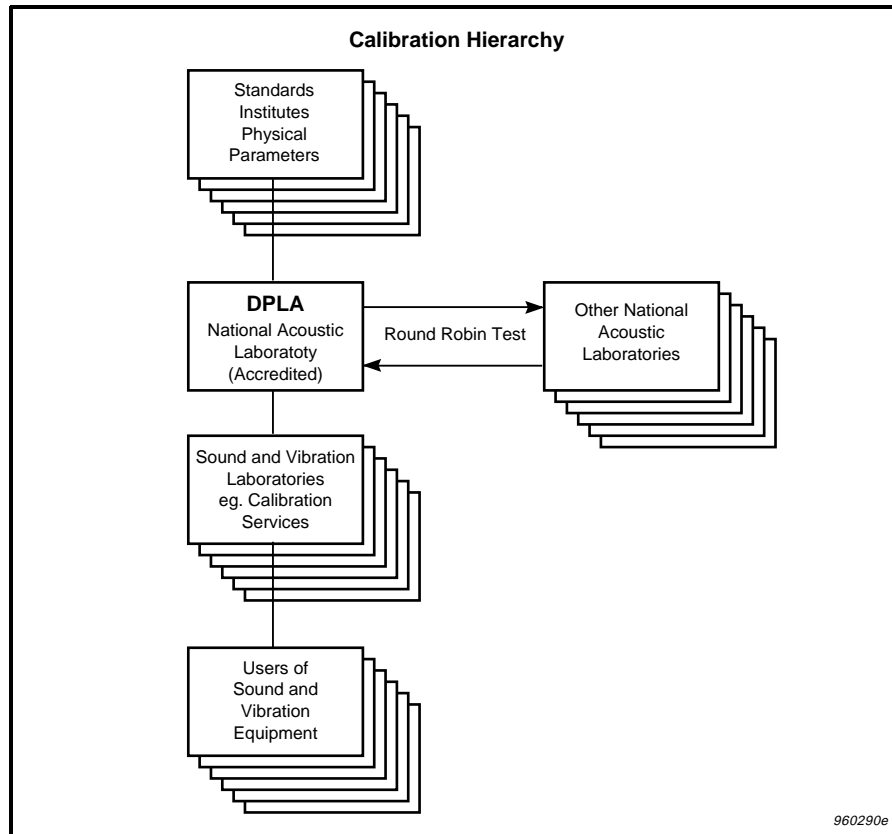

Fig.6.2 Calibration Hierarchy; the national acoustical laboratories use intercomparison methods (Round Robin) to ensure their traceability

Traceability is defined in the *International Vocabulary of Basic and General Terms in Metrology* as “the property of the result of a measurement or the value of a standard whereby it can be related to stated references, usually national or international standards, through an unbroken chain of comparisons, all having stated uncertainties”.

The uncertainty of a measurement is defined as the parameter associated with the result of a measurement that characterises the dispersion of the values that could reasonably be attributed to the measurand.

The accuracy of a measurement is the closeness of the agreement between the result of a measurement and a true value of the measurand. Note that “accuracy” is a qualitative concept. The term “precision” should not be used for “accuracy”.

In the ISO publication *Guide to the Expression of Uncertainty in Measurement*, it is recommended that uncertainty is stated in terms of 2 standard deviations (2-sigma). This means that 95 % of the calibrations will be within the stated uncertainty range for a normal distribution function.

Normally, the uncertainty decreases the higher up in the hierarchy the chain the calibrations are performed, with absolute calibration methods based directly on the physical units at the top of the hierarchy. This position is usually covered by national acoustical calibration laboratories such as DPLA. Calibration laboratories operating at lower levels use comparison or substitution methods based on reference standards calibrated by higher ranking laboratories.

As seen in [Fig. 6.2](#) DPLA obtains traceable accredited calibrations of physical units from other calibration laboratories. DPLA is also accredited by the Danish Trade and Industry body DANAK which accredits laboratories according to DS/EN 45001, *General Criteria for the Operation of Test Laboratories*, 45002 *General Criteria for the evaluation of Test Laboratories* and 45003 *General Criteria for Organisations which issue laboratory accreditations*.

6.6 Calibration Methods

This section gives an overview of calibration methods. These are listed in [Table 6.1](#) with an estimate of the expected uncertainty that can be obtained using the various methods.

Method	Uncertainty
Reciprocity Calibration	0.03 to 0.05 dB
Comparison Method	0.06 to 0.14 dB
Substitution Method	0.06 to 0.14 dB
Pistonphone Sound Level Calibrator	0.07 to 0.3 dB
Actuator Frequency Response	0.1 to 0.5 dB

Table 6.1 Uncertainties (two standard deviations) related to various calibration methods

6.6.1 Reciprocity Calibration Method

This is the most accurate calibration method for determination of the open circuit sensitivity of the microphone cartridges. The sensitivity can be obtained either as a pressure sensitivity or as a free-field sensitivity, by using a coupler (cylinder) or an anechoic chamber respectively. Certain physical requirements of the microphone must be fulfilled to perform the calibration in a coupler, for example, the mechanical configuration as described in IEC 1094-1.



Fig.6.3 Reciprocity calibration. Microphones are held “face to face” by a spring-loaded yoke

The reciprocity method is an absolute method, which means that it requires the measurement of a number of fundamental physical units such as electrical voltage and impedance, length, temperature, humidity and also ambient pressure. But no reference sound pressure is required.

The method determines the unknown sensitivities of three microphones simultaneously. At least two of the microphones must be reciprocal. This means that they can be used both as receivers (microphones) and as transmitters (sound sources).

The coupler properties must be known to a high degree of accuracy.

To conclude a complete calibration, three measurements of receiver voltage and transmitter current ratios must be performed in three different setups (interchanged microphones). The three ratios are then used to solve three equations with three unknowns: the sensitivities of the microphones.

To obtain reliable results, clean and stable environments are required. Practice at performing the calibration is also important. The method is described in detail in IEC 1094-1, *Pressure Calibration* and IEC 1094-3, *Free-field Calibration*.

6.6.2 Substitution method

The substitution method involves the measurement of a device in a given measurement set-up. The device is replaced (substituted) by a reference device, preferably of the same type and the measurement is repeated. Thus the ratio of the sensitivities of the devices are obtained directly.

This method is well suited for both microphones and sound pressure calibrators. If the measurement and reference objects are of the same type, the measurement uncertainty is reduced due to identical measurement conditions. The measurement capability requirements are also reduced, as only a small part of the dynamic range is used i.e. there is no need to know the absolute level.

Any sound source used for the calibration of microphones must obviously be very stable during the measurement and must not be affected by differences in microphone configurations. In this case, the method is well suited for calibration of free-field microphones, provided that a suitable reference microphone is available.

This method is often confused with the comparison method described below.

6.6.3 Comparison Method

In the comparison method, both the measurement- and the reference objects are present at the same time and are exposed to the same sound pressure. As a result, a simultaneous measurement can be performed. In principle something unknown is compared with something known. The method is often confused with the substitution method described above.

The method reduces the number of error sources, and also reduces the stability requirements in situations where external sound sources are used. It also covers the compressor loop principle used in a number of sound level calibrators, where a reference microphone inside the calibrator constantly monitors the sound pressure. In this situation the reference microphone must be very stable as it is the “known” object.

This method is also used for calibration and checking of sound intensity measurement equipment, which ideally requires two identical measurement channels (both

phase and magnitude). In a calibration situation, two microphones are subjected to the same sound pressure field inside a coupler. Calibration is performed by applying a well known sound pressure at a single frequency, and then adjusting both channels to show the correct sound pressure simultaneously. The checking of the pressure-residual intensity index is performed by applying a broad band noise spectrum. Both microphones are subjected to the same signal which in turn means that there is no phase difference between the signals at the microphones and hence no sound intensity should be detected. A measurement in this situation represents the false intensity generated by the measurement system itself due to the phase mis-match between measurement channels. Comparing the actual sound pressure level with the lowest measurable intensity represents the measurement capability of the intensity instrument, see IEC 1043.

6.6.4 Sound Pressure Calibrator Method

The purpose of using a sound pressure calibrator is to get a well defined sound pressure with a certain microphone. This makes the calibrators equally suited for calibration of single microphones as well as entire measurement channels. In most cases, the calibrator has only a single tone frequency in the range 200 to 1000 Hz, at which the calibration is performed, (IEC 942 'Sound Calibrators') but multitone calibrators are also available, usually with frequencies in steps of one octave.

When using the calibrator for microphone calibration, the output from the microphone is measured with the well defined sound pressure from the calibrator applied to its front. The sensitivity is determined by dividing the output voltage by the sound pressure.

When the calibrator is used to calibrate the entire measurement channel, the well defined sound pressure is applied to the front of the microphone and a proper adjustment is made to give the correct reading of the measurement display or output voltage.

If the frequency of the calibrator is so high that the sensitivity in the pressure field and free field environments are not the same, it should be noticed that sound calibrators always establish a pressure field. As a result, a free field calibration can only be performed by applying a suitable correction.

6.6.5 Actuator method

The electrostatic actuator is well suited for calibration of a relative frequency response of microphones with a metallic or metalised diaphragm. It consists of a metallic grid positioned close to the diaphragm (approx. 0.5 mm). By applying 800 VDC and 100 VAC to the actuator, electrostatic forces equivalent to a sound pressure of approximately 100 dB re 20 micropascal are established. The actuator is not suited for absolute calibration due to the extreme dependency of the equivalent sound pressure level on the distance between actuator and diaphragm.

The equivalent sound pressure is only applied to the diaphragm and not to the ambient pressure equalisation vent so that the response measured at low frequencies only applies when the vent is not exposed to the sound field.

The actuator method is a reliable method for determination of the microphones relative frequency response under laboratory conditions. The response obtained with the actuator does not however correspond to any of the acoustical sound fields. Although there is no difference between the actuator response and the pressure field response at low frequencies and only minor difference at higher frequencies for microphones with high impedance diaphragms. It should, however be noted that different types of actuators will give slightly different frequency responses, even for the same microphone.

The frequency responses of the microphone in pressure-, random and free sound fields are determined by adding actuator and microphone type-specific corrections to the individual actuator response.

The disadvantages of the method are that care is required to position the actuator, that the system uses high voltages and that the grid must be removable.

6.6.6 Insert Voltage Calibration Method

Insert voltage calibration is a technique which can be used for two purposes:

1. In calibration laboratories it is used to assess the open circuit sensitivity of microphone cartridges.
2. It can provide a convenient means for checking in the field the electrical sensitivity of a complete sound measuring system, including preamplifiers and cables. However, the method does not account for the mechanical parameters which determine the acoustical properties of the microphone cartridge itself.

The method requires a special preamplifier that can isolate the microphone housing from the preamplifier housing. This makes it possible to apply an electrical signal (the insert voltage) directly to the microphone diaphragm (housing). In the calibration the microphone is first subjected to a sound pressure of a known level and frequency (say 94 dB at 1 kHz). This causes the microphone to generate an internal voltage V_0 (corresponding exactly to the open circuit microphone voltage) which, when loaded by the preamplifier, produces an output voltage V at the preamplifier output. The sound source is then switched off and the insert voltage V_1 of the same frequency is applied (such as the internal reference voltage of a measuring amplifier). The level of the insert voltage is adjusted so that the voltage measured at the preamplifier output is again V .

Provided that this voltage V is noted, when the microphone and preamplifier are used remotely from the measuring equipment, or if for other reasons it is convenient to apply a direct sound pressure to the microphone, the insert voltage method can be used to adjust the sensitivity of the equipment. This will provide a system calibration which relies only on the value of V remaining constant.

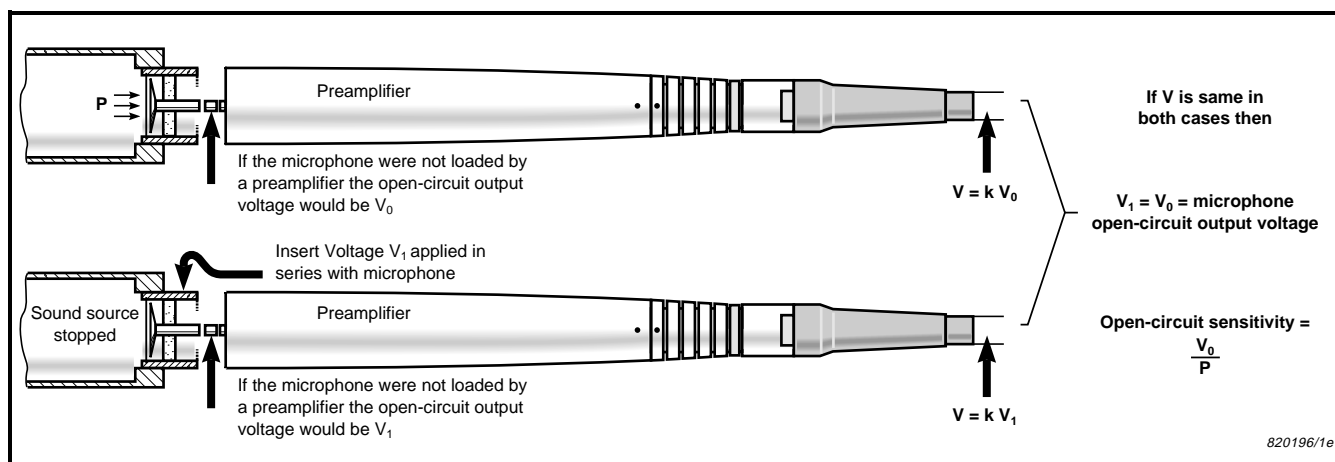

Fig. 6.4 Principle of the Insert Voltage Calibration method

When the method is used for verification of measurement channels, an initial calibration is usually required, after which a reference level is measured with insert voltage. Each time a verification of the channel is required, a new measurement with insert voltage is compared with the reference level.

The disadvantages of the method are that the system is subject to disturbance from electrical noise and that faults in the microphone cartridge cannot be detected.

6.6.7 Charge Injection Calibration Method

This method is developed for monitoring of microphone channels and requires a preamplifier with a small, extremely stable, built-in capacitor which makes it possible to apply an electrical signal to the preamplifier (and microphone) input terminal. The Brüel & Kjær patented charge-injection calibration method is based on detection of changes in impedance at the input terminal. Each verification measurement is compared to an initial reference measurement.

The pin used for the CIC method must be connected to ground potential or to the preamplifier output when the microphone is used for normal measurements. To use the charge injection calibration facility, a test signal, for example, an electrical broad band noise signal, is applied to the capacitor terminal, preferably with no sound on the microphone. The preamplifier output is then measured.

Changes in the measured outputs reflect changes in the microphone and preamplifier input combination. The method is very effective for detecting small changes in microphone capacitance. See chapter 4 for details.

Index

4160 microphone 1-3

4180 microphone 1-3

A

Accessories 5-8

Accredited calibration laboratories 6-6

Accuracy 6-2

Acoustic compliance 2-28

Acoustic impedance 2-27, 2-28

Acoustic resistance 2-36

Actuator method 6-12

Air turbulence 5-9

Air-stiffness 2-18

Amplifier gain 2-34

ANSI S1.12 5-7

ANSI S1.4 5-7

B

Backplate 1-9, 2-8

 Integrated 2-8

Backplate to diaphragm distance 2-8

Bird spikes 5-8

Boltzmanns Constant 2-37

Boot-strapping technique 4-3

C

Calibraation

 Intercomparison method 6-8

Calibration 2-54, 3-2

 Accredited laboratories 6-6

 Accuracy 6-3, 6-9

 Actuator 2-58

 Actuator method 6-5

 Definition 6-2

 Field 6-4

 Hierarchy 6-8

 International standards 6-8

 Laboratory 6-5

 Measurement channel 6-12

 Recalibration interval 6-6

 Reference 6-11

 Reference units 6-3

 Sensitivity 6-3

 Sound source 6-11

 Traceability 6-2, 6-4, 6-8

 Uncertainty 6-8

Calibration chart 1-2, 3-2

calibration chart 1-2

Calibration equipment 1-3

Calibrator load volume 3-13

Capacitance 2-8, 2-13, 2-31, 2-32,

 2-37, 2-43, 3-13, 6-7

 variations 2-11

Capacitance ratio 2-34

CE label 4-13

Charge Injection Calibration 4-15, 6-7

Charge injection calibration 1-4, 6-5

Charge injection calibration method 6-14

CIC 6-14
Comparison Method 6-11
Correction
 Angle of incidence 2-47
 Microphone body 2-48
Correction-factor 3-5
Corrections 2-45, 2-58
Coupler 2-4, 2-43, 6-10

D
DANAK 6-9
Danish Primary Laboratory of Acoustics
 (DPLA) 1-5
Dehumidifier 5-10
Design 2-7
 Description 2-7
Design parameters 2-7
Diameter
 Sensitivity 2-22
Diaphragm 2-8
 Air stiffness 2-15
 Damping resistance 2-21, 2-38
 Diameter 2-21, 2-22
 Frequency range 2-23
 Mass 2-20
 Tension 2-9, 2-20
 tension 1-10, 2-51
 thickness 2-8
Diaphragm material 2-9
Diffuse Field 2-49
Diffuse Field Microphone 2-50
Diffuse sound field. 3-9
Diffuse-field 2-5
 correction 2-49
Diffuse-field correction 2-49, 2-50, 2-54
Diffuse-field measurements 2-2
Diffuse-field response 2-58
Directional characteristics 3-10
Distortion 2-39, 2-43
 Microphone Distortion 2-40
 Preamplifier and microphone system 2-42
Distortion level 3-11
DPLA 6-6, 6-8
Dynamic Range 3-11
Dynamic range 2-31, 2-32, 3-11, 5-2
 Limits 5-4

E
Electret 2-13, 2-15
 Series capacitor 2-14
Electrical resistance 2-36
Electromagnetic compatibility 3-21, 4-13
Electrostatic Actuator 2-54, 2-57
 Pressure-field response 2-58
Electrostatic actuator 2-55, 6-12
 Phase response 3-7
 Response 3-7
Electrostatic Calibration Pressure 2-55
Electrostatic calibration pressure 2-55
Electrostatic pressure 2-55
EMC 4-13
EMC requirements 4-13
EN 50081-1 4-14
En 50082-2 4-14
Environment 5-7
Equivalent diaphragm volume 2-29
Equivalent electric circuit 2-26
Equivalent electric circuits 2-25
Equivalent sound pressure 3-12
Equivalent Volume 2-28, 3-13
Equivalent volume 2-31
 Diaphragm diameter 2-31
External polarisation source 2-11
Externally polarised microphones 3-14
Externally polarized microphones 5-6

F
Falcon Range microphones 5-7
Falcon range microphones 1-4
FET noise 4-9
Field Effect Transistor 4-9
Free-Field 2-45
Free-field 2-4
Free-field correction 2-49, 2-54, 3-9
Free-Field Microphone 2-48
Free-field microphone 2-22, 2-38, 2-48,
 2-59
Free-field response 2-49, 3-9
Free-field sensitivity 2-4
Frequency Response 5-4
Frequency response 2-9, 2-14, 2-17, 2-
 32, 2-48, 5-2, 6-7
 Electrical 2-33, 2-34
 free-field 2-48
 Magnitude and phase 2-22, 2-26
 pressure 2-37

Pressure-field 2-45
Frozen charge 2-13

H

Handling 3-17
High frequency 2-11, 2-21
High frequency response 3-7
High frequency roll-off 2-34
Highpass filter 4-3
Humidity 5-7, 5-9, 5-10
Effect of 3-21

I

IEC 1043 6-8, 6-12
IEC 1094 5-7
IEC 1094.1 6-7
IEC 1094-1 2-7, 6-10, 6-11
IEC 1094-2 3-10
IEC 1094-3 6-11
IEC 1094-4 2-7, 3-6
IEC 1183 2-5, 3-9
IEC 1183-1993 3-9
IEC 651 3-6, 5-7
IEC1043 2-6
IEC-68-2-3 3-21
Impedance analogy 2-25
Influence of Microphone
Sound pressure 2-6
Infra-sound measurement 2-35
Inherent Noise 2-35
Microphone system 2-38
Inherent noise 3-11
Input resistance 2-32
Insert Voltage Calibration 4-15
Insert voltage calibration 6-5
Insert Voltage Calibration method 6-14
Insert voltage calibration method 6-13
Insulator 2-8, 2-10

K

K and Ko 3-5
Ko 3-5

L

Large signal response 4-4
Leakage Resistance 3-16
Leakage resistance 2-10

Loaded Sensitivity 3-4
Low frequency adaptors 2-35
Low frequency calibrator 6-7
Low frequency phase response 2-19
Low frequency response 2-18, 3-6
Low frequency roll-off 2-34
Lower Limiting Frequency 2-18
Lower limiting frequency 2-19, 6-7

M

Magnetic Field
Effect of 3-21
Material 2-9
Maximum output voltage 3-12
Maximum slew rate 4-7
Maximum Sound Pressure Level 3-12
Measurand 6-2
Mechanical tolerances 1-10
Microphone
Array applications 5-8
Diskette 3-2
Long term protection 5-10
Short term protection 5-10
Microphone and Preamplifier 2-32
Electrical circuit 2-32
Transfer Function 2-32
Microphone Capacitance 2-31
Microphone holder 5-8
Microphone impedance 2-31
Microphone Modelling 2-25
Equivalent units 2-25
Microphone Noise 2-36
Microphone selection 5-2
Monel 2-10
Multitone calibrator 1-4, 6-4

N

NIST 6-7
Noise
Measurement system 2-36
Microphone 2-36
Microphone system 2-38
Preamplifier 2-36
Low frequency noise 2-37
Noise data 3-12
Noise pressure 2-36
Noise spectrum
Microphone 2-37

Nose cone 5-8, 5-9

Nyquist and Johnson Noise 2-26

O

Open Circuit Sensitivity 3-3

Open-circuit sensitivity 3-3, 6-7

Optimised response 3-5

Output resistance 2-32

P

Parallel capacitors 2-43

Particle velocity 2-2

Passive capacitance 2-40

Phase match 6-7

Phase response 5-5

Polar plot 3-10

POlarisation

resistor 2-11

Polarisation 5-5

field strength 2-14

Polarisation resistor 3-14

Polarisation Voltage 3-14

Electret 3-14

Polarisation voltage 2-10, 2-14

Resistor 3-14

Polarization voltage 2-10, 2-14, 2-35, 2-58

Polarzation 2-11

Preamplifier

Built-in preamplifier 5-8

Calibration Technique 4-15

Current limitation 4-6

Dynamic Range 4-5

Effect of temperature 4-11

Electromagnetic noise 4-15

Frequency Response 4-2

Gain 3-4

High frequency response 4-3

input impedance 2-32

Low frequency response 4-2

Lower limit of dynamic range 4-8

Maximum acoustical signal 4-6

Maximum current 4-6

Maximum output current 4-6

Maximum output voltage 4-6

Maximum slew rate 4-6

Noise level 4-12

Noise spectrum 4-9

Output impedance 4-4

Phase Response 4-11

Preamplifier and microphone combination 2-31

Preamplifier noise 2-37

Preamplifiers

Characteristics 4-2

Effect of magnetic fields 4-13

Prepolarised microphones 2-14

Pre-polarization principle 2-11

Prepolarized microphone 2-13

Prepolarized microphones 3-15, 5-6

Pressure coefficient 3-19

Pressure equalisation 5-5

Pressure Field Microphone 2-45

Pressure sensing condenser microphones 2-5

Pressure sensitivity 2-4

Pressure-Fiel 2-43

Pressure-field 2-4

Pressure-field calibration 2-4

Pressure-field correction 3-10

Pressure-field microphone 2-48, 2-50, 2-59

Pressure-field response 3-9

Primary calibration laboratories 6-6

Properties of microphones 2-7

Protection grid 2-46

R

Rain cover 5-8

Raincover 5-10

Random incidence 2-49

Random Incidence response 3-9

Rear-vented microphones 2-16

Reciprocity calibration method 6-10

Reference Frequency 2-24

Reference frequency 3-6

Requirements

environmental influences 2-6

Material 2-9

Performance 2-6

Resistance 2-32, 2-35, 2-36

Damping 2-38

Reversible changes 3-18

RF-signal 4-15

S

Selection

Dynamic range 5-2
 Frequency response 5-2, 5-4
 Type of sound field 5-2
 Sensitivity 2-9, 2-24, 2-45, 2-48, 2-50, 3-3, 6-2, 6-10
 Ambient pressure 3-19
 Diffuse-field 2-24
 Side-vented microphones 2-16
 Slew rate 4-4
 Small signal response 4-4
 Sound field parameters 2-2
 Sound intensity 2-2
 Sound intensity calibrator 1-4
 Sound intensity microphones 1-4
 Sound Level Calibrator 6-4
 Sound pressure 2-2
 Sound pressure calibrator method 6-12
 Sound pressure level 2-2, 2-24
 Stability 2-51, 3-17
 Ageing 1-10
 Electret 2-15
 Short term 3-17
 Temperature 2-54
 Variation 1-10
 Stability factors 2-52, 2-54
 Stability 2-9
 Standards
 ANSI S1.12 5-6
 Compliance 5-6
 IEC 651 5-6
 Types 0 to 3 5-6
 Static Pressure Equalization 2-16
 Stray capacitance 2-8, 2-41, 3-13
 Substitution method 6-11
 System Noise Spectra 2-40

T

Temperature 2-51, 2-52, 5-7
 Effect of 3-18
 effect of 1-6
 Testing
 environmental 1-5
 shock, temperature and humidity 1-5
 Thermal resistor 4-8
 Transduction principle 2-11
 Transduction principles 2-11
 Turbulence screen 5-8
 Turbulent pressure 5-10
 Type of Sound Field 5-4

U

Uncertainty 6-2
 Use of Microphone 5-3

V

Vent position 2-17
 Vibration
 Effect of 3-21

W

WE640AA microphone 1-3
 Wind speed 5-9
 Wind, 5-9
 Windscreen 5-8, 5-10

