

SIEMENS



RDG200KN & RDG260KN

Room thermostats with KNX communications

Basic Documentation

Table of contents

1	About this document.....	5
1.1	Revision history	5
1.2	Reference documents.....	5
1.3	Before you start	6
1.3.1	Trademarks	6
1.3.2	Copyright	6
1.3.3	Quality assurance	6
1.3.4	Document user/request to the reader	7
1.4	Target audience, prerequisites.....	7
1.5	Glossary.....	7
2	Overview.....	8
2.1	Types	8
2.2	Functions.....	8
2.3	Accessories.....	10
2.4	Equipment combinations.....	11
2.5	Integration via KNX bus	14
3	Notes.....	16
3.1	Mounting and installation	16
3.2	Commissioning.....	17
3.3	Operation	19
3.4	Remote operation	21
3.5	Disposal	21
3.6	Cyber security disclaimer.....	21
4	Functions.....	22
4.1	Temperature control	22
4.2	Operating modes.....	23
4.2.1	Different ways to influence operating mode	24
4.2.2	Communication examples.....	29
4.3	Room temperature setpoints.....	32
4.3.1	Description.....	32
4.3.2	Setting and adjusting setpoints.....	34
4.4	Application overview	37
4.4.1	Applications for fan coil systems	38
4.4.2	Applications for universal systems.....	39
4.4.3	Application for heat pump systems.....	40
4.5	Power supply selection for RDG200KN.....	41
4.6	Additional functions.....	42
4.6.1	Sensors and changeover functions	43
4.6.2	Presence detector.....	45
4.6.3	Output functions.....	46
4.6.4	Monitoring and limitation functions	49
4.6.5	User operation / Indication	51
4.6.6	Humidity	52

4.6.7	Preventive operation	55
4.6.8	NFC communication.....	55
4.7	Control sequences.....	56
4.7.1	Sequence overview (setting via P001).....	56
4.7.2	Application mode	57
4.7.3	2-pipe fan coil unit.....	59
4.7.4	2-pipe fan coil unit with electric heater.....	60
4.7.5	2-pipe fan coil unit with radiator or floor heating.....	62
4.7.6	2-pipe/2-stage heating or cooling	64
4.7.7	4-pipe fan coil unit.....	66
4.7.8	4-pipe fan coil unit with electric heater.....	69
4.7.9	Chilled/heated ceiling and radiator applications	71
4.7.10	Compressor applications.....	74
4.7.11	Applications with external AQR sensor or QMX room operator unit	75
4.7.12	Setpoints and sequences	76
4.8	Control outputs	78
4.8.1	Overview	78
4.8.2	Control output configuration (setting via DIP switches 7/8 or tool, and P201/P203/P204).....	82
4.9	Fan control	84
4.10	Multifunctional input, digital input.....	92
4.11	Handling system faults.....	94
4.12	KNX communications.....	94
4.12.1	S-Mode.....	94
4.12.2	LTE-Mode.....	95
4.12.3	Zone addressing in LTE-Mode (with Synco)	95
4.12.4	Example of heating and cooling demand zones.....	97
4.12.5	Send heartbeat and receive timeout.....	98
4.12.6	Startup.....	98
4.12.7	Heating and cooling demand.....	98
4.12.8	Fault and alarms function on KNX.....	99
4.13	Communication objects (S-Mode).....	100
4.13.1	Overview	100
4.13.2	Description of communication objects	102
4.14	Communication objects (LTE-Mode).....	107
4.15	Control parameters.....	108
4.15.1	Parameter setting via local HMI.....	108
4.15.2	Setting/downloading parameter via tool.....	109
4.15.3	Commissioning parameter via Smartphone app PCT Go.....	110
4.15.4	Service level parameters.....	111
4.15.5	Expert level parameters with diagnostics and test.....	113
5	Supported KNX tools	118
5.1	ETS.....	118
5.1.1	Setting parameters in ETS	119
5.2	ACS tool.....	121
5.2.1	Setting parameters in ACS.....	122
5.2.2	Operation and monitoring with ACS.....	123

5.2.4	Operation and monitoring with OZW772.....	127
6	Connection.....	128
6.1	Connection terminals	128
6.2	Connection diagrams.....	129
6.3	Application examples.....	132
6.3.1	Humidity control.....	132
6.3.2	Relay functions	135
6.3.3	Swap function and/or fan in the 2nd stage.....	137
7	Technical data	140
8	Dimensions	146
Index	147

1 About this document

1.1 Revision history

Edition	Date	Changes	Section
1	September 2020	First version.	All
2	November 2020	<ul style="list-style-type: none"> Update NFC communication info Update changeover picture Update the picture of DC 0...10 V fan in "Fan control with modulating heating/cooling control" Update info about geographical zones P901 and P902 Update ACS version info 	<ul style="list-style-type: none"> 4.6.8 4.7.9.2 4.9 4.12.3 1.5, 5.2

1.2 Reference documents

Subject	Ref.	Document title	Document number
Room thermostats with KNX communications, RDG2..KN	[1]	Mounting instructions (RDG200KN)	A6V11546008
	[2]	Mounting instructions (RDG260KN)	A6V11844861
	[3]	Operating Instruction	A6V11545973
	[4]	Data sheet	A6V11545853
KNX manual	[5]	Handbook for Home and Building Control – Basic Principles (EN: https://my.knx.org/shop/product?language=en&product_type_category=books&product_type=handbook DE: https://my.knx.org/shop/product?language=de&product_type_category=books&product_type=handbook)	
Synco and KNX (see www.siemens.com/synco)	[6]	KNX bus, Datasheet	CE1N3127
	[7]	Communication via the KNX bus for Synco 700, 900 and RXB/RXL, Basic Documentation	CE1P3127
	[8]	Planning and commissioning protocol, communication Synco 700	XLS template in HIT
	[9]	RMB795B central control unit, Datasheet	CE1N3122
	[10]	RMB795B central control unit, Basic Documentation	CE1P3122
	[11]	KNX S-mode data points	CE1Y3110
	[12]	Product data for ETS	
	[13]	ETS product data compatibility list	CE1J3110
	[14]	Synco Application Manual	0-92168en
	Desigo engineering documents	[15]	Desigo RXB integration – S-mode
[16]		Desigo RXB/RXL integration – Individual Addressing	CM1Y9776
[17]		Third-party integration	CM1Y9777
[18]		Synco integration	CM1Y9778
[19]		Working with ETS	CM1Y9779
Web server OZW772	[20]	Commissioning Instructions	CE1C5701

1.3 Before you start

1.3.1 Trademarks

The table below lists the third-party trademarks used in this document and their legal owners. The use of trademarks is subject to international and domestic provisions of the law.

Trademarks	Legal owner
Synco™	
Android™	Google Inc.

All product names listed in the table are registered (®) or not registered (™) trademarks of the owner listed in the table. We forgo the labeling (e.g. using the symbols ® and ™) of trademarks for the purposes of legibility based on the reference in this section.

1.3.2 Copyright

This document may be duplicated and distributed only with the express permission of Siemens, and may be passed only to authorized persons or companies with the required technical knowledge.

1.3.3 Quality assurance

This document is prepared with great care.

- The contents of this document are checked at regular intervals.
- Any corrections necessary are included in subsequent versions.
- Documents are automatically amended as a consequence of modifications and corrections to the products described.

Please make sure that you are aware of the latest document revision date.

If you find lack of clarity while using this document, or if you have any criticisms or suggestions, please contact the Product Manager in your nearest branch office. The addresses of the Siemens Regional Companies are available at www.buildingtechnologies.siemens.com.

1.3.4 Document user/request to the reader

Before using products from Siemens Industry, Inc., it is important that you read the documents supplied with or ordered at the same time as the products (equipment, applications, tools, and so on) carefully and in full.

We assume that persons using our products and documents are authorized and trained appropriately and have the technical knowledge required to use our products as intended.

More information on the products and applications is available:

- On the intranet (Siemens employees only) at <https://wse04.siemens.com/content/P0002723/SitePages/Home.aspx>
- From the Siemens branch office near you www.buildingtechnologies.siemens.com or from your system supplier
- From the support team at headquarters fieldsupport-zug.ch.sbt@siemens.com if there is no local point of contact

Siemens assumes no liability to the extent allowed under the law for any losses resulting from a failure to comply with the aforementioned points or for the improper compliance of the same.

1.4 Target audience, prerequisites

This document assumes that users of the RDG2..KN room thermostats are familiar with the ETS tool, Synco ACS tool or both and can use them.





It is also assumed that these users are aware of the specific conditions associated with KNX.

In most countries, specific KNX know-how is conveyed through training centers certified by the KNX Association (see www.knx.org/).

For reference documentation, see Reference documents [→ 5].

1.5 Glossary

The inputs, outputs and parameters of an application can be influenced in various ways. These are identified by the following symbols in this document:

	Parameters identified by this symbol are set using ETS.
	Parameters identified by this symbol are set using ACS.
 Note!	Setting RDG2..KN KNX parameters is only supported by the following tool versions: <ul style="list-style-type: none"> • ETS5 or higher versions • ACS version 13.03 or higher
	Inputs and outputs identified by this symbol communicate with other KNX devices. They are called communication objects (CO). The communication objects of the RDG2..KN works partly in S-Mode, partly in LTE-Mode, and partly in both. These objects are described accordingly. A list of the parameters is shown in Control parameters [→ 108].

2 Overview

2.1 Types

For fan coil units, universal applications and compressors in DX-type equipment applications

Product no.	Stock no.	Operating voltage	Fan		Number of control outputs					Built-in sensor
			3-speed	DC	On/Off	PWM	3-pos	DC	On/Off (3-wire)	Humidity, temperature
RDG200KN	S55770-T409	AC 24 V or AC 230 V	✓	✓ ¹⁾	3	3	2	–	2	✓
RDG260KN	S55770-T412	AC 24 V or DC 24 V	✓	✓ ¹⁾	–	–	–	3	–	✓
			–	✓ ¹⁾	2 ²⁾	–	–	–	–	

¹⁾ The terminal Y50 is used as DC 0...10 V output.

²⁾ The output is relay On/Off.

2.2 Functions

Control application

The RDG2..KN KNX room thermostats are designed for use with the following:

Fan coil units via On/Off or modulating/DC control outputs:

- 2-pipe system
- 2-pipe system with electric heater
- 2-pipe system with radiator/floor heating
- 2-pipe/2-stage system
- 4-pipe system
- 4-pipe system with electric heater
- 4-pipe system with PICV and 6-port ball valve as changeover (RDG260KN)

Chilled/heated ceilings (or radiators) via On/Off or modulating/DC control outputs:

- Chilled/heated ceiling
- Chilled/heated ceiling with electric heater
- Chilled/heated ceiling and radiator/floor heating
- Chilled ceiling and radiator/floor heating
- Chilled/heated ceiling/2-stage
- Chilled/heated ceiling (4-pipe) with 6-port ball valve (RDG260KN)
- Chilled/heated ceiling with PICV and 6-port ball valve as changeover (RDG260KN)

Compressor applications via On/Off control:

- Heating or cooling, compressor in DX-type equipment
- Heating or cooling, compressor in DX-type equipment with electric heater
- Heating and cooling, compressor in DX-type equipment
- Heating or cooling/2-stage, compressor in DX-type equipment

-
- General functions**
- Room temperature control via built-in temperature sensor or external room temperature/return air temperature sensor
 - Room relative humidity control via built-in humidity sensor (humidity function can be disabled.)
 - Min./max. humidity control by shifting temperature setpoint and releasing contact for dehumidifier/humidifier
 - Floor heating temperature limitation
 - Min. and max. supply air temperature limitation
 - Selection of operating modes via operating mode button
 - Button lock for all buttons independently (automatically or manually)
 - Changeover between heating and cooling mode (automatic via local sensor or bus, or manually)
 - Parameters protected by password (disabled by default)
 - Purge function together with 2-port valve
 - Valve exercising function to prevent gripping
 - Reminder to clean fan filters
- Setpoints and display**
- Min. and max. limitation of room temperature setpoint:
 - Comfort limitation (min. and max. limitation)
 - Energy saving concept (min. and max. limitation separate for heating and cooling)
 - Temporary Comfort mode extension
 - Green leaf indication function
 - Display of current room temperature or setpoint in °C, °F or both
- Setting**
- Application selection via DIP switches or external commissioning software (ACS, ETS and Siemens smartphone application PCT Go for Android)
 - Parameter download with external commissioning software (ACS, ETS and Siemens smartphone application PCT Go for Android)
 - Reloading factory settings for commissioning and control parameters
- Fan**
- 1-speed, 3-speed or DC 0...10 V fan control on RDG200KN and RDG260KN (automatic or manual fan)
 - Advanced fan control function, e.g. fan kick, fan start delay, selectable fan operation (enable, disable, depending on heating/cooling mode, or min. and max. speed setting)
 - Fan start depending on fan coil temperature (heating) to avoid cool air while heating
 - Enabling fan output only in the 2nd stage (2-pipe/2-stage)
 - Switching fan speed from manual to automatic in the dead zone to avoid energy waste (selectable function)
- Special functions**
- Swap function for 2-pipe and 2-stage application by switching the 1st stage heating to 2nd stage cooling
 - On 2-pipe/2-stage application, limit the number of heating or cooling sequence to one
 - Control of 6-port ball valve for chilled and heated ceiling, DC 0...10 V, DC 2...10 V and inverted signals DC 10...0 V, DC 10...2 V (RDG260KN)
 - Control of 6-port ball valve as changeover (On/Off – open/close signal) and PICV DC 0...10 V for
 - Chilled and heated ceiling/floor (RDG260KN)
 - Fan coil application (RDG260KN)

- Control of 6-port ball valve via KNX S-Mode objects (RDG200KN and RDG260KN)
- Flow limitation function for PICV in heating mode (RDG260KN)

Inputs/outputs

- 3 multifunctional inputs selectable for:
 - Window contact switches operating mode to Protection
 - Presence detector switches operating mode to Comfort
 - Sensor for automatic heating/cooling changeover
 - Switch for manual heating/cooling changeover
 - External room temperature or return air temperature sensor
 - Dewpoint sensor
 - Enable electric heater
 - Fault input
 - Monitor input for temperature sensor or switch status
 - Supply air temperature sensor
 - Coil temperature sensor
 - External temperature limit
 - Hotel presence detector
- Selectable relay functions
 - Switching off external equipment during Protection mode
 - Switching on external equipment (e.g. pump) during heating/cooling demand
 - Output status heating/cooling sequence
 - Dehumidification/humidification control output









KNX communication features

- KNX bus (terminals CE+ and CE-) for communication with Synco devices or KNX compatible devices
- Display of outside temperature or time of day from KNX bus
- Time scheduling and central control of setpoints from KNX bus
- Control of Economy setpoints via KNX bus
- Relative humidity setpoint via KNX bus
- Control of KNX actuators and fan via S-Mode objects
- Energy supply optimization via energy demand signal via Synco RMB795B central control unit
- Interworking with Siemens AQR.. and QMX.. sensors for room humidity and room temperature measurement
- Interworking with Siemens QMX.. room operator units for room humidity, room temperature and operating commands for fan, operating mode and setpoints



2.3 Accessories

Type	Product/stock no.	Datasheet
KNX power supply 160 mA (Siemens BT LV)	5WG1 125-1AB02	TPI_N125
KNX power supply 320 mA (Siemens BT LV)	5WG1 125-1AB12	TPI_N125
KNX power supply 640 mA (Siemens BT LV)	5WG1 125-1AB22	TPI_N125





2.4 Equipment combinations

Type of unit		Product no.	Datasheet *)
Cable temperature or changeover sensor, cable length 2.5 m NTC (3 kΩ at 25 °C)		QAH11.1	1840
Cable temperature sensor PVC 2 m, LG-Ni1000		QPA22	1831
Room temperature sensor NTC (3 kΩ at 25 °C)		QAA32	1747
Room temperature sensor LG-Ni1000		QAA24	1721
Front modules with passive temperature measurement LG-Ni1000		AQR2531ANW	1408
Strap-on temperature sensor LG-Ni1000		QAD22	1801
Condensation monitor		QXA21..	A6V10741072
Flush-mount KNX room sensor (base and front module)		AQR2570N.. AQR2532NNW AQR2533NNW AQR2535NNW	1411
Wall-mounted KNX sensors		QMX3.P30 QMX3.P70	1602









On/Off actuators

Type of unit		Product no.	Datasheet *)
Electromotive On/Off actuator		SFA21.. SFA71..	4863
Electromotive On/Off valve and actuator (only available in AP, UAE, SA and IN)		MVI../MXI..	A6V11251892
Zone valve actuator (only available in AP, UAE, SA and IN)		SUA	4832





On/Off and PWM actuators ¹⁾

Type of unit		Product no.	Datasheet ^{*)}
Thermal actuator (for radiator valves) AC 230 V, NO		STA23.. ¹⁾	4884
Thermal actuator (for radiator valves) AC 24 V, NO		STA73.. ¹⁾	4884
Thermal actuator AC 230 V (for small valves 2.5 mm), NC		STP23.. ¹⁾	4884
Thermal actuator AC 24 V (for small valves 2.5 mm), NC		STP73.. ¹⁾	4884









3-position actuators AC 230 V

Type of unit		Product no.	Datasheet ^{*)}
Electric actuator, 3-position (for radiator valves) AC 230 V		SSA31..	4893
Electric actuator, 3-position (for 2- and 3-port valves/V..P45) AC 230 V		SSC31	4895
Electric actuator, 3-position (for small valves 2.5 mm) AC 230 V		SSP31..	4864
Electric actuator, 3-position (for small valves 5.5 mm) AC 230 V		SSB31..	4891
Electric actuator, 3-position (for small valve 5 mm) AC 230 V		SSD31..	4861
Electric actuator, 3-position (for valves 5.5 mm) AC 230 V		SAS31..	4581
Rotary actuators for ball valves, 3-position		GDB331.9E	4657
Rotary actuators for ball valves, 2 or 3-position		GDB141.9E GDB341.9E	A6V10636150

3-position actuators AC 24 V

Type of unit		Product no.	Datasheet ^{*)}
Electric actuator, 3-position (for radiator valves) AC 24 V		SSA81..	4893
Electric actuator, 3-position (for 2- and 3-port valves/V..P45) AC 24 V		SSC81	4895
Electric actuator, 3-position (for small valves 2.5 mm) AC 24 V		SSP81..	4864
Electric actuator, 3-position (for small valves 5.5 mm) AC 24 V		SSB81..	4891
Electric actuator, 3-position (for small valve 5 mm) AC 24 V		SSD81..	4861

DC 0...10 V actuators

Type of unit		Product no.	Datasheet *)
Electric actuator, DC 0...10 V (for radiator valves)		SSA61..	4893
Electric actuator, DC 0...10 V (for 2- and 3-port valves/V..P45)		SSC61..	4895
Electric actuator, DC 0...10 V (for small valves 2.5 mm)		SSP61..	4864
Electric actuator, DC 0...10 V (for small valves 5.5 mm)		SSB61..	4891
Electromotive actuator, DC 0...10 V (for valves 5.5 mm)		SAS61..	4581
Electrothermal actuator, AC 24 V, NC, DC 0...10 V, 1 m		STA63	4884
Electrothermal actuator, AC 24 V, NO, DC 0...10 V, 1 m		STP63	4884
Rotary actuators for ball valves AC 24 , DC 0...10 V		GDB161.9E	4657

KNX actuators

Type of unit		Product no.	Datasheet *)
Rotary actuators for ball valves KNX S-Mode		GDB111.9E/KN	A6V10725318

*) The documents can be downloaded from <https://hit.sbt.siemens.com>

1) With PWM control, exact parallel run of 2 or more thermal actuators is not possible. If several fan coil units are controlled by the same room thermostat, motorized actuators with On/Off or 3-position control are preferred.

Note:

For more information about parallel operation and the max. number of actuators that can be used, refer to the data sheets of the selected actuator type and the following list:

Max. number of actuators in parallel on RDG200KN (AC 230 V):

- 6 SS..31.. actuators (3-position)
- 4 ST..23.. if used with On/Off control signal
- 10 SFA.., SUA.., MVI.., MXI.. On/Off actuators
- Parallel operation of SAS31 not available

Max. number of actuators in parallel on RDG200KN (AC 24 V):

- 6 SS..81.. actuators (3-position)
- 4 ST..73.. if used with On/Off control signal
- 2 SFA71.. On/Off actuators
- Parallel operation of SAS81 not available

Max. number of actuators in parallel on RDG260KN (AC 24 V):

- 10 SS..61.. actuators (DC)
- 10 ST..23/63/73.. actuators (DC or On/Off)
- 10 SFA.., SUA.., MVI.., MXI.. On/Off actuators
- 10 SAS61.. actuators (DC)
- 10 GDB161.9E

2.5 Integration via KNX bus

The RDG2..KN room thermostats can be integrated as follows:

- Integration into Synco 700 system via LTE-Mode (easy engineering)
- Integration into Desigo via group addressing (ETS) or individual addressing
- Integration into third-party systems via group addressing (ETS)

The following KNX functions are available:

- Central time program and setpoints, e.g., when using the RMB795B central control unit
- Outside temperature or time of day via bus displayed on thermostat
- Remote operation and monitoring with web browser using the OZW772 web server
- Maximum energy efficiency due to exchange of relevant energy information, e.g., with Synco 700 controllers (e.g., heating demand, cooling demand)
- Alarming, e.g., external fault contact, condensation, clean filter, and so on
- Monitoring input for temperature sensor or switch

Engineering and commissioning can be done by using:

- Local DIP switches and HMI
- Synco ACS
- ETS5 or higher versions
- Siemens smartphone application PCT Go for Android

Synco 700

The RDG2..KN room thermostats are especially tailored for integration into the Synco 700 system and operate together in LTE-Mode. This extends the field of use of Synco for individual room control in conjunction with fan coil units, chilled ceilings and radiators.

Synco topology

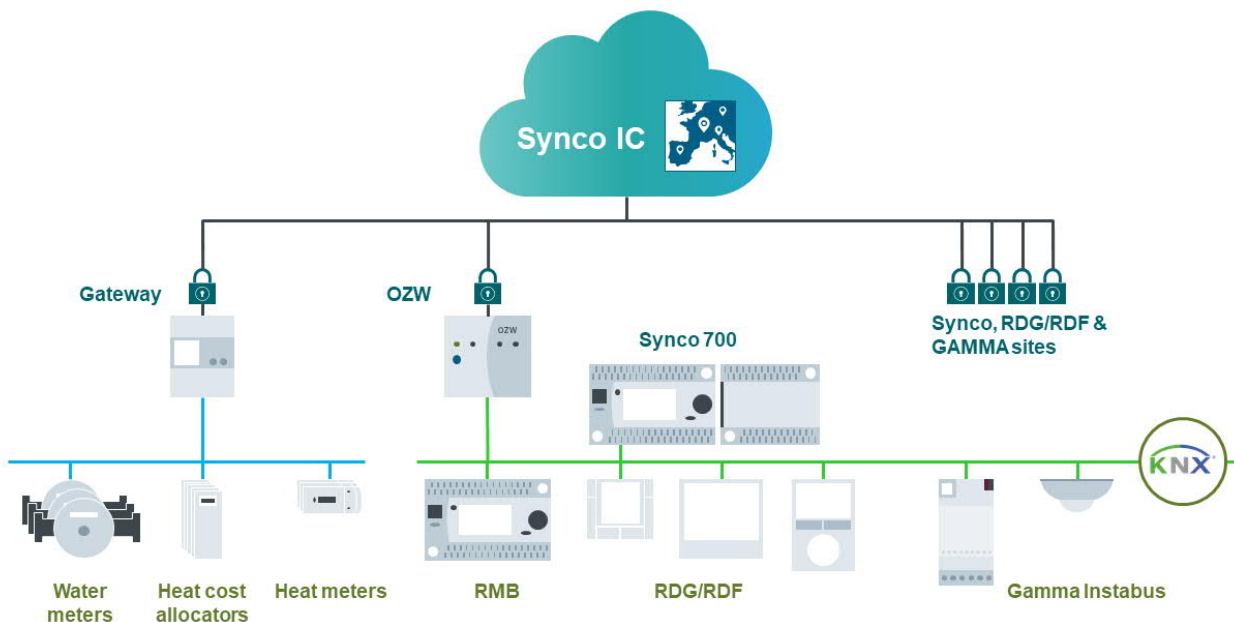

Legend

Synco 700	Building automation and control system (BACS)
Gateway	Connection of meters via Modbus
OZW	Web server, connection of Synco, RDG/RDF & GAMMA
RMB	Central control, RDG/RDF integration
RDG/RDF	Thermostats for room climate control
Gamma Instabus	For lighting control and other room electrical applications

Desigo and third-party systems

The RDG2..KN thermostats can be integrated into the Siemens building automation and control systems (BACS) Desigo or into third-party systems. Either S-Mode (group addressing) or individual addressing can be used for integration.

3 Notes

3.1 Mounting and installation

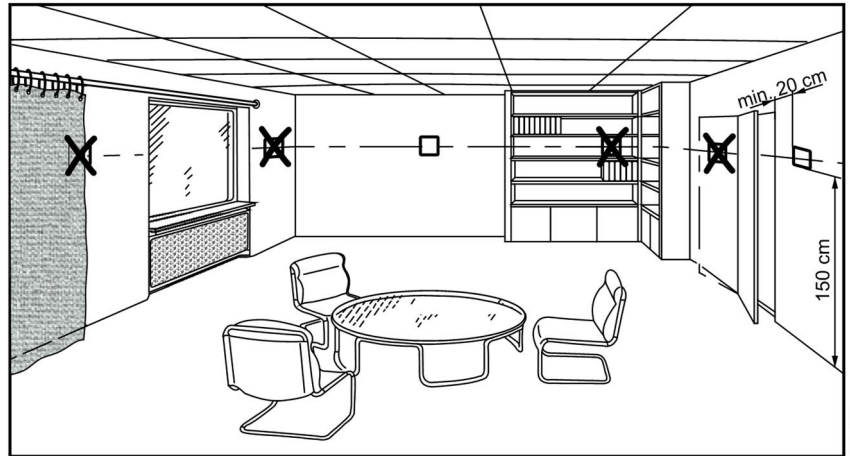

Mounting

- The devices are suitable for wall mounting.
- Recommended height: 1.5 m above the floor.
- Do not mount the devices in recesses, shelves, behind curtains or doors, or above or near heat sources.
- Avoid direct solar radiation and drafts.
- Avoid unheated (uncooled) building area such as outside walls.
- Seal the conduit box or the installation tube if any, as air currents can affect sensor readings.
- Adhere to allowed ambient conditions.
- An external room temperature sensor is recommended if above situations cannot be avoided in the installation area.

Wiring

- Comply with local regulations to wire, protect and earth the thermostat.
- ⚠ **Warning! No internal line protection for supply lines to external consumers (Q1, Q2, Q3, Yx or Yxx)! Risk of fire and injury due to short-circuits!**
- Adapt the line diameters as per local regulations to the rated value of the installed over current protection device.
- The AC 230 V mains supply line must have an external circuit breaker with a rated current of no more than 10 A.
- ⚠ Properly size the cables to the thermostat, fan and valve actuators for AC 230 V mains voltage.
- ⚠ Use valve actuators rated for AC 230 V / AC 24 V / DC 24 V depending on mains voltage.
- ⚠ Inputs X1-M, X2-M or U1-M: Multiple switches (e.g. summer/winter switch) may be connected in parallel. Consider overall maximum contact sensing current for switch rating.
- ⚠ When mains voltage is AC 230 V, SELV inputs X1-M, X2-M and U1-M use cables with min. 230 V insulation.
- Selectable relay function: Follow instructions in basic documentation A6V11545892 (Relay functions [→ 135]) to connect external equipment to the relay outputs.

- ⚠ Disconnect thermostat from power supply before removing from the mounting plate.
- ⚠ If a KNX bus power supply is connected to the line with communicating thermostats and Synco controller, the internal KNX power supply of the Synco controllers must be switched off.

3.2 Commissioning

Applications and settings

The room thermostats are delivered with a fixed set of applications and related parameters. Select and activate the relevant application and settings during commissioning using one of the following tools:

- Local DIP switches and HMI
- Synco ACS
- ETS5 or higher versions
- Siemens smartphone application PCT Go for Android

DIP switches

Set the DIP switches before snapping the thermostat to the mounting plate when selecting an application via DIP switches.

Set all DIP switches to Off (remote configuration) when selecting an application via commissioning tool.

After power is On, the thermostat resets and all LCD segments light up, indicating that reset is correct. After the reset of 3 seconds, the thermostat is ready for commissioning by qualified HVAC staff.

If all DIP switches are Off, **NO APPL** displays, indicating that application commissioning via a tool is required.

Commissioning via Siemens smartphone application PCT Go for Android

The Siemens smartphone application Product Commissioning Tool (PCT Go) for Android is a commissioning tool that allows user to:

- Read and write parameters of the thermostats
- Set the application (e.g. 2-pipe)
- Change settings (e.g. setpoints)
- Set the KNX addressing (device address)

PCT Go APP works via NFC (Near Field Communication) and can be used while the device is either powered, or unpowered, even from the individual package.

To read or write settings, NFC must be activated on the smartphone and the phone must be close to the NFC antenna (built into the thermostat), i.e. at a distance up to ± 2 cm.

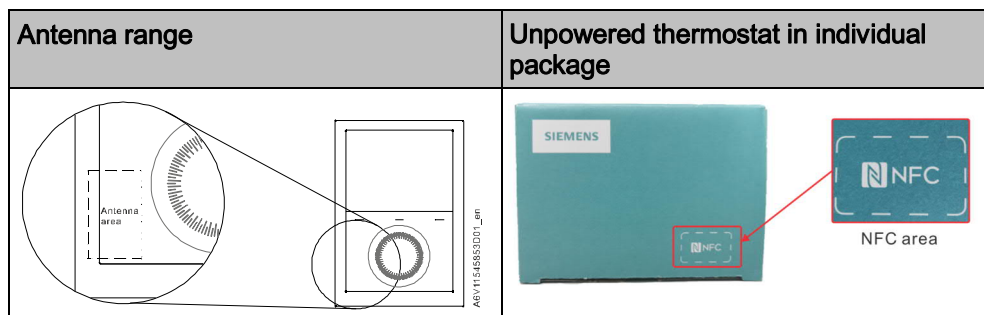

See also Commissioning parameter via Smartphone app PCT Go [→ 110]

Connect tools

Connect the Synco ACS or ETS tools to the KNX bus cable at any point for commissioning.

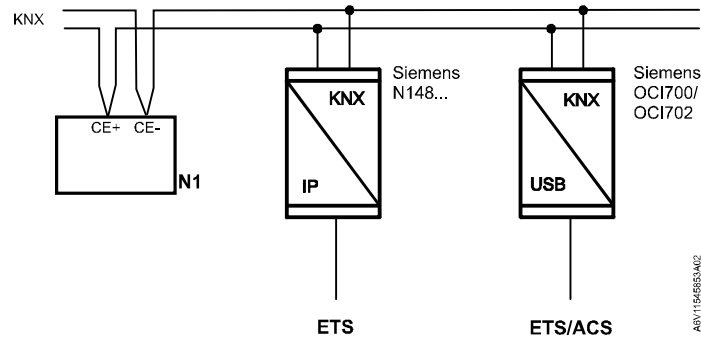

ACS and ETS require an interface:

- KNX interface (e.g. Siemens N148...)
- OC1702 USB-KNX interface

Control sequence

Set the control sequence via parameter P001 depending on the application.
Factory setting:

Application	Factory setting P001
2-pipe and chilled/heated ceiling, and 2-stage	1 = Cooling only
4-pipe, chilled ceiling and radiator, 6-port ball valve applications	4 = Heating and cooling

Calibrate sensor

Recalibrate the temperature sensor, if the room temperature displayed on the thermostat does not match the room temperature measured (after min. 1 hour of operation). To do this, change parameter P006.

Setpoint and range limitation

We recommend to review the setpoints and setpoint ranges (P011, P013...P016, P019, P020) and change them as needed to achieve maximum comfort and save energy.

Programming mode

The programming mode helps identify the thermostat in the KNX network during commissioning.

Touch both the left and right buttons simultaneously for 6 seconds to activate programming mode, indicated on the display by **PROG**.

Programming mode remains active until thermostat identification is complete.

Assign KNX device address

Assign device address (P900) via HMI, ACS, ETS or Siemens smartphone application PCT Go for Android.

Set the device address to 255 to deactivate the communication (no exchange of process data).

Assign KNX group address

Use ETS to assign the KNX group addresses of the thermostat's communication objects.

KNX serial number

Each device has a unique KNX serial number on the rear.

An additional sticker with the same KNX serial number is enclosed in the package. This sticker is intended for documentation purposes of installers.

3.3 Operation



The room thermostat consists of two parts:

- Plastic housing with electronics, operating elements and room temperature sensor
- Mounting plate with the screw terminals

The housing engages in the mounting plate and is secured with 2 screws.

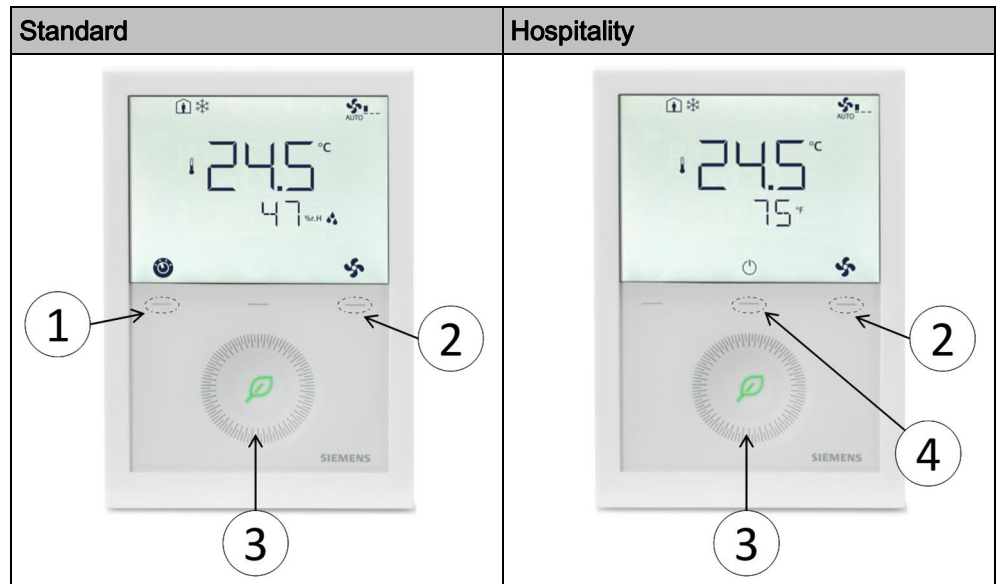
Layout



Number	Description
①	 Operating mode button/Esc
②	 Fan mode button/OK
③	Capacitive rotary knob to adjust setpoints and parameters
④	 Protection hospitality mode button

Button operation

User action	Effect, description
Normal operation	Actual operating mode and state are indicated by symbols.
Press any button (thermostat in normal operation)	Enter operating mode selection; backlight LCD turns on, all possible mode symbols turn on, indicator element (arrow, P001 = 3) displays the current mode/state.
Press left button	Operating mode, indicator element (arrow, P001 = 3) changes to the next mode symbol. After the last press and a timeout of 3 seconds, the newly selected mode is confirmed, the other elements disappear. After a timeout of 20 seconds, the LCD backlight turns off.
Press left button (P001 = 3)	Toggle between heating and cooling.

User action	Effect, description
Press left button while "Operating mode" via bus is Economy	Activate "Extend Comfort mode" (for details, see Different ways to influence operating mode [→ 27]).
Keep left button pressed and turn rotary knob clockwise/counter-clockwise	Activate timer "Extend presence"/"Extend absence" and set the time (for details, see Different ways to influence operating mode [→ 27]).
Press right button >3 seconds	Activate/deactivate button lock.
Press right button for fan coil unit	Change fan mode.
Turn rotary knob	Adjust the room temperature Comfort setpoint.
Press left and right buttons simultaneously for 3 seconds. Release and within 2 seconds, press the right button again until P001 is displayed	Enter parameter setting mode "Service level".
Press left and right button for 3 seconds, release, press left button for 2 seconds until the temperature disappears, then turn rotary knob counterclockwise min. ½ revolution	Enter parameter setting mode "Expert level", diagnostics and test.
Press left and right button simultaneously for 6 seconds	Enter (KNX) programming mode.

Display

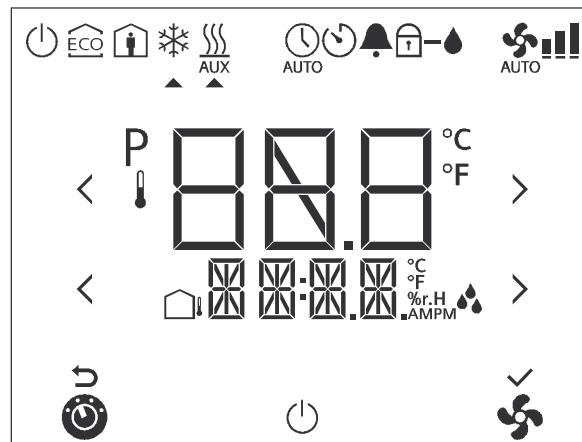

#	Symbol	Description	#	Symbol	Description
1		Operating mode selection	2		Fan speed selection
3		Escape	4		Confirm parameters
5		Outside temperature	6		Additional user information, such as outside temperature, time of day from KNX bus, relative humidity
7	AMPM	Morning: 12-hour format (via bus), Afternoon: 12-hour format (via bus)			
8		Relative humidity	9		Degrees Celsius or Fahrenheit
10	P	Parameter	11		Value with thermometer: Digits for room temperature display

#	Symbol	Description	#	Symbol	Description
12		Digits for setpoint display	13		Protection mode
14		Economy mode	15		Comfort mode
16		Cooling mode	17		Heating mode, electric heater active
18		Heating mode	19		Manual changeover, heating/cooling mode
20		Auto mode	21		Temporary timer
22		Fault	23		Button lock
24		Condensation in room (dewpoint sensor active) or humidity control active	25		Automatic fan
26		Fan speed		Fan speed I	
				Fan speed II	
				Fan speed III	

3.4 Remote operation

The RDG.. room thermostats can be operated from a remote location using the OZW772 web server or the ACS tool.

3.5 Disposal

	<p>The device is considered an electronic device for disposal in accordance with the European Guidelines and may not be disposed of as domestic garbage.</p> <ul style="list-style-type: none"> • Dispose of the device through channels provided for this purpose. • Comply with all local and currently applicable laws and regulations.
--	--

3.6 Cyber security disclaimer

Siemens provides a portfolio of products, solutions, systems and services that includes security functions that support the secure operation of plants, systems, machines and networks. In the field of Building Technologies, this includes building automation and control, fire safety, security management as well as physical security systems. In order to protect plants, systems, machines and networks against cyber threats, it is necessary to implement – and continuously maintain – a holistic, state-of-the-art security concept. Siemens’ portfolio only forms one element of such a concept.

You are responsible for preventing unauthorized access to your plants, systems, machines and networks which should only be connected to an enterprise network or the internet if and to the extent such a connection is necessary and only when appropriate security measures (e.g. firewalls and/or network segmentation) are in place. Additionally, Siemens’ guidance on appropriate security measures should be taken into account. For additional information, please contact your Siemens sales representative or visit <https://www.siemens.com/global/en/home/company/topic-areas/future-of-manufacturing/industrial-security.html>.

Siemens’ portfolio undergoes continuous development to make it more secure. Siemens strongly recommends that updates are applied as soon as they are available and that the latest versions are used. Use of versions that are no longer supported, and failure to apply the latest updates may increase your exposure to cyber threats. Siemens strongly recommends to comply with security advisories on the latest security threats, patches and other related measures, published, among others, under <https://www.siemens.com/cert/en/cert-security-advisories.htm>.

4 Functions

4.1 Temperature control

**General note:
Parameters**

Setting control parameters (P001 etc. mentioned throughout the document), see Control parameters [→ 108].

Temperature control

The thermostat acquires the room temperature via built-in sensor, external room temperature sensor (LG-Ni1000 or NTC 3k), external return air temperature sensor (LG-Ni1000 or NTC 3k) or via KNX (S-Mode or LTE-Mode), and maintains the setpoint by delivering actuator control commands to heating equipment, cooling equipment, or both. The following control outputs are available:

- On/Off control (2-position)
- Modulating PI/P control with PWM output
- Modulating PI/P control with 3-position control output
- Modulating PI/P control with DC 0...10 V control output

The switching differential is 1 K for heating/cooling mode (On/Off valve: P051 and P053).

The proportional band is 2 K for heating mode and 1 K for cooling mode (DC, PWM and 3-pos valves: P050 and P052).

The integral action time for modulating PI control is adjustable via P057 (heating) and P058 (cooling) (factory setting: 45 minutes).

Display

The display shows the acquired room temperature or the Comfort setpoint, selectable via P008. The factory setting displays the current room temperature. Configure P004 to display the room temperature or setpoint in °F or °C as needed.

Note

When P008 = 1, the Comfort setpoint is always displayed even when the operating mode changes.

Room temperature

The acquired room temperature (internal or external sensor) is available as information on the bus.

RDG2..KN can also acquire the room temperature via KNX.

- With automatic changeover or continuous heating/cooling, symbols / indicate that the system is currently in heating or cooling.
- With manual changeover (P001 = 3), symbols / indicate that the system currently is in heating or cooling mode and symbols / indicate that the system is currently in heating or cooling. Thus, the symbols are displayed even when the thermostat operates in the neutral zone.

Concurrent display of °C and °F

Concurrent display of the current room temperature setpoint or current room temperature in °C and °F is available (P009 = 1).

Outside temperature via bus

The outside temperature displays on the thermostat (P009 = 2). This temperature value has only informational character.

In LTE-Mode, the outside temperature can only be received on outside temperature zone 31.

In S-Mode, the corresponding communication object must be bound to a KNX sensor device.

Time of day via bus

Time of day via bus displays on the thermostat (P009 = 3 or 4) in either 12- or 24-hour format.

Information is received from a Synco controller with time master function or any other KNX device, if the corresponding communication object is bound.

Note

When an application program is downloaded to the Synco devices via ETS, the correct group addresses must also be downloaded to display the time of day on the thermostat (see Synco Knowledge Base - KB771).

4.2 Operating modes



**Room operating mode:
State**

The thermostat operating mode can be influenced in different ways (see Different ways to influence operating mode [→ 24]). Specific heating and cooling setpoints are assigned to each operating mode.

The thermostat sends the current room operating mode via bus.
The following operating modes are available:

	Operating mode	Icon	Description
	Auto		In Auto mode, the operating mode is commanded via bus. Auto is replaced by Comfort when no time schedule via bus is present.
 Room operating mode: Presence detector	Comfort		In Comfort mode, the thermostat maintains the Comfort setpoint. This setpoint can be defined via P011, P013...P016, and adjusted via the rotary knob or bus. In Comfort mode, the fan can be set to automatic or manual fan speed: I, II or III. The thermostat switches to Comfort mode when: <ul style="list-style-type: none"> Standard presence mode: The presence detector (local or via KNX) is active (room is occupied) *)
 Room operating mode: Presence detector	Economy		The setpoints (more energy savings than in Comfort mode) can be defined via P019 and P020. The thermostat switches to Economy mode when: <ul style="list-style-type: none"> The operating mode button is pressed (only possible if P002 is set to 2), Economy is sent via bus, Hotel presence mode: When hotel guests leave their rooms, the thermostat switches to Economy. The buttons are locked and symbol displays. *)
 Room operating mode: Window contact	Protection		In Protection mode, the system is: <ul style="list-style-type: none"> Protected against frost (factory setting: 8 °C, configurable via P100) Protected against overheating (factory setting: OFF, configurable via P101) No other operating mode can be selected locally if Protection mode is commanded by time schedule via bus (e.g., from a central control unit RMB795B) and is displayed. The thermostat switches to Protection mode when: <ul style="list-style-type: none"> The operating mode button is pressed Protection is sent via bus The window contact is active (open window) "Window contact" is sent to thermostat via bus, e.g., from a KNX switch *)

Note

*) For details on window contact and presence detector, see Different ways to influence operating mode [→ 24].

4.2.1 Different ways to influence operating mode

Source for change of operating mode



ACS

Different interventions can influence the operating mode.

The source of the actual room operating mode state can be monitored using the "Cause" diagnostic data point in the ACS tool or web server OZW772.

Source	Description	Value of data point "Cause"
Local operation via left button	<ul style="list-style-type: none"> Operating mode is not Auto No time schedule via bus 	Room operating mode selector (preselection)
	Temporary Comfort extension is active	Timer function
	Window contact	Window switch
	Presence detector	Presence detector
 Room op. mode	"Window contact" sent via bus	Window switch
	"Presence detector" sent via bus	Presence detector
	<ul style="list-style-type: none"> Time schedule available via bus <ul style="list-style-type: none"> local operating mode is set to Auto Time schedule sends Protection mode via bus <ul style="list-style-type: none"> operating mode cannot be changed locally 	Time switch

Priority of operating mode interventions

The following table shows the priorities of different interventions.

A lower number means higher priority.

Priority	Description	Remark
①	Commissioning	In parameter setting mode, you can always command an operating mode independent of all other settings or interventions via bus and local input.
②	Protection mode via bus from time schedule	Protection mode, sent by a time schedule, cannot be overridden by the user.
③	Window contact	If the contact is closed, the operating mode changes to Protection. This overrides the operating mode on the thermostat.
③	"Window contact" via bus	"Window contact" sent via bus has the same effect as the local window contact. Note: Only one input source must be used, either local input X1/X2/U1 or KNX bus.

Priority	Description	Remark
④	Presence detector	<ul style="list-style-type: none"> Standard presence mode: If a room is occupied, the operating mode changes to Comfort. This overrides the operating mode on the thermostat. Unoccupied rooms set back the thermostat to the previous operating mode. Hotel presence mode: If a room is unoccupied, the operating mode changes to Economy. This overrides the operating mode on the thermostat. The buttons are locked and symbol  displays. Occupied rooms set back the thermostat to the previous operating mode.
④	Presence detector via bus	<p>"Presence detector" sent via bus has the same effect as the local presence detector.</p> <p>Note: Only one input source must be used, either local input X1/X2/U1 or KNX bus.</p>
④	Operating mode button	Users can change the operating mode using the operating mode button.
④	Operating mode via bus	The operating mode can be changed via bus.
④	Temporary extended Comfort mode via operating mode button	<p>The operating mode can be temporarily changed from Economy to Comfort by pressing the operating mode button, if...</p> <ul style="list-style-type: none"> Economy was sent via bus For an extended Comfort period > 0 (P102) <p>Note: The last option selected is used, either locally or using bus.</p>
④	Time schedule via bus	<p>The operating mode sent via bus can be overridden by all other interventions.</p> <p>Exception: Protection mode has priority 2.</p> <p>Note: If the time schedule switches from Comfort to Economy, but the presence detector is still active (room occupied), the thermostat continues to work in Comfort mode until the room is unoccupied.</p>

Auto mode with time schedule via bus

If a time schedule via bus is present, e.g., from a central control unit, Auto mode  is active. The thermostat automatically changes to Comfort, Economy or Protection according to the time schedule via bus.







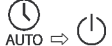

The display shows the Auto mode symbol  along with the symbol for the actual room operating mode (Comfort  or Economy .

You can change the operating mode by pressing the operating mode button. Automatic fan is the default fan speed in Auto mode.

Behavior when bus sends new operating mode

Each time the time schedule sends a new operating mode (switching event), the operating mode of the thermostat is set back to Auto mode. This ensures that the room temperature is maintained according to the time schedule.

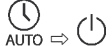
- Pre-Comfort via bus** If the time schedule sends Pre-Comfort mode, the mode is changed either to Economy (factory setting) or Comfort (selectable via P910).
- Behavior when bus sends Protection** No intervention is possible by the user, if Protection mode is set by the time schedule. **OFF** flashes on the display when a button is pressed.
- Availability of Economy mode** The operating mode can be selected locally via the operating mode button. The behavior of the operating mode button (user profile) can be defined via P002, factory setting is P002 = 1.

P002	Without time schedule	With time schedule via bus	Description
1			End user available operating mode button:  <ul style="list-style-type: none"> Switching manually between 2 modes by pressing operating mode button, Economy is not available (factory setting) Suited for commercial buildings If a time schedule via bus is available, then the Comfort mode can be temporarily extended (see Different ways to influence operating mode [→ 27])
2			End user available operating mode button:  <ul style="list-style-type: none"> Switching manually between 3 modes by pressing operating mode button Suited for homes and rooms where manual switching to Economy mode is desired
3			End user available operating mode button:  <ul style="list-style-type: none"> Switching manually between 2 modes by pressing protection hospitality mode button, Economy is not available (factory setting) Suited for hotel guest rooms or commercial buildings If a time schedule via bus is available, then the Comfort mode can be temporarily extended (see Different ways to influence operating mode [→ 27])

Window contact

**Room operating mode:
Window contact**

The thermostat is forced into Protection mode when the window is open. The contact can be connected to multifunctional input X1, X2 or U1. Set P150, P153 or P155 to 3. User operations are ineffective and **OFF** displays if the window contact is active.

The window contact function is also available via the KNX signal "Window contact", e.g., from a KNX switch or a KNX presence detector.



Presence detector

The operating mode can be changed to Comfort or Economy based on room occupancy (room occupied or unoccupied, via presence detector or keycard). For details, see Presence detector [→ 45]

Temporary timer to extend Comfort mode

Comfort mode can be temporarily extended (e.g., working after business hours or on weekends) when the thermostat is in Economy mode.

1. Press the operating mode button to return to Comfort for the preset period (P102).
2. Press the operating mode button again to stop the schedule.

The following conditions must be fulfilled:

- Room is unoccupied (via bus)
or
mode selection via operating mode button is set to "Auto (Comfort)-Protection" (P002 = 1) or "Auto (Comfort)-Protection Hospitality" (P002 = 3) and the time schedule via bus is Economy
- P102 (extend Comfort period) is greater than 0

During the temporary Comfort mode extension, symbol  displays.

When P102 (extend Comfort period) equals 0, extended Comfort cannot be activated; pressing the left button will switch the thermostat to Protection.

If the operating mode window contact is active, press the left button and **OFF** displays (blinking).

Timer to extend presence/absence



The actual room operating mode can be forced temporarily to Comfort or Economy/Protection. The time period is adjusted via the rotary knob:

- Extend presence: Set the thermostat to Comfort for the selected time
- Extend absence: Set the thermostat to Economy/Protection for the selected time

To activate the function, press and hold the left button and, within 3 seconds, turn the rotary knob...











- clockwise for extended presence
- counterclockwise for extended absence

The rotary knob adjusts the time period:

- Extend presence: 0:00...+9:30 in steps of 30 minutes; the symbol  is displayed
- Extend absence: 0:00...-9:30 in steps of 30 minutes; the symbol  or  is displayed

During the extended presence/absence periods, symbol  is displayed.











Function if no time schedule is received via bus

User profile for operating mode (selected via P002)	Operating mode when activating function	Mode button	Function	Operating mode during function	Operating mode at the end of function
P002 = 1:  	Comfort		Extension	Comfort	Protection
	Comfort		Absence	Protection	Comfort
P002 = 2:   	Comfort or Economy		Extension	Comfort	Economy
	Comfort or Economy		Absence	Economy	Comfort
P002 = 3:  	Comfort		Extension	Comfort	Protection hospitality
	Comfort		Absence	Protection hospitality	Comfort

Note

Extension/absence is not available in Protection mode.

Function with time schedule via bus

User profile for operating mode (selected via P002)	Operating mode when activating function	Mode button	Function	Operating mode during function	Operating mode at the end of function
P002 = 1:  <small>AUTO</small> 	Auto		Extension	Comfort	Auto
	Comfort		Extension	Comfort	Auto
	Auto		Absence	Protection	Auto
	Comfort		Absence	Protection	Auto
P002 = 2:  <small>AUTO</small>   	Auto, Comfort or Economy		Extension	Comfort	Auto
	Auto, Comfort or Economy		Absence	Economy	Auto
P002 = 3:  <small>AUTO</small> 	Auto		Extension	Comfort	Auto
	Comfort		Extension	Comfort	Auto
	Auto		Absence	Protection hospitality	Auto
	Comfort		Absence	Protection hospitality	Auto

Note

Extension/absence is not available in Protection mode.

4.2.2 Communication examples

The following examples show 3 typical applications for a central time schedule together with local control of the room operating mode.

The room operating mode in rooms 1...3 of a building is determined by the time schedule. Window contacts are installed in all rooms.

The following conditions are specified:

The rooms are used and controlled by the time schedule as follows:

- Night setback from 17:00 to 08:00 (Economy)
- Lunch break from 12:00 to 13:00 (Pre-Comfort)

The substitution (P910) for Pre-Comfort via bus is set on the thermostats as follows:

- Room 1: Comfort (1)
- Room 2: Economy (0)

Example 1

Window contact

In **Room 1**, the window is opened briefly, once in the morning and once in the late afternoon (1). The opening in the morning and afternoon directly influences the actual room operating mode.

During lunch break (2), the time schedule changes to Pre-Comfort. The mode remains in Comfort as set by parameter "Transformation Pre-Comfort" (P910 = 1).



Example 2
Interaction of user operation (operating mode button) and central time schedule

In **Room 2**, the window is opened briefly, once in the morning and once in the late afternoon (1).

Only the opening in the morning directly influences actual room operating mode.

With the operating mode button, the operating mode can be changed between OFF and Auto or to temporary Comfort extension.

- During lunch break, the time schedule changes to Pre-Comfort. The thermostat mode changes to Economy as set by parameter "Transformation Pre-Comfort" (P910 = 0) (6)
- During lunch break, the user changes the operating mode to Comfort (temporary Comfort extension) by pressing the operating mode button (2)
- At 13:00, the timer is reset due to mode change by the central time schedule
- In the afternoon, the user switches off the thermostat by pressing the operating mode button (3). At 17:00 the user setting is reset to Economy by the time schedule
- At 19:30, the user again extends Comfort mode (4)

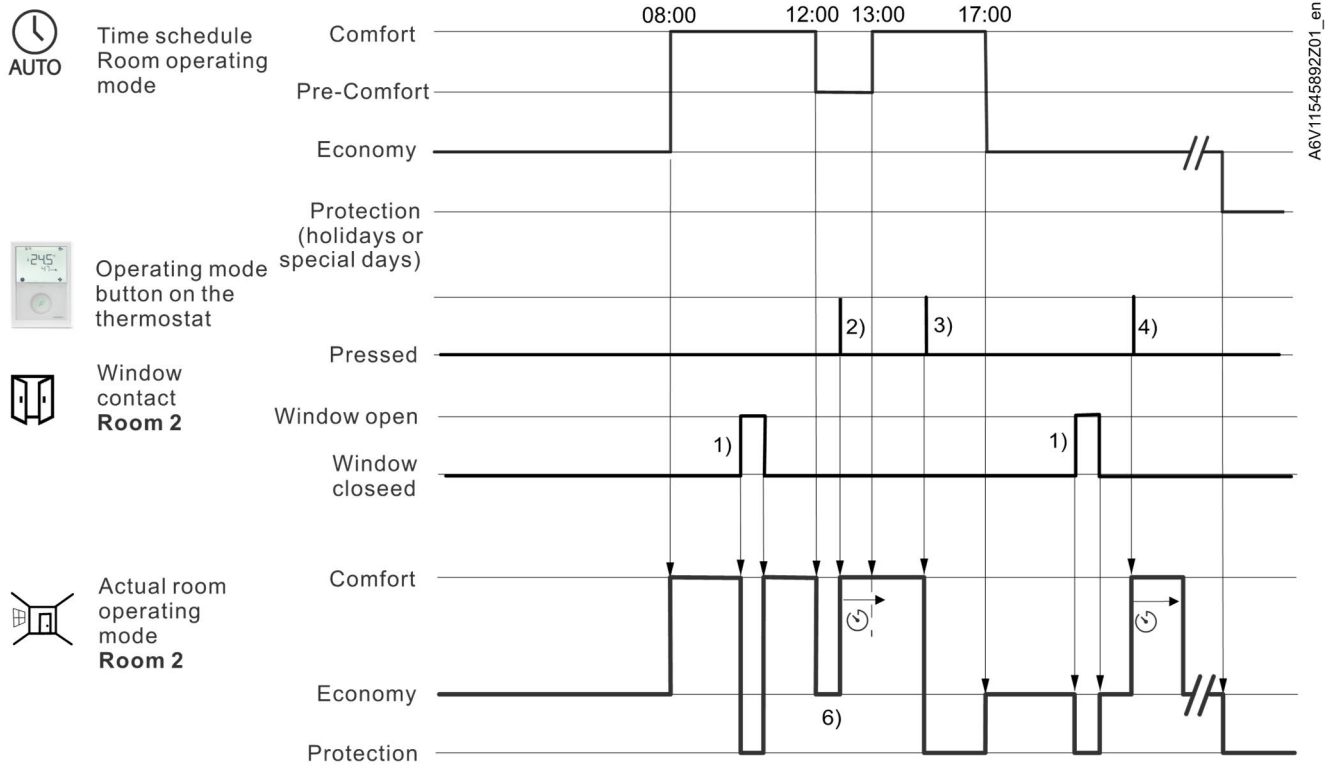

Example 3

Application for "Window contact", "Presence detector" and "Central time schedule"

In **Room 3**, the time schedule is between 13:00 and 17:00.

- In the morning, as soon as presence is detected, the operating mode switches to Comfort (1)
- The users open the window briefly and the operating mode switches to Protection (2)
- In the afternoon, the central time schedule sets Comfort mode from 13:00 to 17:00 (3)
- After 17:00, the room is still occupied, and the operating mode remains in Comfort (occupancy via presence detector) (4)
- The users open the window and exit the room for a short time. The operating mode switches to Protection as long as the window is open (5)
- As soon as the room is unoccupied, the thermostat switches to Economy (6)
- After this time, occupancy detected by the presence detector has no effect, and the central time schedule sets the thermostat to Protection (7)

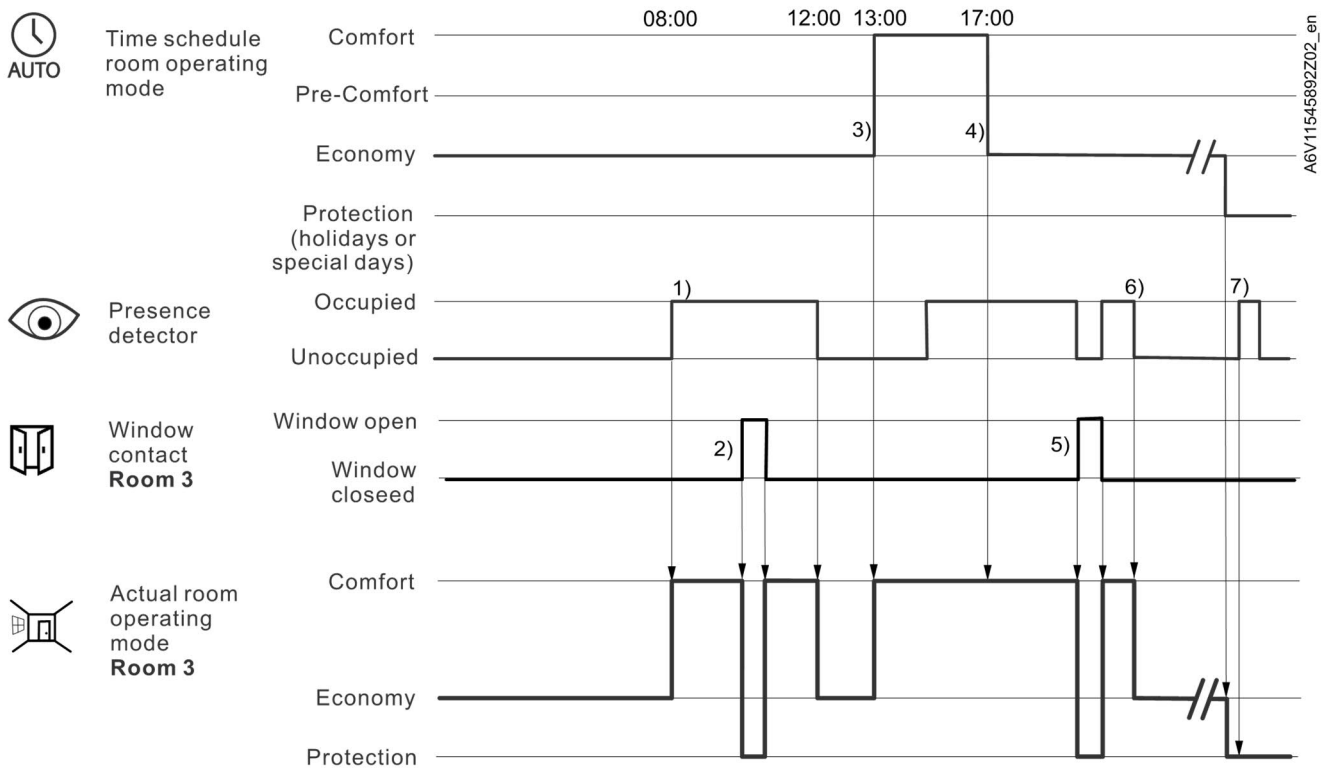

4.3 Room temperature setpoints

4.3.1 Description

Comfort mode



The factory setting for the Comfort basic setpoint is 21 °C and can be changed in the thermostat's EEPROM via P011, bus with communication object "Comfort basic setpoint" or Siemens smartphone application PCT Go for Android. The last option selected is always used.

The Comfort setpoint can be adjusted via rotary knob, or bus from a remote device like a touch panel, operator unit, etc. The last option selected is used.

Temporary comfort setpoint

When "Temporary comfort setpoint" is enabled via P103, the Comfort setpoint is set back to the Comfort basic setpoint stored in P011 only when the operating mode is changed.

Note

This setback is only executed when the change of the operating mode is commanded

P103	Operating mode is commanded by
1	Pressing the mode button or via bus.
2	Pressing the mode button or via bus, not by window contact.
3	Pressing the mode button or via bus, not by presence detector and hotel presence detector (digital input or bus).

When "Temporary comfort setpoint" is disabled via P103, the Comfort setpoint is set back to the Comfort basic setpoint (stored in P011) immediately as soon as the Comfort basic setpoint is changed.

Setpoint limitation

For Comfort or energy saving purposes, the setpoint setting range can be limited by selecting the most appropriate setpoint concept:

- Setpoint Comfort concept (P010 = 1) for maximum user comfort
- Setpoint energy saving concept (P010 = 2) to save energy

Setpoint comfort concept (P010 = 1)

- The setpoint limit can be set via P013 (Comfort setpoint minimum) and P016 (Comfort setpoint maximum). Both heating and cooling setpoints are adjustable between these two limits.
- The user adjusts the desired setpoint and the thermostat controls the room temperature accordingly.
- For 4-pipe applications, the selected Comfort setpoint is in the middle of the dead zone (P055). The unit stops to energize the heating/cooling outputs as soon as the room temperature reaches the dead zone.

Example



Setpoint energy saving concept (P010 = 2)

- This allows users to limit the setpoint setting range for heating and cooling independently.
- The setpoint limits for heating can be set via P013 (Comfort setpoint minimum) and P014 (Comfort setpoint maximum heating). The setpoint limits for cooling can be set via P015 (Comfort setpoint minimum cooling) and P016 (Comfort setpoint maximum cooling).

Example



- For 4-pipe applications:
 - The thermostat runs on the setpoint of the active sequence:
 - In heating mode, the heating setpoint is active and adjustable via rotary knob.
 - In cooling mode, the cooling setpoint is active and adjustable via rotary knob
 - Switching from the heating setpoint to the cooling setpoint and vice-versa occurs when the room temperature reaches the adjusted limitation (P014 or P015) of the **inactive** sequence. E.g., the thermostat is in heating sequence and runs on the heating setpoint. When the room temperature reaches P015, the thermostat switches to cooling and runs on the cooling setpoint, as long as the room temperature does not drop below P014.

Economy mode



Use P019 and P020 to adjust Economy mode setpoints.

The heating setpoint is 15 °C (factory setting), and the cooling setpoint is 30 °C.

Protection mode



Use P100 and P101 to adjust the Protection mode setpoints.

The heating setpoint is 8 °C (frost protection, factory setting) and OFF for cooling.

	<p>⚠ CAUTION</p>
	<p>If a setpoint (Economy or Protection) is set to OFF, the thermostat does not control the room temperature in the corresponding mode (heating or cooling). As a result, there is no protective heating or cooling function and thus risk of frost during heating or risk of overtemperature during cooling!</p>

The Economy setpoints (P019, P020) are accessible at the Service level; the Protection setpoints (P100, P101) are accessible at the Expert level.

4.3.2 Setting and adjusting setpoints

Room temperature setpoints can be...

- Set during commissioning
- Adjusted during runtime

The source can be one of the followings:

- Local HMI
- KNX tool
- Central control unit
- Siemens smartphone application PCT Go for Android

The thermostat saves the setpoints to:

- EEPROM in the form of parameters
- Runtime memory

The figure below shows the interrelation:



Comfort basic setpoint
 Comfort setpoint
 Economy heating setpoint
 4)
 Economy cooling setpoint
 4)

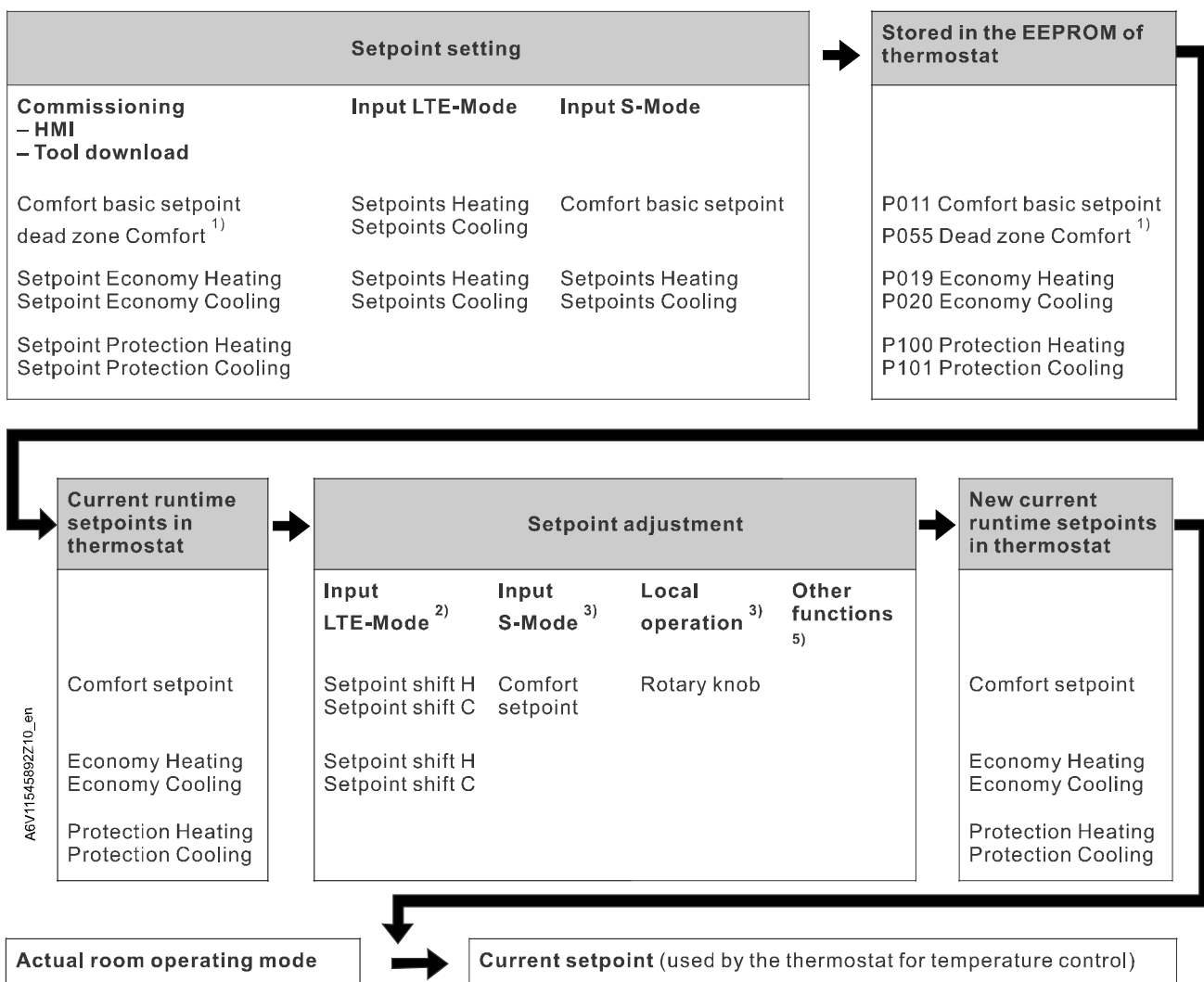

¹⁾ Only required for heating and cooling applications (see Setpoints and sequences [→ 76])

²⁾ LTE-Mode: **Shift is added** to the local shift

³⁾ S-Mode: **The last option selected is always used**, either S-Mode input or local operation

⁴⁾ To display the S-Mode objects of the Economy heating and cooling setpoint (P019/P020), set the control parameter “Room temperature: Economy setpoints” to **as group object** in ETS tool

5) Other functions:

- If current humidity setpoint is not suitable for room humidity, setpoint shift is activated via humidity control strategy (P451).

Cooling setpoint tracking depending on outside temperature (P255)

In cooling mode, a large difference between outside and indoor temperatures can create discomfort and waste energy. The thermostat can track the outside temperature via the bus and adjust the cooling setpoint to make sure the difference is not too great. If the outside temperature is higher than 26 °C and 6 K above the Comfort cooling setpoint, the related setpoint is shifted and kept 6 K below the outside temperature. This function can be enabled or disabled via P255.

The current setpoint (used by the thermostat for temperature control) is available on the bus for use in the central control unit.



Current setpoint

Clarification concerning current setpoint in Comfort mode

The Comfort setpoint w (e.g., customer setting on the display) and the current setpoint $w2$ (used by the thermostat for temperature control, but not displayed) are handled differently depending on the selected application and setting.

2-pipe with P010 = 1 or 4-pipe with P010 = 1 and P001 = 3

Both the Comfort setpoint w and current setpoint $w2$ have the same value.

Heating mode

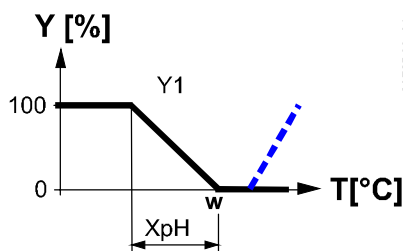

Cooling mode

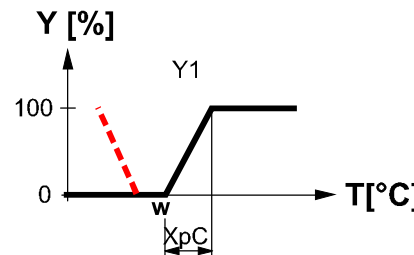

4-pipe with P010 = 1

The Comfort setpoint w (value selectable by e.g., rotary knob) is in the middle of the dead zone (P055). The current setpoints $w2h$ (used by the thermostat for temperature control) are at the boundaries of the dead zone.

$w2h = \text{Comfort setpoint } (w) - \frac{1}{2} \text{ dead zone } (X_{dz})$

$w2c = \text{Comfort setpoint } (w) + \frac{1}{2} \text{ dead zone } (X_{dz})$

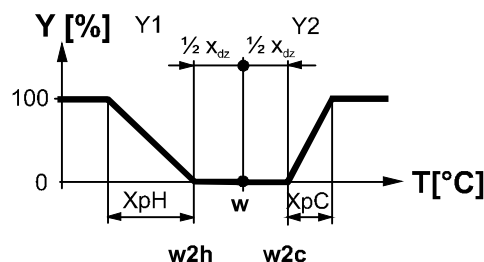

General notes

- The supported communication objects are different in LTE-Mode and S-Mode
- Changes via the local HMI or tools have the same priority (the last option is always used)
- Setting the Comfort basic setpoint resets the runtime Comfort setpoint only when P103 = 0

Notes on setpoint adjustment (LTE-Mode with Synco only)

- Central setpoint shifting is used for summer/winter compensation in particular
- Setpoint shifting does not influence the setpoints stored in P011, P019, P020 and P055

- Local and central shifts are added up
- Applies only to Comfort and Economy setpoints; Protection setpoints are not shifted centrally
- The current setpoint heating and cooling is limited by the Protection setpoint. If the Protection setpoint is Off, both the minimum 5 °C and maximum 40 °C are used
- The current setpoints for cooling and heating of the same operating mode have a minimum distance of 0.5 K
- The result of local and central shifting, together with room operating mode, humidity control or setpoint tracking for cooling, is used by the thermostat for temperature control (current setpoint)

Setpoint priority**Setpoint master (RMB)**



- The room thermostat always takes over the setpoints received from the controller RMB795B. Thus, the setpoints adjusted locally on the thermostats are overridden by the setpoints from the room group (e.g., every 15 minutes)
 - On RMB, the circumstances under which the controller sends out the setpoints can be defined. Refer to CE1P3122 for "Setpoint priority" and "Setpoint Master" functions

4.4 Application overview





The RDG2..KN room thermostats support the following applications, which can be configured using the DIP switches at the rear of the unit or commissioning tool.

Remote configuration

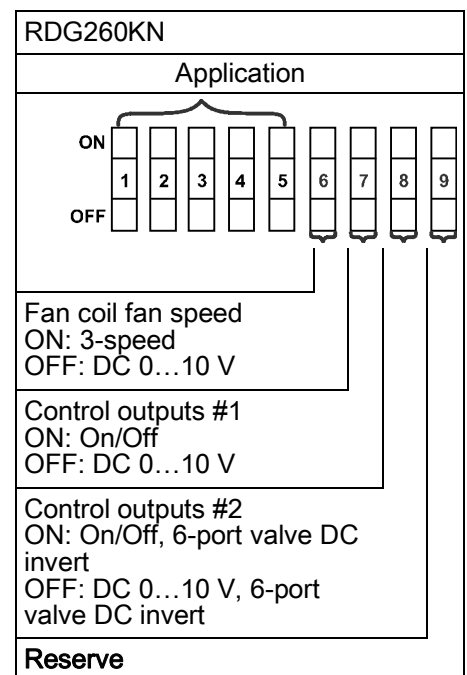
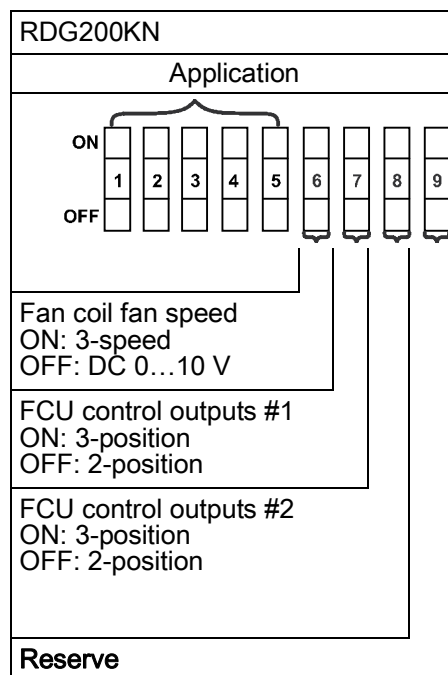
Set DIP switches 1...5 to OFF (remote configuration, factory setting) to select an application via commissioning tool.

Remote configuration, via commissioning tool (factory setting) <ul style="list-style-type: none"> • Synco ACS • ETS • Commissioning via Siemens smartphone application PCT Go for Android 	ON = 
	DIP NO.: 1...5
	OFF = 
	DIP NO.: 1...5

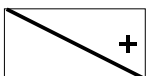
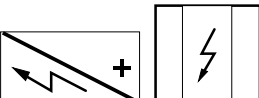
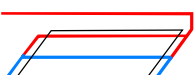
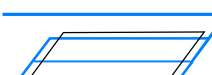
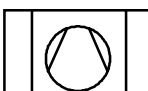







Icon	Description	Icon	Description
	Heating/cooling register		Cooling register
	Heating register		Electric heater
	Chilled/heated ceiling		Chilled ceiling
	Heat pump/compressor		Radiator

4.4.1 Applications for fan coil systems

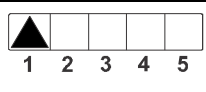
Applications, DIP setting, control outputs					
<ul style="list-style-type: none"> 2-pipe fan coil unit 		<ul style="list-style-type: none"> 2-pipe fan coil unit with electric heater 		<ul style="list-style-type: none"> 2-pipe fan coil unit with radiator/floor heating 	
<ul style="list-style-type: none"> 2-pipe/2-stage fan coil unit 		<ul style="list-style-type: none"> 4-pipe fan coil unit 		<ul style="list-style-type: none"> 4-pipe fan coil unit with electric heater 	
<ul style="list-style-type: none"> 4-pipe fan coil unit with PICV and 6-port ball valve as changeover 		<p>YHC Heating/cooling valve actuator YH Heating valve actuator YC Cooling valve actuator YE Electric heater M1 1-speed or 3-speed fan, DC 0...10 V fan B1 Return air temperature sensor or external room temperature sensor (optional) B2 Changeover sensor (optional)</p>			
	Using RDG260KN				

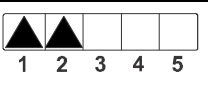
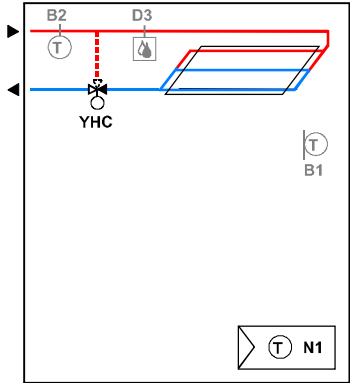
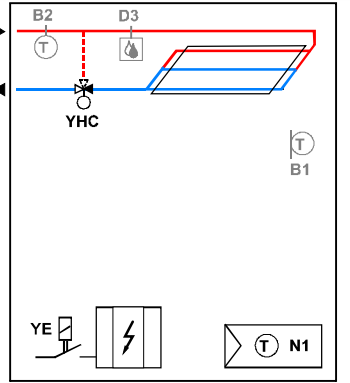
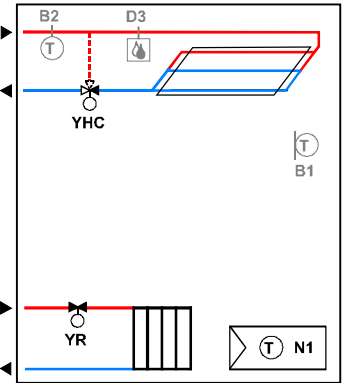
Product No.	Control output	Fan output
RDG200KN	PWM, On/Off, 3-pos	3-speed, 1-speed, DC 0...10 V
RDG260KN	DC 0...10 V	3-speed, 1-speed, DC 0...10 V
	On/Off	DC 0...10 V

4.4.2 Applications for universal systems

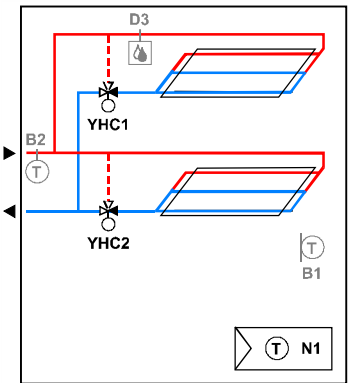
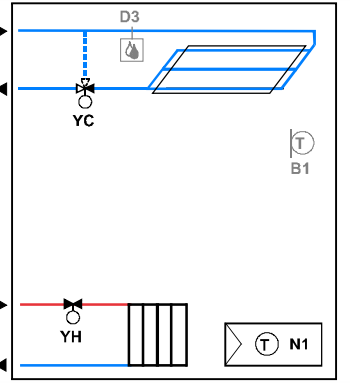
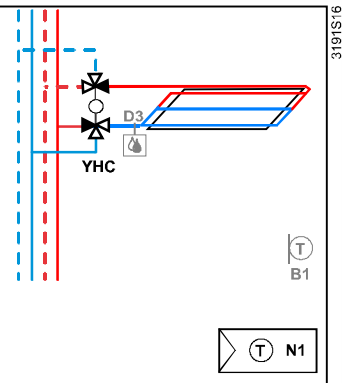
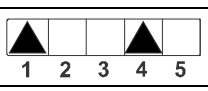
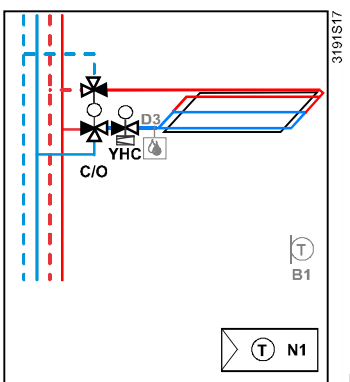
Applications, DIP setting, control outputs		
<ul style="list-style-type: none"> Chilled/heated ceiling 	<ul style="list-style-type: none"> Chilled/heated ceiling and electric heater 	<ul style="list-style-type: none"> Chilled/heated ceiling and radiator/floor heating 
 <p>Using RDG200KN, RDG260KN</p>	 <p>Using RDG200KN, RDG260KN</p>	 <p>Using RDG200KN, RDG260KN</p>
<ul style="list-style-type: none"> 2-stage chilled/heated ceiling 	<ul style="list-style-type: none"> Chilled ceiling and radiator 	<ul style="list-style-type: none"> Chilled and heated ceiling control with 6-port ball valve 
 <p>Using RDG200KN, RDG260KN</p>	 <p>Using RDG200KN, RDG260KN</p>	 <p>Using RDG260KN</p>
<ul style="list-style-type: none"> Chilled and heated ceiling control with PICV and 6-port ball valve as changeover 	 <p>Using RDG260KN</p>	
<p>YHC Heating/cooling valve actuator YH Heating valve actuator YC Cooling valve actuator YE Electric heater D3 Dewpoint sensor M1 1-speed or 3-speed fan, DC 0...10 V fan B1 Return air temperature sensor or external room temperature sensor (optional) B2 Changeover sensor (optional)</p>		

Product No.	Control outputs
RDG200KN	On/Off, PWM, 3-position
RDG260KN	On/Off, DC 0...10 V

4.4.3 Application for heat pump systems

Applications, DIP setting, control outputs	
<ul style="list-style-type: none"> Heated or cooled with compressors <p>Using RDG200KN, RDG260KN</p>	<ul style="list-style-type: none"> Heated or cooled with compressors with electric heater <p>Using RDG200KN, RDG260KN</p>
<ul style="list-style-type: none"> Heated and cooled with compressors <p>Using RDG200KN, RDG260KN</p>	<ul style="list-style-type: none"> 2-stage heated or cooled with compressors <p>Using RDG200KN, RDG260KN</p>
<p>N1 Thermostat Output Y10/Q1: Heating or heating/cooling Output Y20/Q2: Cooling only (heating/cooling)</p>	<p>B1 Return air temperature sensor or external room temperature sensor (optional)</p>
<p>YE Electric heaters</p>	<p>D3 Dewpoint sensor</p>

Product No.	Control output	Fan
RDG200KN	On/Off	Disabled, 1-speed, 3-speed, DC 0...10 V
RDG260KN	On/Off	Disabled, DC 0...10 V

4.5 Power supply selection for RDG200KN

The RDG200KN can be powered either on AC 230 V or AC 24 V.

The desired power supply is selected via the power switch on the rear of the device. The default setting is AC 230 V.

Therefore, RDG200KN can be used with the following combinations:

- AC 230 V or AC 24 V systems with 3-speed and DC 0...10 V fan control
- SELV AC 24 V systems with PWM AC 24 V electrothermal actuators

⚠ Notes:

The outputs (triacs and relays) follow the main power supply, either AC 230 V or AC 24 V.

The device is damaged when set to AC 24 V but powered by AC 230 V.

To select the correct power supply, use the power switch on the rear of the device.

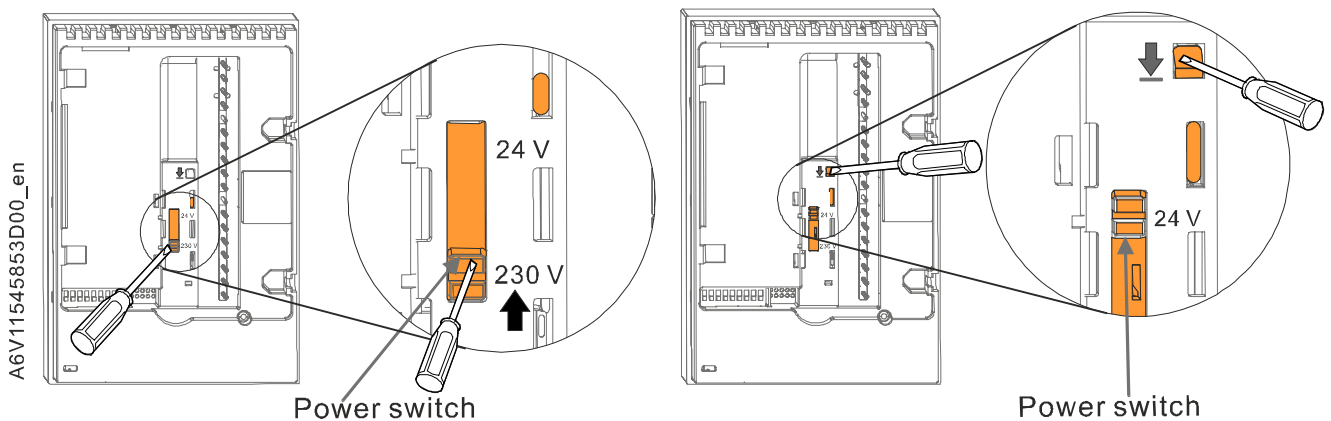

4.6 Additional functions

Functions (parameters)	Description	RDG260KN	
		RDG200KN	
Sensors and changeover functions [→ 43]			
• Heating/cooling changeover via bus (KNX)	Central control of heating / cooling via bus	✓	✓
• Automatic heating/cooling changeover via changeover sensor	Thermostat runs sequences depending on the water temperature	✓	✓
• Changeover switch (P150, P153, P155)		✓	✓
• Manual heating/cooling changeover (P001)	Heating / cooling controlled manually by user (via HMI)	✓	✓
• External/return air temperature sensor (P150, P153, P155)	Temperature measurement using external sensors	✓	✓
Presence detector [→ 45]			
• Standard presence mode (P150 / P153 / P155)	Switch operating mode locally or via bus	✓	✓
• Hotel presence mode (P150 / P153 / P155)	Switch operating mode locally or via bus	✓	✓
Output functions [→ 46]			
• Purge function (P251)	To ensure correct acquisition of the water temperature	✓	✓
• Minimum output On/Off time (P212, P213)	To protect HVAC equipment, e.g., compressor and reduce wear and tear	✓	✓
• Swap outputs for 2-pipe and 2-stage applications (P254)	To optimize use of heating/cooling energy in mixed systems	✓	✓
• Floor heating/cooling (P350)	Application without fan control	✓	✓
• Qx relay switching function (P400, P401, P402)	Control external equipment based on function state (heating/cooling demand, operating mode, sequence, humidity, ...)	✓	✓
Monitoring and limitation functions [→ 49]			
• Floor temperature limitation function (P252)	For user Comfort and floor protection	✓	✓
• Supply air temperature limitation (P063, P064)	To save energy, by avoiding room air that is too hot or cold	✓	✓
• Flow limitation in heating for PICV (P256)	To balance heating and cooling and avoid hydraulic issues due to different flow rates	✓	✓
• Dewpoint monitoring	To prevent condensation damage in the building	✓	✓
• Fault state "condensation" (P150, P153, P155 = 4)		✓	✓
• Valve exercising (P250)	To prevent valve freezing after extended inactivity	✓	✓
User operation / Indication [→ 51]			
• Button lock (P028)	To limit access by unauthorized persons	✓	✓
• Green leaf (P110, P111)	Indication on energy efficiency	✓	✓
Humidity [→ 52]			
• Humidity control (P007, P450)	Limit min. and max. humidity in the room	✓	✓
Preventive operation [→ 55]			
• Avoid cold air in heating mode (P365)	To ensure setpoint temperature is reached during heating	✓	✓
• Avoid damage from moisture (P363, P364)	To prevent damages caused by moisture	✓	✓
NFC communication [→ 55]			
• NFC (P500)	NFC communication via Siemens smartphone application	✓	✓

4.6.1 Sensors and changeover functions

Heating/cooling changeover via bus (KNX)

The heating/cooling changeover information is received via bus. This is only possible if the control sequence is set to automatic heating/cooling changeover (P001 = 2) and no local input (X1, X2, U1) is assigned to this function.



Heating/cooling changeover

If required information is unavailable (e.g., due to data communication issues, power failure, etc.), the thermostat operates in the last valid room operating mode (heating or cooling).

Automatic heating/cooling changeover via changeover sensor

If a cable temperature sensor (LG-Ni1000 or NTC 3k) is connected to X1/X2/U1, and P150/P153/P155 is set to 2, the water temperature acquired by the changeover sensor is used to change over from heating to cooling mode, or vice versa.

- When the water temperature is above 28 °C (adjustable via P060), the thermostat changes over to heating mode and remains in heating mode until the temperature drops below 16 °C (adjustable via P059).
- When the water temperature is below 16 °C (P059), the thermostat changes over to cooling mode and remains in cooling mode until the temperature exceeds 28 °C (P060).
- If the water temperature is between the 2 changeover points immediately after power-up (within hysteresis), the thermostat starts in the previous mode.

The water temperature is acquired and the operating state is updated accordingly.

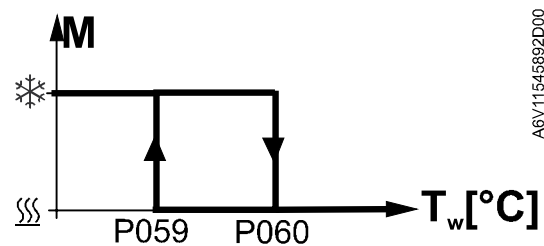

A6V11545892D00

M Operating mode ❄ Cooling mode
 T_w Water temperature 🌊 Heating mode

Note

The setting range is 5 °C...P060-2 K for P059 and P059+2 K... 40 °C for P060.

Changeover switch (P150, P153, P155)

When P001 = 2 (H/C changeover auto) is selected, an NTC 3k or LG-Ni1000 cable temperature sensor for automatic heating/cooling changeover or one external switch for manual or remote changeover can be used to switch the equipment between heating and cooling:

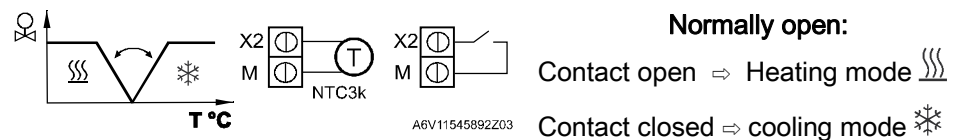





A6V11545892Z03

The sensor or switch can be connected to input terminal X2, X1 or U1 based on the commissioning of the inputs (P150 (X1), P153 (X2), P155 (U1) = 2).

See also Multifunctional input, digital input [→ 92].

Note

When using an external switch for changeover, the operating action is configured via P150, P153 or P155 = 2.

P151 (X1), P154 (X2) or P156 (U1) = 0 (default, normally open)	P151 (X1), P154 (X2) or P156 (U1) = 1 (Normally close)
Contact open ⇒ heating mode 	Contact open ⇒ cooling mode 
Contact closed ⇒ cooling mode 	Contact closed ⇒ heating mode 

**Manual heating/cooling
changeover (P001)**

- Manual heating/cooling changeover means selection via changeover button on the thermostat by repeatedly pushing the button until the required mode is displayed.
- If manual heating/cooling changeover is commissioned (P001 = 3), heating/cooling mode cannot be changed via bus/changeover sensor/switch; it remains in the last mode selected locally via button.

**External/return air
temperature sensor
(P150, P153, P155)**

The thermostat acquires the room temperature via built-in sensor, external room temperature sensor (QAA32), or external return air temperature sensor (NTC 3k or LG-Ni1000) connected to multifunctional input X1, X2 or U1.

Inputs X1, X2 or U1 must be commissioned accordingly. See Multifunctional input, digital input [→ 92].

4.6.2 Presence detector

The operating mode can be changed to Comfort or Economy mode based on room occupancy (room occupied or unoccupied, via presence detector or keycard).

Standard presence mode
(Input: P150 / P153 / P155 = 10)



The presence detector input switches the operating mode to Comfort when the room is occupied and switches back to the previous operating mode when the room is unoccupied.

Presence detection is also possible via bus. In this case, do not assign the function to any local input X1, X2 or U1.

Time schedule via bus	Presence detector behavior
Comfort mode	When the presence detector is activated or deactivated, the operating mode remains in Comfort.
Economy mode	<ul style="list-style-type: none"> When the presence detector is activated, the operating mode changes to Comfort. When the presence detector is deactivated, the operating mode changes to Economy (Auto).
Protection mode	Presence detection has no influence on the operating mode.
Not available	<ul style="list-style-type: none"> When the presence detector is activated, the operating mode changes to Comfort. When the presence detector is deactivated, the operating mode changes to previous operating mode.

Hotel presence mode
(Input: P150 / P153 / P155 = 13)

If a room is unoccupied, the operating mode changes to Economy. This overrides the operating mode on the thermostat. The buttons are locked and symbol  is displayed. An occupied room sets the thermostat back to the previous operating mode. Use a card reader and not a motion detector combined with hotel presence function for hotel applications, as the buttons are locked in case of unoccupancy. Hotel presence detection is also possible via bus. In this case, do not assign the function to local input X1, X2 or U1.

Time schedule via Bus	Presence detector behavior
Comfort mode	When hotel guests leave their rooms (room is unoccupied), the operating mode changes to Economy. The buttons are locked and symbol  is displayed.
Economy mode	<ul style="list-style-type: none"> When hotel guests leave their rooms (room is unoccupied), the operating mode changes to Economy. The buttons are locked and symbol  is displayed. When the room is occupied, the operating mode changes to the previous operating mode.
Protection mode	Presence detection has no influence on the operating mode.
Not available	<ul style="list-style-type: none"> When hotel guests leave their rooms (room is unoccupied), the operating mode changes to Economy. The buttons are locked and symbol  is displayed. When a room is occupied, the operating mode changes to the previous operating mode.

Notes

- When the schedule changes to Economy but the presence detector is still active, the operating mode remains in Comfort mode until the presence detector becomes inactive.
- The contact (e.g., a card reader) can be connected to multifunctional input X1, X2 or U1 (set P150, P153 or P155 to 10) or occupancy is sent via bus from a KNX presence detector (only one input source must be used, either local input X1/X2/U1 or KNX bus).

4.6.3 Output functions

Purge function (P251)

The changeover sensor ensures changeover between heating and cooling mode based on the acquired water temperature. We recommend activating the Purge function (P251) with 2-port valves. This function ensures correct acquisition of the medium temperature even if the 2-port valve is closed for an extended period of time. The valve is opened for 1 to 5 minutes (adjustable) at 2-hour intervals during off hours.

The function is valid for outputs PWM, On/Off, On/Off 3-wire, DC, 3-position and all applications.

Minimum output On/Off time (P212, P213)

Limit the On/Off switching cycle to protect HVAC equipment, e.g., compressor and reduce wear and tear. The minimum output on-time and off-time for the On/Off control output can be adjusted from 1 to 20 minutes via P212 and P213. The factory setting is 1 minute.

Readjusting the setpoint or heating/cooling mode changeover immediately results in calculation of the output state; the outputs may not hold the minimum 1-minute On/Off time.

If P212 or P213 is set to greater than 1 minute, the minimum On/Off time for the control output is maintained as set, even if the setpoint or changeover mode is readjusted.

Swap outputs for 2-pipe and 2-stage applications (P254)

For 2-pipe and 2-stage applications with different equipment, e.g., fan coil units and radiant heating/cooling panels, it is possible to invert the sequence of the equipment to optimize energy use, when the thermostat changes the sequence from heating to cooling (P001 = 2 or 3).

Under factory settings, the 1st stage in heating (YHC1) is also the 1st stage in cooling.

The swap function optimizes use of heating/cooling energy in mixed systems. E.g., when the fan coil units are combined with radiant heating/cooling panels, it is better to start heating using the panels (1st stage heating, YHC1) and start cooling using the fan coil unit (1st stage cooling, YHC2).

Enable the swap function by setting P254 (YHC2 output signal, 1st stage in cooling) to ON, depending on the requested control signal.

Swap function disabled

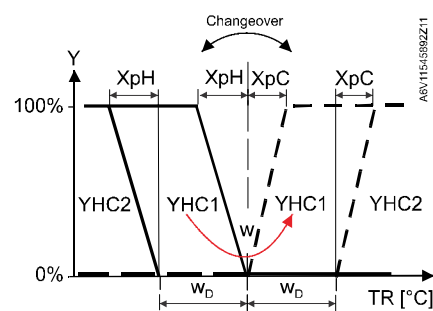

P254 is set to OFF

Swap function enabled

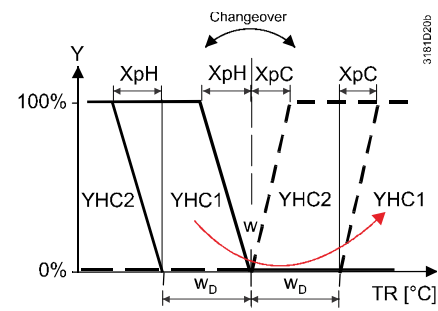

P254 is set to ON

Note

- For 2-pipe/2-stage applications, see 2-pipe/2-stage heating or cooling [→ 64].
- If the equipment requests fan operation only in the 2nd stage (heating and/or cooling), see Fan control [→ 84] to set up the fan function (fan in the 2nd stage).
- For application examples, see Swap function and/or fan in the 2nd stage [→ 137].

Floor heating/Floor cooling (P350)

All heating sequences can also be used for floor heating.

You can use fan coil unit heating/cooling sequences for floor heating or cooling by disabling the fan via P350.

Qx relay switching function (P400, P401, P402)

The following functions allow the control of external equipment connected to the Q1, Q2 and Q3 relay outputs:

Function description	P40X =
No function	0
Switching off external equipment when the thermostat is in Protection mode	1
Switching on external equipment during... <ul style="list-style-type: none"> • heating/cooling demand • heating demand • cooling demand 	2 3 4
Energizing the contact when... <ul style="list-style-type: none"> • the heating sequence is active • the cooling sequence is active 	5 6
Humidity control: <ul style="list-style-type: none"> • Output to control dehumidifier • Output to control humidifier 	7 8

Note

- When P351 = 1 and 2, these functions are not available.
- When fan is DC 0...10 V fan (P351 = 3) or fan is disabled (P350 = 0) and related relays are not occupied by output (configure 1 stage or 2 stage as On/Off on RDG260KN), these functions are available.
- Do not use these functions in combination with On/Off valve control (P201/P203 = 2 / 4 or P204 = 4) to ensure temperature control accuracy. If these functions are required, the total maximum current on the relay outputs (Q1+Q2+Q3) must not exceed 2 A.

The relay output function can be enabled and tested as follows:

Relay output function on ...	Enable function via Expert level parameter	Test function via diagnostic parameter
Q1	P400	d08
Q2	P401	d09
Q3	P402	d10

Switching off external equipment in Protection mode

The external equipment (e.g., fan coil unit) can be switched off via relay output to save energy when the thermostat is in Protection mode and no temperature control is requested.

Set the related output parameter to 1 to enable the function.

Relay contact is open when the thermostat is in Protection mode.



NOTICE! The relay contact does not switch on when the room temperature is below the frost protection setpoint.

For application examples, see Relay functions [→ 135].

Energizing the contact during heating/cooling demand

During heating or cooling demand, the relay contact can be energized to control external equipment, e.g., to run the pump for a water system (fan coil unit) or a compressor.

To reduce wear and tear on HVAC equipment, the minimum output On/Off time of the Qx relay output can be adjusted (1...20 minutes) via P212 and P213. The factory setting is 1 minute.

To enable the function, set the related output parameter:

- To energize the output during heating/cooling demand, set the parameter to 2.
- To energize the output during heating demand, set the parameter to 3.
- To energize the output during cooling demand, set the parameter to 4.

For application examples, see Relay functions [→ 135].

Notes

- During heating demand, the relay contact remains Off only with electric heater or radiator (output signal on Y2/Y20 > 0 V).
- If the purge function (P251) is active (1...5 minutes every 2 hours), the relay contact turns on to run the external equipment, e.g., a water pump.

Output heating/cooling sequence

This function switches the relay output on or off depending on the sequence, either heating or cooling. The output can be used to release a heat pump compressor, a reversing valve or 6-port ball valve as changeover.

To enable the function, set the related output parameter:

- To close the contact when the thermostat is in heating mode (even in the dead zone), set the parameter to 5.
- To close the contact when the thermostat is in cooling mode (even in the dead zone), set the parameter to 6.

For application examples, see Relay functions [→ 135].

To reduce wear and tear on HVAC equipment, the minimum output On/Off time of the Qx relay output can be adjusted (1...20 minutes) via P212 and P213. The factory setting is 1 minute.

Humidity control

Depending on room humidity and the humidity setpoint, the humidity control function switches the relay outputs to control the external equipment, e.g., dehumidifier/humidifier. See Humidity control [→ 132].

To enable the function, set the related output parameter:

- To control the dehumidifier, set the parameter to 7
- To control the humidifier, set the parameter to 8

To reduce wear and tear on the HVAC equipment, the minimum output On/Off time of the Qx relay output can be adjusted (1...20 minutes) via P212 and P213. The factory setting is 1 minute.

Note

When the operating mode is changed from Comfort to Economy or Protection, the relay contact remains energized until the end of the minimum on time set via P212.

4.6.4 Monitoring and limitation functions

Floor temperature limitation function (P252)

The floor temperature should be limited for two reasons: Comfort and protection of the floor.

The floor temperature sensor, connected to multifunctional input X1, X2 or U1, acquires the floor temperature. If the temperature exceeds the parameterized limit (P252), the heating valve is fully closed until the floor temperature drops to a level 2 K below the parameterized limit. The factory setting of P252 is 28 °C.

Input X1, X2 or U1 must be commissioned accordingly (P150, P153, P155 = 11) and the type of sensor need to be selected (P151, P154, P156 = 2 (NTC 3K) or 3 (LG-Ni1000)).

See Multifunctional input, digital input [→ 92].

Recommended values for P252

- Living rooms:
Up to 26 °C for extended presence, up to 28 °C for short presence.
- Bathrooms:
Up to 28 °C for extended presence, up to 30 °C for short presence.

The "Floor temperature limitation" function influences the outputs listed in the table below:

Application	Output Y1/Y10	Output Y2/Y20	Output Y3/Y30	"Floor temp. limit" function has impact on			Remark
				Heating (P001 = 0/2/3)	Cooling P001 = 1/2/3	Heating and Cooling (P001 = 4)	
2-pipe	H/C valve			Y1/Y10	N/A		
2-pipe with electric heater	H/C valve	Electric heater		Y2/Y20	Y2/Y20 *)		Only electric heater
2-pipe with radiator	H/C valve	Radiator		Y2/Y20	Y2/Y20		Only radiator
4-pipe	Heating valve	Cooling valve		Y1/Y10	N/A	Y1/Y10	
4-pipe with electric heater	Heating valve	Cooling valve	Electric heater	Y3/Y30	N/A	Y3/Y30	Only electric heater
2-pipe/2-stage	1 st H/C	2 nd H/C		Y1/Y10, Y2/Y20	N/A		

*) If P027 = ON, electric heater in cooling mode.

Note

Either floor temperature sensor or external room temperature sensor can be used.

Supply air temperature limitation (P063, P064)

This function increases the comfort in the room by keeping the supply air temperature of the fan coil unit between the selected minimum and maximum temperature limits.

If the supply air temperature exceeds a limit, the thermostat reduces the corresponding valve position until the supply air temperature is back in the limits.

In case the air flow is too low (especially with DC 0...10 V fans), this prevents cold air from dumping into the room/warm air from bubbling straight up instead of circulating.

To enable this function, the multifunctional input, to which the supply air sensor is connected, needs to be set to "Supply air sensor" (e.g., P150 = 9). Then the parameters for the limits are displayed (P063: minimum supply air temperature, P064: maximum supply air temperature).

Note

- This function is only active in Comfort mode with:
 - Valve output type is 3-position (RDG200KN) or DC 0...10 V (RDG260KN)
 - Electric heater is PWM / 3-position (RDG200KN) or DC 0...10 V (RDG260KN)
- This function can not be used for radiators.

Flow limitation function for combi valve (PICV) (P256, RDG260KN)

Set different limits to the flow in both sequences, heating and cooling to balance heating and cooling systems and avoid hydraulic problems caused by the different flow rates.

Cooling typically requires a higher flow rate than heating, and the combi valve (PICV) is mechanically and manually set to the cooling flow limit.

However, when the system operates in heating mode, set another flow limitation.

The new limit to the DC 0...10 V signal (new 100 % heating demand) can now be set with the parameter P256.

The function can be enabled on all combined heating/cooling applications with DC 0...10 V output for universal and fan coil unit applications.

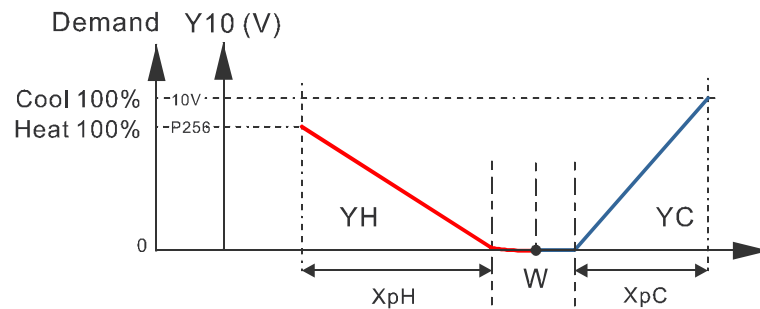

T[°C]	Room temperature	YH	Control command "Valve" (heating)
Y10	DC 0...10 V signal	YC	Control command "Valve" (cooling)
W	Room temperature setpoint		

The function can be enabled for the following heating/cooling applications with DC 0...10 V output. P256 is not visible on other applications.

Fan coil type

- 4-pipe with PICV and 6-port ball valve as changeover

Universal type

- H/C ceiling with PICV and 6-port ball valve as changeover

Dewpoint monitoring

Dewpoint monitoring is essential to prevent condensation on the chilled ceiling (cooling with fan disabled, P350 = 0) and associated damages to the building.

A dewpoint sensor with a potential-free contact is connected to multifunctional input X1, X2 or U1. If there is condensation, the cooling valve is fully closed until no more condensation is detected, and the cooling output is disabled temporarily.

If the fan function is enabled (P350 ≠ 0), the fan continues to work as long as the dewpoint function is active.

Note

When condensation is detected with

- Control only with 6-port control ball valve:
 - If P201 = 6 or 8, the valve closes (5 V).
 - If P201 = 7 or 9, the valve closes (6 V).
- Control with combi-valve (PICV): The PICV closes and the 6-port ball valve remains open.

The condensation symbol  is displayed during temporary override and fault "Condensation in room" is sent via bus.

The input must be commissioned accordingly (P150, P153 and P155). See Multifunctional input, digital input [→ 92].



Fault state "condensation"
 (P150 / P153 / P155 = 4)
Fault information

Valve exercising (P250)

To prevent valve freezing after extended inactivity (e.g. cooling valves in winter), valves need to be activated periodically. To save energy, the valve exercising function is triggered when valves are closed for 91 hours. The valves are then activated for 2 minutes. This function can be enabled via P250.

4.6.5 User operation / Indication

Button lock (P028)

If the "Button lock" function is enabled by P028, lock or unlock them by pressing the right button for 3 seconds.

If "Auto lock" is configured, the thermostat automatically locks the buttons 10 seconds after the last adjustment.

P028 can be configured as following:

P028	
0	Unlocked
1	Auto lock
2	Manual lock
3	Lock operating mode
4	Lock setpoint shift
5	Lock fan speed
6	Lock operating mode and setpoint shift
7	Lock operating mode and fan speed
8	Lock setpoint shift and fan speed

When P028 is set to 3...8, the related function is locked and the corresponding symbol cannot be displayed.



Green leaf indication (P110, P111)

Green leaf is an energy-efficient setting indicating the end user settings:

- Green leaf: Settings are within the preset energy-efficient range
- Red leaf: Settings exceed the preset energy-efficient range

Green leaf functionality is configured via P110:

- 0 = Disabled (OFF)
- 1 = Green and red dimmed down
- 2 = Green dimmed down / red fixed
- 3 = Green and red fixed

<p>Within the preset energy-efficient range</p>	<p>Exceed the preset energy-efficient range End users press the red leaf to return to the energy-efficient range</p>	<p>Return to the preset energy-efficient range</p>
		

P111 (default is 2 K) sets the maximum tolerance of the room temperature setpoint shift value.

4.6.6 Humidity

Humidity control (P007, P450)

Humidity control limits humidity in the room according to the selected setpoint (low/high) by shifting the temperature setpoint, or by enabling outputs to release the external equipment as needed, e.g., the dehumidifier or humidifier.

Humidity control is active in Comfort mode when P450 is set to 1. The function can be disabled by setting P450 to 0 (factory setting).

Humidity function is disabled in Economy or Protection mode.

The humidity level in the room is acquired by the built-in sensor. The thermostat can receive the relative humidity via the bus if a valid humidity value is available and selected on KNX (S-Mode or LTE-Mode).

The priorities are set as follows:

1. S-Mode

- By setting parameter "Room relative humidity" in the ETS to **Receive**, the thermostat can display the relative humidity measured by an external sensor on the bus.
- If the parameter is set to **Transmit** (factory setting), the thermostat can display the humidity value measured by the built-in sensor and the value is sent to the bus.

2. LTE-Mode

The thermostat displays the relative humidity value on the bus if the external KNX sensor is in the same geographic zone apartment and room (A.R.1) as the thermostat.

3. In other cases, the thermostat displays the humidity value measured by the built-in sensor.



Note

To display room humidity (%) on the thermostat, P009 needs to be set to 5.

Setpoint (P024)

The high humidity setpoint (%) is selectable via P024 (setpoint humidity high Comfort) and can be adjusted via parameters in Service level or via bus.

Setting P024 to Off disables high humidity control.



The low humidity setpoint (%) is selectable via P026 (setpoint humidity low) and can be adjusted via parameters in Service level or via bus.

Setting P026 to OFF (default setting) disables low humidity control. The setting range is limited by P024.

S-Mode objects for the humidity setpoint are available, if the parameter "Humidity setpoints" is set to **as group object** in ETS.

Dehumidification

When relative humidity exceeds the high setpoint, the thermostat shifts the temperature setpoint proportionally until P461 (max. shift temp setpoint) is reached. If this control does not sufficiently reduce humidity, an external dehumidifier can be switched on via relay outputs or KNX and related relay function (P400, P401 or P402 is set to 7).

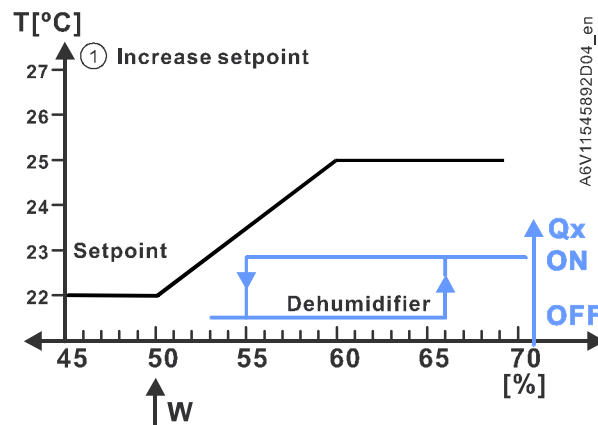

Note The maximum temperature shift setpoint value is reached at setpoint humidity high (P024) +10%. The contact for the dehumidifier is released at setpoint humidity +15%.

Dehumidification Applications with a DC 0...10 V fan:

- Enable the function to control the external dehumidifier directly via relay output by setting P400 (output Q1), P401 (output Q2) or P402 (output Q3) to 7. When the output is energized, S-Mode object dehumidification sends the information "ON" to the bus
- The selected relay output is switched on if relative humidity exceeds the high setpoint by +15%.
- For applications with On/Off valves on Q1 or Q2 or both, the output Q3 (P402 = 7) is used to control the external dehumidifier.
- The relay contact remains closed or open for the minimum On/Off time defined by P212 or P213.

Applications with a 3-speed fan:

- The external dehumidifier is controlled via external DC – On/Off converter connected to analog output Y50. The output signal is DC 10 V if dehumidification control is requested.
- Output Y50 remains On for min. 30 seconds (not selectable).
- This function is available without specific settings (P400, P401 and P402 are not displayed).

Note The current of the external DC – On/Off converter cannot exceed the maximum output current of Y50 (max. 5 mA). We recommend using the converter from Titan (single relay control (IO/1RM) at 3 mA input current).

Humidification The function controls minimum relative humidity in the room and is available only for applications with DC 0...10 V fan or no fan.
The external humidifier connected to the relay output is enabled as soon as humidity drops below setpoint humidity low (P026) at hysteresis is ±5 %.

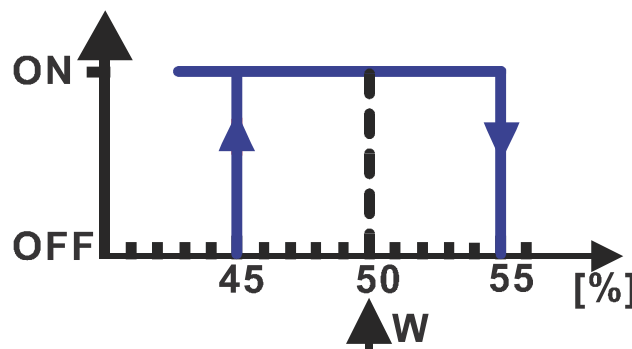

To enable the relay function, set P400 (output Q1), P401 (output Q2) or P402 (output Q3) to 8. The humidification S-Mode object sends On to the bus as soon as the output is energized.

When humidity drops below the low setpoint or exceeds the high setpoint, symbol $\text{—}\blacklozenge$ is displayed and S-Mode object HumDehumMode sends the corresponding state on the bus.

Max. shift temperature setpoint (P461)

When humidity reaches setpoint humidity high (P024), the thermostat shifts the temperature setpoint to reduce relative humidity in the room. The maximum shifting temperature setpoint can be set via P461 at Expert level at a setting range of -3...3 K, depending on the connected equipment. The factory setting is 3 K.
The maximum shifting temperature setpoint value is reached at setpoint humidity high (P024) +10%.



P461 > 0 K

The positive values of P461 (0.5...3.0 K) are used for heating and cooling, or heating in a humid cold environment.

For heating and cooling, both temperature setpoints (heating and cooling) are shifted in parallel (i.e., dead zone remains unchanged).

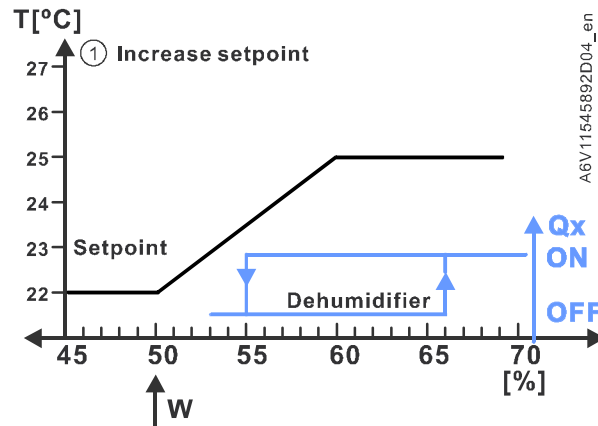
Note

For heating and cooling applications, the value of the dead zone (P055) must be bigger than the maximum shifting temperature setpoint (P461), to avoid changeover between heating and cooling sequences in the event of fast humidity changes in the room.

P461 < 0 K

For applications with powerful cooling water systems (temperature of cold surfaces is lower than the dewpoint temperature of the humid air), dehumidification can be reached by reducing the room temperature, as the vapor in the air condensates on the surface of the cooling equipment. In this case, set P461 to a negative value (-0.5...-3.0 K).

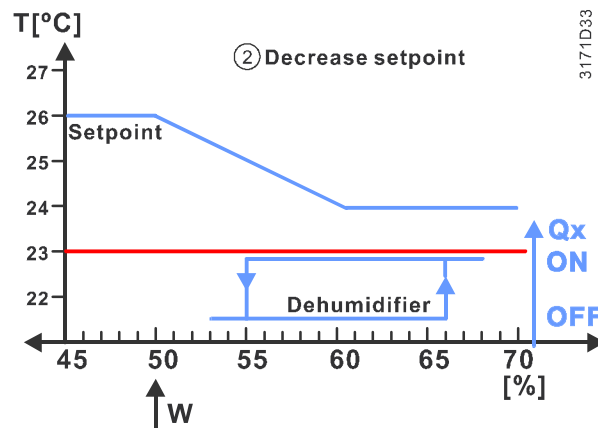
Note

This setting is typically used for cooling applications with fan coil units or split units. When the thermostat is in cooling mode or in the dead zone, the temperature setpoint cooling is shifted only when P461 is less than 0 K. The temperature setpoint heating, if available, remains unchanged. The thermostat guarantees a minimum dead zone between both setpoints.

P461 = 0 K

When P461 is set to 0 K, the temperature setpoints for heating, cooling or both are not shifted. Dehumidification can be achieved by releasing the relay contact for the dehumidifier. The release contact is switched on at 5% above the high humidity setpoint and off at 5% below.

Calibration humidity (P007)

Relative humidity measured by the built-in sensor is also displayed if P009 is set to 5. The sensor can be calibrated (+/-10%) via P007.

When P009 = 5, thermostat can monitor relative humidity via HMI or bus.

For application examples with humidity control, see Humidity control [→ 132].

4.6.7 Preventive operation

Avoid cold air in heating mode (P365)

For the heating coil to reach its temperature, fan start can be delayed by a time period set via P365.

Avoid damage from moisture (P363, P364)

In very warm and humid climates, the fan runs periodically or continuously at a low fan speed (e.g., in empty apartments or shops) in Economy mode via P364, to avoid damage from moisture due to lack of air circulation. Refer to "Fan kick" function in Fan control [→ 84].

4.6.8 NFC communication

NFC (P500)

NFC (near-field communication) is used to commission the thermostat via the Siemens smartphone application PCT Go for Android.

The distance between smartphone and the thermostat must be max. 2 cm while scanning the NFC area on the individual package or antenna area of the thermostat. Data exchange between controller and Siemens smartphone application is 10 s.

P500 enables/disables NFC communication locally or via tool (ETS, ACS or Siemens smartphone application PCT Go for Android). When disabled (default is enabled), the application cannot read or write the thermostat and message "NFC communication is disabled on the thermostat." is displayed.

Using Siemens smartphone application, users can:

- Enable or disable password protection by configuring P502
- Import and export the setting parameter list in CSV format

Note:

- When NFC communication is enabled, the parameters can be configured even if the thermostat has no power.
- The phone must have active NFC functionality.

For commissioning via Siemens smartphone application PCT Go for Android, see Commissioning.

4.7 Control sequences

4.7.1 Sequence overview (setting via P001)

The main control sequence (water coil sequence of the fan coil unit) can be set via P001.

The following sequences can be activated in the thermostats (with or without auxiliary heating).

The available sequences depend on the application (selected via DIP switches, see Application overview [→ 37]).

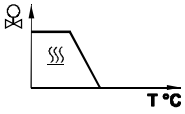
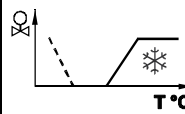
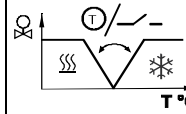
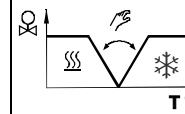
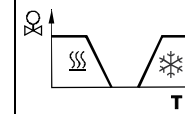
Parameter	P001 = 0	P001 = 1	P001 = 2	P001 = 3	P001 = 4
Sequence					
Available for basic application 1): ↓	Heating	Cooling ↘ = Heating sequence for electric heater/radiator	Automatic heating/cooling changeover via external water temperature sensor or remote switch	Manually select heating or cooling sequence (using HMI)	Heating and cooling sequence, 4-pipe
2-pipe 2-pipe with el. heater 2-pipe with radiator	✓	✓	✓	✓	
4-pipe 4-pipe with el. heater				✓ 2)	✓
2-pipe/2-stage heating or cooling	✓	✓	✓	✓	

1) For chilled/heated ceiling and radiator applications, see Chilled/heated ceiling and radiator applications [→ 71];

2) For manual changeover with 4-pipe applications, see 4-pipe fan coil unit [→ 66].

- 4-pipe manual changeover (P001 = 3) means activating either cooling or heating outputs
- P001 cannot be configured for applications with 6-port ball valve.

For the relationship between setpoints and sequences, see Setpoints and sequences [→ 76].

4.7.2 Application mode



The behavior of the thermostat can be influenced via building automation and control system (BACS) and bus using command "Application mode".

Cooling, heating or both can be enabled or disabled using this signal. Application mode is supported in LTE-Mode and S-Mode.

RDG2..KN KNX thermostats support the following commands:

#	Application mode	Description	Control sequence enabled
0	Auto	The thermostat automatically changes over between heating and cooling.	Heating, cooling or both
1	Heat	The thermostat only allows for heating.	Heating only
2	Morning warm-up	If "Morning warm-up" is received, the room is heated up as fast as possible (as needed). The thermostat only allows for heating.	Heating only
3	Cool	The thermostat only allows for cooling.	Cooling only
4	Night purge	Not supported by fan coil applications.	N/A (= Auto)
5	Pre-cool	If "Pre-cool" is received, the room is cooled down as fast as possible (as needed). The thermostat only allows for cooling.	Cooling only
6	Off	Thermostat does not control outputs, that is, all outputs go to off or 0%.	Neither heating nor cooling
8	Emergency heat	The thermostat heats as much as possible. The thermostat allows only heating.	Heating only
9	Fan only	All control outputs are set to 0% and only the fan is set to high speed. The function is terminated by any operation on the thermostat.	Run fan at high speed

With all other commands, the thermostat behaves as if in Auto mode, thus, heating or cooling by demand.



ACS

Heating or cooling

The heating and cooling states of the thermostat can be monitored with the ACS tool (diagnostic value "Control sequence"). The last active mode is displayed when the thermostat is in the dead zone or temperature control is disabled.

With a 2-pipe application, the control sequence state is determined by the application mode and the state of the heating/cooling changeover signal (via local sensor or bus), or fixed according to the selected control sequence (P001 = heating (0)/cooling (1)).

Application mode (via bus)	State changeover/continuous heating or cooling	Control sequence state (ACS diagnostic value)
Auto (0)	Heating	Heating
	Cooling	Cooling
Heat (1), (2), (8)	Heating	Heating
	Cooling	Heating
Cool (3), (5)	Heating	Cooling
	Cooling	Cooling
Night purge (4), Fan only (9)	Heating	Heating
	Cooling	Cooling

Heating and cooling

With a 4-pipe, 2-pipe with electric heater, and 2-pipe with radiator application, the control sequence state is based on the application mode and heating/cooling demand.

Application mode (via bus)	Heating/cooling demand	Control sequence state (ACS diagnostic value)
Auto (0)	Heating	Heating
	No demand	Heating/cooling depending on last active sequence
	Cooling	Cooling
Heat (1), (2), (8)	Heating	Heating
	No demand	Heating
	Cooling	Heating
Cool (3), (5)	Heating	Cooling
	No demand	Cooling
	Cooling	Cooling
Night purge (4), Fan only (9)	No temperature control active	Heating/cooling based on last active sequence

The diagram below shows the control output value as a function of room temperature for heating and cooling:

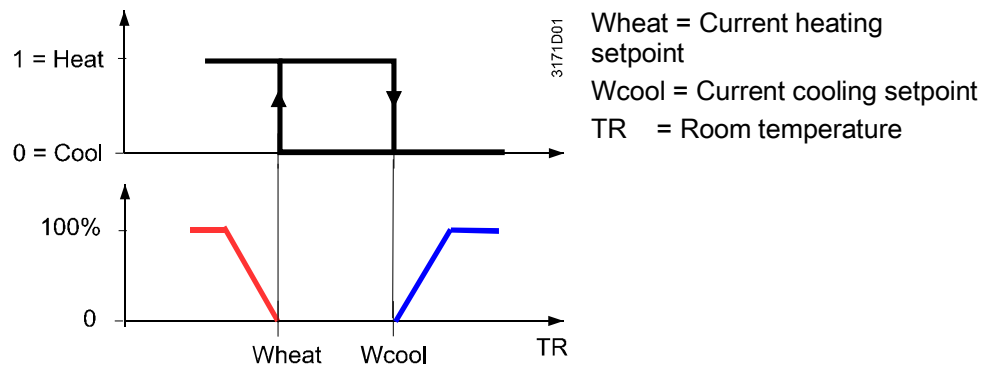

4.7.3 2-pipe fan coil unit

In 2-pipe applications, the thermostat controls a valve in heating/cooling mode with changeover (automatically or manually), heating only, or cooling only (factory setting, P001 = 1).

On/Off control
Control sequence
On/Off control output

The diagrams below show the control sequence for On/Off control.

Heating mode

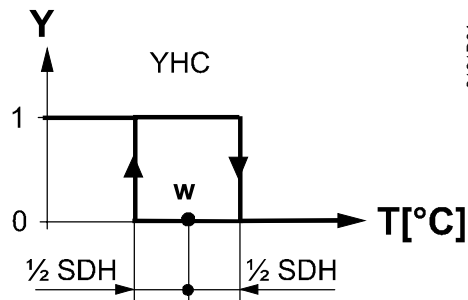

T[°C] Room temperature

w Room temperature setpoint

YHC Control command "Valve"

Cooling mode

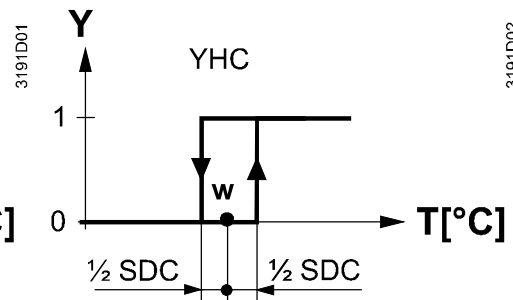

SDH Switching differential "Heating" (P051)

SDC Switching differential "Cooling" (P053)

Modulating control:
3-position, PWM or
DC 0...10 V
Control sequence
modulating output

The diagrams below show the control sequence for modulating PI control.

Heating mode

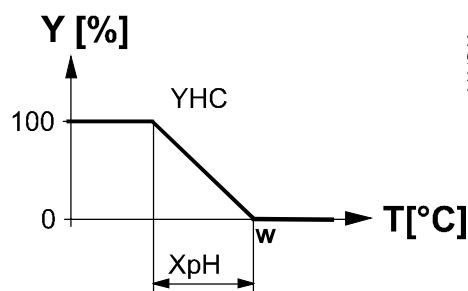

T[°C] Room temperature

w Room temperature setpoint

YHC Control command "Valve"

Cooling mode

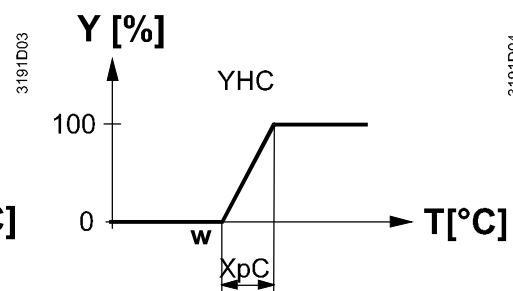

XpH Proportional band "Heating" (P050)

XpC Proportional band "Cooling" (P052)

Note

The diagrams only show the PI thermostat's proportional part.

For setting sequence and control outputs, see Application overview [→ 37], Sequence overview (setting via P001) [→ 56] and Control outputs [→ 78].

Note

Parameter P256 (RDG260KN) sets the heating flow limitation when using a PICV. See Additional functions [→ 42].

4.7.4 2-pipe fan coil unit with electric heater

Heating or cooling with auxiliary heater

In 2-pipe applications with electric heater, the thermostat controls a valve in heating/cooling mode with changeover, heating only, or cooling only plus an auxiliary electric heater.

Cooling only is factory-set (P001 = 1) with enabled electric heater (P027).

Electric heating, active in cooling mode

In cooling mode, the valve receives an Open command if the acquired temperature is above the setpoint.

The electric heater receives an On command if the acquired room temperature drops below "setpoint" minus "dead zone" (= setpoint for electric heater) while the electric heater is enabled (P027 = On).

Note

"Setpoint for electric heater" is limited by parameter "Maximum setpoint for Comfort mode" (P016).

Electric heating in heating mode

In heating mode, the valve receives an Open command if the acquired temperature is below the setpoint. The electric heater is used as an additional heat source when the heating energy controlled by the valve is insufficient.

The electric heater receives an On command, if the temperature is below "setpoint" minus "setpoint differential" (= setpoint for electric heater).

Electric heating and manual changeover

The electric heater is active in heating mode only and the control output for the valve is permanently disabled when manual changeover is selected (P001 = 3).

Digital input "Enable electric heater"

Remote enabling/disabling of the electric heater is possible via input X1, X2 or U1 for tariff regulations, energy savings, etc..

Input X1, X2, or U1 must be commissioned accordingly (P150, P153 and P155). See Multifunctional input, digital input [→ 92].



Enable electric heater

The electric heater can also be enabled/disabled via bus.

Note

Do not assign the function to a local input X1, X2 or U1 if "Enable electric heater" input is used via bus.



CAUTION

The electric heater must always be protected by a safety limit thermostat!

On/Off electric heater with DC 0...10 V fan

- With a DC 0...10 V fan, On/Off control for the electric heater can be selected by setting P203 = 4. The electric heater must be connected to outputs Q2 (RDG260KN), Y2 (RDG200KN).
- The electric heater starts with a delay of 15 seconds, to ensure the fan supplies sufficient air flow to dissipate the heat (also applies to applications with DC control of the electric heater).
- **⚠ CAUTION! If the fan is disabled, the electric heater is not influenced and may still run.**
- To avoid overheating of the electric heater, the thermostat guarantees at least fan speed medium (Auto fan speed: value in the middle of Vmin (P357) – Vmax (P359), manual fan speed: P358) if the electric heater needs to be energized.

Adaptive temperature compensation for electric heater

We generally recommend controlling the electrical heater via one external relay. This applies when the application is covered by RDG20... (max current output on the triac is 1 A), but also for application with RDG26... where the current is lower than the max load supported by Q2.

In this case, an electric heater is connected directly to outputs Q2 (RDG260KN), and the current heats up the relay contact. This falsifies the internal temperature sensor reading. The thermostat compensates the temperature, if the rated power of the electric heating is entered at P217.

Factory setting P217: 0.0 kW, setting range: 0.0...1.2 kW.

On/Off control

Control sequence
On/Off output

The diagrams below show the control sequence for On/Off control.

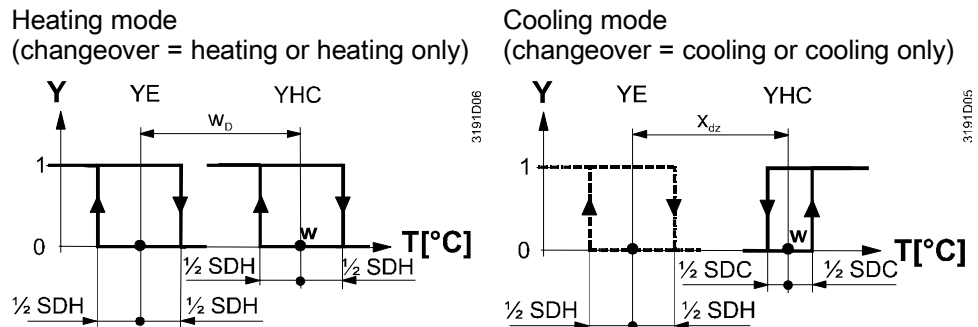

**Modulating control:
3-position, PWM or
DC 0...10 V**

Control sequence
modulating control output

The diagrams below show the control sequence for modulating control.

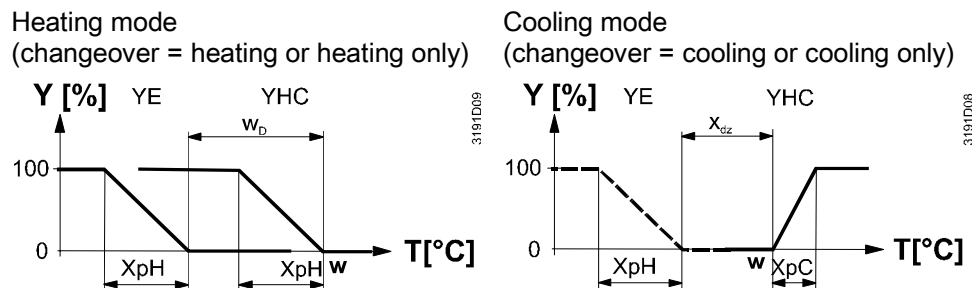

Note

- The diagrams only show the PI thermostat's proportional part. For setting sequence and control outputs, see Application overview [→ 37], Sequence overview (setting via P001) [→ 56] and Control outputs [→ 78].

Note

Parameter P256 (RDG260KN) sets the heating flow limitation when using a PICV. See Additional functions [→ 42].

4.7.5 2-pipe fan coil unit with radiator or floor heating

Heating or cooling with radiator or floor heating

In 2-pipe applications with radiator, the thermostat controls a valve in heating/cooling mode with changeover, heating only, or cooling only plus a radiator valve. Cooling only is factory-set (P001 = 1).

Radiator, active in cooling mode

In cooling mode, the valve receives an Open command if the acquired temperature is above the setpoint.

The radiator receives an On command if the acquired room temperature drops below "setpoint" minus "dead zone" (= setpoint for radiator).

Radiator in heating mode

In heating mode, the radiator receives an Open command if the acquired temperature is below the setpoint. The fan coil unit is used as an additional heat source when the heating energy controlled by the radiator is insufficient.

The fan coil unit receives an On command if the temperature is below "setpoint" minus "setpoint differential" (= setpoint for fan coil unit).

Floor heating

The radiator sequence can also be used for floor heating.

"Floor heating limitation (P252)" function, see Monitoring and limitation functions [→ 49].

On/Off control

The diagrams below show the control sequence for On/Off control.

Heating mode

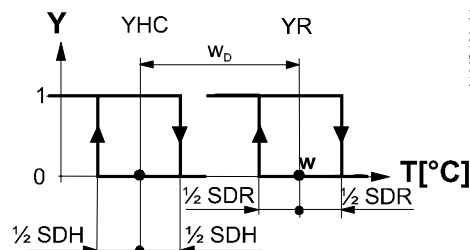

T [°C] Room temperature

w Room temperature setpoint

YHC Control command "Valve" or "Compressor"

YR Control command "Radiator"

Cooling mode

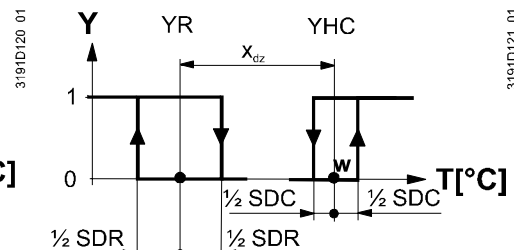

SDH Switching differential "Heating" (P051)

SDC Switching differential "Cooling" (P053)

SDR Switching differential "Radiator" (P054)

X_{dz} Dead zone (P055)

w_D Setpoint differential (P056)

**Modulating control:
3-position, PWM or
DC 0...10 V**

The diagrams below show the control sequence for modulating PI control.

Heating mode

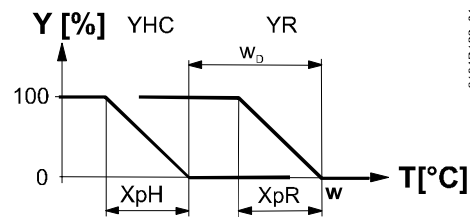

Cooling mode

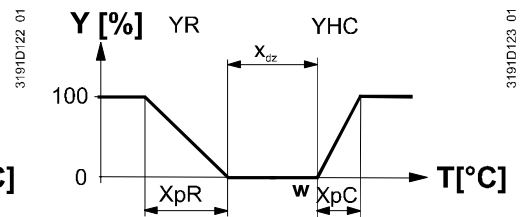

T[°C] Room temperature

w Room temperature setpoint

YHC Control command "Valve" or "Compressor"

YR Control command "Radiator"

XpH Proportional band "Heating" (P050)

XpC Proportional band "Cooling" (P052)

XpR Proportional band "Radiator" (P054)

Xdz Dead zone (P055)

wD Setpoint differential (P056)

Note

The diagrams only show the PI thermostat's proportional part.

For setting sequence and control outputs, see Application overview [→ 37], Sequence overview (setting via P001) [→ 56] and Control outputs [→ 78].

Note

Parameter P256 (RDG260KN) sets the heating flow limitation when using a PICV. See Additional functions [→ 42].

4.7.6 2-pipe/2-stage heating or cooling

- 2-stage heating or cooling** In 2-stage applications, the thermostat controls 2 valves or 2-stage compressors in heating or cooling mode or changeover (automatically or manually). "Cooling only" is factory-set (P001 = 1).
- Heating mode** In heating mode, the 1st stage is activated if the acquired temperature is below the setpoint.
The 2nd stage is activated if the acquired room temperature drops below "setpoint" minus "setpoint differential".
- Cooling mode** In cooling mode, the 1st stage is activated if the acquired temperature is above the setpoint.
The 2nd stage is activated if the acquired room temperature exceeds "setpoint" plus "setpoint differential".
- Swap function** With the swap function enabled, the 1st stage in heating (YHC1) switches to the 2nd stage in cooling. This function optimizes use of heating/cooling energy in systems with different equipment. E.g., fan coil units combined with radiant heating/cooling panels or floor heating/cooling. See Additional functions [→ 42] to enable the function via P254.
- Fan in the 2nd stage** Depending on the equipment, fan control needs to be started in the 2nd stage (in the 1st stage the fan remains Off), either in the heating or cooling sequence. To cover the requested application, the fan can be enabled and disabled in different sequences. For further details, see Fan control [→ 87].
- Limit number of heating/cooling sequence** In the 2-pipe/2-stage application, with parameter P200 "number of heating/cooling sequences", the number of outputs can be limited to one cooling sequence (P200 = 2) or one heating sequence (P200 = 3).

P200 = 1	2 sequence heating, 2 sequence cooling
P200 = 2	2 sequence heating, 1 sequence cooling
P200 = 3	1 sequence heating, 2 sequence cooling

On/Off output

The diagrams below show the control sequence for On/Off control.

Heating mode (P001 = 0)

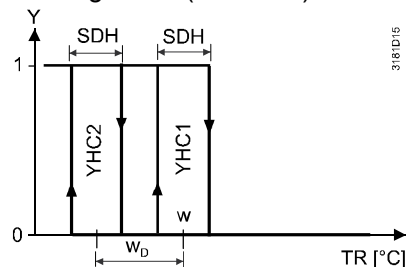

Cooling mode (P001 = 1)

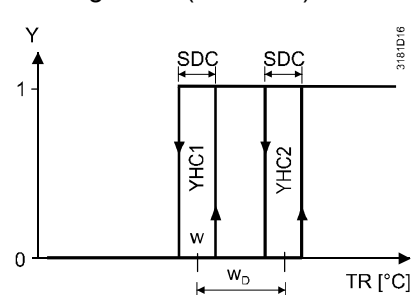

Changeover (P001 = 2 or P001 = 3, P254 = 0)

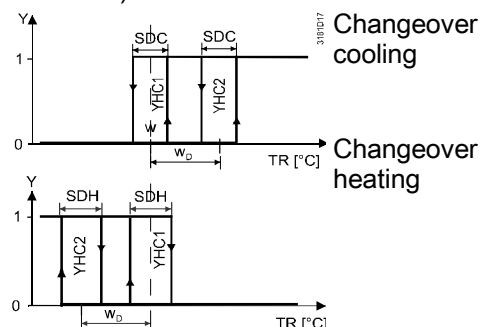

Changeover (P001 = 2 or P001 = 3, P254 = 1) (swap function)

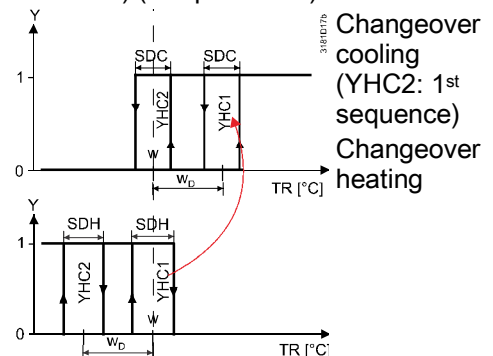

T[°C] Room temperature
w Room temperature setpoint
YHC1 Control command "Stage 1"
YHC2 Control command "Stage 2"

SDH Switching differential "Heating" (P051)
SDC Switching differential "Cooling" (P053)
w_D Setpoint differential (P056)

**Modulating control:
3-position, PWM or
DC 0...10 V**

The diagrams below show the control sequence for modulating PI control.

Heating mode (P001 = 0)

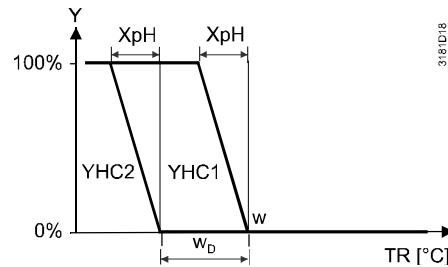

Cooling mode (P001 = 1)

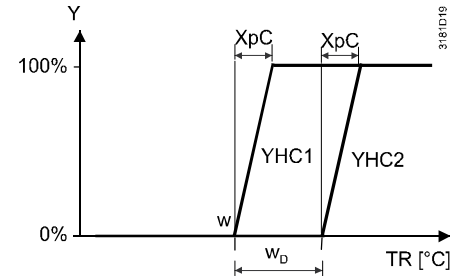

Changeover (P001 = 2 or P001 = 3, P254 = 0)

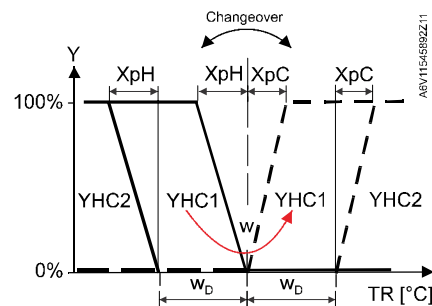

Changeover (P001 = 2 or P001 = 3, P254 = 1) (swap function)

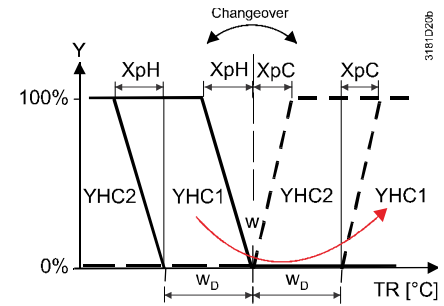

T[°C] Room temperature
w Room temperature setpoint
YHC1 Control command "Stage 1"
YHC2 Control command "Stage 2"

XpH Proportional band "Heating" (P050)
XpC Proportional band "Cooling" (P052)
w_D Setpoint differential (P056)

Note

The diagrams only show the PI thermostat's proportional part.

For setting sequence and control outputs, see Application overview [→ 37], Sequence overview (setting via P001) [→ 56] and Control outputs [→ 78].

Note

- For applications with different signals, On/Off (1st stage) and DC (2nd stage), heating/cooling P-band modulating (P050, P052), a small switching differential SDH / SDC (P051, P053) is suggested to start 1st sequence as soon as heating / cooling demand is requested.
- Set the heating flow limitation function with parameter P256 (RDG260KN) when using a PICV in this application. See Additional functions [→ 42].

4.7.7 4-pipe fan coil unit

Heating and cooling

In 4-pipe applications, the thermostat controls 2 valves in heating and cooling mode, heating/cooling mode by manual selection, or heating and cooling mode with changeover. Heating and cooling mode (P001 = 4) is factory-set.

4-pipe application with manual changeover

The heating or cooling output can be released via operating mode button if P001 is set to Manual (P001 = 3).

On/Off control

The diagrams below show the control sequence for On/Off control.

Heating and cooling mode (P001 = 4)

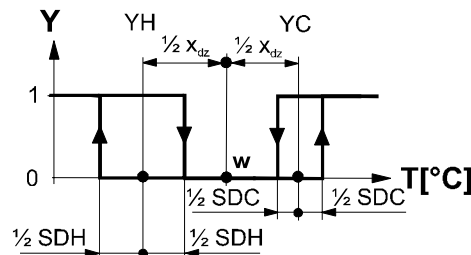

3191D11	T [°C]	Room temperature
	w	Room temperature setpoint
	YH	Control command "Valve" (heating)
	YC	Control command "Valve" (cooling)
	SDH	Switching differential "Heating" (P051)
	SDC	Switching differential "Cooling" (P053)
	X _{dz}	Dead zone (P055)

Heating mode with manual selection (P001 = 3) or energy saving (P010 = 2 & P014) in heating sequence

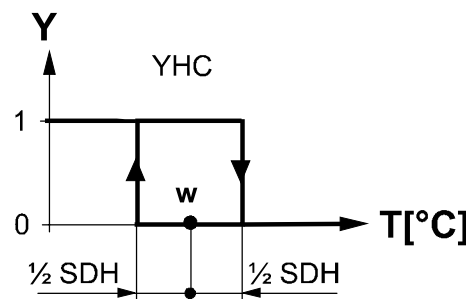

Cooling mode with manual selection (P001 = 3) or energy saving (P010 = 2 & P015) in cooling sequence

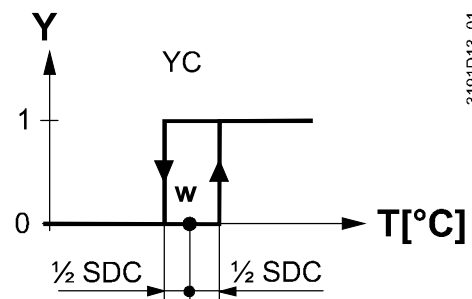

Modulating control: 3-position, PWM, or DC 0...10 V

The diagrams below show the control sequence of modulating PI control.

Heating and cooling mode (P001 = 4)

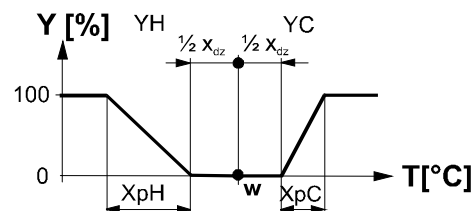

3191D12	T [°C]	Room temperature
	w	Room temperature setpoint
	YH	Control command "Valve" (heating)
	YC	Control command "Valve" (cooling)
	X _{pH}	Proportional band "Heating" (P050)
	X _{pC}	Proportional band "Cooling" (P052)
	X _{dz}	Dead zone (P055)

Heating mode with manual selection
(P001 = 3) or
for energy saving (P010 = 2 & P014) in
heating sequence

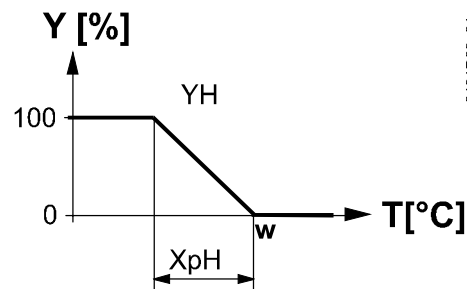

Cooling mode with manual selection
(P001 = 3) or
for energy saving (P010 = 2 & P015) in
cooling sequence

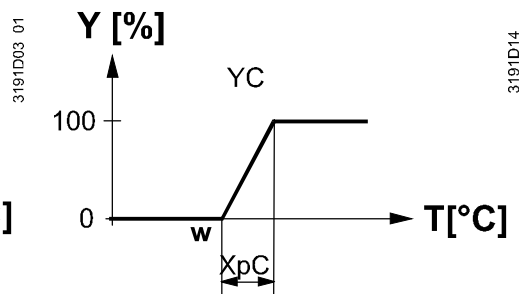

Note

The diagrams only show the PI thermostat's proportional part.
For setting sequence and control outputs, see Application overview [→ 37],
Sequence overview (setting via P001) [→ 56] and Control outputs [→ 78].

4.7.7.1 4-pipe application with PICV and 6-port control ball valve as changeover (RDG260KN)

In a 4-pipe fan coil application with DC 0...10 V fan control, the RDG260KN controls a combi valve (PICV) in combination with a 6-port ball valve as changeover.

Note: Set DIP# 1 & 4 to ON (4-pipe with 6-port ball valve as changeover and PICV).

Principle

This application is used in 4-pipe systems with heat exchanger and differential pressure controller (using a PICV).

The changeover signal DC 0...10 V controls the flow rate in the PICV, while the 6-port ball valve, connected to the relay outputs, is used as changeover to switch the sequence between heating and cooling.

Enable the flow limitation function (for PICV) via parameter P256 to balance heating and cooling and avoid hydraulic problems caused by the different flow rates. (see Additional functions [→ 42]).

The fan can only be set on DC Y50 output in this application.

Set fan operation (P350) to enable (enable by default).

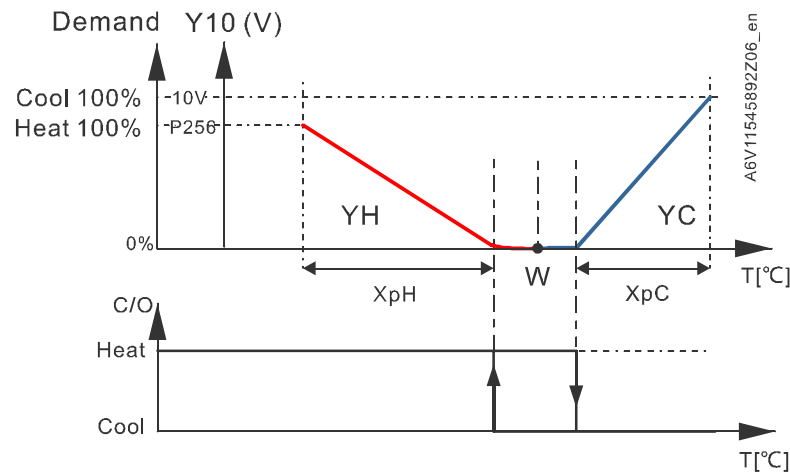

T [°C]	Room temperature	Y10	DC 0...10 V signal
W	Room temperature setpoint	YH	Control command "Valve" (heating)
YC	Control command "Valve" (cooling)	P256	Flow limitation function for heating only

See Chilled/heated ceiling with pressure independent combi valve (PICV) and 6-port ball valve for changeover (RDG260KN) [→ 73] for detailed information on how the thermostat limits the mix of the heating and cooling medium as well as control outputs.

The connection diagram for 4-pipe applications with PICV and 6-port ball valve as changeover is available in Connection diagrams [→ 129].

4.7.8 4-pipe fan coil unit with electric heater

Heating and cooling with auxiliary heater

In 4-pipe applications with electric heater, the thermostat controls 2 valves in heating and cooling mode by manual selection, heating only, or cooling only plus an auxiliary electric heater. Heating and cooling is factory-set (P001 = 4).

Electric heating in heating mode

The electric heater is used as an additional heat source when the heating energy controlled by the valve is insufficient.

The electric heater receives an On command, if the temperature is below "setpoint" minus "1/2 "dead zone" minus "setpoint differential" (= setpoint for electric heater).

Digital input "Enable electric heater

Remote enabling/disabling of the electric heater is possible via input X1, X2, or U1 for tariff regulations, energy saving, etc.

Input X1, X2, or U1 must be commissioned accordingly (P150, P153 and P155). See Multifunctional input, digital input [→ 92].

The electric heater can also be enabled/disabled via bus.



Enable electric heater

Do not assign the function to a local input X1, X2 or U1 if the bus input is used.

⚠ CAUTION! The electric heater must always be protected by a safety limit thermostat!

4-pipe application with manual changeover

The heating or cooling output can be released via operating mode button if P001 is set to Manual (P001 = 3).

On/Off control

The diagrams below show the control sequence for On/Off control.

Heating mode with manual selection (P001 = 3)

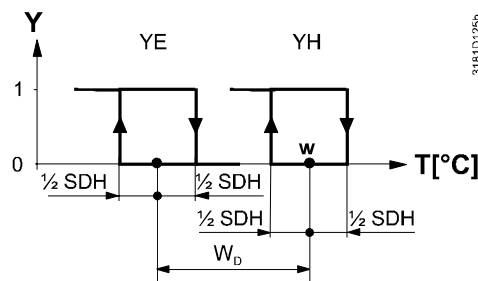

Cooling mode with manual selection (P001 = 3)

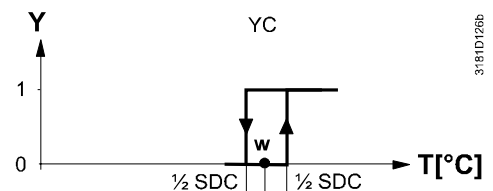

Heating and cooling (P001 = 4)

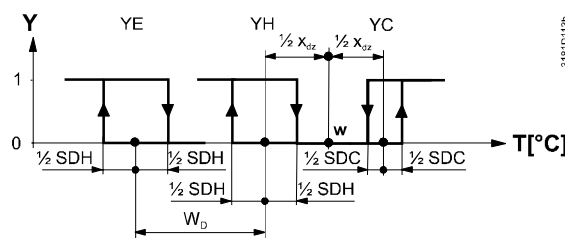

- T [°C] Room temperature
- w Room temperature setpoint
- YE Control command "EI heater"
- YH Control command "Valve" (heating)
- YC Control command "Valve" (cooling)
- SDH Switching differential "Heating" (P051)
- X_{dz} Dead zone (P055)
- w_D Setpoint differential (P056)

**Modulating control:
 3-position or PWM**

The diagrams below show the control sequence for modulating PI control.

Heating mode with manual selection
 (P001 = 3)

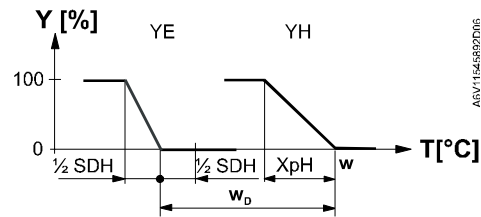

Cooling mode with manual selection
 (P001 = 3)

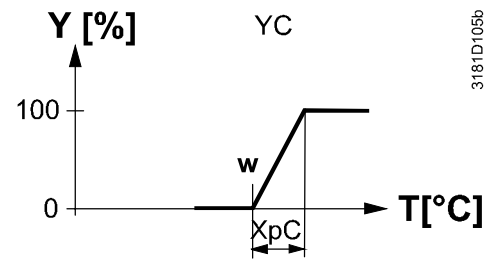

Heating and cooling (P001 = 4)

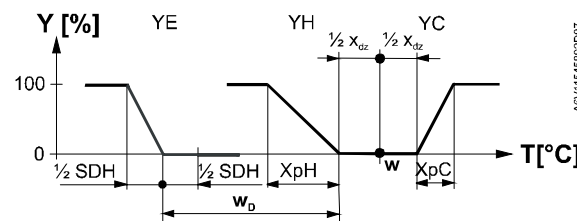

YC Control command "Valve "
 (cooling)

XpC Proportional band "Cooling"
 (P052)

T[°C] Room temperature

w Room temperature
 setpoint

YE Control command "El
 heater"

YH Control command
 "Valve" (heating)

XpH Proportional band
 "Heating" (P050)

Xdz Dead zone (P055)

wD Setpoint differential
 (P056)

Note

The diagrams only show the PI thermostat's proportional part.

For setting sequence and control outputs, see Application overview [→ 37],
 Sequence overview (setting via P001) [→ 56] and Control outputs [→ 78].

Note

- YH can only be DC, On/Off or PWM
- YC can be DC, On/Off, On/Off 3-wired, PWM or 3-position
- YE can only be DC, On/Off or PWM

4.7.9 Chilled/heated ceiling and radiator applications

For chilled/heated ceiling and radiator applications

- Set the corresponding basic application see Application overview [→ 37].
- Disable the fan (P350)

The following applications are available:

Application for chilled/heated ceiling, radiator	Basic application	Section	Sequences
Chilled/heated ceiling with changeover	2-pipe	2-pipe fan coil unit [→ 59]	H (\) C (/)
Chilled/heated ceiling and electric heater (cooling only: disable electric heater via P027)	2-pipe with electric heater	2-pipe fan coil unit with electric heater [→ 60]	EI H + H (\ \) EI H + C (/ /) C (/)
Chilled/heated ceiling and radiator	2-pipe with radiator	2-pipe fan coil unit with radiator or floor heating [→ 62]	H + rad (\ r) Rad + C (r /)
Chilled ceiling and radiator	4-pipe	4-pipe fan coil unit [→ 66]	H + C (\ /)
Chilled/heated ceiling, 2-pipe/2-stage	2-pipe/2-stage heating or cooling	2-pipe/2-stage heating or cooling [→ 64]	H + H (\ \) C + C (/ /)

4.7.9.1 Chilled/heated ceiling with 6-port control ball valve (RDG260KN)

The RDG260KN is able to control a 6-port control ball valve for a chilled and heated ceiling application.

This application is available, if the thermostats are set as 4-pipe with 6-port ball valve applications (DIP4 = ON, see Applications for universal systems [→ 39]).

Principle

Only one signal DC 0...10V (Y10 output) is used to control the 6-port control ball valve for heating and cooling.

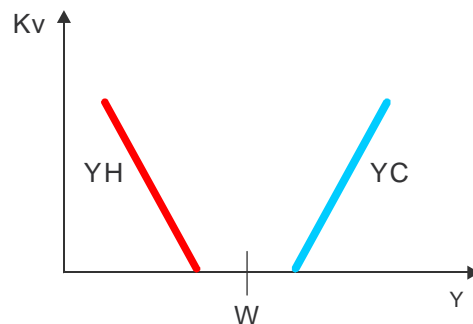
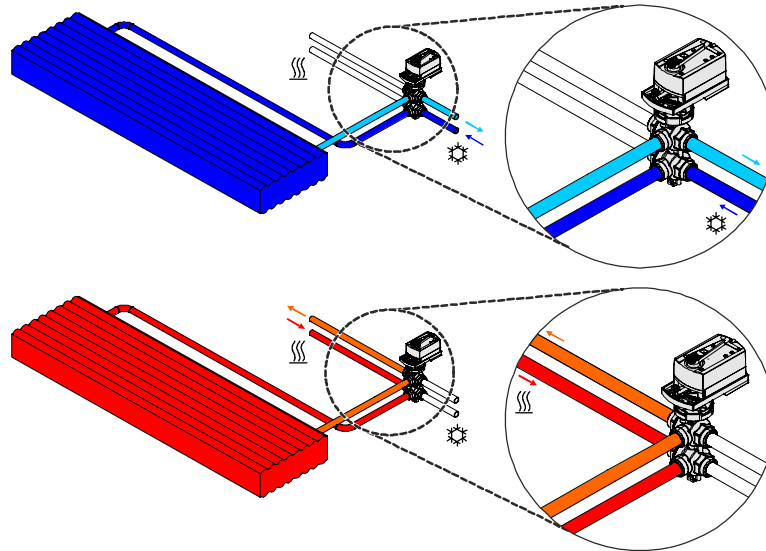

Hydraulic and control diagram of the 6-port control ball valve

- W Room temperature setpoint
- YH Control command "Valve" (heating)
- YC Control command "Valve" (cooling)
- Kv Valve flow

Default integral action time T_N is set to 45 minutes.

Control output configuration

If the thermostat is set to control sequence "H/C ceiling with 6-port control ball valve", only output Y10 can be used to control the 6-port control ball valve.

Output voltage range of Y10 can be configured via P201. For details, see Overview [→ 78].

P201 = 6	6-port valve (DC 0... 10 V control signal)
P201 = 7	6-port valve (DC 2... 10 V control signal)
P201 = 8	Inverse signal, 6-port valve (DC 10... 0 V control signal)
P201 = 9	Inverse signal, 6-port valve (DC 10... 2 V control signal)

Fan control

If the thermostat is set to control sequence "H/C ceiling with 6-port control ball valve", fan control is set to **disable** and cannot be changed.

Parameter P350 (Fan control) is set to 0 and cannot be changed.

4.7.9.2 Chilled/heated ceiling with pressure independent combi valve (PICV) and 6-port ball valve for changeover (RDG260KN)

The RDG260KN is able to control a PICV for a chilled and heated ceiling application together with a 6-port ball valve for changeover.

This application is only available, if the thermostat is set to a 4-pipe with 6-port ball valve as changeover and PICV application (DIP1 & DIP4 = On, see Applications for universal systems [→ 39]).

Principle

This application is used for chilled and heated ceilings (4-pipes) with one heat exchanger and differential pressure controller (using a PICV).

The control sequences (heating and cooling) are managed by one DC 0...10 V signal (Y10), to be used with a combi valve.

A 6-port ball valve must be used for changeover.

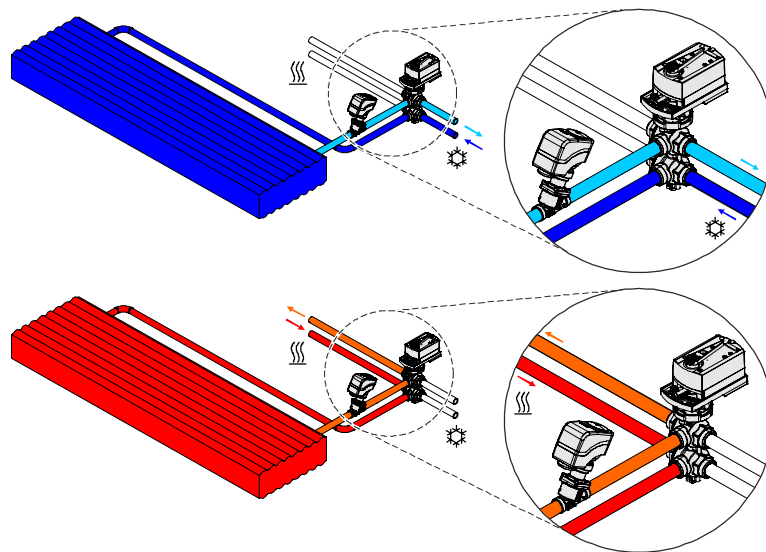

Enable the flow limitation function (for PICV) via parameter P256 to balance heating and cooling and avoid hydraulic problems caused by the different flow rates (see Additional functions [→ 42]).

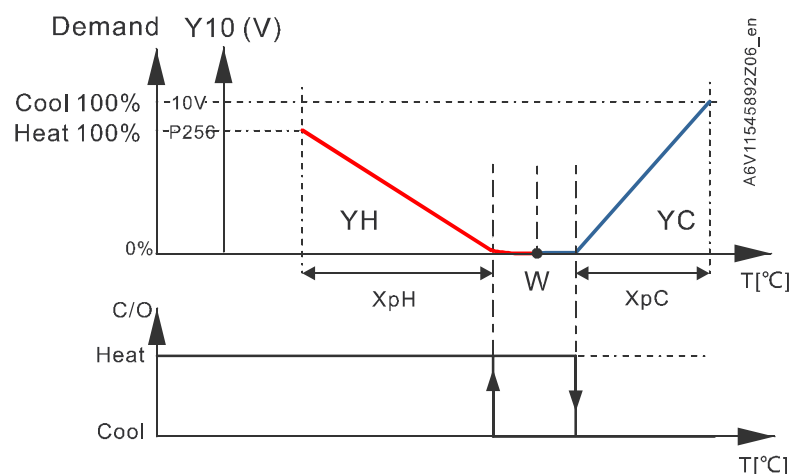

T[°C]	Room temperature	YH	Control command "Valve" (heating)
Y10	DC 0...10 V signal	YC	Control command "Valve" (cooling)
W	Room temperature setpoint	P256	Flow limitation function for heating only

To limit the medium mix (heating and cooling medium), the changeover and the control signal (DC 0...10 V) both work in sequence.

When control sequences change, the thermostat closes the combi valve and releases the corresponding relay to operate the ball valve.

A delay of 120 seconds is needed before the combi valves can be operated by the thermostat.

When the relay to ensure the ball valve is in the right H/C position, the control signal for the combi valve is released.

Control output

If the thermostat is set with control sequence "H/C ceiling with PICV and 6-port ball valve for changeover":

- For **PICV control**, only output Y10 can be used to control the combi valve.
- For **6-port ball valve as changeover** :
 - Relay Q1 is energized, if "Heating sequence active" (P400 = 5, fixed, cannot be changed)
 - Relay Q2 is energized, if "Cooling sequence active" (P401 = 6, fixed, cannot be changed)

The wiring diagram of the application H/C ceiling with PICV and 6-port ball valve for changeover is available in Connection diagrams [→ 129].

4.7.10 Compressor applications

For compressor applications,

- Set the corresponding basic application as per Application overview [→ 37].
- Disable the fan (P350) or set the type of fan speed (P351)
- Select the type of control outputs (On/Off, P201, P203, P204)

The following applications are available:

Application for compressor in DX-type equipment	Basic application	Section	Sequences
1-stage compressor	2-pipe	2-pipe fan coil unit [→ 59]	H (\) C (/)
1-stage compressor with reversing valve	2-pipe	2-pipe fan coil unit [→ 59]	H + C (\ /)
1-stage compressor and electric heater (cooling only: disable electric heater via P027)	2-pipe with electric heater	2-pipe fan coil unit with electric heater [→ 60]	El. H + H (\ \ \) El. H + C (\ / \) C (/)
1-stage compressor for heating and cooling	4-pipe	4-pipe fan coil unit [→ 66]	H + C (\ /)
2-stage compressor	2-stage heating or cooling	2-pipe/2-stage heating or cooling [→ 64]	H + H (\ \) C + C (/ /)

Note

Minimum On/Off time:	P212/P213 (only with On/Off control outputs)
Fan operation:	P350 (0 = disabled, 1 = enabled)
Fan speed:	P351 (1 = 1-speed, 2 = 3-speed, 3 = DC 0...10 V)
Control outputs On/Off:	P201 = 4 (V1) P203 = 4 (V2) (DC 0...10 V fan only)
Control outputs DC 0...10 V:	P201 = 5 (V1) P203 = 5 (V2)

4.7.11 Applications with external AQR sensor or QMX room operator unit

The equipment combination is intended for commercial buildings, offices, schools, museums, shops, etc.

Advantages of equipment combination		AQR/QMX sensor	
		LTE-Mode	S-Mode
a)	Sensor can be installed in the optimal place for temperature and humidity measurement.	✓	✓
b)	Unauthorized persons cannot change settings on sensors installed in the room.	✓	✓
c)	HVAC equipment and measuring point (T, r.h.) are far apart (in large spaces). Installing the thermostat near the equipment and the sensor on the measuring point reduces wiring costs and increases control accuracy.	✓	✓
d)	Several RDG2..KN room thermostats can operate with one room temperature and/or humidity value (in large spaces).	×	✓
e)	AQR/QMX sensor is better suited to interior designs.	✓	✓

With sensor AQR25.. or QMX3..0

Sensor AQR25..., QMX3.P30 or QMX3.P70 supplies relative humidity and room temperature values to the RDG2..KN.

RDG2..KN and the sensors use LTE-Mode (KNX) communication. To exchange information (humidity or room temperature), both units must have the same geographic zone apartment and room (A.R.1, where "A" is the value of P901 and "R" is the value of P902 of the RDG2..KN).

This equipment combination works on a 1-to-1 basis. Values cannot be provided from the sensor to several RDG2..KN room thermostats.

For applications in S-Mode, set the objects for humidity and room temperature of the RDG2..KN to **Receive** in ETS. The thermostat then works with the values acquired by the sensor. Default setting **Transmit** indicates that the RDG2..KN provides the local room temperature and relative humidity over the bus. One sensor sends data to several thermostats.

4.7.12 Setpoints and sequences

2-pipe applications

In changeover applications, the Comfort setpoints for heating and cooling sequence are the same (w).

In 2-pipe applications with electric heater, the Comfort setpoint is either at the first heating sequence (in heating mode) or at the cooling sequence (in cooling mode).

In 2-pipe applications with radiator, the Comfort setpoint is either at the radiator sequence (in heating mode) or at the cooling sequence (in cooling mode).

The setpoints for Economy and Protection are below the Comfort setpoints (for heating) and above the Comfort setpoints (for cooling).

They can be set via P019, P020 (Economy) and P100, P101 (Protection).

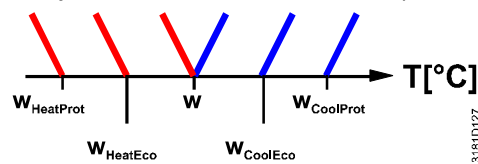

Application	Comfort mode		Economy/Protection mode	
	Heating	Cooling	Heating	Cooling
2-pipe				
2-pipe with electric heater				
2-pipe with radiator				
2-pipe/ 2-stage heating or cooling				

1) If P027 = On

W = Setpoint in Comfort mode

$W_{HeatEco/Prot}$ = Setpoint heating in Economy or Protection mode

$W_{CoolEco/Prot}$ = Setpoint cooling in Economy or Protection mode

YR = Radiator sequence

YE = Electric heater sequence

4-pipe applications

In 4-pipe applications, the Comfort setpoint (w) is in the middle of the dead zone, between the heating and cooling sequences.

The dead zone can be adjusted via P055.

If manual changeover is selected, either the cooling sequence or the heating sequence is released. In this case, the Comfort setpoint is at the selected heating or cooling sequence.

Application	Comfort mode			Economy/Protection mode
	Heating and cooling P010 = 1	Heating only ¹⁾ or heating and cooling P010 = 1	Cooling only ¹⁾ or heating and cooling P010 = 2	Heating and/or cooling
4-pipe				
4-pipe with electric heater				

¹⁾ Manual changeover, P001 = 3

W = Setpoint in Comfort mode

$W_{HeatEco/Prot}$ = Heating setpoint for Economy or Protection mode

$W_{CoolEco/Prot}$ = Cooling setpoint for Economy or Protection mode

YE = Electric heater sequence

4.8 Control outputs

4.8.1 Overview

Overview of control outputs

Different control output signals are available and defined during commissioning (see below).

Control output	On/Off	PWM	3-position	DC 0...10 V	On/Off 3-wire
Product No.					
RDG200KN	Y1, Y2, Y3 (3 x NO *)	Y1, Y2, Y3 (3 x PWM)	Y1/Y3, Y2/Y4 (2 x ▼/▲)	---	Y1/Y3, Y2/Y4 (2 x ▼/▲)
RDG260KN	Q1, Q2 (2 x NO)	---	---	Y10, Y20, Y30	---

*) NO: Normally open

Control output	DC 0...10 V	DC 2...10 V	DC 10...0 V	DC 10...2 V
Product No.				
RDG260KN for 6-port control ball valve application	Y10	Y10	Y10	Y10

On/Off control signal (2-position)

The valve receives the On command via control output Y1 (Q1 on RDG260KN) or Y3 (Q2 on RDG260KN), if:

1. The acquired room temperature is below the setpoint (for heating) or above the setpoint (for cooling),
2. The control outputs are inactive for more than the "Minimum output off time" (factory setting 1 minute, adjustable via P213).

The valve receives the Off command, if:

1. The acquired room temperature is above the setpoint (for heating) or below the setpoint (for cooling),
2. The valve is active for more than the "Minimum output on time" (factory setting 1 minute, adjustable via P212).

Note

- For switching differential (P051, P053, P054), see Control sequences [→ 56].

On/Off control signal (3-wire)

The valve receives the On command via control output Y1 or Y2 on RDG200KN, if:

1. The acquired room temperature is below the setpoint (for heating) or above the setpoint (for cooling),
2. The control outputs are inactive for more than the "Minimum output off time" (factory setting 1 minute, adjustable via P213).

The valve receives the Off command via control output Y3 or Y4 on RDG200KN, if:

1. The acquired room temperature is above the setpoint (for heating) or below the setpoint (for cooling),
2. The valve is active for more than the "Minimum output on time" (factory setting 1 minute, adjustable via P212).

Note

- For switching differential (P051, P053, P054), see Control sequences [→ 56].

Electric heater control signal (On/Off)	<p>The electric heater receives an On command via the auxiliary heating control output (RDG260KN: Q2, RDG200KN: Y2 or Y3, see Mounting Instructions [→ 5] [1] & [2]), if</p> <ol style="list-style-type: none"> 1. The acquired room temperature is below the "Setpoint for electric heater", 2. The electric heater is switched off for at least 1 minute. <p>The Off command for the electric heater is output, if</p> <ol style="list-style-type: none"> 1. The acquired room temperature is above the setpoint (electric heater), 2. The electric heater is switched on for at least 1 minute. <p>⚠ CAUTION! A safety limit thermostat (to prevent overtemperature) must be provided externally.</p>
Note	<p>The electric heater can be controlled via the On/Off control output (RDG260KN: Q2, RDG200KN: Y2 or Y3) by setting P203 or P204 to 4. For adaptive temperature compensation (P217: RDG260KN): see 2-pipe fan coil unit with electric heater [→ 60], 4-pipe fan coil unit with electric heater [→ 69].</p>
3-position control signal (RDG200KN only)	<p>Heating: Output Y1 provides the Open command, and Y3 the Close command to the 3-position actuator. Cooling: Same with Y2 and Y4.</p> <p>The factory setting for the actuator run time is 150 seconds. It can be adjusted via P214 (Y1 and Y3) or P215 (Y2 and Y4).</p> <p>The parameters are displayed only, if 3-position is selected via DIP switches 7 and 8.</p>
Synchronization	<ol style="list-style-type: none"> 1. When the thermostat is powered up, a close command for the actuator run time by + 150 % is issued to ensure the actuator closes fully and synchronizes to the control algorithm. 2. When the thermostat calculates the positions "fully close" or "fully open", the actuator run time is extended by + 150 % to ensure the correct actuator position is synchronized to the control algorithm. 3. After the actuator reaches the position calculated by the thermostat, a waiting time of 30 seconds is applied to stabilize the outputs.
PWM control (RDG200KN only)	<p>The demand calculated from the current room temperature and setpoint is supplied via Y1, Y2 and Y3 to the valve actuator as a PWM (pulse width modulation) signal for thermal actuators. The control output is activated for a period proportional to the heating/cooling demand and then switched off for the rest of the PWM interval.</p> <p>The PWM algorithm cycle time is 1200 seconds (factory setting). It can be adjusted via P206 (Y1), P207 (Y2) or P208 (Y3). These parameters are only displayed if PWM is selected via DIP switches 7 and 8 and if PWM is selected via P201, P203, P204.</p>
Note	<ul style="list-style-type: none"> • For a more accurate control temperature with PWM signals, the integral action time (P057 and P058) must be set to 0 (Proportional control). • For P-band (P050, P052, P054), see Control sequences [→ 56].
PWM for valve actuators (RDG200KN)	<p>For thermal valve actuators (STA, STP), set the PWM algorithm cycle (P206, P207, P208) to 1200 seconds. Proposed setting range for optimization: 900 to 1800 seconds.</p>
Note	<ul style="list-style-type: none"> • It is impossible to ensure exact parallel running of 2 or more thermal valve actuators. Motorized actuators with On/Off or 3 position control take precedence if several fan coil systems are controlled by the same room thermostat.
PWM for electric heaters (RDG200KN)	<p>To control electrical equipment, we recommend using a suitable external switching element to switch the maximum current.</p> <p>If output Y2 controls external mechanical relays, the optimal run time (P207) depends on the technical characteristics of the equipment.</p>

As initial setting, we suggest the following values, which can be modified within the described setting range as needed:

- Electric heater applications: 300 s (5 min) / range 30...60 s
- Electric radiator applications: 1200 s (20 min) / range 120...1800 s (30 min)
- Electric floor heating: 1200 s (20 min) / range 30...1800 s (30 min)

If output Y2 controls one external solid state relay:

- Electric heater applications: 60 s / range 15...60 s
- Electric radiator applications: 300 s (5 min) / range 30...300 s (5 min)
- Electric floor heating: 600 s (10 min) / range 30...900 s (15 min)

To avoid burn-off of mechanical contacts by frequent switching, use a current valve in place of a relay or contactor.

Note

To avoid possible supply problems, when many consumers are switching on at the same time in a building, consider the following:

- Set slightly different PWM cycles
- Do not switch all rooms to Comfort at the same time

DC 0...10 V control

This function is available with RDG260KN only.

**DC 0...10 V
for valve actuators**

The demand calculated by PI control from the current room temperature and setpoint is provided via Y10 and Y20 to the valve actuator as a continuous DC 0...10 V signal.

Note

- Parameter P256 (RDG260KN) sets the heating flow limitation if PICV is installed at output Y10 for heating and cooling. See Additional functions [→ 42].
- For P-band (P050, P052, P054), see Control sequences [→ 56].

**DC 0...10 V
for electric heaters**

- The demand calculated by PI control from the current room temperature and setpoint is provided via Y20 as a continuous DC 0...10 V signal
- The signal converter (SEM61.4) converts the DC 0...10 V signal to AC 24 V PDM pulses for the current valve
- The current valve (SEA45.1) supplies the electric heater with pulsed current

Note

The electric heater can be controlled via the On/Off control output (Q2) by setting P203 or P204 to 4. For adaptive temperature compensation, see 2-pipe fan coil unit with electric heater [→ 60].

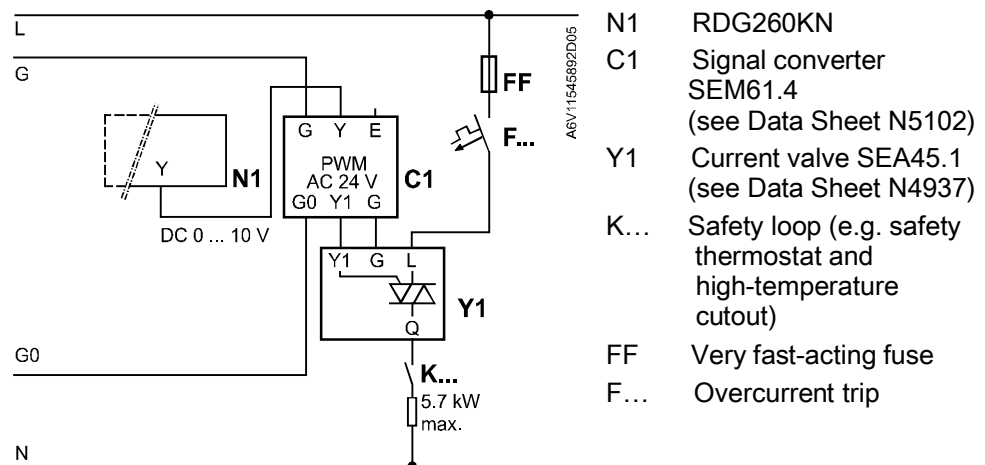
**DC 0...10 V
DC 2...10 V
for 6-port control ball valve
(RDG260KN only)**

The RDG260KN can control a 6-port control ball valve that provides heating and cooling within one DC 0...10 V or DC 2...10 V signal.

These 2 signals allow for controlling Siemens valves as well as DC 2...10 V valves by other suppliers.

For the same application, RDG260KN can also provide an inverse signal DC 10...0 V or DC 10...2 V signal for inversed hydraulic connections on the valve.

The selection of the signal is set with P201.

	Description	Explanations
P201 = 6	6-port valve (DC 0...10 V control signal)	Suitable for Siemens and competitor 6-port control valves and actuators with DC 0...10 V signal
P201 = 7	6-port valve (DC 2...10 V control signal)	Suitable for competitor 6-port control valves and actuators with DC 2...10 V signal (e.g. Belimo)
P201 = 8	inverse signal, 6-port valve (DC 10...0 V control signal)	Useful for inversed hydraulic connection on the 6-port control ball valve with Siemens or competitor DC 0...10 V actuator*
P201 = 9	inverse signal, 6-port valve (DC 10...2 V control signal)	Useful for inversed hydraulic connection on the 6-port control ball valve with competitor DC 2...10 V actuator (e.g. Belimo)*

* Inverting the signal might cause hydraulic balancing issues

4.8.2 Control output configuration (setting via DIP switches 7/8 or tool, and P201/P203/P204)

Overview

Application	Fan		Control outputs					Product no.
	DC 0...10 V	3-speed/ 1-speed	Mod. DC 0...10 V	On/Off (2-pos)	On/Off (3-wire)	Mod. PWM (2-pos)	Mod. 3-pos.	RDG...KN
2-pipe	✓	✓	–	✓	✓	✓	✓	200
	✓	✓	✓	–	–	–	–	260
	✓	–	–	✓	–	–	–	260
2-pipe with electric heater	✓	✓	–	✓	✓	✓	✓	200
	✓	✓	✓	–	–	–	–	260
	✓	–	✓	✓	–	–	–	260
2-pipe with radiator/floor heating	✓	✓	–	✓	✓	✓	✓	200
	✓	✓	✓	–	–	–	–	260
	✓	–	✓	✓	–	–	–	260
2-pipe/2-stage, cooling or heating	✓	✓	–	✓	✓	✓	✓	200
	✓	✓	✓	–	–	–	–	260
	✓	–	✓	✓	–	–	–	260
4-pipe	✓	✓	–	✓	✓	✓	✓	200
	✓	✓	✓	–	–	–	–	260
	✓	–	✓	✓	–	–	–	260
4-pipe with electric heater	✓	✓	–	✓	✓	✓	✓ ¹⁾	200
	✓	✓	✓	–	–	–	–	260
	✓	–	✓	✓ ²⁾	–	–	–	260
Heating / Cooling with 6-port valve	–	–	✓	–	–	–	–	260
Heating / Cooling with 6-port valve as changeover and PICV valve	✓	–	✓	✓ ³⁾	–	–	–	260

¹⁾ Only available for cooling actuator







²⁾ Only selectable for electrical heater

³⁾ Relay outputs for 6-port valve as changeover

Note: On/off (2-pos) on RDG200.. are a triac outputs (max 1A), and relay outputs (max 5(4)A) on RDG260..

RDG200KN

The type of the control outputs (2- or 3-position) is set via DIP switches 7 and 8.
Patterns of DIP switches 7 and 8:

DIP NO.: 7...8 → ON =  , OFF = 	 7 8	 7 8	 7 8	 7 8
Y1/Y3 =	2-position (PWM)	2-position (PWM)	3-position	3-position
Y2/Y4 =	2-position (PWM)	3-position	2-position (PWM)	3-position

Notes

- If 2-position (PWM) is selected via DIP switches, the control output is On/Off (factory setting). To select PWM (pulse width modulation), set P201, P203 and/or P204 to 3.
- 4-pipe with electric heater: As the electric heater requires 1 of 4 outputs, only the cooling valve actuator can be 3-position.
- For commissioning via tool, all DIP switches have to be set to Off or related application configuration. Control outputs need to be set via tools.

For details on connecting field devices and setting the DIP switches, refer to the Mounting Instructions [→ 5] [1] & [2].

RDG260KN

Applications with DC 0...10 V fan control (Y50) or without fan:

The type of valve actuator control outputs can be changed from DC 0...10 V (factory setting) to On/Off.

To select On/Off valve actuator control, set P201 and/or P203 to 4 or DIP switch 7 and/or 8 to ON.

Example for 4-pipe application:

- Cooling: DC 0...10 V Y10 (P201 = 5, default), On/Off on Q1 (P201 = 4)
- Heating: DC 0...10 V Y20 (P203 = 5, default), On/Off on Q2 (P203 = 4)

When RDG260KN is set for chilled and heated ceiling with a 6-port ball valve, the control output is Y10 and cannot be changed.

Notes

- The fan type is selected via P351 or DIP switch 6, see Fan control [→ 84]
- RDG260KN On/Off valve actuator control on applications without fan function, setting sequence:
 - Set DIP switch 6 to OFF and P351 to 3
 - Disable the fan function by setting P350 to 0
 - Set the valve actuators to On/Off by setting P201 and/or P203 to 4
- For commissioning via tools, set all DIP switches to Off or the related application configuration. The control outputs must be set using tools

4.9 Fan control

Overview fan outputs

In RDG200KN and RDG260KN, the available fan output signals are one On/Off 1-speed/3-speed fan or one modulating fan DC 0...10 V and control type can be selected via P351.

The fan control signal (DC 0...10 V or 3-speed) is selected via DIP switch 6, local HMI (P351) or tool (ACS, ETS or Siemens smartphone application PCT Go for Android).

The fan operates in automatic mode or at the speed selected in manual mode.

In automatic mode, the fan speed is based on the setpoint and the current room temperature. When the room temperature reaches the setpoint, the control valve closes and the fan switches off or stays at fan speed I (min. fan speed) as per the setting of P029 (fan stage in dead zone Comfort mode).

The factory setting for "Fan in the dead zone" is Off.

Only one fan output at one time is On, either Q1, Q2 or Q3.

Fan and control outputs on RDG260KN

If the application is set via DIP switches and DIP 6 is set to Off:

- DC 0...10 V fan on Y50 is selected
- P351 = 3 (DC 0...10 V fan) cannot be modified
- 3-speed/1-speed fan output is not available

If the application is set via DIP switches and DIP 6 is set to On:

- 3-speed fan on Q1, Q2, Q3 is selected, P351 = 2
- 1-speed fan (on Q1) can be selected via HMI (P351 = 1) or via tools (ACS or ETS)
- DC 0...10 V fan output is not available
- 3-speed fan output is enabled only if the application has also been selected via DIP switches

If all DIP switches are Off (commissioning via tool ACS or ETS):

- Application and type of fan must be set and downloaded via tools
- If DC 0...10 V fan is set, the type of fan output cannot be modified via HMI
- If 3-speed or 1-speed is selected, P351 can be modified locally to 2 (3-speed) or 1 (1-speed)

Fan speed and mode can be changed via bus.

For this purpose, the fan command value must be enabled.



Fan command value
 Enable fan command value

Fan speed and mode can be monitored via bus.



Fan operation
 Fan stage I-II-III
 Fan output

Fan control with modulating heating/cooling control (PWM, 3-pos or DC 0...10 V)

For 3-speed fan control:

The individual switching points for each fan stage can be adjusted via P353...P355. The fan speed switch off point is 20% below the switch on point. The diagrams below show fan speed control for modulating PI control.

For DC 0...10 V fan control:

If DC 0...10 V fan control is selected, the fan switching points are set using the following parameters:

- P359 & P360: DC 0...10 V fan max. output
- P358: DC 0...10 V middle speed output
- P357: DC 0...10 V fan min. output
- P356: Switching point for fan

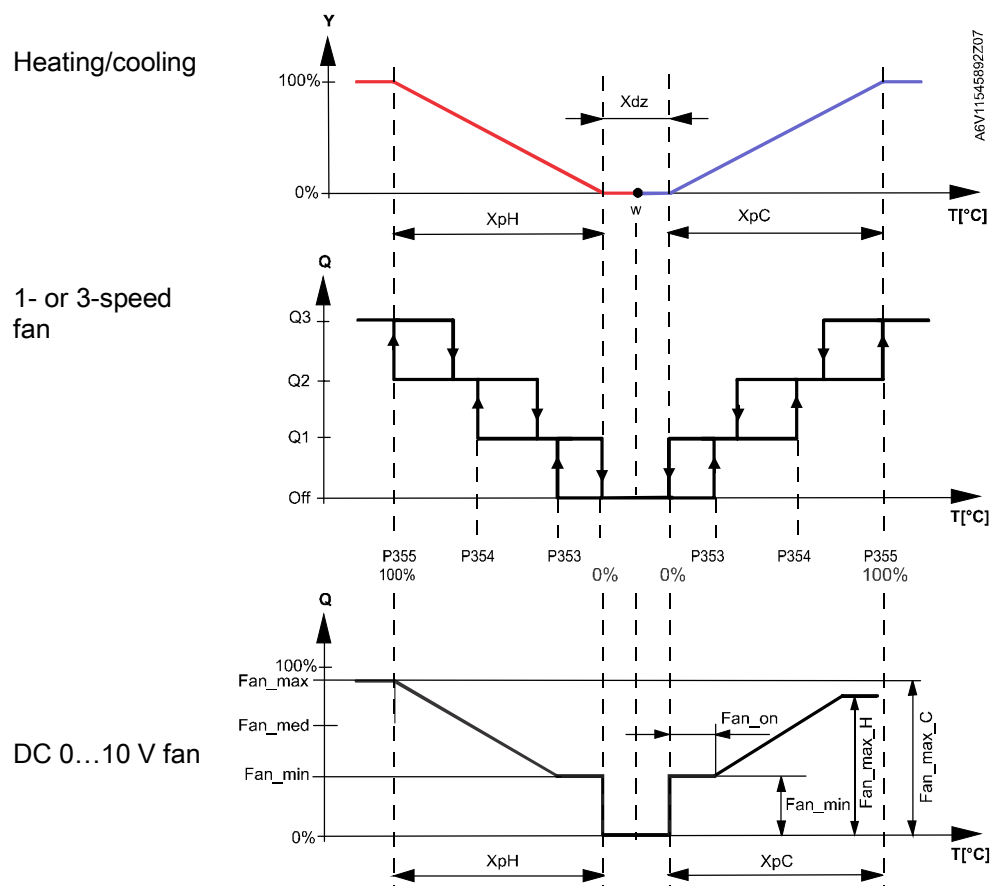

w	Room temperature setpoint	X_{dz}	Dead zone (P055)
Q	Fan speed	Fan_max	Max. DC 0...10 V fan speed (P359 for heating & P360 for cooling)
YH	Control demand "Heating"	Fan_med	Med. DC 0...10 V fan speed (P358)
YC	Control demand "Cooling"	Fan_min	Min. DC 0...10 V fan speed (P357)
X_{pH}	Proportional band "Heating" (P050)	Fan_on	Fan switch-on point (P356)
X_{pC}	Proportional band "Cooling" (P052)		
		Fan_max_H	Fan speed switching point high (P355)
		Fan_max_C	Fan speed switching point low (P353)
		Fan_min	Fan speed switching point med (P354)

Note

The diagram only shows the proportional part of PI control.

Fan control with On/Off heating/cooling control

In applications with On/Off control:

1. The switching point for low fan speed is synchronized to the heating/cooling output. P353 (switching point fan speed low) is not relevant.
2. The maximum switching range of the fan (XpH_{Fan}/XpC_{Fan}) is defined by the switching differential (SDH/SDC) via a reference table.

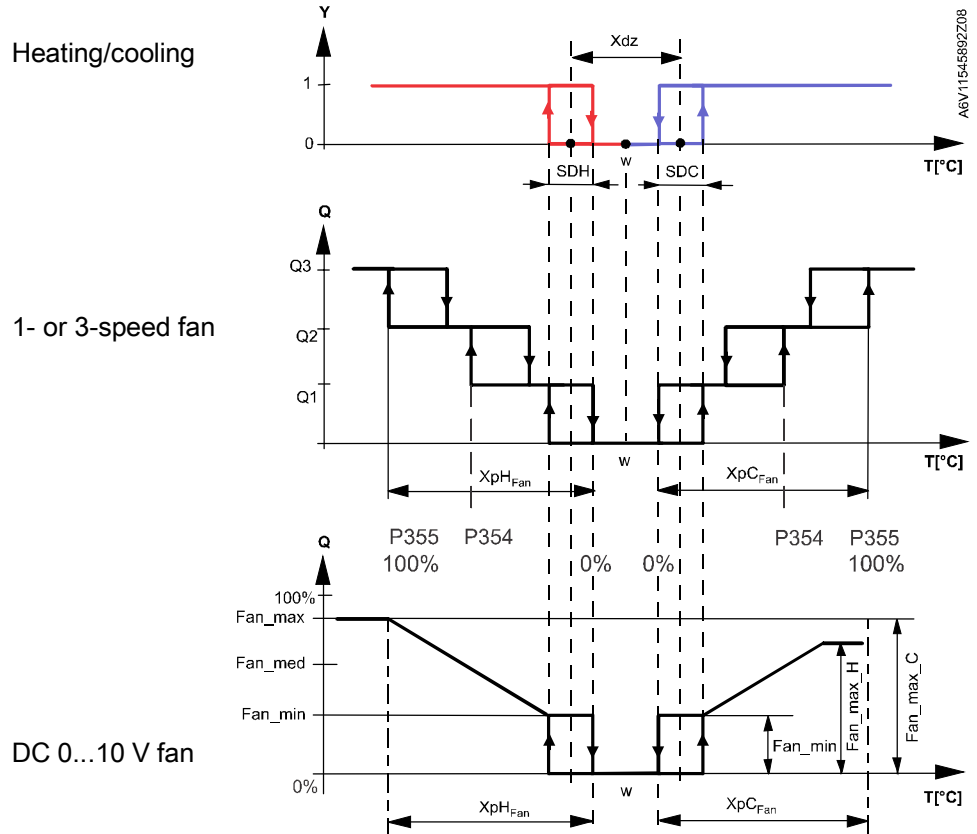

T [°C]	Room temperature	X_{dz}	Dead zone (P055)
w	Room temperature setpoint	XpH_{Fan}	Switching range for fan "Heating" (Table)
Q	Fan speed	XpC_{Fan}	Switching range for fan "Cooling" (Table)
Y	Control command "Valve"		Fan 3-speed switching point high (P355)
SDH	Switching differential "Heating" (P051)		Fan 3-speed switching point med (P354)
SDC	Switching differential "Cooling" (P053)		Fan 3-speed switching point low (P353)
		Fan_max	Max. DC 0...10 V fan speed (P359 for heating & P360 for cooling)
		Fan_med	Med. DC 0...10 V fan speed (P358)
		Fan_min	Min. DC 0...10 V fan speed (P357)

Reference table with On/Off control

SDH/SDC [K]	0.5	1.0	1.5	2.0	2.5	3.0	3.5	4.0	>4.5
XpH_{Fan}/XpC_{Fan} [K]	2	3	4	5	6	7	8	9	10

1-speed/3-speed fan

The thermostat can control a 1- or 3-speed fan (selected via P351). A 1-speed fan is connected to terminal Q1, and a 3-speed fan to terminals Q1, Q2 and Q3.

Manual operation DC 0...10 V fan

Fan speed I = Min. fan speed selectable via P357
Fan speed II = Medium fan speed selectable via P358

Fan speed III = Max. fan speed selectable via P359 (heating), P360 (cooling)

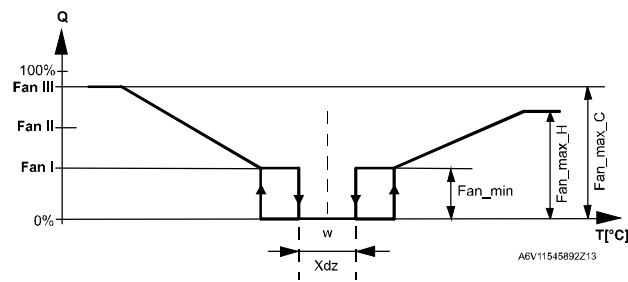

Note: Manual fan settings do not influence control signals "Heating" and "Cooling".

Note

When heating with electric heater only, manual fan speed I is unavailable to guarantee the necessary minimum air flow for the electric heater and to avoid overheating.

2 sequences heating/cooling

For heating or cooling with 2 sequences (e.g. heating with a heating coil and an electric heater, or 2-stage cooling), the fan is always synchronized to the 1st stage.

Fan in the 2nd stage

For 2-pipe and 2-stage applications, based on the equipment, the fan may have to run in the 2-stage only (in the 1st stage the fan remains Off), either in the heating or cooling sequence.

The following settings are available by selecting fan control P350 accordingly:

P350 = 4: 2 nd stage	Fan runs in the 2 nd stage in heating and cooling (example 1 or 2 when combined with the swap function)
P350 = 5: Heating and 2 nd stage cooling	Fan runs in heating mode and in the 2 nd stage cooling (example 3)
P350 = 6: Cooling and 2 nd stage heating	Fan runs in cooling mode and in the 2 nd stage heating
P350 = 7: 2 nd stage cooling only	Fan runs in the 2 nd stage cooling only and not in heating mode
P350 = 8: 2 nd stage heating only	Fan runs in the 2 nd stage heating only and not in cooling mode

Example 1

The fan runs only in the 2nd stage in the heating and cooling sequence (2-pipe and 2-stage application).

Set both P201 and P203 to 4 or 5 (based on the requested control signal) and set P350 to 4 (fan in the 2nd stage).

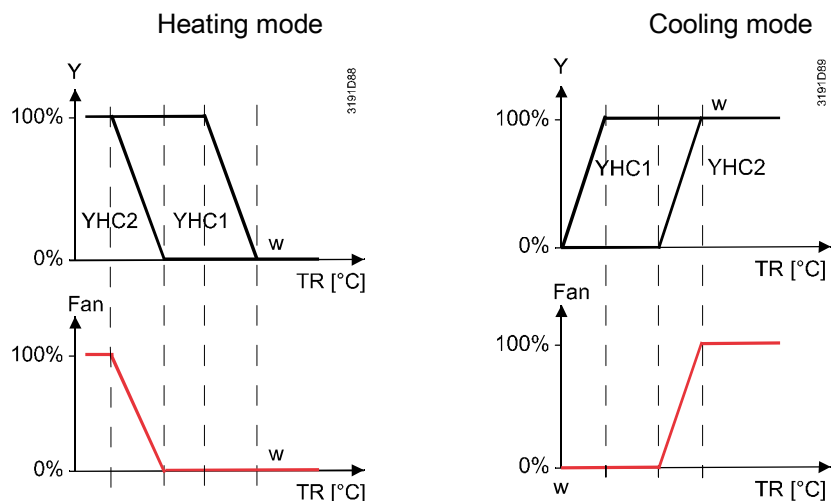

Notes

- The output for the 1st stage (YHC1) in heating mode is also the 1st stage in cooling
- This function is available for DC/3-speed/1-speed fans

Example 2

We recommend enabling the swap function on applications with fan coil units and floor heating/cooling. In this application, the fan runs during cooling demand (fan coil unit and floor cooling) and only in the 2nd heating stage (with the fan coil unit). Set P254 to On or Off, depending on the selected control signal (swap function), and set P350 to 4 (fan in the 2nd stage).

Example 3

The fan runs during heating demand and only in the 2nd cooling stage, e.g. for applications with fan coil units and radiant heating/cooling panels.

This setting is available only when P350 is set to 5, and the swap function is selected (P254 to On or Off).

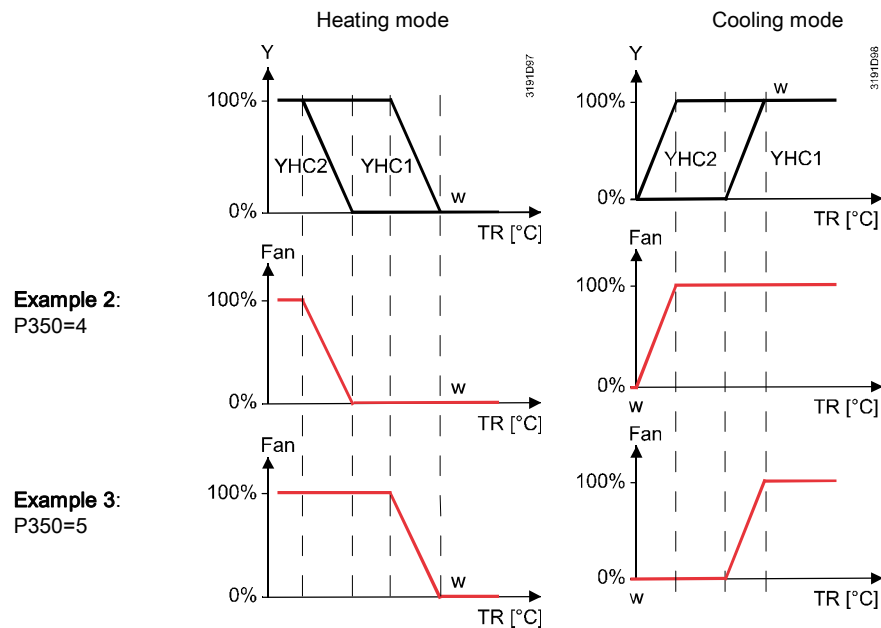
Notes

- Swap function: The output for the 1st stage in heating mode is the 2nd stage for cooling
- This function is available for DC/3-speed/1-speed fans

Examples, other combinations

The following table shows the relation between fan behavior (switching range fan XpH_{Fan}/XpC_{Fan} as per reference table or proportional band XpH/XpC) for 2-pipe / 2-stage applications depending on the selected output signals and synchronization of the fan to the first or second sequence.

Combination	1 st stage signal	2 nd stage signal	Fan type	Fan synchro	Fan behavior
1	On/off	On/off	DC	1 st sequence	XpH_{Fan}/XpC_{Fan} , P-control
2	DC	DC	DC	1 st sequence	XpH/XpC , P/PI control
3	On/off	On/off	DC	2 nd sequence	XpH_{Fan}/XpC_{Fan} , P-control
4	DC	DC	DC	2 nd sequence	XpH/XpC , P/PI control
5	On/off	DC	DC	1 st sequence	XpH_{Fan}/XpC_{Fan} , P-control

Combination	1 st stage signal	2 nd stage signal	Fan type	Fan synchro	Fan behavior
6	On/off	DC	DC	2 nd sequence	XpH/XpC, P/PI control
7	DC	On/off	DC	1 st sequence	XpH/XpC, P/PI control
8	DC	On/off	DC	2 nd sequence	XpH _{Fan} /XpC _{Fan} , P-control
9	DC	DC	3-speed	1 st sequence	XpH/XpC, P/PI control
10	DC	DC	3-speed	2 nd sequence	XpH/XpC, P/PI control

Fan operation as per heating/cooling mode, or disabled

Fan operation can be limited to be active with cooling only or heating only, or even disabled via P350.

When fan operation is disabled, the fan symbol on the display disappears and pressing the fan button has no impact.

This function allows for using the thermostat in universal applications such as chilled/heated ceilings and radiator, etc. (see Chilled/heated ceiling and radiator applications [→ 71]).

Fan minimum on- time

In automatic mode, a dwelling time of 2 minutes (factory setting) is active. The fan maintains each speed for at least 2 minutes before changing to the next speed. The minimum on-time can be adjusted from 1...6 minutes via P362.

Periodic Fan kick (P363, P364)

In automatic fan mode and with the room temperature in the dead zone, the control valve is normally closed and the fan is disabled. With the periodic fan kick function, the fan can be released from time to time at low speed for a minimum on-time (see above) even if the valve is closed.

This function is used to prevent damage from moisture due to a lack of air circulation, or to allow a return air temperature sensor to acquire the correct room temperature.

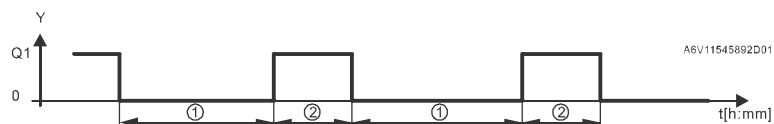

- ① Periodic fan kick
- ② Minimum on-time

Periodic fan kick time can be selected individually for Comfort via P363, and via P364 for Economy.

Notes

- Fan kick value 0 means the fan runs continuously in the dead zone (only selectable in Economy via P364)
- Fan kick value 1 and higher: Value in minutes
- Fan kick value Off means the fan does not run in the dead zone

Fan stage in dead zone P029

The fan speed in the dead zone (Comfort mode) can be set via P029 (Service level) ask per customer preferences.

To save energy, the manual fan in the dead zone is controller same as the auto fan (P029 = 3, 4 or 5).

The following options are available:

- Auto fan does not run in the dead zone (P029 = 0)
- Auto fan runs in the dead zone at low speed during heating and cooling (P029 = 1)

- Auto fan runs in the dead zone at low speed during cooling only (P029 = 2). During heating, the fan does not run in the dead zone.
- Auto or manual fan does not run in the dead zone (P029 = 3)
- Auto or manual fan runs in the dead zone at low speed during heating and cooling (P029 = 4)
- Auto or manual fan runs in the dead zone at low speed during cooling only (P029 = 5). During heating, the fan does not run in the dead zone.

When the fan does not run in the dead zone (P029 = 0), " Periodic fan kick Comfort" (P363) function can be enabled to periodically ventilate the room.

Fan start kick (P361)

When the fan starts from standstill, it starts at speed 3 for 1 second to ensure safe fan motor start by overcoming inertia and friction (selected via P361).

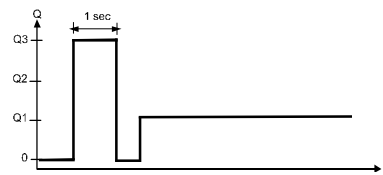

Fan start, minimum hot water temperature (P366)

In the heating sequence, when the return water temperature exceeds 30 °C (factory setting, P366), fan operation is enabled even if the fan start delay time (P365) is not reached.

The universal input "coil temperature" (P150, P153 or P155 = 12) is required to activate this function.

Fan overrun for electric heater

When the electric heater is switched off, the fan overruns for 60 seconds (P352) to avoid overtemperature of the electric heater or prevent the thermal cutout from responding.



⚠ WARNING

Fan failure

In case of fan failure, the thermostat cannot protect the electric heater against overtemperature. For this reason, the electric heater must have a separate safety device (thermal cutout).

Clean fan filter reminder

The "Clean fan filter reminder" function counts the fan operating hours and displays message "FIL 📌" to remind users to change/clean the fan filter as soon as the threshold is reached. This does not impact thermostat, which continues to run normally. The function is set via P501 (default = Off (0)).

The "Clean filter reminder" is reset when the operating mode is manually set to Protection and back.



Fault information

Fan in Auto mode

In Auto mode, the default fan mode is automatic. The fan mode can be changed to Manual by pressing the FAN button. The fan returns to automatic mode after each switchover from Comfort to Economy, and vice versa.

Fan start delay

To allow the heating/cooling coil to reach its temperature, fan start can be delayed by a time period set via P365.

Example

Function for On/Off control outputs is listed as per the following figure:

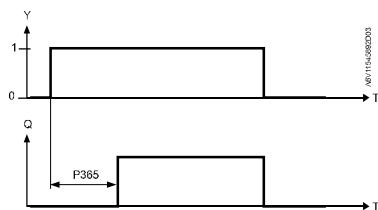

Fan operation with combi valve PICV and a 6-port ball valve as changeover

Fan control is set to enable by default (P350 = 1), if the thermostat is set with control sequence “H/C ceiling with PICV and 6-port ball valve as changeover”. For this application, where the combi valve PICV controls the flow rate and the 6-port ball valve works as changeover heating / cooling, fan control can:

- Also be disabled (P350 = 0)
- Run only in heating (P350 = 2) sequence
- Run only in cooling (P350 = 3) sequence

For this application, only DC fan control is available at output Y50.

4.10 Multifunctional input, digital input

The thermostat has 3 multifunctional inputs X1, X2 and U1. Input U1 will be configured as digital input in a future product version.







An NTC type sensor like NTC 3k, a LG-Ni1000 (AI, analog input) or a switch (DI, digital input) can be connected to the input terminals. The functionality of the inputs can be configured via P150 + P151 for X1, P153 + P154 for X2, and P155 + P156 for U1.

The current temperature or state of the inputs X1/X2 and U1 is available on the bus for monitoring purposes.

The parameters can be set to the following values:



	#	Input function	Description	Type X1/X2/U1
	0	Not used	No function	--
	1	External/return air temperature	Sensor input for external room temperature sensor or return air temperature sensor to acquire the current room temperature.	AI
 Heating/ cooling changeover	2	Heating/cooling changeover	Sensor input for "Automatic heating/cooling changeover" function. A switch can also be connected rather than a sensor. Important: Switching state configured via P151, P154, P156. See also Additional functions [→ 42]. Heating/cooling changeover is possible via bus. In this case, the function must not be assigned to local inputs X1, X2, U1. See also Additional functions [→ 42]. Diagnostic value 0 °C is displayed for closed contact, 100 °C for open contact, if a switch is connected.	AI/DI
 Window contact	3	Window contact	Digital input to change over the operating mode to Protection. If the window contact is active, user operations are ineffective and OFF is displayed. Window contact is also possible via bus. In this case, do not assign the function to local inputs X1, X2 or U1. See also Operating modes [→ 23].	DI
	4	Dewpoint monitor	Digital input for dewpoint sensor to detect condensation. Cooling is stopped in the event of condensation.	DI
 Enable electric heater	5	Enable electric heater	Digital input to enable/disable the electric heater via remote control. Enable electric heater is also possible via bus. In this case, do not assign the function to local inputs X1, X2, U1. See also Control sequences [→ 56].	DI
 Fault information	6	Fault	Digital input to signal an external fault (e.g.: dirty air filter). If the input is active, ALx is displayed and a fault is sent on the bus. See also Fault and alarms function on KNX [→ 99]. (Alarm x, with x = 1 for X1, x = 2 for X2, x = 3 for U1). Note: Fault displays have no impact on thermostat operation. They merely represent a visual signal.	DI

	#	Input function	Description	Type X1/X2/U1
 U1, X1, X2 (Digital)	7	Monitor input (digital)	Digital input to monitor the state of an external switch via bus	DI
 U1, X1, X2 (Digital)	8	Monitor input (temperature)	Sensor input to monitor the state of an external sensor (e.g., NTC 3k) via bus.	AI
 U1, X1, X2 (Temp.)	9	Supply air temperature limitation	Sensor input to acquire supply air temperature. The thermostat controls the room temperature via built-in sensor. The control output (DC 0...10 V) is reduced if the supply air temperature drops below the min. limit or exceeds the max. limit (P063 , P064)	AI
 Presence detector	10	Presence detector	Presence detector input switches the operating mode to Comfort when the room is occupied and returns to previous operating mode when the room is unoccupied. Presence detector is also possible via bus. In this case, do not assign the function to local inputs X1, X2 or U1. See also Presence detector [→ 45].	DI
	11	External temperature limit	The sensor is connected to the pipe and measures the temperature of the floor heating water. When the value exceeds the selected limit (P252), heating is stopped. See also Monitoring and limitation functions [→ 49]	AI
	12	Coil temperature	To avoid cooling flow air in the room, the sensor measures the coil water temperature and releases the fan only when the selected minimum hot water temperature limit is exceeded (P366). See also Fan control [→ 90].	AI
 Hotel presence detector	13	Hotel presence detector	Hotel presence detector input switches the operating mode to Economy when the room is unoccupied and symbol  is displayed (buttons are locked) and returns to previous operating mode when the room is occupied. Hotel presence detector is also possible via bus. In this case, do not assign the function to local inputs X1, X2 or U1. See also Presence detector [→ 45].	DI

- Control action can be changed from normally open (NO) and normally closed (NC) via P151, P154 or P156.
- Each input X1, X2 or U1 must be configured with a different function (1...5 & 9...13). Exception: 1, 2 or 3 inputs can be configured as fault (6) or monitor input (7,8).
- X1 is factory-set to "External sensor" (1), X2 to "Not used" (0), and U1 to "Window contact" (3).

For more detailed information, see Application overview [→ 37].

Note

- For inputs X1, X2, or U1, one physical switch can be used for up to 20 thermostats (parallel connection).

Caution! Do not mix X1/X2 and U1.

- For sensors on inputs X1, X2, or U1, the maximum cable length is 80 m.

4.11 Handling system faults

Temperature out of range If the room temperature exceeds or drops below the measuring range, i.e. above 49 °C or below 0 °C, the limiting temperatures blink, e.g., 0 °C or 49 °C.
 In addition, the heating output is activated if the current setpoint is not set to Off, the thermostat is in heating mode and the temperature is below 0 °C.
 For all other cases, no output is activated.
 The thermostat resumes Comfort mode as soon as the temperature is within the measuring range.

Fault "Er1, Er2, Er3, Er4, Er5" on display

- If the built-in temperature or humidity sensor fails and no external temperature sensor is connected, fault message **Er1** is displayed on the thermostat. If EEPROM is damaged, fault message **Er2** is displayed on the thermostat. Replace the thermostat to measure the room temperature.
- If the external / remote temperature sensor fails and no external sensor is connected, if input X1/X2/U1 is configured as AI except room temp external sensor/return (AI), fault message **Er3, Er4 or Er5** is displayed on the thermostat. Check related sensor input terminals.

Fault	Thermostat	Fault information on bus	
	Display	Error code	Default fault text
Built-in sensor fails and no external sensor is connected	Er1	---	---
EEPROM is damaged	Er2	---	---
External / remote sensor error	Er3	101	[N.X1] sensor error
External / remote sensor error	Er4	102	[N.X2] sensor error
External / remote sensor error	Er5	103	[N.U1] sensor error



For fault status messages on the bus, see Fault and alarms function on KNX [→ 99].

4.12 KNX communications

RDG2..KN thermostats support communications as per KNX specifications.

S-Mode Standard mode; engineering via group addresses.
 LTE-Mode Logical Tag Extended mode, for easy engineering, is used together with Synco.

4.12.1 S-Mode

This mode corresponds to KNX communications.

Connections are established via ETS by assigning communication objects to group addresses.

4.12.2 LTE-Mode

LTE-Mode was specifically designed to simplify engineering. Unlike with S-Mode, individual connections (group addresses) need not be created in the tool. The devices autonomously establish connections.

Definitions

The following circumstances are predefined:

- Every device or subdevice is located within a zone
- Every data point (input or output) is assigned to a zone
- Every data point (input or output) has a precisely defined "name"

Whenever an output and an input with the same "name" are located in the same zone, a connection is established automatically, as shown in the following diagram.

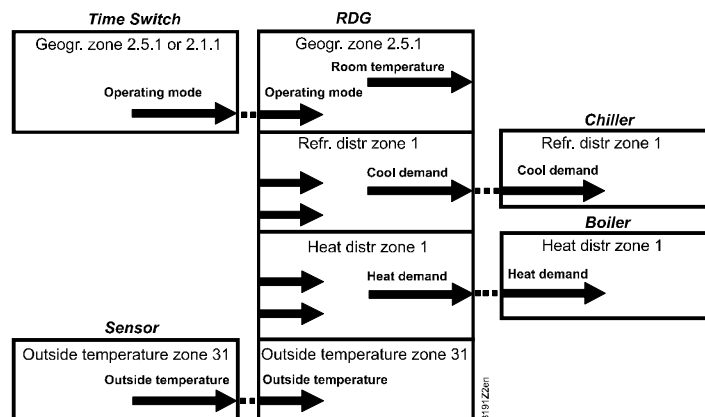

Engineering and commissioning

- For a detailed description of KNX (topology, bus supply, function and setting of LTE zones, filter tables, etc.), see "Communication via the KNX bus for Synco 700, 900 and RXB/RXL, Basic Documentation [→ 5]" [7]
- LTE-Mode data points and settings are described in the Synco Application Manual [→ 5] [14]
- To engineer and commission a specific system, use the Synco700 planning and commissioning protocol [→ 5] (XLS table in HIT, [8])

4.12.3 Zone addressing in LTE-Mode (with Synco)

Zone addresses must be allocated where RDG2..KN KNX room thermostats are used in LTE-Mode (e.g. in conjunction with Synco).

The following zone addresses must be defined together with the Synco devices at the planning stage based on application.

Short description	Factory setting	Parameter
Geographical zone (apartment)	-- (out of service)	P901
Geographical zone (room)	1	P902
Heat distr zone heating coil	-- (out of service)	P903
Refr distr zone cooling coil	-- (out of service)	P904
Heat distr zone heating surface	-- (out of service)	P905

Note

- "Subzone" of "Geographical zone" is fixed at 1 (not adjustable).
The device sends and receives LTE communication signals only, if the zone address is valid (not OSV = not out of service).
- Both geographical zones P901 and P902 cannot be set to same value on two devices simultaneously.

The zones are defined as follows:

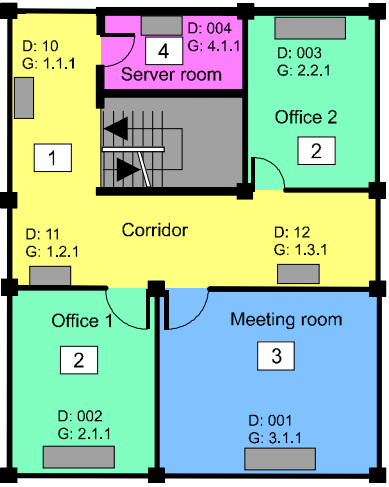
<p>Geographical zone (space zone) (Apartment . Room . Subzone) Apartment = ---, 1...126 Room = ---, 1...63 Subzone = fix 1</p>	<p>Zone where an RDG2..KN KNX room thermostat is physically located. Other room-specific devices may also be located in this zone.</p> <p>Information exchanged in this zone is related specifically to the device like operating mode, setpoints, room temperature, etc.</p> <p>The designations "Apartment", "Room" and "Subzone" are not necessarily literal. E.g., Apartment can be used to refer to a group of rooms, floor or section of a building. "Room", however, really does refer to a room.</p> <p>Subzone is not used for HVAC devices. It is more relevant to other disciplines, such as lighting. Subzone is fixed at "1" and not displayed.</p> <p>The schedule information is expected from the same zone where the thermostat is located (Residential).</p> <p>If no time switch information is received from the same zone, the thermostat uses the information received from the same apartment but with room "1" A.1.1 (Office).</p> <p>Example: Commercial building</p> <p>In a commercial building, the schedule information is sent by the RMB975 central control unit. The zones are divided into so called "Room groups" (e.g., 1...4), where each "Room group" can have an individual schedule. A room thermostat in the same "Room group" must have the same apartment address.</p> <p>Key: D = Device address (P900) G = Geographical zone (P901, P902) (Apartment.Room.Subzone)</p> 
<p>Heat distribution zone heating coil Zone = ---, 1...31</p>	<p>Information related specifically to the hot water system in heating coils is exchanged within this zone. The zone also includes a Synco device to process the information (e.g., RMH7xx or RMU7xx with changeover).</p>
<p>Heat distribution zone heating surface (radiator) Zone = ---, 1...31</p>	<p>Information related specifically to the hot water system of a radiator is exchanged within this zone (e.g., heating demand). This zone also includes a Synco device to process the information (e.g., RMH7xx or RMB795B).</p>
<p>Refrigeration distribution zone cooling coil Zone = ---, 1...31</p>	<p>Information related specifically to the chilled water system is exchanged within this zone (e.g., cooling demand). This zone also includes a Synco device to process the information (e.g., RMU7xx).</p>
<p>Outside temperature zone Zone</p>	<p>Outside temperature received in outside temperature zone 31 can be displayed on the room thermostat when commissioned accordingly (P009 = 2).</p>

4.12.4 Example of heating and cooling demand zones

The building is equipped with Synco controls on the generation side and RDF../RDG../RDG.. room thermostats on the room side.

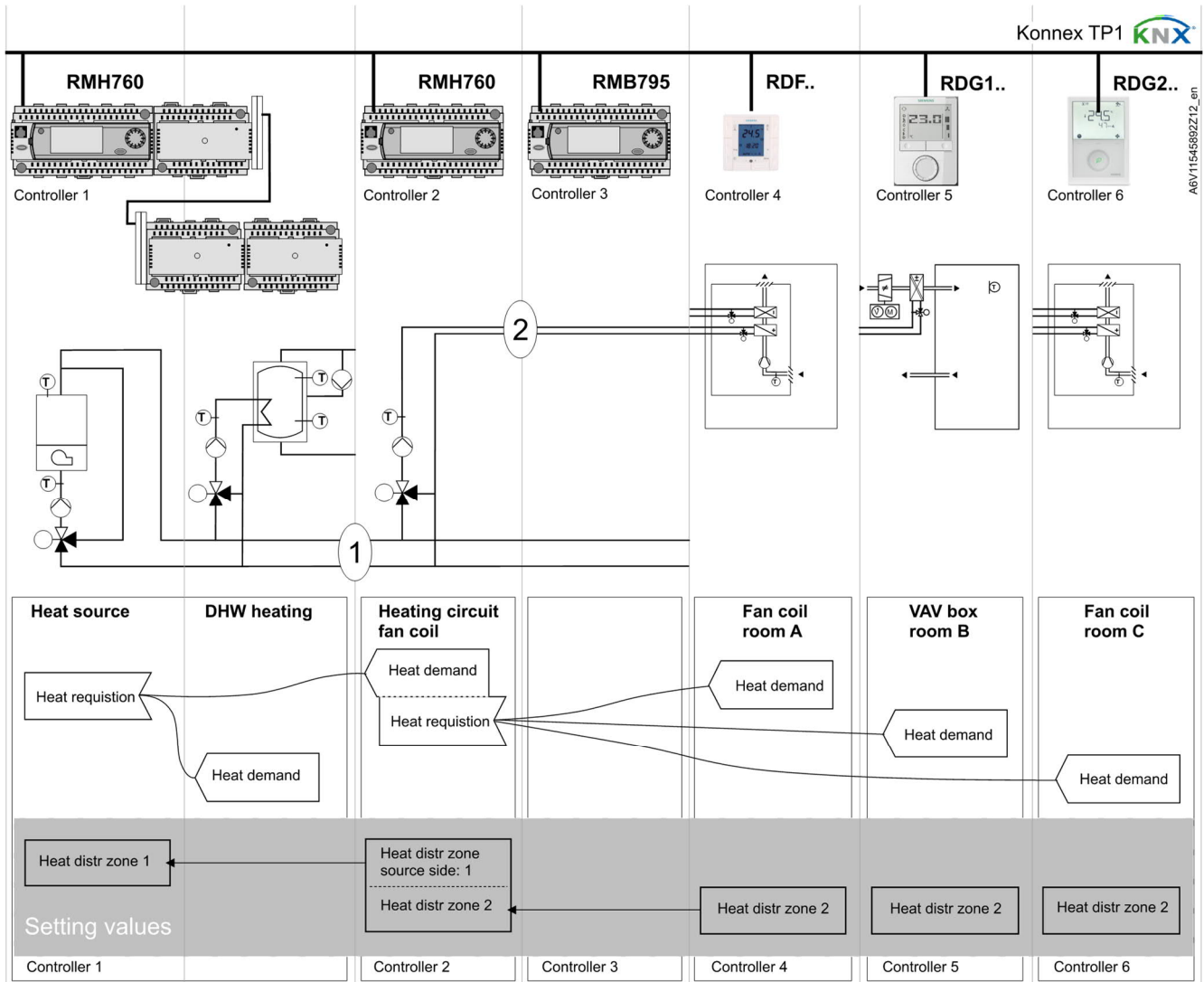

Explanation relating to the illustration

In the case of a typical application, the individual RDF../RDG.. room thermostats send their heat demand to the primary controller (in the above example to the RMH760).

(1) and (2) designate the numbers of the distribution zone.

Notes

- This type of application can also be applied to refrigeration distribution zones.
- If no 2-pipe fan coil unit is used, heat and refrigeration demand signals are sent simultaneously to the primary plant.

4.12.5 Send heartbeat and receive timeout

In a KNX network, S-Mode and LTE-Mode communication objects can be exchanged between individual devices. The "Receive timeout" defines the period of time within which all the communication objects requested from a device is received at least once. If a communication object is not received within this period, a predefined value is used.

Similarly, the "Send heartbeat" defines the period of time within which all the communication objects requested must be transmitted at least once.

LTE-Mode/S-Mode

Fixed times are specified as follows:

- Receive timeout: 31 minutes
- Send heartbeat: 15 minutes

Object [KNX obj. no.]	I/O	Minutes	Default value
Room operating mode: Time switch [13]	Receive	31	Comfort
Application mode [48]	Receive	31	Auto
Heating/Cooling mode status [46]	Receive	31	Heating

Reducing the bus load

Individual zones can also be disabled (out of service) via control parameter if they are not being used. In disabled zones, the LTE signal no longer sends periodically and therefore reduces bus load.

4.12.6 Startup

Startup response

The application is restarted after every reset, so that all the connected motorized valve actuators are synchronized (see Control outputs [→ 78]).

Startup delay

After a reset, it takes up to 5 minutes for all the connected room thermostats to restart. This is designed to avoid overloading the mains power supply when restarting. At the same time, it reduces the load on the KNX network, as not all thermostats transmit data at the same time. The delay ($T_{\text{WaitDevice}}$) is determined by the thermostat's device address. The device starts to send after the delay.

4.12.7 Heating and cooling demand



Heating output primary
 Heating output secondary
 Cooling output primary
 Cooling output secondary

Together with Synco, the heating and/or cooling demand from each room is transmitted to the BACS to provide the required heating or cooling energy.

An example for LTE-Mode is described in 3.11.4.

In S-Mode, the current state signals of the control outputs are available.

4.12.8 Fault and alarms function on KNX

A fault is sent on the bus in the event of a fault (e.g., digital fault input, dewpoint, communication configuration, etc.).

An RDG2..KN room thermostat monitors the bus and sends a fault, if the fault has the highest alarm priority. This ensures that the management station does not miss any alarms.

The alarm with the highest priority is displayed first and sent over the bus if alarms occur at the same time.

Fault transmission is different in LTE-Mode and S-Mode:



S-Mode	LTE-Mode
Fault state	Alarm info (error code + internal information)
Fault information (internal information)	Alarm text (default text can be edited with ACS tool)

The table below shows error codes and default alarm texts.

Priorities	Fault	Thermostat	Fault information on bus		
		Display	Error code	Default fault text	Text adjustable ¹⁾
-	No fault	---	0	No fault	✓
1	Bus power supply ²⁾	🔔 BUS	5000	No bus power supply	---
2	Device address error	🔔 Addr	6001	>1 id device address	---
3	Condensation	🔔 -💧 COND	4930	Condensation in the room	✓
4	External fault input X1	🔔 AL1	9001	Fault input 1	✓
5	External fault input X2	🔔 AL2	9002	Fault input 2	✓
6	External fault input U1	🔔 AL3	9003	Fault input 3	✓
7	Clean filter reminder	🔔 FIL	3911	Dirty filter	✓

¹⁾ Default alarm texts are stored in the thermostat's non-volatile memory and can be adjusted using the ACS commissioning tool.

²⁾ This error is not sent over the bus (because there is no bus, not enough bus power supply, bus is overloaded or bus signal is distorted).

Priority of alarms

- Priority order is #1...7
- External faults #4...6: If faults are active, the display shows **AL1, AL2, AL3**, alternating. Only the fault with the highest priority is sent over the bus.

A supervisor alarm system may command the thermostat to stop sending faults to the bus via the communication object "Fault transmission" (disable/enable).

This has no impact on the local display of faults.

After a timeout of 48 hours, the sending of faults is automatically enabled again.



4.13 Communication objects (S-Mode)

4.13.1 Overview



Object No. and name	Thermostat	Object No. and name
	RDG	
1 System time	➔	4 Fault information
2 Date	➔	➔ 5 Fault status (0 = Normal / 1 = Faulty)
3 Time of day	➔	
		➔ 8 Room operating mode: Preselection
6 Fault transmission (0 = Enable / 1 = Disable)	➔	
7 Room operating mode: Preselection (receive)	➔	➔ 17 Room operating mode: Status
9 Room operating mode: Preselection Auto	➔	➔ 18 Room operating mode: Comfort status
10 Room operating mode: Preselection Comfort	➔	➔ 19 Room operating mode: Economy status
11 Room operating mode: Preselection Economy	➔	➔ 20 Room operating mode: Protection status
12 Room operating mode: Preselection Protection	➔	
13 Room operating mode: Time switch	➔	➔ 27 Room temp: Comfort setpoint abs (send)
14 Room operating mode: Time switch Comfort	➔	➔ 28 Room temp: Current setpoint
15 Room operating mode: Time switch Economy	➔	➔ 31 Setpoint cool set (send)
16 Room operating mode: Time switch Protection	➔	➔ 32 Setpoint heat set (send)
		➔ 34 Room temperature: Comfort setpoint rel (send)
21 Room temp: [P19] Economy heating setpoint	➔	➔ 35 Extended comfort mode status
22 Room temp: [P20] Economy cooling setpoint	➔	➔ 37 Built-in room temperature value
23 Room operating mode: Window contact (0 = Close / 1 = Open)	➔	➔ 38 Frost alarm (0 = Normal / 1 = Alarm)
24 Room operating mode: Presence detector (0 = NotOccupied / 1 = Occupied)	➔	➔ 39 Heat alarm (0 = Normal / 1 = Alarm)
25 Room temp: Comfort basic setpoint	➔	➔ 40 X1: Temperature [°C]
26 Room temp: Comfort setpoint abs (receive)	➔	➔ 41 X1: Digital [0/1]
		➔ 42 X2: Temperature [°C]
29 Setpoint cool set (receive)	➔	➔ 43 X2: Digital [0/1]
30 Setpoint heat set (receive)	➔	➔ 44 U1: Temperature [°C]
33 Room temperature: Comfort setpoint rel (receive)	➔	➔ 45 U1: Digital [0/1]
36 External room temperature value	➔	➔ 47 Heating/Cooling mode status (send) (1 = Heating / 0 = Cooling)
46 Heating/Cooling mode status (receive) (1 = Heating / 0 = Cooling)	➔	➔ 51 Fan operation (0 = Auto / 1 = Manual)
48 Application mode	➔	➔ 53 Fan output
49 Dew point alarm (0 = Normal / 1 = Alarm)	➔	➔ 57 Fan speed 1 (0 = Off / 1 = On)
50 Enable fan command value (0 = Disable / 1 = Enable)	➔	➔ 58 Fan speed 2 (0 = Off / 1 = On)
		➔ 59 Fan speed 3 (0 = Off / 1 = On)
52 Fan command value	➔	
		➔ 61 Heating, control value continuous
54 Fan speed 1 (0 = Off / 1 = On)	➔	➔ 62 Heating, control value continuous, seq 2
55 Fan speed 2 (0 = Off / 1 = On)	➔	➔ 63 Cooling, control value continuous
56 Fan speed 3 (0 = Off / 1 = On)	➔	➔ 64 Cooling, control value continuous, seq 2
60 Outside temperature	➔	➔ 65 Heating, control value status (0 = Off / 1 = On)
		➔ 66 Heating, control value status seq 2 (0 = Off / 1 = On)
76 Enable electric heater (0 = Disable / 1 = Enable)	➔	➔ 67 Cooling, control value status (0 = Off / 1 = On)
		➔ 68 Cooling, control value status seq 2 (0 = Off / 1 = On)
78 External room relative humidity value [% r.h.]	➔	➔ 69 Heating and cooling, control value status (0 = Off / 1 = On)
79 Room rel. humidity: Setpoint high	➔	➔ 70 Heating and cooling, control value status seq2 (0 = Off / 1 = On)
80 Room rel. humidity: Setpoint low	➔	➔ 71 Heating and cooling, control value continuous
81 Reset the Energy efficiency status (Green leaf) (0 = No action / 1 = Reset)	➔	➔ 72 Heating and cooling, control value continuous seq 2
83 Enable or disable Leaf indication (0 = Enable / 1 = Disable)	➔	➔ 73 Control dehumidification (1 = On / 0 = Off)
84 Keypad: Lock fan speed	➔	➔ 74 Control humidification (1 = On / 0 = Off)
85 Keypad: Lock fan speed in "auto" mode	➔	➔ 75 Hum. Control mode (inactive/hum/dehum)
86 Keypad: Lock the setpoint shift	➔	
87 Keypad: Lock the operating mode	➔	➔ 77 Built-in room relative humidity value [%r.h.]
		➔ 82 Energy efficiency status / Green Leaf (0 = Green / 1 = Red)
➔ Input communication object		
➔ Output communication object		

4.13.2 Description of communication objects

Obj	Object name	Function	Type/ length	Flags
1	System time	Time and date	19.001 8 bytes	CWU
System time for display on the room thermostat. See P009 (3 or 4)				
2	Date	Date	11.001 3 bytes	CWU
Day, month and year for display on the room thermostat. See P009 (3 or 4)				
3	Time of day	Time of day	10.001 3 bytes	CWU
Another object for receiving the time of day for display on the room thermostat. See P009 (3 or 4)				
4	Fault information	Alarm Info	219.001 6 bytes	CT
Common alarm output. If an alarm occurs, the alarm number is transmitted.				
5	Fault status	Alarm	1.005 1 bit	CT
Common alarm output. If an alarm occurs, the alarm flag is set.				
6	Fault transmission	Enable Disable	1.003 1 bit	CWU
A supervisory alarm system can disable the broadcasting of alarms sent by the devices. This has no impact on the local display of alarms. After a timeout of 48 hours, the sending of faults is automatically enabled again.				
7	Room operating mode: Preselection (receive)	Auto Comfort PreComf. Economy Protection	20.102 1 byte	CWU
Controls the room operating mode selection of the thermostat via bus. The command can also be submitted as four 1-bit communication objects (9...12). The last interaction wins – either from local operating mode button or via bus. Note: The thermostat will transform Pre-Comfort either into Economy or Comfort (selectable via P910).				
8	Room operating mode: Preselection (send)	Auto Comfort Economy Protection	20.102 1 byte	CRT
Sends the room operating mode selection of the thermostat via bus. The command can also be submitted as four 1-bit communication objects (9...12). The last interaction wins – either from local operating mode button or via bus.				

Obj	Object name	Function	Type/ length	Flags
9 10 11 12	Room operating mode: Preselection - Auto - Comfort - Economy - Protection	Trigger	1.017 1 bit	CW
Switch room operating mode to either Auto, Comfort, Economy or Protection. The last interaction wins – either from the local operating mode button or via bus.				
13	Room operating mode: Time switch	Comfort PreComf. Economy Protection	20.102 1 byte	CWU
This information is provided by a central schedule or a supervisor and defines the actual HVAC operating mode. The command can also be submitted via three 1-bit communication objects (14...16). Protection has the highest priority and cannot be overridden. Note: The thermostat transforms Pre-Comfort either into Economy or Comfort (selectable via P910).				
14 15 16	Room operating mode: Time switch - Comfort - Economy - Protection	Trigger	1.017 1 bit	CW
Switch the HVAC mode to either Comfort, Economy or Protection mode.				
17	Room operating mode: Status	Comfort Economy Protection	20.102 1 byte	CRT
Actual room operating mode used by the thermostat (considering time switch, user selection, window contact, etc.) This state information is available via one 8-bit enumeration or three 1-bit communication objects (18...20).				
18 19 20	Room operating mode: - Comfort status - Economy status - Protection status	ON OFF	1.011 1 bit	CT
Corresponding communication object sends "True".				

Obj	Object name	Function	Type/length	Flags
21	Room temp: [P19] Economy heating setpoint	Temperature	9.001 2 bytes	CW
<p>Communication object adjusts the Economy heating setpoint used by the thermostat (see Setting and adjusting setpoints [→ 34]). It directly changes the value of the local parameter "Economy heating setpoint" P019.</p> <p>S-Mode object needs to be enabled by setting Room temperature: Economy Setpoint to as group object in ETS.</p> <p>The Economy heating setpoint is stored in EEPROM. The service life of the EEPROM depends on the number of write cycles. Never write this communication object cyclically.</p>				
22	Room temp: [P20] Economy cooling setpoint	Temperature	9.001 2 bytes	CW
<p>Communication object adjusts the Economy cooling setpoint used by the thermostat (see Setting and adjusting setpoints [→ 34]). It directly changes the value of the local parameter "Economy cooling setpoint" P020.</p> <p>S-Mode object needs to be enabled by setting Room temperature: Economy Setpoint to as group object in ETS.</p> <p>The Economy cooling setpoint is stored in EEPROM. The service life of the EEPROM depends on the number of write cycles. Never write this communication object cyclically.</p>				
23	Room operating mode: Window contact	Open Closed	1.019 1 bit	CWU
<p>The RDG2..KN operating mode is set to Protection if value "1" (open) is received and switches back to the previous mode for value "0" (closed). The "Window contact" is sent e.g. by a KNX switch and has the same effect as local window contact X1, X2 or U1 (P150, P153 or P155). Only one input source required either a local input X1/X2/U1 or KNX bus.</p>				
24	Room operating mode: Presence detector	Occupied Unoccupied	1.018 1 bit	CWU
<p>Standard presence: The thermostat is set to Comfort mode if value "1" (occupied) is received. It switches back to previous operating mode when the value is "0" (unoccupied).</p> <p>"Presence detector" is sent via KNX. It has the same effect as the local presence detector function on X1, X2, U1 (parameter P150, P153, P155).</p> <p>Only one input source must be used, either local input X1/X2/U1 or KNX bus.</p>				
25	Room temp: Comfort basic setpoint	Temperature	9.001 2 bytes	CWU
<p>If function "Temporary comfort setpoint" is enabled via P103, once operating mode is changed, the setpoint adjustments made by the user and via communication object 25 are dismissed. Then the thermostat is reset to the Comfort basic setpoint.</p> <p>Note: Setpoints that have been changed via the local HMI may be overwritten during a system startup from a central master controller, e.g., RMB795B.</p> <p>The Comfort basic setpoint is stored in EEPROM (see Setting and adjusting setpoints [→ 34]). → The service life of the EEPROM depends on the number of write cycles. Never write this communication object cyclically.</p>				

Obj	Object name	Function	Type/length	Flags
26	Room temp: Comfort setpoint abs (receive)	Temperature	9.001 2 bytes	CWU
<p>Communication object shifts the setpoint (absolute) used by the thermostat received via bus (see Setting and adjusting setpoints [→ 34]). The priority is same as local setpoint shift on the thermostat. The last selected option is always used.</p> <p>Note: The Comfort basic setpoint (object 25) will not be changed.</p>				
27	Room temp: Comfort setpoint abs (send)	Temperature	9.001 2 bytes	CRT
<p>Sends the current Comfort absolute setpoint value used in the RDG2..KN (see Setting and adjusting setpoints [→ 34]).</p>				
28	Room temp: Current setpoint	Temperature	9.001 2 bytes	CRT
<p>Current setpoint, including shift, compensation, etc., used by the thermostat for temperature control.</p>				
29 30	Setpoint cool set (receive) heat set (receive)	Temperature setpoint setting for 4 HVAC modes	275.100 8 bytes	CW
<p>Receive a set of all cool / heat setpoints for all modes. (Comfort, Pre-Comfort, Economy and Protection)</p> <p>Depending on selected application, the relevant setpoint of only heating / only cooling / heating and cooling will be stored accordingly.</p>				
31 32	Setpoint cool set (send) heat set (send)	Temperature setpoint setting for 4 HVAC modes	275.100 8 bytes	CR
<p>Send a set of cool / heat setpoints used in the device for all modes. (Comfort, Economy and Protection)</p> <p>Depending on selected application, the relevant setpoint of only heating / only cooling / heating and cooling will be sent accordingly.</p>				
33	Room temperature: Comfort setpoint rel (receive)	Temperature	9.002 2 bytes	CWU
<p>Communication object shifts the setpoint (relative) used by the thermostat (see Setting and adjusting setpoints [→ 34]). The priority is same as local setpoint shift on the thermostat. The last selected option is always used.</p> <p>Note: The Comfort basic setpoint (object 25) will not be changed.</p>				
34	Room temperature: Comfort setpoint rel (send)	Temperature	9.002 2 bytes	CRT
<p>Sends the current Comfort relative setpoint value used in the RDG2..KN (see Setting and adjusting setpoints [→ 34]).</p> <p>Note: The Comfort basic setpoint (object 25) will not be changed.</p>				

Obj	Object name	Function	Type/ length	Flags
35	Extended comfort mode status	ON OFF	1.011 1 bit	CRT
Indicates the status of Comfort mode extension.				
36	External room temperature value	Temperature	9.001 2 bytes	CWU
The thermostat receives and works with the room temperature from an external sensor.				
37	Built-in room temperature value	Temperature	9.001 2 bytes	CRT
The value of the room temperature measured via built-in sensor or external sensor is available on bus.				
38	Frost alarm	Normal Alarm	1.005 1 bit	CRT
Sends an alarm if the room temperature is below the frost alarm setting.				
39	Heat alarm	Normal Alarm	1.005 1 bit	CRT
Sends an alarm if the room temperature is above the heat alarm setting.				
40 42 44	X1: Temperature X2: Temperature U1: Temperature	Temperature	9.001 2 bytes	CRT
Indicate the values of the temperature sensors connected to the local inputs X1/X2/U1				
41 43 45	X1: Digital X2: Digital U1: Digital	ON OFF	1.001 1 bit	CRT
Indicate the status of the digital inputs (adjusted by P151/P154/P156) including considering of operating action				
46	Heating/Cooling changeover (receive)	Heating: 1 Cooling: 0	1.100 1 bit	CWU
Changeover information received via bus. Default: Current mode before power down. The same function is also available via local multifunctional input X1/X2/U1 (P150, P153, P155). Only one input source must be used, either local input X1/X2/U1 or KNX bus.				
47	Heating/Cooling mode status (send)	Heating: 1 Cooling: 0	1.100 1 bit	CRT
Sends the current heating or cooling mode of the thermostat.				

Obj	Object name	Function	Type/ length	Flags
48	Application mode	HVAC control mode	20.105 1 byte	CWU
0	Auto (default)	Heating and/or cooling		
1	Heat	Heating only		
2	Morning warmup*	Heating only		
3	Cool	Cooling only		
5	Precool*	Cooling only		
6	OFF	Neither heating nor cooling		
8	Emergency heat*	Heating only		
9	Fan only	Fan runs at high speed		
* Function handled like Heat (1) or Cool (3)				
49	Dew point alarm	Normal Alarm	1.005 1 bit	CWU
Indicates the status of dew point operation.				
50	Enable fan command value	Enable Disable	1.003 1 bit	CWU
Set fan mode to Auto (disable) or Manual (enable) by a KNX control unit. If Manual, the value received on Fan command value (52) will be used to command the fan speed. Default: Enable The last interaction wins – either from the local fan mode button or via bus.				
51	Fan operation	Auto Manual	1.001 1 bit	CRT
Indicates the status of the fan mode: Auto (0) or Manual (1).				
52	Fan speed value	0...100 %	5.001 1 byte	CWU
The fan can be set to a specified speed by a KNX control unit when manual fan operation is enabled.				
	Speed	Fan command value (physical KNX value)		
	1	1...33 % (1...85)		
	2	34...67 % (86...170)		
	3	68...100 % (171...255)		
Fan speed "0" is not supported by the thermostat and the fan speed will remain unchanged.				

Obj	Object name	Function	Type/length	Flags
53	Fan output	0...100 %	5.001 1 byte	CRT
Indicates the current fan speed as a value 0...100 %.				
	Speed	Fan output (physical KNX value)		
	OFF	0 % (0)		
	1	33 % (84)		
	2	66 % (186)		
	3	100 % (255)		
54 55 56	Fan speed 1 (receive) Fan speed 2 (receive) Fan speed 3 (receive)	Off On	1.001 1 bit	CWU
The fan can be set to a specified speed by a KNX control unit when manual fan operation is enabled.				
57 58 59	Fan speed 1 (send) Fan speed 2 (send) Fan speed 3 (send)	Off On	1.001 1 bit	CRT
Indicate the state of the relay outputs.				
60	Outside temperature	Temperature	9.001 2 bytes	CWU
The outside temperature measured by a KNX sensor can be displayed on the thermostat, if P009 "Additional display information" is set to 2 (outside temperature).				
61	Heating, control value continuous	0...100 %	5.001 1 byte	CRT
Indicates the position of the heating actuator of the first stage. E.g., 2-pipe with electric heater application: Output of heating coil.				
62	Heating, control value continuous, seq 2	0...100 %	5.001 1 byte	CRT
Indicates the position of the heating actuator of the second stage. E.g., 2-pipe with electric heater application: Output of the electric heater.				
63	Cooling, control value continuous	0...100 %	5.001 1 byte	CRT
Indicates the position of the cooling actuator of the first stage. E.g., 2-pipe with electric heater application: Output of the cooling coil.				
64	Cooling, control value continuous, seq 2	0...100 %	5.001 1 byte	CRT
Indicates the position of the cooling actuator of the second stage. E.g., 2-stage changeover application: Output of the second cooling stage.				

Obj	Object name	Function	Type/length	Flags
65	Heating, control value status	Off On	1.011 1 bit	CRT
Indicates the control status of heating actuator of the first stage				
66	Heating, control value status seq 2	Off On	1.011 1 bit	CRT
Indicates the control status of heating actuator of the second stage.				
67	Cooling, control value status	Off On	1.011 1 bit	CRT
Indicates the control status of cooling actuator of the first stage.				
68	Cooling, control value status seq 2	Off On	1.011 1 bit	CRT
Indicates the control status of cooling actuator of the second stage.				
69	Heating and cooling, control value status	Off On	1.011 1 bit	CRT
Indicates the control status of heating and cooling actuator of the first stage.				
70	Heating and cooling, control value status seq2	Off On	1.011 1 bit	CRT
Indicates the control status of heating and cooling actuator of the second stage.				
71	Heating and cooling, control value continuous	0...100 %	5.001 1 byte	CRT
Indicates the position of the heating and cooling actuator of the first stage.				
72	Heating and cooling, control value continuous seq 2	0...100 %	5.001 1 byte	CRT
Indicates the position of the heating and cooling actuator of the second stage.				
73	Control dehumidification	Off On	1.011 1 bit	CRT
Indicates the control status of the dehumidification.				
74	Control humidification	Off On	1.011 1 bit	CRT
Indicates the control status of the humidification.				

Obj	Object name	Function	Type/ length	Flags
75	Hum. Control mode	Inactive Humidification Dehumidification	20.115 1 byte	CRT
Indicates the mode of the humidity control function: 0 = inactive 1 = humidification; relative humidity lower than setpoint low P026 2 = dehumidification; relative humidity higher than setpoint high P024 3...255 = not used				
76	Enable electric heater	Enable/disable	1.003 1 bit	CWU
An electric heater can be disabled with this communication object (e.g., to meet tariff regulations). The same function is also available via local multifunctional input X1/X2/U1 (P150, P153, P155). Only one input source must be used, either local input X1/X2/U1 or KNX bus.				
77	Built-in room relative humidity value [%r.h.]	I/O	9.007 2 bytes	CRT
The value of the room humidity measured via built-in sensor is available on bus.				
78	External room relative humidity value [%r.h.]	I/O	9.007 2 bytes	CWU
The thermostat receives and works with the relative humidity value from an external sensor.				
79	Room rel. humidity: Setpoint high	I	9.007 2 bytes	CWU
Communication object adjusts the humidity setpoint high used by the thermostat. It changes the value of P024. S-Mode object must be enabled by setting " Humidity setpoints " to " as group object " in ETS. The humidity maximum setpoint is stored in EEPROM. The service life of the EEPROM depends on the number of write cycles. Never write this communication object cyclically.				
80	Room rel. humidity: Setpoint low	I	9.007 2 bytes	CWU
Communication object adjusts the humidity setpoint low used by the thermostat. It changes the value of P026. S-Mode object must be enabled by setting " Humidity setpoints " to " as group object " in ETS. The humidity minimum setpoint is stored in EEPROM. The service life of the EEPROM depends on the number of write cycles. Never write this communication object cyclically.				
81	Reset the Energy efficiency status (Green leaf)	No action Reset	1.017 1 bit	CWU
Resets the settings to green leaf.				
82	Energy efficiency status / Green Leaf	Green Red	1.006 1 bit	CRT
Indicates current status of green leaf.				

Obj	Object name	Function	Type/ length	Flags
83	Enable or disable Leaf indication	Enable Disable	1.003 1 bit	CWU
Enables or disables the leaf (green or red) indication.				
84	Keypad: Lock fan speed	Lock Unlock	1.002 1 bit	CWU
Locks or unlocks the fan operation keypad in current fan speed.				
85	Keypad: Lock fan speed in "auto" mode	Lock Unlock	1.002 1 bit	CWU
Locks or unlocks the fan operation keypad in "auto" speed.				
86	Keypad: Lock the setpoint shift	Lock Unlock	1.002 1 bit	CWU
Locks or unlocks the setpoint shift keypad.				
87	Keypad: Lock the operating mode	Lock Unlock	1.002 1 bit	CWU
Locks or unlocks the operating mode keypad.				

4.14 Communication objects (LTE-Mode)

			RDG		
			Geographical zone A.R.S		
Room operating mode: Time switch		➔	(Time switch zone) X.1.1/X.Y.1		
Application mode		➔	-----		
Room operating mode: Preselection		➔	Geographical zone A.R.S X.Y.1		
				↔	Room temperature
Comfort setpoint		➔		↔	Room humidity [% r.h.]
Setpoint heating		➔			
Setpoint cooling		➔			
Fan speed		➔			
Setpoint shift heating Setpoint shift cooling		➔			
		➔			
			Heat distr. zone	➔	Heating coil energy demand
	}	➔	heating coil		
Heating/cooling changeover			Ref. distr. zone		
		➔	Cooling coil	➔	Cooling coil energy demand
			Heating distr. zone		
			Heating surface	➔	Energy demand heating surface
			Broadcast		
Fault transmission		➔		➔	Fault information
				➔	Fault text
			Outside air temp. zone		
Outside temperature		➔	Fixed at 31		

4.15 Control parameters

To optimize control performance, a number of control parameters can be readjusted on the thermostat via HMI, commissioning/operating tool, or Siemens smartphone application PCT Go for Android. These parameters can also be set during operation without opening the unit.

In the event of a power failure, all control parameter settings are retained.

The control parameters are assigned to 2 levels:

- Service level, and
- Expert level, including communications, diagnostics and test

The Service level contains a small set of parameters to set up the thermostat for the HVAC system and to adjust the user interface. These parameters can be adjusted any time.

The parameters at the Expert level need careful configuration because they impact the thermostat's control performance and functionality.

4.15.1 Parameter setting via local HMI

Enter only Service level

1. Press both left and right buttons simultaneously for 3 seconds or until the device beeps if the buzzer is enabled (P030). Release and within 0.5...4 seconds, press the right button again until **P001** is displayed. Continue with step 2.

Enter Expert level with Diagnostics and test

1. Press both left and right buttons simultaneously for 3 seconds or until the device beeps if the buzzer is enabled (P030). Release and within 0.5...4 seconds, press the left button again until the temperature display disappears. Turn the rotary knob counterclockwise minimum ½ rotation. **P050** displays. Continue with step 2.



Adjust parameters

2. Select the required parameter by turning the rotary knob.
3. Press ✓ (OK); the current value of the selected parameter begins to flash and can be changed by turning the rotary knob.
4. Press ✓ (OK) to confirm the adjusted value or press button ↵ (Esc) to cancel the change.
5. If you want to adjust additional parameters, repeat steps 2...4.
6. Press button ↵ (Esc) to exit parameter setting mode.

Reset parameters

The factory setting for the control parameters can be reloaded via P505, by changing the value to On. Confirm the change by pressing the right button. **8888** is then displayed during reloading and device restarts 4 s later.

Note:

If password protection (needs to be done by HVAC installer) is enabled, users must enter the password to open parameter setting mode. If the password is mistyped 5 times, the thermostat is locked and the password cannot be entered for 5 minutes. Symbols  and  are displayed.

4.15.2 Setting/downloading parameter via tool

The control parameters can be adjusted via bus either by parameter download during commissioning or during normal operation with a tool like ACS.



ACS

With the ACS tool, the parameters can be changed...

- During commissioning via parameter download (all parameters)
- During operation via Popcard (most parameters)

OZW772 Web server

Most parameters can be changed during operations using the OZW772 web server.



ETS

ETS is an engineering tool used to fully commission RDG2..KN KNX room thermostats. Device address, application, and control parameters can be defined and downloaded via ETS.

Note: If users abort operation during commissioning, full commissioning cannot be restarted until the device reboots. Before rebooting, only the application can be downloaded.

Connecting a KNX tool

Connecting a KNX commissioning/operating tool to the RDG2..KN is described in Commissioning.

4.15.3 Commissioning parameter via Smartphone app PCT Go

The Siemens smartphone application Product Commissioning Tool (PCT Go) for Android is a commissioning tool to:

- Read and write thermostat parameters
- Set the application (e.g. 2-pipe)
- Change settings (e.g. setpoints)
- Set KNX addressing (device address)

Quickly setting the devices is useful, if e.g.:

- System and system commissioning tools are not available.
- Function and wiring test need to be carried out.
- The thermostats are used standalone.

When set locally with the PCT Go app, the device can be reset using the system tools and reconfigured as needed.

PCT Go is available for Android phones (version 8 or higher) compatible with NFC. It can be downloaded from Google Play store.

PCT Go uses NFC (Near Field Communication) while the device is either powered, or unpowered, even from the individual package.

To read or write settings, the smartphone must have NFC embedded and activated, and the phone must be held close to the NFC antenna (in the thermostat) at a distance up to ± 2 cm.

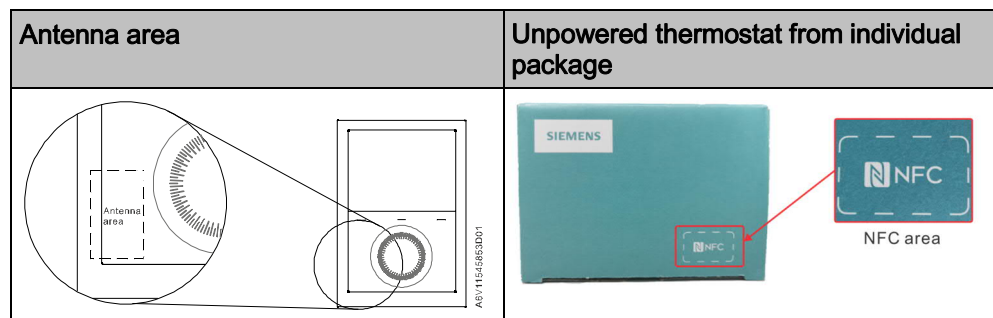

DIP switch settings take priority:

- If all DIP switches are set to Off (default), PCT Go can be used to change the application (e.g. 2-pipe)
- If an application is set via DIP switches, PCT Go cannot change it.

Change settings while the device is powered and running:

- Application settings require a device reboot.
- Settings such as setpoint and HMI tuning take effect a few seconds later.

Change settings while the device is unpowered:

- Current thermostat settings can be read and written any time while unpowered
- The thermostat needs to be powered via to store the new settings and ensure they are correct.

Notes

- Each time the application is changed, the thermostat reloads the factory setting for all control parameters, except KNX device and zone addresses.

Security

- The thermostat setting access can be password protected (P502). PCT Go requires that the password be read and write-protected. If the password is mistyped 5 times, the thermostat is locked, and the password cannot be entered for 5 minutes.
- Commissioning using PCT Go for Android can be disabled via parameters to avoid unexpected changes of the thermostat (P500).

4.15.4 Service level parameters

Parameter	Name	Factory setting	Range	RDG200KN	RDG260KN	Dependencies
	Service level					
P001	Control sequence ¹⁾	2-pipe: 1 = Cooling only 4-pipe: 4 = Heating and cooling	0 = Heating only 1 = Cooling only 2 = H/C changeover auto 3 = H/C changeover manual 4 = Heating and cooling	✓	✓	P002
P002	Operation via room operating mode selector ¹⁾	1	1 = Auto (Comfort) – Protection 2 = Auto - Comfort - Economy - Protection 3 = Auto (Comfort) - Protection Hospitality	✓	✓	P001
P003	Operation via fan operating selector ²⁾	0	0 = Auto - Manual 1 = Manual 2 = Auto - Manual - Protection 3 = Auto – Protection	✓	✓	P350
P004	Unit	0	0 = °C (parameter in °C) 1 = °F (parameter in °F)	✓	✓	–
P006	Measured value correction	0 K	–5...5 K	✓	✓	–
P007	Humidity value correction	0	–10...0...10 %	✓	✓	–
P008	Standard display	0	0 = Room temperature 1 = Setpoint	✓	✓	–
P009	Additional display information	0	0 = --- (No display) 1 = °C and °F 2 = Outside temperature (via bus) 3 = Time of day (12 h) (via bus) 4 = Time of day (24 h) (via bus) 5 = Humidity	✓	✓	–
P010	Setpoint concept	1	1 = Comfort concept 2 = Energy saving concept	✓	✓	P104
P011	Comfort basic setpoint	21 °C (70 °F)	5...40 °C (41...104 °F)	✓	✓	–
P013	Comfort setpoint minimum	5 °C (41 °F)	(P010 = 1): 5 °C (41 °F)...P016-1 K (P010 = 2): 5 °C (41 °F)...P014-1 K	✓	✓	P010
P014	Comfort setpoint maximum heating	21 °C (70 °F)	P013+1 K...P015-1 K	✓	✓	P010
P015	Comfort setpoint minimum cooling	25 °C (77 °F)	P014+1 K...P016 -1 K	✓	✓	P010
P016	Comfort setpoint maximum	35 °C (95 °F)	(P010 = 1): P013 +1 K...40 °C (104 °F) (P010 = 2): P015 +1 K...40 °C (104 °F)	✓	✓	P010
P019	Economy heating setpoint	15 °C (59 °F)	OFF (0), 5 °C...P020 (41 °F...P020) P020 = 40 °C max. (P020 = 104 °F max.)	✓	✓	–
P020	Economy cooling setpoint	30 °C (86 °F)	OFF (0), P019...40 °C (P019...104 °F) P019 = 5 °C min. (P019 = 41 °F min.)	✓	✓	–
P024	Humidity setpoint high	50	OFF (0), P026 or 20...90 %	✓	✓	P450

Parameter	Name	Factory setting	Range	RDG200KN	RDG260KN	Dependencies
	Service level					
P026	Humidity setpoint low	OFF	OFF (0), 20...90 % or P024	✓	✓	P450
P027 ³⁾	Electric heater when cooling	ON	ON: Enabled OFF: Disabled	✓	✓	Appl
P028	Keypad	0	0 = Unlocked 1 = Auto lock 2 = Manual lock 3 = Lock the operating mode 4 = Lock the Setpoint shift 5 = Lock fan speed 6 = Lock operating mode and setpoint shift 7 = Lock operating mode and fan speed 8 = Lock setpoint shift and fan speed	✓	✓	–
P029	Fan: Dead zone Comfort mode ²⁾	0	0 = Fan disable 1 = Low speed (Heat and Cool) 2 = Low speed (Cooling only) 3 = Fan disable Auto & Manual 4 = Low speed (Heat and Cool) Auto & Manual 5 = Low speed (Cooling only) Auto & Manual	✓	✓	P350
P030	Buzzer function	ON	ON = Enabled OFF = Disabled	✓	✓	–
P031	Language	1	1 = English 2 = French 3 = German 4 = Italian 5 = Spanish 6 = Dutch 7 = Turkish 8 = Czech 9 = Finnish 10 = Polish 11 = Hungarian 12 = Slovak 13 = Romanian 14 = Danish 15 = Norwegian	✓	✓	–

Note: Parameter display depends on selected application and function. Appl means application.

¹⁾ P001 cannot be set to 3 if P002 is set to 3, and vice versa.

²⁾ If P350 = 0, P003 is disabled. P029 is invisible.

³⁾ Only available when application is 2-pipe with electric heater

4.15.5 Expert level parameters with diagnostics and test

Parameter	Name	Factory setting	Range	RDG200KN	RDG260KN	Dependencies
	Expert level					
Control settings						
P050	Heat P-band Xp	2 K	0.5...6 K	✓	✓	–
P051	Switching differential heating	1 K	0.5...6 K	✓	✓	–
P052	Cool P-band Xp					
P053	Switching differential cooling					
P054	Radiator P-band Xp/switching differential	2 K	0.5...6 K	✓	✓	–
P055	Dead zone Comfort mode	2 K	0.5...5 K	✓	✓	–
P056	Setpoint differential	2 K	0.5...5 K	✓	✓	–
P057 ¹⁾	Integral action time Tn for heating	45 min	0...120 min	✓	✓	P201, P203, P204
P058 ¹⁾	Integral action time Tn for cooling					
P059 ²⁾	H/C changeover switching point cooling	16 °C (61 °F)	5 °C...P060-2 K (41 °F...P060-2 K)	✓	✓	P001, P150, P153, P155
P060 ²⁾	H/C changeover switching point heating	28 °C (82 °F)	P059+2 K...40 °C (P059+2 K...104 °F)	✓	✓	P001, P150, P153, P155
P063	Minimum supply air temperature	OFF	OFF, 0 °C...P064 (32 °F...P064)	✓	✓	P150, P153, P155
P064	Maximum supply air temperature	OFF	OFF, P063...50 °C (P063...122 °F)	✓	✓	P150, P153, P155
Mode and setpoints						
P100	Protection heating setpoint	8 °C (46 °F)	OFF, 5 °C...P101; (41 °F...P101)	✓	✓	–
P101	Protection cooling setpoint	OFF	OFF, P100...40 °C; (P100...104 °F)	✓	✓	–
P102 ³⁾	Temporary Comfort mode	OFF	OFF, 1...360 min	✓	✓	P002
P103	Temporary Comfort setpoint	OFF	0 = Disabled (OFF) 1 = Enabled (ON) 2 = Enabled (ON), excluded Window contact 3 = Enabled (ON), excluded presence detector (include hotel presence)	✓	✓	–
P104	Setpoint display	1	1 = Absolute setpoints 2 = Relative setpoints	✓	✓	–
P110	Energy indicator	1	OFF = Disabled 1 = Green and Red dimmed out 2 = Green dimmed out / Red fixed 3 = Green and Red fixed	✓	✓	–
P111	Energy indicator range	2 K	0...10 K	✓	✓	–

Parameter	Name	Factory setting	Range	RDG200KN	RDG260KN	Dependencies
	Expert level					
Inputs						
P150	Input X1	P150:1	0 = --- (no function)	✓	✓	P153: P150, P155 P155: P150, P153
P153	Input X2	P153: 0	1 = Room temp ext. sensor / return (AI)			
P155	Input U1	P155: 3	2 = H/C changeover (AI/DI)			
			3 = Window contact [PROT] (DI)			
			4 = Dewpoint sensor (DI)			
			5 = Enable electric heater (DI)			
			6 = Fault input (DI)			
			7 = Monitor input (Digital)(DI)			
			8 = Monitor input (Temp) (AI)			
			9 = Supply air sensor (AI)			
			10 = Presence detector / card reader (DI)			
			11 = External temperature limit (AI)			
			12 = Coil temperature (AI)			
			13 = Hotel presence detector / card reader (DI)			
P151	Normal position and sensor input X1	0 when DI or AI/DI	0 = Normally Open	✓	✓	P151: P150 P154: P153 P156: P155
P154	Normal position and sensor input X2	2 when AI	1 = Normally Close			
P156	Normal position and sensor input U1		2 = NTC-3K			
			3 = LG-Ni1000			
Outputs						
P200 ⁴⁾	Number of heating / cooling sequences Note: for 2-/4-pipe 2-stage application	1	1 = 2 sequence heating, 2 sequence cooling	✓	✓	d01
			2 = 2 sequence heating, 1 sequence cooling			
			3 = 1 sequence heating, 2 sequence cooling			
P201	RDG20xKN: Output Y1 (and Y3 for 3-pos) RDG26xKN: Output Y10 (DC) or Q1 (2-pos)	RDG200KN: 4	1 = 3-position	✓	–	–
		RDG260KN: 5 (6 when application type is 4-pipe with 6-port ball valve)	2 = On/Off 3 wires	✓	–	–
			3 = PWM	✓	–	–
			4 = On/Off	✓	✓	–
			5 = DC	–	✓	–
			6 = 6-port valve (DC 0... 10 V)	–	✓	Appl
			7 = 6-port valve (DC 2... 10 V)	–	✓	Appl
			8 = Inverse signal, 6-port valve (DC 10...0 V)	–	✓	Appl
P203	RDG20xKN: Output Y2 (and Y4 for 3-pos) RDG26xKN: Output Y20 (DC) or Q2 (2-pos)	RDG200KN: 4	1 = 3-position	✓	–	–
		RDG260KN: 5	2 = On/Off 3 wires	✓	–	–
			3 = PWM	✓	–	–
			4 = On/Off	✓	✓	–
			5 = DC	–	✓	–
P204	RDG20xKN: Output Y3 RDG26xKN: Output Y30 (DC)	RDG200KN: 4	3 = PWM	✓	–	–
		RDG260KN: 5	4 = On/Off	✓	✓	–
			5 = DC	–	✓	–

Parameter	Name	Factory setting	Range	RDG200KN	RDG260KN	Dependencies
	Expert level					
P206 ⁵⁾	PWM algorithm cycle Y1	1200 s	20...3600 s	✓	–	P206: P201 P207: P203 P208: P204
P207 ⁵⁾	PWM algorithm cycle Y2					
P208 ⁵⁾	PWM algorithm cycle Y3					
P210	On time minimum PWM output	5 %	1...20 %	✓	–	–
P211	Off time minimum PWM output					
P212	On time minimum 2-pos output	1 min	1...20 min	✓	✓	–
P213	Off time minimum 2-pos output					
P214 ⁶⁾	RDG20xKN: Actuator running time Y1 and Y3 for 3-pos	150 s	20...300 s	✓	–	P214: P201 P215: P203
P215 ⁶⁾	RDG20xKN: Actuator running time Y2 and Y4 for 3-pos					
P217	RDG26xKN: Power of electric heater on Q2	0 kW	0.0...1.2 kW	✓	✓	–
Features						
P250	Valve kick	OFF	ON = Enabled OFF = Disabled	✓	✓	–
P251 ⁷⁾	Purge time (every 2 hours)	OFF	OFF(0, Not active), 1...5 min	✓	✓	–
P252 ⁸⁾	Flow temp limit floor heating	28 °C (82 °F)	10...50 °C (50...122 °F)	✓	✓	–
P254 ⁴⁾	Swap sequences between H and C (2-pipe / 2-stage)	OFF	ON = Enabled OFF = Disabled	✓	✓	–
P255	Track setpoint for cooling depend on outside temperature	OFF	ON = Enabled OFF = Disabled	✓	✓	–
P256	Flow limitation in heating mode for PICV (Y10 only)	10 V	0...10 V	✓	✓	–
Fan control						
P350	Fan control	1	0 = Disabled 1 = Enabled 2 = Heating only 3 = Cooling only 4 = 2 nd stage 5 = Heating and 2 nd stage cooling 6 = Cooling and 2 nd stage heating 7 = 2 nd stage Cooling only 8 = 2 nd stage Heating only	✓	✓	–
P351	Fan speeds	3	1 = 1-speed fan 2 = 3-speed fan 3 = DC 0...10 V fan	✓	✓	P350
P352	Fan overrun time	60 s	0...360 s	✓	✓	–
P353	Fan speed switching point low	10 %	1 %...Fan speed 2 (P354)	✓	✓	P350
P354	Fan speed switching point med	65 %	Fan speed 1 (P353)...fan speed 3 (P355)	✓	✓	P350
P355	Fan speed switching point high	100 %	Fan speed 2 (P354)...100 %	✓	✓	P350, P351
P356	DC fan switching point	DC: 10 %	DC: 1...100 %	✓	✓	P350
P357	DC fan speed low min. output	DC: 30 %	DC: 1 %...Fan speed med (P358)	✓	✓	P350
P358	DC fan speed med output	DC: 60 %	DC: fan speed low (P357)...fan speed high(lower value of P359 and P360)	✓	✓	P350
P359	DC fan speed high max. out. heat	DC: 80 %	DC: fan speed med (P358)...100 %	✓	✓	P350
P360	DC fan speed high max. out.cool					
P361	Fan start kick	ON	ON: Enabled OFF: Disabled	✓	✓	P350
P362	On time minimum fan	2 min	1...6 min	✓	✓	P350
P363	Periodic fan kick Comfort	OFF	1...89 min, OFF	✓	✓	P350
P364	Periodic fan kick Economy	OFF	0...359 min, OFF	✓	✓	P350

Parameter	Name	Factory setting	Range	RDG200KN	RDG260KN	Dependencies
	Expert level					
P365	Fan start delay	0 s	0...360 s	✓	✓	P350
P366	Fan start, minimum hot water temperature	30 °C	OFF,5...60 °C	✓	✓	P350 Input
Relay functions						
P400 ⁹⁾	Output Q1 function	0	0 = No function 1 = Switch OFF in Protection 2 = Switch ON in Heat/Cool demand 3 = Switch ON in Heat demand 4 = Switch ON in Cool demand 5 = Heating sequence active 6 = Cooling sequence active 7 = External dehumidifier control 8 = External humidifier control	✓	✓	P350, P351
P401 ⁹⁾	Output Q2 function					
P402	Output Q3 function					
Controller						
P450	Control strategy	0	0 = Temperature (T) 1 = Temperature (T) + Relative humidity (r.h.)	✓	✓	–
P451	Humidity control strategy	2	1 = With setpoint shift 2 = With setpoint shift + external equipment (humid / dehum)	✓	✓	–
P461	T setpoint shift (humidity)	3 K	-3...3 K	✓	✓	–
Side Features						
P500	NFC	ON	ON = Enabled OFF = Disabled	✓	✓	–
P501	Service filter	OFF	OFF, 100...9900 h	✓	✓	P350
P502	Password	OFF	ON = Enabled OFF = Disabled	✓	✓	–
P503	Password	000	000...999	✓	✓	–
P505	Restore factory setting	OFF	OFF = Disabled ON = Reload start	✓	✓	–
System						
P900	Device address 3)	255	1...255	✓	✓	–
P901	Geographical zone (apartment) 4)	---	---(0), 1...126	✓	✓	–
P902	Geographical zone (room) 3)	1	---(0), 1...63	✓	✓	–
P903	Heat distr zone heating coil	---	---(0), 1...31	✓	✓	–
P904	Refrig distr zone cooling coil					
P905	Heat distr zone heating surface					
P910	Transformation Precomfort	0	0 = Economy 1 = Comfort	✓	✓	–

Note: Parameter display depends on selected application and function. Appl means application.

- 1) When P201/P203 = 1/3/5, P204 = 3/5, P057 & P058 are visible.
- 2) When P150, P153 or P155 = 2 and P001 = 2, P059 & P060 are visible.
- 3) When P002 ≠ 2, P102 is visible.
- 4) Only available for application 2-pipe/2-stage.
- 5) When P201 = 3, P206 is visible; P203 = 3, P207 is visible; P204 = 3, P208 is visible.
- 6) When P201 = 1, P214 is visible; P203 = 1, P215 is visible.
- 7) When "H/C changeover" function on X1, X2, U1 is selected, P251 is visible.
- 8) When "External temperature limit (AI)" on X1, X2, U1 is selected, P252 is visible.
- 9) When application is 4-pipe with 6-port ball valve as changeover and PICV, P400 & P401 are invisible.

Diagnostics and test

Parameter	Name	Range	Dependencies
	Diagnostics and test		
d01	Application number	0 = (No application) 1 = 2-pipe 2 = 2-pipe with electric heater 3 = 2-pipe with radiator 4 = 4-pipe 5 = 2-stage heating or cooling (2-pipe) 6 = 4-pipe with electric heater 7 = 2-stage heating and cooling (4-pipe) 8 = 4-pipe:6-port H/C (no fan) 9 = 4-pipe:6-port CO +PICV	–
d02	X1 state	"--" = Function not selected 0 = Not activated (for DI) 1 = Activated (DI) 0...49 °C = Current temp. value (for AI) 00 ❄️ = H/C Input shorted 100 🌀 = H/C Input open	–
d03	X2 state	"--" = Function not selected 0 = Not activated (for DI) 1 = Activated (DI) 0...49 °C = Current temp. value (for AI) 00 ❄️ = H/C Input shorted 100 🌀 = H/C Input open	–
d04	U1 state	"--" = Function not selected 0 = Not activated (for DI) 1 = Activated (DI) 2 = Activated (DC input) 3 = Activated (DC output) 0...49 °C = Current temp. value (for AI) 00 ❄️ = H/C Input shorted 100 🌀 = H/C Input open	–
d05 ¹⁾	Test mode for checking the Y1/Y3 actuator's running direction 5)	"--" = No signal on outputs Y1 and Y3 OPE = Output Y1 forced opening CLO = Output Y3 forced closing	–
d06 ¹⁾	Test mode for checking the Y2/Y4 actuator's running direction 5)	"--" = No signal on outputs Y2 and Y4 OPE = Output Y2 forced opening CLO = Output Y4 forced closing	–
d08	Test mode for checking the Q1 output (ex P400 function)	"--" = no signal at output Q1 OPE = output Q1 forced opening CLO = output Q1 forced closing	–
d09	Test mode for checking the Q2 output (ex P401 function)	"--" = no signal at output Q2 OPE = output Q2 forced opening CLO = output Q2 forced closing	–
d10	Test mode for checking the Q3 output (ex P403 function)	"--" = no signal at output Q3 OPE = output Q3 forced opening CLO = output Q3 forced closing	–
d14	Software version	Ux.xx is displayed	–
d15	Unit ID number (Serial number)	Unit ID is displayed (Serial number)	–

Note: Parameter display depends on selected application and function.

¹⁾ When output type is 3-position/3-wire, d05 and d06 are visible.

5 Supported KNX tools

5.1 ETS



ETS

ETS is an engineering tool to fully commission RDG2..KN room thermostats.

ETS can implement the following functions:

- Define and download the physical address
- Define and download the application (plant type, control sequence)
- Set up and download thermostat control parameters
- Set up and download group addresses

This document does not describe how to operate ETS and set up a device. Refer to the KNX Manual [5] [→ 5] for more details.

ETS can be updated online.



Note!

5.1.1 Setting parameters in ETS

- 1 Open the project in ETS and select a device.
- 2 Click the **Parameters** tab, and adjust the control parameters as follows:

--- RDG200KN Room Thermostat > Device		
Basic Configuration	[P002] Operation via room op selector	Auto - Comfort - Economy - Protection
Device	[P003] Operation via fan op selector	Auto - Manual
Room Operating Mode	[P004] Unit	<input checked="" type="radio"/> Degrees Celsius <input type="radio"/> Degrees Fahrenheit
Room Temperature and Setpoi...	[P008] Standard display	<input checked="" type="radio"/> Room temperature <input type="radio"/> Setpoint
Room Relative Humidity	[P009] Additional display information	Rel. humidity (%)
Controller	[P028] Button lock	Unlocked
Alarm	[P030] Buzzer function	<input type="radio"/> Disabled <input checked="" type="radio"/> Enabled
Inputs	[P031] HMI language	English
Outputs	[P500] Enable or disable NFC communication	<input type="radio"/> Disabled <input checked="" type="radio"/> Enabled
Fan	[P502] Password protection	<input checked="" type="radio"/> Disabled <input type="radio"/> Enabled

Group Objects Parameter

3 Plant type (application), Control Sequence and other control parameters ([Pxx] description) can be downloaded.

--- RDG200KN Room Thermostat > Basic Configuration

Basic Configuration	[DIP] Plant type	4-pipe
Device	[P001] Control Sequence	<input type="radio"/> H/C changeover manual <input checked="" type="radio"/> Heating and cooling
Room Operating Mode	[P450] Control strategy	<input type="radio"/> Temperature (T) <input checked="" type="radio"/> Temperature (T) + relative humidity (T+ r.H)
Room Temperature and Setpoi...		
Room Relative Humidity		
Controller		
Alarm		
Inputs		
Outputs		
Fan		

Group Objects Parameter

For more details on control parameters, see Control parameters [→ 108].

Notes

- ETS version 4 or higher is used to assign communication objects to group addresses (S-Mode)
- ETS version 4 or higher is used to download the application and parameters

Humidity parameters

- 1 Select **Room relative humidity** in the left pane to display humidity parameters.
- 2 Adjust the parameters as needed. See Control parameters [→ 108] for more details on control parameters.

--- RDG200KN Room Thermostat > Room Relative Humidity

Basic Configuration	Room relative humidity	<input checked="" type="radio"/> Send <input type="radio"/> Receive
Device	Humidity setpoints	<input type="radio"/> As parameters only <input checked="" type="radio"/> As group object
Room Operating Mode	[P451] Humidity control strategy	<input type="radio"/> With setpoint shift <input checked="" type="radio"/> With setpoint shift + external equipment (humi...
Room Temperature and Setpoi...	[P461] Max. shift temp setpoint (dehumid.) [K]	3.0 K
Room Relative Humidity		

- 3 Select **as group object** in checkbox **Humidity setpoints**, to display the S-Mode humidity setpoint in the **Group Objects** tab as follows:

79	Room rel. humidity: [P024]Setpoint high	Receive	2 bytes
80	Room rel. humidity: [P026]Setpoint low	Receive	2 bytes

- 4 Select **Receive** in checkbox **Room relative humidity**. The thermostat then receives the room's relative humidity from an external sensor.

--- RDG200KN Room Thermostat > Room Relative Humidity

Basic Configuration	Room relative humidity	<input type="radio"/> Send <input checked="" type="radio"/> Receive
Device	Humidity setpoints	<input type="radio"/> As parameters only <input checked="" type="radio"/> As group object
Room Operating Mode	[P451] Humidity control strategy	<input type="radio"/> With setpoint shift <input checked="" type="radio"/> With setpoint shift + external equipment (humi...
Room Temperature and Setpoi...	[P461] Max. shift temp setpoint (dehumid.) [K]	3.0 K
Room Relative Humidity		

5.2 ACS tool



ACS

The ACS tool is used to commission the RDG2..KNX KNX room thermostats (physical address, application, parameters). They can be operated or monitored by bus during normal operation.

This section does not describe how to define the physical address and only provides a brief overview of ACS main function.

For more information, refer to the ACS online help.

Setting RDG2..KNX KNX parameters is only supported by ACS version 13.03 or higher.



Note!

5.2.1 Setting parameters in ACS

In the ACS program, select **Plant** → **Open** to open the plant.

To open the parameter settings, select **Applications** → **Plant engineering**.

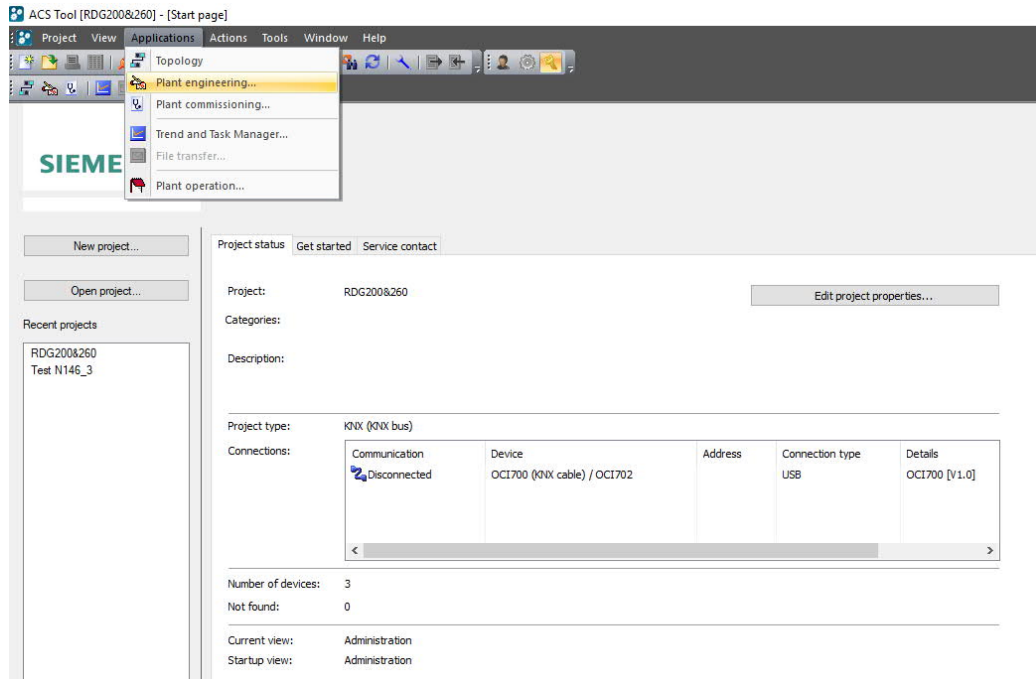

The application and control parameters can be adjusted and downloaded.

Line no. contains the parameter number as displayed in the parameter table. See **Control parameters** [→ 108].

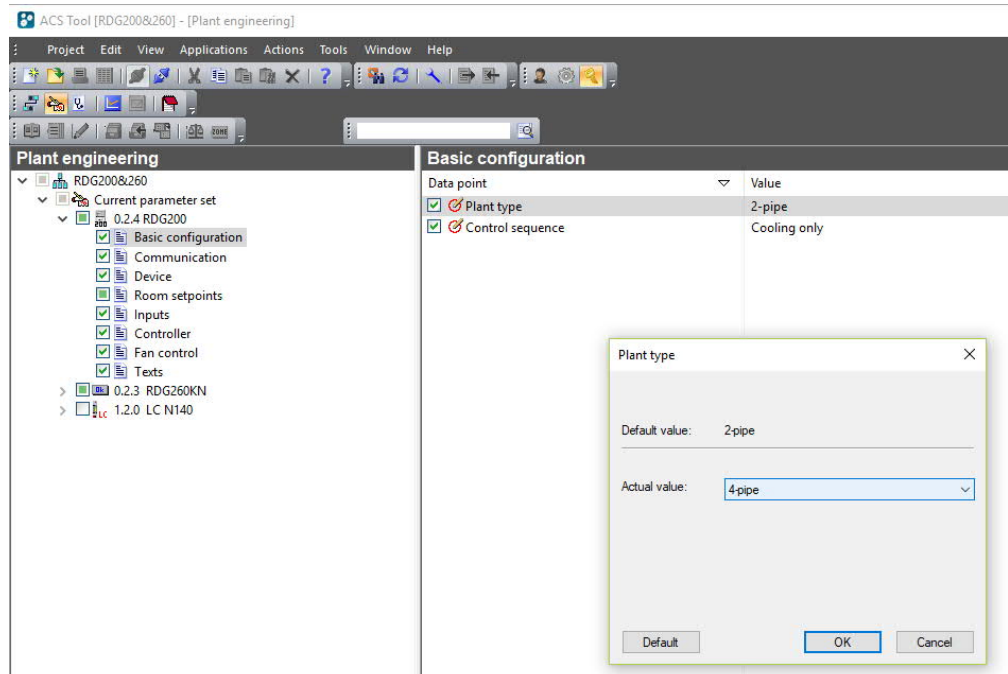

Some parameters in ACS have a range different from that on the room thermostats.

The thermostat does not accept changes outside its range. This can be seen online in that a changed value returns to the original value.

Use the ranges described in the parameter tables in **Control parameters** [→ 108].



Note!

5.2.2 Operation and monitoring with ACS



ACS

In the ACS program, select **Plant** → **Open** to open the plant.

To open monitoring and operation, select **Applications** → **Plant operation**.

Data point	Value
Actual value room temp	25.0
Current room temp setpoint	22.0
Humidity	18
Application mode	Auto
Control sequence	Cooling
Heating output	0
Electric heater	0
Cooling output	100
Manual fan control	-----
Fan output	80
Energy indicator	Disabled

Parameter settings in ACS The ACS tool supports parameter settings even during normal operation.

To change a control parameter, double-click the parameter in **Standard popcard** for the settings.

Notes

- Make sure you are logged in with sufficient access right.
- Only control parameters can be changed, not the application!

Data point	Value
Plant type	2 stage heat or cool
Control sequence	Cooling only
Restore factory setting	---

Control sequence dialog box:

Default value: Cooling only

Actual value: Cooling only

Options in dropdown:

- Cooling only
- Heating only
- Cooling only
- H/C changeover auto
- H/C changeover manual

Buttons: Default, OK, Cancel

Plant diagram in ACS

The ACS tool offers plant diagrams for easy monitoring and operation of the thermostat.

To start the application, select **Applications** → **Plant operation** → **Standard diagram**.

The ACS tool provides standard plant diagrams for RDG2..KN room thermostats, depending on the following configuration:

Plant type	Application configuration	Application configuration
2-pipe	2-pipe fan coil unit – Control sequence: No impact (P001 = any) – Fan operation: Enabled (P350 <> 0)	Single-stage with electric heater – Control sequence: No impact (P001 = any) – Fan operation: Disabled (P350 = 0)
	Chilled/heated ceiling – Control sequence: Changeover – Fan operation: Disabled (P350 = 0)	Chilled ceiling – Control sequence: Cooling only (P001 = 1) – Fan operation: Disabled (P350 = 0)

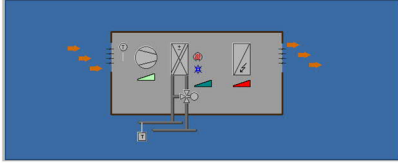
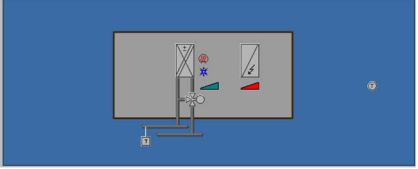
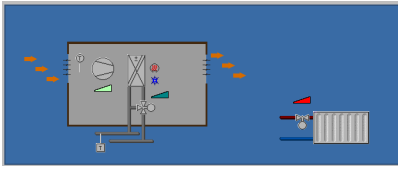
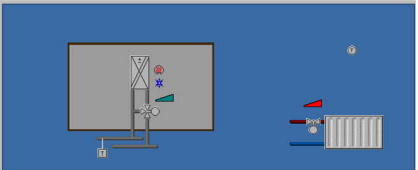
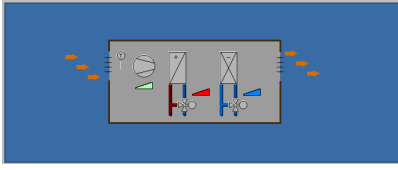
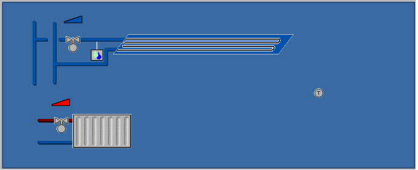
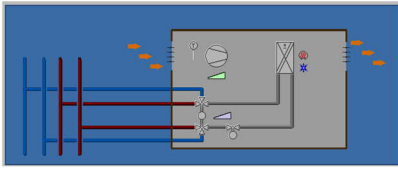
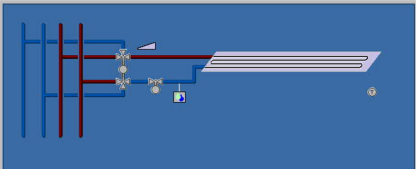
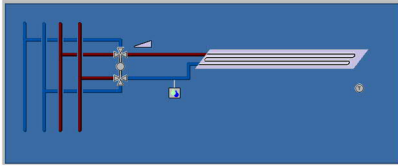
Plant type	Application configuration	Application configuration
2-pipe with electric heater	<p>2-pipe fan coil unit with electric heater</p> <ul style="list-style-type: none"> - Control sequence: No impact (P001 = any) - Fan operation: Enabled (P350 <> 0) 	<p>Single-stage with electric heater</p> <ul style="list-style-type: none"> - Control sequence: No impact (P001 = any) - Fan operation: Disabled (P350 = 0) 
2-pipe with radiator	<p>2-pipe fan coil unit with radiator</p> <ul style="list-style-type: none"> - Control sequence: No impact (P001 = any) - Fan operation: Enabled (P350 <> 0) 	<p>Single-stage with radiator</p> <ul style="list-style-type: none"> - Control sequence: No impact (P001 = any) - Fan operation: Disabled (P350 = 0) 
4-pipe	<p>4-pipe fan coil unit</p> <ul style="list-style-type: none"> - Control sequence: Not auto c/o (P001 <> 3) - Fan operation: Enabled (P350 <> 0) 	<p>Chilled ceiling with radiator</p> <ul style="list-style-type: none"> - Control sequence: No impact (P001 = any) - Fan operation: Disabled (P350 = 0) 
	<p>4-pipe fan coil unit with PICV and 6-port control ball valve as changeover</p> <ul style="list-style-type: none"> - Fan operation: Must be enabled (P350 <> 0) 	<p>H/C ceiling with PICV and 6-port control ball valve as changeover</p> <ul style="list-style-type: none"> - Fan operation: Disabled (P350 = 0) 
	<p>H/C ceiling with 6-port control ball valve</p> <ul style="list-style-type: none"> - Fan operation: Disabled (P350 = 0) 	

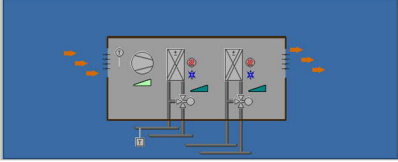
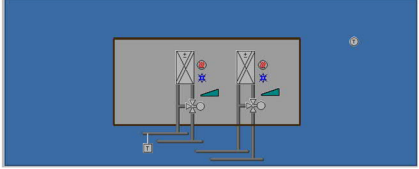
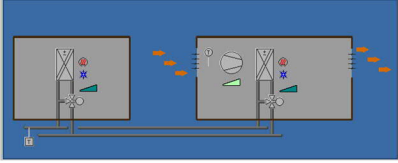
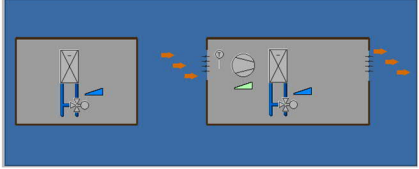
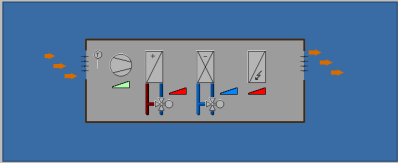
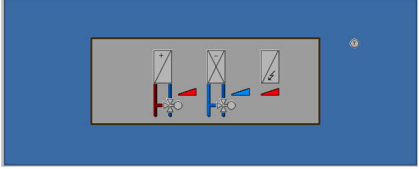
Plant type	Application configuration	Application configuration
2-pipe/2-stage heating or cooling	2-pipe/2-stage fan coil unit – Control sequence: No impact (P001 = any) – Fan operation: Enabled (P350 <> 0) 	2-pipe/2-stage – Control sequence: No impact (P001 = any) – Fan operation: Disabled (P350 = 0) 
	2-pipe/2-stage fan coil unit – Control sequence: No impact (P001 = any) – Fan operation: 2 nd stage (P350 = 4) 	2-pipe/2-stage – Control sequence: No impact (P001 = any) – Fan operation: 2 nd stage (P350 = 5) 
4-pipe with electric heater	4-pipe fan coil unit with electric heater – Control sequence: Not auto c/o (P001 < 2) – Fan operation: Enabled (P350 <> 0) 	1 stage Heat and Cool with electric heater – Control sequence: No impact (P001 <> 2) – Fan operation: Disabled (P350 = 0) 

5.2.4 Operation and monitoring with OZW772

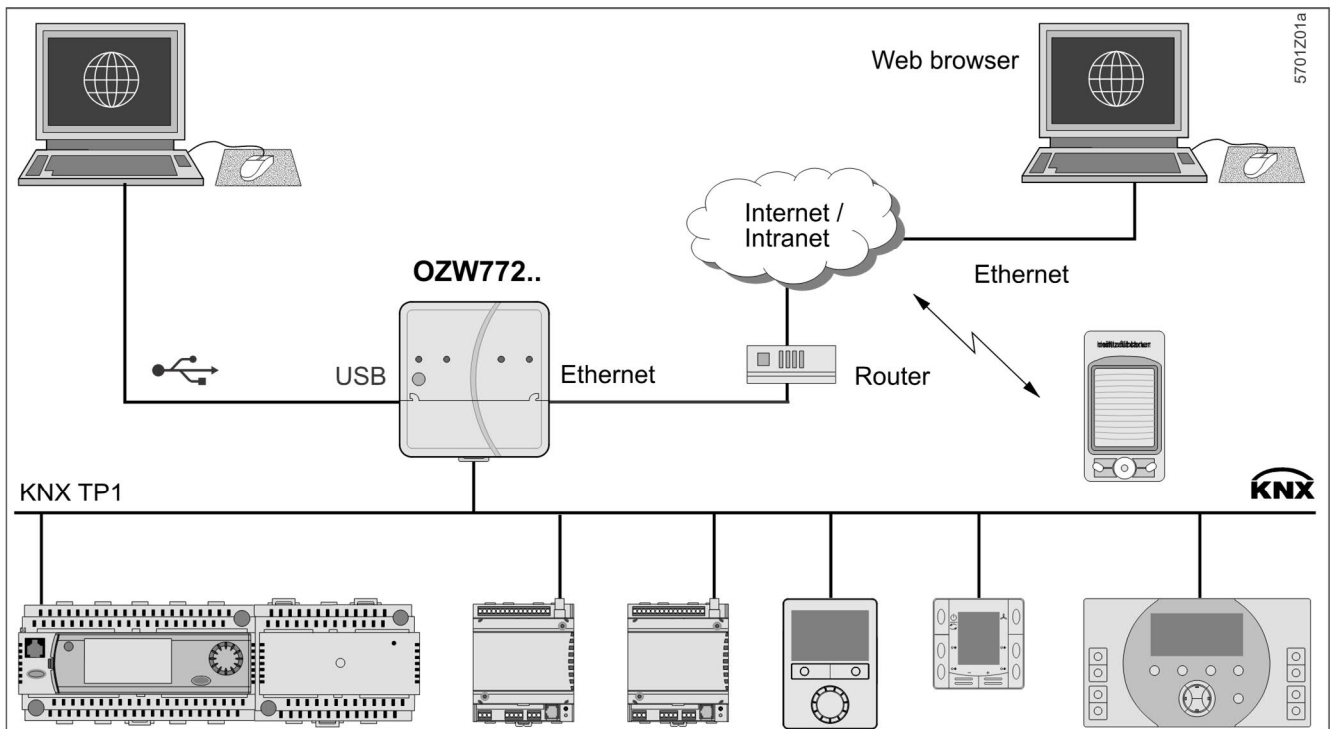

HomeControl app for plant control

The OZW772 web server allows users to operate a Synco HVAC system from a remote location – via a PC or from a smart phone using the HomeControl app.

The start page displays the most important data points. A combination of menu/path navigation allows users to access all data points quickly and easily. The entire installation can be visualized in the form of plant diagrams. Alarm and state messages can be forwarded to different message recipients, such as e-mail, SMS, etc.

For details, see Commissioning Instructions [→ 5] CE1C5701 [20].

6 Connection

6.1 Connection terminals

RDG200KN	
L, N	Operating voltage AC 230 V / AC 24 V
X1, X2	Multifunctional input for temperature sensor (NTC 3k or LG-Ni1000) or potential-free switch (function can be selected via parameter)
U1	Same as multifunctional inputs X1, X2
M	Measuring neutral for sensors and switches
CE+, CE-	KNX Bus + and – terminals
Q1	Control output for fan speed I AC 230 V / AC 24 V
Q2	Control output for fan speed II AC 230 V / AC 24 V
Q3	Control output for fan speed III AC 230 V / AC 24 V
Q1...Q3	Also for special functions AC 230 V / AC 24 V
Y1...Y4	Control outputs "Valve" AC 230 V or AC 24 V (NO triac, for normally open valves), output for electric heater via external relay
Y50	Control output "Fan" DC 0...10 V

RDG260KN	
G, G0	Operating voltage AC 24 V / DC 24 V
L1	Feed for relays AC 24...230 V
X1, X2	Multifunctional input for temperature sensor (NTC 3k or LG-Ni1000) or potential-free switch (function can be selected via parameter)
U1	Same as multifunctional inputs X1, X2
M	Measuring neutral for sensors and switches
CE+, CE-	KNX Bus + and – terminals
Q1 (L1)	Control output for fan speed I AC 230 V / AC 24 V
Q2 (L1)	Control output for fan speed II AC 230 V / AC 24 V
Q3 (L1)	Control output for fan speed III AC 230 V / AC 24 V
Q1...Q3 (L1)	Also for special functions AC 24...230 V
Y10, Y20, Y30	Control outputs "Valve" DC 0...10 V
Y50	Control output "Fan" DC 0...10 V

6.2 Connection diagrams

RDG200KN			DC 0...10 V fan					1-speed/3-speed fan					
Application	V1 ↓	V2 ↓	V3 ↓										
2-pipe	YHC												
Control outputs:	2-pos (PWM)		V1					✓ ✓ ✓ V1					
	3-pos		V1 V1					✓ ✓ ✓ V1 V1					
2-pipe with radiator	YHC	YR											
4-pipe	YH	YC											
2-pipe/2-stage	YHC1	YHC2											
Control outputs:	2-pos (PWM)		V1		V2			✓ ✓ ✓ V1 V2					
	2-pos (PWM)		V1		V2 V2			✓ ✓ ✓ V1 V2 V2					
	3-pos (PWM)		V1 V1		V2			✓ ✓ ✓ V1 V1 V2					
	3-pos (PWM)		V1 V1		V2 V2			✓ ✓ ✓ V1 V1 V2 V2					
2-pipe with electric heater	YHC	YE											
Control outputs:	2-pos (PWM)		V1		V2			✓ ✓ ✓ V1 V2					
	2-pos (PWM)		V1		V2 V2			✓ ✓ ✓ V1 V2 V2					
	3-pos (PWM)		V1 V1		V2			✓ ✓ ✓ V1 V1 V2					
	3-pos (PWM)		V1 V1		V2 V2			✓ ✓ ✓ V1 V1 V2 V2					
4-pipe with electric heater	YH	YC	YE										
Control outputs:	2-pos (PWM)		V1		V2			✓ ✓ ✓ V1 V2 V3					
	2-pos (PWM)		V1		V2 V2			✓ ✓ ✓ V1 V2 V2 V3					

N1	Room thermostat RDG200KN	M1	1-speed or 3-speed fan, DC 0...10 V fan
S1, S2, S3	Switch (keycard, window contact, presence detector etc.)	B1, B2, B3	Temperature sensor (return air temperature, external room temperature, changeover sensor, etc.)
V1, V2, V3	Valve actuators: On/Off or PWM, 3-position, heating, cooling, radiator, heating/cooling, 1 st or 2 nd stage	YH	Heating valve actuator
YE	Electric heater	YC	Cooling valve actuator
K	Relay	YHC	Heating/cooling valve actuator
CE+	KNX data +	YR	Radiator valve actuator
CE-	KNX data -	YHC1/YHC2	1 st /2 nd stage

RDG260KN				DC 0...10 V fan						1-speed/3-speed fan					
Application	V1 ↓	V2 ↓	V3 ↓												
2-pipe	YHC														
	Terminals →			Q1	Q2	Y10	Y20	Y30	Y50	Q1	Q2	Q3	Y10	Y20	Y30
Control outputs:	DC			V1			✓	✓	✓	V1			✓	✓	✓
	On/Off			V1			✓	✓	✓	V1			✓	✓	✓
2-pipe with radiator	YHC	YR													
4-pipe	YH	YC													
2-pipe/2-stage	YHC1	YHC2													
	Terminals →			Q1	Q2	Y10	Y20	Y30	Y50	Q1	Q2	Q3	Y10	Y20	Y30
Control outputs:	DC		DC	V1		V2	✓	✓	✓	V1		V2	✓	✓	✓
	DC		On/Off	V2		V1	✓	✓	✓	V1		V2	✓	✓	✓
	On/Off		DC	V1		V2	✓	✓	✓	V1		V2	✓	✓	✓
	On/Off		On/Off	V1		V2	✓	✓	✓	V1		V2	✓	✓	✓
2-pipe with electric heater	YHC	YE													
	Terminals →			Q1	Q2	Y10	Y20	Y30	Y50	Q1	Q2	Q3	Y10	Y20	Y30
Control outputs:	DC		DC	V1		V2	✓	✓	✓	V1		V2	✓	✓	✓
	DC		On/Off	V2		V1	✓	✓	✓	V1		V2	✓	✓	✓
	On/Off		DC	V1		V2	✓	✓	✓	V1		V2	✓	✓	✓
	On/Off		On/Off	V1		V2	✓	✓	✓	V1		V2	✓	✓	✓
4-pipe with electric heater	YH	YC	YE												
	Terminals →			Q1	Q2	Y10	Y20	Y30	Y50	Q1	Q2	Q3	Y10	Y20	Y30
Control outputs:	DC		DC	V1		V2	V3	✓	✓	✓	V1		V2	V3	✓
	DC		On/Off	V3		V1	V2	✓	✓	✓	V1		V2	V3	✓

N1 Room thermostat RDG260KN

M1 1-speed or 3-speed fan, DC 0...10 V fan

S1, S2, S3 Switch (keycard, window contact, presence detector etc.)

V1, V2, V3

 Valves actuators:
 On/Off or DC 0...10 V, heating, cooling, radiator, heating/cooling, 1st or 2nd stage

YE Electric heater

B1, B2, B3

Temperature sensor (return air temperature, external room temperature, changeover sensor, etc.)

YH Heating valve actuator

DH

 Dehumidifier
 Q3=On/Off, Y50=0...10 V

YC Cooling valve actuator

YHC

Heating/cooling valve actuator

CE+ KNX data +

YR

Radiator valve actuator

CE- KNX data -

YHC1/YHC2

1st/2nd stage

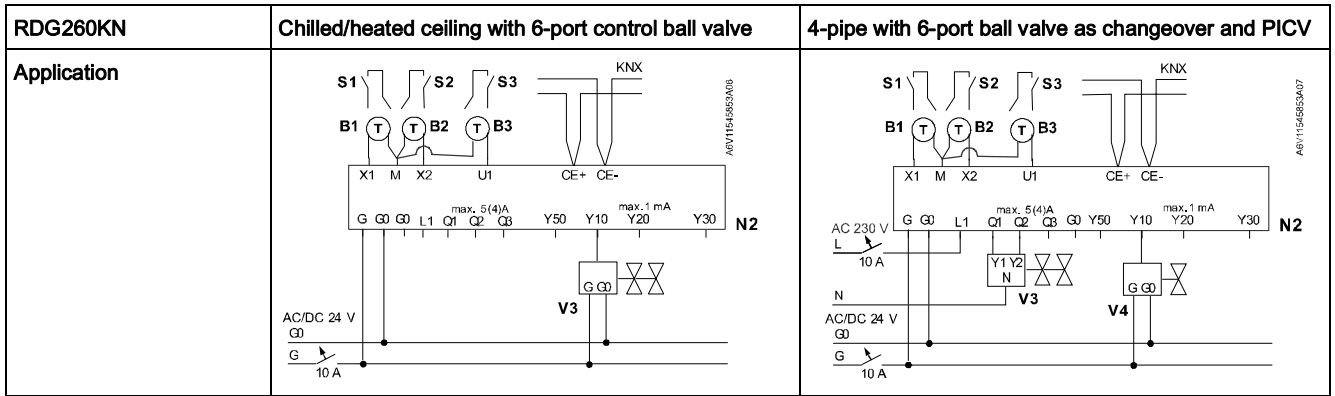

N2	Room thermostat RDG260KN	V3	6-port modulating control actuator
S1, S2, S3	Switch (keycard, window contact, presence detector etc.)	V4	PICV control valve
B1, B2, B3	Temperature sensor (return air temperature, external room temperature, changeover sensor, etc.)		
CE-	KNX data -	CE+	KNX data +

Note: In application "4-pipe with 6-port ball valve as changeover and PICV", Y50 can be connected with a DC 0...10 V fan.

6.3 Application examples

The examples are described for RDG260KN, but they also apply to RDG200KN. Control output (P201, P204) and terminals for the valves (Y1, Y2) need to be adapted accordingly.

6.3.1 Humidity control

Note: In the following examples, P461 is configured based on the connected type of equipment. See details in Humidity [→ 52].

Example 1: Dehumidifier, DC 0...10 V fan and valve 2-pipe fan coil application for dehumidification, with temperature setpoint shifting and dehumidifier contact, DC 0...10 V fan and DC valve:

Commissioning	Outputs used
<ul style="list-style-type: none"> Fan P351 = 3 (or DIP6 = OFF) Control strategy P450 = 1 Setpoint high P024 = 50 % (factory setting) Temp. shift P461 = 3 K (factory setting) Valve P201 = 5 Relay function P402 = 7 (dehumidifier) 	<ul style="list-style-type: none"> M1 DC 0...10 V fan V1 DC valve L3*) Dehumidifier *) Release contact
<p>See Technical data [→ 140] for min. and max. ratings</p>	RDG260KN

Example 2:
Dehumidifier,
DC 0...10 V fan + valve,
No shifting setpoint

2-pipe fan coil application for dehumidification, with DC 0...10 V fan and DC valve (without temperature setpoint shifting):

Commissioning	Outputs used
<ul style="list-style-type: none"> • Fan P351 = 3 (or DIP6 = OFF) • Control strategy P450 = 1 • Setpoint high P024 = 50 % (factory setting) • Temp. shift P461 = 0 • Valve P201 = 5 • Relay function P402 = 7 (dehumidifier) 	<ul style="list-style-type: none"> • M1 DC 0...10 V fan • V1 DC valve • L3*) Dehumidifier <p>*) Release contact</p>
<p>⚠ See Technical data [→ 140] for min. and max. ratings</p>	<p>RDG260KN</p>

Example 3:
Dehum./DC 0...10 V fan,
On/Off valves

4-pipe fan coil application for dehumidification, with temperature setpoint shifting, dehumidifier contact, DC 0...10 V fan and On/Off valves:

Commissioning	Outputs used
<ul style="list-style-type: none"> • Fan P351 = 3 (or DIP6 = OFF) • Control strategy P450 = 1 • Setpoint high P024 = 50 % (factory setting) • Temp. shift P461 = 3 K (factory setting) • Valve P201/P203 = 4 • Relay function P402 = 7 (dehumidifier) 	<ul style="list-style-type: none"> • M1 DC 0...10 V fan • V1, V2 On/Off valves • L3*) Dehumidifier <p>*) Release contact</p>
<p>⚠ See Technical data [→ 140] for min. and max. ratings</p>	<p>RDG260KN</p>

Example 4:
Dehumidifier +
humidifier/DC 0...10 V fan

2-pipe fan coil application for dehumidification, with temperature setpoint shifting, dehumidifier contact, DC 0...10 V fan and DC valve, humidification is controlled by release contact:

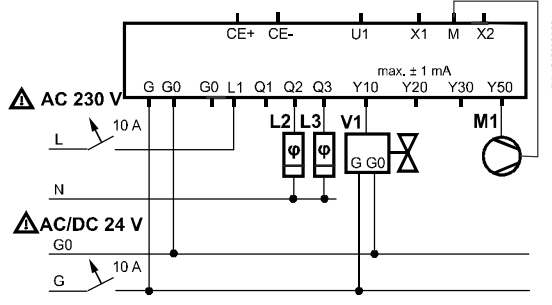
Commissioning	Outputs used
<ul style="list-style-type: none"> Fan P351 = 3 (or DIP6 = OFF) Control strategy P450 = 1 Setpoint high P024 = 50 % (factory setting) Setpoint low P026 = 30 % Temp. shift P461 = 3 K (factory setting) Valve P201 = 5 Relay function P402 = 7 (Q3) (dehum.) Relay function P401 = 8 (Q2) (hum.) 	<ul style="list-style-type: none"> M1 DC 0...10 V fan V1 DC valve L2*) Humidifier L3*) Dehumidifier *) Release contact
 <p>See Technical data [→ 140] for min. and max. ratings</p>	RDG260KN

Example 5:
Dehum./3-speed fan

2-pipe fan coil application for dehumidification, with temperature setpoint shifting, dehumidifier contact (via external converter) and 3-speed fan:

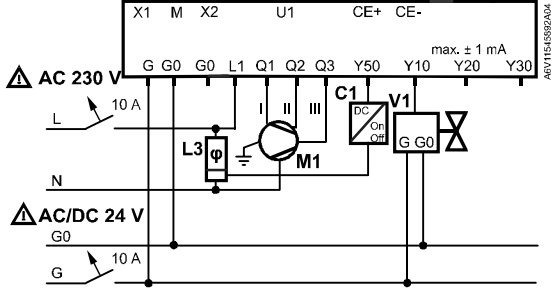
Commissioning	Outputs used
<ul style="list-style-type: none"> Fan P351 = 2 (or DIP6 = ON) Control strategy P450 = 1 Setpoint high P024 = 50 % (factory setting) Temp. shift P461 = 3 K (factory setting) Valve P201 = 5 	<ul style="list-style-type: none"> M1 3-speed fan V1 DC valve C1 DC - On/Off converter L3*) Dehumidifier *) Release contact
 <p>See Technical data [→ 140] for min. and max. ratings</p>	RDG260KN

6.3.2 Relay functions

Example 1:
Switching off the fan coil unit

2-pipe fan coil application, fan coil unit off during Protection mode.

Commissioning	Outputs used
<ul style="list-style-type: none"> Fan P351 = 3 (or DIP6 = OFF) Valve P201 = 5 Relay function P402 = 1 (Protection mode) 	<ul style="list-style-type: none"> M1 DC 0...10 V fan V1 DC valve L3*) Fan coil K Relay <p>*) Release contact</p>
<p>⚠ See Technical data [→ 140] for min. and max. ratings</p>	
<p>RDG260KN</p>	

Example 2:
Switching on pumps

4-pipe fan coil application, pumps on during heating and cooling demand.

Commissioning	Outputs used
<ul style="list-style-type: none"> Fan P351 = 3 (or DIP6 = OFF) Valve P201/P203 = 5 Relay function P401 = 3 (heating pump) Relay function P402 = 4 (cooling pump) 	<ul style="list-style-type: none"> M1 DC 0...10 V fan V1, V2 DC valve L2*) Heating pump L3*) Cooling pump K Relay <p>*) Release contact</p>
<p>⚠ See Technical data [→ 140] for min. and max. ratings</p>	
<p>RDG260KN</p>	

Example 3:
Compressor and
reversing valve

Compressor application, with reversing valve (heating/cooling) and DC 0...10 V fan:

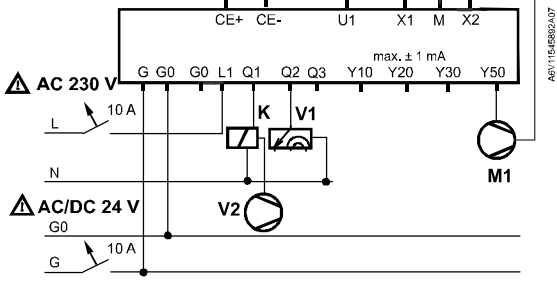
Commissioning	Outputs used
<ul style="list-style-type: none"> • Application 4-pipe • Control output P201 = 4 (On/Off) • Fan P351 = 3 (or DIP6 = OFF) • Relay function Heating/cooling <ul style="list-style-type: none"> – ON in demand: P401 = 2 – Energized mode: Heating P401 = 5 – Energized mode: Cooling P401 = 6 	<ul style="list-style-type: none"> • M1 DC 0...10 V fan • V1*) Reversing valve • V2*) Compressor • K Relay *) Release contact
 <p>See Technical data [→ 140] for min. and max. ratings</p>	RDG260KN

6.3.3 Swap function and/or fan in the 2nd stage

Example 1:
Fan in the 2nd stage

2-pipe fan coil application for floor heating/cooling (2-stage heating/cooling), fan runs only in the 2nd stage:

Commissioning	Outputs used
<ul style="list-style-type: none"> • Fan P350 = 4 (2nd stage) • Valve P201 = 5 (floor) • Valve P203 = 5 (fan coil unit) 	<ul style="list-style-type: none"> • M1 DC 0...10 V fan • V1 DC valve floor • V2 DC valve fan coil units
<p>The top graph shows two outputs, YHC2 and YHC1, plotted against room temperature (TR) in °C. YHC2 starts at 100% and drops to 0% at temperature 'w'. YHC1 starts at 100% and drops to 0% at a higher temperature. The bottom graph shows the Fan output, which is 100% until temperature 'w', then drops to 0%.</p>	<p>The top graph shows two outputs, YHC1 and YHC2, plotted against room temperature (TR) in °C. YHC1 starts at 0% and rises to 100% at temperature 'w'. YHC2 starts at 0% and rises to 100% at a higher temperature. The bottom graph shows the Fan output, which is 0% until temperature 'w', then rises to 100%.</p>
<p>The wiring diagram shows the connection of the RDG260KN control unit. It is powered by AC 230 V (L, N, G) and AC 24 V (G0, G). The control unit has terminals X1, M, X2, U1, CE+, CE-, Y50, Y10, Y20, Y30. Outputs M1, V1, and V2 are connected to the control unit. A note indicates to see technical data for min. and max. ratings.</p>	<p>RDG260KN</p>

Example 2:
Swap and fan in the 2nd
stage

2-pipe and 2-stage application with radiant heating/cooling panels, the fan only operates with the fan coil unit:

- Heating sequence: 1st panel and 2nd fan coil unit
- Cooling sequence: 1st fan coil unit and 2nd panel

Commissioning	Outputs used
<ul style="list-style-type: none"> • Fan P350 = 6 (Cooling and 2nd stage heating) • Valve P201 = 5 (panel) • Valve P203 = 5 (fan coil unit) • Swap P254 = 1 	<ul style="list-style-type: none"> • M1 DC 0...10 V fan (2nd stage) • V1 DC valve panel • V2 DC valve fan coil unit
<p>See Technical data [→ 140] for min. and max. ratings</p>	RDG260KN



**Example 3:
Swap and fan in the 2nd
stage**

2-pipe fan coil and 2-stage application with different types of equipment (On/Off control outputs), the fan only operates if output V1 is energized.



Commissioning	Outputs used
<ul style="list-style-type: none"> Fan P350 = 5 (Heating and 2nd stage cooling) Valve P201 = 2 (equipment 1) Valve P203 = 2 (equipment 2) 	<ul style="list-style-type: none"> M1 DC 0...10 V fan (2nd stage) V1 On/Off valve (equipment 1) V2 On/Off valve (equipment 2)
<p>See Technical data [→ 140] for min. and max. ratings</p>	<p>RDG260KN</p>

7 Technical data

Power supply (RDG200KN)	
Operating voltage (L-N)	AC 24 V \pm 20 % or AC 230 V +10/-15 % (selectable via slider)
Frequency	50/60 Hz
Power consumption	4 VA @ AC 24 V 7 VA @ AC 230 V
 <ul style="list-style-type: none"> • No internal fuse! <p>External preliminary protection with max. C 10 A circuit breaker required in all cases.</p> <ul style="list-style-type: none"> • Before switching on power, select the right power supply needed using the power switch on the rear of the device. 	

Outputs (RDG200KN)	
Fan control Q1, Q2, Q3 – N	AC 24 V or AC 230 V (linked to power supply)
Qx rating min., max. resistive (inductive)	5 mA...5 (4) A
 <p>No internal fuse!</p> <p>External preliminary protection with max. C 10 A circuit breaker required for all cases.</p>	
 <p>Do not connect 3-speed fans in parallel!</p> <p>Connect one fan directly, one relay for each speed for additional fans.</p>	
Use for actuator control (Q1, Q2)	
<ul style="list-style-type: none"> • Q1 - rating min., max. resistive/inductive 	5 mA...1 A
<ul style="list-style-type: none"> • Q2 - rating min., max. resistive/inductive 	5 mA...1 A
<ul style="list-style-type: none"> • Max total load current Q1+Q2+Q3 	5 A
Use for external equipment (Q1, Q2, Q3)	
<ul style="list-style-type: none"> • Rating min., max. resistive/inductive Qx 	5 mA...1 A
<ul style="list-style-type: none"> • Max total load current Q1+Q2+Q3 	2 A
DC 0...10 V fan control; Y50-M	SELV DC 0...10 V, max. \pm 5 mA
Control outputs	Solid state (triacs)
Y1, Y2, Y3, Y4-N	AC 24 V or AC 230 V (linked to power supply)
Yx power limitation	8 mA...1 A 3 A fast microfuse, cannot be exchanged

Power supply (RDG260KN)	
Operating voltage (G-G0) DC 24 V: Make sure to connect G to + and G0 to -	AC 24 V \pm 20 % DC 24 V \pm 2 V
Frequency	50/60 Hz
Power consumption	4 VA @ AC 24 V
 <p>No internal fuse! External preliminary protection with max. C 10 A circuit breaker required for all cases.</p>	

Outputs (RDG260KN)	
Fan control Q1/Q2/Q3/L-N	AC 24...230 V / DC 24 V
Use for 3-speed fan control Rating min, max resistive (inductive)	AC 24...230 V: 5 mA...5 (4) A DC 24 V: 3 A
 <p>No internal fuse! External preliminary protection with max. C 10 A circuit breaker required for all cases.</p>	
 <p>Do NOT connect 3-speed fans in parallel! Connect one fan directly, for additional fans, one relay for each speed.</p>	
Use for actuator control (Q1, Q2)	
<ul style="list-style-type: none"> Q1 - rating min., max. resistive/inductive Q2 - rating min., max. resistive/inductive Max total load current Q1+Q2+Q3 	5 mA...1 A 5 mA...5 (4) A 5 A
Use for external equipment (Q1, Q2, Q3)	
<ul style="list-style-type: none"> Rating min., max. resistive/inductive Qx Max total load current Q1+Q2+Q3 	5 mA...1 A 2 A
 <p>No internal fuse! External preliminary protection with max. C 10 A circuit breaker required for all cases.</p>	
DC 0...10 V fan control (Y50-M)	SELV DC 0...10 V, max. \pm 5 mA
Actuator control (Y10-G0/Y20-G0/Y30-G0 (G))	SELV DC 0...10 V, max. \pm 1 mA

Multifunctional inputs	
X1-M/X2-M/U1-M	
Temperature sensor input	
Type	NTC 3k

Multifunctional inputs	
Temperature range	-20...70 °C
Temperature sensor input	
Type	LG-Ni1000
Temperature range	-40...70 °C
Digital input	
Operating action	Selectable (NO/NC)
Contact sensing	DC 0...5 V, max. 5 mA
Insulation against mains	SELV

KNX bus	
Interface type	KNX, TP Uart 2 (electrically isolated)
Bus current	5 mA
Bus topology: See KNX manual ("Reference documentation")	

Operational data		
Switching differential, adjustable		
Heating mode	(P051)	1 K (0.5...6 K)
Cooling mode	(P053)	1 K (0.5...6 K)
P-band Xp		
Heating mode	(P050)	2 K (0.5...6 K)
Cooling mode	(P052)	1 K (0.5...6 K)
Setpoint setting and setpoint range		
Comfort mode	(P011)	21 °C (5...40 °C)
Economy mode	(P019-P020)	15 °C/30 °C (OFF, 5...40 °C)
Protection mode	(P100-P101)	8 °C/OFF (OFF, 5...40 °C)
Multifunctional inputs X1/X2/U1		Selectable (0...25)
Input X1 default value	(P150)	1 (external temperature sensor, room or return air)
Input X2 default value	(P153)	0 (no function)
Input U1 default value	(P155)	3 (window contact)
Built-in room temperature sensor		
Measuring range		0...49 °C
Accuracy at 25 °C		< ±0.5 K
Temperature calibration range		±3 K
Built-in humidity sensor		
Measuring range		10...90 %
Accuracy (after calibration via P007)		< 5 %

Operational data	
Humidity calibration range	±10 %
Settings and display resolution	
Setpoint	0.5 °C
Present temperature value displayed	0.5 °C

Environmental conditions	
Storage	IEC 60721-3-1
Climatic conditions	Class 1K3
Temperature	-25...65 °C
Humidity	< 95 % r.h.
Transport	IEC 60721-3-2
Climatic conditions	Class 2K3
Temperature	-25...65 °C
Humidity	< 95 % r.h.
Mechanical conditions	Class 2M2
Operation	IEC 60721-3-3
Climatic conditions	Class 3K5
Temperature	0...50 °C
Humidity	< 95 % r.h.

Standards and directives	
EU conformity (CE)	A5W00120120A*
Electronic control type	2.B (micro-disconnection on operation)
RCM conformity	A5W00120121A*
Safety class	II as per EN 60730
Pollution class	Normal
Degree of protection of housing	IP30 as per EN 60529

Standards and directives	
Eco design and labeling directives	Based on EU directive 813/2013 (Eco design directive) and 811/2013 (Labelling directive) concerning space heaters, combination heaters, the following classes apply:
RDG200KN <ul style="list-style-type: none"> Application with On/Off operation of a heater PWM (TPI) room thermostat, for use with On/Off output heaters 	Class I value 1 % Class IV value 2 %
RDG260KN <ul style="list-style-type: none"> Application with On/Off operation of a heater PWM (TPI) room thermostat, for use with On/Off output heaters 	Class I value 1 % Class IV value 2 %
Environmental compatibility	The product environmental declaration (RDG200KN: A5W00085404A*, RDG260KN: A5W00116569A*) contains data on environmentally compatible product design and assessments (RoHS compliance, materials composition, packaging, environmental benefit, disposal).

General	
Connection terminals	Solid wires or stranded wires with wire-end sleeves 1 x 0.4...2.5 mm ² or 2 x 0.4...1.5 mm ²
Minimal wiring cross section on L, N, Q1, Q2, Q3, Y1, Y2, Y3, Y4	Min. 1.5 mm ²
Maximal wiring cross section on L, N, Q1, Q2, Q3, Y1, Y2, Y3, Y4	Max. 2.5 mm ²
Housing front color	RAL 9016 white
Weight without/with packaging	
RDG200KN	266 g/336 g
RDG260KN	242 g/311 g

Reference documentation	Handbook for Home and Building Control - Basic Principles (EN: https://my.knx.org/shop/product?language=en&product_type_category=books&product_type=handbook DE: https://my.knx.org/shop/product?language=de&product_type_category=books&product_type=handbook)
Synco™	CE1P3127 Communication via KNX bus for Synco 700, 900 and RXB/RXL Basic documentation
Desigo	CM1Y9775 Desigo RXB integration – S-Mode CM1Y9776 Desigo RXB/RXL integration – individual addressing CM1Y9777 Third-party integration CM1Y9778 Synco integration CM1Y9779 Working with ETS

*) The documents can be downloaded from <https://hit.sbt.siemens.com>.

8 Dimensions

Dimensions in mm

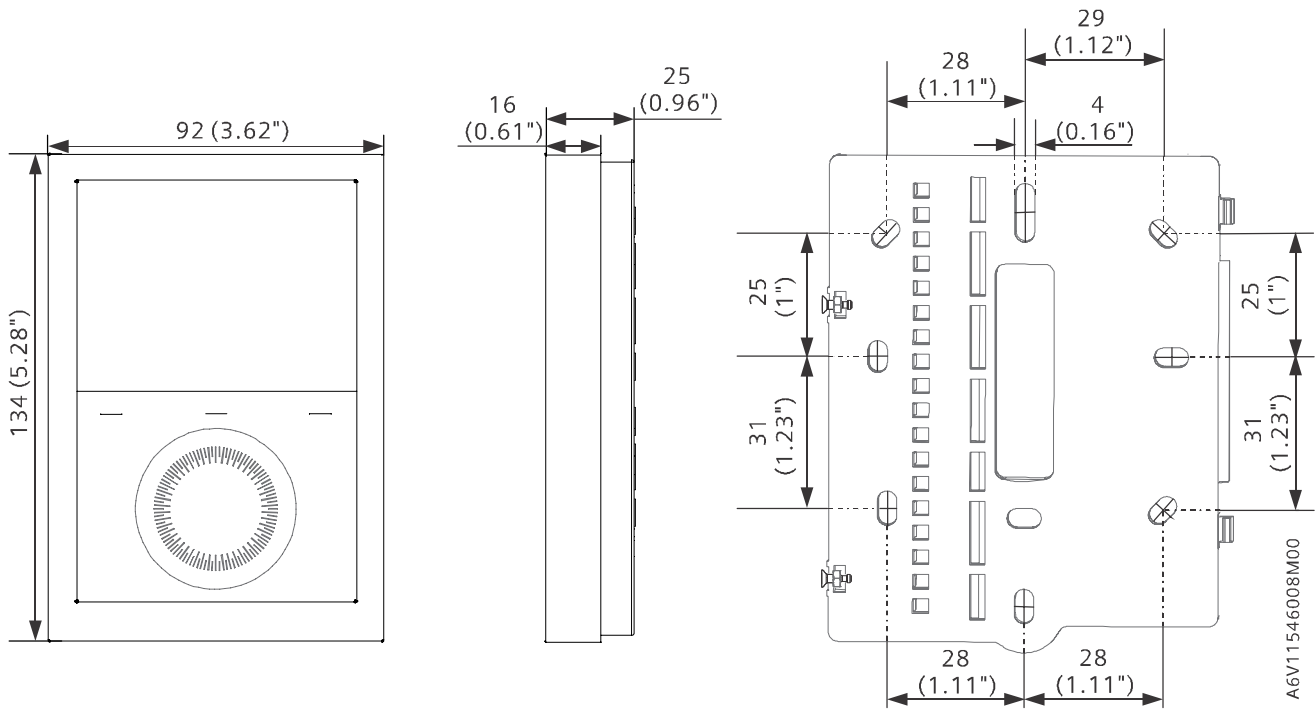

Index

Numerics

1-speed.....	86
3-position control signal.....	78
3-speed.....	86
6-port ball valve.....	74

A

ACS tool.....	121
Adaptive temperature compensation.....	60
Automatic heating/cooling changeover.....	43, 56

B

Basic application.....	71
Bus - setting and adjusting setpoints.....	34
Button lock.....	51

C

Cable length for sensors.....	93
Changeover switch.....	43
Changeover via KNX.....	43, 92
Chilled/heated ceiling applications.....	71
Clean fan filter reminder.....	90
Comfort setpoint.....	32
Commissioning.....	34, 108
Communication objects.....	94, 100
Compressor application.....	74
Control outputs configuration.....	82
Control outputs overview.....	78
Control parameters.....	108
Control sequences.....	56
Cooling demand.....	98
Cooling sequence.....	56

D

DC 0...10 V for electric heaters.....	80
DC 0...10 V for valve actuators.....	80, 80
DC 10...0 V.....	78
DC 2...10 V.....	78
Desigo.....	15
Dewpoint monitoring.....	50, 92
digital input.....	92
DIP switches.....	78, 82
Download via tool.....	109

E

Economy cooling setpoint.....	34
Economy heating setpoint.....	34
Electric heater enable/disable.....	92
Enable/disable electric heater.....	60, 69, 92
Expert level parameters.....	108

External/return air temperature.....	92
External/return air temperature sensor.....	44

F

Fan in Auto mode.....	90
Fan kick.....	89
Fan minimum on- time.....	89
Fan operation as per heating/cooling mode, or disabled.....	89
Fan overrun.....	90
Fan stage in dead zone.....	89
Fan start delay.....	90, 91
Fan start kick.....	90
Fault.....	92
Fault handling.....	94
Fault on KNX.....	99
Floor cooling.....	46
Floor heating.....	46
Floor temperature limitation function.....	49
Flow limitation.....	50

G

Geographical zone.....	96
Green leaf indication.....	51

H

Heartbeat.....	98
Heating and cooling sequence.....	56
Heating demand.....	98
Heating sequence.....	56
Heating/cooling changeover.....	44, 92
Heating/cooling changeover via bus.....	43
HomeControl app.....	127
HumDehumMode.....	53
Humidification.....	53

I

Integration via KNX.....	14
--------------------------	----

K

KNX functions.....	14
KNX LTE-Mode.....	95
KNX overview.....	94
KNX parameters.....	119
KNX S-Mode.....	94
KNX tools.....	118

L

LTE-Mode.....	95
---------------	----

M

Manual heating/cooling changeover.....	44
--	----

Manually select heating or cooling sequence.....	56	S	
Minimum output	46	Sensor input.....	92
Moisture.....	55	Setpoint Comfort mode.....	76
Monitoring with ACS.....	123	Setpoint Economy mode.....	76
Monitoring with OZW772.....	127	Setpoint high	52
Multifunctional input.....	92	Setpoint low	52
N		Setpoint priority.....	36
NFC	55	Setpoint Protection mode.....	76
O		Setpoints - setting via bus	34
On/Off control signal.....	78	Setpoints and sequences.....	76
Operation with ACS.....	123	S-Mode.....	94
Operation with OZW772.....	127	Supply air temperature limitation.....	49
OZW772	127	Swap function.....	46, 50
P		Switching off external equipment	47
Parallel connection of switches	93	Synchronization	79
Parameter setting in ACS.....	119, 122	Synco 700.....	14
Parameter setting via tool.....	109	T	
Parameter settings in ACS	123	Temperature out of range	94, 94
Plant diagram in ACS	124	Temporary comfort setpoint.....	32
Presence detector.....	27	Tool - Parameter setting and download.....	109
Purge function	46	V	
PWM	78	Valve exercising	50
PWM for electric heater	79	W	
R		Window contact	92
Radiator applications.....	71	Z	
Remote heating/cooling changeover.....	43	Zone addressing.....	95
Remote operation	127		
Reset parameters	108		
Room humidity.....	52		

Issued by
Siemens Switzerland Ltd
Smart Infrastructure
Global Headquarters
Theilerstrasse 1a
CH-6300 Zug
+41 58 724 2424
www.siemens.com/buildingtechnologies

© Siemens Switzerland Ltd, 2020
Technical specifications and availability subject to change without notice.

A6V11545892_en--_a