

INSTRUCTION MANUAL



LE GRAND

SELLER'S OBLIGATIONS

Internet sales: In case of purchasing the bicycle within the scope of online sales, the seller is obliged to prepare the bicycle according to seller's obligations.

Customers who purchased the bicycles electronically may execute their rights resulting from the manufacturer warranty for free only at the purchase point.

PRE-SALES ACTION

The seller is obliged to hand the bicycle over to the buyer in operational condition, ready for immediate use and after performing the following pre-sales actions:

01. Bicycle unpacking
02. Installing pedals and their thorough tightening
03. Adjusting and tightening handlebars in position ready for riding
04. Tightening all screws
05. Checking lightning and tyre positioning
06. Brake and switch adjustment
07. Pulling spokes up and centering wheels, if necessary
08. Filling air in tyres to the desired pressure
09. Removing traces of contamination and dirt from bicycle surfaces
10. Thorough filling in trade label and warranty card

In case of a bicycle purchase, the aforementioned actions should be undertaken by the seller.

The buyer confirms that aforementioned actions have been performed.





This manual shall enable you to prepare the bicycle for riding, step by step, and how to use it properly.

You will get to know how adjust some of the bicycle parts to your individual needs – the seat, handlebars, the shock absorbers. You will get to know how adjust brakes and the drive so they operate properly and without faults. Finally, you will get acquainted with how to maintain the bicycle, take care of it, perform small repairs and how to deal with some faults. In case of each of the operations, it was marked whether the action can be undertaken using basic tools or rather in a professional service station.

We hope that the bicycle becomes something more than just means of transport for you. It is our wish that it may become, if not a way of life, then at least a way of spending free time, of relax and healthy life. We believe that riding the bicycle will enable you more frequent contact with nature, and maybe it even becomes your hobby and a lifetime passion.

We wish you pleasant rides – KROSS S.A.



This symbol means that your life or health may be in danger, unless you follow the instructions provided below and situations described therein.



This symbol warns you about actions hazardous for the environment.



Any information which deserves particular attention from the user.

BICYCLE TYPES AND THEIR USE

MOUNTAIN (Extreme, MTB XC, MTB) – all-round bicycles designed for riding in hilly and mountainous terrain. They provide good control on varied surfaces. Wide tires and shock absorption provide comfort and safety. This type of bicycles, and in particular – their brakes – have been designed for a maximum load not exceeding 115 kg (cyclist+bicycle+luggage), where the weight of the cyclist and the luggage together cannot exceed 100 kg.

ROAD (Racer) – light, for fast riding and races on asphalt roads. This type of bicycles, and in particular – their brakes – have been designed for a maximum load not exceeding 115 kg (cyclist+bicycle+luggage), where the weight of the cyclist and the luggage together cannot exceed 100 kg.

CITY AND CLASSIC – designed for save travels down the streets in the cities. They combine comfort and functionality. This type of bicycles, and in particular – their brakes – have been designed for a maximum load not exceeding 125 kg (cyclist+bicycle+luggage), where the weight of the cyclist and the luggage together cannot exceed 105 kg.

CROSS AND COMFORT – universal and multifunctional. Designed for riding on gravel and asphalt roads. Cross and comfort bicycles shall also function well during trips with friends. They are designed for rides within and outside cities. This type of bicycles, and in particular – their brakes – have been designed for a maximum load not exceeding 125 kg (cyclist+bicycle+luggage), where the weight of the cyclist and the luggage together cannot exceed 105 kg.

TREKKING – they work very well on hardened surfaces and paths. They combine ride comfort and dynamics. They have strong frame and big, 28-inch wheels. It allows to cover distances quickly, and not only over asphalt. Positioning on the bicycle is very comfortable and enables multiple-hours long rides. This type of bicycles, and in particular – their brakes – have been designed for a maximum load not exceeding 125 kg (cyclist+bicycle+luggage), where the weight of the cyclist and the luggage together cannot exceed 105 kg.

JUNIOR, KID – designed especially for children in order to provide them with ride comfort and safety. This type of bicycles, and in particular – their brakes – have been designed for a maximum load not exceeding 45 kg (cyclist+bicycle+luggage), where the weight of the cyclist and the luggage together cannot exceed 32 kg. **UTILITY (Lilly / Metz)** - Utility bike was designed taking into account functionality in the city. Thanks to lightweight construction it is a quick, comfortable and also stylish means of transport. Rear rack integrated with the frame will carry all those things needed by a city dweller.

ORIGINALS (Virginia / William) – Inspired by the first bicycles used in the cities. These are classic projects that combine functionality with refined ultra retro look. Originals bike is a perfect choice for stylish rides around the city.

CLASSIC (Madison) – Madison bike, inspired by the classic models from the 50's, is a unique combination of style and ergonomics. Now you can feel the joy of bike ride and admiration of amazed passerby.

COMFORT (Pave) – Pave bike was designed especially for recreational use. Its construction guarantees comfort of ride in concrete jungles, on the parc paths and forest trails.

CRUISER (Sanibel / Bowman) – Sanibel and Bowman were based on the beach cruiser bikes dated back to the 30's of the XX century. Wide tyres, comfy saddles and upright position enabling to admire the surroundings, make you feel like on holidays even though you are in the city.

JUNIOR (Sanibel Jr. / Bowman Jr. / Kevin / Winnie / Pave Jr.) – Junior bikes are smaller versions of Cruiser and Comfort bikes, equally comfortable and good-looking. Every stylish girl and trendy boy will proudly ride their two-wheelers.

KIDS – (Annie/Gilbert/Sanibel Kid/Bowman Kid) – Kids bikes are classic, retro bikes for the youngest riders. Not only adults but also their kids can have a retro, stylish bike.

CAUTION: In groups of bikes: Originals / Classic / Comfort / Cruiser - their brakes – have been designed for a maximum load not exceeding 125 kg (cyclist+bicycle+luggage), where the weight of the cyclist and the luggage together cannot exceed 105 kg. In groups: Junior / Kids - their brakes – have been designed for a maximum load not exceeding 45 kg (cyclist+bicycle+luggage), where the weight of the cyclist and the luggage together cannot exceed 32 kg.

CAUTION: As is the case with any sport, cycling also bears the risk of injury and damage. The user must be aware of existing risks when using the bicycle. Regulations of the Highway Code must be known and always followed. Correct maintenance and use according to the intended use of the bicycle is an obligation of the user, and limits risks of an accident. Correct bicycle maintenance ensures that original working and safety parameters are preserved. Regardless of use of the bicycle, cycling always carries some risks and hazards to it. Always wear properly adjusted and sized protective helmet.

CONDITIONS OF BICYCLE USE AND STORAGE

- The bicycle is not intended to be stored outdoor for longer periods of time (max. 12 hours)
- The bicycle must not be used and stored in places where sand is present
- The bicycle should be stored in a dry place of ambient temperature (not in frosty conditions, in water, damp interiors)
- The bicycle should be stored away from products causing corrosion (pesticides, acids, solvents, batteries) and places with high salt content (for example, on a beach)

 According to traffic regulations, in order to enable riding on public roads, the bicycle must be equipped according to legal regulations in effect in the country in which the bicycle is used

 Suggestions of the manufacturer, related to safe use of bicycles:

1. Before starting the ride, always check the technical condition of the bicycle:
 - Correct brake operation
 - Air pressure in wheels (14,5 PSI = 1 bar = 1 kg/cm² = 100 000 Pa). Follow the range of pressure values defined by the manufacturer, listed on the side of the tyre; the tyre should always be mounted according to the direction indicated on its side (an arrow shows the direction of rotation); tyre state, lack of deformations, breaks, tightness of the tyre and rim
 - Wheel installation, installation of handlebars and its support (whether it rotates)
 - Seat installation (whether it rotates)
 - Lighting operation (whether the ride takes place under limited visibility or after dusk)
 - Bell operation
 - Rim wear – if the safety groove on the sides of the rim becomes invisible, the rim must be replaced (applies to aluminium rims with a groove), remember that the friction generated during braking causes rim wear. When rim shear reaches certain critical point, the rim may break under the pressure of the tyre. Contact your seller or ASO and ask them about checking the remaining rim thickness when you will use the second set of brake pads, at the latest (applies both rims with and without the groove).

- Correct contact of breaking pads with the rim (symmetrical action of both clamps, pads wear, proper distance of pads from the rim)
 - A rim without a groove should have wall thickness of at least 1,2 mm at the contact with the brake pad, if it is smaller, the rim must be replaced
2. It is recommended to wear a safety helmet while riding.
 3. Hold the handlebars with both hands during the ride.
 4. Do not catch cars or other vehicles.
 5. Avoid sharp braking.
 6. Follow the highway code regulations.
 7. Two individuals should never ride a bike together (does not apply to tandem bicycles and child seats).
 8. In order to make the bicycle use visible for other traffic participants, the bicycle should always be equipped with front and tail lights and with reflective lights.
 9. Reflective stripes should be present in both wheels.
 10. During riding in the rain one has to pay particular attention, because the braking length increases and traction is much worse under such conditions.
 11. Avoid riding through mud.
 12. Do not wear loose clothing while riding a bicycle.
 13. The bicycle should be systematically checked in order to determine component wear (i.e. tyres, rims, brake pads, loose spaces in control and support bearings) and potential damage.
The control provides safety and prevents accidents, falls, damage and extends useful lifetime of the bicycle.

NOTE

As is the case with all mechanical elements, the bicycle undergoes wear and is subjected to significant stress. Different materials and elements of the bicycle may react in different ways to stress and material fatigue. If a design resistance of a part of the bicycle is exceeded, it can undergo damage, potentially causing harm to the body of the cyclist. If there are any breaks, scratches or any colour change in the areas of large stress, it means that the durability of an element has expired and it is advised to replace it. It applies mainly to: the frame, the front fork, the seat support, brakes (levers, clips, discs, linings, cables), chain, pedals, cranks, axle of the crank mechanism and the rim, thus it is suggested to check these elements periodically.

14. Children below 12 years of age should ride a bicycle only accompanied by an adult parent or carer.
15. Riding a bicycle after alcohol consumption and under influence of drugs is dangerous and violates the law.
16. Children should be transported in specially prepared and permanently installed on the bicycle child seats, with the individual responsible for the transport providing cover for springs potentially present in the seat in order to prevent squashing fingers.
17. It is advised to perform repairs and inspections before the season in an authorised service station.
18. Only original spare parts should be used for components critical for safety, it applies to the front fork, handlebars, frame, seat support, handlebars support, brakes, chain, pedals, crank mechanism, rim, wheels.
19. It is advised to maintain particular care during riding down.
20. It is advised to adjust the riding style to the type of owned mountain bike (riding down, cross-country riding, etc.)
21. During installation of bicycle accessories it is suggested to follow installation manuals of these accessories or turn to the seller or an authorised service for help.
22. Before a child starts riding, parents should advise the child about proper use of the bicycle, in particular, about safe use of the leg-operated brake.
23. If aerodynamic handlebars extension is used, one has to remember that steering the bicycle and braking is much more difficult and one has to take particular care when doing so.
24. During replacing pedals, tyres, mudshields or cranks (with type other than used with the given bicycle) one has to bear in mind that the minimum distance between the end of the tyre and the mudshield and the pedal axis must be bigger than 89 mm for road and children bicycles and bigger than 100 mm for mountain and city bicycles. It helps avoiding bumping the wheel with the pedal during taking turns.

NOTE

Because of particularly harmful properties to the environment, used batteries should be transferred to a point of electronic waste collection or to the nearest rubbish bin for communal wastes marked with this sign. Used bicycle parts should be segregated and stored in containers for recycling.

All bicycle parts should be installed with suggested moments placed on the elements, or, in case when they are lacking the markings, according to the list of moments listed in this user manual.

Kross and Le Grand bicycles should be used according to their intended use defined by the manufacturer. It is forbidden to use any attachments or wagons while riding the bicycle.

It is acceptable to use baby seats with bicycles equipped with a carrier, under the condition that the combined weight of the seat and the baby does not exceed the maximum load capacity of the carrier and the acceptable total weight defined in this user manual.

Each break, dent, bend, scratch or change of colour of parts exposed to loads may indicate that useful lifetime of this part might have been exceeded. In this case, we suggest an immediate visit at an authorised service in order to perform an inspection or replacement of the part, otherwise it may be suddenly destroyed, causing bodily harm to the cyclist.



Kross and Le Grand bicycles are not designed for children below the age of 3.

Bicycles on wheels smaller than 20 inches in diameter are not approved for transport on public roads, particular care must be taken while using them in order to avoid falls or crashing incidents resulting in bodily harm to the user and other individuals.

WARNING

Follow all safety-related remarks and suggestions included in the bicycle user manual. The condition of safety is proper use, installation and lack of modifications introduced to elements. Always behave thoughtfully and carefully. This product has not been designed for extreme rides down the slopes, jumps or any aggressive riding. Not following these suggestions may lead to element damage or bodily harm. Read the user manual before using the product. The marking above applies to all components used in the purchased bicycle.

BICYCLE INSTALLATION

In case of a bicycle with a MIS type handlebars support (installed using a cone):

1. Take the bicycle and elements attached to it from the box (seat, basket, pedals, handlebars, wheels and mudshields). Detach the handlebars from the frame by removing the securing clipping bands.
2. Remove the lower part of the handlebars support in the stem of the fork so the line limiting maximum protrusion is not visible. Tighten the support with a dynamometric key using moments listed in this manual, setting the handlebars perpendicularly to the bicycle axis. Fig. 1.
3. Before the beginning of wheel installation, unclip the clutches of the front brake. In order to do this, pull the clutches towards each other and pull out the knee joint ("pipe") from the fixture. Fig. 2.
4. Place the wheel in the hooks of the fork, set the wheel equally in the vertical axis of the fork, tighten the nuts with moments defined in this instruction remembering that the groove of the front wheel should run according to the direction of rotation indicated on the tyre. Fig. 3.
5. Bind the brake clutches in a reverse way compared to p. 3. Fig. 4.
6. Pull out the seat with its bracket out of the box. Place the seat support in the underseat pipe so that the marking of the maximum protrusion remains invisible or is located exactly at the edge of the pipe. Install the support using joining elements or (depending on the bicycle model) using quick connectors. The quick connector mechanism is correctly locked if an attempt of twisting the lever around its axis in locked position fails. If action of force on this lever causes it to move, i.e. it has not been properly locked, it must be opened, a nut

located on the opposite side of the lever must be tightened (half a rotation), lock again and check. Repeat the procedure until a positive effect is reached, namely, the lever cannot be rotated while in locked position.

7. Tighten pedals to the crank with moments defined in this manual, remembering, that they have right-handed and left-handed threads, respectively (marked on the axis of the pedals).
8. If the model of the installed bicycle is a complete version, namely, equipped with mudshields and a light, one must remember that the wheel must be screwed in before it is installed. In order to do this, first remove the mudshield from the wheel and install together with the lamp using a screw, placing them in the hole in the fork.
9. If the installed bicycle is a version without the mudshields and the light, a white reflective light is installed instead of the lamp, Fig. 6.
10. If the bicycle has a shock-absorbing fork, then the mudshield and the front light are installed on a handle which is located in the front part of the fork.
11. If the bicycle has horns of the handlebars attached, they must be installed at the ends of the handlebars, parallel to each other. Suggested inclination of the horns is ca. 45 degrees.

After adjustment, the horns of the handlebars must be tightened using moments defined in this instruction, Fig. 7.

In case of a bicycle with TDS type handlebars (Ahead):

1. Take the bicycle and attached elements out of the box.
2. Unclip the handlebars from the frame by removing tightening clipping bands.
3. Unscrew the front part of the handlebars support using a 6 mm or 5 mm Allen key and set the handlebars in thus created space, exactly in the middle of its length, parallel to the ground. Then tighten the front part of the support using a 4 mm or 5 mm Allen key with moments defined in this instruction.
4. The following installation operations are repeated as in the case of a bicycle with a MTS support.

If this instruction does not include instructions on installation or removal of any part of the bicycle, please contact our support team, relevant information may also be found on websites of the manufacturers.

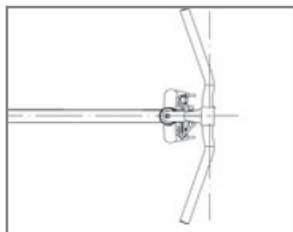

Fig. 1. Handlebars setting

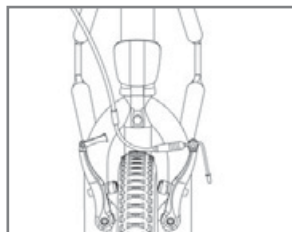

Fig. 2. Unclipping brake clutches

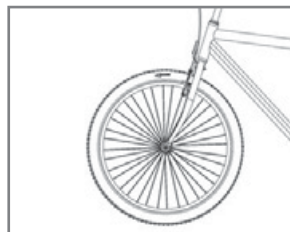

Fig. 3. Wheel installation

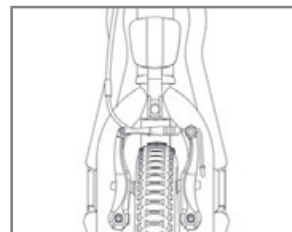

Fig. 4. Clipping brake clutches

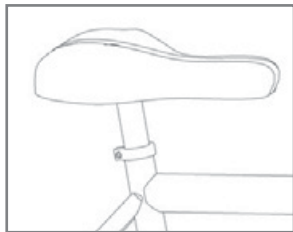

Fig. 5. Installation of seat support

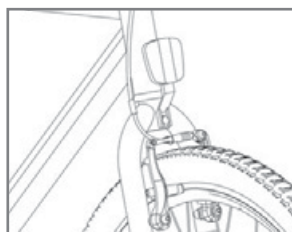

Fig. 6. Reflecting light installation

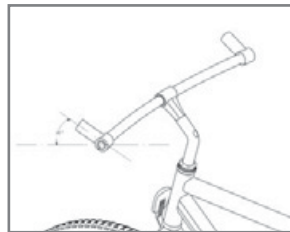

Fig. 7. Installation of handlebars horns

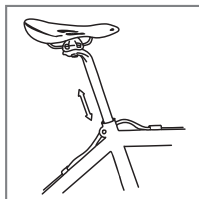

Fig. 8. Seat height regulation

SEAT

Seat regulation is the most important adjustment which must be made by the bicycle user. This adjustment must be performed by the user after the purchase. Over time (as height, forces, cycling experience change), seat adjustment should change. The adjustment influences comfort and positioning during the ride and the pedalling force. The seat may be adjusted in three planes:

Height 🛠️

It is adjusted by pushing in and pulling out the seat from the frame, Fig. 8. One has to remember that the support must be inserted into the frame at least 2,5 x the diameter of the underseat pipe and it must not protrude at more than the mark of maximum protrusion.

- Sit on the bicycle,
- Place the heel on the pedal,
- Set the crank so the pedal reaches the lowest position,
- The seat is located at proper height if your leg is stretched to the maximum. However, you must not lean down on the seat to reach the pedal or to lift the heel off pedal. Fig. 9.

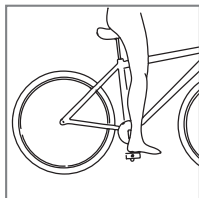

Fig. 9. Properly adjusted seat height

After the adjustment is done, check if the seat is located in the axis of symmetry of the bicycle. At the end, following the values of moments listed in this user manual, tighten the screw or clip locking the support. Fig. 10. A shock absorbing bracket should be adjusted using a screw 1, which, turned left – becomes unscrewed and thus we make the hardness lower. By turning screw 1 to the right, we increase hardness of its operation. Fig. 8.1.

Front-back and up-down 🛠️

These settings result from individual preferences and constitution characteristics of the biker. However, improper adjustment may lead to back pains, aching shoulder or knees. The closer to the handlebars the seat is and the lower its nose – the bigger the force we apply while pressing the pedals, and the crotch area of the biker is less strained. However, in the beginning, it is the best to adjust the seat to a neutral, flat position. Any corrections should be introduced along with gained experience and increasing skills. The adjustment is made by setting the seat tracks in the yoke, Fig. 11 and Fig. 12. Tighten yoke screws with the moment engraved in the component, then according to moments listed in this manual. In case of bicycles with full shock absorption one has to pay attention to the minimum seat height. The bracket set in too deep may hit the elements of the back rocker arm during operation.

NOTE: In case of bicycles with frame made of carbon (carbon fibre), the seat support must be seated in the frame earlier, applying special paste (attached to every bicycle with carbon frame) along the entire circumference of the seat support placed in the frame. It is necessary in order to eliminate minimum loose spaces at joints between elements of a bicycle made of carbon.

HANDLEBARS ⚠️

Handlebars height setting provides comfort and effective pedalling. Handlebars height is regulated depending on the support type – with a wedge, Fig. 13, or a-head, Fig. 14. Check which type is used in your bicycle. Some handlebars supports in Kross and Le Grand bicycles have a regulated setting angle. It enables each user to adjust the handlebars to their own needs.

Bracket with wedge 🛠️ ✂️

In order to adjust the height of this type of bracket, unscrew the fixing screw located at the top of the bracket. It causes the locking wedge in the steering pipe to loosen, and the bracket may be easily slid in and out. While adjusting the handlebars, one must pay attention to maximum protrusion of the handlebars bracket so the upper edge of the warning mark is not exceeded. If there is no warning mark, the handlebars must be installed in such a way that 6.5 cm of the bracket remains inside the fork. After the adjustment has been finished, tighten the bracket screw with a 18-22 Nm moment.

A-head bracket ✂️

In the a-head system, changing the handlebars height is impossible. Because of this, if the height needs to be adjusted, please turn to an authorised service station. Tightening the handlebars support with the handlebar – in order not to destroy the thread – must be performed by tightening uniformly, 3 threads at one, starting with diagonally positioned screws.

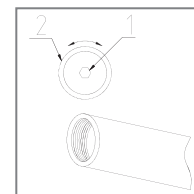

Fig. 8.1.

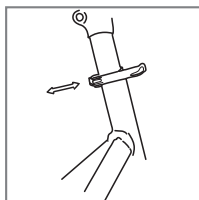

Fig. 10. Clip of seat bracket

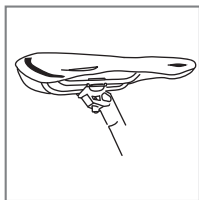

Fig. 11. Seat yoke

Transport 🚚

In order to set the handlebars and the wheel in the axis of symmetry of the bicycle (or to prepare one of these elements for transport – twist in relation to the axis of symmetry) in a system with a wedge one has to loosen the fixing screw at the top of the bracket, and in the a-head system – tightening screws at the side of the bracket. These screws must be tightened according to moments listed in this manual. In the a-head system, do not unscrew the screw located at the top of the bracket, which is used for controls regulation, namely, handlebars bearings.

Controls 🛑

During bicycle use, loose motions may appear in the handlebars bearings. In order to recognize such occurrence, one must press the front brake and put fingers of the other hand to the controls and move the bicycle back and forth. If motion between bearings and handlebars bracket or the head of the frame is palpable, the bicycle must be transported to an authorised service station in order to perform adjustments.

Switch levers 🚦

Set the switch lever/brake assembly at an angle of 45 degrees to the ground.

Switch levers (rotating) should be set in such a way that gear numbers are visible in all positions.

SHOCK ABSORPTION

The shock absorption function is provided by many elements. In most cases their operation may be regulated.

Forks 🚚 🛑

Depending on the amount of air pumped into the air chambers or tyres (in chamber-free systems), the bicycle may cover irregular terrain more or less smoothly. The minimum and maximum pressure value is given on the side of the tyre. One has to remember that too low pressure, although it improves ride comfort, may quickly cause a tyre or air chamber puncture.

Forks 🚚 🛑

Both rigid and shock-absorbing forks are installed in bicycles. The first type provide shock absorption in a rather limited degree. The latter have been devised in particular to increase the ride comfort. In shock-absorbing forks, depending on the model, one can perform just a few adjustments of the initial tension (defining hardness of the fork), pressure damping (defining how quickly does the fork deflect), decompression damping (defining how quickly the fork returns to the initial position). These adjustments are made using easily available knobs, installed at the top of the legs of the fork.

In shock absorbers, which have springs as operating elements, the suspension is regulated by tightening (harder suspension) or loosening (softer suspension) the nut. The operating parts of the legs should be cleaned and preserved using aerosol Teflon grease. The shock absorbers (the front fork and shock absorption of the rear wheel) should be adjusted and preserved according to the user manual. Regulation of fork shock absorption – the adjustment is performed using a knob located in the top part of the legs of the fork, turning the knob clockwise increases hardness of the shock absorber (ride on even terrain – hardened paths and asphalt), turning counterclockwise, we cause the opposite effect (for ride in an uneven terrain). Adjustment of rear wheel shock absorbers – for spring shock absorbers, tightening the nut results in an increased spring stiffness (for rides on even roads).

In case of hydraulic shock absorbers, adjustment is performed using an adjustment knob, tightening results in increased stiffness, loosening – decreased stiffness of the shock absorber. In case of shock absorbing brackets, the adjustment must be made using a 5 or 6 mm Allen key, turning the screw located at the bottom of the shock absorber (after taking the pipe out of the underseat frame). Making a clockwise turn shall increase bracket hardness. Do not loose the screw so at least 2-3 thread lines are invisible on the internal side of the bracket – this may lead to bracket damage.



Use a protective mask when spraying grease. Perform these works in a ventilated area.

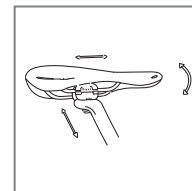
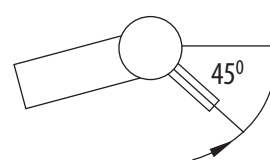

Fig. 12. Seat position adjustment

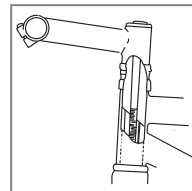

Fig. 13. Support with a wedge

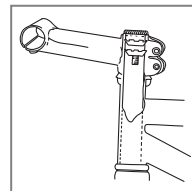

Fig. 14. A-head type support

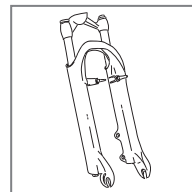

Fig. 15. Shock absorbing fork

Tyre and fork replacement

Bicycle tyres often have different external diameter (tyre width and height). Thus, always check the separation between the tyre and the fork in order to make sure that the tyre does not come in contact with any part of the fork. Remember that the thinnest part of the fork is located close to pivots. If you want to remove a wheel, it might be necessary to empty the tyre in order to make sliding the wheel through the pivots possible.

Tyre distance check

Caution! Use of tyres exceeding maximum tyre size approved for use with the fork is dangerous and may result in an accident, serious bodily damage or even death of the biker.

1. Remove all air from the fork.
2. Press the fork to the end.
3. Measure the distance between the top edge of the tyre and the bottom of the crown. Make sure the distance equals at least 10 mm. Exceeding the maximum permissible tyre size shall result in the bottom of the crown catching the tyre after complete compression of the fork.
4. Pump the fork again.

Remember than using the mudshield limits access. Repeat the “tyre accessibility test” to check if the distance is appropriate. After each tyre change, this test should be repeated. In case of shock absorbers in which the spring is the working element, contact an authorised service station in order to perform the tyre distance test.

Fork maintenance

The design of forks results in them being nearly maintenance-free. However, if the moving parts are exposed to moisture and dirt, efficiency of the fork may decrease after a few rides. In order to retain excellent parameters, safety and durability of the fork, maintenance must be performed regularly.



Please remember that not performing fork maintenance according to maintenance manual causes the warranty of the fork to become null and void. We advise performing fork maintenance more often than specified in case of riding in very difficult weather and terrain conditions (e.g. in winter). Always, when a worse or changed fork operation is noticed, contact an authorised service station immediately in order to perform a fork inspection.

Maintenance schedule	After each ride	Every 25 h	Every 50 h	Every 100 h
Clean the leg pipes and anti-dust seals	●			
Search for upper pipes scratchings	●			
Grease the seals using Teflon oil (e.g. Brunox Deo)	●			
Check air pressure		●		
Check if the main screws are tightened to appropriate moment (Nm)		●		
1st service			●	
2nd service				●

THE 1ST SERVICE INCLUDES: Inspection of fork operation/cleaning and greasing the bushing/line and cover of the remote blockade/control of torque value (tightening), control of air pressure/checking the fork for scratchings, dents, breakages, bends and wear signs.

THE 2ND SERVICE INCLUDES: 1st service + deinstallation/cleaning of the entire fork/greasing anti-dust seals and oil scrapers, greasing top lids of the remote blockade and range regulation/tightening top lids of the air valve by greasing, inspection for air leaks/torque (tightening) control/adjusting to personal preferences of the cyclist. Information about the locations where 1st and 2nd services are performed can be obtained in an authorised service station.

Shock absorber adjustment

BLOCKING SYSTEMS

The function of "blocking" forks is designed for minimising bicycle wobbling ("pumping") during riding, when the cyclist is not seated on the seat or during climbs. The fork shall not be 100% blocked. There still remains a movement range of a few millimeters, necessary for the operation of the fork locking system. This system protects the cyclist if he or she forgets to unlock the fork after entering a difficult terrain.



Despite the above, never block the fork during riding in a difficult terrain, riding downhill or jumps. It carries the risk of damage to the fork caused by its compression under heavy load.

BRAKES

Kross and Le Grand bicycles may use three types of brakes: in the axle (so called torpedo), disc (hydraulic and mechanic), Fig. 23., and rim (v-brake, u-brake). Fig. 24. In case of bicycles sold for riding in right-sided traffic, the right brake lever operates the rear wheel brake, while the left brake lever operates the front wheel brake. In case of bicycles sold for riding in the left-sided traffic (e.g. Great Britain), right brake lever operates the front wheel brake, while the left brake lever operates the rear wheel brake.

Warning: For bikes with hub torpedo (coaster brake), there is only one brake lever and it works on the front brake.

Torpedo

The mechanism in the rear wheel axle allows braking using pedals. In order to stop the bicycle, it is enough to rotate the pedals in the opposite direction. This type of brake may be serviced and repaired only by an authorised servicing station.

Disc brakes

In this system, disc brakes are installed on axis of axles of both wheels. By pulling on the braking lever (so called handle) installed on the handlebars, the cyclist effects compression of pistons which cause friction to the disc through braking pads. Adjustment and maintenance of disc brakes requires knowledge, skills and specialist tools. These actions should be performed by an authorised service station. The user can replace braking pads on their own. In order to do this, remove the wheel, remove pins or springs fixing the pads, remove worn pads, install new pads and proceed with the same operations, performed in reverse. The model of the pads must be identical with the ones in purchased bicycle. Do not press brake levers during braking pads replacement.



Maintaining cleanliness of braking discs significantly improves efficiency of disc brakes and riding safety.

Rim brakes (V-brake, U-brake)

In this system, arms of the brake press the pads to the wheel rim. Distance between the pads and the rim is adjusted using special screws on the arms of brakes or by shortening-lengthening the brake line. The brake line connects the handle on the handlebars with the arms, to which it is connected using a screw (5-8 Nm). Brake lines must be replaced at least once a year or every time where notches and breaks appear on their surface. Brake pads are screwed to arms (6-9 Nm) or slipped into special guide. In order to replace the pads, they must be screwed off the arms or slipped out of the guides, after pulling the pins out. Installing the brake pads requires screwing them to the arm after setting them at an appropriate height or slipping into the guides and putting the pins back on. Wear of brake pads is easy to evaluate thanks to special grooves placed on them. If the surface of the pad was worn to the point where the grooves disappeared completely – the pad must be replaced. As pads gradually wear out, the brake lines must be pulled up. Proper adjustment of pads – providing the most effective braking: pads set almost parallel to the rim, however, in such a way that the back of the pad was ca. 2 mm further away from the rim than the front of the pad. Fig. 25. Please pay attention that the pad does not touch the tyre during braking and was pressed to the rim along its entire surface. If the brake arms do not return on their own, clean and grease fixing points to the fork or to the frame, or replace lines or shields. The brake handle should remain separated from the handlebars by at least 10 mm after pressing the handle.

Drum brakes

Brake mechanism is built into the front wheel hub. A braking force is induced by tightening the lever on the handlebar. This force transmitted by cable and lever causes dilation of the brake shoes and their emphasis on the drum hub. Brake adjustment is made by cable tension.

Checking and adjustment of hydraulic disc brakes

Check the brake lines and their connections for leakages during pressing on the brake lever. If a leakage is found, immediately contact an authorised Kross service station, because a leakage may result in inoperational brakes. Braking levers may be adjusted to the hand size of the cyclist, ensuring optimum braking efficiency. In most cases, the adjustment is made using a small Allen screw or a cross-headed screw located in the cover of the brake lever. Hydraulic brakes are equipped with a mechanism which automatically compensates lining wear. In order to perform brake pressure regulation or replacement of used linings, contact an authorised Kross service station.



Never transport a bicycle with hydraulic brakes with wheels pointing upwards. It may result in inoperational brakes. Clutches of disc brakes must be protected against sliding out with a special insert, if the bicycle is transported with removed wheels.

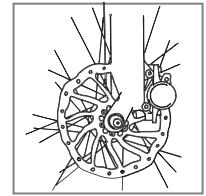

Fig. 23. Disc brake

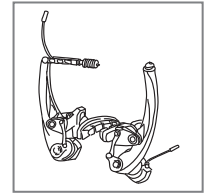

Fig. 24. V-brake type brake

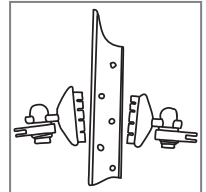

Fig. 25. Correct setting of brake pads

WARNING

- 203 mm and 180 mm discs provide higher braking force than 160 mm discs. Before using the brakes make sure that you have good sense of braking characteristics.
- Please pay special attention and do not insert fingers, during wheel installation or servicing, in the rotating disc of the disc brake. The disc is sharp enough to cause serious wounds if fingers become trapped in openings of the rotating disc. Fig. 26.
- Clutches and disc increase their temperature during brake operation, thus do not touch them during the ride or immediately after dismounting the bicycle, otherwise burns may occur. Before attempting to adjust the brake, check if its elements have cooled down appropriately.
- In case of wet weather, braking distance will be longer. Slow down earlier and delicately use the brake.
- If the road surface is wet, the wheels will slide much easier. In case of a wheel slide, the cyclist may fall off the bicycle. In order to avoid this, slow down earlier and use the brake delicately.
- Before starting the ride, always make sure that front and rear brakes are operational.
- Prevent penetration of oil or grease into the disc or brake clutches, otherwise the brakes may not operate correctly.
- If any grease or oil makes contact with the pads, the pads must be replaced. If any grease or oil makes contact with the disc, the disc must be cleaned. If this is not done, the breaks may operate improperly.
- Before riding the bicycle make sure that lining thickness is 0,5 mm or more. Fig. 27.
- In case of continuous brake use, resulting vapours may cause a brake blockade. In order to remedy this, release the brake lever for a moment.



Fig. 26. Braking disc

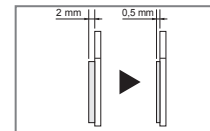

Fig. 27. Lining thickness

Burnout period

- Brake discs have burnout period and at the end of their burnout period their braking force will be gradually increasing. Remember about the increased braking force in case of using brakes in the burnout period. Identical situation occurs in the case of replacement of brake pads or the disc.

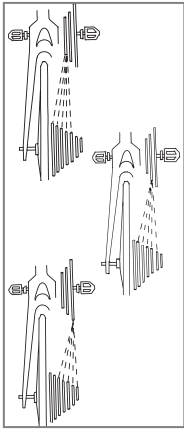

Fig. 47. Proper use of switches

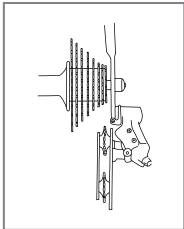

Fig. 48. Rear switch – screws of extreme reach out

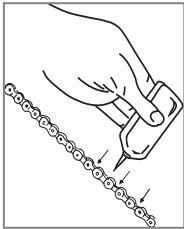

Fig. 49. Chain oiling

DRIVE

Switches, both the front one and the rear one, allow a fluid ride in every terrain. In order for the drive to operate efficiently, quietly and wear out more slowly, and the gears did not repeat, the chain layout on the sprockets in the front and the ratchets in the rear, see Fig. 47. Layout of the chain on particular gears is achieved using levers present on the handlebars. Efficient gear change depends mainly on the shifts and their adjustment. Gear change should be performed only during the ride, while pedalling. In case of rear multi-gear axle (bicycle without an external switch), in order to change gears, stop pedalling for a while, making the change while the gear change when the drive is stationary.

⚠ In case of bicycles with a multi-gear axle, gear change during pedalling may result in damage to the rear axle
Maximum reach out 🛠

In order to adjust the switches, both the front and the rear one, one has to set the maximum reach out of switch guides. Fig. 48 (outside and inside reach), so the chain does not fall outside the discs and ratchets. This adjustment is performed using screws of maximum reach out placed on the bodies of the switches (usually marked with letters H and L). In case of a properly adjusted switch, the guide falls in a line with the smallest and the biggest ratchet or disc.

Gears

 🛠

Adjustment of fluid gear change is performed as follows:

Line of the front switch must have enough tension for the guide to move the chain between the discs efficiently. The adjustment may be performed at the screw fixing the line to the switch (5-8 Nm) or using the barrel screw at the lever:

- Loosen the line of the back switch;
- Set the chain on the middle disc in the front and on the smallest ratchet in the back;
- Pull the line of the rear switch, fixing it with a screw (5-8 Nm) so the carriage of the switch is found directly in a straight line under the smallest ratchet in the rear (where the chain is);
- The rear switch should change gears fluidly. Small corrections are made by changing tension of the line using a barrel screw at the switch or at the lever.

Chain tension and adjustment

 🛠 ✂

Depending on the conditions and rides frequency, the chain is wearing out and increases its length, at the same time damaging the ratchets. In order to check the proper tension of the chain, set the gears in such a way that the chain is located on the biggest rear ratchet and on the biggest disc in the front. Next, try pulling the chain away from the disc. If the chain reaches a distance of more than 3 mm, it must be replaced. Turn to an authorised service station for help. In case of bicycles with only one gear or with the switch built into the rear axle, chain tension may be adjusted by the user, by moving the rear wheel in the hooks of the frame.

Chain tension adjustment

In case of bicycles having only one gear or with the gear system built into an axle, chain tension must be checked systematically (its tension decreases during use). Too high tension may increase the effort put into pedalling and decrease chain durability. Too low tension may cause the chain to fall. With a properly tensed chain, its vertical deflection may not exceed 10 mm. Fig. 49.1. One can adjust the tension by moving the rear wheel in relation to the frame.

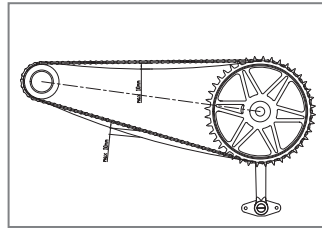

Fig. 49.1

Maintenance

 🛠 ✂

Frequent washing and oiling the drive will ensure good operation of the bike and will make it useful and operational in years to come. Wipe the chain, switch discs and ratchets regularly with a wipe cloth and grease them every 200 km or more often, if the chain is dry. Switches should be dusted and have mud removed after each ride. Using the thumb and the index finger, press teeth of switch discs through the wipe cloth and spin the crank. Insert the cloth between the ratchets of the multigear assembly and move the cloth back and forth. Thoroughly clean the switches and front discs using the wipe cloth. Replace the shields and the lines at least once a year. In order to clean the chain, catch it through the cloth and at the same time, spin the crank. Use oil for bicycle chains (thick oil – wet conditions, thin oil – dry conditions). Pour a drop of oil onto each chain roller. Fig. 49. Grab the chain through the cloth, simultaneously spin the crank and gently wipe the excess oil off the chain. In some Kross/Le Grand bicycles a solution including the switch located in the rear axle has been used. In this case, all repairs and maintenance should be performed by an authorised service station..

WHEELS

Wheels should rotate lightly and fluidly, and the tyres should fit well along the entire rim circumference.

Adjustment ✖

Well lubricated and screwed together axles allow traversing thousands of kilometers without the need for bearing replacement in the wheels. Well centered wheels should also serve well without the need for pulling up the spokes. However, in order to perform these adjustments, one needs experience and specialist tools.

Transport 🛠

In order to remove the wheels for transport, it is enough to unclip the rim brakes (in case of disc brakes, no additional operations are necessary) and loosen the clip or axle nuts which fix the wheel to the fork or to the frame. Then the wheel is slipped out of the hooks. Once the wheels are removed for the transport, put a special insert between the pads of disc brakes. After re-installing the wheels, tighten strongly (25-35 Nm) screws at the axle or press the clip. The clip should be difficult to press so it can be pressed into the hooks of the fork in the locked position.

Air chamber replacement 🛠

Air chamber replacement is performed after releasing the air by lifting an edge of the tyre on one side using special, plastic lever. Another lever is used to lift the edge of the tyre a few centimeters away. The third lever allows to lift the edge of the tyre along the entire length. Fig. 50. After air chamber replacement, pull out the tyre valve as far as possible through an opening in the rim and pump a small amount of air into the air chamber. Slip the tyre back onto the rim and fill the air chamber to the desired air pressure. If the air chamber valve cartridge needs to be replaced, then in the case of AV type valves a special spanner is required, Fig. 51. Other valves are replaced by unscrewing the nut, replacing the cartridge and screwing the nut back on. A securing nut is also necessary, lack of which may result in air losses. Some wheels are constructed on the so called wide axle. Removing them from a shock absorbing fork may require some experience.



In case of bicycles with rim brakes, keep rims and brake pads in particular cleanliness and control their wear.

Fast latching mechanism (QR) (wheels, seat bracket) 🛠

This system enables fast wheel replacement or seat height adjustment and change. In order for the mechanism to operate correctly and ensure maintaining appropriate wheel positioning in relation to the frame or the fork as well as prevent the seat from rotating during the ride, the adjustment nut must be adjusted properly, to achieve the adequate compression – 20 Nm. In order to increase the compression, twist the adjustment nut clockwise, in order to decrease it – counterclockwise. After closing the lever, a “CLOSE” mark (closed) is visible, and after opening it – “OPEN” (opened), Fig. 52. When using the fast latching mechanism for wheel installation, the mechanism should be pressing into the hooks of the fork when it is locked in the locked position. In order to check if the fast latching mechanism of the wheel is properly set, open the fast latching mechanism, hit the top part of the wheel with your hand, with properly set mechanism, the wheel should not fall out of the hooks of the front fork.

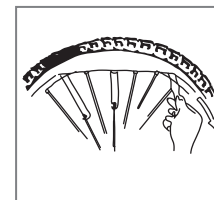

Fig. 50. Proper use of levers during tyre removal

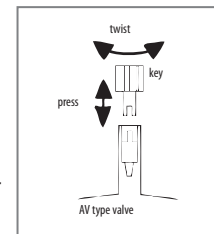

Fig. 51. AV type valve

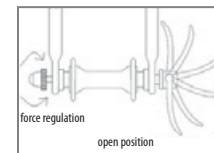

Fig. 52. Fast latching mechanism

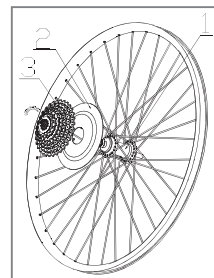

Fig. 52.1

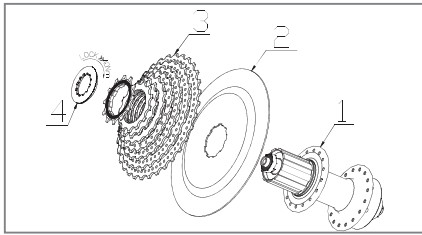

Fig. 52.2

Installation of spoke protectors

In order to prevent wheel rotation interruption or stopping in case of improper switch adjustment or switch damage (in case of bicycles with the rear switch), the bicycle should be equipped with a spoke protector. In case of bicycles with slow gear, its installation is performed by unscrewing the slow gear 3, Fig. 52.1, next the protector is installed on the axle and the slow gear is installed with a 40-50 Nm torque. In case of bicycles with a cassette, Fig. 52.2, the last ratchet of the cassette 4 must be removed, all ratchets 3 must be removed, place protector 2 on axle barrel 1 in such a way that protrusions in the protector and on the axle match each other, then install all ratchets and tighten the last one with torque engraved in the element.

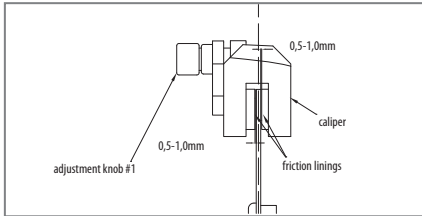

Fig. 53. Brake adjustment

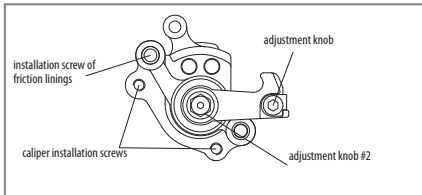

Fig. 54. Brake adjustment

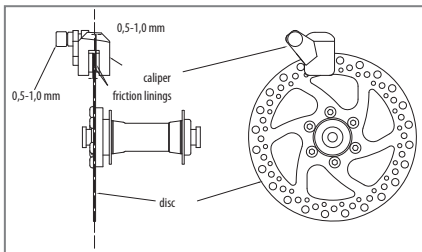

Fig. 55. Brake adjustment

Installation of the front wheel with a disc brake 🛠️ ✂️

1. Unpack the front wheel, remove the protective caps of axle nuts.
2. Loosen the axle nuts and insert the wheel between the friction linings of brake caliper.
3. Tighten the axle nuts with 25-35 Nm torque, remembering about axial wheel positioning in relation to the legs of the front fork. Tighten the right and the left nut simultaneously.
4. Rotate the wheel to check if the brake has been adjusted properly.
5. Proper brake adjustment, front, wheel, Fig. 53, Fig. 54, Fig. 55.

- I. The braking disc does not scratch the friction linings of the caliper.

If friction occurs:

- a) Perform adjustment using knob No 1, setting friction surfaces of the caliper lining parallel to the brake disc.
- b) Loosen the braking line screwing the brake lever regulator in or screwing screw No 2 out – preserving the condition described in p. II.
- II. The distance between the brake lever and the grip on handlebars in the working position after pressing the brake with force (15-20 kg) may not be smaller than 10 mm. The suggested distance between the friction lining and the caliper 0.5-1.0 mm.

In order to adjust the appropriate distances:

- a) Loosen the line fixing screw, increase tension and screw the line back.
- b) Screw in/out the adjustment screw No 2 in order to achieve appropriate distance.
- III. After performing adjustment according to p. I and II, the braking distance is preserved and potential friction of braking elements requires running in in order to have the elements properly adjusted.

Brake levers may be adjusted to the size of hands of the cyclist, ensuring optimum braking efficiency. In most cases, the adjustment is performed using a small Allen screw or a Phillips screw located in the housing of the brake lever. Brake lever motion range becomes longer with wear of brake lining and lengthening of the brake line – it requires the adjustment to be performed again. Contact an authorised Kross service station in order to replace worn linings.

Installation of the front wheel with a dynamo in the axle

Do not lubricate the interior of the axle, since the lubricant shall flow outside, which may possibly result in conductivity problems. An axle with a dynamo results in the wheel rotating harder because of the magnet located in the axle. A version with a clip is depicted in Fig. 56 and Fig. 57. A version with a nut is presented in Fig. 58 and Fig. 59. Tightening the nuts should be performed, changing between both sides in order not to put all effort into tightening and loosening on one side only, otherwise the axle may rotate, leading to overly tightened or loosened nuts. Tighten the nuts with a 20 Nm torque. Do not use a toothed washer as well as a version with a clip. If the cable is not correctly connected to the ground, check if the toothed washer scratches the varnish on the fork. If the washer does not scratch the varnish, the lamp shall not operate properly, then a bit of varnish must be scratched off. It is advised to connect both cables so the current may flow freely.

Cable connection

Cables should be connected as shown on Fig. 63. Connect the cable to the fork or basket fixture in such a way that during the ride it does not entangle in spokes or other elements, Fig. 60. If the position of the axle in relation to the light may change during the ride, for example, as a result of shock absorber use, check if the cable is connected in such a way that it does not loosen too much or does not tense during the ride. Connect the cables so that current from the dynamo flows from the light connector in the axle to the frame connector in the axle. In order to disconnect the light from the dynamo, remove the plug. Do not ride the bicycle if the plug is removed, otherwise the cable may get entangled in the wheel. During the wheel deinstallation, remove the plug first, Fig. 61. If the cables are stretched, they may break or conduct improperly. During wheel installation install the wheel in the fork and then install the connector plug.

Light operation checking

Turn the front wheel and check if the light is on, Fig. 62.

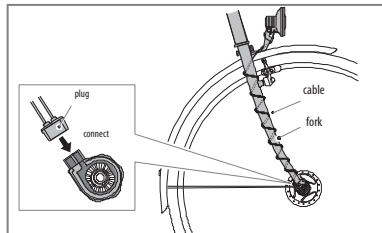

Fig. 60. Cable installation

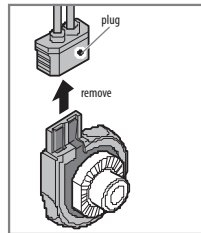

Fig. 61. Plug removal

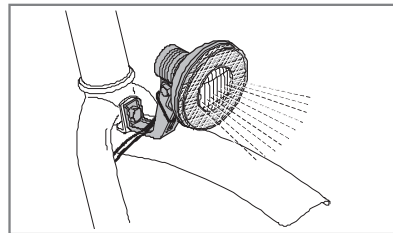

Fig. 62. Light operation check

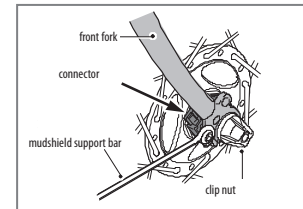

Fig. 56. Version with clip

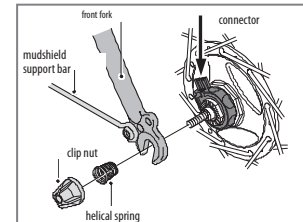

Fig. 57. Version with clip

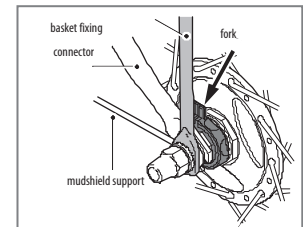

Fig. 58. Nut version

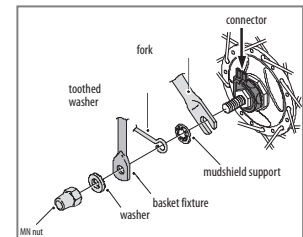

Fig. 59. Nut version

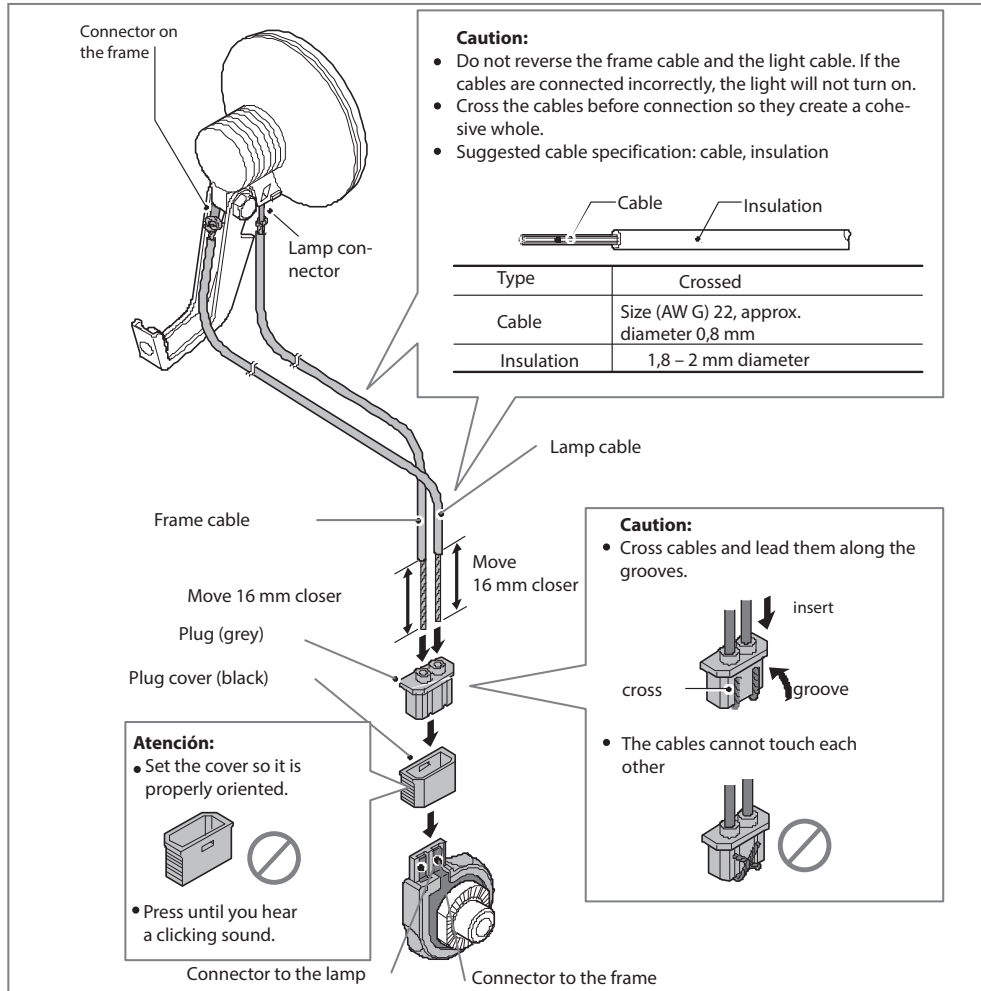

Fig. 63. Cable connection

Installation of the rear wheel with multigear axle Shimano Nexus 3 speed

During wheel installation/removal problems with correct switch operation may occur. In this case, contact an authorised service in order to perform appropriate adjustments.

1. Install the adjusting washer, Fig. 64.
2. Tighten nuts, Fig. 65.
3. Install the pushing bolt, Fig. 66.
4. Install the body of gear change system, Fig. 67.
5. Tighten the brake, Fig. 68.

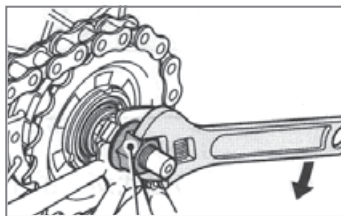

Fig. 65. Nut tightening

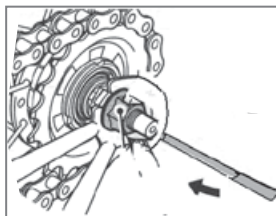

Fig. 66. Pushing bolt installations

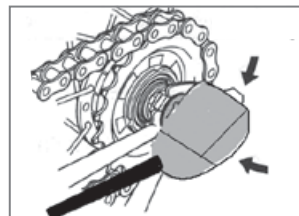

Fig. 67. Body installation

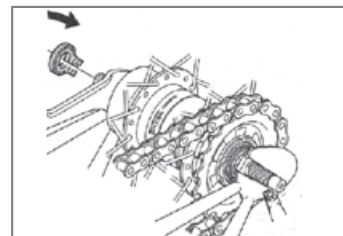

Fig. 64. Installation of adjusting washer

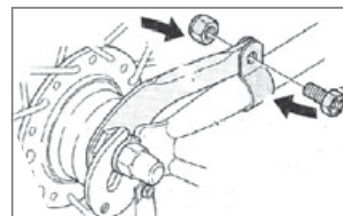

Fig. 68. Brake tightening

Installation of a rear wheel with a multi-gear axle Shimano Nexus 7/8 speed

After wheel installation/removal, problems with proper switch operation may occur. Contact the authorised service station in order to perform adjustment.

1. Latch the line in the handle, Fig. 69.
2. Install adjusting washers, Fig. 70.
3. Tighten the nuts, Fig. 71.
4. Tighten the brake, Fig. 72.

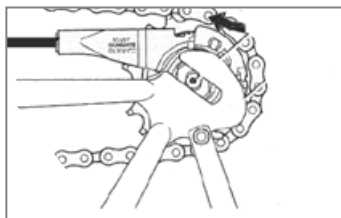

Fig. 69. Link latching



Fig. 70. Installation of adjusting washers

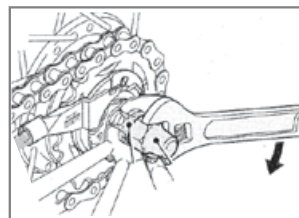

Fig. 71. Nut tightening

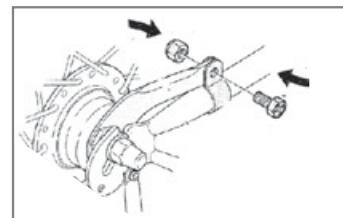

Fig. 72. Brake tightening

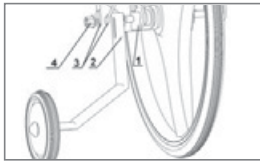

Fig. 73. Installation instruction for support wheels

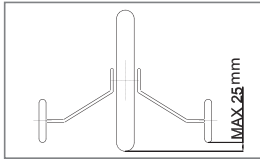

Fig. 74. Minimum clearance of support wheels from the road

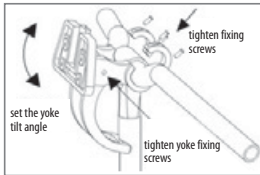

Fig. 75. Basket support installation

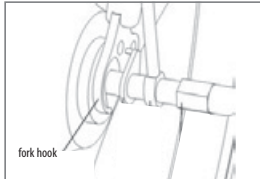

Fig. 76. Basket support installation (fork hook)

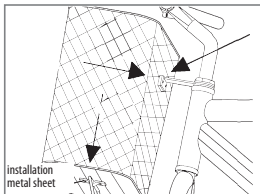

Fig. 77. Basket installation on the support

Installation instructions for support wheels – applies to kids bicycles 🗑️

The rear wheel axle is set and tightened with countering nuts. Installation (removal) of support wheels does not influence its adjustment. In order to install support wheels, Fig. 73, one has to:

1. Remove nuts (4) from the rear wheel.
2. Remove the mudshield bracket (3) (if present), do not remove adjusting handles (1).
3. Install in the order: wheel arms (2), mudshield support (3).
4. Adjust the support wheels so the clearing between the wheels and the ground with a vertically set bicycle was max. 25 mm, Fig. 74. Tighten nuts (4). Tightening torque – 17 Nm.
5. Caution! Kids bicycle with support wheels may be used in flat terrain, under supervision of adults. Danger in case of a bicycle equipped with support wheels may also be posed by barriers in the form of poles, narrow gates that the user can catch. Riding with support wheels in uneven terrain or close to pole-like barriers poses risk of bicycle tipping and as a consequence – injuries resulting from them.

To remove the retaining rings drawing 73 you should:

1. Remove the nuts (4) of the rear wheel axle,
2. Remove the fender supports (3) (if any),
3. Remove the support wheels (2), do not remove the retaining clamps (1)
4. Install the fender supports (3), and then tighten the nut (4) with a torque of 17 Nm.

BASKETS

Installation of a basket handle with a latching clip 🗑️

In order to install the basket handle with a latching clip, Fig. 75.:

1. Tighten fixing screws with a 5-8 Nm torque.
2. Set the angle of yoke tilt.
3. Tighten yoke fixing screws with a 5-8 Nm torque.

Installation of a basket with a support installed on the front wheel axle 🗑️

1. Install the basket support onto the front wheel axle (with the profiled arch on the side of the lighting set) in the following order: hook washer, basket support, nut, Fig. 76.
2. Install the basket on the basket support installed on wheel axle using MS screws, screwing the screws in from the inside of the basket into the installation metal sheet, installed underneath the basket support, Fig. 77.
3. Place the basket at the desired angle and install from the inside using the set: MS screw, washer and a nut.

FOLDED FRAME

Removal of folded frame lock 🗑️

In order to remove the folded frame lock:

1. Unblock the lever, Fig. 78.
2. Move the lever, Fig. 79.
3. Fold the frame arm, Fig. 80.

LIGHT

Light operation

Lighting is one of the basic elements of bicycle user safety and it must be installed. If you intend on riding in low visibility conditions, make sure that the lighting works properly. Bicycles equipped with a lighting set (dynamo + lamps) have electric installation of 6 V, 3 W. In case of bulb replacement, remove the lamp cover installed using screws or a latch. Lamps use bulbs of 6 V, 2,4 W in the front and 6 V, 0,6 W in the back. In case of lamp removal and cable disconnection, during re-installation one must remember about proper connection of lighting cables:

- White-striped cable, minus (ground)
- Non-striped cable, plus (+), according to markings on the lamp.

In the case of LED lighting instead of incandescent lamps they are equipped with LEDs that can not be exchanged. LED life is up to 50 000 hours. Battery Lighting - has built-in batteries that power. Each time before setting off, check the correct operation of the lighting. In the case of use the battery must be replaced.

 **Batteries are a product deemed to be dangerous, after use should be discarded in a container assigned to it.**

PEDALS

Pedal installation

Do not tighten the pedals manually – use a spanner (15 Nm). The pedal marked with the “R” letter is the right bicycle pedal, while installing it onto the crank, turn the pedal clockwise. The pedal marked with the “L” letter is the left bicycle pedal and while installing it onto the crank, turn the pedal counterclockwise.

STAND

Setting the adjustable stand

Stretch the stand at the appropriate length so the bicycle stands on its own, Fig. 80 and Fig. 81.

CLEANING AND MAINTENANCE

The bicycle must be maintained in good technical condition and the user must remember about regular cleaning. The bicycle must be cleaned after every 200 km and in case of riding in rain – after each such ride. It is advised to clean the bicycle thoroughly at the beginning and end of season. Dirt is removed using a wet sponge or cloth often drenched in water. Do not clean the bicycle dry, this may lead to scratching of varnished surfaces. Washed bicycle should be dried using a clean cloth. Do not clean the bicycle using a strong stream of water or water vapour at close distances, because penetration of water vapour to bearings is very probable, as well as increased friction, faster wear and corrosion. In the case of contact with cleaning agents and chain oil (grease) with brake pads, rim walls, brake discs, the brakes may operate very inefficiently and result in an accident.



The frame and bicycle components undergo wear. Any breaks, scratchings and varnish peeling may hint at wear of the given element. Replacement of worn parts is necessary because of cyclist safety.

KROSS S. A. does not equip its bicycles with spare parts. More information about proper bicycle use and maintenance may be obtained on the www.kross.eu site or from an employee of an authorised KROSS service station.

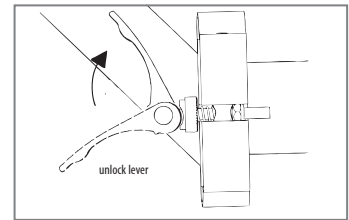

Fig. 78. Lever unlocking

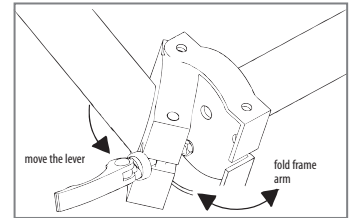

Fig. 79. Lever motion and frame folding

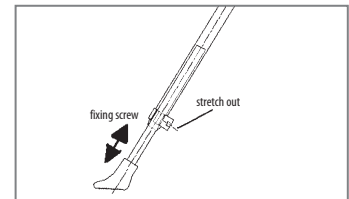

Fig. 80. Stretching the support out

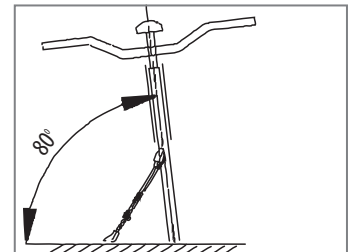

Fig. 81. Stand adjustment

INSTALLATION INSTRUCTION OF A UNIVERSAL BICYCLE CARRIER

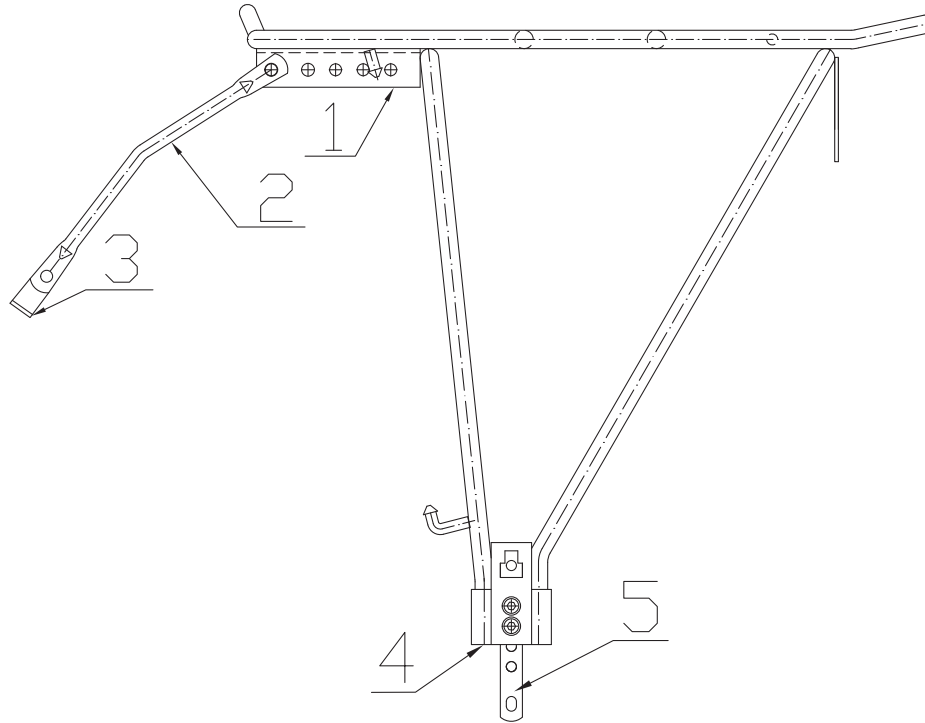

Fig. 78. Installation of a universal bicycle carrier

Screw together, using M5x14 screws and self-countering nuts (re: a, b, d):

1. Metal pad connecting pos. 3 with fixing bar pos. 2 (does not apply to bicycles with side bushings for carrier installation), tightening with 6-8 Nm torque,
2. Metal pad connecting pos. 3 or bars pos. 2 connect with the bicycle frame, tightening with 6-8 Nm torque,
3. Screw carrier supports to the lower part of the frame using M5 or M6 screws – depending on the holes in the frame, tightening with 6-8 Nm torque,
4. Fixing bar pos. 2 with appropriate opening of connector pos. 1, tightening with 6-8 Nm torque.

Perform carrier level adjustment by changing positioning of screws in the connector, pos. 1.

After reaching the desired carrier level, thoroughly and firmly tighten the screw connections.

Because it is possible for the screws to become spontaneously loose, each time before using the carrier, check their tightening.

If the screws became loose, tighten them immediately.

Carrier capacity is 18 kg or 25 kg, depending on the model used.

It is forbidden to perform any modifications to the carrier design. During a ride with encumbered carrier pay attention to different bicycle reactions when taking turns and braking and to uniform luggage weight distribution.

For their own safety, users should install red reflective lights in the rear part of the carrier – they increase cyclist visibility – in particular at dusk and at night.

If rear light is installed on the seat pipe, locate the luggage in such a way that it does not diminish visibility of warning lights.



Suggestions:

- Permissible weight of the bicycle and the cyclist according to the “BICYCLE TYPES AND THEIR USE” of this manual (p. 7)
- Joint elements should be correctly tightened and often checked
- The carrier is not adjusted for pulling a trailer
- The reflexive light or the light may not be covered by the luggage
- All mobile parts of the luggage should be secured against entangling in the wheel
- The luggage should be uniformly placed on both sides of the carrier



Caution!!!

- Check if geometric data and durability of the bicycle on which the carrier is to be installed are conforming with design data
- Do not modify the design of the carrier
- When the carrier is loaded, riding properties of the bicycle may change, in particular ease of control and braking efficiency
- Make sure that the luggage is secured to the carrier
- It is forbidden to attach wagons of any type to the carrier

BICYCLE CARRIER MAY NOT BE USED FOR DIRECT TRANSPORT OF INDIVIDUALS

Installing bicycle baby seats is permissible in case of carriers with 18 kg capacity (9-15 kg seat) or 25 kg (9-22 kg seat).





























Install baby seat on the carrier according to the instructions of the manufacturer.

1. Children should be carried in specially adjusted and permanently installed on the bicycle baby seats, with the cyclist ensuring cover against springs potentially present in the seat, in order to prevent the child from having their fingers crushed by the springs.

BICYCLE PART LUBRICATION

	How often	What lubricant	Our suggestion	Remarks	Service
Chain	After each ride in difficult conditions (mud, sand, rain, snow) or every 200 km	Thick or thin lubricants for bicycle chains, i.e. mineral, plant, wax-based, with Teflon additives	BRUNOX Top-Kett/IX 50 – for chains and switches; leaves not drying, protective-lubricating layer which prevents adhesion of dust and dirt; BRUNOX High Speed – oil for spot lubrication of chain rollers and switches	Selection of lubricant depends on riding conditions	
Controls	Once a year	Bearings lubricant			
Axles	Once a year	Bearings lubricant			
Shock absorbers	According to suggestions of the manufacturer		BRUNOX Deo – for cleaning and maintenance of shock absorber legs (increases shock absorber durability, eliminates spring squeaking in bicycles), suggested by ROCK SHOX and SITTING BULL . Protects simmerings and increases fluidity of shock absorber operation.	For external, working surfaces (upper legs in front, shock-absorbing forks), a small amount of lubricant for shock absorbers, not containing lithium can be applied	
Underseat pipe	After each taking out	Bearings lubricant or thick chain lubricant		Apply a small amount of lubricant on the surface entering the frame	
Pedals	Once a year	Bearings lubricant		Internal bearings	
Brake levers	Once a year or when necessary	Bearings lubricant or thick chain lubricant	BRUNOX Bike Fit – multi-function preparation in aerosol for general maintenance (neutral for varnish, rubber, leather and plastic)	Apply a small amount of lubricant on the axis of rotation of the lever	
Frame lock	Once a year	Bearings lubricant			
Switches	Once a year or when necessary	Well penetrating (thin) lubricants for chains and bearings lubricant	BRUNOX High Speed – oil for spot lubrication of chain rollers and switches	At least once a year clean and lubricate switch wheels. Axis of rotation when required.	

DIAGNOSES

Malfunction	Probable cause	Service
The brake makes squeaking noises during breaking	Wrong adjustment of brake pads The rim contaminated with lubricant Loosened brake clutches Disc of the disc brake contaminated with oil or lubricant	
The chain "jumps"	Dirty or rusty chain Worn chain Incorrectly adjusted switch Worn rear switches Bent rear switch Loose switch ratchet Bent ratchet teeth	     
Pedals move to the sides, knock or twist during the ride	Loose crank Incorrectly screwed pedals to the crank Bent pedal axis Loose or bent support Bent crank Loose pedal bearings	    
Squeaking noises	Not oiled axle bearings or support The seat makes squeaking noises Not oiled rotation axes in rear wheel suspension Rusty or not oiled chain Not oiled, shock absorbing fork Not oiled, shock absorbing support	    
The switch hits the spokes	Incorrectly adjusted rear switch Bent rear switch	 
Screeching noises	Not oiled handlebars/bridge clip Mismatched joint of the bridge and the handlebars Not oiled bridge clamp Support package moves inside the bowl Loose crank Broken frame Not oiled, rusty of loose bracket	     
Stiffness of the control system	Too tightly fastened controls	
Bent wheel	Incorrectly adjusted spokes Broken spoke Bent rim	  

SUGGESTED TIGHTENING TORQUES OF STEEL AND ALUMINIUM PARTS

Seat with support	18-22 Nm	Switch levers/brake levers	6-8 Nm
Seat support to the frame	20-25 Nm	Crank mechanism	35-45 Nm
Countering nut of the steering kit	15-20 Nm	Crank mechanism installed through spline	48-52 Nm
Handlebars support for the fork	18-22 Nm	Front switch (to the frame)	4-6 Nm
Handlebars to the support	15-20 Nm	Rear switch without hook	8-12 Nm
Front and rear wheels nuts	25-35 Nm	Rear switch with hook	5-8 Nm
A-head handlebars support to the fork and handlebars	8-12 Nm	Crank wedge fixing nut (M7)	12-14 Nm
Handlebars support (adjustable) at the adjustment location	15-20 Nm	Side/central support	10-15 Nm
Brake pads	6-9 Nm	Shock absorber	10-14 Nm
Line clips	5-8 Nm	Chain cover	3-6 Nm

SUGGESTED TIGHTENING MOMENTS OF CARBON ELEMENTS

Seat support to the frame	6 Nm
Handlebars support to the fork	4-6 Nm
Handlebars to the support	4-5 Nm
A-head handlebars support to the fork and to the handlebars	4-5 Nm
Front switch (to the frame)	3-5 Nm
Rear switch with hook	6-8 Nm
Disc brake clip to the frame	7-8 Nm
Road brake clip to the frame	7-8 Nm
Support cassette to the frame	Max. 50 Nm
Water bottle basket	3 Nm



Ownership copyrights to materials contained in this instruction belong to KROSS S. A. All trademarks have been used in information purposes only and they belong to their respective owners. The contents of the warranty card and all its elements are protected by Polish and international law, in particular in currently effective Act on copyright law and similar laws. Printing and copying using printing or digital techniques, modification and distribution of materials contained in this Warranty card/User manual, in part or in entirety, for purposes other than non-commercial ones, is possible only after obtaining approval of KROSS S. A.



JOIN OUR FANS AT:

[FACEBOOK.COM/KROSSBIKES](https://www.facebook.com/krossbikes)

[INSTAGRAM.COM/KROSSBIKES](https://www.instagram.com/krossbikes)

[YOUTUBE.COM/KROSSBIKESTV](https://www.youtube.com/krossbikestv)

[FACEBOOK.COM/LEGRANDBIKES](https://www.facebook.com/legrandbikes)

[INSTAGRAM.COM/LEGRANDBIKES](https://www.instagram.com/legrandbikes)

WWW.KROSS.EU

WWW.LEGRANDBIKES.COM

CONTACT IN YOUR COUNTRY

WWW.KROSS.PL/EN/DYSTRYBUTORZY

KROSS S.A.

UL. LESZNO 46

06-300 PRZASNYSZ

TEL./FAX +48 29 752 44 45





5 YEARS WARRANTY
ON ELIGIBLE KROSS BICYCLES



5 YEARS WARRANTY
ON ELIGIBLE LE GRAND BICYCLES