

Go to www.vtechphones.com to register your product for enhanced warranty support and the latest VTech product news.

DS6771-3

DECT 6.0 cordless telephone with BLUETOOTH® wireless technology



vtech®

User's manual

Congratulations

on purchasing your new VTech product. Before using this telephone, please read **Important safety instructions**.

This manual has all the feature operations and troubleshooting necessary to install and operate your new VTech telephone. Please review this manual thoroughly to ensure proper installation and operation of this innovative and feature rich VTech product.

For support, shopping, and everything new at VTech, visit our website at **www.vtechphones.com**. In Canada, please visit **www.vtechcanada.com**.



Telephones identified with this logo have reduced noise and interference when used with most T-coil equipped hearing aids and cochlear implants. The TIA-1083 Compliant Logo is a trademark of the Telecommunications Industry Association. Used under license.



The ENERGY STAR[®] program (www.energystar.gov) recognizes and encourages the use of products that save energy and help protect our environment. We are proud to mark this product with the ENERGY STAR[®] label indicating it meets the latest energy efficiency guidelines.

Important safety instructions

When using your telephone equipment, basic safety precautions should always be followed to reduce the risk of fire, electric shock and injury, including the following:

1. Read and understand all instructions.
2. Follow all warnings and instructions marked on the product.
3. Unplug this product from the wall outlet before cleaning. Do not use liquid or aerosol cleaners. Use a damp cloth for cleaning.
4. Do not use this product near water such as near a bath tub, wash bowl, kitchen sink, laundry tub or swimming pool, or in a wet basement or shower.
5. Do not place this product on an unstable table, shelf, stand or other unstable surfaces.
6. Avoid placing the telephone system in places with extreme temperature, direct sunlight, or other electrical devices. Protect your phone from moisture, dust, corrosive liquids and fumes.
7. Slots and openings in the back or bottom of the telephone base and handset are provided for ventilation. To protect them from overheating, these openings must not be blocked by placing the product on a soft surface such as a bed, sofa or rug. This product should never be placed near or over a radiator or heat register. This product should not be placed in any area where proper ventilation is not provided.
8. This product should be operated only from the type of power source indicated on the marking label. If you are not sure of the type of power supply in your home or office, consult your dealer or local power company.

9. Do not allow anything to rest on the power cord. Do not install this product where the cord may be walked on.
10. Never push objects of any kind into this product through the slots in the telephone base or handset because they may touch dangerous voltage points or create a short circuit. Never spill liquid of any kind on the product.
11. To reduce the risk of electric shock, do not disassemble this product, but take it to an authorized service facility. Opening or removing parts of the telephone base or handset other than specified access doors may expose you to dangerous voltages or other risks. Incorrect reassembling can cause electric shock when the product is subsequently used.
12. Do not overload wall outlets and extension cords.
13. Unplug this product from the wall outlet and refer servicing to an authorized service facility under the following conditions:
 - When the power supply cord or plug is damaged or frayed.
 - If liquid has been spilled onto the product.
 - If the product has been exposed to rain or water.
 - If the product does not operate normally by following the operating instructions. Adjust only those controls that are covered by the operation instructions. Improper adjustment of other controls may result in damage and often requires extensive work by an authorized technician to restore the product to normal operation.
 - If the product has been dropped and the telephone base and/or handset has been damaged.
 - If the product exhibits a distinct change in performance.
14. Avoid using a telephone (other than cordless) during an electrical storm. There is a remote risk of electric shock from lightning.
15. Do not use the telephone to report a gas leak in the vicinity of the leak. Under certain circumstances, a spark may be created when the adapter is plugged into the power outlet, or when the handset is replaced in its cradle. This is a common event associated with the closing of any electrical circuit. The user should not plug the phone into a power outlet, and should not put a charged handset into the cradle, if the phone is located in an environment containing concentrations of flammable or flame-supporting gases, unless there is adequate ventilation. A spark in such an environment could create a fire or explosion. Such environments might include: medical use of oxygen without adequate ventilation; industrial gases (cleaning solvents; gasoline vapors; etc.); a leak of natural gas; etc.
16. Only put the handset of your telephone next to your ear when it is in normal talk mode.
17. The power adapters are intended to be correctly oriented in a vertical or floor mount position. The prongs are not designed to hold the plug in place if it is plugged into a ceiling, under-the-table or cabinet outlet.

SAVE THESE INSTRUCTIONS

Battery

- **CAUTION:** Use Only Supplied Battery.
- Do not dispose of the battery in a fire. Check with local waste management codes for special disposal instructions.
- Do not open or mutilate the battery.

Released electrolyte is corrosive and may cause burns or injury to the eyes or skin. The electrolyte may be toxic if swallowed.

- Exercise care in handling batteries in order not to create a short circuit with conductive materials.
- Charge the battery provided with this product only in accordance with the instructions and limitations specified in this manual.

Precautions for users of implanted cardiac pacemakers

Cardiac pacemakers (applies only to digital cordless telephones):

Wireless Technology Research, LLC (WTR), an independent research entity, led a multidisciplinary evaluation of the interference between portable wireless telephones and implanted cardiac pacemakers. Supported by the U.S. Food and Drug Administration, WTR recommends to physicians that:

Pacemaker patients

- Should keep wireless telephones at least six inches from the pacemaker.
- Should NOT place wireless telephones directly over the pacemaker, such as in a breast pocket, when it is turned ON.
- Should use the wireless telephone at the ear opposite the pacemaker.

WTR's evaluation did not identify any risk to bystanders with pacemakers from other persons using wireless telephones.

About cordless telephones

- **Privacy:** The same features that make a cordless telephone convenient create some limitations. Telephone calls are transmitted between the telephone base and the cordless handset by radio waves, so there is a possibility that the

cordless telephone conversations could be intercepted by radio receiving equipment within range of the cordless handset. For this reason, you should not think of cordless telephone conversations as being as private as those on corded telephones.

- **Electrical power:** The telephone base of this cordless telephone must be connected to a working electrical outlet. The electrical outlet should not be controlled by a wall switch. Calls cannot be made from the cordless handset if the telephone base is unplugged, switched off or if the electrical power is interrupted.
- **Potential TV interference:** Some cordless telephones operate at frequencies that may cause interference to televisions and VCRs. To minimize or prevent such interference, do not place the telephone base of the cordless telephone near or on top of a TV or VCR. If interference is experienced, moving the cordless telephone farther away from the TV or VCR often reduces or eliminates the interference.
- **Rechargeable batteries:** Exercise care in handling batteries in order not to create a short circuit with conducting material such as rings, bracelets and keys. The battery or conductor may overheat and cause harm. Observe proper polarity between the battery and the battery charger.
- **Nickel-metal hydride rechargeable batteries:** Dispose of these batteries in a safe manner. Do not burn or puncture the battery. Like other batteries of this type, if burned or punctured, they could release caustic material which could cause injury.

Table of contents

What's in the box.....	1
Overview	2
Telephone base overview.....	2
Handset overview.....	3
Headset overview.....	4
Charger overview.....	5
Display icons overview.....	5
Telephone base lights overview.....	6
Handset lights overview.....	6
Headset lights and alert tones overview.....	6
Connect.....	7
Connect the telephone base.....	7
Connect the charger.....	7
Install the battery.....	8
Check the battery level.....	8
Charge the battery.....	9
Position the headset.....	10
Replace the pre-installed earbud and earhook.....	10
Adjust the headset to wear on the ear... Over the head band.....	11
Before use.....	12
Set date and time.....	12
Set answering system through voice guide.....	12
Check for dial tone.....	13
Operating range.....	13
Bluetooth.....	13
Glossary of terms.....	14
Bluetooth setup.....	15
VTech Connect to Cell™ application... Add a Bluetooth enabled cell phone... Add a Bluetooth enabled headset.... Auto connection..... Connect a paired cell phone or headset..... Disconnect a paired cell phone or headset..... Review the cell devices list..... Download phonebook contacts.....	16 16 17 18 18 18 18 18

Remote voice control.....	20
Activate remote voice control on handset.....	21
Activate remote voice control on headset.....	21
Configure your telephone	22
Using the handset menu.....	22
Set language.....	22
Set date and time.....	23
Home area code.....	23
Dial mode.....	24
Temporary tone dialing.....	24
Telephone Operations	24
Make a home call.....	25
Predial a home call.....	25
Answer a home call.....	25
End a home call.....	25
Make a cell call.....	25
Predial a cell call.....	25
Answer a cell call.....	26
End a cell call.....	26
Answer a cell call while on a home call.....	26
Answer a home call while on a cell call.....	26
Speakerphone.....	26
Volume.....	26
Mute.....	27
Join a call in progress.....	27
Call waiting on the home line.....	27
Call waiting on the cell line.....	27
Chain dialing.....	27
Find handset.....	28
Redial list	28
Review a redial list entry.....	28
Dial a redial list entry.....	28
Delete a redial list entry.....	28
Multiple handset use.....	29
Intercom.....	29
Answer an incoming call during an intercom call.....	29
Call transfer using intercom.....	29

Phonebook.....30

Add a phonebook entry 30
Review phonebook entries 31
Alphabetical search 31
Delete a phonebook entry 32
Delete all phonebook entries 32
Edit a phonebook entry..... 32
Dial a phonebook entry..... 32

Caller ID33

Review the caller ID log 33
Memory match 33
Missed call indicator 34
View dialing options 34
Dial a caller ID log entry 35
Save a caller ID log entry to the
phonebook 35
Delete a caller ID log entry 35
Delete all caller ID log entries 35

Call block36

Block unknown calls 36
Add a call block list entry 36
Review the call block list 36
Edit a call block list entry 37
Save a caller ID log entry to the
call block list 37
Delete a call block list entry 37
Mute first ring 37

Sound settings38

Key tone 38
Ringer tone 38
Handset ringer volume 38
Telephone base ringer volume 38
Temporary ringer silencing 39

**About the built-in answering
system and voicemail service...39**

**Set your built-in answering
system40**

Turn the answering system on or off 40
Default announcement 40
Record your own announcement..... 41
Play the announcement..... 41
Delete the announcement 41

Set number of rings 41
Turn the call screening on or off 42
Message alert tone 42
Voice guide 42

**Using your built-in answering
system43**

New message indication..... 43
Message playback..... 43
Delete all old messages 44
Remote access 44
Set remote access code 45
Call screening..... 45
Call intercept..... 46
Record, play, and delete memos..... 46

**Using the built-in answering
system and voicemail service...46**

**Retrieve voicemail from
telephone service.....47**

Retrieve voicemail 47
Set your voicemail number 47
Turn off the new voicemail indicators... 47
Cell phone voicemail 47

Expand your telephone system ...48

Screen messages48

ECO mode50

General product care51

Frequently asked questions.....51

The RBRC® seal57

FCC, ACTA and IC regulations...57

**California Energy Commission
battery charging testing
instructions.....59**

For C-UL compliance only.....60

Limited warranty.....63

Technical specifications..... 65

What's in the box

Your telephone package contains the following items. Save your sales receipt and original packaging in case it is necessary to ship your telephone for warranty service.

NOTE

To purchase replacement batteries or power adapters, visit our website at www.vtechphones.com or call 1 (800) 595-9511. In Canada, go to www.vtechcanada.com or dial 1 (800) 267-7377.

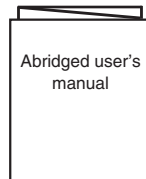
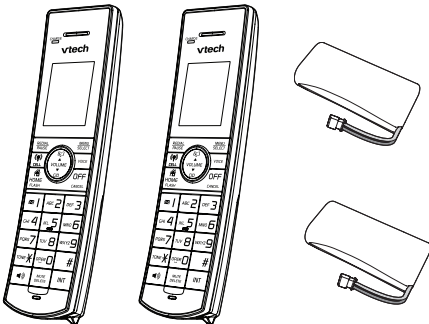
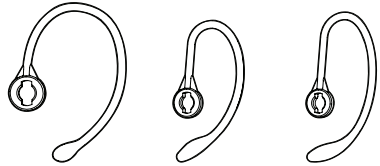
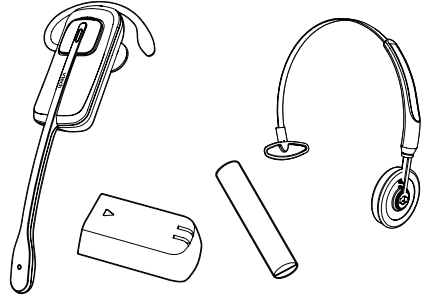
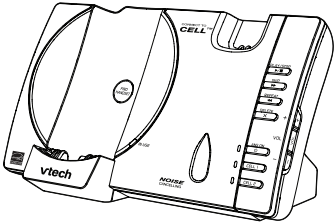
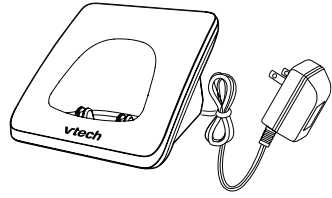

Overview

Telephone base overview

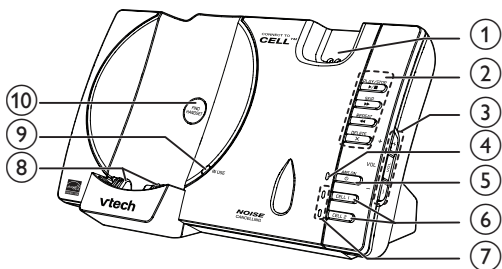

1 – Headset charging cradle

2 – ►/■/PLAY/STOP

- Press to play messages.
- Press to stop message playback.

►/■/SKIP

- Press to skip to the next message.

◀/REPEAT

- Press to repeat a message.
- Press twice to play the previous message.

X/DELETE

- Press to delete the playing message.
- When the handset is not in use, press twice to delete all old messages.

3 – + /VOL/-

- Press to adjust the volume during message playback.
- Press to adjust the telephone base ringer volume when the handset is not in use.

4 – ⏻/ANS ON light

- On when the answering system is on.

5 – ⏻/ANS ON

- Press to turn the answering system on or off.

6 – CELL 1 and CELL 2

- Press to connect the paired cell Bluetooth device.
- Press and hold to add or replace a Bluetooth device.

7 – CELL 1 and CELL 2 lights

- On when the telephone base is paired and connected with a Bluetooth device.
- Flashes when the telephone base is in discoverable mode.

8 – Charging cradle

9 – IN USE light

- On when the handset or headset is in use, or the answering system is answering a call.
- Flashes when there is an incoming call, or another telephone sharing the same line is in use.

10 – FIND HANDSET

- Press to page all system handsets and headset.

Handset overview

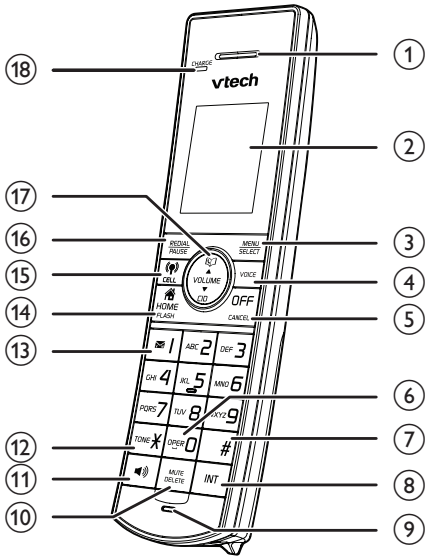

1 – Handset earpiece

2 – LCD display

3 – MENU/SELECT

- Show the menu.
- While in a menu, press to select an item, or save an entry or setting.

4 – VOICE

- Press to activate the voice-controlled application on your connected cell phone.

5 – OFF/CANCEL

- Hang up a call.
- Silence the ringer temporarily while the handset is ringing.
- Press and hold to erase the missed call indicator while the phone is not in use.
- Press to return to the previous menu; or press and hold to return to idle mode, without making changes.

6 – OPER 0

- Press to add a space when entering names.

7 –

- Press repeatedly to show other dialing options when reviewing a caller ID log entry.

8 – INT

- Press to start an intercom conversation or transfer a call.

9 – Microphone

10 – MUTE/DELETE

- Mute the microphone during a call.
- Delete digits or characters while using the dialing keys.
- Silence the ringer temporarily while the handset is ringing.
- Delete the displayed entry while reviewing the phonebook, caller ID log, call block list or redial list.

11 –

- Make or answer a call using the handset speakerphone.
- During a call, press to switch between the speakerphone and the handset.

12 –

- While you have set the dial mode to pulse and on a call, press to switch to tone dialing temporarily.

13 –

- Press repeatedly to add or remove 1 in front of the caller ID log entry before dialing or saving it to the phonebook.
- Press and hold to set or dial your voicemail number.

14 – /HOME/FLASH

- Make or answer a home call.
- Answer an incoming home call when you hear a call waiting alert.

15 – /CELL

- Make or answer a cell call.
- Answer an incoming cell call when you hear a call waiting alert.

16 – REDIAL/PAUSE

- Press repeatedly to review the redial list.
- Press and hold to insert a dialing pause while entering a number.

17 – VOLUME /

- Review the phonebook when the handset is not in use.
- Increase the listening volume during a call.
- Scroll up while in a menu, or in the phonebook, caller ID log, call block list or redial list.
- Move the cursor to the right when entering numbers or names.

VOLUME / CID

- Review the caller ID log when the handset is not in use.
- Decrease the listening volume during a call.
- Scroll down while in a menu, or in the phonebook, caller ID log, call block list or redial list.
- Move the cursor to the left when entering numbers or names.

18 – CHARGE light

- On when the handset is charging.

Headset overview

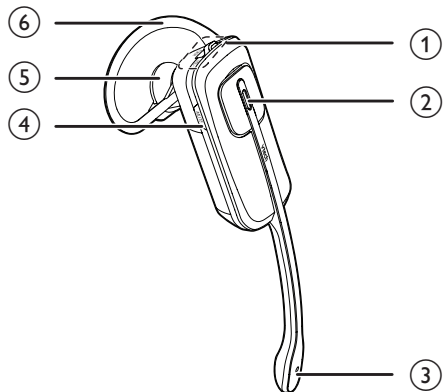

1 – VOL+

- Increase the headset volume.

VOL-

- Decrease the headset volume.

Flash

- While on a call, press and hold to answer an incoming call when you receive a call waiting alert.

2 – ON/OFF light

- On when the headset is charging.

ON/OFF key

- Press to answer or end a call.

3 – Microphone

4 – MUTE

- Press to activate the voice-controlled application on your connected cell phone when idle.
- Mute the microphone during a call.
- When there is an incoming call, press to silence the ringer in the earpiece temporarily.

5 – Earpiece





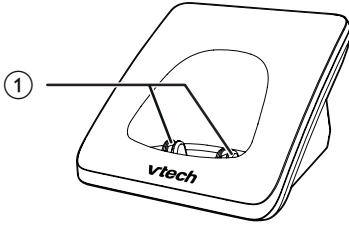



6 – Earhook

Charger overview



1 – Charging pole

Display icons overview

	The battery icon flashes when the battery is low and needs charging.
	The battery icon animates when the battery is charging.
	The battery icon becomes solid when the battery is fully charged.
ECO	The ECO mode activates automatically to reduce power consumption when the handset is within range from the telephone base.
	There are new voicemail received from your telephone service provider.
	On when the home line is in use or there is an incoming home call. Flashes when there is an incoming home waiting call.
 ¹ ₂	There are Bluetooth devices connected on the cell devices list.
	On when the cell line is in use or there is an incoming cell call. Flashes when there is an incoming cell waiting call.
NEW	There are new caller ID log entries.
ANS ON	The answering system is turned on.
	The handset ringer is off.
	The message number currently playing and total number of new/old messages recorded.

Telephone base lights overview

IN USE	<ul style="list-style-type: none"> • On when the telephone line is in use. • On when you are registering a handset. • Flashes quickly when there is an incoming call. • Flashes when another telephone sharing the same line is in use. • Flashes when you are deregistering all handsets.
CELL 1/CELL 2	<ul style="list-style-type: none"> • On when a Bluetooth device is connected to the base. • Flashes when the telephone base is in discoverable mode.
📞/ANS ON/OFF	<ul style="list-style-type: none"> • On when the answering system is turned on.

Handset lights overview

🔇	<ul style="list-style-type: none"> • On when the handset speakerphone is in use.
CHARGE	<ul style="list-style-type: none"> • On when the handset is charging in the telephone base or handset charger.

Headset lights and alert tones overview

Light status

Red	<ul style="list-style-type: none"> • On when the headset battery is charging. • Flashes every 10 seconds when the headset battery is low and needs charging.
Blue	<ul style="list-style-type: none"> • Flashes twice every three seconds when the headset is in use. • Flashes every four seconds when there is an incoming call. • Flashes every 10 seconds when the headset is out of the headset charger and has enough charge.
Red and blue	<ul style="list-style-type: none"> • Flashes slowly when the headset is not registered. • Flashes quickly when the headset is registering to a telephone base.
Off	<ul style="list-style-type: none"> • No battery is installed, or the headset has run out of battery. • The headset is powered off.

Alert tones

One short beep every 30 seconds	<ul style="list-style-type: none"> • The microphone is muted.
Two low beeps	<ul style="list-style-type: none"> • Call waiting alert tone.
Three rising beeps	<ul style="list-style-type: none"> • A conference call has started.

Connect

You can connect the telephone base for desktop usage.

NOTES

- Use only the adapters provided.
- Even if you do not subscribe to any conventional telephone service, you can pair a Bluetooth enabled cell phone to your telephone base (see Bluetooth), and use the cell line alone without plugging in a telephone line cord.
- Make sure the electrical outlets are not controlled by wall switches.
- The adapters are intended to be correctly oriented in a vertical or floor mount position. The prongs are not designed to hold the plug in place if it is plugged into a ceiling, under-the-table or cabinet outlet.

TIP

- If you subscribe to digital subscriber line (DSL) high-speed Internet service through your telephone line, make sure you install a **DSL filter** (not included) between the telephone line cord and telephone wall jack. Contact your DSL service provider for more information.

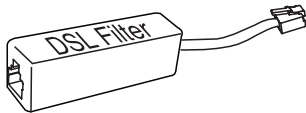

Connect the telephone base

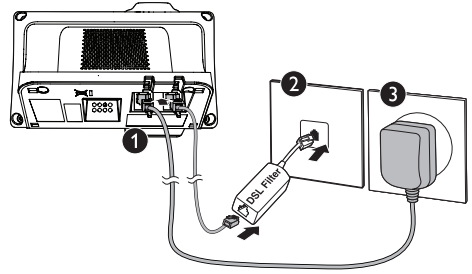

Connect the charger

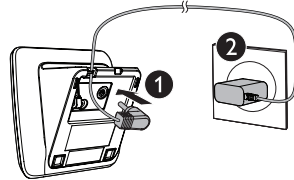

Install the battery

Install the handset battery

Install the handset battery as shown below.

NOTES

- Use only supplied battery.
- If the handset will not be used for a long time, disconnect and remove the battery to prevent possible leakage.

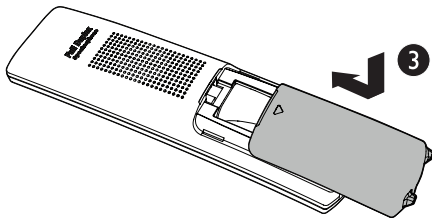
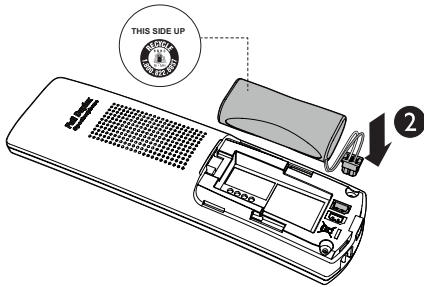
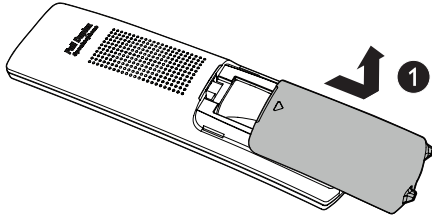

Install the headset battery

Install the headset battery as shown below.

NOTE

- Use only supplied battery.

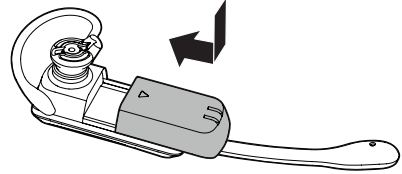

Check the battery level

After you have installed the battery, check the battery level on the handset screen.

- If the battery icon is or , then go to **Before use** section to set the date and time, and set the answering system through voice guide.
- If the screen is blank, or flashes, then the battery needs to be charged. Go to **Charge the battery** section before you do any setting or operation.

Charge the battery

Place the handset in the telephone base or the charger to charge.

Place the headset on the telephone base to charge.

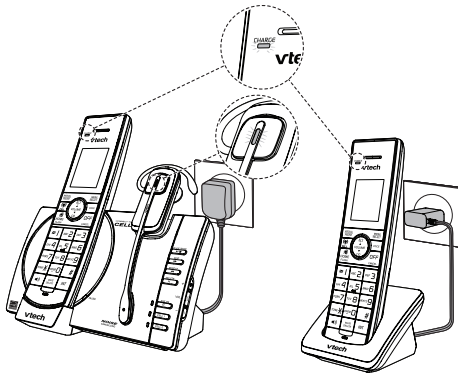

Once you have installed the battery, the handset LCD display indicates the battery status (see the table on next page).

NOTES

- Press **CANCEL** or place the handset in the telephone base or charger will bypass the set date and time, and voice guide.
- For best performance, keep the handset in the telephone base or charger when not in use. Place the headset on the telephone base when not in use.
- The handset battery is fully charged after 12 hours of continuous charging. The headset battery is fully charged after 3 hours of continuous charging.
- If you place the handset in the telephone base or the charger without plugging in the battery, the screen displays **No battery**.

Battery indicators	Battery status	Action
The screen is blank, or shows Put in charger and ⬆ flashes.	The battery has no charge or very little charge. The handset cannot be used.	Charge without interruption (at least 30 minutes).
The screen shows Low battery and ⬆ flashes.	The battery has enough charge to be used for a short time.	Charge without interruption (at least 30 minutes).
The screen shows HANDSET X .	The battery is charged.	To keep the battery charged, place it in the telephone base or charger when not in use.

When it is fully charged, you can expect the following performance:

Operation	Operating time
While in handset use (talking*)	Seven hours
While handset in speakerphone mode (talking*)	Three hours
While handset not in use (standby**)	Five days
While in headset use (talking*)	Four hours
While headset not in use (standby**)	Two days

* Operating times vary depending on your actual use and the age of the battery.

** Handset/headset is not charging or in use.

To manually set the date and time and the answering system, refer to **Configure your telephone** and **Set your built-in answering system** sections.

To manually initiate the voice guide, refer to **Voice guide** under **Set your built-in answering system** section.

Position the headset

There are four earbuds and four earhooks provided. One earbud and one earhook have been attached to the headset.

You can choose a suitable size of earbud, earhook and an appropriate way to position your headset.

Replace the pre-installed earbud and earhook

1. Hold both sides of the earbud. Twist and pull the earbud until it separates from the earpiece.

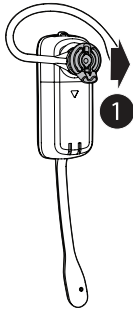

2. Rotate the earhook to vertical direction and then pull the earhook until it separates from the headset.

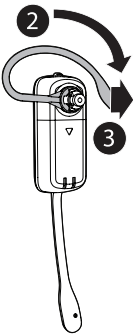

3. Attach a earhook, and then a suitable earbud to the headset until they fit into place.

To wear on the right ear:

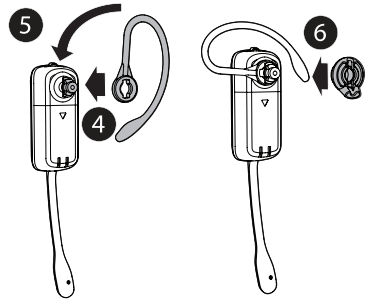

To wear on the left ear:

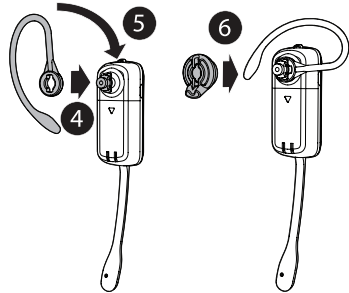

4. Wrap the earhook with the sponge.

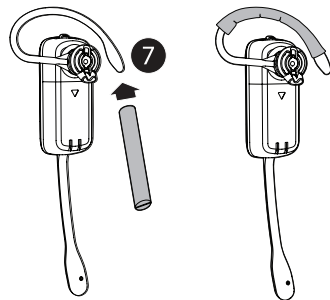

Adjust the headset to wear on the ear

- Hook the headset on your ear. Adjust the angle of the headset until the microphone is pointing towards your mouth. Firmly grip the headset with one hand whenever adjusting the headset microphone up or down.

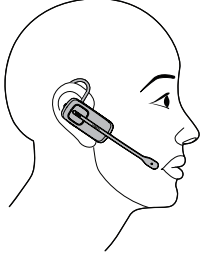

3. Rotate the headset to vertical direction until it clicks into place.

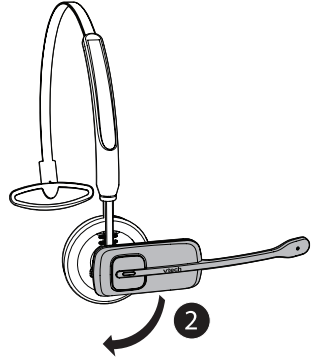

4. Adjust the head band to fit your head. Adjust and rotate the angle of the headset until the microphone is pointing towards your mouth.

Over the head band

To attach the head band to the headset:

1. Refer to Steps 1 and 2 in **Replace the pre-installed earbud and earhook** section to remove the earbud and earhook.
2. Attach the headset to the headband.

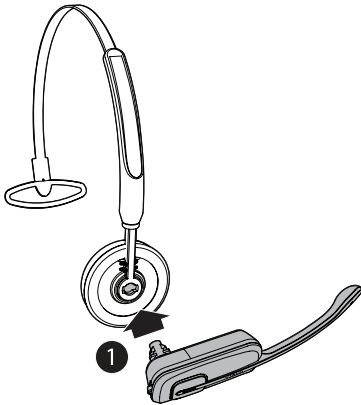

To remove the head band from the headset:

1. Hold the headset with one hand and the head band with your other hand.
2. Rotate the headset to horizontal direction and then pull the headset until it separates from the head band.

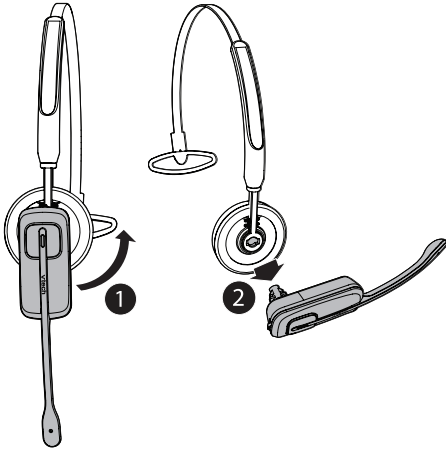

Before use

After you install your telephone or power returns following a power outage and battery depletion, the handset will prompt you to set the date and time, and the answering system through voice guide.

Set date and time

NOTE

- Make sure you set the date and time including the year correctly; otherwise the answering system does not announce the correct day of the week for your recorded messages time stamp.

1. Use the dialing keys (0-9) to enter the month (MM), date (DD) and year (YY). Then press **SELECT**.
2. Use the dialing keys (0-9) to enter the hour (HH) and minute (MM). Then press ▼ or ▲ to choose **AM** or **PM**.
3. Press **SELECT** to save.

After the setting for the date and time, the handset will display **Voice guide to...** and **set up Ans sys?** alternatively.

Set answering system through voice guide

This feature assists you to do the basic setup of the answering system. You can follow the voice guide to record your own announcement, set the number of rings and the message alert tone.

1. Press **SELECT** to start the voice guide for the answering system setup. You hear the voice prompt *"Hello! This voice guide will assist you with the basic setup of your answering system."*
2. Setup your answering system by inputting the designated numbers as instructed in the voice guide.

Check for dial tone

Press ***/HOME**. If you hear a dial tone, the installation is successful.

If you do not hear a dial tone:

- Make sure the installation procedures described above are properly done.
- It may be a wiring problem. If you have changed your telephone service to digital service from a cable company or a VoIP service provider, the telephone line may need to be rewired to allow all existing telephone jacks to work. Contact your cable/VoIP service provider for more information.

Operating range

This cordless telephone operates with the maximum power allowed by the Federal Communications Commission (FCC). Even so, this handset and telephone base can communicate over only a certain distance - which can vary with the locations of the telephone base and handset, the weather, and the layout of your home or office.

When the handset is out of range, the handset displays **Out of range or no pwr at base** alternately.

If there is a call while the handset is out of range, it may not ring, or if it does ring, the call may not connect well when you press ***/HOME** or ***/CELL**. Move closer to the telephone base, and then press ***/HOME** or ***/CELL** to answer the call. If the handset moves out of range during a telephone conversation, there may be interference. To improve reception, move closer to the telephone base.

Bluetooth

Your new **DS6771** telephone system with Bluetooth wireless technology has the following features:

- Pair and connect up to a maximum of two cell phones with the telephone base to make and receive cell calls. Only one cell phone can be active on a call at a time.
- Make and receive calls using your cell phone plan while utilizing the ease and comfort of your home telephone system.
- Receive phonebook entries from your cell phone.

IMPORTANT INFORMATION

- Refer to the user's manual of your Bluetooth enabled cell phone for more information about how that device uses Bluetooth connectivity.
- Bluetooth wireless technology operates within a short range (a maximum of approximately 15 feet) from the telephone base. Keep connected cell phones within this range. For optimal performance, place your cell phone next to the telephone base while using the **DS6771** cell line.

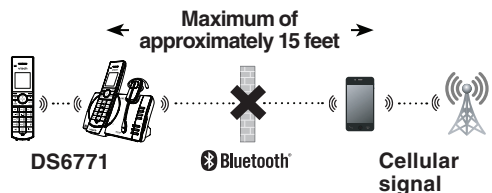

The Bluetooth® word mark and logos are owned by Bluetooth SIG, Inc. and any use of such marks by VTech Holdings Limited is under license. VTech Holdings Limited is a member of Bluetooth SIG, Inc. Other trademarks and trade names are those of their respective owners.

- If your cell phone has poor reception in your home, the **DS6771** cannot improve the reception. However, if there is a location in your house with better reception, you can leave your cell phone at that location while using the **DS6771** cell line.
- If you experience poor sound quality, place your cell phone closer to the **DS6771** to ensure strong Bluetooth signal strength. Make sure there are no physical obstacles between the **DS6771** and the cell phone, such as large furniture or thick walls.
- Charge your cell phone while it is connected to the telephone base. Your cell phone's battery will discharge faster while it is connected to the telephone base via Bluetooth wireless technology.
- Monitor your cell phone's usage because minutes are deducted from your cellular plan for the duration of all cell calls.

Refer to **Bluetooth setup** to learn how to set up and manage your Bluetooth enabled devices. Refer to **Telephone operation** on how to operate your Bluetooth devices with your new **DS6771** telephone system with Bluetooth wireless technology. Refer to **Frequently asked questions** if you experience difficulty using the telephone system.

Glossary of terms

Below are some terms used in this user's manual to help you become familiar with using your Bluetooth enabled cell phone and your new **DS6771** telephone system.

Bluetooth cell phone - refers to a Bluetooth enabled cellular telephone.

Cell line - the telephone line associated with your cell phone service. On your **DS6771** handset, press /CELL to use the cell line.

Connected - when you pair a Bluetooth cell phone to the **DS6771**, it is automatically connected. When a cell phone is connected, **1** and/or **2** displays after  on the handset and the **CELL 1** and/or **CELL 2** light on the telephone base is on. If a cell phone loses its connection to the telephone base, it must be reconnected before you can use the cell phone with the **DS6771**.

Disconnected - when a cell phone is disconnected, the  on the handset no longer displays and the **CELL 1** and/or **CELL 2** light on the telephone base is off.

Discoverable mode - before a Bluetooth enabled device can be paired, it must be set to this mode. When pairing your cell phone, the telephone base will be set to this mode. Depending on the manufacturer, this mode is sometimes referred to as **Find Me** or **Visibility**.

Home line - your conventional telephone land line. On your **DS6771** handset, press /HOME/FLASH to use the home line.

Paired device - once a Bluetooth enabled cell phone has been paired with the telephone base, it appears on the cell devices list. A maximum of two cell phones can be paired with the telephone base.

Pairing - this refers to the process of Bluetooth enabled cell phone registering device information with each other. The telephone base must be paired with the Bluetooth enabled cell phone before it can be used. Depending on the manufacturer, this is also referred to as **Bonding**.

PIN - by default, the PIN is **0000** for the telephone base and for most Bluetooth devices. PIN information must be exchanged between Bluetooth devices before they can be used. This is also known as a **Passkey** or **Passcode**.

Bluetooth setup

NOTE

- Make sure your cell phone has a good cell reception near the telephone base.

To use a Bluetooth enabled cell phone with your **DS6771**, you must first pair and connect it with the telephone base. All **DS6771** handsets can be used to make or answer on the cell phone line.

Bluetooth wireless technology operates within a short range (15 feet). When you pair a Bluetooth cell phone to the telephone base, move closer to the telephone base to maintain sufficient signal strength.

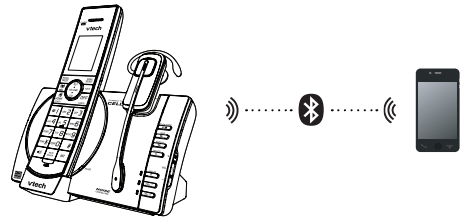

NOTES

- For optimal performance, place your cell phone next to the telephone base while using the cell line.
- To avoid interference from other electronic devices, place your telephone base far away from devices such as baby monitors, wireless routers, microwaves and computers.

VTech Connect to Cell™ application

If you are using Bluetooth enabled Android® phones (OS 2.3 or higher), you can further extend the flexibility of your telephone system with use of this free application.

VTech Connect to Cell comprises **Caller ID manager** and **Alerts manager** that help you integrate your cell phone with your new **DS6771**.

To learn more or download this application via **Google Play® Store**, Scan the QR code on the right, or go to

http://www.vtechphones.com/app_connect_to_cell.



Add a Bluetooth enabled cell phone

Before you begin, make sure that you have cellular coverage and your Bluetooth enabled cell phone is not connected to any other Bluetooth devices. Refer to your cell phone user's manual to learn how to search for or add new Bluetooth devices.

All paired cell phones are shown on the cell devices list.

Once you have paired and connected a device with the telephone base, you do not need to repeat the procedure again unless you want to replace the existing paired cell phone with a new one.

To pair and connect a cell phone:

1. Choose a slot to pair the cell phone. Press and hold **CELL 1** and/or **CELL 2** on the telephone base for about four seconds until the **CELL 1** and/or **CELL 2** light flashes.
 - If there is already a cell phone in the slot, the existing cell phone will be erased from cell devices list.
2. Turn on the Bluetooth feature of your cell phone. Once your cell phone finds your VTech phone (**VTech DS6771**), press the appropriate key on your cell phone to continue the pairing process.
 - Your cell phone may prompt you to enter the PIN of the telephone base. The default PIN of the telephone base is **0000**.
 - All cell phones that are connected to the telephone base are disconnected temporarily until the pairing process is complete.

Android® and Google Play® are registered trademarks of Google Inc.

When the cell phone is successfully paired and connected to the telephone base, the corresponding status icon (📶₁ or 📶₂) displays. The corresponding device light (**CELL 1** and/or **CELL 2**) turns on.

The pairing process may take up to one minute. If the pairing process fails, turn off the Bluetooth feature on your cell phone and on the **DS6771** by pressing **CELL 1/ CELL 2**. Then repeat the steps above to pair and connect again. In some cases, it may take you a few attempts to complete the pairing process.

The steps for the pairing process may vary for different cell phones. If this happens, follow the prompts on your cell phone and your **DS6771** to complete the pairing process.

If you have trouble pairing your cell phone, it may not be compatible with your DS6771. Check the Bluetooth compatibility list at www.vtechphones.com.

Add a Bluetooth enabled headset

To pair and connect a headset:

1. Press **MENU** on the phone when it is not in use.
2. Press ▼ or ▲ to choose **Bluetooth**, and then press **SELECT**.
3. Press ▼ or ▲ to choose **Add BT headset**, and then press **SELECT**. The screen displays **Search headset....**
 - If there is already a cell device in the slot, the existing cell phone will be erased from cell devices list.

4. Set your headset to discoverable mode (refer to the user's manual of your headset on the Bluetooth feature of your headset). Once your handset finds your headset, press **SELECT**.

- Enter the PIN of your headset if required. The PIN for most Bluetooth devices is **0000** (refer to the user's manual of your headset), then press **SELECT**.

5. When the headset is successfully paired and connected to the telephone base, the 📶₂ icon displays. The **CELL 2** device light turns on.

The pairing process may take up to one minute. If the pairing process fails, turn off the Bluetooth feature on your headset and on the **DS6771** by pressing **CELL 2**. Then repeat the steps above to pair and connect again. In some cases, it may take you a few attempts to complete the pairing process.

When a connected headset is charging, it may disconnect from the telephone base and the **CELL 2** light on the telephone base turns off. For some headset models, you may need to turn on the headset and reconnect it to the telephone base again.

If you have trouble pairing your headset, it may not be compatible with your DS6771. Check the Bluetooth compatibility list at www.vtechphones.com.

Auto connection

A cell device may be disconnected from the telephone base when:

- The Bluetooth feature of your connected cell device is turned off.
- The power of your cell device is turned off.
- Your cell device is not within range of the telephone base.



After the cell device is disconnected, wait for about 1 minute. Then, power on the cell device, turn on the Bluetooth feature, or move it within range of the base, the base will try to reconnect to the cell device. If you disconnect the cell device from the cell devices list, the base will not attempt to reconnect unless your cell device is moved out of range and back in range again.

NOTE

- If your cell device does not reconnect to the base automatically, follow the section below to connect it manually.

Connect a paired cell phone or headset

If you need to connect your paired cell phone or headset to the telephone base manually:

1. Press **CELL 1** and/or **CELL 2** on the telephone base when it is not in use. The **CELL 1** and/or **CELL 2** light flashes.
2. When the cell phone or headset is connected to the telephone base, you hear two beeps. The corresponding status icon (¹/₂) displays. The corresponding device light (**CELL 1** and/or **CELL 2**) turns on.

Disconnect a paired cell phone or headset

If you need to disconnect a paired cell phone or headset from the telephone base, refer to the user's manuals of your cell phone or headset for instructions to disconnect a Bluetooth device.

If you press and hold **CELL 1** and/or **CELL 2** on the telephone base, the existing paired cell phone in that slot will be erased. See **Add a Bluetooth enabled cell phone** and **Add a Bluetooth enabled headset** on how to pair and connect a new cell phone or headset.

Review the cell devices list

1. Press **MENU** on the handset when it is not in use.
2. Press **▼** or **▲** to choose **Bluetooth**, and then press **SELECT**.
3. Press **▼** or **▲** to choose **Device list**, and then press **SELECT**.

Download phonebook contacts

You can download phonebook entries to your **DS6771** telephone system via Bluetooth wireless technology. Each downloaded phonebook are stored in the handset phonebook with up to 24 digits for each phone number and 15 characters for each name.

Before downloading the phonebook, make sure the cell phone is paired and connected to the **DS6771**. Make sure the handset battery is charged for at least 10 minutes.

Place your cell phone next to the telephone base while downloading.

To download contacts from your Bluetooth cell phone:

1. Press **MENU** on the phone when it is not in use.
2. Press ▼ or ▲ to choose **Bluetooth**, and then press **SELECT**.
3. Press ▼ or ▲ to choose **Download PB**, and then press **SELECT**. The handset displays **Select a device** briefly.
 - If there is no cell phone paired to the system, the handset displays **Pair cell first** and then returns to the previous menu.
4. Press ▼ or ▲ to choose a desired device when necessary, and then press **SELECT**.
 - If the selected device is not available, the handset displays **DX not avail** and then returns to the previous menu.

During the download, the handset flashes **Downloading...**

All other idle system handsets display **Downloading...**

5. When the downloading process completes or when the memory is full, the handset displays **Entries added: XXX**. Then the handset returns to the Bluetooth menu.

NOTES

- Certain cell phones do not support SIM card download. If this is the case, try transferring the contacts from your SIM card to your cell phone memory first, and then download from your cell phone memory. For more information on how to transfer contacts from your SIM card to your cell phone memory, see the user's manual of your cell phone.
- When downloading the phonebook from your Bluetooth enabled cell phone, some data may not transfer. For example, if you have home, mobile and work numbers for a particular contact, the three categories may not transfer to your **DS6771**.

- For certain cell phones, you may need to press a key on your cell phone to confirm the phonebook download.
- For Android and Blackberry cell phones, you may also download your cell phone phonebook to your **DS6771** via the VTech Contact Share application. Scan the QR code on the right, or go to www.vtechphones.com/apps/contact_share for application download.



Remote voice control

If you have connected a cell phone to your **DS6771** telephone system, you can activate the voice-controlled application (voice app) of the cell phone, such as Siri®, Google Now™ or S Voice®, via your handset or headset. The remote voice control feature works with:

Voice-controlled application	Siri	Google Now	S Voice
Operation System (Versions supported)	iOS (8 or above)	Android (4 or above)	Android (4 or above)

Before using the remote voice control feature, make sure you checked the following:

- Your cell phone is paired and connected to your telephone system via Bluetooth.
- No Bluetooth applications are running in the background of your cell phone.
- Place your cell phone next to the telephone base.
- Do not lock up your cell phone's screen or set passcode for activating the voice app.

- Make sure you have turned on or logged in to the applications on your cell phone that you will be sending your voice commands, such as GPS, email and social networking accounts.
- Your cell phone's data or Wi-Fi signal is in full strength and your cell phone can connect to the Internet.
- Try to activate the voice app on your cell phone to ensure it is in place.

Siri® is a registered trademark of Apple Inc.

Google Now™ is a trademark of Google Inc.

S Voice® is a registered mark of Samsung Electronics Co., Ltd.

Activate remote voice control on handset

1. Press **VOICE** on the handset.
 - If you have connected one cell phone to the telephone, the handset shows the device name of the connected cell phone directly.
 - If you have connected two cell phones to the telephone, the handset shows **Select a device**, followed by the device name list of the connected cell phones. Scroll to choose the desired cell phone, and then press **SELECT**.
2. The handset then shows the remote voice control icon (📞).
 - If the activation fails, the handset displays **Not available**. When the screen returns to idle, try Step 1 again.
3. When the handset plays the confirmation tone as forwarded by the cell phone's voice app, start speaking toward the handset, and then wait for feedback. Make reply to the voice app's feedback, if necessary.
 - You can press (📞) on the handset to turn off the speakerphone and listen to the feedback through the handset earpiece.
4. To end the current remote voice control session, press **CANCEL** on the handset. You can restart by following Steps 1-3 mentioned above.

Activate remote voice control on headset

📞NOTE

- Make sure the **CELL 1** slot on the telephone base is paired and connected with a cell phone.

1. Press **MUTE** on the headset.
2. When the headset plays the confirmation tone as forwarded by the cell phone's voice app, start speaking toward the headset, and then wait for feedback. Make reply to the voice app's feedback, if necessary.
3. To end the current remote voice control session, press the **ON/OFF** key on the headset. You can restart by following Steps 1 and 2 mentioned above.

📞NOTES

- Once you have activated the remote voice control feature, you are using your cell phone's voice app to operate your cell phone.
- Please check the cell phone user's manual and the voice app's help topics to find out what commands you can use and any limitations of the voice app.
- Some cell phone manufacturers or network carriers may customize the phone's operating system and implement their own voice app. If you want to use Google Now, you need to manually set it as your default voice app. For detailed instructions, refer to your cell phone user's manual, or contact your cell phone's manufacturer or network carrier. You may also go to "Google Product Forums" on the Internet and check the corresponding help topics.
- Due to the settings of certain cell phones and voice apps, your cell phone may not support the remote voice control feature. Contact your cell phone's manufacturer or network carrier, or check the voice app's help topics if you encounter any problems.

- During the remote voice control activation, if your Android cell phone comes with both a dedicated voice app and Google Now, it may prompt you to select which voice app to use, and whether use it for just once or always. Select the desired options. If you do not respond to your cell phone's prompt in time, the handset screen will return to idle, and the  icon will disappear. You can restart by following Steps 1-3 mentioned above.
- If you receive a landline or cell line incoming call when you have activated remote voice control on a connected cell phone, the remote voice control operation will be ended.
- The feature may be ended automatically by your cell phone. For example, a cell call has been established via the remote voice control feature and the call has just ended.
- If you need to press dialing keys (**0-9**, ***^{tone}**, **#**) during a cell call, please make the call using the cell lines of your telephone system instead of using the voice app via the remote voice control feature.

Configure your telephone

Using the handset menu

1. Press **MENU** when the handset is not in use.
2. Press **▼** or **▲** until the screen displays the desired feature menu.
3. Press **SELECT** to enter that menu.
 - To return to the previous menu, press **CANCEL** on the handset.
 - To return to idle mode, press and hold **CANCEL** on the handset.

Set language

The LCD language is preset to English. You can select English, French or Spanish to be used in all screen displays.

1. Press **MENU** when the handset is not in use.
2. Press **▼** or **▲** to choose **Settings**, and then press **SELECT**.
3. Press **SELECT** to select **LCD language**.
4. Press **▼** or **▲** to choose **English**, **Français** or **Español**, and then press **SELECT** to save your selection. Then the handset returns to the previous menu. You hear a confirmation tone

NOTE

- If you accidentally changed the LCD language to French or Spanish, you can reset it to English easily by pressing **MENU** and then entering ^{tone}***364#**.

Set date and time



- Make sure you set the date and time including the year correctly; otherwise the answering system does not announce the correct day of the week for your recorded messages time stamp.
1. Press **MENU** when the handset is not in use.
 2. Press ▼ or ▲ to choose **Set date/time**, and then press **SELECT**.
 3. Use the dialing keys (**0-9**) to enter the month (**MM**), date (**DD**) and year (**YY**). Then press **SELECT**.
 4. Use the dialing keys (**0-9**) to enter the hour (**HH**) and minute (**MM**). Then press ▼ or ▲ to choose **AM** or **PM**.
 5. Press **SELECT** to save the settings. You hear a confirmation tone. Then the handset returns to the previous menu.

Home area code

If you dial your local calls using only seven digits (area code not required), you can program your home area code so that when you receive a call within your local area, the telephone number is automatically stored without the area code in the caller ID log.

1. Press **MENU** when the handset is not in use.
2. Press ▼ or ▲ to choose **Settings**, and then press **SELECT**.
3. Press ▼ or ▲ to choose **Home area code**, and then press **SELECT**.
4. Use the dialing keys to enter a three-digit home area code.
5. Press **SELECT** to save your selection. Then the handset returns to the previous menu. You hear a confirmation tone.



- If, in the future, your telephone service provider requires you to dial the area code when making a local call, or, if you move to a location that requires it, delete the home area code you have already programmed, following the steps above. After you have deleted the home area code, _ _ _ will appear on the display.

Dial mode

The dial mode is preset to touch-tone dialing. If you have pulse (rotary) service, you must change the dial mode to pulse dialing before using the telephone to make a call.

1. Press **MENU** when the handset is not in use.
2. Press ▼ or ▲ to choose **Settings**, and then press **SELECT**.
3. Press ▼ or ▲ to choose **Dial mode**, and then press **SELECT**.
4. Press ▼ or ▲ to choose **Touch-tone** or **Pulse**.
5. Press **SELECT** to save your selection. Then the handset returns to the previous menu. You hear a confirmation tone.

Temporary tone dialing

If you have pulse (rotary) service only, you can switch from pulse to touch-tone dialing temporarily during a call. This is useful if you need to send touch-tone signals to access your telephone banking or long distance services.

1. During a call, press **tone** **X**.
2. Use the dialing keys to enter the number you wish to dial.
3. The telephone sends touch-tone signals. The telephone automatically returns to pulse dialing mode after you end the call.

Telephone Operations

Handset control key panel:

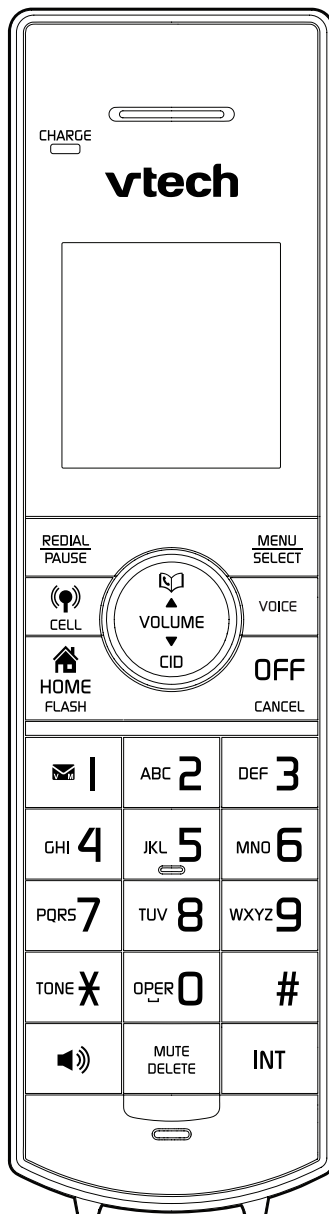

Make a home call

1. Press **🏠/HOME** or **📞** on the handset.
2. When you hear a dial tone, dial the number.
 - The handset displays **Unable to call** if the telephone line is in use.

📞NOTES

- The handset shows the elapsed time as you talk (in hours, minutes and seconds).
- While entering numbers, press and hold PAUSE to insert a dialing pause (a **p** appears).

Predial a home call

1. Enter the telephone number.
2. Press **🏠/HOME** or **📞** to dial.

📞NOTES

- The handset displays **Unable to call** if the telephone line is in use.
- The handset shows the elapsed time as you talk (in hours, minutes and seconds).
- While entering numbers, press **DELETE** or **CANCEL** to make corrections; press and hold PAUSE to insert a dialing pause (a **p** appears).

Answer a home call

Press **🏠/HOME**, **📞**, or any dialing key (**0-9**, **#**, or **TONE X**) to answer.

-OR-

Press **ON/OFF** key on the headset.

End a home call

Press **OFF** on the handset, or place the handset in the telephone base or handset charger.

-OR-

Press **ON/OFF** key on the headset.

Make a cell call

1. Press **📞/CELL** on the handset. The handset displays **Select a device**.
 - If you have only one cell phone connected to the telephone base, press **SELECT** to select the only device.
 - If you have two cell phones connected to the telephone base, press **▼** or **▲** to select a cell phone and then press **SELECT**.
2. Enter the telephone number, and then press **📞/CELL** to dial.
 - The handset displays **Unable to call** if your cell phone is in use.

📞NOTES

- The handset shows the elapsed time as you talk (in hours, minutes and seconds).
- While entering numbers, press **DELETE** or **CANCEL** to make corrections; press and hold PAUSE to insert a dialing pause (a **p** appears).
- While using the cell line, place your cell phone closer to the telephone base, and make sure that there are no physical obstacles such as large furniture or thick walls between the telephone base and the cell phone.

Predial a cell call

1. Enter the telephone number.
2. Press **📞/CELL** to dial.
 - If you have only one cell phone connected to the telephone base, it is automatically selected to make cell calls.
 - If you have two cell phones connected to the telephone base, the handset displays **Select a device**. Press **▼** or **▲** to select a cell phone and then press **SELECT**.

ⓘNOTES

- The handset displays **Unable to call** if your cell phone is in use.
- The handset shows the elapsed time as you talk (in hours, minutes and seconds).
- While entering numbers, press **DELETE** or **CANCEL** to make corrections; press and hold PAUSE to insert a dialing pause (a **p** appears).

Answer a cell call

Press **(P)/CELL**, **(M)**, or any dialing key (**0-9**, **#** or **ⓧ**) to answer.

ⓘNOTE

- You can also use your cell phone to answer the call. If you answer with your cell phone, it will disconnect from the telephone base.

End a cell call

Press **OFF** on the handset, place the handset in the telephone base or handset charger.

Answer a cell call while on a home call

While you are on a home call and you receive an incoming cell call, you hear a beep, and your handset flashes **(P)**. The telephone base and all other handsets ring.

To answer the incoming cell call:

Press **(P)/CELL** on the handset. The home line is put on hold.

To resume the home call on hold:

Press **(H)/HOME** on the handset.

Answer a home call while on a cell call

While you are on a cell call and you receive an incoming home call, you hear a beep, and your handset flashes **(H)**. The telephone base and all other handsets ring.

To answer the incoming home call:

Press **(H)/HOME** on the handset. The cell line is put on hold.

To resume the cell call on hold:

Press **(P)/CELL** on the handset.

Speakerphone

When the handset is on a call, press **(M)** to switch between the speakerphone and the handset earpiece. When the speakerphone is active, the handset displays **Speaker**.

Volume

During a call, press **(V) /VOLUME** or **VOLUME/ (V)** on the handset, or **VOL+** or **VOL-** on the headset to adjust the listening volume.

If this is a cell call and the volume is too loud or quiet, try changing the volume on your cell phone. On some cell phones, changing the volume on the cell phone affects your cell call volume on the **DS6771** handset.

ⓘNOTES

- The handset and speakerphone volume settings are independent.
- When the volume reaches the minimum or maximum setting, you hear two beeps.

Mute

The mute function allows you to hear the other party but the other party cannot hear you.

- During a call, press **MUTE**. The handset displays **Muted** until the mute function is turned off.
- Press **MUTE** again to resume the conversation. The handset briefly displays **Microphone on**.

-OR-

- During a call, press **MUTE** on the headset. The headset announced “*Mute on*”.
- Press **MUTE** again to resume the conversation. The headset announced “*Mute off*”.

Join a call in progress

Another handset can join you on a home call. That call continues until all parties hang up. You can share an outside call with up to two handsets at the same time.

You can buy additional expansion handsets (**DS6072**) for this telephone base. You can register up to five devices to the telephone base.

- When a handset is already on a call, press **🏠/HOME** or **📞** on another handset to join the call.
- Press **OFF** or place the handset in the telephone base or handset charger to exit the call. The call continues on the other handset until both handsets hang up.

📌NOTE

- If you have paired a DECT 6.0 cordless headset and speakerphone to the telephone base, you can also join a call in progress using the paired device. Refer to the user’s manuals of the respective product for more information.

Call waiting on the home line

When you subscribe to call waiting service with your telephone service provider, the handset flashes **📞** and you hear a beep if someone calls while you are already on a call.

- Press **FLASH** on the handset to put your current call on hold and take the new call.
- Press **FLASH** on the handset at any time to switch back and forth between calls.

Call waiting on the cell line

When you subscribe to call waiting service with your cell phone service provider, the handset flashes **📞** and you hear a beep if someone calls while you are already on a call.

- Press **📞/CELL** on the handset to put your current call on hold and take the new call.
- Press **📞/CELL** on the handset at any time to switch back and forth between calls.

Chain dialing

Use this feature to initiate a dialing sequence from numbers stored in the phonebook, caller ID log or redial list while you are on a call.

Chain dialing can be useful if you wish to access other numbers (such as bank account numbers or access codes) from the phonebook, caller ID log or redial list.

To access a number from the phonebook while on a call:

1. Press **MENU**.
2. Press **SELECT** to select **Phonebook**.
3. Press **▼** or **▲** to scroll to the desired entry.

4. Press **SELECT** to dial the displayed number.

To access a number from the caller ID log while on a call:

1. Press **MENU**.
2. Press ▼ or ▲ to choose **Caller ID log**, and then press **SELECT**.
3. Press ▼ or ▲ to scroll to the desired entry.
4. Press **SELECT** to dial the displayed number.

To access a number from the redial list while on a call:

1. Press **REDIAL** to enter the redial list.
2. Press ▼, ▲ or **REDIAL** repeatedly to browse to the desired entry.
3. Press **SELECT** to dial the displayed number.

Find handset

This feature helps you find misplaced handsets.

To start paging:

- Press **FIND HANDSET** on the telephone base.
All idle handsets ring and their screens display **** Paging ****.

To end paging:

- Press **⌂/HOME**, **☎/CELL**, **CANCEL**, **⏪**, or any dialing key (**0-9**, **#** or **ⓧ**) on a handset.

-OR-

- Press **FIND HANDSET** again on the telephone base.

-OR-

- Place the handset in the telephone base or charger.

NOTE

- Do not press and hold **FIND HANDSET** for more than four seconds. It may lead to handset and headset deregistration.

Redial list

Each handset stores the last 10 telephone numbers dialed (up to 30 digits). When there are already 10 entries, the oldest entry is deleted to make room for the new entry.

Review a redial list entry

1. Press **REDIAL** to enter the redial list.
2. Press ▼, ▲ or **REDIAL** repeatedly to browse until the desired entry displays.

Dial a redial list entry

1. Press **REDIAL** to enter the redial list.
2. Press ▼, ▲ or **REDIAL** repeatedly to browse until the desired entry displays.
3. Press **⌂/HOME** or **⏪** to dial using the home line.

-OR-

Press **☎/CELL** to dial using the cell line.

-OR-

1. Press **⌂/HOME** or **⏪** to use the home line.

-OR-

Press **☎/CELL** to use the cell line.

2. Press **REDIAL** to enter the redial list.
3. Press ▼, ▲ or **REDIAL** repeatedly to browse until the desired entry displays.
4. Press **SELECT** to dial the displayed number.

Delete a redial list entry

1. Press **REDIAL** to enter the redial list.
2. Press ▼, ▲ or **REDIAL** repeatedly to browse until the desired entry displays.
3. When the handset displays the number you want to delete, press **DELETE**.

Multiple handset use

Intercom

Use the intercom feature for conversations between two devices. Your telephone base supports up to five devices. You can buy additional expansion handsets (**DS6072**) or headsets for this telephone base.

1. Press **INT** on the handset when idle.
2. Your handset shows **Intercom to:** Use the dialing keys to enter a device number (**1-5**).
The handset shows **Calling HS X**. The destination handset rings and shows **HS X is calling**.
4. To answer the intercom call on the destination handset, press **🏠/HOME**, **📶/CELL**, or any dialing key (**0-9**, **#**, or **☎**). Both handsets now show **Intercom**.

-OR-

To answer the intercom call on the destination headset, press **ON/OFF** key on the headset.

5. To end the intercom call on either handset, one party presses **OFF** or places the handset back in the telephone base or handset charger. Both handsets display **Intercom ended**.

-OR-

Press **ON/OFF** key on the headset.

📌 NOTES

- You can cancel the intercom call before it is answered by pressing **OFF**.
- If the destination handset does not answer the intercom call within 100 seconds, or if it is out of range, on a call, or accessing the phonebook or caller ID log, your handset displays **Unable to call** and then returns to idle mode.
- You can press **OFF** or **MUTE** on the destination handset/headset to temporarily silence the intercom ringer.
- Only one intercom call can be established at a time.

Answer an incoming call during an intercom call

If you receive an incoming home call during an intercom call, you will hear an alert tone. Handsets flash **🏠** and display the caller ID.

If you receive an incoming cell call during an intercom call, you will hear an alert tone. Handsets flash **📶** and display the caller ID.

Using a handset:

- To answer a home call, press **🏠/HOME**. The intercom call ends automatically.
- To answer the cell call, press **OFF** to end the intercom call. The telephone continues to ring. Then press **📶/CELL**.
- To end the intercom call without answering the outside call, press **OFF**. The intercom call ends and the telephone continues to ring.

Using a headset:

- Press **ON/OFF** key to end the intercom call. The telephone continues to ring. Press **ON/OFF** key again to answer the home call.

📌 NOTE

- Headset cannot answer a cell call.

Call transfer using intercom

While on an outside call, you can use the intercom feature to transfer the call from one device to another.

1. Press **INT** on the handset during a call. The current call is put on hold.
2. Your handset shows **Intercom to:** Use the dialing keys to enter a handset number (**1-5**).

Your handset shows **Calling HS X**. The destination handset rings and shows **HS X is calling**.

3. To answer the intercom call on the destination handset, press **HOME**, **CELL**, **MUTE**, or any dialing key (**0-9**, **#**, or **TONEX**). Both handsets now show **Intercom**.

-OR-

To answer the intercom call on the destination headset, press **ON/OFF** key on the headset.

4. To transfer the call, press **OFF** on the initiating handset or place the initiating handset back in the telephone base or charger.

5. To end the call, press **OFF** on the destination handset or place the destination handset back in the telephone base or charger.

-OR-

Press **ON/OFF** key on the headset.

NOTES

- You can cancel the intercom call before it is answered by pressing **OFF**.
- If the destination handset does not answer the intercom call within 100 seconds, or if it is out of range, on a call, or accessing the phonebook or caller ID log, your handset displays **Unable to call** and then returns to idle mode.
- You can press **OFF** or **MUTE** on the destination handset to temporarily silence the intercom ring.
- Only one intercom call can be established at a time.

Phonebook

The phonebook can store up to 1000 entries, which are shared by all handsets. Each entry may consist of a telephone number up to 30 digits, and a name up to 15 characters.

Any additions, deletions or edits made on one handset will be reflected on other handsets.

If the telephone number in the phonebook exceeds 15 digits, a dash appears after the 14th digit and then the remaining digits are shown beginning with a dash alternately.

Add a phonebook entry

1. Enter the number when the handset is not in use. Press **SELECT**, then go to Step 5.

-OR-

Press **MENU** when the handset is not in use.

2. Press **▼** or **▲** to choose **Phonebook**, and then press **SELECT**.
3. Press **SELECT** again to choose **Add new entry**.
4. When **Enter number** displays, use the dialing keys to enter a number (up to 30 digits).



-OR-

Copy a number from the redial list by pressing **REDIAL**. Then press **▼**, **▲** or **REDIAL** repeatedly to find the desired number. Press **SELECT** to copy the number.

5. Press **SELECT** to move on to the name.

6. When **Enter name** displays, use the dialing keys to enter a name (up to 15 characters). Additional key presses show other characters on that key. The first character of every word is capitalized.



7. Press **SELECT** to save. You hear a confirmation tone and then the handset returns to the previous menu.

While entering names and numbers, you can:

- Press ▼ or ▲ to move the cursor to the left or right.
- Press **DELETE** to erase a digit.
- Press and hold **DELETE** to erase all digits.
- Press and hold **PAUSE** to enter a dialing pause (a **p** appears).
- Press ^{tone} ***** to add * († appears) or **#** to add # (‡ appears).
- Press **0** to add a space (for entering names only).

Review phonebook entries

Entries are sorted alphabetically.

1. Press when the handset is not in use. The screen displays the first entry in the phonebook.
2. Press ▼ or ▲ to browse through the phonebook, or use the dialing keys to start a name search.

-OR-

1. Press **MENU** when the handset is not in use.
2. Press ▼ or ▲ to choose **Phonebook**, and then press **SELECT**.
3. Press ▼ or ▲ to choose **Review**, and then press **SELECT**.
4. The screen displays the first phonebook entry. Press ▼ or ▲ to browse through the phonebook.



NOTE

- If the telephone number in the phonebook exceeds 15 digits, - appears in front of the telephone number and shows the remaining numbers alternately.

Alphabetical search

1. Follow the steps in **Review the phonebook entries** to enter the phonebook.
2. Use the dialing keys to enter the letter associated with the name. For example, if you have entries for Jenny, Jessie, Kristen and Laura in your phonebook, press **5** (JKL) once to see Jenny (when **Jenny** displays, press ▼ to see Jessie), twice to see Kristen, or three times to see Laura. If there is no name entry matching your search, the next closest match in alphabetical order appears. If necessary, press ▼ or ▲ to browse.

Delete a phonebook entry

1. Search for the desired entry in the phonebook (see **Review phonebook entries** or **Alphabetical search**).
2. When the desired entry displays, press **DELETE**. The handset displays **Delete entry?**.
3. Press **SELECT** to confirm. The handset displays **Deleting....** You hear a confirmation tone and then the handset returns to the previous menu.



Edit a phonebook entry

1. Search for the desired entry in the phonebook (see **Review phonebook entries** or **Alphabetical search**).
2. When the desired entry displays, press **SELECT**. The handset displays **Enter number**.
3. Use the dialing keys to edit the number, and then press **SELECT**. The handset displays **Enter name**.
4. Use the dialing keys to edit the name.
5. Press **SELECT** to save the entry. The handset displays **Saved** and then the revised entry. You hear a confirmation tone.

Dial a phonebook entry

1. Search for the desired entry in the phonebook (see **Review phonebook entries** or **Alphabetical search**).
2. Press **HOME** or **CALL** to dial using the home line; or press **CELL** to dial using the cell line.

Delete all phonebook entries

1. Press **MENU** when the handset is not in use.
2. Press **DOWN** or **UP** to choose **Phonebook**, and then press **SELECT**.
3. Press **DOWN** or **UP** to choose **Delete all**, and then press **SELECT**.
4. The handset displays **Delete all?** Press **SELECT** to confirm. The handset displays **Deleting...** You hear a confirmation tone and then the handset returns to the previous menu.

Caller ID

If you subscribe to caller ID service, information about each caller appears after the first or second ring. If you answer a call before the caller information appears on the screen, it will not be saved in the caller ID log.

The caller ID log stores up to 50 entries. Each entry has up to 24 digits for the phone number and 15 characters for the name.

If the telephone number has more than 15 digits, only the last 15 digits appear.

If the name has more than 15 characters, only the first 15 characters are shown and saved in the caller ID log.

Entries appear in reverse chronological order. When the caller ID log is full, the oldest entry is deleted to make room for new incoming call information.

Caller ID log entries are shared by all system handsets (for multiple handset models only). Any deletions made on one handset are reflected on all other handsets.

NOTE

- This product can provide information only if both you and the caller are in areas offering caller ID service and if both telephone service providers use compatible equipment. The time and date are sent by your telephone service provider along with the call information.

Review the caller ID log

1. Press **CID** when the handset is not in use. The screen displays the first entry in the caller ID log.

2. Press **▼** or **▲** to browse.

-OR-

1. Press **MENU** on the handset when idle.

2. Press **▼** or **▲** to scroll to **Caller ID log**, and then press **SELECT** twice to choose **Review**. The handset displays the first entry.

3. Press **▼** or **▲** to browse.

NOTE

- You hear a double beep when you reach the beginning or end of the caller ID log.

Memory match

When the incoming telephone number matches the last seven digits of a telephone number in your phonebook, the screen displays the stored name of the phonebook entry.

For example, if Mike Smith calls, his name appears as **Mike** if this is how you entered it into your phonebook.

NOTE

- The number shown in the caller ID log will be in the format sent by the telephone service provider. The telephone service provider usually delivers 10-digit phone numbers (area code plus telephone number). If the phone number of the caller does not match a number in your phonebook, the name will appear as it is delivered by the telephone service provider.

Missed call indicator

When there are calls that have not been reviewed in the caller ID log, the handsets display **XX missed calls**. Each time you review a caller ID log entry marked **NEW**, the number of missed calls decreases by one.



When you have reviewed all the missed calls, the missed call indicator disappears.

If you do not want to review the missed calls one by one, press and hold CANCEL on the idle handset to clear the missed call indicator. All the entries are then considered old.

View dialing options

Although the caller ID log entries received have 10 digits (the area code plus the seven-digit number), in some areas, you may need to dial only the seven digits, or **1** plus the seven digits, or **1** plus the area code plus the seven digits. You can change the number of digits that you dial from the caller ID log and store the new number to the phonebook.

While reviewing the caller ID log, press **#** (pound key) repeatedly to display different dialing options for local and long distance numbers before dialing or saving the telephone number in the phonebook.

Press **1** repeatedly if you need to add or remove 1 in front of the telephone number before dialing or saving it in the phonebook.

When the number is displayed in the correct format for dialing, press **HOME**, **CELL**, or **»** to dial.

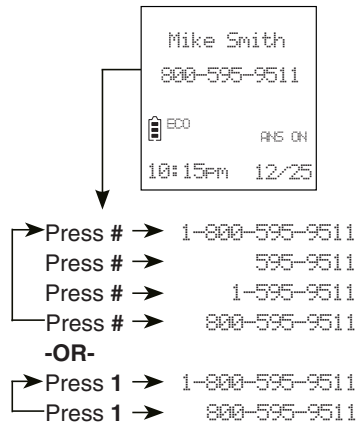

NOTE

- If you have programmed the home area code, only the last seven digits of the incoming phone numbers from that area code will be displayed while reviewing the caller ID log. Press **#** repeatedly to display all possible dialing options.

Dial a caller ID log entry

1. Search for the desired caller ID log entry (see **Review the Caller ID log**).
2. When the desired entry displays, press **HOME**, **CELL** or **CALL** to dial.

Save a caller ID log entry to the phonebook

1. Search for the desired caller ID log entry (see **Review the Caller ID log**).
2. When the desired entry displays, press **SELECT**.
3. Press **SELECT** to choose **To Phonebook**. Then the handset displays **Enter number**.
4. Use the dialing keys to edit the number, when necessary. Press **SELECT** to move to the name. The handset displays **Enter name**.
5. Use the dialing keys to add or edit the name.
6. Press **SELECT** when done and the screen shows **Saved**.

While entering names and numbers, you can:

- Press **▼** or **▲** to move the cursor to the left or right.
- Press **DELETE** to erase a digit.
- Press and hold **DELETE** to erase all digits.
- Press and hold **PAUSE** to enter a dialing pause (a **p** appears).
- Press **0** to add a space (for entering names only).

NOTE

- If you save an entry which already exists in the phonebook, the handset displays **Number repeated** and then returns to previous screen.

Delete a caller ID log entry

1. Search for the desired caller ID log entry (see **Review the Caller ID log**).
2. Press **DELETE** to delete the displayed entry.

Delete all caller ID log entries

1. Press **MENU** when the handset is not in use.
2. Press **▼** or **▲** to scroll to **Caller ID log**, and then press **SELECT**.
3. Press **▼** or **▲** to scroll to **Delete all**, and then press **SELECT**.
4. When the screen shows **Delete all?**, press **SELECT** to delete all entries. You hear a confirmation tone.



Call block

If you have subscribed to caller ID service, you can set the telephone to block unknown calls and certain undesired calls. The call block list stores up to 20 entries.

When a home line call is blocked, the caller will hear a simulated busy tone for one ring cycle. You may pick up the call during the first ring when there is no caller ID information. Otherwise, the call is disconnected.

Block unknown calls

All incoming calls with unknown numbers will be blocked.

1. Press **MENU** when the handset is not in use.
2. Press **▼** or **▲** to choose **Call block**, and then press **SELECT**.
3. Press **▼** or **▲** to choose **Calls w/o num**, and then press **SELECT**.
4. Press **▼** or **▲** to choose **Not block or Block**, then press **SELECT**. You hear a confirmation tone.

Add a call block list entry

1. Press **MENU** when the handset is not in use.
2. Press **▼** or **▲** to choose **Call block**, and then press **SELECT**.
3. Press **▼** or **▲** to choose **Block list**, and then press **SELECT**.
4. Press **▼** or **▲** to choose **Add new entry**, and then press **SELECT**.
5. When **Enter number** displays, use the dialing keys to enter a number (up to 30 digits).

-OR-

Copy a number from the redial list by pressing **REDIAL**. Then press **▼**, **▲** or **REDIAL** repeatedly to find the desired number. Press **SELECT** to copy the number.

6. Press **SELECT** to move on to the name.
7. When **Enter name** displays, use the dialing keys to enter a name (up to 15 characters). Additional key presses produce other characters on that key. The first character of every word is capitalized.
8. Press **SELECT** to save. You hear a confirmation tone and then the screen returns to the previous menu.

While entering names and numbers, you can:

- Press **▼** or **▲** to move the cursor to the left or right.
- Press **DELETE** to erase a digit.
- Press and hold **DELETE** to erase all digits.
- Press and hold **PAUSE** to enter a dialing pause (a **p** appears).
- Press **0** to add a space (for entering names only).

Review the call block list

1. Press **MENU** when the handset is not in use.
2. Press **▼** or **▲** to choose **Call block**, and then press **SELECT**.
3. Press **▼** or **▲** to choose **Block list**, and then press **SELECT**.
4. Press **SELECT** to choose **Review**.
5. When an entry displays, press **▼** or **▲** to browse. You hear a double beep when you reach the beginning or end of the caller block list.

NOTE

- When you access the call block list without records, the screen shows **List empty**.

Edit a call block list entry

1. Search for the desired caller ID log entry (see **Review the call block list**).
2. When the desired entry displays, press **SELECT**. The handset displays **Enter number**.
3. Use the dialing keys to edit the number.
4. Press **SELECT**. The handset displays **Enter name**.
5. Use the dialing keys to edit the name.
6. Press **SELECT** to save the entry. The handset displays the revised entry. You hear a confirmation tone.

Save a caller ID log entry to the call block list

1. Search for the desired caller ID log entry (see **Review the Caller ID log**).
2. When the desired entry displays, press **SELECT**.
3. Press ▼ or ▲ to choose **To Call block**, and then press **SELECT**. Then the handset displays **Enter number**.
4. Use the dialing keys to edit the number, when necessary.
5. Press **SELECT** to move to the name. The handset displays **Enter name**.
6. Use the dialing keys to add or edit the name.
7. Press **SELECT** when done.

NOTE

- If you save an entry which already exists in the call block list, the handset displays **Number repeated** and then returns to previous screen.

Delete a call block list entry

1. Search for the desired caller ID log entry (see **Review the call block list**).
2. Press **DELETE**. You hear a confirmation tone and the handset displays the next entry.

NOTE

- If the call block list is empty after an entry is deleted, the handset displays **List empty**. You hear a confirmation tone.

Mute first ring

Your telephone rings once for blocked calls. You can choose to mute the first ring for all incoming calls, so that there will be no ring for blocked calls. By default, the first ring is set to **On**.

1. Press **MENU** when the handset is not in use.
2. Press **7464#** on the handset.
3. Scroll to choose **First ring:On** to keep the first ring, or **First ring:Off** to mute the first ring.
4. Press **SELECT** to save.

NOTE

- If you have muted the first ring, you will hear one ring less before the answering system and voicemail answer the incoming calls.

Sound settings

Key tone

You can turn the key tone on or off for each handset.

1. Press **MENU** when the handset is not in use.
2. Press ▼ or ▲ to choose **Settings**, and then press **SELECT**.
3. Press ▼ or ▲ to choose **Key tone**, and then press **SELECT**.
4. Press ▼ or ▲ to choose **On** or **Off**.
5. Press **SELECT** to save your selection. Then the handset returns to the previous menu. You hear a confirmation tone.

Ringer tone

You can choose from different ringer tones for each handset.

1. Press **MENU** when the handset is not in use.
2. Press ▼ or ▲ to choose **Ringers**, and then press **SELECT**.
3. Press ▼ or ▲ to choose **Home ringtone** or **Cell ringtone**, and then press **SELECT**.
4. Press ▼ or ▲ to sample each ringer tone.
5. Press **SELECT** to save your selection. Then the handset returns to the previous menu. You hear a confirmation tone.

NOTE

- If you turn off the ringer volume, you will not hear ringer tone samples.

Handset ringer volume

You can set the ringer volume or turn the ringer off on each handset. When the ringer is off,  appears on the screen.

1. Press **MENU** when the handset is not in use.
2. Press ▼ or ▲ to choose **Ringers**, and then press **SELECT**.
3. Press ▼ or ▲ to select **Home volume** or **Cell volume**, and then press **SELECT**.
4. Press ▼ or ▲ to sample each volume level.
5. Press **SELECT** to save your selection. Then the handset returns to the previous menu. You hear a confirmation tone.

NOTE

- The ringer volume also determines the ringer volume for intercom calls. If the ringer volume is set to off, that handset is silenced for all incoming calls except paging tone.

Telephone base ringer volume

Press **- /VOL/+** on the side of telephone base to adjust the ringer volume when the telephone base is not in use.

When you set the ringer volume to zero, the base ringer is off and the system announces, *"Base ringer is off."*

Temporary ringer silencing

When the telephone is ringing, you can temporarily silence the ringer of the handset without disconnecting the call. The next call rings normally at the preset volume.

- Press **OFF** or **MUTE** on the handset and it displays .



NOTES

- Each handset and the base ring when there is an incoming call unless the ringer volume of that device is turned off.
- You can also press ▼ or ▲ on the base unit to adjust the ringer volume. The adjustment will be saved and applied to the next incoming call.

About the built-in answering system and voicemail service

For message recording, your telephone has a built-in answering system, and it also support voicemail service offered by your telephone service provider (subscription is required, and fee may apply).

The main differences between them are:

Category	Built-in answering system	Voicemail from telephone service
Storage	Messages are stored in the telephone base.	Messages are stored in a server or system provided by your telephone service.
	Your messages will not be deleted automatically. You have to delete your messages manually.	Your messages may be automatically deleted after a period of time. Contact your telephone service provider for more details.
Method to retrieve messages	When you received new messages, handset displays XX new messages and the message window on the telephone base flashes.	When you received new messages, the handset displays  and New voicemail .
	To retrieve messages, usually there are two ways: <ul style="list-style-type: none"> • Press /■ on the telephone base; or • Access remotely with an access code. 	To retrieve messages, you need an access number and/or a passcode provided by your telephone service provider.

Set your built-in answering system

The answering system can record and store up to 99 messages. Each message can be up to three minutes in length. The total storage capacity for the announcement, messages and memos is approximately 23 minutes. The actual recording time depends on individual message characteristics.

Your answering system allows you to set your announcement, to save and delete messages, activate call screening, to set number of rings before pick up, and to access remotely.

Telephone base control key panel:

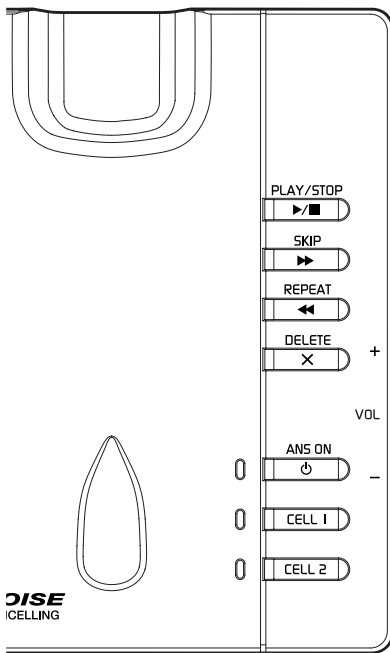

Turn the answering system on or off

The answering system must be turned on to answer and record messages.

When the answering system is turned on, the **ANS ON/OFF** light on the telephone base turns on and **ANS ON** displays on the handset.

To turn on or off with the telephone base:

- Press **ANS ON/OFF** to turn the built-in answering system on or off. When the answering system is turned on, it announces, *"Calls will be answered."* When the answering system is turned off, it announces, *"Calls will not be answered."*

To turn on or off with the handset:

1. Press **MENU** when the handset is not in use.
2. Press **▼** or **▲** to choose **Answering sys**, and then press **SELECT**.
3. Press **▼** or **▲** to choose **Answer on/off**, and then press **SELECT**.
4. Press **▼** or **▲** to choose **On** or **Off**, and then press **SELECT** to save. You hear a confirmation tone.

Default announcement

The telephone is preset with a greeting that answers calls with *"Hello, please leave a message after the tone."* You can use this preset announcement, or replace it with your own.

Record your own announcement

The announcement can be up to 90 seconds in length.

1. Press **MENU** when the handset is not in use.
2. Press ▼ or ▲ to scroll to **Answering sys**, and then press **SELECT**.
3. Press **SELECT** again to choose **Announcement**.
4. The screen displays **Play [2] Del [3] Rec [7]** and it announces, *"To play, press 2. To record, press 7."* Press **7** to record. The handset announces, *"Record after the tone. Press 5 when you are done."* After the tone, speak towards the handset microphone.
5. Press **5** when done.

NOTE

- Announcements shorter than two seconds will not be recorded.

Play the announcement

1. Press **MENU** when the handset is not in use.
2. Press ▼ or ▲ to scroll to **Answering sys**, and then press **SELECT**.
3. Press **SELECT** again to choose **Announcement**.
4. The handset displays **Play [2] Del [3] Rec [7]** and it announces, *"To play, press 2. To record, press 7."*
5. Press **2** to play current announcement.

Delete the announcement

1. Press **MENU** when the handset is not in use.
2. Press ▼ or ▲ to scroll to **Answering sys**, and then press **SELECT**.
3. Press **SELECT** again to choose **Announcement**.
4. The handset displays **Play [2] Del [3] Rec [7]** and it announces, *"To play, press 2. To record, press 7."*
5. Press **3** to delete your recorded announcement. The handset displays **Annc deleted** and then the system announces, *"Announcement deleted."* You hear a confirmation tone.

NOTE

- When your announcement is deleted, calls are answered with the preset announcement.

Set number of rings

You can set the answering system to answer an incoming call after 2, 3, 4, 5 or 6 rings; or toll saver. If you choose toll saver, the answering system answers a call after 2 rings when you have new messages, or after 4 rings when you have no new messages.

1. Press **MENU** when the handset is not in use.
2. Press ▼ or ▲ to scroll to **Answering sys**, and then press **SELECT**.
3. Press ▼ or ▲ to scroll to **Ans sys setup**, and then press **SELECT**.
4. Press ▼ or ▲ to scroll to **# of rings**, and then press **SELECT**.
5. Press ▼ or ▲ to choose **2, 3, 4, 5, 6** or **Toll saver**.
6. Press **SELECT** to save and you hear a confirmation tone.

NOTE

- If you have muted the first ring, you will hear one ring less before the answering system answers the incoming calls.

Turn the call screening on or off

You can hear incoming messages at the telephone base while they are being recorded.

1. Press **MENU** when the handset is not in use.
2. Press ▼ or ▲ to scroll to **Answering sys** then press **SELECT**.
3. Press ▼ or ▲ to scroll to **Ans sys setup** then press **SELECT**.
4. Press **SELECT** choose **Call screening**.
5. Press ▼ or ▲ to choose **On** or **Off**.
6. Press **SELECT** to save and you hear a confirmation tone.

Message alert tone

When the message alert tone is set to on, and there is at least one new message, the telephone base beeps every 10 seconds. The message alert tone is preset to off.

1. Press **MENU** when the handset is not in use.
2. Press ▼ or ▲ to scroll to **Answering sys** then press **SELECT**.
3. Press ▼ or ▲ to scroll to **Ans sys setup** then press **SELECT**.
4. Press ▼ or ▲ to scroll to **Msg alert tone** then press **SELECT**.
5. Press ▼ or ▲ to choose **On** or **Off**.
6. Press **SELECT** to save and you hear a confirmation tone.

NOTES

- The answering system must be turned on for the message alert tone to be functional.
- Press any key on the telephone base (except **FIND HANDSET**) to temporarily silence the message alert tone.

Voice guide

This feature is an alternative way for you to do the basic setup of the answering system. You can follow the voice guide to record your own announcement, set the number of rings and the message alert tone.

1. Press **MENU** when the handset is not in use.
2. Press ▼ or ▲ to scroll to **Answering sys**, and then press **SELECT**.
3. Press ▼ or ▲ to scroll to **Voice guide**, and then press **SELECT**. You hear the voice prompt *"Hello! This voice guide will assist you with the basic setup of your answering system."*
4. Setup your answering system by inputting designated numbers as instructed in the voice guide.

NOTES

- You can press **CANCEL** to quit the voice guide at anytime.
- If the system does not receive any input, it will announce *"Sorry, I still have not received any input. If you want to restart the voice guide, please enter the menu and select Voice guide under Answering system. Good bye."*

Using your built-in answering system

New message indication

When there are new answering system messages, the message window on the telephone base flashes and **XX new messages** displays on the handset.

Message window display	Description
0	No messages.
1-99	Total number of old messages and memos recorded. The message number currently playing.
0-99 (flashing)	Total number of new messages recorded, or the current message number during new message playback. The clock needs to be set.
1-99 & F (alternating)	The answering system memory is full with total number of messages recorded.
1-8	The telephone base speaker volume level while adjusting.
0-6	The telephone base ringer level while adjusting.
--- ---	The answering system is answering a call, or recording a memo or announcement. The telephone is being accessed remotely. The answering system is being programmed. The telephone is on a home line call.

If the message alert tone is turned on, the telephone base beeps every 10 seconds when there are messages that have not been reviewed.

Message playback

If you have new messages, the telephone plays only the new messages (oldest first). If there are no new messages, the telephone plays back all messages (oldest first).

When playback begins, you hear the total number of messages followed by the date and time of the message. After the last message, the telephone announces, “*End of messages.*”

NOTE

- Make sure you set the date and time correctly. Refer to **Set date and time** under the **Configure your telephone** section for more details.

To play messages at the telephone base:

- Press **▶/■/PLAY** when the telephone base is not in use.

Options during playback:

- Press **- /VOL/+** to adjust the speaker volume.
- Press **▶/SKIP** to skip to the next message.
- Press **◀/REPEAT** to repeat the message. Press twice to hear the previous message.
- Press **X/DELETE** to delete the playing message. The system advances to the next message.
- Press **▶/■/STOP** to stop the playback.

To play messages on a handset:

1. Press **MENU** when the handset is not in use.
2. Press **SELECT** to choose **Play messages**.

Options during playback:

- Press **▲** /**VOLUME** or **VOLUME**/ **▼** to adjust the message playback volume.
- Press **6** to skip to the next message.
- Press **4** to repeat the message. Press **4** twice to hear the previous message.
- Press **3** to delete the playing message.
- Press **OFF** to stop the playback.
- Press **◀** to switch between speakerphone mode and handset mode.

NOTES

- Only one handset or the telephone base can access the answering system at a time.
- During message playback, if there is an incoming call or another handset makes a call, message playback will be stopped.

Delete all old messages

You can only delete old messages. You cannot delete new messages until you review them. You cannot retrieve deleted messages.

To delete all old messages at the telephone base:

1. When the phone is not in use, press **X/DELETE**. The system announces, *"To delete all old messages, press DELETE again."*
2. Press **X/DELETE** again. The system announces, *"All old messages deleted."* You hear a confirmation tone.

To delete all old messages on a handset:

1. Press **MENU** when the handset is not in use.
2. Press **▼** or **▲** to scroll to **Answering sys**, and then press **SELECT**.
3. Press **▼** or **▲** to scroll to **Delete all old**.
4. Press **SELECT** to confirm. The handset displays **Deleting...** then **No old messages** and then returns to the previous menu. You hear a confirmation tone.

Remote access

You can set your own remote access code from **00** to **99**.

1. Dial your telephone number from any touch-tone telephone.
2. When the system plays your announcement, enter the two-digit security code.
3. Enter one of the following remote commands.

Command	Description
1	Play all messages.
2	Play new messages.
3	Delete the current message (during playback).
33	Delete all old messages.
4	Repeat the current message (during playback).
5	Stop.
*5	Hear a list of remote commands.
6	Skip to the next message (during playback).
*7	Record a new announcement.

8	End the call.
0	Turn the answering system on or off.

4. Hang up or press **8** to end the call.

NOTES

- If you do not press any keys after you enter the remote access code, all new messages play. If there are no new messages, all old messages play.
- Once the new messages have played, the telephone announces the help menu options. If you do not press any key within 20 seconds, the remote access call automatically disconnects.
- When the answering system memory is full, the telephone announces, "Memory is full. Enter the remote access code."

Set remote access code

You can set your own remote access code from **00** to **99**.

1. Press **MENU** when the handset is not in use.
2. Press **▼** or **▲** to scroll to **Answering sys** then press **SELECT**.
3. Press **▼** or **▲** to scroll to **Ans sys setup** then press **SELECT**.
4. Press **▼** or **▲** to scroll to **Remote code**, and then press **SELECT**.
5. Use the dialing keys to enter a two-digit number.
-OR-
Press **▼** or **▲** to scroll to a desired two-digit number.
6. Press **SELECT** to save and you hear a confirmation tone.

Call screening

To screen a call at the telephone base:

If the answering system and call screening are turned on, the announcement and the incoming message broadcast at the telephone base while the call is answered by the answering system.

Options while a message is being recorded:

- Press **-/VOL/+** to adjust the call screening volume.
- Press **-/VOL/+** to temporarily turn on the call screening if the call screening is set to off.
- Press **▶/■/PLAY/STOP** to temporarily turn on or off the call screening.



To screen a call at a handset:

If the answering system is on, a call is answered by the answering system. At the same time, the handset shows **To screen call press [SELECT]**. Press **SELECT** to screen the call on your handset. The handset shows the caller's information. If you do not subscribe to caller ID service, the handset shows **Screening...**

Options while a message is being recorded:

- Press **▲ /VOLUME** or **VOLUME/ ▼** to adjust the call screening volume.
- Press **Ⓜ** to switch between speakerphone mode and handset mode.

Call intercept

If you want to talk to the caller whose message is being recorded, press /HOME or  on the handset.

Record, play, and delete memos

Memos are your own recorded messages used as reminders for yourself or others using the same answering system. You can record your own memos using a system handset. Each message can be up to 3 minutes in length. Play and delete them in the same way as incoming messages (see **Message playback**).

1. Press **MENU** when the handset is not in use.
2. Press **▼** or **▲** to scroll to **Answering sys**, and then press **SELECT**.
3. Press **▼** or **▲** to scroll to **Record memo**, and then press **SELECT**.
4. The system announces, *“Record after the tone. Press 5 when you are done.”* After the tone, speak towards the microphone.
5. Press **5** to stop recording. The system announces, *“Recorded.”*

NOTES

- The system will announce *“Memory is full”* if you record a memo when the memory is full.
- Memos shorter than two seconds are not recorded.

Using the built-in answering system and voicemail service

You can use your answering system and voicemail service together by setting your answering system to answer before voicemail service answers as described below. To learn how to program your voicemail settings, contact your telephone service provider.

If you are on a call, or if the answering system is busy recording a message and you receive another call, the second caller can leave a voicemail message.

Set your answering system to answer calls at least two rings earlier than your voicemail service is set to answer. For example, if your voicemail service answers after six rings, set your answering system to answer after four rings. Some voicemail service providers may program the delay before answering calls in seconds instead of rings. In this case, allow six seconds per ring when determining the appropriate setting.

Retrieve voicemail from telephone service

Voicemail is a feature available from most telephone service providers. It may be included with your telephone service, or may be optional. Fees may apply.

Retrieve voicemail

When you received a voicemail, the handset displays **New voicemail** and .



To retrieve, you typically dial an access number provided by your telephone service provider, and then enter a security code. Contact your telephone service provider for instructions on how to configure the voicemail settings and listen to messages.

NOTE

- After you have listened to all new voicemail messages, the indicators on the handset turn off automatically.

Set your voicemail number

You can save your access number on each handset for easy access to your voicemail. After you save the voicemail number, you can press and hold  **1** to retrieve voicemail.

1. Press **MENU** when the handset is not in use.
2. Press **▼** or **▲** to scroll to **Settings** and then press **SELECT**.
3. Press **▼** or **▲** to scroll to **Voicemail #** and then press **SELECT**.
4. Use the dialing keys to enter the voicemail number (up to 30 digits).
5. Press **SELECT** to save.

Turn off the new voicemail indicators

If you have retrieved your voicemail while away from home, and the handset still displays the new voicemail indicators, use this feature to turn off the indicators.

NOTE

- This feature turns off the indicators only, it does not delete your voicemail messages.

1. Press **MENU** when the handset is not in use.
2. Press **▼** or **▲** to choose **Settings**, and then press **SELECT**.
3. Press **▼** or **▲** to choose **Clr voicemail**, and then press **SELECT**. You hear a confirmation tone.



Cell phone voicemail

If you have voicemail service active on your cell phone, and you do not answer the incoming cell call, the call will be answered by your cell phone's voicemail. Contact your cell phone service provider for more information about voicemail service.

Expand your telephone system

You can add new handsets (**DS6072**), cordless headsets (**IS6200**) or speakerphones (**AT&T TL80133**) to your telephone system. All accessories are sold separately. Your telephone base supports a maximum of five devices.

For more details, refer to the user's manual that comes with your new device.

Screen messages

Blocked call	There is an incoming call from a blocked caller.
Call log empty	There are no entries in caller ID log history.
Calling HS X	The handset is calling another handset (for intercom calls).
Cell line busy	Another system handset is using the cell line.
Cell <X> low batt	The paired cell phone has low battery.
<XX> *Service_<name>	The phone receives an alert from your cell phone.
Contact deleted	A phonebook entry is deleted.
Downloading...	The telephone system is downloading the phonebook from a cell phone.
Ended	You have just ended a call.
Failed	The handset registration is not successful.
HS X is calling	Another system handset is calling (for intercom calls).
Home line busy	Another system handset is using the home line.
Incoming call	There is a call coming in.
Intercom	The handset is on an intercom call.
Intercom ended	The intercom call has just ended.
Intercom to: (for models with two or more handsets)	You have started the intercom process, and need to enter the desired handset number.

Line in use	An extension phone, or one of the handsets is in use.
List empty	There are no call block list entries.
Low battery	The handset battery needs to be recharged.
Microphone on	The mute function is turned off and the other party can hear you.
Muted	The microphone is off. The other party cannot hear you.
New voicemail	There are new voicemail messages from your telephone service provider.
No battery	The handset in the telephone base or handset charger has no battery installed.
No line	There is no telephone line connection.
Not available	Someone else is using the phonebook, caller ID log or answering system. The cell line is not ready to use.
Number repeated	The entry you try to save is already in the phonebook.
Out of range no fur at base	The telephone base has lost power, or the handset is out of range.
** Paging **	The handset is paged by the telephone base.
Pair cell first	You need to pair a cell phone before making a cell call.
Phone	The handset is on a home call.

Phonebook empty	There are no phonebook entries.
Phonebook full	The phonebook is full. You cannot save any new entries unless you delete some current entries.
Put in charger	The battery is very low. The handset should be charged.
Rec mem full	The system recording time is full.
Rec mem low	The answering system has only three minutes of recording time left.
Registering...	The handset is registering to the telephone base.
Ringer off	The ringer is off temporarily during an incoming call.
Saved	The entry is saved in the phonebook.
Speaker	The handset speakerphone is in use.
To register MS... ...see manual	Screen display on a non-registered handset.
Transferred	You have transferred an outside call to another handset.
Transfer to:	You have started transferring an outside call, and need to enter the desired handset number.
Unable to call	The handset is out of range while on a call. Failed phone call (the telephone line is in use). Failed intercom call (there are already two handsets being used).

✖ missed calls	There are new calls in the caller ID log.
✖ new messages	There are new messages in the answering system.

ECO mode

This power conserving technology reduces power consumption for optimal battery performance. The ECO mode activates automatically whenever the handset is synchronized with the telephone base.

General product care

Taking care of your telephone

Your cordless telephone contains sophisticated electronic parts, so it must be treated with care.

Avoid rough treatment

Place the handset down gently. Save the original packing materials to protect your telephone if you ever need to ship it.

Avoid water

Your telephone can be damaged if it gets wet. Do not use the handset outdoors in the rain, or handle it with wet hands. Do not install the telephone base near a sink, bathtub or shower.

Electrical storms

Electrical storms can sometimes cause power surges harmful to electronic equipment. For your own safety, take caution when using electrical appliances during storms.

Cleaning your telephone

Your telephone has a durable plastic casing that should retain its luster for many years. Clean it only with a dry non-abrasive cloth. Do not use dampened cloth or cleaning solvents of any kind.

Frequently asked questions

Below are the questions most frequently asked about the cordless telephone.

If you cannot find the answer to your question, visit our website at

www.vtechphones.com or call

1 (800) 595-9511 for customer service.

In Canada, go to **www.vtechcanada.com** or call **1 (800) 267-7377**.

My telephone does not work at all.	Make sure the telephone base is installed properly, and battery is installed and charged correctly. For optimum daily performance, return the handset to the telephone base after use.
The display shows No line . I cannot hear the dial tone.	Disconnect the telephone line cord from your telephone and connect it to another telephone. If there is no dial tone on that other telephone either, then the telephone line cord may be defective. Try installing a new telephone line cord. If changing telephone line cord does not help, the wall jack (or the wiring to this wall jack) may be defective. Contact your telephone service provider.
	You may be using a new cable or VoIP service, the existing telephone jacks in your home may no longer work. Contact your service provider for solutions.

I cannot dial out.	Make sure there is a dial tone before dialing. It is normal if the handset takes a second or two to synchronize with the telephone base before producing a dial tone. Wait an extra second before dialing.
	Eliminate any background noise. Mute the handset before dialing, or dial from another room in your home with less background noise.
The display shows To register HS... and ...see manual alternately. The handset does not work at all.	The handset is deregistered from the telephone base. Place the handset in the telephone base to register it back. The handset shows Registered and you hear a beep when the registration process completes. This process takes about 90 seconds to complete.
The headset cannot pick up any call. It announces “ <i>Not registered</i> ”.	The headset is deregistered from the telephone base. Follow the steps below to register it back. 1. Press and hold FIND HANDSET for four seconds. The IN USE light turns on. 2. Place the headset on the telephone base to register it back. During the registration process, the LED light flashes alternatively in red and blue, and turn red after the registration completes. This process takes about 60 seconds. Lift the headset, then press ON/OFF key on the headset. If you hear a dial tone, the registration is successful.

I cannot add and connect my cell phone or headset to the telephone base.	Make sure you have cellular coverage and the Bluetooth function of your cell phone or headset is turned on. See the user’s manual of your cell phone or headset for more information.
	Make sure that the telephone base is in discoverable mode.
	Carefully follow the pairing instructions in this manual.
	Make sure that your Bluetooth cell phone or headset is not connected to any other Bluetooth device, and is connected to the telephone base and active on the device list.
	Turn off your cell phone or headset, and then turn it on again.
The cell phone reception in my house is poor and I cannot connect it to my DS6771 .	If there is a location in your house with better reception, you can leave your cell phone at that location while you use the DS6771 cell line. In order for this to work, the telephone base must be within 15 feet of the cell phone.
The display shows Low battery .	Place the handset in the telephone base or charger for charging.
The battery does not charge in the handset or the handset battery does not accept charge.	Make sure the handset is placed in the telephone base or charger correctly.
	If the battery is completely depleted, charge the battery for at least 30 minutes before use.
	You may need to purchase a new battery.

The telephone does not ring when there is an incoming call.	Make sure the ringer volume is not set to off.
	The handset may be too far from the telephone base. Move it closer to the telephone base.
My handset beeps and is not performing normally.	Move the handset closer to the telephone base. It may be out of range.
I hear other calls when using the telephone.	Disconnect the telephone base from the telephone wall jack. Plug in a different telephone. If you still hear other calls, the problem is probably in the wiring or telephone service. Contact your telephone service provider.
I hear noise on the cordless handset and the keys do not work.	Make sure the telephone line cord is plugged in securely.

There is interference during a telephone conversation. My calls fade out when I am using the cordless handset.	The handset may be out of range. Move it closer to the telephone base.
	If you subscribe to high-speed Internet service (DSL - digital subscriber line) through your telephone line, you must install a DSL filter between the telephone line cord and the telephone wall jack. The filter prevents noise and caller ID problems caused by DSL interference. Contact your DSL service provider for more information about DSL filters.
	Appliances or other cordless telephones plugged into the same circuit as the telephone base can cause interference. Try moving the appliance or telephone base to another outlet.
	The location of your telephone base can impact the performance of your cordless phone. For better reception, install the telephone base in a centralized location within your home or office, away from walls or other obstructions. In many environments, elevating the telephone base improves overall performance.

The telephone does not receive caller ID or the telephone does not show caller ID during call waiting.	Caller ID is a subscription service. You must subscribe to this service from your telephone service provider for this feature to work on your telephone.	The answering system does not record messages.	Make sure the answering system is on. When the answering system is on, ANS ON should display on the handset and the telephone base.
	Both your and the caller's telephone service providers must use equipment compatible with the caller ID service.		When the answering machine memory is full, it does not record new messages until some old messages are deleted.
	The caller may not be calling from an area which supports caller ID.		If you subscribe to voicemail service, change the number of rings so that your answering system answers before your voicemail service answers. To determine how many rings activate your voicemail service, contact your telephone service provider.
	The caller ID information displays after the first or second ring.		
The display shows Out of range or no pwr at base.	The handset may be out of range. Move it closer to the telephone base.	The messages on the answering system are very difficult to hear.	Press ▲/VOLUME on the handset or VOL+ on the telephone base to increase the listening volume.
	Make sure the power cord is securely plugged into the telephone base. Use a working electrical outlet not controlled by a wall switch.		
The outgoing announcement is not clear.	When recording the announcement, make sure you speak in a normal tone of voice towards the microphone of the handset.	The answering system does not announce the correct day of the week for recorded messages time stamp.	Make sure you have set the date and time. See Configure your telephone section.
	Make sure there is no background noise when recording.		
		The messages on the answering system are incomplete.	If a caller leaves a very long message, part of it may be lost when the answering system disconnects the call after the preset recording time.
			If the memory on the answering system becomes full during a message, the answering system stops recording and disconnects the call.

The answering system does not respond to remote commands.	Make sure you enter the correct remote access code.
	Make sure you are calling from a touch-tone telephone. When dialing a number, there should be tones. If there are clicks, then it is not a touch-tone telephone and cannot activate the answering system.
	The answering system may not detect the remote access code when your announcement is playing. Wait until the announcement is over before entering the code.
I subscribe to a nontraditional telephone service that uses my computer to establish connections, and my telephone doesn't work.	Make sure your computer is powered on, and your Internet is working properly.
	Make sure to plug your USB telephone adapter into a dedicated USB port on your computer. Do not plug into a multiple port USB hub (USB splitter) that is not powered.
	In a few rare instances, the USB port on your computer may not have enough power. In these instances, try using a USB hub with its own external power supply.
	If you are using a firewall, it may prevent access to your nontraditional telephone service. Contact your service provider for more information.

I accidentally set my LCD language to Spanish or French, and I don't know how to change it back to English.	While the handset is not in use or is on a call, press MENU and then enter *364# to change the handset
The remote voice control feature does not work.	Make sure the operating system of your cell phone is iOS 8 or later, or Android 4 or later.
	Make sure your cell phone is paired and connected to your telephone system via Bluetooth.
	Make sure no Bluetooth applications are running in the background of your cell phone.
	Place your cell phone next to the telephone base.
	Do not lock up your cell phone's screen or set passcode for activating the voice-controlled application (voice app).
	Make sure you have turned on or logged in to the applications on your cell phone that you will be sending your voice commands, such as GPS, email and social networking accounts.
	Make sure your cell phone's data or Wi-Fi signal is in full strength and your cell phone can connect to the Internet.
	Try to activate the voice app on your cell phone to ensure it is in place.

The remote voice control feature does not work.	Once you have activated the remote voice control feature, you are using your cell phone's voice app to operate your cell phone. If the voice commands do not work, please check the cell phone user's manual and the voice app's help topics to find out what commands you can use and any limitations of the voice app.
	Some cell phone manufacturers or network carriers may customize the phone's operating system and implement their own voice app. If you want to use Google Now, you need to manually set it as your default voice app. For detailed instructions, refer to your cell phone user's manual, or contact your cell phone's manufacturer or network carrier. You may also go to "Google Product Forums" on the Internet and check the corresponding help topics.
	Due to the settings of certain cell phones and voice apps, your cell phone may not support the remote voice control feature. Contact your cell phone's manufacturer or network carrier, or check the voice app's help topics if you encounter any problems.

The remote voice control feature ends unexpectedly while it is in use.	The Bluetooth function of your cell phone may be off, or you may have moved your cell phone out of Bluetooth range of the telephone base. Make sure the Bluetooth function of your cell phone is turned on and place your cell phone next to the telephone base.
	The data or Wi-Fi connection of your cell phone may be lost. Make sure your cell phone's data or Wi-Fi signal is in full strength.
	The feature may be ended automatically by your cell phone. For example, a cell call has been established via the remote voice control feature and the call has just ended.
	If you receive a landline or cell line incoming call when you have activated remote voice control on a connected cell phone, the remote voice control operation will be ended.
	The voice-controlled application of your cell phone may be affected by other cell phone operations in the background. If the problem persists, contact your cell phone's network carrier.

The RBRC® seal

The RBRC® seal on the nickel-metal hydride battery indicates that VTech Communications, Inc. is voluntarily participating in an industry program to collect and recycle these batteries at the end of their useful lives, when taken out of service within the United States and Canada.

The RBRC® program provides a convenient alternative to placing used nickel-metal hydride batteries into the trash or municipal waste, which may be illegal in your area.

VTech's participation in RBRC® makes it easy for you to drop off the spent battery at local retailers participating in the RBRC® program or at authorized VTech product service centers. Please call **1 (800) 8 BATTERY®** for information on Ni-MH battery recycling and disposal bans/restrictions in your area. VTech's involvement in this program is part of its commitment to protecting our environment and conserving natural resources.

RBRC® and 1 (800) 8 BATTERY® are registered trademarks of the Rechargeable Battery Recycling Corporation.



FCC, ACTA and IC regulations

FCC Part 15

NOTE: This equipment has been tested and found to comply with the requirements for a Class B digital device under Part 15 of the Federal Communications Commission (FCC) rules. These requirements are intended to provide reasonable protection against harmful interference in a residential installation. This equipment generates, uses and can radiate radio frequency energy and, if not installed and used in accordance with the instructions, may cause harmful interference to radio communications. However, there is no guarantee that interference will not occur in a particular installation. If this equipment does cause harmful interference to radio or television reception, which can be determined by turning the equipment off and on, the user is encouraged to try to correct the interference by one or more of the following measures:

- Reorient or relocate the receiving antenna.
- Increase the separation between the equipment and receiver.
- Connect the equipment into an outlet on a circuit different from that to which the receiver is connected.
- Consult the dealer or an experienced radio/TV technician for help.

WARNING: Changes or modifications to this equipment not expressly approved by the party responsible for compliance could void the user's authority to operate the equipment.

This device complies with Part 15 of the FCC rules. Operation is subject to the following two conditions: (1) this device

may not cause harmful interference, and (2) this device must accept any interference received, including interference that may cause undesired operation.

Privacy of communications may not be ensured when using this telephone.

To ensure safety of users, the FCC has established criteria for the amount of radio frequency energy that can be safely absorbed by a user or bystander according to the intended usage of the product. This product has been tested and found to comply with the FCC criteria. The handset may be safely held against the ear of the user. The telephone base shall be installed and used such that parts of the user's body other than the hands are maintained at a distance of approximately 20 cm (8 inches) or more.

This Class B digital apparatus complies with Canadian requirement:

CAN ICES-3 (B)/NMB-3(B)

FCC Part 68 and ACTA

This equipment complies with Part 68 of the FCC rules and with technical requirements adopted by the Administrative Council for Terminal Attachments (ACTA). The label on the back or bottom of this equipment contains, among other things, a product identifier in the format US: AAAEQ##TXXXX. This identifier must be provided to your telephone service provider upon request.

The plug and jack used to connect this equipment to premises wiring and the telephone network must comply with applicable Part 68 rules and technical requirements adopted by ACTA. A compliant telephone cord and modular plug is provided with this product. It is designed to be connected to a compatible modular jack that is also compliant.

An RJ11 jack should normally be used for connecting to a single line and an RJ14 jack for two lines. See the installation instructions in the user's manual.

The Ringer Equivalence Number (REN) is used to determine how many devices you may connect to your telephone line and still have them ring when you are called. The REN for this product is encoded as the 6th and 7th characters following the US: in the product identifier (e.g., if ## is 03, the REN is 0.3). In most, but not all areas, the sum of all RENs should be five (5.0) or less. For more information, contact your telephone service provider.

This equipment must not be used with Party Lines. If you have specially wired alarm dialing equipment connected to your telephone line, ensure the connection of this equipment does not disable your alarm equipment. If you have questions about what will disable alarm equipment, consult your telephone service provider or a qualified installer.

If this equipment is malfunctioning, it must be unplugged from the modular jack until the problem has been corrected. Repairs to this telephone equipment can only be made by the manufacturer or its authorized agents. For repair procedures, follow the instructions outlined under the Limited warranty.

If this equipment is causing harm to the telephone network, the telephone service provider may temporarily discontinue your telephone service. The telephone service provider is required to notify you before interrupting service. If advance notice is not practical, you will be notified as soon as possible. You will be given the opportunity to correct the problem and the telephone service provider is required to inform you of your right to file a complaint with the FCC. Your telephone service provider

may make changes in its facilities, equipment, operation, or procedures that could affect the proper functioning of this product. The telephone service provider is required to notify you if such changes are planned.

If this product is equipped with a corded or cordless handset, it is hearing aid compatible.

If this product has memory dialing locations, you may choose to store emergency telephone numbers (e.g., police, fire, medical) in these locations. If you do store or test emergency numbers, please:

Remain on the line and briefly explain the reason for the call before hanging up.

Perform such activities in off-peak hours, such as early morning or late evening.

Industry Canada

Operation is subject to the following two conditions: (1) this device may not cause harmful interference, and (2) this device must accept any interference received, including interference that may cause undesired operation.

Privacy of communications may not be ensured when using this phone.

The term "IC:" before the certification/ registration number only signifies that the Industry Canada technical specifications were met.

The Ringer Equivalence Number (REN) for this terminal equipment is 0.1. The REN indicates the maximum number of devices allowed to be connected to a telephone interface. The termination of an interface may consist of any combination of devices subject only to the requirement that the sum of the RENs of all the devices not exceed five.

This product meets the applicable Innovation, Science and Economic Development Canada technical specifications.

California Energy Commission battery charging testing instructions

This telephone is set up to comply with the energy-conserving standards right out of the box. These instructions are intended for California Energy Commission (CEC) compliance testing only.

When the CEC battery charging testing mode is activated, all telephone functions, except battery charging, will be disabled.

To activate the CEC battery charging testing mode:

1. Unplug the telephone base power adapter from the power outlet. Make sure all handsets are plugged with charged batteries before proceeding.
2. While you press and hold **FIND HANDSET**, plug the telephone base power adapter back to the power outlet.
3. After about 20 seconds, when the **IN USE** light starts flashing, release **FIND HANDSET** and then press it again within 2 seconds.

The process takes up to one minute to complete. When the phone successfully enters the CEC battery charging testing mode, the **IN USE** light turns off and all handsets display **To register HS...** and **...see manual** alternately.

NOTE

- When the phone fails to enter this mode, repeat Step 1 through Step 3 above. The telephone base will be powered up as normal if you fail to press **FIND HANDSET** within 2 seconds in Step 3.

To deactivate the CEC battery charging testing mode:

1. Unplug the telephone base power adapter from the power outlet, and then plug it back in. Then the telephone base is powered up as normal.
2. Place the handset in the telephone base to register it back. The handset displays **Registering...**

NOTE

- The handset shows **Registered** and you hear a beep when the registration process completes. The registration process takes about 90 seconds to complete.

For C-UL compliance only

Mesures de sécurité importantes

Afin de réduire les risques d'incendie, de blessures corporelles ou d'électrocution, suivez toujours ces mesures préventives de base lorsque vous utilisez votre téléphone :

1. Lisez et comprenez bien toutes les instructions.
2. Observez toutes les instructions et mises en garde inscrites sur l'appareil.
3. Débranchez ce téléphone de la prise murale avant de le nettoyer. N'utilisez pas de nettoyeurs liquides ni en aérosol. N'utilisez qu'un chiffon doux et légèrement humecté.
4. N'utilisez pas ce produit près de l'eau, tel que près d'un bain, d'un lavabo, d'un évier de cuisine, d'un bac de lavage ou d'une piscine, ou dans un sous-sol humide ou sous la douche.
5. Ne déposez pas ce téléphone sur un chariot, support ou table chancelants. L'appareil pourrait tomber et être sérieusement endommagé.
6. Évitez d'installer le système téléphonique dans les endroits soumis à une température extrême, à la lumière directe du soleil ou à proximité immédiate d'autres appareils électriques ou électroniques. Protégez votre téléphone contre les sources d'humidité, la poussière, les vapeurs et les liquides corrosifs.
7. Le boîtier de l'appareil est doté de fentes et d'ouvertures d'aération situées à l'arrière ou en dessous. Afin d'empêcher la surchauffe, ces ouvertures ne doivent pas être obstruées en plaçant l'appareil sur un lit, divan, tapis ou autre surface similaires. Ne placez pas cet appareil à proximité d'un élément de

- chauffage ni d'une plinthe électrique. De plus, ne l'installez pas dans une unité murale ou un cabinet fermé qui ne possède pas d'aération adéquate.
8. Ne faites fonctionner cet appareil qu'avec le type d'alimentation indiqué sur les étiquettes de l'appareil. Si vous ne connaissez pas le voltage de votre maison, consultez votre marchand ou votre fournisseur d'électricité.
 9. Ne déposez rien sur le cordon d'alimentation. Installez cet appareil dans un endroit sécuritaire, là où personne ne pourra trébucher sur la ligne d'alimentation ni le cordon téléphonique modulaire.
 10. N'insérez jamais d'objets à travers les fentes et ouvertures de cet appareil, car ils pourraient toucher à des points de tension dangereux ou court-circuiter des pièces, ce qui constituerait un risque d'incendie ou d'électrocution. N'échappez pas de liquides dans l'appareil.
 11. Afin de réduire les risques d'électrocution, ne démontez pas l'appareil, mais apportez-le plutôt à un centre de service qualifié s'il doit être réparé. En enlevant le couvercle, vous vous exposez à des tensions dangereuses ou autres dangers similaires. Un remontage inadéquat peut être à l'origine d'une électrocution lors d'une utilisation ultérieure de l'appareil. Débranchez l'appareil avant de procéder au nettoyage. Utilisez un chiffon humide et doux.
 12. Ne surchargez pas les prises de courant et les rallonges.
 13. Débranchez cet appareil de la prise de courant et communiquez avec le département de service à la clientèle de VTech dans les cas suivants:
 - Lorsque le cordon d'alimentation est endommagé ou écorché.
 - Si du liquide a été échappé dans l'appareil.
 - Si l'appareil a été exposé à une source d'humidité telle que la pluie ou l'eau.
 - Si le produit ne fonctionne pas normalement en respectant les instructions de fonctionnement. Réglez uniquement les commandes indiquées dans les instructions de fonctionnement. Les réglages incorrects des autres commandes pourraient provoquer un dommage qui pourrait exiger un travail exhaustif de la part d'un technicien autorisé afin de rétablir le fonctionnement normal de l'appareil.
 - Si le produit a été échappé et que le socle et/ou le combiné a été endommagé.
 - Si le produit affiche une nette diminution de sa performance.
 14. Évitez d'utiliser un téléphone (autre qu'un sans fil) pendant un orage. Les éclairs peuvent être à l'origine d'une électrocution.
 15. N'utilisez pas le téléphone pour rapporter une fuite de gaz à proximité de la fuite. En certaines circonstances, une flammèche pourrait être provoquée lorsque l'adaptateur est branché à une prise de courant, ou lorsque le combiné est déposé sur le socle. Ceci est un événement commun associé à la fermeture d'un circuit électrique. L'utilisateur ne devrait pas brancher le téléphone à une prise de courant, et ne devrait pas déposer le combiné chargé sur le socle, si le téléphone se trouve à proximité d'un endroit comportant des concentrations de gaz inflammables, à moins que la ventilation soit adéquate. Une flammèche dans un tel endroit pourrait provoquer un incendie ou une explosion.

De tels environnements peuvent comprendre: des endroits où l'on utilise de l'oxygène médical sans ventilation adéquate; des gaz industriels (dissolvants de nettoyage, des vapeurs d'essence, etc.); une fuite de gaz naturel, etc.

16. Ne placez que le combiné de votre téléphone près de votre oreille lorsqu'en mode de conversation.
17. Ces adaptateurs ont été conçus pour être orientés en position verticale ou montés au sol. Les broches ne sont pas conçues pour maintenir l'adaptateur en place si celui-ci est branché dans une prise au plafond ou sous une table/ armoire.

CONSERVEZ CES INSTRUCTIONS

Pile

- MISE EN GARDE : N'utilisez que la pile incluse.
- Ne jetez pas la pile au feu. Vérifiez les instructions spécifiques de mise aux rebus auprès des autorités locales.
- N'ouvrez pas et ne mutilez pas la pile. L'électrolyte qui s'en échapperait est corrosif et pourrait causer des brûlures ou des blessures aux yeux ou à la peau. L'électrolyte est toxique si avalé.
- Soyez prudents lorsque vous manipulez les piles afin d'éviter les courts-circuits provoqués par des matériaux conducteurs.
- Rechargez la pile incluse avec cet appareil, selon les instructions et limites spécifiées dans ce guide d'utilisation.

Stimulateurs cardiaques implantés dans l'organisme

Les simulateurs cardiaques (s'applique uniquement aux téléphones numériques sans fil):

L'organisme 'Wireless Technology Research, LLC (WTR)', une firme de recherche indépendante, a mené une évaluation pluridisciplinaire des interférences entre les téléphones sans fil portatifs et les stimulateurs cardiaques implantés dans l'organisme. Appuyée par l'Administration des aliments et drogues (FDA) des États-Unis, la firme WTR recommande aux médecins:

Avis aux détenteurs de stimulateurs cardiaques

- Ils doivent tenir le téléphone sans fil à une distance d'au moins six pouces du stimulateur cardiaque.
- Ils ne doivent PAS placer le téléphone sans fil directement sur le stimulateur cardiaque, tel que dans une poche de chemise, lorsque celui-ci est en marche.
- Ils doivent utiliser le téléphone sans fil en l'appuyant sur l'oreille qui se trouve dans la direction opposée au stimulateur cardiaque.

L'étude effectuée par l'organisme WRS n'a pas identifié de risque pour les détenteurs de simulateurs cardiaques causés par les gens qui utilisent un téléphone sans fil à proximité de ceux-ci.

propos des téléphones sans fil

- **Alimentation électrique:** Les mêmes caractéristiques qui constituent des avantages pour les téléphones sans fil affichent également des restrictions. Les appels téléphoniques sont transmis entre le combiné sans fil et le socle par le biais d'ondes radio ; il y a donc la possibilité que vos conversations téléphoniques sans fil soient interceptées par des équipements de réception radio se trouvant dans la portée du combiné sans fil. Pour cette raison, vous ne devez pas percevoir les

communications téléphoniques sans fil comme étant aussi confidentielles.

- **Alimentation électrique:** Le socle de ce téléphone sans fil doit être branché à une prise électrique fonctionnelle. La prise électrique ne doit pas être contrôlée par un interrupteur mural. Les appels ne pourront pas être effectués du combiné sans fil si le socle est débranché ou mis hors tension ou si le courant est coupé.
- **Possibilité d'interférences aux téléviseurs:** Certains téléphones sans fil fonctionnent sur des fréquences pouvant causer des interférences aux téléviseurs et aux magnétoscopes. Pour réduire ou prévenir de telles interférences, ne placez pas le socle du téléphone sans fil près ou sur un téléviseur ou magnétoscope. S'il y a présence de parasites, il est conseillé d'éloigner le téléphone sans fil du téléviseur ou du magnétoscope afin de réduire possiblement les interférences.
- **Piles rechargeables:** Manipulez les piles avec soin afin de ne pas les court-circuiter avec des bagues, bracelets ou clés. Les piles ou le conducteur peut surchauffer et causer des blessures. Respectez la polarité adéquate entre la pile et le chargeur.
- **Les bloc-piles rechargeables l'hydrure métallique de nickel:** Jetez ces blocs-piles de manière écologique et sécuritaire. Ne les incinerez pas et ne les percez pas. Tel que les autres piles de ce type, elles pourraient dégager une matière toxique qui peut causer des blessures corporelles si elles sont brûlées ou percées.

Limited warranty

What does this limited warranty cover?

The manufacturer of this VTech Product warrants to the holder of a valid proof of purchase ("Consumer" or "you") that the Product and all accessories provided in the sales package ("Product") are free from defects in material and workmanship, pursuant to the following terms and conditions, when installed and used normally and in accordance with the Product operating instructions. This limited warranty extends only to the Consumer for Products purchased and used in the United States of America and Canada.

What will VTech do if the Product is not free from defects in materials and workmanship during the limited warranty period ("Materially Defective Product")?

During the limited warranty period, VTech's authorized service representative will repair or replace at VTech's option, without charge, a Materially Defective Product. If we repair the Product, we may use new or refurbished replacement parts. If we choose to replace the Product, we may replace it with a new or refurbished Product of the same or similar design. We will retain defective parts, modules, or equipment. Repair or replacement of the Product, at VTech's option, is your exclusive remedy. VTech will return the repaired or replacement Products to you in working condition. You should expect the repair or replacement to take approximately 30 days.

How long is the limited warranty period?

The limited warranty period for the Product extends for ONE (1) YEAR from the date of purchase. If VTech repairs or replaces a Materially Defective Product under the terms of this limited warranty, this limited warranty also applies to the repaired or replacement Product

for a period of either (a) 90 days from the date the repaired or replacement Product is shipped to you or (b) the time remaining on the original one-year warranty; whichever is longer.

What is not covered by this limited warranty?

This limited warranty does not cover:

1. Product that has been subjected to misuse, accident, shipping or other physical damage, improper installation, abnormal operation or handling, neglect, inundation, fire, water or other liquid intrusion; or
2. Product that has been damaged due to repair, alteration or modification by anyone other than an authorized service representative of VTech; or
3. Product to the extent that the problem experienced is caused by signal conditions, network reliability, or cable or antenna systems; or
4. Product to the extent that the problem is caused by use with non-VTech accessories; or
5. Product whose warranty/quality stickers, product serial number plates or electronic serial numbers have been removed, altered or rendered illegible; or
6. Product purchased, used, serviced, or shipped for repair from outside the United States of America or Canada, or used for commercial or institutional purposes (including but not limited to Products used for rental purposes); or
7. Product returned without a valid proof of purchase (see item 2 on the next page); or
8. Charges for installation or set up, adjustment of customer controls, and installation or repair of systems outside the unit.

How do you get warranty service?

To obtain warranty service in the United States of America, please visit our website at www.vtechphones.com or call **1 (800) 595-9511**. In Canada, go to www.vtechcanada.com or dial **1 (800) 267-7377**.

NOTE: Before calling for service, please review the user's manual - a check of the Product's controls and features may save you a service call.

Except as provided by applicable law, you assume the risk of loss or damage during transit and transportation and are responsible for delivery or handling charges incurred in the transport of the Product(s) to the service location. VTech will return repaired or replaced Product under this limited warranty. Transportation, delivery or handling charges are prepaid. VTech assumes no risk for damage or loss of the Product in transit. If the Product failure is not covered by this limited warranty, or proof of purchase does not meet the terms of this limited warranty, VTech will notify you and will request that you authorize the cost of repair prior to any further repair activity. You must pay for the cost of repair and return shipping costs for the repair of Products that are not covered by this limited warranty.

What must you return with the Product to get warranty service?

1. Return the entire original package and contents including the Product to the VTech service location along with a description of the malfunction or difficulty; and
2. Include a "valid proof of purchase" (sales receipt) identifying the Product purchased (Product model) and the date of purchase or receipt; and
3. Provide your name, complete and correct mailing address, and telephone number.

Other limitations

This warranty is the complete and exclusive agreement between you and VTech. It supersedes all other written or oral communications related to this Product. VTech provides no other warranties for this Product. The warranty exclusively describes all of VTech's responsibilities regarding the Product. There are no other express warranties. No one is authorized to make modifications to this limited warranty and you should not rely on any such modification.

State/Provincial Law Rights: This warranty gives you specific legal rights, and you may also have other rights, which vary from state to state or province to province.

Limitations: Implied warranties, including those of fitness for a particular purpose and merchantability (an unwritten warranty that the Product is fit for ordinary use) are limited to one year from the date of purchase. Some states/provinces do not allow limitations on how long an implied warranty lasts, so the above limitation may not apply to you. In no event shall VTech be liable for any indirect, special, incidental, consequential, or similar damages (including, but not limited to lost profits or revenue, inability to use the Product or other associated equipment, the cost of substitute equipment, and claims by third parties) resulting from the use of this Product. Some states/provinces do not allow the exclusion or limitation of incidental or consequential damages, so the above limitation or exclusion may not apply to you.

Please retain your original sales receipt as proof of purchase.

Technical specifications

Transmit frequency	DECT frequency: 1921.536-1928.448 MHz Bluetooth frequency: 2402.000-2480.000 MHz
Channels	DECT channel: 5 Bluetooth channel: 79
Nominal effective range	Maximum power allowed by FCC and IC. Actual operating range may vary according to the environmental conditions at the time of use.
Power requirements	Handset: 2.4V Ni-MH battery Telephone base: Output #1: 6V DC @ 450mA; Output #2: 6V DC @ 300mA Charger: 6V DC @ 400mA
Memory	Phonebook: 1000 memory locations (shared between home and cell lines); up to 30 digits and 15 characters Caller ID log: 50 memory locations; up to 24 digits and 15 characters Call block: 20 entries

The *Bluetooth*[®] word mark and logos are owned by Bluetooth SIG, Inc. and any use of such marks by VTech Holdings Limited is under license. VTech Holdings Limited is a member of Bluetooth SIG, Inc. Other trademarks and trade names are those of their respective owners.



Designed to fit your home.
And your life.

VTech Communications, Inc.
A member of THE VTECH GROUP OF COMPANIES.
VTech is a registered trademark of VTech Holdings Limited.
Specifications are subject to change without notice.
Copyright © 2016 for VTech Communications, Inc.
All rights reserved. 08/16. DS6771_WEB CIB_V3.0
Document order number: 91-010087-020-100

