

2015 POLICE INTERCEPTOR Owner's Manual



fordowner.com



ford.ca

May 2014
First Printing
Owner's Manual
Police Interceptor
Litho in U.S.A.



FL2J 19A321 FA

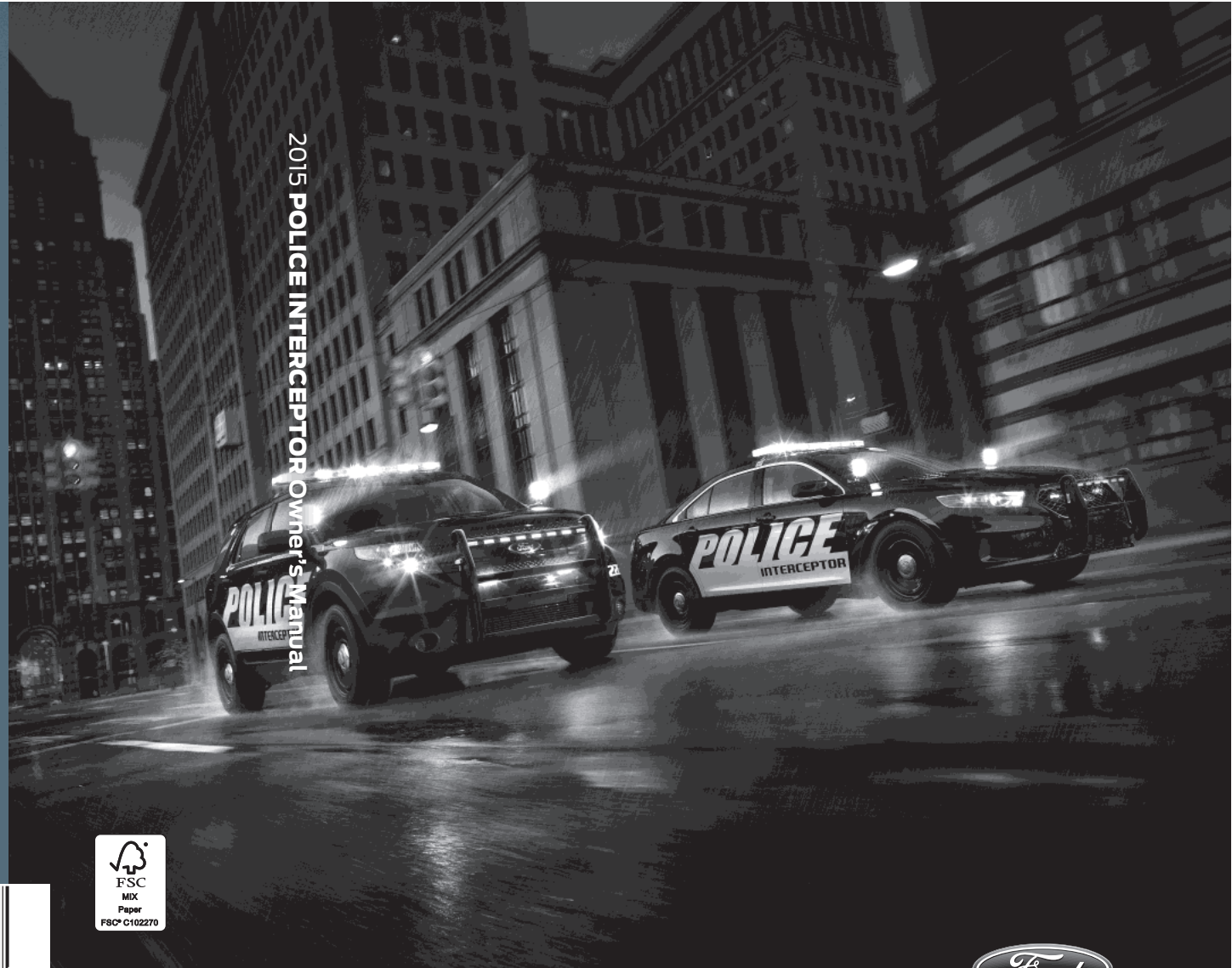

Table of Contents	1
<hr/>	
Introduction	8
Child Safety	17
Child seat positioning19
Booster seats21
Installing child seats24
Child safety locks34
Safety Belts	35
Fastening the safety belts37
Safety belt height adjustment40
Safety belt warning light and indicator chime40
Safety belt-minder41
Child restraint and safety belt maintenance43
Personal Safety System	44
Supplementary Restraints System	45
Driver and passenger airbags47
Front passenger sensing system49
Side airbags51
Safety canopy curtain airbags53
Crash sensors and airbag indicator55
Airbag disposal62
Keys and Remote Control	63
General information on radio frequencies63
Remote control63
Locks	67
Locking and unlocking67
Trunk release70
Interior luggage compartment release71

Security	73
Steering Wheel	74
Adjusting the steering wheel74
Steering wheel controls74
Pedals	77
Adjustable pedals77
Wipers and Washers	78
Windshield wipers78
Windshield washers78
Rear-window wiper and washer79
Lighting	80
Lighting control80
Instrument lighting dimmer83
Daytime running lamps83
Direction indicators84
Interior lamps85
Windows and Mirrors	87
Power windows87
Exterior mirrors89
Interior mirrors91
Sun visors91
Instrument Cluster	92
Gauges92
Warning lamps and indicators93
Audible warnings and indicators97
Information Displays	98
Controls98
Trip computer100
Information messages100

Table of Contents **3**

Climate Control	107
Manual heating and air conditioning	107
Rear window defroster	108
Cabin air filter	109
Seats	110
Sitting in the correct position	110
Head restraints	111
Manual seats	113
Power seats	114
Rear seats	115
Auxiliary Power Points	117
Storage Compartments	118
Center console	118
Overhead console	119
Starting and Stopping the Engine	120
Ignition switch	121
Starting the engine	121
Engine block heater	124
Fuel and Refueling	126
Fuel quality	127
Running out of fuel	128
Refueling	130
Fuel consumption	132
Transmission	137
Automatic transmission	137
All-Wheel Drive (If Equipped)	139
All wheel drive	139

Brakes	148
Brakes148
Hints on driving with anti-lock brakes149
Parking brake149
Traction Control	150
Traction Control™150
Stability Control	151
AdvanceTrac®152
Parking Aids	153
Sensing system153
Rear-view camera system154
Cruise Control	157
Using cruise control157
Driving Aids	159
Blind Spot Information System (BLIS) with Cross Traffic Alert (CTA)159
Steering164
Load Carrying	166
Cargo management system166
Roof racks and load carriers167
Vehicle loading168
Towing	176
Trailer towing176
Wrecker towing181
Recreational towing182
Driving Hints	184
Economical driving184
Driving through water185
Floor mats186

Table of Contents

5

Roadside Emergencies	187
Getting roadside assistance	187
Hazard warning flashers	188
Fuel cut-off switch	188
Jump-starting the vehicle	189
Customer Assistance	192
Reporting safety defects (U.S. only)	199
Reporting safety defects (Canada only)	199
Fuses	200
Changing a fuse	200
Fuse specification chart	200
Maintenance	210
General information	210
Opening and closing the hood	211
Under hood overview	213
Engine oil dipstick	217
Engine oil check	217
Engine coolant check	218
Automatic transmission fluid check	223
Brake fluid check	227
Fuel filter	227
Washer fluid check	228
Changing the vehicle battery	228
Checking the wiper blades	230
Changing the wiper blades	230
Air filter(s)	231
Adjusting the headlamps	234
Changing a bulb	236
Bulb specification chart	244

Vehicle Care	247
Cleaning products247
Cleaning the exterior247
Waxing249
Repairing minor paint damage249
Cleaning the engine249
Cleaning the windows and wiper blades250
Cleaning the interior251
Cleaning the instrument panel and instrument cluster lens251
Cleaning leather seats252
Cleaning the alloy wheels253
Vehicle storage253
Wheels and Tires	256
Tire care258
Tire Pressure Monitoring System (TPMS)276
Changing a road wheel282
Technical specifications291
Wheel lug nut torque291
Capacities and Specifications	292
Part numbers299
Vehicle identification number300
Vehicle certification label301
Transmission code designation301
Extended Service Plan	302
Audio System	305
MyFord™ system307
Auxiliary input jack314
USB port315

Table of Contents 7

SYNC®	316
Pairing your phone for the first time321
911 Assist™336
Vehicle Health Report339
Appendices	363
Scheduled Maintenance	372
Normal scheduled maintenance and log377
Index	391

The information contained in this publication was correct at the time of going to print. In the interest of continuous development, we reserve the right to change specifications, design or equipment at any time without notice or obligation. No part of this publication may be reproduced, transmitted, stored in a retrieval system or translated into any language in any form by any means without our written permission. Errors and omissions excepted.

© Ford Motor Company 2014

ABOUT THIS MANUAL

Thank you for choosing Ford. We recommend that you take some time to get to know your vehicle by reading this manual. The more that you know about it, the greater the safety and pleasure you will get from driving it.



WARNING: Always drive with due care and attention when using and operating the controls and features on your vehicle.

Note: This manual describes product features and options available throughout the range of available models, sometimes even before they are generally available. It may describe options not fitted to your vehicle.

Note: Some of the illustrations in this manual may show features as used in different models, so may appear different to you on your vehicle. However, the essential information in the illustrations is always correct.

Note: Always use and operate your vehicle in line with all applicable laws and regulations.

Note: Pass on this manual when selling your vehicle. It is an integral part of the vehicle.

This manual may qualify the location of a component as left-hand side or right-hand side. The side is determined when facing forward in the seat.

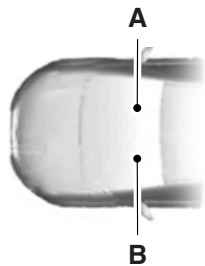

A. Right-hand side

B. Left-hand side

Symbols in this manual

WARNING: You risk death or serious injury to yourself and others if you do not follow the instruction highlighted by the warning symbol.

Symbols on your vehicle

When you see these symbols, read and follow the relevant instructions in this manual before touching or attempting adjustment of any kind.



























**Protecting the Environment**

You must play your part in protecting the environment. Correct vehicle usage and the authorized disposal of waste, cleaning and lubrication materials are significant steps toward this aim.

SYMBOL GLOSSARY

These are some of the symbols you may see on your vehicle.

Symbol	Description	Symbol	Description	Symbol	Description
	Safety alert		See Owner's Manual		Anti-lock braking system
	Avoid smoking, flames, or sparks		Battery		Battery acid
	Brake fluid – non petroleum base		Brake system		Cabin air filter
	Check fuel cap		Child Safety Door Lock and Unlock		Child seat lower anchor
	Child seat tether anchor		Cruise control		Do not open when hot
	Engine air filter		Engine coolant		Engine coolant temperature

Symbol	Description	Symbol	Description	Symbol	Description
	Engine oil		Explosive gas		Fan warning
	Fasten safety belt		Front airbag		Front fog lamps
	Fuel pump reset		Fuse compartment		Hazard warning flasher
	Heated rear window		Interior luggage compartment release		Jack
	Lighting control		Low tire pressure warning		Maintain correct fluid level
	Panic alarm		Parking aid system		Parking brake system
	Power steering fluid		Power windows front and rear		Power window lockout
	Service engine soon		Side airbag		Stability control
	Windshield defrost and demist		Windshield washer and wiper		

DATA RECORDING**Service Data Recording**

Service data recorders in your vehicle are capable of collecting and storing diagnostic information about your vehicle. This potentially includes information about the performance or status of various systems and modules in the vehicle, such as engine, throttle, steering or brake systems. In order to properly diagnose and service your vehicle, Ford Motor Company, Ford of Canada, and service and repair facilities may access or share among them vehicle diagnostic information received through a direct connection to your vehicle when diagnosing or servicing your vehicle. Additionally, when your vehicle is in for service or repair, Ford Motor Company, Ford of Canada, and service and repair facilities may access or share among them data for vehicle improvement purposes. For U.S. only (if equipped), if you choose to use the SYNC® Vehicle Health Report, you consent that certain diagnostic information may also be accessed electronically by Ford Motor Company and Ford authorized service facilities, and that the diagnostic information may be used for any purpose. See the *SYNC®* chapter for more information.

Event Data Recording

This vehicle is equipped with an event data recorder (EDR). The main purpose of an EDR is to record, in certain crash or near crash-like situations, such as an airbag deployment or hitting a road obstacle; this data will assist in understanding how a vehicle's systems performed. The EDR is designed to record data related to vehicle dynamics and safety systems for a short period of time, typically 30 seconds or less. The EDR in this vehicle is designed to record such data as:

- **How various systems in your vehicle were operating;**
- **Whether or not the driver and passenger safety belts were buckled/fastened;**
- **How far (if at all) the driver was depressing the accelerator and/or the brake pedal;**
- **How fast the vehicle was travelling;**
- **Where the driver was positioning the steering wheel.**

This data can help provide a better understanding of the circumstances in which crashes and injuries occur.

Note: EDR data is recorded by your vehicle only if a non-trivial crash situation occurs; no data is recorded by the EDR under

normal driving conditions and no personal data or information (e.g., name, gender, age, and crash location) is recorded (see limitations regarding 911 Assist and Traffic, Directions and Information privacy below). However, parties, such as law enforcement, could combine the EDR data with the type of personally identifying data routinely acquired during a crash investigation.

To read data recorded by an EDR, special equipment is required, and access to the vehicle or the EDR is needed. In addition to the vehicle manufacturer, other parties, such as law enforcement, that have such special equipment, can read the information if they have access to the vehicle or the EDR. Ford Motor Company and Ford of Canada do not access event data recorder information without obtaining consent, unless pursuant to court order or where required by law enforcement, other government authorities or other third parties acting with lawful authority. Other parties may seek to access the information independently of Ford Motor Company and Ford of Canada.

Note: Including to the extent that any law pertaining to Event Data Recorders applies to SYNC® or its features, please note the following: Once 911 Assist (if equipped) is enabled (set ON), 911 Assist may, through any paired and connected cell phone, disclose to emergency services that the vehicle has been in a crash involving the deployment of an airbag or, in certain vehicles, the activation of the fuel pump shut-off. Certain versions or updates to 911 Assist may also be capable of being used to electronically or verbally provide to 911 operators the vehicle location (such as latitude and longitude), and/or other details about the vehicle or crash or personal information about the occupants to assist 911 operators to provide the most appropriate emergency services. If you do not want to disclose this information, do not activate the 911 Assist feature. See your SYNC® chapter for more information.

Additionally, when you connect to Traffic, Directions and Information (if equipped, U.S. only), the service uses GPS technology and advanced vehicle sensors to collect the vehicle's current location, travel direction, and speed ("vehicle travel information"), only to help provide you with the directions, traffic reports, or business searches that you request. If you do not want Ford or its vendors to receive this information, do not activate the service. For more information, see Traffic, Directions and Information, Terms and Conditions. See your SYNC® chapter for more information.

CALIFORNIA PROPOSITION 65

WARNING: Some constituents of engine exhaust, certain vehicle components, certain fluids contained in vehicles and certain products of component wear contain or emit chemicals known to the State of California to cause cancer and birth defects or other reproductive harm.

PERCHLORATE MATERIAL

Note: Certain components in your vehicle, such as airbag modules, safety belt pretensioners, and remote control batteries, may contain perchlorate material. Special handling may apply for service or vehicle end of life disposal. See www.dtsc.ca.gov/hazardouswaste/perchlorate for more information.

FORD CREDIT (U.S. ONLY)

Ford Credit offers a full range of financing and lease plans to help you acquire your vehicle. If you have financed or leased your vehicle through Ford Credit, thank you for your business.

For your convenience, we offer a number of ways to contact us, as well as help manage your account.

Phone: 1-800-727-7000

For more information regarding Ford Credit, as well as access to Account Manager, please go to www.fordcredit.com.

REPLACEMENT PARTS RECOMMENDATION

Your vehicle has been built to the highest standards using quality parts. We recommend that you demand the use of genuine Ford and Motorcraft parts whenever your vehicle requires scheduled maintenance or repair. You can clearly identify genuine Ford and Motorcraft parts by looking for the Ford, FoMoCo or Motorcraft branding on the parts or their packaging.

Scheduled Maintenance and Mechanical Repairs

One of the best ways for you to make sure that your vehicle provides years of service is to have it maintained in line with our recommendations using parts that conform to the specifications detailed in this owner's manual. Genuine Ford and Motorcraft parts meet or exceed these specifications.

Collision Repairs

We hope that you never experience a collision, but accidents do happen. Genuine Ford replacement collision parts meet our stringent requirements for fit, finish, structural integrity, corrosion protection and dent resistance. During vehicle development, we validate that these parts deliver the intended level of protection as a whole system. A great way to know for sure you are getting this level of protection is to use genuine Ford replacement collision parts.

Warranty on Replacement Parts

Genuine Ford and Motorcraft replacement parts are the only replacement parts that benefit from a Ford Warranty. Damage caused to your vehicle as a result of the failure of non-Ford parts may not be covered by the Ford Warranty. For additional information, see the terms and conditions of the Ford Warranty.

SPECIAL NOTICES**New Vehicle Limited Warranty**

For a detailed description of what is covered and what is not covered by your vehicle's New Vehicle Limited Warranty, see the warranty information that is provided to you along with your owner's manual.

Special Instructions

For your added safety, your vehicle is fitted with sophisticated electronic controls.



WARNING: Please read the *Supplementary Restraints System* chapter. Failure to follow the specific warnings and instructions could result in personal injury.



WARNING: Front seat mounted rear-facing child or infant seats should **NEVER** be placed in front of an active passenger airbag.

Notice to owners of pickup trucks and utility type vehicles

WARNING: Utility vehicles have a significantly higher rollover rate than other types of vehicles.

Before you drive your vehicle, please read this Owner's Manual carefully. Your vehicle is not a passenger car. As with other vehicles of this type, failure to operate your vehicle correctly may result in loss of vehicle control, vehicle rollover, personal injury or death.

Using your vehicle with a snowplow**Do not use this vehicle for snowplowing.**

Your vehicle is not equipped with a snowplowing package.

Using your vehicle as an ambulance**Do not use this vehicle as an ambulance.**

Your vehicle is not equipped with the Ford Ambulance Preparation Package.

My Fleet Management (If Equipped)

This feature allows a fleet administrator to control specific vehicle settings using a Ford authorized service tool. This helps the fleet administrator set certain vehicle settings to match administrative policy. The configurable settings are:

- **Vehicle Speed**– Select an alternative speed limit that is below your vehicle's maximum capability. A message displays and a chime sounds when starting your vehicle to indicate the customized speed limit.
- **Audio Volume**– Select a limit for the maximum volume of the audio system in the range of 0% (full mute) to 100% (no limit) in 10% increments.

MOBILE COMMUNICATIONS EQUIPMENT

Using mobile communications equipment is becoming increasingly important in the conduct of business and personal affairs. However, you must not compromise your own or others' safety when using such equipment. Mobile communications can enhance personal safety and security when appropriately used, particularly in emergency situations. Safety must be paramount when using mobile communications equipment to avoid negating these benefits.

Mobile communication equipment includes, but is not limited to, cellular phones, pagers, portable email devices, text messaging devices and portable two-way radios.



WARNING: Driving while distracted can result in loss of vehicle control, crash and injury. We strongly recommend that you use extreme caution when using any device that may take your focus off the road. Your primary responsibility is the safe operation of your vehicle. We recommend against the use of any handheld device while driving and encourage the use of voice-operated systems when possible. Make sure you are aware of all applicable local laws that may affect the use of electronic devices while driving.

EXPORT UNIQUE (NON-UNITED STATES/CANADA) VEHICLE SPECIFIC INFORMATION

For your particular global region, your vehicle may be equipped with features and options that are different from the features and options that are described in this owner's manual. A market unique supplement may be supplied that complements this book. By referring to the market unique supplement, if provided, you can properly identify those features, recommendations and specifications that are unique to your vehicle. This owner's manual is written primarily for the U.S. and Canadian Markets. Features or equipment listed as standard may be different on units built for Export. **See this owner's manual for all other required information and warnings.**

GENERAL INFORMATION

See the following sections for directions on how to properly use safety restraints for children.



WARNING: Always make sure your child is secured properly in a device that is appropriate for their height, age and weight. Child safety restraints must be bought separately from your vehicle. Failure to follow these instructions and guidelines may result in an increased risk of serious injury or death to your child.



WARNING: All children are shaped differently. The recommendations for safety restraints are based on probable child height, age and weight thresholds from NHTSA and other safety organizations, or are the minimum requirements of law. Ford recommends checking with a NHTSA Certified Child Passenger Safety Technician (CPST) and consulting your pediatrician to make sure your child seat is appropriate for your child, and is compatible with and properly installed in your vehicle. To locate a child seat fitting station and CPST, contact the NHTSA toll free at 1-888-327-4236 or on the internet at <http://www.nhtsa.dot.gov>. In Canada, check with your local St. John Ambulance office for referral to a CPST or for further information, contact your provincial ministry of transportation, or locate your local St. John Ambulance office by searching for St. John Ambulance on the internet, or Transport Canada at 1-800-333-0371 (<http://www.tc.gc.ca>). Failure to properly restrain children in safety seats made especially for their height, age, and weight may result in an increased risk of serious injury or death to your child.

Recommendations for Safety Restraints for Children		
	Child size, height, weight, or age	Recommended restraint type
Infants or toddlers	Children weighing 40 lb (18 kg) or less (generally age four or younger).	Use a child safety seat (sometimes called an infant carrier, convertible seat, or toddler seat).
Small children	Children who have outgrown or no longer properly fit in a child safety seat (generally children who are less than 4 ft. 9 in. (1.45 m) tall, are greater than age four (4) and less than age twelve (12), and between 40 lb (18 kg) and 80 lb (36 kg) and upward to 100 lb (45 kg) if recommended by your child restraint manufacturer).	Use a belt-positioning booster seat.
Larger children	Children who have outgrown or no longer properly fit in a belt-positioning booster seat (generally children who are at least 4 ft. 9 in. (1.45 m) tall or greater than 80 lb (36 kg) or 100 lb (45 kg) if recommended by child restraint manufacturer).	Use a vehicle safety belt having the lap belt snug and low across the hips, shoulder belt centered across the shoulder and chest, and seat back upright.

- You are required by law to properly use safety seats for infants and toddlers in the United States and Canada.
- Many states and provinces require that small children use approved booster seats until they reach age eight, a height of 4 feet 9 inches (1.45 meters) tall, or 80 pounds (36 kilograms). Check your local and state or provincial laws for specific requirements about the safety of children in your vehicle.
- When possible, always properly restrain children twelve (12) years of age and under in a rear seating position of your vehicle. Accident statistics suggest that children are safer when properly restrained in the rear seating positions than in a front seating position. See *Front Passenger Sensing System* in the *Supplementary Restraints System* chapter for more information.

CHILD SEAT POSITIONING

WARNING: Airbags can kill or injure a child in a child seat.

Never place a rear-facing child seat in front of an active airbag. If you must use a forward-facing child seat in the front seat, move the vehicle seat upon which the child seat is installed all the way back. When possible, all children age 12 and under should be properly restrained in a rear seating position. If all children cannot be seated and restrained properly in a rear seating position, properly restrain the largest child in the front seat.



WARNING: Always carefully follow the instructions and

warnings provided by the manufacturer of any child restraint to determine if the restraint device is appropriate for your child's size, height, weight, or age. Follow the child restraint manufacturer's instructions and warnings provided for installation and use in conjunction with the instructions and warnings provided by your vehicle manufacturer. A safety seat that is improperly installed or utilized, is inappropriate for your child's height, age or weight, or does not properly fit the child, may increase the risk of serious injury or death.



WARNING: Never let a passenger hold a child on his or her lap

while your vehicle is moving. The passenger cannot protect the child from injury in a crash, which may result in serious injury or death.



WARNING: Never use pillows, books, or towels to boost a child.

They can slide around and increase the likelihood of injury or death in a crash.



WARNING: Always restrain an unoccupied child seat or booster

seat. These objects may become projectiles in a crash or sudden stop, which may increase the risk of serious injury.



WARNING: Never place, or allow a child to place, the shoulder belt under a child's arm or behind the back because it reduces the protection for the upper part of the body and may increase the risk of injury or death in a crash.



WARNING: To avoid risk of injury, do not leave children or pets unattended in your vehicle.

Recommendations for attaching child safety restraints for children

Restraint Type	Combined weight of child and child seat	Use any attachment method as indicated below by X.				
		LATCH (lower anchors and top tether anchor)	LATCH (lower anchors only)	Safety belt and top tether anchor	Safety belt and LATCH (lower anchors and top tether anchor)	Safety belt only
Rear-facing child seat	Up to 65 lb (29.5 kg)		X			X
Rear-facing child seat	Over 65 lb (29.5 kg)					X
Forward-facing child seat	Up to 65 lb (29.5 kg)	X		X	X	
Forward-facing child seat	Over 65 lb (29.5 kg)			X	X	

Note: The child seat must rest tightly against the vehicle seat upon which it is installed. It may be necessary to lift or remove the head restraint. See the *Seats* chapter for information on head restraints.

BOOSTER SEATS

 **WARNING:** Never place, or allow a child to place, the shoulder belt under a child's arm or behind the back because it reduces the protection for the upper part of the body and may increase the risk of injury or death in a crash.

Use a belt-positioning booster seat for children who have outgrown or no longer properly fit in a child safety seat (generally children who are less than 4 feet 9 inches (1.45 meters) tall, are greater than age four (4) and less than age twelve (12), and between 40 pounds (18 kilograms) and 80 pounds (36 kilograms) and upward to 100 pounds (45 kilograms) if recommended by your child restraint manufacturer). Many state and provincial laws require that children use approved booster seats until they reach age eight, a height of 4 feet 9 inches (1.45 meters) tall, or 80 pounds (36 kilograms).

Booster seats should be used until you can answer YES to ALL of these questions when seated without a booster seat.

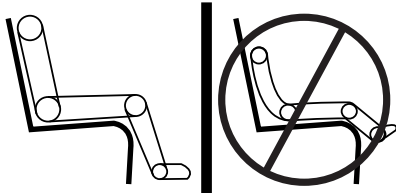

- Can the child sit all the way back against their vehicle seat with knees bent comfortably at the edge of the seat cushion?
- Can the child sit without slouching?

- Does the lap belt rest low across the hips?
- Is the shoulder belt centered on the shoulder and chest?
- Can the child stay seated like this for the whole trip?

Always use booster seats in conjunction with your vehicle lap and shoulder belt.

Types of Booster Seats

- Backless booster seats

If your backless booster seat has a removable shield, remove the shield. If a vehicle seating position has a low seatback or no head restraint, a backless booster seat may place your child's head (as measured at the tops of the ears) above the top of the seat. In this case, move the backless booster to another seating position with a higher seatback or head restraint and lap and shoulder belts, or consider using a high back booster seat.



- High back booster seats

If, with a backless booster seat, you cannot find a seating position that adequately supports your child's head, a high back booster seat would be a better choice.

Children and booster seats vary in size and shape. Choose a booster that keeps the lap belt low and snug across the hips, never up across the stomach, and lets you adjust the shoulder belt to cross the chest and rest snugly near the center of the shoulder. The following drawings compare the ideal fit (center) to a shoulder belt uncomfortably close to the neck and a shoulder belt that could slip off the shoulder. The drawings also show how the lap belt should be low and snug across the child's hips.

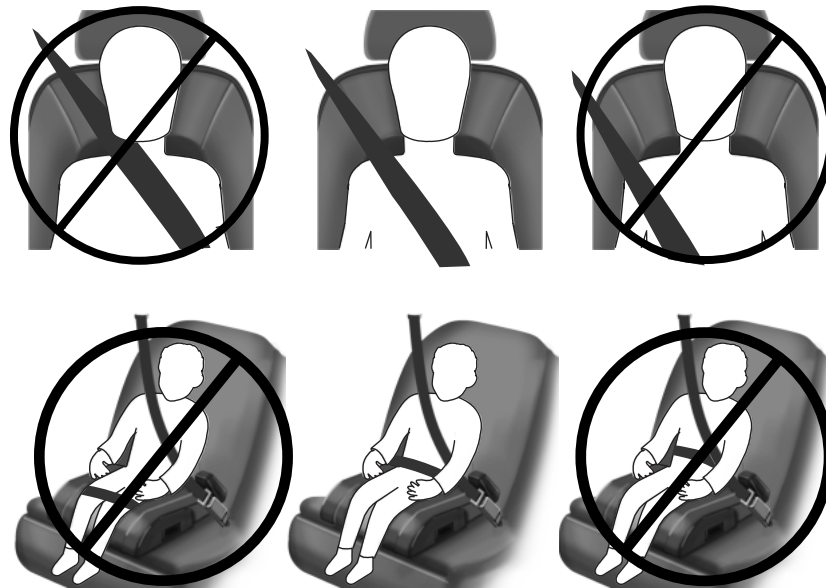

If the booster seat slides on the vehicle seat upon which it is being used, placing a rubberized mesh sold as shelf or carpet liner under the booster seat may improve this condition. Do not introduce any item thicker than this under the booster seat. Check with the booster seat manufacturer's instructions.

INSTALLING CHILD SEATS**Child Seats**

Use a child safety seat (sometimes called an infant carrier, convertible seat, or toddler seat) for infants, toddlers or children weighing 40 pounds (18 kilograms) or less (generally age four or younger).

Using Lap and Shoulder Belts

WARNING: Airbags can kill or injure a child in a child seat.

Never place a rear-facing child seat in front of an active airbag. If you must use a forward-facing child seat in the front seat, move the seat upon which the child seat is installed all the way back.



WARNING: Airbags can kill or injure a child in a child seat.

Children 12 and under should be properly restrained in the rear seat whenever possible.



WARNING: Depending on where you secure a child restraint, and depending on the child restraint design, you may block access to certain safety belt buckle assemblies or LATCH lower anchors, rendering those features potentially unusable. To avoid risk of injury, occupants should only use seating positions where they are able to be properly restrained.

When installing a child safety seat with combination lap and shoulder belts:

- Use the correct safety belt buckle for that seating position.
- Insert the belt tongue into the proper buckle until you hear a snap and feel it latch. Make sure the tongue is securely fastened in the buckle.
- Keep the buckle release button pointing up and away from the safety seat, with the tongue between the child seat and the release button, to prevent accidental unbuckling.
- Place the vehicle seat upon which the child seat will be installed in the upright position.
- For second row seating positions, if needed, the recliner may be adjusted slightly to improve child seat fit. If needed, the head restraints may be removed.
- Put the safety belt in the automatic locking mode. See Step 5. This vehicle does not require the use of a locking clip.

Perform the following steps when installing the child seat with combination lap and shoulder belts:

Note: Although the child seat illustrated is a forward facing child seat, the steps are the same for installing a rear facing child seat.

Note: Follow all instructions provided by the manufacturer of the child restraint regarding the necessary and proper use of the Lock-off device. In some instances these devices have been provided only for use in vehicles with safety belt systems that would otherwise require a locking clip. This vehicle does not require the use of a locking clip.



1. Position the child safety seat in a seat with a combination lap and shoulder belt.

2. After positioning the child safety seat in the proper seating position, do the following:

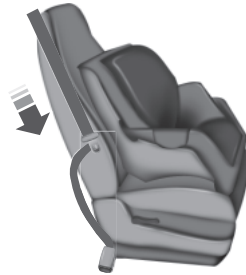

Pull down on the shoulder belt and then grasp the shoulder belt and lap belt together behind the belt tongue.

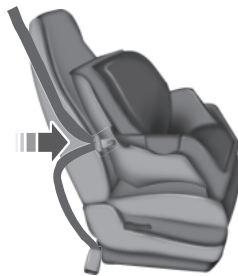

3. While holding the shoulder and lap belt portions together, route the tongue through the child seat according to the child seat manufacturer's instructions. Be sure the belt webbing is not twisted.

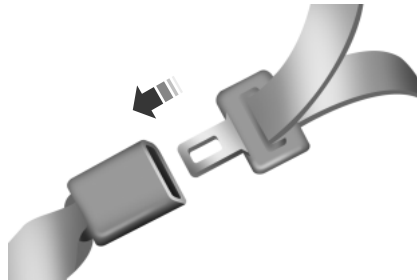

4. Insert the belt tongue into the proper buckle (the buckle closest to the direction the tongue is coming from) for that seating position until you hear a snap and feel the latch engage. Make sure the tongue is latched securely by pulling on it.

5. To put the retractor in the automatic locking mode, do the following;



Grasp the shoulder portion of the belt and pull downward until all of the belt is pulled out.

6. Allow the belt to retract to remove slack. The belt will click as it retracts to indicate it is in the automatic locking mode.

7. Try to pull the belt out of the retractor to make sure the retractor is in the automatic locking mode (you should not be able to pull more belt out). If the retractor is not locked, repeat Steps 5 and 6.

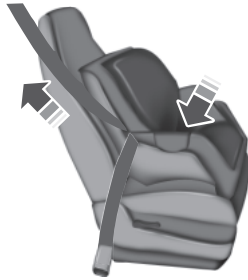

8. Remove remaining slack from the belt. Force the seat down with extra weight, for example, by pressing down or kneeling on the child restraint while pulling up on the shoulder belt in order to force slack from the belt. This is necessary to remove the remaining slack that will exist once the extra weight of the child is added to the child restraint.

It also helps to achieve the proper snugness of the child seat to your vehicle. Sometimes, a slight lean toward the buckle will provide extra help to remove remaining slack from the belt.

9. Attach the tether strap (if the child seat is equipped). See *Using Tether Straps* later in this chapter.

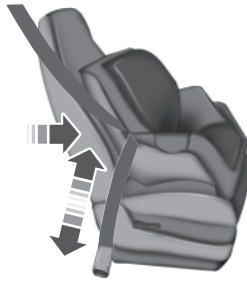

10. Before placing the child in the seat, forcibly move the seat forward and back to make sure the seat is securely held in place. To check this, grab the seat at the belt path and attempt to move it side to side and forward and back. There should be no more than 1 inch (2.5 centimeters) of movement for proper installation.

Ford recommends checking with a NHTSA Certified Child Passenger Safety Technician to make certain the child restraint is properly installed. In Canada, check with your local St. John Ambulance office for referral to a Child Passenger Safety Technician.

Using Lower Anchors and Tethers for Children (LATCH)



WARNING: Never attach two child safety seats to the same anchor. In a crash, one anchor may not be strong enough to hold two child safety seat attachments and may break, causing serious injury or death.



WARNING: Depending on where you secure a child restraint, and depending on the child restraint design, you may block access to certain safety belt buckle assemblies or LATCH lower anchors, rendering those features potentially unusable. To avoid risk of injury, occupants should only use seating positions where they are able to be properly restrained.

The LATCH system is composed of three vehicle anchor points: two lower anchors located where seat back and seat cushion meet (called the seat bight) and one top tether anchor located behind that seating position.

LATCH compatible child safety seats have two rigid or webbing mounted attachments that connect to the two lower anchors at the LATCH equipped seating positions in your vehicle. This type of attachment method eliminates the need to use safety belts to attach the child seat, however the safety belt can still be used to attach the child seat. For forward-facing child seats, the top tether strap must also be attached to the proper top tether anchor, if a top tether strap has been provided with your child seat.

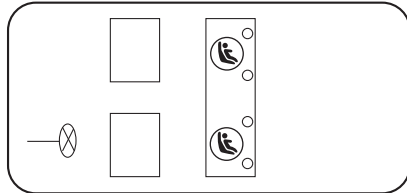

Your vehicle has LATCH lower anchors for child seat installation at the seating positions marked with the child seat symbol.

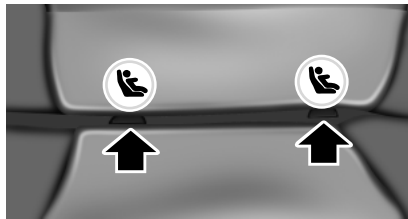

The LATCH anchors are located at the rear section of the rear seat between the cushion and seat back below the symbols as shown. Follow the child seat manufacturer's instructions to properly install a child seat with LATCH attachments.

Follow the instructions on attaching child safety seats with tether straps. See *Using Tether Straps* later in this chapter.

Attach LATCH lower attachments of the child seat only to the anchors shown.

Use of inboard lower anchors from the outboard seating positions (center seating use) (sedan vehicles)

! **WARNING:** The standardized spacing for LATCH lower anchors is 11 inches (28 centimeters) center to center. Do not use LATCH lower anchors for the center seating position unless the child seat manufacturer's instructions permit and specify using anchors spaced at least as far apart as those in this vehicle.

Child seat positioning for LATCH lower anchors

All the LATCH lower anchors are equally spaced, 11 inches (28 centimeters) apart, allowing for the following child seat positioning:

- If a single child seat is installed using the LATCH lower anchors, it can be installed at any rear seating position.
- If two child safety seats are installed using the LATCH lower anchors, they must be placed in the outboard seating positions only.

- Or you can use the LATCH lower anchors for the center child safety seat and the lap and shoulder belts for the other two child safety seats in the outboard positions. Use the tether anchors if applicable. If three child safety seats are installed, you can install two using the LATCH lower anchors by placing them in each outboard seating position and the third in the center using the lap and shoulder belt.

Each time you use the safety seat, check that the seat is properly attached to the lower anchors and tether anchor, if applicable. Tug the child seat from side to side and forward and back where it is secured to your vehicle. The seat should move less than one inch when you do this for a proper installation.

If the safety seat is not anchored properly, the risk of a child being injured in a crash greatly increases.

Use of inboard lower anchors from the outboard seating positions (center seating use) (utility vehicles)



WARNING: The standardized spacing for LATCH lower anchors is 11 inches (28 centimeters) center to center. Do not use LATCH lower anchors for the center seating position unless the child seat manufacturer's instructions permit and specify using anchors spaced at least as far apart as those in this vehicle.

The lower anchors at the center of the second row bench seats are spaced 20.5 inches (52 centimeters) apart. The standardized spacing for LATCH lower anchors is 11 inches (28 centimeters) center to center. A child seat with rigid LATCH attachments cannot be installed at the center seating position. LATCH compatible child seats (with attachments on belt webbing) can only be used at this seating position provided that the child seat manufacturer's instructions permit use with the anchor spacing stated. Do not attach a child seat to any lower anchor if an adjacent child seat is attached to that anchor.

Each time you use the safety seat, check that the seat is properly attached to the lower anchors and tether anchor, if applicable. Tug the child seat from side to side and forward and back where it is secured to your vehicle. The seat should move less than one inch when you do this for a proper installation.

If the safety seat is not anchored properly, the risk of a child being injured in a crash greatly increases.

Combining Safety Belt and LATCH Lower Anchors for Attaching Child Safety Seats

When used in combination, either the safety belt or the LATCH lower anchors may be attached first, provided a proper installation is achieved. Attach the tether strap afterward, if included with the child seat.

Using Tether Straps



Many forward-facing child safety seats include a tether strap which extends from the back of the child safety seat and hooks to an anchoring point called the top tether anchor. Tether straps are available as an accessory for many older safety seats.

Contact the manufacturer of your child seat for information about ordering a tether strap, or to obtain a longer tether strap if the tether strap on your safety seat does not reach the appropriate top tether anchor in your vehicle.

Once the child safety seat has been installed using either the safety belt, the lower anchors of the LATCH system, or both, you can attach the top tether strap.

The tether strap anchors in your vehicle are in the following positions (shown from top view):

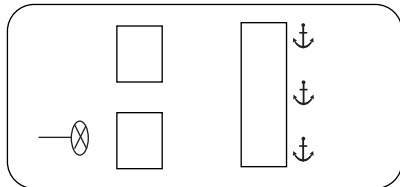

- Second row seats

Perform the following steps to install a child safety seat with tether anchors:

Note: If you install a child seat with rigid LATCH attachments, do not tighten the tether strap enough to lift the child seat off your vehicle seat cushion when the child is seated in it. Keep the tether strap just snug without lifting the front of the child seat. Keeping the child seat just touching your vehicle seat gives the best protection in a severe crash.

Sedan

1. Route the child safety seat tether strap over the back of the seat.



2. Locate the correct anchor for the selected seating position.

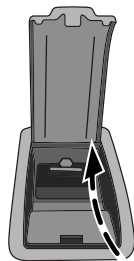

3. Open the tether anchor cover.

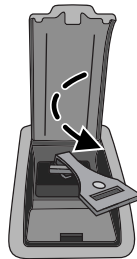

4. Clip the tether strap to the anchor as shown.

5. Tighten the child safety seat tether strap according to the manufacturer's instructions.

Utility

1. Route the child safety seat tether strap over the seat back.

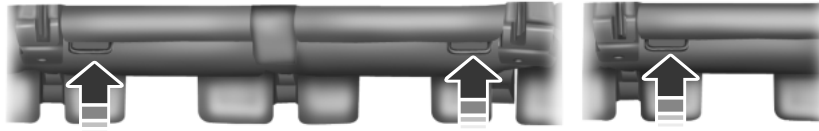

2. Locate the correct anchor for the selected rear seating position:

3. Clip the tether hook to the anchor as shown.



The tether hook may be twisted 1/2 turn to improve installation. If the tether strap is clipped incorrectly, the child safety seat may not be retained properly in the event of a crash.

4. Tighten the child safety seat tether strap according to the manufacturer's instructions.

If the safety seat is not anchored properly, the risk of a child being injured in a crash greatly increases.

If your child restraint system is equipped with a tether strap, and the child restraint manufacturer recommends its use, Ford also recommends its use.

CHILD SAFETY LOCKS

When these locks are set, the rear doors cannot be opened from the inside.





The childproof locks are located on the rear edge of each rear door and must be set separately for each door.

- Insert the key and turn to the lock position (key horizontal) to engage the childproof locks.
- Insert the key and turn to the unlock position (key vertical) to disengage the childproof locks.

PRINCIPLES OF OPERATION

 **WARNING:** Never let a passenger hold a child on his or her lap while your vehicle is moving. The passenger cannot protect the child from injury in a crash.

 **WARNING:** It is extremely dangerous to ride in a cargo area, inside or outside of a vehicle. In a crash, people riding in these areas are more likely to be seriously injured or killed. Do not allow people to ride in any area of your vehicle that is not equipped with seats and safety belts. Be sure everyone in your vehicle is in a seat and using a safety belt properly.

 **WARNING:** Always drive and ride with your seatback upright and the lap belt snug and low across the hips.

 **WARNING:** To reduce the risk of injury, make sure children sit where they can be properly restrained.

 **WARNING:** All occupants of your vehicle, including the driver, should always properly wear their safety belts, even when an airbag supplemental restraint system is provided. Failure to properly wear your safety belt could seriously increase the risk of injury or death.

 **WARNING:** In a rollover crash, an unbelted person is significantly more likely to die than a person wearing a safety belt.

 **WARNING:** Each seating position in your vehicle has a specific safety belt assembly which is made up of one buckle and one tongue that are designed to be used as a pair. 1) Use the shoulder belt on the outside shoulder only. Never wear the shoulder belt under the arm. 2) Never swing the safety belt around your neck over the inside shoulder. 3) Never use a single belt for more than one person.



WARNING: When possible, all children 12 years old and under should be properly restrained in a rear seating position. Failure to follow this could seriously increase the risk of injury or death.





WARNING: Safety belts and seats can become hot in a vehicle that has been closed up in sunny weather; they could burn a small child. Check seat covers and buckles before you place a child anywhere near them.



WARNING: Front and rear seat occupants, including pregnant women, should wear safety belts for optimum protection in an accident.

All seating positions in your vehicle have lap and shoulder safety belts. All occupants of the vehicle should always properly wear their safety belts, even when an airbag supplemental restraint system is provided.

The safety belt system consists of:

- Lap and shoulder safety belts.
- Shoulder safety belt with automatic locking mode (except driver safety belt).
- Height adjuster at the front outboard seating positions (utility only).
- Safety belt pretensioner at the front outboard seating positions.
- Belt tension sensor at the front outboard passenger seating position.
-  • Safety belt warning light and chime. See *Safety belt warning light and indicator chime* later in this chapter.
-  • Crash sensors and monitoring system with readiness indicator. See *Crash sensors and airbag indicator* in the *Supplemental Restraint System* chapter.

The safety belt pretensioners are designed to activate in frontal, near-frontal and side crashes, and in rollovers. The safety belt pretensioners at the front seating positions are designed to tighten the safety belts firmly against the occupant's body when activated. This helps increase the effectiveness of the safety belts. In frontal crashes, the safety belt pretensioners can be activated alone or, if the crash is of sufficient severity, together with the front airbags.

FASTENING THE SAFETY BELTS

The front outboard and rear safety restraints in your vehicle are combination lap and shoulder belts.

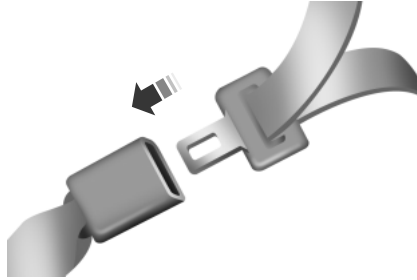

1. Insert the belt tongue into the proper buckle (the buckle closest to the direction the tongue is coming from) until you hear a snap and feel it latch. Make sure the tongue is securely fastened in the buckle.

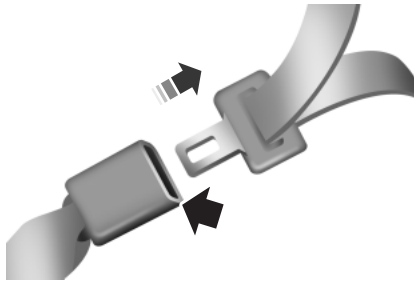

2. To unfasten, press the release button and remove the tongue from the buckle.

Using Safety Belts During Pregnancy



WARNING: Always ride and drive with your seatback upright and the safety belt properly fastened. The lap portion of the safety belt should fit snug and be positioned low across the hips. The shoulder portion of the safety belt should be positioned across the chest. Pregnant women should also follow this practice. See the following figure.

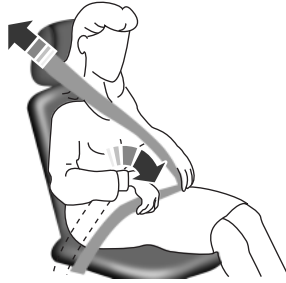

Pregnant women should always wear their safety belts. The lap belt portion of a combination lap and shoulder belt should be positioned low across the hips below the belly and worn as tight as comfort will allow. The shoulder belt should be positioned to cross the middle of the shoulder and the center of the chest.

Safety Belt Locking Modes



WARNING: After any vehicle crash, the safety belt system at all passenger seating positions must be checked by an authorized dealer to verify that the automatic locking retractor feature for child seats is still functioning properly. In addition, all safety belts should be checked for proper function.



WARNING: The belt and retractor assembly must be replaced if the safety belt assembly automatic locking retractor feature or any other safety belt function is not operating properly when checked by an authorized dealer. Failure to replace the belt and retractor assembly could increase the risk of injury in crashes.

All safety restraints in the vehicle are combination lap and shoulder belts. The driver safety belt has the first type of locking mode. The front outboard passenger and rear seat safety belts have both types of locking modes described as follows:

Vehicle Sensitive Mode

This is the normal retractor mode, which allows free shoulder belt length adjustment to your movements and locking in response to vehicle movement. For example, if the driver brakes suddenly or turns a corner sharply, or the vehicle receives an impact of about 5 mph (8 km/h) or more, the combination safety belts will lock to help reduce forward movement of the driver and passengers.

In addition, the retractor is designed to lock if the webbing is pulled out too quickly. If this occurs, let the belt retract slightly and pull webbing out again in a slow and controlled manner.

Automatic Locking Mode

In this mode, the shoulder belt is automatically pre-locked. The belt will still retract to remove any slack in the shoulder belt. The automatic locking mode is not available on the driver safety belt.

When to Use the Automatic Locking Mode

This mode should be used any time a child safety seat, except a booster, is installed in passenger front or rear seating positions. Children 12 years old and under should be properly restrained in a rear seating position whenever possible. See the *Child Safety* chapter.

How to Use the Automatic Locking Mode

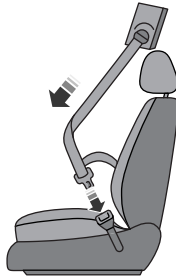

1. Buckle the combination lap and shoulder belt.
2. Grasp the shoulder portion and pull downward until the entire belt is pulled out.
3. Allow the belt to retract. As the belt retracts, you will hear a clicking sound. This indicates the safety belt is now in the automatic locking mode.

How to Disengage the Automatic Locking Mode

Unbuckle the combination lap and shoulder belt and allow it to retract completely to disengage the automatic locking mode and activate the vehicle sensitive (emergency) locking mode.

Safety Belt Extension Assembly



WARNING: Do not use extensions to change the fit of the shoulder belt across the torso.

If the safety belt is too short when fully extended, you can obtain a safety belt extension assembly from an authorized dealer.

Use only extensions manufactured by the same supplier as the safety belt. Manufacturer identification is on a label located either at the end of the webbing or on the retractor behind the trim. Also, use the safety belt extension only if the safety belt is too short for you when fully extended.

SAFETY BELT HEIGHT ADJUSTMENT (UTILITY)

WARNING: Position the safety belt height adjusters so that the belt rests across the middle of your shoulder. Failure to adjust the safety belt properly could reduce the effectiveness of the seat belt and increase the risk of injury in a crash.

Your vehicle has safety belt height adjustments for the front outboard seating positions.

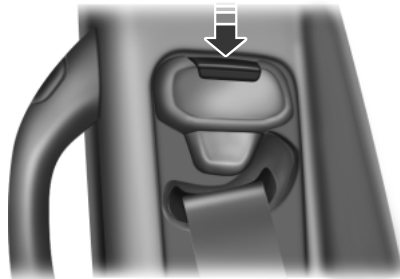

1. Adjust the height of the shoulder belt so the belt rests across the middle of your shoulder.
2. Slide the adjuster up to raise the belt. Push the button and slide it down to lower the belt.

SAFETY BELT WARNING LIGHT AND INDICATOR CHIME

This lamp illuminates and an audible warning will sound if the driver's safety belt has not been fastened when the vehicle's ignition is turned on.

Conditions of Operation

If...	Then...
The driver safety belt is not buckled before the ignition switch is turned to the on position...	The safety belt warning light illuminates 1-2 minutes and the warning chime sounds 4-8 seconds.
The driver safety belt is buckled while the indicator light is illuminated and the warning chime is sounding...	The safety belt warning light and warning chime turn off.
The driver safety belt is buckled before the ignition switch is turned to the on position...	The safety belt warning light and indicator chime remain off.

SAFETY BELT-MINDER™

This feature supplements the safety belt warning function by providing additional reminders that intermittently sound a tone and illuminate the safety belt warning light when you are in the driver seat or you have a front seat passenger and a safety belt is unbuckled.

The system uses information from the front passenger sensing system to determine if a front seat passenger is present and therefore potentially in need of a warning. To avoid activating the Belt-Minder feature for objects placed in the front passenger seat, warnings will only be given to front seat occupants as determined by the front passenger sensing system.

If the Belt-Minder warnings have expired (warnings for about five minutes) for one occupant (driver or front passenger), the other occupant can still activate the Belt-Minder feature.

If...	Then...
You and the front seat passenger buckle your safety belts before you switch the ignition on or less than 1-2 minutes elapse after you switch the ignition on...	The Belt-Minder feature will not activate.
You or the front seat passenger do not buckle your safety belts before your vehicle reaches at least 6 mph (9.7 km/h) and 1-2 minutes elapse after you switch the ignition...	The Belt-Minder feature activates, the safety belt warning light illuminates and a warning tone sounds for 6 seconds every 25 seconds, repeating for about 5 minutes or until you and the front seat passenger buckle your safety belts.
The driver or front passenger safety belt becomes unbuckled for about one minute while the vehicle is traveling at least 6 mph (9.7 km/h) and more than 1-2 minutes elapse after you switch the ignition on...	The Belt-Minder feature activates, the safety belt warning light illuminates and a warning tone sounds for 6 seconds every 25 seconds, repeating for about 5 minutes or until you and the front seat passenger buckle your safety belts.

Deactivating and Activating the Belt-Minder Feature

WARNING: While the system allows you to deactivate it, this system is designed to improve your chances of being safely belted and surviving an accident. We recommend you leave the system activated for yourself and others who may use your vehicle. To reduce the risk of injury, do not deactivate or activate the system while driving your vehicle.

Note: The driver and front passenger warning are deactivated and activated independently. When deactivating or activating one seating position, do not buckle the other position as this will terminate the process.

Read Steps 1 - 4 thoroughly before proceeding with the programming procedure.

Before following the procedure, make sure that:

- The parking brake is set.
 - The transmission is in park (P).
 - The ignition is off.
 - The driver and front passenger safety belts are unbuckled.
1. Turn the ignition on. Do not start the engine.
 2. Wait until the safety belt warning light turns off (about one minute).
 - Once the next step is started, the procedure must be completed within 60 seconds.
 3. Buckle then unbuckle the safety belt four times at a moderate speed, ending in the unbuckled state.
 - After Step 3, the safety belt warning light will flash as a confirmation.
 4. Within about seven seconds of the light turning off, buckle then unbuckle the safety belt.
 - This will disable the feature for that seating position if it is currently enabled.
 - This will enable the feature for that seating position if it is currently disabled.

CHILD RESTRAINT AND SAFETY BELT MAINTENANCE

Inspect the vehicle safety belts and child safety seat systems periodically to make sure they work properly and are not damaged. Inspect the vehicle and child seat safety belts to make sure there are no nicks, tears or cuts. Replace if necessary. All vehicle safety belt assemblies, including retractors, buckles, front safety belt buckle assemblies, buckle support assemblies (slide bar-if equipped), shoulder belt height adjusters (if equipped), shoulder belt guide on seat back (if equipped), child safety seat LATCH and tether anchors, and attaching hardware, should be inspected after a crash. Read the child restraint manufacturer's instructions for additional inspection and maintenance information specific to the child restraint.

Ford Motor Company recommends that all safety belt assemblies in use in vehicles involved in a crash be replaced. However, if the crash was minor and an authorized dealer finds that the belts do not show damage and continue to operate properly, they do not need to be replaced. Safety belt assemblies not in use during a crash should also be inspected and replaced if either damage or improper operation is noted.

For proper care of soiled safety belts, see *Cleaning the Interior* in the *Vehicle Care* chapter.

PERSONAL SAFETY SYSTEM™

The Personal Safety System provides an improved overall level of frontal crash protection to front seat occupants and is designed to help further reduce the risk of airbag-related injuries. The system is able to analyze different occupant conditions and crash severity before activating the appropriate safety devices to help better protect a range of occupants in a variety of frontal crash situations.

Your vehicle's Personal Safety System consists of:

- Driver and passenger dual-stage airbag supplemental restraints.
- Front outboard safety belts with pretensioners, energy management retractors (first row only), and safety belt usage sensors.
- Driver seat position sensor.
- Front passenger sensing system.
- Passenger airbag off and on indicator lamp.
- Front crash severity sensors.
- Restraints control module with impact and safing sensors.
- Restraint system warning light and backup tone.
- The electrical wiring for the airbags, crash sensor(s), safety belt pretensioners, front safety belt usage sensors, driver seat position sensor, front passenger sensing system, and indicator lights.

How Does the Personal Safety System Work?

The Personal Safety System can adapt the deployment strategy of your vehicle's safety devices according to crash severity and occupant conditions. A collection of crash and occupant sensors provides information to the restraints control module. During a crash, the restraints control module may activate the safety belt pretensioners and/or either one or both stages of the dual-stage airbag supplemental restraints based on crash severity and occupant conditions.

PRINCIPLES OF OPERATION

WARNING: Airbags do not inflate slowly or gently, and the risk of injury from a deploying airbag is the greatest close to the trim covering the airbag module.



WARNING: All occupants of your vehicle, including the driver, should always properly wear their safety belts, even when an airbag supplemental restraint system is provided. Failure to properly wear your safety belt could seriously increase the risk of injury or death.



WARNING: Airbags can kill or injure a child in a child seat. Always transport children 12 years old and under in the back seat and always properly use appropriate child restraints.



WARNING: Never place your arm over the airbag module, as a deploying airbag can result in serious arm fractures or other injuries.



WARNING: Airbags can kill or injure a child in a child seat. Never place a rear-facing child seat in front of an active airbag. If you must use a forward-facing child seat in the front seat, move the seat upon which the child seat is installed all the way back.



WARNING: Do not attempt to service, repair, or modify the airbag supplemental restraint systems or its fuses as you could be seriously injured or killed. Contact your authorized dealer as soon as possible.



WARNING: Several airbag system components get hot after inflation. Do not touch them after inflation as this may result in serious injury.



WARNING: If the airbag has deployed, the airbag will not function again and must be replaced immediately. If the airbag is not replaced, the unrepaired area will increase the risk of injury in a crash.

The airbags are a supplemental restraint system and are designed to work with the safety belts to help protect the driver and right front passenger from certain upper body injuries. Airbags do not inflate slowly; there is a risk of injury from a deploying airbag.

Note: You will hear a loud bang and see a cloud of harmless powdery residue if an airbag deploys. This is normal.

The airbags inflate and deflate rapidly upon activation. After airbag deployment, it is normal to notice a smoke-like, powdery residue or smell the burnt propellant. This may consist of cornstarch, talcum powder (to lubricate the bag) or sodium compounds (for example, baking soda) that result from the combustion process that inflates the airbag. Small amounts of sodium hydroxide may be present which may irritate the skin and eyes, but none of the residue is toxic.

While the system is designed to help reduce serious injuries, contact with a deploying airbag may also cause abrasions or swelling. Temporary hearing loss is also a possibility as a result of the noise associated with a deploying airbag. Because airbags must inflate rapidly and with considerable force, there is the risk of death or serious injuries, such as fractures, facial and eye injuries or internal injuries, particularly to occupants who are not properly restrained or are otherwise out of position at the time of airbag deployment. Thus, it is extremely important that occupants be properly restrained as far away from the airbag module as possible while maintaining vehicle control.

Routine maintenance of the airbags is not required.

SOS POST-CRASH ALERT SYSTEM™

The system flashes the direction indicator lamps and the horn sounds (intermittently) in the event of a serious impact that deploys an airbag equipped on your vehicle.

The horn and lamps turn off when:

- You press the hazard button.
- You press the panic button (if equipped) on the remote entry transmitter.
- Your vehicle runs out of power.

DRIVER AND PASSENGER AIRBAGS

 **WARNING:** Never place your arm or any objects over an airbag module. Placing your arm over a deploying airbag can result in serious arm fractures or other injuries. Objects placed on or over the airbag inflation area may cause those objects to be propelled by the airbag into your face and torso causing serious injury.

 **WARNING:** Airbags can kill or injure a child in a child seat. Never place a rear-facing child seat in front of an active airbag. If you must use a forward-facing child seat in the front seat, move the seat upon which the child seat is installed all the way back.

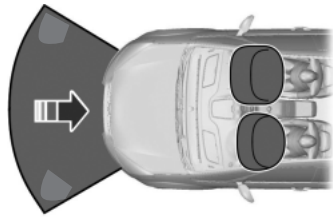

The driver and front passenger airbags will deploy during significant frontal and near-frontal crashes.

The driver and passenger front airbag system consists of:

- Driver and passenger airbag modules.
- Front passenger sensing system.
-  • Crash sensors and monitoring system with readiness indicator. See *Crash Sensors and Airbag Indicator* later in this chapter.

Proper Driver and Front Passenger Seating Adjustment

 **WARNING:** The National Highway Traffic Safety Administration recommends a minimum distance of at least 10 inches (25 centimeters) between an occupant's chest and the driver airbag module.

48 Supplementary Restraints System

To properly position yourself away from the airbag:

- Move your seat to the rear as far as you can while still reaching the pedals comfortably.
- Recline the seat slightly (one or two degrees) from the upright position.

After all occupants have adjusted their seats and put on safety belts, it is very important that they continue to sit properly. Properly seated occupants sit upright, lean against the seat back, and center themselves on the seat cushion, with their feet comfortably extended on the floor. Sitting improperly can increase the chance of injury in a crash event. For example, if an occupant slouches, lies down, turns sideways, sits forward, leans forward or sideways, or puts one or both feet up, the chance of injury during a crash is greatly increased.

Children and Airbags



WARNING: Airbags can kill or injure a child in a child seat.

Never place a rear-facing child seat in front of an active airbag. If you must use a forward-facing child seat in the front seat, move the seat upon which the child seat is installed all the way back.



Children must always be properly restrained. Accident statistics suggest that children are safer when properly restrained in the rear seating positions than in the front seating position. Failure to follow these instructions may increase the risk of injury in a crash.

Knee Airbag System (Passenger Side Only – If Equipped)

The knee airbag is located under the instrument panel. During a crash, the restraints control module may activate the passenger knee airbag based on crash severity and occupant conditions. Under certain crash and occupant conditions, the passenger knee airbag may deploy but the passenger front airbag may not activate.

As with front and side airbags, it is important to be properly seated and restrained to reduce the risk of death or serious injury.

FRONT PASSENGER SENSING SYSTEM

! **WARNING:** Even with Advanced Restraints Systems, children 12 and under should be properly restrained in a rear seating position. Failure to follow this could seriously increase the risk of injury or death.

! **WARNING:** Sitting improperly out of position or with the seat back reclined too far can take off weight from the seat cushion and affect the decision of the front passenger sensing system, resulting in serious injury or death in a crash.
Always sit upright against your seatback, with your feet on the floor.

! **WARNING:** Any alteration or modification to the front passenger seat may affect the performance of the front passenger sensing system which could seriously increase the risk of injury or death.

This system works with sensors that are part of the front passenger’s seat and safety belt to detect the presence of a properly-seated occupant and determine if the front passenger’s frontal airbag should be enabled (may inflate) or not.

Utility

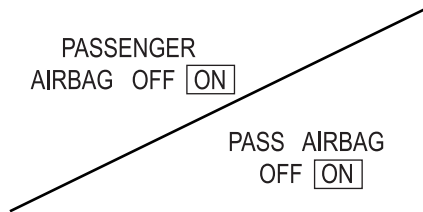

Sedan

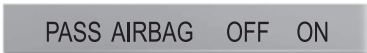

The front passenger sensing system uses a passenger airbag status indicator which will illuminate indicating that the front passenger frontal airbag is either ON (enabled) or OFF (disabled). The indicator lamp is located in the center stack of the instrument panel.

50 **Supplementary Restraints System**

Note: When the ignition is first turned on, the passenger airbag status indicator OFF and ON lamps will illuminate for a short period of time to confirm they are functional.

The front passenger sensing system is designed to disable (will not inflate) the front passenger's frontal airbag when the front passenger seat is unoccupied, or a rear facing infant seat, a forward-facing child restraint, or a booster seat is detected. Even with this technology, parents are **strongly** encouraged to always properly restrain children in the rear seat. The sensor also turns off the passenger front airbag and seat-mounted side airbag when the passenger seat is empty.

- When the front passenger sensing system disables (will not inflate) the front passenger frontal airbag, the passenger airbag status indicator will illuminate the OFF lamp and stay lit to remind you that the front passenger frontal airbag is disabled.
- If the child restraint has been installed and the passenger airbag status indicator illuminates the ON lamp, then turn the vehicle off, remove the child restraint from the vehicle and reinstall the restraint following the child restraint manufacturer's instructions.

The front passenger sensing system is designed to enable (may inflate) the front passenger's frontal airbag anytime the system senses that a person of adult size is sitting properly in the front passenger seat.

- When the front passenger sensing system enables the front passenger frontal airbag (may inflate), the passenger airbag status indicator will illuminate the ON lamp and remain illuminated.

If a person of adult size is sitting in the front passenger's seat, but the passenger airbag status indicator OFF lamp is lit, it is possible that the person is not sitting properly in the seat. If this happens:

- Turn the vehicle off and ask the person to place the seatback in the full upright position.
- Have the person sit upright in the seat, centered on the seat cushion, with the person's legs comfortably extended.
- Restart the vehicle and have the person remain in this position for about two minutes. This will allow the system to detect that person and enable the passenger's frontal airbag.
- If the passenger airbag status indicator OFF lamp remains lit even after this, the person should be advised to ride in the rear seat.

Occupant	Passenger airbag status indicator	Passenger airbag
Empty	OFF: Lit	Disabled
	ON: Unlit	
Child	OFF: Lit	Disabled
	ON: Unlit	
Adult	OFF: Unlit	Enabled
	ON: Lit	

Note: When the passenger airbag status indicator OFF lamp is illuminated, the passenger side airbag (seat mounted) may be disabled to avoid the risk of airbag deployment injuries.

After all occupants have adjusted their seats and put on safety belts, it is very important that they continue to sit properly. A properly seated occupant sits upright, leaning against the seatback, and centered on the seat cushion, with their feet comfortably extended on the floor. Sitting improperly can increase the chance of injury in a crash event. For example, if an occupant slouches, lies down, turns sideways, sits forward, leans forward or sideways, or puts one or both feet up, the chance of injury during a crash is greatly increased.



In case there is a problem with the front passenger sensing system, the airbag readiness light in the instrument cluster will stay lit.

Do not attempt to repair or service the system. Take your vehicle immediately to an authorized dealer.

If it is necessary to modify an advanced front airbag system to accommodate a person with disabilities, contact the Ford Customer Relationship Center at the phone number shown in the *Getting the services you need* section of the *Customer Assistance* chapter, or see your authorized dealer.

SIDE AIRBAGS





WARNING: Do not place objects or mount equipment on or near the airbag cover, on the side of the seatbacks (of the front seats), or in front seat areas that may come into contact with a deploying airbag. Failure to follow these instructions may increase the risk of personal injury in the event of a crash.

52 Supplementary Restraints System

 **WARNING:** Do not use accessory seat covers. The use of accessory seat covers may prevent the deployment of the side airbags and increase the risk of injury in an accident.

 **WARNING:** Do not lean your head on the door. The side airbag could injure you as it deploys from the side of the seatback.

 **WARNING:** Do not attempt to service, repair, or modify the airbag, its fuses or the seat cover on a seat containing an airbag, as you could be seriously injured or killed. Contact your authorized dealer as soon as possible.

 **WARNING:** If the side airbag has deployed, the airbag will not function again. The side airbag system (including the seat) must be inspected and serviced by an authorized dealer. If the airbag is not replaced, the unrepaired area will increase the risk of injury in a crash.

The side airbags are located on the outboard side of the seat backs of the front seats. In certain sideways crashes, the airbag on the side affected by the crash will be inflated. The airbag was designed to inflate between the door panel and occupant to further enhance the protection provided occupants in side impact crashes.



The system consists of the following:

- A tag on the seatback indicating that side airbags are found on your vehicle.
 - Side airbags located inside the seatback of the driver and front passenger seats.
 - Front passenger sensing system.
-  • Crash sensors and monitoring system with readiness indicator. See *Crash Sensors and Airbag Indicator* later in this chapter.

Note: The passenger sensing system will deactivate the passenger seat-mounted side airbag if it detects an empty passenger seat.

The design and development of the side airbag system included recommended testing procedures that were developed by a group of automotive safety experts known as the Side Airbag Technical Working Group. These recommended testing procedures help reduce the risk of injuries related to the deployment of side airbags.

SAFETY CANOPY™ CURTAIN AIRBAGS



WARNING: Do not place objects or mount equipment on or near the headliner at the siderail that may come into contact with a deploying curtain airbag. Failure to follow these instructions may increase the risk of personal injury in the event of a crash.



WARNING: Do not lean your head on the door. The curtain airbag could injure you as it deploys from the headliner.



WARNING: Do not attempt to service, repair, or modify the curtain airbags, its fuses, the A, B, or C pillar trim, or the headliner on a vehicle containing curtain airbags, as you could be seriously injured or killed. Contact your authorized dealer as soon as possible.



WARNING: All occupants of your vehicle including the driver should always wear their safety belts even when an airbag supplemental restraint system and curtain airbag is provided. Failure to properly wear your safety belt could seriously increase the risk of injury or death.



WARNING: To reduce risk of injury, do not obstruct or place objects in the deployment path of the curtain airbag.



WARNING: If the curtain airbags have deployed, the curtain airbags will not function again. The curtain airbags (including the A, B and C pillar trim and headliner) must be inspected and serviced by an authorized dealer. If the curtain airbag is not replaced, the unrepaired area will increase the risk of injury in a crash.

54 Supplementary Restraints System

The Safety Canopy will deploy during significant side crashes or when a certain likelihood of a rollover event is detected by the rollover sensor. The Safety Canopy is mounted to the roof side-rail sheet metal, behind the headliner, above each row of seats. In certain sideways crashes or rollover events, the Safety Canopy will be activated, regardless of which seats are occupied. The Safety Canopy is designed to inflate between the side window area and occupants to further enhance protection provided in side impact crashes and rollover events.

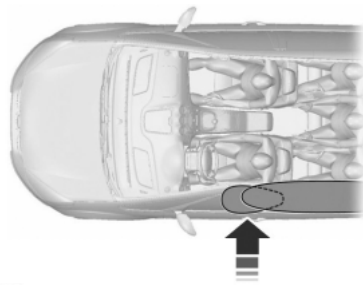

The system consists of:

- Safety canopy curtain airbags located above the trim panels over the front and rear side windows identified by wording on the B-pillar trim.
- A flexible headliner which opens above the side doors to allow air curtain deployment.
-  Crash sensors and monitoring system with readiness indicator. See *Crash Sensors and Airbag Indicator* in this chapter.

Children 12 years old and under should always be properly restrained in the rear seats. The Safety Canopy will not interfere with children restrained using a properly installed child or booster seat because it is designed to inflate downward from the headliner above the doors along the side window opening.

The design and development of the Safety Canopy included recommended testing procedures that were developed by a group of automotive safety experts known as the Side Airbag Technical Working Group. These recommended testing procedures help reduce the risk of injuries related to the deployment of side airbags (including the Safety Canopy).

CRASH SENSORS AND AIRBAG INDICATOR

WARNING: Modifying or adding equipment to the front end of your vehicle (including frame, bumper, front end body structure and tow hooks) may affect the performance of the airbag system, increasing the risk of injury. Do not modify the front end of your vehicle.

Your vehicle has a collection of crash and occupant sensors which provide information to the restraints control module. The restraints control module deploys (activates) the front safety belt pretensioners, driver airbag, passenger airbag, seat mounted side airbags, and the Safety Canopy. Based on the type of accident (frontal impact, side impact or rollover) the restraints control module will deploy the appropriate safety devices.

The restraints control module also monitors the readiness of the above safety devices plus the crash sensors. The readiness of the safety system is indicated by a warning indicator light in the instrument cluster or by a backup tone if the warning light is not working. See the *Instrument Cluster* chapter. Routine maintenance of the airbag is not required.

A difficulty with the system is indicated by one or more of the following:



- The readiness light will either flash or stay lit.
- The readiness light will not illuminate immediately after the ignition is turned on.
- A series of five beeps will be heard. The tone pattern will repeat periodically until the problem or light are repaired.

If any of these things happen, even intermittently, have the supplemental restraint system serviced at an authorized dealer immediately. Unless serviced, the system may not function properly in the event of a crash.

The safety belt pretensioners and the airbag supplemental restraint system are designed to activate when the vehicle sustains frontal or sideways deceleration sufficient to cause the restraints control module to deploy a safety device or when a certain likelihood of a rollover event is detected by the rollover sensor.

The fact that the safety belt pretensioners or airbags did not activate for both front seat occupants in a crash does not mean that something is wrong with the system. Rather, it means the restraints control module determined the accident conditions (such as crash severity, belt usage) were not appropriate to activate these safety devices.

56 Supplementary Restraints System

- The design of the front airbags is to activate only in frontal and near-frontal crashes (not rollovers, side impacts or rear impacts) unless the crash causes sufficient frontal deceleration.
- The design of the safety belt pretensioners is to activate in frontal, near-frontal and side crashes, and in rollovers.
- The design of the side airbags is to inflate in certain side impact crashes. Side airbags may activate in other types of crashes if the vehicle experiences sufficient sideways motion or deformation.
- The design of the Safety Canopy is to inflate in certain side impact crashes or rollover events. The Safety Canopy may activate in other types of crashes if the vehicle experiences sufficient sideways motion or deformation, or a certain likelihood of rollover.

Airbags and Police Equipment



WARNING: Do not place objects or mount equipment in front of the airbag module cover or in front of the seat areas that may come in contact with a deploying airbag. Failure to follow this instruction could result in personal injury.



WARNING: Dash, tunnel or console-mounted equipment should not be placed outside of the specified zone. Failure to follow this instruction could result in personal injury.



WARNING: Do not mount equipment between the side of front seat to the door trim to block deployment of the side airbag. Failure to follow this instruction could result in personal injury.

Dual driver and passenger airbags, side airbags and knee airbags affect the way police equipment can be mounted in police vehicles.

Any surfaces that could come into contact with an airbag, once it has deployed, must not damage the airbag or alter its deployment path.

Once the airbag has fully deployed, any peripheral equipment surfaces that could come into contact with the airbag (such as when the airbag deflates with the loading of an occupant) must not damage the airbag or alter its deployment path. Sharp edges, corners or protrusions could damage the nylon airbag material and reduce the effectiveness of the airbag.

Some approximate dimensions for airbags, at full inflation, are provided in Figures 1 through 5. These dimensions are somewhat flexible and represent free form deployments without the loading of occupants. The shaded areas in Figures 6 through 8 represent available police equipment mounting zones. These zones are shown for police vehicles equipped with standard bucket seats. The zone dimensions provided in Figures 6 through 8 are approximate and will vary with the loading of occupants in the seats.

All airbag and equipment mounting zone dimensions are approximate due to different airbag deployment characteristics.

No equipment will mount between the side of the front seat and the door trim to block deployment of the side airbag.

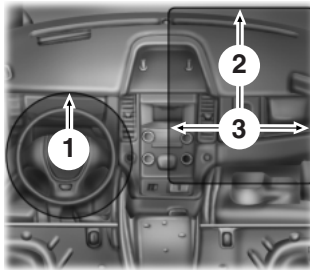

Figure 1 - Sedan

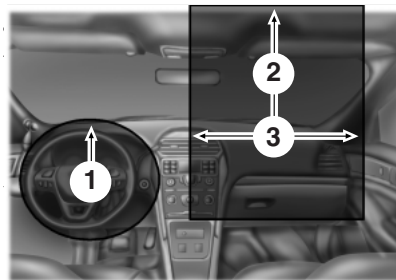

Figure 1 - Utility

1. **Sedan:** 13 inches (330 millimeters) from center of emblem; **utility:** 9.5 inches (240 millimeters) from center of emblem

58 Supplementary Restraints System

2. **Sedan:** 13.2 inches (335 millimeters) from center of airbag door;
utility: 13.8 inches (350 millimeters) from center of airbag door
3. **Sedan:** 29.5 inches (750 millimeters); **utility:** 28.3 inches (720 millimeters)

No objects should be placed between the airbags due to airbag variability.

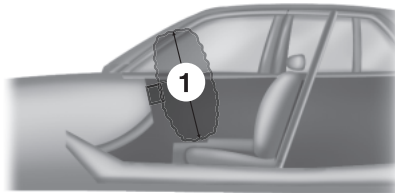

Figure 2

1. **Sedan:** 29.9 inches (760 millimeters); **utility:** 27.5 inches (700 millimeters)

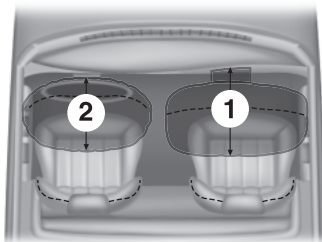

Figure 3

Note: No objects should be placed between the driver side steering wheel airbag and the passenger side dash airbag.

1. Front passenger airbag – **sedan:** 27.5 inches (700 millimeters);
utility: 22.8 inches (580 millimeters)
2. Front driver – 17 inches (430 millimeters)

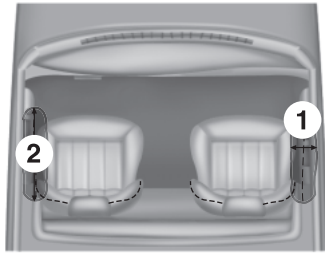

Figure 4 (if equipped)

- 1. From outboard side of seat – **sedan:** 6 inches (152 millimeters); **utility:** 8 inches (200 millimeters)
- 2. Forward of seat back – **sedan:** 14 inches (356 millimeters); **utility:** 15 inches (380 millimeters)

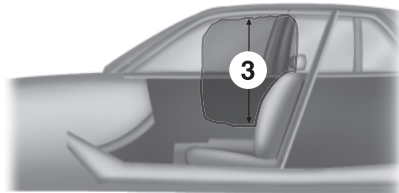

Figure 5 (if equipped)

! **WARNING:** The partition and the installation hardware of the partition must not interfere with the operation and deployment of the roll over curtain air bags and seat side air bags. Failure to follow these instructions may cause personal injury.

- 3. Up from side airbag module – **sedan:** 16 inches (406 millimeters); **utility:** 27.5 inches (700 millimeters)

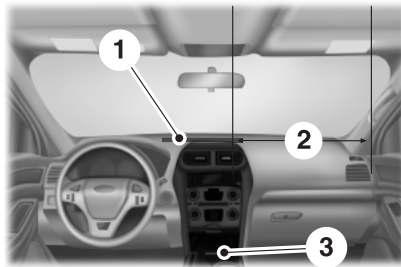

Figure 6 - Sedan

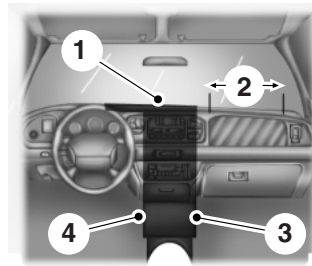

Figure 6 - Utility

1. Area on top of the instrument panel (**Note:** Equipment must not interfere with driver visibility)
2. Airbag door must be kept clear for deployment of the airbag
3. **Sedan:** Area in front of the electronic finish panel from the bottom to the top of the instrument panel; **utility:** Area in front of the center console from the bottom to the top of the instrument panel
4. **Utility:** Area in front of electronic finish panel from the bottom to the top of the instrument panel

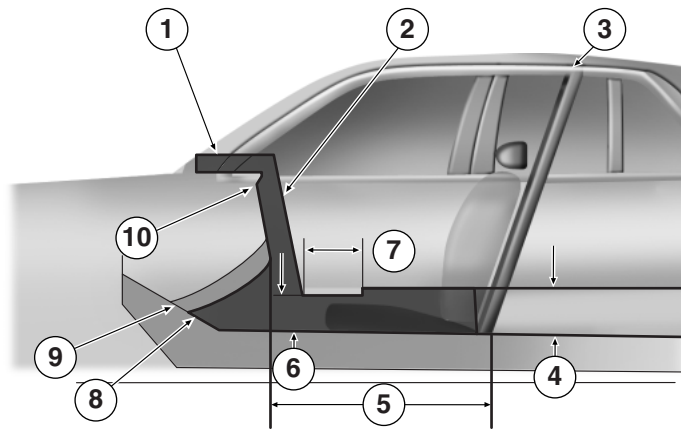
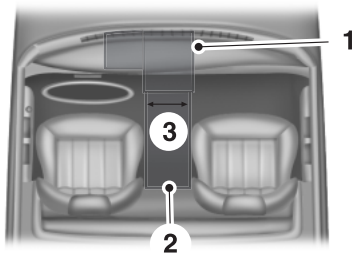

Figure 7

1. Area on top of instrument panel
2. Area in front of center console from tunnel up to instrument panel
3. Prisoner screen (reference only)
4. 10 inches (254 millimeters)
5. Area on tunnel between seats
6. Height: 8.5 inches (216 millimeters)
7. 12 inches (305 millimeters)
8. Area on tunnel beneath center console
9. Tunnel
10. Depth: 1.5 inches (38 millimeters)

**Figure 8**

1. Area on top of the instrument panel.

Note: Equipment must not interfere with driver visibility.

2. Area on tunnel between seats

3. 9 inches (229 millimeters)

AIRBAG DISPOSAL

Contact your authorized dealer as soon as possible. Airbags must be disposed of by qualified personnel.

GENERAL INFORMATION ON RADIO FREQUENCIES

This device complies with part 15 of the FCC Rules and with Industry Canada license-exempt RSS standard(s). Operation is subject to the following two conditions: (1) This device may not cause harmful interference, and (2) This device must accept any interference received, including interference that may cause undesired operation.

Note: Changes or modifications not expressly approved by the party responsible for compliance could void the user's authority to operate the equipment. The term **IC** before the radio certification number only signifies that Industry Canada technical specifications were met.

The typical operating range for your transmitter is approximately 33 feet (10 meters). Vehicles with the remote start feature will have a greater range. A decrease in operating range could be caused by:

- weather conditions
- nearby radio towers
- structures around your vehicle
- other vehicles parked next to your vehicle.

The radio frequency used by your remote control can also be used by other short-distance radio transmissions, for example amateur radios, medical equipment, wireless headphones, remote controls and alarm systems. If the frequencies are jammed, you will not be able to use your remote control. You can lock and unlock the doors with the key.

Note: Make sure your vehicle is locked before leaving it unattended.

Note: If you are in range, the remote control will operate if you press any button unintentionally.

REMOTE CONTROL (IF EQUIPPED)

If there are problems with the remote entry system, make sure to take all remote entry transmitters with you to the authorized dealer in order to aid in troubleshooting the problem.

Replacing the Battery

Note: Refer to local regulations when disposing of transmitter batteries.

Note: Replacing the battery will not delete the remote control from your vehicle. The remote control should operate normally after battery replacement.

The remote entry transmitter uses one coin type three-volt lithium battery CR2032 or equivalent.

To replace the battery:



1. Twist a thin coin between the two halves of the remote entry transmitter near the key ring. **Note:** Do not take the rubber cover and circuit board off the front housing of the remote entry transmitter.

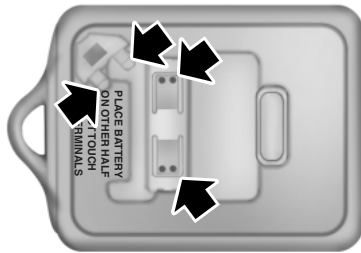

2. Do not wipe off any grease on the battery terminals on the back surface of the circuit board.

3. Remove the old battery.

4. Insert the new battery. Refer to the diagram inside the remote entry transmitter for the correct orientation of the battery. Press the battery down to ensure that the battery is fully seated in the battery housing cavity.

5. Snap the two halves back together.

Replacing Lost Remote Entry Transmitters

If you would like to have your remote entry transmitter reprogrammed because you lost one, or would like to buy additional remote entry transmitters, you can either reprogram them yourself, or take all remote entry transmitters to your authorized dealer for reprogramming.

How to Reprogram Your Remote Entry Transmitters

You must have all remote entry transmitters (maximum of four) available before beginning this procedure. **Note:** Do not press the brake pedal at any time during this procedure. If the brake pedal is pressed at any time during this procedure, programming mode will be exited and the entire procedure must be repeated.

Note: Ensure the brake pedal is not pressed during this sequence.

To reprogram the remote entry transmitters:

1. Make sure your vehicle is electronically unlocked.
2. Put the key in the ignition.
3. Cycle eight times rapidly (within 10 seconds) between the off and on positions. **Note:** The eighth turn must end in the on position.
4. The doors will lock, then unlock, to confirm that the programming mode has been activated.
5. Within 20 seconds press any button on the remote entry transmitter. **Note:** If more than 20 seconds have passed you will need to start the procedure over again.
6. The doors will lock, then unlock, to confirm that this remote entry transmitter has been programmed.
7. Repeat Step 5 to program each additional remote entry transmitter.
8. Turn the ignition to the off position after you have finished programming all of the remote entry transmitters. **Note:** After 20 seconds, you will automatically exit the programming mode.
9. The doors will lock, then unlock, to confirm that the programming mode has been exited.

Car Finder

Note: This feature will not work with the Dark Car feature.



Press the button twice within three seconds. The horn will sound and the turn signals will flash. We recommend you use this method to locate your vehicle, rather than using the panic alarm.

Sounding a Panic Alarm (Utility Only)

Press the button to activate the alarm. Press the button again or switch the ignition on to deactivate.

Note: The panic alarm will only operate when the ignition is off.

REPLACEMENT KEYS

If your keys are lost or stolen and you do not have an extra key, see an authorized dealer to purchase additional spare or replacement keys.

LOCKING AND UNLOCKING

You can use the power door lock control or the remote control to lock and unlock your vehicle.

Power Door Locks (If Equipped)

The power door lock switches are on the driver and front passenger door panels.

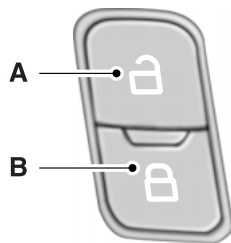

- A. Unlock
- B. Lock

Hidden Rear Door Locks (If Equipped)

You can manually lock or unlock the rear doors using the hidden lock knob on the inside front edge of the rear doors. Open the front doors to access the lock knob.

Pull the knob to unlock and push the knob to lock.

Sedan

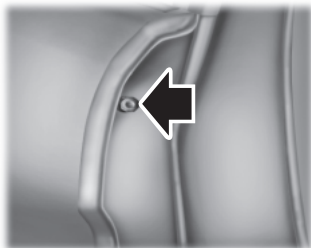

Utility

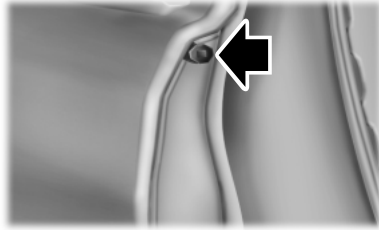
**Remote Control**

You can use the remote control anytime your vehicle is not running.

Note: If equipped with Dark Car feature, the turn signals will not flash and the horn will not sound when unlocking or locking your vehicle.

Unlocking the Doors (Two-Stage Unlock)

Press the button to unlock the driver door.

Press the button again within three seconds to unlock all doors. The turn signals will flash.

Press and hold both the lock and unlock buttons on the remote control for four seconds to disable or enable two-stage unlocking. Disabling two-stage unlocking allows all vehicle doors to unlock with one press of the button. The turn signals will flash twice to indicate the unlocking mode was changed.

Locking the Doors

Press the button to lock all the doors. The turn signals will illuminate.

Press the button again within three seconds to confirm that all the doors are closed. The doors will lock again, the horn will sound and the turn signals will illuminate if all the doors and the liftgate or trunk are closed.

Note: If any door or the liftgate or trunk is open, or if the hood is open on vehicles with an anti-theft alarm, the horn will sound twice and the lamps will not flash.

Opening the Trunk (Sedan Only)

Press the button twice within three seconds to open the trunk.

Make sure the trunk is closed and latched before driving your vehicle. An unlatched trunk may cause objects to fall out or block the driver's rear view.

Smart Locks (If Equipped)

This feature helps to prevent you from locking yourself out of your vehicle if your key is still in the ignition.

When you open one of the front doors and lock your vehicle with the power door lock control (on the driver or passenger door trim panel), all the doors will lock, then all doors will automatically unlock reminding you that your key is still in the ignition.

Your vehicle can still be locked, with the key in the ignition, by locking the driver door with a key or using the lock control on the remote control.

If both front doors and the liftgate are closed, your vehicle can be locked from any method, regardless of whether the key is in the ignition or not.

Illuminated Entry (If Equipped)

The interior lamps and parking lamps will illuminate when you use the remote control to unlock the doors or when you open any door.

The illuminated entry system will turn off the lights:

- if you switch the ignition on,
- if you press the remote control lock button,
- after 25 seconds of illumination.

The interior lights will not turn off if:

- you turn them on with the dimmer control, or
- any door is open.

Illuminated Exit (If Equipped)

When all vehicle doors are closed and you remove the key from the ignition, the interior lamps will illuminate.

The lamps will turn off if all the doors remain closed and

- 25 seconds elapse, or
- you insert the key in the ignition.

Battery Saver

The battery saver shuts off the lamps 10 minutes after you switch the ignition off.

- If you switched the dome lamps on using the panel dimmer control, the battery saver shuts them off 10 minutes after you switch the ignition off.
- If the courtesy lamps turn on because you opened one of your vehicle doors or the trunk or liftgate, the battery saver shuts them off 10 minutes after you switch the ignition off.
- The battery saver shuts off the headlamps 10 minutes after you switch the ignition off.

TRUNK RELEASE (SEDAN)

To open the trunk from outside your vehicle, use the key in the trunk lock cylinder.



To open the trunk from inside your vehicle, press the button located on the instrument panel.

Your dealer can set the trunk-release button to open the trunk only when the ignition is in the on position, or to open the trunk when the ignition is in any position. See your authorized dealer to change these settings.

LIFTGATE (UTILITY)

WARNING: Make sure to close and latch the liftgate to prevent drawing exhaust fumes into your vehicle. This will also prevent passengers and cargo from falling out. If you must drive with the liftgate open, keep the vents or windows open so outside air comes into your vehicle. Failure to follow this warning could result in serious personal injury.

Note: Be careful when opening or closing the liftgate in a garage or other enclosed area to avoid damaging the liftgate.

Note: Do not hang anything, for example a bike rack, from the spoiler, glass or liftgate. This could damage the liftgate and its components.

Note: Do not leave the liftgate open while driving. This could damage the liftgate and its components.

Note: Make sure the liftgate is closed and latched before driving your vehicle. An unlatched liftgate may cause objects to fall out or block your rear view.

The liftgate area is only intended for cargo, not passengers.

Open the liftgate using the outside button if your vehicle is unlocked or use the key when your vehicle is locked.

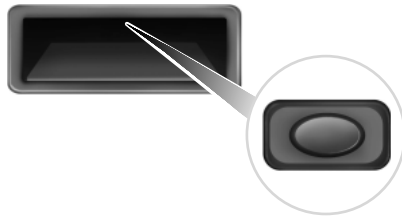

Outside button: Press the button located in the top of the liftgate pull cup handle to unlatch the liftgate, then pull on the outside handle.



Key: Insert the key into the key cylinder and turn it clockwise. Hold it in this position and pull on the liftgate handle to open the liftgate.

INTERIOR LUGGAGE COMPARTMENT RELEASE (SEDAN)

! **WARNING:** Keep vehicle doors and luggage compartment locked and keep keys and remote transmitters out of a child's reach. Unsupervised children could lock themselves in the trunk and risk injury. Children should be taught not to play in vehicles.

! **WARNING:** Do not leave children, unreliable adults, or animals unattended in your vehicle. On hot days, the temperature in the trunk or vehicle interior can rise very quickly. Exposure of people or animals to these high temperatures for even a short time can cause death or serious heat-related injuries, including brain damage. Small children are particularly at risk.

Your vehicle is equipped with a release handle that provides a means of escape for children and adults if they become locked inside the luggage compartment.

Adults should familiarize themselves with the operation and location of the release handle.

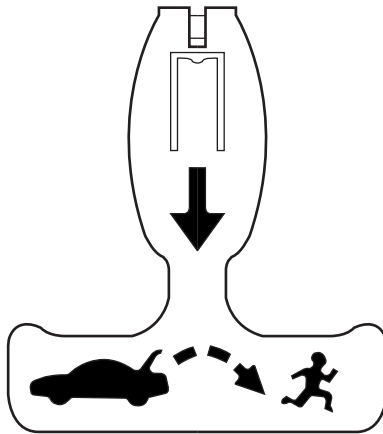

The handle is located inside the luggage compartment either on the luggage compartment door (lid) or near the tail lamps. It is composed of a material that will glow for hours in darkness following brief exposure to ambient light.

Pull the handle and push up on the luggage compartment door (lid) to open from within the luggage compartment.

ANTI-THEFT ALARM (IF EQUIPPED)

The system will warn you of an unauthorized entry to your vehicle.

The park and turn lamps flash and the horn sounds if unauthorized entry is attempted while the alarm is armed. It triggers immediately if the luggage compartment or the hood opens, and after a 12-second delay if any door opens.

Take all remote controls to an authorized dealer if there is any potential alarm problem with your vehicle.

Arming the Alarm

The alarm is ready to arm when there is not a key in the ignition. Press the door lock button and close the door to arm the alarm.

Disarming the Alarm

Disarm the alarm by any of the following actions:

- Unlock the doors or luggage compartment with the remote control.
- Switch the ignition on or start your vehicle.
- Use a key in the driver door to unlock your vehicle, and then switch the ignition on within 12 seconds.

Note: The system will not disarm by unlocking the door with the key.

ADJUSTING THE STEERING WHEEL

WARNING: Do not adjust the steering wheel when your vehicle is moving.

Note: Make sure that you are sitting in the correct position. Refer to *Sitting in the Correct Position* in the *Seats* chapter.

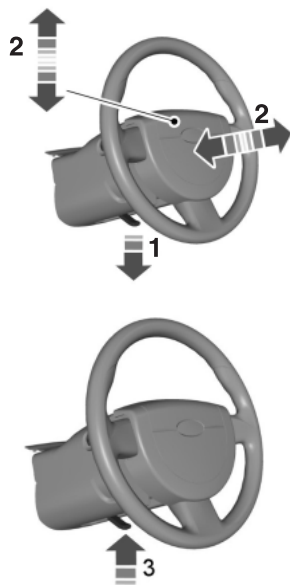

1. Unlock the steering column.
2. Adjust the steering wheel to the desired position.

Note: The telescope adjustment feature is only available on the sedan.

3. Lock the steering column.

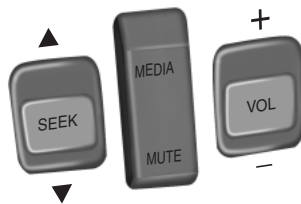
AUDIO CONTROL

SEEK: Press to select the next or previous stored preset or track. Press and hold to select the next or previous frequency or seek through a track.

MEDIA: Press repeatedly to scroll through available audio modes.

MUTE: Press to silence the radio.

VOL (Volume): Press to increase or decrease the volume.

VOICE CONTROL (IF EQUIPPED)

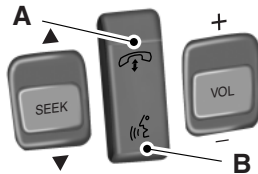

- A. Phone mode
- B. Voice recognition

See the *SYNC* chapter.

CRUISE CONTROL

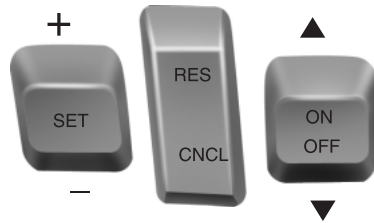

See the *Cruise Control* chapter for information on this feature.

INFORMATION DISPLAY CONTROL



See the *Information Displays* chapter for more information.

Cluster Display Control Features

This control functions the same as the center control on the faceplate. See the *Audio System* chapter.

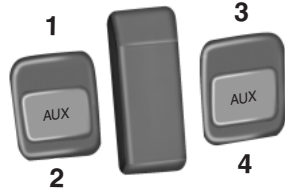
CONFIGURABLE STEERING WHEEL CONTROLS (IF EQUIPPED)

The steering wheel controls can be configured to operate frequently used police equipment. A graphic in the information display will show when an auxiliary switch is activated.

ADJUSTABLE PEDALS

WARNING: Never adjust the accelerator and brake pedal with feet on the pedals while the vehicle is moving.

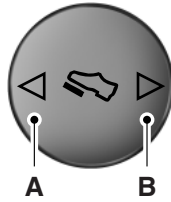

- A. Farther
- B. Closer

The control is located on the left side of the steering column. Press and hold the appropriate control to move the pedals.

The pedals should only be adjusted when the vehicle is parked.

WINDSHIELD WIPERS

Note: Fully defrost the windshield before switching on the windshield wipers.

Note: Make sure you switch off the windshield wipers before entering a car wash.

Note: Clean the windshield and wiper blades if they begin to leave streaks or smears. If that does not resolve the issue, install new wiper blades.

Note: Do not operate the wipers on a dry windshield. This may scratch the glass, damage the wiper blades or cause the wiper motor to burn out. Always use the windshield washers before wiping a dry windshield.

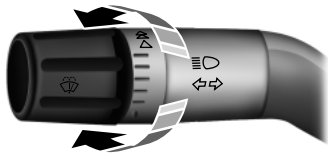

Rotate the end of the control away from you to increase the speed of the wipers. Rotate toward you to decrease the speed of the wipers.

Speed Dependent Wipers (Utility Only)

When your vehicle speed increases, the interval between wipers will decrease when intermittent wipe is selected.

WINDSHIELD WASHERS

Note: Do not operate the wipers on a dry windshield. This may scratch the glass, damage the wiper blades or cause the wiper motor to burn out. Always use the windshield washer before wiping a dry windshield.

Note: Do not operate the washer when the washer reservoir is empty. This may cause the washer pump to overheat.



Press the end of the stalk to activate the washer.

- A brief press causes a single wipe without washer fluid.

- A quick press and hold causes the wipers to swipe three times with washer fluid.
- A long press and hold will activate the wipers and washer fluid for up to 10 seconds.

A wipe will occur a few seconds after washing to clear any remaining washer fluid. You can switch this feature on and off in the information display.

REAR-WINDOW WIPER AND WASHERS (UTILITY ONLY)

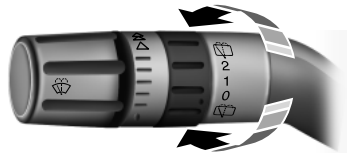

Rotate the control to the desired position. Select:

2 — Intermittent operation (shortest pause between wipes).

1 — Intermittent operation (longest pause between wipes).

0 — Off.

Rotate and hold the control to either the top or bottom position to activate the rear washer. The control will return to the **2** or **0** position when you release it.

When you select reverse gear, the rear wiper will switch on to intermittent if the front wipers are activated. This feature may be enabled or disabled in the information display.

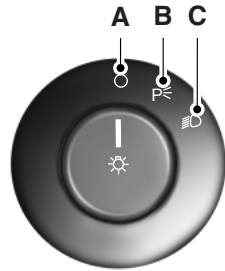
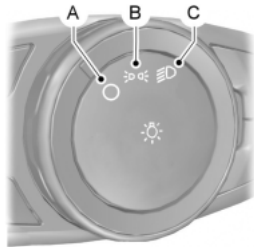
LIGHTING CONTROL**Sedan****Utility**

A. Off

B. Parking lamps, instrument panel lamps, license plate lamps and tail lamps.

C. Headlamps

High Beams Sedan

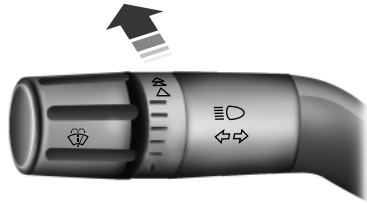

Utility

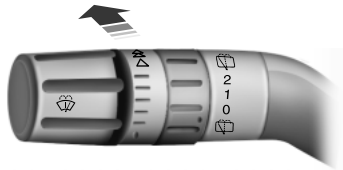

- Push the lever toward the instrument panel to switch the high beams on.
- Push the lever toward the instrument panel again or pull the lever towards you to switch the high beams off.

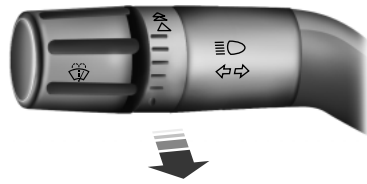
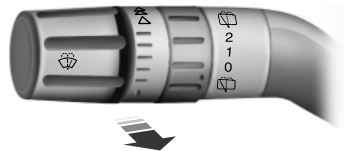
**Headlamp Flasher
Sedan****Utility**

Pull toward you slightly to activate and release to deactivate.

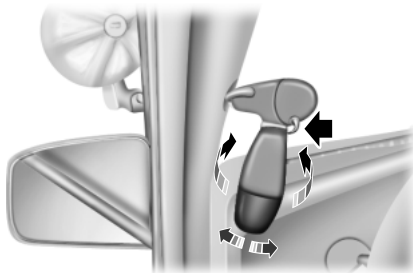
SPOT LIGHT CONTROL (IF EQUIPPED)

- Use the switch on the chrome handle to turn the spot light on and off.
- Rotate and twist the handle to adjust the position of the spot light.

INSTRUMENT LIGHTING DIMMER**Sedan**

turn on the interior courtesy lights. Press and hold the bottom of the control to turn off the interior courtesy lights.

- Press repeatedly or press and hold until the desired level is reached.
- If the vehicle is not equipped with the Dark Car feature, press and hold the top of the control to the full on position to activate the “dome on” feature. This will turn on the interior courtesy lights. Press and hold the bottom of the control to turn off the interior courtesy lights.
- If equipped with the Dark Car feature, courtesy illumination is disabled. Press and hold the bottom of the control to turn off the instrument cluster lights and the information display lights.

Utility

- Press repeatedly or press and hold the top control to brighten the instrument cluster and information display lighting.
- Press repeatedly or press and hold the bottom control to dim the instrument cluster and information display lighting. If equipped with the Dark Car feature, you may turn off the instrument cluster and information display lighting.

Note: If the battery is disconnected, discharged, or a new battery is installed, the dimmer will set the illuminated components to the maximum setting automatically.

DAYTIME RUNNING LAMPS (IF EQUIPPED)

WARNING: Always remember to turn on your headlamps at dusk or during inclement weather. The Daytime Running Lamp (DRL) system does not activate the tail lamps and generally may not provide adequate lighting during these conditions. Failure to activate your headlamps under these conditions may result in a collision.

The system turns the headlamps on with a reduced output.

To activate:

- the ignition must be in the on position and
- the lighting control is in the off, autolamp, or parking lamp position and
- the transmission is not in PARK.

DIRECTION INDICATORS

Sedan



Utility

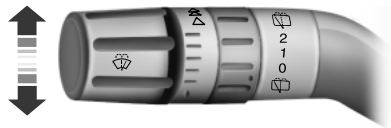

- To operate the left direction indicator, push the lever down until it stops.
- To operate the right direction indicator, push the lever up until it stops.

Note: Tap the lever up or down to make the direction indicators flash only three times to indicate a lane change.

INTERIOR LAMPS**Dome Lamp Control (Utility)**

Press the control to switch on the interior courtesy lights. The lights will remain on until the control is pressed again.

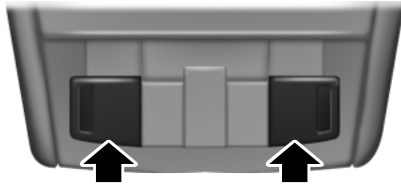
Front Row Map Lamps (If Equipped)

The front row map lamp lights when:

- any door is opened.
- the dome lamp button on the instrument panel is activated (Utility).

- the instrument panel dimmer button is pressed until the courtesy lamp comes on (Sedan).
- the remote entry controls are pressed and the ignition is off.

To manually turn on the map lamps, press the outer edge of the clear lens.

Note: If equipped with Dark Car feature, courtesy illumination is disabled.

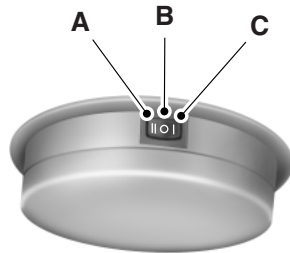
Dome Task Lamp (If Equipped)

- A. Night-vision red light on
- B. OFF position
- C. White light on

The police vehicle may be equipped with one or two red/white dome task lamps. The lamp may be located in the headliner between the driver and front seat passenger. The lamp may be located in the headliner at the rear of the vehicle.

Note: Always remember to return the dome lamp switch to the OFF position when finished to prevent discharging the vehicle battery.

Third Row Cargo Lamp (Utility) (If Equipped)

The cargo lamp can also be turned on and off manually by pressing the control switch.

Note: Always remember to switch off the lamp (press the control switch) when finished to prevent discharging the vehicle battery.

POWER WINDOWS

 **WARNING:** Do not leave children unattended in your vehicle and do not let children play with the power windows. They may seriously injure themselves.

 **WARNING:** When closing the power windows, you should verify they are free of obstructions and make sure that children and pets are not in the proximity of the window openings.

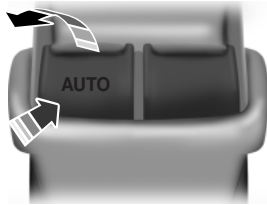

Press or lift the switches to operate the windows.

- Press the switch to the first detent and hold to open the window.
- Lift the switch to the first detent and hold to close the window.

Rear Window Buffeting

You may hear a pulsing noise when one or both of the rear windows are open. This noise can be reduced by lowering a front window approximately 2–3 inches (5–8 centimeters).

One-Touch Down (Driver's Window, Utility Only)

This feature automatically opens the window.

Press the switch completely down and release. The window will open fully. Press or lift it again to stop the window.

One-Touch Up or Down (Driver's Window, Sedan Only)

This feature automatically opens or closes the window.

Press or lift the switch completely and release. The window will fully open or close. Press or lift it again to stop the window.

Bounce-Back

The window will stop automatically while closing and reverse some distance if there is an obstacle in the way.

Overriding the Bounce-Back Feature

WARNING: When you override the bounce-back feature the window will not reverse if it detects an obstacle. Take care when closing the windows to avoid personal injury or damage to your vehicle.

Pull up the window switch and hold within two seconds of the window reaching the bounce-back position. The window will travel up with no bounce-back protection. The window will stop if you release the switch before the window is fully closed.

Window Lock

Press the control to lock or unlock the rear window controls (if equipped).

Accessory Delay

You can use the window switches for several minutes after you switch the ignition off, or until you open either front door.

EXTERIOR MIRRORS**Power Exterior Mirrors**

WARNING: Do not adjust the mirror while your vehicle is in motion.



- A. Left mirror
- B. Adjustment control
- C. Right mirror

1. Press the button to select the mirror you want to adjust. An indicator light on the button will illuminate.
2. Use the adjustment control to adjust the position of the mirror.
3. Press the mirror button again to deselect the mirror. The indicator light will turn off.

Foldaway Exterior Mirrors

Push the mirror toward the door window glass. Make sure that you fully engage the mirror in its support when returning it to its original position.

Heated Exterior Mirror (If Equipped)

The heated exterior mirrors switch on with the heated rear window. See *Heated Windows and Mirrors* in the *Climate Control* chapter.

Integrated Blind Spot Mirrors (If Equipped)

WARNING: Objects in the blind spot mirror are closer than they appear.

Blind spot mirrors have an integrated convex mirror built into the upper outboard corner of the exterior mirrors. They are designed to assist you by increasing visibility along the side of your vehicle.

Check the main mirror first before a lane change, then check the blind spot mirror. If no vehicles are present in the blind spot mirror and the traffic in the adjacent lane is at a safe distance, signal that you are going to change lanes. Glance over your shoulder to verify traffic is clear, and carefully change lanes.

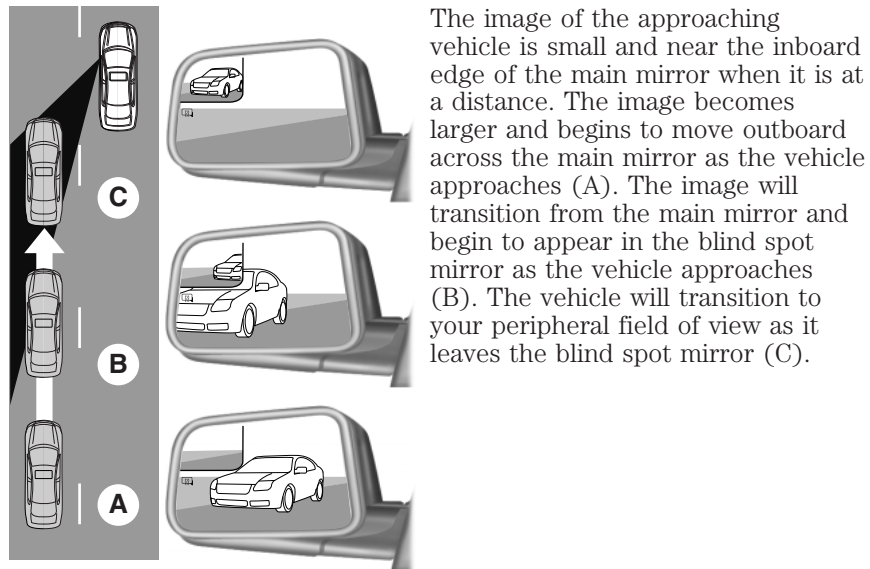

The image of the approaching vehicle is small and near the inboard edge of the main mirror when it is at a distance. The image becomes larger and begins to move outboard across the main mirror as the vehicle approaches (A). The image will transition from the main mirror and begin to appear in the blind spot mirror as the vehicle approaches (B). The vehicle will transition to your peripheral field of view as it leaves the blind spot mirror (C).

Blind Spot Information System (BLIS®) with Cross Traffic Alert (CTA) (If Equipped)

Refer to *Blind Spot Information System (BLIS®) with Cross Traffic Alert (CTA)* in the *Driving Aids* chapter.

INTERIOR MIRROR

WARNING: Do not adjust the mirror when your vehicle is moving.

Note: Do not clean the housing or glass of any mirror with harsh abrasives, fuel or other petroleum or ammonia based cleaning products.

You can adjust the interior mirror to your preference. Some mirrors also have a second pivot point. This lets you move the mirror head up or down and from side to side.

Pull the tab below the mirror toward you to reduce glare at night.

Auto-Dimming Mirror (If Equipped)

Note: Do not block the sensors on the front and back of the mirror. Mirror performance may be affected. A rear center passenger or raised rear center head restraint may also block light from reaching the sensor.

The mirror will dim automatically to reduce glare when bright lights are detected from behind your vehicle. It will automatically return to normal reflection when you select reverse gear to make sure you have a clear view when backing up.

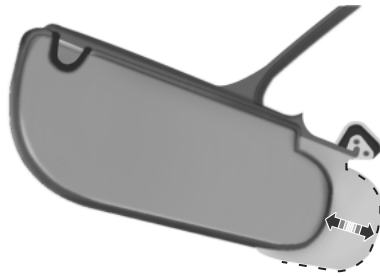
SUN VISORS**Slide-On-Rod**

Rotate the visor toward the side window and extend it rearward for extra sunlight coverage.

Retract the visor before moving it back toward the windshield and storing it.

GAUGES

Cluster shown in standard measure – metric clusters similar.

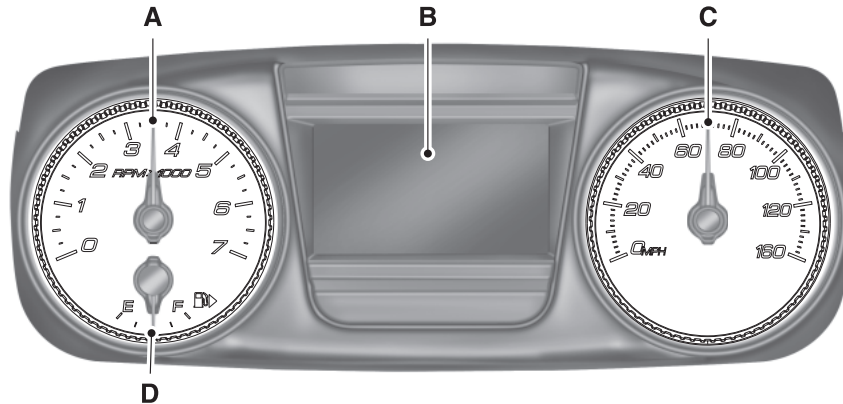

- A. Tachometer
- B. Information display. See *Information displays* for more information.
- C. Speedometer
- D. Fuel gauge

Speedometer

The vehicle is shipped with a certified digital speedometer and analog gauge. If your local procedures require calibration, utilize the distance per time on-road test or a radar-based speed test. If a dynamometer calibration is required, reference the calibration procedure found at www.Fleet.Ford.com or check OASIS for updated information.

Fuel Gauge

Note: The fuel gauge may vary slightly when your vehicle is moving or on a gradient.

Switch the ignition on. The fuel gauge will indicate approximately how much fuel is left in the fuel tank. The arrow adjacent to the fuel pump symbol indicates on which side of your vehicle the fuel filler door is located.

The needle should move toward F when you refuel your vehicle. If the needle points to E after adding fuel, this indicates your vehicle needs service soon.

After refueling some variability in needle position is normal:

- It may take a short time for the needle to reach F after leaving the gas station. This is normal and depends upon the slope of pavement at the gas station.
- The fuel amount dispensed into the tank is a little less or more than the gauge indicated. This is normal and depends upon the slope of pavement at the gas station.
- If the gas station nozzle shuts off before the tank is full, try a different gas pump nozzle.

Low Fuel Reminder

A low fuel reminder triggers when the fuel gauge needle is at 1/16th.

Driving type (fuel economy conditions)	Fuel gauge position	Distance-to-empty
Highway driving	1/16th	35 miles to 80 miles (56 km to 129 km)
Severe duty driving (trailer towing, extended idle)	1/16th	35 miles (56km)

WARNING LAMPS AND INDICATORS

These indicators can alert you to a vehicle condition that may become serious enough to cause expensive repairs. Many lights will illuminate when you start your vehicle to make sure they work. If any light remains on after starting the vehicle, refer to the respective system warning light for additional information.

Note: Some warning indicators are reconfigurable telltales (RTT). These indicators appear in the information display and function the same as a warning light, but do not display on startup.

Airbag readiness



If this light fails to illuminate when the ignition is turned on, continues to flash or remains on, contact your authorized dealer as soon as possible. A chime will sound when there is a malfunction in the indicator light.

Anti-lock brake system

If the ABS light stays illuminated or continues to flash, a malfunction has been detected. Contact your authorized dealer as soon as possible. Normal braking is still functional unless the brake warning light also is illuminated.

Brake system warning light

To confirm the brake system warning light is functional, it will momentarily illuminate when the ignition is turned to the on position when the engine is not running, or in a position between on and start, or by applying the parking brake when the ignition is turned to the on position.

If it illuminates when you are driving, check that the parking brake is not engaged. If the parking brake is not engaged, this indicates low brake fluid level or a brake system malfunction. Have the system checked immediately by your authorized dealer.



WARNING: Driving a vehicle with the brake system warning light on is dangerous. A significant decrease in braking performance may occur. It will take you longer to stop the vehicle. Have the vehicle checked by your authorized dealer as soon as possible. Driving extended distances with the parking brake engaged can cause brake failure and the risk of personal injury.

Charging system (RTT)

Illuminates when the battery is not charging properly. If it stays on while the engine is running, there may be a malfunction with the charging system. Contact your authorized dealer as soon as possible. This indicates a problem with the electrical system or a related component.

Door ajar (RTT)

Displays when the ignition is on and any door is not completely closed.

Engine oil pressure (RTT)

Illuminates when the oil pressure falls below the normal range.

Engine coolant temperature (RTT)

Illuminates when the engine coolant temperature is high. Stop the vehicle as soon as possible, switch off the engine and let cool.

High beams

Illuminates when the high-beam headlamps are on.

Low fuel (RTT)

Illuminates when the fuel level in the fuel tank is at or near empty.

Low tire pressure warning

Illuminates when your tire pressure is low. If the light remains on at start up or while driving, the tire pressure should be checked. When the ignition is first turned to on, the light will illuminate for 3 seconds to ensure the bulb is working. If the light does not turn on or begins to flash, contact your authorized dealer as soon as possible.

Low washer fluid (RTT)

Illuminates when the windshield washer fluid is low.

Park lamps

Illuminates when the park lamps are on.

Powertrain malfunction/reduced power (RTT)

Illuminates when a powertrain or an AWD/4WD fault has been detected. Contact your authorized dealer as soon as possible.

Safety belt

Reminds you to fasten your safety belt. A Belt-Minder® chime will also sound to remind you to fasten your safety belt.

Service engine soon

The *service engine soon* indicator light illuminates when the ignition is first turned to the on position to check the bulb and to indicate whether the vehicle is ready for

Inspection/Maintenance (I/M) testing. Normally, the “service engine soon” light will stay on until the engine is cranked, then turn itself off if no malfunctions are present. However, if after 15 seconds the “service engine soon” light blinks eight times, it means that the vehicle is not ready for I/M testing. See the *Readiness for inspection/maintenance (I/M) testing* in the *Fuel and Refueling* chapter.

Solid illumination after the engine is started indicates the on-board diagnostics system (OBD-II) has detected a malfunction. Refer to *On-board diagnostics (OBD-II)* in the *Fuel and Refueling* chapter. If the light is blinking, engine misfire is occurring which could damage your catalytic converter. Drive in a moderate fashion (avoid heavy acceleration and deceleration) and have your vehicle serviced immediately by your authorized dealer.



WARNING: Under engine misfire conditions, excessive exhaust temperatures could damage the catalytic converter, the fuel system, interior floor coverings or other vehicle components, possibly causing a fire.

Speed control (if equipped) (RTT)

The speed control system indicator light changes color to indicate what mode the system is in:

- On (gray light): Illuminates when the speed control system is turned on. Turns off when the speed control system is turned off.
- Engaged (white light): Illuminates when the speed control system is engaged. Turns off when the speed control system is disengaged.

Stability Control System

Displays when the AdvanceTrac/Traction control is active. If the light remains on, have the system serviced immediately.

Stability Control System Off

Illuminates when AdvanceTrac/Traction control has been disabled by the driver.

Turn signal

Illuminates when the left or right turn signal or the hazard warning flasher is turned on. If the indicators stay on or flash faster, check for a burned out bulb.

AUDIBLE WARNINGS AND INDICATORS**Key In Ignition Warning Chime**

Sounds when the key is left in the ignition in the off or accessory position and the driver's door is opened.

Headlamps On Warning Chime

Sounds when the headlamps or parking lamps are on, the ignition is off (the key is not in the ignition) and the driver's door is opened.

Parking Brake On Warning Chime

Sounds when you have left the parking brake on and drive your vehicle. If the warning chime remains on after you have released the parking brake, have the system checked by your authorized dealer immediately.

GENERAL INFORMATION

WARNING: Driving while distracted can result in loss of vehicle control, crash and injury. We strongly recommend that you use extreme caution when using any device that may take your focus off the road. Your primary responsibility is the safe operation of your vehicle. We recommend against the use of any handheld device while driving and encourage the use of voice-operated systems when possible. Make sure you are aware of all applicable local laws that may affect the use of electronic devices while driving..

Various systems on your vehicle can be controlled using the information display controls on the steering wheel. Corresponding information is displayed in the information display.

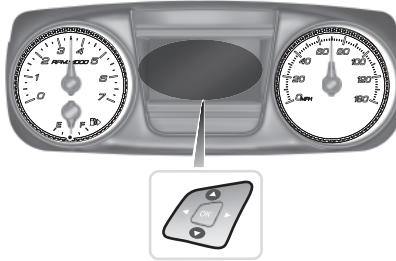
Information Display Controls

- Press the up and down arrow buttons to scroll through and highlight the options within a menu.
- Press the right arrow button to enter a sub-menu.
- Press the left arrow button to exit a menu.
- Press the **OK** button to choose and confirm a setting or messages.

Menu

You can access the menus using the information display control.

Note: Some options may appear slightly different or not at all if the items are optional for sedan and utility.

†Trip 1 / 2
Digital Speedometer
Trip Odometer
Trip Timer
Average Fuel
Total Odometer (located in lower right of display). Note: this will also display in other menus.
†See <i>Trip computer</i> later in this section for more information.

†Fuel Economy			
Distance to E			
Inst Fuel Econ			
Average Fuel			
†See <i>Trip computer</i> later in this section for more information.			
Information			
Coolant Temp. — The engine coolant indicator will change colors indicating: blue for cool, gray for normal and red for hot. If the engine coolant temperature exceeds the normal range, stop the vehicle as soon as safely possible, switch off the engine and let the engine cool.			
Engine hours — Displays the hours of engine run time.			
Engine Idle hours — Indicates how much time the vehicle is idling in Park or Neutral.			
Settings			
Driver Assist	Traction Ctrl		
	Blind Spot		
	Cross Traffic		
	Rear Park Aid		
Display	Language	English, Español or Français	
	Units	Distance	Miles & Gal.
			km/L
		L/100 km	
Temperature	Fahrenheit (°F) or Celsius (°C)		
Convenience	DTE Calculation	Normal or Towing	
	Locks	Remote Unlock	All Doors or Driver First
	Oil life Reset	Set XXX% — Hold OK to Reset	
	Wipers	Courtesy Wipe	

Trip Computer***Resetting the Trip Computer***

Press and hold OK on the current screen to reset the respective trip, distance, time and fuel information.

Trip Odometer

Registers the mileage of individual journeys.

Distance to E

Indicates the approximate distance the vehicle will travel on the fuel remaining in the tank. Changes in driving pattern may cause the value to vary.

Average fuel

Indicates the average fuel consumption since the function was last reset.

Fuel Used

Shows the amount of fuel used for a given trip.

Total Odometer

Registers the total mileage of the vehicle.

INFORMATION MESSAGES

Note: Depending on the vehicle options equipped with your vehicle, not all of the messages will display or be available. Certain messages may be abbreviated or shortened depending upon which cluster type you have.



Press the OK button to acknowledge and remove some messages from the information display. Other messages will be removed automatically after a short time. When a warning message appears, you must wait two seconds before being able to clear it. Certain messages need to be confirmed before you can access the menus.

Message indicators: Some messages will be supplemented by a system specific symbol.

AdvanceTrac® / Traction Control Messages	Action / Description
Service AdvanceTrac	Displayed when the AdvanceTrac® system has detected a condition that requires service. Contact your authorized dealer as soon as possible.
Trailer Sway Reduce Speed	Displayed when the trailer sway control has detected trailer sway.
Alarm/Security Messages	Action / Description
To Stop Alarm, Start Vehicle	Displayed when the perimeter alarm system is armed and the vehicle is entered using the key on the driver's side door. In order to prevent the perimeter alarm system from triggering, the ignition must be turned to start or on before the 12 second chime expires.
AWD Messages	Action / Description
AWD Off	Displayed when the system has been automatically disabled to protect itself. This is caused by operating the vehicle with the compact spare tire installed or if the system is overheating. The system will resume normal function and clear this message after cycling the ignition on and off and driving a short distance with the road tire re-installed or after the system is allowed to cool.
Check AWD	Displayed in conjunction with the powertrain malfunction/reduced power light when the system is not operating properly. If the warning stays on or continues to come on, contact your authorized dealer as soon as possible.

AWD Messages	Action / Description
Change AWD Power Transfer Unit Lube	Displayed when the system needs its power transfer unit lubrication changed. This message may be set if the vehicle has experienced extended periods of extreme/severe duty cycle driving.
Battery and Charging System Messages	Action / Description
Check Charging System	Displayed when the charging system needs servicing. If the warning stays on or continues to come on, contact your authorized dealer as soon as possible.
Turn Power Off to Save Battery	Displayed when the battery management system determines that: <ul style="list-style-type: none"> • the battery is at a low state of charge or, • the ignition has been in accessory position or on position with the engine off for approximately 45 minutes. Turn the ignition off as soon as possible to protect the battery. This message will clear once the vehicle has been started and the battery state of charge has recovered. Turning off unnecessary electrical loads will allow faster battery state-of-charge recovery.
Transport Mode Contact Dealer	Contact your authorized dealer as soon as possible.
Factory Mode Contact Dealer	Contact your authorized dealer as soon as possible.

Battery and Charging System Messages	Action / Description
Low Battery Features Temporarily Turned Off	Displayed when the battery management system detects an extended low-voltage condition. Various vehicle features will be disabled to help preserve the battery. Turn off as many of the electrical loads as soon as possible to improve system voltage. If the system voltage has recovered, the disabled features will operate again as normal.
BLIS® Messages	Action / Description
Blind Spot Not Available Sensor Blocked	Displayed when the blind spot information system/cross traffic alert system sensors are blocked. Driver can typically clean the sensor to resolve.
Blind Spot System Fault	Displayed when a fault with the blind spot information system has occurred. Contact your authorized dealer as soon as possible.
Cross Traffic Not Available Sensor Blocked	Displayed when the blind spot information system/cross traffic alert system sensors are blocked. Driver can typically clean the sensor to resolve.
Cross Traffic System Fault	Displayed when a fault with the cross traffic alert system has occurred. Contact your authorized dealer as soon as possible.
Vehicle Coming From X	Displayed when the blind spot information system with cross traffic alert (CTA) system is operating and senses a vehicle.

Information Displays

Brake System Messages	Action / Description
Brake Fluid Level Low	Indicates the brake fluid level is low and the brake system should be inspected immediately.
Check Brake System	Displayed when the brake system needs servicing. If the warning stays on or continues to come on, contact your authorized dealer as soon as possible.
Park Brake Engaged	Displayed when the parking brake is set, the engine is running and the vehicle is driven more than 3 mph (5 km/h). If the warning stays on after the parking brake is released, contact your authorized dealer as soon as possible.
Door Messages	Action / Description
X Door Ajar	Displayed when a door is not completely closed.
Liftgate Ajar	Displayed when the liftgate is not completely closed.
Trunk Ajar	Displayed when the trunk is not completely closed.
Fuel Messages	Action / Description
Check Fuel Fill Inlet	Displayed when the fuel fill inlet may not be properly closed.
Fuel Level Low	Displayed as an early reminder of a low fuel condition.

Maintenance Messages	Action / Description
LOW Engine Oil Pressure	Stop the vehicle as soon as safely possible, turn off the engine. Check the oil level. If the warning stays on or continues to come on with your engine running, contact your authorized dealer as soon as possible.
Change Engine Oil Soon	Displayed when the engine oil life remaining is 10% or less.
Oil Change Required	Displayed when the oil life left reaches 0%.
Engine Coolant Over Temp	Displayed when the engine coolant temperature is excessively high.
Washer Fluid Level Low	Indicates the washer fluid reservoir is less than one quarter full. Check the washer fluid level.
Steering Malfunction Service Now	Displays when the steering system needs service. See your authorized dealer.
Service Power Steering Now	The power steering system has detected a condition within the power steering system that requires service immediately. See your authorized dealer.
Power Steering Assist Fault	The power steering system has disabled power steering assist due to a system error. See your authorized dealer.
Park Aid Messages	Action / Description
Check Park Aid	Displayed when the transmission is in R (Reverse) and the park aid is disabled.
Check Rear Park Aid	Displayed when the transmission is in R (Reverse) and the park aid is disabled.
Rear Park Aid On Off	Displays the rear park aid status.

Passenger Sensing System Messages	Action / Description
Remove Objects Near Passenger Seat	Displayed when objects are by the passenger seat. After the objects are moved away from the seat, if the warning stays on or continues to come on contact your authorized dealer as soon as possible.
Reminder Messages	Action / Description
Steering Lock Turn Wheel to Unlock	Displays when you need to turn the steering wheel in order to disengage the steering lock.
Shift to Park	Displays as a reminder to shift into park.
Engine On	Displayed when the engine is on, the vehicle is in park and the driver's door is opened.
Speed Limited to xx MPH/km/h	Displayed at key on when the vehicle's top speed is limited.
Tire Messages	Action / Description
Low Tire Pressure	Displays when one or more tires on your vehicle have low tire pressure.
Tire Pressure Monitor Fault	Displays when the tire pressure monitoring system is malfunctioning. If the warning stays on or continues to come on, contact your authorized dealer.
Tire Pressure Sensor Fault	Displayed when a tire pressure sensor is malfunctioning, or your spare tire is in use. For more information on how the system operates under these conditions, refer to <i>Tire Pressure Monitoring System (TPMS)</i> in the <i>Wheels and tires</i> chapter. If the warning stays on or continues to come on, contact your authorized dealer as soon as possible.

MANUAL HEATING AND AIR CONDITIONING SYSTEM

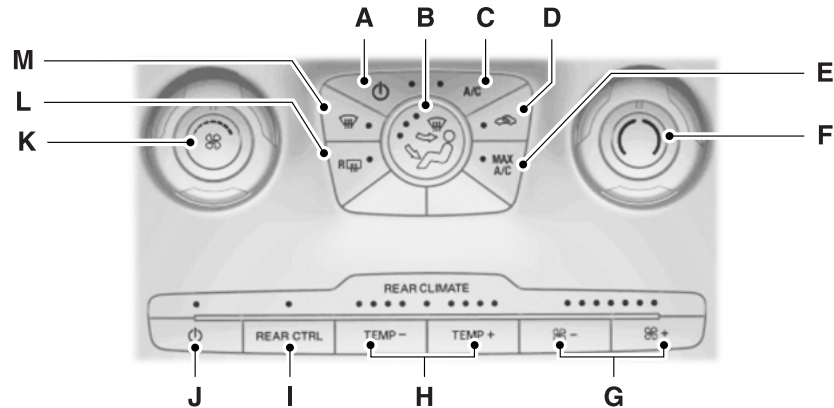

Note: The rear climate controls (G through J) are only available on some utility models.

A. **Power:** Press the button to turn the system on and off. Switching off the climate control system prevents outside air from entering the vehicle.

B. **Air distribution control:** Press these buttons to turn airflow from the windshield, instrument panel, or footwell vents on or off. The system can distribute air through any combination of these vents.

C. **A/C:** Press the button to turn air conditioning compressor on or off. Use air conditioning with recirculated air to improve cooling performance and efficiency.

D. **Recirculated air:** Press the button to switch between outside air and recirculated air. When recirculated air is selected, the air currently in the passenger compartment recirculates. This may reduce the time needed to cool the interior (when used with **A/C**) and may also reduce unwanted odors from entering your vehicle.

Note: Recirculated air may turn off automatically (or be prevented from turning on) in all airflow modes except **MAX A/C** to reduce risk of fogging.

E. **MAX A/C:** Turn the temperature control dial all the way past the full cool position to maximize cooling. Recirculated air flows through the instrument panel vents, air conditioning automatically turns on, and the fan automatically adjusts to the highest speed.

F. **Front temperature control:** Controls the temperature of the airflow in the front of your vehicle. Adjust to select the desired temperature.

G. **Rear fan speed control:** Controls the volume of air circulated in the rear of your vehicle. Press **+** or **-** to select the desired fan speed.

H. **Rear temperature control:** Controls the temperature of the airflow in the rear of your vehicle. Press **TEMP +** and **TEMP -** to select the desired temperature.

I. **REAR CTRL:** Press to change control of the rear climate controls system from the front controls to the rear controls.

J. **Rear climate control system power:** Press the button to turn the rear climate system on and off.

K. **Front fan speed control:** Controls the volume of air circulated in your vehicle. Adjust to select the desired fan speed.

L. **Heated rear window:** Turns the heated rear window on and off. See *Heated windows and mirrors* later in this chapter for more information.

M. **Defrost:** Press the button to distribute air to the windshield vents and de-mister. Air distribution to instrument panel and footwell vents turn off. You can use this setting to defog and clear the windshield of a thin covering of ice.

HEATED WINDOWS AND MIRRORS (IF EQUIPPED)

Heated Rear Window

Note: The ignition must be switched on to use this feature.

Press the button to clear the rear window of thin ice and fog. Press the button again within 10 minutes to switch it off. It switches off automatically after 10 minutes, or when you switch the ignition off.

Do not use razor blades or other sharp objects to clean the inside of the rear window or to remove decals from the inside of the rear window. This may cause damage to the heated grid lines. Your warranty does not cover this damage.

Heated Exterior Mirrors (If Equipped)

Note: Do not remove ice from the mirrors with a scraper or attempt to readjust the mirror glass that has frozen in place. These actions could cause damage to the glass and mirrors.

Note: Do not clean the housing or glass of any mirror with harsh abrasives, fuel or other petroleum-based cleaning products.

Both mirrors heat to remove ice, mist and fog when you switch on the heated rear window.

CABIN AIR FILTER

Note: Make sure you have a cabin air filter installed at all times. This prevents foreign objects from entering the system. Running the system without a filter in place could result in degradation or damage to the system.

Your vehicle is equipped with a cabin air filter, which is located just in front of the windshield under the cowl grille on the passenger side of your vehicle.

The particulate air filtration system reduces the concentration of airborne particles, such as dust, spores and pollen, in the air supplied to the interior of your vehicle. The particulate filtration system gives the following benefits to customers:

- Improves the customer's driving comfort by reducing particle concentration.
- Improves the interior compartment cleanliness.
- Protects the climate control components from particle deposits.

For more information regarding the interval at which you should replace the cabin air filter, see the *Scheduled Maintenance* chapter.

For additional cabin air filter information, or to replace the filter, see an authorized dealer.

SITTING IN THE CORRECT POSITION

 **WARNING:** Sitting improperly out of position or with the seat back reclined too far can take off weight from the seat cushion and affect the decision of the passenger sensing system, resulting in serious injury or death in a crash. Always sit upright against your seat back, with your feet on the floor.

 **WARNING:** Do not recline the seat back as this can cause the occupant to slide under the seat's safety belt, resulting in severe personal injury in the event of a crash.

 **WARNING:** Do not place objects higher than the seat backs to reduce the risk of injury in a crash or during heavy braking or when stopping suddenly.

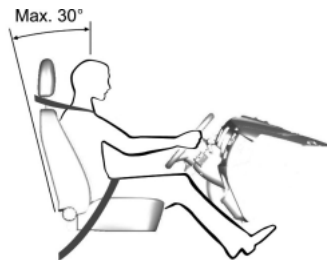

When you use them properly, the seat, head restraint, safety belt and airbags will provide optimum protection in the event of a crash.

We recommend that you follow these guidelines:

- Do not recline the seat back more than 30 degrees from vertical.
- Sit in an upright position with the base of your spine as far back as possible.
- Adjust the head restraint so that the top of it is level with the top of your head and as far forward as possible, remaining comfortable.
- Keep sufficient distance between yourself and the steering wheel. We recommend a minimum of 10 inches (25 centimeters) between your breastbone and the airbag cover.
- Hold the steering wheel with your arms slightly bent.
- Bend your legs slightly so that you can press the pedals fully.
- Position the shoulder strap of the safety belt over the center of your shoulder and position the lap strap tightly across your hips.

Make sure that your driving position is comfortable and that you can maintain full control of your vehicle.

HEAD RESTRAINTS

 **WARNING:** To minimize the risk of neck injury in the event of a crash, the driver and passenger occupants should not sit in or operate the vehicle, until the head restraint is placed in its proper position. The driver should never adjust the head restraint while the vehicle is in motion.

 **WARNING:** The adjustable head restraint is a safety device. Whenever possible it should be installed and properly adjusted when the seat is occupied. An improperly adjusted head restraint may provide reduced protection to an occupant during certain rear impacts.

 **WARNING:** Install the head restraint properly to minimize the risk of neck injury in the event of a crash.

Note: Before adjusting any head restraint, adjust the seatback to an upright driving or riding position. Properly adjust the head restraint so that the top of the head restraint is even with the top of your head and positioned as close as possible to the back of your head. For occupants of extremely tall stature, adjust the head restraint to its full up position. To adjust the head restraint, do the following:

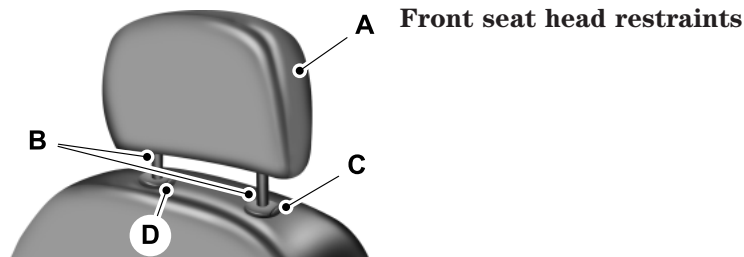

The head restraints consist of:

- A. Energy absorbing head restraint.
- B. Steel stems.
- C. Guide sleeve adjust and release button.
- D. Guide sleeve unlock and remove button.
- Raise: Pull up on the head restraint (A).

- Lower: Press and hold the guide sleeve adjust and release button (C) and push down on the head restraint (A).
- Remove: Pull up the head restraint until it reaches the highest adjustment position. Insert and push a tool, such as a large paper clip, into the pin hole located on the side of the guide sleeve adjust and release button (D), and press the guide sleeve adjust and release button (C), then pull the head restraint upward.
- Reinstall: Align the steel stems into the guide sleeves and push the head restraint down until it locks.

Tilting Head Restraints (If Equipped)

The front head restraints may tilt for extra comfort. To tilt the head restraint, do the following:



1. Adjust the seatback to an upright driving or riding position.
2. Tilt the head restraint forward by gently pulling the top of the head restraint.

Once it is in its forward-most position, tilt it forward once more to release it to the upright position.

Note: Do not attempt to force the head restraint backward after it is tilted. Instead, continue tilting it forward until the head restraint releases to the upright position.

MANUAL SEATS**Recline Adjustment**

! **WARNING:** Before returning the seatback to its original position, make sure that cargo or any objects are not trapped behind the seatback. After returning the seatback to its original position, pull on the seatback to make sure that it has fully latched. An unlatched seat may become dangerous in the event of a sudden stop or crash.

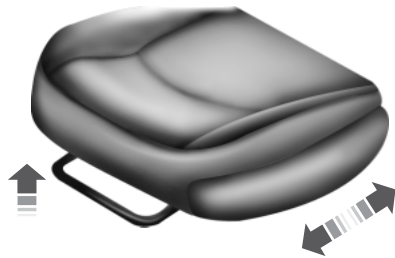
Moving the Seats Backward and Forward

! **WARNING:** Do not adjust the driver seat or seatback while the vehicle is moving. This may result in sudden seat movement, causing loss of control of your vehicle.

! **WARNING:** Rock the seat backward and forward after releasing the lever to make sure that it is fully engaged.

Lumbar Adjustment (If Equipped)**POWER SEATS (IF EQUIPPED)**

 **WARNING:** Do not adjust the driver seat or seatback while the vehicle is moving. This may result in sudden seat movement, causing loss of control of your vehicle.

 **WARNING:** Before returning the seatback to its original position, make sure that cargo or any objects are not trapped behind the seatback.

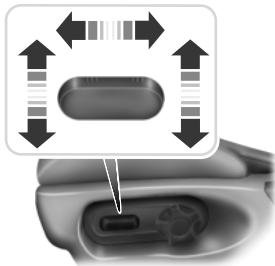

The control is located on the outboard side of the seat. Move the switch in the direction of the arrow to raise or lower the seat cushion or to move the seat forward, backward, up or down.

REAR SEATS (Utility Only)**Recline Adjustment (If Equipped)**

WARNING: Always drive and ride with your seatback upright and the lap belt snug and low across the hips.



WARNING: Reclining the seatback can cause an occupant to slide under the seat's safety belt, resulting in severe personal injuries in the event of a crash.



Lift the handle to adjust the seatback rearward or forward. The seatback can also fold forward until it is flat.

Fold-flat Seatback (If Equipped)

WARNING: Before returning the seatback to its original position, make sure that cargo or any objects are not trapped behind the seatback. After returning the seatback to its original position, pull on the seatback to make sure that it has fully latched. An unlatched seat may become dangerous in the event of a sudden stop or crash .

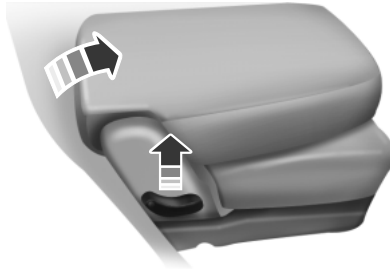

Lift the handle and fold the seatback forward until it is flat.

Note: For the bench seats, make sure the center safety belt is unbuckled before folding the seatback.



Lift the seatback toward the rear of the vehicle until you hear a click.

AUXILIARY POWER POINTS

WARNING: Do not plug optional electrical accessories into the cigarette lighter socket (if equipped). Improper use of the lighter can cause damage not covered by your warranty, and can result in fire or serious injury.

Note: If used when the engine is not running, the battery will discharge. There may be insufficient power to restart your engine.

Note: Do not insert objects other than an accessory plug into the power point. This will damage the outlet and blow the fuse.

Note: Do not hang any type of accessory or accessory bracket from the plug.

Note: Do not use the power point over the vehicle capacity of 12 volts DC 180 watts or a fuse may blow.

Note: Do not use the power point for operating a cigarette lighter element.

Note: Improper use of the power outlet can cause damage not covered by your warranty.

Note: Always keep the power point caps closed when not being used.

Run the engine for full capacity use of the power point. To prevent the battery from being discharged:

- Do not use the power point longer than necessary when the engine is not running.
- Do not leave devices plugged in overnight or when the vehicle is parked for extended periods.

Locations

Power points may be found:

- on the instrument panel
- inside the center console storage compartment
- on the rear of the center console (utility only).

CENTER CONSOLE (IF EQUIPPED)

Stow items in the cupholder carefully as items may become loose during hard braking, acceleration or collisions, including hot drinks which may spill.

Available console features include:

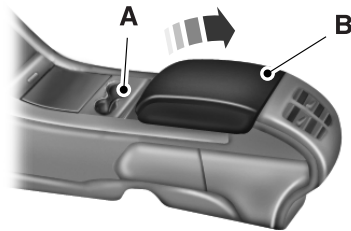
Sedan

- A. Cupholders.
- B. Utility compartment.

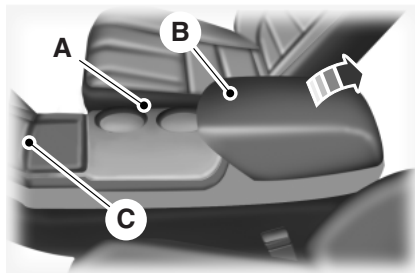
Utility

- Available console features include:
- A. Cupholders.
 - B. Utility storage compartment with powerpoint.
 - C. Auxiliary AV connections, USB ports and powerpoint.

Console Mounting Plates (If Equipped)

The mounting plates should only be removed and replaced during the upfitting process. They should not be removed permanently.

Universal Top Tray

The trim on the top of the instrument panel can be removed to aid in upfitting aftermarket accessories or mounting equipment.

OVERHEAD CONSOLE

The appearance of the overhead console will vary according to your option package.

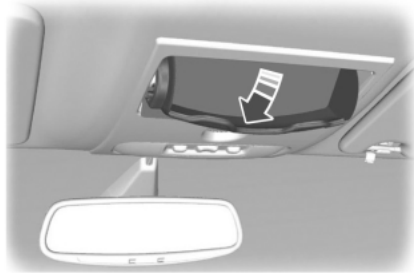



Press near the rear edge of the door to open it.

120 Starting and Stopping the Engine

GENERAL INFORMATION

 **WARNING:** Extended idling at high engine speeds can produce very high temperatures in the engine and exhaust system, creating the risk of fire or other damage.

 **WARNING:** Do not park, idle, or drive your vehicle on dry grass or other dry ground cover. The emission system heats up the engine compartment and exhaust system, which can start a fire.

 **WARNING:** Do not start your vehicle in a closed garage or in other enclosed areas. Exhaust fumes can be toxic. Always open the garage door before you start the engine.

 **WARNING:** If you smell exhaust fumes inside your vehicle, have your vehicle checked by an authorized dealer immediately. Do not drive if you smell exhaust fumes.

If you disconnect the battery, your vehicle may exhibit some unusual driving characteristics for approximately 5 miles (8 kilometers) after you connect it. This is because the engine management system must realign itself with the engine. You may disregard any unusual driving characteristics during this period.

The powertrain control system meets all Canadian interference-causing equipment standard requirements regulating the impulse electrical field or radio noise.

Do not press the accelerator pedal while starting the engine. If you have difficulty starting the engine, see *Failure to start* later in this section.

IGNITION SWITCH

Note: Do not store the key in the ignition after the vehicle is turned off and you have left the vehicle. This could cause a drain on the battery.

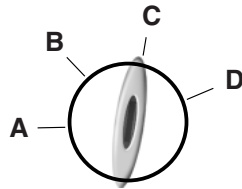

A. **Off:** The ignition is off.

B. **Accessory:** Allows the electrical accessories, such as the radio, to operate while the engine is not running.

C. **On:** All the electrical circuits are operational. Warning lights are illuminated. This is the key position when driving.

D. **Start:** Cranks the engine. Release the key as soon as the engine starts.

STARTING A GASOLINE ENGINE

When the engine starts, the idle RPM runs faster to warm the engine. If the engine idle speed does not slow down automatically, have the vehicle checked.

Note: You can crank the engine for a total of 60 seconds (without the engine starting) before the starting system temporarily disables. The 60 seconds does not have to be all at once. For example, if you crank the engine three times for 20 seconds each time, without the engine starting, you reached the 60-second time limit. A message appears in the information display alerting you that you exceeded the cranking time. You cannot attempt to start the engine for at least 15 minutes. After 15 minutes, you are limited to a 15-second engine cranking time. You need to wait 60 minutes before you can crank the engine for 60 seconds again.

Before starting the vehicle:

- Make sure all occupants buckle their safety belts.

122 Starting and Stopping the Engine

- Make sure the headlamps and electrical accessories are off.
- Make sure the parking brake is set.
- Make sure the gearshift is in position **P**.
- Turn the key to on without turning the key to start.

Some warning lights will briefly illuminate.

Note: Do not touch the accelerator pedal.

1. Fully press the brake pedal.
2. Select position **P** or **N**.
3. Turn the key to start the engine. The engine may continue cranking for up to 15 seconds or until the vehicle starts.

Note: If the engine does not start on the first try, wait for a short period of time and try again.

If you have difficulty starting the engine when the temperature is below -13°F (-25°C), press the accelerator pedal slightly and try again.

If the engine does not start after three attempts, wait 10 seconds and follow this flooded engine procedure.

1. Fully press the brake pedal.
2. Fully press the accelerator pedal and hold it there.
3. Select position **P** or **N**.
4. Start the engine.

Failure to Start

If you cannot start the engine after three attempts, wait 10 seconds and follow this procedure:

1. Fully press the brake pedal.
2. Fully press the accelerator pedal and hold it there.
3. Start the engine.

Stopping the Engine When Your Vehicle is Stationary

1. Move the transmission selector lever to position **P**.
2. Turn the key to the off position.
3. Apply the parking brake.

Stopping the Engine When Your Vehicle is Moving



WARNING: When you switch off the engine when your vehicle is still moving, this results in a loss of brake and steering assistance. The steering does not lock, but higher effort is required. When you switch off the ignition, some electrical circuits, warning lamps and indicators may also be off.

1. Move the transmission selector lever to position **N** and use the brakes to bring your vehicle to a safe stop.
2. When your vehicle has stopped, move the transmission selector lever to position **P** and turn the key to the off position.
3. Apply the parking brake.

Cold Weather Starting (Flexible Fuel Vehicles Only)

The starting characteristics of all grades of E-85 ethanol make it unsuitable for use when ambient temperatures fall below 0°F (-18°C). Consult your fuel distributor for the availability of winter grade ethanol. As the outside temperature approaches freezing, ethanol fuel distributors should supply winter grade ethanol (same as with unleaded gasoline). If summer grade ethanol is used in cold weather conditions, 0°F to 32°F (-18°C to 0°C), you may experience increased cranking times, rough idle or hesitation until the engine has warmed up.

You may experience a decrease in peak performance when the engine is cold when operating on E-85 ethanol.

Do not crank the engine for more than 10 seconds at a time as starter damage may occur. If the engine fails to start, turn the key to off and wait 30 seconds before trying again.

Do not use starting fluid such as ether in the air intake system. Such fluid could cause immediate explosive damage to the engine and possible personal injury.

If you should experience cold weather starting problems on E-85 ethanol, and neither an alternative brand of E-85 ethanol nor an engine block heater is available, the addition of unleaded gasoline to your tank improves cold starting performance. Your vehicle is designed to operate on E-85 ethanol alone, unleaded gasoline alone, or any mixture of the two.

If the Engine Fails to Start Using the Preceding Instructions (Flexible Fuel Vehicles Only)

1. Press and hold down the accelerator 1/3 to 1/2 way to floor, then crank the engine.
2. When the engine starts, release the key, then gradually release the accelerator pedal as the engine speeds up. If the engine still fails to start, repeat Step 1.

Guarding Against Exhaust Fumes



WARNING: If you smell exhaust fumes inside your vehicle, have this checked immediately. Do not drive your vehicle if you smell exhaust fumes. Carbon monoxide is present in exhaust fumes. Take precautions to avoid its dangerous effects.

Important Ventilating Information

If you stop your vehicle and leave the engine idling for long periods, we recommend that you do one of the following:

- Open the windows at least 1 inch (2.5 centimeters).
- Set your climate control to outside air.

ENGINE BLOCK HEATER (IF EQUIPPED)



WARNING: Failure to follow engine block heater instructions could result in property damage or personal injury.



WARNING: Do not use your heater with ungrounded electrical systems or two-pronged (cheater) adapters. There is a risk of electrical shock.

Note: The heater is most effective when outdoor temperatures are below 0°F (-18°C).

The heater acts as a starting aid by warming the engine coolant. This allows the climate control system to respond quickly. The equipment includes a heater element (installed in the engine block) and a wire harness. You can connect the system to a grounded 120-volt A/C electrical source.

We recommend that you do the following for safe and correct operation:

- Use a 16-gauge outdoor extension cord that is product certified by Underwriter's Laboratory or Canadian Standards Association. This extension cord must be suitable for use outdoors, in cold temperatures, and be clearly marked *Suitable for Use with Outdoor Appliances*. Never use an indoor extension cord outdoors; it could result in an electric shock or become a fire hazard.
- Use as short an extension cord as possible.
- Do not use multiple extension cords.

- Make sure that when in operation, the extension cord plug and the heater cord plug connections are free and clear of water. This could cause an electric shock or fire.
- Make sure your vehicle is parked in a clean area, clear of combustibles.
- Make sure the heater, heater cord and extension cord are firmly connected.
- Check for heat anywhere in the electrical hookup once the system has been operating for approximately 30 minutes.
- Make sure the system is unplugged and properly stowed before driving your vehicle. Make sure the protective cover seals the prongs of the block heater cord plug when not in use.
- Keep plug terminals clean and free of dirt and corrosion.
- Make sure the heater system is checked for proper operation before winter.

Using the Engine Block Heater

Make sure the receptacle terminals are clean and dry before use. To clean them, use a dry cloth.

The heater uses 0.4 to 1.0 kilowatt-hours of energy per hour of use. The system does not have a thermostat. It achieves maximum temperature after approximately three hours of operation. Using the heater longer than three hours does not improve system performance and unnecessarily uses electricity.

SAFETY PRECAUTIONS

WARNING: Do not overfill the fuel tank. The pressure in an overfilled tank may cause leakage and lead to fuel spray and fire.



WARNING: The fuel system may be under pressure. If you hear a hissing sound near the fuel filler inlet, do not refuel until the sound stops. Otherwise, fuel may spray out, which could cause serious personal injury.



WARNING: Automotive fuels can cause serious injury or death if misused or mishandled.



WARNING: The flow of fuel through a fuel pump nozzle can produce static electricity, which can cause a fire if fuel is pumped into an ungrounded fuel container.



WARNING: Fuel ethanol and gasoline may contain benzene, which is a cancer-causing agent.



WARNING: When refueling always shut the engine off and never allow sparks or open flames near the filler neck. Never smoke while refueling. Fuel vapor is extremely hazardous under certain conditions. Care should be taken to avoid inhaling excess fumes.

Observe the following guidelines when handling automotive fuel:

- Extinguish all smoking materials and any open flames before refueling your vehicle.
- Always turn off the vehicle before refueling.
- Automotive fuels can be harmful or fatal if swallowed. Fuel, such as gasoline, is highly toxic and if swallowed can cause death or permanent injury. If fuel is swallowed, call a physician immediately, even if no symptoms are immediately apparent. The toxic effects of fuel may not be visible for hours.
- Avoid inhaling fuel vapors. Inhaling too much fuel vapor of any kind can lead to eye and respiratory tract irritation. In severe cases, excessive or prolonged breathing of fuel vapor can cause serious illness and permanent injury.

- Avoid getting fuel liquid in your eyes. If fuel is splashed in the eyes, remove contact lenses (if worn), flush with water for 15 minutes and seek medical attention. Failure to seek proper medical attention could lead to permanent injury.
- Fuels can also be harmful if absorbed through the skin. If fuel is splashed on the skin or clothing, promptly remove contaminated clothing and wash skin thoroughly with soap and water. Repeated or prolonged skin contact with fuel liquid or vapor causes skin irritation.
- Be particularly careful if you are taking Antabuse or other forms of disulfiram for the treatment of alcoholism. Breathing gasoline vapors, or skin contact could cause an adverse reaction. In sensitive individuals, serious personal injury or sickness may result. If fuel is splashed on the skin, promptly wash skin thoroughly with soap and water. Consult a physician immediately if you experience an adverse reaction.

FUEL QUALITY

Use of any fuel other than those recommended may cause powertrain damage, a loss of vehicle performance, and repairs may not be covered under warranty.

Choosing the Right Fuel (Gasoline Engines)

Use only UNLEADED gasoline or UNLEADED gasoline blended with a maximum of 15% ethanol in your gasoline vehicle. If your vehicle is a Flex Fuel Vehicle (FFV), it will have a yellow bezel placed over the fuel fill inlet.

Do not use:

- Fuels containing more than 15% ethanol or E-85 fuel.
- Fuels containing methanol.
- Fuels containing metallic based additives, including manganese-based compounds.
- Fuels containing the octane booster additive, methylcyclopentadienyl manganese tricarbonyl (MMT).
- Leaded-fuel (The use of leaded fuel is prohibited by law).

Note: Use of any fuel other than recommended fuel can cause powertrain damage, impair the emission control system or cause loss of vehicle performance. Any damage to vehicle that is caused by use of fuel not recommended will not be covered under warranty.

Octane Recommendations**3.5L and 3.7L V6 engines**

Regular unleaded gasoline with a pump (R+M)/2 octane rating of 87 is recommended. Some stations offer fuels posted as Regular with an octane rating below 87, particularly in high altitude areas. Do not use fuels with a posted octane rating below 87.

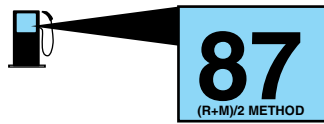
**2.0L and 3.5L V6 EcoBoost® engines**

Regular unleaded gasoline with a pump (R+M)/2 octane rating of 87 is recommended. Some stations

offer fuels posted as Regular with an octane rating below 87, particularly in high altitude areas. Fuels with octane levels below 87 are not recommended. Premium fuel will provide improved performance and is recommended for severe duty usage such as trailer tow.

Do not be concerned if your engine sometimes knocks lightly. However, if it knocks heavily under most driving conditions while you are using fuel with the recommended octane rating, see your authorized dealer to prevent any engine damage.

RUNNING OUT OF FUEL

Avoid running out of fuel because this situation may have an adverse effect on powertrain components.

If you have run out of fuel:

- You may need to cycle the ignition from off to on several times after refueling to allow the fuel system to pump the fuel from the tank to the engine. On restarting, crank time will be a few seconds longer than normal. With keyless ignition, just start the engine. Crank time will be longer than usual.
- Normally, adding 1 gallon (3.8 liters) of fuel is enough to restart the engine. If the vehicle is out of fuel and on a steep grade, more than 1 gallon (3.8 liters) may be required.
- The service engine soon indicator may come on. For more information on the service engine soon indicator, see *Warning Lamps and Indicators* in the *Instrument Cluster* chapter.

Refilling with a Portable Fuel Container

 **WARNING:** Do not insert the nozzle of a portable fuel container or aftermarket funnel into the capless fuel system. This could damage the fuel system and its seal, and may cause fuel to run onto the ground instead of filling the tank, which could result in serious personal injury.

 **WARNING:** Do not try to pry open or push open the capless fuel system with foreign objects. This could damage the fuel system and its seal and cause injury to you or others.

Note: Do not use aftermarket funnels; they will not work with the capless fuel system and can damage it. The included funnel has been specially designed to work safely with your vehicle.

When filling the vehicle's fuel tank from a portable fuel container, use the funnel included with the vehicle.

1. Locate the white plastic funnel in the spare tire compartment.

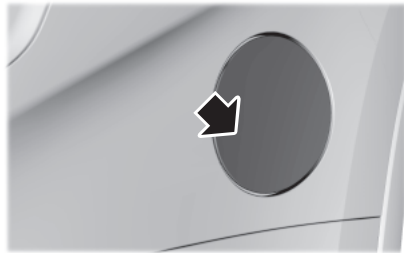

2. To open the fuel filler door, press the center of the rear edge and then release.

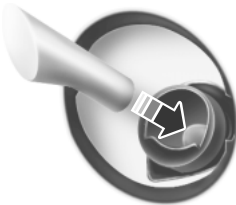

3. Slowly insert the funnel into the capless fuel system.

4. Fill the vehicle with fuel from the portable fuel container.

5. When done, clean the funnel or properly dispose of it. Extra funnels can be purchased from your authorized dealer if you choose to dispose of the funnel.

REFUELING

WARNING: Fuel vapor burns violently and a fuel fire can cause severe injuries. To help avoid injuries to you and others:

- Read and follow all the instructions on the pump island.
- Turn off your engine when you are refueling.
- Do not smoke if you are near fuel or refueling your vehicle.
- Keep sparks, flames and smoking materials away from fuel.
- Stay outside your vehicle and do not leave the fuel pump unattended when refueling your vehicle - this is against the law in some places.
- Keep children away from the fuel pump; never let children pump fuel.
- Do not use personal electronic devices while refueling.

Use the following guidelines to avoid electrostatic charge build-up when filling an ungrounded fuel container:

- Place approved fuel container on the ground.
- DO NOT fill a fuel container while it is in the vehicle (including the cargo area).
- Keep the fuel pump nozzle in contact with the fuel container while filling.
- DO NOT use a device that would hold the fuel pump handle in the fill position.

Easy Fuel® No Cap Fuel System

WARNING: The fuel system may be under pressure. If you hear a hissing sound near the fuel filler door, do not refuel until the sound stops. Otherwise, fuel may spray out, which could cause serious personal injury.

When fueling your vehicle:

1. Turn the engine off.

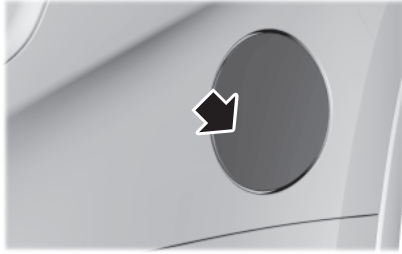

2. To open the fuel filler door, press the center of the rear edge and then release.

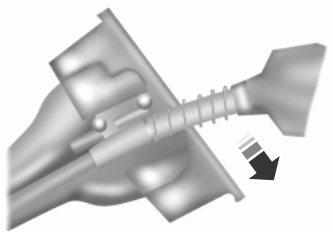

3. Slowly insert the fuel filler nozzle fully into the fuel system, and leave the nozzle fully inserted to open the door until you are done pumping. Hold handle higher during insertion for easier access.

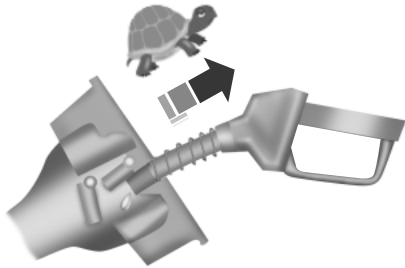

4. After you are done pumping fuel, slowly remove the fuel filler nozzle—allow about five to ten seconds after pumping fuel before removing the fuel filler nozzle. This allows residual fuel to drain back into the fuel tank and not spill onto the vehicle.

Note: A fuel spillage concern may occur if overfilling the fuel tank. Do not overfill the tank to the point that the fuel is able to bypass the fuel filler nozzle. The overfilled fuel may run down the drain located within the fuel filler housing and to the ground.

5. To close the fuel filler door, press the center of the rear edge and then release. The fuel door with latch closed.

If the fuel fill inlet was not properly closed, a Check Fuel Fill Inlet message may appear on the information display.

At the next opportunity, do the following:

1. Safely pull off the road.
2. Turn off the engine.
3. Open the fuel filler door and remove any visible debris from the fuel fill opening.
4. Insert either the fuel fill nozzle or the fuel fill funnel provided with the vehicle several times to dislodge any debris and allow the inlet to close properly.

If this action corrects the problem, the message may not reset immediately. It may take several driving cycles for the message to turn off. A driving cycle consists of an engine start-up (after four or more hours with the engine off) followed by city or highway driving. Continuing to drive with the message on may cause the service engine soon lamp to turn on as well.

FUEL CONSUMPTION

Filling the Tank

The advertised capacity is the indicated capacity and the empty reserve combined. Indicated capacity is the difference in the amount of fuel in a full tank and a tank when the fuel gauge indicates empty. Empty reserve is the amount of fuel in the tank after the fuel gauge indicates empty.

Note: The amount of usable fuel in the empty reserve varies and should not be relied upon to increase driving range. When refueling your vehicle after the fuel gauge indicates empty, you might not be able to refuel the full amount of the advertised capacity of the fuel tank due to the empty reserve still present in the tank.

For consistent results when filling the fuel tank:

- Turn the ignition off before fueling; an inaccurate reading results if the engine is left running.
- Use the same fill rate (low–medium–high) each time the tank is filled.
- Allow no more than two automatic click–offs when filling.

Results are most accurate when the filling method is consistent.

Calculating Fuel Economy

Do not measure fuel economy during the first 1000 miles (1600 kilometers) of driving (this is your engine's break-in period); a more accurate measurement is obtained after 2000 miles–3000 miles (3200 kilometers–4800 kilometers). Also, fuel expense, frequency of fill-ups or fuel gauge readings are not accurate ways to measure fuel economy.

1. Fill the fuel tank completely and record the initial odometer reading.
2. Each time you fill the tank, record the amount of fuel added.
3. After at least three to five tank fill-ups, fill the fuel tank and record the current odometer reading.
4. Subtract your initial odometer reading from the current odometer reading.
5. Calculate fuel economy as follows:

Standard: Divide miles traveled by gallons used.

Metric: Multiply liters used by 100, then divide by kilometers traveled.

Keep a record for at least one month and record the type of driving (city or highway). This provides an accurate estimate of the vehicle's fuel economy under current driving conditions. Additionally, keeping records during summer and winter show how temperature impacts fuel economy. In general, lower temperatures mean lower fuel economy.

EMISSION CONTROL SYSTEM

WARNING: Do not park, idle, or drive your vehicle in dry grass or other dry ground cover. The emission system heats up the engine compartment and exhaust system, which can start a fire.



WARNING: Exhaust leaks may result in entry of harmful and potentially lethal fumes into the passenger compartment. If you smell exhaust fumes inside your vehicle, have your dealer inspect your vehicle immediately. Do not drive if you smell exhaust fumes.

Your vehicle is equipped with various emission control components and a catalytic converter which will enable your vehicle to comply with applicable exhaust emission standards. To make sure that the catalytic converter and other emission control components continue to work properly:

- Use only the specified fuel listed.
- Avoid running out of fuel.
- Do not turn off the ignition while your vehicle is moving, especially at high speeds.
- Have the items listed in *Scheduled Maintenance Information* performed according to the specified schedule.

The scheduled maintenance items listed in *Scheduled Maintenance Information* are essential to the life and performance of your vehicle and to its emissions system.

If other than Ford, Motorcraft® or Ford-authorized parts are used for maintenance replacements or for service of components affecting emission control, such non-Ford parts should be equivalent to genuine Ford Motor Company parts in performance and durability.

Illumination of the service engine soon indicator, charging system warning light or the temperature warning light, fluid leaks, strange odors, smoke or loss of engine power could indicate that the emission control system is not working properly.

An improperly operating or damaged exhaust system may allow exhaust to enter the vehicle. Have a damaged or improperly operating exhaust system inspected and repaired immediately.

Do not make any unauthorized changes to your vehicle or engine. By law, vehicle owners and anyone who manufactures, repairs, services, sells, leases, trades vehicles, or supervises a fleet of vehicles are not permitted to intentionally remove an emission control device or prevent it from working. Information about your vehicle's emission system is on the Vehicle Emission Control Information Decal located on or near the engine. This decal also lists engine displacement.

Please consult your warranty information for complete emission warranty information.

On-board Diagnostics (OBD-II)

Your vehicle is equipped with a computer that monitors the engine's emission control system. This system is commonly known as the on-board diagnostics system (OBD-II). The OBD-II system protects the environment by ensuring that your vehicle continues to meet government emission standards. The OBD-II system also assists your authorized dealer in properly servicing your vehicle.



When the service engine soon indicator illuminates, the OBD-II system has detected a malfunction. Temporary malfunctions may cause the service engine soon indicator to illuminate.

Examples are:

1. The vehicle has run out of fuel—the engine may misfire or run poorly.
2. Poor fuel quality or water in the fuel—the engine may misfire or run poorly.
3. The fuel fill inlet may not have been properly closed. See *Easy Fuel® No Cap Fuel System* in this chapter.
4. Driving through deep water—the electrical system may be wet.

These temporary malfunctions can be corrected by filling the fuel tank with good quality fuel, properly closing the fuel fill inlet or letting the electrical system dry out. After three driving cycles without these or any other temporary malfunctions present, the service engine soon indicator should stay off the next time the engine is started. A driving cycle consists of a cold engine start-up followed by mixed city or highway driving. No additional vehicle service is required.

If the service engine soon indicator remains on, have your vehicle serviced at the first available opportunity. Although some malfunctions detected by the OBD-II may not have symptoms that are apparent, continued driving with the service engine soon indicator on can result in increased emissions, lower fuel economy, reduced engine and transmission smoothness, and can lead to more costly repairs.

Readiness for Inspection/Maintenance (I/M) Testing

Some state, provincial and local governments may have Inspection/Maintenance (I/M) programs to inspect the emission control equipment on your vehicle. Failure to pass this inspection could prevent you from getting a vehicle registration.



If the service engine soon indicator is on or the bulb does not work, the vehicle may need to be serviced. See *On-board Diagnostics (OBD-II)* in this chapter.

Your vehicle may not pass the I/M test if the service engine soon indicator is on or not working properly (bulb is burned out), or if the OBD-II system has determined that some of the emission control systems have not been properly checked. In this case, the vehicle is considered not ready for I/M testing.

If the vehicle's engine or transmission has just been serviced, or the battery has recently run down or been replaced, the OBD-II system may indicate that the vehicle is not ready for I/M testing. To determine if the vehicle is ready for I/M testing, turn the ignition key to the on position for 15 seconds without cranking the engine. If the service engine soon indicator blinks eight times, it means that the vehicle is not ready for I/M testing; if the service engine soon indicator stays on solid, it means that the vehicle is ready for I/M testing.

The OBD-II system is designed to check the emission control system during normal driving. A complete check may take several days. If the vehicle is not ready for I/M testing, the following driving cycle consisting of mixed city and highway driving may be performed:

15 minutes of steady driving on an expressway or highway followed by 20 minutes of stop-and-go driving with at least four 30-second idle periods.

Allow the vehicle to sit for at least eight hours without starting the engine. Then, start the engine and complete the above driving cycle. The engine must warm up to its normal operating temperature. Once the engine is started, do not turn off the engine until the above driving cycle is complete. If the vehicle is still not ready for I/M testing, the above driving cycle will have to be repeated.

AUTOMATIC TRANSMISSION

WARNING: Always set the parking brake fully and make sure the gearshift is latched in P (Park). Turn the ignition to the off position and remove the key whenever you leave your vehicle.

Your vehicle has been designed to improve fuel economy by reducing fuel usage while coasting or decelerating. When you take your foot off the accelerator pedal and the vehicle begins to slow down, the torque converter clutch locks up and aggressively shuts off fuel flow to the engine while decelerating. This fuel economy benefit may be perceived as a light to medium braking sensation when removing your foot from the accelerator pedal.

P (Park)

This position locks the transmission and prevents the front wheels from turning.

To put your vehicle in gear:

- Press the brake pedal
- Move the gearshift lever into the desired gear

To put your vehicle in P (Park):

- Come to a complete stop
- Move the gearshift lever and securely latch it in P (Park)

R (Reverse)

With the gearshift lever in R (Reverse), the vehicle will move backward. Always come to a complete stop before shifting into and out of R (Reverse).

N (Neutral)

With the gearshift lever in N (Neutral), the vehicle can be started and is free to roll. Hold the brake pedal down while in this position.

D (Drive)

The normal driving position for the best fuel economy. Transmission operates in gears one through six.

**L (Low Gear)**

The low button is located at the end of the column shifter. Activating (L) Low Gear automatically:

- Provides maximum engine braking.
 - Will downshift to the lowest available gear for the current vehicle speed; allows for first gear when vehicle reaches lower speeds.
- Is not intended for use under extended or normal driving conditions and results in lower fuel economy.

Automatic Transmission Adaptive Learning

This feature is designed to increase durability and provide consistent shift feel over the life of the vehicle. A new vehicle or transmission may have firm shifts, soft shifts or both. This operation is considered normal and will not affect function or durability of the transmission. Over time, the adaptive learning process will fully update transmission operation. Additionally, whenever the battery is disconnected or a new battery installed, the strategy must be relearned.

If Your Vehicle Gets Stuck in Mud or Snow

Note: Do not rock the vehicle if the engine is not at normal operating temperature or damage to the transmission may occur.

Note: Do not rock the vehicle for more than a minute or damage to the transmission and tires may occur, or the engine may overheat.

If your vehicle gets stuck in mud or snow, it may be rocked out by shifting between forward and reverse gears, stopping between shifts in a steady pattern. Press lightly on the accelerator in each gear.

USING YOUR ALL-WHEEL-DRIVE (AWD) SYSTEM

AWD uses all four wheels to power the vehicle. This increases traction, enabling you to drive over terrain and road conditions that a conventional two-wheel drive vehicles cannot. The AWD system is active all the time and requires no input from the operator.

Note: Your AWD vehicle is not intended for off-road use. The AWD feature gives your vehicle some limited off-road capabilities in which driving surfaces are relatively level, obstruction-free and otherwise similar to normal on-road driving conditions. Operating your vehicle under other than those conditions could subject the vehicle to excessive stress which might result in damage which is not covered under your warranty.

Note: When an AWD system fault is present, the warning Check AWD will display in the message center. The AWD system is not functioning correctly and defaulted to front-wheel drive. When this warning is displayed, have your vehicle serviced at an authorized dealer.

Note: The AWD Off message may also be displayed in the message center if the AWD system has overheated and defaulted to front-wheel drive. This condition may occur if the vehicle was operated in extreme conditions with excessive wheel slip, such as deep sand. To resume normal AWD function as soon as possible, stop the vehicle in a safe location and stop the engine for at least 10 minutes. After the engine has been restarted and the AWD system has adequately cooled, the AWD Off message will turn off and normal AWD function will return. In the event the engine is not stopped, the AWD Off message will turn off when the system cools and normal AWD function returns.

The Power Transfer Unit (PTU) in police vehicles does not require any normal scheduled maintenance. The system is electronically monitored and notifies the driver of required service by displaying the message Change AWD Power Transfer Unit Lube in the information display. The PTU lube will be more likely to require a fluid change if the vehicle has experienced extended periods of extreme/severe duty cycle driving. Do not check or change the PTU lubricant unless the unit has been submerged in water, shows signs of leakage or a message indicating required service is displayed. Contact your authorized dealer for service and to reset the PTU lube life monitor.

Operating AWD Vehicles With Spare Tires

A spare tire of a different size other than the tire provided should never be used. The AWD system may disable automatically and enter front-wheel drive only mode to protect driveline components if a non-full sized tire is installed. This condition may be indicated by an AWD Off message in the information display. If there is an AWD Off message in the message center from using a non-full sized spare tire, this indicator should turn off after reinstalling the repaired or replaced normal road tire and cycling the ignition off and on. It is recommended to reinstall the repaired or replaced road tire as soon as possible. Major dissimilar tire sizes between the front and rear axles could cause the AWD system to stop functioning and default to front-wheel drive or damage the AWD system.

Major dissimilar tire sizes between the front and rear axles (for example, 17 inch low profile tires on the front axle and 22 inch high profile tires on the rear axle) could cause the AWD system to stop functioning and default to front-wheel drive or damage the AWD system. However, the AWD system is capable of tolerating any combination of new and worn tires of the same original tire size. For example, using 3 worn tread tires and 1 new tread tire all of the same original tire size, can be tolerated by the AWD system.

Operating AWD Vehicles With Mismatched Tires

WARNING: Only use replacement tires and wheels that are the same size, load index, speed rating and type (such as P-metric versus LT-metric or all-season versus all-terrain) as those originally provided by Ford. The recommended tire and wheel size may be found on either the Safety Compliance Certification Label (affixed to either the door hinge pillar, door-latch post, or the door edge that meets the door-latch post, next to the driver's seating position), or the Tire Label which is located on the B-Pillar or edge of the driver's door. If this information is not found on these labels, then you should contact your authorized dealer as soon as possible. Use of any tire or wheel not recommended by Ford can affect the safety and performance of your vehicle, which could result in an increased risk of loss of vehicle control, vehicle rollover, personal injury and death. Additionally the use of non-recommended tires and wheels could cause steering, suspension, axle, transfer case or power transfer unit failure. If you have questions regarding tire replacement, contact your authorized dealer as soon as possible.

Major dissimilar tire sizes between the front and rear axles (for example, 17 inch low profile tires on the front axle and 22 inch high profile tires on the rear axle) could cause the AWD system to stop functioning and default to front-wheel drive or damage the AWD system. However, the AWD system is capable of tolerating any combination of new and worn tires of the same original tire size. For example, using 3 worn tread tires and 1 new tread tire all of the same original tire size, can be tolerated by the AWD system.

How Utility Vehicles Differ from Other Vehicles (If Equipped)

Truck and utility vehicles can differ from some other vehicles. Your vehicle may be higher to allow it to travel over rough terrain without getting hung up or damaging underbody components.

The differences that make your vehicle so versatile also make it handle differently than an ordinary passenger car.

Maintain steering wheel control at all times, especially in rough terrain. Since sudden changes in terrain can result in abrupt steering wheel motion, make sure you grip the steering wheel from the outside. Do not grip the spokes.

Drive cautiously to avoid vehicle damage from concealed objects such as rocks and stumps.

You should either know the terrain or examine maps of the area before driving. Map out your route before driving in the area. To maintain steering and braking control of your vehicle, you must have all four wheels on the ground and they must be rolling, not sliding or spinning.

Driving In Special Conditions With All-Wheel Drive

All-Wheel Drive (AWD) vehicles are equipped for driving on sand, snow, mud and rough roads and have operating characteristics that are somewhat different from conventional vehicles, both on and off the highway.

When driving at slow speeds in deep sand under high outside temperatures, use a low gear when possible. Lower gear operation will maximize the engine and transmission cooling capability.

Under severe operating conditions, the A/C may cycle on and off to protect overheating of the engine.

Basic operating principles in special conditions

- Drive slower in strong crosswinds which can affect the normal steering characteristics of your vehicle.
- Be extremely careful when driving on pavement made slippery by loose sand, water, gravel, snow or ice.

If your vehicle goes off the edge of the pavement

- If your vehicle goes off the edge of the pavement, slow down, but avoid severe brake application, ease the vehicle back onto the pavement only after reducing your speed. Do not turn the steering wheel too sharply while returning to the road surface.
- It may be safer to stay on the apron or shoulder of the road and slow down gradually before returning to the pavement. You may lose control if you do not slow down or if you turn the steering wheel too sharply or abruptly.
- It often may be less risky to strike small objects, such as highway reflectors, with minor damage to your vehicle rather than attempt a sudden return to the pavement which could cause the vehicle to slide sideways out of control or rollover. Remember, your safety and the safety of others should be your primary concern.

If your vehicle gets stuck

WARNING: Always set the parking brake fully and make sure the gearshift is latched in P (Park). Turn the ignition to the lock position and remove the key whenever you leave your vehicle.



WARNING: If the parking brake is fully released, but the brake warning lamp remains illuminated, the brakes may not be working properly. See your authorized dealer.



WARNING: Do not spin the wheels at over 35 mph (56 km/h). The tires may fail and injure a passenger or bystander.

Note: Do not rock the vehicle if the engine is not at normal operating temperature or damage to the transmission may occur.

Note: Do not rock the vehicle for more than a few minutes or damage to the transmission and tires may occur or the engine may overheat.

If your vehicle gets stuck in mud or snow it may be rocked out by shifting between forward and reverse gears, stopping between shifts, in a steady pattern. Press lightly on the accelerator in each gear.

If your vehicle is equipped with AdvanceTrac® with Roll Stability Control™, it may be beneficial to disengage the AdvanceTrac® with Roll Stability Control™ system while attempting to rock the vehicle.

Emergency maneuvers

- In an unavoidable emergency situation where a sudden sharp turn must be made, remember to avoid “over-driving” your vehicle (i.e., turn the steering wheel only as rapidly and as far as required to avoid the emergency). Excessive steering will result in less vehicle control, not more. Additionally, smooth variations of the accelerator and/or brake pedal pressure should be utilized if changes in vehicle speed are called for. Avoid abrupt steering, acceleration or braking which could result in an increased risk of loss of vehicle control, vehicle rollover and/or personal injury. Use all available road surface to return the vehicle to a safe direction of travel.
- In the event of an emergency stop, avoid skidding the tires and do not attempt any sharp steering wheel movements.
- If the vehicle goes from one type of surface to another (i.e., from concrete to gravel) there will be a change in the way the vehicle responds to a maneuver (steering, acceleration or braking). Again, avoid these abrupt inputs.

Sand

When driving over sand, try to keep all four wheels on the most solid area of the trail. Avoid reducing the tire pressures but shift to a lower gear and drive steadily through the terrain. Apply the accelerator slowly and avoid excessive wheel slip.

Do not drive your vehicle in deep sand for an extended period of time. This could cause the AWD system to overheat and default to front-wheel drive. If this occurs **AWD Off** will be displayed in the Information Display.

To resume normal AWD function as soon as possible, stop the vehicle in a safe location and stop the engine for at least 10 minutes. After the engine has been restarted and the AWD system has adequately cooled, the **AWD Off** message will turn off and normal AWD function will return. In the event the engine is not stopped, the **AWD Off** message will turn off when the system cools and normal AWD function returns.

When driving at slow speeds in deep sand under high outside temperatures, use L (Low) gear when possible. L (Low) gear operation will maximize the engine and transmission cooling capability.

Under severe operating conditions, the A/C may cycle on and off to protect overheating of the engine.

Avoid driving at excessive speeds, this could cause vehicle momentum to work against you and your vehicle could become damaged or stuck to the point that assistance may be required from another vehicle. Remember, you may be able to back out the way you came if you proceed with caution.

Mud and water

If you must drive through high water, drive slowly. Traction or brake capability may be limited.

When driving through water, determine the depth; avoid water higher than the bottom of the wheel rims (for cars) or the bottom of the hubs (for trucks) (if possible) and proceed slowly. If the ignition system gets wet, the vehicle may stall.

Once through water, always try the brakes. Wet brakes do not stop the vehicle as effectively as dry brakes. Drying can be improved by moving your vehicle slowly while applying light pressure on the brake pedal.

Be cautious of sudden changes in vehicle speed or direction when you are driving in mud. Even AWD vehicles can lose traction in slick mud. As when you are driving over sand, apply the accelerator slowly and avoid spinning your wheels. If the vehicle does slide, steer in the direction of the slide until you regain control of the vehicle.

After driving through mud, clean off residue stuck to rotating drive shafts and tires. Excess mud stuck on tires and rotating drive shafts causes an imbalance that could damage drive components.

Note: Driving through deep water may damage the transmission.

If the front or rear axle is submerged in water, the axle lubricant and PTU (power transfer unit) lubricant should be checked and changed if necessary.



“Tread Lightly” is an educational program designed to increase public awareness of land-use regulations and responsibilities in our nations wilderness areas. Ford Motor Company joins the U.S. Forest

Service and the Bureau of Land Management in encouraging you to help preserve our national forest and other public and private lands by “treading lightly.”

Driving on hilly or sloping terrain

Note: Avoid driving crosswise or turning on steep slopes or hills. A danger lies in losing traction, slipping sideways and possibly rolling over. Whenever driving on a hill, determine beforehand the route you will use. Do not drive over the crest of a hill without seeing what conditions are on the other side. Do not drive in reverse over a hill without the aid of an observer.

Although natural obstacles may make it necessary to travel diagonally up or down a hill or steep incline, you should always try to drive straight up or straight down.

When climbing a steep slope or hill, start in a lower gear rather than downshifting to a lower gear from a higher gear once the ascent has started. This reduces strain on the engine and the possibility of stalling.

If you do stall out, do not try to turnaround because you might roll over. It is better to back down to a safe location.

Apply just enough power to the wheels to climb the hill. Too much power will cause the tires to slip, spin or lose traction, resulting in loss of vehicle control.

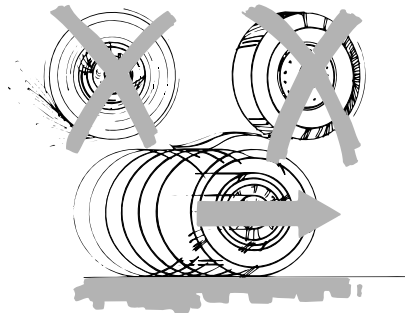

Descend a hill in the same gear you would use to climb up the hill to avoid excessive brake application and brake overheating. Do not descend in neutral; instead, disengage overdrive or manually shift to a lower gear. When descending a steep hill, avoid sudden hard braking as you could lose control. The front wheels have to be turning in order to steer the vehicle.

Your vehicle has anti-lock brakes, therefore apply the brakes steadily. Do not “pump” the brakes.

Driving on snow and ice

WARNING: If you are driving in slippery conditions that require tire chains or cables, then it is critical that you drive cautiously. Keep speeds down, allow for longer stopping distances and avoid aggressive steering to reduce the chances of a loss of vehicle control which can lead to serious injury or death. If the rear end of the vehicle slides while cornering, steer in the direction of the slide until you regain control of the vehicle.

Note: Excessive tire slippage can cause transmission damage.

AWD vehicles have advantages over 2WD vehicles in snow and ice but can skid like any other vehicle.

Should you start to slide while driving on snowy or icy roads, turn the steering wheel in the direction of the slide until you regain control.

Avoid sudden applications of power and quick changes of direction on snow and ice. Apply the accelerator slowly and steadily when starting from a full stop.

Avoid sudden braking as well. Although an AWD vehicle may accelerate better than a two-wheel drive vehicle in snow and ice, it won't stop any faster, because as in other vehicles, braking occurs at all four wheels. Do not become overconfident as to road conditions.

Make sure you allow sufficient distance between you and other vehicles for stopping. Drive slower than usual and consider using one of the lower gears. In emergency stopping situations, apply the brake steadily. Since your vehicle is equipped with a four wheel anti-lock brake system (ABS), do not "pump" the brakes. Refer to the *Brakes* section of this chapter for additional information on the operation of the anti-lock brake system.

Maintenance and modifications

The suspension and steering systems on your vehicle have been designed and tested to provide predictable performance whether loaded or empty and durable load carrying capability. For this reason, Ford Motor Company strongly recommends that you do not make modifications such as adding or removing parts (such as lift kits or stabilizer bars) or by using replacement parts not equivalent to the original factory equipment.

Any modifications to a vehicle that raise the center of gravity can make it more likely the vehicle will rollover as a result of a loss of control. Ford Motor Company recommends that caution be used with any vehicle equipped with a high load or device (such as ladder or luggage racks).

Failure to maintain your vehicle properly may void the warranty, increase your repair cost, reduce vehicle performance and operational capabilities and adversely affect driver and passenger safety. Frequent inspection of vehicle chassis components is recommended if the vehicle is subjected to off-highway usage.

GENERAL INFORMATION

Note: Occasional brake noise is normal. If a metal-to-metal, continuous grinding or continuous squeal sound is present, the brake linings may be worn out. Have them inspected by an authorized dealer. If your vehicle has continuous vibration or shudder in the steering wheel while braking, have your vehicle inspected by an authorized dealer.

Note: Brake dust may accumulate on the wheels, even under normal driving conditions. Some dust is inevitable as the brakes wear and does not contribute to brake noise. See the *Vehicle Care* chapter for wheel cleaning instructions.

This vehicle is equipped with heavy-duty front disc brake pads to meet the varying demands of different police service for fade resistance and other performance requirements.

Ford recommends brake system inspection and maintenance according to service manual procedures following high speed pursuits with heavy brake usage.



See the *Instrument Cluster* chapter for information on the brake system warning light.

Wet brakes result in reduced braking efficiency. Gently press the brake pedal a few times when driving from a car wash or standing water to dry the brakes.

Brake Over Accelerator

In the event the accelerator pedal becomes stuck or entrapped, apply steady and firm pressure to the brake pedal to slow your vehicle and reduce engine power. If you experience this condition, apply the brakes and bring your vehicle to a safe stop. Turn the engine off, shift to park (P) and apply the parking brake. Inspect the accelerator pedal and the area around it for any items or debris that may be obstructing its movement. If none are found and the condition persists, have your vehicle towed to the nearest authorized dealer.

Brake Assist

Brake assist detects when you brake heavily by measuring the rate at which you press the brake pedal. It provides maximum braking efficiency as long as you press the pedal. Brake assist can reduce stopping distances in critical situations.

Anti-Lock Brake System

This system helps you maintain steering control during emergency stops by keeping the brakes from locking.



This lamp momentarily illuminates when you turn the ignition on. If the light does not illuminate during start-up, remains on or flashes, the anti-lock brake system may be disabled and may need to be serviced.



If the anti-lock brake system is disabled, normal braking is still effective. If the brake warning lamp illuminates with the parking brake released, have your brake system serviced immediately.

HINTS ON DRIVING WITH ANTI-LOCK BRAKES

When the system is operating, the brake pedal will pulse and may travel further. Maintain pressure on the brake pedal. You may also hear a noise from the system. This is normal.

The anti-lock braking system will not eliminate the risks when:

- You drive too closely to the vehicle in front of you.
- Your vehicle is hydroplaning.
- You take corners too fast.
- The road surface is poor.

PARKING BRAKE



WARNING: If the parking brake is fully released, but the brake warning lamp remains illuminated, then driving your vehicle could result in reduced braking ability, increased stopping distances and potential loss of brakes. See your authorized dealer as soon as possible.



WARNING: Always set the parking brake fully and make sure that the transmission is securely latched in park (P). Failure to set the parking brake and engage park could result in vehicle roll-away, property damage or bodily injury.

To set the parking brake, press the parking brake pedal down to its fullest extent.

To release the parking brake, press the parking brake pedal down again.

PRINCIPLES OF OPERATION

The traction control system helps avoid drive wheel spin and loss of traction.

If your vehicle begins to slide, the system applies the brakes to individual wheels and, when needed, reduces engine power at the same time. If the wheels spin when accelerating on slippery or loose surfaces, the system reduces engine power in order to increase traction.

USING TRACTION CONTROL

In certain situations (for example, stuck in snow or mud), turning the traction control off may be beneficial as this allows the wheels to spin with full engine power.

Turn the traction control system off through the information display. See the *Information Displays* chapter.

System indicator lights and messages

WARNING: If a failure has been detected within the AdvanceTrac® system, the stability control light will illuminate steadily. Verify that the AdvanceTrac® system was not manually disabled using the information display control. If the stability control light still illuminates steadily, have the system serviced by an authorized dealer immediately. Operating your vehicle with AdvanceTrac® disabled could lead to an increased risk of loss of vehicle control, vehicle rollover, personal injury and death.



The stability control light temporarily illuminates on engine start-up and flashes when a driving condition activates the stability system.



The stability control off light temporarily illuminates on engine start-up and stays on when the traction control system is turned off.

When the traction control system is turned off or on, a message appears in the information display showing system status.

PRINCIPLES OF OPERATION

WARNING: Vehicle modifications involving braking system, aftermarket roof racks, suspension, steering system, tire construction and wheel or tire size may change the handling characteristics of your vehicle and may adversely affect the performance of the AdvanceTrac® system. In addition, installing any stereo loudspeakers may interfere with and adversely affect the AdvanceTrac® system. Install any aftermarket stereo loudspeaker as far as possible from the front center console, the tunnel, and the front seats in order to minimize the risk of interfering with the AdvanceTrac® sensors. Reducing the effectiveness of the AdvanceTrac® system could lead to an increased risk of loss of vehicle control, vehicle rollover, personal injury and death.



WARNING: Remember that even advanced technology cannot defy the laws of physics. It's always possible to lose control of a vehicle due to inappropriate driver input for the conditions. Aggressive driving on any road condition can cause you to lose control of your vehicle increasing the risk of personal injury or property damage. Activation of the AdvanceTrac® system is an indication that at least some of the tires have exceeded their ability to grip the road; this could reduce the operator's ability to control the vehicle potentially resulting in a loss of vehicle control, vehicle rollover, personal injury and death. If your AdvanceTrac® system activates, SLOW DOWN.

The AdvanceTrac® system helps you keep control of your vehicle when on a slippery surface. The electronic stability control portion of the system helps avoid skids and lateral slides. The traction control system helps avoid drive wheel spin and loss of traction. See the *Traction Control* chapter for details on traction control system operation.

Note: On utility models, the system also includes curve control. Curve control assists in vehicle handling in following the road during adverse maneuvering, and roll stability control which helps avoid a vehicle rollover.

A Vehicle without AdvanceTrac® skidding off its intended route.

B Vehicle with AdvanceTrac® maintaining control on a slippery surface.

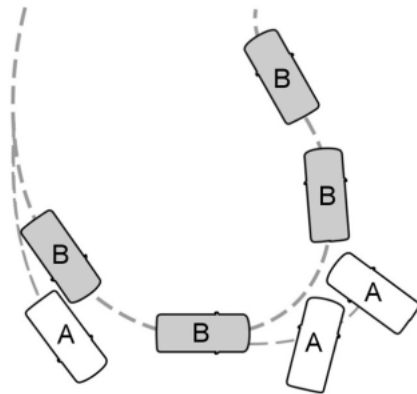



USING ADVANCETRAC® WITH RSC®

The system automatically activates when you start your engine. The AdvanceTrac® with RSC® system cannot be completely turned off, but the electronic stability control and roll stability control portions of the system are disabled when the transmission is in reverse (R). You can turn the traction control portion of the system off independently. See the *Traction Control* chapter.

SENSING SYSTEM (IF EQUIPPED)

 **WARNING:** To help avoid personal injury, please read and understand the limitations of the system as contained in this section. Sensing is only an aid for some (generally large and fixed) objects when moving in reverse on a flat surface at parking speeds. Traffic control systems, inclement weather, air brakes, and external motors and fans may also affect the function of the sensing system; this may include reduced performance or a false activation.

 **WARNING:** To help avoid personal injury, always use caution when the transmission is in **R** and when using the sensing system.

 **WARNING:** This system is not designed to prevent contact with small or moving objects. The system is designed to provide a warning to assist the driver in detecting large stationary objects to avoid damaging the vehicle. The system may not detect smaller objects, particularly those close to the ground.

 **WARNING:** Certain add-on devices, such as large trailer hitches, bike or surfboard racks and any device that may block the normal detection zone of the system, may create false beeps.

Note: Keep the sensors (located on the bumper/fascia) free from snow, ice and large accumulations of dirt. If the sensors are covered, the system's accuracy can be affected. Do not clean the sensors with sharp objects.

Note: If your vehicle sustains damage to the bumper/fascia, leaving it misaligned or bent, the sensing zone may be altered causing inaccurate measurement of obstacles or false alarms.

The sensing system warns the driver of obstacles within a certain range of the bumper area. The system turns on automatically whenever the ignition is switched on.

When receiving a detection warning, the radio volume is reduced to a predetermined level. After the warning goes away, the radio volume returns to the previous level.

The system can be turned off using the information display control. See the *Information Display* chapter. If a fault is present in the system, a warning message appears in the information display and does not allow the driver to switch the faulted system on.

Using the Rear Sensing System

The rear sensors are only active when the transmission is in **R**. As the vehicle moves closer to the obstacle, the rate of the audible warning increases. When the obstacle is fewer than 12 inches (30 centimeters) away, the warning sounds continuously. If a stationary or receding object is detected farther than 12 inches (30 centimeters) from the side of the vehicle, the tone sounds for only three seconds. Once the system detects an object approaching, the warning sounds again.

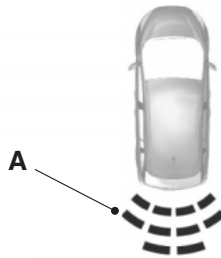

A. Coverage area of up to 6 feet (2 meters) from the rear bumper (with a decreased coverage area at the outer corners of the bumper).

The system detects certain objects while the transmission is in **R**:

- and moving toward a stationary object at a speed of 3 mph (5 km/h) or less.
- but not moving, and a moving object is approaching the rear of the vehicle at a speed of 3 mph (5 km/h) or less.
- and moving at a speed of less than 3 mph (5 km/h) and a moving object is approaching the rear of the vehicle at a speed of less than 3 mph (5 km/h).

REAR VIEW CAMERA SYSTEM (IF EQUIPPED)





WARNING: The rear view camera system is a reverse aid supplement device that still requires the driver to use it in conjunction with the interior and exterior mirrors for maximum coverage.



WARNING: Objects that are close to either corner of the bumper or under the bumper, might not be seen on the screen due to the limited coverage of the camera system.

 **WARNING:** Back up as slow as possible since higher speeds might limit your reaction time to stop the vehicle.

 **WARNING:** Use caution when using the rear video camera and the trunk/liftgate is ajar. If the trunk/liftgate is ajar, the camera will be out of position and the video image may be incorrect. All guidelines (if enabled) have been removed when the trunk/liftgate is ajar.

 **WARNING:** Use caution when turning camera features on or off while in R (Reverse). Make sure the vehicle is not moving.

The rear view camera system provides a video image of the area behind the vehicle.

During operation, lines appear in the display which represent your vehicle's path and proximity to objects behind the vehicle.

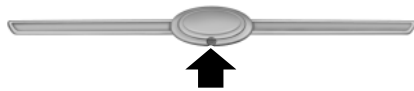

On sedan models, the camera is located on the trunk under the Ford badge.



On utility models, the camera is located on the liftgate.

Using the Rear View Camera System

The rear view camera system displays what is behind your vehicle when you place the transmission in **R** (Reverse). The system uses fixed guidelines which show the actual path the vehicle is moving in while reversing in a straight line. This can be helpful when backing into a parking space or aligning the vehicle with another object behind the vehicle.

Note: Do not use the camera system if either the trunk (sedan) or the liftgate (utility) is ajar.

Note: If the image does not turn off while the transmission is not in **R** (Reverse) and your driving over a speed of 5 mph (8 km/h), have the system inspected by your authorized dealer.

Note: When towing, the camera only sees what is being towed behind the vehicle. This might not provide adequate coverage as it usually provides in normal operation and some objects might not be seen. In some vehicles the guidelines (if equipped) may disappear once the trailer tow connector is engaged.

Note: The camera may not operate correctly under the following conditions:

- Nighttime or dark areas if one or both reverse lamps are not operating.
- The camera's view is obstructed by mud, water or debris. Clean the lens with a soft, lint-free cloth and non-abrasive cleaner.
- The rear of the vehicle is hit or damaged, causing the camera to become misaligned.

Guidelines

Note: The guidelines are only available when the transmission is in **R**.

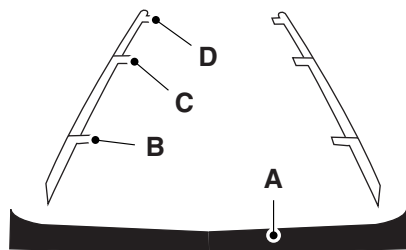

- A. Rear bumper
- B. Fixed guideline: Red zone
- C. Fixed guideline: Yellow zone
- D. Fixed guideline: Green zone

Always use caution while reversing. Objects in the red zone are closest to your vehicle and objects in the green zone are further away. Objects are getting closer to your vehicle as they move from the green zone to the yellow or red zones. Use the side view mirrors and rear view mirror to get better coverage on both sides and rear of the vehicle.

Rear Camera Delay

The camera image in the rear view mirror remains on for a few seconds to assist in parking or attaching a trailer.

PRINCIPLES OF OPERATION

Cruise control lets you maintain a set speed without keeping your foot on the accelerator pedal.

USING CRUISE CONTROL

 **WARNING:** Do not use cruise control in heavy traffic, on winding roads or when the road surface is slippery. This could result in loss of vehicle control, serious injury or death.

 **WARNING:** When you are going downhill, your vehicle speed may increase above the set speed. The system will not apply the brakes. Change down a gear to assist the system in maintaining the set speed. Failure to do so could result in loss of vehicle control, serious injury or death.

Note: Cruise control will disengage if your vehicle speed decreases more than 10 mph (16 km/h) below your set speed while driving uphill.

The cruise controls are located on the steering wheel.

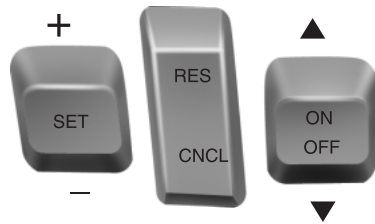
**Switching Cruise Control On**

Press the **ON** control up and release.



The indicator will appear in the instrument cluster.

Setting a Speed

1. Accelerate to the desired speed.
2. Press the **SET** control upward and release.
3. Take your foot off the accelerator pedal.

The indicator will change colors in the instrument cluster.

Changing the Set Speed

Note: If you accelerate by pressing the accelerator pedal, the set speed will not change. When you release the accelerator pedal, you will return to the speed that you previously set.

- Press **SET** up or down and hold to increase or decrease the set speed. Release the control when you reach the desired speed.
- Press **SET** up or down and release. The set speed will change in approximately 1 mph (2 km/h) increments.
- Press the accelerator pedal or brake pedal until you reach the desired speed. Press **SET** up and release.

Canceling the Set Speed

Press **CNCL** or tap the brake pedal. The set speed will not be erased.

Resuming the Set Speed

Press and release **RES**.

Switching Cruise Control Off

Note: The set speed is erased when you switch off cruise control.

Press the **OFF** control down and release or turn off the ignition.

BLIND SPOT INFORMATION SYSTEM (BLIS®) WITH CROSS TRAFFIC ALERT (CTA) (IF EQUIPPED)

! **WARNING:** To help avoid injuries, NEVER use the BLIS® as a replacement for using the interior and exterior mirrors and looking over your shoulder before changing lanes. BLIS® is not a replacement for careful driving.

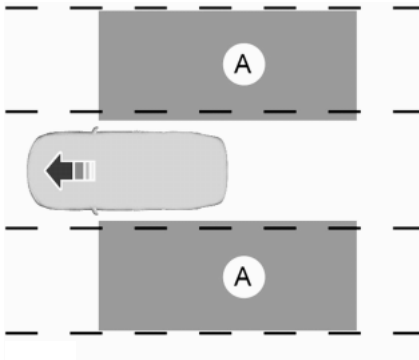

BLIS® aids the driver in detecting vehicles that may have entered the blind spot zone (A). The detection area is on both sides of the vehicle, extending rearward from the exterior mirrors to approximately 10 feet (3 meters) beyond the bumper. The system alerts you if certain vehicles enter the blind spot zone while driving.

CTA warns the driver of vehicles approaching from the sides when the transmission is in R (Reverse).

Note: BLIS® is not designed to prevent contact with other vehicles or objects; or to detect parked vehicles, people, animals or infrastructure (fences, guardrails, trees, etc.). It is designed to alert the driver to vehicles in the blind zones.

Note: When a vehicle passes quickly through the blind zone (typically fewer than two seconds), the system does not trigger.

Using the Systems

BLIS® turns on when the engine is started and the vehicle is driven forward above 3 mph (5 km/h); it remains on while the transmission is in D (Drive) or N (Neutral). If shifted out of D (Drive) or N (Neutral), the system enters CTA mode. Once shifted back into D (Drive), BLIS® turns back on when the vehicle is driven above 3 mph (5 km/h).

Note: BLIS® does not function in R (Reverse) or P (Park) or provide any additional warning when a turn signal is on.

CTA detects approaching vehicles from up to 45 feet (14 meters) away though coverage decreases when the sensors are blocked. Reversing slowly helps increase the coverage area and effectiveness.

WARNING: To help avoid personal injury, NEVER use the CTA system as a replacement for using the interior and exterior mirrors and looking over your shoulder before backing out of a parking space. CTA is not a replacement for careful driving.

In this first example, the left sensor is only partially obstructed; zone coverage is nearly maximized.

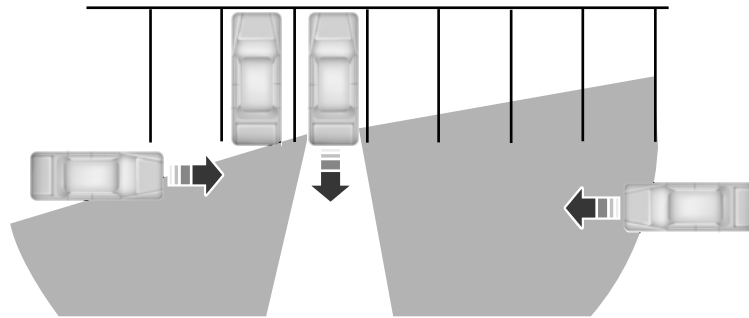

Zone coverage also decreases when parking at shallow angles. Here, the left sensor is mostly obstructed; zone coverage on that side is severely limited.

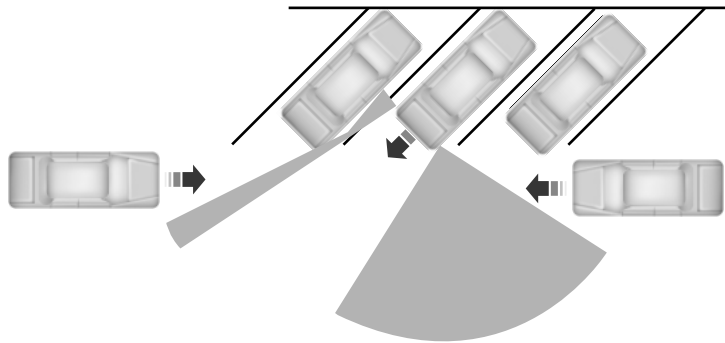

System Lights and Messages



The BLIS® and CTA systems illuminate a yellow alert indicator in the outside mirror on the side of the vehicle the approaching vehicle is coming from.

Note: The alert indicator dims when nighttime darkness is detected.

CTA also sounds an audible alarm and a message appears in the information display indicating a vehicle is coming from the right or left. CTA works with the reverse sensing system which sounds its own audible alarm; see the *Parking Aids* chapter.

System Sensors

WARNING: Just prior to the system recognizing a blocked condition and alerting the driver, the number of missed objects will increase. To help avoid injuries, NEVER use the BLIS® as a replacement for using the side and rear view mirrors and looking over your shoulder before changing lanes. BLIS® is not a replacement for careful driving.

Note: It is possible to get a blockage warning with no blockage present; this is rare and known as a false blockage warning. A false blocked condition either self-corrects or clears after a key cycle.

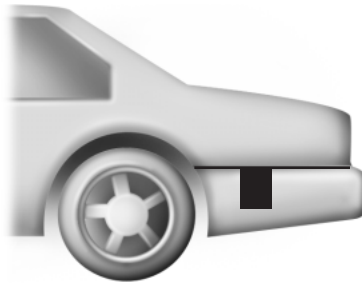

The system uses radar sensors which are located behind the bumper fascia on each side of the vehicle. Do not allow these areas to become obstructed by mud, snow or bumper stickers, as this can cause degraded system performance.

If the system detects a degraded performance condition, a blocked sensor warning or low visibility warning will appear in the information display and the alert indicator illuminates in the appropriate mirror(s). The information display warning can be cleared but the alert indicator remains illuminated.

When the blockage is removed, the system can be reset in two ways: 1) when at least two objects are detected while driving, or 2) turn the ignition key from on to off, then back on. If the blockage is still present after the key cycle, the system senses again that it is blocked after driving in traffic.

Reasons for messages being displayed	
The radar surface is dirty or obstructed	Clean the fascia area in front of the radar or remove the obstruction.
The radar surface is not dirty or obstructed	Drive normally in traffic for a few minutes to allow the radar to detect passing vehicles so it can clear the blocked state.
Heavy rainfall/snowfall interferes with the radar signals	No action required. The system automatically resets to an unblocked state once the rainfall/snowfall rate decreases or stops. Do not use BLIS® and/or CTA in these conditions.

System Limitations

The BLIS® and CTA systems do have their limitations; situations such as severe weather conditions or debris build-up on the sensor area may limit vehicle detection.

The following are other situations that may limit the BLIS®:

- Certain maneuvering of vehicles entering and exiting the blind zone.
- Vehicles passing through the blind zone at very fast rates.
- When several vehicles forming a convoy pass through the blind zone.

The following are other situations that may limit the CTA system:

- Adjacently parked vehicles or objects obstructing the sensors.
- Approaching vehicles passing at speeds greater than 15 mph (24 km/h).
- Driving in reverse faster than 3 mph (5 km/h).
- Backing out of an angled parking spot.

False Alerts

Note: If you connected a trailer to your vehicle the BLIS® system may detect the trailer causing a false alert. To avoid false alerts you may want to turn the BLIS off manually.

There may be certain instances when either the BLIS® or CTA systems illuminate the alert indicator with no vehicle in the coverage zone; this is known as a false alert. Some amount of false alerts are normal; they are temporary and self-correct.

System Errors

If either system senses a problem with the left or right sensor, the BLIS® indicator in the information display will illuminate and remain on. Also, **BLIND SPOT SYSTEM FAULT** or **CROSS TRAFFIC SYSTEM FAULT** message will appear. When problems that may cause the left or right indicator not to illuminate, only the information display message faults appear.

Switching the Systems Off and On

One or both systems can be switched off temporarily by using the information display control; refer to the *Information Display* chapter. When the BLIS® is switched off, the driver does not receive alerts and the information display shows BLIND SPOT SYS OFF and/or CTA SYSTEM OFF. The system switches back on whenever the ignition is switched on.

One or both systems can also be switched off permanently at your authorized dealer. Once switched off, switching it back on must also be done at the dealership.

STEERING**Electric Power Steering**

WARNING: The electric power steering system has diagnostic checks that continuously monitor the system to ensure proper operation. When a system error is detected a steering message will appear in the information display.



WARNING: The electric power steering system has diagnostic checks that continuously monitor the system to ensure proper operation of the electronic system. When an electronic error is detected, a message will be displayed in the information display. If this happens, stop the vehicle in a safe place, and turn off the engine. After at least 10 seconds, reset the system by restarting the engine, and watch the information display for a steering message. If a steering message returns, or returns while driving, take the vehicle to your dealer to have it checked.



WARNING: Obtain immediate service if a system error is detected. You may not notice any difference in the feel of your steering, but a serious condition may exist. Failure to do so may result in loss of steering control.

Your vehicle is equipped with an electric power-assisted steering system. There is no fluid reservoir to check or fill.

If your vehicle loses electrical power while you are driving (or if the ignition is turned off), you can steer the vehicle manually, but it takes more effort. Extreme continuous steering may increase the effort it takes for you to steer. This occurs to prevent internal overheating and permanent damage to your steering system. If this should occur, you will neither lose the ability to steer the vehicle manually nor will it cause permanent damage. Typical steering and driving maneuvers will allow the system to cool and steering assist will return to normal.

When a steering system error is detected, steering messages may appear in the information display.

Steering Tips

If the steering wanders or pulls, check for:

- an improperly inflated tire
- uneven tire wear
- loose or worn suspension components
- loose or worn steering components
- improper vehicle alignment

A high crown in the road or high crosswinds may also make the steering seem to wander/pull.

CARGO MANAGEMENT**Load Safe Label**

Refer to the label on the trunk lid or liftgate for additional information about the spare wheel and tire.

Load Floor

Do not permanently remove the foam structure under the load floor that surrounds the spare tire. It is necessary to properly support the load floor.

The maximum load floor cargo weight, evenly distributed and with a full size spare tire installed, is:

- Utility — 800 pounds (362 kilograms)
- Sedan — 420 pounds (190 kilograms)

Cargo Vault (If Equipped)

Use the key to lock and unlock the door. Turn the handle to open it.

Electronic Utility Tray (If Equipped, Sedan Only)

Note: Make sure the key is not in the trunk vault before moving the tray rearward.

Note: You must latch the tray in the forward position before operating the vehicle. This helps prevent damage to your vehicle or equipment.



You can use the tray to mount electronic equipment. It will latch in either the full-forward or full-rearward position. Push down on the levers on both sides of the tray to release the latches and move the tray.

ROOF RACKS AND LOAD CARRIERS (IF EQUIPPED, UTILITY ONLY)

! **WARNING:** When loading the roof rail crossbars, it is recommended to evenly distribute the load, as well as maintain a low center of gravity. Loaded vehicles, with higher centers of gravity, may handle differently than unloaded vehicles. Extra precautions, such as slower speeds and increased stopping distance, should be taken when driving a heavily loaded vehicle.

Note: The maximum recommended load is 100 pounds (45 kilograms), evenly distributed on the crossbars.

Note: Never place loads directly on the roof panel. The roof panel is not designed to directly carry a load.

For proper function of the roof rack system, you must place loads directly on crossbars affixed to the roof rack side rails. Your vehicle may be equipped with factory-installed crossbars. Ford Genuine Accessory crossbars, designed specifically for your vehicle, are also recommended for use with your roof rack system.

Make sure that the load is securely fastened. Check the tightness of the load before driving and at each fuel stop.

Adjusting the Crossbars (If Equipped)

Note: Wind noise can be minimized by either removing or repositioning the crossbars when they are not in use. Position the rear crossbar fully rearward and the front crossbar 10 inches (25 centimeters) from the front end-cap.

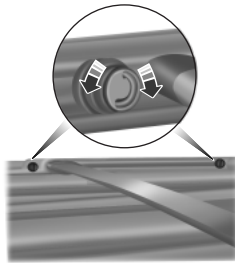

1. Loosen the tie-down hooks at both sides of the crossbar by turning them counterclockwise. A small screwdriver or similar tool can be used to break the torque by inserting the shaft into the tie-down hook and twisting.
2. Slide the crossbar to the desired position. This may require someone on each side of the crossbar.
3. Tighten the tie-down hooks at both sides of the crossbar by turning them clockwise until tight. A small screwdriver or similar tool can be used to

tighten the hook an additional half turn.

Make sure to check that the tie-down hooks are tight each time a load is added or removed from the roof rack, and periodically while traveling. Make sure that the load is secure before traveling.

LOAD LIMIT**Vehicle Loading – With and Without a Trailer**

This section will guide you in the proper loading of your vehicle and/or trailer, to keep your loaded vehicle weight within its design rating capability, with or without a trailer. Properly loading your vehicle will provide maximum return of vehicle design performance. Before loading your vehicle, familiarize yourself with the following terms for determining your vehicle's weight ratings, with or without a trailer, from the vehicle's Tire Label or Safety Compliance Certification Label:

Base Curb Weight – is the weight of the vehicle including a full tank of fuel and all standard equipment. It does not include passengers, cargo, or optional equipment.

Vehicle Curb Weight – is the weight of your new vehicle when you picked it up from your authorized dealer plus any aftermarket equipment.

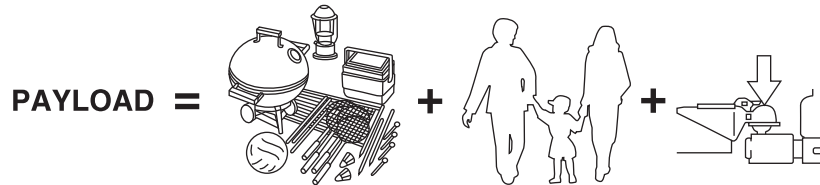

Payload – is the combined weight of cargo and passengers that the vehicle is carrying. The maximum payload for your vehicle can be found on the Tire Label on the B-Pillar or the edge of the driver's door (vehicles exported outside the US and Canada may not have a Tire Label). Look for **“THE COMBINED WEIGHT OF OCCUPANTS AND CARGO SHOULD NEVER EXCEED XXX kg OR XXX lb.”** for maximum payload. The payload listed on the Tire Label is the maximum payload for the vehicle as built by the assembly plant. If any aftermarket or authorized-dealer installed equipment has been installed on the vehicle, the weight of the equipment must be subtracted from the payload listed on the Tire Label in order to determine the new payload.



WARNING: The appropriate loading capacity of your vehicle can be limited either by volume capacity (how much space is available) or by payload capacity (how much weight the vehicle should carry). Once you have reached the maximum payload of your vehicle, do not add more cargo, even if there is space available. Overloading or improperly loading your vehicle can contribute to loss of vehicle control and vehicle rollover.

Example only:

TIRE AND LOADING INFORMATION

SEATING CAPACITY TOTAL 5 FRONT 2 REAR 3

The combined weight of occupants and cargo should never exceed : XXX kg or XXX lbs.

TIRE	SIZE	COLD TIRE PRESSURE	SEE OWNERS MANUAL FOR ADDITIONAL INFORMATION
FRONT	LT225/75R 16.5E	200 KPA, 29 PSI	
REAR	LT225/75R 16.5E	200 KPA, 29 PSI	
SPARE	T145/80D16 P225/60R17	420 KPA, 60 PSI 200 KPA, 29 PSI	

TIRE AND LOADING INFORMATION
RENSEIGNEMENTS SUR LES PNEUS ET LE CHARGEMENT

SEATING CAPACITY TOTAL 5 FRONT 2 REAR 3
NOMBRE DE PLACES TOTAL 5 AVANT 2 ARRIERE 3

The combined weight of occupants and cargo should never exceed 492 kg or 1085 lbs.
Le poids total des occupants et du chargement ne doit jamais dépasser 492 kg ou 1085 lb.

TIRE PNEU	SIZE DIMENSIONS	COLD TIRE PRESSURE PRESSION DES PNEUS A FROID	SEE OWNER'S MANUAL FOR ADDITIONAL INFORMATION
FRONT AVANT	P235/70R16	240 KPA, 35 PSI	VOIR LE MANUEL DE L'USAGER POUR PLUS DE RENSEIGNEMENTS
REAR ARRIERE	P235/70R16	240 KPA, 35 PSI	
SPARE DE SECOURS	T145/90R17	415 KPA, 60 PSI	

CARGO =

=



+

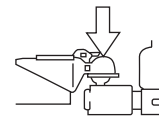

Cargo Weight – includes all weight added to the Base Curb Weight, including cargo and optional equipment. When towing, trailer tongue load weight is also part of cargo weight.

GAW (Gross Axle Weight) – is the total weight placed on each axle (front and rear) – including vehicle curb weight and all payload.

GAWR (Gross Axle Weight Rating) – is the maximum allowable weight that can be carried by a single axle (front or rear). **These numbers are shown on the Safety Compliance Certification Label. The label shall be affixed to either the door hinge pillar, door-latch post, or the door edge that meets the door-latch post, next to the driver's seating position. The total load on each axle must never exceed its GAWR.**

Note: For trailer towing information refer to *Trailer towing* found in this chapter or the *RV and Trailer Towing Guide* provided by your authorized dealer.

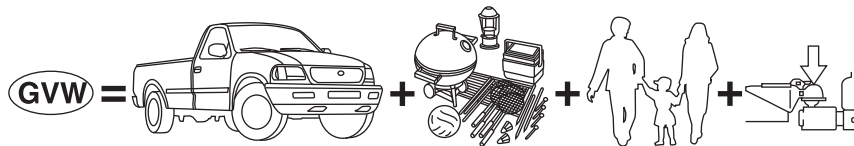

GVW (Gross Vehicle Weight) – is the Vehicle Curb Weight + cargo + passengers.

GVWR (Gross Vehicle Weight Rating) – is the maximum allowable weight of the fully loaded vehicle (including all options, equipment, passengers and cargo). **The GVWR is shown on the Safety Compliance Certification Label. The label shall be affixed to either the door hinge pillar, door-latch post, or the door edge that meets the door-latch post, next to the driver's seating position. The GVW must never exceed the GVWR.**

- Example only:

MFD. BY FORD MOTOR CO.

DATE: XX/XX GVWR: XXXXXLB/ XXXXXKG
 FRONT GAWR: XXXXL REAR GAWR: XXXXLB
 XXXXKG WITH XXXXKG WITH
 XXXX/XXXXXX TIRES: XXXX/XXXXXX TIRES
 XXXX.XX RIMS: XXXX.XX RIMS
 AT XXX kPa/XX PSI COLD AT XXX kPa/XX PSI COLD

THIS VEHICLE CONFORMS TO ALL APPLICABLE FEDERAL MOTOR VEHICLE SAFETY STANDARDS IN EFFECT ON THE DATE OF MANUFACTURE SHOWN ABOVE.

VIN: XXXXXXXXXXXXXXXXXXXX XXXXX
 TYPE: XXX XXXXX



EXT PNT: XX RC: XX DSO:
 WB¹ INT TR¹ TP/PS¹ R¹ AXLE¹ TR¹ SPR¹ XXXXX
 XXX XX X XX X XX XXX

XXXXXXXXXXXXXXXX XXX XXXX-XXXXXXXX-XX

MFD. BY FORD MOTOR CO.

DATE: xx/xx GVWR/PNBV: xxxxx LB/xxxxxKG
 FRONT GAWR/PNBE AV / REAR GAWR/ PNBE AR
 xxxxx/xxxxxB / xxxxxKG/xxxxxB
 WITH/AVEC TIRES/PNEUS
 xxxxx/xxxxx
 xxxxx/xxxxx
 xxxxxx RIMS/JANTES xxxxxx

AT/A kPa/PSI/LPC xxx/xx COLD/A FROID xxx/xx
 /JUMELEES

VIN: xxxxxxxxxxxxxxxxxxxx
 TYPE: xxx/xxxxx COMPLIES: xxxxx/xxx-xxx xxxxxx
 xxxxxx



EXT PNT: U RC: xx DSO:
 WB¹ INT TR¹ TP/PS¹ R¹ AXLE¹ TR¹ SPR¹ xxxxxx
 xxx xx x xx x xxxxx xxx

XXXXXXXXXXXXXXXX XXX XXXX-XXXXXXXX-XX



WARNING: Exceeding the Safety Compliance Certification Label vehicle weight rating limits could result in substandard vehicle handling or performance, engine, transmission and/or structural damage, serious damage to the vehicle, loss of control and personal injury.



GCW (Gross Combined Weight) – is the weight of the loaded vehicle (GVW) plus the weight of the fully loaded trailer.

GCWR (Gross Combined Weight Rating) – is the maximum allowable weight of the vehicle and the loaded trailer – including all cargo and passengers – that the vehicle can handle without risking damage.

(Important: The towing vehicle's braking system is rated for operation at GVWR, not at GCWR. Separate functional brakes should be used for safe control of towed vehicles and for trailers where the GCW of the towing vehicle plus the trailer exceed the GVWR of the towing vehicle. **The GCW must never exceed the GCWR.**

Maximum Loaded Trailer Weight – is the highest possible weight of a fully loaded trailer the vehicle can tow. It assumes a vehicle with only mandatory options, no cargo (internal or external), a tongue load of 10–15% (conventional trailer), and driver only (150 lb. [68 kg]). **Consult your authorized dealer (or the *RV and Trailer Towing Guide* provided by your authorized dealer) for more detailed information.**



WARNING: Do not exceed the GVWR or the GAWR specified on the Safety Compliance Certification Label.



WARNING: Do not use replacement tires with lower load carrying capacities than the original tires because they may lower the vehicle's GVWR and GAWR limitations. Replacement tires with a higher limit than the original tires do not increase the GVWR and GAWR limitations.



WARNING: Exceeding any vehicle weight rating limitation could result in serious damage to the vehicle and/or personal injury.

Steps for determining the correct load limit:

1. Locate the statement "The combined weight of occupants and cargo should never exceed XXX kg or XXX lbs." on your vehicle's placard.
2. Determine the combined weight of the driver and passengers that will be riding in your vehicle.
3. Subtract the combined weight of the driver and passengers from XXX kg or XXX lbs.
4. The resulting figure equals the available amount of cargo and luggage load capacity. For example, if the "XXX" amount equals 1,400 lbs. and there will be five 150 lb. passengers in your vehicle, the amount of available cargo and luggage load capacity is 650 lbs. ($1400 - 750$ (5×150) = 650 lb.).
5. Determine the combined weight of luggage and cargo being loaded on the vehicle. That weight may not safely exceed the available cargo and luggage load capacity calculated in Step 4.
6. If your vehicle will be towing a trailer, load from your trailer will be transferred to your vehicle. Consult this manual to determine how this reduces the available cargo and luggage load capacity of your vehicle.

The following gives you a few examples on how to calculate the available amount of cargo and luggage load capacity:

- Suppose your vehicle has a 1400 lb. (635 kg) cargo and luggage capacity. You decide to go golfing. Is there enough load capacity to carry you, 4 of your friends and all the golf bags? You and four friends average 220 lb. (99 kg) each and the golf bags weigh approximately 30 lb. (13.5 kg) each. The calculation would be: $1,400 - (5 \times 220) - (5 \times 30) = 1,400 - 1,100 - 150 = 150$ lb. Yes, you have enough load capacity in your vehicle to transport four friends and your golf bags. In metric units, the calculation would be: $635 \text{ kg} - (5 \times 99 \text{ kg}) - (5 \times 13.5 \text{ kg}) = 635 - 495 - 67.5 = 72.5$ kg.
- Suppose your vehicle has a 1400 lb. (635 kg) cargo and luggage capacity. You and one of your friends decide to pick up cement from the local home improvement store to finish that patio you have been planning for the past 2 years. Measuring the inside of the vehicle with the rear seat folded down, you have room for 12-100 lb. (45 kg) bags of cement. Do you have enough load capacity to transport the cement to your home? If you and your friend each weigh 220 lb. (99 kg), the calculation would be: $1,400 - (2 \times 220) - (12 \times 100) = 1,400 - 440 - 1,200 = -240$ lb. No, you do not have enough cargo capacity to carry that much weight. In metric units, the calculation would be: $635 \text{ kg} - (2 \times 99 \text{ kg}) - (12 \times 45 \text{ kg}) = 635 - 198 - 540 = -103$ kg. You will need

to reduce the load weight by at least 240 lb. (104 kg). If you remove 3-100 lb. (45 kg) cement bags, then the load calculation would be:

$1,400 - (2 \times 220) - (9 \times 100) = 1,400 - 440 - 900 = 60$ lb. Now you have the load capacity to transport the cement and your friend home. In metric units, the calculation would be: $635 \text{ kg} - (2 \times 99 \text{ kg}) - (9 \times 45 \text{ kg}) = 635 - 198 - 405 = 32$ kg.

The above calculations also assume that the loads are positioned in your vehicle in a manner that does not overload the Front or the Rear Gross Axle Weight Rating specified for your vehicle on the Safety Compliance Certification Label. The label shall be affixed to either the door hinge pillar, door-latch post, or the door edge that meets the door-latch post, next to the driver's seating position.

Special Loading Instructions for Owners of Pick-up Trucks and Utility-type Vehicles



WARNING: Loaded vehicles may handle differently than unloaded vehicles. Extra precautions, such as slower speeds and increased stopping distance, should be taken when driving a heavily loaded vehicle.

Your vehicle can haul more cargo and people than most passenger cars. Depending upon the type and placement of the load, hauling cargo and people may raise the center of gravity of the vehicle.

TOWING A TRAILER

WARNING: Do not exceed the GVWR or the GAWR specified on the certification label.



WARNING: Towing trailers beyond the maximum recommended gross trailer weight exceeds the limit of your vehicle and could result in engine damage, transmission damage, structural damage, loss of vehicle control, vehicle rollover and personal injury.

Note: For information on electrical items such as fuses or relays, see the *Fuses* chapter.

The load capacity of your vehicle is designated by weight not volume. You may not necessarily be able to use all available space when loading your vehicle or trailer.

Towing a trailer places extra load on the engine, transmission, axle, brakes, tires, and suspension. Inspect these components before, during and after towing.

Load Placement

To help minimize how trailer movement affects your vehicle when driving:

- Load the heaviest items closest to the trailer floor.
- Load the heaviest items centered between the left and right side trailer tires.
- Load the heaviest items above the trailer axles or just slightly forward toward the trailer tongue. Do not allow the final trailer tongue weight to go above or below 10–15% of the loaded trailer weight.
- Select a tow bar with the correct rise or drop. When both the loaded vehicle and trailer are connected, the trailer frame should be level, or slightly angled down toward your vehicle, when viewed from the side.

When driving with a trailer or payload, a slight takeoff vibration or shudder may be present due to the increased payload weight. You can find more information about proper trailer loading and setting your vehicle up for towing under *Load limit* in the *Load Carrying* chapter.

You can also find information in the *RV and Trailer Towing Guide* available at your authorized dealer.

RECOMMENDED TOWING WEIGHTS

Note: Do not tow a trailer during patrol or pursuit situations.

Note: Do not exceed the trailer weight for your vehicle configuration listed in the chart below.

Note: Make sure to take into consideration trailer frontal area. Do not exceed:

- 12 feet² (1.11 meters²) trailer frontal area on sedans.
- 20 feet² (1.86 meters²) trailer frontal area on utility vehicles.

Note: For high altitude operation, reduce the gross combined weight by 2% per 1000 feet (300 meters) starting at the 1000 foot (300 meter) elevation point.

Note: Certain states require electric trailer brakes for trailers over a specified weight. Be sure to check state regulations for this specified weight. The maximum trailer weights listed may be limited to this specified weight, as your vehicle's electrical system may not include the wiring connector needed to use electric trailer brakes.

Your vehicle may tow a trailer provided the maximum trailer weight is less than or equal to the maximum trailer weight listed for your vehicle configuration on the following chart.

Sedan	
Powertrain	Maximum trailer weight
2.0L GTDI front-wheel drive	1000 lb (454 kg)
3.5L TiVCT front-wheel drive	1000 lb (454 kg)
3.5L TiVCT all-wheel drive	1000 lb (454 kg)
3.5L GTDI all-wheel drive	1000 lb (454 kg)
3.7L TiVCT all-wheel drive	1000 lb (454 kg)
Utility	
Powertrain	Maximum trailer weight
3.5L GTDI all-wheel drive	2500 lb (1134 kg)
3.7L TiVCT front-wheel drive	2500 lb (1134 kg)
3.7L TiVCT all-wheel drive	2500 lb (1134 kg)

ESSENTIAL TOWING CHECKS

Follow these guidelines for safe towing:

- Do not tow a trailer until you drive your vehicle at least 1000 miles (1600 kilometers).
- Consult your local motor vehicle laws for towing a trailer.
- See the instructions included with towing accessories for the proper installation and adjustment specifications.
- Service your vehicle more frequently if you tow a trailer. See your scheduled maintenance information.
- If you use a rental trailer, follow the instructions the rental agency gives you.

For load specification terms found on the tire label and Safety Compliance label and for instructions on calculating your vehicle's load, refer to *Load limit* in the *Load Carrying* chapter.

Remember to account for the trailer tongue weight as part of your vehicle load when calculating the total vehicle weight.

Hitches

Do not use a hitch that either clamps onto the bumper or attaches to the axle.

Distribute the trailer load so 10-15% of the total trailer weight is on the tongue.

Safety Chains

Note: Never attach safety chains to the bumper.

Always connect the safety chains to the hook retainers of your vehicle hitch.

To connect the safety chains, cross them under the trailer tongue and allow enough slack for turning tight corners. Do not allow the chains to drag on the ground.

Trailer Brakes

WARNING: Do not connect a trailer's hydraulic brake system directly to your vehicle's brake system. Your vehicle may not have enough braking power and your chances of having a collision greatly increase.

Electric brakes and manual, automatic or surge-type trailer brakes are safe if you install them properly and adjust them to the manufacturer's specifications. The trailer brakes must meet local and federal regulations.

The rating for the tow vehicle's braking system operation is at the gross vehicle weight rating, not the gross combined weight rating.

Separate functioning brake systems are required for safe control of towed vehicles and trailers weighing more than 1500 pounds (680 kilograms) when loaded.

Trailer Lamps



WARNING: Never connect any trailer lamp wiring to the vehicle's tail lamp wiring; this may damage the electrical system resulting in a fire. Contact an authorized dealer as soon as possible for assistance in proper trailer tow wiring installation. Additional electrical equipment may be required.

Trailer lamps are required on most towed vehicles. Make sure all running lights, brake lights, turn signals and hazard lights are working.

Before Towing a Trailer

Practice turning, stopping and backing up to get the feel of your vehicle-trailer combination before starting on a trip. When turning, make wider turns so the trailer wheels clear curbs and other obstacles.

When Towing a Trailer

- Do not drive faster than 70 mph (113 km/h) during the first 500 miles (800 kilometers).
- Do not make full-throttle starts.
- Check your hitch, electrical connections and trailer wheel lug nuts thoroughly after you have traveled 50 miles (80 kilometers).
- When stopped in congested or heavy traffic during hot weather, place the gearshift in position **P** to aid engine and transmission cooling and to help air conditioning performance.
- Turn off the speed control with heavy loads or in hilly terrain. The speed control may turn off automatically when you are towing on long, steep grades.
- Shift to a lower gear when driving down a long or steep hill. Do not apply the brakes continuously, as they may overheat and become less effective.

- If your transmission is equipped with a Grade Assist or Tow/Haul feature, use this feature when towing. This provides engine braking and helps eliminate excessive transmission shifting for optimum fuel economy and transmission cooling.
- Allow more distance for stopping with a trailer attached. Anticipate stops and brake gradually.
- Avoid parking on a grade. However, if you must park on a grade:
 1. Turn the steering wheel to point your vehicle tires away from traffic flow.
 2. Set your vehicle parking brake.
 3. Place the automatic transmission in position **P**.
 4. Place wheel chocks in front and back of the trailer wheels.
(Chocks not included with vehicle.)

Launching or Retrieving a Boat or Personal Watercraft (PWC)

Note: Disconnect the wiring to the trailer **before** backing the trailer into the water.

Note: Reconnect the wiring to the trailer **after** removing the trailer from the water.

When backing down a ramp during boat launching or retrieval:

- Do not allow the static water level to rise above the bottom edge of the rear bumper.
- Do not allow waves to break higher than 6 inches (15 centimeters) above the bottom edge of the rear bumper.

Exceeding these limits may allow water to enter vehicle components:

- Causing internal damage to the components.
- Affecting driveability, emissions, and reliability.

Replace the rear axle lubricant anytime the rear axle submerges in water. Water may have contaminated the rear axle lubricant, which does not normally require checking or changing unless it is leaking or other axle repair is required.

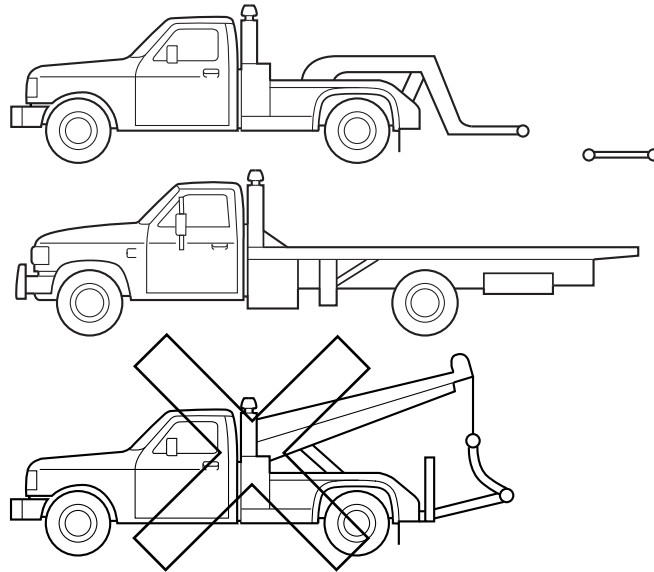
TRANSPORTING THE VEHICLE

If you need to have your vehicle towed, contact a professional towing service or, if you are a member of a roadside assistance program, your roadside assistance service provider.

We recommend the use of a wheel lift and dollies or flatbed equipment to tow your vehicle. Do not tow with a slingbelt. Ford Motor Company has not approved a slingbelt towing procedure. Vehicle damage may occur if towed incorrectly, or by any other means.

Ford Motor Company produces a towing manual for all authorized tow truck operators. Have your tow truck operator refer to this manual for proper hook-up and towing procedures for your vehicle.

It is acceptable to have your front-wheel drive vehicle towed from the front if using proper wheel lift equipment to raise the front wheels off the ground. When towing in this manner, the rear wheels can remain on the ground.

Front-wheel drive vehicles must have the front wheels placed on a tow dolly when towing your vehicle from the rear using wheel lift equipment. This prevents damage to the transmission.

Towing an all-wheel drive vehicle requires that all wheels be off the ground, such as using a wheel lift and dollies or flatbed equipment. This prevents damage to the transmission, all-wheel drive system and vehicle.

TOWING THE VEHICLE ON FOUR WHEELS

Emergency Towing

If your vehicle becomes inoperable (without access to wheel dollies, car-hauling trailer, or flatbed transport vehicle), it can be flat-towed (all wheels on the ground, regardless of the powertrain and transmission configuration) under the following conditions:

- Your vehicle is facing forward for towing in a forward direction.
- Place the transmission in position **N**. See *Automatic transmission* in the *Transmission* chapter if you cannot move the transmission into **N**.
- Maximum speed is 35 mph (56 km/h).
- Maximum distance is 50 miles (80 kilometers).

Recreational Towing

Vehicles Equipped with a 2.0L Engine

Note: Put your climate control system in recirculated air mode to prevent exhaust fumes from entering your vehicle. See the *Climate Control* chapter.

Follow these guidelines if you have a need for recreational towing, such as towing your vehicle behind a motorhome. We designed these guidelines to prevent damage to your transmission.

Front-wheel drive vehicles **CANNOT** be flat-towed (all wheels on the ground) as vehicle or transmission damage may occur. You must place the front wheels on a two-wheel tow dolly. If you are using a tow dolly, follow the instructions specified by the equipment provider.

Vehicles Equipped with a 3.5L or 3.7L Engine

Note: Put your climate control system in recirculated air mode to prevent exhaust fumes from entering your vehicle. See the *Climate Control* chapter.

Follow these guidelines if you have a need for recreational towing, such as towing your vehicle behind a motorhome or truck. We designed these guidelines to prevent damage to your vehicle after it is hooked-up to the recreational vehicle or tow dolly.

You can tow your front-wheel drive vehicle with all four wheels on the ground or with the front wheels off the ground by using a tow dolly. If you are using a tow dolly, follow the instructions specified by the equipment provider. If you are towing with all four wheels on the ground, see the following instructions.

You can tow your all-wheel drive vehicle with all four wheels on the ground or with all four wheels off the ground using a vehicle transport trailer. Do not tow your all-wheel drive vehicle with the front wheels off the ground (by using a tow dolly) and the rear wheels on the ground. This causes damage to your all-wheel drive system. If you are using a vehicle transport trailer, follow the instructions specified by the equipment provider. If you are towing with all four wheels on the ground, see the following instructions.

If you tow your vehicle with all four wheels on the ground:

- Tow only in the forward direction.
- Release the parking brake.
- Place the transmission in position **N**.
- Do not exceed 65 mph (105 km/h).
- Start the engine and allow it to run for five minutes at the beginning of each day and every six hours thereafter. With the engine running and your foot on the brake, shift into position **D** and then into position **R** before shifting back into position **N**.

BREAKING-IN

You need to break in new tires for approximately 300 miles (480 kilometers). During this time, your vehicle may exhibit some unique driving characteristics. Avoid driving too fast during the first 1000 miles (1600 kilometers). Vary your speed frequently and change up through the gears early. Do not labor the engine. Do not tow during the first 1000 miles (1600 kilometers).

ECONOMICAL DRIVING

Fuel economy is affected by several things, such as how you drive, the conditions you drive under and how you maintain your vehicle.

There are some things to keep in mind that may improve your fuel economy:

- Accelerate and slow down in a smooth, moderate fashion.
- Drive at steady speeds without stopping.
- Anticipate stops; slowing down may eliminate the need to stop.
- Combine errands and minimize stop-and-go driving.
- Close the windows for high-speed driving.
- Drive at reasonable speeds (traveling at 55 mph [88 km/h] uses 15% less fuel than traveling at 65 mph [105 km/h]).
- Keep the tires properly inflated and use only the recommended size.
- Use the recommended engine oil.
- Perform all regularly scheduled maintenance.

There are also some things you may not want to do because they may reduce your fuel economy:

- Sudden or hard accelerations.
- Rev the engine before turning it off.
- Idle for periods longer than one minute.
- Warm up your vehicle on cold mornings.
- Use the air conditioner or front defroster.
- Use the speed control in hilly terrain.
- Rest your foot on the brake pedal while driving.
- Drive a heavily loaded vehicle or tow a trailer.
- Carry unnecessary weight (approximately 1 mpg [0.4 km/L] is lost for every 400 pounds [180 kilograms] of weight carried).

- Add particular accessories to your vehicle (e.g.; bug deflectors, rollbars or light bars, running boards, ski racks).
- Drive with the wheels out of alignment.

DRIVING THROUGH WATER



WARNING: Drive through water in an emergency only, and not as part of normal driving.



WARNING: Engine damage can occur if water enters the air filter.

Note: Driving through deep water may allow water into the transmission or air intake and can cause internal vehicle damage or cause it to stall.

Note: Once through the water, always dry the brakes by moving your vehicle slowly while applying light pressure on the brake pedal.

If driving through deep or standing water is unavoidable, proceed very slowly. Never drive through water that is higher than the bottom of the wheel rims (for cars) or the bottom of the hubs (for trucks).

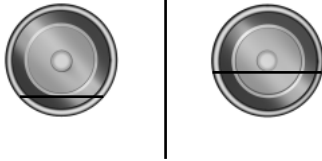

When driving through water, traction or brake capability may be limited. Also, water may enter your engine's air intake and severely damage your engine or your vehicle may stall.

Wet brakes do not stop the vehicle as quickly as dry brakes.

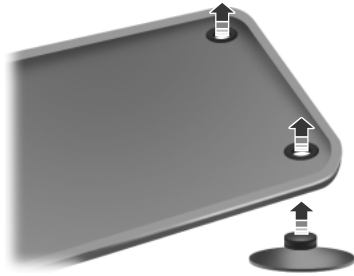
FLOOR MATS (IF EQUIPPED)

- !** **WARNING:** Always use floor mats that are designed to fit the foot well of your vehicle. Only use floor mats that leave the pedal area unobstructed. Only use floor mats that are firmly secured to retention posts so that they cannot slip out of position and interfere with the pedals or impair safe operation of your vehicle in other ways.
- Incorrectly fitted floor mats can cause the accelerator pedal to become stuck in the open position. This can cause loss of vehicle control.
 - Always correctly install the floor mats to the retention posts so that they cannot slip out of position or obstruct pedal operation.
 - Do not place unsecured floor mats or any other covering in the foot well.
 - Do not place additional floor mats or any other covering on top of the original floor mats. This will reduce the pedal clearance and interfere with the pedal operation.
 - Do not allow objects to fall or become trapped under the pedals of your vehicle. This can cause loss of vehicle control.
 - Carry out regular inspections to make sure the floor mats are secure.

To install the floor mats, position the floor mat eyelet over the retention post and press down to lock in position.

Remove in reverse order.

ROADSIDE ASSISTANCE**Vehicles Sold in the United States: Getting Roadside Assistance**

To fully assist you should you have a vehicle concern, Ford Motor Company offers a complimentary Roadside Assistance program. This program is separate from the New Vehicle Limited Warranty. The service is available:

- 24 hours a day, seven days a week.
- For the coverage period listed on the Roadside Assistance Card included in your Owner's Manual portfolio.

Roadside assistance will cover:

- A flat tire change with a good spare (except vehicles that have been supplied with a tire inflation kit).
- Battery jump start.
- Lock-out assistance (key replacement cost is the customer's responsibility).
- Fuel delivery – Independent Service Contractors, if not prohibited by state, local or municipal law, shall deliver up to 2.0 gallons (7.5 liters) of gasoline or 5.0 gallons (18.9 liters) of diesel fuel to a disabled vehicle. Fuel delivery service is limited to two no-charge occurrences within a 12-month period.
- Winch out – available within 100 feet (30.5 meters) of a paved or county maintained road, no recoveries.
- Towing – Ford eligible vehicles will be towed to an authorized dealer within 35 miles (56.3 kilometers) of the disablement location or to the nearest authorized dealer. If a member requests to be towed to an authorized dealer more than 35 miles (56.3 kilometers) from the disablement location, the member shall be responsible for any mileage costs in excess of 35 miles (56.3 kilometers).

Roadside Assistance will include up to \$200 coverage for a towed trailer if the disabled eligible vehicle requires service at the nearest authorized dealer. If the towing vehicle is operational but the trailer is not, then the trailer does not qualify for any roadside services.

Vehicles Sold in the United States: Using Roadside Assistance

Complete the roadside assistance identification card and place it in your wallet for quick reference. This card is found in the owner's manual portfolio in the glove compartment.

U.S. Ford vehicle customers who require Roadside Assistance, call 1-800-241-3673.

If you need to arrange roadside assistance for yourself, Ford Motor Company will reimburse a reasonable amount for towing to the nearest dealership within 35 miles (56.3 kilometers). To obtain reimbursement information, U.S. Ford vehicle customers call 1-800-241-3673. Customers will be asked to submit their original receipts.

Vehicles Sold in Canada: Getting Roadside Assistance

Canadian clients who require roadside assistance, call 1-800-665-2006.

Vehicles Sold in Canada: Using Roadside Assistance

For your convenience, you may complete the roadside assistance identification card found in the centerfold of this warranty guide and retain for future reference.

Canadian roadside coverage and benefits may differ from the U.S. coverage. If you require more information, please refer to the coverage section of your warranty guide, call us in Canada at 1-800-665-2006 or visit our website at www.ford.ca.

HAZARD WARNING FLASHERS



The hazard flasher control is located on the instrument panel by the radio. Use it when your vehicle is disabled and is creating a safety hazard for other motorists.

- Press the flasher control and all front and rear direction signals will flash.
- Press the flasher control again to turn them off.

Note: With extended use, the flashers may run down your 12-volt battery.

FUEL SHUTOFF



WARNING: Failure to inspect and if necessary repair fuel leaks after a collision may increase the risk of fire and serious injury. Ford Motor Company recommends that the fuel system be inspected by an authorized dealer after any collision.

In the event of a moderate to severe collision, this vehicle is equipped with a fuel pump shut-off feature that stops the flow of fuel to the engine. Not every impact will cause a shut-off.

Should your vehicle shut off after a collision, you may restart your vehicle by doing the following:

1. Switch off the ignition and wait 10 seconds.
2. Switch on the ignition.
3. Repeat steps 1 and 2 to re-enable fuel pump.

Note: When you try to restart your vehicle after a fuel shutoff, the vehicle makes sure that various systems are safe to restart. One your vehicle determines that the systems are safe, then the vehicle will allow you to restart.

Note: In the event that your vehicle does not restart after your third attempt, contact an authorized dealer.

JUMP-STARTING THE VEHICLE



WARNING: The gases around the battery can explode if exposed to flames, sparks, or lit cigarettes. An explosion could result in injury or vehicle damage.



WARNING: Batteries contain sulfuric acid which can burn skin, eyes and clothing, if contacted.

Do not attempt to push-start your automatic transmission vehicle. Automatic transmissions do not have push-start capability. Attempting to push-start a vehicle with an automatic transmission may cause transmission damage.

When the battery is disconnected or a new battery is installed, the automatic transmission must relearn its shift strategy. As a result, the transmission may exhibit a combination of firm and soft shifts. This operation is considered normal and will not affect function or durability of the transmission. Over time, the adaptive learning process will fully update transmission operation.

Preparing Your Vehicle

Note: Use only a 12-volt supply to start your vehicle.

Note: Do not disconnect the battery of the disabled vehicle as this could damage the vehicle's electrical system.

1. Park the booster vehicle close to the hood of the disabled vehicle making sure the two vehicles do not touch. Set the parking brake on both vehicles and stay clear of the engine cooling fan and other moving parts.

2. Check all battery terminals. Remove the positive terminal cover (if equipped) and any excessive corrosion before you attach the battery cables. Ensure that vent caps are tight and level.
3. Turn the heater fan on in both vehicles to protect from any electrical surges. Turn all other accessories off.

Connecting the Jumper Cables



WARNING: Do not connect the end of the second cable to the negative (-) terminal of the battery to be jumped. A spark may cause an explosion of the gases that surround the battery.

Note: Do not attach the negative (-) cable to fuel lines, engine rocker covers, the intake manifold or electrical components as grounding points.

Note: In the illustration, the vehicle on the bottom is used to designate the assisting (boosting) battery.

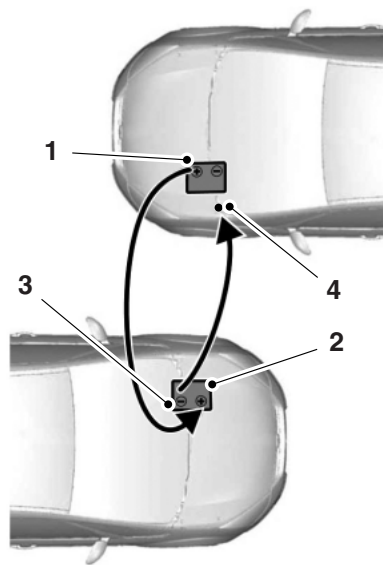

1. Connect the positive (+) jumper cable to the positive (+) terminal of the discharged battery.
2. Connect the other end of the positive (+) cable to the positive (+) terminal of the assisting battery.
3. Connect the negative (-) cable to the negative (-) terminal of the assisting battery.
4. Make the final connection of the negative (-) cable to an exposed metal part of the stalled vehicle's engine, away from the battery and the carburetor or fuel injection system.

Ensure that the cables are clear of fan blades, belts, moving parts of both engines, or any fuel delivery system parts.

Jump Starting

1. Start the engine of the booster vehicle and run the engine at a moderately increased speed.
2. Start the engine of the disabled vehicle.
3. Once the disabled vehicle has been started, run both engines for an additional three minutes before disconnecting the jumper cables.

Removing the Jumper Cables

Note: In the illustration, the vehicle on the bottom is used to designate the assisting (boosting) battery.

Remove the jumper cables in the reverse order that they were connected.

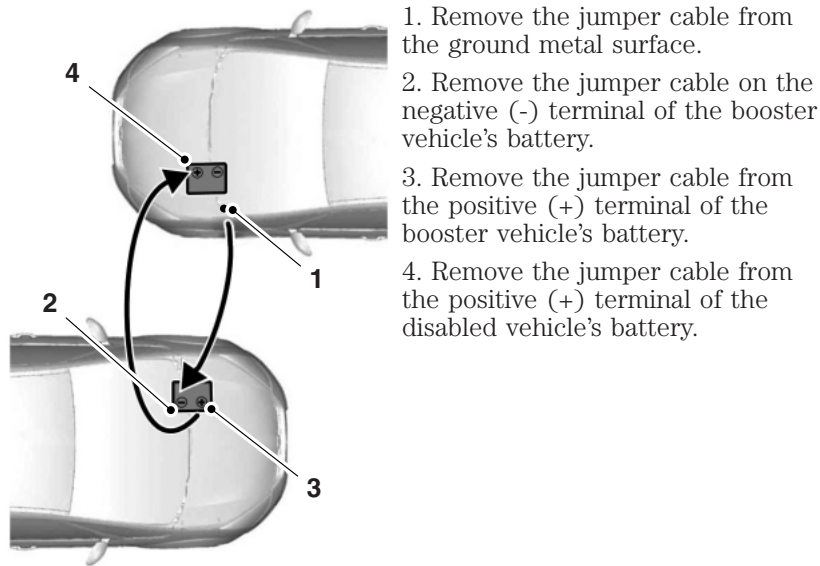

After the disabled vehicle has been started and the jumper cables removed, allow it to idle for several minutes so the engine computer can relearn its idle conditions.

GETTING THE SERVICES YOU NEED

Warranty repairs to your vehicle must be performed by an authorized dealer. While any authorized dealer handling your vehicle line will provide warranty service, we recommend you return to your selling authorized dealer who wants to ensure your continued satisfaction.

Please note that certain warranty repairs require special training, equipment or both, so not all authorized dealers are authorized to perform all warranty repairs. This means that, depending on the warranty repair needed, you may have to take your vehicle to another authorized dealer.

A reasonable time must be allowed to perform a repair after taking your vehicle to the authorized dealer. Repairs will be made using Ford or Motorcraft parts, or remanufactured or other parts that are authorized by Ford.

Away from Home

If you are away from home when your vehicle needs service, contact the Ford Customer Relationship Center or use the online resources listed below to find the nearest authorized dealer.

In the United States:

Mailing Address

Ford Motor Company
Customer Relationship Center
P.O. Box 6248
Dearborn, MI 48121

Telephone

1-800-392-3673 (FORD)
(TDD for the hearing impaired: 1-800-232-5952)

Online

Additional information and resources are available online at www.fordowner.com.

These are some of the items that can be found online:

- U.S. Dealer Locator by Dealer Name, City/State, or Zip Code
- Owner Manuals
- Maintenance Schedules
- Recalls
- Ford Extended Service Plans
- Ford Genuine Accessories
- Service specials and promotions.

In Canada:

Mailing address

Customer Relationship Centre
Ford Motor Company of Canada, Limited
P.O. Box 2000
Oakville, Ontario L6K 1C8

Telephone

1-800-565-3673 (FORD)

Online

www.ford.ca

Twitter

@FordServiceCA (English Canada)

@FordServiceQC (Quebec)

Additional Assistance

If you have questions or concerns, or are unsatisfied with the service you are receiving, follow these steps:

1. Contact your Sales Representative or Service Advisor at your selling or servicing authorized dealer.
2. If your inquiry or concern remains unresolved, contact the Sales Manager, Service Manager or Customer Relations Manager.
3. If you require assistance or clarification on Ford Motor Company policies, please contact the Ford Customer Relationship Center.

In order to help serve you better, please have the following information available when contacting a Customer Relationship Center:

- Vehicle Identification Number (VIN)
- Your telephone number (home and business)
- The name of the authorized dealer and city where located
- The vehicle's current odometer reading.

In some states, you must directly notify Ford in writing before pursuing remedies under your state's warranty laws. Ford is also allowed a final repair attempt in some states.

In the United States, a warranty dispute must be submitted to the BBB AUTO LINE before taking action under the Magnuson-Moss Warranty Act, or to the extent allowed by state law, before pursuing replacement or repurchase remedies provided by certain state laws. This dispute handling procedure is not required prior to enforcing state created rights

or other rights which are independent of the Magnuson-Moss Warranty Act or state replacement or repurchase laws.

IN CALIFORNIA (U.S. ONLY)

California Civil Code Section 1793.2(d) requires that, if a manufacturer or its representative is unable to repair a motor vehicle to conform to the vehicle's applicable express warranty after a reasonable number of attempts, the manufacturer shall be required to either replace the vehicle with one substantially identical or repurchase the vehicle and reimburse the buyer in an amount equal to the actual price paid or payable by the consumer (less a reasonable allowance for consumer use). The consumer has the right to choose whether to receive a refund or replacement vehicle.

California Civil Code Section 1793.22(b) presumes that the manufacturer has had a reasonable number of attempts to conform the vehicle to its applicable express warranties if, within the first 18 months of ownership of a new vehicle or the first 18000 mi (29 000 km), whichever occurs first:

1. Two or more repair attempts are made on the same nonconformity likely to cause death or serious bodily injury OR
2. Four or more repair attempts are made on the same nonconformity (a defect or condition that substantially impairs the use, value or safety of the vehicle) OR
3. The vehicle is out of service for repair of nonconformities for a total of more than 30 calendar days (not necessarily all at one time).

In the case of 1 or 2 above, the consumer must also notify the manufacturer of the need for the repair of the nonconformity at the following address:

Ford Motor Company
16800 Executive Plaza Drive
Mail Drop 3NE-B
Dearborn, MI 48126

You are required to submit your warranty dispute to BBB AUTO LINE before asserting in court any rights or remedies conferred by California Civil Code Section 1793.22(b). You are also required to use BBB AUTO LINE before exercising rights or seeking remedies created by the Federal Magnuson-Moss Warranty Act, 15 U.S.C. sec. 2301 et seq. If you choose to seek redress by pursuing rights and remedies not created by California Civil Code Section 1793.22(b) or the Magnuson-Moss Warranty Act, resorting to BBB AUTO LINE is not required by those statutes.

**THE BETTER BUSINESS BUREAU (BBB) AUTO LINE PROGRAM
(U.S. ONLY)**

Your satisfaction is important to Ford Motor Company and to your dealer. If a warranty concern has not been resolved using the three-step procedure outlined earlier in this chapter in the *Getting the Services You Need* section, you may be eligible to participate in the BBB AUTO LINE program.

The BBB AUTO LINE program consists of two parts – mediation and arbitration. During mediation, a representative of the BBB will contact both you and Ford Motor Company to explore options for settlement of the claim. If an agreement is not reached during mediation or you do not want to participate in mediation, and if your claim is eligible, you may participate in the arbitration process. An arbitration hearing will be scheduled so that you can present your case in an informal setting before an impartial person. The arbitrator will consider the testimony provided and make a decision after the hearing.

Disputes submitted to the BBB AUTO LINE program are usually decided within 40 days after you file your claim with the BBB. You are not bound by the decision, and may reject the decision and proceed to court where all findings of the BBB Auto Line dispute, and decision, are admissible in the court action. Should you choose to accept the BBB AUTO LINE decision, Ford is then bound by the decision, and must comply with the decision within 30 days of receipt of your acceptance letter.

BBB AUTO LINE Application: Using the information provided below, please call or write to request a program application. You will be asked for your name and address, general information about your new vehicle, information about your warranty concerns, and any steps you have already taken to try to resolve them. A Customer Claim Form will be mailed that will need to be completed, signed and returned to the BBB along with proof of ownership. Upon receipt, the BBB will review the claim for eligibility under the Program Summary Guidelines.

You can get more information by calling BBB AUTO LINE at 1-800-955-5100, or writing to:

**BBB AUTO LINE
3033 Wilson Boulevard, Suite 600
Arlington, Virginia 22201**

BBB AUTO LINE applications can also be requested by calling the Ford Motor Company Customer Relationship Center at 1-800-392-3673.

Note: Ford Motor Company reserves the right to change eligibility limitations, modify procedures, or to discontinue this process at any time without notice and without obligation.

UTILIZING THE MEDIATION or ARBITRATION PROGRAM (CANADA ONLY)

This pertains to vehicles delivered to authorized Canadian dealers. In those cases, where you continue to feel that the efforts by Ford of Canada and the authorized dealer to resolve a factory-related vehicle service concern have been unsatisfactory, Ford of Canada participates in an impartial third party mediation or arbitration program administered by the Canadian Motor Vehicle Arbitration Plan (CAMVAP).

The CAMVAP program is a straightforward and relatively speedy alternative to resolve a disagreement when all other efforts to produce a settlement have failed. This procedure is without cost to you and is designed to eliminate the need for lengthy and expensive legal proceedings.

In the CAMVAP program, impartial third-party arbitrators conduct hearings at mutually convenient times and places in an informal environment. These impartial arbitrators review the positions of the parties, make decisions and, when appropriate, render awards to resolve disputes. CAMVAP decisions are fast, fair, and final as the arbitrator's award is binding on both you and Ford of Canada.

CAMVAP services are available in all Canadian territories and provinces. For more information, without charge or obligation, call your CAMVAP Provincial Administrator directly at 1-800-207-0685 or visit www.camvap.ca.

GETTING ASSISTANCE OUTSIDE THE U.S. AND CANADA

Before exporting your vehicle to a foreign country, contact the appropriate foreign embassy or consulate. These officials can inform you of local vehicle registration regulations and where to find unleaded fuel.

If you cannot find unleaded fuel or can only get fuel with an anti-knock index lower than is recommended for your vehicle, contact our Customer Relationship Center.

The use of leaded fuel in your vehicle without proper conversion may damage the effectiveness of your emission control system and may cause engine knocking or serious engine damage. Ford Motor Company or Ford of Canada is not responsible for any damage caused by use of improper fuel. Using leaded fuel may also result in difficulty importing your vehicle back into the United States.

If your vehicle must be serviced while you are traveling or living in Asia-Pacific Region, Sub-Saharan Africa, U.S. Virgin Islands, Central America, the Caribbean, and Israel, contact the nearest authorized dealer. If the authorized dealer cannot help you, contact:

FORD MOTOR COMPANY

Customer Relationship Center
1555 Fairlane Drive
Fairlane Business Park #3
Allen Park, Michigan 48101
U.S.A.
Telephone: (313) 594-4857
FAX: (313) 390-0804
Email: expcac@ford.com

For customers in Guam, the Commonwealth of the Northern Mariana Islands (CNMI), America Samoa, and the U.S. Virgin Islands, please feel free to call our Toll-Free Number:

(800) 841-FORD (3673)

If your vehicle must be serviced while you are traveling or living in Puerto Rico, contact the nearest authorized dealer. If the authorized dealer cannot help you, contact:

FORD MOTOR COMPANY

Customer Relationship Center
1555 Fairlane Drive
Fairlane Business Park #3
Allen Park, Michigan 48101
Telephone: (800) 841-FORD (3673)
FAX: (313) 390-0804
Email: prcac@ford.com
www.ford.com.pr

If your vehicle must be serviced while you are traveling or living in the Middle East, contact the nearest authorized dealer. If the authorized dealer cannot help you, contact:

FORD MOTOR COMPANY

Customer Relationship Center
1555 Fairlane Drive
Fairlane Business Park #3
Allen Park, Michigan 48101
Telephone: +971 4 3326084
Toll-Free Number of the Kingdom of Saudi Arabia: 800 8971409
Local Telephone Number of Kuwait: 24810575
FAX: +971 4 3327299
Email: menacac@ford.com
www.me.ford.com

If you buy your vehicle in North America and then relocate to any of the above locations, register your vehicle identification number (VIN) and new address with Ford Motor Company Export Operations & Global Growth Initiatives by emailing expcac@ford.com.

If you are in another foreign country, contact the nearest authorized dealer. In the event your inquiry is unresolved, communicate your concern with the dealership's Sales Manager, Service Manager or Customer Relations Manager. If you require additional assistance or clarification, please contact the respective Customer Relationship Center as previously listed.

Customers in the U.S. should call 1-800-392-3673.

ORDERING ADDITIONAL OWNER'S LITERATURE

To order the publications in this portfolio, contact Helm, Incorporated at:

HELM, INCORPORATED
47911 Halyard Drive
Plymouth, Michigan 48170
Attention: Customer Service

Or to order a free publication catalog, call toll free: 1-800-782-4356

Monday-Friday 8:00 a.m. - 6:00 p.m. EST

Helm, Incorporated can also be reached by their website:
www.helminc.com.

(Items in this catalog may be purchased by credit card, check or money order.)

Obtaining a French Owner's Manual

A French owner's manual can be obtained from your authorized dealer or by contacting Helm, Incorporated using the contact information listed previously in this section.

REPORTING SAFETY DEFECTS (U.S. ONLY)



If you believe that your vehicle has a defect which could cause a crash or could cause injury or death, you should immediately inform the National Highway Traffic Safety

Administration (NHTSA) in addition to notifying Ford Motor Company.

If NHTSA receives similar complaints, it may open an investigation, and if it finds that a safety defect exists in a group of vehicles, it may order a recall and remedy campaign. However, NHTSA cannot become involved in individual problems between you, your dealer, or Ford Motor Company.

To contact NHTSA, you may call the Vehicle Safety Hotline toll-free at 1-888-327-4236 (TTY: 1-800-424-9153); go to <http://www.safercar.gov>; or write to:

Administrator
1200 New Jersey Avenue, Southeast
Washington, D.C. 20590

You can also obtain other information about motor vehicle safety from <http://www.safercar.gov>.

REPORTING SAFETY DEFECTS (CANADA ONLY)

If you believe that your vehicle has a defect which could cause a crash or could cause injury or death, you should immediately inform Transport Canada, using their toll-free number: 1-800-333-0510, or online at: <http://www.tc.gc.ca/eng/roadsafety/menu.htm>

CHANGING A FUSE**Fuses**

 **WARNING:** Always replace a fuse with one that has the specified amperage rating. Using a fuse with a higher amperage rating can cause severe wire damage and could start a fire.

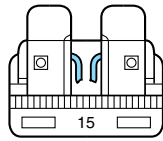

If electrical components in your vehicle are not working, a fuse may have blown. Blown fuses are identified by a broken wire within the fuse. Check the appropriate fuses before replacing any electrical components.

FUSE SPECIFICATION CHART**Power Distribution Box**

 **WARNING:** Always disconnect the battery before servicing high current fuses.

 **WARNING:** To reduce risk of electrical shock, always replace the cover to the power distribution box before reconnecting the battery or refilling fluid reservoirs.

The power distribution box is located in the engine compartment. It has high-current fuses that protect your vehicle's main electrical systems from overloads.

If the battery has been disconnected and reconnected, see *Changing the Vehicle Battery* in the *Maintenance* chapter.

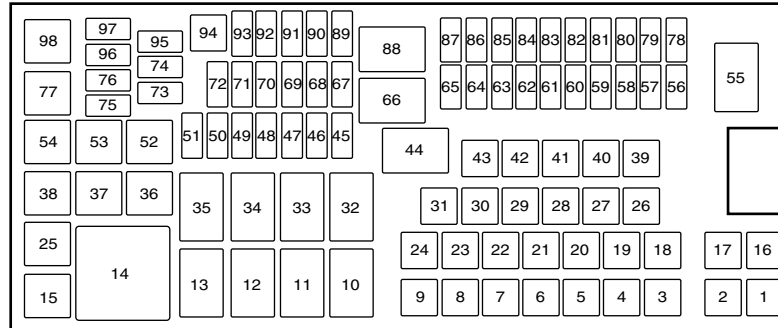

Fuse or relay number	Fuse amp rating	Protected components
1	50A**	Rear power point tap feed 1
2	50A**	Rear power point tap feed 2
3	—	Not used
4	30A**	Wiper motor relay
5	50A**	Anti-lock brake system pump
6	40A**	Center console 6-way B+ feed 2
7	—	Not used
8	20A**	PTU Cooler Pump
9	—	Not used
10	—	PTU Cooler Pump Relay
11	—	Rear window defroster relay, Mirror relay (Sedan)
12	—	Run/start relay
13	—	Starter motor relay
14	—	Engine cooling fan #2 high speed relay
15	—	Fuel pump relay

Fuse or relay number	Fuse amp rating	Protected components
16	40A**	Center console 6 way B+ feed 3
17	—	Not used
18	40A**	Front blower motor relay
19	30A**	Starter relay
20	20A**	Center console power point #2
21	—	Not used
22	—	Not used
23	30A**	Driver power seat
24	40A**	Police run/start relay
25	—	Not used
26	40A**	Rear window defrost relay
27	20A**	Center console power point #1
28	—	Not used
29	40A**	Engine cooling fan #1 high speed power, Engine cooling fan #1 and #2 low speed primary fuse
30	40A**	Engine cooling fan #2 high speed fuse
31	25A**	Engine cooling fan #1 and #2 low speed secondary fuse
32	—	Auxiliary blower motor relay (Utility)
33	—	Engine cooling fan #1 and #2 low speed relay #2
34	—	Blower motor relay
35	—	Engine cooling fan #1 high speed relay, Engine cooling fan #1 and #2 low speed relay #1
36	—	Not used
37	—	Right-hand trailer tow stop/turn lamps relay (Utility)
38	—	Not used

Fuse or relay number	Fuse amp rating	Protected components
39	40A**	Auxiliary blower motor (Utility)
40	40A**	Center console 6-way B+ feed 1
41	—	Not used
42	30A**	Passenger seat (Sedan)
43	40A**	Anti-lock brake system valves (Utility)
	20A**	Anti-lock brake system valves (Sedan)
44	—	Rear washer relay (Utility)
45	—	Not used
46	—	Not used
47	—	Not used
48	—	Not used
49	—	Not used
50	15A*	Heated mirrors
51	—	Not used
52	—	Not used
53	—	Left-hand trailer tow stop/turn lamps relay (Utility)
54	—	Not used
55	—	Wiper relay
56	—	Not used
57	—	Not used
58	10A*	Alternator A-line
59	10A*	Brake on/off switch
60	—	Not used
61	—	Not used
62	10A*	Air conditioner clutch relay
63	15A*	Trailer tow stop/turn lamps (Utility)
64	15A*	Rear wipers (Utility)
65	30A*	Fuel pump relay

Fuse or relay number	Fuse amp rating	Protected components
66	—	Powertrain control module relay
67	20A*	Oxygen sensor heater, Mass airflow sensor, Variable camshaft timing solenoid valve, Canister vent solenoid, Canister purge solenoid
68	20A*	Ignition coils
69	20A*	Vehicle power #1 (Powertrain control module)
70	15A*	(Sedan) — Air conditioner variable compressor control, Fan control relay coils, Variable air conditioning compressor, Auxiliary transmission warm-up, Turbo charge waste-gate control, Electronic compressor bypass valve, All-wheel drive module, Positive crankcase ventilation heater
	10A*	(Utility) — same as above
71	—	Not used
72	—	Not used
73	20A*	Center console run/start feed #1
74	20A*	Center console run/start feed #2
75	—	Diode
76	—	Not used
77	—	Trailer tow park lamps relay (Utility)
78	—	Not used
79	—	Not used
80	25A*	Police rear flasher / Package tray lighting access circuit (Sedan)

Fuses

205

Fuse or relay number	Fuse amp rating	Protected components
81	20A*	Spot lights
82	15A*	Rear washer (Utility)
83	—	Not used
84	20A*	Trailer tow park lamps (Utility)
85	—	Not used
86	7.5A*	Powertrain control module keep-alive power and relay, Canister vent solenoid
87	5A*	Run/start relay coil
88	—	Run/start relay
89	5A*	Front blower relay coil, Electrical power assist steering module
90	10A*	Powertrain control module run/start
91	—	Not used
92	10A*	Anti-lock brake system module
93	5A*	Rear window defroster relay, Run/start relay, Trunk release relay
94	30A**	Passenger compartment fuse panel run/start
95	2A*	Center console start feed
96	—	Not used
97	—	Not used
98	—	Air conditioner clutch relay
*Mini Fuses **Cartridge Fuses		

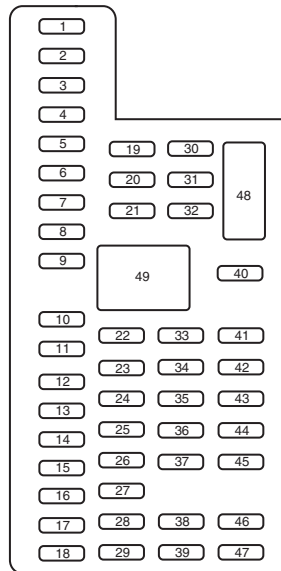
Passenger Compartment Fuse Panel

The fuse panel is located under the instrument panel to the left of the steering wheel.

Fuse or relay number	Fuse amp rating	Protected components
1	30A	Driver side front window, Rear windows (Sedan)
2	15A	Driver seat switch, 14-way B+ feed #1
3	30A	Not used (spare)
4	10A	Demand lamps battery saver relay, Glove box lamp, Visor lamps (Utility), Task lamp
5	20A	14-way B+ feed #3
6	5A	Not used (spare)
7	7.5A	Not used (spare)

Fuse or relay number	Fuse amp rating	Protected components
8	10A	Not used (spare)
9	10A	SYNC, Displays, Electronic finish panel, Radio frequency transceiver module (Sedan)
10	10A	Run accessory relay
11	10A	Cluster (Utility)
12	15A	Backlighting LED, Interior lighting, Backlighting feed
13	15A	Right rear stop/turn, Right turn (Sedan), Right rear police fuse/relay box
14	15A	Left rear stop/turn, Left turn (Sedan), Left rear police fuse/relay box
15	15A	Stop lamp, Backup lamp, High-mounted stop lamp (Utility)
16	10A	Right front low beam
17	10A	Left front low beam
18	10A	Brake shift interlock, Powertrain control module wake-up
19	20A	Police B+ #8 access circuit center console, 14-way B+ feed #2
20	20A	All lock motor relay, Driver lock motor relay
21	10A	Not used (spare)
22	20A	Horn relay
23	15A	Steering wheel control module logic, Instrument cluster, Headlamp switch (Utility)
24	15A	Steering wheel control module, Datalink
25	15A	Liftgate release (Utility)

Fuse or relay number	Fuse amp rating	Protected components
26	5A	Ignition switch (Sedan), Frequency transceiver module (Utility)
27	20A	Not used (spare)
28	15A	Ignition switch (Utility)
29	20A	Radio, GPS module
30	15A	Front park lamps
31	5A	Brake signal for police equipment
32	15A	Master window/mirror switch, Lock switch illumination, Police console inline delayed accessory feed, Delayed accessory feed
33	10A	Occupant classification module (Utility)
34	10A	Reverse park aid module, Blind spot monitor module, Rear video camera
35	5A	Motorized humidity sensor, Overdrive cancel switch (Low gear switch feed), Column shift – low gear, Headlamp switch (Utility)
36	10A	Not used (spare)
37	10A	Restraints control module (Utility)
38	10A	Auto-dimming mirror, Rear camera display mirror
39	15A	High beam headlamp shutters
40	10A	Rear park lamps, License plate lamps (Utility)
41	7.5A	Occupant classification sensor, Restraint control module (Utility), Brake shift interlock (Utility)

Fuses

209

Fuse or relay number	Fuse amp rating	Protected components
42	5A	Police 4-button steering wheel control module
43	10A	Not used (spare)
44	10A	Not used (spare)
45	5A	Not used (spare)
46	10A	Climate control module
47	15A	Not used (spare)
48	30A Circuit Breaker	Window switches
49	Relay	Delayed accessory

GENERAL INFORMATION

Have your vehicle serviced regularly to help maintain its roadworthiness and resale value. There is a large network of Ford authorized dealers who are there to help you with their professional servicing expertise. We believe that their specially trained technicians are best qualified to service your vehicle properly and expertly. They are supported by a wide range of highly specialized tools developed specifically for servicing your vehicle.

To help you service your vehicle, we provide *Scheduled Maintenance Information* which makes tracking routine service easy.

If your vehicle requires professional service, your authorized dealer can provide the necessary parts and service. Check your warranty information to find out which parts and services are covered.

Use only recommended fuels, lubricants, fluids and service parts conforming to specifications. Motorcraft® parts are designed and built to provide the best performance in your vehicle.

Precautions

- Do not work on a hot engine.
- Make sure that nothing gets caught in moving parts.
- Do not work on a vehicle with the engine running in an enclosed space, unless you are sure you have enough ventilation.
- Keep all open flames and other burning material (such as cigarettes) away from the battery and all fuel related parts.

Working with the Engine Off

1. Set the parking brake and shift to **P** (Park).
2. Turn off the engine and remove the key (if equipped).
3. Block the wheels.

Working with the Engine On

WARNING: To reduce the risk of vehicle damage or personal burn injuries, do not start your engine with the air cleaner removed and do not remove it while the engine is running.

1. Set the parking brake and shift to position **P** (Park) .
2. Block the wheels.

OPENING AND CLOSING THE HOOD**Sedan**

1. Inside the vehicle, pull the hood release handle located under the bottom of the instrument panel near the steering column.

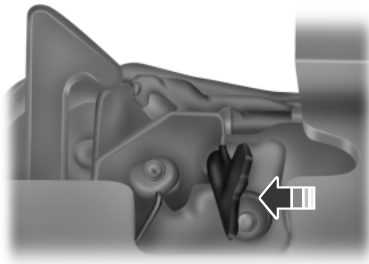

2. Go to the front of the vehicle and release the auxiliary latch that is located under the front center of the hood.

3. Lift the hood.

4. Lower the hood and allow it to drop the last 8 to 11 inches (20 to 30 centimeters).

Note: Make sure the hood is properly closed.

Utility



1. Inside the vehicle, pull the hood release handle located under the bottom left corner of the instrument panel.

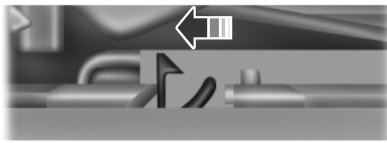

2. Go to the front of the vehicle and release the auxiliary latch that is located under the front center of the hood.

3. Raise the hood and support it with the prop rod.

4. Lower and secure the prop rod in the clip.

5. Lower the hood and allow it to drop the last 8 to 11 inches (20 to 30 centimeters).

Note: Make sure the hood is properly closed.

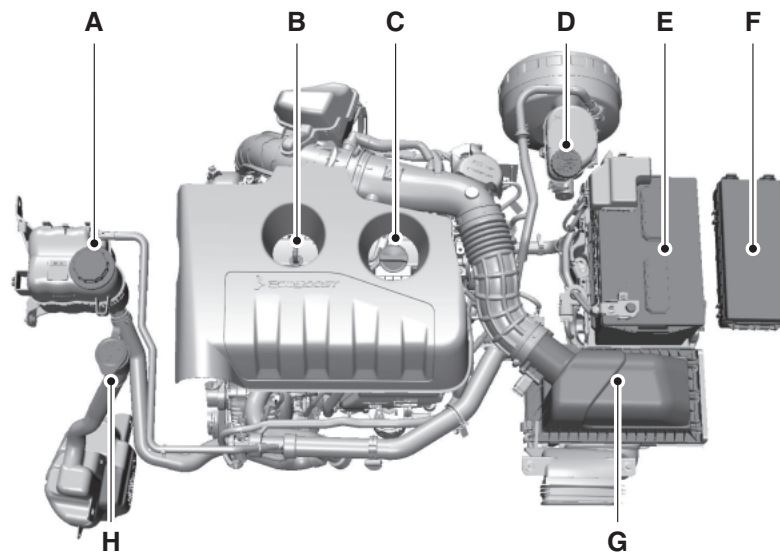
UNDER HOOD OVERVIEW**2.0L EcoBoost**

- A. Engine coolant reservoir
- B. Engine oil dipstick
- C. Engine oil filler cap
- D. Brake fluid reservoir
- E. Battery
- F. Power distribution box
- G. Air filter assembly
- H. Windshield washer fluid reservoir

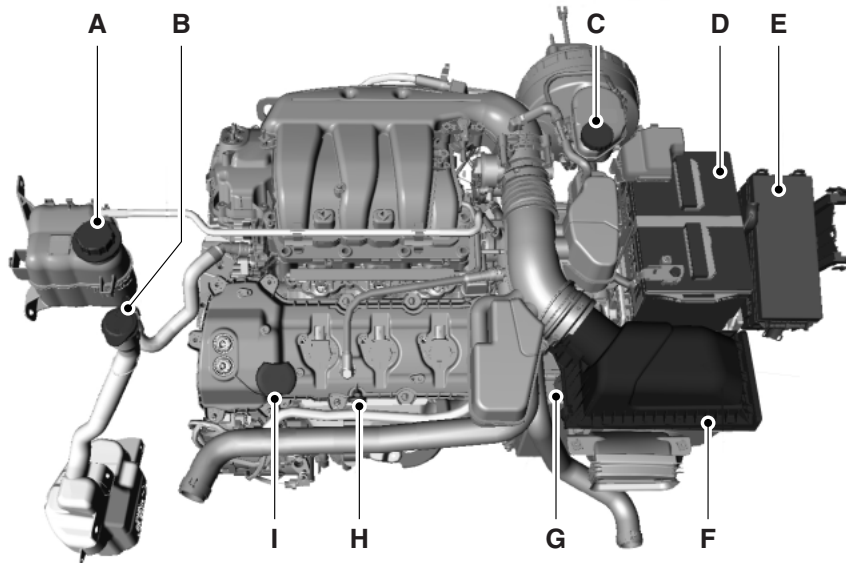
3.5L V6 engine

- A. Engine coolant reservoir
- B. Windshield washer fluid reservoir
- C. Brake fluid reservoir
- D. Battery
- E. Power distribution box
- F. Air filter assembly
- G. Automatic transmission fluid dipstick
- H. Engine oil dipstick
- I. Engine oil filler cap

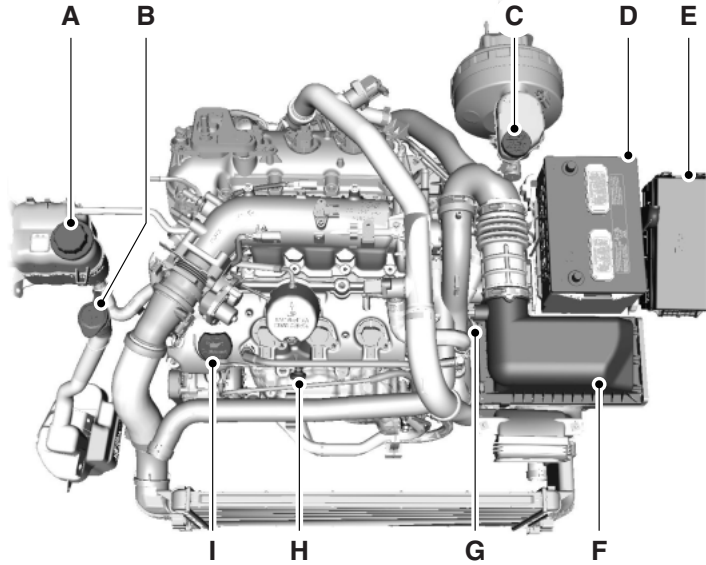
3.5L V6 EcoBoost® engine

- A. Engine coolant reservoir
- B. Windshield washer fluid reservoir
- C. Brake fluid reservoir
- D. Battery
- E. Power distribution box
- F. Air filter assembly
- G. Automatic transmission fluid dipstick
- H. Engine oil dipstick
- I. Engine oil filler cap

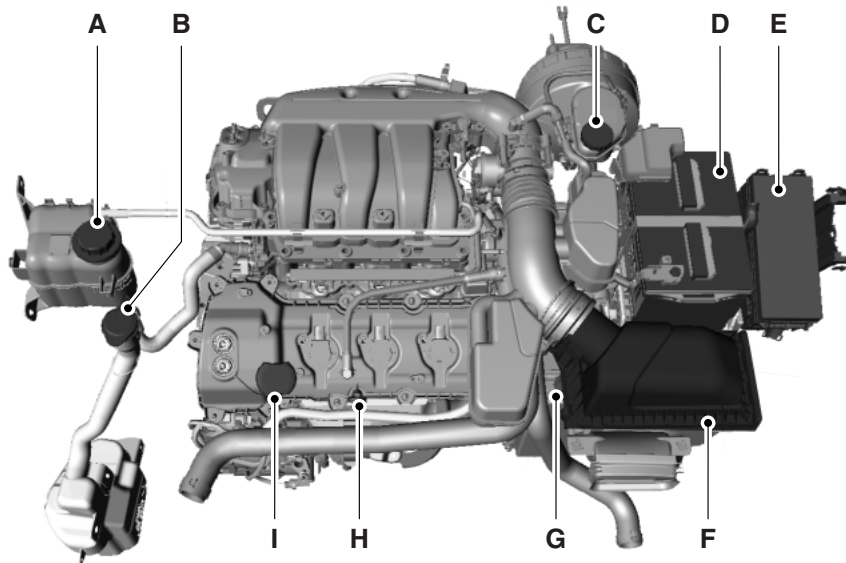
3.7L V6 engine

- A. Engine coolant reservoir
- B. Windshield washer fluid reservoir
- C. Brake fluid reservoir
- D. Battery
- E. Power distribution box
- F. Air filter assembly
- G. Automatic transmission fluid dipstick
- H. Engine oil dipstick
- I. Engine oil filler cap

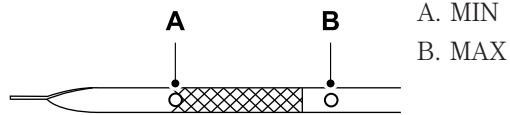
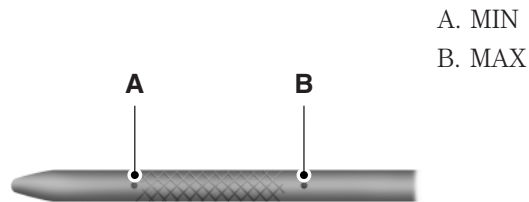
ENGINE OIL DIPSTICK**2.0L EcoBoost****3.5L, 3.7L and 3.5L EcoBoost****ENGINE OIL CHECK**

Note: Check the level before starting the engine.

Note: Make sure that the level is between the MIN and MAX marks.

1. Make sure that your vehicle is on level ground.
2. Turn the engine off and wait 10 minutes for the oil to drain into the oil pan.
3. Remove the dipstick and wipe it with a clean, lint-free cloth. Replace the dipstick and remove it again to check the oil level.

If the level is at the MIN mark, add oil immediately.

Adding Engine Oil

Note: Do not remove the filler cap when the engine is running.

Note: Do not add engine oil further than the MAX mark. Oil levels above the MAX mark may cause engine damage.



Only use oils certified for gasoline engines by the American Petroleum Institute (API). An oil with this trademark symbol conforms to the current engine and emission system protection standards and fuel economy requirements of the International Lubricants Specification Advisory Council (ILSAC), comprised of U.S. and Japanese automobile manufacturers.

1. Remove the filler cap.
2. Add engine oil that meets Ford specifications. See *Capacities and Specifications* for more information.
3. Replace the filler cap. Turn it until you feel a strong resistance.

ENGINE COOLANT CHECK

Checking the Engine Coolant

The concentration and level of engine coolant should be checked at the intervals listed in *Scheduled Maintenance Information*.

The coolant concentration should be maintained within 48% to 50%, which equates to a freeze point between -30°F (-34°C) and -34°F (-37°C).

Note: For best results, coolant concentration should be tested with a refractometer such as Robinair Coolant and Battery Refractometer 75240. We do not recommend the use of hydrometers or coolant test strips for measuring coolant concentrations.

Note: Make sure that the level is between the MIN and MAX marks on the coolant reservoir.

Note: Coolant expands when it is hot. The level may extend beyond the MAX mark.

If the level is at the MIN mark, add coolant immediately. See *Adding Engine Coolant* in this chapter.

Note: Automotive fluids are not interchangeable. Do not use engine coolant/antifreeze or windshield washer fluid outside of its specified function and vehicle location.

Adding Engine Coolant



WARNING: Do not add engine coolant when the engine is hot. Steam and scalding liquids released from a hot cooling system can burn you badly. Also, you can be burned if you spill coolant on hot engine parts.

 **WARNING:** Do not put engine coolant in the windshield washer fluid container. If sprayed on the windshield, engine coolant could make it difficult to see through the windshield.

 **WARNING:** To reduce the risk of personal injury, make sure the engine is cool before unscrewing the coolant pressure relief cap. The cooling system is under pressure; steam and hot liquid can come out forcefully when the cap is loosened slightly.

 **WARNING:** Do not add coolant further than the MAX mark.

Note: Do not use stop leak pellets, cooling system sealants or additives as they can cause damage to the engine cooling or heating systems. This damage would not be covered under your vehicle's warranty.

Note: During normal vehicle operation, the engine coolant may change color from orange to pink or light red. As long as the engine coolant is clear and uncontaminated, this color change does not indicate the engine coolant has degraded nor does it require the engine coolant to be drained, the system to be flushed, or the engine coolant to be replaced.

- DO NOT MIX different colors or types of coolant in your vehicle. Make sure the correct coolant is used. Mixing of engine coolants may harm your engine's cooling system. The use of an improper coolant may harm engine and cooling system components and may void the warranty.
- In case of emergency, a large amount of water without engine coolant may be added in order to reach a vehicle service location. In this instance, the cooling system must be drained, chemically cleaned with Motorcraft Premium Cooling System Flush, and refilled with engine coolant as soon as possible. Water alone (without engine coolant) can cause engine damage from corrosion, overheating or freezing.
- Do not use alcohol, methanol, brine or any engine coolants mixed with alcohol or methanol antifreeze (coolant). Alcohol and other liquids can cause engine damage from overheating or freezing.
- Do not add extra inhibitors or additives to the coolant. These can be harmful and compromise the corrosion protection of the engine coolant.

Unscrew the cap slowly. Any pressure will escape as you unscrew the cap.

Add prediluted engine coolant meeting the Ford specification. See *Capacities and Specifications* for more information.

Whenever coolant has been added, the coolant level in the coolant reservoir should be checked the next few times you drive the vehicle. If necessary, add enough prediluted engine coolant to bring the coolant level to the proper level.

Recycled Engine Coolant

Ford Motor Company does NOT recommend the use of recycled engine coolant since a Ford-approved recycling process is not yet available.



Used engine coolant should be disposed of in an appropriate manner. Follow your community's regulations and standards for recycling and disposing of automotive fluids.

Severe Climates

If you drive in extremely cold climates:

- It may be necessary to have a Ford authorized dealer increase the coolant concentration above 50%.
- A coolant concentration of 60% will provide improved freeze point protection. Engine coolant concentrations above 60% will decrease the overheat protection characteristics of the engine coolant and may cause engine damage.

If you drive in extremely hot climates:

- It may be necessary to have a Ford authorized dealer decrease the coolant concentration to 40%.
- A coolant concentration of 40% will provide improved overheat protection. Engine coolant concentrations below 40% will decrease the corrosion and freeze protection characteristics of the engine coolant and may cause engine damage.

Vehicles driven year-round in non-extreme climates should use prediluted engine coolant for optimum cooling system and engine protection.

Engine fluid temperature management (EcoBoost engine only)



WARNING: To reduce the risk of collision and injury, be prepared that the vehicle speed may reduce and the vehicle may not be able to accelerate with full power until the fluid temperatures reduce.

Your vehicle has been designed to pull a trailer, but because of the added load, the vehicle's engine may temporarily reach higher temperatures during severe operating conditions such as ascending a long or steep grade while pulling a trailer in hot ambient temperatures.

At this time, you may notice your engine coolant temperature gauge needle move toward the H (hot) and the POWER REDUCED TO LOWER TEMP message may appear on the message center.

You may notice a reduction in the vehicle's speed caused by reduced engine power. Your vehicle has been designed to enter this mode if certain high temperature/high load conditions take place in order to manage the engine's fluid temperatures. The amount of speed reduction will depend on the vehicle loading, towing, grade, ambient temperature, and other factors. If this occurs, there is no need to pull off the road. The vehicle can continue to be driven while this message is active.

The air conditioning may also cycle on and off during severe operating conditions to protect overheating of the engine. When the engine coolant temperature decreases to a more normal operating temperature, the air conditioning will turn on once again.

If you notice any of the following:

- the engine coolant temperature gauge moves fully into the red (hot) area
 - the coolant temperature warning light illuminates
 - the service engine soon indicator illuminates
1. Pull off the road as soon as safely possible and place the vehicle in P (Park).
 2. Leave the engine running until the coolant temperature gauge needle moves away from the H range. After several minutes, if this does not happen, follow the remaining steps.
 3. Turn the engine off and wait for it to cool before checking the coolant level.



WARNING: Never remove the coolant reservoir cap while the engine is running or hot.

4. If the coolant level is normal, you may restart your engine and continue on.
5. If the coolant is low, add coolant, restart the engine and take your vehicle to an authorized dealer. See *Adding engine coolant* in this chapter for more information.

Refer to fail-safe cooling for additional information.

What you should know about fail-safe cooling

If the engine coolant supply is depleted, this feature allows the vehicle to be driven temporarily before incremental component damage is incurred. The “fail-safe” distance depends on ambient temperatures, vehicle load and terrain.

How fail-safe cooling works

If the engine begins to overheat:

- The engine coolant temperature gauge will move to the red (hot) area.



- The service engine soon indicator will illuminate.

If the engine reaches a preset over-temperature condition, the engine will automatically switch to alternating cylinder operation. Each disabled cylinder acts as an air pump and cools the engine.

When this occurs the vehicle will still operate. However:

- The engine power will be limited.
- The air conditioning system will be disabled.

Continued operation will increase the engine temperature and the engine will completely shut down, causing steering and braking effort to increase.

Once the engine temperature cools, the engine can be re-started. Take your vehicle to an authorized dealer as soon as possible to minimize engine damage.

When fail-safe mode is activated

WARNING: Fail-safe mode is for use during emergencies only.

Operate the vehicle in fail-safe mode only as long as necessary to bring the vehicle to rest in a safe location and seek immediate repairs. When in fail-safe mode, the vehicle will have limited power, will not be able to maintain high-speed operation, and may completely shut down without warning, potentially losing engine power, power steering assist, and power brake assist, which may increase the possibility of a crash resulting in serious injury.

You have limited engine power when in the fail-safe mode, so drive the vehicle with caution. The vehicle will not be able to maintain high-speed operation and the engine will run rough. Remember that the engine is capable of completely shutting down automatically to prevent engine damage, therefore:

1. Pull off the road as soon as safely possible and turn off the engine.
2. Arrange for the vehicle to be taken to an authorized dealer.
3. If this is not possible, wait a short period for the engine to cool.
4. Check the coolant level and replenish if low.



WARNING: Never remove the coolant reservoir cap while the engine is running or hot. The hot coolant is under pressure and may cause serious burns.

5. Re-start the engine and take your vehicle to an authorized dealer.

Note: Driving the vehicle without repairing the engine problem increases the chance of engine damage. Take your vehicle to an authorized dealer as soon as possible.

AUTOMATIC TRANSMISSION FLUID CHECK



WARNING: The dipstick cap and surrounding components may be hot; gloves are recommended.

Note: Automatic transmission fluid expands when warmed. To obtain an accurate fluid check, drive the vehicle until it is warmed up (approximately 20 miles [30 km]). If your vehicle has been operated for an extended period at high speeds, in city traffic during hot weather or pulling a trailer, the vehicle should be turned off until normal operating temperatures are reached to allow the fluid to cool before checking. Depending on vehicle use, cooling times could take up to 30 minutes or longer.

Refer to your *scheduled maintenance information* for scheduled intervals for fluid checks and changes. Your transmission does not consume fluid. However, the fluid level should be checked if the transmission is not working properly, i.e., if the transmission slips or shifts slowly or if you notice some sign of fluid leakage.

1. Drive the vehicle 20 miles (30 km) or until it reaches normal operating temperature.
2. Park the vehicle on a level surface and engage the parking brake.

3. With the parking brake engaged and your foot on the brake pedal, start the engine and move the gearshift lever through all of the gear ranges. Allow a minimum of 10 seconds for each gear to engage.
4. Latch the gearshift lever in P (Park) and leave the engine running.
5. Remove the dipstick, wiping it clean with a clean, dry lint free rag. If necessary, refer to *Under hood overview* in this chapter for the location of the dipstick.
6. Install the dipstick making sure it is fully seated in the filler tube by turning it to the locked position.
7. Remove the dipstick and inspect the fluid level. The fluid should be in the designated areas for normal operating temperature.

Moving the Air Filter Assembly (EcoBoost engine)



WARNING: Do not run engine with the air filter disconnected

1. Shut the engine off.
2. Clean the area around the clamp that connects the air filter assembly to the rubber hose (1).

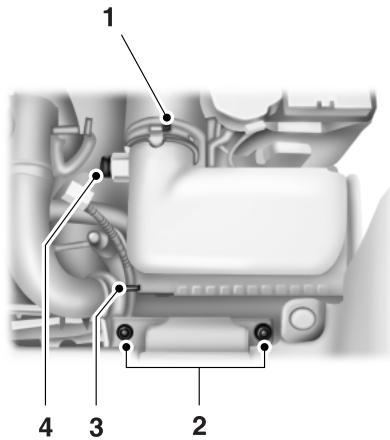

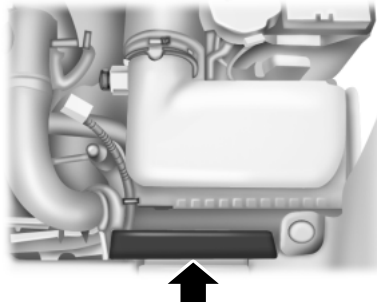

3. Remove the bolt cover (if equipped).
4. Remove two bolts that attach the air filter assembly to the front of the vehicle (2).
5. Loosen the clamp holding the air filter assembly to the rubber hose (1).
6. Remove the harness retaining clip by pulling up (3). Do not disconnect the sensor (4).

7. Without disconnecting the sensor (4), pull the air filter assembly up to disconnect the air filter assembly from the seated grommets located underneath the air filter assembly.

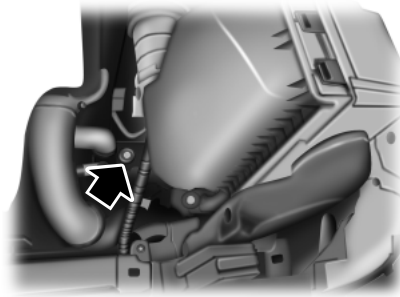

8. Rotate the air filter assembly 90 degrees counterclockwise and reinstall into the rubber hose.
9. Tighten the clamp (1).
10. The transmission fluid level indicator can now be accessed.

Low fluid level

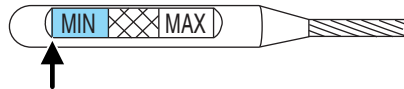

If the fluid level is below the MIN range of the dipstick, add fluid to reach the hash mark level. **Note:** If the fluid level is below the MIN level, do not drive the vehicle. An underfill condition may cause shift and/or engagement concerns and/or possible damage.

Correct fluid level

The transmission fluid should be checked at normal operating temperature 180°F-200°F (82°C-93°C) on a level surface. The normal operating temperature can be reached after approximately 20 miles (30 km) of driving.

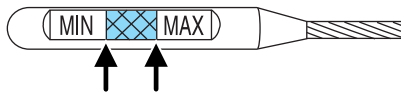

The transmission fluid level should be targeted within the cross-hatch area if at normal operating temperature 180°F-200°F (82°C-93°C).

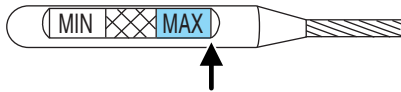
High fluid level

If the fluid level is above the MAX range of the dipstick, remove fluid to reach the hashmark level. **Note:** Fluid level above the MAX level may cause shift and/or engagement concerns and/or possible damage.

High fluid levels can be caused by an overheating condition. If your vehicle has been operated for an extended period at high speeds, in city traffic during hot weather or pulling a trailer, the vehicle should be turned off until normal operating temperatures are reached. Depending on vehicle use, cooling times could take up to 30 minutes or longer.

Adjusting automatic transmission fluid levels

Before adding any fluid, make sure the correct type is used. The type of fluid used is normally indicated on the dipstick and also in the *Capacities and Specifications* chapter.

Note: Use of a non-approved automatic transmission fluid may cause internal transmission component damage.

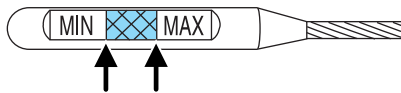

If necessary, add fluid in 1/2 pint (250 ml) increments through the filler tube until the level is correct.



If an overfill occurs, excess fluid should be removed by an authorized dealer.

Note: An overfill condition of transmission fluid may cause shift and/or engagement concerns and/or possible damage.

Do not use supplemental transmission fluid additives, treatments or cleaning agents. The use of these materials may affect transmission operation and result in damage to internal transmission components.

6F35 TRANSMISSION (if equipped)

Note: Transmission fluid should be checked by an authorized dealer. If required, fluid should be added by an authorized dealer.

The automatic transmission does not have a transmission fluid dipstick.

Refer to your *scheduled maintenance information* for scheduled intervals for fluid checks and changes. Your transmission does not consume fluid. However, the fluid level should be checked if the transmission is not working properly, (i.e., if the transmission slips or shifts slowly) or if you notice some sign of fluid leakage.

Do not use supplemental transmission fluid additives, treatments or cleaning agents. The use of these materials may affect transmission operation and result in damage to internal transmission components.

BRAKE FLUID CHECK

Fluid levels between the MIN and MAX lines are within the normal operating range; there is no need to add fluid. If the fluid levels are outside of the normal operating range, the performance of the system could be compromised; seek service from your authorized dealer immediately.

Note: Police pursuits, involving hard braking, result in high temperatures in the brake system - including the brake fluid. Over time, repeated exposure to high brake temperatures can degrade brake fluid, potentially reducing its boiling point. A lower boiling point could cause long brake pedal travel and a loss of braking confidence during subsequent pursuit driving. Ford recommends that police fleets replace the brake fluid at every brake pad service interval according to the service procedure. Brake fluid should be replaced on vehicles involved in high speed pursuits with heavy brake usage.

POWER STEERING FLUID CHECK

Your vehicle is equipped with an electric power steering (EPS) system. There is no fluid reservoir to check or fill. For additional information on the electric power steering (EPS) system, Refer to *Driving Aids*.

FUEL FILTER

Your vehicle is equipped with a lifetime fuel filter that is integrated with the fuel tank. Regular maintenance or replacement is not needed.

WASHER FLUID CHECK

WARNING: If you operate your vehicle in temperatures below 40°F (5°C), use washer fluid with antifreeze protection. Failure to use washer fluid with antifreeze protection in cold weather could result in impaired windshield vision and increase the risk of injury or accident.

Add fluid to fill the reservoir if the level is low. Only use a washer fluid that meets Ford specifications. See the technical specifications chart in the *Capacities and Specifications* chapter.

Note: The front and rear washer systems are supplied from the same reservoir.

State or local regulations on volatile organic compounds may restrict the use of methanol, a common windshield washer antifreeze additive. Washer fluids containing non-methanol antifreeze agents should be used only if they provide cold weather protection without damaging the vehicle's paint finish, wiper blades or washer system.

CHANGING THE VEHICLE BATTERY

WARNING: Batteries normally produce explosive gases which can cause personal injury. Therefore, do not allow flames, sparks or lighted substances to come near the battery. When working near the battery, always shield your face and protect your eyes. Always provide proper ventilation.



WARNING: When lifting a plastic-cased battery, excessive pressure on the end walls could cause acid to flow through the vent caps, resulting in personal injury and/or damage to the vehicle or battery. Lift the battery with a battery carrier or with your hands on opposite corners.



WARNING: Keep batteries out of reach of children. Batteries contain sulfuric acid. Avoid contact with skin, eyes or clothing. Shield your eyes when working near the battery to protect against possible splashing of acid solution. In case of acid contact with skin or eyes, flush immediately with water for a minimum of 15 minutes and get prompt medical attention. If acid is swallowed, call a physician immediately.



WARNING: Battery posts, terminals and related accessories contain lead and lead compounds. **Note:** Wash hands after handling.

Note: If your battery has a cover/shield, make sure it is reinstalled after the battery has been cleaned or replaced.

For longer, trouble-free operation, keep the top of the battery clean and dry. Also, make certain the battery cables are always tightly fastened to the battery terminals.

Note: Electrical or electronic accessories or components added to the vehicle by the dealer or the owner may adversely affect battery performance and durability.

The Motorcraft® maintenance-free battery normally does not require additional water during its life of service.

If you see any corrosion on the battery or terminals, remove the cables from the terminals and clean with a wire brush. You can neutralize the acid with a solution of baking soda and water.

It is recommended that the negative battery cable terminal be disconnected from the battery if you plan to store your vehicle for an extended period of time. This will minimize the discharge of your battery during storage.

Because your vehicle's engine is electronically controlled by a computer, some control conditions are maintained by power from the battery. When the battery is disconnected or a new battery is installed, the engine must relearn its idle and fuel trim strategy for optimum driveability and performance. To begin this process:

1. With the vehicle at a complete stop, set the parking brake.
2. Put the gearshift in P (Park), turn off all accessories and start the engine.
3. Run the engine until it reaches normal operating temperature.

4. Allow the engine to idle for at least one minute.
5. Turn the A/C on and allow the engine to idle for at least one minute.
6. Drive the vehicle to complete the relearning process.
 - The vehicle may need to be driven 10 miles (16 km) or more to relearn the idle and fuel trim strategy.
 - **Note:** If you do not allow the engine to relearn its idle trim, the idle quality of your vehicle may be adversely affected until the idle trim is eventually relearned.

If the battery has been disconnected or a new battery has been installed, the clock and radio settings must be reset once the battery is reconnected.

CHECKING THE WIPER BLADES

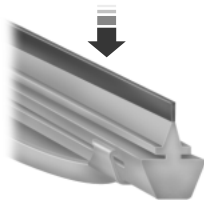

Run the tip of your fingers over the edge of the blade to check for roughness.

Clean the wiper blades with washer fluid or water applied with a soft sponge or cloth.

CHANGING THE WIPER BLADES

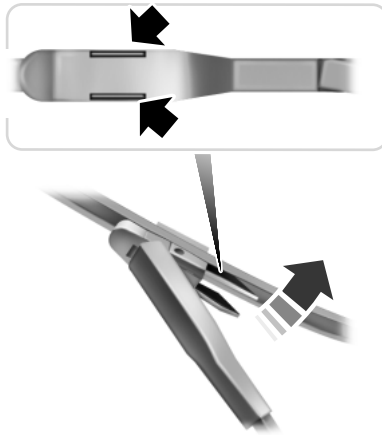

1. Pull the wiper blade and arm away from the glass.

2. Squeeze the locking tabs to release the blade from the arm and pull the blade away from the arm to remove it.

3. Attach the new blade to the arm and snap it into place.

Replace wiper blades at least once per year for optimum performance.

Poor wiper quality can be improved by cleaning the wiper blades and the windshield.

To prolong the life of the wiper blades, it is highly recommended to scrape off the ice on the windshield before turning on the wipers. The layer of ice has many sharp edges and can damage the micro edge of the wiper rubber element.

Changing the rear window wiper blade (Utility only)

To replace the rear wiper blade:

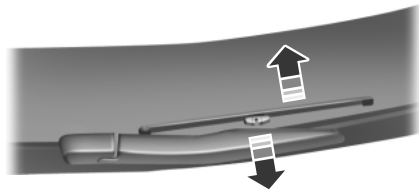

1. Press the wiper blade against the glass with one hand and hold it.

2. Pull the wiper arm away from the wiper blade to separate.

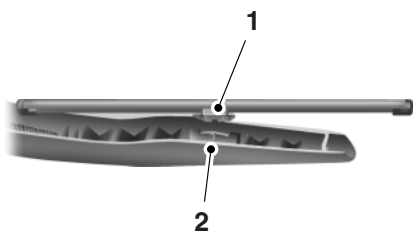

3. To attach the new wiper to the wiper arm, align the slot (1) and cross pin (2) and firmly press the wiper arm into the wiper blade until a click is heard.

If you find this procedure too difficult, please see your dealer.

AIR FILTER CHECK



WARNING: To reduce the risk of vehicle damage and/or personal burn injuries, do not start your engine with the air cleaner removed and do not remove it while the engine is running.

When changing the air filter element, use only the air filter element listed. Refer to *Motorcraft® Part Numbers* in the *Capacities and Specifications* chapter.

For EcoBoost equipped vehicles: When servicing the air cleaner, it is important that no foreign material enter the air induction system. The engine and turbocharger are susceptible to damage from even small particles.

Refer to *Scheduled Maintenance* for the appropriate intervals for changing the air filter element.

Note: Failure to use the correct air filter element may result in severe engine damage. The customer warranty may be void for any damage to the engine if the correct air filter element is not used.

Changing the air filter element

2.0L EcoBoost™ engines

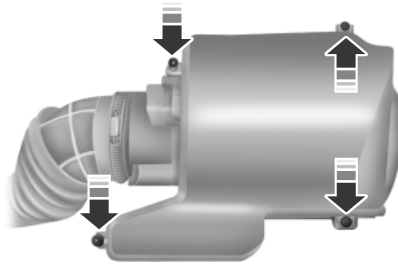

1. Loosen the screws on the air tube clamp that fasten it to the air filter assembly tray.
2. Separate the clean air tube from the air cleaner.
3. Remove the air cleaner from the vehicle.
4. Loosen the screws that secure the air filter housing cover.
5. Carefully separate the two halves of the air filter housing.
6. Remove the air filter element from the air filter housing.
7. Wipe the air filter housing and cover clean to remove any dirt or debris and to ensure good sealing.
8. Slide the open end of the air filter element in first, below the tab. Then push the closed end cap into the bottom of the tray. The closed end cap should fit inside the groove in the tray. The tab at the end of the closed end cap should be oriented down and fit between the forks on the tray.

9. Replace the air filter housing cover and secure the screws.
10. Reinstall the air cleaner assembly into the vehicle.
11. Reinstall the clean air tube assembly into the air cleaner assembly.
12. Tighten the air tube fastening screws.

Changing the air filter element

3.5L V6 engine, 3.5L EcoBoost and 3.7L engines

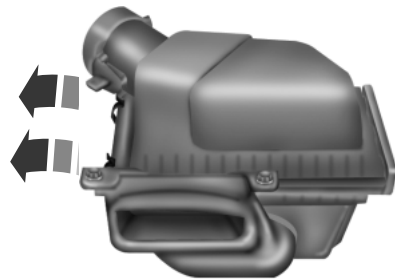

3.5L V6 engine shown, 3.5L EcoBoost and 3.7L engines similar

1. Release the clamps that secure the air filter housing cover.
2. Carefully separate the two halves of the air filter housing.
3. Remove the air filter element from the air filter housing.
4. Wipe the air filter housing and cover clean to remove any dirt or debris and to ensure good sealing.
5. Install a new air filter element. Be careful not to crimp the filter element edges between the air filter housing and cover. This could cause filter damage and allow unfiltered air to enter the engine if not properly seated.

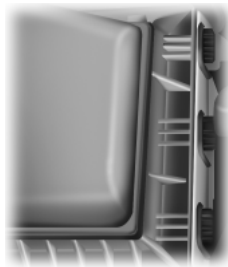

6. Replace the air filter housing cover and secure the clamps. Be sure that the air cleaner cover tabs are engaged into the slots of the air cleaner housing.

ADJUSTING THE HEADLAMPS

The headlamps on your vehicle are properly aimed at the assembly plant. If your vehicle has been in an accident, an authorized dealer should check the alignment of your headlamps.

Vertical Aim Adjustment

1. Park the vehicle directly in front of a wall or screen on a level surface, approximately 25 feet (7.6 meters) away.

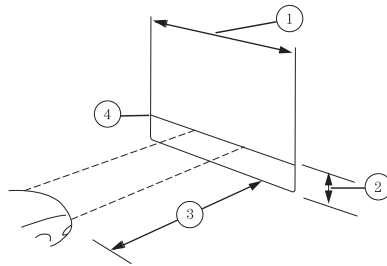

- (1) 8 feet (2.4 meters)
- (2) Center height of lamp to ground
- (3) 25 feet (7.6 meters)
- (4) Horizontal reference line

2. Measure the height of the headlamp bulb center from the ground and mark an 8 foot (2.4 meter) horizontal reference line on the vertical wall or screen at this height.

3. Turn on the low beam headlamps to illuminate the wall or screen and open the hood.

To see a clearer light pattern for adjusting, you may want to block the light from one headlamp while adjusting the other.

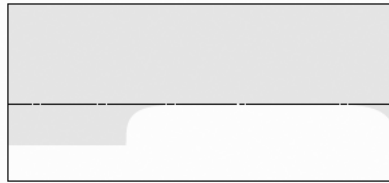

On the wall or screen you will observe a flat zone of high intensity light located at the top of the right hand portion of the beam pattern. If the top edge of the high intensity light zone is not at the horizontal reference line, the headlamp will need to be adjusted.

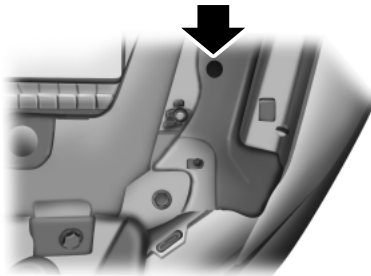
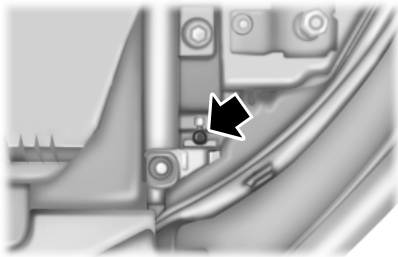
Sedan:**Utility:**

4. Locate the vertical adjuster on each headlamp. Using a Phillips number 2 screwdriver, turn the adjuster either clockwise or counterclockwise in order to adjust the vertical aim of the headlamp. The horizontal edge of the brighter light should touch the horizontal reference line.

5. Close the hood and turn off the lamps.

HORIZONTAL AIM IS NOT REQUIRED FOR THIS VEHICLE AND IS NOT ADJUSTABLE.

CHANGING A BULB**Lamp Assembly Condensation**

Exterior lamps are vented to accommodate normal changes in pressure. Condensation can be a natural by-product of this design. When moist air enters the lamp assembly through the vents, there is a possibility that condensation can occur when the temperature is cold. When normal condensation occurs, a thin film of mist can form on the interior of the lens. The thin mist eventually clears and exits through the vents during normal operation. Clearing time may take as long as 48 hours under dry weather conditions.

These are examples of acceptable condensation:

- Presence of thin mist (no streaks, drip marks or droplets).
- Fine mist covers less than 50% of the lens.

These are examples of unacceptable moisture (usually caused by a lamp water leak):

- Water puddle inside the lamp.
- Large water droplets, drip marks or streaks present on the interior of the lens.

Take your vehicle to a dealer for service if any of the above conditions of unacceptable moisture are present.

Replacing headlamp bulbs

WARNING: Handle a halogen headlamp bulb carefully and keep out of children's reach. Grasp the bulb only by its plastic base and do not touch the glass. The oil from your hand could cause the bulb to break the next time the headlamps are operated.

Note: If the bulb is accidentally touched, it should be cleaned with rubbing alcohol before being used.

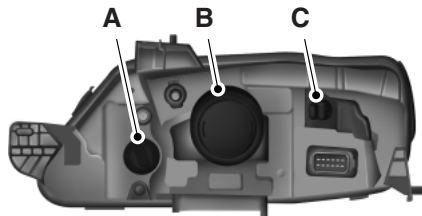

Headlamp (Sedan):

- A. Front parking lamp/turn signal bulb
- B. Low/High beam headlamp bulb
- C. Sidemarker bulb

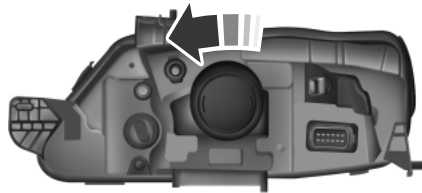

Low/High beam bulbs (Sedan)

1. Make sure the headlamp switch is in the off position, then open the hood.
2. Reach in behind the headlamp assembly to access the bulbs and connectors.
3. Remove service cap.
4. Remove bulb from the headlamp assembly by turning it counterclockwise, then pull it straight out.

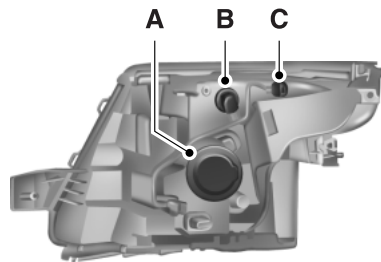

Headlamp (Utility):

- A. Low/High beam headlamp bulb
- B. Front parking lamp/turn signal bulb
- C. Sidemarker bulb

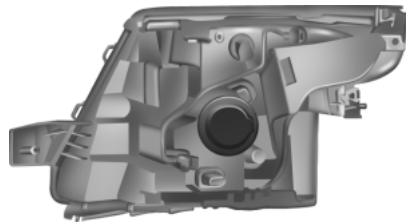
**Low/High beam bulbs (Utility)**

1. Make sure the headlamp switch is in the off position, then open the hood.
2. Reach in behind the headlamp assembly to access the bulbs and connectors.
3. Remove service cap.



4. Turn the bulb base counterclockwise and remove it.
5. Disconnect the electrical connector.

Reverse steps to reinstall bulb(s).

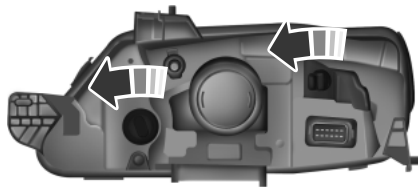
Front parking lamp/turn signal/sidemarkers without wig-wags (Sedan)

1. Make sure headlamp switch is in the off position, then open the hood.
2. Reach in behind the headlamp assembly to access the bulb sockets and connectors.
3. Rotate the bulb socket counterclockwise and remove from the lamp assembly.

4. Carefully pull the bulb out of the socket and push in the new bulb.
- Install the new bulbs in reverse order from the steps above.

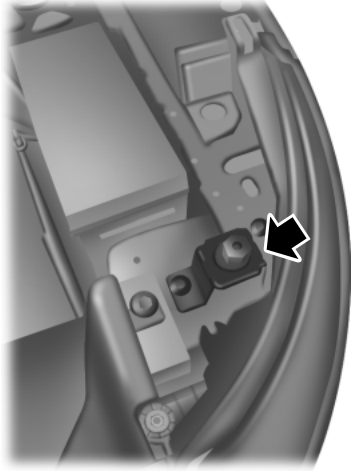
Front parking lamp/turn signal and sidemarker bulbs without wig-wags (Utility)

1. Make sure that the headlamp control is in the off position.
2. Open the hood.
3. Remove the hood overslam bumper tower to service park/turn or sidemarker bulbs (if needed).

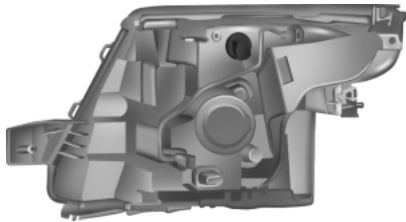
Replacing front parking lamp/turn signal bulbs without wig-wags (Utility)

1. Rotate the bulb socket counterclockwise and remove it from the lamp assembly.
2. Pull the bulb straight out of the socket.

Reverse steps to reinstall bulb(s).

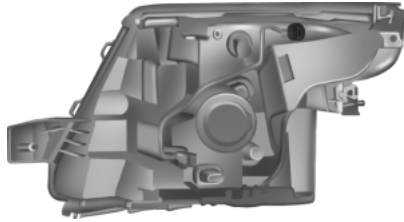
Replacing sidemarker bulbs (Utility)

1. Rotate the bulb socket counterclockwise and remove it from the lamp assembly.
2. Pull the bulb straight out of the socket.

Reverse steps to reinstall bulb(s).

Front parking lamp/turn signal flashers (wig-wags) (If equipped)

Your vehicle is equipped with an LED front parking lamp/turn signal flashers (wig-wags). It is designed to last the life of the vehicle. If replacement is required, it is recommended that you see your authorized dealer.

Note: Use of the wig-wag feature overrides normal operation of the park/turn indicator.

Spot lights (If equipped)

Your vehicle is equipped with a spot light attached to one or both of the A-Pillars. It is designed to last the life of the vehicle. If replacement is required, it is recommended that you see your authorized dealer.

Replacing stop/tail/turn and sidemarker lamp bulbs (Sedan)

1. Make sure the headlamp switch is in the off position and open the trunk.



2. Remove the press pin and cargo net fastener (if equipped) and carefully pull the carpet away to expose the backside of the tail lamp assembly.
3. Remove the nut and washer assemblies, then pull the lamp assembly away from the vehicle.

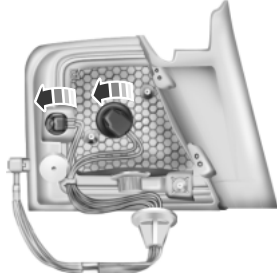

4. Remove the bulb socket by rotating it counterclockwise, then pulling it out of the lamp assembly.

5. Pull the bulb straight from the socket.

Install new bulb(s) in reverse order.

Replacing backup lamp bulbs (Sedan)

1. Make sure the headlamp switch is in the off position.

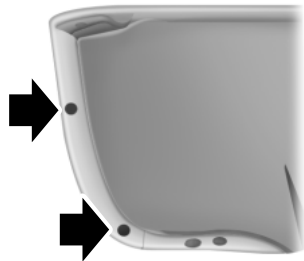

2. Remove the deck lid trim panel press pins and carefully pull the panel away to expose the backside of the backup lamp assembly.

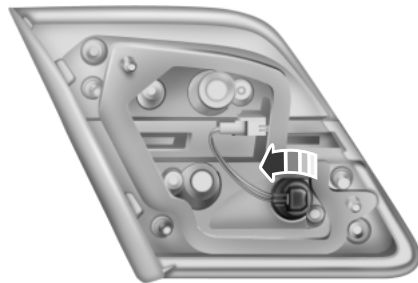

3. Remove bulb socket by rotating it counterclockwise, then pull it out of the lamp assembly.



4. Pull the bulb straight from the socket.

5. Install the new bulb in reverse order.

Replacing high-mount brake lamp bulbs (Sedan)

Your vehicle is equipped with an LED high-mount brake lamp. It is designed to last the life of the vehicle. If replacement is required, it is recommended that you see your authorized dealer.

Replacing license plate lamp bulbs (Sedan)

1. Make sure the headlamp switch is in the off position.



2. Remove the two screws from the license plate lamp assembly.

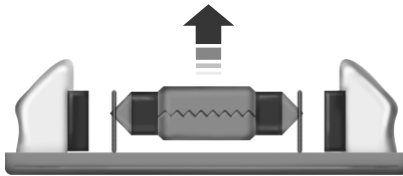

3. Carefully pull the bulb out from the contacts.

Install new bulb(s) in reverse order.

Replacing supplemental park lamp bulbs (Sedan)

Your vehicle is equipped with an LED supplemental park lamps. The LED supplemental park lamps bulbs are located in the headlamp and tail lamp and indicate the corners of the vehicle. It is designed to last the life of the vehicle. If replacement is required, it is recommended that you see your authorized dealer.

Replacing turn/backup lamp bulbs (Utility)

The turn/backup lamp bulbs are located in the same area of the tail lamp assembly, one below the other. Follow the same steps to replace these bulbs:



1. Make sure the headlamp switch is in the off position, then open the liftgate to expose the lamp assembly bolts.
2. Remove the two bolts covers using a standard flat tip screwdriver.
3. Remove the two bolts from the lamp assembly.
4. Carefully remove the lamp assembly away from the vehicle by pulling the assembly straight out to expose the bulb socket.



5. Remove the bulb socket from the lamp assembly by turning it counterclockwise.

6. Pull bulb straight out of socket.
7. Install the new bulb in reverse order.

Carefully install the tail lamp assembly on the vehicle by securing the lamp assembly with two bolts. Reinstall bolt covers.

Replacing tail/brake lamp bulbs (Utility)

For bulb replacement, see your authorized dealer.

Replacing high-mount brake lamp bulb (Utility)

Your vehicle is equipped with an LED center high-mount stop lamp located in the spoiler. It is designed to last the life of the vehicle. If replacement is required, see your authorized dealer.

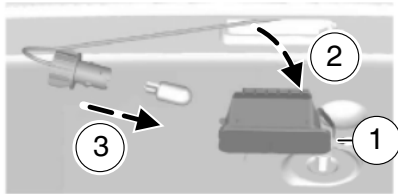
Replacing license plate lamp bulb (Utility)

1. Carefully release the spring clip (1).
 2. Remove the lamp (2).
 3. Remove the bulb (3).
- Reverse steps to reinstall bulb.

Replacing rear quarter glass LED lamp (Utility) (if equipped)

Your vehicle is equipped with an LED rear quarter glass lamp. It is designed to last the life of the vehicle. If replacement is required, see your authorized dealer.

Replacing exterior mirror LED lamp (Utility) (if equipped)

Your vehicle is equipped with an LED strobe located in the mirror cap. It is designed to last the life of the vehicle. If replacement is required, see your authorized dealer.

Replacing fender vent LED lamp (Sedan) (if equipped)

Your vehicle is equipped with an LED strobe located in the fender vent. It is designed to last the life of the vehicle. If replacement is required, see your authorized dealer.

BULB SPECIFICATION CHART

Replacement bulbs are specified in the chart below. Headlamp bulbs must be marked with an authorized "D.O.T." for North America and an "E" for Europe to ensure lamp performance, light brightness and pattern and safe visibility. The correct bulbs will not damage the lamp assembly or void the lamp assembly warranty and will provide quality bulb burn time.

Function	Number of bulbs	Trade number
Low/high beam headlamp	2	HIR2 (Sedan)
		HB3 (Utility)
Front park/turn lamp (without wig-wag)	2	3457AK (amber) (Sedan)
		3457K (Utility)
* Front park/turn/wig-wag lamp	2	LED
Sidemarker lamp (front)	2	168 (Sedan)
		W5W (Utility)
Sidemarker lamp (rear) (Sedan)	2	168
Stop/tail/turn lamp (Sedan)	2	3157K
* Tail/brake lamp (Utility)	2	LED
Rear turn lamp (Utility)	2	WY21W (amber)
Backup lamp	2	921 (Sedan)
		W21W (Utility)
License plate lamp	2	C5W (Sedan)
		W5W (Utility)
* High-mount brake lamp	1	LED
* Supplemental park lamp (Sedan)	2	LED
Front map lamp	2	W5WL (Sedan)
		168 (T10) (Utility)

Function	Number of bulbs	Trade number
* Rear quarter glass lamp (Utility) (if equipped)	2	LED
* Third row cargo lamp (Utility)	1	LED
* Exterior mirror lamp (Utility) (if equipped)	2	LED
* Fender vent lamp (Sedan) (if equipped)	2	LED
All replacement bulbs are clear in color except where noted.		
To replace all instrument panel lights - see your authorized dealer.		
* To replace these lights - see your authorized dealer.		

GENERAL INFORMATION

Your Ford or Lincoln authorized dealer has many quality products available to clean your vehicle and protect its finishes.

CLEANING PRODUCTS

For best results, use the following products or products of equivalent quality:

- Motorcraft Bug and Tar Remover (ZC-42)
- Motorcraft Custom Bright Metal Cleaner (ZC-15)
- Motorcraft Detail Wash (ZC-3-A)
- Motorcraft Dusting Cloth (ZC-24)
- Motorcraft Engine Shampoo and Degreaser (United States only) (ZC-20)
- Motorcraft Engine Shampoo (Canada only) (CXC-66-A)
- Motorcraft Multi-Purpose Cleaner (Canada only) (CXC-101)
- Motorcraft Premium Glass Cleaner (Canada only) (CXC-100)
- Motorcraft Premium Quality Windshield Washer Fluid (Canada only) [CXC-37-(A, B, D or F)]
- Motorcraft Premium Windshield Wash Concentrate with Bitterant (United States only) (ZC-32-B2)
- Motorcraft Professional Strength Carpet & Upholstery Cleaner (ZC-54)
- Motorcraft Premium Leather and Vinyl Cleaner (ZC-56)
- Motorcraft Spot and Stain Remover (United States only) (ZC-14)
- Motorcraft Ultra-Clear Spray Glass Cleaner (ZC-23)
- Motorcraft Wheel and Tire Cleaner (ZC-37-A)

CLEANING THE EXTERIOR

Wash your vehicle regularly with cool or lukewarm water and a neutral pH shampoo, such as Motorcraft Detail Wash.

- Never use strong household detergents or soap, such as dish washing or laundry liquid. These products can discolor and spot painted surfaces.
- Never wash a vehicle that is hot to the touch or during exposure to strong, direct sunlight.
- Dry the vehicle with a chamois or soft terry cloth towel in order to eliminate water spotting.

- Immediately remove items such as gasoline, diesel fuel, bird droppings and insect deposits because they can cause damage to the vehicle's paintwork and trim over time. Use Motorcraft Bug and Tar Remover.
- **Note:** Suntan lotions and insect repellents can damage any painted surface; if these substances come in contact with your vehicle, wash it off as soon as possible.
- Remove any exterior accessories before entering a car wash.

Police Interceptor Vinyl Wrap or Graphics (if equipped)

Although hand washing is the preferred cleaning method, pressure washing may be used under the following conditions:

- Never use water pressure higher than 2000 psi (14 MPa).
- Never use water temperature higher than 180°F (82°C).
- Use a spray nozzle with a 40 degree wide spray angle pattern.
- Keep the nozzle at least 12 inches (305 mm) away from and at a 90 degree angle to the vehicle surface. Holding the nozzle of a pressure washer at an angle to the vehicle surface may lift the edges of the film and cause the film to peel away from the surface.

Exterior Chrome

Note: Never use abrasive materials such as steel wool or plastic pads as they can scratch the chrome surface.

Note: Do not use chrome cleaner, metal cleaner or polish on wheels and wheel covers.

- Wash the vehicle first, using cool or lukewarm water and a neutral pH shampoo, such as Motorcraft Detail Wash.
- Use Motorcraft Custom Bright Metal Cleaner. Apply the product as you would a wax to clean bumpers and other chrome parts; allow the cleaner to dry for a few minutes, then wipe off the haze with a clean, dry rag.
- Do not apply cleaning product to hot surfaces and do not leave cleaning product on chrome surfaces for a period of time exceeding that which is recommended.
- **Note:** Using other non-recommended cleaners can result in severe and permanent cosmetic damage.

Underbody

Flush the complete underside of your vehicle frequently. Keep body and door drain holes free from packed dirt.

Cleaning Plastic Exterior Parts

Use only approved products to clean plastic parts.

- For routine cleaning, use Motorcraft Detail Wash.
- If tar or grease spots are present, use Motorcraft Bug and Tar Remover.

WAXING

Regular waxing is necessary to protect the paint on your car from the elements. We recommend that you wash and wax the painted surface once or twice a year.

When washing and waxing, park your vehicle in a shaded area out of direct sunlight. Always wash your vehicle before applying wax.

- Use a quality wax that does not contain abrasives.
- Follow the manufacturer's instructions to apply and remove the wax.
- Apply a small amount of wax in a back-and-forth motion, not in circles.
- Do not allow wax to come in contact with any non-body (low-gloss black) colored trim. The wax discolors or stains the parts over time, such as:
 - Bumpers
 - Grained door handles
 - Side mouldings
 - Mirror housings
 - Windshield cowl area.
- Do not apply wax to glass areas.
- After waxing, your car's paint should feel smooth, and be free of streaks and smudges.

REPAIRING MINOR PAINT DAMAGE

Your authorized dealer has touch-up paint to match your vehicle's color. Take your color code (printed on a sticker in the driver's door jamb) to an authorized dealer to make sure you get the correct color.

- Before repairing minor paint damage, use a cleaner such as Motorcraft Bug and Tar Remover to remove particles such as bird droppings, tree sap, insect deposits, tar spots, road salt and industrial fallout before repairing paint chips.
- Always read the instructions before using the products.

CLEANING THE ENGINE

Engines are more efficient when they are clean because grease and dirt buildup keep the engine warmer than normal.

When washing:

- Take care when using a power washer to clean the engine. The high-pressure fluid could penetrate the sealed parts and cause damage.
- Do not spray a hot engine with cold water to avoid cracking the engine block or other engine components.
- Spray Motorcraft Engine Shampoo and Degreaser on all parts that require cleaning and pressure rinse clean. In Canada, use Motorcraft Engine Shampoo.
- Never wash or rinse the engine while it is hot or running; water in the running engine may cause internal damage.
- Never wash or rinse any ignition coil, spark plug wire or spark plug well, or the area in and around these locations.
- Cover the battery, power distribution box, and air filter assembly to prevent water damage when cleaning the engine.

CLEANING THE WINDOWS AND WIPER BLADES

The windows and wiper blades should be cleaned regularly. If the wipers do not wipe properly, substances on the vehicle's glass or the wiper blades may cause squeaking or chatter noise from the blades, and streaking and smearing of the windshield. To clean these items, follow these tips:

- The windows may be cleaned with a non-abrasive cleaner such as Motorcraft® Ultra-Clear Spray Glass Cleaner (U.S.) or Motorcraft Premium Glass Cleaner (Canada).
- The wiper blades can be cleaned with isopropyl (rubbing) alcohol or Motorcraft Premium Windshield Washer Concentrates in the U.S., or Motorcraft Premium Quality Windshield Washer Fluid in Canada. Replace your wiper blades when they appear worn or do not function properly.
- Do not use abrasive materials, as they may cause scratches.
- Do not use fuel, kerosene, or paint thinner to clean any parts.

If you cannot remove those streaks after cleaning with the glass cleaner or if the wipers chatter and move in a jerky motion, clean the outer surface of the windshield and the wiper blades using a sponge or soft cloth with a neutral detergent or mild-abrasive cleaning solution. After cleaning, rinse the windshield and wiper blades with clean water. The windshield is clean if beads do not form when you rinse the windshield with water.

Note: Do not use sharp objects, such as a razor blade, to clean the inside of the rear window or to remove decals, as it may cause damage to the rear window defroster's heated grid lines.

CLEANING THE INTERIOR



WARNING: Do not use cleaning solvents, bleach or dye on the vehicle's safety belts, as these actions may weaken the belt webbing.



WARNING: On vehicles equipped with seat-mounted airbags, do not use chemical solvents or strong detergents. Such products could contaminate the side airbag system and affect performance of the side airbag in a collision.

For fabric, carpets, cloth seats, safety belts and seats equipped with side airbags:

- Remove dust and loose dirt with a vacuum cleaner.
- Apply a layer of high quality foam cleaner designed for automotive interiors, such as Motorcraft Carpet and Upholstery Cleaner, to the dry stained area(s) of the item you are cleaning and let it soak in for one minute.
- If grease or tar is present on the material, spot-clean the area first with Motorcraft Spot and Stain Remover. In Canada, use Motorcraft Multi-Purpose Cleaner.
- If a ring forms on the fabric after spot cleaning, clean the entire area immediately (but do not oversaturate) or the ring can set.
- Do not use household cleaning products or glass cleaners, which can stain and discolor the fabric and affect the flame retardant abilities of the seat materials.

CLEANING THE INSTRUMENT PANEL AND INSTRUMENT CLUSTER LENS



WARNING: Do not use chemical solvents or strong detergents when cleaning the steering wheel or instrument panel to avoid contamination of the airbag system.

Note: Follow the same procedure as cleaning leather seats for cleaning leather instrument panels and leather interior trim surfaces. See *Cleaning Leather Seats* in this chapter.

Clean the instrument panel and cluster lens with a clean, damp, white, cotton cloth, then use a clean and dry, white, cotton cloth to dry these areas.

- Avoid cleaners or polishes that increase the gloss of the upper portion of the instrument panel. The dull finish in this area helps protect the driver from undesirable windshield reflection.
- Be certain to wash or wipe your hands clean if you have been in contact with certain products, such as insect repellent and suntan lotion, in order to avoid possible damage to the interior painted surfaces.
- Do not use household or glass cleaners as these may damage the finish of the instrument panel, interior trim and cluster lens.
- Do not allow air fresheners and hand sanitizers to spill on interior surfaces. If a spill occurs, wipe off immediately. Damage may not be covered by your warranty.

If a staining liquid like coffee or juice has been spilled on the instrument panel or on interior trim surfaces, clean as follows:

1. Wipe up spilled liquid using a clean, white, cotton cloth.
2. Use Motorcraft Premium Leather and Vinyl Cleaner or a commercially available leather cleaning product for automotive interiors. Test any cleaner or stain remover on an inconspicuous area.
3. Alternatively, wipe the surface with a damp, clean, white, cotton cloth and a mild soap and water solution. Dry the area with a clean, soft cloth.
4. If necessary, apply more soap and water solution or cleaning product to a clean, white, cotton cloth and press the cloth onto the soiled area. Allow this to set at room temperature for 30 minutes.
5. Remove the soaked cloth, then with a clean, damp cloth, use a rubbing motion for 60 seconds on the soiled area.
6. Following this, wipe area dry with a clean, white, cotton cloth.

CLEANING LEATHER SEATS (IF EQUIPPED)

Note: Follow the same procedure as cleaning leather seats for cleaning leather instrument panels and leather interior trim surfaces.

For routine cleaning, wipe the surface with a soft, damp cloth and a mild soap and water solution. Dry the area with a clean, soft cloth.

For cleaning and removing spots and stains such as dye transfer, use Motorcraft Premium Leather and Vinyl Cleaner or a commercially available leather cleaning product for automotive interiors.

Note: Test any cleaner or stain remover on an inconspicuous area.

You should:

- Remove dust and loose dirt with a vacuum cleaner.
- Clean and treat spills and stains as soon as possible.

Do not use the following products as these may damage the leather:

- Oil and petroleum or silicone-based leather conditioners.
- Household cleaners.
- Alcohol solutions.
- Solvents or cleaners intended specifically for rubber, vinyl and plastics.

CLEANING THE ALLOY WHEELS

Note: Do not use chrome cleaner, metal cleaner or polish on wheels and wheel covers.

A clearcoat paint finish coats aluminum wheels and wheel covers. In order to maintain their condition:

- Clean weekly with Motorcraft Wheel and Tire Cleaner. Use a sponge to remove heavy deposits of dirt and brake dust accumulation. Rinse thoroughly with a strong stream of water when you have completed the cleaning process.
- To remove tar and grease, use Motorcraft Bug and Tar Remover.
- Never apply any cleaning chemical to hot or warm wheel rims or covers.
- Some automatic car washes may cause damage to the finish on your wheel rims or covers.
- Industrial-strength (heavy-duty) cleaners, or cleaning chemicals, in combination with brush agitation to remove brake dust and dirt, could wear away the clearcoat finish over time.
- Do not use hydrofluoric acid-based or high caustic-based wheel cleaners, steel wool, fuels or strong household detergent.
- If you intend on parking your vehicle for an extended period after cleaning the wheels with a wheel cleaner, drive your vehicle for a few minutes before doing so. This reduces the risk of increased corrosion of the brake discs.

VEHICLE STORAGE

If you plan on storing your vehicle for an extended period of time (30 days or more), read the following maintenance recommendations to make sure your vehicle stays in good operating condition.

All motor vehicles and their components were engineered and tested for reliable, regular driving. Long-term storage under various conditions may lead to component degradation or failure unless specific precautions are taken to preserve the components.

General

- Store all vehicles in a dry, ventilated place.
- Protect from sunlight, if possible.
- If vehicles are stored outside, they require regular maintenance to protect against rust and damage.

Body

- Wash vehicle thoroughly to remove dirt, grease, oil, tar or mud from exterior surfaces, rear-wheel housing and underside of front fenders.
- Periodically wash vehicles stored in exposed locations.
- Touch up raw or primed metal to prevent rust.
- Cover chrome and stainless steel parts with a thick coat of auto wax to prevent discoloration. Re-wax as necessary when the vehicle is washed.
- Lubricate hood latch, all door latches and trunk lid hinges with a light grade oil.
- Cover interior trim to prevent fading.
- Keep all rubber parts free from oil and solvents.

Engine

- The engine oil and filter should be changed prior to storage, as used engine oil contains contaminants that may cause engine damage.
- Start the engine every 15 days. Run at fast idle until it reaches normal operating temperature.
- With your foot on the brake, shift through all the gears while the engine is running.

Fuel system

- Fill the fuel tank with high-quality fuel until the first automatic shutoff of the fuel pump nozzle.

Cooling system

- Protect against freezing temperatures.
- When removing vehicle from storage, check coolant fluid level. Confirm there are no cooling system leaks, and fluid is at the recommended level.

Battery

- Check and recharge as necessary. Keep connections clean.
- If storing your vehicle for more than 30 days without recharging the battery, it may be advisable to disconnect the battery cables to ensure battery charge is maintained for quick starting.

Note: If battery cables are disconnected, it will be necessary to reset memory features.

Brakes

- Make sure brakes and parking brake are fully released.

Tires

- Maintain recommended air pressure.

Miscellaneous

- Make sure all linkages, cables, levers and pins under vehicle are covered with grease to prevent rust.
- Move vehicles at least 25 feet (8 meters) every 15 days to lubricate working parts and prevent corrosion.

Removing Vehicle from Storage

When your vehicle is ready to come out of storage, do the following:

- Wash your vehicle to remove any dirt or grease film build-up on window surfaces.
- Check windshield wipers for any deterioration.
- Check under the hood for any foreign material that may have collected during storage (mice/squirrel nests).
- Check the exhaust for any foreign material that may have collected during storage.
- Check tire pressures and set tire inflation per the Tire Label.
- Check brake pedal operation. Drive the vehicle 15 feet (4.5 meters) back and forth to remove rust build-up.
- Check fluid levels (including coolant, oil and gas) to make sure there are no leaks and fluids are at recommended levels.
- If the battery was removed, clean the battery cable ends and inspect.

Contact your authorized dealer if you have any concerns or issues.

GENERAL INFORMATION**Notice to Utility Vehicle, Van and Truck Owners**

WARNING: Utility vehicles have a significantly higher rollover rate than other types of vehicles. To reduce the risk of serious injury or death from a rollover or other crash you must:

- Avoid sharp turns and abrupt maneuvers.
- Drive at safe speeds for the conditions.
- Keep tires properly inflated.
- Never overload or improperly load your vehicle.
- Make sure every passenger is properly restrained.



WARNING: In a rollover crash, an unbelted person is significantly more likely to die than a person wearing a seat belt. All occupants must wear seat belts. Children and infants must use appropriate restraints to minimize the risk of injury or ejection.



Utility vehicles, vans and trucks handle differently than passenger cars in the various driving conditions that are encountered on streets, highways and off-road. Utility vehicles, vans and trucks are not designed for cornering at speeds as high as passenger cars any more than low-slung sports cars are designed to perform satisfactorily under off-road conditions.

All-Wheel Drive System (If Equipped)

WARNING: Do not become overconfident in the ability of all-wheel drive vehicles. Although an all-wheel drive vehicle may accelerate better than a two-wheel drive vehicle in low-traction situations, it will not stop any faster than two-wheel drive vehicles. Always drive at a safe speed.

Note: Your all-wheel drive vehicle is not intended for off-road use. This feature gives your vehicle some limited off-road capabilities in which driving surfaces are relatively level, obstruction-free and otherwise similar to normal on-road driving conditions. Operating your vehicle under other than those conditions could subject the vehicle to excessive stress which might result in damage which is not covered under your warranty.

With the all-wheel drive option, power will be delivered to the front wheels and distributed to the rear wheels as needed. This increases traction which may enable you to safely drive over terrain and road conditions that a conventional two-wheel drive vehicle cannot. The system is active all the time and requires no input from the operator.

For all-wheel drive vehicles, a spare tire of a different size other than the tire provided should never be used. A dissimilar spare tire size (other than the spare tire provided) or major dissimilar tire sized between the front and rear axles could cause the system to stop functioning and default to front-wheel drive.

How Your Vehicle Differs from Other Vehicles

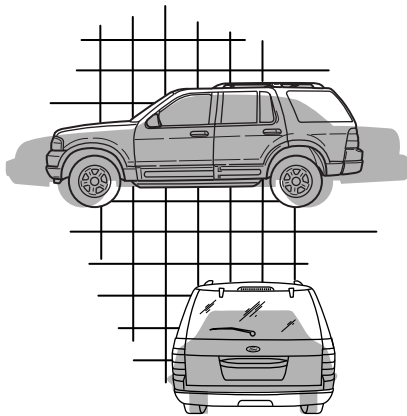

Sport-utility vehicles, vans and trucks can differ from some other vehicles in a few noticeable ways. Your vehicle may be:

- Higher – to allow higher load carrying capacity and to allow it to travel over rough terrain without getting hung up or damaging underbody components.
- Shorter – to give it the capability to approach inclines and drive over the crest of a hill without getting hung up or damaging underbody components. All other things held equal, a shorter

wheelbase may make your vehicle quicker to respond to steering inputs than a vehicle with a longer wheelbase.

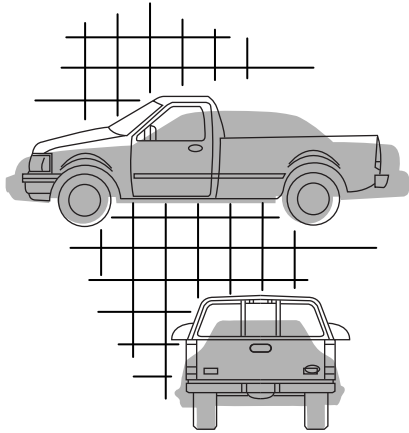

- Narrower – to provide greater maneuverability in tight spaces, particularly in off-road use.

As a result of the above dimensional differences, sport-utility vehicles, vans and trucks often will have a higher center of gravity and a greater difference in center of gravity between the loaded and unloaded condition.

These differences that make your vehicle so versatile also make it handle differently than an ordinary passenger car.

TIRE CARE

Information About Uniform Tire Quality Grading



Tire Quality Grades apply to new pneumatic passenger car tires. The Tire Quality Grades can be found where applicable on the tire sidewall between tread shoulder and maximum section width. For example:

- **Treadwear 200 Traction AA Temperature A**

These Tire Quality Grades are determined by standards that the United States Department of Transportation has set.

Tire Quality Grades apply to new pneumatic passenger car tires. They do not apply to deep tread, winter-type snow tires, space-saver or temporary use spare tires, light truck or LT type tires, tires with nominal rim diameters of 10 to 12 inches or limited production tires as defined in Title 49 Code of Federal Regulations Part 575.104(c)(2).

U.S. Department of Transportation-Tire quality grades: The U.S. Department of Transportation requires Ford Motor Company to give you the following information about tire grades exactly as the government has written it.

Treadwear

The treadwear grade is a comparative rating based on the wear rate of the tire when tested under controlled conditions on a specified government test course. For example, a tire graded 150 would wear 1½ times as well on the government course as a tire graded 100. The relative performance of tires depends upon the actual conditions of their use, however, and may depart significantly from the norm due to variations in driving habits, service practices, and differences in road characteristics and climate.

Traction AA A B C



WARNING: The traction grade assigned to this tire is based on straight-ahead braking traction tests, and does not include acceleration, cornering, hydroplaning or peak traction characteristics.

The traction grades, from highest to lowest are AA, A, B, and C. The grades represent the tire's ability to stop on wet pavement as measured under controlled conditions on specified government test surfaces of asphalt and concrete. A tire marked C may have poor traction performance.

Temperature A B C



WARNING: The temperature grade for this tire is established for a tire that is properly inflated and not overloaded. Excessive speed, underinflation, or excessive loading, either separately or in combination, can cause heat buildup and possible tire failure.

The temperature grades are A (the highest), B and C, representing the tire's resistance to the generation of heat and its ability to dissipate heat when tested under controlled conditions on a specified indoor laboratory test wheel. Sustained high temperature can cause the material of the tire to degenerate and reduce tire life, and excessive temperature can lead to sudden tire failure. The grade C corresponds to a level of performance which all passenger car tires must meet under the Federal Motor Vehicle Safety Standard No. 139. Grades B and A represent higher levels of performance on the laboratory test wheel than the minimum required by law.

Glossary of Tire Terminology

- **Tire label:** A label showing the OE (Original Equipment) tire sizes, recommended inflation pressure and the maximum weight the vehicle can carry.

- **Tire Identification Number (TIN):** A number on the sidewall of each tire providing information about the tire brand and manufacturing plant, tire size and date of manufacture. Also referred to as DOT code.
- **Inflation pressure:** A measure of the amount of air in a tire.
- **Standard load:** A class of P-metric or Metric tires designed to carry a maximum load at set pressure. For example: For P-metric tires 35 psi (2.4 bar) or 36 (2.5 bar) depending on tire size and for Metric tires 36 psi (2.5 bar). Increasing the inflation pressure beyond this pressure will not increase the tire capability.
- **Extra load:** A class of P-metric or Metric tires designed to carry a heavier maximum load at 42 psi (2.9 bar). Increasing the inflation pressure beyond this pressure will not increase the tire's load-carrying capability.
- **kPa:** KiloPascal, a metric unit of air pressure.
- **PSI:** Pounds per square inch, a standard unit of air pressure.
- **Cold tire pressure:** The tire pressure when the vehicle has been stationary and out of direct sunlight for an hour or more and prior to the vehicle being driven for 1 mile (1.6 kilometers).
- **Recommended inflation pressure:** The cold inflation pressure found on the Safety Compliance Certification Label (affixed to either the door hinge pillar, door-latch post, or the door edge that meets the door-latch post, next to the driver's seating position) or Tire Label located on the B-Pillar or the edge of the driver's door.
- **B-pillar:** The structural member at the side of the vehicle behind the front door.
- **Bead area of the tire:** Area of the tire next to the rim.
- **Sidewall of the tire:** Area between the bead area and the tread.
- **Tread area of the tire:** Area of the perimeter of the tire that contacts the road when mounted on the vehicle.
- **Rim:** The metal support (wheel) for a tire or a tire and tube assembly upon which the tire beads are seated.

INFORMATION CONTAINED ON THE TIRE SIDEWALL

Both U.S. and Canada Federal regulations require tire manufacturers to place standardized information on the sidewall of all tires. This information identifies and describes the fundamental characteristics of the tire and also provides a U.S. DOT Tire Identification Number for safety standard certification and in case of a recall.

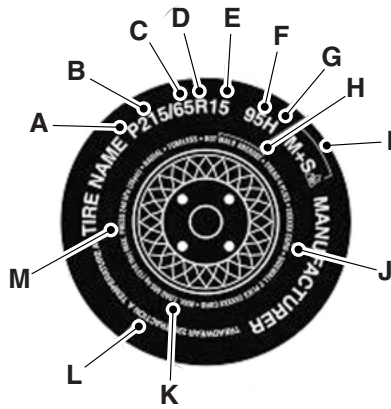
Information on P Type Tires

P215/65R15 95H is an example of a tire size, load index and speed rating. The definitions of these items are listed below. (Note that the tire size, load index and speed rating for your vehicle may be different from this example.)

A. **P:** Indicates a tire, designated by the Tire and Rim Association, that may be used for service on cars, sport utility vehicles, minivans and light trucks.

Note: If your tire size does not begin with a letter, this may mean it is designated by either the European Tire and Rim Technical Organization or the Japan Tire Manufacturing Association.

B. **215:** Indicates the nominal width of the tire in millimeters from sidewall edge to sidewall edge. In general, the larger the number, the wider the tire.

C. **65:** Indicates the aspect ratio which gives the tire's ratio of height to width.

D. **R:** Indicates a radial type tire.

E. **15:** Indicates the wheel or rim diameter in inches. If you change your wheel size, you will have to purchase new tires to match the new wheel diameter.

F. **95:** Indicates the tire's load index. It is an index that relates to how much weight a tire can carry. You may find this information in your owner's manual. If not, contact a local tire dealer.

Note: You may not find this information on all tires because it is not required by federal law.

G. **H:** Indicates the tire's speed rating. The speed rating denotes the speed at which a tire is designed to be driven for extended periods of time under a standard condition of load and inflation pressure. The tires on your vehicle may operate at different conditions for load and inflation pressure. These speed ratings may need to be adjusted for the difference in conditions. The ratings range from 81 mph (130 km/h) to 186 mph (299 km/h). These ratings are listed in the following chart.

Note: You may not find this information on all tires because it is not required by federal law.

Letter rating	Speed rating - mph (km/h)
M	81 (130)
N	87 (140)
Q	99 (159)
R	106 (171)
S	112 (180)
T	118 (190)
U	124 (200)
H	130 (210)
V	149 (240)
W	168 (270)
Y	186 (299)

Note: For tires with a maximum speed capability over 149 mph (240 km/h), tire manufacturers sometimes use the letters ZR. For those with a maximum speed capability over 186 mph (299 km/h), tire manufacturers always use the letters ZR.

H. **U.S. DOT Tire Identification Number (TIN):** This begins with the letters DOT and indicates that the tire meets all federal standards. The next two numbers or letters are the plant code designating where it was manufactured, the next two are the tire size code and the last four numbers represent the week and year the tire was built. For example, the numbers 317 mean the 31st week of 1997. After 2000 the numbers go to four digits. For example, 2501 means the 25th week of 2001. The numbers in between are identification codes used for traceability. This information is used to contact customers if a tire defect requires a recall.

I. **M+S or M/S:** Mud and Snow, or

AT: All Terrain, or

AS: All Season.

J. Tire Ply Composition and Material Used: Indicates the number of plies or the number of layers of rubber-coated fabric in the tire tread and sidewall. Tire manufacturers also must indicate the ply materials in the tire and the sidewall, which include steel, nylon, polyester, and others.

K. Maximum Load: Indicates the maximum load in kilograms and pounds that can be carried by the tire. See the Safety Compliance Certification Label (affixed to either the door hinge pillar, door-latch post, or the door edge that meets the door-latch post, next to the driver's seating position), for the correct tire pressure for your vehicle.

L. Treadwear, Traction and Temperature Grades

- **Treadwear:** The treadwear grade is a comparative rating based on the wear rate of the tire when tested under controlled conditions on a specified government test course. For example, a tire graded 150 would wear one and one-half (1½) times as well on the government course as a tire graded 100.
- **Traction:** The traction grades, from highest to lowest, are AA, A, B, and C. The grades represent the tire's ability to stop on wet pavement as measured under controlled conditions on specified government test surfaces of asphalt and concrete. A tire marked C may have poor traction performance.
- **Temperature:** The temperature grades are A (the highest), B and C, representing the tire's resistance to the generation of heat and its ability to dissipate heat when tested under controlled conditions on a specified indoor laboratory test wheel.

M. Maximum Inflation Pressure: Indicates the tire manufacturer's maximum permissible pressure or the pressure at which the maximum load can be carried by the tire. This pressure is normally higher than the vehicle manufacturer's recommended cold inflation pressure, which can be found on the Safety Compliance Certification Label (affixed to either the door hinge pillar, door-latch post, or the door edge that meets the door-latch post, next to the driver's seating position), or Tire Label which is located on the B-Pillar or the edge of the driver's door. The cold inflation pressure should never be set lower than the recommended pressure on the vehicle label.

The tire suppliers may have additional markings, notes or warnings, such as standard load or radial tubeless.

Additional Information Contained on the Tire Sidewall for LT Type Tires

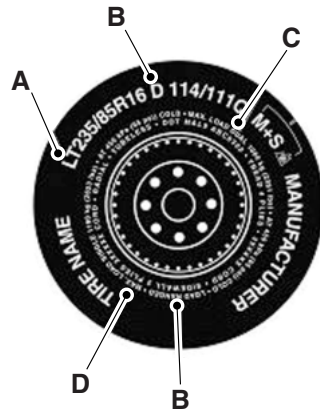

LT type tires have some additional information beyond those of P type tires. These differences are described below.

Note: Tire Quality Grades do not apply to this type of tire.

A. **LT:** Indicates a tire, designated by the Tire and Rim Association, that is intended for service on light trucks.

B. **Load Range/Load Inflation Limits:** Indicates the tire's load-carrying capabilities and its inflation limits.

C. **Maximum Load Dual lb (kg) at psi (kPa) cold:** Indicates the maximum load and tire pressure when the tire is used as a dual, defined as four tires on the rear axle (a total of six or more tires on the vehicle).

D. **Maximum Load Single lb (kg) at psi (kPa) cold:** Indicates the maximum load and tire pressure when the tire is used as a single, defined as two tires (total) on the rear axle.

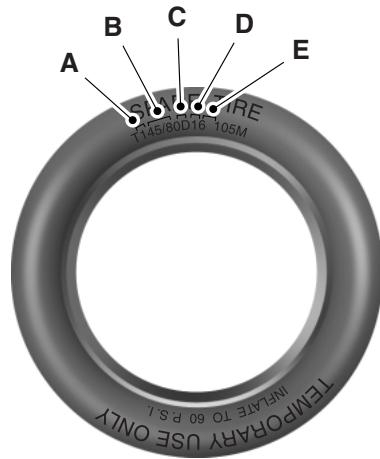
Information on T Type Tires

T type tires have some additional information beyond those of P type tires. These differences are described below.

T145/80D16 is an example of a tire size.

Note: The temporary tire size for your vehicle may be different from this example. Tire Quality Grades do not apply to this type of tire.

A. **T:** Indicates a type of tire, designated by the Tire and Rim Association, that is intended for temporary service on cars, sport-utility vehicles, minivans and light trucks.

B. **145:** Indicates the nominal width of the tire in millimeters from sidewall edge to sidewall edge. In general, the larger the number, the wider the tire.

C. **80:** Indicates the aspect ratio, which gives the tire's ratio of height to width. Numbers of 70 or lower indicate a short sidewall.

D. **D:** Indicates a diagonal type tire. **R:** Indicates a radial type tire.

E. **16:** Indicates the wheel or rim diameter in inches. If you change your wheel size, you will have to purchase new tires to match the new wheel diameter.

Location of the Tire Label

You will find a Tire Label containing tire inflation pressure by tire size and other important information located on the B-Pillar or the edge of the driver's door. See the payload description and graphic in the *Load Carrying* chapter.

INFLATING YOUR TIRES

Safe operation of your vehicle requires that your tires are properly inflated. Remember that a tire can lose up to half of its air pressure without appearing flat.

Every day before you drive, check your tires. If one looks lower than the others, use a tire gauge to check pressure of all tires and adjust if required.

At least once a month and before long trips, inspect each tire and check the tire pressure with a tire gauge (including spare, if equipped). Inflate all tires to the inflation pressure recommended by Ford Motor Company.



WARNING: Under-inflation is the most common cause of tire failures and may result in severe tire cracking, tread separation or blowout, with unexpected loss of vehicle control and increased risk of injury. Under-inflation increases sidewall flexing and rolling resistance, resulting in heat build-up and internal damage to the tire. It also may result in unnecessary tire stress, irregular wear, loss of vehicle control and accidents. A tire can lose up to half of its air pressure and not appear to be flat!

You are strongly urged to buy a reliable tire pressure gauge, as automatic service station gauges may be inaccurate. Ford recommends the use of a digital or dial-type tire pressure gauge rather than a stick-type tire pressure gauge.

Use the recommended cold inflation pressure for optimum tire performance and wear. Under-inflation or over-inflation may cause uneven treadwear patterns.

Always inflate your tires to the Ford recommended inflation pressure even if it is less than the maximum inflation pressure information found on the tire. The Ford recommended tire inflation pressure is found on the Safety Compliance Certification Label (affixed to either the door hinge pillar, door-latch post, or the door edge that meets the door-latch post, next to the driver's seating position), or Tire Label which is located on the B-Pillar or the edge of the driver's door. Failure to follow the tire pressure recommendations can cause uneven treadwear patterns and adversely affect the way your vehicle handles.

Maximum Inflation Pressure is the tire manufacturer's maximum permissible pressure or the pressure at which the maximum load can be carried by the tire. This pressure is normally higher than the manufacturer's recommended cold inflation pressure, which can be found

on the Safety Compliance Certification Label (affixed to either the door hinge pillar, door-latch post, or the door edge that meets the door-latch post, next to the driver's seating position), or Tire Label which is located on the B-Pillar or the edge of the driver's door. The cold inflation pressure should never be set lower than the recommended pressure on the Safety Compliance Certification Label or Tire Label.

When weather temperature changes occur, tire inflation pressures also change. A 10°F (6°C) temperature drop can cause a corresponding drop of 1 psi (7 kPa) in inflation pressure. Check your tire pressures frequently and adjust them to the proper pressure which can be found on the Safety Compliance Certification Label or Tire Label.

To check the pressure in your tire(s):

1. Make sure the tires are cool, meaning they are not hot from driving even a mile.

Note: If you are checking tire pressure when the tire is hot (for example, driven more than 1 mile [1.6 kilometers]), never bleed or reduce air pressure. The tires are hot from driving and it is normal for pressures to increase above recommended cold pressures. A hot tire at or below recommended cold inflation pressure could be significantly under-inflated.

Note: If you have to drive a distance to get air for your tire(s), check and record the tire pressure first and add the appropriate air pressure when you get to the pump. It is normal for tires to heat up and the air pressure inside to go up as you drive.

2. Remove the cap from the valve on one tire, then firmly press the tire gauge onto the valve and measure the pressure.

3. Add enough air to reach the recommended air pressure.

Note: If you overfill the tire, release air by pressing on the metal stem in the center of the valve. Then recheck the pressure with your tire gauge.

4. Replace the valve cap.

5. Repeat this procedure for each tire, including the spare.

Note: Some spare tires operate at a higher inflation pressure than the other tires. For T-type mini-spare tires, see the *Dissimilar Spare Tire and Wheel Assembly Information* section. Store and maintain at 60 psi (4.15 bar). For full-size and dissimilar spare tires, see *Dissimilar Spare Tire and Wheel Assembly Information* under *Changing a Road Wheel* in this chapter. Store and maintain at the higher of the front and rear inflation pressure as shown on the Tire Label.

6. Visually inspect the tires to make sure there are no nails or other objects embedded that could poke a hole in the tire and cause an air leak.
7. Check the sidewalls to make sure there are no gouges, cuts or bulges.

Inspecting Your Tires and Wheel Valve Stems

Periodically inspect the tire treads for uneven or excessive wear and remove objects such as stones, nails or glass that may be wedged in the tread grooves. Check the tire and valve stems for holes, cracks, or cuts that may permit air leakage and repair or replace the tire and replace the valve stem. Inspect the tire sidewalls for cracking, cuts, bruises and other signs of damage or excessive wear. If internal damage to the tire is suspected, have the tire demounted and inspected in case it needs to be repaired or replaced. For your safety, tires that are damaged or show signs of excessive wear should not be used because they are more likely to blow out or fail.

Improper or inadequate vehicle maintenance can cause tires to wear abnormally. Inspect all your tires, including the spare, frequently, and replace them if one or more of the following conditions exist:

Tire Wear

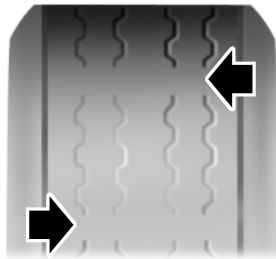

When the tread is worn down to 1/16th of an inch (2 millimeters), tires must be replaced to help prevent your vehicle from skidding and hydroplaning. Built-in treadwear indicators, or wear bars, which look like narrow strips of smooth rubber across the tread will appear on the tire when the tread is worn down to 1/16th of an inch (2 millimeters).

When the tire tread wears down to the same height as these wear bars, the tire is worn out and must be replaced.

Damage

Periodically inspect the tire treads and sidewalls for damage (such as bulges in the tread or sidewalls, cracks in the tread groove and separation in the tread or sidewall). If damage is observed or suspected, have the tire inspected by a tire professional. Tires can be damaged during off-road use, so inspection after off-road use is also recommended.

**WARNING: Age**

Tires degrade over time depending on many factors such as weather, storage conditions, and conditions of use (such as load, speed, inflation pressure) the tires experience throughout their lives.

In general, tires should be replaced after six years regardless of tread wear. However, heat caused by hot climates or frequent high loading conditions can accelerate the aging process and may require tires to be replaced more frequently.

You should replace your spare tire when you replace the road tires or after six years due to aging even if it has not been used.

U.S. DOT Tire Identification Number

Both U.S. and Canada Federal regulations require tire manufacturers to place standardized information on the sidewall of all tires. This information identifies and describes the fundamental characteristics of the tire and also provides a U.S. DOT Tire Identification Number for safety standard certification and in case of a recall.

This begins with the letters DOT and indicates that the tire meets all federal standards. The next two numbers or letters are the plant code designating where it was manufactured, the next two are the tire size code and the last four numbers represent the week and year the tire was built. For example, the numbers 317 mean the 31st week of 1997. After 2000 the numbers go to four digits. For example, 2501 means the 25th week of 2001. The numbers in between are identification codes used for traceability. This information is used to contact customers if a tire defect requires a recall.

Tire Replacement Requirements

WARNING: Only use replacement tires and wheels that are the same size, load index, speed rating and type (such as P-metric versus LT-metric or all-season versus all-terrain) as those originally provided by Ford. The recommended tire and wheel size may be found on either the Safety Compliance Certification Label (affixed to either the door hinge pillar, door-latch post, or the door edge that meets the door-latch post, next to the driver's seating position), or the Tire Label which is located on the B-Pillar or edge of the driver's door. If this information is not found on these labels, then you should contact your authorized dealer as soon as possible. Use of any tire or wheel not recommended by Ford can affect the safety and performance of your vehicle, which could result in an increased risk of loss of vehicle control, vehicle rollover, personal injury and death. Additionally the use of non-recommended tires and wheels could cause steering, suspension, axle, transfer case or power transfer unit failure. If you have questions regarding tire replacement, contact your authorized dealer as soon as possible.



WARNING: To reduce the risk of serious injury, when mounting replacement tires and wheels, you should not exceed the maximum pressure indicated on the sidewall of the tire to set the beads without additional precautions listed below. If the beads do not seat at the maximum pressure indicated, re-lubricate and try again. When inflating the tire for mounting pressures up to 20 psi (1.38 bar) greater than the maximum pressure on the tire sidewall, the following precautions must be taken to protect the person mounting the tire:

1. Make sure that you have the correct tire and wheel size.
2. Lubricate the tire bead and wheel bead seat area again.
3. Stand at a minimum of 12 feet (3.66 meters) away from the tire wheel assembly.
4. Use both eye and ear protection.

For a mounting pressure more than 20 psi (1.38 bar) greater than the maximum pressure, a Ford dealer or other tire service professional should do the mounting.

Always inflate steel carcass tires with a remote air fill with the person inflating standing at a minimum of 12 feet (3.66 meters) away from the tire wheel assembly.

Your vehicle is equipped with tires designed to provide a safe ride and handling capability.

Important: Remember to replace the wheel valve stems when the road tires are replaced on your vehicle.

The two front tires or two rear tires should generally be replaced as a pair.

The tire pressure sensors mounted in the wheels (originally installed on your vehicle) are not designed to be used in aftermarket wheels.

The use of wheels or tires not recommended by Ford Motor Company may affect the operation of your tire pressure monitoring system.

If the tire pressure monitoring system indicator is flashing, the system is malfunctioning. Your replacement tire might be incompatible with your tire pressure monitoring system, or some component of the system may be damaged.

Safety Practices

WARNING: If your vehicle is stuck in snow, mud, or sand, do not rapidly spin the tires. Spinning the tires can tear the tire and cause an explosion. A tire can explode in as little as three to five seconds.



WARNING: Do not spin the wheels at over 35 mph (56 km/h). The tires may fail and injure a passenger or bystander.

Driving habits have a great deal to do with your tire mileage and safety.

- Observe posted speed limits.
- Avoid fast starts, stops and turns.
- Avoid potholes and objects on the road.
- Do not run over curbs or hit the tire against a curb when parking.

Highway Hazards

No matter how carefully you drive, there is always the possibility that you may eventually have a flat tire on the highway. Drive slowly to the closest safe area out of traffic. This may further damage the flat tire, but your safety is more important.

If you feel a sudden vibration or ride disturbance while driving, or you suspect your tire or vehicle has been damaged, immediately reduce your speed. Drive with caution until you can safely pull off the road. Stop and inspect the tires for damage. If a tire is under-inflated or damaged, deflate it, remove the wheel and replace it with your spare tire and wheel. If you cannot detect a cause, have the vehicle towed to the nearest repair facility or tire dealer to have the vehicle inspected.

Tire and Wheel Alignment

A bad jolt from hitting a curb or pothole can cause the front end of your vehicle to become misaligned or cause damage to your tires. If your vehicle seems to pull to one side when you are driving, the wheels may be out of alignment. Have an authorized dealer check the wheel alignment periodically.

Wheel misalignment in the front or the rear can cause uneven and rapid treadwear of your tires and should be corrected by an authorized dealer. Front-wheel drive vehicles and those with an independent rear suspension may require alignment of all four wheels.

The tires should also be balanced periodically. An unbalanced tire and wheel assembly may result in irregular tire wear.

Tire Rotation

Note: If your tires show uneven wear ask an authorized dealer to check for and correct any wheel misalignment, tire imbalance or mechanical problem involved before tire rotation.

Note: Your vehicle may be equipped with a dissimilar spare tire and wheel assembly. A dissimilar spare tire and wheel assembly is defined as a spare tire or wheel that is different in brand, size or appearance from the road tires and wheels. If you have a dissimilar spare tire and wheel assembly, it is intended for temporary use only and should not be used in a tire rotation.

Note: After having your tires rotated, inflation pressure must be checked and adjusted to the vehicle requirements.

Rotating your tires at the recommended interval (as indicated in the scheduled maintenance information) will help your tires wear more evenly, providing better tire performance and longer tire life.

Utility:

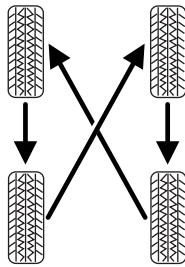

- Front-wheel drive vehicles (front tires at top of diagram)

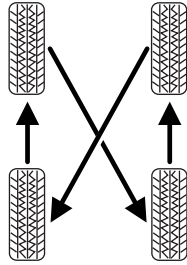

- All-wheel drive vehicles (front tires at top of diagram)

Sedan:

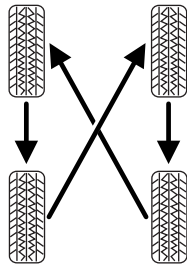

- Front-wheel drive and all-wheel drive vehicles (front tires at top of diagram)

Sometimes irregular tire wear can be corrected by rotating the tires.

POLICE TIRES

Wheel rims - police

To withstand the demands placed on vehicles driven under heavy duty service conditions, Ford Motor Company installs heavy duty wheels.

Tires - police

Tires (including the spare) are speed-rated radials for police use. Use only the recommended tire size and speed ratings.

In regions with snow and ice during the winter months, installation of snow tires may be desirable. Snow tires will usually exhibit a drop in dry pavement handling, but many show an increase in snow and ice traction. When snow tires are used, they should be installed on all four wheels, never on the drive wheels only.

Tires - long term storage

Most high performance tires are made with a nylon overlay.

As such, the following steps should be taken to avoid flatspotting when the vehicles are not used for a period of time.

- Fleets should store the vehicles with 44 psi (303 kPa) in the tires.
- If the vehicle is stored for periods longer than 30 days, it should be moved several feet at least once during each 30-day period, so that a different portion of the tread contacts the ground.
- Tire pressure should be reduced to the recommended pressure shown on the vehicle certification label before the vehicle is placed back into service.

USING SNOW CHAINS

WARNING: Snow tires must be the same size, load index, speed rating as those originally provided by Ford. Use of any tire or wheel not recommended by Ford can affect the safety and performance of your vehicle, which could result in an increased risk of loss of vehicle control, vehicle rollover, personal injury and death. Additionally, the use of non-recommended tires and wheels could cause steering, suspension, axle, transfer case or power transfer unit failure.

Note: The suspension insulation and bumpers will help prevent vehicle damage. Do not remove these components from your vehicle when using snow tires and chains.

The tires on your vehicle have all-weather treads to provide traction in rain and snow. However, in some climates, you may need to use snow tires and cables. If you need to use cables, it is recommended that steel wheels (of the same size and specifications) be used, as cables may chip aluminum wheels.

Follow these guidelines when using snow tires and chains:

- If possible, avoid fully loading your vehicle.
- For police sedan, do not use snow chains or cables on this vehicle as they may cause damage to your vehicle which may lead to loss of vehicle control.

- For police utility, use only SAE Class S snow chains, snow cables or equivalent on the front axle for 245/55R18 equipped vehicles. The use of snow chains, snow cables or other traction assist devices that are larger than SAE Class S may cause damage to your vehicle's wheel house, suspension and/or body.
- Do not install tire chains, cables, or optional traction devices on the rear tires. This could cause damage to the vehicle's wheel house or body.
- Install cable chains securely, verifying that the cables do not touch any wiring, brake lines or fuel lines.
- Do not exceed 30 mph (48 km/h) with tire cables on your vehicle.
- Drive cautiously. If you hear the cables rub or bang against your vehicle, stop and retighten the cables. If this does not work, remove the cables to prevent damage to your vehicle.
- Remove the tire cables when they are no longer needed. Do not use tire cables on dry roads.

TIRE PRESSURE MONITORING SYSTEM



WARNING: The tire pressure monitoring system is NOT a substitute for manually checking tire pressure. The tire pressure should be checked periodically (at least monthly) using a tire gauge. See *Inflating Your Tires* in this chapter. Failure to properly maintain your tire pressure could increase the risk of tire failure, loss of control, vehicle rollover and personal injury.



Each tire, including the spare (if provided), should be checked monthly when cold and inflated to the inflation pressure recommended by the vehicle manufacturer on the vehicle placard or tire inflation pressure label. (If your vehicle has tires of a different size than the size indicated on the vehicle placard or tire inflation pressure label, you should determine the proper tire inflation pressure for those tires.)

As an added safety feature, your vehicle has been equipped with a tire pressure monitoring system (TPMS) that illuminates a low tire pressure telltale when one or more of your tires is significantly under-inflated. Accordingly, when the low tire pressure telltale illuminates, you should stop and check your tires as soon as possible, and inflate them to the proper pressure. Driving on a significantly under-inflated tire causes the tire to overheat and can lead to tire failure. Under-inflation also reduces fuel efficiency and tire tread life, and may affect the vehicle's handling and stopping ability.

Please note that the TPMS is not a substitute for proper tire maintenance, and it is the driver's responsibility to maintain correct tire pressure, even if under-inflation has not reached the level to trigger illumination of the TPMS low tire pressure telltale.

Your vehicle has also been equipped with a TPMS malfunction indicator to indicate when the system is not operating properly. The TPMS malfunction indicator is combined with the low tire pressure telltale. When the system detects a malfunction, the telltale will flash for approximately one minute and then remain continuously illuminated. This sequence will continue upon subsequent vehicle start-ups as long as the malfunction exists.

When the malfunction indicator is illuminated, the system may not be able to detect or signal low tire pressure as intended. TPMS malfunctions may occur for a variety of reasons, including the installation of replacement or alternate tires or wheels on the vehicle that prevent the TPMS from functioning properly. Always check the TPMS malfunction telltale after replacing one or more tires or wheels on your vehicle to ensure that the replacement or alternate tires and wheels allow the TPMS to continue to function properly.

The tire pressure monitoring system complies with part 15 of the FCC rules and with RSS-210 of Industry Canada. Operation is subject to the following two conditions: (1) This device may not cause harmful interference, and (2) This device must accept any interference received, including interference that may cause undesired operation.

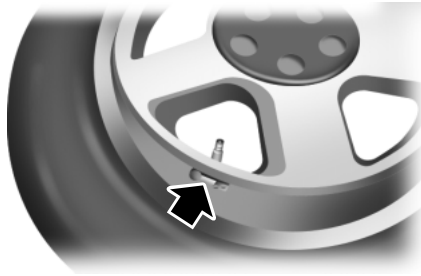
Changing Tires with a Tire Pressure Monitoring System

Note: Each road tire and full-size spare is equipped with a tire pressure sensor located inside the tire and wheel cavity. The pressure sensor is attached to the valve stem. The pressure sensor is covered by the tire and is not visible unless the tire is removed. Take care when changing the tire to avoid damaging the sensor.

You should always have your tires serviced by an authorized dealer.

Check the tire pressure periodically (at least monthly) using an accurate tire gauge. See *Inflating Your Tires* in this chapter.

Understanding Your Tire Pressure Monitoring System

The tire pressure monitoring system measures pressure in your four road tires and sends the tire pressure readings to your vehicle. The low tire pressure warning light will turn on if the tire pressure is significantly low. Once the light is illuminated, your tires are under-inflated and need to be inflated to the manufacturer's recommended tire pressure. Even if the light turns on and a short time later turns off, your tire pressure still needs to be checked.

When a new wheel and tire is installed

When one of your road tires is replaced by a new tire and wheel, the system sensor located in the new tire and wheel needs to be trained to the vehicle.

System training tools

Tire pressure monitoring system training tools are available through the Rotunda catalog or through a Ford dealership. The steps for training the sensors are outlined below.

System sensor training procedure

Note: To reduce the chances of interference from another vehicle, system training should be performed at least three feet (one meter) away from another Ford Motor Company vehicle undergoing the system training procedure at the same time.

Note: Do not wait more than two minutes between resetting each tire sensor or the system will time-out and the entire procedure will have to be repeated on all four wheels.

A double horn chirp indicates the need to repeat the procedure.

System training procedure

Note: It is recommended that you read the entire procedure before attempting.

Note: To enter the training mode, Steps 1–6 must be completed within 60 seconds.

1. Place the ignition in the off position and keep the key in the ignition.
2. Press and release the brake pedal.
3. Cycle the ignition from off to on three times ending in the on position - Do not start the engine.
4. Press and hold the brake pedal for two seconds, then release.
5. Turn the ignition to off - Do not remove the key.
6. Cycle the ignition from off to on three times ending in on - Do not start the engine.

If the training mode has been entered successfully, the horn will sound once, the system indicator will flash, and the information display will show TRAIN LF TIRE.

If after repeated attempts to enter the training mode, the horn does not sound, the system indicator does not flash, and the information display does not show TRAIN LF TIRE, seek service from your authorized dealer.

Training procedure

Note: It may take up to six seconds to activate a tire pressure sensor. During this time, the tool must remain in place at the valve stem.

1. Place the tool on the LF tire sidewall at the valve stem. Press and release the test button on the tool. The horn will sound briefly to indicate that the tire pressure sensor has been recognized by the on-board module.
2. Within two minutes of the horn sounding, place the tool on the RF tire sidewall of the valve stem and press and release the test button to train the RF tire pressure sensor.

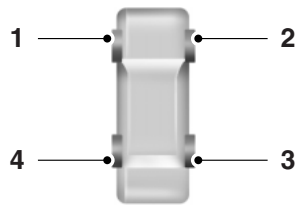

Note: Do not wait more than two minutes between training each sensor or the module will time out and the entire procedure must be repeated.

3. Repeat Step 2 for the RR and LR tires. The procedure is completed after the last tire has been trained. When the training procedure is complete, the information display (if equipped) will show TIRE TRAINING COMPLETE. For vehicles not equipped with an information display, successful completion of the training procedure will be verified by turning the ignition switch to the off position without the horn sounding. If the horn sounds twice when the switch is turned to the off position, the training procedure was not successful.

When you believe your system is not operating properly

The main function of the tire pressure monitoring system is to warn you when your tires need air. It can also warn you in the event the system is no longer capable of functioning as intended. See the following chart for information concerning your tire pressure monitoring system:

Low tire pressure warning light	Possible cause	Customer action required
Solid warning light	Tire(s) under-inflated	1. Make sure tires are at the proper pressure. See <i>Inflating your tires</i> in this chapter. 2. After inflating your tires to the manufacturer's recommended pressure as shown on the Tire Label (located on the edge of driver's door or the B-Pillar), the vehicle must be driven for at least two minutes over 20 mph (32 km/h) before the light turns off.
	Wheel and tire swap without training	Train the sensors to the vehicle. See the TPMS <i>Training procedure</i> in this section.
	TPMS malfunction	If the tires are properly inflated and installed and trained, and the light remains on, contact your authorized dealer as soon as possible.
Flashing warning light	Wheel and tire swap without training	Train the sensors to the vehicle. See the TPMS <i>Training procedure</i> in this section.
	TPMS malfunction	If the tires are properly inflated, but the light remains on, contact your authorized dealer as soon as possible.

When inflating your tires

When putting air into your tires (such as at a gas station or in your garage), the tire pressure monitoring system may not respond immediately to the air added to your tires.

It may take up to two minutes of driving over 20 mph (32 km/h) for the light to turn off after you have filled your tires to the recommended inflation pressure.

How temperature affects your tire pressure

The tire pressure monitoring system monitors tire pressure in each pneumatic tire. While driving in a normal manner, a typical passenger tire inflation pressure may increase approximately 2 to 4 psi (14 to 28 kPa) from a cold start situation. If the vehicle is stationary overnight with the outside temperature significantly lower than the daytime temperature, the tire pressure may decrease approximately 3 psi (21 kPa) for a drop of 30°F (17°C) in ambient temperature. This lower pressure value may be detected by the system as being significantly lower than the recommended inflation pressure and activate the system warning light for low tire pressure. If the low tire pressure warning light is on, visually check each tire to verify that no tire is flat. If one or more tires are flat, repair as necessary. Check air pressure in the road tires. If any tire is under-inflated, carefully drive the vehicle to the nearest location where air can be added to the tires. Inflate all the tires to the recommended inflation pressure.

CHANGING A ROAD WHEEL

WARNING: The use of tire sealant may damage your tire pressure monitoring system and should only be used in roadside emergencies. If you must use a sealant, the Ford Tire Mobility Kit sealant should be used. The tire pressure monitoring system sensor and valve stem on the wheel must be replaced by an authorized dealer after use of the sealant.



WARNING: See *Tire Pressure Monitoring System* in this chapter for important information. If the tire pressure monitor sensor becomes damaged, it will no longer function.

Note: The tire pressure monitoring system indicator light will illuminate when the spare tire is in use until the spare's tire pressure monitoring system sensor is trained.

If you get a flat tire while driving, do not apply the brake heavily. Instead, gradually decrease your speed. Hold the steering wheel firmly and slowly move to a safe place on the side of the road.

Have a flat serviced by an authorized dealer in order to prevent damage to the system sensors. See *Tire Pressure Monitoring System* earlier in the chapter. During repairing or replacing of the flat tire, have the authorized dealer inspect the system sensor for damage.

Tire Change Procedure



WARNING: When one of the front wheels is off the ground, the transmission alone will not prevent your vehicle from moving or slipping off the jack, even if the transmission is in park (**P**).



WARNING: To help prevent your vehicle from moving when you change a tire, be sure to place the transmission in park (**P**), set the parking brake and block (in both directions) the wheel that is diagonally opposite (other side and end of your vehicle) to the tire being changed.



WARNING: Never get underneath a vehicle that is supported only by a jack. If the vehicle slips off the jack, you or someone else could be seriously injured.



WARNING: Do not attempt to change a tire on the side of your vehicle close to moving traffic. Pull far enough off the road to avoid the danger of being hit when operating the jack or changing the wheel.



WARNING: Always use the jack provided as original equipment with your vehicle. If using a jack other than the one provided as original equipment with your vehicle, make sure the jack capacity is adequate for the vehicle weight, including any vehicle cargo or modifications.



WARNING: To reduce the risk of possible serious injury or death, do not remove the full size spare tire from the factory secured location. This location is necessary to achieve police-rated 75 mph (120 km/h) rear impact crash-test performance. Removal increases the risk of fuel leak in high-speed rear impacts.

Note: Passengers should not remain in the vehicle when the vehicle is being jacked.

Note: For sedan, only the original equipment tire or 245/55R18 tire with outer diameter less than 725 millimeters will stow in the tire tub.

Utility

1. Park on a level surface, set the parking brake and activate the hazard flashers.
2. Place the transmission in park (**P**) and turn the engine off.
3. Lift the floor cargo cover, then remove the wing nut that secures the spare tire by turning it counterclockwise.
4. Lift and remove the spare tire from the spare tire well.

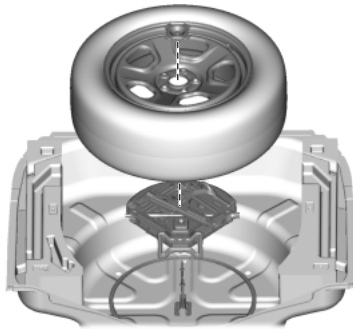

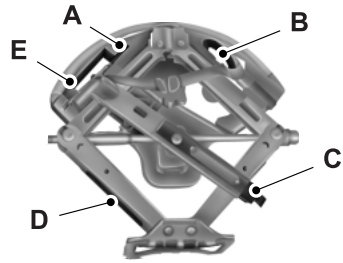

5. Remove the wing bolt that secures the jack kit by turning it counterclockwise.

6. Remove the jack kit which includes the jack (D), wheel wrench (lug wrench) (C), wheel chock (E), L-shaped bolt (A) and the tow recovery hook (B).

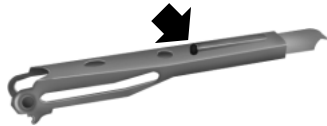

7. Turn the lead screw (where the lug wrench attaches) of the jack by hand to release the wheel wrench from the jack. Press the button on the wrench to extend the handle. Fold down the wrench socket.

Sedan

1. Park on a level surface, set the parking brake and activate the hazard flashers.
2. Place the transmission in park (**P**) and turn the engine off.

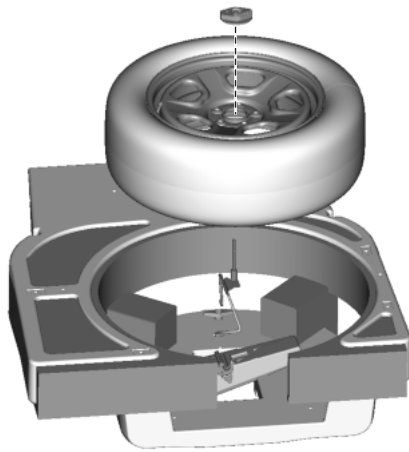

3. Lift the trunk cargo cover, then remove the wing nut that secures the spare tire by turning it counterclockwise.

4. Lift and remove the spare tire from the trunk.

5. Remove the second wing nut that secures the jack retention bracket by turning it counterclockwise, then remove the jack kit from the vehicle.

6. Remove the jack and the wrench from the felt bag. Fold down the wrench socket to use to loosen the lug nuts and to operate the jack.

Vehicle Jacking

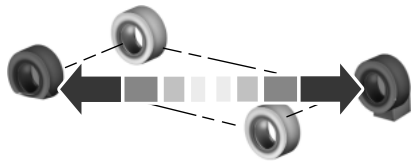

1. Block the diagonally opposite wheel.

2. Loosen each wheel lug nut one-half turn counterclockwise but do not remove them until the wheel is raised off the ground.

3. The vehicle jacking points are shown here, and are depicted on the yellow warning label on the jack.

Note: Jack at the specified locations to avoid damage to the vehicle.

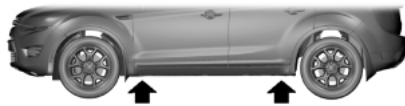

4. Small arrow-shaped marks on the sills show the location of the jacking points.

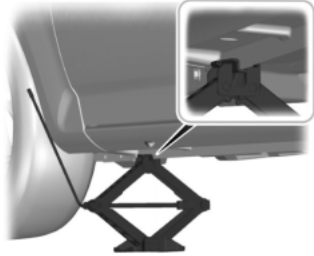

5. Remove the lug nuts with the lug wrench.
6. Replace the flat tire with the spare tire, making sure the valve stem is facing outward. Reinstall the lug nuts until the wheel is snug against the hub. Do not fully tighten the lug nuts until the wheel has been lowered.
7. Lower the wheel by turning the jack handle counterclockwise.

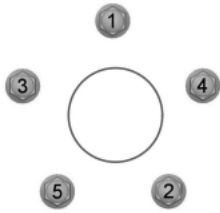

8. Remove the jack and fully tighten the lug nuts in the order shown. See *Wheel Lug Nut Torque Specifications*.

Stowing the Spare and Jack (Utility)

1. Replace the wheel chock in the foam tray.

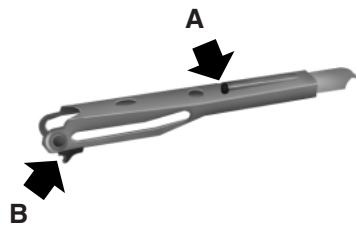

2. Adjust the jack to the proper height to install the wrench. Turn the jack lead screw until the arrow on the upper link is slightly below the circle indicator shown on the lower link.

Push the button (A) to retract the wrench handle and place the wrench over the raised tab on the lower link and drop the tang (B) through the hole in the diagonally opposite upper link. Turn the lead screw of jack clockwise until the arrow aligns with the circle indicator to secure the wrench onto the jack.

3. Place the jack in the foam tray and secure it with the attached strap.

4. Place the foam tray over the mounting bracket on the floor of the spare tire well.

5. Replace the spare over the jack and secure with the wing nut.

Stowing the Flat Tire

Utility

1. Place the flat tire into the spare tire well.
2. Secure the flat tire with the wing nut.

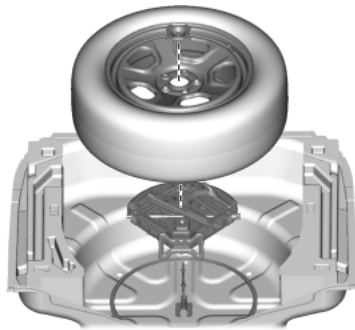

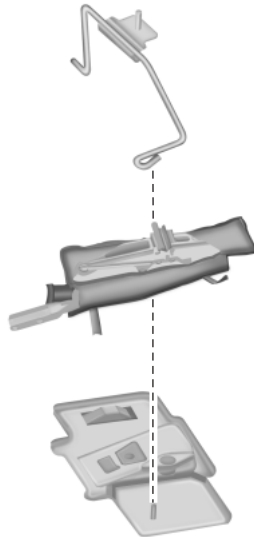
Sedan

1. Insert the straight end of the jack retention bracket through the eyelet of the angled bracket and swing the retention bracket over the jack. With the jack in place, place the end of the retention bracket over the threaded stud in the trunk floor and secure it with the plastic wing nut.

2. Screw the extension bolt onto the threaded stud of the jack retention bracket.



3. Place the flat tire in the spare tire well with the wheel facing up.

4. Safely secure the wheel by screwing the large wing nut onto the extension bolt.

TECHNICAL SPECIFICATIONS

Wheel Lug Nut Torque Specifications

! **WARNING:** When a wheel is installed, always remove any corrosion, dirt or foreign materials present on the mounting surfaces of the wheel or the surface of the wheel hub, brake drum or brake disc that contacts the wheel. Make sure that any fasteners that attach the rotor to the hub are secured so they do not interfere with the mounting surfaces of the wheel. Installing wheels without correct metal-to-metal contact at the wheel mounting surfaces can cause the wheel nuts to loosen and the wheel to come off while your vehicle is in motion, resulting in loss of control.

Retighten the lug nuts to the specified torque at 100 miles (160 kilometers), and again at 500 miles (800 kilometers) of new vehicle operation and after any wheel disturbance (such as tire rotation, changing a flat tire, wheel removal).

Lug nut socket size/bolt size	Wheel lug nut torque*	
	ft-lb	N•m
½ x 20	110	149

* Torque specifications are for nut and bolt threads free of dirt and rust. Use only Ford recommended replacement fasteners.



Note: Inspect the wheel pilot hole and mounting surface prior to installation. Remove any visible corrosion or loose particles.

Engine	2.0L EcoBoost engine	3.5L V6 engine	3.5L V6 EcoBoost engine	3.7L V6 engine
Cubic inches	122	214	214	227
Required fuel	Minimum 87 octane	Minimum 87 octane or Ethanol (E-85)	Minimum 87 octane	Minimum 87 octane or Ethanol (E-85)
Firing order	1-3-4-2	1-4-2-5-3-6	1-4-2-5-3-6	1-4-2-5-3-6
Ignition system	Coil on plug	Coil on plug	Coil on plug	Coil on plug
Spark plug gap	0.027-0.031 in. (0.70-0.80 mm)	0.049-0.053 in. (1.25-1.35 mm)	0.033-0.037 in. (.85-.95 mm)	0.049-0.053 in. (1.25-1.35 mm)
Compression ratio	9.3:1	10.8:1	10.0:1	10.5:1

Engine drivebelt routing

2.0L EcoBoost engines

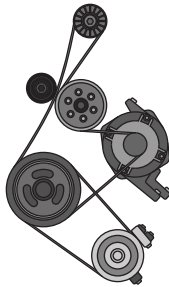

3.5L/3.7L V6 engines



1. Short drivebelt is on first pulley groove closest to engine (except vehicles with electric power assisted steering).

2. Long drivebelt is on second pulley groove farthest from engine.

TECHNICAL SPECIFICATIONS

Items	Capacity	Recommended Fluids and Lubricants	Ford part number / Ford specification
Brake fluid ¹	Between MIN and MAX on reservoir	Motorcraft DOT 4 Low Viscosity High Performance Motor Vehicle Brake Fluid	PM-20 / WSS-M6C65-A2
Door latch, hood latch, auxiliary hood latch, seat tracks, trunk and liftgate latches	—	Motorcraft Multi-Purpose Grease Spray	XL-5 / ESB-M1C93-B
Lock cylinders	—	Motorcraft Penetrating and Lock Lubricant	XL-1 / None
Automatic transmission fluid ^{2,3}	6F35 transmission 9.0 qt (8.5L)	Motorcraft MERCON LV	XT-10-QLVC (U.S.); CXT-10-LV12 (Canada) / MERCON LV
	6F50 transmission 10.9 qt (10.3L)		
	6F55 transmission 11.6 qt (11.0L)		
Rear differential fluid	2.4 pt (1.15L)	Motorcraft SAE 80W-90 Premium Rear Axle Lubricant	XY-80W90-QL / WSP-M2C197-A

Items	Capacity	Recommended Fluids and Lubricants	Ford part number / Ford specification
Sedan and Utility Power Transfer Unit fluid (All Wheel Drive) ⁴	18 oz (0.53L)	Motorcraft SAE 75W-140 Synthetic Rear Axle Lubricant	XY-75W140-QL / WSL-M2C192-A
2.0L EcoBoost engine oil ^{5, 6, 7}	5.7 qt (5.4L)	Motorcraft SAE 5W-30 Premium Synthetic Blend Motor Oil or Motorcraft SAE 5W-30 Full Synthetic Motor Oil	XO-5W30-QSP or XO-5W30-QFS (U.S.) / WSS-M2C946-A
			CXO-5W30-LSP12 or CXO-5W30-LFS12 (Canada) / WSS-M2C946-A
3.5L V6 engine oil ^{5, 6, 7}	6.0 qt (5.7L)	Motorcraft SAE 5W-20 Premium Synthetic Blend Motor Oil or Motorcraft SAE 5W-20 Full Synthetic Motor Oil	XO-5W20-QSP or XO-5W20-QFS (U.S.) / WSS-M2C945-A
			CXO-5W20-LSP12 or CXO-5W20-LFS12 (Canada) / WSS-M2C945-A
3.7L V6 engine oil ^{5, 6, 7}	6.0 qt (5.7L)		

Items	Capacity	Recommended Fluids and Lubricants	Ford part number / Ford specification
3.5L V6 EcoBoost engine oil ^{5, 6, 7}	6.0 qt (5.7L)	Motorcraft SAE 5W-30 Premium Synthetic Blend Motor Oil or Motorcraft SAE 5W-30 Full Synthetic Motor Oil	XO-5W30-QSP or XO-5W30-QFS (U.S.) / WSS-M2C946-A CXO-5W30-LSP12 or CXO-5W30-LFS12 (Canada) / WSS-M2C946-A
Engine coolant ⁸	(2.0L EcoBoost engines) 8.9 qt (8.4L)	Motorcraft Orange Antifreeze/Coolant Prediluted	VC-3DIL-B (U.S.) CVC-3DIL-B (Canada) / WSS-M97B44-D2
	(3.5L V6/3.7L V6 engines) 11.5 qt (10.9L)		
	(3.5L V6 EcoBoost engine) 11.8 qt (11.2L)		
Windshield washer fluid	Fill as required	Motorcraft Premium Windshield Washer Concentrates with Bitterant (U.S.) Premium Quality Windshield Washer Fluid (Canada)	ZC-32-B2 (U.S.) CXC-37-(A, B, D, and F) (Canada) / WSB-M8B16-A2

Items	Capacity	Recommended Fluids and Lubricants	Ford part number / Ford specification
Fuel tank	Sedan 19.0 gal (72L) Utility 18.6 gal (70L)	—	—
Sedan A/C refrigerant (Without auxiliary A/C) ⁹	2.0L/3.5L GTDI: 1.63 lb (0.74 kg) 3.5L/3.7L TiVCT 1.81 lb (0.82 kg)	Motorcraft R-134a Refrigerant	YN-19 (U.S.) CYN-16-R (Canada) / WSH-M17B19-A
Utility A/C refrigerant (Without auxiliary A/C) ⁹	3.7L TiVCT: 1.63 lb (0.74 kg) 3.5L GTDI: 2.1 lb (0.95 kg)	Motorcraft R-134a Refrigerant	YN-19 (U.S.) CYN-16-R (Canada) / WSH-M17B19-A
Utility A/C refrigerant (With auxiliary A/C) ⁹	3.7L TiVCT: 2.31 lb (1.04 kg) 3.5L GTDI 2.94 lb (1.33 kg)	Motorcraft R-134a Refrigerant	YN-19 (U.S.); CYN-16-R (Canada) / WSH-M17B19-A

Items	Capacity	Recommended Fluids and Lubricants	Ford part number / Ford specification
Sedan A/C compressor oil (Without auxiliary A/C)	2.0L/3.5L GTDI and 3.5L/3.7L TiVCT 5.24 fl oz (155 ml)	Motorcraft PAG Refrigerant Compressor Oil	YN-12-D / WSH-M1C231-B
	3.7L TiVCT: 5.24 fl oz (155 ml)		
	3.5L GTDI 5.58 fl oz (165 ml)		
Utility A/C compressor oil (Without auxiliary A/C)	3.7L TiVCT: 7.9 fl oz (235 ml)		
	3.5L GTDI 7.27 fl oz (215 ml)		
Utility A/C compressor oil (With auxiliary A/C)			

¹Ford recommends using Motorcraft (Ford) DOT 4 Low Viscosity High Performance Brake Fluid or equivalent meeting WSS-M6C65-A2. Use of any fluid other than the recommended fluid may cause degraded brake performance and not meet the Ford performance standards. Keep brake fluid clean and dry. Contamination with dirt, water, petroleum products or other materials may result in brake system damage and possible failure.

²Approximate dry fill capacity. Actual amount may vary during fluid changes.

³Automatic transmissions that require MERCON LV should only use MERCON LV fluid. Refer to *scheduled maintenance information* to determine the correct service interval. Use of any fluid other than the recommended fluid may cause transmission damage.

⁴See your authorized dealer for fluid level checking or filling.

Items	Capacity	Recommended Fluids and Lubricants	Ford part number / Ford specification
⁵ Use of synthetic or synthetic blend motor oil is not mandatory. Only use fluid that meets Ford specifications. Motor oils of the recommended viscosity grade that meet API SN requirements and display the API Certification Mark for gasoline engines are also acceptable. Do not use oil labeled with API SN service category unless the label also displays the API certification mark.			
⁶ An oil that displays the API Certification Mark symbol conforms to current engine, emission system and fuel economy performance standards of the International Lubricant Standardization and Approval Committee (ILSAC).			
⁷ Do not use supplemental engine oil additives. They are unnecessary and could lead to engine damage that is not covered by your Ford warranty.			
⁸ Add the coolant type originally equipped in your vehicle.			
⁹ See warning below:			



WARNING: The air conditioning refrigerant system contains refrigerant R134a under high pressure. Opening the air conditioning refrigerant system can cause personal injury. Only qualified personnel should service the air conditioning refrigerant system.

Motorcraft part numbers

Component	2.0L EcoBoost engine	3.5L V6 engine	3.5L V6 EcoBoost engine	3.7L V6 engine
Air filter element	FA-1884	FA-1884	FA-1884	FA-1884
Battery	BXT-65-750	BXT-65-750	BXT-65-750	BXT-65-750
Oil filter	FL-910-S	FL-500-S	FL-500-S	FL-500-S
Spark plugs	SP-537	SP-534 ¹	SP-534 ¹	SP-520 ¹
Cabin air filter	FP68			
Windshield wiper blade	Sedan WW-2601-PF (driver side) WW-2001-PF (passenger side) Utility WW-2206 (driver side) WW-2600 (passenger side) WW-1106 (rear wiper blade)			
¹ Refer to <i>scheduled maintenance information</i> for the appropriate intervals for changing the spark plugs.				

We recommend Motorcraft replacement parts available at your Ford dealer or at fordparts.com for scheduled maintenance. These parts meet or exceed Ford Motor Company's specifications and are engineered for your vehicle. Use of other parts may impact vehicle performance, emissions and durability. Your warranty may be void for any damage related to use of other parts.

If a Motorcraft oil filter is not available, use an oil filter that meets industry performance specification SAE/USCAR-36.

For spark plug replacement, contact an authorized dealer. Replace the spark plugs at the appropriate intervals. See *Scheduled Maintenance*.

VEHICLE IDENTIFICATION NUMBER

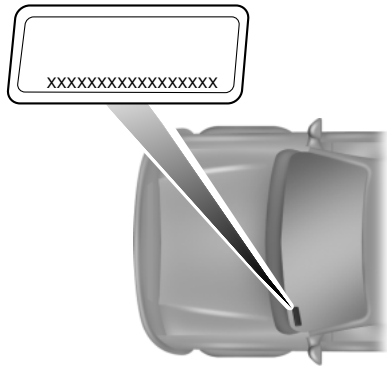

The vehicle identification number is located on the driver's side instrument panel.

Please note that in the graphic, XXXX is representative of your vehicle identification number.

The Vehicle Identification Number (VIN) contains the following information:

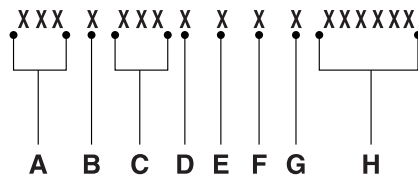

- A. World manufacturer identifier
- B. Brake system / Gross Vehicle Weight Rating (GVWR) / Restraint Devices and their location
- C. Make, vehicle line, series, body type
- D. Engine type
- E. Check digit
- F. Model year

- G. Assembly plant
- H. Production sequence number.

VEHICLE CERTIFICATION LABEL

MFD. BY FORD MOTOR CO.
 DATE: XX/XX GVWR: XXXX KG (XXXX LB)
 FRONT GAWR: REAR GAWR:
 XXXX KG (XXXX LB) WITH XXXX KG (XXXX LB) WITH
 XXXXXXXXXXXXXXXX TIRES XXXXXXXXXXXXXXXX TIRES
 XXXXXXX RIMS XXXXXXX RIMS
 AT XXXX kPa/ XXX PSI COLD AT XXXX kPa/ XXX PSI COLD

THIS VEHICLE CONFORMS TO ALL APPLICABLE FEDERAL MOTOR VEHICLE SAFETY AND THEFT PREVENTION STANDARDS IN EFFECT ON THE DATE OF MANUFACTURE SHOWN ABOVE.

VIN: XXXXXXXXXXXXXXXX XXXX
 TYPE: XXXX XXXX



EXT. PNT: XX XXXXXX I.R.C. XX DSO: XXXX
 WB INT TR TP/PS R AXLE TR SPR XXXX
 XXX XX XXX X XX X XXXX XXXX
 XXXXXXXXXXXXXXX XXX XXXX-XXXXXX-XX

The National Highway Traffic Safety Administration Regulations require that a Safety Compliance Certification Label be affixed to a vehicle and prescribe where the Safety Compliance Certification Label may be located. The Safety Compliance Certification Label shall be affixed to either the door hinge pillar, the door latch post, or the edge of the door near the door latch, next to the driver's seating position.

TRANSMISSION CODE DESIGNATION

MFD. BY FORD MOTOR CO.
 DATE: XX/XX GVWR: XXXX KG (XXXX LB)
 FRONT GAWR: REAR GAWR:
 XXXX KG (XXXX LB) WITH XXXX KG (XXXX LB) WITH
 XXXXXXXXXXXXXXXX TIRES XXXXXXXXXXXXXXXX TIRES
 XXXXXXX RIMS XXXXXXX RIMS
 AT XXXX kPa/ XXX PSI COLD AT XXXX kPa/ XXX PSI COLD

THIS VEHICLE CONFORMS TO ALL APPLICABLE FEDERAL MOTOR VEHICLE SAFETY AND THEFT PREVENTION STANDARDS IN EFFECT ON THE DATE OF MANUFACTURE SHOWN ABOVE.

VIN: XXXXXXXXXXXXXXXX XXXX
 TYPE: XXXX XXXX



EXT. PNT: XX XXXXXX I.R.C. XX DSO: XXXX
 WB INT TR TP/PS R AXLE TR SPR XXXX
 XXX XX XXX X XX X XXXX XXXX
 XXXXXXXXXXXXXXX XXX XXXX-XXXXXX-XX

You can find a transmission code on the Safety Compliance Certification Label. The following table tells you which transmission each code represents.

Description	Code
6-speed automatic transmission (6F35)	6
6-speed automatic transmission (6F50)	J
6-speed automatic transmission (6F55)	C

Extended Service Plan

PROTECT YOURSELF FROM THE RISING COST OF VEHICLE REPAIRS WITH A FORD EXTENDED SERVICE PLAN.

SERVICE PLANS (U.S. Only)

More than 32 million Ford owners have discovered the powerful protection of Ford Extended Service Plan. It is the only extended service plan backed by Ford Motor Company, and provides peace of mind protection beyond the New Vehicle Limited Warranty coverage.

Ford ESP Can Quickly Pay for Itself

One service bill – the cost of parts and labor – can easily exceed the price of your Ford Extended Service Plan. With Ford ESP, you minimize your risk for unexpected repair bills and rising repair costs.

Up to 1,000+ Covered Vehicle Components

There are four Extended Service Plans with different levels of coverage. Ask your authorized dealer for details.

1. PremiumCARE - Our most comprehensive coverage. With over 1,000 covered components, this plan is so complete that we generally only discuss what's not covered.
2. ExtraCARE - Covers 113 components, and includes many high-tech items.
3. BaseCARE - Covers 84 components.
4. PowertrainCARE - Covers 29 critical components.

Ford Extended Service Plan is honored by all authorized Ford dealers in the U.S. and Canada. It is the only extended service plan authorized and backed by Ford Motor Company.

That means you get:

- Reliable, quality service at any Ford or Lincoln dealership
- Repairs performed by factory trained technicians, using genuine parts

Rental Car Reimbursement*1st day Rental Benefit*

You take advantage of replacement transportation if your vehicle is at your authorized dealer for same day covered repairs.

Extended Rental Benefits

If your vehicle is kept overnight for covered repairs, you are eligible for rental car coverage, including bumper to bumper warranty repairs, and Field Service Actions.

Roadside Assistance

Exclusive 24/7 roadside assistance, including:

- Towing, flat-tire change and battery jump starts
- Out of fuel and lock-out assistance
- Travel expense reimbursement for lodging, meals and rental car
- Destination assistance for taxi, shuttle, rental car coverage and emergency transportation

Transferable Coverage

If you sell your vehicle before your Ford Extended Service Plan coverage expires, you can transfer any remaining coverage to the new owner. Whenever you sell your vehicle, prospective buyers may have a higher degree of confidence that vehicle was properly maintained with Ford ESP, thereby improving resale value.

Avoid the Rising Cost of Properly Maintaining Your Vehicle!

Ford Extended Service Plan also offers a Premium Maintenance Plan that covers all scheduled maintenance, and selected wear items. The coverage is prepaid, so you never have to worry about affording your vehicle's maintenance. It covers regular checkups, routine inspections, preventive care and replacement of select items that require periodic attention for normal wear:

- Windshield wiper blades
- Spark plugs (except in California)
- The clutch disc
- Brake pads and linings
- Shock absorbers
- Belts and hoses
- Diesel exhaust fluid replenishment

Contact your selling authorized Ford or Lincoln dealership today so they can customize a Ford Extended Service Plan that fits your driving lifestyle and budget.

Interest Free Finance Options Available

Take advantage of our interest free installment payment plan. Just a 10% down payment will provide you with an affordable, no interest, no fee payment program allowing you all the security and benefits Ford ESP has to offer while paying over time. You are pre-approved with no credit checks, no hassles! To learn more, call our Ford ESP specialists at 800-367-3377.

Ford ESP
P.O. Box 8072
Royal Oak, MI 48068-0039

SERVICE PLANS (CANADA ONLY)

You can get more protection for your vehicle by purchasing a Ford Extended Service Plan. Ford Extended Service Plan is the only service contract backed by Ford Motor Company of Canada, Limited. Depending on the plan you purchase, Ford Extended Service Plan provides benefits such as:

- Rental reimbursement
- Coverage for certain maintenance and wear items
- Protection against repair costs after your New Vehicle Limited Warranty Coverage expires
- Roadside Assistance benefits

There are several Ford Extended Service Plans available in various time, distance and deductible combinations. Each plan is tailored to fit your own driving needs, including reimbursement for towing and rental. When you purchase Ford Extended Service Plan, you receive added peace-of-mind protection throughout Canada and the United States, provided by a network of participating authorized Ford Motor Company dealers.

Note: Repairs performed outside of Canada and the United States are not eligible for Ford Extended Service Plan coverage.

This information is subject to change. For more information, visit your local Ford of Canada dealer or www.ford.ca to find the Ford Extended Service Plan that is right for you.

GENERAL INFORMATION

Radio Frequencies and Reception Factors

AM and FM frequencies are established by the Federal Communications Commission (FCC) and the Canadian Radio and Telecommunications Commission (CRTC). Those frequencies are:

AM: 530, 540–1700, 1710 kHz

FM: 87.9–107.7, 107.9 MHz

Radio reception factors	
Distance and strength	The further you travel from an FM station, the weaker the signal and the weaker the reception.
Terrain	Hills, mountains, tall buildings, bridges, tunnels, freeway overpasses, parking garages, dense tree foliage and thunderstorms can interfere with the reception.
Station overload	When you pass a ground-based broadcast repeating tower, a stronger signal may overtake a weaker one and result in the audio system muting.

CD and CD Player Information

Note: CD units play commercially pressed 4.75-inch (12 centimeter) audio compact discs only. Due to technical incompatibility, certain recordable and re-recordable compact discs may not function correctly when used in Ford CD players.

Note: Do not insert CDs with homemade paper (adhesive) labels into the CD player as the label may peel and cause the CD to become jammed. You should use a permanent felt tip marker rather than adhesive labels on your homemade CDs. Ballpoint pens may damage CDs. Please contact your authorized dealer for further information.

Note: Do not use any irregularly shaped discs or discs with a scratch protection film attached.

Always handle discs by their edges only. Clean the disc with an approved CD cleaner only. Wipe it from the center of the disc toward the edge. Do not clean in a circular motion.

Do not expose discs to direct sunlight or heat sources for extended periods.

MP3 Track and Folder Structure

Audio systems capable of recognizing and playing MP3 individual tracks and folder structures work as follows:

- There are two different modes for MP3 disc playback: MP3 track mode (system default) and MP3 folder mode.
- MP3 track mode ignores any folder structure on the MP3 disc. The player numbers each MP3 track on the disc (noted by the .mp3 file extension) from T001 to a maximum of T255. **Note:** The maximum number of playable MP3 files may be less depending on the structure of the CD and exact model of radio present.
- MP3 folder mode represents a folder structure consisting of one level of folders. The CD player numbers all MP3 tracks on the disc (noted by the .mp3 file extension) and all folders containing MP3 files, from F001 (folder) T001 (track) to F253 T255.
- Creating discs with only one level of folders helps with navigation through the disc files.

If you are burning your own MP3 discs, it is important to understand how the system reads the structures you create. While various files may be present, (files with extensions other than mp3), only files with the .mp3 extension are played; other files are ignored by the system. This enables you to use the same MP3 disc for a variety of tasks on your work computer, home computer and your in-vehicle system.

In track mode, the system displays and plays the structure as if it were only one level deep (all .mp3 files play, regardless of being in a specific folder). In folder mode, the system only plays the .mp3 files in the current folder.

MyFord® SYSTEM

Sedan Shown; Utility Similar

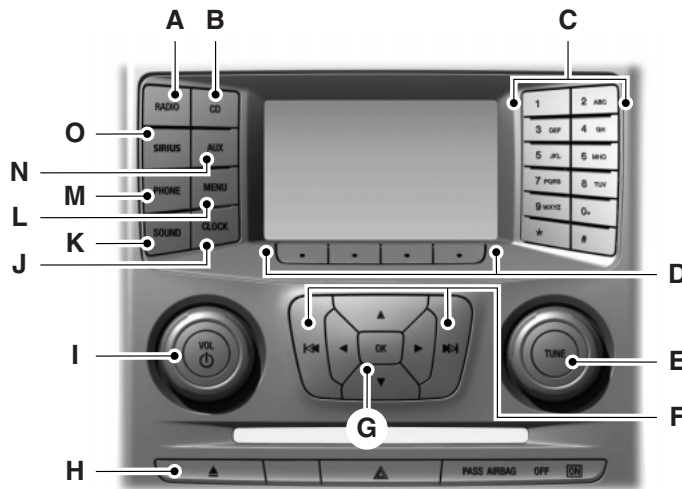

! **WARNING:** Driving while distracted can result in loss of vehicle control, crash and injury. We strongly recommend that you use extreme caution when using any device that may take your focus off the road. Your primary responsibility is the safe operation of your vehicle. We recommend against the use of any hand-held device while driving and encourage the use of voice-operated systems when possible. Make sure you are aware of all applicable local laws that may affect the use of electronic devices while driving.

Note: Utility Police Interceptors: To improve the rear speaker performance in units equipped with rear speaker covers, please follow instructions shown in the *Modifiers Guide*.

A. **RADIO:** Press this button to listen to the radio or change radio frequency bands. Press the function buttons below the radio screen to select different radio functions.

B. **CD:** Press this button to listen to a CD. Press the function buttons below the radio screen to select on-screen options of Repeat or Shuffle.

C. **Memory presets:**

- In radio mode, store your favorite radio stations. To store a radio station, tune to the station, then press and hold a preset button until sound returns.
- In CD mode, press one of these buttons to select a track.

D. **Function buttons:** Select different functions of the audio system depending on which mode you are in (such as Radio mode or CD mode).

E. **TUNE:**

- In radio mode, turn the control to manually search the frequency band.
- In satellite radio mode, turn the control to tune to the next or previous channel.

F. **Reverse and Fast Forward; AM/FM/CD Seek:**

- In radio mode, select a frequency band and press one of these buttons. The system stops at the first station it finds in that direction. Press and hold one of these buttons to move quickly in that direction to the next strong radio station or memory preset.
- In Sirius mode, press one of these buttons to select the previous or next channel. If you select a specific category (such as Jazz, Rock or News), use these buttons to find the previous or next channel in the selected category. Press and hold one of these buttons to move quickly in that direction to the next channel or category.
- In CD mode, press one of these buttons to select the previous or next track. Press and hold one of these buttons to move quickly in that direction within the current track.

G. **OK and arrow buttons:**

- Press the up and down or left and right arrow buttons to browse menu selections.
- Press **OK** to confirm menu selections.

H. **Eject:** Press this button to eject a CD.

I. **Power and Volume:**

- Press this button to switch the system off and on.
- Turn it to adjust the volume.

J. **CLOCK:** Press this button to access the clock setting. Use the center arrow controls to change the hours and minutes.

K. **SOUND:** Press this button to adjust settings for Treble, Midrange, Bass, Balance and Fade.

L. **MENU:** Press this button to access different audio system features. See *Menu structure* later in this section.

M. **PHONE:** Press this button to access the phone features of the SYNC system. See the *SYNC®* chapter for more information.

N. **AUX:** Press this button to access your auxiliary input jack or switch between devices you plug into the input jack or USB port. See *Auxiliary input jack* later in this chapter.

O. **SIRIUS:** This button is not functional.

Menu Structure

Note: Depending on your system, some options may appear slightly different.

Press **MENU**.

Press the up and down arrow buttons to scroll through the options.

Press the right arrow to enter a menu. Press the left arrow to exit a menu.

Press **OK** to confirm a selection.

Radio Settings	
Scan	Select for a brief sampling of all available channels.
Set Category	Select to have the system search by certain music categories (such as Rock, Pop or Country).
RBDS/RDS Text	Select to view additional broadcast data, if available. This feature defaults to off. RBDS must be on for you to set a category.
Audio Settings	
Speed Compensated Volume	Automatically adjusts the volume to compensate for speed and wind noise. You can set the system between 0 and +7.
Sound	Select to adjust settings for Treble, Midrange, Bass, Fade and Balance.
Occupancy Mode	Select to optimize sound quality for the chosen seating position.

CD Settings	
Scan All	Select to scan all disc selections.
Scan Folder	Select to scan all music in the current MP3 folder.
CD Compression	Select to bring soft and loud passages together for a more consistent listening level.
Clock Settings	
Set Time	Select to set the time.
Set Date	Select to set the calendar date.
24h Mode	Select to view clock time in a 12-hour mode or 24-hour mode.
Display Settings	
Dimming	Select to change display brightness.
Language	Select to display the language in English, French or Spanish.
Temp. Setting	Select to display the outside temperature in Fahrenheit or Celsius.

HD RADIO™ INFORMATION (IF AVAILABLE)

Note: HD Radio broadcasts are not available in all markets.

HD Radio technology is the digital evolution of analog AM/FM radio. Your system has a special receiver that allows it to receive digital broadcasts (where available) in addition to the analog broadcasts, it already receives. Digital broadcasts provide a better sound quality than analog broadcasts with free, crystal-clear audio and no static or distortion. For more information, and a guide to available stations and programming, please visit www.hdradio.com.

When HD Radio is on and you tune to a station broadcasting HD Radio technology, you may notice the HD Radio logo on your screen. When this logo is available, you may also see Title and Artist fields on-screen.

The multicast indicator appears in FM mode (only) if the current station is broadcasting multiple digital broadcasts. The highlighted numbers signify available digital channels where new or different content is available. HD1 signifies the main programming status and is available in analog and digital broadcasts. Other multicast stations (HD2 through HD7) are only available digitally.

When HD Radio broadcasts are active, you can access the following functions:

When you select:	You can:
Scan	Hear a brief sampling of all available stations. This feature still works when HD Radio reception is on, although it does not scan for HD2-HD7 channels. You may see the HD logo appear if the station has a digital broadcast.
To save a multicast station as a preset	When the channel is active on-screen, press and hold a memory preset slot until the sound returns. There is a brief mute while the radio saves the station. Sound returns when finished. When recalling a HD2 or HD3 memory preset, there is a mute before the digital audio plays, as the system must once again acquire the digital signal. As with any saved radio station, you cannot access the saved station if your vehicle is outside the station's reception area.

HD Radio Reception and Station Troubleshooting

Potential reception issues	
Reception area	<p>If you are listening to a multicast station and you are on the fringe of the reception area, the station may mute due to weak signal strength.</p> <p>If you are listening to HD1, the system switches back to the analog broadcast until the digital broadcast is available again.</p> <p>However, if you are listening to any of the possible HD2 through HD7 multicast channels, the station mutes and stays muted unless it is able to connect to the digital signal again.</p>
Station blending	<p>When the system first receives a station (aside from HD2-HD7 multicast stations), it first plays the station in the analog version. Once the receiver verifies the station is an HD Radio station, it shifts to the digital version. Depending on the station quality, you may hear a slight sound change when the station changes from analog to digital. Blending is the shift from analog to digital sound or digital back to analog sound.</p>

In order to provide the best possible experience, use the contact form to report any station issues found while listening to a station broadcasting with HD Radio technology. Independent entities own and operate each station. These stations are responsible for making sure all audio streams and data fields are accurate.

Potential station issues		
Issue	Cause	Action
Echo, stutter, skip or repeat in audio. Increase or decrease in audio volume.	This is poor time alignment by the radio broadcaster.	No action required. This is a broadcast issue.

Potential station issues		
Issue	Cause	Action
Sound fading or blending in and out.	The radio is shifting between analog and digital audio.	No action required. The reception issue may clear up as you continue to drive.
There is an audio mute delay when selecting HD2 or HD3, multicast preset or Direct Tune .	The digital multicast is not available until the HD Radio broadcast is decoded. Once decoded, the audio is available.	No action required. This is normal behavior. Wait until the audio is available.
Cannot access HD2 or HD3 multicast channel when recalling a preset or from a direct tune.	The previously stored multicast preset or direct tune is not available in your current reception area.	No action required. The station is not available in your current location.
Text information does not match currently playing audio.	Data service issue by the radio broadcaster.	Fill out the station issue form at website listed below.*
There is no text information shown for currently selected frequency.	Data service issue by the radio broadcaster.	Fill out the station issue form at website listed below.*
HD2-HD7 stations not found when Scan is pressed.	Pressing Scan disables HD2-HD7 channel search.	No action required. This is normal behavior.

*http://www.ibiquity.com/automotive/report_radio_station_experiences

HD Radio™ Technology manufactured under license from iBiquity Digital Corp. U.S. and foreign patents. HD Radio™ and the HD and HD Radio logos are proprietary trademarks of iBiquity Digital Corp. Ford Motor Company and iBiquity Digital Corp. are not responsible for the content sent using HD Radio technology. Content may be changed, added or deleted at any time at the station owner's discretion.

AUXILIARY INPUT JACK (IF EQUIPPED)

WARNING: Driving while distracted can result in loss of vehicle control, crash and injury. We strongly recommend that you use extreme caution when using any device that may take your focus off the road. Your primary responsibility is the safe operation of your vehicle. We recommend against the use of any hand-held device while driving and encourage the use of voice-operated systems when possible. Make sure you are aware of all applicable local laws that may affect the use of electronic devices while driving.



WARNING: For safety reasons, do not connect or adjust the settings on your portable music player while your vehicle is moving.



WARNING: Store the portable music player in a secure location, such as the center console or the glove box, when your vehicle is moving. Hard objects may become projectiles in a crash or sudden stop, which may increase the risk of serious injury. The audio extension cable must be long enough to allow the portable music player to be safely stored while your vehicle is moving.

The auxiliary input jack allows you to connect and play music from your portable music player through your vehicle speakers. You can use any portable music player designed for use with headphones. Your audio extension cable must have male 1/8-inch (3.5 millimeter) connectors at each end.

1. Switch off the engine, radio and portable music player. Set the parking brake and put the transmission in position **P**.
2. Plug the extension cable from the portable music player into the auxiliary input jack.
3. Switch the radio on. Select either a tuned FM station or a CD.
4. Adjust the volume as desired.
5. Switch your portable music player on and adjust its volume to half its maximum level.
6. Press **AUX** until **LINE** or **LINE IN** appears in the display. You should hear music from your device even if it is low.
7. Adjust the volume on your portable music player until it reaches the volume level of the FM station or CD. Do this by switching back and forth between the AUX and FM or CD controls.

USB PORT (IF EQUIPPED)

 **WARNING:** Driving while distracted can result in loss of vehicle control, crash and injury. We strongly recommend that you use extreme caution when using any device that may take your focus off the road. Your primary responsibility is the safe operation of your vehicle. We recommend against the use of any hand-held device while driving and encourage the use of voice-operated systems when possible. Make sure you are aware of all applicable local laws that may affect the use of electronic devices while driving.

The USB port allows you to plug in media playing devices, memory sticks and charge devices (if supported). See the *SYNC* chapter for more information.

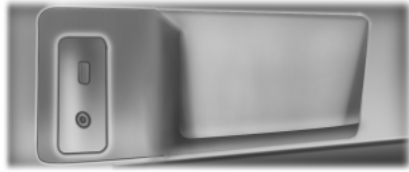

On sedan models, it is located on the instrument panel.

 **WARNING:** Do not use a memory stick that would present a sharp edge rearward in your vehicle where it may have potential to damage a deploying passenger airbag.

On utility models, it is located in the center console or lower center of the instrument panel.

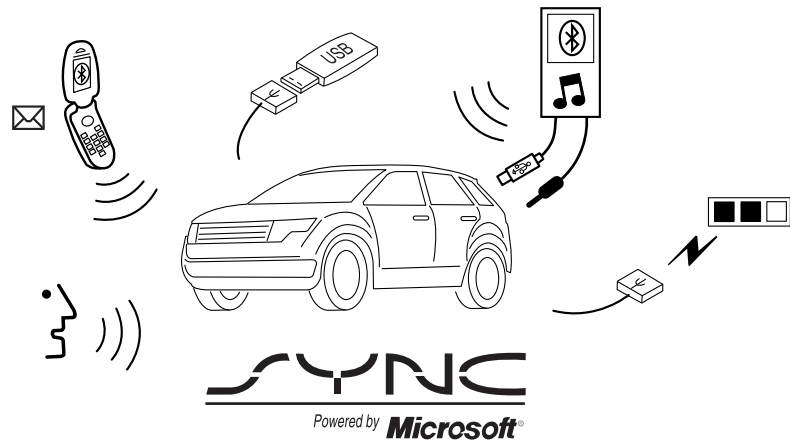

SYNC is an in-vehicle communications system that works with your Bluetooth-enabled cellular phone and portable media player. This allows you to:

- Make and receive calls.
- Access and play music from your portable music player.
- Use 911 Assist, Vehicle Health Report and SYNC Services (Traffic, Directions & Information) (if equipped).
- Use applications, such as Pandora and Stitcher, via SYNC AppLink™ (if applicable).
- Access phonebook contacts and music via voice commands.
- Stream music from your connected phone.
- Text message.
- Use the advanced voice recognition system.
- USB device charging (if your device supports this).

GENERAL INFORMATION

Make sure you review your device's manual before using it with SYNC.

Support

The SYNC support team is available to help you with any questions you cannot answer on your own.

Monday-Saturday, 8:30am-9:00pm EST.

Sunday, 10:30am-7:30pm EST.

In the United States, call: 1-800-392-3673.

In Canada, call: 1-800-565-3673.

Times are subject to change due to holidays.

Driving Restrictions

For your safety, certain features are speed-dependent and restricted when your vehicle is traveling over 3 mph (5 km/h).

Safety Information



WARNING: Driving while distracted can result in loss of vehicle control, crash and injury. We strongly recommend that you use extreme caution when using any device that may take your focus off the road. Your primary responsibility is the safe operation of your vehicle. We recommend against the use of any handheld device while driving and encourage the use of voice-operated systems when possible. Make sure you are aware of all applicable local laws that may affect the use of electronic devices while driving.

When using SYNC:

- Do not operate playing devices if the power cords or cables are broken, split or damaged. Place cords and cables out of the way, so they do not interfere with the operation of pedals, seats, compartments or safe driving abilities.
- Do not leave playing devices in your vehicle during extreme conditions as it could cause them damage. See your device's manual for further information.
- Do not attempt to service or repair the system. See your authorized dealer.

For your safety, some SYNC functions are speed-dependent. Their use is limited to when your vehicle is traveling at speeds under 3 mph (5 km/h).

Make sure that you review your device's manual before using it with SYNC.

Privacy Information

When a cellular phone is connected to SYNC, the system creates a profile within your vehicle that is linked to that cellular phone. This profile is created in order to offer you more cellular features and to operate more efficiently. Among other things, this profile may contain data about your cellular phone book, text messages (read and unread), and call history, including history of calls when your cell phone was not connected to the system. In addition, if you connect a media device, the system creates and retains an index of supported media content. The system also records a short development log of approximately 10 minutes of all recent system activity. The log profile and other system data may be used to improve the system and help diagnose any problems that may occur.

The cellular profile, media device index, and development log remain in the vehicle unless you delete them and are generally accessible only in the vehicle when the cellular phone or media player is connected. If you no longer plan to use the system or the vehicle, we recommend you perform a Master Reset to erase all stored information.

System data cannot be accessed without special equipment and access to the vehicle's SYNC module. Ford Motor Company and Ford of Canada do not access the system data for any purpose other than as described absent consent, a court order, or where required by law enforcement, other government authorities, or other third parties acting with lawful authority. Other parties may seek to access the information independently of Ford Motor Company and Ford of Canada. For further privacy information, see the sections on 911 Assist, Vehicle Health Report, and Traffic, Directions and Information.

USING VOICE RECOGNITION

This system helps you control many features using voice commands. This allows you to keep your hands on the wheel and focus on what is in front of you.

Initiating a Voice Session



Push the voice icon; a tone sounds and Listening appears in the display. Say any of the following:

Say:	If you want to:
“Phone”	Make calls.
“USB”	Access the device connected to your USB port.
“Bluetooth Audio”	Stream audio from your phone.
“Line in”	Access the device connected to the auxiliary input jack.
“Cancel”	Cancel the requested action.
“SYNC”	Return to the main menu.
“Voice settings”	Adjust the level of voice interaction and feedback.
“Vehicle Health Report”	Run a vehicle health report.*
“Services”	Access the SYNC Services portal.*
“Mobile apps”	Access mobile applications.*
“Help”	Hear a list of voice commands available in the current mode.

*If equipped, U.S. only.

System Interaction and Feedback

The system provides feedback through audible tones, prompts, questions and spoken confirmations depending on the situation and the chosen level of interaction (voice settings). You can customize the voice recognition system to provide more or less instruction and feedback.

The default setting is to a higher level of interaction in order to help you learn to use the system. You can change these settings at any time.

Adjusting the Interaction Level

Push the voice icon; when prompted, say “Voice settings”, then any of the following:

When you say:	The system:
“Interaction mode standard”	Provides more detailed interaction and guidance.
“Interaction mode advanced”	Provides less audible interaction and more tone prompts.

The system defaults to the standard interaction mode.

Confirmation prompts are short questions the system asks when it is not sure of your request or when there are multiple possible responses to your request. (For example, the system may ask “Phone, is that correct?”) If turned off, the system simply makes a best guess as to what you requested and you may still occasionally be asked to confirm settings.

“Confirmation prompts on”
“Confirmation prompts off”

The system creates candidate lists when it has the same confidence level of several options based on your voice command. When turned on, you may be prompted with as many as four possibilities for clarification.

For example, “Say 1 after the tone to call John Doe at home. Say 2 after the tone to call Johnny Doe on mobile. Say 3 after the tone to call Jane Doe at home.” Or, “Say 1 after the tone to play John Doe, Say 2 after the tone to play Johnny Doe.”

“Phone candidate lists on”
“Phone candidate lists off”
“Media candidate lists on”
“Media candidate lists off”

Helpful Hints

- Make sure the interior of the vehicle is as quiet as possible. Wind noise from open windows and road vibrations may prevent the system from correctly recognizing spoken commands.
- After pressing the voice icon, wait until after the tone sounds and Listening appears before saying a command. Any command spoken prior to this does not register with the system.
- Speak naturally, without long pauses between words.
- At any time you can interrupt the system while it is speaking by pressing the voice icon.

USING SYNC WITH YOUR PHONE

Hands-free calling is one of the main features of SYNC. While the system supports a variety of features, many are dependent on your cellular phone's functionality. At a minimum, most cellular phones with Bluetooth wireless technology support the following functions:

- Answering an incoming call
- Ending a call
- Using privacy mode
- Dialing a number
- Redialing
- Call waiting notification
- Caller ID.

Other features, such as text messaging using Bluetooth and automatic phonebook download, are phone-dependent features. To check your phone's compatibility, see your phone's user manual and visit www.SYNCMyRide.com, www.SYNCMyRide.ca or www.syncmaroute.ca.

Pairing a Phone for the First Time

Note: SYNC can support downloading up to approximately 1000 entries per Bluetooth-enabled cellular phone.

Note: Make sure the vehicle ignition and radio are turned on and the transmission is in position **P**.

Note: To scroll through the menus, press the up and down arrows on your audio system.

Wirelessly pairing your phone with SYNC allows you to make and receive hands-free calls.

1. Press the phone button; when the display indicates no phone is paired, press **OK**.
2. When **Find SYNC** appears in the display, press **OK**.
3. Put your phone into Bluetooth discovery mode. See your phone's user guide if necessary.
4. When prompted on your phone's display, enter the six-digit PIN provided by SYNC in the radio display.
5. The display indicates when the pairing is successful.

Depending on your phone's capability and your market, the system may prompt you with questions such as setting the current phone as the primary phone (the phone SYNC automatically tries to connect with first upon vehicle start-up), downloading your phone book, etc.

Pairing Subsequent Phones

Note: To scroll through the menus, press the up and down arrows on your audio system.

Note: Make sure the vehicle ignition and radio are turned on and that the transmission is in position **P**.

1. Press the phone button and scroll until System Settings is selected.
2. Press OK and scroll until Bluetooth Devices is selected and press OK.
3. Scroll until Add Bluetooth Device is selected and press OK.
4. When Find SYNC appears in the display, press OK.
5. Put your phone into Bluetooth discovery mode. See your phone's user guide if necessary.
6. When prompted on your phone's display, enter the six-digit PIN provided by SYNC in the radio display. The display indicates when the pairing is successful.
7. The system then prompts with questions such as if you would like to set the current phone as the primary phone (the phone SYNC automatically tries to connect with first upon vehicle start-up), download your phone book, etc.

Phone Voice Commands



Press the voice icon and say “Phone”. Say any of the following:

“PHONE”
“Call <name>” ^{1,2}
“Call <name> on mobile OR cell” ^{1,2}
“Call <name> on other” ^{1,2}
“Phone book <name> at home” ²
“Phone book <name> on mobile OR cell” ²
“Call history outgoing” ²
“Phone book <name> on Other” ²
“Call history missed” ²
“Menu” ^{2,3}
“Join”
“Call <name> at home” ^{1,2}
“Call <name> at work” OR “Call <name> in office” ^{1,2}
“Dial” ^{1,4}
“Phone book <name>” ²
“Phone book <name> at work” OR “Phone book <name> at office” ²
“Call history incoming” ²
“Connections” ²
“Go to privacy”
“Hold”

¹These commands do not require you to say “Phone” first.

²These commands are not available until phone information is completely downloaded using Bluetooth.

³See “MENU” table below.

⁴See “DIAL” table below.

“MENU”
“(Phone) connections”*
“(Phone) settings (message) notification off”*
“(Phone) settings (message) notification on”*
“(Phone) settings (set) phone ringer”*
“(Phone) settings (set) ringer 1”*
“(Phone) settings (set) ringer 2”*
“(Phone) settings (set) ringer 3”*
“(Phone) settings (set) ringer off”*
“Battery”
“Phone name”
“Signal”
“Text message inbox”

*Words in () are optional and do not have to be spoken for the system to understand the command.

Phone book commands: When you ask SYNC® to access a phone book name, number, etc., the requested information appears in the display to view. Press the phone button and say “Call” to call the contact.

“DIAL”
“411” (four-one-one), “911” (nine-one-one)
“700 (seven hundred)” (seven hundred)
“800 (eight hundred)” (eight hundred)
“900 (nine hundred)” (nine hundred)
“#” (pound)
“<number> 0-9”
“Asterisk” (*)
“Clear” (deletes all entered digits)
“Delete” (deletes one digit)
“Plus”
“Star”

Note: To exit dial mode, press and hold the phone button or press MENU to go to the PHONE menu.

Making Calls

Press the voice icon and when prompted say:

1. Say “Call <name>” or “Dial”, then the desired number.
2. When the system confirms the number, say “Dial” again to initiate the call.

To erase the last spoken digit, say “Delete” or press the left arrow button. To erase all spoken digits, say “Clear” or press and hold the left arrow button.

To end the call, press and hold the phone button.

Receiving Calls

When receiving a call, you can:

- Answer the call by pressing the phone button.
- Reject the call by pressing and holding the phone button.
- Ignore the call by doing nothing.

Phone Options during an Active Call

During an active call, you have additional menu features which become available such as putting a call on hold, joining calls, etc. Use the arrow buttons to scroll through the menu options.

To access:

1. Press MENU during an active call.
2. When Active Call Menu is selected, press OK.
3. Scroll to cycle through the following options:

When you select:	You can:
Mute Call?	Mute the call.
Privacy	Switch a call from an active hands-free environment to your cellular phone for a more private conversation. Press OK when Privacy on/off appears. (The display indicates In Privacy and the system transfers your call.)
Call Hold	Put an active call on hold. Press OK when Place Call on Hold? appears. To answer another call at this time, press the phone button.

When you select:	You can:
Join Calls	Join two separate calls. 1. Press the phone button. 2. Access the desired contact through SYNC or use voice commands to place the second call. Once actively in the second call, press MENU. 3. Scroll until Join Calls appears and press OK. Press OK again when Join Calls? appears. Note: SYNC supports a maximum of three callers on a multiparty/conference call.
Enter Tones	Enter “tones” such as numbers for passwords. Scroll until the desired number appears in the display, then press OK; a tone sounds as confirmation. Repeat as necessary.
Phonebook	Access your phonebook contacts. 1. Press OK to select, then scroll through your phonebook contacts. 2. Press OK again when the desired selection appears in the display. 3. Press the phone button.
Call History	Access your call history log. 1. Press OK to select, then scroll through your call history options (incoming, outgoing or missed). 2. Press OK when the desired selection appears in the display. 3. Press the phone button to call the selection.
Return	Exit the current menu.

Accessing Features through the Phone Menu

The SYNC phone menu allows you to redial a number, access your call history and phone book and send text messages as well as access phone and system settings. You can also access advanced features, such as 911 Assist, Vehicle Health Report and SYNC Services.

1. Press the phone button to enter the Phone Menu.
2. Scroll to cycle through:

When you select:	You can:
Phone Redial	Redial the last number called (if available). Press OK to select, then press OK again to confirm.
Call History¹	Allows you to access any previously dialed, received or missed calls while your phone has been connected to the system. 1. Press OK to select. 2. Scroll to select from Call History Incoming, Call History Outgoing or Call History Missed. Press OK make your selection. 3. Press OK or the phone button to call the desired selection. Note: The system attempts to automatically re-download your phone book and call history each time your phone connects to SYNC (if the auto download feature is on and your Bluetooth-enabled cellular phone supports this feature).
Phonebook^{1,2}	Allows you to access your downloaded phonebook. 1. Press OK to confirm and enter. If your phonebook has fewer than 255 listings, they appear alphabetically in flat file mode. If there are more, they are organized into alphabetical categories. 2. Scroll until the desired contact appears, then press OK. 3. Press OK or the phone button.

When you select:	You can:
Text Message ¹	Enables you to send, download and delete text messages.
Phone Settings ¹	Allows you to view your phone's status, set ring tones, select your message notification, change phone book entries and automatically download your cellular phone among other features.
SYNC Services ³	Access the SYNC services portal where you can request various types of information, traffic reports and directions.
911 Assist ⁴	Place an emergency call to a 911 operator for you after an accident (if the feature is used properly).
Vehicle Health Report ³	Create and receive a diagnostic report card on your vehicle.
Mobile Apps ³	Interact with SYNC-capable mobile applications on your smartphone.
System Settings	Access Bluetooth Devices menu listings (add, connect, set as primary, on/off, delete) as well as Advanced menu listings (prompts, languages, defaults, master reset, install application and system information).
Exit Phone Menu	Exit the phone menu by pressing OK.

¹This is a phone-dependent feature.

²This is a phone-dependent and speed-dependent feature.

³If equipped, United States only.

⁴If equipped, United States and Canada only.

Text Messaging

Note: This is a phone-dependent feature.

SYNC allows you to receive, send, download and delete text messages. The system can also read incoming text messages to you so that you do not have to take your eyes off the road.

Receiving a Text Message

Note: This is a phone-dependent feature. Your phone must support downloading text messages using Bluetooth to receive incoming text messages.

Note: Forwarding a text message is a speed-dependent feature and can only be done when the vehicle is traveling at 3 mph (5 km/h) or less.

Note: Only one recipient is allowed per text message.

When a new message arrives, an audible tone sounds and the display indicates you have a new message. You have these options:

1. Press the voice button, wait for the prompt and say "Read Message" to have SYNC read the message to you.
2. Press OK to receive and open the text message or do nothing and the message goes into your text message inbox. Press OK again and SYNC reads your message aloud as you are not able to view the message. You can then also choose whether you'd like to reply or forward the message.
3. Press OK and scroll to choose between:
 - Reply to Text Message: Press OK to access and then scroll through the list of pre-defined messages to send.
 - Forward Text Message: Press OK to forward the message to anyone in your Phonebook or Call History. You can also choose Enter Number.

Sending, Downloading and Deleting Your Text Messages

Text messaging is a phone-dependent feature. If your phone is compatible, SYNC allows you to receive, send, download and delete text messages.

1. Press the phone button.
2. Scroll until Text Message appears and press OK.
3. Scroll to select from the following options:

Send Text Message? enables you to send a new text message based on a pre-defined set of 15 messages.

Download Unread Msgs allows you to download your unread messages (only) to SYNC. To download the messages, press OK to select. The display indicates your messages are being downloaded. When complete, SYNC takes you to your inbox.

Delete All Messages? allows you to delete current text messages from SYNC (not your phone). To delete the messages, press OK to select. The display indicates when all your text messages have been deleted and SYNC returns you to the text message menu.

Note: SYNC does not automatically download all of your unread text messages at every ignition cycle (as it does with call history and phonebook if automatic download is set to on).

Return exits the current menu when you press OK.

If you select **Send Text Message?**:

1. Press OK to select. If the system detects your phone does not support this feature, Unsupported appears in the display and SYNC returns to the main menu.
2. Scroll to cycle through the message options in the following chart.
3. Press OK when the desired selection is in the display. The system now needs to know who to send the message to.
4. Scroll to cycle through Phonebook or Call History entries. You can also select Enter Number to audibly enter a desired number.
5. Press OK to enter the desired menu and scroll to select the specific contact.
6. Press OK when the contact appears and press OK again to confirm when the system asks if you would like to send the message. Each text message is sent with the following signature: "This message was sent from my <Ford or Lincoln>".

Pre-defined text message options
Can't talk right now
Call me
Call you later
Be there in 10 minutes
Be there in 20 minutes
Yes
No
Why?
Thanks
Where R you?
I need more directions
I love you
Too funny
Can't wait to see you
I'm stuck in traffic

Accessing Your Phone Settings

These are phone-dependent features. Your phone settings allow you to access and adjust features such as your ring tone, text message notification, modify your phone book and also set up automatic download.

1. Press the phone button.
2. Scroll until Phone Settings appears, then press OK.
3. Scroll to select from the following options:

When you select:	You can:
Phone Status	See the provider, name, signal power, battery power and roaming status of your connected phone. Press OK to select and scroll to view the information. When done, press OK again to return to the phone status menu.
Set Ringer	Select which ring tone sounds during an incoming call (one of the system's or your phone's). 1. Press OK to select and scroll to hear Ringer 1, Ringer 2, Ringer 3 and Phone Ringer. 2. Press OK to select. Note: If your phone supports in-band ringing, your phone's ringer sounds when Phone Ringer is chosen.
Message Notification	Have the option of hearing an audible tone to notify you when a text message arrives. 1. Press OK to select and scroll between Message Notification On or Message Notification Off. 2. Press OK to select.

When you select:	You can:
Modify Phonebook	<p>Modify the contents of your phone book (such as add, delete, download). Press OK to select and scroll between:</p> <p>Add Contacts: Press OK to add more contacts from your phone book. Push the desired contact(s) on your phone. See your phone's user guide on how to push contacts.</p> <p>Delete Phonebook: Press OK to delete the current phone book and call history. When Delete Phonebook appears, press OK to confirm. SYNC takes you back to the Phone Settings menu.</p> <p>Download Phonebook: Press OK to select and press OK again when Confirm Download? appears.</p>
Auto Download	<p>Automatically download your phone book each time your phone connects to SYNC. Press OK to select. When Auto Download On? appears, press OK to have your phonebook automatically downloaded each time.</p> <p>Select Off to NOT download your phonebook every time your phone connects to SYNC. Your phonebook, call history and text messages can only be accessed when your specific phone is connected to SYNC.</p> <p>Note: Downloading times are phone- and quantity-dependent.</p> <p>Note: When auto download is on, any changes, additions or deletions saved since your last download are deleted.</p>
Return	Exit the current menu.

System Settings

System Settings provide access to your Bluetooth Devices and Advanced menu features. Use the arrow buttons to scroll through the menu options.

The Bluetooth Devices menu allows you to add, connect, delete and set a phone as primary as well as turn your Bluetooth feature on and off.

The Advanced menu allows you to access and set prompts, languages, defaults, perform a master reset, install an application and view system information.

Bluetooth Devices Menu Options

This menu allows you to add, connect, delete, set a phone as primary, and turn Bluetooth on or off.

1. Press the phone button to enter the Phone Menu.
2. Scroll until System Settings appears and press OK.
3. Scroll until Bluetooth Devices appears and select OK.
4. Scroll to select from the following options:

If you select:	You can:
Add Bluetooth Device*	See <i>Using SYNC with your phone</i> earlier in this chapter for pairing instructions.
Connect Bluetooth Device	Connect a previously paired Bluetooth-enabled phone. 1. Press OK to select and view a list of previously paired phones. 2. Scroll until the desired device is chosen, then press OK to connect the phone. Note: Only one device can be connected at a time. When another phone is connected, the previous one is disconnected.
Set Primary Phone	Set a previously paired phone as your primary phone. Press OK to select and scroll to select the desired phone. Press OK to confirm. Note: SYNC attempts to connect with the primary phone at every ignition cycle. When a phone is selected as primary, it appears first in the list and is marked with an asterisk (*).

If you select:	You can:
Set Bluetooth On/Off	Turn the Bluetooth feature on and off. Press OK and scroll to toggle between On and Off. When the desired selection is chosen, press OK. Note: Turning Bluetooth off disconnects all Bluetooth devices and deactivates all Bluetooth features.
Delete Device	Delete a paired phone. Press OK and scroll to select the device. Press OK to confirm.
Delete All Devices	Delete all previously paired phones (and all information originally saved with those phones). Press OK to select.
Return	Exit the current menu.

*This is a speed-dependent feature.

Advanced Menu Options

This menu allows you to access settings such as prompts, languages, defaults, perform a master reset, install an application and view system information.

1. Press the phone button to enter the Phone Menu.
2. Scroll until System Settings appears and press OK.
3. Scroll until Advanced appears and select OK.
4. Scroll to select from the following options:

If you select:	You can:
Prompts	Get help from SYNC by using questions, helpful hints or asking you for a specific action. To turn these prompts on or off: 1. Press OK to select and scroll to select between on or off. 2. Press OK when the desired selection appears in the display. SYNC takes you back to the Advanced menu.

If you select:	You can:
Languages	<p>Choose between English, Espanol and Francais. Once selected, all of SYNC's radio displays and prompts are in the selected language.</p> <ol style="list-style-type: none"> 1. Press OK to select and then scroll through the languages. 2. Press OK when the desired selection appears in the display. If you change the language setting, the display indicates that the system is updating. When complete, SYNC takes you back to the Advanced menu.
Factory Defaults	<p>Return to the factory default settings. This selection does not erase your indexed information (phonebook, call history, text messages and paired devices).</p> <ol style="list-style-type: none"> 1. Press OK to select and then press OK again when Restore Defaults? appears in the display. 2. Press OK to confirm.
Master Reset	<p>Completely erase all information stored on SYNC (phonebook, call history, text messages and paired devices) and return to the factory default settings.</p> <p>Press OK to select. The display indicates when complete and SYNC takes you back to the Advanced menu.</p>
Install Application	<p>Install applications you have downloaded. Press OK and scroll to select. Press OK to confirm.</p>
System Info	<p>Access the Auto Version number as well as the FPN number.</p> <p>Press OK to select.</p>
MAP Profile	<p>This is a Bluetooth component which can further help your phone with the exchange of text messages.</p>
Return	<p>Exit the current menu.</p>

SYNC APPLICATIONS AND SERVICES (IF EQUIPPED)

Note: In order for the following features to work, your cellular phone must be compatible with SYNC. To check your phone's compatibility, visit www.SYNCMYride.com, www.SYNCMYride.ca or www.syncmaroute.ca.

- SYNC Services (if equipped, United States only): Provides access to traffic, directions and information such as travel, horoscopes, stock prices and more.
- 911 Assist: Can alert 911 in the event of an emergency.
- Vehicle Health Report (if equipped, United States only): Provides a diagnostic and maintenance report card of your vehicle.

911 Assist®

WARNING: Unless the 911 Assist setting is set on prior to a crash, the system will not dial for help which could delay response time, potentially increasing the risk of serious injury or death after a crash.



WARNING: Do not wait for 911 Assist to make an emergency call if you can do it yourself. Dial emergency services immediately to avoid delayed response time which could increase the risk of serious injury or death after a crash. If you do not hear 911 Assist within five seconds of the crash, the system or phone may be damaged or non-functional.



WARNING: Always place your phone in a secure location in the vehicle so it does not become a projectile or get damaged in a crash. Failure to do so may cause serious injury to someone or damage the phone which could prevent 911 Assist from working properly.

Note: SYNC 911 Assist feature must be set on prior to the incident.

Note: Before setting this feature on, ensure that you read the 911 Assist privacy notice later in this section for important information.

Note: If 911 Assist is turned on or off by any user, that setting applies for all paired phones. If 911 Assist is turned off, a voice message plays and/or a display message/icon comes on when the vehicle is started after a previously paired phone connects.

Note: Every phone operates differently. While SYNC 911 Assist works with most cellular phones, some may have trouble using this feature.

If a crash deploys an airbag (excludes knee airbags and rear inflatable safety belts [if equipped]) or activates the fuel pump shut-off, your SYNC equipped vehicle may be able to contact emergency services by dialing 911 through a paired and connected Bluetooth-enabled phone. For more information about 911 Assist, visit www.SYNCMyRide.com, www.SYNCMyRide.ca or www.syncmaroute.ca.

- For information on airbag deployment, see the *Supplementary Restraints System* chapter.
- For information on the fuel pump shut-off, see the *Roadside Emergencies* chapter.

Setting 911 Assist On

Perform the following:

1. Press the phone button to enter the Phone Menu.
2. Scroll until 911 Assist is selected.
3. Press OK to confirm and enter the 911 Assist menu.
4. Scroll to select between On and Off selections.
5. Press OK when the desired option appears in the radio display. Set On or Set Off appears in the display as confirmation.

Off selections include: Off with reminder and Off without reminder. Off with reminder provides a display and voice reminder at phone connection at vehicle start. Off without reminder provides a display reminder only without a voice reminder at phone connection.

To make sure that 911 Assist works properly:

- SYNC must be powered and working properly at the time of the incident and throughout feature activation and use.
- SYNC 911 Assist feature must be set on prior to the incident.
- A Bluetooth-enabled and compatible phone has to be paired and connected to SYNC.
- A connected Bluetooth-enabled phone must have the ability to make and maintain an outgoing call at the time of the incident.
- A connected Bluetooth-enabled phone must have adequate network coverage, battery power and signal strength.
- The vehicle must have battery power and be located in the United States, Canada or in a territory in which 911 is the emergency number.

In the Event of a Crash

Not all crashes deploy an airbag or activate the fuel pump shut-off (which would activate 911 Assist); however, if 911 Assist is triggered, SYNC tries to contact emergency services. If a connected phone is damaged or loses connection to SYNC, SYNC searches for, and tries to connect to, any available previously paired phone and tries to make the call to 911.

Before making the call:

- SYNC provides a short window of time (about 10 seconds) to cancel the call. Failure to cancel the call results in SYNC attempting to dial 911.
- SYNC says the following, or a similar message: “SYNC will attempt to call 911, to cancel the call, press Cancel on your screen or press and hold the phone button on your steering wheel.”

If the call is not cancelled and a successful call is made, a pre-recorded message is played for the 911 operator, then the occupant(s) in the vehicle is able to talk with the operator. Be prepared to provide your name, phone number and location immediately, because not all 911 systems are capable of receiving this information electronically.

911 Assist May Not Work If

- Your cellular phone or 911 Assist hardware was damaged in a crash.
- The vehicle’s battery or SYNC system has no power.
- The phone(s) paired and connected to the system was thrown from the vehicle.

911 Assist Privacy Notice

Once 911 Assist is set on, it may disclose to emergency services that the vehicle has been in a crash involving the deployment of an airbag or activation of the fuel pump shut-off. Certain versions or updates to 911 Assist may also be capable of electronically or verbally disclosing to 911 operators the vehicle location, and/or other details about the vehicle or crash to assist 911 operators to provide the most appropriate emergency services. If you do not want to disclose this information, do not turn the feature on.

Vehicle Health Report



WARNING: Always follow scheduled maintenance instructions, regularly inspect your vehicle, and seek repair for any damage or problem you suspect. Vehicle Health Report supplements, but cannot replace normal maintenance and vehicle inspection. Vehicle Health Report only monitors certain systems that are electronically monitored by the vehicle and will not monitor or report the status of any other system, (such as brake lining wear). Failure to perform scheduled maintenance and regularly inspect your vehicle may result in vehicle damage and serious injury.

Note: Your Vehicle Health Report feature requires activation prior to use. Visit www.SYNCMYRide.com to register. There is no fee or subscription associated with Vehicle Health Report, but you must register to use this feature.

Note: This feature may not function properly if you have enabled caller ID blocking on your mobile phone. Before running a report, review the *Vehicle Health Report privacy notice*.

Note: In order to allow a break-in period for your vehicle, you may not be able to create a Vehicle Health Report until your vehicle odometer has reached 200 miles.

Register for Vehicle Health Report and set your report preferences at www.SYNCMYRide.com. After registering, you can request a Vehicle Health Report (inside your vehicle). Return to your account at www.SYNCMYRide.com to view your report. You can also choose for SYNC to automatically remind you to run reports at specific mileage intervals. Cellular phone airtime usage may apply when reporting.

The system allows you to check your vehicle's overall health in the form of a diagnostic report card. The vehicle health report contains valuable information such as:

- Vehicle Diagnostic Information
- Scheduled maintenance
- Open Recalls and Field Service Actions
- Unserviced items from vehicle inspections by your authorized dealer.

You can run a report (after the vehicle has been running a minimum of 60 seconds) by pressing the voice button and saying "Vehicle health report", or pressing the phone button.

To run a report using the phone button:

1. Press the phone button to enter Phone Menu.
2. Scroll until Vehicle Health is selected and press OK.
3. Scroll to select from the following options:

Vehicle Health Report options	
User Preferences: Press OK to select and enter the menu. Scroll to select from:	<p>Automatic Reports: Press OK and select on or off. Select On to have SYNC automatically prompt you to run a health report at certain mileage intervals. Note: You must first turn this feature on before you can select the mileage intervals at which you would like to be prompted.</p> <p>Mileage Intervals: Press OK. Scroll to select between 5000, 7500 or 10000 mile intervals and press OK to make your selection.</p> <p>Return: Press OK to exit the menu.</p>
Run Report?	Press OK for SYNC to run a health report of your vehicle's diagnostic systems and send the results to Ford where it is combined with scheduled maintenance information, open recalls and other field service actions and unserviced vehicle inspection items from your authorized dealer.

Vehicle Health Report Privacy Notice

When you run a Vehicle Health Report, Ford Motor Company may collect your cellular phone number (to process your report request) and diagnostic information about your vehicle. Certain versions or updates to Vehicle Health Report may also collect additional vehicle information. Ford may use the vehicle information it collects for any purpose. If you do not want to disclose your cellular phone number or vehicle information, do not run the feature or set up your Vehicle Health Report profile at www.SYNCMYride.com. See www.SYNCMYride.com - Vehicle Health Report Terms and Conditions, and Privacy Statement - for more information.

**SYNC Services: Traffic, Directions & Information (TDI)
(If Equipped, United States Only)**

Note: SYNC Services varies by trim level and model year and may require a subscription. Traffic alerts and turn-by-turn directions available in select markets. Message and data rates may apply. Ford Motor Company reserves the right to change or discontinue this product service at any time without prior notification or incurring any future obligation.

Note: SYNC Services requires activation prior to use. Visit www.SYNCMYride.com to register and check your eligibility for complimentary services. Standard phone and message rates may apply. Subscription may be required. You must also have the active SYNC Services Bluetooth-enabled cellular phone paired and connected to the system in order to connect to, and use, SYNC Services. See *Using SYNC with your phone* for pairing instructions.

Note: This feature does not function properly if you have enabled caller ID blocking on your mobile phone. Make sure your mobile phone is not blocking caller ID before using SYNC Services.

Note: The driver is ultimately responsible for the safe operation of the vehicle, and therefore, must evaluate whether it is safe to follow the suggested directions. Any navigation features are provided only as an aid. Make your driving decisions based on your observations of local conditions and existing traffic regulations. Do not follow the route suggestions if doing so would result in an unsafe or illegal maneuver, if you would be placed in an unsafe situation, or if you would be directed into an area that you consider unsafe. Maps used by this system may be inaccurate because of errors, changes in roads, traffic conditions or driving conditions.

Note: When you connect, the service uses GPS technology and advanced vehicle sensors to collect the vehicle's current location, travel direction and speed to help provide you with the directions, traffic reports, or business searches you request. Further, to provide the services you request and for continuous improvement, the service may collect and record call details and voice communications. For more information, see SYNC Services Terms and Conditions at www.SYNCMYride.com. If you do not want Ford or its service providers to collect the vehicle travel information or other information identified in the Terms and Conditions, do not activate or use the service.

SYNC Services uses advanced vehicle sensors, integrated GPS technology and comprehensive map and traffic data, to give you personalized traffic reports, precise turn-by-turn directions, business search, news, sports, weather and more. For a complete list of services, or to learn more, please visit www.SYNCMYride.com.

Connecting to SYNC Services Using Voice Commands

1. Press the voice button.
2. When prompted, say “Services”. This initiates an outgoing call to SYNC Services using your paired and connected Bluetooth-enabled cellular phone.
3. Once you are connected to the service, follow the voice prompts to request the desired service, such as “Traffic” or “Directions”. You can also say “What are my choices?” to receive a complete list of available services from which to choose.
4. Say “Services” to return to the services main menu or for help, say “Help”.

Connecting to SYNC Services Using the Phone Menu

1. Press the phone button to enter the Phone Menu.
2. Scroll until *Services* appears in the display.
3. Press OK to confirm and enter the Services menu. The display indicates the system is connecting.
4. Press OK. SYNC initiates the call to the Services portal.
5. Once connected, follow the voice prompts to request your desired Service, such as Traffic or Directions. You can also say “What are my choices?” to receive a complete list of available services from which to choose.
6. To return to the Services menu, say “Services” or for help, say “Help”.

Receiving Turn-by-Turn Directions

1. When connected to SYNC Services, say “Directions” or “Business search”. To find the closest business or type of business to your current location, just say “Business search” and then “Search near me”. If you need further assistance in finding a location you can say “Operator” at any time within a Directions or Business search to speak with a live operator. You may also be prompted to speak with an operator when the automatic system has difficulty matching your voice request. The live operator can assist you by searching for businesses by name or by category, residential addresses by street address or by name or specific street intersections. Operator Assist is a feature of your SYNC Services subscription. For more information on Operator Assist visit www.SYNCMYride.com/support.
2. Follow the voice prompts to select your destination. Once your destination is selected, your current vehicle location is uploaded and a route based on current traffic conditions is calculated and sent back to your vehicle. After the route download is complete, the phone call is automatically ended. You then receive audible and visual driving instructions as you travel toward your destination.

3. While on an active route, you can select or say “Route summary” or “Route status” to view the Route Summary turn list or the Route Status ETA. You can also turn voice guidance on or off, cancel the route or update the route.

If you miss a turn, SYNC automatically asks if you want the route updated. Just say, “Yes” when prompted and a new route will be delivered to your vehicle.

Disconnecting from SYNC Services

1. Press and hold the phone button on the steering wheel.
2. Say “Good-bye” from the SYNC Services main menu.

SYNC Services quick tips	
Personalizing	You can personalize your Services feature to provide quicker access to your most used or favorite information. You can save address points such as work or home. You can also save favorite information like sports teams or a news category. To learn more, log onto www.SYNCMYride.com .
Push to interrupt	Press the voice button at any time (while you are connected to SYNC Services) to interrupt a voice prompt or an audio clip (such as a sports report), wait for the listening tone, and say your voice command.
Portable	Your subscription is associated with your Bluetooth-enabled cellular phone number, not your VIN (Vehicle Identification Number). You can pair and connect your phone to any vehicle equipped with SYNC Services and continue enjoying your personalized services. You can even access your account outside the vehicle. Just use the number on your phone’s call history. Traffic and Directions features do not function properly but information services and the 411 connect and text message features are available.

USING SYNC WITH YOUR MEDIA PLAYER

You can access and play music from your digital music player over the vehicle's speaker system using the system's media menu or voice commands. You can also sort and play your music by specific categories, such as artists or albums.

Note: The system is capable of indexing up to 6,000 songs.

SYNC is capable of hosting nearly any digital media player including: iPod, Zune™, Plays from device players, and most USB drives. SYNC also supports audio formats such as MP3, WMA, WAV and ACC.

Connecting Your Digital Media Player via the USB Port

Note: If your digital media player has a power switch, ensure that the device is turned on.

To connect using voice commands:

1. Plug the device into the vehicle's USB port.
2. Press the voice icon and when prompted, say "USB".
3. You can now play music by saying any of the appropriate voice commands. See the media voice commands.

To connect using the system menu:

1. Plug the device into the vehicle's USB port.
2. Press AUX and then MENU to enter the Media Menu.
3. Scroll until Select Source appears and press OK.
4. Scroll to select USB and press OK.
5. Depending on how many digital media files are on your connected device, Indexing may appear in the radio display. When indexing is complete, the screen returns to the Play Menu.
6. Press OK and scroll through selections of:
 - Play All
 - Artists
 - Albums
 - Genres
 - Playlists
 - Tracks
 - Explore USB
 - Similar Music
 - Return

When the desired selection appears in the display, press OK to build your desired music selection.

What's Playing?



At any time when a track is playing, you can press the voice icon and ask the system, "What's playing?". The system reads the metadata tags (if populated) of the playing track to you.

Media Voice Commands



Press the voice icon and, when prompted, say "USB" then any of the following:

"USB"
"Autoplay off"
"Autoplay on"
"(Phone) (Media) (Bluetooth) Connections"
"Pause"
"Play"
"Play album <name>" ^{1,3}
"Play all"
"Play artist <name>" ^{1,3}
"Play genre <name>" ^{1,3}
"Play next folder" ²
"Play next track"
"Play playlist <name>" ^{1,3}
"Play previous folder" ²
"Play previous track"
"Play song <name>" ^{1,3}
"Play track <name>" ^{1,3}
"Refine album <name>" ^{1,3}
"Refine artist <name>" ^{1,3}
"Refine song <name>" ^{1,3}
"Refine track <name>" ^{1,3}
"Repeat off"
"Repeat on"
"Search album <name>" ^{1,3}
"Search artist <name>" ^{1,3}
"Search genre <name>" ^{1,3}

“USB”
“Search song <name>” ^{1,3}
“Search track <name>” ^{1,3}
“Shuffle off”
“Shuffle on”
“Similar music”
“What’s playing?”

¹“<name>” is a dynamic listing, meaning that it could be the name of any desired group, artist, etc.

²Voice commands which are only available in folder mode.

³Voice commands which are not available until indexing is complete.

Voice command guide	
“Autoplay”	Turn on to listen to music which has already been randomly indexed during the indexing process. Turn off and the system does not begin to play any of your music until all media has all been indexed. Indexing times can vary from device to device and also with regard to the number of songs being indexed.
“Search/Play Genre”	The system searches all the data from your indexed music and, if available, begins to play the chosen type of music. You can only play genres of music which are present in the GENRE metadata tags that you have on your digital media player.
“Similar Music”	The system compiles a playlist and then plays similar music to what is currently playing from the USB port using indexed metadata information.
“Search/Play Artist/Track/Album”	The system searches for a specific artist/track/album from the music indexed through the USB port.

Voice command guide	
“Refine”	This allows you to make your previous command more specific. For example, if you asked to search and play all music by a certain artist, you could then say “refine album” and choose a specific album from the list to view. If you then select Play, the system only plays music from that specific album.

Press the voice icon and when prompted say “Bluetooth Audio” and then any of the following:

“BLUETOOTH AUDIO”
“(Phone) (Media) (Bluetooth) Connections”
“Pause”
“Play”
“Play next track ”
“Play previous track ”

Media Menu Features

The media menu allows you to select your media source, how to play your music (by artist, genre, shuffle, repeat, etc.), and also to add, connect or delete devices.

1. Press AUX and then MENU to enter the Media Menu.
2. Scroll to cycle through:

When you select:	You can:
Play Menu	Play your music by artist, album, genre, playlists, tracks, similar music or to simply, play all. You can also choose to Explore USB to view the supported digital music files on your playing device. See Play Menu later in this section for more information.

When you select:	You can:
Select Source	<p>SYNC USB: Press OK to access music plugged into your USB port. You can also plug in devices to charge them (if supported by your device). Once connected, the system indexes any readable media files. (The time required to complete this depends on the size of the media content being indexed.) If Autoplay is on, you can access media files randomly as they are indexed. If turned off, indexed media is not available until the indexing process is complete. SYNC is capable of indexing thousands of average size media and notifies you if the maximum indexing file size is reached.</p> <p>Bluetooth Audio: This is a phone-dependent feature which allows you to stream music playing on your Bluetooth-enabled phone. If supported by your device, you can press SEEK to play the previous or next track.</p> <p>SYNC Line In: Press OK to select and play music from your portable music player over the vehicle's speakers.</p> <p>Note: If you have already connected a device to the USB port, you cannot access the line in feature. Some digital media players require both USB and line in ports to stream data and music separately.</p>

When you select:	You can:
<p>Media Settings</p>	<p>Choose to shuffle or repeat your music and select your Autoplay settings. Once these selections are turned on, they remain on until turned off. Press SEEK to play the previous or next track.</p> <p>Note: Some digital media players require both USB and line in ports to stream data and music separately. Press OK to select and then scroll to choose from:</p> <p>Shuffle: Press OK to shuffle available media files in the current playlist. Note: To shuffle all media tracks, you must select Play All in the Play Menu and then select Shuffle.</p> <p>Repeat: Press OK to repeat any song.</p> <p>Autoplay: Press OK to listen to music which has already been randomly indexed during the indexing process.</p>
<p>Mobile Apps</p>	<p>Interact with SYNC-capable mobile applications on your smart phone. See <i>SYNC AppLink</i> earlier in this chapter for more information.</p>
<p>System Settings</p>	<p>Access Bluetooth Device menu listings (add, connect, set as primary, on/off, delete) as well as Advanced menu listings (prompts, languages, defaults, master reset, install application and system information).</p> <p>Note: See System Settings for more information.</p>
<p>Exit Media Menu</p>	<p>Press OK to exit the media menu.</p>

Accessing Your Play Menu

This menu allows you to select and play your media by artist, album, genre, playlist, track, similar music or even to explore what is on your USB device.

1. Make sure that your device is plugged into the USB port and is turned on.
2. Press AUX and then MENU to enter the Media Menu.
3. Scroll to select the Play Menu and press OK.

If there are no media files to access, the display indicates there is no media. If there are media files, you have the following options to scroll through and select from:

When you select:	You can:
Play All	Play all indexed media (tracks) from your playing device in flat file mode, one at a time in numerical order. Press OK to select. The first track title appears in the display.
Artists	Sort all indexed media by artist. Once selected, the system lists and then play all artists and tracks alphabetically. If there are less than 255 indexed artist, they are listed alphabetically in flat file mode. If there are more, they are categorized in alphabetical categories. 1. Press OK to select. You can select to play All Artists or any indexed artist. 2. Scroll until the desired artist is chosen and press OK.

When you select:	You can:
Albums	<p>Sort all indexed media by albums. If there are less than 255 indexed albums, they are listed alphabetically in flat file mode. If there are more, they are organized into alphabetical categories.</p> <ol style="list-style-type: none"> 1. Press OK to enter the album menu and select from playing all albums or from any individual indexed album. 2. Scroll until the desired album is chosen and press OK.
Genres	<p>Sort indexed music by genre (category) type. SYNC lists the genres alphabetically in flat file mode. If there are more than 255, SYNC automatically organizes them into alphabetical categories.</p> <p>Press OK to select and then scroll to select the desired genre and press OK.</p>
Playlists	<p>Access your playlists (from formats such as ASX, .M3U, .WPL, .MTP.). The system lists your playlists alphabetically in flat file mode. If there are more than 255, they are organized into alphabetical categories.</p> <p>Press OK to select. Then scroll to select the desired playlist and press OK.</p>
Tracks	<p>Search for and play a specific track which has been indexed. SYNC lists your tracks alphabetically in flat file mode. If there are more than 255, SYNC automatically organizes them into alphabetical categories.</p> <p>Press OK to select. Then scroll to select the desired track and press OK.</p>

When you select:	You can:
Explore USB	Explore all supported digital media on your media device connected to the USB port. You can only view media content which is compatible with SYNC; other files saved are not visible. Press OK to select. Then scroll to explore indexed media on your flash drive.
Similar Music	Play music similar to what is currently playing from the USB port. The system uses the metadata information of each song to compile a playlist for you. Press OK to select. The system creates a new list of similar songs and begins playing. The metadata tags must be populated for this feature to include each track. Note: With certain playing devices, if your metadata tags are not populated, the tracks won't be available in voice recognition, play menu or similar music. However, if you place these tracks onto your playing device in "Mass Storage Device Mode", they are available in voice recognition, play menu browsing and similar music. Unknowns are placed into any unpopulated metadata tag.
Return	Exit the current menu.

System Settings

System settings provide access to your Bluetooth Devices and Advanced menu features.

The Bluetooth Devices menu allows you to add, connect and delete a device as turn the Bluetooth feature on and off.

Your Advanced menu allows you to access and set prompts, languages, defaults and perform a master reset.

Bluetooth Devices Menu Options

This menu allows you to add, connect and delete devices as well as turn Bluetooth on and off.

1. Press AUX and then MENU to enter the Media Menu.
2. Scroll until System Settings appears and select OK.
3. Scroll until Bluetooth Devices appears.
4. Press OK and then scroll to select from:

When you select:	You can:
Add Bluetooth Device *	Allows you to pair additional devices to the system. 1. Press OK to select and press OK again when Find SYNC appears in the display. 2. Follow the directions in your phone's user guide to put your phone into discovery mode. A six-digit PIN appears in the display. 3. When prompted on your phone's six-digit display, enter the PIN.
Connect Bluetooth Device	Connect a previously paired Bluetooth-enabled phone. 1. Press OK to select and view a list of devices. 2. Scroll until the desired device is chosen and press OK to connect the device.
Set Bluetooth On/Off	Turn the Bluetooth feature on and off. Press OK and scroll to toggle between On and Off. When the desired selection is chosen, press OK. Turning Bluetooth off disconnects all Bluetooth devices and deactivates Bluetooth features.
Delete Device	Delete a paired media device. Press OK and scroll to select the device. Press OK to confirm.
Delete All Devices	Delete all previously paired devices. Press OK to select.
Return	Exit the current menu.

*This is a speed-dependent feature

Advanced Menu Options

This menu allows you to access settings such as prompts, language, performing a master reset as well as returning to factory defaults.

1. Press AUX and then MENU to access the Media Menu.
2. Scroll until System Settings appears and select OK.
3. Scroll until Advanced appears.
4. Press OK and then scroll to select from the following:

When you select:	You can:
Prompts	<p>Have SYNC guide you via questions, helpful hints or ask you for a specific action.</p> <ol style="list-style-type: none"> 1. Press OK to select and scroll to select between on or off. 2. Press OK when the desired selection appears in the display. SYNC takes you back to the Advanced menu.
Languages	<p>Choose from English, Francais and Espanol. The displays and prompts are in the selected language.</p> <ol style="list-style-type: none"> 1. Press OK to select and then scroll through the languages. 2. Press OK when the desired selection appears in the display. 3. If you change the language setting, the display indicates that the system is updating. When complete, SYNC takes you back to the Advanced menu.
Factory Defaults	<p>Return to the factory default settings. This selection does not erase your indexed information (phonebook, call history, text messages and paired devices).</p> <ol style="list-style-type: none"> 1. Press OK to select and then press OK again when Restore Defaults? appears in the display. 2. Press OK to confirm.

When you select:	You can:
Master Reset	Completely erase all information stored on SYNC (all phonebook, call history, text messages and all paired devices) and return to the factory default settings.
Application	Download new software applications (if available) and then load the desired applications through your USB port. See the web site for more information.
Return	Exit the current menu.

TROUBLESHOOTING

Your SYNC system is easy to use. However, should questions arise, see the tables below.

Use the website at any time to check your phone’s compatibility, register your account and set preferences as well as access a customer representative via an online chat (during certain hours). Visit www.SYNCMYRide.com, www.SYNCMYRide.ca or www.syncmaroute.ca for more information.

Phone issues		
Issue	Possible cause(s)	Possible solution(s)
Excessive background noise during a phone call.	The audio control settings on your phone may be affecting SYNC performance.	Review your phone’s user guide regarding audio adjustments.
During a call, I can hear the other person but they cannot hear me.	Possible phone malfunction.	Try turning off the device, resetting the device, removing the device’s battery, then trying again.

Phone issues		
Issue	Possible cause(s)	Possible solution(s)
SYNC is not able to download my phonebook.	<ul style="list-style-type: none"> • This is a phone-dependent feature, OR • Possible phone malfunction. 	<ul style="list-style-type: none"> • Go to the website to review your phone's compatibility. • Try turning off the device, resetting the device or removing the device's battery, then trying again. • Try pushing your phonebook contacts to SYNC by using the Add Contacts feature. • Use the SYNCmyphone feature available on the website.
The system says Phonebook Downloaded but my phonebook in SYNC is empty or is missing contacts.	Limitations on your phone's capability.	<ul style="list-style-type: none"> • Try pushing your phonebook contacts to SYNC by using the Add Contacts feature. • If the missing contacts are stored on your SIM card, try moving them to the device memory. • Remove any pictures or special ring tones associated with the missing contact.

Phone issues		
Issue	Possible cause(s)	Possible solution(s)
I am having trouble connecting my phone to SYNC.	<ul style="list-style-type: none"> • This is a phone-dependent feature, OR • Possible phone malfunction. 	<ul style="list-style-type: none"> • Go to the website to review your phone's compatibility. • Try turning off the device, resetting the device or removing the device's battery, then trying again. • Try deleting your device from SYNC, deleting SYNC from your device and trying again. • Check the security and auto accept/prompt always settings relative to the SYNC Bluetooth connection on your phone. • Update your device's software firmware. • Turn off the Auto phonebook download setting.
Text messaging is not working on SYNC.	<ul style="list-style-type: none"> • This is a phone-dependent feature, OR • Possible phone malfunction. 	<ul style="list-style-type: none"> • Go to the website to review your phone's compatibility. • Try turning off the device, resetting the device or removing the device's battery, then trying again.

USB and media issues		
Issue	Possible cause(s)	Possible solution(s)
I am having trouble connecting my device.	Possible device malfunction.	<ul style="list-style-type: none"> • Try turning off the device, resetting the device or removing the device's battery, then trying again. • Make sure you are using the manufacturer's cable. • Make sure the USB cable is properly inserted into the device and the vehicle's USB port. • Make sure that the device does not have an auto-install program or active security settings.
SYNC does not recognize my device when I turn on the car.	This is a device limitation.	Make sure you are not leaving the device in your vehicle during very hot or cold temperatures.
Bluetooth audio does not stream.	<ul style="list-style-type: none"> • This is a phone-dependent feature, OR • The device is not connected. 	Make sure the device is connected to SYNC and that you have pressed play on your device.
SYNC does not recognize music that is on my device.	<ul style="list-style-type: none"> • Your music files may not contain the proper artist, song title, album or genre information, OR • The file may be corrupted, OR • The song may have copyright protection which does not allow it to play. 	<ul style="list-style-type: none"> • Make sure that all song details are populated. • Some devices require you to change the USB settings from mass storage to MTP class.

Vehicle Health Report and SYNC Services (Traffic, Directions and Information) issues		
Issue	Possible cause(s)	Possible solution(s)
I received a text that the Vehicle Health Report is not activated.	<ul style="list-style-type: none"> Your account may not be activated on the website, OR You may have the wrong VIN (vehicle identification number) listed. 	<ul style="list-style-type: none"> This is a free feature, but you must first register online to use it. Make sure that your VIN is correctly listed in your account.
I am unable to retrieve the report on the website, or I receive a system error.	The preferred dealer information did not load correctly.	When you register your account, you must list a preferred dealer. If one is already listed, try selecting another dealer and logging out. Log back in and change it back to your preferred dealer and retrieve the report.
I am unable to submit a report.	<ul style="list-style-type: none"> This could be due to your phone's compatibility, OR Bad signal strength, OR Your phone may not be activated on the website. 	<ul style="list-style-type: none"> Update your mobile number in your account on the website. Make sure you have full signal strength and that your <i>Bluetooth</i> volume level has been turned up. Try deleting your phone and performing a clean pairing.
I heard a commercial when I tried to use Traffic, Directions and Information.	<ul style="list-style-type: none"> The phone in use is not activated, OR Your phone has ID blocker active. 	<ul style="list-style-type: none"> This is a free feature, but you must first register online to use it. Turn off ID blocker on your phone as the system recognizes you by your phone number. Make sure the currently connected phone is the same one that is registered on your SyncMyRide account.

Voice command issues		
Issue	Possible cause(s)	Possible solution(s)
SYNC does not understand what I am saying.	<ul style="list-style-type: none"> • You may be using the wrong voice commands, OR • You may be speaking too soon or at the wrong time. 	<ul style="list-style-type: none"> • Review the Phone voice commands and the Media voice commands at the beginning of their respective sections. • Be aware that the microphone for SYNC is either in your rear view mirror or in the headliner just above the windshield.
SYNC does not understand the name of a song or artist.	<ul style="list-style-type: none"> • You may be using the wrong voice commands, OR • You may not be saying the name exactly as it is saved, OR • The system may not be reading the name the same way you are saying it. 	<ul style="list-style-type: none"> • Review the media voice commands at the beginning of the media section. • Say the song or artist exactly as listed. If you say, "Play Artist Prince", the system does not play music by Prince and the Revolution or Prince and the New Power Generation. • Make sure you are saying the complete title, such as "California remix featuring Jennifer Nettles". • If the songs are saved in all CAPS, you have to spell them. LOLA requires you to say, "Play L-O-L-A". • Do not use special characters in the title as the system does not recognize them.

Voice command issues		
Issue	Possible cause(s)	Possible solution(s)
<p>SYNC does not understand or is calling the wrong contact when I want to make a call.</p>	<ul style="list-style-type: none"> • You may be using the wrong voice commands, OR • You may not be saying the name exactly as it is saved, OR • Contacts in your phonebook may be very short and similar, or they may contain special characters, OR • Your phonebook contacts may be saved in CAPS. 	<ul style="list-style-type: none"> • Review the phone voice commands at the beginning of the phone section. • Make sure you are saying the contacts exactly as listed. For example, if a contact is saved as Joe Wilson, say “Call Joe Wilson”. • The system works better if you list full names, such as “Joe Wilson” rather than “Joe”. • Do not use special characters such as 123 or ICE, as the system does not recognize them. • If contacts are saved in CAPS, you have to spell them. JAKE requires you to say, “Call J-A-K-E”.

AppLink issues		
Issue	Possible cause(s)	Possible solution(s)
SYNC does not find any mobile apps that are on my phone.	<ul style="list-style-type: none"> • Your device may not support the AppLink feature, OR • The application does not support AppLink., OR • If you have an iPhone, it may not be plugged in, OR • Your phone may not be paired or connected. 	<ul style="list-style-type: none"> • Check the website for compatible devices and applications. • Make sure your device is paired and connected. If you have an iPhone, make sure it is plugged in using the USB and that the application is running in the foreground.

GENERAL INFORMATION**SYNC® End User License Agreement (EULA)**

- You have acquired a device (“DEVICE”) that includes software licensed by Ford Motor Company and its affiliates (“FORD MOTOR COMPANY”) from an affiliate of Microsoft Corporation (“MS”). Those installed software products of MS origin, as well as associated media, printed materials, and “online” or electronic documentation (“MS SOFTWARE”) are protected by international intellectual property laws and treaties. The MS SOFTWARE is licensed, not sold. All rights reserved.
- The MS SOFTWARE may interface with and/or communicate with, or may be later upgraded to interface with and/or communicate with additional software and/or systems provided by FORD MOTOR COMPANY. The additional software and systems of FORD MOTOR COMPANY origin, as well as associated media, printed materials, and “online” or electronic documentation (“FORD SOFTWARE”) are protected by international intellectual property laws and treaties. The FORD SOFTWARE is licensed, not sold. All rights reserved.
- The MS SOFTWARE and/or FORD SOFTWARE may interface with and/or communicate with, or may be later upgraded to interface with and/or communicate with additional software and/or systems provided by third party software and service suppliers. The additional software and services of third party origin, as well as associated media, printed materials, and “online” or electronic documentation (“THIRD PARTY SOFTWARE”) are protected by international intellectual property laws and treaties. The THIRD PARTY SOFTWARE is licensed, not sold. All rights reserved.
- The MS SOFTWARE, FORD SOFTWARE and THIRD PARTY SOFTWARE hereinafter collectively and individually will be referred to as “SOFTWARE.”

IF YOU DO NOT AGREE TO THIS END USER LICENSE AGREEMENT (“EULA”), DO NOT USE THE DEVICE OR COPY THE SOFTWARE. ANY USE OF THE SOFTWARE, INCLUDING BUT NOT LIMITED TO USE ON THE DEVICE, WILL CONSTITUTE YOUR AGREEMENT TO THIS EULA (OR RATIFICATION OF ANY PREVIOUS CONSENT).

GRANT OF SOFTWARE LICENSE: This EULA grants you the following license:

- You may use the SOFTWARE as installed on the DEVICE and as otherwise interfacing with systems and/or services provide by or through FORD MOTOR COMPANY or its third party software and service providers.

DESCRIPTION OF OTHER RIGHTS AND LIMITATIONS:

- **Speech Recognition:** If the SOFTWARE includes speech recognition component(s), you should understand that speech recognition is an inherently statistical process and that recognition errors are inherent in the process. Neither FORD MOTOR COMPANY nor its suppliers shall be liable for any damages arising out of errors in the speech recognition process.
- **Limitations on Reverse Engineering, Decompilation and Disassembly:** You may not reverse engineer, decompile, or disassemble nor permit others to reverse engineer, decompile or disassemble the SOFTWARE, except and only to the extent that such activity is expressly permitted by applicable law notwithstanding this limitation.
- **Limitations on Distributing, Copying, Modifying and Creating Derivative Works:** You may not distribute, copy, make modifications to or create derivative works based on the SOFTWARE, except and only to the extent that such activity is expressly permitted by applicable law notwithstanding this limitation.
- **Single EULA:** The end user documentation for the DEVICE and related systems and services may contain multiple EULAs, such as multiple translations and/or multiple media versions (e.g., in the user documentation and in the software). Even if you receive multiple EULAs, you are licensed to use only one (1) copy of the SOFTWARE.
- **SOFTWARE Transfer:** You may permanently transfer your rights under this EULA only as part of a sale or transfer of the DEVICE, provided you retain no copies, you transfer all of the SOFTWARE (including all component parts, the media and printed materials, any upgrades, and, if applicable, the Certificate(s) of Authenticity), and the recipient agrees to the terms of this EULA. If the SOFTWARE is an upgrade, any transfer must include all prior versions of the SOFTWARE.
- **Termination:** Without prejudice to any other rights, FORD MOTOR COMPANY or MS may terminate this EULA if you fail to comply with the terms and conditions of this EULA.

- **Security Updates/Digital Rights Management:** Content owners use the WMDRM technology included in your DEVICE to protect their intellectual property, included copyrighted content. Portions of the SOFTWARE on your DEVICE use WMDRM software to access WMDRM-protected content. If the WMDRM software fails to protect the content, content owners may ask Microsoft to revoke the SOFTWARE's ability to use WMDRM to play or copy protected content. This action does not affect unprotected content. When your DEVICE downloads licenses for protected content, you agree that Microsoft may include a revocation list with the licenses. Content owners may require you to upgrade the SOFTWARE on your DEVICE to access their content. If you decline an upgrade, you will not be able to access content that requires the upgrade.
- **Consent to Use of Data:** You agree that MS, Microsoft Corporation, FORD MOTOR COMPANY, third party software and systems suppliers, their affiliates and/or their designated agent may collect and use technical information gathered in any manner as part of product support services related to the SOFTWARE or related services. MS, Microsoft Corporation, FORD MOTOR COMPANY, third party software and services suppliers, their affiliates and/or their designated agent may use this information solely to improve their products or to provide customized services or technologies to you. MS, Microsoft Corporation, FORD MOTOR COMPANY, third party software and systems suppliers, their affiliates and/or their designated agent may disclose this information to others, but not in a form that personally identifies you.
- **Internet-Based Services Components:** The SOFTWARE may contain components that enable and facilitate the use of certain Internet-based services. You acknowledge and agree that MS, Microsoft Corporation, FORD MOTOR COMPANY, third party software and service suppliers, their affiliates and/or their designated agent may automatically check the version of the SOFTWARE and/or its components that you are utilizing and may provide upgrades or supplements to the SOFTWARE that may be automatically downloaded to your DEVICE.
- **Additional Software/Services:** The SOFTWARE may permit FORD MOTOR COMPANY, third party software and service suppliers, MS, Microsoft Corporation, their affiliates and/or their designated agent to provide or make available to you SOFTWARE updates, supplements, add-on components, or Internet-based services components of the SOFTWARE after the date you obtain your initial copy of the SOFTWARE ("Supplemental Components").

If FORD MOTOR COMPANY or third party software and services suppliers provide or make available to you Supplemental Components and no other EULA terms are provided along with the Supplemental Components, then the terms of this EULA shall apply.

If MS, Microsoft Corporation, their affiliates and/or their designated agent make available Supplemental Components, and no other EULA terms are provided, then the terms of this EULA shall apply, except that the MS, Microsoft Corporation or affiliate entity providing the Supplemental Component(s) shall be the licensor of the Supplemental Component(s).

FORD MOTOR COMPANY, MS, Microsoft Corporation, their affiliates and/or their designated agent reserve the right to discontinue without liability any Internet-based services provided to you or made available to you through the use of the SOFTWARE.

- **Links to Third Party Sites:** The MS SOFTWARE may provide you with the ability to link to third party sites through the use of the SOFTWARE. The third party sites are not under the control of MS, Microsoft Corporation, their affiliates and/or their designated agent. Neither MS nor Microsoft Corporation nor their affiliates nor their designated agent are responsible for (i) the contents of any third party sites, any links contained in third party sites, or any changes or updates to third party sites, or (ii) webcasting or any other form of transmission received from any third party sites. If the SOFTWARE provides links to third party sites, those links are provided to you only as a convenience, and the inclusion of any link does not imply an endorsement of the third party site by MS, Microsoft Corporation, their affiliates and/or their designated agent.
- **Obligation to Drive Responsibly:** You recognize your obligation to drive responsibly and keep attention on the road. You will read and abide with the DEVICE operating instructions particularly as they pertain to safety and assumes any risk associated with the use of the DEVICE.

UPGRADES AND RECOVERY MEDIA: If the SOFTWARE is provided by FORD MOTOR COMPANY separate from the DEVICE on media such as a ROM chip, CD ROM disk(s) or via web download or other means, and is labeled "For Upgrade Purposes Only" or "For Recovery Purposes Only" you may install one (1) copy of such SOFTWARE onto the DEVICE as a replacement copy for the existing SOFTWARE, and use it in accordance with this EULA, including any additional EULA terms accompanying the upgrade SOFTWARE.

INTELLECTUAL PROPERTY RIGHTS: All title and intellectual property rights in and to the SOFTWARE (including but not limited to any images, photographs, animations, video, audio, music, text and “applets,” incorporated into the SOFTWARE), the accompanying printed materials, and any copies of the SOFTWARE, are owned by MS, Microsoft Corporation, FORD MOTOR COMPANY, or their affiliates or suppliers. The SOFTWARE is licensed, not sold. You may not copy the printed materials accompanying the SOFTWARE. All title and intellectual property rights in and to the content which may be accessed through use of the SOFTWARE is the property of the respective content owner and may be protected by applicable copyright or other intellectual property laws and treaties. This EULA grants you no rights to use such content. All rights not specifically granted under this EULA are reserved by MS, Microsoft Corporation, FORD MOTOR COMPANY, third party software and service providers, their affiliates and suppliers. Use of any on-line services which may be accessed through the SOFTWARE may be governed by the respective terms of use relating to such services. If this SOFTWARE contains documentation that is provided only in electronic form, you may print one copy of such electronic documentation.

EXPORT RESTRICTIONS: You acknowledge that the SOFTWARE is subject to U.S. and European Union export jurisdiction. You agree to comply with all applicable international and national laws that apply to the SOFTWARE, including the U.S. Export Administration Regulations, as well as end-user, end-use and destination restrictions issued by U.S. and other governments. For additional information, see <http://www.microsoft.com/exporting/>.

TRADEMARKS: This EULA does not grant you any rights in connection with any trademarks or service marks of FORD MOTOR COMPANY, MS, Microsoft Corporation, third party software or service providers, their affiliates or suppliers.

PRODUCT SUPPORT: Product support for the SOFTWARE is not provided by MS, its parent corporation Microsoft Corporation, or their affiliates or subsidiaries. For product support, please refer to FORD MOTOR COMPANY instructions provided in the documentation for the DEVICE. Should you have any questions concerning this EULA, or if you desire to contact FORD MOTOR COMPANY for any other reason, please refer to the address provided in the documentation for the DEVICE.

No Liability for Certain Damages: EXCEPT AS PROHIBITED BY LAW, FORD MOTOR COMPANY, ANY THIRD PARTY SOFTWARE OR SERVICES SUPPLIERS, MS, MICROSOFT CORPORATION AND THEIR AFFILIATES SHALL HAVE NO LIABILITY FOR ANY INDIRECT, SPECIAL, CONSEQUENTIAL OR INCIDENTAL DAMAGES ARISING FROM OR IN CONNECTION WITH THE USE OR PERFORMANCE OF THE SOFTWARE. THIS LIMITATION SHALL APPLY EVEN IF ANY REMEDY FAILS OF ITS ESSENTIAL PURPOSE. IN NO EVENT SHALL MS, MICROSOFT CORPORATION AND/OR THEIR AFFILIATES BE LIABLE FOR ANY AMOUNT IN EXCESS OF U.S. TWO HUNDRED FIFTY DOLLARS (U.S.\$250.00).

- THERE ARE NO WARRANTIES OTHER THAN THOSE THAT MAY EXPRESSLY BE PROVIDED FOR YOUR NEW VEHICLE.

Adobe

Contains Adobe® [Flash® Player] or [AIR®] technology by Adobe Systems Incorporated. This [Licensee Product] contains [Adobe® Flash® Player] [Adobe® AIR®] software under license from Adobe Systems Incorporated, Copyright © 1995-2009 Adobe Macromedia Software LLC. All rights reserved. Adobe, Flash and AIR are trademarks of Adobe Systems Incorporated.

End user notice

Microsoft® Windows® Mobile for Automotive Important Safety Information

This system Ford SYNC™ contains software that is licensed to Manufacturer FORD MOTOR COMPANY by an affiliate of Microsoft Corporation pursuant to a license agreement. Any removal, reproduction, reverse engineering or other unauthorized use of the software from this system in violation of the license agreement is strictly prohibited and may subject you to legal action.

Read and follow instructions

Before using your Windows Automotive-based system, read and follow all instructions and safety information provided in this end user manual (“User’s Guide”). Not following precautions found in this User’s Guide can lead to an accident or other serious consequences.

Keep User's Guide in Vehicle

When kept in the vehicle, the User's Guide will be a ready reference for you and other users unfamiliar with the Windows Automotive-based system. Please make certain that before using the system for the first time, all persons have access to the User's Guide and read its instructions and safety information carefully.



WARNING: Operating certain parts of this system while driving can distract your attention away from the road, and possibly cause an accident or other serious consequences. Do not change system settings or enter data non-verbally (using your hands) while driving. Stop the vehicle in a safe and legal manner before attempting these operations. This is important since while setting up or changing some functions you might be required to distract your attention away from the road and remove your hands from the wheel.

General operation**Voice Command Control**

Functions within the Windows Automotive-based system may be accomplished using only voice commands. Using voice commands while driving allows you to operate the system without removing your hands from the wheel.

Prolonged Views of Screen

Do not access any function requiring a prolonged view of the screen while you are driving. Pull over in a safe and legal manner before attempting to access a function of the system requiring prolonged attention. Even occasional short scans to the screen may be hazardous if your attention has been diverted away from your driving task at a critical time.

Volume Setting

Do not raise the volume excessively. Keep the volume at a level where you can still hear outside traffic and emergency signals while driving. Driving while unable to hear these sounds could cause an accident.

Use of Speech Recognition Functions

Speech recognition software is inherently a statistical process which is subject to errors. It is your responsibility to monitor any speech recognition functions included in the system and address any errors.

Navigation Features

Any navigation features included in the system are intended to provide turn by turn instructions to get you to a desired destination. Please make certain all persons using this system carefully read and follow instructions and safety information fully.

Distraction Hazard

Any navigation features may require manual (non-verbal) setup. Attempting to perform such set-up or insert data while driving can seriously distract your attention and could cause an accident or other serious consequences. Stop the vehicle in a safe and legal manner before attempting these operations.

Let Your Judgment Prevail

Any navigation features are provided only as an aid. Make your driving decisions based on your observations of local conditions and existing traffic regulations. Any such feature is not a substitute for your personal judgment. Any route suggestions made by this system should never replace any local traffic regulations or your personal judgment or knowledge of safe driving practices.

Route Safety

Do not follow the route suggestions if doing so would result in an unsafe or illegal maneuver, if you would be placed in an unsafe situation, or if you would be directed into an area that you consider unsafe. The driver is ultimately responsible for the safe operation of the vehicle and therefore, must evaluate whether it is safe to follow the suggested directions.

Potential Map Inaccuracy

Maps used by this system may be inaccurate because of changes in roads, traffic controls or driving conditions. Always use good judgment and common sense when following the suggested routes.

Emergency Services

Do not rely on any navigation features included in the system to route you to emergency services. Ask local authorities or an emergency services operator for these locations. Not all emergency services such as police, fire stations, hospitals and clinics are likely to be contained in the map database for such navigation features.

Vehicle with SYNC only

FCC ID: KMHSG1G1 IC: 1422A-SG1G1

Vehicle with SYNC and MyFord Touch or MyLincoln Touch

FCC ID: KMHSYNG2 IC: 1422A-SYNG2

This device complies with Part 15 of the FCC Rules and with RSS-210 of Industry Canada. Operation is subject to the following two conditions:

(1) This device may not cause harmful interference, and (2) this device must accept any interference received, including interference that may cause undesired operation.



WARNING: Changes or modifications not expressly approved by the party responsible for compliance could void the user's authority to operate the equipment. The term "IC:" before the radio certification number only signifies that Industry Canada technical specifications were met.

The antenna used for this transmitter must not be co-located or operating in conjunction with any other antenna or transmitter.

GENERAL MAINTENANCE INFORMATION**Why Maintain Your Vehicle?**

Carefully following the maintenance schedule helps protect against major repair expenses resulting from neglect or inadequate maintenance and may help to increase the value of your vehicle when you sell or trade it. Keep all receipts for completed maintenance with your vehicle.

We have established regular maintenance intervals for your vehicle based upon rigorous testing. It is important that you have your vehicle serviced at the proper times. These intervals serve two purposes; one is to maintain the reliability of your vehicle and the second is to keep your cost of owning your vehicle down.

It is your responsibility to have all scheduled maintenance performed and to make sure that the materials used meet the specifications identified in the *Capacities and Specifications* chapter of this owner's manual.

Failure to perform scheduled maintenance invalidates warranty coverage on parts affected by the lack of maintenance.

Why Maintain Your Vehicle at Your Dealership?***Factory-Trained Technicians***

Service technicians participate in extensive factory-sponsored certification training to help them become experts on the operation of your vehicle. Ask your dealership about the training and certification their technicians have received.

Genuine Ford and Motorcraft® Replacement Parts

Dealerships stock Ford, Motorcraft and Ford-authorized branded re-manufactured replacement parts. These parts meet or exceed our specifications. Parts installed at your dealership carry a nationwide 24-month or unlimited miles (kilometers) parts and labor limited warranty.

If you do not use Ford authorized parts they may not meet our specifications and depending on the part, it could affect emissions compliance.

Convenience

Many dealerships have extended evening and Saturday hours to make your service visit more convenient and they offer one stop shopping. They can perform any services that are required on your vehicle, from general maintenance to collision repairs.

Note: Not all dealers have extended hours or body shops. Please contact your dealer for details.

Protecting Your Investment

Maintenance is an investment that will pay dividends in the form of improved reliability, durability and resale value. To maintain the proper performance of your vehicle and its emission control systems, it is imperative that scheduled maintenance be completed at the designated intervals.

Your vehicle is equipped with the Intelligent Oil-Life Monitor (IOLM) system which displays a message in the information display at the proper oil change service interval; this interval may be up to one year or 10000 miles (16000 kilometers). When ENGINE OIL CHANGE DUE or OIL CHANGE REQUIRED appears in the information display, it is time for an oil change; the oil change must be done within two weeks or 500 miles (800 kilometers) of the ENGINE OIL CHANGE DUE or OIL CHANGE REQUIRED message appearing. The Intelligent Oil-Life Monitor must be reset after each oil change; see the *Information Displays* chapter.

If your information display is prematurely reset or becomes inoperative, you should perform the oil change interval at six months or 5000 miles (8000 kilometers) from your last oil change. Never exceed one year or 10000 miles (16000 kilometers) between oil change intervals.

Your vehicle is very sophisticated and built with multiple, complex, performance systems. Every manufacturer develops these systems using different specifications and performance features. That is why it is important to rely upon your dealership to properly diagnose and repair your vehicle.

Ford Motor Company has recommended maintenance intervals for various parts and component systems based upon engineering testing. Ford Motor Company relies upon this testing to determine the most appropriate mileage for replacement of oils and fluids to protect your vehicle at the lowest overall cost to you and recommends against maintenance schedules that deviate from the scheduled maintenance information.

Ford strongly recommends the use of only genuine Ford, Motorcraft or Ford-authorized remanufactured replacement parts because they are engineered for your vehicle.

Additives and Chemicals

Ford Motor Company recommended additives and chemicals are listed in the owner manual and in the Ford Workshop Manual. Additional chemicals or additives not approved by Ford Motor Company are not recommended as part of normal maintenance. Please consult your warranty information.

Oils, Fluids and Flushing

In many cases, fluid discoloration is a normal operating characteristic and, by itself, does not necessarily indicate a concern or that the fluid needs to be changed. However, discolored fluids that also show signs of overheating and foreign material contamination should be inspected immediately by a qualified expert, such as the factory-trained technicians at your dealership. Your vehicle's oils and fluids should be changed at the specified intervals or in conjunction with a repair. Flushing is a viable way to change fluid for many vehicle sub-systems during scheduled maintenance. It is critical that systems are flushed only with new fluid that is the same as that required to fill and operate the system, or using a Ford-approved flushing chemical.

Owner Checks and Services

Certain basic maintenance checks and inspections should be performed every month or at six month intervals.

Check every month
Engine oil level.
Function of all interior and exterior lights.
Tires (including spare) for wear and proper pressure.
Windshield washer fluid level.
Check every six months
Battery connections. Clean if necessary.
Body and door drain holes for obstructions. Clean if necessary.
Cooling system fluid level and coolant strength.
Door weatherstrips for wear. Lubricate if necessary.
Hinges, latches and outside locks for proper operation. Lubricate if necessary.
Parking brake for proper operation.
Safety belts and seat latches for wear and function.
Safety warning lamps (brake, ABS, airbag, safety belt) for operation.
Washer spray and wiper operation. Clean or replace blades as necessary.

Multi-point Inspection

In order to keep your vehicle running right, it is important to have the systems on your vehicle checked regularly. This can help identify potential issues and prevent major problems. Ford Motor Company recommends the following multi-point inspection be performed at every scheduled maintenance interval to help make sure your vehicle keeps running great.

Multi-point Inspection	
Accessory drive belt(s)	Half-shaft dust boots (if equipped)
Battery performance	Horn operation
Clutch operation (if equipped)	Radiator, cooler, heater and A/C hoses
Engine air filter	Suspension component for leaks or damage
Exhaust system	Steering and linkage
Exterior lamps and hazard warning system operation	Tires (including spare) for wear and proper pressure**
Fluid levels*; fill if necessary	Windshield for cracks, chips or pits
For oil and fluid leaks	Washer spray and wiper operation

*Brake, coolant recovery reservoir, manual and automatic transmission (with an underhood dipstick), power steering (if equipped) and window washer

**If your vehicle is equipped with a temporary mobility kit, check the tire sealant expiration Use By date on the canister. Replace as needed.

Be sure to ask your dealership service advisor or technician about the multi-point vehicle inspection. It's a comprehensive way to perform a thorough inspection of your vehicle. It's your checklist that gives you immediate feedback on the overall condition of your vehicle. You'll know what's been checked, what's okay, as well as those things that may require future or immediate attention. The multi-point vehicle inspection is one more way to keep your vehicle running great!



LINK & PIN

GENUINE
PARTS & SERVICE

Owner Advantage
Fleet's Member of
Fleet's Service Business

Multi-Point Inspection Report Card as Recommended by Ford Motor Company

Name: _____ Today's Date: _____ Mileage: _____ State Inspection Month: _____

E-Mail Address: _____ Make/Model/Year: _____

SCHEDULED MAINTENANCE		THINGS TO DO FOR SERVICES ON THIS MILEAGE	
<input type="checkbox"/> Engine Air Filter	<input type="checkbox"/> Oil	<input type="checkbox"/> Oil Filter	<input type="checkbox"/> Spark Plugs
<input type="checkbox"/> Engine Air Filter	<input type="checkbox"/> Spark Plugs	<input type="checkbox"/> Spark Plugs	<input type="checkbox"/> Tire Rotation
<input type="checkbox"/> Engine Coolant	<input type="checkbox"/> Transmission Fluid	<input type="checkbox"/> Transmission Fluid	<input type="checkbox"/> Transmission Fluid
<input type="checkbox"/> Fuel Filter	<input type="checkbox"/> Transmission Fluid	<input type="checkbox"/> Transmission Fluid	<input type="checkbox"/> Transmission Fluid
<input type="checkbox"/> Oil Change	<input type="checkbox"/> Transmission Fluid	<input type="checkbox"/> Transmission Fluid	<input type="checkbox"/> Transmission Fluid

*This is only a partial list of vehicle maintenance items and is NOT all-inclusive. Please consult your Owner Manual or visit www.fordmotor.com for vehicle specific maintenance requirements.

CHECK FLUID LEVELS AND FILL		OK	OK/FILL	OK/FILL
<input type="checkbox"/> Oil and/or fluid leaks	<input type="checkbox"/> Power Steering	<input type="checkbox"/> Windshield Washer	<input type="checkbox"/> Windshield Washer	<input type="checkbox"/> Windshield Washer
<input type="checkbox"/> Coolant	<input type="checkbox"/> Brake	<input type="checkbox"/> Power Steering	<input type="checkbox"/> Windshield Washer	<input type="checkbox"/> Windshield Washer
<input type="checkbox"/> Brake	<input type="checkbox"/> Windshield Washer	<input type="checkbox"/> Windshield Washer	<input type="checkbox"/> Windshield Washer	<input type="checkbox"/> Windshield Washer

BATTERY		OK	OK/FILL	OK/FILL
<input type="checkbox"/> State of Health	<input type="checkbox"/> Condition of Cell	<input type="checkbox"/> Condition of Cell	<input type="checkbox"/> Condition of Cell	<input type="checkbox"/> Condition of Cell
<input type="checkbox"/> Factory spec cold cranking amps	<input type="checkbox"/> Anticorrosion	<input type="checkbox"/> Anticorrosion	<input type="checkbox"/> Anticorrosion	<input type="checkbox"/> Anticorrosion

EXTERIOR BODY		OK	OK/FILL	OK/FILL
<input type="checkbox"/> Note any existing exterior body damage or defects	<input type="checkbox"/> Note any existing exterior body damage or defects	<input type="checkbox"/> Note any existing exterior body damage or defects	<input type="checkbox"/> Note any existing exterior body damage or defects	<input type="checkbox"/> Note any existing exterior body damage or defects
<input type="checkbox"/> Wheel/tire condition	<input type="checkbox"/> Wheel/tire condition	<input type="checkbox"/> Wheel/tire condition	<input type="checkbox"/> Wheel/tire condition	<input type="checkbox"/> Wheel/tire condition

BRAKE LIVING		OK	OK/FILL	OK/FILL
<input type="checkbox"/> Front	<input type="checkbox"/> Rear	<input type="checkbox"/> Front	<input type="checkbox"/> Rear	<input type="checkbox"/> Front
<input type="checkbox"/> Front	<input type="checkbox"/> Rear	<input type="checkbox"/> Front	<input type="checkbox"/> Rear	<input type="checkbox"/> Front

TIRE TREAD		OK	OK/FILL	OK/FILL
<input type="checkbox"/> Front	<input type="checkbox"/> Rear	<input type="checkbox"/> Front	<input type="checkbox"/> Rear	<input type="checkbox"/> Front
<input type="checkbox"/> Front	<input type="checkbox"/> Rear	<input type="checkbox"/> Front	<input type="checkbox"/> Rear	<input type="checkbox"/> Front

Comments: _____

Service Advisor: _____ Customer's Signature: _____

Technician: _____

12-XXXXXXXX

© 2014 Ford Motor Company. All Rights Reserved. Customer Copy

2015 Police (pol)
 Owners Guide gf, 1st Printing, April 2014
 USA (fus)

NORMAL SCHEDULED MAINTENANCE AND LOG

Intelligent Oil-Life Monitor®

Your vehicle is equipped with an Intelligent Oil-Life Monitor that determines when the engine oil needs to be changed based on how your vehicle is used. By using several important factors in its calculations, the monitor helps reduce the cost of owning your vehicle and reduce environmental waste at the same time. This means you won't have to remember to change the oil on a mileage-based schedule; the vehicle lets you know when an oil change is due by displaying ENGINE OIL CHANGE DUE or OIL CHANGE REQUIRED in the information display. The following table is intended to provide examples of vehicle use and its impact on engine oil change intervals; it is provided as a guideline only. Actual engine oil change intervals depend on several factors and generally decrease with severity of use.

When to expect the OIL CHANGE REQUIRED message	
Interval	Vehicle use and examples
7500-10000 miles (12000-16000 km)	Normal
	<ul style="list-style-type: none"> - Normal commuting with highway driving - No, or moderate, load or towing - Flat to moderately hilly roads - No extended idling
5000-7499 miles (8000-11999 km)	Severe
	<ul style="list-style-type: none"> - Moderate to heavy load or towing - Mountainous or off-road conditions - Extended idling - Extended hot or cold operation
3000-4999 miles (4800-7999 km)	Extreme
	<ul style="list-style-type: none"> - Maximum load or towing - Extreme hot or cold operation

Normal scheduled maintenance*	
At every oil change interval as indicated by the information display	Change engine oil and filter.**
	Rotate tires, inspect tire wear and measure tread depth.
	Perform multi-point inspection (recommended).
	Inspect automatic transmission fluid level (if equipped with dipstick). Consult dealer for requirements.
	Inspect brake pads, shoes, rotors, drums, brake linings, hoses and parking brake.
	Inspect engine cooling system strength and hoses.
	Inspect exhaust system and heat shields.
	Inspect rear axle and U-joints. Lubricate if equipped with grease fittings (All-wheel drive vehicles).
	Inspect half-shaft boots (if equipped).
	Inspect steering linkage, ball joints, suspension, tie-rod ends, driveshaft and U-joints. Lubricate if equipped with grease fittings.
	Inspect wheels and related components for abnormal noise, wear, looseness or drag.

*Do not exceed one year or 10000 miles (16000 kilometers) between service intervals.

**Reset your Intelligent Oil-Life Monitor after each engine oil and filter change. See the *Instrument Cluster* chapter.

Other maintenance items¹	
Every 20000 miles (32000 km)	Replace cabin air filter (if equipped).
Every 30000 miles (48000 km)	Replace climate-controlled (heated and cooled) seat filter ² .
	Replace engine air filter.
At 100000 miles (160000 km)	Change engine coolant. ³
Every 100000 miles (160000 km)	Replace spark plugs.
	Inspect accessory drive belt(s). ⁴
Every 150000 miles (240000 km)	Change automatic transmission fluid.
	Replace accessory drive belt(s) if not replaced within the last 100000 miles (160000 km).

¹These maintenance items can be performed within 3000 miles (4800 kilometers) of the last oil change. Do not exceed the designated distance for the interval.

²If your vehicle has climate-controlled (heated and cooled) seats.

³Initial replacement at six years or 100000 miles (160000 kilometers), then every three years or 50000 miles (80000 kilometers).

⁴After initial inspection, inspect every other oil change until replaced.

Maintenance Schedule Log

<p>DEALER VALIDATION:</p> <p>RO#: P&A CODE: HOURS: DATE: MILEAGE:</p>	<p>DEALER VALIDATION:</p> <p>RO#: P&A CODE: HOURS: DATE: MILEAGE:</p>
<p>DEALER VALIDATION:</p> <p>RO#: P&A CODE: HOURS: DATE: MILEAGE:</p>	<p>DEALER VALIDATION:</p> <p>RO#: P&A CODE: HOURS: DATE: MILEAGE:</p>
<p>DEALER VALIDATION:</p> <p>RO#: P&A CODE: HOURS: DATE: MILEAGE:</p>	<p>DEALER VALIDATION:</p> <p>RO#: P&A CODE: HOURS: DATE: MILEAGE:</p>
<p>DEALER VALIDATION:</p> <p>RO#: P&A CODE: HOURS: DATE: MILEAGE:</p>	<p>DEALER VALIDATION:</p> <p>RO#: P&A CODE: HOURS: DATE: MILEAGE:</p>
<p>DEALER VALIDATION:</p> <p>RO#: P&A CODE: HOURS: DATE: MILEAGE:</p>	<p>DEALER VALIDATION:</p> <p>RO#: P&A CODE: HOURS: DATE: MILEAGE:</p>

Scheduled Maintenance

381

<p style="text-align: center;">DEALER VALIDATION:</p> <p style="text-align: center;">P&A CODE:</p> <p>RO#: HOURS:</p> <p>DATE: MILEAGE:</p>	<p style="text-align: center;">DEALER VALIDATION:</p> <p style="text-align: center;">P&A CODE:</p> <p>RO#: HOURS:</p> <p>DATE: MILEAGE:</p>
<p style="text-align: center;">DEALER VALIDATION:</p> <p style="text-align: center;">P&A CODE:</p> <p>RO#: HOURS:</p> <p>DATE: MILEAGE:</p>	<p style="text-align: center;">DEALER VALIDATION:</p> <p style="text-align: center;">P&A CODE:</p> <p>RO#: HOURS:</p> <p>DATE: MILEAGE:</p>
<p style="text-align: center;">DEALER VALIDATION:</p> <p style="text-align: center;">P&A CODE:</p> <p>RO#: HOURS:</p> <p>DATE: MILEAGE:</p>	<p style="text-align: center;">DEALER VALIDATION:</p> <p style="text-align: center;">P&A CODE:</p> <p>RO#: HOURS:</p> <p>DATE: MILEAGE:</p>
<p style="text-align: center;">DEALER VALIDATION:</p> <p style="text-align: center;">P&A CODE:</p> <p>RO#: HOURS:</p> <p>DATE: MILEAGE:</p>	<p style="text-align: center;">DEALER VALIDATION:</p> <p style="text-align: center;">P&A CODE:</p> <p>RO#: HOURS:</p> <p>DATE: MILEAGE:</p>
<p style="text-align: center;">DEALER VALIDATION:</p> <p style="text-align: center;">P&A CODE:</p> <p>RO#: HOURS:</p> <p>DATE: MILEAGE:</p>	<p style="text-align: center;">DEALER VALIDATION:</p> <p style="text-align: center;">P&A CODE:</p> <p>RO#: HOURS:</p> <p>DATE: MILEAGE:</p>

Scheduled Maintenance

<p>DEALER VALIDATION:</p> <p>P&A CODE:</p> <p>RO#: HOURS:</p> <p>DATE: MILEAGE:</p>	<p>DEALER VALIDATION:</p> <p>P&A CODE:</p> <p>RO#: HOURS:</p> <p>DATE: MILEAGE:</p>
<p>DEALER VALIDATION:</p> <p>P&A CODE:</p> <p>RO#: HOURS:</p> <p>DATE: MILEAGE:</p>	<p>DEALER VALIDATION:</p> <p>P&A CODE:</p> <p>RO#: HOURS:</p> <p>DATE: MILEAGE:</p>
<p>DEALER VALIDATION:</p> <p>P&A CODE:</p> <p>RO#: HOURS:</p> <p>DATE: MILEAGE:</p>	<p>DEALER VALIDATION:</p> <p>P&A CODE:</p> <p>RO#: HOURS:</p> <p>DATE: MILEAGE:</p>
<p>DEALER VALIDATION:</p> <p>P&A CODE:</p> <p>RO#: HOURS:</p> <p>DATE: MILEAGE:</p>	<p>DEALER VALIDATION:</p> <p>P&A CODE:</p> <p>RO#: HOURS:</p> <p>DATE: MILEAGE:</p>
<p>DEALER VALIDATION:</p> <p>P&A CODE:</p> <p>RO#: HOURS:</p> <p>DATE: MILEAGE:</p>	<p>DEALER VALIDATION:</p> <p>P&A CODE:</p> <p>RO#: HOURS:</p> <p>DATE: MILEAGE:</p>

SPECIAL OPERATING CONDITIONS

If you operate your vehicle **primarily** in any of the following conditions, you need to perform additional maintenance as indicated. If you **occasionally** operate your vehicle under any of these conditions, it is not necessary to perform the additional maintenance. For specific recommendations, see your dealership service advisor or technician.

Perform the services shown in the following tables when specified or within 3000 miles (4800 kilometers) of the OIL CHANGE REQUIRED message appearing in the information display.

Example #1: The OIL CHANGE REQUIRED message comes on at 28751 miles (46270 kilometers); perform the 30000 mile (48000 kilometer) automatic transmission fluid replacement.

Example #2: The OIL CHANGE REQUIRED message has **not** come on, but the odometer reads 30000 miles (48000 kilometers); perform the engine air filter replacement. (for example, the Intelligent Oil-Life Monitor was reset at 25000 miles [40000 kilometers].)

Towing a trailer or using a camper or car-top carrier	
As required	Change engine oil and filter as indicated by the information display and perform services listed in the Normal Scheduled Maintenance chart.
Inspect frequently, service as required	Inspect and lubricate U-joints.
	See axle maintenance items under <i>Exceptions</i> .
Every 30000 miles (48000 km)	Change automatic transmission fluid.

Extensive idling or low-speed driving for long distances as in heavy commercial use (such as delivery, taxi, patrol car or livery)	
As required	Change engine oil and filter as indicated by the information display and perform services listed in the Normal Scheduled Maintenance chart.
Inspect frequently, service as required	Replace cabin air filter (if equipped).
	Replace engine air filter.
Every 30000 miles (48000 km)	Change automatic transmission fluid.
Every 60000 miles (96000 km)	Replace spark plugs.
Operating in dusty or sandy conditions such as unpaved or dusty roads	
Inspect frequently, service as required	Replace cabin air filter (if equipped).
	Replace engine air filter.
Every 5000 miles (8000 km)	Inspect the wheels and related components for abnormal noise, wear, looseness or drag.
	Rotate tires, inspect tires for wear and measure tread depth.
Every 5000 miles (8000 km) or six months	Change engine oil and filter.*
	Perform multi-point inspection.
Every 30000 miles (48000 km)	Change automatic transmission fluid.
*Reset your Intelligent Oil-Life Monitor after each engine oil and filter change. See the <i>Instrument Cluster</i> chapter.	
Exclusive use of E85 (flex fuel vehicles only)	
Every oil change	If ran exclusively on E85, fill the fuel tank full with regular unleaded fuel.

Police interceptor equipped with an engine idle hour meter	
Inspect frequently, service as required	Replace cabin air filter (if equipped).
Every 5000 miles (8000 km)	Inspect the brake system.
	Lubricate control arm and steering ball joints if equipped with grease fittings.
	Rotate tires, inspect tires for wear and measure tread depth.
Every 5000 miles (8000 km) or six months or as indicated by time/mileage calculation (see description below)	Change engine oil and filter.*
	Perform multi-point inspection.
Every 30000 miles (48000 km)	Change automatic transmission fluid.
Every 60000 miles (96000 km)	Replace spark plugs.

*Reset your Intelligent Oil-Life Monitor after each engine oil and filter change. See the *Instrument Cluster* chapter.

ENGINE IDLE HOUR METER (IF EQUIPPED):

Your vehicle may be equipped with an idle meter to indicate how much time the vehicle is idling in position **P** or **N**. The meter is incorporated with the vehicle odometer. Depressing the odometer-reset button once displays the trip odometer (miles [kilometers] followed by a “T” for trip odometer); depressing the odometer-reset button a second time displays the idle meter (hours followed by an “H” for hours). The idle meter only accumulates time when the vehicle is in position **P** or **N**. Displayed time is cumulative for the vehicle. **It cannot be reset to zero.** Police/Fleet vehicles often experience long periods of idling, during which engine oil continues to break down but distance is not accumulated on the odometer.

To assist fleet managers in maintaining proper oil change intervals, the idle meter helps determine when an oil change is required. For every hour that the vehicle idles, it has accumulated the equivalent of approximately 33 miles (53 kilometers) of driving. Using the combination of the vehicle odometer and idle meter allows the fleet manager to better determine when the oil needs to be changed.

Engine idle hour meter calculation:

Idle hours x 33 = miles (kilometers) equivalency

Miles (kilometers) driven + miles (kilometers) equivalency = oil change interval

Example: When the odometer has accumulated 3000 miles (4800 kilometers) and the idle meter shows 61 hours, a 5000 mile (8000 kilometer) oil change interval has been reached: 3000 road miles (4800 road kilometers) + (61 idle hours x 33 miles [53 km]/idle hour) = 5013 miles (8067 kilometers).

Special Operating Condition Log

<p>DEALER VALIDATION:</p> <p>RO#: P&A CODE: HOURS: DATE: MILEAGE:</p>	<p>DEALER VALIDATION:</p> <p>RO#: P&A CODE: HOURS: DATE: MILEAGE:</p>
<p>DEALER VALIDATION:</p> <p>RO#: P&A CODE: HOURS: DATE: MILEAGE:</p>	<p>DEALER VALIDATION:</p> <p>RO#: P&A CODE: HOURS: DATE: MILEAGE:</p>
<p>DEALER VALIDATION:</p> <p>RO#: P&A CODE: HOURS: DATE: MILEAGE:</p>	<p>DEALER VALIDATION:</p> <p>RO#: P&A CODE: HOURS: DATE: MILEAGE:</p>
<p>DEALER VALIDATION:</p> <p>RO#: P&A CODE: HOURS: DATE: MILEAGE:</p>	<p>DEALER VALIDATION:</p> <p>RO#: P&A CODE: HOURS: DATE: MILEAGE:</p>
<p>DEALER VALIDATION:</p> <p>RO#: P&A CODE: HOURS: DATE: MILEAGE:</p>	<p>DEALER VALIDATION:</p> <p>RO#: P&A CODE: HOURS: DATE: MILEAGE:</p>

Scheduled Maintenance

<p>DEALER VALIDATION:</p> <p>P&A CODE:</p> <p>RO#: HOURS:</p> <p>DATE: MILEAGE:</p>	<p>DEALER VALIDATION:</p> <p>P&A CODE:</p> <p>RO#: HOURS:</p> <p>DATE: MILEAGE:</p>
<p>DEALER VALIDATION:</p> <p>P&A CODE:</p> <p>RO#: HOURS:</p> <p>DATE: MILEAGE:</p>	<p>DEALER VALIDATION:</p> <p>P&A CODE:</p> <p>RO#: HOURS:</p> <p>DATE: MILEAGE:</p>
<p>DEALER VALIDATION:</p> <p>P&A CODE:</p> <p>RO#: HOURS:</p> <p>DATE: MILEAGE:</p>	<p>DEALER VALIDATION:</p> <p>P&A CODE:</p> <p>RO#: HOURS:</p> <p>DATE: MILEAGE:</p>
<p>DEALER VALIDATION:</p> <p>P&A CODE:</p> <p>RO#: HOURS:</p> <p>DATE: MILEAGE:</p>	<p>DEALER VALIDATION:</p> <p>P&A CODE:</p> <p>RO#: HOURS:</p> <p>DATE: MILEAGE:</p>
<p>DEALER VALIDATION:</p> <p>P&A CODE:</p> <p>RO#: HOURS:</p> <p>DATE: MILEAGE:</p>	<p>DEALER VALIDATION:</p> <p>P&A CODE:</p> <p>RO#: HOURS:</p> <p>DATE: MILEAGE:</p>

EXCEPTIONS

Axle Maintenance

Change the axle fluid anytime an axle is submerged in water.

California Fuel Filter Replacement

If you register your vehicle in California, the California Air Resources Board has determined that the failure to perform this maintenance item does not nullify the emission warranty or limit recall liability before the completion of your vehicle’s useful life. Ford Motor Company, however, urges you to have all recommended maintenance services performed at the specified intervals and to record all vehicle service.

Hot Climate Oil Change Intervals

Vehicles operating in the Middle East, North Africa, Sub-Saharan Africa or locations with similar climates using an American Petroleum Institute (API) Certified for Gasoline Engines (Certification mark) oil of SM or SN quality, the normal oil change interval is 3000 miles (5000 kilometers).

If the available API SM or SN oils are not available, then the oil change interval is 1800 miles (3000 kilometers).

Engine Air Filter and Cabin Air Filter Replacement

The life of the engine air filter and cabin air filter is dependent on exposure to dusty and dirty conditions. Vehicles operated in these conditions require frequent inspection and replacement of the engine air filter and cabin air filter.

ENGINE COOLANT CHANGE RECORD

Initial change	Six years or 100000 miles (160000 km) (whichever comes first)
After initial change	Every three years or 50000 miles (80000 km)

Engine Coolant Change Log

<p>DEALER VALIDATION:</p> <p>RO#: P&A CODE: DATE: HOURS: MILEAGE:</p>	<p>DEALER VALIDATION:</p> <p>RO#: P&A CODE: DATE: HOURS: MILEAGE:</p>
<p>DEALER VALIDATION:</p> <p>RO#: P&A CODE: DATE: HOURS: MILEAGE:</p>	<p>DEALER VALIDATION:</p> <p>RO#: P&A CODE: DATE: HOURS: MILEAGE:</p>
<p>DEALER VALIDATION:</p> <p>RO#: P&A CODE: DATE: HOURS: MILEAGE:</p>	<p>DEALER VALIDATION:</p> <p>RO#: P&A CODE: DATE: HOURS: MILEAGE:</p>

-
- 911 Assist™336
- A**
- ABS (see Brakes)149
- Accessing call history/phone
book during active call325
- Accessing your media menu
features347
- Accessing your phone menu
features327
- Accessory delay88
- Active call menu options325
- Advanced menu options ...334, 354
- Advanced menu options
(prompts, languages, defaults,
master reset, installing
applications)334
- Airbag supplemental restraint
system47
and child safety seats48
description47
disposal62
driver airbag47
passenger airbag47
side airbag47, 51
- Air cleaner filter231, 233, 299
- Air conditioning107
manual heating and air
conditioning system107
- Air filter, cabin109
- All Wheel Drive (AWD),
driving off road139
- Ambulance packages15
- Antifreeze
(see Engine coolant)218
- Anti-lock brake system
(see Brakes)149
- Anti-theft system
arming the system73
disarming a triggered system ..73
- Audio system
Single CD307
- Audio system (see Radio)307
- Automatic transmission137
fluid, adding223, 227
fluid, checking223, 227
fluid, refill capacities293
fluid, specification293
- Auxiliary input jack (Line in) ..314
- Auxiliary powerpoint117
- B**
- Battery228
acid, treating emergencies228
jumping a disabled battery189
maintenance-free228
replacement, specifications ...299
servicing228
- Blind Spot Information
System159
- Booster seats22
- Brakes148
anti-lock149
anti-lock brake system (ABS)
warning light149
brake warning light149
fluid, checking and adding227
fluid, refill capacities293
fluid, specifications293
lubricant specifications293
parking149
trailer178

C

Capacities for refilling fluids293
 Cargo management system166
 CD307
 CD player305
 Cell phone use16
 Changing a tire282
 Child safety restraints28, 31
 Child safety seats
 attaching with tether straps31
 automatic locking mode
 (retractor)38
 LATCH28
 Child safety seats - booster
 seats22
 Cleaning your vehicle247
 engine compartment249
 instrument panel251
 interior251
 plastic parts249
 washing247
 waxing249
 wheels253
 wiper blades250
 Climate control (see Air
 conditioning or Heating)107
 Clock307
 Console118
 overhead119
 Coolant218
 checking and adding218
 refill capacities293
 specifications293
 Cross Traffic Alert159
 Cruise control157
 Customer Assistance187

Ford Extended Service
 Plan302
 Getting roadside assistance ...187
 Getting the service you
 need192
 Ordering additional owner's
 literature198
 Utilizing the
 Mediation/Arbitration
 Program196

D

Defrost107
 rear window108
 Dipstick
 automatic transmission
 fluid223, 227
 engine oil217
 Driving under special
 conditions138, 142, 145
 sand143
 snow and ice146
 through water144, 185

E

Electronic message center98
 Electronic stability control152
 Emergencies, roadside
 jump-starting189
 running out of fuel128
 Emergency brake
 (see Parking brake)149
 Emission control system133
 End user license agreement363
 Engine292
 cleaning249
 coolant218
 fail-safe cooling222

idle speed control	228	trip/reset button	100
lubrication specifications	293	Fuses	200
refill capacities	293	G	
service points	213, 215	Gas cap (see Fuel cap)	130
Engine block heater	124	Gauges	92
Engine oil		odometer	100
checking and adding	217	trip odometer	100
dipstick	217	H	
filter, specifications	299	Hazard flashers	188
refill capacities	293	Headlamps	
specifications	293	aiming	234
Event data recording	11	bulb specifications	244
Exhaust fumes	124	flash to pass	82
F		high beam	81
Fail safe cooling	222	replacing bulbs	236
Floor mats	186	Head restraints	111
Fluid capacities	293	Heating	107
Four-Wheel Drive vehicles		Hood	211
driving off road	141	I	
Fuel		Ignition	121
cap	130	Illuminated visor mirror	91
capacity	293	Information displays	98
choosing the right fuel	127	Inspection/maintenance (I/M)	
filler funnel	128	testing	136
filling your vehicle with fuel ..	130	Instrument panel	
filter, specifications	227, 299	cleaning	251
fuel pump shut-off	188	cluster	93
octane rating	128	J	
quality	127	Jack	282
running out of fuel	128	positioning	282
safety information relating to		storage	282
automotive fuels	126		
Fuel and distance computer	100		
outside temperature			
indicator	100		
to empty indicator	100		
trip distance	100		

-
- Joining two calls
(multiparty/conference call)325
- Jump-starting your vehicle189
- K**
- Keys66
positions of the ignition121
- L**
- Lamps
bulb replacement
specifications chart244
headlamps, flash to pass82
interior lamps85
replacing bulbs236
- LATCH anchors28
- Liftgate70
- Lights, warning and indicator93
- Loading instructions175
- Load limits168
- Locks
childproof34
doors67
- Lubricant specifications293
- Lug nuts291
- M**
- Media Bluetooth menu options
(adding, connecting, deleting,
turning on/off)353
- Message center98
warning messages100
- Mirrors89, 91
fold away89
side view mirrors (power)89
- Motorcraft® parts247, 299
- O**
- Octane rating128
- P**
- Pairing other phones322
- Pairing your phone for the first
time321
- Parking brake149
- Parts
(see Motorcraft® parts)299
- Passenger Occupant
Classification Sensor49
- Phone Bluetooth menu options
(adding, connecting, deleting,
turning on/off)333
- Phone redial327
- Playing music (by artist,
album, genre, playlist, tracks,
similar)350
- Power distribution box
(see Fuses)200
- Power door locks67
- Power mirrors89
- Powerpoint117
- Power steering164
fluid, checking and adding227
fluid, refill capacity293
fluid, specifications293
- Power Windows87
- Privacy information318
- Putting a call on/off hold325
- R**
- Radio307

Single CD	307	safety belt maintenance	43
Radio reception	305	seat belt maintenance	43
Rear view camera display	154	warning light and chime	40
Rear window defroster	107	Safety restraints - LATCH	
Receiving a text message	329	anchors	28
Recommendations for		Safety seats for children	24
attaching safety restraints for		Safety Compliance	
children	24	Certification Label	301
Relays	200	Satellite Radio	307
Remote entry system		Scheduled Maintenance Guide	
illuminated entry	69	Normal Scheduled	
locking/unlocking doors	68	Maintenance and Log	377
opening the trunk	69	Seat belts (see Safety	
replacement/additional		restraints)	37
transmitters	64	Seats	115
replacing the batteries	63	child safety seats	24
Reverse sensing system	154	front seats	113–114
Roadside assistance	187	second row seats	115
Roll stability control	152	Selecting your media source	
Roof rack	167	(USB, Line in, BT audio)	347
S		Setting the clock	307
Safety Belt Maintenance	43	Side air curtain	53
Safety belts (see Safety		Side-curtain airbags system	53
restraints)	37, 40	SIRIUS® satellite radio	307
Safety defects, reporting	199	Snowplowing	15
Safety information	317	SOS Post Crash Alert	46
Safety restraints	37–38, 40	Spark plugs, specifications	299
Belt-Minder®	40	Special notice	
Belt-Minder®,		ambulance conversions	15
deactivating/activating	42	utility-type vehicles	15
extension assembly	39	Specification chart,	
for adults	37–38	lubricants	293
for children	24	Stability system	152
Occupant Classification		Starting a flex fuel vehicle	123
Sensor	49	Starting your vehicle	121, 123

-
- jump starting189
 - Steering wheel74
 - controls74
 - tilting74
 - Sun visor91
 - Supplemental Restraint System (SRS) (see airbags)47
 - SYNC® customer support317
 - SYNC® Services341
- T**
- Temperature control (see Climate control)107
 - Text messaging328
 - Text messaging (sending, downloading, deleting)329, 331
 - Tilt steering wheel74
 - Tires258–259, 282
 - alignment272
 - care258
 - changing282–283
 - checking the pressure268
 - inflating266
 - label265
 - police vehicles274
 - replacing270
 - rotating273
 - safety practices272
 - sidewall information260
 - snow tires and chains275
 - terminology259
 - tire grades259
 - treadwear259, 268
 - Towing176, 181–182
 - recreational towing182
 - trailer towing176
 - wrecker181
 - Traction control150
 - Traffic, Directions and Information341
 - Transaxle
 - fluid, refill capacities293
 - lubricant specifications293
 - Transmission
 - fluid, checking and adding (automatic)223, 227
 - Trunk70–71
 - remote release69
 - Turn signal84
- U**
- USB port315
 - Using privacy mode325
- V**
- Vehicle health report339
 - Vehicle Identification Number (VIN)300
 - Vehicle loading168
 - Ventilating your vehicle124
 - Voice commands in media mode345
 - Voice commands in phone mode323
- W**
- Warning lights (see Lights)93
 - Washer fluid228
 - Water, Driving through185
 - Windows
 - power87
 - rear wiper/washer79

Index

397

Windshield washer fluid and wipers	78	replacing wiper blades ...	230–231
checking and adding fluid	228	Wrecker towing	181