

NON ORIGINAL REPLACEMENT PARTS FOR :  
SAME-LAMBORGHINI-HÜRLIMANN



**SAME**

**LAMBORGHINI**

**HÜRLIMANN**

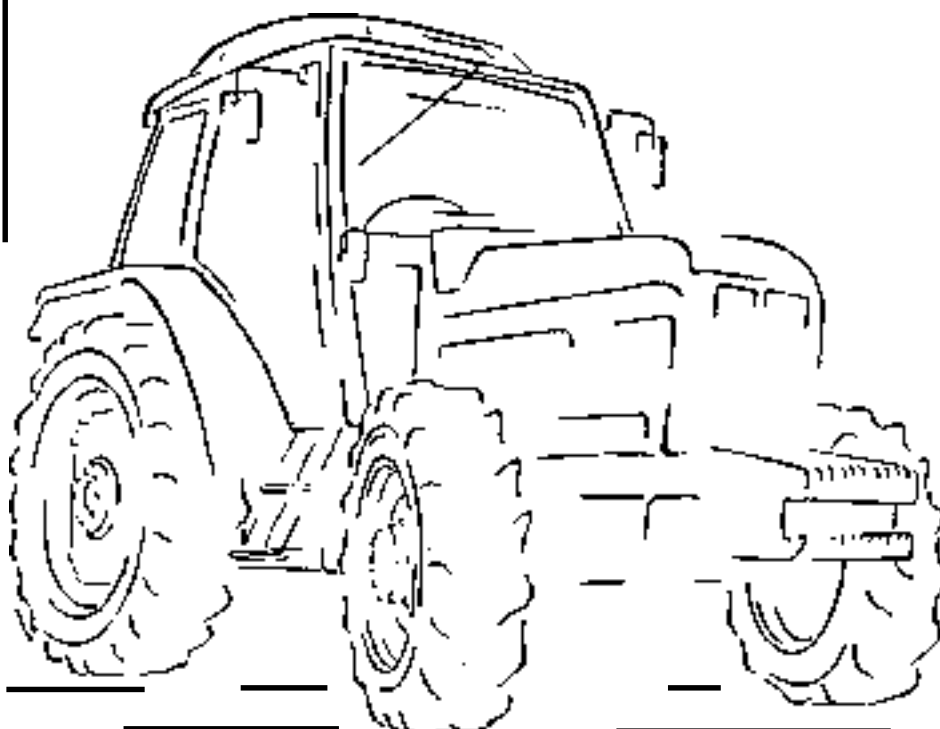

*NEW/29/2.0-FE*

# INDEX

ALTERNATEURS ..... 75-76	ALTERNATORS ..... 75-76
BAGUES D'ETANCHEITE ..... 83	BEARINGS (AIR COOLING) ..... 1
BOUGIES DE PRECHAUFFAGE ..... 11	BRAKES ..... 58-63
BOUTONS POUSSOIRS ..... 41	BUTTONS ..... 41
CONTACTEURS DIVERS ..... 15	CABS ELEMENTS ..... 80
COURROIES DE VENTILATEUR ..... 14	CLUTCH ASSEMBLIES & PLATES ..... 45-55
COUSSINETS (REFROIDISSEMENT PAR AIR) ..... 1	COVER SEAL ..... 83
DEMARREURS ..... 77	ENGINE GASKET & BEARINGS SETS (WATER COOLING) ..... 2
DISTRIBUTEURS HYDRAULIQUES ..... 73	ENGINE GASKET SETS (AIR COOLING) ..... 7-8
ECHAPPEMENTS ..... 35	FAN BELTS ..... 14
ECLAIRAGE - FEUX ARRIÈRES ..... 39	FILTERS ..... 16-34
ECLAIRAGE - FEUX DE POSITION & CLIGNOTANTS ..... 38	FLANGE & SPLINED AXLES ..... 65
ECLAIRAGE - PHARES AVANTS ..... 36-37	FUEL PUMPS & REPAIR KITS ..... 9-10
ECLAIRAGE - PHARES DE TRAVAIL ..... 40	GAS STRUTS ..... 81-82
ELEMENTS DE CABINES ..... 80	HEATER PLUGS ..... 11
ETAIS A GAZ ..... 81-82	HYDRAULIC PUMPS ..... 70-72
FILTRATION ..... 16-34	HYDRAULIC VALVE ..... 73
FLASQUE & MANCHONS CANNELES ..... 65	INJECTOR NOZZLES ..... 11
FREINAGE ..... 58-63	INSTRUMENTS (MISCELLANEOUS) ..... 42-44
INSTRUMENTS DE BORD ..... 42-44	LIFTING RODS ..... 74
JOINTS & COUSSINETS DE MOTEUR (EAU) ..... 2	LIGHTING - REAR LIGHTS ..... 39
JOINTS DE MOTEUR (AIR) ..... 7-8	LIGHTING - FRONT LIGHT ..... 36-37
KITS DE DIRECTION ASSISTEE ..... 65	LIGHTING - PLOUGH LAMPS ..... 40
MAITRE CYLINDRE ..... 50	LIGHTING - SIDE LIGHTS & INDICATORS ..... 38
MECANISMES ET DISQUES D'EMBRAYAGE ..... 45-55	MASTER & SLAVE CYLINDERS (CLUTCHES) ..... 50
NEZ D'INJECTEURS ..... 11	MISCELLANEOUS PARTS FOR «BOSCH» GENERATOR ..... 76
PEINTURE ..... 79	MISCELLANEOUS PARTS FOR ORIGINAL ALTERNATORS ..... 76
PIECES DE RECHANGE POUR DEMARREURS «BOSCH» ..... 78	PAINT ..... 79
PIECES DETACHEES POUR EMBRAYAGES VALEO ..... 56	PISTONS, ... (WATER COOLING) ..... 5-6
PIECES DIVERSES POUR ALTERNATEURS D'ORIGINE ..... 76	PISTONS, ... (AIR COOLING) ..... 3-4
PIECES DIVERSES POUR DYNAMO «BOSCH» ..... 76	POWER STEERING KITS ..... 65
PISTONS, ... (REFROIDISSEMENT PAR AIR) ..... 3-4	PTO DRIVE ..... 57
PISTONS, ... (REFROIDISSEMENT PAR EAU) ..... 5-6	REPLACEMENT PARTS FOR VALEO CLUTCHES ..... 56
POMPES A EAU ..... 12-13	SEAT ..... 79
POMPES D'ALIMENTATION & KITS DE REPARATION ..... 9-10	SILENCERS ..... 35
POMPES HYDRAULIQUES ..... 70-72	SPARE PARTS FOR «BOSCH» STARTER MOTORS ..... 78
PTO ..... 57	STABILISERS ..... 73
ROTULES & TIRANTS DE DIRECTION ..... 66-69	STARTER MOTORS ..... 77
SIÈGE ..... 79	STEERING LINKS & SOCKETS ..... 66-69
STABILISATEURS ..... 73	SWITCHES (MISCELLANEOUS) ..... 15
TIRANTS DE RELEVAGE ..... 74	TRANSMISSION ..... 64
TRANSMISSION ..... 64	WATER PUMPS ..... 12-13

Les références des pièces sont indicatives.  
Nos pièces ne sont pas d'origine.

Part numbers are quoted for reference purposes only.  
Our parts and accessories are not original.



**"THE RELIABLE SERVICE"**



**VILEBREQUINS & PIÈCES CONNEXES**  
**CRANKSHAFT & RELATED PARTS**

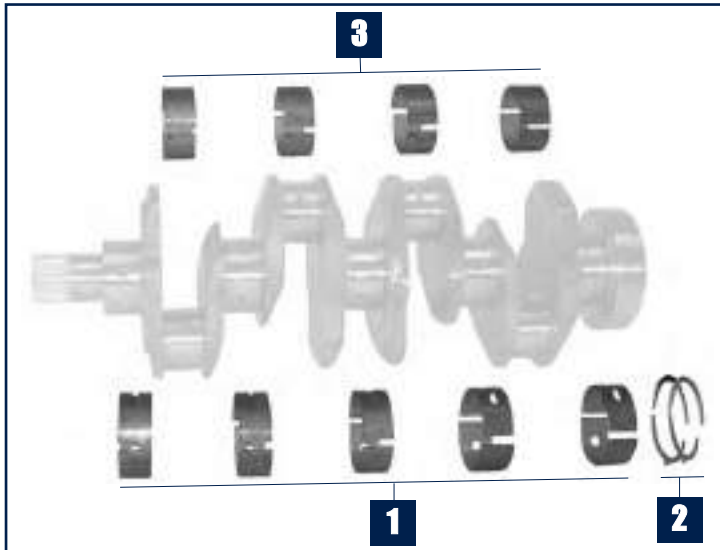

**Same**

Tracteurs Tractors	Type Type	Cous. palier Main bearing	Ep. latérale Trust washer	Cous. bielle Conrod bearing	Bague de bielle Small end bush	Bague avant Front oil seal	Bague arrière Rear oil seal
		1	2	3	4	5	6
<b>Moteurs 4 cylindres / 4 cylinder engines</b>							
Row Crop 100	1000.4WT	29/7-404 (1x 0.065.1215.0 1x 0.065.1216.0)	29/6-404 (4x 0.065.1218.0)	29/9-404 (2x 0.065.1225.0)	29/28-404 (2.1559.114.0/10)	29/11-404 (2.1529.141.0) 70 x 90 x 12	29/13-404 (2.1529.073.0) 110 x 130 x 13
<b>Moteurs 6 cylindres / 6 cylinder engines</b>							
Diamond 230, 260 Diamond II 230, 260 (A): sans/less intercooler (B): avec/with intercooler	BF6M1013	29/7-405 (02929430)	29/6-405 (02929438)	32/9-405 (A) (02929434) 32/9-406 (B) (02931473 02931297)	29/28-405 (04200024)	29/11-405 (04253373)	29/13-405 (04253333)
Rubin 120, 135 Silver 110, 130	1000.6WT	29/7-404 (1x 0.065.1215.0 1x 0.065.1216.0)	29/6-404 (4x 0.065.1218.0)	29/9-404 (2x 0.065.1225.0)	29/28-404 (2.1559.114.0/10)	29/11-404 (2.1529.141.0) 70 x 90 x 12	29/13-404 (2.1529.073.0) 110 x 130 x 13
Rubin 150, 160 Rubin 160 Galileo Silver 160, 180 Titan 150 (⇒ 3001) Titan 160, 190	1000.6WT				29/28-403 (2.1559.255.0)		
Rubin 180, 200 Rubin 180, 200 Galileo Titan 165, 190 (⇒ 3001) Supertitan	1000.6WTI						

Les références des pièces sont indicatives.  
Nos pièces ne sont pas d'origine

**"THE RELIABLE SERVICE"**

Part numbers are quoted for reference purposes only.  
Our parts and accessories are not original.

## VILEBREQUINS & PIECES CONNEXES CRANKSHAFT & RELATED PARTS

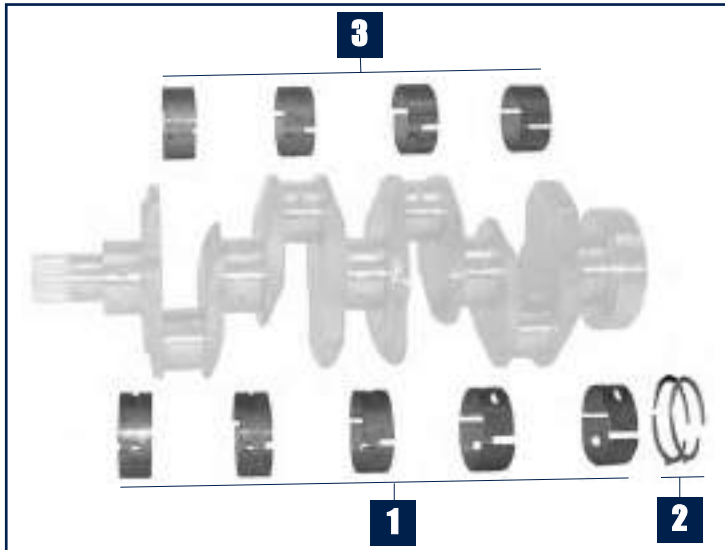

### Lamborghini

Tracteurs Tractors	Type Type	Cous. palier Main bearing	Ep. latérale Trust washer	Cous. bielle Conrod bearing	Bague de bielle Small end bush	Bague avant Front oil seal	Bague arrière Rear oil seal
		1	2	3	4	5	6
<b>Moteurs 3 cylindres / 3cylinder engines</b>							
Agile 660-s F Plus 775 Sprint 654-55, 664-60, 665-65	1000.3W	<b>32/7-404</b> (1x 0.065.1215.0 1x 0.065.1216.0)	<b>32/6-404</b> (4x 0.065.1218.0)	<b>32/9-404</b> (2x 0.065.1225.0)	<b>32/28-404</b> (2.1559.114.0/10)	<b>32/11-404</b> (2.1529.141.0) 70x90x12	<b>32/13-404</b> (2.1529.073.0) 110x130x13
Agile 770-s	1000.3WT						
<b>Moteurs 4 cylindres / 4 cylinder engines</b>							
C674, C774, R674, R774	916.4W	<b>32/7-404</b> (1x 0.065.1215.0 1x 0.065.1216.0)	<b>32/6-404</b> (4x 0.065.1218.0)	<b>32/9-404</b> (2x 0.065.1225.0)	<b>32/28-404</b> (2.1559.114.0/10)	<b>32/11-404</b> (2.1529.141.0) 70x90x12	<b>32/13-404</b> (2.1529.073.0) 110x130x13
674-70 N, 774-80 N Agile 880-s Cross 674-70 N Ergomatic C 674-70, 774-80 F Plus 880 Grand Prix 674-70, 774-80 Sprint 674-70, 674-75 Triumph 80, 90, 100	1000.4W						
Agile 990-s Ergomatic C 874-90 F Plus 990 Grand Prix 874-90T Premium 850, 950, 1050 Sprint 684-85	1000.4WT						
<b>Moteurs 6 cylindres / 6 cylinder engines</b>							
956-100	916W1	<b>32/7-404</b> (1x 0.065.1215.0 1x 0.065.1216.0)	<b>32/6-404</b> (4x 0.065.1218.0)	<b>32/9-404</b> (2x 0.065.1225.0)	<b>32/28-407</b> (0.065.1227.0)	<b>32/11-404</b> (2.1529.141.0) 70x90x12	<b>32/13-404</b> (2.1529.073.0) 110x130x13
1106	916.6W2						
1306	916.6WT						
1506	1106/14 T	<b>32/7-419</b> (2x 0.073.1215.0)	<b>32/6-419</b> (2x 0.042.1218.0 2x 0.042.1219.0)	<b>32/9-419</b> (0.062.1225.0)	<b>32/28-419</b> (2.1559.144.0/10)	<b>32/11-419</b> (2.1519.010.0) 58x80x10	<b>32/13-419</b> (2.1519.009.0/10) 98x120x13
1706	1106/17 T						

Les références des pièces sont indicatives.  
Nos pièces ne sont pas d'origine

**"THE RELIABLE SERVICE"**

Part numbers are quoted for reference purposes only.  
Our parts and accessories are not original.

**VILEBREQUINS & PIÈCES CONNEXES**  
**CRANKSHAFT & RELATED PARTS**

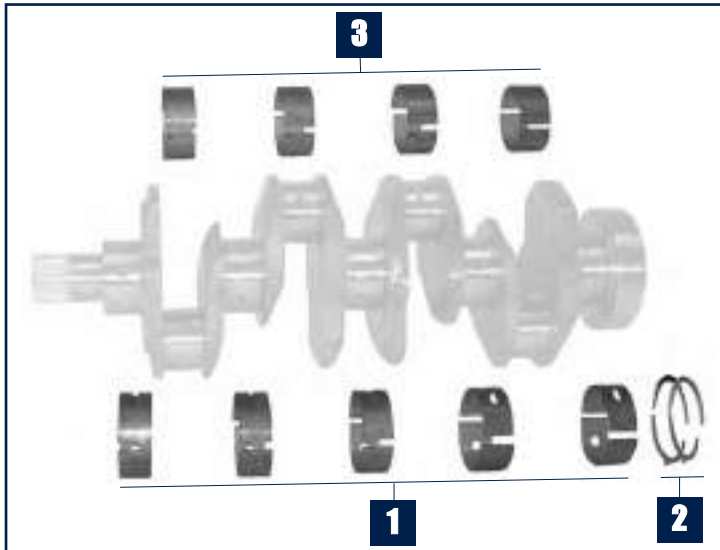

**Lamborghini**

Tracteurs Tractors	Type Type	Cous. palier Main bearing	Ep. latérale Trust washer	Cous. bielle Conrod bearing	Bague de bielle Small end bush	Bague avant Front oil seal	Bague arrière Rear oil seal
		1	2	3	4	5	6
<b>Moteurs 6 cylindres / 6 cylinder engines</b>							
Formula 115 Premium 1060, 1100	1000.6W	32/7-404 (1x 0.065.1215.0 1x 0.065.1216.0)	32/6-404 (4x 0.065.1218.0)	32/9-404 (2x 0.065.1225.0)	32/28-404 (2.1559.114.0/10)	32/11-404 (2.1529.141.0) 70x90x12	32/13-404 (2.1529.073.0) 110x130x13
Formula 135 Premium 1100, 1300	1000.6WT				32/28-403 (2.1559.255.0)		
Champion 120, 135, 160, 180, 200 Champion Intel Cab 160, 180, 200 Premium 1600, 1800 Racing 150, 165, 190	1000.6WT						
Champion 150	1000.6WTI						
Victory 230, 260 Victory Plus 230, 260 (A): sans/less intercooler (B): avec/with intercooler	BF6M1013	32/7-405 (1x 02929430)	32/6-405 (02929438)	32/9-405 (A) (02929434) 32/9-406 (B) (02931473 02931297)	32/28-405 (04200024)	32/11-405 (04253373)	32/13-405 (04253333)

## VILEBREQUINS & PIECES CONNEXES CRANKSHAFT & RELATED PARTS

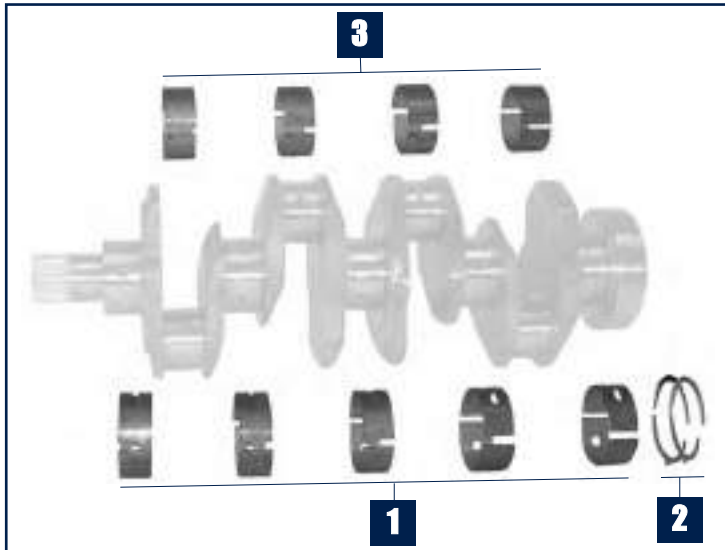

### Hürlimann

Tracteurs Tractors	Type Type	Cous. palier Main bearing	Ep. latérale Trust washer	Cous. bielle Conrod bearing	Bague de bielle Small end bush	Bague avant Front oil seal	Bague arrière Rear oil seal
		1	2	3	4	5	6
<b>Moteurs 3 cylindres / 3 cylinder engines</b>							
Prestige H-358 XA-606, 655 XN-706	1000.3W	33/7-404 (1x 0.065.1215.0 1x 0.065.1216.0)	33/6-404 (4x 0.065.1218.0)	33/9-404 (2x 0.065.1225.0)	33/28-404 (2.1559.114.0/10)	33/11-404 (2.1529.141.0) 70x90x12	33/13-404 (2.1529.073.0) 110 x 130 x 13
H-476-XF XA-656T XN-707	1000.3WT						
<b>Moteurs 4 cylindres / 4 cylinder engines</b>							
Club H468-4 H-478-4 H-481-XF Prestige H-468, 478 XA-607, 657 XN-708	1000.4W	33/7-404 (1x 0.065.1215.0 1x 0.065.1216.0)	33/6-404 (4x 0.065.1218.0)	33/9-404 (2x 0.065.1225.0)	33/28-404 (2.1559.114.0/10)	33/11-404 (2.1529.141.0) 70x90x12	33/13-404 (2.1529.073.0) 110 x 130 x 13
H-491-XF Prestige H-488T XA-658 XN-709 XT-908, 909, 910.4	1000.4WT						
<b>Moteurs 6 cylindres / 6 cylinder engines</b>							
Elite 6115-XB	1000.6W	33/7-404 (1x 0.065.1215.0 1x 0.065.1216.0)	33/6-404 (4x 0.065.1218.0)	33/9-404 (2x 0.065.1225.0)	33/28-404 (2.1559.114.0/10)	33/11-404 (2.1529.141.0) 70x90x12	33/13-404 (2.1529.073.0) 110 x 130 x 13
Elite 6135-XB SX-1200, 1350 XT-910.6, 911, 913	1000.6WT						
Master H-6165, 6190 Master H.P. SX-1500, 1600, 1800, 2000	1000.6WT				33/28-403 (2.1559.255.0)		

Les références des pièces sont indicatives.  
Nos pièces ne sont pas d'origine

**"THE RELIABLE SERVICE"**

Part numbers are quoted for reference purposes only.  
Our parts and accessories are not original.

**PISTONS, JEUX DE SEGMENTS & CHEMISES**  
**PISTONS, RING SETS & LINERS**



**1**



**2**



**3**

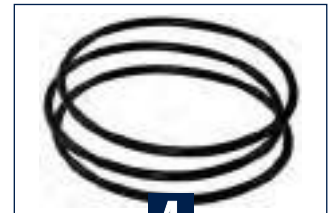

**4**

**Same**

Tracteurs Tractors	Type Type	Piston + segments Piston + rings	Segments Ring set	Chemise Liner	Joint de chemise Liner seals
		1	2	3	4
<b>Moteurs 4 cylindres / 4 cylinder engines</b>					
Row Crop 100	1000.4WT	<b>29/32-240</b> (0.087.0060.6/10 0.087.0060.6/30 0.087.0060.A)	<b>29/34-400</b> (0.086.0052.6/10)  <b>29/34-401</b> (0.081.0090.6/10)	<b>29/35-403</b> (0.011.0183.0/20 0.B12.2675.0)	<b>29/38-403</b> (2.1539.193.0)
<b>Moteurs 6 cylindres / 6 cylinder engines</b>					
Diamond 230, 260	BF6M1013	<b>29/32-405</b> (04253314, 04253386)	<b>29/34-405</b> (04207776, 04253389)	<b>29/35-405</b> (04203065, 04253771)	<b>29/38-405</b> (01181178)
Diamond II 230, 260	BF6M1013	<b>29/32-405</b> (04253314, 04253386)  <b>29/32-406</b> (04259101)		<b>29/35-405</b> (04203065, 04253771)  <b>29/35-406</b> (04253772)	
Rubin 120 (A): ⇒ 1189 (B): 1190 ⇒	1000.6WT	<b>29/32-401 (A)</b> (0.379.0060.6 0.379.0060.6/10 0.379.0060.A)  <b>29/32-411 (B)</b> (0.382.0060.6 0.382.0060.6/10 0.382.0060.A) Cat. A  <b>29/32-412 (B)</b> (0.382.0060.B) Cat. B	<b>29/34-400</b> (0.086.0052.6/10)  <b>29/34-401</b> (0.081.0090.6/10)	<b>29/35-402</b> (0.A12.2675.0) Cat. A  <b>29/35-403</b> (0.011.0183.0/20 0.B12.2675.0) Cat. B	<b>29/38-403</b> (2.1539.193.0)
Rubin 135	1000.6WT	<b>29/32-401</b> (0.379.0060.6 0.379.0060.6/10 0.379.0060.A) Cat. A  <b>29/32-403</b> (0.379.0060.B) Cat. B			

Les références des pièces sont indicatives.  
Nos pièces ne sont pas d'origine

Part numbers are quoted for reference purposes only.  
Our parts and accessories are not original.

## PISTONS, JEUX DE SEGMENTS & CHEMISES PISTONS, RING SETS & LINERS



1



2

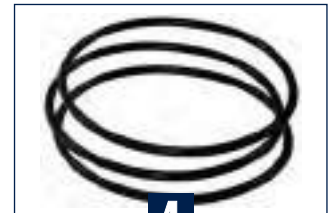

4

Same

Tracteurs Tractors	Type Type	Piston + segments Piston + rings	Segments Ring set	Chemise Liner	Joint de chemise Liner seals
		1	2	3	4
<b>Moteurs 6 cylindres / 6 cylinder engines</b>					
Rubin 150, 160 Rubin 160 Galileo	1000.6WT	<b>29/32-402</b> (0.383.0060.6 0.383.0060.A) Cat. A	<b>29/34-402</b> (0.338.0052.6 0.338.0052.6/10 0.338.0052.6/20)	<b>29/35-402</b> (0.A12.2675.0) Cat. A	<b>29/38-403</b> (2.1539.193.0)
Rubin 180, 200 Rubin 180, 200 Galileo	1000.6WTI	<b>29/32-404</b> (0.383.0060.B) Cat. B		<b>29/35-403</b> (0.011.0183.0/20 0.B12.2675.0) Cat. B	
Silver 110	1000.6WT	<b>29/32-401</b> (0.379.0060.6 0.379.0060.6/10 0.379.0060.A)	<b>29/34-400</b> (0.086.0052.6/10)	<b>29/35-403</b> (0.011.0183.0/20 0.B12.2675.0)	
Silver 130	1000.6WT	<b>29/32-240</b> (0.087.0060.6/10 0.087.0060.6/30 0.087.0060.A)			
Silver 110 (⇒ 3001)	1000.6WT	<b>29/32-411</b> (0.382.0060.6 0.382.0060.6/10 0.382.0060.A) Cat. A  <b>29/32-412</b> (0.382.0060.B) Cat. B		<b>29/34-401</b> (0.081.0090.6/10)	
Silver 130 (⇒ 3001)	1000.6WT	<b>29/32-401</b> (0.379.0060.6 0.379.0060.6/10 0.379.0060.A) Cat. A  <b>29/32-403</b> (0.379.0060.B) Cat. B		<b>29/35-403</b> (0.011.0183.0/20 0.B12.2675.0) Cat. B	



**PISTONS, JEUX DE SEGMENTS & CHEMISES**  
**PISTONS, RING SETS & LINERS**

**1**

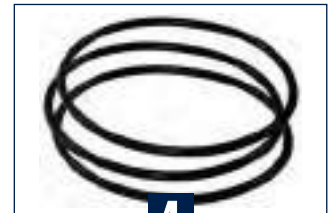
**2**

**4**
**Same**

Tracteurs Tractors	Type Type	Piston + segments Piston + rings	Segments Ring set	Chemise Liner	Joint de chemise Liner seals
		1	2	3	4
<b>Moteurs 6 cylindres / 6 cylinder engines</b>					
Silver 160, 180	1000.6WT	<b>29/32-402</b> (0.383.0060.6 0.383.0060.A) Cat. A  <b>29/32-404</b> (0.383.0060.B) Cat. B		<b>29/35-402</b> (0.A12.2675.0) Cat. A  <b>29/35-403</b> (0.011.0183.0/20 0.B12.2675.0) Cat. B	<b>29/38-403</b> (2.1539.193.0)
Titan 150 (⇒ 3001)	1000.6WT			<b>29/35-403</b> (0.011.0183.0/20 0.B12.2675.0)	
Titan 165, 190 (⇒ 3001) Supertitan	1000.6WTI			<b>29/34-402</b> (0.338.0052.6 0.338.0052.6/10 0.338.0052.6/20)	<b>29/35-400 (A)</b> (0.009.7500.0/10) Cat. A  <b>29/35-401 (B)</b> (0.011.0582.0) Cat. B  <b>29/35-403 (C)</b> (0.011.0183.0/20 0.B12.2675.0) Cat. B
Titan 160 (B): ⇒ 2234 (C): 2235 ⇒ (D): ⇒ 2234  Titan 190 (A): ⇒ 1592 (B): 1593 ⇒ 2502 (C): 2503 ⇒ (D): ⇒ 2502	1000.6WT	<b>29/32-407</b> (0.340.0060.6 0.340.0060.6/10 0.340.0060.A)			

## PISTONS, JEUX DE SEGMENTS & CHEMISES PISTONS, RING SETS & LINERS



1



2

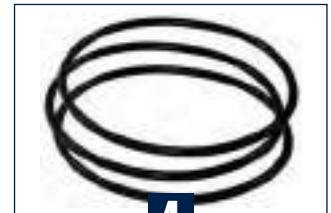

4

### Lamborghini

Tracteurs Tractors	Type Type	Piston + segments Piston + rings	Segments Ring set	Chemise Liner	Joints de chemise Liner seals
		1	2	3	4
<b>Moteurs 3 cylindres / 3 cylinder engines</b>					
Agile 660-s (A): ⇒ 1064 (B): 1242 ⇒ (C): 1065 ⇒	1000.3W	<b>32/32-401</b> (0.379.0060.6 0.379.0060.6/10 0.379.0060.A) Cat. A	<b>32/34-400</b> (0.086.0052.6/10)	<b>32/35-401 (A)</b> (0.011.0582.0)	<b>32/38-400 (A)</b> (2.1519.096.0/20)
Sprint 654-55 (B): 1051 ⇒	1000.3W	<b>32/32-403 (B)</b> (0.379.0060.B) Cat. B		<b>32/35-402 (B)</b> (0.A12.2675.0) Cat. A	
Sprint 664-65 (B): 1191 ⇒	1000.3W			<b>32/35-403 (C)</b> (0.011.0183.0/20 0.B12.2675.0) Cat. B	<b>32/38-403 (C)</b> (2.1539.193.0)
Agile 770-s (A): ⇒ 1072 (B): 1073 ⇒	1000.3WT	<b>32/32-408</b> (0.381.0060.6 0.381.0060.6/10 0.381.0060.A) Cat. A	<b>32/34-402</b> (0.338.0052.6 0.338.0052.6/10 0.338.0052.6/20)	<b>32/35-401 (A)</b> (0.011.0582.0)	<b>32/38-400 (A)</b> (2.1519.096.0/20)
		<b>32/32-409</b> (0.381.0060.B) Cat. B		<b>32/35-402 (B)</b> (0.A12.2675.0) Cat. A	
				<b>32/35-403 (C)</b> (0.011.0183.0/20 0.B12.2675.0) Cat. B	

**PISTONS, JEUX DE SEGMENTS & CHEMISES**  
**PISTONS, RING SETS & LINERS**

**1**

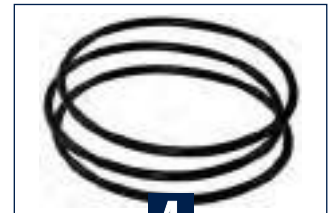
**2**

**4**
**Lamborghini**

Tracteurs Tractors	Type Type	Piston + segments Piston + rings	Segments Ring set	Chemise Liner	Joints de chemise Liner seals
		1	2	3	4
<b>Moteurs 3 cylindres / 3 cylinder engines</b>					
F Plus 775 (A): ⇒ 2348 (B): 2349 ⇒ (C): ⇒ 1465 (D): 1466 ⇒ 2059 (E): 2060 ⇒ (F): ⇒ 2059	1000.3W	<b>32/32-413 (A)</b> (0.338.0060.6/20 0.338.0060.A) Cat. A  <b>32/32-408 (B)</b> (0.381.0060.6 0.381.0060.6/10 0.381.0060.A) Cat. A  <b>32/32-409 (B)</b> (0.381.0060.B) Cat. B	<b>32/34-402</b> (0.338.0052.6 0.338.0052.6/10 0.338.0052.6/20)	<b>32/35-400 (C)</b> (0.009.7500.0/10) Cat. A  <b>32/35-401 (D)</b> (0.011.0582.0) Cat. B  <b>32/35-402 (E)</b> (0.A12.2675.0) Cat. A  <b>32/35-403 (E)</b> (0.011.0183.0/20 0.B12.2675.0) Cat. B	<b>32/38-400 (F)</b> (2.1519.096.0/20)  <b>32/38-403 (E)</b> (2.1539.193.0)
Sprint 664-60 (A): ⇒ 2771 (B): 2771 ⇒	1000.3W	<b>32/32-90</b> (0.086.0060.6/30)	<b>32/34-400</b> (0.086.0052.6/10)	<b>32/35-400</b> (0.009.7500.0/10)  <b>32/35-401 (A)</b> (0.011.0582.0)  <b>32/35-403 (B)</b> (0.011.0183.0/20 0.B12.2675.0)	<b>32/38-400 (A)</b> (2.1519.096.0/20)  <b>32/38-403 (B)</b> (2.1539.193.0)
<b>Moteurs 4 cylindres / 4 cylinder engines</b>					
Agile 880-s (A): ⇒ 2376 (B): 2377 ⇒	1000.4W	<b>32/32-401</b> (0.379.0060.6 0.379.0060.6/10 0.379.0060.A) Cat. A  <b>32/32-403</b> (0.379.0060.B) Cat. B	<b>32/34-400</b> (0.086.0052.6/10)	<b>32/35-401 (A)</b> (0.011.0582.0)  <b>32/35-402 (B)</b> (0.A12.2675.0) Cat. A  <b>32/35-403 (B)</b> (0.011.0183.0/20 0.B12.2675.0) Cat. B	<b>32/38-400 (A)</b> (2.1519.096.0/20)  <b>32/38-403 (B)</b> (2.1539.193.0)

## PISTONS, JEUX DE SEGMENTS & CHEMISES PISTONS, RING SETS & LINERS



1



2

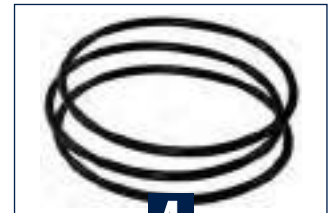

4

### Lamborghini

Tracteurs Tractors	Type Type	Piston + segments Piston + rings	Segments Ring set	Chemise Liner	Joint de chemise Liner seals
		1	2	3	4
<b>Moteurs 4 cylindres / 4 cylinder engines</b>					
Agile 990-s (A): ⇒ 1042 (B): 1043 ⇒	1000.4WT	<b>32/32-411</b> (0.382.0060.6 0.382.0060.6/10 0.382.0060.A) Cat. A  <b>32/32-412</b> (0.382.0060.B) Cat. B	<b>32/34-400</b> (0.086.0052.6/10)  <b>32/34-401</b> (0.081.0090.6/10)	<b>32/35-401 (A)</b> (0.011.0582.0)  <b>32/35-402</b> (0.A12.2675.0) Cat. A  <b>32/35-403</b> (0.011.0183.0/20 0.B12.2675.0) Cat. B	<b>32/38-400 (A)</b> (2.1519.096.0/20)  <b>32/38-403 (B)</b> (2.1539.193.0)
Cross 674-70 N (A): ⇒ 24943 (B): 24944 ⇒	1000.4W	<b>32/32-400</b> (0.089.0060.6)	<b>32/34-400</b> (0.086.0052.6/10)	<b>32/35-400</b> (0.009.7500.0/10)  <b>32/35-401 (A)</b> (0.011.0582.0)  <b>32/35-403 (B)</b> (0.011.0183.0/20 0.B12.2675.0)	
Ergomatic 674-70 (A): ⇒ 30080 (B): 30081 ⇒ (C): ⇒ 17701 (D): 17702 ⇒ 24865 (E): 24866 ⇒ (F): ⇒ 24865 Ergomatic 774-80 (A): ⇒ 30463 (B): 30464 ⇒ (C): ⇒ 17701 (D): 17702 ⇒ 24955 (E): 24956 ⇒ (F): ⇒ 24955 F Plus 880 (A): ⇒ 4241 (B): 4242 ⇒ (C): ⇒ 1120 (D): 1121 ⇒ 2448 (E): 2449 ⇒ (F): ⇒ 2448	1000.4W	<b>32/32-90 (A)</b> (0.086.0060.6/30)  <b>32/32-401 (B)</b> (0.379.0060.6 0.379.0060.6/10 0.379.0060.A) Cat. A  <b>32/32-403 (B)</b> (0.379.0060.B) Cat. B	<b>32/34-400</b> (0.086.0052.6/10)  <b>32/34-400</b> (0.086.0052.6/10)  <b>32/34-401</b> (0.081.0090.6/10)	<b>32/35-400 (C)</b> (0.009.7500.0/10) Cat. A  <b>32/35-401 (D)</b> (0.011.0582.0) Cat. B  <b>32/35-402 (E)</b> (0.A12.2675.0) Cat. A  <b>32/35-403 (E)</b> (0.011.0183.0/20 0.B12.2675.0) Cat. B	<b>32/38-400 (F)</b> (2.1519.096.0/20)  <b>32/38-403 (E)</b> (2.1539.193.0)

Les références des pièces sont indicatives.  
Nos pièces ne sont pas d'origine

**"THE RELIABLE SERVICE"**

Part numbers are quoted for reference purposes only.  
Our parts and accessories are not original.

**PISTONS, JEUX DE SEGMENTS & CHEMISES**  
**PISTONS, RING SETS & LINERS**



**1**



**2**

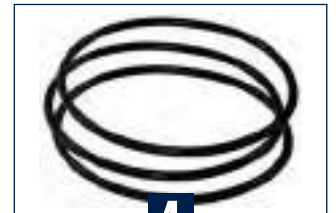

**4**

**Lamborghini**

Tracteurs Tractors	Type Type	Piston + segments Piston + rings	Segments Ring set	Chemise Liner	Joint de chemise Liner seals
		1	2	3	4
<b>Moteurs 4 cylindres / 4 cylinder engines</b>					
Ergomatic 874-90 Turbo (A): → 8736 (B): 8737 → (C): → 1852 (D): 1853 → 6848 (E): 6849 → (F): → 6848 F Plus 990 (A): → 4148 (B): 4149 → (C): → 1439 (D): 1440 → 2714 (E): 2715 → (F): → 2714	1000.4WT	<b>32/32-240 (A)</b> (0.087.0060.6/10 0.087.0060.6/30 0.087.0060.A) Cat. A  <b>32/32-411 (B)</b> (0.382.0060.6 0.382.0060.6/10 0.382.0060.A) Cat. A  <b>32/32-412 (B)</b> (0.382.0060.B) Cat. B	<b>32/34-400</b> (0.086.0052.6/10)  <b>32/34-401</b> (0.081.0090.6/10)	<b>32/35-400 (C)</b> (0.009.7500.0/10)  <b>32/35-401 (D)</b> (0.011.0582.0)  <b>32/35-402 (E)</b> (0.A12.2675.0) Cat. A  <b>32/35-403 (E)</b> (0.011.0183.0/20 0.B12.2675.0) Cat. B	<b>32/38-400 (F)</b> (2.1519.096.0/20)  <b>32/38-403 (E)</b> (2.1539.193.0)
674-70N (B-D): → 24952 (C): 24953 → 774-80N (B-D): → 25099 (C): 25100 → Grand Prix 674-70 (A): → 17700 (B): 17701 → 25065 (C): 25066 → (D): → 25065 Grand Prix 774-80 (A): → 17700 (B): 17701 → 24928 (C): 24929 → (D): → 24928 Sprint 674-70 (B-D): → 24631 (C): 24632 →	1000.4W	<b>32/32-90</b> (0.086.0060.6/30)	<b>32/34-400</b> (0.086.0052.6/10)	<b>32/35-400 (A)</b> (0.009.7500.0/10) Cat. A  <b>32/35-401 (B)</b> (0.011.0582.0) Cat. B  <b>32/35-403 (C)</b> (0.011.0183.0/20 0.B12.2675.0) Cat. B	<b>32/38-400 (D)</b> (2.1519.096.0/20)  <b>32/38-403 (C)</b> (2.1539.193.0)
Premium 850 (A): → 1015 (B): 1016 → 2403 (C): 2404 → (D): → 2403	1000.4WT				

Les références des pièces sont indicatives.  
Nos pièces ne sont pas d'origine

Part numbers are quoted for reference purposes only.  
Our parts and accessories are not original.

## PISTONS, JEUX DE SEGMENTS & CHEMISES PISTONS, RING SETS & LINERS

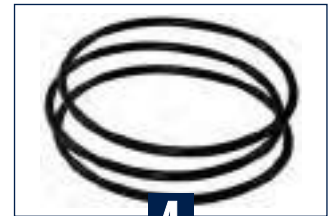

### Lamborghini

Tracteurs Tractors	Type Type	Piston + segments Piston + rings	Segments Ring set	Chemise Liner	Joints de chemise Liner seals
		1	2	3	4
<b>Moteurs 4 cylindres / 4 cylinder engines</b>					
Grand Prix 874-90T (A): ⇒ 5428 (B): 5429 ⇒ 6740 (C): 6741 ⇒ (D): ⇒ 6740	1000.4WT	<b>32/32-240</b> (0.087.0060.6/10 0.087.0060.6/30 0.087.0060.A)		<b>32/35-400 (A)</b> (0.009.7500.0/10) Cat. A	<b>32/38-400 (D)</b> (2.1519.096.0/20)  <b>32/38-403 (C)</b> (2.1539.193.0)
Premium 950 (A): ⇒ 1018 (B): 1019 ⇒ 2528 (C): 2529 ⇒ (D): ⇒ 2528				<b>32/35-401 (B)</b> (0.011.0582.0) Cat. B	
Premium 1050 (B-D): ⇒ 52204 (C): 52205 ⇒				<b>32/35-403 (C)</b> (0.011.0183.0/20 0.B12.2675.0) Cat. B	
High Clearance 90	1000.4WT		<b>32/34-400</b> (0.086.0052.6/10)	<b>32/35-403</b> (0.011.0183.0/20 0.B12.2675.0)	
Sprint 674-75	1000.4W	<b>32/32-401</b> (0.379.0060.6 0.379.0060.6/10 0.379.0060.A) Cat. A	<b>32/34-401</b> (0.081.0090.6/10)	<b>32/35-402</b> (0.A12.2675.0) Cat. A	
Sprint 684-85	1000.4WT	<b>32/32-403</b> (0.379.0060.B) Cat. B		<b>32/35-403</b> (0.011.0183.0/20 0.B12.2675.0) Cat. B	<b>32/38-403</b> (2.1539.193.0)
Triumph 80	1000.4W	<b>32/32-401</b> (0.379.0060.6 0.379.0060.6/10 0.379.0060.A)			
Triumph 90, 100	1000.4W	<b>32/32-***</b> (0.007.1787.4/20)			

**PISTONS, JEUX DE SEGMENTS & CHEMISES**  
**PISTONS, RING SETS & LINERS**

**1**

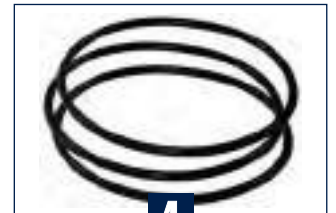
**2**

**4**
**Lamborghini**

Tracteurs Tractors	Type Type	Piston + segments Piston + rings	Segments Ring set	Chemise Liner	Joint de chemise Liner seals
		1	2	3	4
<b>Moteurs 6 cylindres / 6cylinder engines</b>					
956-100 (A): ⇒ 3528 (B): 3529 ⇒ 3642 (C): 3643 ⇒ (D): ⇒ 3642	916W1	<b>32/32-414</b> (0.069.0060.6)	<b>32/34-414</b> (0.069.0052.6)	<b>32/35-414 (A)</b> (0.066.1120.0/20)	<b>32/38-400 (D)</b> (2.1519.096.0/20)  <b>32/38-403 (C)</b> (2.1539.193.0)
1106 (A): ⇒ 1463 (B): 1464 ⇒ 1965 (C): 1966 ⇒ (D): ⇒ 1965	916.6W2				
1306 (A): ⇒ 1764 (B): 1765 ⇒ 1802 (C): 1803 ⇒ (D): ⇒ 1802	916.6WT				
1506	1106/14T	<b>32/32-417</b> (0.064.0060.6)	<b>32/34-417</b> (0.064.0051.6)	<b>32/35-417</b> (0.057.1120.0)	<b>32/38-417</b> (2.1539.029.0)
1706	1106/17T				
Champion 120, 135	1000.6WT	<b>32/32-418</b> (0.392.0060.A) Cat. A	<b>32/34-402</b> (0.338.0052.6 0.338.0052.6/10 0.338.0052.6/20)	<b>32/35-402</b> (0.A12.2675.0) Cat. A	<b>32/38-403</b> (2.1539.193.0)
Champion 150	1000.6WTI	<b>32/32-419</b> (0.392.0060.B) Cat. B		<b>32/35-403</b> (0.011.0183.0/20 0.B12.2675.0) Cat. B	
Champion 160, 180, 200 Champion 180 Intel-Cab	1000.6WT	<b>32/32-420</b> (0.098.0060.A 0.098.0060.6/10)			
Champion 160 Intel-Cab 1002 ⇒ Champion 200 Intel-Cab 1005 ⇒	1000.6WT				

## PISTONS, JEUX DE SEGMENTS & CHEMISES PISTONS, RING SETS & LINERS



1



2

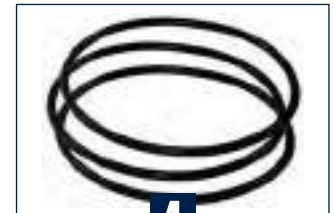

4

### Lamborghini

Tracteurs Tractors	Type Type	Piston + segments Piston + rings	Segments Ring set	Chemise Liner	Joints de chemise Liner seals
		1	2	3	4
<b>Moteurs 6 cylindres / 6cylinder engines</b>					
Formula 115 (A): ⇒ 2086 (B): 2087 ⇒ 2817 (C): 2818 ⇒ (D): ⇒ 2817	1000.6W	<b>32/32-90</b> (0.086.0060.6/30)	<b>32/34-400</b> (0.086.0052.6/10)	<b>32/35-400 (A)</b> (0.009.7500.0/10) Cat. A	<b>32/38-400 (D)</b> (2.1519.096.0/20)  <b>32/38-403 (C)</b> (2.1539.193.0)
Premium 1060 (A): ⇒ 1024 (B): 1025 ⇒ 2828 (C): 2829 ⇒ (D): ⇒ 2828				<b>32/35-401 (B)</b> (0.011.0582.0) Cat. B	
Formula 135 (A): ⇒ 1936 (B): 1937 ⇒ 3094 (C): 3095 ⇒ (D): ⇒ 3094	1000.6WT	<b>32/32-240</b> (0.087.0060.6/10 0.087.0060.6/30 0.087.0060.A)	<b>32/34-400</b> (0.086.0052.6/10)  <b>32/34-401</b> (0.081.0090.6/10)	<b>32/35-403 (C)</b> (0.011.0183.0/20 0.B12.2675.0) Cat. B	<b>32/38-403</b> (2.1539.193.0)
Premium 1100	1000.6WT	<b>32/32-401</b> (0.379.0060.6 0.379.0060.6/10 0.379.0060.A)		<b>32/35-403</b> (0.011.0183.0/20 0.B12.2675.0)	
Premium 1300	1000.6WT	<b>32/32-240</b> (0.087.0060.6/10 0.087.0060.6/30 0.087.0060.A)			
Premium 1100 (⇒ 3001)	1000.6WT	<b>32/32-411</b> (0.382.0060.6 0.382.0060.6/10 0.382.0060.A) Cat. A  <b>32/32-412</b> (0.382.0060.B) Cat. B		<b>32/35-402</b> (0.A12.2675.0) Cat. A	
Premium 1300 (⇒ 3001)	1000.6WT	<b>32/32-401</b> (0.379.0060.6 0.379.0060.6/10 0.379.0060.A) Cat. A  <b>32/32-403</b> (0.379.0060.B) Cat. B		<b>32/35-403</b> (0.011.0183.0/20 0.B12.2675.0) Cat. B	

Les références des pièces sont indicatives.  
Nos pièces ne sont pas d'origine

**"THE RELIABLE SERVICE"**

Part numbers are quoted for reference purposes only.  
Our parts and accessories are not original.



**PISTONS, JEUX DE SEGMENTS & CHEMISES**  
**PISTONS, RING SETS & LINERS**

**1**

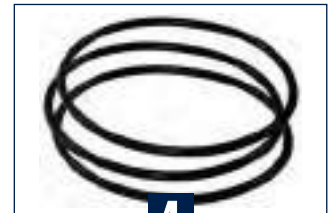
**2**

**4**
**Lamborghini**

Tracteurs Tractors	Type Type	Piston + segments Piston + rings	Segments Ring set	Chemise Liner	Joint de chemise Liner seals
		1	2	3	4
<b>Moteurs 6 cylindres / 6cylinder engines</b>					
Premium 1600, 1800	1000.6WT	<b>32/32-402</b> (0.383.0060.6 0.383.0060.A) Cat. A  <b>32/32-404</b> (0.383.0060.B) Cat. B	<b>32/34-402</b> (0.338.0052.6 0.338.0052.6/10 0.338.0052.6/20)	<b>32/35-402</b> (0.A12.2675.0) Cat. A  <b>32/35-403</b> (0.011.0183.0/20 0.B12.2675.0) Cat. B	<b>32/38-403</b> (2.1539.193.0)
Racing 150 (A): ⇒ 2228 (B): 2229 ⇒	1000.6WT			<b>32/35-401 (A)</b> (0.011.0582.0)  <b>32/35-403 (B)</b> (0.011.0183.0/20 0.B12.2675.0)	<b>32/38-400 (A)</b> (2.1519.096.0/20)  <b>32/38-403 (B)</b> (2.1539.193.0)
Racing 150, 165, 190 (⇒ 3001) Racing Hi. Per.	1000.6WT	<b>32/32-407</b> (0.340.0060.6 0.340.0060.6/10 0.340.0060.A)		<b>32/35-403</b> (0.011.0183.0/20 0.B12.2675.0)	<b>32/38-403</b> (2.1539.193.0)
Racing 165 (A): ⇒ 1471 (B): 1472 ⇒ 2229 (C): 2230 ⇒ (D): ⇒ 2229 Racing 190 (A): ⇒ 1593 (B): 1594 ⇒ 2532 (C): 2533 ⇒ (D): ⇒ 2532	1000.6WT			<b>32/35-400 (A)</b> (0.009.7500.0/10) Cat. A  <b>32/35-401 (B)</b> (0.011.0582.0) Cat. B  <b>32/35-403 (C)</b> (0.011.0183.0/20 0.B12.2675.0) Cat. B	<b>32/38-400 (D)</b> (2.1519.096.0/20)  <b>32/38-403 (C)</b> (2.1539.193.0)
Victory 230, 260	BF6M1013	<b>32/32-405</b> (04253314, 04253386)	<b>32/34-405</b> (04207776, 04253389)	<b>32/35-405</b> (04203065, 04253771)	<b>32/38-405</b> (01181178)
Victory Plus 230, 260	BF6M1013	<b>32/32-405</b> (04253314, 04253386)  <b>32/32-406</b> (04259101)		<b>32/35-405</b> (04203065, 04253771)  <b>32/35-406</b> (04253772)	

 Les références des pièces sont indicatives.  
 Nos pièces ne sont pas d'origine

**"THE RELIABLE SERVICE"**

 Part numbers are quoted for reference purposes only.  
 Our parts and accessories are not original.

## PISTONS, JEUX DE SEGMENTS & CHEMISES PISTONS, RING SETS & LINERS



**1**



**2**

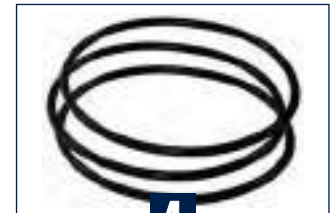

**4**

### Hürlimann

Tracteurs Tractors	Type Type	Piston + segments Piston + rings	Segments Ring set	Chemise Liner	Joints de chemise Liner seals
		1	2	3	4
<b>Moteurs 3 cylindres / 3 cylinder engines</b>					
H-476-XF (A): ⇒ 2347 (B): 2348 ⇒ (C): ⇒ 1465 (D): 1466 ⇒ 2012 (E): 2013 ⇒ (F): ⇒ 2012	1000.3WT	<b>33/32-413 (A)</b> (0.338.0060.6/20 0.338.0060.A)  <b>33/32-408 (B)</b> (0.381.0060.6 0.381.0060.6/10 0.381.0060.A)  <b>33/32-409 (B)</b> (0.381.0060.B)	<b>33/34-402</b> (0.338.0052.6 0.338.0052.6/10 0.338.0052.6/20)	<b>33/35-400 (C)</b> (0.009.7500.0/10)  <b>33/35-401 (D)</b> (0.011.0582.0)  <b>33/35-402 (E)</b> (0.A12.2675.0)  <b>33/35-403 (E)</b> (0.011.0183.0/20 0.B12.2675.0)	<b>33/38-400 (F)</b> 2.1519.096.0/20  <b>33/38-403 (E)</b> 2.1539.193.0
Prestige H-358 (A): ⇒ 1628 (B): 1629 ⇒ ... (C): ... ⇒ (D): ⇒ ... XA-606 (A) ⇒ ... (B) ... ⇒ 2774 (C): 2775 ⇒ (D): ⇒ 2774	1000.3W	<b>33/32-90</b> (0.086.0060.6/30)	<b>33/34-400</b> (0.086.0052.6/10)	<b>33/35-400 (A)</b> (0.009.7500.0/10)  <b>33/35-401 (B)</b> (0.011.0582.0)  <b>33/35-403 (C)</b> (0.011.0183.0/20 0.B12.2675.0)	<b>33/38-400 (D)</b> 2.1519.096.0/20  <b>33/38-403 (C)</b> 2.1539.193.0
XA-655	1000.3W	<b>33/32-401</b> (0.379.0060.6 0.379.0060.6/10 0.379.0060.A)	<b>32/34-400</b> (0.086.0052.6/10)  <b>32/34-401</b> (0.081.0090.6/10)	<b>33/35-402</b> (0.A12.2675.0)	<b>33/38-403</b> (2.1539.193.0)
XA-656T	1000.3WT			<b>33/35-403</b> (0.011.0183.0/20 0.B12.2675.0)	
XN-706 (A): (B): (C): (D):	1000.3W	<b>33/32-403</b> (0.379.0060.B)		<b>33/35-401 (A)</b> (0.011.0582.0)  <b>33/35-402 (B)</b> (0.A12.2675.0)	<b>33/38-400 (D)</b> 2.1519.096.0/20
XN-707 (A): (B): (C): (D):	1000.3WT	<b>33/32-408</b> (0.381.0060.6 0.381.0060.6/10 0.381.0060.A)  <b>33/32-409</b> (0.381.0060.B)	<b>33/34-402</b> (0.338.0052.6 0.338.0052.6/10 0.338.0052.6/20)	<b>33/35-403 (C)</b> (0.011.0183.0/20 0.B12.2675.0)	<b>33/38-403 (C)</b> 2.1539.193.0

Les références des pièces sont indicatives.  
Nos pièces ne sont pas d'origine

**"THE RELIABLE SERVICE"**

Part numbers are quoted for reference purposes only.  
Our parts and accessories are not original.

**PISTONS, JEUX DE SEGMENTS & CHEMISES**  
**PISTONS, RING SETS & LINERS**



**1**



**2**

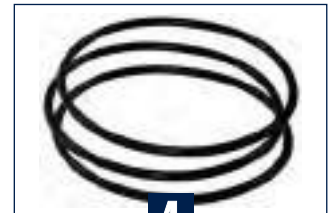

**4**

**Hürlimann**

Tracteurs Tractors	Type Type	Piston + segments Piston + rings	Segments Ring set	Chemise Liner	Joint de chemise Liner seals
		1	2	3	4
<b>Moteurs 4 cylindres / 4 cylinder engines</b>					
H-468-4 (B-D): ⇒ 25198 (C): 25199 ⇒	1000.4W	<b>33/32-400</b> (0.089.0060.6)			
H-478-4 (B-D): ⇒ 25080 (C): 25081 ⇒ Prestige H-468 (A): ⇒ 17700 (B): 17701 ⇒ 25055 (C): 25056 ⇒ (D): ⇒ 25055 Prestige H-478 (A): ⇒ 17700 (B): 17701 ⇒ 24932 (C): 24933 ⇒ (D): ⇒ 24932 XA-607 (B-D): ⇒ 24989 (C): 24990 ⇒	1000.4W	<b>33/32-90</b> (0.086.0060.6/30)	<b>33/34-400</b> (0.086.0052.6/10)	<b>33/35-400 (A)</b> (0.009.7500.0/10) <b>33/35-401 (B)</b> (0.011.0582.0) <b>33/35-403 (C)</b> (0.011.0183.0/20 0.B12.2675.0)	<b>33/38-400 (D)</b> (2.1519.096.0/20) <b>33/38-403 (C)</b> (2.1539.193.0)
XT-908 (A): ⇒ 1015 (B): 1016 ⇒ 2479 (C): 2480 ⇒ (D): ⇒ 2479	1000.4WT				
Prestige H-488T (A): ⇒ 1851 (B): 1852 ⇒ 1936 (C): 1937 ⇒ (D): ⇒ 1936 XT-909 (A): ⇒ 1018 (B): 1019 ⇒ 2451 (C): 2452 ⇒ (D): ⇒ 2451 XT-910.4 (B-D): ⇒ 52259 (C): 52260 ⇒	1000.4WT	<b>33/32-240</b> (0.087.0060.6/10 0.087.0060.6/30 0.087.0060.A)	<b>32/34-400</b> (0.086.0052.6/10) <b>32/34-401</b> (0.081.0090.6/10)		

Les références des pièces sont indicatives.  
Nos pièces ne sont pas d'origine

Part numbers are quoted for reference purposes only.  
Our parts and accessories are not original.

## PISTONS, JEUX DE SEGMENTS & CHEMISES PISTONS, RING SETS & LINERS



1



2

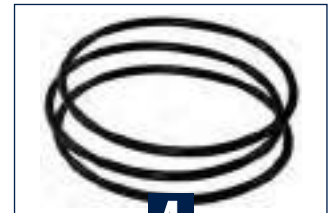

4

### Hürlimann

Tracteurs Tractors	Type Type	Piston + segments Piston + rings	Segments Ring set	Chemise Liner	Joint de chemise Liner seals
		1	2	3	4
<b>Moteurs 4 cylindres / 4 cylinder engines</b>					
H-481-XF (A): ⇒ 4230 (B): 4231 ⇒ (C): ⇒ 1120 (D): 1121 ⇒ 2437 (E): 2438 ⇒ (F): ⇒ 2437	1000.4WT	<b>33/32-90 (A)</b> (0.086.0060.6/30)  <b>33/32-401 (B)</b> (0.379.0060.6 0.379.0060.6/10 0.379.0060.A)  <b>33/32-403 (B)</b> (0.379.0060.B)	<b>33/34-400</b> (0.086.0052.6/10)	<b>33/35-400 (C)</b> (0.009.7500.0/10)  <b>33/35-401 (D)</b> (0.011.0582.0)  <b>33/35-402 (E)</b> (0.A12.2675.0)  <b>33/35-403 (E)</b> (0.011.0183.0/20 0.B12.2675.0)	<b>33/38-400 (F)</b> 2.1519.096.0/20  <b>33/38-403 (E)</b> 2.1539.193.0
H-491-XF (A): ⇒ 4141 (B): 4142 ⇒ (C): ⇒ 1439 (D): 1440 ⇒ 2688 (E): 2689 ⇒ (F): ⇒ 2688	1000.4WT	<b>33/32-240</b> (0.087.0060.6/10 0.087.0060.6/30 0.087.0060.A)  <b>33/32-411</b> (0.382.0060.6 0.382.0060.6/10 0.382.0060.A)  <b>33/32-412</b> (0.382.0060.B)	<b>33/34-400</b> (0.086.0052.6/10)  <b>33/34-401</b> (0.081.0090.6/10)	<b>33/35-402</b> (0.A12.2675.0)  <b>33/35-403</b> (0.011.0183.0/20 0.B12.2675.0)	<b>33/38-403</b> (2.1539.193.0)
XA-657 XA-658	1000.4W 1000.4WT	<b>33/32-401</b> (0.379.0060.6 0.379.0060.6/10 0.379.0060.A)		<b>33/35-402</b> (0.A12.2675.0)  <b>33/35-403</b> (0.011.0183.0/20 0.B12.2675.0)	<b>33/38-403</b> (2.1539.193.0)
XN-708 (A): ⇒ 1018 (B): 1019 ⇒	1000.4W	<b>33/32-403</b> (0.379.0060.B)		<b>33/35-401 (A)</b> (0.011.0582.0)	<b>33/38-400 (A)</b> 2.1519.096.0/20
XN-709 (A): ⇒ 1013 (B): 1014 ⇒	1000.4WT	<b>33/32-411</b> (0.382.0060.6 0.382.0060.6/10 0.382.0060.A)  <b>33/32-412</b> (0.382.0060.B)		<b>33/35-402</b> (0.A12.2675.0)  <b>33/35-403</b> (0.011.0183.0/20 0.B12.2675.0)	<b>33/38-403 (B)</b> 2.1539.193.0

Les références des pièces sont indicatives.  
Nos pièces ne sont pas d'origine

**"THE RELIABLE SERVICE"**

Part numbers are quoted for reference purposes only.  
Our parts and accessories are not original.

**PISTONS, JEUX DE SEGMENTS & CHEMISES**  
**PISTONS, RING SETS & LINERS**



**1**



**2**

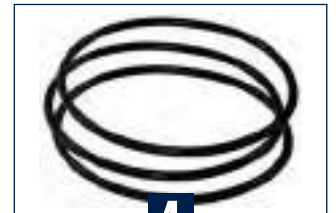

**4**

**Hürlimann**

Tracteurs Tractors	Type Type	Piston + segments Piston + rings	Segments Ring set	Chemise Liner	Joint de chemise Liner seals
		1	2	3	4
<b>Moteurs 6 cylindres / 6 cylinder engines</b>					
Elite 6115-XB (A): ⇒ 2086 (B): 2087 ⇒ 2808 (C): 2809 ⇒ (D): ⇒ 2808	1000.6W	<b>33/32-90</b> (0.086.0060.6/30)	<b>33/34-400</b> (0.086.0052.6/10)	<b>33/35-400 (A)</b> (0.009.7500.0/10)  <b>33/35-401 (B)</b> (0.011.0582.0)  <b>33/35-403 (C)</b> (0.011.0183.0/20 0.B12.2675.0)	<b>33/38-400 (D)</b> 2.1519.096.0/20  <b>33/38-403 (C)</b> 2.1539.193.0
XT-910.6 (A): ⇒ 1024 (B): 1025 ⇒ 2725 (C): 2726 ⇒ (D): ⇒ 2725	1000.6WT				
Elite 6135-XB (A): ⇒ 1936 (B): 1937 ⇒ 3142 (C): 3143 ⇒ (D): ⇒ 3142	1000.6WT	<b>33/32-240</b> (0.087.0060.6/10 0.087.0060.6/30 0.087.0060.A)	<b>33/34-400</b> (0.086.0052.6/10)  <b>33/34-401</b> (0.081.0090.6/10)		
Master H-6165 (A): ⇒ 1471 (B): 1472 ⇒ 2195 (C): 2196 ⇒ (D): ⇒ 2195	1000.6WT	<b>33/32-407</b> (0.340.0060.6 0.340.0060.6/10 0.340.0060.A)	<b>33/34-402</b> (0.338.0052.6 0.338.0052.6/10 0.338.0052.6/20)		
Master H-6190 (A): ⇒ 1592 (B): 1593 ⇒ 2523 (C): 2524 ⇒ (D): ⇒ 2523	1000.6WT				
Master H-6165, 6190 (⇒ 2001) Master H.P.	1000.6WT			<b>33/35-403</b> (0.011.0183.0/20 0.B12.2675.0)	
SX-1200 XT-911 (⇒ 3001)	1000.6WT	<b>33/32-411</b> (0.382.0060.6 0.382.0060.6/10 0.382.0060.A)  <b>33/32-412</b> (0.382.0060.B)	<b>33/34-400</b> (0.086.0052.6/10)	<b>33/35-402</b> (0.A12.2675.0)	<b>33/38-403</b> 2.1539.193.0
SX-1350 XT-913 (⇒ 3001)	1000.6WT	<b>33/32-401</b> (0.379.0060.6 0.379.0060.6/10 0.379.0060.A)  <b>33/32-403</b> (0.379.0060.B)			

Les références des pièces sont indicatives.  
Nos pièces ne sont pas d'origine

**"THE RELIABLE SERVICE"**

Part numbers are quoted for reference purposes only.  
Our parts and accessories are not original.

## PISTONS, JEUX DE SEGMENTS & CHEMISES PISTONS, RING SETS & LINERS



1



2

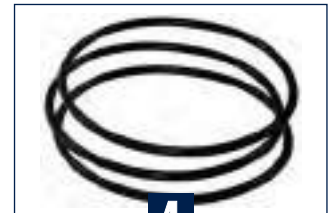

4

### Hürlimann

Tracteurs Tractors	Type Type	Piston + segments Piston + rings	Segments Ring set	Chemise Liner	Joints de chemise Liner seals
		1	2	3	4
<b>Moteurs 6 cylindres / 6 cylinder engines</b>					
SX-1500, 1600, 1800, 2000	1000.6WT	<b>33/32-402</b> (0.383.0060.6 0.383.0060.A)  <b>33/32-404</b> (0.383.0060.B)	<b>33/34-402</b> (0.338.0052.6 0.338.0052.6/10 0.338.0052.6/20)	<b>33/35-402</b> (0.A12.2675.0)  <b>33/35-403</b> (0.011.0183.0/20 0.B12.2675.0)	<b>33/38-403</b> (2.1539.193.0)
XT-911	1000.6WT	<b>33/32-401</b> (0.379.0060.6 0.379.0060.6/10 0.379.0060.A)	<b>33/34-400</b> (0.086.0052.6/10)	<b>33/35-403</b> (0.011.0183.0/20 0.B12.2675.0)	
XT-913	1000.6WT	<b>33/32-240</b> (0.087.0060.6/10 0.087.0060.6/30 0.087.0060.A)	<b>33/34-401</b> (0.081.0090.6/10)		

**PISTONS**  
**PISTONS**

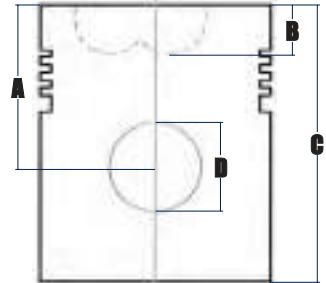
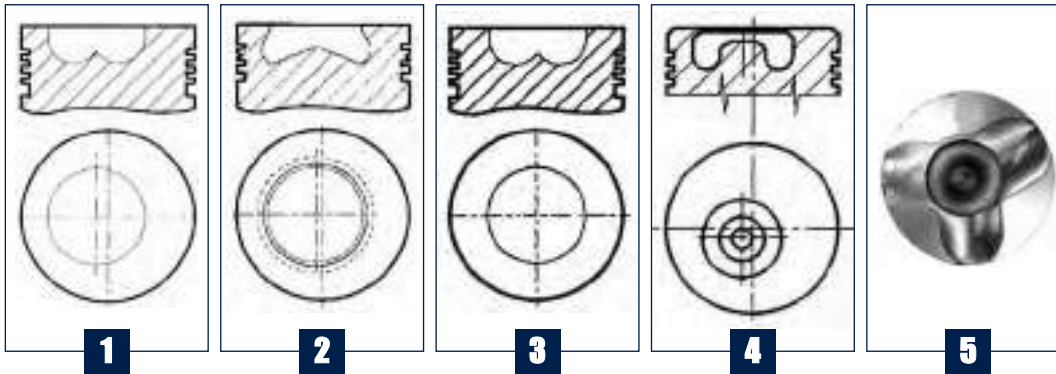

- A : Hauteur de compres.  
Compression height
- B : Profond. ch. combust.  
Combustion bowl depth
- C : Hauteur totale  
Overall length
- D : Ø de l'axe de piston  
Gudgeon pin diameter

**Same - Lamborghini - Hürlimann**

Réf. Ref.	Moteurs Engines	Alésage Bore Ø	Type Type	Classe Classe	Segments Rings	Al-fin Al-fin	A mm	B mm	C mm	D mm
32-90	1000.3W 1000.4W / WT 1000.6W / WT	105.00	-	-	-	-	-	-	-	-
32-240	1000.4WT 1000.6WT	105.00	1	-	3	Y	57.25	20.85	97.25	35.00
32-400	1000.4W	105.00	-	-	-	-	-	-	-	-
32-401	1000.3W / WT 1000.4W / WT 1000.6WT	105.00	2	A	3	N	57.15	19.40	97.35	35.00
32-402	1000.6WT	105.00	2	A	3	Y	62.15	21.50	102.25	35.00
32-403	1000.3W / WT 1000.4W / WT 1000.6WT	105.00	2	B	3	N	57.20	19.40	97.25	35.00
32-404	1000.6WT	105.00	2	B	3	Y	62.15	21.50	102.25	35.00
32-405	BF6M1013	108.00	3	-	3	Y	71.00	16.50	107.85	42.00
32-406	BF6M1013	108.00	4	-	3	Y	71.00	19.95	107.95	42.00
32-407	1000.6WT	105.00	3	-	3	Y	62.25	21.20	102.20	35.00
32-408	1000.3W / WT	105.00	2	A	3	Y	57.15	21.50	97.25	35.00
32-409	1000.3W / WT	105.00	2	B	3	Y	57.15	21.50	97.25	35.00
32-411	1000.4WT 1000.6WT	105.00	2	A	3	Y	57.15	19.20	97.25	35.00
32-412	1000.4WT 1000.6WT	105.00	2	B	3	Y	57.20	19.40	97.25	35.00
32-413	1000.3W / WT	105.00	1	A	3	Y	57.30	20.85	97.25	35.00
32-414	916W1 916.6W2	103.00	1	-	3	-	60.00	20.60	100.00	32.00
32-415	916.6WT	103.00	1	-	3	Y	60.05	22.10	100.00	35.00
32-417	1106/14T 1106/17T	110.00	1	-	3	Y	74.00	26.00	130.00	40.00
32-418	1000.6 WT / WT1	105.00	5	A	3	Y	62.15	24.00	102.35	35.00
32-419	1000.6 WT / WT1	105.00	5	B	3	Y	62.25	24.00	102.35	35.00
32-420	1000.6WT	105.00	5	A	3	Y	62.20	24.00	102.35	35.00











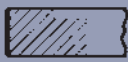
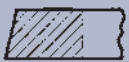

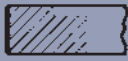
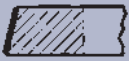
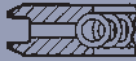
Les références des pièces sont indicatives.  
Nos pièces ne sont pas d'origine

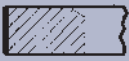
**"THE RELIABLE SERVICE"**

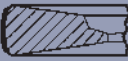
Part numbers are quoted for reference purposes only.  
Our parts and accessories are not original.

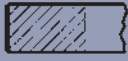
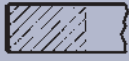
## SEGMENTS RINGS

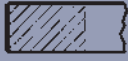
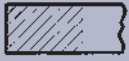
### Same - Lamborghini - Hürlimann

Réf. Ref.	Alésage Bore Ø						
34-400	105.00		CP2 3.00		T1 2.50		CBEH 4.00
34-401	105.00		CP2 3.00		CT1 2.50		CBEH 4.00
34-402	105.00		CK1 3.00		CP3 2.50		CBEH 4.00
34-405	108.00		CK2 2.80		CT5 2.00		CBEH 3.50
34-414	103.00		CP1 3.00		CP1 3.00		CBEH 4.00
34-417	110.00		CP1 2.95		P1 2.95		CBEH 6.00

**CBEH** : Chromé chanfreiné avec ressort hélicoïdal / *Chrome plated bevelled edge with helical coil spring*

**CP1** : Rectangulaire chromé / *Chrome plated parallel faced*

**CP2** : Rectangulaire chromé, épaulement intérieur en haut / *Chrome plated parallel faced internally stepped top*

**CP3** : Rectangulaire chromé chanfrein intérieur en haut / *Chrome plated parallel faced internally bevelled top*

**CK1** : Trapézoïdal bilatéral chromé / *Chrome plated keystone*

**CK2** : Trapézoïdal bilatéral chromé / *Chrome plated keystone ID step*

**CT1** : Portée conique chromé / *Chrome plated taper faced*

**CT5** : Portée conique chromé épaulement intérieur en bas / *Chrome plated taper faced internally bevelled bottom*

**P1** : Rectangulaire / *Parallel faced plain*

**T1** : Portée conique / *Taper faced plain*



**CHEMISES  
LINERS**

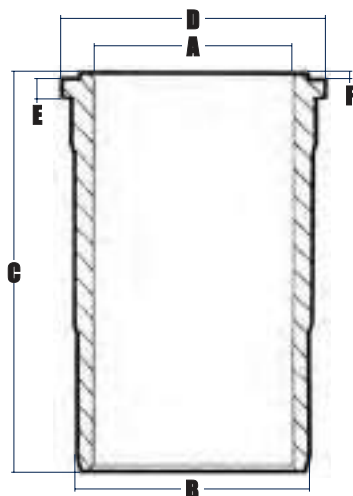

- A** : Alésage (mm)  
Nominal bore diameter (mm)
- B** : Diamètre extérieur (mm)  
Outside diameter (mm)
- C** : Hauteur totale (mm)  
Overall length (mm)
- D** : Diamètre colerette (mm)  
Flange diameter (mm)
- E** : Hauteur colerette (mm)  
Flange width (mm)
- F** : Hauteur lèvre de feu (mm)  
Fire lip height (mm)

**Same - Lamborghini - Hürlimann**

Réf. Ref.	A mm	B mm	C mm	D mm	E mm	F mm
35-400	105.00	112.00	195.00	123.00	7.00	1.00
35-401	105.00	112.00	195.00	123.00	7.00	1.00
35-402	105.00	-	-	-	-	-
35-403	105.00	112.80	193.00	123.00	7.00	1.00
35-405	108.00	117.55	228.00	128.40	9.00	1.15
35-406	108.00	117.65	228.00	128.40	9.00	1.15
35-414	103.00	111.90	195.00	122.95	7.00	0.90
35-415	103.00	111.90	195.00	122.95	7.00	0.95
35-416	103.00	-	-	-	-	-
35-417	110.00	127.95	227.00	140.00	10.10	0.95

## JOINTS DE MOTEUR ENGINE GASKET SETS

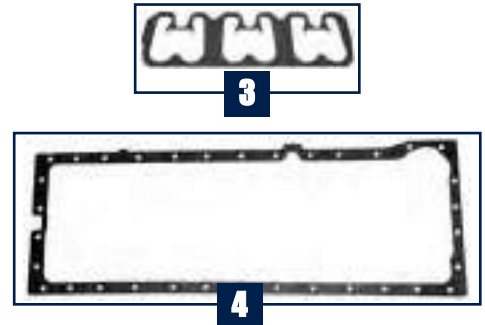
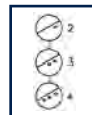
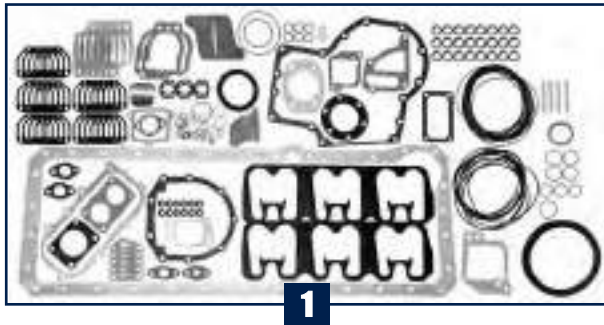

Same

Tracteurs Tractors	Type Type	Pochette complete Full gasket set	Joint de culasse Cylinder head gasket	Joint cache soupapes Rocker cover gasket	Joint de carter Sump gasket
		1	2	3	4
<b>Moteurs 4 cylindres / 4 cylinder engines</b>					
Row Crop 100	1000.4WT	<b>29/69-400</b> (0.335.0050.6, 0.335.0050.6/10)	<b>29/73-400 (A)</b> (0.078.1451.0/40)  <b>29/73-401 (B)</b> (0.078.1452.0/30)  <b>29/73-402 (C)</b> (0.078.1453.0/40)	<b>29/74-48</b> (0.065.1450.0/30)	<b>29/75-400</b> (0.065.1550.0/10 0.065.1550.0/30)
<b>Moteurs 6 cylindres / 6 cylinder engines</b>					
Diamond 230, 260 Diamond II 230, 260	BF6M1013	<b>29/69-408</b> (02931279)	<b>29/73-408 (2)</b> (04203968 04201559)  <b>29/73-409 (3)</b> (04201560)  <b>29/73-410 (4)</b> (04201561)	<b>29/74-408</b> (04205894)	<b>29/75-408</b> (04201000)
Rubin 120, 130, 150, 160 Rubin 160 Galileo Silver 110, 130 Titan 150, 160, 190	1000.6WT	<b>29/69-402</b> (0.337.0050.6, 0.337.0050.6/10)	<b>29/73-400 (A)</b> (0.078.1451.0/40)	<b>29/74-402</b> (0.009.3877.0/10)	<b>29/75-402</b> (0.007.0849.0/10)
Rubin 180, 200 Rubin 180, 200, Galileo Titan 165, 190 Supertitan	1000.6WTI		<b>29/73-401 (B)</b> (0.078.1452.0/30)		
Silver 160, 180	1000.6WT		<b>29/73-402 (C)</b> (0.078.1453.0/40)		

Les références des pièces sont indicatives.  
Nos pièces ne sont pas d'origine

**"THE RELIABLE SERVICE"**

Part numbers are quoted for reference purposes only.  
Our parts and accessories are not original.

**JOINTS DE MOTEUR**  
**ENGINE GASKET SETS**

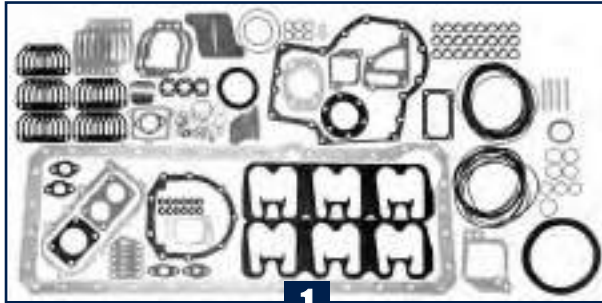

**1**



**2**



**3**



**4**

**Lamborghini**

Tracteurs Tractors	Type Type	Pochette complete Full gasket set	Joint de culasse Cylinder head gasket	Joint cache soupapes Rocker cover gasket	Joint de carter Sump gasket
		1	2	3	4
<b>Moteurs 3 cylindres / 3 cylinder engines</b>					
Agile 660-s F Plus 775 Sprint 654-55, 664-60, 664-65	1000.3W	<b>32/69-403</b> (0.070.0050.6, 0.070.0050.6/10)	<b>32/73-400 (A)</b> (0.078.1451.0/40)	<b>32/74-49</b> (0.069.1450.0/30)	<b>32/75-403</b> (0.007.0614.0/10)
Agile 770-s	1000.3WT		<b>32/73-401 (B)</b> (0.078.1452.0/30)		
<b>Moteurs 4 cylindres / 4 cylinder engines</b>					
674-70 N, 774-80 N Agile 880-s Cross 674-70 N Ergomatic 674-70, 774-80 F Plus 880 Grand Prix 674-70, 774-80 Sprint 674-70, 674-75 Triumph 80, 90, 100	1000.4W	<b>32/69-404</b> (0.089.0050.6, 0.089.0050.6/10)	<b>32/73-400 (A)</b> (0.078.1451.0/40)	<b>32/74-48</b> (0.065.1450.0/30, 0.009.3878.0/10)	<b>29/75-400</b> (0.065.1550.0/10 0.065.1550.0/30)
Agile 990-s Ergomatic 874-90 T F Plus 990 Grand Prix 874-90 T High Clearance 90 Sprint 684-85	1000.4WT				
Premium 850, 950, 1050		<b>32/69-405</b> (0.090.0050.6, 0.090.0050.6/10)	<b>32/73-402 (C)</b> (0.078.1453.0/40)		
		<b>32/69-400</b> (0.335.0050.6, 0.335.0050.6/10)			
<b>Moteurs 6 cylindres / 6 cylinder engines</b>					
956-100	916W1	<b>32/69-406</b> (0.075.0050.6, 0.075.0050.6/10)	<b>32/73-400 (A)</b> (0.078.1451.0/40)	<b>32/74-402</b> (0.009.3877.0/10)	<b>32/75-406</b> (0.075.1512.0)
1106	916.6W2				
1306	916.6WT	<b>32/69-407</b> (0.078.0050.6, 0.078.0050.6/10)	<b>32/73-402 (C)</b> (0.078.1453.0/40)		
1506	1106/14T	<b>32/70-419</b> (0.064.0050.6)	<b>32/73-419</b> (0.057.1456.0/30)	<b>32/74-419</b> (0.057.1457.0/20)	<b>32/75-419</b> (0.037.1512.0)
1706	1106/17T				

Les références des pièces sont indicatives.  
Nos pièces ne sont pas d'origine

**"THE RELIABLE SERVICE"**

Part numbers are quoted for reference purposes only.  
Our parts and accessories are not original.

## JOINTS DE MOTEUR ENGINE GASKET SETS

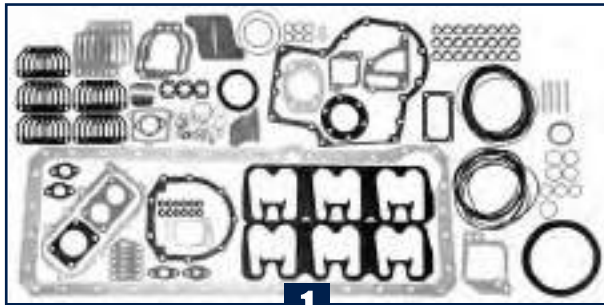

### Lamborghini

Tracteurs Tractors	Type Type	Pochette complete Full gasket set	Joint de culasse Cylinder head gasket	Joint cache soupapes Rocker cover gasket	Joint de carter Sump gasket	
		1	2	3	4	
<b>Moteurs 6 cylindres / 6 cylinder engines</b>						
Champion 120, 135, 160, 180, 200 Champion Intel Cab 160, 180, 200	1000.6WT	32/69-402 (0.337.0050.6, 0.337.0050.6/10)	32/73-400 (A) (0.078.1451.0/40)	32/74-401 (0.010.9065.0)	32/75-402 (0.007.0849.0/10)	
Champion 150	1000.6WTI			32/73-401 (B) (0.078.1452.0/30)		32/74-402 (0.009.3877.0/10)
Formula 115	1000.6W			32/73-402 (C) (0.078.1453.0/40)		32/74-49 (0.069.1450.0/30)
Formula 135 Premium 1100, 1300 Racing 150, 165, 190 Racing Hi. Per.	1000.6WT					
Premium 1600, 1800	1000.6WT					
Premium 1060	1000.6W	32/69-402 (0.337.0050.6, 0.337.0050.6/10)				
Victory 230, 260 Victory Plus 230, 260	BF6M1013	32/69-408 (02931279)	32/73-408 (2) (04203968 04201559) 32/73-409 (3) (04201560) 32/73-410 (4) (04201561)	32/74-408 (04205894)	32/75-408 (04201000)	

**JOINTS DE MOTEUR  
ENGINE GASKET SETS**

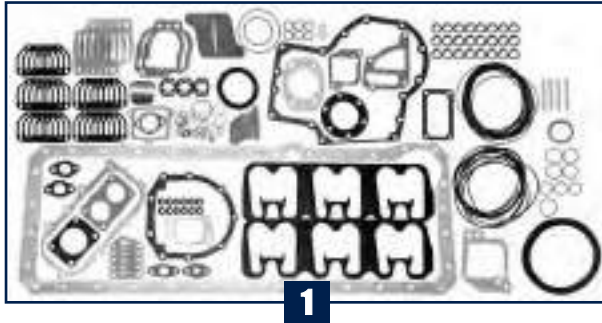

**Hürlimann**

Tracteurs Tractors	Type Type	Pochette complete Full gasket set	Joint de culasse Cylinder head gasket	Joint cache soupapes Rocker cover gasket	Joint de carter Sump gasket	
		1	2	3	4	
<b>Moteurs 3 cylindres / 3 cylinder engines</b>						
Prestige H-358	1000.3W	<b>33/69-403</b> (0.070.0050.6, 0.070.0050.6/10)	<b>33/73-400 (A)</b> (0.078.1451.0/40)	<b>33/74-49</b> (0.069.1450.0/30)	<b>33/75-403</b> (0.007.0614.0/10)	
XA-606, 655 XN-706	1000.3W		<b>33/73-401 (B)</b> (0.078.1452.0/30)			
H-476-XF XA-656T XN-707	1000.3WT		<b>33/73-402 (C)</b> (0.078.1453.0/40)			
<b>Moteurs 4 cylindres / 4 cylinder engines</b>						
Club H468-4 H-478-4 H-481-XF Prestige H-468, 478 XA-607, 657 XN-708	1000.4W	<b>33/69-404</b> (0.089.0050.6, 0.089.0050.6/10)	<b>33/73-400 (A)</b> (0.078.1451.0/40)	<b>33/74-48</b> (0.065.1450.0/30, 0.009.3878.0/10)	<b>29/75-400</b> (0.065.1550.0/10 0.065.1550.0/30)	
H-491-XF Prestige H-488T XA-658 XN-709	1000.4WT	<b>33/69-405</b> (0.090.0050.6, 0.090.0050.6/10)				<b>33/73-401 (B)</b> (0.078.1452.0/30)
XT-908, 909, 910.4		<b>33/69-405</b> (0.090.0050.6, 0.090.0050.6/10)  <b>33/69-400</b> (0.335.0050.6, 0.335.0050.6/10)				<b>33/73-402 (C)</b> (0.078.1453.0/40)
<b>Moteurs 6 cylindres / 6 cylinder engines</b>						
Elite 6115-XB	1000.6W	<b>33/69-402</b> (0.337.0050.6, 0.337.0050.6/10)	<b>33/73-400 (A)</b> (0.078.1451.0/40)	<b>33/74-402</b> (0.009.3877.0/10)	<b>33/75-402</b> (0.007.0849.0/10)	
Elite 6135-XB Master H-6165, 6190, H.P. SX-1200, 1350, 1500, 1600, 1800, 2000 XT-911, 913	1000.6WT		<b>33/73-401 (B)</b> (0.078.1452.0/30)			
XT-910.6	1000.6WT		<b>33/73-402 (C)</b> (0.078.1453.0/40)	<b>33/74-49</b> (0.069.1450.0/30)		

Les références des pièces sont indicatives.  
Nos pièces ne sont pas d'origine

**"THE RELIABLE SERVICE"**

Part numbers are quoted for reference purposes only.  
Our parts and accessories are not original.

## SOUPAPES ET PIÈCES CONNEXES CYLINDER HEAD PARTS



Same

Tracteurs Tractors	Type Type	Guide Guide	Soup. admis. Inlet valve	Soup. échap. Outlet valve	Ressort Spring	Clavettes Cotter	Joint Seal
		1	2	3	4	5	6
<b>Moteurs 4 cylindres / 4 cylinder engines</b>							
Row Crop 100	1000.4WT	29/41-400 (0.007.1779.0/10)	29/42-400 (0.010.6017.0)	29/43-400 (0.010.6022.0)	29/44-400 (2.4019.287.0)	29/46-400 (0.074.1423.0)	29/47-400 (2.1519.117.0)
<b>Moteurs 6 cylindres / 6 cylinder engines</b>							
Diamond 230, 260 Diamond II 230, 260	BF6M1013	29/41-405 (04201238)	29/42-405 (04283380 04209110 04255254 04255883)	29/43-405 (04283381 04209111 04255255)	29/44-405 (04200150)	29/46-405 (12164698)	29/47-405 (01153857)
Rubin 135 Silver 130	1000.6WT	29/41-400 (0.007.1779.0/10)	29/42-400 (0.010.6017.0)	29/43-400 (0.010.6022.0)	29/44-400 (2.4019.287.0)	29/46-400 (0.074.1423.0)	29/47-400 (2.1519.117.0)
Silver 110	1000.6WT		29/42-28 (0.010.6016.0)	29/43-402 (0.066.1421.0)			
Rubin 120, 150, 160 Rubin 160 Galileo Silver 130, 160, 180 Titan 150 (⇒ 3001) Titan 160, 190	1000.6WT		29/42-401 (0.007.1146.0/10)	29/43-401 (0.007.1147.0/10)			
Rubin 180, 200 Rubin 180, 200 Galileo Titan 165, 190 (⇒ 3001) Supertitan	1000.6WTI						

**SOUPAPES ET PIÈCES CONNEXES**  
**CYLINDER HEAD PARTS**



**Lamborghini**

Tracteurs Tractors	Type Type	Guide Guide	Soup. admis. Inlet valve	Soup. échap. Outlet valve	Ressort Spring	Clavettes Cotter	Joint Seal
		1	2	3	4	5	6
<b>Moteurs 3 cylindres / 3 cylinder engines</b>							
Agile 660-s Sprint 654-55, 664-60, 664-65	1000.3W	32/41-400 (0.007.1779.0/10)	32/42-28 (0.010.6016.0)	32/43-402 (0.066.1421.0)	32/44-400 (2.4019.287.0)	32/46-400 (0.074.1423.0)	32/47-400 (2.1519.117.0)
F Plus 775	1000.3W		32/42-418 (A) (0.081.1420.0)	32/43-402 (A) (0.066.1421.0)			
			32/42-400 (B) (0.010.6017.0)	32/43-400 (B) (0.010.6022.0)			
Agile 770-s	1000.3WT		32/42-400 (0.010.6017.0)	32/43-400 (0.010.6022.0)			
<b>Moteurs 4 cylindres / 4 cylinder engines</b>							
674-70 N, 774-80 N Agile 880-s Cross 674-70 N Ergomatic 674-70, 774-80 F Plus 880 Grand Prix 674-70, 774-80 Sprint 674-70, 674-75 Triumph 80	1000.4W	32/41-400 (0.007.1779.0/10)	32/42-28 (0.010.6016.0)	32/43-402 (0.066.1421.0)	32/44-400 (2.4019.287.0)	32/46-400 (0.074.1423.0)	32/47-400 (2.1519.117.0)
Premium 850 Sprint 684-85	1000.4WT						
Agile 990-s High Clearance 90	1000.4WT		32/42-400 (0.010.6017.0)	32/43-400 (0.010.6022.0)			
Triumph 90, 100	1000.4W						
Ergomatic 874-90 T F Plus 990 Grand Prix 874-90 T Premium 950, 1050	1000.4WT		32/42-418 (A) (0.081.1420.0)	32/43-402 (A) (0.066.1421.0)			
			32/42-400 (B) (0.010.6017.0)	32/43-400 (B) (0.010.6022.0)			

Les références des pièces sont indicatives.  
Nos pièces ne sont pas d'origine

**"THE RELIABLE SERVICE"**

Part numbers are quoted for reference purposes only.  
Our parts and accessories are not original.

## SOUPAPES ET PIÈCES CONNEXES CYLINDER HEAD PARTS



### Lamborghini

Tracteurs Tractors	Type Type	Guide Guide	Soup. admis. Inlet valve	Soup. échap. Outlet valve	Ressort Spring	Clavettes Cotter	Joint Seal
		1	2	3	4	5	6
<b>Moteurs 6 cylindres / 6 cylinder engines</b>							
956-100	916W1	32/41-400 (0.007.1779.0/10)	32/42-28 (0.010.6016.0)	32/43-402 (0.066.1421.0)	32/44-400 (2.4019.287.0)	32/46-400 (0.074.1423.0)	32/47-400 (2.1519.117.0)
1106	916.6W2		32/42-418 (A) (0.081.1420.0)	32/43-402 (A) (0.066.1421.0)			
1306	916.6WT	32/42-400 (B) (0.010.6017.0)	32/43-400 (B) (0.010.6022.0)				
1506	1106/14T	32/41-419 (0.057.1416.0)	32/42-419 (0.009.7266.0)	32/43-419 (0.009.7267.2)	32/44-419 (2.4019.228.0)	32/46-419 (0.058.1423.0)	
Champion 120, 135, 160, 180, 200 Champion Intel Cab 160, 180, 200	1000.6WT	32/41-403 (0.007.1505.0/20)	32/42-403 (0.007.1509.0/10)	32/43-403 (0.007.1508.0)	32/44-403 (2.4019.484.0 + 2.4019.485.0)	32/46-403 (0.007.1507.0/10)	
Champion 150	1000.6WTI						
Formula 115 Premium 1060	1000.6W	32/41-400 (0.007.1779.0/10)	32/42-28 (0.010.6016.0)	32/43-402 (0.066.1421.0)	32/44-400 (2.4019.287.0)	32/46-400 (0.074.1423.0)	32/47-400 (2.1519.117.0)
Formula 135	1000.6WT		32/42-418 (A) (0.081.1420.0)	32/43-402 (A) (0.066.1421.0)			
Premium 1300	1000.6WT		32/42-400 (B) (0.010.6017.0)	32/43-400 (B) (0.010.6022.0)			
Premium 1600, 1800 Racing 150, 165, 190 Racing Hi. Per.	1000.6WT		32/42-401 (0.007.1146.0/10)	32/43-401 (0.007.1147.0/10)			
Victory 230, 260 Victory Plus 230, 260	BF6M1013	29/41-405 (04201238)	29/42-405 (04283380 04209110 04255254 04255883)	29/43-405 (04283381 04209111 04255255)	29/44-405 (04200150)	29/46-405 (12164698)	29/47-405 (01153857)

Les références des pièces sont indicatives.  
Nos pièces ne sont pas d'origine

**"THE RELIABLE SERVICE"**

Part numbers are quoted for reference purposes only.  
Our parts and accessories are not original.



**SOUPAPES ET PIÈCES CONNEXES**  
**CYLINDER HEAD PARTS**



**Hürlimann**

Tracteurs Tractors	Type Type	Guide Guide	Soup. admis. Inlet valve	Soup. échap. Outlet valve	Ressort Spring	Clavettes Cotter	Joint Seal
		1	2	3	4	5	6
<b>Moteurs 3 cylindres / 3 cylinder engines</b>							
Prestige H-358 XA-606, 655 XN-706	1000.3W	33/41-400 (0.007.1779.0/10)	33/42-28 (0.010.6016.0)	33/43-402 (0.066.1421.0)	33/44-400 (2.4019.287.0)	33/46-400 (0.074.1423.0)	33/47-400 (2.1519.117.0)
XA-656T	1000.3WT		33/42-418 (A) (0.081.1420.0)	33/43-402 (A) (0.066.1421.0)			
H-476-XF	1000.3WT		33/42-400 (B) (0.010.6017.0)	33/43-400 (B) (0.010.6022.0)			
XN-707	1000.3WT		33/42-400 (0.010.6017.0)	33/43-400 (0.010.6022.0)			
<b>Moteurs 4 cylindres / 4 cylinder engines</b>							
Club H-468-4 H-478-4 H-481-XF Prestige H-468, 478 XA-607, 657 XN-708	1000.4W	33/41-400 (0.007.1779.0/10)	33/42-28 (0.010.6016.0)	33/43-402 (0.066.1421.0)	33/44-400 (2.4019.287.0)	33/46-400 (0.074.1423.0)	33/47-400 (2.1519.117.0)
XA-658 XT-908	1000.4WT		33/42-418 (A) (0.081.1420.0)	33/43-402 (A) (0.066.1421.0)			
Prestige H-488T H-491-XF XT-909, 910.4	1000.4WT		33/42-400 (B) (0.010.6017.0)	33/43-400 (B) (0.010.6022.0)			
XN-709	1000.4WT		33/42-400 (0.010.6017.0)	33/43-400 (0.010.6022.0)			

Les références des pièces sont indicatives.  
Nos pièces ne sont pas d'origine

**"THE RELIABLE SERVICE"**

Part numbers are quoted for reference purposes only.  
Our parts and accessories are not original.

## SOUPAPES ET PIÈCES CONNEXES CYLINDER HEAD PARTS





### Hürlimann

Tracteurs Tractors	Type Type	Guide Guide	Soup. admis. Inlet valve	Soup. échap. Outlet valve	Ressort Spring	Clavettes Cotter	Joint Seal
		1	2	3	4	5	6
<b>Moteurs 6 cylindres / 6 cylinder engines</b>							
Elite 6115-XB	1000.6W	33/41-400 (0.007.1779.0/10)	33/42-28 (0.010.6016.0)	33/43-402 (0.066.1421.0)	33/44-400 (2.4019.287.0)	33/46-400 (0.074.1423.0)	33/47-400 (2.1519.117.0)
SX-1200 XT-910.6, 911	1000.6WT						
Master H-6165, 6190 Master H.P. SX-1500, 1600, 1800, 2000	1000.6WT						
Elite 6135-XB	1000.6WT						
SX-1350 XT-913	1000.6WT						

**POMPES A EAU**  
**WATER PUMPS**

**Same**

<b>Tracteurs</b> <i>Tractors</i>	<b>Type</b> <i>Type</i>	<b>Illustration</b> <i>Illustration</i>	<b>Réf.</b> <i>Ref.</i>	<b>OEM</b> <i>OEM</i>
Diamond 230, 260 Diamond II 230, 260	BF6M1013		29/130-101	04205959, 04256853
Rubin 120, 135, 150, 160 Rubin 160 Galileo Silver 110, 130, 160, 180 Titan 150 (⇒ 3001) Titan 160, 190	1000.6 WT		29/130-39	0.010.1138.4/30
Rubin 180, 200 Rubin 180, 200 Galileo Titan 165, 190 (⇒ 3001) SuperTitan	1000.6 WTI			

## FILTRATION FILTERS



**1**



**2**



**3**

### Same

Tracteurs Tractors	Type Type	Air		Huile Oil	Combustible Fuel	Hudraulique Hydraulic
		Ext. Out.	Int. Inn.			
		1	2	3		
Diamond 230, 260 Diamond II 230, 2606	BF6M1013	60/161-53	60/162-53	60/97-39 (01174421)	60/111-56 (01180597)	60/240-52 (04417454)
Row Crop 100	1000.4 WT	60/161-104 (2.4249.310.4)	60/162-25 (2.4249.130.7)			60/240-69 (2.4419.350.0) 60/240-67 (2.4419.320.0/10) 60/641-32 (2.4419.640.0) 60/240-67 (2.4419.320.0/10) 60/240-153 (2.4419.670.0/20) 60/240-154 (2.4419.730.0) 60/240-155 (2.4419.450.0) 60/652-1 (0.9012.428.2) 60/240-150 (2.4419.491.0) 60/240-153 (2.4419.670.0/20) 60/240-154 (2.4419.730.0) 60/240-155 (2.4419.450.0) 60/652-1 (0.9012.428.2) 60/240-150 (2.4419.491.0)
Rubin 120, 135, 150	1000.6 WT	60/161-131 (0.010.2183.0)	60/162-93 (2.4249.380.2)	60/97-22 (2.4419.340.0)	60/111-25 (0.009.4687.0)	
Rubin 160 Rubin 180, 200	1000.6 WT 1000.6WTI	60/161-135 (0.010.2800.1)	60/162-135 (0.010.2800.2)			

Les références des pièces sont indicatives.  
Nos pièces ne sont pas d'origine

**"THE RELIABLE SERVICE"**

Part numbers are quoted for reference purposes only.  
Our parts and accessories are not original.

**FILTRATION  
 FILTERS**
**Same**

Tracteurs Tractors	Type Type	Air		Huile Oil	Combustible Fuel	Hudraulique Hydraulic
		Ext. Out.	Int. Inn.			
		1	2	3	4	5
Rubin 160 Galileo Rubin 180, 200 Galileo	1000.6 WT 1000.6 WTI	<b>60/161-135</b> (0.010.2800.1)	<b>60/162-135</b> (0.010.2800.2)			<b>60/240-153</b> (2.4419.670.0/20)  <b>60/240-154</b> (2.4419.730.0)  <b>60/240-155</b> (2.4419.450.0)  <b>60/652-1</b> (0.9012.428.2)  <b>60/240-150</b> (2.4419.491.0)  <b>60/240-156</b> (0.010.8872.0/10)  <b>60/641-32</b> (2.4419.640.0)
Silver 110, 130	1000.6 WT	<b>60/161-131</b> (0.010.2183.0)  <b>60/161-93</b> (0.009.4144.1)	<b>60/162-93</b> (2.4249.380.2)	<b>60/97-22</b> (2.4419.340.0)	<b>60/111-25</b> (0.009.4687.0)	<b>60/240-155</b> (2.4419.450.0)  <b>60/652-1</b> (0.9012.428.2)  <b>60/240-150</b> (2.4419.491.0)  <b>60/240-66</b> (2.4419.280.0)
Silver 110, 130 (⇒ 3001)	1000.6 WT					<b>60/240-155</b> (2.4419.450.0)  <b>60/240-150</b> (2.4419.491.0)  <b>60/240-153</b> (2.4419.670.0/20)
Silver 160, 180	1000.6 WT	<b>60/161-77</b> (0.009.4876.0)	<b>60/162-77</b> (0.009.4270.1)		<b>60/111-4</b> (2.4319.130.1)	<b>60/641-32</b> (2.4419.640.0)  <b>60/240-67</b> (2.4419.320.0/10)  <b>60/240-155</b> (2.4419.450.0)  <b>60/240-150</b> (2.4419.491.0)

Les références des pièces sont indicatives.  
 Nos pièces ne sont pas d'origine

**"THE RELIABLE SERVICE"**

Part numbers are quoted for reference purposes only.  
 Our parts and accessories are not original.

## FILTRATION FILTERS

### Same

Tracteurs Tractors	Type Type	Air		Huile Oil	Combustible Fuel	Hudraulique Hydraulic
		Ext. Out.	Int. Inn.			
		1	2	3	4	5
Titan 160, 190	1000.6 WT	<b>60/161-77</b> (0.009.4876.0)  <b>60/161-132</b> (0.009.4270.0)  <b>60/161-133</b> (0.009.4340.0)				<b>60/240-155</b> (2.4419.450.0)  <b>60/652-1</b> (0.9012.428.2)  <b>60/240-150</b> (2.4419.491.0)  <b>60/240-67</b> (2.4419.320.0/10)  <b>60/240-69</b> (2.4419.350.0)
Titan 150 (⇒ 3001) Titan 165, 109 (⇒ 3001) SuperTitan	1000.6 WT 1000.6 WTI 1000.6 WTI	<b>60/161-77</b> (0.009.4876.0)	<b>60/162-77</b> (0.009.4270.1)	<b>60/97-22</b> (2.4419.340.0)	<b>60/111-4</b> (2.4319.130.1)	<b>60/641-32</b> (2.4419.640.0)  <b>60/240-155</b> (2.4419.450.0)  <b>60/652-1</b> (0.9012.428.2)  <b>60/240-150</b> (2.4419.491.0)  <b>60/574-7 M</b> (2.4419.611.0)  <b>60/240-67</b> (2.4419.320.0/10)

**FILTRATION  
 FILTERS**
**Lamborghini**

Tracteurs Tractors	Type Type	Air		Huile Oil	Combustible Fuel	Hudraulique Hydraulic
		Ext. Out.	Int. Inn.			
		1	2	3	4	5
674-70 N (⇒ 12000)	1000.4 W	<b>60/161-112</b> (2.4249.410.7 2.4249.340.1)	<b>60/162-112</b> (2.4249.410.5 2.4249.340.2)	<b>60/97-36</b> (0.044.1567.0)	<b>60/111-3</b> (2.4319.060.1)	<b>60/240-69</b> (2.4419.350.0)
774-80 N (⇒ 12000)	1000.4 W	<b>60/161-104</b> (2.4249.310.4)	<b>60/162-25</b> (2.4249.130.7)		<b>60/97-22</b> (2.4419.340.0)	<b>60/111-4</b> (2.4319.130.1)
956-100	916 W1					
1106	916.6 W2					
1306	916.6 WT			<b>60/97-21</b> (0.052.1565.0)		<b>60/240-158</b> (0.264.6360.2)
1506	1106/14 T	<b>60/161-166</b> (2.4249.380.1)	<b>60/162-93</b> (2.4249.380.2)	<b>60/97-21</b> (0.052.1565.0)		
1706	1106/17 T	<b>60/161-64</b> (2.4249.280.3)	<b>60/162-64</b> (2.4249.280.1)			
Agile 660-s Agile 770-s Agile 880-s	1000.3 W 1000.3 WT 1000.4 W	<b>60/161-104</b> (2.4249.131.0)	<b>60/162-25</b> (2.4249.130.7)	<b>60/97-36</b> (0.044.1567.0)	<b>60/111-3</b> (2.4319.060.1)	<b>60/574-7 M</b> (2.4419.611.0)
Agile 990-s	1000.4 WT					<b>60/655-6</b> (2.4419.483.0)
		<b>60/240-41</b> (2.4419.721.0)				
		<b>60/641-32</b> (2.4419.640.0)				
						<b>60/652-1</b> (0.9012.428.2)
						<b>60/240-157</b> (2.4419.680.0/10)
Champion 120, 135 Champion 150	1000.6 WT 1000.6 WTI	<b>60/161-131</b> (0.010.2183.0)	<b>60/162-93</b> (2.4249.380.2)	<b>60/97-22</b> (2.4419.340.0)	<b>60/111-25</b> (0.009.4687.0)	<b>60/240-155</b> (2.4419.450.0)
						<b>60/240-67</b> (2.4419.320.0/10)
						<b>60/641-32</b> (2.4419.640.0)
						<b>60/240-150</b> (2.4419.491.0)
						<b>60/240-153</b> (2.4419.670.0/20)
						<b>60/240-154</b> (2.4419.730.0)
						<b>60/652-1</b> (0.9012.428.2)

Les références des pièces sont indicatives.  
 Nos pièces ne sont pas d'origine

**"THE RELIABLE SERVICE"**

Part numbers are quoted for reference purposes only.  
 Our parts and accessories are not original.

## FILTRATION FILTERS

### Lamborghini

Tracteurs Tractors	Type Type	Air		Huile Oil	Combustible Fuel	Hydraulique Hydraulic
		Ext. Out.	Int. Inn.			
		1	2	3	4	5
Champion 160, 180, 200	1000.6 WT	60/161-135 (0.010.2800.1)	60/162-135 (0.010.2800.2)	60/97-22 (2.4419.340.0)	60/111-25 (0.009.4687.0)	60/240-153 (2.4419.670.0/20)
						60/240-154 (2.4419.730.0)
Champion 160, 180, 200 Intel Cab	1000.6 WT					60/240-155 (2.4419.450.0)
						60/652-1 (0.9012.428.2)
						60/240-150 (2.4419.491.0)
						60/240-150 (2.4419.491)
						60/240-156 (0.010.8872.0/10)
Cross 674-70 N	1000.4 W	60/161-112 (2.4249.410.7 2.4249.340.1)	60/162-112 (2.4249.410.5 2.4249.340.2)			60/652-1 (0.9012.428.2)
						60/240-69 (2.4419.350.0)
						60/240-159 (0.008.3100.0)
C674, C774 R674, R774	916.4 W			60/97-36 (0.044.1567.0)		
Ergomatic C 674-70, 774-80 Ergomatic C 874-90	1000.4 W 1000.4 WT	60/161-104 (2.4249.310.4)	60/162-25 (2.4249.130.7)			
F Plus 660	1000.3 W	60/161-112 (2.4249.410.7 2.4249.340.1)	60/162-112 (2.4249.410.5 2.4249.340.2)			60/240-155 (2.4419.450.0)
F Plus 775 F Plus 880 F Plus 990	1000.3 W 1000.4 W 1000.4 WT	60/161-104 (2.4249.310.4)				60/240-67 (2.4419.320.0/10)
F Plus 990	1000.4 WT		60/162-25 (2.4249.130.7)	60/97-22 (2.4419.340.0)		60/240-66 (2.4419.280.0)
Formula 115 (⇒ 3001)	1000.6 W	60/161-104 (0.009.4108.0 2.4249.131.0)		60/97-36 (0.044.1567.0)		60/240-155 (2.4419.450.0)
		60/161-136 (0.010.2179.0)				
Formula 135 (⇒ 3001)	1000.6 WT	60/161-131 (0.010.2183.0)	60/162-93 (2.4249.380.2)	60/97-22 (2.4419.340.0)		60/652-1 (0.9012.428.2)
		60/161-93 (0.009.4144.1)				

Les références des pièces sont indicatives.  
Nos pièces ne sont pas d'origine

**"THE RELIABLE SERVICE"**

Part numbers are quoted for reference purposes only.  
Our parts and accessories are not original.



**FILTRATION  
 FILTERS**
**Lamborghini**

Tracteurs Tractors	Type Type	Air		Huile Oil	Combustible Fuel	Hudraulique Hydraulic
		Ext. Out.	Int. Inn.			
		1	2	3	4	5
Grand Prix 674-70	1000.4 W	<b>60/161-112</b> (2.4249.410.7 2.4249.340.1)	<b>60/162-112</b> (2.4249.410.5 2.4249.340.2)	<b>60/97-36</b> (0.044.1567.0)	<b>60/111-3</b> (2.4319.060.1)	<b>60/240-155</b> (2.4419.450.0)  <b>60/652-1</b> (0.9012.428.2)  <b>60/240-69</b> (2.4419.350.0)
Grand Prix 774-80	1000.4 W					<b>60/240-155</b> (2.4419.450.0)  <b>60/652-1</b> (0.9012.428.2)
Grand Prix 874-90T	1000.4 WT					<b>60/240-69</b> (2.4419.350.0)  <b>60/240-68</b> (2.4419.270.0)
Premium 850, 950, 1050	1000.4 WT	<b>60/161-104</b> (2.4249.310.4)	<b>60/162-25</b> (2.4249.130.7)	<b>60/97-22</b> (2.4419.340.0)	<b>60/111-25</b> (0.009.4687.0)	<b>60/240-155</b> (2.4419.450.0)  <b>60/652-1</b> (0.9012.428.2)  <b>60/240-69</b> (2.4419.350.0)  <b>60/240-66</b> (2.4419.280.0)
Premium 1060	1000.6 W			<b>60/97-36</b> (0.044.1567.0)		<b>60/240-156</b> (0.010.8872.0/10)  <b>60/240-160</b> (2.4419.690.0)  <b>60/240-161</b> (2.4419.750.0)
Premium 1100, 1300	1000.6 WT					<b>60/161-131</b> (0.010.2183.0)  <b>60/161-93</b> (0.009.4144.1)

## FILTRATION FILTERS

### Lamborghini

Tracteurs Tractors	Type Type	Air		Huile Oil	Combustible Fuel	Hudraulique Hydraulic
		Ext. Out.	Int. Inn.			
		1	2	3	4	5
Premium 1600, 1800	1000.6 WT	<b>60/161-77</b> (0.009.4876.0)	<b>60/162-77</b> (0.009.4270.1)	<b>60/97-22</b> (2.4419.340.0)	<b>60/111-4</b> (2.4319.130.1)	<b>60/641-32</b> (2.4419.640.0)
						<b>60/240-155</b> (2.4419.450.0)
						<b>60/652-1</b> (0.9012.428.2)
Racing 150, 165, 190	1000.6 WT	<b>60/161-77</b> (0.009.4876.0) <b>60/161-132</b> (0.009.4270.0) <b>60/161-133</b> (0.009.4340.0)				<b>60/240-150</b> (2.4419.491.0) <b>60/240-67</b> (2.4419.320.0/10) <b>60/240-69</b> (2.4419.350.0)
Racing 150, 165, 190 (⇒ 3001) Racing Hi. Per.	1000.6 WT	<b>60/161-77</b> (0.009.4876.0)				<b>60/240-155</b> (2.4419.450.0) <b>60/652-1</b> (0.9012.428.2) <b>60/240-150</b> (2.4419.491.0) <b>60/574-7 M</b> (2.4419.611.0) <b>60/641-32</b> (2.4419.640.0) <b>60/240-67</b> (2.4419.320.0/10)
Sprint 654-55, 664-65 Sprint 674-75	1000.3 W 1000.4 W	<b>60/161-104</b> (2.4249.131.0)	<b>60/162-25</b> (2.4249.130.7)	<b>60/97-36</b> (0.044.1567.0)	<b>60/111-25</b> (0.009.4687.0)	<b>60/652-1</b> (0.9012.428.2)
Sprint 684-85	1000.4 W			<b>60/97-22</b> (2.4419.340.0)		<b>60/240-156</b> (0.010.8872.0/10)
Sprint 664-60	1000.3 W	<b>60/161-104</b> (2.4249.131.0) <b>60/161-143</b> (0.010.2095.0)	<b>60/162-25</b> (2.4249.130.7) <b>60/162-143</b> (0.010.2094.0)	<b>60/97-36</b> (0.044.1567.0)		<b>60/240-66</b> (2.4419.280.0) <b>60/240-69</b> (2.4419.350.0)
Sprint 674-70	1000.4 W	<b>60/161-104</b> (2.4249.131.0)	<b>60/162-25</b> (2.4249.130.7)			<b>60/240-159</b> (0.008.3100.0)

**FILTRATION  
 FILTERS**
**Lamborghini**

Tracteurs Tractors	Type Type	Air		Huile Oil	Combustible Fuel	Hydraulique Hydraulic
		Ext. Out.	Int. Inn.			
		1	2	3	4	5
Triumph 80	1000.4 W	60/161-104 (2.4249.131.0)	60/162-25 (2.4249.130.7)	60/97-36 (0.044.1567.0)	60/111-3 (2.4319.060.1)	60/240-67 (2.4419.320.0/10)
Triumph 90, 100	1000.4 W			60/97-22 (2.4419.340.0)	60/111-25 (0.009.4687.0)	
Victory 230, 260 Victory Plus 230, 260	BF6M1013	60/161-53	60/162-53	60/97-39 (01174421)	60/111-56 (01180597)	60/240-52 (04417454)

**Hürlimann**

Tracteurs Tractors	Type Type	Air		Huile Oil	Combustible Fuel	Hydraulique Hydraulic
		Ext. Out.	Int. Inn.			
		1	2	3	4	5
Club H-468-4	1000.4 W	60/161-112 (2.4249.410.7 2.4249.340.1)	60/162-112 (2.4249.410.5 2.4249.340.2)	60/97-36 (0.044.1567.0)	60/111-3 (2.4319.060.1)	60/652-1 (0.9012.428.2)
Elite 6115-XB	1000.6 W	60/161-104 (0.009.4108.0 2.4249.131.0)	60/162-25 (2.4249.130.7)	60/97-22 (2.4419.340.0)	60/111-4 (2.4319.130.1)	60/240-69 (2.4419.350.0)
		60/161-136 (0.010.2179.0)				
Elite 6135-XB	1000.6 WT	60/161-131 (0.010.2183.0)	60/162-93 (2.4249.380.2)			60/652-1 (0.9012.428.2)
		60/161-93 (0.009.4144.1)				60/240-155 (2.4419.450.0)
H-478-4 (⇒ 10500)	1000.4 W	60/161-104 (2.4249.310.4)	60/162-25 (2.4249.130.7)	60/97-36 (0.044.1567.0)	60/111-3 (2.4319.060.1)	60/240-150 (2.4419.491.0/10)
H-476-XF H-481-XF H-491-XF	1000.3 WT 1000.4 W 1000.4 WT					60/240-69 (2.4419.350.0)
						60/240-155 (2.4419.450.0)
						60/240-67 (2.4419.320.0/10)
						60/652-1 (0.9012.428.2)
						60/240-66 (2.4419.280.0)

## FILTRATION FILTERS

### Hürlimann

Tracteurs Tractors	Type Type	Air		Huile Oil	Combustible Fuel	Hydraulique Hydraulic
		Ext. Out.	Int. Inn.			
		1	2	3	4	5
Master H-6165, 6190	1000.6 WT	<b>60/161-77</b> (0.009.4876.0)  <b>60/161-132</b> (0.009.4270.0)  <b>60/161-133</b> (0.009.4340.0)				<b>60/240-155</b> (2.4419.450.0)  <b>60/240-67</b> (2.4419.320.0/10)  <b>60/240-150</b> (2.4419.491.0/10)  <b>60/652-1</b> (0.9012.428.2)  <b>60/240-69</b> (2.4419.350.0)
Master H-6165, 6190 (⇒ 2001) Master H.P.	1000.6 WT	<b>60/161-77</b> (0.009.4876.0)	<b>60/162-77</b> (0.009.4270.1)	<b>60/97-22</b> (2.4419.340.0)	<b>60/111-4</b> (2.4319.130.1)	<b>60/240-155</b> (2.4419.450.0)  <b>60/240-67</b> (2.4419.320.0/10)  <b>60/641-32</b> (2.4419.640.0)  <b>60/240-150</b> (2.4419.491.0/10)  <b>60/652-1</b> (0.9012.428.2)  <b>60/574-7 M</b> (2.4419.611.0)
Prestige H-358 Prestige H-468	1000.3 W 1000.4 W	<b>60/161-112</b> (2.4249.410.7 2.4249.340.1)	<b>60/162-112</b> (2.4249.410.5 2.4249.340.2)			<b>60/240-155</b> (2.4419.450.0)  <b>60/652-1</b> (0.9012.428.2)  <b>60/240-69</b> (2.4419.350.0)
Prestige H-478 Prestige H-488 T	1000.4 W 1000.4 WT	<b>60/161-104</b> (2.4249.310.4)	<b>60/162-25</b> (2.4249.130.7)	<b>60/97-36</b> (0.044.1567.0)	<b>60/111-3</b> (2.4319.060.1)	<b>60/240-155</b> (2.4419.450.0)  <b>60/652-1</b> (0.9012.428.2)  <b>60/240-66</b> (2.4419.280.0)  <b>60/240-69</b> (2.4419.350.0)  <b>60/240-68</b> (2.4419.270.0)

**FILTRATION  
 FILTERS**
**Hürlimann**

Tracteurs Tractors	Type Type	Air		Huile Oil	Combustible Fuel	Hudraulique Hydraulic
		Ext. Out.	Int. Inn.			
		1	2	3	4	5
SX-1200, 1350, 1500	1000.6 WT	<b>60/161-131</b> (0.010.2183.0)	<b>60/162-93</b> (2.4249.380.2)	<b>60/97-22</b> (2.4419.340.0)		<b>60/240-67</b> (2.4419.320.0/10)
						<b>60/641-32</b> (2.4419.640.0)
SX-1600, 1800, 2000	1000.6 WT	<b>60/161-135</b> (0.010.2800.1)	<b>60/162-135</b> (0.010.2800.2)		<b>60/111-25</b> (0.009.4687.0)	<b>60/240-155</b> (2.4419.450.0)
						<b>60/240-150</b> (2.4419.491.0/10)
XA-606, 655	1000.3 W	<b>60/161-104</b> (2.4249.131.0)	<b>60/162-25</b> (2.4249.130.7)	<b>60/97-36</b> (0.044.1567.0)		<b>60/240-153</b> (2.4419.670.0/20)
		<b>60/161-143</b> (0.010.2095.0)	<b>60/162-143</b> (0.010.2094.0)			<b>60/652-1</b> (0.9012.428.2)
XA-607, 657 XA-656 T XA-658	1000.4 W 1000.3 WT 1000.4 WT					<b>60/240-156</b> (0.010.8872.0/10)
						<b>60/240-66</b> (2.4419.280.0)
XA-658	1000.4 WT			<b>60/97-22</b> (2.4419.340.0)		<b>60/240-69</b> (2.4419.350.0)
XN-706 XN-707 XN-708	1000.3 W 1000.3 WT 1000.4 W	<b>60/161-104</b> (2.4249.131.0)	<b>60/162-25</b> (2.4249.130.7)	<b>60/97-36</b> (0.044.1567.0)		<b>60/240-159</b> (0.008.3100.0)
						<b>60/652-1</b> (0.9012.428.2)
XN-709	1000.4 WT			<b>60/97-22</b> (2.4419.340.0)		<b>60/240-157</b> (2.4419.680.0/10)
					<b>60/111-3</b> (2.4319.060.1)	<b>60/655-6</b> (2.4419.483.0)
						<b>60/240-41</b> (2.4419.721.0)
						<b>60/574-7 M</b> (2.4419.611.0)

## FILTRATION FILTERS



### Hürlimann

Tracteurs Tractors	Type Type	Air		Huile Oil	Combustible Fuel	Hudraulique Hydraulic
		Ext. Out.	Int. Inn.			
		1	2	3	4	5
XT-908, 909, 910.4	1000.4 WT	<b>60/161-104</b> (2.4249.310.4)	<b>60/162-25</b> (2.4249.130.7)	<b>60/97-22</b> (2.4419.340.0)	<b>60/111-25</b> (0.009.4687.0)	<b>60/240-155</b> (2.4419.450.0)
XT-910.6	1000.6 WT	<b>60/161-134</b> (0.010.2173.0)	<b>60/162-134</b> (0.010.2173.1)	<b>60/97-36</b> (0.044.1567.0)		<b>60/652-1</b> (0.9012.428.2)
XT-911, 913	1000.6 WT	<b>60/161-131</b> (0.010.2183.0) <b>60/161-93</b> (0.009.4144.1)	<b>60/162-93</b> (2.4249.380.2)	<b>60/97-22</b> (2.4419.340.0)		<b>60/240-156</b> (0.010.8872.0/10)
						<b>60/240-66</b> (2.4419.280.0)
						<b>60/240-69</b> (2.4419.350.0)
						<b>60/240-160</b> (2.4419.690.0)
						<b>60/240-161</b> (2.4419.750.0)
						<b>60/240-150</b> (2.4419.491.0/10)
						<b>60/652-1</b> (0.9012.428.2)
						<b>60/240-66</b> (2.4419.280.0)



### S.L.H PARTS

#### Filtre hydraulique - Hydraulic filter - Hydraulikfilter - Hydrauliekfilter - Filtro hidráulico

	Part N°	Dimensions - Size - Abmessungen - Afmetingen -Dimensiones	Fig.
<p><b>SAME</b> Antares II 110, 130 Rubin 120, 135, 150, 160, 180, 200 Silver 110, 130, 160, 180 Titan 150, 165, 190</p> <p><b>LAMBORGHINI</b> Champion 120, 135, 150, 160, 180, 200 Formula 115, 135 Premium 1100, 1300, 1600, 1800 Racing 150, 165, 190</p> <p><b>HÜRLIMANN</b> SX 1200, 1350, 1500, 1600, 1800, 2000 XT 911, 913 Elite XB 6115, 6135 Master H6165, H6190</p>	<p><b>60/240-150</b> (2.4419.491.0)</p>	<p>210mm x 69mm</p>	
<p><b>SAME</b> Diamond II 230, 260</p> <p><b>LAMBORGHINI</b> Victory Plus 230, 260</p>	<p><b>60/240-151</b> (04437774)</p>	<p>230mm x 80mm</p>	









## S.L.H PARTS

Rotules & tirants de direction - Steering links & sockets - Stuurkogels en stangen - Kugelgelenke und Spurstangen - Rótulas y acoples de dirección



	Fig.	Part N°	OEM	Filet Thread Gewinde Schroefdraad Rosca	Longueur Lenght Länge Lengte Longitud	Conicité Cone Konus Conisch Cono
<b>Same</b>						
Diamond 230, 260 Diamond II 230, 260	1	<b>29/497-302</b>	04435178	M26x1.5 M28x1.5	240mm	-
	2	<b>29/495-302</b>	0.010.3338.0	F28x1.5	470mm	18/20
<b>Lamborghini</b>						
Victory 230, 260 Victory Plus 230, 260	1	<b>32/497-302</b>	04435178	M26x1.5 M28x1.5	240mm	-
	2	<b>32/495-302</b>	0.010.3338.0	F28x1.5	470mm	18/20









# S.L.H PARTS

Démarreurs - Starter motors - Anlasser - Startmotors - Motores de arranque

Applications <i>Applications</i>	Réf. <i>Ref.</i>	OEM	A A x B B	Z Z L
<b>Lamborghini</b>				
503, 603	<b>62/930-234</b> (Magneton) Avec réducteur <i>With reducer</i>  12V 2,7KW <b>New</b>	01172683 01303970	2x105 	9Z 220
	<b>62/930-28</b> (Iskra)  12V 3,0KW		2x105 	9Z 259







# SLH PARTS

Pompe hydraulique - Hydraulic pump - Hydraulikpumpe -  
hydrauliekpomp - Bomba hidráulica

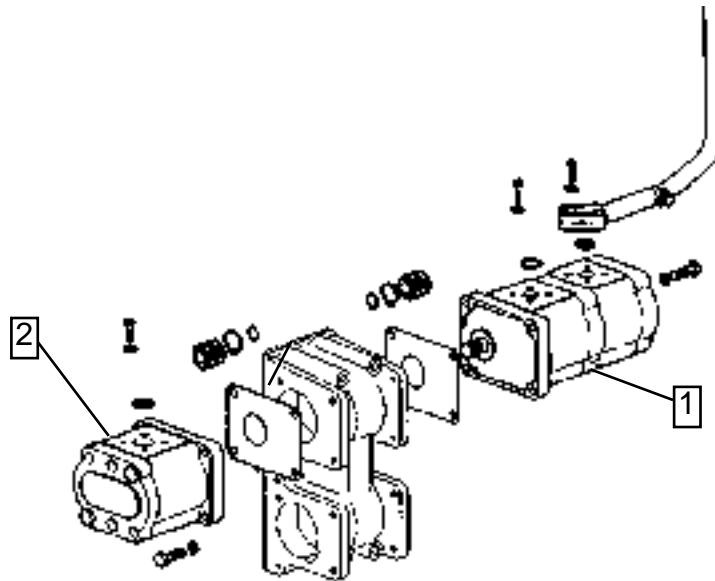

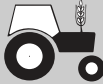
	1	2
<b>SAME</b>		
Rubin 120 (⇒1174) Rubin 135 (⇒1410) Rubin 150 (⇒1462) Titan 145 (1445⇒) Titan 160 (2154⇒) Titan 190 (1710⇒)	<b>69/566-234</b>	
<b>LAMBORGHINI</b>		
Champion 120 (⇒1096) Champion 135 (⇒1258) Champion 150 (⇒1280) Racing 150 (1243⇒) Racing 165 (1324⇒) Racing 190 (1349⇒)	<b>69/566-235</b> (2.4539.810.0/10)	<b>69/565-51</b> (2.4539.430.0) ∪ G / LH / L / I 14CC
<b>HÜRLIMANN</b>		
H-6165 Master (1119⇒) H-6190Master (1139⇒) SX-1200 (⇒1017) SX-1350 (⇒1043) SX-1500 (⇒1051)		







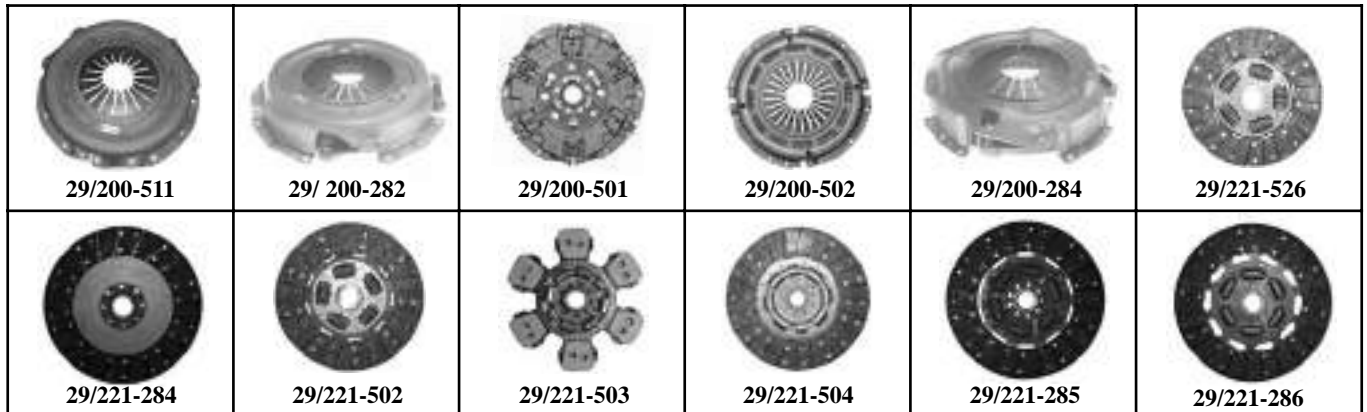

# SLH PARTS

## Embrayage - Clutch - Drukgroep - Kupplung - Embrague



	Embrayage - Clutch - Drukgroep Kupplung - Embrague		Disque - Plate - Koppelingsplaat Scheibe - Disco		
	Ø	Part N°	Ø	Part N°	
<b>SAME</b>					
DORADO 55, 60, 65 EXPLORER 60, 70 II SPECIAL EXPLORER II 60, 70 GOLDEN 60V, 60, 65 COMPATTO	280 TF	<b>29/200-511</b> (0.009.6914.3/20) 255.2320.3/10	280 LN	<b>29/221-526</b> (0.009.6913.3/10, 270.2330.3/10) TF 24Z 36 x 40	<b>29/231-500</b> (2.2999.193.0) MS
<b>LAMBORGHINI</b>					
574-60N, 674-70N CROSS 660S, 660V, 770S AGILE 674-70 GRAND PRIX SPRINT 654-55, 664-60, 664-65	280 TF	<b>32/200-511</b> (0.009.6914.3/20, 255.2320.3/10)	280 LN	<b>32/221-526</b> (0.009.6913.3/10, 270.2330.3/10) TF 24Z 36 x 40	<b>32/231-500</b> (2.2999.193.0) MS
<b>HÜRLIMANN</b>					
XA606, XA655, XA656T XN706, XN707 H358, H468 PRESTIGE H358-4, H468-4, H468-4B CLUB	280 TF	<b>33/200-511</b> (0.009.6914.3/20) 255.2320.3/10	280 LN	<b>33/221-526</b> (0.009.6913.3/10, 270.2330.3/10) TF 24Z 36 x 40	<b>33/231-500</b> (2.2999.193.0) MS
<b>SAME</b>					
DORADO 55, 65, 75, 85 EXPLORER 70, 80, 90T C ERGOMATIC GOLDEN 60, 65, 75, 85 COMPATTO GOLDEN 60V, 75V KRYPTON 80, 90 KRYPTON F 78M, 78N, 78C, 88M, 88N, 88C, 98M, 98N, 98C	310 DV	<b>29/200-282</b> (0.008.4254.3/10)	310 LN	<b>29/221-284</b> (0294.2330.3/10) UF 24Z 36 x 40	<b>29/231-500</b> (2.2999.193.0) MS
<b>LAMBORGHINI</b>					
660S, 660V, 770S, 775V, 880S, 990S AGILE C 674-70, 774-80, 874-90T, ERGOMATIC CF. 78L, 78N, 78S, 88L, 88N, 88ST, 98L, 98N, 98ST SPRINT 654-55, 664-65, 674-75, 684-85 TRIUMPH 80, 90	310 DV	<b>32/200-282</b> (0.008.4254.3/10)	310 LN	<b>32/221-284</b> (0294.2330.3/10) UF 24Z 36 x 40	<b>32/231-500</b> (2.2999.193.0) MS
<b>HÜRLIMANN</b>					
XA655, XA656T, XA657, XA658 XN706, XN707, XN708, XN709	310 DV	<b>33/200-282</b> (0.008.4254.3/10)	310 LN	<b>33/221-284</b> (0294.2330.3/10) UF 24Z 36 x 40	<b>33/231-500</b> (2.2999.193.0) MS

Les références des pièces sont indicatives.  
Nos pièces ne sont pas d'origine.

Part numbers are quoted for reference purposes only.  
Our parts and accessories are not original.



**"THE RELIABLE SERVICE"**

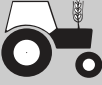

# SLH PARTS

	Embrayage - Clutch - Drukgroep Kupplung - Embrague		Disque - Plate - Koppelingsplaat Scheibe - Disco		
	Ø	Part N°	Ø	Part N°	
<b>SAME</b>					
DORADO 70, 75, 85 EXPLORER 70, 70BASSO, 80BASSO II SPECIAL EXPLORER II 60, 70, 80, 90T GOLDEN 75, 85 COMPATTO GOLDEN 75V	310 GU6	<b>29/200-501</b> (294.2320.3)	310 LN	<b>29/221-502</b> (009.6924.3/20, 445.2330.3) TF 24Z 36 x 40	<b>29/231-500</b> (2.2999.193.0) MS
<b>LAMBORGHINI</b>					
674-70, 774-80, 874-90T GRAND PRIX 674-70N, 674-70NB CROSS 775V, 880S, 990S AGILE SPRINT 674-70, 674-75, 684-85	310 GU6	<b>32/200-501</b> (294.2320.3)	310 LN	<b>32/221-502</b> (009.6924.3/20, 445.2330.3) TF 24Z 36 x 40	<b>32/231-500</b> (2.2999.193.0) MS
<b>HÜRLIMANN</b>					
H358, H468, H478, H488T PRESTIGE H468-4, H468-4B CLUB XA607, XA657, XA658 XN708, XN709	310 GU6	<b>33/200-501</b> (294.2320.3)	310 LN	<b>33/221-502</b> (009.6924.3/20, 445.2330.3) TF 24Z 36 x 40	<b>33/231-500</b> (2.2999.193.0) MS
<b>SAME</b>					
ANTARES 110 II EXPLORER II 90T EXPLORER SPECIAL 80, 90, 80LP, 90LP ROW CROP 90, 100, 100.6 SILVER 80, 90, 100.4, 100.6, 110	330 DV	<b>29/200-502</b> (0.010.8764.3/10, 008.4184.3)	330 LN	<b>29/221-503</b> (0.010.7535.3/10, 009.6533.3) TC-LT 24Z 36,5 x 41	<b>29/231-513</b> (2.2999.207.0) MS 55 x 91
EXPLORER II 90T EXPLORER SPECIAL 80, 90, 80LP, 90LP SILVER 80, 90, 100.4, 100.6			330 LN	<b>29/221-504</b> (008.9937.3) TF 24Z 36,5 x 41	
<b>LAMBORGHINI</b>					
850, 950, 1050, 1060, 1100 PREMIUM FORMULA 115	330 DV	<b>32/200-502</b> (0.010.8764.3/10, 008.4184.3)	330 LN	<b>32/221-503</b> (0.010.7535.3/10, 009.6533.3) TC-LT 24Z 36,5 x 41	<b>32/231-513</b> (2.2999.207.0) MS 55 x 91
HIGH CLEARANCE 90					
850, 950, 1050, 1060 PREMIUM			330 LN	<b>32/221-504</b> (008.9937.3) TF 24Z 36,5 x 41	<b>32/231-513</b> (2.2999.207.0) MS 55 x 91
<b>HÜRLIMANN</b>					
ELITE XB 6115 XT 908, 909, 910.4, 910.6, 911	330 DV	<b>33/200-502</b> (0.010.8764.3/10, 008.4184.3)	330 LN	<b>33/221-503</b> (0.010.7535.3/10, 009.6533.3) TC-LT 24Z 36,5 x 41	<b>33/231-513</b> (2.2999.207.0) MS 55 x 91
XT 908, 909, 910.4, 910.6			330 LN	<b>29/221-504</b> (008.9937.3) TF 24Z 36,5 x 41	

Les références des pièces sont indicatives.  
Nos pièces ne sont pas d'origine.

Part numbers are quoted for reference purposes only.  
Our parts and accessories are not original.



**"THE RELIABLE SERVICE"**



<https://tractormanualz.com/>



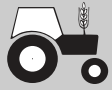

# SLH PARTS

	Embrayage - Clutch - Drukgroep Kupplung - Embrague		Disque - Plate - Koppelingsplaat Scheibe - Disco		
	Ø	Part N°	Ø	Part N°	
<b>SAME</b>					
ANTARES 110 II EXPLORER II 80, 90T EXPLORER SPECIAL 80, 90, 80LP, 90LP ROW CROP 100.6 SILVER 80, 90, 100.4, 100.6, 110	350 DV	<b>29/200-284</b> (0.010.6912.3)	330 LN	<b>29/221-285</b> (0.007.7928.3/10) TC 24Z 36 x 41	<b>29/231-500</b> (2.2999.193.0) MS
			350 LN	<b>29/221-286</b> (0.007.7929.3/20) TC 24Z 36 x 41	
<b>LAMBORGHINI</b>					
774-80, 774-80N, 874-90T GRAND PRIX 850, 950, 1050, 1060, 1100 PREMIUM FORMULA 115	350 DV	<b>32/200-284</b> (0.010.6912.3)	330 LN	<b>32/221-285</b> (0.007.7928.3/10) TC 24Z 36 x 41	<b>32/231-500</b> (2.2999.193.0) MS
			350 LN	<b>32/221-286</b> (0.007.7929.3/20) TC 24Z 36 x 41	
<b>HÜRLIMANN</b>					
H478, H488T PRESTIGE H478-4 ELITE XB 6115 XT 908, 909, 910.4, 910.6, 911	350 DV	<b>33/200-284</b> (0.010.6912.3)	330 LN	<b>32/221-285</b> (0.007.7928.3/10) TC 24Z 36 x 41	<b>33/231-500</b> (2.2999.193.0) MS
			350 LN	<b>32/221-286</b> (0.007.7929.3/20) TC 24Z 36 x 41	

**GU6** = Commande indépendante, 6 doigts / Independent clutch, 6 levers / Unabhängiggeschaltet / Onafhankelijke bediening, 6 vingers / Independiente, 6 pastillas

**MS** = Petit Ø / Small diameter / Mit kleinem Durchmesser / Kleine Ø / Pequeño Ø

**DV** = Diaphragme, volant creux / Diaphragm, pot flywheel / Tellerfeder, vertieftes / Diafragma, geen vlak vliegwiel / Diafragma, volante rebajado

**LN** = Friction d'avancement côté moteur, libre / Main disc, eginge side, loose / Fahrscheibe Motorseitig, lose / Loose rijplaat aan motorzijde / Disco principal, lado motor libre

**LT** = 6 paires de pastilles / 6 pairs of pads / 6 Paar Beläge / Met 6 paar pads / Con 6 pares de palas

**TC** = Cera-métallique à ressort / Spring cera-metallic / Cerasinter-Belag, gefedert / Sintermetaal met veren / Cerametalico con muelles

**TF** = Organique à ressort / Spring organic / Organischer-Belag, gefedert / Organisch met veren / Orgánico con muelles

**UF** = Organique fixe / Fixed organic / Organischer-Belag, ungefedert / Organisch zonder veren / Orgánico sin muelles

**UC** = Céra-métallique fixe / Fixed cera-metallic / Cerasinter-Belag, ungefedert / Sintermetaal vast, niet geveerd / Cerametalico sin muelles









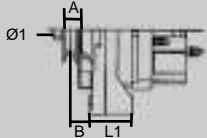
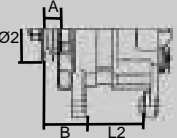

# S.L.H PARTS

## Alternateur - Alternator - Drehstromlichtmaschine - Wisselstroomdynamo - Alternador

	Parts N°			
<p><b>SAME</b> Dorado 55, 60, 65, 70, 75, 85 Golden 60, 65, 75, 85 compatto Golden 60V, 75V</p> <p><b>LAMBORGHINI</b> 660-V Agile 775-V Agile</p>	<p><b>62/920-165</b> (2.9439.440.10)</p>	<p>14V / 70A</p>	 <p>             Ø1 L1            15 29         </p>	







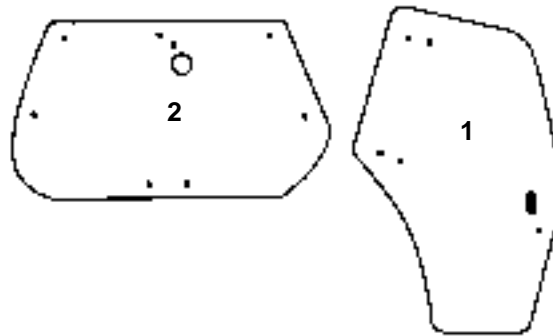

# S.L.H PARTS

Vitre de cabine - Cab glass - Kabinenscheiben - Kabineruiten - Cristal de cabina



	Fig.	Parts N°	OEM	Pos.	Specification			
<b>SAME</b>								
Diamond II 230, 260 Rubin 120, 135, 150, 160, 180, 200	1	<b>29/4039-41T</b>	04418951	C	L-6H-CO	1525x1120x6	T	BLT
	1	<b>29/4038-41T</b>	04418952	C	R-6H-CO	1525x1120x6	T	BLT
	2	<b>29/4072-92T</b>	04429137	E	9H-CO	1420x895x5	T	BLT
<b>LAMBORGHINI</b>								
Champion 120, 135, 150, 160, 180, 200 Victory Plus 230, 260	1	<b>32/4039-41T</b>	04418951	C	L-6H-CO	1525x1120x6	T	BLT
	1	<b>32/4038-41T</b>	04418952	C	R-6H-CO	1525x1120x6	T	BLT
	2	<b>32/4072-92T</b>	04429137	E	9H-CO	1420x895x5	T	BLT
<b>HÜRLIMANN</b>								
SX1200, SX1350, SX1500, SX1600, SX1800, SX2000	1	<b>33/4039-41T</b>	04418951	C	L-6H-CO	1525x1120x6	T	BLT
	1	<b>33/4038-41T</b>	04418952	C	R-6H-CO	1525x1120x6	T	BLT
	2	<b>33/4072-92T</b>	04429137	E	9H-CO	1420x895x5	T	BLT

**C** = Porte / Door / Türscheibe / Deur / Puerta  
**E** = Arrière haut / Upper rear / Hinten oben / Achteraan bovenaan / Trasero superior  
**6H** = 6 Trous / 6 Holes / 6 Bohrungen / 6 Gaten / 6 Agujeros  
**9H** = 9 Trous / 9 Holes / 9 Bohrungen / 9 Gaten / 9 Agujeros  
**CO** = Convexe / Curved / Konvex / Convex / Convexo  
**L** = Gauche / Left / Links / Links / Izquierdo  
**R** = Droite / Right / Rechts / Rechts / Derecho  
**T** = Tintée / Tinted / Getönt / Getint / Tintado  
**BLT** = Visser / Bolt on / Fest / Vast / con tornillos / Fijo

Les références des pièces sont indicatives.  
Nos pièces ne sont pas d'origine.

Part numbers are quoted for reference purposes only.  
Our parts and accessories are not original.



**"THE RELIABLE SERVICE"**







## SLH PARTS

**Pompe d'alimentation - Fuel pump - Kraftstoffförderpump -  
Opvoerpomp - Bomba de gas-oil**



	Part N°	OEM
<b>SAME</b>		
Diamond 230, 260 Diamond II 230, 260	<b>29/100-45</b>	04207013 02112672
<b>LAMBORGHINI</b>		
Victory 230, 260 Victory Plus 230, 260	<b>32/100-45</b>	04207013 02112672













## S.L.H PARTS

Amortisseur de torsion - Torsion damper - Torsiondämpfer - Torsiedemper -  
Amortiguador de torsión

	Parts N°	Dimensions	
<b>SAME</b>			
SILVER 80, 90, 100.4, 100.6 Hydrive	<b>29/196-31</b> (0.011.3942.4)	24Z 45,3 x 48.9	
<b>LAMBORGHINI</b>			
PREMIUM 850, 950, 1050, 1060 Directronic	<b>32/196-31</b> (0.011.3942.4)	24Z 45,3 x 48.9	
<b>HÜRLIMANN</b>			
XT908, XT909, XT910.4, XT910.6 Fastdrive	<b>33/196-31</b> (0.011.3942.4)	24Z 45,3 x 48.9	









# SLH PARTS

Filtre hydraulique (PTO) - Hydraulic filter (PTO)- Hydraulikfilter (Zapfwelle) -  
Hydrauliekfilter (Aftakas) - Filtro hidráulico (PDF)

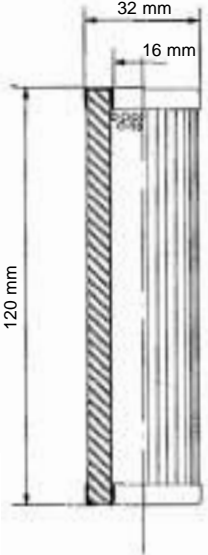
	Part N°	Fig.	
<p><b>SAME</b> ANTARES 110, 130 II ASTER 60, 70 DORADO 55, 60, 65, 70, 75, 85 EXPLORER 60, 70, 70BASSO, 80BASSO II SPECIAL EXPLORER II 60, 70, 80, 90T FRUTTEO 60, 75, 85 II GOLDEN 60, 65, 75, 85 COMPATTO ROW CROP 100.6 RUBIN 120, 135, 150, 160, 180, 200 RUBIN 160, 180, 200 GALILEO SILVER 80, 90, 100.4, 100.6, 110, 130, 160, 180 TITAN 145, 160, 190 TITAN 150N 165N 190 SUPERTITAN</p>			
<p><b>LAMBORGHINI</b> 574-60N, 674-70N, 674-70NB CROSS 600, 700 660F, 775F, 880F, 990F PLUS 660S, 770S, 880S, 990S AGILE 674-70, 774-80, 874-90T GRAND PRIX 850, 950, 1050, 1060 PREMIUM CHAMPION 120, 135, 150, 160, 180, 200 CHAMPION 160, 180, 200 INTEL-CAB FORMULA 115, 135 PREMIUM 1100, 1300, 1600, 1800 RACING 150, 165, 190 RACING 150, 165, 190 HI. PER. SPRINT 654-55, 664-60, 664-65, 674-70, 674-75, 684-85</p>	<p><b>60/652-1</b> (0.9012.428.2)</p>		
<p><b>HÜRLIMANN</b> XA606, XA607, XA655, XA656T, XA657, XA658 H358, H468, H478, H488T PRESTIGE H358, H468, H468-4B CLUB H361, H476, H481, H491 XF H362, H372 H6165, H6190 MASTER SX1200, SX1350, SX1500, SX1600, SX1800, SX2000 XN706, XN707, XN708, XN709 XT908, XT909, XT910.4, XT910.6, XT911, XT913 ELITE XB 6115, 6135 MASTER H6165, H6190 HP</p>			

Les références des pièces sont indicatives.  
Nos pièces ne sont pas d'origine.

Part numbers are quoted for reference purposes only.  
Our parts and accessories are not original.



**"THE RELIABLE SERVICE"**







**TRACPIECES**

**PRODUCT  
NEWS-SHEET**

**PAGE : N°7412  
DATE : 07/05**

## SLH PARTS

Filtre d'aspiration (hydraulique) - Breather filter (hydraulic) - Saugfilter (hydraulik) - Aanzuigfilter (hydrauliek) - Filtro hidràulicode aspiración

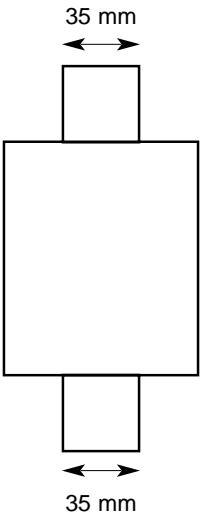

	Part N°	OEM	
<b>SAME</b> GOLDEN 60, 65, 75, 85 COMPATTO GOLDEN 60V, 70V RUBIN 120, 135, 150 RUBIN 160, 180, 200 GALILEO SILVER 160, 180 TITAN 150, 165, 190 SUPERTITAN	<b>60/641-32</b>	2.4419.640.0	
<b>LAMBORGHINI</b> 660S, 770S, 880S, 990S, 660V, 775V AGILE CHAMPION 120, 135, 150 CHAMPION 160, 180, 200 INTEL-CAB PREMIUM 1600, 1800 RACING 150, 165, 190 HI. PER.			
<b>HÜRLIMANN</b> SX-1200, SX-1350, SX-1500 XN-706, XN-707, XN-708, XN-709 MASTER H-6165, H-6190 HP			

Les références des pièces sont indicatives.  
Nos pièces ne sont pas d'origine.

Part numbers are quoted for reference purposes only.  
Our parts and accessories are not original.



**"THE RELIABLE SERVICE"**







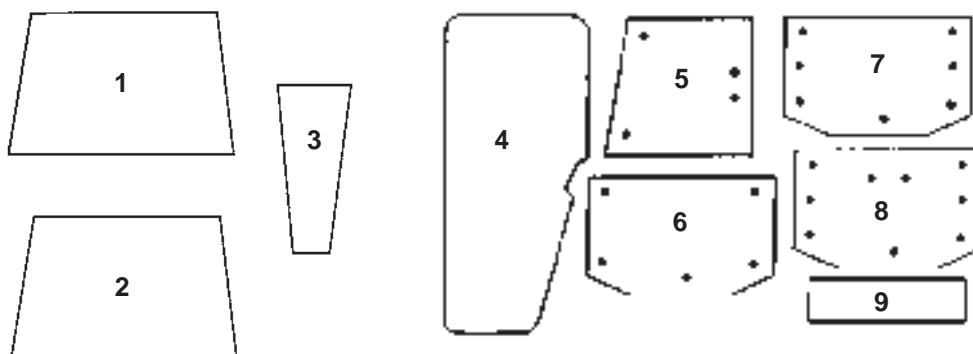

### S.L.H PARTS

Vitre de cabine - Cab glass - Kabinenscheiben - Kabineruiten - Cristal de cabina



	Fig.	Parts N°	OEM	Pos.	Specification		
<b>SAME</b>							
Explorer 55, 60, 65, 70, 75, 80, 90T, 90TII	1	29/4001-27	9231 210 0/10	A		857x782x5	GR
	2	29/4001-28	9241 210 0	A		858x772x5	GR
	3	29/4014-9T	9231 211 0/10	B	L & R	635x163x6	GR
	4	29/4020-41	9231 212 0	C	L & R	1360x555x5	GR
	5	29/4047-85T	9231 214 0	D	L & R - 4H	723x660x6	K/BLT
	6	29/4072-96T	9231 215 0	E	5H	1240x778x6	K/BLT
	7	29/4072-97T	9231 268 0	E	7H	1240x778x6	K/BLT
	8	29/4072-98T	9231 268 0/20	E	9H	1240x778x6	GR
	9	29/4073-46	9231 255 0	F		880x366x4	GR
<b>LAMBORGHINI</b>							
674-70, 774-80, 874-90	2	32/4001-28	9241 210 0	A		858x772x5	GR
	3	32/4014-9T	9231 211 0/10	B	L & R	635x163x6	GR
	4	32/4020-41	9231 212 0	C	L & R	1360x555x5	GR
	5	32/4047-85T	9231 214 0	D	L & R - 4H	723x660x6	K/BLT
	6	32/4072-97T	9231 268 0	E	7H	1240x778x6	K/BLT
	9	32/4073-46	9231 255 0	F		880x366x4	GR
<b>HÜRLIMANN</b>							
356, 358, 446, 468, 476, 478, 488	1	33/4001-27	9231 210 0/10	A		857x782x5	GR
	3	33/4014-9T	9231 211 0/10	B	L & R	635x163x6	GR
	4	33/4020-41	9231 212 0	C	L & R	1360x555x5	GR
	5	33/4047-85T	9231 214 0	D	L & R - 4H	723x660x6	K/BLT
	6	33/4072-96T	9231 215 0	E	5H	1240x778x6	K/BLT
	7	33/4072-97T	9231 268 0	E	7H	1240x778x6	K/BLT
	9	33/4073-46	9231 255 0	F		880x366x4	GR

Les références des pièces sont indicatives.  
Nos pièces ne sont pas d'origine.

Part numbers are quoted for reference purposes only.  
Our parts and accessories are not original.



**"THE RELIABLE SERVICE"**



# S.L.H PARTS

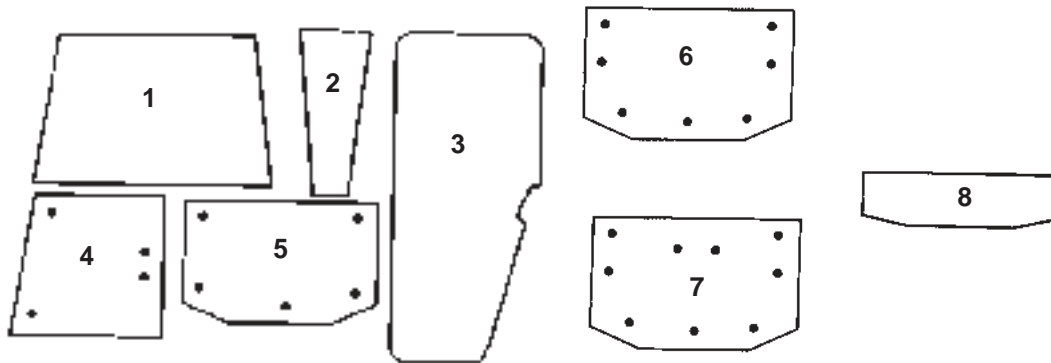

	Fig.	Parts N°	OEM	Pos.	Specification			
<b>SAME</b>								
LASER 90, 100, 110, 130, 150  GALAXY 90, 100, 110, 130, 150	1	29/4001-29	9234 210 0/30	A		1000x745x6	T	GR
	2	29/4014-10T	9234 211 0/10	B	L & R	662x197x6	T	GR
	3	29/4020-44T	9234 212 0/20	C	L & R	1360x588x5	T	GR
	4	29/4047-86T	9234 214 0/20	D	L & R - 4H	745x600x6	T	K/BLT
	5	29/4072-99T	9234 215 0/20	E	5H	1217x815x6	T	K/BLT
	6	29/4072-100T	9234 273 0	E	7H	1217x815x6	T	K/BLT
	7	29/4072-101T	2905545	E	9H	1217x815x6	T	K/BLT
	8	29/4073-96T	9234 216 0/20	F		800x350x4	T	GR
<b>LAMBORGHINI</b>								
956, 1106, 1306	1	32/4001-29	9234 210 0/30	A		1000x745x6	T	GR
	2	32/4014-10T	9234 211 0/10	B	L & R	662x197x6	T	GR
	3	32/4020-44T	9234 212 0/20	C	L & R	1360x588x5	T	GR
	4	32/4047-86T	9234 214 0/20	D	L & R - 4H	745x600x6	T	K/BLT
	6	32/4072-100T	9234 273 0	E	7H	1217x815x6	T	K/BLT
	8	32/4073-96T	9234 216 0/20	F		800x350x4	T	GR
<b>HÜRLIMANN</b>								
496, 5116, 6136, 6170	1	33/4001-29	9234 210 0/30	A		1000x745x6	T	GR
	2	33/4014-10T	9234 211 0/10	B	L & R	662x197x6	T	GR
	3	33/4020-44T	9234 212 0/20	C	L & R	1360x588x5	T	GR
	4	33/4047-86T	9234 214 0/20	D	L & R - 4H	745x600x6	T	K/BLT
	5	33/4072-99T	9234 215 0/20	E	5H	1217x815x6	T	K/BLT
	6	33/4072-100T	9234 273 0	E	7H	1217x815x6	T	K/BLT
	8	33/4073-96T	9234 216 0/20	F		800x350x4	T	GR

Les références des pièces sont indicatives.  
Nos pièces ne sont pas d'origine.

Part numbers are quoted for reference purposes only.  
Our parts and accessories are not original.





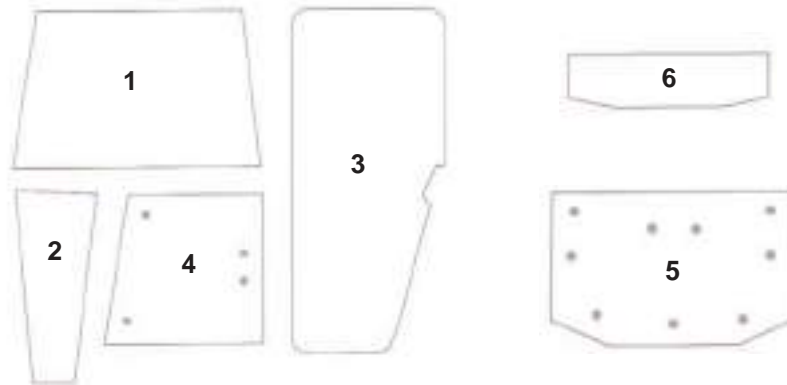

# S.L.H PARTS

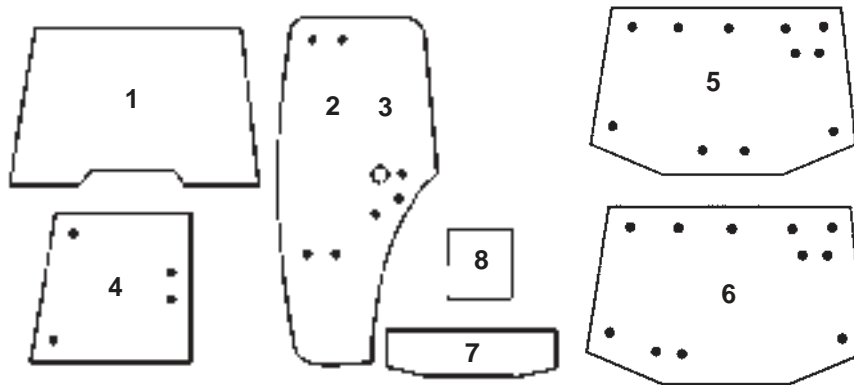

	Fig.	Parts N°	OEM	Pos.	Specification		
<b>SAME</b>							
ANTARES I 100	1	29/4001-28	9241 210 0	A		858x772x5	GR
	2	29/4014-9T	9231 211 0/10	B	L & R	635x163x6	GR
	3	29/4020-41	9231 212 0	C	L & R	1360x555x5	GR
	4	29/4047-85T	9231 214 0	D	L & R - 4H	723x660x6	K/BLT
	5	29/4072-98T	9231 268 0/20	E	9H	1240x778x6	K/BLT
	6	29/4073-46	9231 255 0	F		880x366x4	GR



	Fig.	Parts N°	OEM	Pos.	Specification		
<b>SAME</b>							
ANTARES II 110, 130	1	29/4000-100	009 0300 0	A		1045x795x6	B
	2	29/4038-44T	00773360/10	C	R - 8H	1464x826x6	K/BLT
	3	29/4039-44T	00773350/10	C	L - 8H	1464x826x6	K/BLT
	4	29/4047-87T	007 5106 0/10	D	L & R - 4H	780x542x6	K/BLT
	5	29/4072-85T	007 5181 0/20	E	11H	1360x830x6	K/BLT
	6	29/4072-102T	009 1306 0	E	11H	1360x830x6	K/BLT
	7	29/4073-97T	007 5312 0/10	F		850x275x5	GR
	8	29/4073-98T	009 0969 0	F		338x264x5	GR

Les références des pièces sont indicatives.  
Nos pièces ne sont pas d'origine.

Part numbers are quoted for reference purposes only.  
Our parts and accessories are not original.





**"THE RELIABLE SERVICE"**



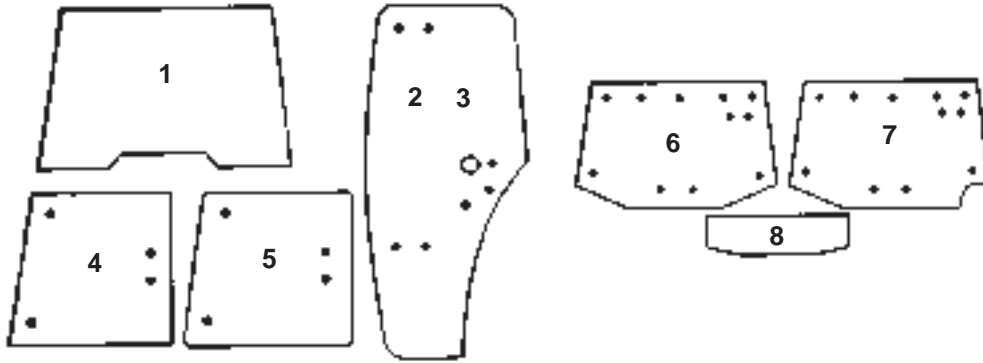

<https://tractormanualz.com/>

# S.L.H PARTS

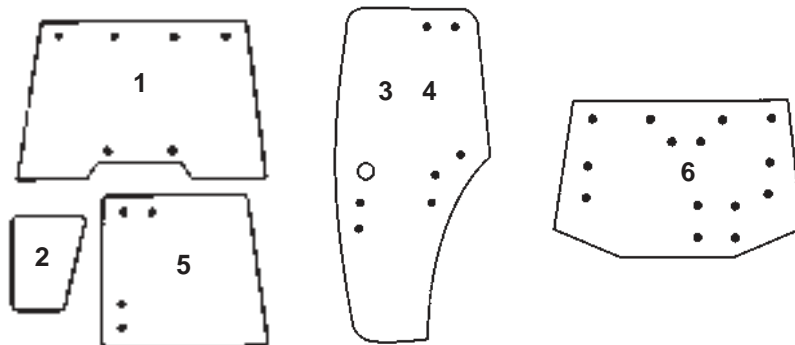

	Fig.	Parts N°	OEM	Pos.	Specification			
<b>SAME</b>								
SILVER 80, 90, 100-4, 100-6	1	29/4000-100	009 0300 0	A		1045x795x6	CL	B
	2	29/4038-44T	00773360/10	C	R - 8H	1464x826x6	T	K/BLT
	3	29/4039-44T	00773350/10	C	L - 8H	1464x826x6	T	K/BLT
	4	29/4047-87T	007 5106 0/10	D	L & R - 4H	780x542x6	T	K/BLT
	5	29/4047-88T	007 7337 0/10	D	L & R - 4H	775x535x6	T	K/BLT
	6	29/4072-85T	007 5181 0/20	E	11H	1350x830x6	T	K/BLT
	7	29/4072-86T	007 7338 0/10	E	11H	1350x830x6	T	K/BLT
	8	29/4073-97T	007 5312 0/10	F		850x275x5	T	GR



	Fig.	Parts N°	OEM	Pos.	Specification			
<b>SAME</b>								
ASTER 60, 70	1	29/4000-103	00827210/20	A	O - 6H	1103x910x6	CL	K/BLT
	2	29/4014-11T	00827220/10	B	L & R	555x262x6	T	GR
	3	29/4039-45T	00823370/10	C	L- 8H	1467x825x6	T	K/BLT
	4	29/4038-45T	00823360/10	C	R- 8H	1467x825x6	T	K/BLT
	5	29/4047-89T	00824070/10	D	L & R - 4H	640x447x5	T	K/BLT
	6	29/4047-103T	00728600	E	14H	1213x823x6	T	K/BLT

A = Pare-brise / Windscreen / Frontscheibe / Voorruit / Parabrisa  
 B = Avant bas / lower front / Vorne / Voorruit / Delantero inferior  
 C = Porte / Door / Türscheibe / Deur / Puerta  
 D = Latérale / Side / Seite / Zijkant / Lateral  
 E = Arrière haut / Upper rear / Hinten oben /  
 Achteraan bovenaan / Trasero superior  
 F = Arrière bas / Lower rear / Hinten unten /  
 Achteraan beneden / Trasero inferior  
 4H = 4 Trous / 4 Holes / 4 Bohrungen / 4 Gaten / 4 Agujeros  
 5H = 5 Trous / 5 Holes / 5 Bohrungen / 5 Gaten / 5 Agujeros  
 6H = 6 Trous / 6 Holes / 6 Bohrungen / 6 Gaten / 6 Agujeros  
 7H = 7 Trous / 7 Holes / 7 Bohrungen / 7 Gaten / 7 Agujeros  
 8H = 8 Trous / 8 Holes / 8 Bohrungen / 8 Gaten / 8 Agujeros  
 9H = 9 Trous / 9 Holes / 9 Bohrungen / 9 Gaten / 9 Agujeros

11H = 11 Trous / 11 Holes / 11 Bohrungen / 11 Gaten / 11 Agujeros  
 14H = 14 Trous / 14 Holes / 14 Bohrungen / 14 Gaten / 14 Agujeros  
 L = Gauche / Left / Links / Links / Izquierda  
 O = Ouvrant / Opening / Öffnet / Schuifdak / Abatible  
 R = Droite / Right / Rechts / Rechts / Derecho  
 T = Tintée / Tinted / Getönte / Getint / Tintado  
 CL = Claire / Clear / Klar / Helder / Claro  
 BO = Bombée / Bonded / Gewölbt / Bol / Abombado  
 BLT = Visser / Bolt on / Fest / Vast / Fijado  
 FR = Encadrée / Framed / Eingerahnt / Omkaderd / Marco  
 GR = Avec joint / Glazing rubber / Dichtung / Ruitrubbers / Con perfil  
 K = Avec butoir caoutchouc / Knock on rubber / Mit Gummi Einlage  
 Rubber inzetring / Con goma

Les références des pièces sont indicatives.  
 Nos pièces ne sont pas d'origine.

Part numbers are quoted for reference purposes only.  
 Our parts and accessories are not original.





## SLH PARTS

Pompe hydraulique - Hydraulic pump - hydrauliekpompe -  
Hydraulikpump - Bomba hidráulica



	Part N°	OEM	Débit - Flow - Druck - Debiet - Flujo	↻
<b>SAME</b> DORADO 55, 60, 56, 70, 75, 85	<b>69/565-233</b>	2.4539.090.0	19 cc.	Gauche - LH - L. - Izqda.
<b>LAMBORGHINI</b> SPRINT 654-55, 664-60, 664-65, 674-70, 674-75, 684-85				
<b>HÜRLIMANN</b> XA-606, XA-607, XA655, XA-657, XA-658, XA656T				









## SLH PARTS

Moteur d'essuie-glace - Wiper motor - Ruitenwissermotor  
Scheibenwischermotor - Motor del limpiaparabrisa

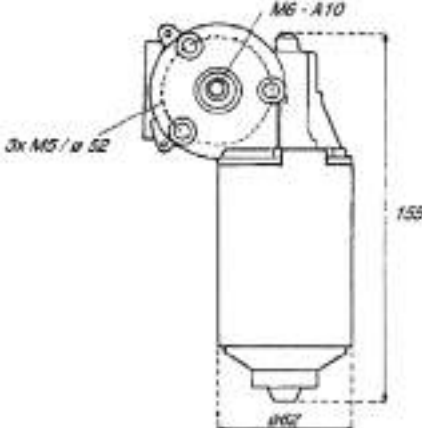

	Part N°	V.		Nm	
<p><b>SAME</b> ANTARES 110, 130 II EXPLORER II 60, 70, 80, 90T LASER 100, 110, 130, 150 ROW CROP 100.6 SILVER 80, 90, 100.4, 100.6, 110, 130, 160, 180 TITAN 145, 160, 190 TITAN 150, 165, 190 SUPERTITAN</p>					
<p><b>LAMBORGHINI</b> 956-100, 1106, 1306, 1506 674-70, 774-80, 874-90T GRAND PRIX PREMIUM 850, 950, 1050, 1060, 1100, 1300 FORMULA 115, 135 RACING 150, 165, 190, 190 HI.PER.</p>	<p><b>63/1980-14</b> 2.9019.070.0/10</p>	12V	360°	25	
<p><b>HÜRLIMANN</b> H358, H468, H478, H488T PRESTIGE H6165, H6190 MASTER ELITE XB 6115, 6135 MASTER H6165, H6190 H.P. XT908, XT990, XT910.4, XT910.6, XT911, XT913</p>					<p>2 vitesses / 2 speed / 2 Geschwindigkeiten 2 snelheden / 2 velocidades intermittent - intervall intermetierend - intermitente 40/58 RPM</p>

Les références des pièces sont indicatives.  
Nos pièces ne sont pas d'origine.

Part numbers are quoted for reference purposes only.  
Our parts and accessories are not original.



**"THE RELIABLE SERVICE"**







## S.L.H PARTS

### Flotteur de réservoir - Fuel sender unit - Tankschwimmer - Tankvlotter - Flotador

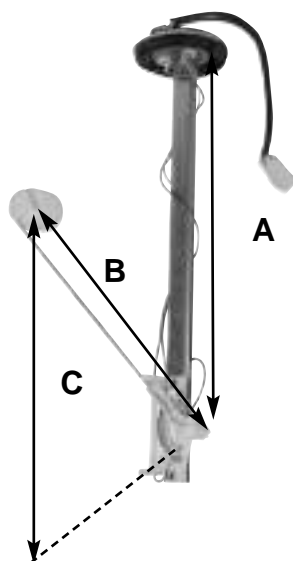

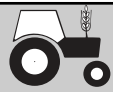
	Part N°	Oem	Observation
Frutteto 60II, 75II, 85II 660F, 775F PLUS H361, H476-F	<b>29/172-102</b>	2.7059.590.0/10	A : 280mm - B : 235mm C : 452mm - 6 Holes

















### SAME PARTS

Optiques - Front lights - Frontscheinwerfer - Koplamp - Faros delanteros

Part N°		Fig.	
 <b>29/189-60</b> 280297100/02	1x <b>63/1955-410</b> 12V 45/50W Asym. - Asim.		
 <b>29/189-61</b> 280297400/21	1x <b>63/1955-472</b> H4 12V 55-60W		
 <b>29/189-62</b> 280297600/30	1x <b>63/1955-472</b> H4 12V 55-60W		ARGON 50, 55, 60, 65, 70, 75F DORADO 55, 60, 65, 70, 75, 85 EXPLORER II 60, 70, 80, 90T FRUTTETO 60, 75, 85II GOLDEN 60, 65, 75, 85 COMPATTO GOLDEN 60V, 75V KRYPTON 80, 90, 100 KRYPTON F 78M, 78N, 78C, 88M, 88N, 88C, 98M, 98N, 98C ROCK 50, 60, 70 ROW CROP 100.6 RUBIN 120, 135, 150 SILVER 80, 90, 100.4, 100.6, 110, 130



Phare - Headlamp - Werklamp  
Scheinwerfer - Faro



Cabochon - Glass - Glas  
Glas - Tulipa



Ampoule - Bulb - Gloeilamp  
Glühlampe - Bombilla

Les références des pièces sont indicatives.  
Nos pièces ne sont pas d'origine.

Part numbers are quoted for reference purposes only.  
Our parts and accessories are not original.



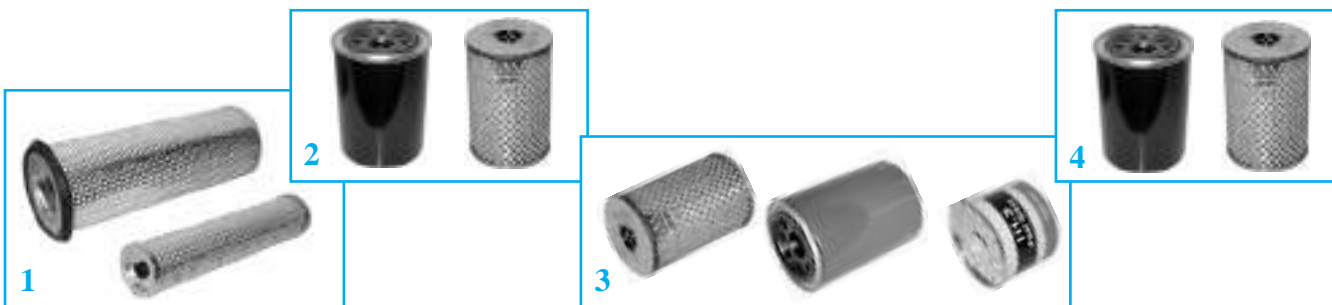

**SAME (SUPPLEMENT)**

Tracteurs Tractors	1		2	3	4
	Air		Huile Oil	Combustible Fuel	Hydraulique Hydraulic
	Ext. / Out.	Int. / Inn.			
Frutteto I 60, 75	<b>60/161-112</b> (242493401)	<b>60/162-112</b> (242493402)	<b>60/97-36</b> (04415670, 04415510)	<b>60/111-3</b> (243190601) (Repl. CAV 296)	<b>60/240-69</b> (244192800, 244193500)
Frutteto I 85			<b>60/97-22</b> (244193400)		
Frutteto II 60, 75	<b>60/161-104</b> (242491300, 242491310, 242493100/10, 242493104)	<b>60/162-25</b> (242491302, 242491307, 242491309)	<b>60/97-36</b> (04415670, 04415510)		
Frutteto II 85			<b>60/97-22</b> (244193400)		
Golden 60, 65, 75, 85			<b>60/111-25</b> (00946870)		
Dorado 70			<b>60/97-36</b> (04415670, 04415510)		

Les références des pièces sont indicatives.  
Nos pièces ne sont pas d'origine.

Part numbers are quoted for reference purposes only.  
Our parts and accessories are not original.



## **SAME (SUPPLEMENT)**

Les références des pièces sont indicatives.  
Nos pièces ne sont pas d'origine.

*Part numbers are quoted for reference purposes only.  
Our parts and accessories are not original.*

**COUSSINETS (REFROIDISSEMENT PAR AIR)**  
**BEARINGS (AIR COOLING)**

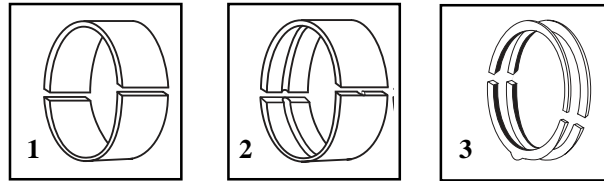

**SAME**

Figures	1	2	3
<b>Tracteurs</b> <i>Tractors</i>	<b>Coussinets de bielle</b> <i>Conrod bearings</i> (Par cyl. / Per cyl.)	<b>Coussinets de palier</b> <i>Main bearings</i> (Par palier / Per hub)	<b>Epaisseurs latérales</b> <i>Thrust washers</i> (Par mot. / Per engine)
Aurora, Buffalo 120, Corsaro, Delfino (1973 ⇄), Drago 100, 120, Falcon, Minitauro, Minitauro 60, Panther, Saturno, Sirenetta (1973 ⇄), Laser 150, Hercules, Galaxy Solar 50, 60, Tiger 100, Moteurs 982, 983, 984, 985, 986, 1052, DA 1053, 1054, 1055, 1056 <i>Engines</i>	<b>062.1225K</b> (2x 062.1225.0) Larg. / Width : 27mm	<b>073.1215K</b> (2x 029.1215.0) Larg. / Width : 32mm	<b>042.1218K</b> (2x 042.1218.0 + 2x 042.1219.0)
Antarès 100, 110, 130 Aster 60, Explorer 60, 70, 80, 90, Frutteto 60, 75, Solar 60C, Vigneron 62, 75, Moteurs 1053P, 1000.3A, 1000.4A, 1000.6A <i>Engines</i>	<b>065.1225K</b> (2x 065.1225.0) Larg. / Width : 29mm	<b>065.1216K</b> (1x 065.1215.0 + 1x 065.1216.0) Larg. / Width : 26,25mm	<b>065.1218K</b> (4x 065.1218.0)

**LAMBORGHINI**

Figures	1	2	3
<b>Tracteurs</b> <i>Tractors</i>	<b>Coussinets de bielle</b> <i>Conrod bearings</i> (Par cyl. / Per cyl.)	<b>Coussinets de palier</b> <i>Main bearings</i> (Par palier / Per hub)	<b>Epaisseurs latérales</b> <i>Thrust washers</i> (Par mot. / Per engine)
R235, C362, C453, C533, C553, R503, R603, R653, C653, R654, R754, R784, R854, R955, R1156, R1356, R1556	<b>062.1225K</b> (2x 062.1225.0) Larg. / Width : 27mm	<b>073.1215K</b> (2x 029.1215.0) Larg. / Width : 32mm	<b>042.1218K</b> (2x 042.1218.0 + 2x 042.1219.0)

Coussinets & épaisseurs latérales disponibles en côte réparation.  
*Bearings and thrust washers are available in oversize.*



**JOINTS & COUSSINETS DE MOTEUR (REFROIDISSEMENT PAR EAU)**  
**ENGINE GASKET & BEARINGS SETS (WATER COOLING)**

**LAMBORGHINI**

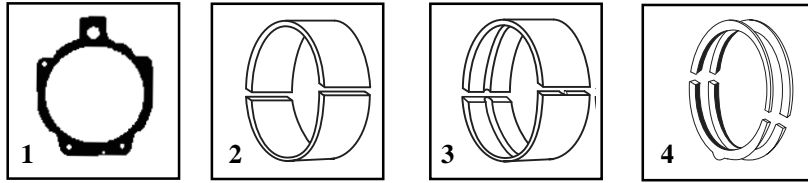

Figures		1	2	3	4
Tracteurs Tractors	Pochette complète Full gasket set	Joint de culasse Cyl. head gasket (Par cyl. / Per cyl.)	Coussinets de bielle Conrod bearings (Par cyl. / Per cyl.)	Coussinets de palier Main bearings (Par palier / Per hub)	Epaisseurs latérales Thrust washers (Par mot. / Per engine)
R.674, R.674.5, C.674, R.774, C.774, 774-5 (4 cyl.)	<b>066.0050.6</b> (A)	<b>078.1451.0</b> Languette sans trou Strip less hole Ep./Thick. : 1,2mm			
R.956, R.956-100, R.1106, R.1306 (6 cyl.)	<b>078.0050.6</b> (A)				
R.674-70, R.674-70N, C.674-70 Grand-Prix, R.774-80, R.774-80N, C.774-80, C.774-80 Grand-Prix, C.874-70T, C.874-90T Grand-Prix, L.105 (4 cyl.)	<b>089.0050.6</b> (A)	<b>078.1452.0</b> Languette avec 2 trous Strip with 2 holes Ep./Thick. : 1,4mm	<b>065.1225K</b> (2x 065.1225.0)	<b>065.1216K</b> (1x 065.1215.0 + 1x 065.1216.0)	<b>065.1218K</b> (4x 065.1218.0)
L.115, Formula 115, L.135, Formula 135, 6135 Elite (6 cyl.)	<b>337.0050.6</b> (A)	<b>078.1453.0</b> Languette avec 1 trou Strip with 1 hole Ep./Thick. : 1,6mm			
R.1506, R.1706 (6 cyl.)	<b>064.0050.6</b> (B)	<b>057.1456.0</b>	<b>062.1225K</b> (2x 062.1225.0)	<b>073.1215K</b> (2x 029.1215.0)	<b>042.1218K</b> (2x 042.1218.0 + 2x 042.1219.0)

**HÜRLIMANN**

Figures		1	2	3	4
Tracteurs Tractors	Pochette complète Full gasket set	Joint de culasse Cyl. head gasket (Par cyl. / Per cyl.)	Coussinets de bielle Conrod bearings (Par cyl. / Per cyl.)	Coussinets de palier Main bearings (Par palier / Per hub)	Epaisseurs latérales Thrust washers (Par mot. / Per engine)
H.466, H.476, H.486 (4 cyl.)	<b>066.0050.6</b> (A)	<b>078.1451.0</b> Languette sans trou Strip less hole Ep. /Thick. : 1,2mm			
H.468, H.468.4, H.468 Prestige, H.476F, H.478, H.478 Prestige, H.488T, H.488 Prestige, H.775F, H.775V (4 cyl.)	<b>089.0050.6</b> (A)				
H.6115 Elite H.6135 Elite, H.6165 (6 cyl.)	<b>337.0050.6</b> (A)	<b>078.1453.0</b> Languette avec 1 trou Strip with 1 hole Ep. /Thick. : 1,6mm			
H.360 (3 cyl.)		<b>057.1456.0</b>		<b>073.1215K</b> (2x 029.1215.0)	<b>042.1218K</b> (2x 042.1218.0 + 2x 042.1219.0)
H.470, H.480 (4 cyl.)	<b>SLT.714/14254</b> (B)				
H.6130, H.6136, H.6160T, H.6170 (6 cyl.)	<b>064.0050.6</b> (B) (057.0050.6)				
H.490T, H.496T (4 cyl.)	<b>SLT.714/14254</b> (B) (059.0050.6)				
H.5110T, H.5116T (5 cyl.)	<b>058.0050.6</b> (B)				

Coussinets & épaisseurs latérales disponibles en côte réparation. / Bearings and thrust washers are available in oversize.

(A) Sans joint de culasse / Less cyl. head gasket

(B) Avec joint de culasse / With cyl. head gasket

Les références des pièces sont indicatives.

Nos pièces ne sont pas d'origine.

Part numbers are quoted for reference purposes only.

Our parts and accessories are not original.



**PISTONS, JEUX DE SEGMENTS & CYLINDRES (REFROIDISSEMENT PAR AIR)**  
**PISTONS, RING SETS & CYLINDERS (AIR COOLING)**

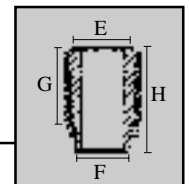
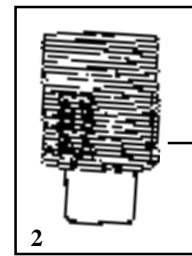
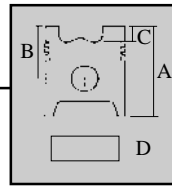
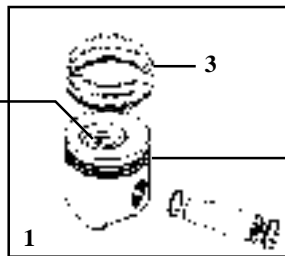
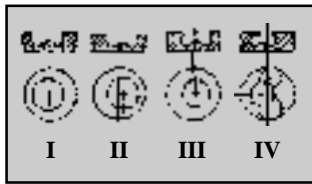

**SAME**

Figures			1	2	3
Tracteurs Tractors	Alésage Bore	Fig. Fig.	Pistons & segments Pistons & ring set	Cylindre Cylinder	Jeu de segments Ring set
Atlanta, Centauro, Delfino Minitauro (Mot. 953 Engine)	95				<b>S.021/00526</b> (5 segments 5 rings set)
Sirenetta, Delfino 35, Aurora 45, Corsaro 70 Drago, Falcon Vigneron (Mot. 982, 983, 984, 986/L Engine) Solar 50	98	IV	<b>S.303900</b> Ø Chambre Ø Chamber 55mm	<b>S.103900</b>	E : 115 F : 117 G : 158 H : 223
Panther (Mot. 985/041 Engine), Drago			<b>S.304350</b> Ø Chambre Ø Chamber 46,5mm		
Tiger Six 105, Panther 90, Corsaro 70SY Condor 55SY (Mot. 983, 984, 985, P-986P Engine)		III	<b>S.305000</b>	<b>S.105000</b>	E : 118,5 F : 114 G : 152 H : 217,5
Italia 35, Leone 70 (Mot. 1002V, 1004V Engine)	100	IV	<b>S.303340</b>	<b>S.103340</b>	E : 115 F : 112 G : 148 H : 231
Tiger Six (Mot. 1006P Engine), Condor, Solar C55, C554, (Mot. 1003P Engine), Corsaro 70 Synchro, Vigneron 70 (Mot.1004P Engine), Laser 110 (Mot.1006P Engine)		II	<b>S.304840</b> (Std./Std.) <b>S.304843</b> (Ø + 0,5)	A : 119 B : 69 C : -21,80 D : 35x80	<b>S.104840</b>
Explorer 55 (Mot. 916.3.A Engine), Explorer 65/65C/65SP, Explorer 75C/75Exp./75SP (Mot. 916.4.A Engine)	103	III	<b>S.304194</b>	<b>S.104194</b>	E : 116 F : 112,8 G : 72 H : 194,5
Drago 120, Tiger 100, Leopard 85, Buffalo 130, Laser 100, Laser 130, Saturno 80SY, Trident 130, Centurion 75, Jaguar 95, Panther 95, Taurus (Mot. 1054, 1055, 1056/P Engine), Minitaurus, Mercury 85	105*120	I	<b>S.304600</b> (Std./Std.) <b>S.460/05</b> (Ø + 0,5)	<b>S.104600</b>	E : 118,5 F : 114 G : 152 H : 217,5
Minitauro 60, Buffalo 120, Saturno 80 (Mot. 1052, 1053, 1054, 1055, 1056/L Engine)		IV	<b>S.304180</b> (Std./Std.) <b>S.418/05</b> (Ø + 0,5)		
Leopard 90, Laser 90 (Mot. 1054PT Engine) Hercules 160, Galaxy 170, Laser 150T (Mot. 1056PT Engine) (1979 ⇄)	105*120	III	<b>S.304136</b> (Std./Std.) <b>S.413/05</b> (Ø + 0,5)	<b>S.104136</b> ou/ou <b>S.104600</b>	E : 124 F : 114 G : 152 H : 217,5

Pistons & segments disponibles en côte réparation +0.5 & +1.0. / Pistons & ring sets are available in oversize + 0.5 & 1.0.

Les références des pièces sont indicatives.  
Nos pièces ne sont pas d'origine.

Part numbers are quoted for reference purposes only.  
Our parts and accessories are not original.



**PISTONS, JEUX DE SEGMENTS & CYLINDRES (REFROIDISSEMENT PAR AIR)**  
**PISTONS, RING SETS & CYLINDERS (AIR COOLING)**

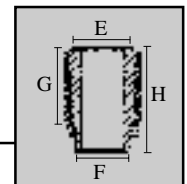
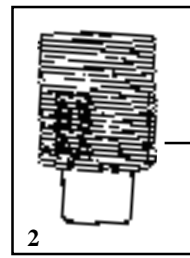
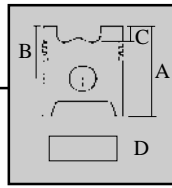
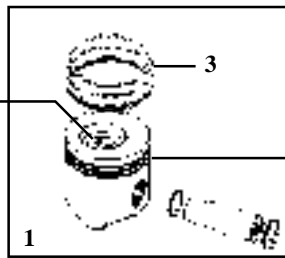
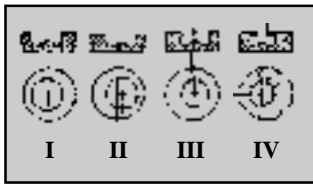

**SAME**

Figures			1	2	3	
Tracteurs Tractors	Alésage Bore	Fig. Fig.	Pistons & segments Pistons & ring set	Cylindre Cylinder	Jeu de segments Ring set	
Aster 60, Explorer 60/60SP/60II, Frutetto 60 Vigneron 62 (Mot. 1000-3A Engine) Explorer 70/70SP/70II/70C, Antares 110 Frutetto 75, Explorer 80SP/80II/80C (Mot. 1000-4A/4A1 Engine)	105*115,5	II	<b>086.0060.6</b>	S.104239 (0851120) ⇨ 26012	E : 116 F : 114,8 G : 72,5 H : 194,5	<b>086.0052.6</b> (3 segments/3 rings set)
Antares 130 Silver 80, 90 Explorer II 90 (Mot. 1000-4AT Engine)			<b>338.0060.6</b> Renforcé Heavy duty			
<b>JOINT DE CYLINDRE CYLINDER GASKET</b>			<b>Cylindre/Cylinder</b>		<b>Réf./Ref.</b>	<b>Dimensions</b>
			S.104239		2.1519.096.0	107,65x1,78
			S.070762		2.1539.130.0	117,07x3,53

**LAMBORGHINI - HÜRLIMANN**

Figures			1	2	3	
Tracteurs Tractors	Alésage Bore	Fig. Fig.	Pistons & segments Pistons & ring set	Cylindre Cylinder	Jeu de segments Ring set	
<b>Lamborghini</b> 235S, R.500, R.550, 654 C.362, C.453, C.533, C.352 <b>Hürlimann</b> H.351, Mot. 982L, 983L Engine	98	IV	<b>S.303900</b> (Std./Std.)	S.103900	E : 115 F : 117 G : 158 H : 223	<b>S.034/00526</b> (4 segments 4 rings set)
<b>Lamborghini</b> R.1056, R.754, R.654, R.550, R.483 R.1156			<b>S.305000</b> (Std./Std.)			
<b>Lamborghini</b> R.653, 784, 854, 955, 1256 R.754, C.754, R.1156, R.1056, R.1256, C.653 <b>Hürlimann</b> H361	105*120	I	<b>S.304600</b> (Std./Std.)	S.104600	E : 118,5 F : 114 G : 152 H : 217,5	<b>S.038/00526</b> (4 segments 4 rings set)
<b>Hürlimann</b> H361			<b>S.460/05</b> (Ø + 0,5)			
<b>Lamborghini</b> R.573-60N, R.574-60N, 600, 660F, 660V (Mot. 1000-3A Engine) <b>Hürlimann</b> H306XE, H362, H361V, H361F, H361XF	105*115,5	II	<b>S.304239</b> (Std./Std.)	S.104239	E : 116 F : 114,8 G : 72,5 H : 194,5	<b>S.014/13952</b> (3 segments 3 rings set)
<b>Hürlimann</b> H306XE, H362, H361V, H361F, H361XF						

Les références des pièces sont indicatives.  
Nos pièces ne sont pas d'origine.

Part numbers are quoted for reference purposes only.  
Our parts and accessories are not original.





**PISTONS, JEUX DE SEGMENTS & CHEMISES (REFROIDISSEMENT PAR EAU)**  
**PISTONS, RING SETS & LINERS (WATER COOLING)**

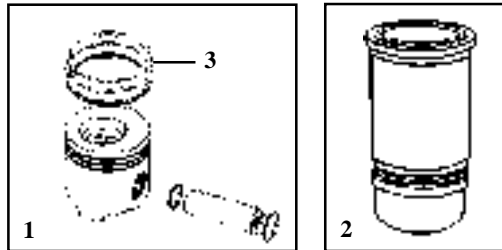

**LAMBORGHINI**

Figures			1	2	3
Tracteurs Tractors	Type de moteur Engine type	Alésage Bore	Piston et segments Piston & ring set	Chemise (Sans joints) Liner (Less gaskets)	Jeu de segments Ring set
R.674, R.674.5, C.674	916.4W (4 cyl.)	103	<b>SLT.714/13301</b> (066.0060.6, 069.00600.6) Axe / Pin : 32x77mm	<b>SLT.714/13302</b> (066.1120.0)	<b>SLT.714/14252</b> (065.0052.6) (3 segments 3 rings set)
R.774, C.774, 774-5	916.4W/1 (4 cyl.)				
R.956, R.956-100	916.6W/1 (6 cyl.)				
R.1106	916.6W/2 (6 cyl.)				
R.1306	916.6WT (6 cyl.)		<b>078.0060.6</b> Axe / Pin : 35x86mm		
R.674-70, R.674-70N, C.674-70 Grand-Prix	1000.4W (4 cyl.)	105	<b>086.0060.6</b> Axe / Pin : 35x86mm	<b>088.1120.0</b>	<b>086.0052.6</b> (3 segments 3 rings set)
R.774-80, R.774-80N, C.774-80, C.774-80 Grand-Prix	1000.4W1 (4 cyl.)				
C.874-70T, C.874-90T Grand-Prix	1000.4WT (4 cyl.)				
L.105	1000.4WTI (4 cyl.)				
L.115, Formula 115	1000.6W1 (6 cyl.)		<b>086.0060.6</b> Axe / Pin : 35x86mm		<b>086.0052.6</b> (3 segments 3 rings set)
L.135, Formula 135	1000.6WTI (6 cyl.)		<b>087.0060.6</b> Axe / Pin : 35x86mm		<b>081.0090.6</b> (3 segments 3 rings set)
R.1506	1106/14T (6 cyl.)	110	<b>064.0060.6</b> Axe / Pin : 40x93mm	<b>057.1120.0</b>	<b>057.0051.6</b> (3 segments 3 rings set)
R.1706	1106/17T (6 cyl.)				

Les références des pièces sont indicatives.  
Nos pièces ne sont pas d'origine.

Part numbers are quoted for reference purposes only.  
Our parts and accessories are not original.



**PISTONS, JEUX DE SEGMENTS & CHEMISES (REFROIDISSEMENT PAR EAU)**  
**PISTONS, RING SETS & LINERS (WATER COOLING)**

**HÜRLIMANN**

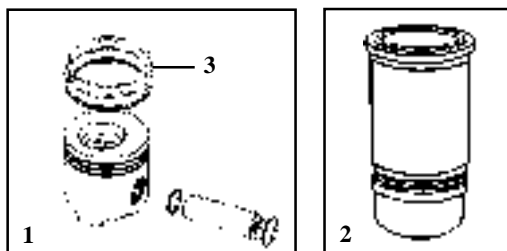

Figures			1	2	3
Tracteurs Tractors	Type de moteur Engine type	Alésage Bore	Piston et segments Piston & ring set	Chemise (Sans joints) Liner (Less gaskets)	Jeu de segments Ring set
H.356	916.3W	103	<b>SLT.714/13301</b> (066.0060.6, 069.00600.6) Axe / Pin : 32x77mm	<b>SLT.714/13302</b> (066.1120.0)	<b>SLT.714/14252</b> (065.0052.6) (3 segments 3 rings set)
H.466, H.476	916.4W (4 cyl.)		<b>078.0060.6</b> Axe / Pin : 35x86mm		
H.486	916.4WT (4 cyl.)				
H.468, H.468.4, H.468 Prestige, H.476F, H.775F, H.775V	1000.4W (4 cyl.)	105	<b>086.0060.6</b> Axe / Pin : 35x86mm	<b>088.1120.0</b>	<b>086.0052.6</b> (3 segments 3 rings set)
H.478, H.478 Prestige	1000.4W1 (4 cyl.)				
H.488T, H.488 Prestige	1000.4WT (4 cyl.)		<b>087.0060.6</b> Axe / Pin : 35x86mm		
H.6115 Elite	1000.6W1 (6 cyl.)		<b>086.0060.6</b> Axe / Pin : 35x86mm		
H.6135 Elite	1000.6WTI (6 cyl.)		<b>087.0060.6</b> Axe / Pin : 35x86mm		
H.360	1103/5 (3 cyl.)	110	<b>058.0060.06</b> Axe / Pin : 35x82mm	<b>057.1120.0</b>	<b>057.0051.6</b> (3 segments 3 rings set)
H.470	1104/6 (4 cyl.)				
H.480	1104/7 (4 cyl.)				
H.6130	1106/12 (6 cyl.)				
H.6136	1106/13 (6 cyl.)				
H.6160T	1106/15 (6 cyl.)				
H.490T, H.496T	1104/8T (4 cyl.)		<b>064.0060.6</b> Axe / Pin : 40x93mm		
H.5110T	1105/10T (5 cyl.)				
H.5116T	1105/11T (5 cyl.)				
H.6170	1106/17T (6 cyl.)				

Les références des pièces sont indicatives.  
Nos pièces ne sont pas d'origine.

Part numbers are quoted for reference purposes only.  
Our parts and accessories are not original.



**JOINTS DE MOTEUR (REFROIDISSEMENT PAR AIR)**  
**ENGINE GASKET SETS (AIR COOLING)**

**SAME**

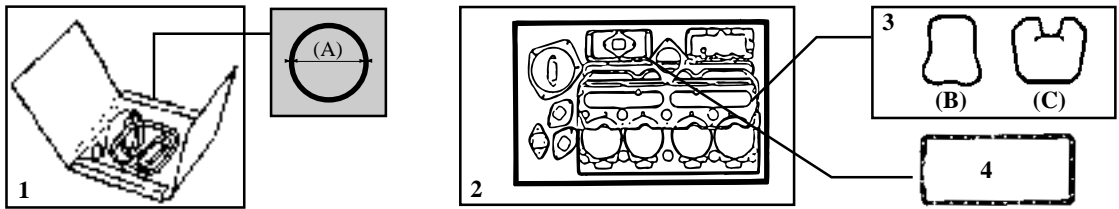

Figures	1	2	3	4
Tracteurs Tractors	Pochette rodage Top gasket set (Par cyl. / Per cyl.)	Pochette complète Full gasket set	Joint cache-soupapes Rocker cover gasket	Joint de carter Sump gasket
Delfino 35, Fox 35, Vigneron (2 cyl.)	<b>S.034/0057D</b> (A) 99x114mm	<b>29/A.31321</b> (034.0050.6)	<b>S.029/1450</b> (B)	<b>S.027/1512A</b>
Aurora 45, Fox 45/55, Vigneron 45 (3 cyl.)		<b>29/A.31320</b> (035.0050.6)		<b>S.029/1512B</b>
Condor 55 Syn., Minitaurus 60 Syn., Taurus 60 (3 cyl.)	<b>S.054/0057G</b> (A) 106x118mm	<b>29/A.31327</b> (054.0050.6)		<b>S.029/1455A</b> (C)
Explorer 65, 75, 85 (Mot.916 A/A Engine, 4 cyl.)	<b>S.065/0057K</b> (A) 104x114mm	<b>29/A.31328</b> (065.0050.6)		
Centauro 70, Corsaro 70, Tiger Six Exp. (Mot. 984L Engine, 4 cyl.)	<b>S.047/0057F</b> (A) 103x117mm	<b>29/A.31322</b> (045.0050.6)	<b>S.029/1450</b> (B)	<b>S.036/1512C</b>
Centurion 75 Exp., Leopard 85 Exp., Mercury 85 Exp., Saturno 80 Syn. (Mot. 1054 Engine, 4 cyl.)	<b>S.042/0057H</b> (A) 106x118mm	<b>29/A.31323</b> (044.0050.6)		
Centauro 75, Laser 90 (Mot. 1054 Engine, 4 cyl.)	<b>S.080/0057N</b> (A) 106x118mm	<b>29/A.31329</b>		
Jaguar 95 Exp., Panther 95, Laser 100, Tiger 100 (Mot. 1055 Engine, 5 cyl.)	<b>S.042/0057H</b> (A) 106x118mm	<b>29/A.31326</b> (042.0050.6)		
Laser 110 (Mot. 1006/PA Engine, 6 cyl.) Tiger Six 105	<b>S.072/0057L</b> (A) 104x117mm	<b>29/A.31330</b> (072.0050.6)		
Laser 130 (Mot. 1056/PA Engine, 6 cyl.)	<b>S.073/0057M</b> (A) 106x118mm	<b>29/A.31331</b> (073.0050.6)		<b>S.00/54043</b>
Buffalo 130, Drago 120, Trident 130 (Mot. 1056/P Engine, 6 cyl.)	<b>S.042/0057</b> (A) 106x118mm	<b>29/A.32083</b>		
Hercules 160	<b>S.052/00576</b> (A) 106x118mm	<b>S.052/00506</b>		
Laser 150, Galaxy 170	<b>S.071/00576</b> (A) 107x124x2,5mm	<b>S.071/00506</b>		
Sametto, Italia 32, Atlanta 42, Centauro 55	<b>S.021/0057A</b> (A) 97x108mm			
Sirenetta, Delfino 32, Minitauro 46, 50, 55	<b>S.029/0057C</b> (A) 97x110mm			
Panther 88	<b>S.041/0057E</b> (A) 99x114mm			
Italia 35, Sametto, Leone, Atlanta 45	<b>S.024/0057B</b> (A) 102x114mm			
Minitauro 60, Saturno 80, Buffalo 120	<b>S.038/0057K</b> (A) 107x121mm			

Les références des pièces sont indicatives.  
Nos pièces ne sont pas d'origine.

Part numbers are quoted for reference purposes only.  
Our parts and accessories are not original.



**JOINTS DE MOTEUR (REFROIDISSEMENT PAR AIR)**  
**ENGINE GASKET SETS (AIR COOLING)**

**LAMBORGHINI**

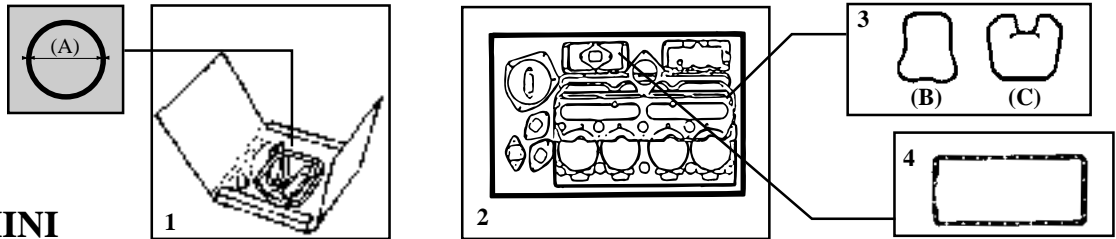

Figures	1	2	3	4
Tracteurs Tractors	Pochette ro dage Top gasket set (Par cyl. / Per cyl.)	Pochette complète Full gasket set	Joint cache-soupapes Rocker cover gasket	Joint de carter Sump gasket
R.235, R.235DT, C.352 (2 cyl.)	<b>S.034/0057D</b> 99x114mm (A)	<b>29/A.31321</b> (034.0050.6)	<b>S.029/1450</b> (B)	<b>S.027/1512A</b>
R.653, C.653 (3 cyl.)	<b>S.054/0057G</b> 106x118mm (A)	<b>29/A.31327</b> (054.0050.6)		<b>S.029/1512B</b>
R.654, R.754 (4 cyl.)	<b>S.047/0057F</b> 103x117mm (A)	<b>29/A.31322</b> (045.0050.6)		<b>S.036/1512C</b>
R.784, R.784DT (4 cyl.)	<b>S.072/0057L</b> 104x117mm (A)			
754, 754DT, 854DT (4 cyl.)	<b>S.042/0057H</b> 106x118mm (A)	<b>29/A.31323</b> (044.0050.6)		
955, 1055 (5 cyl.)		<b>29/A.31326</b> (042.0050.6)		<b>S.041/1512D</b>

Les références des pièces sont indicatives.  
Nos pièces ne sont pas d'origine.

Part numbers are quoted for reference purposes only.  
Our parts and accessories are not original.



**POMPES D'ALIMENTATION & KITS DE REPARATION**  
**FUEL PUMPS & REPAIR KITS**

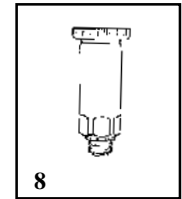
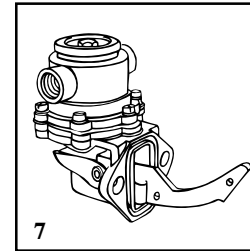
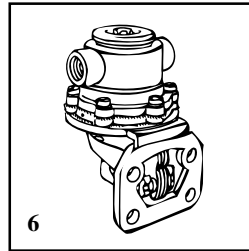
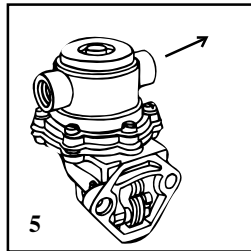
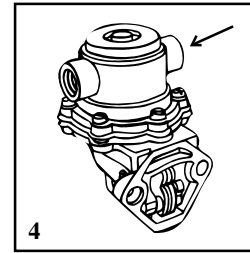
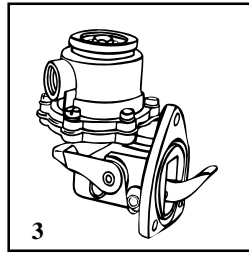
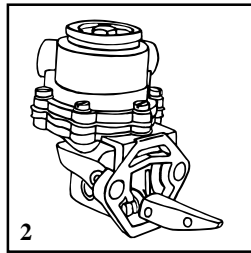
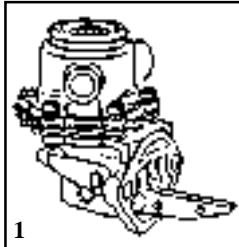

**SAME**

Tracteurs Tractors	Fig. Fig.	Référence Reference	OEM	Kit réparation Repair kit	OEM
Atlanta, Centauro, Leone	1	<b>S.4519/010</b> Filet./Thread : 10x1	245190100	<b>S.390K</b>	24519139
	2	<b>S.4519/130</b> Filet./Thread : 14x,5	245191300	<b>S.390K</b>	24519239
Samitalia, Sametto	3	<b>S.4519/020</b>		<b>S.341K</b>	24519019
Aurora, Corsaro, Centurion 75, Delfino Falcon, Minitauro, Saturno, Sirenetta	4	<b>S.4519/100</b>	00383196 245191600 245191900	<b>S.298K</b>	24519189
Buffalo, Corsaro, Drago, Leopard Minitauro, Panther, Saturno, Tiger	5	<b>S.4519/140</b>	245191400 245191500 245191800 245192000	<b>S.400K</b>	24519129
Buffalo 130, 140, Drago 120, Centurion, Condor, Corsaro 70, Jaguar 95, Mercury, Minitaurus, Panther 90, Saturno 80, Taurus, Tiger 100, 105, Leopard 85, 90 Laser 90, 100, 110, 130, 150 Minitauro 60 synchro	6	<b>S.4519/230</b>	245192200 245192300 245192900	<b>S.4519/239</b>	24519239
Antares 110, 130, Aster 60, Explorer, Silver, Titan, Frutteto 60	7	<b>S.4519/280</b>	245193000	<b>S.4519/269</b>	24519269
Drago	8	<b>S.2212</b>			
6 cylindres & industriels 6 cylinders & industrials	7	<b>S.4519/310</b>	245193100		

Pour d'autres types de tracteurs, se référer aux figures de ce programme  
For other models, check the pictures

Les références des pièces sont indicatives.  
Nos pièces ne sont pas d'origine.

Part numbers are quoted for reference purposes only.  
Our parts and accessories are not original.



**POMPES D'ALIMENTATION & KITS DE REPARATION**  
**FUEL PUMPS & REPAIR KITS**

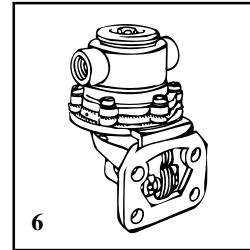
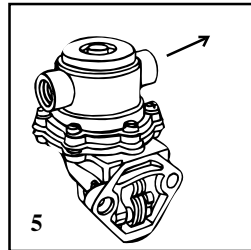
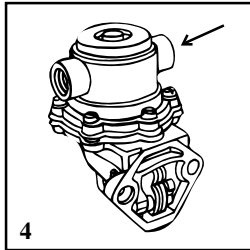
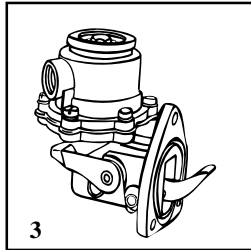

**LAMBORGHINI**

Tracteurs Tractors	Fig. Fig.	Référence Reference	OEM	Kit réparation Repair kit	OEM
Anciens montages / Previous fittings	3	S.4519/020		S.341K	24519019
553, 653, 753, 854, 654	4	S.4519/100	00383196 245191600 245191900	S.298K	24519189
R.1056 (⇄ 1979)	5	S.4519/140	245191400 245191500 245191800 245192000	S.400K	24519129
1056, 653, R.854, R.754	6	S.4519/230	245192200 245192300 245192900	S.4519/239	24519239

**HÜRLIMANN**

Tracteurs Tractors	Fig. Fig.	Référence Reference	OEM	Kit de réparation Repair kit	OEM
H.6160	6	S.4519/230	245192200 245192300 245192900	S.4519/239	24519239

Pour d'autres types de tracteurs, se référer aux figures de ce programme  
For other models, check the pictures

Les références des pièces sont indicatives.  
Nos pièces ne sont pas d'origine.

Part numbers are quoted for reference purposes only.  
Our parts and accessories are not original.



**BOUGIES DE PRECHAUFFAGE**  
**HEATER PLUGS**

**SAME**

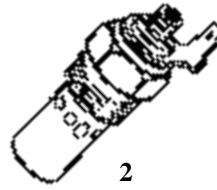

Tracteurs Tractors	Fig. Fig.	Réf. Ref.	Filetage Thread	Volts Volts	Ampères Amperes
Equipement "BOSCH" <i>Equipment</i>	1	S.7659/013	M20x1,5	9,5	22
Equipement "CAV" <i>Equipment</i>	2	S.7659/007	1/2" BSP	12	12,5

**NEZ D'INJECTEURS**  
**INJECTOR NOZZLES**

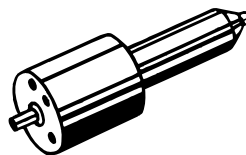

**SAME**

Tracteurs Tractors	Référence Reference	N° sur injecteur N° on the nozzle
Buffalo 130, Centurion 70, Corsaro, Faleon, Condor 55, Delfino 35, Leopard, Jaguar, Laser 90 ⇄ 130, Minitauro, Minitaurus	<b>29/71095</b> (247290100)	433271079 DLLA160S255
Drago 100, Saturno, Buffalo 120, Corsaro	<b>29/71233</b> (247290500)	DLLA160S608
Laser 150, Galaxy 170, Hercules 160	<b>29/4729-090</b> (247290900)	DLLA150S830
Explorer 60, 70, 75, 80, 90, Aster 60, Frutteto 60, 75, Vigneron 62, 75, Antares 110, 130, Silver	<b>29/4729-100</b> (247291000)	DDLA150S925 DLLA150S690

**LAMBORGHINI**

R.235, 653, 854, 754, 455, 1056DT, 1256DT	<b>29/71095</b> (247290100)	433271079 DLLA160S255
674-70, 874-90, 774-80, 600, 700, 1106, 1306, 105, 775F	<b>29/4729-100</b> (247291000)	DDLA150S925 DLLA150S690

**HÜRLIMANN**

Selon applications <i>Some applications</i>	<b>29/71199</b> (247290800)	433271855 DLLA150S806
H.351, H.361	<b>29/71095</b> (247290100)	433271079 DLLA160S255
H.358, 362, 468, 478, 488T, 4105	<b>29/4729-100</b>	DDLA150S925 DLLA150S690

Les références des pièces sont indicatives.  
Nos pièces ne sont pas d'origine.

Part numbers are quoted for reference purposes only.  
Our parts and accessories are not original.



**POMPES A EAU**  
**WATER PUMPS**

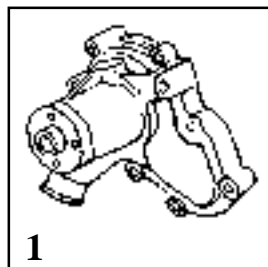

**SAME**

Tracteurs Tractors	Fig. Fig.	OEM	Pompe Pump
Silver 80, 90, 100.4	1	08217404 / 10-20-30-40-50 08217406	<b>082.1740.450 (B)</b> 3 sorties + Trou fileté 3 outlets + threaded hole
Titan 145, 160, 190	2	0641740620	<b>064.1740.620 (B)</b>
Silver 100.6	3	0751740450 07517404/60	<b>075.1740.450 (B)</b>
Antares II, 110, 130	4	0781740450 07817404/60	<b>078.1740.450 (B)</b>

**LAMBORGHINI**

Tracteurs Tractors	Fig. Fig.	OEM	Pompe Pump
674, 674.70, 674.70GP, 774.5 Sprint 664.60, 664.70, 774.80 Cross 574.60, 674.70 Plus 660, 775, 880, 990 Vigneto 660, 775	1	06617404 / 10-20-30-40-50-60 00970396	<b>066.1740.460 (B)</b> 2 sorties / 2 outlets
774.80, 774.80GP, 775, 874.90, 874.90GP Premium 850, 950, 1050 Formula 105		08217404 / 10-20-30-40-50 08217406	<b>082.1740.450 (B)</b> 3 sorties + Trou fileté 3 outlets + threaded hole
874-90 avec airco / With airco		08217564	<b>082.1756.4 (B)</b> 4 sorties / 4 outlets
1106, 1306, 1356, 1556, 1506, 1706 Racing 150, 165, 190	2	0641740620	<b>064.1740.620 (B)</b>
956, 1306, 1060 Formula 115, 135	3	0751740450 07517404/60	<b>075.1740.450 (B)</b>
1106, 1306	4	0781740450 07817404/60	<b>078.1740.450 (B)</b>
Formula 115-135, Premium 1060, Racing 150, 165, 190	5	00705954/30 01011384/20	<b>010.1138.4 (B)</b>

(B) Sans poulie / Less pulley

Les références des pièces sont indicatives.  
Nos pièces ne sont pas d'origine.

Part numbers are quoted for reference purposes only.  
Our parts and accessories are not original.





**POMPES A EAU**  
**WATER PUMPS**

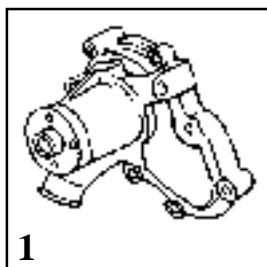

**HÜRLIMANN**

Tracteurs Tractors	Fig. Fig.	OEM	Pompe Pump
H.356, H.358	1	06617404 / 10-20-30-40-50-60 00970396	<b>066.1740.460</b> (B) 2 sorties / 2 outlets
Club H358.4, H468.4		08217404 / 10-20-30-40-50 08217406	<b>082.1740.450</b> (B) 3 sorties + Trou fileté 3 outlets + threaded hole
488T, XA606, XA607, XT908, XT909, XT910.4		08217564 08217406	<b>082.1756.4</b> (B) 4 sorties / 4 outlets
360, 470, 480, 490, 5110, 6130, H.5110T, 6136, 496T, 5116T, 6170T, 6165, 6190	2	0641740620	<b>064.1740.620</b> (B)
Elite 6115, 6135, XT908, XT909, XT910.4	3	0751740450 07517404/60	<b>075.1740.450</b> (B)
XT910.6	4	0781740450 07817404/60	<b>078.1740.450</b> (B)
H.6115, H.6135 Elite, Master H.6165, 6190	5	00705954/30 01011384/20	<b>010.1138.4</b> (B)

(B) Sans poulie / Less pulley



**COURROIES DE VENTILATEUR**  
**FAN BELTS**

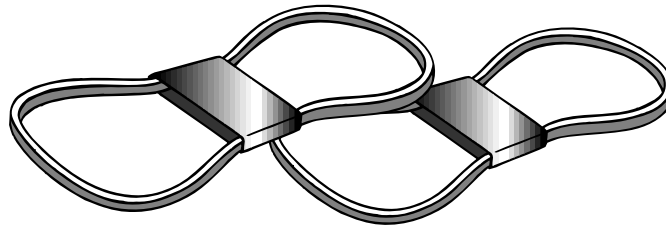

**SAME**

Tracteurs Tractors	Réf. par pair Ref. by pair	OEM
Corsaro 70, Minitauro 60	<b>S.4119/001</b> 2x(AVX10-1400)	241190010, 241190360, 241190610
Aurora, Delfino, Minitauro 50, Vigneron 35, 45, 50 Falcon, Solar 50, Saturno 80, Explorer 65, 70, 75, 80	<b>S.4119/007</b> 2x(AVX10-1350)	241190070, 241190510 244190740
Buffalo 120, Drago 100	<b>S.4119/034</b> 2x(AVX10-1525)	241190340
Buffalo 130, Jaguar 95, 100, Tiger 100, 105, Drago 120 Panther 90, Laser 110, 130	<b>S.4119/040</b> 2x(AVX10-1550)	241190400 241190860
Centauro 70, Leopard 85, 90, Mercury 85, Saturno 80, Centurion 75	<b>S.4119/053</b> 2x(AVX10-1450)	241190530, 241190420, 241190760
Hercules 160, Panther 88, 95 Tiger 105 (⇔ 8469), Trident 130, Laser 100	<b>S.4119/054</b> 2x(AVX10-1575)	241190540, 241190390 241190500, 241190770
Minitauro 55	<b>S.4119/066</b> 2x(AVX10-1375)	241190660, 241190120
Corsaro 70, Condor 55, Minitaurus, Solar 60 Taurus 60, Vigneron 60	<b>S.4119/075</b> 2x(AVX10-1425)	241190750, 241190410 241190460, 241190520
Titan 145, 160, Antares 110, 130	<b>S.4119/118</b> 2x(AVX13-1450)	041191180

**LAMBORGHINI**

Tracteurs Tractors	Réf. Ref.
360, 360DT	<b>AVX13-1325</b>
483, 503, 503S, 503DT, 583, 603, 603DT	<b>AVX10-1150</b>
704, 704DT, 804, 804DT, 904, 904DT	<b>AVX13-1275</b>
550, 660, 654, 754, 784, 854	<b>AVX10-1475</b>
674, 774, 874	<b>AVX10-1225</b>
955, 1056, 1156, 1256	<b>AVX10-1500</b>
1356, 1556	<b>AVX10-1625</b>
653, 683, 684	<b>AVX10-1425</b>
956	<b>AVX13-1300</b>
1106	<b>AVX13-1425</b>
1306	<b>AVX13-1350</b>
1506, 1706	<b>AVX10-1575</b>

**HÜRLIMANN**





Tracteurs Tractors	Réf. Ref.
H5110T, H5116T, H6130, H6136 6160 (⇔ 20400221)	<b>AVX10-1625</b>
6160 (20400222 ⇔), H6170T	<b>AVX10-1575</b>
H345	<b>AVX10-1350</b>
H355F	<b>AVX10-1425</b>
H356 mot. / engine 916.3 (⇔ 1110)	<b>AVX10-1225</b>
H356 mot. / engine 916.3 (1111 ⇔)	<b>AVX10-1200</b>
H466, H466-4, mot. / engine 916-4	<b>AVX10-1225</b>
H470, H480, H490	<b>AVX10-1400</b>

Les références des pièces sont indicatives.  
Nos pièces ne sont pas d'origine.

Part numbers are quoted for reference purposes only.  
Our parts and accessories are not original.



**CONTACTEURS DIVERS**  
**SWITCHES (MISCELLANEOUS)**

<b>S.7099/040</b> (70990100)	Huile (Fil. 10x1)(↔ 50ps) <i>Oil (Thread : 10x1)</i>	
<b>S.7099/1205</b> (70790400/10)	Huile (Fil. 12x1,75)(50ps ↔) <i>Oil (Thread : 12x1,75)</i>	
<b>S.7099/180</b> (270991800)	Prise de force <i>PTO drive</i>	
<b>S.7099/190</b> (270991900)	Hydraulique stop <i>Hydraulic stop</i>	
<b>S.7099/320</b> (27099320)	Colmatage filtre à air <i>Plugging of air filter</i>	
<b>29/7659.008</b> (27659008)	Sécurité, ouvert, 2 plots <i>Safety, open, 2 plugs</i>	
<b>S.7659/021</b> (276590210/01)	Sécurité, ouvert, 4 plots <i>Safety, open, 4 plugs</i>	
<b>S.7659/0140</b> (27659014/01)	Sécurité, fermé <i>Safety, closed</i>	
<b>S.7659/05</b> (276590050)	Position/contact/démarrage 5 plots <i>Position/switch/starter</i> 5 plugs	
<b>S.7659/6</b> (276590060/01)	Préchauffage/contact/démarrage 7 plots <i>Heating/switch/starter</i> 7 plugs	
<b>S.7659/12</b> (276590240)	Préchauffage/contact/démarrage 8 plots <i>Heating/switch/starter</i> 8 plugs	
<b>S.7069/040</b> (270690400/01)	Contacteur de température <i>Temperature switch</i>  Same Buffalo, Drago	

**JAUGES DE RESERVOIR**  
**SENDER UNIT**

Types sans réserve / *Types less reserve*

- S.7059/800** Lg. : 390mm
- S.7059/130** Lg. : 455mm
- S.7059/100** Lg. : 295mm
- S.7059/120** Lg. : 428mm
- S.7059/022** Lg. : 480mm

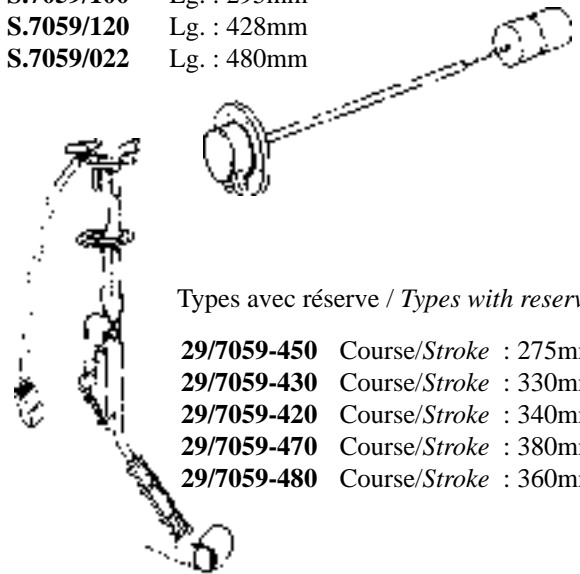

Types avec réserve / *Types with reserve*

- 29/7059-450** Course/Stroke : 275mm
- 29/7059-430** Course/Stroke : 330mm
- 29/7059-420** Course/Stroke : 340mm
- 29/7059-470** Course/Stroke : 380mm
- 29/7059-480** Course/Stroke : 360mm

Les références des pièces sont indicatives.  
Nos pièces ne sont pas d'origine.

Part numbers are quoted for reference purposes only.  
Our parts and accessories are not original.



**FILTRATION - SAME**  
**FILTERS - SAME**

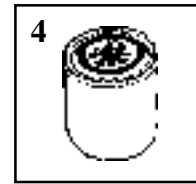
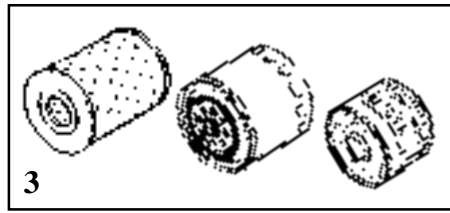
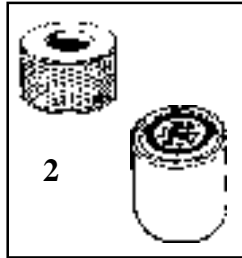
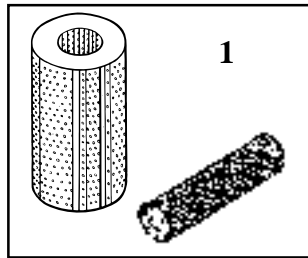

Tracteurs Tractors	1		2	3	4
	Air		Huile Oil	Combustible Fuel	Hydraulique Hydraulic
	Ext. / Out.	Int. / Inn.			
Antares 100 Syncro	<b>60/161-104</b> (TFA.581)	<b>60/162-25</b> (2466)	<b>60/97-38</b> (309/F)	<b>60/111-4</b> (1193/F) (Repl. CAV 796)	<b>60/240-69</b> Ht.: 180mm Filet / Thread M40x2
Antares 110 Moteur A6 110HP Engine					ou / or
Antares 130 Turbo Moteur AT 127HP Engine					<b>60/240-68</b> Ht.: 186mm Filet / Thread 1"1/8
Atlanta, Samecar 42, Samecar 45			<b>60/96-3</b> (102T)	<b>60/111-64</b> (F.1007)  + <b>60/111-32</b> (1007)	
Argon 50, 60, Crono 50, 60			<b>60/97-36</b> (294/F)	<b>60/111-25</b> (5006/F) (Repl. CAV 496)	
Argon 70, Crono 70	<b>60/161-104</b> (TFA.581)	<b>60/162-25</b> (2466)	<b>60/97-22</b> (169)	<b>60/111-16</b> (1194/F)	
Ariete 137			<b>60/96-19</b> (109) (Cartouche Cartridge)  ou / or  <b>60/97-4</b> (305/F) (A visser / Spin on)	<b>60/111-65</b> (F.1008)  + <b>60/111-33</b> (1008)	
Aster 60	<b>60/161-112</b> (TM.254) (Conique, vis centrale Conical type, central nut)	<b>60/162-112</b> (TM.255)	<b>60/97-36</b> (294/F)	<b>60/111-3</b> (1087/PK) (Repl. CAV 296)	<b>60/240-66</b> (SLT.4419/280) Ht.: 232mm Filet / Thread M40x2
Aster 70 Turbo Moteur 1000-3AT Engine	<b>60/161-104</b> (TFA.581)	<b>60/162-25</b> (2466)	<b>60/97-22</b> (169)		
Aurora 45 (2RM / WD), Aurora 45 (4RM / WD) Vigneto	<b>60/161-63</b> (2500)	<b>60/162-1</b> (568)	<b>60/97-2</b> (599AR/F)		

Les références des pièces sont indicatives.  
Nos pièces ne sont pas d'origine.

Part numbers are quoted for reference purposes only.  
Our parts and accessories are not original.



**"THE RELIABLE SERVICE"**



Tracteurs Tractors	1		2	3	4
	Air		Huile Oil	Combustible Fuel	Hydraulique Hydraulic
	Ext. / Out.	Int. / Inn.			
Buffalo 120 (2RM / WD), 120 (4RM / WD), 130 (4RM / WD)	<b>60/161-60</b> (2465) Couvercle / Cap Ø 155mm (↔ 9/81)	<b>60/162-25</b> (2466)	<b>60/97-40</b> (332/F)	<b>60/111-3</b> (1087/PK) (Repl. CAV 296)  ou / or  <b>60/111-4</b> (1193/F) (Repl. CAV 796)	
	<b>60/161-104</b> (TFA.581) Couvercle / Cap Ø 214mm (9/81 ↔)	<b>60/162-25</b> (2466)			
Buffalo 130, Buffalo 130 Export	<b>60/161-60</b> (2465) Couvercle / Cap Ø 200mm (↔ Série / Serie 5960)	<b>60/162-25</b> (2466)	<b>60/97-38</b> (309/F)	<b>60/111-4</b> (1193/F) (Repl. CAV 796)	
	<b>60/161-104</b> (TFA.581) Couvercle / Cap Ø 214mm (Série / Serie 5961 ↔)	<b>60/162-25</b> (2466)			
Centauro 60, Centauro 65	<b>60/161-54</b> (2127) (Sans ailettes Less fins)		<b>60/97-25</b> (370) (Filet / Thread 22x1,5) (↔ 15807)	<b>60/111-64</b> (F.1007)  +  <b>60/111-32</b> (1007)  ou / or  <b>60/111-3</b> (1087/PK) (Repl. CAV 296)	
			<b>60/96-3</b> (102T) (Cartouche Cartridge)  ou / or  <b>60/97-2</b> (599AR/F) (A visser / Spin on)		
Centauro 70 Export	<b>60/161-112</b> (TM.254)	<b>60/162-112</b> (TM.255)			<b>60/240-67</b> (SLT.4419/320) Ht.: 264mm Filet / Thread M40x2
Centauro 70 Syncro	<b>60/161-66</b> (7293) (Conique, 2 pattes Conical type, 2 fixings holes) (↔ 12/82)	<b>60/162-66</b> (7285)	<b>60/97-36</b> (294/F)	<b>60/111-3</b> (1087/PK) (Repl. CAV 296)	<b>60/240-66</b> (SLT.4419/280) Ht.: 232mm Filet / Thread M40x2
	<b>60/161-112</b> (TM.254) (Conique, vis centrale Conical type, central nut) (1/83 ↔)	<b>60/162-112</b> (TM.255)			

Les références des pièces sont indicatives.  
Nos pièces ne sont pas d'origine.

Part numbers are quoted for reference purposes only.  
Our parts and accessories are not original.



**"THE RELIABLE SERVICE"**



Tracteurs Tractors	1		2	3	4	
	Air		Huile Oil	Combustible Fuel	Hydraulique Hydraulic	
	Ext. / Out.	Int. / Inn.				
Centurion 75	<b>60/161-59</b> (2449) (↔ Série / Serie 2870)  <b>60/161-66</b> (7293) (Conique, 2 pattes <i>Conical type,</i> 2 fixings holes) (Série / Serie 2871 ↔ 5000)  <b>60/161-112</b> (TM.254) (Conique, vis centrale <i>Conical type,</i> central nut) (Série / Serie 5001 ↔)	<b>60/162-59</b> (2464)  <b>60/162-66</b> (7285)  <b>60/162-112</b> (TM.255)	<b>60/97-36</b> (294/F)	<b>60/111-3</b> (1087/PK) (Repl. CAV 296)	<b>60/240-67</b> (SLT.4419/320) Ht.: 264mm Filet / Thread M40x2 (↔ Série / Serie 5000)  <b>60/240-66</b> (SLT.4419/280) Ht.: 232mm Filet / Thread M40x2 (Série / Serie 5001 ↔)	
Centurion 75 Export	<b>60/161-66</b> (7293) (Conique, 2 pattes <i>Conical type,</i> 2 fixings holes) (↔ 12/82)  <b>60/161-112</b> (TM.254) (Conique, vis centrale <i>Conical type,</i> central nut) (1/83 ↔)	<b>60/162-66</b> (7285)  <b>60/162-112</b> (TM.255)				
Centurion 75 Special	<b>60/161-112</b> (TM.254)	<b>60/162-112</b> (TM.255)				<b>60/240-66</b> (SLT.4419/280) Ht.: 232mm Filet / Thread M40x2
Condor C	<b>60/161-8</b> (2543)	<b>60/162-8</b> (2544)				
Condor 55, Condor 55 Syncro	<b>60/161-8</b> (2543) (↔ Série / Serie 12000)  <b>60/161-112</b> (TM.254) (Conique, vis centrale <i>Conical type,</i> central nut) (Série / Serie 12001 ↔)	<b>60/162-8</b> (2544)  <b>60/162-112</b> (TM.255)				

Les références des pièces sont indicatives.  
 Nos pièces ne sont pas d'origine.

Part numbers are quoted for reference purposes only.  
 Our parts and accessories are not original.



Tracteurs Tractors	1		2	3	4
	Air		Huile Oil	Combustible Fuel	Hydraulique Hydraulic
Ext. / Out.	Int. / Inn.				
Corsaro 60, 70 (2RM / WD), 70 (4RM / WD)	<b>60/161-54</b> (2127) (Sans ailettes <i>Less fins</i> ) (⇔ Série / Serie 10122)		<b>60/97-36</b> (294/F)		
	<b>60/161-62</b> (2498) (Série / Serie 10123 ⇔)	<b>60/162-62</b> (2499)			
	ou / or <b>60/161-112</b> (TM.254) (Conique, vis centrale <i>Conical type, central nut</i> )	<b>60/162-112</b> (TM.255)			
Corsaro 70 Syncro, DT	<b>60/161-62</b> (2498)	<b>60/162-62</b> (2499)			
Corsaro 70 Frutteto	<b>60/161-66</b> (7293) (Conique 2 pattes <i>Conical type 2 fixings holes</i> ) (⇔ 12/82)	<b>60/162-66</b> (7285)		<b>60/111-3</b> (1087/PK) (Repl. CAV 296)	<b>60/240-68</b> (SLT.4419/270) Ht.: 186mm Filet / Thread 1 1/8"
	<b>60/161-112</b> (TM.254) (Conique, vis centrale <i>Conical type, central nut</i> ) (1/83 ⇔)	<b>60/162-112</b> (TM.255)			
Delfino 32	<b>60/161-87</b> (2477)		<b>60/96-24</b> (101/F)		
Delfino 32 (2RM / WD), 32 (4RM / WD) Frutteto					
Delfino 32 Speciale					
Delfino 35 (4RM / WD), 35 (4RM / WD) Frutteto	<b>60/161-63</b> (2500)	<b>60/162-1</b> (568)	<b>60/97-4</b> (305/F)		
Delfino 35 Deserto	<b>60/161-8</b> (2543)	<b>60/162-8</b> (2544)			
Dinosauro, Elefante TS/TS/W, TSA			<b>60/96-19</b> (109)	<b>60/111-65</b> (F.1008)  + <b>60/111-33</b> (1008)	

Les références des pièces sont indicatives.  
Nos pièces ne sont pas d'origine.

Part numbers are quoted for reference purposes only.  
Our parts and accessories are not original.



**"THE RELIABLE SERVICE"**



Tracteurs Tractors	1		2	3	4
	Air		Huile Oil	Combustible Fuel	Hydraulique Hydraulic
	Ext. / Out.	Int. / Inn.			
Dorado 60 Moteur 1003A 60HP Engine			<b>60/97-36</b> (294/F)	<b>60/111-3</b> (1087/PK) (Repl. CAV 296)	<b>60/240-69</b> (SLT.4419/350) Ht.: 180mm Filet / Thread M40x2
Dorado 70 Moteur 1004A 70HP Engine					
Drago 100	<b>60/161-59</b> (2449) Ø 134mm (↔ Série / Serie 5347)  <b>60/161-60</b> (2465) Ø 155mm (Série / Serie 5348 ↔)	<b>60/162-59</b> (2464)  <b>60/162-25</b> (2466)	<b>60/97-40</b> (332/F) (↔ 12/75)  <b>60/97-38</b> (309/F) (1/76 ↔)		
Drago 120	<b>60/161-60</b> (2465) Couvercle / Cap Ø 155mm (↔ Série / Serie 10604)  <b>60/161-104</b> (TFA.581) Couvercle / Cap Ø 214mm (Série / Serie 10605 ↔)	<b>60/162-25</b> (2466)  <b>60/162-25</b> (2466)	<b>60/97-38</b> (309/F)	<b>60/111-4</b> (1193/F) (Repl. CAV 796)	
Explorer 55, 65, 75	<b>60/161-112</b> (TM.254) (Conique, vis centrale Conical type, central nut)	<b>60/162-112</b> (TM.255)	<b>60/97-36</b> (294/F)	<b>60/111-3</b> (1087/PK) (Repl. CAV 296)	<b>60/240-69</b> (SLT.4419/350) Ht.: 180mm Filet / Thread M40x2
Explorer 55 Export, Explorer 65 Export, Special					
Explorer 60, Explorer 60 II, Explorer 60 Special, Explorer 75					
Explorer 60 Frutteto, 75 Frutetto					
Explorer 60DT					
Explorer 65C Ergomatic, Explorer 70C Ergomatic, Explorer 75C Ergomatic					
Explorer 70, Explorer 70C Special, Explorer 70 II					
Explorer 70C, 80C, 90C	<b>60/161-104</b> (TFA.581)	<b>60/162-25</b> (2466)	<b>60/97-22</b> (169)	<b>60/111-4</b> (1193/F) (Repl. CAV 796)	
Explorer 75, Export, Special, Explorer 85, Export, Special					<b>60/240-66</b> (SLT.4419/280) Ht.: 232mm Filet / Thread M40x2
Explorer 80 II, Explorer 80 Special, Explorer 80 Special Basso, Explorer 80C Ergomatic					<b>60/240-69</b> (SLT.4419/350) Ht.: 180mm Filet / Thread M40x2
Explorer 90 Turbo, Explorer 90 II Turbo					

Les références des pièces sont indicatives.  
Nos pièces ne sont pas d'origine.

Part numbers are quoted for reference purposes only.  
Our parts and accessories are not original.



"THE RELIABLE SERVICE"





Tracteurs Tractors	1		2	3	4
	Air		Huile Oil	Combustible Fuel	Hydraulique Hydraulic
	Ext. / Out.	Int. / Inn.			
Falcon C	<b>60/161-8</b> (2543)	<b>60/162-8</b> (2544)	<b>60/97-2</b> (599AR/F) (↔ 12/75)  <b>60/97-36</b> (294/F) (1/76 ↔)	<b>60/111-3</b> (1087/PK) (Repl. CAV 296)	
Falcon (2RM / WD), (4RM / WD)	<b>60/161-63</b> (2500) Ht.: 235mm (↔ Série / Serie 7209)  <b>60/161-8</b> (2543) Ht.: 315mm (Série / Serie 7210 ↔)	<b>60/162-1</b> (568)  <b>60/162-8</b> (2544)	<b>60/97-2</b> (599AR/F)		
Falcon CC, Falcon CL, Falcon CN	<b>60/161-8</b> (2543)	<b>60/162-8</b> (2544)			
Falcon 50					
Fox 35, Fox 45, Fox 55			<b>60/97-4</b> (305/F)		
Frutteto 60			<b>60/97-36</b> (294/F)	<b>60/240-69</b> (SLT.4419/350) Ht.: 180mm Filet / Thread M40x2	
Galaxy 170, Galaxy 170 Turbo				<b>60/111-4</b> (1193/F) (Repl. CAV 796)	<b>60/240-65</b> (SLT.4419/260) Ht.: 211mm Filet / Thread 1"
Hercules 160 Export	<b>60/161-64</b> (2553)	<b>60/162-64</b> (TFA.734)	<b>60/97-21</b> (121)		
Italia V, VDT, Italia 35			<b>60/96-24</b> (101/F)	<b>60/111-28</b> (1009) (↔ Série / Serie 6495)  <b>60/111-3</b> (1087/PK) (Repl. CAV 296) (Série / Serie 6496 ↔)	
Jaguar 95	<b>60/161-60</b> (2465) Couvercle / Cap Ø 155mm (↔ 8/81)  <b>60/161-104</b> (TFA.581) Couvercle / Cap Ø 214mm (9/81 ↔)	<b>60/162-25</b> (2466)  <b>60/162-25</b> (2466)	<b>60/97-38</b> (309/F)	<b>60/111-4</b> (1193/F) (Repl. CAV 796)	
Jaguar 95 Export	<b>60/161-104</b> (TFA.581)	<b>60/162-25</b> (2466)			<b>60/240-65</b> (SLT.4419/260) Ht.: 211mm Filet / Thread 1"

Les références des pièces sont indicatives.  
Nos pièces ne sont pas d'origine.

Part numbers are quoted for reference purposes only.  
Our parts and accessories are not original.



**"THE RELIABLE SERVICE"**



Tracteurs Tractors	1		2	3	4
	Air		Huile Oil	Combustible Fuel	Hydraulique Hydraulic
	Ext. / Out.	Int. / Inn.			
Laser 90	<b>60/161-104</b> (TFA.581)	<b>60/162-25</b> (2466)	<b>60/97-22</b> (169)	<b>60/111-4</b> (1193/F) (Repl. CAV 796)	<b>60/240-66</b> (SLT.4419/280) Ht.: 232mm Filet / Thread M40x2
Laser 100, Laser 110, Laser 130			<b>60/97-38</b> (309/F)		
Laser 150, Laser 150 Turbo	<b>60/161-64</b> (2553)	<b>60/162-64</b> (TFA.734)	<b>60/97-21</b> (121)		
Leopard C			<b>60/97-36</b> (294/F)	<b>60/111-3</b> (1087/PK) (Repl. CAV 296)	<b>60/240-69</b> (SLT.4419/350) Ht.: 180mm Filet / Thread M40x2
Leopard 85, Leopard 85 Export	<b>60/161-59</b> (2449)	<b>60/162-59</b> (2464)			
Leopard 90 Turbo	<b>60/161-104</b> (TFA.581)	<b>60/162-25</b> (2466)	<b>60/97-22</b> (169)	<b>60/111-4</b> (1193/F) (Repl. CAV 796)	<b>60/240-65</b> (SLT.4419/260) Ht.: 211mm Filet / Thread 1"
Mercury 85 Export, Mercury 85 Special	<b>60/161-66</b> (7293) (Conique, 2 pattes Conical type, 2 fixings holes) (↔ 12/82)	<b>60/162-66</b> (7285)	<b>60/97-36</b> (294/F)	<b>60/111-3</b> (1087/PK) (Repl. CAV 296)	<b>60/240-65</b> (SLT.4419/260) Ht.: 211mm Filet / Thread 1" (85 Export)
	<b>60/161-112</b> (TM.254) (Conique, vis centrale Conical type, central nut) (1/83 ↔)	<b>60/162-112</b> (TM.255)			<b>60/240-66</b> (SLT.4419/280) Ht.: 232mm Filet / Thread M40x2 (85 Special)
Minitauro C			<b>60/97-2</b> (599AR/F)	<b>60/111-3</b> (1087/PK) (Repl. CAV 296)	
Minitauro 55, Leone 70, Leone 75	<b>60/161-54</b> (2127) (Sans ailettes Less fins)		<b>60/96-3</b> (102T) (Cartouche Cartridge)  ou / or  <b>60/97-2</b> (599AR/F) (A visser / Spin on)	<b>60/111-64</b> (F.1007)  +  <b>60/111-32</b> (1007)  ou / or  <b>60/111-3</b> (1087/PK) (Repl. CAV 296)	
Minitauro 60, Minitauro 60 Frutteto	<b>60/161-62</b> (2498)	<b>60/162-62</b> (2499)	<b>60/97-2</b> (599AR/F)		
Minitauro 60 Syncro					<b>60/240-64</b> (SLT.4419/250) Ht.: 143mm Filet / Thread 1"
Minitauro 60, 60 Syncro, Minitauro C			<b>60/97-36</b> (294/F)	<b>60/111-3</b> (1087/PK) (Repl. CAV 296)	
Minitauro, Frutteto	<b>60/161-112</b> (TM.254)	<b>60/162-112</b> (TM.255)			

Les références des pièces sont indicatives.  
Nos pièces ne sont pas d'origine.

Part numbers are quoted for reference purposes only.  
Our parts and accessories are not original.



"THE RELIABLE SERVICE"



Tracteurs Tractors	1		2	3	4	
	Air		Huile Oil	Combustible Fuel	Hydraulique Hydraulic	
	Ext. / Out.	Int. / Inn.				
Panther 88	<b>60/161-59</b> (2449)	<b>60/162-59</b> (2464)	<b>60/97-38</b> (309/F)	<b>60/111-3</b> (1087/PK) (Repl. CAV 296)		
Panther 90	<b>60/161-59</b> (2449) Couvercle / Cap Ø 133mm (↔ Série / Serie 5000)	<b>60/162-59</b> (2464)		<b>60/111-4</b> (1193/F) (Repl. CAV 796)		
	<b>60/161-60</b> (2465) Couvercle / Cap Ø 155mm (Série / Serie 5001 ↔)	<b>60/162-25</b> (2466)				
	ou / or <b>60/161-104</b> (TFA.581) Couvercle / Cap Ø 214mm	<b>60/162-25</b> (2466)				
Panther 95	<b>60/161-60</b> (2465) Couvercle / Cap Ø 155mm (↔ Série / Serie 2606)	<b>60/162-25</b> (2466)			<b>60/240-65</b> (SLT.4419/260) Ht.: 211mm Filet / Thread 1"	
	<b>60/161-104</b> (TFA.581) Couvercle / Cap Ø 214mm (Série / Serie 2607 ↔)	<b>60/162-25</b> (2466)				
Ranger 45, 45 Frutteto	<b>60/161-63</b> (2500)	<b>60/162-1</b> (568)	<b>60/97-2</b> (599AR/F)	<b>60/111-3</b> (1087/PK) (Repl. CAV 296)		
Row Crop 80	<b>60/161-62</b> (2498)		<b>60/97-36</b> (294/F)		<b>60/240-64</b> (SLT.4419/250) Ht.: 143mm Filet / Thread 1"  ou / or <b>60/240-69</b> (SLT.4419/350) Ht.: 180mm Filet / Thread M40x2	

Les références des pièces sont indicatives.  
Nos pièces ne sont pas d'origine.

Part numbers are quoted for reference purposes only.  
Our parts and accessories are not original.



**"THE RELIABLE SERVICE"**



Tracteurs Tractors	1		2	3	4
	Air		Huile Oil	Combustible Fuel	Hydraulique Hydraulic
	Ext. / Out.	Int. / Inn.			
Row Crop 85	<b>60/161-62</b> (2498)  ou / or  <b>60/161-66</b> (7293) (Conique 2 pattes Conical type 2 fixings holes) (⇨ 12/82)  <b>60/161-112</b> (TM.254) (Conique, vis centrale Conical type, central nut) (1/83 ⇨)	<b>60/162-66</b> (7285)  <b>60/162-112</b> (TM.255)	<b>60/97-36</b> (294/F)	<b>60/111-3</b> (1087/PK) (Repl. CAV 296)	<b>60/240-69</b> (SLT.4419/350) Ht.: 180mm Filet / Thread M40x2
Sametto, Sametto 120				<b>60/111-28</b> (1009)	
Sametto V, VDT			<b>60/96-24</b> (101/F)		
Saturno 80 (2RM / WD), Saturno 80 (4RM / WD)	<b>60/161-63</b> (2500) Ht.: 235mm (⇨ Série / Serie 9356)  <b>60/161-62</b> (2498) Ht.: 265mm (Série / Serie 9357 ⇨)	<b>60/162-62</b> (2499)	<b>60/97-36</b> (294/F)	<b>60/111-3</b> (1087/PK) (Repl. CAV 296)	
Saturno 80 Syncro	<b>60/161-62</b> (2498)	<b>60/162-62</b> (2499)			
Silver 80.DT (2RM / WD) Moteur 1000.4-A4 80HP Engine					<b>60/240-66</b> (SLT.4419/280) Ht.: 232mm Filet / Thread M40x2
Silver 90.DT (2RM / WD) Moteur 1000.4AT2 90HP Engine			<b>60/97-22</b> (169)		
Silver 100.4 DT Moteur 1000.4AT1 100HP Engine	<b>60/161-104</b> (TFA.581)	<b>60/162-25</b> (2466)	<b>60/97-21</b> (121)	<b>60/111-4</b> (1193/F) (Repl. CAV 796)	<b>60/240-67</b> (SLT.4419/320) Ht.: 264mm Filet / Thread M40x2
Silver 100.6 Moteur 1000.6A1 100HP Engine					
Sirenetta (2RM / WD), (4RM / WD)	<b>60/161-87</b> (2477) Ht.: 185mm  ou / or  <b>60/162-63</b> (2500) Ht.: 235mm		<b>60/97-4</b> (305/F)	<b>60/111-3</b> (1087/PK) (Repl. CAV 296)	

Les références des pièces sont indicatives.  
Nos pièces ne sont pas d'origine.

Part numbers are quoted for reference purposes only.  
Our parts and accessories are not original.



"THE RELIABLE SERVICE"



Tracteurs Tractors	1		2	3	4
	Air		Huile Oil	Combustible Fuel	Hydraulique Hydraulic
	Ext. / Out.	Int. / Inn.			
Solar 50	<b>60/161-112</b> (TM.254)	<b>60/162-112</b> (TM.255)	<b>60/97-2</b> (599AR/F)	<b>60/111-3</b> (1087/PK) (Repl. CAV 296)	<b>60/240-66</b> (SLT.4419/280) Ht.: 232mm Filet / Thread M40x2
Solar 55, 55C, 55C Compact, 60			<b>60/97-36</b> (294/F)		<b>60/240-69</b> (SLT.4419/350) Ht.: 180mm Filet / Thread M40x2
Solar 60C Ergomatic					
Solaris 35 Moteur Mitsubishi K4F-D Engine	<b>60/161-63</b> (2500)	<b>60/162-1</b> (568)	<b>60/240-66</b> (SLT.4419/280)		
Taurus C			<b>60/97-2</b> (599AR/F)		
Taurus 60 Export	<b>60/161-59</b> (2449) (↔ Série / Serie 2675)	<b>60/162-59</b> (2464)	<b>60/97-36</b> (294/F)	<b>60/111-3</b> (1087/PK) (Repl. CAV 296)	<b>60/240-64</b> (SLT.4419/250) Ht.: 143mm Filet / Thread 1"
	<b>60/161-66</b> (7293) (Conique, 2 pattes Conical type 2 fixings holes) (Série / Serie 2676 ↔)	<b>60/162-66</b> (7285)			
	ou / or <b>60/161-112</b> (TM.254) (Conique, vis centrale Conical type, central nut)	<b>60/162-112</b> (TM.255)			
Tiger 100 (2RM / WD), Tiger 100 (4RM / WD)	<b>60/161-60</b> (2465) Couvercle / Cap Ø 155mm (↔ 8/81)	<b>60/162-25</b> (2466)	<b>60/97-38</b> (309/F)	<b>60/111-3</b> (1087/PK) (Repl. CAV 296)	
	<b>60/161-104</b> (TFA.581) Couvercle / Cap Ø 214mm (9/81 ↔)	<b>60/162-25</b> (2466)		<b>60/111-4</b> (1193/F) (Repl. CAV 796)	ou / or
Tiger Six 105				<b>60/111-4</b> (1193/F) (Repl. CAV 796)	<b>60/240-65</b> (SLT.4419/260) Ht.: 211mm Filet / Thread 1"
Titan 145	<b>60/161-64</b> (2553)	<b>60/162-64</b> (TFA.734)	<b>60/97-21</b> (121)	<b>60/111-4</b> (1193/F) (Repl. CAV 796)	<b>60/240-67</b> (SLT.4419/320) Ht.: 264mm Filet / Thread M40x2
Titan 160 Turbo Moteur 1000.6AT1 159HP Engine					
Titan 190 Turbo Moteur 1000.6WTIR 189HP Engine					

Les références des pièces sont indicatives.  
Nos pièces ne sont pas d'origine.

Part numbers are quoted for reference purposes only.  
Our parts and accessories are not original.



**"THE RELIABLE SERVICE"**



Tracteurs Tractors	1		2	3	4
	Air		Huile Oil	Combustible Fuel	Hydraulique Hydraulic
	Ext. / Out.	Int. / Inn.			
Trident 130 Export	<b>60/161-60</b> (2465) Couvercle / Cap Ø 155mm (⌀ 8/81)	<b>60/162-25</b> (2466)	<b>60/97-38</b> (309/F)	<b>60/111-4</b> (1193/F) (Repl. CAV 796)	<b>60/240-67</b> (SLT.4419/320) Ht.: 264mm Filet / Thread M40x2
	<b>60/161-104</b> (TFA.581) Couvercle / Cap Ø 214mm (9/81 ⌀)	<b>60/162-25</b> (2466)			
Toro, Toro V, AT, TS			<b>60/96-3</b> (102T)	<b>60/111-64</b> (F.1007)  + <b>60/111-32</b> (1007)	
Vigneron 35, 45, 50	<b>60/161-63</b> (2500) Ht.: 235mm		<b>60/97-4</b> (305/F)	<b>60/111-3</b> (1087/PK) (Repl. CAV 296)	
Vigneron 60, 62, 70	<b>60/161-112</b> (TM.254)	<b>60/162-112</b> (TM.255)	<b>60/97-36</b> (294/F)		

**Filtre de direction assistée**  
*Power steering filter*
**60/574-15**  
 (S.136/6376)

 Ø 86mm  
 Ht.: 38mm

Leopard, Centurion, ...

 Les références des pièces sont indicatives.  
 Nos pièces ne sont pas d'origine.

 Part numbers are quoted for reference purposes only.  
 Our parts and accessories are not original.

**FILTRATION - LAMBORGHINI**  
**FILTERS - LAMBORGHINI**

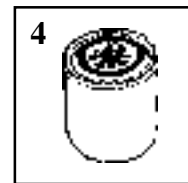
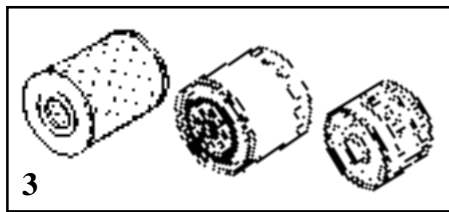
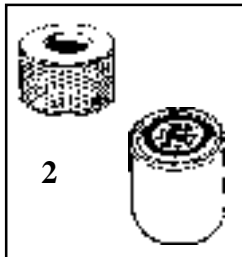
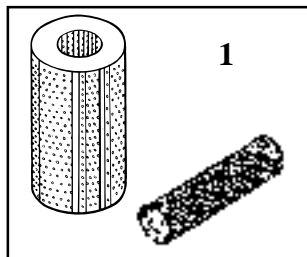

Tracteurs Tractors	1 Air		2 Huile Oil	3 Combustible Fuel	4 Hydraulique Hydraulic
	Ext. / Out.	Int. / Inn.			
1R, 1C				<b>60/111-32</b> (1007)	
2R, 4R, 5C, 4C				<b>60/111-64</b> (F.1007)	
7R, 7RDT, R 355				+ <b>60/111-32</b> (1007)	<b>60/96-3</b> (102T)
105 Formula Power Speed				<b>60/111-3</b> (1087/PK) (Repl. CAV 296)	
115, 135 Formula Moteur 100.WT6 Engine	<b>60/161-104</b> (TFA.581)	<b>60/162-25</b> (2466)	<b>60/97-38</b> (309/F)	<b>60/111-16</b> (1194/F)	<b>60/240-69</b> (SLT.4419/350) Ht.: 180mm Filet / Thread M40x2
165, 190 Racing Moteur 100.WT6 Turbo Engine				+ <b>60/111-25</b> (5006/F)	
165 Racing			<b>60/97-22</b> (169)	<b>60/111-4</b> (1193/F) (Repl. CAV 796)	
R 226, C 226				<b>60/111-32</b> (1007)	<b>60/96-2</b> (103)
R 230, C 230, C 230S					
R 235, R 235DT	<b>60/161-63</b> (2500)	<b>60/162-1</b> (568)	<b>60/97-4</b> (305/F)	<b>60/111-3</b> (1087/PK) (Repl. CAV 296)	
R 240			<b>60/97-36</b> (294/F)	<b>60/111-39</b> (1158)	
R 340, C 340, C 350				<b>60/111-64</b> (F.1007)  + <b>60/111-32</b> (1007)	
R 345	<b>60/161-112</b> (TM.254) (Conique, vis centrale Conical type, central nut)	<b>60/162- 112</b> (TM.255)	<b>60/97-36</b> (294/F)	<b>60/111-3</b> (1087/PK) (Repl. CAV 296)	

Les références des pièces sont indicatives.  
Nos pièces ne sont pas d'origine.

Part numbers are quoted for reference purposes only.  
Our parts and accessories are not original.



**"THE RELIABLE SERVICE"**



Tracteurs Tractors	1		2	3	4	
	Air		Huile Oil	Combustible Fuel	Hydraulique Hydraulic	
	Ext. / Out.	Int. / Inn.				
R 350			<b>60/97-38</b> (309/F)	<b>60/111-39</b> (1158)		
C 352, C 352L, C 352S, C 352SL	<b>60/161-8</b> (2543)	<b>60/162-8</b> (2544)	<b>60/97-4</b> (305/F)	<b>60/111-3</b> (1087/PK) (Repl. CAV 296)		
C 353L, C 353LL, CL 653, C 653L			<b>60/97-2</b> (599AR/F)			
R 360, R 365, 452, R 470, R 475, 480, 485				<b>60/111-64</b> (F.1007)  + <b>60/111-32</b> (1007)		
C 483			<b>60/97-4</b> (305/F)	<b>60/111-3</b> (1087/PK) (Repl. CAV 296)	<b>60/240-68</b> (SLT.4419/270) Ht.: 186mm Filet / Thread 1 1/8"	
R 500, R 550DT	<b>60/161-112</b> (TM.254) (Conique, vis centrale Conical type, central nut)	<b>60/162-112</b> (TM.255)	<b>60/97-2</b> (599AR/F)			
C 503, C 603 Moteur Same 983P Engine	<b>60/161-8</b> (2543)	<b>60/162-8</b> (2544)				
C 503S, C 553S			<b>60/240-46</b> (652)			
R 503S, R 503DTS, R 603, R 603DT			<b>60/97-38</b> (309/F)	<b>60/111-39</b> (1158)	<b>60/240-11</b> (529) (Cartouche Cartridge)	
C 553P, C 653P Moteur Same 1053P Engine			<b>60/97-4</b> (305/F)	<b>60/111-3</b> (1087/PK) (Repl. CAV 296)		
C 554, C 554 Compact Ergomatic 554-50, 564-60 Moteur 1003.3A Engine	<b>60/161-112</b> (TM.254) (Conique, vis centrale Conical type, central nut)	<b>60/162-112</b> (TM.255)	<b>60/97-36</b> (294/F)			
574-74 Moteur 1003.3A Engine, R 574-60N, R 674-70, R 674-70N, C 674-70 Ergomatic, R 674-70 Grand Prix					<b>60/240-69</b> (SLT.4419/350) Ht.: 180mm Filet / Thread M40x2	
C 583			<b>60/97-4</b> (305/F)			<b>60/240-68</b> (SLT.4419/270) Ht.: 186mm Filet / Thread 1 1/8"
R 583			<b>60/97-38</b> (309/F)			
R 600, R 600DT	<b>60/161-112</b> (TM.254) (Conique, vis centrale Conical type, central nut)	<b>60/162-112</b> (TM.255)	<b>60/97-36</b> (294/F)			<b>60/240-66</b> (SLT.4419/280) Ht.: 232mm Filet / Thread M40x2
C 653			<b>60/97-4</b> (305/F)			

Les références des pièces sont indicatives.  
Nos pièces ne sont pas d'origine.

Part numbers are quoted for reference purposes only.  
Our parts and accessories are not original.



"THE RELIABLE SERVICE"





Tracteurs Tractors	1		2	3	4
	Air		Huile Oil	Combustible Fuel	Hydraulique Hydraulic
	Ext. / Out.	Int. / Inn.			
R 653, R654, R654DT					<b>60/240-11</b> (529) (Cartouche Cartridge)
R 660, R 660DT, C664 Ergomatic	<b>60/161-112</b> (TM.254) (Conique, vis centrale Conical type, central nut)	<b>60/162- 112</b> (TM.255)	<b>60/97-36</b> (294/F)	<b>60/111-3</b> (1087/PK) (Repl. CAV 296)	
R 660 Frutteto, R 660 Vigneto, R 775 Frutteto					
C 683			<b>60/97-4</b> (305/F)		<b>60/240-68</b> (SLT.4419/270) Ht.: 186mm Filet / Thread 1 1/8"
R 683			<b>60/97-36</b> (294/F)		<b>60/240-66</b> (SLT.4419/280) Ht.: 232mm Filet / Thread M40x2
C 684, R 684					
R 700, R 700DT	<b>60/161-104</b> (TFA.581)	<b>60/162-25</b> (2466)			
R 704, R 704DT, R 804, R 804DT Export				<b>60/111-56</b> (1157/F)	
R 754, R 754DT			<b>60/97-36</b> (294/F)	<b>60/111-3</b> (1087/PK) (Repl. CAV 296)	<b>60/96-28</b> (394) (Cartouche Cartridge)
R 754 Ergomatic					<b>60/240-66</b> (SLT.4419/280) Ht.: 232mm Filet / Thread M40x2
C 774-80 Ergomatic, R 774-80, R 774-80 Grand Prix	<b>60/161- 104</b> (TFA.581)	<b>60/162-25</b> (2466)			<b>60/240-68</b> (SLT.4419/270) Ht.: 186mm Filet / Thread 1 1/8"
R 775 Frutteto, R 775 Vigneto, 775F Plus Moteur 1003.3A Engine					<b>60/240-69</b> (SLT.4419/350) Ht.: 180mm Filet / Thread M40x2
R 784, C 784					
R 854, R 854DT					<b>60/96-28</b> (394) (Cartouche Cartridge) Ht.: 209mm  ou / or  <b>60/240-11</b> (529) (Cartouche Cartridge) Ht.: 177mm

Les références des pièces sont indicatives.  
Nos pièces ne sont pas d'origine.

Part numbers are quoted for reference purposes only.  
Our parts and accessories are not original.



**"THE RELIABLE SERVICE"**



Tracteurs Tractors	1		2	3	4
	Air		Huile Oil	Combustible Fuel	Hydraulique Hydraulic
	Ext. / Out.	Int. / Inn.			
R 874-90 Turbo, R 874-90 Turbo Grand Prix	<b>60/161- 104</b> (TFA.581)	<b>60/162-25</b> (2466)	<b>60/97-22</b> (169)	<b>60/111-3</b> (1087/PK) (Repl. CAV 296)	<b>60/240-69</b> (SLT.4419/350) Ht.: 180mm Filet / Thread M40x2 (↔ 3/87)  <b>60/240-68</b> (SLT.4419/270) Ht.: 186mm Filet / Thread 1 1/8" (4/87 ↔)
R 904, R 904DT Export	<b>60/161-59</b> (2449)	<b>60/162-59</b> (2464)		<b>60/111-56</b> (1157/F)	
R 955			<b>60/97-38</b> (309/F)	<b>60/111-4</b> (1193/F) (Repl. CAV 796)	<b>60/96-28</b> (394) (Cartouche Cartridge) (↔ 82)  <b>60/240-68</b> (SLT.4419/270) Ht.: 186mm Filet / Thread 1 1/8" (83 ↔)
R 956, R 956DT, R956-100	<b>60/161- 104</b> (TFA.581)	<b>60/162-25</b> (2466)	<b>60/97-36</b> (294/F)		<b>60/240-66</b> (SLT.4419/280) Ht.: 232mm Filet / Thread M40x2
990F Plus Moteur 1000.4WT Engine					<b>60/111-3</b> (1087/PK) (Repl. CAV 296)
R 1056, R 1056DT, R 1256			<b>60/97-38</b> (309/F)	<b>60/111-4</b> (1193/F) (Repl. CAV 796)	<b>60/96-28</b> (394) (Cartouche Cartridge)  ou / or  <b>60/240-68</b> (SLT.4419/270) Ht.: 186mm Filet / Thread 1 1/8"
R 1106, R 1106DT	<b>60/161- 104</b> (TFA.581)	<b>60/162-25</b> (2466)	<b>60/97-36</b> (294/F)		<b>60/240-66</b> (SLT.4419/280) Ht.: 232mm Filet / Thread M40x2
R 1156, R 1156DT			<b>60/97-38</b> (309/F)	<b>60/111-3</b> (1087/PK) (Repl. CAV 296)	<b>60/240-68</b> (SLT.4419/270) Ht.: 186mm Filet / Thread 1 1/8"
R 1306DT Turbo	<b>60/161- 104</b> (TFA.581)	<b>60/162-25</b> (2466)	<b>60/97-22</b> (169)	<b>60/111-4</b> (1193/F) (Repl. CAV 796)	<b>60/240-66</b> (SLT.4419/280) Ht.: 232mm Filet / Thread M40x2

Les références des pièces sont indicatives.  
Nos pièces ne sont pas d'origine.

Part numbers are quoted for reference purposes only.  
Our parts and accessories are not original.



"THE RELIABLE SERVICE"



Tracteurs Tractors	1		2	3	4	
	Air		Huile Oil	Combustible Fuel	Hydraulique Hydraulic	
	Ext. / Out.	Int. / Inn.				
R 1356, R 1356DT	<b>60/161-64</b> (2553)	<b>60/162-64</b> (TFA.734)	<b>60/97-38</b> (309/F)	<b>60/111-4</b> (1193/F) (Repl. CAV 796)	<b>60/240-68</b> (SLT.4419/270) Ht.: 186mm Filet / Thread 1 1/8" (⇔ 12/81)	
R 1506DT Turbo					<b>60/240-67</b> (SLT.4419/320) Ht.: 264mm Filet / Thread M40x2 (01/82 ⇔)	
R 1556DT				<b>60/97-21</b> (121)	<b>60/111-57</b> (1167/F) (⇔ 9/81)	<b>60/240-68</b> (SLT.4419/270) Ht.: 186mm Filet / Thread 1 1/8" (⇔ 9/81)
R 1706DT Turbo					<b>60/111-3</b> (1087/PK) (Repl. CAV 296) (10/81 ⇔)	<b>60/240-67</b> (SLT.4419/320) Ht.: 264mm Filet / Thread M40x2 (10/81 ⇔)
				<b>60/111-4</b> (1193/F) (Repl. CAV 796)	<b>60/240-68</b> (SLT.4419/270) Ht.: 186mm Filet / Thread 1 1/8"	

Les références des pièces sont indicatives.  
Nos pièces ne sont pas d'origine.

Part numbers are quoted for reference purposes only.  
Our parts and accessories are not original.



**FILTRATION - HÜRLIMANN**  
**FILTERS - HÜRLIMANN**

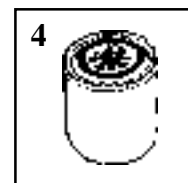
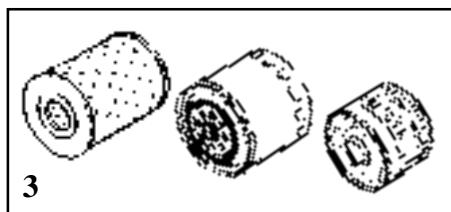
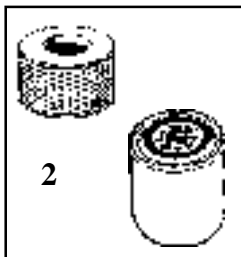
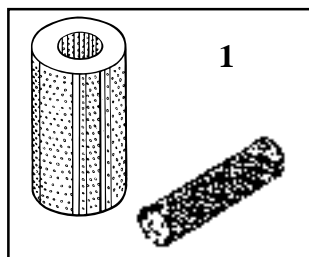

Tracteurs Tractors	1		2	3	4		
	Ext. / Out.	Int. / Inn.	Huile Oil	Combustible Fuel	Hydraulique Hydraulic		
D 60, D 70, D 80, D 100				<b>60/111-33</b> (1008)			
D 95, D 100, D 110, D 115, D 115T, D 150, D 310T			<b>60/97-27</b> (439)	<b>60/111-56</b> (1157/F)			
D 120				<b>60/111-33</b> (1008)			
D 180, D 210, D 310, D 500				<b>60/111-56</b> (1157/F)			
H 35FDT			<b>60/97-36</b> (294/F)	<b>60/111-3</b> (1087/PK) (Repl. CAV 296)	<b>60/240-69</b> (SLT.4419/350) Ht.: 180mm Filet / Thread M40x2		
H 345			<b>60/97-2</b> (599AR/F)				
H 351	<b>60/161-112</b> (TM.254)	<b>60/162-112</b> (TM.255)	<b>60/97-36</b> (294/F)				
H 355, H 360, H 460, H 465, H 470, H 480, H 485	<b>60/161-66</b> (7293) (Conique, fixation 2 pattes Conical, Installed with 2 screws)	<b>60/162-66</b> (7285)					
H 356, H 466, H 466-4	<b>60/161-112</b> (TM.254)	<b>60/162-112</b> (TM.255)					
H 358-4, H 358 Prestige							
H 360	<b>60/161-66</b> (7293) (Conique, fixation 2 pattes Conical, Installed with 2 screws)	<b>60/162-66</b> (7285)					
H 361, H 361 Frutteto	<b>60/161-112</b> (TM.254)	<b>60/162-112</b> (TM.255)					
							<b>60/240-69</b> (SLT.4419/350) Ht.: 180mm Filet / Thread M40x2 (⇨ 12/87)
							<b>60/240-66</b> (SLT.4419/280) Ht.: 232mm Filet / Thread M40x2 (1/88 ⇨)

Les références des pièces sont indicatives.  
Nos pièces ne sont pas d'origine.

Part numbers are quoted for reference purposes only.  
Our parts and accessories are not original.



Tracteurs Tractors	1		2	3	4			
	Air		Huile Oil	Combustible Fuel	Hydraulique Hydraulic			
	Ext. / Out.	Int. / Inn.						
H 362	<b>60/161-112</b> (TM.254)	<b>60/162-112</b> (TM.255)	<b>60/97-36</b> (294/F)	<b>60/111-3</b> (1087/PK) (Repl. CAV 296)	<b>60/240-66</b> (SLT.4419/280) Ht.: 232mm Filet / Thread M40x2			
H 372, H 372DT	<b>60/161-104</b> (TFA.581)	<b>60/162-25</b> (2466)			<b>60/97-22</b> (169)	<b>60/240-69</b> (SLT.4419/350) Ht.: 180mm Filet / Thread M40x2		
H 372 Turbo moteur 1000.3AT engine								
H 460, H 465 moteur 1000.3A engine	<b>60/161-66</b> (7293) (Conique, fixation 2 pattes Conical, Installed with 2 screws)	<b>60/162-66</b> (7285)	<b>60/97-36</b> (294/F)		<b>60/240-69</b> (SLT.4419/350) Ht.: 180mm Filet / Thread M40x2			
H 466-4 moteur 1000.3A engine	<b>60/161-112</b> (TM.254)	<b>60/162-112</b> (TM.255)						
H 468, H 468 Club, H 478, H 478-4, H 478 Prestige	<b>60/161-104</b> (TFA.581)	<b>60/162-25</b> (2466)	<b>60/97-22</b> (169)				<b>60/240-69</b> (SLT.4419/350) Ht.: 180mm Filet / Thread M40x2	
H 476, H 476 Frutteto								
H 488T								
H 490	<b>60/161-102</b> (9516K)	<b>60/162-102</b> (9637)	<b>60/97-38</b> (309/F)					<b>60/96-28</b> (394)
H 496T	<b>60/161-104</b> (TFA.581)	<b>60/162-25</b> (2466)	<b>60/97-22</b> (169)					<b>60/111-4</b> (1193/F) (Repl. CAV 796)
H 4105 Elite			<b>60/97-38</b> (309/F)	<b>60/240-66</b> (SLT.4419/280) Ht.: 232mm Filet / Thread M40x2				
H 5105	<b>60/161-102</b> (9516K) Ht.: 342mm (↔ 8/81)	<b>60/162-102</b> (9637)	<b>60/97-21</b> (121)	<b>60/111-16</b> (1194/F) (↔ 8/81)				
H 5110 moteur 5 cyl. engine						<b>60/161-104</b> (TFA.581) Ht.: 395mm (9/81 ↔)		
H 5116 TURBO	<b>60/161-104</b> (TFA.581)	<b>60/162-25</b> (2466)	<b>60/97-38</b> (309/F)	<b>60/111-4</b> (1193/F) (Repl. CAV 796)				
H 6115T			<b>60/97-21</b> (121)		<b>60/240-66</b> (SLT.4419/280) Ht.: 232mm Filet / Thread M40x2			
H 6125, H 6155	<b>60/161-72</b> (9631)		<b>60/97-38</b> (309/F)					

Les références des pièces sont indicatives.  
Nos pièces ne sont pas d'origine.

Part numbers are quoted for reference purposes only.  
Our parts and accessories are not original.



**"THE RELIABLE SERVICE"**



Tracteurs Tractors	1		2	3	4
	Air		Huile Oil	Combustible Fuel	Hydraulique Hydraulic
	Ext. / Out.	Int. / Inn.			
H 6130	<b>60/161-102</b> (9516K) Ht.: 342mm (Avec ailettes With fins)  ou / or  <b>60/161-83</b> (944) Ht.: 345mm (Sans ailettes Less fin)	<b>60/162-102</b> (9637)     <b>60/162-83</b> (9617)	<b>60/97-38</b> (309/F)	<b>60/111-4</b> (1193/F) (Repl. CAV 796)	
H 6135 Elite moteur 1000.6WT Turbo engine			<b>60/97-22</b> (169)		
H 6136	<b>60/161-104</b> (TFA.581)	<b>60/162-25</b> (2466)	<b>60/97-38</b> (309/F)		<b>60/240-66</b> (SLT.4419/280) Ht.: 232mm Filet / Thread M40x2
H 6136 Turbo					
H 6160 Turbo	<b>60/162-83</b> (944)	<b>60/162-83</b> (9617)	<b>60/97-21</b> (121)		
H 6170T	<b>60/161-64</b> (2553)	<b>60/162-64</b> (TFA.734)			
T 5200, T 6200, T 7700			<b>60/97-2</b> (599AR/F)	<b>60/111-56</b> (1157/F)	

**Références interchangeables Same - Lamborghini - Hürlimann**  
*Cross reference Same - Lamborghini - Hürlimann*

Réf. OEM OEM Ref.	Réf. Cde Order Nr.	Réf. OEM OEM Ref.	Réf. Cde Order Nr.	Réf. OEM OEM Ref.	Réf. Cde Order Nr.	Réf. OEM OEM Ref.	Réf. Cde Order Nr.
001.0780.0	<b>60/111-65</b>	2.4249.050.1	<b>60/161-62</b>	2.4249.131.0	<b>60/161-104</b>	2.4419.130.1	<b>60/97-2</b>
001.0780.7	<b>60/111-33</b>	2.4249.050.4	<b>60/162-8</b>	2.4249.170.6	<b>60/161-8</b>	2.4419.140.1	<b>60/97-4</b>
002.7793.0	<b>60/96-3</b>	2.4249.060.1	<b>60/161-59</b>	2.4249.190.1	<b>60/161-63</b>	2.4419.150.1	<b>60/97-2</b>
002.7794.0	<b>60/96-24</b>	2.4249.060.8	<b>60/161-59</b>	2.4249.250.1	<b>60/161-66</b>	2.4419.170.1	<b>60/97-40</b>
003.1407.0	<b>60/111-28</b>	2.4249.070.2	<b>60/162-59</b>	2.4249.250.2	<b>60/162-66</b>	2.4419.190.1	<b>60/240-46</b>
003.1408.0	<b>60/111-28</b>	2.4249.070.4	<b>60/162-59</b>	2.4249.280.1	<b>60/162-64</b>	2.4419.210.1/10	<b>60/240-68</b>
003.1412.0	<b>60/111-64</b>	2.4249.080.1	<b>60/161-8</b>	2.4249.280.3	<b>60/161-64</b>	2.4419.250.2	<b>60/240-64</b>
003.1413.0	<b>60/111-32</b>	2.4249.080.2	<b>60/162-8</b>	2.4249.290.1	<b>60/161-102</b>	2.4419.260.2	<b>60/240-65</b>
041.1553.0	<b>60/97-38</b>	2.4249.090.1	<b>60/161-54</b>	2.4249.310.0/10	<b>60/161-104</b>	2.4419.270.1	<b>60/240-68</b>
041.1556.0	<b>60/97-38</b>	2.4249.110.1	<b>60/161-62</b>	2.4249.310.4	<b>60/161-104</b>	2.4419.280.1	<b>60/240-66</b>
044.1551.0	<b>60/97-36</b>	2.4249.110.2	<b>60/161-62</b>	2.4249.340.1	<b>60/161-112</b>	2.4419.320.0	<b>60/240-67</b>
044.1567.0	<b>60/97-36</b>	2.4249.120.1	<b>60/162-62</b>	2.4249.340.2	<b>60/162-112</b>	2.4419.340.0	<b>60/97-22</b>
052.1565.0	<b>60/97-21</b>	2.4249.120.5	<b>60/162-62</b>	2.4319.060.1	<b>60/111-3</b>	2.4419.350.0	<b>60/240-69</b>
136.6376-2/10	<b>60/574-15</b>	2.4249.130.0	<b>60/161-104</b>	2.4319.130.1	<b>60/111-4</b>	2.4419.410.0	<b>60/240-68</b>
2.4249.010.1	<b>60/161-87</b>	2.4249.130.1	<b>60/161-60</b>	2.4319.500.1	<b>60/111-56</b>	2.4529.030.9	<b>60/574-15</b>
2.4249.010.6	<b>60/161-87</b>	2.4249.130.2	<b>60/162-25</b>	2.4319.530.3	<b>60/111-64</b>	4 004 608	<b>60/96-3</b>
2.4249.020.1	<b>60/161-54</b>	2.4249.130.7	<b>60/162-25</b>	2.4319.530.4	<b>60/111-32</b>	7016.255.0	<b>60/240-11</b>
2.4249.040.2	<b>60/162-1</b>	2.4249.130.8	<b>60/161-60</b>	2.4419.041.1	<b>60/96-19</b>	9032.259.0	<b>60/96-28</b>
2.4249.040.3	<b>60/162-1</b>	2.4249.130.9	<b>60/162-25</b>	2.4419.100.2	<b>60/97-25</b>		

 Les références des pièces sont indicatives.  
 Nos pièces ne sont pas d'origine.

 Part numbers are quoted for reference purposes only.  
 Our parts and accessories are not original.

ECHAPPEMENTS  
SILENCERS

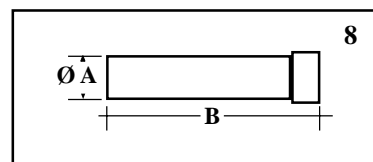
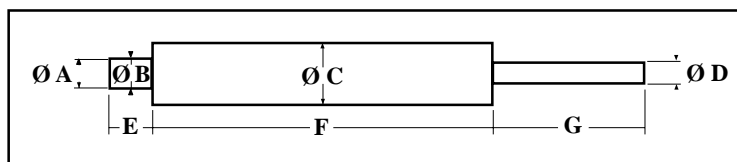
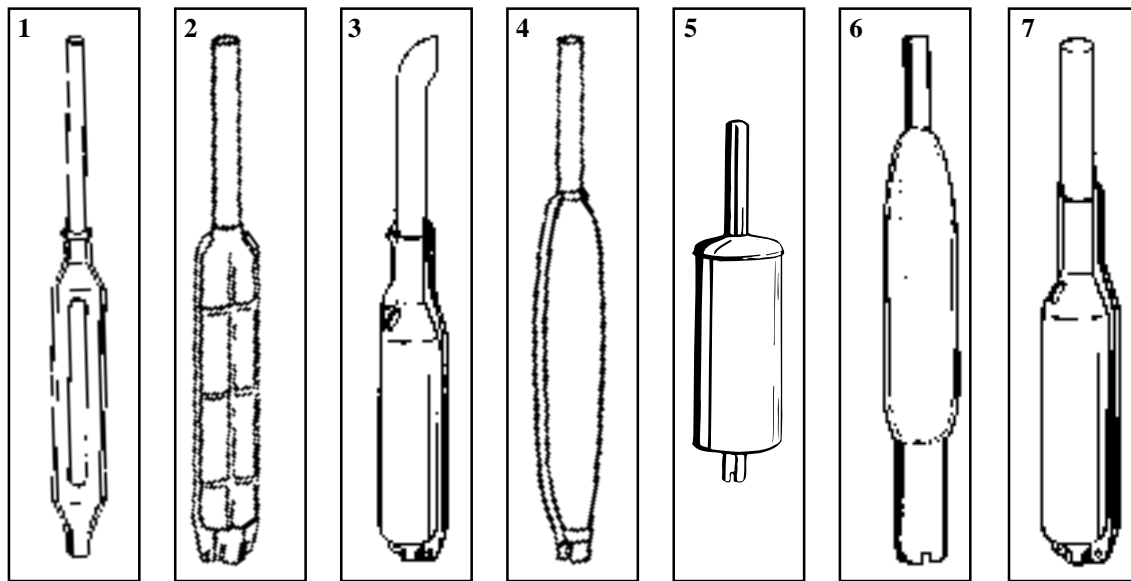

Tracteurs Tractors	Référence Reference	Fig. Fig.	Forme Shape	Tuyau Pipe	ØA	ØB	Ø C1-C2	ØD	E	F	G
H.468 Prestige, H.466, H.476, H.478, H.470 Lamb. 674, 774, 874 Aster 60, Explorer 90 Turbo, Explorer 60, 65, 70, 75, 80	<b>S.255/6303</b> (25556303/30)	4	Rond Round		66	72	120	42	60	700	300
Laser 100, 110, 130 Tiger Six 105, Trident 130, Buffalo 130	<b>S.170/5630</b> (17056303)	2	Rect. Rect.		65	73	178/92	48	40	930	280
Delfino 35, Minitauro 60, Corsaro 70 Synchro	<b>S.150/5610</b> (1505610210)	3	Carré Square		52	60	90/100		50	600	150
Leopard 90 Turbo, Laser 90	<b>S.250/5630</b> (25056303)	7	Rond Round		65	70	150	43	65	650	485
Selon applications Some applications	<b>SLT.5610/65</b>	5	Oval Oval		65	70	90/173	61	70	560	440
	<b>SLT.5610/75</b>				75	78	125/210	70	120	720	290
	<b>SLT.5610/54</b>	1	Carré Square		54	58	93/96	45	110	620	460
	<b>SLT.5610/80</b>	6	Rond Round		80	84	112	50	210	690	435
	<b>SLT.5610/50</b>	1	Rond Round		50	54	98	45	100	660	410
Antares 100 Explorer II -60, 70, 80, 90		8		<b>29/166-10</b> (00839200/20)	80	1115					
Antares 110, 130 Titan 145, 160, 190				<b>29/166-11</b> (00765140/20)	60	1080					



Les références des pièces sont indicatives.  
Nos pièces ne sont pas d'origine.

Part numbers are quoted for reference purposes only.  
Our parts and accessories are not original.

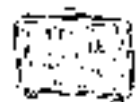

**ECLAIRAGE - PHARES AVANTS**  
**LIGHTING - FRONT LIGHT**

**SAME**

<b>29/8029-900</b>	2.8029.900 2.8029.910.0/10	Optique de phare <i>Front light lens</i>		Explorer série II / <i>Serie</i> Antares 100	
<b>29/7.5269</b>	007.5269.0/10	Optique de phare <i>Front light lens</i>		Antares 110, 130 Titan	
<b>29/8029-670</b>	2.8029.670.0 2.8029.680.0	Phare avant / <i>Front light</i> Fixation par clips / <i>Fitting with clips</i> Droit, modèle asymétrique / <i>Straight, asymmetrical model</i>		Laser, Explorer, Galaxy	
		<u>Grille / Grille</u> : <b>S.8029/342</b> (2.8029.340.2)			
		<u>Glace / Glass</u> : <b>S.8029/341</b> (2.8029.340.1)			
		<u>Joint / Gasket</u> : <b>S.8029/343</b> (2.8029.340.3)			
<b>S.8029/170</b>	2.8029.170.0/11 2.8029.180.0	Phare avant / <i>Front light</i> Fixation par clips / <i>Fitting with clips</i> Inclinaison 8° / <i>8° inclination</i>			(↔ 1979)
		<u>Grille / Grille</u> : <b>S.8029/10N</b> (2.8029.170.1/10)			
		<u>Glace / Glass</u> : <b>S.8029/93</b> (2.8029.090.3)			
		<u>Joint / Gasket</u> : <b>S.8029/94</b> (2.8029.090.4)			
<b>S.8029/160</b>	2.8029.150.0/11 2.8029.160.0	Phare avant / <i>Front light</i> Fixation par clips / <i>Fitting with clips</i> Inclinaison 9° / <i>9° inclination</i>			
		<u>Grille / Grille</u> : <b>S.8029/10N</b> (2.8029.170.1/10)			
		<u>Glace / Glass</u> : <b>S.8029/93</b> (2.8029.090.3)			
		<u>Joint / Gasket</u> : <b>S.8029/94</b> (2.8029.090.4)			
<b>S.8029/340</b>	2.8029.390.0/01 2.8029.400.0/01	Phare avant / <i>Front light</i> Fixation par clips / <i>Fitting with clips</i> Inclinaison 8° / <i>8° inclination</i> Modèle asymétrique / <i>Asymmetrical model</i>		Tous modèles <i>All models</i> 1973-1983	
		<u>Grille / Grille</u> : <b>S.8029/342</b> (2.8029.340.2)			
		<u>Glace / Glass</u> : <b>S.8029/341</b> (2.8029.340.1)			
		<u>Joint / Gasket</u> : <b>S.8029/343</b> (2.8029.340.3)			

Les références des pièces sont indicatives.  
Nos pièces ne sont pas d'origine.







Part numbers are quoted for reference purposes only.  
Our parts and accessories are not original.





**ECLAIRAGE - PHARES AVANTS**  
**LIGHTING - FRONT LIGHT**

**LAMBORGHINI - HÜRLIMANN**

<b>29/8029-900</b>	2.8029.900	Optique de phare <i>Front light lens</i>		Séries 674, 774, 874 <i>Series</i>
<b>29/8029-700</b>	2.8029.700.0/10	Optique de phare <i>Front light lens</i>		Séries 956, 1256, 1356 <i>Series</i>
<b>S.8029/630</b>	2.8029.630.0	Phare avant / <i>Front light</i> Fixation par vis / <i>Screw connection</i> Droit / <i>Straight</i>  <u>Grille / Grille</u> : <b>S.8029/10N</b> (2.8029.170.1/10) <u>Glace / Glass</u> : <b>S.8029/93</b> (2.8029.090.3) <u>Joint / Gasket</u> : <b>S.8029/94</b> (2.8029.090.4)		Suivant applications <i>Some applications</i>
<b>SLT.8029/620</b>	2.8029.260.0	Phare avant / <i>Front light</i> Fixation par clips / <i>Fitting with clips</i> Inclinaison 8° / <i>8° inclination</i>  <u>Grille / Grille</u> : <b>S.8029/10N</b> (2.8029.170.1/10) <u>Glace / Glass</u> : <b>S.8029/93</b> (2.8029.090.3) <u>Joint / Gasket</u> : <b>S.8029/94</b> (2.8029.090.4)		Suivant applications <i>Some applications</i>
<b>SLT.8029/660</b>	2.8029.660.0	Phare avant / <i>Front light</i> Fixation par clips / <i>Fitting with clips</i> Inclinaison 8° / <i>8° inclination</i> Modèle asymétrique / <i>Asymetrical model</i>  <u>Grille / Grille</u> : <b>S.8029/342</b> (2.8029.340.2) <u>Glace / Glass</u> : <b>S.8029/341</b> (2.8029.340.1) <u>Joint / Gasket</u> : <b>S.8029/343</b> (2.8029.340.3)		Suivant applications <i>Some applications</i>
<b>27/1700HU</b>	2.8029.410.0	Phare complet / <i>Complete front light</i>  <u>Glace / Glass</u> : <b>27/1701HU</b>		H.360, H.370
<b>SLT.8029/310</b>	2.8029.310.0/10	Optique de phare Ø 144mm <i>Front light lens Ø 144mm</i>		573, 673, R.654, R.674, R.684
<b>SLT.188/250</b>		Cercle de phare <i>Light circle</i>		
<b>SLT.30/3323</b>		Coiffe <i>Cowl</i>		





Les références des pièces sont indicatives.  
Nos pièces ne sont pas d'origine.

Part numbers are quoted for reference purposes only.  
Our parts and accessories are not original.





**ECLAIRAGE - FEUX DE POSITION & CLIGNOTANTS**  
**LIGHTING - SIDE LIGHTS & INDICATORS**

**SAME**

<b>S.8019/20</b>	2.8019.200.0/02	<u>Cabochon / Glass</u> : <b>S.8019/201</b> (2.8019.200.1)		Suivant applications <i>Some applications</i>
<b>S.8019/400</b>	2.8019.480.0/02	<u>Cabochon / Glass</u> : <b>S.8019/481</b>		Taurus, Centurion
<b>S.8019/960</b> (G/LH)	2.8019.960.0/02 402067AA	<u>Cabochon / Glass</u> : <b>S.8019/201</b>		Laser 110 Titan 145-160-190 Antares 100 Aster 60-70 Explorer II 60-70-80-90
<b>S.8019/970</b> (D/RH)	2.8019.970.0/02			
<b>S.8019/720</b>	2.8019.720.0/10			Suivant applications <i>Some applications</i>

**LAMBORGHINI - HÜRLIMANN**

<b>S.8019/20</b>	2.8019.200.0/02	<u>Cabochon / Glass</u> : <b>S.8019/201</b> (2.8019.200.1)		Suivant applications <i>Some applications</i>
<b>S.8019/159</b> (D/RH)	400481AA	169 x 62 mm		Suivant applications <i>Some applications</i>
<b>S.8019/158</b> (G/LH)	400480AA	<u>Cabochons / Glass</u> : <b>S.8019/161</b> (D/RH) (2.8019.460.1)  <b>S.8019/160</b> (G/LH) (2.8019.470.1)		





Les références des pièces sont indicatives.  
Nos pièces ne sont pas d'origine.

Part numbers are quoted for reference purposes only.  
Our parts and accessories are not original.





**ECLAIRAGE - FEUX ARRIÈRES**  
**LIGHTING - REAR LIGHTS**

**SAME**

<b>S.8019/19</b>		Eclaire-plaque amovible <i>Removable number plate light</i>  <u>Cabochon / Glass</u> : <b>S.8019/181</b> (2.8019.860)		Same Delfino, Centaurio, Drago, Minitauro, Tiger
<b>S.8019/430</b> (D/RH)	2.8019.490.0/02	Avec éclaire-plaque / <i>With number plate light</i>  <u>Cabochons / Glass</u> : <b>S.8019/490</b> (D/RH) (2.8019.490.1)		Centurion 75
<b>S.8019/420</b> (G/LH)	2.8019.740.0/02	<b>S.8019/740</b> (G/LH) (2.8019.740.1)		
<b>SLT.8059/090</b> (D/RH)	2.8059.090.0/02 2.8059.160.0	177 x 81 mm  <u>Cabochons / Glass</u> : <b>SLT.8059/091</b> (D/RH) (2.8059.090.1)		Explorer
<b>SLT.8059/080</b> (G/LH)	2.8059.150.0, 2.8059.080.0	<b>SLT.8059/081</b> (G/LH) (2.8059.080.1)		
<b>29/8019-980</b> (D/RH)	2.8019.980.0/20	280 x 120mm  <u>Cabochons / Glass</u> : <b>29/8019-981</b> (D/RH) (2.8019.980.1)		Laser
<b>29/8019-990</b> (G/LH)	2.8019.990.0/20	<b>29/8019-991</b> (G/LH) (2.8019.990.1)		
<b>29/8059-010</b>		Eclaire-plaque / <i>Number plate light</i>		Explorer Laser-Galaxy

**LAMBORGHINI - HÜRLIMANN**

<b>S.8019/19</b>		Eclaire-plaque amovible <i>Removable number plate light</i>  <u>Cabochon / Glass</u> : <b>S.8019/181</b> (2.8019.860)		Séries 503, 653, 953, 956 Series
<b>S.8019/2351</b> (D/RH)	2.8019.440.0 400483AA	300 x 60mm  <u>Cabochons / Glass</u> : <b>S.8019/2353</b> (D/RH) (2.8019.400.1)		Suivant applications <i>Some applications</i>
<b>S.8019/2350</b> (G/LH)	2.8019.450.0 400482AA	<b>S.8019/2352</b> (G/LH) (2.8019.450.1)		
<b>SLT.8059/090</b> (D/RH)	2.8059.090.0/02 2.8059.160.0	177 x 81 mm  <u>Cabochons / Glass</u> : <b>SLT.8059/091</b> (D/RH) (2.8059.090.1)		H.356, H.466, H.478, H.488, R.674, 774, 874
<b>SLT.8059/080</b> (G/LH)	2.8059.150.0, 2.8059.080.0	<b>SLT.8059/081</b> (G/LH) (2.8059.080.1)		

Les références des pièces sont indicatives.  
Nos pièces ne sont pas d'origine.

Part numbers are quoted for reference purposes only.  
Our parts and accessories are not original.

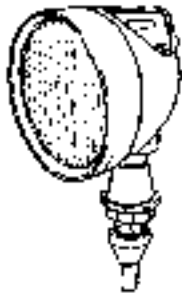

**ECLAIRAGE - PHARES DE TRAVAIL**  
**LIGHTING - PLOUGH LAMPS**

<b>S.8029/2T</b>	280293000	<p>Ø 105mm - Avec interrupteur Ø 105mm - With switch</p> <p><u>Ampoule / Bulb</u> : <b>63/1955-96</b> (Ex. : 10/12247) 12V, 45W</p> <p><u>Glace / Glass</u> : <b>S.8029/590</b></p>	
<b>29/8029.460</b>	280294600	<p>Ø 125mm - Avec interrupteur Ø 125mm - With switch</p> <p><u>Ampoule / Bulb</u> : <b>63/1955-96</b> (Ex. : 10/12247) 12V, 45W</p> <p><u>Glace / Glass</u> : <b>29/8029/461</b></p>	
<b>SLT.8029/450</b>	280294400	<p>Ø 130mm - Avec interrupteur Ø 130mm - With switch</p> <p><u>Ampoule / Bulb</u> : <b>63/1955-453</b> (Ex. : 10/12336) H3, 12V, 55W</p> <p><u>Optique / Front light lens</u> : <b>29/8029/440</b></p>	

**63/1931-3**  
(ET.5171)

*TWIN-POWER*

Réflecteur à surface complexe  
Boîtier plastique anti-choc  
Très large amplitude  
Halogène H3 - Sans poignée

*Work lamp with free-form reflector  
Extremely wide-angled illumination  
Halogen H3 - Less handle*



Ampoules / Bulbs : **63/1955-453** (12V./55W)(2x)  
(Ex : 10/12336)

**63/1931-5**  
(10/W.394)

Phare orientable 360°  
Halogène H3 - 112 x 126mm  
(Glace : 82 x 82mm)

*Adjustable lamp 360°  
Halogen H3 - 112 x 126mm  
(Glass : 82 x 82mm)*



Ampoule / Bulb : **63/1955-453** (12V./55W)  
(Ex : 10/12336)

**63/1934-5** (ET.131) Support de 1931-5 / Bracket for 1931-5

**63/1931-4**  
(ET.1253/F)

Halogène H3  
Avec interrupteur

*Halogen H3  
With switch*

Ampoule / Bulb : **63/1955-453** (12V./55W)  
(Ex : 10/12336)

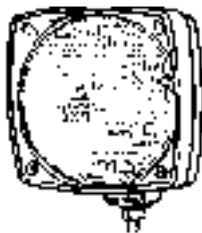

**63/1931-6**  
(ET.1251/H)

182 x 100mm  
Halogène H3  
Halogen H3

Ampoule / Bulb : **63/1955-453** (12V./55W)  
(Ex : 10/12336)

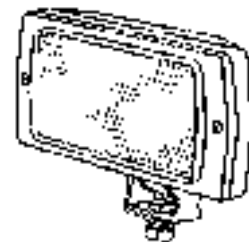

Les références des pièces sont indicatives.  
Nos pièces ne sont pas d'origine.

Part numbers are quoted for reference purposes only.  
Our parts and accessories are not original.



**BOUTONS POUSSOIRS**  
**BUTTONS**

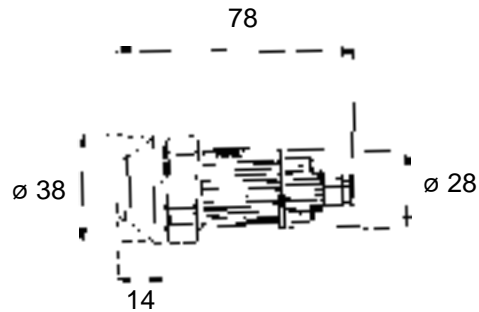

	Réf. Ref.	OEM	Description Description
	63/1884-4	S.L.H. 008.1277.0	Automatique Bouton poussoir "Push push" avec éclairage 12V <i>Automatic Push push switches with 12 V bulb</i>
	63/1884-5	S.L.H. 2.7659.111.0	Feu de travail arrière Bouton poussoir "Push push" avec éclairage 12V <i>Back side lights Push push switches with 12 V bulb</i>
	63/1884-6	S.L.H. 2.7659.109.0	Feu de travail avant Bouton poussoir "Push push" avec éclairage 12V <i>Front side light Push push switches with 12 V bulb</i>
	63/1884-7	S.L.H. 27659.118.0	Gyrophare Bouton poussoir "Push push" avec éclairage 12V <i>Rotating light Push push switches with 12 V bulb</i>
	63/1884-8	S.L.H. 008.1335.0	Blocage du différentiel Bouton poussoir "Push push" avec éclairage 12V <i>Differential lock Push push switches with 12 V bulb</i>
	63/1884-9	S.L.H. 007.5944.0/20	Blocage du différentiel Bouton poussoir "Push push" avec éclairage 12V <i>Differential lock Push push switches with 12 V bulb</i>
	63/1884-10	S.L.H. 007.5945.0/20	Enclenchement du pont avant Bouton poussoir "Push push" avec éclairage 12V <i>4 wheel drive Push push switches with 12 V bulb</i>
	63/1884-11	S.L.H. 2.7659.110.0	Feu de détresse Bouton poussoir "Push push" avec éclairage 12V <i>Hazard Push push switches with 12 V bulb</i>
	63/1884-12	S.L.H. 2.7659.113.0	Arrêt moteur Bouton poussoir "Push push" avec éclairage 12V <i>Engine stop Push push switches with 12 V bulb</i>
	63/1884-14	S.L.H. 2.7659.108.0/10	Commande de prise de force Bouton poussoir "Push push" avec éclairage 12V <i>P.T.O. command Push push switches with 12 V bulb</i>
	63/1884-20	S.L.H. 008.80490	Monter/descendre Bouton poussoir "Push" avec éclairage 12V <i>Lift &amp; lower Push switches with 12 V bulb</i>

Les références des pièces sont indicatives.  
Nos pièces ne sont pas d'origine.

Part numbers are quoted for reference purposes only.  
Our parts and accessories are not original.



**INSTRUMENTS DE BORD**  
**INSTRUMENTS (MISCELLANEOUS)**

**COMPTE-HEURES**  
**TACHOMETER**

**S.7049/610** Saturno, Corsaro, Mercury,  
(270494300) Centurion, Centauro,  
Taurus, Trident,  
Tiger, Leopard, Jaguar



**S.7049/270** Drago, Buffalo,  
(270493200) Saturno, Corsaro

**S.7049/660** Explorer 65, 70, 75, 80, 90  
(27049660) Lamborghini : 674, 774, 874

**RENOVI**  
**GEAR DRIVE**

**S.7049/670** Explorer 65, 70, 75, 80, 90  
Lamborghini :  
674, 774, 874



**CABLES D'ARRET**  
**STOP CABLE**

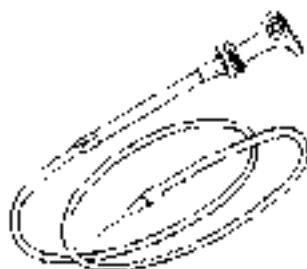

**S.169/6730** Tiger Lg. : 795mm

**29/169-6730** Buffalo, Tiger

**TRANSMISSIONS FLEXIBLES**  
**DRIVE CABLES**



**S.154/7464** Drago, Buffalo

**S.158/7450** Corsaro, Saturno

**S.167/7451** Same :  
Buffalo, Leopard, Centurion, Hercule,  
Taurus, Tiger, Jaguar  
Lamborghini : 754  
Hürlimann : 490

**S.179/7435** Minitauro, Corsaro

**29/235.7435** Explorer 55, 65, 70  
Trident

**29/255.7435** Explorer 75, 80,85, 90 (≠1 Série/Serie)  
Lamborghini : 674, 774, 874

**26/290.7435** Explorer 75, 80,85, 90 (≠2 Série/Serie)

**29/264.7435** Laser 90, 100, 110, 130, 150  
Galaxy

**S.150/7462** Same :  
Delfino 32  
Lg. : 1150mm

**SLT.150/7450** Lamborghini :  
R854, 855, 1056, 1156  
Lg. : 1000mm

**CONNECTEUR**  
**PLUG SOCKET**

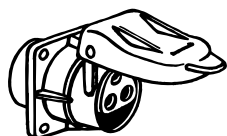

**10/250110**  
Prise 2 pôles  
2 point socket poles



**10/250331**  
Prise 2 pôles  
2 point socket poles

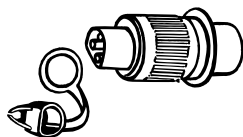

**10/250112**  
Fiche 2 pôles  
2 point socket

Les références des pièces sont indicatives.  
Nos pièces ne sont pas d'origine.

Part numbers are quoted for reference purposes only.  
Our parts and accessories are not original.



**INSTRUMENTS DE BORD**  
**INSTRUMENTS (MISCELLANEOUS)**

**INTERRUPTEURS RECTANGULAIRES**  
**RECTANGULAR SWITCHES**



- S.7659/23** Eclairage 3 positions - 7 plots  
*Lighting 3 positions - 7 plugs*
- S.7659/30** Polyvalent - 2 plots  
*Polyvalent - 2 plugs*
- S.7659/64** Phare de travail avant - 5 plots  
*Front plough lamps - 5 plugs*
- 29/7659.065** Phare de travail arrière - 5 plots  
*Rear plough lamps - 5 plugs*
- S.8819/090** Phare de travail 36x18,5  
*Plough lamps 36x18,5*
- S.8819/110** Ventilation  
*Ventilation*
- S.7659/070** Essuie & lave-glaces  
*Wiper*  
Antares 100, Aster 60, 70  
Explorer II 60, 70, 80, 90

**INTERRUPTEURS CLIGNOTANTS**  
**INDICATORS SWITCHES**

**S.7649/4**

Same  
Lamborghini



**INTERRUPTEURS FEUX "STOP" & "PTO"**  
**LIGHTS "STOP" & "PTO" SWITCH**

**S.7649/5**  
(276490500/10)



**INTERRUPTEURS-SELECTEUR "PTO"**  
**"PTO" SWITCH**

- 29/7649-100** Sélecteur 540/1000T  
*Switch 540/1000T*  
**Same**  
Antares, Titan  
**Lamborghini**  
Selon équipement  
*According fitment*  
**Hürlimann**



**POUSSOIR AVERTISSEUR**  
**HORN SWITCH**

**S.7409/17**  
(2.8819.010.0)



**BOITE CLIGNOTANTE**  
**FLASHING UNIT**

**29/8639-003** 6 broches/6 pins  
2+1+1(8)x21W

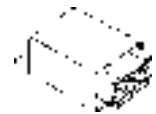

**BOITE A FUSIBLES**  
**FUSE HOLDERS**

**S.7719/002** 6 fusibles/6 fuses  
**S.7719/004** 8 fusibles/8 fuses  
**29/7719-12** 12 fusibles/12 fuses



**INDICATEURS LUMINEUX**  
**ROCKERS INDICATORS SWITCHES**



- S.8339/028** Rouge, préchauffage  
*Red, Starter switch*  
Vert, indicateur direction  
*Green, gauge steering*
- S.8339/031** Rouge, PTO  
*Red, PTO*  
Vert, indicateur direction  
*Green, gauge steering*
- S.8339/020** Vert/vert, remorques  
*Green/green, Trailers*
- S.8339/600** Rouge/rouge, sans sigles  
*Red/red, less acronym.*
- S.8339/019** Rouge, alternateur  
*Red, alternator*  
Rouge, pression d'huile  
*Red, Oil pressure switch*
- S.8339/018** Bleu, feux avant  
*Blue, front lights*  
Rouge, niveau carburant  
*Red, Fuel gauge*

Les références des pièces sont indicatives.  
Nos pièces ne sont pas d'origine.

Part numbers are quoted for reference purposes only.  
Our parts and accessories are not original.



**INSTRUMENTS DIVERS**  
**INSTRUMENTS (MISCELLANEOUS)**

**RELAIS**  
**RELAIS**

<b>29/7659.016</b> (1.8050.000)		4 plots/plugs
<b>29/7659.017</b> (1.8049.000)		3 plots/plugs
<b>29/7659.018</b> (1.8038.000)		4 plots/plugs
<b>29/7659.019</b> (1.8098.000)		5 plots/plugs
<b>29/7659.099</b> (1.8073.000)		5 plots/plugs
<b>S.7659/027</b> (1.8064.000)		5 plots/plugs
<b>29/7659.028</b> (1.8059.000)		5 plots/plugs

**INTERRUPTEURS COMBINES**  
**STEERING COLUMN SWITCHES**



<b>S.199/8551</b>	R.653, 1256, 603
<b>29/254.8450</b>	R.653, 654, 1256
<b>S.005/1849</b>	Titan
<b>29/7650.054</b> (276590540)	Explorer, Laser, Galaxy
<b>S.008/1268</b> (00812684/20)	Same : Antares 110, 130 Titan 145, 160, 190  Lamborghini : Formula 115, 135 Racing 150, 165, 190  Hürlimann : Elite

**CONTACTEURS D'ECLAIRAGE**  
**LICHTING SWITCHES**



**S.7410/1** 0/1/2/3  
Plots : 3 simples, 2 doubles  
Plugs : 3 singles, 2 doubles



**S.7409/3** 0/1/2/3 + claxon/horn  
(2.7409.030.0) Plots : 5 simples  
Plugs : 5 singles

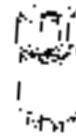

**S.7409/060** 0/1/2/3 + claxon/horn  
(2.7409.060.0) Plots : 4 simples, 1 double  
Plugs : 4 singles, 1 double

**REFROIDISSEUR D'HUILE**  
**OIL COOLER**

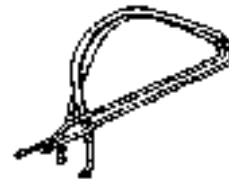

<b>S.2115/422K</b>	Centauro, Leone (Paire/paar)
<b>S.37/1542</b>	Drago Gauche/LH
<b>S.37/1543</b>	Drago Droit/RH

Les références des pièces sont indicatives.  
Nos pièces ne sont pas d'origine.

Part numbers are quoted for reference purposes only.  
Our parts and accessories are not original.





**MECANISMES & DISQUES D'EMBRAYAGE**  
**CLUTCH ASSEMBLIES & PLATES**



**SAME**

Tracteurs Tractors	Embrayage Clutch		Disque Plate		Butée de débrayage Release Bearing
	Ø	N°	Ø	N°	
Antares 100 Row Crop 90 (1358 ⇔) Silver 100.6 (⇔ 3222)	310 DF Valéo	<b>29/200- 500</b> Ø Ext. / Out. 368 mm (008.4293.3) (131 0229 30)	310	<b>29/221-501</b> TC-LT 24Z 36x40 (008.4292.3) (331 0184 30)	<b>29/231-500</b> 55x91x26 (2.2999.193.0) (500 0076 20)
	310 DF B. & B.	<b>29/200- 501</b> Ø Ext. / Out. 365 mm (294.2320.3) (131 0228 50)	310	<b>29/221-502</b> TF 24Z 36x40 (445.2330.3) (331 0179 36)	
	330 DV Valéo	<b>29/200-502</b> (008.4184.3) (133 0220 30)	330	<b>29/221-503</b> TC-LT 24Z 36,5x41 (009.6533.3) (333 0116 30)  <b>29/221-504</b> TF 24Z 36,5x41 (008.9937.3) (333 0117 30)	<b>29/231- 501</b> MV Lg. 213 mm (2.2999.207.0) (500 0846 30)
Antares 100 110 II (⇔ 4243) 127 130 (⇔ 2026)	330 DV	<b>29/200-502</b> (008.4184.3) (133 0220 30)	330	<b>29/221-505</b> TC-LT 21Z 41x45 (009.9769.3) (333 0115 30)	
Antares 130 (2027 ⇔) 130 II 130 V	350 DV	<b>29/200-503</b> (008.5595.3) (135 0241 10)	348	<b>29/221-506</b> TC-LT 21Z 41x45 (0.008.5596.3) (335 0186 10)	
Argon 50	250/250 GU6	<b>29/200-504</b> (122.564.4) (225 0055 10)	250 LG	<b>29/221-507</b> UF 20Z 36x40 (122.565.3) (325 0198 10)	<b>29/231-502</b> 50x82 / 90x22 (2.2999.153.0) (500 0459 00)  <b>29/231-503</b> 65x100x18 (2.2021.017.0)
			225 LM	<b>29/212-501</b> UF 10Z 22x25 (119.063.3) (323 0556 10)	

Les références des pièces sont indicatives.  
Nos pièces ne sont pas d'origine

Part numbers are quoted for reference purposes only.  
Our parts and accessories are not original.



**MECANISMES & DISQUES D'EMBRAYAGE**  
**CLUTCH ASSEMBLIES & PLATES**

Tracteurs Tractors	Embrayage Clutch		Disque Plate		Butée de débrayage Release Bearing
	Ø	N°	Ø	N°	
Argon 60 70  Frutetto 85 II Rock 55, 60, 70	280/280 GU6	<b>29/200-505</b> (122.574.4) (228 0133 10)	280 LG	<b>29/221-508</b> UC-LT 20Z 36x40 (122.577.3) (328 0378 12)	<b>29/231-502</b> 50x82 / 90x22 (2.2999.153.0) (500 0459 00)  <b>29/231-503</b> 65x100x18 (2.2021.017.0)
280 LM			<b>29/212-502</b> UC-LQ 14Z 22x25 (119.073.3) (328 0377 11)		
Argon  Frutetto 60 II 75 II Rock 55, 60	280/280 GU6	<b>29/200-506</b> (122.571.4) (228 0133 11)	280 LG	<b>29/221-509</b> UC-LS 20Z 36x40 (122.572.3) (328 0378 11)	<b>29/230-500</b> AU (2.2041.008.0)
280 LM			<b>29/212-503</b> UC-LR 14Z 22x25 (119.067.3) (328 0377 10)		
Ariette	350/350 SAME		350 LG	<b>29/221-528</b> UF 24Z 46x50 (263.2313.8)	
350 LG			<b>29/221-510</b> UF-VZ 24Z 46x50		
350 LG			<b>29/221-511</b> TF-VZ 24Z 46x50 (154.2213.3/10)		
350 LG			<b>29/221-512</b> UC-LT 24Z 46x50		
350 LM			<b>29/212-504</b> UF 17Z 28x32 (154.2222.3)		
Aster 60, 70 Suite page suivante <i>Continuation on following page</i>	280/280 GU6 Valéo	<b>29/200-507</b> DV	280 LG	<b>29/221-513</b> UC-LS 20Z 36x40 (328 0017 11)	<b>29/231-502</b> 50x82 / 90x22 (2.2999.153.0) (500 0459 00)
			280 LM	<b>29/212-505</b> UF 14Z 22x25 (422.2222.3/20)	
	280/280 GU6 Luk	<b>29/200-508</b> DV-AA-AN (228 0040 12)	280 LG	<b>29/221-513</b> UC-LS 20Z 36x40 (328 0017 11)	<b>29/231-504</b> 70x110x20  <b>29/230-500</b> AU (2.2041.008.0)
			280 LM	<b>29/212-506</b> UF 14Z 22x25 (84751.3/10) (328 0318 30)	

Les références des pièces sont indicatives.  
Nos pièces ne sont pas d'origine

Part numbers are quoted for reference purposes only.  
Our parts and accessories are not original.



**"THE RELIABLE SERVICE"**



**MECANISMES & DISQUES D'EMBRAYAGE**  
**CLUTCH ASSEMBLIES & PLATES**

Tracteurs Tractors	Embrayage Clutch		Disque Plate		Butée de débrayage Release Bearing
	Ø	N°	Ø	N°	
Aster 60, 70 Suite de la page précédente <i>Continuation from the previous page</i>	280/280 GU6 Luk	<b>29/200-509</b> DV (228 0040 13)	280 LG	<b>29/221-514</b> UF 20Z 36x40 (328 0017 16)	<b>29/231-502</b> 50x82 / 90x22 (2.2999.153.0) (500 0459 00)
			280 LM	<b>29/212-506</b> UF 14Z 22x25 (84751.3/10) (328 0318 30)	
Atlanta 55	250/280 SAME		250 LK	<b>29/212-507</b> UF-VZ 20Z 36x40 (0.146.2222.3/10)	
			280 LN	<b>29/221-515</b> VZ 10Z 23x29	
Aurora 45	230/250 SAME		230 LK	<b>29/212-508</b> UF 14Z 36x40	
			250 LN	<b>29/221-516</b> TF 10Z 21x25	
Buffalo 130	350 G3 SAME		350	<b>29/221-517</b> UC-MH 24Z 46x50 (212.2359.3/10) (335 0162 30)	<b>29/231-505</b> 65x102x27
			350	<b>29/221-510</b> UF-VZ 24Z 46x50	
			350	<b>29/221-511</b> TF-VZ 24Z 46x50 (154.2213.3/10)	
			350	<b>29/221-512</b> UC-LT 24Z 46x50	
Drago Drago 120	350/350 GU6 SAME		350 LG	<b>29/221-528</b> UF 24Z 46x50 (263.2313.8)	
			350 LG	<b>29/221-510</b> UF-VZ 24Z 46x50	
			350 LG	<b>29/221-511</b> TF-VZ 24Z 46x50 (154.2213.3/10)	
			350 LG	<b>29/221-512</b> UC-LT 24Z 46x50	
			350 LM	<b>29/212-504</b> UF 17Z 28x32 (154.2222.3)	

Les références des pièces sont indicatives.  
Nos pièces ne sont pas d'origine

Part numbers are quoted for reference purposes only.  
Our parts and accessories are not original.



**MECANISMES & DISQUES D'EMBRAYAGE**  
**CLUTCH ASSEMBLIES & PLATES**

Tracteurs Tractors	Embrayage Clutch		Disque Plate		Butée de débrayage Release Bearing
	Ø	N°	Ø	N°	
Centauro 60 Export 70 Corsaro 70	250/290 G3 SAME		250 LK  290 LN  290	<b>29/212-509</b> UF-VZ 22Z 41x45 (135.2222.3)  <b>29/221-518</b> UF-VZ 10Z 23x29 (157.2213.3)  <b>29/221-519</b> UC-VZ 10Z 23x29	29/231-505 65x102x27
Centurion 75 (nr. 3371⇒)  Leone 70, 80 Saturno 80 Mercury 85	265/320 GU6 SAME		265 LK  320 LN  320 LN  320 LN	<b>29/212-510</b> UF-VZ 22Z 41x45 (136.2222.3/10)  <b>29/221-520</b> UF-VZ 10Z 23x29  <b>29/221-521</b> TF-VZ 10Z 23x29  <b>29/221-522</b> TC-ML-VZ 10Z 23x29	
Condor 55 Corsaro 70 /S  Falcon 50 Frutteto 60 Minitauro 60 Minitaurus 60 Taurus 60 Vigneron 60	250/280 GU6 Luk  250/280 GU6 Valéo	<b>29/200- 510</b> DF Sans moyeu de commande de pompe hydraulique <i>Less hydraulic pump drive hub</i>  (194.2210.4) (228 0067 11)	250 LK  250 LK  280 LN  280 LN	<b>29/212-511</b> UF 20Z 36x40 (194.2222.3) (325 0114 16)  <b>29/212-512</b> VZ 20Z 36x40  <b>29/221-523</b> TF 14Z 22x25 (194.2213.3) (328 0127 16)  <b>29/221-524</b> UF 20Z 36x40 (203.2222.3)  <b>29/212-513</b> TF 14Z 22x25 (283.2213.3) (328 0270 36)  <b>29/221-527</b> VZ 14Z 22x25	

Les références des pièces sont indicatives.  
Nos pièces ne sont pas d'origine

Part numbers are quoted for reference purposes only.  
Our parts and accessories are not original.



**"THE RELIABLE SERVICE"**



**MECANISMES & DISQUES D'EMBRAYAGE**  
**CLUTCH ASSEMBLIES & PLATES**

Tracteurs Tractors	Embrayage Clutch		Disque Plate		Butée de débrayage Release Bearing
	Ø	N°	Ø	N°	
Dorado 60, 70 /DT	310 DF Valéo	<b>29/200-500</b> Ø Ext. / Out. 368 mm (008.4293.3) (131 0229 30)	310	<b>29/221-501</b> TC-LT 24Z 36x40 (008.4292.3) (331 0184 30)	
	310 DF B. & B.	<b>29/200-501</b> Ø Ext. / Out. 365 mmm (294.2320.3) (131 0228 50)	310	<b>29/221-502</b> TF 24Z 36x40 (445.2330.3) (331 0179 36)	
Explorer 55, 60, 65 Same 65	280 DF Valéo 6 goujons 6 studs	<b>29/200-511</b> (255.2320.3/10) (128 0248 30)	280	<b>29/221-526</b> TF 24Z 36x40 (270.2330.3/10)	<b>29/231-500</b> 55x91x26 (2.2999.193.0) (500 0076 20)
	280 DF B. & B. 8 goujons 8 studs	<b>29/200-512</b> (255.230.3) (128 0243 50)			
Explorer 70, 75, 80, 90 70 II /DT (⇒ 22091) 90 /DT  Spécial / Special 70, 70 II Spécial / Special Basso 70 II 80 II /LP Top 90 II Golden Compatto 75 85 /DT Row Crop 90 /DT (⇒ 1357)	310 DF Valéo	<b>29/200-500</b> Ø Ext. / Out. 368 mm (008.4293.3) (131 0229 30)	310	<b>29/221-501</b> TC-LT 24Z 36x40 (008.4292.3) (331 0184 30)	
	310 DF B. & B.	<b>29/200-501</b> Ø Ext. / Out. 365 mmm (294.2320.3) (131 0228 50)	310	<b>29/221-502</b> TF 24Z 36x40 (445.2330.3) (331 0179 36)	
Explorer 80 II /DT  Spécial 80 (⇒ 15592) 80 /LP 80 II /LP 90 (⇒ 2974) 90 /LP (⇒ 1075) Top 90 II Silver 80, 90, 100.4	330 DV Valéo	<b>29/200-502</b> (008.4184.3) (133 0220 30)	330	<b>29/221-503</b> TC-LT 24Z 36,5x41 (009.6533.3) (333 0116 30)	<b>29/231-501</b> MV lg. 213 mm (2.2999.207.0) (500 0846 30)
				<b>29/221-504</b> TF 24Z 36,5x41 (008.9937.3) (333 0117 30)	
Falcon N°3241⇒	250/280 3GU SAME		280 LN	<b>29/221-527</b> VZ 14Z 22x25	<b>29/231-505</b> 65x102x27
			250 LK	<b>29/212-507</b> VZ 20Z 36x40 (146.2222.3/10)	

Les références des pièces sont indicatives.  
Nos pièces ne sont pas d'origine

Part numbers are quoted for reference purposes only.  
Our parts and accessories are not original.



**"THE RELIABLE SERVICE"**



**MECANISMES & DISQUES D'EMBRAYAGE**  
**CLUTCH ASSEMBLIES & PLATES**

Tracteurs Tractors	Embrayage Clutch		Disque Plate		Butée de débrayage Release Bearing		
	Ø	N°	Ø	N°			
Frutetto 60 II, 75 II ⇒ Voir / See Argon							
Frutetto 85 II ⇒ Voir / See Argon 60							
Galaxy 170	350 DV Valéo	<b>29/200-513</b> (269.2310.4) (135 0230 30)	350	<b>29/221-517</b> UC-MH 24Z 46x50 (212.2359.3/10) (335 0162 30)			
	350 SAME		350			<b>29/221-512</b> UC-LT 24Z 46x50	
			350			<b>29/221-528</b> UF 24Z 46x50 (263.2313.8)	
			350			<b>29/221-510</b> UF 24Z 46x50	
			350			<b>29/221-511</b> TF 24Z 46x50 (154.2213.3/10)	
Golden Compatto 75, 85 /DT ⇒ Voir / See Explorer							
Hercules 160	350 DV Valéo	<b>29/200-513</b> (269.2310.4) (135 0230 30)	350	<b>29/221-517</b> UC-MH 24Z 46x50 (212.2359.3/10) (335 0162 30)			
	350 SAME		350			<b>29/221-512</b> UC-LT 24Z 46x50	
			350			<b>29/221-510</b> UF 24Z 46x50	<b>29/231-505</b> 65x102x27
			350			<b>29/221-511</b> TF 24Z 46x50 (154.2313.3/10)	

Les références des pièces sont indicatives.  
Nos pièces ne sont pas d'origine

Part numbers are quoted for reference purposes only.  
Our parts and accessories are not original.



**"THE RELIABLE SERVICE"**



**MECANISMES & DISQUES D'EMBRAYAGE**  
**CLUTCH ASSEMBLIES & PLATES**

Tracteurs Tractors	Embrayage Clutch		Disque Plate		Butée de débrayage Release Bearing
	Ø	N°	Ø	N°	
Jaguar 95 Léopard 85, 90 Panther 95	330 4 doigts + bague d'appui 4 levers + split ring B. & B.	<b>29/200-514</b> Volant plat <i>Flat flywheel</i> (176.235.4) (133 0027 50)	330	<b>29/221-529</b> TF 24Z 46x50 (176.2352.3)	<b>29/231-505</b> 65x102x27
325			<b>29/221-530</b> TF 24Z 46x50		
325			<b>29/221-531</b> TC 24Z 46x50 15 paires de pastilles <i>15 pairs of pads</i>		
325			<b>29/221-532</b> TF 24Z 46x50 renforcé / <i>Strengthened</i>		
Jaguar 100 Laser 90, 100, 110 Léopard 90 turbo Tiger 100 Tiger Six 105	350 DV Valéo	<b>29/200-513</b> (269.2310.4) (135 0230 30)	350	<b>29/221-517</b> UC-MH 24Z 46x50 212.2359.3/10 (335 162 30)	<b>29/231-501</b> MV Lg. 213 mm ⇒20175 (2.2999.207.0) (500 0846 30)
350			<b>29/221-512</b> UC-LT 24Z 46x50		
350			<b>29/221-528</b> UF 24Z 46x50 (263.2313.8)	<b>29/231-507</b> Lg. 224 mm 20176⇒ (202.6551.3) Laser 100 Laser 110 (1280⇒)	
350			<b>29/221-510</b> UF 24Z 46x50		
350			<b>29/221-511</b> TF 24Z 46x50 (154.2313.3/10)		
Krypton 80, 90, 100	330 DF	<b>29/200-515</b> (133 0259 10)	327	<b>29/221-534</b> TC-LS 24Z 36,5x41,1 (333 0186 10)	
Laser 130, 150, 170 Suite page suivante <i>Continuation on following page</i>	350 DV Valéo	<b>29/200-516</b> (212.2358.4/10)	350	<b>29/221-517</b> UC-MH 24Z 46x50 (212.2359.3/10) (335 0162 30)	<b>29/231-501</b> MV Lg. 213 mm (2.2999.207.0) (500 0846 30)
350			<b>29/221-512</b> UC-LT 24Z 46x50		
350			<b>29/221-528</b> UF 24Z 46x50 (263.2313.8)		

Les références des pièces sont indicatives.  
Nos pièces ne sont pas d'origine

Part numbers are quoted for reference purposes only.  
Our parts and accessories are not original.



**MECANISMES & DISQUES D'EMBRAYAGE**  
**CLUTCH ASSEMBLIES & PLATES**

Tracteurs Tractors	Embrayage Clutch		Disque Plate		Butée de débrayage Release Bearing
	Ø	N°	Ø	N°	
Laser 130, 150, 170 Suite de la page précédente <i>Continuation from the previous page</i>	350 DV Valéo	<b>29/200-516</b> (212.2358.4/10)	350  350	<b>29/221-510</b> UF 24Z 46x50  <b>29/221-511</b> TF 24Z 46x50 (154.2213.3/10)	<b>29/231-501</b> MV Lg. 213 mm (2.2999.207.0) (500 0846 30)
Léone 70 ⇒ Voir / See Centurion 75					
Léopard 85, 90 90T (⇒ 20 174) ⇒ Voir / See Jaguar 95					
Léopard 90 T (20 175 ⇒) ⇒ Voir / See Jaguar 100					
Léopard C, 85C Léopard Crawler	310/310		310 LG  310 LM	<b>29/221-535</b> UF 20Z 36x40 (331 0172 36)  <b>29/212-514</b> UF 14Z 22x25 (331 0171 36)	
Mercury 85 ⇒ Voir / See Centurion 75					
Minitauro 60 Minitaurus 60 ⇒ Voir / See Condor 55					
Panther	330 3 doigts 3 levers SAME		325	<b>29/221-536</b> TF 23Z 44x48	
Panther 90 ⇒ Voir / See Léopard					
Panther 95 ⇒ Voir / See Jaguar 95					
Rock 55, 60 ⇒ Voir / See Argon					
Rock 55, 60, 70 ⇒ Voir / See Argon 60					
Row Crop 90 /DT (⇒1357) ⇒ Voir / See Explorer Top 90 II					

Les références des pièces sont indicatives.  
Nos pièces ne sont pas d'origine

Part numbers are quoted for reference purposes only.  
Our parts and accessories are not original.



**"THE RELIABLE SERVICE"**





**MECANISMES & DISQUES D'EMBRAYAGE**  
**CLUTCH ASSEMBLIES & PLATES**

Tracteurs <i>Tractors</i>	Embrayage <i>Clutch</i>		Disque <i>Plate</i>		Butée de débrayage <i>Release Bearing</i>
	Ø	N°	Ø	N°	
Row Crop 90 (1358 ⇒) ⇒ Voir / See Antares 100					
Same 65 ⇒ Voir / See Explorer 55, 60, 65, 70					
Saturnsynchro 80 ⇒ Voir / See Centurion 75 (3371⇒)					
Silver 80 (⇒ 2073) Silver 90 (⇒ 2963) Silver 100.4 (⇒ 1874) ⇒ Voir / See Explorer 80 II /DT					
Silver 100.6 (⇒ 3222) ⇒ Voir / See Antares 100					
Taurus 60 ⇒ Voir / See Condor 55					
Tiger Six /105 Titan 105, 106 Trident 130 Export	350 DV Valéo	<b>29/200-513</b> (269.2310.4) (135 0230 30)	350	<b>29/221-537</b> UF 24Z 46x50 (250.2313.3) (335 0163 36)	<b>29/231-508</b> MV Lg. 164 mm
	-----		350	<b>29/221-517</b> UC-MH 24Z 46x50 (212.2359.3/10) (335 0162 30)	
	350 3 doigts 3 levers SAME		350	<b>29/221-512</b> UC-LT 24Z 46x50	
			350	<b>29/221-510</b> UF 24Z 46x50	
			350	<b>29/221-511</b> TF 24Z 46x50 (154.2213.3/10)	

- AA En option
- AN Renforcé
- AU Roulement pilote
- DF Diaphragme, volant plat
- DV Diaphragme, volant creux
- G3 3 doigts
- GU6 Commande indépendante, 6 doigts
- LG Friction d'avancement côté BV, montée
- LK Friction prise de force côté BV, montée
- LM Friction prise de force côté moteur, libre
- LN Friction d'avancement côté moteur, libre
- LQ 3 paires de pastilles
- LR 4 paires de pastilles
- LS 5 paires de pastilles
- LT 6 paires de pastilles
- MH 7 paires de pastilles
- ML 10 paires de pastilles
- MV Butée avec support
- TC Cera-métallique à ressorts
- TF Organique à ressorts
- UC Cera-métallique fixe
- UF Organique à fixe
- VZ Version économique

- AA *Optional*
- AN *Heavy duty*
- AU *Spigot bearing*
- DF *Diaphragm, flat flywheel*
- DV *Diaphragm, pot flywheel*
- G3 *3 levers*
- GU6 *Independent clutch, 6 levers*
- LG *Main disc, transmission side, mounted*
- LK *PTO disc, transmission side, mounted*
- LM *PTO disc, engine side, loose*
- LN *Main disc, engine side, loose*
- LQ *3 pairs of pads*
- LR *4 pairs of pads*
- LS *5 pairs of pads*
- LT *6 pairs of pads*
- MH *7 pairs of pads*
- ML *10 pairs of pads*
- MV *Release bearing with carrier*
- TC *Spring cera-metallic*
- TF *Spring organic*
- UC *Fixed cera-metallic*
- UF *Fixed organic*
- VZ *Economic version*

Les références des pièces sont indicatives.  
Nos pièces ne sont pas d'origine

Part numbers are quoted for reference purposes only.  
Our parts and accessories are not original.



**MECANISMES & DISQUES D'EMBRAYAGE**  
**CLUTCH ASSEMBLIES & PLATES**
**LAMBORGHINI**

Tracteurs Tractors	Embrayage Clutch		Disque Plate		Butée de débrayage Release Bearing
	Ø	N°	Ø	N°	
C 65	280 DF Valéo	<b>32/200-511</b> (128 0248 30)	280	<b>32/221-526</b> TF 24Z 36x40 (328 0275 36)	
C 75	310 DF Valéo	<b>32/200-501</b> (131 0228 50)	310	<b>32/221-502</b> TF 24Z 36x40 (331 0179 36)	
C 352	225/225 GA3 Luk	<b>32/200-517</b> (431.2210.4) (223 0007 11)	225 LG  225 LM	<b>32/221-540</b> UF 20Z 36x40 (2.316.746) (323 0035 16)  <b>32/212-515</b> UF 13Z 19x22 (431.2222.3) (323 0117 16)	
R 483 /DT	250/230 GU6 Valéo	<b>32/200-518</b>	250 LG  230 LM	<b>32/221-541</b> 20Z 36x40  <b>32/212-516</b> 14Z 22x25	
F 660 Plus /DT F 775 Plus /DT F 880 Plus /DT F 990 Plus /DT	280/280 GU6 Luk	<b>32/200-519</b> (228 0133 10)	280 LG  280 LM	<b>32/221-508</b> UC-LT 20Z 36x40 (328 0378 12)  <b>32/212-517</b> UC-LQ 14Z 22x25 (328 0377 11)	
C 483, R 483, C 503, R 503, C 553, R 553, C 583, R 583, C 603, C 633, C 654, R 654, C 683, R 683, R 724, R 754, R 754 DT, R 824, R 845 DT, R 854, R 854 DT, R 955, 990 (1975⇒)  <b>LUK ET / AND VALÉO</b> <b>NON INTERCHANGEABLE</b> <b>NOT INTERCHANGEABLE</b> Suite à la page suivante <i>Continuation on following page</i>	280/280 GU6 Luk	<b>32/200-509</b> (171.2252.4/11) (228 0040 13)	280 LG  280 LG  250 LM	<b>32/221-514</b> UF 20Z 36x40 (422.2261.3) (328 0017 16)  <b>32/221-542</b> UF 20Z 36x40  <b>32/212-505</b> UF 14Z 22x25	<b>32/231-509</b> 50x94x21  <b>32/231-510</b> 70x110x20 (500 0284 00)

Les références des pièces sont indicatives.  
Nos pièces ne sont pas d'origine

Part numbers are quoted for reference purposes only.  
Our parts and accessories are not original.



**"THE RELIABLE SERVICE"**



**MECANISMES & DISQUES D'EMBRAYAGE**  
**CLUTCH ASSEMBLIES & PLATES**

Tracteurs Tractors	Embrayage Clutch		Disque Plate		Butée de débrayage Release Bearing
	Ø	N°	Ø	N°	
C 483, R 483, C 503, R 503, C 553, R 553, C 583, R 583, C 603, C 633, C 654, R 654, C 683, R 683, R 724, R 754, R 754 DT, R 824, R 845 DT, R 854, R 854 DT, R 955, 990 (1975⇒)  <b>LUK ET / AND VALÉO</b> <b>NON INTERCHANGEABLE</b> <b>NOT INTERCHANGEABLE</b>  Suite de la page précédente <i>Continuation from the previous page</i>	280/280 GU6 Luk	<b>32/200-508</b> (171.2250.4) (228 0040 12)	280 LG	<b>32/221-513</b> UC-LS 20Z 36x40 (328 0017 11)	<b>32/231-509</b> 50x94x21  <b>32/231-510</b> 70x110x20 (500 0284 00)
			280 LM	<b>32/212-506</b> UF 14Z 22x25 (328 0318 30)	
	280/280 GU6 Valéo	<b>32/200-520</b>	280 LG	<b>32/221-543</b> UF 20Z 36x40	
			280 LM	<b>32/212-505</b> UF 14Z 22x25	
	280/280 GU6 Valéo	<b>32/200-507</b>	280 LG	<b>32/221-513</b> UC-LS 20Z 36x40 (328 0017 11)	
			280 LG	<b>32/221-544</b> UF 20Z 36x40	
280 LM			<b>32/212-506</b> UF 14Z 22x25 (328 0318 30)		
280 LM	<b>32/212-518</b> UF 14Z 22x25				
R 674 (⇒1970)	280 Diaphr. B. & B 8 goujons 8 studs	<b>32/200-512</b> (128 0243 50)	280	<b>32/221-526</b> TF 24Z 36x40 (328 0275 36)	<b>32/231-500</b> 55x91x26 (500 0076 20)
C 635, R 573, R 674	280 Diaphr. Valéo 6 goujons 6 studs	<b>32/200-511</b> (128 0248 30)	280	<b>32/221-526</b> TF 24Z 36x40 (328 0275 36)	
R 704, R 804	280/280 GU6 Luk	<b>32/200-521</b> (427.2410.4/10) (228 0068 10)	280 LG	<b>32/221-545</b> UC-LT 23Z 44x48 (4.272.851) (328 0093 10)	<b>32/231-509</b> 50x94x21
			280 LM		<b>32/231-510</b> 70x110x20 (500 0284 00)

Les références des pièces sont indicatives.  
Nos pièces ne sont pas d'origine

Part numbers are quoted for reference purposes only.  
Our parts and accessories are not original.



**"THE RELIABLE SERVICE"**



**MECANISMES & DISQUES D'EMBRAYAGE**  
**CLUTCH ASSEMBLIES & PLATES**

Tracteurs Tractors	Embrayage Clutch		Disque Plate		Butée de débrayage Release Bearing
	Ø	N°	Ø	N°	
R 704, R 754, R 784, 845 DT, 854 DT, R 955 /DT	310/310 3 doigts 3 levers		310 LG	<b>32/221-535</b> UF 20Z 36x40 (331 0172 36)	
	Diaphr. Valéo		310 LG	<b>32/221-546</b> UC-LT 20Z 36x40	
			310 LM	<b>32/212-514</b> UF 14Z 22x25 (331 0171 36)	
R 774-80 Grand Prix, R 874-90 Grand Prix, R 974-90 Grand Prix	310 DF Diaphr. B. & B	<b>32/200-501</b> Ø Ext. / Out 365 mm (131 0228 50)	310	<b>32/221-501</b> TC-LT 24Z 36x40 (331 0184 30)	<b>32/231-500</b> 55x91x26 (500 0076 20)
	310 DF Diaphr. Valéo	<b>32/200-500</b> Ø Ext. / Out 368 mm (131 0229 30)	310	<b>32/221-502</b> TF 24Z 36x40 (331 0179 36)	
R 904	330/310 GU6 Luk	<b>32/200-522</b> (429.2453.4) (233 0004 10) Remplace ancien modèle Walterscheid  <i>Replaces old Walterscheid clutch</i>	330 LG	<b>32/221-547</b> UC-LT 23Z 44x48 (429.2451.4) (333 0004 10)	<b>32/231-511</b> 65x97 (500 0059 10)  <b>32/231-512</b> 75x115x20 (500 0378 00)
			310 LM	<b>32/212-519</b> UF 16Z 27x30	
			310 LG	<b>32/221-547</b> UC-LT 23Z 44x48 (429.2451.4) (333 0004 10)	
			310 LM	<b>32/212-514</b> UF 14Z 22x25 (195.2222.3) (331 0171 36)	
R 956 /DT R 1056 /DT R 1106 /DT R 1156 /DT R 1256 DT R 1306 /DT R 1356 /DT R 1556 /DT	350 DV Valéo	<b>32/200-513</b> (135 0230 30)	350	<b>32/221-517</b> UC-MH 24Z 46x50 (212.2359.3/10) (335 0162 30)	<b>32/231-508</b> MV Lg. 164 mm
			350	<b>32/221-510</b> UF 24Z 46x50	
			350	<b>32/221-532</b> TF 24Z 46x50	

Les références des pièces sont indicatives.  
Nos pièces ne sont pas d'origine

Part numbers are quoted for reference purposes only.  
Our parts and accessories are not original.



**"THE RELIABLE SERVICE"**



**MECANISMES & DISQUES D'EMBRAYAGE**  
**CLUTCH ASSEMBLIES & PLATES**

Tracteurs Tractors	Embrayage Clutch		Disque Plate		Butée de débrayage Release Bearing
	Ø	N°	Ø	N°	
R 1306 Turbo R 1506 Turbo	350 DV Valéo	<b>32/200-513</b> (135 0230 30)	350	<b>32/221-517</b> UC-MH 24Z 46x50 (212.2359.3/10) (335 0162 30)	<b>32/231-508</b> MV lg. 213 mm
350			<b>32/221-510</b> UF 24Z 46x50		
350			<b>32/221-532</b> TF 24Z 46x50		
R 1706 Turbo	350 DV Valéo	<b>32/200-513</b> (135 0230 30)	350	<b>32/221-517</b> UC-MH 24Z 46x50 (212.2359.3/10) (335 0162 30)	
350			<b>32/221-510</b> UF 24Z 46x50		
350			<b>32/221-532</b> TF 24Z 46x50		
Formula 105	310 DV Valéo	<b>32/200-500</b> Ø Ext. / Out. 368 mm (131 0229 30)	310	<b>32/221-501</b> TC-LT 24Z 36x40 (331 0184 30)	<b>32/231-500</b> 55x91x26 (500 0076 20)
	310 DV B. & B.	<b>32/200-501</b> Ø Ext. / Out. 365 mm (131 0228 50)	310	<b>32/221-502</b> TF 24Z 36x40 (331 0179 36)	
Formula 105 Formula 115 (⇒ 3129) Formula 125 Formula 135	330 DV Valéo	<b>32/200-502</b> (133 0220 30)	330	<b>32/221-503</b> TC-LT 24Z 36,5x41 (333 0116 30)	<b>32/231-501</b> MV Lg.213mm (500 0846 30)
Formula 135	350 DV Luk	<b>32/200-503</b> (135 0241 10)	348	<b>32/221-506</b> TC-LT 21Z 41x45 (335 0186 10)	<b>32/231-501</b> MV Lg.213mm (500 0846 30)
	350 Valéo DV	<b>32/200-513</b> (135 0230 30)	350	<b>32/221-517</b> UC-MH 24Z 46x50 (212.2359.3/10) (335 0162 30)	
N Cross 674-70	310 DF Valéo	<b>32/200-500</b> Ø Ext. / Out. 368 mm (131 0229 30)	310	<b>32/221-501</b> TC-LT 24Z 36x40 (331 0184 30)	<b>32/231-500</b> 55x91x26 (500 0076 20)

Les références des pièces sont indicatives.  
Nos pièces ne sont pas d'origine

Part numbers are quoted for reference purposes only.  
Our parts and accessories are not original.



**"THE RELIABLE SERVICE"**



**MECANISMES & DISQUES D'EMBRAYAGE**  
**CLUTCH ASSEMBLIES & PLATES**

Tracteurs Tractors	Embrayage Clutch		Disque Plate		Butée de débrayage Release Bearing
	Ø	N°	Ø	N°	
Premium 150 (⇒ 1433) Premium 160 (⇒ 2077) Premium 850 Premium 950	330 DF	<b>32/200-502</b> (008.4184.3) (133 0220 30)	330	<b>32/221-503</b> TC-LT 24Z 36,5x41 (009.6533.3) (333 0116 30)  <b>32/221-504</b> TF 24Z 36,5x41 (008.9937.3) (333 0117 30)	<b>32/231-501</b> MV Lg.213mm (500 0846 30)
Sprint 664-60 Sprint 674-70	310 DF Valéo	<b>32/200-500</b> Ø Ext. / Out. 368mm (131 0229 30)	310	<b>32/221-501</b> TC-LT 24Z 36x40 (331 0184 30)	<b>32/231-500</b> 55x91x28 (500 0076 20)

DF Diaphragme, volant plat  
DV Diaphragme, volant creux  
G3 3 Doigts  
GA6 Commande combinée, 6 doigts  
GU6 Commande indépendante, 6 doigts  
LG Friction d'avancement côté BV, montée  
LM Friction prise de force côté moteur, libre  
LQ 3 paires de pastilles  
LS 5 paires de pastilles  
LT 6 paires de pastilles  
MH 7 paires de pastilles  
MV Butée avec support  
TC Cera-métallique à ressorts  
TF Organique à ressorts  
UC Cera-métallique fixe  
UF Organique fixe

DF Diaphragm, flat flywheel  
DV Diaphragm, pot flywheel  
G3 3 levers  
GA6 Combined clutch, 6 levers  
GU6 Independent clutch, 6 levers  
LG Main disc, transmission side, mounted  
LM PTO disc, engine side, loose  
LQ 3 pairs of pads  
LS 5 pairs of pads  
LT 6 pairs of pads  
MH 7 pairs of pads  
MV Release bearing with carrier  
TC Spring cera-metallic  
TF Spring organic  
UC Fixed cera-metallic  
UF Fixed organic

Les références des pièces sont indicatives.  
Nos pièces ne sont pas d'origine

Part numbers are quoted for reference purposes only.  
Our parts and accessories are not original.



**MECANISMES & DISQUES D'EMBRAYAGE**  
**CLUTCH ASSEMBLIES & PLATES**

**HÜRLIMANN**

Tracteurs Tractors	Embrayage Clutch		Disque Plate		Butée de débrayage Release Bearing
	Ø	N°	Ø	N°	
H 355, H 360 H 470, H 476 H 480, H 481  <b>LUK ET / AND VALÉO</b> <b>NON INTERCHANGEABLE</b> <b>NOT INTERCHANGEABLE</b>	280/280 GU6 Luk	<b>33/200-508</b> (228 0040 12)	280 LG	<b>33/221-513</b> UC-LS 20Z 36x40 (328 0017 11)	<b>33/231-509</b> 50x94x21  <b>33/231-510</b> 70x110x20 (500 0284 00)
			280 LM	<b>33/212-518</b> UF 14Z 22x25	
	ou / or	280 LM	<b>33/212-506</b> UF 14Z 22x25 (328 0318 30)		
			280 LG	<b>33/221- 548</b> UF 20Z 36x40	
280/280 3 doigts 3 levers Diaphr. Valéo	280 LM	<b>33/212-518</b> UF 14Z 22X25			
		280 LM	<b>33/212-518</b> UF 14Z 22X25		
H 356, H 358, H 466, H 468	280 Diaphr. B. & B. 8 goujons 8 studs	<b>33/200-512</b> (128 0243 50)	280	<b>33/221-526</b> TF 24Z 36x40 (328 0275 36)	<b>33/231-500</b> 55x91x26 (500 0076 20)
	ou / or	280 Diaphr. Valéo 6 goujons 6 studs			
H 480	310/310 3 doigts 3 levers Diaphr. Valéo		310 LG	<b>33/221-546</b> UC-LT 20Z 36x40	
			310 LM	<b>33/212-514</b> UR 14Z 22x25 (331 0171 36)	
H 476, H 478, H 488  <b>B. &amp; B. ET / AND VALÉO</b> <b>NON INTERCHANGEABLE</b> <b>NON INTERCHANGEABLE</b>	310 DF Diaphr. B. & B.	<b>33/200-501</b> Ø Ext. / Out. 365 mm (131 0228 50)	310	<b>33/221-501</b> TC-LT 24Z 36x40 (331 0184 30)	<b>33/231-500</b> 55x91x26 (500 0076 20)
	310 DF Diaphr. Valéo	<b>33/200-500</b> Ø Ext. / Out. 368 mm (131 0229 30)			

Les références des pièces sont indicatives.  
Nos pièces ne sont pas d'origine

Part numbers are quoted for reference purposes only.  
Our parts and accessories are not original.



**MECANISMES & DISQUES D'EMBRAYAGE**  
**CLUTCH ASSEMBLIES & PLATES**

Tracteurs Tractors	Embrayage Clutch		Disque Plate		Butée de débrayage Release Bearing
	Ø	N°	Ø	N°	
H 490 H496T H5116 H 5160 H 6160 H 6170	350 DV Valéo	<b>33/200-513</b> (135 0230 30)	350  350	<b>33/221-517</b> UC-MH 24Z 46x50 (335 0162 30)  <b>33/221-510</b> UF 24Z 46x50	<b>33/231-508</b> MV Lg. 164 mm
H 490 H 5160 H 6160	350 Origine		350  350	<b>33/221-517</b> UC-MH 24Z 46x50 (335 0162 30)  <b>33/221-510</b> UF 24Z 46x50	
H 6135 XB Elite	350 DV LuK	<b>33/200-503</b> (135 0241 10)	348	<b>33/221-506</b> TC-LT 21Z 41x45 (335 0186 10)	<b>33/231-501</b> MV Lg.213mm (500 0846 30)
XA 607	310 DF	<b>33/200-501</b> (131 0228 50)	310	<b>33/221-502</b> TF 24Z 36x40 (331 0179 36)	<b>33/231-500</b> 55x91x26 (500 0076 20)
XT910.6	330 DV Valéo	<b>33/200-502</b> (133 0220 30)	330	<b>33/221-503</b> TC-LT 24Z 36,5x41 (333 0116 30)	<b>33/231-501</b> MV Lg.213mm (500 0846 30)
H6115 XT909 XT910.4	330 DV Valéo	<b>33/200-502</b> (133 0220 30)	330	<b>33/221-504</b> TF 24Z 36,5x41 (333 0117 30)	

DF Diaphragme, volant plat  
DV Diaphragme, volant creux  
GU6 Commande indépendante, 6 doigts  
LG Friction d'avancement côté BV, montée  
LM Friction prise de force côté moteur, libre  
LS 5 paires de pastilles  
LT 6 paires de pastilles  
MH 7 paires de pastilles  
MV Butée avec support  
TC Cera-métallique à ressorts  
TF Organique à ressorts  
UC Cera-métallique fixe  
UF Organique fixe

DF Diaphragm, flat flywheel  
DV Diaphragm, pot flywheel  
GU6 Independent clutch, 6 levers  
LG Main disc, transmission side, mounted  
LM PTO disc, engine side, loose  
LS 5 pairs of pads  
LT 6 pairs of pads  
MH 7 pairs of pads  
MV Release bearing with carrier  
TC Spring cera-metallic  
TF Spring organic  
UC Fixed cera-metallic  
UF Fixed organic

Les références des pièces sont indicatives.  
Nos pièces ne sont pas d'origine

Part numbers are quoted for reference purposes only.  
Our parts and accessories are not original.





**MAITRE CYLINDRE & CYLINDRE RECEPTEUR D'EMBRAYAGES**  
**MASTER & SLAVE CYLINDERS (CLUTCHES)**

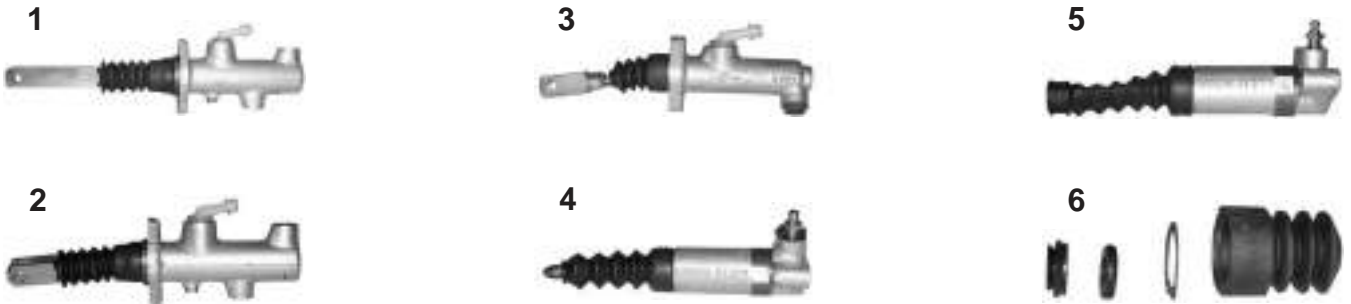

	Fig. Fig.	Réf. Ref.	OEM OEM	Désignation Description
Premium 850, 950, 1050, 1060, 1100, 1300 Formula 115, 135 XT908, 909, 910-4, 910-6, 911, 913 Elite XB 6115, 6135 Antares 110, 130 II Row crop 100.6 Silver 80, 90, 100-4, 100-6, 110, 130	1	<b>29/008-2753</b>	0.008.2753.4/10	Maître cylindre Master cilinder
Laser 100, 110, 130, 160 956, 956-100, 1106, 1306, 1506	2	<b>29/257-6538-4</b>	257.6538.4/10	Maître cylindre Master cilinder
574-60N, 674-70N, 674-70N B, 674-70N, 774-80N Grand prix 674-70, 774-80, 874-90T High clearance 90 Sprint 654-55, 664-60, 664-65, 674-70, 675-75 H358, H468, H478, H484T P, H358-4, H468-4, H468-4B C Prestige H478, H488T H478-4 XA606, XA607, XA655, XA656T, XA657, XA658 Explorer II 60, 70, 80, 90T	3	<b>S.255/6538</b>	0.255.6538.4/50	Maître cylindre Master cilinder
574-60N, 674-70N, 674-70N B, 674-70N, 774-80N Grand prix 674-70, 774-80, 874-90T High clearance 90 Premium 850, 950, 1050, 1060, 1100, 1300 Formula 115, 135 Prestige H-358, H468, H-478, H-488T Antares 110, 130 II Explorer 60, 70 Explorer 60, 70, 80 Basso Explorer 80 SKD Explorer 60, 70, 80, 90T Explorer special 70, 80, 90-8 Row crop 90, 100, 100.6 Silver 80, 90, 100-4, 100-6, 110, 130	4	<b>29/255-6537</b>	0.255.6537.4/60	Cylindre récepteur Slave cilinder
956DT, 956-100, 1106, 1306, 1506 Laser 100, 110, 130, 150 Laser transporter 85	5	<b>S.257/6537</b>	0.257.6537.4/40	Cylindre récepteur Slave cilinder
H358, H468, H478, H488T P, H358-4, H468-4, H468-4B C, H478-4 XA606, XA607, XA655, XA656T, XA657, XA658 574-60N, 674-70N, 674-70N B Grand prix 674-70, 774-80, 874-90T 674-70N, 774-80N High clearance 90 Sprint 654-55, 664-60, 664-65, 674-70, 675-75 Explorer II 60, 70, 80, 90T	6	<b>29/255-6538-6</b>	0.255.6538.6	Kit réparation du cyl. récepteur Repair kit of Slave cilinder
956-100, 1106, 1306, 1506 Laser 100, 110, 130, 150 Laser Transporter 85	6	<b>29/235-6557</b>	0.235.6557.6	Kit réparation du maître cyl. Repair kit of master cilinder



**PIECES DETACHEES POUR EMBRAYAGES VALEO**  
**REPLACEMENT PARTS FOR VALEO CLUTCHES**

**Embrayage / Clutch 29/M.226 (171.2252.4)**

Lamborghini :R.653, 654, 684

Hürlimann : H.355, 360, 470

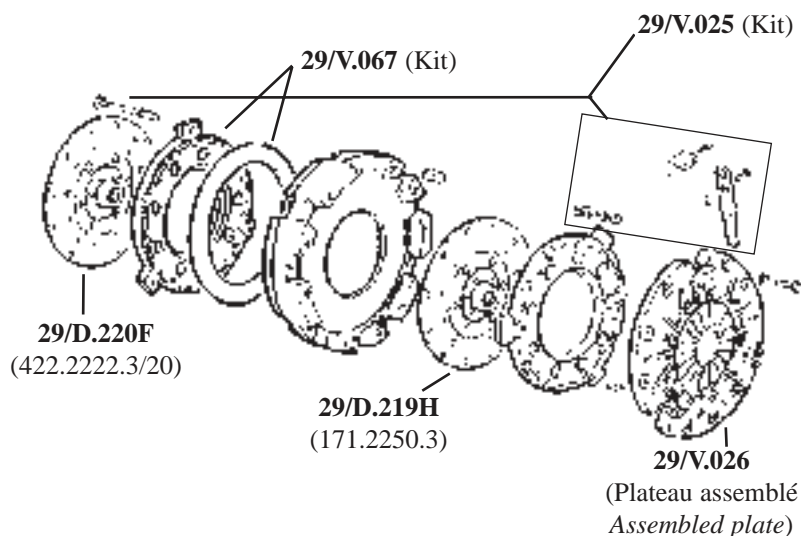

**29/V.016 (Kit)**



**Embrayage / Clutch 29/M.230 (216.2410.4)**

Lamborghini :R.784

Same : Leopard C

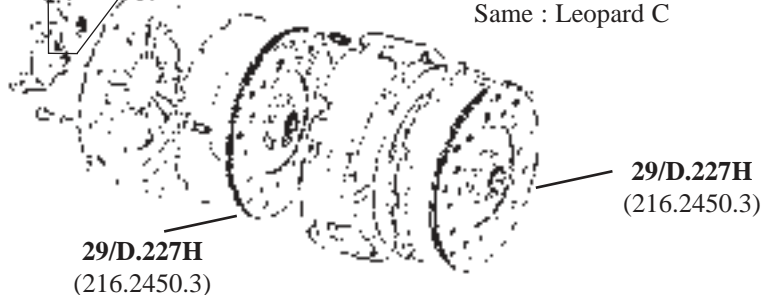

**Embrayage / Clutch 29/M.229 (195.2210.4)**

Lamborghini :R.955, 784

Hürlimann : H.480

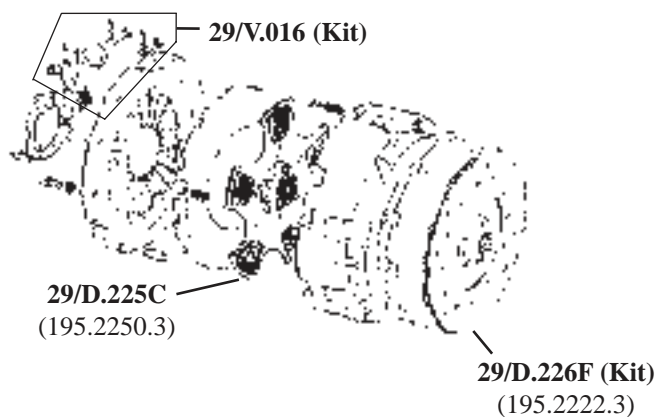

Les références des pièces sont indicatives.  
Nos pièces ne sont pas d'origine

Part numbers are quoted for reference purposes only.  
Our parts and accessories are not original.



**COMMANDE DE PRISE DE FORCE**  
**PTO DRIVE**

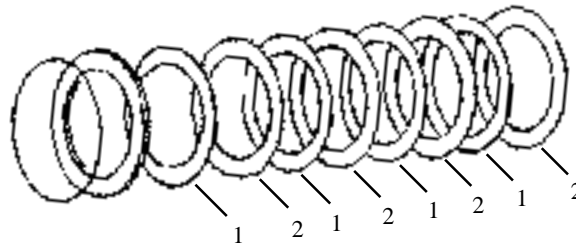

Tracteurs Tractors	Fig. Fig.	PTO	Dents Teeth
Buffalo 120, 130 Exp., Galaxy 170 Turbo, Hercules 160 Exp.	1	29/164-3642	45
	2	29/164-3643	54
Jaguar 95 Exp., Laser 90, 100, 110, Leopard 85, 90, Panther 95, Tiger 100, Tiger Six 105 Exp.	1	29/163-3654	52
	2	29/163-3655	60
Explorer 65C, 70C Ergomatic, 75C	1	29/292-5714	62
	2	29/292-5715	87
Explorer 55, 60, 65 Spécial, 70, 75, 80, 90	1	29/255-3970	48
	2	29/255-3936	

**ARBRE DE PRISE DE FORCE**  
**PTO SHAFTS**

**Type long / Long type**

**S.136/3612** (13636123) Type long - 1 3/8" - 6 cannelures  
Long type - 1 3/8" - 6 splines  
Centaurus, Centurion, Corsaro, Leone, Drago, Saturno

**S.146/3612** (14636123) **NEW** Taurus 60 Export, Minitauro, Falcon, Minitaurus

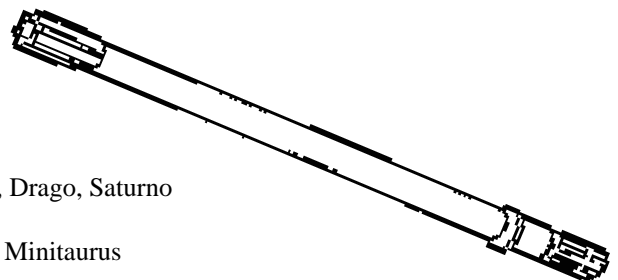

**Type à plateau / Plate type**

**S.167/3660** (16736600/30) 1 3/8" - 6 cannelures / splines  
Antares 100, 110, 130, Aster 60, 70, Titan 145, 160, Explorer II 60, 70, Leopard,  
Jaguar 95, Export, Buffalo 130, Tiger 100, Laser 100, 130, Tiger Six 105

**S.167/3661** (16736610/20) 1 3/4" - 6 cannelures / splines  
Buffalo, Tiger 100, Explorer II 60, 70

**S.163/3671** (16336710/40) **NEW** 1 3/8" - 21 cannelures / splines  
Antares 100, 110, 130, Aster 60, 70, Explorer II 60, 70, Laser,  
Leopard, Titan, Tiger Six 105, Panther

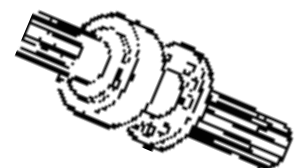

Les références des pièces sont indicatives.  
Nos pièces ne sont pas d'origine.

Part numbers are quoted for reference purposes only.  
Our parts and accessories are not original.



**FREINAGE  
BRAKES**

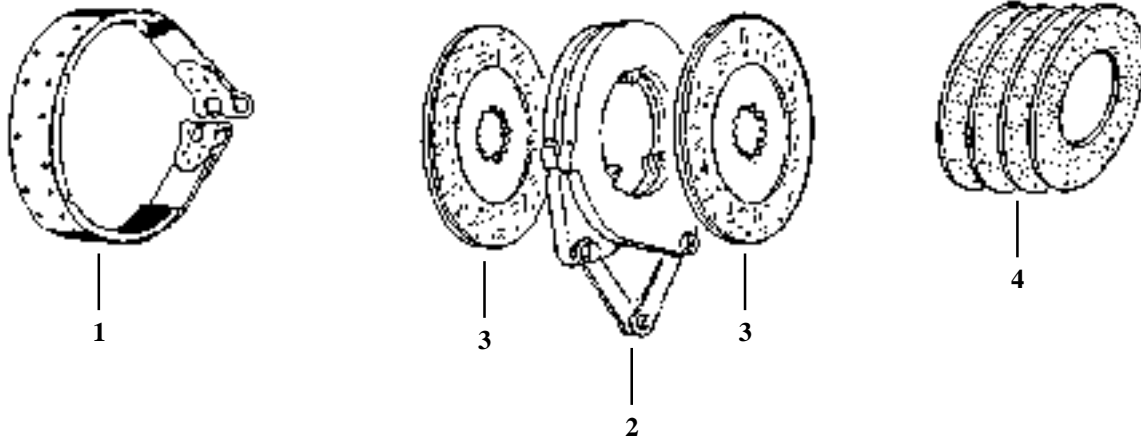

Tracteurs Tractors	Fig. Fig.	Réf. Ref.	OEM	Ø Ext. (mm) Outer Ø (mm)	Cannelures Splines	Ø cannel. (mm) Splines Ø (mm)
<b>FREINS A BANDE / BRAKE BAND</b>						
Same Centaurus 55, 60, 65 Corsaro 70, 70 synchro	1	S.157/5411	15754113/10	250		
Same Falcon, Minitauro 50, 55, 60 Frutteto, 60 Vigneto		S.146/5411	14654113/20	225		
<b>FREINS A DISQUES SECS / BRAKE DISCS (DRY)</b>						
Same Aurora 35,45, Sirenetta Vigneron 35,45, Delfino	2	S.159/5432	15954323	102		
Lamborghini R235, 235DT, 235S	3	S.151/5450	15154503		23	28x31
Same Centurion 75 Export Condor 55 synchro (↔ N.10000) Corsaro 70, 70 synchro Corsaro Frutteto Minitaurus 60 synchro (↔ 53753) Saturno, Saturno 80 synchro Taurus 60 Export	2	S.136/5432K	13654323	178		
	3	S.158/5434	15854343		13	38 x 44
	4	S.136/5435K	13654350			
Lamborghini R483, 483DT (N.1149 ↔ ) R503, 503DT, R603, 603DT (82 ↔ ) R583, 583DT, R653, 653DT R654, 654DT, R653 Frutteto R683, 683DT, R684, 684DT R684DT Frutteto, R724, 724DT	2	S.136/5432K	13654323			
	3	SLT.177/5434	17754343		23	44 x 48
Hürlimann H345, H355, H360 (↔ N.00626)	4	S.136/5435K	13654350			

Les références des pièces sont indicatives.  
Nos pièces ne sont pas d'origine.

Part numbers are quoted for reference purposes only.  
Our parts and accessories are not original.



**FREINAGE  
BRAKES**

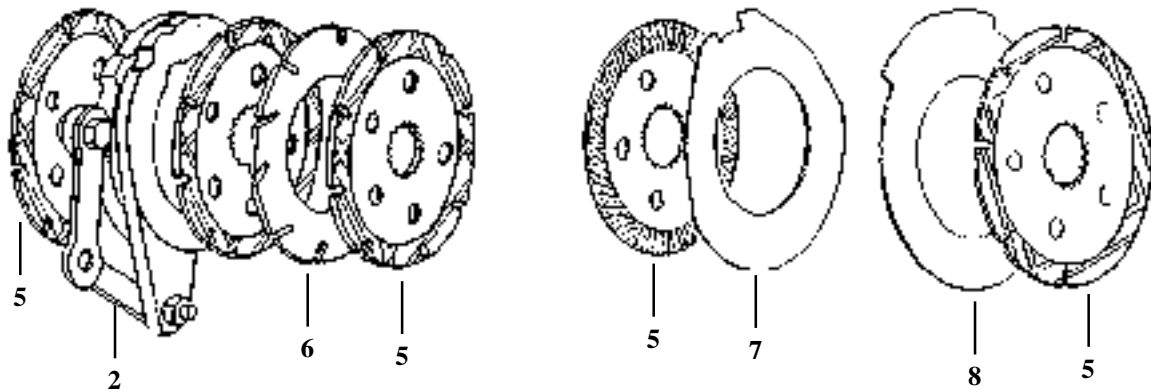

Tracteurs Tractors	Fig. Fig.	Réf. Ref.	OEM	Ø Ext. (mm) Outer Ø (mm)	Cannelures Splines	Ø cannel. Splines Ø (mm)
<b>FREINS A DISQUES SOUS HUILE A COMMANDE MECANIQUE BRAKE DISCS (OIL BATH)(MECHANICAL)</b>						
<b>Same</b> Buffalo 120, 130 Export Drago 100, 120 Hercules 160 Export (⇔ N.1240) Panther 95  <b>Lamborghini</b> R360, 360DT, R365, 365DT R470, 470DT, R475, 475DT  <b>Hürlimann</b> H5160, H6160, H6170T (⇔ N.00161) Roue arrière/Rear wheel	2	S.154/5461K				
	5	S.154/5459	15454590	224	27	55 x 61
	6	S.154/5460	15454600	228		Ø int./inn 127
<b>Lamborghini</b> R704, 704DT R804, 804DT, R904, 904DT  <b>Hürlimann</b> R480, 480DT, R485, 485DT, R490	2	SLT.427/5461K				
	5	SLT.427/5454	42754340	224	22	53 x 60
	7	SLT.427/5455	42754550	228		Ø int./inn 127
<b>Same</b> Condor 55 synchro (1001 ⇔) Explorer 60 II & 60 special Minitaurus 60 Frutteto Minitaurus 60 synchro (N.53754 ⇔)	5	S.194/5464	19454642	178	13	38 x 45
	8	S.194/5465	19454650	184		Ø int./inn 125
<b>FREINS A DISQUES SOUS HUILE A COMMANDE HYDRAULIQUE BRAKE DISCS (OIL BATH)(HYDRAULIC)</b>						
<b>Same</b> Centauro 70 special Centurion 75 special Hercules 160 Export (N.1241 ⇔) Galaxy 170 Turbo Roue arrière/Rear wheel Mercury 85 special  <b>Hürlimann</b> H6130, H5160, H6160, H6170T (N.00162 ⇔) Roue arrière/Rear wheel	5	S.154/5459	15454590/10	224	27	55 x 61
	6	S.154/5460	15454600/10	228		Ø int./inn 127

Les références des pièces sont indicatives.  
Nos pièces ne sont pas d'origine.

Part numbers are quoted for reference purposes only.  
Our parts and accessories are not original.



**FREINAGE  
BRAKES**

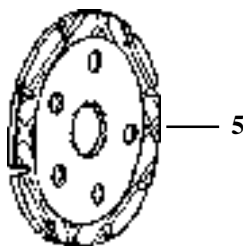

Tracteurs Tractors	Fig. Fig.	Réf. Ref.	OEM	Ø Ext. (mm) Outer Ø (mm)	Cannel. Splines	Ø canal. (mm) Splines Ø (mm)
<b>FREINS A DISQUES SOUS HUILE / BRAKE DISCS (OIL BATH)</b>						
<b>Same</b> (Roue arrière / <i>Rear wheels</i> ) Jaguar 95 Export Laser 90, 100, 110, 130, 150T Leopard 85 Export, 90 Turbo Tiger 100, Tiger Six 105 Export Trident 130 Export Titan 145, 160, 190	5	<b>S.170/5434</b>	17054340	304	12	51 x 68
<b>Lamborghini</b> (Roue arrière / <i>Rear wheels</i> ) R956, R956-100, R1106 R1056, R1306 Turbo DT, R1356DT R1506DT Turbo, A1556 DT						
<b>Hürlimann</b> (Roue arrière / <i>Rear wheels</i> ) H490, H496T, H5110 H6136, H6165 Master, H6190 Master						
<b>Same</b> (Roue arrière / <i>Rear wheels</i> ) Explorer 55, 60 Explorer 60 II, 60 Special, 65, 65 Special 70 II, 70 Special, 70 II Special	5	<b>29/255-5447</b>	25554472/10	282	13	46 x 59
<b>Lamborghini</b> (Roue arrière / <i>Rear wheels</i> ) R573-60N, R574-60N, R674, R674-5 R674-70N, R674-70 Grand Prix						
<b>Hürlimann</b> (Roue arrière / <i>Rear wheels</i> ) H356, H358, H358-4 Club H358 Prestige, H466, H468						
<b>Same</b> (Roue arrière / <i>Rear wheels</i> ) Explorer 75, 80II, 80 Special, 80 II Special 90 II Turbo Silver 80, 90, 100-4, 100-6	5	<b>29/445-5447</b>	44554472/10 00970672	282	12	46 x 59
<b>Lamborghini</b> (Roue arrière / <i>Rear wheels</i> ) R774, 774DT, 774-5, 774-80, 774-80N 774-80 Grand Prix, 874 Turbo 874-90T Grand Prix, 674-70 Grand Prix Premium 850, 950, 1050, 1060						
<b>Hürlimann</b> (Roue arrière / <i>Rear wheels</i> ) H476, H478, H486, H488 H6115 Elite, H6135 Elite						

Les références des pièces sont indicatives.  
Nos pièces ne sont pas d'origine.

Part numbers are quoted for reference purposes only.  
Our parts and accessories are not original.



**FREINAGE  
BRAKES**

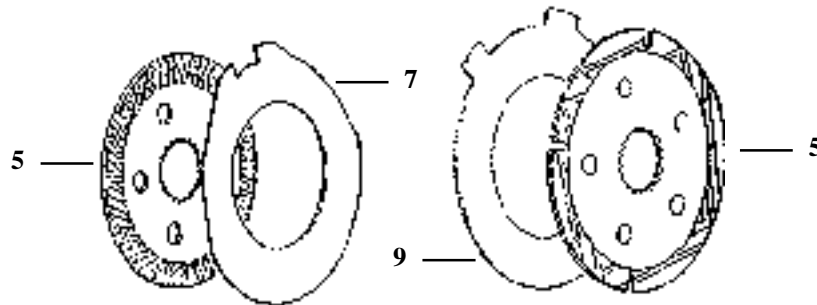

Tracteurs Tractors	Fig. Fig.	Réf. Ref.	OEM	Ø Ext. (mm) Outer Ø (mm)	Cannel. Splines	Ø canal. mm Splines Ø (mm)
<b>FREINS A DISQUES SOUS HUILE / BRAKE DISCS (OIL BATH)</b>						
<b>Same</b> Frutteto 60, 75, Solar 50, 60, Vigneron 75	5	SLT.256/5434	25654340/10 25654340	178	23	44 x 48
<b>Lamborghini</b> R483, 483DT, R550, 550DT, R583, 583DT, R653, 653DT, R654, 654DT, R653 Frutteto, R683, 683DT, R684, 684DT, R684 Frutteto, R724, 724DT, 660, 660DT, 660F, 660V, 775, 775F	7	SLT.256/5436	25654560 17754750	184		Ø int./inn 114
<b>Hürlimann</b> H351, H355F, H360 (N.00811⚡ ) H470 (N. 00627⚡ ), H361, H476F						
<b>Lamborghini</b> R1156, R1256		SLT.188/5434	18854340	342		58 x 83
<b>Lamborghini</b> R754, 754DT, R955, 955DT R784, 784DT, R854, 854DT		SLT.171/5434	17154342	260	12	51 x 68
<b>Hürlimann</b> H480	5					
<b>Same (Roue avant / Front whell)</b> Centauro Export, Centurion 75 Special Explorer 65, 65 Special & 70 II Explorer 75, 80 II, 80 Special, 80 II Special Galaxy 170 Turbo, Laser 90, 100, 110, 130, 150T Silver 80, 90, 100-4, 100-6, Antares 100, 110, 130 Titan 145, 160, 190		S.224/5434	22454340	224	27	55 x 61
<b>Lamborghini (Roue avant / Front whell)</b> R774, 674, R956, R956-100, R1106, R1106DT R1306 Turbo DT, R1356DT, R1506 Turbo DT R1556DT, R1706 Turbo DT, Formula 115, 135, Grand Prix 674-90, 774-80, Grand Prix 874-90T Premium 850, 950, 1050, 1060 Racing 150, 165, 190	9	S.275/4351	27543510	228		Ø int. /inn 140
<b>Hürlimann (Roue avant / Front whell)</b> H496T, H466, 468, 476, 478, 486, 488 H6136, H6115 Elite, H6135 Elite H6165 Master, H6190 Master						
<b>Hürlimann</b> H5160, 6160, 6170T (Roue avant & arrière/ Front & rear whell)						

Les références des pièces sont indicatives.  
Nos pièces ne sont pas d'origine.

Part numbers are quoted for reference purposes only.  
Our parts and accessories are not original.



**FREINAGE  
BRAKES**

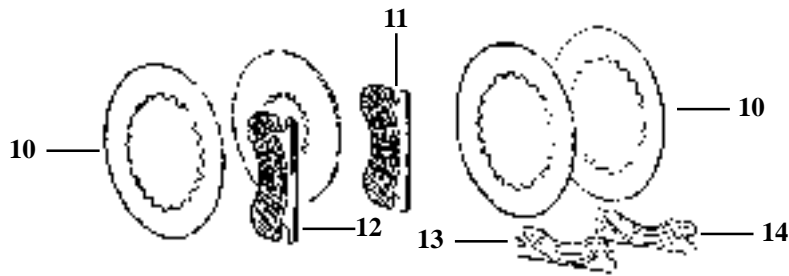

Tracteurs Tractors	Fig. Fig.	Réf. Ref.	OEM	Ø Ext. (mm) Outer Ø (mm)	Cannelures Splines	Ø cannel. Splines Ø (mm)
<b>FREINS DE STATIONNEMENT / HANDBRAKE DISCS</b>						
<b>Lamborghini</b> R573, R574, R674 R674-70 Grand Prix, R774, R874 774-80, 874-90T Premium 850, 950	10	29/255-5452	25554520	150	19	59 x 68
	11	29/224-5451	17154512	Simple Singles		
	12	29/224-5459	17154592	Double Double		
<b>Same</b> Jaguar95 Export (N.5131 ⇄) Laser 90, 100, 110, 130, 150 Turbo Leopard 90 Turbo, Tiger 100 Tiger Six 105 Export, Trident 130 Export	10	S.188/5458	18854580	185	26	64 x 70
	11	29/224-5451	17154512	Simple Singles		
	12	29/224-5459	17154592	Double Double		
<b>Lamborghini</b> R956, R1106, R1056, R1256, R1156, R1306, R1356, R1506, R1556	10	S.171/5457	17154570	170	26	64 x 70
	11	29/224-5451	17154512	Simple Singles		
	12	29/224-5459	17154592	Double Double		
<b>Hürlimann</b> H355, H360, H470, H480	10	S.171/5457	17154570	170	26	64 x 70
	11	29/224-5451	17154512	Simple Singles		
	12	29/224-5459	17154592	Double Double		
<b>Same</b> Antares 100, 110, 130, Aster 60, 70	11	29/224-5451	17154512	Simple Singles		
	12	29/224-5459	17154592	Double Double		
	10	29/224-5464	22454640/20	165	25	104 x 115
<b>Lamborghini</b> Formula 115, 135 Plus 660F, 775F, 880F 990F Premium 1050, 1060	11	29/224-5451	17154512	Simple Singles		
	12	29/224-5459	17154592	Double Double		
	10	29/224-5464	22454640/20	165	25	104 x 115
<b>Hürlimann</b> H6115 Elite, H6135 Elite	13	29/224-5458	22454580/10	Simple Singles		
	14	29/224-5465	22454650/10	Double Double		
	10	29/224-5464	22454640/20	165	25	104 x 115
<b>Same</b> Centauro 70 Export, 70 Special Centurion 75 Special Mercury 85 Export, 85 Special	13	29/224-5458	22454580/10	Simple Singles		
	14	29/224-5465	22454650/10	Double Double		
	10	29/224-5464	22454640/20	165	25	104 x 115

Les références des pièces sont indicatives.  
Nos pièces ne sont pas d'origine.

Part numbers are quoted for reference purposes only.  
Our parts and accessories are not original.





**FREINAGE  
BRAKES**

**MAITRE CYLINDRES DE FREIN  
MASTER CYLINDER (BRAKE)**



Tracteurs Tractors	Emetteur Master	Kit réparation Repair Kit
Antares	29/008-2190 (x2)	
Explorer Laser	29/257-6638 (x2)	
Centauro Jaguar Leopard Panther Tiger, Tiger Six	S.169/6665	29/169-6665

**CABLES DE FREIN  
BRAKE CABLES**

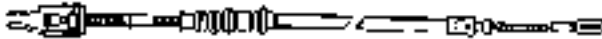

S.170/6670	Lg. : 1005mm	Tiger
S.174/6650	Lg. : 560mm	Buffalo
29/202-6625	Lg. : 760mm	Tiger Six
S.264/6636 (26466360)	Lg. : 825mm	Laser

**RESERVOIR HUILE DE FREIN  
OIL BRAKE TANK**

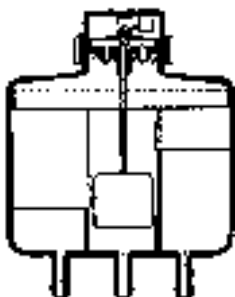

S.257/6654  
(25766544/10)

Antares 100, 110, 130  
Laser 110  
Explorer II 60, 70, 80, 90

**GOUJONS & ECROUS DE ROUES  
STUDS & NUT WHEEL**



S.135/4737A	Ø 20x52mm Ariete, Drago, Panther, ... H456
S.1011/311	Ecrou dito Nut for dito
S.146/4737X	Ø 16x37mm Minitauro, Minitaurus, Taurus
S.1099/016	Ecrou dito Nut for dito
S.148/4737	Ø 20x64mm Corsaro, Centurion, Leopard, Tiger, Saturno, ...
S.1011/311	Ecrou dito Nut for dito

**VIS DE ROUES AVANTS  
SCREWS (FRONT WHEEL)**



S.399/003	Ø 20x25mm Suivant montage 2 & 4 RM Some applications 2 & 4 WD
S.399/018	Ø 18x19mm Suivant montage 2 & 4 RM Some applications 2 & 4 WD
S.399/020	Ø 16x16mm Suivant montage 2 & 4 RM Some applications 2 & 4 WD

Les références des pièces sont indicatives.  
Nos pièces ne sont pas d'origine.

Part numbers are quoted for reference purposes only.  
Our parts and accessories are not original.



**TRANSMISSION**  
**TRANSMISSION**

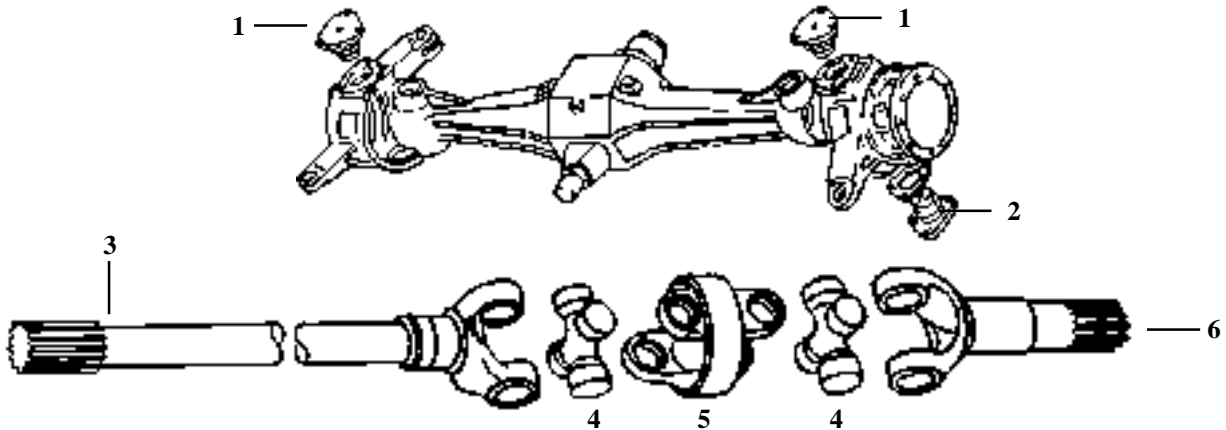

Tracteurs Tractors	Fig. Fig.	Référence Reference		Ømm Ømm	OEM
Saturno, Minitauro, Falcon	1	S.135/4335	<b>NEW</b>		13543350
Drago, Buffalo, Panther	2	S.135/4367	<b>NEW</b>		13543670
		S.148/4337			14843370/10
Saturno, Mercury, Centurion, Leopard, Corsaro	3	S.135/4630	<b>NEW</b>		13546300/20
Taurus, Minitauro, Minitaurus, Falcon		S.146/4630			14646300/20
Jaguar, Panther		S.148/4630			14846300/10
Trident 130, Drago, Buffalo, Tiger 100, Tiger Six 105		S.154/4630			15446300/10
Falcon, Minitaurus, Minitauro, Taurus, Explorer, Aurora, Titan, Aster, Antares110, 130 <b>Hürlimann</b> : H.360		S.146/4632		23,8x61	14646326/10
Saturno, Trident 130, Mercury, Drago, Centurion, Leopard, Jaguar, Buffalo, Panther, Aurora, Corsaro, Tiger 100, Tiger Six 105	4	S.150/4632		27x82	15046326/20
Laser		29/258.4632		30,2x92	2584632/10
Titan		S.212/4632		30,5x107	2124632/10
Mercury, Leopard, Jaguar, Panther, Corsaro	5	S.135/4633	<b>NEW</b>		13546330/05
Taurus, Minitauro, Minitaurus, Falcon		S.146/4633			14646330
Aurora, Tiger 100, Buffalo, Trident, Explorer II, Antares 100, Drago, Tiger Six 105 <b>Lamborghini</b> : 774, 874		S.150/4633			15046330/10
Aster 60, 70		S.270/4633			27046330/20
Saturno, Corsaro	6	S.135/4634	<b>NEW</b>	Z = 17	13546340/08
Saturno, Mercury, Centurion, Leopard, Corsaro		S.136/4634		Z = 16	13646340/20
Taurus, Minitaurus, Falcon		S.146/4634			14646340/30
Drago		S.154/4634		Z = 13	15446340/06
Buffalo, Tiger, Tiger Six 105, Tiger 100		S.164/4634A		Z = 12	16446340/02

Les références des pièces sont indicatives.  
Nos pièces ne sont pas d'origine.

Part numbers are quoted for reference purposes only.  
Our parts and accessories are not original.



**FLASQUE & MANCHONS CANNELES**  
**FLANGE & SPLINED AXLES**

**S.135/2620**  
(13526200)

Flasque / Flange  
Saturno, Mercury 85 Export,  
Centurion 75 Export, Taurus Export 60,  
Minitauro, Minitaurus 60 Synchro,  
Corsaro 70 Synchro, Falcon, Aurora

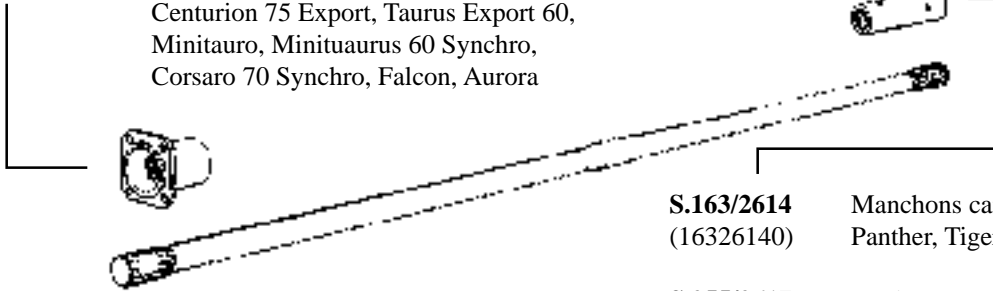

**S.163/2614**  
(16326140)

Manchons cannelés / Splined axles  
Panther, Tiger 100, Laser, Tiger Six 105

**S.255/2617**  
(25526170)

Explorer, Explorer II, Antares  
Lamborghini 674, 774, 874

**KITS DE DIRECTION ASSISTEE**  
**POWER STEERING KITS**

**SAME**

- DA.180 ATLANTA 45 DT
- DA.181 DELFINO 2 RM,  
SIRENETTA 2 RM
- DA.182 FALCON 2 RM
- DA.183 FALCON 4 RM - (A)
- DA.184 FALCON 4 RM - (A)
- DA.185 DELFINO 4 RM
- DA.186 RANGER, AURORA 2 RM
- DA.187 RANGER, AURORA 4 RM - (A)
- DA.188 CORSARO, SATURNO 2 RM
- DA.189 CORSARO, SATURNO 4 RM
- DA.190 CORSARO, SATURNO  
2 RM SYNCHRO
- DA.191 CORSARO, SATURNO  
4 RM SYNCHRO
- DA.192 CORSARO, SATURNO  
4 RM - (A)
- DA.193 CORSARO, SATURNO  
4 RM SYNCHRO - (A)
- DA.194 MINITAURO 2 RM
- DA.195 MINITAURO 4 RM
- DA.196 MINITAURUS, CONDOR  
2 RM SYNCHRO
- DA.197 MINITAURUS 4 RM SYNCHRO
- DA.198 MINITAURO 4 RM - (A)
- DA.199 MINITAURUS 4 RM SYNCHRO - (A)
- DA.062 LEONE, CENTAURO 2 RM
- DA.200 LEONE, CENTAURO 4 RM
- DA.201 LEONE, CENTAURO 4 RM - (A)
- DA.202 BUFALO, PANTHER, DRAGO, 4 RM
- DA.203 BUFALO, PANTHER, DRAGO - (A)
- DA.204 SOLAR 50 2 RM
- DA.205 SOLAR 60 2 RM

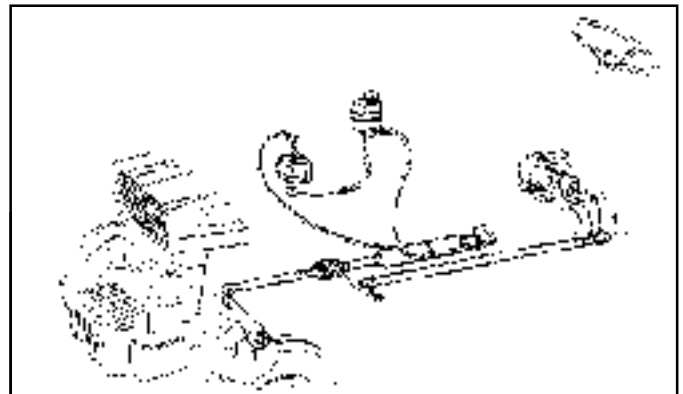

**LAMBORGHINI**

- DA.150 R 475 - 485 - 804 - 704
- DA.151 503 DT - 305 DT - 503 DT-B
- DA.152 503 DT/DTB - (A)
- DA.153 603 DT/DTB - (A)
- DA.154 603
- DA.155 603 DT
- DA.156 603 DT-B
- DA.157 483 DT
- DA.158 654
- DA.159 654 DT
- DA.160 354
- DA.161 660

Ces kits sont fournis avec toutes les pièces nécessaires au montage.  
*These kits are supplied with all parts needed for installation.*  
(A) Hydrostatique / Hydrostatic

**KIT DE RECONDITIONNEMENT DU FILETAGE DES FUSEES DE ROUES AVANT**  
**FRONT SPINDLE THREAD REPAIR KIT**



**70/457-9** (Ex : LN.10-24M)

Filetage/ Thread 24 x 150mm

L'écrou cône intérieur se visse sur le filetage usé et est serré par l'écrou extérieur.  
*The inner cone nut is screwed on the worn thread and is locked by the outer nut.*

Les références des pièces sont indicatives.  
Nos pièces ne sont pas d'origine.

Part numbers are quoted for reference purposes only.  
Our parts and accessories are not original.



**ROTULES & TIRANTS DE DIRECTION**  
**STEERING LINKS & SOCKETS**

POSITIONS

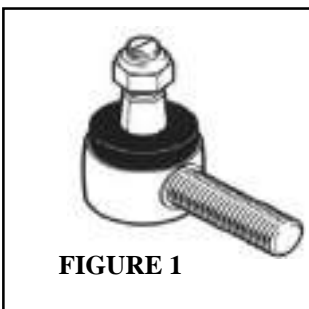
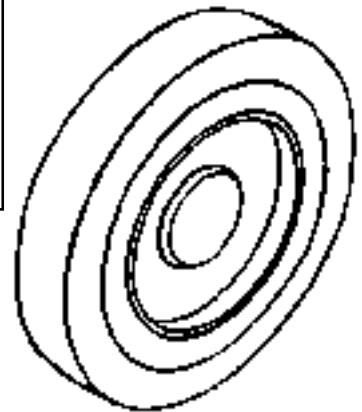
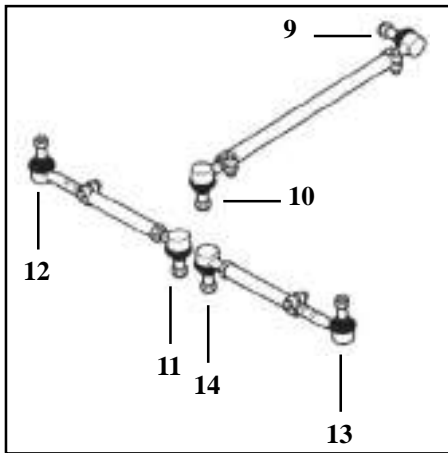
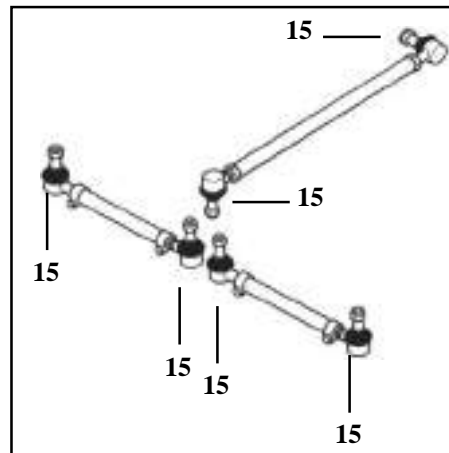
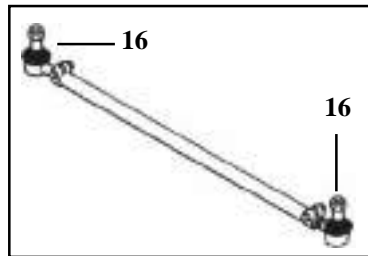
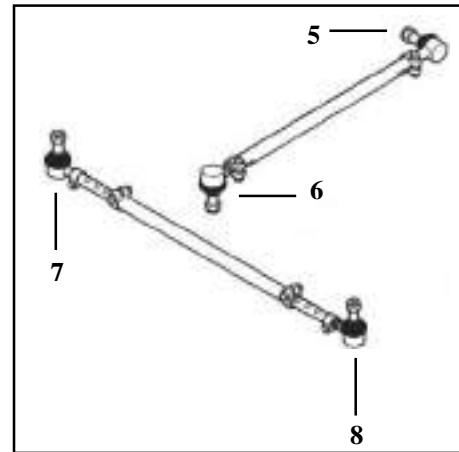
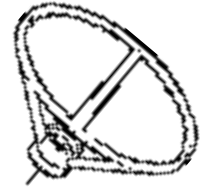
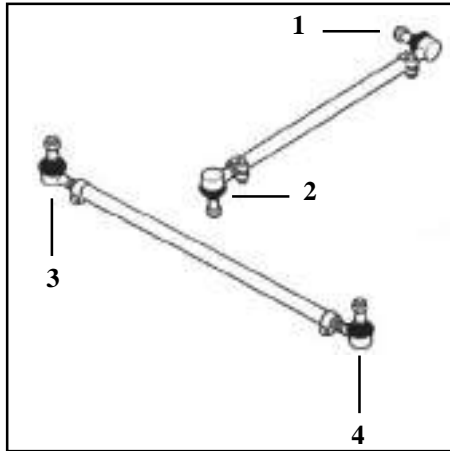

**FIGURE 1**

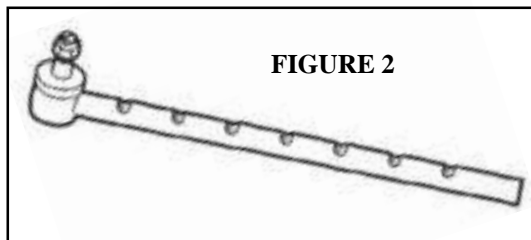

**FIGURE 2**

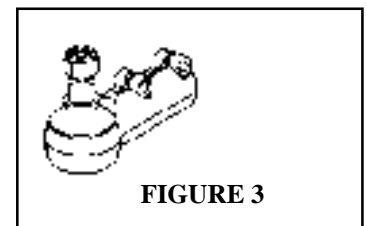

**FIGURE 3**

Les références des pièces sont indicatives.  
Nos pièces ne sont pas d'origine.

Part numbers are quoted for reference purposes only.  
Our parts and accessories are not original.



**ROTULES & TIRANTS DE DIRECTION**  
**STEERING LINKS & SOCKETS**

Figures &amp; position : consultez la planche de travail page SLH-66 / See page SLH-66 for figures &amp; position

Tracteurs Tractors	Fig. Fig.	Position Position	Filetage ou Ø Thread or Ø	Longueur Length	Conicité Cone
Italia DT, Atlanta DT	1	1	M18 x 1,5	100mm	16/18
		2			
		3		90mm	14/16,5
4					
Italia Vigneto DT Atlanta Vigneto DT		1			
		2			
		3			
		4			
Taurus 60 Minitauro DT Panther Falcon DT Condor DT		1	M24 x 1,5	105mm	18/20
		2			
		3			
		4			
Solar 50 Solar 60	3	M18 x 1,5	100mm	16/18	
	4				
Solar 50DT Solar 60DT	1	M24 x 1,5	105mm	18/20	
	2				
Drago Buffalo	3	M22 x 1,5	100mm	18/20	
	4				
	3				
	4				
Tiger Six 105DT	1	M18 x 1,5	90mm	14/16	
	2				
	3				
	4				
Aurora DT, Delfino DT Sirenetta DT, Ranger 45DT Falcon, Minitauro, Vigneron DT Frutteto DT, Condor Vigneron 35, 45, 60	5	M16 x 1,5	75mm	11/12,5	
	6				
	7	M18 x 1,5	100mm	16/18	
	8				
Corsaro Drago Saturno Leopard	5	M14 x 1,5	75mm	11/12,5	
	6				
	7				
	8				
Aurora Minitaurus Taurus Italia 35 Atlanta	5	M18 x 1,5	100mm	16/18	
	6				
	7	M18 x 1,5	100mm	16/18	
	8				

 Les références des pièces sont indicatives.  
 Nos pièces ne sont pas d'origine.

 Part numbers are quoted for reference purposes only.  
 Our parts and accessories are not original.

**ROTULES & TIRANTS DE DIRECTION**  
**STEERING LINKS & SOCKETS**

Figures &amp; position : consultez la planche de travail page SLH-66 / See page SLH-66 for figures &amp; position

Tracteurs Tractors	Fig. Fig.		Position Position	Filetage ou Ø Thread or Ø	Longueur Length	Conicité Cone
Ariete	1	S.135/4237 (13542374)	9	M18 x 1,5	100mm	16/18
			10			
Centaurus 55, 65, 70 Leone 70, 75	1	S.135/4345 (13543454)	9	M22 x 1,5	100mm	16/18
			10			
Centaurus 55, 65, 70 Leone 70, 75	2	S.135/4237 (13542374)	11	M18 x 1,5	300mm	16/18
				12		
			13			
Centaurus DT, Leone DT Corsaro DT, Saturno DT	1	S.135/4237 (13542374)	14	M18 x 1,5	100mm	16/18
				15		
Drago DT, Buffalo DT, Panther DT	1	S.148/6126 (14861264)	16	M24 x 1,5	105mm	18/20
Leopard 90, Hercules DT, Leopard DT Leopard 90 Turbo, Taurus 60 DT Tiger DT, Jaguar DT, Explorer 50 Explorer 60, 65, 70 Export Explorer 65, 75, 80 Speed Frutteto 60-75 Aster 60, 70 (4RM/4WD) Antares 100 (4RM / 4WD) Antares 110, 130 (2RM / 2WD) Centurion 75 Export (+ DT) Laser 90, 100, 110 (2RM / 2WD) Explorer II 60, 70, 80, 90 (4RM / 4WD)						
Laser 90, 100, 110, 130, 150 (4RM / 4WD) Galaxy 170 (4RM / 4WD) Titan 145, 160, 190 (4RM / 4WD)		29/257/4345 (25743454)		M24 x 1,5		20/22
Aster 60, 70 (2RM / 2WD)		S.135/4237 (13542374)		M18 x 1,5	100mm	16/18
Antares 100 (2RM / 2WD) Explorer II, 60, 70, 80, 90 (2RM / 2WD)		S.135/4345 (13543454)		M22 x 1,5		
Hürlimann Suivant applications Some applications		27/1730HU		M22x1,5	100mm	16/18
		27/1731HU				18/20
		27/1732HU		M24x1,5		16/18
	3	27/1733HU		F36x1,5	145mm	27/29
Lamborghini R.754, R.854	1	S.135/4345 (13543454)	1	M22 x 1,5	100mm	16/18
			2			
		S.135/4237 (13542374)	3	M18 x 1,5		
			4			

 Les références des pièces sont indicatives.  
 Nos pièces ne sont pas d'origine.

 Part numbers are quoted for reference purposes only.  
 Our parts and accessories are not original.

**ROTULES & TIRANTS DE DIRECTION**  
**STEERING LINKS & SOCKETS**

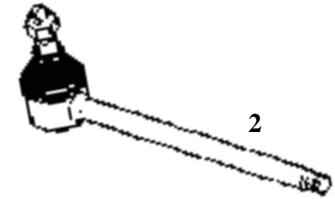
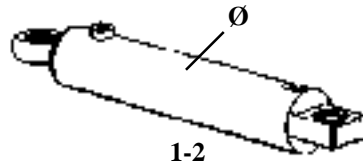

Figures	1		2		Jeu réparation du vérin Ram cylinder repair kit
Tracteurs Tractors	Vérin Ram cylinder	Remarques Comments	Tirant Rod	Remarques Comments	
Same Jaguar 95, Tiger 100, Leopard 90 Tiger Six 105, Falcon Lamborghini Hürlimann : H.480, H.490	<b>S.169/6352</b> (16963524) 1-1	A : 215 B : 380 C : 24/26	<b>S.169/6376</b> (16963763)	E : 340mm Ø : 22mm C : 24/26	<b>S.169/6378</b> (16963786)
Same Leopard 85, Centurion 75, Centauro, Mercury DT Lamborghini : R.754, R.654	<b>S.176/6354</b> (17663544) 1-1	A : 215 B : 390 C : 20/22	<b>S.176/6360</b> (17663603)	E : 340mm Ø : 22mm C : 20/22	<b>S.176/6365</b> (17663656)
Same Minitaurus 60, Condor 55 Taurus 60	<b>S.193/6362</b> (19363624) 1-1	A : 170 B : 340 C : 20/22	<b>S.193/6360A</b> (19363693)	E : 290mm Ø : 22mm C : 20/22	
Tracteurs étroits Narrow tractors	<b>S.463/6342</b> (46363423) 1-1	A : 215 B : 380 C : 20/22			
Same 4RM / 4WD Laser, Antares 100, 110, 130 Explorer II 70, 80, 90 Titan 145, 160, 190	<b>29/264-6342</b> (26463424/10) N°970100240 Ø 57mm 1-2	A : 200 B : 358 D : Ø 20mm	<b>NEW</b>		
Same 2RM / 2WD Explorer II 60, 70, 80, 90, Antares 100 Same 4RM / 4WD Explorer II 70, 80, 90 Vérin standard/Standart ram cylinder Lamborghini 2RM / 2WD 674, 774, 874, 674-70, 774-70, 874-70 Hürlimann 2RM / 2WD H466, 476, 486, 478, 488 T908, 909, 910-4, 910-6	<b>S.255/6342</b> (25563424) N°970440030 Ø 55mm 1-2	B : 334 D : Ø 20mm	<b>NEW</b>		
Same 4RM / 4WD Explorer II 70, 80, 90 Vérin renforcé/Heavy duty ram cylinder Lamborghini 4RM / 4WD 674, 774, 874, 674-70, 774-70, 874-70 Hürlimann 4RM / 4WD H466, 476, 486, 478, 488 T908, 909, 910-4, 910-6	<b>S.448/6342</b> (44863424) N°980430031 Ø 62mm 1-2	B : 330 D : Ø 20mm	<b>NEW</b>		
Lamborghini			<b>SLT429/6371</b> (42963713)	E : 295mm Ø : 20mm C : 16/18	
			<b>SLT429/6370A</b> (42963704)	E : 300mm Ø : 20mm C : 18/20	

(A) : Course / Stroke  
(D) : Rotule / Tie rod

(B) : Longueur fermée / Closed length  
(E) : Longueur tige / Length shaft

(C) : Cône / Cone

Les références des pièces sont indicatives.  
Nos pièces ne sont pas d'origine.

Part numbers are quoted for reference purposes only.  
Our parts and accessories are not original.



**POMPES HYDRAULIQUES**  
**HYDRAULIC PUMPS**

**SAME**

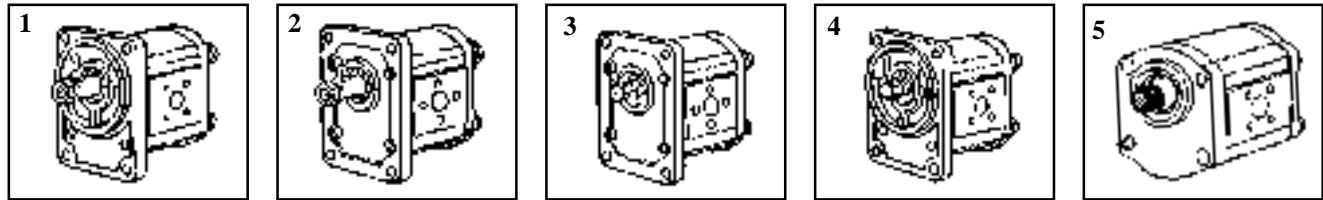

Tracteurs Tractors	Référence Reference	Fig. Fig.	Type Type	Débit Flow	Rotation Rotation	OEM
Antares 100, 110, 130	<b>BH.515.338</b>	5	DA	14cc	Gauche LH	245297900 245299200
Antares 100	<b>BH.615.023</b>		R	16cc	Droite RH	245297400
Antares 110, 130	<b>BH.715.008</b>		R	22,5cc		245297800
Centauro 70 exp., Centurion 75 Exp., Condor 55 Jaguar 95 Exp., Leopard 85, Leopard 85 Exp. Mercury 85 Exp., Minitaurus 60 Exp., Taurus 60 Exp. Tiger Six 105 Exp.	<b>BH.425.307</b>	1	DA	8cc	Gauche LH	245292700/10
Delfino 35, Falcon 50, Aurora 45, Vigneron 35, 45, 60, Ranger 45	<b>BH.325.307</b> <b>BH.425.308</b>	4		5,5cc 8cc		245292500
Centauro 70SP, Centurion 75SP, Galaxy 170, Laser 90, 100, 110, 130, 150, Leopard 90, 90DT Mercury 85SP	<b>BH.525.024</b>	3		11cc	Droite RH	245294200
Leopard 75C, Trident 130	<b>29/4529-430</b> <b>29/4529-480</b> <b>BH.525.329</b>		11cc 12cc 14cc	Gauche LH	24529430, 0510525331 P78120062 24529390	
Explorer 55, 60, 65, 70, 75, 80, 90	<b>29/4529-470</b>		8cc		245294700/10 0510415328	
Centauro 70SP, 70 Exp., Centurion 75SP, 75 Exp., Mercury 85SP, 85 Exp.	<b>BH.525.329</b> <b>29/4529-480</b> <b>BH.625.332</b>	3	14cc 12cc 19cc		24529390 P781200GLX 245294000	
Laser 90, 100, 110, 130, Galaxy 170, Leopard 90, 90DT, Buffalo 130, Hercule 160, Jaguar 95, Tiger Six 105, Panther 95	<b>BH.725.348</b>		R	22,5cc	245293000/10	
Explorer 55, 60, 65, 70, 75, 80	<b>29/4529-440</b>		5	14cc	Droite RH	0510515013 245294400/10
Explorer II, 80, 90	<b>BH.615.023</b>	16cc		245297400		
Leopard 90	<b>BH.525.311</b> <b>SLT.4529/290</b>	1	DA	11cc	Gauche LH	245292900 P87120061
Aster 60, 70	<b>BH.625.315</b>		R	16cc		245290160 P781600GLX
Jaguar 100, Trident 130	<b>BH.625.327</b> <b>S.4529/330</b>	3	R	16cc 16cc		
Buffalo 130	<b>BH.425.307</b> <b>BH.525.024</b>	1 3	DA	8cc 11cc	Gauche/LH Droite/RH	245292700/10 245294200

R : Relevage / Lift  
DA : Direction assistée / Power steering

Références "BH..." references : Bosch  
Références "29/..." & "SLT..." references : Bendix

Les références des pièces sont indicatives.  
Nos pièces ne sont pas d'origine.

Part numbers are quoted for reference purposes only.  
Our parts and accessories are not original.





**POMPES HYDRAULIQUES**  
**HYDRAULIC PUMPS**

**LAMBORGHINI**

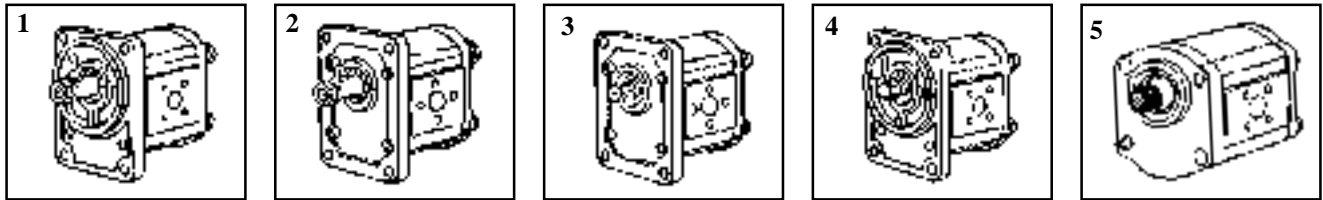

Tracteurs Tractors	Référence Reference	Fig. Fig.	Type Type	Débit (cc) Flow (cc)	Rotation Rotation	OEM	
R.235 (4666 ⇄), 503, 603, 704, A.183	<b>BH.425.009</b>	1	R	8	Droite / RH	245292800 640R2031	
	<b>29/4529-280</b>					P870800D1X	
583, 653, 654, 683, 684, 754, 784, 854, 904, 955, A.182	<b>BH.525.313</b>	2	DA	11	Droite / RH	245291500 640R2050	
583, 653, 654, 683, 684, 851, 904, 655, 754, 784	<b>29/4529-430</b>	3	R			16	Gauche / LH
1056, 1156, 1356 (⇄ 1133), 1556	<b>BH.625.327</b> <b>S.4529/330</b>			22,5	245293300 P781600G2X		
956, 1106-1306, 1556, 1706T, 1256, 1356 (1134 ⇄), 3056	<b>BH.725348</b>						
754, 854, 1356	<b>BH.625.318</b>	2		16		245293100	
674, 774, 874	<b>29/4529-470</b>	5	DA	8		P650800G2 0510415328 245294700	
674	<b>29/4529-440</b>		R	14	Droite / RH	P651400D2X 0510515013 245294400/10	
774, 874, Formula 105	<b>BH.615.023</b>			16		245297400	
956, 1106, 1306, 1506, 1706, R.105	<b>BH.525.024</b>	3	DA	11		245294200	
1156, 1356	<b>BH.625.332</b>		R	19	Gauche / LH	245294000 640R2090	
A.184, 684	<b>BH.425.307</b>	1	DA	8		245292700/10	
Formula 115, 135	<b>BH.515.338</b>	5		14		245297900	
Racing	<b>29/4529-480</b>	3		12	245294000		
Formula 115, 135	<b>BH.715.008</b>	5	R	22,5	Droite / RH	245297800	
804	<b>BH.525311</b> <b>SLT.4529/290</b>	1		11	Gauche / LH	245292900 P871200G1X	
956, 1106, 1306, 1506, 1706, 1556	<b>BH.725.331</b>	2		22,5			

R : Relevage / Lift

DA : Direction assistée / Power steering

Les références des pièces sont indicatives.  
Nos pièces ne sont pas d'origine.

Références "BH..." references : Bosch

Références "29/..." & "SLT..." references : Bendix

Part numbers are quoted for reference purposes only.  
Our parts and accessories are not original.



**POMPES HYDRAULIQUES**  
**HYDRAULIC PUMPS**

**HÜRLIMANN**

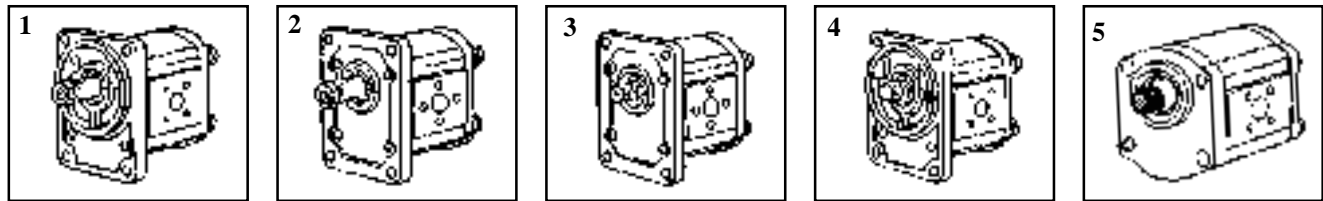

Tracteurs Tractors	Référence Reference	Fig. Fig.	Type Type	Débit (cc) Flow (cc)	Rotation Rotation	OEM
H.5110	<b>BH.625.315</b>	1	R	16	Gauche / LH	
H.6130	<b>BH.625.317</b>	4		16		
H.6160	<b>BH.625.316</b>			19		
H.6135	<b>BH.515.338</b>	5	DA	14		245297900
H.468, H.478, H.488	<b>BH.615.023</b>				16	Droite / RH
H.496, H.5116, H.6136, H.6170	<b>BH.725.331</b>	2	R	22,5		
	<b>BH.725.348</b>	3				
H.360, H.470, H.480	<b>B.525.313</b>	2				245293600
H.5110, H.360, H.470, H.480, H.490	<b>BH.525.311</b>	1	DA	11	Gauche / LH	Bendix
	<b>SLT.4529/290</b>					
H.490	<b>BH.525.311</b>	1	R			
	<b>SLT.4529/290</b>					
H.496	<b>BH.525.024</b>	3	DA		Droite / RH	
H.356, H.466, H.478, H.488	<b>29/4529-470</b>	5		8	Gauche / LH	0510415328

R : Relevage / Lift

DA : Direction assistée / Power steering

Références "BH..." references : Bosch

Références "29/..." & "SLT..." references : Bendix

**Liste de conversion des anciennes références TRACPIECES**

**Cross-reference previous TRACPIECES numbers**

Ancienne référence Previous reference	Nouvelle référence New reference	Ancienne référence Previous reference	Nouvelle référence New reference
S.4529/005B	<b>BH.425.308</b>	S.4529/300	<b>BH.525.748</b>
S.4529/006S	<b>BH.325.307</b>	S.4529/016	<b>BH.625.327</b>
S.4529/009	<b>BH.425.307</b>	SLT.4529/570	<b>BH.425.009</b>
S.4529/015	<b>BH.525.329</b>	27/1740HU	<b>BH.525.313</b>
S.4529/420	<b>BH.525.024</b>	SLT.4529/310	<b>BH.625.318</b>

Les références des pièces sont indicatives.  
Nos pièces ne sont pas d'origine.

Part numbers are quoted for reference purposes only.  
Our parts and accessories are not original.



**DISTRIBUTEURS HYDRAULIQUES**  
**HYDRAULIC VALVE**



**HB.47/SA** Simple effet / *single acting*

**HB.47/DA** Double effet / *double acting*

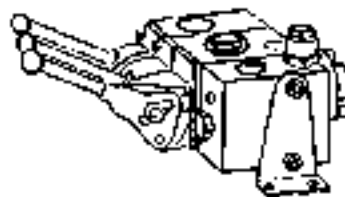

**STABILISATEURS**  
**STABILISERS**

**STABILISATEURSAVEC POSITION FLOTTANTE**  
**STABILISER WITH FLOATING POSITION**

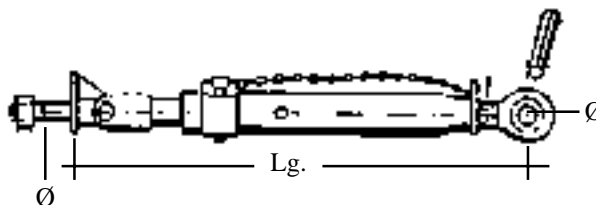

Réf. Ref.	Lg. fermée Closed Lg.	Lg. ouverte Opened Lg.	Ø Piton Ø Pin	Ø Rotule Ø Tie rod	Flottement Floating	Filetage Thread
AT.9001/E	410	510	18	19	30	M27x3
AT.9002/D	490	630	28			
AT.9003/C	600	710				
AT.9004/B	580	700	25	40	M36x3	
AT.9005/A	680	830				

**STABILISATEUR TYPE ORIGINE**  
**STABILISER GENUINE TYPE**

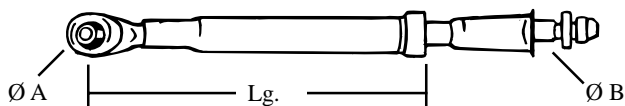

**S.9605/426** Lg. : 386mm  
ØA : 19mm  
ØB : 20mm

**S.9605/1506** Lg. : 350mm  
ØA : 19mm  
ØB : 28mm

**GOUPILLE**  
**SAFETY PIN**



**S.96017/514** Ø 14mm  
**S.96001/574** Ø 16mm  
**S.96026/553** Ø 20mm

Les références des pièces sont indicatives.  
Nos pièces ne sont pas d'origine.

Part numbers are quoted for reference purposes only.  
Our parts and accessories are not original.



**TIRANTS DE RELEVAGE**  
**LIFTING RODS**

**BRAS DE RELEVAGE**  
**LIFT ARM**

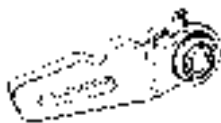

- S.9605/354**    Extrémité droite / *Outside RH*  
Leopard, Tiger, Panther  
Cat.2, Ø 28
- S.9605/355**    Extrémité gauche / *Outside LH*  
Leopard, Tiger, Panther  
Cat.2, Ø 28

**VERIN D'ASSISTANCE DE RELEVAGE**  
**RAM CYLINDER LIFT ARM**

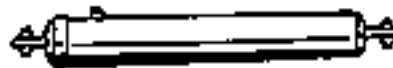

- HYSE.298**    Ø tige 40mm / Ø rod 40mm  
2 rotules Ø 22mm / 2 tie rods Ø 22mm  
Lg. fermée entre-axes : 550mm  
Lg. closed : 550mm  
Course : 380mm / Stroke : 380mm

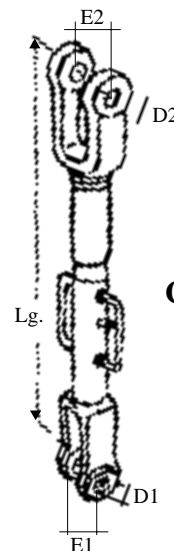
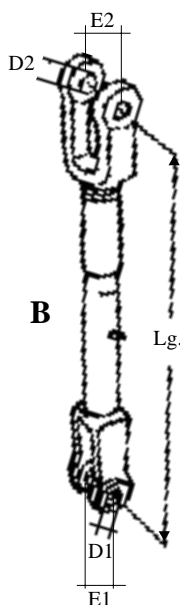
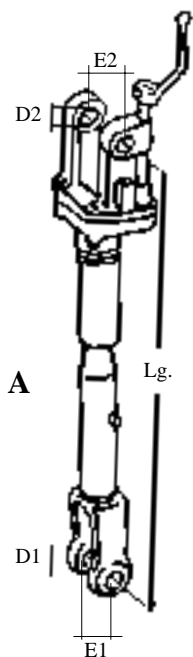

Réf. Ref.	Description Description	Type Type	L (mm)	D1 Ø (mm)	D2 Ø (mm)	E1 (mm)	E2 (mm)
<b>29/76057</b> (76057354)	Tirant réglable / <i>Adjustable rod</i> Explorer 80, 90 + Ancienne gamme / <i>Old range</i>	A	680			30	45
<b>29/76036</b> (76035364)	Tirant fixe / <i>Fixed rod</i> Explorer 60, 70 Lamborghini 874-90DT	B	645	24	24	25	45
<b>29/76058</b> (76057364)	Tirant fixe / <i>Fixed rod</i> Explorer 80, 90		680				
<b>29/96047</b> (96047364)	Tirant fixe / <i>Fixed rod</i> Laser 110, Antares 110, 130, 150		735				
<b>29/76039 (*)</b> (76039354)	Tirant gauche ou droit / <i>Rod (LH or RH)</i> Titan 160	C	820	28	28	32	51

(\*) Livrable jusqu'à épuisement des stocks / *Stocks in exhaust*

Les références des pièces sont indicatives.  
Nos pièces ne sont pas d'origine.

Part numbers are quoted for reference purposes only.  
Our parts and accessories are not original.

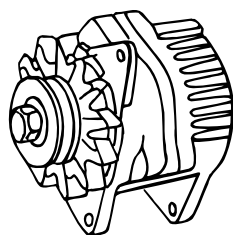

**ALTERNATEURS**  
**ALTERNATORS**
**SAME**

Tracteurs Tractors	Réf. Cde Order N°	Remarques Observations	Capacité Capacity	Régulateur Regulator	OEM
Falcon, Panther, Buffalo, Minitauro, Saturno	<b>510.E.385</b>	Montage à droite <i>RH assembling</i>	14V., 35 Amp.	Séparé / <i>Separate</i> : <b>205/01001</b>	294390700 9AL2969F
Buffalo 130, Centauro 70, Centurion 75, Condor 55, Corsaro, Delfino 35, Drago 120, Falcon, Jaguar 95 & 100, Leopard, Mercury, Panther 90, Taurus 60, Tiger 100, Vigneron 35, 50 & 70	<b>SLT.9439/090</b>  <b>510.E.414</b> <b>15/1071</b>  <b>15/1405 (W)</b>	VALEO Raccord à fiches <i>Plug connection</i> Raccord à vis Montage à droite <i>Screw connection</i> <i>RH assembling</i>	14V., 33 Amp.  14V., 45 Amp. 14V., 55 Amp.  14V., 55 Amp.	<b>205/01007</b>  <b>505.E.106</b> <b>205/04034</b>  <b>205/05122</b>	294390900  294391300 9AR50066
Antares 100, 110 & 130, Aster 60, Explorer 55, 65, 75 & 85, Centauro 70 & 75, Galaxy, Hercules 60, Jaguar 95 & 100, Laser 90, 100, 110, 130, 150, Leopard 85 & 90, Mercury 85, Panther 95, Taurus 60, Tiger Six 105	<b>15/1242</b>  <b>15/8463 (W)</b>  <b>15/1357 (W)</b>  <b>15/1336 (W)</b>	Raccord à vis, Sans poulie <i>Screw connection</i> <i>Without pulley</i> Sans poulie <i>Without pulley</i> Raccord à vis, Poulie double déportée <i>Screw connection</i> <i>Twin pulley (offset)</i> Raccord à vis, Poulie simple <i>Screw connection</i> <i>Single pulley</i>	14V., 55 Amp.  14V., 65 Amp.  14V., 65 Amp.  14V., 55 Amp.	<b>205/05122</b>  <b>205/05122</b>  <b>205/04034</b>  <b>205/04034</b>	294391300   294392900
Solar, Titan, Explorer, Antares	<b>15/5514</b>	Pour chauffage Sans poulie <i>For heating</i> <i>Without pulley</i>	14V., 65 Amp.	Sans régulateur <i>Less regulator</i> Séparé / <i>Separate</i> : <b>16.906.339</b>	
Corsaro 70, Panther 90, Leopard 85, Saturno 80, Tiger 100	<b>15/1405 (W)</b>	Raccord à vis <i>Screw connection</i>	14V., 55 Amp.	<b>205/05122</b>	9AR2968K
Silver 80, 90, 100-4, 100-6	<b>15/1667</b>	Pour chauffage Rotation gauche <i>For heating</i> <i>LH rotation</i>	14V., 85 Amp.	<b>AER1606</b>	294394700
Ancien montage <i>Old Assembly</i>	<b>510.E.384</b>  <b>15/1309 (W)</b>	VALEO Axe/ <i>Shaft</i> : Ø 17mm	14V., 50 Amp.  14V., 55 Amp.	<b>505.E.079</b>  <b>205/05122</b>	

 (W) Raccordement électrique du compteur / *Electrical tachometer connection*

 Les références des pièces sont indicatives.  
 Nos pièces ne sont pas d'origine.

 Part numbers are quoted for reference purposes only.  
 Our parts and accessories are not original.

**ALTERNATEURS  
ALTERNATORS**

**LAMBORGHINI**

Tracteurs Tractors	Réf. Cde Order N°	Remarques Observations	Capacité Capacity	Régulateur Regulator	OEM
360, 483	15/1995		14V., 33 Amp.	205/01007	
503, 603, 704, 804, 904	K.552 (W)		14V., 33 Amp.	205/01007	
553, 653, 654, 683, 684, 754, 784, 854	SLT.9439/090		14V., 33 Amp.	205/01007	294390900
674, 774, 874, 956, 1106, 1156, 1256, 1306, 1356, 1506, 1706	15/1242	Raccord à fiches Plug connection	14V., 55 Amp.	205/05122	294391300
	15/8463 (W)	Sans poulie Less pulley	14V., 65 Amp.	205/05122	
	15/1357 (W)	Raccord à fiches Plug connection Poulie double déportée Twin pulley (offset)	14V., 65 Amp.	205/04034	

**HÜRLIMANN**

Tracteurs Tractors	Réf. Cde Order N°	Remarques Observations	Capacité Capacity	Régulateur Regulator	Réf. OEM Ref. OEM
H356, 466, 466-4, 476, H486T, 6170T, 6670, 6680, 6690, 8610, 8630	15/1242 15/8463 (W)	Sans poulie Less pulley	14V., 55 Amp. 14V., 65 Amp.	205/05122 205/05122	

(W) Raccordement électrique du compteur / Electrical tachometer connection

**PIECES DIVERSES POUR DYNAMO "BOSCH"  
MISCELLANEOUS PARTS FOR "BOSCH" GENERATOR**

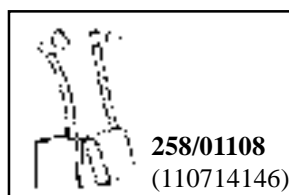
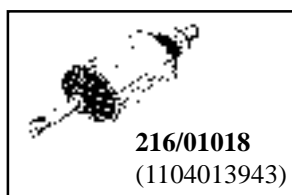

**PIECES DIVERSES POUR ALTERNATEURS D'ORIGINE  
MISCELLANEOUS PARTS FOR ORIGINAL ALTERNATORS**

Balai / *Brushe*

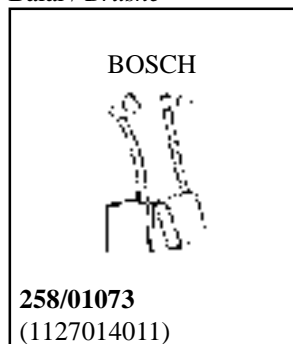

Bloc balai / *Brushe set*

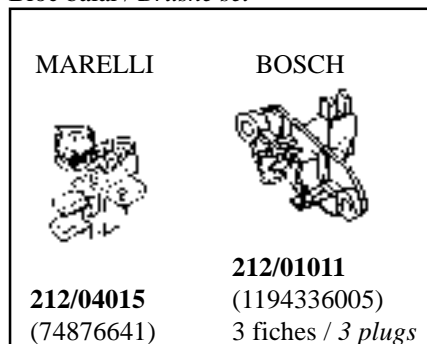

Régulateur / *Control box*

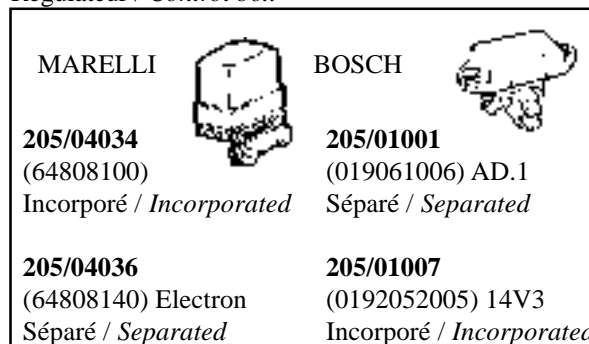

Les références des pièces sont indicatives.  
Nos pièces ne sont pas d'origine.

Part numbers are quoted for reference purposes only.  
Our parts and accessories are not original.

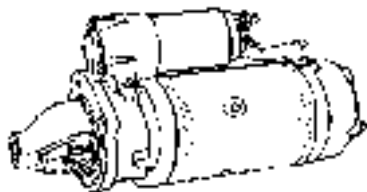

**DEMARREURS**  
**STARTER MOTORS**

**SAME**

Tracteurs Tractors	Réf. Cde Order N°	Lanceur Drive ass.	Fixation Fitting	Lg. sortante Prominent lg.	Capacité Capacity	OEM
Antares 110, 130 & 150, Explorer 80 & 90, Galaxy 170, Laser 110, 130 & 150 (Certains / Some)	<b>S.9619/180N</b>	9Z	2L	254mm	12V., 3,5 KW	296192300
Minitauro 55/60, Corsaro 70, Delfino, Explorer 60, Falcon, Aurora, Saturno	<b>S.9619/080</b>	11Z	2L	224mm	12V., 1,8 KW	296190800
Antares 110 & 130, Drago 120, Buffalo 130, Centauro 70, Centurion 75, Condor 55, Corsaro 70, Explorer 55, 65, 75 & 85, Galaxy 170, Herculus 160, Jaguar 95 & 100, Laser 90, 110, 130, 150 (3/83 ⇄ 12/87) Leopard 85 & 90, Mercury 85, Minitauro 60, Minitaurus 60, Panther 90 & 95, Saturno 80, Solar 60, Taurus 60, Tiger 100, Tiger Six 105, Titan 160 & 190	<b>SLT.9619/110</b>	11Z	2L	254mm	12V., 3,5 KW	296191800

**LAMBORGHINI**

Tracteurs Tractors	Réf. Cde Order N°	Lanceur Drive ass.	Fixation Fitting	Lg. sortante Prominent lg.	Capacité Capacity	OEM
503, 603 (3/71 ⇄)	<b>SLT.2040</b>	9Z	2L	228mm	12V., 2,7 KW	
235, 653, 784	<b>S.9619/080</b>	11Z	2L	224mm	12V., 1,8 KW	296190800
804, 904	<b>SLT.073</b>	9Z	3L	262mm	12V., 3 KW	296195000
235, 345, 503, 603, 613, 653, 654, 674, 684, 704, 714, 754, 774, 784, 804, 854, 874, 955, 1056, 1156, 1256, 1556, 574-60, 874-90, 674-70, 774-80	<b>SLT.9619/110</b>	11Z	2L	254mm	12V., 3,5 KW	296191800
503, 603, 1106, 1306, 1506, 1706, 1356, 674-70, 774-80, 874-90 Formula 115, 135	<b>S.9619/180N</b>	9Z	2L	254mm	12V., 3,5 KW	296192300

**HÜRLIMANN**

Tracteurs Tractors	Réf. Cde Order N°	Lanceur Drive ass.	Fixation Fitting	Lg. sortante Prominent lg.	Capacité Capacity	OEM
H355, 360, H470, 480, 490, H5110, H6110, H476U, H488T, 496T, 5116T, 6115, 6130, 6135, 6136, 6160, 6165, 6190	<b>SLT.9619/110</b>	11Z	2L	254mm	12V., 3,5 KW	296191800
356, 468, 478, H468-70, 468L, LA, B, H468-80, 488-90, 5116, 6170T, 6136	<b>S.9619/180N</b>	9Z	2L	254mm	12V., 3,5 KW	296192300

Les références des pièces sont indicatives.  
Nos pièces ne sont pas d'origine.

Part numbers are quoted for reference purposes only.  
Our parts and accessories are not original.



**PIECES DE RECHANGE POUR DEMARREURS "BOSCH"**  
**SPARE PARTS FOR "BOSCH" STARTER MOTORS**

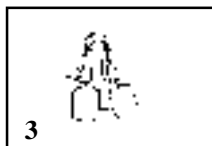
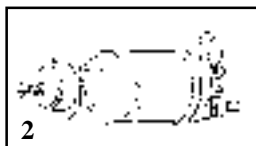

Figures		1	2	3	4
Tracteurs Tractors	Démarrreur Starter motor	Lanceur Drive ass.	Relais Solenoid	Jeu de balais Brushes	Induit Armature
Ariete, Drago (11/71 ⇄ 2/73)	0.00.1359.013	<b>224/01061</b> (2006209301)	<b>203/01056</b> (0331401001)	<b>258/01056B</b> (2007014052)	
Atlanta, Centauro, Delfino, Italia Minitauro (1/72 ⇄ 12/73), Sametto	0.00.1362.099 0.00.1362.009	<b>224/01122</b> (2006209245)	<b>203/01063</b> (0331401032)	<b>258/01058</b> (2007014053)	<b>220/01048</b> (2004004072)
Aurora (11/71 ⇄ 2/73), Corsaro (2/72 ⇄ 6/76), Falcon 983L Saturno (3/72 ⇄ 6/76)	0.00.1362.022				<b>220/01034</b> (2004004061)
Aurora (3/73 ⇄), Centurion (9/78 ⇄) Condor (2/79 ⇄), Corsaro (7/76 ⇄) Delphino (1/72 ⇄ 9/80) Falcon (7/75 ⇄ 9/80), Jaguar Leopard (1/78), Minitauro (⇄ 9/80) Panther (2/79 ⇄), Saturno (7/76 ⇄) Sirenetta (1/72 ⇄), Taurus (11/78 ⇄) C.352, 553, 653, 503 (7/76 ⇄) 784 (1/80 ⇄)	0.00.1362.035	<b>224/01269</b> (200620475)	<b>203/01065</b> (0331402003)	<b>258/01059</b> (2007014057)	<b>220/01059</b> (2004004074)
Buffalo (7/74 ⇄ 1/75) Drago (3/73 ⇄ 1/75) Panther (7/74 ⇄ 1/75) C.603, R.704, 804, 904 (73/75)	0.00.1359.053	<b>224/01189</b> (2006209408)	<b>203/01057</b> (0331401004)		
Buffalo (2/75 ⇄ 7/79) Drago (2/75 ⇄ 7/79) Panther (2/75 ⇄ 7/79) C.603, R.704, 804, 904 (75/78) R.1056, 955	0.00.1359.099 0.00.1359.108	<b>224/01134</b> (2006209438)	<b>203/01069</b> (0331402002)	<b>258/01056B</b> (2007014052)	
Leone (1/67 ⇄ 12/71) C.603, R.704, 804, 904 (4/73 ⇄ 10/73) 955	0.00.1359.004	<b>224/01058</b> (2006209302)	<b>203/01056</b> (0331401001)		
R.503, 603 (3/71 ⇄)	0.00.1362.040	<b>224/01149</b> (2006209476)	<b>203/01064</b> (0331402001)	<b>258/01059</b> (2007014057)	
R.1256 (6/78 ⇄), R.955, R.1056	0.00.1367.005	<b>224/01150</b> (2006209492)	<b>203/01069</b> (0331402002)	<b>258/01062</b> (2007014062)	

Les références des pièces sont indicatives.  
Nos pièces ne sont pas d'origine.

Part numbers are quoted for reference purposes only.  
Our parts and accessories are not original.





**DIVERS**  
**MISCELLANEOUS**

**LA MEILLEURE  
PEINTURE DU MARCHE**



64/LA.2036/L  
64/LA.1004/L

Bleu foncé / *Drak blue* - Lamborghini  
Blanc avorio / *Avorio white* - Lamborghini

64/LA.2034/L  
64/LA.2034/SP  
64/LA.3034/L  
64/LA.3034/SP  
64/LA.6034/L  
64/LA.6034/SP

Bleu / *Blue* - Same  
Bleu / *Blue* - Same  
Orange / *Orange* - Same  
Orange / *Orange* - Same  
Gris châssis / *Chassis grey* - Same  
Gris châssis / *Chassis grey* - Same

**LAQUE AMERICAINE**

**THE BEST PAINT ON  
THE MARKET**

(1 litre / 1 liter)  
(1 litre / 1 liter)

(1 litre / 1 liter)  
(Spray)  
(1 litre / 1 liter)  
(Spray)  
(1 litre / 1 liter)  
(Spray)



**SIGLE  
MEDALLION**



29/174006

Ø 80,5mm  
Plastique / *Plastic*

**61/830-301**

(Ex : 1050/BON)



**SIEGE COMPLET / COMPLETE SEAT**

Caractéristiques techniques

- Modèle spécial pour les montages où l'espace arrière est limité
- Réglage en hauteur
- Glissières
- Revêtement synthétique noir

Technical data

- *Special model to fit where rear space is limited*
- *Height adjustment*
- *Slide rails adjustment*
- *Synthetic black leather*

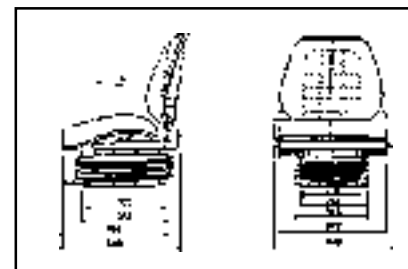

**REGARNITURES DE SIEGES  
SEAT TRIMS**



S.157/751H

Siège Grammer  
*Seat Grammer*

S.165/7518H

Siège Bostrom  
*Seat Bostrom*

Les références des pièces sont indicatives.  
Nos pièces ne sont pas d'origine.

Part numbers are quoted for reference purposes only.  
Our parts and accessories are not original.



**ELEMENTS DE CABINES**  
**CABS ELEMENTS**

**RACLETTES D'ESSUIE-GLACE**  
**WIPER BLADES**



**10/3223** Balai assemblé / Wiper blade  
Lg. : 400-410mm

**10/3225** Balai assemblé / Wiper blade  
Lg. : 450-460mm

**MOTEUR D'ESSUIE-GLACE**  
**WIPER MOTOR**

**ET.12032**



R/404A

**SUPPORT DE RETROVISEUR**  
**MIRROR BRACKET**

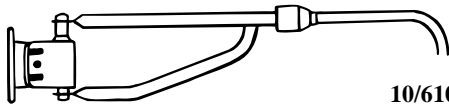

**10/6100K**  
(0083741437429)

Support extensible pour rétroviseur (Gauche ou droit)  
Sans cuvette  
Extensible bracket for mirror (LH or RH)  
Less mirror

**RETROVISEURS**  
**REAR VIEW MIRRORS**



**29/9234.147** Rétroviseur droit  
Mirror RH



**29/9234.149** Rétroviseur gauche  
Mirror LH



**29/9233.183** Cuvette 237x180mm  
Mirror 237x180mm

**29/9200.147** Cuvette 354x169mm  
Mirror 354x169mm

**PIECES DE PORTE DE CABINE**  
**DOOR PARTS CAB**

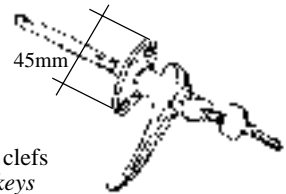

**6734** - Poignée avec clefs  
(92001726/10) Handle with keys  
Cabine "SIAC" Cab

**6821** - Poignée intérieure  
(9200158020) Inner handle  
Cabine "SIAC" Cab



**29/9200-156** - Serrure droite  
Lock (RH)

**29/9200-155** - Serrure gauche  
Lock (LH)



**ETAIS A GAZ**  
**GAS STRUTS**

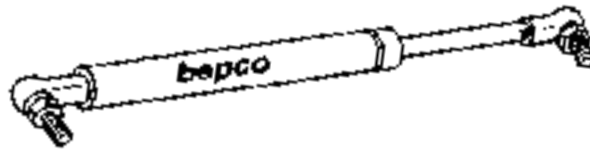

**SAME**

Tracteurs Tractors	Pare-brise Windscreen	Porte Door	Toit Roof	Vitre arrière Rear glas
Antares, Titan	29/9206-194 (9200.170.3) 255mm	29/872-23 (00820894/20) 390mm	SLT.9234/373 320mm	29/872-37 (00754070) 715mm
Aster				SLT.9208/140 515mm - 350 Newtons
Centaurio		S.9206/194 500mm	S.9206/194 500mm - 220 Newtons	
Centurion, Leopard Buffalo		SLT.9241/140 (92411404) 500mm		SLT.9234/373 320mm
Explorer			29/870-38 (92061984/10)	
Explorer II, 60, 70, 80, 90		SLT.9233/167 502mm - 230 Newtons		
Galaxy			SLT.9233/167 502mm - 230 Newtons	
Hercules		SLT.9208/140 515mm - 350 Newtons		
Jaguar			SLT.9208/140 515mm - 350 Newtons	
Laser		SLT.9234/373 320mm	SLT.9233/167 502mm - 230 Newtons	
Solar		SLT.9241/140 500mm	SLT.9241/140 500mm	SLT.9208/140 515mm - 350 Newtons
Taurus				S.9206/194 500mm - 220 Newtons
Tiger, Trident		SLT.9241/140 500mm	SLT.9208/140 515mm - 350 Newtons	

Les références des pièces sont indicatives.  
Nos pièces ne sont pas d'origine.

Part numbers are quoted for reference purposes only.  
Our parts and accessories are not original.



**ETAIS A GAZ**  
**GAS STRUTS**

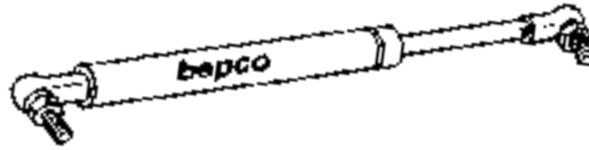

**LAMBORGHINI**

Tracteurs Tractors	Pare-brise Windscreen	Porte Door	Toit Roof	Vitre arrière Rear glas
R.674, R.874	SLT.9241/140 (9233.166.4) 500mm	SLT.9241/140 (9233.166.4) 500mm	SLT.9234/373 320mm	SLT.9241/140 (9233.166.4) 500mm - 200 Newtons
R.956, R.1106, R.1306, R.1506				
R.774				SLT.9233/167 502mm - 230 Newtons
R.774-80, R.874T				
R.874-90T, R.874-90T Grand Prix, 105 Formula		SLT.9241/140 (9233.166.4) 500mm		
Hürlimann XT Lamborghini Premium		29/872-23 (00820894/20) 390mm		29/872-37 (00754070) 715mm

**HÜRLIMANN**

Tracteurs Tractors	Pare-brise Windscreen	Porte Door	Toit Roof	Vitre arrière Rear glas
H356, H358, H466 H476, H468, H478, H488		SLT.9241/140 (92411404) 500mm	SLT.9234/373 320mm	29/872-38 (92061984/10) 520mm - 200 N
490, 5110, 480				29/872-37 (00754070) 700mm - 350 N
XT				
6115, 6135		29/872-23 (00820894/20) 385mm - 570 N		

Les références des pièces sont indicatives.  
Nos pièces ne sont pas d'origine.

Part numbers are quoted for reference purposes only.  
Our parts and accessories are not original.



**BAGUES D'ETANCHEITE**  
**OIL SEALS**

Dimensions Ø Dimensions Ø	Réf. SAME Ref. SAME	Type Type	Réf. Ref.	Dimensions Ø Dimensions Ø	Réf. SAME Ref. SAME	Type Type	Réf. Ref.
12x20x7	2.1519.042.0		<b>29/1519.042</b>	58x80x10	2.1519.001.0 (2.1519.010.0)	SP	<b>29/1519.010</b>
30x40x7	2.1510.013.0		<b>29/1510.013</b>	58x80x10	2.1520.130.0	2	<b>29/1520.130</b>
34x52x10/13	2.1510.216.0 (2.1520.116.0) (2.1529.010.0)	3	<b>29/1510.216</b>	60x75x8	2.1510.031.0 (2.1520.131.0)	2	<b>29/1520.131</b>
34x46x10	2.1529.021.0	3	<b>29/1529.021</b>	65x85x10	2.1510.331.0		<b>29/1510.331</b>
35x47x7	2.1510.017.0		<b>29/1510.017</b>	60x80x10	2.1520.231.0	2	<b>29/1520.231</b>
35x62x10	2.1510.617.0 (2.1529.030.0)	3	<b>29/1510.617</b>	70x85x8	2.1510.036.0		<b>29/1510.036</b>
35x62x12	2.1520.217.0	2	<b>29/1520.217</b>	70x90x10/12	2.1510.136.0 (2.1520.036.0) (2.1529.004.0)	3	<b>29/1529.004</b>
35x72x12	2.1520.317.0	2	<b>29/1520.317</b>	70x100x10	2.1520.336.0	2	<b>29/1520.336</b>
35x55x10	2.1529.033.0	3	<b>29/1529.033</b>	70x100x12	2.1529.026.0	3	<b>29/1529.026</b>
38x50x7	2.1510.019.0		<b>29/1510.019</b>	70x90x12/9,5	2.1529.072.0	3	<b>29/1529.072</b>
38x52x7	2.1510.119.0		<b>29/1510.119</b>	80x100x10/13	2.1510.041.0 (2.1529.005.0) (2.1520.141.0)	3	<b>29/1520.141</b>
40x56x8	2.1510.120.0		<b>29/1510.120</b>	85x110x12	2.1529.501.0 (2.1520.043.0)	2	<b>29/1529.501</b>
40x80x10	2.1520.420.0	2	<b>29/1520.420</b>	95x120x13	2.1510.447.0		<b>29/1510.447</b>
40x68x10/13	2.1529.016.0	3	<b>29/1529.016</b>	98x120x13	2.1519.002.0 (2.1519.009.0)	SP	<b>29/1519.009</b>
42x56x7	2.1510.021.0		<b>29/1510.021</b>	100x120x12	2.1510.049.0 (2.1520.049.0)	2	<b>29/1520.049</b>
42x60x10	2.1510.221.0		<b>29/1510.221</b>	100x125x12	2.1510.149.0 (2.1529.013.0)	3	<b>29/1529.013</b>
45x62x10	2.1510.123.0 (2.1520.023.0)	2	<b>29/1520.023</b>	110x140x13	2.1529.056.0		<b>29/1529.056</b>
45x65x10	2.1510.223.0 (2.1520.123.0) (2.1529.031.0)	3	<b>29/1529.031</b>	110x130x13	2.1529.073.0	3	<b>29/1529.073</b>
45x62x10	2.1529.036.0 (2.1529.029.0)	3	<b>29/1529.036</b>	125x150x13	2.1529.040.0	3	<b>29/1529.040</b>
45x62x16	2.1529.078.0	3	<b>29/1529.078</b>	130x160x12	2.1510.055.0	3	<b>29/1510.055</b>
48x62x8	2.1510.025.0		<b>29/1510.025</b>	135x160x15	2.1529.023.0	3	<b>29/1529.023</b>
50x72x10/8	2.1510.426.0		<b>29/1510.426</b>	145x180x15	2.1529.006.0 (2.1529.064.0)	3	<b>29/1529.064</b>
50x68x10	2.1520.026.0	2	<b>29/1520.026</b>	145x170x13	2.1529.038.0	3	<b>29/1529.038</b>
50x72x10	2.1529.041.0	3	<b>29/1529.041</b>	150x180x15	2.1529.065.0 (2.1529.002.0)	3	<b>29/1529.065</b>
55x72x12	2.1510.129.0 (2.1520.329.0) (2.1529.032.0)	3	<b>29/1529.032</b>	180x205x23	2.1529.081.0/20	3	<b>29/1529.081</b>
55x80x10	2.1529.022.0	3	<b>29/1529.022</b>	240x270x25	2.1529.069.0	3	<b>29/1529.069</b>

 (2) Double lèvre / *Twin lip*

 (3) Triple lèvre, carcasse acier / *Triple lip, steel armature*

 (SP) Spécial / *Special*

 Les références des pièces sont indicatives.  
 Nos pièces ne sont pas d'origine.

 Part numbers are quoted for reference purposes only.  
 Our parts and accessories are not original.