

Molded Case Circuit Breakers, Motor Protection Circuit Breakers, and Motor Circuit Protectors



Technical Data



LISTEN.
THINK.
SOLVE.®



Table of Contents

Introduction.....	4
Definitions	5
Product Range	8
Product Line Overview	11
Product Specifications	
Molded Case Circuit Breakers.....	24
Motor Circuit Protectors	42
Motor Protection Circuit Breakers.....	52
Accessories	
Auxiliary & Alarm Contacts	55
Shunt Trip.....	58
Undervoltage Release	60
Motor Operators.....	62
Residual Current Release Module	64
Time-Current Curves	
Motor Circuit Protectors	66
Thermal Magnetic Molded Case Circuit Breakers	76
Electronic Molded Case Circuit Breakers	102
Let-Through Energy Curves [I^2t].....	116
Peak Let-Through Current Curves	121

140G Molded Case Circuit Breakers

Introduction to Molded Case Circuit Breakers

What is a Circuit Breaker?

What is a circuit breaker? This is the first question to answer in understanding Molded Case Circuit Breakers. The definition of a circuit breaker varies between the standards organizations, but the most commonly used definitions are:

The National Electrical Manufacturers Association (NEMA) defines circuit breakers as “devices designed to open and close a circuit by non-automatic means, and to open the circuit automatically on a predetermined overcurrent without injury to itself when properly applied within its rating.”

The International Electrotechnical Commission (IEC) Standard IEC 60947-2 defines a circuit breaker as “a mechanical switching device, capable of making, carrying and breaking currents under normal circuit conditions and also making, carrying for a specified time and breaking currents under specified abnormal circuit conditions such as those of short-circuit.”

There are also similar definitions, that further identify circuit breakers by type of construction and functionality. Within the IEC specification for circuit breakers, there are several distinctions of types of circuit breakers by classification:

Utilization Category

Interrupting medium

- Air break
- Vacuum break
- Gas break

Design

- Open case
- Moulded (molded) case

Method of controlling the operating mechanism

- Dependent manual operation
- Independent manual operation
- Dependent power operation
- Independent power operation
- Stored energy operation

Type of overcurrent release

- Instantaneous
- Definite time delay
- Inverse time delay

In reviewing the attributes just listed, it is understandable that many people are confused about what type of circuit breaker to use, where to use it, and how to select it properly. In this section, the focus will be placed on the definition, application and selection of Molded Case Circuit Breakers (MCCBs) with an inverse time delay as applied to industrial control panels.

This publication will focus on the application and selection of MCCBs, Motor Protection Circuit Breakers (MPCBs) and Motor Circuit Protectors (MCPs). The primary focus will be on products that are packaged in a molded case design, but much of the information can be applied to other circuit breakers that are commonly found in control panels.



Definitions

Each of the product categories we mentioned earlier is packaged in a molded case and confusion develops because of the physical similarity of the products.

The Molded Case Circuit Breaker is a specific type of circuit breaker. NEMA defines circuit breakers as devices designed to open or close a circuit by nonautomatic means, and to open the circuit automatically on a predetermined overcurrent without damage to itself when properly applied within its rating. The term “molded case” simply refers to the construction of the circuit breaker and refers to the fact that the circuit breaker is an assembled unit in a supporting housing of an insulating material.

Within the realm of MCCBs, three distinct product variations exist, each with specific protection properties and uses within the industrial control panel. The main categories are:

Molded Case Circuit Breakers or Feeder Breakers

MCCBs are intended to provide overcurrent protection for conductors and equipment by opening automatically before the current reaches a value and duration that will cause an excessive or dangerous temperature in conductors or conductor insulation. Additionally, these devices can serve as the main disconnecting means for a control panel. This protection pertains to low level overcurrent, and short-circuit current. Traditionally these types of circuit breakers are generically described as thermal magnetic devices, though an increasing number of these devices are also electronic circuit breakers which provide the same type of protection, with the exception that the electronics allow the protection curves to be customized to the specific application. In the United States, the National Electrical Code (NEC) defines how this protection is selected in Sections 240-2, 240-3 and 240-4. In Canada there are similar references in the Canadian Electric Code, C22.1-12. For IEC applications, IEC 60204-1 provides guidance for the construction of industrial control panels.

Motor Protection Circuit Breakers

Application-specific variations of the MCCB, these breakers combine the short-circuit and isolation functionality of the MCCB with the motor overcurrent protection of a traditional overload relay. These devices are traditionally used in two-component starter applications, with a contactor to control a motor load. MPCBs are UL 489 Listed as circuit breakers and verified as motor overload relays. Allen-Bradley® MPCBs are UL Listed as 100% breakers, allowing utilization of the full range of motor protection provided. Note: most circuit breakers applied in North America are 80% rated, meaning they can only be used continuously at 80% of their thermal rating. Allen-Bradley MPCBs are 100% rated, allowing full use of the circuit breakers’ thermal capacity in motor protection applications.

Motor Circuit Protectors

Another application-specific version of the MCCB, the Motor Circuit Protector (MCP) is a magnetic trip only version of the MCCB. These circuit breakers provide no overload protection and, as a result, when applied in motor circuit need to be applied with a controller in order to provide short-circuit and overcurrent protection. In the United States, the MCP is UL Listed with a controller and together they form a combination starter. The advantage of this combination is the choice in overload protection that can be applied to the starter. Listed combinations can include thermal as well as electronic overload relays, providing users with protection that is customized for their application. The MCP can also be provided in several variations, including high magnetic trip versions that allow them to be used with high-efficiency motors, reducing the chance of nuisance tripping due to the characteristic high inrush currents associated with these motors.

Where are each of these breakers used? The diagram below represents a typical multi-starter control panel. Note that the main disconnecting means is an MCCB, which is acting as both the main disconnect and feeder protection. There are several branches within this control panel. Both MCPs and MPCBs are being used to provide the branch a circuit breaker as a device in the case of the MCP, and branch short-circuit protection as well as overload protection in the case of the MPCB.

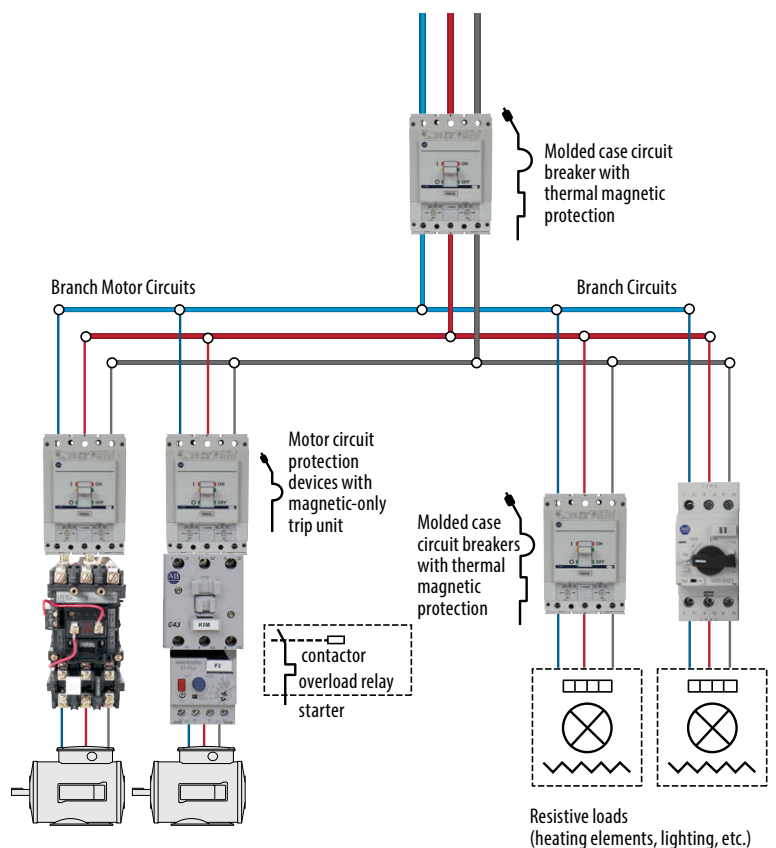

Breaker Theory and Construction

When used in an industrial control panel application, the purpose of the MCCB is to provide overcurrent protection. This definition can be divided into short-circuit protection and thermal overcurrent protection. A short circuit can range from hundreds of amps to over 100,000 amps, depending upon the power source and where the short circuit would occur in the circuit.

An arc chamber is integral to all MCCBs. This arc chamber will be similar in all forms of the circuit breakers and performs several important functions in providing short-circuit protection. This chamber surrounds the switching contacts within the circuit breaker and the contacts open during a short circuit. The opening of these contacts generates an arc. The arc chamber and its components, the arc chutes and splitter plates, draw the arc away from the contacts, dividing and cooling the arc. Ultimately, this leads to the extinguishing of the arc and the circuit opening and current flow stopping. One of the remarkable elements is that this entire operation occurs in milliseconds, with short-circuit currents that can be 100,000 A or greater, depending upon the available current in the circuit.

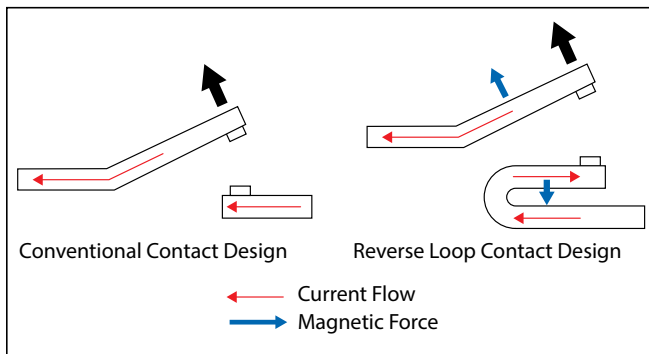

Conventional contact design compared to reverse loop contact design.

Depending upon the design of the circuit breaker and intended short-circuit interruption capability, differences in the construction of the contact assemblies exist. The most commonly used contact assemblies are shown here.

The reverse loop design is used in modern circuit breakers as its design uses the magnetic forces created by current flowing in opposite direction to assist in the opening of the contacts under short-circuit conditions. Additionally, the amount of repulsive force generated is proportional to the value of the short-circuit current being experienced by the circuit breaker. This provides for faster interruption time as the short-circuit currents increase.

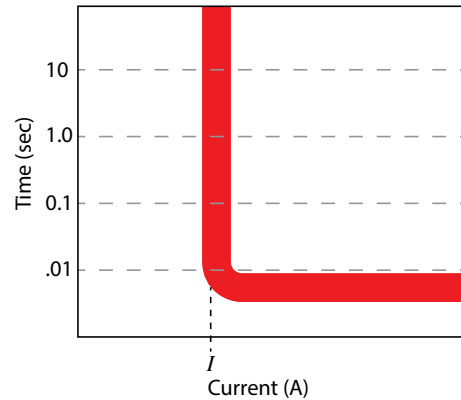

Example of magnetic time vs. current curve.

Using these magnetic trip units, we are able to provide short-circuit protection that can be represented in a curve as shown above.

This document is not designed to be a reference to circuit breaker design. However, the construction of the arc chamber is being discussed as it is important to understand that MCCBs with a 25 kA interrupting rating will require fewer arc splitters and smaller arc chutes to interrupt a short circuit than will a comparable device rated for 100 kA of interruption. Therefore, when selecting an MCCB for a specific application, it is very important to take into consideration the amount of short-circuit current available and then select the circuit breaker with an interrupting rating sufficient to meet the requirements of the application.

The MCCB also provides thermal protection for the control panel and, as we will see later, the branch circuit. This thermal protection can be provided either through the use of bimetallic heater elements similar to those found in overload relays or through the use of electronics, which simulate the operation of heater element and can provide adjustable overcurrent protection for the application.

Trip Curve for a Thermal Magnetic MCCB

The most commonly selected form of thermal protection is the bimetallic version. This works similarly to a traditional overload relay in which a bimetallic element is heated, causing a deflection, which then exerts pressure on a trip bar and causes the circuit breaker to trip.

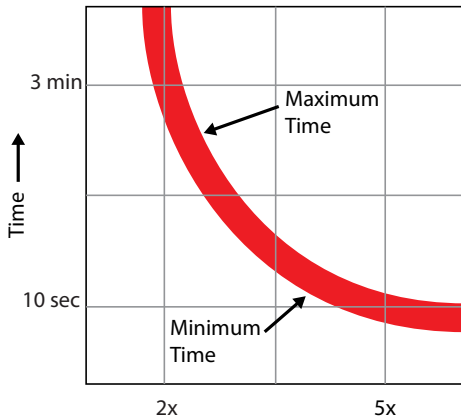

Using the bimetallic model, we can provide a thermal protection curve as shown at left.

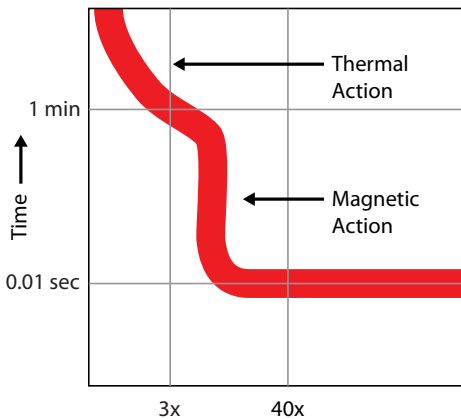

Combining the short-circuit and overcurrent protection provides us with a protection curve that looks like this.

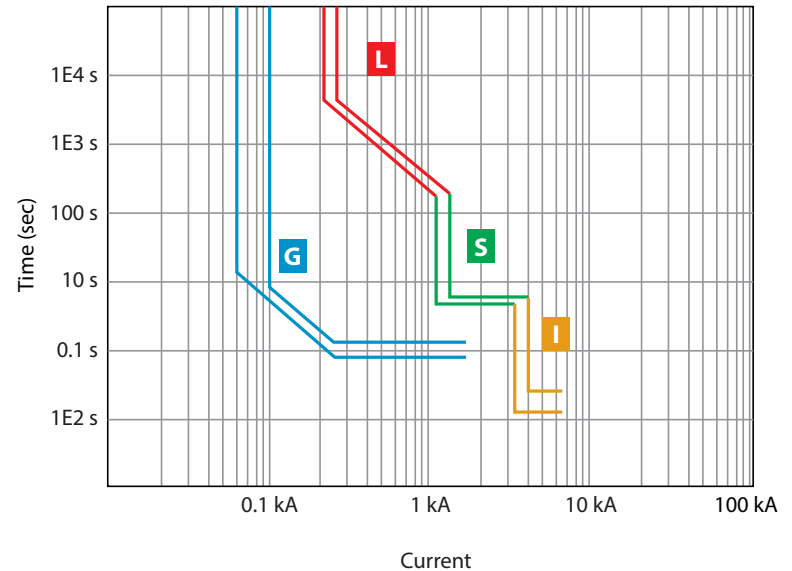

- L** – Overcurrent Protection **L**ong Time Delay
- S** – Short-circuit Protection **S**hort Time Delay
- I** – Short-circuit Protection **I**ntermediate Trip
- G** – Ground Fault Protection

In the application section of this introduction we will examine trip curves in greater detail. For now, we are presenting the electronic trip units for the purpose of understanding the scope of a Molded Case Circuit Breaker offering.

Electronic trip units are available in a variety of trip settings. The most common combinations are LSI, LSIG and M-LIV trip settings; therefore a wide variety of options exist for customizing the protection the circuit breaker provide within the control panel.

Rockwell Automation offers a full range of Allen-Bradley Molded Case Circuit Breakers for use in industrial control panel applications. In an effort to simplify the application of MCCBs and their complimentary products, this application guide will help you properly select and apply circuit breakers used in an industrial control panel.

Trip Curve for an Electronic MCCB

An alternative to using fixed-thermal protection is to use electronic overcurrent protection, which can electronically replicate the function of the mechanical overcurrent device. One of the benefits of using electronic trip units is their ability to tailor the tripping characteristics of the circuit breaker for the application.

The electronic trip unit has the ability to provide advanced protection in the form of additional trip functionality such as adjustable:

Long Time – Allows the long time between 1.05 and ~1.3 x the thermal rating to be delayed, similar to how an adjustable relay changes classes

Short Time – Adjustable short time between thermal and short-circuit

Instantaneous Trip – Adjustable instantaneous short-circuit trip time

Ground Fault – Adjustable time and value of ground fault tripping

Applying Molded Case Circuit Breakers to North American Guidelines

The MCCB is most commonly used as either a feeder breaker or a single circuit breaker where disconnecting, short-circuit, and thermal protection functionality is required. When selecting an MCCB, the following items need to be taken in to consideration:

- Application voltage
- Available short-circuit current
- Amperage of the load or wiring to be protected

Additionally, local code requirements will also need to be taken into consideration and may ultimately affect the type and functionality of the MCCB selected.

MCCB

- Magnetic and Thermal Trip Currents may be fixed or adjustable
- Must be sized per NEC/CEC rules
- May be used for motor circuits, but 140MG (MCP) is first choice
- Motor Current (thermal rating)
 - ≤ 250% motor FLA
 - ≤ 300% for motors ≤ 100 A if the circuit trips on start
 - ≤ 400% for motors ≥ 100 A if the circuit breaker trips on start
- Magnetic Trip Current is generally set at 1000% (10x) of circuit breaker thermal ratings
- May be UL Listed as part of UL 508/UL 60947-4-1
- May also be used for motor control-circuit transformers, but Bulletin 1489 MCBs are the first choice

Motor Protection Circuit Breakers

While globally these devices are considered motor protection circuit breakers, in North America they are defined as manual Type E self-protecting combination motor controllers:

- Sized at 100% of the motor full-load current (FLA)
- Motor current setting is adjustable (thermal rating)
- IEC & UL/CSA calibration requirements require overload to trip at 120 & 125% FLA
- Motor is able to run into the Service Factor when set at 100% of the motor current
- Magnetic Trip Current setting is adjustable (magnetic rating)
- Adjustable at 1300% (13x) highest motor current setting on circuit breaker
- Higher Magnetic Trip Current settings are available if circuit breaker trips on start (140M-C2T-***)
- Example of an MPCB using 140M-C2E-C10:
 - Motor Current is adjustable from 6.3...10 A
 - Set at 100% FLA for proper motor protection
 - Magnetic Trip Current is fixed at 130 A
 - This is where circuit breaker begins to trip in a “short-circuit” condition

- Motor Protection Circuit Breakers are relatively new to the North American market
- NEC/CEC (Canadian Electrical Code) do not specifically recognize this classification of circuit breaker and, therefore, do not describe how to size them (e.g. 100% FLA sizing)

Motor Circuit Protectors

- Motor current setting (thermal) is not specified by NEC/CEC
- MCPs are magnetic only
- Thermal capability should be greater than or equal to motor FLA and less than or equal to overload relay setting
- Motor overload protection must be provided separately
- MCPs are UL Recognized
- Must be tested and listed with specific contactors and overloads
- UL Listing is obtained as part of UL 508/UL 60947-4-1
- Magnetic trip current is adjustable
- Adjustability is required by UL489 standard
- Must be sized per NEC/CEC rules
 - ≤ 800% motor FLA for standard efficiency motors
 - ≤ 1300% motor FLA allowed if motor will not start
 - ≤ 1100% motor FLA for high efficiency motors
 - ≤ 1700% motor FLA allowed if motor will not start
- MCPs are the most popular choice for motor circuits in the North American market
- Used in combination starters and Motor Control Center unit inserts (buckets) for many years
- Provide choice in overload protection

Product Line Overview

Rockwell Automation offers a complete line of Allen-Bradley Molded Case Circuit Breakers, Motor Circuit Protectors and Motor Protection Circuit Breakers.

In the MCCB family there are eight frame sizes of MCCBs, from 15 A through 3000 A, with dual-rated EN/IEC 60947-2 and UL489 breakers in 3- and 4-pole configurations. All frame sizes feature full sets of accessories as well as common accessories, which allows reduced inventory and maximum flexibility.

In the MCP family of products, there are seven frames, ranging from 3 A through 1200 A. The MCPs, like the MCCBs, share the same accessories and provide the same flexibility. In the MPCB range of products there are three frames ranging from 25 A through 150 A, which share the same accessories as MCPs and MCCBs.

MCCB Portfolio Overview								
Frame Reference	G	H	I	J	K	M	N/NS	R
Molded Case Circuit Breakers <ul style="list-style-type: none"> • Bulletin 140G globally rated MCCBs • UL 489, EN 60947-2, CE, CCC • Feeder circuits and disconnects • 3- and 4-pole versions 	15...125 A*	15...125 A*	60...225 A	25...250 A	120...400 A	240...800 A	480...1200 A	800...3000 A
Motor Protection Circuit Breakers <ul style="list-style-type: none"> • Bulletin 140MG globally rated MPCBs • UL 489, EN 60947-2, CE • Branch protection, 2-component starters • 3-pole versions 		25...100A		40...150 A				
Motor Circuit Protectors <ul style="list-style-type: none"> • Bulletin 140MG globally rated MCPs • UL 489, EN 60947-2, CE • Branch protection, 3-component starters • 3-pole versions 	3...125 A	3...125 A	100...150 A	150...250 A	300...400 A	600...800 A	1200 A	

* 160 A IEC only

Auxiliary Contacts (AX)

Auxiliary contacts perform the function of electrically signaling the circuit breaker's operating status.

The auxiliary contacts change state when the circuit breaker is opened, closed, or tripped.

Auxiliary contacts indicate the ON/OFF status of the MCCB. The 140G auxiliary contacts are changeover contacts (Form C).

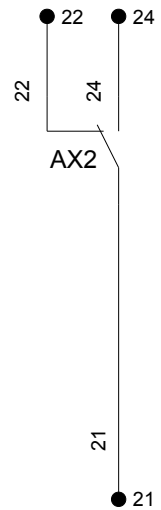

Alarm Contacts (AL)

Alarm Contacts (AL) are a special form of auxiliary contacts that indicate the trip status of the MCCB due to:

- Trip due to overload
- Trip due to short circuit
- Trip due to residual current (if equipped)
- Trip due to shunt trip and/or undervoltage release (if equipped)
- Trip initiated by pressing the "test" button

After initial alarm contact change of state, the Alarm Contacts (AL) change state only when one of the above conditions occur. Manual operation of the breaker to Off does not affect the state of these contacts. The 140G Alarm contacts are changeover contacts (Form C).

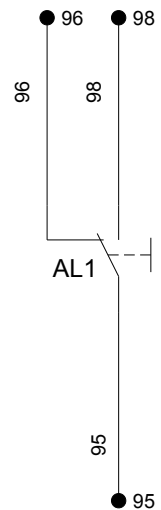

Combination Auxiliary Alarm Contacts

Auxiliary/Alarm contacts include contacts to perform both the Auxiliary Contact (AX) function and the Alarm Contact (AL) function.

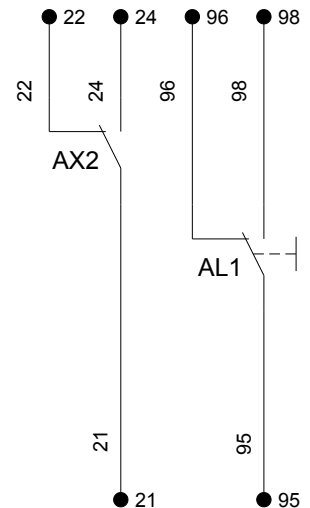

DIN Rail Adapters

In many applications, the ease with which an MCCB can be installed via the use of a DIN Rail adapter. Rockwell Automation provides DIN Rail adapters as accessories for use with its 140G G-, H-, I- and J-Frame breakers.



Flex Cable Operators

Flexible Cable Operators are useful accessories when installing a circuit breaker in a flanged enclosure and the MCCB needs to be controlled externally. Traditionally in North America, flange operators that consist of operating rods or special mounting plates for the breakers have been used. In each case, the circuit breaker must be mounted directly or nearly directly behind the external handle, which is located on the flange. This type of installation is reliable; however, the positioning of the circuit breaker is less than ideal in terms of working room, especially in small enclosures.

The Flexible Cable Operator uses a similar flange-mounted operating handle to control the MCCB; however, rather than operating rods, the breaker is operated by a flexible cable, which provides flexibility in the circuit breaker placement. In many industrial control panels, incoming power to the panel may actually be on the hinged side of the panel and when using traditional flange-mounted operators, the main feeder wires would need to be routed across the panel to the line side of the MCCB. Using a flexible cable-operated MCCB allows the MCCB to be installed closer to the incoming feeder wires and can significantly improve the installation of the control panel.

Another application where Flexible Cable Operators are used is in conjunction with busbar mounting systems installed within an industrial control panel. When an MCCB is being used on the busbar system as the main disconnect or feeder protector, the location of the feeder breaker isn't restricted to the area behind the flange.

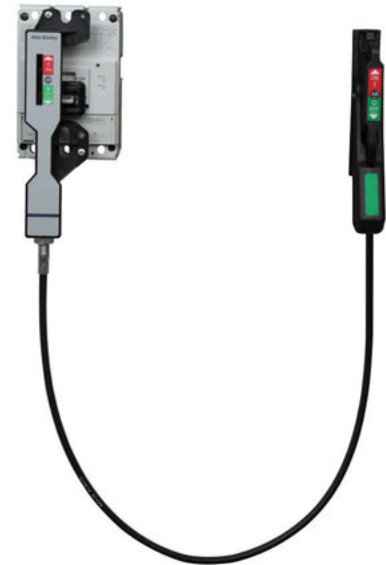

End Cap Kits

All 140G MCCBs are furnished with end caps mounted on the circuit breaker as standard. Replacement end cap kits are available.

Many customers prefer to use a “crimp-on” ring lug (ring tongue terminal) or forked terminal as the wire termination method to the MCCB. Others prefer wire connection to a terminal lug. A broad selection of terminal lugs are available to meet specific application requirements.

The replacement end cap kit consists of a captive nut and bolt or termination screw, which allows for the termination of wires without the need to use terminal lugs.



Terminal Covers

The terminal shield prevents accidental contact with live parts, they also provide phase to phase insulation.

Ingress Protection

The table indicates the degrees of protection against intrusion and accidental contact per IEC 60529 Standard.

Location	Without Terminal Covers	With High Terminal Covers (&)
A	IP40**	–
B	IP20*	IP40*
C	–	IP40†

* G through M frames.

** Also with direct or variable depth rotary operator.

† After installation.

(&) High terminal covers have a height of 60 mm and are designated with a suffix “H” in the catalog number, (i.e. 140G-G-TC3H).

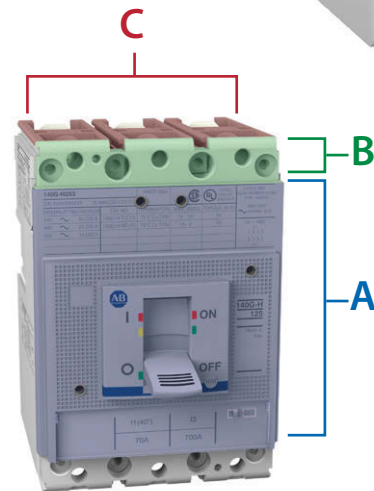
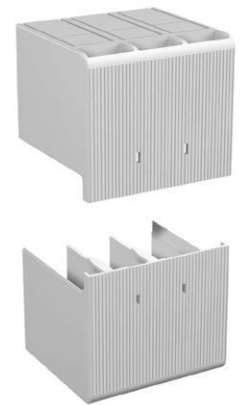

Motor Operators

The operating mechanism enables remote opening and closing of the circuit breaker and is particularly suitable for use in power supply network supervisory control systems. It comes complete with a padlock device.

The motor operating mechanism is fitted on the front of the circuit breaker as an alternative to the front flange or rotary operating mechanism. Motor-operated circuit breakers are normally used in applications where switching is done infrequently and generally are not used to replace contactors that are applied in series with the circuit breaker.



Shunt Trip

Shunt trips allow the circuit breaker to be opened using an electric command (opening release). The shunt trip is housed and fitted in a slot within the circuit breaker.

Shunt trips are used in applications where a remote signal to open or isolate a circuit is required.



Undervoltage Release

Undervoltage releases allow the circuit breaker to be opened using a change in the voltage of the power supply to the circuit breaker terminals. The undervoltage release is fitted in a slot within the circuit breaker. Undervoltage releases work when the application voltage is reduced below 75% of the rating of the release unit voltage rating.

Use of undervoltage releases can protect a system against low voltage, particularly when running or starting motors, by removing power to the circuit by opening the circuit breaker in low-voltage situations. In some applications, the undervoltage release can be used to quickly remove power to a machine or machines by opening a push button contact, wired in series with the undervoltage releases.



Rotary Operators

When MCCBs are installed as the main or feeder circuit breaker in an industrial control panel and a non-flanged enclosure is used, a common means for operating the circuit breaker is through the use of a rotary operator mechanism. The use of a rotary operator converts a rotary motion to a vertical motion that “toggles” the MCCB. In this situation, the rotary operator kit would consist of:

- External operating handle
- Operating shaft
- Circuit breaker mounted rotary operating mechanism

Using these kits allows external operation of the circuit breaker with the capability of turning the circuit breaker on/off, and even resetting the circuit breaker without having to open the enclosure. Traditionally, these kits are sold with an operating shaft that allows the customer to use the kit with enclosures of various depths. The operating handles will also provide status indication when the circuit breakers trip.



NFPA 79 Operators

A NFPA 79-compliant Internal Rotary Operating Handle Kit for Bulletin 140G Molded Case Circuit Breakers (MCCBs), Bulletin 140MG Motor Circuit Protectors (MCPs), and Bulletin 140MG Motor Protection Circuit Breakers (MPCBs) is available to address current requirements of the NFPA 79 standard. The NFPA 79 kits are available for G-, H-, I-, J-, K-, M- and N-Frame Circuit Breaker product lines.

Compliance with the current NFPA 79 standard enables operators to maintain control of the main disconnecting means when the door is open; an issue for rotary-operated through-the-door disconnect switches and circuit breakers alike.

This standard requires that the rotary main disconnecting means to be operable without the use of accessory tools or devices (independent of door position) and restates the requirement for an interlocking provision to prevent the closing of the disconnecting means while the enclosure door is open, unless the interlock is operated by a deliberate action. Without this requirement, rotary operated devices may have a shaft protruding from the panel when the door is open. If the panel is powered and it is necessary to turn power off, it is difficult to de-energize the panel by the operating shaft alone. This standard is to reduce the possibility of personnel not being able to turn an energized panel off with the door opened.

Why is This Relatively Simple Product Important to You?

The trend in the market is obviously moving toward building smaller and less-expensive control panels. To achieve this, many panel builders and OEMs have moved toward using rotary operators because they are easier to install and the non-flanged enclosure is significantly less expensive. With the introduction of this internal handle, customers can now comply with the NFPA 79 requirement and use the less-expensive, non-flanged enclosure with circuit breakers.

Applications Where NFPA 79 Compliance is Required as an Upgrade

From an installation perspective, the internal handle replaces the existing operating shaft. Externally, the same 140G handle is used. In the case of an existing 140G installation, installing the kit can be as simple as removing the existing operating shaft, measuring it, and then cutting the new internal operating handle shaft to the same length. It is then installed in place of the existing operating shaft.

Easy to Use, No-Tools-Required Internal Handle Operation

When the door is open, the kit provides an internal handle with a positive grip, allowing users to operate the breaker. If the enclosure were opened using the defater on the external handle with the circuit breaker on, the user could then turn the breaker off using the internal handle, rather than using a tool to rotate the operating shaft.

Compliance with “Deliberate Action Required”

Finally, the handle complies with the NFPA 79 requirement to: “Prevent closing of the disconnecting means while the enclosure door is open, unless an interlock is operated by deliberate action.” The internal handle must be pulled out before it can be turned, otherwise the handle itself will just ratchet on the shaft.



Phase Barriers

These allow the insulation characteristics between the phases at the connections to be increased. Phase Barriers provide additional electrical clearance between each phase when special connections extend past the circuit breaker housing. They are mounted from the front, even with the circuit breaker already installed.

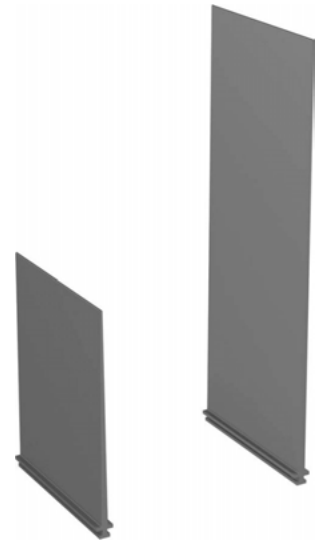

Mechanical Accessories

Terminal Lugs

Mechanical Terminal Lugs may be used to terminate line and load wiring to the MCCB. The 140G product line includes, as standard, the capability to terminate wiring using customer furnished "crimp-on" ring lug (ring tongue) or forked lug termination.

For customers who prefer terminating wiring to Mechanical Terminal Lugs, the 140G line offers a variety of mechanical terminal lugs to match the frame and application wiring.

Multiple tap terminal lugs are available for those customers terminating multiple wires to a MCCB pole, either to line or load connection. Use of a multi-tap connection can save on panel space, making wiring easier due to using (multiple) smaller diameter wire. For applications following the UL guidelines for panel short-circuit current rating (SCCR), the use of multiple wire termination on the load size permits the termination to be rated at the SCCR level of the circuit breaker, which may allow a higher SCCR than may be available using a separate power distribution block.

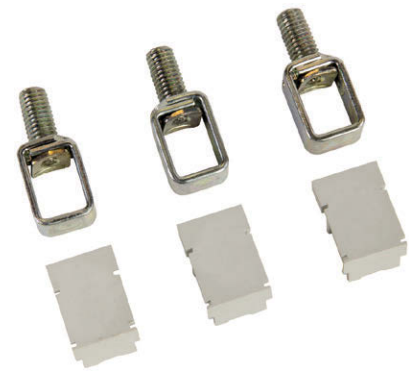

Padlock Attachments

Padlocking hasps are available for the range of MCCB line. This attachment allows the user the ability to padlock the MCCB in the off position. It prevents operation of the circuit breaker when the attachment and a padlock are in place.



Using Trip Curves

One of the most common questions encountered after "How is an MCCB properly sized?" is "How do I interpret the trip curves provided?"

A logical starting point is to explain what the curve actually is. The curve is a representation of how the circuit breaker will react to overcurrents and short-circuit currents. It should be noted that the curve is determined by a specific set of test conditions, and as such, the curve should be used as a guideline; real world deviations from the test criteria may alter the individual results as compared to the curve.

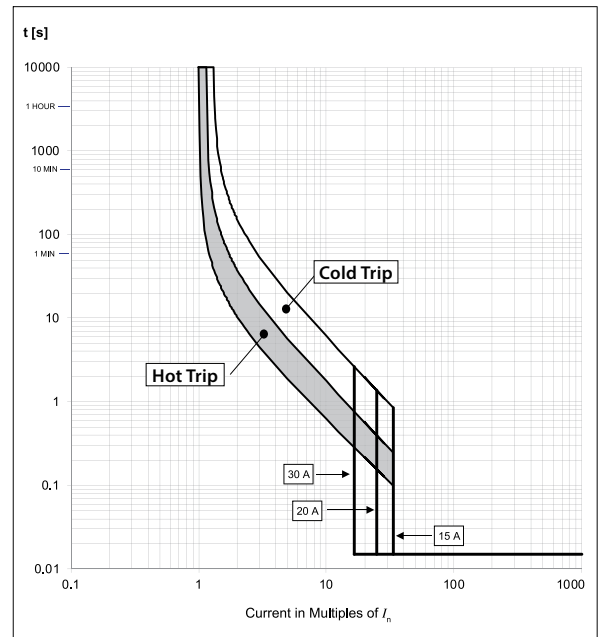

Time-Current Curves for 140G-G thermal magnetic Molded Case Circuit Breakers

Neutral Pole

When applying 4 pole MCCB, the neutral pole is rated at 100% for thermal magnetics, and adjustable 100%, 50% or 0% for electronics.

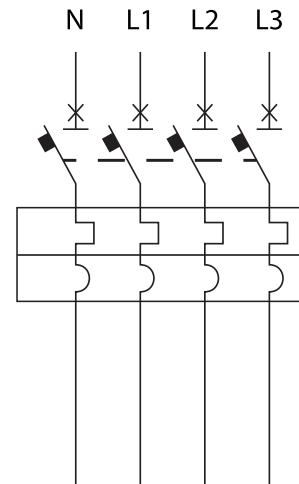

For all 4 pole 140G MCCB and Molded Case Switches the neutral is the left outside pole, as shown in the illustration.

Reverse-Fed Circuit Breaker

Due to physical equipment arrangements in panelboards, switchboards, and industrial control panels, it is often desirable to reverse feed a molded case circuit breaker. For this application, the circuit breaker must be tested and listed accordingly.

Please note that all Bulletin 140G circuit breakers may be reverse fed. When reverse feeding these devices, the line and load side terminals need to be identified properly.

Note: Maximum voltage for reverse fed.

Reverse Fed		
Bulletin 140G & 140MG	Maximum AC Voltage [V]	
	UL/CSA	IEC
G	600Y/347	690
H	480	480
I	600Y/347	690
J	600	600
K	600	690
M	600	690
N, NS	600	690
R	600	690

Note: The NEC Article 404.7 states "Where these switch or circuit breaker handles are operated vertically rather than rotationally or horizontally, the up position of the handle shall be the (on) position." Refer to applicable codes and standards for specific application requirements.

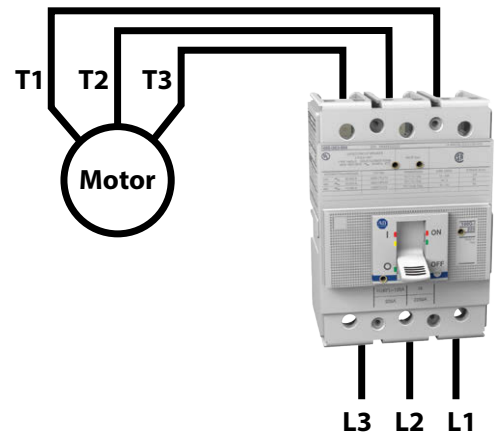

Interrupting Ratings

The maximum amount of fault current supplied by a system can be calculated at any point in that system. One rule must be followed for applying the correct circuit breaker. The interrupting rating of the breaker must be equal to or greater than the amount of fault current that can be delivered at that point in the system where the breaker is applied. The interrupting rating of the breaker is the maximum amount of fault current it can safely interrupt without damaging itself. A breaker's interrupting rating always decreases as the voltage increases. Interrupting rating is one of the most critical factors in the breaker selection process.



Certifications

To provide customers with third-party assurance that Rockwell Automation® MCCBs meet industry standards, our circuit breakers comply with various global standards. The Bulletin 140G MCCB and 140MG MCP and MPCBs comply with UL, CSA and IEC standards and as such, are UL Listed, CSA Certified, and CCC Certified.

Other certifications exist for the family of MCCBs. The certification of these products is an ongoing process and additional ratings and certifications are continually being pursued. For information about compliance with a particular standard, contact your local Rockwell Automation sales office or Allen-Bradley distributor.

In each of the product sections, the latest certifications at the time of publication are listed for the specific product type.



Selecting a Circuit Breaker, When Application is to Follow U.S. Guidelines

The next step is selecting a breaker for use in an industrial control panel. In the following section we will focus on the MCCB for use as a feeder and as a branch circuit protective device.

Selecting The MCCB for Use as The Main Disconnect or Feeder

A typical industrial control panel is a feeder circuit as defined by the NEC, where a feeder is composed of the wires between the service entrance of the panel or line side of the MCCB and the line side of the branch protective devices.

In many industrial control applications, motor control is involved. In that case, the application must then follow Article 430 of the NEC, which states that breakers for feeders having mixed loads, e.g. heating (lighting and heat appliances) and motors should have ratings suitable for carrying the heating loads, plus the capacity required by the motor loads.

For motor loads, Article 430 states that breakers for motor feeders shall have a rating not greater than the sum of the highest breaker rating of any of its branches and the full-load currents of all other motors served by the feeder.

Feeder Breaker Thermal Rating Selection Example

This assumes that the circuit breaker selected has a voltage rating equal or greater than the application and that the interrupting rating is equal or greater to the available short-circuit current. The panel contains a main feeder breaker supply with three motor branch circuits.

In our application, the feeder is supplying a 3-motor system at a voltage of 480V.

- Motor 1 is 10 Hp. Current value from Table 430.250 of the NEC is 14 A.
- Motor 2 is 5 Hp. Current value from Table 430.250 of the NEC is 7.6 A.
- Motor 3 is 5 Hp. Current value from Table 430.250 of the NEC is 7.6 A.

Calculation of panel wiring includes:

- **For single motors.** Per [430.22], size motor branch circuit conductors no smaller than 125 percent of the motor FLC rating listed in Table 430.147 or 430.148 (Figure 430-4). Size the branch circuit short-circuit and ground-fault protection device per 240.6(A) and 430.52(C)(1) Ex. 1.
- **For multiple motors.** Per [430.24], size multiple motor conductors as follows. First, multiply the full-load current rating of the highest-load motor by 1.25. Then, add up the full-load current ratings of all the other motors in the group. Add these two numbers. That's your motor load for calculating ampacity. Add any other loads on that conductor, to calculate total conductor ampacity.

Current Calculation is:

Motor 1 (14 A* 1.25)	17.5 A
Motor 2	7.6 A
Motor 3	7.6 A
Total	32.7 A

Since the total load comes to 32.7 A and there is not a commercially available breaker available for 32.7 A, the NEC allows the next largest standard-sized breaker to be used. Therefore, a 35 A MCCB could be selected to protect this control panel. Note: each motor branch would also need protection.

Thermal Magnetic Circuit Breakers Used as Branch Short-circuit Devices

It is also possible to use an MCCB as a branch protective device for a motor load, and while we will show the calculation for applying an MCCB in this manner, there are other circuit breakers, such as the MCP and MPCB, that are better suited for this application. After the calculation for sizing is completed, it should be apparent that even though this is technically correct, in some cases, the motor protection and wire protection can be less than ideal.

Per NEC Article 430.52(B), the motor branch circuit short-circuit and ground fault device shall be capable of carrying the starting current of the motor. Further, 430.52(C) indicates that the protective device that has a rating or setting not exceeding the value calculated according to the values given in Table 430.52 shall be used. In the case of an inverse time MCCB, such as the 140G, the calculation for the maximum setting or rating of the protective device is 250% of the motor being protected.

Example

An MCCB is being used to protect a branch motor circuit with a 10 Hp 460V motor. Using Table 430.250 of the NEC, a value of FLC of 14 A is supplied for this motor.

Calculating the maximum branch circuit protective device rating or setting is:

$$14 \text{ A} * 250\% = 35 \text{ A}$$

Therefore, the maximum size MCCB that could be used in this example is 35 A. This is the maximum rating and therefore smaller devices could be selected for this application. A point to consider is that generally MCCBs have a magnetic trip of approximately 10X the rating of the MCCB. When starting, motors usually exhibit an inrush characteristic of 6 to 10 times the full load rating of the motor, depending on the type of motor being used. In this case, the circuit breaker trip point is approximately 350 A and the motor starting current of locked rotor current is approximately 140 A if a 10x ratio of running to starting current is assumed. A smaller breaker could be selected without concern for nuisance tripping. In that case, there may be more concern about the thermal protection provided by the circuit breaker being based on a 35 A breaker with only a 14 A load. The motor and the wiring may not be adequately protected if larger wire isn't selected or if a motor overload relay is not used.

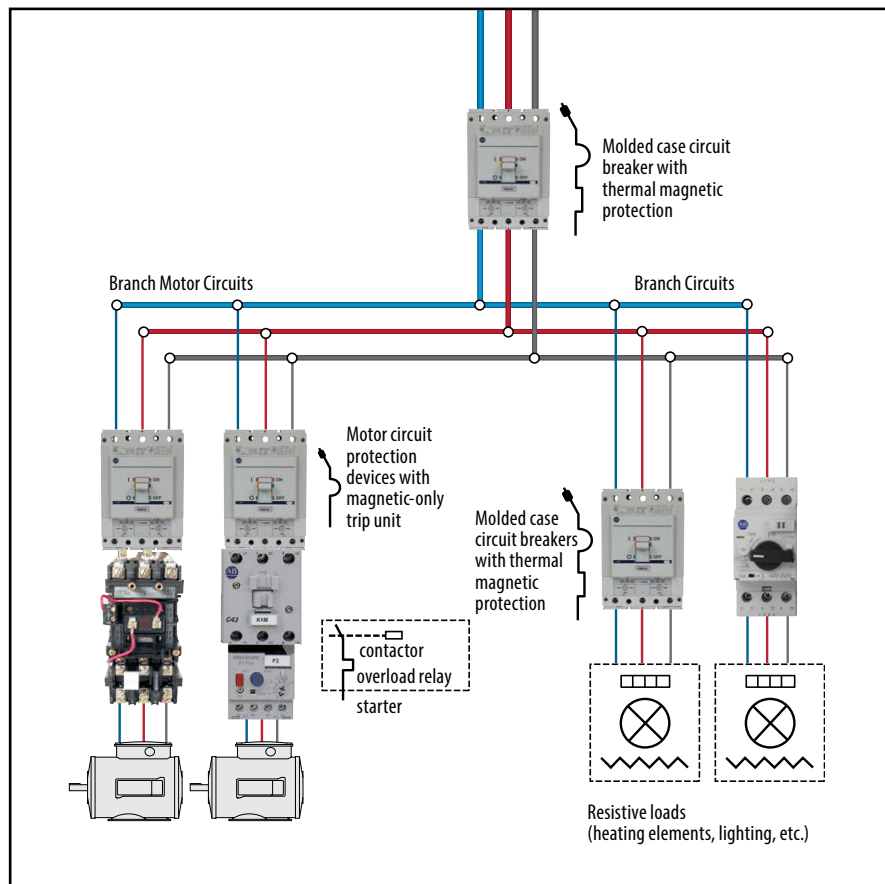

MCCB Application and Sizing

The Bulletin 140G MCCBs are traditionally used for protection of branch and feeder circuit in an industrial control application. In the role of a feeder circuit breaker, the MCCB provides isolation and short-circuit protection for the panel and thermal protection for the feeder wires and as a branch circuit breaker provides the same protection for the branch wires in the panel. For illustrative purposes, the feeder will be shown at the wiring from the load side of the main or feeder MCCB to the line connection of the branch short-circuit protective devices to which the feeder is supplying power.

The following example is a generic interpretation of the US National Electrical Code (NEC), and should be used only as a reference for applying the MCCB. Final authority regarding the sizing and components used is governed by local and/or national electrical standards and the Jurisdiction Having Authority. Consult these standards before installing or designing any electrical system using short-circuit protective devices (SCPDs).

While this discussion is not intended to be a comprehensive guidebook to designing industrial control panels, we will present several categories of typical applications where a feeder SCPD device will be applied:

- A panel where only motor loads are being fed by the breaker
- A panel where fixed loads are being fed by the breaker
- A panel where mixed loads are being protected by the feeder breaker

In all cases, the examples given here are for reference and users should reference their local electrical code requirements, as they may vary from location to location. The applier should verify that their selection and installation complies with local codes, regulations, and/or standards.

A feeder is composed of the conductors of a wiring system between the service equipment or the generator switchboard of an isolated plant and the branch circuit overcurrent device.

NEC Article 220 states:

Where a feeder supplies continuous loads or any combination of continuous and noncontinuous loads, the rating of the overcurrent device shall not be less than the noncontinuous load plus 125% of the continuous load. Exception: Where the assembly including the overcurrent devices protecting the feeder(s) are listed for operation at 100% of their rating, neither the ampere rating of the overcurrent device nor the ampacity of the feeder conductors shall be less than the sum of the continuous load plus the noncontinuous load. Only breakers listed for 100% application, and so labeled can be applied under the exception (for example N Frame and R Frame 140G's that are specifically marked and rated 100%). Breakers without a 100% application listing and label are applied at 80% of rating.

NEC Article 430 states:

Breakers for feeders having mixed loads; e.g., heating (lighting and heat appliances) and motors, should have ratings suitable for carrying the heating loads plus the capacity required by the motor loads. . . breakers for motor feeders shall have a rating not greater than the sum of the highest breaker rating of any of its branches and the full load currents of all other motors served by the feeder.

A molded case circuit breaker is rated in rms amperes at a specific ambient temperature. This ampere rating is the maximum continuous current it may carry in the ambient temperature for which it is calibrated. To minimize the need for derating, Allen-Bradley thermal magnetic breakers are calibrated for an ambient temperature of 40 °C (104 °F), which is the average temperature within an enclosure. If the enclosure ambient temperature is known to exceed 40 °C, the breaker used should either be specially calibrated for that temperature, or be derated accordingly.

80% Continuous Rated

All 140G Molded Case Circuit Breakers are rated for 80% continuous load unless marked for 100% loads. The NEC requires that only 100% rated continuous load be marked special with the load designation. In all general applications the unmarked circuit breaker is to be applied at no more than 80% continuous load of its rated current (I_n). Typically 100% rated current MCCBs are devices with electronic trip units. The 140G product line has 100% rated electronic trip MCCBs. Visit www.rockwellautomation.com for specific devices.

Cable Selection

UL Listed circuit breakers rated 125 A or less shall be marked as being suitable for 60 °C (140 °F), 75 °C (167 °F) only or 60/75 °C (140/167 °F) wire. All Allen-Bradley breakers rated 125 A or less are marked for 60/75 °C wire. All UL Listed circuit breakers rated over 125 A are suitable for 75 °C conductors. Conductors rated for higher temperatures may be used, but must not be loaded to carry more current than the 75 °C ampacity of that size conductor for equipment marked or rated 75 °C, or the 60 °C ampacity of that size conductor for equipment marked or rated 60 °C. However, the full 90 °C (194 °F) ampacity may be used when applying derating factors, so long as the actual load does not exceed the lower of the derated ampacity or the 75 °C or 60 °C ampacity that applies.

Unusual Operating Conditions

Operation below 0 °C

Bulletin 140G MCCBs may be applied in ambient temperatures (near the MCCB within an enclosure) below 0 °C. Applications below 0 °C must consider the possibility of ice forming within or on the MCCB and interfering with the internal or external operating mechanisms. All ratings below 0 °C are based on the absence of freezing water or other elements.

Trip Unit Temperatures

Thermal magnetic circuit breakers are temperature sensitive. At ambient temperatures below 40 °C (104 °F), circuit breakers may carry more current than their continuous current rating. Nuisance tripping is not a problem under these lower temperature conditions, although consideration should be given to closer protection coordination to compensate for the additional current-carrying capability. In addition, the actual mechanical operation of the breaker could be affected if the ambient temperature is significantly below the 40 °C standard.

For ambient temperatures above 40 °C, breakers should carry less current than their continuous current rating. Under this condition, the circuit breaker should be derated for the higher ambient temperature.

Electronic trip units are insensitive to ambient temperatures within a certain temperature range. The temperature range for most electronic trip units is -25 °C...+70 °C (-13 °F...+158 °F). Allen-Bradley MCCBs are designed to include temperature protective circuits that initiate a tripping operation and provide self-protection, should the internal temperature rise to an unsafe level.

Circuit Breaker Temperatures

The temperature of the air immediately surrounding a circuit breaker is the ambient temperature. All Allen-Bradley standard breakers are calibrated to a 40 °C ambient temperature. For any ambient temperature application significantly above or below 40 °C, it is recommended that rerating of the circuit breaker be considered or Rockwell Automation be consulted about any possible re-rating.

Altitude

Low voltage circuit breakers must be derated for voltage and interrupting rating at altitudes above 2000 m (6560 ft) above sea level. The thinner air at higher altitudes reduces cooling and dielectric characteristics compared to the denser air found at lower altitudes.

Use the following tables to derate as appropriate.

Voltage Rating Operational Voltage U_e [V]				
Altitude	2000 m (6560 ft)	3000 m (9840 ft)	4000 m (13,120 ft)	5000 m (16,400 ft)
All Frames	100%	90%	79%	67%

Current Rating Rated Uninterrupted Current I_u [A]				
Altitude	2000 m (6560 ft)	3000 m (9840 ft)	4000 m (13,120 ft)	5000 m (16,400 ft)
All Frames	100%	98%	93%	90%

Unusual Mounting Configurations

Generally, circuit breakers may be mounted in any position, up or down, horizontal or vertical, without affecting the tripping characteristics or interrupting rating. However, mounting circuit breakers in a vertical position with the ON position other than UP will be in violation of Article 240-81 of the NEC.

Tropicalization

The 140G/MG Circuit breakers are tested in compliance with IEC Standards, making these devices suitable for hot-humid conditions defined in IEC 60721-2-1, climatograph 8. These devices include:

- Moldings of glass fiber reinforced synthetic resins
- Metallic parts treated for anti-corrosion
- Zinc plating protected by a conversion layer (hexavalent-chromium free) (e.g. RoHS compliant)
- Electronic circuits protected for anti-condensation

Electromagnetic Compatibility

The 140G/MG Circuit Breakers electronic trip units and electronic residual current releases are in compliance with EN 60947-2 Appendix B and Appendix F and European Directive No. 2004/108/EC regarding EMC – electromagnetic compatibility.

Maintenance Mode (MM)

Maintenance Mode (MM) offers a preset set of protection parameters. MM allows systems testing when the molded case circuit breaker is energized or ON. This feature is a manual adjustment on the molded case circuit breaker, via a DIP switch. Preset values for Maintenance Mode are indicated in the selection guide for each frame size.

MCCB Performance Characteristics

		G-Frame			H-Frame					I-Frame		
Maximum Rated Current [A]		125/160 ⑥			125/160 ⑥					225		
Rated Insulation Voltage, U _i IEC [V]		800			1000					800		
NEMA, UL, CSA	Interrupting Rating Code ①	G2	G3	G6	H2	H3	H6	H0	H15	I2	I3	
	240V 50/60 Hz (AC) [kA]	50	65	100	65	100	150	200	200	50	65	
	480V 50/60 Hz (AC) [kA]	25	35	65	25	35	65	100	150	25	35	
	600Y-347V 50/60Hz (AC) [kA]	10	14	25						10	10	
	600V 50/60 Hz (AC) [kA]				14	18	25	35	42			
	(DC) 250V – 2 Poles in Series ⑤ [kA]	35	42	50	35	50	65	75	85	25	35	
	(DC) 500V – 2 Poles in Series ⑤ [kA]											
	(DC) 500V – 3 Poles in Series ⑤ [kA]				35	50	65	75	85			
	(DC) 500V – 4 Poles in Series ⑤ [kA]	35	50	50								
	(DC) 600V – 3 Poles in Series ⑤ [kA]											
IEC 60947-2	Rated Ultimate Short-circuit Breaking Capacity, <i>I_{cu}</i>											
	220-230V 50/60 Hz (AC) ② [kA]	65	85	100	65	85	100	150	200	50	85	
	380V 50/60 Hz (AC) [kA]	36	50	70	36	50	70	120	150	30	50	
	400-415V 50/60 Hz (AC) [kA]	36	50	70	36	50	70	120	150	36	50	
	440V 50/60 Hz (AC) ② [kA]	36	50	65	30	36	50	60	70	20	40	
	500V 50/60 Hz (AC) [kA]	30	36	50	20	25	30	36	50	13	20	
	525V 50/60 Hz (AC) [kA]	22	35	35	10	12	15	18	20	5	6	
	690V 50/60 Hz (AC) [kA]	6	8	10	10	12	15	18	20	5	8	
	(DC) 250V – 2 Poles in Series ⑤ [kA]	36	50	70	36	50	70	85	100	36	50	
	(DC) 500V – 2 Poles in Series ⑤ [kA]											
	(DC) 500V – 3 Poles in Series ⑤ [kA]	36 ③	50 ③	70 ③	36	50	70	85	100	36	50	
	(DC) 750V – 3 Poles in Series ⑤ [kA]											
	Rated Service Short-circuit Breaking Capacity, <i>I_{cs}</i>											
	220-230V 50/60 Hz (AC) [kA]	75% (50)	75%	75%	100%	100%	100%	100%	100%	100%	75%	50%
	380V 50/60 Hz (AC) [kA]	100%	100%	75%	100%	100%	100%	100%	100%	100%	75%	50% (27)
400-415V 50/60 Hz (AC) [kA]	100%	75%	50%	100%	100%	100%	100%	100%	100%	75%	50% (27)	
440V 50/60 Hz (AC) [kA]	50%	50%	50%	100%	100%	100%	100%	100%	100%	75%	50%	
500V 50/60 Hz (AC) [kA]	50%	50%	50%	100%	100%	100%	100%	100%	100%	75%	50%	
525V 50/60 Hz (AC) [kA]	50%	50%	50%	100%	100%	100%	100%	100%	100%	75%	50%	
690V 50/60 Hz (AC) [kA]	75%	50%	50%	100%	100%	100%	100%	75%	75%	50%		
(DC) 250V – 2 Poles in Series ⑤ [kA]	100%	75%	75%	100%	100%	100%	100%	100%	100%	75%		
(DC) 500V – 2 Poles in Series ⑤ [kA]												
(DC) 500V – 3 Poles in Series ⑤ [kA]	100%	75%	75%	100%	100%	100%	100%	100%	100%	75%		
(DC) 750V – 3 Poles in Series ⑤ [kA]												
Mechanical Life [No. of Operations]		25000			25000					25000		
	[Operations per Hour]	240			240					240		
Electrical Life @ 415V (AC) [No. of Operations]		8000			8000					8000		
	[Operations per Hour]	120			120					120		
Wire Temperature Rating ④ [°C]		Cu 75 °C			Cu 75 °C					Al or Cu 75 °C		
Ambient Temperature w/out derating °F [°C]		104 °F [40 °C]			104 °F [40 °C]					104 °F [40 °C]		
Storage Temperature °F [°C]		-40...176 °F [-40...+80 °C]			-40...176 °F [-40...+80 °C]					-40...176 °F [-40...+80 °C]		
Dimensions 3 Pole [mm]		76.2x70x130			90x82.5x130					105x70x150		
	[Width/Depth/Height] 4 Pole [mm]	101.6x70x130			120x82.5x130					140x70x150		

① Explanation of Interrupting Code - G2 for example: G=G Frame 2= 25 kA@480V. See table for complete ratings.

② These ratings have not been tested for the CCC listing.

③ 500V DC 4 Poles in series.

④ Wire Temperature Ratings is determined by testing the circuit breaker under full load current with the conductors sized for 75 °C.

⑤ DC rating is applicable for thermal-magnetic trip units only.

⑥ IEC version with a 160 A *I_{cu}* rating.

J-Frame				K-Frame				M-Frame			N & NS-Frame			R-Frame
250				400				800			1200			2000/2500/3000
1000				1000				1000			1000			
J2	J3	J6	J0	K3	K6	K0	K15	K5	K6	K0	N5	N6	N0	R12
65	100	150	200	100	150	200	200	100	200	200	65	100	150	125
25	35	65	100	35	65	100	150	50	65	100	50	65	100	125
14	18	25	35	25	35	65	100	25	35	42	25	50	65	100
35	42	50	85											
				35	50	65	100	35	50	65				
35	50	65	75	25	35	50	65	20	35	50				
65	85	100	150	85	100	200	200	85	100	200	85	100	200	130
36	50	70	120	50	70	120	200	50	70	100	50	70	120	80
36	50	70	120	50	70	120	200	50	70	100	50	70	120	80
36	50	65	100	40	65	100	180	45	50	80	50	65	100	80
30	36	50	60	30	50	85	150	35	50	65	40	50	85	40
20	25	45	50	25	40	70	100	25	35	42	30	50	65	40
10	12	15	20	25	40	70	100	22	25	30	30	42	50	40
36	50	70	85	50	70	100	150	50	70	100				
36	50	70	85	36	50	70	100	35	50	65				
36	50	70	85											
				25	36	50	70	20	36	50				
100%	100%	100%	100%	100%	100%	100%	100%	100%	100%	100%	100%	100%	100%	100%
100%	100%	100%	100%	100%	100%	100%	100%	100%	100%	100%	100%	100%	100%	100%
100%	100%	100%	100%	100%	100%	100%	100%	100%	100%	100%	100%	100%	100%	100%
100%	100%	100%	100%	100%	100%	100%	100%	100%	100%	100%	100%	100%	100%	100%
100%	100%	100%	100%	100%	100%	100%	100%	100%	100%	100%	100%	100%	75%	100%
100%	100%	100%	100%	100%	100%	100%	75%(80 kA)	75% (18 kA)	50% (19 kA)	50% (22.5 kA)	75%(30 kA)	50%(31.5 kA)	50% (37.5 kA)	100%
100%	100%	100%	100%	100%	100%	100%	100%	75%	75%	75%	100%	75%	75%	100%
100%	100%	100%	100%	100%	100%	100%	100%	75%	75%	75%				
100%	100%	100%	100%	100%	100%	100%	100%	75%	75%	75%				
100%	100%	100%	100%											
				100%	100%	100%	100%	75%	75%	75%				
25000				20000				20000			10000			15000
240				120				120			60			60
8000				7000 (400A) – 5000 (600A)				7000 (600 – 630A) – 5000 (800A)			2000			4500(2000A) – 4000 (2500A) – 3000 (3200A)
120				60				60			60			60
Al or Cu 75 °C				Al or Cu 75 °C				Al or Cu 75 °C			Al or Cu 75 °C			Al or Cu 75 °C
104 °F [40 °C]				104 °F [40 °C]				104 °F [40 °C]			104 °F [40 °C]			104 °F [40 °C]
-40...176 °F [-40...+80 °C]				-40...176 °F [-40...+80 °C]				-40...176 °F [-40...+80 °C]			-40...176 °F [-40...+80 °C]			-40...176 °F [-40...+80 °C]
105x82.5x160				140x108.5x205				210x103.5x268			210x154(N)/178(NS)x268			427x282x382
140x82.5x160				185x103.5x205				280x103.5x268			280x154(N)/178(NS)x268			553x282x382

140G-G Frame Specifications

125 A (UL/CSA)

160 A (IEC)



Interrupting Rating/Breaking Capacity – Thermal Magnetic Circuit Breakers (See page 24 for additional voltages – breaking capacities)

Interrupting Rating (50/60 Hz), UL 489/CSA C22.2-5, No. 5 [kA]			EN 60947-2											
			Breaking Capacity (50/60 Hz)								Breaking Capacity (DC)			
240V	480V	600Y/ 347V	220V*		415V		440V*		690V		250V DC (2-pole in series)		500V DC (3-pole in series)	
			I_{cu} [kA]	I_{cs} [% I_{cu}]	I_{cu} [kA]	I_{cs} [% I_{cu}]	I_{cu} [kA]	I_{cs} [% I_{cu}]	I_{cu} [kA]	I_{cs} [% I_{cu}]	I_{cu} [kA]	I_{cs} [% I_{cu}]	I_{cu} [kA]	I_{cs} [% I_{cu}]
50	25	10	65	75	36	100	36	50	6	75	36	100	36	100
65	35	14	85	75	50	75	50	50	8	50	50	100	50	100
100	65	25	100	75	70	50	65	50	10	50	70	75	70	75

* These ratings have not been tested for the CCC listing.

Watt Loss

Type	Rated Current I_n [A]	Watt Loss [W]	
		3 Poles	4 Poles
Thermal Magnetic	15	4.0	5.3
	16	4.5	6.0
	20	5.4	7.2
	25	6.0	8.0
	30	5.5	7.4
	32	6.3	8.4
	35	6.0	8.0
	40	7.8	10.4
	45	9.0	12.0
	50	11.1	14.8
	60	11.7	15.6
	63	12.9	17.2
	70	11.0	14.7
	80	14.4	19.2
	90	17.0	22.7
	100	21.0	28.0
Molded Case Switch	110	24.9	33.1
	125	32.1	42.8
	160(*)	45.0	60.0
	25	1.2	1.6
	50	4.9	6.6
	75	11.1	14.8
100	19.8	26.4	
125	30.9	41.2	

* IEC only.

Molded Case Switch

Rated Current I_n [A]	Magnetic Trip I_m [A]
125 (600Y/247V AC)	1500

Dimensions (mm)

Plus Terminals

Height	130
Width (3-pole)	76.2
Width (4-pole)	101.2
Depth (case)	70
Depth (op handle)	101

Weight (kg)

3 Poles	1.1
4 Poles	1.4

Mechanical Endurance

Electrical Life (on-off) at 120 operations per hour	8000
Mechanical (on-off) at 240 operations per hour	25,000

Electrical Specifications

	UL/CSA	IEC
Maximum Rated Current (I_r) [A]	125	160
Frame Ratings (I_u) Rated Uninterrupted Current [A]	125	160
Rated Insulation Voltage (U_i) [V]	800	
Rated Impulse Withstand Voltage (U_{imp}) [kV]	8	
Rated Operational Voltage (U_o) – AC UL/CSA (60 Hz) IEC (50 Hz) [V]	600Y/347V	690
Number of Poles	3 and 4	

Standards Compliance

UL489	Yes
CSA 22.2 No. 5	Yes
EN 60947-2	Yes
CCC GB 14048.2	Yes

Temperature Specification*

Ambient Operating Temperature Range (based on the absence of freezing water or other elements)	-25...+70 °C (-13...+158 °F)
Storage Temperature	-40...+70 °C (-40...+158 °F)
Calibration Temperature	40 °C (104 °F)

* For use at temperatures other than 40 °C (104 °F), see the Temperature Performances information following.

Temperature Performance

140G-G Frame Thermal Magnetic Circuit Breakers

The G frame thermal magnetic circuit breaker is calibrated at 40 °C (104 °F). For applications at other temperatures there is a variation in the thermal tripping as indicated below.

T amb [°C]	40	50	60	70
I_n [A]	Max. [A]	Max. [A]	Max. [A]	Max. [A]
15	15	14	13	12
16	16	15	14	13
20	20	19	18	16
25	25	23	22	20
30	30	28	26	24
32	32	30	28	26
40	40	38	35	33
45	45	42	40	37
50	50	47	44	41
60	60	56	52	49
63	63	59	55	51
70	70	66	61	57
80	80	75	70	65
90	90	85	79	73
100	100	94	88	81
110	110	103	96	90
125	125	117	109	102
160*	160*	150*	140*	130*

* IEC only.

Molded Case Switch and Motor Circuit Protectors

Molded case switch and motor circuit protectors do not undergo tripping variations due to ambient temperature. However, even though ambient temperature does not affect the tripping characteristic, for temperatures exceeding +40 °C it is advisable to reduce the maximum current to prevent terminal overheating.

The tables below show the maximum current to prevent terminal overheating.

North America

40 °C (104 °F)	50 °C (122 °F)	60 °C (140 °F)	70 °C (158 °F)
I_{max} [A]	I_{max} [A]	I_{max} [A]	I_{max} [A]
3	3	3	3
7	7	7	7
15	15	15	15
30	30	30	30
50	50	50	50
70	70	70	70
80	80	79	79
100	93	84	79
125	112	97	79

IEC

40 °C (104 °F)	50 °C (122 °F)	60 °C (140 °F)	70 °C (158 °F)
I_{max} [A]	I_{max} [A]	I_{max} [A]	I_{max} [A]
3	3	3	3
7	7	7	7
15	15	15	15
30	30	30	30
50	50	50	50
70	70	70	70
80	80	80	80
100	100	100	100
125	125	125	125
160	160	153	136



140G-H Frame Specifications

125 A (UL/CSA)

160 A (IEC)

Interrupting Rating/Breaking Capacity – Thermal Magnetic and Electronic Circuit Breakers

(See page 24 for additional voltages – breaking capacities)

Interrupting Rating (50/60 Hz), UL 489/CSA C22.2-5, No. 5 [kA]			EN 60947-2											
			Breaking Capacity (50/60 Hz)								Breaking Capacity (DC) †			
240V	480V	600V	220V*		415V		440V*		690V		250V DC (2-pole in series)		500V DC (3-pole in series)	
			I_{cu} [kA]	I_{cs} [% I_{cu}]	I_{cu} [kA]	I_{cs} [% I_{cu}]	I_{cu} [kA]	I_{cs} [% I_{cu}]	I_{cu} [kA]	I_{cs} [% I_{cu}]	I_{cu} [kA]	I_{cs} [% I_{cu}]	I_{cu} [kA]	I_{cs} [% I_{cu}]
65	25	14	65	100	36	100	36	100	10	100	36	100	36	100
100	35	18	85	100	50	100	50	100	12	100	50	100	50	100
150	65	25	100	100	70	100	65	100	15	100	70	100	70	100
200	100	35	150	100	120	100	100	100	18	75	85	100	85	100
200	150	42	200	100	150	100	150	100	20	75	100	100	100	100

* These ratings have not been tested for the CCC listing.

† DC rating is applicable for thermal magnetic trip unit only.

Watt Loss

Type	Rated Current I_n [A]	Watt Loss [W]	
		3 Poles	4 Poles
Thermal Magnetic	15	3.4	4.6
	16	3.9	5.2
	20	4.8	6.4
	25	5.4	7.2
	30	6.9	9.1
	32	7.8	10.4
	35	8.5	11.3
	40	11.1	14.8
	50	12.3	16.4
	60	13.1	17.4
	63	14.4	19.2
	70	13.3	17.8
	80	17.4	23.2
	90	19.7	26.2
	100	24.3	32.4
Electronic	10	0.3	0.4
	25	2.4	3.2
	60	4.5	6.0
	100	12.6	16.8
	125	19.8	26.4
Molded Case Switch	25	0.8	1.1
	50	3.2	4.2
	75	7.1	9.5
	100	12.7	16.9
	125	19.8	26.4

* IEC only.

Molded Case Switch

Rated Current I_n [A]	Magnetic Trip I_m [A]
125	1500

Dimensions (mm)

Plus Terminals

Height	130
Width (3-pole)	90
Width (4-pole)	120
Depth (case)	82.5
Depth (op handle)	101

Weight (kg)

3 Poles	1.2
4 Poles	1.6

Mechanical Endurance

Electrical Life (on-off) at 120 operations per hour	8000
Mechanical (on-off) at 240 operations per hour	25,000

Electrical Specifications

	UL/CSA	IEC
Maximum Rated Current (I_n) [A]	125	160
Frame Ratings (I_u) Rated Uninterrupted Current [A]	125	160
Rated Insulation Voltage (U) [V]	1000	
Rated Impulse Withstand Voltage (U_{imp}) [kV]	8	
Rated Operational Voltage (U_o) – AC UL/CSA (60 Hz) IEC (50 Hz) [V]	600	690
Maximum Reverse Fed Voltage [V AC]	480	480
Number of Poles	3 and 4	

Standards Compliance

UL489	Yes
CSA 22.2 No. 5	Yes
EN 60947-2	Yes
CCC GB 14048.2	Yes

Temperature Specification*

Ambient Operating Temperature Range (based on the absence of freezing water or other elements)	-25...+70 °C (-13...+158 °F)
Storage Temperature	-40...+70 °C (-40...+158 °F)
Calibration Temperature	40 °C (104 °F)

* For use at temperatures other than 40 °C (104 °F), see the Temperature Performances information following.

Temperature Performance

140G-H Frame Thermal Magnetic Circuit Breakers

The H frame thermal magnetic circuit breaker is calibrated at 40 °C (104 °F). For applications at other temperatures there is a variation in the thermal tripping as indicated below.

T amb [°C]	40	50	60	70
I_n [A]	Max. [A]	Max. [A]	Max. [A]	Max. [A]
15	15	14	13	12
16	16	15	14	13
20	20	19	17	16
25	25	23	22	20
30	30	28	26	24
32	32	30	28	26
40	40	37	35	32
50	50	47	43	40
60	60	56	52	49
63	63	59	55	51
70	70	66	61	57
80	80	75	70	65
90	90	86	78	73
100	100	93	87	81
110	110	103	96	89
125	125	117	109	101
160*	160*	150*	139*	129*

* IEC only.

Electronic Trip Circuit Breakers, Molded Case Switches and Motor Circuit Protectors

The electronic trip circuit breakers do not undergo tripping variations due to ambient temperature. However, even though ambient temperature does not affect the tripping characteristic, for temperatures exceeding +40 °C it is advisable to reduce the maximum current to prevent terminal overheating.

The same considerations are appropriate for molded case switch and motor circuit protectors.

The tables below show the maximum current to prevent terminal overheating.

North America

40 °C (104 °F)	50 °C (122 °F)	60 °C (140 °F)	70 °C (158 °F)
I_{max} [A]	I_{max} [A]	I_{max} [A]	I_{max} [A]
3	3	3	3
7	7	7	7
15	15	15	15
30	30	30	30
50	50	50	50
70	70	70	70
80	80	79	79
100	93	84	79
125	112	97	79

IEC

40 °C (104 °F)	50 °C (122 °F)	60 °C (140 °F)	70 °C (158 °F)
I_{max} [A]	I_{max} [A]	I_{max} [A]	I_{max} [A]
3	3	3	3
7	7	7	7
15	15	15	15
30	30	30	30
50	50	50	50
70	70	70	70
80	80	80	80
100	100	100	100
125	125	125	125
160	160	146	131

140G-I Frame Specifications

225 A (UL/CSA)

225 A (IEC)



Interrupting Rating/Breaking Capacity – Thermal Magnetic Circuit Breakers (See page 24 for additional voltages – breaking capacities)

Interrupting Rating (50/60 Hz), UL 489/CSA C22.2-5, No. 5 [kA]			EN 60947-2											
			Breaking Capacity (50/60 Hz)								Breaking Capacity (DC)			
240V	480V	600Y/ 347V	220V*		415V		440V*		690V		250V DC (2-pole in series)		500V DC (3-pole in series)	
			I_{cu} [kA]	I_{cs} [% I_{cu}]	I_{cu} [kA]	I_{cs} [% I_{cu}]	I_{cu} [kA]	I_{cs} [% I_{cu}]	I_{cu} [kA]	I_{cs} [% I_{cu}]	I_{cu} [kA]	I_{cs} [% I_{cu}]	I_{cu} [kA]	I_{cs} [% I_{cu}]
50	25	10	50	75	36	75	25	75	5	50	36	100	36	100
65	35	10	85	50	50	50	40	50	6	50	50	75	50	75

* These ratings have not been tested for the CCC listing.

Watt Loss

Type	Rated Current I_n [A]	Watt Loss [W]	
		3 Poles	4 Poles
Thermal Magnetic	60	11.7	15.6
	63	12.9	17.2
	70	11.0	14.7
	80	14.4	19.2
	90	13.6	18.1
	100	16.8	22.4
	110	17.4	23.2
	125	19.8	26.4
	150	20.8	27.8
	160	23.7	31.6
	175	30.3	40.4
	200	39.6	52.8
Molded Case Switch	225	43.2	57.6
	25	0.5	0.7
	50	2.1	2.8
	75	4.8	6.4
	100	8.5	11.4
	125	13.3	17.8
	150	19.2	25.6
	175	26.1	34.8
200	34.1	45.5	
225	43.2	57.6	

Molded Case Switch

Rated Current I_n [A]	Magnetic Trip I_m [A]
225	2700

Dimensions (mm)

Plus Terminals

Height	150
Width (3-pole)	105
Width (4-pole)	140
Depth (case)	70
Depth (op handle)	101

Weight (kg)

3 Poles	1.7
4 Poles	2.1

Mechanical Endurance

Electrical Life (on-off) at 120 operations per hour	8000
Mechanical (on-off) at 240 operations per hour	25,000

Electrical Specifications

	UL/CSA	IEC
Maximum Rated Current (I_n) [A]	225	225
Frame Ratings (I_U) Rated Uninterrupted Current [A]	225	225
Rated Insulation Voltage (U) [V]	800	
Rated Impulse Withstand Voltage (U_{imp}) [kV]	8	
Rated Operational Voltage (U_o) – AC UL/CSA (60 Hz) IEC (50 Hz) [V]	600Y/347V	690
Number of Poles	3 and 4	

Standards Compliance

UL489	Yes
CSA 22.2 No. 5	Yes
EN 60947-2	Yes
CCC GB 14048.2	Yes

Temperature Specification*

Ambient Operating Temperature Range (based on the absence of freezing water or other elements)	-25...+70 °C (-13...+158 °F)
Storage Temperature	-40...+70 °C (-40...+158 °F)
Calibration Temperature	40 °C (104 °F)

* For use at temperatures other than 40 °C (104 °F), see the Temperature Performances information following.

Temperature Performance

140G-I Frame Thermal Magnetic Circuit Breakers

The I frame thermal magnetic circuit breaker is calibrated at 40 °C (104 °F). For applications at other temperatures there is a variation in the thermal tripping as indicated below.

T amb [°C]	40	50	60	70
I_n [A]	Max. [A]	Max. [A]	Max. [A]	Max. [A]
60	60	56	52	49
63	63	59	55	51
70	70	66	60	56
80	80	75	69	64
90	90	84	78	72
100	100	93	87	80
110	110	102	95	88
125	125	116	108	100
150	150	140	130	121
160	160	149	139	129
200	200	186	173	161
225	225	210	196	181

Molded Case Switch and Motor Circuit Protectors

Molded case switch and motor circuit protectors do not undergo tripping variations due to ambient temperature. However, even though ambient temperature does not affect the tripping characteristic, for temperatures exceeding +40 °C it is advisable to reduce the maximum current to prevent terminal overheating.

The tables below show the maximum current to prevent terminal overheating.

North America

40 °C (104 °F)	50 °C (122 °F)	60 °C (140 °F)	70 °C (158 °F)
I_{max} [A]	I_{max} [A]	I_{max} [A]	I_{max} [A]
100	100	100	100
110	110	110	110
125	125	125	125
150	148	153	142
200	181	161	142
225	199	175	142

IEC

40 °C (104 °F)	50 °C (122 °F)	60 °C (140 °F)	70 °C (158 °F)
I_{max} [A]	I_{max} [A]	I_{max} [A]	I_{max} [A]
100	100	100	100
110	110	110	110
125	125	125	125
150	150	150	150
200	200	200	200
225	225	214	204

140G-J Frame Specifications

250 A (UL/CSA)

250 A (IEC)



Interrupting Rating/Breaking Capacity – Thermal Magnetic and Electronic Circuit Breakers

(See page 25 for additional voltages – breaking capacities)

Interrupting Rating (50/60 Hz), UL 489/CSA C22.2-5, No. 5 [kA]			EN 60947-2											
			Breaking Capacity (50/60 Hz)								Breaking Capacity (DC) †			
240V	480V	600V	220V*		415V		440V*		690V		250V DC (2-pole in series)		500V DC (3-pole in series)	
			I_{cu} [kA]	I_{cs} [% I_{cu}]	I_{cu} [kA]	I_{cs} [% I_{cu}]	I_{cu} [kA]	I_{cs} [% I_{cu}]	I_{cu} [kA]	I_{cs} [% I_{cu}]	I_{cu} [kA]	I_{cs} [% I_{cu}]	I_{cu} [kA]	I_{cs} [% I_{cu}]
65	25	14	65	100	36	100	36	100	10	100	36	100	36	100
100	35	18	85	100	50	100	50	100	12	100	50	100	50	100
150	65	25	100	100	70	100	65	100	15	100	70	100	70	100
200	100	35	150	100	120	100	100	100	20	100	85	100	85	100

* These ratings have not been tested for the CCC listing.

† DC rating is applicable for thermal magnetic trip unit only.

Watt Loss

Type	Rated Current I_n [A]	Watt Loss [W]	
		3 Poles	4 Poles
Thermal Magnetic	25	8.1	10.7
	30	11.6	15.5
	32	13.2	17.6
	35	13.2	17.6
	40	13.5	18.0
	50	14.1	18.8
	60	14.4	19.2
	63	15.9	21.2
	70	16.2	21.6
	80	16.5	22.0
	90	18.0	24.0
	100	18.6	24.8
	110	20.1	26.8
	125	22.2	29.6
	150	23.5	31.3
	160	26.7	35.6
175	27.3	36.4	
200	35.7	47.6	
225	39.9	53.1	
250	49.2	65.6	
Electronic	40	1.8	2.4
	60	3.8	5.1
	63	4.2	5.6
	100	10.5	14.0
	150	23.5	31.4
225	53.0	70.6	
250	65.4	87.2	
Molded Case Switch	25	0.7	0.9
	50	2.6	3.5
	75	5.9	7.8
	100	10.5	14.0
	125	16.4	21.8
	150	23.5	31.4
	175	32.0	42.7
	200	41.9	55.8
	225	53.0	70.6
	250	65.4	87.2

Molded Case Switch

Rated Current I_n [A]	Magnetic Trip I_m [A]
250	3000

Dimensions (mm)

Plus Terminals

Height	160
Width (3-pole)	105
Width (4-pole)	140
Depth (case)	82.5
Depth (op handle)	117

Weight (kg)

3 Poles	2.5
4 Poles	3.5

Mechanical Endurance

Electrical Life (on-off) at 120 operations per hour	8000
Mechanical (on-off) at 240 operations per hour	25,000

Electrical Specifications

	UL/CSA	IEC
Maximum Rated Current (I_n) [A]	250	250
Frame Ratings (I_n) Rated Uninterrupted Current [A]	250	250
Rated Insulation Voltage (U) [V]	1000	
Rated Impulse Withstand Voltage (U_{imp}) [kV]	8	
Rated Operational Voltage (U_o) – AC UL/CSA (60 Hz) IEC (50 Hz) [V]	600	690
Maximum Reverse Fed Voltage [V AC]	600	600
Number of Poles	3 and 4	

Standards Compliance

UL489	Yes
CSA 22.2 No. 5	Yes
EN 60947-2	Yes
CCC GB 14048.2	Yes

Temperature Specification*

Ambient Operating Temperature Range (based on the absence of freezing water or other elements)	-25...+70 °C (-13...+158 °F)
Storage Temperature	-40...+70 °C (-40...+158 °F)
Calibration Temperature	40 °C (104 °F)

* For use at temperatures other than 40 °C (104 °F), see the Temperature Performances information following.

Temperature Performance

140G-J Frame Thermal Magnetic Circuit Breakers

The J frame thermal magnetic circuit breaker is calibrated at 40 °C (104 °F). For applications at other temperatures there is a variation in the thermal tripping as indicated below.

T amb [°C]	40	50	60	70
I_n [A]	Max. [A]	Max. [A]	Max. [A]	Max. [A]
25	25	23	21	19
30	30	25	23	20
32	32	27	24	21
35	35	32	30	26
40	40	37	34	30
50	50	46	42	39
60	60	56	51	45
63	63	58	53	48
70	70	65	58	51
80	80	74	66	58
90	90	86	77	68
100	100	95	85	75
110	110	101	92	84
125	125	115	105	95
160	160	150	137	140
175	175	166	153	142
200	200	190	175	160
225	225	208	190	170
250	250	240	230	220

Electronic Trip Circuit Breakers, Molded Case Switches and Motor Circuit Protectors

The electronic trip circuit breakers do not undergo tripping variations due to ambient temperature. However, even though ambient temperature does not affect the tripping characteristic, for temperatures exceeding +40 °C it is advisable to reduce the maximum current to prevent terminal overheating.

The same considerations are appropriate for molded case switch and motor circuit protectors.

The tables below show the maximum current to prevent terminal overheating.

North America

40 °C (104 °F)	50 °C (122 °F)	60 °C (140 °F)	70 °C (158 °F)
I_{max} [A]	I_{max} [A]	I_{max} [A]	I_{max} [A]
150	150	150	150
175	175	164	158
200	200	172	158
225	225	180	158
250	250	222	158

IEC

40 °C (104 °F)	50 °C (122 °F)	60 °C (140 °F)	70 °C (158 °F)
I_{max} [A]	I_{max} [A]	I_{max} [A]	I_{max} [A]
150	150	150	150
175	175	175	175
200	200	200	200
225	225	221	213
250	250	238	213

140G-K Frame Specifications

400 A (UL/CSA)

400 A (IEC)



Interrupting Rating/Breaking Capacity – Thermal Magnetic Circuit Breakers (See page 25 for additional voltages – breaking capacities)

Interrupting Rating (50/60 Hz), UL 489/CSA C22.2-5, No. 5 [kA]					EN 60947-2									
					Breaking Capacity (50/60 Hz)								Breaking Capacity (DC)	
240V	480V	600V	2-pole in series	3-pole in series	220V*		415V		440V*		690V		500V DC (3-pole in series)	
			500V DC	600V DC	I_{cu} [kA]	I_{cs} [% I_{cu}]	I_{cu} [kA]	I_{cs} [% I_{cu}]	I_{cu} [kA]	I_{cs} [% I_{cu}]	I_{cu} [kA]	I_{cs} [% I_{cu}]	I_{cu} [kA]	I_{cs} [% I_{cu}]
100	35	25	35	25	85	100	50	100	40	100	25	100	36	100
150	65	35	50	35	100	100	70	100	65	100	40	100	50	100
200	100	65	65	50	200	100	120	100	100	100	70	100	70	100
200	150	100	100	65	200	100	200	100	180	100	80	100	100	100

* These ratings have not been tested for the CCC listing.

Watt Loss

Type	Rated Current I_n [A]	Watt Loss [W]	
		3 Poles	4 Poles
Thermal Magnetic	300	40.8	54.4
	400	58.5	78.0
Molded Case Switch and Electronic	300	31.8	42.4
	400	49.5	66

Molded Case Switch

Rated Current I_n [A]	Magnetic Trip I_m [A]
400	5000

Dimensions (mm)

Plus Terminals

Height	205
Width (3-pole)	139.5
Width (4-pole)	186
Depth (case)	103.5
Depth (op handle)	139

Weight (kg)

3 Poles	3.25
4 Poles	4.15

Mechanical Endurance

Electrical Life (on-off) at 60 operations per hour	7000
Mechanical (on-off) at 120 operations per hour	20,000

Electrical Specifications

	UL/CSA	IEC
Maximum Rated Current (I_n) [A]	400	400
Frame Ratings (I_p) Rated Uninterrupted Current [A]	400	400
Rated Insulation Voltage (U) [V]	1000	
Rated Impulse Withstand Voltage (U_{imp}) [kV]	8	
Rated Operational Voltage (U_o) – AC UL/CSA (60 Hz) IEC (50 Hz) [V]	600	690
Number of Poles	3 and 4	

Standards Compliance

UL489	Yes
CSA 22.2 No. 5	Yes
EN 60947-2	Yes
CCC GB 14048.2	Yes

Temperature Specification*

Ambient Operating Temperature Range (based on the absence of freezing water or other elements)	-25...+70 °C (-13...+158 °F)
Storage Temperature	-40...+70 °C (-40...+158 °F)
Calibration Temperature	40 °C (104 °F)

* For use at temperatures other than 40 °C (104 °F), see the Temperature Performances information following.

Temperature Performance

140G-K Frame Thermal Magnetic Circuit Breakers

The K frame thermal magnetic circuit breaker is calibrated at 40 °C (104 °F). For applications at other temperatures there is a variation in the thermal tripping as indicated below.

T amb [°C]	40	50	60	70
I_n [A]	Max. [A]	Max. [A]	Max. [A]	Max. [A]
300	300	286	267	247
400	400	380	355	325

Electronic Trip Circuit Breakers, Molded Case Switches and Motor Circuit Protectors

The electronic trip circuit breakers do not undergo tripping variations due to ambient temperature. However, even though ambient temperature does not affect the tripping characteristic, for temperatures exceeding +40 °C it is advisable to reduce the maximum current to prevent terminal overheating.

The same considerations are appropriate for molded case switch and motor circuit protectors.

The tables below show the maximum current to prevent terminal overheating.

North America

	40 °C (104 °F)	50 °C (122 °F)	60 °C (140 °F)	70 °C (158 °F)
I_n [A]	I_{max} [A]	I_{max} [A]	I_{max} [A]	I_{max} [A]
300	300	264	228	189
400	400	352	304	252

IEC

	40 °C (104 °F)	50 °C (122 °F)	60 °C (140 °F)	70 °C (158 °F)
I_n [A]	I_{max} [A]	I_{max} [A]	I_{max} [A]	I_{max} [A]
300	300	300	300	300
400	400	400	400	352

140G-M Frame Specifications

800 A (UL/CSA)
 800 A (IEC)



Interrupting Rating/Breaking Capacity – Thermal Magnetic Circuit Breakers (See page 25 for additional voltages – breaking capacities)

Interrupting Rating (50/60 Hz), UL 489/CSA C22.2-5, No. 5 [kA]				EN 60947-2							
				Breaking Capacity (50/60 Hz)						Breaking Capacity (DC)	
240V	480V	600V	3-pole in series 600V DC	220V*		415V		690V		500V DC (3-pole in series)	
				I_{cu} [kA]	I_{cs} [% I_{cu}]	I_{cu} [kA]	I_{cs} [% I_{cu}]	I_{cu} [kA]	I_{cs} [% I_{cu}]	I_{cu} [kA]	I_{cs} [% I_{cu}]
100	50	25	20	85	100	50	100	22	75	16	75
200	65	35	35	100	100	70	100	25	75	36	75
200	100	42	50	200	75	100	75	30	75	50	75

* These ratings have not been tested for the CCC listing.

Watt Loss

Type	Rated Current I_n [A]	Watt Loss [W]	
		3 Poles	4 Poles
Thermal Magnetic	600	90.0	120.0
	630 (*)	91.8	122.4
	800	93.0	124.0
Molded Case Switch and Electronic	600	86.4	115.2
	630 (*)	90.0	120.0
	800	96.0	128.0

* IEC only

Molded Case Switch

Rated Current I_n [A]	Magnetic Trip I_m [A]
800	10,000

Dimensions (mm)

Plus Terminals

Height	268
Width (3-pole)	210
Width (4-pole)	280
Depth (case)	103.5
Depth (op handle)	159

Weight (kg)

3 Poles	12.1
4 Poles	15.1

Mechanical Endurance

Electrical Life (on-off) at 60 operations per hour	7000 (630 A) 5000 (800 A)
Mechanical (on-off) at 120 operations per hour	20,000

Electrical Specifications

	UL/CSA	IEC
Maximum Rated Current (I_r) [A]	800	800
Frame Ratings (I_f) Rated Uninterrupted Current [A]	800	800
Rated Insulation Voltage (U_i) [V]	1000	
Rated Impulse Withstand Voltage (U_{imp}) [kV]	8	
Rated Operational Voltage (U_o) – AC UL/CSA (60 Hz) IEC (50 Hz) [V]	600	690
Number of Poles	3 and 4	

Standards Compliance

UL489	Yes
CSA 22.2 No. 5	Yes
EN 60947-2	Yes
CCC GB 14048.2	Yes

Temperature Specification*

Ambient Operating Temperature Range (based on the absence of freezing water or other elements)	-25...+70 °C (-13...+158 °F)
Storage Temperature	-40...+70 °C (-40...+158 °F)
Calibration Temperature	40 °C (104 °F)

* For use at temperatures other than 40 °C (104 °F), see the Temperature Performances information following.

Temperature Performance

140G-M Frame Thermal Magnetic Circuit Breakers

The M frame thermal magnetic circuit breaker is calibrated at 40 °C (104 °F). For applications at other temperatures there is a variation in the thermal tripping as indicated below.

T amb [°C]	40	50	60	70
I_n [A]	Max. [A]	Max. [A]	Max. [A]	Max. [A]
600	600	552	514	476
630*	630	580	540	500
800	800	740	670	610

* IEC only.

Electronic Trip Circuit Breakers, Molded Case Switches and Motor Circuit Protectors

The electronic trip circuit breakers do not undergo tripping variations due to ambient temperature. However, even though ambient temperature does not affect the tripping characteristic, for temperatures exceeding +40 °C it is advisable to reduce the maximum current to prevent terminal overheating.

The same considerations are appropriate for molded case switch and motor circuit protectors.

The tables below show the maximum current to prevent terminal overheating.

North America

	40 °C (104 °F)	50 °C (122 °F)	60 °C (140 °F)	70 °C (158 °F)
I_n [A]	I_{max} [A]	I_{max} [A]	I_{max} [A]	I_{max} [A]
600	600	528	456	378
800	800	704	608	504

IEC

	40 °C (104 °F)	50 °C (122 °F)	60 °C (140 °F)	70 °C (158 °F)
I_n [A]	I_{max} [A]	I_{max} [A]	I_{max} [A]	I_{max} [A]
630	630	630	598.5	567
800	800	800	760	720

140G-N/NS Frame Specifications

1200 A (UL/CSA)

1200 A (IEC)



Interrupting Rating/Breaking Capacity – Electronic Circuit Breakers (See page 25 for additional voltages – breaking capacities)

Interrupting Rating (50/60 Hz), UL 489/CSA C22.2-5, No. 5 [kA]			Breaking Capacity (50/60 Hz), EN 60947-2									
240V	480V	600V	220V		415V		440V		500V		690V	
			I_{cu} [kA]	I_{cs} [% I_{cu}]	I_{cu} [kA]	I_{cs} [% I_{cu}]	I_{cu} [kA]	I_{cs} [% I_{cu}]	I_{cu} [kA]	I_{cs} [% I_{cu}]	I_{cu} [kA]	I_{cs} [% I_{cu}]
65	50	25	85	85	50	50	50	50	40	40	30	30
100	65	50	100	100	70	70	65	65	50	50	42	32
150	100	65	200	200	120	120	100	100	85	64	50	38

Watt Loss – Electronic and Molded Case Switch

Rated Current I_n [A]	Watt Loss [W]	
	3 Poles	4 Poles
1200	252.0	336.0

Molded Case Switch

Rated Current I_n [A]	Magnetic Trip I_m [A]
1200	20,000

Dimensions (mm)

Plus Terminals

Height	268
Width (3-pole)	210
Width (4-pole)	280
Depth (case)	125
Depth (op handle)	225

Weight (kg)

N – 3/4 Poles	9.7/12.5
NS – 3/4 Poles	11/14

Mechanical Endurance

Electrical Life (on-off) at 60 operations per hour	2000
Mechanical (on-off) at 60 operations per hour	10,000

Electrical Specifications

	UL/CSA	IEC
Maximum Rated Current (I_n) [A]	1200	1200
Frame Ratings (I_n) Rated Uninterrupted Current [A]	1200	1200
Rated Insulation Voltage (U_i) [V]	1000	
Rated Impulse Withstand Voltage (U_{imp}) [kV]	8	
Rated Operational Voltage (U_o) – AC UL/CSA (60 Hz) IEC (50 Hz) [V]	600	690
Number of Poles	3 and 4	

Standards Compliance

UL489	Yes
CSA 22.2 No. 5	Yes
EN 60947-2	Yes
CCC GB 14048.2	Yes

Temperature Specification*

Ambient Operating Temperature Range (based on the absence of freezing water or other elements)	-25...+70 °C (-13...+158 °F)
Storage Temperature	-40...+70 °C (-40...+158 °F)
Calibration Temperature	40 °C (104 °F)

* For use at temperatures other than 40 °C (104 °F), see the Temperature Performances information following.

Temperature Performance

140G-N/NS Frame Electronic Trip Circuit Breakers, Molded Case Switches and Motor Circuit Protectors

The N/NS frame electronic trip circuit breakers do not undergo tripping variations due to ambient temperature. However, even though ambient temperature does not affect the tripping characteristic, for temperatures exceeding +40 °C it is advisable to reduce the maximum current to prevent terminal overheating.

The same considerations are appropriate for molded case switch and motor circuit protectors.

The tables below show the maximum current to prevent terminal overheating.

North America

	40 °C (104 °F)	50 °C (122 °F)	60 °C (140 °F)	70 °C (158 °F)
I_n [A]	I_{max} [A]	I_{max} [A]	I_{max} [A]	I_{max} [A]
1200	1200	1056	815	756

IEC

	40 °C (104 °F)	50 °C (122 °F)	60 °C (140 °F)	70 °C (158 °F)
I_n [A]	I_{max} [A]	I_{max} [A]	I_{max} [A]	I_{max} [A]
1250	1250	1250	1118	980

140G-R Frame Specifications

2000/2500/3000 A (UL/CSA/IEC)



Interrupting Rating/Breaking Capacity – Electronic Circuit Breakers (See page 25 for additional voltages – breaking capacities)

Interrupting Rating (50/60 Hz), UL 489/CSA C22.2-5, No. 5 [kA]			Breaking Capacity (50/60 Hz), EN 60947-2									
240V	480V	600V	220V		415V		440V		500V		690V	
			I_{cu} [kA]	I_{cs} [% I_{cu}]	I_{cu} [kA]	I_{cs} [% I_{cu}]	I_{cu} [kA]	I_{cs} [% I_{cu}]	I_{cu} [kA]	I_{cs} [% I_{cu}]	I_{cu} [kA]	I_{cs} [% I_{cu}]
125	125	100	130	97.5	80	60	80	60	40	40	40	40

Watt Loss – Electronic and Molded Case Switch

Rated Current I_n [A]	Watt Loss [W]	
	3 Poles	4 Poles
2000	138	184
2500	219	292
3000	351	468

Molded Case Switch

Rated Current I_n [A]	Magnetic Trip I_m [A]
2500	40,000

Dimensions (mm)

Plus Terminals

Height	382
Width (3-pole)	428
Width (4-pole)	554
Depth (case)	231
Depth (op handle)	284

Weight (kg)

3 Pole	73
--------	----

Mechanical Endurance

Electrical Life (on-off) at 60 operations per hour	4500 (2000 A) 4000 (3000 A)
Mechanical (on-off) at 60 operations per hour	15,000

Electrical Specifications

	UL/CSA	IEC
Maximum Rated Current (I_n) [A]	3000	3000
Frame Ratings (I_n) Rated Uninterrupted Current [A]	3000	3000
Rated Insulation Voltage (U_i) [V]	1000	
Rated Impulse Withstand Voltage (U_{imp}) [kV]	12	
Rated Operational Voltage (U_o) – AC UL/CSA (60 Hz) IEC (50 Hz) [V]	600	690
Number of Poles	3 and 4	

Standards Compliance

UL489	Yes
CSA 22.2 No. 5	Yes
EN 60947-2	Yes
CCC GB 14048.2	Yes

Temperature Specification*

Ambient Operating Temperature Range (based on the absence of freezing water or other elements)	-25...+70 °C (-13...+158 °F)
Storage Temperature	-40...+70 °C (-40...+158 °F)
Calibration Temperature	40 °C (104 °F)

* For use at temperatures other than 40 °C (104 °F), see the Temperature Performances information following.

Temperature Performance

140G-R Frame Electronic Trip Circuit Breakers and Molded Case Switches

The R frame electronic trip circuit breakers do not undergo tripping variations due to ambient temperature. However, even though ambient temperature does not affect the tripping characteristic, for temperatures exceeding +40 °C it is advisable to reduce the maximum setting for external thermal protection against overloads per the following.

The same considerations are appropriate for molded case switches, except instead of a current adjustment, the table should be used to reflect the maximum current at the specific temperature.

The tables below show the maximum adjustment at which the threshold I_1 of the overcurrent protection (L) must be set according to the ambient temperature.

North America

	40 °C (104 °F)	50 °C (122 °F)	60 °C (140 °F)	70 °C (158 °F)
I_n [A]	I_{max} [A]	I_{max} [A]	I_{max} [A]	I_{max} [A]
2000	2000	1760	1520	1260
2500	2500	2200	1900	1575
3000	3000	2640	2280	1890

IEC

	40 °C (104 °F)	50 °C (122 °F)	60 °C (140 °F)	70 °C (158 °F)
I_n [A]	I_{max} [A]	I_{max} [A]	I_{max} [A]	I_{max} [A]
2000	2000	2000	1826	1633
2500	2500	2500	2283	2042
3000	3000	3000	2800	2613

MCP Performance Characteristics

		G-Frame	H-Frame	I-Frame	
Frame Size	[A]	125	125	225	
Poles		3	3	3	
Instantaneous Trip Settings	[A]	3...125	3...125	100...150	
Rated Insulation Voltage, U, IEC	[V]	800	1000	800	
NEMA, UL, CSA	UL 489 Instantaneous Trip Circuit Breaker (Magnetic Only) Max SCCR. Combination Controller Rating ②				
	480V AC	[kA]	65	65	35
	600/347V AC	[kA]	25	–	10
	600V AC	[kA]	–	25	
IEC 60947-2 GB14048.2	Rated Ultimate Short-circuit Breaking Capacity, I_{cu}				
	220-230V AC ①	[kA]	65 ⑤	100 ⑥	85
	400-415V AC	[kA]	36 ⑤	70 ⑥	50
	440V AC ①	[kA]	36 ⑤	65 ⑥	40
	500V AC	[kA]	30 ⑤	50 ⑥	30
	525V AC	[kA]	22 ⑤	30 ⑥	20
	690V AC	[kA]	6 ⑤	15 ⑥	6
	(DC) 250V – 2 Poles in Series	[kA]	36 ⑤	36 ⑥	50
	(DC) 500V – 3 Poles in Series	[kA]	–	36 ⑥	50
	Rated Service Short-circuit Breaking Capacity, I_{cs}				
	220-230V AC ①	[kA]	75% ⑤	100% ⑥	50%
	400-415V AC	[kA]	100% ⑤	100% ⑥	50% (27)
	440V AC ①	[kA]	50% ⑤	100% ⑥	50% (27)
	500V AC	[kA]	50% ⑤	100% ⑥	50%
	525V AC	[kA]	50% ⑤	100% ⑥	50%
	690V AC	[kA]	75% ⑤	100% ⑥	50%
	(DC) 250V – 2 Poles in Series	[kA]	100% ⑤	100% ⑥	75%
	(DC) 500V – 3 Poles in Series	[kA]	–	100% ⑥	75%
Mechanical Life	[No. of Operations]	25000	25000	25000	
	[Operations per Hour]	240	240	240	
Electrical Life @ 415V (AC)	[No. of Operations]	8000	8000	8000	
	[Operations per Hour]	120	120	120	
Wire Temperature Rating ④	[°C]	Cu 75 °C	Al or Cu 75 °C	Al or Cu 75 °C	
Ambient Temperature w/out derating	°F [°C]	104 °F [40 °C]	104 °F [40 °C]	104 °F [40 °C]	
Operating Temperature	°F [°C]	-13...+158 °F [-25...+70 °C]	-13...+158 °F [-25...+70 °C]	-13...+158 °F [-25...+70 °C]	
Storage Temperature	°F [°C]	-40...158 °F [-40...+70 °C]	-40...158 °F [-40...+70 °C]	-40...158 °F [-40...+70 °C]	
Dimensions	[mm]	76.2x70x130	90x82.5x130	105x70x150	
[Width/Depth/Height]	[inches]	3x2.76x5.12	3.54x3.25x5.12	4.13x2.76x5.9	
Weight (approximate)	lb [kg]	2.4 [1.1]	2.6 [1.2]	3.7 [1.7]	

- ① These ratings have not been tested for the CCC listing.
 ② The Short Circuit value is based on a combined of MCP, motor contactor and overload relay as a UL60497-4-1 Type D Combination Motor Controller. Refer to the AB Global Short Circuit Current Ratings Tables, or contact your local Allen Bradley Representative.
 ③ Adjustable between 1...10x motor FLA. Value based on 1200A rating plug.
 ④ Wire temperature Rating is determined by testing the Motor Circuit Protector under full load current with the conductors sized for 75 °C.

3A–7A, G Frame

		230V	415V	440V	500–525V	690V	250V DC
⑤	I_{cu} [kA]	5	5	3	3	3	5
	I_{cs} [kA]	100%	100%	100%	100%	100%	100%

J-Frame	K-Frame	M-Frame	N-Frame
250	400	800	1200
3	3	3	3
150...250	300 & 400	600 & 800	1200 ③
1000	1000	1000	1000
 			
65	65	65	–
–	–	–	–
25	35	35	–
 			
100	100	100	100
70	70	70	70
65	65	50	65
50	50	50	50
45	40	25	42
15	40	25	42
70	–	–	–
70	–	–	–
 			
100%	100%	100%	100%
100%	100%	100%	100%
100%	100%	100%	100%
100%	100%	100%	100%
100%	100%	75%	75%
100%	100%	75%	75%
100%	–	–	–
100%	–	–	–
25000	20000	20000	10000
240	120	120	60
8000	7000	5000	2000
120	60	60	60
Al or Cu 75 °C	Al or Cu 75 °C	Al or Cu 75 °C	Al or Cu 75 °C
104 °F [40 °C]	104 °F [40 °C]	104 °F [40 °C]	104 °F [40 °C]
-13...+158 °F [-25...+70 °C]	-13...+158 °F [-25...+70 °C]	-13...+158 °F [-25...+70 °C]	-13...+158 °F [-25...+70 °C]
-40...158 °F [-40...+70 °C]	-40...158 °F [-40...+70 °C]	-40...158 °F [-40...+70 °C]	-40...158 °F [-40...+70 °C]
105x82.5x160	140x108.5x205	210x103.5x268	210x154x268
4.13x3.25x6.3	5.51x4.27x8.07	8.27x4.07x10.55	8.27x6.06x10.55
5.5 [2.5]	7.2 [3.25]	21 [9.5]	21.4 [9.7]

3A–7A, H Frame

		230V	415V	440V	500–525V	690V	250V DC	500V DC
③	I_{cu} [kA]	5	5	3	3	3	5	5
	I_{cs} [kA]	100%	100%	100%	100%	100%	100%	100%

140MG-G Frame Specifications



	Maximum		
UL Hp Rating @ 60 Hz	230V AC	460V AC	575V AC
	40	100	125
IEC kW Rating @ 50 Hz	230V AC	400/415V AC	690V AC
	22	45	110

Interrupting Rating/Breaking Capacity – Motor Circuit Protector

See page 42 for Interrupting Rating/Breaking Capacity values.

Dimensions (mm)

Plus Terminals

Height	130
Width (3-pole)	76.2
Depth (case)	70
Depth (op handle)	101

Mechanical Endurance

Electrical Life (on-off) at 120 operations per hour	8000
Mechanical (on-off) at 240 operations per hour	25,000

Watt Loss

Rated Current I_n [A]	Watt Loss [W]
3	4.2
7	9.9
15	3.3
30	6.9
50	9.3
70	15.9
80	15.9
100	19.8
125	30.9

Electrical Specifications

		Maximum
Maximum Rated Current [I_n]	[A]	125
Frame Ratings [I_u]		
Rated Uninterrupted Current	[A]	125
Rated Insulation Voltage [U_i]	[kV]	800
Rated Impulse Withstand Voltage [U_{imp}]	[kV]	8
Rated Operational Voltage [U_e] – AC	UL/CSA [60 Hz]	600Y/347V
	IEC [50 Hz]	690
Number of Poles		3

Standards Compliance

UL489	Yes
CSA 22.2 No. 5	Yes
EN 60947-2	Yes
CCC GB 14048.2	Yes

Temperature Specification*

Ambient Operating Temperature Range (based on the absence of freezing water or other elements)	-25...+70 °C (-13...+158 °F)
Storage Temperature	-40...+70 °C (-40...+158 °F)
Calibration Temperature	40 °C (104 °F)

* For use at temperatures other than 40 °C (104 °F), see the Temperature Performance information on page 27.

140MG-H Frame Specifications



	Maximum		
UL Hp Rating @ 60 Hz	230V AC	460V AC	575V AC
	40	100	125
IEC kW Rating @ 50 Hz	230V AC	400/415V AC	690V AC
	22	45	110

Interrupting Rating/Breaking Capacity – Motor Circuit Protector

See page 42 for Interrupting Rating/Breaking Capacity values.

Dimensions (mm)

Plus Terminals

Height	130
Width (3-pole)	90
Depth (case)	82.5
Depth (op handle)	101

Mechanical Endurance

Electrical Life (on-off) at 120 operations per hour	8000
Mechanical (on-off) at 240 operations per hour	25,000

Watt Loss

Rated Current I_n [A]	Watt Loss [W]
3	11.1
7	27.9
15	19.2
30	11.4
50	15
70	16.5
80	20.4
100	24.3
125	42

Electrical Specifications

		Maximum
Maximum Rated Current [I_n]	[A]	125
Frame Ratings [I_n]		
Rated Uninterrupted Current	[A]	125
Rated Insulation Voltage [U_i]	[kV]	1000
Rated Impulse Withstand Voltage [U_{imp}]	[kV]	8
Rated Operational Voltage [U_e] – AC	[V]	
		UL/CSA [60 Hz] 600 IEC [50 Hz] 690
Maximum Reverse Fed Voltage [V AC]		
		UL/CSA [60 Hz] 480 IEC [50 Hz] 480
Number of Poles		3

Standards Compliance

UL489	Yes
CSA 22.2 No. 5	Yes
EN 60947-2	Yes
CCC GB 14048.2	Yes

Temperature Specification*

Ambient Operating Temperature Range (based on the absence of freezing water or other elements)	-25...+70 °C (-13...+158 °F)
Storage Temperature	-40...+70 °C (-40...+158 °F)
Calibration Temperature	40 °C (104 °F)

* For use at temperatures other than 40 °C (104 °F), see the Temperature Performance information on page 29.

140MG-I Frame Specifications



	Maximum		
UL Hp Rating @ 60 Hz	230V AC	460V AC	575V AC
	50	100	125
IEC kW Rating @ 50 Hz	230V AC	400/415V AC	690V AC
	22	45	90

Interrupting Rating/Breaking Capacity – Motor Circuit Protector

See page 42 for Interrupting Rating/Breaking Capacity values.

Dimensions (mm)

Plus Terminals

Height	150
Width (3-pole)	105
Depth (case)	70
Depth (op handle)	101

Mechanical Endurance

Electrical Life (on-off) at 120 operations per hour	8000
Mechanical (on-off) at 240 operations per hour	25,000

Watt Loss

Rated Current I_n [A]	Watt Loss [W]
100	13.5
110	9.9
125	12.3
150	19.5

Electrical Specifications

		Maximum
Maximum Rated Current [I_n]	[A]	225
Frame Ratings [I_u]		
Rated Uninterrupted Current	[A]	225
Rated Insulation Voltage [U_i]	[kV]	800
Rated Impulse Withstand Voltage [U_{imp}]	[kV]	8
Rated Operational Voltage [U_e] – AC	UL/CSA [60 Hz]	600Y/347V
	IEC [50 Hz]	690
Number of Poles		3

Standards Compliance

UL489	Yes
CSA 22.2 No. 5	Yes
EN 60947-2	Yes
CCC GB 14048.2	Yes

Temperature Specification*

Ambient Operating Temperature Range (based on the absence of freezing water or other elements)	-25...+70 °C (-13...+158 °F)
Storage Temperature	-40...+70 °C (-40...+158 °F)
Calibration Temperature	40 °C (104 °F)

* For use at temperatures other than 40 °C (104 °F), see the Temperature Performance information on page 31.

140MG-J Frame Specifications



	Maximum		
UL Hp Rating @ 60 Hz	230V AC	460V AC	575V AC
	100	200	250
IEC kW Rating @ 50 Hz	230V AC	400/415V AC	690V AC
	55	90	160

Interrupting Rating/Breaking Capacity – Motor Circuit Protector

See page 43 for Interrupting Rating/Breaking Capacity values.

Dimensions (mm)

Plus Terminals

Height	160
Width (3-pole)	105
Depth (case)	82.5
Depth (op handle)	117

Mechanical Endurance

Electrical Life (on-off) at 120 operations per hour	8000
Mechanical (on-off) at 240 operations per hour	25,000

Watt Loss

Rated Current I_n [A]	Watt Loss [W]
150	23.4
175	27.3
200	35.7
225	39.9
250	49.2

Electrical Specifications

		Maximum
Maximum Rated Current [I_n]	[A]	250
Frame Ratings [I_u]		
Rated Uninterrupted Current	[A]	250
Rated Insulation Voltage [U_i]	[kV]	1000
Rated Impulse Withstand Voltage [U_{imp}]	[kV]	8
Rated Operational Voltage [U_e] – AC	[V]	
		UL/CSA [60 Hz] 600 IEC [50 Hz] 690
Maximum Reverse Fed Voltage [V AC]		
		UL/CSA [60 Hz] 600 IEC [50 Hz] 600
Number of Poles		3

Standards Compliance

UL489	Yes
CSA 22.2 No. 5	Yes
EN 60947-2	Yes
CCC GB 14048.2	Yes

Temperature Specification*

Ambient Operating Temperature Range (based on the absence of freezing water or other elements)	-25...+70 °C (-13...+158 °F)
Storage Temperature	-40...+70 °C (-40...+158 °F)
Calibration Temperature	40 °C (104 °F)

* For use at temperatures other than 40 °C (104 °F), see the Temperature Performance information on page 33.

140MG-K Frame Specifications



	Maximum		
UL Hp Rating @ 60 Hz	230V AC	460V AC	575V AC
	100	250	300
IEC kW Rating @ 50 Hz	230V AC	400/415V AC	690V AC
	90	160	250

Interrupting Rating/Breaking Capacity – Motor Circuit Protector

See page 43 for Interrupting Rating/Breaking Capacity values.

Dimensions (mm)

Plus Terminals

Height	205
Width (3-pole)	139.5
Depth (case)	103.5
Depth (op handle)	139

Mechanical Endurance

Electrical Life (on-off) at 60 operations per hour	7000
Mechanical (on-off) at 120 operations per hour	20,000

Watt Loss

Rated Current I_n [A]	Watt Loss [W]
300	31.8
400	49.5

Electrical Specifications

		Maximum
Maximum Rated Current [I_n]	[A]	400
Frame Ratings [I_u]		
Rated Uninterrupted Current	[A]	400
Rated Insulation Voltage [U_i]	[kV]	1000
Rated Impulse Withstand Voltage [U_{imp}]	[kV]	8
Rated Operational Voltage [U_e] – AC	UL/CSA [60 Hz]	600
	IEC [50 Hz]	690
Number of Poles		3

Standards Compliance

UL489	Yes
CSA 22.2 No. 5	Yes
EN 60947-2	Yes
CCC GB 14048.2	Yes

Temperature Specification*

Ambient Operating Temperature Range (based on the absence of freezing water or other elements)	-25...+70 °C (-13...+158 °F)
Storage Temperature	-40...+70 °C (-40...+158 °F)
Calibration Temperature	40 °C (104 °F)

* For use at temperatures other than 40 °C (104 °F), see the Temperature Performance information on page 35.

140MG-M Frame Specifications



	Maximum		
UL Hp Rating @ 60 Hz	230V AC	460V AC	575V AC
	200	400	500
IEC kW Rating @ 50 Hz	230V AC	400/415V AC	690V AC
	160	250	500

Interrupting Rating/Breaking Capacity – Motor Circuit Protector

See page 43 for Interrupting Rating/Breaking Capacity values.

Dimensions (mm)

Plus Terminals

Height	268
Width (3-pole)	210
Depth (case)	103.5
Depth (op handle)	159

Mechanical Endurance

Electrical Life (on-off) at 60 operations per hour	7000 (630 A)
	5000 (800 A)
Mechanical (on-off) at 120 operations per hour	20,000

Watt Loss

Rated Current I_n [A]	Watt Loss [W]
600	86.4
800	96.0

Electrical Specifications

		Maximum
Maximum Rated Current [I_n]	[A]	800
Frame Ratings [I_u]		
Rated Uninterrupted Current	[A]	800
Rated Insulation Voltage [U_i]	[kV]	1000
Rated Impulse Withstand Voltage [U_{imp}]	[kV]	8
Rated Operational Voltage [U_e] – AC	UL/CSA [60 Hz]	600
	IEC [50 Hz]	690
Number of Poles		3

Standards Compliance

UL489	Yes
CSA 22.2 No. 5	Yes
EN 60947-2	Yes
CCC GB 14048.2	Yes

Temperature Specification*

Ambient Operating Temperature Range (based on the absence of freezing water or other elements)	-25...+70 °C (-13...+158 °F)
Storage Temperature	-40...+70 °C (-40...+158 °F)
Calibration Temperature	40 °C (104 °F)

* For use at temperatures other than 40 °C (104 °F), see the Temperature Performance information on page 37.

140MG-N Frame Specifications



	Maximum		
UL Hp Rating @ 60 Hz	230V AC	460V AC	575V AC
	300	600	700
IEC kW Rating @ 50 Hz	230V AC	400/415V AC	690V AC
	200	250	710

Interrupting Rating/Breaking Capacity – Motor Circuit Protector

See page 42 for Interrupting Rating/Breaking Capacity values.

Dimensions (mm)

Plus Terminals

Height	268
Width (3-pole)	210
Depth (case)	125
Depth (op handle)	225

Mechanical Endurance

Electrical Life (on-off) at 60 operations per hour	2000
Mechanical (on-off) at 60 operations per hour	10,000

Watt Loss

Rated Current I_n [A]	Watt Loss [W]
1200	252.0

Electrical Specifications

		Maximum
Maximum Rated Current [I_n]	[A]	1200
Frame Ratings [I_u]		
Rated Uninterrupted Current	[A]	1200
Rated Insulation Voltage [U_i]	[kV]	1000
Rated Impulse Withstand Voltage [U_{imp}]	[kV]	8
Rated Operational Voltage [U_e] – AC	UL/CSA [60 Hz]	600
	IEC [50 Hz]	690
Number of Poles		3

Standards Compliance

UL489	Yes
CSA 22.2 No. 5	Yes
EN 60947-2	Yes
CCC GB 14048.2	Yes

Temperature Specification*

Ambient Operating Temperature Range (based on the absence of freezing water or other elements)	-25...+70 °C (-13...+158 °F)
Storage Temperature	-40...+70 °C (-40...+158 °F)
Calibration Temperature	40 °C (104 °F)

* For use at temperatures other than 40 °C (104 °F), see the Temperature Performance information on page 39.

Page Left Blank Intentionally

MPCB Performance Characteristics

		H-Frame	J-Frame
Maximum Rated Current [A]		100	150
Rated Insulation Voltage, U _i IEC [V]		1000	1000
NEMA, UL, CSA	Interrupting Rating Code ①	H8	J8
	240V 50/60 Hz (AC) [kA]	150	150
	480V 50/60 Hz (AC) [kA]	65	65
	600V 50/60 Hz (AC) [kA]	25	25
Rated Ultimate Short-circuit Breaking Capacity, I _{cu}			
220-230V 50/60 Hz (AC) ② [kA]		100	100
380V 50/60 Hz (AC) [kA]		70	70
400-415V 50/60 Hz (AC) [kA]		70	70
440V 50/60 Hz (AC) ② [kA]		65	65
525V 50/60 Hz (AC) [kA]		15	45
550V 50/60 Hz (AC) [kA]		15	45
690V 50/60 Hz (AC) [kA]		15	15
Rated Service Short-circuit Breaking Capacity, I _{cs}			
220-230V 50/60 Hz (AC) ② [kA]		100%	100%
380V 50/60 Hz (AC) [kA]		100%	100%
400-415V 50/60 Hz (AC) [kA]		100%	100%
440V 50/60 Hz (AC) ② [kA]		100%	100%
525V 50/60 Hz (AC) [kA]		100%	100%
550V 50/60 Hz (AC) [kA]		100%	100%
690V 50/60 Hz (AC) [kA]		100%	100%
Mechanical Life [No. of Operations]		25000	25000
[Operations per Hour]		240	240
Electrical Life @ 415V (AC) [No. of Operations]		8000	8000
[Operations per Hour]		120	120
Wire Temperature Rating ③ [°C]		Cu 75 °C	Al or Cu 75 °C
Ambient Temperature w/out derating °F [°C]		104 °F [40 °C]	104 °F [40 °C]
Operational Temperature °F [°C]		-13...+158 °F [-25...+70 °C]	-13...+158 °F [-25...+70 °C]
Storage Temperature °F [°C]		-40...158 °F [-40...+70 °C]	-40...158 °F [-40...+70 °C]
Dimensions [mm]		90x82.5x130	105x82.5x160
[Width/Depth/Height] [inches]		3.54x3.25x5.12	4.13x3.25x6.3
Weight (approximate) lb [kg]		2.6 [1.2]	5.5 [2.5]

① Explanation of Interrupting Code – H8 for example: H=H Frame & 8=65 kA@480V. See table for complete ratings.

② These ratings have not been tested for the CCC listing.

③ Wire temperature Rating is determined by testing the Motor Circuit Protector under full load current with the conductors sized for 75 °C.

140MG-H Frame Specifications

25 A, 60 A, 100 A



Interrupting Rating/Breaking Capacity – Motor Protection Circuit Breaker (See page 52 for additional voltages – breaking capacities)

Interrupting Rating (50/60 Hz), UL 489/CSA C22.2-5, No. 5-02 [kA]			EN 60947-2											
			Breaking Capacity (50/60 Hz)								Breaking Capacity (DC)			
240V	480V	600V	220V*		415V		440V*		690V		250V DC (2-pole in series)		500V DC (3-pole in series)	
			I_{cu} [kA]	I_{cs} [% I_{cu}]	I_{cu} [kA]	I_{cs} [% I_{cu}]	I_{cu} [kA]	I_{cs} [% I_{cu}]	I_{cu} [kA]	I_{cs} [% I_{cu}]	I_{cu} [kA]	I_{cs} [% I_{cu}]	I_{cu} [kA]	I_{cs} [% I_{cu}]
150	65	25	100	100	70	100	65	100	15	100	70	100	70	100

* These ratings have not been tested for the CCC listing.

Dimensions (mm)

Plus Terminals

Height	130
Width (3-pole)	90
Depth (case)	82.5
Depth (op handle)	101

Mechanical Endurance

Electrical Life (on-off) at 120 operations per hour	8000
Mechanical (on-off) at 240 operations per hour	25,000

Watt Loss

Rated Current I_n [A]	Watt Loss [W]
10	0.3
25	2.4
60	4.5
100	12.6

Electrical Specifications

	Maximum
Maximum Rated Current [I_n] [A]	100
Frame Ratings [I_p] Rated Uninterrupted Current [A]	100
Rated Insulation Voltage [U_i] [kV]	1000
Rated Impulse Withstand Voltage [U_{imp}] [kV]	8
Rated Operational Voltage [U_e] – AC [V]	UL/CSA [60 Hz] 600
	IEC [50 Hz] 690
Maximum Reverse Fed Voltage [V AC]	UL/CSA [60 Hz] 480
	IEC [50 Hz] 480
Number of Poles	3

Standards Compliance

UL489	Yes
CSA 22.2 No. 5	Yes
EN 60947-2	Yes
CCC GB 14048.2	Yes

Temperature Specification*

Ambient Operating Temperature Range (based on the absence of freezing water or other elements)	-25...+70 °C (-13...+158 °F)
Storage Temperature	-40...+70 °C (-40...+158 °F)
Calibration Temperature	40 °C (104 °F)

* For use at temperatures other than 40 °C (104 °F), see the Temperature Performance information on page 29.

140MG-J Frame Specifications

40 A, 60 A, 100 A, 150 A



Interrupting Rating/Breaking Capacity – Motor Protection Circuit Breaker (See page 52 for additional voltages – breaking capacities)

Interrupting Rating (50/60 Hz), UL 489/CSA C22.2-5, No. 5-02 [kA]			EN 60947-2											
			Breaking Capacity (50/60 Hz)								Breaking Capacity (DC)			
240V	480V	600V	220V*		415V		440V*		690V		250V DC (2-pole in series)		500V DC (3-pole in series)	
			I_{cu} [kA]	I_{cs} [% I_{cu}]	I_{cu} [kA]	I_{cs} [% I_{cu}]	I_{cu} [kA]	I_{cs} [% I_{cu}]	I_{cu} [kA]	I_{cs} [% I_{cu}]	I_{cu} [kA]	I_{cs} [% I_{cu}]	I_{cu} [kA]	I_{cs} [% I_{cu}]
150	65	25	100	100	70	100	65	100	15	100	70	100	70	100

* These ratings have not been tested for the CCC listing.

Dimensions (mm)

Plus Terminals

Height	160
Width (3-pole)	105
Depth (case)	82.5
Depth (op handle)	117

Mechanical Endurance

Electrical Life (on-off) at 120 operations per hour	8000
Mechanical (on-off) at 240 operations per hour	25,000

Watt Loss

Rated Current I_n [A]	Watt Loss [W]
40	1.8
60	3.8
63	4.2
100	10.5
150	23.5

Electrical Specifications

		Maximum
Maximum Rated Current [I_n]	[A]	250
Frame Ratings [I_u]		
Rated Uninterrupted Current	[A]	250
Rated Insulation Voltage [U_i]	[kV]	1000
Rated Impulse Withstand Voltage [U_{imp}]	[kV]	8
Rated Operational Voltage [U_e] – AC	[V]	
	UL/CSA [60 Hz]	600
Maximum Reverse Fed Voltage [V AC]	[V AC]	
	UL/CSA [60 Hz]	600
	IEC [50 Hz]	600
Number of Poles		3

Standards Compliance

UL489	Yes
CSA 22.2 No. 5	Yes
EN 60947-2	Yes
CCC GB 14048.2	Yes

Temperature Specification*

Ambient Operating Temperature Range (based on the absence of freezing water or other elements)	-25...+70 °C (-13...+158 °F)
Storage Temperature	-40...+70 °C (-40...+158 °F)
Calibration Temperature	40 °C (104 °F)

* For use at temperatures other than 40 °C (104 °F), see the Temperature Performance information on page 33.

Auxiliary & Alarm Contacts

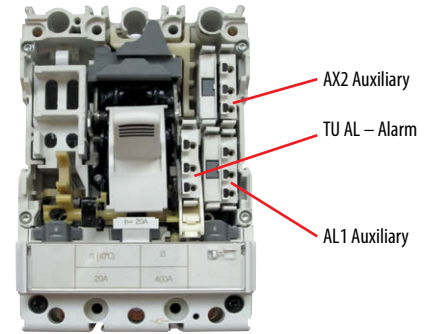
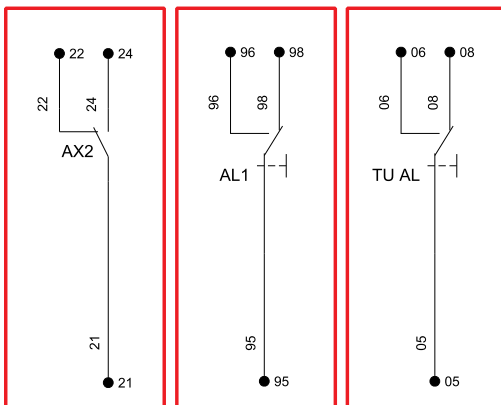
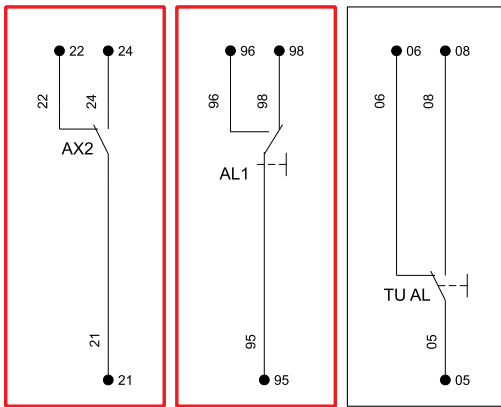
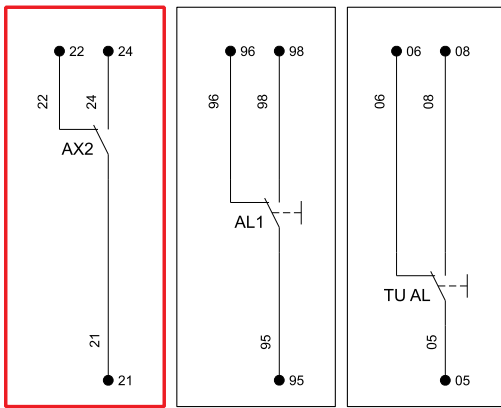
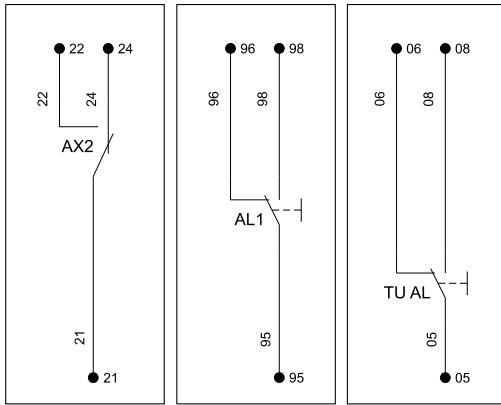

Position of the AX, AL or TU AL Contacts when installed and the Circuit Breaker is ON or the AX contact not installed.



Position of the Contacts when the Circuit Breaker OFF.

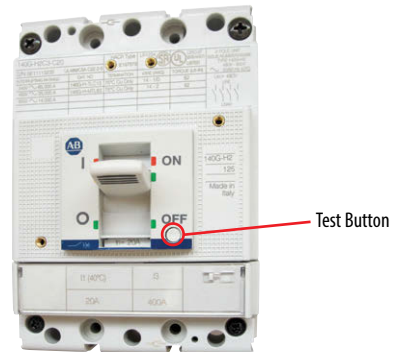

Position of the Contacts when the Circuit Breaker is TRIPPED via the TEST Button on the face of the Circuit Breaker or Shunt Trip or Undervoltage Release.

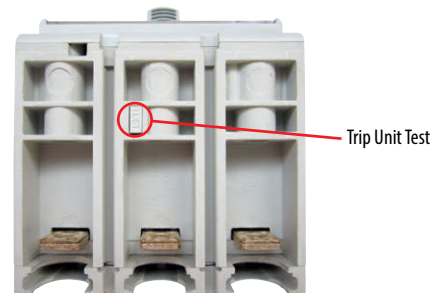

Position of the Contacts when the Circuit Breaker Trip Unit has TRIPPED. This can occur from fault current of thermal overload or via the Test Button on the center pole of TM trip units.

Auxiliary & Alarm Contacts

Application Ratings										Electrical Operating Ratings (Nominal Values)							
Order Code	Catalog Number	140G Family								Description	Rated Voltage U _e [V]	Wire Size			IEC Rating		UL Rating
		Frame										AWG	mm ²	Wire Length	Rated Operational Current (AC)	Rated Operational Current (DC)	
		G	H	I	J	K	M	N, NS	R								
AA	140G-G-EA1R1A	X	X	X	X	O	O	O	O	(1) Aux - Form C (1) AL - Form C	250V	20	0.5	1 m (39 in.)	6 A @ 250 V AC (#)	5 A @ 24V DC 0.5 A @ 110V DC 0.3 A @ 250V DC (min. 0.03 A DC)	5 A @ 125V AC 3 A @ 250V AC
	140G-K-EA1R1A	O	O	O	O	X	X	O	O	(1) Aux - Form C (1) AL - Form C	250V	20	0.5	1 m (39 in.)	6 A @ 250V AC (#)	5 A @ 24V DC 0.5 A @ 110V DC 0.3 A @ 250V DC (min. 0.03 A DC)	5 A @ 125V AC 6 A @ 250V AC
AB	140G-H-EA1R1ZB	O	X	O	X	O	O	O	O	(1) Aux - Form C (1) AL - Form C	400V	17	1	1 m (39 in.)	12 A @ 250V AC 3 A @ 400V AC	0.5 A @ 125V DC 0.3 A @ 250V DC	10 A @ 125V AC 10 A @ 250V AC
	140G-K-EA1R1B	O	O	O	O	X	X	O	O	(1) Aux - Form C (1) AL - Form C	400V	17	1	1 m (39 in.)	12 A @ 250V AC 3 A @ 400V AC	0.5 A @ 125V DC 0.3 A @ 250V DC	12 A @ 125V AC 12 A @ 250V AC
	140G-N-EA1R1B	O	O	O	O	O	O	X (N only)	O	(1) Aux - Form C (1) AL - Form C	400V	17	1	1 m (39 in.)	12 A @ 250V AC 3 A @ 400V AC	0.5 A @ 125V DC 0.3 A @ 250V DC	12 A @ 125V AC 12 A @ 250V AC
AJ	140G-G-EA1R1J	X	X	X	X	O	O	O	O	((1) Aux - Form C (1) AL - Form C	24V	20	0.5	1 m (39 in.)	—	Max. – 0.1 A @ 24V DC Min. – 0.01 A @ 5V DC min.	
	140G-N-EA1R1J	O	O	O	O	O	O	X (N only)	O	(1) Aux - Form C (1) AL - Form C	24V	20	0.5	1 m (39 in.)	—	Max. – 0.1 A @ 24V DC Min. – 0.01 A @ 5V DC min.	
BA	140G-G-EA2R1A	X	X	X	X	O	O	O	O	(2) Aux - Form C (1) AL - Form C	250V	20	0.5	1 m (39 in.)	6 A @ 250V AC (#)	5 A @ 24V DC 0.5 A @ 110V DC 0.3 A @ 250V DC (min. 0.03 A DC)	5 A @ 125V AC 3 A @ 250V AC
CA	140G-H-EA3R1A	O	X	X	X	O	O	O	O	(3) Aux - Form C (1) AL - Form C	250V	20	0.5	1 m (39 in.)	6 A @ 250V AC (#)	5 A @ 24V DC 0.5 A @ 110V DC 0.3 A @ 250V DC (min. 0.03 A DC)	5 A @ 125V AC 3 A @ 250V AC
	140G-K-EA3R1A	O	O	O	O	X	X	O	O	(3) Aux - Form C (1) AL - Form C	250V	20	0.5	1 m (39 in.)	6 A @ 250V AC (#)	5 A @ 24V DC 0.5 A @ 110V DC 0.3 A @ 250V DC (min. 0.03 A DC)	5 A @ 125V AC 6 A @ 250V AC
CJ	140G-H-EA3R1J	O	X	X	X	O	O	O	O	(3) Aux - Form C (1) AL - Form C	24V	20	0.5	1 m (39 in.)	—	Max. – 0.1 A @ 24V DC Min. – 0.01 A @ 5V DC min.	
	140G-K-EA3R1J	O	O	O	O	X	X	O	O	(3) Aux - Form C (1) AL - Form C	24V	20	0.5	1 m (39 in.)	—	Max. – 0.1 A @ 24V DC Min. – 0.01 A @ 5V DC min.	
DA	140G-H-EA1TA	O	X	O	X	O	O	O	O	(1) TU AL - Form C (Thermal)	250V	20	0.5	1 m (39 in.)	6 A @ 250V AC (#)	5 A @ 24V DC 0.5 A @ 110V DC 0.3 A @ 250V DC (min. 0.03 A DC)	5 A @ 125V AC 3 A @ 250V AC
DJ	140G-H-EA1TJ	O	X	O	X	O	O	O	O	(1) TU AL - Form C (Thermal)	24V	20	0.5	1 m (39 in.)	—	Max. – 0.1 A @ 24V DC Min. – 0.01 A @ 5V DC min.	
FB	140G-H-EA2B	O	X	O	X	O	O	O	O	(2) Aux - Form C	400V	17	1	1 m (39 in.)	12 A @ 250V AC 3 A @ 400V AC	0.5 A @ 125V DC 0.3 A @ 250V DC	12 A @ 125V AC 12 A @ 250V AC
	140G-K-EA2B	O	O	O	O	X	X	O	O	(2) Aux - Form C	400V	17	1	1 m (39 in.)	12 A @ 250V AC 3 A @ 400V AC	0.5 A @ 125V DC 0.3 A @ 250V DC	10 A @ 125V AC 10 A @ 250V AC
KA	140G-G-EA1A	X	X	X	X	O	O	O	O	(1) Aux - Form C	250V	20	0.5	1 m (39 in.)	6 A @ 250V AC (#)	0.5 A @ 110V DC 0.3 A @ 250V DC (min. 0.03 A DC)	5 A @ 125V AC 3 A @ 250V AC
TA	140G-G-EA1AU	X	X	X	X	O	O	O	O	(1) Aux - Form C or (1) AL - Form C	250V	20	0.5	1 m (39 in.)	6 A @ 250V AC (#)	5 A @ 24V DC 0.5 A @ 110V DC 0.3 A @ 250V DC (min. 0.03 A DC)	—
—	140G-G-EA1J	X	X	X	X	O	O	O	O	(1) Aux - Form C or (1) AL - Form C	24V	20	0.5	1 m (39 in.)	—	Max. – 0.1 A @ 24V DC Min. – 0.01 A @ 5V DC min.	

Application Ratings										Electrical Operating Ratings (Nominal Values)							
Order Code	Catalog Number	140G Family								Electrical Specifications (&)							
		Frame								Description	Rated Voltage U _e [V]	Wire Size		Wire Length	IEC Rating		UL Rating
		G	H	I	J	K	M	N, NS	R			AWG	mm ²		Rated Operational Current (AC)	Rated Operational Current (DC)	
—	140G-H-EA2R2TA	O	X	O	X	O	O	O	O	(2) Aux - Form C (2) AL - Form C (Thermal)	250V	20	0.5	1 m (39 in.)	6 A @ 250V AC (#)	5 A @ 24V DC 0.5 A @ 110V DC 0.3 A @ 250V DC (min. 0.03 A DC)	5 A @ 125V AC 3 A @ 250V AC
—	140G-H-EA3R2A	O	X	O	X	O	O	O	O	(3) Aux - Form C (2) AL - Form C	250V	20	0.5	1 m (39 in.)	6 A @ 250V AC (#)	5 A @ 24V DC 0.5 A @ 110V DC 0.3 A @ 250V DC (min. 0.03 A DC)	5 A @ 125V AC 3 A @ 250V AC
—	140G-N-EA1TA	O	O	O	O	O	O	X	O	(1) AL - Form C (Thermal)	250V	20	0.5	1 m (39 in.)	6 A @ 250V AC (#)	0.5 A @ 110V DC 0.3 A @ 250V DC (min. 0.03 A DC)	—
—	140G-N-EA2B	O	O	O	O	O	O	X	O	(2) Aux - Form C	400V	17	1	1 m (39 in.)	12 A @ 250V AC 3 A @ 400V AC	0.5 A @ 125V DC 0.3 A @ 250V DC	12 A @ 125V AC 12 A @ 250V AC
—	140G-N-EA2J	O	O	O	O	O	O	X	O	(2) Aux - Form C	24V	20	0.5	1 m (39 in.)	—	Max. – 0.1 A @ 24V DC Min. – 0.01 A @ 5V DC min.	Yes
—	140G-R-EA1TA	O	O	O	O	O	O	O	X	(1) AL - Form C (Thermal)	250V	†	†	†	6 A @ 250V AC (#)	0.5 A @ 110V DC 0.3 A @ 250V DC (min. 0.03 A DC)	—
—	140G-R-EA4A	O	O	O	O	O	O	O	X	(4) Aux - Form C	400V	†	†	†	12 A @ 250V AC 3 A @ 400V AC	0.5 A @ 125V DC 0.3 A @ 250V DC	15 A @ 125V AC 15 A @ 250V AC
—	140G-R-EA4J	O	O	O	O	O	O	O	X	(4) Aux - Form C	24V	†	†	†	—	Max. – 0.1 A @ 24V DC Min. – 0.01 A @ 5V DC min.	Yes
—	140G-G-EAB1B	X	X	X	X	O	O	O	O	Quantity 2 Each (1) N.C. Early Break	400 V	17	1	1 m (39 in.)	12 A @ 250V AC 3 A @ 400V AC	0.5 A @ 125V DC 0.3 A @ 250V DC	12 A @ 125V AC 12 A @ 250V AC
—	140G-G-EAM1B	X	X	X	X	O	O	O	O	Quantity 2 Each (1) N.O. Early Make	400 V	17	1	1 m (39 in.)	12 A @ 250V AC 3 A @ 400V AC	0.5 A @ 125V DC 0.3 A @ 250V DC	12 A @ 125V AC 12 A @ 250V AC
—	140G-K-EAM1A	—				X	O	O	O	Quantity 2 Each (1) N.O. Early Make	250V	20	0.5	1 m (39 in.)	6 A @ 250V AC (#)	0.5 A @ 110V DC 0.3 A @ 250V DC (min. 0.03 A DC)	—
—	140G-M-EAM1A	—				O	X	O	O	Quantity 2 Each (1) N.O. Early Make	250V	20	0.5	1 m (39 in.)	6 A @ 250V AC (#)	0.5 A @ 110V DC 0.3 A @ 250V DC (min. 0.03 A DC)	—

† Contact Rockwell Automation.

(&) Contacts are wired with 600 V (UL/CSA) insulated wire. No voltage derating of circuit breaker required.

* For use with 140G-G-RMB, -RMY, -RMX 140G-H-RMB, -RMY, RMX handle mechanisms.

** For use with 140G-K-RMB, -RMY, -RMX handle mechanisms.

(#) 250 V AC/DC Expanded Description

Voltage	Class of use	AC	DC
110V DC	DC-12	—	0.5 A
	DC-14	—	0.05 A
125V AC/DC	AC-12, AC-13, AC-14	6 A	—
250V AC/DC	AC-15	5 A	—
	AC-12 and DC-12	6 A	0.3 A
	AC-13	6 A	—
	AC-14, DC-14	5 A	0.03 A
	AC-15	4 A	—

Shunt Trip Devices

Application Ratings				Electrical Operating Ratings (Nominal Values)					
140G Frames G, H, I, J									
Order Code	Catalog Number	Rated Voltage U _e [V]	Wire Length – Size	Shunt Open Release	Operation Voltage [V]		Inrush Power Consumption		Opening Time [ms] *
					Min.	Max.	AC [VA]	DC [W]	
—	140G-G-SNR	12V DC	1 m 0.5 mm ² 20 AWG	Shunt Open Release	8.4	13.2	—	50	≤ 15
SJ	140G-G-SNJ	24...30V AC/DC	1 m 0.5 mm ² 20 AWG		16.8	33	50	50	
SK	140G-G-SNKY	48...60V AC/DC	1 m 0.5 mm ² 20 AWG		33.6	66	60	60	
SD	140G-G-SND	110...127V AC 110...125V DC	1 m 0.5 mm ² 20 AWG		77	139 AC 137 DC	50	50	
SA	140G-G-SNA	220...240V AC 220...250V DC	1 m 0.5 mm ² 20 AWG		154	278 AC 274 DC	50	50	
SB	140G-G-SNB	380...440V AC	1 m 1 mm ² 17 AWG		266	484	55	—	
SC	140G-G-SNC	480...525V AC	1 m 1 mm ² 17 AWG		336	577	55	—	
140G Frames K, M									
—	140G-K-SNR	12V DC	1 m 0.5 mm ² 20 AWG	Shunt Open Release	8.4	13.2	—	50	≤ 15
SJ	140G-K-SNJ	24...30V AC/DC	1 m 0.5 mm ² 20 AWG		16.8	33	50	50	
SK	140G-K-SNKY	48...60V AC/DC	1 m 0.5 mm ² 20 AWG		33.6	66	60	60	
SD	140G-K-SND	110...127V AC 110...125V DC	1 m 0.5 mm ² 20 AWG		77	139 AC 137 DC	50	50	
SA	140G-K-SNA	220...240V AC 220...250V DC	1 m 0.5 mm ² 20 AWG		154	278 AC 274 DC	50	50	
SB	140G-K-SNB	380...440V AC	1 m 1 mm ² 17 AWG		266	484	55	—	
SC	140G-K-SNC	480...525V AC	1 m 1 mm ² 17 AWG		336	577	55	—	

All wired with 600V (UL/CSA) insulated wire. No voltage derating required.

* The time it takes to signal the coil and open the power contacts with **no load**. Under load conditions add 25 ms.

Application Ratings				Electrical Operating Ratings (Nominal Values)					
140G Frames N, NS									
Order Code	Catalog Number	Rated Voltage U _e [V]	Wire Length – Size		Operation Voltage [V]		Inrush Power Consumption		Opening Time [ms]
					Min.	Max.	AC [VA]	DC [W]	
SJ	140G-N-SNJ	24V AC/DC	1 m 0.5 mm ² 20 AWG	Shunt Open Release	16.8	26.4	—	300	≤ 20
SK	140G-N-SNKY	48V AC/DC	1 m 0.5 mm ² 20 AWG		33.6	52.8	300	300	
SD	140G-N-SND	110...120V AC/DC	1 m 0.5 mm ² 20 AWG		77	132	300	300	
SA	140G-N-SNA	220...240V AC/DC	1 m 0.5 mm ² 20 AWG		154	264	300	300	
SB	140G-N-SNB	380...400V AC	1 m 1 mm ² 17 AWG		266	440	300	—	
RJ	140G-NS-SNCJ	24V AC/DC	1 m 0.5 mm ² 20 AWG	Shunt Close Release	20.4	26.4	300	300	≤ 80
RK	140G-NS-SNCKY	48V AC/DC	1 m 0.5 mm ² 20 AWG		40.8	52.8	300	300	
RD	140G-NS-SNCD	110...120V AC/DC	1 m 0.5 mm ² 20 AWG		93.5	126.5	300	300	
RA	140G-NS-SNCA	220...240V AC/DC	1 m 0.5 mm ² 20 AWG		187	196.5	300	300	
RB	140G-NS-SNCB	380...400V AC	1 m 1 mm ² 17 AWG		323	440	300	—	
140G Frame R									
SJ	140G-R-SNJ	24V AC/DC	1 m 0.5 mm ² 20 AWG	Shunt Open Release	16.8	26.4	—	200	≤ 60
SK	140G-R-SNKY	48V AC/DC	1 m 0.5 mm ² 20 AWG		33.6	52.8	200	200	
SD	140G-R-SND	110...120V AC/DC	1 m 0.5 mm ² 20 AWG		77	132	200	200	
SA	140G-R-SNA	220...240V AC/DC	1 m 0.5 mm ² 20 AWG		154	264	200	200	
SB	140G-R-SNB	380...400V AC/DC	1 m 1 mm ² 17 AWG		266	440	200	—	
RJ	140G-R-SNCJ	24V AC/DC	1 m 0.5 mm ² 20 AWG	Shunt Close Release	20.4	26.4	—	200	≤ 80
RK	140G-R-SNCKY	48V AC/DC	1 m 0.5 mm ² 20 AWG		40.8	52.8	200	200	
RD	140G-R-SNCD	110...120V AC/DC	1 m 0.5 mm ² 20 AWG		93.5	126.5	200	200	
RA	140G-R-SNCA	220...240V AC/DC	1 m 0.5 mm ² 20 AWG		187	196.5	200	200	
RB	140G-R-SNCB	380...400V AC/DC	1 m 1 mm ² 17 AWG		323	440	200	—	

All wired with 600V (UL/CSA) insulated wire. No voltage derating required.

Undervoltage Release

Application Ratings				Electrical Operating Ratings (Nominal Values)					
140G Frames G, H, I, J									
Order Code	Catalog Number	Rated Voltage U _e [V]	Wire Length – Size	Electrical Specifications					
				Dropout Voltage [V]		Pickup Voltage Max. [V]	UVR Power Absorbed During Normal Operation		Opening Time
				Min.	Max.		AC [VA]	DC [W]	
UJ	140G-G-UVJ	24...30V AC/DC	1 m 0.5 mm ² 20 AWG	8.4	21	25.5	1.5	1.5	≤ 15
UR	140G-G-UVR	48V AC/DC	1 m 0.5 mm ² 20 AWG	16.8	33.6	40.8	1	1	
—	140G-G-UVKY	60V AC/DC	1 m 0.5 mm ² 20 AWG	21	42	51	1	1	
UD	140G-G-UVD	110...127V AC 110...125V DC	1 m 0.5 mm ² 20 AWG	38.5	88.9 AC 87.5 DC	108 AC 106 DC	2	2	
UA	140G-G-UVA	220...240V AC 220...250V DC	1 m 0.5 mm ² 20 AWG	77	154 AC 175 DC	208 AC 212.5 DC	2.5	2.5	
UB	140G-G-UVB	380...440V AC	1 m 1 mm ² 17 AWG	133	308	374	3	—	
UC	140G-G-UVC	480...525V AC	1 m 1 mm ² 17 AWG	168	367.5	446	4	—	
140G Frames K, M									
UJ	140G-K-UVJ	24...30V AC/DC	1 m 0.5 mm ² 20 AWG	8.4	21	25.5	1.5	1.5	≤ 25
UR	140G-K-UVR	48V AC/DC	1 m 0.5 mm ² 20 AWG	16.8	33.6	40.8	1	1	
—	140G-K-UVKY	60V AC/DC	1 m 0.5 mm ² 20 AWG	21	42	51	1	1	
UD	140G-K-UVD	110...127V AC 110...125V DC	1 m 0.5 mm ² 20 AWG	38.5	88.9 AC 87.5 DC	108 AC 106 DC	2	2	
UA	140G-K-UVA	220...240V AC 220...250V DC	1 m 0.5 mm ² 20 AWG	77	154 AC 175 DC	208 AC 212.5 DC	2.5	2.5	
UB	140G-K-UVB	380...440V AC	1 m 1 mm ² 17 AWG	133	308	374	3	—	
UC	140G-K-UVC	480...525V AC	1 m 1 mm ² 17 AWG	168	367.5	446	4	—	

All wired with 600V (UL/CSA) insulated wire. No voltage derating required.

Application Ratings				Electrical Operating Ratings (Nominal Values)					
140G Frames N, NS									
Order Code	Catalog Number	Rated Voltage U _e [V]	Wire Length – Size	Electrical Specifications					Opening Time
				Dropout Voltage [V]		Pickup Voltage Max. [V]	UVR Power Absorbed During Normal Operation		
				Min.	Max.		AC [VA]	DC [W]	
UJ	140G-N-UVJ	24V AC/DC	1 m 0.5 mm ² 20 AWG	8.4	21	25.5	—	5	≤ 20
—	140G-N-UVKY	60V AC/DC	1 m 0.5 mm ² 20 AWG	21	42	51	5	5	
UD	140G-N-UVD	110...120V AC/DC	1 m 0.5 mm ² 20 AWG	38.5	88.9 AC 87.5 DC	108 AC 106 DC	5	5	
UA	140G-N-UVA	220...240V AC/DC	1 m 0.5 mm ² 20 AWG	77	154 AC 175 DC	208 AC 212.5 DC	5	5	
UB	140G-N-UVB	380...400V AC	1 m 1 mm ² 17 AWG	133	308	374	5	—	
UC	140G-N-UVC	415...440V AC	1 m 1 mm ² 17 AWG	168	367.5	446	5	—	
140G Frame R									
UJ	140G-R-UVJ	24V AC/DC	1 m 0.5 mm ² 20 AWG	8.4	21	25.5	—	5	≤ 30
—	140G-R-UVKY	60V AC/DC	1 m 0.5 mm ² 20 AWG	21	42	51	5	5	
UD	140G-R-UVD	110...120V AC/DC	1 m 0.5 mm ² 20 AWG	38.5	88.9 AC 87.5 DC	108 AC 106 DC	5	5	
UA	140G-R-UVA	220...240V AC/DC	1 m 0.5 mm ² 20 AWG	77	154 AC 175 DC	208 AC 212.5 DC	5	5	
UB	140G-R-UVB	380...400V AC	1 m 1 mm ² 17 AWG	133	308	374	5	—	
UC	140G-R-UVC	415...440V AC	1 m 0.5 mm ² 20 AWG	168	367.5	446	5	—	

All wired with 600V (UL/CSA) insulated wire. No voltage derating required.

Motor Operators

Application Ratings						Electrical Operating Ratings (Nominal Values)										
Catalog Number	Rated Voltage U _e [V]	140G Family				Wire Length – Size	Application Specifications									
		Frame					Operating Voltage		Opening Time [s]	Closing Time [s]	Resetting Time [s]	Min. Control Impulse Time (opening and closing) [ms]	Inrush Power		UVR Power Absorbed During Normal Operation	
		G	H	I	J		Min. [V]	Max. [V]					AC [VA]	DC [W]	AC [VA]	DC [W]
140G-G-EOPJ	24 V DC	X	O	X	O	1 m 0.5 mm ² 20 AWG	†	†	†	†	†	†	†	—	†	
140G-H-EOPJ		O	X	O	X		20.4	26.4	0.1	0.1	†	≥ 150	—	500	—	350
140G-G-EOPKY	48...60 V DC	X	O	X	O	1 m 0.5 mm ² 20 AWG	†	†	†	†	†	†	—	†	—	350
140G-H-EOPKY		O	X	O	X		40.8	66	0.1	0.1	†	≥ 150	—	500	—	350
140G-G-EOPD	110...125 V AC/DC	X	O	X	O	1 m 0.5 mm ² 20 AWG	†	†	†	†	†	†	†	†	†	†
140G-H-EOPD		O	X	O	X		106.3	137	0.1	0.1	†	≥ 150	500	500	350	350
140G-G-EOPA	220...250 V AC/DC	X	O	X	O	1 m 0.5 mm ² 20 AWG	†	†	†	†	†	†	†	†	†	†
140G-H-EOPA		O	X	O	X		212.6	275	0.1	0.1	†	≥ 150	500	500	350	350
140G-G-EOPB	380...440 V AC	X	O	X	O	1 m 1 mm ² 17 AWG	†	†	†	†	†	†	—	†	—	
140G-H-EOPB		O	X	O	X		374	484	0.1	0.1	†	≥ 150	500	—	350	—
140G-G-EOPC	480...525 V AC	X	O	X	O	1 m 1 mm ² 17 AWG	†	†	†	†	†	†	—	†	—	
140G-H-EOPC		O	X	O	X		†	†	†	†	†	†	†	†	†	†

Catalog Number	Rated Voltage U _e [V]	Frame		Wire Length – Size	Operating Voltage		Opening Time [s]	Closing Time [s]	Resetting Time [s]	Min. Control Impulse Time (opening and closing) [ms]	Inrush Power		UVR Power Absorbed During Normal Operation	
		K	M		Min. [V]	Max. [V]					AC [VA]	DC [W]	AC [VA]	DC [W]
		140G-K-EOPJ	24 V DC		X	O	1 m 0.5 mm ² 20 AWG	20.4	26.4	1.5	< 0.1	3	≥ 100	—
140G-M-EOPJ	O	X			20.4	26.4	3	< 0.1	5	≥ 100	—	300	—	150
140G-K-EOPKY	48...60 V DC	X	O	1 m 0.5 mm ² 20 AWG	40.8	66	1.5	< 0.1	3	≥ 100	—	300	—	150
140G-M-EOPKY		O	X		40.8	66	3	< 0.1	5	≥ 100	—	300	—	150
140G-K-EOPD	110...125 V AC/DC	X	O	1 m 0.5 mm ² 20 AWG	106.3	137	1.5	< 0.1	3	≥ 100	300	300	150	150
140G-M-EOPD		O	X		106.3	137	3	< 0.1	5	≥ 100	300	300	150	150
140G-K-EOPA	220...250 V AC/DC	X	O	1 m 0.5 mm ² 20 AWG	212.6	275	1.5	< 0.1	3	≥ 100	300	300	150	150
140G-M-EOPA		O	X		212.6	275	3	< 0.1	5	≥ 100	300	300	150	150
140G-K-EOPB	380 V AC	X	O	1 m 1 mm ² 17 AWG	374	484	1.5	< 0.1	3	≥ 100	300	—	150	—
140G-M-EOPB		O	X		374	484	3	< 0.1	5	≥ 100	300	—	150	—

† Contact Rockwell Automation.

All wired with 600V (UL/CSA) insulated wire. No voltage derating required.

Motor Operators

Application Ratings					Electrical Operating Ratings (Nominal Values)				
Catalog Number Spring Charging Motor	Rated Voltage U _e [V]	140G Family		Wire Length – Size	Application Specifications				
		Frame			Operating Voltage		Charging Time [s]	Inrush Power	
		N	NS		Min. [V]	Max. [V]		AC [VA]	DC [W]
140G-NS-SCMJ	24...30 V AC/DC	O	X	1 m 0.5 mm ² 20 AWG	20.4	33	8 - 10	≤ 400	≤ 400
140G-NS-SCMKY	48...60 V AC/DC	O	X	1 m 0.5 mm ² 20 AWG	40.8	66	8 - 10	≤ 400	≤ 400
140G-NS-SCMD	100...130 V AC/DC	O	X	1 m 0.5 mm ² 20 AWG	106.3	143	8 - 10	≤ 400	≤ 400
140G-NS-SCMA	220...250 V AC/DC	O	X	1 m 0.5 mm ² 20 AWG	212.6	275	8 - 10	≤ 400	≤ 400
140G-NS-SCMB	380...415 V AC	O	X	1 m 1 mm ² 17 AWG	323	456	8 - 10	≤ 400	—

Catalog Number	Rated Voltage U _e [V]	Frame		Wire Length – Size	Operating Voltage		Inrush Time [s]	Charging Time [s]	Inrush Power	
		R			Min. [V]	Max. [V]			AC [VA]	DC [W]
		140G-R-SCMJ	24...30 V AC/DC		X	X	1 m 0.5 mm ² 20 AWG	20.4	33	0.2
140G-R-SCMKY	48...60 V AC/DC	X	X	1 m 0.5 mm ² 20 AWG	40.8	66	0.2	4 - 5	500	500
140G-R-SCMD	100...130 V AC/DC	X	X	1 m 0.5 mm ² 20 AWG	106.3	143	0.2	4 - 5	500	500
140G-R-SCMA	220...250 V AC/DC	X	X	1 m 1 mm ² 17 AWG	212.6	275	0.2	4 - 5	500	500

† Contact Rockwell Automation.

All wired with 600V (UL/CSA) insulated wire. No voltage derating required.

Residual Current Release Module

Electrical Characteristics	Residual Current Device				
	140G-G-ELP* ②	140G-H-ELP* ③	140G-I-ELP* ②	140G-G-ELP* ②	140G-J-ELP* ③
Primary Power Supply Voltage [V]	85...690	85...690	85...690	85...690	415...690
Operating Frequency [Hz]	45...66	45...66	45...66	45...66	45...66
Fault Frequency [Hz]	50-60	50-60	50-60	50-60	50-60
Test Operating Range [V]	85...690	85...690	85...690	85...690	415...690
Rated Operating Current [A]	160 A Max.	160 A Max.	250 A Max.	250 A Max.	400 A Max.
Adjustable Trip Threshold [A]	0.03-0.05-0.1-0.3-0.5-1-3-5-10	0.03-0.05-0.1-0.3-0.5-1-3-5-10	0.03-0.05-0.1-0.3-0.5-1-3-5-10	0.03-0.05-0.1-0.3-0.5-1-3-5-10	0.03-0.05-0.1-0.3-0.5-1-3-5-10
Selective Type S	√	√	√	√	√
Adjustable NON-trip Time Settings [s] at $2 \times I_{\Delta n}$	Instantaneous	Instantaneous	Instantaneous	Instantaneous	Instantaneous
	0.1-0.2-0.3-0.5-1-2-3	0.1-0.2-0.3-0.5-1-2-3	0.1-0.2-0.3-0.5-1-2-3	0.1-0.2-0.3-0.5-1-2-3	0.1-0.2-0.3-0.5-1-2-3
Power Consumption	<5 W at 690V AC	<5 W at 690V AC	<5 W at 690V AC	<5 W at 690V AC	<10 W at 690V AC
Trip Coil with Switch Contact for Trip Signal	√	√	√	√	√
N.O. Contact for Pre-alarm Signal	√	√	√	√	√
N.O. Contact for Alarm Signal	√	√	√	√	√
Pre-alarm Indication from 25% $I_{\Delta n}$ Steady Yellow LED Light	√	√	√	√	√
Alarm Timing Indication at 75% $I_{\Delta n}$ Flashing Yellow LED Light ④	√	√	√	√	√
Type A for Pulsating Alternating Current Type AC for Alternating Current	√	√	√	√	√

④ Indication of alarm timing at 90% $I_{\Delta n}$ for 30 mA.

② 3- or 4- pole devices.

③ 4-pole only.

Time-Current Curves

Motor Circuit Protectors

Bulletin 140MG-G.....	66
Bulletin 140MG-H.....	67
Bulletin 140MG-I.....	69
Bulletin 140MG-J.....	70
Bulletin 140MG-K.....	71
Bulletin 140MG-M.....	72
Bulletin 140MG-N.....	73
Bulletin 140MG-H8E.....	74
Bulletin 140MG-J8E.....	75

Thermal Magnetic Molded Case Circuit Protectors

Bulletin 140G-G.....	76
Bulletin 140G-H.....	82
Bulletin 140G-I.....	89
Bulletin 140G-J.....	92
Bulletin 140G-K.....	98
Bulletin 140G-M.....	99

Electronic Molded Case Circuit Protectors

Bulletin 140G-H.....	102
Bulletin 140G-J.....	104
Bulletin 140G-K.....	106
Bulletin 140G-M.....	108
Bulletin 140G-N, -NS.....	110
Bulletin 140G-R.....	114

Let-Through Energy Curves

I^2t @ 240V.....	116
I^2t @ 415V.....	117
I^2t @ 480V.....	118
I^2t @ 600V.....	119
I^2t @ 690V.....	120

Peak Let-Through Current Curves

Peak, kA @ 240V.....	121
Peak, kA @ 415V.....	122
Peak, kA @ 480V.....	123
Peak, kA @ 600V.....	124
Peak, kA @ 690V.....	125

Bulletin 140MG-G

Maximum Current: 3...125 A

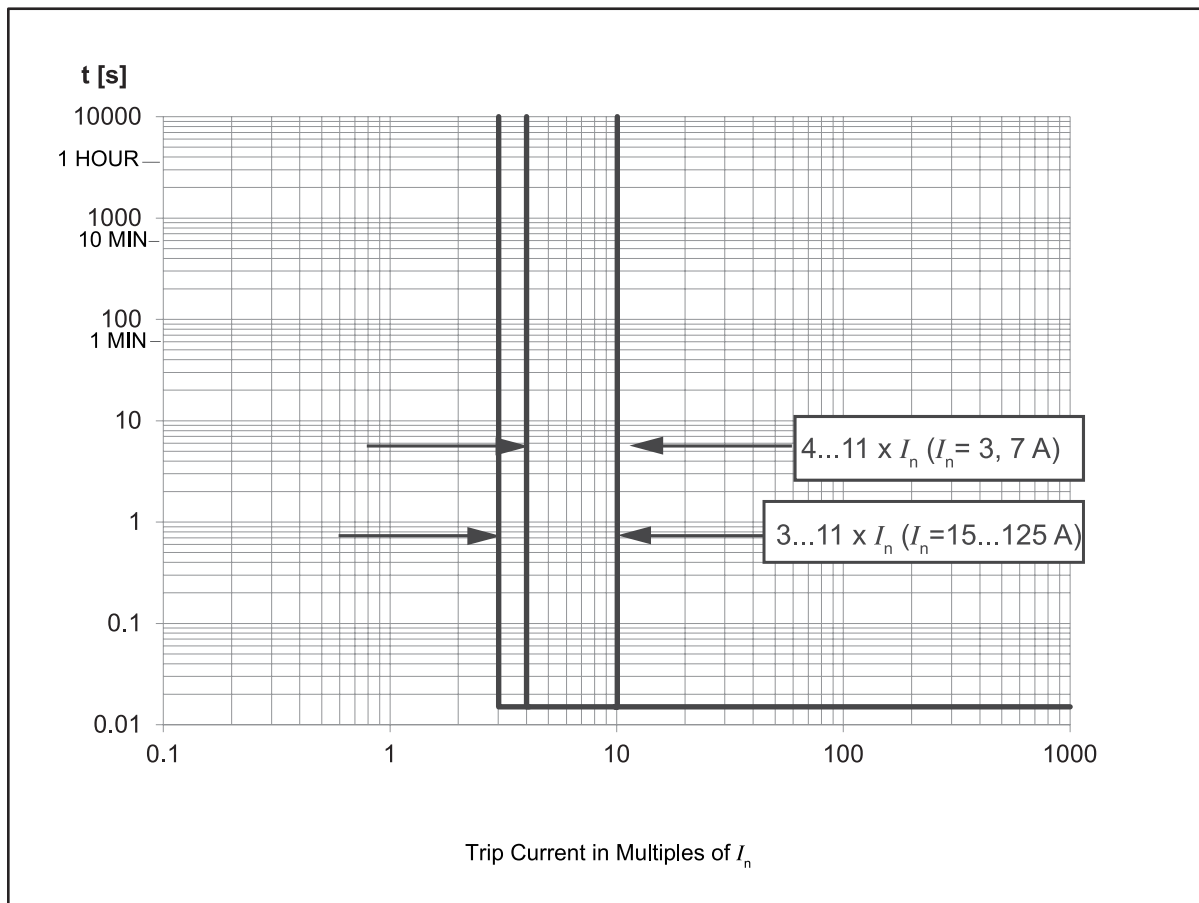

Instantaneous Pick-up Setting (Amperes)

Catalog Number	A	B	C	D	E	F	G	H	I
140MG-G8P-B30	12	15	17	20	23	25	28	30	33
140MG-G8P-B70	28	34	40	46	53	59	65	71	77
140MG-G8P-C15	45	60	75	90	105	120	135	150	165
140MG-G8P-C30	90	120	150	180	210	240	270	300	330
140MG-G8P-C50	150	200	250	300	350	400	450	500	550
140MG-G8P-C70	210	280	350	420	490	560	630	700	770
140MG-G8P-C80	240	320	400	480	560	640	720	800	880
140MG-G8P-D10	300	400	500	600	700	800	900	1000	1100
140MG-G8P-D12	375	500	625	750	875	1000	1125	1250	1375

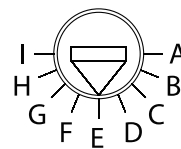

Typical Trip Unit Nameplate

I_s [A]									
A	B	C	D	E	F	G	H	I	
300	400	500	600	700	800	900	1000	1100	

See chart on left for trip setting values.

Note: Motor circuit protectors are for use only in combination controllers. For DC applications, pick-up settings are approximately 40% higher.

Bulletin 140MG-H

Maximum Current: 3...100 A

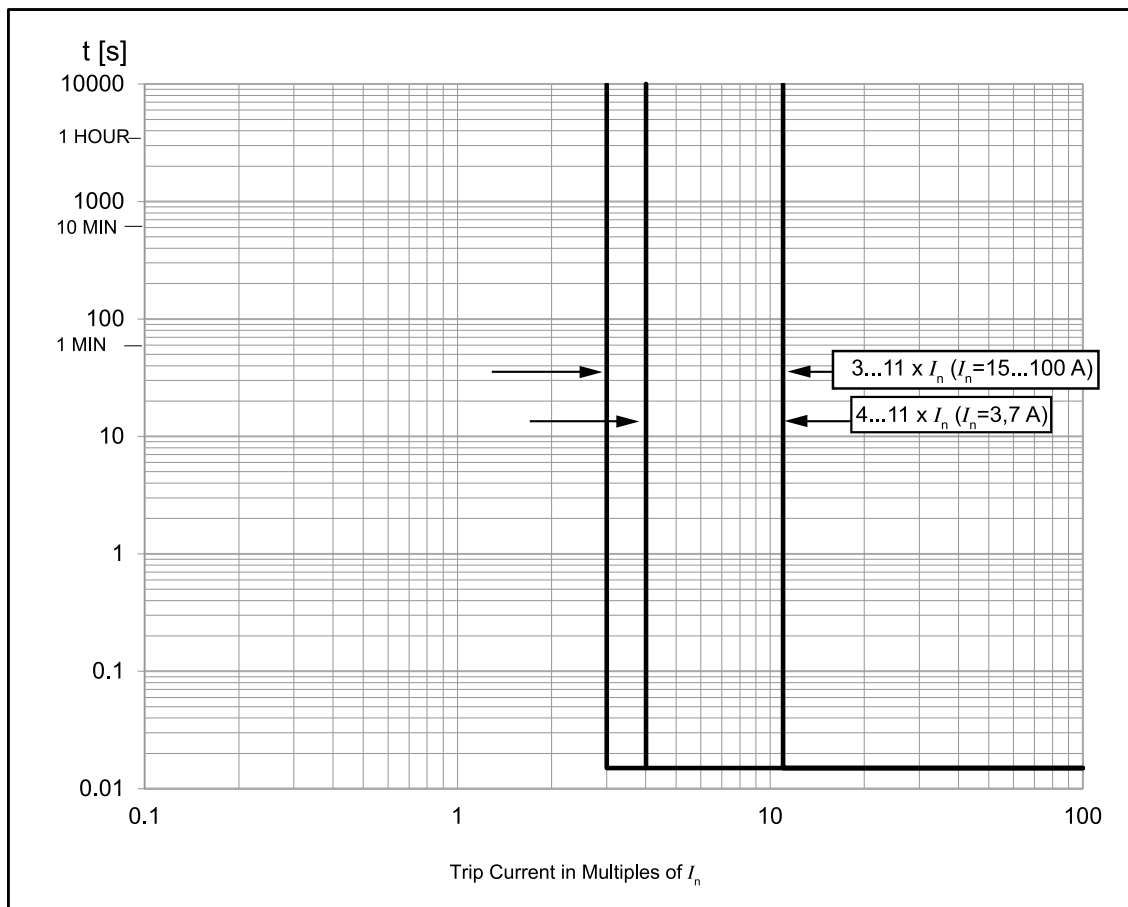

Instantaneous Pick-up Setting (Amperes)

Catalog Number	A	B	C	D	E	F	G	H	I
140MG-H8P-B30	12	15	17	20	23	25	28	30	33
140MG-H8P-B70	28	34	40	46	53	59	65	71	77
140MG-H8P-C15	45	60	75	90	105	120	135	150	165
140MG-H8P-C30	90	120	150	180	210	240	270	300	330
140MG-H8P-C50	150	200	250	300	350	400	450	500	550
140MG-H8P-C70	210	280	350	420	490	560	630	700	770
140MG-H8P-C80	240	320	400	480	560	640	720	800	880
140MG-H8P-D10	300	400	500	600	700	800	900	1000	1100



Typical Trip Unit Nameplate

I_3 [A]									
A	B	C	D	E	F	G	H	I	
300	400	500	600	700	800	900	1000	1100	

See chart on left for trip setting values.

Note: Motor circuit protectors are for use only in combination controllers.
 For DC applications, pick-up settings are approximately 40% higher.

Bulletin 140MG-H

Maximum Current: 125 A

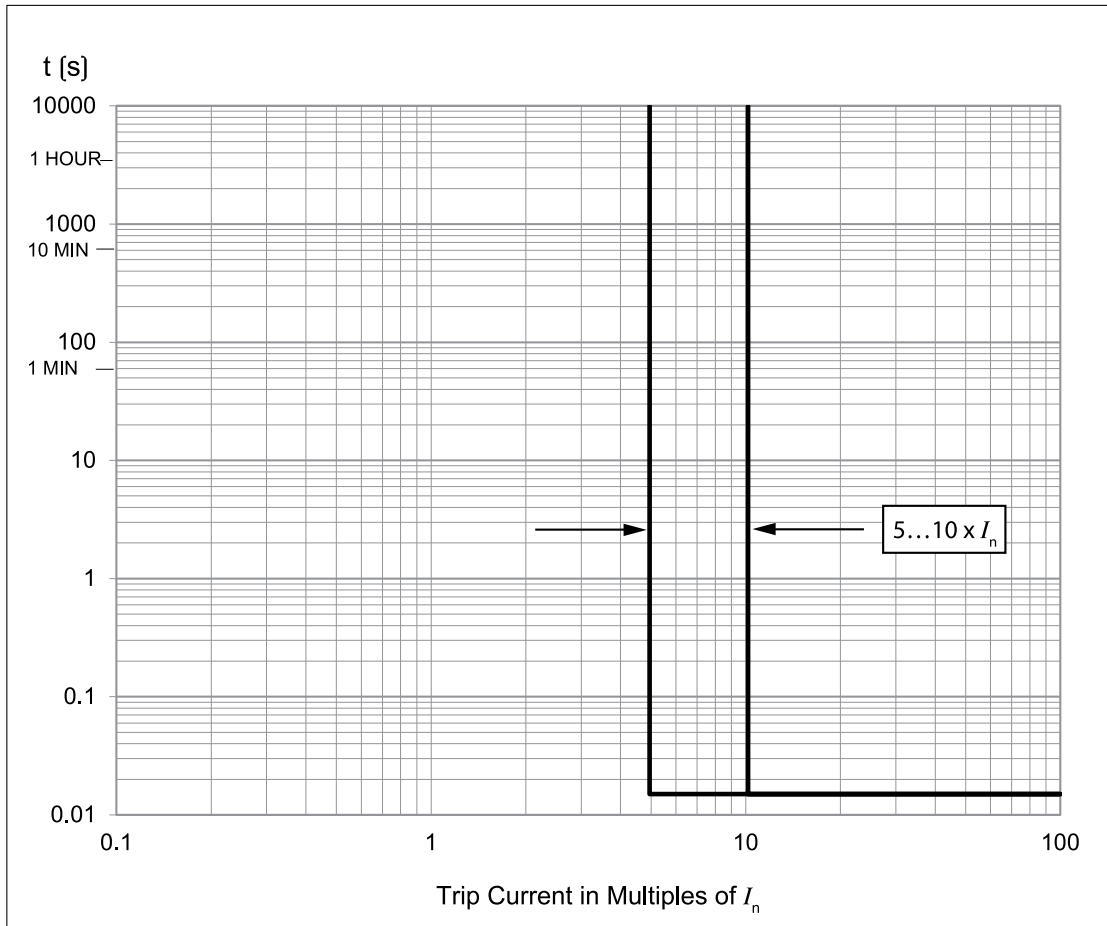

Typical Trip Unit Nameplate

I_3 [A]								
A	B	C	D	E	F	G	H	I
625	703	781	859	938	1016	1094	1172	1250

Note: Motor circuit protectors are for use only in combination controllers.
 For DC applications, pick-up settings are approximately 40% higher.

Bulletin 140MG-I

Maximum Current: 100...150 A

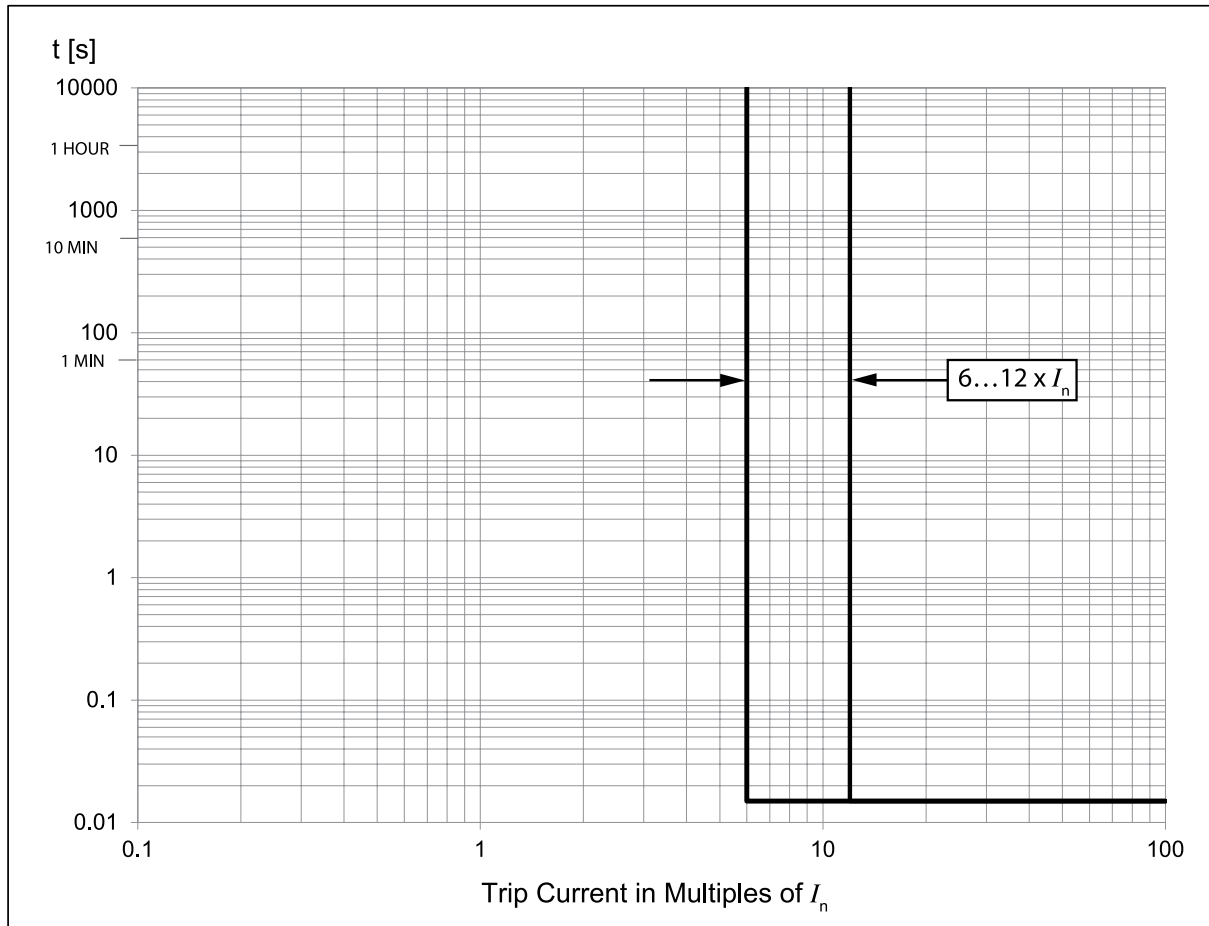

Instantaneous Pick-up Setting (Amperes)

Catalog Number	A	B	C	D	E	F	G	H	I
140MG-I8P-D10	600	675	750	825	900	975	1050	1125	1200
140MG-I8P-D11	660	743	825	908	990	1073	1155	1238	1320
140MG-I8P-D12	750	844	938	1031	1125	1219	1313	1406	1500
140MG-I8P-D15	900	1013	1125	1238	1350	1463	1575	1688	1800

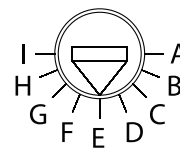

Typical Trip Unit Nameplate

I_s [A]									
A	B	C	D	E	F	G	H	I	
600	675	750	825	900	975	1050	1125	1200	

See chart on left for trip setting values.

Note: Motor circuit protectors are for use only in combination controllers.
 For DC applications, pick-up settings are approximately 40% higher.

Bulletin 140MG-J

Maximum Current: 150...250 A

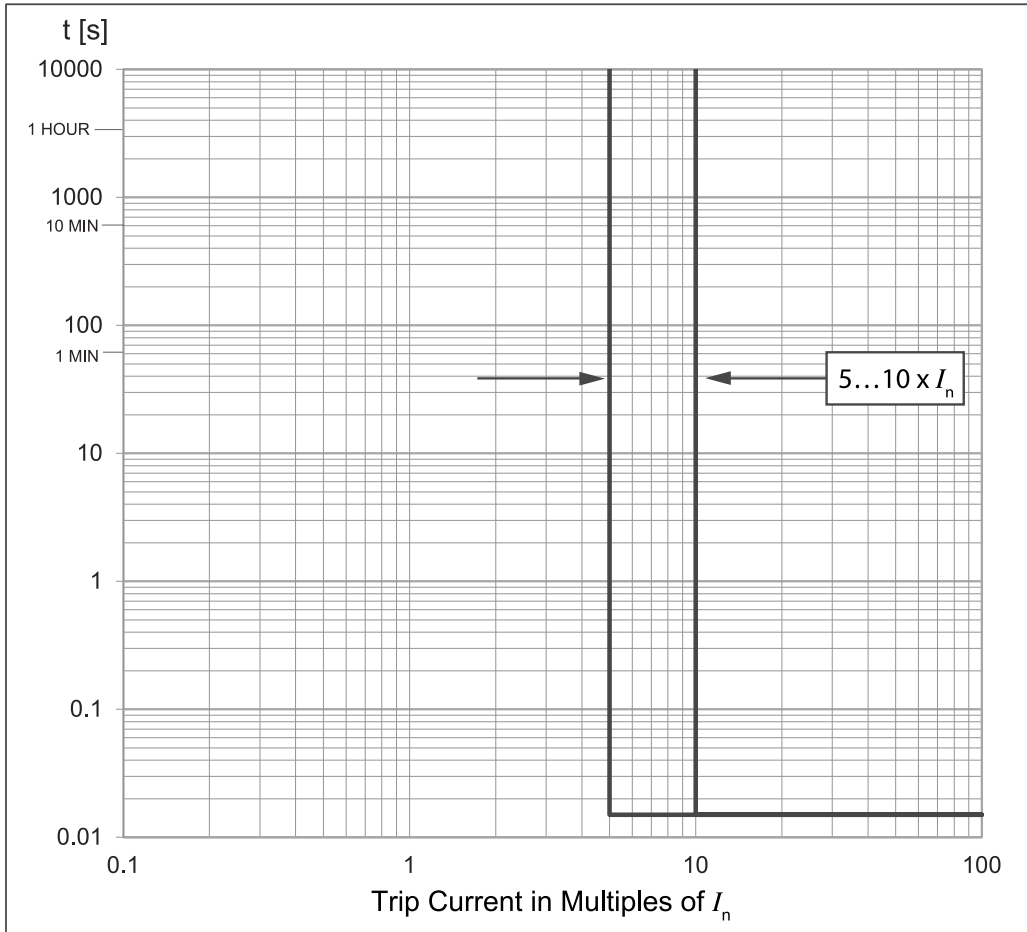

Instantaneous Pick-up Setting (Amperes)

Catalog Number	A	B	C	D	E	F	G	H	I
140MG-J8P-D15	750	844	938	1031	1125	1219	1313	1406	1500
140MG-J8P-D17	875	984	1094	1203	1313	1422	1531	1641	1750
140MG-J8P-D20	1000	1125	1250	1375	1500	1625	1750	1875	2000
140MG-J8P-D22	1125	1266	1406	1547	1688	1828	1969	2109	2250
140MG-J8P-D25	1250	1406	1563	1719	1875	2031	2188	2344	2500



Typical Trip Unit Nameplate

I_3 [A]									
A	B	C	D	E	F	G	H	I	
750	844	938	1031	1125	1219	1313	1406	1500	

See chart on left for trip setting values.

Note: Motor circuit protectors are for use only in combination controllers.
 For DC applications, pick-up settings are approximately 40% higher.

Bulletin 140MG-K

Maximum Current: 300 A, 400 A

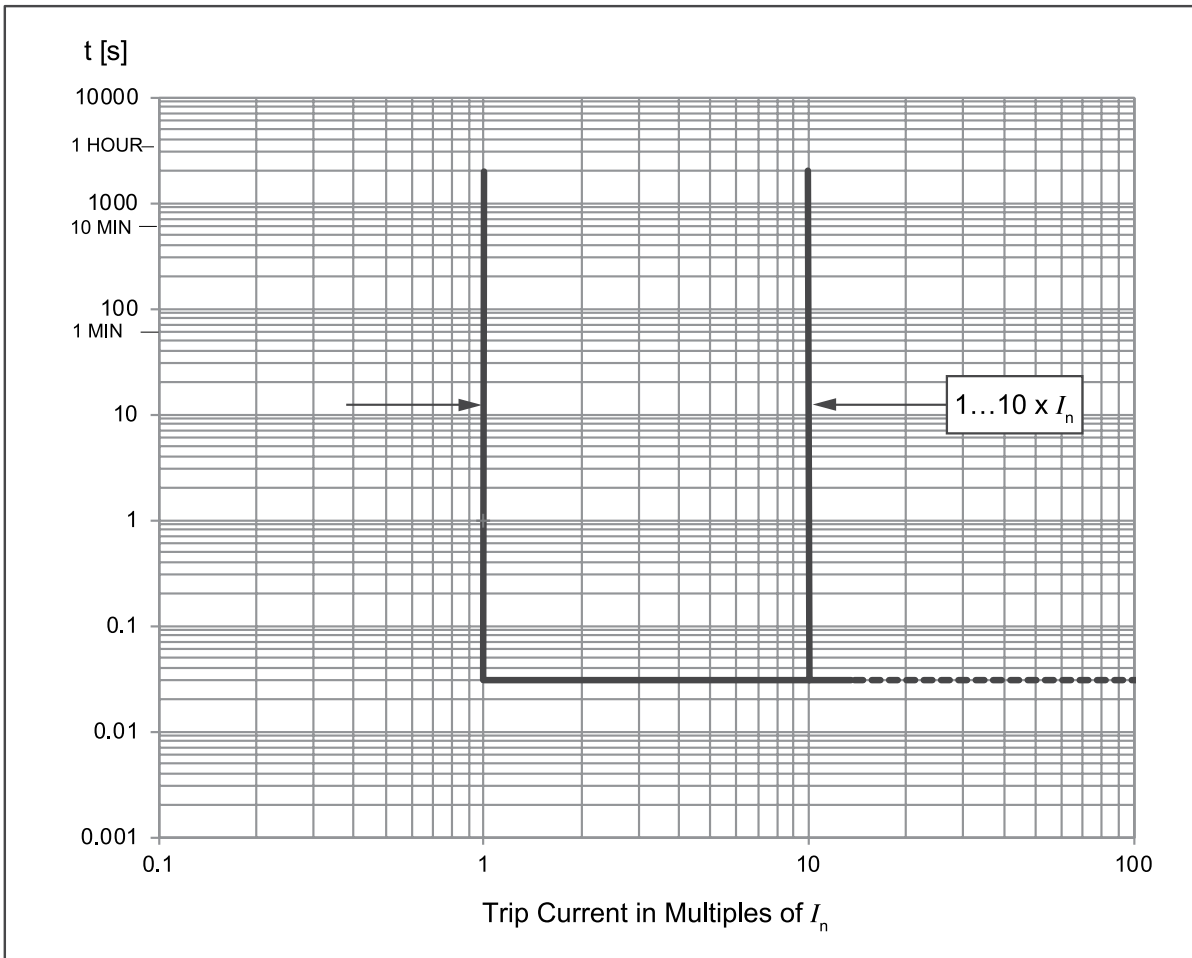

Note: Motor circuit protectors are for use only in combination controllers. For DC applications, pick-up settings are approximately 40% higher.

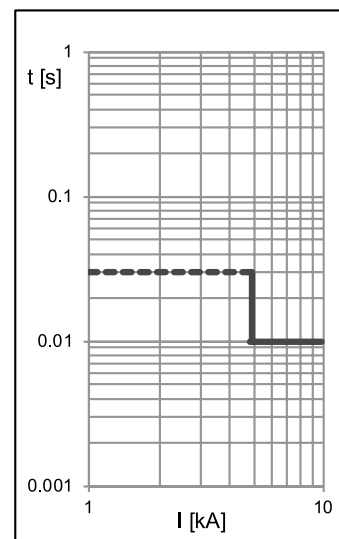

Bulletin 140MG-M

Maximum Current: 600 A, 800 A

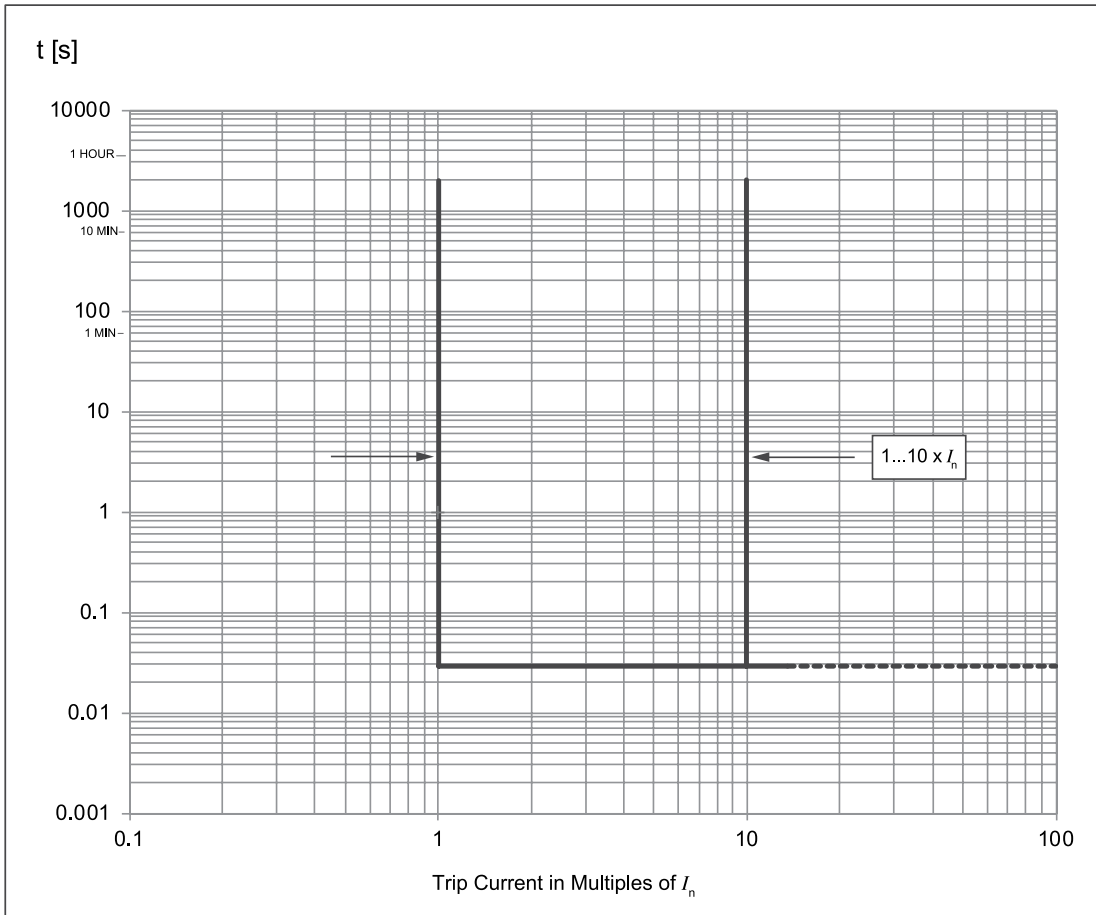

Note: Motor circuit protectors are for use only in combination controllers. For high fault current levels an additional fixed instantaneous override is provided at 9.6 kA.

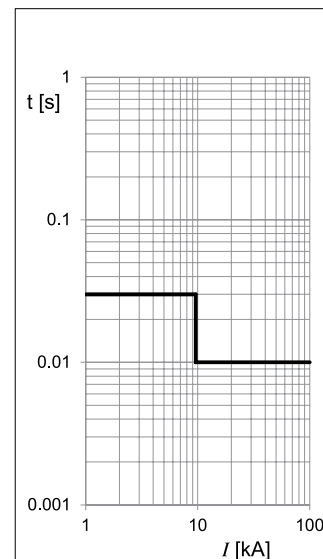

Bulletin 140MG-N

Maximum Current: 1200 A

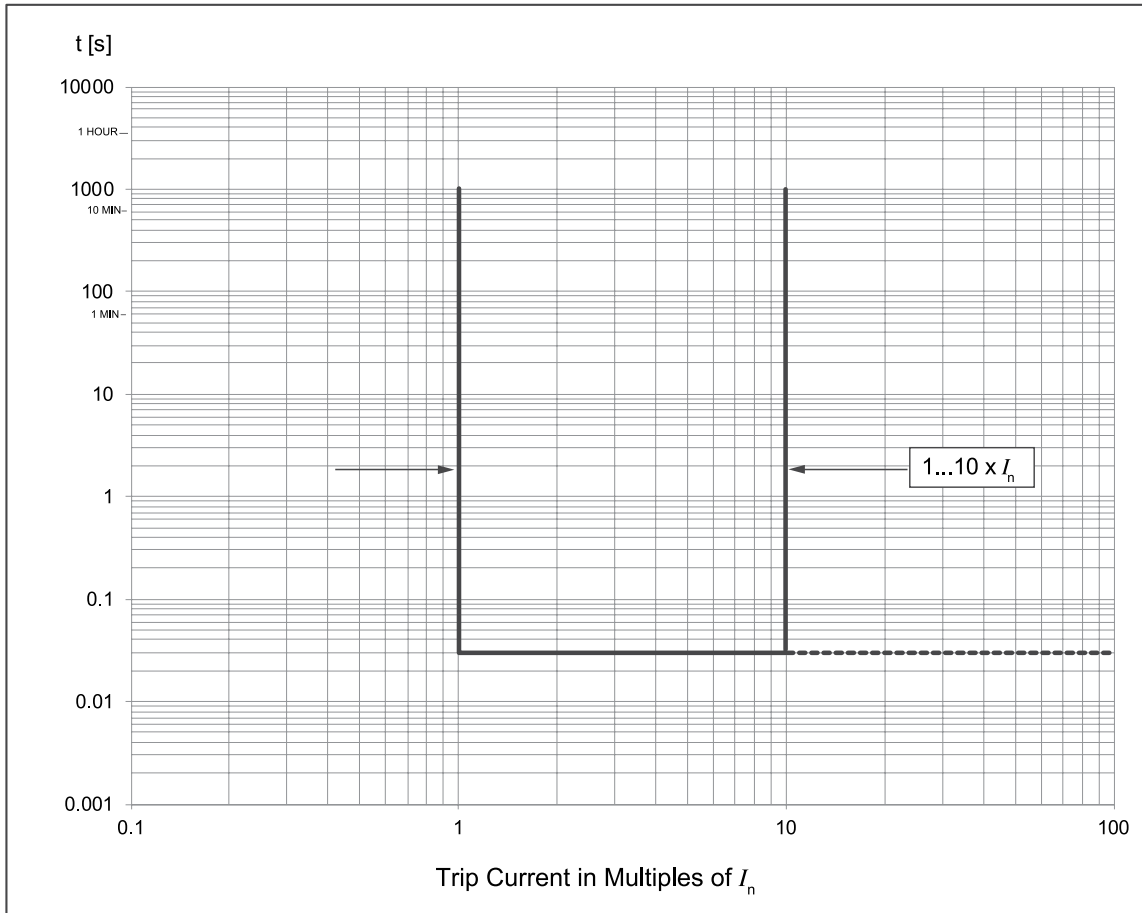

Note: Motor circuit protectors are for use only in combination controllers. For high fault current levels an additional fixed instantaneous override is provided at 22 kA.

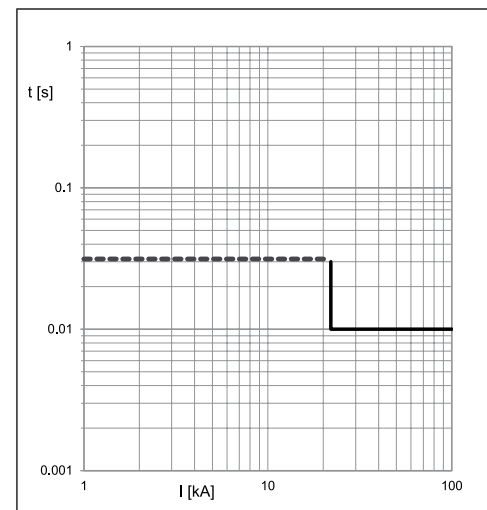

Bulletin 140MG-H8E

Available Current Sensors: 25 A, 60 A, 100 A

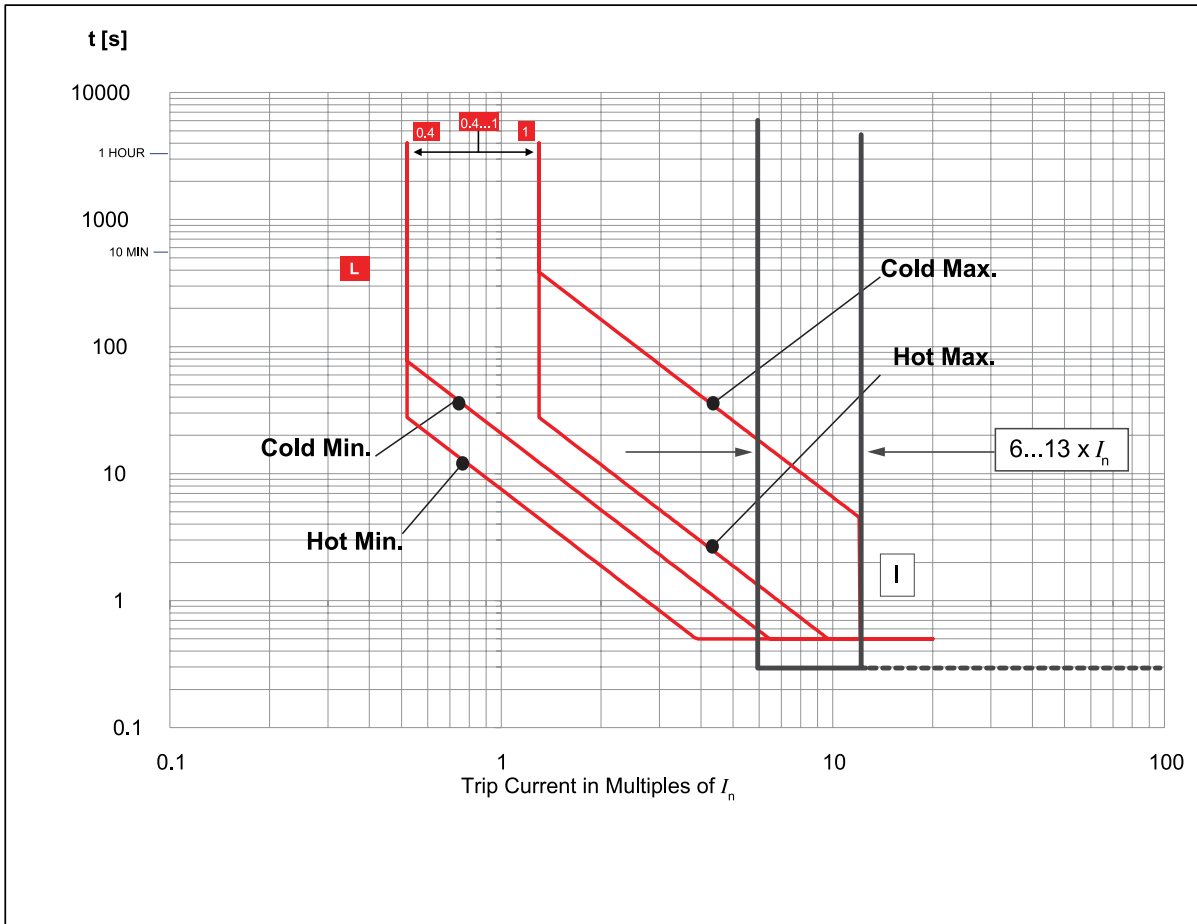

Note: Set L function value equal motor FLA.

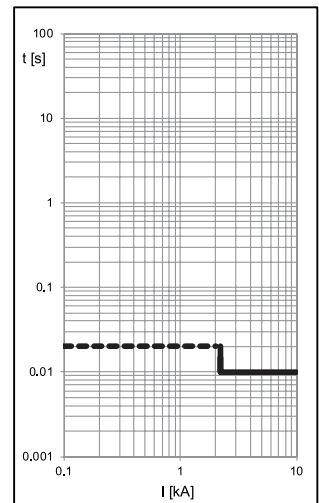

Bulletin 140MG-J8E

Available Current Sensors: 40 A, 60 A, 100 A, 150 A

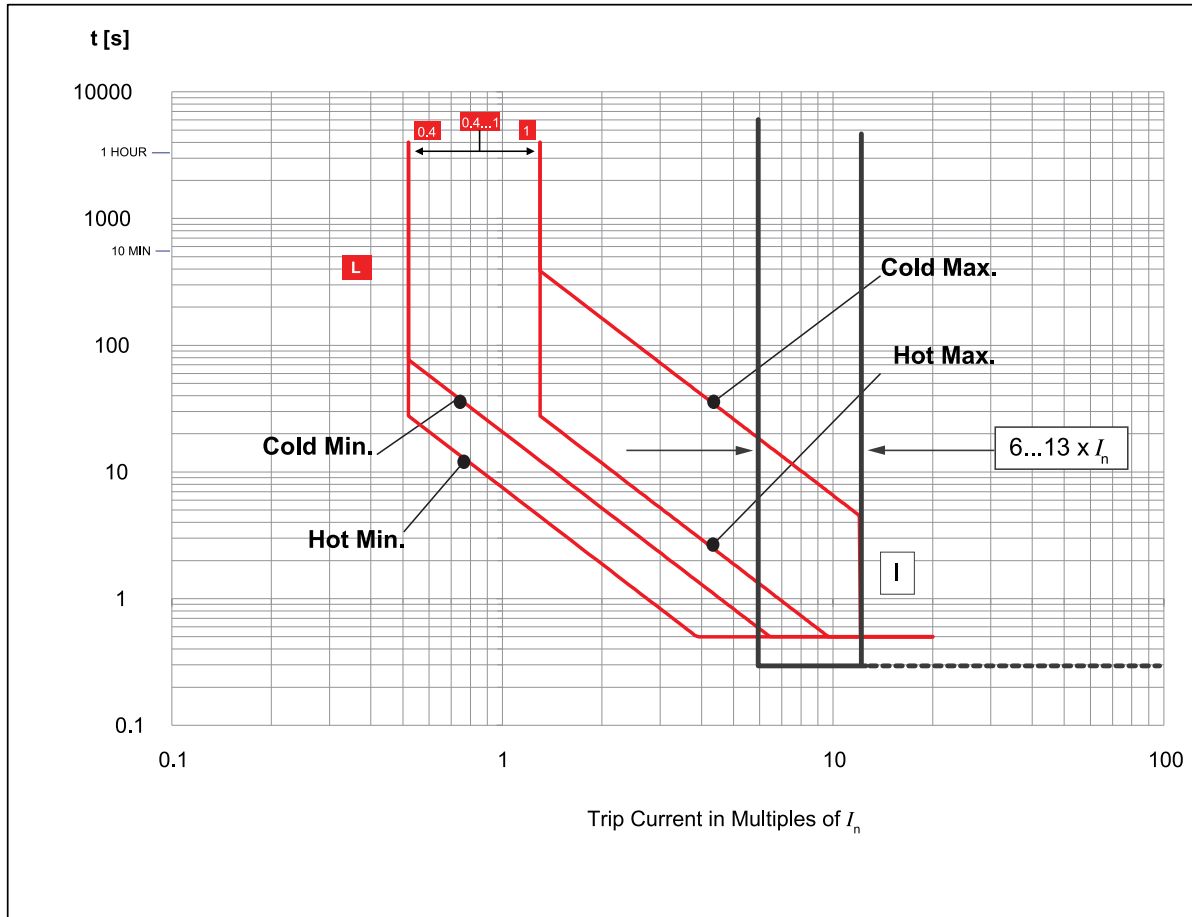

Note: Set L function value equal motor FLA.

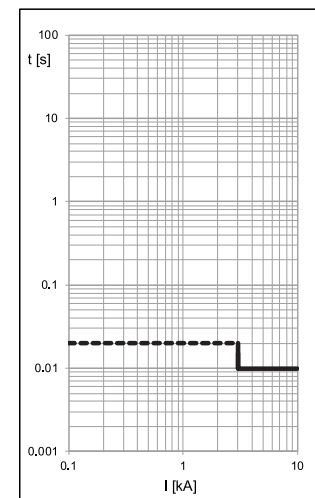

Bulletin 140G-G

Maximum Current: 15...30 A

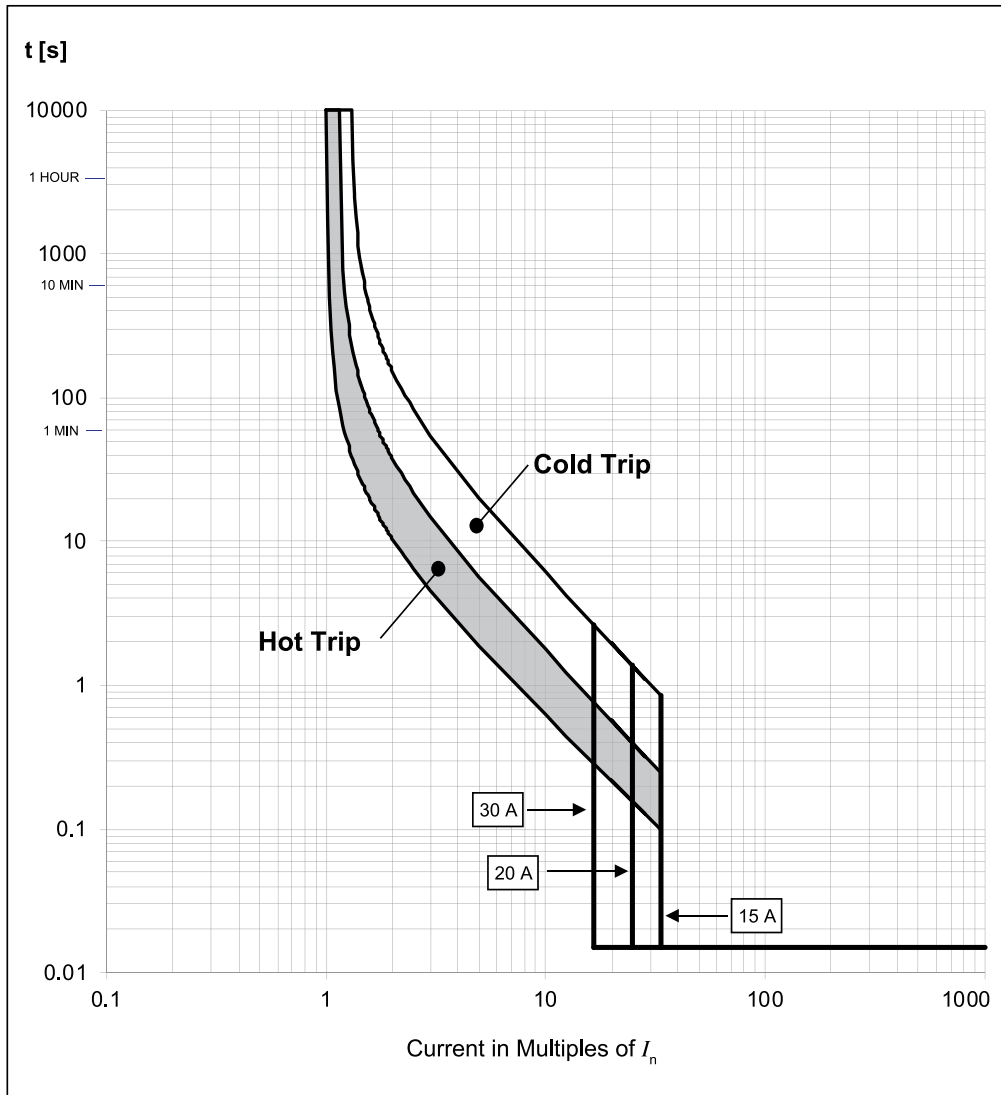

Rated Current I_n [A]	Magnetic Trip I_m [A]
15...30	500

Bulletin 140G-G

Maximum Current: 32 A

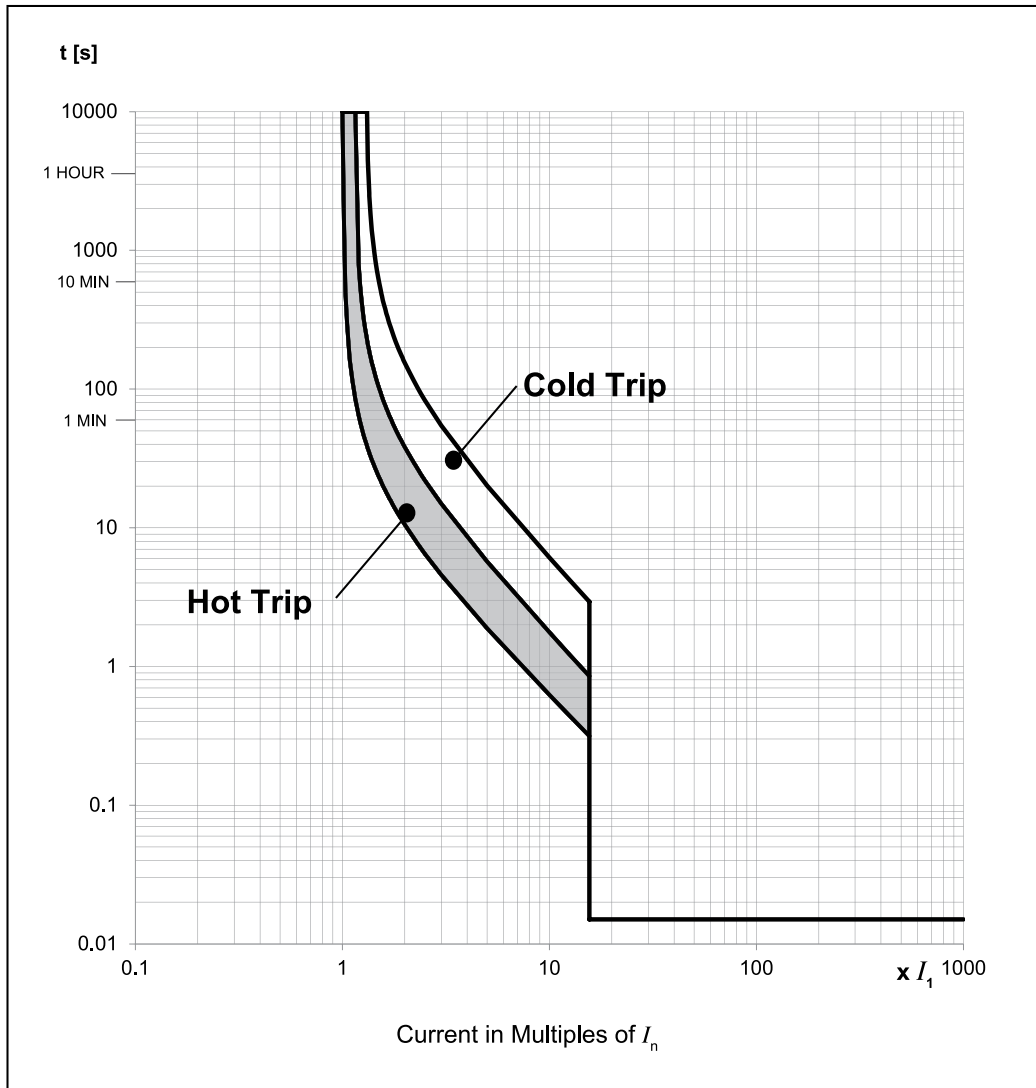

Bulletin 140G-G

Maximum Current: 35...50 A

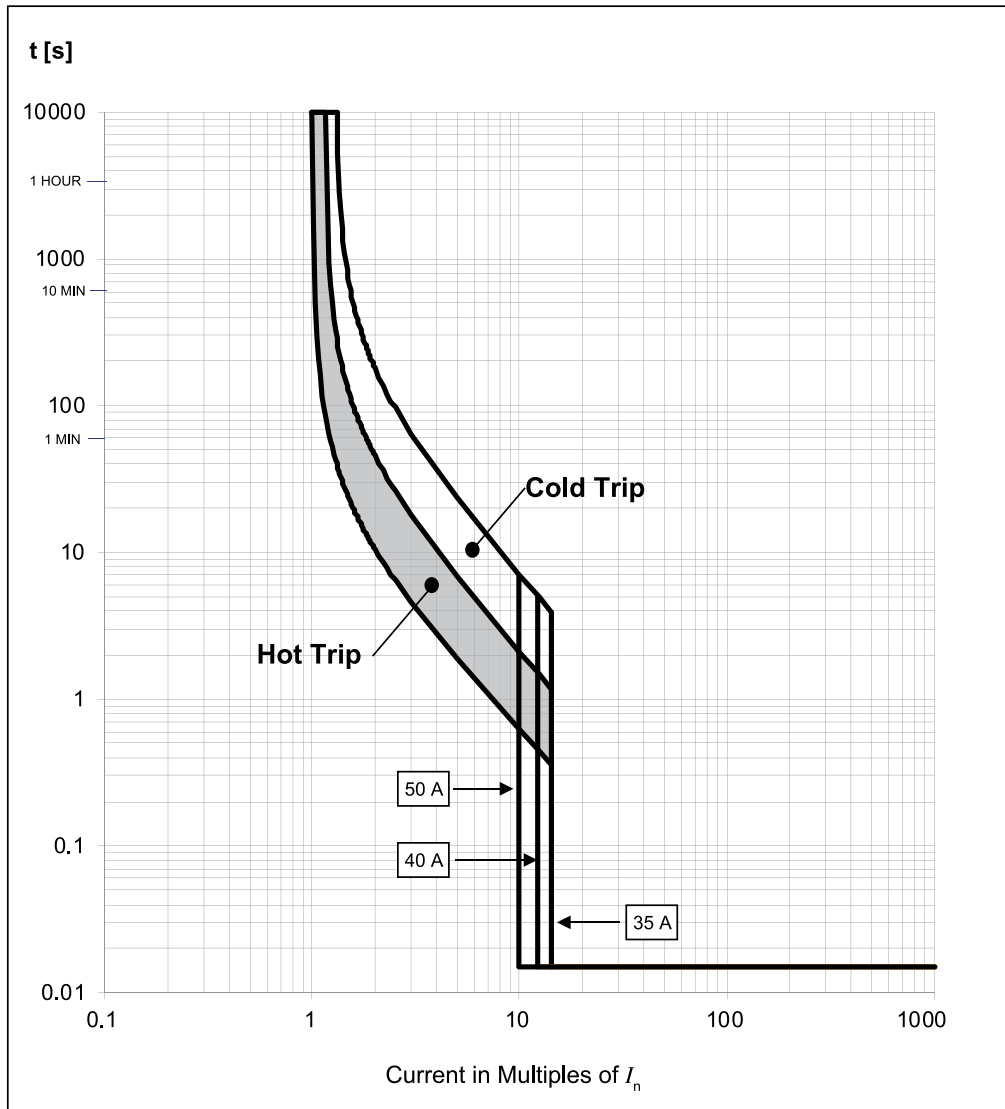

Rated Current I_n [A]	Magnetic Trip I_m [A]
35...50	500

Bulletin 140G-G

Maximum Current: 60...100 A

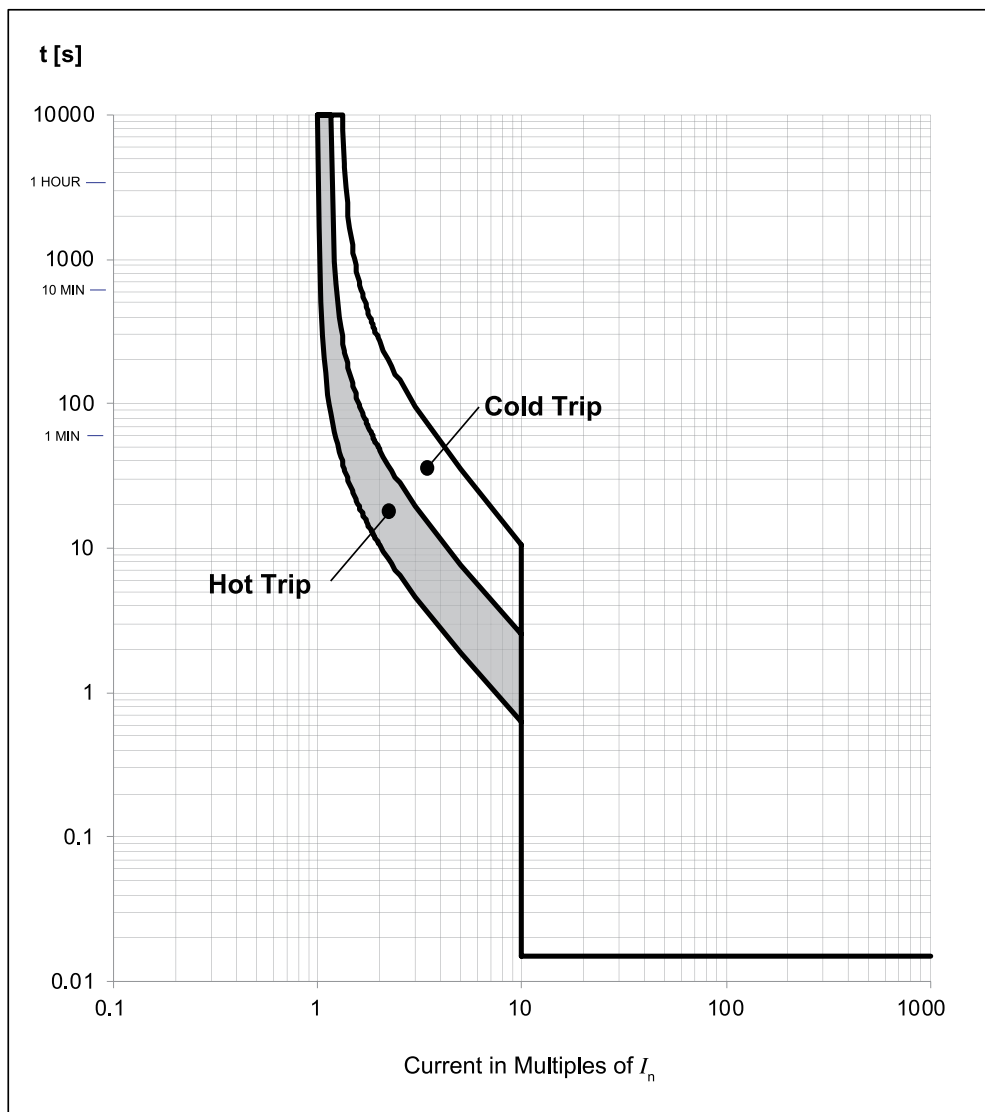

Rated Current I_n [A]	Magnetic Trip I_m [A]
60	600
63	630
70	700
80	800
90	900
100	1000

Bulletin 140G-G

Maximum Current: 125 A

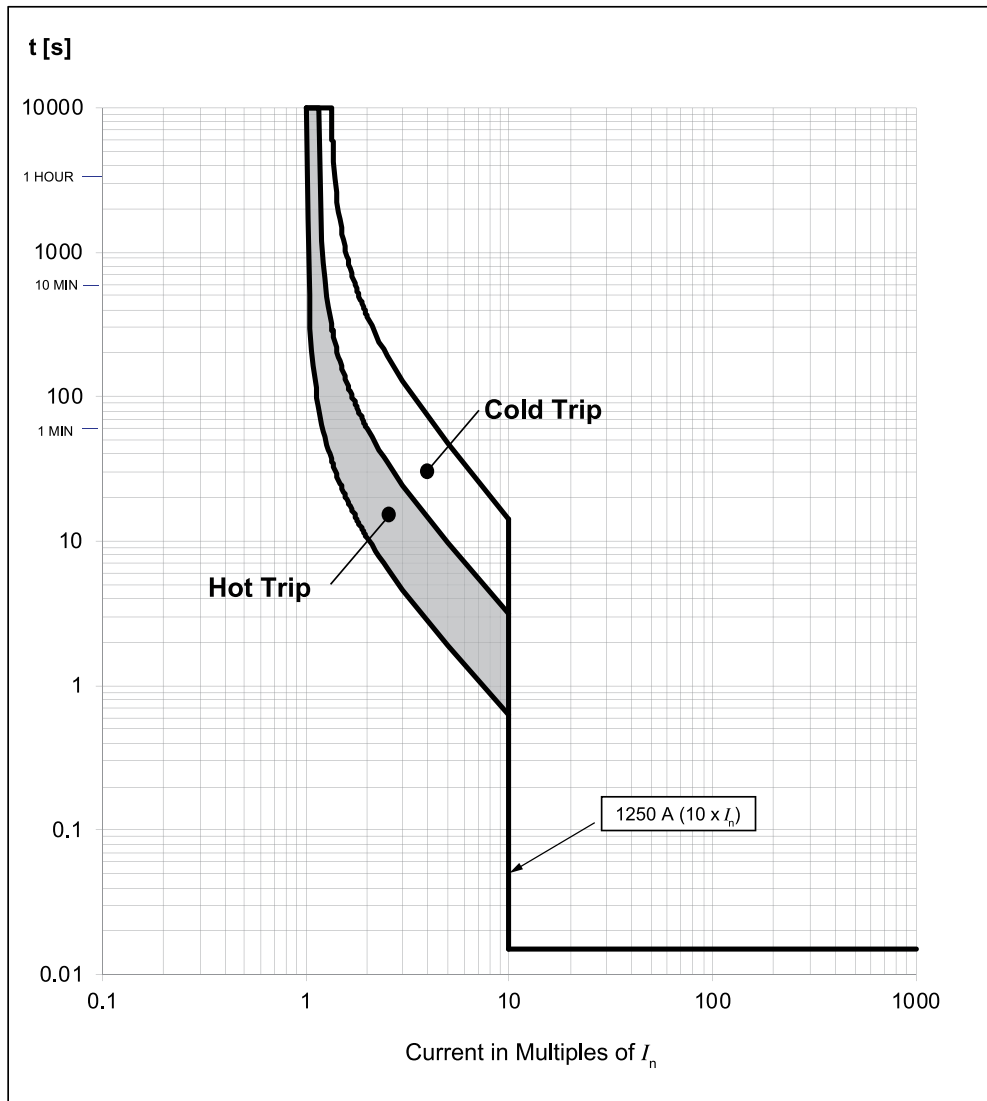

Bulletin 140G-G

Maximum Current: 160 A

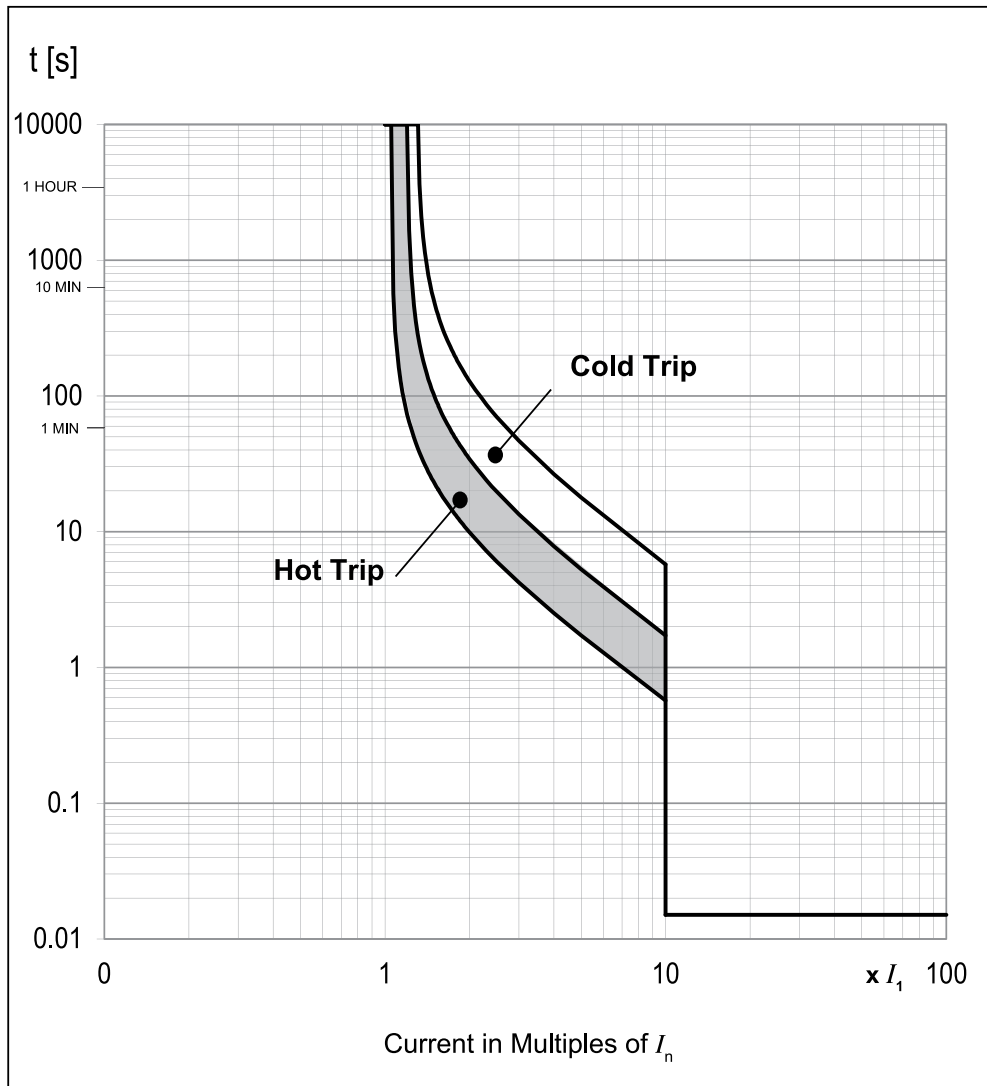

Bulletin 140G-H

Maximum Current: 15...30 A

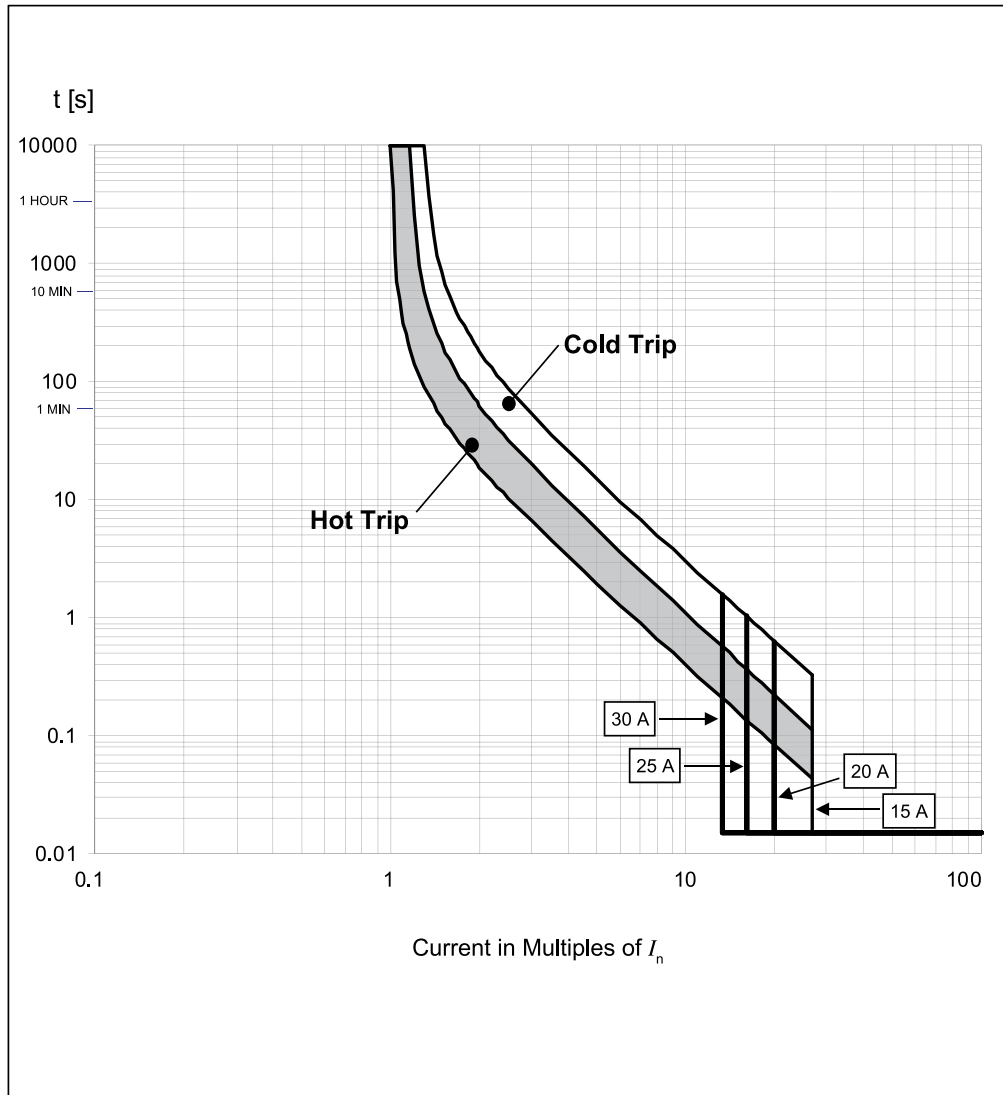

Rated Current I_n [A]	Magnetic Trip I_m [A]
15...30	400

Bulletin 140G-H

Maximum Current: 32 A

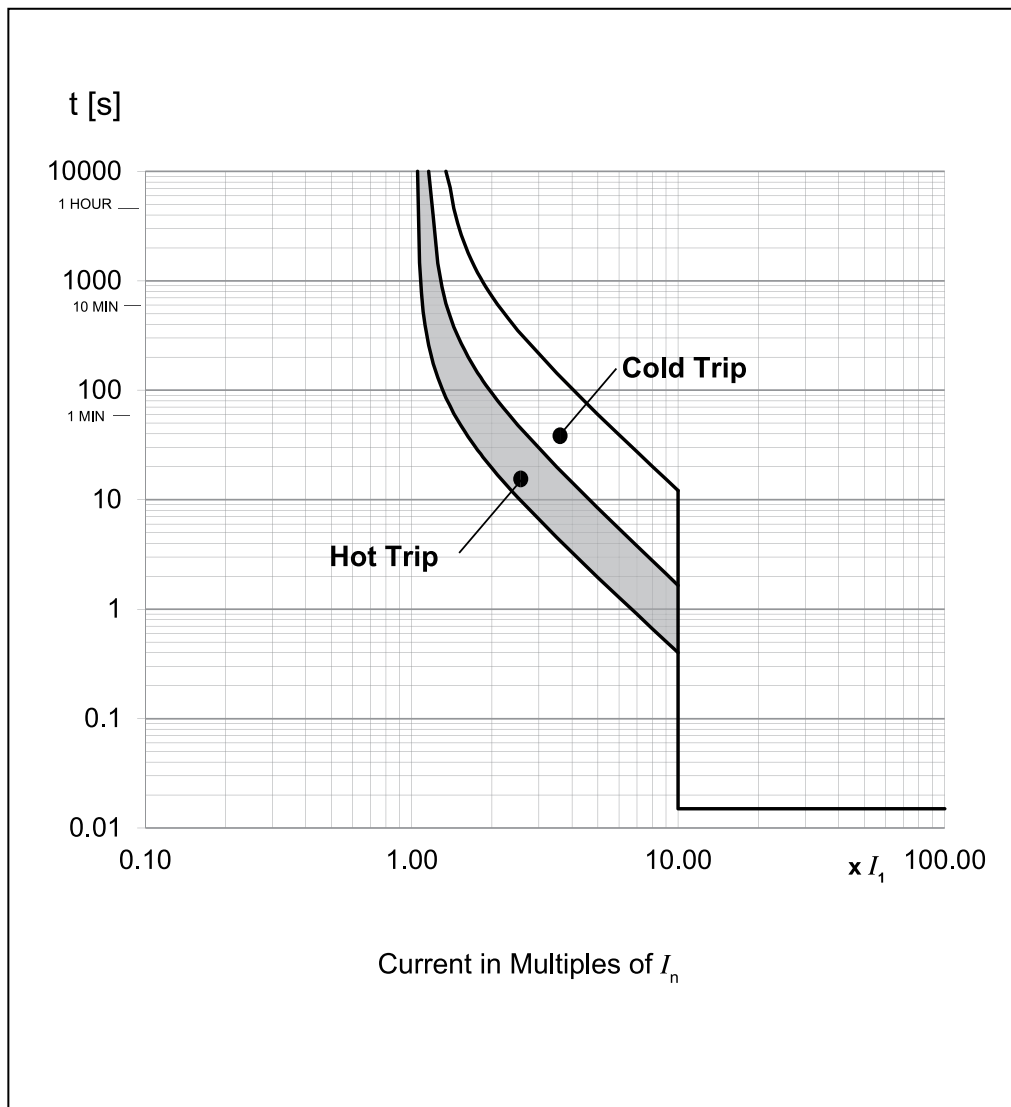

Bulletin 140G-H

Maximum Current: 35...50 A

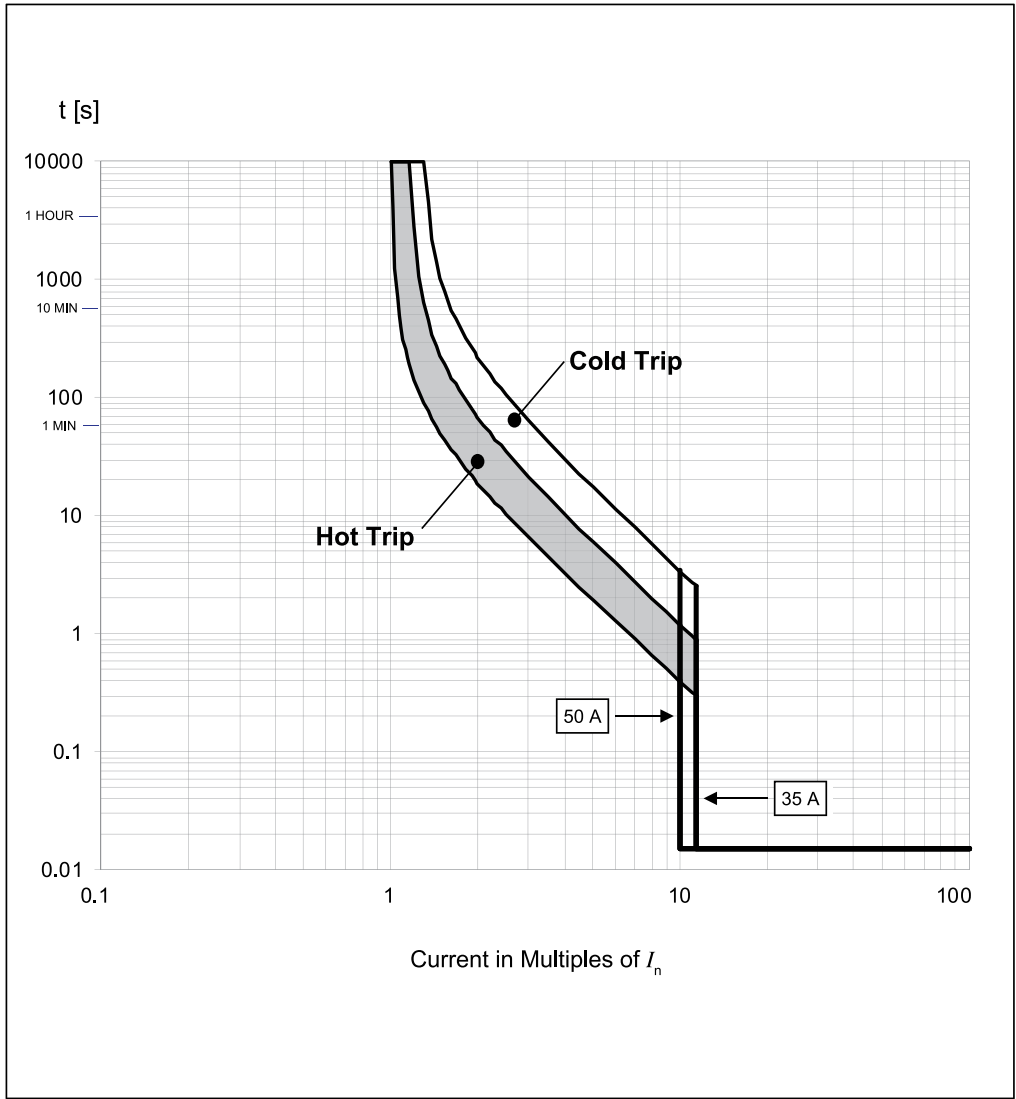

Rated Current I_n [A]	Magnetic Trip I_m [A]
35	400
40	400
50	500

Bulletin 140G-H

Maximum Current: 60...70 A

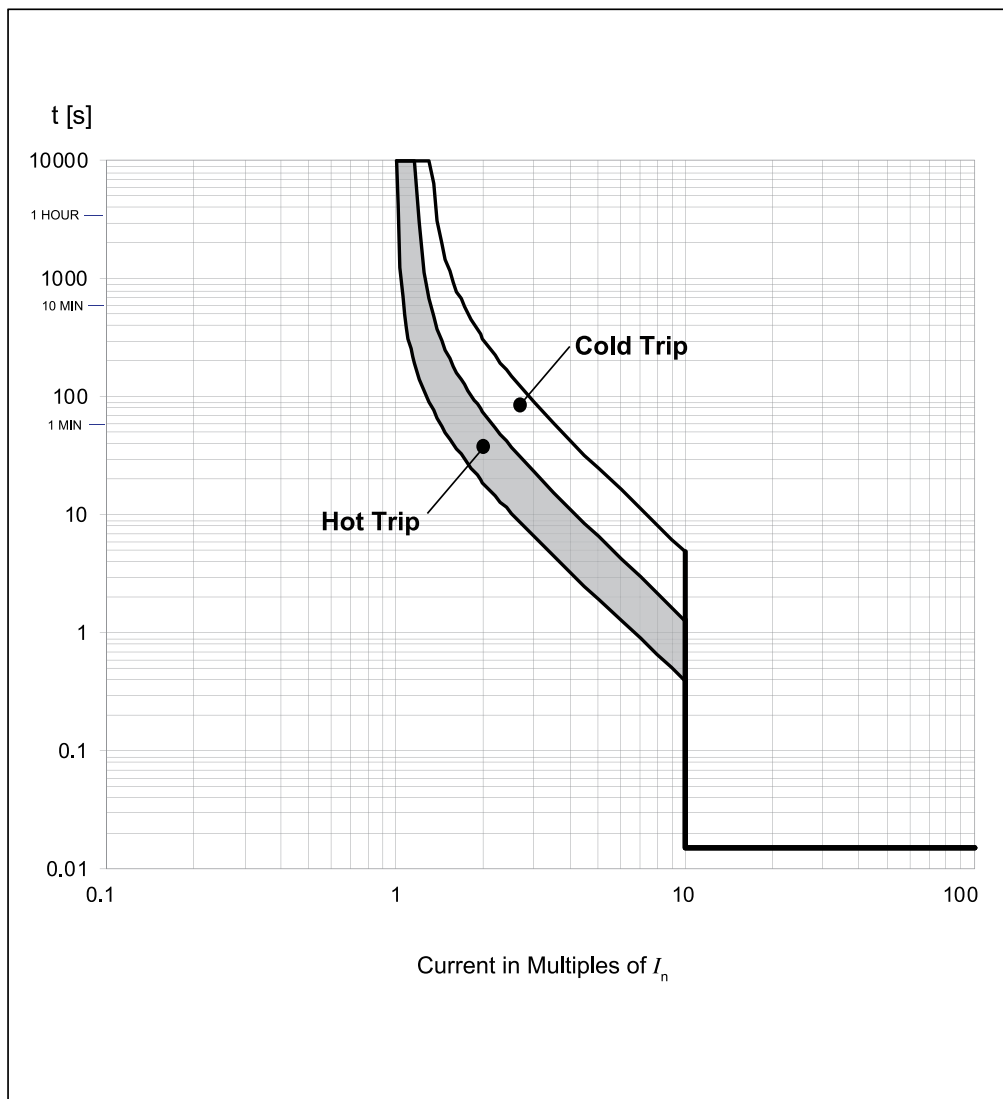

Rated Current I_n [A]	Magnetic Trip I_m [A]
60	600
63	630
70	700

Bulletin 140G-H

Maximum Current: 80...100 A

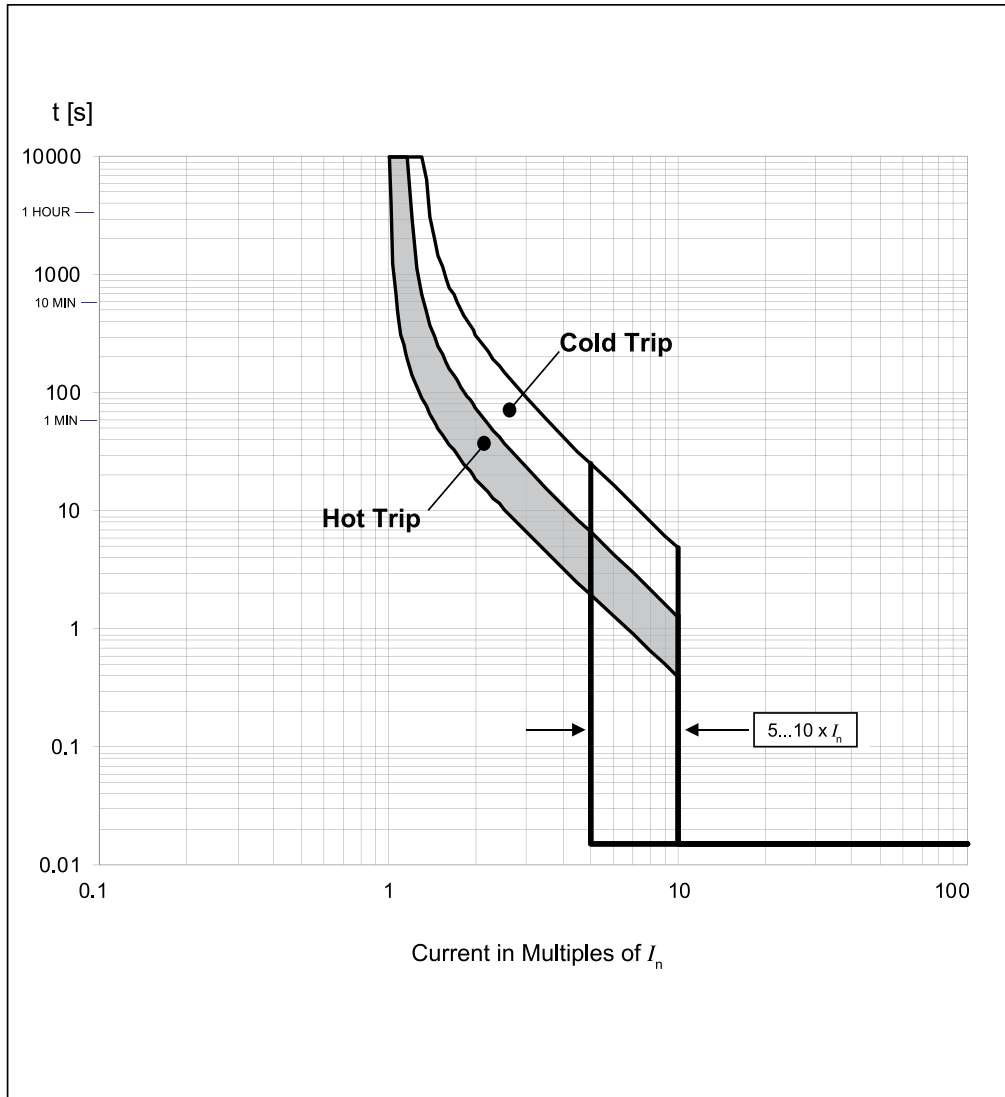

Bulletin 140G-H

Maximum Current: 110...125 A

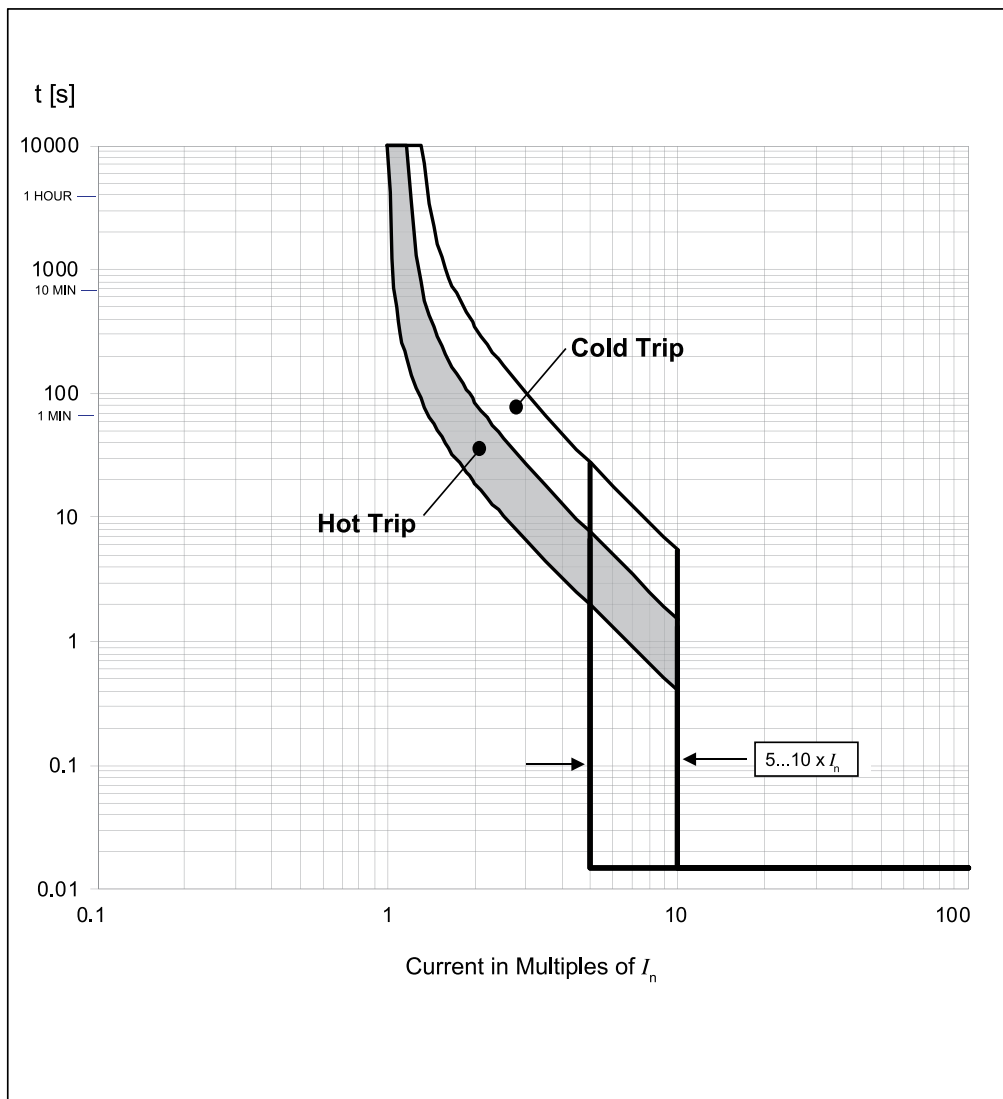

Bulletin 140G-H

Maximum Current: 160 A

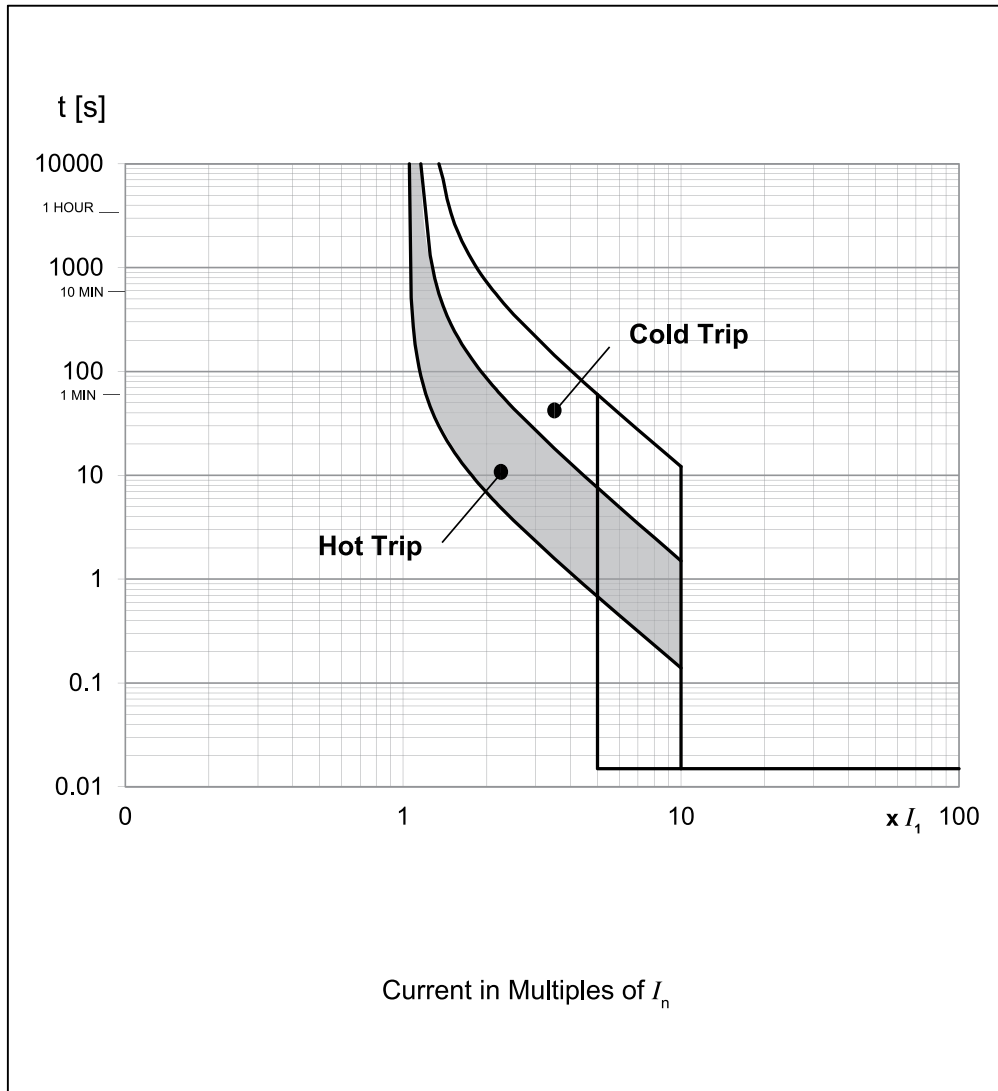

Bulletin 140G-I

Maximum Current: 60...100 A

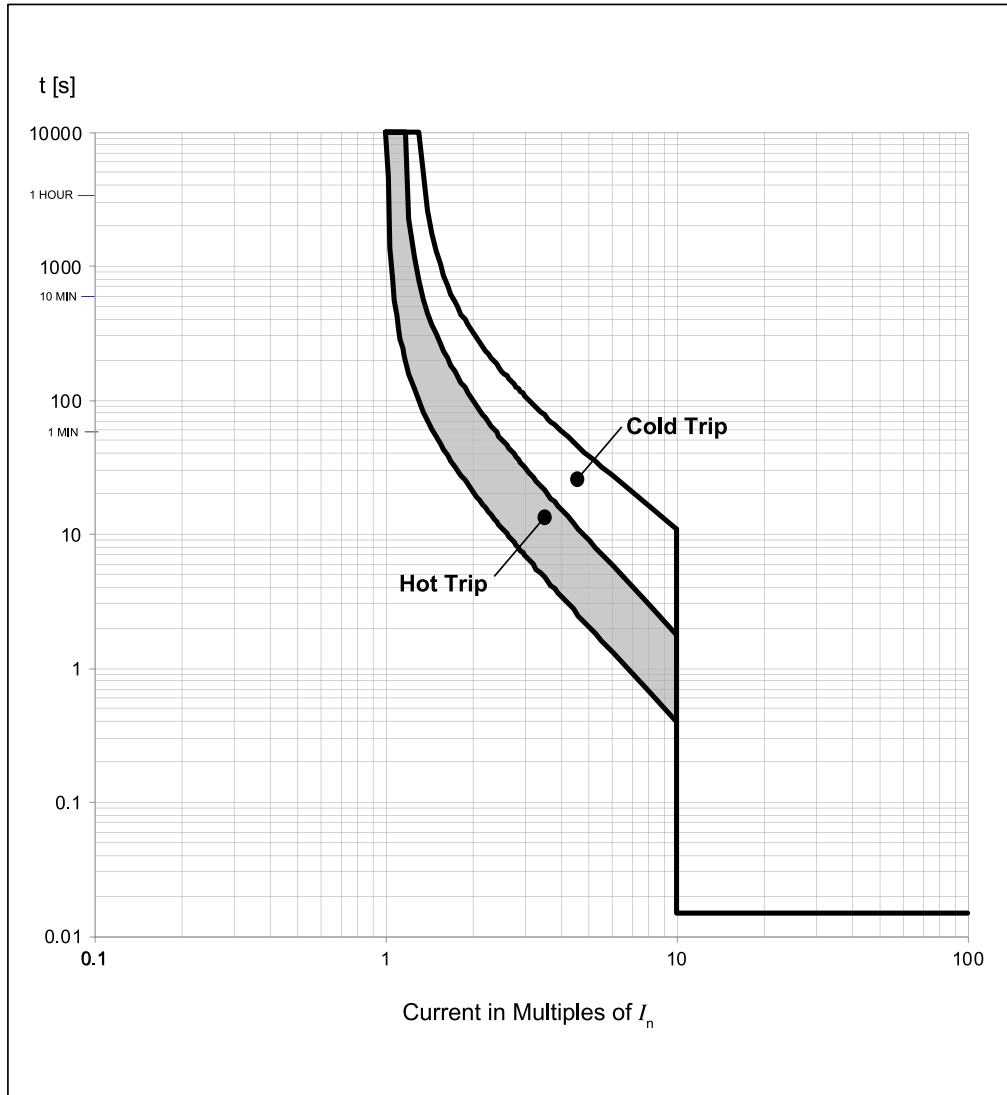

Bulletin 140G-I

Maximum Current: 100...150 A

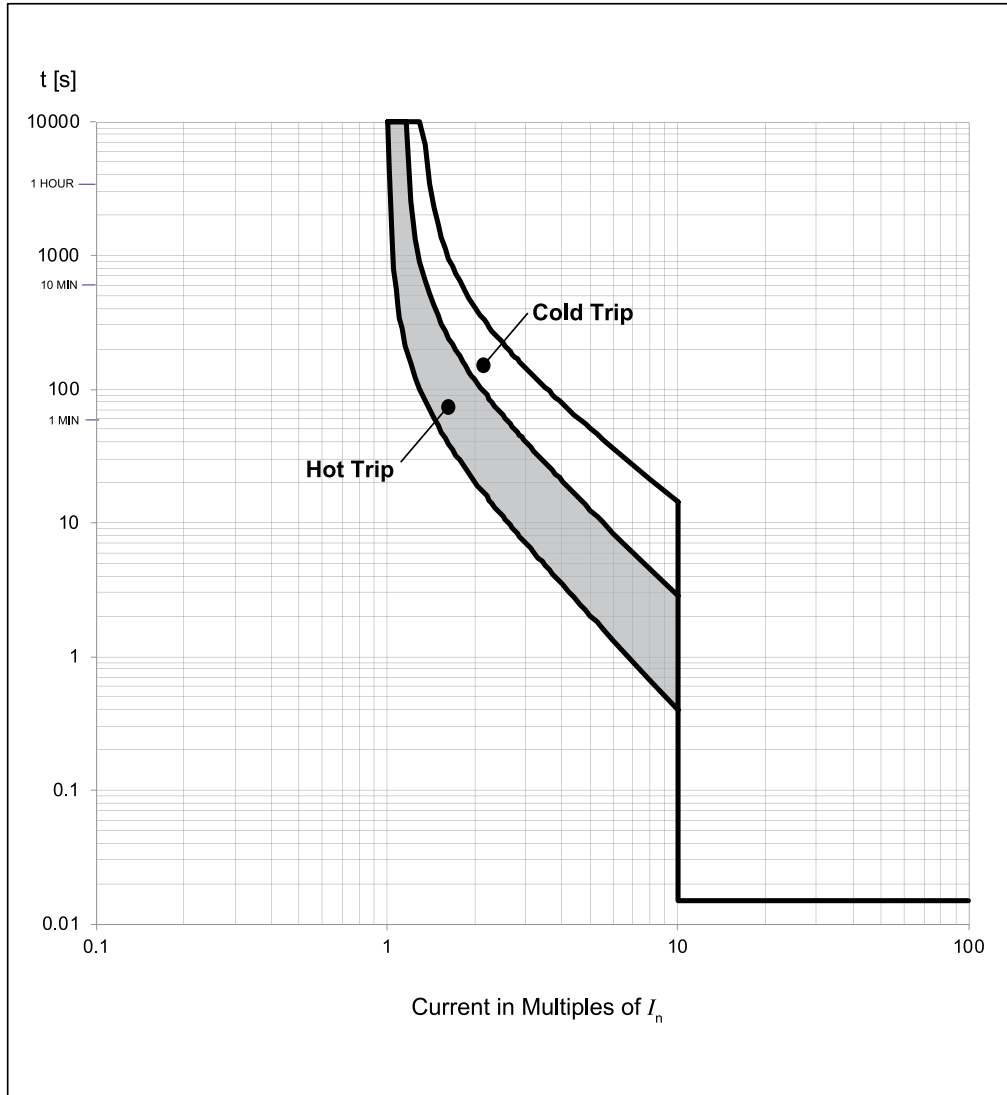

Bulletin 140G-I

Maximum Current: 160...225 A

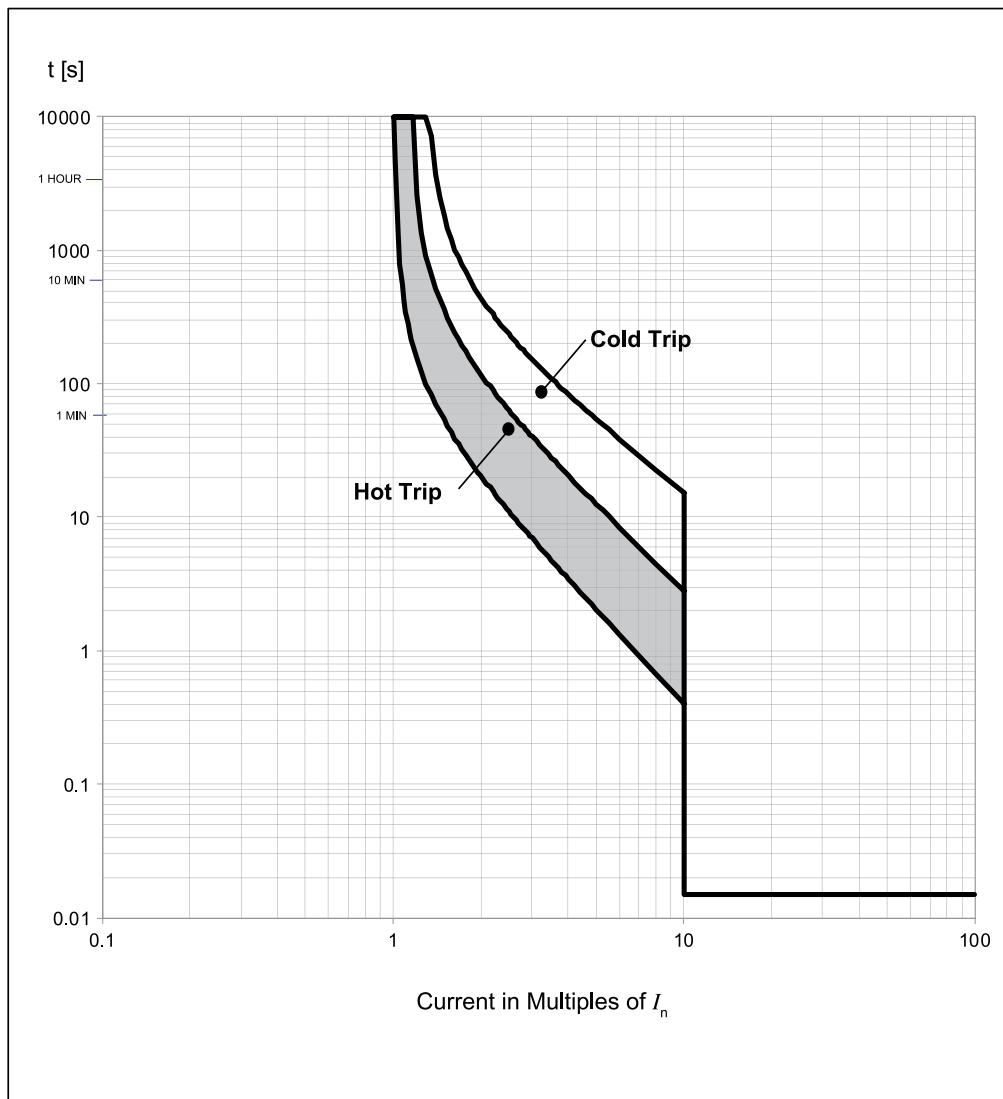

Bulletin 140G-J

Maximum Current: 25...50 A

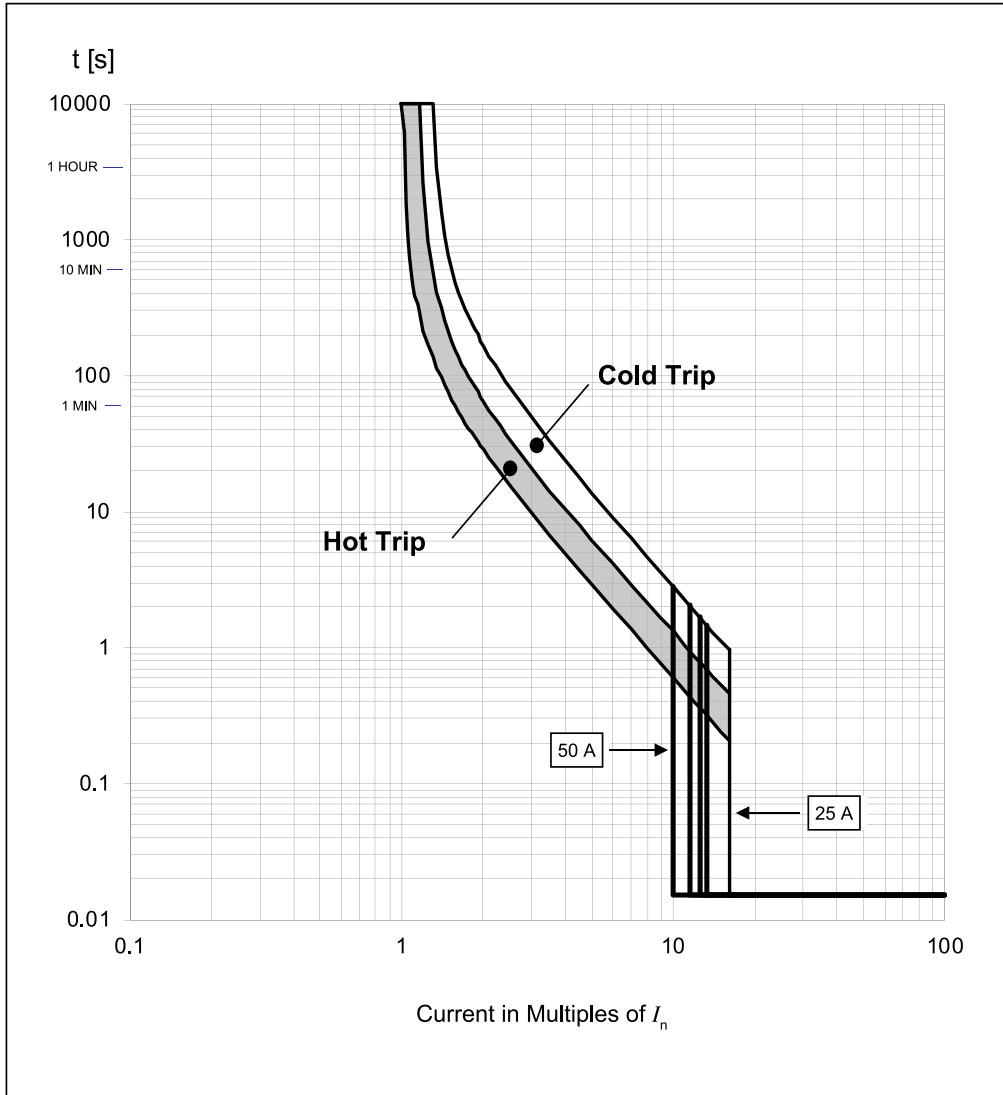

Rated Current I_n [A]	Magnetic Trip I_m [A]
25...40	400
50	500

Bulletin 140G-J

Maximum Current: 60...70 A

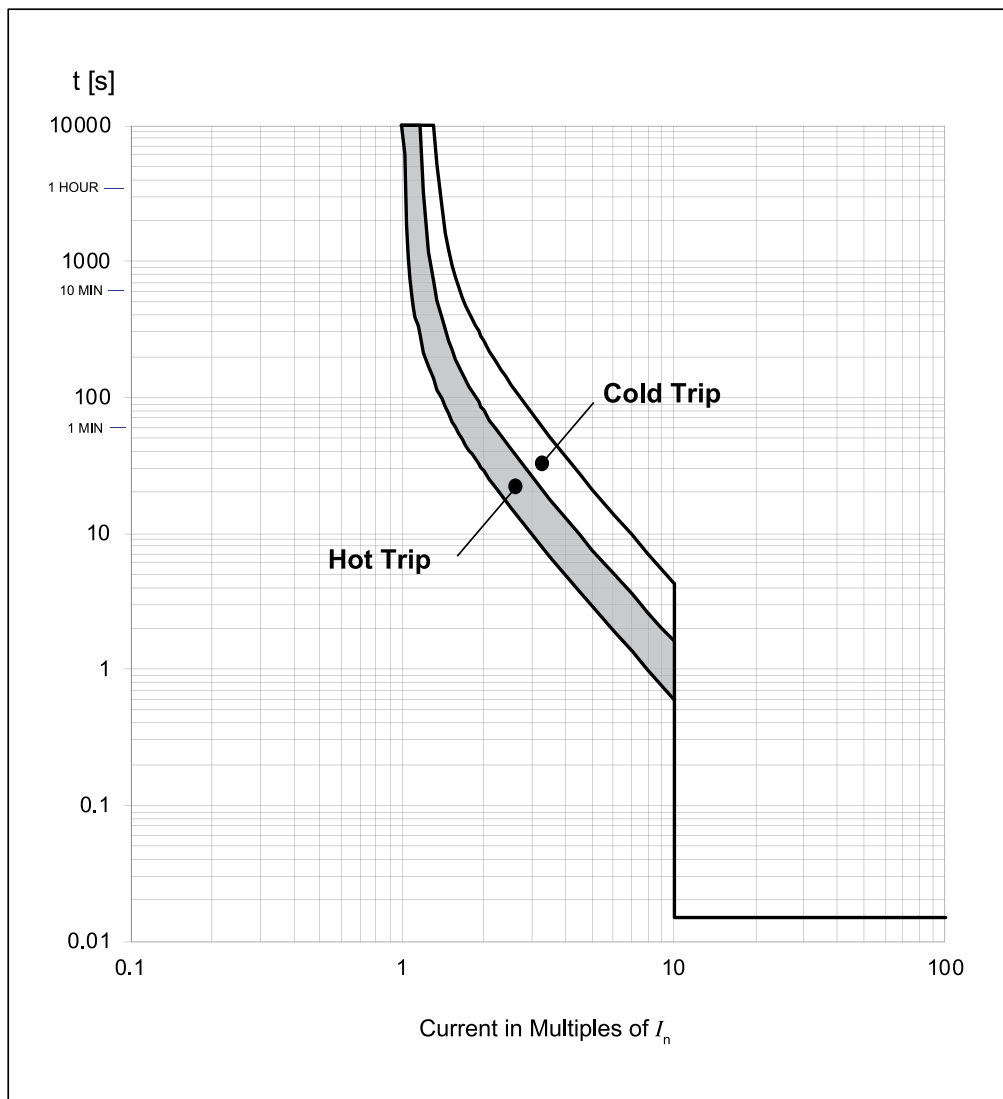

Rated Current I_n [A]	Magnetic Trip I_m [A]
60	600
63	630
70	700

Bulletin 140G-J

Maximum Current: 80...100 A

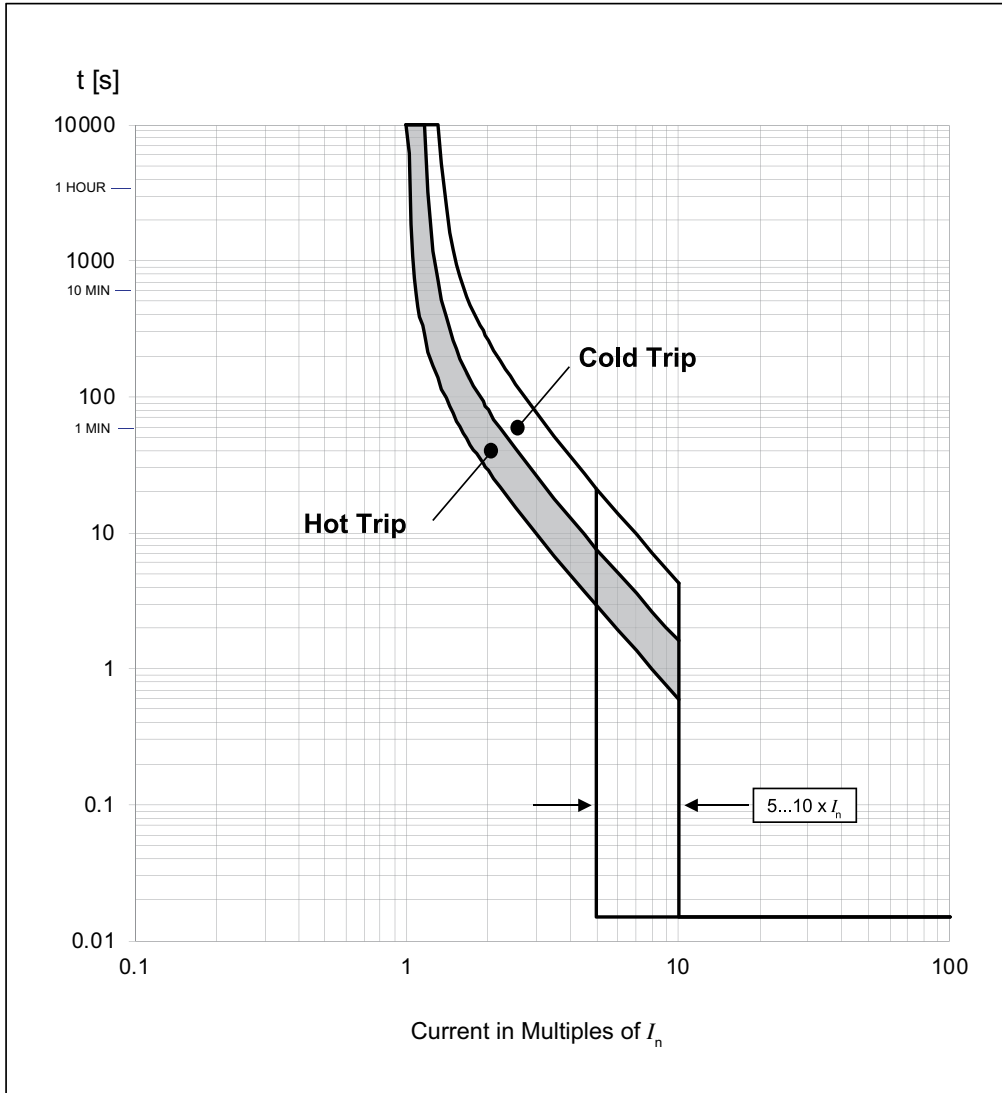

Bulletin 140G-J

Maximum Current: 110...150 A

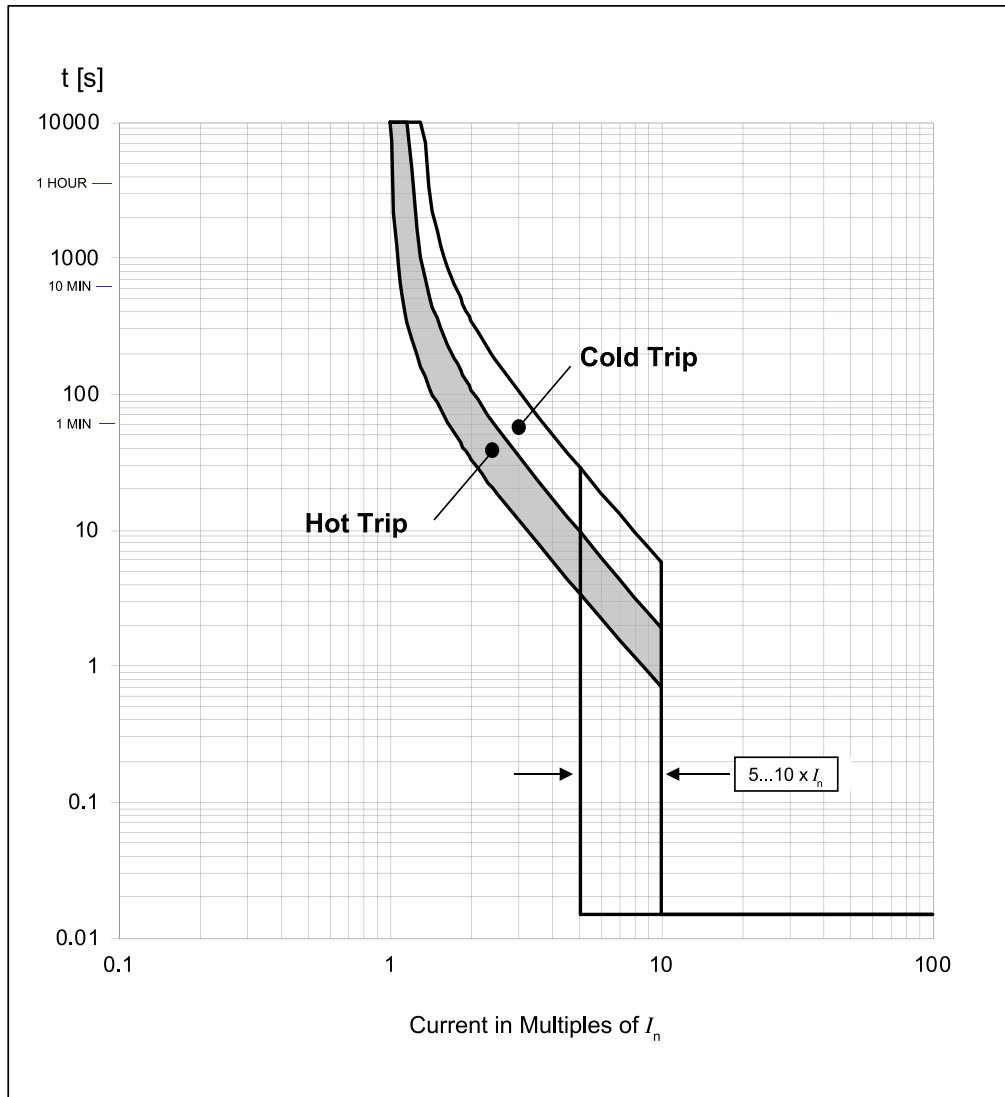

Bulletin 140G-J

Maximum Current: 160...225 A

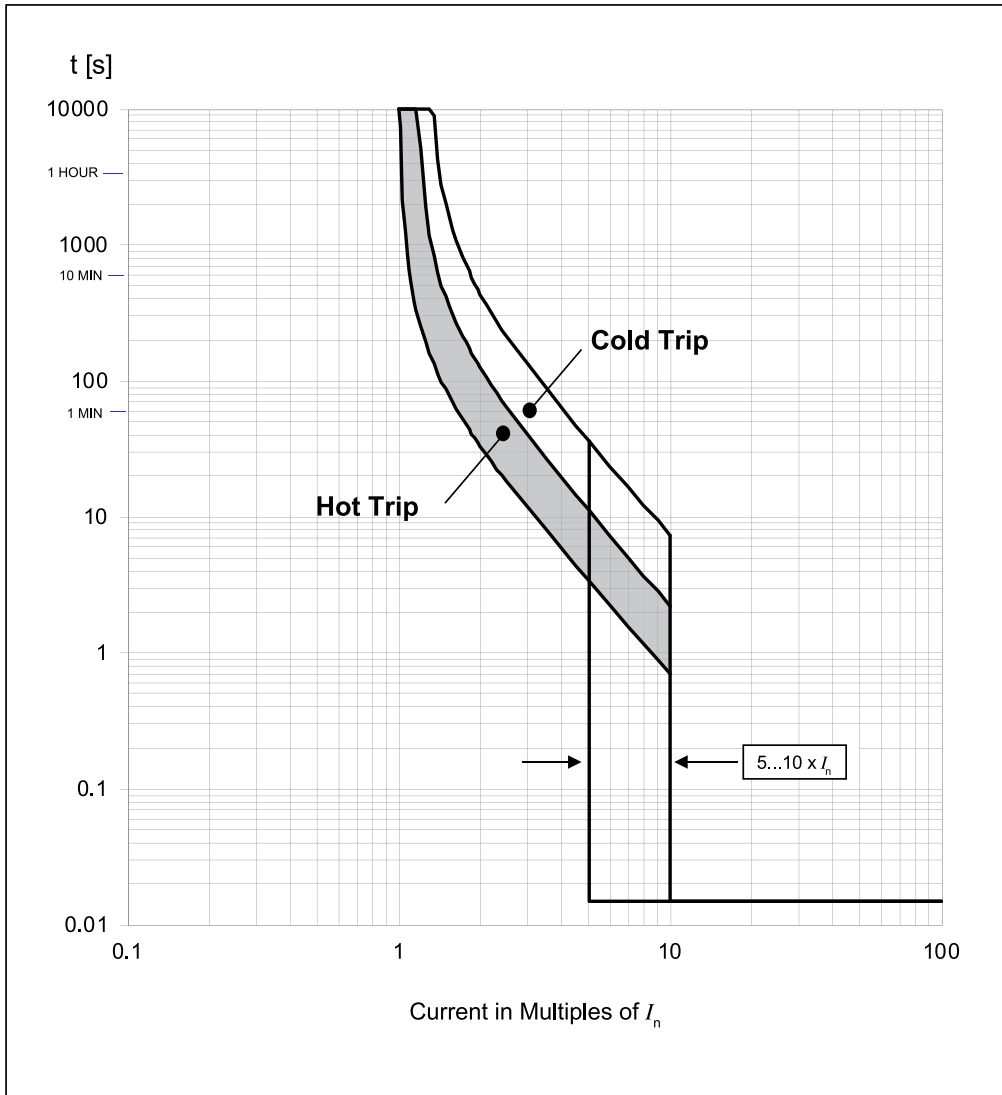

Bulletin 140G-J

Maximum Current: 250 A

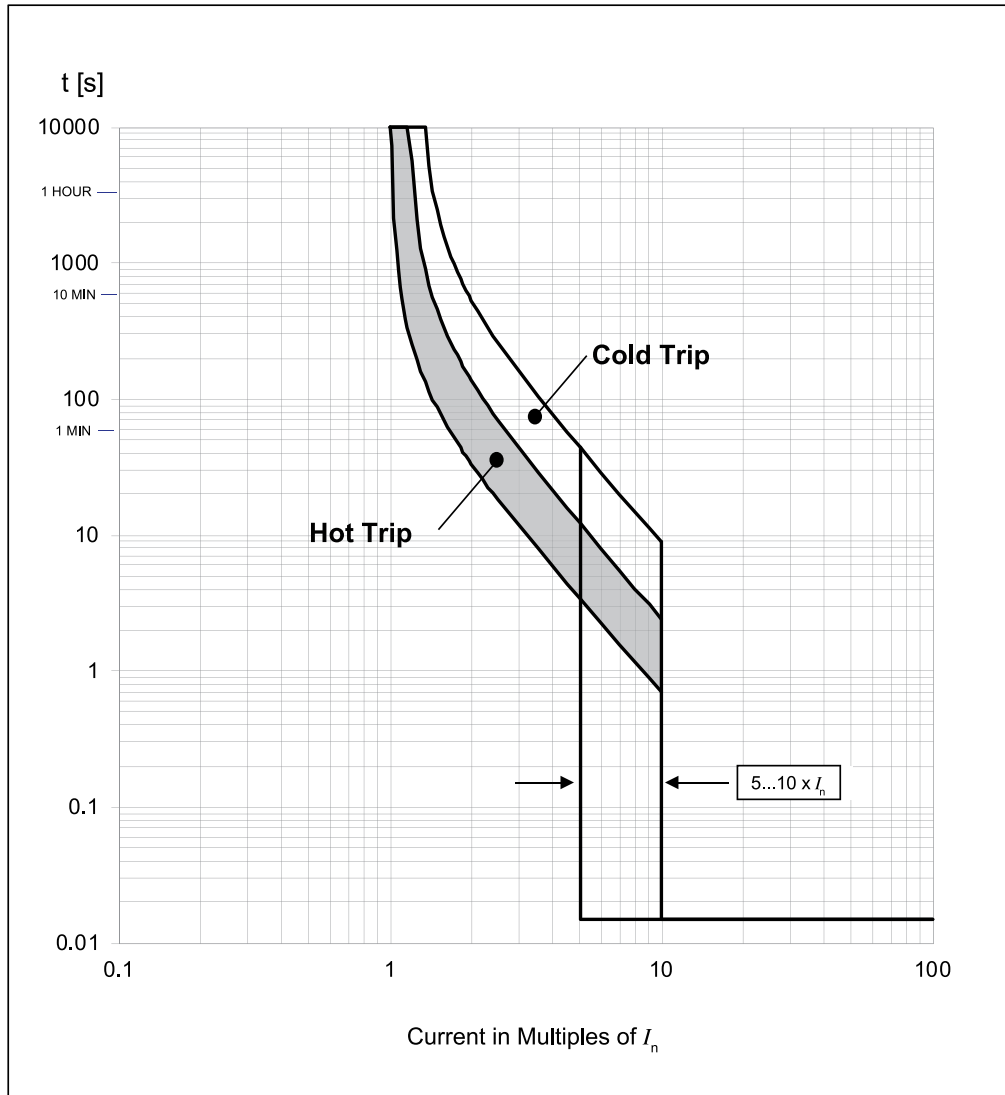

Bulletin 140G-K

Maximum Current: 300 A, 400 A

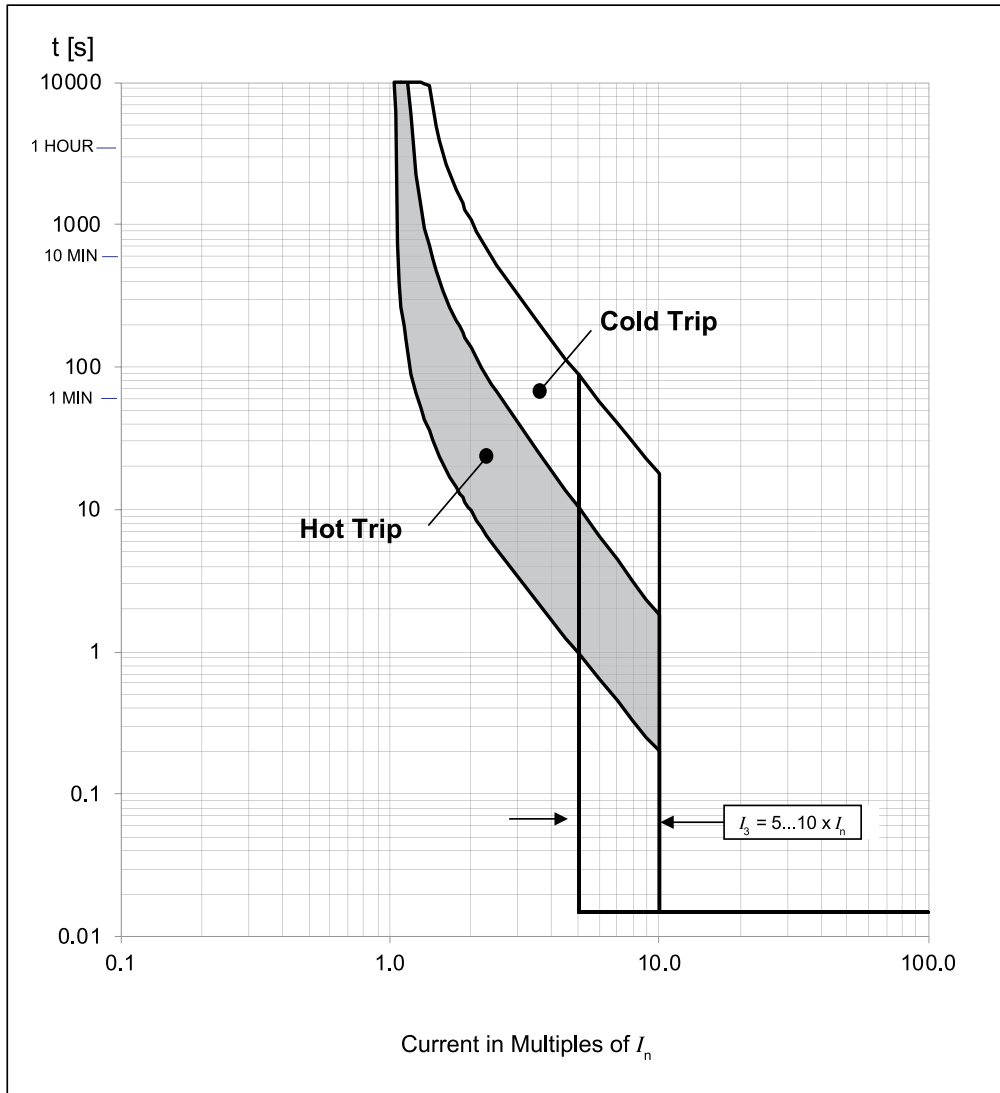

Bulletin 140G-M

Maximum Current: 600 A

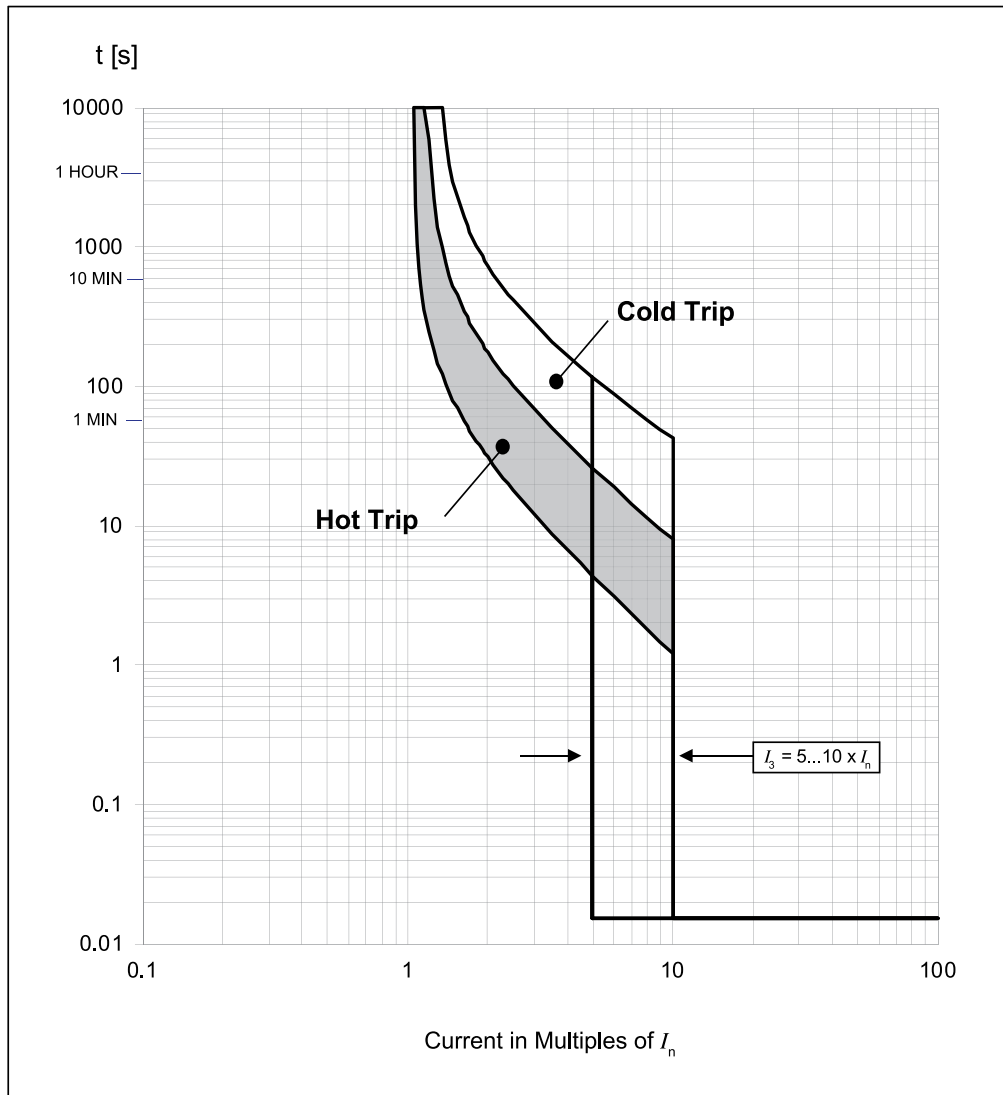

Bulletin 140G-M

Maximum Current: 800 A

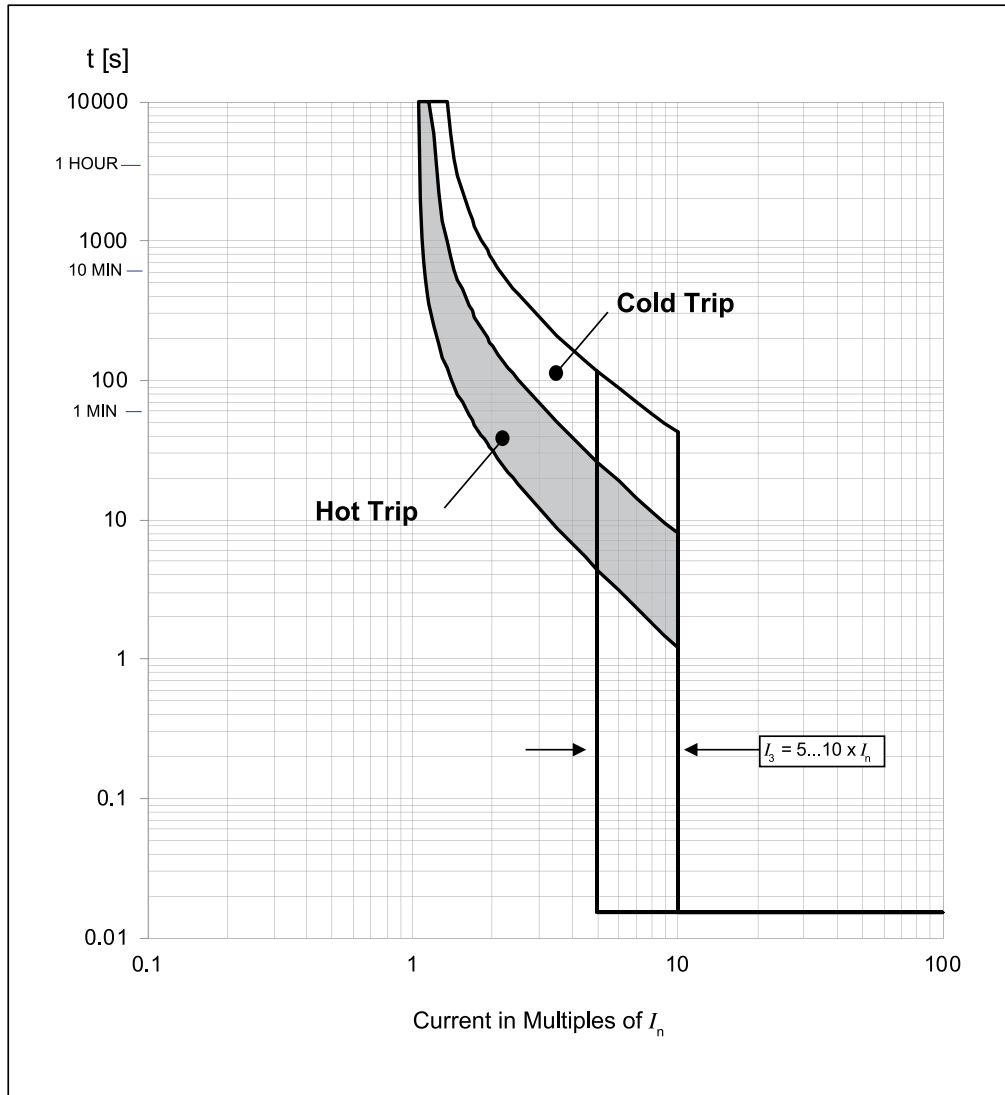

Page Left Blank Intentionally

Bulletin 140G-H

Available Sensors (I_n): 25 A, 60 A, 100 A, 125 A

Electronic Trip Unit. Long Delay Response, Short Delay with I^2t Response, and Instantaneous Curve

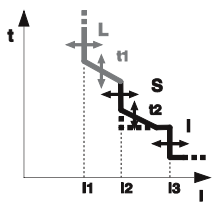
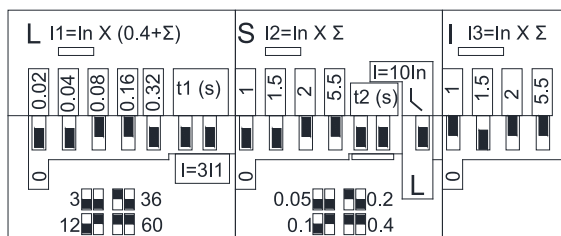
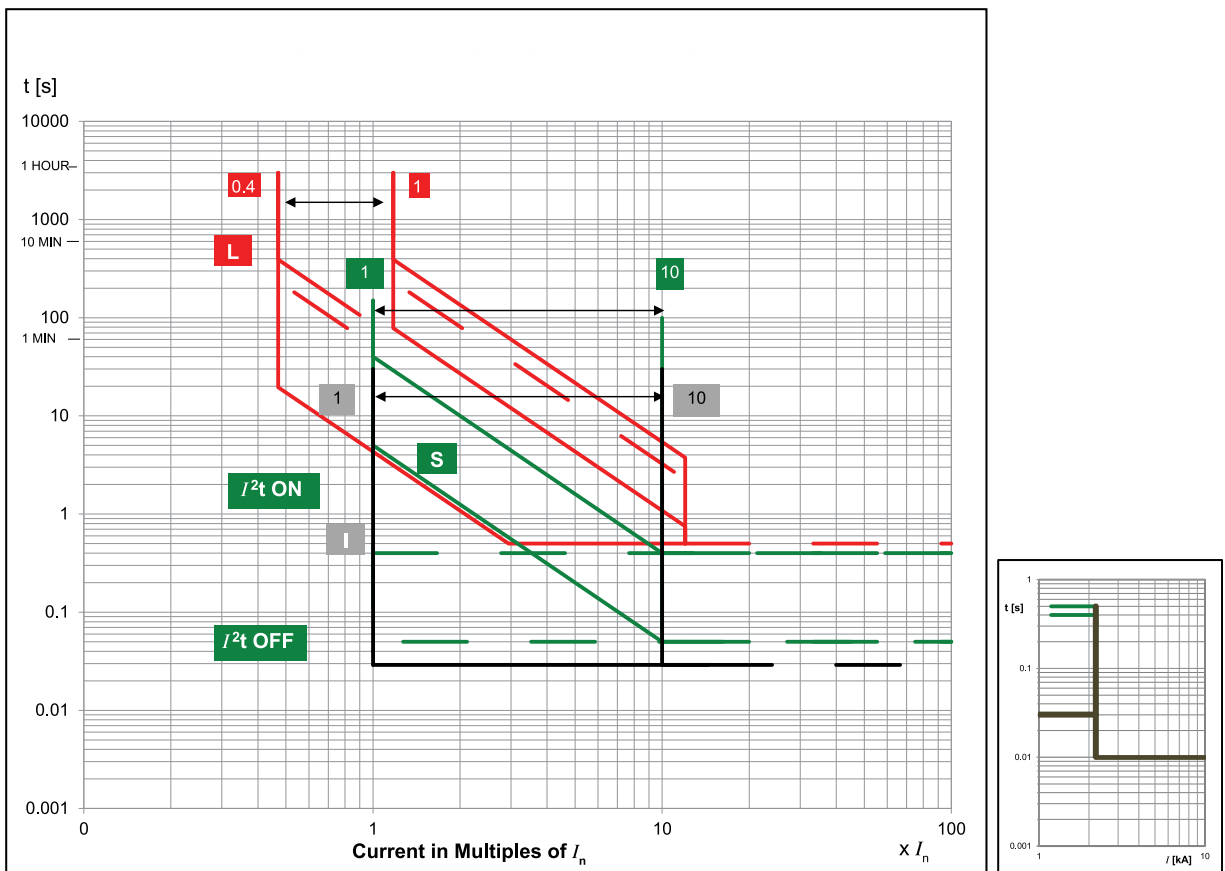

Tolerance Values

Protection	Trip Threshold	Trip Time
L	$1.05 \leq xI_1 \leq 1.25$	$\pm 20\%$
S	$\pm 10\%$	$\pm 20\%$
I	$\pm 15\%$	$\leq 60 \text{ ms}$
Others	$\pm 20\%$	

Notes:

1. Curve accuracy applies from -20°C to $+55^\circ\text{C}$ (-4°F to $+131^\circ\text{F}$) ambient temperature. For possible continuous ampere derating for ambient temperature above 40°C (104°F), consult your local Rockwell Automation sales office or Allen-Bradley distributor.
2. The right portion of the curve is determined by the interrupting rating of the circuit breaker.
3. Total clearing times shown include the response times of the trip unit, the breaker opening, and the interruption of the current.
4. For high fault current levels an additional fixed instantaneous hardware override is provided at 2.2 kA.

Bulletin 140G-H

Ground Fault Protection Curve

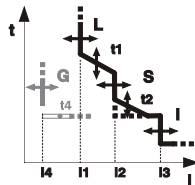
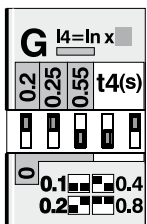
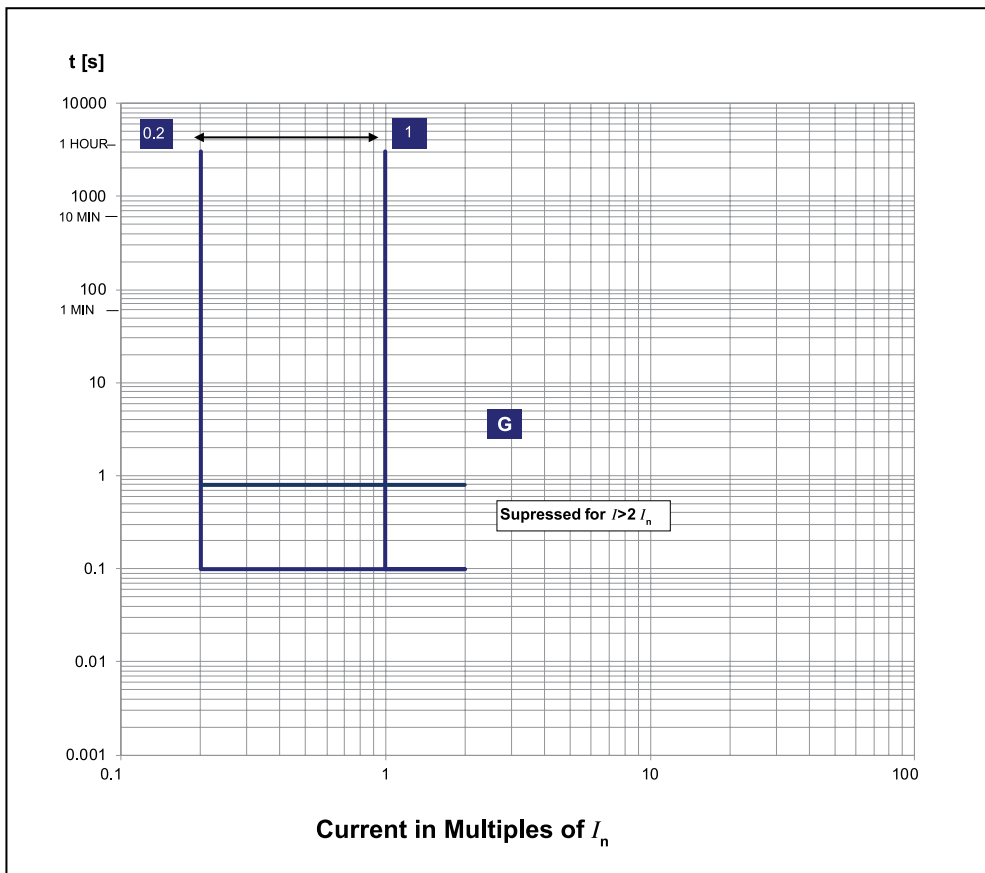

		$I_4 [I_n]$						
$I_n [A]$		0.2	0.25	0.45	0.55	0.75	0.8	1
140G-H	25	5	6.25	11.3	13.8	18.8	20	25
	60	12	15	27	33	45	48	60
	100	20	25	45	55	75	80	100
	125	25	31.3	56.3	68.8	93.8	100	125
	160*	32	40	72	88	120	128	160

Tolerance Values

Protection	Trip Threshold	Trip Time
G	± 10%	± 20%

For L-S-I trip curve see Pub. 140G-TD021.

Bulletin 140G-J

Available Sensors (I_n): 40 A, 60 A, 100 A, 150 A, 250 A

Electronic Trip Unit. Long Delay Response, Short Delay with I^2t Response, and Instantaneous Curve

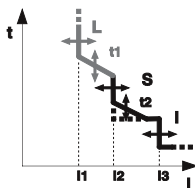
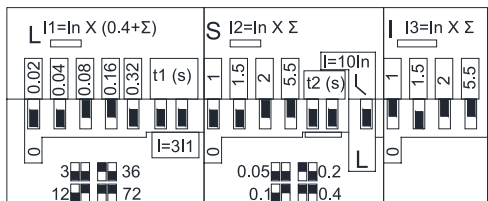
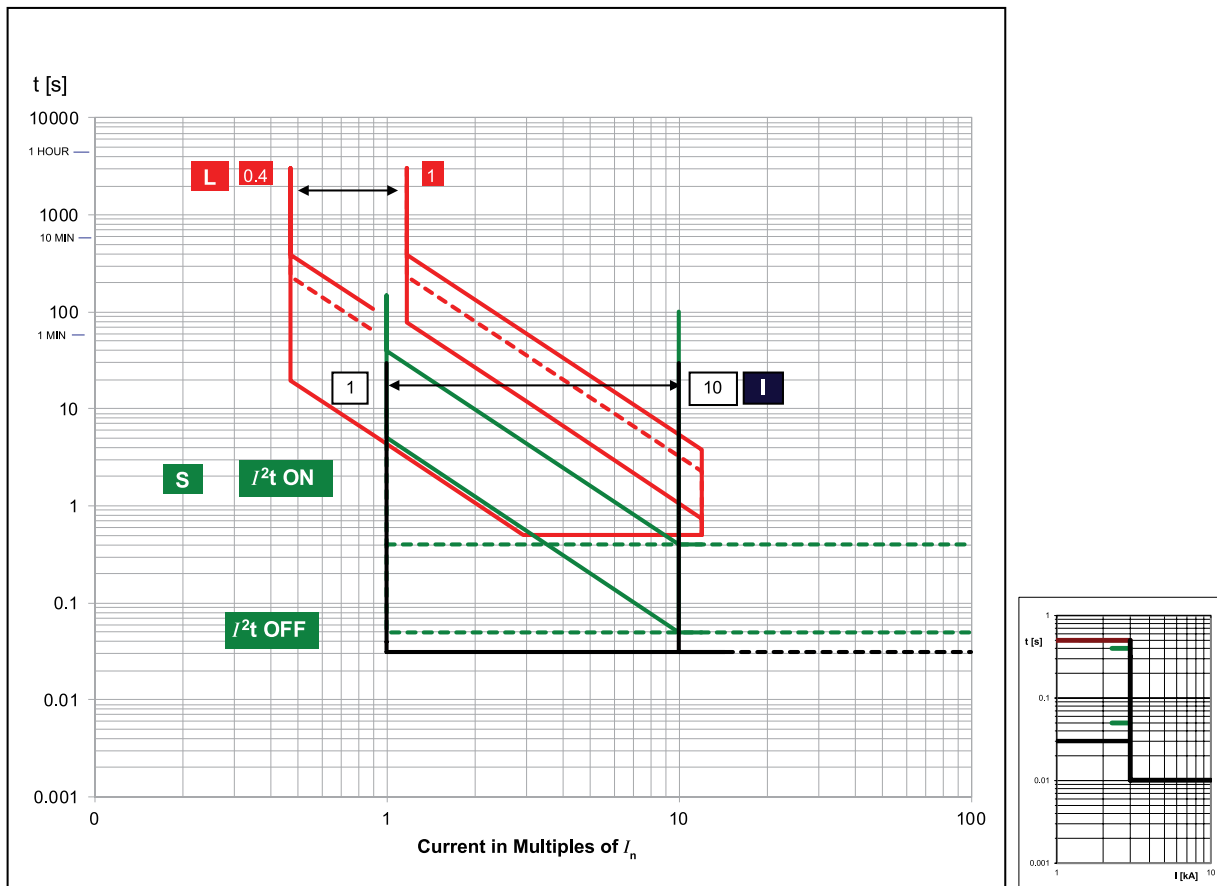

Tolerance Values

Protection	Trip Threshold	Trip Time
L	$1.05 \leq xI_1 \leq 1.25$	$\pm 20\%$
S	$\pm 10\%$	$\pm 20\%$
I	$\pm 15\%$	≤ 60 ms
Others	$\pm 20\%$	

Notes:

1. Curve accuracy applies from -20°C to $+55^\circ\text{C}$ (-4°F to $+131^\circ\text{F}$) ambient temperature. For possible continuous ampere derating for ambient temperature above 40°C (104°F), consult your local Rockwell Automation sales office or Allen-Bradley distributor.
2. The right portion of the curve is determined by the interrupting rating of the circuit breaker.
3. Total clearing times shown include the response times of the trip unit, the breaker opening, and the interruption of the current.
4. For high fault current levels an additional fixed instantaneous hardware override is provided at 3 kA.

Bulletin 140G-J

Ground Fault Protection Curve for LSI G MCCBS

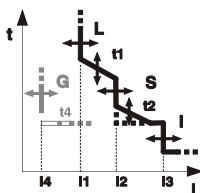
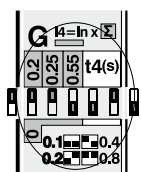
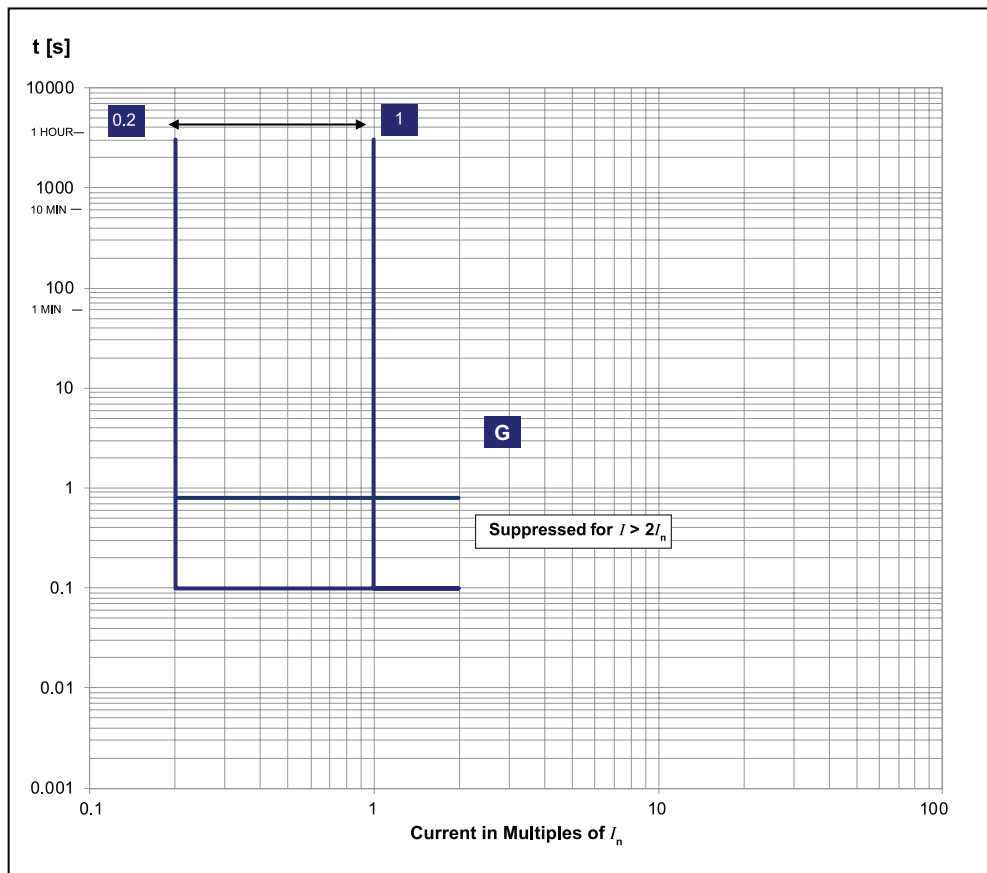

Example:
 $I_n = 100 \text{ A}$
 $I_4 = 100 \times (0.2 + 0.25) = 45 \text{ A}$
 $t_4 = 0.2 \text{ s @ } I > I_4$

		$I_4 [I_n]$						
		0.2	0.25	0.45	0.55	0.75	0.8	1
140G-J	$I_n [A]$	40	60	100	150	250		
	8	12	20	30	50			
	10	15	25	37.5	62.5			
	18	27	45	67.5	113			
	22	33	55	82.5	138			
	30	45	75	113	188			
	32	48	80	120	200			
	40	60	100	150	250			

Tolerance Values

Protection	Trip Threshold	Trip Time
G	± 10%	± 20%

For L-S-I trip curve see Pub. 140G-TD023.

Bulletin 140G-K

Available Sensors (I_n): 300 A, 400 A

Electronic Trip Unit. Long Delay Response, Short Delay with I^2t Response, and Instantaneous Curve

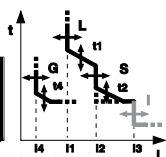
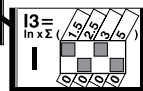
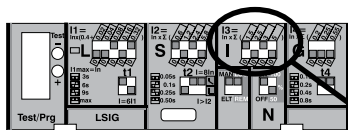
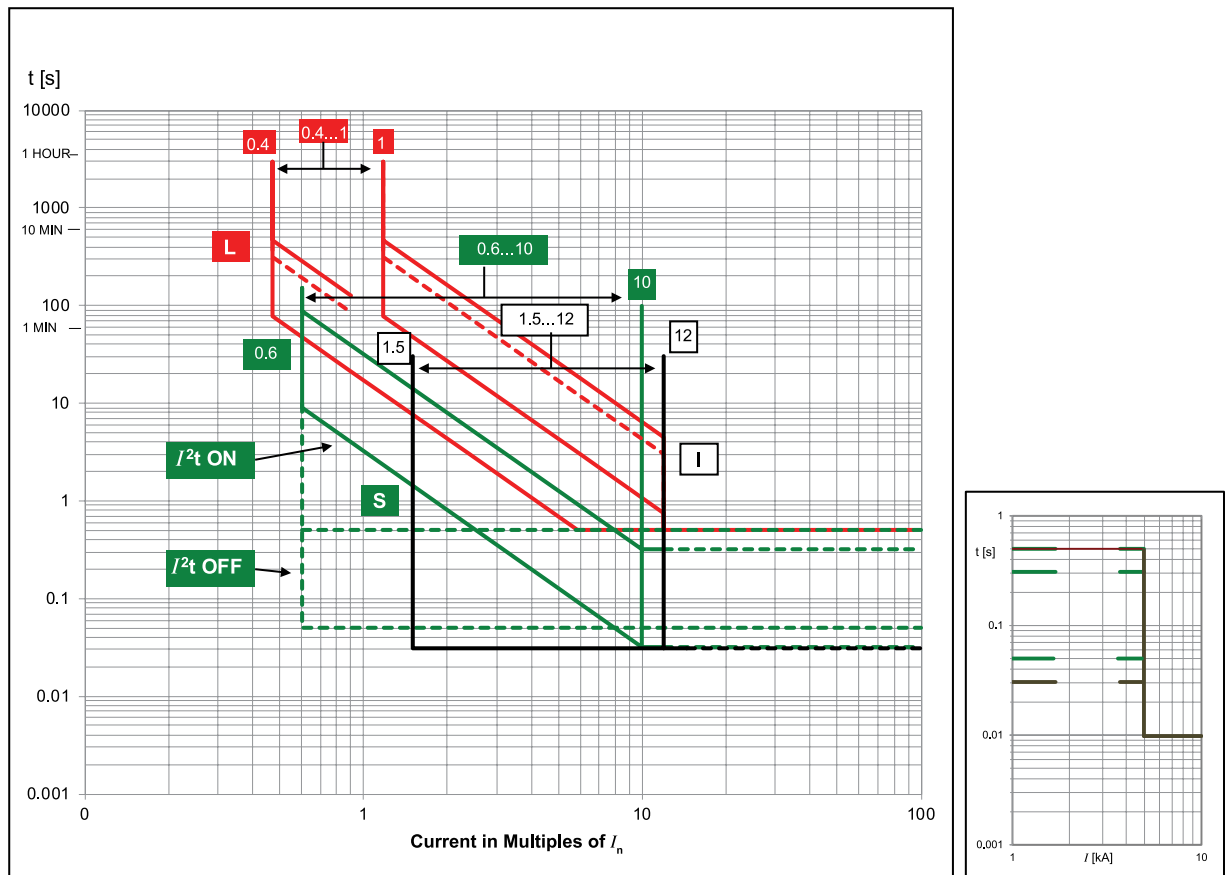

Example:

$$I_n = 300 \text{ A}$$

$$I_3 = 300 \times (1.5 + 3) = 1350 \text{ A}$$

Tolerance Values

Protection	Trip Threshold	Trip Time
L	$1.05 \leq x I_n \leq 1.25$	$\pm 20\%$
S	$\pm 10\%$	$\pm 20\%$
I	$\pm 1 \text{ 5\%}$	$\leq 60 \text{ ms}$
Others	$\pm 20\%$	

I_n [A]	I_3 [I_n]														
	1.5	2.5	3	4	4.5	5	5.5	6.5	7	7.5	8	9	9.5	10.5	12
300	450	750	900	1200	1350	1500	1650	1950	2100	2250	2400	2700	2850	3150	3600
400	600	1000	1200	1600	1800	2000	2200	2600	2800	3000	3200	3600	3800	4200	4800

Notes:

1. Curve accuracy applies from $-20 \text{ }^\circ\text{C}$ to $+55 \text{ }^\circ\text{C}$ ($-4 \text{ }^\circ\text{F}$ to $+131 \text{ }^\circ\text{F}$) ambient temperature. For possible continuous ampere derating for ambient temperature above $40 \text{ }^\circ\text{C}$ ($104 \text{ }^\circ\text{F}$), consult your local Rockwell Automation sales office or Allen-Bradley distributor.
2. The right portion of the curve is determined by the interrupting rating of the circuit breaker.
3. Total clearing times shown include the response times of the trip unit, the breaker opening, and the interruption of the current.
4. For high fault current levels an additional fixed instantaneous hardware override is provided at 5 kA.

Bulletin 140G-K

Ground Fault Protection Curve for LSIG MCCBS

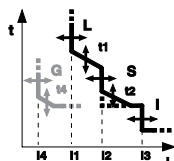
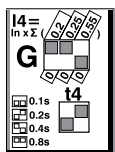
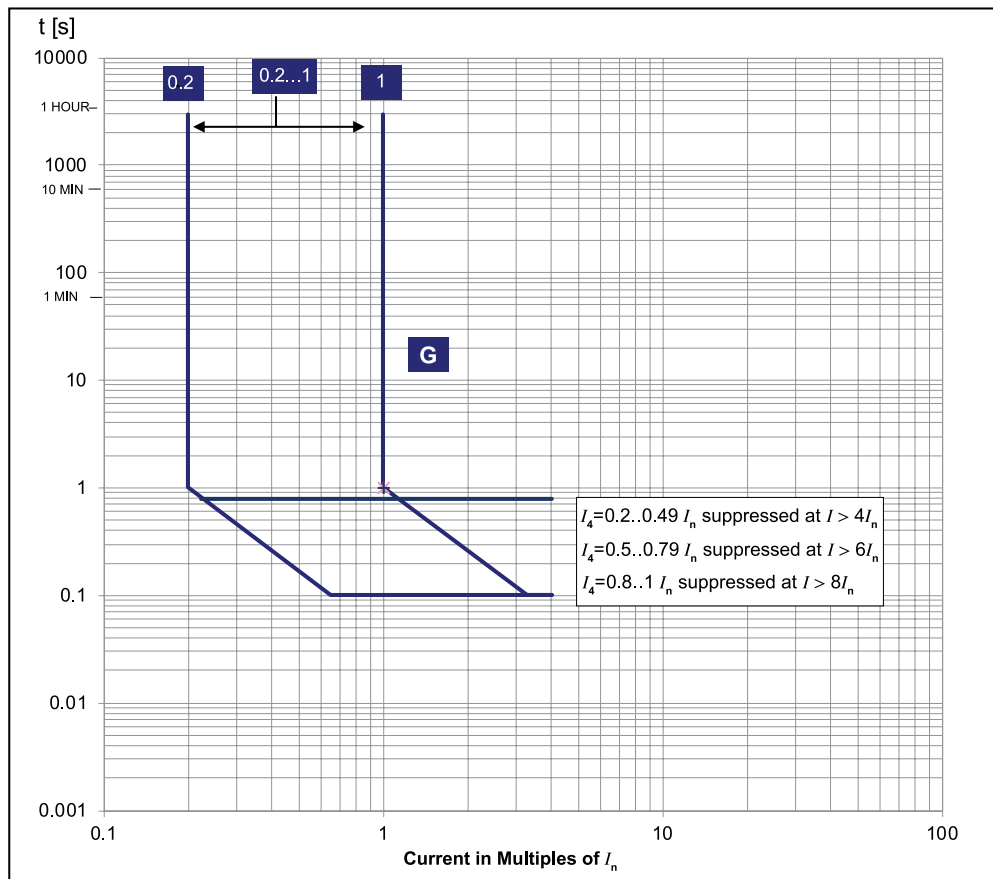

Example:

$$I_n = 100 \text{ A}$$

$$I_4 = 100 \times (0.2 + 0.25) = 45 \text{ A}$$

$$t_4 = 0.2 \text{ s}$$

	$I_4 [I_n]$						
$I_n [A]$	0.2	0.25	0.45	0.55	0.75	0.8	1
300	60	75	135	165	225	240	300
400	80	100	180	220	300	320	400

Tolerance Values

Protection	Trip Threshold	Trip Time
G	± 10%	± 20%

For L-S-I trip curve see Pub. 140G-TD025.

Bulletin 140G-M

Available Sensors (I_n): 600 A, 800 A

Electronic Trip Unit. Long Delay Response, Short Delay with I^2t Response, and Instantaneous Curve

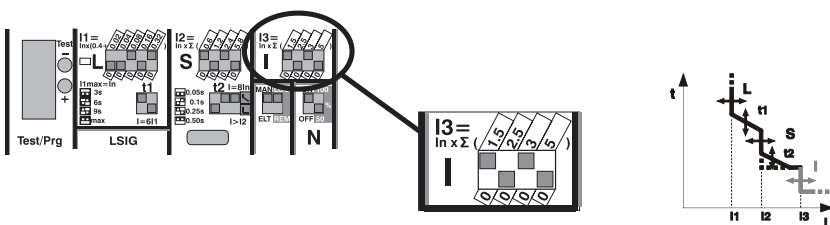
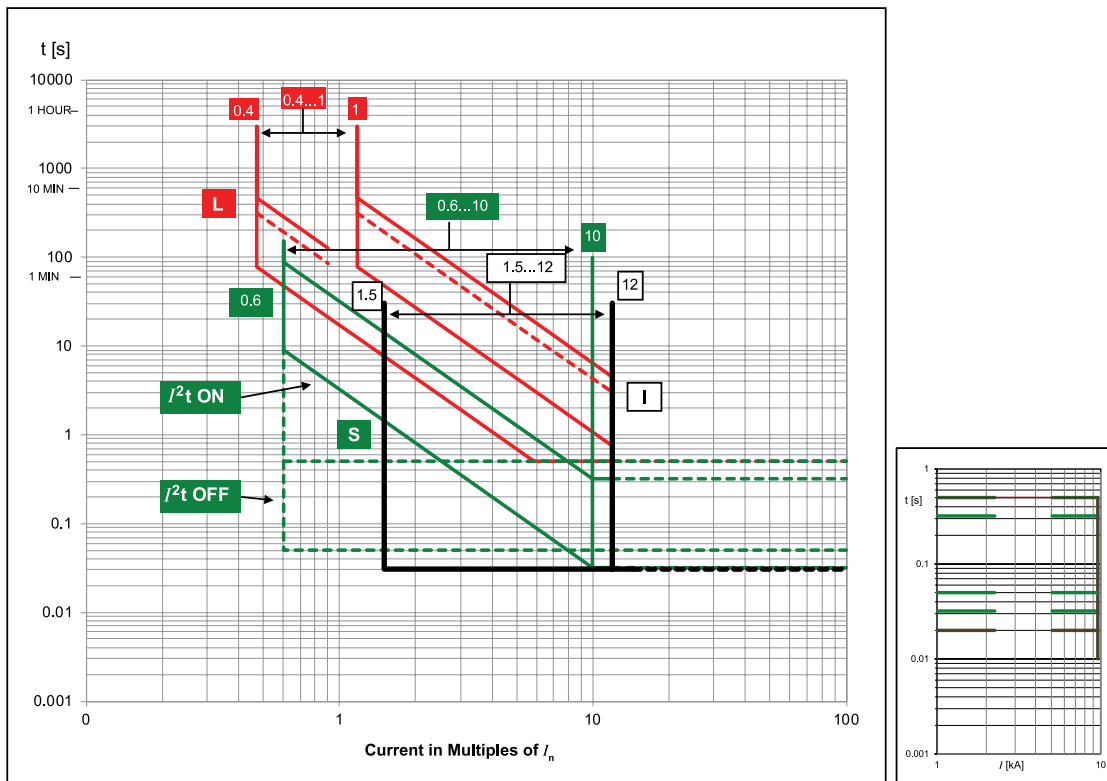

Example:

$$I_n = 600 \text{ A}$$

$$I_3 = 600 \times (1.5 + 3) = 2700 \text{ A}$$

Tolerance Values

Protection	Trip Threshold	Trip Time
L	$1.05 \leq xI_1 \leq 1.25$	$\pm 20\%$
S	$\pm 10\%$	$\pm 20\%$
I	$\pm 15\%$	$\leq 60 \text{ ms}$
Others	$\pm 20\%$	

Notes:

1. Curve accuracy applies from -20°C to $+55^\circ\text{C}$ (-4°F to $+131^\circ\text{F}$) ambient temperature. For possible continuous ampere derating for ambient temperature above 40°C (104°F), consult your local Rockwell Automation sales office or Allen-Bradley distributor.
2. The right portion of the curve is determined by the interrupting rating of the circuit breaker.
3. Total clearing times shown include the response times of the trip unit, the breaker opening, and the interruption of the current.
4. For high fault current levels an additional fixed instantaneous hardware override is provided at 9.6 kA.

Bulletin 140G-M

Available Sensors (I_n): 600 A, 800 A

Ground Fault Protection Curve for LSIG MCCBS

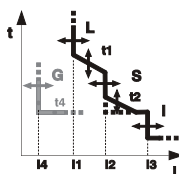
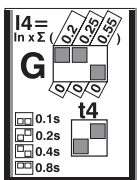
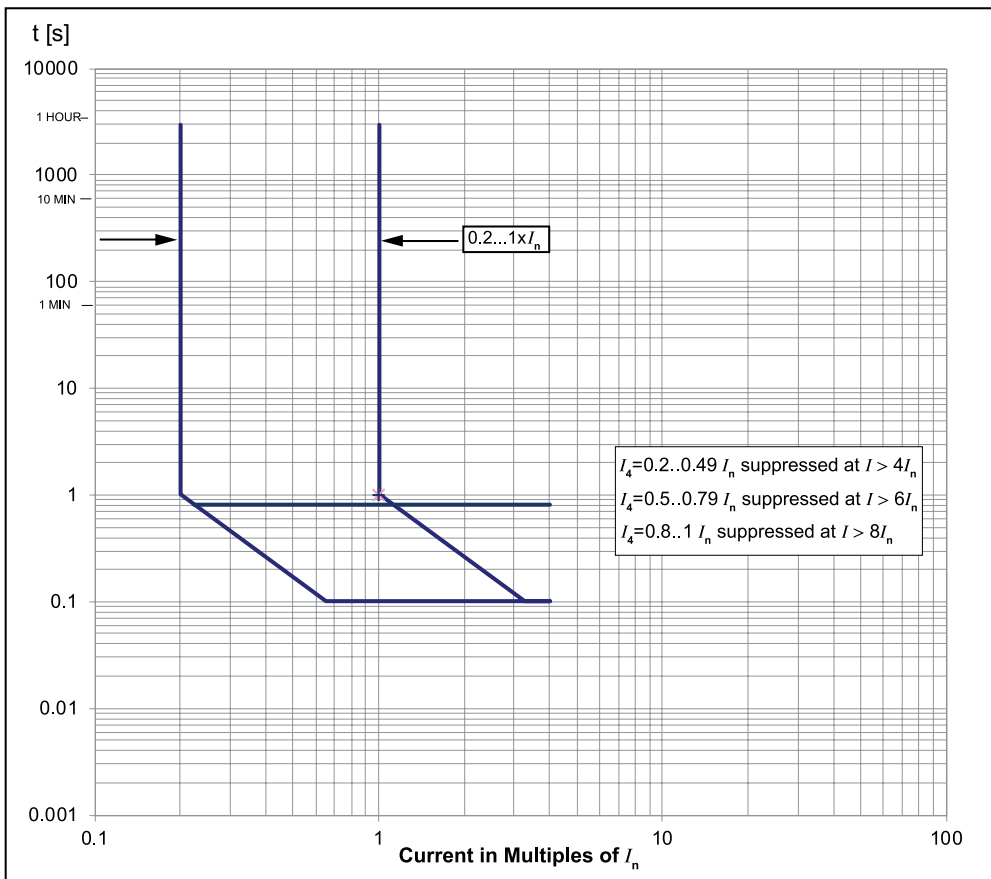

Tolerance Values

Protection	Trip Threshold	Trip Time
G	± 10%	± 20%

Example:

$$I_n = 600 \text{ A}$$

$$I_4 = 600 \times (0.2 + 0.25) = 270 \text{ A}$$

$$t_4 = 0.2 \text{ s}$$

For L-S-I trip curve see Pub. 140G-TD028.

Bulletin 140G-N, -NS

Available Rating Plugs (I_n): 400 A, 800 A, 1000 A, 1200 A, 1250 A (IEC)

LSI

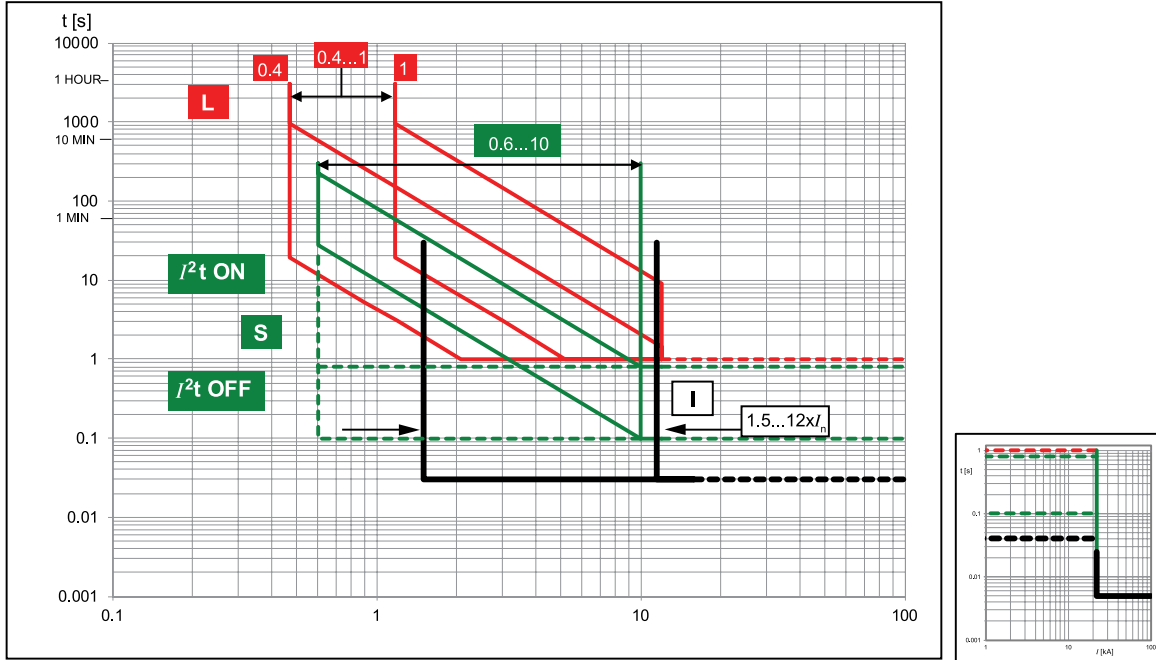

Protection	Disable	Trip Threshold	Trip Time	Trip Threshold Tolerance ⁽²⁾	Trip Time Tolerance ⁽²⁾
L ($t=k/I$)		$I_1=0.4-0.44-0.48-0.52\dots 1 \times I_n$	$t_1=3-6-12-18 \text{ s}^{(1)} @ 6I_1$	Release between 1.05 and $1.2 \times I_1$	$\pm 10\% I_f \leq 6 \times I_n$
S ($t=k$)	✓	$I_2=0.6-0.8-1.2-1.8-2.4-3-3.6-4.2-5-5.8-6.6-7.4-8.2-9-10 \times I_n$	with $I > I_2$ $t_2=0.1-0.25-0.5-0.8 \text{ s}$	$\pm 7\% I_f \leq 6 \times I_n$ $\pm 10\% I_f > 6 \times I_n$	The best of: $\pm 10\%$ or $\pm 40 \text{ ms}$
S ($t=k/I$)	✓	$I_2=0.6-0.8-1.2-1.8-2.4-3-3.6-4.2-5-5.8-6.6-7.4-8.2-9-10 \times I_n$	$I=10 \times I_n$ $t_2=0.1-0.25-0.5-0.8 \text{ s}$	$\pm 7\% I_f \leq 6 \times I_n$ $\pm 10\% I_f > 6 \times I_n$	$\pm 15\% I_f \leq 6 \times I_n$ $\pm 20\% I_f > 6 \times I_n$
I ($t=k$)	✓	$I_3=1.5-2.5-3-4-4.5-5-5.5-6.5-7-7.5-8-9-9.5-10.5-12 \times I_n$	$\leq 30 \text{ ms}$	$\pm 10\%$	

Notes:

- The minimum value of this trip is 1 s regardless of curve type (self-protection)
- These tolerances apply under the following conditions:
 - self-powered relay at full power (without start-up)
 - presence of auxiliary power supply
 - two-phase or three-phase power supply
 - preset trip time $\geq 100 \text{ ms}$
- Curve accuracy applies from $-20 \text{ }^\circ\text{C}$ to $+55 \text{ }^\circ\text{C}$ ambient. For possible continuous ampere derating for ambient above $40 \text{ }^\circ\text{C}$, consult Rockwell Automation.
- The right portion of the curve is determined by the interrupting rating of the circuit breaker.
- Total clearing times shown include the response times of the trip unit, the breaker opening, and the interruption of the current.
- For high fault current levels an additional fixed instantaneous hardware override is provided at 22 kA.

For all cases not covered by the above assumptions, the following tolerance values apply:

Protection	Trip Threshold	Trip Time
L	$1.05 \leq xI_1 \leq 1.25$	$\pm 20\%$
S	$\pm 10\%$	$\pm 20\%$
I	$\pm 15\%$	$\leq 60 \text{ ms}$
Others	$\pm 20\%$	

Page Left Blank Intentionally

Bulletin 140G-N, -NS

Available Rating Plugs (I_n): 400 A, 800 A, 1000 A, 1200 A, 1250 A (IEC)

LSIG

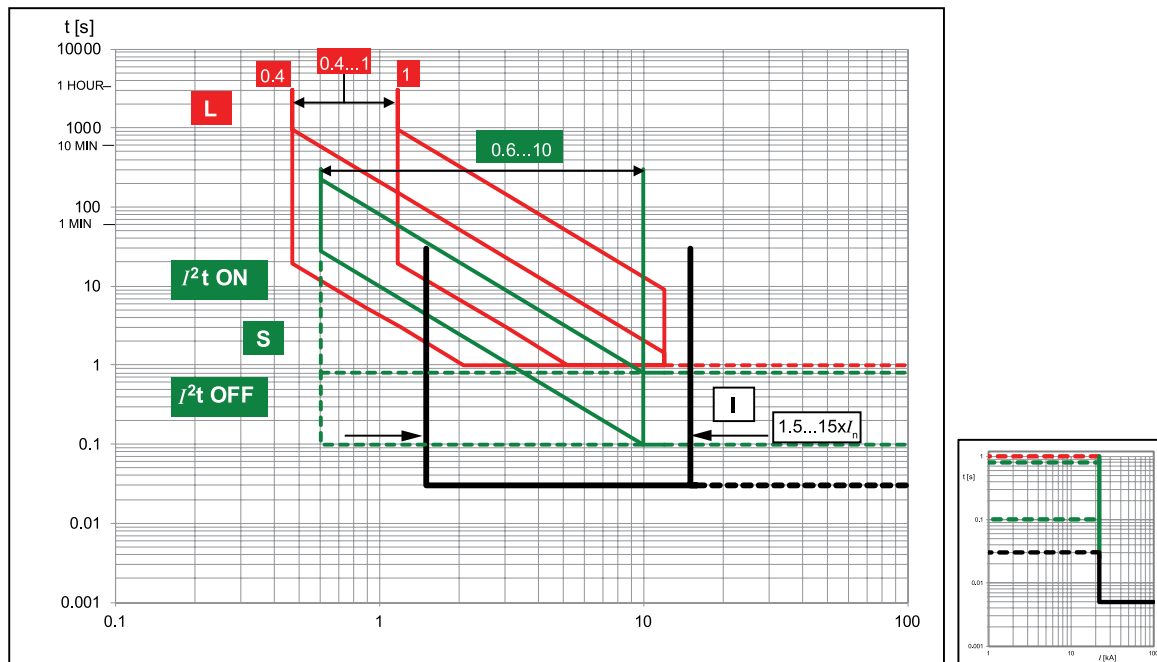

Protection	Disable	Trip Threshold	Trip Time	Trip Threshold Tolerance ⁽²⁾	Trip Time Tolerance ⁽²⁾
L ($t=k/I$)		$I_1=0.4-0.425-0.45-0.475-0.5\dots-1 \times I_n$	$t_1=3-12-24-36-48-72-108-144 \text{ s}^{(1)} @ 3I_1$	Release between 1.05 and $1.2 \times I_1$	$\pm 10\% I_f \leq 6 \times I_n$
S ($t=k$)	✓	$I_2=0.6-0.8-1.2-1.8-2.4-3-3.6-4.2-5-5.8-6.6-7.4-8.2-9-10 \times I_n$	with $I > I_2$ $t_2=0.1-0.2-0.3-0.4-0.5-0.6-0.7-0.8 \text{ s}$	$\pm 7\% I_f \leq 6 \times I_n$ $\pm 10\% I_f > 6 \times I_n$	The best of: $\pm 10\%$ or $\pm 40 \text{ ms}$
S ($t=k/I$)	✓	$I_2=0.6-0.8-1.2-1.8-2.4-3-3.6-4.2-5-5.8-6.6-7.4-8.2-9-10 \times I_n$	$t_3=0.1-0.2-0.3-0.4-0.5-0.6-0.7-0.8 \text{ s}$ @ $10 I_n$	$\pm 7\% I_f \leq 6 \times I_n$ $\pm 10\% I_f > 6 \times I_n$	$\pm 15\% I_f \leq 6 \times I_n$ $\pm 20\% I_f > 6 \times I_n$
I ($t=k$)	✓	$I_3=1.5-2-3-4-5-6-7-8-9-10-11-12-13-14-15 \times I_n$	$\leq 30 \text{ ms}$	$\pm 10\%$	

Notes:

- The minimum value of this trip is 1 s regardless of curve type (self-protection)
- These tolerances apply under the following conditions:
 - self-powered relay at full power (without start-up)
 - presence of auxiliary power supply
 - two-phase or three-phase power supply
 - preset trip time $\geq 100 \text{ ms}$
- Curve accuracy applies from $-20 \text{ }^\circ\text{C}$ to $+55 \text{ }^\circ\text{C}$ ambient. For possible continuous ampere derating for ambient above $40 \text{ }^\circ\text{C}$, consult Rockwell Automation.
- The right portion of the curve is determined by the interrupting rating of the circuit breaker.
- Total clearing times shown include the response times of the trip unit, the breaker opening, and the interruption of the current.
- For high fault current levels an additional fixed instantaneous hardware override is provided at 22 kA.

For all cases not covered by the above assumptions, the following tolerance values apply:

Protection	Trip Threshold	Trip Time
L	$1.05 \leq x I_1 \leq 1.25$	$\pm 20\%$
S	$\pm 10\%$	$\pm 20\%$
I	$\pm 15\%$	$\leq 60 \text{ ms}$
Others	$\pm 20\%$	

Bulletin 140G-N, -NS

Ground Fault Protection Curve for LSIG MCCB

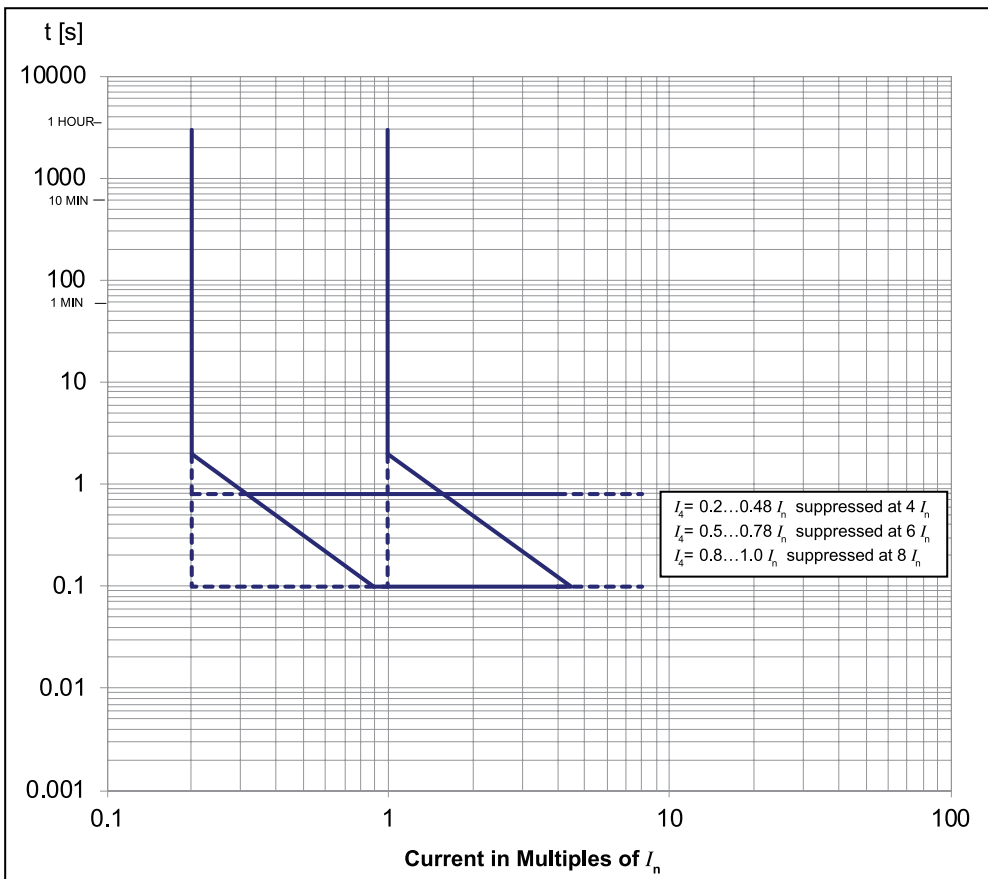

Protection	Disable	Trip Threshold	Trip Time	Trip Threshold Tolerance	Trip Time Tolerance
G (t=k)	✓	$I_4=0.2-0.3-0.4-0.6-0.8-0.9-1 \times I_n$	with $I > I_4$ $t_4=0.1-0.2-0.4-0.8$ s	± 7%	The best of: ± 10% or ± 40 ms
G (t=k/I ²)	✓	$I_4=0.2-0.3-0.4-0.6-0.8-0.9-1 \times I_n$	$t_4=0.1$ @ $4.47 I_4$ $t_4=0.2$ @ $3.16 I_4$ $t_4=0.4$ @ $2.24 I_4$ $t_4=0.8$ @ $1.58 I_4$	± 7%	± 15%

For all cases not covered by the above assumptions, the following tolerance values apply:

Protection	Trip Threshold	Trip Time
G	± 10%	± 20%
Others	± 20%	

For L-S-I trip curve see Pub. 140G-TD031.

Bulletin 140G-R

Available Sensors (I_n): 2000 A, 2500 A, 3000 A

Electronic Trip Unit. Long Delay Response, Short Delay with I^2t Response, and Instantaneous Curve

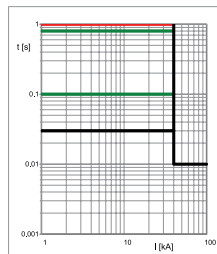
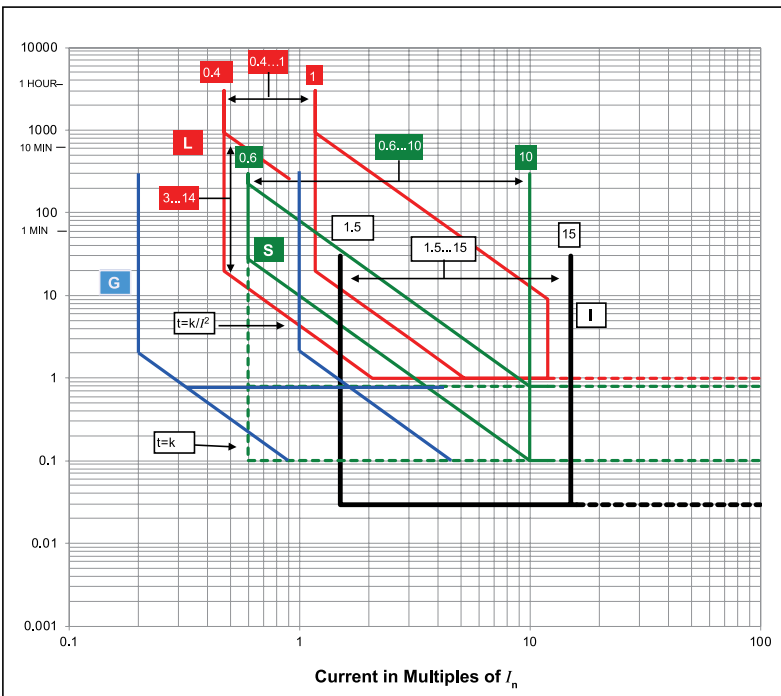

Protection	Disable	Trip Threshold	Trip Time	Trip Threshold Tolerance ⁽²⁾	Trip Time Tolerance ⁽²⁾
L ($t=k/I^2$)		$I_1=0.4-0.425-0.45-0.475-0.5\dots-1 \times I_n$	$t_1=3-12-24-36-48-72-108-144 \text{ s}^{(1)} @ 3I_1$	Release between 1.05 and $1.2 \times I_1$	$\pm 10\% I_f \leq 6 \times I_n$
S ($t=k$)	✓	$I_2=0.6-0.8-1.2-1.8-2.4-3-3.6-4.2-5-5.8-6.6-7.4-8.2-9-10 \times I_n$	with $I > I_2$ $t_2=0.1-0.2-0.3-0.4-0.5-0.6-0.7-0.8 \text{ s}$	$\pm 7\% I_f \leq 6 \times I_n$ $\pm 10\% I_f > 6 \times I_n$	The best of: $\pm 10\%$ or $\pm 40 \text{ ms}$
S ($t=k/I^2$)	✓	$I_2=0.6-0.8-1.2-1.8-2.4-3-3.6-4.2-5-5.8-6.6-7.4-8.2-9-10 \times I_n$	$t_2=0.1-0.2-0.3-0.4-0.5-0.6-0.7-0.8 \text{ s}$ @ $10 I_n$	$\pm 7\% I_f \leq 6 \times I_n$ $\pm 10\% I_f > 6 \times I_n$	$\pm 15\% I_f \leq 6 \times I_n$ $\pm 20\% I_f > 6 \times I_n$
I ($t=k$)	✓	$I_3=1.5-2-3-4-5-6-7-8-9-10-11-12-13-14-15 \times I_n$	$\leq 30 \text{ ms}$	$\pm 10\%$	
G ($t=k$)	✓	$I_4=0.2-0.3-0.4-0.6-0.8-0.9-1 \times I_n$	with $I > I_4$ $t_4=0.1-0.2-0.4-0.8 \text{ s}$	$\pm 7\%$	The best of: $\pm 10\%$ or $\pm 40 \text{ ms}$
G ($t=k/I^2$)	✓	$I_4=0.2-0.3-0.4-0.6-0.8-0.9-1 \times I_n$	$t_4=0.1 @ 4.47 I_4$ $t_4=0.4 @ 2.24 I_4$ $t_4=0.2 @ 3.16 I_4$ $t_4=0.8 @ 1.58 I_4$	$\pm 7\%$	$\pm 15\%$

Notes:

- The minimum value of this trip is 1s regardless of curve type (self-protection)
- These tolerances apply under the following conditions:
 - self-powered relay at full power (without start-up)
 - two-phase or three-phase power supply
 - presence of auxiliary power supply
 - preset trip time $\geq 100 \text{ ms}$
- Curve accuracy applies from $-20 \text{ }^\circ\text{C}$ to $+55 \text{ }^\circ\text{C}$ ($-4 \text{ }^\circ\text{F}$ to $+131 \text{ }^\circ\text{F}$) ambient temperature. For possible continuous ampere derating for ambient temperature above $40 \text{ }^\circ\text{C}$ ($104 \text{ }^\circ\text{F}$), consult your local Rockwell Automation sales office or Allen-Bradley distributor.
- The right portion of the curve is determined by the interrupting rating of the circuit breaker.
- Total clearing times shown include the response times of the trip unit, the breaker opening, and the interruption of the current.
- For high fault current levels an additional fixed instantaneous hardware override is provided at 40 kA.

For all cases not covered by the above assumptions, the following tolerance values apply:

Protection	Trip Threshold	Trip Time
L	$1.05 \leq I_f \leq 1.25$	$\pm 20\%$
S	$\pm 10\%$	$\pm 20\%$
I	$\pm 15\%$	$\leq 60 \text{ ms}$
G	$\pm 10\%$	$\pm 20\%$
Others	$\pm 20\%$	

Page Left Blank Intentionally

Bulletin 140G

I^2t Let-Through Energy Curve @ 240V

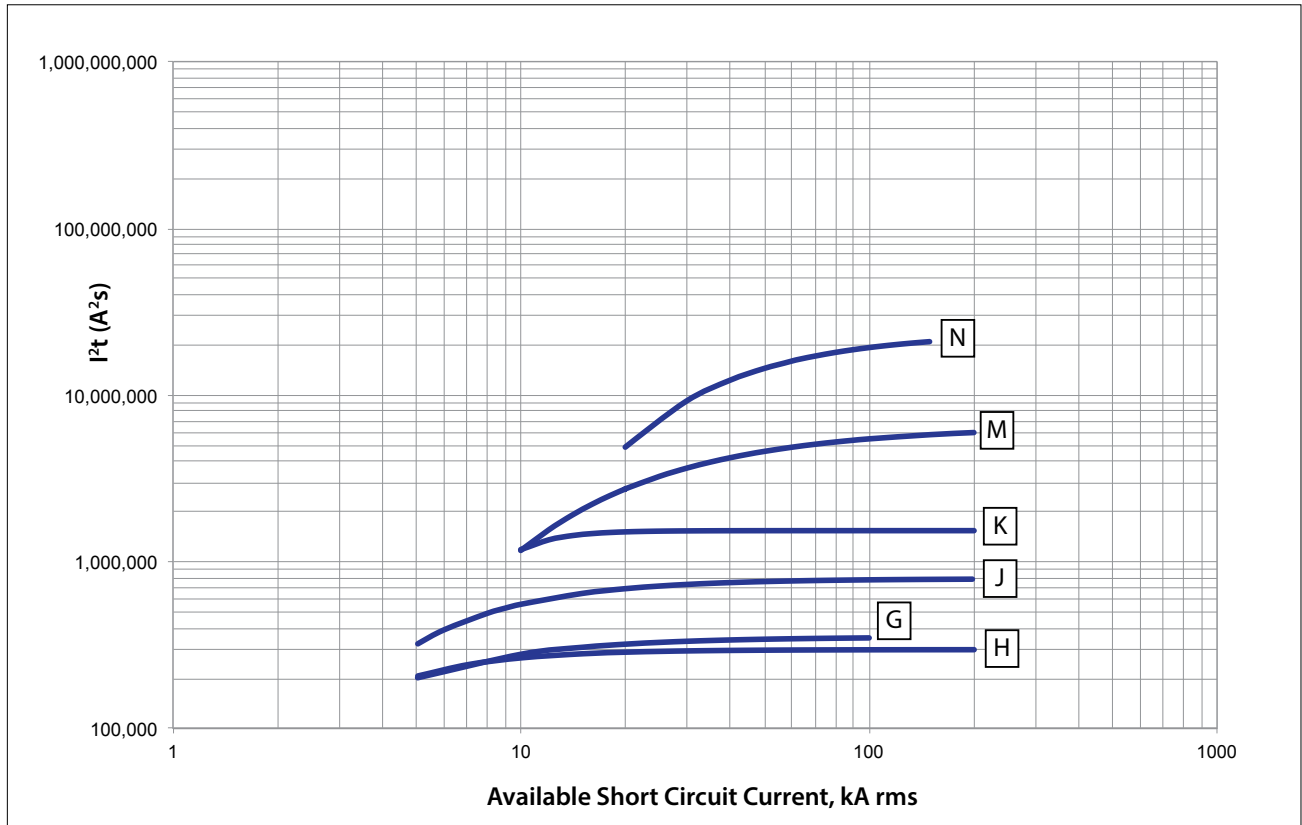

Bulletin 140G

I^2t Let-Through Energy Curve @ 415V

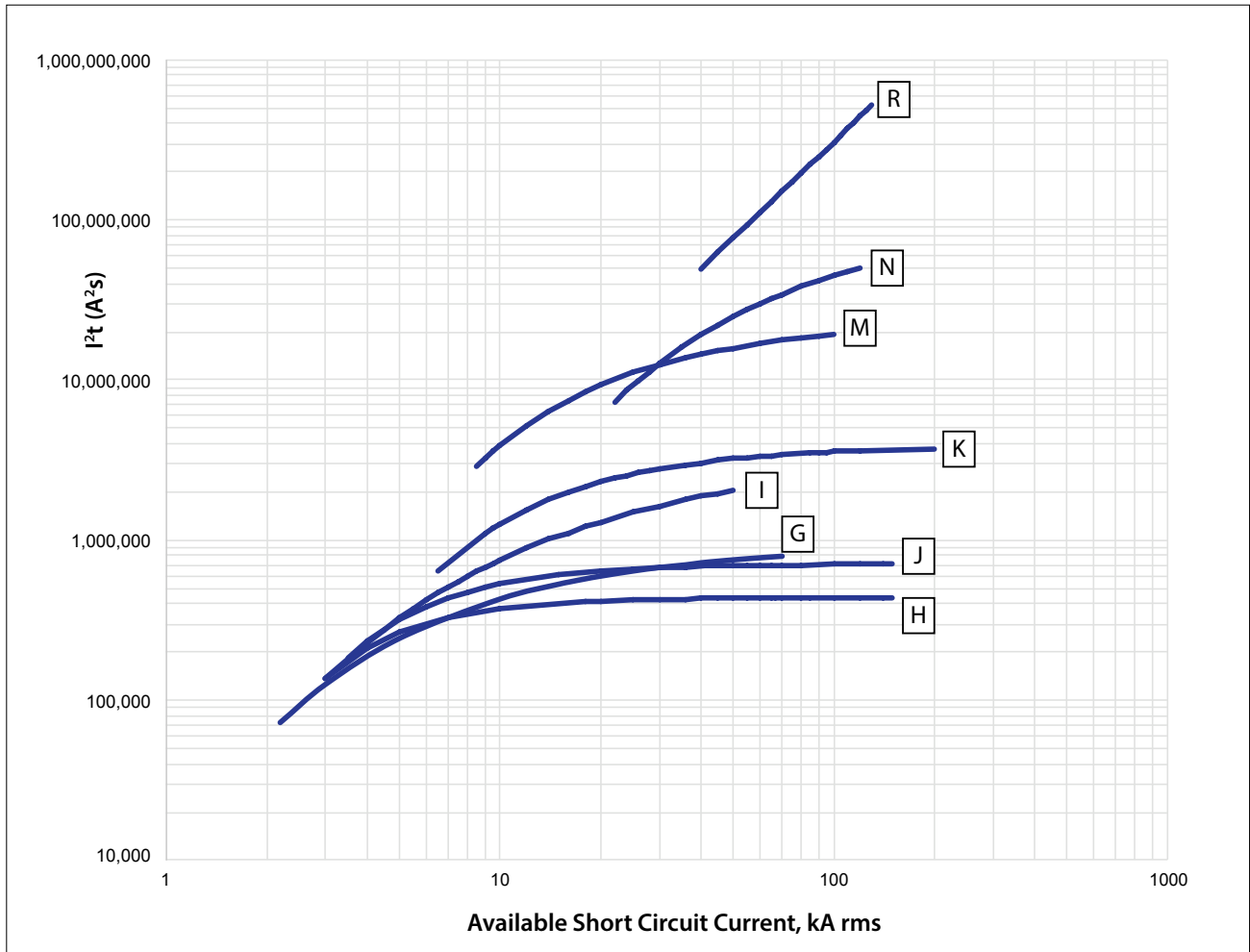

Bulletin 140G

I^2t Let-Through Energy Curve @ 480V

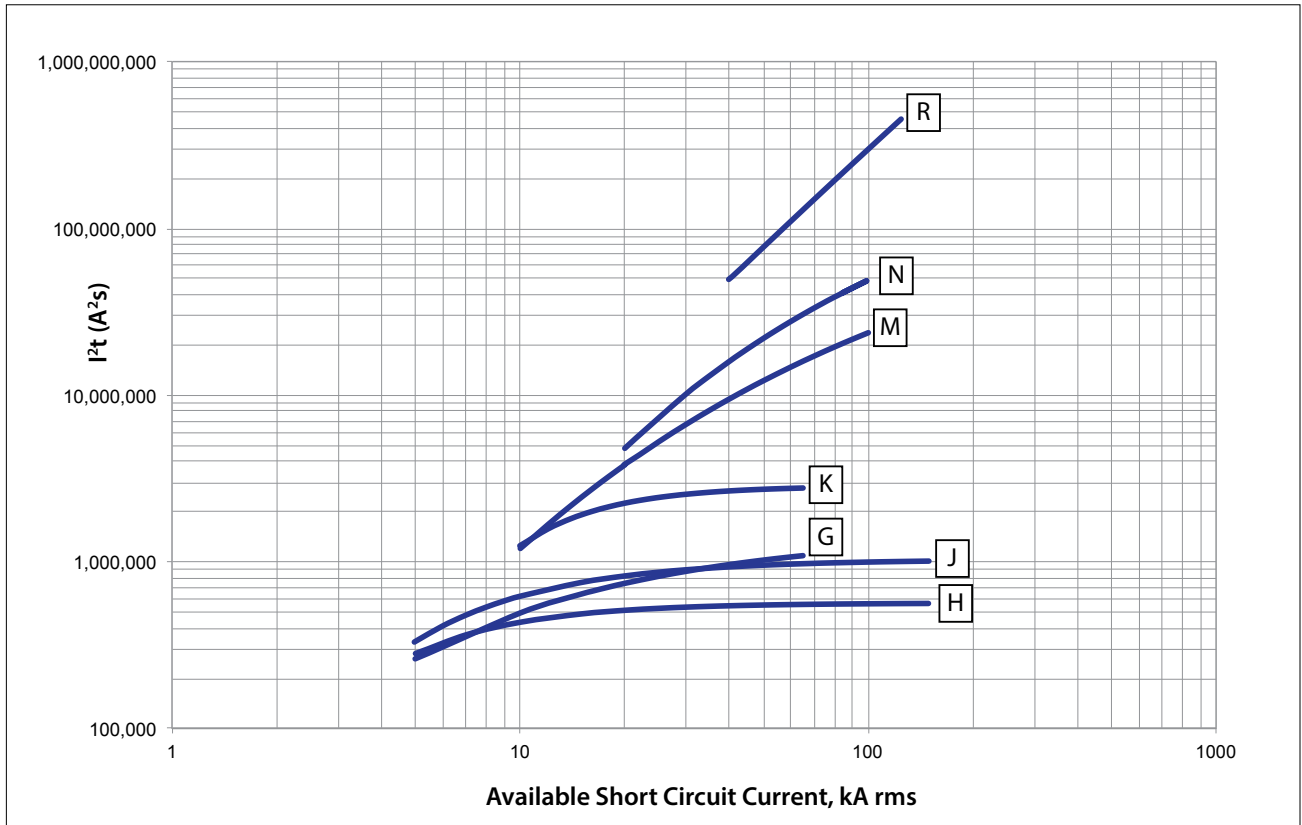

Bulletin 140G

I^2t Let-Through Energy Curve @ 600V

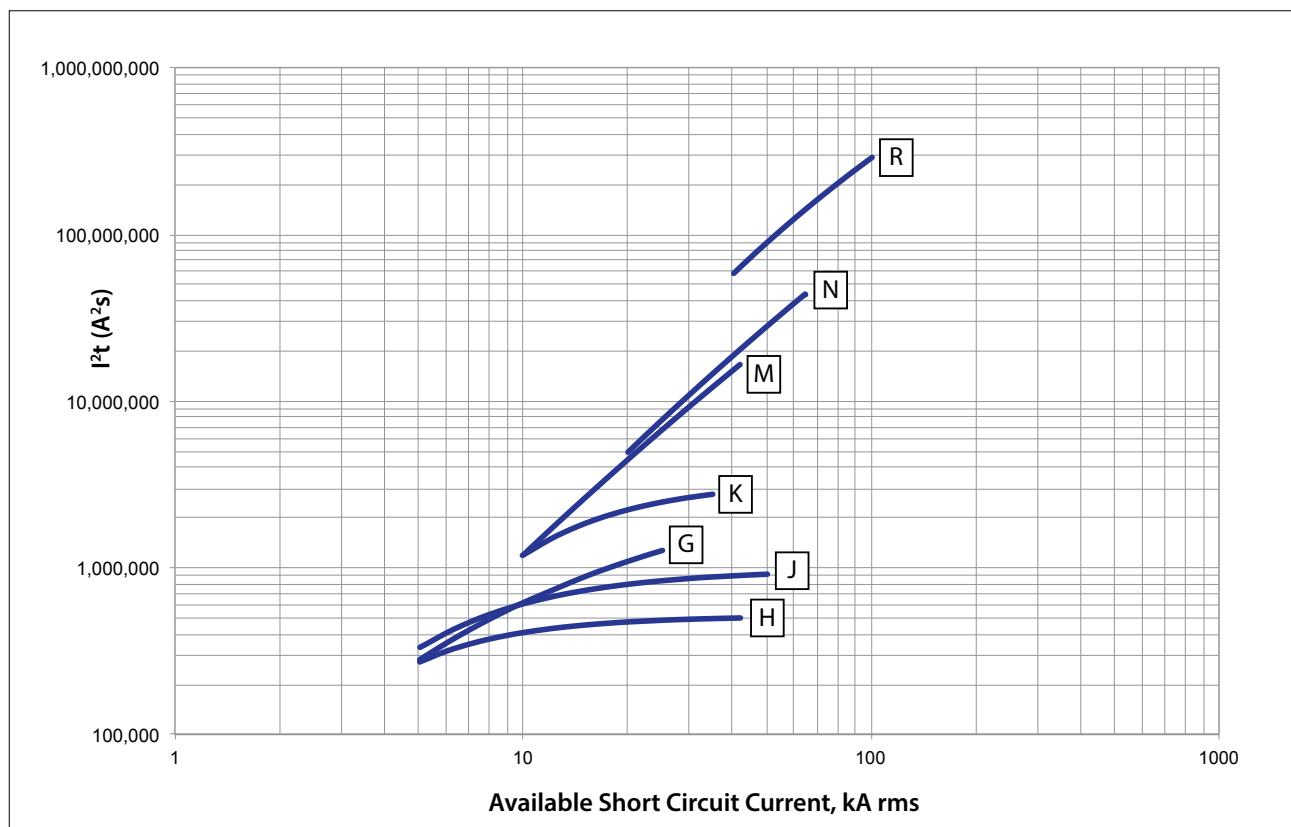

Bulletin 140G

I^2t Let-Through Energy Curve @ 690V

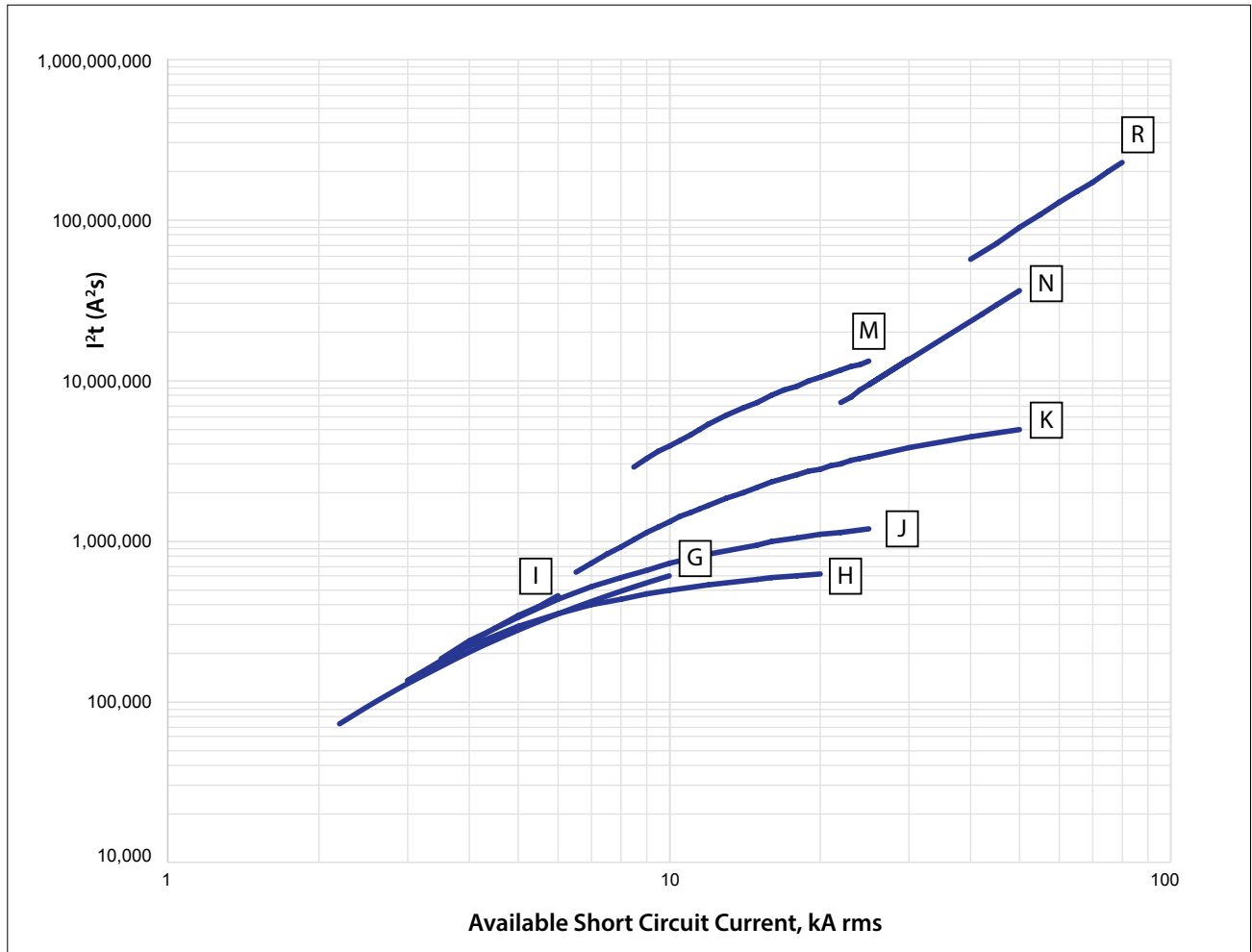

Bulletin 140G

Peak Let-Through Current, kA @ 240V

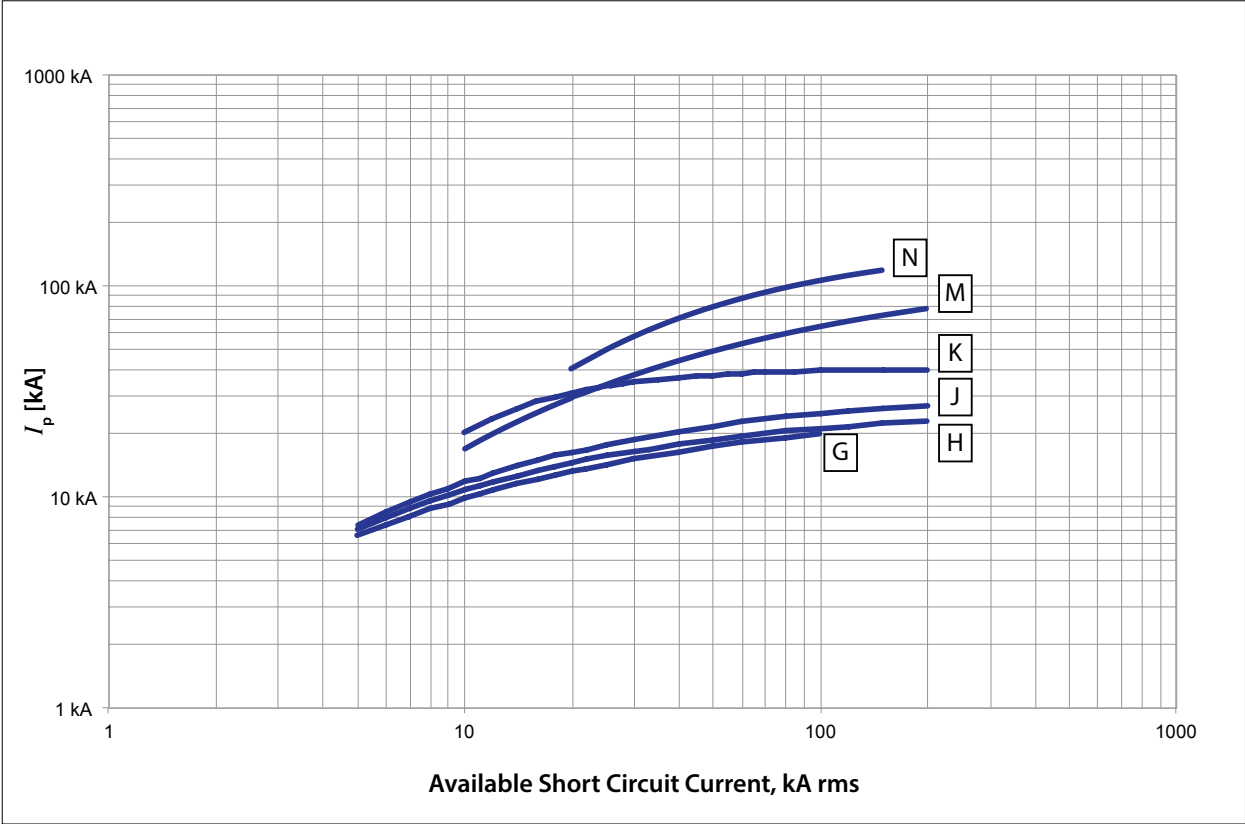

Bulletin 140G

Peak Let-Through Current, kA @ 415V

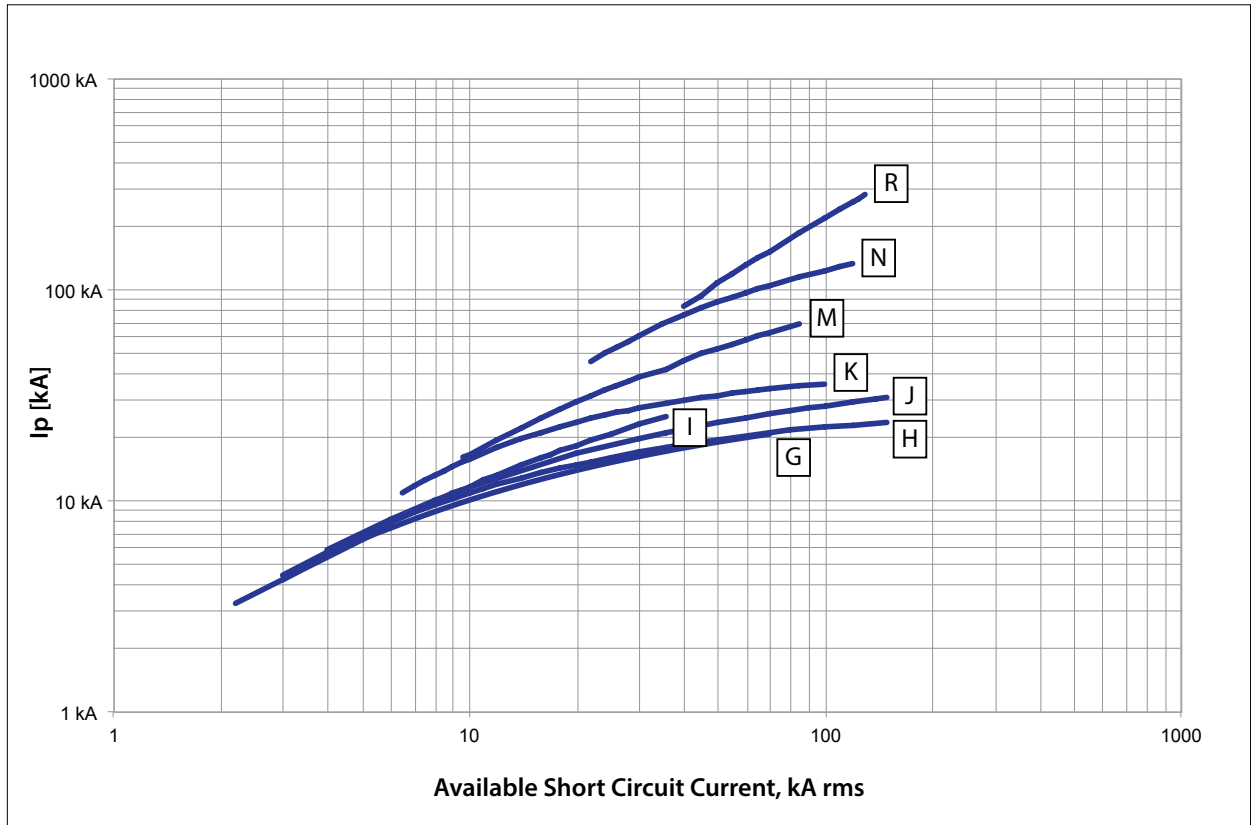

Bulletin 140G

Peak Let-Through Current, kA @ 480V

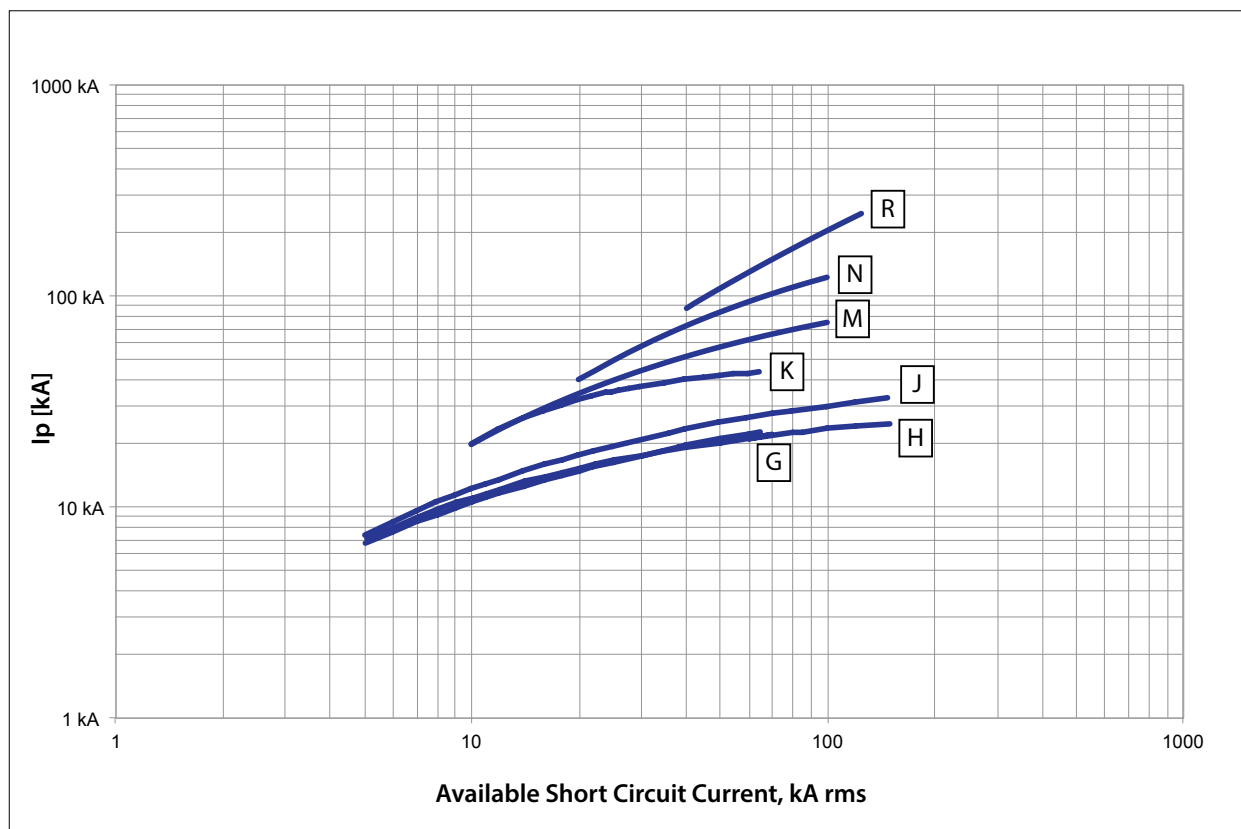

Bulletin 140G

Peak Let-Through Current, kA @ 600V

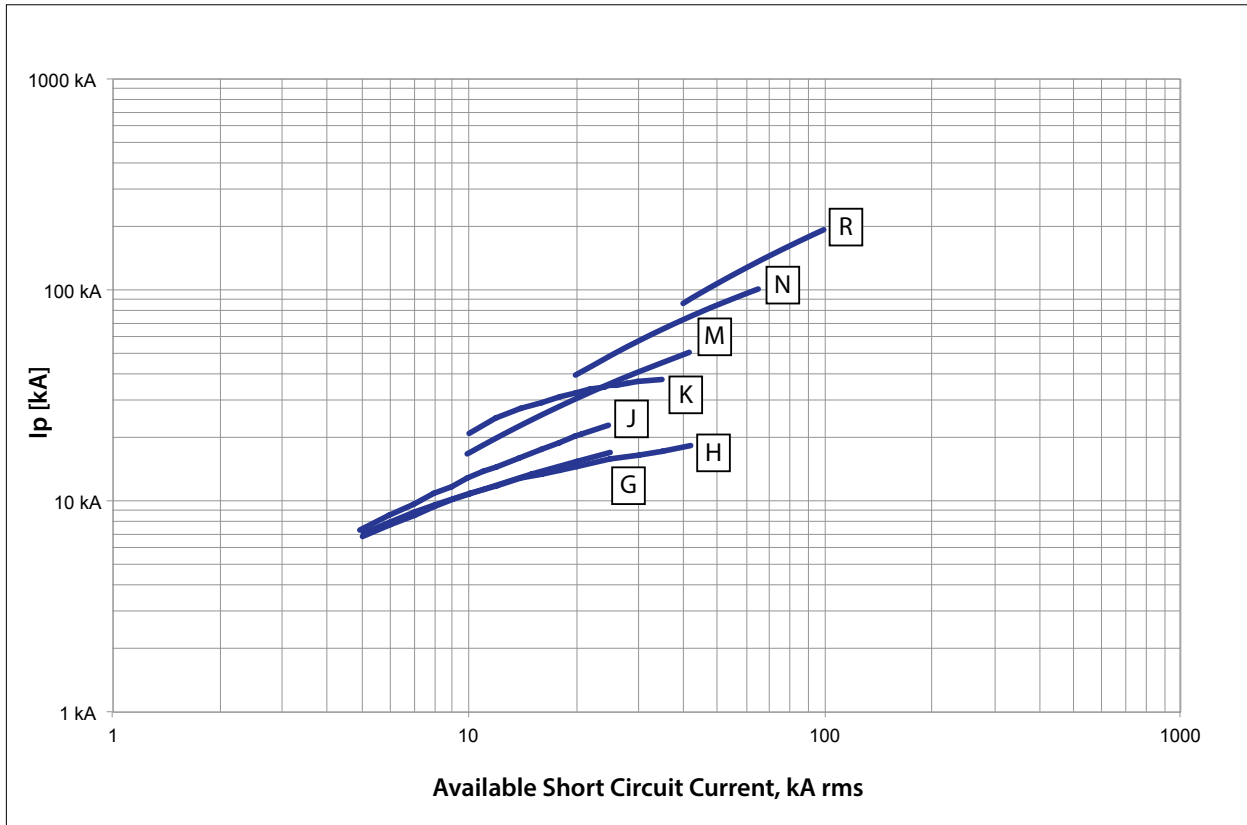

Bulletin 140G

Peak Let-Through Current, kA @ 690V

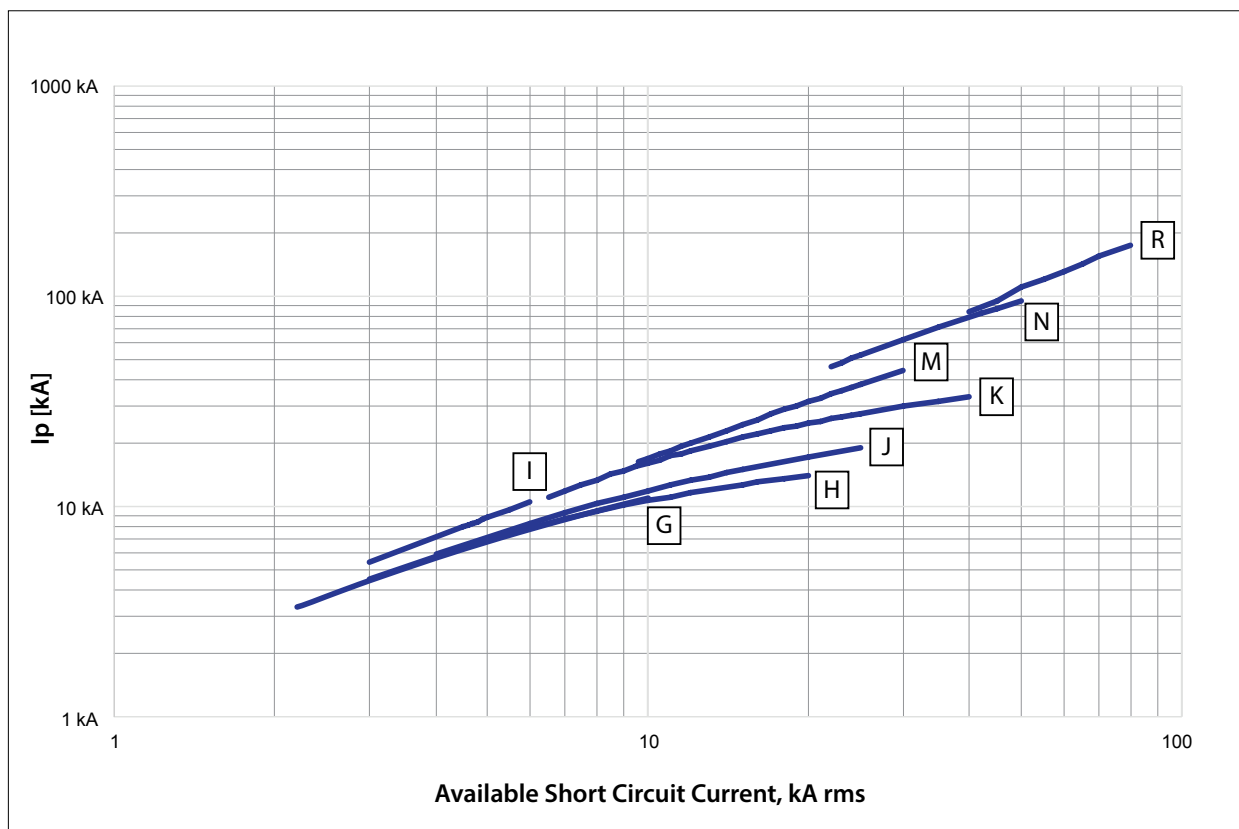

Selection and Application Tools

Circuit breakers from Rockwell Automation provide a range of tools to help you understand and apply these products in your application. You can access these tools online or through your local distributor.



CAD drawings in a range of formats

Selection guides and technical documentation

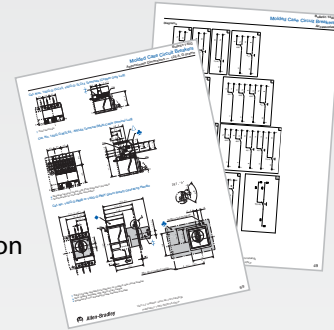

Local Distributor

Visit our website to find your local Distributor.

www.rockwellautomation.com/distributor



On-Line Product Directory

Our extensive product portfolio is designed to improve your processes through every stage of your manufacturing cycle.

<http://ab.rockwellautomation.com/Circuit-and-Load-Protection/Circuit-Breakers>



Product Selection Toolbox

Our powerful range of product selection and system configuration tools assist you in choosing and applying our products.

www.rockwellautomation.com/en/e-tools



Rockwell Automation, Inc. (NYSE:ROK), the world's largest company dedicated to industrial automation, makes its customers more productive and the world more sustainable. Throughout the world, our flagship Allen-Bradley® and Rockwell Software® product brands are recognized for innovation and excellence.



Allen-Bradley, LISTEN. THINK. SOLVE. and Rockwell Software are trademarks of Rockwell Automation, Inc. Trademarks not belonging to Rockwell Automation are property of their respective companies.

www.rockwellautomation.com

Power, Control and Information Solutions Headquarters

Americas: Rockwell Automation, 1201 South Second Street, Milwaukee, WI 53204-2496 USA, Tel: (1) 414.382.2000, Fax: (1) 414.382.4444

Europe/Middle East/Africa: Rockwell Automation NV, Pegasus Park, De Kleetlaan 12a, 1831 Diegem, Belgium, Tel: (32) 2 663 0600, Fax: (32) 2 663 0640

Asia Pacific: Rockwell Automation, Level 14, Core F, Cyberport 3, 100 Cyberport Road, Hong Kong, Tel: (852) 2887 4788, Fax: (852) 2508 1846