

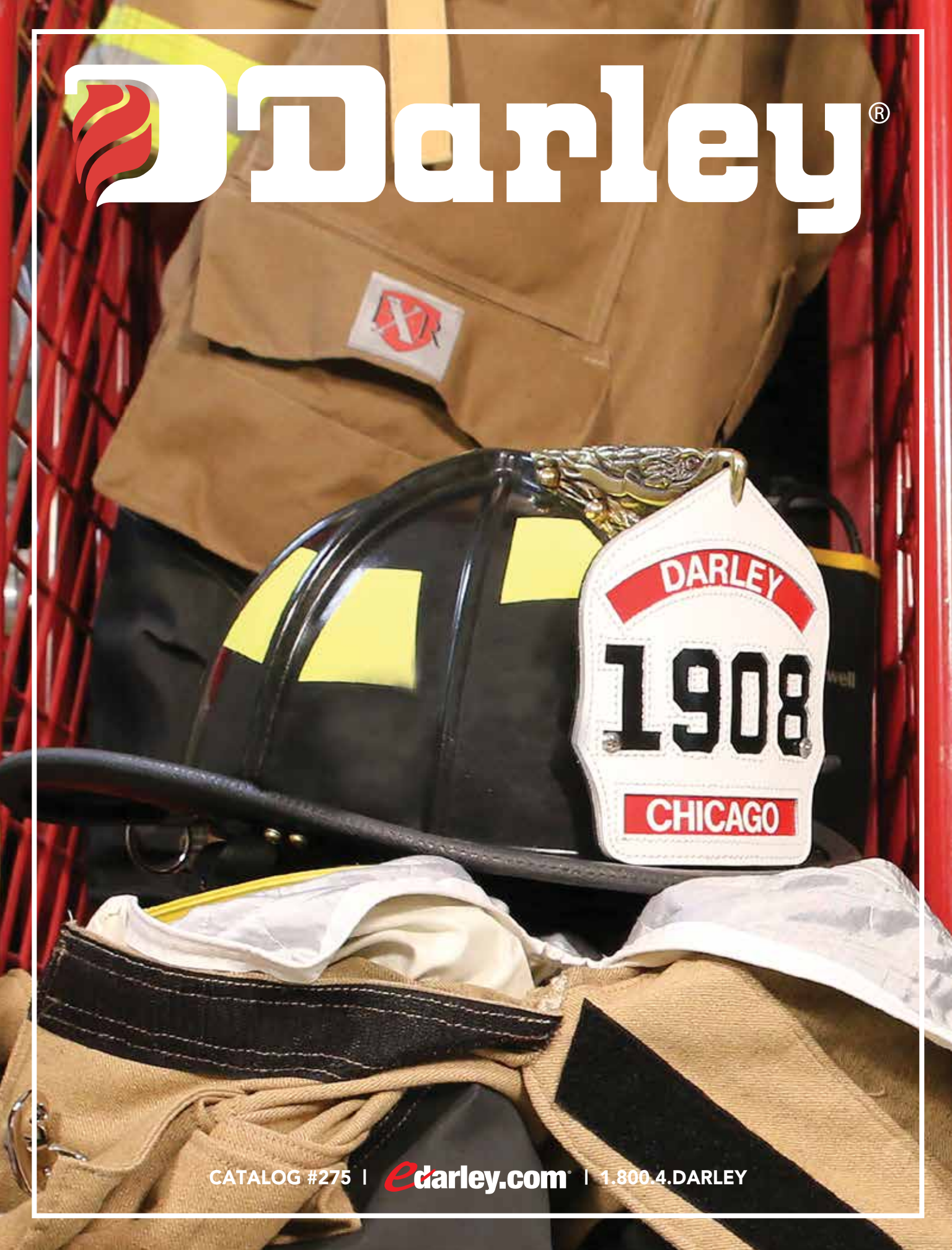

Darley®



CATALOG #275 | darley.com | 1.800.4.DARLEY

WELCOME



A lot has changed over the years, but our commitment to the fire service has not. We truly value our relationship with you, appreciate the trust that you've placed in us and thank you for the opportunity to serve you.

We hope you enjoy shopping our newest catalog, #275, designed for the fire and public safety professional. This catalog features a collection of products selected from customer favorites, our best sellers, and our highest rated products. We stock most of these items in our warehouses to offer immediate delivery. Can't find what you're looking for? Check us out at edarley.com or call one of our industry experts. View our entire product selection on eDarley.com.

We thank you for the trust you've placed in us in the past, and welcome you if you're a new customer. If we have not exceeded your expectations, I'll consider it a personal favor if you let me know.

Sincerely,

Paul C. Darley
President & Chief Executive Officer
pauldarley@darley.com
708.273.6920

NEW PRODUCTS



We listen. Based in part on your feedback, we've added a lot of innovative new products to this catalog - quality products from the name brands that you trust, and innovative items from new partners. We've added a "video online" icon so that you can see the product in action on eDarley.com.

If there is a product that you need and can't locate it in this catalog, please contact any of our customer service experts to assist you.

LOW PRICE GUARANTEE



Our employees have a passion for this business and it shows in our commitment to your complete satisfaction. It is also reflected in our Low Price Guarantee and No Hassle Return Policy. If you can find it anywhere for less, let us know and we'll match the price.

Darley offers the equipment you need at affordable pricing. Ask about our volume discounts and our municipal leasing options.

WE'RE HERE FOR YOU



Contact one of our expert product specialists at 630.735.3500 or e-mail us at questions@edarley.com with questions and to place an order today.

SIMPLIFY YOUR ORDERING PROCESS



Contact us today to set up an eDarley.com account for your department or visit www.edarley.com/departments-accounts.



BBB RATING: A+



INFECTION CONTROL PPE 2 - 5

Cleaning Wipes
 Decontamination Bags & Kits
 Decontamination Kits
 Face Shields
 Gowns
 Gloves
 Goggles
 Hand Sanitizer
 Masks
 Thermometers
 Washer Extractors

NOZZLES 6 - 17

Handline Nozzles
 Master Stream
 Piercing Nozzles
 Playpipes

MONITORS 18 - 21

Forestry/Wildland
 Master Stream
 Manual
 Portable
 Remote Controlled

HOSE 22 - 33

Attack Hose
 Booster Hose
 Forestry Hose
 Hose Accessories
 Large-Diameter Hose
 Rack Hose
 Suction Hose
 Supply Hose

WATER SUPPLIES 34 - 41

Hose Testers
 Hydrant Testing
 Pump Testing
 Strainers & Accessories
 Water Tanks

ADAPTERS & VALVES 42 - 51

Caps
 Gaskets
 Storz Adapters
 Threaded Adapters
 Valves

FOAM 52 - 60

Foam Concentrate
 Foam Nozzles
 Foam Systems
 Eductors
 Testing Kits

WATER PURIFICATION 61

Bag-In-Box Water
 Decentralized Treatment System
 Man-Portable Systems

PUMPS 62 - 71

Accessories
 CAF Systems
 Davey Portables
 Diesel Portable
 Engine Driven
 Fast Attack Skids
 Front/Rear Mounted
 Gasoline Portable
 Marine
 Midship Mounted
 Modules
 Ohler Pumps
 PTO
 UTVs

TURNOUT GEAR 72 - 99

ARFF Gear
 Belts
 Boots
 Faceshields/Goggles
 Gear Accessories
 Gear Bags
 Gloves
 Helmets
 Hoods
 Turnouts

THERMAL IMAGING 100 - 104

Batteries
 Thermal Imagers
 Truck Chargers

AIR SYSTEMS 105 - 111

Cylinders
 PASS Devices
 SCBA
 SCBA Cleaning
 SCBA Storage
 SCBA Training

WILDLAND 112 - 125

Backpack Pumps
 Hand Tools
 Hose Accessories
 Ignition Devices
 Packs
 Safety Equipment
 Wildland Clothing

ACTIVE SHOOTER 126 - 128

Body Armor
 Ballistic Helmets
 IFAK & Trauma Kits
 Plate Carriers
 Plates

HAZMAT 129 - 139

Decon
 Gas Detection
 Non-Sparking Tools
 Personal Protection
 Spill Containment

EMERGENCY MEDICAL SUPPLIES 140 - 148

Burn Care
 Defibrillators
 First Aid Kits
 Immobilization
 Training Manikins

TRAFFIC CONTROL 149 - 153

Barricades
 Flares & Beacons
 Safety Vests
 Traffic Cones
 Warning Signs

APPARATUS EQUIPMENT 154 - 174

Apparatus Valves
 Battery Chargers
 Camera Systems
 Ejection Units
 Emergency Lights
 Equipment Mounts
 Ground Ladders
 Reels
 Sirens
 Vehicle Accessories
 Water Level Indicators

APPARATUS 175 - 184

Aerials
 Challenger
 Custom Builds
 EZ Spec Program
 Initial Attack
 Rescue
 PolyBilt®
 Vision
 Wildland

ROBOTICS 185 - 189

FAA Needs
 Payloads
 ROV
 SUAS
 Support
 Training
 UAV

RESCUE TOOLS 190 - 223

Axes
 Bolt Cutters
 Confined Space
 Halligans
 Mounts
 Pike Holes
 Rope Rescue
 Saws
 Vehicle Rescue
 Water Rescue

TRAINING 224 - 227

FLAIM Trainer™
 FLAIM Extinguisher™
 RiVR - Classroom in a Box
 HazSim Training Simulation

HAND-HELD LIGHTS 228 - 235

Flashlights
 Helmet Lights
 Lanterns
 Portable Scene Lights

VENTILATION 236 - 240

Accessories
 PPV Fans
 Smoke Ejectors

FIRE PROTECTION 241 - 247

CO Alarms
 Gas Detection
 Hydrant Boosters
 Mounts
 Sprinkler
 Pump Solutions
 Suppression Systems

STATION SUPPLIES 248 - 259

Cleaning & Decon
 Dryers
 Hose Handling
 Outdoor Warning Sirens
 Salvage Covers
 Smoke Training
 Storage Racks

BADGES 260 - 261

Badges
 Badge Centers

TERMS & ORDER FORM 262 - 263**DARLEY DEFENSE CAPABILITIES 264**

AAMI LEVEL 3 NON-SURGICAL ISOLATION GOWNS

WASHABLE AND HIGHLY DURABLE

Gowns exceed CDC guidance for COVID-19 related responses and are made with Stedair® TX L3. They are washable and highly durable to withstand the demands of front-line emergency services while offering added barrier protection from fluids. Universal fit and features elastic wrists and an adjustable tie back. Visit edarley.com for usage and care recommendations.

NEW



FireDex

BP324 AAMI Level 3 Non-Surgical Isolation Gown \$104.95

DISPOSABLE HOSPITAL GOWN

HIGH LEVEL OF FLUID REPELLENCY

Disposable isolation gown is made from high-performance isolation protective material.

- Latex-free, abrasion-resistant, low lint
- High level of fluid repellency
- PPE disposable isolation gown
- Microporous disposable isolation gown
- Ties around the waist
- Sold in box of 20

NEW



SPECIFY SIZE: L or XL

BP329 Disposable Hospital Gown \$220.95/Box of 20

DERMA-LITE™ NITRILE GLOVES

DURABILITY & PUNCTURE RESISTANCE

The smart choice to protect today's EMS professionals from blood borne pathogens. Three times as puncture/tear resistant as natural rubber latex gloves of the same thickness. The great feel and contour shape hug your hand maximum comfort yet they're thin enough to let you get an accurate pulse; plus micro texture gives you better grip. Other features include ambidextrous fit, non-sterile and your choice of lightly powdered or powder free.

- Sold in box of 100
- 5 mil.
- Ambidextrous fit
- Powder or powder-free
- Latex-free



SPECIFY SIZE: L or XL

AR195 Derma-Lite™ Gloves, Lightly Powdered \$6.95/Box of 100
 AR196 Derma-Lite™ Gloves, Powder Free \$12.95/Box of 100

INFECTIOUS DISEASE CONTROL (IDC) FACE SHIELD

NEW

Disposable infectious disease control face shield with elastic attachment band and foam forehead cushion.

Each unit can be disposed of after use. The re-sealable bag keeps the unused product clean and ready for use. Individual units can be rolled and stowed in a pocket for easy access when needed. One size fits most.

- **Material:** Face Shield: Anti-static Mylar; Forehead Cushion: Foam; Strap: Elastic
- **Applications:** Suitable for hospitals, medical centers and laboratory use
- **Dimensions:** 9"x13"
- Sold in box of 10
- Made in America



ML6256413 Infectious Disease Control (IDC) Face Shield \$24.95/Box of 10

EXTECH IR200: NON-CONTACT FOREHEAD INFRARED THERMOMETER

IDEAL FOR QUICKLY DETECTING ELEVATED BODY TEMPERATURE

The IR200 is ideal for quickly detecting elevated body temperature using a non-contact design that eliminates the need for replacement probe covers and other supplies. Intended as an initial screening service.

- Measures skin temperature from 89.6 to 108.5°F (32.0 to 42.5°C) without contact
- Accurate to 0.5°F (0.3°C) with 0.1°F/°C resolution; fast response (0.5 seconds)
- Optimum measurement distance of 1.9 to 5.9 in (5 to 15 cm)
- Non-contact design eliminates need for replacement supplies
- Adjustable alarm alerts user visually and audibly when temperature exceeds programmed limit
- Memory stores up to 32 readings for easy recall
- Large backlit LCD display
- Complete with 2 AA batteries and pouch

NEW

VIDEO ONLINE



BP309 Extech IR200: Non-Contact Thermometer

\$129.95

KN95 MASK

NEW

- Lightweight, comfortable and easy-to-use
- Soft multi-layer construction provides a comfortable fit and increases wear time
- Adjustable nose clip helps reduce eye protection fogging, and produces a better seal
- Elastic ear loop provides quick application and removal
- Non adhesive Ultrasonic welded construction
- Bacterial filtration => 95%
- Meets GB2626-2006 and CE EN 149: 2001 + A1: 2009 standards
- FDA Approved

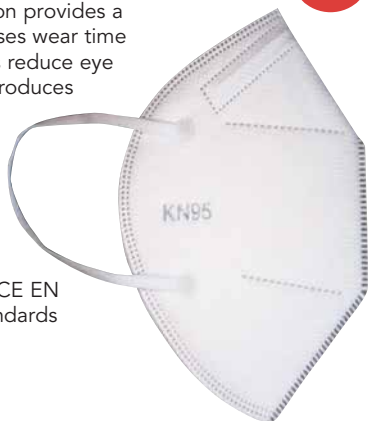

BP364 KN95 Mask

\$54.95/Box of 20

DISPOSABLE FACE MASK

Disposable face masks shield the mouth and nose from large-particle droplets, splashes, sprays or splatters.

NEW



- Construction:
 - Triple-layer construction, ear loops
 - 100% non-woven polypropylene inner and outer mask, 100% melt-blown polypropylene interior material; Spandex/polyester blend ear loops, adjustable nose clip
- Triple-layer construction
- Non-woven material
- Comfortable stretch polyester ear loops
- Adjustable nose clip prevents eyewear from fogging



BP365 Disposable 3-Layer Face Mask

\$16.95/Box of 50

SOFT SIDE DIRECT-VENTED SAFETY GOGGLES

The Soft Side Direct-Vented Safety Goggles feature clear lenses and direct ventilated frames for splash resistance. They provide exceptional value with a comfortable fit and allow for good peripheral vision. These high impact safety glasses meet ANSI Z87 high impact standards.

NEW



- Clear, impact-resistant lens meets ANSI Z87.1 2010 High Impact Standard
- Direct vented frame reduces fogging
- Polycarbonate lens, PVC frame
- Soft, clear plastic construction for a comfortable fit and good peripheral vision
- Durable elastic strap



BP366 Side Side Direct-Vented Safety Goggles

\$2.95

SPEEDBOX HAND SANITIZER

HEALTHY AND SAFE. NO RINSING NEEDED.

NEW

Use beauty soft hand sanitizer to take care of your family. It's gel formula helps eliminate bacteria and prevent diseases. It does not require rinsing.

- 70% alcohol
- Washes away 99.9% of bacteria
- Helps to eliminate germs
- With moisturizer
- Scent free
- Case of 6 - 64 oz. bottles



BP341 Speedbox Hand Sanitizer

\$137.95/Case of 6

FIREWIPES® - INDUSTRIAL STRENGTH DISPOSABLE CLEANING WIPES

Firewipes® are used primarily to aid in the cleaning and removal of soot, smoke and other potential carcinogens of complete and incomplete combustion. The Firewipe is an 8"x12" textured industrial strength disposable wipe infused with cleansing compounds for use on all external dermal areas.



Cat#	Description	Quantity	Price
BN562	FireWipes®	12 Wipes (1 box)	\$13.95
BN563	FireWipes®	288 Wipes (24 boxes)	\$299.95

HY-D REVOLUTIONARY MASS DECONTAMINATION KIT

Hy-D is a low cost alternative to mass shower decontamination that can be mounted directly to a hydrant or truck. The complete kit includes a gate valve, 30° elbow, hydrant wrench, and the patented HY-D bag. Works in all weather conditions including below freezing.

- Single person installation
- Low water usage minimizes runoff
- FEMA approved (as equipment, gross decontamination application - 08D2-02-EDCS) and eligible for FEMA grant programs



BP135	HY-D Hydrant Decontamination (Nozzle Only)	\$369.95
BP136	HY-D Kit (30° Elbow, Gate Valve, and Bag)	\$829.95

TRUE NORTH DECON BAG

The Decon™ Bag has a very important job; to protect the firefighter from cancer-causing contaminants left on dirty turnout gear. With its airtight design and abrasion-resistant construction, this roomy bag reliably traps soiled gear and prevents carcinogens on PPE from migrating to the apparatus' cabin until items can be safely laundered.

BP094	Decon Bag (75L)	\$55.95
-------	-----------------	---------

BULLARD CARES KIT

Our Bullard Cares Kit gives firefighters an extra set of fire helmet components, bundled in a washable mesh bag that can easily be laundered without falling apart or tangling. Firefighters now have an extra set of clean fire helmet components when they return from answering a call. Bullard's components (ratchet cover, brow pad, and ENP) are easy to remove to help facilitate quick and easy cleaning of your fire helmet. *Material: Nomex®, Color: Black.*



BP090	Bullard Cares Kit with Neck Protector (UST/FX/PX)	\$35.95
BP091	Bullard Cares Kit with Throat Strap (UST/FX/PX)	\$42.95
BP092	Bullard Cares Kit with Neck Protector (LT/USRX)	\$35.95
BP093	Bullard Cares Kit with Throat Strap (LT/USRX)	\$42.95

CONTAMINATED PPE BAG

Puncture resistant bag is designed to hold a full set of turnout ensemble equipment or other PPE after decontamination at the scene and for transport to the station or to your Verified ISP. Use this bag to help prevent cross contaminating the truck cab or other vehicles. Keep your gear bagged at the station until you are ready to perform advanced cleaning in the washer. The bag will hold a complete set of structural turnout gear and an SCBA pack.

- Puncture resistant
- 2 or 6 mil thickness
- 40"Wx 46"H



BP342	Contaminated PPE Bag, 2 Mil., Yellow	\$35.95/Pack of 50
BP343	Contaminated PPE Bag, 6 Mil., Clear	\$98.95/Pack of 50



EXTRACTOR 22 / 30

SPECIFICATIONS:

- Meets current NFPA 1851 recommendations
- Front load design
- Commercial quality construction
- Automatic soap dispenser compatible
- Utilizes standard plumbing hookups
- Requires only 120v electrical
- Soft-mount design, easy install
- Easy to use, preprogrammed wash cycles

BP208:

- 22 lb. capacity / 2 sets of gear
- Requires only 120v electrical
- Dimensions: 27"L x 30.5"D x 38.7 H
- Weight: 190 lbs.

BP242:

- 30 lb. capacity / 3-4 sets of gear
- Requires only 120v electrical
- Dimensions: 29"L x 32"D x 40.8"H
- Weight: 221 lbs.

ELECTRICAL SPECIFICATIONS:

- 120V/60HZ - Recommended Breaker - 20 amp

Cat#	Description	Dimensions	Weight	Price
BP208	Extractor 22 / 120V	40"x48"x49"	260 lbs.	\$4,949.95
BP242	Extractor 30 / 120V	40"x48"x51"	300 lbs.	\$7,449.95



BP208

NEW



BP242



PPE GEAR WASHER EXTRACTORS

Fire contaminants can expose firefighters to cancer-causing carcinogens and eventually weaken the gear meant to protect them. Blood and body fluids can further expose them to deadly diseases. That's why the NFPA recommends washing soiled turnout gear immediately after exposure to fire or body fluids. The NFPA also warns against cleaning gear in homes or public laundries to avoid cross-contamination. Continental washer-extractors properly clean turnout gear, removing contaminants and biohazards while preserving fabric integrity. They offer a compact design, so machines fit into unconventional locations like truck bays and utility rooms. The programmable control ensures water temperature, extract speed, cleaning chemicals, fill levels and cycle times are perfectly suited to properly clean and decontaminate turnout gear according to manufacturer recommendations. Continental washer-extractors are designed with the future in mind, and are programmable to handle future changes in protective fabrics. So, fire departments can feel secure knowing their investment will handle their laundry needs today and tomorrow.



NEW

BP243	CACHD-35 Hard Mount Extractor	\$8,700.95
BP244	CACHD-45 Hard Mount Extractor	\$10,922.95
BP245	CACHD-65 Hard Mount Extractor	\$13,090.95

CITROSQUEEZE® PPE/TURNOUT GEAR CLEANER

Preserves the quality of gear with Citrosqueeze®, the turnout gear cleaner used by some of the largest US fire departments and by authorized turnout gear cleaning and repair centers nationwide. Citrosqueeze® is formulated to remove the harmful and stubborn hydrocarbons and soils resulting from fires and chemical spills while maintaining the integrity of turnout gear. *Citrosqueeze® PPE cleaner is tested and proven safe by Dupont, Southern Mills, W.L. Gore & Assocos. (Germany), 3M Products, Safety Comments International, Inc., and CIBA Specialty Chemicals.*



BK065

BK064	Four 1-gallon Bottles	\$133.95
BK065	One 5-gallon Pail	\$165.95

VERSITOL SOLUTION FOR ALL WASHING MACHINES

A highly-effective yet gentle multi-purpose cleaner. Safe for all automatic washing machines. Removes smoke residue from all washable fabrics and surfaces, especially from expensive turnout gear containing Kevlar®, Nomex®, Duck, Nylon, PBI, Hypalon, Nitrile Rubber and Fiberglass.

Ship. wt. 37 lbs.



AC258	Versitol Solution 1 gal./Case of 4	\$126.95
-------	------------------------------------	----------

SELECT-O-MATIC XD™ NOZZLES

SELECT-O-MATIC XD™ NOZZLES AUTOMATIC LOW PRESSURE NOZZLE

The Select-O-Matic XD automatic handline nozzle adjusts to fluctuating water supply conditions to maintain effective pressure and a consistent fire stream in all flow ranges. It does so by generating back pressure by using a patented internal spring design that leaves the waterway unobstructed. This mechanism ensures a quality fire stream, regardless of flow. All indicators and markings are laser etched, with no labels to peel off or scratch. Its durability and efficiency are unmatched of any automatic nozzle on the market. Standard configuration with yellow protective bumper and yellow grip inserts.

- Forged shutoff body and bale handle
- Full round metal ball for optimum performance
- Spinning stainless steel metal teeth and ergonomic grip inserts
- Flow range from 60-200 GPM @ 75 psi



BP344

Mid-Range 1 1/2" GPM/PSI	
60-200 gpm @ 75 psi	60-200 gpm @ 100 psi

High-Range 1 1/2" GPM/PSI	
75-325 gpm @ 75 psi	75-325 gpm @ 100 psi

High-Range 2 1/2" GPM/PSI	
75-325 gpm @ 75 psi	75-325 gpm @ 100 psi



1.5" MID-RANGE
SELECT-O-MATIC XD
LOW PRESSURE NOZZLE

SELECT-O-MATIC XD

ELKHART BRASS
FIRE FIGHTING EQUIPMENT A SAFE FLEET BRAND

SPECIFY 75 OR 100 PSI

Cat#	Description	GPM	
BP344	Mid-Range 1 1/2" Select-O-Matic XD™ Nozzles	60-200	\$859.95
BP345	High-Range 1 1/2" Select-O-Matic XD™ Nozzles	75-325	\$1,019.95
BP346	High-Range 2 1/2" Select-O-Matic XD™ Nozzles	75-325	\$1,039.95

SPECIFY 75 OR 100 PSI

Cat#	Description	GPM	
BP347	Mid-Range 1 1/2" Select-O-Matic XD™ Nozzles with Pistol Grip	60-200	\$899.95
BP348	High-Range 1 1/2" Select-O-Matic XD™ Nozzles with Pistol Grip	75-325	\$1,069.95
BP349	High-Range 2 1/2" Select-O-Matic XD™ Nozzles with Pistol Grip	75-325	\$1,089.95

ELKHART BRASS XD SHUTOFFS & PLAYPIPES

XD SHUTOFFS

Elkhart Brass XD Shutoffs and Playpipes are designed and constructed for rugged use and reliable performance. They are built strong with forged shutoff bodies and forged metal bale handles earning the title Xtreme Duty, or XD. They provide an excellent foundation for break-apart applications using smooth bore or fog nozzle tips. Elkhart Brass XD Shutoffs are available with a variety of options, including built-in smooth bore discharges that can be used with fog nozzle tips for maximum versatility.

XD SHUTOFFS WITH INTEGRAL SMOOTH BORE

- Available Discharge Sizes: 7/8", 15/16", 1", 1 1/16", 1 1/8", 1 3/16", 1 1/4"



BP04901	1 1/2" XD Shutoff	\$353.95
BP04902	1 1/2" XD Shutoff with Pistol Grip	\$399.95
BP05101	2 1/2" XD Shutoff	\$447.95
BP05102	2 1/2" XD Shutoff with Pistol Grip	\$490.95
BP05001	1 1/2" XD Shutoff with Smooth Bore	\$399.95
BP05002	1 1/2" XD Shutoff with Smooth Bore and Pistol Grip	\$446.95

XD PLAYPIPES

Elkhart Brass XD Playpipe Shutoffs are designed and constructed for rugged use and reliable performance. They are built strong with forged shutoff bodies and forged metal bale handles earning the title Xtreme Duty, or XD. They provide an excellent foundation for break-apart applications using smooth bore or fog nozzle tips. Equipped with full round metal ball to deliver optimum stream quality regardless of attached tip. Standard configuration with black grip inserts. 2.5" NHT female swivel inlet.



BP05301	Elkhart Brass 2 1/2" XD Playpipe Shutoff	\$757.95
---------	------------------------------------------	----------

NEW



BP05102

NEW



BP05001

NEW



BP05301

SMOOTH BORE SINGLE TIPS

Elkhart Brass took two classic smooth bore tips to the next level. The 187-XD and 188-XD smooth bore tips feature durable urethane bumpers and laser etching. Extra knurling has also been added for increased control and grip.

SMOOTH BORE SINGLE TIPS

- Available Discharge Sizes: 7/8", 15/16", 1", 1 1/16", 1 1/8", 1 3/16", 1 1/4"

SMOOTH BORE STACKED TIPS

- Available Discharge Sizes: 15/16" & 1 1/8"



BP055

BP058

BP054

NEW



SPECIFY DISCHARGE SIZE - Call for Details

BP054	187-XD Short Barrel Smooth Bore Nozzle Tip	\$107.95
BP055	188-XD Long Barrel Smooth Bore Nozzle Tip	\$139.95
BP058	ST-185-XD-CAFS Stack Smooth Bore Nozzle Tip	\$231.95



BP054

CHIEF™ XD NOZZLES

CHIEF™ XD NOZZLES

NEW

The Chief XD takes the industry standard for handline nozzles to a whole new level. It offers accurate high volume flows at low tip pressures and is built tough like no other nozzle for Xtreme Duty, or XD. The Chief XD is the only handline nozzle that offers a forged shutoff body and forged metal bale handle for maximum strength. It also includes as standard a full round metal ball for the best stream performance, as well as fixed molded urethane or spinning stainless steel metal teeth that don't break. All indicators and markings are laser etched, with no labels to peel off or scratch. Ergonomic grip inserts help with handling and can also be color coded. It's durability and efficiency ensures an embedded level of safety for you and your crew, fire after fire.



BN749

MULTIPLE CONFIGURATIONS

- Color coded bumper along with bale handle and pistol grip inserts
- Spinning stainless steel or fixed molded urethane teeth
- Accurate and wide range of flows
- Available with 50, 75, or 100 psi operating pressure
- Fixed gallonage from straight stream to full fog
- Forged aluminum shutoff body and bale handle
- Dual drive shutoff with full round metal ball



BN746



Mid-Range 1½" GPM/PSI		
150 gpm @ 50 psi	125 gpm @ 75 psi	195 gpm @ 100 psi
160 gpm @ 50 psi	150 gpm @ 75 psi	125 gpm @ 100 psi
175 gpm @ 50 psi	175 gpm @ 75 psi	150 gpm @ 100 psi
-	185 gpm @ 75 psi	175 gpm @ 100 psi
-	200 gpm @ 75 psi	-

High-Range 1½" GPM/PSI		
185 gpm @ 50 psi	250 gpm @ 75 psi	250 gpm @ 100 psi
210 gpm @ 50 psi	300 gpm @ 75 psi	-
250 gpm @ 50 psi	-	-
265 gpm @ 50 psi	-	-

High-Range 2½" GPM/PSI		
185 gpm @ 50 psi	250 gpm @ 75 psi	250 gpm @ 100 psi
210 gpm @ 50 psi	300 gpm @ 75 psi	-
250 gpm @ 50 psi	-	-
265 gpm @ 50 psi	-	-

CHIEF™ XD NOZZLES

SPECIFY GPM/PSI - Call for Details

BN746	Mid-Range 1½" Free Swivel Base	\$731.95
BN747	High-Range 1½" Free Swivel Base	\$786.95
BN748	High-Range 2½" Free Swivel Base	\$786.95

CHIEF™ XD NOZZLES WITH PISTOL GRIP

SPECIFY GPM/PSI - Call for Details

BN749	Mid-Range 1½" Free Swivel Base	\$731.95
BN750	High-Range 1½" Free Swivel Base	\$786.95
BN751	High-Range 2½" Free Swivel Base	\$786.95



DARLEY FIRE STORM NOZZLE

DELIVERS QUALITY AND PERFORMANCE

The new Fire Storm nozzle delivers the quality and performance you are looking for in a selectable nozzle with the value you expect from Darley. Choose from fog or straight stream patterns with flows from 30-150 gpm at 100 psi. Design includes spinning turbine teeth, single piece rubber handle and bumper and aluminum body construction. The nozzle has a 110° fog pattern, full-time swivel inlet, is capable of being flushed without shutting down and a 5-year warranty. *Meets all aspects of NFPA 1964. Ship. wt. 5.1 lbs.*

- Simple to operate pattern control (1/4" turn from straight stream to fog)
- Great stream performance
- **Flow Rates:** 30-60-95-125-150 gpm @ 100 psi
- Raised lug marks straight stream for limited visibility operations
- **Inlet:** 1 1/2" NH F
- NFPA 1964
- 5-year warranty
- Made in USA



BL569 Darley Fire Storm Nozzle

\$529.95

TURBOJET® NOZZLES

The Akron® adjustable gallonage TurboJet® nozzle is unmatched in today's fire service for its flexibility and flow control. The TurboJet® is an adjustable gallonage nozzle, where flow remains the same in all patterns at each GPM (LPM) setting. Use the TurboJet® one time and it is easy to see why it's the "nozzle of choice" by fire fighters worldwide. Colored handles and pistol grip kit included.

- Improved handle for operational flexibility with extra room for the gloved hand and 1 3/4" hose
- Larger, more legible labels
- Easy to service & repair
- Meets new European Standard
- 1 1/2" Mid-Range, Wide Range, High Range and 2 1/2" TurboJets meet Insurance Services Office (ISO) Requirements
- 100 psi (7 bar) Rated Pressure Standard - 75 psi (5 bar) optional with Quality Flow Performance as Low as 50 psi (3.45 bar)
- Simple to operate (1/4 turn from straight stream to fog, raised lug marks straight stream for limited visibility operations)
- Updated, ergonomic pistol grip for great handling
- Durable patent-pending design for easy "snap-on" grips and handle colors to help identify pre-connects and better manage inventory
- Tough, black nozzle body hard coat for expected performance and quality
- Etched smooth bore tips with pressure and flow indicators for easier training and operations
- Enhanced shutoff ball valve alignment when nozzle is open



T365



COLORED HANDLES AND PISTOL GRIP KIT

OPTIONS:

- Wide-ranging selection of nozzle flow and pressure options
- Nozzle handle and pistol grip color
- Bumper color
- Custom etch
- Custom threads and choice of inlet type
- Full range of certifications

Cat#	Description	GPM	Ship. Wt.	Price
T363	1" Low-Range TurboJet® Nozzle with Pistol Grip	13-25-40-60	3 lbs.	\$830.95
T364	1" Low-Range TurboJet® Nozzle	13-25-40-60	3 lbs.	\$824.95
T365	1 1/2" TurboJet® Nozzle	30-60-90-125	4 lbs.	\$875.95
AS154	1 1/2" TurboJet® Breakapart Nozzle	30-60-90-125	3 lbs.	\$952.95
T366	1 1/2" TurboJet® Nozzle with Pistol Grip	30-60-90-125	4 lbs.	\$875.95
W146	1 1/2" Mid-Range TurboJet® Nozzle	95-125-150-200	6 lbs.	\$976.95
T367	2 1/2" High-Range TurboJet® Nozzle Direct Connect	125-150-200-250	6 lbs.	\$1,063.95
AS155	1 1/2" Wide Range TurboJet® Nozzle	30-95-125-150-200	6 lbs.	\$872.95





ASSAULT™ NOZZLES

FIXED ORIFICE NOZZLES

Assault™ Nozzles combine the quality stream performance at a variety of pressures with the simplicity of a fixed orifice. Durable and simple design make the Assault™ an unbeatable value. *Meets all aspects of NFPA 1964.*

- Colored handles and pistol grip kit included
- Specify with or without pistol grip
- NFPA 1964, EN - 15182, FM (Please specify)

Available GPM/PSI		
150 @ 50	125 @ 75	95 @ 100
161 @ 50	150 @ 75	125 @ 100
175 @ 50	175 @ 75	150 @ 100
185 @ 50	200 @ 75	175 @ 100
-	-	200 @ 100



SPECIFY GPM/PSI

AJ500	Mid Range Assault™ Nozzle	\$711.95
AJ503	Mid Range Assault™ Nozzle with Pistol Grip	\$846.95

ULTRAJET HANDLINE NOZZLE

MULTI-PURPOSE NOZZLE

The UltraJet combines the powerful punch of a true smooth bore and the widespread protection of a full fog. This nozzle simplifies fire ground operations with intuitive functionality, the ability to change patterns without shutting down and matching flows in all patterns, so there is no need to control pressure at the pump. *Meets all NFPA 1964.*

- All-in-one
- Colored handles and pistol grip kit included
- Flow range from 118 to 210 gpm @ 50 psi
- One pressure, one flow, regardless of stream
- Standard operations, minimal training
- Full grip bumper for excellent operating control at the nozzle
- Inlet: 1 1/2" NST, 2 1/2" NST



Specify Tip Size: 3/4", 7/8", 15/16", 1"

BN578	UltraJet Handline Nozzle	\$1,098.95
-------	--------------------------	------------

PYROLITE SHUTOFFS

Tough, lightweight ball shutoffs with a full-time restricted swivel base ensures the handle can be positioned for easier operation. *Ship. wt. 5 lbs.*

- Colored handles and pistol grip kit included
- Specify with or without pistol grip
- Pair with an Akron Brass fog or smooth bore tip for break-apart combo of your choice



AW125	Shutoff 1" Swivel Inlet x 1" Male, 1" Waterway	\$416.95
AW126	Shutoff w/Pistol Grip 1" Swivel Inlet x 1" Male, 1" Waterway	\$419.95
AW128	Shutoff w/Pistol Grip 2 1/2" Swivel Inlet x 1 1/2" Male, 1 3/8" Waterway	\$491.95
AW129	Shutoff w/Pistol Grip 1 1/2" Swivel Inlet x 1 1/2" Male, 1 3/8" Waterway	\$409.95
AW130	Shutoff 1 1/2" Swivel Inlet x 1 1/2" Male, 1 3/8" Waterway	\$406.95

SABERJET™ DSO NOZZLE

MULTI-PURPOSE NOZZLE

The nozzle is capable of operating efficiently at pressures as low as 50 psi for reduced firefighter fatigue, or up to 100 psi for maximum flow. This versatile nozzle is well-suited for multiple applications. 10-year warranty. More sizes available, call for details. *Ship. wt. 3 lbs.*

SABERJET™ DUAL SHUTOFF NOZZLE

- Colored handles and pistol grip kit included
- Sizes Available:
 - 3/4", 7/8", 15/16" and 1" orifices with 1/2" or 2 1/2" inlet, Fog Flow 135 at 100 psi



COLORED HANDLES AND PISTOL GRIP KIT



AS246 SaberJet™ (DSO) Nozzle with Pistol Grip \$1,137.95
 *Combination streams apply only to SaberJet™ Dual Shutoff Nozzles

DARLEY SMOOTH BORE NOZZLES

Rugged smooth bore nozzle with the largest waterway available for outstanding flow. All aluminum construction (shut-off valve, tip, ball, handle) with stainless steel fasteners. 15/16" (1 1/2" nozzles) or 1/8" (2 1/2" nozzles) smooth bore tip with rubber bumper is 5 1/2" long. Choice of High-Rise shutoff, 1 1/2" or 2 1/2" NH connection with full 1 1/2" waterway. Anodized aluminum finish. *Ship wt. 1 lb.*



BL495	1 1/2" Darley Smooth Bore Nozzle	\$208.95
BL666	2 1/2" Darley Smooth Bore Nozzle	\$259.95
BL839	1 1/2" Darley Smooth Bore Nozzle with Pistol Grip	\$228.95
BL840	2 1/2" Darley Smooth Bore Nozzle with Pistol Grip	\$280.95
BL506	1 1/2" NH Mini Stream Shaper	\$41.95

DARLEY 1 1/2" BREAKAPART NOZZLES

- Ball valve shut-off
- Pistol grip design
- Ideal for wildland or industrial fire protection
- Tip also shuts off



AW227	Darley 1 1/2" Breakapart Nozzle (100 gpm Constant Flow)	\$348.95
AW228	Darley 1 1/2" Breakapart Nozzle (20-60 gpm Dual Range)	\$342.95



BL089

AUTOMATIC



BL090

SELECTABLE



BL091

FIXED GALLONAGE

G-FORCE NOZZLES

The G-Force Series of Task Force Tips handline nozzles are designed to provide high performance fire streams in a highly affordable package. Offering your choice of regular or low pressure in fixed, selectable and automatic configurations, the G-Force nozzles integrate an exclusive slide style valve for turbulence free performance even when gated. Other high quality features include an inlet debris screen to prevent stream pattern disruption and easily identified color coded pistol grips and handle covers. Each nozzle incorporates G-Force's unique stainless steel spinning teeth for a wide protective fog pattern, bonded front rubber bumper, reflective labeling, and a standard five year warranty.

- Durable polymer handle developed for the harshest fire ground operations while offering reduced maintenance costs
- Color-coded shut-off handle, grips, and Scotchlite™ labels
- Unique inlet debris screen - unparalleled protection from debris that can affect stream quality
- Flush without shutdown, integrated tactile pattern indicator, and bonded long lasting rubber bumper
- Unique slide valve design - total firefighter flow control and outstanding stream quality, even with the nozzle valve gated and the flow reduced
- Stainless steel spinning teeth for wide fog pattern - tactile indicator provides easy pattern selection
- NFPA #1964 compliant (2008) edition
- Ship. wt. 5 lbs.



VIDEO ONLINE

LOW PRESSURE NOZZLES ALSO AVAILABLE



Cat#	Type	Inlet	Flow Rates GPM	Price
BL089	Automatic	1½" F	60-150 gpm @ 100 psi	\$550.95
BL090	Selectable	1½" F	30-60-95-125-150 gpm @ 100 psi	\$550.95
BL091	Fixed Gallonage	1½" F	150 gpm @ 100 psi	\$550.95

TFT HANDLINE AUTOMATIC NOZZLES

TFT handline nozzle is all conventional handline sizes in one. The wide range flow of 95-300 gpm allows The Handline nozzle to be used on any size hose. The TFT handline nozzle is fully automatic with a flow capacity of 95-300 gpm. The handline nozzle's integral pistol grip is mounted below the valve. Handline nozzle consists of all lightweight materials and full time swivel. *Ship. wt. 5 lbs.*

- Use on any size hose
- Pressure assist flush without shutting down
- Patented slide type valve for turbulence free nozzleman flow control
- Six detent flow positions
- Molded rubber bumper with "power fog" teeth
- "Gasket Grabber" inlet screen.

		Hose	Thread	GPM	Price
Z318	Nozzle with Grip	1½"-2½"	1½"	95-300	\$1,084.95
AC704	Nozzle without Grip	1½"-2½"	1½"	95-300	\$1,104.95



VIDEO ONLINE

VIPER FIRE FIGHTING NOZZLE

The Viper Industrial Heavy-Duty Nozzle with ergonomic rubber-coated pistol grip is an exceptional value for in-plant fire protection or wildland firefighting. It can break apart to help extend hose lines with both the tip and the pistol grip capable of shutting off. The spinning teeth add to the full fog pattern and the protective rubber bumper keeps the tip from sparking. A 95 gpm tip is standard and various tips are available making it the best value in its class.



SPECIFY THREADS: NST or NPSH		Ship. Wt.	Price
AM141	Viper 1 1/2" Fire Fighting Nozzle	6 lbs.	\$359.95

VIPER AUTOMATIC NOZZLES

Rugged and durable nozzles that offer quality and at an affordable price in an automatic nozzle. You'll have the versatility of variable pattern control from straight stream to wide angle fog and capability of flushing without pattern changes or shutting down. Spinning teeth give superior fog protection and reach. Carbon-composite shutoff ball valve and control are highly resistant to wear and corrosion and give greater impact resistance. Other features include full time swivel inlet, hi-impact absorbing rubber bumper and pistol grip. *Made of anodized aluminum. Ship. wt. 6 lbs.*



SPECIFY 1" OR 1 1/2" THREADS: NST or NPSH; 2 1/2" is NST only			
Cat#	Inlet	Flow Rates GPM	Price
AM132	1"	15 - 50	\$520.95
AM133	1 1/2"	25 - 100	\$538.95
AM134	1 1/2"	50 - 160	\$538.95
AM13501	1 1/2"	80 - 200	\$631.95
AM13502	2 1/2"	80 - 200	\$678.95

VIPER SELECT GALLONAGE NOZZLES



- Compact and lightweight
- Easy maintenance
- Ergonomic design
- Pistol grip and ball shutoff

SPECIFY 1" OR 1 1/2" THREADS: NST or NPSH
2 1/2" is NST only AM145 SPECIFY INLET SIZE: 1 1/2" or 2 1/2"

Cat#	Inlet	Flow Rates GPM	Price
AM142	1"	15 - 30 - 50 - 60	\$485.95
AM143	1 1/2"	30 - 60 - 95 - 125	\$512.95
AM144	1 1/2"	75 - 100 - 125 - 150	\$512.95
AM145	1 1/2" or 2 1/2"	95 - 125 - 150 - 200	\$599.95
AM146	2 1/2"	125 - 150 - 200 - 250	\$578.95

1" VIPER NOZZLE

Low flow, high quality, high performance MOP UP nozzle that flows from 5 gpm to 40 gpm. 1" select gallonage nozzle with ball shutoff, bail handle, and pistol grip.



- Extruded from E-LITE alloy
- Hard-coated for corrosion protection and durability
- Spinning teeth offer a wide, complete fog pattern
- Selector ring has 4 flow positions
- Constant gallonage in all positions
- MOP(5)-10-25-40 gpm @ 100 psi

SPECIFY THREADS: NST or NPSH	
BL424	1" Viper Nozzle \$524.95

DARLEY BALL SHUTOFF VALVES

Feature female swivel base, horseshoe shut off, hard anodized aluminum construction, polymer ball and seats, neoprene seals and stainless steel swivel bearings. *Ship. wt. 2 lbs.*



VERSATILE BALL SHUTOFF

SPECIFY THREADS: NH OR NPSH

AM071	1" Ball Shutoff	\$169.95
AM072	1 1/2" Ball Shutoff	\$169.95
AM073	1" Ball Shutoff with Pistol Grip	\$195.95
AM074	1 1/2" Ball Shutoff with Pistol Grip	\$197.95

ADJUSTABLE FOG NOZZLES

Adjustable Fog Nozzles are constructed of hard coated aluminum with brass and stainless steel internal components. They come with a heavy duty rubber bumper for added protection. These nozzles flow from 10 gpm or less and are ideal for wildland fire fighting, industrial fire protection and wash down applications.



AW102	1" 10-23 gpm Nozzle	\$107.95
AW103	1" 10-23 gpm Nozzle (Bumperless)	\$93.95
AW104	1 1/2" 20-60 gpm Nozzle	\$127.95
AW105	1 1/2" 20-90 gpm Nozzle	\$127.95

VIPER BLACK KNIGHT NOZZLE

The Black Knight is constructed in 1 1/2" size and adjustable from wide fog to shut off position, with flows up to 95 gpm. The Black Knight is much more durable and dependable compared to conventional polymer nozzles as it is highly reinforced with fiberglass which allows the nozzle to hold its shape under heat and pressure. It includes brass internal stems for corrosion resistance, and has a rubber bumper. Great for brush, wildland fires and industrial applications. *Ship. wt. 2 lbs.*



AW106	1 1/2" Viper Black Knight Nozzle 95 gpm	\$27.95
-------	-----------------------------------------	---------

PLAYPIPE NOZZLES

Axial Playpipe with stacked tip smooth bore nozzle with 1 1/4", 1 1/8" & 1" outlets. Equipped with removable debris screen, durable metal ball and a smooth waterway. Available with full time 2 1/2" Swivel, NST only.



BL238	2 1/2" x 1 1/2" Playpipe with Triple Stack Tip, 1 1/4", 1 1/8" & 1" Outlets	\$785.95
-------	-----------------------------------------------------------------------------	----------



BLUE DEVIL NOZZLE
HIGH PERFORMANCE NOZZLE
WITH SELECT FLOW



- New 90° rotation from 30° fog to straight stream (one twist of the hand)
- Raised lug indicators on the selector and fog barrels
- Rylostatic teeth in the nozzle head to break up the water
- Metal ball with front and rear seals to work under higher pressures (max 580 psi)
- 4 and 5 gallonage selection ring, without pattern change
- FLUSH without shutting down
- Constant flow through fog and straight stream
- Standard operating pressure @ 100 psi
- Swivel inlet NST or NPSH threads (2 1/2" NST only)

SPECIFY THREAD: NST or NPSH

Cat#	Description	Performance	Weight	Price
BE268	1"	5-15-25-50 gpm	5 lbs.	\$681.95
BL818	1"	15-30-50-60 gpm	4 lbs.	\$668.95
BL819	1 1/2"	30-60-95-125-150 gpm	4 lbs.	\$719.95
BL820	1 1/2"	75-100-125-150 gpm	4 lbs.	\$719.95
BL821	2 1/2"	95-125-150-200 gpm	8 lbs.	\$1,033.95

TRANSFORMER PIERCING NOZZLE SYSTEM

The Transformer Piercing Nozzle is designed to deliver water or foam solutions to areas inaccessible to the firefighter. A series of jets near the point apply a wide reaching pattern at a rated flow of 150 gpm at 100 psi. The easy to use and rugged, twist-grip shutoff valve, regulates nozzle flow without the need for an additional shut-off valve. The 3 port junction block and strike head allow the nozzle to be configured to short, medium, long and L-shaped combinations, making it easily adaptable to specific fireground situations. The Transformer Piercing Nozzle features a hardened point, is constructed of hard coated extruded aluminum, and includes a sturdy canvas carrying bag with compartments for each component.

BL670 INCLUDES:

- Twist-grip shutoff valve
- 3 port junction block with striking head
- 2" - 19" extension tubes
- 14" flow tube with piercing point

BL949 (SHOWN) INCLUDES:

- Twist-grip shutoff valve
- 3 port junction block with striking head
- 2" - 19" extension tubes
- 14" flow tube with piercing point
- Distribution nozzle rated at 150 gpm (570 l/min)
- Adapter that allows the distributor nozzle to be used on any 1 1/2" NH threaded hoseline

FEATURES:

- Re-configurable for specific fireground situations
- 150 gpm at 100 psi
- 3 port junction block and twist-grip shutoff valve
- Hardened point
- Canvas carrying bag



NOZZLES



BL670	PA1 Transformer Piercing Nozzle System	\$750.95
BL949	PA2 Transformer Piercing Nozzle System	\$1,125.95

FYRESTICK PIERCING NOZZLE

THE PERFECT FIRE FIGHTING TOOL FOR:

- Attic and Roof Fires: Shingle, slate, metal, wood
- Underhood Vehicle Fires: Car hoods and doors
- Mobile Home Fires: Walls and doors
- Warehouse Fires: Garage doors and roofs
- Many more applications

FEATURES:

- Sledge-head replaceable anvil
- Patented spray head & piercing blade
- Spray jets flow 100 gpm @ 100 psi
- 20° angled replaceable hardened tip
- 1 1/2" NST hose fitting
- 16 1/2" penetration
- Slip-resistant handle surface
- Reinforced handle grip
- Designed and manufactured in the USA



BK008	Fyrestick Piercing Nozzle	\$878.95
-------	---------------------------	----------

AUGUSTUS FIRE TOOLS

Augustus Fire Tool for Portable Extinguishers - Operates in conjunction with CO2, Pressurized Water or Dry Chemical extinguishers. Supplied with a six' hose, to replace the existing hose on the extinguisher, and is fitted with a quick-connect male coupling to connect to the tool's inlet handle female brass safety-lock coupling. *Ship. wt. 14 lbs.*

Augustus Fire Tool for Hose Lines - Designed to be used with a booster tank operation. The tool can be supplied from a booster tank using either a 1" booster line, 1 1/2" or 1 3/4" pre-connect hose line with a flow in excess of 55 gpm. Comes with a female swivel connection for either 1" or 1 1/2" hose equipped with National Standard Hose Thread or any thread. Use on vehicles and confined spaces. Portable or hose line. *Ship. wt. 15 lbs.*



AG065	Fire Tool with CO2 Hose	\$1,178.95
AG066	Fire Tool with Dry Chemical Hose	\$1,178.95
AG067	Fire Tool with Water Foam Hose	\$1,178.95
AK174	Fire Tool Portable Complete Package	\$1,293.95
AG069	Fire Tool w/1" Female Swivel	\$1,154.95
AG070	Fire Tool w/1" Flat Hose Whip & Swivels	\$1,238.95
AK175	Complete Package Augustus Fire Tool	\$1,521.95

900 SERIES PIERCING NOZZLES

These nozzles combine the best of durability, flexibility and are light in weight. They can accommodate extensions for extra reach (2' per extension). They can also be driven in with a mallet if needed. This unique nozzle design needs to be driven in only 3.75" to have full penetration of the sprayer unit. Ideal for walls with coverage of up to 25' in all directions. It's powerful enough for fires in attics, basements, mobile homes, garages, vehicles or any confined space. These piercing nozzles feature a unique safety handle that allows a firefighter to safely hold the unit when a mallet is being used to drive the nozzle in. The handle is removable if needed. They come with 1.5" NST threads as standard; other threads are available. Designed for the rugged demands of the Fire Service worldwide. *Mounting hardware is included. Made in the USA. Ship. wt. 9-24 lbs.*

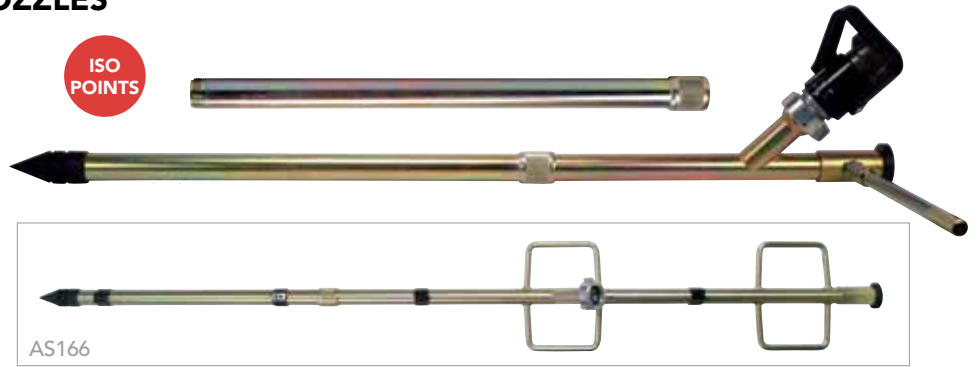

Cat#	Description	Ship. Wt.	Price
AS160	Nozzle 2' with (1) 2' Extension	9 lbs.	\$901.95
AS161	Nozzle 2' with (1) 2' Extension and Shutoff Valve	9 lbs.	\$1,217.95
AS162	Nozzle 2' with (2) 2' Extensions	12 lbs.	\$1,107.95
AS163	Nozzle 2' with (2) 2' Extensions and Shutoff Valve	12 lbs.	\$1,348.95
AS166	Battering Ram Nozzle Plus (1) 2' Extension	24 lbs.	\$1,141.95
AS167	Battering Ram Nozzle Plus (1) 2' Extension with Shutoff Valve	24 lbs.	\$1,453.95

LIGHTWEIGHT NOZZLES

The Lightweight FlameFighter is a lighter weight 3' applicator made of high-quality steel and aluminum. Comes with 1 1/2" pistol grip ball shutoff. Providing quick and efficient access through roofs, doors, walls, floors and even foundation blocks to extinguish fires from attic to basement. It gets you to the source of a fire quickly. In just seconds one or two firefighters can insert the FlameFighter into virtually any desired entry point and generate a high pressure water spray covering up to 2,400 sq. ft. at 150 psi delivering 212 gpm. For vehicle fires, it easily pierces the hood, door or trunk to make for quick extinguishing. What's more, whether you're using water or foam, the precisely placed openings in the nozzle send out a pressuring spray that extinguishes or cools most any fire. Adapt to foam applications. Mounting hardware is included. Made in the USA. 5-yr. warranty. *Ship. wt. 45 lbs.*

USES:

- Houses
- Cars and trucks
- Garages
- Barns
- Mobile Homes



AJ549	6' Piercing Applicator Nozzle	\$1,091.95
-------	-------------------------------	------------

900 SERIES 90° PIERCING NOZZLES



- Ideal for use on car fires or confined space
- All FlameFighter nozzles qualify for ISO points
- Delivers up to 139 gpm
- Storage brackets included
- 1 1/2" NSTF
- 38" long
- Includes mounting hardware
- Made in the USA
- 5-year warranty
- Ship wt. 9-12 lbs.



AS164	Nozzle 90° (Car Fires)	\$792.95
AS165	Nozzle 90° (Car Fires) with Shut Off Valve	\$1,067.95

PIERCING APPLICATOR NOZZLE

Use a sledge hammer to drive the Piercing Applicator Nozzle through concrete blocks, mobile homes, etc. Designed to get water or foam to hidden trouble spots. Flows 125 gpm at 100 psi. Driving button and point are made of hardened tool steel with impinging jets for a dense fog pattern. Compatible with AFFF and Class A foams. 1 1/2" inlet. *Ship. wt. 14 lbs.*



AF239	3' Piercing Applicator Nozzle	\$903.95
AF240	6' Piercing Applicator Nozzle	\$968.95

1 1/2" SMOOTH BORE TIPS

THE NEW STANDARD IN SMOOTH BORE TIPS



- 4" length
- Constructed of anodized aluminum
- 1 1/2" Rigid Base NST



BB032	1/2" Outlet	\$96.95
BB033	3/4" Outlet	\$96.95
BB034	15/16" Outlet	\$96.95

STACKED TIPS



SEE PAGE 124 FOR LEXAN NOZZLES

- Sold as a set, taper from 1 1/4" to 1 1/8" to 1"
- Constructed of anodized aluminum
- 1 1/2" rigid base NST



BB036	Stacked Tips, Outlet 1 1/4" to 1 1/8" to 1" (Set of 3)	\$176.95
-------	--------------------------------------------------------	----------

1 1/2" DOUBLE STACKED TIP

NEW



- Double stack tapers from 15/16" to 1/2" outlet
- Constructed of anodized aluminum
- 1 1/2" NST inlet



BP339	Stack Tips, Double 15/16" to 1/2", 1 1/2" NST Base	\$116.95
-------	----------------------------------------------------	----------

DELUGE STACK TIP

- 12" and 17" long
- 2 1/2" base thread
- Two middle threads, underwriters P.P.S. 2" NH
- 1 1/2" top thread
- 1 3/8", 1 1/2", 1 3/4" orifices
- Hardcoat aluminum



Ship wt. 3 lbs.

AJ534	12" Triple Deluge Stack Tip	\$260.95
AJ537	17" Quad Deluge Stack Tip	\$317.95

CELLAR NOZZLE

The Cellar Nozzle has a ball bearing revolving action for attacking fires in hard-to-reach places. The AF242 has a 1 1/2" rigid base with 6 variable angle orifices. It flows 95 gpm at 50 psi; measures 3 1/2"L. The AF241 has a 2 1/2" base with 9 variable angle orifices. It flows 250 gpm at 100 psi; measures 5 1/8"L. Ship. wt. 2 lbs.



AF242	1 1/2" Cellar Nozzle	\$513.95
AF241	2 1/2" Cellar Nozzle	\$678.95

CHIMNEY SNUFFER KIT

The Chimney Snuffer quickly and safely suppresses chimney fires using an ultra-fine spray, greatly reducing potential water damage. The durable 5 lb. nozzle head is simply operated by a single firefighter and easily breaks through potential blockages within the chimney. Eight strategically placed nozzles provide 40 gallons per hour at 60 psi, allowing the Chimney Snuffer to be supplied by an attack line, 1" line, or even a garden hose. The entire package weighs less than 15 lbs. and is easily stored in apparatus compartment. Ship. wt. 19 lbs.

- Includes: Nozzle head, burn resistant rubber hose, 1" ball style shut off, 1 1/2"x1" adapter and 3/4" garden hose adapter
- Compact, lightweight and simple to deploy
- Ideal for use in all types of chimney liners
- Head easily breaks through creosote buildup, nests or other debris



AR159	Chimney Snuffer Kit	\$695.95
-------	---------------------	----------



NEW

MERCURY FLOWGUARD INTRODUCING FLOWGUARD FOR THE MERCURY QUICK ATTACK LE PORTABLE FIRE MONITOR

The Mercury FlowGuard is designed to reduce hazard risk for your crew and give them confidence while firefighting. Not only does the FlowGuard protect your crew, but also your pump. When the hose or the monitor experiences excessive, potentially hazardous movement while flowing, the Mercury FlowGuard, will automatically reduce water flow.

DOES NOT SHUT DOWN ALL THE FLOW:

- Reduces to about 1/3 of the flow
- No water hammer off the pump

FAST AND EASY RESET:

- Close monitor valve, turn reset button a 1/4 turn, put hose back in line, open monitor valve and start flowing

LIGHTWEIGHT AND COMPACT WITH A SLIM PROFILE:

- Weighing 4.6 lbs. or 2 kg
- 9.125" long or 231 mm

LOW FRICTION LOSS:

- 8 PSI or less than 1 bar at 500 gpm or 1900 lpm (total friction loss at 500 gpm is 14 PSI or 1 bar with FlowGuard)



BP338 Mercury FlowGuard

\$735.95



BOTTOM VIEW



SIDE VIEW

MERCURY QUICK ATTACK LE PORTABLE MONITOR

HIT LOW, HIT HARD AND HIT FAR WITH THE NEW MERCURY QUICK ATTACK LE MONITOR

The Mercury Quick Attack LE portable monitor sets a new standard in the market and is the only portable monitor that meets NFPA 1964 and EN-15767-1. It is compact and lightweight at 15 pounds and flows 500 GPM. Now even better, it can hit low at 10° and far up to 250 feet at 100 psi. Easy and quick to deploy, friction loss is minimal.

- Hits low at 10°
- Improved reach up to 250 feet with the NEW Mercury Adjustable Nozzle and the only fog nozzle with the reach of a smooth bore
- Only portable monitor to meet NFPA 1964 and EN-15767-1
- Compact size and weighs only 15 lbs. for quick deployment
- Easy open/close valve
- Strap attached with bag for easy stowing



NEW

VIDEO ONLINE

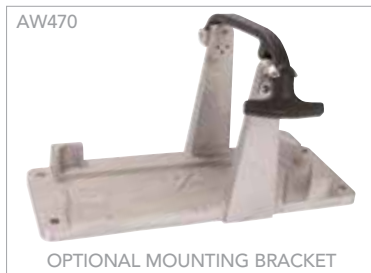

OPTIONAL MOUNTING BRACKET



AW469



AW468

AW467	Mercury Quick Attack LE Monitor	\$1,816.95
AW468	Stacked Tips	\$439.95
AW469	Mercury Adjustable Nozzle 250-375-500 gpm	\$527.95
AW470	Mounting Bracket	\$214.95

FORESTRY MONITOR

300 GPM (1140 LPM)

The Forestry Monitor is the latest addition to the Akron Brass electric monitor family. It provides an extremely rugged durable design ideal for brush and wildland firefighting. This compact monitor features a fully sealed integrated electrical control system with waterproof locking connectors for pinpoint stream positioning and accuracy. *Ship. wt. 25 lbs. (Not including nozzle.)*

- Low flow adjustable electric fog nozzle with flush 30-60-95-125 gpm
- CAN proportional speed joystick control
- Lightweight Pyrolite construction
- Integrated and sealed electronics
- Waterproof (IP 67 rated) locking connectors
- Simple "plug and play" installation
- 320° maximum rotation range with stops at +/-90°
- 135° maximum elevation range with stops at -45° and -20°
- 12v or 24v option
- Dimensions: 13⁷/₁₆" H x 11⁹/₁₆" W x 8²⁹/₃₂" D
- Inlet: 2"
- Outlet: 1¹/₂"



SPECIFY: 12v or 24v Monitor

BK395	Forestry Monitor	\$5,409.95
BL693	2" Electrically Actuated Valve with 2" NPTF	\$1,387.95

APOLLO™ 2-INLET MONITOR

This lightweight, portable monitor (36 lbs. without tube and tip) can be either truck mounted as a deck mount or quickly removed and used remotely from the truck. Rugged Pyrolite® construction with 3" waterway and (2) 2¹/₂" clappered, swivel inlets (3" available upon request). Rated at 1250 gpm (deck flow), it allows less than 10 psi pressure loss @ 800 gpm. Comes with 3" flange for deck mount units. Available with or without tube and tips or with a master stream nozzle. *Ship. wt. 36 lbs.*

- 360° rotation when mounted in the deck mode, 180° in the portable mode
- Vertical travel from 80° above to 15° below horizontal with built-in 35° safety stop
- 3" waterway with cast-in turning vanes for efficient flow
- Direct mount - A combination 3" NPT female and 3" flange
- Carbide spikes for extended wear
- 1000 gpm monitor

NEW LOW PRICE



Y310	Apollo™ Deck/Portable Monitor with Tube and Tips	\$4,080.95
AC980	Apollo™ Portable Monitor with Tube and Tips	\$3,758.95
AC984	Apollo™ Portable Monitor without Tube and Tips	\$3,025.95
AC982	Apollo™ Portable Monitor, with 1000 gpm Automatic Nozzle	\$4,082.95

BLITZFORCE PORTABLE MONITOR

The BlitzForce is Task Force Tips' innovative, lightweight, and highly versatile portable attack monitor. Rated up to 500 gpm with either a combination nozzle or stacked tips, BlitzForce integrates a low loss waterway with positive locking valve control, and a corrosion preventing anodized and powder coat finish. An exclusive high strength tie-down strap and carbide tipped folding legs offer extreme stability in varying fire environments. With an integral stream shaper for superior reach and penetration performance, the BlitzForce delivers a 20° side to side and a 20° to 60° up and down range of stream motion. 5-year warranty and Apparatus Storage bracket are standard.

- Stores securely for a rapid deployment in a space of only 19" x 9" x 12"
- Full flow 2" waterway provides 500gpm initial attack flows with only 9psi loss
- High strength folding aluminum alloy legs
- Horizontal rotation of 20° either side of the center and an elevation range of 30-60° in unmanned mode, or a low 20° angle when manned, the BlitzForce provides amazing operational versatility
- Each monitor is produced from hard coat anodized aluminum alloy, stainless steel, and is powder coated for maximum corrosion and abrasion resistance



BL087	BlitzForce Portable Monitor ZN Combination	\$1,680.95
BL088	BlitzForce Portable Monitor Stacked Tips	\$1,680.95

RAM XD MONITOR

NOW WITH 14° LOWER ATTACK ANGLE



The improved RAM XD features enhancements from the standard RAM monitor specifically designed for eXtreme Duty Use, or XD. The most significant enhancement is a new lower attack angle of 14°. It still features the largest deployed footprint of any portable monitor and only 9 psi friction loss at the rated 500 gpm flow at only 75 psi! The standard hydraulic safety system automatically increases down force under conditions that normally limit stability.

- Industry leading stability and safety
- Designed for unmanned operation



14° LOWER ATTACK ANGLE



BN409	RAM XD Monitor	\$2,381.95
BB104	RAN (Rapid Attack Nozzle)	\$547.95
BB105	Mounting Bracket (Not Shown)	\$172.95
BB106	Triple Stacked Tips	\$340.95
BB107	Deluge Tip	\$215.95
BB108	Stream Shaper (For Stacked and Deluge Tips Only)	\$178.95

BRUSHHAWK ELECTRIC MONITOR

FLOW RATES UP TO 500 GPM (2000 LPM)

With a small swing radius and low stow height, the BrushHawk is the most compact monitor in its class. Perfect for limited bumper space on brush and wildland trucks while also improving field of vision. Utilizing CANbus control, the BrushHawk comes with a proportional joystick controller that provides monitor controls for up/down/left/right and nozzle fog/stream controls. The joystick also includes on/off and trigger control for the optional valve kit. No intermediate junction box is required between the joystick and monitor, streamlining installation and space requirements.

FEATURES:

- Designed specifically for wildland and quick attack firefighting
- Simple plug and play with full CANbus communication
- Field adjustable vertical and horizontal electronic stops
- Fully proportional joystick includes all monitor controls including trigger for water valve control
- Electronics are located and sealed within monitor body - no separate module required

SPECIFICATIONS:

- Inlet: 1.5" and 2.0" FNPT
- Outlet: 1.5" MNHT
- Vertical Travel: -30°/+90° or -45°/+45°
- Horizontal: Left 175°/Right 175° or Left 90°/Right 90°
- Swing Radius: 6.9" (175mm)
- Stow Height: 11.2" (285 mm)
- Weight: 13.5 lbs. (6.1 kg)

NEW



BP350	BrushHawk Electric Monitor Package - Includes Joystick	\$6,795.95
-------	--------------------------------------------------------	------------



SIDEWINDER® EXM MONITOR

The Sidewinder® EXM is a complete monitor with an integrated control box, ready for 2-wire connection to any other EXM enabled component. It is ideal for front bumper applications and can be controlled via joystick. Its compact, elliptical waterway delivers up to 700 gpm. As standard, enabled for either wired or wireless EXM network connection. Motors NEMA 4 rated, 11-27 VDC power. Inlet: 2.5" F NPT or 2.5" F BSPP. Outlet: 2.5" NHT & BSPP.

- Ideal for front bumper installations
- 135° vertical travel; 350° horizontal travel
- EXM Technology-plug and play J1939 CAN Bus network

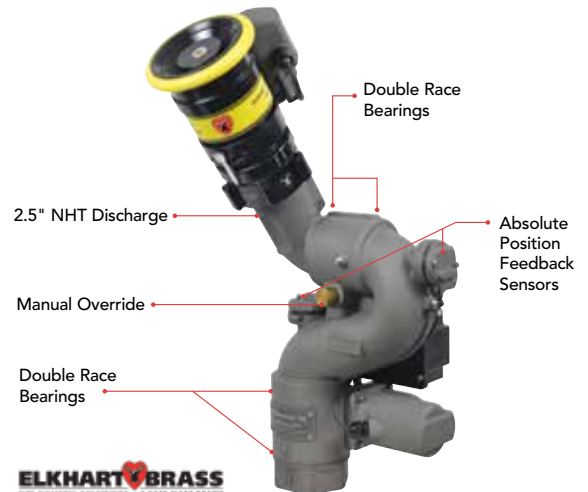

BN418	The Sidewinder® EXM 2.5" NPT/NHT, Monitor Only	\$4,769.95
BN419	Panel Mount Controller	\$1,054.95
BN420	Joystick Controller	\$2,645.95



EF1 REMOTE CONTROL MONITOR

TFT'S MOST COMPACT MONITOR WITH FLOWS UP TO 200GPM

The EF1 remotely controlled monitor is a great option for wildland and interface apparatus. At less than 13" (319mm) tall, the EF1 is an ideal forestry bumper turret. The EF1 is hard-coated aluminum alloy which is then powder coated inside and out. All electronics are tightly contained in a sealed control box that is part of the monitor casting. Monitor wiring is reduced to a minimum and installs easily using a one plug connection.



BP036	EF1 RC 1 1/2" NPTF X 1 1/2" M	\$3,674.95
BP037	EF1 RC 2" NPTF X 1 1/2" M	\$3,674.95
BP038	ER Bubble Cup Tip	\$869.95
BP039	Joystick Operator Station	\$1,088.95



BP039



CROSSFIRE® MASTER STREAM APPLIANCE

Crossfire® utilizes the Safe-Tak valve to help ensure firefighter safety. It's a lever-operated butterfly valve connected to a foot on the base of the monitor. In normal operation, the valve is open allowing maximum flow of 1,250 gpm. However, should the monitor start to tip for any reason, the valve closes, cutting the flow area by 90% and reducing the reaction force. By not closing completely, it allows a continued flow, minimizing water hammer. Take a look at all the great features of the Crossfire®. Features include safety plunger, high-visibility gauge, multiple inlets (double 2 1/2" or single 3", 3 1/2", 4", 4 1/2" NST, 4" or 5" Storz), rotational lock lever, quick connect base, stainless steel legs with carbide-tipped spikes, automatic drain and safety strap. *Ship. wt. 50 lbs.*



5-YEAR WARRANTY

SPECIFY INLET SIZE

AF249	Crossfire® Monitor with Stack Tips	\$3,688.95
AF250	Crossfire® Monitor with M-R Nozzle	\$3,868.95

PERMANENT MOUNT STATION MONITORS

Station monitors were specifically designed to meet all the needs of municipal and industrial applications. The balanced, full flow, seamless, 2 1/2" single waterway configuration reduces friction loss, improving streams and distance. Operates easily at all pressure ranges. 140° vertical, 360° horizontal (750 gpm); 140° vertical, 360° horizontal (1200 gpm). Carbon steel construction with stainless steel discharge and Zerk fittings for lubrication. Your choice of permanent mount tiller bar or steering wheel handle. Red epoxy finish inside and out for effective corrosion resistance. 3" flange base. *Ship. wt. 50 lbs.*

2 1/2", 3" OR 4" INLET

- Less friction loss
- Single waterway
- Carbon steel construction
- Stainless steel discharge
- Balanced flow design
- 2 1/2", 3" or 4" waterways

SPECIFY INLET SIZE

AB079	Station Monitor, 750 gpm, with Tiller Bar	\$1,219.95
AB080	Station Monitor, 750 gpm with Steering Wheel	\$1,209.95
AJ092	Station Monitor, 750 gpm with Tiller-Short Radius	\$962.95



HOSE

DARLEY 800 HOSE POLYESTER DOUBLE JACKET 800 PSI HOSE

NFPA 1961

- Designed specifically for the toughest fire fighting jobs
- Long-lasting synthetic rubber lining and rugged double jacket construction
- Jackets are woven from the finest high-tensile
- 100% polyester yarn
- Tight weave in both jackets mean no drying is required
- Mildew resistant
- First choice of many fire departments and industrial users
- Color: White



10-YEAR WARRANTY

HOW TO ORDER DARLEY 800 OR CORD HOSE

Length: All hose will be shipped in 50' lengths. 75' or 100' lengths are also available (call for pricing).

Couplings: All hose will be shipped with hard-coated, lightweight, rocker lug couplings, unless otherwise specified (brass couplings available for an additional charge).

Threads: NST (NH) threads are standard. IPT (NPSH) available at no additional charge (other threads available for \$5.00 per set).

Cat#	Hose Size	Test Pressure	Annual Service Test	Weight per 50' Coupled	Price per 50' Coupled
R755	1 1/2"	800 psi	400 psi	18 lbs.	\$96.95
T410	1 3/4"	800 psi	400 psi	19 lbs.	\$113.95
R757	2 1/2"	800 psi	400 psi	32 lbs.	\$156.95
R758	3"	800 psi	400 psi	40 lbs.	\$218.95

3" Standard: 3" x 2 1/2" NH

DARLEY CORD HOSE

ALL-POLYESTER DOUBLE JACKET 800 PSI HI-TECH POLYMER IMPREGNATION HOSE

NFPA 1961

Darley - Cord 800 is a unique attack-grade fire hose, developed specifically for the rigorous environment of fire department use.

- All-polyester double jacket construction
- Ozone-resistant, high-tensile synthetic rubber liner
- Most advanced fire hose in the industry
- Lightweight and extremely durable
- Outside jacket is thoroughly impregnated with a heat-set High-Tech Polymer, providing durability and ease of maintenance (superior to Hypalon)
- Completely immune to any effects of mildew

SPECIFY COLOR:

Black, Blue, Orange, Red, Tan or Yellow



Cat#	Hose Size	Test Pressure	Annual Service Test	Weight per 50' Coupled	Price per 50' Coupled
U273	1 1/2"	800 psi	400 psi	18 lbs.	\$120.95
U275	1 3/4"	800 psi	400 psi	19 lbs.	\$140.95
U276	2 1/2"	800 psi	400 psi	32 lbs.	\$190.95
W109	3"	800 psi	400 psi	40 lbs.	\$259.95

3" Standard: 3" x 2 1/2" NH



MAGNUM 800-NYLON HOSE

This double jacket attack hose is manufactured using tightly woven entangled filament nylon 6.6 yarns in both the inner and outer jackets to promote abrasion resistance and kink-resistance. With higher tensile strength than that of polyester, the Magnum 800 is designed for aggressive fire department use.

- 100% all synthetic entangled NYLON 6.6 Tube
- EPDM rubber lined for the best ozone resistance

Hose Size	Weight 50' Coupled	Annual Service Test Press.	Hose Size Test Press.
1 3/4"	18 lbs.	400 psi	800 psi
2 1/2"	28 lbs.	400 psi	800 psi



Yellow Orange

SPECIFY COLOR: Yellow or Orange

BH092	1 3/4" x 50' Magnum 800 Hose	\$155.95
BH093	2 1/2" x 50' Magnum 800 Hose	\$211.95

LIGHTWEIGHT DOUBLE JACKET POLYESTER HOSE

BACKED BY A 10-YEAR WARRANTY

- 100% synthetic all polyester double jacket
- 100% mildew resistant
- Thin wall high tensile EPDM rubber liner
- UL listed
- Couplings: 1½"-3" NST, 4"-5" Storz
- Packs tighter
- 25% lighter
- 10-year warranty
- Made in the USA

NFPA 1961

HOSE



Eco-10 hose

SPECIFY COLOR: Red, Orange, Blue, Yellow, or White



		White	Colored
BL283	Eco-10 1½" x 50' Hose	\$85.95	\$101.95
BL284	Eco-10 1¾" x 50' Hose	\$97.95	\$123.95
BL286	Eco-10 2½" x 50' Hose	\$138.95	\$157.95
BL287	Eco-10 3" x 50' Hose	\$201.95	\$221.95

Lightweight DJ Rubber-Lined Supply Hose

BL621 SPECIFY Color: Red, Orange, Blue, Yellow, or White

50' 100'

BL621	4" with Alum Storz Coupling	\$379.95	\$599.95
BL622	5" with Alum Storz Coupling	\$455.95	\$724.95

TRU-ID HOSE

Introducing TRU-ID, the first and only true internal diameter hose specifically designed for combat fire fighting. Classic performance in an innovative design and rugged construction guaranteed to withstand the rigors of the fire ground. TRU-ID comes standard with lightweight, laser engraved, extruded aluminum alloy couplings. These anodized, threaded expansion ring couplings are guaranteed for the life of the hose. Virtually kink resistant, TRU-ID handlines are designed for use with low pressure/high volume nozzles built to reduce hose whip and optimize friction loss, all while delivering targeted flow rates, guaranteed. Seize the power of targeted flows with command and control performance, specify TRU-ID. Backed by a 10-year warranty.

NFPA 1961



FEATURES:

- True internal diameters
- Available diameters: 1¾", 2¼", and 2½"
- Heavy duty EPDM rubber liner
- Lightweight 100% polyester double jacket
- Heavy duty EPDM rubber liner
- Mildew resistant
- Comes standard with light weight, laser engraved, extruded aluminum alloy couplings



SPECIFY COLOR: Red, Orange, Blue, Yellow, Black, Tan, Clear Coat, or Green

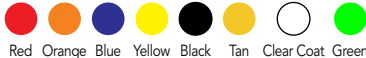

BP169	TRU-ID 1.75" x 50'	\$188.95
-------	--------------------	----------

SPECIFY COLOR: Red, Orange, Blue, Yellow, Black, Tan, Clear Coat, or Green

BP170	TRU-ID 2.25" x 50'	\$284.95
-------	--------------------	----------

SPECIFY COLOR: Red, Orange, Blue, Yellow, Black, Tan, Clear Coat, or Green

BP171	TRU-ID 2.5" x 50'	\$299.95
-------	-------------------	----------



COMBAT READY HOSE

This hose is designed specifically for aggressive interior fire attack operations. The outer jacket is woven from staple polyester yarns over an inner liner consisting of a one-piece extruded through-the-weave tube. Combat Ready is manufactured in a high-visibility white with one red and one blue stripe running the length of the hose. This heat-resistant, drag-resistant, ozone-resistant and kink-resistant hose has superior friction loss characteristics. *Ship. wt. 18-26 lbs.*

NFPA 1961



- Abrasion-resistant
- High visibility
- 10-year warranty
- Low friction loss



Cat#	Hose Diameter	Service Pressure	Acceptance Pressure	Weight Per 50' Coupled	Price Per 50' Coupled
AS322	1¾"	500 psi	1000 psi	18 lbs.	\$272.95
AS323	2½"	500 psi	1000 psi	26 lbs.	\$352.95

NFPA 1961

DARLEY EXTRUDED RUBBER ATTACK HOSE

Darley Extruded Rubber Attack Hose is specially formulated with a rubber compound that provides a tough cover that resists tear and abrasion, snags, hot embers, cuts and most chemicals.



SPECIFY COLOR: Refer to chart below

Cat#	Size	Colors Available	Price		
			100' Coupled	50' Coupled	25' Coupled
AC659	1"	Yellow Only	\$220.95	\$124.95	\$76.95
AC665	1½"	Blue, Black, Red, Yellow	\$261.95	\$137.95	\$85.95
AC666	1¾"	Blue, Green, Orange, Red, Yellow	\$296.95	\$156.95	\$99.95
AC667	2"	Blue, Red, Yellow	\$346.95	\$201.95	\$128.95
AC668	2½"	Blue, Orange, Red, Yellow	\$394.95	\$194.95	\$130.95
AC669	3"	Blue, Green, Red, Yellow	\$469.95	\$259.95	\$171.95

DARLEY HI-RISE HOSE

Lightweight hose ideal for high-rise packs. At about half the weight of standard double jacketed hose, it is easier and less stressful to carry up stairs. Made of 100% synthetic nylon and completely protected by an abrasion and chemical-resistant orange colored nitrile rubber cover. 1¾" size is coupled with 1½" NST lightweight anodized couplings standard. Tensile strength of 2000 psi. 50' of Darley Hi-Rise Hose coils to only 10". 5-year warranty. Color: Hi-visibility orange.



Cat#	Hose Size	50'	75'	100'
AM104	1¾"	\$161.95	\$230.95	\$338.95
BH087	2½"	\$209.95	\$292.95	\$375.95

NFPA 1961

DARLEY LARGE DIAMETER HOSE (L.D.H.)

Uncoupled hose available - pricing upon request.
SPECIFY NST with Rocker Lug or Storz Coupling
SPECIFY COLOR: Red, Orange, Blue, or Yellow



Cat#	Size	Price		
		100' Coupled	50' Coupled	25' Coupled
AC670	4"	\$527.95	\$350.95	\$281.95
AC671	5"	\$630.95	\$413.95	\$329.95
BH005	6"	\$1,133.95	\$769.95	\$587.95

NFPA 1961

SUPPLYLINE™ HOSE

Double jacket all-polyester hose intended to transfer large volumes of water with minimal friction loss. Lightweight and compact, occupies less space than conventional rubber-covered LDH. Flexible to -60°F. Construction: circular woven, double jacket, 100% virgin spun polyester. Tube: Extruded T.P.U. elastomer - ozone and age resistant.



Hose Size	Threaded Bowl Size	Weight 100' Uncpld.	Proof Press.	Service Test Press.	Burst Press.
4"	4¾"	68 lbs.	600 PSIG	300 PSIG	900 PSIG
5"	5¾"	84 lbs.	600 PSIG	300 PSIG	900 PSIG

Hose comes with Storz coupling		25'	50'	100'
BB109	4" SUPPLYLINE™ Hose with Encap Treatment	\$338.95	\$469.95	\$725.95
BB110	5" SUPPLYLINE™ Hose with Encap Treatment	\$463.95	\$599.95	\$943.95

SPEC 187 FORESTRY HOSE

Extremely lightweight all synthetic forestry hose which meets or exceeds all USDA Spec 187 TYPE 2 specifications. This all polyester polyurethane lined fire hose is super light weight, however designed for everyday fire department use. Available in either yellow (according to TYPE 2 spec) or white. Construction: Circular bias woven, single jacket, 100% all polyester. Tube: Extruded TPU—ozone and age resistant. 300 psi service test.



White Yellow

SPECIFY COLOR: White or Yellow		50'	100'
BH088	1" White SPEC 187 Type 2 Hose	\$70.95	\$113.95
BH089	1 1/2" White SPEC 187 Type 2 Hose	\$73.95	\$120.95
BH090	1" Yellow SPEC 187 Type 2 Hose	\$83.95	\$140.95
BH091	1 1/2" Yellow SPEC 187 Type 2 Hose	\$88.95	\$149.95



RACK HOSE™

All-polyester single jacket interior protection hose for buildings and plants. Lightweight and compact, replaces unlined linen foot for foot. Approximately half the weight of standard rubber lined single jacket hose. Construction: Single jacket, all-virgin filament polyester, circular plain weave. Tube: Extruded T.P.U. elastomer - ozone and age resistant. 250 psi service test.



		50'	75'	100'
AS176	1 1/2" Rack Hose™ with Brass NST Couplings	\$67.95	\$89.95	\$110.95
AS177	2 1/2" Rack Hose™ with Alum. NST Couplings	\$231.95	\$295.95	\$369.95

BOOST YOUR ON-SCENE EFFECTIVENESS

A. DARLEY BOOSTER HOSE

For service pumpers we recommend our BG280 and BG281 Booster Hose. It assures all around dependable service and years of trouble-free use. Couplings come in aluminum pin hole. NST.

Other threads available. Call for pricing.

Cat#	Inside Diameter	PSI	50'	100'
BG280	3/4"	800	\$266.95	\$448.95
BG281	1"	800	\$343.95	\$527.95
BK222	1 1/2"	200	\$218.95	\$427.95



B. LIGHTWEIGHT BOOSTER HOSE



- Lightweight, kink resistant, non collapsible
- Equipped with full flow expansion ring and 1" lightweight aluminum RTC (pin hole) couplings
- Single jacket, 1005 high tensile strength virgin polyester yarns; smooth TPU lining ensures the minimum friction for maximum flow
- Highly resistant to ozone abrasion, offering outstanding low temperature performance, excellent mechanical properties, and as good resistance to oil and grease
- 300 psi service pressure

		50'	100'
BL385	1" Booster Hose w/Repairable Couplings	\$216.95	\$440.95

C. LIGHTWEIGHT BOOSTER HOSE

- 400 psi service test pressure
- Half the weight of other brands of booster hose
- Fits standard reels without kinking (4 1/2" radius)
- Non-collapsible rigid booster reel hose
- Single jacket with yellow Yermatex® treatment
- Polyurethane lined yielding low friction loss and easy handling

COUPLINGS

- BD113 Coupling - Aluminum 1"x11/16" NH forestry pin hole set
- BD114 Coupling - Aluminum 1"x19/32" NH R/L

Cat#	Description	50'	100'
BD113	3/4" Yellow Hose with Coupling	\$184.95	\$324.95
BD114	1" Yellow Hose with Coupling	\$189.95	\$359.95

SEE PAGE 164 FOR BOOSTER REELS





4"X10', 4 1/2"X10', 5"X10', & 6"X10'

DARLEY CLEAR PVC SUCTION HOSE LIGHTWEIGHT - TIGHT BEND RADIUS

This lightweight suction hose can be easily handled by one firefighter. Black ridged helix (1 1/2"x10' and 2 1/2"x10' are white/clear) and smooth bore give this hose unrestricted flow. Clear flexible connector web allows for visual monitoring of incoming water. Sold standard in 10-foot lengths, coupled. NST threads standard. *Ship. wt. 45 lbs.*

- Operates in extreme temperatures
- Sold complete with end couplings
- For drafting only



1 1/2"X10', 2 1/2"X10', & 3"X10'
ARE WHITE/CLEAR RIDGED HELIX

AA841 Specify Size:

1 1/2" x 10' RLF x RLM	\$61.95
2 1/2" x 10' RLF x RLM	\$120.95
3" x 10' RLF x RLM	\$144.95
4" x 10' LHF x RLM	\$277.95
4 1/2" x 10' LHF x RLM	\$339.95
5" x 10' LHF x RLM	\$339.95
6" x 10' LHF x RLM	\$385.95

AW135 Specify Size:

4" x 10' Storz LH	\$365.95
5" x 10' Storz LH	\$478.95
6" x 10' Storz LH	\$617.95

DARLEY HARD SUCTION HOSE

Smooth bore, hard suction hose for heavy-duty service. Meets NFPA 1961 and 1901. Comes with lightweight anodized couplings installed; long handle female x rocker lug male. *Price on request for other lengths.*



PRICE PER 10-FOOT SECTION COUPLED

Cat#	Size	Ship. Wt.	Price
T165	2 1/2"	26 lbs.	\$167.95
T166	3"	32 lbs.	\$199.95
T167	4"	46 lbs.	\$349.95
T168	4 1/2"	49 lbs.	\$462.95
T169	5"	59 lbs.	\$617.95
T170	6"	70 lbs.	\$671.95

FEMALE BASKET SUCTION STRAINER-DIFFUSER

Basket strainers provide the best performance when drafting, while reducing debris from entering a pump and provides full flow into the suction hose. This same device can be used to diffuse water when testing hydrants to diffuse the flow safely. *Ship. wt. 45 lbs.*



- Available in female sizes 2 1/2" through 6"
- NH, NST, or NPSH threads standard
- Rocker lug for easy secure tightening
- Includes flat face gasket

FEMALE BASKET SUCTION STRAINER-DIFFUSER

Cat#	Size	Price
BP184	2 1/2"	\$131.95
BP185	3"	\$136.95
BP186	4"	\$156.95
BP187	4 1/2"	\$162.95
BP188	5"	\$162.95
BP189	6"	\$213.95



BARREL STRAINERS

Bottom and bronze inlet are welded into one unit. Cylindrical holes provide a greater area of entrance for the water and allow full capacity pumping. *Made of coated aluminum. NST threads. Ship. wt. 7 lbs.*

	2 1/2"	3"	4"	4 1/2"	5"	6"
AM107	\$124.95	\$132.95	\$168.95	\$193.95	\$193.95	\$193.95

FOOT VALVE BARREL STRAINERS

Opens and closes automatically when you start and stop drafting water. Allows full flow for capacity but when you stop pumping it closes instantly and keeps the pump primed by preventing water from flowing out. Complete with eyebolt for rope. *Made of coated aluminum. NST threads. Prices on request for other threads. Ship. wt. 28 lbs.*

	2 1/2"	3"	4"	4 1/2"	5"	6"
AM106	\$240.95	\$258.95	\$267.95	\$267.95	\$360.95	\$360.95



HIGH-RISE HOSE STRAP

Strap consists of 4 quick release color-coded Velcro® brand closures for a range of carry options. U-Shaped design keeps hose center of gravity close to your own for better balance and mobility.

- Carry up to 100 ft. of hose
- 4 heavy-duty nylon straps cinch the hose tight
- Carry over SCBA or shoulder for hands-free movement
- Allows for fast movement in narrow spaces
- Color-Coded Reflective Trim: Silver marks the nozzle
- U-Shaped Design: Keeps hose center of gravity close to your own



BB065 High-Rise Hose Strap

\$76.95

A. THE CLEVELAND HOSE GRIP

The Cleveland Hose Grip is a clever hose pack that is designed to easily deploy in tight spaces while eliminating hose kinking. Minimal man power is required to deploy the hose. Made of 2" nylon webbing with 2" Nexus quick side release buckles that are easily released with your gloves on. There is a looped end for cinching up and removable shoulder strap for easy carrying. The grip holds 100' of 1 3/4" hose with the nozzle attached. The Cleveland Hose Grip is designed for a stand pipe operation or to be connected to an existing line with a gated wye. Color: Royal Blue. Weight: 1 1/2 lbs.



BN212 The Cleveland Hose Grip

\$79.95

B. GRIPPER HOSE SYSTEM AN EFFECTIVE WAY OF TRANSPORTING HOSE

The Gripper Hose System consists of three heavy duty nylon straps, with a padded shoulder sling, all sewn together to create a hose harness. The gripper has a padded high visibility shoulder sling, with three 2" wide, 42" long, 3000 pound strength webbing to secure the hose and carries 150' of 1 3/4" hose. Utilizes cam buckles and torque rings and is easily opened with a gloved hand. The 42" long straps have the capacity to hold more hose than the average firefighter can carry. *Ship. wt. 4 lbs.*



AF151 Gripper Hose System

\$149.95

C. HOSE VICE CARRY MORE HOSE EASIER

The Hose Vice is the latest in the evolution of our hose carrying systems. This product incorporates many ideas given to us by our customers. Features include: an updated shoulder strap, which is adjustable and removable. The shoulder strap is long enough that a firefighter can carry the bundle across the body for better balance. Two fire-fighters can also carry The Hose Vice. Handles have been incorporated into the ends of the four straps, along with two molded rubber grips on top. The overall length is 35" and each strap has an adjustable circumference range of 20" - 38". Capacity is 150 OR 200' of 1 3/4" hose as shown. 3M reflective has been added to increase visibility. Made in the USA. *Ship. wt. 3 lbs.*



AK187 Hose Vice

\$255.95

LARGE DIAMETER HOSE STRAP

The Large Diameter Hose Strap (LDHS) assists in getting large diameter hose off the hose bed for attachment to a water source safely and allows the engine to proceed for fire operations. Constructed of 3" nylon webbing, with a tensile strength of 22,550 lbs. Strong stitching with heavy brass rivets give you long life. This device allows the firefighter to pull the hose off the rig and place it over a hydrant with additional hose secured with the hook & loop strap, with plenty of spare hose for attachment. Also works great for tanker operations to secure the hose with a heavy hook & loop closure with a zinc-plated adjuster, allowing for additional hose for hydrant operations. Tab allows for operations with heavy firefighting gloves. When used in conjunction with the Oversized Hydrant Tool Kit or the Tool Bag, the firefighter has everything needed to complete efficient and safe hydrant operations. *Color: yellow, length: 60", weight: 32 oz. Ship. wt. 5 lbs.*

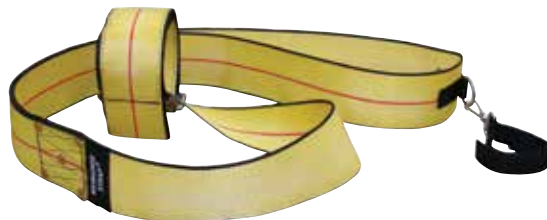

BG151 Large Diameter Hose Strap

\$65.95

PICK THE RIGHT WRENCH FOR THE JOB

A. BL889: Wrench will accommodate pentagon heads to 1 $\frac{7}{8}$ " and square heads to 1 $\frac{1}{2}$ ". Double spanner head is designed to fit $\frac{3}{4}$ " through 6 rocker lug or pin lug fittings. Jaw is replaceable. Length is 19 $\frac{1}{2}$ ". *Ship. wt. 5 lbs.*

B. E119: Malleable iron, cadmium plated hydrant wrench adjusts to pentagon nuts from 1 $\frac{1}{4}$ " to 1 $\frac{3}{4}$ " or square nuts to 1 $\frac{1}{4}$ ". Fits couplings from 1 $\frac{1}{2}$ " to 6". *Ship. wt. 5 lbs.*

C. C285: Zinc plated ductile iron head and $\frac{7}{8}$ " steel handle. Opening accepts any pentagon nut up to 1 $\frac{3}{4}$ " or 1 $\frac{1}{4}$ " square nut. Fits 2 $\frac{1}{2}$ " pin or rocker lug. *Ship. wt. 5 lbs.*



BL889	Adjustable Hydrant Wrench w/Double Spanner Head	\$56.95
E119	Hydrant Wrench	\$27.95
C285	Hydrant Wrench	\$38.95

DARLEY HYDRANT STRAP

NEVER LOSE YOUR TOOLS

The Hydrant Strap increases the speed and safety of your hydrant hook-ups. The complete Hydrant Strap includes a six-foot loop of heavy-duty nylon webbing fastened to the end of your supply or suction line by a three-foot hose strap. The hose strap is made from seat belt material with a seat belt type buckle. Attached to the hose strap is a tool pouch containing the tools needed for hydrant hook-up. The firefighter stands on the ground and pulls the Hydrant Strap fastened to the end of the supply line in the hose bed and loops the strap over the hydrant. The engine can then lay the hose line. After the hose lay is finished, it is simply unbuckled. *Ship. wt. 1 lb. without tools.*

AC961:

- Hydrant wrench
- 2 - Spanner wrenches for rocker lug couplings

AC962:

- Hydrant wrench
- 2 - Spanner wrenches for 4" or 5" Storz

AC960	Hydrant Strap without Tools	\$54.95
AC961	Hydrant Strap with Tools	\$97.95
AC962	Hydrant Strap with Tools	\$97.95



HYDRANT BAG

A large 22 oz. vinyl bag designed to hold all of the equipment you need for a hydrant operation. The Velcro® closure on top allows for quick access with your gloves on. This bag will hold large gated valves, wyes, wrenches, reducers, etc. A high density padded bottom helps to protect equipment. The molded TUFF bottom provides an almost indestructible base. *Dimensions: 24" Lx12" Wx9" H.*



BL628	Hydrant Bag	\$122.95
-------	-------------	----------

SUPER SPANNER WRENCH

Fits any standard 4" and 5" Storz or locking type Storz coupling on one end; the other end fits 1½" to 3" rocker lug type fire hose couplings. Use the center slot as a gas shutoff. Wrench set includes 4 Super Spanner Wrenches and Mounting Plate. *Ship. wt. 1-7 lbs.*

BN581	Super Spanner Wrench	\$23.95
BN582	Super Spanner Holder	\$53.95
BN583	Super Spanner Wrench Set	\$147.95



DARLEY STORZ SPANNER WRENCH SET

Wrench set includes your choice of 2 or 4 Storz Spanner Wrenches mounted on a cast aluminum holder base plate. Holder is powder-coated for corrosion resistance and surface-mountable. Wrenches are made of a lightweight aluminum casting with comfortable grip for 4"-5" Storz connections. *Ship. wt. 2 lbs. (4 wrench set).*

INCLUDES:

- BK374: 1 wrench
- BK375: 2 wrenches and holder
- BK376: 4 wrenches and holder



BK374	Spanner Wrench 4" - 5"	\$17.95
BK375	Double Storz Wrench Set	\$79.95
BK376	Quad Storz Spanner Wrench Set	\$96.95



WRENCH HOLDER SET

Mounts on apparatus for easy accessibility. Convenient, snap action aluminum holder complete with two spanners for any style or size coupling from 1¼" to 4". Also includes an adjustable hydrant wrench for pentagon nuts up to 1¾" or square nuts to 1¼". Hydrant wrench fits 2½" couplings. Ductile iron zinc plated head. Handle is steel zinc plated. *Ship. wt. 9 lbs.*

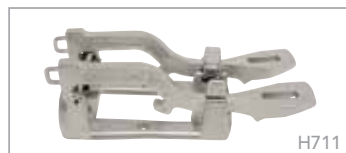

H711	Holder w/2 Spanner Wrenches	\$66.95
L780	Holder w/2 Spanner Wrenches & Hydrant Wrench	\$97.95

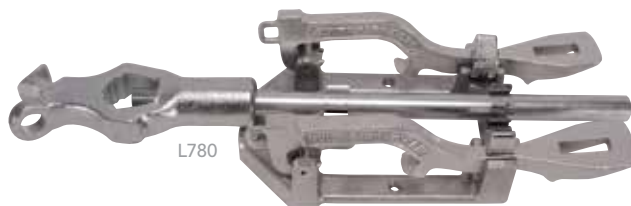

BOWRING PERSONAL FIREFIGHTER TOOL

The Bowering firefighting tool is 8.1" tall 5.9" wide .375" thick and weighs 22oz, so it easily fits into a firefighters bunker pants. It is made of 17-4 steel and incredibly strong with no plastic or moving parts.

- Hose advancement
- RIT firefighter drag
- High-rise tool (use as a cheater-bar, standpipe wheel, spanner wrench)
- Gas shutoff
- Windshield removal and glass ripper
- O2 wrench
- Door wedge
- Nance drill - Denver drill
- Water shutoff
- Mattress hook
- Forcible entry tool
- Spanner wrench (fits pin lugs, rocker-lugs, and storz lugs)
- Gypsum board ripper (cleanly rips through while looking for hot spots)



BL240	Bowering Personal Firefighter Tool	\$124.95
-------	------------------------------------	----------

BEST
SELLER

DARLEY SPANNER WRENCH

Lightweight aluminum spanner. Includes belt hook eye, hammer head and gas cock shut-off. Fits couplings from $\frac{3}{4}$ " to 4". *Ship. wt. 1 lb.*

B397 Darley Spanner Wrench

\$15.95

DOUBLE END SPANNER WRENCH

Double end hole type spanner, fits $\frac{3}{4}$ " and 1" booster hose couplings and $2\frac{1}{2}$ " hole type fittings. *Ship. wt. 1 lb.*

L800 Double End Spanner Wrench

\$18.95

FOLDING SPANNER WRENCH/BELT RING

Ultra-light non-sparking folding spanner with extra wide pry end, and gas shut-off. Fits couplings from $\frac{3}{4}$ " to 6" *Ship. wt. 1 lb.*

AZ357 Folding Spanner Wrench/Belt Ring

\$41.95

PREMIUM QUALITY SPANNER WRENCH

It's made from aerospace alloy aluminum. This means it's ultra-light and super strong. Plus, because it is non-sparking, it's safe to use in hazardous situations. You'll never go wrong with the best. Compatible with most brackets. Fits up to $31\frac{1}{2}$ " couplings, has gas cock shutoff. *Ship. wt. 1 lb.*



AJ281 Premium Quality Spanner Wrench

\$26.95

WELLZ TOOL™

When shopping for firefighter forcible entry tools, your department won't find a more versatile personal carry tool than the Wellz Tool™. This multi-use tool is small enough to fit into a responder's pocket, while its folding design provides a number of essential uses. The folding handle can be angled 90° to block hinges, 135° to breach doors, 0° to utilize built-in tools and 270° to create a different prying vantage. *Dimensions: 4.3"Hx7.5"Wx9.5"L. Ship. wt. 4 lbs.*

- **Teflon-Coated Shaft:** Provides smooth actuation
- **Knurled Finger Nut:** Tightens and locks tool into varying positions
- **Hydrant Socket:** Makes this the most versatile forcible entry tool
- **7075 Anodized-Hardened Aluminum Hook Plate:** Breaches doors
- **Shoulder Bolt:** Acts as a durable hinge in this foldable design
- **Open:** 2"Hx14"L, **Closed:** 2"Hx7.5"L



BL758 WELLZ Tool™

\$149.95

HYDRANT WRENCH

- Fits hydrant stems both 1" (square and pentagon) and $1\frac{1}{2}$ " (pentagon)
- Will work on worn stems
- No more adjusting, just put the open end over the hydrant stem and pull the handle, the harder you pull, the tighter the grip
- To release, just relax and lift it off the stem
- Will actually stay on the stem and not in the mud while you work
- The spanner end of the wrench is designed for use on $2\frac{1}{2}$ " and larger fittings
- **Weight:** 5 lbs.
- **Length:** 18"



BL425 Hydrant Wrench

\$90.95

RES-Q-RENCH

- Spanner wrench works with $1\frac{1}{2}$ " and $2\frac{1}{2}$ " rocker lug couplings
- Only folding spanner that works with 4" & 5" storz locking couplings
- Made from glass-reinforced nylon
- Folds compactly into your pocket
- Integrated carbide tip
- Heavy-duty seat belt cutter
- Prying tool
- 12" open; 8" close
- **Ship. wt. 1 lb.**

ROCKER LUG &
STORZ WRENCHVIDEO
ONLINE

WINDOW PUNCH



PRY TOOL



SEATBELT CUTTER



GAS SHUTOFF

AM292 Res-Q-Rench

\$22.95

EXPANSION UNITS

Complete expansion unit assembly for attaching 1" through 6" couplings. *Note: Red Head expansion units are compatible with some other manufacturers' expanders. Please specify the manufacturer and model. Ship. wt. 1 lb.*



AF202	1" with Drawbar (Pull Type)	\$515.95
AF204	1½" with Drawbar	\$448.95
AF209	1¾" with Drawbar	\$487.95
AF214	2½" with Drawbar	\$458.95
AF217	3" x 2½" with Drawbar	\$621.95
AF218	3" without Drawbar	\$515.95

BRUTE BENCH MODEL

ATTACH 1"- 6" COUPLINGS

- 3,000 lb. pump - 2,500 lbs. workable
- 1½ h.p. single phase 220V 3
- 3450 rpm motor
- Foot pedal control
- Average cycle time 13 seconds
- Cylinder - 6" stroke, 4" bore
- Manually set external pressure relief valve
- Dimensions: 22"Wx22"Dx16"H
- Total thrust 38,000 lbs.
- Oil capacity 9.5 gallons



AF201 Brute Bench Model \$7,771.95

EXPANSION RINGS

The metal used is a scientifically correct mixture which is best adapted for the purpose of giving the maximum coefficient of expansion without fracture. *Ship. wt. 1 lb.*



Cat#	O.D.	Length	Price
41602	1"	1"	\$2.95
41603	1½"	1"	\$2.95
41604	2½"	1½"	\$4.95
41605	3"	2"	\$9.95

BRUTE X-PANDER

Weighing 45 lbs. and 32% less than the Brute I, the X-Pander is perfect for in-house or mounted in a service van for field repairs. Requires 50% fewer strokes to expand and 75% fewer strokes to release than the Brute I. The X-Pander can couple from 1" through 3" couplings. *Ship. wt. 50 lbs.*

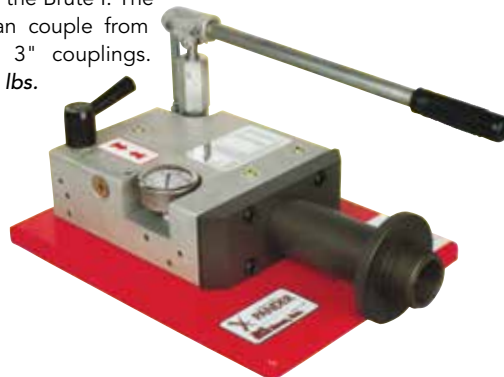

AZ356 Brute X-Pander \$3,178.95

HOSE CUTTER

- Heavy duty aluminum construction
- Powder coated for a tough, hard finish
- Easy and safe to use
- Ratchet handle raises & lowers steel blade
- Handgrips for easy transporting
- Makes clean, straight cuts
- Cuts hose up to 6"

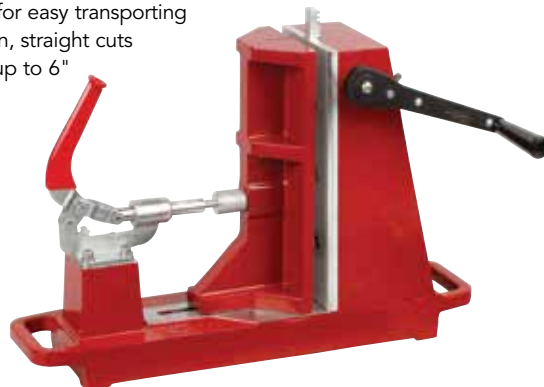

BH170 Hose Cutter \$1,426.95

NEOPRENE GASKETS

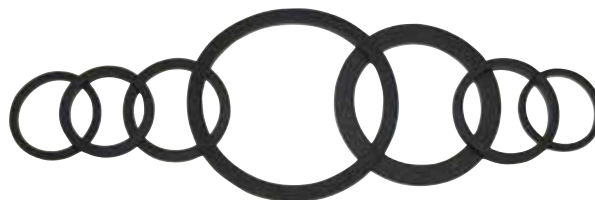

F850 Neoprene Face Gaskets, for cap and female swivels, remain fresh and resilient for years and will not swell or distort out of shape. R664 Tail Gaskets for the coupling bowl are made of a "live-liner" Neoprene to prevent "bulge out" under the expansion ring. *Ship. wt. 1 lb.*

RECOUPLING GASKETS FOR HOSE

PRICED PER DOZEN

Cat#	1½"DJ	1½"SJ	2½"DJ	2½"SJ	3"DJ	3"SJ
R664	\$11.95	\$11.95	\$17.95	\$17.95	\$25.95	\$25.95

FEMALE SWIVEL GASKETS

PRICED PER DOZEN

Cat#	¾"	1"	1½"	2½"	3"	4"	4½"	5"
F850	\$5.95	\$11.95	\$11.95	\$17.95	\$25.95	\$45.95	\$51.95	\$54.95

QUIC-BRIDGE® HOSE GUARDS



One of the most economically priced hose bridges available and requires little storage space. Made of extruded aluminum to accommodate 16" or 24" widths (5" hose). Each bridge consists of one center hose guard and two ramps; neoprene feet hold the bridge firmly in place and vehicle tires do not come into contact with the hose line. Remove one ramp and bridge can be used to jump a curb. *Ship. wt. 192 lbs.*



Sold in sets of two bridges

AM098	16" Hose Ramp	\$971.95/set
AM099	24" Hose Ramp	\$1,269.95/set

HOSE RAMPS

No rust aluminum supports up to 50,000 lb. loads. Ramps are traction ribbed and stiffened for extra strength. Other features include non-skid bottom, one piece construction and won't bend or sag. Easily stack sets for convenient transport. *Ship. wt. 90 lbs.*



Sold in sets of six 2' sections

J545	16" Hose Ramp	\$780.95/set
------	---------------	--------------

HOSE WASHER

Effective in cleaning all types of dirty and caked hoses. Simply connect to a fire hydrant or pumper (40-60 operating psi recommended) and these units will blast the hose clean of all debris. These machines operate by using water pressure to produce a conical multi-jet water stream while using no moving parts. This ensures long life and no loss of performance over time. Manufactured and assembled in USA.



AJ515 - automatic feed washer, 1.5" NST connection, AJ453 - manual feed washer, 2.5" NST connection. *Ship. wt. 15 lbs.*



AJ515	3" Max Hose Size, 1.5" NST Connection	\$566.95
AJ453	5" Max Hose Size, 2.5" NST Connection	\$1,067.95

HOSE JACKET SLEEVE

STOPS A LEAKY HOSE

Use for emergency repair of burst/leaky hose or even as an emergency adapter for the connection of two hose lines with different threads in situations where pressures do not exceed 150 psi. Made of reinforced cast Akrolite® body with molded neoprene inner liner. *Fits all 2 1/2" hose (from 2 3/4" to 3 5/16" O.D.) Measures 13" long. Red only. Ship. wt. 20 lbs.*

ISO POINTS

FOR 2 1/2" HOSE

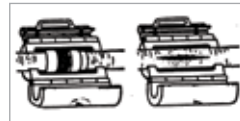

B683	Hose Jacket Sleeve	\$883.95
------	--------------------	----------

HOSE CLAMPS

HOSE SHUTOFF CLAMP

A lightweight shutoff clamp for double jacket hose up to 3". Press down on handle and the rubber jaws lock in place. Comes complete with mounting bracket. *Ship. wt. 18 lbs.*



ISO POINTS

H875	Hose Shutoff Clamp	\$635.95
------	--------------------	----------

HEBERT HOSE CLAMP

Saves time and labor when removing burst hose, relieving pressure on a line or changing fittings without damaging hose. Simple to operate and releases quickly. *Dimensions: 12 1/2" Hx15" Wx5.5" D, 6" opening. Ship. wt. 24 lbs.*



ISO POINTS

G301	Up To 3" Hose	\$271.95
G30102	Up To 6" Hose	\$454.95
G30101	Running Board Bracket	\$51.95

FIRE HOSE TESTER WITH TOOL TRAY

The Flamefighter hose tester features an industry leading design which incorporates the pump mounting position into a wrench and adapter tray keeping necessary tools sorted and off the work floor. Made specifically for use in the fire industry this unit is capable of testing up to 6" diameter hose and up to 300' per discharge. The wheeled cart is able to fit through a standard 36" doorway, is equipped with 10" tires for superior maneuverability, and features stainless steel ball valves for years of trouble free operation. Options available include 1.5" or 2.5" NST adapters for hassle free connecting. The pump is capable of pumping 4 gpm at 600 psi. This hose testing unit is manufactured and assembled in USA.



BG535	Hose Tester with Pressure Washer 1.5" NH	\$2,774.95
BL831	Hose Tester without Pressure Washer 1.5" NH	\$2,398.95
BL832	Hose Tester without Pressure Washer 2.5" NH	\$2,446.95
BL833	Hose Tester with Pressure Washer 2.5" NH	\$2,811.95

HOSE ROLLERS

REMOVE AIR & WATER EASILY FROM YOUR HOSE

Hose Rollers are designed to remove air and water from your 1½" to 5" single or double jacket hose. Heavy duty nylon rollers are durable for years of dependable service. Simply feed the hose through and walk the length of the hose. Two-person model AF155 is hinged at one end to clamp around the hose. One-person model AF154 slips over the end of the hose and the handles compress the rollers against the hose. **Ship. wt. 10 lbs.**

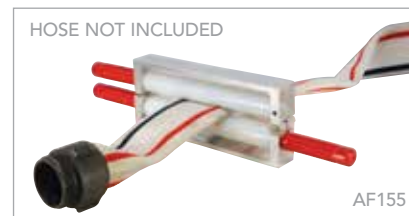

AF154	One-Person Hose Roller	\$199.95
AF155	Two-Person Hose Roller	\$152.95

HOSE HOIST

- For raising/lowering hose, ladders, etc. to and from the roof or through windows
- Akrolite™ construction



J735	Hose Hoist	\$389.95
------	------------	----------

HOSE & LADDER STRAP

Use the hose and ladder strap to advance hose, drag pre-connected hose from the truck or carry non-charged hose up a ladder. Tough nylon webbing with lightweight aluminum alloy drag handle on one end and adjustable hook end on other. Fits up to 2½" hose. **Ship. wt. 1 lb.**



M684	Hose & Ladder Strap	\$32.95
------	---------------------	---------



Y899

**BEST
SELLER**

DARLEY FLOW TEST KIT

ACCURATELY MEASURE FLOW IN HYDRANT SYSTEMS & FIRE PUMPS

Darley offers its own Flow Test Kit with several outstanding design features that make it easier to use than kits offered by others. Precise flow measurement accurately measures flows from 160-1500 gpm within 30-200 psi pitot gauge range. Reliable conversion table-flow results based on standard flow charts and proven with extensive water volume tests. Liquid-filled dial gauge 3 1/2" diameter, Grade A-1% accuracy, 0-200 psi range and vibration free readings. Tester body nozzles and swivel inlet are made of heat-treated aluminum alloy. Parts are hard-coated anodized to provide an extremely durable, protective surface. Automatic coupling design for instant and positive nozzle bore change. Renewable Brass Pitot Blade allows easy, inexpensive pitot blade replacement. Order the complete Darley Flow Test or Economy Kit. *Ship. wt. 18 lbs.*



AF328

COMPLETE FLOW TEST KIT

- Set of Six Nozzle Tips: 1", 1 1/4", 1 1/2", 1 3/4", 2" & 2 1/4"
- One - 2 1/2" NST Female swivel inlet
- Complete instructions and flow chart
- Molded plastic foam padded case

ECONOMY FLOW TEST KIT

- Choice of four nozzle tip sizes
- One - 2 1/2" NST Female swivel inlet
- Plastic tool box with tool tray



AF328 SPECIFY 4 NOZZLE TIP SIZES: 1", 1 1/4", 1 1/2", 1 3/4", 2" & 2 1/4"

Y899	Darley Flow Test Kit with Carrying Case	\$1,033.95
Y899L	Darley Flow Test Kit with Metric Conversion Card	\$1,033.95
AF328	Darley Economy Flow Test Kit	\$848.95
4408207	Replacement Pitot Blade	\$77.95
4408107	Optional 2 1/2" Nozzle	\$158.95



2 1/2" HYDRANT FLOW TEST KIT

- Includes a 2 1/2" barrel with a pitot tube positioned in the waterway and water diffuser assembly
- 3.5" liquid filled 0-160 psi (0-1100 kpa) gauge
- Supplied with flow charts for accurate measuring
- Pitot tube is positioned for accurate readings
- Large, heavy duty, black case 18 3/8" L x 14 1/4" W x 8" H

BL913	2 1/2" Hydrant Flow Test Kit	\$1,089.95
-------	------------------------------	------------

APPARATUS FLOW TEST KIT

The Apparatus Flow Test Kit includes 9 tips available to choose from, ranging from 3/4" to 2 1/2" in 1/8" increments. Please contact Darley if you wish to select different tip sizes at 1.800.4.DARLEY.

- Durable pyrolite construction
- Designed for easy operation providing highly accurate results
- 3 1/2" liquid filled 0-160 psi gauge with large, easy to read increments
- Large heavy duty carrying case
- Case Dimensions: 18 3/8" W x 14 1/4" D x 8" H
- Flow test kit comes standard with 4 tip sizes: 1 1/2", 1 3/4", 2", 2 1/4"

BL912	Apparatus Flow Test Kit	\$1,376.95
-------	-------------------------	------------



HYDRANT DIFFUSER

PROTECT PROPERTY AND VEHICLES FROM POSSIBLE WATER FORCE DAMAGE

Created to overcome the constant problem of traffic disruption and water force damage to property and vegetation in the testing area. Discharge stream velocity is slowed and redirected while flowing through a series of steel grids. The pattern diverter, on outer edge of discharge cone, directs diffused stream to side or down, depending on adjustable settings. Slots in the case inlet adapter permit a firm hold of pitot gauge against the full water force before diffusion, assuring a more accurate pitot reading. The pipe-like projection at the right serves as a handle for easy threading during hydrant attachment. Even high pressure hydrants delivering 1125 gpm are now limited to a discharge distance of 5'. Fully in accord with "Special Interest Bulletins" of the American Insurance Association. 2 1/2" NST threads. 17"Hx17"Wx29"L. *Ship. wt. 22 lbs.*



BEST SELLER

S672 Hydrant Diffuser \$560.95

DARLEY PUMP AND HYDRANT TESTING PIEZOMETER

Take pressure readings and determine the amount of water flowing from openings up to 8" in diameter with this Piezometer. Accurately reads flowing pressures to check the fire fighting efficiency of pumpers and hydrants. You may have gauges that give you the static pressure (the pressure when no water is flowing), but without the Piezometer, you cannot determine how much water can actually be delivered through the outlet with out checking the flowing or velocity pressure. Constructed of all brass tube with bleeder valve. Made to Underwriters specifications; Discharge table included. *Ship. wt. 2 lbs.*



R558	Piezometer with Gauge and Case	\$175.95
F626	Piezometer with Gauge	\$144.95
R560	Piezometer Only	\$120.95
U359	Piezometer with Liquid-Filled Gauge and Vibration-Free Performance	\$204.95

DARLEY HYDRANT FLAGS

Darley flags improve fire hydrant's visibility when covered by snow or weeds. Simply remove the 2 1/2" cap, slip on and position the flag in an upright position, then tighten cap. It's that easy. 3/8"x52" steel rod and 3"x5" flag have a powder-coated red finish. *Ship. wt. 3 lbs.*



NEW LOW PRICE



SOLD IN LOTS OF 25 OR MORE

S840	Hydrant Flags	\$9.95/ea.
	Order lots of 50 for	\$8.95/ea.

HYDRANTPRO DIFFUSER

- **New Design:** Lightweight with quality aluminum swivel adapter
- Estimates gallons flushed
- Available in 100psi/1680gpm or 160psi/2120gpm high quality liquid filled gauge
- Diffuses flow to reduce damage while flushing hydrant
- Swivels to Aim Flow - Point the flow where you want to flush
- Ruggedly constructed to provide years of dependable service
- Replaceable pressure tube assembly and ball-bearing swivel hydrant adapter



HydrantPro

BK126	2 1/2" NST HydrantPro Diffuser (100psi/1680gpm)	\$569.95
BK127	2 1/2" NST HydrantPro Diffuser (160psi/2120gpm)	\$569.95
AM163	Inner Tube for 2 1/2" Diffuser	\$38.95
BK128	Carrying Case for BK126 & BK127	\$105.95
AF331	4 1/2" NST Swivel Piezo Diffuser	\$781.95

DARLEY FIRE HYDRANT PRESSURE GAUGE

TEST STATIC PRESSURE

Shows pressure in the main or hydrant. Complete with 2 1/2" gauge, bleed-off valve and chrome-plated brass cap. Easily installed by removing the hydrant cap and screwing on the pressure gauge assembly. Rocker lugs afford an easy grip with a spanner wrench. Gauge instantly shows the static pressure in the hydrant when it is turned on. Dial pressure is 100 psi unless 200 psi is specified. Made only for 2 1/2" NST. *Ship. wt. 5 lbs.*



R530	Fire Hydrant Pressure Gauge	\$105.95
------	-----------------------------	----------

THE HOSE MONSTER®

THE SAFEST, MOST ACCURATE WAY TO TEST FIRE PUMPS, FLUSH & EVALUATE WATER SUPPLIES THROUGH HYDRANTS



The 2 1/2" Hose Monster™ utilizes a built-in-pitot and is used for hydrant flow testing, hydrant flushing, and fire pump testing. The patented design minimizes damage to landscaping and passing autos by controlling and dramatically reducing the force of flowing water. The 4" and 4 1/2" Hose Monster™ utilizes a precisely machined orifice plate and is used for hydrant flow testing, hydrant flushing, and fire pump testing. *The Hose Monster should be used with a length of hose; attachment directly to the hydrant is not recommended. Ship. wt. AK246: 27 lbs., AK248: 45 lbs.*



- **AK246:** Use for pump testing and hydrant flow testing; includes built-in pitot system
- **AK248:** Use for hydrant flow testing; includes internal orifice plate for flow rate readings



AK246	2 1/2" Hose Monster®	\$1,260.95
AK248	4 1/2" Hose Monster®	\$1,329.95

BIGBOY HOSE MONSTER™

The BigBoy Hose Monster™ is used for fire flow testing of hydrants, water main flushing, and fire pump testing from connections 4" or larger. The BigBoy Hose Monster incorporates the patented FM approved Pitotless Nozzle™ so rocks and flushing debris pass through without causing pitot damage and accurately measures water flow-rates from 750 to 2,700 GPM. The BigBoy Hose Monster body is made from Polypropylene and the Pitotless Nozzle is made from precision machined aluminum. *The BigBoy Hose Monster is intended to be used with a hose and should not be attached directly to a hydrant. The unit comes standard with a 4" NH connection and can be flowed from a larger sized connection by use reducing hose or adapters. Your hose choice will depend on: 1) the diameter of the water source connection, 2) the thread or connection type, and 3) the hose length.*



TAKING FLOW READINGS

The BigBoy GPM Gauge is calibrated to read flow-rate directly from the gauge face. No conversion chart is necessary. If you use another pressure gauge instead of the BigBoy GPM Gauge the BigBoy Hose Monster flow chart must be used to convert from psi to GPM. A 0-60 psi gauge is the most suitable range.

FEATURES

- Perfect for Hydrant Flow Testing or Water Main Flushing
- Uses the patented FM Approved Pitotless Nozzle™ so you'll never have to change out a pitot because it got hit by a rock.
- Read your GPM flow-rate directly on the gauge face while flowing
- Weighs only 13 lbs. yet handles high flow hydrants up to 2,700 GPM
- 4" NH standard connection size, other thread specs are available.
- Flow from 4.5", or 5" STORZ connections with additional accessories

INCLUDES:

- Big Boy Hose Monster Body: Made from glass-filled Polypropylene
- Big Boy Pitotless Nozzle 4": Measures 750 to 2,700 GPM; Factory-installed
- Big Boy GPM Gauge: Reads both GPM flow-rate and psi; 4" dial; liquid-filled



BP018	BigBoy Hose Monster™	\$1,053.95
-------	----------------------	------------

\$1,053.95

RICE PORTABLE HOSE TESTER SERIES

THE RICE HYDRO LINE OF PORTABLE FIRE HOSE TESTERS IS THE CULMINATION OF A DESIGN EFFORT INCORPORATING OVER 44 YEARS OF EXPERIENCE. ALL RICE HOSE TESTERS MEET OR EXCEED NFPA STANDARDS AND COME WITH A 5-YEAR FULL PRODUCT WARRANTY.

FOUR-OUTLET HOSE TESTER

Offers 3 gpm at 500 psi, powered by a 1 HP 50/60 hertz TEFC motor. Capable of testing to 6" diameter coupled hose, up to 300 feet. Features 4 independently controlled stainless steel ball valves, with 1 1/2" NST male discharges and 2 1/2" NST female inlet swivel. *Ship. wt. 175 lbs.*



AA930 Four-Outlet Hose Tester \$2,490.95

TWO-OUTLET HOSE TESTER

Offering the same features as the model AA930, in a portable Two-Outlet unit. With a footprint of 28"x23"x19", this lightweight, compact design is perfect for tight and confined spaces, such as on board ships and vessels. *Ship. wt. 127 lbs.*



AF416 Two-Outlet Hose Tester \$2,096.95

FIRE HOSE TESTER

A full line of hose testers offering various gpm and pressure ratings. Featuring four independently controlled stainless steel ball valves, 1 1/2" NST outlets, 2 1/2" NST swivel inlet, enclosed in a rugged, heavy-duty, welded steel chassis. *Ship. wt. 194 lbs.*

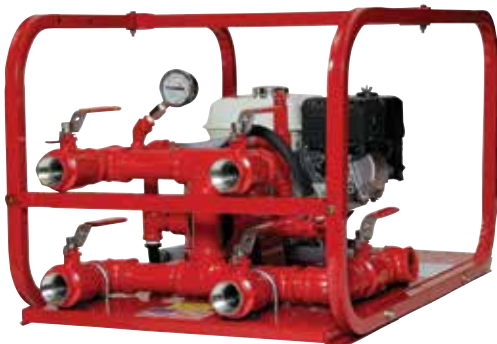

Cat#	Description	GPM	PSI	Price
AW146	5.5 HP Gas B&S	5	1000	\$4,229.95
AW147	5.5 HP Gas Honda	5	1000	\$4,375.95
AZ517	3 HP Electric	5	800	\$4,900.95
AZ518	3 HP Electric	4	1000	\$5,320.95
AZ519	5.5 HP Gas Honda	3.5	1000	\$3,831.95
AZ520	5.5 HP Gas B&S	3.5	1000	\$3,751.95
AZ521	5.5 HP Gas Honda	10	450	\$3,685.95
AZ522	5.5 HP Gas B&S	10	450	\$3,460.95

HOSE TESTER ACCESSORIES

ADAPTERS AND CAPS WITH CHAIN AND PETCOCK



BK073

BK072	1 1/2" Cap with Chain and Petcock	\$38.95
BK073	2 1/2" Cap with Chain and Petcock	\$48.95
BP293	4" Storz Cap with Chain and Petcock	\$72.95
BK074	5" Storz Cap with Chain and Petcock	\$98.95



FLOW METERS

STANDPIPE FLOWMETER

The standpipe flowmeter is made to hook up to the standpipe in highrise applications ensuring you have adequate flow and pressure at the fire floor. It measures both flow and pressure accurately using an integrated sensor, having a completely self-contained battery powered digital readout. Constructed of anodized aluminum, with a swiveling 45° elbow on the inlet side to reduce kinking. The unit is powered by a 9V rechargeable lithium battery which will power the unit for up to 5 hours. It has a low battery warning which activates when the battery has 90 minutes of life left, as well as a battery check feature.



NEW



- Compact design for high-rise kit applications
- 9V battery operation with quick change housing
- Dual LED display - Pressure and Flow
- Battery saving Standby operation
- One touch battery meter
- Lightweight aluminum construction



BN574 Standpipe Flowmeter \$1,878.95

AKROFLOW™ PORTABLE FLOW METER & TEST KIT

Knowing your flow is critical to optimal on-scene operations. The AkroFlow Portable Flow Meter & Test Kit provides the necessary components to accomplish all your water flow testing needs. Included in the Flow Meter & Test Kit is the most highly accurate portable flow meter, the AkroFlow, plus the gauges and adapter commonly used when performing water flow testing.

NEW



- Flow test nozzles and portable monitors to maintain optimal performance
- Comply with annual NFPA 1962 test of nozzles, hose and appliances
- Conduct comprehensive nozzle and hose training
- Accurately determine fire flows, friction loss and pump discharge pressures



BP334	AkroFlow™ Meter 2½ NH x 2½ NH	\$1,634.95
BP335	1½" Line Gauge, NST Swivel, 160 PSI	\$397.95
BP336	2½" Line Gauge, NST Swivel, 160 PSI	\$397.95
BP337	Base Direct Connect 2½ NH x 1½ NH	\$285.95

INSIGHT PORTABLE FLOW AND PRESSURE METER

Use the new Insight Portable Flow Tester to determine the flow and pressure capabilities of suppression systems or flow test your automatic nozzles, pumpers or hydrants. Test your department's effectiveness, calibrate your automatic nozzles, pumpers or hydrants. All Insight Portable Flow Tester series meters incorporate a new processor that allows for new features including multiple flow point calibration and multiple tube size. The Insight Portable Flow Tester series is an easy-to-use meter which displays gpm directly. Cap the tube for static pressure.

- Flow readout in 4-digit LED display & accurate to within 1% or reading
- Based on the DFA400 series flow meter
- Displays both flow rate and total flow
- Paddle wheel flow sensor
- Hard shell case with handle (10¾" Hx9¾" Wx7" H)



AS538	Portable Flow and Pressure Meter	\$2,457.95
AS539	Portable Flow and Pitot Pressure	\$2,587.95
AW310	4" Tube (No Sensors) NPTM/ Flow Port	\$477.95
AW311	Paddle Wheel Flow Sensor	\$152.95



LOW LEVEL STRAINER WITH JET SIPHON

This compact unit can be used as both a water transfer device as well as a low level strainer. Features lightweight 6061-T6 aluminum construction with red powder coat finish for long life. Will draft in as little as 3" of water without whirlpooling. Pivoting neck enables base to stay flat on the tank bottom. Comes standard with internal screen (all sizes) and jet siphon (4"-6"). **Ship. wt. 25 lbs.**

2 1/2" AND 3" ARE NOT MANUFACTURED WITH A JET SIPHON.
CALL FOR PRICING ON STORZ AND CAM LOCK FITTINGS.



	2 1/2"	3"	4"	4 1/2"	5"	6"
AS227	\$340.95	\$366.95	\$393.95	\$398.95	\$437.95	\$519.95

SELF LEVELING FLOATING STRAINERS

Kochek Self Leveling Floating Strainers feature increased flow rates due to high intake ratio and maximum pump flows.

- Increased flow rates due to high intake ratio
- Maximum pump flows
- Light weight design
- New compact design for easy storage
- Handle for ease of carrying
- Vortex Shield protects against whirlpooling
- Full time swiveling strainer
- Most efficient strainers on the market

	Description	Size	Price
BK012	Self Leveling Floating Strainers	1 1/2"	\$191.95
BK013	Self Leveling Floating Strainers	2 1/2"	\$267.95
BK014	Self Leveling Floating Strainers	3"	\$313.95
BK015	Self Leveling Floating Strainers	4"	\$495.95
BK016	Self Leveling Floating Strainers	4 1/2"	\$643.95
BK017	Self Leveling Floating Strainers	5"	\$656.95
BK018	Self Leveling Floating Strainers*	6"	\$690.95

* RECOMMENDED FOR PUMPS 1250 TO 1500 GPM



FLOAT-DOCK® STRAINER PUMP POND WATER FREE OF DEBRIS

The Float-Dock® strainer is a valuable piece of equipment that can save the day in many fire fighting situations. Float-Dock® lets you use the water in ponds or streams, both shallow and deep. Because it operates below scum and debris and above sand and muck, it screens out the materials that wear out impellers, packing and bearings. Since Float-Dock® strainers are self-leveling, there are no whirlpools or suction loss. It will draft in as little as 5" of pond water at pump's rated capacity. In deep water, Float Dock® drafts clean water below the surface. Each unit is fully guaranteed.



Cat#	Strainer	Float	Coupling	Price
H224	4"x6"x14"	5"x15"x18 1/2"	2 1/2"	\$350.95
H22401	4"x6"x14"	5"x15"x18 1/2"	3"	\$438.95
H225	7"x10"x18 1/2"	7"x21"x26 1/2"	4"	\$557.95
H22502	6"x8"x18 1/2"	7"x21 1/2"x26 1/2"	4 1/2"	\$585.95
H22603	6"x8"x18 1/2"	7"x21 1/2"x26 1/2"	5"	\$637.95
T134	7"x16"x18 1/2"	7"x21 1/2"x26 1/2"	6"	\$744.95

LOW-FLOW STRAINER

Strainer will perform at maximum pumping capacity down to a water level of just 1 1/2" with no suction loss. Surface turbulence will not affect this strainer. Can be easily stored in truck compartment. Sizes 4" through 6" come with 1 1/2" cast aluminum jet siphon. **Ship. wt. 24 lbs.**

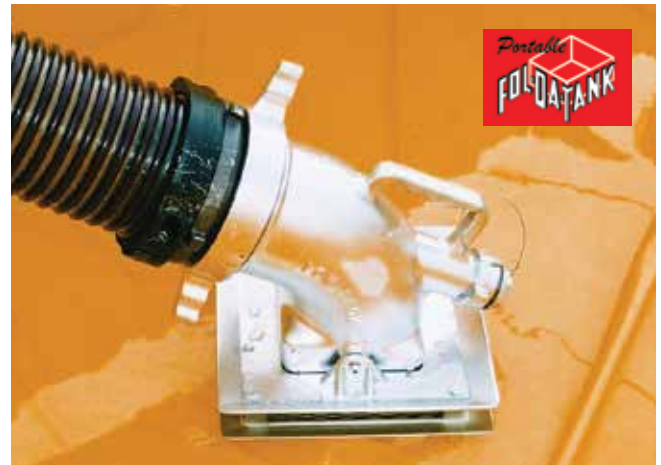

X892	Low-Flow Strainer	2 1/2"	\$365.95
X893	Low-Flow Strainer	3"	\$371.95
X894	Low-Flow Strainer	4"	\$440.95
X895	Low-Flow Strainer	4 1/2"	\$450.95
X896	Low-Flow Strainer	5"	\$492.95
X897	Low-Flow Strainer	6"	\$587.95

PORTABLE COLLAPSIBLE FOL-DA-TANK

THE FIRST AND STILL THE BEST

It was more than 50 years ago that the first Fol-Da-Tank was introduced to firefighters, who recognized its value and quality immediately. Fol-Da-Tank Co. has been continually improving frame and fabric designs to help provide the most reliable portable water tank in the industry. Fol-Da-Tank has proved to be the practical answer as an extra water supply for rural areas, where water pressure is low or as a back-up facility for municipal fire departments. Fol-Da-Tank doubles the fire fighting ability of a tanker truck at an affordable price. Two firefighters can unload from the truck and set up in 30 seconds. While pumper empties the Fol-Da-Tank, a tanker can be supplying more water. With the fire out, Fol-Da-Tank can be emptied quickly with the exclusive 10" diameter drain sleeve, which stores inside or outside of the tank.



ALSO AVAILABLE IN ALUMINUM.
CALL FOR PRICING 1.800.323.0244

CONSTRUCTION FEATURES:

- **Liners:** High performance rubber (HPR), FDA
- **Frames:** Steel, resistance welded 14-gauge 7/8" square steel tubing with snag-free finish
- **Hinges:** Die-cut
- **Grommets:** Solid brass
- **Bolts:** Heavy-duty



SPECIFY COLOR: Red or Yellow



Fol-Da-Tank with Steel Frame		Gallons						
Cat#	Description	600	1000	1500	2100	2500	3000	4000
BL234	17oz. HPR	\$788.95	\$975.95	\$1,150.95	\$1,360.95	\$1,496.95	\$1,690.95	\$2,012.95
BL235	22oz. HPR	\$874.95	\$1,113.95	\$1,345.95	\$1503.95	\$1,641.95	\$1,888.95	\$2,051.95
Liners								
BL236	17oz. HPR	\$542.95	\$675.95	\$800.95	\$899.95	\$1,026.95	\$1,200.95	\$1,419.95
BL237	22oz. HPR	\$647.95	\$759.95	\$914.95	\$1,012.95	\$1,203.95	\$1,390.95	\$1,517.95



EASY 1-PERSON
SETUP

SELF-SUPPORTING FRAMELESS PORTABLE WATER TANK

These self-supporting frameless water tanks have been designed to meet the most stringent requirements of rural/urban fire fighting. Problems with inadequate or unusable supplies of water are eliminated by the use of open top self-supporting portable water tanks. In remote areas, the self-supporting tanks are designed for standby water containment, water shuttling situations and to provide a continuous portable water supply. In remote areas, the SST may be filled by pumping water from a natural water source, such as a stream or creek, with a small gas-operated pump. As the self-supporting tank begins to fill with water, its unique design allows it to become self supporting automatically. The SST can be used as a mixing tank as well as a temporary holding in hazardous waste situations. It may be quickly drained through a threaded flange fitting on the side. The tank is totally collapsible and easily stored in its own compact storage bag. Made of heavy-duty industrial PVC.

- No frame, assembly, foot pump, auxiliary air or need to inflate
- Use as mixing tank, water relay, water storage
- Use for fire fighting, hazardous waste, etc

SPECIFY: NST or IPT, Male or Female Threaded Flange Coupling, Installed.

SPECIFY SIZE OF THREADED DRAIN FLANGE

COUPLING: 1 1/2"-5" Available, 6" Additional Cost.

SPECIFY COLOR: Red, Orange or Yellow



Cat#	Gal.	Size Open	Ship. wt.	Price
AJ182	500	2'8"x5'0"x6'6"	50 lbs.	\$666.95
AJ183	1000	2'8"x7'3"x8'10"	55 lbs.	\$977.95
AJ184	1500	2'8"x9'2"x11'10"	60 lbs.	\$1,077.95
AJ185	2000	2'8"x10'x12'5"	65 lbs.	\$1,464.95
AJ186	2500	2'8"x12'x13'6"	70 lbs.	\$2,115.95
AJ187	3000	2'8"x13'x14'9"	75 lbs.	\$2,049.95
AJ188	4000	2'8"x14'x16'	90 lbs.	\$2,375.95
AJ189	5000	2'8"x17'x19'	100 lbs.	\$3,026.95

BC001 6" Flange Coupling \$301.95

SUPPLY LINE HOLDER



Secures hose quickly and minimizes turbulence. 2 1/2" and 3" hose sizes. Frees up personnel for other duties. Ship. wt. 18 lbs.

Y211	Supply Line Holder, 2 1/2"	\$226.95
Y212	Supply Line Holder, 3"	\$265.95

TURBO DRAFT™ FIRE EDUCTOR

THE PORTABLE FIRE HYDRANT

- Gain access to remote water supplies up to 250' away
- Generate usable fire flows up to 670 gpm
- No need for cumbersome hard sleeve
- Recognized by insurance agencies as an alternate water supply source
- Lightweight design sets up in minutes with standard fire hose

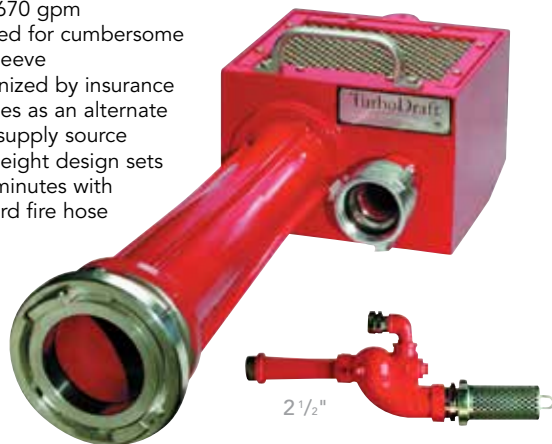

Cat#	Description	Ship. wt.	Price
AZ137	5" Turbo Draft™	55 lbs.	\$3,907.95
AZ138	2 1/2" Turbo Draft™	20 lbs.	\$2,958.95

NEWTON KWIK DUMP VALVE

...BECAUSE EVERY SECOND COUNTS

The Newton Kwik-Dump Water Valve is 29% faster than any other conventional gravity flow valve tested. It can dump 3000 gallons of water per minute, under ideal conditions. As an average, an 1800 gallon tanker can be emptied in less than one minute. All Newton Valves are constructed so that all parts constantly in contact with water are made of stainless steel, brass, or rubber, to give many years of trouble-free service. The remainder of the valve is made of hot-rolled, prime painted mild steel. Can be readily adapted to tanker trucks already in use. Standard 24" valves can be shortened and remote handle configuration is also available for additional costs.

- The standard valve comes with top-mounted controls and handle, and a 3° angle on the flange
- Outlets are 10"x10" square

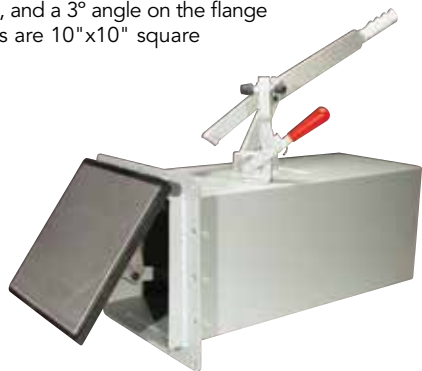

AJ173	Kwik Dump, Angle Flange	\$705.95
AR281	Kwik Dump, Handle and Controls on Left	\$815.95
AR282	Kwik Dump, Handle and Controls on Right	\$815.95
AR288	Kwik Dump, Controlled by Air Cylinder	\$1,627.95
AR297	Additional Charge for Stainless Steel Flange on Mild Steel Valve	\$67.95
X601	24" Slip on Extension for 10" Valve	\$227.95
X602	36" Slip on Extension Chute for 10" Valve	\$277.95
X603	48" Slip on Extension Chute for 10" Valve	\$320.95
AR293	90° Elbow Chute for 10" Valve	\$463.95
X605	36" Telescoping Chute for 10" Valve	\$556.95

PRE-CON SUCTION VALVE

This suction inlet valve is designed to operate as an automatic flow control valve eliminating the need for manual adjustments in relation to water flow. During hydrant operation, it automatically opens in proportion to flow demand while the automatic check valve action helps prevent water hammer. During drafting operation, the check valve action holds prime water when flow is stopped, plus allows switching to booster tank and back to draft without flow interruption. Valve can be greased without removal from pumper. *Ship. wt. 20 lbs.*



- Compact design
- Versatile application
- Overall Length: 9 1/2"
- Automatically balances the flow between multiple sources
- Any thread size male or female combination from 4" to 6"

SPECIFY SIZE AND THREADS OF FEMALE AND MALE

T280	Pre-Con Suction Valve	\$1,868.95
------	-----------------------	------------

PORTABLE TANK RACK

QUICKLY DEPLOY YOUR FOLDING RACK

Easy-to-install on either elliptical or side step body tankers. Manually pulls down to deploy folding tanks of all sizes. *Ship. wt. 100 lbs.*



- All welds are Tig welded
- Easy to get tanks in and out of rack rubber padding to protect your tanker
- All standard sizes
- 3 hinged feet with 4 bolts each
- 2 locking points, one on each side



SPECIFY: Aluminum or Stainless Steel

BL596	1000 Gallon Portable Tank Rack	\$1,379.95
BL597	1500 Gallon Portable Tank Rack	\$1,435.95
BL598	2100 Gallon Portable Tank Rack	\$1,454.95
BL599	2500 Gallon Portable Tank Rack	\$1,470.95
BL600	3000 Gallon Portable Tank Rack	\$1,486.95
BL601	3500 Gallon Portable Tank Rack	\$1,558.95
BL602	4000 Gallon Portable Tank Rack	\$1,629.95
BL603	5000 Gallon Portable Tank Rack	\$1,735.95
BL604	Aluminum Tread Plate Windbreak for Rack	\$612.95

2 1/2" NST 45° ELBOW

RELIEVE STRAIN AND PREVENT HOSE KINKING

Angle elbows are used on the discharge gate of a pumper to relieve strain and prevent kinking of hose. Rocker lug swivel. *Ship. wt. 3 lbs.*

- Prevent kinking
- Relieve hose strain

45° ELBOW



R477 2 1/2" NST 45° Elbow \$88.95

BRITISH INSTANTANEOUS FITTINGS

Darley offers a complete line of British Instantaneous fittings. Fittings have hard-coat anodized finish. All 2 1/2" connections are made to conform to the BS336 standard. *Ship. wt. 3 lbs.*



BITF (British Instantaneous Fittings)

AJ089	2 1/2" BITF x 2 1/2" MNST Fitting	\$111.95
AJ088	2 1/2" BITM x 2 1/2" MNST Fitting	\$31.95
AJ087	2 1/2" BITM x 2 1/2" FNST Fitting	\$31.95
BD006	2 1/2" BITF x 2 1/2" FNST Fitting	\$105.95
BD007	2 1/2" BIT Cap	\$108.95
BD008	2 1/2" BIT Plug	\$25.95

SWIVEL BUSHING

Chrome-plated brass, double female bushing, internal lug, rocker lug swivel. *Ship. wt. 4 lbs.*



AK061: Double Female Swivel Bushing

1 1/2" NPT x 1 1/2" NST Swivel	\$96.95
1 1/2" NPT x 2 1/2" NST Swivel	\$111.95
2 1/2" NPT x 2 1/2" NST Swivel	\$98.95
3" NPT x 2 1/2" NST Swivel	\$134.95

AK062: Double Female Swivel Bushing w/Screen Insert

1 1/2" NPT x 2 1/2" NST Swivel	\$113.95
2 1/2" NPT x 2 1/2" NST Swivel	\$103.95
3" NPT x 2 1/2" NST Swivel	\$131.95

SUCTION ELBOW SWIVEL FEMALE TO MALE

Ideal for fire apparatus with front suction connections. Aluminum elbows from 2 1/2" through 6". Long handle female swivel x male rigid standard. Specify ST, NPSH or NPT threads. Call for pricing on special threads, Storz fittings and/or rocker lug design. *Ship. wt. 4-7 lbs.*



AS125 Specify: 45° or 90° Male x Female

	2 1/2"	4"	4 1/2"	5"	6"
2 1/2"	\$168.95	\$214.95	\$207.95	\$213.95	—
4"	\$217.95	\$238.95	\$232.95	\$270.95	\$263.95
4 1/2"	\$232.95	\$244.95	\$239.95	\$287.95	\$293.95
5"	\$238.95	\$274.95	\$290.95	\$295.95	\$300.95
6"	—	\$283.95	\$296.95	\$296.95	\$318.95

SUCTION SWIVEL ADAPTER

Chrome-plated brass with screen; 2 1/2" NST swivel female x 2 1/2" NPT male. *Ship. wt. 3 lbs.*



W505 Adapter \$99.95

CHROME-PLATED BRASS BUSHINGS

Female NPT by male hose thread bushing with internal lugs. Available with or without screen. *Ship. wt. 4 lbs.*



W504: Chrome-Plated Bushing

1 1/2" NPT F x 1 1/2" NST M	\$78.95
2 1/2" NPT F x 2 1/2" NST M	\$41.95
4" NPT F x 4" NST M	\$147.95
4 1/2" NPT F x 4 1/2" NST M	\$288.95
5" NPT F x 5" NST M	\$279.95
6" NPT F x 6" NST M	\$301.95

AK014: Chrome-Plated Lug Bushing with Screen

2 1/2" NPT F x 2 1/2" NST M	\$35.95
4" NPT F x 4" NST M	\$161.95
4 1/2" NPT F x 4 1/2" NST M	\$231.95
5" NPT F x 5" NST M	\$271.95
6" NPT F x 6" NST M	\$309.95

DARLEY BRASS HEX HOSE ADAPTERS

AM137: NPT Male x NST Male

NPT MALE	NST MALE			
	1"	1 1/2"	2 1/2"	3"
1"	\$26.95	—	—	—
1 1/2"	\$44.95	\$12.95	—	—
2"	—	\$46.95	\$49.95	—
2 1/2"	—	\$84.95	\$24.95	—
3"	—	—	\$91.95	\$152.95



AM138: NPT Female x NST Male

NPT FEMALE	NST MALE			
	1"	1 1/2"	2 1/2"	3"
1"	\$32.95	—	—	—
1 1/2"	—	\$21.95	—	—
2"	—	\$46.95	—	—
2 1/2"	—	—	\$52.95	—
3"	—	—	\$82.95	\$117.95



Note: NPT has a tapered thread and is used for plumbing applications. Requires tape or pipe sealant.

HYDRANT AND SUCTION HOSE CONNECTIONS

B268 has a double swivel with long handles on both ends (pin lugs on one end or both ends same price). B269 is a solid fitting with long handles (pin lugs same price). Chrome-plated brass. Ship. wt. 21 lbs.

B268: NST Female x NST Female

NST FEMALE	NST FEMALE			
	4"	4 1/2"	5"	6"
2 1/2"	\$422.95	\$464.95	\$493.95	\$557.95
4"	\$482.95	\$505.95	\$540.95	\$678.95
4 1/2"	—	\$524.95	\$598.95	\$636.95
5"	—	—	\$796.95	\$751.95



B269: NST Male x NST Female

NST MALE	NST FEMALE			
	4"	4 1/2"	5"	6"
2 1/2"	\$253.95	\$262.95	\$320.95	\$341.95
4"	\$232.95	\$333.95	\$398.95	\$398.95
4 1/2"	—	\$329.95	\$366.95	\$417.95
5"	—	—	\$441.95	\$437.95
6"	—	—	—	\$511.95



LONG HANDLE CHROME SUCTION CAPS

AW060	4" Chrome NH Cap	\$185.95
AW061	4 1/2" Chrome NH Cap	\$271.95
AW062	5" Chrome NH Cap	\$277.95
AW063	6" Chrome NH Cap	\$292.95



ALUMINUM CHROME CAPS

Chrome-plated aluminum hose caps include chain. NST thread standard. Ship. wt. 1 lb.

AW089	1" Chrome Cap	\$44.95
AW090	1 1/2" Chrome Cap	\$46.95
AW091	2" Chrome Cap	\$59.95
AW092	2 1/2" Chrome Cap	\$62.95



DOUBLE MALE AND DOUBLE FEMALE CONNECTIONS

Ship. wt. 2 lbs.

Chrome-Plated/Brass Double Male

B24301	2 1/2" Chrome, NST	\$79.95
B24302	1 1/2" Chrome, NST	\$70.95
B24303	2 1/2" Chrome, Other Thread	\$97.95
B24304	1 1/2" Chrome, Other Thread	\$32.95
B24305	2 1/2" Brass, Any Thread	\$94.95
B24306	1 1/2" Brass, Any Thread	\$76.95



Chrome-Plated/Brass Double Female

B24401	2 1/2" Chrome, NST	\$141.95
B24402	1 1/2" Chrome, NST	\$115.95
B24403	2 1/2" Chrome, Other Thread	\$166.95
B24404	1 1/2" Chrome, Other Thread	\$149.95
B24405	2 1/2" Brass, Any Thread	\$166.95
B24406	1 1/2" Brass, Any Thread	\$105.95



HOSE PLUG FOR FEMALE THREAD

Chrome-plated brass hose plugs. Ship. wt. 1 lb.



L87701	1 1/2" Rough Brass	\$39.95
L87702	1 1/2" Chrome Hose Plug	\$41.95
L87703	2 1/2" Rough Brass	\$27.95
L87704	2 1/2" Chrome Hose Plug	\$46.95

HOSE REDUCERS

Chrome-Plated Brass

42B04	1 1/2" NST x 3/4" GHT	\$45.95
42B	2 1/2" NST x 1 1/2" NST	\$38.95

Polished Brass

42B01	1 1/2" NST x 3/4" GHT	\$35.95
42B02	2 1/2" NST x 1" NST	\$54.95
42B03	2 1/2" NST x 1 1/2" NST	\$36.95



CHROME-PLATED HOSE CAPS

Chrome-plated brass hose caps include chain. NST thread standard. Ship. wt. 1 lb.

B52600	1" Hose Cap	\$44.95
B52601	1 1/2" Hose Cap	\$26.95
B52602	2 1/2" Hose Cap	\$30.95
B52603	3" Hose Cap	\$68.95



LEXAN THREADED CAPS

Cut the cost of theft, while providing maximum protection. Includes sturdy, plated attaching chain and inside gasket. NST, SIPT(NPSH). Color: Red.

U81401	1 1/2" Threaded Cap	\$5.95
U81402	2 1/2" Threaded Cap	\$5.95



DOUBLE SWIVEL FEMALE...

...for adapting from male to female. Made from extruded lightweight aluminum alloy, then hardcoated to resist corrosion and abrasion. *Ship. wt. 1-6 lbs.*



AC725: Double Female

F	1"	1 1/2"	2"	2 1/2"	3"	4"	4 1/2"	5"	6"
1"	\$18.95	\$25.95							
1 1/2"	\$29.95	\$23.95	\$35.95	\$40.95					
2"		\$35.95	\$35.95	\$45.95					
2 1/2"		\$40.95	\$45.95	\$34.95	\$70.95	\$101.95	\$104.95	\$149.95	\$264.95
3"			\$70.95	\$55.95	\$113.95	\$134.95	\$158.95	\$245.95	
4"			\$101.95	\$113.95	\$84.95	\$106.95	\$157.95	\$192.95	
4 1/2"			\$104.95	\$134.95	\$121.95	\$100.95	\$157.95	\$195.95	
5"			\$149.95	\$157.95	\$157.95	\$157.95	\$153.95	\$216.95	
6"			\$264.95	\$211.95	\$192.95	\$195.95	\$216.95	\$198.95	

LONG HANDLE DOUBLE SWIVEL FEMALE...

...for adapting male hydrant or suction thread to female hose thread. Made from extruded lightweight aluminum alloy, hardcoated to resist corrosion and abrasion. *Ship. wt. 1-6 lbs.*



AC727: Long Handle Double Female

F	2 1/2"	3"	4"	4 1/2"	5"	6"
2 1/2"	\$53.95	\$93.95	\$113.95	\$124.95	\$177.95	\$283.95
3"	\$97.95	\$91.95	\$171.95	\$180.95	\$193.95	\$223.95
4"	\$114.95	\$171.95	\$135.95	\$151.95	\$177.95	\$205.95
4 1/2"	\$125.95	\$163.95	\$151.95	\$145.95	\$163.95	\$207.95
5"	\$177.95	\$193.95	\$177.95	\$163.95	\$206.95	\$221.95
6"	\$222.95	\$266.95	\$205.95	\$207.95	\$221.95	\$219.95

LONG HANDLE SWIVEL FEMALE...

...to rocker lug rigid female. For adapting male to female. Made from extruded light weight aluminum alloy, hardcoated to resist corrosion and abrasion. *Ship. wt. 1-6 lbs.*



AC729: Rigid Female

SF	1 1/2"	2"	2 1/2"	3"	4"	4 1/2"	5"	6"
2 1/2"	\$58.95	\$67.95	\$71.95	\$113.95	\$69.95	\$135.95	\$258.95	\$316.95
3"		\$115.95	\$117.95	\$199.95	\$215.95	\$260.95	\$295.95	
4"		\$107.95	\$178.95	\$180.95	\$271.95	\$322.95	\$286.95	
4 1/2"		\$168.95	\$215.95	\$253.95	\$194.95	\$273.95	\$332.95	
5"		\$232.95	\$236.95	\$288.95	\$272.95	\$369.95	\$299.95	
6"		\$373.95	\$394.95	\$274.95	\$321.95	\$298.95	\$310.95	

RIGID LONG HANDLE FEMALE...

...to male adapter. For changing hydrant or suction hose threads or sizes. Made from lightweight aluminum alloy, hardcoated to resist corrosion and abrasion. *Ship. wt. 1-6 lbs.*



AC731: Male

F	2 1/2"	3"	4"	4 1/2"	5"	6"
2 1/2"		\$78.95	\$126.95	\$138.95	\$209.95	\$255.95
3"	\$86.95	\$81.95	\$150.95	\$171.95	\$191.95	\$250.95
4"	\$115.95	\$134.95	\$125.95	\$152.95	\$159.95	\$191.95
4 1/2"	\$124.95	\$149.95	\$138.95	\$188.95	\$212.95	\$216.95
5"	\$151.95	\$180.95	\$145.95	\$146.95	\$201.95	\$224.95
6"	\$273.95	\$292.95	\$185.95	\$195.95	\$210.95	\$238.95

DOUBLE MALE...

...for adapting from female to male. Made from extruded lightweight aluminum alloy, hardcoated to resist corrosion and abrasion. *Ship. wt. 1-6 lbs.*



AC726: Double Male

M	1"	1 1/2"	2"	2 1/2"	3"	4"	4 1/2"	5"	6"
1"	\$16.95	\$29.95	\$30.95	\$30.95					
1 1/2"	\$29.95	\$15.95	\$27.95	\$28.95					
2"		\$26.95	\$27.95	\$29.95	\$73.95				
2 1/2"	\$30.95	\$28.95	\$30.95	\$19.95	\$53.95	\$78.95	\$87.95	\$171.95	
3"			\$72.95	\$53.95	\$48.95	\$105.95	\$106.95	\$230.95	
4"			\$78.95	\$105.95	\$78.95	\$114.95	\$110.95	\$141.95	
4 1/2"			\$87.95	\$106.95	\$114.95	\$86.95	\$125.95	\$135.95	
5"			\$153.95	\$241.95	\$123.95	\$106.95	\$90.95	\$116.95	
6"					\$154.95	\$135.95	\$116.95	\$121.95	

RIGID ROCKER LUG FEMALE...

...to male adapter. If an adapter is ordered with the same size/thread on both ends it will only serve as an extension. Made from extruded aluminum alloy, hardcoated to resist corrosion and abrasion. *Ship. wt. 1-6 lbs.*



AC728: Male

F	1"	1 1/2"	2"	2 1/2"	3"	4"	4 1/2"	5"	6"
1"	\$13.95	\$20.95	\$35.95	\$33.95					
1 1/2"	\$18.95	\$19.95	\$20.95	\$18.95	\$20.95				
2"		\$20.95	\$32.95	\$34.95	\$78.95				
2 1/2"	\$37.95	\$18.95	\$22.95	\$23.95	\$44.95	\$86.95	\$99.95	\$138.95	\$147.95
3"	\$82.95	\$72.95	\$71.95	\$51.95	\$52.95	\$98.95	\$111.95	\$158.95	\$171.95
4"			\$105.95	\$124.95	\$91.95	\$115.95	\$143.95	\$182.95	
4 1/2"			\$104.95	\$125.95	\$111.95	\$109.95	\$110.95	\$200.95	
5"			\$126.95	\$132.95	\$129.95	\$154.95	\$132.95	\$148.95	
6"			\$198.95	\$290.95	\$161.95	\$168.95	\$168.95	\$154.95	

ROCKER LUG SWIVEL FEMALE...

...to rocker lug rigid female. For adapting male to female. Made from extruded lightweight aluminum alloy, hardcoated to resist corrosion and abrasion. *Ship. wt. 1-6 lbs.*



AC730: Rocker Lug Female Adapter

SF	1 1/2"	2"	2 1/2"	3"	4"	4 1/2"	5"	6"
2 1/2"	\$31.95	\$36.95	\$36.95					
2"	\$35.95	\$36.95	\$57.95					
2 1/2"	\$43.95	\$58.95	\$64.95	\$81.95	\$99.95	\$143.95	\$255.95	\$193.95
3"			\$84.95	\$75.95	\$175.95	\$191.95	\$237.95	\$272.95
4"			\$92.95	\$153.95	\$172.95	\$237.95	\$231.95	\$298.95
4 1/2"			\$165.95	\$191.95	\$203.95	\$191.95	\$259.95	\$349.95
5"			\$206.95	\$213.95	\$271.95	\$307.95	\$287.95	\$321.95
6"			\$346.95	\$371.95	\$268.95	\$364.95	\$284.95	\$300.95

LONG HANDLE SWIVEL FEMALE...

...to male adapter. Made from extruded lightweight aluminum alloy, hardcoated to resist corrosion and abrasion. *Ship. wt. 1-6 lbs.*



AC732: Male

F	2 1/2"	3"	4"	4 1/2"	5"	6"
2 1/2"	\$72.95	\$100.95	\$106.95	\$142.95	\$240.95	\$309.95
3"	\$96.95	\$89.95	\$187.95	\$202.95	\$250.95	\$291.95
4"	\$136.95	\$165.95	\$183.95	\$215.95	\$275.95	\$279.95
4 1/2"	\$160.95	\$202.95	\$202.95	\$205.95	\$279.95	\$324.95
5"	\$266.95	\$224.95	\$285.95	\$272.95	\$313.95	\$314.95
6"	\$346.95	\$385.95	\$276.95	\$316.95	\$309.95	\$386.95

NST shipped unless otherwise specified. Prices other than National Standard (NH or NST) or Iron Pipe (NPSH, IPT or SIPT) available on request.

LIGHTWEIGHT GATED VALVE

No more heavy brass valves to carry around. Our light weight line wyes with aluminum construction cut the overall weight by more than 30% when compared to traditional brass valves. *Ship. wt. 8 lbs.*



BE257	2 1/2" NSTF Inlet x (2) 1 1/2" NSTM Outlet Valve	\$214.95
BE315	2 1/2" NSTF Inlet x (2) 2 1/2" NSTM Outlet Valve	\$329.95

HYDRANT VALVE

- Lightweight alloy
- 2 1/2" full flow waterway
- Adapter easily removed for seat adjustment
- 2 1/2" female inlet x 2 1/2" male outlet
- Self-locking handle for positive positioning
- *Ship. wt. 8 lbs.*



BK221	2 1/2" Hydrant Valve	\$279.95
-------	----------------------	----------

HYDRANT BALL VALVE

Lightweight, full-flow hydrant ball valve with 2 1/2" F NST inlet and 2 1/2" M NST outlet. Standard color is silver with black connections and handle. Valve weighs 5 1/2 lbs. Rated at 250 psi working pressure. Self-locking handle for positive positioning.



BL909	2 1/2" Hydrant Ball Valve	\$264.95
-------	---------------------------	----------

HYDRANT GATE VALVE

All aluminum hydrant gate valve with resilient seat design. Includes a corrosion resistant stainless steel stem with an aluminum wedge with full flow water output. All aluminum parts are hard coated before powder coating to improve corrosion resistance. Opening/closing takes 12 turns of the hand wheel meeting NFPA requirements to prevent water hammer. 2 1/2" NH female swivel x 2 1/2" NH male.



BN205	2 1/2" Hydrant Gate Valve	\$182.95
-------	---------------------------	----------

MULTI-USE ADAPTER

The latest multi-use adapter. Perfect for hazmat decontamination. Other uses include forestry units, portable water, an portable drinking water. You will also find it useful for vehicle wash down. Available in 1 1/2" or 2 1/2" NST. *Ship. wt. 3 lbs.*



AJ09901	Hazmat Adapter 1 1/2" F x (2) GHT M	\$38.95
AJ09902	Hazmat Adapter 2 1/2" F x (2) GHT M	\$63.95

2.5" HYDRANT GATE VALVE

Lightweight non-rising stem gate valve 2.5" NH female swivel x 2.5" NH male is excellent for hydrant and other hose line/water control. There is a spinning knob on hand wheel for easy open/close, with a built in slow close safety operation. The gate, spindle, female swivel, male threads, and the body inside and out are all anodized for maximum corrosion resistance. This valve has low friction loss and is maintenance free. This compact valve weighs 4.5lbs, length 6", height 9", and width 5". The gate valve has a working pressure of 250 PSI.



BL337	2.5" Hydrant Gate Valve	\$276.95
-------	-------------------------	----------

BLACK MAX™ PISTON INTAKE VALVE

The Black Max™ Piston Intake Valve has been designed for harsh environments of today's fire service. It's superior materials and enlarged waterway allows you to maximize flows and efficiency. *Ship. wt. 32 lbs.*



10-YEAR WARRANTY

- **Improved Corrosion Resistance:** Combines stainless steel piston housing, poly-impregnated body and polymer piston for maximum product life
- **Field Serviceable:** Unique 2-piece design allows the piston intake valve to be field serviceable
- **Extended Durability:** Full 10-year warranty against manufacturing defects and corrosion
- **Full Flow:** 2000 gpm (7600 lpm) - Enlarged waterway for maximum flow efficiency
- **Low Friction Loss:** Only 7 psi @ 2000 gpm (.5 bar @ 7600 lpm)



AS126	4" Storz x 5" NSTFSW	\$2,360.95
AS127	4" Storz x 6" NSTFSW	\$2,360.95
AS128	5" Storz x 5" NSTFSW	\$2,360.95
AS129	5" Storz x 6" NSTFSW	\$2,360.95
AS130	6" Storz x 5" NSTFSW	\$2,360.95
AS131	6" Storz x 6" NSTFSW	\$2,360.95

LIGHTWEIGHT LEADER LINE WYE

Lightweight Leader Line Wye has a 2½" NST swivel female inlet x (2) 1½" NST male outlets. Used to divide (1) 2½" hose into (2) 1½" hose lines. Each 1½" outlet is independently controlled by high strength polymer handles. *Ship. wt. 5 lbs.*



TWO 1½" INDEPENDENTLY CONTROLLED OUTLETS



AF787	Lightweight Leader Line Wye	\$482.95
-------	-----------------------------	----------

HYDRANT WYE

The Hydrant Wye is made of lightweight aluminum alloy and is used for laying two lines from a hydrant to a pumper or for branching a 2½" or larger supply line to two 2½" lines. Has self-locking valves for positive handle positioning. Available in sizes 2½" to 6" female inlet x (2) 2½" NST male swivel valves outlets. *Ship. wt. 17 lbs.*



AF78801	2½" F x (2) 2½" M	\$1,544.95
AF78802	3" F x (2) 2½" M	\$1,649.95
AF78804	4" F x (2) 2½" M	\$1,807.95
AF78805	4½" F x (2) 2½" M	\$1,852.95
AF78806	5" F x (2) 2½" M	\$1,899.95
AF78807	6" F x (2) 2½" M	\$2,084.95

SUCTION SIAMESE

Suction Siamese is made of lightweight aluminum alloy. Used to feed pumper suction or aerial platforms with one or two, 2½" or 3" hose lines. Has self-locking valves for positive handle positioning. Available in sizes 2½" to 6" female swivel x (2) 2½" NST swivel female valved inlets. *Ship. wt. 19 lbs.*



AF78901	(2) 2½" F x 2½" F	\$1,559.95
AF78902	(2) 2½" F x 3" F	\$1,694.95
AF78903	(2) 2½" F x 4" F	\$1,852.95
AF78904	(2) 2½" F x 4½" F	\$1,903.95
AF78905	(2) 2½" F x 5" F	\$2,054.95
AF78906	(2) 2½" F x 6" F	\$2,143.95

STORZ ADAPTERS 2 1/2" THROUGH 6"

LOCKING STORZ ON ALL ADAPTERS TO MEET NFPA

STORZ TO LONG HANDLE SWIVEL FEMALE

Storz to long handle swivel female adapter. Made of 6061-T6 aluminum alloy, then hardcoated to reduce corrosion and abrasion. *Ship. wt. 3 lbs.*



AG733: Female

S	2 1/2"	3"	3 1/2"	4"	4 1/2"	5"	6"
4"	\$147.95	\$180.95	\$196.95	\$209.95	\$211.95	\$208.95	\$275.95
5"	\$173.95	\$205.95	\$211.95	\$218.95	\$221.95	\$227.95	\$283.95

STORZ TO RIGID FEMALE

Storz to rigid female adapter. 6061-T6 aluminum alloy, hardcoated to reduce corrosion and abrasion. *Ship. wt. 3 lbs.*



AG735: Female

S	2 1/2"	3"	3 1/2"	4"	4 1/2"	5"	6"
4"	\$120.95	\$121.95	\$120.95	\$134.95	\$141.95	\$226.95	\$193.95
5"	\$136.95	\$139.95	\$163.95	\$161.95	\$162.95	\$177.95	\$237.95

STORZ TO SWIVEL FEMALE ELBOW

Storz to female swivel 30° elbow, long handles. Storz head made of 6061-T6 aluminum alloy, elbow made from tough, lightweight AL-MAG 35. Hardcoat anodized to resist abrasion and corrosion. *Ship. wt. 3 lbs.*



AG732: Female

S	2 1/2"	3"	3 1/2"	4"	4 1/2"	5"	6"
4"	\$204.95	\$294.95	\$237.95	\$250.95	\$262.95	\$296.95	\$349.95
5"	\$235.95	\$268.95	\$254.95	\$267.95	\$294.95	\$296.95	\$310.95

STORZ TO STORZ ADAPTERS

Storz to Storz adapters allow you to connect Storz couplings of different sizes. They are particularly useful in mutual aid evolutions. This adapter can be used in combinations from 1" - 6" Storz. For use on 4" or 5" hose. *Ship. wt. 3 lbs.*



AJ100	5" Storz x 4" Rigid Storz	\$227.22
AJ101	5" Storz x 4" Swivel Storz	\$400.95
AW068	6" Storz x 4" Storz	\$296.95
AW069	6" Storz x 5" Storz	\$282.13

STORZ TO RIGID MALE

Storz to rigid male adapter. 6061-T6 lightweight aluminum alloy, hardcoated for protection against corrosion and abrasion. *Ship. wt. 3 lbs.*



AG737: Male

S	2 1/2"	3"	3 1/2"	4"	4 1/2"	5"	6"
4"	\$117.95	\$125.95	\$116.95	\$131.95	\$166.95	\$180.95	\$150.95
5"	\$140.95	\$140.95	\$158.95	\$155.95	\$173.95	\$168.95	\$191.95

STORZ TO SWIVEL FEMALE

Storz to rocker lug swivel female adapter. 6061-T6 aluminum alloy, hardcoated for protection against corrosion and abrasion. *Ship. wt. 3 lbs.*



AG734: Female

S	2 1/2"	3"	3 1/2"	4"	4 1/2"	5"	6"
4"	\$132.95	\$166.95	\$165.95	\$193.95	\$196.95	\$194.95	\$260.95
5"	\$159.95	\$191.95	\$196.95	\$204.95	207.95	\$213.95	\$269.95

STORZ TO SWIVEL FEMALE 30° ELBOW

Storz to female swivel 30° elbow, rocker lug. Storz heads made of 6061-T6 aluminum alloy, elbow made from tough, lightweight AL-MAG 35. Hardcoat anodized to resist abrasion and corrosion. *Ship. wt. 3 lbs.*



AG731: Female

S	2 1/2"	3"	3 1/2"	4"	4 1/2"	5"	6"
4"	\$194.95	\$280.95	\$273.95	\$240.95	\$248.95	\$290.95	\$335.95
5"	\$221.95	\$254.95	\$300.95	\$253.95	\$280.95	\$281.95	\$317.95

STORZ BLIND CAPS

Storz blind cap is made of aluminum alloy, hard-coated for resistance to abrasion and corrosion. Comes with standard 18" stainless steel cable. Suction gasket comes standard. *Ship. wt. 3 lbs.*



NEW LOW PRICE

AG73625	Storz 2 1/2" Blind Cap	\$22.95
AG73630	Storz 3" Blind Cap	\$20.95
AG73640	Storz 4" Blind Cap	\$59.95
AG73650	Storz 5" Blind Cap	\$89.95
AG73660	Storz 6" Blind Cap	\$161.95

GATE VALVE WITH 25° ELBOW

Lightweight aluminum alloy design includes non-rising stem, elbow, relief valve, air bleeder and 4" through 6" female swivel. For use on pumper intake. *Ship. wt. 29 lbs.*



LOCKING STORZ

AR122	4" Storz to 4" NST Female Swivel	\$865.95
AR123	4" Storz to 4 1/2" NST Female Swivel	\$865.95
AR124	4" Storz to 5" NST Female Swivel	\$865.95
AR125	4" Storz to 6" NST Female Swivel	\$902.95
AR126	4" Storz to 4" Storz Female Swivel	\$902.95
AR127	5" Storz to 4" NST Female Swivel	\$865.95
AR128	5" Storz to 4 1/2" NST Female Swivel	\$865.95
AR129	5" Storz to 5" NST Female Swivel	\$902.95
AR130	5" Storz to 6" NST Female Swivel	\$902.95
AR131	5" Storz to 5" Storz Female Swivel	\$902.95

GATE VALVE

A lightweight, compact, non-rising stem gate valve with air bleed off and 4" through 6". It is used for use on the hydrant steamer connection. *Ship. wt. 24 lbs.*



LOCKING STORZ

AR132	4" Storz to 4" NST Female Swivel	\$751.95
AR133	4" Storz to 4 1/2" NST Female Swivel	\$754.95
AR134	4" Storz to 5" NST Female Swivel	\$785.95
AR135	4" Storz to 6" NST Female Swivel	\$755.95
AR136	4" Storz to 4" Storz Swivel	\$792.95
AR137	5" Storz to 4" NST Female Swivel	\$752.95
AR138	5" Storz to 4 1/2" NST Female Swivel	\$797.95
AR139	5" Storz to 5" NST Female Swivel	\$784.95
AR140	5" Storz to 6" NST Female Swivel	\$807.95
AR141	5" Storz to 5" Storz Swivel	\$798.95

STAINLESS STEEL PISTON INTAKE RELIEF VALVE

Stainless Steel Piston Intake Relief Valve was designed to incorporate quick-connection, fast but controlled opening, with air bleeder and relief valve. 45° inlet provides smooth water flow for reduced friction loss. This valve is covered by a 10-year warranty against failure due to corrosion. *Ship. wt. 27 lbs.*



AW070	4" Inlet Storz x 4 1/2" NH F Outlet	\$1,186.36
AW071	4" Inlet Storz x 5" NH F Outlet	\$1,156.46
AW072	4" Inlet Storz x 6" NH F Outlet	\$1,155.38
AW073	5" Inlet Storz x 4 1/2" NH F Outlet	\$1,159.92
AW074	5" Inlet Storz x 5" NH F Outlet	\$1,126.92
AW075	5" Inlet Storz x 6" NH F Outlet	\$1,125.84

MEGA FLOW VALVE

Our newest compact design for pumper intake control allows easy maintenance. By removing only five bolts, all moving parts can be removed in one assembly. The new design offers the lowest friction loss and largest waterway available. *Ship. wt. 35 lbs.*

- Low profile 30° integrated elbow
- Field-adjustable pressure relief valve
- Full 3/4" air bleeder
- Friction loss at 1000 GPM: 2.3 PSI
- Extension: 10 1/2" L x 8" W x 17" H



BL633	4" Inlet Storz x 5" NH F Outlet	\$938.95
BL634	4" Inlet Storz x 6" NH F Outlet	\$637.95
BL635	5" Inlet Storz x 4 1/2" NH F Outlet	\$940.95
BL636	5" Inlet Storz x 5" NH F Outlet	\$909.95
BL637	5" Inlet Storz x 6" NH F Outlet	\$909.95

3-WAY BALL VALVE

Designed to distribute water to three small diameter lines from a large diameter line, or supply a large diameter line from smaller supply lines. 3-way ball valve features an adjustable pressure relief valve to reduce water hammer. Ball valve body is made of lightweight, high-strength aluminum with powder coat finish. Ball assembly is hard-coat anodized aluminum. Large waterways help minimize pressure loss. *Ship. wt. 21 lbs.*

- Locking storz
- 3-way ball valve
- 12¹/₄"Lx16"Wx11"H

AS142	4" S x (3) 2 ¹ / ₂ " NSTM	\$843.95
AS143	4" S x (3) 2 ¹ / ₂ " NSTF	\$1,008.97
AS144	5" S x (3) 2 ¹ / ₂ " NSTM	\$814.76
AS145	5" S x (3) 2 ¹ / ₂ " NSTF	\$911.83



5-WAY MANIFOLD

Sizes come with 4" or 5" Storz connection on both. Large intake and gated discharge plus (4) 2¹/₂" gated discharges. Portable manifold is designed to take advantage of the increased flow capabilities of large diameter hose. Can supply multiple attack lines without a pumper. Brings your hydrant to the fire scene. Fabricated from lightweight, high-strength aluminum alloy and is hard coat anodized. Provided with large full flow waterways, relief valve and a glycerine filled pressure gauge to indicate residual pressure. *Ship. wt. 51 lbs.*

- Locking storz
- 5-way manifold
- 16"Lx21"Wx13"H

AR142	4" Storz Intake to (4) 2 ¹ / ₂ " NST Male Outlets and (1) 4" Storz Gated Outlet	\$1,582.39
AR143	5" Storz Intake to (4) 2 ¹ / ₂ " NST Male Outlets and (1) 5" Storz Gated Outlet	\$1,605.24



2-WAY BALL VALVE

Designed to distribute water to two small diameter lines from a large diameter line, or supply a large diameter line from smaller supply lines. Ball valve body is made of lightweight, high-strength aluminum with red powder coat finish. Ball assembly is hard-coat anodized aluminum. Large waterways help minimize pressure loss. *Ship. wt. 12 lbs.*

- Locking storz
- 2-way ball valve
- 10"Lx9"Wx8"H

AS146	4" S x (2) 2 ¹ / ₂ " NSTM	\$438.36
AS147	4" S x (2) 2 ¹ / ₂ " NSTF	\$507.55
AS148	5" S x (2) 2 ¹ / ₂ " NSTM	\$493.97
AS149	5" S x (2) 2 ¹ / ₂ " NSTF	\$563.16



3-WAY MANIFOLD

This lightweight, compact unit is a simple, economical way to feed multiple small lines with one large line, and continue with a large line. All outlets are valved. Relief valve and pressure gauge are standard. *Ship. wt. 42 lbs.*

- 17¹/₂"Lx21¹/₂"Wx13"H

BC006	4" Storz Inlet x 4" Storz Outlet x (2) 2 ¹ / ₂ " NH M	\$1,428.99
BC007	5" Storz Inlet x 5" Storz Outlet x (2) 2 ¹ / ₂ " NH M	\$1,396.95





LOW PROFILE BALL INTAKE VALVE

EXTREMELY COMPACT AND LIGHTWEIGHT

- Compact lightweight design fits easily into tight pump panel configurations
- 5 year warranty against corrosion
- Integrated adjustable pressure relief valve
- Flow efficient waterway has less than 5 psi loss and rated 1250 gpm flow
- Individually serialized
- Highly visible valve position indicator and slow close operation exceeds all standards requirements



BN220	5" FSWRL x 4" Rigid STZ	\$925.95
BN221	5" FSWRL x 5" Rigid STZ	\$925.95
BN223	6" FSWRL x 4" Rigid STZ	\$925.95
BN224	6" FSWRL x 5" Rigid STZ	\$925.95



AW078



INTAKE SIAMESE

These reliable clappered Siamese valves are used for feeding one large line with multiple smaller lines. Clapper valve allows for single line usage. Powder-coat aluminum finish with carrying handle. 10½" Lx10"Wx5"H. *Ship. wt. 8 lbs.*

- Single clapper

3-WAY SIAMESE:

- Aluminum construction
- Large waterways
- 2½" NST female swivel inlets
- Convenient carrying handle
- *Ship. wt. 18 lbs.*

AS138	2-Way Siamese 4" Storz x (2) 2½" NST F SW	\$318.95
AS139	2-Way Siamese 4" Storz x (2) 2½" NST M	\$318.95
AS140	2-Way Siamese 5" Storz x (2) 2½" NST F SW	\$318.95
AS141	2-Way Siamese 5" Storz x (2) 2½" NST M	\$318.95
AW078	3-Way Siamese 4" S x (3) 2½" NH Inlet	\$652.95
AW079	3-Way Siamese 5" S x (3) 2½" NH Inlet	\$622.60



SIAMESE 2-WAY CLAPPERED

The Siamese 2-way clappered is made primarily of aluminum alloy that has been heat treated. The Siamese's other major components are made of stainless steel and galvanized brass. This lightweight and smaller design minimizes the friction loss by up to 3 times. *Ship. wt. 8 lbs.*

AW080	(2) 2½" F Inlet x 2½" M Outlet	\$245.95
AW081	(2) 2½" F Inlet x 4" M Outlet	\$587.95
AW083	(2) 2½" F Inlet x 4" Storz Outlet	\$592.95
AW084	(2) 4" Storz x 4" Storz Outlet	\$1,317.95



SUPER FLOW LARGE BALL VALVE

Designed specifically for feeding to or from large diameter hoses. This locking storz valve has full flow 4½" waterways. Each outlet is provided with a ball gate valve to permit easy shutoff. Adjustable relief valve reduces the effects of water hammer. The large gated wye eliminates the need to lay multiple lines. Particularly useful in supplying multiple apparatus with large diameter hose.

Ship. wt. 8 lbs.

AR120	4" Storz to (2) 4" Storz Super Flow Ball Valve	\$1,720.95
AR121	5" Storz to (2) 5" Storz Super Flow Ball Valve	\$1,720.95

REVOLUTION INTAKE VALVE

The Revolution has all of the standard features you expect from an intake valve with flows capable up to 2000 gpm (7600 lpm) making it ideal for the most demanding apparatus intake applications.



- Robust, integrated Pyrolite patent-pending handwheel for easy operation
- Critical pump side waterway components constructed of non-corrosive stainless steel
- Durable, powder coated interior and exterior finish
- Field adjustable relief valve between 50-250 psi (requires 7/8" wrench to adjust), includes 1 1/2" NPT female thread
- Built-in Open/Close indicator
- 2000 gpm max flow
- All parts that stay in contact with water are constructed of stainless steel
- Field serviceable design
- 10-year heavy-duty warranty against manufacturing defects and corrosion
- Quick turn Bleeder valve operation - vents into relief discharge
- NFPA 1901 compliant



REVOLUTION INTAKE VALVE SWIVEL ELBOW INLET

Cat#	Storz		Price
	Female Inlet	Outlet	
BN088	4"	5" Rocker Lug	\$1,930.95
BN089	4"	6" Rocker Lug	\$1,930.95
BN090	5"	5" Rocker Lug	\$1,930.95
BN091	5"	5" Long Handle	\$1,930.95
BN092	5"	6" Rocker Lug	\$1,930.95
BN093	5"	6" Long Handle	\$1,930.95
BN094	6"	5" Rocker Lug	\$2,285.95
BN095	6"	5" Long Handle	\$2,285.95
BN096	6"	6" Rocker Lug	\$2,285.95
BN097	6"	6" Long Handle	\$2,285.95

REVOLUTION INTAKE VALVE STRAIGHT INLET

Cat#	Storz		Price
	Female Inlet	Outlet	
BN098	4"	5" Rocker Lug	\$1,864.95
BN099	4"	6" Rocker Lug	\$1,864.95
BN100	5"	5" Rocker Lug	\$1,864.95
BN101	5"	5" Long Handle	\$1,864.95
BN102	5"	6" Rocker Lug	\$1,864.95
BN103	5"	6" Long Handle	\$1,864.95
BN104	6"	5" Rocker Lug	\$2,220.95
BN105	6"	5" Long Handle	\$2,220.95
BN106	6"	6" Rocker Lug	\$2,220.95
BN107	6"	6" Long Handle	\$2,220.95

BUTTERFLY VALVES

- Rotating the handle to open disc 1/4 turn allows an almost unrestricted water flow
- The 10 position lever handle with positive detents allows the valve to be opened or closed incrementally for a controlled water flow
- Comes standard with a bleeder valve
- Available with 4", 4 1/2", 5" or 6" male or female hose
- Ship. wt. 45 lbs.



LEVER HANDLE

BL272	6" NHSWFLH x 6" NHM	\$889.95
BL273	5" NHSWFLH x 5" NHM	\$1,036.95
BL274	4.5" NHSWFLH x 4.5" NHM	\$889.95
BL275	4" NHSWFLH x 4" NHM	\$889.95

HANDWHEEL

BL276	6" NHSWFLH x 6" NHM	\$1,036.95
BL277	5" NHSWFLH x 5" NHM	\$1,036.95
BL278	4.5" NHSWFLH x 4.5" NHM	\$1,036.95
BL279	4" NHSWFLH x 4" NHM	\$1,036.95

PERMANENT HYDRANT ADAPTER

- Connect Fire Hose to Hydrant in Seconds
- No more time-consuming threading and tightening
- Only 1/4 turn connects hose to hydrant
- A must where multiple steamer thread sizes are used in your area
- Special threads also available
- Ship wt. 5 lbs.



AS225	4" Storz x 4 1/2" NST	\$204.95
AS226	5" Storz x 4 1/2" NST	\$204.95

1% FLUORINE FREE CLASS A/B FOAM CONCENTRATE

The first dual certified fluorine free Class A/B firefighting foam, PHOS-CHEK 1% A/B, was developed for use on both Class A and B hydrocarbon fires as an environmentally responsible next generation option. It is not intended for use on polar solvent fueled fires. UL certified against NFPA 18 as an effective wetting agent for Class A fires including materials such as wood, cloth, paper, etc. at 0.1% use rate and UL 162 listed as a Class B foam at 1% use rate. Unlike some other A/B foams, PHOS-CHEK 1% A/B contains no PFAS chemicals including but not limited to PFOS or PFOA. This foam can be used with most existing foam equipment such as eductors and onboard foam systems that are designed for traditional 0.1-1% Class A foam systems.



SOLD IN 5-GALLON PAILS

BP332 1% Fluorine Free Class A/B Foam Concentrate \$109.95/pail



3X6% FLUORINE FREE CLASS B FOAM CONCENTRATE

This environmentally responsible next generation foam concentrate meets the current needs for Class B hydrocarbon and polar solvent fuel fires when used with fresh water. Designed for to fight a broad range of Class B flammable liquid fires including hydrocarbon fuel fires gasoline and diesel and polar solvents such as ketones and alcohol. Unlike legacy C8 foams which are considered to be bioaccumulative PHOS-CHEK 3X6% fluorine free alcohol resistant foam concentrate does not contain PFAS chemicals including but limited to, PFOS or PFOA. This foam can be used with most existing foam equipment such as eductors and onboard foam systems that are designed for traditional 3%-6% B foam systems. Never to be mixed with other Class B foam concentrates. Meets UL 162 Listed, EN 1568-3:2008 (Class IA) and EN 1568-4:2008 (Class IB).



SOLD IN 5-GALLON PAILS

BP333 3X6% Fluorine Free Class B Foam \$104.95/pail



SILV-EX FOAM CONCENTRATE

A multiple expansion Class A foam concentrate formulated from specialty hydrocarbon surfactants, stabilizers, inhibitors and solvents. Its combination of surfactants and solvents provide extremely good cold weather performance. The original forest fire control concentrate. *Ship. wt. 45 lbs.*



- Proven effective on many deep seated Class A fires
- Can be proportioned from 0.1% to 1.0% in fresh, brackish or sea water



SOLD IN 5-GALLON PAILS

AB410 Silv-ex Foam Concentrate \$129.95/pail

PRACTICE FOAM

Practice Foam is an answer to the requests "give us an inexpensive product to train with!" Practice Foam is a variable percentage Class A type product. Safe and inexpensive to use, Practice Foam may be educted at low to high percentages to achieve the desired results of your training session. Although not intended for a "working fire", Practice Foam is entirely suitable for extinguishing training ground fires. *For training only; NOT for fire fighting.*



- Non-toxic, bio-degradable and self-dissipating
- Plenty of suds - no clean up required

SOLD IN 5-GALLON PAILS

BG113 Practice Foam \$39.95/pail

CLASS A PLUS FOAM CONCENTRATE

Chemguard Class "A" is a non-corrosive, non-toxic, biodegradable foam concentrate. When mixed with water in the correct proportion, it changes the properties of water. It reduces the surface tension of the water, and produces foam, which allows the water to cling to vertical or horizontal surfaces without run off. This allows the water to absorb more heat and provides greater penetration into Class "A" fuels. *Ship. wt. 45 lbs.*

**NEW
LOW
PRICE**



**VIDEO
ONLINE**

CHEMGUARD

SOLD IN 5-GALLON PAILS

AC721 Class A Plus
Foam Concentrate \$84.95/pail

CLASS A FOAM CONCENTRATE & WETTING AGENT

First Response is a new Class A foam manufactured by the makers of the well known Phos-Chek® brand fire suppression products. It's formulated to make water more effective by the reducing the water's surface tension and, when mixed with air, creates a foam blanket that surrounds fuels with a thick layer of water. Foam reduces the amount of water needed to extinguish the fire reducing water damage and increasing fire fighter safety through quicker knockdown and reduced mop-up/overhaul. *Ship wt. 45 lbs.*



- Wetting Agent: 0.2%
- Direct Attack: 0.6% to 1.0%
- Mop Up/Overhaul: 0.2% to 0.6%
- Tested and Qualified for USDA Forest Service
- Meets NFPA 1150
- Effective use in Compressed Air Foam Systems (CAFS)

SOLD IN 5-GALLON PAILS

BL712 Class A Foam Concentrate
& Wetting Agent \$102.95/pail

PHOS-CHEK® CLASS A FOAM

Phos-Chek® Class A foam provides superior foam generation and is the most concentrated Class A foam product available today. Phos-Chek® is a unique combination of surfactants that make water more effective for fire fighting. Phos-Chek has been tested and approved for use by the U.S. Forest Service. U.S. Forest Service testing includes product Environmental, Health & Safety, and Corrosion criteria. Phos-Chek® is also a U.L. listed Wetting Agent at a very low use rate of 0.1% for Class A and 0.25% for Class B fires. Phos-Chek® meets the requirements of NFPA 1150, contains no EPA listed hazardous materials, and is readily biodegradable. Phos-Chek® works extremely well with CAFS at ratios of 0.2 to 0.3%. *Ship. wt. 45 lbs.*



SOLD IN VARIOUS VOLUME AND QUANTITIES, SEE BELOW

AS285 Phos-Chek® Class A
Foam 5-gal. Container \$127.95/pail

AS286 Phos-Chek® Class A
Foam 4 oz./Case of 36 \$122.95/case

AS289 Phos-Chek® Class A
Foam 55-gal. Drum \$1,320.95/drum

PRECISION FOAM TESTING KIT

The Precision Foam Testing Kit is designed to simplify the process of testing foam systems for proportioning accuracy. This kit utilizes liquid conductivity and a precision digital scale to accurately prepare standards and test discharge samples; the same method used by nationally recognized testing laboratories when testing systems for listing and approval. *Ship. wt. 6 lbs.*

INCLUDES:

- Protective carrying case with foam protective padding
- Precision digital electronic 250 gram scale with 0.1 gram accuracy
- 6 - 150ml graduated sample beakers
- 100ml graduated cylinder
- 250ml wash bottle
- 2 - 10ml sample pipettes (12" L)
- 5 - 3ml sample pipettes (6" L)
- 500ml water sample bottle
- 2 - 10ml sample syringes
- 10 - Test charts (reproducible)
- Instruction manual

CHEMGUARD

AZ292 Precision Foam Testing Kit

\$784.95



PRO/pak FOAM SYSTEM

EVERYTHING YOU NEED IN ONE PORTABLE UNIT TO APPLY FOAM QUICKLY

Making great foam is easy with the PRO/pak. Everything you need is contained in one lightweight package that attaches to the end of your 1" fire hose. It can work on pressures as low as 50 psi. With its small size and versatile nozzles you can have foam capability without the expense of built-in systems costing thousands of dollars. Features a high-impact 2½ gallon foam reservoir with built-in eductor that can be set to the ratio of your choice. Large, easy-open fill port has an indicator to show the type of liquid in the tank. The flow is controlled by a twist grip valve/carrying handle. With each quarter turn you select the discharge velocity for inlet pressures between 40 and 500 psi. System comes complete with a straight stream nozzle, low expansion nozzle and medium expansion nozzle. Nozzles can be directly attached to the eductor for one-handed operation, or a short section of hose can be added for maneuverability. *Designed for Class A 3% or 6% AFFF & AR Foams. Ship. wt. 15 lbs.*



VIDEO ONLINE

INCLUDES:

- PRO/pak unit
- 3' extension hose
- Shoulder strap
- 3 - quick-connect nozzles



SPECIFY INLET THREADS; 1" NH OR NPSH

AJ255	PRO/pak Foam System	\$775.95
AJ256	Piercing Nozzle	\$176.95
AJ257	Mounting Bracket	\$88.95
AJ258	25' Discharge Hose	\$205.95
AJ259	Waist Strap	\$26.95



FOAMPRO® 1600 SERIES PROPORTIONING SYSTEM

No other system delivers foam as easily and accurately as the FoamPro®. All it takes is a flip of the switch to start the system. FoamPro® adjusts automatically to any changes in flow rate or pressures. Plus, the patented, high-tech, electronic controller does all of the work for you. To make the foam wetter or drier simply adjust the dial to change the foam concentrate level. When you use the FoamPro®, you don't have to worry if the foam solution is correct-the system does the proportioning all automatically. Simply set the percentage you want on the control module. Because the precise proportioning is done by measuring flow instead of pressure, you do not have to shut down to add lines, change pressure or refill the foam tank. What's more, the FoamPro® conveniently interfaces with Compressed Air Foam Systems. *Meets NFPA Standards. Ship. wt. 68 lbs.*

EXCLUSIVE FEATURES:

- Automatic proportioning
- Adjustable dial control
- Proportions continuously
- No foam goes through the fire pump
- No in-line restrictions
- Installs in new or existing apparatus
- Delivers 0.1 to 1.7 gpm of concentrate



TANK SENSOR REQUIRED

AJ247	FoamPro® with 1½" Flowmeter	\$3,628.95
AJ248	FoamPro® with 2" Flowmeter	\$3,682.95
AJ249	Tank Sensor, Vertical Mount	\$79.95

AVAILABLE OPTIONS

AJ251	8 gal. Polypropylene Foam Tank	\$234.95
-------	--------------------------------	----------

FAST FOAM 150

CLASS "A" FOAM PROPORTIONING SYSTEM

The Fast Foam 150 system offers a reliable, accurate, compact foam proportioning system at an economical price. This model treats up to 150 gpm @ 1% at pressures up to 175 psi. *Call for pricing at 877-634-6223.*

ENGINE

- 12 VDC, 1/2 hp continuous speed electric motor. The maximum amp draw at full load, 175 psi (12 bar) is 39 amps. The pump is a continuous duty, piston type, positive displacement pump. The pump is rated at 1.5 gpm. Pump is supplied with a 250 psi (17.2 bar) safety relief valve for protection against over pressurization. The Venturi flows up to 150 gpm.

DIMENSIONS

- 21" L x 10" W x 12" H, 75 lbs.

APPLICATIONS

- Mini pumper, pumper, pumper tanker, rescue pumper, wildland/quick attack fire vehicle

FEATURES

- 1.5 gpm/150 gpm, 1/2 hp 12vdc motor, pilot operated relief valve
- Low concentrate float switch
- Venturi 1 1/2" NPT
- Includes installation kit
- Control panel placard with on/off switch and low concentrate light, adjustable foam percentage valve

PERFORMANCE

- Up to 150 gpm @ 1% at pressures up to 175 psi



ADDITIONAL FAST FOAM SYSTEMS

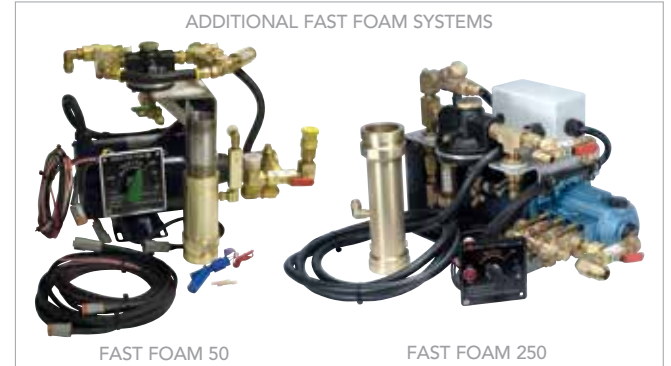

DARLEY FOAM REFILL SYSTEM

The Darley Foam Refill System is designed to create a safe alternative to refilling your Class A foam tank without the need to climb on top of your truck. The Foam Refill System kit includes all the necessary equipment needed for a simple installation into new or existing apparatus. Once installed, simply attach the pickup hose, insert the tube into the foam pail, hold the switch to on, and fill your foam tank from a safe position until the green foam full light appears on. *Call for pricing at 877-634-6223.*



INSTALLATION OPTIONS

- **Panel Mounted Kit:** Includes all the necessary components needed for a simple install. The control panel will be separate from the pump, allowing you to remote mount parts as needed to fit into tighter spaces.
- **Self-Contained Kit:** Includes all the same parts as the panel mounted kit but will be fully assembled with an aluminum bracket to minimize assembly/installation for the end-user.

PERFORMANCE

- Pumps at 4 to 6 GPM and is capable of 10' of lift

PUMP

- Pump and motor are 12 VDC capable
- Pump utilizes a Nitrile impeller for optimal performance and durability

OPERATION PLACARD / PROTECTION BOX

- Placard is made of 16-gauge stainless steel and mounted with stainless screws
- Overlay is made of Bayfol UV-1 laminate. Offers superior protection against UV exposure and is resistant to scratches and cracking
- Momentary switch and green foam full indicator light included on the placard

PICKUP TUBE

- Clear 3/4" plastic tube with a female camlock fitting to connect to the panel and a stainless pickup tube making it easy to utilize all of the foam in a pail

CAFS ACCESSORIES



ODIN® AUTOFILL™



Electronic control that fully automates the tank fill process from a pressurized source. System comes with operational control placard and wire harness complete with weather tight connectors. Requires a tank level gauge and sensor - sold separately. *Call for pricing at 877-634-6223.*

- 1 1/2", 2", 2 1/2", 3"

ODIN® AUTOVALVE™

The AutoValve™ system has predetermined flow settings for simplified water and air valve operations with the push of a button. It is also equipped with a "Slug Flow Interlock" safety feature which is designed to prevent the slug flow that occurs when water and air are mixed without foam concentrate. The AutoValve™ is a user programmable electronic valve system that can be used in CAFS, powered by 12 or 24 volt battery power. *Call for pricing at 877-634-6223.*

- 1 1/2", 2", 2 1/2", 3"

IN-LINE FOAM EDUCTORS

In-line Foam Eductors have a metering head with easy-read knob for use with Class A foam at .25% and .5% and with ARC-AFFF foam at 1%, 3% and 6%. Extra large 36" pickup hose and stainless steel wand are ideal for use with high viscosity foams. The meter head is equipped with a unique backflush push-button for fast cleaning, and is secured to the eductor body with a rugged disconnect. All controls are easy to use with gloves. Made of hardcoat anodized aluminum for corrosion protection. The required inlet pressure is 200 psi. The maximum allowable back pressure is 130 psi.



Cat#	Description	Inlet	GPM	Price
BL376	In-Line Foam Eductor	1 1/2" NH	60	\$692.95
BL377	In-Line Foam Eductor	2 1/2" NH	60	\$692.95
BL378	In-Line Foam Eductor	1 1/2" NH	95	\$692.95
BL379	In-Line Foam Eductor	2 1/2" NH	95	\$692.95
BL380	In-Line Foam Eductor	1 1/2" NH	125	\$692.95
BL381	In-Line Foam Eductor	2 1/2" NH	125	\$692.95

PORTABLE BY-PASS EDUCTOR

The Portable By-Pass Eductor has a built-in by-pass chamber, allowing the operator to change from water to foam without shutting down.



- Brass with chrome trim
- 8 quick-change handle positions with a Swing-Out™ valve handle



Cat#	GPM	Inlet	Outlet	Price
BL032	95	1 1/2"	1 1/2"	\$1,941.95

"THROUGH-THE-PUMP" FOAM EDUCTOR/MIXER

- Educts foam concentrate into hose lines through a pump's suction and discharge sides, also known as an "Around-The-Pump" system
- Will educt concentrates at percentages of 0% to 3.75% at flow rates from 15 to 125 gpm at 100 psi
- Maximum operating pressure of 300 psi
- Includes an 18" pressure hose and a 48" foam pick-up hose
- 1 1/2" and 2" cast aluminum connecting tee

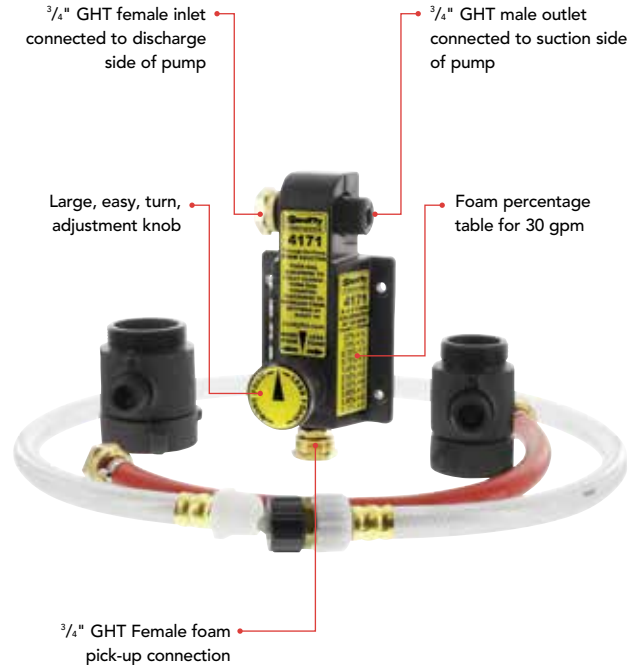

AJ253	"Through-the-Pump" Foam Eductor/Mixer	\$507.95
-------	---------------------------------------	----------

PYROLITE® IN-LINE EDUCTORS

Akron Municipal Eductors feature a large, easy to read, and removable metering dial with infinite settings between 0 and 6%. Detents at 1/4, 1/2, 1, 3, and 6%. The Eductors are rated to flow at 200 psi (14 bar) inlet pressure and works well with nozzles rated at 75 and 100 psi (5 and 7 bar). *Ship. wt. 8 lbs.*



- 1 1/2" or 2 1/2" swivel inlet x 1 1/2" male, except where noted
- 48" pickup hose standard on 250 gpm (950 lpm)



Cat#	GPM	Pick Up Hose	Price
AZ340	60 gpm	30"	\$863.95
AZ341	95 gpm	30"	\$812.95
AZ342	125 gpm	30"	\$854.95
AZ343	250 gpm	48"	\$1,284.95

ATP FOAM FLURRY™

The ATP FOAM FLURRY™ is our most economical proportioner. It is simple-to-install and operate. For your next Darley portable pump purchase, or for retrofitting your current pump, the ATP FOAM FLURRY™ will deliver foam cost effectively.

- All brass construction – no plastic
- Fast adjusting variable control ball valve
- Capable of .5% injection rate up to 130 gpm
- Remote mount operation placard
- Includes installation kit

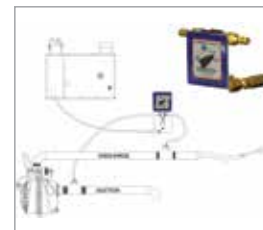

ATP00001 ATP FOAM FLURRY™ \$614.95

BUBBLE CUP NOZZLES

The dual or single-gallonage Bubble Cup nozzle is a uniquely designed aspirating fog/ foam nozzle created to be used with AFFF and Protein type foams for fire brigades and hazardous materials incidents or for structural and wildfire applications of Class A foaming agents. Capable of producing a conventional straight stream, wide protective fog pattern and aspirating foam, the Bubble Cup is a nozzle that provides an extra measure of protection. Nozzles are backed by a full 5-yr factory warranty and 24-hr. Certified repair. *Ship. wt. 4 lbs.*



NEW
LOW
PRICE



SPECIFY GPM: 20/60 or 20/95

AC990	1 1/2" Bubble Cup Nozzle Tip	\$286.95
AC991	1 1/2" Bubble Cup Nozzle with Shut-Off	\$433.95
AC992	1 1/2" Bubble Cup Nozzle with Shut-Off & Pistol Grip	\$433.95

VIPER FOAM NOZZLE



- Durable Viper Ball Valve
- Up to 12:1 expansion ratio
- Available in your choice of 60 or 95 gpm
- Construction: Lightweight aluminum
- Length: 19"
- *Ship. wt. 4 lbs.*



Cat#	GPM	Inlet	Price
BL034	60	1 1/2"	\$420.95
BL035	95	1 1/2"	\$420.95

MADD DOG FOAM NOZZLE EXPANSION ASPIRATING FOAM ATTACHMENT

The Madd Dog Attachment makes better foam than any other multiple expansion aspirating nozzle. Designed by a fire captain with firefighter safety, quality, versatility, performance and cost in mind. Produces low-expansion foam with excellent stream projection or medium expansion foam with incredible production. The aspirating attachment is constructed of pressure-injected polymer resins which make it economical, lightweight and incredibly rugged and will fit a variety of combination nozzles. *Ship. wt. 2 lbs.*



AK244	Madd Dog Foam Nozzle	\$172.95
L685	1 1/2" Lexan Nozzle	\$13.95

2 1/2" CAFS PISTOL GRIP NOZZLE

Do you want to pack the most CAFS punch possible in a 2 1/2" hand line? Most 2 1/2" nozzles are nothing more than a 1 3/8" waterway shutoff with a 2 1/2" swivel inlet. Not this nozzle... this pistol grip ball shutoff features a 2 1/2" swivel inlet and a 2 1/2" threaded outlet with a full 2" internal ball opening. This allows more CAFS to be propelled unobstructed through this lightweight pistol grip ball shut-off. We also finish off this Brutus of a shut off with a set of dual stacked tips so you can choose between the 2 1/4" and a 2" tip opening. Easily flows 120 gallons per minute of foam solution and 120 cfm of compressed air at the NFPA recommended 125 psi. *Ship. wt. 7 lbs.*



BH190 2 1/2" CAFS Pistol Grip Nozzle \$869.95

FOAM GUN COMBO



BN011:

- 1" shutoff with pistol grip
- 1" foam gun proportioner
- 1" nozzle tip 10/23 gpm
- Length: 25"
- Ship. wt. 5 lbs.

BN012:

- 1 1/2" shutoff with pistol grip
- 1 1/2" foam gun proportioner
- 1 1/2" nozzle tip 20/60 gpm
- Length: 25"
- Ship. wt. 5 lbs.

BN011 1" Foam Gun Combo \$530.95
 BN012 1 1/2" Foam Gun Combo \$552.95
 BN076 12" Class A Foam Cartridge \$29.95

CAFS NOZZLES

BL036:

- Combination of the ball shutoff with full 1" inlet waterway and the 1 5/16" outlet smooth bore tip. Both parts are constructed of hard coated aluminum.

BL037:

- Combination of the ball shutoff with full 1 1/2" inlet waterway and 1 1/8" outlet smooth bore tip. Both parts are constructed of hard coated aluminum.



SPECIFY NST OR NPSH FOR INLET

Cat#	Description	Inlet	Length	Weight	Price
BL036	1" CAFS Nozzle	1"	10"	2 lbs.	\$255.95
BL037	1 1/2" CAFS Nozzle	1 1/2"	10 1/2"	4 lbs.	\$358.95

SABERJET DUAL SHUTOFF CAFS NOZZLE

This very versatile pistol-grip ball shutoff features a large 1 3/8" ball opening and 1 1/8" smooth bore tip which produces a strong CAFS stream for wet to medium foam types. It also features a secondary control for spraying plain water, foam solution, or wet CAFS stream through the fog spray nozzle. The SaberJet Dual Shutoff CAFS Nozzle is a great tool for your CAFS attack lines and provides a wide variety of real world spray stream options as well as the ability to spray plain water if desired. Includes colored handles and pistol grip kit shown.



COLORED HANDLES AND PISTOL GRIP KIT



BL386 1 1/2" SaberJet Dual Shutoff CAFS Nozzle \$1,201.95

ODIN COMPRESSED AIR FOAM SYSTEMS

CALL FOR PRICING AND AN EXTENDED LIST OF FEATURES 877-634-6223



FOAM

HORNET™

LOWER COST, LIGHTWEIGHT, COMPACT, MINI-CAFS

ENGINE

- Briggs & Stratton Vanguard: 23 HP @ 3600 rpm, 4 cycle, air-cooled, gasoline-powered, pressure lubricated, 16 amp alternator, 12 vdc electric start

PUMP

- Darley 2BE single-stage centrifugal pump

DIMENSIONS & WEIGHT

- 40"W x 24"H x 32"D
- 450 lbs. (204 kg)

PERFORMANCE

- 80 gpm @ 40 psi @ 100 psi
- 250 gpm @ 40 psi - Water Only
- 40 gpm @ 125 psi - Air Only

APPLICATIONS

- Wildland
- Quick Attack
- Rescue
- Skid Unit



DERRINGER 100/50 DIESEL

ENGINE

- Kubota V1505: 33.5 HP Diesel engine, liquid cooled, indirect injection, naturally aspirated, pressure lubricated 12VDC 40 amp alternator, glow plugs, remote oil drain

PUMP

- Darley 1-1/2AGE single-stage centrifugal pump
- Designed to provide up to 130 gpm and pressures up to 170 psi

DIMENSIONS & WEIGHT

- 54.5"L x 47.5"W x 39"H
- 1,250 lbs. (567 kg)

WATER PERFORMANCE

- 135 gpm @ 150 psi
- 160 gpm @ 100 psi

SIMULTANEOUS FLOW

- 100 gpm & 50 cfm @ 125 psi

AIR PERFORMANCE

- 60 cfm @ 125 psi

SIMULTANEOUS FLOW

- 130 gpm & 60 cfm @ 100 psi

APPLICATIONS

- Wildland
- Quick Attack
- Rescue
- Skid Unit



WEAPON 200/100

ENGINE

- Deutz BF4L2011F: 73 HP @ 2600RPM, air/oil cooled, indirect injection, turbo-charged diesel engine

PUMP

- Darley 2-1/2AGE single-stage, centrifugal pump
- Designed to provide up to 250 gpm and pressures up to 250 psi

DIMENSIONS & WEIGHT

- 56"L x 47.5"W x 40"H
- 1,750 lbs. (794 kg)

WATER PERFORMANCE

- 250 gpm @ 150 psi
- 175 gpm @ 200 psi
- 125 gpm @ 250 psi

AIR PERFORMANCE

- 125 cfm @ 125 psi

SIMULTANEOUS FLOW

- 200 gpm & 100 cfm @ 125 psi

APPLICATIONS

- Wildland
- Quick Attack
- Rescue
- Skid Unit



MONGOOSE

ENGINE

- Kawasaki: 31 HP @ 3600 rpm, liquid cooled, V twin, 2 cylinder, gasoline-powered, 12 vdc electric start, multi-port digital fuel injected

PUMP

- Darley Model 2BE: Fully adjustable 1 1/2" CAF discharge mix point, 2 1/2" water discharge, 2 1/2" direct tank fill, 2 1/2" NPT suction inlet, 2 1/2" water and air pressure gauges, pump drain valve, stainless steel plumbing, Darley 12v primer

DIMENSIONS & WEIGHT

- 36"(+6")L x 47 1/4"W x 33"H
- 875 lbs. (397 kg)

WATER PERFORMANCE

- 120 gpm @ 100 psi
- 250 gpm @ 40 psi

SIMULTANEOUS FLOW

- 46 gpm & 23 cfm @ 125 psi

AIR PERFORMANCE

- 50 cfm @ 125 psi

SIMULTANEOUS FLOW

- 80 gpm & 40 cfm @ 100 psi

APPLICATIONS

- Wildland
- Quick Attack
- Rescue
- Skid Unit



MONGOOSE GAS

 **WARNING:** Cancer and Reproductive Harm – www.P65Warnings.ca.gov

Mongoose Diesel also available. Call for details.

FOAM SYSTEMS

FOAM

LDMBC COMPRESSED AIR FOAM SYSTEM (CAFS)

AVAILABLE AS A
COMPLETE MODULE

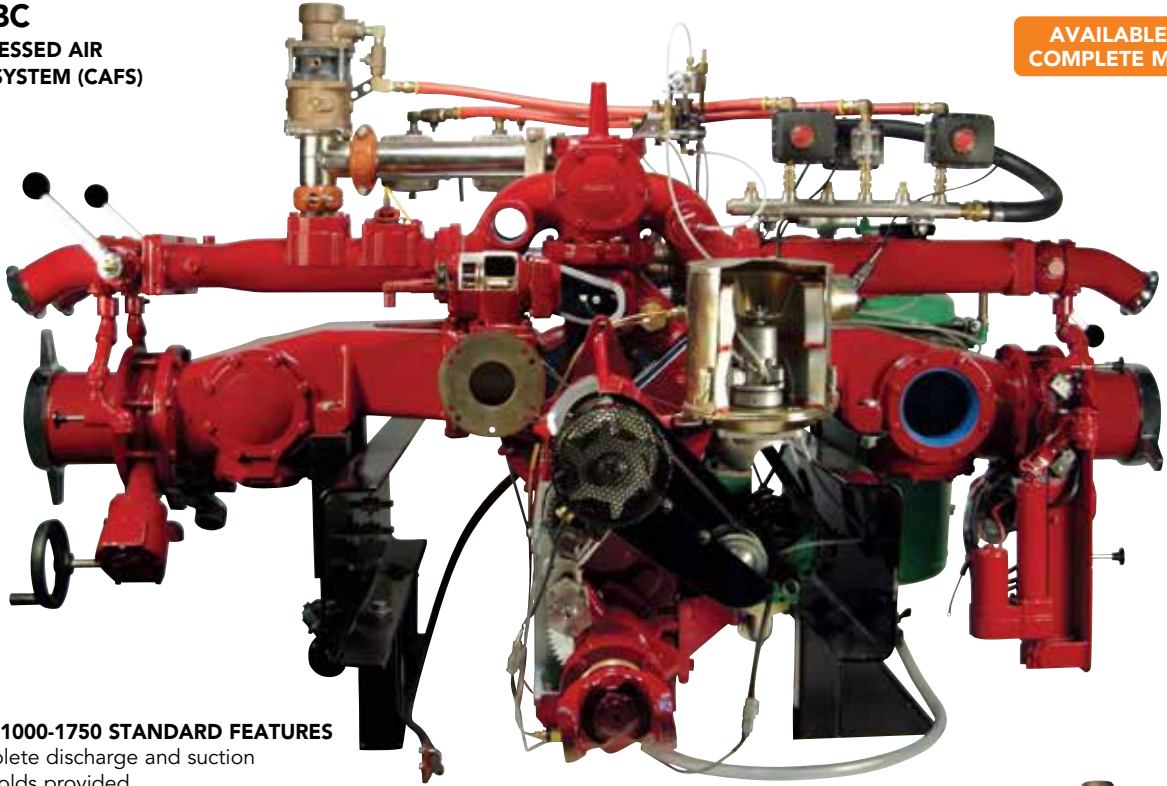

LDMBC 1000-1750 STANDARD FEATURES

- Complete discharge and suction manifolds provided
- 4 - 2 1/2" NH, 1/4 turn, self-locking ball valves
- 2 - 5" or 6" NH suction adapters and Darley caps
- Optional behind the panel intake valve(s) available
- Discharge and suction flanges as needed
- Air pump shift
- 1610 or 1710 full round yokes standard
- Extended pump shaft to drive 220 cfm compressor package
- Remote packing adjustment cables or mechanical seal
- Fully tested water and air systems

LDMBC - COMMONLY SPECIFIED OPTIONS FOR A COMPLETE PACKAGE

- FoamPro 2001/2002 foam System with paddle wheel
- CAFS/Foam stainless steel plumbing manifold
- Optional 1 1/2", 2", and 2 1/2" CAFS valve packages
- CAFS check valves for foam discharges
- Air flow control valves and check valves
- Optional manual or electric valve controls
- Can be used with AutoValve™
- Can be completely plumbed and service tested

APPLICATIONS

- Aerial
- Pumper
- Rescue pumper
- Pumper tanker

DIMENSIONS & WEIGHT

- 40" L x 76" W x 46" H
- 2,200 lbs. (997 kg)

USES

- Single stage
- Centrifugal
- Midship mounted
- Pump forward



LDMBC
FRONT VIEW

AutoCAFS®

SIMULTANEOUS WATER PERFORMANCE

Up to 6624 L/M (1750 gpm) @ 8.6 bar (125 psi)
NFPA Ratings From 1000 - 1750

SIMULTANEOUS COMPRESSED AIR PERFORMANCE

6229 L/M (220 cfm) @ 8.6 bar (125 psi)



AutoCAFS® Commander control system. Indicates and operates all CAFS functions and system information.

Call for pricing and an extended list of features 800-634-7812

1.800.323.0244 | EDARLEY.COM/FOAM

WATER PURIFICATION SYSTEMS

Darley offers a full range of safe drinking water solutions for everyday use, disaster response, humanitarian, municipal government, and military applications. Darley solutions utilize membrane technology to create a physical barrier between impurities and safe drinking water. Complete water solutions include customizable water treatment, water pressure, water storage and water distribution solutions for your needs. Contact your Darley representative for pricing.

BAG-IN-BOX WATER

AFFORDABLE, SUSTAINABLE, STORABLE AND PORTABLE

10 liter Bag-in-Box Water with single-use, ultra-clean and eco-friendly packaging solution with a 3 year shelf life. Long shelf life is attainable due to innovative filling and pouring process. Water is protected from UV light and air, which seals out risk of bacterial contamination. *Sold by pallet of 80 boxes.*



NEW

\$815 + SHIPPING

- **Everyday Usage:** Home, office, school, hospitals, fire stations
- **Emergency Response:** Natural Disaster, Humanitarian Relief
- Ideal for fundraising and as a marketing platform
- 3 year shelf life

VERSA SEA PAK

MAN-PORTABLE SALT WATER PURIFICATION SYSTEM



VIDEO ONLINE

STARTING AT \$6,879

- **Output:** 200 or 360 GPD*
- **Technology:** Reverse Osmosis, Hydraulic pressure intensifier and energy recovery technology (10% recovery rate)
- **Power:** VSP 200 - 12 or 24 VDC, VSP 360 - 24 VDC
- **Power:** External power (battery, car, generator, solar). No internal power provided.
- **Power Draw:** VSP 200 - 10A at 12 VDC and 5A at 24 VDC, VSP 360 - 10A at 24 VDC
- **Dimensions:** 31" x 20.5" x 15.5"
- **Weight:** VSP 200 - 65 lbs. or VSP 360 82 lbs.

FEATURES

- Ideal for disaster response and military applications
- Simple operation, no training required
- Green to Red filter condition gauge for 5 micron pre-filter
- Analog gauges and controls
- Rugged Pelican case

*Output can vary depending on power source, raw water source, suction lift, pressure variations and filter condition.

DARLEY SUNSPRING®

DECENTRALIZED WATER TREATMENT SYSTEM

SPECIFICATIONS

- **Output:** 5,000 gallons per day*
- **Technology:** Ultrafiltration, backwashable membrane
- **Power:** 24 VDC, 2 - 100 AH batteries, 2 - 160 watt solar modules and 160 watt wind turbine
- **Power draw:** 3.5 to 5.5 AMPS
- **Dimensions:** 2' diameter x 14.5' tall

STARTING AT \$24,495

FEATURES

- Ideal for hospitals, schools, remote villages, and disaster response
- No outside power required
- Stainless steel, reusable 100 micron pre-filter
- Diamond plate aluminum system enclosure
- Self-cleaning membrane maintenance cycle
- Post carbon activated filter for smell and taste enhancement
- Post filter GAC for taste and odors
- Larger fresh water versions available (Up to 50,000 gallons per day)
- Salt water versions not available



VERSA FRESH PAK

MAN-PORTABLE FRESH WATER PURIFICATION SYSTEM



VIDEO ONLINE

STARTING AT \$4,300

- **Output:** 1,000 GPD*
- **Technology:** Ultrafiltration, Back washable membrane
- **Power:** 12 VDC, external power (battery, car, generator) and/or 20 AMP hour internal battery & 75 watt foldable solar modules
- **Power draw:** 2 AMPS
- **Dimensions:** 22" x 16" x 11"
- **Weight:** 62 lbs. with lithium and 72 lbs. with standard gel battery

FEATURES

- Ideal for disaster response and military applications
- 20 micron pre-filter
- Post carbon activated filter for smell and taste enhancement
- Prefilter for sediment removal and Post filter GAC for taste and odors
- Rugged Pelican case

DARLEY PUMPS

PUMPS

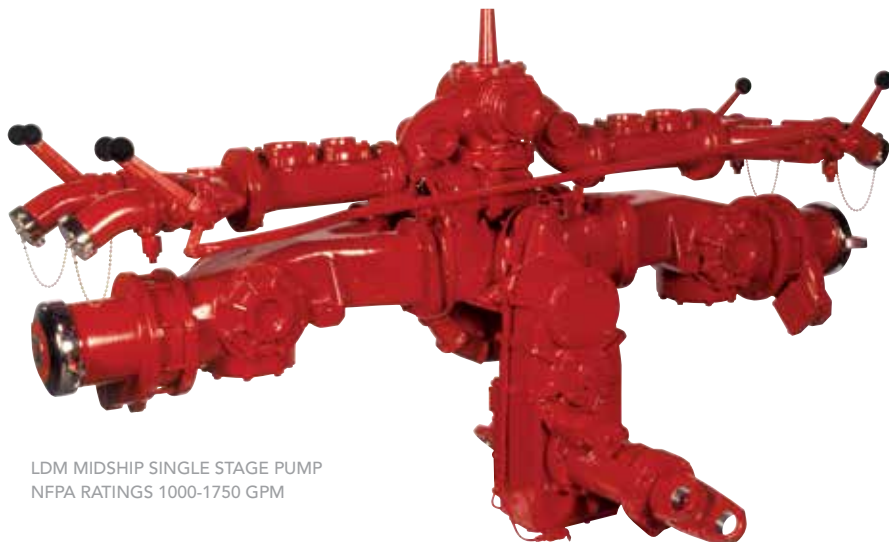

LDM MIDSHIP SINGLE STAGE PUMP
NFPA RATINGS 1000-1750 GPM



DQS Inc.
W.S. DARLEY & COMPANY
REGISTERED TO ISO 9001:2015
CERT# 10000076

WHY DEMAND DARLEY PUMPS?

ISO 9001 CERTIFIED

Our pump division is registered as an ISO 9001:2015 Certified facility accredited by Underwriters Laboratories Inc.

ENGINEERED FOR LIFE

Darley engineers use the latest technology platforms such as ANSYS CFD and Solidworks to design our pumps.

SALES AND SERVICE

We strive to ship most Darley parts orders within 24 hours.

SELF-LOCKING DISCHARGE VALVES

Stainless steel ball valves stay secure in the position you choose.



DISCHARGE CHECK VALVE

Prime pumps with discharge gates open and caps removed for rapid water deployment.



AUTOCOOL™ AND MAGNATRANS™

Darley pump transmissions are the strongest in the market. The patented AutoCool™ ensures oil cooling without the possibility of water contamination.



VACUUM CAST IMPELLER

Durable and efficient, balanced to fit a 10-splined stainless steel pump.



MECHANICAL SEAL

Extremely hard and heat dissipative silicon carbide stationary face allows pumps to run dry for short durations maintenance and is drip free.



LONGEST WARRANTY

The longest and most comprehensive warranty in the industry with a six year manufacturer's warranty. Includes three years of parts and labor coverage at no charge on our Midship and PTO pumps. We've got your back.



DARLEY FAMILY OF PUMPS

Darley offers over 300 high quality, highly efficient and competitively priced pumps, CAFS and related products for virtually any application. Darley pumps are 100% manufactured in the USA and backed by the industry's longest warranty. Visit darley.com to view our complete selection and learn more reasons why you should switch to Darley pumps. Contact PumpSales@darley.com to find the right pump to meet your needs.

GASOLINE PORTABLE PUMPS

Darley Gasoline Portable Pump models are available with a wide variety of engines from Briggs & Stratton Vanguard, Honda, and Rotax.



COMPRESSED AIR FOAM SYSTEMS

Darley offers the widest variety of CAFS on the market. Darley AutoCAFS™ and Odin CAFS provide the solution to all your CAFS needs.



DIESEL PORTABLE PUMPS

Darley Diesel Portable Pump models are available with a wide variety of engines from Yanmar, Kubota, Cummins, John Deere and Deutz.



FAST ATTACK SKIDS

Darley Fast Attack Skid units are ideal for brush firefighting needs. Designed to fit into the standard 8' bed of any pickup truck, the unit features a 200 gallon poly tank with "C" channel construction for easy installation and removal.



ENGINE DRIVEN PUMPS

Darley Engine Driven Pump models are available with a wide variety of engines from Cummins, Deutz, Ford, GMC, Kubota and John Deere.



PUMP MODULES

Darley offers a large variety of Pump Modules from our compact Solution Series™ PTO driven Modules to Top-Mounted Midship Modules.



FRONT/REAR MOUNTED PUMPS

Darley continues to offer a wide variety of Front and Rear Mount pump configurations.



MARINE PUMPS

Darley offers marinised versions of our portable, front mount and engine driven pumps featuring engines from Honda and Steyr.



PTO PUMPS

Darley has a wide variety of PTO and hydraulically driven pumps with flows up to 1500 gpm ideal for pump and roll applications.



OHLER PUMPS AND CUSTOM PUMP SOLUTIONS

Ohler pumps offer a range of pumps for industrial applications including diesel fuel, mining and trash flow.



MIDSHIP MOUNTED PUMPS

Darley offers both manifolded and non-manifolded midship pumps with ratings from 1000 to 6000 gpm.



PUMP ACCESSORIES

Darley has a wide variety of pump accessories such as control panels, adapters, mechanical seals, primers, valves, gauges and more.



AFFORDABLE, PORTABLE, ENGINE-DRIVEN SELF-PRIMING DAVEY PORT

The Darley® Davey pumps, also known as the “affordable portables” are the most economical choice in portable, high-efficiency pumps. Their compact design makes them ideal for a variety of applications such as firefighting, tank filling and water transfers.

PUMP DESIGN FEATURES

- MARINE-GRADE ALUMINUM CASING
- 3-WAY DISCHARGE PORT WITH 1 - 1½" NPTM, 2 - 1" NPTM
- 1½" NPTM SUCTION
- ZINC-PLATED CASING BOLTS
- MECHANICAL SHAFT SEAL
- NITRILE RUBBER SEAL AND CASING "O" RINGS
- SELF-PRIMING UP TO 19'
- EASY INSTALLATION
- COMPACT AND LIGHTWEIGHT
- HIGH PUMPING EFFICIENCY
- LOW OIL PROTECTION
- SPARK ARRESTOR/EXHAUSTER DIVERTER

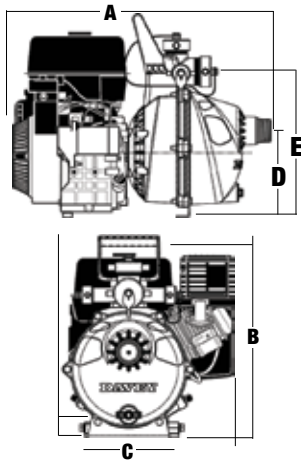

Cat#	A	B	C	D	E
AK300	23.8"	15.3"	15.6"	6.7"	11.7"
AK301	22"	17.7"	16.8"	7.5"	12.6"
AK302	17.5"	15.3"	15.3"	6.7"	11.7"
AK305	22.9"	18.7"	18.0"	7.5"	12.6"
AK306	22.4"	17.5"	17.9"	7.5"	12.6"
AK308	21.4"	17.7"	17.1"	7.5"	12.6"
AK312	20.1"	15.3"	14.8"	6.7"	11.7"
AK313	25"	19.5"	18.5"	7.9"	13"
AK314	22.8"	15.3"	15.8"	6.7"	11.7"
AK315	22.8"	15.3"	15.8"	6.7"	11.7"

6.5 HP SINGLE-IMPELLER

AK312: 6.5 HP SINGLE-IMPELLER

EMAIL YOUR INQUIRIES TO INSTOCK@DARLEY.COM



PERFORMANCE

- 95 gpm (378 L/M) @ 39 psi (2.7 bar)
- 60 gpm (227 L/M) @ 70 psi (4.8 bar)
- 20 gpm (76 L/M) @ 90 psi (6.2 bar)

AK312 6.5 HP Briggs & Stratton OHV Vanguard with Recoil Rope Start \$1,330.00

6.5 HP TWIN-IMPELLER

AK300: 6.5 HP TWIN-IMPELLER

AK314: 6.5 HP TWIN-IMPELLER



FEATURES

- 6.5 HP Briggs & Stratton OHV Vanguard with recoil rope start
- 6.5 HP Honda with and without electric start
- Spark arrestor/exhauster diverter
- 60 lbs. (27 kg)

PERFORMANCE

- 65 gpm (246 L/M) @ 48 psi (3.3 bar)
- 50 gpm (189 L/M) @ 81 psi (5.6 bar)
- 20 gpm (76 L/M) @ 120 psi (9.0 bar)

AK300 6.5 HP Briggs & Stratton OHV Vanguard \$1,630.00
 AK314 6.5 HP Twin-Impeller Honda Electric Start \$1,930.00
 AK315 6.5 HP Twin-Impeller Honda Non-Electric Start (Not Pictured) \$1,630.00

⚠ WARNING: Cancer and Reproductive Harm – www.P65Warnings.ca.gov

ABLE PUMPS

9 HP & 10 HP TWIN-IMPELLER

AK301: 10 HP
TWIN-IMPELLER



AK313: 10 HP
TWIN-IMPELLER



FEATURES

- 9 HP Honda and 10 HP Briggs & Stratton OHV Vanguard or Yanmar diesel with electric start and recoil
- Spark arrestor/exhauster diverter
- 80 lbs. (36 kg)

PERFORMANCE

- 120 gpm (454 L/M) @ 36 psi (2.5 bar)
- 95 gpm (378 L/M) @ 83 psi (5.7 bar)
- 60 gpm (227 L/M) @ 118 psi (8.1 bar)
- 20 gpm (76 L/M) @ 144 psi (9.9 bar)

AK308	9.0 HP Honda - GX270 (Not Pictured)	\$3,087.00
AK301	10.0 HP Briggs & Stratton OHV Vanguard	\$2,630.00
AK313	10.0 HP Yanmar Diesel	\$5,180.00

13 HP TWIN-IMPELLER

AK305: 13 HP
TWIN-IMPELLER



AK306: 13 HP
TWIN-IMPELLER



FEATURES

- 13 HP Honda and Briggs & Stratton with electric start and recoil back-up
- Spark arrestor/exhauster diverter
- 92 lbs. (42 kg)

PERFORMANCE

- 120 gpm (454 L/M) @ 40 psi (2.8 bar)
- 95 gpm (378 L/M) @ 108 psi (7.4 bar)
- 60 gpm (227 L/M) @ 133 psi (9.2 bar)
- 20 gpm (76 L/M) @ 146 psi (10.0 bar)

AK305	13.0 HP Briggs & Stratton	\$3,020.00
AK306	13.0 HP Honda-GX390	\$3,330.00

⚠ WARNING: Cancer and Reproductive Harm – www.P65Warnings.ca.gov

DAVEY PUMP OPTIONS

SUCTION HOSE AND STRAINER KIT



- 16' FCAM x NH 1 1/2" x 16'
- FCAM x FH with adapter and brass NH foot valve

HF-SHSK150	Suction Hose and Strainer Kit	\$159.95
------------	-------------------------------	----------

DISCHARGE HOSE & NOZZLE KIT

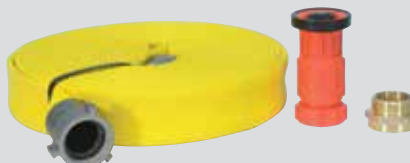

- 1 1/2" for firefighting pumps
- Brass 1 1/2" NH adapter
- 1 1/2" x 50' T2 hose
- Polymer nozzle

HFDHNK150P	Discharge Hose and Nozzle Kit	\$189.95
------------	-------------------------------	----------

AUTOMATIC PRESSURE RELIEF VALVE KIT



BE078	Automatic Pressure Relief Valve Kit	\$150.00
-------	-------------------------------------	----------

ROLL CAGE WITH BATTERY TRAY



Pre-drilled powder-coated roll cage with battery tray fits 6.5-13 HP gasoline-driven Davey Firefighter pumps. **Dimensions:** 30"x19"x21".

AK310	Pump Roll Cage with Battery Tray	\$496.00
-------	----------------------------------	----------

DARLEY GASOLINE

AVAILABLE WITH BRIGGS & STRATTON VANGUARD, AND

FEATURES THAT SET DARLEY PORTABLES APART

- 1 - OPTIONAL DARLEY CHROME CAPS AND BRASS ADAPTERS**
- 2 - EXHAUST PRIMER**
Allows pump to be primed with lifts up to 22'
- 3 - STANDARD MECHANICAL SEAL**
Injection packing is optional at no additional cost
- 4 - STOW AWAY CARRYING HANDLES**
With ergonomic grips

2BE 21H SHOWN WITH OPTIONS

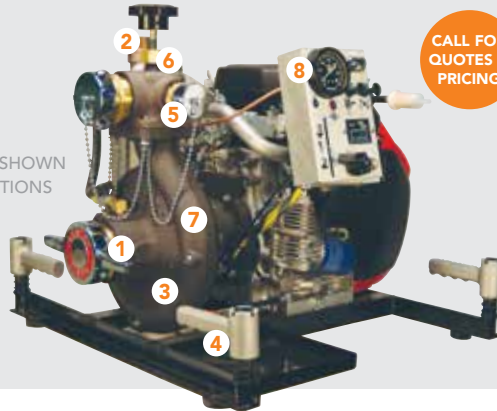

CALL FOR QUOTES & PRICING

- 5 - USER-FRIENDLY DISCHARGE VALVE WITH INTEGRATED CHECK VALVE**
Allows pump to be primed with discharge valves open
- 6 - 1-1/2" NPT VENTED EXHAUST**
- 7 - HARD COATED ANODIZED PUMP CASES**
Standard on most portable pumps
- 8 - WIDE VARIETY OF CONTROL PANELS**
Including pressure gauges, wireless controls, remote priming, start button, kill switch and light

FLOATING PUMPS

HEF 10.5BS FEATURES

- High volume
- Briggs & Stratton, 10.5 HP single cylinder, 4 cycle, 2.8 qt. fuel tank, recoil rope start
- 33"L x 30"W x 20"H, 110 lbs. (50 kg)
- Hard anodized aluminum alloy pump casing
- Bronze impeller
- 11 HP: 2011 Carb Compliant
- High-density polyethylene filled with closed-cell polyurethane foam
- Four built-in carrying handles
- Self priming
- 4" screened suction inlet
- 2-1/2" NH discharge

HEF 10.5BS PERFORMANCE

- 390 gpm (1450 L/M) @ 20 psi (1.4 bar)
- 250 gpm (946 L/M) @ 40 psi (2.8 bar)
- 200 gpm (757 L/M) @ 45 psi (3.1 bar)
- 100 gpm (378 L/M) @ 60 psi (4.1 bar)



HEF 10.5BS DOLPHIN™

ADDITIONAL FLOATING PUMPS

HEF 11H DOLPHIN™



2BEF-BS PORPOISE™



18 HP PORTABLE PUMPS

2BE 18V FEATURES

- Medium pressure, high volume, direct drive
- Briggs & Stratton: 4 cycle, 18 HP, V-twin, OHV, replaceable oil filter, 8.35 qt. fuel tank, 34.75 cu. in. displacement, 12-volt starter, recoil rope start back-up, 16 amp regulated alternator
- 27"L x 21"W x 25"H, 145 lbs. (66 kg)
- Bronze impeller and seal ring
- Stainless steel impeller shaft
- Mechanical seal
- Built-in discharge check valve
- Adjustable discharge valve
- Aluminum alloy casing and discharge valve
- Exhaust primer
- 3" NPT suction
- 2-1/2" NPT or 1-2/2" NPT discharges

2BE 18V PERFORMANCE

- 375 gpm (1420 L/M) @ 25 psi (1.7 bar)
- 300 gpm (1136 L/M) @ 45 psi (3.1 bar)
- 100 gpm (379 L/M) @ 140 psi (9.7 bar)



2BE 18V

ADDITIONAL 18 HP PORTABLE PUMPS

1-1/4AGE 18V



2BE 18VX



1-1/2AGE 18V



HE 18V



⚠ WARNING: Cancer and Reproductive Harm – www.P65Warnings.ca.gov

PORTABLE PUMPS

HONDA ENGINES. CALL FOR QUOTES AND PRICING

MANY MODELS IN STOCK FOR IMMEDIATE DELIVERY

PUMPS

21 HP PORTABLE PUMPS

2BE 21H FEATURES

- Medium pressure, high volume, direct drive, engine mounted
- Honda GX 630: 4 cycle, 21 HP, V-twin, OHV, replaceable oil filter, 38.5 cu. in. displacement, 12-volt starter, 20 amp regulated alternator, 6 gal. fuel tank, hose and adapter
- 24" L x 27" W x 22" H, 190 lbs. (86 kg)
- Aluminum alloy casing
- Bronze impeller and wear ring
- Stainless steel impeller shaft
- Mechanical seal
- Adjustable throttle
- 3" NPT suction, 1-2¹/₂" & 2-1¹/₂" or 1-2¹/₂" NPT discharge

2BE 21H PERFORMANCE

- 380 gpm (1438 L/M) @ 25 psi (1.7 bar)
- 150 gpm (568 L/M) @ 115 psi (7.9 bar)
- 100 gpm (378 L/M) @ 135 psi (9.3 bar)



2BE 21H SHOWN WITH OPTIONAL SMARTSTART™



ADDITIONAL 21 HP PORTABLE PUMPS

1-1/2AGE 21H MARINE VERSION



1-1/2AGE 21H



23 HP PORTABLE PUMPS

2BE 23V FEATURES

- Medium pressure, high volume, direct drive, engine mounted
- Briggs & Stratton Vanguard: 4 cycle, 23 HP, V-twin, OHV, replaceable oil filter, 12-volt starter, recoil rope start back-up, 16 amp regulated alternator, 6 gal. fuel tank, hose and adapter
- 24" L x 21" W x 24" H, 195 lbs. (89 kg)
- Hard anodized aluminum alloy casing and discharge valve
- Sulfuric anodized aluminum alloy gear case and engine adapter
- Bronze impeller and wear ring
- Heat treated alloy steel helical gears
- Ball bearing construction pump and engine
- Built-in discharge check valve
- Adjustable discharge valve
- 3" NPT suction, 2-1¹/₂" & 1-2¹/₂" NPT discharge

2BE 23V PERFORMANCE

- 390 gpm (1476 L/M) @ 30 psi (2.1 bar)
- 200 gpm (757 L/M) @ 110 psi (7.6 bar)
- 100 gpm (378 L/M) @ 140 psi (9.7 bar)



2BE 23V



HE 23V



ADDITIONAL 23 HP PORTABLE PUMPS

1-1/2AGE 23V



2-1/2AGE 23V



64 HP PORTABLE PUMPS

HE 64RP FEATURES

- Ultra high performance
- Rotax 582: 2 cylinder, 2-cycle, 64 HP, liquid-cooled, 12-volt electric start and recoil rope start back-up, 6 gal. fuel tank, hose and adapter
- 34" L x 30" W x 26" H, 225 lbs. (102 kg)
- 170W lighting and recharging coil
- Aluminum alloy casing
- Bronze impeller and seal ring
- Stainless steel impeller shaft
- Belt driven rotary primer
- Heat exchanger with thermal protection circuit
- Loss of prime shutdown
- Pressure governor
- Vernier throttle
- 4" NH suction, 2-1/4" turn self-locking 2¹/₂" NH discharge ball valves with caps
- Available with wheels

HE 64RP PERFORMANCE

- 575 gpm (2176 L/M) @ 100 psi (6.9 bar)
- 320 gpm (1211 L/M) @ 200 psi (13.8 bar)
- 165 gpm (625 L/M) @ 250 psi (17.2 bar)

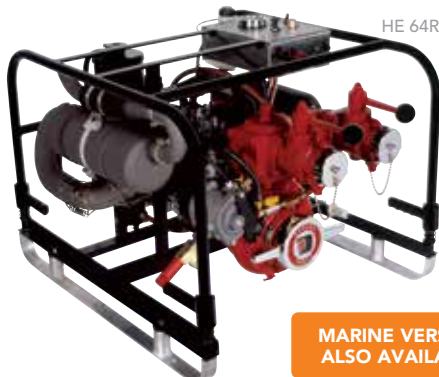

HE 64RP

MARINE VERSION ALSO AVAILABLE

AVAILABLE AS A SKID MOUNT

HE 64RS



⚠ WARNING: Cancer and Reproductive Harm – www.P65Warnings.ca.gov

DARLEY DIESEL PORTABLE PUMPS

AVAILABLE WITH YANMAR, KUBOTA, CUMMINS, JOHN DEERE AND DEUTZ ENGINES. CALL FOR QUOTES AND PRICING

1-1/2AGE 24K FEATURES

- High pressure, low volume, gear driven, engine mounted
- Kubota D902 Diesel: 24 HP, liquid cooled, 12 volt starter, 40 amp. alternator, fuel and oil pump filters
- 36" L x 22" W x 26" H, 376 lbs. (170 kg)
- Aluminum alloy casing and discharge valve
- Aluminum alloy gear case and engine adapter
- Bronze impeller and wear rings
- Stainless steel impeller shaft
- Heat treated alloy steel helical gears
- Ball bearing construction
- 2" NPT suction
- 2-1/2" NPT or 1-2/2" NPT discharges
- Skid base

1-1/2AGE 24K PERFORMANCE

- 2.70 ratio, Standard Impeller
 - 20 gpm (76 L/M) @ 310 psi (21.4 bar)
 - 140 gpm (530 L/M) @ 145 psi (10.0 bar)
 - 180 gpm (681 L/M) @ 80 psi (5.5 bar)
- 3.17 Ratio, High Pressure Impeller
 - 25 gpm (95 L/M) @ 375 psi (25.9 bar)
 - 75 gpm (284 L/M) @ 245 psi (16.9 bar)
 - 120 gpm (454 L/M) @ 150 psi (10.3 bar)



1-1/2AGE 24K

ADDITIONAL TIER 4 DIESEL PORTABLE PUMPS



⚠ WARNING: Cancer and Reproductive Harm – www.P65Warnings.ca.gov

DARLEY MODULES

SOLUTION SERIES™, PUMP MODULES, AUTOCAFS® AND PURIFIRE MODULES. CALL FOR QUOTES AND PRICING

PSM STANDARD MODULE FEATURES

- Darley AutoControl™ governor
- Stainless steel or Vinyl clad aluminum panels
- Foam capable
- Ratings from 500-2000 gpm

OPTIONS

- Top mount
- Top mount with walkway
- Foam systems
- Customer specified discharges
- Deck gun
- Odin AutoFill™
- Crosslay covers
- Deadlays
- Hose trays
- Walkway storage
- Darley factory install

ADDITIONAL MODULES

- PTO Modules
- Midship Modules
- CAFS Modules
- 4S10F PuriFire® Module



HM 500 PTO MODULE



PSM STANDARD MODULE

DARLEY PTO PUMPS

PTO AND HYDRAULICALLY DRIVEN PUMPS WITH FLOWS UP TO 3000 IDEAL FOR PUMP AND ROLL APPLICATIONS. CALL FOR QUOTES AND PRICING



HM 250, 350, 500

ASSEMBLY #1 FEATURES

- Single stage, centrifugal, gearbox assembly
- Vertically split, cast iron, bronze fitted pump casing
- Impeller seal ring opposed design to eliminate end thrust
- Splined impeller (not keyed) for longer life
- Oversized, deep groove radial type bearings for longer life
- 10 tooth splined shaft for durability
- Helical cut gears
- 2 1/2" NPT discharge
- 16" x 11"W x 18"H, 140 lbs. (64 kg)

ADDITIONAL ASSEMBLY OPTIONS

ASSEMBLY #2

- Single stage, centrifugal pump, gearbox assembly, suction elbow, discharge head with check valve, 2 - 2 1/2" NPT discharge, 3 - 3" suction (HM250/350), 3 - 4" victaulic suction (HM500)

ASSEMBLY #3

- Single stage, centrifugal pump, gearbox assembly, suction elbow, discharge head with check valve, complete manifolds, discharge valves, adapters and caps, 2 - 2 1/2" NH 1 1/4" turn ball valves, 2 - 3" NH suction adapters and caps (HM250/350), 2 - 4" NH suction adapters and caps (HM500)

HM 500 PERFORMANCE

- 500 gpm (1893 L/M) @ 150 psi (10.3 bar)
- 350 gpm (1325 L/M) @ 200 psi (13.8 bar)
- 250 gpm (946 L/M) @ 250 psi (17.2 bar)



HM 500 ASSEMBLY #1

JMP 500 FEATURES

- Two stage, series/parallel, centrifugal, PTO driven
- 3 - 2 1/2" NPT discharge flanges
- 3 - 4" NPT suction flanges
- Rotation: engine or opposite engine
- Gear ratio to fit PTO
- Mounting angles
- 1310/1410 lock on companion drive flange
- JMP 500 NH: Manual control staging valve
- 24 1/2" L x 12" W x 26" H, 250 lbs. (114 kg)

JMP 500 PERFORMANCE

- 500 gpm (1893 L/M) @ 150 psi (10.3 bar)
- 375 gpm (1325 L/M) @ 200 psi (13.8 bar)
- 250 gpm (946 L/M) @ 250 psi (17.2 bar)
- 100 gpm (378 L/M) @ 500 psi (34.5 bar)



JMP 500 3-GEAR



JMP 500 2-GEAR

ADDITIONAL PTO PUMPS

1 1/2 AG & 2 1/2 AG



HSP 250

1 1/2 AGH & 2 1/2 AGH



KSP 500-1000

1 1/2 AGD & 2 1/2 AGD



KSPAH 500-1000

HH 250-500



LSP 500-1000

LSH 500-1000



LSPH 500-1000

H 100 BOOSTER



PSP 1000-1500



PSD 1000-1500



TSP 2000



ZSP 3000



KDM-HX-PTO



MAGNATRANSM™



MEGATRANSM™

FEATURED TRANSMISSIONS

FAST ATTACK SKIDS

IDEAL FOR BRUSH FIREFIGHTING NEEDS, DESIGNED TO FIT INTO STANDARD 8' PICKUP TRUCK BEDS

The **Fast Attack 1** comes with a 13 hp Davey two-stage pump with a 200 gallon Pro Poly tank and Hannay electric booster reel with 100' of 1" hose.

ATTACK 1 FEATURES

- 13 HP twin impeller Darley Davey pump with Briggs & Stratton engine
- 200 gallon Pro Poly tank
- F4000 Hannay electric rewind reel
- 100' of 1" booster hose
- Self-priming up to 19'
- 1½" or 2½" NST suction adapter
- 1" tank recirculation
- 1½" tank to pump and discharge
- All stainless steel manifold & piping
- 94"L x 48"W x 42"H, 700 lbs. (318 kg)

OPTIONS

- Water/foam nozzle packages for N.A.F.S.
- Roller and spool hose guide
- Built-in 10 gallon foam cell
- ATP Foam Flurry™ proportioner
- 1½" Mattydale swivel
- Work light
- Poly hose tray
- Additional 2½" discharge
- Custom tank sizes
- Additional custom option available

BENEFITS

- Ergonomically designed
- Forkliftable to standard pick-up bed
- Solid pump performance for grass firefighting

1 - ROLLER & SPOOL HOSE GUIDE

2 - POLY HOSE TRAY

3 - WORK LIGHT

4 - 250/300 GALLON TANK

5 - WATER/FOAM NOZZLE PACKAGES FOR N.A.F.S.

6 - 1.5" MATTYDALE SWIVEL

7 - BUILT-IN FOAM CELL

8 - 13HP HONDA ENGINE

9 - ATP FOAM FLURRY™ PROPORTIONER

FA 1
STARTING
AT \$8,900

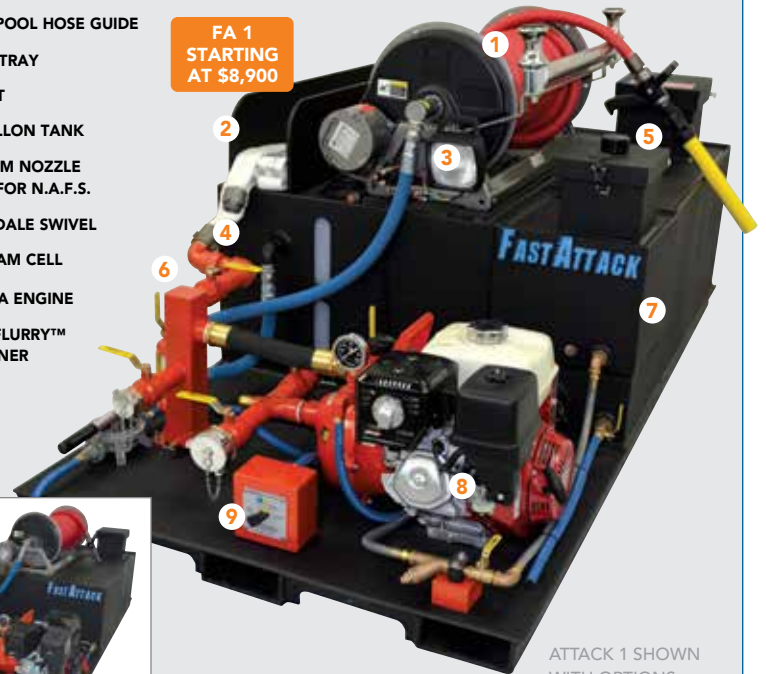

ATTACK 1 SHOWN WITH OPTIONS

ATTACK 1 PERFORMANCE AK305

- 120 gpm (454 L/M) @ 40 psi (2.8 bar)
- 95 gpm (360 L/M) @ 108 psi (7.4 bar)
- 20 gpm (76 L/M) @ 146 psi (10.1 bar)

THEORETICAL FRICTION LOSS IN 100' OF 1" BOOSTER @ 100 PSI

- 12 gpm (45 L/M) @ 2 psi (.1 bar)
- 20 gpm (76 L/M) @ 6 psi (5.2 bar)
- 30 gpm (114 L/M) @ 14 psi (7.9 bar)

The **Attack 2** has the same tank and reel as the Attack 1 but standardizes on our gear-driven or direct-drive Darley pump coupled to an 18 hp engine with control panel.



ATTACK 2 FEATURES

- Darley 18 hp pump
- Exhaust primer
- 200 gallon Pro Poly tank
- Hannay electric rewind reel
- 100' of 1" booster hose
- All stainless steel manifold & piping
- 94"L x 48"W x 42"H, 900 lbs. (409 kg)

OPTIONS (SAME AS ATTACK 1 PLUS:)

- Briggs Vanguard, Honda and diesel engines
- N.A.F.S. Nozzle Aspirated Foam Systems
- JakPak drop-in bodies

ATTACK 2 PERFORMANCE

1.5AGE 18V

- 120 gpm (454 L/M) @ 130 psi (9 bar)
- 100 gpm (379 L/M) @ 170 psi (11.7 bar)
- 25 gpm (95 L/M) @ 270 psi (18.6 bar)

2BE 18V

- 375 gpm (1416 L/M) @ 25 psi (1.7 bar)
- 300 gpm (1136 L/M) @ 45 psi (3.1 bar)
- 100 gpm (379 L/M) @ 140 psi (9.7 bar)

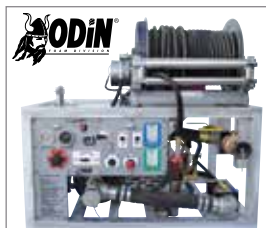

UHP-HV® ULTRA HIGH PRESSURE - HIGH VOLUME



FA 2
STARTING
AT \$11,500



ATTACK 2 SHOWN WITH OPTIONS

⚠ **WARNING:** Cancer and Reproductive Harm – www.P65Warnings.ca.gov

POLARIS UTV

DESIGNED FOR SAFETY, DURABILITY, AND SERVICEABILITY

FIRELITE TRANSPORT SUPERMAX FST-204

- All aluminum diamond plate construction with aluminum tubing sub-frame
- Darley Davey® Two Stage High Pressure 6.5 HP Pump (also available in 9HP & 13 HP)
- Pump features all stainless steel piping & brass valves
- 85 gallon NFPA baffled poly water tank
- Pre-connected F4000 Series Electric Rewind Hannay Reel®
- 100' of 3/4" Boostlite hose
- Scotty 4171 Through the Pump Foam System with 5 gallon foam cell
- Hose bed storage section for hard suction, forestry hose, nozzles, etc.
- Water tank sight gauge

ADDITIONAL OPTIONS AVAILABLE. CALL FOR DETAILS.



PUMPS

BILLY GOAT UTV

THE ULTIMATE OFF-ROAD FIREFIGHTING VEHICLE

The Billy Goat UTV features The Intimidator Truck Series UTV and is armed with powerful, tough, and durable features from top to bottom. Key features include a 6' black powder-coated aluminum truck bed that conveniently folds down into a flatbed that can handle 1,200 lb., LED headlights, premium seats with headrests for up to three adult passengers, and an overall 2,100 lbs. towing capacity. The Intimidator Truck Series is a powerhouse designed to make even your toughest jobs easy.

INTIMIDATOR TRUCK FEATURES

- Plastic top
- Warn vantage 4000 lb. electric winch
- Front cargo bed tie down hooks
- Custom graphics
- LED dual purpose warning/scene light
- Rear flashing LED lights
- Brush guard front bumper
- 2" receiver hitch standard on front and rear
- 4 wheel drive
- Optional multi-disc to create fire breaks
- Under bed storage compartments on each side

- 1 - THE INTIMIDATOR ROLL CAGE IS BUILT AND MANUFACTURED ACCORDING TO ROHVA COMPLIANCE TESTING
- 2 - COMES STANDARD WITH A 2" FRONT RECEIVER HITCH THAT IS SECURED TO THE FRAME AT FOUR ATTACHMENT POINTS
- 3 - BUILT WITH LEGENDARY BRUTE STRENGTH AND DURABILITY FOR LONG LIFE WITH PUSH-BUTTON LOCKING DIFFERENTIAL AND 4X4 CAPABILITY
- 4 - COMES STANDARD WITH UNDERBELLY METAL SKID PLATES TO PROTECT THEIR GUTS
- 5 - 6' ALUMINUM BED WITH FOLDING SIDES. 1,200 LBS. CARGO RATING

The Billy Goat and Polaris UTV feature a 6' aluminum truck bed.

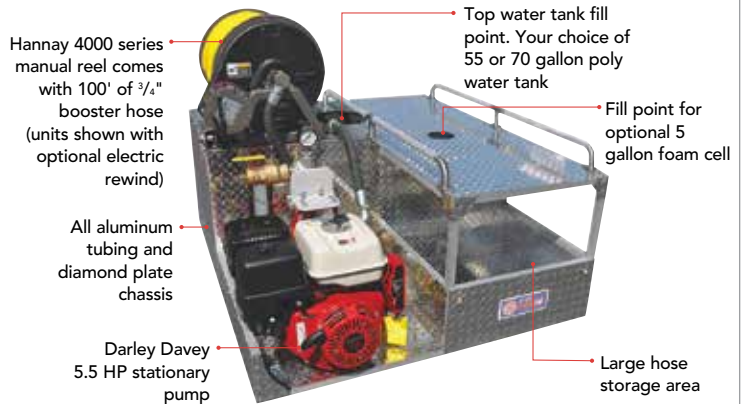

BP060	Billy Goat UTV Skid Unit (Gas Engine 4x4)	\$34,495.00
BP061	Billy Goat UTV Skid Unit (Kohler Diesel Engine 4x4)	\$37,295.00
N/A	Polaris UTV Unit (Gas Engine 4x4)	Call for Pricing

 CONTACT TOMDARLEY@DARLEY.COM FOR MORE INFORMATION

 **WARNING:** Cancer and Reproductive Harm – www.P65Warnings.ca.gov

As an industry, we have been trained to think that you have to sacrifice thermal protective performance (TPP) in order to achieve maximum total heat loss (THL). Introducing a game changer for the fire industry, TECGEN71. Fire-Dex FXR turnouts are specifically designed to minimize firefighter stress and fatigue through Active Posture Design™, allowing for full range of motion - especially while wearing your SCBA!

FIRE-DEX EXCLUSIVE TECGEN71 OUTER SHELL

THE BEST TPP/THL BALANCE IN THE HISTORY OF TURNOUT GEAR



ENSEMBLE FEATURES

- LIGHTWEIGHT AND FLEXIBLE TECGEN71 OUTER SHELL
- STEDAIR® 4000 MOISTURE BARRIER
- GLIDE ICE™ THERMAL LINER WITH SUPERIOR WICKABILITY
- THERMOPLASTIC ZIPPERS
- 3" NYC SCOTCHLITE™ LIME/SILVER TRIM
- PCA REINFORCED CUFFS

TECGEN71 FEATURES RIP TWILL CONSTRUCTION:

The proven strength of 60/40 Kevlar®/Nomex® on the face of the fabric, while creating a super structure of the TECGEN® fiber inside. This combination provides a lightweight solution, weighing in at 6.5 oz/yd2.

DOUBLE LOCK STITCHING

Fire-Dex uses lock stitching on all major seams, cuffs, and reinforcements, with 4 rows of lock stitch on all reflective trim and hook & loop closure material.

SUPERIOR POCKETS

All Bellows Pockets are reinforced with Kevlar® for the best cut resistance. All Radio Pockets are fully lined with moisture barrier, including the pocket flap. All pocket flaps are extra long to ensure complete closure, no matter the bulk inside.

COAT FEATURES:

- 30" coat length
- Zipper with hook and loop closure
- Combo handwarmer/semi-bellows pockets
- Radio pocket with double notched flap
- Flashlight holder
- Mic clip above radio pocket
- Optional lettering available



Black Gold

PANT FEATURES:

- Zipper with hook and loop closure
- 2 take-up straps at waist
- Semi-bellows pockets
- Padded knees
- Deluxe H-Back padded suspenders with cam-lock

TECGEN 71

Fire  Dex

TURNOUT GEAR SIZING

COAT			PANTS		
Size	Chest	Sleeve	Size	Waist	Inseam
Small	38"	32"	Small	32"	29"
Medium	42"	34"	Medium	36"	29"
Large	46"	35"	Large	40"	29"
XLarge	50"	35"	XLarge	44"	29"
2XLarge	54"	36"	2XLarge	48"	29"
3XLarge	58"	36"	3XLarge	52"	29"

* For detailed measuring instructions go to www.edarley.com/turnoutmeasuring

Cat#	Description	Size	Color	Price
BP164	TECGEN71 Coat, 6.5 oz.	S-XXXL	Gold	\$1,730.95
BP165	TECGEN71 Pants, 6.5 oz.	S-XXXL	Gold	\$1,249.95
BP166	TECGEN71 Coat, 6.5 oz.	S-XXXL	Black	\$1,849.95
BP167	TECGEN71 Pant, 6.5 oz.	S-XXXL	Black	\$1,292.95

REVOLUTIONARY NEW TECGEN71 MATERIAL

LIGHTWEIGHT AND FLEXIBLE

A structural firefighting outer shell designed to lessen heat stress by reducing weight and increasing flexibility. TECGEN71 features a rip twill weave that combines the proven durability of DuPont™ Kevlar®/Nomex® and the unique benefits of the TECGEN fiber. TECGEN71 is the first of its kind to address this growing health concern with innovative technology aimed at providing the perfect balance of breathability, comfort, TPP and THL, all while offering an overall reduction in composite weight.



TECGEN71 COMPOSITES VS. TYPICAL COMBINATIONS:



20% Lighter



45% Thinner



70% More Flexible



50% Higher Total Heat Loss

WITHOUT SACRIFICING THERMAL PROTECTIVE PERFORMANCE



SEAMLESS COLLAR

Comfort and NFPA compliant protection without the need for a throat tab

OMNIDEX™ SHOULDER

Eliminates coat rise and sleeve retraction by moving the shoulder seam to the natural bending point, allowing for optimal SCBA positioning

ATHLETIC PANT DESIGN

Provides natural movement and comfort in a forward firefighting position

DEXFLEX™ KNEES AND ELBOWS

Move freely and reduce resistance with naturally-bent knees and elbows

edarley.com
SHOP OUR COMPLETE SELECTION OF TECGEN GEAR ON EDARLEY.COM/TECGEN



REINFORCED CUFFS



RADIO POCKET WITH DOUBLE NOTCHED FLAP



3" NYC SCOTCHLITE™ LIME/SILVER TRIM



COMBO HANDWARMER/SEMI-BELLOWS POCKETS

SEE PAGES 112-113 FOR TECGEN 51

STACK UP THE SAVINGS WITH OUR DARLEY ARMOR AP™ GEAR PACKAGE

STEP UP YOUR GAME WITH THE BEST DUPONT NOMEX®/KEVLAR® OUTER SHELL BLEND

For at least two decades, fire departments choosing outer shells made of 40% DuPont™ Nomex®/60% DuPont™ Kevlar® have been limited to stiff and uncomfortable gear...until now. Utilizing the groundbreaking Filament Twill Technology™ used in PBI Max™, the new Armor AP™ fills the needs of firefighters who prefer improved mobility, durability, and improved protection at an economical price. Armor AP™ - a 6.5 oz. outer shell with absolute performance.

ABSOLUTE PERFORMANCE

How does one achieve absolute performance utilizing the same fibers (meta-aramid, para-aramid) used in Fusion™ and TenCate Advance™...and not increase the cost 25-50%? The answer lies in Filament Twill Technology™. Like PBI Max™, Armor AP™ is powered by DuPont™ Kevlar® filament in a twill weave. The result is a lighter weight outer shell (6.5 oz.) with improved comfort/flexibility, improved strength and durability, and equal to improved protection.

IMPROVED DURABILITY

DuPont™ Kevlar® filament allows Armor AP™ to resist tearing for a longer period of time than traditional outer shells like Fusion™ and TenCate Advance™...improving durability.

IMPROVED COMFORT/FLEXIBILITY

Better comfort and flexibility lead to better mobility. Better mobility can make all the difference in a life threatening situation. Firefighters wearing Fusion and TenCate Advance don't need to sacrifice mobility any longer...Armor AP is the answer.

SAVE
15%



ARMOR AP™ GEAR
AVAILABLE IN 3 COLORS.



Black Gold Khaki

PACKAGE INCLUDES:

- DARLEY ARMOR AP™ GEAR COAT
- DARLEY ARMOR AP™ GEAR PANTS
- H41 INTERCEPTOR HOOD
- RIPSTOP 3XL TURNOUT GEAR BAG
- PRO-TECH 8 FUSION GLOVES
- FIRE-DEX LEATHER BOOTS
- EVI TRADITIONAL HELMET



H41 INTERCEPTOR HOOD
WITH STEDAIR® PREVENT



RIPSTOP 3XL TURNOUT GEAR BAG



PRO-TECH 8 FUSION PRO GLOVES



FIRE-DEX LEATHER BOOTS



EVI TRADITIONAL HELMET

PACKAGE SAVINGS OF \$491

DARLEY ARMOR AP™ GEAR PACKAGE INCLUDES:

Cat#	Description	Size	Color	Price
BN190	Darley Armor AP™ Gear Coat	S-XXXL	Black, Gold or Khaki	\$1,351.95
BN191	Darley Armor AP™ Gear Pants	S-XXXL	Black, Gold or Khaki	\$955.95
BP008	H41 Interceptor Hood w/Stedair® PREVENT	N/A	N/A	\$115.95
BN532	Ripstop 3XL Turnout Gear Bag	3XL	N/A	\$73.95
BL943	Pro-Tech 8 Fusion Pro Gloves	S-XXL	N/A	\$72.95
BL247	EVI Traditional Helmet	N/A	Red, Black, Yellow or White	\$353.95
BP212	Fire-Dex® FDXL200 Leather Boots	8-11, 12, 13, 14		\$349.95
	GEAR PURCHASED SEPARATELY			\$3,274.65
	DARLEY ARMOR AP™ GEAR PACKAGE			\$2,783.45



Fire Dex

UTILIZING FILAMENT TWILL TECHNOLOGY™
LIGHTWEIGHT AND BUILT FOR **IMPROVED MOBILITY,**
DURABILITY AND **PROTECTION.**



TURNOUT GEAR

YOUR SAFETY IS MOST IMPORTANT SO WE'VE LOADED OUR GEAR WITH THE BEST FEATURES

- STEDAIR® 3000 MOISTURE BARRIER
- LIGHTWEIGHT OUTER SHELL
- REMOVABLE DRD
- OVERLAPPING COLLAR
- MIC CLIP AND HOOK
- RADIO POCKET
- ZIPPER WITH VELCRO® CLOSURE
- RESQ8001 THERMAL LINER
- PATCH POCKETS
- THUMB STRAPS
- REFLECTIVE TRIM
- MOISTURE BARRIER & LINER
- HIGH BACK PANTS & SUSPENDERS
- LARGE BELLOWS POCKETS
- REINFORCED KNEE PADS
- ARASHIELD PANT CUFFS & KNEES



REINFORCED KNEE PADS



ZIPPER W/VELCRO® OUTER CLOSURE



DRAG RESCUE DEVICE



HIGH BACK PANTS WITH SUSPENDERS



ACTION BACK



RADIO POCKET WITH FLAP



ARASHIELD PANT CUFFS AND KNEES



THUMB STRAPS



MOISTURE BARRIER AND LINER

ARMOR AP™ GEAR SIZING

COAT			PANTS		
Size	Chest	Sleeve	Size	Waist	Inseam
Small	38"	32"	Small	32"	29"
Medium	42"	34"	Medium	36"	29"
Large	46"	35"	Large	40"	29"
XLarge	50"	35"	XLarge	44"	29"
2XLarge	54"	36"	2XLarge	48"	29"
3XLarge	58"	36"	3XLarge	52"	29"



* For detailed measuring instructions go to www.edarley.com/turnoutmeasuring

DARLEY CHAMPION™ GEAR HEAD-TO-TOE GEAR PACKAGE

INSIDE EVERY FIREFIGHTER BEATS THE HEART OF A CHAMPION.
THOSE WITH THE PASSION TO RISE TO THE OCCASION.



Darley now offers a head-to-toe solution for your turnout gear needs at a special package price. Package includes Nomex® turnout gear coat and pants, Fire-Dex® 911™ helmet, Darley gold gauntlet gloves, Nomex® hood, Hellfire™ structural and hazmat firefighting boots, and Fire Fighter gear bag with carrying strap.

Our Champion™ gear is built to hold up in the toughest of conditions and is loaded with all the features you expect including plenty of large pockets and clips for your tools and communication equipment, reinforced knees, double-stitched seams and comfortable overlapping collar. Your safety is most important so we've included bright, reflective 3M™ Scotchlite™ triple trim, a fire resistant Nomex® IIIA outer shell and Drag Rescue Device per the latest NFPA safety standard.

- OVERLAPPING COLLAR
- 2 - MIC CLIPS
- RADIO POCKET
- EMBROIDERED PATCH
- COAT CLOSURE
- 2 - PATCH POCKETS
- REFLECTIVE TRIM
- REMOVABLE DRD
- COAT LINER
- SUSPENDERS
- 32" COAT
- REINFORCED KNEES
- PANTS
- PANT CLOSURE
- 2 - BELLOWS POCKETS
- TAKE-UP STRAPS



CHAMPION™ GEAR TURNOUT SIZING

COAT			PANTS		
Size	Chest	Sleeve	Size	Waist	Inseam
Small	38"	32"	Small	32"	29"
Medium	42"	34"	Medium	36"	29"
Large	46"	35"	Large	40"	29"
XLarge	50"	35"	XLarge	44"	29"
2XLarge	54"	36"	2XLarge	48"	29"
3XLarge	58"	36"	3XLarge	52"	29"

* For detailed measuring instructions go to www.edarley.com/turnoutmeasuring



ACCESSORIES SOLD SEPARATELY



NOMEX® HOOD



JUMBO GEAR BAG



DARLEY GOLD GAUNTLET GLOVES



HELLFIRE™ STRUCTURAL AND HAZMAT FF BOOTS



FIRE-DEX 911™ HELMET

PACKAGE SAVINGS OF \$189

DARLEY CHAMPION™ GEAR PACKAGE INCLUDES:

Cat#	Description	Size	Color					Price
			Navy	Red	Black	Yellow	Tan	
BK407	Darley Champion™ Gear Coat - Nomex®	S-XXXL	Navy, Red, Black, Yellow or Tan					\$883.95
BK408	Darley Champion™ Gear Pants - Nomex®	S-XXXL	Navy, Red, Black, Yellow or Tan					\$485.95
BB009	Hellfire™ Structural and Hazmat Felt-Lined FF Boots	Size: 7-14, 15 Width: M, W, XW			Black			\$143.00
BH127	Darley Gold Gauntlet Gloves	S-XL, Jumbo			Gold			\$70.95
AM003	Fire-Dex® 911™ Helmet	N/A	Red, Black, Yellow or White					\$207.95
AK020	Nomex® Hood	One Size Fits All			White			\$29.95
AS037	Jumbo Gear Bag	N/A			Red with Black Trim			\$75.95
	GEAR PURCHASED SEPARATELY							\$1,897.70
	DARLEY CHAMPION™ GEAR PACKAGE							\$1,708.70



RDG40 TURNOUT GEAR

DURABILITY, MOBILITY, AND PROTECTION AT A PRICE THAT FITS

Shorter front, longer back coat. Low-rise pant. Streamline design packed with a host of innovative, ergonomic features. Based on Innotex Energy Pattern.

NEW

TURNOUT GEAR

- **Variable Height Collar™:** Low-rise front, high-rise back neck/collar configuration. US Patent 8,151,371
- **No-Gap™ Throat Flap:** Provides a NO-GAP™ thermal protection
- **Ergonomic Full Motion Noseam™ Shoulder:** Designed to follow natural arm movements for optimal mobility. Seams are placed away from high-abrasion areas
- **Retractable Action Back:** Adds length across your back. Increased mobility when reaching and stretching
- **Durahem™ Sleeve and Leg Hems:** Ultra-resistant aramid-coated piping sewn to the cuff. Protects cuffs from abrasion
- **Angled Cuff Sleeve Hem:** Increases protection for the top of the hand without compromising hand mobility
- **Offset Seam Design:** Seams are positioned away from high-abrasion areas, increasing wear life
- **Adjustable Belt:** Comes with a 2" Nomex™ belt
- **Complete Motion Crotch:** Allows greater freedom of movement and prevents twisting
- **Enhanced Mobility Knee™ (EMK™):** Enhances mobility without tugging. Ensures that the knee protection stays securely in place.
- **No-Bulk™ Pant Closure:** Streamlined 3-layer pant closure flap
- **Reflective Piping Seams:** Increases visibility
- **Easy-to-Grip Padded Pull Tab:** Oversized and padded for easy handling with gloves

SHIPS WITHIN 15 DAYS



RDG40™ TURNOUT SIZING

COAT		PANTS	
Size	Chest	Size	Waist
Small	36"	Small	30"
Medium	40"	Medium	34"
Large	44"	Large	38"
XLarge	48"	XLarge	42"
2XLarge	52"	2XLarge	46"
3XLarge	56"	3XLarge	50"



ADDS LENGTH ACROSS YOUR BACK, FOR INCREASED MOBILITY AND COMFORT WHEN REACHING AND STRETCHING. RETRACTS WHEN NOT IN USE.

* For detailed measuring instructions go to www.edarley.com/turnoutmeasuring

ACCESSORIES SOLD SEPARATELY



ENHANCED MOBILITY KNEE™ ENSURES KNEE PROTECTION THAT STAYS SECURELY IN PLACE



OVERSIZED AND PADDED POCKET FLAPS FOR EASY HANDLING WITH GLOVES



COMES WITH A 2" NOMEX™ BELT



ANGLED CUFF SLEEVE HEM INCREASES PROTECTION FOR TOP OF THE HAND

SPECIFY SIZE: S-3XL

BP278 RDG40 Turnout Gear Coat
BP279 RDG40 Turnout Gear Pants



\$1,297.95
\$796.95

MORNING PRIDE® EDGE GEAR

ALL-AROUND MOBILITY, COMFORT AND PERFORMANCE

Morning Pride® EDGE is made for the firefighter who wants the latest technology, yet wishes to keep a traditional cut. Proven and versatile in all environments, Edge delivers the high level of performance you need to depend on.

COAT FEATURES:

- In-collar DRD™ proprietary design
- Hybrid wristlet increases comfort and dexterity
- Bar-tack reinforced stress points
- Ergonomically curved 2-piece arm design
- Full-cut body design
- Flex-back pleats
- Dead air panels
- Underarm gussets in all 3 layers
- 9"x9" full-bellows coat pockets
- Uninterrupted zip-in liner

PANT FEATURES:

- Bi-flex knees
- Internal adjustable belt system
- Dyna-Fit removable suspenders
- Nomex® webbing side adjustment pull-tabs
- 10"x10" full bellows pant pocket
- Uninterrupted zip-in liner
- Angled cuffs



ACCESSORIES SOLD SEPARATELY

TURNOUT SIZING

COAT			PANTS		
Size	Chest	Sleeve	Size	Waist	Inseam
Small	38"	34½"	Small	30"-32"	30"
Medium	42"	35"	Medium	34"-36"	30"
Large	46"	36"	Large	38"-40"	30"
XLarge	45"	36½"	XLarge	42"-44"	30"
2XLarge	54"	37"	2XLarge	46"-48"	30"



SPECIFY SIZE: S-XXL

BN240 & BN241 SPECIFY COLOR: Black, Khaki or Gold

BN240	Morning Pride® EDGE Coat - Armor AP	\$1,363.95
BN241	Morning Pride® EDGE Pants - Armor AP	\$1,041.95
BN242	Morning Pride® EDGE Coat - Gold PBI	\$1,434.95
BN243	Morning Pride® EDGE Pants - Gold PBI	\$1,147.95
BN244	Morning Pride® EDGE Coat - Black PBI	\$1,432.95
BN245	Morning Pride® EDGE Pants - Black PBI	\$1,133.95

INNOTEX TURNOUT GEAR



FEATURES:

- Moisture Barrier: Stedair® 3000 moisture barrier
- Arashield® reinforcement on cuffs and knees (gray)
- Thermal Barrier: Q-8™, 8.0 oz.
- BL526 & BL527: Outer shell: Brigade Nomex®, Thermal liner: Q-8, 8.0 oz.
- BL649 & BL650: Outer shell: Pioneer Kevlar®/Nomex blend, Thermal liner: Defender MNP

SHIPS WITHIN 15 DAYS

COAT FEATURES:

- Unique patented BR-1™ 4-layer collar (3")
- 32" style coat
- Hook and loop throat flap
- Zip and hook and loop attachment
- RHL™ rounded hook & loop
- Left chest radio pocket 8"x4"x2" with mic loop
- 2 - Semi bellow 8"x10" pockets
- Inside left pocket
- NFPA style 3" triple trim (lime/yellow with silver center)
- Nomex® wristlets with thumb hole
- BL649: Flashlight holder on right chest

PANT FEATURES:

- Hook & D-ring and hook & loop closure
- Double Fly Protection: 5 layers
- 2 - Semi bellow 10"x10" pockets
- Extra Nomex® felt padding in knee
- BL527: Waist adjustment straps
- BL527: Deluxe heavy duty removable cotton "H" style suspenders
- BL650: Waist adjustments with FR plastic buckles
- BL650: Heavy-duty quick-adjust and removable "H" style deluxe cotton suspenders with padding



ACCESSORIES SOLD SEPARATELY

TURNOUT SIZING

COAT		PANTS	
Size	Chest	Size	Waist
Small	34"-36"	Small	28"-30"
Medium	38"-40"	Medium	32"-34"
Large	42"-44"	Large	36"-38"
XLarge	46"-58"	XLarge	40"-42"
2XLarge	50"-52"	2XLarge	44"-46"
3XLarge	54"-56"	3XLarge	48"-50"

SPECIFY SIZE: S-XXXL

BL526	Nomex® Yellow Turnout Coat	\$1,023.95
BL527	Nomex® Yellow Turnout Pants	\$665.95
BL649	Nomex®/Kevlar® Khaki Turnout Coat	\$1,120.95
BL650	Nomex®/Kevlar® Khaki Turnout Pants	\$774.95

PROXIMITY FIREFIGHTING

PROXIMITY GEAR

TRADITIONAL ARFF TURNOUTS

COAT FEATURES:

- Outer Shell: Drag Rescue Device in 7.5oz. aluminized Basofil/Para-Aramid
- Thermal Liner: In Q-8™, inspection opening
- Moisture Barrier: Stedair® 3000
- Coat Closure: Inner zipper and outer hook and loop
- White Nomex® knit wrist
- Aluminized Kevlar® cuff reinforcement
- Additional layer of thermal liner placed on shoulders, elbows, and knees for added protection
- Radio pocket 7"x3"x2" with notched flap for antenna
- 10"x10" patch pockets
- NFPA compliant 1971

PANT FEATURES:

- Low rise pants
- Closure inner hook and loop with hook & dee
- Black padded suspenders, parachute pull adjustment, with post attachment
- Side cinch take up straps for fine individual size adjustment (2 provided)
- 10"x10"x2" full bellows pockets
- Reverse tapered cuff, shell material.
- NFPA compliant 1971
- Standard Inseam: 29" Optional Inseam: 32"



BOOTS NOT INCLUDED



DRAG RESCUE DEVICE



THERMAL LINER AND MOISTURE BARRIER



HIGH BACK WITH H-STYLE SUSPENDERS

SPECIFY SIZE: S-XL

BL852	Proximity Coat	\$1,103.95
BL853	Proximity Pants	\$873.95



ALUMINIZED COVER HELMET

The Aluminized Cover Helmet provides all of the improved fit, ride, components and tough "FYR-Glass" shell. "Lite Force Plus Proximity" is certified to meet these new requirements. *Ship. wt. 5 lbs.*

FEATURES:

- Standard "Prox" configuration with adjustable throat protector
- Shroud/ear flaps have breathable W.L. Gore moisture barrier and are lined with a "Protective Comfort" quilted FR cotton facecloth thermal liner



INCLUDES:

- Gold-coated, 6" faceshield
- Helmet cover

AS306	Aluminized Cover Helmet	\$543.95
-------	-------------------------	----------

FIREWALL® ARFF GLOVES

- Crosstech® Direct Grip® glove liner
- Aluminized PBI®/Kevlar™ knit
- 2-Ply Nomex® wristlet
- Breathable
- Meets NFPA 1971, current ed.



SPECIFY SIZE: S-XXL

AW114	FIREWALL® ARFF Gloves	\$201.95/pr.
-------	-----------------------	--------------

FIRE GLOVES

PRO-TECH 8 GLOVES

Pro-Tech 8's have an exclusive multi-layer knuckle guard system to provide unmatched thermal protection and cut/puncture resistance.

- Advanced multi-layer design reinforces vulnerable areas and features exclusive knuckle guard
- Fully lined with Kevlar® for added cut resistance
- Flexible finger sidewalls of Kevlar® and Nomex® maximize dexterity
- NFPA 1971 compliant fire-retardant moisture and blood borne pathogen barrier
- Palm layers stitched down with high-burst Kevlar® thread to strengthen grip



A. BP067 - TPR GOLD GLOVES

- Fully knitted 100% modacrylic inner liner for easy on and off
- FR Gel Pads in palm and thumb for enhanced grip
- Cut level 8 TPR knuckle guard system

B. BL943 - FUSION PRO GLOVES

- Fully knitted 100% modacrylic inner liner for easy on and off
- Stays soft and flexible after drying

C. BP944 - TITAN GLOVES

- 100% Nomex® inner liner
- Fully reinforced leather inner cuff
- Goatskin/Kevlar®



SPECIFY SIZE: S-XXL

BP067	Pro-Tech 8 TPR Gold Gloves	\$79.95/pr.
BL943	Pro-Tech 8 Fusion Pro Gloves	\$72.95/pr.
BL944	Pro-Tech 8 Titan Gloves	\$86.95/pr.

RINGERS STRUCTURAL GLOVES

Ringers Gloves develops and sells advanced-technology, task-specific safety gloves for applications that demand extreme reliability. These industries include drilling and production, manufacturing, construction and engineering, mining, utilities and public safety. *Ship. wt. 1 lb.*

- Durable Eversoft® thermal split cowhide leather on top and palm of the gloves
- Kevlar® stitching construction for maximum structural durability
- Constructed with Porelle® insert for optimum breathability and waterproof barrier
- Lined with Kovenex® for thermal and flame resistance
- Seamless fingertip construction for flexibility and dexterity



BP004	Gauntlet Ringers Structural Gloves	\$72.95
BP005	Wristlet Ringers Structural Gloves	\$92.95



DEX-PRO GLOVES

MAXIMUM DEXTERITY, EXTREME DURABILITY & SUPERIOR PROTECTION



- Ergonomic keystone thumb
- Top grain cowhide
- Goatskin fourchettes
- Leather reinforcements
- Military-grade DuPont™ Nomex® thermal liner sewn with Tex-80® Nomex® thread
- Vapor Flex™ moisture barrier
- Reverse grain cowhide
- Liner-Loc™ technology
- 60+ TPP and two layers of thermal that extend all the way down the fingers

SPECIFY SIZE: S-XXL



BL690	Dex-Pro Gloves - Wristlet	\$98.95/pr.
BL691	Dex-Pro Gloves - Gauntlet	\$98.95/pr.

BIG JAKE



- Unique Elk and Cowhide leather two-piece back for better fit and flex with less seam exposure
- Direct grip fabric lining provides a strong and secure grip. Lining grips the hand vs. the hand trying to grip a soft and cushy lining
- Crosstech® film technology
- Kevlar®/tech-fleece
- Direct grip fabric
- Koala® tanned cowhide leather

SPECIFY SIZE: XXS-J



BP153	Big Jake Gloves (Wristlet)	\$105.95/pr.
BP154	Big Jake Gloves (Gauntlet)	\$105.95/pr.

DRAGON FIRE X2 FIRE GLOVES



- Full and complete natural leather outer shell
- No fabric utilized on outer shell
- Unequaled wet grip strength
- Strategic wear and grip pads on finger tips/thumb
- Excellent cut/rip/abrasion resistance
- Extreme dexterity with no sacrifice of protection
- Glove refuses to harden or stiffen and remains soft and pliable
- Liner remains intact (no pull out) and is guaranteed
- Critical palm and back of hand (greater knuckle region) have highest obtainable certification
- TPP rating of greater than 60
- Certified to latest NFPA 1971 standard

SPECIFY SIZE: S-XXL

BP177	Gauntlet Dragon Fire X2 Fire Gloves	\$80.00/pr.
BP178	Wristlet Dragon Fire X2 Fire Gloves	\$85.00/pr.

SUPER GLOVES



- True 3-D hand-shaped styling with staggered layer seaming
- Bubble-Flex and Flex-Tuck construction
- Eversoft black cowhide cuffs
- Digiroo™ digital kangaroo grip on palm and fingers
- 3-D Air Assist™ thermal lining
- Top grain kangaroo leather on back
- Durable Crosstech® moisture barrier
- Wool 3-D heat guard on the back of hand delivers extra insulation
- BG123: NFPA 1971 Edition certified
- BG124: NFPA 1971, NFPA 1951, NFPA 1999 and NFPA 1992 Edition certified

SPECIFY SIZE: S-XXL



BG123	Gauntlet Super Gloves	\$160.95/pr.
BG124	Wristlet Super Gloves	\$166.95/pr.

TURNOUT GEAR

DARLEY GOLD GLOVES

NOW WITH GORE PROTECTION

- Offers unmatched comfort, protection and performance in an NFPA fire glove
- Gore RT7100 waterproof, breathable barrier system is the same proven technology used by many of the leading turnout gear manufacturers
- Every liner is sewn, seam sealed and 100% dunk tested
- Best in class technology means better dexterity, no liner pull-outs and performance even after exposures in hot structural environments
- Heavy weight Koala tanned outer shell will remain soft after repeated soakings



SPECIFY SIZE: S-XL, Jumbo

BH127 Darley Gold Gauntlet Gloves

\$70.95/pr.

ELK/PIG NFPA GLOVES



- Grain elk hide and Shelby abrasion-resistant brushed pigskin
- Gore™ RT7100 glove barrier fabric
- NFPA & CE compliant
- Heavy-weight
- Fire retardant
- Shelby "Black Line" Nomex® wristlet



SPECIFY SIZE: S-XL, Jumbo

BD144 Elk/Pig NFPA Wristlet Gloves

\$103.95/pr.

BD145 Elk/Pig NFPA Gauntlet Gloves

\$100.95/pr.

PIGSKIN FIREWALL® GLOVES



Wash and Wear Pigskin Firewall® Gloves last 4x longer than others. Outer shell stays soft and supple even after repeated soakings. Gloves come with a sewn-in, breathable, liquid-proof barrier for bacteria and chemicals. Meets the highest requirements in terms of durability and abrasion resistance. AC542 and BA003 meet NFPA 1971. Made in USA. Ship. wt. 1 lb.

- Nomex® knitwrist
- Vapor barrier (NFPA only)
- Gunn cut seamless palm
- Thermal lining
- OSHA and NFPA styles available



SPECIFY SIZE: S-XL

AC542 Pigskin Firewall® Gloves, NFPA Wristlet

\$98.95/pr.

BA003 Pigskin Firewall® Gloves, NFPA Gauntlet

\$90.95/pr.

AC543 Pigskin Firewall® Gloves, OSHA Wristlet

\$67.95/pr.

KOALA GLOVES



- Shelby® Koala tanned, split cowhide
- Gore™ glove barrier fabric
- Fire retardant
- Wing thumb
- Nomex® wristlet
- Breathable barrier
- Sewn in liner/barrier systems
- NFPA/CE compliant
- Ship. wt. 1 lb.



SPECIFY SIZE: S-XL

AW122 Koala Gloves Wristlet

\$88.95/pr.

BA002 Koala Gloves Gauntlet

\$85.95/pr.

FIRE BOOTS

FIRE-DEX® FDXL200 LEATHER BOOTS PROTECTION FOR THE HEAT OF THE BATTLE

- **Easy Don and Doff:** Quickly don with wide integrated pull handles, reinforced with an extra layer of leather for longevity. A finished edge also helps resist against skin abrasion.
- **Added Visibility:** Be seen in low-light conditions with bright reflective 3M™ Scotchlite™ trim.
- **Quality Leather:** Feel extra comfort & protection with shin cushioning & Flame Stop leather-made from the finest U.S. steer.
- **Flex and Mobility:** Climb and crawl with greater mobility. Additional flex points at the ankle eliminate pitch points and allow for a larger range of motion.
- **Long-Lasting Support:** Stay energized during long hours with a naturally-shaped, shock absorbent sole that features toe & heel springs to reduce impact zones.
- **Extreme Durability:** Resist tearing with Nomex® and Kevlar® lining.



SPECIFY SIZE: 8-11, 12, 13, 14 SPECIFY WIDTH: M, W or XW
BP212 Fire-Dex® FDXL200 Leather Boots \$349.95

BLACK DIAMOND X2-BOOTS

- **Calf-Fit System™:** Exclusive calf-fit system™ allows for maximum comfort and fit
- **Leather Upper:** Fire retardant, genuine heavyweight FireTuff™ leather
- **Lining:** CROSSTECH® fabric with Omaha lining is a high performance, wicking fabric, originally developed for aggressive military applications
- **Lining Construction:** Stitch-down “Stroble” lining ensures no liner pull-out and maximum fit
- **3-Point Heel Lock System:** Exclusive for fit and comfort
- **3M Scotchlite™ Reflective Material:** Flame-resistant fluorescent and reflective material for added visibility
- **Toe Cap Protection:** Rubber toe cap for high-abrasion and steel toe HI 500 Oblique Comfort Toe meets or exceeds ASTM standard
- **Footbed:** Tri-density, multi-fit, removable comfort footbed with TPU arch support, anti-microbial, breathable and shock absorption
- **Certification:** NFPA 1971 for Structural Firefighting and NFPA 1992 for Liquid Splash



SPECIFY SIZE: 7-11, 12, 13, 14 SPECIFY WIDTH: M, W or XW
MBK274 Black Diamond X2-Boots \$330.95

PROXIMITY / BUNKER BOOTS

- Athletically designed for unencumbered performance and agility
- Specially designed profiled boot to accommodate the largest legs fitting comfortably under proximity pants
- Proven for more than 20 years in the fire service, the Goodyear welt is made to withstand the harsh proximity environment
- Improved heel pocket and comfortable molded insert defend against heel slippage while stabilizing and minimizing back and leg strain
- Vibram® lug soles with FIRE&ICE™ compound are cemented and security stitched for the greatest protection possible in extreme radiant heat conditions
- Steel bottom plate and shank for complete protection
- Double radiant layers and aluminized shield keep heat transfer away from your feet in high heat conditions
- Full height bootie with 7.5 oz. of Virgin Kevlar® felt quilted to Cambrelle® and laminated to Crosstech®



SPECIFY SIZE: 7-13, 14, 15, 16 SPECIFY WIDTH: D, E, EEE
MBK254 Proximity / Bunker Boots \$661.95

14" KNOCKDOWN ELITE STRUCTURAL BUNKER BOOTS

- Height: 14"
- GORE® CROSSTECH® triple-layer moisture barrier projects against blood-borne pathogens
- Black prime waterproof, flame-resisting, and cut-resisting leather
- StedAir® waterproof, blood-borne pathogen compliant, breathable membrane
- Rugged pull straps designed to stay flush against the boot
- Wrap-around shin guard
- Ankle lock system keeps ankle firmly in place
- Non-metallic composite safety toe
- Side wall lugs allow for better traction
- Reflective high-visibility 3M™ Scotchlite™ piping won't darken in high temperatures
- LION by Thorogood's exclusive Vibram® FIRE and Ice ATS (All-Terrain Sole)
- NFPA 1971 and 1992 splash over Hazmat certified



SPECIFY SIZE: 7-16
 SPECIFY WIDTH: M, W, XW
 BL617 14" Knockdown Elite Structural Bunker Boots \$412.00

14" STRUCTURAL-POWER QR14 BUNKER BOOTS

- Height: 14"
- Upper: Waterproof, flame- and cut-resisting leather upper with abrasion-resisting rubber toe
- 3M™ Scotchlite™ HI-VIS
- Construction: Cement
- Lining: GORE® CROSSTECH® waterproof linings
- Outsole: Proprietary Traction Flex outsole
- GORE® CROSSTECH® triple-layer moisture barrier protects against blood-borne pathogens
- Cement Construction
- Extra shin and ankle padding
- Steel Triple-rib Ladder Shank with riveted load spreader provides lateral stability
- NFPA 1971 Certified



SPECIFY SIZE: 7-16
 SPECIFY WIDTH: M, W or XW
 MBG100 14" Structural - Power QR14 Bunker Boots \$321.00

WIDE TOE BUNKER BOOTS

- Black boulder, waterproof, full-grain, fire-resistant leather upper
- Goodyear storm welt construction
- Vibram® Chiseled Edge Fire & Ice outside
- Removable, polyurethane footbed
- Superknit lining
- Rubber midsole
- StedAir® Waterproof
- Blood borne pathogen resisting membrane
- Roomier wide toe design
- Steel triple ladder shank



SPECIFY SIZE: 5-13, 14, 15
 SPECIFY WIDTH: M,W and XW
 MAW019 Wide Toe Bunker Boots \$359.00

STATION 1™ 9" LEATHER BOOTS

- GORE® CROSSTECH® triple-layer waterproof lining is blood-borne pathogen resistant
- Full grain, flame/cut-resisting leather
- Steel triple-rib logger shank
- Exclusive Vibram® ATS outsole
- Cement construction
- Certified to meet NFPA 1999 EMS & NFPA 1977 Wildland
- Not designed for NFPA 1971 structural fire fighting
- Ventilated collar with climate control allows the boot to breathe



SPECIFY SIZE: 7-14, 15
 SPECIFY WIDTH: M,W and XW
 MBK125 Station 1™ 9" Leather Boots \$299.00

FELT-LINED HELLFIRE™ BOOT

Hellfire™ series provides superior protection for structural and hazmat fire fighting. *Ship. wt. 6 lbs.*

- **Upper:** Flame-resisting, heat-resisting rubber
- **Construction:** Vulcanized
- **Lining:** 3.5 mm polyester needled felt with heel reinforcement
- **Insole:** Removable superknit covered polyurethane footbed
- **Midssole:** Stainless steel, puncture-resisting bottom plate
- **Shank:** Steel triple ladder shank
- **Outsole:** Hellfire™ traction lug
- Double reinforced pull loops and cushioned shin guard
- Light-reflecting instep and heel patches
- Abrasion-resisting rubber T-Toe
- Blood-borne pathogen compliant
- NFPA 1971 & 1992 Certified
- ASTM F2413-11 M I/75/C/75 oversized steel toe



SPECIFY SIZE: 7-14, 15 SPECIFY WIDTH: M, W, XW
 BB009 Felt-Lined Hellfire™ Boot \$143.00

INSULATED HELLFIRE™ BOOT

Hellfire™ series provides superior protection for structural and hazmat fire fighting. *Ship. wt. 6 lbs.*

- **Upper:** Flame-resisting, heat-resisting rubber
- **Construction:** Vulcanized
- **Insole:** Removable superknit covered polyurethane footbed
- **Midssole:** Stainless steel, puncture-resisting bottom plate
- **Shank:** Steel triple ladder shank
- **Outsole:** Hellfire™ traction lug
- Double reinforced pull loops and cushioned shin guard
- Light-reflecting instep and heel patches
- Abrasion-resisting rubber T-Toe
- NFPA 1971 & 1992 Certified



SPECIFY SIZE: 7-14, 15 SPECIFY WIDTH: M, W, XW
 MAZ250 Insulated Hellfire™ Boot \$180.00

INSULATED KEVLAR®/NOMEX® LINED BOOTS

Insulated light weight boots feature Kevlar®/Nomex® lining and are equipped with a shin-guard for additional ladder-rung shin protection. Roomy steel toe provides extra comfort, and steel bottom plates and shanks offer unmatched impact/compression and puncture protection.



SPECIFY SIZE: 7-15 1/2, 16
 SPECIFY WIDTH: N, M, or W
 BL105 Insulated Kevlar®/Nomex® Lined Model 1500 Boots \$219.95

31" INSULATED HIP BOOTS

- Steel, toe cap, midssole and shank
- Natural rubber compound
- Rugged, rubber outsole, anti-slip, abrasion resistant
- Internal mid-way pull on loops
- Wool felt lining
- Height: 31"
- Non-NFPA certified



SPECIFY SIZE: 7-14 Whole Sizes
 WIDTH: Medium
 BL662 31" Insulated Hip Boots \$170.95

FIRE FIGHTER GEAR BAG



- One of the biggest gear bags in the industry
- Now available with wheels
- Overall Size: 29"Lx16"Wx17"H
- Main Compartment: 18"Lx16"Wx17"H
- 4 additional pockets including an extra large helmet pocket
- Reflective trim along straps and on bottom
- Vented main compartment with Velcro® front closure



BK201

BK200	Fire Fighter Gear Bag with Carrying Strap	\$63.95
BK201	Fire Fighter Gear Bag with Wheels	\$89.95

JUMBO GEAR BAG

There is plenty of room in this one. It has four pockets along with the main storage area. The end pocket on the left is 8"Wx15"D x17"H, the right pocket is 3"Wx15"Dx17"H, along with two slot pockets. *The overall measurements are 33"Lx15"Wx17"H. ID window, handle wrap, and Maltese Cross. Nylon. Red with Maltese Cross. Ship. wt. 3 lbs.*



AS037	Jumbo Gear Bag	\$75.95
-------	----------------	---------

PREMIUM TURNOUT BAG WITH WHEELS



- Fully molded top, bottom and sides
- Largest zippers available
- Retractable luggage-style handle can be zipped away
- Larger and wider wheels than similar bags
- Rear and bottom are reinforced with diamond embossed waterproof neoprene
- Rubber reinforced corners and high-stress areas
- Large top flap opens the full length of the bag
- Hi-Vis lime-yellow/silver triple reflective trim
- Reflective tape stitched into all Firefighter webbing and handle
- Embroidered Maltese Cross logo, not screen printed
- Larger bag than ANY competitors
- Dimensions: 32"Lx18"Wx18"H



SPECIFY Color: Black or Red		Black Red
BL430	Premium Turnout Bag with Wheels	\$158.95

RIPSTOP 3XL TURNOUT GEAR BAG

The Lightning X Ripstop 3XL Turnout Gear Bag is made to match the look and durability of your turnout gear by using heavy duty RIPSTOP nylon in a golden/tan color variation. This fabric ensures that any punctures don't turn into a large tear that ruins your bag. It's large enough to hold all of your turnout gear, helmet, SCBA mask, jumpsuit and other items. The Ripstop 3XL turnout gear bag is large, rugged, reflective and looks good!



ACCESSORIES NOT INCLUDED

SPECIFY Color: Tan or Camo		Black Red Tan Camo
BN532	Ripstop 3XL Turnout Gear Bag	\$73.95

X-LARGE TURNOUT BAG



- Multiple pockets and compartments
- Padded shoulder strap
- Reflective stitching
- Heavy-duty zippers
- 600 denier polyester outer shell fabric
- Grab-n-go pull strap with grabber
- Overall Size: 16"Hx25"Lx15"W
- Side Pockets: 16"Hx2"Dx15"W
- Total Capacity: 7,280 cu. in.



SPECIFY COLOR: Red or Black

BL429 X-Large Turnout Bag

\$49.95

BOOT STYLE TURNOUT GEAR BAG

- 2" wide nylon webbing
- 550 cubic feet larger
- Maltese Cross
- Lime triple trim
- Reinforced bottom
- Nylon strap grabber
- ID window
- Dimensions: 17"x18"x20 1/2"



BL414 Boot Style Turnout Gear Bag

\$42.95

QUAD-VENT TURNOUT GEAR BAG

Lightning X Products has been making quality public safety bags for nearly 20 years. From time to time we get the urge to improve upon existing bag designs. The LXFB45M uses Quad-Vent Technology that features four uniquely shaped mesh vents located at each corner of the turnout gear compartment to promote cross ventilation. This keeps your gear fresh and helps prevent mildew from forming. Our competitors only offer a bag with one vent, in the rear of the bag... how is air supposed to flow through just one vent? The Quad-Vent bag is large enough to hold all of your gear, boots and helmet comfortably – without being so big that it becomes cumbersome to carry around.

- Four PVC reinforced mesh air vents front & back provide full ventilation for your gear
- Comparable bags only offer a single air vent
- Cross ventilation allows gear to dry faster
- Helps prevent the growth of mildew from storing damp turnout gear
- Adjustable padded shoulder strap with heavy-duty snap hooks



SPECIFY COLOR: Red, Fluorescent Yellow or Black

BP197 Quad-Vent Turnout Gear Bag

\$58.95

DARLEY TURNOUT GEAR BAG

- Available in two sizes, this bag is designed to hold your gear. Features a front outside zippered pocket to carry smaller items
- Standard bag measures 13 1/2"L x 13"H x 24"W
- Extra large bag has 25% more room measuring 13 1/2"L x 16"H x 24"W
- Available in choice of plain red, red with Maltese Cross or Royal Blue with Star of Life. Ship. wt. 3 lbs.



AJ027

AJ093 Darley Turnout Gear Bag

\$71.95

AJ027 X-Large Royal Blue Darley Turnout Gear Bag

\$84.95

LITE FORCE PLUS MODERN HELMETS

Morning Pride's very best modern helmet is the perfect choice for comfort, safe head protection. *Ship. wt. 4 lbs.*

- Strongest Shell on the Market - Test show that FYR-Glass is 42% more resistant to impact penetration than helmets made of fiberglass
- FYR-Glass Technology - Provides a helmet that is lighter, lower ride, more comfortable and better fitting
- High Heat Performance - No other shell finish stands up to high heat like FYR-Glass
- Low Ride, Better Fit, Low Center of Gravity - 8-point suspension and wider interior gives wearer superior comfort and fit
- More Sizes, More Adjustability - Our headband/ratchet will fit the largest range of hat sizes of any NFPA helmet on the market, plus for position depth adjustments
- Accessories - Padded adjustable ratchet system, protective Nomex® earflaps, combo adjustable chin strap, Reflexite® trim
- Meets and exceeds NFPA 1971-2007



BL252



SPECIFY COLOR: Red, Black, Yellow, White

AR321	Lite Force Plus Helmet with Goggles	\$235.95
AR320	Lite Force Plus Helmet with Faceshield	\$232.95
BL251	Lite Force Plus Low Rider Helmet with Goggles	\$235.95
BL252	Lite Force Plus Low Rider Helmet with Faceshield	\$235.95

FIRE-DEX® 911™ HELMET

The 911® helmet provides solid, dependable, comfortable protection in a multitude of environments and still allows for a wide range of vision and long-use. Helmet shell is made of the lightest fiberglass composite offering superior protection against high temperature and chemical hazards. Its unique foam impact insert assembly provides even more top and side protection. Long lasting, easy-to-clean, high-gloss, flame-retardant finish resists scratches and UV rays. Replaceable 4" PPC wrap around face shield features an easy-to-operate tension adjustment and plastic bracket to provide maximum dielectric protection. *Meets current NFPA standards. Ship. wt. 5 lbs.*

- Colored throughout fiberglass compression molded shell
- Fiberglass shell has superior flame and heat resistance
- Thermal impact cap is a low density injection mold
- 2 pieces that are inseparable
- 6 way overhead suspension straps allowing for a more customized helmet "ride"
- 3 piece headband with ratchet assembly for easy adjustments (6 1/2" - 9")



SPECIFY COLOR: Red, Black, Yellow, White

AM003	Fire-Dex® 911™ Helmet	\$207.95
-------	-----------------------	----------

CAIRNS 660C FIBERGLASS HELMET

Helmet shell is reinforced, high-temperature resistant molded fiberglass. Cairns' patented shell release helps reduce the chance of neck injury by allowing the shell to release, leaving the impact cap behind for protection under severe upward impact. Beneath the shell is a high-temperature foam cap for increased thermal and impact protection. Headband features adjustable front for perfect fit between helmet and SCBA mask and 3-position rear ratchet adjustment. Other features include full brim, high-temperature edge trim, faceshield wing protectors, Nomex® chinstrap with quick-release and postman slide, Nomex® neck/ear protector and 4" Tuffshield faceshield. Helmet fronts sold separately. *Meets NFPA 1971. Ship. wt. 5 lbs.*

SPECIFY COLOR: Red, Black, Yellow, White, Blue



AA843	Cairns 660C Fiberglass Helmet	\$290.95
AF093	Cairns 660C Replacement Faceshield	\$66.95



FIREDOME® FX, PX, AND LT HELMETS

- FIBERGLASS OR THERMOPLASTIC OUTER SHELL
- URETHANE FOAM IMPACT LINER PROVIDES INSULATION FROM HEAT, IMPACT AND PENETRATION
- CHIN STRAP WITH COMBINATION ADJUSTMENT
- NOMEX® EAR/NECK PROTECTOR

FIREDOME® FX HELMET-FIBERGLASS

Firefighters frequently exposed to chemicals and hydrocarbons appreciate the FireDome® FX with a resin-bonded fiberglass outer shell. Fiberglass helmets are more resistant to chemical attack and more stable at extreme temperatures than those made of thermoplastic. Meets NFPA 1971 Standard. *Ship. wt. 5 lbs.*



SPECIFY COLOR: Red, Black, Yellow, White, Blue, Orange, Lime

AF086	FireDome® FX Helmet with Faceshield	\$247.95
AS354	FireDome® FX Helmet with Goggles	\$256.95



FIREDOME® PX HELMET-THERMOPLASTIC

Firefighters who need a more durable helmet choose the FireDome® helmet with injection-molded thermoplastic outer shell. Constructed with a high-heat thermoplastic providing greater impact and penetration resistance than fiberglass; plus it's more reliable with repeated heat exposures. Meets NFPA 1971. *Ship. wt. 5 lbs.*



SPECIFY COLOR: Red, Black, Yellow, White, Blue, Orange, Lime

AF088	FireDome® PX Helmet with Faceshield	\$259.95
AS027	FireDome® PX Helmet with Goggles	\$264.95



THE FIREDOME® LT HELMET

The FireDome® LT structural fire helmet is the result of 20 years of Bullard engineering, polymer technology and expertise. The Bullard Tough LT comes standard with the all-new and innovative, patented Quick-Attach Blade System, that permits the firefighter to simply press on or off either a blade-mounted faceshield or blade-mounted goggles in seconds. This helmet can also be enhanced with a variety of optically correct visors, goggles, and neck protectors to equip your fire department with complete head, face and neck protection to meet your specific applications. With the new compact design and lower center of gravity, the LT keeps weight evenly distributed and holds the helmet stable on the head. Meets NFPA 1971. *Ship. wt. 5 lbs.*



SPECIFY COLOR: Red, Black, Yellow, White, Blue, Orange, Lime

AW498	FireDome® LT Helmet with Faceshield	\$207.95
AW499	FireDome® LT Helmet with Goggles	\$212.95



FIREDOME® UST TRADITIONAL HELMET

Comfort and protection is now better than ever. The UST's outer shell is made with Thermoglas® offering a new standard of toughness and durability without sacrificing comfort. Chipping and cracking found in conventional fiberglass helmets is virtually eliminated while still providing chemical resistance and stability at extreme temperatures. The UST features impact liner, high-heat thermoplastic inner shell, Sure-Lock® adjustable headband, replaceable and washable brow pad, Nomex® chin strap with quick-release buckle and postman's slide fastener, Nomex® ear/neck protector, brass eagle, reflective tetrahedrons, and your choice of 4" faceshield or goggles. Meets NFPA 1971. Helmet fronts sold separately. *Ship. wt. 5 lbs.*



AW373



SPECIFY COLOR: Red, Black, Yellow, White

AW373	FireDome® UST Helmet with Faceshield	\$298.95
AW374	FireDome® UST Helmet with Goggles	\$308.95

USTM HELMET WITH RETRAK

Bullard ReTrak Series Traditional Helmet offers emergency responders a fire helmet with an integrated visor engineered based directly on feedback from firefighters. *NFPA 1971/ANSI/ISEA Z87.1+Requirements. Traditional Style Helmet, Matte Finish. Made in USA.*

- Simple one-handed operation
- Easily accommodates eyewear
- Increased area of protection
- Comfort nosepiece
- Quick removal for cleaning



SPECIFY COLOR: Red, Black, Yellow, White

BN609	USTM Helmet with RETRAK	\$281.95
-------	-------------------------	----------



CAIRNS 1010 TRADITIONAL STYLE HELMETS

Features new tough, through color, reinforced, high-temperature resistant, molded fiberglass composite shell that resists cracking and chipping. Cairns' patented shell release helps reduce the chance of neck injury by allowing the shell to release, leaving the impact cap behind for protection under severe upward impact. Beneath the shell is a high-temperature foam cap for increased thermal and impact protection. Headband features adjustable front for perfect fit between helmet and SCBA mask and 3-position rear ratchet adjustment. Other features include high-temperature edge trim, faceshield wing protectors, Nomex® chinstrap with quick-release and postman slide, Nomex® neck/ear protector and 4" Tuffshield faceshield. Helmet fronts sold separately. Meets NFPA 1971-2007 Edition. *Ship. wt. 5 lbs.*

SPECIFY COLOR:

Red, Black, Yellow, Blue, White



AF781	Cairns 1010 Helmet	\$357.95
AF094	Cairns 1010 Replacement Faceshield	\$76.95



BEN FRANKLIN 2 PLUS TRADITIONAL HELMETS

You can't beat the combinations of a traditional styled helmet with the strongest outer shell on the market by Morning Pride. *Ship. wt. 4 lbs.*

- **Strongest Shell on the Market** - Test show that FYR-Glass is 42% more resistant to impact penetration than helmets made of fiberglass
- **FYR-Glass Technology** - Provides a helmet that is lighter, lower ride, more comfortable and better fitting
- **High Heat Performance** - No other shell finish stands up to high heat like FYR-Glass
- **Low Ride, Better Fit, Low Center of Gravity** - 8-point suspension and wider interior gives wearer superior comfort and fit
- **More Sizes, More Adjustability** - Our headband/ratchet will fit the largest range of hat sizes of any NFPA helmet on the market, plus for position depth adjustments
- **Accessories** - Screaming eagle, padded adjustable ratchet system, protective Nomex® earflaps, combo adjustable chin strap, Reflexite® patches (Leather shield not included)
- Meets and exceeds NFPA 1971, 2000

SPECIFY COLOR: Red, Black, Yellow, White



AR319	Ben Franklin 2 Plus Helmet with Goggles	\$313.95
AR318	Ben Franklin 2 Plus Helmet with Faceshield	\$313.95
BL249	Ben Franklin 2 Plus Low Rider Helmet w/Goggles	\$315.95
BL250	Ben Franklin 2 Plus Low Rider Helmet w/Faceshield	\$313.95



BL249

EV1 TRADITIONAL HELMET

The progressive interface and cutting-edge features of EV1 helmets offer unmatched performance with a sturdy, sleek, lightweight design that customizes fit for unparalleled comfort and superior functionality. Low-profile design combined with lighter-weight materials provides superior comfort, optimal fit, and improved balance. Proprietary EZ Touch feature allows for one-touch deployment of your face and eye protection. No fuss. No hassle. Stows internally and provides adjustment to fit your face perfectly. Features a safety lock and a cushioned nose guard. EZ Touch face and eye protection is released at the touch of a finger and is the only solution for quick one-hand deployment.

- EZ Touch internal face and eye protection with safety lock
- Black Nomex® 2-layer FR cotton ear covers
- EZ Clip replaceable and reversible chinstrap with quick-release and postman slide
- Composite fiberglass shell
- Large hang-up loop
- Bulldog edge beading
- Golden alloy-plated eagle front holder
- Anti-catch safety bracket for leather fronts
- 8 Reflexite® lime trapezoids
- Certified to NFPA 1971

SPECIFY COLOR: Red, Black, Yellow, White



BL247	EV1 Traditional Helmet	\$353.95
-------	------------------------	----------



BL363

FIRE-DEX® 1910 TRADITIONAL STYLE HELMET

The 1910 features a fiberglass compression molded shell with superior flame and heat resistance, thermal impact cap, ratchet adjustment, and an adjustable headband that fits all SCBAs. SEI Certified to meet or exceed NFPA 1971. *Ship. wt. 5 lbs.*



SPECIFY COLOR: Red, Black, Yellow, White



BL363	Fire-Dex® 1910 Helmet with 4" Visor	\$298.95
BL364	Fire-Dex® 1910 Helmet with Innerzone 3™ Goggles	\$298.95

A-TAC® FIREFIGHTER'S GOGGLES

Protective goggles designed to specifically protect the firefighter in structural, wildland and other emergency situations. A-Tac® firefighter's goggles pass the NFPA 5000 5-minute heat exposure test. Features a silicone strap and body with hard coated/anti-fog inner and outer lens. Fits over prescription, safety and sunglasses. Can be removed from the helmet, without tools and worn directly on head. Includes goggle clips for both traditional and contemporary helmets. Meets NFPA and ANSI. *Ship. wt. 1 lb.*



AM058 A-Tac® Firefighter's Goggles

\$64.08

INNERZONE 3™ WRAPAROUND STRAPS

The ESS Innerzone 3™ features a wrap-around strap system that secures to structural helmets with two Velcro® tabs. Designed to protect eyes during extrications, USAR, and other hazardous situations that demand primary eye protections. The Innerzone 3™ is fully NFPA compliant, including the 500° 5-minute NFPA oven test. *NFPA 1971.*

- Functions well with all major structural firefighting helmet designs
- Patented Speed Clip™ strap system makes adjustment quick and easy
- 2-piece strap system made of 26mm-wide, high-memory woven Nomex®
- Frame made from high heat-resistant materials
- Full-perimeter ventilation and filtration system
- Lenses feature ESS ClearZone™ anti-fog and anti-scratch lens coating
- Lenses provide 100 UVA/UVB protection and precise optical clarity for distortion-free vision
- Lenses are highly impact resistant and exceed the impact requirements of ANSI Z87.1-2010+



BC014 Innerzone 3™ with Wraparound Straps

\$57.95

BL467 FirePro1971 FS Goggles

\$57.95



WRAPAROUND STRAP



BL467



BC014

BOURKE EYE SHIELD

Made of extremely tough polycarbonate plastic. Offers excellent eye and upper face protection, yet won't trap smoke. Mounts easily and snugly on helmet brim. Lens holders are aluminum, other parts stainless steel. Hinged feature allows instant protection. Uses two brass screws to hold shield to brim. *Ship. wt. 1 lb.*



BEST
SELLER

SPECIFY COLOR: Clear, Smoke, Amber, or High Temp Yellow

R726 Bourke Eye Shield

\$53.95

PX/FX REPLACEMENT FACESHIELDS



4" FACESHIELD

- Hard-coated PPC
- Enhanced optics
- Mounting hardware not included

6" FACESHIELD

- Hard-coated polycarbonate
- Mounting hardware not included



AF091 Replacement Faceshield 6"

\$64.95

AF092 Replacement Faceshield 4"

\$74.95

PARTICULATE HOODS

H41 INTERCEPTOR™ HOOD WITH DUPONT NOMEX® NANO FLEX

The H41 Interceptor™ Hood is made with a layer of DuPont™ Nomex® Nano Flex inside that acts as a filter to reduce firefighters' exposure to persistent fireground carcinogens and other contaminants. We've used this revolutionary material sewn between two layers of knit 6.0 oz. PBI®/Lenzing (20%/80%) to provide the maximum performance for particle barrier filtration, comfort, and thermal and flashover protection.

SCIENTIFIC DATA

The H41 Interceptor™ blocks 95% of particulates at .2 micron in size or larger. For perspective, there are 25,400 microns in one inch and a human hair is about 75-100 microns wide, so a .2 micron particulate is about 500x smaller than a strand of hair. Testing has shown that the particulates sized at less than .2 microns don't have enough mass to make it through the double layer knit and the Nomex® Nano Flex; essentially meaning that this hood blocks 100% of particulates less than .2 microns.



SPECIFY SIZE: XL

BN358 H41 Interceptor™ Hood



\$139.95

H41 INTERCEPTOR™ HOOD WITH STEDAIR® PREVENT



Choose the H41 Interceptor™ to reduce the absorption of carcinogens in the highly-permeable skin around your face and neck.

This 2-layer hood features an inner layer of Stedair® PREVENT with one outer layer of 8oz. Nomex® 100%.

- Unmatched breathability compared to moisture barrier technology
- Maintains excellent flame and heat resistance
- Exceeds NFPA 1971 requirements for TPP, THL and burst strength
- Built for durability
- Mask not included



BP008 H41 Interceptor™ Hood w/Stedair® PREVENT



\$115.95

GORE® PARTICULATE HOOD GEN2 NOMEX BLEND

IMPROVED COMFORT, WITHOUT COMPROMISING PERFORMANCE

As we continue to learn about the potentially harmful contaminants found at the fireground, the need for protection against those particulate hazards has become more crucial. Wearing the GORE® Particulate Hood GEN2 will give you the additional protection you need while maximizing comfort.



- One size fits all convenience
- Continues to block 99.9% of particles in the 0.1 to 1.0 micron-range after laundering; exceeds strength requirements in the NFPA 1971-2018 standard
- Excellent breathability
- Excellent durability

BP276 GORE® Particulate Hood Gen2 Nomex® Blend (White) \$99.99

GORE® PARTICULATE HOOD GEN2 ULTRA C6

IMPROVED COMFORT, WITHOUT COMPROMISING PERFORMANCE

As we continue to learn about the potentially harmful contaminants found at the fireground, the need for protection against those particulate hazards has become more crucial. Wearing the GORE® Particulate Hood GEN2 will give you the additional protection you need while maximizing comfort.



- One size fits all convenience
- Continues to block 99.9% of particles in the 0.1 to 1.0 micron-range after laundering; exceeds strength requirements in the NFPA 1971-2018 standard
- Excellent breathability
- Excellent durability

BP277 GORE® Particulate Hood Gen2 Ultra C6 (Black) \$112.49

PARTICULATE HOODS

INNOTEX GRAY™ PARTICULATE BLOCKING HOOD 25

NEW

Developed to meet the proposed requirements of NFPA 1971, the particulate blocking layer blocks carcinogenic particulates 0.1 µm to 1.0 µm that are found in the combustion of structural fires by greater than 98%. Yet, that same layer also allows for air permeation, which is essential to reduce the risk of increased core temperature.

3 LAYER APPROACH

The INNOTEX GRAY™ Hoods use a 3 layer approach similar to Turnout Gear. The two inner layers are laminated together to increase comfort and reduce bulk.

PARTICULATE BLOCKING LAYER

INNOTEX GRAY™ Hoods use a proprietary version of Stedair® PREVENT, which blocks carcinogenic particulates 0.1 µm to 1.0 µm (microns) by greater than 99%.

AIR PERMEABILITY

The INNOTEX GRAY™ Hoods are air permeable, which means air can pass through them. Body heat can dissipate, helping reduce the risk of increased body temperature.



SPECIFY SIZE: M/L or XL

BN698 INNOTEX GRAY™ Particulate Blocking Hood 25 \$108.95

COBRA™ BARRIAIRE GOLD™ HOODS

CERTIFIED TO NFPA 1971

BarriAire Gold Hoods combine superior comfort, increased protection and maximum durability. Your fire hood is an investment in your health and safety — go for the gold, BarriAire Gold Hoods only from PGI. Lightweight inner layer of DuPont™ Nomex® Nano flex fabric inhibits penetration of harmful contaminants and carcinogenic particulates between 0.1 and 1.0 microns.



BN721 COMPLETE COVERAGE

Particulate coverage includes entire head except for Sure-Fit™ panel at crown. Front and back bib extends particulate barrier coverage beyond critical areas as identified by NFPA - Maximum Protection.

BN722 CRITICAL COVERAGE

Particulate coverage from base of the neck and around entire head except for Sure-Fit™ panel at crown. All critical areas of particulate penetration as identified by NFPA have particulate barrier.



BN721 PGI BarriAire Complete Coverage Hood \$102.95
BN722 PGI BarriAire Critical Coverage Hood \$89.95

VERIDIAN™ PREVENT BARRIER

NEW

Developed to meet the proposed requirements of NFPA 1971, the particulate blocking layer blocks carcinogenic particulates 0.1 µm to 1.0 µm that are found in the combustion of structural fires by greater than 98%. Yet, that same layer also allows for air permeation, which is essential to reduce the risk of increased core temperature.



- 99.99% blocking efficiency after 100 wash/dry cycles
- Highest THL in the industry
- Superb durability
- Revolutionary design achieves less bulk
- Tailored design allows for maximum comfort
- NFPA 1971 optional requirements for protective barrier hoods



BP220 Veridian™ Prevent Barrier Hood \$75.95

VERIDIAN™ NOMEX NANO FLEX

NEW

Developed to meet the proposed requirements of NFPA 1971, the particulate blocking layer blocks carcinogenic particulates 0.1 µm to 1.0 µm that are found in the combustion of structural fires by greater than 98%. Yet, that same layer also allows for air permeation, which is essential to reduce the risk of increased core temperature.



- Water-repellent outer layer
- Stretchable materials provide maximum comfort and unrestricted range of motion
- One size fits all
- Seam free on the top of the head allows for maximum breathability and comfort
- Unique "Barcoded" ID for tracking
- NFPA 1971 Optional requirements for protective barrier hoods



BP221 Veridian™ Nano Flex Hood \$89.95

OUR BEST HOOD DEAL

NOMEX® BLEND HOOD

Our most popular NFPA hood at an affordable price point. This hood is made of 20% Nomex/80% Lenzing FR fabric with rib knit construction. Single one piece design with notched shoulders for safe head and neck protection.

- Thermal protective rating of 29.4
- Certified NFPA 1971
- One-piece construction with notched shoulder
- 18" overall length
- One size fits all
- Nomex blend
- 22.7 cal/cm² TPP rating



AZ152 Nomex® Hood \$23.95

PROTECTIVE HOODS THAT GO ON EASY & SEAL TIGHT

CERTIFIED TO NFPA 1971

Features easy sealing face opening that fits snugly for maximum protection and keeps its shape even after repeated usage; elastic face opening stretches to 15" for easier donning. Flat seams won't dig and seamless chin area provide for added comfort. Full 13" double layer head for better face and neck protection. Double 8" back bib and 6" front bib keeps hood from coming untucked. Lenzing is a permanently flame resistant fiber that wears like cotton and helps wick moisture. *One size fits all. Ship. wt. 1 lb.*



NOTCHED SHOULDER

AK020 Nomex® Hood \$29.95
AK022 PBI Hood \$35.95

ULTRA C6 HOOD NFPA 1971-2007 EDITION

The new carbon tri-blend Ultra C6 has been engineered to address the concerns and needs in the safety world. Its unique mix of fibers maximizes the inherent performance properties of each fiber to provide optimal protection and comfort. Enhanced comfort adds to functionality and improves performance and efficiency in the workplace. *Ship. wt. 1 lb.*



COLOR: Black
BH029 Ultra C6 Hood \$39.95

DARLEY HOOD

Darley has teamed with PGI to develop a new standard in hood protection. We've selected Para-Tek FR™ as a proprietary Tri-Blend that leverages the benefits of three fibers, high strength Para-Aramid, Lenzing® and High Tenacity Nylon. The end result is a lightweight, breathable hood that offers exceptional flame and heat resistance.



- Excellent TPP rating – 34.8 after five washings
- Provides double layer coverage of neck, upper chest, shoulders and shoulder blades
- Improved styling for better fit and maximum coverage
- Superb flame resistance – lowest vertical char lengths of all hood fabrics
- UL classified to NFPA 1971
- Comfort and excellent moisture absorbency



BL577 Darley Hood \$27.95

CARBON X HOODS

CERTIFIED TO NFPA 1971

Carbon shield is a flame resistant fabric based on carbon fiber technology. If exposed to extreme heat or flame, fabric glows but won't burn. Retains a certain tenacity at temperatures exceeding 2300° for over 90 seconds



ONE SIZE FITS ALL

AW017 Ultimate™ Carbon X Hood \$34.95
AW115 Classic™ Carbon X Hood \$27.95

ADD A LITTLE COLOR

MEETS NFPA STANDARDS 1971 (CURRENT EDITION)

Features easy-sealing face opening that fits snugly for maximum protection and keeps its shape even after repeated usage. Elastic face opening stretches to 15" for easier donning. Flat seams won't dig and seamless chin area provides for added comfort. Hood is 2-piece construction, notched shoulder bib design. *One size fits all. 21" length. Ship. wt. 1 lb.*



SPECIFY COLOR:
Red, Black, Yellow, Navy or Gray



AK021 P84 Hood \$42.95

EZ ADJUST PADDED SUSPENDERS

Designed with 8-point attachment. EZ release - just push up with finger or thumb. EZ tighten - just pull down on the EZ to find round rings. Pads are made with FR rated closed cell foam and sewn to allow for adjustment by end user. 47" length. *Ship. wt. 1 lb.*



BG243 EZ Adjust Padded Suspenders

\$35.95

LEATHER FIREMAN'S SUSPENDERS

Leather Fireman's Suspenders are handcrafted in the U.S.A. with the finest quality.

- 10-12 oz English bridle leather
- Full grain
- Drum-dyed



BH103 Leather Fireman's Suspenders 39 1/2" - 45 1/2" \$62.95

BH104 Leather Fireman's Suspenders 39 1/2" - 48 1/2" \$64.30

PADDED SUSPENDERS

- 8-point heavy-duty button attachment
- Extra large "quick adjust" rings to accommodate gloved fingers
- "H" back design
- Heavy-duty cotton webbing
- Foam padded straps



SPECIFY SIZE: S (36"), M (42"), L (48")

BG568 Padded Suspenders

\$19.95

TRADITIONAL SUSPENDERS

MATERIALS:

- Straps: Polypropylene red, heavy-duty elastic,
- 2" wide, .055" thickness, 400 minimum tensile strength
- Attachment Point Elastic: 1/2" wide, double layer, 5 1/2" long for each of 8 button tabs
- Leather Tabs: Eight leather tabs for button attachment
- Leather back patch

CONSTRUCTION:

- Crossover style, heavy-duty elastic
- Crossed in rear with leather back patch
- 8-point leather tabs
- 42" long
- All seams double stitched for added strength



BD015 Traditional Suspenders

\$22.95

H-STYLE SUSPENDERS

Features your choice of 2" elastic or non-elastic webbing with leather ends. An excellent choice for high back pants. *Ship. wt. 1 lb.*



AW117 Non-Elastic Suspenders

\$25.95

NYLON LIFE BELTS

MADE FOR MAXIMUM SAFETY, DURABILITY, VERSATILITY AND COMFORT

Life Belts are made with nylon especially woven to meet rigorous strength, texture and durability requirements. Webbing has a minimum breaking strength of 9,000 pounds. Assembled belt will withstand 2,000 pounds. The 3" wide buckle strap, sewn with high-tenacity nylon thread and riveted with copper rivets to the 5" wide body strap, is fitted with a double tongue buckle, which enables fast engagement and release of belt. *Ship. wt. 5 lbs.*



SPECIFY BELT SIZE: XS (34"-40"), S (36"-42"), M (40"-46"), L (44"-50"), XL (46"-56")

J922 Life Belt with Pompier Hook only \$168.95

LEATHER TRUCKMAN'S BELT

The traditional firefighter's Truckman's belt now has an improved design; use it for just about anything. Constructed of top-grain leather, measures 1 1/2" wide and is fully adjustable. Includes heavy-duty snap hook and 2 heavy-duty rings. Folds are riveted as well as stitched for durability. All hardware is chrome plated brass. Optional equipment hook and ring are easily added with secure screw rivets. *Ship. wt. 3 lbs.*



H992 Leather Truckman's Belt \$58.95
 AR308 Equipment Hook \$13.95
 AR309 Equipment Ring \$12.95

COBRA-D UNIFORM RAPPTEL BELT

DESIGNED FOR EMERGENCY RAPPTEL

In a class by itself, CMC offers the only NFPA Certified Uniform Rappel Belt available. Designed for everyday wear but with the performance needed for an emergency rappel or belay. Standard uniform wear for fire fighters, search and rescue, and SWAT personnel, the belt is constructed to the same exacting standards as their harness line and is the only certified uniform belt available.



SPECIFY COLOR: Black or Coyote



BN054 Cobra-D Uniform Rappel Belt \$86.95

PAC MULE ULTRA LADDER BELT

THE ULTIMATE HANDS-FREE TRUCKMAN'S BELT
 DESIGNED BY FIREFIGHTERS

These lightweight belts provide 4" of Coolmax back padding for wraparound support and keep SCBA from hitting your spine. Carry tools and equipment in any situation without slipping or tangling. D-rings Velcro® up and out of the way when not being used. Belt is made from 3M Scotchlite, flame-resistant, highly reflective material. Adjusts easily to fit over your turnout gear. Features rear carabiner slots, a carabiner and an 18" lanyard. BK122 has the same features as AZ241 with added capabilities of making a ladder belt into a Class II harness by attaching the leg straps. *Color coded by size for quick identification. Ship. wt. 2 lbs.*

X-LARGE SHOWN



VIDEO ONLINE

WAIST SIZE AND COLOR

Medium, Black: 28"-33" Large, Blue: 34"-40"	X-Large, Yellow: 42"-50" XX-Large, Red: 52" & UP
------------------------------------------------	-----------------------------------------------------

SPECIFY SIZE

AZ241 Pac Mule Ultra Ladder Belt \$181.95
 BK122 Pac Mule Ultra Ladder Belt with Harness \$231.95

ESCAPE BELTS

First Kevlar® fire Escape Belt certified to NFPA Class I personal escape harness standards. Waist belt of harness utilizes quick connect "Double Locking" snap hook and D-ring adjuster system. Forged D-ring used for main attachment point has a minimum breaking strength of 5000 lbs., epoxy coated red. Truck/escape belt is constructed of 9000 lbs. *NFPA 1983 Certified. Ship. wt. 2 lbs.*



- AZ102: Escape belt nylon holster can be used for carrying fire axe or halligan tool

SPECIFY SIZE: L (34"-54"), XL (44"-68")

AZ100 NFPA Kevlar® Escape Belt \$156.95
 AZ101 Nylon Escape Belt \$107.95
 AZ102 Fire Tool Holster for Escape Belt \$34.95

CUSTOM ACCOUNTABILITY TAGS

Be sure all firefighters are accounted for! Heavy-duty trigger snap attaches to turnout gear and is easily opened while wearing gloves. Guaranteed against breakage for 10 years. Inscribe up to 3 lines, 13-22 characters per line. Yellow and white tags inscribed with black lettering, all other colors feature white lettering. Dimensions: 3 1/2"x2 1/8". Ship. wt. 1 lb.



SPECIFY COLOR:

Red, Black, Orange, Yellow, Blue, Brown, Gray, White, Light Blue, Bright Green

SPECIFY INSCRIPTION

AF084 Accountability Tags

\$9.95/ea.

LEATHER SHIELDS WITH PASSPORT

The shield and passport allow fire departments to know the whereabouts of their firefighters at all times. Each Passport shield comes with a removable, Velcro® center piece Passport bearing the firefighter's name. When he takes a position, he removes the passport and places it on the engine. Shields are custom-made and non-returnable. Ship. wt. 1 lb.



SHIELD ORDERING FORM CAN BE FOUND ONLINE AT WWW.EDARLEY.COM/ORDERING

SPECIFY SIZE: 4" or 6".

SPECIFY COLOR OF SHIELD, PANEL AND LETTERING.

AR032	Leather Shields with Passport	\$51.95
AR03402	Passport Only	\$21.95



AUTHENTIC LEATHER HELMET SHIELDS

Made the old-fashioned way, these shields combine tightly sewn layers of first rate, 100% genuine leather throughout with meticulous detailing. No other leather shield is finer. Shields are custom-made and non-returnable. Available in both 4" or 6" sizes and your choice of color for shield, panel, lettering and center piece, as well as different configurations. Ask your Darley representative for a Shield Ordering Form. Ship. wt. 1 lb.

SHIELD CENTERS

A variety of shield centers are available at an additional cost.



SHIELD ORDERING FORM CAN BE FOUND ONLINE AT WWW.EDARLEY.COM/ORDERING

AR031	Authentic Leather Shield	\$48.95
AR03401	Center Ornament for 4" Shield	\$17.95
AR035	Center Ornament for 6" Shield	\$19.95
AR036	Center Decal for 4" and 6" Shield	\$7.95

PERSONALIZED CRESCENTS

Try our personalized crescents! Each personalized crescent comes with white background and your choice of color letters (minimum order 25).



SPECIFY PERSONALIZED TITLE

AF095 Personalized Crescents

\$7.95/ea.

CRESCENTS

- White background with black letters

CRESCENT TITLES



Firefighter	First Responder
Captain	Firefighter/EMT
Chief	Fire Rescue
Deputy Chief	Engineer
Lieutenant	EMT
Rescue	Fire Police
Asst. Chief	Reserve
Battalion Chief	Fire Marshal
Commissioner	Safety Officer
Paramedic	Volunteer
Hazmat Team	

SPECIFY TITLE

R714 Crescents

\$4.95/ea.

UNIVERSAL RADIO HOLDER

Three-part system (sold separately) mates comfortably with scissor snaps and D-Rings. The radio holder is universal to fit most radios and the anti-sway strap was designed to keep your radio on a tether and reach at all times.

- 1 1/4" wide and made of heavy duty leather
- Speaker mic attaches to a leather loop for easy access
- Strap can be used on either shoulder
- Scissor snaps on both ends of the Anti-Sway strap allow for easy placement on your rig keeping your radio in reach at all times
- Designed to securely fits most radios
- 2 elastic cords help secure the radio while 2D-Rings allow it to mate with the radio strap

AW285	Universal Radio Holder	\$37.95
AW286	Leather Radio Strap	\$35.95
BH101	Anti-Sway Strap	\$10.95



HELMET EMBLEMS

Your choice of emblems. **Rescue Emblem:** Blue EMS symbol on white circular background, self adhesive, 2 1/2" wide. **Fire Emblem:** Metallic gold/white fire symbol, Fire Department imprinted, self adhesive, 2 1/2" wide. **Flag Emblem:** Red, white and blue American flag emblem, self adhesive, 2" wide. **Ship. wt. 1 lb.**

R715	Rescue Decal	\$5.95
R717	Fire Helmet Decal	\$5.95
AF096	Flag Helmet Decal	\$3.95



SHIELD SAVER

- Protects both sides of faceshield to prevent scratches
- Reduces eye injuries
- Durable marine-grade vinyl reduces frequency of faceshield replacement
- Velcro® closure
- Available for 4" or 6" faceshields
- Ship. wt. 2 lbs.

SPECIFY SIZE: 4" or 6"

AW142	Shield Saver	\$14.95/ea.
-------	--------------	-------------



FOX FIRE® ILLUMINATING PRODUCTS

Identify your crew in total darkness with these illuminating tetrahedrons. Patented combination of high-output photo luminescent and extreme reflectivity. High temperature resistance with a strong bonding adhesive backing.

- Increases visibility and positional orientation
- Can be charged by any light source (sun, artificial light, low light)
- Illuminates up to 17 hours when fully charged
- Glow/illumination serves as a "light emitter"
- May be recharged repeatedly by any light condition
- Energy efficient, eco-friendly and no batteries required
- Made of industrial grade high temperature resistant silicone
- Can withstand high temperatures

VIDEO ONLINE



HELMET NOT INCLUDED



BL227	Helmet Sticker TET (Single)	\$4.95
BL228	Helmet Sticker TET (Set of 8)	\$37.95
BL224	Helmet Bands	\$22.95



FLIR K45, K55 AND K65 THERMAL IMAGING CAMERA KITS WITH FSX™ FLEXIBLE SCENE ENHANCEMENT

FSX™ realtime digital processing results in ultrasharp images defining extraordinary structural attributes, edges, and other instantly recognizable details.

CLEAR AND CRISP THERMAL IMAGES

The maintenance free uncooled microbolometer sensor produces detail rich images at 320 x 240 pixels (K55 & K65) and 240 x 180 pixels (K45). Thermal images are displayed on a large bright 4" LCD for easier navigation and the ability to make more efficient, accurate decisions.

NFPA® COMPLIANT K65 ONLY

The K65 is an advanced, feature rich thermal imaging camera which is fully compliant with the National Fire Protection Association®(NFPA) 1801 2018 Standard for Thermal Imagers covering usability, image quality, and durability for firefighting.

EXPANDED WARRANTY

All new K-Series cameras are protected by our exclusive FLIR 2-5-10 Warranty that includes 2-years of coverage on batteries, 5-years on the camera, and 10-years on the detector.

RUGGED & RELIABLE

The K-Series is designed to meet tough operating conditions. They withstand drops from 2 meters onto a concrete floor, are water resistant (IP67) and fully operational up to +260°C/+500°F for 5 minutes.

EASY-TO-USE; EVEN WITH GLOVES ON

An intuitive and simple user interface allows you to focus on the job at hand. FLIR® K45, K55, and K65 cameras are controlled by 3 large buttons, ideal for a gloved firefighter's hand.

PRODUCE ANALYTICAL REPORTS

Store up to 200 thermal images in the FLIR K-Series on-board archive (K45, K55, and K65) that may later be used to produce analytical reports of what happened at the scene.

IN-CAMERA VIDEO STORAGE (K55 & K65 ONLY)

Not only can the FLIR K55 and K65 save hundreds of still images, they can record and store 200 video files in clips of 5 minutes (maximum) each. K55 and K65 videos are useful for on-site analysis and ideal for training purposes. Videos playback directly from the in-camera archive or download to your computer via USB.

EXTREMELY AFFORDABLE: A THERMAL IMAGING CAMERA FOR EVERY FIRE TRUCK

FLIR's integrated production capabilities allow us to offer the K-series at an extremely affordable price. Increase more of your team's safety within your department's budget.



BL797	FLIR K45 Thermal Camera Kit with FSX™	\$4,495.00
BL798	FLIR K55 Thermal Camera Kit with FSX™	\$5,995.00
BL810	FLIR K65 Thermal Camera Kit - NFPA Compliant	\$6,995.00
BL505	Truck Charger	\$725.00
BN699	FLIR Li-Ion Battery	\$175.00



FLIR K33 & K53 THERMAL CAMERA KITS WITH FSX™

FLEXIBLE SCENE ENHANCEMENT

The K33 and K53 feature FLIR's FSX™ Flexible Scene Enhancement that intensifies structural and textural details in thermal images for better perspective and orientation to help improve situational awareness and give firefighters a greater sense of confidence and safety.



THERMAL IMAGING

STREAMLINED HIGH PERFORMANCE MADE EVEN MORE ECONOMICAL

FLIR offers two affordable, easy-to-use options which do not sacrifice FLIR's renowned clarity, reliability, and performance.

FIREPOWER SIMPLIFIED

Don't need all the bells and whistles...the K33 and K53 are the cameras of choice when you're looking for high image quality with simple, straight-forward operation that is ready for action.

- One glove-friendly on/off button quickly fires up the camera in TI-Basic mode
- An easy trigger pull freezes an image on the K33 or capture stills and video on the K53
- 2-bay charging station makes it a cinch to stay prepared

UNCOMPROMISING RESOLUTION

Both the K33 and K53 offer high-resolution thermal imaging with real-time FSX Flexible Scene Enhancement for intensified detail for greater visibility.

- K33's 240 × 180 thermal imaging matches the resolution of the K45
- K53's 320 × 240 resolution equals the image quality of the K55 and K65
- Bright 4" LCD shows smooth 60Hz thermal image that keeps up with the action

AFFORDABILITY REDEFINED

With the K33 and K53, FLIR offers the firefighting and rescue community the broadest cost-effective range of high performance TICs – part of our mission to help you stretch your budget and put more of these essential tools into the hands of those who could use them most.



BN318	FLIR K33 Thermal Camera Kit with FSX™	\$3,245.00
BN319	FLIR K53 Thermal Camera Kit with FSX™	\$5,345.00
BL505	Truck Charger	\$725.00
BN699	FLIR Li-Ion Battery	\$175.00



AERIAL THERMAL IMAGING
SEE PAGE 187 FOR INNOVATIVE
DRONES FEATURING FLIR THERMAL
IMAGING CAPABILITIES

FLIR K1

A RUGGED, COMPACT THERMAL CAMERA THAT SERVES AS AN EXTRA SET OF EYES ON THE FIRE SCENE

With a bright, integrated flashlight, the FLIR K1 illuminates the scene to help the user steer and manage the crew more effectively. It also displays 160 × 120 pixel thermal images that help users gain additional situation awareness that is not possible with the naked eye.

FEATURES:

- 160 × 120 pixel IR detector
- MSX® image enhancement for added perspective
- 57° × 44° field of view
- Integrated 300-lumen flashlight
- Drop-resistant to 2m (6 ft)
- IP67 rating
- Pistol-grip design offers line of sight viewing
- Save up to 10k visual and thermal image sets
- Up to 5.5 hours of power from a built-in rechargeable Li-ion battery, charged via USB-C
- **Warranty:** 2-years parts and labor, 10-years for the detector, after camera registration

BP081 FLIR K1

\$599.00

FLIR K2 TIC WITH MSX®

EXTREMELY AFFORDABLE THERMAL IMAGING CAMERA FOR FIREFIGHTERS

The FLIR K2 is a rugged, reliable, and extremely economical thermal imaging camera specially designed to help outfit more firefighters with the power to see through thick smoke and expedite decisions when seconds count.

MSX® MULTI-SPECTRAL DYNAMIC IMAGING

The K2 uses FLIR's patented MSX technology that embosses key details from the built-in visible camera onto thermal images, providing extra perspective to help you stay oriented and safer while saving others.

COMPACT AND EASY TO USE

FLIR K2's design makes it light and easy to attach to turnouts. A single large button activates the camera even with heavy gloves on. And the brilliant display and intuitive interface help show you the way through dark, smoky conditions immediately, so you can stay focused on the critical job in front of you.

RUGGED & RELIABLE

Engineered to survive tough operating conditions, the K2 withstands a 2-meter drop onto concrete, is water resistant (IP67) and is fully operational up to +500°F (for up to 3 minutes).

MULTIPLE IMAGE MODES

FLIR K2 can be set to one of seven different thermal imaging modes dependent upon the camera's primary use. Switch between modes using FLIR Tools software that you can download free from www.flir.com.

MULTIPLE FIREFIGHTING APPLICATIONS

Fire up the K2 as soon as you arrive on scene for the 360° size-up. Take it inside to see your way through smoke, keep track of others, and determine where to focus fire attack efforts. Find stranded victims faster. And scan for hot spots during overhaul.

A NEW LEVEL OF AFFORDABILITY

The K2's economical price makes powerful thermal imaging more accessible to more firefighters – a small investment that can help pay big dividends when it comes to safety, saving lives, and protecting property.

BN082 FLIR K2 Thermal Camera Kit with MSX®
 BN475 Truck Mount and Battery Charger
 BN723 FLIR K2 Battery

\$1,395.00
 \$325.00
 \$175.00



NEW



ECONOMICAL PRICE



BN475 TRUCK MOUNT AND BATTERY CHARGER. CAMERA SOLD SEPARATELY.



FLIR SCOUT TK THERMAL MONOCULAR

POCKET-SIZED THERMAL IMAGING

The FLIR Scout TK is a pocket-sized thermal vision monocular for exploring the outdoors at night and in lowlight conditions. Scout TK reveals your surroundings and helps you see people, objects and animals over 100 yards (90 m) away. Simple to use, with still image and video recording, Scout TK is the perfect companion, whether in the back country or your own backyard.



NEW

EXPLORE LIKE NEVER BEFORE

- See animals/people over 100 yards away
- Pocket-sized, lightweight (6 oz. / 170 g)
- Rugged design withstands bumps and splashes
- Records video and still images to share with others



GRAB AND GO SIMPLICITY

- Single-handed operation
- Simple four-button design and intuitive interface
- Multiple Video Color Palettes to enhance viewing: (White/Black Hot, InstAlert™, Graded Fire, and more)

STAY AWARE, STAY SAFE

- Keep an eye on your property 24/7
- Search for missing pets or check for predators
- Scan sidewalks, parking lots, and parks in the dark
- 5-hour rechargeable Li-Ion battery



BP027	FLIR Scout TK Thermal Monocular	\$599.00
BP351	FLIR Scout III 320 Thermal Image Monocular	\$1,795.00
BP352	FLIR Scout III 640 Thermal Image Monocular	\$2,395.00

FLIR LS-X & LS-XR

TACTICAL HANDHELD THERMAL MONOCULAR

The FLIR LS-X and LS-XR handheld thermal monoculars are designed for the men and women who serve and protect. This powerful, easy-to-use imager gives officers the tactical advantage when pursuing suspects, looking for evidence, or conducting search and rescue. The LS-X and LS-XR feature high resolution displays, extended zooming capabilities, and video output. Whatever you need to see, find it with the FLIR LS-X and LS-XR.



NEW

FLIR SCION OTM

OUTDOOR THERMAL MONOCULAR

The FLIR Scion® OTM captures clear thermal imaging and leverages a refined user interface to quickly detect objects of interest in complete darkness and through glaring light or haze. The Scion OTM produces 9 or 60 Hz thermal imaging and records geotagged video and still images for playback long after the day is done. IP67-rated allows single-hand operation in harsh weather conditions, maintaining reliable thermal imaging in the most demanding outdoor environments.



NEW



BP361	FLIR Monocular Thermal LS-X, 336x256	\$2,599.00
BP362	FLIR Monocular Thermal LS-XR, 640x512	\$3,599.00
BP358	FLIR Monocular Thermal Scion, 16° 320x240	\$2,495.00
BP359	FLIR Monocular Thermal Scion, 12° 320x240	\$2,795.00
BP360	FLIR Monocular Thermal Scion, 24° 640x480	\$2,995.00

FLIR ONE® PRO

PRO-GRADE THERMAL CAMERA FOR SMART PHONES

The FLIR ONE Pro lets you find invisible problems faster than ever. Measuring temperatures up to 400°C (752°F) and packing powerful measurement tools, FLIR ONE Pro will work as hard as you do. Whether you're inspecting electrical panels, looking for HVAC problems, or finding water damage, the FLIR ONE Pro is a tool no serious professional should be without.

IMAGE DETAIL & CLARITY

Powerful Image Processing Technology delivers unparalleled pixel-for-pixel performance. System features MSX® for improved sharpness and on-scene perspective; VividIR™ for improved sensitivity and image quality and features, 19,200 pixels (160x120) image resolution and the thermal sensitivity needed to detect temperature differences down to 70 mK resolution.

EXPANDED MEASUREMENT

Measure temperatures between -4°F and 752°F (-20° to 400°C) with up to three spot temperature meters and six temperature regions of interest.

JOBSITE TOUGH

Built to withstand every day job site abuse, the FLIR ONE Pro is rated for 1.8 meter (5'9") drop test onto concrete.

AVAILABLE FOR IOS, ANDROID (USB-C), ANDROID (MICRO USB)

BN743	FLIR ONE® Pro	\$399.99
-------	---------------	----------



PHONES NOT INCLUDED



ARGUS® MI-TIC THERMAL IMAGING CAMERAS

Mi-TIC range of cameras is the smallest, lightest, and lowest cost NFPA 1801 compliant thermal imagers on the market. Offering approved standard accessories and features.

BN307 & BN308 MI-TIC E FEATURES:

- Most affordable NFPA certified TIC
- Small and wearable at just 1.6 lbs. (737g)
- Large 2.7" display
- Available in 1 or 3 button options
- High Dynamic Temperature Range: 1400°F for excellent detail in day-to-day fire scenarios

BN306 MI-TIC S FEATURES:

- Most advanced thermal imager for firefighters
- Oversized 3.5" display for a clearer view of the fire scene and lightweight at just 1.7 lbs. (793g)
- Highest Dynamic Temperature Range: 2000°F for greater scene detail in larger, hotter fire scenarios
- Heat Seeker and Cold Seeker indicators
- Laser pointer and electronic compass

BL310 MI-TIC 320 FEATURES:

- Small and wearable at just 1.6 lbs. (737g)
- Large 2.7" display
- Available in 1 or 3 button options
- Highest Dynamic Temperature Range: 2000°F for excellent detail in heavy firefighting scenarios
- Heat Seeker and Cold Seeker indicators



BN306

argus®
thermal imaging from Avon Protection

Cat#	Description	Buttons	Warranty	Price
BN307	argus® Mi-TIC E 30 Hz Thermal Imager	1 Button	3/5/10	\$4,998.95
BN308	argus® Mi-TIC E 30 Hz Thermal Imager	3 Button	3/5/10	\$5,298.95
BN306	argus® Mi-TIC S 30 Hz Thermal Imager	3 Button	5/5/10	\$6,998.95
BL310	argus® Mi-TIC 320 30 Hz Thermal Imager	3 Button	5/5/10	\$6,198.95

BATTERIES

BL311	argus® Mi-TIC Lithium Phosphate Battery (Standard) Red			\$311.95
BL312	argus® Mi-TIC Lithium Phosphate Battery (Large)			\$374.95

LEICA BLK360 IMAGING SCANNER

Leica Imaging Scanner is light, portable and allows for quick capturing of HDR and thermal images as well as laser scans.

LIGHT AND PORTABLE

- 2.2 lbs.
- 3.9"x6.5"

ONE BUTTON SIMPLICITY

- Press once to power on
- Press it again to begin reality capture

FAST

About 3 minutes for...

- HDR image
- Thermal image
- Laser scan

HDR IMAGING

- Three cameras creates a 150 megapixel calibrated spherical image
- Full-dome field of view = 360° by 300°
- High Dynamic Range (HDR) photography
- Three LED flash units

THERMAL IMAGING

- FLIR infrared panorama image

SCANNING

- Measures 360,000 3D points per second
- Up to 60 meter radius
- Ranging accuracy : 4mm @ 10m / 7mm @ 20m
- Eyesafe, infrared, Laser Class 1

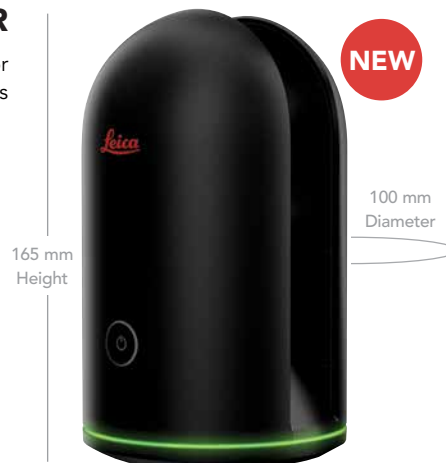

NEW

100 mm
Diameter

165 mm
Height

STANDALONE OPERATION

- No cables or SD cards to lose
- Solid state internal data storage
- Holds 100+ reality captures
- Battery for 40+ reality captures
- Indoor and outdoor use
- Operating Temperature Range: 41° - 104° F

INCLUDES

- BLK360 laser scanner
- Transport hood
- One 1 lithium-ion battery
- Battery charger
- 1 yr subscription to Recap Pro

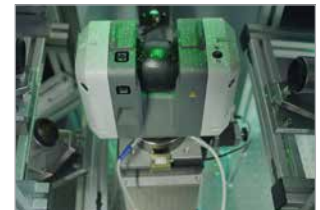

BP009	Leica BLK360 Imaging Scanner	\$18,500.00
-------	------------------------------	-------------

 CONTACT TOMDARLEY@DARLEY.COM FOR PRICE DISCOUNTS

DRÄGER PSS® 5000 & 7000 SELF-CONTAINED BREATHING APPARATUS COMFORT, DURABILITY, SAFETY AND PERFORMANCE IN THE HARSHTEST ENVIRONMENTS

The Dräger PSS® 5000 and 7000 are ergonomically advanced SCBA that offer increased comfort, safety and performance. With a wide range of configurable features, such as bi-lateral hose routing and quick cylinder connection, the PSS 5000 meets your needs wherever breathing protection is required. The ergonomic PSS 7000 combines trusted pneumatics, flexible fit, and quick cylinder connection, freeing you to concentrate on the task at hand.



PROVEN TECHNOLOGY

- OUTSTANDING RESISTANCE TO HEAT, IMPACT AND CHEMICALS
- EASY MAINTENANCE AND SERVICE
- MEETS OR EXCEEDS ALL NFPA 1981 & 1982 STANDARDS (MOST CURRENT)

INTEGRATED SYSTEMS & INCREASED VERSATILITY

- ELECTRONICS AND AIR HOSES ARE INTEGRATED INTO THE BACK PLATE
- ADJUSTABLE BACKFRAME ALONG WITH FREEDOM OF MOVEMENT WITH WAIST PAD ASSEMBLY - ADD EXTREME ERGONOMICS

EASY MAINTENANCE & LOW COST OF OWNERSHIP

- HARNESS & WAIST PAD ASSEMBLY: DOES NOT ABSORB LIQUIDS OR CHEMICALS AND IS HIGHLY RESISTANT TO ABRASION AND HEAT. CLEANING IS REDUCED TO MINIMAL EFFORT.
- STANDARD BATTERIES: 5 AA FOR THE BACK PLATE, 1 CR123 FOR THE HUD
- LONGEST BATTERY LIFE IN THE INDUSTRY: RATED AT 1 HR./DAY FOR 365 DAYS
- NO ANNUAL MANUFACTURER-REQUIRED OR RECOMMENDED OVERHAUL

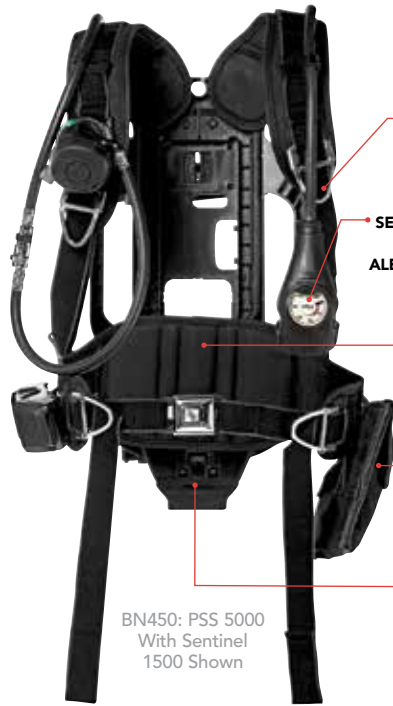

BN450: PSS 5000 With Sentinel 1500 Shown

15 WARRANTY YEAR

CARRY HANDLES
Rated up to 600 lbs. pull force to use as a drag handle

SENTINEL 1500 GAUGE WITH INTEGRATED PERSONNEL ALERT SAFETY SYSTEM (PASS)
Communicates wirelessly with HUD

PIVOTING LUMBER SUPPORT WAIST BELT
Allows free movement while holding the SCBA firmly in position

OPTIONAL BUDDY BREATHER
Keeps an emergency breathing supply system within easy reach

QUICK CONNECT CYLINDER ATTACHMENT
Enables a secure change out of cylinders in less than 10 seconds



HEADS UP DISPLAY (HUD)

FPS 7000 MASK WITH HUD

Cat#	Description	4500 PSI Cyl.
BN450	PSS 5000 w/Sentinel 1500, FPS 7000 Mask w/HUD	30 min.
BN451	PSS 5000 w/Sentinel 1500, FPS 7000 Mask w/HUD	45 min.
BN452	PSS 5000 w/Sentinel 7000, FPS 7000 Mask w/HUD	30 min.
BN453	PSS 5000 w/Sentinel 7000, FPS 7000 Mask w/HUD	45 min.
BN454	PSS 7000 w/Sentinel 1500, FPS 7000 Mask w/HUD	30 min.
BN455	PSS 7000 w/Sentinel 1500, FPS 7000 Mask w/HUD	45 min.
BN456	PSS 7000 w/Sentinel 7000, FPS 7000 Mask w/HUD	30 min.
BN457	PSS 7000 w/Sentinel 7000, FPS 7000 Mask w/HUD	45 min.

ACCESSORIES

- BN458 30 min 4500 PSI Cylinder
- BN459 45 min 4500 PSI Cylinder
- BN460 FPS Communication Amplifier
- BN461 40" Buddy Breather with Pouch

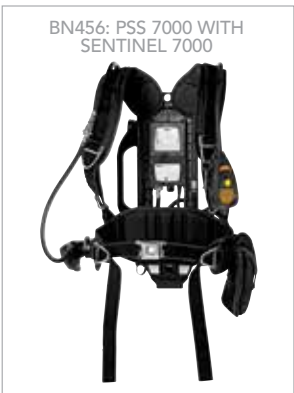

BN456: PSS 7000 WITH SENTINEL 7000



BREATHING AIR CASCADE SYSTEMS

4500 PSI & 6000 PSI PIGTAILED SYSTEMS

With a pigtailed system, each cylinder is connected together with a tee connection and a 24" flexible pigtail. To cascade this system when filling SCBA cylinders, the operator must open and close each storage cylinder valve individually as needed. Cylinders are DOT Approved. *Fill hoses not included.*

SYSTEM INCLUDES:

- Your choice of 4500 or 6000 psi cylinders
- Cylinders with valve and cap
- Tee connections
- Seal-tight inlet cap
- 24" flexible pigtail between each cylinder
- Steel storage rack (also available without rack)

4500 PSI SYSTEM				6000 PSI SYSTEM			
Cat#	System	Price w/ Rack	Price w/out Rack	Cat#	System	Price w/ Rack	Price w/out Rack
AJ362	2 Cylinder	\$2,349.95	\$1,709.95	AJ368	2 Cylinder	\$3,919.95	\$2,929.95
AJ363	3 Cylinder	\$3,159.95	\$2,489.95	AJ369	3 Cylinder	\$4,999.95	\$4,349.95
AJ364	4 Cylinder	\$3,639.95	\$3,259.95	AJ370	4 Cylinder	\$7,189.95	\$6,499.95
AJ365	5 Cylinder	\$4,516.95	\$3,419.95	AJ371	5 Cylinder	\$8,809.95	\$8,235.95



PRESSURE REDUCING REGULATORS

AJ376: For use on systems over 3000 psi and below 5500 psi. 0-6000 psi inlet, 0-5000 outlet. CGA-347 nut and nipple on the inlet side and male thread on outlet side. 0-6000 psi gauge on both inlet and outlet of regulator.

AJ377: For use on 6000 psi systems. 0-6000 psi inlet, 0-5000 outlet. #4 JIC male inlet, CGA-347 male outlet. 0-7500 psi inlet gauge, 0-6000 psi outlet gauge. *Ship. wt. 5 lbs.*



AJ376	Pressure Reducing Regulator	\$434.95
AJ377	Pressure Reducing Regulator	\$449.95

FILL HOSE

Deluxe fill hose is 6' long with shut-off valve. Features 6000 psi gauge with a rubber boot, bleeder valve and hand-tight nut and nipple that will fill either 2216 psi or 4500 psi. Connects directly to a CGA 347 male thread. *Ship. wt. 5 lbs.*



AJ374	Fill Hose	\$283.95
-------	-----------	----------

TECH-RESCUE™ CART

The Tech-Rescue™ Cart was designed to provide air for all of the various respirators and unique rescue tools used by Fire and Technical Rescue teams. Two 4500 psi cylinders or high pressure cascade (fire truck) cylinder air can be used to operate the air control panel. The standard features of the Tech-Rescue™ Cart make it the most versatile and unique air cart in the fire service industry. *Cylinders not included.*

- **Yellow - Respirator Side:** Fold down handle, respirator L/P alarm whistle 4, respirator fittings, and lower hose rack with quick release pin
- **Blue - Tool Side:** CGA-347 auxiliary inlet, air isolation valve, 4 tool fittings, low pressure accessory air tool/lift bag fitting



BA024	Tech-Rescue™ Cart	\$3,984.95
BA025	(AC-60) 60 cf DOT Aluminum Cylinder 2216	\$494.95
BA026	(AC-87) 87 cf DOT Carbon Fiber Cylinder 4500	\$1,280.95

MULTI-PAK™ RESCUE AIR CART

The Multi-Pak™ Rescue Air Cart offers many of the same features as the Tech-Rescue™ Cart at a more economical price. The cart uses SCBA cylinders to provide breathing air and a second low-pressure regulator allows air tools or lift bags to be used. The Rescue Air Cart is supplied with a high pressure CGA-347 inlet for extended use.

FEATURES:

- Universal hand tight CGA fittings with bleeder valves
- Quick release hose rack
- In-line check valves
- Cylinder selection switch



BA021	Multi-Pak™ 2 Cylinder Air Cart 4500 psi with 2 Outlet Manifold	\$1,438.95
BA022	Multi-Pak™ 2 Cylinder Air Cart 4500 psi with 4 outlet Manifold High Flow Regulator	\$1,539.95
BA023	Multi-Pak™ 2 Cylinder Air Cart 4500 psi with 4 outlet Manifold, Powder Coat Steel	\$2,185.95
BA027	Nylon Cart Cover	\$234.95

SUPERPASS® 5 AND 5X - NFPA COMPLIANT

RUGGED, NFPA STANDALONE "PASS" PERSONAL ALERT SAFETY SYSTEM

NEW

AIR SYSTEMS

BN416

- Heat stress temperature and motion sensing alarm, auto-on activation
- Includes new NFPA sound signature
- Bright, highly visible, LED status indicators
- Compliant to NFPA 1982, (TIA) 13-2 requirements for PASS
- Intrinsically safe to UL913, and CSA C22.2, No 157
- Standalone pass requires no SCBA



BN416



BN417, ALL THE FEATURES OF THE SUPERPASS® 5 PLUS:

- Purchase and use as a SUPERPASS® 5 and field upgrade to the RF signaling capabilities of a TPASS 5
- Ideal migration path for budget conscious departments
- Use upgraded 5X with in-Command® first-in tablet and in-Command® full crew

BN416	SuperPASS® 5 - NFPA Compliant	\$494.95
BN417	SuperPASS® 5X - NFPA Compliant	\$664.95

SCBA REPLACEMENT CYLINDERS

Worthington has been manufacturing composite cylinders for over 35 years. With over two million cylinders sold, Worthington cylinders have never had a field service failure or major recall. The standard cylinder is durable, lightweight and performance based - no other cylinder compares in price.

- D.O.T. and TC approved
- Industry Leader: Worthington has over 2 million units in service without a field service failure
- Superior Quality: 15-year life expectancy
- Bottles Only: Valves sold separately

4 CYLINDER ORDER MINIMUM

Cat#	Approx. Duration	Description	For Use With	Price
BG217	30 min. LP	Low Press., 2216 psi	All Brands of Packs (Except MSA)	\$494.95
BG218	30 min. LP	Low Press., 2216 psi	For MSA Packs	\$494.95
BG219	30 min. HP	High Press., 4500 psi	All Brands of Packs (Except ISI & Survivair)	\$494.95
BG220	30 min. HP	High Press., 4500 psi	For ISI & Survivair Air Packs	\$494.95
BG221	45 min. HP	Stubby Sized, 4500 psi	All Brands of Packs (Except ISI)	\$549.95
BG223	45 min. HP	High Press., 4500 psi	All Brands of Packs (Except ISI & Survivair)	\$549.95
BG224	45 min. HP	High Press., 4500 psi	For ISI & Survivair Air Packs	\$549.95
BG225	60 min. HP	High Press., 4500 psi	All Brands of Packs (Except ISI & Survivair)	\$674.95
BG226	60 min. HP	High Press., 4500 psi Std.	For ISI & Survivair Air Packs	\$674.95



VALVES SOLD SEPARATELY

THREAD SAVER®

PREVENT VALVE DAMAGE

Damaged valve threads can disable your SCBA. The Thread Saver® is the most inexpensive way to help prevent damage. This simple plastic device slips easily onto the valve orifice to keep elements such as ice, dust or dirt away; plus they glow in the dark for easy identification. Ship. wt. 1 lb.



AR068	Thread Saver®	\$4.95
-------	---------------	--------

ALUMINUM AND CARBON BOTTLES

30, 45 AND 60-MINUTE



Dräger

AS085	30-Minute 2216 psi Aluminum Bottle	\$470.95
AZ493	30-Minute 2216 psi Carbon Bottle	\$837.95
AS086	30-Minute 4500 psi Carbon Bottle	\$917.95
AS087	45-Minute 4500 psi Carbon Bottle	\$1,207.95
AZ494	60-Minute 4500 psi Carbon Bottle	\$1,262.95

NORTHERN STAR COMPASS

The Northern Star is the best line of defense when it comes to battling disorientation in low visibility environments. Every day firefighters around the world charge blindly into dangerous, unfamiliar environments without knowing the floorplan - all in the name of saving lives and property conservation. This can lead to disorientation, injury or even death. To keep you safe, trust the Northern Star to guide you home with its patented directional awareness technology. The Northern Star is powered by a rechargeable lithium battery. It features a durable, waterproof design that is responsive to movement, making it very user friendly and easy-to-use.



NEW



- Quarter-size
- Waterproof and durable
- NFPA 1981 tested

INCLUDES:

- Two rechargeable lithium batteries with each purchase
- Easy installation with a 3M two-sided adhesive

MOUNTS INSIDE MASK. MASK NOT INCLUDED.

BN716	Northern Star Compass	\$129.95
BN717	Northern Star Compass - Dual Bank Charger	\$17.95

BLASTMASK® TRAINING REGULATOR

BlastMask® training regulators attach to your facepiece and simulate real-world SCBA breathing without draining your cylinders, or your budget. And now with new enhancements, including a bypass valve and slide latch that mimics SCBA functionality, it's even more true to life. So you can train like it's real. And be tactically fit when it counts.



NEW



BN631

- Easy Air Bypass Valve: Instant access to full air with a half turn
- Rugged Slide Latch: Attaches just like an SCBA regulator
- Superior Construction: Upgraded polycarbonate resin



BN632

MASK NOT INCLUDED

BN631	BlastMask®-110 - Fits Scott AV-2000 & AV-3000	\$119.00
BN632	BlastMask®-210 - Fits MSA G1	\$119.00

MASKHAZE® SIMULATED SMOKE TRAINING TOOL

MASKhaze® Simulated Smoke Training Tool is reusable, waterproof and allows for safe and effective training exercises. To apply the MASKhaze to a compatible SCBA mask, remove the MASKhaze sheet from the package, wipe the SCBA mask lens to remove any loose dust, and stick the center of the MASKhaze's film to the top center of the SCBA lens and lightly press downward on the film to secure properly.

- Simulated smoke training for firefighter SCBAs
- Most realistic smoke training tool
- Safest way to train
- Use for RIT, self-rescue, search and rescue
- Patent pending image altering technology
- No residue after use
- Reusable up to 3 times
- Works even when wet
- Available in packs of 10, 25, or 50



NEW



BN648

MASK NOT INCLUDED



BN645



BN647



BN649

MASK NOT INCLUDED

Specify Mask style and quantity

	10 Pack	25 Pack	50 Pack
MASKhaze® Smoke Simulation - Scott AV-3000	BN645 / \$39.95	BN650 / \$84.95	BN655 / \$149.95
MASKhaze® Smoke Simulation - Drager FPS-7000	BN646 / \$39.95	BN651 / \$84.95	BN656 / \$149.95
MASKhaze® Smoke Simulation - MSA Ultra Elite	BN647 / \$39.95	BN652 / \$84.95	BN657 / \$149.95
MASKhaze® Smoke Simulation - Interspiro Spiromatic S8	BN648 / \$39.95	BN653 / \$84.95	BN658 / \$149.95
MASKhaze® Smoke Simulation - MSA G1	BN649 / \$39.95	BN654 / \$84.95	BN659 / \$149.95

SCBA CARE & MAINTENANCE

DELUXE SCBA MASK BAG PROTECT YOUR SCBA

Deluxe SCBA mask bag fits any modern-style SCBA face piece with MMR, models NFPA 1997 or newer. The bag will hold a face piece with the regulator attached as well as most voice amp and comms devices, an airline face piece or mask with APR cartridges attached. L-shaped side opening allows for quick deployment of the mask when needed.

- Dual inner liner protects against scratches
- Hook and loop closure
- Nylon webbing loop and trigger snap hook
- Heavy-duty water resistant nylon with screen printed Maltese Cross logo
- Lime yellow/silver reflective trim with leather binding reinforcement provides added visibility



NEW



SPECIFY COLOR: Red, Black, Fluorescent Yellow

BN579 Deluxe SCBA Mask Bag

\$18.95

PROTECT SCBA CYLINDERS WITH QUIC-ACCESS CABINETS

Safely store SCBA air packs and spare cylinders in the harshest of indoor and outdoor environments; easily accessible when seconds count. Cabinets can also accommodate protective clothing, emergency equipment, or emergency respirators. *Ship. wt. 21-29 lbs.*

- UV-stabilized ABS plastic with highly visible "safety yellow" doors
- Bulb seal gasket locks out moisture and dirt
- Thermoplastic hinges and latches are highly resistant to corrosive chemicals and ultraviolet exposure
- Windows allow for easy visual inspection of contents
- Stick-on labels indicate minutes duration of SCBA inside



SINGLE CYLINDER

DOUBLE CYLINDER

SCBA QUIC-ACCESS CABINET
SCBA BRACKETS SOLD SEPARATELY

	Cylinder Type	Dimensions	Price
AK007	Single Cylinder	21½"Wx32½"Hx14¼"D	\$501.95
AK008	Double Cylinder	32"Wx32½"Hx14¼"D	\$664.95

AIR MASK BAG

This 400 denier nylon SCBA mask bag is lined with soft flannel fabric to prevent scratches to the face piece. Velcro® closure, D-ring for hanging and an ID window. It fits all current SCBA masks. *Measures: 14"Hx6"D. Ship. wt. 1 lb.*



SEE MORE BAGS
IN TURNOUT GEAR



COLOR: Red

AW107 Air Mask Bag

\$17.95

CYLINDER MATE MOBILE UNIT

- 300-lb capacity wheels
- All units bolted together for added stability
- 2 - 11" commercial grade urethane handles
- Front wheel locks



PERFORMANCE
ADVANTAGE
COMPANY

BH027	Fits (12-Pack) 30-40 minute bottles	\$1,877.95
BL668	Fits (16-Pack) 30-40 minute bottles	\$2,493.95
BN586	Fits (12-Pack) 60 minute bottles	\$2,088.95
BN587	Fits (16-Pack) 60 minute bottles	\$2,858.95

PLASTIC AIR CYLINDER STORAGE RACK

Keep your SCBA cylinders organized and protected with these heavy-duty, stackable racks. *Ship. wt. for rack 4.1 lbs. Ship wt. for strap 0.4 lbs.*

- One-piece molded plastic construction
- Easily link to build honeycomb grids
- Fits all makes/models of air cylinder
- Holes allow for air flow and water runoff
- Mounts horizontally or vertically



ZICO
ZIAMATIC CORP

TWO UNITS SHOWN TOGETHER
WITH STRAPS, SOLD SEPARATELY.

BG527	Plastic Air Cylinder Storage Rack	\$82.95
BG528	Straps	\$19.95

ULTRASONIC SCBA CLEANING SYSTEM

SPECIALLY DESIGNED TO CLEAN YOUR SCBA MASKS BETTER

Our systems and solutions are easy-to-use, environmentally friendly, and cost efficient. Fire departments and industrial safety facilities throughout the country depend on us to get their equipment flawlessly clean without damaging the integrity of the apparatus. Major mask manufacturers recognize Ultrasonic Cleaning technology as an accepted SCBA cleaning method. Ultrasonic Cleaning offers the most thorough cleaning and disinfecting process with minimal disassembly; it reaches both interior and exterior surface areas, where most manual cleaning processes will miss. Ultrasonic Cleaning gives you the best overall cleaning at an affordable price. *Number of masks cleaned at one time will vary depending on mask size.*



EASY-TO-OPERATE

ALL SYSTEMS INCLUDE: Ultrasonic Cleaning Unit, SCBA Rack and Cleaning Solution

Cat#	Description	# of Masks	Price
AK194	AG-360 Cleaning System	1-2	\$2,220.95
AK195	AG-650 Cleaning System	2-4	\$2,835.95
AK196	AG-1000 Cleaning System	4-6	\$4,179.95

BAUER OCEANUS COMPRESSOR SYSTEMS

A PORTABLE, ECONOMICAL, COMPACT, HIGH PRESSURE COMPRESSOR

This pressure-lubricated 5000 psi compressor is ideal for the emergency response team that requires a highly portable compressor for filling SCBA or SCUBA cylinders. Standard equipment includes the compressor, 4.9 SCFM Charging Rate, the Bauer Triplex Purifier, a snorkel for the intake, and your choice of one-phase electric, three phase electric or gasoline engine all mounted on a stainless steel base. The gasoline powered model features a Subaru engine, a pressure shutdown switch, and hour meter. Suitable for use with a maximum of a 2 cylinder, 4500 psi cascade system. Automation package includes magnetic starter, pressure switch, auto drains and 10' of power cord. *Ship. wt. 200 lbs.*

**NEW
LOW
PRICE**



AZ457

AZ457	Gasoline-Powered Bauer Oceanus Compressor System	\$6,409.95
AZ458	One-Phase 220-240 Volt Bauer Oceanus Compressor System	\$5,598.95
BH068	Automation Package for AZ458 (Highly Recommended. Call for Details)	\$2,999.95

ENCLOSED FILL STATIONS

These heavy-duty steel NFPA compliant fill stations protect the operator and bystanders in the event of an SCBA cylinder rupture while filling. These each have an inlet gauge, Fill Pressure Regulator, regulated pressure gauge, 1 fill valve and gauge per fill position. Each fill line is equipped with hand tight universal fill connector to fit all standard SCBA cylinders 2216, 3000, and 4500 psi. The SCBA cylinder holders are lined to prevent scuffing of the cylinders. Painted with a durable powder coat finish. *Ship. wt. 800 lbs.*



AM026

Cat#	Cylinder	Cascade Controls	Price
AZ456	One	None	\$6,406.95
AM025	Two	None	\$7,577.95
AM026	Two	Four	\$10,788.95
AM027	Three	None	\$8,630.95
AM028	Three	Four	\$11,841.95

A. SCBA BRACKETS

The rugged design of our original SCBA bracket has been safeguarding your SCBA cylinders from scarring and damage since 1988. All brackets are constructed of powder coated steel with removable spring clips featuring a high quality nylon protective coating. The resilient cylinder clips are constructed of 1075 spring steel making them ideal for both fiberglass and carbon fiber tanks. We guarantee our brackets to be the best with our industry leading Lifetime Warranty. Manufactured and assembled in USA. *Ship. wt. 5 lbs.*

- Clip only available for standalone use, retrofit, and tank changes
- Horizontal & diagonal drill pattern standard



AR043	SCBA Bracket, 30 min. High Pressure / 5.25"	\$52.95
AR044	SCBA Bracket, 30 min. Low or 45 min. High / 6.10" - 6.75"	\$52.95
AR045	SCBA Bracket, 60 min. High Pressure / 7.25"	\$52.95
AR046	Bracket Clip, 30 min. High Pressure / 5.25"	\$17.95
AR047	Bracket Clip, 30 min. Low or 45 min. High / 6.10" - 6.75"	\$17.95
AR048	Bracket Clip, 60 min. High Pressure / 7.25"	\$17.95

B. NFPA COMPLIANT SCBA BRACKET WITH SAFETY STRAP

This bracket is required for securing SCBA within crew compartment areas. It features a 3-point release that keeps your SCBA locked and securely in place. Simply don the SCBA while enroute and keep it safely secured. On the scene pull that lanyard from between your legs or along the side of your seat and you are ready to go. This universal bracket is designed to fit all SCBA. Additionally this bracket is NFPA compliant meeting the 1901-03 2009 standard. We guarantee our brackets to be the best with our industry leading Lifetime Warranty. Manufactured and assembled in USA. *Ship. wt. 5 lbs.*



AZ618	Complete Universal NFPA Compliant Bracket	\$124.95
AZ534	Clip Only - Universal "V" Clip	\$12.95

EZ-LOC SCBA MECHANICAL BRACKET

- No straps or levers. Locks quickly and easily by simply pressing down on the top clamp
- Ratcheting design safely locks SCBA in place over a range of engagement - no struggling to achieve a lock or slamming the cylinder against a backplate
- Fully adjustable. Fits most makes/models of SCBA with only minor adjustments
- Footplate Guide makes stowing the air pack an easy, no-look process
- NFPA 1901 compliant and third party tested to exceed NFPA 9G standard
- *Ship. wt. 12.8 lbs.*



BK252	EZ-LOC Mechanical Bracket	\$375.95
-------	---------------------------	----------

WALKAWAY® BRACKETS

Rely on these classic brackets for secure storage and quick, easy access to breathing apparatus. All brackets are constructed of heavy-duty steel with a smooth, crack-resistant thermoplastic coating to protect the cylinder and make retrieval a breeze. Standard coating is ideal for low to moderate use. High cycle coating (tested to over 50,000 cycles) adds yellow tips for moderate to high use. *Meets NFPA Requirements (For installation in a crew cab when used with AS075 Collision Restraint Strap).* *Ship. wt. ranges from 4-6 lb.*

	5.4" - 5.8" (15 - 30 min. cylinder)	6.75" (30 - 45 min. cylinder)	7.25" (60 min. cylinder)
AS070	•	•	•
AS071	•	•	•
AS072	•	•	•
AS073	•	•	•



SPECIFY SIZE (see chart above)

AS070	Knockdown Walkaway® Bracket (Standard)	\$45.95
AS071	Knockdown Walkaway® Bracket (High Cycle)	\$48.95
AS072	Scott Knockdown Walkaway® Bracket (High Cycle)	\$80.95
AS073	Scott Knockdown Walkaway® Bracket (High Cycle) w/PHS Strap Assembled	\$82.95

ACCESSORIES

AS074	Positive Holding Strap	\$12.95
AS075	Collision Restraint Strap	\$43.95



AS070

AS071

AS072

TECGEN51 MULTIPURPOSE GEAR

When a call comes in, research indicates that 90% of the time it's not a structure fire. Why wear hot, bulky turnout gear on every call if you don't have to? Dual-certified TECGEN51 is all you need for your calls, including wildland, extrication, MVAs traffic control and incident command - for a third of the cost of traditional turnout gear. Reduce exposing your valuable turnout gear to hazards such as rips, tears, contamination and UV light degradation. Choose TECGEN51. *TECGEN® brand fire resistant garments are UL certified to exceed NFPA 1951 (Technical Rescue) and NFPA 1977 (Wildland Firefighting).*

SAVES EXPENSIVE TURNOUT GEAR

90% of your calls are not structure fire related.

LESS EXPOSURE TO CARCINOGENS

Wearing TECGEN51 on those 90% of calls eliminates potential exposure to hazards such as carcinogens and other harmful particulates that can accumulate on your turnouts.

LESS CARDIOVASCULAR STRESS & FATIGUE

Breathable, lighter weight, single layer garment

TECHNOLOGY

TECGEN® fabrics are made with a high density TECGEN® fiber blend and para-aramid in a comfortable and durable construction. TECGEN® fiber is an inherently flame resistant fiber providing advanced heat and flame protection capabilities. This technology allows us to develop fabrics that offer high levels of thermal protection (TPP) and breathability (THL). You no longer have to sacrifice one for the other.

HEAT STRESS

Whether carrying heavy equipment, dragging hoses or removing car doors, the intense physical activities associated with firefighting can cause firefighters' bodies to generate increased heat. TECGEN51 is ideal for departments looking for gear that offers enhanced comfort, high levels of thermal protection and a solution that is designed to help prevent heat stress.



DELUXE GEAR HAS ALL THE SAME FEATURES AS STANDARD GEAR PLUS:

- 2" Reflective Triple Trim
- STEDSHIELD® FR reinforced elbows, knees with replaceable padded inserts and cuffs
- Pass-through pockets on pants
- Thermoplastic zipper
- Articulated knee
- Handwarmer pockets on coat



TECGEN51 JACKET SIZING			
Coat Size	Chest	Length	Sleeve*
Small	33"-36"	Regular	33"
Medium	37"-40"	Regular	34"
Large	41"-44"	Regular	35"
XLarge	45"-48"	Regular	36"
2XLarge	49"-52"	Regular	37"
3XLarge	53"-56"	Regular	38"
4XLarge	57"-60"	Regular	38"
5XLarge	61"-64"	Regular	38"

*For "Tall", Sleeve length is 1" longer.

TECGEN51 PANT SIZING		
Pant Size	Waist	Inseam*
Small	27"-30"	26-36"
Medium	31"-34"	26-36"
Large	35"-38"	26-36"
XLarge	39"-42"	26-36"
2XLarge	43"-46"	26-36"
3XLarge	47"-50"	26-36"
4XLarge	51"-54"	26-36"
5XLarge	55"-58"	26-36"

*Inseam must be specified in order code.

APPLICATIONS:

- Extrication
- MVA
- Wildland, grass and brush fires
- Trench rescue
- Junior firefighter/explorer programs
- Training
- Search and rescue
- Confined space
- High/low angle rescue
- Support personnel

TEST	NFPA 1977	NFPA 1951	TECGEN® FABRIC
RADIANT PROTECTIVE PERFORMANCE (RPP)	> = 7	N/A	15+
THERMAL PROTECTIVE PERFORMANCE (TPP)	N/A	> = 10	15.6
TOTAL HEAT LOSS (THL)	> = 450 w/m2	> = 650 w/wm2	779 w/m2
FLAME RESISTANCE (After 100 Launderings)	< 4"	< 4"	< .5"
HEAT AND THERMAL SHRINKAGE	< = 10%	< = 10%	1% x 2.1%
TEAR RESISTANCE	> = 5 lbs.	> = 6.75 lbs.	32 lbs.
CLEANING SHRINKAGE	< 5%	< 5%	.9% x 1.8%
BREAKING STRENGTH	N/A	> = 90 lbs.	221 lbs.
ABRASION RESISTANCE TEST	N/A	> = 50 lbs.	110 lbs.
WATER ABSORPTION TEXT (After 10 Washes)	N/A	< = 15%	5.4%

FINALLY - A COOL, COMFORTABLE, CUTTING-EDGE ALTERNATIVE TO TURNOUT GEAR

WILDLAND

SPECIFICATIONS:

- **Dual-Certified:** NFPA 1951 (Technical Rescue) and NFPA 1977 (Wildland FF)
- **Lightweight:** Engineered to protect you without weighing you down
- **Comfortable:** Provides enhanced mobility for confined spaces
- **Repels Moisture:** Helps keep you cool and dry
- **Breathable:** Managing the heat is easier when your clothes can breathe*
- **Active posture design**
- **Durable:** Flexible TECGEN® fiber provides increased durability over typical carbon-based fibers
* High THL rating allows body heat to escape

COMFORT & ADVANCED HEAT PROTECTION



STANDARD COAT FEATURES:

- 3.5" x 8" x 3" radio pocket with mic tab
- 6 1/2" x 5 1/2" patch pocket w/ flap closure on right chest
- 2 - 7" x 7" cargo hand pockets
- 2" 3M Scotchlite® triple trim
- Bi-wing back design for ease of movement
- Full width collar closure
- Glove interface adjustments

STANDARD PANT FEATURES:

- Comfortable and efficient BDU design 4" waist adjustment via take up straps
- Belt loops accommodate 2" belt
- 2 - 8 1/2" x 8 1/2" cargo pockets w/ flaps located on outside legs
- Front hand pockets
- 2 - rear pockets
- 2" 3M Scotchlite® triple trim
- Boot interface / leg take up adjustments
- 12" zippered leg openings for easy donning over boots
- Suspender loops

TECGEN® FIBER HEAT BLOCKING EFFECT

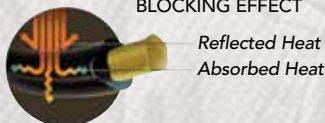

FULL WIDTH COLLAR CLOSURE

12" ZIPPERED LEG OPENINGS

4" WAIST TAKE UP

RADIO POCKET WITH MIC TAB

6" x 6 1/2" REAR POCKETS

STEDSHIELD® FR REINFORCED KNEES

CARGO POCKETS WITH CLOSURE

BI-WING BACK DESIGN

CARGO HAND POCKETS

STEDSHIELD® FR REINFORCED ELBOWS

BOOT INTERFACE

CUSTOMIZED LETTERING
* Extra Cost

SPECIFY COLOR: Tan or Black

SPECIFY SIZE: S-XXL

SPECIFY INSEAM: 28", 30", 32", 34" or 36"

BN235	TECGEN® 51 - Coat - Standard	\$317.95
BN236	TECGEN® 51 - Pants - Standard	\$272.95
BN237	TECGEN® 51 - Coat - Deluxe	\$404.95
BN238	TECGEN® 51 - Pants - Deluxe	\$404.95

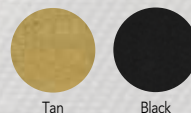

UNSURPASSED COMFORT,

WILDLAND

FIRELINE™ DELUXE™ JUMPSUIT

The DELUXE™ Jumpsuit has the best features of our DELUXE™ Coat and Pant combined into one. Meticulously engineered to provide unrestricted freedom of movement and unsurpassed comfort and protection. Complete protection in a convenient one-piece jumpsuit.

- Full length two-way self-locking zipper front closure extends to the top of the collar and is covered by a self-fabric storm flap which secures shut with five intermittent spaced hook and loop closure system
- Elasticized waistband with adjustable side take-up straps allow 4" waist adjustments
- Radio pocket on left chest with hook and loop flap closure and mic holder loop set above flap
- Cell phone/pager pocket on right breast with hook and loop flap closure and D-Ring loop at pocket bottom for hanging gear or gloves
- Extra deep front slash pockets with hook and loop flap closures
- Two large rear pockets with hook and loop flap closures
- Gusseted leg and sleeve cuffs are elasticized and have adjustable hook and loop closures
- Extra-long leg zippers
- 2" wide 3M Scotchlite™ Reflective Material-9587 Fluorescent Lime/Yellow Fire
- Meets or exceeds NFPA 1977 Standard on Protective Clothing and Equipment for Wildland Fire Fighting (Current Edition)
- Meets CAL-OSHA Requirements – Passes Fed. Test 191, Method 5903.2; CAL-OSHA Sections 3406(d)

Jumpsuits	
Size	Chest
Small	34"-36"
Medium	38"-40"
Large	42"-44"
XLarge	46"-48"
2XLarge	50"-52"
3XLarge	54"-56"
Size	Inseam
Short	5'4"-5'7 1/2"
Regular	5'8"-6'1 1/2"
Tall	6'1"-6'4"

FIRELINE



SPECIFY SIZE: S-XXXL

		S-XL	XXL	XXXL
BL007	Yellow Indura® Ultra Soft® 9 oz. Fireline™ DELUXE™ Jumpsuit	\$368.95	\$405.95	\$441.95
BL008	Yellow Nomex® III Fireline™ DELUXE™ Jumpsuit	\$432.95	\$476.95	\$518.95
BP147	Yellow Tecasafe Fireline™ DELUXE™ Jumpsuit	\$384.95	\$426.95	\$462.95

FIRELINE™ WILDLAND GEAR

THE MOST COMFORTABLE FABRIC FOR WILDLAND GARMENTS ON THE MARKET!

COAT FEATURES:

- 3M™ Scotchlite™ Flame-Resistant Retro Reflective lime/yellow 2" wide triple trim
- Large cargo hip pockets with hook/loop flap closures expand
- 4" high collar, no bulky throat strap, hanger loop at neck
- Double pull Zytel FR50 Delrin zipper
- Articulated elbows
- Gusset at cuff has secondary hook/loop strip
- Adjustable cuffs incorporate hook/loop tab
- Radial sleeve design allows full arm movement
- Radio pocket with hook/loop closure
- Seamless shoulders

Coat	
Size	Chest
Small	34"-36"
Medium	38"-40"
Large	42"-44"
XLarge	46"-48"
2XLarge	50"-52"
3XLarge	54"-56"

How to Order

- Specify coat size and length
- Specify pant size and inseam

Pant	
Size	Waist
Small	27"-31"
Medium	31"-35"
Large	35"-39"
XLarge	39"-43"
2XLarge	43"-47"
3XLarge	47"-51"
Inseam	
Size	Length
Regular	28"-32"
Long	32"-35"

FIRELINE



PANT FEATURES:

- Self-locking double pull Zytel FR50 Delrin zipper
- Corrosion-resistant anodized brass snap at waist and anodized carbon steel ladder buckle with cotton take-up straps
- Self material waistband with elasticized back and seven 2" wide belt loops
- Optional knee pad made from super soft 100% flame-resistant closed cell Neoprene
- Welt-style rear pockets have spade-style flaps
- Front slash-style pockets have extra deep contoured pocket bags
- Knee-high brass leg zippers mounted to Nomex® tape
- 3M™ Scotchlite™ Flame-Resistant Retro reflective lime/yellow
- Articulated knees with inside knee pocket
- Expandable over-sized mid thigh cargo pockets
- 2" wide triple trim sewn around legs
- Partially elasticized cuffs

Cat#	Description	S-XL	XXL	XXXL
BD026	Yellow 9 oz. Indura® Ultra Soft FireLine™ Coat	\$239.95	\$251.95	\$275.95
BD027	Yellow 9 oz. Indura® Ultra Soft FireLine™ Pants	\$235.95	\$252.95	\$285.95
BD028	Yellow 6 oz. Nomex® IIIA FireLine™ Coat	\$274.95	\$304.95	\$333.95
BD029	Yellow 6 oz. Nomex® IIIA FireLine™ Pants	\$274.95	\$293.95	\$342.95
BP145	Yellow 7 oz. Tecasafe IIIA FireLine™ Coat	\$240.95	\$266.95	\$289.95
BP146	Yellow 7 oz. Tecasafe IIIA FireLine™ Pants	\$251.95	\$277.95	\$303.95

COAT OPTIONS

BD030	Reflective 3" High Silver Scotchlite™ Iron-On Letters	\$2.95/ea.
-------	-------------------------------------------------------	------------

PANT OPTIONS

BD031	Knee Pads - FR Neoprene	\$8.95/pr.
-------	-------------------------	------------

MOBILITY AND PROTECTION

FIRELINE™ SHIRT

Designed in accordance to the U.S. Forest Service Specifications. Generously patterned to allow unrestricted range of motion and comfort. Can be worn by itself as a shirt or layered over your favorite tee as a lightweight jacket.

- 3" high shirt style collar
- 3" hanger loop at neck
- Two large patch style breast pockets with hook and loop flap closures
- Left pocket includes pen/pencil slot
- Set-in style sleeves with adjustable hook and loop tab closure at cuffs
- Extra large melamine button front closure
- Shirt tails are extra-long and squared off to be worn either tucked in or outside pants
- Meets or exceeds NFPA 1977 Standard on Protective Clothing and Equipment for Wildland Fire Fighting (Current Edition)
- Meets CAL-OSHA Requirements – Passes Fed. Test 191, Method 5903.2; CAL-OSHA Sections 3406(d). Complies with OSHA Rule 29 CFR Part 1910, 269



BL002



SPECIFY SIZE: S-XL

BL001	Yellow Indura® Ultra Soft Fireline™ Shirt	\$91.95
BL002	Yellow Nomex® 111A Plain Weave Fireline™ Shirt	\$132.95
BP148	Yellow Tecasafe 111A Plain Weave Fireline™ Shirt	\$99.95

DOUBLE DUTY™ BDU PANTS

PGI's Double-Duty™ pants are dual classified to NFPA 1975 and 1977 Standards by Underwriters Laboratories for use as both station wear and wildland firefighting PPE. Now you can get the best of both worlds – a good looking and comfortable station wear pant which is great for working around the station or being worn in public yet rugged and protective enough to be worn on the fireline. PGI's signature relaxed fit and functional design is sure to make the Double-Duty™ BDU pant a station wear favorite.

- Signature relaxed fit for maximum mobility and comfort
- Rear of waistband is elasticized for maximum freedom of movement and comfort
- Oversized double needle top stitched bellowed cargo pockets on thighs expand to give you plenty of storage capacity and secure with hook and loop closures
- Contoured front slash pockets have extra deep bags
- Two large rear double needle top stitched patch pockets with hook and loop flap closures
- Corrosion-resistant brass snap at waist
- Double reinforced crotch panel extends wear life
- Adjustable hook and loop ankle straps backed with self-fabric
- Leg outseams are sewn with five-thread safety stitch, then top stitched with a double-needle lockstitch
- All points of stress are bartacked
- Meets or exceeds NFPA 1977 Standard on Protective Clothing and Equipment for Wildland Fire Fighting (Current Edition)
- Compliant with NFPA 70E (Current Edition) – Meeting the performance specifications of ASTM – F-1506 for wearing apparel used by electrical workers exposed to arc and related thermal exposures
- Meets CAL-OSHA Requirements – Passes Fed. Test 191, Method 5903.2; CAL-OSHA Sections 3406(d)
- Complies with OSHA Rule 29 CFR Part 1910, 269



Pants		
Size	Waist	Inseam
Small	27"-30"	28"
Medium	31"-34"	30"
Large	35"-38"	32"
XLarge	39"-42"	34"
2XLarge	43"-46"	36"
3XLarge	47"-50"	38"

SPECIFY COLOR: Yellow or Green

SPECIFY SIZE: S-XXXL

	S-XL	XXL	XXXL
BL003	Yellow Indura® Ultra Soft® Double Duty™ Fireline™ Pants	\$184.95	\$220.95
BL004	Green Indura® Ultra Soft® Double Duty™ Fireline™ Pants	\$194.95	\$230.95
BL005	Yellow Nomex® Double Duty™ Fireline™ Pants	\$230.95	\$273.95
BL006	Green Nomex® Double Duty™ Fireline™ Pants	\$237.95	\$285.95
BP149	Yellow Tecasafe Double Duty™ Fireline™ Pants	\$187.95	\$225.95
BP150	Green Tecasafe Double Duty™ Fireline™ Pants	\$192.95	\$231.95



BETAX WILDLAND FIRE SHIRT

- Airflow vents in each bicep area and chest area
- ¾ front zipper for breathability and easy on/off capabilities
- 2 slanted bicep pockets with segmented Velcro®
- 5.8 oz. lightweight fabric provides unmatched comfort
- Excellent moisture management
- FR properties won't wash or wear out
- 7.0 oz. material for toughness
- Mil Spec Velcro® wrist straps
- Top button neck closure
- Lifetime warranty
- UL certified to NFPA 1977-2011 specifications



SPECIFY COLOR: Yellow, Yellow/Green or Yellow/Navy



SPECIFY SIZE: S-XXL

Cat#	Description	S-XL	XXL
BN085	BetaX Wildland Fire Shirt	\$138.95	\$145.95

ETHOS WILDLAND FIRE PANTS

- Tecasafe Plus 7oz. + Advance 7.2 oz. materials
- Patent Pending "XVent" Technology
- Minimize chafing with our new underside pattern design
- Articulated areas provide excellent comfort and fit
- Aggressively cut for maximum mobility
- Double reinforced in high-stress areas to take the abuse
- Super tough black oxidized YKK fly zipper assures a long life
- Double closure system with Mil Spec Velcro® and melamine button makes a solid closure system
- Backed by 100% guarantee
- UL certified to NFPA 1977-2011 specifications



SPECIFY SIZE: S-XXXL

Cat#	Description	S-XL	XXL	XXXL
BN084	Ethos Wildland Fire Pants	\$193.95	\$200.95	\$209.95

SAWBUCK CHAPS

SawBuck Chainsaw Chaps offer greater protection and comfort than ballistic nylon chaps. The difference is the combination of woven para-aramid and needle punch para-aramid fabrics which, pound for pound are 5x stronger than steel!

ALL CHAPS FEATURE:

- Shell front and back is 1000 denier Cordura nylon, urethane coated to prevent penetration of liquids
- 2" wide waist belt and 1" wide leg straps of heavy nylon webbing with adjustable nylon buckles

BP321 FEATURES:

- Constructed with 3 plies of woven para-aramid and 2 plies of para-aramid felt
- Four compartment tool pocket with snap closure flap sewn to waist belt
- UL Classified to NFPA 1977, Standard on Protective Clothing and Equipment for Wildland Firefighting, ASTM F 1897-08 Standard Specification for Leg Protection for Chain Saw Users. This chap is built in accordance with US Forestry Specification 6170-4G.

BP322 FEATURES:

- Constructed with 2 plies of woven para-aramid and 2 plies of para-aramid felt. Chaps provide 180° coverage across the front of both legs and an extra 4" of protection along the left side of both leg.
- Dual UL Classified to ASTM F 1897-04 and ASTM F 1897-08 Standard Specification for Leg Protection for Chain Saw Users

BP323 FEATURES:

- Constructed with 2 plies of woven para-aramid and 2 plies of para-aramid felt
- Three compartment tool pocket with snap flap closure is sewn to waist belt



BP323



BP321

NEW



SPECIFY COLOR: Green or Orange SPECIFY SIZE: 28", 32", 36" or 40"

Cat#	Description	28"	32"	36"	40"
BP321	SawBuck Wildland & Forestry Chaps	N/A	\$153.95	\$162.95	\$215.95
BP322	SawBuck UL Classified Chaps	N/A	\$100.95	\$105.95	\$114.95
BP323	SawBuck Original Chainsaw Chaps	\$99.95	\$105.95	\$114.95	\$124.95

All Chaps fit waist sizes 32" to 46". Measure length from waist down 2" below top of boot to determine proper length to order.

WILDFIRE PROTECTIVE HEADGEAR

Designed specifically to meet the requirements of wildland firefighters. They offer fire fighters protection, versatility, comfort, and value. Made of high-heat thermoplastic which offers superior impact protection and penetration resistance in non-structural, high-heat environments. In addition, they deliver added electrical insulation required for ANSI Z891-1986 Class A & B helmet specifications. Features include glare-reducing texture, shell-bonded goggle retainer clips for secure storage of eye protection and reflective strips for increased wearer visibility through smoke at night. Accepts a full range of mounting brackets for face shield visors or face shield screens. *Meets NFPA 1971. Ship. wt. 1 lb.*

- More secure suspension attachments
- Adjustable headband for custom fit
- Larger replaceable pillowed brow pad
- Seamless suspension straps



SPECIFY COLOR: Red, Black, Yellow, White, Blue, Orange, Lime

AC511	WildFire Front Bill Cap Helmet	\$55.95
AC512	WildFire Full Brim Hat Helmet	\$58.95
AC513	Nomex® Ear/Neck/Face Protector	\$44.95
AC516	6" Clear Polycarbonate Visor	\$26.95
BD016	Nomex® Shroud	\$44.95



WILDLAND

PRO-TECH 8 WILDLAND GLOVES



- Designed and constructed for protection during wildland firefighting activities
- 100% full grain cow hide
- Modacrylic inner liner for extra protection and comfort is sewn in at each fingertip
- Kevlar® high burst thread throughout
- Reflective trim
- Meets current NFPA standards

SPECIFY SIZE: S-XXL

BN616	Pro-Tech 8 Wildland Gloves	\$35.95
-------	----------------------------	---------

WILDLAND FIREFIGHTING GLOVES



Constructed of heavy-weight, abrasion resistant pigskin with wristlet for wildland and rescue applications. Keystone design allows for natural thumb movement and better dexterity. Seams are lock stitched and sewn with Kevlar® thread. CE Compliant. Meets NFPA 1977 Standard on Protective Clothing and Equipment for Wildland Fire Fighting.

SPECIFY SIZE: XS-XL, J

BK209	Wildland Firefighting Gloves	\$49.95
-------	------------------------------	---------

9" POWER EMS/WILDLAND BOOTS

- Full-grain, flame-cut-resisting leather
- Flexible Lenzi L-Protection® puncture-resisting insole material
- Shaft vapor exhaust vents
- NFPA 1977 and 1999 Certified

SPECIFY SIZE: 7-14, 15
SPECIFY WIDTH: M, W, XW

MBK125	9" Power EMS/Wildland Boots	\$299.00
--------	-----------------------------	----------



HOT SHIELD WILDLAND FIREFIGHTER FACE MASK

The Hot Shield Wildland Firefighter Face Mask is a patented highly flame resistant face protector designed by firefighters for use in all wildland firefighting operations. BK088 offers the extreme protection against burns to the face/neck with the added benefit of blocking and reducing the inhalation of smoke and ash particulate. Multiple layers of patented CarbonX help maintain the crucial airspace firefighters want and human skin needs to survive extreme temperatures. The soft comfortable inside liners (also CarbonX) absorb perspiration, adding to user comfort.

- One size fits all (hook & loop fasteners behind neck)
- Extreme thermal protection (radiant heat or direct flame) of major portions of the face and neck
- Reduction of inhalation of airborne particulate by means of a screening mesh and use of a disposable filter with exhalation valve
- One year materials and workmanship warranty
- Main Users: Firefighters and other workers that are subject to direct flame, radiant heat, smoke and airborne particulate hazards in an outdoor environment and where use of a self-contained breathing apparatus is either impractical or impossible



BK088	Hot Shield Wildland Firefighter Face Mask	\$74.95
BK089	Filters for Face Mask	\$34.95/Case of 10

WILDLAND FIRE PACK



10 POCKETS!

- Fire shelter case drop-down feature
- Compression straps keeps load secure
- Modular pack system for multiple set-up options
- Aluminum stay harness structuring
- Patent pending Dual Action Stabilizer (D.A.S.)
- Main pack side pocket lids stow when not needed
- Holds MOLLE or alice clip accessories
- 4 grommets on each side pocket provide maximum drainage
- Additional inside mesh storage pockets
- Daisy chain w/built-in ladderloc to attach belt-loop accessories
- 102 oz. water reservoir case with dual hose ports
- New generation fire shelter case with alice clips
- Reflective material
- Adjustable hip belt/torso to fit multiple sizes
- Ergonomically designed harness system
- Webbing reinforced stress points
- Glove pocket on fire shelter case
- 2 side pockets for water bottles
- 2 covered side pockets for fuseses
- Lifetime warranty

SPECIFY COLOR: Red, Black or Orange



BN086	Wildland Fire Pack	\$248.95
-------	--------------------	----------

RCP-1 PRO RADIO CHEST HARNESS

Unparalleled in design and workmanship, the RCP-1 Pro radio chest harness comes loaded with all the bells and whistles. Perfected over time from customers' feedback to become the most comfortable and functional radio chest harness anyone can wear.



BN087	RCP-1 Pro Radio Chest Harness	\$55.95
-------	-------------------------------	---------

FIRE SHELTER WITH CASE

No wildland firefighter should be without a personal fire shelter. In an emergency situation, the fire shelter could save a life. The shelter meets Forest Service specs. Changes from the prior standard include the addition of a shelter floor and quick-grab handles for faster deployment. *Training/Practice Fire Shelters are not fire resistant and should not be used as a fire shelter. Ship. wt. 5 lbs.*



AB397

AB397	Fire Shelter with Case (Standard Size)	\$466.95
BP019	Fire Shelter with Case (Large)	\$547.95
BP020	Training/Practice Fire Shelter (Standard)	\$189.95
BP021	Training/Practice Fire Shelter (Large)	\$200.95

V80 WILDCAT GOGGLES

WILDCAT Goggles will not drip, melt, or ignite at temperatures up to 350°F (for five minutes). They offer superior comfort, too, thanks to pivot headbands, adjustable side vents, and a contoured fit that blocks out airborne contaminants. Meets ANSI impact standards.

- **Extreme Heat Resistance:** will not melt, drip, ignite at 350°
- Adjustable side vents help increase airflow
- Fits naturally to the contour of your face
- Lightweight and comfortable with a pivot headband for optimal placement
- Metal-free design to minimize electrical transference risk
- D4 rating for dust protection
- D3 rating for droplet and splash protection
- Meets ANSI Z87.1+ impact standard and CSA Z94.3 compliant



BP172 V80 WILDCAT Goggles \$19.95

FIREPRO-1971™ FS GOGGLES

The FirePro-1971™ FS goggles feature a one-piece, wraparound strap that easily secures to any helmet with Velcro® tabs. This system keeps the goggles on hand at all times, with the flexibility of quickly removing them if needed.

- NFPA compliant 1971-2013 Edition - including the 5-minute, 500°F oven test
- U.S. Federal OSHA compliant
- Exceeds the requirements of ANSI Z87.1-2010
- All components are heat and flame resistant



BL467 FirePro-1971™ FS Goggles \$57.95

FIREPRO™ WILDLAND GOGGLES

EVOLUTIONARY EYE PROTECTION

The compact, low-profile FirePro™ frame optimizes fit and function with all helmets, while the full-perimeter ventilation and filtration system minimizes lens fogging and filters airborne particles, dust, and debris. The ESS FirePro-EX™ model features a two-piece strap system and Snap-On/Snap-Off™ helmet mounting brackets which attach to a helmet brim (no drilling required). The extra-thick, 2.8mm high-impact lenses provide wide peripheral vision and distortion-free optics. All ESS FirePro™ goggles exceed ANSI Z87.1+, US Federal OSHA, and are compliant with wildland fire equipment performance requirements including the 350°F for 5-minute oven test. FirePro-FS™ and FirePro-EX™ goggles are certified as complaint to NFPA 1977 Standard on Protective Clothing and Equipment for Wildland Fire Fighting.

FEATURES:

- Interchangeable lenses
- Durable face padding
- Speed-clip straps
- Extra-wide field of view
- 2.8mm lenses
- ClearZone FlowCoat anti-fog and anti-scratch lens coatings
- Anti-microbial face padding
- Rx available



Cat#	Description	Includes	Price
BK004	ESS FirePro-EX™ Wildland Goggles	Snap-On/Snap-Off™ Helmet Mounting Brackets, 1-Piece Strap System	\$57.95
BK003	ESS FirePro-FS™ Wildland Goggles	2-Piece Wraparound Strap with Velcro® Tabs	\$57.95
BL011	Nomex® HeatSleeve™		\$20.95

DARLEY DRIP TORCH

- 14" closed, 25½" assembled
- 6" diameter
- 1¼ gallon capacity
- Fuel trap in spout prevents flashback
- Breather valve sealed outlets and oil proof gaskets prevent fuel spills
- Reversible burner for easy storage
- Check valve to protect against flashback
- Large diameter mouth for easy filling
- Double bottom for extra durability
- Heavy duty, lightweight aluminum body
- Red body complies with new OSHA regulations (29 CFR 1910.114)
- Meets DOT regulations for transport of flammable fuel UN#IBI-Y-150 and Forest Service Specification 5100-614
- *Ship. wt. 6 lbs.*



W439	Darley Drip Torch	\$198.95
W440	Truck Mounting Bracket	\$75.95

SMOKECHASER PRO

- Padded shoulder straps, back panel and waist belt
- 5 gallon capacity
- Large filler cap is located on top of the bag
- Two grab handles making filling easier
- USFS approved, quick priming pump
- FEDCO brass hand pump



BP026	Smokechaser Pro	\$216.95
-------	-----------------	----------

RANGER RIGID-PAK BRUSH PUMP

Thick walled polyethylene plastic tank will take rough handling and harsh environments. Non-slosh rounded design keeps the unit comfortable, balanced and steady. The full padded pillow comforts that impinging feel of other tanks. The unit is completely corrosion resistant. It will not rust like galvanized steel models and is less expensive than stainless steel tanks. Adjustable padded shoulder straps are rugged yet fit comfortably and distribute the weight evenly down your back. Tank holds 5 gallons. *Ship. wt. 2 lbs.*

AS242 FEATURES:

- Aluminum base and quick-release strap keeps your Ranger Brush Tank secure on your apparatus

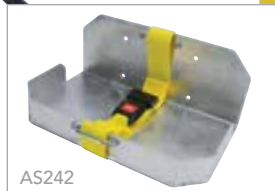

AS241	Ranger Rigid-Pak Brush Pump	\$164.95
AS242	Ranger Carrying Bracket	\$134.95

INDIAN FIRE PUMP

A 5-gallon portable hand-operated pump and tank. Brass pump is durable and easy to clean. Nozzle easily changes from straight stream to cone spray quickly. Tank cap has cam lock with watertight gasket and ventilation hole to prevent collapse. Heavy-duty, 1¾" removable polypropylene shoulder straps and carrying handle. *Ship. wt. 18 lbs.*

- All-brass pump
- Nozzle chain
- Carrying straps
- 5 gallon tank



B690	Indian Fire Pump, Galvanized	\$196.95
L574	Indian Fire Pump, Stainless Steel	\$288.95

Accessories

E743	Running Board Rack, Red Enamel with Straps	\$48.95
S896	Polypropylene Carrying Strap	\$11.95
S897	Pump 18" Long Less Adjustable Nozzle	\$128.95
S899	Strap for Running Board Rack	\$23.95

BACKPACKS & PUMPS

COLLAPSIBLE BACK PUMP

**BEST
SELLER**



Corrosion-resistant Neoprene coated Nylon bag and single-stroke brass pump make the U235 one of the best values on the market. Lightweight, collapsible bag holds 5 gallons of water, conforming to the shape of your back. Watertight and reinforced construction means you stay dry. Straps won't rip, mildew or twist while in service. Oil-proof, 44" hose with stainless steel, monel and brass connections, connects 18" pump. Hose has rustproof quick connectors. The new 4" ABS polymer cap makes it much easier to fill with less time; replaces the old 2.5" metal cap. The seams have doubled in strength with a new ultrasonic welding process. *Ship. wt. 5 lbs.*

U235 Collapsible Back Pump \$159.95

INDIAN CHIEF DUAL BAG FIRE PUMP

**VIDEO
ONLINE**



The "Indian Chief" is a 5 gallon inner bag liner inside a protective, nylon fabric, collapsible outer bag. It forms to your back for greater comfort.

- Rugged outer bag offers more protection from punctures
- Harness straps with chest cinch strap help balance the load and prevent straps from pulling outward
- 2 liners come with fire pump – extra liner is stored in the outer pouch of the nylon bag
- Indian "Fedco" all brass pump, quick connect and dual nozzle

BL243 Indian Chief Dual Bag Fire Pump \$197.95

FORESTRY PUMP & BACKPACK

BK210:

The Scotty pump is a single action pump with a foam eduction attachment and air aspirating nozzle. It eliminates the need to batch mix when Class A foam is required. Each time the pump is charged, 1% of foam concentrate is educted into the pump chamber. The air aspirating nozzle generates foam when the pump is discharged.

BK211:

Single action pump. The pump has a brass pump chamber protected by an engineering-grade polymer sleeve. No tools are required to disassemble the unit. It can be completely disassembled by hand for in-the-field maintenance.

**VIDEO
ONLINE**



BK211

BK210 Forestry Foam Pump and Backpack \$210.95
 BK211 Forestry Water Pump and Backpack \$159.95

TOOLS TO GET THE JOB DONE

WILDLAND



A. LONG HANDLE FIREFIGHTING SHOVEL

- Forged steel head
- Solid shank blade
- Rear turned steps
- 44" wood handle
- Ship. wt. 7 lbs.

AJ462 Long Handle Firefighting Shovel \$65.95

B. FIRE SWATTER

The flexible swatter beats the air away from the flames, smothering the fire instantly. Made of rubber treated belting 12"x15". Riveted to a shank cleated on the underside. Shank is driven into the ferruled end of a 60" ash handle, with rivet through ferrule and shank. *Ship. wt. 2 lbs.*

E252 Fire Swatter \$56.95

C. FORESTRY "MCLEOD" FIRE TOOL

- Combination hoe/rake
- Bolted blade
- 3 1/2" teeth
- 48" wood handle
- Ship. wt. 6 lbs.

AJ463 Forestry "McLeod" Fire Tool \$93.95

D. STEEL FIRE RAKE

In forest fire and prairie fire fighting this tool is valuable for raking fire lines, cutting underbrush and weeds, cleaning ditch-banks, etc. Soft steel eye and back with TEMPERED steel blades or teeth. Price includes 60" fitted ash handle. *Ship. wt. 5 lbs.*

D114 Steel Fire Rake \$49.95

E. PULASKI AXE

The Pulaski Axe is a special forest fighting tool. Along with the standard single bit edge, there is also a special Mattock blade for dirt grubbing and trenching. Comes with polished red finish and 36" hickory handle. *Ship. wt. 5 lbs.*

X586 Pulaski Axe \$60.95

HI-VIZ FORESTRY VALVES

STOP LOSING EQUIPMENT, DEMAND HI-VIZ



Hi-Viz Wye Valves

BN540	1" F Swivel x (2) 1" M Outlet	\$301.95
BN541	1 1/2" F Swivel x (2) 1" M Outlet	\$301.95
BN542	1 1/2" F Swivel x (2) 1 1/2" M Outlet	\$301.95

Hi-Viz T-Valve

BN543	1 1/2" F x 1 1/2" M x 1" M	\$123.95
-------	----------------------------	----------

WATER THIEF INLINE T-VALVE

Designed to be installed at intervals in long lines to provide independently controlled outlets for 1" branch lines with full 1/2" waterway. When used in fire-line sprinkler systems, these valves provide the ability to adjust water flow to each sprinkler in the line. Valuable for mop-up work and for filling canteens and backpumps. Meets U.S. Forest Service specifications.

- 1 1/2" F x 1 1/2" M x 1" M
- Ship wt. 2 lbs.



AJ478	Water Thief Inline Tee Valve	\$112.95
-------	------------------------------	----------

1 1/2" NH FEMALE BARREL STRAINER WITH POPPET

- High performance design
- Pump capacity
- Lightweight

NEW



SEE PAGE 26 & 39 FOR MORE STRAINERS



BP144	1 1/2" NH Female Barrel Strainer with Poppet	\$99.95
-------	----------------------------------------------	---------

WILDLAND HOSE CLAMP

C&S Supply has designed a new Wildland Hose Clamp. Offering a much more rigid design, the clamp is capable of withstanding the most brutal and rough operations, yet is user friendly enough to quickly accomplish the task at hand.

- Knuckle guard with wide opening for use with gloves
- Step plate to assist opening while on a charged hose line
- Long bars on the top and bottom for maximum leverage
- Curved clamping area aids in collapsing the hose
- Integrated spanner wrench
- Lightweight and compact
- For use with 1" and 1 1/2" single jacket hose
- Dimensions: 10 3/4" x 3 3/4" x 1 1/2"
- Made in the USA
- Ship. wt. 3 lbs.



BN004	Wildland Hose Clamp	\$104.95
BN544	Hi-Viz Wildland Hose Clamp	\$135.95

GATED WYE VALVES

Rugged lightweight wye valves divide one line into two; female inlet with two male outlets. Constructed of high-quality aluminum and plastic with hard-coated threads. Valves are quarter turn. Meet or exceed GSA requirements for use by the US Forest Service. Ship. wt. 4 lbs.



SPECIFY ANY THREAD COMBINATION: NST or NPSH

AM076	Gated Wye, 1" Inlet x 2-1" Outlets	\$285.95
AM077	Gated Wye, 1 1/2" Inlet x 2-1" Outlets	\$289.95
AM075	Gated Wye, 1 1/2" Inlet x 2-1 1/2" Outlets	\$289.95
AM078	Gated Wye, 2 1/2" x 2-1 1/2" Outlets	\$306.95

FORESTRY WYE

Male adapters are easily removed for adjustments of seats.

- 1 1/2" female inlet x two 1 1/2" male outlets
- Ship. wt. 3 lbs.



BK218	1" NSTF x (2) 1" NSTM Forestry Wye	\$176.95
BK219	1 1/2" NSTF x (2) 1 1/2" NSTM Forestry Wye	\$176.95
BK220	1 1/2" NSTF x (2) 1" NSTM Forestry Wye	\$176.95

ROCKET NOZZLE

- Adjustable nozzle produces super fine jet stream and a cone fog spray
- Standard $\frac{3}{4}$ " GHT
- Flows at 1.25 GPM in straight stream
- Effective reach of stream 30' (9 m) Jet, 15' (4½ m) full cone
- High visibility fluorescent yellow
- Made of corrosion proof, glass fiber filled nylon

BP140 Rocket Nozzle \$9.95



TWIN TIP FORESTRY NOZZLE

The S&H Forestry Twin Tip Nozzle is the time tested forestry nozzle. Made from high-quality cast aluminum with stainless steel internal parts, it comes standard with a $\frac{3}{16}$ " straight stream tip and a 3 GPM fog spray tip. The nozzle has a fog spray position, a straight stream position, and an off position. The straight stream tip threads are $\frac{3}{4}$ " GHT (garden hose). The 1" nozzle inlet threads are available in NPSH or NH (NST).

- Available in 1 NP (NPSH) or 1 NH (NST) thread
- Cast aluminum construction
- **Straight Stream Tip Options:** $\frac{3}{16}$ "
- **Fog Tip Options:** 3 GPM
- Built-in 3 position on/off valve
- 1½ pounds
- Meets Forest Service Specifications (FSS)
- Optional tip features. Call 1-800-4-Darley for more information

BP158 Twin Tip Forestry Nozzle \$299.95



SPANNER/GAS WRENCH

- Used to tighten and loosen 1" (25 mm) to 3" (76 mm) hose coupler fittings
- Made from tough GRP in a high visibility yellow color
- Opens standard 70 mm caps on 5 gallon foam concentrate containers
- Includes a municipal gas and oxygen tank shut off
- Spark and corrosion proof, with quick release snap hook
- Weighs just 2¾ oz (79 g) and is 7½" (190 mm) long



BE271Y Spanner/Gas Wrench \$11.95

WILDLAND SPANNER

Lightweight aluminum construction designed for wildland firefighting. The single ended spanner fits 1" and 1½" couplings.

- Lightweight aluminum
- Fits 1" and 1½" rocker lug couplings
- Meets Forest Service Specifications (FSS)
- Made in the U.S.A.



BP168 Wildland Spanner Wrench \$18.95

FORESTRY NOZZLE

Our 1" forestry nozzle is a dual flow, adjustable pattern nozzle designed with the lower flow rates and rugged simplicity needed for wildland/forestry applications. Its simple twist operation takes you through the following settings: off, low flow straight stream, low flow narrow fog, high flow straight stream and high flow fog. **Ship. wt. 1 lb.**

- **Dual Flow:** 10 and 30 gpm
- 1" rigid female inlet
- Durable, lightweight Pyrolite
- Small, compact design - 4" length



BB097 Forestry Nozzle \$139.95

LEXAN COMBINATION NOZZLES

1½" STRAIGHT STREAM/FOG NOZZLE
Constructed of polycarbonate and precision molded from the latest developments in the industry. Ideal for industrial and commercial installations, as well as small fire companies. **Available Threads:** 1½" NST, SIPT(NPSH); **Height:** 4 $\frac{5}{8}$ "; **Gallage:** 75 GPM. **Ship. wt. 1 lb.**

¾" AND 1" COMBINATION FOG NOZZLE
Molded from polycarbonate material. Designed for booster lines, and small diameter hose. Ideal for fighting grass fires. **Available Threads:** 1" NST, SIPT(NPSH) & $\frac{3}{4}$ " GHT; **Height:** 4 $\frac{3}{4}$ "; **Gallage:** 1"-22 GPM, $\frac{3}{4}$ "-8 GPM. **Ship. wt. 1 lb.**



M767 $\frac{3}{4}$ " and 1" Combination Fog Nozzle \$14.95
L685 1½" Straight Stream/ Fog Nozzle \$13.95

KEY PENCIL LINE HOSE

LIGHTWEIGHT CIRCULAR WOVEN FIREHOUSE TECHNOLOGY

Lightweight, circular woven fire hose technology incorporating high tensile, all polyester woven jacket, lined with high tensile NSF polyurethane. This workhorse hose packs tight and features brass GHT threaded couplings with strain reliefs.

- Dependable high tensile, NSF 61 approved polyurethane liner
- Exceeds U.S. government federal specification 4210-01-167-1061

NEW

SEE PAGE 25 FOR FORESTRY HOSE



50' 100'

BP151	Key Pencil Line Hose (5/8")	\$51.95	\$91.95
BP152	Key Pencil Line Hose (3/4")	\$64.95	\$104.95

WILDLAND

WILDLAND HOSE PACK

Designed with the rugged demands of wildland firefighting in mind. This ergonomically designed hose pack allows the firefighter to transport up to 300 ft. of forestry hose and appliances comfortably while allowing the firefighter to have their hands free to carry tools or navigate difficult terrain. Made of ballistic nylon.

- 2 or 3 hose pockets designed to hold 100' lengths of 1" or 1 1/2" hose
- Capable of mixed loads which can be deployed independently
- Single buckle release for hose deployment
- Heavily padded, contoured shoulder straps
- Made of heavy duty Ballistic Nylon



Back view



Tools and hose not included



BL438	Wildland Hose Pack 2-100' Rolls	\$173.95
BL439	Wildland Hose Pack 3-100' Rolls	\$198.95

WEATHERHAWK WINDMATE™ WIND METER

HAND-HELD COMPREHENSIVE WEATHER MONITOR

The WeatherHawk Windmate WM hand-held wind meter is a comprehensive weather monitor that measures a full range of environmental data specific to your location. It includes a 48-hr visually displayed bar graph for every function, hour-by-hour. The USA-made fluxgate compass reads when held vertically, gives wind direction in degrees and compass points; and it calculates crosswind, head/tail wind. The compass can be calibrated for variation, declination and deviation. In addition to wind speed and direction, temperature, barometric pressure, altitude, and humidity, the unit includes Wind Chill, Wet Bulb, Dew Point, Delta T and Density Altitude. WM-350 provides an audible storm alarm that alerts you to weather changes, even if the unit is off. The unit includes the AccuWeather Comfort Index and it can be adjusted based on sun intensity to provide a superior human based "feel" for Heat Index. All WindMates are designed with a wind speed accuracy of better than +/- 3% and have a 2-Year warranty.

NEW



BP137	WindMate™ 300 Wind Meter	\$149.95
BK246	WindMate™ 350 Wind Meter	\$209.95

FIRE ARMOR FIRST RESPONDER VEST

With the new NFPA 3000 recommendations of NIJ Certified Level IIIA Ballistic Protection for Active Shooter/Hostile Event Responses (ASHER), the "First Responder" was developed for Fire & Medical personnel responding to Active Shooter events, Mass Casualty Incidents and dangerous domestic calls.

Developed and designed by Firefighter/Paramedics that work in the industry, who wanted to provide the best Ballistic Protection to our brothers and sisters in a "One Size Fits Most" design, alleviating the need for agencies to have multi-sized vest or making time consuming size adjustments when seconds count.

The system is designed to look like "Bunker Gear", as an external "wear over the shirt or uniform" design, it provides maximum Ballistic Protection in front, back and side coverage, utilizing NIJ 0101.6 Certified Level IIIA soft armor as well as the ability or option of adding 10"x12" NIJ Certified Level III+ (see below). No matter who is sitting in the "seat", the goal is to ensure all responders have a properly fitted vest.

CARRIER SYSTEM:

- Easily adjusts to individual firefighter
- 5 color options designed around Fire/EMS uniforms and equipment
- Carrier System is constructed of 2 parts (1 front panel and 1 rear panel) for universal sizing ranging from 20" up to a 60" waist
- Carrier is constructed of 1000d Cordura™ Nylon material
- Enlarged/integrated front "Bunker Gear" style pocket for Individual First-Aid Kits (IFAK) and/or radio with internal elastic to secure items
- Heavy duty Drag Rescue Device (DRD) handle
- Fully adjustable, closed cell foam-padded shoulders with channels for optional ballistic shoulder inserts
- 360° of 3M™ Hi-Viz reflective tape and 3M™ reflective ID lettering
- Top loading hard armor insert pockets on the front and rear capable of accepting either full size or shooters cut rifle armor

LEGEND OPTIONS

- Fire
- Fire-Rescue
- EMS
- RTF
- Custom legend (11 character limit including spaces)

BALLISTIC PANEL INSERTS:

- 2-piece NIJ 0101.6 Certified ballistic panel inserts also consist of a front and a rear panel, the rear panel is constructed with "wings" to provide maximum "flank" coverage on all sides
- Integrated 10" ballistic cummerbund
- Provides 360° of NIJ Certified Level IIIA Ballistic coverage
- **Weight:** Approximately 12 lbs.

SPECIFY LEGEND AND LETTERING COLOR (3"): Red/Orange, Lime Yellow
SPECIFY TRIPLE TRIM COLOR: Red/Orange, Lime Yellow

BP117	Fire Armor First Responder Vest	\$749.98
BP326	Modular Fire Plate Carrier (No Ballistics, See Plates Below)	\$349.95



SEE EDARLEY.COM FOR DONNING INFORMATION



LEVEL III+ STAR 647 STEEL PLATES

We do more than just protectively coat our very own armor. We're also passionate advocates for what will serve Police, Fire and EMS personnel best in the field. That commitment also means our armor is tested by an independent 3rd party, ensuring our warranty will always stand between them and an emergency. Because having the right kind of armor, means the difference between uncertainty and knowing they are prepared. **Dimensions:** 10" x 12".

- 5mm thickness
- NIJ III 0101.06 Certified (P5mmSAN600)
- 10 year warranty
- Maximum durability
- Multi-hit capability
- Standard black color
- Single curve

SPECIFY CUT: Full Size or Shooters

Cat#	Description	Weight	Cuts	Price Per Plate
BP283	Level III+ Steel Plates	6.3 lbs.	Full Size or Shooters	\$95.00

SEE EDARLEY.COM FOR NIJ INFORMATION



MODULAR OPERATOR PLATE CARRIER

NEW

Condor Modular Operator Plate Carrier is designed to carry both soft armor and plate. It will accept Large or X-Large SPEAR/BALC cut soft armor, up to 10.25" x 13.25" front and back plates, and up to 6" x 8" side plates.

SPECIFICATIONS:

- Emergency drag handle
- Removable padded shoulder pads, with hook and loop guides
- Adjustable shoulder straps
- Heavyweight webbing for modular attachments
- Padded mesh interior lining
- Adjustable cummerbund with soft armor pockets - Accepts up to 6"x 8" side panel plates
- Internal sleeves for soft armor
- Easy access plate pockets
- Adjustable in girth and height
- Imported



ACTIVE SHOOTER

SIZING:

- Medium - X Large adjustable sizing
- Accepts Large or X-Large BALCS/ SPEAR cut soft armor, and plates up to 10.25"x13.25"

MBN503 COLOR: Black



Black

MBN503 Modular Operator Plate Carrier
BN564 Level IIIA Soft Armor

\$88.95
\$525.95

RESCUE TASK FORCE RESPONDER VEST

The RTF Responder Vest provides the combination of ballistic protection, rapidly accessible medical supplies and custom configurability. Two combination external, front mounted Tourniquet/Shears Holders provide rapid access for major hemorrhage control. The drop down front medical pouch can be easily accessed and has a variety of elastic loops and pockets for organizing medical supplies. The Med Pouch also offers a fast "rip away" functionality that allows it to be quickly removed from the vest for use by other team members. Steel III+ plates can be added for protection against some rifle rounds.

BN177 INCLUDES:

- 2 - C.A.T. black tourniquets
- 2 - 7.5" EMT shears
- 4 - Compressed gauze
- 2 - 6" Israeli emergency pressure dressings
- 2 - NAR Hyfin twin vent chest seal twin packs
- 2 - Hypothermia rescue blankets
- 3 - Pairs of Nitrile gloves
- 4 - TCCC cards
- 1 - Sharpie marker
- 2 - Nasopharyngeal airways, 28Fr, with lube



BN177 & BN178 SPECIFY COLOR: Red, Black, Coyote or Olive Drab

BN177	RTF Responder Vest without Armor - with Supplies	\$325.95
BN178	RTF Responder Vest without Armor - without Supplies (Red N/A)	\$166.95
BN348	Level IIIA Soft Armor	\$499.95

BATLSKIN VIPER HELMETS

Revision's BATLSKIN VIPER A3 HELMET, designed specifically for Law Enforcement, Special Forces and SWAT personnel, stops NIJ IIIA level threats. Manufactured to meet stringent quality standards, the helmet delivers the level of ballistic and impact head protection demanded for tough tactical operations. The Viper A3 helmet is made of aramid materials and built in the ACH shape. The Batlskin Viper A3 Helmet is the foundation for all Batlskin modular components, including the Front Mount, Interlocking and Mandible Guard & Visor.

BN180 FEATURES

- **Ballistic Performance:**
 - Significantly exceeds 2200 ft/s (670 m/s), 1.1 g (17 gr) FSP
 - Stops NIJ IIIA level threats (9mm, 44 mag & .357 SIG) (NIJ 0106.01)
 - Meets U.S Army Standard for impact protection (CO/PD-05-04)
- **Weight:**
 - Full cut system – 52 oz (1485 g) – Size Medium
 - High cut system – 48 oz (1355 g) – Size Medium
- Low-profile design
- Designed for comfort
- Compatible with standard face shields, NVGs, Chem/Bio Masks and communication devices
- Offers unsurpassed impact protection and ballistic-rated hardware
- Tested for ballistic performance from -40°F to 158°F (-40°C to 70°C)



SPECIFY SIZE: S-XL

BN180 Revision Batlskin Viper A3 Helmet with MSS



Black

\$369.95

ACTIVE SHOOTER CASUALTY RESPONSE

ACTIVE SHOOTER EVENT CASUALTY RESPONSE KIT

This kit is designed to deliver the most critical "point of wounding" supplies for First Responders, Fire Rescue or EMS personnel. Shoulder strap and carry handles allow easy on-scene transport options, and internal organizer pockets can accommodate additional supplies if desired. *Dimensions: 8"x8"x12".*

INCLUDES:

- 1 - Quiklitter™
- 4 - Cat tourniquet
- 3 - Halo chest seal
- 2 - 4" trauma dressings
- Additional supplies



Black Olive Drab

SPECIFY COLOR: Black or Olive Drab

BN185 Active Shooter Event Casualty Response Kit

\$329.95

RESCUE ESSENTIALS QUIKLITTER™

The Rescue Essentials QuikLitter™ is the lowest-cost emergency stretcher available. It features ten large handholds, allowing for easy patient handling. With a load capacity tested to 500 lbs., it can be employed for everyday use, Mass Casualty and Disaster Preparedness, as a Backboard cover and Strapping Support System, as a Patient Transfer System to move the patient from the backboard to the hospital gurney, as a Gurney Sheet, as a Search and Rescue Gurney, as a Patient Transfer System to move the patient from the bed to a chair and back, or as a Seated Patient Evacuation System. The QuikLitter™ is constructed of water-resistant coated non-woven material, is latex-free, and is rated to 500 lbs.



BN181 Rescue Essentials Quiklitter™

\$16.95

ONESUIT® FLASH 2 HAZMAT SUIT

ONESUIT® Flash 2 is the industry leading flash fire chemical protective suit, offering the highest level of protection against chemical/biological agents as well as chemical flash fire resistance and thermal protection. Designed to allow for excellent maneuverability and user comfort, ONESUIT® Flash 2 comes standard with Saint-Gobain's new ONESUIT® Hazglove-91 high performance chemical protective gloves.

- Certified to the highest level of chemical protection: NFPA 1991-2016 Edition, including: Optional liquefied gas protection and optional chemical flash fire escape protection
- Incredible operational mobility and peripheral visibility through NEW streamlined suit design
- Excellent comfort derived from the single-skin lightweight ensemble construction (<13 lbs)
- Permanent anti-fog resistance using NEW single-layer CORETECH® Clearguard Visor
- Enhanced glove comfort and dexterity using new ONESUIT® Hazglove-91
- Excellent flame resistance and mechanical durability using tough abrasion resistant material technology
- 15 year minimum shelf life giving low life cycle cost
- Ultra-compact for convenient, space-saving storage
- Reusable, multi-exposure design



BOOTS NOT INCLUDED

SPECIFY SIZE: S-XXXL

BG530 ONESuit® Flash 2 Hazmat Suit

\$2,947.95

FRONTLINE® 500 NFPA 1991 CHEMICAL SUIT

CHEMICAL, FLASH, RADIANT - THREE HAZARDS, ONE SUIT

Now get triple assurance with a single suit certified to NFPA 1991 base plus optional Flash Fire and Liquefied Gas requirements. Frontline® 500 offers three-way protection - broad chemical holdout, plus flame resistance and superior radiant heat protection for the additional hazards encountered in a chemical flash-fire. With Frontline® 500, Kappler's got your back - and your front.

FEATURES:

- Single garment eliminates need for typical 2-suit NFPA 1991 configuration
- Combines chemical, flash-fire and radiant heat protection in a single suit
- Seams are sewn and double heat-sealed/taped for added protection
- Large, expanded-view face shield improves field of vision
- Unique 2N1™ glove system prevents inner glove inversion when removing hands
- Removable knitted Kevlar overglove, plus field-replaceable 2N1® Glove System which eliminates inner glove inversion
- Highly flexible 48" gas-tight AquaSeal® zipper facilitates easier donning and doffing

SIZING:

- Small/Medium: 5'3" - 5'7", 120-160 lbs.
- Large/X-Large: 5'7" - 6'2", 160-220 lbs.
- 2X-Large/3X-Large: 6'2" - 6'5", 220-300 lbs.

SPECIFY SIZE: S/M, L/XL & 2XL/3XL

BL630 Frontline® 500 NFPA 1991 Chemical Suit

S/M

L/XL

2XL/3XL

\$2,317.95

\$2,317.95

\$2,548.95



ZYTRON® 500 TOTALLY ENCAPSULATING SUIT

Zytron® 500 is top of the class - and the classic responder choice for hazmat and other demanding situations. It's tough, built for mobility, and based on patented technology that created the first material to survive eight full hours against the ASTM F1001 Test Battery with no breakthrough.

BL102 FEATURES:

- Rear entry, expanded back design
- Large, expanded-view face shield made of 40 mil FR PVC
- Cloth zipper w/overlapping double storm flaps w/hook-and-loop closure
- One exhaust port with cover
- Attached sock boots with boot flaps
- Elastic wrists

BL103 FEATURES:

- Double-taped seams
- Front entry, expanded back design
- Large, expanded-view face shield made of 40 mil FR PVC
- Gas tight PVC zipper with overlapping double storm flaps with hook-and-loop closure
- One exhaust port with cover
- Attached sock boots with boot flaps
- 2N1™ glove system
- Roomy tapered sleeves and ergonomic garment design

SPECIFY COLOR: Orange, Charcoal



Orange Charcoal

SPECIFY SIZE: S-XXXL

S-XL 2XL-3XL

BL102	Zytron® 500 Totally Encapsulating Level B Suit Rear Entry	\$351.95	\$385.95
BL103	Zytron® 500 NFPA 1994/2007 Edition Class 2 Certified Totally Encapsulating Level A Suit Front Entry	\$1,175.95	\$1,294.11



BL102

INTERCEPTOR® LEVEL A DELUXE SUIT

Interceptor® is the apex of Lakeland Industries' chemical protective clothing line. There is an Interceptor® suit for your needs; gas, vapor, aerosol, liquid or particulate protection. Interceptor® offers dependable protection, superior performance and patented garment features that have been proven over a broad range of chemical challenges in a wide range of environments.

- Patented ShurSeal Teflon® visor process permanently seals the visor into the suit with no sewing involved so that liquids can't penetrate the visor edge
- Teflon® outer layer on visor prevents impairment of vision due to chemical contact
- Seams sealed inside and out for maximum protection
- Fully encapsulated front entry vapor-protective level A deluxe suit



BOOTS NOT INCLUDED



SPECIFY SIZE: S-XXL

S-XL XXL

BL067	Interceptor® Level A Deluxe Wide-View Suit	\$1,002.95	\$1,052.95
BL068	Interceptor® Level A Deluxe Suit	\$936.95	\$982.95

PPE DRYING STAND

DESIGNED FOR CHEMICAL SUITS OR WET AND DRY DIVE GEAR

- Tough epoxy powder coat finish
- Naturally air dries suits and gear
- Durable steel construction
- Accepts all suit styles and sizes
- Corrosion-resistant
- Economically priced

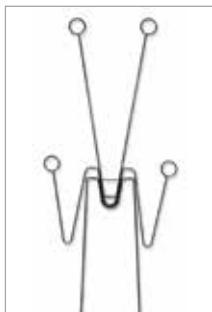

BC097 Personal Protective Equipment Drying Stand \$169.95

UNIVERSAL PRESSURE TEST KIT

Universal Test Kit for Lakeland Interceptor or other brand chemical suits. Features an integrated air compressor, magnehelic gauge, timer and quick disconnects for ease of use and testing. It's everything you need to keep your encapsulated suit in top working order. *Ship. wt. 10 lbs.*



BL073 Universal Pressure Test Kit \$1,750.95

GUARDIAN NEOPRENE GLOVES

When you work with dangerous chemicals, you want your glove to protect exactly as promised, with uncompromising consistency. You want a glove to be comfortable and rugged with total performance features. The Guardian is all of this plus it's fire retardant. It's made with painstaking precision and each glove is "solution dipped" for maximum chemical impermeability. Manufactured to the NFPA 1992 Splash Garment Specifications Level "B". When worn over the Silver Shield gloves, they meet the NFPA 1991 Standard on Vapor Protective Suit for Hazardous Chemicals Level "A". *Ship. wt. 1 lb.*



SPECIFY SIZE: S-L

AC970 Guardian Neoprene Gloves \$45.95/pr.

CHEM-TAPE®

An innovative solution for added protection in liquid chemical situations. It has been tested and proven against warfare agents and many other chemicals. *Ship. wt. 1 lb.*



AK036 Chem-Tape® \$33.95/roll

FENTANYL/OPIOID PPE KIT BASIC

Warthog Fentanyl/Opioid PPE Kit Basic was developed using guidelines from the CDC, NIOSH, DEA and The White House Fentanyl Safety Recommendations for First Responders.

- Disposable gown
- Goggles
- Size XL nitrile powder free gloves
- Disposable N100 mask
- Biohazard bag

Some kits on the market save cost by only using a N95 rated mask. Specifically, the CDC recommends using an N100 rated mask.

BN760 Fentanyl/Opioid PPE Kit Basic

\$24.95



HAZMAX® BOOTS

THE FINEST BOOT MADE FOR HAZARDOUS MATERIALS HANDLING

- 16" boot height
- Meets and surpasses NFPA 1991, 2000 edition for chemical permeation resistance requirements
- Meets requirements for the optional chemical and biological certification
- **Steel safety toe:** Built in Steel toe complies with ASTM F2413-05 for impact and compression
- Full steel midsole
- **Steel ladder shank:** Provides arch protection and support
- One-piece injection molded construction, eliminates seams
- Boots are constructed of a high viscosity and flexible PVC alloy
- Non-absorbent polyester lining for easy cleaning and quick drying
- Replaceable cushioned insoles
- Cut off bands
- Kick off lug
- *Ship. wt. 7 lbs.*



SPECIFY SIZE: Mens 6-15

AW038 HAZMAX® Boots \$101.95

HAZPROOF® BOOTS

With the growing reality that chemical warfare agents are now a threat to the civilian population, domestic preparedness programs are developing rapidly. The HazProof® boot, made of special polymer material, has also been tested to Military Standard 282 and will provide protection against certain chemical warfare blister and nerve agents! Certified to NFPA 1991, 2005 Edition for chemical and hazmat cleanup, emergency response, and domestic preparedness.

- Injection molded seamless construction for 100% liquid-proof protection
- Larger foot area is engineered to accommodate the extra bulk of an encapsulated suit, for comfortable fit
- Smooth exterior surface for easy decontamination
- Stretch fastener closure system allows for easy on/off while wearing gloves
- Meets ANSI spec. Z41 PT99 M I/75 C/75 EH, for steel toe impact and compression, and electrical protection
- Steel mid-sole meets and exceed ANSI Z41 PT 99 PR
- Steel shank provides firm arch support
- Blown closed cell EVA mid-sole for all day cushion comfort
- Sure grip cleated outsole has excellent abrasion and slip resistance



SPECIFY SIZE: 7-13

BH108 HazProof® Boots \$88.95



BW CLIP4 MULTI-GAS (4) PORTABLE GAS DETECTOR

The latest in wearable 4-gas detection. Just clip it on and get the job done. Because for 2 years, you know - IT'S ON.

- User-friendly tamper-proof operation with just one button
- Compatible with IntelliDoX docking system and instrument management system
- Real-time gas concentrations shown on LCD
- Daily full function self-test of sensors, battery status, circuit integrity, and audible/visual alarms
- Built-in concussion proof boot
- Requires calibration every 6 months, calibration gas and regulator not included



Honeywell
THE POWER OF CONNECTED

BW Clip4

SPECIFY COLOR: Black or Yellow

BN501 BW Clip4 Multi-Gas Portable Gas Detector* \$552.95



CALIBRATION EQUIPMENT

BN726	Quad-gas: (CO, 100 ppm), LEL-50%, H2S-25PPM, O2-18%, BAL-N, 34L	\$151.95
BN737	Calibration Gas Regulator (SS 0.5LPM)	\$151.95

* This unit cannot be returned once it has been activated.

SINGLE GAS BW CLIP MAINTENANCE-FREE SINGLE-GAS DETECTORS

The BW Clip Series of single-gas detectors provides up to three years maintenance-free operation: just turn on the device and it runs continuously - no need for sensor and battery replacement or battery charging. That means great reliability and no downtime.

- Automatic logging of the 35 most recent gas events and bump test results
- Designed for a range of harsh environments and extreme temperatures
- Automated self-test of battery, sensor and electronics



Honeywell
THE POWER OF CONNECTED

SINGLE GAS BW CLIP

BN292	Single-Gas CO BW Clip Monitor* - 24 month warranty	\$203.95
BN730	Single-Gas CO BW Clip Monitor* -36 month warranty	\$244.95

* This unit cannot be returned once it has been activated.

BW SOLO FEATURING THE 1-SERIES SENSOR

The Honeywell BW™ Solo is easy to operate and service and includes an extensive selection of sensor options. It can help reduce the cost of ownership for serviceable single-gas detectors and includes a wireless option for enabling connected workers. The profile is small and lightweight, and the design is ruggedized for years of reliable service.

- User-friendly operation
- Easy-to-read display
- User maintainable
- New 1-Series sensor for enhanced reliability

NEW



Honeywell
THE POWER OF CONNECTED

Wireless units & other gasses available.

Contact us for more information

SPECIFY COLOR: Black or Yellow



BP114	BW Solo - Carbon Monoxide	\$379.95
BP115	BW Solo - Hydrogen Cyanide	\$469.95
BP116	BW Solo - Chlorine	\$469.95

BW GasAlertQuattro

Rugged and reliable, the GasAlertQuattro four-gas detector combines a comprehensive range of features with simple one-button operation.

- Rechargeable
- Alkaline pack with three AA batteries
- Calibration cap and tubing
- Reversible screwdriver



Honeywell
THE POWER OF CONNECTED

BW GasAlertQuattro

Specify Color: Black or Yellow

BK056	GasAlertQuattro 4-Gas Detector (%LEL, O2, H2S, CO)	\$749.95
BN729	GasAlertQuattro 4-Gas Detector, Rechargeable	\$806.95

CALIBRATION EQUIPMENT

BN726	Quad-gas: (CO, 100 ppm), LEL-50%, H2S-25PPM, O2-18%, BAL-N, 34L	\$151.95
BN737	Calibration Gas Regulator (SS 0.5LPM)	\$184.95

GasAlertMicroClip GAS DETECTOR

The industrial GasAlertMicroClip is the world's most popular multi-gas portable detector, delivering long runtime and reliability - plus small size, low cost and the easiest user experience.

- GasAlertMicroClip X3 for extended reliability with 3-year warranty
- GasAlertMicroClip XL for standard operation with 2-year warranty
- Guaranteed to run an entire shift - even at -4°F (-20°C)
- IP68 rating - unmatched water protection
- Compact, lightweight and easy to use - with one-button operation and no extensive training



Honeywell

THE POWER OF CONNECTED

GasAlertMicroClip XL GAS DETECTOR SPECIFY COLOR: Black or Yellow



BL319	GasAlertMicroClip XL 4 Gas Detector - 2 Year Warranty	\$592.95
BN728	GasAlertMicroClip X3 4 Gas Detector - 3 Year Warranty	\$672.95

CALIBRATION EQUIPMENT

BN726	Quad-gas: (CO, 100 ppm), LEL-50%, H2S-25PPM, O2-18%, BAL-N, 34L	\$151.95
BN737	Calibration Gas Regulator (SS 0.5LPM)	\$184.95

SENSIT® GOLD SERIES GAS DETECTORS

Sensit Gold gas detection instruments are designed to provide personal protection from potentially hazardous conditions and help you quickly find the source of combustible gases. *Ship. wt. 2 lbs.*

- Internal pump
- Push button operation
- Field calibration
- LED warning lights
- Operation memory
- Infrared download
- Bright LCD display
- Made in the USA



- AS076: SENSIT® EX-CO - detects combustibles and carbon monoxide
- AS078: SENSIT® EX-CO Plus - detects combustibles, carbon monoxide, and oxygen
- AS080: SENSIT® 4 Gas - detects combustibles, carbon monoxide, oxygen, and hydrogen sulfide



AS076	SENSIT® GOLD Series 2 Gas Detector with Pump	\$1,124.95
AS077	Calibration Kit for AS076	\$277.95
AS078	SENSIT® GOLD Series 3 Gas Detector	\$1,665.95
AS079	Calibration Kit for AS078	\$307.95
AS080	SENSIT® GOLD Series 4 Gas Detector with Pump	\$2,145.95
AS081	Calibration Kit for AS080	\$710.95

GasAlert Max XT II

SIMPLE OPERATION, WITH SMARTSAMPLE PUMP.

Honeywell BW™ Max XT II reliably monitors up to four hazards and combines straightforward one-button operation with a robust, motorized pump for intelligent, remote sampling, ideal for confined spaces. The Honeywell BW™ Max XT II is fully compatible with MicroDock II automated test and calibration system.



- Integrated sampling pump
- Continuous LCD shows real-time gas concentrations
- Simple automatic calibration procedure
- One-button operation with robust, motorized pump
- Equipped with standard datalogging and event logging
- Monitors HS2, CO, O2 and combustibles
- Best in class block detection with semi-conductor pressure sensor

Honeywell

THE POWER OF CONNECTED

SPECIFY COLOR: Black or Yellow



BN731	GasAlert Max XT II	\$888.95
-------	--------------------	----------



CALIBRATION GAS

Darley offers a complete line of calibration gas for all gas detector manufacturers. Darley makes it easy to keep your gas monitors working and up to manufactures specifications. Order your Darley Test Gas Today and stay compliant and safe.



SPECIFY: Detector Model & Manufacturer

BL321	34 Ltr. Alum. Cyl. (CO, H2S, Comb. & O2)	\$160.95
BL322	58 Ltr. Alum. Cyl. (CO, H2S, Comb. & O2)	\$220.95
BL323	34 Ltr. Steel Cyl. 100 ppm Isobutylene	\$65.95
BL324	34 Ltr. Steel Cyl. Sensit® Gas Mix (Methane)	\$46.95

MAXIWEDGE KIT

This kit offers greater versatility by increasing leak sealing solutions to problems resulting from punctures, gashes, slits and slashes in tanks, cylinders and containers both mobile and stationary. Gas, liquid and bulk material leaks can now be controlled until more permanent solutions are available. When soaked in liquid, softwood will slightly swell forming a tighter seal.



WEDGES INCLUDES:

- 7 - 5/8" x 1" x 8"
- 5 - 1 1/2" x 10" x 10"
- 7 - 5/8" x 2" x 8"
- 3 - 4" x 4" x 18"
- 7 - 5/8" x 3" x 8"
- 7 - 3" x 3" x 12"
- 7 - 2" x 3" x 12"
- 7 - 1" x 3" x 12"
- 7 - 1 1/2" x 2" x 10"
- 7 - 1 1/2" x 1" x 10"
- 7 - 1 1/2" x 3" x 10"

PLUGS INCLUDES:

- 10 - 1" x 3"
- 10 - 2" x 4"
- 10 - 3" x 8"
- 1" x 5" x 10"

ALSO INCLUDES:

- Non-spark mallet
- Carrying crate
- Kit (Case) Dimensions: 24" x 15.5" x 15.5"
- Kit Weight: 39 lbs.



BK124 MAXIWEDGE Kit

\$448.95

EMERGENCY SPILL KIT

INCLUDES:

- 1 - 1 3/4 lb. Super sorbent shaker carton
- 15 - 3x4' Haz socks
- 2 - Pairs of P.V.C. gloves
- 2 - Disposable suits with hoods and boots
- 100 - Univ. green sorbent pads
- 2 - Pairs of goggles
- 8 - Disposable bags w/ties
- 1 - Roll of caution tape
- 1 - 20 lbs. Cob fractions
- 1 - Respirator
- 1 - Emergency Response Guide Book
- 1 - 30 gal. blue poly drum



BH063 Emergency Spill Kit

\$309.95

DARLEY ECONOMY LEAK CONTROL KIT

This kit includes 38 wood plugs, 15 wood wedges, a rubber mallet and comes in a durable fabric drawstring bag.



PLUGS INCLUDED:

- 15 - 1" x 1/4" x 3"
- 10 - 2" x 1/4" x 4"
- 10 - 3" x 1/4" x 8"
- 3 - 5" x 1" x 10"

WEDGES INCLUDED:

- 5 - 3" x 1" x 12"
- 5 - 3" x 2" x 12"
- 5 - 3" x 3" x 12"



BN742 Darley Economy Leak Control Kit

\$298.95

POLY DRUM SPILL KITS

INCLUDES:

- 40 - 3" x 46" General purpose socks
- 200 - Green universal sorbent pads
- 10 - Hazardous pillows
- 12 - 3" x 10' haz socks
- 5 - Disposal bags with ties
- 2 pr. - Nitrile gloves
- 1 pr. - Goggles
- Emergency Response Guidebook
- 1 - 95 gal. yellow poly over pack with screw lid



BH061 Poly Drum Spill Kit

\$529.95

HAZARDOUS MATERIALS PATCH AND PLUG RESPONSE KITS

The Series "AE" is a collection of over 40 common components for emergency and temporary leak stoppage due to punctures, gashes, cracks and surface rotting. Series "C-1" Pipe Plugger with Valve Kit - Allows hazardous materials to be temporarily contained, piped off to alternate location or flared. Series "C-2" External Pipe Leak kit - Has unlimited uses in municipalities, chemical plants, manufacturing facilities or anywhere a pipe line is used. Contains pipe bandages covering nominal pipe sizes from 1/2" to 4".

SERIES "AE" KIT INCLUDES:

- Sheet metal screws with neoprene compression seals
- Tubeless tire repair kit
- OSHA-approved 200" roll of barricade tape
- 8"x12" piece of solid neoprene
- 22" piece of foam material
- Lead wool epoxy putty that hardens like steel, hot or cold hose repair tape, basic tool set for patching
- Twin "T" stainless plate with foam
- 8"x2" stainless backed neoprene patch-hardwood cribbing
- 2 - 22' nylon straps and buckles
- 2 - "T" bolt crack patches
- 6 - Surface plugs for curved surfaces, wedged wooden plugs covered with felt
- 2 - Ball plugs
- Carrying case
- **Ship. wt. 33 lbs.**

SERIES "C-1" KIT INCLUDES:

- 20' vinyl tube, tool kit
- 10 - Standard pipe plugs
- 3/4" regulating valve
- Carrying case
- **Ship. wt. 35 lbs.**

SERIES "C-2" KIT INCLUDES:

- 10 - Pipe bandages for covering pipe sizes from 1/2" to 4"
- Soft and hard neoprene liner material and comes complete with your choice of standard or non-sparking tools
- Carrying case
- **Ship. wt. 33 lbs.**



AE



C-1



C-2

AB975	Series "AE" Kit	\$623.95
AF132	Series "AE" with Non-Sparking Tools	\$869.95
AB976	Series "C-1"	\$685.95
AF032	Series "C-2" with Standard Tools	\$482.95
AF105	Series "C-2" with Non-Sparking Tools	\$763.95

CLASSIFIER KITS

FIRST STEP: IDENTIFY THE SPILL

With these classifier kits, chemicals or elements of waste water can be classified quickly. Each kit uses classifier strips which change color when in contact with the unknown liquid. Just match that color on the classifier color chart to classify the type of chemical present. Each kit contains six classifier strips, polypropylene thread, one pair of nitrile gloves, and a reusable classifier chart, all in a convenient carrying tube. **Ship. wt. 1 lb.**



SPILEYTER®

AA803	Chemical Classifier Kit	\$63.95
AB912	Wastewater Classifier Kit	\$63.95

PLUG N' DIKE PRE-MIX

Non-toxic material which forms an immediate seal to control flammable and/or hazardous leaks and spills. It is a combination of a polymer in a bentonite base that produces a seal against penetration of fuels and chemicals. No surface preparation needed. Plug N' Dike Pre-Mix is a plugging material; it does not absorb. **Ship. wt. 10 lbs.**



X878	10 lbs./1 gal.	\$49.95
X877	1 lb. Container	\$20.95

SYNTHO-PLUGS FOOTBALL & GOLFBALL

Syntho-Plug is a football/golfball shaped, polyurethane impregnated, water activated foam plug used to temporarily stop the flow from a leak in anything from spill containment and marine thru-hull damage. Initially pliable to insert into a void and quickly expands and hardens to fill the void. It can even be applied below the water line.

- Ready to use
- Simple and effective
- No mixing, no mess
- Hardens in minutes



BL406	Syntho-Plug Football	\$92.95
BP120	Syntho-Plug Golfball	\$53.95

CHLORINE INSTITUTE EMERGENCY KITS

HAZMAT

EMERGENCY KIT "A"

FOR 100-150 LB. CHLORINE CYLINDERS

The emergency kit "A" contains devices to stop leaks at the valve, fusible plug, and in the side walls of chlorine 100 and 150 lb. cylinders which conforms to specification DOT 3A480. Two instruction booklets explaining application of each device are included. Includes accessory equipment and tools which are labeled and color coded. Kit is packaged within a heavy-duty plastic box measuring 35"x13¹/₄"x14". *Ship. wt. 115 lbs.*

AF033 Emergency Kit "A" \$3,051.95



EMERGENCY KIT "B"

FOR ONE-TON CONTAINERS

The emergency kit "B" contains devices to stop leaks at the valves, fusible plugs, and side walls of chlorine one-ton containers which conform to specifications DOT 106A500X. Two instruction booklets explaining application of each device are included. Will contain leaks in container valves, will seal leaks in container side wall and will contain leaks in container fusible plugs. Includes accessory equipment and tools which are labeled and color coded. Packaged in a heavy-duty plastic box measuring 35"x13¹/₄"x14". *Ship. wt. 113 lbs.*

AF034 Emergency Kit "B" \$3,067.95



EMERGENCY KIT "C"

FOR TANK CARS & TANK TRUCKS

The emergency kit "C" contains devices to stop leaks at the safety valve or angle valves of chlorine tank cars and trucks. Conforms to DOT 105A500W and MC331 specifications, for chlorine service. 2 instruction booklets explaining application of devices are included. Will contain leaks in tank car angle valves and safety relief valve. Includes accessory equipment and tools which are labeled and color coded. Kit is packaged within a heavy-duty plastic tool box measuring 36"x18¹/₂"x20". *Ship. wt. 168 lbs.*

AF035 Emergency Kit "C" \$3,378.95



GASKET KITS

All gaskets are molded from EPDM elastomer. The AF767 kit is for application with kit "A" to stop leaks in SO₂ containers. The AF768 kit will stop leaks in one-ton containers when using kit "B" and the AF769 kit will stop leaks in tank cars when using kit "C". *Ship. wt. 6 lbs.*

AF767	Sulfur Dioxide Cylinder Gasket Kit with 4 Gaskets	\$427.95
AF768	Sulfur Dioxide One-Ton Container Gasket Kit with 6 Gaskets	\$571.95
AF769	Sulfur Dioxide Tank Car & Tank Truck Gasket Kit with 4 Gaskets	\$480.95



17-PIECE TOOL KIT

INCLUDES:

- Shoe handle brush
- 9" crate opener
- 16 oz. claw hammer with fiberglass handle
- Common knife 5³/₄" blade, 10³/₄" OAL
- Deck scraper, 1¹/₂" blade x 7³/₄" OAL
- Spray booth scraper 3" blade x 9¹/₄" long
- Standard screwdriver 5¹/₁₆" tip, 6" blade
- 12" groove joint pliers
- #3 phillips screwdriver
- 12" tin snips
- 8" adjustable wrench
- 12" adjustable wrench
- 14" pipe wrench (aluminum)
- 12" bung wrench (fits 3/4"x2")
- 7" long nose pliers with cutters
- 8" combination pliers
- **Ship. wt. 20 lbs.**



TEAM
EQUIPMENT, INC.

11-PIECE TOOL KIT

INCLUDES:

- 8" combination pliers
- Shoe handle brush
- Putty knife (stiff) 1¹/₄"x3⁹/₁₆" blade 7³/₄" OAL
- Common knife 3¹/₈" blade 6³/₄" OAL
- 10" groove joint pliers
- #2 phillips screwdriver
- Standard screwdriver 5¹/₁₆" tip, 6" blade
- 16 oz. claw hammer w/fiberglass handle
- 6" adjustable end wrench
- 10" adjustable end wrench
- 10" adjustable pipe wrench
- **Ship. wt. 11 lbs.**



AF040 17-Piece Tool Kit

\$1,358.95

W174 11-Piece Tool Kit

\$768.95

HAZMAT HOOLIGAN TOOL

This heavy-duty forcible entry tool was designed for emergency service personnel operating in the presence of hazardous vapors. Combining the design of one of the world's most popular forcible entry tools and manufactured from spark-resistant material makes this an important addition to your hazmat team. Features duckbill and your choice of standard or metal cutting claw. Standard Claw is gently curved for maximum prying leverage and machine sharpened with recessed nail puller. Claw will fit over locks, hasps and many gas shut offs. Metal Cutting Claw combines the capability of prying and cutting heavy-gauge metal and composites. **Ship. wt. 13 lbs.**

- Heavy-duty
- Spark-resistant material
- Standard or metal cutting claw



AC622

AC623

AC622 Hazmat Hooligan Tool, Standard Claw

\$621.95

AC623 Hazmat Hooligan Tool, Metal Cutting Claw

\$607.95

DECONTAMINATION EQUIPMENT

HAZMAT

STANDARD DECONTAMINATION SHOWER SYSTEM

SPECIFICATIONS:

- Total Output: 15 gpm (2.5 gpm per shower head)
- Dimensions: Assembled 42"x36"x84"; unassembled 74"x27"x27"
- Single Water Inlet: Standard garden hose
- Approximate Set-up Time: 3-4 minutes
- Ship. wt. 192 lbs.



FEATURES:

- Unique quick-connects for fast assembly
- Fully collapsible design
- Six shower heads plus an independent hand-held sprayer
- Heavy-duty, chemical-resistant privacy enclosure
- Translucent roof panel to allow light into shower
- Stores and transports in two easy-to-carry vinyl bags

SYSTEM INCLUDES SHOWER, POOL, ELEVATION GRIDS AND CARRYING BAGS

BA061 Standard Decontamination Shower System \$3,254.95

QUICK RESPONSE™ SHOWER SYSTEM

Designed for field response, the Quick Response™ Shower is durably constructed to withstand frequent training, and compact enough to fit in a portable carry bag. System includes Quick Response™ Shower, compact pool, elevation grid and vinyl carrying bag. Ship. wt. 96 lbs.

SHOWER FEATURES:

- Unique quick-connects for fast assembly
- 3 shower heads plus an independent hand-held sprayer
- Tough construction for frequent training and use
- Vinyl bag for storage and transport

SHOWER SPECIFICATIONS:

- Total Output: 7.5 gpm
- Dimensions: Assembled 43.2"x46.8"x88.8"; unassembled 49"x15.5"x9.5"
- Single Water Inlet: Standard garden hose
- Approximate Set-up Time: 2-3 minutes



BA062 Quick Response™ Shower System \$1,779.95

DECON SHOWERS AND ACCESSORIES

BA068

Portable pneumatic hazmat decon Shower. Two line mass casualty decon Shower System that can handle two non-ambulatory stretchers or four ambulatory personnel or combinations of the above. Approximately 10'Wx10'L x 9'H, 100 sq. ft. - 139 lbs.

BA069

Portable pneumatic hazmat decon shower - four line three or four mass casualty decon shower system, decons four non-ambulatory, four to eight ambulatory, or any combination. Approximately 14.5'Wx23'Lx9' H - 340 lbs.



HEATING SYSTEM



CONVEYER ROLLER SYSTEM



BA069

DECON SHOWERS

		Ship. wt.	Price
BA068	10'Wx10'Lx9'H Hazmat Decon Shower System	95 lbs.	\$15,941.95
BA069	13'Wx23'Lx9'H Hazmat Decon Shower System	350 lbs.	\$27,877.95
BA070	Hazmat Decon Elevation Grid 3'Wx2'Lx27/8"H	15 lbs.	\$198.95
BA071	1/4 HP Electric Submersible Pump	20 lbs.	\$684.95

ACCESSORIES

BA072	Conveyer Roller System Adjustable 2' - 9' Length	151 lbs.	\$1,482.95
BA073	Conveyer Roller System Adjustable 3' - 12' Length	151 lbs.	\$2,617.95
BA074	"CLIMATE 40 A" Heating System with 10 gal. Fuel Tank	275 lbs.	\$9,338.95
BA075	13,200 BTU 110-volt Air Conditioner	165 lbs.	\$10,267.95

PORTABLE DECON SHOWER AND DISPOSABLE POOL

The **Hazmat Decon Shower** is a portable, collapsible, 1½" PVC shower that is designed for decontaminating emergency response personnel. The unit is color-coded for ease of assembly and sets up in only five minutes. A crisscross water flow pattern is provided from the upper support bars. Shower comes in a canvas carrying duffel bag measuring approximately 42"x26"x12". **Ship. wt. 65 lbs. The Hazmat Decon Pool** (sold 2 per case) is disposable and compact. It is easily stored in a space of only 60"x21"x3". The pool has a 12 mil. polyethylene liner, is durable and weighs only 15 lbs. The pool sets up in 30 seconds. **Ship. wt. 30 lbs.**



AC164	Decon Shower	\$799.95
AC165	Decon Pool - 2 pools per case	\$333.95/case

DECON/PAK™

The DECON/pak™ is a self-contained agent proportioning and rinse application system helping to provide simple and gross decontamination of firefighting personnel and equipment.



- Flow is controlled by a twist grip valve that also functions as a carrying handle. Cleaning agents are added through the large, easy-open fill port that includes a debris screen
- Large selector for agent proportioning from 0.1 to 0.5% for cleaning agent** or set to rinse with water only
- Stores easily in tight compartment spaces
- Studies show that field decon using soap, water and brush can reduce cancer causing contamination on turnout gear by 85%*

* Source: Journal of Occupational and Environmental Hygiene DOI: 10.1080/15459624.2017.1334904
 ** Contact your turnout gear manufacturer for cleaning agent recommendation for your specific gear.

BN720	Decon/Pak™	\$775.95
-------	------------	----------

PORTABLE DECON SPRAY HOOP

FAST, CONVENIENT, COST-EFFICIENT DECON SYSTEM

The Portable Decon Hoop has dozens of decontamination applications. The hoop design concentrates water at the area being decontaminated, minimizing the amount of water required and offers better control. It's constructed of durable, lightweight, corrosion-free aluminum pipe and tube. On/Off control on hoop and uses standard ¾" hose connection. Comes with two 43" handles extendible to 66". **Ship. wt. 4 lbs.**

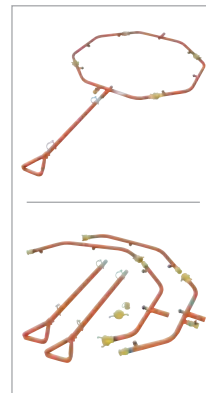

USES:

- Self wash-off
- Two-person
- Three-person
- Equipment
- 55 gallon barrels
- Overpacks
- Backboard patients
- Bunker gear



AB958	Decon Hoop, 2-piece with Outside Handles	\$848.95
AJ427	Decon Hoop, 4-piece Design Includes Inside & Outside Handles	\$1,148.95
AJ428	Decon Hoop Storage Bag (For AJ427 Only)	\$307.95

MULTI MANIFOLD

Quickly connecting standard ¾" hose to hydrants, fire hoses or fire apparatus. Constructed of corrosion-free aluminum pipe, fittings and 500 PSI certified brass ¼ turn ball valves. Ideal for multiple hose connections. **Ship. wt. 5-8 lbs.**



AW042	1-1½" NH Inlet / 6 - ¼ Turn One-Way Ball Valves	\$661.95
AW043	1-2½" NH Inlet / 6 - ¼ Turn One-Way Ball Valves	\$608.95

DECONTAMINATION MANIFOLD

- Decontamination Manifold reduces the flow of water from a 1½" fire hose to a series of three spigots
- Garden hoses can be attached directly to the manifold and run to a decon shower or used separately as needed



BN605	Decontamination Manifold	\$114.95
-------	--------------------------	----------

HEARTSTART ONSITE DEFIBRILLATOR

THE FIRST DEFIBRILLATOR AVAILABLE WITHOUT A PRESCRIPTION TO COMMERCIAL USERS



SELF-TEST ENSURES READINESS:

- Daily self-tests check electrical components, subsystem, pads and battery
- Self-test also verifies that the pads cartridge is installed and in working order
- Blinking green "Ready" light means the OnSite has passed its last self-test, so you can be confident the defibrillator is ready for use

LONG BATTERY LIFE:

- 5-year shelf life plus 4-year installed life
- Same battery technology used with confidence in millions of cameras

EASY-TO-USE:

- Using the HeartStart Defibrillator is simple. Pulling the green handle activates the defibrillator and voice instructions. These instructions are paced to your actions, to help guide you through the entire process from placing each pad on the patient to delivering a defibrillation shock.

BG129 HeartStart OnSite Defibrillator \$1,313.95

ZOLL® AED DEFIBRILLATORS

THE FIRST AND ONLY FULL-RESCUE AED



BH199



INSIDE PANEL VIEW



BL856



VISUAL PROMPTS GIVEN DURING CPR:

- Not pushing hard/deep enough? Prompts will tell you to push harder.
- Pushing hard enough? It will say, "Good compressions."
- Not pushing fast enough? A metronome will lead you to the right rate. It will even show you the depth of each compression. In real time.
- Not yet started? The AED Plus® will tell you to get started.
- Compressions stopped? It will tell you to continue.

ZOLL AED PRO® ALSO FEATURES:

- Ruggedness, portability and advanced functionality
- Superior AED design and rubber over-molds built to withstand challenging conditions

DEFIBRILLATORS

BH199	ZOLL® AED Plus®	\$1,649.95
BL856	ZOLL® AED Pro®	\$2,890.95

ACCESSORIES

BL857	Plus® & Pro® Adult One-Piece Electrode CPR-D Padz	\$169.95
BL858	Plus® & Pro® Adult Stat Padz™ II	\$59.95
BL859	Plus® & Pro® Pediatric Stat Padz™	\$95.95
BL860	Plus® Lithium Batteries - Sleeve of 10	\$75.95
BL861	Pro® Non-Rechargeable Battery	\$160.95
BL862	Pro® ECG Cable AAMI	\$160.95

DEFIBTECH LIFELINE AEDS

Defibtech Lifeline AED's breakthrough in design technology makes it possible for every budget to afford a life-saving AED. Mere seconds can mean the difference between life and death. The Defibtech Lifeline AED can be used with minimal steps to analyze and treat the patient's condition. From the moment someone suffers sudden cardiac arrest, the inspired design features of the Defibtech Lifeline AED (Automatic External Defibrillator) shaves precious seconds off the defibrillation process. Seconds that could save more lives.

DEFIBTECH LIFELINE VIEW WITH SCREEN ALSO FEATURES:

- **Video Screen:** Shows you what to do in an emergency. Just one touch turns on the AED, lights up the interactive screen and a clear, calm voice tells you what to do with clear, easy to understand pictures and text so you can read it, see it and hear it.

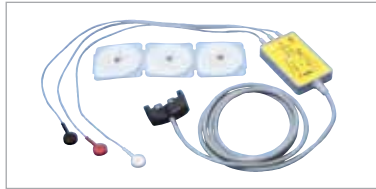

DEFIBTECH LIFELINE

BL863	Semi-Automatic Defibtech Lifeline	\$1,245.95
BL864	Fully-Automatic Defibtech Lifeline	\$1,295.95
BL865	Adult Pads	\$38.95
BL866	Pediatric Pads	\$99.95
BL867	5-Year Battery	\$149.95
BL868	7-Year High Use Battery	\$199.95

DEFIBTECH LIFELINE VIEW WITH SCREEN

BL869	Semi-Automatic Defibtech Lifeline View with Screen	\$1,595.95
BL870	Semi-Automatic Defibtech Lifeline View Pro with Screen, Manual Mode and 3-Lead ECG	\$2,795.95
BL871	Adult Defibrillation Pads	\$59.95
BL872	Pediatric Defibrillation Pads	\$99.95
BL873	4-Year Replacement Battery	\$169.95
BL874	Pro® 3-Lead Cable	\$185.95

PHYSIO-CONTROL LIFEPAK AEDS

Featuring the same advanced technology trusted by emergency medical professionals.

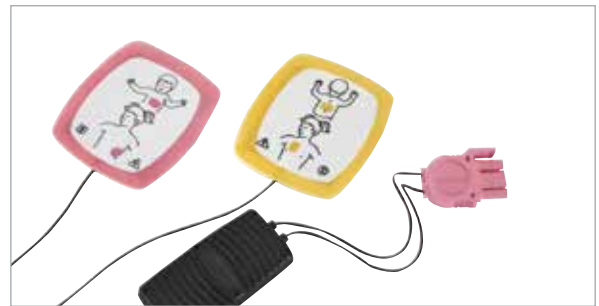

PHYSIO-CONTROL LIFEPAK 1000

BL875	LIFEPAK 1000 Defibrillator/Monitor Device - Screen Only	\$2,395.95
BL876	LIFEPAK 1000 Defibrillator/Monitor Device with 3-Lead ECG (Manual Mode) and 3-Lead Cable	\$2,995.95
BL877	EDGE System Adult Electrode Pads (Leads Out)	\$42.95
BL878	EDGE System Adult Electrode Pads (Leads In)	\$37.95
BL879	LIFE•PATCH® Adult Electrode Pads - Pack of 3	\$3.95
BL880	Non-Rechargeable LiMnO2 Battery	\$340.95

PHYSIO-CONTROL LIFEPAK CR Plus & EXPRESS

BL881	Semi-Automatic LIFEPAK EXPRESS	\$1,308.95
BL882	Semi-Automatic LIFEPAK CR Plus	\$1,695.95
BL884	Replacement Infant/Child Reduced Energy Defibrillation Pads	\$110.95
BL885	Replacement Kit for CHARGE-PAK With 2 Sets of Electrode Pads	\$107.95

WATER RESCUE MANIKINS

These adult and adolescent models are made of durable vinyl plastic with rust-resistant skeletons, articulated joints, and optional CPR capabilities. When filled with water, the manikin will submerge to the neck. Add an additional 5-10 pound weight to sink.



- BA114 Adult Water Rescue Training Manikin \$775.95
- BA115 Adult Water Rescue Training Manikin and CPR \$1,017.95

RESCUE RANDY™

Randy's fully articulated body duplicates the weight and resiliency of a human body and can be positioned for realistic patient handling or extrication in situations too hazardous or uncomfortable for volunteer victims. His rugged construction means years of use in any rescue training environment. *Clothing not included. Ship. wt. 125 - 185 lbs.*



- AC057 Rescue Randy™, 105 lbs. \$1,018.95
- AL246 Rescue Rudy™, African American, 105 lbs. \$1,039.95
- AC058 Rescue Randy™, 145 lbs. \$1,208.95
- AL247 Rescue Rudy™, African American, 145 lbs. \$1,232.95
- AC059 Rescue Randy™, 165 lbs. \$1,377.95
- AL248 Rescue Rudy™, African American, 165 lbs. \$1,405.95
- AS369 Rescue Randy™ Combat Challenge, 165 lbs. \$1,377.95
- AS370 I.A.F.F. Rescue Randy™ with Additional Reinforcement, 165 lbs. \$1,444.95

WATER-JEL FIRE BLANKET

A one-step system for Emergency First Aid on a burn victim. It puts out the fire, stops burn progression and cools the skin, eases pain, and protects against airborne contamination. Water-Jel Fire Blankets consist of a scientifically formulated cooling gel and a special carrier. The 100% worsted wool blanket is soaked in a water-based/water-soluble, bacteriostatic and biodegradable gel. The full size blanket adequately covers a patient or can be used to douse a fire or dangerous white phosphorous. *Dimensions: 5'x6'. Shelf life: 5 years. Ship. wt. 21 lbs.*



- AA714 Water-Jel Fire Blanket \$169.95

WATER-JEL BURN WRAP

Smallest and most versatile of the blankets, it is ideal for covering torso, leg, or entire back injuries. *Dimensions: 3'x2 1/2'. Shelf Life: 5 years. Ship. wt. 10 lbs.*



- X856 Water-Jel Burn Wrap \$75.95

FLAME RESISTANT WOOL BLANKET

An ideal emergency blanket for every rescue vehicle. Made of 80% wool and can be cleaned.

- Dimensions: 66"x84"
- Ship. wt. 4 lbs.

COLOR: Maroon

Maroon

- BK006 Flame Resistant Wool Blanket \$40.95





LARGE EMS DUFFEL WITH SUPPLIES

Easily-accessible main compartment, ten inside pockets, four outside pockets and numerous elastic hold-downs. Removable padded insert to hold "D" sized oxygen tank.

- Oxygen cylinder "D" tank
- Regulator (left handed, 0-25 lpm)
- Bag valve resuscitator (adult)
- Sodium chloride irrigation 500ml
- Airway kit
- Sphygmomanometer/stethoscope set (adult)
- Sphygmomanometer (pediatric)
- Utility scissors 5 1/2"
- Penlight flashlight
- 4 - Gloves
- Pair goggles
- Face mask - Earloop
- 3 - Non-rebreather O2 masks (adult)
- 2 - Non-rebreather O2 masks (pediatric)
- 3 - Nasal cannula (adult)
- Oxygen tubing
- Oral glucose tube
- 2 - Multi-trauma dressing
- 6 - Combine dressing 5"x9"
- 15 - Gauze pads 4"x4"
- 10 - Gauze pads 2"x2"
- 2 - Vaseline dressing 4"x4"
- Sterile burn sheet
- 60 - Bandages assorted (3/4"x3", 1", 3 5/8"x2 1/4")
- 6 - Roll gauze 3"
- 6 - Roll gauze 4"
- Tape 1"x10"yds. uncovered
- Tape 2"x10"yds. uncovered
- Tape 3"x10"yds. uncovered
- 3 - Triangle bandages
- 2 - Biohazard bags 10 gal.
- 3 - Instant cold packs 4"x5"
- Obstetrical kit
- Foil baby bunting
- 2 - Bulb syringe
- Rescue "Space Blanket"
- 3 - Disposable cuffed masks (adult)
- 2 - Disposable cuffed masks (child/sm. adult)
- Flashlight
- Elastic bandage 3"
- Elastic bandage 4"
- Pressure bandage super thick
- Pressure bandage 4"x4"

BH039	Large EMS Duffel with Supplies, Cylinder and Regulator	\$484.95
BH040	Large EMS Duffel with Supplies	\$350.95



LARGE INTERMEDIATE MODULAR TRAUMA BAG

The new BL886 is a premium mid-sized ALS trauma bag, meaning it will hold virtually all of the medical supplies needed for a trauma call, less the oxygen bottle. The BL886 is heavily reinforced from top to bottom so it will withstand years of abuse. It also features multiple pockets, pouches, loops and compartments – including four removable color-coded zippered pouches for quick access to high priority items. The main hold also includes six removable foam dividers that can be customized along with the colored pouches – or removed completely to suit the users' needs. Multiple points of hi-vis reflective around the bag ensures that it remains visible on-scene.

- Raised PVC/Nylon reinforcement covers bottom and lower half of bag for water and abrasion resistance
- Yellow/silver triple trim reflective striping surrounds bag and 3M scotchlite stitched into webbing and straps
- Blue and white embroidered star of life logo with silver reflective overlay
- Front and side pockets stretch full-length of bag and feature interior elastic instrument loops and nylon pockets with dividers
- Each colored quick access pouch includes clear vinyl window and interior pocket; green has elastic loops for berman airways
- Main flap is padded and features three clear zippered compartments for access to often-used items without disturbing main-hold supplies
- Shoulder strap is stitched with reflective tape and includes ergonomically shaped shoulder pad; adjustable and removable strap is attached with spring loaded metal US hooks
- Rear of bag has nylon webbing reinforced I.D. pouch with clear vinyl cover
- All pockets and compartments feature double zippers – can be locked for logistical purposes
- Overall Dimensions: 20"L x 16"W x 10"H

BL886	Large Intermediate Modular Trauma Bag	\$260.95
-------	---------------------------------------	----------

MEDIC KIT

Case is rust-proof, dent-proof, and chemical resistant. Dimensions: 16 1/2" L x 8 3/4" H x 7 1/2" D.

- Bandages assorted, 60/bx
- 2 - Burn dressings 4"x4"
- Cohesive bandage 3"x5 yds.
- 4 - Cold packs 5"x6", disposable
- 10 - Gauze pads, sterile 2"x2"
- 10 - Gauze pads, sterile 4"x4"
- 2 - Rescue blankets 56"x84"
- 3 - Triangular bandages 40"x40"
- Tape 1/2"x10 yds. uncovered
- 25 - BZK towelettes
- 2 - Pressure bandages
- Splinter forceps (tweezers)
- 4 - Roll Gauze 4"x4 yds.
- Triple antibiotic ointment 1 oz.
- 4 - Eye pads, medium
- Eyewash 4 oz.
- 10 - Gloves, vinyl
- Hydrogen peroxide
- Scissors, paramedic
- CPR Microshield®
- Tape 1"x10 yds.

AZ430	Medic Kit	\$138.95
-------	-----------	----------





TACTICAL MOLLE MED BACKPACK WITH MODULAR POUCHES AND HYDRATION PORT WITH TRAUMA AND BLEEDING MEDIC FILL KIT

The Modular Tactical Medic Backpack is the culmination of two years of research, design and customer feedback by Lightning X for a practical and useful EMS bag for the tactical market. Far too often, tactical medics are forced to buy a military bag with no EMS features, or an EMS bag with no tactical features. Now you can have the best of both worlds, with a well organized and great looking bag all-in-one. The BP202 comes with two small and two large grab-n-go pouches with transparent windows plus one foam lined organizer with six dividers, all of which are completely removable or interchangeable within the main compartment.

- 1 - Tweezer
- 1 - Kelly Hemostats
- 1 box of 10 - Ammonia Ampules
- 100 - 3/4" x 3" Adhesive Bandage
- 25 packs of 2 - 4"x4" Gauze Pad 50
- 2 - 2" Roll Gauze
- 2 - 3" Roll Gauze
- 2 - 4" Roll Gauze
- 2 - Cohesive Self-Adherent Bandage
- 2 - 5" x 9" ABD Pad
- 2 - 8" x 10" ABD Pad
- 1 - 1" Cloth Medical Tape
- 10 - Iodine Wipes
- 10 - Alcohol Prep Wipes
- 1 - Triple Antibiotic Ointment 1/2 oz.
- 1 - 7 1/2 Trauma Shears
- 2 - Instant Cold Pack
- 2 - Oval Eye Pad
- 2 - Triangle Bandage
- 1 - Sprague Stethoscope
- 1 - Eye Wash
- 1 - Berman Airway / 6 pieces
- 2 Pairs - Nitrile Gloves
- 1 - Universal Finger Splint
- 1 - Bandage Shears
- 10 - Sting and Bite Relief Pads



COLOR: Black, Desert Tan or Red

BP202 Tactical MOLLE Medical Backpack with Medic Fill Kit \$232.95

EMERGENCY BURN KIT

A complete burn kit, easily portable, for risk environments where burn injuries are possible. Dimensions: 12"Lx10"Hx3"D.

- 2 - Burn dressings 4"x4"
- Burn dressings 8"x8"
- 6 - Burn gel packs 1/8 oz.
- 3 - Roll gauze pads 4"x4 yds.
- 4 - Cold packs 4"x5"
- 4 - Gloves
- Cohesive bandage 3"x5 yds.
- 8 - Gauze pads 3"x3"
- 2 - Adhesive tapes 1"x5 yds.
- Paramedic scissors

BK233 Emergency Burn Kit \$63.95



COMPLETELY STOCKED TRAUMA BAG

Cordura® Trauma Bag features all the first aid supplies you'll need. Large main compartment divided into three sections along with a roomy front pocket plus two zippered side pockets. Dimensions: 20 1/4" Lx7" Hx11 1/2" D.

- 10 - Alcohol wipes
- 10 - Benzalkonium chloride towelettes
- 4 oz. eyewash
- 10 - Iodine swab sticks
- 10 - Triple-Antibiotic ointment
- 10 - Vionex® wipes and dry towelettes
- 5 - Water-Jel® Burn Jel®
- 6 - Eye pads
- 4 - Combine pads 5"x9"
- 10 - Gauze pads 2"x2"
- 10 - Gauze pads 3"x3"
- 10 - Gauze pads 4"x4"
- 2 - Tapes 1"-2"x5 yds.
- Trauma dressing - 10"x30"
- 4 - Conforming bandages 2"x4 yds.
- 2 - Conforming bandages 3" x 4yds.
- 4 - Conforming bandages 4" x 4yds.
- 100 - Plastic bandages 3/4"x3"
- 2 - Bio-waste bags (1 gallon, 11"x14")
- 1 - Rescue Space® blanket 56"x84"
- 10 - Cotton applicator 6" 2 pk.
- 2 - Triangular bandages 40"x40"
- 2 - Disposable cold packs
- Elastic bandage 3"x5 yds.
- Blood pressure cuff
- Water-Jel® Burn dressing 4"x4"
- Airway (6 sizes)
- 10 - Ammonia inhalants
- CPR Microshield®
- Bulb syringe
- 8 - Gloves
- Penlight
- Bite stick
- Sam® splint
- Paramedic scissors
- Splinter forceps
- Stethoscope
- 3 - Thermometers
- Glucose (15 gm)
- Poison antidote kit

AM253 Trauma Bag Only \$69.95
 AM254 Stocked Trauma Bag \$232.95



PRO RESPONSE BASIC KIT

With the Pro Response Basic Kit allows you to handle most basic emergencies and rescues at an affordable cost. The 1000 denier nylon bag has three spacious main compartments and two side zippered end pockets. The inside top flap has a meshed zippered pocket to hold airways, shears or other instruments. The bag also has a carrying handle and an adjustable detachable sling. It is trimmed with a reflective star of life emblem and reflective yellow trim on both sides of the bag. Dimensions: 14"Lx9"Wx6"H.

- Triangular bandage
- 1" adhesive tape
- 2 - 3" sterile conforming bandages
- 2 - 4" sterile conforming bandages
- 8 - 4"x4" sterile pads
- 2 - 5"x9" abdominal pads
- 25 - 1"x3" adhesive bandages
- 3" elastic bandage
- Burn/blood stopper bandage
- Plastic bite stick
- CPR Lifeshield™
- 2 - 4"x4" instant ice packs
- 5"x9" instant ice packs
- 8 - Antimicrobial hand wipes
- 10 - Triple antibiotic ointments
- 4 - Ammonia inhalants
- Thermal rescue blanket
- Window punch
- EMI splint
- Starlite flashlight
- First in rescue knife
- 4 - Latex gloves
- **Instrument Pack:** 4½" splinter forcep, 5½" bandage scissor, 5½" St. Kelly forcep, deluxe shears, penlight, lifesaver seatbelt cutter



BL612 Pro Response Basic Kit \$74.95

INITIAL STOCK FOR TRAUMA BAG

Prepackaged poly bag with all the supplies needed to initially stock trauma bags.

- Rescue shears
- Bandage shears
- Penlight with pupil gauge
- B/P cuff
- Stethoscope dual head
- 2 - 1" tape (adhesive)
- 3 - 5"x9" combi pads
- 3 - 2" comforting gauge (sterile)
- 3 - 4" comforting gauge (sterile)
- 10 - 2"x2" gauze pads
- 10 - Antiseptic towelettes
- 10 - Triple antibiotic wipes
- Oral airway set
- 4"x4" gauze pads
- 10 - 1" band-aids or assorted
- 5 - Pairs of gloves
- CPR mask
- 10 - Alcohol preps
- Multi-trauma dressing
- Foil rescue blanket
- 4 - Triangular bandage
- Burn sheet
- Bite stick
- 15 gram glucose
- 2 - Cold packs



BG069 Initial Stock for Trauma Bag \$167.95

TRAUMA PAC™

Trauma Pac™ offers the essential basic life support components for the first responder. The adjustable nylon webbing can fit 20" to 54" waists. Reflective trimmed pac measures 10"Lx6"Hx5"W.

- Triangular bandage
- 1" adhesive tape
- 3 - 3" sterile conforming bandages
- 8 - 4"x4" sterile pads
- 2 - 5"x9" abdominal pads
- 25 - 1"x3" adhesive bandages
- 3" elastic bandage
- Burn/blood stopper bandage
- CPR Lifeshield™
- Plastic bite stick
- 2 - 5"x9" instant ice packs
- 8 - Antimicrobial hand wipes
- 10 - Triple antibiotic ointments
- 4 - Ammonia inhalants
- Thermal rescue blanket
- 4 - Latex gloves
- **Instrumental Pack:** (4½" splinter forcep, 5½" bandage scissor, 5½" St. Kelly forcep, deluxe shears, penlight, lifesaver belt cutter)



Orange Navy

BG244 Trauma Pac™ \$46.95
BG245 Trauma Pac™ Refill Kit \$28.95

DARLEY FIRST AID KIT

KEEP IT ANYWHERE - 25 PERSON

- 30 - Antiseptic wipes
- 6 - First Aid/burn cream packets, .9 gm
- 6 - Triple antibiotic ointment packets, .5 gm
- Bottle 4 oz. eye flush
- 2 - Eye pads w. strips
- 12 - Pain relief tablets
- Instant cold pack
- 1 - ea. 40" triangular bandage
- 1 - ea. 4" gauze bandage
- 4 - Fabric knuckle bandages
- 5 - Fabric fingertip bandages
- First Aid Guide (ANSI 2009 version)
- 60 - Plastic adhesive strips, 1"x3"
- Scissors
- Forceps
- 5 - Sterile gauze pads, 4"x4"
- Large wound pad
- 4 - Nitrile exam gloves
- Roll 1/2" x 5 yds. adhesive tape



AG100 Darley First Aid Kit \$20.95

CPR MICROMASK™

Includes one pair of Nitrile gloves and single use, disposable Micromask™ featuring one-way, replaceable filtered valve and adjustable cushion for proper seal on adults, children or infants. Packaged in blue nylon, zippered pouch convenient to carry on your belt. *Ship. wt. 1 lb.*



AK238 CPR Micromask™ \$14.95

OXYGEN BAG INITIAL STOCK

Prepackaged poly bag with all the supplies needed to initially stock the oxygen bag.

- Oxygen regular (Brass) 0-15L constant flow
- Aluminum "D" oxygen tank with toggle handle
- Bag-valve-mask (adult)
- 2 - Adult-non-rebreather mask
- 3 - Pediatric non-rebreather mask
- 2 - Adult nasal cannula



BL112 Oxygen Bag Initial Stock \$377.95

EMERGENCY OXYGEN

Durable emergency oxygen system packaged in an attractive and molded attach-type case. The system comes filled and ready-to-use. When full, the unit will deliver over 1 hour of emergency oxygen for use between the time of an incident that involves respiratory difficulty and the arrival of professionally trained personnel. Includes 0-15 lpm adjustable flow regulator. Unit is refillable for maximum economy. *Ship. wt. 10 lbs.*



U268 Emergency Oxygen \$294.95

DERMA-LITE™ NITRILE GLOVES

The smart choice to protect today's EMS professionals from bloodborne pathogens. 3x the puncture/tear resistance as natural rubber latex gloves of the same thickness. Great feel and contour shape hug your hand for maximum comfort yet they're thin enough to let you get an accurate pulse; plus micro texture gives you a better grip. *Ship. wt. 2 lbs.*

- Sold in box of 100
- 5 mil.
- Ambidextrous fit
- Powder or powder-free
- Latex-free



SPECIFY SIZE: L or XL

AR195 Derma-Lite™ Gloves, Lightly Powdered \$11.95/box
 AR196 Derma-Lite™ Gloves, Powder Free \$12.95/box

OXYGEN CASE

Designed for an ambulance company to provide extra protection for regulator. 1/2" foam padding, four inside pockets for tubing and supplies. Holds a D-sized tank. Imported. 1000D nylon in green. Dimensions: 21 1/2" L x 8" D.

- Oxygen cylinder D-sized tank w/toggle
- Oxygen brass regulator 0-25 lpm left handed
- 2 - Non-rebreather masks - adult
- Non-rebreather mask - pediatric
- 2 - Nasal cannula - adult
- 2 - Oxygen tubing supply
- 4 - Gloves (latex/vinyl)

BB080 Oxygen Case \$30.95
 BB081 Oxygen Case with Supplies \$239.95



PLASTIC, SCOOP, AND SPLINT STRETCHERS

PLASTIC BACKBOARD

Rugged, one-piece, lightweight polyethylene spineboard with twelve large handholds for easy handling, built-in runners, low profile and X-ray translucent. *Bright yellow. Dimensions: 72"Lx16"W. Load Capacity: 400 lbs. Ship. wt. 20 lbs.*

ONE-PIECE
POLYETHYLENE

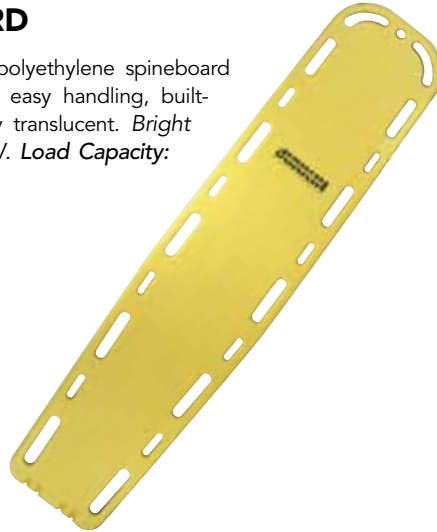

AR226 Plastic Backboard

\$177.95

SPLINT STRETCHERS

STANDARD SPLINT STRETCHER

Nylon web straps at chest, abdomen, thigh, and calf. Adjustable foot rests for vertical lifting. Frame is $\frac{5}{8}$ " steel tubing: cross braces and runners $\frac{3}{16}$ "x $\frac{3}{4}$ " flat steel. Basket is 18 gauge. 1" hexagon steel mesh netting.



AW207 Standard Splint Stretcher

\$280.95

SCOOP STRETCHER

- Thermally-treated polymer construction does not get too hot or cold
- Ergonomic ease of use
- X-ray translucent
- Twin safety lock for smooth and non-binding locking and unlocking
- Narrow foot-end frame
- Head section recessed to maintain proper cervical alignment
- 4 length options accommodates patients of different heights: 65", 70", 74", and 79"
- Easy-to-clean surface is impervious to fluids
- Folds to 47" for compact storage
- Includes three burgundy restraints



BD171 Scoop Stretcher

\$995.95

BD172 Storage Case

\$81.95

BREAK-AWAY SPLINT STRETCHER

The stretcher breaks into two halves which can be back-packed to the point of rescue and assembled in seconds. It can be secured to a standard back-pack for carrying. Three positive lock clamps secure two halves together. Four 60" web straps are standard. Stores in space 44"x12"x24".



AW208 Break-Away Splint Stretcher

\$618.95

PLASTIC STRETCHER

IDEAL FOR RUGGED RESCUE SITUATIONS

Yellow high-density polyethylene shell, supported by a stainless steel outer rail, permanently attached with stainless steel semi-tubular rivets. Features molded runners, fully exposed outer rail, non-absorbent foam pad secured to stretcher and four patient restraint straps. *Dimensions: 84 $\frac{1}{2}$ "x24"x7 $\frac{1}{2}$ ". Load Capacity: 1,200 lbs. Ship. wt. 31 lbs.*

PLASTIC
STRETCHER

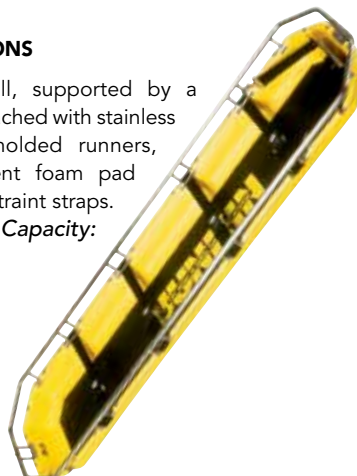

AF742 Plastic Stretcher

\$652.95

STRETCHER BRIDLE SLING

The Stretcher Bridle Sling provides vertical or horizontal lifting capacity of up to 2,000 lbs. Made of 1" nylon webbing resistant to moisture and fungus rot with forged snap hooks and 3" ID forged steel suspension ring. *Ship. wt. 5 lbs.*



AF743 Stretcher Bridle Sling

\$117.95

PATROL VEHICLE TRAUMA KIT

North American Rescue Patrol Vehicle Trauma Kit was designed to provide personnel with an easily accessible, quick to deploy medical kit from your Patrol Vehicle. It's modular storage system comes organized with an array of medical products ranging from basic first aid to more intermediate trauma care. One side of the bag's exterior includes trauma shears at the ready as well as several pairs of nitrile gloves, while the opposite side features a MOLLE-style system to accommodate extra equipment as needed, such as additional tourniquets, ammo, or personal protective equipment. This arrangement is ideal for customizing the carriage of gear that requires immediate access. Once the zippered bag is opened, one compartment contains items to cover all your agency needs for basic first aid and community assistance while the opposite side offers a first time combination of both Basic First Aid and Basic Trauma medical items. This configuration gives every officer not just a basic first aid kit, but everything needed to save a life in more extreme injuries.

SPECIFICATIONS:

- Provide personnel with an easily accessible, quick to deploy medical kit from your Patrol Vehicle
- Modular storage system comes organized with an array of medical products ranging from basic first aid to more intermediate trauma care
- One side covers all your agency needs to administer basic first aid and community assistance
- Second side offers a first time combination of Basic First Aid and Basic Trauma medical items
- Exterior includes MOLLE-style system to accommodate extra equipment as needed

DIMENSIONS:

- 7"H x 12"W x 5"D
- Weight: 6 lb.

- 1 - Black nylon bag
- 3 - Large pair bear claw nitrile trauma gloves
- 1 - Black C-A-T® (Combat Application Tourniquet®)
- 2 - Compressed gauze (4½" x 4.1 yd.)
- 1 - 6" responder ETD (Emergency Trauma Dressing)
- 1 - HyFin® vent chest seal twin pack
- 1 - Burntec® burn dressing 4" x 4" (10 cm x 10cm)
- 25 - Flexible fabric bandage (¾" x 3")
- 2 - Gauze pad pack (2 per pack) (4" x 4")
- 1 - SAM® splint II
- 2 - Elastic wrap bandages (4" x 5 yd)
- 1- Trauma shears (7¼")
- 2 - Polycarbonate eye shield (PES)
- 1 - Mini surgical tape (2")
- 1 - Eye wash solution (4 oz)
- 1 - Pocket penlight
- 1 - CPR mask
- 1 - Splinter forceps (4½")
- 1 - Permanent marker
- 1 - Emergency survival blanket (52" x 84")
- 2 - Triangular bandage (40" x 40" x 56")



BN516 Patrol Vehicle Trauma Kit

\$233.95

8" X 8" BURN DRESSING

Excellent to cover sizeable areas such as the thigh, shoulder, or back area. Large enough to wrap around the bottom portion of the leg or the thorax area. Gel-soaked, sterile, and foil-packed. Shelf life of 5 years. *Ship wt. 3 lbs.*



X857 8" x 8" Burn Dressing

\$14.95

EMERGENCY DISPOSABLE PENLIGHTS

Disposable penlight with pocket clip activation.

Ship wt. 1 lb.

- Disposable penlight with pocket clip activation
- Sold in packs of 6 penlights



AH251

AH251 Emergency Disposable Penlights \$9.56

AS340 Emergency Disposable Penlights w/
Pupil Gauge \$14.95

SPEED STRETCHER

The R&B Speed Stretcher is a flexible easily conveyable alternative to back boarding. The design is Ergonomic, strong and durable, constructed of 22 oz. heavy-weight vinyl with hardwood slats positioned between two layers of material. *Weight capacity: 700 lbs.*



BN209 Speed Stretcher

\$305.95

ULTRABRIGHT RED-FIRE CLASS II PUBLIC SAFETY VEST

Introducing the Ultrabright Red-Fire Class II Public Safety Vest. This product features a “zip-off” double Velcro® zipper front closure that allows the vest to breakaway from both sides of the zipper, making it the only 6 point breakaway vest on the market. The “performance cut” offers max comfort and allows access to turnout jacket pockets or portable radios at the waistline. The “chevron” reflective pattern on the back offers max visibility and distinct contrast. The shoulder breakaway points have been upgraded with 2” “re-force” Velcro® to ensure that the vest does not fall apart when donned over a turnout jacket but will still break away in emergency situations.



NEW

SPECIFY SIZE: S, M, L

BN732 Ultrabright Red-Fire Class II Public Safety Vest

\$39.95

DUAL CERTIFIED SAFETY VEST

Our BK230 has everything you want in a public safety vest at an unbeatable price. Vest meets both the ANSI-ISEA 207-2006 FR NFPA 701 and 107-2004 Class II Level II FR NFPA-701 standards. Polyester mesh construction with FR treatment, 5 point breakaway, 3M reflective tape with contrasting trim. The vest is loaded with pockets for your radio/mic loop, pens, plus two on the inside. One size fits L – 5XL (48"-66") with adjustable waist. Imported.

BL047: Same as BK230 with direct printing on the back and the front of the vest. Direct printing is in black.



BK230

BK230 Dual Certified Safety Vest

\$24.95

BL047 Dual Certified Safety Vest with Legend

\$38.95

PUBLIC SAFETY VESTS

Public Safety Vests meet the new ANSI/ ISEA 207-2006: American National Standard for high-visibility public safety vests. Their breakaway design prevents entanglement. Easy on/off with hook and loop front closure and fully adjustable sides. Added features include mic tab, clear badge chest pocket with closure and radio chest pocket with flap closure. Made with ANSI tricot fabric and 3M™ Scotchlite® reflective tape.



BG516

SPECIFY SIZE: M/L, XL/2X, 3X/4X

BG516 Public Safety Vest FIRE

\$32.95

BG517 Public Safety Vest POLICE

\$32.95

KEEP EMERGENCY PERSONNEL SAFE AT THE SCENE

TRAFFIC CONTROL

ROLL-UP STOP/SLOW PADDLE

Roll-Up Stop/Slow paddle offers a full size paddle in a compact, lightweight, and easy to store design. Paddle comes in Super Bright reflective, double sided, 24" octagon material with an adjustable staff to 6' or 7'. The kit comes complete with double sided roll-up sign face, handle, and storage bag. Roll-up design protects sign face from damage and provides compact storage. Telescopic handle is ABS plastic with tube and socket connectors and locking spring buttons.



- Meets all MUTCD specifications
- 24" double side sign made of super bright reflective material
- ABS plastic staff adjusts to 6' or 7'

BP113 Roll-Up Stop/Slow paddle \$141.95

FOLD & ROLL™ SIGN SYSTEM

Emergency personnel face not only the hazard at the situation they are attempting to suppress, but they are also facing hazards from motorists driving through or near an emergency scene. Advanced warning signs alert motorists of hazardous conditions ahead and create a higher level of awareness. Proper training in the use and deployment of signage is essential as are general safety guidelines to be used in hazardous situations. *Ship. wt. for sign 8 lbs., sign and stand 27 lbs.*

LEGENDS:

- Accident Ahead
- Detour. *Extra charge for arrows, call your Darley representative for pricing.*
- Emergency Scene Ahead
- Collapse Zone
- Superbright reflective
- Command Post
- Incident Ahead
- Fire Area Keep Out
- Traffic Emergency Ahead
- Fire Training Ahead

SPECIFY LEGEND: See Above

SPECIFY COLOR: Orange or Pink



BA107	36" Sign/Stand Fold & Roll™ Sign System	\$282.95
BA108	48" Sign/Stand Fold & Roll™ Sign System	\$332.95
BA109	36" Sign Only	\$137.95
BA110	48" Sign Only	\$197.95



BARRICADE BANNER TAPE

It's so inexpensive that you can carry a spool in every emergency vehicle. Each spool is 3"x1000' and made of tough 2 mil. Polyethylene. Available in various colors and legends. *Ship. wt. 4 lbs.*

1000-FOOT ROLLS!

Titles
FIRE LINE DO NOT CROSS
CAUTION DO NOT ENTER
CAUTION RADIATION AREA
DANGER DO NOT ENTER
CAUTION BIOHAZARD



SPECIFY LEGEND

AJ351 Barricade Banner Tape \$11.95/roll

DAY/NIGHT BARRICADE TAPE

The brand new technology of Day/Night visibility barricade tape is formulated with an exclusive night time visibility silver ink that is combined with our superior co-extruded polyethylene to provide a cost-effective and disposable solution to your night time needs. *Length: 3"x1000', thickness: 3 mil. Ship. wt. 4 lbs.*



SPECIFY LEGEND:

Caution, Danger, Fire Line Do Not Cross
BA101 Day/Night Barricade Tape \$15.95/roll

DARLEY TRAFFIC CONES

Feature brilliant Day-Glo fluorescent orange color with ultraviolet additives to protect against color fading and wide base for maximum stability. Available with or without reflective collars.

All Cones		
Size	Case	Weight
12"	30	45 lbs.
18"	20	68 lbs.
28"	10	58 lbs.
36"	10	110 lbs.

Color: Orange

Without Reflective Collars

T444	12" Traffic Cone	\$6.95
T445	18" Traffic Cone	\$8.95
T446	28" Traffic Cone	\$13.95
T447	36" Traffic Cone	\$22.95

With Reflective Collars

AK263	12" Traffic Cone with 4" Collar	\$10.95
AK264	18" Traffic Cone with 6" Collar	\$14.95
AK265	28" Traffic Cone with 4" and 6" Collars	\$23.95
AK266	36" Traffic Cone with 4" and 6" Collars	\$26.95



Orange



BEST SELLER

TRAFFIC CONTROL

QUICK DEPLOY™ SPRING CONE™ TOTE AND BAG SYSTEM

- Compact for easy storage on any truck, or in vehicle trunk
- Meets MUTCD requirements for 28" highway traffic cone
- Flexible Spring Cone™ splits wind for increased stability
- Quickly deployed Spring Cone™ delineates traffic at any scene
- Cone is made of a durable, bright orange, flexible mesh material
- Rubber base holds cone in place and grips the road for stability
- Flexible spring allows cone to automatically self deploy
- Lightweight - cones are half the weight and pack in one-third the space of traditional highway cones

Spring Cones with Wire/Mesh Tote Storage System

BB073	(4) 28" Reflective (6" and 4"), 3 lb. Spring Cones and 1 Tote	\$177.95
BG143	(4) 28" Reflective (6" and 4"), 5 lb. Spring Cones and 1 Tote	\$191.95
BB075	(6) 28" Reflective (6" and 4"), 3 lb. Spring Cones and 1 Tote	\$241.95
BG144	(6) 28" Reflective (6" and 4"), 5 lb. Spring Cones and 1 Tote	\$277.95

Spring Cones

BB077	28" Reflective (6" and 4"), 3 lb. Spring Cone	\$36.95
BG145	28" Reflective (6" and 4"), 5 lb. Spring Cone	\$43.95



POP-UP FLASHING CONES

- Safe, compact, highly visible and collapses flat for easy storage
- Meets MUTCD Standards
- Constructed of orange waterproof nylon
- Internal light has two settings: Steady burn and flashing
- Replaceable lithium battery
- Cone light endures 100,000 flashes or 36 hrs. of steady burn
- Sold in packs of 4 or 5 cones with one carrying bag included
- Meets the new 2009 NFPA 1901 apparatus standard for fire apparatus
- *Ship. wt. 17 lbs.*



CARRYING BAG INCLUDED

BG503	28" Pop-Up Flashing Cones with Orange Plastic Base (Set of 4)	\$129.95
BH143	28" Pop-Up Flashing Cones with Orange Plastic Base (Set of 5)	\$171.95
BH144	30" Pop-Up Flashing Cones with Black Rubber Base (Set of 5)	\$189.95



LIGHTWEIGHT MEGAPHONE

Piezo Dynamic technology is revolutionary technique that allows a megaphone to operate more efficiently, and with less weight than ever before.

- Patented Piezo Dynamic technology allows efficient operation
- Lasts 40 hrs. Continuously on 8 "C" cells
- Weighs 50% less than a conventional model
- Adjustable volume
- Can also use rechargeable batteries
- Charge with 12V DC car cable or plug-in DC transformer
- Dimensions: 14 1/4" x 8 1/2"
- *Ship. wt:* 3 lbs.



BH058 Lightweight Megaphone

\$73.95

FLARE CONTAINER

CONVENIENTLY STORE YOUR FLARES AND KEEP THEM FROM DAMAGE

Keep your flares together, easily accessible and safe from damage. Flare Container can hold up to twelve 30-minute flares. Easy to open cap and large handle make it user-friendly. It's so inexpensive, one can be kept in every vehicle. *Ship. wt.* 1 lb.



AH002 Flare Container

\$14.95

DARLEY SAFETY FLARES

15 and 20-minute flares sold in cases of 72. 30-minute flares sold in case of 36.

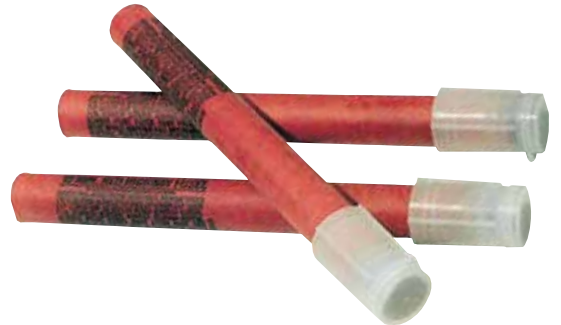

Cat#	Description	Case Price
AF409	15 Minute, No Spike	\$117.95
W947	20 Minute, No Spike	\$132.95
W948	30 Minute, No Spike	\$95.95
AF410	15 Minute, With Spike	\$139.95
W949	20 Minute, With Spike	\$160.95
W950	30 Minute, With Spike	\$112.95
W951	20 Minute, With Stand	\$156.95
AF411	30 Minute, With Stand	\$108.95

THREE-TRIANGLE VEHICLE WARNING KIT

No flares or electric flashers are necessary with the Vehicle Warning Kit. The kit includes three fold-out reflective triangles that snap into position in seconds. Each triangle is attached to a heavy four pound weighted base. Made of tough plastic with reflective red and fluorescent orange on both faces. Comes complete with handy carrying case for easy storage. *Ship. wt.* 15 lbs.. *Ship. wt.* 15 lbs.



P639 Three-Triangle Vehicle Warning Kit

\$28.95

FLASHBACK™ LED LIGHT BATON



The FLASHBACK™ LED Light Baton is the most visible flashing signal light available. The 6 highly-luminous LED bulbs can be seen for up to $\frac{3}{4}$ of a mile and flash approximately 150 times per minute. FLASHBACK™ provides a minimum of 300 hours of continuous flashing operation. The three stage switch provides off, flashing or steady light. The weather resistant body is made of ABS high impact plastic, while the tube is PC transparent material.
Ship. wt. 1 lb.

BB069 FLASHBACK™ LED Light Baton \$31.95

FLIGHT SITE LANDING ZONE KIT

The Flight Site 5-strobe system, with it's 12,800' ceiling, identifies the landing zone to the pilots from great distances. It's easy-to-use and quickly deployed. Patented Weightwashers™ will not allow the strobes to move even under the heaviest rotor wash conditions. Enhance your medivac landing zones as well as emergency scenes. *Ship. wt. 5 lbs.*

INCLUDES:

- 5 - Xenon Strobe
- 5 - clear lenses
- 5 - amber lenses
- 5 - red lenses
- 5 - Weightwashers™ for Stabilizing strobes
- 10 - AA batteries
- Carrying bag



AK281 Flight Site Landing Zone Kit \$239.95

360° HIGH VISIBILITY FLASHING BEACONS AND KITS

FEATURES:

- 360° high-visibility flashing LED beacons
- Portable, safe, easy-to-use, and cost effective (2 cents/hr.)
- Bright, clear colors
- Up to 80 hr. battery life with low battery indicator
- Tough and dependable with one year limited warranty

SPECIFICATIONS:

- **Beam Brightness:** 15,000 - 25,000 millicandela
- **Max beam Conspicuity:** Between horizontal and 10° above horizontal
- **Flash Rate:** 120 flashes per minute
- **Batteries:** 2 Alkaline D cells (not included)
- **Battery Life:** Up to 80 hrs. at full brightness
- **Height:** 8" (including optional base)
- **Weight:** 1 lb. (including batteries)



SHOWN WITH OPTIONAL BASE (BE276)

Detachable optional base (BE276)



360° High-Visibility Red Beacon with 8 LEDs

BE275 Red Beacon with Low Battery Indicator \$74.95

BE276 Rubber Base \$8.95

BE277 INCLUDES:

- 4 amber units with 1 blue unit
- Storage bag
- 5 rubber bases
- Laminated instruction card

HELICOPTER LANDING ZONE KIT WITH BEACONS

BE277 4 Amber Beacons and 1 Blue Beacon \$425.95



P.A.C. TOOL MOUNTING SYSTEMS



TOOLOK AND TOOLOK HD

- Fast, easy locking and instant release
- Grip range 1/8" to 1 1/2"
- NFPA 1901 Compliant 9G impact
- Tested and certified NFPA 1901 compliant

TOOLOK HD

- Wider mounting base for increased stability
- Stronger, more durable base
- Thicker walled locking strap
- Lifetime warranty



NEW

BN470 Toolok HD

\$28.95

STOW-N-LOC

IDEAL FOR EXTERIOR MOUNTING

FAST tool storage with clamp-action brackets.
PLUS simple positive locking strap when ready.

- Grip range 1" to 1 1/2" diameter
- Adjustable, high-strength, fast-action locking strap
- **2 Heights:** Tall: For long hooks
Short: For close mounting
- NFPA 1901 Compliant 9G impact



BL264



BL263 Stow-N-Loc Tall

\$46.95

BL264 Stow-N-Loc Short

\$46.95

COIL LOK

- Easily adjusted strap for various conditions and sizes
- Stainless steel fasteners provided
- Multiple objects can be hung together
- Non-conclusive
- Adjustable lock strap capable to 5400 psi tensile strength
- Strap retainer block included
- Adjusted to mount horizontally
- Mounts to PAC tool boards and other flat surfaces



NEW

BN317 Coil Lok

\$43.95

JUMBO LOK

- 3 pivot positions
- Adjustable mounting bracket with grip range of .375" to 3.250"
- 3" square Hurst rams and 3" D Holmatro rams
- Mounts folding ladders, electric drills, heavy-duty jacks, nozzles, chains and more
- NFPA 1901 Compliant 9G impact
- Dual poles
- Playpipes
- *Ship. wt. 1 lb.*



BC018 Jumbo Lok

\$64.95

HANDLELOC STRETCHLOK SYSTEM

- Innovative, adjustable mounting bracket
- Secure mounting for tools, axe handles, poles and equipment up to 1 3/4" in diameter
- Quick release for easy retrieval
- Made of elastomer
- NFPA 1901 Compliant 9G impact
- *Ship. wt. 1 lb*



AF659 Handleloc Stretchlok System

\$39.95

KEEP YOUR TOOLS ORGANIZED WITH P.A.C. MOUNTS



FLEXMOUNT BRACKETS

Flexible Y-shaped mounting brackets designed to provide a secure grip-type mount that wraps around poles, nozzles and a wide variety of other tools and equipment with a grip range from 1½" to 2½". Made from a unique state-of-the-art elastomer that is exceptionally tough, non-sparking and resistant to impact. There's no springs to corrode or break. Hardware/fasteners included. *Ship. wt. 1 lb.*



AF658	Flexmount Bracket	\$42.95
AW337	Short Flexmount Bracket	\$37.95

FAST LOK KIT

SECURING LARGER & HEAVIER ITEMS HAS NEVER BEEN EASIER

FEATURES:

- Easily and quickly secure equipment even with gloved hands
- Track base provides fast setup and adjustment
- No metal to metal contact
- UV resistant
- Fast locking lever
- Adjustable strap length and width supports
- NFPA 1901 Compliant

SECURES:

- Fire extinguishers
- Air cylinders
- Hydraulic pumps
- Rescue tools
- Chain saws
- Oxygen cylinders
- Much more

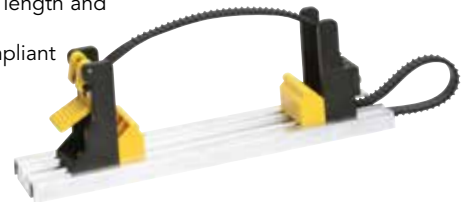

BL664	Fast Lok Kit 18" Black Strap, 15" Usable Strap	\$119.95
BL665	Fast Lok Kit 33" Black Strap, 30" Usable Strap	\$133.95

UNIVERSAL SAW KIT

The Universal Saw Kit provides a simple easy to use mount for rescue saws. This kit can also be used for many other saw mounting applications. Includes two Universal Mounts, Extended Super Adjustamount, Spacer Blocks and a 12" long unistrut section.



- Molded from high quality materials
- Includes stainless steel fasteners
- Weather, UV resistant
- Non-conductive

BN313	Universal Saw Kit	\$137.95
-------	-------------------	----------

IRONSLOK AND IRONSLOK HD

NEW

- Safe, secure and dependable storage
- Fits 30" halligan, 36" flathead, 6 or 8 lb. force axe
- Mounts horizontal or vertical
- NFPA 1901 Compliant 9G impact
- *Ship. wt. 7 lbs*

IRONSLOK HD

- Designed for larger irons, including the PIG axe



AW391	Ironslok	\$261.95
BN314	Ironslok HD Kit	\$309.95

CYLINDER MOUNT

NEW

- Perfect fit for 1 quart fuel cans and small extinguishers
- Two sizes: 5" (medium) and 7" (tall)
- Mounts cylindrical items up to 3½" diameter
- Wall mounted
- PAC Trac compatible
- Non-metallic
- Chemical resistant material
- Lightweight and durable
- Flame retardant



BN588	Cylinder Mount - Med	\$44.95
BN589	Cylinder Mount - Tall	\$47.95

SPREADER BASE MOUNT KIT

- Mounts vertically or horizontally
- Provides secure, quick-acting mounting
- Made of rugged, molded urethane
- Resistant to weather, impact, UV and corrosion
- Includes spreader base, adjustamount kit and fastener packet
- *Ship. wt. 3 lbs.*

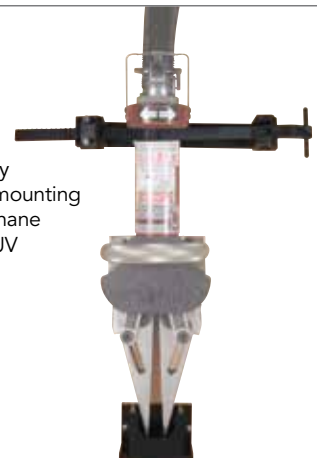

BN585FL	Spreader Base Mount Kit with Fastlok	\$159.95
BN585JL	Spreader Base Mount Kit with Jumbo	\$107.95
BN585SA	Spreader Base Mount Kit with Super Adjustamount	\$107.95

SECURE YOUR TOOLS WITH ZIAMATIC

APPARATUS EQUIPMENT

WALL MOUNT CAN HOLDERS

Wall mount can holders lower the risk of rolling, falling, leaking, denting, and puncturing during transport. Keeps cans organized and easy to locate in a hurry. Mount it to a compartment wall and save space on the shelf below. *Ship. wt. 3-5.1 lbs.*

- BL674 and BL754: Fits 32 oz. (3³/₈" diameter) cans or 32 oz. (2⁷/₈"x4¹/₄" quart containers
- BL713: Fits 12 oz. cans up to 2³/₄" diameter
- BL755: Fits 1 gallon cans (7"x4¹/₂"")



BL754



BL755

BL674	Premixed Can Holder	\$49.95
BL713	Spray Can Holder	\$49.95
BL754	Double Premix Holder	\$89.95
BL755	Gallon Premix Holder	\$49.95

SLEDGE HAMMER BRACKET

Designed for use with 2 to 16 lb. Double Face Sledges and 1 to 3 lb. Dead Blow Hammers. Bracket is 2³/₄"Hx3"D - expandable from 5¹/₄" to 8³/₄"W to fit various-sized tools. Made of stainless steel for years of lasting service. *Ship. wt. 3 lbs.*

AS325	Sledge Hammer Bracket	\$90.95
-------	-----------------------	---------

AXE HOLDER BRACKET

Designed for use with 6-pound flat or pick head axe. Bracket is 5"Hx2¹/₈"D. Expands from 7¹/₄" to 8¹/₄"W to fit most axeheads. 2¹/₂"Hx1¹/₄"W slot in end for pick to protrude. Axe blade protected by a replaceable plastic sleeve. Pinned handle holder accepts up to 2⁵/₁₆"W handle. Stainless steel for trouble-free service. *Ship. wt. 4 lbs.*

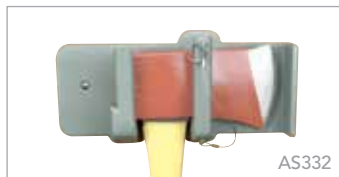

AS332



AS325

AS331	Axe Holder Bracket	\$168.95
AS332	Axe Wall Mounting Bracket	\$143.95

QUIC-MOUNT® BOLT CUTTER BRACKET

Designed for use with 18" to 36" bolt cutters with adjustable stop and pin. Utility straps hold the bolt cutter handles firmly in place. Comes with one fixed strap and one variable strap. *Ship. wt. 3 lbs.*



AR158	Quic-Mount® Bolt Cutter Bracket	\$93.95
-------	---------------------------------	---------

ROUND GAS CAN MOUNT

Round gas can mount was designed for safety cans with 9" and 13" diameter bases. The safety can is held in place by a 1" nylon safety strap with a quick-release buckle. *Ship. wt. 7 lbs.*



CAN NOT INCLUDED

AS328	Gas Can Mount Up to 2 Gal.	9 ³ / ₄ "IDx2 ¹ / ₈ "D	\$91.95
BD079	Gas Can Mount Up to 5 Gal.	13 ¹ / ₂ "IDx2 ¹ / ₈ "D	\$105.95

CHAIN SAW MOUNT

Mount chain saws, abrasive cut-off saws and other gasoline engine tools on these specially designed brackets. Absorbent pad collects fluids and may be changed as required. Safety strap secures the saw on the bracket. *Ship. wt. 10-12 lbs.*



SAW NOT INCLUDED

AS326	Large Mount - 11 ¹ / ₂ "x17 ¹ / ₂ "	\$148.95
AS327	Small Mount - 10"x15"	\$141.95

QUIC-BAR®/AXE MOUNTING BRACKET SET

Brackets may be mounted to store the bar and axe combination either vertically or horizontally. Variable straps secure the tools for carrying. Add an adjustable shoulder strap and you are ready for business. *Ship. wt. 7 lbs.*



TOOLS NOT INCLUDED

AS329	Quic-Bar/Axe Mounting Bracket Set w/Stop	\$189.95
AS330	Straps for Quic-Bar® & Axe Mounting Bracket	\$78.95

D-SIZE OXYGEN CYLINDER BRACKET

The Oxygen Cylinder Bracket has two 4" clips to securely hold a D-size oxygen cylinder. Durable green powder coated steel clips, backplate and footplate. Multiple sets of countersunk holes allow the bracket assembly to flush mount to any surface and gives multiple positioning for the clips and the footplate. A Velcro® safety strap is attached to each bracket.



BL511 D-Size Oxygen Cylinder Bracket \$78.95

UNIVERSAL SAW BRACKET

This unique Universal Saw Bracket is able to mount chain saws, rotary saws, electric and all others. Made from 1/8" powder coated aluminum, it offers multiple anchor points to attach the heavy duty Velcro® strap. An absorbent, replaceable felt pad is supplied and held in place by the mounting bolts.



BL510 Universal Saw Bracket \$141.95

SHOVEL MOUNTING BRACKET

New shovel mounting system holds one or two shovels securely in place. Bracket adjusts to hold one or two handles with no rattle or movement. Hanger projections secure the shovel heads with a 7 1/4"Wx4"H base and four mounting holes.



BE076 Shovel Hanger 7 1/4"Wx4"H Base \$61.95
 BE077 Shovel Bracket for 1 or 2 Tools \$39.95

ADAPTER HANGER

Adapter hanger is ideal for mounting couplings, adapters, electrical cords, hoses, etc. Mounting plate is 4" square, post is 6" long and mounted on a 60° angle. *Ship. wt. 1 lb.*



AS324 Adapter Hanger \$45.95

NYLON STRAP KIT

Nylon Strap Kits include two bolt down footman loops brackets and a 1.00" nylon strap with a pinch and release buckle. Ideal for strapping down tools and or large equipment such as vent fans, cribbing, rescue jacks and other hard to secure items. Sizes listed are listed are the maximum lengths and may be adjusted to secure smaller items.



BH118 1"x30" Nylon Strap Kit \$25.95
 BH119 1"x48" Nylon Strap Kit \$27.95
 BH120 1"x64" Nylon Strap Kit \$29.95

HORIZONTAL MOUNTING POSTS

Want to eliminate the head-ache of stacking 1 1/2"-2 1/2" couplings, adapters and accessories? These remarkably simple and unique Horizontal Mounting Posts for double male or female configurations are designed to save cabinet storage space and improve overall truck neatness and efficiency. With no stacking, you can instantly spot the size adapter or coupling you need. Special stainless steel spring clip provides secure holding yet quick-action release. Durable construction materials will not corrode, swell or crack. Single screw mounting takes only minutes.



BE304	Double Female 1 1/2"	\$27.95
BE305	Double Male 1 1/2"	\$27.95
BE306	Double Female 2 1/2"	\$34.95
BE307	Double Male 2 1/2"	\$34.95

STORZ HARDCOAT MOUNTING PLATES

High-tensile aluminum construction with anodized finish to resist abrasion and corrosion. *Ship wt. 1 lb.*



AF63801	4" Plate	\$28.95
AF63802	5" Plate	\$29.95

STORZ LOK

- Corrosion-free
- Mounts in any position
- **Strong:** Resistant to heat and cold
- **Fast Acting:** Mount or dismount
- **Easy-to-use:** No moving parts
- **Self-locking:** The automatic lock on the coupling locks it in place
- **Rattle Resistant:** The "quiet mount" no metal-to-metal contact



BL265

BC019	Storz Lok 4" Mount	\$45.95
BC020	Storz Lok 5" Mount	\$52.95
BL265	Storz Lok 6" Mount	\$72.95

MOUNTING PLATE

Male mounting plate is made of aluminum. *Ship. wt. 1 lb.*



BL365	1 1/2"	2 1/2"	3"	4"	4 1/2"	5"	6"
	\$25.95	\$30.95	\$34.95	\$51.95	\$58.95	\$67.95	\$69.95

HOLDS ANY THREADED FITTING SECURELY

Self-draining with three center mounting holes. Aluminum NST Threads.



BL366	1 1/2"	2 1/2"	3"	4"	4 1/2"	5"	6"
	\$29.95	\$39.95	\$47.95	\$64.95	\$70.95	\$80.95	\$86.95

QUICK ACTION NOZZLE HOLDER

Running board holder for nozzles and fittings. Positive grip, triple-lock lugs. Designed for NST threads, but will fit similar threads. The spring and lever handle permits proper tension with a quick, easy release. *Ship. wt. 2 lbs.*



G321	2 1/2" Chrome Plated	\$39.95
G421	1 1/2" Chrome Plated	\$38.95

BOOSTER NOZZLE HOLDER TWO-POSITION MOUNTING BRACKET FOR VERSATILITY

This neoprene rubber cup mount is the ideal way to mount pre-connected nozzles on fire and emergency vehicles. Bracket sold separately. *Ship. wt. 3 lbs.*



SHOWN WITH
OPTIONAL U402

U400	Nozzle Cup Mount 3 1/2" I.D.	\$78.95
U401	Nozzle Cup Mount 5 1/2" I.D.	\$101.95
U402	Nylon Coated Bracket (Black)	\$45.95

AUTO CHARGE 11-FOR DUAL BATTERIES

Auto Charge 11 is a fully automatic battery charger for vehicles with dual battery systems. The unit contains two completely independent chargers to sense and control the current to the batteries. Thus parasitic loads on one battery have no effect on the second battery. Total output current is limited to protect the charger but may be supplied to either battery if the adjacent battery does not require it. Normally the current output is proportioned between batteries as required. Comes complete with charging indicator panel. 3-year warranty. 120v input. *Ship. wt. 12 lbs.*



SPECIFY VOLTAGE: 6, 12, or 24

Y644 Auto Charge 11 \$533.95

AUTO CHARGE 2000 KIT

COMPLETE CHARGING SYSTEM AT AN AFFORDABLE PRICE

Auto Charge 2000 is a high-output, dual battery charger that independently charges two batteries. Includes the Auto Charge 2000 automatic battery charger and Auto Eject (20 amp) automatic power line disconnect, providing a complete vehicle charging system that saves you money. Unique electronic sensing circuits sense the true battery voltage while eliminating the need for external sense wires. There is no overcharging and no water boil off. What's more, a built-in battery saver handles the problem of battery loading from rechargeable hand lights, portable radios and other loads. Comes complete with weatherproof, bar graph display that shows the charging condition of each battery; may be remotely mounted. 120v input, 15 amp output. 3-year warranty. *Ship. wt. 17 lbs.*



- Auto Charge 2000
- Auto Eject (20 amp)
- Charge display

AC905 Auto Charge 2000 Kit \$921.95

PUMP PLUS

AIR COMPRESSOR/BATTERY CHARGER PACKAGE

The Pump Plus is a small air compressor and a completely automatic battery charger packaged together. The air compressor is designed to be mounted on vehicles with air brakes to maintain the air pressure in the air brake system while the vehicle is not in use. A pressure switch senses the system pressure and operates the compressor whenever the pressure drops below a predetermined level. Battery charger is completely automatic and is for vehicles with dual battery systems. The batteries are automatically charged and maintain full charge while still being isolated from each other. This unit contains two independent chargers to sense and control the current to the batteries. Designed to mount directly on the vehicle. 12v compressor has 1-yr. warranty; Battery Charger comes with 3-yr. warranty. *Ship. wt. 20 lbs.*



AUTOMATIC DUAL BATTERY CHARGER

Z112A	Pump Plus HO Package	\$1,064.95
Z111	12v DC Auto Pump Compressor	\$575.95
Z112	120v AC Auto Pump Compressor	\$654.95

USB DUAL PORT

- Dual USB charging ports
- Quick and easy way to recharge electronic devices in a vehicle
- 3 Amps max output allows simultaneous charging of two USB devices
- Built-in LED indicator indicates device is powered
- Designed for easy installation in vehicle switch panels
- Reverse polarity protected
- Can be connected to 12V switched ignition or directly to battery
- **Cut-Out-Size:** 1.45"x0.83"
- 3-year warranty
- *Ship. wt. 1 lb.*



BL645	USB Dual Port	\$46.95
BN592	USB Dual Port with Cover	\$58.95

BACK-UP CAMERA SYSTEMS

Proven in the industry, 5" or 7" HD digital LCD system with ultra-clear image in a durable housing, 3 A/V inputs with audio, IP 69 waterproof camera with night vision (white infrared), 65' camera cable, remote bracket. Verity Rear Vision Systems will include a slim base heavy-duty mount free of charge to make installing a breeze.



BN144	Back-Up Camera System with 5" Diagonal Monitor	\$475.95
BN145	Back-Up Camera System with 7" Diagonal Monitor	\$515.95

INVIEW 360 CAMERA

The inView 360™ provides the apparatus driver with split screen view. The bird's-eye view is always visible providing a 360° view around the vehicle. This unique view allows the operator to see pedestrians and obstacles in close proximity to the apparatus or vehicle. The second view on the display switches between front/left/right/rear views depending on the operational conditions. The system is networked between the turn signals, and vehicle reverse so the screen automatically switches to left, right, and rear viewing when turning or backing up. An in-cab toggle switch allows the operator to override the default camera view for complete control over the system.



PACKAGE INCLUDES:

- Front camera
- Rear camera
- 2 side cameras
- Controller
- Cable kit
- Toggle switch
- Monitor is available as an option



BN328	inView 360™ Camera	\$1,949.95
-------	--------------------	------------

SUPER AUTO EJECT & AUTO EJECT

Super Auto Eject is a completely sealed automatic power line disconnect. This prevents contamination of the mechanism by road dirt and insures long, reliable life. Comes with a weatherproof cover that is spring loaded to close, preventing water from entering. A solenoid wired to the vehicle's starter is energized when the engine is started. This instantaneously drives the plug from the receptacle. This simple, reliable device eliminates the broken cables which result when drivers forget to remove the shore line when driving away. The Auto Eject comes without sealed housing. All units come with 120v AC connector. Both models are weatherproof. *Ship. wt. 2 lbs.*

SUPER AUTO EJECT
REAR HOUSING INCLUDED



AUTO EJECT
REAR HOUSING
NOT INCLUDED



SPECIFY COLOR: Red, White, Yellow or Gray

AG130	Super Auto Eject, 15 Amp	\$318.95
AG131	Super Auto Eject, 20 Amp	\$350.95
Y885	Auto Eject, 15 Amp	\$248.95
AF527	Auto Eject, 20 Amp	\$286.95

AUTOMATIC AIR EJECT

This simple, reliable, solid brass device permits pressurizing the vehicle's air pressure system from an external source. Automatically, when the engine is started, the air line is disconnected. Comes with the mating connector, check valve and simple installation instructions. Full 2-year warranty. *Ship. wt. 3 lbs.*

- Automatically disconnects air line when vehicle is started
- Eliminates broken air lines



AG133



AB034	Automatic Air Eject	\$298.95
AG133	Weatherproof Adapter Kit	\$60.95

TANKVISION PRO 300

The TankVision Pro is the fire industry's first multi-color tank level display. It uses a pressure sensor to sense the amount of liquid in the tank and can be calibrated to accurately display the volume in tanks of all shapes and sizes. *Ship. wt. 3 lbs.*



NEW



- Various Programmable multi-color tank level displays available
- More accurate tank level display
- Fractional scale standard, also available with percentage scale
- 9 LED level indicators with fractional scale
- 10 LED level indicators with percentage scale
- Programmable brightness control
- Full 180° wide-view, easy to see display
- The TankVision Pro is available for water, class A foam, and class B foam tanks
- Each display has a distinctive color and style



AR317	TankVision Pro 300 Gauge Kit, with Master Display Sensor and 10' Cable	\$482.14
AS309	TankVision Pro In-Cab Mini Display for Water	\$182.75
AS312	TankVision Pro Remote Driver for "Large Light" Display	\$299.95

WATER LEVEL MONITOR

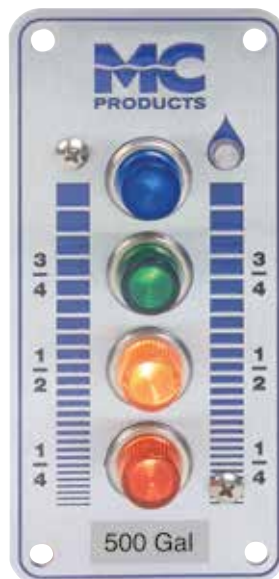

R157

Easy-to-read indicator. Water Level Monitor uses four red lights to show water level in sequence as water drains away. Complete unit includes control box, bezel plate, and stainless steel sensor. *Ship. wt. 1 lb.*

AB016 Includes: 4 domed lenses, 4 replacement bulbs, 2 plate screws and 1 bulb extracting tool

R157 SPECIFY: 12 or 24-Volt, and Tank Dimensions

R157	Water Level Monitor - Negative Ground	\$189.95
AB016	Service Kit for Water Level Monitor	\$19.95

QUINT WATER LEVEL MONITOR

Five-light readout that uses green, amber and red lenses with red flashing refill light. Complete unit consists of readout, bezel plate and stainless steel sensor. Additional readout available without sensor. *Ship. wt. 5 lbs.*

AB017 Includes: 5 domed lenses, 4 replacement bulbs, 1 flasher replacement bulb, 2 plate screws and 1 bulb extracting tool

X940 SPECIFY: 12 or 24-volt, and Tank Dimensions

X940	Quint Water Level Monitor - Negative Ground	\$233.95
X942	Additional Readout	\$129.95
AB017	Service Kit for Quint Level Monitor	\$24.95

LIQUID-FILLED GAUGES

ELIMINATES NEEDLE PULSATION FOR ACCURATE AND EASY READINGS

Crystal-clear Interlube keeps needle fluctuation to a minimum. The SUBZ II freeze-proof isolator keeps gauge working down to -40°F. It's also weather tight so there is no condensation; stops corrosion. Lubricates internal parts, stops wear, maintains accuracy under temperature fluctuations. Zytel (nylon) case with bright stainless steel trim ring has plexiglass lens. 6" gauge has cast aluminum case. Gauges measure 0-600 psi and up to 30" vacuum. *Ship. wt. 5 lbs.*

BLACK AND WHITE FACE GAUGES WITHOUT LOGO ARE AVAILABLE

T179	2 1/2" Liquid-Filled Compound Gauge	\$45.95
AK075	2 1/2" Liquid-Filled Compound Gauge with Bottom Connection	\$43.95
T180	3 1/2" Liquid-Filled Compound Gauge	\$71.95
AK076	3 1/2" Liquid-Filled Compound Gauge with Bottom Connection	\$71.95
T181	4 1/2" Liquid-Filled Compound Gauge	\$96.95
U966	Similar to T181 but with 1000 psi	\$96.95
U967	6" Liquid-Filled Compound Gauge	\$540.95



PANEL HOLE SIZE NEEDED FOR GAUGE INSTALLATION:

2.5" 2.69"(68.33mm)	3.5" 3.78"(96.01mm)
4.5" 4.85"(123.19mm)	Tolerance -.020"(0.51mm)

HEAVY DUTY SWING-OUT™ VALVES

Designed for the harsh realities of today's fire service when water contaminants challenge a valve's sealing capabilities. Swing-Out™ design for quicker and easier servicing. No need to remove valves from plumbing when servicing. Operating pressures to 250 psi (17 bar).

MEETS NFPA



- 90° handle travel
- Stainless steel ball with Hydromax provides longer valve life and improved sealing abilities
- Simple two seated design



Cat#	Description	Size	Weight	Price
P880	Heavy Duty Swing-Out™ Valve	1"	6 lbs.	\$200.95
P881	Heavy Duty Swing-Out™ Valve	1½"	8 lbs.	\$254.95
P882	Heavy Duty Swing-Out™ Valve	2"	12 lbs.	\$344.95
P883	Heavy Duty Swing-Out™ Valve	2½"	24 lbs.	\$419.95
P884	Heavy Duty Swing-Out™ Valve	3"	28 lbs.	\$630.95

BUTTERFLY VALVES

- Rotating the handle to open disc ¼ turn allows an almost unrestricted water flow
- The 10 position lever handle with positive detents allows the valve to be opened or closed incrementally for a controlled water flow
- Comes standard with a bleeder valve
- Available with 4", 4½", 5" or 6" male or female hose
- *Ship. wt. 45 lbs.*



LEVER HANDLE

BL272	6" NHSWFLH x 6" NHM	\$889.95
BL273	5" NHSWFLH x 5" NHM	\$889.95
BL274	4.5" NHSWFLH x 4.5" NHM	\$889.95
BL275	4" NHSWFLH x 4" NHM	\$889.95

HANDWHEEL

BL276	6" NHSWFLH x 6" NHM	\$1,036.95
BL277	5" NHSWFLH x 5" NHM	\$1,036.95
BL278	4.5" NHSWFLH x 4.5" NHM	\$1,036.95
BL279	4" NHSWFLH x 4" NHM	\$1,036.95

VALVE REPAIR KITS

Valve repair kits are convenient, economical and easy-to-use. Each kit contains the most frequently replaced parts to help cut down on maintenance time and costs. Kits come sealed to ensure a clean and adequate supply of parts for each job. Kits now are with new Fusion CF™ Composite ball. *Ship. wt. 1 lb.*

* Valve and nozzle repair kits are available for most Akron, Elkhart and more. Call for details.



Kits for Akron 7800 & 7600 Swing-Out™ Series Valves w/Tork-Lok

AK103	1" Valve Repair Kit	\$72.95
AK104	1½" Valve Repair Kit	\$85.95
AK105	2" Valve Repair Kit	\$116.95
AK106	2½" Valve Repair Kit	\$107.95
AK107	3" & 3½" Valve Repair Kit	\$183.95

Kits for Darley Standard and Full-Flow Valves (excludes ball)

KA00007	2½" Valve Repair Kit for Standard Valves	\$50.95
KA00009	2½" Valve Repair Kit for Full Flow Valves	\$100.95

TANKER DUMP VALVE

Install your own dump valve. Simply screw in the male NPT threaded flange that comes with the package. To this you bolt the valve itself and another NPT threaded flange (gaskets included). It's quick-opening, full-flow, compact, bubble-tight, is easily maintained and mounts in any position. The valve body is rust-proof epoxy coated aluminum. *Allow 4-6 weeks for delivery. Ship wt. 19 lbs.*



SPECIFY THREADS AND SIZES

		Disc Diameter	
M718	3" Dump Valve Package	3⅜"	\$145.95
M719	4" Dump Valve Package	4⅜"	\$209.95
M720	5" Dump Valve Package	5⅞"	\$560.95
R689	6" Dump Valve Package	6⅞"	\$680.95



MAGNESIUM ANODE POLE
ATTRACTS RUST & CORROSION

Sacrificial catalytic action of these magnesium anodes can help to prevent rust or corrosion from attacking your booster tank. Threaded mounting plate suspends the 3/4"x32" solid anode in the tank water. Bar is easily cut to fit tanks less than 32" deep. Comes with flange and gasket. *Ship. wt. 3 lbs.*

U971	Magnesium Anode Pole	\$67.95
------	----------------------	---------



GROUND SWEEP NOZZLE

Designed for use in fixed system applications. Adjustable nozzles can be pre-set at the factory or set in the field at time of installation. The fog pattern, which can be set up to 120°, can easily be set or adjusted at the job site. *Ship. wt. 1 lb.*

SPECIFY MALE OR FEMALE NPT (TAPERED)

Z321	3/4" Fixed Nozzle	\$190.95
Z322	1" Fixed Nozzle	\$212.95



MATTYDALE SWIVEL

Rugged cast brass elbow for use with mattydale hose beds. 1 1/2" NPT female free swivel inlet with 1 1/2" NST male outlet. Rough brass finish. *Ship. wt. 4 lbs.*

U307A	1 1/2" NPT x 1 1/2" NST	\$113.95
U307B	2" NPT x 1 1/2" NST	\$118.95
U307C	2 1/2" NPT x 2 1/2" NST	\$334.95

DARLEY HEAT EXCHANGER

Can be installed in the engine cooling system of any pumper. Instead of going directly into the engine cooling system, mixing with the anti-freeze solution, diluting it and then going out through the radiator overflow pipe, the flow of cool water from the pump bypasses through the condenser coils in the Heat Exchanger. The liquid in the cooling system circulates around the condenser coils and is completely cooled. Prevents loss of anti-freeze solution. Measures 24" long. *Ship. wt. 10 lbs.*



F618	Darley Heat Exchanger	\$260.95
------	-----------------------	----------

RADIATOR HEAT EXCHANGER

FITS BETWEEN RADIATOR HOSES

Does the same job as our F618 Heat Exchanger but fits between the radiator hoses to make installation easier. Only additional connections required are tube lines from pump discharge to return line to suction side of pump. Measures 9 1/2" long. *Ship. wt. 9 lbs.*



SPECIFY SIZE: 1 3/4", 2" or 2 1/4"

R592A	Radiator Heat Exchanger	\$265.95
-------	-------------------------	----------

VERNIER THROTTLE CONTROL

Easily installed throttle designed for apparatus. Provides both instant and micro meter fine adjustment together with a locking action which is not affected by vibration while pumping. Throttles are shipped complete, ready-to-install in 15' or 20' lengths. *Ship. wt. 5 lbs.*



NEW LOW PRICE

F62101	15' Vernier Throttle Control	\$36.95
F62103	20' Vernier Throttle Control	\$39.95

AIR PRIMER

- Super quiet
- Lightweight and small mounting space
- **Power:** Air operated (No electrical power required)
- Corrosion resistant brass construction
- **Oil-less Design:** Environmentally safe
- Self draining
- No moving parts
- **Air Requirements:** (2) Barrel = 7 cfm (3) Barrel = 10 cfm
- BL012 & BL013: For Darley/Waterous pumps
- BL014 & BL015: For Hale pumps

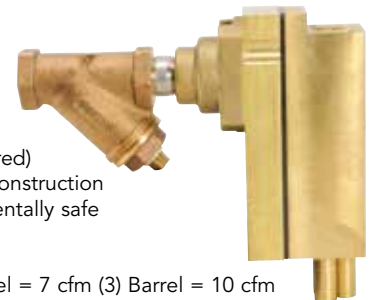

BL012	Air Primer (2) Barrel .75" F NPT-Remote Mtd.	\$932.95
BL013	Air Primer (3) Barrel .75" F NPT-Remote Mtd.	\$932.95
BL014	Air Primer (2) Barrel H-Midship Direct Mtd.	\$932.95
BL015	Air Primer (3) Barrel H-Midship Direct Mtd.	\$932.95

BOOSTER HOSE REELS

INCLUDE ALL THE INFORMATION BELOW.
SPECIFY LEFT/RIGHT BASED ON FACING OUTLET.

For Manual: Specify crank side (left or right)
Specify inlet side (left or right)
Note: Must be same side as motor/crank
Specify Color: Red, Silver, White or Primer Coat
Specify Size No. (see chart)
Specify 90° or Straight Inlet swivel
Specify size (3/4" or 1") and outlet thread type

For Electric: Specify motor side (left or right)
and motor position (front or back)
Note: Must be same side as motor/crank



**RUGGED, LONG
LASTING BOOSTER
HOSE REEL IN CHOICE OF
STEEL OR ALUMINUM TO
HANDLE YOUR 3/4" OR 1"
I.D. BOOSTER HOSE.**

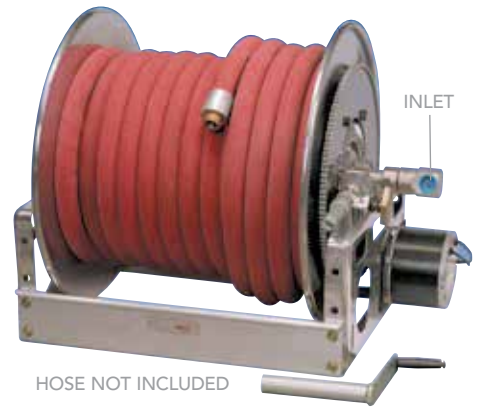

HOSE NOT INCLUDED

ELECTRIC REWIND BOOSTER HOSE REELS

AM167	Aluminum Booster Hose Reel	\$1,539.95
AM168	Steel Booster Hose Reel	\$1,184.95

MANUAL BOOSTER HOSE REELS

AM169	Aluminum Booster Hose Reel	\$1,099.95
AM170	Steel Booster Hose Reel	\$714.95

OPTION

AZ633	Roller and Spool Installed	\$189.95
-------	----------------------------	----------

Size No.	HOSE REEL CAPACITY IN FEET		OVERALL REEL DIMENSIONS IN INCHES			APPROX. STEEL WT. LBS. (CRANK)		APPROX. ALUMINUM WT. LBS. (CRANK)	
	I.D. 3/4" O.D. 1 1/32"	I.D. 1" O.D. 1 1/16"	E	F	G	Net.	Ship.	Net.	Ship.
01	150	100	21 5/8	34 1/4	21 1/2	102	144	80	122
02	150	100	23	25 3/4	23 1/2	92	134	75	117
03	250	150	23	32 1/4	23 1/2	105	147	82	124
04	200	100	28 3/4	18 1/4	29 7/8	100	150	80	130
05	250	150	28 3/4	21 1/4	29 7/8	107	157	83	133

"F" dimension is the same for both electric & manual models. Add 40 lbs. to weights shown for electric models.

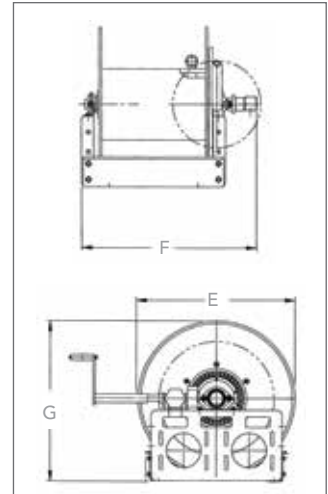

ROLLER AND SPOOL ASSEMBLY

Speed your hose handling and reduce wear on hose. Buffed stainless steel rollers. Assembly includes roller, 2 blocks, 2 spools, bearings and all fastenings. Length of roller should be the same as the reel drum length. (Larger sizes are available for an extra charge). *Ship. wt. 13 lbs.*



SPECIFY LENGTH: Up to 38"

R698	Roller and Spool Assembly	\$154.95
------	---------------------------	----------

SWIVEL JOINTS

Pressure balanced design for low rotation torque. Hardened carbon steel barrel for strength and long wear. NPT threads. *Ship. wt. 3 lbs.*



AF774	1 1/2" Swivel Joint	\$249.95
T961	1" Swivel Joint	\$101.95
T963	1" Seal Kit for T961	\$39.95

DROP-IN STYLE BOOSTER REEL

These reels are an excellent choice for drop-in units or smaller apparatus compartments where space is a premium. They're built to the same design standards as our larger reels, just lighter in weight and more compact. Available in either electric or crank rewind. Reels will hold up to 100' of 1" or 200' of 3/4" booster hose. **Dimensions:** (E) Crank/16.5", (E) Elec/19", (F) Crank/46.62", (F) Elec/39.75", (G) 18.12".

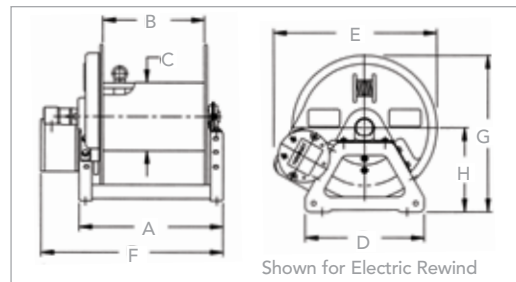

Shown for Electric Rewind

AJ513	Drop-In Style Booster Reel/Electric	\$799.95
AJ514	Drop-In Style Booster Reel/Crank	\$399.95

BRACKETS, TUBING & GRAB RAILS

The F615 Surface Mount End Bracket bolts to any horizontal or vertical flat surface. The F617 Center Mount Bracket is used in the center of long railings for support. The AB044 Slip-Resistant Grab Rail is extruded aluminum tubing with black rubber inserts. *Ship. wt. 1 lb.*



AB044: SPECIFY LENGTH NEEDED

F615	Surface Mount End Bracket	\$13.95/ea.
F617	Center Mount Bracket	\$12.95/ea.
AB044	Aluminum Slip-Resistant Grab Rail	\$16.95/ft.

DECORATIVE CHROME-PLATED FIRE BELL

Beautiful, large 12" Fire Bell, cast in bronze with polished chrome finish. Comes with stand and clapper. Available with your choice of decorative ornamental top eagle or acorn nut. *Ship. wt. 40 lbs.*



R181	12" Bell with Eagle, Chrome-Plated	\$1,445.95
R182	12" Bell with Acorn, Chrome-Plated	\$1,515.95
AS418	12" Bell with Eagle, Gold	\$1,643.95

QUIC-CHOC® FOLDING WHEEL CHOCK

This new folding aluminum wheel chock requires only a 6"Hx10½"W x20⅞"D area for storage. Can be stored under fire or rescue vehicles. The collapsible design allows the chock to lock in the open position simply by pulling out the back casting and pushing down. Just release the safety latch to close back into the folding position. Convenient carrying handle makes transport and placement of chock a snap. Made of high-tensile strength aluminum with rear opening, hand grip and a double row of rugged teeth to grip almost any surface. Meets applicable NFPA standards.



REQUIRES LESS STORAGE SPACE



- Can be used with tires up to 44" in diameter in the open position



AG083	Folding Wheel Chock	\$308.95
AG084	Folding Wheel Chock Horizontal Holder	\$89.95

CONVERT YOUR WHEEL CHOCK FOR WILDLAND FIRE FIGHTING

BA159	Wildlands Adapter for Folding Wheel Chock	\$54.95
BA160	Wildlands Adapter Horizontal Holder	\$129.95

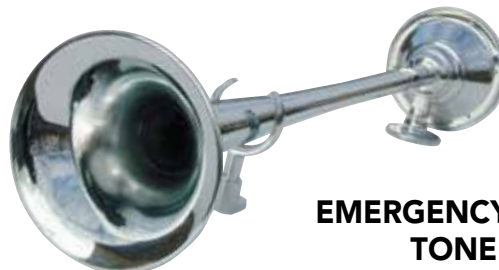

EMERGENCY STUTTER TONE AIRHORN

Emergency vehicles can travel with more safety when equipped with emergency airhorns emitting directional, machine gun series of blasts. Operates on pressure up to 125 lbs. controlled by an electric valve. Connects directly to air brake junction box. Chrome plated; measures 24½" with 6" flare. *Ship. wt. 7 lbs.*

AA957	Emergency Stutter Tone Airhorn	\$314.95
-------	--------------------------------	----------

OVERSIZED FOLDING STEPS

Easily installed on apparatus wherever a convenient assist step is needed. Folds up flush against mounting surface. Made of high-strength die cast, zinc/aluminum alloy with corrugated safety step to prevent slipping. *Ship. wt. 1 lb.*



AB990	Oversize Folding Step	\$65.95
AB043	Stainless Steel Folding Handhold	\$21.95

FOLDING STEP



- High quality CASS 24 chrome plate finish
- Dual LED light integration with full seal housing
- Ball-bearing rotation with no metal to metal contact
- Integral grab handle
- Largest platform on the market (8.7"x6.7")
- Reflective tape with color options
- Cast recess for circular logo options on platform
- Bolt pattern retrofitable
- NFPA Compliant tread pattern for the most weatherable conditions

BN604	Folding Step	\$58.95
BN320	Folding Step with Lights	\$63.95

TURTLE TILE® COMPARTMENT MATTING

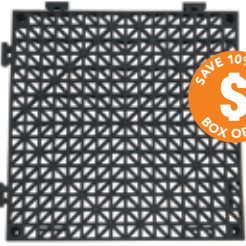

SAVE 10% ON
BOX OF 36



SHOWN WITH OPTIONAL
EDGE & CORNER RAMPS

- 3/4" profile
- Heavy-duty
- Fast and easy-to-install
- Open grid profile for instant drainage
- Made in USA from recycled plastic
- Modular and interlocking
- Resistant to most hydraulic fluids
- Mount brackets directly to tiles
- Dimensions: 12"x12"x3/4"
- Shop additional colors on edarley.com

COLOR: Black		Box of 36	Each
AF680	Turtle Tile®	\$179.95	\$6.95
AF681	Male Edge	—	\$4.95
AF682	Female Edge	—	\$4.95
BP370	Male Corner Ramp	—	\$3.95
BP372	Female Corner Ramp	—	\$3.95



TRUCK MADE™ STORAGE SOLUTIONS

"ORGANIZING AMERICA'S FIRE TRUCKS"



- Won't rust, crack or dent
- Mounts directly into compartments with the U308 equipment glides
- FDA-approved non-porous material
- Lightweight and stackable
- Perfect for any hazardous or bio-terrorist compliance issue
- Custom sizes and engravable front plates are available. Call for details.



SPECIFY COLOR: Matte Black, Gloss Black, Gloss White, Matte Blue, Matte Red or Matte Yellow

AZ526	3"x22"x30" Polypropylene Tray	\$159.95
AZ527	3"x22"x40" Polypropylene Tray	\$159.95
AZ528	10"x10"x22" Polypropylene Box	\$144.95
AZ529	10"x10"x40" Polypropylene Box	\$199.95

EMERGENCY VEHICLE REFLECTIVE STRIPING

For improved visibility and a more professional look to all your emergency vehicles. Reflective striping with pressure-sensitive adhesive backing. Comes in 150' rolls so you can cut to size depending on the area of coverage. Easy-to-install. Comes standard in white. *Ship. wt. 5 lbs.*

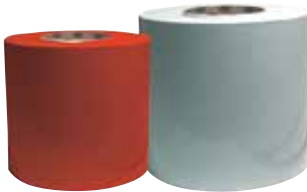

Cat#		1"	2"	3"	4"	6"
AZ467	Red Striping	\$61.95	\$132.95	\$196.95	N/A	N/A
AZ469	White Striping	\$61.95	\$132.95	\$183.95	\$245.95	\$393.95

FIREMAN'S FRIEND DRYING CLOTH

This large 17"x27" drying cloth soaks up large volumes of water and other liquids quickly. The soft, absorbent material will not scratch or leave lint. It dries quicker and easier than chamois or any other towel you can find. *Ship. wt. 1 lb.*



T235	Fireman's Friend Case of 6	\$12.95 \$9.95/ea.
------	----------------------------	-----------------------



SUNSTRIP ULTRABRIGHT LED LIGHT

ULTRABRIGHT WHITE LED LIGHT FOR COMPARTMENTS, PANELS, UNDER BODY APPLICATIONS, WALKWAYS & STAIRWELLS

- More than 300 lumens of LED light per 18" length
- LEDs housed in a strong 5/8" diameter lexan tube
- Designed tough to withstand any vehicle vibration
- Waterproof and submersible
- Great for all applications and easy to install
- Long operating hours – rated at 50,000 hours
- 5-year LED lighting warranty

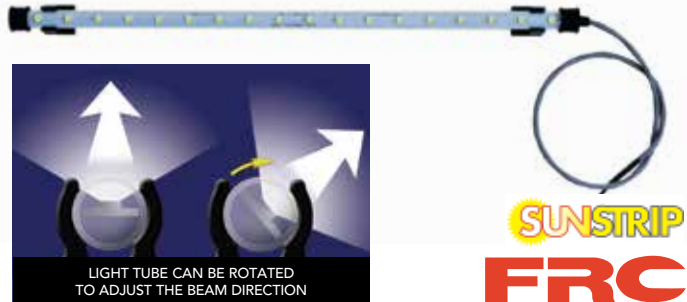

LIGHT TUBE CAN BE ROTATED TO ADJUST THE BEAM DIRECTION



A Safe Fleet Brand

Cat#	Description	Length	Lumens	Current@12v	Price
BK352	LED 12vdc SUNSTRIP Light	9"	150	0.17 amps	\$65.92
BK353	LED 12vdc SUNSTRIP Light	18"	300	0.35 amps	\$81.81
BK354	LED 12vdc SUNSTRIP Light	27"	450	0.52 amps	\$114.66
BK355	LED 12vdc SUNSTRIP Light	36"	600	0.70 amps	\$133.56
BK356	LED 12vdc SUNSTRIP Light	45"	750	0.87 amps	\$167.45

LITTLE GIANT DEFENDER™ LADDER

The Little Giant Defender™ was specifically engineered for firefighters who need speed and strength in a rapid-response portable ladder system.

- Reflective, heat sensitive labels
- Easy-to-use Rock Lock® adjuster
- Built-in dual Ratchet™ levers. Adjust up to 8.5" on each side over uneven ground
- Tip & Glide™ wheels
- Wide-flared extension ladder for improved side-tip stability
- Adapts to almost any situation, offering a safe, stable climbing solution
- Capable of dozens of configurations, including A-frame, staircase, extension, and 90°
- Exceeds all OSHA & ANSI standards. Certified to NFPA requirements 1931/1932
- Rated to 300 lbs.
- Built-in dual Ratchet Levelers™ adjust up to 8.5" on each side over uneven ground
- Counts as ISO footage on apparatus

Cat#	Description	Stepladder		Extension		Wt.	Price
		Min Ht.	Max Ht.	Min Ht.	Max Ht.		
BN613	17' Defender™ Ladder	4'	7'	9'	15'	39 lbs.	\$503.95
BN614	22' Defender™ Ladder	5'	9'	11'	19'	47 lbs.	\$571.95



LITTLE GIANT OVERHAUL LADDER

Little Giant Ladder Overhaul Ladder extends to 17', but it is small enough to carry into an elevator, up a flight of stairs, or around tight corners. The ladder is just 47" tall when retracted. Articulating ladder systems that meet the requirements of NFPA 1901-2009.

- Safety Insight™ photo-luminescent glowing rungs
- Patented Rock Lock™ adjusters
- Wide-stance leg levelers adjust over uneven ground
- Tip & Glide™ wheels
- 90° position for extraction rescue
- Access uneven surfaces, staircases, and hard-to-reach places
- Ratchet Levelers™
- Roof and rafter hooks
- Dual-position spike feet
- Counts as ISO footage on apparatus

Cat#	Description	Stepladder		Extension		Wt.	Price
		Min Ht.	Max Ht.	Min Ht.	Max Ht.		
BN615	17' Overhaul Ladder	4'	7'	9'	15'	52.3 lbs.	\$1,036.95



All ladders over 8' are shipped via motor freight. All orders **MUST BE** inspected before acceptance upon delivery.

USE SKULL SAVERS DON'T RISK LADDER INJURIES

Walking into the heel of a ladders always painful and extremely dangerous. Skull Saver is easily visible and cushions any contact. Slight tug opens the Velcro® fastener, closes with finger pressure. Stays on in high winds, rain, or ice. Includes extra strap for permanent attachment to apparatus. *Contact us for pricing on custom sizes. Ship. wt. 6 lbs.*



AW345



R891	Single Leg 4" Hx9"Wx5"D	\$70.92
R891XA	Super (A)* 23" Hx9"Wx8"D	\$119.90
R891XB	Super (B)** 22" Hx5"Wx8"D	\$119.90
U697	Super Duper 27" Hx12"Wx8"D	\$134.88
AW345	USA Flag 23" Hx9"Wx8"D	\$119.90
AW346	USA Flag 27" Hx12"Wx8"D	\$134.88

*Super (A) model is for two-section ladders made after June 1984.

**Super (B) model is for two-section ladders made prior to June 1984.

LOCKING LADDER BRACKET



SHOP FOR EVEN MORE APPARATUS ACCESSORIES ON EDARLEY.COM/APPARATUSEQUIP

AF694	Locking Ladder Bracket	\$109.95/ea.
-------	------------------------	--------------

DUO SAFETY LADDERS



ALUMINUM FIRE LADDERS

TWO-SECTION (900-A SERIES)

Solid beam aluminum construction. Duo-Safety exclusive tongue and groove construction that holds sections firmly and rigidly, without brackets, hooks, or obstructions.

Cat#	Length	Closed	Width	Weight	Price
S965A	20'	12' 2 ³ / ₄ "	21 ³ / ₄ "	60 lbs.	\$580.95
S965	24'	14' 2 ³ / ₄ "	21 ³ / ₄ "	71 lbs.	\$648.95

Banking thickness = 5³/₈"

THREE-SECTION (1225-A SERIES)

Cat#	Length	Closed	Width	Weight	Price
S970A	30'	13' 3"	24"	108 lbs.	\$990.95
S970	35'	15' 3"	24"	130 lbs.	\$1,085.95

Banking thickness = 9¹/₈"

FOLDING LADDERS

Lightweight, these ladders fold into a compact bundle for storing or carrying. In the open position, special locking devices keep the ladders absolutely rigid. Equipped with Duo-Safety Ladder shoes as an extra precaution. 300 lb. duty rated.

ALUMINUM (585-A SERIES)

Cat#	Length	Closed	Width	Weight	Price
S956	8' 3 ¹ / ₄ "	9' 3 ¹ / ₂ "	12 ¹ / ₈ "	14 lbs.	\$183.95
S956A	9' 3 ¹ / ₄ "	10' 3 ¹ / ₂ "	12 ¹ / ₈ "	16 lbs.	\$206.95
S957	10' 3 ¹ / ₄ "	11' 3 ¹ / ₂ "	12 ¹ / ₈ "	19 lbs.	\$221.95
S958	12' 3 ¹ / ₄ "	13' 3 ¹ / ₂ "	12 ¹ / ₈ "	21 lbs.	\$239.95
S959	14' 3 ¹ / ₄ "	15' 3 ¹ / ₂ "	12 ¹ / ₈ "	24 lbs.	\$253.95

Banking thickness = 1³/₄" x 3¹/₄"

FIBERGLASS FIRE LADDERS

Fire ladders using extruded fiberglass channel rail construction and aluminum rungs welded to aluminum bocks and riveted to the fiberglass side rails. Safety yellow color for better visibility.

TWO-SECTION LADDERS (YGE-2 SERIES)

Cat#	Extended	Closed	Width	Nested	Weight	Price
R639	16'	10'	23"	7"	80 lbs.	\$699.95
R640	20'	12' 3 ¹ / ₂ "	23"	7"	94 lbs.	\$961.95
R641	24'	14' 3 ¹ / ₂ "	23"	7"	105 lbs.	\$1,040.95

WALL LADDERS (YGW SERIES)

Cat#	Length	Width	Height	Weight	Price
R642	12'	19 ¹ / ₄ "	3 ³ / ₈ "	28 lbs.	\$347.95
R643	14'	19 ¹ / ₄ "	3 ³ / ₈ "	32 lbs.	\$370.95
R644	16'	19 ¹ / ₄ "	3 ³ / ₈ "	37 lbs.	\$381.95

ROOF LADDERS (YGR SERIES)

Cat#	Length	Closed	Width	Weight	Price
R645	12'	19 ¹ / ₄ "	3 ³ / ₈ "	33 lbs.	\$370.95
R646	14'	19 ¹ / ₄ "	3 ³ / ₈ "	38 lbs.	\$401.95
R647	16'	19 ¹ / ₄ "	3 ³ / ₈ "	42 lbs.	\$452.95

ALUMINUM ROOF LADDERS

Channel Rail construction gives extra strength without cumbersome weight.

(775-A SERIES)

Cat#	Length	Width	Weight	Price
S976	10' 2 ¹ / ₂ "	19"	24 lbs.	\$253.95
S977	12' 2 ¹ / ₂ "	19"	28 lbs.	\$277.95
S978	14' 2 ¹ / ₂ "	19"	31 lbs.	\$302.95

Banking thickness = 2³/₄"

All ladders over 8' are shipped via motor freight. All orders **MUST BE** inspected before acceptance upon delivery.

ALCO-LITE ALUMINUM LADDER COMPANY

TRUSS TYPE LADDERS

TWO-SECTION LADDERS (TEL SERIES)

Oversized 2 1/4" pulley for easy operation. 45' and larger ladders equipped with stay poles.

	Ext. Closed		Banking		Wt.	Price
	L	L	W	Thickness		
Z354	20'	13'0"	22 1/4"	6 7/16"	93 lbs.	\$1,011.95
Z355	24'	15'4"	22 1/4"	6 7/16"	110 lbs.	\$1,113.95
Z356	28'	16'6"	22 1/4"	6 7/16"	118 lbs.	\$1,312.95
Z357	30'	17'8"	22 1/4"	6 7/16"	126 lbs.	\$1,421.95
Z358	35'	20'0"	22 1/4"	6 7/16"	141 lbs.	\$2,029.95
Z359	40'	22'4"	23 1/2"	8 1/8"	214 lbs.	\$2,222.95
Z360	45'	25'10"	23 1/2"	8 1/8"	232 lbs.	\$2,306.95

THREE-SECTION LADDERS (TEL3 SERIES)

3-fly section activated by cable and operates automatically with center section. Oversized 2 1/4" pulley for easy operation. 45' and larger ladders equipped with stay poles.

	Ext. Closed		Banking		Wt.	Price
	L	L	W	Thickness		
Z347	24'	12'0"	25 3/8"	9 1/16"	142 lbs.	\$1,801.95
Z348	28'	13'2"	25 3/8"	9 1/16"	154 lbs.	\$1,832.95
Z349	30'	14'4"	25 3/8"	9 1/16"	163 lbs.	\$1,520.95
Z350	35'	15'6"	25 3/8"	9 1/16"	175 lbs.	\$1,885.95
Z351	40'	16'8"	27"	9 1/16"	223 lbs.	\$1,996.95
Z352	45'	19'0"	27"	10 3/4"	242 lbs.	\$2,635.95
Z353	50'	20'2"	27"	10 3/4"	273 lbs.	\$2,928.95

ROOF LADDERS (TRL SERIES)

Designed for scaling roofs. High-strength steel, 3/4" rotating roof hooks with reinforcing brace.

	L	W	Wt.	Price
Z362	12'5"	19 1/16"	43 lbs.	\$532.95
Z363	14'9"	19 1/16"	50 lbs.	\$563.95
Z364	16'11"	19 1/16"	56 lbs.	\$640.95
Z365	18'2"	19 1/16"	60 lbs.	\$668.95

Z362-Z367 Banking thickness = 3 3/4"

	L	W	Wt.	Price
Z366	20'6"	19 1/16"	65 lbs.	\$586.95
Z367	24'0"	19 1/16"	76 lbs.	\$851.95
AR162	26'4"	19 1/16"	92 lbs.	\$945.95
AR163	28'8"	19 1/16"	100 lbs.	\$1,020.95

AR162 and AR163 Banking thickness = 5 1/8"

COMBINATION LADDERS

Functionally engineered for ease of operation as a step or extension ladder with dozens of uses. Compact design converts easily to extension ladder or "A" ladder. Accessible from both sides. Special heavy duty "A" bracket allows for quick, easy set-up. Meets NFPA.

	L		A-Ht		A-W		Wt.	Price
	L	A-Ht	A-W	W				
P704	6'2"	5'10"	4'3"	20 1/2"	27 lbs.	\$522.95		
P705	7'4"	7'0"	4'11"	20 1/2"	29 lbs.	\$588.95		
P706	8'6"	8'2"	5'4"	20 1/2"	33 lbs.	\$622.95		
P707	9'8"	9'1"	6'5"	20 1/2"	38 lbs.	\$671.95		

Banking thickness = 6 3/8"

ALUMINUM PUMPER TYPE LADDERS

TWO-SECTION LADDER (PEL SERIES)

Oversized 2 1/4" pulley for easy operation.

	Ext. Closed		Banking		Wt.	Price
	L	L	W	Thickness		
Z373	12'	8'5"	21"	5 1/16"	48 lbs.	\$494.95
Z374	14'	9'7"	21"	5 1/16"	53 lbs.	\$545.95
Z375	16'	10'9"	21"	5 1/16"	59 lbs.	\$598.95
Z376	20'	12'0"	21"	5 1/16"	66 lbs.	\$672.95
Z377	24'	14'3"	21"	5 1/16"	75 lbs.	\$748.95
Z378	28'	16'7"	22"	5 13/16"	114 lbs.	\$971.95
Z379	30'	17'9"	22"	5 13/16"	122 lbs.	\$1,048.95
Z380	35'	20'1"	22"	5 13/16"	139 lbs.	\$1,181.95

THREE-SECTION LADDERS (PEL3 SERIES)

3-fly section activated by cable and operates automatically with center section. Oversized 2 1/4" pulley for easy operation.

	Extd. Closed		Banking		Wt.	Price
	L	L	W	Thickness		
Z368	24'	12'2"	23 1/2"	7 1/4"	105 lbs.	\$1,070.95
Z369	28'	13'4"	25"	8 1/4"	145 lbs.	\$1,170.95
Z370	30'	14'6"	25"	8 1/4"	158 lbs.	\$1,295.95
Z371	35'	15'8"	25"	8 1/4"	170 lbs.	\$1,388.95
Z372	40'	17'0"	26"	8 1/4"	220 lbs.	\$2,027.95

ROOF LADDERS (PRL SERIES)

High-strength steel, 3/4" rotating roof hooks with reinforcing brace for durability.

	L	W	Wt.	Price
Z381	8'5"	18 1/2"	27 lbs.	\$254.95
Z382	10'9"	18 1/2"	33 lbs.	\$319.95
Z383	12'0"	18 1/2"	36 lbs.	\$340.95
Z384	14'3"	18 1/2"	42 lbs.	\$364.95

Banking thickness = 2 7/8"

	L	W	Wt.	Price
Z385	16'7"	18 1/2"	48 lbs.	\$413.95
AR160	18'10"	18 1/2"	54 lbs.	\$421.95
AR161	20'0"	18 1/2"	60 lbs.	\$589.95

Banking thickness = 2 7/8"

FOLDING ATTIC LADDERS

The ultimate in lightweight portability for low to medium height access. Folds laterally into 5 1/4" wide. Hinge locks ladder into position. Features carrying handles and large, heavy cast aluminum swivel safety shoes for traction. Meets NFPA.

	Open		Folded		Wt.	Price
	L	L	W	W		
Z390	8'3"	9'3"	5 1/4"	15 1/2"	12 lbs.	\$221.95
Z391	10'6"	11'5"	5 1/4"	15 1/2"	14 lbs.	\$265.95
Z392	12'8"	13'8"	5 1/4"	15 1/2"	17 lbs.	\$288.95
Z393	14'11"	15'11"	5 1/4"	15 1/2"	21 lbs.	\$314.95

Banking thickness = 2"



All ladders over 8' are shipped via motor freight. All orders **MUST BE** inspected before acceptance upon delivery.

EMERGENCY LIGHTS AND SIRENS

FOCUS LAMPHEAD

VERSATILE LOW PROFILE LAMPHEAD. COMPACT. DURABLE.

DON'T WASTE PRECIOUS LIGHT

The high intensity FOCUS lamphead does not waste precious light. It is designed to focus 100% of the light produced into the area where it is needed. The FOCUS is built tough and has a compact design that allows it to be mounted in places that traditional lighting fixtures do not fit.

BREAKTHROUGH IN SCENE LIGHTING

The FOCUS lamphead was designed to light up the emergency scene evenly, putting 100% of the light on the scene. A high percentage of the light produced by a conventional light fixture is wasted away from the emergency scene and gets dim at a distance. The FOCUS lamphead uses a uniquely designed patented reflector to eliminate wasted light. The curved reflector has over 50 parabolic surfaces that redirect all of the light produced and focus it evenly into the action areas. This allows the FOCUS to put all of the light onto the scene, providing more light close to the vehicle as well as being brighter at a distance.

- AM262: Top mount, top raise pole with FOCUS lamphead
- AM263: Side mount, bottom raise pole with FOCUS lamphead
- AM266: FOCUS lamphead only

SPECIFY WATTAGE

Watts	Volts	Amps	AM262	AM263	AM266
300	12	25	\$810.55	\$810.55	\$416.38
500	120	4.2	\$716.81	\$716.81	\$323.78
1000	120	8.3	\$810.35	—	\$387.53
1000	240	4.2	\$810.55	—	\$387.53



SPECTRA LED LAMPHEAD SERIES

THE BRIGHTEST LED SCENE LIGHTS AVAILABLE.

The SPECTRA LED lamphead outputs an impressive 20,000 lumens of super bright white light. The advanced lens and unique arrangement of LEDs generates a uniform flood and spot combination light pattern. This light pattern provides enhanced work area visibility as well as illuminates objects at a farther distance. The NEW SPECTRA MAX outputs an unmatched 28,000 lumens of ultrabright light making it the brightest LED scene light available. All SPECTRA series lampheads can be used with any FRC telescopic poles, tripods, non-telescopic mounts, and brow mounts.

- Available as 20,000 lumens SPECTRA or 28,000 lumens SPECTRA MAX
- Unique arrangement of LEDs provides more light in a compact lamphead
- Models available in 120/240 VAC or 12/24 VDC
- Whiter light, closer to natural sunlight
- Uniform high quality white light with the widest light pattern
- Long operating hours, rated at 50,000 hours
- Instant-on at full intensity
- 5-year LED lighting warranty



BL749	SPECTRA LED Lamphead 120 VAC 20k Lumens	\$1,420.95
BL750	SPECTRA MAX LED Lamphead 12/24 VDC 28k Lumens	\$1,562.95
BL751	SPECTRA LED Lamphead 120 VAC 20k Lumens Portable with On/Off Switch	\$1,714.95
BL752	SPECTRA MAX LED Lamphead 120 VAC 28k Lumens with Standard Tripod	\$2,059.95

STREAMLIGHT™ PORTABLE SCENE LIGHT II 10,000 LUMENS, WATERPROOF, STACKABLE

Turn to a higher power with the Portable Scene Light II. With zero deployment time, it features a compact footprint, a 360° rotating head, and it's stackable for "light tower" capability with multi-level lighting. *Dimensions: 16"x11"x12"*

- 18 LEDs within wide pattern parabolic reflectors produce a smooth, high lumen flood pattern
- Five intensity levels correspond to desired run time
- 360° rotating head
- High-impact, thermoplastic housing mounted in a virtually indestructible alloy steel frame IPX7 rated; waterproof to 1m for 30 minutes
- Lithium ion batteries charge in 6 hours
- Batteries will continue to charge while plugged into an AC or DC power source
- Limited lifetime warranty



STACKABLE,
SOLD INDIVIDUALLY



BP080 Streamlight™ Portable Scene Light II - 120 AC/12V DC

\$799.95

QUADRAFLARE™ 9"X7" LED PERIMETER WARNING LIGHT

- NFPA 1901 and GSA KKK-E compliant models
- Outstanding off-axis warning
- 26 built-in flash patterns, including "Quad-X" and "Steady"
- Flash patterns are push-button programmable
- Independent side control on split LED models
- Clear or color lens options
- Available with built-in flasher featuring 16 selectable patterns
- 5-year warranty on LED components

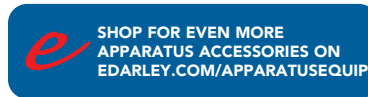

SPECIFY LED COLOR: Amber, Blue or Red

BG199	QuadraFlare™ Color Lens LED Warning Light*	\$151.95
BG200	QuadraFlare™ Clear Lens LED Warning Light	\$151.95
BG201	Chrome Trim Bezel with Gasket	\$14.95
BH077	9"x7" QuadraFlare™ LED Warning Light Colored Lens	\$235.95
BH078	9"x7" QuadraFlare™ LED Warning Light Clear Lens	\$235.95
BH095	Chrome Trim Bezel	\$21.95
BH096	Black Trim Bezel	\$19.95



SHOWN W/BG201

VANTAGEPOINT REMOTE CONTROL LIGHT ALLOWS FOR MAXIMUM PAN-TILT MOTION

Whether searching for a person in an emergency situation or illuminating a house number, VantagePoint offers the ultimate in remote control lighting. High-intensity LEDs deliver ultra-bright white light taking performance to the next level. Control the unit from inside the vehicle or remotely from up to 130' (40 m) away. Operators will appreciate the unique stow feature because the light returns to the forward facing position when turned off.

- 360° continuous horizontal rotation
- Pan and tilt motion
- Total tilt positioning of 115°
- Ultra bright 6720 lumens
- Weatherproof to IP67
- Two remote controls included
- Flashing alert
- 5 year limited warranty



BP327 VantagePoint Remote Control LED Light

\$547.95

HONDA GENERATOR LIGHTS

EU1000/EU2000 Honda Generator with 500W LED/quartz lamp head kit provides 500 watts of LED lighting. These generator/lighting units are powered by the Honda inverter-style generator and are light-weight and fold for compact storage.

- **Clean Power:** run sensitive electronics
- **Eco-Throttle Technology:** long running time
- **Parallel Operation:** optional linking doubles power
- **Simultaneous AC/DC**

USES

- Emergencies
- Public Services & Utilities
- Recreation

Cat#	Generator	Light Watts	Price
BN256	Honda EU1000	500 Quartz Lamp	\$1,685.95
BN257	Honda EU1000	500 LED Lamp	\$2,608.95
BN258	Honda EU2000	500 Quartz Lamp	\$2,018.95
BN259	Honda EU2000	500 LED Lamp	\$2,938.95



NEW

THE REVEL SCOUT SCENE LIGHT

Revel Scout Scene Light is designed to increase the safety of both firefighters and emergency responders. With versatile mounting options; set, hang, strap, spike and a removable, rechargeable battery, the Revel Scout revolutionizes the operational ease of fire scene lighting. The Revel Scout combines a spot and flood light pattern of 14,000 lumens in a 12 lb. package, and the LED tactical scene light can be used to evenly light exterior scenes and interior spaces.

- Fast, flexible deployment
- Light where you need it
- Integrated strap included to secure to horizontal object, ladder rung, etc.
- On/off toggle switch to turn light on and off and adjust to 4 light levels
- Corrosion-free construction
- Zero deployment time
- **Battery Type:** 28v LI-ION, **Weight:** 3 lbs. **charge time:** 1 hr
- **Warranty:** Light Assembly: 6 years, battery and charger: 1 year



VIDEO ONLINE ▶

LIGHT PERFORMANCE

- **Four Light Levels:** High, medium, low, spot
- **Light Output:** 14,000, 8,000, 2,000, 6,000 lumens
- **Average Run Time:** high - 1.2 hrs, medium - 3 hrs, low - 7 hrs, spot - 3.5 hrs



BN312	Revel Scout Scene Light	\$1,267.95
-------	-------------------------	------------

OPTIMUM PORTABLE LIGHT BRIGHTEST LAMPHEADS AVAILABLE

EFFICIENCY

- The brightest and best designed lights in the industry. A unique reflector design transfers more light from the bulb to the scene.

RELIABLE & TESTED

- Manufactured from heavy-duty, thick aluminum for long life and many hours of dependable performance. Tested under actual emergency situations.



AZ509	Portable Light 500W 120V QTZ with 15 Amp 3-Prong Twist-Lock	\$639.45
-------	-------------------------------------------------------------	----------

PORTABLE HAND LIGHT

A powerful 500w (120v) light head features a highly-polished specular hammertone reflector which almost doubles its light output. Sturdy aluminum housing with high-temperature carrying handle and tilt control knob. Heavy-duty ground tripod base with rubber footings. Optional mounting bracket allows you to mount it in any position. *Meets NFPA; UL Listed.*
Ship. wt. 3 lbs.



AR301	Portable Hand Light	\$332.95
AR302	Mounting Bracket	\$60.95

HONDA 4000 W ECONOMY SERIES GENERATOR

RUGGED AND RELIABLE, THE ECONOMY SERIES GENERATORS ARE EASY TO TAKE ANYWHERE. JUST LOAD 'EM UP AND GO.

- 4000 watts maximum of rugged economical, portable power
- Honda GX commercial grade engine
- Oil alert
- Digital Automatic Voltage Regulator (DAVR)
- AC circuit breaker/protectors and 120/240V operation
- Recoil start
- Runs 15 hrs. on 1/2 load
- Delivers the best of both worlds: reliability and cost savings
- Dimensions: 26.8"x22.8"x22.5"
- Weight: 155 lbs.
- 3-year warranty



BL748 Honda 4000 W Economy Series Generator \$1,793.95

DIESEL GENERATORS

- Individual circuit breakers
- Kohler® engine
- Electric start/recoil start
- Automatic low-oil shutdown
- Voltmeter
- Hour meter
- Heavy-duty frame
- Steel fuel tank
- Extended run-time
- Easy maintenance
- 2-year warranty
- Weight: 266 lbs.
- Run-Time: 14 hrs @ 50% load



Cat#	Watts	HP	Weight	Dimensions	Price
BL418	6000	10	187 lbs.	35 1/2"x23"x24 1/2"	\$5,899.95

HONDA GENERATORS



- Heavy-duty frame protects generator from damage
- Larger 6.6 gallon fuel tank for longer run times
- Multiple front panel outlets for easy power connections
- Wide handles for easy transport
- Honda GX Industrial Commercial engine for easy starting, reliability, and Oil Alert®
- Oversized muffler for quieter operation
- Four step fuel filtering provides consistent fuel to prevent carburetor plugging
- AVR provides consistent, stable power output, superior to brushless generators
- Auto Choke for easier starting in varying conditions

Cat#	Watts	HP	Weight	Dimensions	Price
BB088	5000	11	223 lbs.	41.9"x27.2"x29.2"	\$2,613.95
BB089	6500	13	227 lbs.	41.9"x27.2"x29.2"	\$3,286.95

CORD REEL LIGHT

Cord Reel Lights are reverse-wired live cord reels, which allows a plug on the cord to be plugged into a power source while the Cord Reel Light is carried to the fire ground or work site. The Cord Reel Light allows the scene to be illuminated while providing a receptacle for additional tools or lights. Akron Brass Cord Reel Lights come in 10" cord reels with either 500 or 750 watt low profile Beta Light heads.

- Heavy-duty construction
- Powder coated
- Live slip ring design
- Adjustable tension nut
- 6' direct wire pigtail (10/3 Black)
- Meets NFPA requirements



Cord not included

BB090	Cord Reel Light 500 Watt	\$1,034.95
BB092	Cord Reel Light 750 Watt	\$1,067.95



FEDERAL SIGNAL 100 WATT SPEAKER

The 100 watt speaker uses advanced housing material and field replaceable neodymium drivers to provide effective, high-quality sound at an affordable price. The speaker only weighs 6 lbs. and measures 7.7"Wx5.7"Hx4.7"D. The speaker is easily rotated allowing for either vertical, or horizontal mount orientation, and the P.E.T. (polyethylene terephthalate) housing material is exceptionally strong, while resistant to heat, moisture and will not corrode as most metallic materials do. *Ship wt. 6 lbs.*



AW243 100 Watt Speaker \$177.95

TRUCK MOUNT SPEAKER

Rectangular speaker is perfect for truck mounting. Made to take the heavy and extended use of today's vehicle applications. Has black baked enamel finish on the driver and rectangular bell is black plastic. *Ship. wt. 10 lbs.*



AB343 100-Watt Truck Mount Speaker \$136.95

PA 300 ELECTRONIC SIREN

PLUG IN PC BOARD - INCLUDES AIRHORN SOUND

The W691 provides all basic siren tones; TAP II, PA, radio rebroadcast, as well as a built-in airhorn sound with siren override. It is protected against all failure modes by a fuse that is replaceable without tools and can operate from any 12-volt positive or negative ground vehicle electrical system. Taps are included for 100 or 200-watt speakers. Comes complete with a swinging bracket which enables mounting in a variety of positions. *Ship. wt. 6 lbs.*



ILLUMINATED
FACE PLATE



W691 PA 300 Electronic Siren \$356.95

FEDERAL Q ELECTROMECHANICAL SIREN

**BEAUTIFUL, STREAMLINED, CHROME PLATED,
COMMANDS RESPECT**

This siren includes grille, brake, and chrome finish. It is designed to be pedestal mounted but is also offered less the rear housing for flush mounting. Heavy-duty coaster clutch is subject to very little wear. The unique clutch design delivers a longer coast-down sound once power is removed, thereby reducing battery drain. For quick silencing, an electric brake is also a standard feature. 12-volt, operating current 100 amps. The AC895 model comes complete with stainless steel finish, grille, brake, pedestal and rear housing. Model AC896 is for flush mounting and does not include pedestal or rear housing. 123 dB at 10 feet *Ship. wt. 49 lbs.*



CHROME PLATED



AC895 Electromechanical Siren \$1,941.95
AC896 Electromechanical Siren, for Flush Mounting \$1,743.95

APPARATUS

APPARATUS

THE FIRETRUCK PREMIER APPARATUS



QUALITY & SERVICE

You can expect an unmatched level of quality and service from our entire line of vehicles.

OUR TEAM

The Darley Apparatus sales team consists of knowledgeable experts with a relentless focus on customer service. We've built a passionate team second to none.

EZ SPEC PROGRAM

Darley offers a uniquely simple program to determine which apparatus will work best for you. View our full EZ Spec Program on www.darley.com/apparatus.

APPARATUS DEMOS

Contact us today to schedule a demo or engineer a custom apparatus to meet your needs.

CHOICE OF CHASSIS

Select either a Custom Chassis or Commercial Chassis with multiple seating options. There dozens of options, including 4 Wheel Drive and Severe Duty Service. Darley offers full size pumpers, rescues, aerial devices, and compact Quick Attack units built to your specifications!

POLYBILT® BODIES

Choose from a variety of tough and rugged PolyBilt® bodies custom made from durable, impact-resistant CoPolymer material. Featuring patented integrated compartmentation so tough, PolyBilt® bodies are virtually indestructible.

DARLEY PUMP SYSTEM

Darley LDMBC CAFS 1500 GPM single stage pump system.

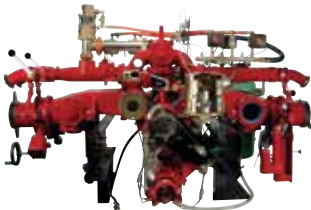

POLYBILT® BODY

Rugged, impact-resistant, corrosion-free, polymer construction with integral tanks and limited lifetime warranties.



SIDE CONTROL PANELS

Unique ergonomically friendly controls. Standard or unique curbside panels available.



TOP CONTROL PANELS

Unique Total Vision panel with patented wraparound colored design.



DARLEY CUSTOM DESIGNED VISION SERIES

Darley offers a full range of apparatus, including mini-pumpers, tankers, commercial and custom pumpers. We are known for building specialized apparatus that often includes compressed air foam systems and co-polymer bodies.

VISION PUMPERS



WILDLAND



CURBSIDE COMMERCIAL PUMPERS



LIGHT RESCUE



AERIALS



HEAVY DUTY RESCUE



COMMERCIAL TOP MOUNT



CUSTOM TOP MOUNT ENCLOSED



WASP PUMPER



RESCUE PUMPER



TRUSTED WORLDWIDE SINCE 1908



DARLEY.COM/APPARATUS 1.800.323.0244



VISION SERIES PUMPER

INNOVATIVE TECHNOLOGY

TO APPRECIATE ITS REAL BEAUTY, YOU HAVE TO SEE IT WORK AT A FIRE. THE ULTIMATE IN FIRE SUPPRESSION PERFORMANCE, DURABILITY AND OVERALL DESIGN - ALL BACKED BY INDUSTRY LEADING SUPPORT INCLUDING TRAINING EXPERTS, MANUALS, SCHOOLS, AUTHORIZED SERVICE AND REPAIRMEN.

PUMP SYSTEM

Darley LDMBC 1500 GPM single stage pump. Fully engineered and integrated flagship pump

CHOICE OF CHASSIS

Custom cabs designed for space, safety, performance and service.

CAFS

AutoCAFS® with a 220 CFM hot shift controlled compressor. One touch air engagement and foam controls.





● **POLYBILT® BODY**
 PolyBilt® Integral Series Pumper Rescue body with integrated tanks. Limited lifetime body warranty is standard

● **MATERIALS**
 Impact resistant and corrosion free. Easy to repair and hard to damage.

● **CONTROL PANEL**
 Unique Total Vision panel with wraparound, colored design. So ergonomically friendly, we had to patent it.



WILDLAND ATTACK/STRUCTURAL PROTECTION "WASP" QUICK ATTACK

DARLEY'S NEW WILDLAND ATTACK/STRUCTURAL PROTECTION (WASP) QUICK ATTACK PUMPER IS ENGINEERED TO GET TO THE FIRE QUICKLY AND INTO PLACES THAT A FULL SIZE PUMPER JUST CAN'T ACCESS. THIS UNIT FEATURES ALL-WHEEL DRIVE, AN OVERALL HEIGHT UNDER 8' TALL, AND AN OPTIONAL CURBSIDE PUMP PANEL THAT ADDS INCREASED SAFETY FOR THE PUMP OPERATOR DURING HIGHWAY RESPONSE. ONCE ON SCENE, DARLEY'S VERY EASY-TO-OPERATE AUTOCAFS™ COMPRESSED AIR FOAM SYSTEM REALLY PACKS A PUNCH.

FIRE PUMP

- Darley model PSMC with a UL rating of 1500 gpm at 150 psi
- 3 CAFS discharges above pump panel: 2 - 1½" and 1 - 2½" (Option for deck gun, hose reel, hosebed discharge, or front discharge)
- Maintenance free reliable mechanical seal
- All stainless steel plumbing package
- Gear driven 120 cfm rotary screw air compressor for the AutoCAFS™ pumping system with a FoamPro 2001 foam proportioner

POLYBILT® BODY

- PolyBilt® Integral Series Pump-Rescue
- 300/30 gallon integral tanks
- Limited lifetime warranty

COMPARTMENT

- Compartments 1 & 4: 12.81 cu. ft. ea
- Compartments 2 & 5: 23.46 cu. ft. ea
- Compartments 3 & 6: 26.35 cu. ft. ea
- Compartment 7: 22.57 cu. ft.
- Total Compartmentation: 147.8 cu. ft.



SUPER SINGLE TIRE & WHEEL PACKAGE AVAILABLE





CONTACT
DARLEY FOR
A DEMO!



CHOICE OF CHASSIS

- Ford F550 XLT all aluminum crew cab
- 4 door 4x4 chassis (203" wheelbase, 84" CA)
- 6.7 L diesel engine rated at 330 hp
- Automatic transmission with all-wheel drive
- Seating for four with optional SCBA seating (Officer and both rear seats)
- Polished aluminum wheels
- Kussmaul battery conditioner with AutoEject™
- Customized factory Ford center console

FEATURES

- Compliant with applicable NFPA standards
- Curbside and operator's side control panel available
- LED emergency and scene lighting
- Includes a 2 1/2" Darley AutoFill™ - keeps the water tank between 1/2 and "FULL" automatically
- Options for receiver winches, SCBA storage, equipment mounting
- Lifetime warranties available on Pump, Tank & Body!



DARLEY'S EZ

DETERMINE WHICH APPARATUS WILL WORK BEST FOR YOU.

VISION SERIES PUMPER



DARLEY VISION PUMPER
VS002 (CAFS Option Included)
Pump (1000-1750)
1000 Gallon Tank
Copolymer Rescue Pumper Body
High Sides Both Sides



DARLEY VISION PUMPER (The Fire Truck)
VS003 (CAFS Option Included)
Pump (1000-1750)
1000 Gallon Tank
Copolymer Rescue Pumper Body
High Sides Both Sides



DARLEY VISION TOP CONTROL PUMPER
VS005 (CAFS Option Included)
Pump (1000-1750)
1000 Gallon Tank
Copolymer Rescue Pumper Body
High Sides Both Sides



DARLEY VISION TOP CONTROL PUMPER (The Fire Truck)
VS006 (CAFS Option Included)
Pump (1000-1750)
1000 Gallon Tank
Copolymer Rescue Pumper Body
High Sides Both Sides



DARLEY VISION ENCLOSED TOP CONTROL PUMPER
VS007 (CAFS Option Included)
Pump (1000-1750)
1000 Gallon Tank
Copolymer Rescue Pumper Body
High Sides Both Sides



DARLEY VISION REAR PUMP PUMPER
VS008 (CAFS Option Included)
Pump (1000-1500)
1000 Gallon Tank
Copolymer Rescue Pumper Body
High Sides Both Sides



DARLEY VISION FRONT PUMP PUMPER
VS009 (CAFS Option Included)
Pump (1000-1500)
1000 Gallon Tank
Copolymer Rescue Pumper Body
High Sides Both Sides



DARLEY VISION PUMPER
VS010 (CAFS Option Included)
Pump (1000-1750)
1500 Gallon Tank
Copolymer Rescue Pumper Body
High Sides Both Sides

VISION & CHALLENGER SERIES PUMPER & TANKERS



DARLEY VISION PUMPER TANKER
VS012 (CAFS Option Included)
Pump (1000-1750)
2500 Gallon Tank
Copolymer Rescue Pumper Body
High Sides Both Sides



DARLEY VISION TANKER
VT001
2200 Gallon Tank
Copolymer Tanker Body
One Low Compartment Each Side



DARLEY VISION TANKER
VT003
Pump (500)
2200 Gallon Tank
Copolymer Tanker Body
One Low Compartment Each Side



DARLEY VISION TANKER
VT005 (CAFS Option Included)
Pump (1000-1500)
2200 Gallon Tank
Copolymer Tanker Body
Low Compartments - Fold Tank/Ladders Hi Sides



DARLEY CHALLENGER PUMPER
CH001
Pump (1000-1750)
1000 Gallon Tank
Aluminum Pumper Body
Low Right Side With Ladders



DARLEY CHALLENGER PUMPER
CH002
Pump (1000-1750)
1000 Gallon Tank
Aluminum Rescue Pumper Body
High Sides Both Sides



DARLEY CHALLENGER PUMPER
CH003 (CAFS Option Included)
Pump (1000-1750)
1000 Gallon Tank
Aluminum Rescue Pumper Body
High Sides Both Sides



DARLEY CHALLENGER TOP CONTROL PUMPER
CH006 (CAFS Option Included)
Pump (1000-1750)
1000 Gallon Tank
Aluminum Rescue Pumper Body
High Sides Both Sides

SPEC PROGRAM

VIEW OUR FULL LIBRARY ON DARLEY.COM/APPARATUS



**DARLEY VISION
WALK-AROUND RESCUE**
RS001
Copolymer Rescue Body



**DARLEY VISION
WALK-AROUND RESCUE**
RS002
Copolymer Rescue Body



**DARLEY CHALLENGER
WALK-AROUND RESCUE**
RS003
Aluminum Rescue Body



**DARLEY CHALLENGER
WALK-AROUND RESCUE**
RS004
Aluminum Rescue Body



**DARLEY VISION WALK-AROUND
RESCUE**
RS005
Copolymer Rescue Body



DARLEY VISION 78 AERIAL
AR002 (CAFS Option Included)
Pump (1000-1750)
500 Gallon Tank
Copolymer Aerial Body



DARLEY VISION 109 AERIAL
AR005 (CAFS Option Included)
Pump (1000-1750)
300 Gallon Tank
Copolymer Aerial Body



**DARLEY VISION 104 AERIAL
PLATFORM**
AR006 (CAFS Option Included)
Pump (1000-1750)
300 Gallon Tank
Copolymer Aerial Body



DARLEY VISION INITIAL ATTACK
IA005 (CAFS Option Included)
Pump (1000-1500)
300 Gallon Tank
Copolymer Attack Body



DARLEY VISION INITIAL ATTACK
IA007 (CAFS)
Pump (Odin Lethal Weapon)
300 Gallon Tank
Copolymer Attack Body



DARLEY VISION INITIAL ATTACK
IA010 (CAFS Option Included)
Pump (1000)
500 Gallon Tank
Copolymer Attack Body



DARLEY VISION INITIAL ATTACK
IA011 (CAFS Option Included)
Pump (1000)
350 Gallon Tank
Copolymer Attack Body



DARLEY VISION WILDLAND
WL004 (CAFS Option Included)
Pump (HE500 BS 39K)
450 Gallon Tank
Copolymer StakPak Body



DARLEY VISION WILDLAND
WL006 (CAFS Option Included)
Pump (HE500 BS 39K)
400 Gallon Tank
Copolymer PolyPak Body



DARLEY VISION WILDLAND
WL009
Pump (1.5 AGE 18V)
350 Gallon Tank
Copolymer PolyPak Body



DARLEY VISION WILDLAND
WL010 (CAFS Option Included)
Pump (KHM500)
375 Gallon Tank
Copolymer PolyPak Body

POLYBILT® TRUCK BODIES

TOUGH AND RUGGED BODIES - BUILT FOR LIFE

POLYBILT® TRUCK BODIES FEATURE PATENTED, INTEGRATED COMPARTMENTATION THAT ARE SO TOUGH, THEY ARE VIRTUALLY BULLETPROOF. FROM INITIAL ATTACK TO HEAVY DUTY CUSTOMS – WE OFFER COMPLETE BODY SOLUTIONS TO MEET YOUR NEEDS. POLYBILT® TRUCK BODIES ARE BUILT AND BACKED BY THE BEST, WITH OVER 100 YEARS OF COMBINED FIRE INDUSTRY SUPPORT. CONTACT US TODAY AT 1.800.864.3817 OR LEARN MORE AT WWW.POLYBILT.COM.



SELECTION

- CUSTOM OR STANDARD DESIGNS
- BUILT FOR OEMS, DISTRIBUTORS, SERVICE CENTERS AND FIRE DEPARTMENTS
- CHOICE OF FINISHED OR UNFINISHED CONSTRUCTION
- DESIGNED TO FIT ANY STYLE EMERGENCY VEHICLE AND/OR FIRE VEHICLE

BENEFITS

- CORROSION FREE
- TOUGH, DURABLE COPOLYMER
- LIMITED LIFETIME WARRANTY
- LIGHTWEIGHT
- RECYCLABLE
- SAFETY: LOW CENTER OF GRAVITY FOR IMPROVED STABILITY

MULTIPLE APPLICATIONS

- PUMPERS
- FIRE/EMERGENCY RESCUE RESPONSE
- QUICK ATTACK
- DISASTER RESPONSE
- WILDLAND
- TANKERS
- SERVICE BODIES

BUILT BULL TOUGH IN PARTNERSHIP WITH



POLYBILT® BODY



CUSTOM ROLL-UP COMPARTMENT DOORS™



PUMPS AVAILABLE FOR STANDARD & CUSTOM BODIES



CORROSION FREE



DARLEY OFFERS END TO END SOLUTIONS FOR YOUR AGENCY'S ROBOTICS PROGRAM

There is more to a successful drone program than just purchasing equipment. Our experienced team will help guide your agency through the different regulatory requirements, training, equipment selection, and policy review.

EQUIPMENT

Working with industry leading manufacturers, we have solutions to fit all needs and budgets. Equipment listed in this brochure is a small sample of what we offer. If you are unsure on the different equipment available, please reach out to us to learn about the differences in the different systems.

TRAINING

We understand that utilizing new technology can be daunting. Thankfully, our network of trainers have been working with public safety to develop the most practical training methods. Training can be customized and includes, but is not limited to the following:

- Part 107 course
- Basic public safety training
- Advanced public safety training
- **Specialty Training:** Scene reconstruction, 5-Day integration into law enforcement, UAS in crisis negotiations, UAS in search & rescue
- Additional customer requests

SUPPORT AND OPERATING PROCEDURES

Having a network of departments using and learning these new technologies helps create the framework needed to start your own Standard Operating Procedures without the need to reinvent the wheel. We will assist with outlining your SOPs and continue to support your program beyond just equipment selection.

REGULATIONS AND FAA REQUIREMENTS

Want to learn how your department can obtain a Certificate of Authorization from the FAA? Darley is pleased to recommend Skyfire Consulting to help with your department's legal services. These services include, but are not limited to:

- Certificate of Authorization (COA) Processing - Blanket & Jurisdictional
- Certificate of Authorization (COA) Renewals
- Safety case preparation
- Waiver processing
- One-on-one consulting

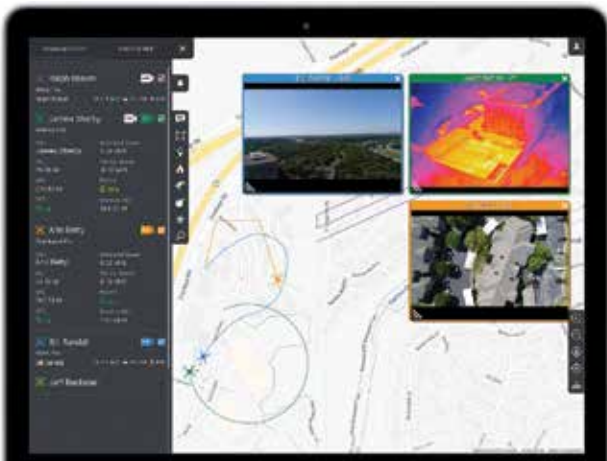

SCENE RECONSTRUCTION



CUSTOM TRAINING CLASSES

MATRICE 300 RTK

INTELLIGENCE WITH HIGH-PERFORMANCE.



MATRICE 300 RTK

The M300 sets a new standard for the Public Safety Drone Industry. Offering up to 55 minutes of flight time, advanced AI capabilities, 6 Directional Sensing & Positioning, and more, the M300 RTK sets a whole new standard by combining intelligence with high-performance and unrivaled reliability. The aircraft is IP45 rated and can operate in temperatures from -20 degrees to 50 degrees Celsius. The new M300 also has a new health management system to give agencies peace of mind that their aircraft is in tip-top shape.

IMPROVED TRANSMISSION SYSTEM

The all-new OcuSync Enterprise enables transmission up to 15 km away and supports triple-channel 1080p video. Real-time auto-switching between 2.4 GHz and 5.8 GHz enables more reliable flight near high-interference environments, while AES-256 encryption offers secure data transmission.

MULTIPLE PAYLOAD CONFIGURATIONS

Configure your M300 RTK to fit your mission needs. Mount up to 3 payloads simultaneously, with a maximum payload capacity of 2.7 kg. In addition to the new H20 and H20T, the DJI Z30 and XT2 are both compatible with the M300.

A POWERFUL VISION SYSTEM YOU CAN RELY ON

To enhance in-flight safety and aircraft stability, dual-vision and TOF sensors appear on all six sides of the aircraft, offering a maximum detection range of up to 40m, with options to customize the aircraft's sensing behavior via the DJI Pilot App. Even in complex operating environments, this 6 Directional Sensing and Positioning system helps keep the aircraft and the mission safe.

CALL FOR PRICING!



MATRICE 300 RTK

CUSTOMIZE YOUR MATRICE WITH OPTIONAL PAYLOADS

ZENMUSE XT2

The Zenmuse XT2 is DJI's most powerful camera to date. It incorporates FLIR's industry leading thermal technology with 4K high-definition, creating the most advanced aerial camera on the market. The XT2 quickly transforms aerial data into powerful insights that save time, money - and lives.

ZENMUSE Z30

The Zenmuse Z30 is the most powerful integrated aerial zoom camera on the market with 30x optical and 6x digital zoom for a total magnification up to 180x.

ZENMUSE H20/H20T

The new H20 series from DJI is a state-of-the-art multi-sensor payload. The unique intelligence and integrated design provide unprecedented aerial imaging capabilities for a range of public safety drone applications. Capture everything up close or from a distance, in true living color or thermal. An integrated laser rangefinder (LRF) measures the distance to an object at up to 1200 m away. A powerful, integrated payload that unleashes advanced intelligent capabilities for DJI's industrial drone platforms.



ZENMUSE XT2



ZENMUSE Z30



H20 SIDE FACE



H20T SIDE FACE

ZENMUSE H20/H20T



MAVIC 2 ENTERPRISE

DUAL AND ZOOM MODELS



MAVIC 2 ENTERPRISE

The modular design of the Mavic 2 Enterprise makes it a perfect choice for your department. With a powerful and portable thermal imaging camera your drone can go everywhere you go. Added data security features, ADS-B receiver, and obstacle avoidance can give you more piece of mind while flying.

LEAD WITHOUT LIMITS. WORK BEYOND YOUR BOUNDARIES.

Unlock the possibilities of flight with an extended port that allows you to connect additional devices onto the drone, helping you perform at your best in a variety of daily and critical missions.



MAVIC 2 ENTERPRISE DUAL W/ SPEAKER

CALL FOR PRICING!

EASY TO USE THERMAL CAPABILITIES

DJI MAVIC 2 ENTERPRISE DUAL

VISIBLE AND THERMAL IMAGERY

- Integrated Radiometric FLIR Thermal Sensor
- Adjustable Parameters for Emissivity & Reflective Surfaces
- Multiple Display Modes: FLIR MSX[™], Infrared & Visible

DJI MAVIC 2 ENTERPRISE ZOOM

POWERFUL ZOOM CAPABILITY

- 12 MP 1/2.3" CMOS Sensor
- Dynamic Zoom: 2x Optical 3x Digital Zoom Capability
- Post Analysis Metadata: GPS Timestamping

A REVOLUTIONARY PLATFORM FOR EVERYDAY WORKERS

Designed to empower a new generation of workers, the Mavic 2 Enterprise is the ultimate expression of a tool that delivers beyond expectation to meet current workplace challenges and future demands.

FOLDABLE. COMPACT. PORTABLE.

At 905 g the Mavic 2 Enterprise is rapidly foldable and swiftly slides in the side of your belt package, giving you instant power that's easily accessible and transportable – wherever you operate.



M2E BEACON



M2E SPOTLIGHT

FEATURES

- Max Flight Time: 31 mins.
- Standard zoom camera for both zoom and dual
- Thermal camera included with dual
- Standard spotlight
- Standard beacon
- Standard speaker
- Standard obstacle avoidance system
- Operating Temperature: 14° - 104°F
- Hot Swap speaker, beacon, and spotlight options
- 24 GB internal storage
- 2x digital 2x optical zoom

THERMAL CAMERA SPECS

- Sensor: Uncooled VOx Microbolometer
- Lens: HFOV: 57°
- Aperture: f/1.1
- Resolution: 160x120
- Pixel Pitch: 12 μm
- Spectral Band: 8-14 μm
- Image Size: 640x480 (4:3), 640x360 (16:9)
- Still Photography Modes: Single shot, burst shooting (3/5/7 frames)
- Video Recording Modes: 640x360 @ 8.7fps



AUTEL ROBOTICS EVO II SERIES

MOST CAPABLE FOLDING DRONE ON THE PLANET

EVO II SERIES

The only 8K folding drone on the planet. Capture content at resolutions up to a massive 8000x6000. EVO II comes standard with a 7100mAh rechargeable battery and uses our patented Battlock system to guard against battery ejection in high-speed maneuvers or hard landings. Control your drone up to 9km away, keeping you connected in crowded urban environments and thick forests.

FEATURES:

- 12 optical sensors and 2 sonar sensors creating 360° protection
- Detect hazards up to 30m away and control the speed to avoid collision
- Pro Model has a 1" sensor with 6K
- Dual model has thermal resolution of up to 640x512 by FLIR and an 8K sensor

INCLUDES:

- Batteries
- Prop guards
- Charging hub
- Car charger
- Spare remote
- GPC case
- Live deck

AIRCRAFT SPECS

- Takeoff Weight: 1127g-1192g
- Wheelbase: 397mm
- Max Speed: Standard: 15m/s // Ludicrous: 20m/s
- Max Service Ceiling: 7000m
- Max Flight Time: Hover: 35min // Moving: 40min
- Transmission Type: FCC: 2.4GHz ALink
- Max Transmission Distance: 9km
- Storage: Internal: 8GB Max SD: 128GB
- Battery Type: LiPo 3s
- Battery Size: 7100mAh
- Controller Screen: 3.3in OLED 330 Nits
- Controller Battery: 5000mAh

NEW

CALL FOR PRICING!



DUAL CAMERA



8K CAMERA



6K CAMERA



EVO II



EMILY BY HYDRONALIX

EMERGENCY INTEGRATED LIFESAVING LANYARD

EMILY BY HYDRONALIX

The EMILY platforms are designed as an asset for public safety and homeland security. It offers scene stability in dangerous and hazardous waters by helping the victim and keeping the rescuer on the shore. The EMILY technology complements public safety teams and homeland security personnel by adding valuable, timely resources without adding additional personnel. The key element to this technology is the fact that it keeps the rescuers out of the hazard zone until the scene is stabilized and the victim(s) can be rescued. The fact that this is a battery powered jet boat that is operated and controlled remotely through line of sight technology, the EMILY systems have the ability to penetrate areas/zones that normal watercraft could not access.

FEATURES:

- Weight: 26 lbs.
- Length: 50 in.
- Positive buoyancy: 150 lbs.
- Self-righting
- Perimeter grab rope: 8 ft.
- Waterproof internal modular components
- D-Ring tow line attachments
- Jet pump drive made of aerospace composites and ceramic bearings

INCLUDES:

- Float cover
- Battery charger 2-pack
- Battery module
- Flag
- Boat stand
- Lanyard 2-pack
- Futaba transmitter
- User manual
- 2.4 GHz transmitter controller with amplifier



EMILY KIT

INCLUDES:

- 2 additional steering arm boot seals
- Electrical anti-corrosion solution
- 3 additional inlet grates
- Flags 3-pack
- Tool kit
- Lanyard 3-pack
- Canvas carry bag
- Additional impeller

SWIFT WATER RESCUE EMILY

INCLUDES:

- SWRE Float Cover
- Life Jacket
- Helmet
- Headlight

MAN OVERBOARD EMILY KIT

INCLUDES:

- MOBE Cover
- 2 additional steering arm boot seals
- Additional inlet grate
- Additional impeller
- Flags 3-pack
- Headlight
- 2000 ft. reel
- Reflective strips
- Navigation lights (Port red light, Starboard green light)



Rescue Reel



EMILY KIT



SWIFT WATER EMILY



MAN OVERBOARD EMILY KIT

CONTACT  LOUVICELLI@DARLEY.COM FOR PRICING

DARLEY FIRE AXES

Your choice of handles. Fiberglass handle fire axes are stronger than steel, lighter than aluminum and as flexible as hickory. Fiberglass handles won't splinter and will not conduct electricity. The Pick-Point Crucible Steel Axe Head is epoxy-bonded to a cushion grip fiberglass handle.



DARLEY AXES, 6 LBS.

L957	36" Pick-Point Axe, Fiberglass Handle	\$74.95
370	36" Pick-Point Axe, Hickory Handle	\$74.95
T225	36" Flat Head Axe, Fiberglass Handle	\$70.95
J745	36" Flat Head Axe, Hickory Handle	\$67.95
L958	Replacement Fiberglass Handle	\$27.95

OTHER WEIGHTS

AW187	36" Pick-Point Axe, 8 lb., Fiberglass Handle	\$145.95
AW188	36" Flat-Head Axe, 8 lb., Fiberglass Handle	\$137.95
BK273	28" Pick-Point Axe, 2 ³ / ₄ lb., Hickory Handle	\$60.95

T-N-T MULTI-PURPOSE FIRE TOOL



- Ventilate
- Pull ceilings
- Force entry
- Breach walls
- Cut holes
- Axe, bar, double jacket and a pike pole all in one
- Handle is solid fiberglass
- Head and pike ends are made from high-carbon, heat-treated steel
- *Ship. wt. 14 lbs.*

4 TOOLS IN 1

AJ237	8.5 lb. Head, 40" Handle	\$318.95
AJ238	6.5 lb. Head, 40" Handle	\$296.95
AJ239	6.5 lb. Head, 35" Handle	\$296.95
AJ240	6.5 lb. Head, 30" Handle	\$296.95

HI-VIZ 36" FLAT AXE

- Made in the USA
- Rugged and perfect for ventilation, forcible entry or overhaul
- Handle construction is solid Hi-Viz pultruded fiberglass with non-slip grip
- Yellow handle construction is a strong pultruded fiberglass core with an injection molded jacket for added strength
- Axe heads are bonded to the fiberglass handle with strong two part epoxy
- Axe heads are drop forged with high carbon steel



SPECIFY HANDLE COLOR:
Hi-Viz Orange with Reflective Tape, Hi-Viz Lime with Reflective Tape, or Yellow

BK382	6 lb. 36" Flat Axe	\$67.95
BK383	8 lb. 36" Flat Axe	\$121.95
BK384	6 lb. 36" Pick Axe	\$69.95
BK385	8 lb. 36" Pick Axe	\$128.95

LEATHER AXE SHEATH

Made from top-grain, tanned cowhide, sewn and riveted for strength. Features heavy-duty double belt clips. Fits 6 lb. pick head axe. *Ship. wt. 1 lb.*



AF425	Leather Axe Sheath	\$48.95
-------	--------------------	---------

HI-VIZ 36" PICK AXE

- Made in the USA
- Rugged and perfect for ventilation, forcible entry or overhaul
- Handle construction is solid Hi-Viz pultruded fiberglass with non-slip grip
- Axe heads are bonded to the fiberglass handle with strong two part epoxy
- Axe heads are drop forged with high carbon steel

SPECIAL PRICING



BK384L	6 lb. 36" Pick Axe	\$69.95
--------	--------------------	---------

A. EMERGENCY FIRE TOOL SET

- 6 lb. or 8 lb. flathead axe
- Marringing strap
- 30" halligan bar

AJ115	Emergency Fire Tool Set with 8 lb. Axe	\$329.95
BL534	Emergency Fire Tool Set with 6 lb. Axe	\$274.95
AJ114	Velcro® Marringing Strap Only	\$15.95

B. BLACK-MAXX SLEDGE/MAUL

This hybrid sledge/maul features an 8.5 pound striking-force head with a pointed blade cutter, works well with a baseball swing for easy forcible entry. Provides an instant foot hold when the pointed end is sunk into a slanted or pitched roof. Features a nesting slot for the fork of a Halligan tool to carry both tools with one hand, plus an over-strike rubber and measurement guide for hand placement. Handle features embossed thermo-rubber grip. A mini-battering ram! *Ship. wt. 12 lbs.*

BN761	Black-Maxx Sledge/Maul	\$184.95
-------	------------------------	----------

C. SLEDGE HAMMERS

IDEAL FOR VENTILATION, FORCIBLE ENTRY OR OVERHAUL

- Hi-Viz handle construction is solid pultruded fiberglass with non-slip grip
- Yellow handle construction is strong pultruded fiberglass core with injection-molded jacket for added strength
- Sledge head is bonded to the fiberglass handle with strong two part epoxy
- Sledge head is drop forged with high carbon steel
- Reflective striping added to aid in low light
- Made in USA

BH044	6 lb. Sledge Hammer 24"	\$47.95
BH045	8 lb. Sledge Hammer 36"	\$47.95
BK216	10 lb. Sledge Hammer 36"	\$54.95



THE BIEL TOOL

The new Biel Tool is now one piece made out of heat treated, electro-polished stainless steel with an extremely durable ergonomically rubber molded handle. The new Biel Tool incorporates many of the features found in the world famous Pry Axe®, but is much smaller and light enough to wear on a belt or carry in the pocket of a bunker coat. This is a perfect personal size multi-purpose forcible entry and rescue tool; designed for forcing door and windows, prying and twisting hasps and locks, light overhauling, nail removal, gas shutoff, metal cutting and chopping. *Ship. wt. 4 lbs.*

W509	Biel Tool	\$213.95
W509A	Sheath	\$41.95

MULTI-PURPOSE PRY AXE®

The Pry Axe® has been the best-selling tool for over 40 years and is used by departments worldwide. It's a lightweight, multi-purpose, slam and ram tool designed to pry, twist, chop, cut metal, twist off locks or latches and much more. This efficient tool allows forcible entry by a single person when time is critical. Pry Axe® heads are forged from alloy steel and heat-treated for maximum strength. The claws are stainless steel investment castings that are heat-treated and electro-polished. Solid steel shaft extends the axe to 25" and rubber sleeve provides a sure grip. *Ship. wt. 8 lbs.*

Z117	Pry Axe® with Metal Cutting Claw (18.33" Closed, 25.1" Open)	\$303.95
Z118	Pry Axe® with Standard Claw (18.33" Closed, 25.1" Open)	\$319.95
Z119	Pry Axe® with Both Claws	\$422.95
Z123	Sheath for Pry Axe®	\$46.95
AF350	Mounting Bracket	\$68.95

DARLEY STANDARD & SERRATED CRASH AXES

- Insulated steel handle to 20,000v. 15" long.
- Ship. wt. 3 lbs.

J728	Serrated Crash Axe	\$100.95
J729	Standard Crash Axe	\$95.95
J72801	Leather Sheath	\$26.95



HALLIGAN BARS

RUGGED HALLIGAN BAR IS PERFECT FOR VENTILATION, FORCIBLE ENTRY OR OVERHAUL



- 100% manufactured in the U.S.A. with American materials and craftsmanship
- Perfect for ventilation, forcible entry or overhaul
- Available in 24" 30" and 36" lengths
- All forged design to last a lifetime
- Drop forged with high carbon steel, fully heat treated and zinc plated

STANDARD CLAW HALLIGAN BAR - FORGED

BN226	24"	\$229.95
BN227	30"	\$241.95
BN228	36"	\$258.95

FORCIBLE ENTRY TOOL

The design of this tool stays true to the original halligan with the correct widths, lengths, and angles that firefighters worldwide have come to expect. Cast from high strength steel and heat treated to ensure durability; this tool is tough. However, just in case the unexpected happens it carries our industry leading lifetime warranty. The entire tool is coated in a textured silver powder coat that provides superior grip and control.

- Textured silver powder coat
- Superior grip
- Lifetime warranty

FORCIBLE ENTRY TOOL

BN594	24"	\$119.95
BN595	30"	\$134.95
BN596	36"	\$149.95

HOOLOGAN TOOL

These heavy-duty tools were designed to pound, puncture, pry, twist, and cut most obstacles you may encounter. Features your choice of standard or metal cutting claw, machine-grooved non-slip grips. Duckbill has long, smooth incline to force windows and interiors doors. Pike is long, sharp, tapered and gently curved to fit a lock or latch. Electroless Nickel finish. *Ship. wt. 13 lbs.*



STANDARD CLAW HOOLOGAN TOOL

R631	30"	\$217.95
T982	36"	\$228.95
T983	42"	\$238.95
AF350	Mounting Bracket	\$68.95

METAL CUTTING CLAW HOOLOGAN TOOL

AK176	30"	\$217.95
AK177	36"	\$229.95
AK178	42"	\$259.95
AF350	Mounting Bracket	\$68.95

PRO BAR

A Halligan-type forcible entry tool. One-piece construction of aircraft alloy steel, drop forged. The fork, adz and point are designed with the correct lengths, widths and tapers to enable easy penetration and maximum leverage. *Ship. wt. 10 lbs.*

edarley.com
 SHOP OUR COMPLETE SELECTION OF HALLIGAN BARS ON EDARLEY.COM/HALLIGANBARS

PRO-BAR SPECIFY FINISH: **Black or Silver**

Z150	30"	\$234.95
BL802	36"	\$272.95



NEW



LIGHTWEIGHT ALUMINUM HOOLIGAN TOOL STANDARD CLAW WITH ELECTROLESS NICKEL FINISH

The Hooligan Tool is one of the world's most popular entry tools. These heavy-duty tools were designed to pound, puncture, pry, twist and cut all types of barriers encountered by emergency service personnel. *Ship. wt. 8 lbs.*



METAL CUTTING CLAW WITH NAIL PULLER

- Parallel claw opening for gas valve shutoffs, locks and hasps
- Machine sharpened claws and recessed nail puller
- Machined grooved non-slip grips

LIGHTWEIGHT ALUMINUM HOOLIGAN TOOL		
AZ391	24"	\$223.95
AZ392	30"	\$234.95

ALL PURPOSE HOOK

The most versatile hook used in the fire service today. Multitude of uses, such as opening ceilings, walls, floors, moldings and casings to the rapid removal of wood, lath and plaster, tin and sheet metal, plasterboard, fiberboard and sheetrock. Features specially tapered hook-head point, two workable ends, super strength fiberglass pole, stainless steel wear sleeve, choice of knob end, electrically non-conductive, and Celtex grips.



ALL PURPOSE HOOK		
BL019	6'	\$119.95
BL799	8'	\$133.95
BL800	10'	\$178.95
BL801	12'	\$199.95

NEW YORK HOOK

- Chisel end is ideal for prying, pulling and lifting during forcible entry and overhaul
- Ends forged with high carbon steel
- Heat treated to meet or exceed ANSI specifications
- Strong DROP-Forged for a lifetime of use
- Body is made of thick wall, carbon steel tube
- Made in the USA



FINISH: Black Powder Coat NEW YORK HOOK

BN476	3'	\$82.95
BN477	4'	\$85.95
BN478	5'	\$96.95
BN479	6'	\$105.95
BN480	8'	\$128.95

GRIFF HOOK

A unique tool for officers, nozzles and roof men. The chisel end is used as a prying tool for cuttle hatches and roof doors. Features all-purpose head, aircraft steel shaft, Celtex grip, 2 welded rings and heavy-duty carrying sling.



GRIFF HOOK		
AR174	36"	\$117.95

CHANNELLOCK® 5 'N 1 RESCUE TOOL

26 ounces of valve-twisting, wire-cutting, life-saving power packed with functionality. So small, it'll fit in your pocket. So light, it won't slow you down.

- Aggressive cross-hatch teeth twist and pull anything that gets in your way
- Laser heat-treated cutting edges on BH098 cut wires and cables easily
- Pry-bar quickly pries open windows and doors
- Slot for shutting off standard gas safety valves
- Spanner wrench tightens and loosens up to 6" hose couplings
- Standard battery cables are no match for its cutting power
- Made in USA

BH098	Linesman Cutter Rescue Tool	\$49.95
BH148	Cable Cutter Rescue Tool	\$49.95
BH102	Closed Top Holster	\$30.95



FIRE SERVICE BOLT CUTTERS

- High-carbon machined steel jaws cut rods, bolts, bars & chains, etc.
- Tubular steel handles with angled grips allow maximum leverage
- Turn 50 lbs. of hand pressure into 4,000 lbs. of cutting pressure
- Drop-forged jaws with center-cut blades
- Lifetime warranty

BK241	14" Fire Service Bolt Cutters	\$29.95
BK242	18" Fire Service Bolt Cutters	\$39.95
BK243	24" Fire Service Bolt Cutters	\$48.95
BK244	36" Fire Service Bolt Cutters	\$76.95
BK245	42" Fire Service Bolt Cutters	\$127.95



H.K. PORTER HEAVY-DUTY INDUSTRIAL

Extra-heavy jaw bolts and straps make these the most rugged around. Center cut, round edge cutters up to Brinell 455, Rockwell C48 hardness. Have nose straps for longer jaw life. *Ship wt. 18 lbs.*

- Heavy-duty
- Extended nose straps
- Extra heavy jaw bolts

T988	36" Heavy Duty Bolt Cutter	\$267.95
T987	36" Industrial Grade Bolt Cutter	\$186.95
J874	36" Industrial Grade Bolt Cutter with Fiberglass Handles	\$246.95
H962	42" Chain & Padlock Cutters	\$313.95



STANLEY® FUBAR® FORCIBLE ENTRY TOOLS

Introducing Stanley® FuBar® Forcible Entry Tools. At up to 30" in length and 9 lbs. in weight, these extreme tools provide outstanding leverage and excellent grips for more destructive demolition work.

- 8-in-1 tool
- Demolition head
- Gas shut-off feature
- Spanner wrench
- Pry bar for ripping
- Board jaw sized for grabbing lumber
- 2nd tier board jaw fits square hydrant nuts
- Hydrant wrench
- Beveled nail slot
- One-piece forged steel
- Flame-resistant grips
- Carabiner holes
- Heat-treated and tempered striking face
- Hi-visibility 3M™ Scotchlite™

BG519	18" Stanley® FuBar® Forcible Entry Tool	\$87.95
BG520	30" Stanley® FuBar® Forcible Entry Tool	\$154.95



LEATHERHEAD PIKE POLES



PRO-LITE (ROUND HOLLOW) & DOG-BONE (I-BEAM)

NEW

RESCUE TOOLS

- Pro-Lite pike poles are constructed with hollow pultruded fiberglass
- Heavy duty light weight construction
- Choice of yellow or Hi-Viz lime color with reflective striping for locating in dark areas
- D-handle and heads are bonded to the fiberglass with strong two-part epoxy, Pro-Lite also features steel pins
- Hooks are fabricated in USA with American steel



Hi-Viz Lime
Yellow

DOG-BONE (I-BEAM) PIKE POLES

SPECIFY COLOR: Hi-Viz Lime or Yellow

	American Hook	Rubbish Hook	Dry Wall Hook
3' Dog-Bone Pike Pole with D-Handle	MBN371 / \$88.95	MBN377 / \$107.95	MBN383 / \$111.95
4' Dog-Bone Pike Pole with D-Handle	MBN372 / \$86.95	MBN378 / \$113.95	MBN384 / \$118.95
6' Dog-Bone Pike Pole with Butt End	MBN373 / \$76.95	MBN379 / \$104.95	MBN385 / \$108.95
*8' Dog-Bone Pike Pole with Butt End	MBN374 / \$85.95	MBN380 / \$112.95	MBN386 / \$117.95
*10' Dog-Bone Pike Pole with Butt End	MBN375 / \$94.95	MBN381 / \$121.95	MBN387 / \$124.95
*12' Dog-Bone Pike Pole with Butt End	MBN376 / \$111.95	MBN382 / \$138.95	MBN388 / \$142.95

PRO-LITE (ROUND HOLLOW) PIKE POLES

SPECIFY COLOR: Hi-Viz Lime or Yellow

	American Hook	Rubbish Hook	Dry Wall Hook
3' Pro-Lite Pike Pole with D-Handle	MBN389 / \$58.95	MBN395 / \$84.95	MBN401 / \$90.95
4' Pro-Lite Pike Pole with D-Handle	MBN390 / \$63.95	MBN396 / \$91.95	MBN402 / \$95.95
6' Pro-Lite Pike Pole with Butt End	MBN391 / \$61.95	MBN397 / \$88.95	MBN403 / \$94.95
*8' Pro-Lite Pike Pole with Butt End	MBN392 / \$67.95	MBN398 / \$94.95	MBN404 / \$98.95
*10' Pro-Lite Pike Pole with Butt End	MBN393 / \$74.95	MBN399 / \$103.95	MBN406 / \$108.95
*12' Pro-Lite Pike Pole with Butt End	MBN394 / \$86.95	MBN400 / \$112.95	MBN407 / \$118.95

CLOSET HOOK

Ideal for opening halls, closets, crawl spaces or upholstery. Plastic core handle will not crack, splinter, warp, rot or absorb moisture. Malleable iron pike and "D" handle are bonded in epoxy.



P819	32" Closet Hook	\$92.95
T981	"D" Handle for Pike Pole	\$44.95

FIBERGLASS-HOLLOW OR WOOD CORE



Length	T979 - Wood Core	T980 - Hollow Core
6'	\$146.95	\$72.95
*8'	\$154.95	\$79.95
*10'	\$198.95	\$117.95
*12'	\$225.95	\$132.95
*14'	\$253.95	\$164.95

PIKE POLE, AXE & TOOL BRACKETS



P807	Tool Bracket, Bottom Mount, Vinyl Covered, 3/4" to 1" OD	\$65.95
P808	Tool Bracket, Bottom Mount, Vinyl Covered, 1 1/2" to 2 1/2" OD	\$65.95
P809	Tool Bracket, Side Mount, Vinyl Covered, 3/4" to 1" OD	\$65.95
P810	Tool Bracket, Side Mount, Vinyl Covered, 1 1/2" to 2 1/2" OD	\$65.95
U330P	Pike Pole Handle Bracket, Side Mount, 1 1/2" OD	\$24.95
M754	Pike Pole Ring, Aluminum OD, 2 1/8"	\$18.95
M755	Pike Pole Ring, Cast Brass OD, 2 1/8"	\$50.95
AW202	Axe Blade Bracket, Zinc CP	\$25.95
BK215	Axe Handle Side Mount Bracket, Zinc CP	\$20.95

*All 8' Pike Poles are an actual size of 7'9" unless specified. All Pike Poles 8' or longer will incur additional LTL Freight shipping cost.

"V" BLADE RESCUE KNIFE

Cuts through seat belts. Precision made of high-strength aluminum alloy. Tip fitted with Dzus Key for opening aircraft panels. The blade will cut 10,000 lb. strength webbing with one stroke. *Ship. wt. 3 lbs.*



L470	"V" Blade Rescue Knife	\$56.95
L470X	Replacement Blade	\$18.95

THE GLAS-MASTER

REMOVES GLASS IN LESS THAN A MINUTE

The Glas-Master is truly an extraordinary tool that is manually operated; no electricity or hydraulics needed. No other tool cuts glass windshields faster and more effectively, helping reduce rescue time significantly. Cuts on pull stroke thereby pulling glass to the outside, away from the victim. It can also be used on fiberglass, wood, plaster or even underwater rescue. What's more, the Glas-Master has its own storage of the spring-loaded center punch so it won't get lost or misplaced when it is needed most. *Ship. wt. 4 lbs.*

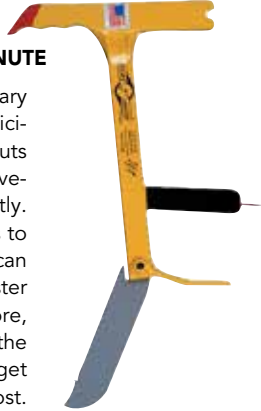

- Window punch
- Front guard
- Spike
- Blade with cover
- "T" handle

AB885	Glas-Master	\$180.95
AB885A	Glas-Master Replacement Blade	\$26.95

MV FIRE/RESCUE CRASH KIT

- Hood release tool
- Quik-Kut glass removal tool
- Pyroshield rescue blanket
- Glass hammer
- MV plug pattie
- Battery cable cutter
- Pro hacksaw
- Spring window punch
- Valve stem tool
- 9 1/2" tongue & groove pliers
- MX 4-in-1 screwdriver
- 8" adjustable wrench



BA125	MV Fire/Rescue Crash Kit (Red)	\$718.95
-------	--------------------------------	----------

COMPLETE CRASH AND RESCUE TOOL KIT

All-purpose set of tools for use in crash and fire emergencies. Contains everything needed to quickly and efficiently cut through metal, webbing, wood, rope, and other obstructions. *Ship. wt. 15 lbs.*

- Metal cutting saw - 16" blade
- Aircraft cable cutter - cuts 1/8" to 1/4" capacity and 14" long
- Lineman's Pliers - 8" long/extra strong
- Hack saw frame - adjusts from 8" to 12", faces 4 ways, and adjusts 90° for vertical or horizontal cuts
- 3 - Hack saw blades - hard toothed, silver steel for fast cutting
- Grappling hook & rope - 52" sling
- 2 - Phillips head screwdrivers - 6" and 8"
- 2 - Slotted head screwdrivers - 6" and 8"
- 3 - Wooden plugs - plug fuel and control lines
- Vise grip wrench - 10" long
- Serrated edge hand axe - 15" long with handle insulated for 20,000v
- Safety V blade rescue knife
- Weather-resistant, mildew-resistant, rubber-coated nylon hi-vis yellow carrying case
- Complete kit folds into an easy-to-carry case



L471	Complete Crash and Rescue Tool Kit	\$472.95
------	------------------------------------	----------

HAND TOOL RESCUE KIT

The Hand Tool Rescue Kit you have always wanted to put together but never did. Now you can pound, cut, pry, saw, seal, loosen, tighten and dig with an assortment of top-quality industrial-grade hand tools built to deliver years of dependable service. Kit features Snap-On "ergonomic" tools specially designed to reduce or end work-related injuries. The kit also includes a heavy-duty seat belt cutter, cable cutter with insulated handles for working on live voltages up to 1,000 volts, military spec tri-fold shovel and more. All tools carried in a black plastic case. *Ship. wt. 40 lbs.*



AR178	Hand Tool Rescue Kit	\$1,124.95
-------	----------------------	------------

A. LONG HANDLE FIREFIGHTING SHOVEL



- Forged steel head
- Solid shank blade
- Rear turned steps
- 44" wood handle
- Ship. wt. 7 lbs.

AJ462 Long Handle Firefighting Shovel \$65.95

B. COLLAPSIBLE RESCUE SHOVEL



The Collapsible Rescue Shovel has been the tool of choice for many first responders. Its compact, lightweight design makes it easily transportable, yet rugged enough to get the job done under extreme conditions. The blade is engineered to be used as a shovel, axe, saw, hoe or piercing tool. Ship. wt. 3 lbs.

USES:

- Shovel
- Axe
- Saw
- Hoe
- Piercing tool

SHOP
MOUNTING
BRACKETS
IN APP. EQUIP.
Pages 154-174

AK010 Collapsible Rescue Shovel \$24.95

C. FIREFIGHTING SHOVELS



AZ378

Round point shovels are hollow back with 8 1/2"x12" blade. Square point shovels are also hollow back with 9 1/2"x11 1/2" blades and rolled step. The fiberglass handles provide unsurpassed life, comfort and safety. Heat treated and tempered blades resist wear and breakage. Ship. wt. 5 lbs.



AZ380

AZ378	Round Point 48" Handle Shovel	\$54.95
AZ379	Round Point 27" D-Handle Shovel	\$37.95
AZ380	Square Point 48" Handle Shovel	\$54.95
AZ381	Square Point 27" D-Handle Shovel	\$37.95

D. ALUMINUM SCOOP SHOVEL



The large, heavy-duty square blade is heat treated and tempered to resist wear and breakage. Ideal for getting rid of fire debris, scooping gravel and other coarse materials. Shovel blade measures 15 1/4"x19 3/4" with 27" handle. Ship. wt. 5 lbs.



AB045 Aluminum Scoop Shovel \$70.95

DARLEY RAM JAMMERS

FOR VEHICLE EXTRICATION

When doing a dash roll-up, place the Ram Jammers against the B-posts on each side of the vehicle. Then, instead of only getting one push with the medium hydraulic rams, Ram Jammers give you a secure base to make a second and then a third push for the "Maximum Dash Roll-Up." This will give you a large amount of room in the front of the patient, making it easier to apply spinal immobilization devices. They also absorb the force of the rams to prevent fractures at the B-post. *Ship. wt. 45 lbs.*

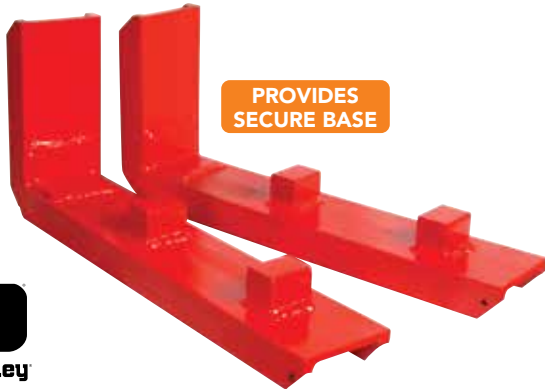

AF349 Darley Ram Jammers \$204.95/set of 2

HYDRA-RAM HYDRAULIC EMERGENCY ENTRY TOOL

10,000 pounds of force is presented by 138 lbs. of pumping to acquire 1/4" stroke to a maximum thrust opening of 4 inches. The Hydra-Ram can be placed in any position, even upside down, without any effect on its operation; this is a first in hydraulics. Because of its unique size, 13" and only 12 lbs., it can be slung or carried on your belt. The entire unit can be controlled by one user alone, making it truly a one-person operation tool. No hoses, tanks or pumps so there is no maintenance or leaking fluid. Jaws are made of stainless steel with 220,000 psi tensile strength. Special finger grips give a non-slip holding surface. *Ship. wt. 15 lbs.*



INCLUDES:

- A. HYDRA-RAM tool
- B. Cordura® carrying bag
- C. Mallet
- D. Carrying sling



AE097 HYDRA-RAM Hydraulic Emergency Entry Tool \$2,128.95

PERCUSSIVE RESCUE KIT

You'll feel the difference as soon as you hold it. This slam and ram tool exerts a striking force as you've never seen. You'll hear the solid "thud" as the slam bar strikes one of the six assorted tool bits. The ram travels up to 13.6" for maximum impact. Whether you're breaking a brick/block wall or pounding through locks and latches, this tool makes you more efficient. With the slam and ram feature, there is no deflection of pounding force. All of the energy is used to strike effective, penetrating blows by a single person. When hydraulic, electric and pneumatic power is gone or unavailable, you'll still be punching and pounding with this rescue tool.



COMPLETE KIT INCLUDES:

- Percussive tool bar
- Lockbreaker claw
- Metal cutting claw
- Bull point
- Chisel
- Wide chisel
- Carrying bag



Cat#	Description	Weight	Price
AC614	Complete Rescue Tool Kit	29 lbs.	\$1,079.95
AC621	Percussive Rescue Tool Only	14.2 lbs.	\$650.95

RESCUE SAWS, KITS, BLADES & ACCESSORIES

AM083 Contains: Partner/Husqvarna K-12 FD 94cc 14" fire rescue saw, full size steel case or aluminum space saver case, fire-department carbide tipped blade, 2 combination steel/concrete rescue abrasive wheels, safety gas can, hearing protector, goggles, spare belt and air filter, air filter oil, 2-cycle engine oil, can of gasoline stabilizer, combination screwdriver/wrench and instruction manual.

AR179 Contains: Modified 94cc Partner/Husqvarna K970 94cc active 2 cycle gas engine. Fire Department modifications include: constant on "READY START" ignition switch, large "D" Handle starter grip, lightweight magnesium guard with welded "D" ring for attaching saw sling and saw carrying sling.

AW198 Contains: Partner/Husqvarna K-12 FD 94cc 14" saw, diamond plate aluminum case, Maxi blade, four rescue abrasive wheels for cutting both steel and concrete, safety gas can, hearing protector, goggles, spare belt and air filter, air filter oil, 2-cycle engine oil, can of gasoline stabilizer, combination screwdriver/wrench and instruction manual.



BLADE SOLD SEPARATELY

FEATURES:

- 94cc 2-cycle gas engine
- Lightweight - 22.7 lbs.
- Lightweight magnesium guard
- Large "D" handle starter
- Carrying sling
- Reflective lettering

KIT INCLUDES:

- Partner/Husqvarna K-12 FD 94cc 14" saw
- Steel case
- Carbide tipped blade
- 2-Rescue abrasive wheels
- Safety gas can
- Hearing protector
- Goggles
- Spare belt and air filter

- Air filter oil and engine oil
- Gasoline stabilizer
- Combo screwdriver/wrench
- Instruction manual



AM083	K-12 FD Standard 14" Rescue Saw Kit with Full Size Steel Case	\$2,748.95
AR179	K-12 FD Fire Department Rescue Saw 14" Guard 94cc Gas Engine	\$1,913.95
AW198	K-12 FD Mega 14" Rescue Saw Kit with Full Size Aluminum Case	\$3,292.95
BE278	14" Lightning Diamond Blade - Use/Metal and Masonry	\$274.95

TEAM/HUSQVARNA K-12 FD 74CC RESCUE SAW

Contains: K-12 FD 74cc 12" fire rescue saw. Modified 74CC Partner/Husqvarna K760 Active 2 cycle gas engine. Fire Department modifications include: constant on "READY START" ignition switch, large D Handle starter grip, lightweight magnesium guard with welded "D" ring for attaching saw sling and saw carrying sling.

FEATURES:

- Air-cooled 2-stroke engine
- Active Air Filtration™
- X-Torc®
- SmartCarb™
- DuraStarter™
- EasyStart™
- Reversible cutting arm
- Easy-adjust blade guard
- Wet Kit
- Replaceable arbor bushing



BLADE AND SLING SOLD SEPARATELY



BL100	Team/HUSQVARNA K-12 FD 74 Rescue Saw	\$1,268.95
BL101	Optional Sling Assembly	\$199.95
BG238	12" Piraya Blade	\$203.95

TEAM HUSQVARNA K12FD9 SAW BUNDLE

The TEAM Husqvarna K12FD9 is a lightweight battery power cutter with low vibrations and user-friendly ergonomics. The excellent power-to-weight ratio makes it versatile for lighter cutting needs. The saws brushless motor produces zero emissions, makes minimal noise and has a built-in wet cutting kit to control dust. The K12FD9 weighs 7.7 lbs. and perfect for quick and efficient cuts in confined spaces. Paired with a 9" Piraya Diamond Blade you'll make fast and efficient single pass cuts and scores in steel, rebar and concrete up to 3 in. deep. The K12FD9 uses the Husqvarna BLi200/300 batteries.



NEW

FEATURES:

- Brushless motor
- 36V, 1.6hp output
- 5.2Ah/187Watt battery
- 3" cutting depth
- Wet or dry cutting
- Integrated eyelet for carrying
- Electric retarder
- Reflective letters
- 9" blades.

CALL DARLEY FOR MORE INFORMATION

TEAM
EQUIPMENT, INC.

BP173	Team Husqvarna K12FD9 Saw Bundle with Charger & Two BLi200 Batteries	\$1,404.95
BP302	BLi-300 Battery	\$304.95
BP303	Team Husqvarna K12FD9 Saw Bundle with Charger & Two BLi300 Batteries	\$1,508.95

SHARK II VENTILATION SAW

BESTSELLING ALL-AROUND PRIMARY RESCUE SAW WITH THE BEST POWER TO WEIGHT RATIO AND UNLIMITED CUTTING CAPABILITY.

Specifically designed for Fire Department use, outlasts up to 10 regular chains and stays sharp up to 25 times longer. Control cutting depth from 2" to 10" when plunge cutting. Easy, fast removal when full length of bar is needed. Keeps chain properly lubricated in diverse conditions with no oil flow at idle. Air injection filters out 98% of incoming dust prior to reaching the heavy-duty air filter for longer life and better filtration.



NEW

FEATURES:

- Easy to check fuel level with transparent fuel indicator
- Easy to open and secure firmly, even with thick winter gloves
- Peak performance even under heavy loads with 12% higher cutting capacity
- The AutoTune Carburetor compensates for different fuels

TEAM
EQUIPMENT, INC.

BP304	SHARK II Ventilation Chainsaw With 16 Bar, Terminator Carbide Tipped Chain and Depth Adjuster Only	\$2,124.95
BP305	SHARK II Ventilation Chainsaw With 20 Bar, 64 Drive Link Terminator Carbide Tipped Chain and Depth Adjuster Only	\$2,159.95
BP306	SHARK II Ventilation Chainsaw With 20 Bar, 66 Drive Link Terminator Carbide Tipped Chain and Depth Adjuster Only	\$2,174.95

BatShark

The BatShark giving you a unique combination of high efficiency and clean operation in a lightweight, powerful machine. Reduced overall cost of ownership with this high-performance battery machine compared to an equivalent gas-powered chainsaw. The BatShark eliminates direct emissions, operates quieter with lower vibrations and minimized maintenance and never needs gas. Without the worry of bad fuel or dirt ingestion causing carburetor or engine repairs, the BatShark will give you years of dependable service. *Battery and charger sold separately or in bundles below.*

CALL DARLEY FOR MORE INFORMATION



NEW

FEATURES:

- High chain speed for optimal wood cutting performance. Operated using an intuitive push button keypad.
- Extremely easy to start and stop
- Lightweight and ergonomically balanced
- Zero emissions, 36-volt Li-Ion battery performance
- Low vibration - low noise
- Angled front handle for better grip and natural working position

INCLUDES:

- Battery-powered chainsaw
- Reflective fire department labeling
- 14" bar
- Wood cutting chain
- Bar & chain cover
- Rear eyelet
- Srench tool with holder

SPECIFICATIONS:

- Brushless motor
- Chain type - wood cutting only
- Automatic oil pump tank volume
- Sound power level - guaranteed (LWA) - 106dB(A)
- Sound power level, measured - 104 dB(A)

TEAM
EQUIPMENT, INC.

BP297	BatShark Chainsaw, 14" Bar and Chain, Batteries & Charger not included	\$524.95
BP298	BatShark Chainsaw, 14" with Charger, 1 BLi200 Battery (5ah 36v)	\$859.95
BP299	BatShark Chainsaw, 14" with Charger, 1 BLi300 Battery (9.4ah 36v)	\$961.95
BP300	BatShark Chainsaw, 14" with Charger, 2 BLi200 Battery (5ah 36v)	\$1,062.95
BP301	BatShark Chainsaw, 14" with Charger, 2 BLi300 Battery (9.4ah 36v)	\$1,266.95

SUPER VC4 POWER PRO CUTOFF SAW

The SVC4 is an update to the popular SVC3. A smaller and lighter design improves mobility and the Dolmar 2 stroke engine turns the same 14" diamond blade cutting wheel at 500 more RPM. These high performance saws are designed for the fire and rescue service and proves to cut through concrete, asphalt, stone, and more with ease. The SVC4s extremely user-friendly with EasyStart technology for reliable starts, a Touch & Stop lever for immediate shutoff, built in scrench tool for making quick adjustments, and an upright fuel inlet allowing for easier and cleaner refueling. It has a window to check fuel levels on the fly.



Cat#	Dimensions	BHP	RPM	Diam.	Weight
BG206	15.25"Hx30"Wx11"D	4.3	9850	14"	19.6

- Aluminum D-ring pull handle
- Ultimate debris removal system and filters
- Flow of exhaust against dust direction
- 2-year warranty



BG206	14" Cutoff Saw with Tiger Tooth Blade	\$1,890.95
BG207	14" Cutoff Saw, Full Kit, Tread Plate Box	\$2,523.95

WARTHOG™ VENTILATION BLADE THE LAST ROOF VENTILATION BLADE YOU'LL EVER BUY

The Warthog™ blade easily and quickly cuts through roofing materials, wood flooring and siding. Heavy-duty construction helps prevent tip loss, which is the major problem with standard carbide tipped blades. The tip is mounted to the blade by a special process. This process cushions the tip mounting and makes this blade the most durable, and probably the last, ventilation saw blade you will ever buy. *Ship. wt. 7 lbs.*



- Doesn't bind or clog
- Heavy-duty tips are a full 3/8" wide and 5/8" tall

Blade comes standard with 1" arbor (center) hole.
AS269: 20mm to 1" spacer (Stihl and other saws with 20mm arbors)
AS268: 7/8" to 1" spacer (saws with 7/8" arbors)

AJ572	Warthog™ Blade	\$298.95
AS268	Warthog™ Blade 7/8" to 1" Spacer	\$9.95
AS269	Warthog™ Blade 20mm to 1" Spacer	\$15.95

PIRAYA DIAMOND BLADES

For years the fire service has requested "one blade that cuts all materials" for rescue saws. The Piraya Diamond Blade is as close to meeting this requirement as is technically possible in today's Diamond Blade industry. The Piraya Diamond Blade is vacuum-braided using high-quality grade diamonds for fast, smooth cutting and long blade life. Fits all rescue saws using 12" and 14" diameter blades. Fits 1" or 22mm arbor with included 22mm bushing.



USES:

- Concrete
- Wood
- Auto parts
- Masonry
- Copper
- Aluminum
- Metal
- Glass block
- Stainless steel
- Plastic
- Windshields
- Corrugated roofing

BP310	9" Piraya Diamond Blade	\$124.95
BG238	12" Piraya Diamond Blade	\$203.95
BG239	14" Piraya Diamond Blade	\$228.95

FIRE TIGER TOOTH BLADES

Fire Tiger Tooth and Safety Diamond Blades outlast abrasive cutting discs 100 to 1, saving valuable time replacing abrasive blades as they wear down. *Fits on 4", 4 1/2" hand-held grinders, 7" circular saws, 12"-14" gas saws, and chop saws. Includes 22mm bushing.*



USES:

- Masonry
- Concrete
- Roof tile
- Dry wall
- Stainless steel
- Copper pipe
- Steel
- Plastic
- Stucco
- PVC
- Rebar
- Wood
- Tile backer board
- Corrugated roofing
- Polyethylene pipes

Cat#	Description	Diameter	Arbor	Width	Price
BE273	Fire Tiger Tooth Blade	12"	1"	.125	\$194.95
BE274	Fire Tiger Tooth Blade	14"	1"	.125	\$244.95

VENTMASTER® HEAVY-DUTY FIRE RESCUE SAWS

The VentMaster® Fire Rescue Saws is ready for demanding work by Fire Fighters. At just 14 1/2 lbs., the 572HD has a better power-to-weight ratio and 12% higher cutting capacity than the previous 576HD model. Excellent cooling and heavy duty filtration maximize reliability, while a smart design accommodates longer guide bars.



SHOWN WITH BK202

- **VentMaster® COBALT Guide Bar:** Extremely hard COBALT alloy inserts at the wear points provide excellent wear, galling, and impact resistance. Retains these properties even at very high operating temperatures.
- **Tool-Less KIS-40 Depth Gauge:** Accurately control cutting depth, protect operator and safely speed cut. Fast, simple installation and removal, and eliminates the need to "roll the rafters."
- **Raptor Carbide Chain:** Engineered specifically to withstand the rigors of fire and rescue operations. Features an "open dual raker" design to protect the carbide cutters and control the depth of cut.
- **Sealed & Protected Carburetor/Air Filter:** Equipped with state-of-the-art filtration system 572HD® carries a large surface heavy duty filter for longer and better filtration. The filter has a larger filtration area compared to previous generation. Providing a chainsaw with a healthier engine optimised for long working hours.
- **Centrifugal Force Air Cleaning System:** Cleaner intake air means longer intervals between filter cleanings, longer runs at full power, and reduced internal engine wear.

TEMPEST

BC064	VentMaster® 572HD w/16" Guide Bar and Depth Gauge, .404 Pitch	\$2,454.95
BC065	VentMaster® 572HD w/20" Guide Bar and Depth Gauge, .404 Pitch	\$2,544.95
AM115	Raptor Carbide Chain, 16" with .404 Pitch	\$270.95
AM116	Raptor Carbide Chain, 20" with .404 Pitch	\$328.95
BK202	Optional LED Light	\$158.95

UNIVENT PRO-SAW

The Univent Pro-Saw is ideal when your compartment space is limited. It has the best power to weight ratio compared to any other saw in its class. This is virtually the safest saw ever built with our exclusive spring loaded depth gauge. It also gives the operator more reach and comfort while using the saw, and eliminates cutting rafters out from under you. The Pro-Saw was designed and engineered just for the rugged demands of the fire service with features no other saw can offer.



- Large D-ring handle
- Smart start
- Full wrap handle is standard
- 71 cc (4.5 cubic inch)
- 6.5 hp
- 13,500 rpm
- 13 lbs. (without bar or chain)

BD043	Univent Pro-Saw 16" with Depth Gauge/Sabretooth FD Chain	\$2,168.95
BD044	Univent Pro-Saw 16" with Depth Gauge/Cobra Chain	\$2,294.95
BD045	Univent Pro-Saw 20" with Depth Gauge/Sabretooth FD Chain	\$2,317.95
BD046	Univent Pro-Saw 20" with Depth Gauge/Cobra Chain	\$2,467.95

SUPER POWER PRO V3 VENTILATION SAW

With a powerful Dolmar 6.3 HP engine that turns at 13,500 RPM, your department can rely on the Super Vac SV3 Power Pro Saw for venting and rescue operations. With a handle designed for maximum versatility, this saw tackles a variety of operations with ease, including cutting through residential roofing, removing downed trees, and ripping through various building materials. With a quick-start compression release and an "always on" ignition, the SV3 is ready-to-go when you are.

- Chisel chain/depth gauge
- Airmaster filtration
- Quick Silver aluminum D-ring pull handle



BG208	16" Saw with Guard/Depth Gauge	\$2,474.95
BG209	Chisel Chain Loop for 16" Bar	\$298.95
BG210	16" Vent Saw, Full Kit, Tread Plate Box	\$3,041.95
BG211	20" Saw with Guard/Depth Gauge	\$2,532.95
BG212	Chisel Chain Loop for 20" Bar	\$335.95
BG213	20" Vent Saw, Full Kit, Tread Plate Box	\$3,124.95



Cat#	Dimensions	HP	Bar	Weight
BG208	11.25"Hx13"Wx34.5"D	6.3	16"	20.8
BG211	11.25"Hx13"Wx38.5"D	6.3	20"	21.6

AIR HAMMER RESCUE KITS

High-quality Air Hammer Rescue Kits have been designed specifically for extrication and are field-proven not only for emergency extrications but for all types of emergency cutting such as: factory doors, casement windows, fire doors and many other jobs. Release the trigger and the tool stops instantly. Completely portable and compact enough to be easily carried in fire trucks and rescue vehicles. Operated off fresh air tanks, compressors, nitrogen bottles, cascade systems or air brake outlets. Use with either 2216 or 4500 psi air tanks.



STANDARD DUTY KIT

Complete Kit with everything necessary to hook up to an air tank and begin extrication work.

- Hammer for .401" shank tools
- Retainer
- Regulator
- 2 - Double blade panel cutter (non-turn)
- 2 - Kwik cutter (non-turn)
- 2 - 18" Kwik cutter (non-turn)
- Moil point (turn-type)
- 15 ft. 1/4" hose
- 2 - Male connector (1/4" NPT hose and hammer)
- Male coupler (1/4" NPT regulator)
- Female coupler (1/4" NPT hose)
- Gauge guard
- 20" steel kit box
- Kit box liner
- 4 oz. oil
- Trim removal tool



S878

S878 Standard Duty Air Hammer Kit \$970.95

HEAVY-DUTY KIT

Features Heavy-Duty Hammer with longer piston stroke for more powerful cutting action. Includes non-turn and turn-type chisels.

- Hammer for .401" shank tools
- Retainer
- Regulator
- 2 - Double blade panel cutter (non-turn)
- 2 - Kwik cutter (non-turn)
- 2 - 18" Kwik cutter (non-turn)
- 2 - Panel cutter (turn-type)
- 2 - Kwik cutter (turn-type)
- 2 - 18" Kwik cutter (turn-type)
- Ripper chisel (turn-type)
- Moil point (turn-type)
- 15 ft. 1/4" hose
- 2 - Male connector (1/4" NPT hose and hammer)
- Male coupler (1/4" NPT regulator)
- Female coupler (1/4" NPT hose)
- Gauge guard
- 20" steel kit box
- Kit box liner
- 4 oz. oil
- Trim removal tool



AJ318

AJ318 Heavy-Duty Air Hammer Kit \$1,597.95

SUPER-DUTY KIT

Features Super-Duty Hammer, our most powerful and hardest hitting hammer. Includes non-turn and turn-type chisels.

- Hammer for .498" shank tools
- Retainer
- Regulator
- 2 - Ergo chisel grip (non-turn)
- 12" moil point (non-turn)
- 2 - Double blade panel cutter (non-turn)
- 2 - Kwik cutter (non-turn)
- 2 - 8" Kwik cutter (non-turn)
- 2 - Double blade panel cutter (turn-type)
- 2 - Kwik cutter (turn-type)
- 2 - 18" Kwik cutter (turn-type)
- 15 ft. 3/8" hose
- 3/8" Male connector (1/4" NPT hammer)
- 3/8" Male connector (1/4" NPT regulator)
- 3/8" Female coupler (3/8" NPT hose)
- Gauge guard
- 20" steel kit box
- Kit box liner
- 4 oz. oil
- Trim removal tool



AJ472

AJ472 Super-Duty Air Hammer Kit \$2,394.95

PROFESSIONAL EXTRICATOR HYDRAULIC RESCUE KITS

EXTRICATOR FORCIBLE ENTRY KIT

Use it to open damaged doors in plants and factories, or raise clutch and brake pedals in auto rescue extraction by using the Spreader and Wedge combination. Come-a-longs and chains are used to pull seats, doors, steering columns, and to roll quarter panels out of the way. The straight Ram and attachments are used to lift heavy objects and push metal within the vehicle to free trapped victims. This kit will allow you to move in multiple directions at the same time. *Ship. wt. 150 lbs.*



T861 Extricator Forcible Entry Kit \$7,289.95

10-TON DELUXE RESCUE KIT

The capability for providing big power in compact spaces. Spreader toes lift heavy machinery, elevators, etc. "Wedgie" and "Spreader" rams open car doors, move steering columns, bumpers and obstructing metal. Two powerful rams are included. Includes 16 gauge metal box. *Ship. wt. 122 lbs.*

L871 10-Ton Deluxe Rescue Kit \$6,289.95

5-TON DELUXE RESCUE KIT

This compact set provides professional capability at a low cost. Includes large "Spreader" ram for lifting fallen objects, prying doors, bars, damaged sections, etc. Contains "Wedgie" and a powerful 5-ton ram with a 5" stroke. 16 gauge lockable/sealable metal box included. *Ship. wt. 64 lbs.*

L870 5-Ton Deluxe Rescue Kit \$5,372.95

5-TON RESCUE KIT

A lightweight set, stores easily and provides basic tools for emergency extrication work. Ideal for patrol cars and emergency vehicles. Includes 2-rams, "Wedgie" and 5 1/4" stroke ram with 5-ton capacity. *Ship. wt. 28 lbs.*

L869 5-Ton Rescue Kit \$3,194.95

AIRGUN KIT

1600-1700 high impact blows per minute, 7 pound, pneumatic impact tool. Combining ease of handling, very low air consumption and high power output. It is an ideal tool for rescue work. Vehicle crash sites, metal clad buildings, aircraft penetration, exhaust ducts and composite structural material are typical barriers often faced by rescue personnel. The Airgun, using one of several specially designed tool bits, should be your tool of choice when faced by these situations. Ideal confined space tool. *Ship. wt. 31 lbs.*

- Airgun, with inline oiler
- Pressure regulator, 5,500 - 300 psi
- 3/8" diameter, 32' hose
- 10" curved metal cutter bit
- 11" bullpoint bit
- 11" chisel, 3/4" wide bit
- Lubricating oil, 4 oz.
- Retainer service tool
- Hex key 7/32"
- Hex key 3/16"
- Operating and instruction manual
- Plastic safety goggles
- Ballistic nylon carrying case 23"x10 1/4"x13"



PARATECH.

BB136 Airgun Kit \$3,428.95

WORKING AIR® CYLINDER

These are lightweight, sturdy cylinders, ready to use. Have an economical air supply on hand. Made of strong, high density aluminum; standup design allows more convenient vertical storage. They take the rough handling at an emergency scene without the concern for costly fiber damage to your SCBA cylinder. Best of all, they cost much less than new high-pressure breathing air cylinders. This means that your department can economically maintain a high-capacity air system without tapping SCBA resources. *Note: not for breathing air. Ship. wt. 10 lbs.*



PARATECH.

AC630 Working Air® Cylinder / 13 cu. ft. \$625.95

HEAVY RESCUE OUTFIT

The PETROGEN® Heavy Rescue Outfit is designed for extensive steel cutting in a heavy rescue situation. The components were assembled with the input of firefighters and USAR members. Hundreds of fire departments and USAR teams are using the PETROGEN® system. *Ship. wt. 45 lbs.*



BA126 Heavy Rescue Outfit

\$2,364.95

DARLEY CHAIN KIT

- 6' "J" hook
- 3' "C" hook
- 2' "T" hook
- 7' Pull chain assembly
- 12' Extension chain
- 2 - Cheater chains
- Carrying container
- *Ship. wt. 50 lbs.*



AZ525 Darley Chain Kit

\$592.95

FIREFIGHTER RESCUE CHAIN PACKAGE

For safety and maximum efficiency chains are matched with a 3 ton heavy duty chain come-a-long ensuring that the system will never be overloaded as long as all components are used together. Because of the size and weight of components in this package, it is not practical to store in a carrying container. All items should be stowed loose in a compartment for easier handling.

INCLUDES:

- Loading hook
- 3 ton chain come-a-long
- 7' chain sling
- 10' chain sling
- 16' pulling chain
- "Cheater" chain
- "J" hook



NEW



BP311 Firefighter Rescue Chain Package

\$1,549.95

DARLEY DELUXE CHAIN KIT

The Darley Deluxe Chain Kit can help save time and lives in a crash rescue situation involving pulling or moving of steering columns, seats, doors, dash boards, etc. Kit can be used separately or as a companion to your hydraulic equipment.

INCLUDES:

- 20' slip hook/grab hook
- 20' "cheater" chain - dual grab hooks
- "J" hook assembly with round ring and shackle
- 6' chain with "J" hook on one end, "T" hook and grab hook other end
- 1½ ton capacity series 653 lever hoist with 5' lift
- Carrying container

NEW

GRADE 70
CHAIN CAPACITY



BN081 Darley Deluxe Chain Kit

\$649.95

SURE CUT SYSTEM

The Sure Cut System will cut virtually any metal, both ferrous and non-ferrous, and is faster than conventional oxy-acetylene cutting. Our system does not require preheating or cleaning the material before cutting. It is easy-to-use and is cost effective for most applications.



FEATURES:

- **No Carbon Residue:** Clean cuts with no carbon to grind away
- **Portable:** It can be used in remote areas with the use of a 12v battery
- **Easy-to-Use:** All you need is an ignition source (welder, 12 or 24v battery or torch) and oxygen to operate
- **Faster:** Sure Cut is as much as five times faster than oxy-acetylene cutting and up to ten times faster than Carbon Arch Gouging, depending on the thickness of material to be cut

BH017 Tool Box Kit with Standard Holder and 24 Rods*

\$753.95

* 12 each ¼" and 12 each ⅜"x24" QC rods

PACKEXE® SMASH KIT

Packexe® SMASH is the original time-critical glass management tool. For use in extrication on all types of glass. Packexe® SMASH holds glass in place, reducing the risk of injury from glass fragments and dust.

FEATURES:

- Dispenser
- SMASH roll (12.25" x 164" perforated every 4", fits dispenser)
- SMASH roll (12.25" x 164" un-perforated hand application)
- Film cutter
- Safety knife
- Squeegee
- Cloth
- Carrying bag



BP100 Packexe® SMASH Kit

\$359.95



NEW

SMASH HAND ROLL

The dispenser applies the adhesive film quickly. Perforations on the film then permit easy and exact placement on the surface. *SMASH Hand application roll only (12.25" x 164" unperforated).*

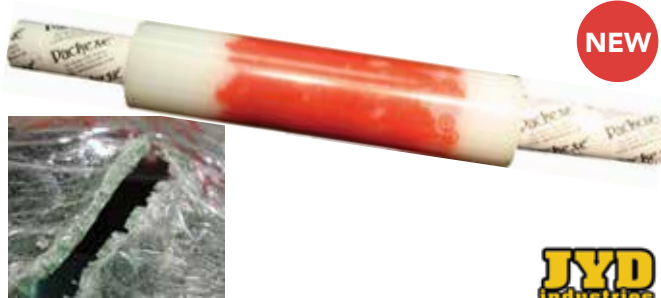

NEW



BP101 SMASH Hand Roll

\$78.95

DOGGIE BAG

The uniquely engineered JYD Doggie Bag is designed as an economical solution for responders to conveniently carry specifically selected components to assist during the stabilization process as well as to work effortlessly with JYD Rescue Struts

- 2 - Ratchet straps with 20' of webbing
- 2 - Axle straps
- 2 - Open hook straps
- 2 - Cluster hooks
- C-Hook on webbing



NEW



BP103 Doggie Bag

\$454.95

EXTRICATION PROTECTION KIT

- For protection of rescuers and patients during extrications
- Covers posts and other jagged edges
- Durable exterior - made of 22 oz. poly coated vinyl
- Strong pliable inner material - Kovenex® Aramid material
- Washable, non-wicking



NEW



BP104 Extrication Protection Kit

\$470.95

GLASS KNIFE KIT

Engineered to fit any drill and capable of cutting laminated glass in newer model vehicles. The Glass Knife and drill work independently for use in any position. Available to purchase with or without drill set.

- Glass knife head
- Bag pry bar
- 5 - N95 dust mask
- Safety glasses
- Can of wetting agent



NEW



BP098 Glass Knife Kit

\$595.95

BP099 Glass Knife Kit with 12v Milwaukee Drill

\$715.95

MINI PULLER KIT

MINI LEVER PULLER

- 1/2 ton come along (1,000 lbs.)
- Compact, lightweight carbon steel design
- Non-slip rubber handle
- High output, short handle for tight spaces
- 5', grade 100, nickel-plated load chain
- Free chain mechanism
- Load chain guide for smooth operation
- Both hooks have notched safety latches
- Meets ASME b30, every hoist is tested to 125% of rated capacity
- 5' x 9/32" grade 100 adjustable anchor chain
- Labeled carrying bag



BP102 Mini Puller Kit

\$519.95



NEW

CRASH BAG KITS

JYD Industries Crash Bag Kits were designed for responders to utilize as a first-in tool at a vehicle crash. With 18+ industrial quality tools carried in one bag, the Crash Bag Kit contains the basic equipment necessary to start initial stabilization and quick entry for patient assessment. Crash Bags contain a removable magnetic tool board with pockets for individual tools to magnetically attached to a vehicle with a built-in semi-removable divider to hold additional large tools. The ELITE Crash Bag Kit includes JYD's laminated glass cutter, an essential for today's responders.

STANDARD FEATURES:

- Channellock® 6-in-1 screwdriver
- Channellock® pliers
- Channellock® 10" adjustable wrench
- Channellock® cable cutters
- Ajax Strip & Peek pry tool
- Rescue shears
- Spring-Ring window punch
- Lenox® 12" hacksaw
- 4 - Spare Lenox® hacksaw blades
- JYD Industries seat belt cutter
- 4 - Tire valve deflator/inflators
- GlassMaster saw with center punch
- Kovenex® rapid response rescue blanket
- Standard Crash Bag Kit: 25" (L) x 6" (W) x 19" (H), 13.5 lbs.
- Elite Crash Bag Kit: 25" (L) x 8" (W) x 19" (H), 28 lbs.



BP096	Standard Crash Bag Kit	\$722.95
BP097	Elite Crash Bag Kit	\$1,236.95

ZSTRUT STABILIZING KIT

JYD Industries ZSTRUT style Rescue Struts are designed with Patented ZipNut® Technology, an engineered deployment method that ELIMINATES THE NEED FOR PINS all together. ZSTRUTs allow for quick and simple deployment and adjustments with the ability to follow lifts and have a safe WLL of 5000 lbs. with a 2:1 Safety factor. Approach any scenario with confidence by arming your department with one of JYD's combination Stabilizing Kits. With x2 Small ZSTRUT Struts w/ accessories, x2 Large ZSTRUT Struts with accessories, x2 Sidewinder Jack Kits, x2 Cleat Bases and a Milwaukee Kit, JYD's Stabilization Kits have everything you need for conventional and unconventional stabilization needs, all in one convenient package.

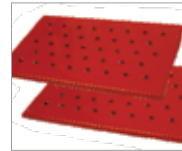

BP110	ZSTRUT Stabilizing Kit #1	\$8,076.95
-------	---------------------------	------------

XTEND STABILIZING KITS

JYD Industries XTEND style Struts use heavy duty, top quality, stainless steel Locking Adjustment "T" Pins for quick and secure deployment and have a safe WLL of 5000 lbs. with a 2:1 Safety factor. Approach any scenario with confidence by arming your department with one of JYD's combination Stabilizing Kits. With x2 Small XTEND Struts w/ accessories, x2 Large XTEND Struts with accessories, x2 Sidewinder Jack Kits, x2 Cleat Bases and a Milwaukee Kit, JYD's Stabilizing Kits have everything you need for conventional and unconventional stabilization needs, all in one convenient package.



NEW



BP108	XTEND Stabilizing Kit #1	\$5,527.95
BP109	XTEND Stabilizing Kit #2	\$7,125.95

SIDEWINDER JACK KIT

ENGINEERED SCISSOR OPERATION SPECIFICALLY DESIGNED FOR RESCUE WORK



FEATURES:

- Enclosed threaded rod
- Roller bearings for smooth action
- Wide base - polymer coated bottom
- Tilted head for angled adjustment
- Pivoting carry handle
- Rate at WWL of 7,500 lbs.
- Lifts from 5.25" to 13.25"
- Attached clevis for securing with ratchet strap
- Can be operated manually or with power tools (sold separately)



BP095	SideWinder Jack Kit	\$824.95
-------	---------------------	----------

TURTLE PLASTICS® CRIBBING AND CHOCKS

RESCUE TOOLS

AUTO X CRIB TOOL KITS

THE MOST POPULAR KITS FOR ANY SIZED FIRE STATION.

The most popular kits for any sized fire station. Turtle Plastics has worked with fire trainers and our fire customers to create different combinations of Dura Crib/Dura Stat items such as Hybrid Crib, Super Crib, Step Chocks, Lock Blocks, wedges and Mod Pads, into comprehensive auto extrication kits. Replace dirty and dangerous wood with engineered products that are washable, load rate, and ready for quick deployment.



AS273



CRIB TOTER



AS274



Description	Kit A	Kit B	Kit C	Kit D
2"x4"x18" Pyramid Crib	6	12	12	12
2"x4"x12" Wedge	2	4	4	4
Hybrid Crib 4"x4"x18"	9	18	36	36
4"x4"x20" Wedge	2	2	8	8
6"x7"x24" Super Crib			8	8
6"x7"x24" Super Wedge			2	4
3"Wx8.5" Long Wedge	1	2	2	4
6"Wx8.5" Long Wedge	1	2	2	4
1" Thick x 9" Sq. Turtle Lock Block	1	1		4
2" Thick x 9" Sq. Turtle Lock Block	1	1		4
3" Thick x 9" Sq. Turtle Lock Block	1	1		4
Standard Step Chock	2	2	4	4
Pair of Wheel Chocks	1	2	4	4
18"x18"x1.5" Mod Pad with Level	1	1	2	2
Cog Step Chock				2
Carrying Bag	1	2	4	4
Crib Toter	1	2	4	4

Cat#	Description	Ship. wt.	Price
AS273	Auto X Crib Tool Kit A	257 lbs.	\$1,086.95
AS274	Auto X Crib Tool Kit B	513.5 lbs.	\$1,756.95
AS275	Auto X Crib Tool Kit C	1,214.5 lbs.	\$3,610.95
AS276	Auto X Crib Tool Kit D	1,368.5 lbs.	\$4,563.95

QUICK RESPONSE TOOL KITS

IDEAL FOR RURAL POLICE, CHIEF'S VEHICLES AND SMALL RESCUES

INCLUDES:

- 2 - Standard step chocks
- Double wheel chock
- 2 - 3" wedges
- 1"x9" square lock block
- 2"x9" square lock block
- 25"x15"x6" carrying bag
- Weight: 58 lbs.
- Color: Black (Wheel chocks are yellow)



Cat#	Description	Price
BE295	Quick Response Tool Kit	\$425.95

STANDARD, MEDIUM, GIANT AND COG STEP CHOCKS

- Quick stabilization and leveling
- Super stability for passenger cars, trucks, buses and heavy rescue
- Lightweight with very stable base dimensions
- Built-in hand hold
- COG features locking wedge and incline for maximum stability
- Dimensions:
 - AJ328 - 24 1/2"x5 3/4" (base)x3 3/4" (top)x10 3/4" H, step is 3 3/4" W
 - BN305 - 29 1/2"x9" (base)x4 1/2" (top)x17 1/4" H, step is 4 1/2" W
 - AS271 - 31 1/2"x11" (base)x5" (top)x22" H, step is 5"Wx6"D
 - BN301 - 24 3/8"x6 5/8"x10 3/4" H, step is 5"Wx3 1/2"D
- Color: Black



24 1/2" Length



31 1/2" Length



29 1/2" Length



Cat#	Description	Weight	Price
AJ328	Standard Step Chock	17 lbs.	\$104.95
BN305	Medium Step Chock	37 lbs.	\$249.95
AS271	Giant Step Chock	63 lbs.	\$453.95
BN301	COG Step Chock	24 lbs.	\$169.95

ARAMID LIFTING BAGS

Matjack's unique construction of four full layers of aramid fiber provide for a lifting bag unequaled in strength and durability. All Matjack air lifting bags are marked with a distinct white numbered, "bull's eye" for ease of centering under the load, and have a conical, interlocking surface to limit slippage and aid in stacking. All Matjacks have either carry handles or tabs molded right on for lifting or attaching to fixtures. The Matjack "state-of-the-art" deadman controller allows for independent or simultaneous operation of one or more airbags. Supply hoses are color coded to help eliminate confusion during simultaneous operation of more than one airbag. *Made in the USA.*



BL979

Cat#	Dimensions	Capacity	Height	Weight	Eyelets Tabs	Handles	Price
BL969	6" x 6" x 3/4"	1.5 tons	2.5" Lift	2 lbs.	2	-	\$292.95
BL970	6" x 12" x 3/4"	3.3 tons	3" Lift	3 lbs.	4	-	\$379.95
BL971	10" x 10" x 1"	6 tons	4.5" Lift	4 lbs.	4	-	\$565.95
BL973	15" x 15" x 1"	13 tons	7.5" Lift	11 lbs.	4	-	\$774.95
BL975	20" x 20" x 1"	22 tons	9.5" Lift	22 lbs.	-	1	\$1,020.95
BL977	21" x 25" x 1"	32 tons	12" Lift	28 lbs.	-	1	\$1,145.95
BL979	42" x 16" x 1"	37 tons	9" Lift	33 lbs.	7	2	\$1,381.95
BL981	29" x 29" x 1"	50 tons	15" Lift	45 lbs.	-	2	\$1,758.95
BL983	34" x 34" x 1"	70 tons	18" Lift	60 lbs.	-	2	\$2,319.95

HIGH PRESSURE AIR LIFTING BAG KITS

BL966 INCLUDES:

- 2 - 22 ton aramid reinforced high pressure air bag
- Dual deadman control with safety coupler
- 2 - 20' supply hose with safety coupler (blue & red)
- 10' regulator hose with safety coupler
- Regulator for 4500 air bottle with safety coupler

BL967 INCLUDES:

- 2 - 22 ton aramid reinforced high pressure air bag
- 2 - 50 ton aramid reinforced high pressure air bag
- Dual deadman control with safety coupler
- 4 - 32' supply hose with safety coupler (red, blue, black, gray)
- 10' regulator hose with safety coupler
- Regulator for 4500 air bottle with safety coupler

BL968 INCLUDES:

- 13 ton aramid reinforced high pressure air bag
- 2 - 22 ton aramid reinforced high pressure air bag
- 37 ton aramid reinforced high pressure air bag
- 2 - 50 ton aramid reinforced high pressure air bag
- 2 - Dual deadman control with safety coupler
- 6 - 32' supply hose with safety coupler (red, blue, black, gray)
- 2 - 10' regulator hose with safety coupler
- 2 - Regulator for 4500 air bottle with safety coupler



BL966



All Matjack high pressure air bags come with a 5-year warranty. *Made in the USA.*

BL966	Small High Pressure Lifting Bag Kit	\$3,597.95
BL967	Medium High Pressure Lifting Bag Kit	\$7,641.95
BL968	Large High Pressure Lifting Bag Kit	\$10,766.95

AUTO CRIB-IT™ STEP CHOCK

SPRING ACTIVATED FOR STABILIZING VEHICLES IN SECONDS



BH117

- Automatically re-adjusts and locks during operations
- Super compact! Leaves storage space for other vital equipment
- Taller than most step-chocks
- Can be positioned completely under and parallel to rocker panels to avoid trip hazards
- Lightweight high-strength aluminum
- Easily decontaminated

BH117:

- Weight: 14.5 lbs.
- Height: 13"
- Rated for 2,000 lbs. max. load

BN077:

- Weight: 23.5 lbs.
- Height: 17"
- Rated for 2,800 lbs. max. load



BH117	AUTO CRIB-IT™ Step Chock	\$997.95/set of 2
BN077	AUTO CRIB-IT™ for SUV's and Light Duty Trucks	\$1,223.95/set of 2

TELESCOPING ALUMINUM SUPPORT SYSTEMS

Designed primarily for stabilizing motor vehicles involved in crashes, the TASS is a patented, 3-tiered telescoping aluminum support system. Like all Prospan products, the TASS has been designed to be simple to use and incredibly strong. Independent testing by the University of Illinois, shows the TASS to be one of the strongest vehicle stabilization products in the world.



- 3-tiered, telescoping aluminum pistons
- Knurled, easy-grab collars
- Tethered detent ball pins
- Anodized finish
- Durable design
- Simple to maintain



INCLUDES:

- Telescoping aluminum supports 26"- 48" span
- Baseplate - 10" with detent pins
- Baseplate shoring adapters
- Vehicle adapters
- V-Grip attachments
- Conical-shaped attachments
- Ratchet straps - 20" with hook cluster



BC028	Telescoping Aluminum Support Kit 26"-48"	\$1,902.95
BL623	Telescoping Aluminum Support Kit 43"-102"	\$2,188.95
BL624	Telescoping Aluminum Support Kit, Combined BC028 & BL623	\$4,091.95

THE BEAST™

AVAILABLE AS A COMPLETE SYSTEM, OR ORDER COMPONENTS INDIVIDUALLY. COMPATIBLE WITH ANY EXISTING RESCUE TOOL.

The BEAST™ is tested and proven to handle the most demanding 5 star crash rated vehicles. Made in the USA.

FEATURES:

- Weight: 51.9 lbs.
- Dimensions: 28.0"x12.5"x8.0"
- Operating Pressure: 5,000 psi
- Compatible with any low pressure system
- Limited lifetime warranty

BD170:

- Cutter and Spreader in one tool, you can change from full size cutter to a powerful spreader in seconds by pulling three pins
- Generates 35% more cutting force than any other 5,000 psi tool in the market
- Outfitted with Champion's patented laminated cutting blades with internal safety restraints
- Opening: 10.75" Cutter with 3.5" Power Notch; 28.0" spreader with 16.0" of parallel travel
- Accessories Include: 1 full size USAR cutting head and 1 full size spreading head for one low price

BL201:

- Type of Tool: Scissor
- Opening: 10.75" Cutter with 3.5" Power Notch
- Outfitted with Champion's patented laminated cutting blades with internal safety restraints
- Generates 35% more cutting force than any other 5000 psi tool in the market
- Accessories Include: 1 full size USAR cutting head



CUTTER

SPREADER



BL202:

Dash displacements, door removals or just skinning a vehicle quickly to expose cutting points, The BEAST™ Spreader is the tool for the job.

- Type of Tool: Spreader
- Opening: 28.0" Spreader with 16.0" of parallel travel
- Accessories Include: 1 full size spreading head



	Multi-Tool	Cutter	Spreader
Type of Tool	Scissor Cutter & Spreader	Scissor Cutter	Spreader
Cutting Force	294,000 lbs.	294,000 lbs.	-
Spreading Force	65,000 lbs.	-	65,000 lbs.

BD170	The BEAST™ Multi-Tool	\$5,895.95
BL201	The BEAST™ Cutter	\$5,595.95
BL202	The BEAST™ Spreader	\$5,595.95

TECGEN® 51 GEAR

FINALLY - A COOL, COMFORTABLE, CUTTING-EDGE ALTERNATIVE TO TURNOUT GEAR

LESS EXPOSURE TO CARCINOGENS

Wearing TECGEN51 on those 90% of calls eliminates potential exposure to hazards such as carcinogens and other harmful particulates that can accumulate on your turnouts.

LESS CARDIOVASCULAR STRESS & FATIGUE

Breathable, lighter weight, single layer garment

MORE DETAILS ON PAGES 112-113

SPECIFICATIONS:

- Dual-Certified: NFPA 1951 (Technical Rescue) and NFPA 1977 (Wildland FF)
 - Lightweight: Engineered to protect you without weighing you down
 - Comfortable: Provides enhanced mobility for confined spaces
 - Repels Moisture: Helps keep you cool and dry
 - Breathable: Managing the heat is easier when your clothes can breathe*
 - Active posture design
 - Durable: Flexible TECGEN® fiber provides increased durability over typical carbon-based fibers
- * High THL rating allows body heat to escape

STANDARD COAT FEATURES:

- 3.5" x 8" x 3" radio pocket with mic tab
- 6 1/2" x 5 1/2" patch pocket w/ flap closure on right chest
- 2 - 7" x 7" cargo hand pockets
- 2" 3M Scotchlite® triple trim
- Bi-wing back design for ease of movement
- Full width collar closure
- Glove interface adjustments

STANDARD PANT FEATURES:

- Comfortable and efficient BDU design 4" waist adjustment via take up straps
- Belt loops accommodate 2" belt
- 2 - 8 1/2" x 8 1/2" cargo pockets w/ flaps located on outside legs
- Front hand pockets
- 2 - rear pockets
- 2" 3M Scotchlite® triple trim
- Boot interface / leg take up adjustments
- 12" zippered leg openings for easy donning over boots
- Suspender loops

NEW



DELUXE GEAR HAS ALL THE SAME FEATURES AS STANDARD GEAR PLUS:

- 2" Reflective Triple Trim
- STEDSHIELD® FR reinforced elbows, knees with replaceable padded inserts and cuffs
- Pass-through pockets on pants
- Thermoplastic zipper
- Articulated knee
- Handwarmer pockets on coat



SPECIFY COLOR: Tan or Black

SPECIFY SIZE: S-XXL

SPECIFY INSEAM: 28", 30", 32", 34" or 36"



BN235	TECGEN® 51 - Coat - Standard	\$317.95
BN236	TECGEN® 51 - Pants - Standard	\$272.95
BN237	TECGEN® 51 - Coat - Deluxe	\$404.95
BN238	TECGEN® 51 - Pants - Deluxe	\$404.95

FR INDURA® COTTON COVERALLS

- 9.0 oz. per square yard Indura®
- Heavy-duty, two-way brass zipper
- Nickel plated brass snaps
- Two patch breast pockets, pencil slot in left pocket
- Two hip pockets with a snap closure on the left
- 2-in-1 utility/tool pocket on right leg
- Side access to pants with snap closure
- Adjustable cuffs with snap closures
- Sewn throughout with Nomex® thread
- Short: 5'4" - 5'7"
- Regular: 5'7 1/2" - 5'11"
- Tall: 5'11 1/2" - 6'3"



Chest	36	38	40	42	44	46	48	50	52	54	56
Short	•	•	•	•	•	•	•	•	•	•	•
Regular	•	•	•	•	•	•	•	•	•	•	•
Tall	•	•	•	•	•	•	•	•	•	•	•

SPECIFY COLOR: Tan or Navy

SPECIFY SIZE: Short, Regular, or Tall



BL461	FR Indura® Cotton Coveralls	\$130.95
-------	-----------------------------	----------



XTRICATION® RESCUE GLOVES

Shelby Xtrication® Rescue Gloves features reflective finger tips and a Kevlar® reinforced palm for excellent protection and durability.



FEATURES:

- Kevlar® reinforced palm and fingers
- Injection molded TPR padding covering back of hand and knuckles
- Cotton terry braw wipe and lining
- Reinforced rubber pull with carabineer loop
- Custom finger-back rubber guards
- Reflective finger tips
- Quick access pocket for EMT glove storage



FIT/COMFORT:

- Pre-curved glove with two-way stretch
- Air flow cordura back
- Soft cotton terry lining with "snuggler" and taslon debris blocker



SPECIFY SIZE: S-XXL

BN618 Xtrication® Rescue Gloves

\$57.95

EXTRICATION RESCUE GLOVES



- TPR impact protection on top of hand with full coverage for knuckles and fingers
- Knuckle TPR design with two detached fingers for better flexibility
- KevLoc padded palm panels and finger tips with reinforced stitching
- Secured cuff closure with hook and loop TPR pull tab closure
- High visibility colors for increased safety
- Reflective finger tips and stripe for better visibility
- Kevlar® stitching



SPECIFY SIZE: S-XXL

BN617 Extrication Rescue Gloves

\$29.95/pr.

HYBRID EXTRICATION HI-VIS GLOVES



- ResQLoc Grip System
- SuperCuff technology for full range of motion
- CE Rated 4343, Level 3 cut and puncture protection
- TPR impact protection on top of hand and full length of fingers
- High visibility for increased safety



SPECIFY SIZE: S-XXL

BK277 Hybrid Extrication Hi-Vis Gloves

\$42.95/pr.

911 BARRIER EXTRICATION GLOVES



- Waterproof and breathable Hipora® barrier to protect hands from micro-organisms such as TB, Hepatitis, Staph and HIV
- O.S.H.A. Bloodborne Pathogens Standards (29CFR 1910.1310)
- Molded TPR (Thermal Plastic Rubber) knuckles reduce impact and increase dexterity
- Boxed finger tip design for better fit and comfort
- Cut resistant Kevlar® palm, thumb, finger and side panels



SPECIFY SIZE: S-XXL

BD141 911 Barrier Extrication Gloves

\$60.95/pr.

VERTEX® VENTED HELMET

- Six-point mesh liner conforms to the shape of the head for improved comfort
- Shock absorption achieved through deformation of the outer shell
- CenterFit adjustment system ensures centering and optimal stability of the helmet on the head
- Adjustable ventilation holes with sliding shutters

- Side slots for mounting hearing protection
- Inserts for accepting a VIZIR face shield
- Slot for mounting a PIXA headlamp
- Four clips for mounting a headlamp with an elastic headband
- Chin strap designed to limit risk of losing helmet during a fall (strength greater than 50 daN)

SPECIFY COLOR:

Red, Black, Yellow or White

BK351 Vertex® Vented Helmet



\$112.95



USRX URBAN SEARCH & RESCUE HELMET

- Urethane impact liner
- M-Pact shell
- Sure-Lock® ratchet suspension
- Black rip-stop Nomex® ear/neck protector
- Quick-Attach™ faceshield
- Quick release 3-point chinstrap
- Edge beading
- Leather ratchet cover

SPECIFY COLOR: Red, Black, Yellow, White, Blue or Lime Yellow

BC075 USRX Urban Search & Rescue Helmet



\$204.95



FIRE RESCUE HARNESS™

UL CLASSIFIED TO NFPA 1983

The Fire-Rescue Harness™ remains one of the most versatile, multiple-use harnesses available. Used worldwide by fire department rescue teams, USAR teams, helicopter crews and wilderness SAR teams, this popular harness features multiple D-ring attachment points and CMC's JackBack™ removable padding with breathable D3 cloth.

- Dorsal D-ring allows adjustment for different size users, but stays in place when loaded
- Front waist D-ring allows a stable sitting position for rappels
- Gear loops offer easy access to equipment, and quick-connect shoulder straps
- Leg loops make donning the harness quick
- Pads on the leg loops can be adjusted to the most comfortable position
- Front lift assembly accepts screw links for adding a chest ascender or safety lanyards.



Size	Waist
S/M	26" - 34"
L/XL	34" - 46"



SPECIFY SIZE: S/M or L/XL

BP308 Fire Rescue Harness™

\$437.95

ATOM™ RESCUE HARNESS

UL CLASSIFIED TO ANSI Z359.11, CSA Z259.10 AND NFPA 1983

The ATOM™ Series, CMC's most comfortable harness line ever developed, is the culmination of stripping harness design down to the basics and re-imagining a performance-enhancing tool for rescue and rope access.

- Improved architecture molds to the user for a lightweight, low profile fit
- Ergonomic design for maximum comfort and support
- Y-back construction and bridged front lift
- Constructed with polyester webbing
- Gear loop over-braid is based on a 32-carrier polyester
- Multiple accessory attachment points provide ample space for stowing and organizing hardware and tools
- Made in the USA of domestic and foreign components
- Red webbing at the shoulders and front leg drop provide higher visibility
- Steel attachment points at the waist, chest and back
- Cobra quick-connect buckles at legs and right shoulder make donning quick and efficient
- Flexible gear loops offer a low profile gear stowage solution



Size	Waist
Small	26" - 32"
Medium	32" - 42"
Large	42" - 48"



SPECIFY SIZE: S, M or L

BP307 Atom™ Rescue Harness

\$477.95

FCX ESCAPE SYSTEMS

With the introduction of the FCX Descent Control Device and the FireTech2 100% Technora® escape rope, Sterling is able to offer a wide range of the most advanced personal escape systems available. The FCX systems are customizable with your choice of escape rope, anchor hook and storage bag. FCX escape systems are NFPA 1983.



BN702	FCX FireTech2 Crosby Hip Escape System	\$469.95
BN703	FCX FireTech2 LGT Pkt Escape System	\$400.95
BN704	FCX SafeTech Hip Escape System	\$368.95
BN705	FCX SafeTech LGT Pkt Escape System	\$367.95
BN709	FireTech2 Escape Rope - 50'	\$114.95



NEW

VIDEO ONLINE

1/2" (12.5MM) SUPERSTATIC2™ (NYLON) AND HTP™ STATIC ROPE (POLYESTER)



- HTP - 100% high tenacity polyester
- SuperStatic2™ - a new core and 100% nylon construction
- NFPA 1983: General

SPECIFY LENGTH

SPECIFY COLOR: Blue w/Tracer, Yellow w/Tracer, white w/Tracer, and Red w/Tracer

Cat#	Description	Tensile	Price
AW392	SuperStatic2™ Nylon 150'	9,284 lbs.	\$179.95
AW393	SuperStatic2™ Nylon 200'	9,284 lbs.	\$238.95
AW394	SuperStatic2™ Nylon 300'	9,284 lbs.	\$354.95
AW395	HTP™ Static 150'	9,081 lbs.	\$163.95
AW396	HTP™ Static 200'	9,081 lbs.	\$216.95
AW397	HTP™ Static 300'	9,081 lbs.	\$323.95

RIT HEAT RESISTANT SEARCH ROPE

Rapid Intervention Teams (RIT) face the most demanding and extreme conditions during search operations. Overcoming extreme heat, ground obstacles, and poor visibility are just some of the hurdles faced when searching for and rescuing trapped firefighters or civilians. Firefighter safety and survival has become an important focus and Sterling RIT Lines are an integral rescue tool in search and bailout operations.



Cat#	Desc.	Tensile	150'	200'	300'
AS277	RIT 900	4,200 lbs.	\$171.95	\$228.95	\$341.95

FCX DESCENT CONTROL DEVICE

Sterling Rope FCX Descent Control Device uses a unique cam feature that allows smooth modulation so the user can easily control the speed of descent with one hand and a click-to-neutral feature allows for easy horizontal movement.



NEW

VIDEO ONLINE



- Compatible Ropes: FireTech2 and SafeTech
- NFPA 1983: Escape Descent Device



BN707	FCX Descent Control Device	\$98.95
-------	----------------------------	---------

TUBULAR WEBBING

1" MIL SPEC webbing is a must have for rescue personnel. It can be used for building anchors, making improvised harnesses, lashing litters, and many other uses. MIL SPEC webbing is rated to 4,000 lbs.



SPECIFY COLOR: Red, Black, Yellow, Blue, Orange, Purple or Olive Drab



AW411	1"x300' Tubular Webbing	\$111.95
-------	-------------------------	----------

CMC PMP SWIVEL PULLEY

The Prusik-minding swivel pulley (PMP) is an ideal building mechanical advantage in raising systems, high anchor points, or tripod use. The rotating swivel aligns the rope with the direction of the pull. Its stainless steel sheave can be used with either rescue rope or wire cable. By combining the swivel with the pulley, overall system length is minimized, increasing travel. The patented pivoting side plate allows the rope to be quickly inserted. The PMP Swivel Pulley can be used with confidence in work-at-height maneuvers for industrial rope access or technical rope rescue.

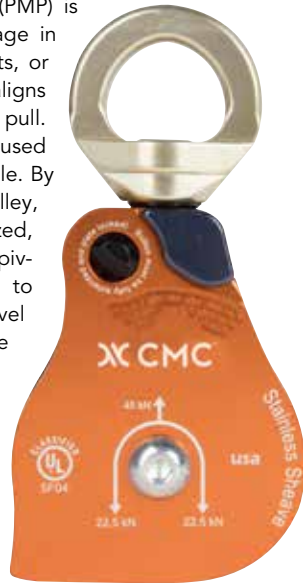

FEATURES

- Stainless steel sheave allows use with wire cable or rescue rope
- Prusik-minding side plate opens without having to disconnect the pulley from the anchor
- Double-detent button prevents accidental opening of side plate
- Sealed ball bearings provide maximum efficiency



BN219 CMC PMP Swivel Pulley \$145.95

CMC MPD™

UL CLASSIFIED TO NFPA 1983 – GENERAL USE

The MPD™ allows you to go from lowering to raising without changing hardware. The MPD's high-efficiency pulley, with an integral rope-grab mechanism, allows it to be used as a lowering device on the main line and belay line systems and be quickly changed over to a raising system without switching out or replacing hardware. The combination of essential features into a single device simplifies on-scene rigging, expediting the rescue.



FEATURES:

- Variable-friction descent control device for rescue systems and rappels
- High-efficiency pulley with integral rope-locking mechanism (ratchet) for a haul system
- Built-in bucket allows cleaner rigging and more efficient pulley systems
- MPD allows main line and belay line rigging or can be used as a two-tension system
- One device functions as both a lowering brake and ratcheting pulley for raising
- Converts rapidly to a retrieval line for confined space operations
- Meets BCCTR Rescue Belay Competency Criteria
- Red model accommodates 13 mm rope (11mm blue model also available)



BL022 CMC MPD™ 13mm \$822.95

CMC MPD™ ROPE RESCUE TRUCK CACHE™ KIT

When setting up systems, this well-organized kit provides efficient access to all the rigging hardware needed to set up a main line and belay. The case can be laid on the ground or suspended from the side of a vehicle with integrated gutter hooks, yet when closed, fits easily into a vehicle cabinet or behind the seat.

KIT INCLUDES:

- 1 - UltraPro 4 edge protector
- 2 - FastLink anchor strap
- 2 - Bound-Loop Prusiks
- 1 - Double swivel pulley
- 5 - ProSeries screw-lock carabiners
- 2 - Anchor strap sleeve
- Truck cache
- 2 - MPD (13mm)
- 1" web - 40' (2x20')
- 1 - XL Edge pad
- 3 - Single swivel pulleys



BL023 CMC MPD™ Rope Rescue Truck Cache™ Kit \$3,333.95

ENFORCER

Enforcer (with/case) is a compact aluminum load cell that measures force up to 20 kN. Utilizing two sampling modes, the Enforcer is able to monitor systems, and log drop testing in high resolution. Unique features like Bluetooth connectivity with the enFORcer iOS App and swivel attachment points separate the Enforcer into a class of its own.



NEW

FEATURES:

- Lightweight aluminum construction
- Compact and portable design facilitates “in-line” use in rigging systems
- Swivel attachment points diminish potentially dangerous torsional and off-axis forces
- Features two sampling modes: “Slow” for monitoring and “Fast” for drop-testing
- Monitor forces wirelessly on your iPhone with built-in Bluetooth connectivity
- Record and download graphs of events (Enforcer app required, sold separately)
- Measures force in kg, lbf and kN

**Not for use with steel cables or wire rope.*

BN522	Enforcer	\$842.95
-------	----------	----------

rockSTEEL AUTO-LOCK CARABINER

The rockSteel offers a surprising strength-to-weight ratio in a carabiner of its capacity. Most steel carabiners are made from 1/2 diameter steel. We use a lighter, 7/16” diameter steel that is heat treated for added strength. The rockSteel frames are CNC machined for precise fittings and exact tolerances. The result is a carabiner with a high strength-to-weight ratio, keylock snag-resistant nose and a feel like no other steel carabiner in the world. The rockSteel carabiner is ANSI Z359.12 (09) and NFPA G compliant. The gate/sleeve is rated at 16kN or 3600 lbs, to protect against inward force against gate.



NEW

- Large frame, with large, 1.2” gate opening
- Impressively strong, yet lightweight
- Rated for inward gate force
- ANSI Z359.12 (09) and NFPA G compliant

Cat#	Description	MBS	Price
BN531	rockSteel Auto-Lock Carabiner	3,600 lbs.	\$39.95

CMC STEEL LOCKING D CARABINERS UL CLASSIFIED TO NFPA 1983 – GENERAL USE

This proven workhorse of General Use carabiners is available in both Screw-Lock and Auto-Lock gates. On the Screw-Lock models the nut locks against the gate to prevent jamming. Auto-locking carabiners decrease the possibility that the user will forget to lock the gate or that the gate will vibrate unlocked while in use. With the safety of a three-stage auto-locking gate that can be easily opened with one hand, these compact models maximize strength yet allow a gate opening wide enough to fit over most litter rails. Every carabiner is proof loaded.



Cat#	Gate Type	Finish	MBS	Price
BG271	Auto-Lock	Gold	16,186 lbf.	\$49.95
BG272	Screw-Lock	Gold	16,186 lbf.	\$40.95
BG273	Screw-Lock	Black	16,186 lbf.	\$42.95

NFPA LADDER AND CARABINER HOOK SCREW AND TWIST LOCKS

NFPA and UL certified high tensile steel Ladder Hook with captive pin is designed to fit over ladder rungs, pipes, safety rails, building apparatus or anywhere you may need the huge gate clearance of these exceptional and strong ladder hooks. The gate clearance of our zinc plated ladder hook is enhanced by our unique screw-lock gate mechanism, which enables the gate to open beyond the ladder hook spine, providing a massive gate opening, even for a ladder hook of this size!



- High tensile steel
- Zinc plated finish
- High strength
- Smooth operation

Cat#	Description	Price
BN247	NFPA Steel Ladder Hook Screw Lock	\$22.95
BN248	NFPA Steel Ladder Hook Twist Lock	\$28.95
BN249	NFPA Large D Carabiner Screw Lock	\$16.95
BN250	NFPA Large D Carabiner Twist Lock	\$22.95
BN251	NFPA Aluminum Carabiner Twist Lock	\$14.95

CMC LEVR™ ESCAPE SYSTEM

UL CLASSIFIED TO NFPA 1983-GENERAL USE

The most compact escape system available. Designed to assure rapid emergency egress with safe, controllable descent. Built around the new CMC LEVR descender, a next-generation device with improved descent control, fast and easy pay-out, and reliable edge transition.

FEATURES:

- LEVR™ design provides smooth and reliable edge transition, minimizing potential for hang-up at window sill
- Engineered for quick, easy horizontal payout of web to allow fast egress from remote anchor points
- Designed to reduce impact force on escape anchor if shock loaded during bailout
- Low-profile side carry bag designed for right or left-handed deployment
- Fire Escape Web T™ is constructed from 100% Technora® fiber for high strength and heat resistance, and dramatically reduces space required for storage
- U.S. Patent Pending

INCLUDES:

- LEVR™ descender reeved with 15.2m (50') of 11mm Fire Escape Web™ (UL Classified to NFPA 1983 - Fire Escape Web)
- FlashLite™ Hook (UL Classified to NFPA 1983 - Escape Use)
- Nomex® fabric waist carry bag
- ProTech™ Aluminum Auto-Lock Carabiner (UL Classified to NFPA 1983 - Technical Use) with sewn Kevlar® fiber tether

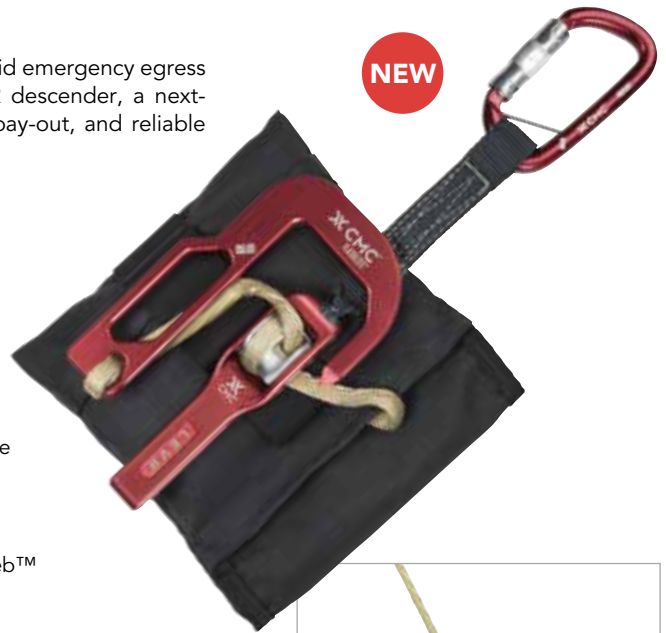

NEW



BP049 CMC LEVR™ Escape System

\$523.95

CMC 3D™ LOCKING-BAR DESCENDER

The 3D features two sliding bars for optimum friction control and efficiency. The horn design works well with 13mm rope and smaller, making it easy to add or subtract friction as needed throughout the evolution. The frame dimensions allow for larger rescue-sized carabiners to be used without any contact or friction with the rope. The descender can be loaded or unloaded while connected to your harness for rappelling or to an anchor for one- or two-person rescue lowers. *Ship. wt. 1 lb.*



NEW

- Compact, lightweight design
- 3-stage locking center bar for added safety
- Ambidextrous design allows loading from top or bottom or controlling descent from either side of device
- Optimal rack length allows two rescue-sized carabiners to be attached without rope contact or friction from carabiner
- Large horn size allows for easy addition or subtraction of friction, even on larger 13mm lifeline
- 100% aircraft-grade aluminum and stainless steel components
- Patented



BN326 CMC 3D™ Locking-Bar Descender

\$249.95

PETZL I'D SELF-BRAKING DESCENDERS

It's auto-locking feature combined with a locking position for the handle make the Petzl I'D an excellent descender for working on rope. Additional safety features include an anti-panic function that stops the descent if the handle is pushed too far and an anti-error safety catch that reduces the risk of an accident from the incorrect installation on the rope. Maximum descent distance: 660' (200m). The small model has a safety clip on the swinging side plate that reduces the risk of dropping the device when removed from the rope, such as when passing intermediate anchors. *UL classified to NFPA 198 EN 341 Class A.*



- Unblock the rope and control the descent with the hand on the free end of the rope
- Move more easily on horizontal or low-angle terrain, thanks to the button on the handle
- Get into position without having to tie off the device
- Anti-panic function is engaged if the user pulls too strongly on the handle brakes and stops the descent automatically
- Anti-error safety catch to reduce the risk of an accident due to incorrect installation of the device on the rope. The shape of the cam is designed to improve rope glide when ascending



Cat#	Description	Finish	NFPA Rating	Price
BG121	Self-Breaking Descender	Gold	Light Use	\$238.95
BG122	Self-Breaking Descender	Red	General Use	\$238.95

CMC CSR² PULLEY SYSTEM™

The patented locking mechanism in our updated CSR² Pulley™ is easy to release under load, creating much greater efficiency with the lowering and raising necessary to a confined space rescue. The machined aluminum swivels at both ends of the system eliminate any potential twisting of the lines. This system is also an excellent choice for confined space entry or rope access work where a heavy-duty pulley system is desired. Systems comes completed reeved and packed into its storage bag ready to use.

- All-new stronger, lighter-weight design
- Available with either 11mm (7/16") or 12.5mm (1/2") Static-Pro Lifeline
- Systems are UL Classified to NFPA 1983 (2017 ED) - General Use
- CSR² Pulley MBS 46 kN(10,341 lbf)/CSR² Double Pulley MBS 45 kN (10,116 lbf)
- Machined from solid block of aircraft-grade aluminum
- Includes (2) ProSeries® Aluminum Screw-Lock Carabiners, MBS 47 kN (10,566 lbf) - General Use
- Made in USA



INCLUDES:

- 11mm (7/16") Static-Pro Lifeline, Blue (1 x 200') or 12½ mm (½") Static-Pro Lifeline, Red (1 x 200')
- CSR² Pulley
- CSR² Double Pulley
- ProSeries Aluminum Screw-Lock Carabiner (2)
- #3 Rope Bag, Red



BG274 CSR² Pulley System™ \$1,420.95

CMC AZTEK PROSERIES® SYSTEM

The CMC Rescue AZTEK ProSeries System leaves no detail ignored. Capable of more than 100 rigging solutions, it reflects the philosophy of keeping rigging equipment simple, efficient, non-specialized, light and small. The CMC Rescue AZTEK ProSeries System is the only AZTEK system UL Classified to NFPA 1983 (2012 ED.) General Use, Manufactured System. *Ship. wt. 4 lbs.*



- Innovation-loaded and designed for wear on the waist or thigh
- Travel restraint with more than 40' of adjustable travel
- Mesh bottom for optimal breathing
- AZTEK OMNI set of four provides 4:1 or 5:1 M/A options
- Quickly adjust a litter attendant or litter position
- Easily pass knots
- Back-tie or redirect anchors
- Promptly establish dynamic fixed brakes
- Establish travel restriction
- Correct disoriented equipment under load
- Dynamic directionals and lowers
- Hauling systems
- High angle attendant tether and litter scoops
- Load-releasing hitch
- Personal mechanical advantage (PMA)
- Solo pick-off
- Tensioned guying

BL803 CMC AZTEK ProSeries® System \$474.95

AZTEK ELITE NFPA-G SYSTEM

A unique, multi-functional system, the AZTEK is a simple and versatile tool for mechanical advantage rigging. The opposite end of the rope functions as an individual edge restraint system utilizing the included travel restraint and screwlink. The AZTEK Omni Block pulleys keep loads oriented correctly when tensioned. The system is easily transported or swapped between users thanks to its accessible pouch-style carry case. *Ship. wt. 3.8 lbs.*

INCLUDES:

- 2 - AZTEK Omni Block pulleys
- 50' of 8 mm Edge Restraint with sewn eye
- 2 - 6 mm sewn ratchet prusiks
- 1 - SafeD carabiners for connecting Edge Restraints to anchor
- 2 - Steel Carabiners
- 8 mm Steel Screwlink
- 6 mm Travel Restraint
- AZTEK Carrying Bag



edarley.com
 SHOP OUR COMPLETE SELECTION OF RESCUE TOOLS ON EDARLEY.COM/RESCUE



BN708 Aztek Elite NFPA-G System \$429.95

SEARCHLITE KIT

Search kits are an integral tool for fire departments performing large area search. The kit comes standard with our highly-reflective SearchLite rope. Large snap-hook on one end allows for connection to substantial objects, while the small snaphook secures the rope to the bag.

INCLUDES:

- 220' of SearchLite Kit search rope
- Double action snaphook
- Swivel Snap
- SearchLite bag



NEW

BN706 SearchLite Kit

\$383.95

TRAVERSE 540° RESCUE BELAYS

UL CLASSIFIED TO NFPA-GENERAL USE

Developed specifically to meet the needs of rescue system belays, the 540° Rescue Belay is a self-locking device that meets demanding drop-test criteria able to hold falling loads quickly while limiting the peak force. This well-engineered device is easy to rig and the symmetrical design reduces the risk of improper loading. A built-in release lever releases the tension on the belay rope, eliminating the need for a release hitch. Designed for use with kernmantle rescue ropes from 11.5 to 13mm. 3 MBS: 8,093 lbs. Passes the BCCTR Rescue Belay Competence Drop Test Criteria. *Ship. wt. 3 lbs.*

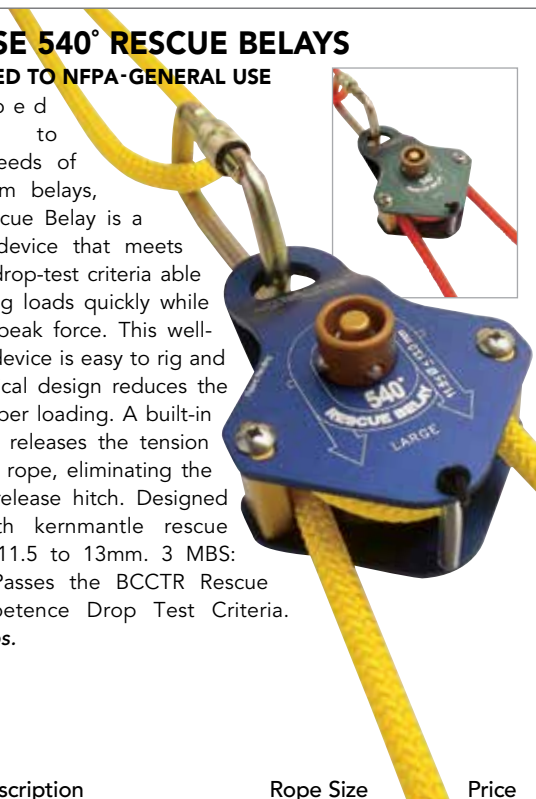

Cat#	Description	Rope Size	Price
BG267	Small 540° Rescue Belay	10.6-11.5mm (7/16")	\$524.95
BG268	Large 540° Rescue Belay	11.5-13mm (1/2")	\$524.95

AZTEK PRO KIT

The Aztek Pro Kit can be used as a pick off, adjustable directional, high directional guyline, high angle attendant tether, high angle litter scoop, load release hitch and much more. Each pulley is color coded to match with a corresponding prusik for quick identification. The AZTEK pulleys are machined from solid aluminum, feature swivel connection points, and utilize high efficiency bearings.



NEW

COLOR CODED FOR QUICK IDENTIFICATION

BN523 Aztek Pro Kit

\$377.95

360 SEARCH AND RESCUE BOUNCE IMAGING CAMERA

The 360 Search and Rescue Bounce Imaging provides 360° views of difficult-to-reach spaces, in a small, easy-to-carry camera that pairs directly to a smartphone app. Our stabilization means that your 12 o'clock stays constant, even in virtual reality - allowing you to precisely understand the layout of the target environment. Everything is recorded, so you can always review what was happening behind you.

- Simultaneously view different angles and directions
- Search confined spaces instantly
- Maintain your orientation



NEW



BP028 360 Search and Rescue Bounce Imaging Camera

\$2,949.95

UNIVERSAL SWIFT WATER RESCUE VEST

INDUSTRY LEADING UNIVERSAL PFD FOR SWIFT WATER RESCUE

- 25 lbs. (111 N) buoyancy
- Drag handle and D ring
- Quick donning with 7 adjustment tabs to create a customized fit for chest sizes from 30" - 52"
- Layered flotation
- MOLLE® webbing on both shoulders and back
- Velcro® panel on back for ID patches
- 2 large self draining pockets provide ample storage options
- Durable harness with 2" webbing
- Quick release belt
- 500 denier, Cordura® outer shell
- Over 62 sq. in. of SOLAS™ tape



BL462 Universal Swift Water Rescue Vest \$268.95

ICE COMMANDER™ RESCUE SUIT

The Mustang Ice Commander™ is the suit of choice for search and rescue teams, fire departments, and ice rescue professionals. The flotation and insulation performance of a snap in buoyancy liner allows users to immerse themselves for long periods of time in icy cold water and maintain mental and physical capabilities.

- Water-tight hood and face seal
- Integrated gloves and attached boots
- SOLAS™ reflective tape and Velcro® patch for light attachment
- Heavy duty, full-length, water-tight zipper
- Waterproof and durable welded nylon outer shell
- High performance urethane-coated nylon exterior
- Integral self-adjusting safety harness
- Ergonomic ice awl pockets - secured with Velcro® (ice awls not included)
- Reinforced knees padded with 2.5 mm neoprene
- Removable inner buoyancy liner - constructed of closed-cell AirSoft™
- Reinforced seat and elbows
- Measurements: Adult universal sizing, fits height: 4'11" - 6'6", and weight: 110 lbs. - 330 lbs.



BL315 Ice Commander™ Suit (Universal Adult) \$1,139.95



UNIVERSAL HI-VIZ YELLOW ICE RESCUE SUIT

Rescue professionals need gear that allows them to respond safely and quickly to emergency situations. The RS-1000 Rescue Suit has been engineered to don quickly for cold water and ice rescue operations. This universal suit features a rugged hi-tenacity nylon shell that is stitched and taped for the ultimate in durability. A snap out, internal laminated nylon/foam liner allows the user to easily slip the suit on and off.

- Shell Material: 400 Denier Nylon Shell
- Construction Method: Seams are stitched and sealed (taped) (not RF welded)
- Harness System: Vertical and horizontal adjustment
- Ice Pick Pockets: Easy access and secure storage of ice picks
- Gloves are supple and felt lined
- Internal suspenders for height adjustment
- Knee and Elbow Patches: Foam padded with rough texture covering for extra grip
- Wear Patches: Reinforced butt, knees and elbows
- Boots: Size 13 for fitting wide range of users
- Adjustment Straps: At thighs and wrist for improved suit control
- Carry Bag: 500D bag is nylon lined for easy discharge of suit (from bag). Includes zippered mesh accessory pocket

BL591 Universal Hi-Viz Yellow Ice Rescue Suit \$618.95

COMPACT SAR ASSIST VEST

Easily stows in sea, land and air vehicles. Vacuum sealed for long shelf life. Easily removed from its package and donned like an airline PFD. Orally inflate until the black hook and loop strap pops on the right lobe.

- Reversible and can be folded and stowed after use
- Weighs 1.32 lbs. in its vacuum pack
- Easy to throw and catch
- Vacuum pack floats
- Hi-vis color with reflective patches and ink
- 19 lbs. of buoyancy when inflated



BN759 Compact SAR Assist Vest \$55.95

STEARNS SAR MESH PFD VEST

The "Mesh" PFD provides added comfort in warm weather conditions. The soft, lightweight mesh provides a high level of ventilation. Soft Aquafoam™ and durable Crosstech® foam provide comfort as well as the flotation. Two large pockets close with hook and loop fastener. Zippered front is backed by three 1½" belts. *USCG Approved Type III. Color: International Orange.*



Size	Waist	Size	Waist
Small	36"-38"	XLarge	48"-50"
Medium	40"-42"	2XLarge	50"-52"
Large	44"-46"	3XLarge	54"-56"



SPECIFY SIZE: S-XXXL
BA086 Stearns SAR Mesh PFD Chest Vest \$93.95

STEARNS RESCUE VEST

Made with rugged 500 denier Cordura® outer-shell for strength and durability, it has a soft 200 denier nylon interior for comfort with a built in front pocket. The lower front pocket provides room for storage and a quick-release belt with "O" ring for tether use. With fold out side panels, front and back, provide side protection for full range of sizes; panels conveniently fold in for added ventilation.

- Four rugged 1½" front adjustable straps for a secure fit
- Lash tabs on left and right chest and shoulders for fastening a knife and tools
- Minimum 22.5 lbs. of buoyancy



BP161 Stearns Rescue Vest \$199.95
BP162 Stearns Pocket \$39.95
BP163 Stearns Tether \$3.95

ARM LOC™

The ARM-LOC™ has high visible solar reflective tape, which is the same type as what the Coast Guard uses. The ARM-LOC™ also locks on the victim so there is no need for the victim to hold onto the rope. Plus, you will be able to float the ARM-LOC™ on top of the water. It is a safety tool that can be used ANY time you need to get a GRIP on a victim in distress, on land or in the water. ARM-LOC™ has 75' of ¾" Sterling floatable line.

INCLUDES:

- 1 ARM-LOC™
- 75' of Sterling Floatable Rescue Line
- 1 Omega non locking carabiner
- 1 Throw bag and carrying case
- ¾" threaded Cadmium plated CO₂ cartridges



BP157 ARM-LOC™ \$495.95

CMC RESCUE ROPE RESCUE TEAM KIT-RIGGING (TRADITIONAL)

Containing the minimum equipment required to handle most high or low-angle rope rescue responses, this kit includes a main line with mechanical advantage for raising and a descent control device for lowering, a belay line, a litter with a patient-packaging system, and gear for setting up anchors. In addition to this equipment, we recommend each member of the team carry the personal equipment included in our Rescuer Personal Kit.

- 2 - Rope Bags, #2 size
- Truck cache
- Stainless steel rescue litter
- ProSeries Litter Harness
- Etrier with Tie-In
- FastLink™ Pick-Off Strap
- 4 - Adjustable Litter Straps
- 2 - Edge Pad - XL
- Tubular Webbing - 24' (1 x 12')
- Tubular Webbing - 40' (2 x 20')
- Shasta Gear Bag
- Litter Pack
- Litter Insert
- Patient Tie-In System
- Lifesaver Victim Harness
- 2 - CMC Ascenders
- FastLink Anchor Strap - Medium
- Anchor Strap Sleeve - Medium
- Ultra-Pro 4 Edge Protector
- 2 - ProTech Auto-Lock Carabiners
- Rope Rescue Manual
- 2 - CMC Lifeline - 200' of 1/2"
- 2 - Load Release Straps
- Rescue Rack
- 15 - ProSeries® Screw-Lock Carabiners - Brite
- AZ Bound-Loop Prusik - Long
- 8 - AZ Bound-Loop Prusiks - Short
- Aluminum Oval Carabiner
- Anchor Plate
- 5 - PMP Swivel Pulleys



BD051 CMC Rope Rescue Team Kit - Rigging \$6,539.95

CMC RESCUE USAR TASK FORCE KIT

A great package for a truck or engine company that responds to over-the-side rescues or needs a vertical lift capability for trench or confined space rescues, this kit contains the primary rope rescue equipment on most of the FEMA and USA requirements lists.

- 2 - Rope Bags, #2 size
- Truck Cache
- 2 - Response Harness
- Litter Insert
- Patient tie-in system
- 2 - CMC Ascender
- 4 - Adjustable Litter Strap
- 2 - FastLink Anchor Strap - Medium
- Ultra-Pro 4 Edge Protector
- Tubular Webbing - 30' (6x5')
- Tubular Webbing - 90' (6x15')
- ProTech Auto-Lock Carabiner
- Shasta Gear Bag
- Litter Pack
- Stainless Steel Rescue Litter
- ProSeries Litter Harness
- Etrier with Tie-In
- Rescue 8
- FastLink Pick-Off Strap
- 2 - Anchor Strap Sleeve - Medium
- 2 - Edge Pad - XL
- 2 - Static-Pro 1/2 in Lifeline - 200'
- Tubular Webbing - 72' (6x12')
- Tubular Webbing - 120' (6x20')
- 15 - ProSeries Screw-Lock Carabiners
- 5 - PMP Swivel Pulleys
- 2 - Load Release Strap
- 6 - AZ Bound-Loop Prusik - Short
- Aluminum Oval Carabiner
- Anchor Plate
- AZ Bound-Loop Prusik - Long
- Rescue Pack



BD050 CMC USAR Task Force Kit \$7,393.95

SKED® BASIC RESCUE SYSTEM

The original and still the best solution for confined space, high angle or technical rescue, and traditional land based applications. The Sked® stretcher is a revolutionary design which provides outstanding patient protection and security. The Sked® comes equipped for hoisting by helicopter in horizontal position spaces. When the patient is packaged, the stretcher becomes rigid. The durable plastic provides protection for the patient while allowing extrication through the most demanding confined spaces. The stretcher is rolled for storage in a tough Cordura® backpack which is included with the system. The system ships at 19 lbs. and comes complete for most applications. Available in International Orange. Ship. wt. 19 lbs.



AS452 Sked® Basic Rescue System \$639.95

RESCUE KIT 1 WITH POWER TALK BOX

The CON-SPACE Rescue Kit 1 with Power Talk Box is configured for a team of five rescuers consisting of two primary rescuers, two standby rescuers and a hole watch/team leader, for entries of 100' (maximum distance 1500'). They system can be configured for up to fourteen people using available modules and accessories. The command module is battery-powered, compact and lightweight making it completely portable. Three 1.5v alkaline "C" cells provide 400 hr. life on standby and all electronics are fuse protected. A low battery LED indicator gives 12 hr. warning battery replacement. System and accessories are waterproof. Molded fiberglass enclosures, knobs, and cables are impervious to a wide range of chemicals.

INCLUDES:

- CSI-2100 command module
- CSI-2131 power talk box
- Cable splitter - Double w/mic mute switch
- Operator headset single-side, 32"
- 4 - Rescue facemask com set with universal speaker
- 4 - Speaker harnesses
- 1' operator cable w/mic mute switch
- 20' operator cable w/mic mute switch
- 50' cable with connectors
- 4 - 100' cable with connectors with strain relief/snap hook
- Cable coiler
- Cable bag for 100'-300' of cable
- 2000 carrying case



AZ400 Rescue Kit 1 with Power Talk Box \$9,566.95

HOTSTICK VOLTAGE DETECTOR

HIGH SENSITIVITY DETECTOR FOR EMERGENCY RESPONDERS

The HotStick provides warning of exposed high voltage AC from a safe distance without the need to contact the surface carrying the current. It gives early audible ("beeping") and visual (flashing LED) warnings, and beeps and flashes more rapidly the closer it comes to the voltage. Comes with a built-in self test so there is no doubt about it functioning properly.



- CONFIRM power shutdown, lockout, tag out, disconnects
- FIND hidden sources of dangerous AC from a safe distance
- DETECT power line back feeds from motor generators and energized pools of water
- ENSURE a safe environment for your vehicular rescue
- PROTECT the life of your first responders
- CHECK IT trust is good – checking is better

BL318 HotStick Voltage Detector \$358.95

SKED-EVAC™ TRIPOD

The Sked-Evac™ Tripod extends to ten feet high at the three anchors which are available to clip into. Each of the anchors is anodized red for easy identification, and all are equally well centered to handle a load. The anchors, header, and legs are interconnected with 1/2" stainless steel bolts to provide maximum strength. When at full extension, this tripod allows you to bring the patient in a stretcher completely out of the hole. It is rated to handle an NFPA rescue load. Included with the tripod is a chain which passes through the feet to provide greater strength and stability. The legs are adjustable in 5" increments, and Skedco provides safe working load data for each tripod height on each tripod. Brackets are available for mounting most popular winches. *Ship. wt. 74 lbs.*



AS441 Sked-Evac™ Rescue/Entry Tripod \$1,610.95
 AS442 Sked-Evac™ Tripod Carrying Case \$107.95

COMPLIMENT YOUR EXISTING TRAINING EFFORTS WITH IMMERSIVE LEARNING OPPORTUNITIES USING VIRTUAL REALITY.

FLAIM TRAINER

PACKAGE INCLUDES:

- SCBA WITH COMPUTER AND MASK
- PERSONAL HEAT VEST WITH HEAT GENERATION COMPONENTS
- HOSE-LINE SYSTEM
- NOZZLE
- VIVE VR HEADSET

SCENARIOS INCLUDES:

- RESIDENTIAL FIRES
- SUBURBAN FIRES
- PETROL/GAS STATION
- RURAL
- MINING
- DEFENSE
- SPECIALIZED

VR HEADSET

FLAIM Trainer creates an immersive 360° training experience.

HEAT VEST

Heated vest adds realism with heat generation.

REAL NOZZLE

Patented haptic force feedback system mimics a fire nozzle reaction.

NEW



The FLAIM Trainer is a virtual reality training simulator. The FLAIM Trainer combines VR technology with traditional first responder equipment; patented haptic feedback system, breathing apparatus and heated personal protective equipment. The unique product offers first responders safe, repeatable, hands-on training experience in immersive and realistic environments.



BLEVE EXPLOSION



CAR RUNNING FUEL FIRE



GRASSFIRE



REFINERY

INTEGRATE THE FLAIM TRAINER INTO EXISTING TRAINING PROGRAMS.

This helps bridge the gap between classroom learning, in field training and real-life incidents. The FLAIM Trainer will never replace real training and only enable fire fighters the opportunity to obtain ongoing training repetitions within safe training environments.

- Practice Fire Fighter Operations in a risk-free virtual environment
- Use virtual reality to overcome difficulties of training that include unsafe conditions, expensive costs and environmental restraints
- Offers Fire Fighter trainees a chance to practice and be assessed on their ability to correctly manage different tasks
- Ensure your actions and decisions are correct and effectively making the proper decisions and operating procedures

FLAIM Trainer

\$45,000

SAFE AND COMPLIANT EXTINGUISHER TRAINING

UTILIZE VR TECHNOLOGY TO EXTINGUISH A VIRTUAL FIRE USING THE PASS TECHNIQUE.

NEW

FLAIM EXTINGUISHER TRAINING KIT

EMPOWERING FIRST RESPONDERS AND COMMUNITY

Educates users on how to handle a fire extinguisher during a variety of common household and business fires. Encourage trainees to extinguish the fire themselves within a virtual setting. No accelerants, fumes or cleanups. FLAIM Trainer is fit for all users.

INCLUDES:

- QUANTITY 1: FLAIM EXTINGUISHER TRAINING SYSTEM
- MORE THAN 20 PRE-LOADED SCENES
- VIVE FOCUS HEADSET AND CONTROLLER MOUNTABLE ON ANY FIRE EXTINGUISHER
- TRANSPORT CASE, CORDS AND ACCESSORIES
- EMPTY EXTINGUISHER



Realistic training scenarios arm firefighters with the skills and confidence they need to respond effectively and efficiently during real-life incidents. Live field exercises provide hands-on training, but they are often costly, time consuming and can be hazardous. Training simulation provides an ideal alternative, offering organizations the ability to get more from their current training programs.



A REALISTIC EXPERIENCE IN A VIRTUAL WORLD

No more need for archaic training methods. FLAIM Extinguisher provides a portable and immersive experience. VR training is as simple as plug-and-play and working in any room with ample space.

SCENARIOS INCLUDED:

- COPY MACHINE IN OFFICE ON FIRE
- SEAT IN A TRAIN
- TIRE OF A TRUCK
- PALLET INSIDE A WAREHOUSE
- KITCHEN STOVE TOP ON FIRE



FLAIM Extinguisher Training Kit

\$7,000

IMMERSIVE FIREFIGHTER TRAINING

RiVR LINK - CLASSROOM IN A BOX

FULL IMMERSION COMBINED WITH INSTRUCTOR LED TRAINING
ALLOWS FOR BLENDED LEARNING WITH LASTING RESULTS

ENGAGED LEARNING

The instructor can monitor and interact with the session from the 2D tablet and is able to give central feedback by pausing the 360° video and focusing all students' attention to key learning points. Using a virtual marker (VR Chalk), the instructor can draw directly onto the video, visible to everyone, and, using wireless communications, can speak directly into the students' headsets.

INCLUDES:

- 5-15 virtual reality headsets per kit
- Tablet, wireless router, headsets, Pelican case and cords
- Software that links the headsets, router and tablet
- Ability to play, fast forward, rewind and make chalk dictations on the video
- Management of content library



NEW



RiVR INVESTIGATE - INVESTIGATION TRAINING

PHOTOREALISTIC CONTENT TO HELP RETRAIN ARSON INVESTIGATORS ON SKILLS TRAINING AND SCENE WORK FUNCTIONALITY

Students can fully examine a scene, take photographs, record on a Dictaphone and examine evidence prior to making professional conclusions. All of this activity is recorded in real time allowing playback for professional discussion at any point in the future. Development of this global training library allows fire services around the world to share their different training techniques.

PHOTO REALISM

The photorealistic scenarios in RiVR Investigate offer a near-to-life immersive presence in fire and crime scenes. Using advanced 3D modelling techniques like photogrammetry, the scene is turned into an interactive learning environment. RiVR improves the realism of investigation training and increases the number of scenarios trainees are confronted with during training.



NEW

INCLUDES:

- Subscription to global library of arson investigation scenarios consisting of different causes of fire
- HTC Vive kit, gaming laptop and accessories to operate

RiVR Link - Classroom in a Box
RiVR Investigate - Investigation Training

\$17,000
\$26,000

HAZSIM® TRAINING SIMULATION SYSTEM

INTERACTIVE LEARNING FOR GROWING TEAMS



The world's most innovative and effective hazmat training system is now better than ever! With intuitive and scalable new features for growing teams, now is a great time to enhance your hazmat training with the HazSim Pro 2.0



NEW

HAZSIM HANDHELD METER:

- Ruggedized housing - 13.2"x8.6"x.7", 3.6 lbs.
- Super responsive touch screen and large external buttons
- Loud audible alarms
- Confined space probe with tubing included

HAZSIM INSTRUCTOR SERVER:

- Convertible laptop tablet with full keyboard and case
- Group meters (if using more than one handheld) can be synced or controlled separately
- Ability to create custom meters

INTERACTIVE LEARNING:

- Instructor can send questions in real time
- Students answer questions via HazSim handheld
- Use HazSim's preloaded questions or create your own
- Customizable alarms for your team's specific needs

METERS:

- Multi-gas - 4, 5, or 6 gas meters
- Radiation - alpha, beta, gamma
- WMD meter (bar graph)

PLUS:

- Pelican Case for safe transport
- Standard one year warranty, with option to extend

INCLUDED

- UNLIMITED METERS AND VARIATIONS INCLUDING CHEMICAL, RADIATION AND WMD
- EXTENDED RANGE LAN, UP TO 1000' WITH OPTION TO EXTEND
- SCALABLE PLATFORM FOR ADDITIONAL HAZSIM METERS
- LARGER TOUCH SCREEN AND LONGER BATTERY LIFE
- EXTERNAL BUTTONS ALLOW QUESTIONS TO BE ANSWERED EASILY WITH GLOVED HANDS
- TAG FUNCTION ALLOWS INSTRUCTORS TO MAKE NOTES IN EVOLUTION



HazSim GO

FEATURES	HAZSIM GO	HAZSIM PRO 2.0
Single Gas	Y	Y
4 gas / 5 gas / 6 gas	Y/Y/Y	Y/Y/Y
Rad (alpha, beta, gamma)	Y	Y
WMD meter (bar graph)	N	Y
Custom Skins	N	Y
Custom Alarms	Y	Y
Question & Answer Feature	Y	Y
Log of training evolution with instructor notes	N	Y
Control multiple handhelds individually	Y	Y

BP295	HazSim Pro 2.0 System (1) HazSim Pro 2.0 handheld with (1) convertible laptop/tablet instructor server	\$8,549.99
BP296	HazSim GO Trainer (1) HazSim GO handheld with (1) instructor tablet	\$5,499.99

DUALIE® 3AA FLASHLIGHT INTRINSICALLY SAFE, MULTI-FUNCTION FLASHLIGHT

The Dualie® 3AA Flashlight lets you see what's ahead and around you. It produces a focused spot light and soft flood light to illuminate your work area and help to avoid slips, trips and falls.

- Three Output Modes: Spot, flood, both (spot and flood simultaneously)
- Spot: 140 lumens; 7,300 candela; 171m beam distance; runs 18 hours
- Flood: 140 lumens; 80 candela; 18m beam distance; runs 18 hours
- Simultaneous Spot and Flood: 245 lumens; runs 9 hours
- One-handed operation of all lighting modes
- Ergonomically designed for maximum hand comfort
- IPX7 waterproof to 1m for 30 minutes; 2m impact resistance tested
- 7"; 6.8 oz. with AA alkaline batteries (included); 5.9 oz. (167g) with AA lithium batteries
- Limited Lifetime Warranty
- Class I, II, Division 1, Groups A, B, C, D, E, F, G; Class III; CL I, ZN 0, IIC; Exia; T-Code: T4



Durable, non-conductive, corrosion-proof polymer resin

Rugged, integrated, snag-free clip

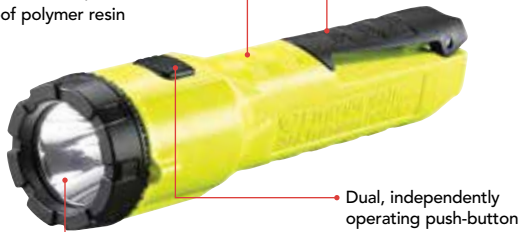

Dual, independently operating push-button switches

Unbreakable polycarbonate lens with scratch-resistant coating



HELMET AND BRACKET NOT INCLUDED



BN369 Propolymer® Dualie® 3AA Flashlight \$41.95

3AA PROPOLYMER® HAZ-LO® HELMET LIGHTING KIT

Universal lighting kit fits both traditional and modern style firefighting helmets. It is a low-profile, lightweight, economical alternative for securely mounting a flashlight to almost any style fire helmet.

INCLUDES:

- 3AA ProPolymer® HAZ-LO® with alkaline batteries
- Streamlight helmet mount and rubber helmet strap

FEATURES:

- 120 lumens; runs 6.5 hours
- High-performance, anti-static, thermoplastic material resistant to chemicals and solvents
- O-ring sealed, dust-proof, water-tight enclosure
- IP67 rated for dust-tight and waterproof to 1 meter for 30 minutes
- IPX4 for water spray
- 3 meter impact resistance tested
- 7"; 7.5 oz. with batteries (included)
- Class I, Division 1, Groups A, B, C, D; Class II, Division 1, Group E, F, G; Class III; Exia; Temperature Code T4
- For use in places with an explosive gas atmosphere (other than mines susceptible to firedamp) that is present continually or for longer periods



HELMET MOUNT AND RUBBER STRAP



HELMET NOT INCLUDED

BL584 3AA ProPolymer® HAZ-LO® Helmet Lighting Kit \$60.95

SABRELITE™ 2010 LED™ RECOIL LED TECHNOLOGY™

- Lumen Value: 109
- 3 C alkaline batteries (not included)
- Run-Time: 32 hours
- O-ring sealed w/ twist-on shroud
- Polarity battery guard tray included
- Approvals: Class I, II, III, Div. 1 Gp. DFG T4, Class I, Div. 2, Gp. ABD/CD T4 CE II 3 GD T135°C EEx nL IIC T4



SPECIFY COLOR: Black or Yellow

BE045 SabreLite™ 2010 LED™ \$58.95

3315 COMPACT LED FLASHLIGHT

The new 3315 LED flashlight is a lightweight, compact design housing only 3AA batteries powers a single LED for 113 lumens of super bright LED light. Safety approved for the most volatile work environments, the 3315 LED flashlight is safe, and one of the most efficient flashlights on the market today.



COLOR: Yellow

BL464 3315 Compact LED Flashlight \$38.95

FOXFURY COMMAND 20

ULTRA-SLIM 20 LED FIRE HELMET LIGHT

Fits ALL fire helmets with goggles, Bourke eye shields, EZ-Flips, and Defender visors, and external face shields. Meets NFPA fire resistant requirements (500°F for 30 minutes). *Ship. wt. 1 lb.*



- 60 lumens
- 20 LEDs: 18 white, 2 green
- 4 AA batteries
- Battery Life: 7 to 12 hrs.
- 3 modes
- Optimized blend of focused, distance, and panoramic light
- Rear safety LED (Red)
- Tap on/off switch
- Polycarbonate housing
- Fire and impact resistant
- Waterproof to 20'
- Dimensions: 4.8"Wx0.7"Dx1"H

BK367 Command 20 Fire Helmet Light \$104.95

FOXFURY DISCOVER TASKER

FIRE HELMET LIGHT

Fits ALL fire helmets with goggles, Bourke eye shields, EZ-Flips, and Defender visors, and external face shields. Meets NFPA fire resistant requirements (500°F for 30 minutes). *Ship. wt. 1 lb.*



- 100 lumens
- 3 white LEDs
- 6061 aluminum housing with stainless steel sidepods
- Fire and impact resistant
- Waterproof to 10'
- 4 AA batteries
- Battery Life: 7 to 12 hrs.
- Tap on/off switch
- 2 Modes: low (45%), high (100%)
- Removable lens - can be replaced if damaged
- Uniform horizontal beam
- Rear safety LED (Red)
- Dimensions: 2.8"Wx0.7"Dx0.6"H

BK368 Discover Tasker Fire Helmet Light \$139.95

VANTAGE® HELMET-MOUNTED LIGHT

COMPACT, POWERFUL, SHOCK-PROOF & VIRTUALLY INDESTRUCTIBLE

- Lightweight, compact, low profile design easily attaches above or below full brim on fire helmets
- Anodized aircraft aluminum, high impact, chemically resistant engineering polymer LED housing
- Fits both traditional and modern style helmets & hard hats
- Solid-state current regulation for consistent illumination
- IPX7 rated, waterproof up to 1 meter for 30 minutes
- 115 lumens; 167 meter beam distance; runs 6 hours
- Meets NFPA 1971-8.6 (2013) requirements
- Length: 3.26"
- Ship. wt. 1 lb.

Tighten with your fingers

Textured parabolic reflector produces a smooth beam hotspot

C4 LED is 2-3x brighter than previous generation LEDs

Reflective strip

Uses two 3V CR123A lithium batteries (included)



Rotates 360°



ULTRA-BRIGHT BLUE TAILLIGHT LED



BG518 Vantage® Helmet-Mounted Tactical Light \$125.95

TACTICAL FIRE LIGHT WITH MULTI-ANGLE HELMET MOUNT

The Tactical Fire Light is rated at 180 Lumens and has a tight long-throw beam that is distance-rated at 190 meters. The entire system is IP-X7 waterproof and is drop rated at 2 meters.

The mount can be attached to either side of the helmet to provide hands-free illumination for the wearer. Additionally, the user can set the angle of the mount through 140 degrees of adjustment to provide clearance around face shields, goggles or other helmet-mounted equipment.



NEW

BN166 Tactical Fire Light with Multi-Angle Helmet Mount

\$41.95

VANTAGE® 180X HELMET/RIGHT-ANGLE FLASHLIGHT

The Streamlight Vantage® 180X Helmet/Right-Angle Flashlight gives you the ultimate versatility in a firefighter's light and goes instantly from a helmet light to a handheld light to a right-angle light. So wear it, hold it, clip it, or even hang it!

- 250 lumens (high)
- Helmet/right-angle/handheld light
- 180° rotating head (for right-angle use)
- Rear LED taillight changes from blue to white

NEW LOW PRICE

VIDEO ONLINE



BN500 Streamlight Vantage® 180X Helmet/Right-Angle Flashlight

\$83.95



HELMET-MOUNTED MULTI-FUNCTION DUAL-LIGHT™ FLASHLIGHT

Outshines the competition with its powerful 220 lumen tightly-focused Flashlight and a beam distance rating of 600'. Choose from two additional lower lumen settings at 100 or 30 lumens. User-selectable brightness Floodlight with a soft unfocused light pattern. Brightness and choice of 100 or 50 lumens for typical use, as well as a "Survival" mode at 15 lumens for emergency situations. Additionally, in Dual-Light mode the user can light up the distance and the ground at the same time. Also features a green, rear facing LED light for easy identification. Fits any fire helmet (or side-brim hard hat) thanks to the multi-angle adjustment feature. IP-X7 rated waterproof and meets the requirement for NFPA-1971-8.6 (2013). Powered by 2 CR-123 batteries (included.)

VIDEO ONLINE



- CREE LED technology - 50,000+ hours LED life
- Cast from ADC12 aluminum alloy
- Waterproof
- Impact and chemical resistant
- Meets the requirements for NFPA-1971-8.6 (2013)

BN171 Helmet-Mounted Multi-Function Dual-Light™ Flashlight

\$86.95

GUTS HM1 HELMET MOUNTING SYSTEM



- Any shape AA or AAA flashlight
- Bullet camera
- Rapid access - one tug release with the QuickStrap™
- Small tool or window punch
- Mount to front or side brim
- Made from NFPA rated materials

SPECIFY COLOR: Black, Red, Silver



BL887 GUTS HM1 Helmet Mounting System

\$33.95

KNUCKLEHEAD® SPOT LIGHT
VERSATILE & DESIGNED TO PUT LIGHT WHERE YOU NEED IT



- Shockproof LED technology
- Durable spring-loaded clip for easy attachment to turnout gear
- Features a 210° articulating head



BL496	Knucklehead® Spot 120V AC/12V DC Light	\$165.95
BL497	Knucklehead® Spot Alkaline Light	\$91.95

SURVIVOR® FLASHLIGHT
SAFETY-RATED FIREFIGHTERS RIGHT ANGLE LIGHT

- Available in rechargeable and alkaline models
- Features LED technology with four lighting modes



BD203	Survivor® Rechargeable with AC/DC	\$138.95
BD204	Survivor® Rechargeable with AC	\$159.95
BD205	Survivor® Rechargeable with DC	\$159.95
BD206	Survivor® (Alkaline Model) - Orange	\$65.95
BD206	Survivor® (Alkaline Model) - Yellow	\$65.95

HAND-HELD LIGHTS

INTRANT™ DUAL-LIGHT™
ANGLE LIGHT - 205 LUMENS

- cULus, ATEX and IECEx listed Intrinsically Safe
- Flashlight/Floodlight/Dual-Light
- Flashlight pivots 90° with 45° downward angled floodlight



BN718	INTRANT™ Intrinsically Safe Dual-Light™ Angle Light - 3AA	\$70.95
BN719	INTRANT™ Intrinsically Safe Dual-Light™ Angle Light - Rechargeable	\$122.95

INTEGRITAS™ INTRINSICALLY SAFE
RECHARGEABLE LANTERN
NIGHTSTICKS MOST POWERFUL HANDHELD LIGHT

- 1,750 Lumens on High, 600 Lumens on Low
- Class 1, Division II intrinsically safe, meets NFPA-1971-8.6 (2013) requirements
- Dustproof/Waterproof
- 180° Downward pivoting head
- Rear green safety lights
- Rechargeable Li-ion battery pack with locking snap-in charger
- Extended run time to 11.5 hours
- AC and DC power supply
- Removable shoulder strap



BP045	INTEGRITAS™ Rechargeable Lantern	\$215.95
-------	----------------------------------	----------

VULCAN® 180 LED LANTERN

The lightest portable lantern of its kind, the Vulcan 180 is designed to burn brighter and run longer making it an essential firefighting tool. This rechargeable, waterproof lantern has a 180 degree tilting head which allows you to direct the light where you need it. Three ultra-bright white LEDs bring you extreme brightness along with two blue taillight LEDs for visibility in thick smoke.

- 1,200 lumens; runs 4.75 hours; 548m beam distance
- 180° articulating head aims the beam where you need it
- Flat base area allows light to stand on its own for scene lighting
- Two ultra-bright blue taillight LEDs make certain you can be seen even in thick smoke
- High-impact, super-tough nylon body; head constructed from high grade aluminum encased in super-tough nylon
- Taillight LEDs can be programmed on or off



BN672	Vulcan® 180 LED Lantern Standard System	\$242.95
BN673	Vulcan® 180 LED Lantern Vehicle Mount System	\$228.95

FIRE VULCAN® LANTERNS

AZ116 FEATURES:

- Ultra-Bright Blue Taillight LEDs Offer 2 Modes: Steady and blinking
- Easy-to-operate toggle switch
- High-visibility orange
- Compact and lightweight
- Extremely Powerful: 80,000 cp, 145 lumens
- Rugged, high-impact thermoplastic housing
- Waterproof
- Fits existing Vulcan® chargers
- Ship. wt. 4 lbs.

BG522 FEATURES:

- Up to 80,000 candela peak central intensity; 150 lumens
- 2 lightweight lithium ion nanotechnology cells: recharges in 5 hrs.
- Charger base meets requirements of NFPA 1901
- IPX7 rated design - waterproof to 1 meter for 30 minutes
- Deep-dish parabolic reflector produces a tight beam with optimum peripheral illumination
- Rated product, Class I Division 2 Groups A, B, C, D, Temperature T4A; Class II Division 2 Groups F, G, Class III, Temperature T-54°C (T6)
- Run-Times:
Steady high LED & taillights: Up to 3 hrs to the 10% output level
low: Up to 6 hrs
- C4 LED, impervious to shock with a 50,000 hr lifetime
- 8 programmable functions
- About 45% lighter than the halogen Fire Vulcan®
- Ship. wt. 3 lbs.



BG522	Fire Vulcan® LED Standard System w/AC/DC	\$189.95
BG523	Fire Vulcan® LED Vehicle Mount w/12v DC	\$183.95
BG524	Fire Vulcan® LED without Charger	\$161.95



BN672



BG522

E-FLOOD® LED LANTERNS

The E-Flood® and E-Spot® models are industrial-duty, rechargeable, portable lanterns featuring power LED technology for high brightness, long runtime and high reliability. The E-Flood® models use 6 LEDs and wide pattern reflectors to produce a uniform flood pattern.

- Optimized electronics provide regulated intensity
- **2 Levels of Lighting:**
High: 4,000 candela, 615 lumens, 8 hrs. run-time
Low: 2,150 candela, 330 lumens, 18 hrs. run-time
- Zero-maintenance, 6V, 12 amp-hr sealed lead acid battery is rechargeable up to 500 times
- High impact ABS thermoplastic housing
- Rubberized impact bumper, lens ring and cushioned-grip handle
- Fits existing LiteBox® chargers
- IPX4 Rated for weather resistant operation



BK047	E-Flood® LiteBox® Standard System with AC/DC, Shoulder Strap & Mounting Rack	\$211.95
BK048	E-Flood® LiteBox® Firebox Vehicle Mount System with DC, Shoulder Strap	\$204.95
BK049	E-Flood® FireBox® Standard System with Dual Rear LED's, AC/DC, Shoulder Strap & Mounting Rack	\$223.95
BK050	E-Flood® FireBox® Vehicle System with Dual Rear LED's, DC, Shoulder Strap	\$214.95
BK371	E-Flood® Upgrade Kit	\$71.95

E-SPOT® LED LANTERNS

The E-Spot® model is an industrial-duty, rechargeable, portable lanterns featuring power LED technology for high brightness, long runtime and high reliability. *Mounting rack meets NFPA requirements mounted in any position.*

E-SPOT® FEATURES:

- 2 user programmable ultra-bright blue tail-light LED's
- **2 Levels of Lighting:**
High: 55,000 candela peak beam intensity, 540 lumens, up to 7 hrs.
Low: 32,000 candela peak beam intensity, 330 lumens, up to 15 hrs.
- Shoulder strap



BK226	E-Spot® FireBox® with 120V AC/12V DC	\$202.95
BK227	E-Spot® FireBox® with Vehicle Mount System	\$195.95
BK228	E-Spot® LiteBox® with 120V AC/12V DC	\$190.95
BK229	E-Spot® LiteBox® with Vehicle Mount System	\$183.95
BK370	E-Spot® Upgrade Kit	\$53.95



BK047



BK226

PORTABLE SCENE LIGHT RECHARGEABLE LANTERN

Rapidly deployed and easily stowed, the Portable Scene Light brings 5,300 lumens to your work area. With its narrow footprint and 72" extension pole, this light goes almost anywhere, from wide open places to tight, confined spaces.

- **Light Source:** 6 LEDs and wide pattern reflectors produce a uniform flood pattern with two selectable beam widths and three light output intensities
- **Battery:** Zero-maintenance 12V, 7.2Ah sealed lead acid batteries are rechargeable up to 500 times
- 10 hour charge to 90% battery capacity
- AC charger included for continued use
- Packs to a compact size (22") for storage
- 90° swivel for optimum peripheral illumination
- **Dimensions:** 22" L x 6.5" W x 11" H
- **Weight:** 25 lbs. (11.3 kg) with batteries



VIDEO ONLINE



BL661 Portable Scene Light Rechargeable Lantern

\$750.95

NOMAD 360 RECHARGEABLE SCENE LIGHT

PORTABLE, CORDLESS & DEPLOYS QUICKLY

- 7000 lumens
- **3 Modes:** Low, medium and high
- Use as 360° scene light, 120° area light or 12° spotlight
- Telescopes up to 99"
- Rechargeable Li-ion battery system
- **Run-Time:** 3-24 hours
- **Charge Time:** 7 hours
- Battery level indicator
- AC or DC charge/drive
- **Weight:** 23 lbs.
- Shoulder strap for easy carry
- Waterproof and fire scene ready

VIDEO ONLINE



FOLDS INTO 38.6" TUBE



HEAD OPEN - SLIDING DIFFUSER LENS CHANGES TYPE



BL733 Nomad 360 Rechargeable Scene Light

\$2,505.95

9490 REMOTE AREA LIGHTING SYSTEM

- Maintenance free LED array with 50,000 hour life expectancy
- Intelligent control (allows for various light output levels)
- Full time battery level indication with low level flashing indicator
- Quick release / hot swappable battery design with 12 volt power supply
- Deployable 6' mast with 340° rotation
- Multiple deployment positions
- Convenient shoulder strap
- **Switch Type:** Silicone rubber keypad
- **Lumens:** Up to 6,000
- **Closed Dimensions:** 6.5"x20"x11.25"
- **Run-Time:** Low: 24 hrs., Medium: 12 hrs., High: 3.5 hrs.
- **Weight:** 32 lbs.

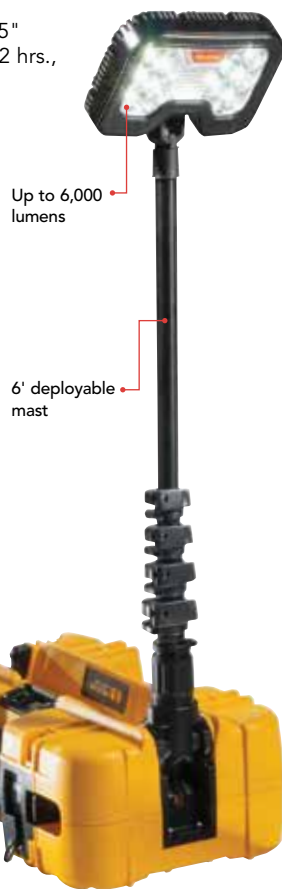

Up to 6,000 lumens

6' deployable mast



SPECIFY COLOR: Black or Yellow

BL827 9490 Remote Area Lighting System



Black Yellow

\$983.95

REMOTE AREA LIGHTING SYSTEM

Using solid-state mounted LEDs coupled with a thermally efficient light engine and the Pelican Protector™ Case. The Remote Area Lighting Systems (RALS) gives the user the ultimate maintenance free portable floodlight station to get the job done efficiently, safely and on time. The RALS houses two of its light heads and its multi-stage charger for that total self-contained convenience. It is also equipped with a telescopic handle and rugged wheels for ease of transport. Includes a convenient low battery warning system and waterproof activation switch.

- High Flux LED, 50,000 hr. life
- Lumen Value: 3,000 (low) and 6,000 (high)
- 2 lamp heads, 6 LEDs per head
- 90° beam spread
- 2 brightness settings
- 12v rechargeable battery, 9 hr. charge time
- **Battery Burn Time:** 14 hrs. (low), 7 hrs. (high) from full discharge
- 500 cycle battery life
- Low battery warning
- **Head Dimensions:** 6.5" Lx7.87" Wx2.56" D
- **Cord Length:** 13.78"
- **Weight:** 51 lbs.



BK403 Remote Area Lighting System

\$1,992.95

HANDHELD REMOTE AREA LIGHTING SYSTEM

- Polycarbonate lens is lightweight and impact-resistant
- Maintenance-free LED array with life expectancy of 50,000 hrs.
- Fully extendable mast with 360° rotating head
- Waterproof rubber activation switch
- Mast extension lock
- Variable tension angle lets light shine at any angle
- Metal battery chassis distributes load to handle
- Durable base soaks up impact
- Up to 3,000 lumens of tested LED light output
- Silent, energy efficient, rechargeable battery
- Retractable handle and rugged wheels for easy mobility
- Low heat
- Ship. wt. 25 lbs.



BH018 Handheld Remote Area Lighting System

\$ 885.95

BATTERY-POWERED BLOWER



- **180° Tilt:** Provides the largest tilt range among battery fans, allowing airflow to be directed virtually anywhere
- **Compact, Roll-Cage Frame:** Features one of the most compact, lightweight designs among battery PPVs with its aluminum frame design
- **Polymer Blade:** Minimizes weight; Super Vac's single-piece cast aluminum blade is available by request
- **Precision-Spun Steel Shroud with StreamShaper Guard:** Shroud provides durability with max airflow, while the StreamShaper guard allows for flexible setback; Air Cone Guard available by request

16" MILWAUKEE POWERED

Cat#	Dimensions	Amp-Hour/Runtime	Charger Type	CFM	Wt.	Price
BP222	22 ³ / ₄ "x23 ¹ / ₂ "x12"			9,800	42 lbs.	\$3,037.95
BP223	22 ³ / ₄ "x23 ¹ / ₂ "x12"	8Ah/30 Min.	AC	9,800	42 lbs.	\$3,620.95
BP224	22 ³ / ₄ "x23 ¹ / ₂ "x12"	8Ah/30 Min.	AC	9,800	42 lbs.	\$3,966.95
BP225	22 ³ / ₄ "x23 ¹ / ₂ "x12"	12Ah/40 Min.	AC	9,800	42 lbs.	\$3,852.95
BP226	22 ³ / ₄ "x23 ¹ / ₂ "x12"	12Ah/40 Min.	AC	9,800	42 lbs.	\$4,198.95
BP227	22 ³ / ₄ "x23 ¹ / ₂ "x12"	Shore Power		9,800	42 lbs.	\$4,261.95

18" MILWAUKEE POWERED

Cat#	Dimensions	Amp-Hour/Runtime	Charger Type	CFM	Wt.	Price
BP228	25 ³ / ₄ "x25 ³ / ₄ "x12"			10,800	46 lbs.	\$3,685.95
BP229	25 ³ / ₄ "x25 ³ / ₄ "x12"	8Ah/30 Min.	AC	10,800	46 lbs.	\$4,268.95
BP230	25 ³ / ₄ "x25 ³ / ₄ "x12"	8Ah/30 Min.	AC	10,800	46 lbs.	\$4,614.95
BP231	25 ³ / ₄ "x25 ³ / ₄ "x12"	12Ah/40 Min.	AC	10,800	46 lbs.	\$4,500.95
BP232	25 ³ / ₄ "x25 ³ / ₄ "x12"	12Ah/40 Min.	AC	10,800	46 lbs.	\$4,846.95
BP233	25 ³ / ₄ "x25 ³ / ₄ "x12"	Shore Power		10,800	46 lbs.	\$4,032.95

16" DEWALT POWERED

Cat#	Dimensions	Amp-Hour/Runtime	Charger Type	CFM	Wt.	Price
BP250	22 ³ / ₄ "x23 ¹ / ₂ "x12"			9,816	42 lbs.	\$3,037.95
BP251	22 ³ / ₄ "x23 ¹ / ₂ "x12"	9Ah/30 Min.	AC	9,816	42 lbs.	\$3,620.95
BP252	22 ³ / ₄ "x23 ¹ / ₂ "x12"	9Ah/30 Min.	AC	9,816	42 lbs.	\$3,966.95
BP253	22 ³ / ₄ "x23 ¹ / ₂ "x12"	12Ah/40 Min.	AC	9,816	42 lbs.	\$3,852.95
BP254	22 ³ / ₄ "x23 ¹ / ₂ "x12"	12Ah/40 Min.	AC	9,816	42 lbs.	\$4,198.95
BP255	22 ³ / ₄ "x23 ¹ / ₂ "x12"	Shore Power		9,816	42 lbs.	\$4,261.95

18" DEWALT POWERED

Cat#	Dimensions	Amp-Hour/Runtime	Charger Type	CFM	Wt.	Price
BP256	25 ³ / ₄ "x25 ³ / ₄ "x12"			10,840	46 lbs.	\$3,685.95
BP070	25 ³ / ₄ "x25 ³ / ₄ "x12"	9Ah/30 Min.	AC	10,840	46 lbs.	\$4,268.95
BP257	25 ³ / ₄ "x25 ³ / ₄ "x12"	9Ah/30 Min.	AC	10,840	46 lbs.	\$4,614.95
BP072	25 ³ / ₄ "x25 ³ / ₄ "x12"	12Ah/40 Min.	AC	10,840	46 lbs.	\$4,500.95
BP258	25 ³ / ₄ "x25 ³ / ₄ "x12"	12Ah/40 Min.	AC	10,840	46 lbs.	\$4,846.95
BP259	25 ³ / ₄ "x25 ³ / ₄ "x12"	Shore Power		10,840	46 lbs.	\$4,032.95



VALOR VENTILATION FANS



The Valor Series is engineered to take on the toughest ventilation challenges. Featuring a tough, tubular aluminum frame, rubber never-flat tires, and a 7-position tilt system with a quick step pad. Ducting attaches easily to Valor Series Fans, allowing for quick deployment. The seven point aluminum airfoil blade is manufactured to withstand the heat of structure fires and precision engineered to last a lifetime.

Cat#	Size	Dimensions	Motor	CFM	Wt.	Price
BN229	18"	23 ¹ / ₂ "x22"x21"	Single Speed	6,378	80 lbs.	\$2,561.95
BN230	18"	23 ¹ / ₂ "x22"x21"	Variable Speed	11,709	84 lbs.	\$3,107.95
BN231	18"	23 ¹ / ₂ "x22"x21"	Hazardous Location	6,378	90 lbs.	\$2,981.95
BN232	20"	26 ¹ / ₂ "x25"x21 ¹ / ₂ "	Single Speed	9,007	82 lbs.	\$2,679.95
BN233	20"	26 ¹ / ₂ "x25"x21 ¹ / ₂ "	Variable Speed	13,788	86 lbs.	\$3,199.95
BN234	20"	26 ¹ / ₂ "x25"x21 ¹ / ₂ "	Hazardous Location	9,007	92 lbs.	\$3,073.95

Cat#	Size	Dimensions	Engine	CFM	Wt.	Price
BN287	18"	23 ¹ / ₂ "x22"x21"	GX200 Honda	15,168	84 lbs.	\$3,208.95
BN286	18"	23 ¹ / ₂ "x22"x21"	GC160 Honda	13,223	76 lbs.	\$2,743.95
BN285	18"	23 ¹ / ₂ "x22"x21"	Vanguard	14,342	84 lbs.	\$3,012.95
BN290	20"	26 ¹ / ₂ "x25"x21 ¹ / ₂ "	GX200 Honda	18,182	86 lbs.	\$3,301.95
BN289	20"	26 ¹ / ₂ "x25"x21 ¹ / ₂ "	GC160 Honda	15,499	78 lbs.	\$2,882.95
BN288	20"	26 ¹ / ₂ "x25"x21 ¹ / ₂ "	Vanguard	17,064	86 lbs.	\$2,928.95

7 SERIES GAS PPVS

SUPERVAC

Featuring a durable steel-frame, roll-cage design with 4-position tilt for -10°, 0°, 10°, 20° angles to ventilate stairwells and basements, this PPV has proven itself for decades as one of Super Vac's most trusted PPVs. This fan is available in a variety of sizes (16", 18", 20" and 24" fans) with a variety of Honda engine choices, making this a fan favorite.

- **Fold-Down Ergonomic Handle:** Folds down into frame for compact storage; features full-width handle for easy grip with heavy-duty gloves
- **Flat-Proof Rubber Tires:** Eliminates flat tires; rolls up stairs/curbs easily
- **Single-Piece Cast Aluminum Blade:** Holds up better than plastic in high heat
- **Precision-Spun Steel Shroud:** Provides durability with max airflow
- **Air Cone Guard:** Classic design for maximum airflow; StreamShaper Guard optional



Cat#	Size	Dimensions	Engine	CFM	Wt.	Price
BD033	16"	20"x20 1/2"x16"	GX120 Honda	11,740	74 lbs.	\$2,097.95
AC952	18"	22"x23 1/2"x19 1/2"	GX200 Honda	15,168	86 lbs.	\$2,630.95
BL618	18"	22"x23 1/2"x19 1/2"	GC160 Honda	13,223	78 lbs.	\$2,488.95
AC953	20"	25 1/2"x26"x19 1/2"	GX200 Honda	18,182	96 lbs.	\$2,713.95
AC954	24"	28"x29 1/2"x21"	GX270 Honda	20,920	134 lbs.	\$3,469.95

ELECTRIC SMOKE EJECTORS

SUPERVAC

The most popular smoke ejector in the fire service, the Super Vac Electric Smoke Ejector features a patented 4-tip recurved aluminum propeller, which produces a greater intake of air into the vacuum side of the fan, eliminating turbulence at the tips. All Super Vac's are designed to easily accept spiral duct with adapters on the output side for positive ventilation or the input side for negative ventilation.



- **Patented 4-Tip Recurved Aluminum Blade:** Creates a tight spiral of air to eject smoke and fumes away from the building; aluminum holds up better than plastic in high heat
- **Precision-Balanced Blade:** Maximizes output
- **Heavy-Duty Rubber Feet:** Adds friction to keep fan in place
- **4 Carry Handles:** Makes transportation easy with one or two people
- **Front and Rear Guards:** Prevents accidental contact with key components

16" BLADE SMOKE EJECTOR

- **Explosion Proof Motor:** J594 & J594A
- **Overall Dimensions:** 19 1/4"x18 3/4"x13"
- AC948 has explosion-proof motor

Cat#	Size	RPM	Voltage	Housing	CFM	Wt.	Price
J593	16"	1,725	115/230	Steel	5,200	44 lbs.	\$1,157.95
J593A	16"	1,725	115/230	Alum.	5,200	39 lbs.	\$1,297.95
AC947	16"	3,450	115/230	Alum.	9,620	59 lbs.	\$2,573.95
J594	16"	1,725	115/230	Steel	5,200	49 lbs.	\$1,835.95
J594A	16"	1,725	115/230	Alum.	5,200	44 lbs.	\$1,985.95
AC948	16"	3,450	115/230	Alum.	9,620	63 lbs.	\$3,320.95

20" BLADE SMOKE EJECTOR

- **Explosion Proof Motor:** M912 & M912A
- **Overall Dimensions:** 25 1/2"x24 3/4"x16 1/4"

Cat#	Size	RPM	Voltage	Housing	CFM	Wt.	Price
M910	20"	1,725	115/230	Steel	9,800	85 lbs.	\$2,106.95
M910A	20"	1,725	115/230	Alum.	9,800	85 lbs.	\$2,294.95
M912	20"	1,725	115/230	Steel	9,800	93 lbs.	\$2,568.95
M912A	20"	1,725	115/230	Alum.	9,800	93 lbs.	\$2,749.95

24" BLADE SMOKE EJECTOR

- **Explosion Proof Motor:** J598
- **Overall Dimensions:** 28 1/2"x28"x18 3/4"

Minimum 6kw generator w/20amp circuit is recommended to power these blowers.

Cat#	Size	RPM	Voltage	Housing	CFM	Wt.	Price
J597	24"	1,725	115/230	Steel	11,800	110 lbs.	\$2,713.95
J598	24"	1,725	115/230	Steel	11,800	115 lbs.	\$3,636.95



STANDARD
SINGLE SPEED



EXPLOSION PROOF MOTOR

DIRECT DRIVE GAS SMOKE EJECTOR

Among the smallest gas-powered fans in the industry, the 16" and 18" Fits into tight compartments and yet pack a cfm output that matches larger electrical smoke ejectors thanks to the powerful Honda GX engine. Totally enclosed housing, which protects the fan's moving parts, gives crews the ability to stack multiple units on top of each other. **GX120: 16" Dimensions: 19.5"x19"x15.5". Weight: 55 lbs. / 58 lbs. for GP167S. 18":23.5"x23"x16.5". Weight:76lbs.MadeinUSA.Ship.wt.55lbs.**

- **Single-Piece Cast Aluminum Blade:** Holds up better than plastic in high heat
- **Precision-Balanced Blade:** Maximizes output
- **Front and Rear Guards:** Prevents accidental contact with key components
- **Heavy-Duty Rubber Feet:** Adds friction to keep fan in place
- **4 Carry Handles:** Makes transportation easy with one or two people



FREE SHIPPING



SUPERVAC

J670 Direct Drive Gas Smoke Ejector

\$2,181.95

SPECIAL OPERATIONS BLOWERS

The Tempest Special Operations Power Blower is the latest addition to the positive pressure ventilation and attack arsenal. The fan's unique grille and shroud design create a Laminar Air Flow (LAF) which uses an increased setback (9' to 11') and is highly effective in unique fireground scenarios such as multi-story stairwells, highrise structures, complex structures and commercial structures > 5,000 ft. The SP blower also showcases a number of new features like wheels now located in the back and a wider footprint for increased stability.



VIDEO ONLINE

TEMPEST



Cat#	Description	Size	Dimensions	CFM	Weight	Price
BL415	Special Operations Blower	18"	20 ¹ / ₂ "x21 ¹ / ₂ "x22 ¹ / ₂ "	15,792	88 lbs.	\$2,677.95
BL416	Special Operations Blower	21"	24 ¹ / ₄ "x24"x25 ¹ / ₂ "	19,396	122 lbs.	\$2,946.95
BL828	Special Operations Blower Variable Speed Electric	18"	21 ³ / ₄ "x21 ¹ / ₂ "x25 ³ / ₄ "	13,338	105 lbs.	\$3,112.95

DIRECT-DRIVE GAS POWERED BLOWERS

Tempest Direct-Drive Gas Power Blowers were some of the first units designed and used on the fire ground. With a level a durability and performance backed only by the Tempest name, these units offer the perfect balance in features, performance, cost and versatility.

- AMCA Certified Performance
- Reliable Honda GX or Briggs & Stratton engine
- Rugged construction with stands use and abuse
- Tempest exclusive features makes use easy and economical



TEMPEST



Cat#	Size	HP	Engine	Dimensions	CFM	Weight	Price
AM118	16"	4.8	Honda	20 ¹ / ₂ "x19 ³ / ₄ "x21 ³ / ₄ "	12,008	79 lbs.	\$2,049.95
AM120	18"	4.8	Honda	22 ³ / ₄ "x21"x24 ¹ / ₄ "	14,773	85 lbs.	\$2,321.95
AM122	21"	5.5	Honda	25"x21"x26 ¹ / ₄ "	20,152	90 lbs.	\$2,408.95
BL838	24"	5.5	Honda	28"x21"x30"	19,606	99 lbs.	\$2,485.95
BK038	16"	3.5	Briggs	20 ¹ / ₂ "x19 ³ / ₄ "x21 ³ / ₄ "	11,541	73 lbs.	\$1,776.95
BK039	18"	5.5	Briggs	23 ¹ / ₂ "x21"x25"	14,341	83 lbs.	\$1,919.95
BK040	21"	5.5	Briggs	25 ¹ / ₂ "x21"x26 ¹ / ₄ "	18,025	87 lbs.	\$2,009.95
BK041	24"	5.5	Briggs	28"x21"x30"	19,232	97 lbs.	\$2,099.95

SINGLE & VARIABLE SPEED ELECTRIC BLOWERS

The most comprehensive line of Electric Powered Blowers for PPV and NPV available today. Built on the same chassis that has been so successful for our Tempest Gasoline Powered Blowers, Electric Powered Blowers are powerful, durable and versatile while maintaining the ability to operate on a standard household current.

- No exhaust emissions, which can collect Carbon Monoxide inside the structure that you are trying to ventilate
- Never requires "oil change" or has gas go bad while sitting in storage
- Designed to start and run off a standard residential 120v 20amp receptacle without tripping the circuit breaker
- Power supply is readily available at most sites



TEMPEST

Cat#	Description	HP	Dimensions	CFM	RPM	Weight	Price
AS106	16" Single Speed Electric Blower	1.5 TEFC	20 ¹ / ₂ "x19 ³ / ₄ "x21 ³ / ₄ "	11,804	3,450	74 lbs.	\$1,919.95
AS107	18" Single Speed Electric Blower	1 TEFC	22"x21"x24 ¹ / ₄ "	8,748	1,750	76 lbs.	\$2,009.95
AS108	21" Single Speed Electric Blower	1 TEFC	24 ³ / ₄ "x21"x26 ¹ / ₄ "	11,698	1,731	81 lbs.	\$2,093.95
BG288	24" Single Speed Electric Blower	1 TEFC	28"x21"x30"	12,867	1,736	90 lbs.	\$2,187.95

Cat#	Description	HP	Dimensions	CFM	Weight	Price
BP354	16" Variable Speed Electric Blower	2 TEFC	21"x19 ³ / ₄ "x23"	11,551	98 lbs.	\$2,808.95
BP355	18" Variable Speed Electric Blower	2 TEFC	23"x21"x24.90"	12,839	104 lbs.	\$2,893.95
BP356	21" Variable Speed Electric Blower	2 TEFC	26"x21"x26 ¹ / ₄ "	14,836	108 lbs.	\$2,978.95
BP357	24" Variable Speed Electric Blower	2 TEFC	29 ¹ / ₂ "x21"x30"	15,663	119 lbs.	\$3,063.95

ELECTRIC SMOKE EJECTOR

Used by fire departments around the globe for more than fifty years, traditional smoke ejectors have proven to be the most versatile tool for smoke ventilation. Tempest smoke ejectors have all the standard features including the AirFlex Composite Impeller and other designs to provide years of dependable service, with a durable steel housing, rigid frame and optional duct adapter that easily attaches to a blower's inlet or outlet. Dimensions: 18.75"x14.25"x19.5", 16" blade.



TEMPEST

Cat#	Description	HP	CFM	RPM	Weight	Price
AW179	Smoke Ejector	.3 TEFC	3,200	1,736	47 lbs.	\$1,094.95
AZ571	Ducting Adapter with 16"x15' Ducting					\$481.95

GAS SMOKE EJECTOR

The Tempest GBS-16-HP is a popular unit for all forms of confined space ventilation, a design that's been used for decades. It's light and small enough to ventilate tight areas yet still built to Tempest's high standard of long lasting durability and reliability. The GBS's 3.5 (Honda GX 120) and 4.8 HP (Honda GX 160) engine options deliver massive performance out of a compact footprint. Suck the smoke/fumes/particulates out from almost any location, or turn it around and blow them out. Dimensions: 3.5 HP: 18.75"x14.00"x19.5" | 4.8 HP: 21"x17"x21"



TEMPEST

Cat#	Description	HP	CFM	Weight	Price
BP367	Gas Smoke Ejector	3.5	9,372	70 lbs.	\$1,995.95
BP368	Gas Smoke Ejector	4.8	11,172	72 lbs.	\$2,082.95
BP369	Ducting Hose Adapter, Fits GBS 4.8 HP				\$133.95

For international customers only.

BATTERY POWERED FANS AND ACCESSORIES

VENTILATION

TEMPEST VS-1/VS-1.2 BATTERY BLOWERS

The Tempest Technology 18" Battery Powered PPV Blower features a 70 minute, interchangeable battery allows this blower to be used on every call, not "one and done" like the others.

- 70 minute operating time at full speed
- Removable lithium-ion battery rated IP65 & quick charges in 4 hours
- Lightweight design, welded tubular aluminum frame. Only 52 lbs. with battery
- AMCA certified air flow 10,887 cfm
- Variable speed motor rated at IP65
- Thin-Vane air straightener grill and composite impeller
- LED flow-path lighting positioned low for visibility below the smoke
- Tapered lightweight steel shroud maximizes airflow performance
- Ergonomic patent pending frame design with transverse wheels
- Small footprint 22.88"Wx26"Hx11"D (half the size of a gas blower) Dynamic Battery Control System that protects the battery during charge/discharge as well as monitors all cells for optimum performance and diagnostics

BP207

- Folding handle
- Weight: 53 lbs.



TEMPEST

BN584	18" Battery Powered Tempest Blower	\$4,639.95
BP207	18" Battery Powered Tempest Blower w/Folding Handle	\$4,918.95

NEW



BATFAN II

PORTABLE, LIGHTWEIGHT AND THE MOST VERSATILE POWERED BATTERY FAN

FEATURES:

- **Totally Self-Contained:** No power socket or need for a generator
- **Compact and Mobile:** Fold, tow, and portable by one person
- **Quicker to Set-Up:** Starts off instantly
- **Dimensions:** 21.25"Lx20.87"Hx10.6"D
- **Engine:** 600w with variable speed drive-IP66
- **Adjustable Tilt:** From +65° to -90° with locking system
- **NiMH Battery:** Low maintenance: 1 full recharge every 6 weeks, no restrictions on air transport, battery charge indicator

BP034

- Weight: 51.8 lbs.
- Run Time at Full Speed: 20 min
- Charging Time: 100% in 4 hrs.

BP035

- Weight: 58.4 lbs.
- Run Time at Full Speed: 45 min.
- Charging Time: 100% in 7 hrs./20 min.

LEADER

BP034	Batfan II 20	\$4,093.95
BP035	Batfan II 45	\$4,447.95



NEW

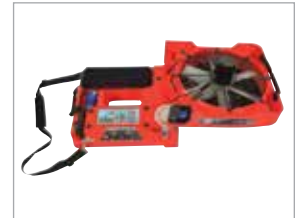

FLEXIBLE DUCT & ADAPTERS

These hose sections are tough, lightweight, extremely flexible and crush-resistant. They attach easily to the Smoke Ejector with a quick-release attachment on the adapter ring. They're ideal for moving large quantities of air for ventilation, air conditioning, and fume and smoke control in hard-to-reach places. *Hoses are priced with fan to hose adapter. Call for prices on longer hose extensions. Ship. wt. 1 lb./per foot.*

SUPERVAC

AC937D	16"x20'	\$1,002.95
AC937F	20"x20'	\$1,284.95
AC937H	24"x20'	\$1,582.95



FREE SHIPPING

SMOKE EJECTOR HOLDER

Made from high-tensile aluminum alloy for maximum strength. Locking action permits adequate pressure to secure the smoke ejector against door jams or window frames. Rubber cushion and pads remain pliable down to -40° F. Includes set of hanger hooks, extras available. Adjusts from 28" to 40". *Ship. wt. 8 lbs.*

FREE SHIPPING



P780	Smoke Ejector Holder	\$100.95
R720	Hanger Hooks	\$14.95/Set of 2

HALOTRON™ I CLEAN AGENT FOR A, B & C FIRES

Halotron™ I clean fire extinguishing agent discharges as a rapidly evaporating liquid, which is non-conductive, non-corrosive, and leaves behind no residue. Determined to be the most environmentally beneficial halocarbon agent on the market that meets wide performance standards. The primary raw material in the agent is HCFC-123, which has an outstanding profile of near-zero ozone depleting potential (0.0098, CFC-11=1.0) and a low global warming potential (77, 100 yr. CO2 time horizon). *Bracket included. Manufactured and tested to ANSI/UL standards. Complies with NFPA 10 standard. ISO-9001/ ISO-14001 certified. UL listed.*

- 6-year manufacturer's warranty
- Stored pressure design
- Dependable drawn steel cylinders
- Durable high gloss polyester powder paint
- All metal valve construction
- Temperature range -40°F to 120°F
- EPA approved "Clean Agent" for Class A, B and C hazards
- Low GWP (Global Warming Potential)
- Low ODP (Ozone Depletion Potential)
- Short atmospheric lifetime

Cat#	Size	UL Rating	Valve	Application	Bracket	Price
AR089	1.4 lbs.	1B:C	Alum.	Nozzle	Wall/Vehicle	\$111.95
AR090	2.5 lbs.	2B:C	Alum.	Nozzle	Wall/Vehicle	\$148.95
AR091	5 lbs.	5B:C	Alum.	Nozzle	Wall/Vehicle	\$211.95
AR092	11 lbs.	1A:10B:C	Brass	Hose & Nozzle	Wall	\$420.95
AR093	15.5 lbs.	2A10B:C	Brass	Hose & Nozzle	Wall	\$591.95



ABC DRY CHEMICAL EXTINGUISHERS

ABC or Multi-Purpose extinguishers utilize a specially fluidized and siliconized mono ammonium phosphate dry chemical. It chemically insulates Class A fires by melting at approximately 350°F and coats surface to which it is applied. It smothers and breaks the chain reaction of Class B fires and will not conduct electricity back to the operator. *Bracket included. Manufactured and tested to ANSI/UL standards. Complies with NFPA 10 standard. ISO-9001/ ISO-14001 certified. UL listed.*

- 6-year manufacturer's warranty
- Stored pressure design
- Dependable drawn steel cylinders
- Durable high gloss polyester powder paint
- All metal valve construction
- Temperature range -65°F to 120°F
- Easy and economical to maintain
- Large loop pull pin
- Bar coded and bi-lingual labels

Cat#	Size	UL Rating	Valve	Application	Bracket	Price
P614	2½ lbs.	1A:10B:C	Alum.	Nozzle	Wall/Vehicle	\$39.95
P615	5 lbs.	2A:10B:C	Alum.	Hose & Nozzle	Wall/Vehicle	\$53.95
AF557	5 lbs.	2A:10B:C	Brass	Hose & Nozzle	Wall	\$79.95
AF553	5 lbs.	3A:40B:C	Alum.	Hose & Nozzle	Wall/Vehicle	\$55.95
AF554	10 lbs.	4A:80B:C	Alum.	Hose & Nozzle	Wall	\$77.95
AF558	10 lbs.	4A:80B:C	Brass	Hose & Nozzle	Wall	\$108.95
AF555	20 lbs.	20A:120B:C	Alum.	Hose & Nozzle	Wall	\$143.95
J559	20 lbs.	20A:120B:C	Brass	Hose & Nozzle	Wall	\$171.95



PURPLE K B:C POTASSIUM BICARBONATE EXTINGUISHERS

Purple K extinguishers contain specially fluidized and siliconized potassium bicarbonate dry chemical which is particularly effective on Class B flammable liquids and pressurized gases. It is electrically non-conductive. Purple K has been the choice of oil, gas, chemical and utilities industries as the preferred fire fighting agent. *Bracket included. Manufactured and tested to ANSI/UL standards. Complies with NFPA 10 standard. ISO-9001/ ISO-14001 certified. UL listed.*

- 6-year warranty
- Stored pressure design
- Dependable drawn steel cylinders
- Durable high gloss polyester powder paint
- All metal valve construction
- Temperature range -65°F to 120°F
- Easy and economical to maintain
- Bar coded and bi-lingual labels

Cat#	Size	UL Rating	Valve	Application	Bracket	Price
AF569	2½ lbs.	10B:C	Alum.	Nozzle	Wall/Vehicle	\$45.95
AF570	5 lbs.	30B:C	Alum.	Hose & Nozzle	Wall/Vehicle	\$68.95
AF571	20 lbs.	120B:C	Alum.	Hose & Nozzle	Wall	\$183.95
AF572	10 lbs.	80B:C	Brass	Hose & Nozzle	Wall	\$119.95
AF573	20 lbs.	120B:C	Brass	Hose & Nozzle	Wall	\$190.95



PEERLESS PUMP TYPE WATER EXTINGUISHERS

Rated 2A, Peerless Pump Type Water Extinguishers can be filled while in use and are simple-to-operate. You can test it without loss of water by directing the stream back into the tank. The operator controls the discharge. Moving parts made of corrosion-resistant brass and copper. Immediate operation; no priming needed.



2 1/2 GALLON SIZE

AF577	Polished Copper	\$599.95
R588	Chrome Plated Copper	\$620.95
R587	Red Enamel Copper	\$478.95
H897	Red Enamel Steel	\$434.95
R589	Vehicle Bracket	\$246.95

5 GALLON SIZE

AF578	Polished Copper	\$618.95
R591	Chrome Plated Copper	\$537.95
R590	Red Enamel Copper	\$484.95
H798	Red Enamel Steel	\$467.95
R592	Vehicle Bracket	\$255.95

WATER EXTINGUISHERS

H795 Water Extinguisher: Utilizes the cooling, soaking and penetrating effect of 45-55' stream of water for Class A fires. Hose and nozzle application. *Optional loaded stream/anti-freeze charge protects from freezing.*

Manufactured and tested to ANSI/UL standards. Complies with NFPA 10 standard. ISO-9001/ISO-14001 certified. UL listed.

- 5-year manufacturer's warranty
- Stored pressure design
- Polished stainless steel cylinders
- All metal valve construction
- Temperature range -65°F to 120°F
- Exclusive crevice-free, butt-welded cylinders
- Maximum visibility during discharge
- Large loop stainless steel pull pin
- Bar coded and bi-lingual labels



Cat#	Type	Size	UL Rating	Bracket	Price
H795	Water	2 1/2 gal.	2A	Wall	\$122.95

OPTIONS

BA180	Loaded Stream/Anti-Freeze Charge (Two 2 1/2 gal. bottles)	\$126.95
-------	--------------------------------------------------------------	----------

CARBON DIOXIDE EXTINGUISHERS

Carbon dioxide is discharged as a white cloud of "snow" which smothers a fire by eliminating oxygen. It is effective for Class B flammable liquids and is electrically non-conductive. Carbon Dioxide is a clean, non-contaminating, odorless gas. *Bracket included. Manufactured and tested to ANSI/UL standards. Complies with NFPA 10 standard. ISO-9001/ ISO-14001 certified. UL listed.*

- 5-year warranty
- All metal valve construction
- Rust-free aluminum cylinders
- Durable high gloss polyester powder paint
- Temperature range -22°F to 120°F
- Large loop stainless steel pull pin
- Bar coded and bi-lingual labels
- Meets many hospital medical equipment requirements



Cat#	Size	UL Rating	Valve	Application	Bracket	Price
H790	5 lbs.	5B:C	Brass	Horn	Wall	\$160.95
H791	10 lbs.	10B:C	Brass	Hose and Horn	Wall	\$234.95
H792	15 lbs.	10B:C	Brass	Hose and Horn	Wall	\$279.95
H793	20 lbs.	10B:C	Brass	Hose and Horn	Wall	\$340.95

EXTINGUISHER CHEMICAL REFILL

90% OR MORE ACTIVE FIREFIGHTING AGENTS

Made to recharge your fire extinguisher. Manufactured to rigid quality specifications to assure high-performance and superior flow characteristics. *Ship wt. 50 lbs.*



Cat#	Type	Chemical	Price
AF561	ABC	Monoammonium Phosphate	\$147.95
AF562	BC Reg.	Sodium Bicarbonate	\$49.95
AF563	BC Purple K	Potassium Bicarbonate	\$118.95

UNIVERSAL VEHICLE CHEMICAL EXTINGUISHER BRACKETS

Universal brackets have a heavy-duty steel back with weather and scratch-resistant polyurethane enamel paint finish. Large rubber grommets on bracket back cushion cylinder while strong securing cords keep the cylinder in place. Securing cords easily attach for either left or right hand closings and are impervious to extreme temperatures. There are no moving metal parts to break, loosen or wear out and the bracket is adjustable to several cylinder sizes. *Ship. wt. 3 lbs.*



AF869	Fits 2½ and 5 lb. Dry Chemical Extinguishers	\$32.95
AF870	Fits 6 and 10 lb. Dry Chemical Extinguishers, 5 lb. CO ² Extinguishers, 11 and 15.5 lb. Halotron 1 Extinguishers	\$35.95
AF871	Fits 20 lb. Dry Chemical Extinguisher, 2½ gal. water extinguisher, 15 and 20 lb. and CO ² Extinguishers	\$49.95

X-TINGUISH® FST

PREVENT FLASH-OVER AND BACK-DRAFT

Flame Guard USA X-Tinguish® FST is designed for mobile total flooding fire suppression applications on land and sea. The FST is a highly effective tool for the suppression of early stage and fully developed fires; preventing flash-over and back-draft.



FIRE PROTECTION

BN619	X-Tinguish® FST	\$899.95
-------	-----------------	----------

HEAVY-DUTY EXTINGUISHER BRACKETS

Brackets listed below are for Amerex extinguishers, but will fit any other extinguisher with same size cylinder. If you are unsure or are in need of a bracket not listed, please call your Darley representative.



AF868



AF863



AF864



Type	Size	Rating	\$11.95 AF868	\$44.95 AF863	\$47.95 AF864
Halotron	5 lbs.	5B:C	•		
CO2	5 lbs.	5B:C		•	
CO2	10 lbs.	10B:C			•
CO2	15 lbs.	10B:C			•
ABC	5 lbs.	2A:10B:C	•		
ABC	5 lbs.	3A:40B:C	•		
ABC	10 lbs.	4A:60B:C		•	
ABC	20 lbs.	20A:120B:C			•
BC	5 lbs.	10B:C	•		
BC	6 lbs.	40B:C		•	
BC	10 lbs.	60B:C		•	
BC	20 lbs.	120B:C			•
Purple K	5 lbs.	30B:C	•		
Purple K	10 lbs.	80B:C		•	
Purple K	20 lbs.	120B:C			•
Water	2.5 gal.	2A			•
Foam	2.5 gal.	3A:20B			•

PROFESSIONAL IR THERMOMETERS

The Professional IR Thermometers are a heavy-duty IR dual-laser thermometer with advanced temperature processing, high resolution optics and built-in LED Flashlight. Advanced system-on-chip engineering is the key ingredient of the series of long range infrared thermometers.

- Dual laser sighting
- Hi/low alarm
- MAX, MIN, DIF and AVG temp. settings
- Distance/Spot: 50:1
- Accuracy +/- 2%
- Temperature Range: -76° to 1832° (-60° to 1000°C)
- High intensity white LED flashlight
- High and Low audible temperature alarms

BK248	Extra Long Range IR Thermometer	\$359.95
-------	---------------------------------	----------



TYPE I SAFETY CANS

EASY-TO-FILL AND EASY-TO-USE, AND THE ECONOMICAL CHOICE FOR FLAMMABLES

Compliant Type I Safety Cans are designed with a single spout to filling and pouring. The self-closing, leakproof lid controls vapors and provides security from spills and leaks.

- Fully compliant - meets OSHA and NFPA Code 30
- Premium 24-gauge coated steel body and handle durability and chemical resistance
- Quality backed by exclusive 10-year warranty



D89802	One-Gallon Type I Safety Can	\$37.95
D89803	Two-Gallon Type I Safety Can	\$42.95
D89804	Five-Gallon Type I Safety Can	\$40.95

TYPE II ACCUFLOW™ TRANSFER CANS

COMBINE SAFETY WITH MAXIMUM CONVENIENCE WHEN HANDLING FLAMMABLES

Compliant Type II AccuFlow™ Safety Cans offer additional convenience with two openings: top opening with ergonomically designed life lever for easy filling, and a second opening equipped with a flexible metal hose for targeted pouring into small apertures. The 5/8"x9" nose also provides a safe bonding path to the receiving vessel. Patented, innovative manifold automatically vents to provide fast, precision, glug-free pouring. *Ship. wt. 9 lbs.*



AK045	One-Gallon Transfer Safety Can	\$82.95
AK046	Two-Gallon Transfer Safety Can	\$82.95
AK047	Five-Gallon Transfer Safety Can	\$90.95

SAFETY CAN CABINETS

CENTRAL STORAGE FOR YOUR FLAMMABLE LIQUIDS

Now you can have on-site storage for your flammables or combustibles. These cabinets offer hands-on easy access with minimal exposure plus provide central storage for your corrosive liquids. They save traveling time, minimize employee exposure and seal off your flammables when temperatures get too high. As high-quality safety storage cabinets, they're designed to meet safety requirements in a variety of applications such as laboratories, production areas, schools, hospitals etc., wherever space for flammable and hazardous liquids is needed and at a premium. For even more space-saving storage try the Undercounter Storage Cabinets. They mount flush with other cabinetry and feature vent openings in back wall. *Ship. wt. 190 lbs.-387 lbs.*

UNDERCOUNTER CABINETS

CHECK OUT THESE OUTSTANDING FEATURES:

- **Double-Wall Thermal Barrier:** Cabinet puts an 18-gauge, double-wall insulated air between you and your flammable liquids
- **Maximum Storage/Efficiency:** Reinforced shelves have built-in troughs, and leak proof wells to contain spills
- **Locking Mechanism:** 3-point lock with fail-safe closing mechanism
- **Tri-Lingual Label:** English, Spanish, and French
- **Dual Vents:** Vents are strategically placed with built-in flash arresters
- **Leakproof Sill:** Base of cabinet is a full 2" deep to contain spills
- **Superior Powder Finish:** Powder coat, high-gloss, paint finish resists solvents, acids and alkalis
- **Adjustable Leveling Feet:** Adjustable at all four cabinet corners to ensure proper alignment for tight door closure



CABINETS COME IN HI-GLOSS YELLOW ONLY

Cat#	Description	Size	Shelves	Doors	Dimensions	Price
AK048	Safety Can Storage Cabinet	60 gal.	2	2	65"x34"x34"	\$1,226.95
AK049	Safety Can Storage Cabinet	45 gal.	2	2	65"x43"x18"	\$1,028.95
AK050	Safety Can Storage Cabinet	30 gal.	1	2	44"x43"x18"	\$744.95
AK051	Undercounter Storage Cabinet, 22-gal. with Manual Closing Doors	22 gal.	1	2	35"x35"x22"	\$724.95
AK052	Undercounter Storage Cabinet, 22-gal. with Self-Closing Doors	22 gal.	1	2	35"x35"x22"	\$814.95

FIREBOY®-XINTEX®

FIRE SAFETY AND SUPPRESSION EQUIPMENT

FIRE PROTECTION

SINGLE SENSOR GAS DETECTION SYSTEMS

The Xintex Single Sensor Gas Detection Systems are engineered for all vehicles operating on natural gas (LNG or CNG) or propane (LPG).

- Compact, integrated design incorporates the sensor and monitor in a single unit
- Provides early warning of dangerous gas levels in the cab
- Visual alarm at 20% and audible alarm at 50% of the L.E.L.
- Ideal for all CNG / LNG conversions and fleet vehicles
- Yellow "Fault" LED indicates any system issues
- In-line audible horn
- "Test and Reset" membrane touch button
- Fast, simple installation
- Low power consumption

For more information and to order, contact Darley at 800.323.0244 or visit www.edarley.com/brands/fireboy-xintex



METHANE (CNG) GAS DETECTION
12/24 VDC
2-5/8 in. (76 mm) Square
Current Draw @ 12 VDC: 40 mA
One Integral Sensor



PROPANE (LPG) DETECTION
12/24 VDC
2-5/8 in. (76 mm) Square
Current Draw @ 12 VDC: 40 mA
One Integral Sensor

CG2 & MA2 SERIES AUTOMATIC FIRE EXTINGUISHING SYSTEMS A CLEAN AGENT SYSTEM

Featuring the HFC-227ea with coverage from 25-1,500 ft³ (0.7-28.3 m³) for engine rooms, machinery spaces, and other enclosed spaces for Class B fires. Factory Mutual and USCG Approved - Clean Agents are approved by all notified bodies.

CG2 SERIES

- Automatic discharge only (@ 175°F / 79°C)
- Engine rooms up to 1,000 ft³ (28.3 m³)
- Vertical or horizontal mounting
- Heavy-duty mounting bracket
- Helm display

MA2 SERIES

- Automatic and manual discharge when used with a Fireboy manual discharge cable (sold separately)
- Engine rooms up to 1,500 ft³ (42.5 m³)
- Vertical or horizontal mounting
- Heavy-duty mounting bracket
- Helm display

For more information and to order, contact Darley at 800.323.0244 or visit www.edarley.com/brands/fireboy-xintex



ALSO AVAILABLE WITH 3MT™ NOVECT™ 1230 FIRE PROTECTION FLUID

FIREBOY®-XINTEX® CMD5-MB BATTERY POWERED CO ALARM

The Xintex CMD5-MB CO alarm uses a sensor operating with a microprocessor to measure Carbon Monoxide (CO) levels. Using a "TimeWeighted Average" (TWA) process, it monitors CO concentration, temperature and time to calculate levels of Carboxyhemoglobin (COHb). COHb is the degree to which the oxygen carrying capacity of the blood is impeded by the union of carbon monoxide to the hemoglobin and is expressed as a percentage. The human body absorbs CO easier than oxygen and COHb is the ratio of absorbed carbon monoxide to oxygen in the bloodstream. The CMD5-MB alarm calculates this COHb as a function of time and determines the appropriate alarm response.

- Internal battery power - no external power required
- Electrochemical sensor
- Rapid start-up - no "burn-off" period
- More stable sensing
- Reduced false alarms
- Extremely low current draw (<4 mA)
- Modern, low profile design for inconspicuous protection
- Multiple location warning

SPECIFY COLOR: White or Black

BN630 CMD5-MB Battery Powered CO Alarm



For more information and to order, contact Darley at 800.323.0244 or visit www.edarley.com/brands/fireboy-xintex



White Black

\$109.95

FIREBOY MAE FIRE DETECTION & SUPPRESSION SYSTEM

PRE-ENGINEERED SYSTEM

The new patent-pending Fireboy MAE pre-engineered fire detection and A-C or A-B-C rated suppression system is designed to protect enclosed spaces up to 3,600 cu. ft. The easy-to-install complete kit uses 3M™ Novec™ 1230 Fire Protection Fluid and an electric release.

FEATURES:

- Pre-engineered system
- Complete kit
- Fast installation with one technician
- No engineering or piping calculations required

PERFECT FOR USE IN:

- Server rooms
- Laboratories
- Computer rooms
- Media storage
- Clean rooms
- Textile manufacturing
- Military applications
- Historical collections
- Other enclosed spaces

For more information and to order, contact Darley at 800.323.0244 or visit www.edarley.com/brands/fireboy-xintex



FIREBOY - XINTEX
AETNA ENGINEERING

A Darley Company



NEW

FIREBOY PORTABLE DRY CHEMICAL ABC FIRE EXTINGUISHERS

Each extinguisher features a heavy-duty steel cylinder with a metal valve and pressure gauge, and is rechargeable. The 5.5, 10 and 20 lb. models include a wall hook, hook ring and hose with strap. A heavy-duty USCG approved marine/vehicle bracket for mounting in boats or motor vehicles is included with the 2.5 and 5.5 lb. models. A white 2.5 lb. model will also be available soon for Marine use. Vehicle/marine brackets are optional for the 10 and 20 lb. models.

FEATURES				
	2.5 lbs.	5.5 lbs.	10 lbs.	20 lbs.
WALL HOOK RING	N/A	X	X	X
WALL HOOK	N/A	Specify "WH"	X	X
MARINE/VEHICLE BRACKET	Standard	Specify "VM"	Optional Buy Separately	Optional Buy Separately
HOSE STRAP	N/A	Standard with "WH"	Standard	Standard

For more information and to order, contact Darley at 800.323.0244 or visit www.edarley.com/brands/fireboy-xintex



COMPLETE TABLE SPECIFICATIONS ON WWW.EDARLEY.COM/BRANDS/FIREBOY-XINTEX

FIREBOY - XINTEX
AETNA ENGINEERING

A Darley Company

NEW

HOSE PIN RACK UNITS

Darley® Pin Rack Units are designed for standpipe use and are assembled and packaged before shipment. Furnished with a rough brass valve, red enamel rack and machined brass nipple, couplings and nozzle. They consist of U.L. listed and F.M. approved valve, rack hose and nozzle as follows:

1½" Assembly: Includes 1½" angle valve, hose rack, 1½" rack nipple, 1½" rack light hose, 1½" couplings, pin or rocker lugs and 1½" fog nozzle.

2½" Assembly: Includes 2½" angle valve, hose rack, 2½" rack nipple, 2½"x1½" reducer, 1½" rack light hose, 1½" couplings, pin or rocker lugs and 1½" fog nozzle.

1½" ASSEMBLY - SPECIFY THREAD TYPE	Ship. wt.	Price
T32301 1½" Assembly with 50' of Hose	14 lbs.	\$232.95
T32302 1½" Assembly with 75' of Hose	17 lbs.	\$259.95
T32303 1½" Assembly with 100' of Hose	19 lbs.	\$289.95

2½" ASSEMBLY - SPECIFY THREAD TYPE	Ship. wt.	Price
T32304 2½" Assembly with 50' of Hose	22 lbs.	\$381.95
T32305 2½" Assembly with 75' of Hose	24 lbs.	\$381.95
T32306 2½" Assembly with 100' of Hose	25 lbs.	\$391.95



CUSTOM PUMP SOLUTIONS

J.A.W.S.
Just Add Water Systems



SELF-CONTAINED NFPA 13D SPRINKLER SYSTEM

The Just Add Water System (J.A.W.S.) is everything you need to provide pressure and flow to a residential fire sprinkler system in a self-contained package. J.A.W.S. is designed with the contractor in mind; efficient, reliable and easy-to-install. Just add water, connect to plumbing and your power source and the J.A.W.S is ready to go.

FLEXIBLE PUMP THAT MEETS A WIDE RANGE OF PSI AND GPM REQUIREMENTS

PERFORMANCE

- 30 PSI: 20, 25, 30, 40, 45, 50, and 55 GPM
- 40 PSI: 20, 25, 30, 40, 45, 50, and 55 GPM
- 45 PSI: 20, 25, 30, 40, 45, 50, and 52 GPM
- 50 PSI: 20, 25, 30, 40, 45, 50 GPM
- 55 PSI: 20, 25, 30, 40, and 43 GPM
- 60 PSI: 25, 30, and 35 GPM

PUMP & MOTOR INFORMATION

- Pump and Motor: All stainless steel construction
- Motor: 2 HP 230V 1 phase 13.4 amp

PANEL HIGHLIGHTS

- Pressure transducer based, built-in automatic weekly test that when enabled will run the pump for 2½ minutes every week
- Pump minimum run timer, prevents rapid cycling
- Pump restart time delay, prevents rapid cycling
- Built in motor thermal protection
- Third party monitor contacts for pump running and power failure alarm
- Inputs: Flow switch start, remote start, low and high tank level alerts (requires a float)

DIMENSIONS

- 57" L x 29" W x 73" H

FEATURES

- Easy to install
- Low cost of ownership
- Quiet operations
- Easy to install
- Low cost of ownership
- Quiet operations

CONTACT DARLEY
FOR A QUOTE



EASY ORDERING • EASY INSTALLATION • PREASSEMBLED
ORDER THE J.A.W.S. TODAY AT STARTERPAQ.COM!

SELF-TESTING HYDRANT BOOSTER

BOOST HYDRANT PRESSURE IN ANY AREA WITH INADEQUATE WATER PRESSURE

The Darley Self-Testing Hydrant Booster is your solution for consistent, reliable hydrant pressure for rural areas or any area with inadequate water pressure. Have water pressure when you need it, where you need it.

- Production Rate: Up to 300 GPM @ 250 PSI
- Patented self-testing technology
- Mounted on a fully integrated skid unit
- Self-test is a real test based solely on the pump's reaction and performance when a true drop in pressure is created on the discharge line
- Panel contains full web browser capability and its own IP address
- Status of pump running, test mode activation, test successful and system fault light can be monitored from the web and emailed
- Panel is a single point connection design that holds controls for both the primary pump and jockey pump, reducing installation cost
- Jockey Pump is controlled by a variable speed VFD controller that helps further reduce set up time and pump hammering, and prolongs the life of the pumps
- Also includes manual start button
- Automatic operation

LOWER YOUR
ISO SCORE



DUAL PURPOSE DRYER

DRIES HOSE OR CLOTHING IN JUST A FEW HOURS



The Dual Purpose Dryer allows hose and turnout gear to be dried quickly and safely, minimizing shrinkage while ensuring a rapid return to service. When emergencies arise, you want your equipment ready to go, so it's essential to get hose and turnout gear back into service as quickly as possible. Our high capacity drying cabinet handles up to 500' of 5" hose. Ten removable galvanized steel shelves permit other items to be dried in the cabinet, and a 12-hr. timer shuts down the dryer automatically. You'll use less energy and never overheat and damage the hose. *Call for detailed specifications.* **Ship. wt. 1,100 lbs.**



SPECIFY VOLTAGE REQUIREMENTS

AJ457 Dual Purpose Dryer \$9,895.95

PPE EXPRESS DRYER

RAPIDLY DRY UP TO FOUR SETS OF GEAR

NEW



Circul-Air PPE Express Dryer can quickly dry up to four sets of turnout gear, boots, hoses, and gloves.

- Dry hoses, boots and gloves
- No additional accessories needed
- Durable powder coat finish
- Conforms to NFPA 1851
- 1000 CFM
- 6 year warranty
- Independently Verified – ETL/CSA Listed
- Dimensions: 34"Dx72.5"Hx40"L
- Weight: 450 lbs.

INCLUDES:

- 5 - Metal gear hangers
- 5 - Metal glove hangers
- 4 - Removable hose/boot drying shelves



BN535 PPE Express Dryer 240V \$7,295.95
 BN536 PPE Express Dryer 208V \$7,295.95

THE AUTOMATIC FIRE HOSE WASHER

"IT ALL COMES OUT IN THE WASH"

You'll be amazed at how thoroughly, easily and quickly this remarkable cleaner does its job. Ashes, dirt, silt, mud and sludge are all scrubbed and flushed away, restoring hose to its original color. Quiet, chain-drive operation eliminates need for service and repairs. Built to last a lifetime and equipped with long wearing, genuine nylon brushes. Check out all the great features of the Automatic Fire Hose Washer. **Ship. wt. 680 lbs.**

- **Hose is Self-Propelled:** Convenient foot pedal applies pressure on pivoted wringer roll, pulling hose through the washer under its own power
- **Uniform Washing:** Wringers propel hose through washer, ensuring an even, uniform cleaning at a rate of about 30 ft. per minute
- **Cleaning Action:** Hose is soaked in immersion tank filled with lukewarm or cold water. Add detergent as you see fit



SHOWN WITH OPTIONAL HOSE LOADING TABLE

H887 Automatic Fire Hose Washer \$11,448.95
 H686 Hose Loading Table \$1,285.85

RED RACK™ STORAGE SYSTEMS



The open air design of Red Rack™, along with our Dry Kwik accessories, provides for free air circulation and helps dry PPE much faster. As a result, mold and mildew will not prematurely destroy the fibers of your gear and it will last longer. Red Rack™ components are coated with a durable red powder coat finish.

STANDARD FEATURES:

- 20" and 24" wide sections
- 20"Dx72"H compartments
- Adjustable helmet shelf
- Adjustable boot shelf
- Adjustable apparel hooks
- 2 - Hanging hooks per compartment
- Heavy-duty powder coat finish
- Label holder for nameplate
- Horizontal hanger rod

A. WALL MOUNTED RED RACK™ TURNOUT GEAR STORAGE SYSTEMS

Cat#	Openings	20"Wx20"Dx72"H (Per Opening)	24"Wx20"Dx72"H (Per Opening)
BD085	1	\$393.95	\$398.95
BD086	2	\$635.95	\$646.95
BD087	3	\$874.95	\$892.95
BD088	4	\$1,143.95	\$1,169.95
BD089	5	\$1,378.95	\$1,426.95
BD090	6	\$1,631.95	\$1,669.95
BD091	7	\$1,882.95	\$1,935.95
BD092	8	\$2,137.95	\$2,189.95
BD093	9	\$2,379.95	\$2,353.95
BD094	10	\$2,624.95	\$2,709.95

Call your Darley representative for pricing on more openings.



A

B. SINGLE-SIDED MOBILE RED RACK™

Cat#	Three 20" Sections 64"Lx20"Dx81"H	Three 24" Sections 76"Lx20"Dx81"H
BD095	\$1,098.95	\$1,129.95

Units are supplied with four swivel caster - two with foot-operated brakes.



B

C. DOUBLE-SIDED MOBILE RED RACK™

Cat#	Six 20" Sections 64"Lx40"Dx81"H	Six 24" Sections 76"Lx40"Dx81"H
BD096	\$1,666.95	\$1,759.95

Units are supplied with four swivel casters - two with foot-operated brakes.



C



TECH WALL MOUNTED READY RACK™

- Chrome plated
- 2 levels of open wire shelving
- New Tech wall mount shelf-supports
- Full-length grid dividers separate sections
- 2 - Hanging apparel hooks per compartment
- Label holder
- Hanging pole runs the length of the unit
- Dimensions: 21"Dx78"Hx Length specified

**MAXIMIZE
STORAGE
CAPACITY**

**AJ154-TECH WALL MOUNTED RACK**

Sections	Length	Price
4	72"	\$776.95
6	108"	\$1,228.95
8	144"	\$1,462.95
10	180"	\$1,881.95
12	216"	\$2,116.95
15	270"	\$2,661.95



AJ154

FREESTANDING READY RACK™

- Chrome plated
- 2 levels of open wire shelving
- 74" tall support posts
- Standard compartments are 18" wide
- Full-length grid dividers separate sections
- 2 - Hanging apparel hooks per compartment
- Label holder
- Hanging pole runs the length of the unit
- AJ155: Includes 4" tall back ledges
- AJ155: 21"Dx74"Hx Length specified
- AJ156: 36"Dx74"Hx Length specified

**AJ155-SINGLE-SIDED FREESTANDING SINGLE RACK**

Sections	Length	Price
4	72"	\$841.95
6	108"	\$1,291.95
8	144"	\$1,581.95
12	216"	\$2,321.95

AJ156-DOUBLE-SIDED FREESTANDING DOUBLE RACK

Sections	Length	Price
8	72"	\$1,282.95
12	108"	\$1,991.95
16	144"	\$2,414.95



DOUBLE-SIDED

AJ156

MOBILE READY RACK™

- Chrome plated
- 2 levels of open wire shelving
- 4 heavy duty casters - 2 with foot operated brakes
- Full-length grid dividers separate sections
- 2 - Hanging apparel hooks per compartment
- Label holder
- Hanging pole runs the length of the unit
- AB444: Includes 4" tall back ledges on both shelf levels



Cat#	Description	Dimensions	Price
AB444	Single-Sided Mobile Rack	21"Dx72"Lx79"H	\$949.95
AB445	Double-Sided Mobile Rack	36"Dx72"Lx79"H	\$1,390.95



SINGLE-SIDED

AB444

USA SINGLE-SIDED MOBILE RED RACK™

Count on the superior design of the new Red Rack™ as your storage system. This open-air design helps for a much quicker dry for any gear. As a result, mold and mildew will not destroy the fibers of your gear and it will ultimately last longer. Designed to stand up to the rugged demands of the Fire Service Tubular steel design is the strongest configuration on the market and does not require a rear grid. Open back design allows easy access to your station's building code approved electrical outlets.

BL124: Security option single sided

INCLUDES:

- Top security shelf
- Rear security panel
- Lockable door



BL124



BL123

Three 24" Sections

76"Lx20"Dx81"H

Cat#		Price
BL123	USA Single-Sided Mobile Red Rack™	\$1,417.95
BL124	USA Single-Sided Mobile Red Rack™	\$2,348.95

Units are supplied with four swivel casters - two with foot-operated brakes.

S.O.S. RACKS



BH145



BH146



BH147

Design accommodates SCUBA cylinders, Oxygen bottles, and SCBA cylinders. The modular design allows you to configure each compartment with any combination of specialized shelves and/or flat shelving for gear bags, turnout gear and dive gear storage/drying. The S.O.S. Rack features four 1,050 lb. capacity casters and is constructed of heavy duty steel tubing with high strength wire. A durable powder coat finish protects the rack and will provide years of service.

- Dimensions: 32"Dx81"Hx76"L
- Store up to 18 low profile SCBA cylinders per vertical section
- Flat shelves available for gear bags and other equipment
- Specialized bottle shelves hold SCUBA, Oxygen, and SCBA cylinders securely
- Legendary Ready Rack quality
- Ships knocked down to save you money

BH145	S.O.S. Rack	\$1,821.95
BH146	S.O.S. Rack Bag Storage with 12 HBS Shelves	\$1,886.95
BH147	S.O.S. Rack Cylinder Storage with 12 V Shelves	\$1,886.95



HANG-DRY®

Hang-Dry® is used to dry many different suits and gear with the use of a high-powered fan that is built into the unit.



- Built out of strong plastic and features a 12' cord
- Supports around 100 lbs.
- Handle transporting convenience
- Plastic tubular shape forces the air through the suit with pressure
- Fan features a die-cast aluminum housing, steel impeller directly welded onto the rotor, ball bearing
- **Motor Output:** 250.1 CFM
- 5-year warranty, activated on date of purchase



BP074	Hang-Dry® - Black	\$199.95
BP075	Hang-Dry® - Yellow	\$199.95
BP076	Hang-Dry® - Red	\$199.95

FAST DRY COAT HANGER

Keeps expensive coats organized and dry! Gear dries quicker because air circulates better inside the garment, allowing fabric-fibers to dry faster. Specify open or closed hook style. *Ship wt. 1 lb.*



DRY GEAR FASTER!



AF072	Fast Dry Coat Hanger	\$9.95
-------	----------------------	--------

VERSAMIST® MISTING FAN

The VersaMist® portable misting fan combines low pressure mist and high speed air movement to create cool comfort indoors or out for athletes, rescue squads, firemen, construction workers, assembly line workers, tents, patios, pool decks and other hot spots.

- 18" UL507 rated, imported 3-speed fan; up to 6600 cfm
- 1.4 tons (16,000 BTU/hour) of cooling capacity
- Cools the air up to 30°F
- Runs on 115V; 12V and 220V models available
- Large 10 gallon reservoir allows 5 hours of continuous use
- Low pressure mist pump enclosed in rugged enclosure with tip switch
- Includes 25' outdoor-rated power cord with integrated GFCI
- Also available with wheels for greater flexibility and convenience (BH028)
- 2-year limited warranty
- Made in the USA



AS431	VersaMist® Misting Fan	\$641.95
BH028	VersaMist® Misting Fan with Wheels	\$695.95



MAXXDRYXL™ BOOT, SHOE AND GLOVE DRYER

ELIMINATES ODOR! DRIES IN ABOUT 1 HOUR!™

The MaxxDryXL™ uses DryComfort™ "Forced Air" technology to gently dry four garments in about an hour. MaxxDryXL™ works quickly to remove moisture, perspiration, bacteria and mold - the primary cause of odor! A totally flexible multi-dryer dries a combination of tall boots and short boots, boots and gloves, two pair of gloves and requires no additional attachments. Whether using heat or not, the MaxxDryXL™ will not harm materials.

- DryComfort™ "Forced Air" Technology
- 4 durable air chambers for simultaneously drying
- Kills odor
- High impact lightweight construction
- Heat / no heat switch
- 3 hour timer
- Quiet: 80,000 hour-rated whisper quiet rotary blower
- Dry Time: Approximately 1 - 2 hours
- Power: 120V AC household outlet
- Dimensions: 9"Dx10.75"Hx9"W
- Max. Temperature: 105° F / 40.5° C
- Cord: 6' length
- 1-year warranty



GEAR NOT INCLUDED

BL620	MaxxDryXL™ Boot, Shoe and Glove Dryer	\$63.95
-------	---------------------------------------	---------

FREESTANDING & MOBILE HOSE CART

Save time and eliminate back strain from carrying hose with the Hose Cart. Mobile unit has heavy-duty brake casters that allow for ease of rolling and hold the cart in place when loading or unloaded. Heavy-duty steel rails with a durable red powder coat finish easily support 100' coils. Ships knocked down for freight savings. Easy to assemble. Available in 2 or 3 tier units mobile or freestanding. Freestanding model may be bolted to floor for additional stability. An optional cover plate (AR117) provides a flat surface for holding bottle carriers or other items. *Ship. wt. 315-560 lbs.*

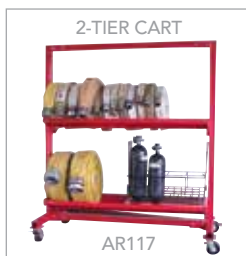

Cat#	# of Tiers	Hose Storage	Dimensions	Ship. wt.	Mobile	Freestanding
BH032	2-Tier	Up To 1,300' of 2 1/2" Hose	72"L x 79"H x 34"W	250 lbs.	\$1,788.95	\$1,688.95
BH033	2-Tier	Up To 2,000' of 2 1/2" Hose	104"L x 79"H x 34"W	425 lbs.	\$2,284.95	\$2,298.95
AS214	3-Tier	Up To 2,000' of 2 1/2" Hose	72"L x 87"H x 34"W	315 lbs.	\$2,061.95	\$1,961.95
AS215	3-Tier	Up To 3,000' of 2 1/2" Hose	104"L x 87" x 34"W	560 lbs.	\$2,060.95	\$2,681.95

ACCESSORIES

AR117	20" x 31" Cover Plate	\$82.95
AS213	Hose Winder	\$524.95

LARGE DIAMETER HOSE WINDER

Wind 100' sections of LDH up to 6" wide in seconds. Having the ability to steer the winder while rolling the hose, the Large Diameter Hose Winder (LDHW) turns winding into a one-man operation. With no need to recharge batteries, downtime is drastically reduced. The LDHW drains the hose as you wind it, prolonging hose life. Reduces the risk of back injuries by limiting firefighter fatigue.

- 2 - Swivel with brake casters
- 2 - Rigid with brake casters
- Dimensions: 48" L x 36" W x 49" H



BN014	Large Diameter Hose Winder	\$1,593.95
-------	----------------------------	------------

CYCLONE DRYING SYSTEMS

For all firefighters who need fast effective drying of their gloves, boots and turnout gear. Heated air blows through vented drying arms to quickly dry wet gear from the inside out - providing comfort, eliminating mildew and ensuring safety in high heat situations. Boots and gloves are dry in an hour. With drying arm extensions to reach further down the arms of coats or the legs of pants the BK402 can dry 1 set of wet turnout gear in about 2 hours, a fraction of the normal time. Cyclone Dryers can be plugged into an existing 120v wall outlet and once anchored to standard 16" wall stud centers extend less than 14" from the wall. Fit with an efficient, custom motor, these dryers boast very low operating costs and unbelievably low noise levels. A digital 120-minute timer allows you to set the time needed for drying and forget about it.

- Weight: 65 lbs.
- Dimensions: 17 1/4" W x 66" H x 13 1/2" D

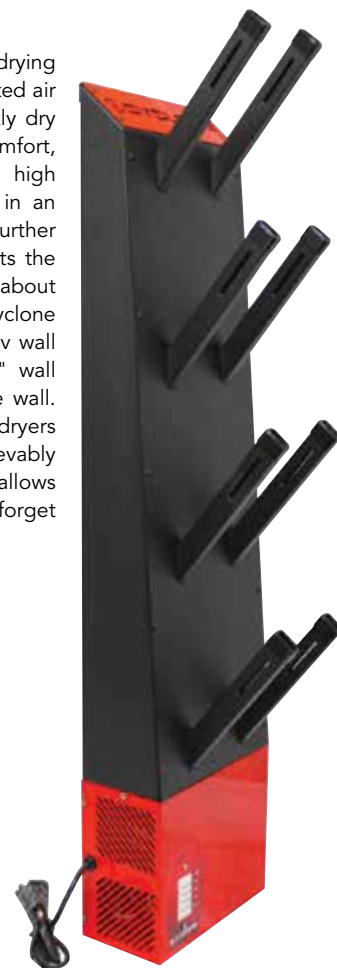

BK059	Cyclone Boot/Glove Drying System	\$899.95
BK402	Cyclone with Drying Arm Extensions for Turnout Gear	\$1,019.95

HOSE NOT INCLUDED



DRY AND STORE HOSE RACK

With the Dry and Store Hose Rack, you can dry hose and store it on the same unit. Unit consists of the top mounted drying rack where hose and other equipment dries naturally and quickly, and one lower level storage rack. Dry up to 900' of 1 1/2" to 1 3/4" hose or up to 600' of 2 1/2" to 3 1/2" hose and simultaneously store up to 650' of 2 1/2" hose. Heavy-duty steel construction with durable red powder coat finish. Ideal for use in smaller stations. *Ship. wt. 330 lbs.*

BB039 Dry and Store Hose Rack \$2,203.95



HOSE NOT INCLUDED

HOLDS HOSE ON BOTH SIDES

MOBILE HOSE DRYER

With the Mobile Dryer, equipment dries naturally and quickly with fresh air, prolonging the life of your equipment. Used to dry immersion entry suits, wet or dry dive gear, and decontaminated hazmat entry suits. The Mobile Hose Dryer holds up to 1200' of 1 1/2" or 1 3/4" or up to 800' of 2 1/2" - 3" hose. *Ship. wt. 290 lbs.*

- SAFE - no more climbing to hang or retrieve hose
- Costs thousands less than conventionally built towers
- Stores and dries in small area
- Durable red powder coat finish
- Dimensions: 80"Lx33"Wx88"H

AS703 Mobile Hose Dryer \$1,932.95



HOSE RACK BRACKETS

BUILD YOUR OWN HOSE RACK

Protect your hose with ample ventilation and allow quick and easy access for inspection. Build your own rack with pipe and lumber using these handy brackets designed for easy adjustable installation. *Ship. wt. 4 lbs.*

- Lightweight, high-strength aluminum
- Easily adjusts up or down pipe for desired height

AR346 Small Bracket for 1 1/2" Pipe \$48.95
 AR347 Large Bracket for 2" Pipe \$50.95



WALL MOUNTING BRACKET

THE HOSE COILER

ROLL HOSE QUICKER AND EASIER THAN EVER

Designed by a firefighter to make it quicker and easier to coil 1" to 3" double jacket hose in lengths up to 50 feet (single jacket forestry hose in lengths of 100 feet). Simply attach the mounting bracket to the rear of your apparatus, pickup truck or any emergency vehicle waist-high, insert the coiler crank and roll away. The coiler itself is made of two parts which nest together for compact storage. Once the hose is coiled simply remove the tight coil from the inside section and you're done; no more bending over to pick up heavy coils. Use this system anywhere you choose to install the mounting bracket (included). Also available are trailer hitch mounts. Call for pricing. Fits in hitch receiver and Wildland Mounts pound in the ground.

Cat#	Description	Ship. wt.	Price
AM100	Hose Coiler, for 1" to 1 1/2" Hose	8 lbs.	\$277.95
AM101	Hose Coiler, for 1 1/2" to 3" Hose	8 lbs.	\$277.95
BE026	Hose Coiler, for 5" to 7" Hose	12 lbs.	\$521.95

SALVAGE-MASTER WET VACUUM

HIGHLY EFFICIENT WET VACUUM UNIT

Salvage-Master's ability to remove water from deep floor cracks, carpets, tile, concrete, asphalt and wood floors greatly reduces overall fire or spill damages and subsequent insurance loses. In addition, Salvage-Master's fast action performance (the 5.9 gallon tank fills in 18 seconds and empties in 14 seconds) helps prevent warpage, curling floors and seepage through ceilings. As an extra convenience, Salvage-Master features a special float device that automatically activates a high-pitched sound to indicate when the tank is full. Comes complete with a rubber squeegee, GFCI plug, and 1-year warranty.

- Shoulder On/Off switch
- 5.9 gallon tank capacity
- Drain hose
- Two piece wand
- Ground fault circuit plug
- 50' electrical cord
- Ship. wt. 35 lbs.



BH141	Salvage-Master Wet Vacuum	\$1,830.95
BH142	Optional Carpet Adapter	\$123.95

SALVAGE COVERS AND RUNNERS

Canvas: Treated with a fire and water resistant finish. Meets requirements for California State Fire Marshall, NFPA-701 (large scale), and CPAI Section 6. Water-resistant finish and mildew inhibitors added. Color: Green.

Vinyl: Excellent wear and tear resistance, waterproof. Meets California State Fire Marshall requirements, UL-214 Classified, ASTM-E-84, Class A Flame standard. Easily wipes clean. Color: Red.



SALVAGE COVERS WITH GROMMETS

Cat#	Material	Size	Ship. wt.	Price
J860	Canvas	12'x14'	15 lbs.	\$140.95
J861	Canvas	12'x18'	19 lbs.	\$179.95
J862	Canvas	14'x18'	22 lbs.	\$209.95
J857	Vinyl	12'x14'	20 lbs.	\$120.95
J858	Vinyl	12'x18'	26 lbs.	\$161.95
J859	Vinyl	14'x18'	30 lbs.	\$182.95

RUNNERS WITHOUT GROMMETS

Cat#	Material	Size	Ship. wt.	Price
AR103	Canvas	24"x20'	6 lbs.	\$45.95
AR104	Canvas	30"x20'	6 lbs.	\$46.95
AR101	Vinyl	24"x20'	6 lbs.	\$36.95
AR102	Vinyl	30"x20'	6 lbs.	\$37.95

"MOP-UP" DEWATERING PUMP

IF YOU NEED TO MOVE 1,000 GALLONS OF WATER FAST, WE'VE GOT THE PUMP FOR YOU!

The "Mop-up" Pump is perfect for flat roofs, flooded garages and basements. Features a unique non-return valve built-in just below the impeller. Liquid will stay in the pump and pump-line after shutdown and not release out on the floor. The pump bottom is rubber clad to protect against damage to the floor surface. It will pump down to 1/12 of an inch, and start up in only a small puddle of liquid.

Ship. wt. 27 lbs.

- Superior motor, with protection for longer life
- Less maintenance and less downtime



AF412	"Mop-up" Dewatering Pump	\$603.95
-------	--------------------------	----------

FIRE BROOM

The hardwood handle, stiff textured Palmyra fiber and metal cap are locked under tons of pressure to prevent loose handles and fiber fallout. Bonded red finish, inside and out, to resist chipping, flaking and rusting. This broom has been designed to exceed the rigorous demands of fire suppression work while being light enough to be easily carried to remote areas; it's used by fire fighters under the harshest of conditions. Overall length: 53 3/4". Ship. wt. 3 lbs.



H755	Palmyra Fire Broom	\$20.95
------	--------------------	---------

SLIDING POLE LANDING MAT

No fire station equipped with a sliding pole should be without a landing mat. It's 2" thick foam pad with unicell construction which helps cushion landings. Measures approximately 32" in diameter with a 3 1/2" center hole. The materials are similar to those used in marine applications and as such are impervious to oils and will resist dry rot. Installs by sliding over top of station pole. Also available for larger or smaller diameter poles. Ship. wt. 10 lbs.



AL233	Sliding Pole Landing Mat	\$280.95
S888A	Brass Sliding Pole	Call for pricing

FIREBASE SG-Z1200 SMOKE GENERATOR

The Z-Series dominates the entry level price range small to medium scale smoke generator market with its high performance fog output and high tech features. The Z-Series is equipped with the ECO thermal control system and the patented UNICORE heater technology. The Z-Series comes with a high quality pump and electronic low-fluid detector also known as Thermal Cut-Off (TCO) which automatically shuts off the pump when the fluid level is low, protecting the machine from damage. The Z1000 and Z1200 heater cores can easily be taken out from the heater block for a quick and easy cleaning to prevent clogging and insure trouble-free performance.

FEATURES:

- Higher output/Low fluid shut off
- Easily removable heater core
- Integrated DMX control

INCLUDES:

- Timer remote - SG-Z1200-Timer
- Optional wireless remote (Contact Darley for details)



18000 CFM



BN765	Firebase SG-Z1200 Smoke Generator	\$724.99
BN767	Fire Rescue Smoke Fluid - XD Formula	\$23.99

BATTLE FOGGER



4200 CFM

The Battle Fogger's simple design is an extremely effective fog machine incorporating a large heating block, a strong whisper-quiet pump, and our cutting-edge Rapid Change Technology (RCT) capillary tube replacement system. The large one-gallon integrated fluid tank prevents leaks and drips, a special hammer-tone finish resists scratches and wear, and a built-in handle balances off the sleek, rugged chassis. The Pro Fogger comes standard with a 25' deluxe remote, and onboard microprocessor, a built-in hose adapter, and a replacement RCT capillary tube kit. *Ship. wt. 25 lbs.*

AW352	Battle Fogger	\$1,205.95
AW415	Smoke Fluid, 4-Liter	\$58.95

SUPERIOR SMOKE MACHINE



4800 CFM

With a powerful 1300-watt heating core and reliable high-pressure piston pump, this machine delivers an impressive output of 4800 cfm. It will quickly fill your training area with dense, persistent, non-irritating smoke with excellent obscuring power. Comes standard with 32-foot wired remote control featuring a selection for manual or self-timed operation. Simply set the control flow rate, duration of smoke blasts and interval between blasts. The Superior Smoke Machine will continuously refill an area with smoke at a steady, constant rate. Other features include thermal cutoff to prevent "wet smoke" and LED status lights. Unit holds one gallon of smoke fluid. UL listed. *Ship. wt. 32 lbs.*

AM240	Superior Smoke Machine	\$837.95
AM241	Smoke Fluid, 1-Gallon	\$42.95

PASSFIRE™ BURN PAN TRAINING UNIT

The Halcyon Product's Passfire™ Burn Pan Training Unit is a cost-effective, portable solution for contained, controlled burns for training purposes. It is used by fire departments and training firms for fire extinguisher training.

- Conduct safe, inexpensive fire extinguisher training
- Firefighter designed and approved
- Helps businesses and organizations comply with OSHA 1910.157
- Uses clean burning propane and is environmentally-friendly
- Fire is contained within the deep, durable stainless steel pan and does not affect the surrounding training areas, eliminating mess and damage
- Sturdy supports for set up on any flat surface
- Contains quick disconnects for easy set up and tear down and provides additional security, controlling the supply of propane to the copper burn element
- Drain in bottom of pan for easy clean up and water disposal
- 25' propane hose
- Dimensions: 25" Lx25"Wx16"H
- *Ship. wt. 57 lbs.*



PROPANE
NOT INCLUDED

BK069	Passfire™ Burn Pan Training Unit	\$2,944.95
-------	----------------------------------	------------

\$2,944.95

FIRE STATION REELS

SPRING DRIVEN HEAVY DUTY HOSE REEL

The SH Series "Super Hub™" spring driven hose reels have a long history of dependable performance. The larger chassis and frame accommodate longer lengths and larger diameters of hose. Coxreels' original Super Hub™ dual axle support system increases the stability during operation, reduces vibration, and strengthens the structural integrity of the reel. Model equipped with EZ-Coil® System that provided controlled hose retraction reducing the rewind speed by as much as 80% over conventional reels.



NEW

3/8" I.D., 50' HOSE, 300 PSI
BN733 Spring Driven Heavy Duty Hose Reel \$423.95

DUAL PURPOSE AIR/ELECTRIC REEL

The C Series "Combination" spring driven air hose/electric cord reels are two reels in one compact assembly. They are perfect for applications that require pneumatic air and an electrical power feed. The single expanded mounting base creates stability and adds to the convenience of one mounting pattern.



NEW

SINGLE INDUSTRIAL RECEPTACLE
3/8" I.D., 50' HOSE, 300 PSI, 50' CORD, 12 AWG
BN734 Dual Purpose Air/Electric Reel \$737.95

POWER CORD REEL

The PC Series spring driven "Power Cord" reels are heavy duty, industrial grade power sources. They replace tangled extension cords and self-retract to increase safety, productivity, and efficiency. Modeled after the P and SH Series, the PC Series is designed for long-lasting, hassle-free performance even under the most demanding conditions.



NEW

SINGLE INDUSTRIAL RECEPTACLE
50' CORD, 12 AWG
BN735 Power Cord Reel \$432.95

HAND CRANK HOSE REEL

The 1125 Series hand crank hose reels have the features demanded by industry professionals. The industry preferred design features a sturdy one piece all welded "A" frame base, low profile outlet riser and open drum slot design provides a non-crimping, flat smooth hose wrap.



NEW

3/4" I.D., 100' HOSE CAPACITY, LESS HOSE, 3000 PSI
BN736 Hand Crank Hose Reel \$318.95

OUTDOOR WARNING SIRENS

OUR MOST POPULAR SINGLE-TONE SIREN

The AR245/AR246 is Darley's most popular outdoor warning siren. This power-packed unit has been used around the world for everything from severe weather warning to correctional facility security. Featuring a 7.5HP continuous-duty motor and omni-directional sound projection horns, this siren pounds its intense 112dB(C)* sound output throughout the area it serves. If your siren needs to be compact, powerful, and simple, look no further! Estimated 70dB(C) effective range: 2,800 ft. Available in single phase or three phase power. *Shipping wt. 450lbs. Also available with a battery backup option. Call for details.*

SEE SIREN ACCESSORIES BELOW

AR245	7.5 HP Three-Phase Siren with Horns	\$4,972.95
AR246	7.5 HP Single-Phase Siren with Horns	\$5,969.95

THE FINEST MID-SIZED OUTDOOR WARNING SIREN

The Y772/Y774 is one of the most widely-used sirens in the world. This 10HP brute provides continuous-duty service and omni-directional sound output, all with a 115dB(C) SPL rating*. This siren has literally seen it all – it has been installed for municipal weather warning, at fire stations, in industrial applications, and even at the Kennedy Space Center! Estimated 70dB(C) effective range: 3,300 ft. Available in single phase or three phase power. *Shipping wt. 530lbs.*

SEE SIREN ACCESSORIES BELOW

Y772	10 HP, Three-Phase Siren with Horns	\$5,721.95
Y774	10 HP, Single-Phase Siren with Horns	\$5,981.95

SIREN ACCESSORIES

AC460	Motor Starter for 7.5 HP, Three-Phase Siren/Weatherproof Enclosure	\$749.95
AC462	Motor Starter for 7.5 HP, Single-Phase Siren/Weatherproof Enclosure	\$1,022.95
AC464	Motor Starter for 10 HP, Three-Phase Siren/Weatherproof Enclosure	\$1,012.95
AC466	Motor Starter for 10 HP, Single-Phase Siren/Weatherproof Enclosure	\$1,224.95
AB331	Utility Pole Mounting Bracket	\$486.95
AB934	Siren Heating System	\$786.95

SINGLE-PHASE OR THREE-PHASE SIREN WITH PROJECTION HORNS

With over 3,000 units in service world-wide, this rock solid model has seen it all. The 3V8-H features a 5 HP, continuous duty motor pushing its aluminum rotor and is rated at 109 dB(c) @ 100 ft. continuously*. At home in a variety of environments, the 3V8-H is a seamless fit in the Mining, Industrial, Shipping, and Manufacturing industries. Of course, the majority of 3V8-H's will find their way to the tops of utility poles where they will warn of approaching tornadoes or burning fires. The 3V8-H is available in single or three phase power. *The siren is available in a DC/battery primary configuration. Shipping wt. 400lbs.*

SIRENS

AC46702	Motor Starter for 5 HP, Three-Phase Siren/Weatherproof Enclosure	\$3,869.95
AC46802	Motor Starter for 5 HP, Single-Phase Siren/Weatherproof Enclosure	\$4,561.95
BN684	Battery Primary Warning System (Includes DC Contactor)	\$7,609.95

SIREN ACCESSORIES

AC456	Motor Control, Three-Phase Siren/Weatherproof Enclosure	\$640.95
AC458	Motor Control, Single-Phase Siren/Weatherproof Enclosure	\$721.95

OMNI-DIRECTIONAL SINGLE-TONE SIREN

If your application requires a siren at the top of the food chain, then the Darley 14V is where your search ends. This siren partners a 91% efficiency premium three phase, 15HP, continuous-duty motor with omni-directional projection horns for maintenance-free service. The design is compact, and installation is simple. The best part? This siren, rated at 127dB(C)*, is the most powerful omni-directional single-tone siren in production! The biggest, the best – the Darley 14V. Estimated 70dB(C) effective range: 1-2 miles. AC version available in three phase power only. *Shipping wt. 800lbs.*

BN685	15 HP Warning Siren, Three-Phase Power	\$8,704.95
-------	----------------------------------------	------------



E-5 PREMIUM FIRE & INDUSTRIAL TONE AND SOUNDER

The ER-5 is the next generation of premium industrial or fire alarm sounders with 45 different tone options. The ER-5 is housed in a robust fire retardant Type 4/4X/3R/13, IP66 housing ensure the siren is suitable for all general signaling applications including fire, security and process control. For applications with high ambient background noise, combined siren and strobe units are available.

- Up to 126 dB peak SPL
- 45 user selectable tones
- Integrated Xenon or LED strobe available
- UL, CSA, and cULs approvals
- IP 66 protection for harsh environments



BP046	Premium Fire & Industrial Tone and Sounder (10-30v DC)	\$318.95
BP047	Premium Fire & Industrial Tone and Sounder (115VAC)	\$318.95
BP048	Premium Fire & Industrial Tone and Sounder (230VAC)	\$318.95

110V ELECTRO-MECHANICAL INDOOR/ OUTDOOR ALARM SIREN

Tens of thousands of satisfied customers have used this siren in a wide range of industrial, municipal, and emergency signaling applications. This siren employs a carefully machined and balanced aluminum fan and housing, and aluminum, powder coated projectors. The air intake is screened to protect against foreign matter. Corrosion protected, it is suitable for permanent outdoor installation. The model F-2 tested @ 117 dB. @ 10 ft. outdoor, 113 dB. @ 10 ft. in an anechoic chamber, and at 103 dB(A) in a reverberant room to U.L. Standard 464. This model runs on 120 volt AC/DC power, with running amperage of 2.5 amps. It can also be ordered in 240/250 AC/DC. *Ship. wt. 13 lbs.*



R828	Darley 110-Volt Alarm Siren	\$587.95
BN686	Darley 220-Volt Alarm Siren	\$587.95

E-6 INDUSTRIAL WARNING SIREN

For areas with high ambient heat or significant dust/sediment in the air, look no further than our model E-6. Featuring 45 different tone options, output levels up to 126dB(A) at 10ft., IP66 rating, and adjustable volume control, the E-6 is a perfect fit for indoor industrial applications, schools, fire station bays, and more. *Ship. wt. 7 lbs.*

- Continuous duty rated
- Stainless steel bracket
- Ratchet adjustable for 360° mounting
- Duplicate cable terminations for daisy chain installations
- High output warning with minimal power draw
- 45 selectable alarm tones to distinguish this unit from other sounders
- Intense, focused sound for maximum effectiveness with adjustable volume control



BN687	E-6 Industrial Warning Siren	\$1,117.95
-------	------------------------------	------------

G3 SIREN CONTROLLER

WIRELESS SIREN ACTIVATION AND CONTROL

- Integrates seamlessly into most existing radio systems
- User programmable
- Does not use proprietary software
- Whip antenna standard
- Compatible with two-tone sequential or DTMF standard. FSK available
- VHF or UHF standard. 800MHz, 900MHz, low band available
- Two-way/report back communication available (G5 series)
- Windows based programming environment
- Battery backup capability available



G1 SIREN CONTROLLER

HAND WIRED ACTIVATION AND CONTROL

- PLC based environment (Programmable Logic Controller)
- Auto Test Function standard
- User programmable siren timing controls
- Push-button activation
- Windows based programming environment
- Battery backup capability available.



SPECIFY FREQUENCY, TONE CODES, AND SIGNAL TIMING

BG167	G3 Siren Controller	\$2,047.95
BG168	G1 Siren Controller	\$1,117.95

SIX GREAT BLACKINTON FINISHES TO CHOOSE FROM

- Nickel Plate: Nickel Plating over polished badge base
- Rhodium Plate: Platinum over nickel-brilliant white finish
- Gold Electroplate: Gold tone with rich, bright appearance
- Hi-Glo®: Gold tone with brilliant luster and clear coating
- Karatclad®: Gold tone with heavy coating of karat gold
- Two Tone: Combination of gold and silver colors



BADGE ORDERING FORM CAN BE FOUND ONLINE AT WWW.EDARLEY.COM/ORDERING

(No Badge Phone Orders Accepted)

Cat#	Nickel	Rhodium	Gold Plate	Hi-Glo	T.T.	Karatclad®
B484	\$48.95	\$51.95	\$59.95	\$94.95	\$84.95	\$133.95
B544	\$54.95	\$59.95	\$68.95	\$94.95	\$103.95	\$142.95
B652	\$75.95	\$90.95	\$97.95	\$123.95	\$123.95	\$191.95
B899	\$90.95	\$96.95	\$107.95	\$129.95	\$129.95	\$197.95
B1496	\$54.95	\$59.95	\$68.95	\$94.95	\$103.95	\$142.95
B30	\$54.95	\$59.95	\$68.95	\$94.95	\$103.95	\$142.95
B427	\$59.95	\$64.95	\$71.95	\$97.95	\$106.95	\$148.95
B523	\$54.95	\$94.95	\$68.95	\$94.95	\$103.95	\$142.95
B539	\$65.95	\$66.95	\$76.95	\$102.95	\$110.95	\$156.95
B736	\$90.95	\$96.95	\$107.95	\$129.95	\$129.95	\$197.95
B1009	\$51.95	\$57.95	\$65.95	\$90.95	\$94.95	\$135.95

Ask About Darley's Special Quantity Discounts





B38



B957



B538



B296

BADGE CENTERS



STATE CENTERS

ALL 50 STATES AVAILABLE



PLAIN

FREE with any badge purchase



RIM COLOR

FREE with Hi-Glo, Two-Tone or Karatclad® Badge (\$3.00 additional on other)



FULL COLOR

FREE with Hi-Glo, Two-Tone or Karatclad® Badge (\$5.00 additional on other)

FIREFIGHTER CENTERS

ALL LEVELS OF COMMAND AVAILABLE

PLAIN

FREE with any badge purchase



ONE COLOR

FREE with Hi-Glo, Two-Tone or Karatclad® Badge (\$3.00 additional on other)



SPECIFY STYLE & COMMAND ON ORDERING FORM

EMS CENTERS

PLAIN

FREE with any badge purchase



A6193



A4247

ONE COLOR

FREE with Hi-Glo, Two-Tone or Karatclad® Badge (\$3.00 additional on other)



A4256

TWO COLOR

FREE with Hi-Glo, Two-Tone or Karatclad® Badge (\$5.00 additional on other)



A3948



A4013

SPECIFY CENTER NUMBER & STYLE ON ORDERING FORM



B96



B537



B519



B297



B39

BADGE ORDERING FORM CAN BE FOUND ONLINE AT

WWW.EDARLEY.COM/ORDERING

(No Badge Phone Orders Accepted)

	Nickel	Rhodium	Gold Plate	Hi-Glo	T.T.	Karatclad®
B38	\$51.95	\$57.95	\$65.95	\$90.95	\$94.95	\$135.95
B39	\$51.95	\$57.95	\$65.95	\$90.95	\$94.95	\$135.95
B96	\$51.95	\$57.95	\$65.95	\$90.95	\$94.95	\$135.95
B296	\$51.95	\$57.95	\$65.95	\$90.95	\$94.95	\$135.95
B297	\$51.95	\$57.95	\$65.95	\$90.95	\$94.95	\$135.95
B519	\$51.95	\$57.95	\$65.95	\$90.95	\$94.95	\$135.95
B537	\$65.95	\$66.95	\$76.95	\$102.95	\$110.95	\$156.95
B538	\$51.95	\$57.95	\$65.95	\$90.95	\$94.95	\$135.95
B957	\$51.95	\$57.95	\$65.95	\$90.95	\$94.95	\$135.95

Ask About Darley's Special Quantity Discounts



325 Spring Lake Drive
Itasca, IL 60143-2072
1-800-4-DARLEY
Monday - Friday
7:00 a.m. - 5:30 p.m. CT

TERMS AND CONDITIONS

100% SATISFACTION GUARANTEED
OR YOUR MONEY BACK

PRICING

Prices listed in this catalog are current as of June 1, 2020. Due to the wide selection of products being offered, prices may change without notice. We also reserve the right to make corrections in the event of a misprint. Please confirm pricing with a Darley® representative at time of order. Volume discounts are available. Darley will match pricing on any lower offer from another supplier.

OPEN ACCOUNT TERMS

Terms of Net 15 Days shall be extended to city and other governmental agencies in good standing. These terms are also granted to businesses rated "good" or "high" and have a rating from CC to 5A by Dun & Bradstreet. Those companies that do not have a D&B rating in this range should contact our Credit Department at 1-630-735-3500 for a complete credit application. We encourage new customers placing their first order to make their initial payment by check or credit card. This will help avoid any shipping delays that may occur during the credit review process.

ORDERS PLACED BY INDIVIDUAL

All individual orders must be accompanied by full payment (cashiers check, money order or credit card) plus shipping charges and applicable state tax. We accept Visa, MasterCard, and American Express.

SALES TAX

We are required by law to add sales tax to goods shipping into the following states: CA, CO, FL, GA, HI, IA, IL, MN, NC, OH, PA, SC, TN, TX, VA, WI, WA. State laws require us to have your signed exempt/resale certificate on file at our offices. We will be forced to charge you sales tax, if we do not have this documentation. All sales to individuals in these listed states are always taxable.

ORDER FORMS / TURNOUT MEASUREMENT GUIDE

Now available online at: www.edarley.com/ordering and www.edarley.com/turnoutmeasuring

DAMAGED GOODS / SHORTAGES

In the event that you receive a damaged or short shipment, you must immediately file a claim with the carrier. Under ICC regulations this claim is the consignee's (your) responsibility. Please contact our Customer Service Department 1-800-4-DARLEY for assistance.

NO HASSLE RETURNS

Please contact our Customer Service Department at 1-800-4-DARLEY. For return instructions. A return authorization number (RMA) will be required.

RESTRICTED SALES ITEMS

Darley® carries a wide range of products intended for sale to public safety professionals. Orders for goods including, but not limited to, badges, personal identification, emblems and nameplates must be placed on department letterhead with official identification.

CHANGE OF ADDRESS / DUPLICATE MAILINGS

It's important for Darley® to keep our mailing lists as current as possible. Please advise us of any change of address or personnel. In the event you've received duplicate mailings, simply scan the back of the catalog and email changes to catalog@edarley.com. As a token of our appreciation, we'll take \$5 off your next purchase.

GOVERNMENT ORDERS

Darley offers many products throughout our catalog which can be ordered at substantially reduced government pricing through the GSA schedule:

- Phone: 630-735-3500 for a GSA quote
- Email: GSA@darley.com for a GSA quote



SCHEDULE 84: GS-07F-0387Y
SCHEDULE 78: GS-03F-044CA
SCHEDULE 23V: GS-30F-006GA
SCHEDULE 56: GS-07F-180GA

SHIPPING & HANDLING CHARGES

PRE-PAID DOMESTIC ORDERS

- Order will ship most economical way unless otherwise requested.
- Rates apply to prepaid orders shipped via UPS Ground.
- All other orders will be invoiced at the actual freight charge plus \$2.50 for handling & insurance.
- Maximum weight allowed per package is 70 lbs.
- Maximum size per package is 108" (length & girth).
- Rates apply to U.S. Continental 48 States.
- Hazardous Material charges are additional.

Value of Merchandise

Charge

0 - \$25.00	\$7.95
\$25.01 - \$50.00	\$9.95
\$50.01 - \$100.00	\$11.95
\$100.01 - \$200.00	\$15.95
\$200.01 - \$300.00	\$19.95
\$300.01 - \$400.00	\$24.95
\$400.01 - \$500.00	\$26.95
\$500.01 and up	3% of Order

Please Add Shipping and Handling



325 Spring Lake Drive
Itasca, IL 60143-2072
1-800-4-DARLEY
Monday - Friday
7:00 a.m. - 5:30 p.m. CT

BADGE ORDER FORM

- NO PHONE ORDERS ACCEPTED -
PLEASE MAIL OR FAX BADGE ORDER FORM

TERMS / ORDER FORMS

STEP 1:

Name (please print) _____
Municipality / Agency / Company _____
Mailing Address _____
City _____ State _____ Zip _____
Phone _____ Fax _____
Signature _____ Title _____

STEP 2:

- INDIVIDUAL** (Full payment enclosed)
 BILL US (Cities, Towns, Gov. Agencies, etc. by officials authorized to purchase badges)
 OTHER (Orders from companies will be entered only after credit is established)
- We cannot ship to a P.O. Box
 - Allow 30-60 days for shipment
 - 3% discount for payment with order
 - No credit card orders accepted for badges

STEP 3:

Badge Style # _____ Quantity _____

**LETTERING: (PLEASE PRINT)
FILL IN ONLY THOSE PANELS
PERTAINING TO BADGE SELECTED**

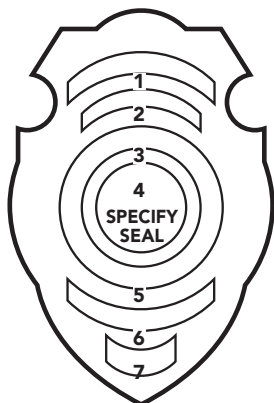

1. _____
2. _____
3. _____
4. Seal or Center _____
5. _____
6. _____
7. _____

LETTERING COLOR: Black Blue Red

STEP 4:

CHOOSE BADGE FINISH

- Nickel Plate
 Rhodium Plate
 Gold Electroplate
 Hi-Glo
 Two-Tone Hi-Glo Panels on Rhodium Badge
 Two-Tone Rhodium Panels on Hi-Glo Badge
 Karatclad

STEP 5:

CHOOSE YOUR ATTACHMENT...No extra cost

- Screw Back...for cap badge



- Safety Catch...for shirt & coat badges



- Clutch Back...for collar insignias & name bars



- Wallet Clip...



STEP 6:

CHECK YOUR EXTRAS, IF ANY

- One color hard enamel **\$3.00** (Included with Hi-Glo, Two-Tone & Karatclad) State Seal-lettered border only / Fire center...background only Black Blue Red White
 Seals or Centers with two or more colors **\$5.00** (Included with Hi-Glo, Two-Tone & Karatclad)
 Lettered disc for center **\$4.60**
 Hard enamel badge lettering **\$5.00** (Included with High-Glo, Two-Tone & Karatclad)
 Extra panels, specify lettering **\$5.00** (If badge space allows)
 Synthetic diamond, ruby or emerald stone set in the eagle's eye **\$7.60**
 Engraving on back **.60 per letter**
 Money clip attachment **\$3.40**
 Extra Tabs, specify number or letters **\$3.40**

ORDERS BY TOLL-FREE FAX: 1-800-932-9514

ORDERS BY MAIL:

DARLEY
325 SPRING LAKE DRIVE
ITASCA, IL 60143-2072 USA

BADGE QUANTITY PRICE DISCOUNTS

These quantity discounts apply to badges all lettered alike. Discount does not apply to badges with different wording, except for numbers or titles.

13-24	5%
25-49	10%
50-99	15%
100+	20%

PLACING YOUR BADGE ORDER

PLEASE...follow all information when ordering. This will help us to enter your order without writing for more information. If more order forms are needed let us know. Prices include state seals, regular enamel lettering and the attachment you select. Please be sure to print clearly. All badges are made to order and not refundable unless we have made an error. Also, orders are not subject to cancellation once the order is received by the factory.

All Badge Orders Are Shipped Via UPS - charges apply



325 Spring Lake Drive
Itasca, IL 60143-2072
1-800-4-DARLEY
Monday - Friday
7:00 a.m. - 5:30 p.m. CT

BADGE ORDER FORM

- NO PHONE ORDERS ACCEPTED -
PLEASE MAIL OR FAX BADGE ORDER FORM

TERMS / ORDER FORMS

STEP 1:

Name (please print) _____
Municipality / Agency / Company _____
Mailing Address _____
City _____ State _____ Zip _____
Phone _____ Fax _____
Signature _____ Title _____

STEP 2:

- INDIVIDUAL** (Full payment enclosed)
 BILL US (Cities, Towns, Gov. Agencies, etc. by officials authorized to purchase badges)
 OTHER (Orders from companies will be entered only after credit is established)
- We cannot ship to a P.O. Box
 - Allow 30-60 days for shipment
 - 3% discount for payment with order
 - No credit card orders accepted for badges

STEP 3:

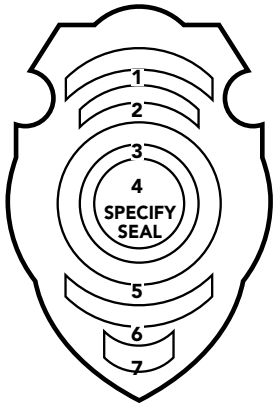

Badge Style # _____ Quantity _____

**LETTERING: (PLEASE PRINT)
FILL IN ONLY THOSE PANELS
PERTAINING TO BADGE SELECTED**

1. _____
2. _____
3. _____
4. Seal or Center _____
5. _____
6. _____
7. _____

LETTERING COLOR: Black Blue Red

STEP 4:

CHOOSE BADGE FINISH

- Nickel Plate
 Rhodium Plate
 Gold Electroplate
 Hi-Glo
 Two-Tone Hi-Glo Panels on Rhodium Badge
 Two-Tone Rhodium Panels on Hi-Glo Badge
 Karatclad

STEP 5:

CHOOSE YOUR ATTACHMENT...No extra cost

- Screw Back...for cap badge



- Safety Catch...for shirt & coat badges

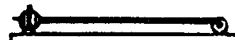

- Clutch Back...for collar insignias & name bars



- Wallet Clip...

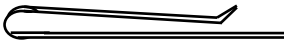

STEP 6:

CHECK YOUR EXTRAS, IF ANY

- One color hard enamel **\$3.00** (Included with Hi-Glo, Two-Tone & Karatclad) State Seal-lettered border only / Fire center...background only Black Blue Red White
 Seals or Centers with two or more colors **\$5.00** (Included with Hi-Glo, Two-Tone & Karatclad)
 Lettered disc for center **\$4.60**
 Hard enamel badge lettering **\$5.00** (Included with High-Glo, Two-Tone & Karatclad)
 Extra panels, specify lettering **\$5.00** (If badge space allows)
 Synthetic diamond, ruby or emerald stone set in the eagle's eye **\$7.60**
 Engraving on back **.60 per letter**
 Money clip attachment **\$3.40**
 Extra Tabs, specify number or letters **\$3.40**

ORDERS BY TOLL-FREE FAX: 1-800-932-9514

ORDERS BY MAIL:

DARLEY
325 SPRING LAKE DRIVE
ITASCA, IL 60143-2072 USA

BADGE QUANTITY PRICE DISCOUNTS

These quantity discounts apply to badges all lettered alike. Discount does not apply to badges with different wording, except for numbers or titles.

13-24	5%
25-49	10%
50-99	15%
100+	20%

PLACING YOUR BADGE ORDER

PLEASE...follow all information when ordering. This will help us to enter your order without writing for more information. If more order forms are needed let us know. Prices include state seals, regular enamel lettering and the attachment you select. Please be sure to print clearly. All badges are made to order and not refundable unless we have made an error. Also, orders are not subject to cancellation once the order is received by the factory.

All Badge Orders Are Shipped Via UPS - charges apply

COVID-19 RESPONSE

Our relationship-based, long-term partnerships with numerous suppliers allows us to help government agencies find and resource critical equipment and services needed to address the COVID-19 pandemic.

F&ESE

Since 1908, we have proudly offered an extensive selection of must-have items from trusted brands, all designed to keep you safe and performing effectively.

MILITARY FIRE APPARATUS SERVICE PROGRAM (MFASP)

Designed to achieve compliance and safety certification for military firefighting equipment and apparatus, our customer-focused program will improve your organization's Fire and Emergency Services readiness.

C4ISR

Effective command and control is crucial to success on the battlefield. Darley Defense strives to ensure our warfighters have access to the most capable and relevant technologies available.

OCIE & PPE

Head-to-toe, Darley Defense has you covered.

EXPEDITIONARY

Shelters, power, storage solutions and accessories add to the extensive list of modern amenities Darley offers increasing your comfort and mobility during training and deployment.

SPECIAL OPERATIONS SUPPORT

Darley offers world-class specialized equipment needed to carry out operations requiring unique methods and resources.

WEAPON ACCESSORIES & OPTICS

Near or far, day or night, Darley Defense helps you get on target with our vision enhancement and aiming solutions.

TRAINING SUPPORT

Train how you fight. Darley Defense provides cutting-edge, hyper-realistic training aids and courses designed to give you the strategic advantage.

CLASS I & CLASS VIII

Food, health and medical support are basic needs of vital importance while on base or the road. Darley has sourced items needed to support your unit in diverse environments.



CAPABILITIES

Darley Defense has a wide range of firefighting, special operation, training and defense capabilities across categories ranging from PPE gear packages to service and training. We pride ourselves on serving the world's first responder and tactical communities by providing high-quality, safe, and innovative products with unmatched customer service and expertise. We maintain a growing list of vendor partners, committed to creating unique solutions for any mission requirement.

OUR TEAM

The Darley Defense Team consists of subject matter experts, many of whom are former operators and veterans of the U.S. Military, with extensive knowledge of equipment, capabilities requirements and federal procurement options. Combining this expertise with a relentless focus on customer service and we work with one goal in mind: equipping our Nation's first responders with the necessary capabilities to accomplish any mission.

PROCUREMENT

Darley offers industry-leading tailored equipment and training solutions vital to our customers unique mission requirements. The Department of Defense continues to recognize Darley's integrity, reliability and customer focus awarding contracts through TLS, GSA, DoD FEDMALL, Unicon, S2P2 and GPC with focus on Fire and Emergency Services Equipment (FS&E) and Special Operational Equipment (SOE). Not familiar with these contract vehicles? Let our team of experts guide you through the most efficient and cost-effective means to get you what you need.

PURCHASING

WE ASSIST UNITS WITH EDUCATION AND SUPPORT

- We can teach anyone in your organization to understand and utilize most DoD methods of resource acquisition.
- Tell us the operational or tactical capability you are trying to achieve, and we will show you several options that fulfill your requirement. If not, we will work closely with you and our vendors to create a solution.
- Product Integrity: Berry Amendment and TAA compliance, where applicable

CONTRACT OPTIONS

Darley Defense maintains numerous DoD contracts to find you the best possible solution including these vehicles and more.

TLS	GSA	DOD FEDMALL
UNICON	S2P2	GOC

SCAN THE QR CODE TO LEARN MORE OR VISIT
WWW.DARLEYDEFENSE.COM/FIREEQUIPSUPPORT



The appearance of U.S. Department of Defense (DoD) visual information does not imply or constitute DoD endorsement. Images ©DVIDS.



CAR FIRE BLANKET PRO

The fire and smoke are isolated within seconds of spreading the blanket over the car. Ideal solution for parking garages, shopping centers, hospitals, hotels, boat ferries, car dealerships, metropolitan areas, etc. Bridgehill car fire blanket pro is reusable and provides a quick and effective way to extinguish a car fire by removing oxygen supply. Toxic gases and smoke are stifled immediately in fossil fuel cars. Same immediate result is achieved in electric cars, whose batteries have not been affected by the fire. *For more information on Lithium and Extreme Blankets, please call Darley.*

NEW



VIDEO ONLINE

DIRECTIONS:

- Unroll the blanket in front of or behind the car/ burning object
- Grab the handles in the corners, and pull over the blanket in one movement
- Wrap the blanket tightly around the car to reduce the supply of oxygen
- Fire is contained in minutes



BP193	Car Fire Blanket Pro	\$2,422.00
BP195	Lithium Blanket - 1.8x1.8 Meters	\$597.00
BP196	Extreme Blanket (Box of 10 pcs.)	\$2,313.00

AQUA BLASTER FIRE HOSE HARNESS

The Aqua Blaster is a harness/frame which supports a fire hose with attached nozzle and can be operated by a single firefighter. The firefighter's torso and lower body strength give enhanced control of the fire hose and nozzle. Advancing and maneuvering is done without assistance. The Aqua Blaster reduces injuries like chronic pains in the joints and back that are often associated with the long-term use of fire hoses. The flow control components of the Aqua Blaster consist of two 90° elbow swivels attached to a connecting tube. The Aqua Blaster allows the user to easily pivot to the left or right adjusting the direction of the water stream. The fire nozzle can be rotated up and down and locked at a fixed vertical angle. *The Aqua Blaster is supplied without nozzle.*

NEW

OPERATED BY SINGLE FIREFIGHTER

NOZZLE NOT INCLUDED

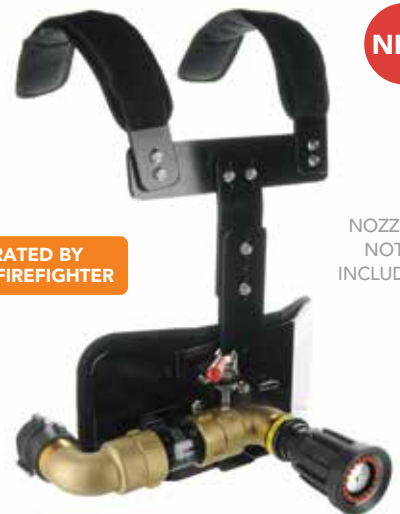

- Fire hose can be maneuvered hands-free
- Hands-free operations is more balanced
- Reduces fatigue when a charged fire hose is being used for an extended period of time
- Ideal for exterior, Hazmat and Wildland firefighting

BP294	Aqua Blaster Fire Hose Harness	\$1,125.95
-------	--------------------------------	------------

HA-5 TRANSPONDER

COLLISION PREVENTION, SAFETY CLOUD® SERVICE

The HA-5 enables collision prevention service that delivers real-time digital alerts to let motorists know to slow down and move over for crews and apparatus any time the emergency flashing lights or E-Master is engaged. Motorists receive advanced warning, providing them more time to make safer, smarter driving decisions and comply with "Move Over" laws. When emergency crews are on-scene and responding, vital safety and road hazard information is sent to drivers via navigation apps and in-vehicle systems. **Pricing does not reflect software subscription. Contact Darley for fleet pricing.*

NEW

VIDEO ONLINE

SPECIFICATIONS:

- Dimensions: 5.4"x2.7"x1.3"
- Cellular: 3G or 4G LTE
- Input Voltage - Power: 12.5V - 15V
- Input Voltage - Flashing Lights Main Wire (E-Master): 12V - 15V
- Amperage: 120 mA peak draw
- Operating Temperature Range: -40° to 85°C
- Weight: 7 oz.

FEATURES:

- Connects any flashing emergency lights
- Cellular, GPS, real-time Safety Cloud® connectivity
- 100% passive to crews and personnel
- Automatic low voltage shut-off
- No data plan required



TRANSPONDER



BP123	HA-5 Transponder	\$399.00
-------	------------------	----------



Corporate Headquarters
325 Spring Lake Drive
Itasca, IL 60143-2072

PRSR.T. STD.
U.S. POSTAGE
PAID
W.S. Darley
& Company

Code: Account:

CHIEF XD™

NEWLY REDESIGNED FIXED FLOW CHIEF XD

The Chief XD is the only handline nozzle that offers a forged shutoff body and forged metal bale handle for maximum strength. It also includes a standard full round metal ball for the best stream performance, as well as fixed molded urethane or spinning stainless steel metal teeth that don't break.

- Forged aluminum shutoff body and bale handle
- Full round metal ball with perfectly aligned waterway
- Laser etched markings



MULTIPLE CONFIGURATIONS



SEE
p8 FOR
DETAILS



BN749 Chief XD™ - Mid-Range 1 1/2" Free Swivel Base \$731.95

RAM XD™

BIG WATER...FAST

Ideal for quick attack, high rise, and industrial applications, the RAM XD Rapid Attack Portable Monitor can be easily deployed by a single firefighter to flow up to 500 gallons per minute fast! Lightweight and compact, the RAM XD can lower down to 14° above horizontal making it easy to flow into overhead doors, traditional size man doors, or store fronts. It's angled waterway shape and four foldout legs help to harness nozzle reaction making an extremely stable and safe design.

- Low 14° elevation angle
- 500 GPM @ 75psi operating measure
- Lightweight only at 19 lbs.

VIDEO ONLINE



SEE
p20 FOR
DETAILS



BN409 Ram XD™ Monitor \$2,381.95



OUTFIT YOUR DEPARTMENT
WITH THE LATEST IN
DRONE TECHNOLOGY

MATRICE 300 RTK
INTELLIGENCE WITH HIGH-PERFORMANCE.

Shop [darley.com/robotics](http://www.darley.com/robotics)

3030 Jolley
WWW.GODARLEY.COM 800-322-3-0224
2020 #275