

Hobie



SAILING PARTS & ACCESSORIES





CONTENTS

ITEM	PAGE
LIFE VESTS / PFD	2-3
PET PFD / WET WEAR / SAFETY	4
TRAPEZE / GLOVES	5
TRAPEZE	6-7
WING SEATS / BACK RESTS	8
<hr/>	
SAILS	9-11
BATTENS / SAIL ACCESSORIES	12-13
WIND INDICATORS	14
TRAMPOLINES	15
RIGHTING	16-17
<hr/>	
STEERING / RUDDERS / TILLERS	18-19
SAIL TRIMMING / HARDWARE	20-25
LINE	26
HATCHES / BAGS	27
<hr/>	
TRAILERS, STORAGE	28
TRAILER ACCESSORIES / MAST STEPPING	29
BEACH WHEELS / CARTS	30
COVERS / BAGS	30-31
STICKERS / TOOLS / REPAIRS / MAINTENANCE	32-33
MISC. ACCESSORIES / HOBIE BOOK	34-35
HOBIE SUNGLASSES	36-39
APPAREL / HATS / ACCESSORIES	40-41

Note: Freight to dealers is not included in pricing.
 No portion of this catalog may be reproduced without the express permission of the Hobie Cat Company.
 All rights reserved. ©2020 Hobie Cat Company. Oceanside, CA 92056
 Pricing subject to change. Printed in USA

LIFE VESTS & PFDs



S6103xx (xx = size)
MEN'S SUN

HOBIE THIN-BACK by Stohlquist

Features a thin foam back design ... perfect for use with Hobie Vantage seats. This thinner back profile provides more mobility and comfort, while reducing interference with taller seat backs.

THIN-BACK S6103-6

THIN-BACK FISH S6107

FEATURES:

Thin back design works with all seat styles; Graded Sizing provides the best possible fit; Open sides for ventilation; Cross-chest cinch harness for zero ride-up; Mesh shoulders & interior panels for maximum ventilation; Adjustable shoulders, and dual forward pulls for a custom fit; Zippered front pockets offer organization; Built-in beverage holder and neoprene sunglasses sleeve; Entry grip tab at zipper base; #10 YKK zipper with non-corroding slider; Lightweight PE Foam; Type III PFD with sea level buoyancy: SM: 16 lbs, 8oz / LXL: 17 lbs / XXL: 17 lbs, 8oz

CONSTRUCTION:

- Mini Ripstop nylon outer shell
- 200 denier oxford liner
- USCG approved

SIZING:

MEN'S		WOMEN'S	
SIZE	CHEST	SIZE	CHEST
SM	30" - 40"	XSS	28" - 34"
LXL	40" - 46"	ML	34" - 40"
XXL	46" - 52"	PL	40" - 46"



S6104xx (xx = size)
MEN'S SLATE



S6107xx (xx = size)
MEN'S FISH SLATE GREEN



S6105xx (xx = size)
WOMEN'S SUN



S6106xx (xx = size)
WOMEN'S SLATE

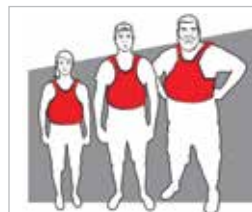

GRADED PFD SIZING

Fine tuned for each individual size, and sculpted foam footprint and foam thickness to provide a better fitting, and more comfortable PFD for people of all sizes.



HOBIE MIRAGE PFD

This PFD was designed for Vantage high back seats on Hobie Mirage Kayaks. The flotation in the back is thin for more comfort while seated and helps to prevent the vest from riding up as you pedal. A vent along the spine adds to the comfort. Front zip entry for easy on and off. Large pockets on the front for easy storage and access of small items. High waistline cut so the vest does not ride-up while pedaling. Huge arm cutouts and the short waist allow excellent freedom of movement. Adjustable side straps offer enough size variation for many layers underneath or none! Reflective tapes for visibility during low light conditions. Back logos vary between "H" and Penguin Logo.

(xxx = SMD - MLG) (UL - Approved) for use in USA Only

S6800xxx PFD MIRAGE GRAY

SIZING

SIZE	CHEST
SM	33" - 39"
LXL	40" - 46"
XXL	48" - 54"



HOBIE EDGE by Stohlquist

An innovative, high mobility, low profile boating vest for kayaking, SUP, and wetsailing.

S6108xxx (xxx = size)

FEATURES:

Ergonomic WRAPTURE™ shaped torso; Adjustable shoulders, 4 side pulls, and front waist buckle closure; Low cut, offset front-zip entry; Large arm openings for unrestricted whitewater and SUP paddling; Contoured padded shoulder straps; High visibility 3M™ reflective accents; Roomy, top loading front pocket for secure storage and easy accessibility; Mesh sides for maximum ventilation; Mini-Ripstop nylon shell & 200 denier oxford liner; Type III PFD with sea level buoyancy listed: SM: 15 lbs, 8oz / LXL: 16 lbs, 8oz / XXL: 17 lbs, 8oz

CONSTRUCTION:

- Mini Ripstop nylon outer shell
- 200 denier oxford liner
- USCG approved

SAFETY TIP

LIFE VESTS: Get a good, comfortable life vest and WEAR IT! A life vest does you little good stored on your boat, especially if you get tossed into the water and away from your boat. Accidents happen and by their nature, they happen when you are not prepared. A life vest can keep you afloat until you can rescue yourself or you can be rescued by others. In the worst cases when injuries or cold water are involved, your life vest can make all the difference! Be sure everyone onboard your boat wears a life vest too! Pass the word! Federal law now requires that all persons below the age of 13 must wear a life jacket while aboard a boat.



HOBIE INFLATABLE PFDs

Light weight and comfortable. Ready when you need it, manual CO2 inflation or by mouth inflator allows for swimming, wading and intentional immersion. **NOTE: AIR SHIPPING RESTRICTIONS CO2 / DANGEROUS GOODS**

Coast Guard Approved Type III Nearly twice the buoyancy of USCG foam PFD Shortened slim fit shell for improved comfort when pedaling a Mirage kayak Mesh Yoke Back Strap for breathability and preventing ride-up Large Easy Access Storage pocket for increased storage capacity Inflates manually for flotation only when it's desired D-ring for accessory attachment Accessory attachment straps Interior pocket for holding spare CO2 inflation cylinder Fits 30-52" chests and users 16+ years Included 24g CO2 cylinder provides 26 lbs. of flotation

S6782BL PFD INFLATABLE BLUE - 24g

S6782GR PFD INFLATABLE GREEN - 24g

S6782RD PFD INFLATABLE RED - 24g

S6782TN PFD INFLATABLE TAN - 24g

S6779R PFD INFLATABLE REARM KIT 24g



16g YELLOW

16g BLUE

HOBIE INFLATABLE BELT PACK PFDs

Belt carried PFD designs are cooler and more comfortable than typical PFDs. Functional design for multiple types of water sports from fishing, kayaking, sailing to stand up paddling (SUP). USCG Approved Type III PFD, approved for use by persons 80 lbs and 16 years of age or older. Size: Universal Adult Size. Durable ripstop nylon pack. 2" wide, adjustable, nylon waist belt. Includes (1) CO2 Cylinder and instructions.

16g offers Buoyancy 16.5 Pounds. Slim fit. **NOTE: AIR SHIPPING RESTRICTIONS CO2 / DANGEROUS GOODS**

S6783BL PFD BELT PACK BLUE 16g

S6783YL PFD BELT PACK YELLOW 16g

S6780R PFD INFLATABLE REARM KIT 16g

HOBIE INFANT/CHILD/YOUTH VESTS

These are easy to adjust for different small sized crews.

(Lime Green)

S6771CLG LIME 30-50#

S6771ILG LIME <30#

S6771YLG LIME 50-90#





HOBIE PET PFDs

You can now take your best friend with you safely and in Hobie Style! Added flotation as a swim assist and grab handles, so you can help them back aboard more easily. Adjustable fit, leash attachment, side pockets, grab handles and soft foam undercarriage support. Happy days for dogs!

FEATURES:

Tri segmented soft foam design; Foam supported Ripstop-nylon collar; Dual cargo pockets (S, M, L, XL); Dual integrated grab handle design (M, L, XL); Soft foam undercarriage support chassis; Integrated leash attachment

- S9000XS** PET PFD XS MANGO <12#
- S9000SM** PET PFD SM MANGO 12-24#
- S9000MD** PET PFD MD MANGO 24-60#
- S9000LG** PET PFD LG MANGO 60-90#
- S9000XL** PET PFD XL MANGO >90#

SIZING:

SIZE	WEIGHT	COLLAR	BODY GIRTH
XS	12 lbs.	8" - 12"	13" - 17"
S	12 - 24 lbs.	10" - 14"	15" - 21"
M	24 - 60 lbs.	13" - 19"	18" - 30"
L	60 - 90 lbs.	18" - 26"	24" - 36"
XL	90 - 120 lbs.	22" - 30"	30" - 42"



HOBIE FIRST AID KIT

Waterproof 3600 Plano box with essential first aid items.

72020078 HOBIE FIRST AID KIT

SAFETY WHISTLE

A whistle can save your life! Keep one attached to your PFD in case of overboard emergency. Alert approaching vessles. Alert other boaters or people ashore that you need help.

MK0053 SAFETY WHISTLE



HYDROSTAR - SOS DELUXE

Everything you need for lighting in one compact waterproof package.

72020003 HYDRO STAR SOS LIGHT

HYDRO STAR

FEATURES:

- 5 light settings
- Magnetic base
- Suction cup base
- Lanyard clip
- Integrated safety whistle
- Submersible to 50ft

SPECS / FUNCTION:

- Dimensions: 6in H x 1.25in DIA
- 1 CLICK : 3 LED Light (10LM)
- 2 CLICKS : 3 LED Strobe (15LM)
- 3 CLICKS : 360° Deck Light (Red:6LM/Green 2LM)
- 4 CLICKS : Emergency 1 Watt LED Strobe (65LM)
- 5 SECOND HOLD : SOS Signal (65LM)*



TELESCOPING PADDLE

Measures just 20" in closed position (45" when fully extended). Light-weight, anodized aluminum shaft corrosion resistant design. Floats too! 6 1/2" wide blade will fit into an 8" hatch opening.

3091 TELESCOPING PADDLE



ANCHOR KIT

Folding 3 lb anchor, bag and 60 feet of line.

80035A ANCHOR

FULL "AUTO" HARNESS

For those looking for added back support and comfort while on the trapeze. Great for spending lots of time on the wire. New spreader ratcheting feature allows easy adjustment of harness around hips as well as quick release feature to get out of harness quickly. Crotchless design with neoprene leg straps, adjustable lumbar support, neoprene covers over side buckles, and reinforced patch on the seat. Comes with ratchet adjust 10" stainless spreader bar that can only be used with this harness. Colors may vary.

1476xx Full "Auto" Harness

(xx = size) (SM,MD,LG,XL)

CONVERTIBLE HARNESS

"Converts" easily from a half harness to full harness with the addition of shoulder straps (included). The all around harness for both racers and recreational sailors where comfort, support and mobility are key. For the recreational sailor the half harness has enough back support to keep you comfortable on the tramp or the trap. For the racer, just add the shoulder straps for those long days out on the trapeze where extra back support is needed. Extra stiff back support, padded leg straps/shoulder straps, neoprene covers over buckles and a 10" stainless spreader bar. It all adds up to keeping you comfortable and having fun on the water. Shoulder straps included with harness. Colors may vary.

1478xx CONVERTIBLE HARNESS

(xx = size) (SM/MD,LG,XL)



SKIPPERS HARNESS

The harness for both racers and recreational sailors where comfort and mobility on the trampoline are most important. For the sailor who spends less time on the trapeze or prefers to "sit up" rather than lean out more. Unique leg strap design combining neoprene and webbing to eliminate chafe. Neoprene covers over side buckles and a 10" stainless spreader bar.

Reinforced seat. Colors may vary.

1488xx SKIPPERS HARNESS

(xx = size) (SM, MD, LG, XL)



HOBIE GLOVES

Protect your hands while increasing your grip strength. Gloves add grip strength on lines which can ease up on the amount of force you need to exert. Available in small, medium, large & extra-large. (xx = size)

3188xx HOBIE GLOVE

RONSTAN GLOVES

Double thickness palm and fingers for protection and grip. Mesh panels for flexibility, comfort and quick drying. Low cut neoprene wrist band. Sticky gloves reduce fatigue by minimizing the physical effort required to hold ropes.

(xx = size XS/SM/MD/LG/XL)



RF4851xx Three Finger Glove



RF4850xx Short Finger Glove

TECH TIP!

SAILING GLOVES: Get a good grip on your lines. Sailing gloves absorb and distribute the sheet rope load, as well as protect your skin from wear and tear. Lower cost gloves are fine for the casual sailor. The more rigorous the sailing conditions the more a higher quality glove is required. Our high end gloves are double thickness leather in high wear areas, padded to spread out the squeeze load on your hand and reasonably easy to get on and off.



COATED TRAP WIRE SETS

Highest quality aircraft stainless wire coated with UV tolerant black or white vinyl coating for all of our wire products. Molded nylon handles are installed at the right place for easy in and out maneuvering. Also available in kits which include the trapeze shock cord.

- 1472W ABOVE w/ SHOCKCORD (16 only)
- 1471B H16,17,SPORT PAIR-BLACK
- 1472B ABOVE w/ SHOCKCORD (16 only)
- 1473W H18 PR (1 SIDE)-WHITE
- 1473B H18 PAIR (1 SIDE)-BLACK
- 1474B ABOVE w/ SHOCKCORDS
- 1475B H14 PAIR-BLACK
- 1476B ABOVE w/ SHOCKCORD
- 1478B GETAWAY PAIR-BLACK

WAVE / GETAWAY TRAPEZE KITS

Add a trapeze system to your Hobie Wave or Getaway. Complete with wires (pr), return bungee system, lines, blocks, locks and dog bones. Just add a trapeze harness and you are flying! Wave kit includes adjustment lins with internal shockcords and hull attachment hardware.

- 38140001 WAVE TRAPEZE KIT
- 37140001 GETAWAY TRAPEZE KIT

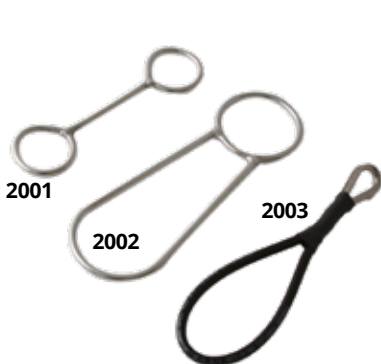

TRAPEZE DOGBONES

These dogbones feature high grade 316 stainless steel with welded construction for superior strength.

- 2001 STANDARD
- 2002 KEYHOLE SHAPE
- 2003 FLEXIBLE DOGBONE



HARKEN MICRO FIDDLE BLOCK

Superior quality Micro Fiddle Block with V-Jam cleat from Harken. For use with 7/32" to 5/16" (5mm-8mm) line to make adjustable trapeze system. H244 Each

DOUBLE ADJUSTABLE TRAPEZE

Adjust the level of the entire system, ring and handle. Always have the trapeze "T" handle at the proper comfortable to reach level. Crew can move fore and aft to extremes and maintain efficient and comfortable trapezing level. Bungee gives constant upwards pull on trapeze ring to ensure that you stay hooked up. Stock trapeze wire must be shortened by approx. 8". Order trapeze rings and bungee separately.

1204 Kit



J & H HANDLES

Open design combination dogbone/trapeze handle makes getting hooked and unhooked very simple. Choose a different color for the skipper and crew for easy identification.

- 2004BLK PAIR-BLACK
- 2004WHT PAIR-WHITE

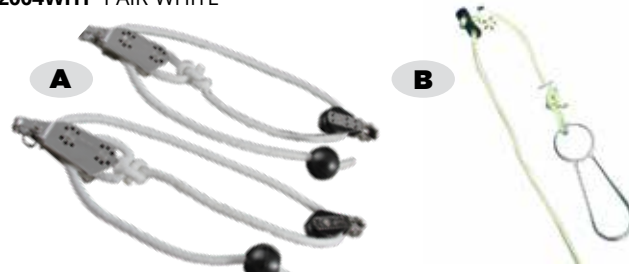

A. DELUXE ADJUSTABLE TRAPEZE RIG

The original trap rig. Adjust your position while you are out on the wire. V-Jam pulley system allows you to compensate for that puff or lull in the wind without coming in off the wire. Comes complete with all blocks, ropes, and swivels needed for one pair.

1203 w/o DOGBONES

B. STANDARD ADJUSTABLE TRAPEZE RIG

The standard kit includes blocks with removable sheaves, rope, rope locks and stop washers. Can be purchased with #2002 dogbones or without dogbones (for possible use with J&H Handles.)

- 3101 w/ DOGBONES
- 3102 w/o DOGBONES



MOLDED TRAPEZE HANDLE

Strong and comfortable molded grips are contoured to fit the hand. Wire guide shank keeps wire from cutting between the fingers. This is the "standard" handle on all wires.

2011 Each

REPLACEABLE TRAPEZE HANDLE

This simple, rubber padded, all aluminum handle can be installed on any 3/32" wire without disconnecting anything. Just screw the 2 halves together and it's ready to use.

2010 Each

RAIL RUG

Provides excellent footing when out on the trapeze. Kit includes a high quality grade of carpeting which absorbs less water, keeping weight down and reducing mildew. Also included in each kit; industrial grade contact cement (much better than the hardware store variety), brush and easy to follow instructions. For all catamarans.

- 1671BLK H14/16-BLACK
- 16703 CONTACT CEMENT-PT



NEOPRENE RAIL KITS

Provides excellent footing while out on the trapeze and cushions the non-skid areas. Eliminates abrasion on your skin or clothing because it sheds sand. Zero water retention. Made out of 1/8" thick knobby black neoprene. Kit includes industrial grade contact cement, brush, and instructions for easy installation on any boat. Race strips are for hull decks rear of trampoline frame. H16 kits are full wrap around as used in Worlds boats.

- 16706 H14 / H16 KIT
- 16707 RACE STRIPS-PAIR
- 16708 H18 KIT (H18 Die Cut - Shown Above)



REMOVABLE SHEAVE TRAP RIG BLOCK

This is the block we include in our basic trap rig kits. No need to cut wires to install this block. Simply remove the clevis pin that acts as the sheave axle, slide the sheave out of the frame, place the frame through the trap wire thimble and reinstall the sheave.

3103 Each



TRAP STAY

An easy answer to wandering wires and "who's whose" confusion on the Hobie 16. Mount these little keepers under the side rails and drop the shockcord in. Works great to keep everything in its place.

176 Pair



ROPE LOCK

Use on trapeze rope to make your trapeze system adjustable.

61530000 Each

TECH TIP!

Trapezing: While sitting on the edge of the boat, attach the trapeze dogbone to the trapeze hook on your harness. Grab onto the trapeze wire's handle with your forward hand. Place your other hand on the hull behind you. Using your hands for balance ease yourself off the side of the boat and place your forward foot on the rail. Push yourself away from the boat with your rear hand and forward foot till you can place the rear foot on the rail. Stand on the rail of the boat with your weight on the trapeze wire. Keep your forward leg more ridged and aft leg slightly bent. This position will help keep you from falling forward.

While learning to trapeze, beginners should set their trapeze height just at the rail level or slightly above. This will make it easier to get in and out. Keep your legs spread several feet apart for balance. As you get used to the feel of trapezing you can begin to lower your trapeze height and move your legs closer together. Once you become an expert on the trap wire, your proper body position should be parallel to the deck with your feet right next to each other.

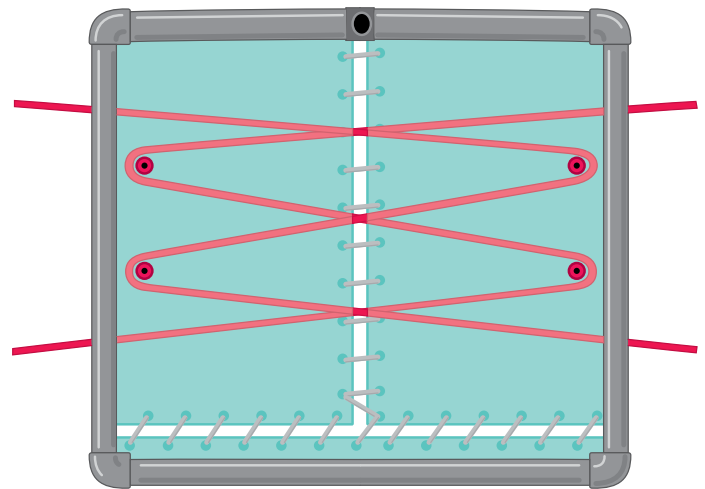

TRAPEZE RIG RETURN SYSTEM

Custom system with double-length shockcord reduces the unpleasant forward pull when you're trapped out off the stern on a reach. It also prevents breakage of the shockcord when you stuff a lee bow and the crew takes a spin around the forestay. All required hardware is included.

14709 H16 KIT

PERFORMANCE COMFORT

GETAWAY WING SEATS

These are perfect for lazy day sailing, relaxed hiking out on your Hobie Getaway or for high performance fun. Turquoise vinyl mesh covers aluminum extrusions that are contoured to make a very comfortable back rest or seat. Remove two quick pins per side and they rotate in for trailering.

37001000 WING ASSEMBLY WITH TURQ SEAT COVER <=2016

37001030 WING ASSEMBLY WITH GREY SUS SEAT COVER 2017+

37971058 REPLACEMENT COVER - (PRE SUS) TURQ MESH <=2016

37977058 REPLACEMENT COVER - (PRE SUS) GREY MESH 2017+



HOBIE WAVE

WAVE BACK RESTS

These simple to install Back Rests are perfect for lazy day sailing on your Hobie Wave. The last word in sailing comfort. They plug into the front and rear cross beams. On or off in 3 minutes or less.

38040011 BACK REST, SET (BLUE)

38040012 BACK REST, SET (GREY)

38041001 REPLACEMENT PAD COVER (BLUE)

38041002 REPLACEMENT PAD COVER (GREY)

8020181 FAST PIN (EACH) FOR QUICK RELEASE OF BACK RESTS. FOUR REQUIRED. SOLD SEPARATELY.

NOTE: ADDITIONAL FREIGHT CHARGE ITEMS

Items shown on this page will incur additional freight charges from the factory that are not included in pricing shown.



**Bravo
MARTINQ**



BRAVO

- 90990021 SAIL, BRAVO MAIN SEABREEZE
- 90990022 SAIL BRAVO 3.8 OZ-MARTINIQ

WAVE

- 38991000 SAIL, WAVE MAIN "V" WHITE
- 38991079 SAIL WAVE MAIN "V" MARTINIQ
- 38991050 SAIL, WAVE MAIN "H" RESORT WHITE
- 38992010 SAIL, WAVE JIB WHITE
- 38992007 SAIL, WAVE JIB YELLOW
- 38992072 SAIL WAVE JIB ORANGE (25 sq ft)

GETAWAY

- 37991077 SAIL GETAWAY MAIN "V" MARTINIQ
- 37992072 SAIL GETAWAY JIB ORANGE

**H16
CAYMAN**



**H16
TORTOLA**



HOBIE 14

- 10990010 SAIL, H14 MAIN, WHITE
- 10992511 SAIL, H14 JIB, WHITE

HOBIE 16

- 20991011 SAIL, H16 MAIN, WHITE
 - 20991089 SAIL H16 MAIN TORTOLA
 - 20991090 SAIL H16 MAIN CAYMAN
 - 20992010 SAIL, H16 JIB, WHITE
 - 20992089 SAIL H16 JIB TORTOLA
 - 20992090 SAIL H16 JIB CHAR (CAYMAN)
 - 20992310 SAIL, H16 JIB, WHITE (VELCRO*)
- VELCRO* = Velcro closure / tensioned battens (less halyard hangup)

HOBIE 18

- 60991011 SAIL, H18 MAIN, WHITE
- 60992011 SAIL, H18 JIB, WHITE

SEE PARTS LIST FOR ALL OTHERS



HOBIE WAVE JIB KIT

Bring your Wave sailing up a level. More sail area (jib adds 25 sq ft) equals more speed and performance in light wind conditions. The Wave jib accelerates learning and encourages participation of your crew in sailing. Our jib hardware kit comes complete with bow spreader pole, all the nuts, bolts, and blocks required. Order jib separately.

- 38999001** WAVE JIB HARDWARE KIT
- 38992010** WAVE JIB, WHITE
- 38992007** WAVE JIB, YELLOW
- 38992072** WAVE JIB, ORANGE

JIB KIT SPARE PARTS

- 38999021** BOW SPREADER POLE ONLY
- 38120041** TANG FOR BOW SPREADER POLE



HOBIE 14 TURBO KIT (JIB & FURLER)

Add Turbo power and enjoy the excitement of trapezing from the 14 with the complete Turbo kit (comes complete with trapeze and jib sheeting hardware). A dolphin striker is required for trapezing. If your boat is pre-1982, order the upgrade kit for new length shrouds, chain plates and tramp jib grommets. Order jib separately.

- 80200000** TURBO KIT w/ HOBIE FURLER
- 80200010** DOLPHIN STRIKER KIT (pre-'82)

10992511 WHITE JIB

TECH TIP!

ROLLER FURLING JIBS: Just roll the jib up when you come into the beach or de-power if it gets too windy. Want to fly a spinnaker? The furling systems work great for easy spinnaker flying. A roller furling jib system can increase the life of your jib by avoiding flogging the jib material while on the beach or between races. Allows you to store the boat without lowering the jib (jib "snorkle" cover suggested). Kits available for the Hobie 20, 17, 16, 14.

HOBIE JIB FURLER SYSTEMS

Just roll the jib up when you come into the beach or de-power if it gets too windy. Speed, excitement and convenience all rolled into one!

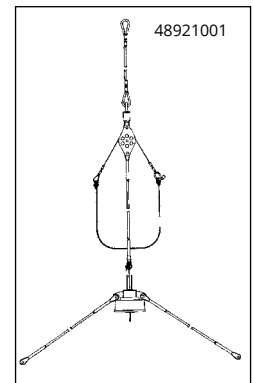

HOBIE 16 FURLER KIT

Order a new furling jib separately or requires a re-cut of the standard jib.

- 8001** KIT w/ HOBIE FURLER
- 8002** WHITE FURLING JIB

HOBIE 16 FURLING GENNAKER SYSTEM

Increase your off-the-wind sailing performance with this pole-mounted furling gennaker. A large reaching genoa attached to a furling drum mounted on a pole which moves the sail area further forward like a spinnaker, but furling for easy deployment and retrieval.

- 20999201** POLE, FURLER, HARDWARE AND WHITE GENNAKER



17 SPORT "BOOMLET" SAIL FOOT

When the boom is removed, it is much easier for your passengers and crew to travel from one side of the boat to the other while tacking or jibing. 1995 and newer Hobie 17 "SE" sails can easily be converted to a "Boomless Sport" by adding the "Boomlet".

- 52722011** '95 AND NEWER SPORT "BOOMLET"

SPINNAKERS

SPINNAKER SYSTEMS

Quick setup, ease of use, and maximum performance were just a few of the design criteria. Our spinnaker kits provide better sail control with fewer lines. The Spinnaker Pole and Rig Kit contain all the equipment and lines to control hoisting, setting the tack and sheeting the Spinnaker. Just pull on the halyard...the sail is hoisted and the tack is hauled out to the pole end!

HOBIE 16 / GETAWAY* TRUMPET SNUFFER SPINNAKER SYSTEM (*GETAWAY USE REQUIRES SOME KIT MODIFICATIONS. INSTRUCTIONS ONLINE)

20999020 POLE, SNUFFER, SPINNAKER & HARDWARE
F16032110 SPINNAKER REPLACEMENT (COLORS VARY)

HOBIE WAVE

38999000 WAVE POLE & HARDWARE KIT ONLY
38999052 WAVE SPINNAKER (COLORS VARY)



HOBIE GETAWAY



HOBIE 16 / SNUFFER SYSTEM

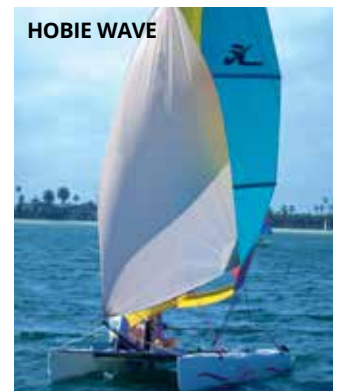

HOBIE WAVE

TECH TIP!

SPINNAKERS: Flying a spinnaker is one of the great thrills of sailing. And one of the great challenges for both skipper and crew. Spinnakers increase downwind speed while actually creating lift at the bows! Few things compare to the thrill of running off the wind under a huge and colorful spinnaker! Spinnakers require special rigging. A survey of the products on these pages will give you a good idea of the options available.

UNIVERSAL BATTENS

Availability of the correct batten has often been a problem. The various models of Hobie Cats all use different batten and taper lengths. In earlier years, each model Hobie used a different color batten. The battens were all the same specification, just a different color. We now stock only white sail battens for all models.

Complete battens sets, cut and tapered to specification length are available for some models. Individual battens are filled from stock as shown in the following table. Batten numbers start from the bottom batten in each sail (#1). Battens are trimmed by purchaser to exact length. Stock batten lengths are shown in the illustrated Hobie parts pages. (T)=Tapered

82010001 BATTEN (max 107 7/8", min 87 5/16") *not tapered*

82020001 BATTEN (max 82 3/8", min 72 1/8") *not tapered*

82030001 BATTEN (max 90 1/8", min 46 1/8") 27" *taper*

82040001 BATTEN (max 42 11/16", min 39 1/16") 27" *taper*

82060001 BATTEN (max 100 9/16", min 67 7/8") 27" *taper*

82070001 BATTEN (max 67", min 51 3/4") *not tapered*

82080001 BATTEN (max 43 3/4", min 24 1/8") *not tapered*

	82010001	82020001	82030001	82040001	82060001	82070001	82080001
	107 7/8"	82 3/8"	90 1/8"(T)	42 11/16"(T)	100 9/16"(T)	67" (J)	43 3/4" (J)
WAVE		1,2,3				4	5
H14	1,2		3,4,5	6			
GETAWAY	1,2		3,4,5,6,7				8
H16M	1,2,3,4	5,6	7	8			
H16j						1,2	3,4
H17			3,4		1,2	5	6
H18	1,2,3,4,5		6,7,8	9			10
H18SX	1,2,3		8		4,5,6,7		9
H21SE	1,2,3		4,5,6				7



TECH TIP!

SAIL CARE: At the end of the day most cat sailors roll their sails on the lower batten or around the boom. If you do, roll your sail loosely. Any sharp bends in the sail cloth break down the resin coating on the cloth. This weakens the cloth leading to premature stretching or pin size holes that will grow. You can lengthen the life of your sails with careful handling and by using some of the special accessories we offer. The various tapes and sleeves we offer are all intended to protect the sail from sharp edges and abrasive areas on the boat that wear away at the sail's fabric until suddenly there's a hole and next a tear. It's never too late to slow down wear and tear.



SUPER JIB BATTENS

Work your jib with greater ease. Light and limber fiberglass battens virtually eliminate hangups when tacking the Hobie 16 and give your jib superior shape in light air when you need it most. Increases drive compared to the stock jib battens. Not class legal for racing but so nice to use the rest of the time. Complete with end caps.

122 SET OF FOUR

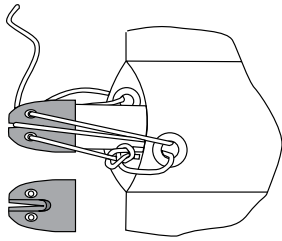

TRENTEC LUFF CAPS

Prevent "poke through"! These Trentec caps slip over the luff (front) end of your mainsail battens to increase the life of your sails and of the batten-pocket protectors. Each cap is molded at the angle to match the angle at which the batten meets the luff.

- 1561 H14 KIT (6)
- 1562 H16 MAIN KIT
- 1563 H18 KIT
- 1566 H16 JIB KIT



HOBIE CAT LEACH & LUFF CAPS

Release the batten tension whenever you store your sails. This will prolong the life of your sails. Luff caps and adjustable leach caps are made of high strength, ultra-violet tolerant Delrin®. No knots to tie or untie. Tension adjustment lines not included. Sold individually. 4:1 mechanical advantage allows finer adjustment than does Trentec 2:1 caps.

- 11323000 MAIN LEACH
- 21333000 JIB LEACH
- 11322011 MAIN LUFF TIP

BATTEN CAP SETS

- 1521H HOBIE 14/17 SET
- 1522H HOBIE 16 MAIN SET
- 1531H HOBIE 16 JIB SET
- 1523H HOBIE 18 SET



SAIL CHAFE PROTECTOR SET

From Harken. A split roller predrilled to fit up to 3/16" diameter wire. Replaces diamond wire rollers.

- H285 SET



SPREADER BAR END COVERS

Smooth and resilient vinyl spreader bar end covers protect the jib luff from wear and tear on cotter keys and sharp edges. A real sail-saver.

- 3262 PAIR



JIB PROTECTOR KIT

Install hard plastic covers specially designed for cotter keys and Hobie 18 and 20 spreader bar ends. No slitting or taping required.

- 1512 H18 Kit
- 1513 H20 Kit



BATTEN POCKET ANTI-CHAFE TAPE

Your sail is expensive! Save it from an early grave with space age tape that affords ultimate protection to the batten pockets—where the shrouds eat through the cloth. Even covered shrouds don't postpone this for long! This remarkable material has up to 10 times the abrasion resistance of steel and yet this transparent tape will not hide your sail's colors or leave you with a gummy, unsightly residue that Duct tape and other tapes will. **Great for use on all full-battened sails!**

- 1492 H14/17 MAIN
- 1493 H18 MAIN 3



SAIL REPAIR TAPE

Don't get caught with your sails down! Extra strong, Rip Stop white tape for temporary on-the-spot repairs to torn sails, canvas, even foul weather gear. Keep a roll in your toolbox for emergencies.

- 1662 2" x 25' ROLL



SAIL REPAIR KIT

Takes care of emergency repairs to sails and trampolines. Kit includes 3 different weights of thread, 3 sizes of needles, and 6" x 6" white sail cloth.

- 1665 KIT



TECH TIP!

WIND INDICATORS: When sailing downwind, without a bridle fly, you can't gauge apparent wind direction without looking up and taking your attention off the action (boats crossing) on the water. The light weight indicators are most suitable in moderate and stronger wind conditions. Not severely affected by wave action, they work well tacking downwind. They are both durable and sensitive. The heavier Telo Cat is the most durable. It stands up to crashing waves sailing in rough conditions. A bridle fly is very effective when sailing off the wind, especially in light and moderate air, but will also give you indication of wind shifts on any point of sail.

CM7703

HOBIE BRIDLE FLIES

Durable Mylar wind vane with excellent light to moderate air response. Adjust your sails to the apparent wind angle. A must for best downwind sailing performance. Stainless steel mounting shaft. Quick removal for trailering.

- CM7703 STD BRIDLE VANE
- CM7704 REPLACEMENT VANE
- CM7705 HOBIE FURLER ADAPTER



CM7705



CM7704



TELO CAT WIND VANE

Tough molded plastic vane. Rugged heavy duty stainless steel shaft with Teflon bearings. Tacking arms can be set to desired vane angle for optimum performance setting. Easy removal—no tools required. Fits Hobie 14/16.

- 377 TELO CAT
- 378 VANE ONLY

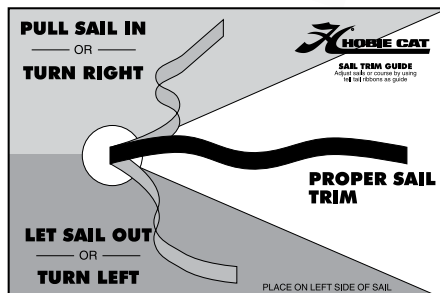
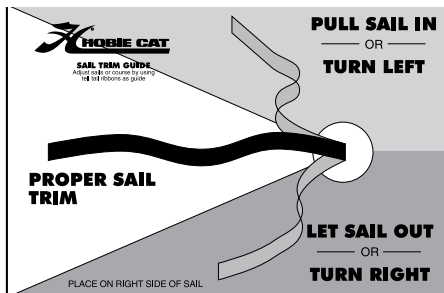

AIR-FLOW TELS

Trim your sails for optimum performance. Attached air flow over sails is critical. Air flow directions are indicated by these tell tails. Made of light weight rip stop nylon (Red / Green). Attaches to sails with waterproof adhesive disks.

- 334 SET OF 14



HOBIE TRAMPOLINES

All of our HOBIE trampolines are heat welded rather than stitched for the ultimate in longevity and easy maintenance. There is no potential of UV degradation of thread or loose thread unraveling an entire seam. This is a HOBIE exclusive, longer lasting by far!! All include halyard pocket. Note: Hobie Class Association racing requires the Hobie Cat factory supplied trampoline. **See parts Guides and parts list for trampolines & available color options.**



TRAMPOLINE DOUBLE GROMMET KIT

Hobie Cat doubled the number of grommets across the rear of the trampoline in 1983 to reduce stress and strengthen the trampoline. This kit includes 24 spur grommets and installation tools. Buy an additional 24 grommets to do the center lacing.

2061 COMPLETE KIT
2062 24 GROMMETS



HALYARD POCKET ON ALL TRAMPOLINES



TRAMP LACING KIT

Many sailors prefer lacing their trampoline with shock cord. This kit includes three pieces of 3/8" nylon covered black coated nylon shockcord and 12 clamping rings. Fits the H14, 16, and 18. Not shown.

2064 KIT

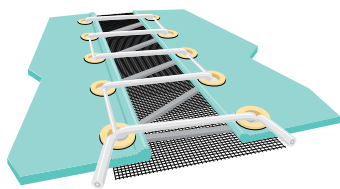

MAINSHEET OVERBOARD PREVENTER

This neat little piece of mesh laces into the existing tramp grommets, filling the center gap that the mainsheet is forever falling through. Existing lacing does not need to be undone. Kit includes line for lacing the preventer.

2067 66 INCHES

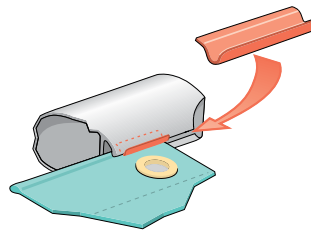

TRENTec™ TRAMP CLAMP™

Prevents trampoline from pulling out of aluminum extrusion. Increases trampoline life. Minimizes chafing of the trampoline at the critical stress points.

2066 SET



TRAMPOLINE DRINK HOLDER

You can add drink holders to your trampoline too! Requires a hole cut into the trampoline and stitching. Can be done by a sail loft or upholstery shop.

1125 Drink Holder

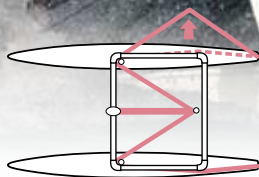
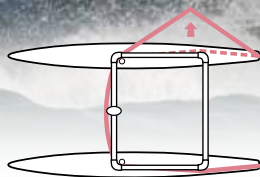

EASY RITE

Internal shock cord recoils this righting line automatically. Made from 1/2" hollow braid line with internal shockcord. It requires no blocks or shackles. Installs in minutes without tools. Also functions as crew safety line. Our best selling righting system.

- 30105 H14/16/17
- 30106 H18/21
- 30108 H20
- 30109 GETAWAY

EASY UP

Favored Hawaiian style righting line system and trapeze safety line. (H14/16 only.) Retracts fully—it's there when you need it and out of the way when you don't. No tools required to install.

- 30101 H14/16
- 30102 H18

RIGHTING BUCKET

Simple, easy to carry, and easy to use. Comes complete with no-rot canvas bucket, premeasured line, shoulder pad (not shown) and snap. The righting bucket holds as much as 150 pounds of water to assist your body weight to right your catamaran.

- 30107 KIT

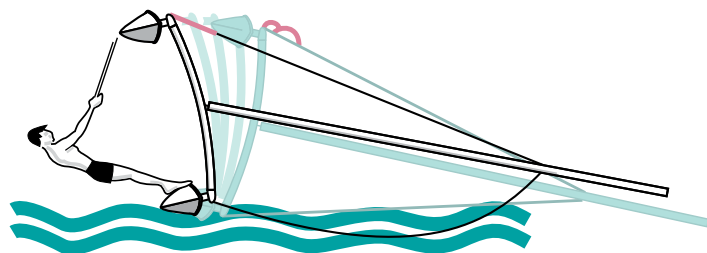

THE UPRIGHT SOLO RIGHTING SYSTEM

The Upright installs easily. No holes to drill, no measurements are needed. Attaches in five minutes to the existing shroud adjusters with a pair of pliers. Racing rules allow carrying the Upright for emergencies, but it may not be used while racing. The Upright is designed for a single reason, to make sailing your small catamaran safer.

- 1263 H16



ANTI PITCH POLE HYDRO FOIL

A simple bow plane that attaches to the bow tang bolt. As the bow starts to dive the bow plane's 55 square inches of surface comes in contact with the water and halts the submerging of the bow before the deck goes under water. Easy to install or remove for racing. Makes sailing a lot more fun for the recreational sailor.

- 30110 H14/16 PAIR



RESCUE STEP

"How do I get back in if I fall out?" The RescueStep features quick and easy installation and operation for vessel re-entry assistance, righting an overturned kayak and can also be used to tow or portage your kayak. Its compact size makes it easy to bring along anywhere you need it.

- 72020092 RESCUE STEP KAYAK
- 1266 RESCUE STEP BOAT

SHROUD EXTENDER

Tension and de-tension shrouds easily for the "perfect" rig tension. Use in conjunction with "shroud extending" righting systems for complete re-tensioning while out on the water. Requires shrouds be shortened. Check class rules for racing.

- 10049 EACH



TECH TIP!

RIGHTING YOUR HOBIE: On that reach...flying through the air and water then...WHAM!!! Your Hobie Cat has forced you to swim instead of sail. Not really what you had in mind? If you have planned ahead you will be up and sailing again quickly. Whether sailing single handed or with a few friends, righting your boat can be quick and easy...

First, preventing your mast from becoming one with the bottom, or "turtling" is a priority. We at Hobie have designed mast floats to help keep your Hobie Cat from becoming a 'mudhen'. The floats attach to the top of your mast and will prevent the mast tip from sinking.

The next objective will be to get back to sailing! Righting systems vary a bit, but the theory is the same. A line is attached to your Hobie, thrown over the hull in the air and then weight (yours and or your friends) is used to lever the boat back to an upright and sailable position.

After you have checked that everyone is OK, turn your hulls and mast into the wind (see diagram) and uncleat your sails. You and your friend now need to congregate on the hull that is in the water. Grab the righting line, lean away from the trampoline and get as close to the water as you can. Try to stay out of the water. If you don't have enough body weight to right the cat we have the Righting Bucket! Just attach it to the boat, with the hook that is provided, throw over the upper hull and fill the bucket with water! With the bucket strap over your shoulder, lean your weight out from the boat. The bag comes clear of the water and up the cat will come!! Grab the dolphin striker or crossbar as it comes up, climb aboard, sheet in and GO!

Tipping your Hobie over can be a great way to cool off and enjoy the water... try it! It's excellent practice for when you weren't planning to go for a swim but your Hobie decided that you needed to cool off!

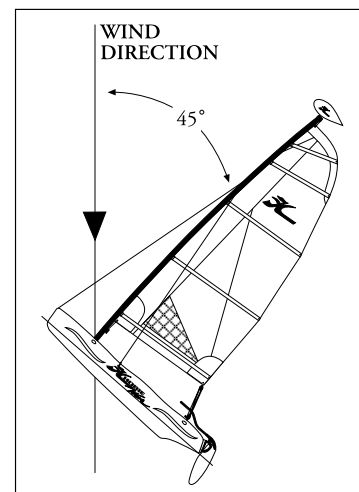

MAST FLOAT "BABY BOB"

(Standard on the Wave) Designed by the Hobie Cat team to offer the safety and security of mast head flotation while limiting the resistance (drag) through the air. If you capsize, the Hobie mast float can give you the time you need to prepare to right the boat without the worry of going turtle (mast straight down). This also helps prevent damage to your rig and sails that can be caused if the mast comes in contact with the bottom when capsized. Great for Hobie 14 and Hobie 16 as well as others with mast head castings capable of bolting in a similar fashion. It is fixed in position to the mast head and rotates with the mast. Displaces 32 pounds of water and measures 1/2 cubic foot in volume. Bracket mounting allows easy removal for racing or trailering. Kit includes mounting brackets and fasteners.
30115 WAVE, H14, H16



MAST FLOAT "MAMA BOB"

Offers more flotation volume while using the same bracket mounting system as the Baby Bob shown above. Displaces 59 pounds of water (just under 1 cubic foot in volume). Mama Bob has nearly the same vertical dimension as the Baby, but it is wider. More volume further inhibits a boat from going turtle when capsized in rough and windy conditions. This is standard on the Getaway due to both weight and trampoline area which pushes the mast downward with more wind force when capsized. Extra volume, extra safety margin! Kit includes mounting brackets and fasteners.
30119 GETAWAY



UNIVERSAL MAST FLOAT

"Mama Bob" float incorporating a universal attachment system to fit a wider variety of mast configurations. This is a shaft mounting system originally conceived for the Hobie 21 Sport Cruiser. Can attach to any mast. This streamlined float is shaft mounted to the side of any mast and is easily removed for racing or trailering. This float is contoured and held in alignment with the mast for minimum drag while sailing. Includes shaft mount hardware and fasteners.
30112 FITS ALL CATS

EPO3 RUDDER BLADES

This third generation rudder the EPO3 combines the original shape of the EPO2 rudder with an improved trailing edge. We developed the EPO3 rudder blade as the next generation performance rudder blade for the 14, 16, 17, 18 and 20. With this proven foil shape and a fine trailing edge, the EPO3 offers reduced cavitation with smoother, more forgiving control. The EPO3 rudder is stiff where it counts due to its hand laid fiberglass construction incorporating extra cloth for longitudinal stiffness. We have placed extra glass in all the right places to ensure that it is tough enough for the most demanding sailors using extreme mast rake. You will experience supreme performance and handling not found with other rudder blades. White EPO3: Gucci looks, stiff and light weight.

20490030 EPO3 RUDDER BLADE - EACH



DIE CAST GUDGEONS

Standard on current production Hobie 16s, these die cast aluminum gudgeons are now available for your Hobie 16, 17 or 18. Their one piece construction and plastic bushed pin holes guarantee pin hole alignment, reducing rudder pin wear, slop and drag.

50102011 H16 EACH

60102011 H17-18 EACH*

(*H18 Cast Gudgeon includes a rudder pin, cotter keys and washers.)



LOCKING GUDGEON SCREWS

No more re-tightening gudgeon screws. As of 1996, Hobie Cat changed gudgeon screws on all new boats to "long lock" screws. Similar to a Nylock Nut, this screw has a nylon insert almost the full length of the threads. The nylon insert screws into the aluminum transom plate and provides the same resistance to movement that the nylock nut does.

8030401 SCREWS, 12-24 LONG LOCK GUDGEON SCREWS

PACK OF 16

8030402 SCREW, 12-24 LONG LOCK 1EA

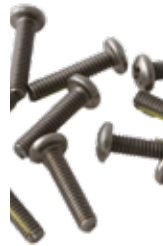

STAINLESS STEEL RUDDER PINS

Made from 3/8" stainless steel rod, these rudder pins are extremely durable. Sold Each.

20880011 H14,16 EACH

60880011 H18 EACH



FIBERGLASS RUDDER PINS

Durable, wear resistant fiberglass rudder pins won't corrode in salt water. 3/8" diameter provides tight fit and eliminates some of the slop due to worn out gudgeons. Sold in pairs.

5051 H14/16 PAIR

5052 H17/18 PAIR

STANDARD RUDDER PINS

Sold Each.

10881000 H14 NYLON

20880001 H14/16 ALUM

60880001 H17/18 ALUM

RUDDER CASTING BUSHING

Are you plagued by sloppy rudders? Do your nyliners keep slipping out? Open up the holes in your rudder castings to 7/16" and install these insulating, self lubricating nylon bushings.

8062001 SET OF FOUR



TECH TIP!

RUDDER RAKE

Excessive weather helm (when you must pull hard on the hiking stick to keep the boat from turning towards the wind) can be corrected by cocking the rudders farther (forward) under the boat. If you have too much lee helm (very little pull on the hiking stick, with the boat tending to turn away from the wind), this is corrected by unscrewing the adjustment and cocking the rudders back (aft). The amount of rudder rake needed depends on how far back the mast is raked and how much weight is being carried. The biggest problem with rudder adjustment is when a skipper changes the blade adjustment screw without reseating the cam plate in the upper casting. Even a very minor adjustment to the rudder could cause the cam to lock partially rotated, dramatically reducing the kick-up resistance. That means every time you make a blade rake adjustment, you must also reseat the plate AFTER you have finished adjusting the blade rake. There are three very important adjustments that should be made to the rudder assembly.



1. The rudder rake screw which adjusts blade angle.
2. The cam plate bolt which holds the blade forward.
3. The cam tension screw which adjusts kick-up tension.

When system adjustments are made improperly, the system won't work right. You must follow these steps in order!

1. Lift the rudder arm to unlock the assembly.
2. Using an allen wrench, adjust the rudder rake screw to give the desired rudder blade angle (rake).
3. Make sure that the blade is seated forward against the adjustment screw, loosen the cam plate bolt and lock down the assembly. Slide the plate back a little and then forward as far as it will go up into the cam. Retighten the bolt with a 1/2" socket.
4. Adjust the kick-up tension screw with a screw driver. You can calibrate the tension with a fish scale by making a loop of rope and putting it on the rudder blade about 24" down from the front bolt hole. Hook the scale to the loop and pull. Factory kick-up tension is set between 18-22 pounds.

STANDARD HIKING STICKS

See the part diagrams pages for the standard hiking stick to fit your model Hobie.

CARBON WILD CAT HIKING STICK

F99502360 EXTENDABLE

WAVE HIKING STICK KIT (EZ LOC RUDDERS ONLY)

Add a (tiller) hiking stick to your Hobie Wave! A tiller allows you to hike out or move your weight forward for better down wind speed. Standard tiller and hinge yoke included. For EZ LOC rudder system.

39550001 Wave Tiller Kit



HIKING STICK SOFT GRIP

This soft grip for your tiller extension eliminates "slippery stick". Twelve inches long, made of UV tolerant closed cell foam. Glues on.

3207 FX/Hot STICKS

3206 STANDARD TILLERS



THIRD HAND

This is the closest thing you can get to "self-steering" on a Hobie Cat. This handy little device grips the hiking stick, holding the tiller at whatever position you please. Great for light air sailing or when paddling in if the wind dies. It also keeps the rudders from flopping around when on the beach. Attaches at each end of the traveler track. For the Hobie 14 & 16 only.

204 PAIR

BALL LOCK PINS

Remove hiking stick from the cross bar for trailering or storage without the hassle of unwinding and dropping "ring-dings".

20303 ALUMINUM

20304 HOT STICKS



TILLER CONNECTOR (HOBIE MIRACLE 20 STYLE)

We've taken the tiller connection system for the Hobie 20 and adapted it to all of the Hobies. Now you can have the no slop, easy adjustment, 10 second assembly/disassembly convenience of the latest in tiller crossbar connection systems. There is no better tiller connection and adjustment available at any price! Now available in a version (1957) for Wave and Getaway (standard on newer boats / non-adjustable). Same easy release system.

1953 PAIR ALL BOATS

1957 PAIR WAVE/GTWY



RUDDER CAM KIT

Replace the rudder cam and flared pin with this kit that includes a pair of cams and a pair of binding post screws.

5202 H14/16

5204 WAVE, 17 and up (H18 '86 & up)



TILLER CONNECTION KIT

Complete tiller linkage replacement kit. The contoured spacers fit snugly against the tiller end caps and crossbar alignment end cap to eliminate linkage sloppiness without spending a fortune. Includes all required parts.

3052 PAIR



RUDDER CAM SISTERSCREWS

Replace your old flared pins with these reusable pins. No more riveting and drilling. These reusable binding post screws let you change rudder cams with the turn of a screwdriver. Sold by the pair.

5201 H14/16

5203 WAVE, 17 and up (H18 '86 & up)



RUDDER STIFFENING KIT

Beware of imitations! Features special high density polyurethane washers that will last and last. Highest quality components. These washers and stainless steel Nyloc nuts work great to give your rudders that tight fit. Eliminate wobble between rudder blade and upper casting. Don't settle for less—Get the ORIGINAL.

136 KIT



KICK BACK KIT

Returns rudders to locking position quickly and effortlessly. Really great when sailing in weed filled waters. Installs on the existing rudder bolts. Fits all Hobie 14's/16's. Class legal.

1544 KIT



JIB TRAVELER CARS

For the integrated track crossbar on the Hobie 16! Standard equipment as of late 2005. This jib traveler is constructed of Zytel.

Zytel is made of glass reinforced nylon which results in a very strong material. This resists fatigue and impact failure. Brass traveler bearings for easier

movement under load. Includes holes for anchoring traveler and traveler return lines. See H16 parts diagrams for replacement parts.

25232201 PORT

25232211 STBD



LO-PROFILE JIB BLOCK

For the Hobie 16 original SS Tracks. It is a basic swivel cam cleat with roller fairlead and Harken aluminum jaw cammatic, mounted on a stainless steel slide. It self aligns with the angle from which the sheet rope is being held for ease of cleating no matter where the crew is positioned. It's one piece, easy to install, light weight, low profile, interchangeable with left or right side and self aimed at the windward side of the boat. (Tracks vary slightly. May require preying open some tracks slightly)

1075 w/ CAMMATIC

1076 w/o CAMMATIC



LANCE CLEATS

The lance cleat utilizes a single rugged aluminum alloy cam mounted vertically in a black molded frame. Just slide the rope sideways and it runs freely in the fairlead, which has a colored roller incorporated in the top for easier sheeting and identification. Ideal for use in confined spaces. For use with 1/4" line. The base size is 1/16" x 15/16". Height is 7/8".

R359S STBD

R359P PORT

SWIVEL CAM CLEAT

Swivel cam cleats feature the Harken Cammatic Cleat. The Cammatic is matched with either the standard bullseye fairlead or the Roller Fairlead. The bullseye fairlead is available with either the plastic jaw Cammatic H365 or the aluminum H150. The roller fairlead is matched with the aluminum jaw H150 Cammatic only.

50007 EYE w/ H365

50009 EYE w/ H150

50013 ROLLERS w/ H150

TRETEC JIB TRAVELER CAR

Provides the super low profile needed with raked back masts. Slides in track easily. Can be used with bullet block shackled to sheet rope lead eye to reduce friction to a minimum. Requires preying open some tracks slightly.

1552 H16 PAIR FOR ORIGINAL SS TRACK



1071 Swivel cleat system

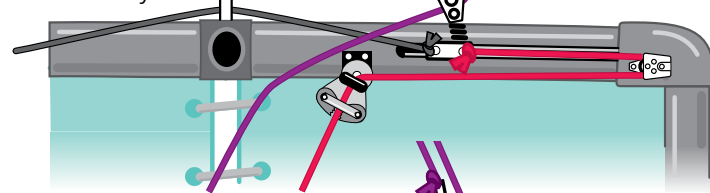

1073

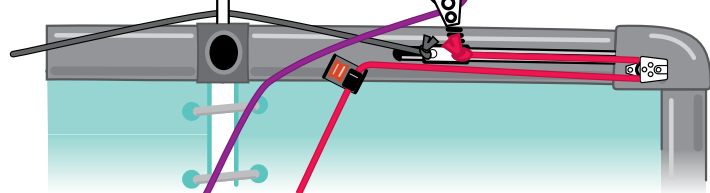

JIB TRAVELER TRIM KITS

These traveler adjustment systems can be used while out on the trapeze. They work with all of the jib cars available. They can both be set up to self return the cars inboard or outboard. Color coded trim lines and all hardware are included. The 1071 kit with swivel cam cleats allow cleating and uncleating from any position on the boat. Lance cleats in the 1073 kit limit the location from which trim lines can be cleated.

1071 KIT W/SWIVEL CAM CLEATS

B323 DEAD EYE



ROLLER FAIRLEAD KIT

Simple to install kit converts cleat arrangements that use "bullseye" fairleads to roller fairleads, reducing friction and line chafing. With all hardware. A screwdriver is the only tool needed. Accepts up to 1/2" line.

50012 KIT



SWIVEL CAM CLEAT

HOLT ALLEN SWIVEL

50017 EACH

11901010 PAD

SWIVEL CAM MOUNTING PLATE

Universal mounting plate for swivel cam cleats. High strength black Delrin® construction that is ultraviolet tolerant.

1161 w/o HARDWARE

1162 w/ HARDWARE





HARKEN CAMMATIC CLEAT

Rounded jaws assure quick cleating/release action and smoother teeth mean longer life for your sheets. Hardkote teflon impregnated die-cast aluminum cams and base with three rows of ball bearings provide a long lasting investment. Use with #50010 Adapter Plate for most change overs.

H150 CLEAT ALUM JAW

1/8" to 1/2" line

H365 CARBON MATRIX JAW

1/8" to 5/16" line

HSB56 REPLACEMENT SPRING

Fits 150/365

H471 MICRO CLEAT, CARBO JAW

1/8" to 1/4" line

Fairleads and eyestraps designed specifically for each Cammatic model, the wedges put the Cammatic on a 15 degree angle for ease of cleating or releasing. The fairleads are molded into a replacement base for each Cammatic. The eyestraps are designed to be held in place over the cams by the mounting screws.

WEDGE KITS

H145 (H150 & H365)

H297 (H471)

WIRE FAIRLEADS

H284 (H471)

EYESTRAPPS

H137 (H150 & H365)

H201 LOW (H150 & H365)

H281 (H471)



H2640



H194

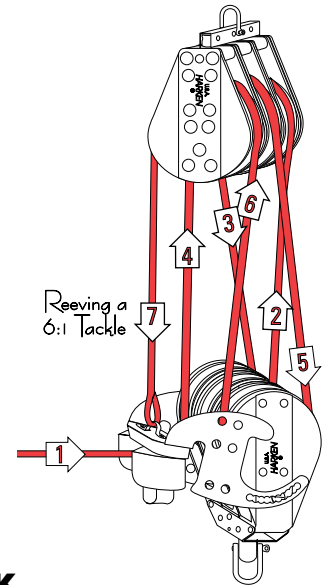

HARKEN 2 1/4" BLOCK LOW PROFILE 6:1

Successful racers have gone to super low profile systems on Hobie 16's (6:1) and 18's (7:1). This allows the sailors to achieve more mast rake for better pointing ability and reduced pitch pole tendency. They are using the Harken 2 1/4" ratchet block and boom blocks with 3/8" line. The lower block is customized to allow the post to enter the traveler car hinge plate on the Hobie 16. To convert to 7:1, H18 sailors add a mini-block to the eye that's normally used to tie off to and then tie the line off on an empty boom bail.

New Hobie 16s come with H194

Lower ratchet and H2640 Carbo upper.

H2640* UPR 40mm CARBO

H194* LWR 2.25" BLOCK

*use 3/8" sheet rope for smooth flow of line through blocks.

H125 MINI BLOCK (to 7:1)

Note: add 8' to sheet rope length when converting to 7:1 system.



ADAPTER PLATE

Universal mounting plate that allows you to add the Cammatic Cleat to nearly any cleating system now in use. Includes mounting hardware.

50010 KIT

TECH TIP!

BOAT CHECK LIST

There are a number of items to check on your boat. Do this on a regular basis and before sailing for the first time each season. Here are a few of the basics...

STANDING RIGGING (wires)

Check for broken strands. Inspect and slightly bend at all fittings to find broken strands (replace if needed). Check all clevis pins and keepers.

HARDWARE

Check for bent or damaged shackles and other components.

LINES

Check for wear.

HULLS

Check for leaks and possible structural problems. Delamination of the hull structure could lead to major failure.

MAST

Check mast and all aluminum spars for corrosion and other damage. Corrosion can cause structural failure.

RUDDERS

Check the cam lock-down system. This should be free of dirt and sand. Grease regularly to allow free rotation motion.

DRAIN PLUGS!

Need we say more.

TRAVELER TAMER™

Travel Tamer™ replaces the plastic sheaves on the traveler car with larger, ball bearing rollers to reduce friction.

50014 TAMER



HOBIE CLUB WAVE MAIN TRAVELER KIT

Upgrade any Wave Club model to have a main traveler system. The addition of a main sail traveler will offer better sail control in higher winds and down wind sailing angles. Helps to limit heeling in higher winds while optimizing speed potential. Also reduces loads on the bows, therefore reducing the amount of dive or pitch pole potential. Go faster with better control! Kit includes deep profile traveler track, rivets, #111 brass wheel traveler car, swivel cleat, mount and instructions.

39250000 CLUB WAVE MAIN TRAVELER KIT





HARKEN MICRO BLOCKS

Small blocks with high load capabilities, but light weight. Accepts up to 1/4" line, 1200 pound load, 7/8" diameter sheave.

- H224** SINGLE
- H225** SINGLE w/ BECKET
- H226** DOUBLE
- H227** DOUBLE w/ BECKET
- H228** TRIPLE
- H231** *TRIPLE w/ BECKET & CAM
- H232** TRAVELER (*not shown)
- H233** CHEEK
- H244** FIDDLE MICRO

HARKEN BULLET BLOCKS

Medium size blocks that work well for control line or jib sheeting lines. Accepts up to 5/16" line, 2000 pound load, 1 1/8" diameter sheave.

- H082** SINGLE
- H083** SINGLE w/ BECKET
- H084** DOUBLE
- H092** CHEEK
- H166** SINGLE w/ SWIVEL
- H167** SINGLE w/ SWIVEL & BECKET
- H353** TRAVELER



HARKEN 16MM AIR BLOCKS

Harken's newest small blocks for control lines. Accepts up to 7/32" line, 900 pound load, 5/8" sheave diameter. Ultra light weight.

- H404** SINGLE
- H406** DOUBLE
- H407** DOUBLE W/BCKT

AUTO RATCHET BLOCK

BY RONSTAN

Perfect for spinnaker sheet turning blocks. This Ronstan block is free wheeling at low wind velocity. As the wind velocity increases the pressure on the sheave automatically engages the ratchet. The sheet rope is never trapped in the sheave and can slide out the same as any other ratchet block without first pulling in and then releasing. 55mm sheave.

RF56100 AUTO RATCHET

HARKEN BIG BULLET BLOCKS AND DINGHY BLOCKS

Big blocks accept up to 3/8" line, 2000 pound load, 1 1/2" sheave.

- H125** SINGLE
- H126** SINGLE W/BECKET

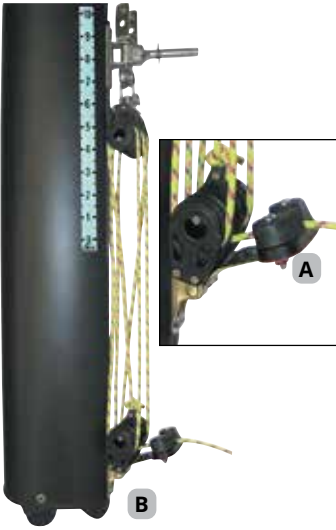

A 6:1 DOWNHAUL KIT

Downhaul system for Hobie 14 and 16. Now Class Legal. Kit comes complete with Harken carbo triple block and triple with cleat. Includes class approved attachment for base of mast, all hardware and line. Use with the gooseneck slide kit # 1511. **2089 6:1 KIT**

B DOWNHAUL SCALE

Can you ever remember where the downhaul was set that day you "smoked" everyone. This handy stick on scale takes the guess work out of setting the downhaul. **2082 EACH**

POWER PAK

6:1 Downhaul , 2:1 Outhaul systems for Hobie 14 and 16. Rotation control for H14. Jib halyard upgrade for H16. **2090 H14 POWER PAK**

2091 H16 POWER PAK



DOWNHAUL/HALYARD SHEAVE

Ease raising the sail and/or adjusting the downhaul with Harken ball bearing sheaves. They really make the job a whole lot easier. A direct replacement for the sheaves that came with the early Hobie 17's. **H160 EACH**

H228



H231



HARKEN TRIPLE W/BECKET & CAMMATIC

Perfect for H16 or H17 downhaul. **H231 EACH**
H228 EACH

EYE STRAP FOR BOOM VANG

Heavy duty eye strap for connecting boom vang at the mast base rather than at the trampoline slot in the cross bar. **2072 w/ FASTENERS**



TRENTEC SUPER GOOSE

Adds convenience and security of attachment at the boom to mast connection. Replace the vertex that connects the boom pin to the gooseneck yoke assembly on the mast. Custom made for the Hobie 18, machined from a block of 6061-T6 aluminum and hard coat anodized. Will not bend and open up no matter how strong the wind. Go a step further and permanently secure the clevis pin that connects that Super Goose to the boom pin with a cotter key. Replace the nut and bolt connecting the vertex to the mast yoke with a 20304 ball lock pin. **1510 EACH**



GOOSENECK BEARING

Eliminates drag and prevents gouging the gooseneck slide on Hobie 14, Hobie One-14 (Holder) Monohull and Hobie 16 luff track. Delivers a fantastic improvement in downhaul adjustability! **1511 KIT**



HALYARD GRIP

Keeps those halyards close in to the mast and out of the way so that the jib doesn't hang up on them. Molded from strong Delrin and contoured to the curve of the mast. One on each side of the H16 mast does the trick. **114 EACH w/ HARDWARE**



HOBIE 16 "AUSSIE" JIB HALYARD

Reduces mast compression which allows easier tacking, better mast rotation and consistent mast bend! Complete kit includes hardware, 70' (Dyneema® or equivalent) halyard line, zippered pouch, and instructions. Racing class legal. **80660000 KIT**

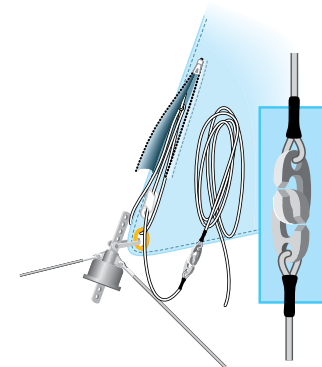

L'IL SISTER CLIPS

The answer to "What to do with all the jib halyard?" L'il Sister Clip speeds the untie and retie of your H18 jib halyard. Includes both segments of jib halyard. **CM7732 SET**



HOBIE "AUSSIE" HALYARD RING

The Aussie Halyard Ring makes engaging and disengaging the halyard ring from the halyard hook a real snap. This device helps to keep the ring aligned with the hook. Welded one piece design has a clevis pin that is drilled, so a clevis ring can be added to keep it locked to the sail. **3064 EACH**



BOW SHACKLE - THREADED PIN

Part #	Pin Dia.	Width	Length	Max Ld#
SP150061	1/4"	9/16"	15/16"	4400



"D" SHACKLES - THREADED PIN

Part #	Pin Dia.	Width	Length	Max Ld#
SP150041	5/32"	3/8"	5/8"	1100
SP150051	3/16"	1/2"	11/16"	2640
SP150052	3/16"	5/8"	15/16"	2640



SAFETY SHACKLE WITH 1/2 TURN CAPTIVE PIN

Part #	Pin Dia.	Width	Length	Max Ld#
SP185205	3/16"	1/2"	1"	2640
SP180005	3/16"	5/8"	1 7/16"	2640
SP180006	1/4"	7/8"	1 5/8"	4400



SWIVEL SHACKLE

Complete with clevis & split rings. Align blocks, Fittings, etc. B-094 is extra heavy duty.

Part # Pin Dia. Width Length Max Ld#

B094 1/4" 1/2" 11/2" 1000



FAST SHACKLE

The Fast Shackle was created for the jib clew blocks on the Hobie 16 & 18. It's a halyard shackle and an Avibank ball lock pin permanently wired to the shackle so it won't drop in the drink when the blocks are released from the jib clew.

3062 EACH



SNAP SHACKLE

Makes it easy to remove expensive mainsheet systems from your boat when it's parked on the beach or for ease of take down and set up for trailering.

20803 EACH



SPARE PARTS - ALL PACKAGED IN 12" ZIPPERED POUCHES

	Wave/Get	H16	H17
Shackle tool	•	•	•
2 Drain plugs w/gskts	•	•	•
Pair of rudder pins		•	•
Clevis pin set	•	•	•
3/16" Bow shackle	•	•	
1/4" Bow shackle	•	•	•
Mast bearing(s)		•	
3 Batten tie lines	•	•	•
1 Ft. sail repair tape	•	•	•
Part #: 303-	08	06	14



CONVENIENCE PARTS

	H16
QR Pin for forestay adjuster	•
Fast shackle or jib tack shackle	•
Quick release pin for main traveler car	•
Quick release pin for hiking stick	•
Shockcord hooks(4) for trapeze shock cord	•
Quick release pin for outhaul	•
Quick release pin for boom to mast	•
Safety pins for rudder pins	•
Part number: 303-	11



CLEVIS PIN ASSORTMENTS

For Hobie Wave, Getaway, 16 and late model 14. Kit contains appropriate 1/4" clevis pins, 3/16" clevis pin for traveler car, 1/4" clevis pin for mast step link. Split rings are included.

30303 H16/14 SET

30302 WAVE/GETAWAY SET



KEEPER PINS

Great little helpers for quick rudder removal. Forget the aggravation of straightening those cotter pins! A definite plus for trailering. Stainless Steel.

20501 5/16" DIAMETER

20502 3/8" DIAMETER

20503 SAFETY PIN



BALL LOCK PINS

BALL LOCK PINS

Take the hassle out of rigging and de-rigging your boat. Replace 3/16" and 1/4" clevis pins that use ring dings with easy-to-use push button pins. These "quick pins" are usable in a variety of places on your boat and will not work free by themselves. Use them anywhere a clevis pin can be used! Caution is advised when using these for standing rigging as some inspection or maintenance of the ball lock system may be required to avoid a de-masting.

	FSTAY SHRDS	HIKING STICK	OUTHAUL	GOOSE-NECK	TRAVELER CAR	JIB TACK
20301 3/16"x3/4" Cup Head					14,16,17	
20302 1/4"x3/4" Cup Head	•		18,21			
20303 1/4"x1 1/4" Ring Hd		Std				
20304 1/4"x1" Ring Head				•		
20305 1/4"x1" Cup Head				•		
20306 #20305 w/Tack shackle & lanyard			20		18,20,21	•
20307 1/4"x1 1/2" Cup Head		Extendables				
20311 3/16"x3/4" Ring Head	Old H14			•	14,16,17	
20312 1/4"x3/4" Ring Head	•					
20313 3/16"x1/2" Ring Head					14,16,17	
20314 1/4"x1/2" Ring Head	•					
20310 8" X 1/16" Wire Keeper with NicoPress Sleeves						



SUPER LOW STRETCH LINE

For Halyards, Trapeze adjustment and trampoline laces. Pre-stretched polyester line with superior fatigue and abrasion resistance. Our line (3/16"-3/8") tested as the lowest stretch (.5%) of any all polyester line available. Sold per foot.

- RH112WHT** 1/12" WHITE
- RH018WHT** 1/8" WHITE
- RH316WHT** 3/16" WHITE
- RH014WHT** 1/4" WHITE
- RH516WHT** 5/16" WHITE
- RH038WHT** 3/8" WHITE



SPUN DACRON

Best for sheets. Soft matte finish rope. Runs well thru blocks and fairleads, has good abrasion resistance, is spliceable and easy to hold with wet hands. Available in white, black, red, blue. This rope is not designed for winching. Sold per foot. Specify color choice.

(White, Blue, Red or Black xxx = color)

- RM014WHT** 1/4" WHITE
- RM014XXX** 1/4" COLOR
- RM516WHT** 5/16" WHITE
- RM516XXX** 5/16" COLOR
- RM038WHT** 3/8" WHITE
- RM038XXX** 3/8" COLOR
- RM716WHT** 7/16" WHITE
- RM716XXX** 7/16" COLOR

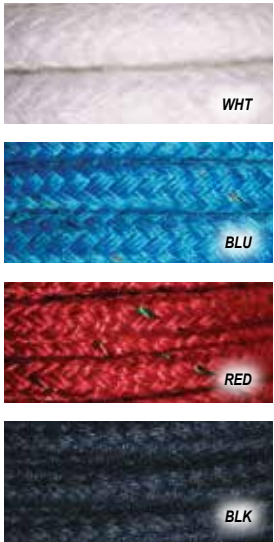

SUPER STRETCH SHOCKCORD

This midnight-black shockcord has double the stretch of ordinary cord. If you've been getting your shockcord from the hardware store, you're in for a treat. The durable black cover is woven around an extra-flexible rubber core.

- RS018BLK** 1/8"
- RS316BLK** 3/16"
- RS014BLK** 1/4"
- RS516BLK** 5/16"
- RS038BLK** 3/8"
- RS716BLK** 7/16"



LIROS MAGIC LINE

The ultimate racing sheet and multi-purpose rope. Stock lines on the Current Hobie 16:

- RLH4BYB** LINE 4MM MAGIC GOLD BLK/YEL/BL Tramp Lace Line CTR 10m / 32.8', AFT 4.5m / 14.76' X2
- RLH5BLU** LINE 5MM HERCULES COLOUR BLUE Main Halyard Line (Non-Comptip) 11m / 36.09'
- RLH5RYB** LINE 5MM MAGIC GOLD RED/YEL/BL Traveler Line 4m / 13.12' X2
- RLH5YEL** LINE 5MM MAGIC D PRO YELLOW Jib Halyard (Aussie) Line 21m / 69.9'
- RLH5YRB** LINE 5MM MAGIC GOLD YEL/RED/BL Trapeze Adjuster Line 1.1m / 3.6' X4
- RLM10YEL** LINE 10MM NAUTIC YELLOW Righting Line 5m / 16.0'
- RLM7OW** LINE 7MM MAGIC SHEET ORG/WHT F Jib Sheet Line 10m / 32.81'
- RLM9SW** LINE 9MM MAGIC SHEET SILV/WHT Mainsheet Line 11m / 36.09'
- RLS4BLK** SHOCKCORD 4MM BLACK Jib Traveler Shock Cord .8m / 2.62' X2
- RLS5BLK** SHOCKCORD 5MM BLACK Trapeze Shock Cord 2.1m / 6.8' X2

AMSTEEL

High modulus Polyethylene (aka SK75 Dyneema) 12 strand single braid and is urethane coated for maximum performance. Used for H16 Aussie Halyard. Its tolerance to abrasion is excellent and it is resistant to degradation from ultra violet. This line will also float and has zero water uptake. Color may vary.

8004951 AMSTEEL



ONE WRAP VELCRO®

Cut this double faced Velcro® product to length and wrap it around items, line or whatever you need to secure. One side is hook and the other a loop, so a single piece is all you need.

7904 One Wrap, per foot



SHOCKCORD SNAP HOOKS

Easy to install shockcord snap hook. No tools required. Reusable!

- 2101** HOOK-1/4"
- 2102** HOOK-5/16"





HOBIE TWIST AND SEAL HATCHES

Lids hinge open, so you never lose the lid. A simple twist of the handle opens or closes the hatch. The hatch does not have to be held down against a flat surface to seal. This allows the hatch to seal even if the lid is partially open or tipped. Available in 6" and 8" diameters. * Kits include gaskets and screws (8031131).

- 71701001 6" TWIST AND SEAL KIT *
- 71701011 6" TWIST AND SEAL HATCH
- 71321001 6" MOUNT GASKET
- 71701021 6" TWIST AND SEAL O RING

- 71702001 8" TWIST AND SEAL KIT *
- 71702011 8" TWIST AND SEAL HATCH
- 71331001 8" MOUNT GASKET
- 71702021 8" TWIST AND SEAL O RING

HOBIE SMALL ROLL TOP DRY BAG

8" diameter x 14". This dry bag is built of tough materials. Seals tight to keep your stuff dry.
71703001 8" HOBIE DRY BAG



VIEW DRY BAG

Transparent 13 oz. vinyl bags make quick work of locating things. Its cylindrical shape will hold various shapes such as clothing, cameras, binoculars, lunches, etc. without distortion of bag and resultant potential leakage. Air purge vent.
72210L VIEW VENTED (10L)



72230L VIEW VENTED (30L)



HOBIE RECTANGULAR TWIST AND SEAL HATCH KIT

The Horizontal hatch is stiff and strong as designed for standing-on. Unique Hobie designed seal and flange lip drainage keeps water out. Add the optional tackle management tray that deploys two tackle boxes as you open the hatch or the drop-in hatch bucket for versatile small parts storage (both shown below). Includes backing ring. The kit includes the Hatch, gasket, backing ring, screws and instructions.

71707003 HOBIE RECTANGULAR HATCH KIT



HOBIE RECTANGULAR HATCH ACCESSORIES

Add a drop-in "storage box" to your Hobie rectangular hatch or tackle management tray that deploys two tackle boxes as you open the hatch.

- 71709002 HOBIE RECTANGULAR BUCKET
- 71708001 HOBIE TACKLE MANAGEMENT

GUSSETED STOW BAG

Our 6" by 12" gusseted tramp bag rises to the occasion. It has hooks on both ends to clip to your boat and carries the Hobie logo. Also available in 8" x 15" size. Securely stow tool, gloves or small parts for easy access on board your boat.

- 72000B 6"x12" GUSSETED TRAMP BAG
- 72005B 8"x15" GUSSETED TRAMP BAG



TRAMPOLINE STORAGE BAG

The Trampoline Storage Bag is designed to store loose items you want to carry on your catamaran. Low profile to eliminate line hang-ups. Designed to attach between the hiking straps. One compartment (18' x 36"). Includes a clear plastic map pocket. (Built of tough Cordura fabric, not waterproof.)

3128 WITH MAP POCKET



ROLLING DUFFLE/GEARBAG

Back by popular demand. Great travel bag. High volume allows you to bring it all!

80000R ROLLING DUFFLE/GEARBAG



HOBIE-TRAILEX ALUMINUM TRAILERS

TRAILERS

Anodized aluminum trailers by Trailex, custom designed for Hobie. The best trailers for light weight and long, low maintenance, life.

Getaway / H16 / Tiger trailer (Pictured here) is shown with optional double rollers. Includes forward mast stand. Rollers or cradle attachment hardware is optional. Double roller kit is recommended for Getaway, H16 and similar cats. Cradle attachment kit is recommended for Tiger or other cats to 18' using cradles. Order roller kit, cradle attachment kit and cradles separately. An optional rear mast stand is also shown.

Wave / Bravo trailer has single rollers and carpeted bunk guide pads for the hulls to rest on, does not include a forward mast stand (Optional, order separately).

38653000

TRAILER HOBIE GETAWAY / H16 TIGER / WILD CAT

(Shown with options: rollers, pads and rear mast stand)

38651200

Rear Mast Stand
Optional

NOTE: Loads may require a red warning flag if over hanging lites by over 4 feet.

1 7/8" Coupler

38651000 HOBIE-TRAILEX Trailer WAVE / BRAVO

38651100 FORWARD MAST STAND

38653000 HOBIE-TRAILEX Trailer GETWY, 16, TIGER, WC

38653100 HOBIE-TRAILEX DOUBLE ROLLER KIT

38651200 REAR MAST STAND

Trailer prices DO NOT include freight to dealer or assembly costs.

HULL CRADLES

For hulls, cradles distribute the loads over a larger area of the hull to reduce stresses while trailering or using Cat Trax. (Includes installation hardware to mount the cradles to a 2" diameter tube or roller).

1624 UNIVERSAL SHAPE - pair



38653200 HOBIE-TRAILEX CRADLE ATTACHMENT KIT is required to adapt the Trailex trailer to 2" diameter rollers (4) which enables 1624 cradle attachment / use. For use with 2 sets of 1624 (4) cradles.



HOBIE TIE DOWN STRAPS

Rack tie-down straps, made of durable black polypropylene webbing. Diagonal cut and ironed ends make threading ends into buckles easier.

72042001 TIE DOWNS 12' (Pair)

72043001 TIE DOWNS 15' (Pair)



MK0046 HOBIE CAUTION FLAG



SAIL STORAGE BOX "TOY BOX"

The original Toy Box! Made by roto-molding as one seamless piece with molded-in graphics. Big enough to hold two sets of Hobie sails, booms, daggerboards, rudders and have room left for odds and ends. The bottom is ribbed to allow wet things to drain. There is full access from front and back, even with the boat on the trailer. Mounting hardware is not included. This storage box doesn't care if you sit on it, fill it full of rocks and drop it from 10' or however else you brutalize it. It's tough. Length 10' 4", Width (rear) 21", Depth (rear) 13", Width (front) 19 1/2", Depth (front) 10", Weight 55 lb

Prices DO NOT include freight to dealer.

1825WHT ONE PIECE SAIL BOX



TIE DOWN STRAPS

This outstanding four strap system features patented over center cam action locking buckles coupled with super-strong 2000 lb. test web straps and hooks. The tie downs secure your boat to any trailer in seconds. Full 1 year warranty on all parts. Custom Tie Downs come complete with all mounting hardware and instructions.

1793 H14/16



"ACROSS THE HULLS" TIE DOWNS

One piece tie downs with hooks (and retainers) at each end and paddle handle buckle for easy adjustment. Each tie down is 2" wide by 13' long.

1795 EACH



SHOCKCORD BALL TIES

Lashing the wires to your mast for trailering is quick and easy with this handy tie-down. Use a couple to keep your jib furled on the beach and your sails rolled in the bag. Dozens of other uses.

370 EACH



HOBIE MAST CRADLE

Molded to the shape of the rear cross bar and carpeted to protect the mast and cross bar. Includes a simple single shock cord tie down that secures the cradle to the cross bar and the mast to the cradle. Mast Cradle for Hobie Wave, Getaway, 14, 16, 17, 20 & 21SC

3175

HOBIE MAST STEPPER

This system has a gin pole that rests on a foot attached to the trailer. The mast is stabilized by tying a trap wire on each side to the front cross bar. Attach the trailer's winch (not provided) to the forestay and hoist away. Utilizes bridles to stabilize the gin pole while hoisting the mast.

3152 MAST STEPPER

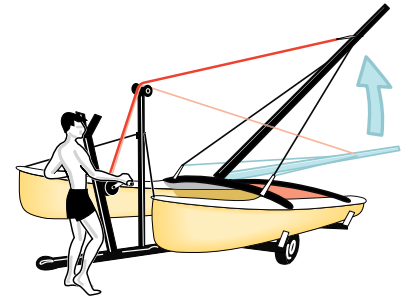

MAST STEPPER II

Easy to install because it eliminates the trailer mounted gin pole. However, the Mast Stepper II system does require that the trailer's forward mast support be 30" taller than the mast step. The mast is stabilized by tying a trap wire on each side to the front cross bar. The kit includes all necessary lines, shackles, blocks and instructions. Purchase winch separately.

3155 MAST STEPPER II

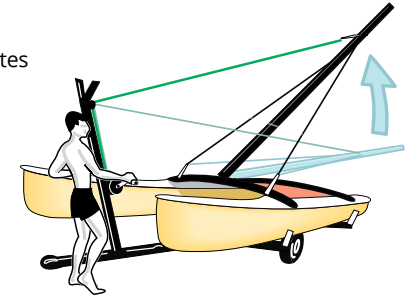

HOBIE MAST STEPPER III

Specifically designed for the Hobie Getaway due to the rotated mast position when stepping. Step your mast with ease and safety. Specially designed bracket attaches to mast at base. A pole plugs into the bracket to create a gin pole arrangement that allows you to singlehandedly raise and lower your mast. It uses the trailer's winch (not provided) for power. Lines snap in place to eliminate side-to-side sway. Attaches quickly without tools. No modifications to boat. Can adjust to fit other rotated-position stepping masts. May also be modified to work on Hobie 17, Tiger and 20 (no instructions are provided for this modification).

3156 HOBIE MAST STEPPER III

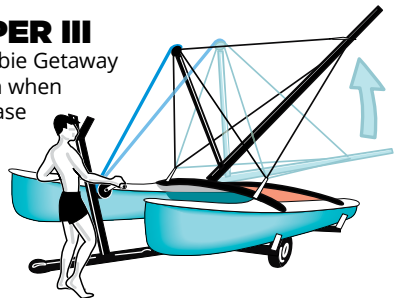

TECH TIP!

Mast Stepping: Usually a two person job. For those days you need help, want to single hand or be able to rig the boat alone for any reason, a mast stepping aid is what you need. The primary function of a mast stepping aid is to raise the mast while restraining side movement induced by a cross wind. Often it is more difficult to handle the side motion than it is to raise the mast. It's the side motion that breaks or bends the hinges and/or mast base castings.

NOTE: ADDITIONAL FREIGHT CHARGE ITEMS

Carts and Trax items shown on this page incur additional freight charges.



CAT TRAX

CAT TRAX Cat Trax is the dolly for moving catamarans over sand, mud, rocks, or any surface. Lightweight and rustproof. Fast and simple tiedown attachment. Your cat rolls effortlessly on smooth running low friction Delrin® bearings. Jumbo 11" x 21" balloon tires disperse weight, don't dig in on soft surfaces. Tough padded end-caps hold the boat in line. Cradles not included except as noted.

- 1630 WAVE - 7' BEAM (Includes Axel pad and end caps)
- 1621 CATS TO 8' BEAM (Includes Axel pad and end caps)
- 1622 HOBIE 20/21SC (8'6" beam / Requires added cradles) (H20 add cradles #48010001, All others add cradles #1624)



H16 Dolly

DOLLY This dolly includes a handle so you can easily slide the cart under the boat and push or pull along holding the handle. Box tube aluminum frame and air inflated tires. Frame has dual contact points / crossbars, so hull is balanced on the cart. (Wheels: *Two / **Four)

- 90870000 BRAVO DOLLY *
- 39870000 WAVE DOLLY *
- 70000111 H16 DOLLY **



TRAX

BLUE TRAX The "hard wheeled" version of the all time favorite catamaran beach dolly. Wheels that never need air so they won't go flat. Features the same needle bearings as the Cat Trax. Light weight.

- 1626 BLUE TRAX (8' BEAM)
- 1625 BLUE WAVE TRAX (7' BEAM)



HULL CRADLES-BEACH DOLLY

Cradles distribute the boat load over 400 sq. in. of the hull to assure there are no excess stresses while carrying. Fits all popular beach dollies.

- 1624 UNIVERSAL PAIR



TRAX "T" HANDLE

TRAX ACCESSORIES

- 1623 T HANDLE - ATTACH TO AXLE (SHOWN ABOVE)
- 1620 END CAP-EACH
- 1635 REPLACEMENT CAT TRAX WHEEL ASSY
- 1636 REPLACEMENT BLUE TRAX WHEEL ASSY

TECH TIP!

Boat Covers: Boat covers are designed to protect your boat from UV degradation and dirt. Universal storage covers are one piece and designed for easy installation. They fulfill their purpose mast up (with minor modification) or mast down, on the beach or on the trailer. The fabric is woven polyethylene that is film coated on both sides to cover the woven fabric. It has fantastic tear resistance and is specifically designed for outside use. UV tolerance is one of its major attributes.



UNIVERSAL COVERS Designed to fit a variety of boat lengths, cut into general catamaran shape. It's made of tough woven polyethylene that is coated on both sides, one side silver, one side white. We've chosen this polyethylene because of its excellent resistance to ultra-violet degradation. It is a woven rather than sheet fabric to provide great tear strength. These covers will tolerate sun, wind, rain, high and low temperatures. Install with silver side out.

Each cover is cut to be used for a boat length range. Tapes are sewn in place to allow you to secure the cover around the hulls and crossbars. Custom features such as cut outs or slits for wires or wings can be created with scissors. We include 5 feet of adhesive backed velcro with each kit to be used to prevent openings from flapping in the breeze.

These covers are not designed to be used while trailering.

- 314-13ALL HOBIE WAVE
- 314-14TO17 14' TO 16'8" RANGE
- 314-16-GTWY2 GETAWAY >=2017 / UNIVERSAL
- 314-17TO18 17' TO 18' RANGE
- 314-19TO20 H20

DELUXE HOBIE SAIL BAG

Stop fighting with your sail and boom cover. This sail and boom bag zips full length for ease and convenience and will fit any Hobie sail and boom. Full ventilation on each end with vinyl coated mesh. Added convenience with a separate compartment for line and blocks. Made with nylon Cordura®, includes double shoulder straps for maximum ease while carrying. Ends unzip to extend for extra long parts (Color may vary).

3121 DELUXE SAIL BAG



STANDARD SAIL AND BOOM BAG

Pulls over boom and sail like a sock. Open end closes with a drawstring and nylon clasp. Material and color may vary.

21310000 STD 9' 5"

38990050 WAVE



RUDDER COVERS

For your Hobie Cat. Excellent quality. Fastex fasteners keep the rudder covers firmly in place, even when trailering. Protects your rudders from nicks and grime. Sold in Pairs. Style and color may vary.

82420000 ALL BUT 21SE



WILD CAT RUDDER COVERS

Protect those boards! This is an absolute must for the racer.

F99268010 WILD CAT RUDDER COVERS (PAIR)



DAGGERBOARD COVER TIGER/FOX/FXONE

Protect those daggerboards! This two pocket, woven polyethylene lined cover is padded and has a tough, Cordura (600 denier) outer material. It has carrying handles and velcro closures. Very important for preventing dings, gouges, and scrapes while storing and trailering. This is an absolute must for the racer. Room for two daggerboards. Style and color may vary.

72410001 TIGER/FOX/FXONE

SNORKEL JIB COVER

Protect your roller-furled jib from attack by ultraviolet light and the weather. Easy to install and remove—the Snorkel is a must for protecting your expensive sail from eventual destruction by the elements. The Snorkel is a zip-on cover for roller-furled jibs. Made from durable fabric with a full length zipper. Snorkel covers are not intended for long term storage. Jibs must be furled tightly, have luff tension and be secure for windy conditions. Loose jibs and cover may cause chafing damage to sail.



1811 H18/H16/Sport/21S

1812 H14 TURBO/H1-14

1813 H20/H21SE/H18SX

1815 GETAWAY

TECH TIP!

Covers: Protect sails and hardware from sun and abrasion damage. Perhaps the greatest enemy of many modern fabrics is the sun's ultra violet radiation. It deteriorates nylon unless it's specially treated and it attacks dacron sail cloth and weakens it. Fortunately, nylon can be treated to make it UV tolerant and acrylic fabrics exhibit seemingly endless resistance to UV radiation. These sail bags and sail covers can be used to protect your dacron sails from UV radiation damage.

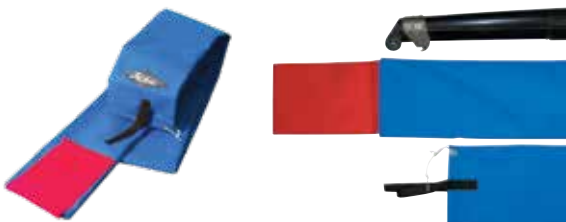

COMPTIP COVER

Hobie Cat recommends that the Comptip portion of the mast be covered to protect it from ultraviolet rays. Our cover is made of UV resistance treated nylon. Ties on to the mast with line that is provided. Fits all Hobie Cats. Will not work with mast floats installed. Royal blue.

3125 COVER- H16/18/20

3127 COVER-H17/21

STICKERS



- 13001001 HOBIE "FLYING H" BLACK 12 5/8"
- 36601000 HOBIE "FLYING H" BLACK 6"
- 36601011 HOBIE "FLYING H" WHITE 6"



- 12451050 "SCRIPT" BLACK 24"
- 12451051 "SCRIPT" WHITE 24"



- 12453031 HOBIE "TEQ SUNRISE" DOME 4 1/2"



- 79545001 HOBIE "H" DOME 2 1/4"



- 12453023 HOBIE CHROME BLACK



- 12453026 HOBIE SAILING ASSORTED COLORS

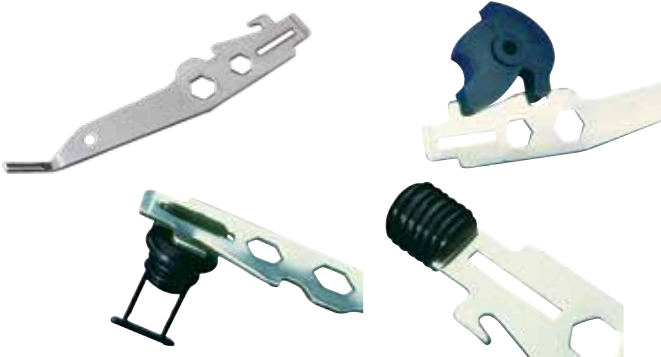

SAILORS' ALL PURPOSE TOOL
Handles screws, bolts, and shackles. Wide blade fits up into Hobie Cat's lower rudder castings for adjusting cam spring tension. Narrow blade fits the rudder stop screw and its built in hook is designed specifically to return locked "down" rudder cams to the "up" position with the twist of the wrist.
83103 EACH

EASY RIG Great little temporary handle for halyards, outhauls, downhauls and trampoline tightening. Lay the line in the slot and pull. The line seats in the easy rig handle and provides a handle for tensioning the system. Also available in aluminum from Clamcleat as "Tug Cleat"

- 2065 UP TO 3/16" LINE
- 2069 1/4" to 1/2"
- 2070 TUG CLEAT 1/8"-1/4"



WIRE CUTTER

Do it yourself. Precision designed triangular jaws close and cut. No uneven ends.
83105 EACH

STAINLESS STEEL POCKET KNIFE

DELUXE - Marlin spike, knife blade, shackle tool, and screwdriver. 4.0 oz.
1551 DELUXE



GERBER NEEDLENOSE MULTI-PLIER®

Since 1939 Gerber has produced high quality innovative products for the outdoors. Features included in this model are; needlenose pliers, wire cutter, crimper, standard/ metric scale, lanyard ring, cross head screwdriver, bottle/ can opener, serrated sheeps foot blade, large, medium, and small flathead screwdrivers, file, drop point blade, and it adapts to the Gerber Tool Kit! This Multi-Plier® comes with the S.A.F.T. PLUS™ System where each component opens independently of all others, locks tightly against a positive stop roll bar and stays tight until you unlock it. Stainless steel construction with a limited lifetime warranty!
83102 GERBER TOOL

SWAGE-IT TOOL

Make your own wires for those special gadgets you like. Swaging pressure is applied with a box or socket wrench. For 1/16", 3/32", and 1/8" wire sleeves.
83106 EACH



HOG RING PLIERS

Cinch rings, hog rings, upholsterers clamp. They are all the same and these are the pliers to crimp them with. Use them on shockcord.
83104 EACH





HOBIE MULTI-LUBE is a planet-safe lubricant recommended for lubricating in-the-water applications. Hobie Multi-Lube offers excellent lubrication, is an anti corrosive coating, great for cleaning and many other uses... use on nearly anything that squeaks, rusts, corrodes or binds up; MirageDrives, rudder drums, cams, fishing reels and more.



The 1 oz size is perfect for getting the lubricant into tight spaces by using the needle applicator. The 4 oz size has a spray applicator for coating chains and larger surfaces, shafts and bulky parts.

5120 MULTI LUBE 1 OZ
5121 MULTI LUBE 4 OZ

SILICONE SPRAY

Dry silicone spray for cleats, hatch O-rings. (Image above may not represent current packaging or volume)
5107 SILICONE 7oz.



STARBRITE FIBERGLASS COLOR RESTORER

Brings back original color and luster. Removes heavy oxidation, chalking and fading. Protects against future fading. Will not scratch gelcoat. Excellent for all dark colored boats. No hard rubbing is necessary.
1618 16 oz. BOTTLE



HOBIE UV PROTECTANT

Protect and rejuvenate fiberglass, polyethylene, vinyl and PVC materials. Wipe on, the protectant absorbs into the material and leaves a UV protective layer. Reduce the loss of essential oils and deflect the sun's harmful UV rays. 12 oz.
70060001 HOBIE UV PROTECTANT



TEAR-AID

Each TEAR-AID® repair patch is made from an exceptionally tough, matte finish, abrasion resistant, elastomer that resists puncture and tearing. It is combined with an aggressive adhesive formulated for high bond strength to a variety of surfaces such as canvas, leather, rubber,

nylon, most plastics, paints, aluminum, stainless steel, fiberglass, polyurethane, polyethylene, polypropylene, vinyl and vinyl coated. TEAR-AID® Type A and TEAR-AID® Type B provide a simple and easy method of patching holes and tears, as well as an excellent protective film solution.

72020030 TEAR-AID / TYPE A (POLY)
72020031 TEAR-AID / TYPE B (VINYL)

EACH PATCH KIT CONTAINS: (1) 3" x 12" TEAR-AID® Patch that cuts with scissors to any size, (1) 7/8" x 7/8" Patch, (1) 1 3/8" x 1 3/8" Patch, (1) 12" Reinforcement Filament for repairing tears at edges, (2) Alcohol Prep Pads, (1) Illustrated Instructions and a Product Repair List.

CLEAR SILICONE SEALER

Make sure your hulls are watertight! Clear Silicone seals leaks around all thru-hull fittings such as gudgeons, drain plug housings, tangs, and pylons. Use when re-riveting mast, boom, and crossbar fittings.

376 1.5 oz. TUBE



AQUASEAL MIRAZYME ODOR ELIMINATOR

There's nothing quite like the odor of damp sailing gear left in your car trunk for a couple of days. With one application eliminate those odors from booties, wet-suits, dry-suits and the rest of your gear. A 100% biodegradable product made from a blend of 10 highly specialized, light activated microbial elements. Works by penetrating into pores of fabric, rubber and even hard surfaces to eliminate odor naturally.

7003 8oz.



SEA SPRAY TRAMP CLEANER

We've formulated our own trampoline cleaner. It comes in a pump spray bottle so you can apply a light spray to the trampoline, brush and rinse off. It removes dirt, stains, and mildew. Cleans new trampolines and restores old ones.

1619 TRAMP CLEANER

MAGICA RUST REMOVER

Easily clean rust stains from fiberglass, plastic surfaces, metal parts or fabrics. Although metal parts are made from high quality stainless steel, machining tools often leave carbon particles imbedded in the metal surfaces. This material can bleed a rust stain onto other surfaces. Magica simply dissolves the rust away.

1603 MAGICA GEL 8 oz. BOTTLE



STARBRITE POLISH

During the many months of storage, wind can force dirt into the microscopic pores of your hull and leave the surfaces dull and gritty. To prevent this, an application of Starbrite Marine Polish will seal the hull of your boat and insure a bright and shiny surface when spring comes around. Weather resistant protective coating will keep your hull dirt and stain free.

1611 16 oz. BOTTLE



FSR Fiberglass Stain Remover, is a unique stain absorbing gel. Ideal for removing oil, rust, exhaust, waterline, and transom stains yet it can also be used anywhere else fiberglass stains may crop up - shower stalls, furniture, etc. Removes road soil. Non-abrasive. Requires no sanding or compounding. Simply apply with a brush, sponge, or cloth, wait a few minutes, then wipe off.

790 ONE PINT

ROOF RACK PADS

Beefy car roofrack pads, made from durable black polyester with Hobie logo. Easy-on split bottom with Velcro™ closure.

72045 24" ROOF RACK PAD (PAIR)

72046 36" ROOF RACK PAD (PAIR)



SHROUD ADJUSTER COVERS

Protect hands and feet by covering up sharp edges with these soft vinyl molded adjuster covers. Also great for keeping clevis pin rings from getting snagged and working out of the pin. Sold in pairs.

3261B BLACK, 12"



WIRE COVERS

Standard wires come with molded covers. If your wires are bare you can cover up with these durable vinyl covers for shroud, trapeze wires, stays, etc. Comes in 6 foot lengths. The H16 and H17 shrouds and forestays are 1/8". The H18 shrouds and forestays are 5/32". Many customers prefer to order the next size larger. They will fit just as well and are easier to install.

3252W 1/8" WHITE

3253W 5/32" WHITE

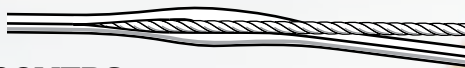

BARNACLE PLUS BLUETOOTH SPEAKER

Features:

- Waterproof
- Floats
- Stores up to 1,000 songs / 4 GB internal memory
- Industrial suction cup base
- Sand / Dust proof
- Water pressure proof charging port
- Built-in mic & caller ID



Hobie® and Speaqua have partnered up to bring a portable, waterproof speaker into the accessories lineup! This floating, tennis ball sized speaker is both convenient and functional with Bluetooth connectivity, call-taking capability and built-in 4 GB memory for holding up to 1,000 songs. It mounts to any smooth surface using an industrial suction cup base, and is perfect for a sailboat, kayak, SUP or Eclipse.

72026103 SPEAKER BLUE TOOTH AND 4GB

HOBIE STANDARD MAST BEARING

Package of 3 for the 14 & 16.

11110005 3 BEARINGS



H18 MAST BEARING KIT

For H18. Eliminate that screech when your mast rotates. Get a new bearing with a Teflon™ disk to fit under the bearing.

1132 BEARING & DISK



HOBIE KEY FLOAT

Don't lose those keys! Keep a few bucks dry, inside the small compartment, while you sail.

72010 EACH



®

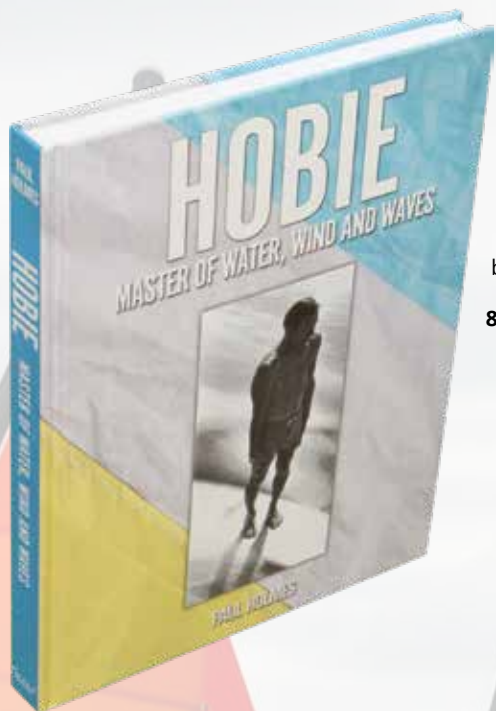

HOBIE-MASTER OF WATER, WIND, AND WAVES

The man, Hobie, known by just one name worldwide, has an epic life story. This 12" x 9" hard-cover book shows how it all came to be, and more, in 17 chapters with 300 pages, 120,000 words of text and 585 photographs and illustrations. The book is available through Hobie Cat and Hobie Kayak dealers worldwide.

Surfboards, catamarans and boats, RC model airplanes (the Hobie Hawk), and a whole lot more "toys"—as Hobie himself describes his amazing life's work—will all be celebrated in the biography of the man who defined a lifestyle in surfing and sailing.

87369116 BOOK, HOBIE-MASTER OF WATER, WIND, AND WAVES



LICENSE FRAME

3043 "HOBIE" CHROME



STAINLESS WATER BOTTLE

71995001 20oz



HOBIE CROAKIES

Keep your glasses in place! Made from wetsuit fabric that will not stretch or lose shape when wet. Remains secure whether worn normally, raised or lowered around your neck.

1553CR EACH



SLIDE YOUR SIDES

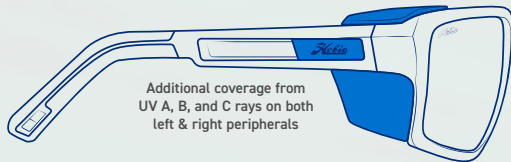
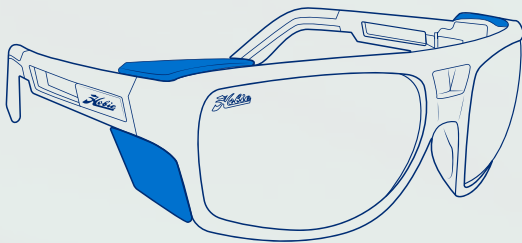

Additional coverage from UV A, B, and C rays on both left & right peripherals

SunShields slide along temple track to open when wearing, and close for easy storage.



Fully integrated coverage for EVERY adventure. Protective SunShields glide into place when temples arms are extended. Co-molded rubber pads the arms and nose for extra comfort and zero slippage. Perfect for all day kayak excursions and bright days patrolling the southern California coast.

EL MATADOR **NEW**

L FIT 61-15-130 | HYDRO 360° POLARIZED LENSES | TR-90 FRAME | CO-MOLDED MEGOL RUBBER | INTEGRATED HINGES | RETRACTING SIDE SHIELDS | 8 BASE POLYCARBONATE LENSES | RX FRIENDLY



SATIN BROWN TORTOISE | SIGHTMASTER+
ELMATADOR-978138



SATIN BLACK | GREY
ELMATADOR-0100108

EVERGLADES **NEW**

L FIT 63-18-129 | HYDRO 360° POLARIZED LENSES | TR-90 FRAME CO-MOLDED MEGOL RUBBER | INTEGRATED HINGES | 8 BASE POLYCARBONATE LENSES | RX FRIENDLY



SATIN BLACK | COPPER w. SEA GREEN MIRROR
EVGLADE-010126

SATIN BLACK | SIGHTMASTER+
EVGLADE-010138

SNOOK **NEW**

M FIT 60-17-132 | HYDRO 360° POLARIZED LENSES | TR-90 FRAME CO-MOLDED MEGOL RUBBER | INTEGRATED HINGES | 8 BASE POLYCARBONATE LENSES | RX FRIENDLY



SATIN BLACK | COPPER w. SEA GREEN MIRROR
SNOOK-010126

SATIN BLACK w. SIGHTMASTER+
SNOOK-010138

LIFETIME WARRANTY

NO-HASSLE, FRIENDLY, LIFETIME WARRANTY FOR RETAILERS AND CONSUMERS

Hobie Polarized sunglasses are warranted to the original registered purchaser against defects in materials and workmanship for the LIFETIME of the sunglass. Take advantage of servicing your customer directly or sending them to Hobie Polarized for warranty services. Either way you will receive great, fast and friendly service. For instances where a manufacturer defect has not occurred, Hobie Polarized may choose to replace sunglasses under its discretion.

To learn more, visit www.hobiepolarized.com/warranty.

See Life Easy

BAJA

XL FIT 64-18-123 | HYDRO 360° POLARIZED LENSES | CO-MOLDED MEGOL RUBBER ANTI-FOG GASKET | TR-90 FRAME | PRECISION FLEX HINGES | 8 BASE POLYCARBONATE LENSES | RX FRIENDLY



SATIN BLACK | GREY w. COBALT MIRROR
BAJA-010168

SATIN BLACK | COPPER w. SEA GREEN MIRROR
BAJA-010139

BAYSIDE

XL FIT 65-17-125 | HYDRO 360° POLARIZED LENSES | MEGOL RUBBER NOSE PADS TR-90 FRAME | PRECISION FLEX HINGES | 8 BASE POLYCARBONATE LENSES | RX FRIENDLY



SATIN BLACK | GREY
BAYSIDE-010108

CABO

M FIT 60-16-125 | HYDRO 360° POLARIZED LENSES | TR-90 FRAME | PRECISION FLEX HINGES 8 BASE POLYCARBONATE LENSES | RX FRIENDLY



SATIN BLACK | GREY
CABO-48PGY

SHINY BLACK | GREY
CABO-50PGY

SHINY BROWN WOOD GRAIN | COPPER
CABO-58PCP

HUNTINGTON NEW RAPID INTERCHANGE SYSTEM

BUILD YOUR OWN

M/L FIT 65-18-132 | HYDRO 360° POLARIZED LENSES | TR-90 FRAME | CO-MOLDED MEGOL RUBBER | INTEGRATED HINGES | 6 BASE LENSES

ONE FRAME



HUNTING-010199
SATIN BLACK FRAME



CATCH & RELEASE

Unique frame and lens design allows lenses to securely click into frame for all day wear. Detach from frame by pushing dual triggers located on both temples.

LENS OPTIONS

FULL RIM



SATIN BLACK | GREY
NEW HUNTING-L0108

FULL RIM



SATIN BLACK | COPPER
NEW HUNTING-L0128

RIMLESS



SATIN BLACK
GREY w. COBALT MIRROR
NEW HUNTING-L9968

RIMLESS



SATIN BLACK
COPPER w. SEA GREEN MIRROR
NEW HUNTING-L9926

Hobie

POLARIZED

COASTAL **NEW FLOATING**

M/L FIT 54-18-138 | HYDRO 360° POLARIZED LENSES | TRFE FLOATING FRAME
INTEGRATED HINGES | 6 BASE POLYCARBONATE LENSES | RX FRIENDLY



SATIN BLACK | GREY w. COBALT MIRROR
COASTAL-B010168

SATIN BLACK | COPPER w. SEA GREEN MIRROR
COASTAL-B010126

MOJO **FLOATING**

XL FIT 67-18-120 | HYDRO 360° POLARIZED LENSES | TPX FRAME | TR-90 FRAME
TR-90 TEMPLES | INTEGRATED HINGES | 8 BASE POLYCARBONATE LENSES



SATIN BLACK | COPPER w. SEA GREEN MIRROR
MOJO-B010188

SHINY BROWN WOOD GRAIN | COPPER
MOJO-B292928

MAVERICKS **NEW MEMORY METAL**

L FIT 58-16-135 | HYDROCLEAN™ POLARIZED LENSES | STAINLESS STEEL FRAME
INTEGRATED HINGES | MEMORY METAL NOSE BRIDGE | ADJUSTABLE NOSE PADS
6 BASE POLYCARBONATE LENS | RX FRIENDLY



SHINY SILVER | GREY
MAVERIC-920008

SHINY GOLD | COPPER GRADIENT MIRROR
MAVERIC-940027

BROAD

M/L FIT 59-13-137 | HYDROCLEAN™ POLARIZED LENSES | STAINLESS STEEL FRAME
INTEGRATED HINGES | ADJUSTABLE SILICONE NOSE PADS | 6 BASE POLYCARBONATE
LENSES | RX FRIENDLY



SHINY GOLD | GREY w. COBALT MIRROR
BROAD-949468

TRESTLES

M/L FIT 58-16-134 | HYDROCLEAN™ POLARIZED LENSES | MEGOL RUBBER NOSE PADS
TR-90 FRAME | INTEGRATED HINGES | 6 BASE POLYCARBONATE LENSES | RX FRIENDLY



SATIN BLACK | COPPER w. SEA GREEN MIRROR
TRESTLES-010139

SANDCUT

L FIT 56-18-146 | HYDROCLEAN™ POLARIZED LENSES | TR-90 FRAME
INTEGRATED HINGES | 6 BASE POLYCARBONATE LENSES | RX FRIENDLY



SATIN BLACK | GREY w. COBALT MIRROR
SANDCUT-010168

See Life Easy

WOODY

M/L FIT 58-19-130 | HYDROCLEAN™ POLARIZED LENSES | TR-90 FRAME
INTEGRATED HINGES | 6 BASE POLYCARBONATE LENSES | RX FRIENDLY



SHINY BLACK | GREY
WOODY-50PGY



SHINY TORTOISE | COPPER
WOODY-94PCP

WRIGHTS

S FIT 48-22-146 | HYDROCLEAN™ POLARIZED LENSES | TR-90 FRAME
INTEGRATED HINGES | 4 BASE POLYCARBONATE LENSES | RX FRIENDLY



SHINY BROWN TORTOISE | COPPER
WRIGHTS-949428



SHINY CRYSTAL OLIVE | COPPER
WRIGHTS-323228

DANA **NEW** WOMENS

L FIT 58-17-137 | HYDROCLEAN™ POLARIZED LENSES | TR-90 FRAME | INTEGRATED
HINGES | 6 BASE POLYCARBONATE LENSES | RX FRIENDLY



SHINY BLACK | GREY
DANA-000008



SHINY CRYSTAL BROWN | COPPER
DANA-222228



MONICA **WOMENS**

M FIT 56-17-145 | HYDROCLEAN™ POLARIZED LENSES | CX FRONT FRAME & ACETATE
TEMPLES | INTEGRATED HINGES | 6 BASE POLYCARBONATE LENSES | RX FRIENDLY



SATIN BLACK | GREY
MONICA-010108



SATIN AQUA | GREY
MONICA-444408

KAYLEE **NEW** WOMENS

L FIT 62-16-127 | HYDROCLEAN™ POLARIZED LENSES | TR-90 FRAME
INTEGRATED HINGES | 8 BASE POLYCARBONATE LENSES | RX FRIENDLY



SHINY BLACK | GREY
KAYLEE-000008



SHINY BROWN TORTOISE | COPPER
KAYLEE-282828

IMPERIAL **NEW** BI-FOCAL READER

M FIT 55-17-136 | HYDROCLEAN™ POLARIZED LENSES | TR-90 FRAME | INTEGRATED
HINGES | MEGOL RUBBER NOSE PADS | FOLDING FRAME | 6 BASE POLYCARBONATE
READER LENS | RX FRIENDLY



SHINY BLACK | COPPER
+1.5 | +2.0 | +2.5 | POLARIZED
IMPE150-000128 | IMPE200-000128 | IMPE250-000128



Always be ready to read with this sunglass and bi-focal reader in one! Imperial features our 100% polarized lenses with reader magnifications at the bottom.



FOLD UP!

Fully polarized and fully portable.
Each pair is accompanied with a
compact neoprene carrying case.

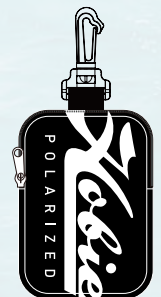



6507X
Men's Grey L/S
T-Shirt
Hobie Script



6506X
Men's Black T-Shirt
Classic Diamond



6519X
Fishing Char/
Lime S/S

6502X
Men's Cream T-Shirt
Hobie California Logo

OFFICIAL GEAR
FOR LIFE ON THE WATER hobie.com

Apparel, Eyewear & Accessories For Men & Women



5059
Water
Hat, Tan



5033LXL
Patch,
Fitted



5042
Lifeguard,
Straw



5046
Red Red-
fish, Snap



5047
Bass, Snap



6523X
Baja Stripe Charcoal
PO Hoodie



6521X
Unisex Sky Blu
PO Hoodie
Script Logo



6514X
Unisex Burnt Orange Zip Hoodie
California Logo

6000
Beach Towel,
Orange

6001
Beach Towel,
Lime

6002
Beach Towel,
Yellow

6003
Beach Towel,
Aqua



72026103
Speaqua Bluetooth
Speake

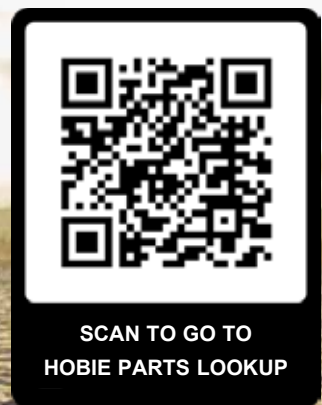

View the complete selection of Apparel, Eyewear and Accessories on hobie.com

HOBIE CAT ILLUSTRATED PART GUIDES BRAVO, WAVE, GETAWAY, 14, 16, 17, 18

TECHNICAL SUPPORT / ONLINE SUPPORT / FORUMS

Be sure to see the Hobie Sailor forums for online technical help. This includes an FAQ section and many ongoing technical and sailing topics.

PARTS GUIDES AVAILABLE ONLINE

All Illustrated Parts Guides including Tiger, Wild Cat, Fox, H20, H21SE, Sport Cruiser, Trifoiler, Hobie One/Holder are available online in our support and parts sections.

HOBIE.COM/support

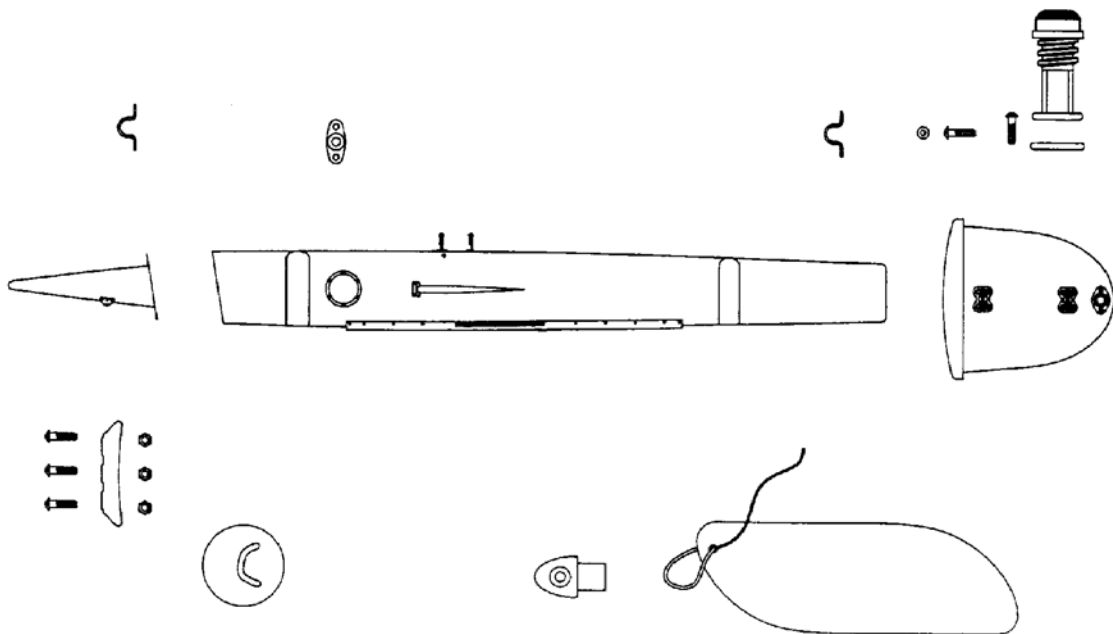

HOBIE CAT PARTS - WARRANTY POLICY

HOBIE PARTS WARRANTY Hobie Cat warrants all Hobie Cat manufactured parts and accessories against failure due to materials or workmanship defects for a period of one year.

OUTSIDE USA WARRANTY INFORMATION - Regions Outside of the USA refer to warranty policy statement issued in each country.

OTHER WARRANTY Any accessories and other merchandise sold by Hobie Cat not mentioned in the paragraph above are not warranted by Hobie Cat. Said accessories and other merchandise may be covered by the manufacturer's warranty, a copy of which can be furnished by Hobie Cat upon written request.

HOBIE CAT'S OBLIGATION Hobie Cat at its option will repair or replace without charge any part or accessory which is found to be defective under the terms and within the period of this Warranty. Buyer must return the accessory with a sales slip as proof of purchase date.

BUYER'S OBLIGATION Upon discovery of a suspected defect, Buyer must-at his/her own expense-promptly return the equipment to the Hobie Kayak dealer for inspection. Warranty is void if equipment is

operated after a suspected defect is, or should have been, discovered.

WHO IS ENTITLED TO WARRANTY Only the original Buyer of the equipment and accessories from Hobie Cat is entitled to warranty. Warranty may not be transferred.

NO WARRANTY OF USED EQUIPMENT Used equipment is sold AS IS; Hobie Cat makes NO WARRANTY concerning its merchantability, condition, durability, age or model year, or fitness for any purpose whatsoever.

MUTUAL AGREEMENTS It is agreed that this warranty sets forth Buyer's exclusive right and remedy against Hobie Cat with respect to the equipment and accessories. It is in lieu of all other express warranties and all implied warranties, including implied warranties of merchantability and fitness. Hobie Cat assumes no other like or unlike liability for loss of cargo, use, profit or consequential damages of any kind in connection with the sale, alteration, use, repair or replacement of equipment or any part thereof.

HOBIE BRAVO

REPLACEMENT HULL - 90010010

Handle '08 71190021
Handle 71190011
Screw 8030201 (2)

Decals -
12450015 "Curtis" Set
12450016 "Bravo" Each

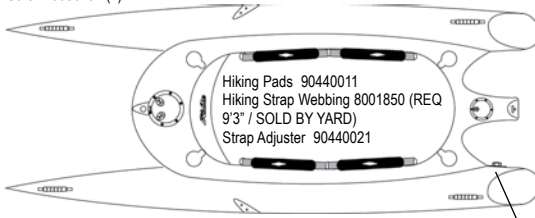

Drain Plug w/ gasket
10091000 (2)
EZ LOC Rudder Pintles
Upper Pintle 90880211
Lower Pintle 90880221
Pintles: (For Aluminum
Castings / Pre-March 2004)
Upper Pintle 90880111
Lower Pintle 38101401
Screw 8030171
Righting Line RL012BLU 10' 9"
Cheek Block H233
Screws 8030071

Fwd Hatch 8" 71702011
Fwd Hatch Gasket 71331001
Screws 8031130

Rear Hatch 6" 71701011
Rear Gasket 71320001
Screw 8030261

RUDDER ASSEMBLY - EZ LOC

90312000

Tiller Extension 90550011 Grip 3206

Tiller Hinge 10532010
Screw 8032061
Nut 8050101
Hinge Yoke 3205
End Cap 90560041
Screw 8031191
Washer 8080561

Tiller Arm 90382011
Rudder Linkage 50313201
Tube Rivet 50313301

Mainsheet Bracket 90700201
Screw 8030981
Nut 8050211
Upper Bolt 8040391
Nut 8050331

EZ LOC Housing 50313001
Detent Plunger 20492021
Retainer Clip 90880231
Bungee (3/16" x 10") RS316BLK
Lower Bolt 8040321
Washer 8080671
Nut 8050331

Up-Lock pin kit
50314001

EZ LOC
Rudder Blade
20491000

RUDDER ASSEMBLY

(PRE-"EZ LOC" RUDDER SYSTEM)
3/04 - Serial 6129

Tiller Extension 90550001 End Cap 10560000

Tiller Connector Cap
90560020
Tendon 37561011
Screw 8030701 (2)
Tiller End Cap
37561001

QR PIN
8020141
Upper Casting
50311031
Lower Casting
50322001
Cam
10480000

Rudder Bushing
Upper 8062001
Lower 38360001
Bolt 8040331
Nut 8050311

Rudder Blade
20493000

Bravo Mast Float w/Straps and Buckles

90600012 UNIVERSAL



Nylon "Saddle" Strap 90600021 (2 Per)
Screw 8030071 (4 Per)
Attachment Web Strap
W/ Buckle 90600041 (2 Per)

MAST

Comptip
90611001

Lower Mast
90613000
(Fits newer boats serial
663-Higher) Older boats
require modified step assy
#90172011

Eyelet Posts (2)
41220001
Mast Collars (3)
90610101
Delrin Balls (48)
90610111 1 EA
90610112 12 EA

Mast Bearing
90612111

Furler Line
90610121

Mast Base
90640011

Screw 8031151

SAIL

Bravo Sail
9099XXXX

Sail Bag
90992000

Mast/Sail Bag
90991000

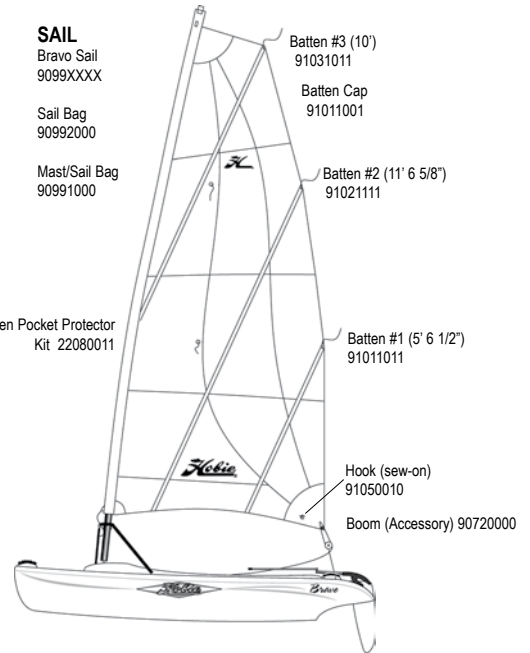

Batten #3 (10')
91031011

Batten Cap
91011001

Batten #2 (11' 6 5/8")
91021111

Batten #1 (5' 6 1/2")
91011011

Hook (sew-on)
91050010

Boom (Accessory) 90720000

Luff Batten Pocket Protector
Kit 22080011

A-FRAME

2 Pc A-frame 90701001*

Screw
8030361

Mast Keeper Knob 90502031
Hinged Gate Knob 90502041

Padeye 71220001
Camcleat 37380001

Hinge/Gate Assy
Original Style 90500021
Screw 8031130

Newer Gate design is not
designed as an upgrade

Cover Plate
90700050
Screw
8031130

*A-Frame Attachment Kit

Serial 0001-0501
Part #90711001

Serial 0502-Current
Part #90711011

Screws (4)
8032011

Mast Ball
90640021
Screw
8030411

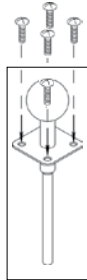

MAST STEP ASSY

Mast Step Assy 90170011
(Serial 663-NEWER)
Mast Step Assy 90170001
(Serial 662-OLDER)

BRAVO RIVET GUIDE

() Indicates quantity need to fasten part

Mast

Comptip Notch 8010181(1)
Collars 8010131 (4/collar)
Eyelet Posts 8011231 (1/post)

A-Frame

Gate Hinge 8012062 (1)
Padeye 8010131 (2)
Cam Cleat 8010131 (2)

Vertical Support Tube

Base 8010181 (4)
Webbing Strap 8010181 (2)
A-frame Connector 8010131 (2)

Rudder

Upper Casting 8010131 (3)
Tiller End Cap 8010131 (2)
Bravo Extension Cap 8010181 (1)

Boom

End Cap 57130000(2)
Boom Cap Casting 8010131 (2)
Padeyes 8010131 (2/padeye)
Cam Cleat 8010131 (2)

RIGHTING LINE



Single Block 90440050

Righting Line
RL012BLU (10' 9")

Bungee Cord
RS014BLK (7)

Cheek Block H233

Mainsheet Line
RM516BLU (28 1/2')

Pre-EZ LOC

Nut 8050111
Low Pro Nut
8050101

Older Cable
Mainsheet
attachment
assembly
90700011

Lower Block
With Post
90700131
CAM CLEAT
RF5011 CAM CLEAT
RF5015 FAIRLEAD
8030241 SCREW (2)

HOBIE CLUB WAVE PARTS

WAVE VERSION NOTES:

CLUB WAVE -THREE PIECE TRAMPOLINE, SHROUDS AND BRIDLES CONNECT WITH CLEVIS PINS.

CLASSIC WAVE - ONE PIECE TRAMPOLINE, SHROUDS AND BRIDLES CONNECT TO HULL WITH HOOKS.

BRIDLE
EYESTRAP
38120011

ANCHOR PLATE 39100011 (PAIR)
SCREW 8030331
PUSH-IN PANEL RIVET (INBOARD) 38120031

SCREW
8030331

EZ LOC RUDDER PINTLES
UPPER PINTLE 90880211
LOWER PINTLE 90880221

SCREW 8030171
SCREW (2009+) 8030331

REPLACEMENT HULL - LEFT 39010001
REPLACEMENT HULL - RIGHT 39020001

DRAIN PLUG
W/ GASKET 10091000

12451031 "Hobie" Diamond 36" Turq/Silver

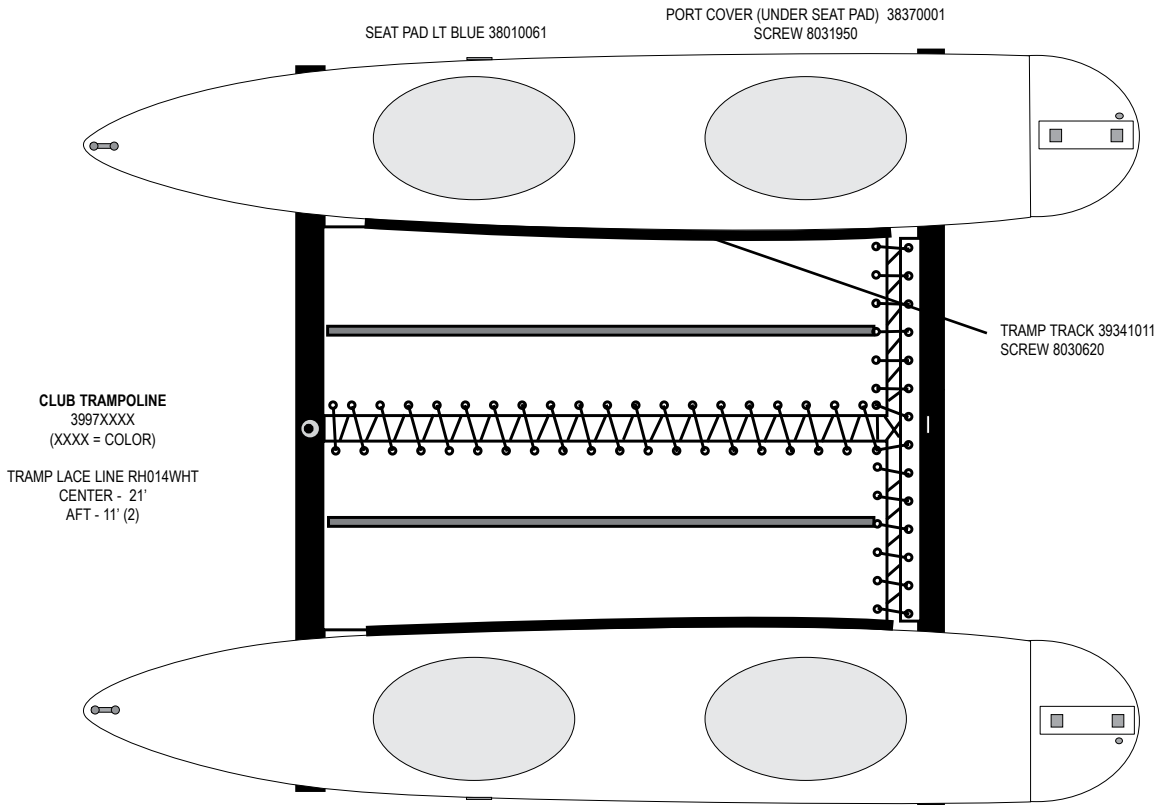
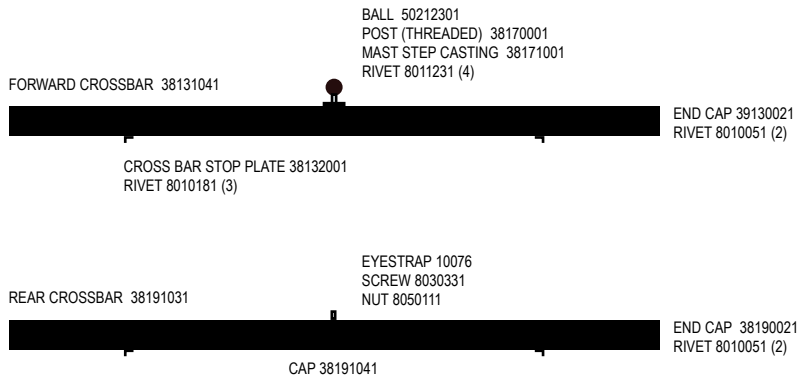

TILLER CROSSBAR - EZ LOC 39524001 (67" TUBE)

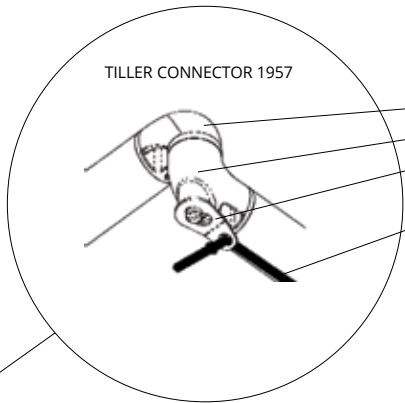
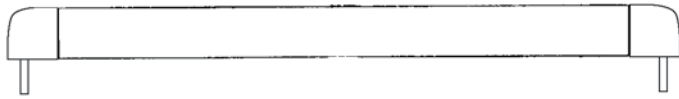

TILLER CONNECTOR 1957

- END CAP - WITH PIN 37561203
- END CAP - THROUGH HOLE 37561200
- TILLER CONNECTOR RETAINER 40590001
- SHOCK CORD (10") RS316BLK
- SCREW 8031151
- RIVET 8010261

EZ LOC RUDDER ASSEMBLY
39312000

TILLER ARM
39382011

RETAINER CLIP EZ LOC RDR HOUSING 90880231
BUNGEE (3/16" X 10") RS316BLK

EZ LOC HOUSING 50313001
LOWER BOLT 8040321
WASHER 8080671
NUT 8050331
EZ LOC PLUNGER 20492021

UPPER BOLT 8040391
NUT 8050331

RUDDER LINKAGE (2)
50313201
TUBE RIVET
50313301

UP-LOCK PIN KIT
50314001
(PIN, LANYARD 37661091,
2-RING 20860000)

EZ LOC
RUDDER
BLADE
20491000

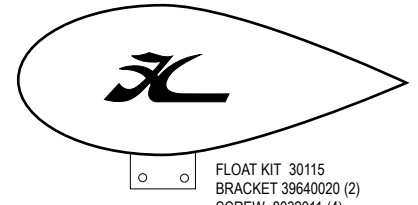

FLOAT KIT 30115
BRACKET 39640020 (2)
SCREW 8032011 (4)

MAST HEAD ASSY 10602111
RIVET 8010131 (2)
SHEAVE 20614210 (2)
SPACER 20614231 (2)
CLEVIS PIN 8020340 (2)
LOCK RING 10860001 (2)

MAST ASSEMBLY 38581041
COMPTIP 38582100
LOWER MAST 38583141

HALYARD HOOK 10680000
RIVET 8010181 (2)
CAP 8011291 (2)

LUFF TRACK
38584001

HALYARD
38651001

MAST TANG 10690000
RIVET 8010181 (6)
CAP 8011291 (6)

FOAM PLUG
10060000

DANGER LABEL / WATCH FOR
WIRES 13440010

MAST CAUTION LABEL 13440000

HALYARD CLEAT 10730000
RIVET 8010121 (2)
RIVET CAP 8011291 (2)

DOWNHAUL CLEAT 10730000
SCREW 8030111 (2)
NUT 8051301 (2)

MAST STEP PIN 8020451

MAST BASE 38641001
RIVET 8010131 (3)
RIVET CAP 8011291 (3)

**UPDATE OLDER WAVE
TO EZ LOC**

- (2) **39312000** EZ LOC RUDDER ASSEMBLY
- (1) **39524001** TILLER CROSSBAR
- (2) **90880211** PINTLE - UPPER
- (2) **90880221** PINTLE - LOWER
- (12) **8030171** SCREW 12-24 X 3/4

DANGER:

ALWAYS USE EXTREME CAUTION WHILE
RAISING AND LOWERING YOUR MAST, CONTACT
WITH A POWER LINE COULD BE FATAL.

FORESTAY / BRIDLES

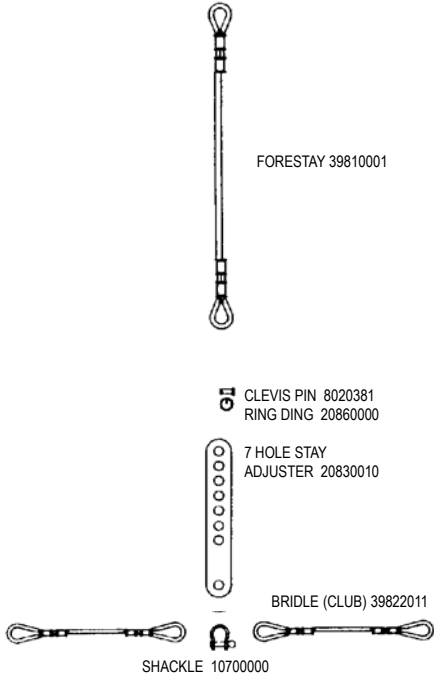

SHROUDS

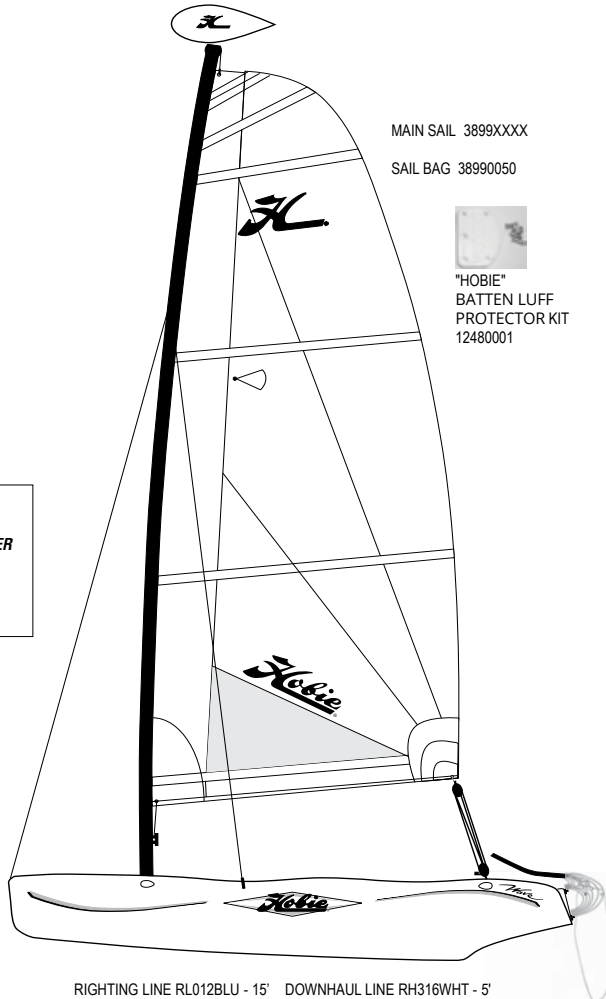
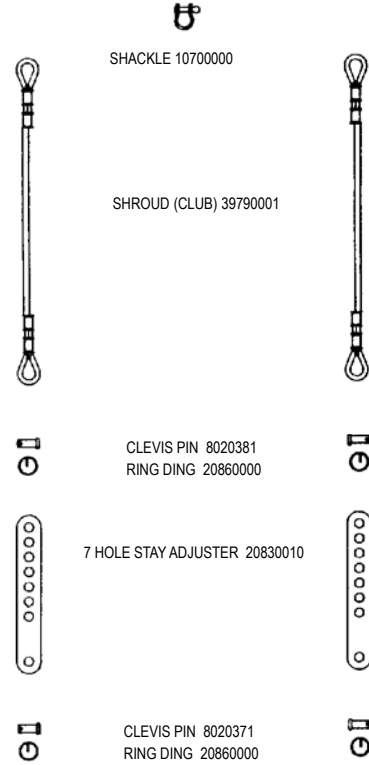

MAST
SERIAL NUMBER 1438 AND NEWER
MAST ASSEMBLY 38581041
LOWER MAST 38583141
MAST BASE (CUP) 38641001

(H16 JIB) BATTEN #5 36"
(H16 JIB) BATTEN #4 50"
BATTEN #3 66 7/8"
BATTEN #2 77 7/8"
BATTEN #1 82 3/8"

38016001 HOBIE WAVE BATTEN SET
(FOR INDIVIDUAL BATTENS SEE UNIVERSAL BATTENS IN CATALOG)

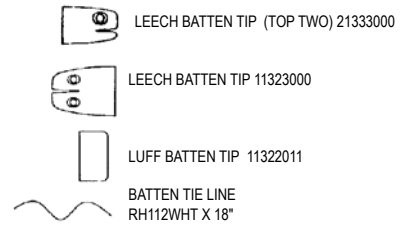

"S" HOOK 38900031
SHACKLE 11220000

UPPER BLOCK
38900061

MAINSHEET
RM516BLU X 35'

LOWER
BLOCK 38900071
CAM CLEAT
RF5001 CAM CLEAT
RF5005 FAIRLEAD
8031011 SCREW (2)

MODEL / YEAR / ACCESSORY VARIATIONS

CLASSIC WAVE

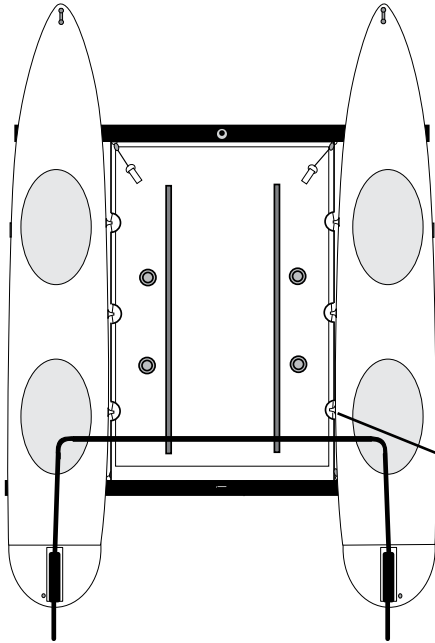

WAVE CLASSIC WIRES
 SHROUD CLASSIC W/HOOKS 38790001
 FORESTAY 39810001
 BRIDLE CLASSIC W/HOOKS 38822011

OLDER -
 TRAMPOLINE ANCHOR HOOK 38760031
 NEWER-
 (BOATS WITH TRACKS)
 TRAMP TENSION SLIDE 38760071
 STOPPER / FOAM 8003255 12 PCS X 2" (FT)

TILLER CROSS BARS
 39521001 CLUB BOLT (62")
 39522001 TENDON (62")

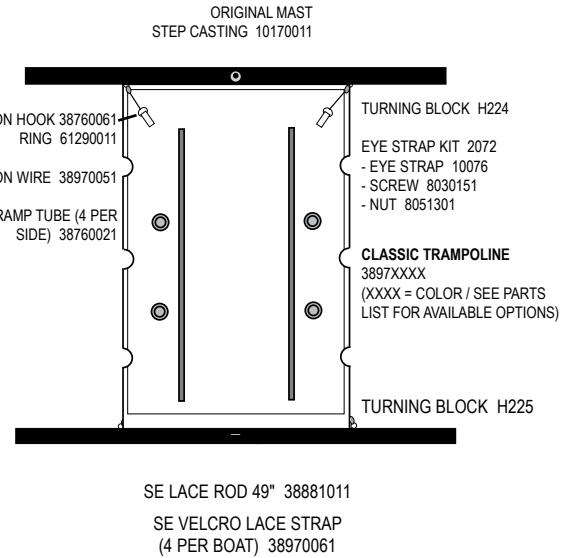

RUDDER ASSEMBLY
 Pre-"EZ LOC" Rudder System
 * = SUB ASSEMBLY PART / INCLUDED WITH CASTING

OLDER TILLER CONNECTOR PARTS

CLUB TILLER CONNECTOR (1954 / 1956)

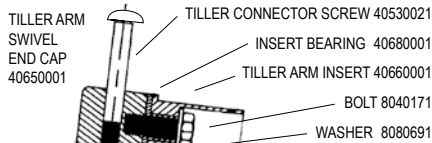

1956 KIT - CLUB TILLER CONNECTOR
 (REPLACES TENDON STYLE WITH CLUB BOLT STYLE)
 1954 KIT - CLUB TILLER CONNECTOR / UPGRADE FOR EARLY BOATS WITH ORIGINAL CURVED TENDON CONNECTORS.
 INCLUDES TILLER CROSS BAR AND ALL TILLER CONNECTOR FITTINGS

TENDON TILLER CONNECTOR

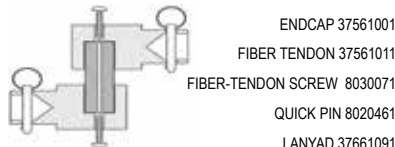

ALUMINUM RUDDER CASTINGS
 UPPER PINTLE 38101301
 LOWER PINTLE 38101401
 KEEPER PIN W/ LANYARD 38490011

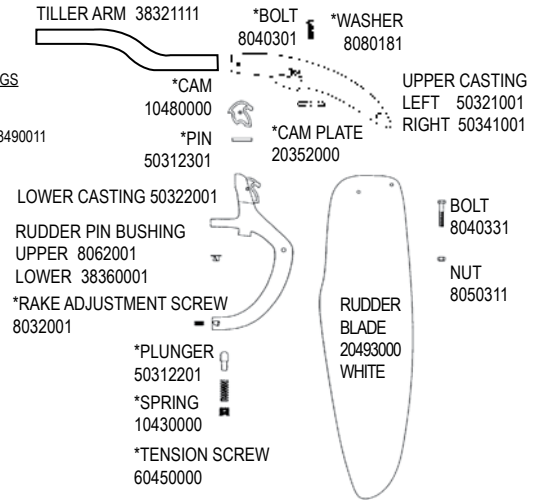

Wave Rivet Guide () Quantity needed to fasten part

MAST		REAR CROSSBAR	
HEAD	8010131 (2)	PAD EYE	8010181 (2)
HALYARD HOOK	8010181 (2)	FRONT CROSSBAR	
	8011291 (2)	MAST STEP	8011231 (4)
TANG	8010181 (6)	RUDDER ASSEMBLY	
	8011291 (6)	UPPER CASTING	8010131 (2)
HALYARD CLEAT	8010121 (2)	(UNDERSIDE)	8011231 (1)
BASE	8010131 (3)	TILLER END CAP	8010131 (2)

MAST

SERIAL NUMBER 0 THROUGH 1437
 OLD MAST ASSEMBLY NLA (SEE NEW STYLE REQUIRES MAST STEP RETROFIT.
 MAST BASE (HOBIE14 STYLE) 10640011

COMMON ACCESSORIES

- BOW SPREADER 38999021
- END CAP 38950011
- BOW SPREADER TANG 38120041
- SEAT BACKREST KIT 38040011
- BACKREST INSTALLATION QUICK PIN 8020181
- BACKREST PLUG, FORWARD 38660011
- BACKREST PLUG, AFT 38660031
- MAIN TRAVELER KIT (CLUB) 39250000
- HIKING STICK KIT (EZ LOC) 39550001

HOBIE GETAWAY PARTS

REPLACEMENT HULL -2016 / left 37010001
 REPLACEMENT HULL -2016 / right 37020001
 REPLACEMENT HULL 2017+ / left 37010002
 REPLACEMENT HULL 2017+ / right 37020002

EZ LOC RUDDER PINTLES
 UPPER PINTLE 90880211
 LOWER PINTLE 90880221

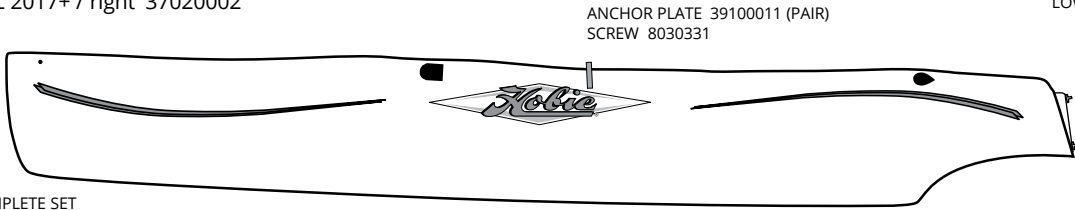

ANCHOR PLATE 39100011 (PAIR)
 SCREW 8030331

SCREW 8030171
 SCREW (2009+) 8030331

DRAIN PLUG
 W / GASKET
 10091000

DECALS -
 37440150 "CURLS" COMPLETE SET
 37440151 "GETAWAY" EACH
 12451031 "Hobie" Diamond 36" Turq/Silver

BOW SPREADER 37500001
 (37501701 2017+)

BOW TANG 20120000
 BOLT 8040341
 NUT 8050311
 PLATE 37500021
 RIVET 8010181

END BLOCK 37500031
 RIVET 8010201 (4)
 BOLT 8030291
 WASHER 8080671

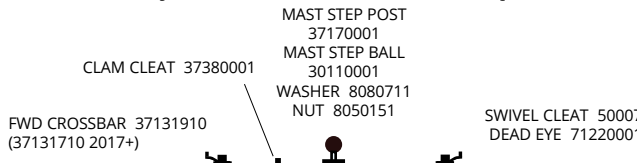

MAST STEP POST 37170001
 MAST STEP BALL 30110001
 WASHER 8080711
 NUT 8050151

CLAM CLEAT 37380001

FWD CROSSBAR 37131910
 (37131710 2017+)

SWIVEL CLEAT 50007
 DEAD EYE 71220001

CROSS BAR STOP PLATE 38132001
 RIVET 8010181 (3)

FWD END CAP 37151041

REAR CROSSBAR 37191910
 (37191710 2017+)

TRAVELER SWIVEL CAM PLATE 37760041
 SWIVEL CLEAT 50007

REAR END CAP 37201021



CROSS BAR STOP PLATE 38132001
 RIVET 8010181 (3)

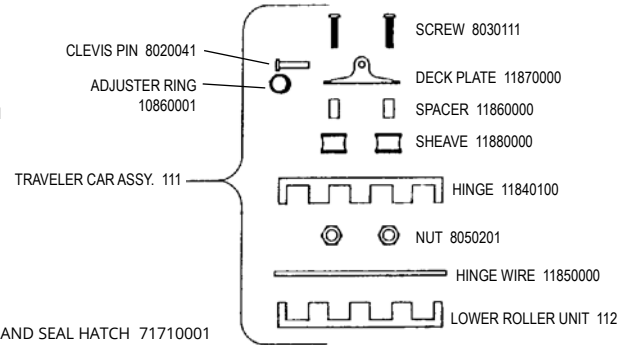

CLEVIS PIN 8020041
 ADJUSTER RING 10860001

SCREW 8030111

DECK PLATE 11870000

SPACER 11860000

SHEAVE 11880000

HINGE 11840100

NUT 8050201

HINGE WIRE 11850000

LOWER ROLLER UNIT 112

ORIGINAL HATCH*
 * Replacement "O" Ring Seal
 # SPA-4SEAL-S Available from imtra.com
 Not stocked by Hobie Cat

HOBIE TWIST AND SEAL HATCH 71710001
 GASKET 71707002 (REQ 2)
 SCREWS 8032121 (REQ 14)
 5" HATCH (INSIDE) 41370001
 DRAIN ELBOW FITTING 37370036

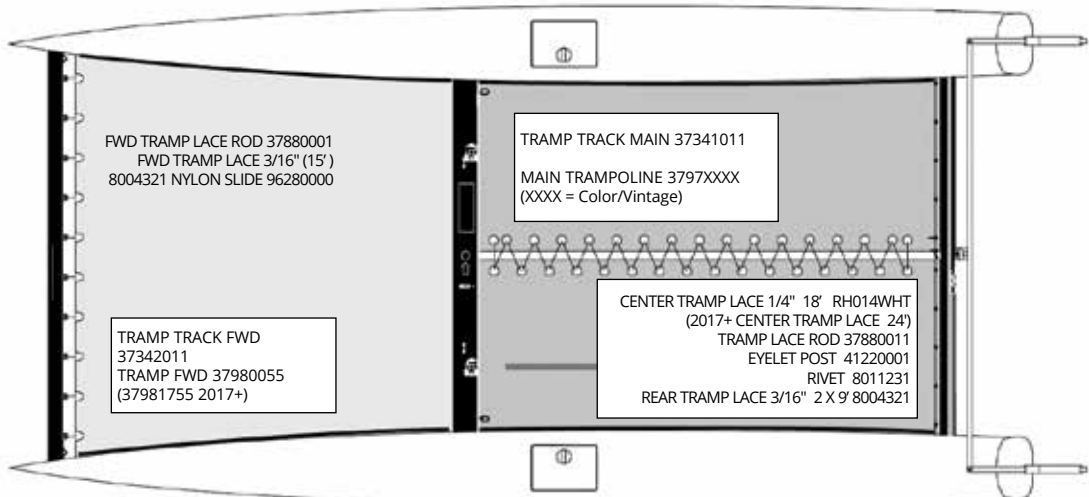

FWD TRAMP LACE ROD 37880001
 FWD TRAMP LACE 3/16" (15')
 8004321 NYLON SLIDE 96280000

TRAMP TRACK MAIN 37341011

MAIN TRAMPOLINE 3797XXXX
 (XXXX = Color/Vintage)

TRAMP TRACK FWD
 37342011
 TRAMP FWD 37980055
 (37981755 2017+)

CENTER TRAMP LACE 1/4" 18' RH014WHT
 (2017+ CENTER TRAMP LACE 24')
 TRAMP LACE ROD 37880011
 EYELET POST 41220001
 RIVET 8011231
 REAR TRAMP LACE 3/16" 2 X 9' 8004321

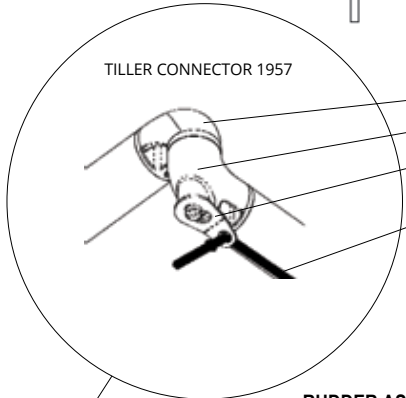
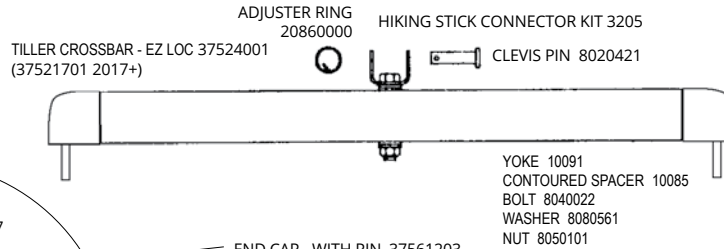
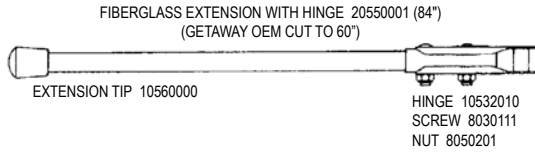

- END CAP - WITH PIN 37561203
- END CAP - THROUGH HOLE 37561200
- TILLER CONNECTOR RETAINER 40590001
- SHOCK CORD (10") RS316BLK
- SCREW 8031151
- RIVET 8010261

RUDDER ASSEMBLY - EZ LOC
37312000

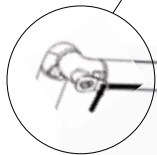

TILLER ARM 37382011

UPPER BOLT 8040391
NUT 8050331

RETAINER CLIP 90880231
BUNGEE (3/16" X 10") RS316BLK

EZ LOC HOUSING 50313001
LOWER BOLT 8040321
WASHER 8080671
NUT 8050331
EZ LOC PLUNGER 20492021

RUDDER LINKAGE (2)
50313201
TUBE RIVET
50313301

UP-LOCK PIN KIT
50314001
(PIN, LANYARD 37661091,
2-RING 20860000)

EZ LOC
RUDDER
BLADE
20491000

MAST ASSEMBLY
37610000

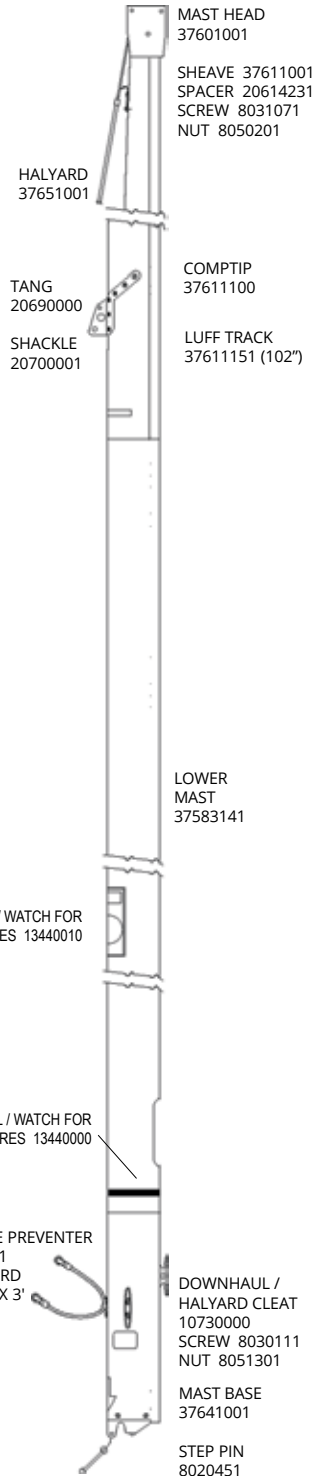

UPDATE OLDER GETAWAY TO EZ LOC

- (2) **37312000** EZ LOC RUDDER ASSEMBLY
- (1) **37524001** TILLER CROSSBAR
- (1) **20550001** HIKING STICK
- (2) **90880211** PINTLE - UPPER
- (2) **90880221** PINTLE - LOWER
- (12) **8030171** SCREW 12-24 X 3/4

DANGER:
ALWAYS USE EXTREME CAUTION WHILE RAISING AND LOWERING YOUR MAST, CONTACT WITH A POWER LINE COULD BE FATAL.

FORESTAY / BRIDLES



FORESTAY ASSY 37810001
 FORESTAY ASSY INCLUDES:
 *SHACKLE W/KEEPER WIRE 20700001
 *SWIVEL 61230000
 *YOKE 37810030
 *SCREW HSPAP
 *LOCK NUT 8050111
 *LOWER FORESTAY 37810021

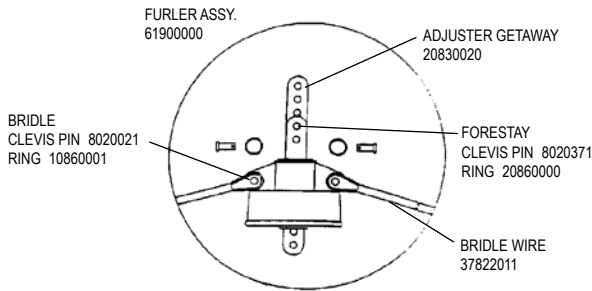

ROLLER FURLER DETAIL

FURLER TUNE UP KIT 61900900
 INCLUDES: BEARINGS, BEARING CAGE, NYLINER, NYLON SLEEVE, DARBY RINGS, SPOOL, HOUSING

- CLEVIS PIN 8020371 RING 20860000
- SHACKLE 10700000
- ADJUSTER 20830020 FLATTENED
- NYLINER 8061101
- NYLON SLEEVE 61940000
- YOKE 61980000
- SPOOL & HOUSING SEE BELOW
- SLEEVE 61950001
- DARBY RING 8062511
- BEARING RACE 61920000
- ***** BEARINGS (REQUIRES 18) 61670000
- BEARING CAGE 61930000
- BEARING RACE 61920000
- DARBY RING 8062501
- TUBE 61910000
- SPOOL & HOUSING 61960001
- NOT SHOWN
- LINE RH018WHT X 18' SCREW 8030501

SHROUDS

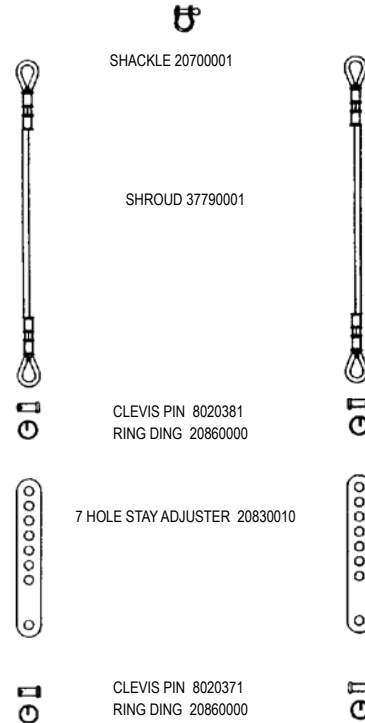

- LEECH BATTEN TIP (TOP) 21333000
- LEECH BATTEN TIP 11323000
- LUFF BATTEN TIP 11322011
- BATTEN TIE LINE RH112WHT X 18"
- BATTEN #8 34 1/2" (H16 JIB)
- BATTEN #7 55"
- BATTEN #6 69"
- BATTEN #5 77 3/4"
- BATTEN #4 84 1/4"
- BATTEN #3 88 3/4"
- BATTEN #2 90 3/4"
- BATTEN #1 92"
- 37016001 BATTEN SET (FOR INDIVIDUAL BATTENS SEE UNIVERSAL BATTENS IN CATALOG)

FLOAT KIT 30119
 SCREW 8032011

BATTEN POCKET END PROTECTOR 22080905

"HOBIE" BATTEN LUFF PROTECTOR KIT 12480001

JIB COVER 1815
 SNAP HOOK 53790040

MAIN SAIL 37991XXX
 JIB SAIL 37992XXX
 SEE SEQUENTIAL PRICE LIST OR SAIL COLOR SELECTION IN CATALOG

"S" HOOK 38900031
 SHACKLE 11220000
 UPPER BLOCK 37900021

MAIN SHEET RM038RED X 38'

LOWER BLOCK 37900011
 CAM CLEAT RF5011
 CAM CLEAT RF5015
 FAIRLEAD RF5015
 SCREW (2) 8030241

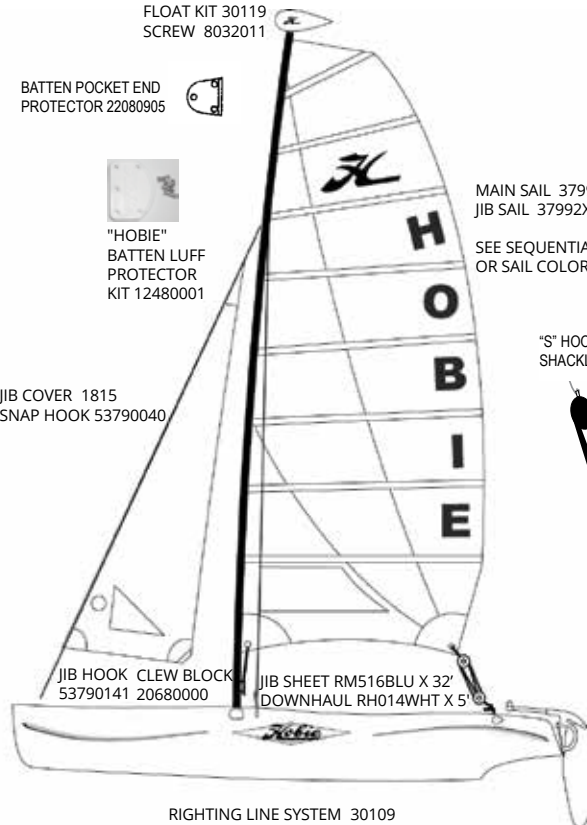

RIGHTING LINE SYSTEM 30109

MODEL / YEAR / ACCESSORY VARIATIONS

TILLER CROSSBAR 37521001 (OLDER RUDDER CASTINGS / M20 STYLE CONNECTORS)
 TILLER CROSSBAR 37522001 (OLDER RUDDER CASTINGS / TENDON STYLE CONNECTORS)
 TILLER CROSSBAR 37523001 (EZ LOC RUDDERS / TENDON CONNECTORS)

OLDER TILLER CONNECTOR PARTS

CLUB TILLER CONNECTOR (1954 / 1956)

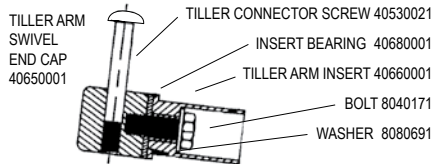

1956 KIT - CLUB TILLER CONNECTOR
 (REPLACES TENDON STYLE WITH CLUB BOLT STYLE)
 1954 KIT - CLUB TILLER CONNECTOR / UPGRADE FOR EARLY BOATS
 WITH ORIGINAL CURVED TENDON CONNECTORS:
 INCLUDES TILLER CROSS BAR AND ALL TILLER CONNECTOR FITTINGS

TENDON TILLER CONNECTOR

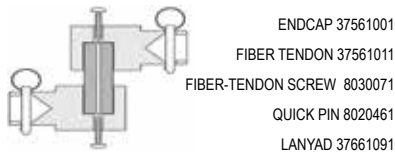

ALUMINUM RUDDER CASTINGS
 UPPER PINTLE 38101301
 LOWER PINTLE 38101401
 KEEPER PIN W/ LANYARD 38490011

RUDDER PARTS

Pre-"EZ LOC" Rudder System

* = SUB ASSEMBLY PART / INCLUDED WITH CASTING

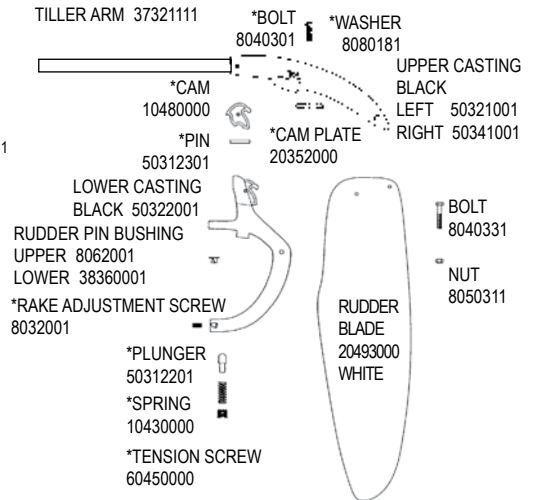

37001020 GETAWAY WING ASSEMBLY (WITH TURQUOISE COVER)
 37001010 GETAWAY WING ASSEMBLY 2017+ SUS (WITH GREY COVER)

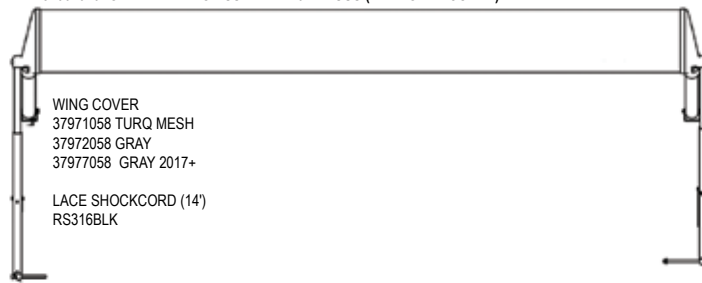

GETAWAY RIVET GUIDE

() INDICATES QUANTITY NEEDED TO FASTEN PART

MAST	
HEAD	8010121 (2)
HALYARD HOOK	8011231 (2)
TANG	8010121 (12)
	8011291 (12)
BUNGEE PAD EYE	8010181 (2)
	8011291 (2)
HALYARD CLEAT	8010121 (2)
	8011291 (2)
BASE	8010131 (4)
	8011291 (4)

BOW SPREADER BAR	
PLATES, BRIDLE BOW TANG	8010181 (4)
INTERNAL STIFFENER	8010201 (4)

MAIN CROSSBAR	
BEAM STOP PLATES	8010181 (6)
CLEAT	8010181 (1)
PADEYES	8010181 (4)
JAM CLEAT	8010131 (1)
CLEATS, SWIVEL	8010131 (6)
PADEYES	8010131 (4)
END CAPS	8010201 (10)

REAR CROSS BAR	
PADEYE	8010181 (2)
BEAM STOP PLATES	8010181 (6)
CLEAT PLATE	8010131 (4)
TRAMP LACE POSTS	8011231 (10)
END CAPS	8010201 (8)

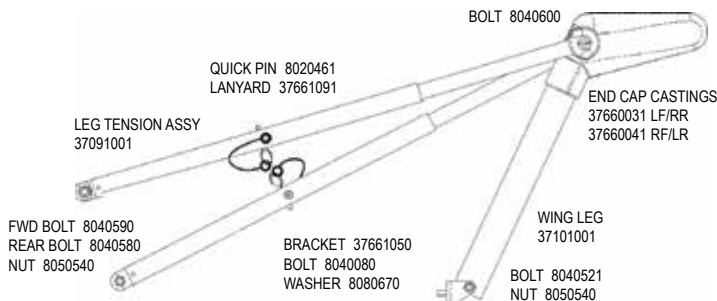

HOBIE H14 / H16

REPLACEMENT HULL H16 WHITE - LEFT
25010001
REPLACEMENT HULL H16 WHITE - RIGHT
25020001

Older Decals -
12452160 "16" Silver
12452000 Silver pin stripe (ft)

Decals -
12452161 "16" Silver
12452121 "Hobie Cat" Black
12451061 "Hobie" Diamond 36" Silver
12452000 Silver pin stripe (ft)

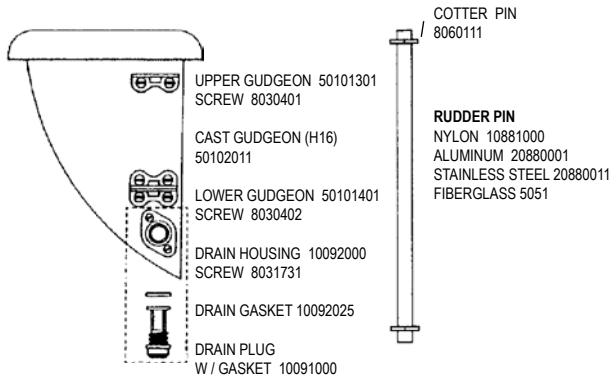
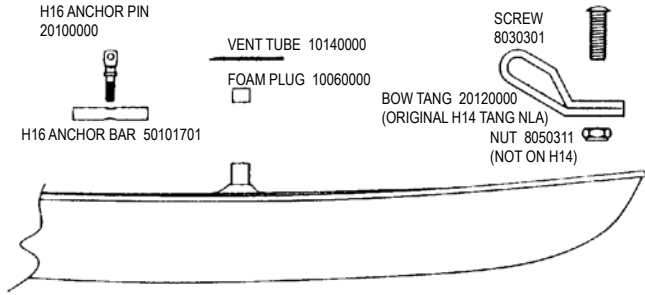

H14 / H16 FRONT CROSSBAR

H14 BLACK FRONT CROSSBAR W/MAST STEP 10131910
H16 BLACK FRONT CROSSBAR W/MAST STEP / INTEGRATED TRACK 25131910

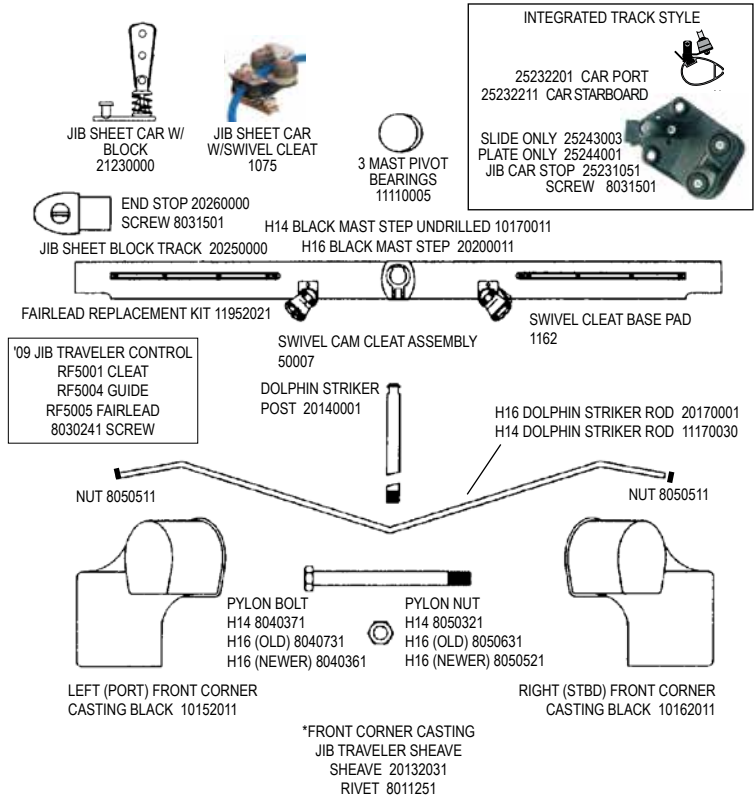

COMPLETE BOAT LINE PACKAGE 20781001

H14 / H16 TRAMPOLINE, SIDEBAR

H14 COMPLETE TRAMPOLINE
(Does not include lace lines)
1097XXXX
(XXXX = Color / See parts list for available options)

H16 COMPLETE TRAMPOLINE
(Does not include lace line)
2097XXXX
(XXXX = Color / See parts list for available options)

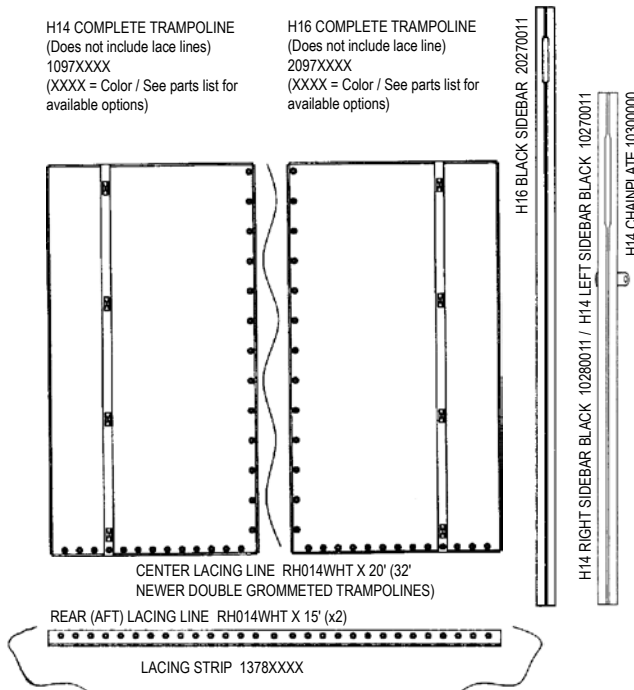

H14 / H16 REAR CROSSBAR

CROSSBAR EXTRUSION w/ INTEGRATED TRACK, REAR (AFT)
WITHOUT CORNER CASTINGS, BLACK - INCLUDES CAR ACCESS PLATE
H16 25191911
H14 10191910
'94 AND NEWER CAR ACCESS PLATE 11810011

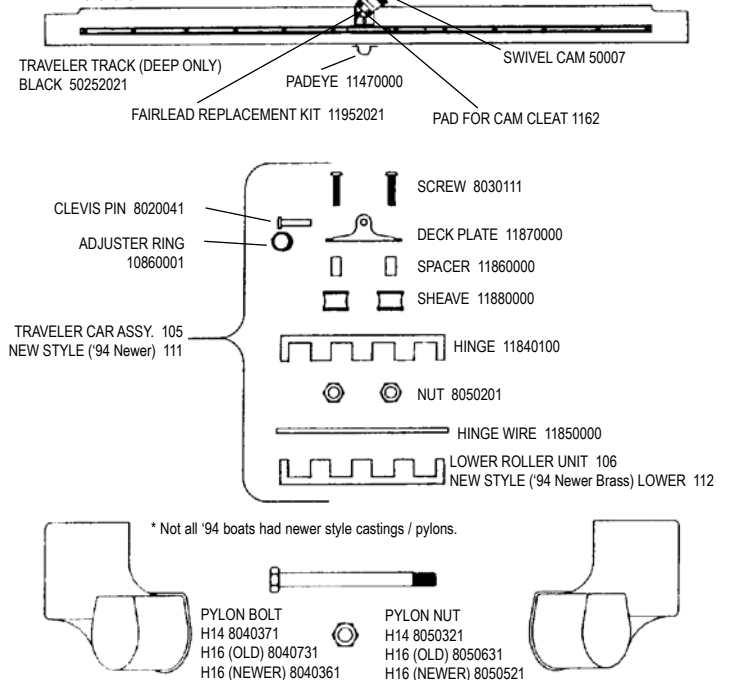

BLACK LEFT REAR CORNER CASTING 10212011

BLACK RIGHT REAR CORNER CASTING 10202011

H14 / H16 RUDDER

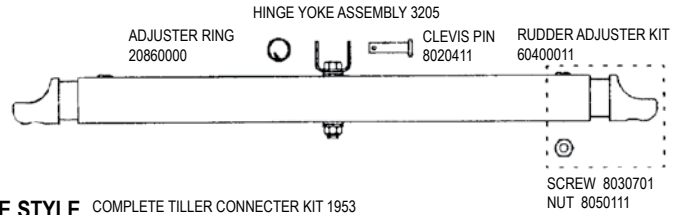
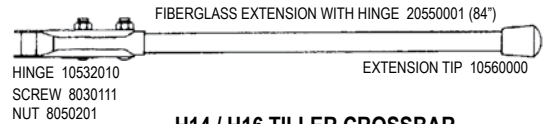
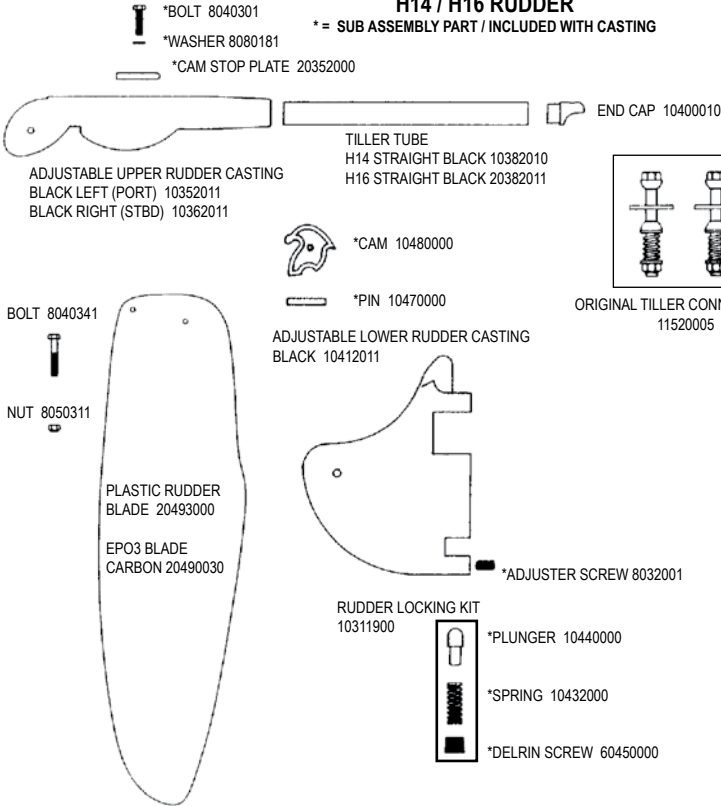

MIRACLE STYLE COMPLETE TILLER CONNECTER KIT 1953

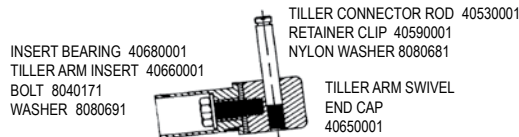

MIRACLE STYLE TILLER CROSSBAR

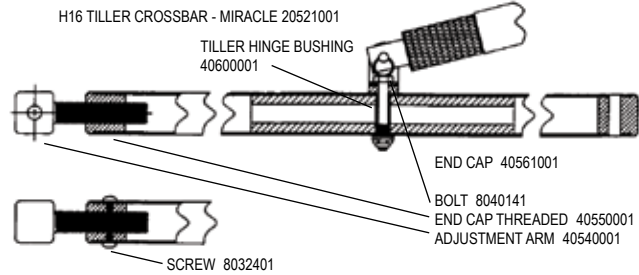

H14 / H16 MAST

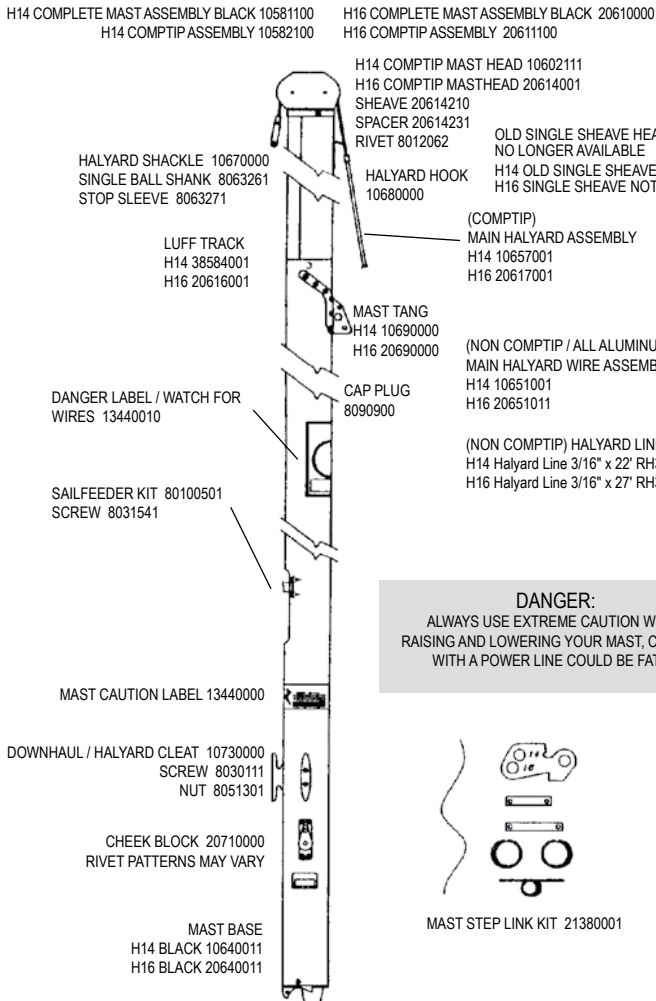

WARNING:
ALWAYS USE EXTREME CAUTION WHILE RAISING AND LOWERING YOUR MAST, CONTACT WITH A POWER LINE COULD BE FATAL.

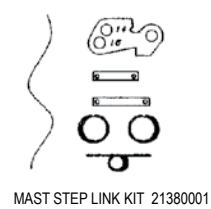

H14 Rivet Guide

() = Quantity needed to fasten part

Mast

Head	8010131 (2)
Halyard Hook	8010181 (2) 8011291 (2)
Tang	8010181 (6) 8011291 (6)
Halyard Cleat	8010121 (2) 8011291 (2)
Base	8010131 (3)
Sidebar	
Chain Plate	8010181 (3)
Rear Crossbar	
Corner Casting	8011231 (6)
Traveler Track	8010201 (18) 8010161 (18)
Pad Eye	8010181 (2)
Swivel Jam Cleat	8010201 (1) 8031501 (2) 8031231 (1) 8050801 (1) 8080101 (1)
Boom	
Front End Cap	8010131 (3)
Tang	8010181 (4)
Barrel Cleat	8010181 (2)
Block Hanger	8010181 (4)
Rear End Cap	8010131 (3)
Front Crossbar	
Mast Step	8011231 (4)
Corner Casting	8011231 (6)
Rudder Assembly	
Upper Casting	8010131 (2)
(Underside)	8011231 (1)
Tiller End Cap	8010131 (2)
Sail	
Headboard	8010020 (16)
Tack/Clew plate	8010020 (6)
Pocket Protector	8010020 (4)
(Requires setting machine-not available as hand tool)	

H16 Rivet Guide

() = Quantity needed to fasten part

Mast

Head	8010131 (4)
Halyard Hook	8011231 (4) 8011291 (2)
Tang	8010181 (12) 8011291 (12)
Halyard Cleat	8010121 (2) 8011291 (3)
Base	8010181 (4)
Downhaul Cheek Block	8010181 (4) 8011291 (4)
Front Crossbar	
Corner Casting	8011231 (6)
Mast Step	8011231 (4)
Jib Track	8010201 (6)
Swivel Jam Cleat	8010201 (1) 8010131 (1) 8031501 (2)
or	
Swivel Jam Cleat	8031231 (1) 8050801 (1) 8080101 (1)
Rudder Assembly	
Upper Casting	8010131 (2)
(underside)	8011231 (1)
Tiller End Cap	8010131 (2)
Boom	
Front End Cap	8010131 (3)
Tang	8010181 (4)
Barrel Cleat	8010181 (2)
Block Hanger	8010181 (4)
Rear End Cap	8010131 (2)
Rear Crossbar	
Corner Casting	8011231 (6)
Traveler Track	8010201 (20)
Pad Eye	8010181 (2)
Swivel Jam Cleat	8010201 (1) 8031501 (2) 8031231 (1) 8050801 (1) 8080101 (1)
Sail	
Main Headboard	8010020 (16)
Tack/Clew Plate	8010020 (6)
Main Pocket Prtc	8010020 (4)
Jib Clew Plate	8010020 (16)
Jib Pocket Prtc	8010020 (3)

H14 / H16 FORESTAY ASSEMBLIES

- H14 FORESTAY BLACK 10812101
- H16 UPPER FORESTAY (PIG TAIL) 20810011

H16 JIB HALYARD AND LOWER FORESTAY

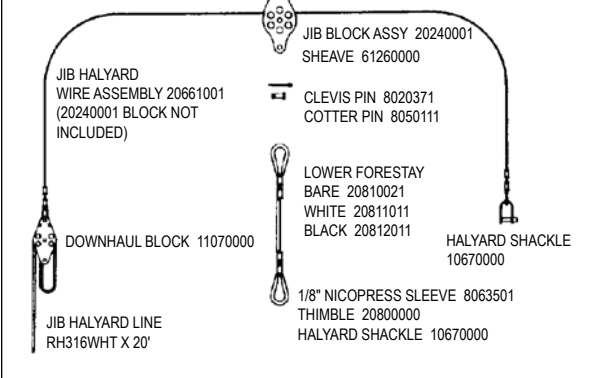

PIN AND RING SET 30303

CLEVIS PIN 8020381
RING DING 20860000

10 HOLE STAY
ADJUSTER 20830020

H14 BRIDLE BLACK 10822101

H16 BRIDLE WHITE 20820011
H16 BRIDLE BLACK 20822011



SHACKLE 10700000



SHACKLES (FOR H14 WITH
BOW PLATES) 10870000

H16 "AUSSIE" FORESTAY
AND JIB HALYARD

80660000 Assembly

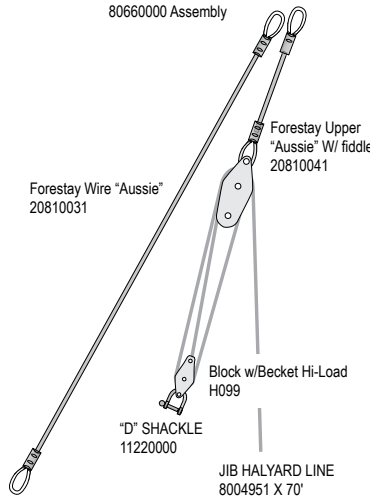

H14 / H16 SHROUDS



H14 SHACKLE 10700000
H16 SHACKLE 20700001

H14 SHROUD BLACK 10792100
H16 SHROUD WHITE 20790011
H16 SHROUD BLACK 20792011

1/8" NICOPRESS SLEEVE 8063501
THIMBLE 20800000

CLEVIS PIN 8020381
RING DING 20860000

7 HOLE STAY ADJUSTER 20830010

CLEVIS PIN 8020371
RING DING 20860000

TWIST TOGGLE 20210000

CLEVIS PIN 8020381
RING DING 20860000

H16 TRAPEZE



SHROUD SHACKLE 10700000
THIMBLE 20800000
3/32" NICOPRESS SLEEVE 8063761

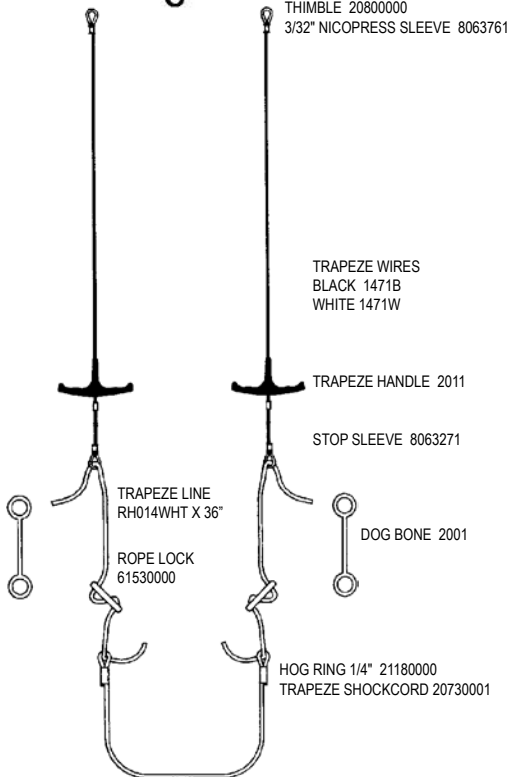





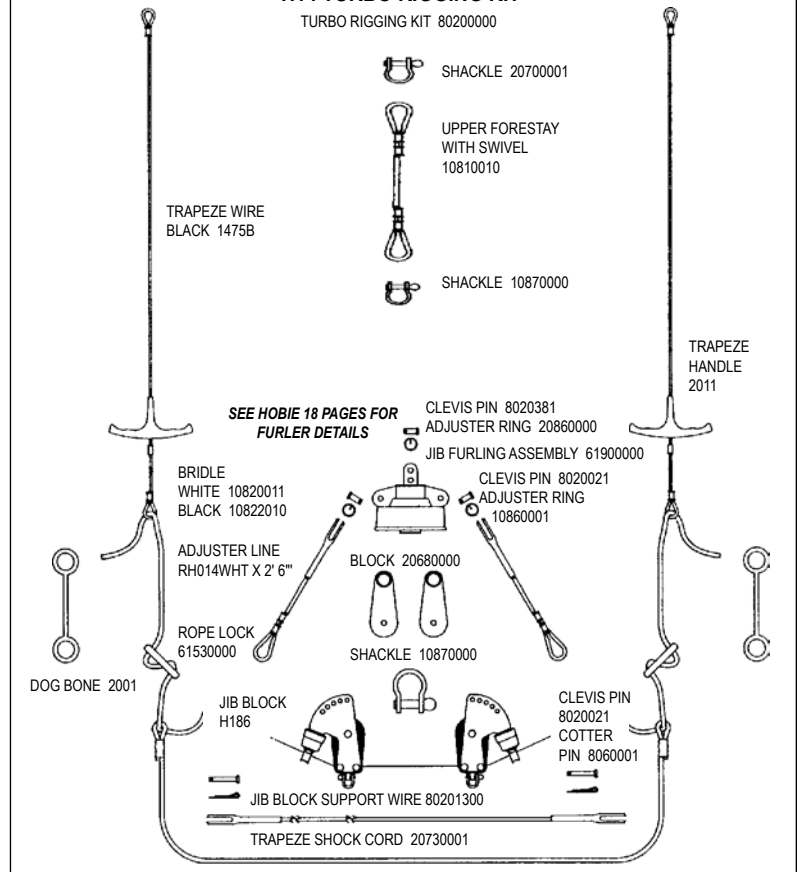



H14 TURBO RIGGING KIT

TURBO RIGGING KIT 80200000



H14 / H16 MAIN SAIL & BATTENS

H14 MAIN SAIL 1099XXXX
 H16 MAIN SAIL 20991XXX
 SEE SEQUENTIAL PARTS LIST
 OR SAIL COLOR SELECTION SHEET

-  HEADBOARD W/RIVETS 68330011
-  BATTEN POCKET END PROTECTOR KIT 80550005
-  "HOBIE" PROTECTOR KIT 12480001
-  PAIR OF WHITE HOBIE LOGOS 12430001
 PAIR OF BLACK HOBIE LOGOS 12430001
-  H14 CLASS INSIGNIA 12440000
 H16 CLASS INSIGNIA 22330000
-  SAIL WIND INDICATOR 335
-  LEECH BATTEN TIP 11323000
-  LUFF BATTEN TIP 11322011
-  BATTEN TIE LINE RH112WHT X 18"

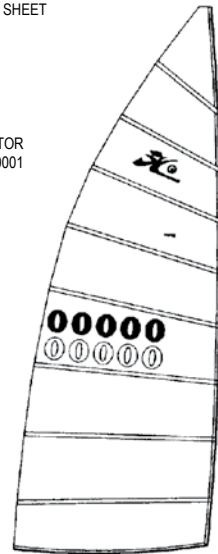

 CLEW/TACK PLATE SET 12240000

SAIL BAG/COVER 21310000

SAIL NUMBERS

BLACK

#0	12700030
#1	12710030
#2	12720030
#3	12730030
#4	12740030
#5	12750030
#6 & #9	12760030
#7	12770030
#8	12780030











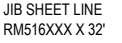

MAINSAIL BATTEN LENGTHS

H16 BATTEN	H14 BATTEN
#8 41"	
#7 59 1/8"	
#6 72 1/8"	#6 42 11/16"
#5 82 3/8"	#5 60 7/16"
#4 90 3/4"	#4 74 1/16"
#3 97 3/8"	#3 84 13/16"
#2 103 7/8"	#2 93 5/16"
#1 107 7/8"	#1 97 7/16"

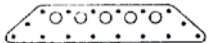
H16 MAIN BATTEN SET 21000001
 (FOR INDIVIDUAL BATTENS SEE UNIVERSAL BATTENS PAGE)

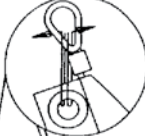
H14 / H16 JIB SAIL & BATTENS

H14 JIB 10992XXX SEE SEQUENTIAL PARTS LIST
 H16 JIB 20992XXX SEE SEQUENTIAL PARTS LIST

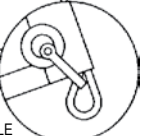









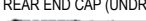

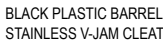
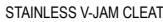



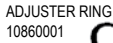

-  JIB HANK W/SCREW 22090001
-  SAIL WIND INDICATOR 334
-  BATTEN POCKET END PROTECTOR 22080905
-  BATTEN TIE LINE RH112WHT X 18"
-  JIB SHEET LINE RM516XXX X 32'
-  BELL SHACKLE 10870000
-  JIB CLEW BLOCK 20680000
 NEWER CONFIGURATION H224
-  ADJUSTABLE JIB CLEW PLATE 22240000
-  JIB LEACH CAP 21333000
-  CLOSED END THIMBLE 20840000
-  NICOPRESS SLEEVE 8063501
-  JIB SAILS 20992XXX
 SEE SEQUENTIAL PARTS LIST
-  SHACKLE 11220000
-  1/8" HEADSTAY THIMBLE 20800000

-  BATTEN #4 28"
-  BATTEN #3 43 3/4"
-  BATTEN #2 56"
-  BATTEN #1 67"

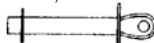
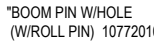







H14 JIB BATTEN SET 20400001*
 (* Current Production Lengths)
 FOR INDIVIDUAL BATTENS SEE
 UNIVERSAL BATTENS PAGE

H14 / H16 BOOM

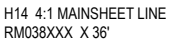
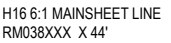
H14 BOOM ASSEMBLY BLACK 10720011
 H16 BOOM ASSEMBLY BLACK 20720011

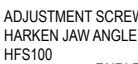
-  REAR END CAP (UNDRILLED BLACK) 10741031
-  FRONT END CAP BLACK 10740011
-  BLOCK HANGER 10760000
-  BLACK PLASTIC BARREL CLEAT 10262000
-  STAINLESS V-JAM CLEAT 10261000
-  GOOSENECK ASSEMBLY 10770001
-  GOOSENECK BEARING KIT 1511
-  OUTHAUL LINE RH316WHT X 7'4"
-  ADJUSTER RING 10860001
-  CLEVIS PIN 8020421
 NEWER - BOLT 8040001
-  CLEVIS PIN 8020061
-  SHACKLE 10772020
-  NUT 8050121
-  VERTEX 50772031
-  SLIDE 10772001
-  "E" CLIP 8062521
 FOR BOOM PIN THAT IS GROOVED.
 (OLD STYLE)
-  "BOOM PIN W/HOLE (W/ROLL PIN) 10772010
-  ROLL PIN 50502201
 FOR BOOM PIN THAT HAS A HOLE.
 (CURRENT STYLE)
-  BOLT 8040021
-  DOWNHAUL RING 10772070
-  COTTER PIN 8060101
 NEWER - NUT 8050101
-  DOWNHAUL LINE RH316WHT X 5'

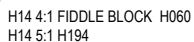
H14 / H16 BLOCK SETS

-  SHACKLE H138
-  H14 5:1 DOUBLE W/BCKET H004
 H16 6:1 UPPER BLOCK H2640**
-  H14 4:1 MAINSHEET LINE RM038XXX X 36'
-  H16 6:1 MAINSHEET LINE RM038XXX X 44'
-  CAMMATIC JAWS H150
-  ADJUSTMENT SCREW HARKEN JAW ANGLE HFS100
-  FAIRLEAD H137
-  SHACKLE H138
-  H14 4:1 FIDDLE BLOCK H060
-  H14 5:1 H194
-  H16 6:1 LOWER BLOCK H194**

** CURRENT H16 STOCK SETUP

HOBIE 17 / 17 SPORT

REPLACEMENT HULL WHITE - LEFT 50101001
 REPLACEMENT HULL WHITE - RIGHT 50102001

Decals -
 12451061 "Hobie" Diamond 36" Silver
 12452000 Silver pin stripe (ft)

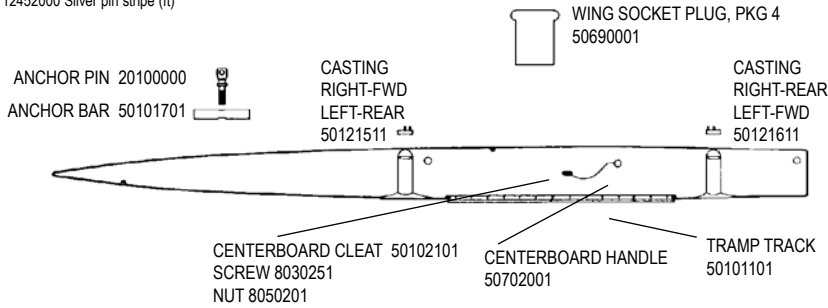

H17 HULL/DECK

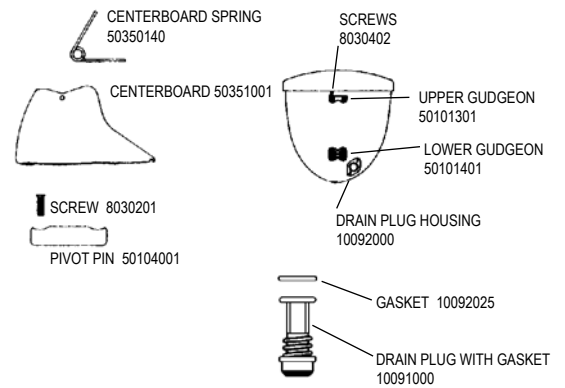

FWD CROSSBAR EXTRUSION ONLY

BLACK 50221001

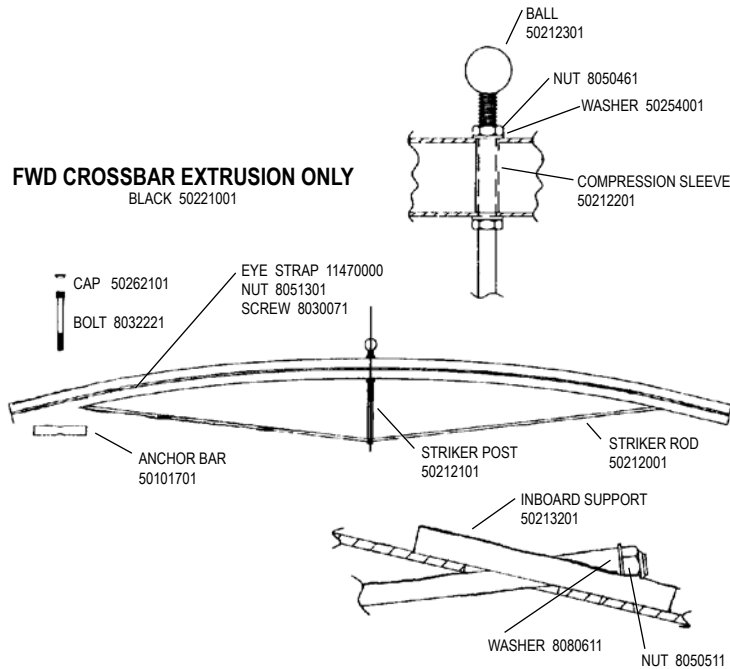

H17 TRAMPOLINE

COMPLETE TRAMPOLINES (Does not include lace line)
 5067XXXX
 (XXXX = Color / See parts list for available options)

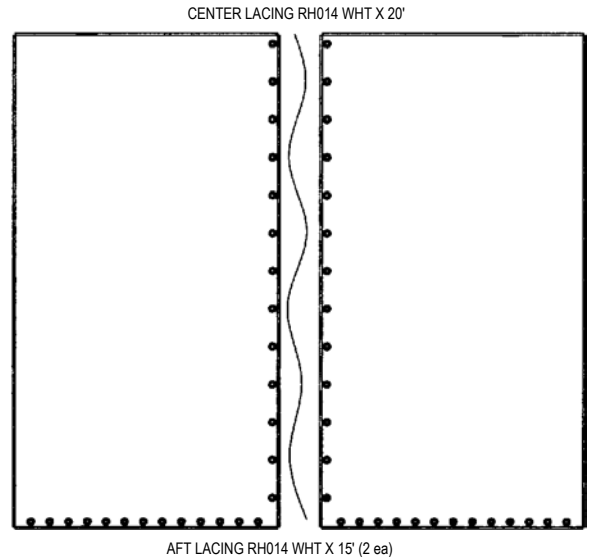

REAR CROSSBAR EXTRUSION ONLY

BLACK 50261001

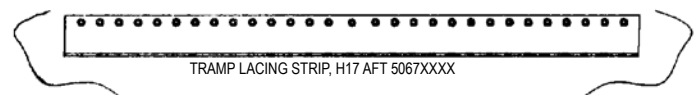
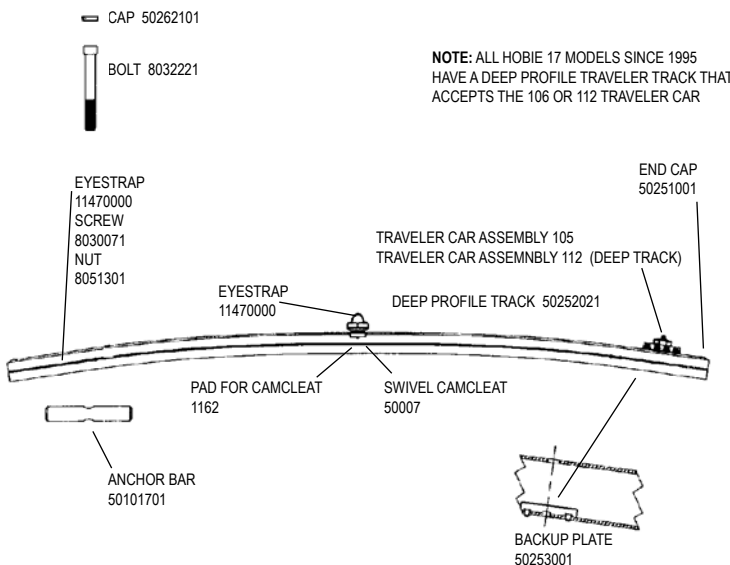

H17 RUDDER ASSEMBLY

* = SUB ASSEMBLY PART / INCLUDED WITH CASTING

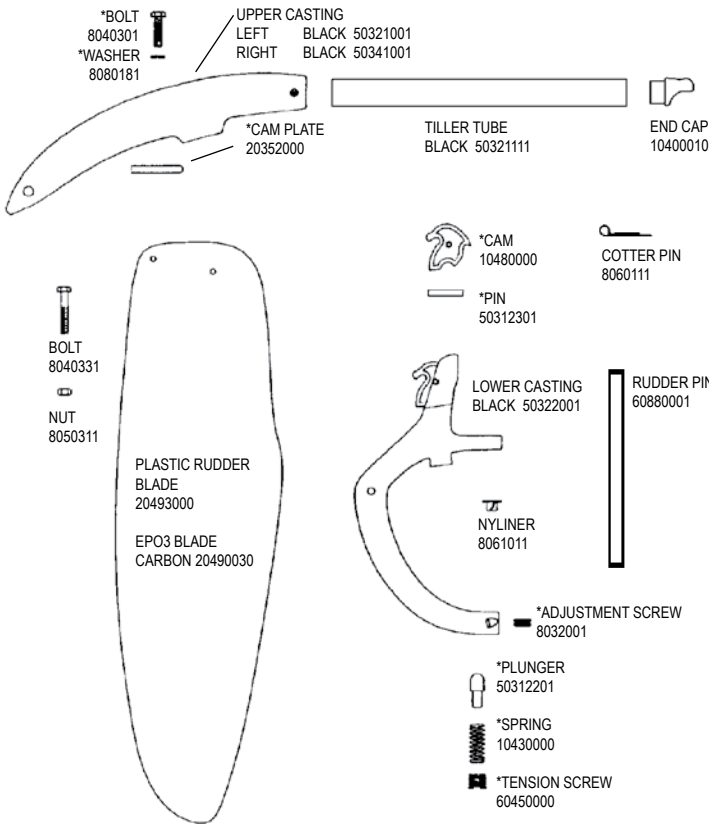

H17 TILLER

TILLER CONNECTOR KIT 11520005

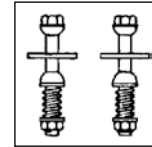

TILLER CROSSBAR BLACK 20520011
'95 - NEWER 20521001

HINGE YOKE ASSY. 3205

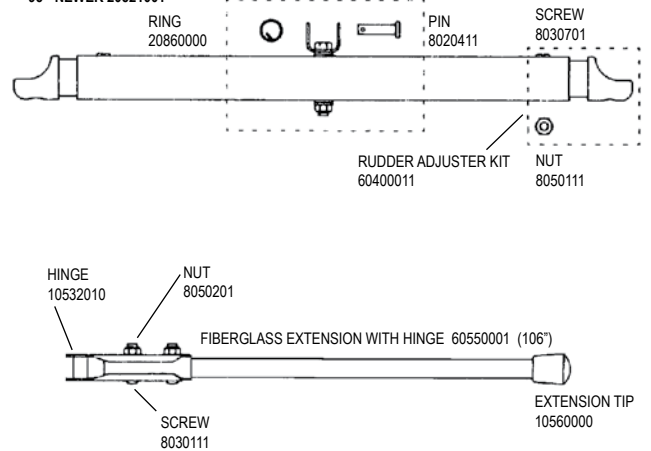

H17 WIRES

(See following page for 17 Sport-Specific Wires)

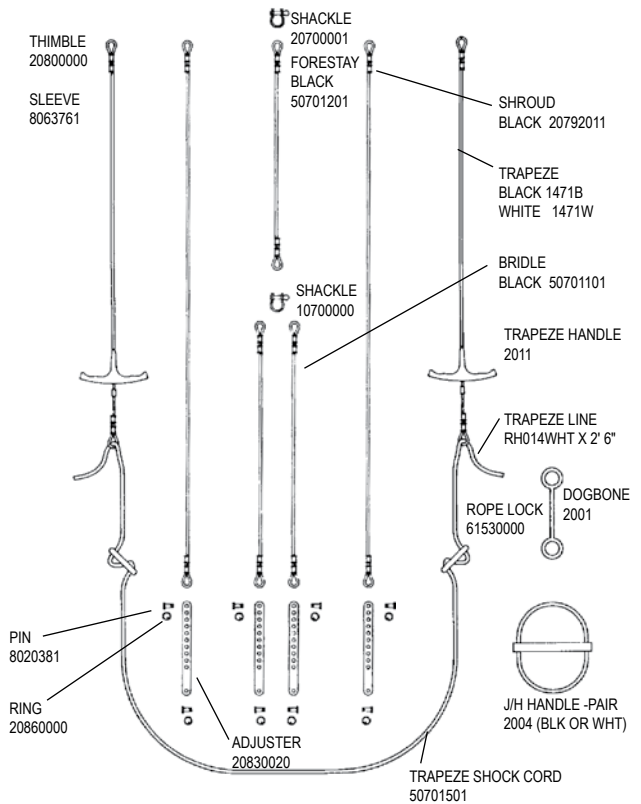

H17 MAST

MAST ASSY. BLACK 51410000
COMPTIP ASSY. 50611101

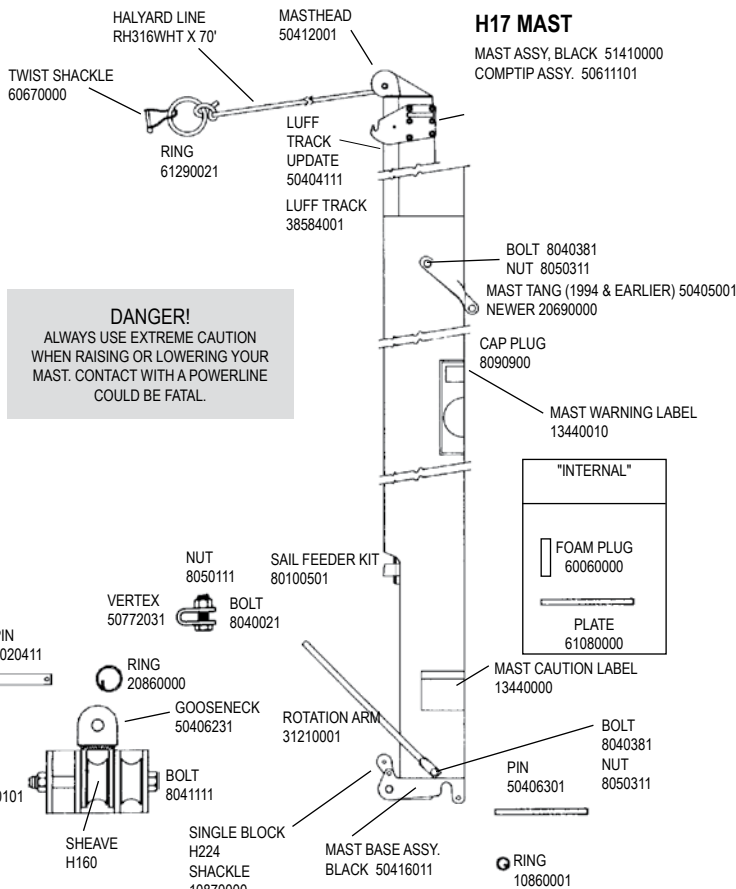

DANGER!
ALWAYS USE EXTREME CAUTION WHEN RAISING OR LOWERING YOUR MAST. CONTACT WITH A POWERLINE COULD BE FATAL.

H17 SAIL

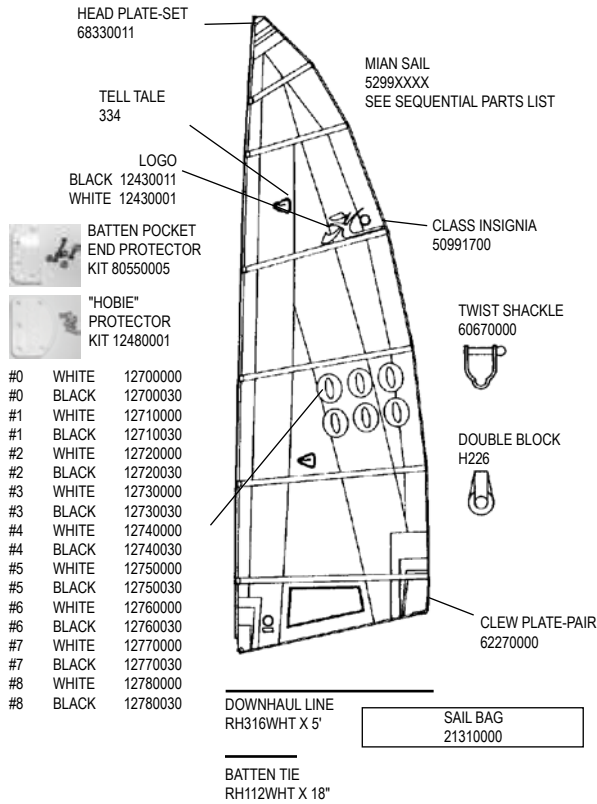

H17 BLOCK SET

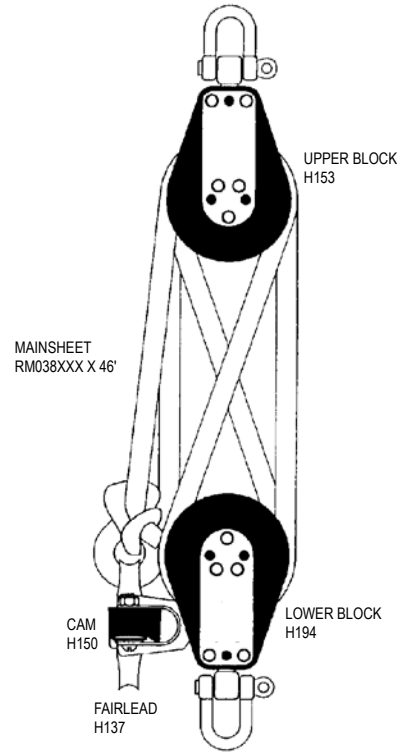

H17 Rivet Guide
() indicates quantity needed to fasten part

Mast	
Head	8010131 (2)
Halyard Hook	8011231 (3)
Base	8010131 (2)
Rear Crossbar	
Swivel Jammer	8010201 (1)
	8031501 (2)
	8031231 (2)
	8080011 (1)
	8050801 (1)
Dead Eye	8010181 (4)
Back Up Plate	8010201 (4)
Track	8010201 (44)
Hull	
Trampoline Track	8010121 (9)
(back up washers required on above,61360000)	
Boom	
End Cap (gooseneck)	8010131 (2)
Block Hanger	8010181 (4)
End Cap	8010131 (2)
Rudder (Upper Casting)	
Casting	8011231 (4)
End Cap	8010131 (2)
Sail Hardware	
Headboard	8010020 (16)
Main Clew Plate	8010020 (10)
Batten Pocket	8010020 (4)
Jib Clew Plate	8010020 (6)
(above rivets require setting machine which is not available in a hand tool)	
Wing	
End Cap	8010051 (1)
Castings	8010131 (8)
Forward Cross Bar - Sport	
Swivel Cam Cleats	8010131 (4)

H17 BOOM

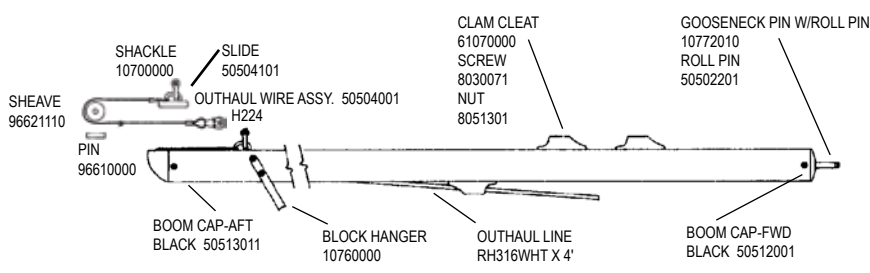

H17 WINGS
SET W/O TRAMPOLINES
50650000

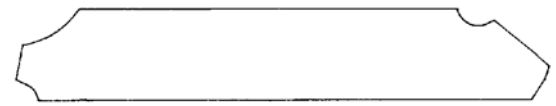

H17 / 17 SPORT BATTENS

(FOR INDIVIDUAL BATTENS SEE UNIVERSAL BATTENS PAGE)

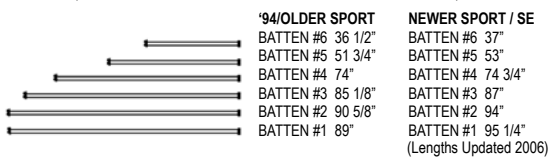

RIGHT-WING ASSY.
50680001

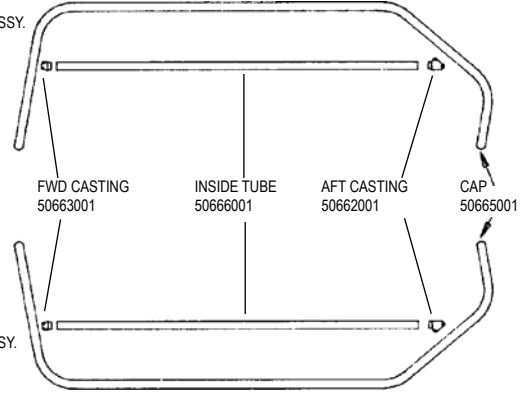

LEFT-WING ASSY.
50660001



HOBIE 17 SPORT SPECIFIC

NOTE: WHERE A SPECIFIC ITEM IS NOT IDENTIFIED, USE THE STANDARD HOBIE 17 LINE DRAWINGS.

H17 SPORT FORESTAY

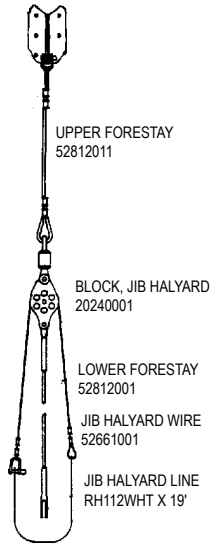

SPORT BOOMLET ASSEMBLY (NEWER, 95 - CURRENT) 52722011



ORIGINAL H17 SPORT REAR CROSSBAR, MAINSHEET SYSTEM AND OUTHAUL SYSTEM-1994 AND EARLIER

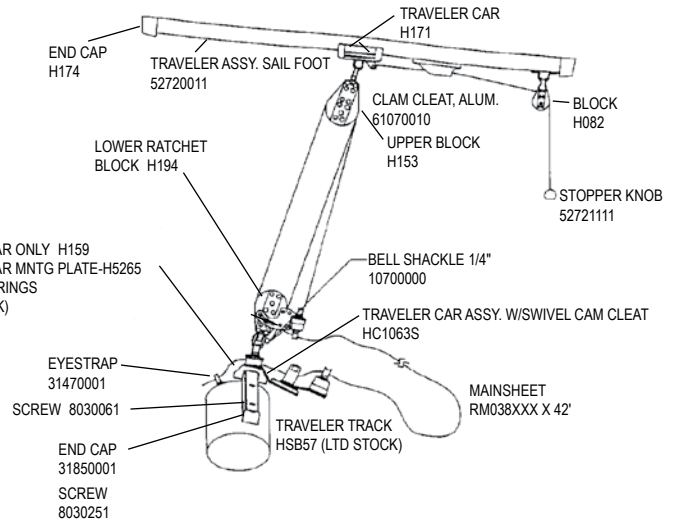

H17 SPORT SPREADER POLE & FURLER

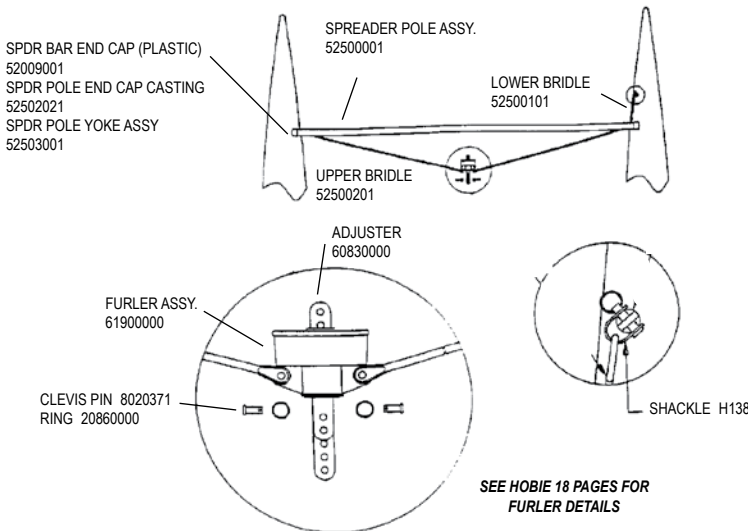

H17 SPORT MAST ASSY. & DOWNHAUL

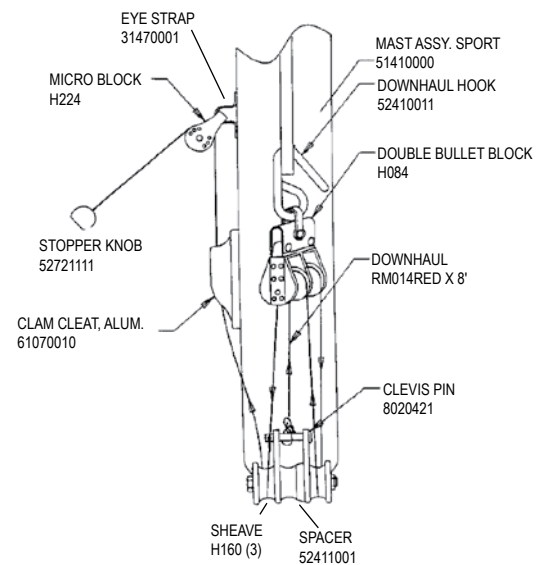

H17 SPORT FRONT CROSSBAR

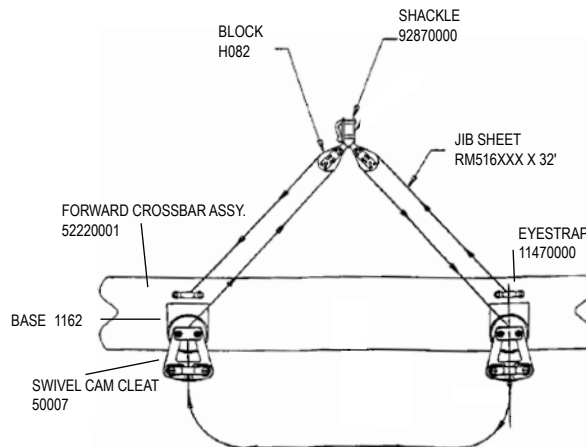

HOBIE 18 / 18 SX

Decals -
12451061 "Hobie" Diamond 36" Silver
12452000 Silver pin stripe (ft)

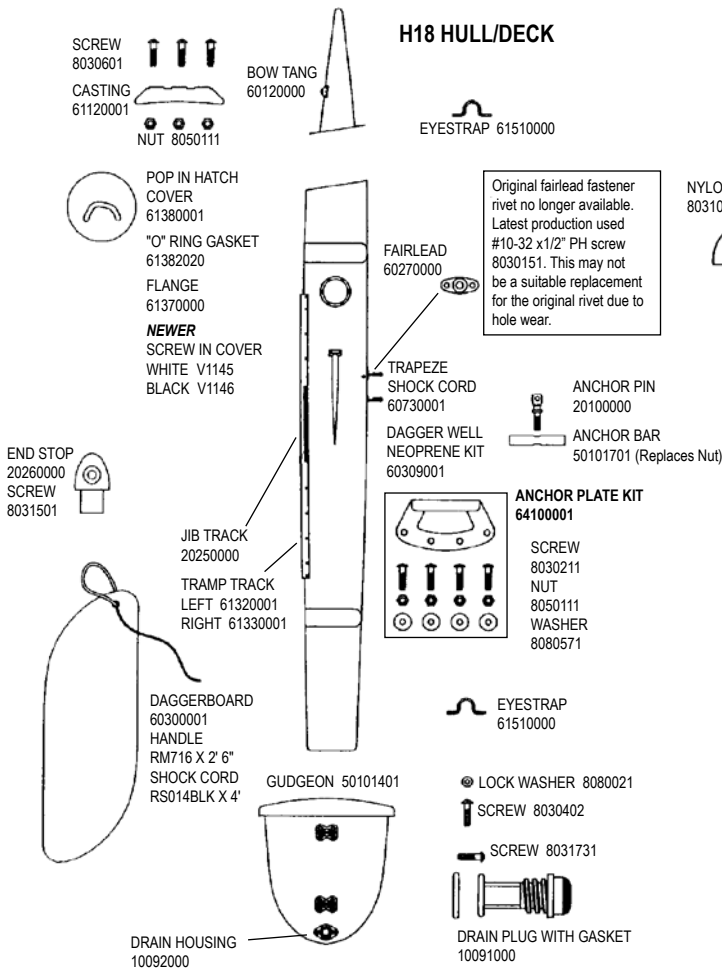

H18 TRAMPOLINE

COMPLETE TRAMPOLINE 6097XXXX
(XXXX = Color / See parts list for available options)
(Does not include lace line)

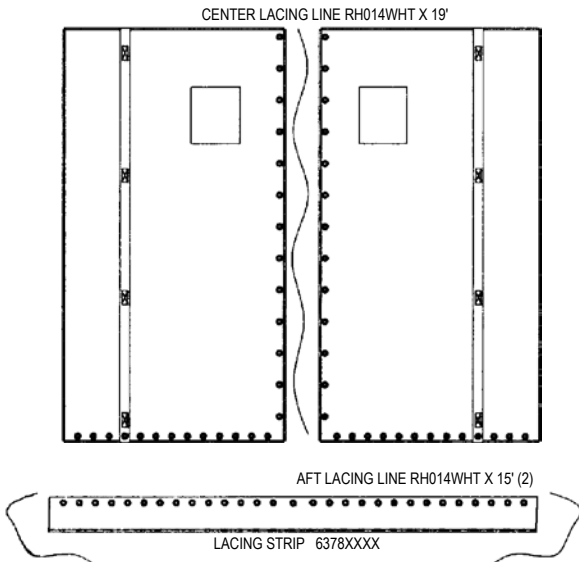

H18 FWD CROSSBAR

CROSSBAR WITH STEP CASTING BLACK 60132010

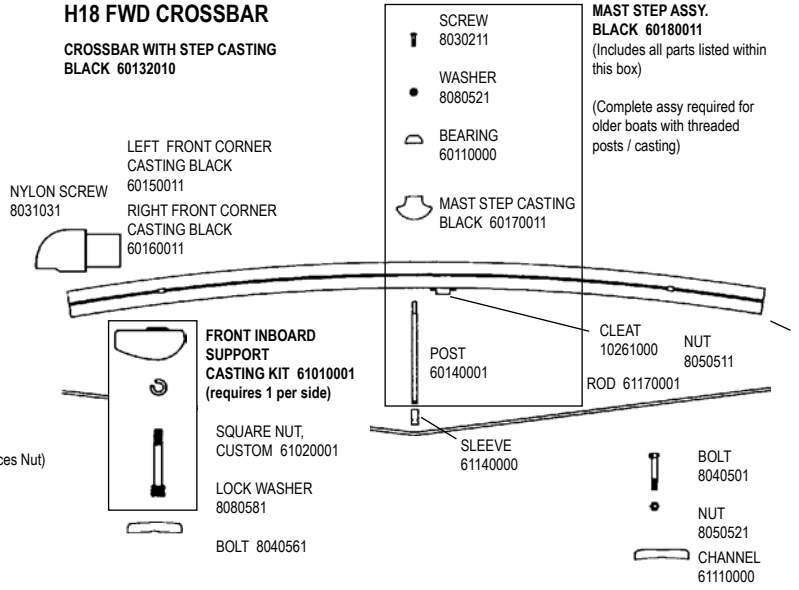

H18 REAR CROSSBAR

REAR CROSSBAR - EXTRUSION ONLY BLACK 60191211

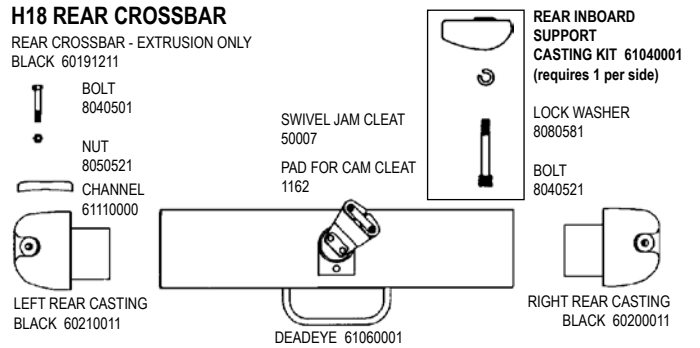

H18 MAIN TRAVELER CAR

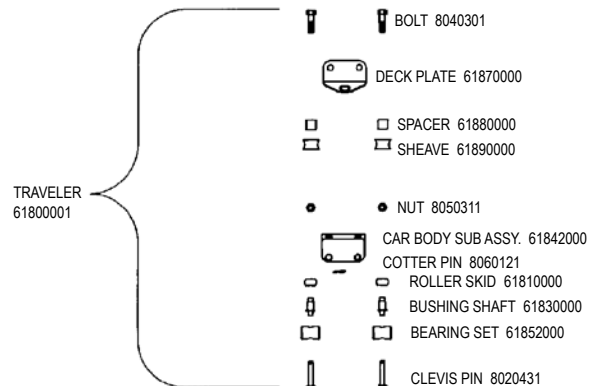

H18 / H18SXRUDDER ASSEMBLY

* = SUB ASSEMBLY PART // INCLUDED WITH CASTING

1986 AND EARLIER
60331010 CONVERSION KIT REQUIRED
INCLUDES: UPPER CASTING ASSEMBLIES, TUBE, END CAP, LOWER CASTING ASSEMBLIES, NUTS, BOLTS, GUDGEONS. FOR BOTH SIDES.

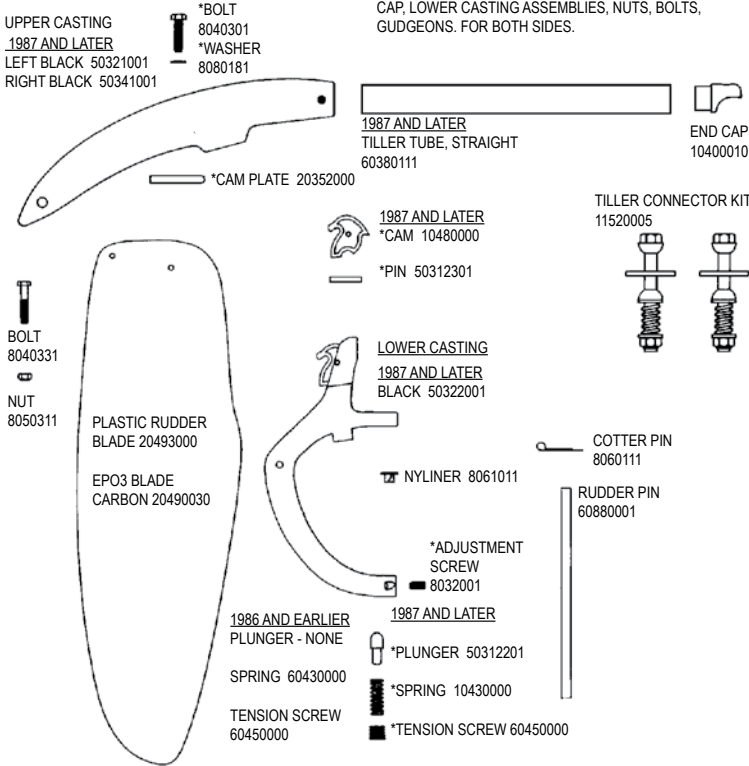

H18 / H18SX TILLER CROSSBAR & EXTENSION

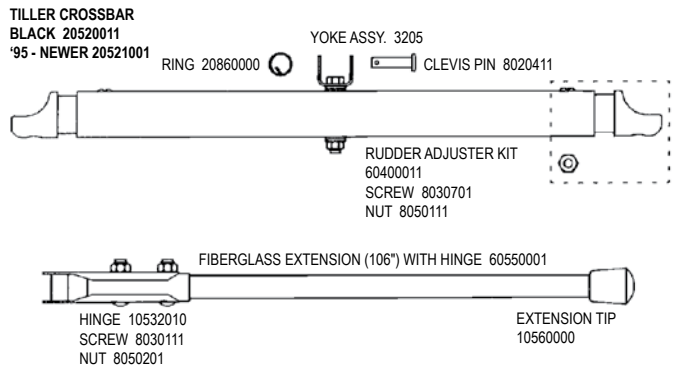

H18 / H18SX MAST

18 MAST ASSY. BLACK 60611001
18SX MAST ASSY. BLACK 68581000

COMPTIP ASSEMBLY 60611100

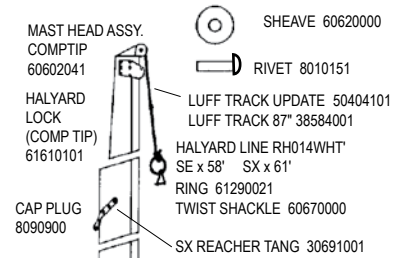

DANGER!
ALWAYS USE EXTREME CAUTION WHILE RAISING AND LOWERING YOUR MAST, CONTACT WITH A POWER LINE COULD BE FATAL.

H18 / H18SX DIAMOND WIRES

18 DIAMOND WIRE 61750001
18SX DIAMOND WIRE 68750001

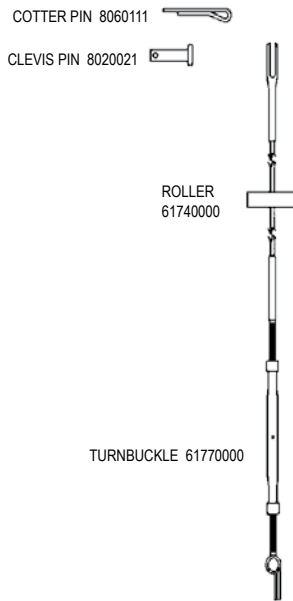

H18 / H18SX SPREADERS

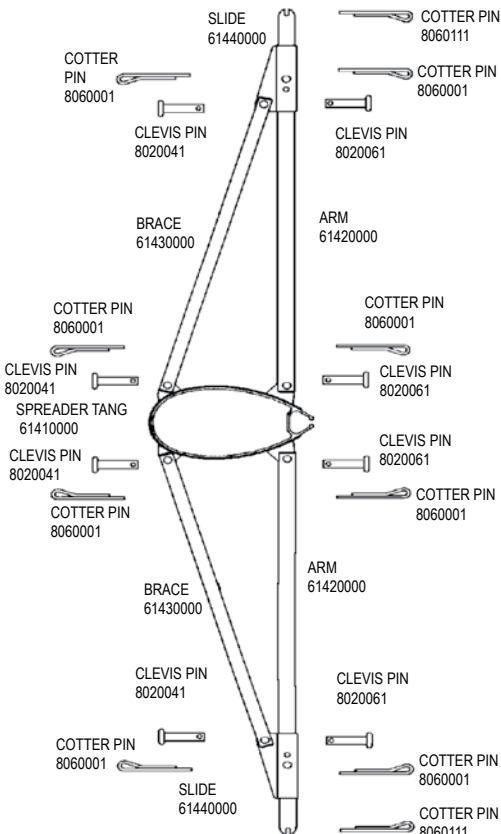

H18 / H18SX ROTATION ARM

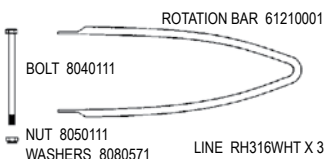

H18 / H18SX FORESTAY & JIB HALYARD

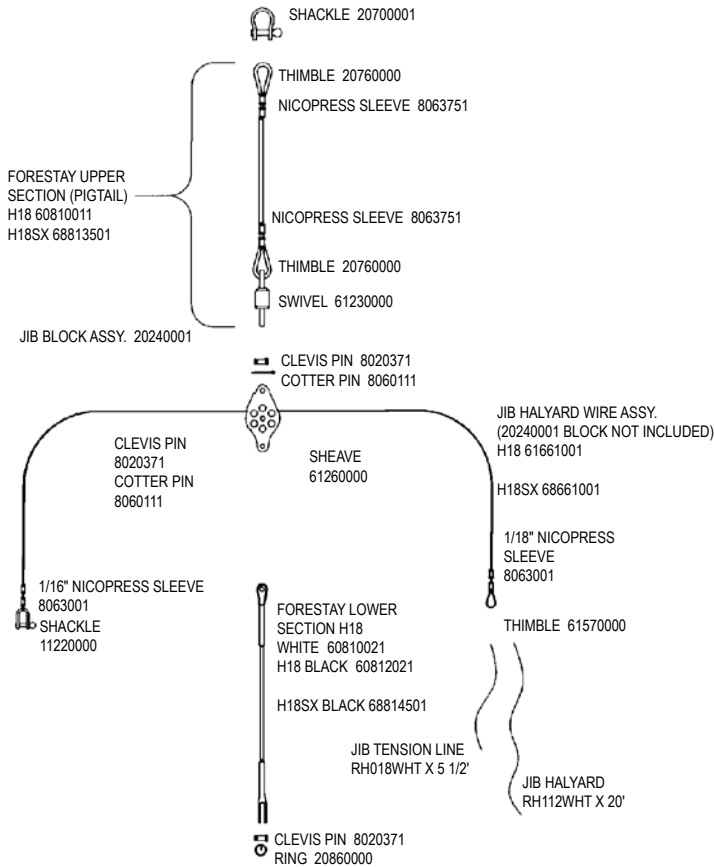

H18 / H18SX ROLLER FURLER

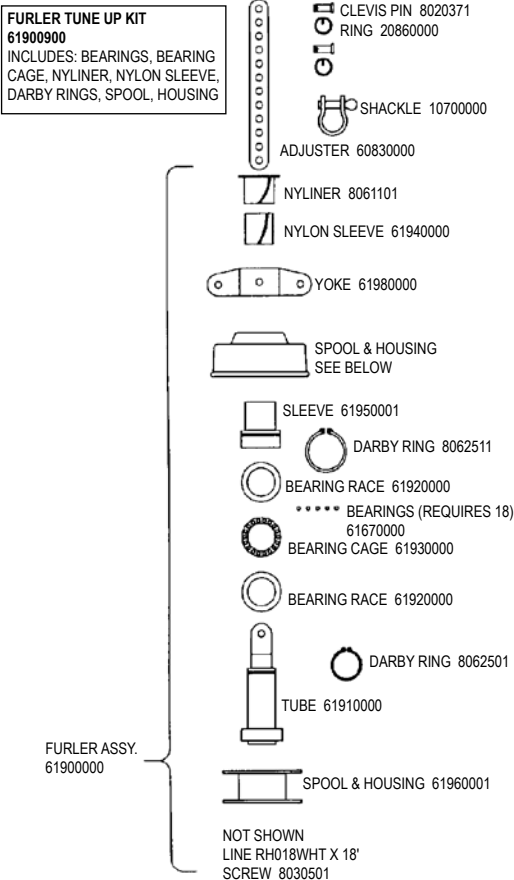

H18 / H18SX SHROUDS & ADJUSTERS

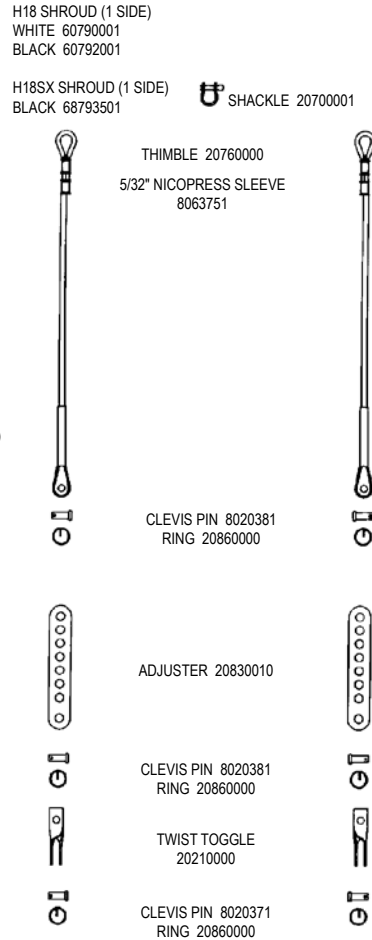

H18 RIVET GUIDE

() Indicates quantity needed to fasten part.

MAST	
HEAD	8010131 (2)
HALYARD HOOK	8011231 (6)
TANG	8010181 (12)
DIAMOND TANG	8010181 (3)
SPREADER TANG	8010181 (8)
COMPRESSION PLATE	8010181 (4)
GOOSENECK PLATE	8010181 (4)
GOOSENECK CLEAR	8010131 (2)
GOOSENECK BLOCK	8010131 (2)
BASE	8010131 (2)

(Note: all 8010181 mast rivets require 08011291 rivet caps)

REAR CROSSBAR	
CORNER CASTING	8011231 (6)
INBOARD SUPPORT	8010131 (2)
SWIVEL JAMMER	8010201 (1)
	8031501 (2)
	8031231 (1)
	8080011 (1)
	8050801 (1)
DEAD EYE	8010181 (4)

HULL	
TRAMPOLINE TRACK	8010121 (9)
(backup washers required on above, 8080551)	
ACCESS PORT FLANGE	8010141 (12)
EYE STRAP	8010131 (2)

BOOM	
END CAP	8010131 (2)

FRONT CROSSBAR	
MAST STEP	8010131 (4)
INBOARD SUPPORT	8010131 (2)
JAM CLEAT	8010181 (2)

RUDDER (UPPER CASTING)	
CASTING	8011231 (3)
END CAP	8010131 (2)

SAIL HARDWARE	
HEADBOARD	8010020 (16)
MAIN CLEW PLATE	8010020 (10)
BATTEN POCKET	8010020 (4)
JIB CLEW PLATE	8010020 (6)
(above rivets requires setting machine which is not available in a hand tool.)	

H18 / H18SX TRAPEZE WIRES



H18 / H18SX BRIDLES

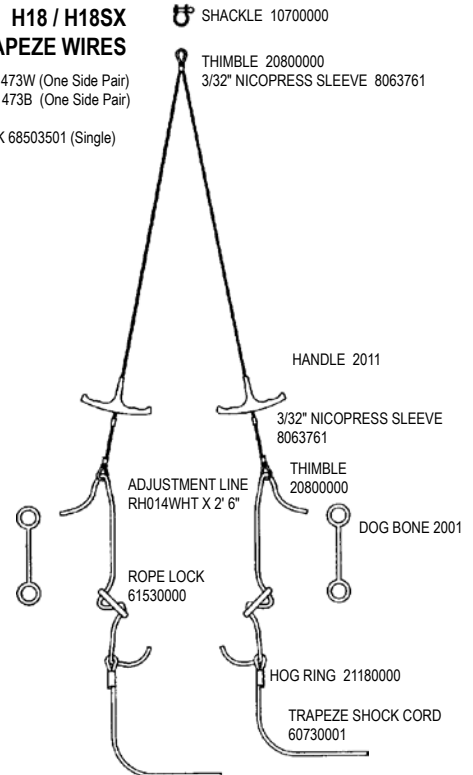
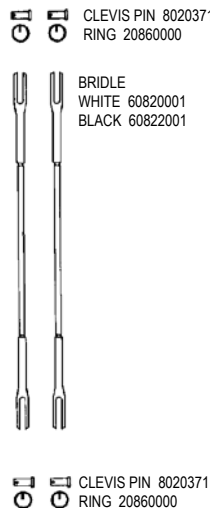

H18 MAIN SAIL & BATTENS

H18 60991XXX / H18SX 68991XXX
SEE NUMERICAL SECTION



- | | |
|---------------------|----------------------|
| HOBIE 18 | HOBIE 18SX |
| BATTEN #10 24 1/8" | BATTEN #9 28 1/2" |
| BATTEN #9 39 1/16" | BATTEN #8 46 1/8" |
| BATTEN #8 56 5/16" | BATTEN #7 67 7/8" |
| BATTEN #7 68 13/16" | BATTEN #6 83 5/16" |
| BATTEN #6 79 5/16" | BATTEN #5 93 7/8" |
| BATTEN #5 87 5/16" | BATTEN #4 100 9/16" |
| BATTEN #4 93 7/8" | BATTEN #3 103 3/4" |
| BATTEN #3 97 5/16" | BATTEN #2 104 11/16" |
| BATTEN #2 101 5/16" | BATTEN #1 102 11/16" |
| BATTEN #1 101 5/16" | |

SAIL WIND INDICATOR
335

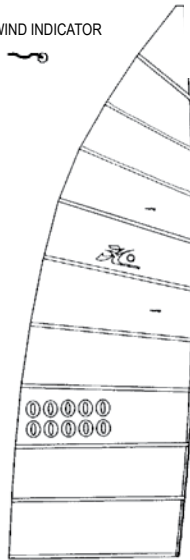

- HEADBOARD W/RIVETS 68330011
- LOGO (PAIR)
WHITE 12430001
BLACK 12430011
- CLASS INSIGNIA 62330000

JIB SAIL
H18 60992XXX
H18SX 68992XXX

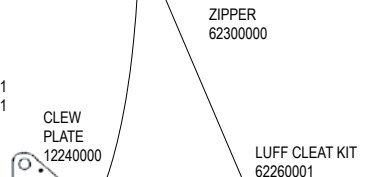

- ZIPPER 62300000
- CLEW PLATE 12240000
- LUFF CLEAT KIT 62260001
- SHACKLE 10870000
- CLEW BLOCK 20680000

(FOR INDIVIDUAL BATTENS SEE UNIVERSAL BATTENS PAGE)

LEECH BATTEN TIP 11323000

LUFF TIP 11322011

BATTEN TIE LINE RH112WHT X 18"

SAIL BAG 21310000

14" SAIL NUMBERS

	BLACK	WHITE
#1	12710030	12710000
#2	12720030	12720000
#3	12730030	12730000
#4	12740030	12740000
#5	12750030	12750000
#6&9	12760030	12760000
#7	12770030	12770000
#8	12780030	12780000
#0	12700030	12700000

MAIN CLEW PLATE-PAIR (W/RIVETS) 62270000

H18 / H18SX BOOM

BOOM ASSEMBLY BLACK 60720011



CLEAT 61070000
SCREW 8031011
CLAMP 61711000

BOOM CAP DRILLED BLACK 60751010

BOOM PIN 10772010
ROLL PIN 50502201

JIB SHEET BLOCK HARKEN 60330041

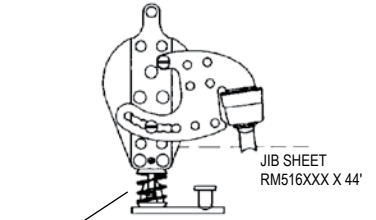

SPRING H071

SLIDE ONLY 60330031
EYE 60330040
SCREW 8030721 (2)

Part	Description	OS
105	TRAVELER CAR ASSEMBLY	-
106	LOWER ROLLER UNIT (PRE-95 H14/	-
111	TRAVELER CAR ASSY BRASS WHEEL	-
112	LOWER ROLLER UNIT BRASS WHEEL	-
114	HALYARD GRIP	-
122	BATTENS-SSI SUPER JIB SET	OS
136	RUDDER STIFFENING KIT	-
176	TRAP STAYS	-
204	THIRD HAND	-
334	AIR FLOW TELS, RED / GREEN	-
370	SHOCK CORD BALL TIES	-
374	TELO CAT, COLLAR, SET SCREW	-
376	SILICON RTV 100% 3 OZ.	-
377	TELO CAT	-
378	TELO CAT REPLACEMENT VANE	-
790	FIBERGLASS STAIN REMOVER	-
1071	JIB TRAV. TRIM KIT W/SW.	-
1075	SWIVEL CAM CLEAT / CAR + CLEAT	-
1076	SWIVEL CAM CLEAT / CAR	-
1125	CAN HOLDER, TRAMP/WING	-
1132	MAST BEARING W/DISK KIT - H18	-
1161	PAD SWVL CAM CLEAT	-
1162	MOUNTING PLATE W/HARDWARE	-
1203	TRAPEZE RIG ADJ.PAIR W/O	-
1204	TRAPEZE RIG ADJ KIT DOUBL	-
1263	UPRIGHT- H-16	-
1266	RESCUE STEP - BOAT	-
1510	SUPERGOOSE.TRENTEC	-
1511	GOOSENECK BEARING, TRENTEC	-
1512	JIB PROTECTOR KIT-TRENTEC	-
1513	JIB PROTECTOR KIT, H20-TRENTEC	-
1544	KICK BACK KIT, TRENTEC	-
1551	KNIFE, DLX STAINLESS	-
1552	JIB CARS, H16-TRENTEC-PR.	-
1561	LUFF CAP KIT H14 TRENTEC	-
1562	LUFF CAP KIT H16 TRENTEC	-
1563	LUFF CAP KIT H18 TRENTEC	-
1566	BATTEN CAP H16 JIB LUFF	-
1603	MAGICA RUST REMOVER GEL 8 OZ B	-
1611	POLISH, STARBRITE MARINE	-
1618	POLISH, FIBERGLASS COLOR	-
1620	END CAP CAT & TIGER TRAX	-
1621	CAT TRAX W/ 8' AXLE	OS
1622	CAT TRAX W/8.5' AXLE H20	OS
1623	CAT TRAX T-HANDLE	OS
1624	CAT CRADLES, FITS ALL BOATS, C	-
1625	WAVE BLUE TRAX	OS

OS-Oversized, OST-Truck, HAZ-Hazmat / Additional handling charges apply

1626	BLUE TRAX W/ 8' AXLE	OS
1630	CAT TRAX - WAVE 7' AXLE	OS
1635	CAT TRAX WHEEL ONLY REPL.	OS
1636	BLUE TRAX WHEEL ONLY REP	OS
1640	CAT TRAX REPLA. BEARINGS	-
1641	CAT TRAX NYLON WASHERS	-
1642	CAT TRAX S.S. WASHERS	-
1643	CAT TRAX COTTER PINS	-
1644	AXLE HOSE C.T. OR T.T.	-
1645	AXLE, CAT TRAX 8' REPLACEMENT	OS
1646	AXLE, CAT TRAX 8 1/2' REPLACEMENT	OS
1647	AXLE, TIGER TRAX 8' REPLACEMENT	OS
1648	AXLE, TIGER TRAX WAVE 7' REPLA	OS
1662	TAPE, SAIL REPAIR 2'X 25' ROLL	-
1665	REPAIR KIT, SAIL	-
1793	TIEDOWN H16 CUSTOM	-
1795	TIE DOWN: ONE PIECE	-
1811	SNORKEL - H16/SPRT/18/21SC JIB	-
1812	SNORKEL - H1-14/H-14 TURBO JIB	-
1813	SNORKEL - H18SX/20/21SE JIB	-
1815	SNORKEL - GETAWAY JIB	-
1953	TILLER CONNECTOR KIT	-
1954	TILLER CONNECTER KIT,WAVE	-
1956	CLUB TILLER CONNECTOR KIT	-
1957	TILLER CONNECTION KIT '07 ROTO	-
2001	DOG BONE. STD	-
2002	DOG BONE, MODIFIED	-
2003	DOG BONE FLEXIBLE	-
2010	TRAP HANDLE, ALUMINUM	-
2011	HANDLE TRAPEZE	-
2061	GROMMET & TOOL KIT	-
2062	GROMMETS #4 BRAS PKG. 24	-
2064	TRAMP LACE KIT H14/16/18	-
2065	TOOL, EASY RIG	-
2066	TRAMP CLAMP, TRENTEC	-
2067	MAIN SHEET OVRBD. PREV.66"	-
2069	TOOL, EASY RIG-MAXI	-
2070	CLAMCLEAT TUG CLEAT	-
2072	BOOM VANG EYE STRAP	-
2081	DOWNHAUL KIT H14/16	-
2082	SCALE - DOWN HAUL / FISH	-
2089	DOWNHAUL KIT 6:1 H14/16	-
2090	HOBIE 14 "POWER PAK"	-
2091	HOBIE 16 "POWER PAK"	-
2101	SHOCK CORD HOOK 1/4" - HOBIE	-
2102	SHOCK CORD FASTENER (SCH) 5/16	-
3043	LICENSE FRAME - CHROME "HOBIE"	-

INDEX

Part	Description	OS	OS-Oversized, TR-Truck, HZ-Hazmat / Additional handling charges apply
3052	TILLER CONNECTOR DLX KIT	-	65035 DIAMOND WHT MENS S/S T XXL
3062	SHACKLE, FAST	-	65036 DIAMOND WHT MENS S/S T XXXL
3064	HALYARD RING-AUSSIE	-	65041 CLASSIC WHT MENS S/S T S
3091	PADDLE, TELESCOPING 20"-39"	-	65042 CLASSIC WHT MENS S/S T M
3101	TRAPEZE RIG KIT, W/DOG BN	-	65043 CLASSIC WHT MENS S/S T L
3102	TRAPEZE RIG KIT W/O BONES	-	65044 CLASSIC WHT MENS S/S T XL
3103	BLOCK, MINI W/AXLE	-	65045 CLASSIC WHT MENS S/S T XXL
3121	DELUXE SAIL BAG	-	65051 CLASSIC BLK MENS S/S T S
3125	COMPTIP COVER, H16/18/20	-	65052 CLASSIC BLK MENS S/S T M
3127	COMPTIP COVER, HOBIE 17/21	-	65053 CLASSIC BLK MENS S/S T L
3128	BAG TRAMP STORAGE W/ MAP	-	65054 CLASSIC BLK MENS S/S T XL
3152	HOBIE MAST STEPPER	OS	65055 CLASSIC BLK MENS S/S T XXL
3155	HOBIE MAST STEPPER II	-	65056 CLASSIC BLK MENS S/S T XXXL
3156	HOBIE MAST STEPPER III	OS	65061 DIAMOND BLK MENS S/S T S
3175	MAST CRADLE HOBIE	-	65062 DIAMOND BLK MENS S/S T M
3205	HIKING STICK YOKE CONN.	-	65063 DIAMOND BLK MENS S/S T L
3206	BLACK FOAM GRIP .570 X 11"	-	65064 DIAMOND BLK MENS S/S T XL
3207	BLACK FOAM GRIP .940" X 12"	-	65065 DIAMOND BLK MENS S/S T XXL
3262	SPREADER BAR END COVER	-	65072 SCRIPT AHGRY MENS L/S T M
5040	HAT, HOBIE CLASSIC SURF NAVY	-	65073 SCRIPT AHGRY MENS L/S T L
5041	HAT, HOBIE CLASSIC DIAMOND NAV	-	65074 SCRIPT AHGRY MENS L/S T XL
5042	HAT, HOBIE LIFEGUARD	-	65075 SCRIPT AHGRY MENS L/S T XXL
5045	HAT, HOBIE CAMO REDFISH	-	65082 SCRIPT CHAR MENS L/S T M
5051	RUDDER PIN, H14/16 FG (PAIR)	-	65083 SCRIPT CHAR MENS L/S T L
5052	RUDDER PIN H17/18 FG (PAIR)	-	65085 SCRIPT CHAR MENS L/S T XXL
5057	BEANIE/HAT, HOBIE GREY	-	65111 SCRIPT OATH PO HOODIE S
5059	HAT, HOBIE WATER-TAN	-	65112 SCRIPT OATH PO HOODIE M
5071	HOBIE CORAL DISCOVER HAT	-	65113 SCRIPT OATH PO HOODIE L
5107	SILICONE SPRAY 7oz	-	65114 SCRIPT OATH PO HOODIE XL
5120	HOBIE MULTI LUBE 1 OZ	-	65115 SCRIPT OATH PO HOODIE XXL
5121	HOBIE MULTI LUBE 4 OZ	-	65121 SCRIPT BUORH PO HOODIE S
5201	RUDDER CAM SCREW, H14/16	-	65122 SCRIPT BUORH PO HOODIE M
5202	RUDDER CAM KIT H14/16	-	65123 SCRIPT BUORH PO HOODIE L
5203	RUDDER CAM SCREWS H17/18/20	-	65124 SCRIPT BUORH PO HOODIE XL
5204	RUDDER CAM KIT H17/18/20	-	65125 SCRIPT BUORH PO HOODIE XXL
6000	HOBIE BEACH TOWEL-ORANGE 35x60	-	65141 CALIF BUORH ZIP HOODIE S
6001	HOBIE BEACH TOWEL-LIME 35x60	-	65142 CALIF BUORH ZIP HOODIE M
6002	HOBIE BEACH TOWEL-YELLOW 35x60	-	65143 CALIF BUORH ZIP HOODIE L
6003	HOBIE BEACH TOWEL-AQUA 35x60	-	65144 CALIF BUORH ZIP HOODIE XL
7003	MIRA ZYME 10 oz ODOR ELIMINATO	-	65145 CALIF BUORH ZIP HOODIE XXL
7904	VELCRO ONE WRAP 1" BLACK	-	65151 CALIF OATH ZIP HOODIE S
8001	ROLLER FURLER KIT, H16	-	65152 CALIF OATH ZIP HOODIE M
8002	SAIL H16 JIB REC - WHITE	-	65153 CALIF OATH ZIP HOODIE L
10049	QUICK RELEASE LEVER 1/4	-	65154 CALIF OATH ZIP HOODIE XL
10072	MINI BLOCK	-	65155 CALIF OATH ZIP HOODIE XXL
10075	SWV CAM CLEAT PLATE	-	65192 FISHING CHAR/LIME S/S M
10076	DECK EYE	-	65193 FISHING CHAR/LIME S/S L
10085	CONTOURED SPACER	-	65194 FISHING CHAR/LIME S/S XL
13826	SPREADER BAR, HOBIE HARNESS	-	65195 FISHING CHAR/LIME S/S XXL
14709	TRAPEZE RIG RETURN SYSTEM	-	65211 UNISEX SKY BLU PO HOODIE S
16703	CONTACT CEMENT	-	65212 UNISEX SKY BLU PO HOODIE M
16706	RAIL KIT, H16 / H14 NEOPRENE	-	65213 UNISEX SKY BLU PO HOODIE L
16707	NEOPRENE RACE STRIPS	-	65214 UNISEX SKY BLU PO HOODIE XL
16708	RAIL KIT, H18 NEOPRENE	-	65215 UNISEX SKY BLU PO HOODIE XXL
20301	PIN, QR 3/16 X 3/4 CUP	-	65231 BAJA STRIPE CHAR PO HOODIE S
20302	PIN, QR 1/4 X 3/4 CUP	-	65232 BAJA STRIPE CHAR PO HOODIE M
20303	PIN, QR 1/4 X 1-1/4 RING	-	65233 BAJA STRIPE CHAR PO HOODIE L
20304	PIN, QR 1/4 X 1 RING	-	65234 BAJA STRIPE CHAR PO HOODIE XL
20305	PIN, QR 1/4 X 1 CUP	-	65235 BAJA STRIPE CHAR PO HOODIE XXL
20306	PIN, QR W/LANYD & SHACKLE	-	72010 KEY FLOAT/SCUPPER PLUG
20307	PIN, QR 1/4 X 1-1/2 CUP	-	72040 QUICK STRAP RACK W/TIE DN
20310	QR WIRE KEEPER	-	72041 MULTI STRAP SYSTEM
20311	PIN, QR 3/16 X 3/4 RING	-	72044 PADS AERO BAR - 24"
20312	PIN, QR 1/4 X 3/4 RING	-	72045 PADS ROOF RACK - 24"
20313	PIN, QR 3/16 X 1/2 RING	-	72046 PADS ROOF RACK - 36"
20314	PIN, QR 1/4 X 1/2 RING	-	72049 PADS AERO BAR - 36"
20501	HAIRPIN COTTER 5/16" 302 SS	-	83102 TOOL GERBER MULTI-PLIER 600
20502	HAIRPIN COTTER 3/8" 302 SS	-	83103 TOOL ALL PURPOSE
20503	SAFETY PIN 1-9/16" LENGTH	-	83104 TOOL, HOG RING PLIERS
20803	TOGGLE SNAP SHACKLE 2-3/4"	-	83105 TOOL, CABLE CUTTER
30101	EASY UP H14/16	-	83106 TOOL, SWAGE-IT
30102	RIGHTING SYSTEM, EASY UP - H18	-	8000341 LOCTITE BLUE .5 ML CAPSULE
30105	EASY RITE H14/16/17	-	8000432 MAST GLUE KIT- BOND CTIP TO MA
30106	EASY RITE H18/21	-	8001821 HIKING STRAP, TRAMPS (PER YD)
30107	RIGHTING BUCKET	-	8001850 WEBBING 2" BLACK
30108	EASY RITE H20	-	8003500 GELCOAT 1/2 PT-WHITE
30109	EASY RITE GETAWAY- REPLACEMENT	-	8004321 LINE 3/16" SGL BRAID-BLACK
30110	HYDROFOILS H14/16	-	8004631 LINE DINGHY LIGHT 5/16"
30112	MAST FLOAT KIT - MAMA UNIVERSA	-	8004651 LINE DINGHY LIGHT 1/4"
30115	MAST FLOAT KIT W/H14/16 "BABY	-	8004811 SHOCKCORD, 1/4" SILVER
30116	MAST FLOAT ATTACH H14/16	-	8004831 SHOCKCORD, 3/16" SILVER
30119	MAST FLOAT KIT "MAMA BOB" STD	-	8004951 LINE JIB HLYD AMSTEELBLUE (TM)
30120	MOUNT KIT ONLY - MAMA UNIVERSA	-	8005611 GELCOAT QUART-WHITE
30302	CLEVIS PIN SET WAVE/GTWY	-	8010020 RIVET 1/8 X 5/16, BRASS
30303	CLEVIS PIN SET H14/16	-	8010051 RIVET 4-8 CSK ALUM
30306	SPARE PARTS KIT H16	-	8010071 RIVET 3/16x 5/16 ALUM
30308	SPARE PARTS KIT WAVE/GTWY	-	8010121 RIVET POP 3/16x5/8 PH-SS
30311	CONVENIENCE KIT H16	-	8010131 RIVET POP 3/16x3/8 PH-SS
30314	SPARE PARTS KIT H17	-	8010151 RIVET, MASTHEAD SHEAVE SINGLE
50007	CAM CLEAT SW W/BULLSEYE	-	8010181 RIVET POP 3/16x1/4 PH
50009	SWIVEL CLEAT/H150/BUL EYE	-	8010201 RIVET 3/16 X 3/8" CSK
50010	ADPTR PLATE W/HWDWR FOR	-	8010261 RIVET 3/16 x 3/16 SS
50012	ROLLER FAIRLEAD KIT	-	8011101 RIVET SEMI 3/16 x 9/16 ALUM
50013	CAM CLEAT W/ROLLER	-	8011231 RIVET POP 3/16x1/2 PH
50014	TRAVELER TAMER KIT	-	8011251 RIVET 3/16 x 1-1/8 PH-AL
50017	SWIVEL CAM CLEAT	-	8011281 RIVET 1/4 X 1 RH SOLID-302 SS
65012	CALIF BLK MENS S/S T M	-	8011291 RIVET CAP
65013	CALIF BLK MENS S/S T L	-	8012062 RIVET SEMI 3/16x27/32 SS
65014	CALIF BLK MENS S/S T XL	-	8020021 CLEVIS PIN 3/16x.453 GRIP
65015	CALIF BLK MENS S/S T XXL	-	8020041 CLEVIS PIN 3/16x.570 GRIP
65022	CALIF CRM MENS S/S T M	-	8020051 CLEVIS PIN 3/16x.709 GRIP
65023	CALIF CRM MENS S/S T L	-	8020061 CLEVIS PIN 3/16x.753 GRIP
65024	CALIF CRM MENS S/S T XL	-	8020080 MAST STEP PIN, 3/16 X 2.125 SS
65025	CALIF CRM MENS S/S T XXL	-	8020101 CLEVIS PIN 5/16 x 2.032 GRIP
65031	DIAMOND WHT MENS S/S T S	-	8020181 QUICK PIN 1/4"x1-1/2"
65032	DIAMOND WHT MENS S/S T M	-	8020340 CLEVIS PIN 3/16x1.062 GRP
65033	DIAMOND WHT MENS S/S T L	-	8020351 CLEVIS PIN 1/4x.3285 GRIP
65034	DIAMOND WHT MENS S/S T XL	-	8020361 CLEVIS PIN 1/4x.675 GRIP

INDEX

8020371	CLEVIS PIN 1/4x.469 GRIP	-	8062001	BUSHING, RUDDER CSTG PKG OF 4	-
8020381	CLEVIS PIN 1/4x.578 GRIP	-	8062501	RING, RETAINING DARBY #1400-10	-
8020391	CLEVIS PIN 1/4x.8285 GRIP	-	8062511	RING, RETAINER, DARBY 1400-143	-
8020411	CLEVIS PIN 1/4x1.0785 GRIP	-	8062521	RING, RETAINER	-
8020421	CLEVIS PIN 1/4x1.141 GRIP	-	8063001	SLEEVE NICROPRESS 1/16"	-
8020431	CLEVIS PIN 1/4x1.328 GRIP	-	8063271	SLEEVE STOP 3/32 WIRE	-
8020451	DETENT RING PIN 1/4 X 2	-	8063281	SLEEVE, STOP 1/8-COPPER	-
8020461	DETENT RING PIN 1/4" X 1-1/8"	-	8063501	SLEEVE NICROPRESS 1/8"	-
8020501	CLEVIS PIN, 1/4X3-1/2 MAST	-	8063751	SLEEVE NICROPRESS 5/32"	-
8020601	CLEVIS PIN 5/16 X 1 3/8	-	8063761	SLEEVE, NICROPRESS 3/32" *	-
8030001	SCREW 12-24 X 1" PHMS-P SS	-	8080011	WASHER, STAR LOCK, 8 EXT	-
8030071	SCREW 10-32 X 1/2 FHMS	-	8080021	WASHER, STAR LOCK, 12 INT.	-
8030111	SCREW 10-32 X 1 PHMS-P SS	-	8080101	WASHER 1/4 X 1/2" LOCK	-
8030131	SCREW 10-32 X 7/8 PHMS SS	-	8080181	WASHER 5/16 X 9/16 FLAT	-
8030151	SCREW 10-32 X 1/2 PHMS-P SS	-	8080481	WASHER 5/16 SPRING	-
8030161	SCREW 10-32 X 1-1/2 PHMS-P SS	-	8080551	WASHER-FLAT .227 X .453 SS	-
8030171	SCREW 12-24 X 3/4 RHMS-P SS* (-	8080561	WASHER 1/4 X 1/2 X .032 SS	-
8030201	SCREW #10x1 FHMS-P SS	-	8080571	WASHER FLAT 1/4x3/4x.063 SS	-
8030211	SCREW 1/4-20 X 1" RHMS-PH SS	-	8080581	WASHER 3/8" HC SPLIT-LOCK	-
8030241	SCREW 10-32x1-1/2 FHMS-P	-	8080611	WASHER FLAT 3/8 X 3/4 SS	-
8030251	SCREW 10-32 X 1" FHMS	-	8080631	WASHER 3/8 X 1 X .062 NYL TRIF	-
8030281	SCREW 10-32 X 3/4" RHMS-P SS	-	8080671	WASHER 5/16 X 3/4 FLAT SS	-
8030291	SCREW 5/16-18 X 2" PHMS-P SS	-	8080681	WASHER 5/16 X 1/2 X .030 NYLON	-
8030301	SCREW 5/16-18 X 1-1/4 RHMS SS	-	8080691	WASHER 3/8 X 3/4 NYLON-FLAT	-
8030311	SCREW 5/16-18x 1-1/2 RHMS	-	8080701	WASHER 1/4 X 1 SS HP	-
8030331	SCREW 1/4-20 X 5/8 PHMS-P SS	-	8080711	WASHER 5/8 X 1-5/16 SS	-
8030361	SCREW 5/16-18 X 1-1/4 SOC HD	-	8080891	WASHER 11/16 X 5/16 X .065 SS	-
8030401	GUIDEON SCREW PKG OF 16	-	8080901	WASHER 1/4 X 3/4 FLAT-NEOPRENE	-
8030402	SCREW 12-24x1 PH-LONG LOK*	-	8081011	WASHER 5/8 X 1" NYLON	-
8030501	SCREW 8-32 X 3/8" THMS-P SS	-	8090900	COMPTIP CAPLUG	-
8030601	SCREW 1/4-20 X 1-5/8 THMS	-	10060000	PLUG, MAST & PYLON	-
8030620	SCREW #10 X 1 3/4 PHMS-PSS	-	10091000	DRAIN PLUG W/GASKET	-
8030701	SCREW 1/4-20 X 1" THMS-P SS	-	10092000	DRAIN PLUG HOUSING	-
8030711	SCREW 1/4-20 X 3/8 RHMS-P SS	-	10092010	DRAIN PLUG-EACH	-
8030981	SCREW 10-32 X 3/4 PHMS	-	10092025	GASKET-BLACK RUBBER	-
8030991	SCREW 10-32 X 3/4" P-FHMS	-	10092100	DRAIN PLUGS-PKG 100	-
8031011	SCREW 10-24 X 1-1/4" FHMS-S SS	-	10092120	DRAIN PLUG GASKET-PKG/100	-
8031071	SCREW 10-32 X 1-1/4 PHMS-P	-	10131910	XBAR H14 FWD BLACK	OS
8031131	SCREW #10x 3/4 PHSM-PH SS(ABA	-	10140000	PYLON VENT TUBE	-
8031151	SCREW #10 X 1/2 PHMS-P	-	10152011	CORNER CSTG H16 RACE L/FWD #1	-
8031191	SCREW 1/4-20 X 1-1/4" PHMS	-	10162011	CORNER CSTG H16 RACE R/FWD #2	-
8031231	SCREW 8-32 X 7/8" FHMS	-	10170011	MAST STEP H14/WV BLACK	-
8031501	SCREW 8 X 3/4" FHMS-P SS	-	10191910	XBAR H14 AFT W/O CAST BK (INTE	OS
8031511	SCREW 8 X 1 FHMS	-	10202011	CORNER CSTG H16 RACE R/R #3	-
8031541	SCREW 8 X 3/4" PHMS-P SS	-	10212011	CORNER CSTG H16 RACE L/R #4	-
8031731	SCREW 8 X 1 PHMS-P SS	-	10261000	CLEAT, STNLS V-JAMMING	-
8031771	SCREW 5/16-18 X 7/8 SOC HD-CAP	-	10262000	CLEAT, BARREL	-
8031810	STUD 5/16-18 X 1-1/4" 18-8 SS	-	10270011	SIDEBAR H14 LEFT BLACK	OS
8031821	SCREW 5/16-24 X 2 SKT SET *	-	10280011	SIDEBAR H14 RIGHT BLACK	OS
8031891	SCREW #14 X 3/4 P-PHMS	-	10300000	CHAIN PLATE, "TURBO"	-
8031950	SCREW #10 X 5/8 FHMS-P SS	-	10311900	RUDDER LOCKING KIT H14/16	-
8032001	SCREW 3/8-16 X 3/4 DELRIN	-	10352011	UPR RDR CSTG H14/16 LEFT	-
8032011	SCREW 1/4-20x1/2 RHMS-P SS	-	10362011	UPR RDR CSTG H14/16 RIGHT	-
8032061	SCREW 1/4-20x1 1/4 PHMS	-	10382010	TILLER ARM H14 STRGHT BLK	-
8032091	SCREW 3/8-16 x1/2 NYLON PHMS-S	-	10400010	TILLER END CAP	-
8032121	SCREW #10 X 1 PHMS-P TF-12	-	10412011	LWR RDR CSTG H14/16 BLK	-
8032211	SCREW 10-32 X 2-1/2 PHMS	-	10430000	SPRING RUDDER CASTING	-
8032221	SCREW 5/16-18x2-1/2 SOC-HD CAP	-	10432000	SPRING H16 LWR CASTING	-
8032401	SCREW 10-24x1/4 PHMS-P SS	-	10440000	PLUNGER, RUDDER H14/16	-
8040001	BOLT 1/4-20x1 1/2	-	10470000	CAM PIN RUDDER CASTING	-
8040011	BOLT 1/4-20 X 1-3/4 HX HD SS	-	10480000	CAM	-
8040021	BOLT 1/4-20 X 7/8 HX HD SS	-	10520011	TILLER XBAR H14 BLACK	OS
8040022	BOLT 1/4-20 X 2 HX HD C/S SS	-	10532010	TILLER EXTENTION HINGE	-
8040051	BOLT 1/4-20 X 3" HEX HD SS	-	10532020	TILLER EXTENTION YOKE	-
8040061	BOLT 3/8-16 X 5"	-	10560000	CAP-ROUND POLYETHYLENE, BLACK	-
8040081	BOLT, 5/16-18 X 3/4"	-	10581100	MAST ASSY H14 BLACK	OST
8040111	BOLT 1/4-20 X 5 HEXCAP	-	10582100	COMPTIP H14	OS
8040131	BOLT 1/4-20 X 3 1/2	-	10602111	MAST HEAD, H14 COMPTIP	-
8040171	BOLT 5/16-18 X 1 HEX HD SS	-	10640011	MAST BASE H14/WV BLACK	-
8040301	BOLT 5/16-18 X 1-1/4 SS	-	10651001	HALYARD - H14 (NON COMPTIP)	-
8040321	BOLT 5/16-18 X 2-1/2" HX HD	-	10657001	HALYARD - H14 (COMPTIP)	-
8040331	BOLT 5/16-18 X 2" HX HD	-	10670000	SHACKLE, HALYARD	-
8040341	BOLT 5/16-18 X 2-3/8 HEX SS	-	10680000	HOOK, HALYARD (12 GA)	-
8040361	BOLT 3/8-16 X 3-1/2" HX HD	-	10690000	MAST TANG H14/WV	-
8040371	BOLT 5/16-18 X 3 7/16	-	10700000	SHACKLE "BOW" 6.4 MM	-
8040381	BOLT 5/16-18 X 3-3/4	-	10730000	CLEAT-MAST	-
8040391	BOLT 5/16-18 X 2-3/4" HX HD	-	10740011	BOOM CAP, H14/16/21SC FWD	-
8040501	BOLT 3/8-16 X 2"	-	10741031	BOOM CAP, H14/16 AFT BLACK	-
8040521	BOLT 3/8-16 X 2-1/2 SCK H	-	10760000	BLOCK HANGER	-
8040561	BOLT 3/8-16 X 3-3/4 SOCHD (CUS	-	10770001	GOOSENECK ASSY H-14, 16	-
8040600	SCREW 3/8-16 X 4" PHMS-P	-	10772001	GOOSENECK SLIDE	-
8040731	BOLT 1/2-13 X 3-5/8" SS*	-	10772010	GNECK BOOM PIN (W/RL PIN)	-
8041111	BOLT 1/4-20x2-3/4 HX HD MS-SS	-	10772020	GOOSENECK SHACKLE	-
8050101	NUT 1/4-20 NYLOCK LOPRO	-	10772070	GOOSENECK DOWNHAUL RING	-
8050111	NUT 1/4-20 HX NYLOCK	-	10792100	WIRE SHROUD H14 BLACK	-
8050121	NUT 1/4-20 CNTRLOCK SS	-	10810010	WIRE FORESTAY H14T UPPER	-
8050151	NUT 5/8-18 HEX FIN JAM SS	-	10812101	WIRE FORESTAY H14 BLACK	-
8050201	NUT 10-32 HEX NYLOCK	-	10822010	WIRE BRIDLE H14 TURBO BLK	-
8050211	NUT 10-32 NYLOCK LOPRO	-	10822101	WIRE BRIDLE H14 BLACK	-
8050301	NUT 5/16-18 NYLON	-	10860001	LOCK RING 3/16"	-
8050311	NUT 5/16-18 NYLOCK STD	-	10860100	LOCK RING 3/16" - 100 PACK	-
8050331	NUT 5/16-18 HX NYLOCK LP	-	10870000	SHACKLE "BOW" 4.7 MM	-
8050341	NUT 5/16-24 NYLOCK LOPRO	-	10881000	RUDDER PIN H14, NYLON	-
8050421	NUT #12-24 NYLOCK, HEX	-	10970000	TRAMP SET H14 WHITE	-
8050511	NUT 3/8-24 NYLOCK HEAVY	-	10970055	TRAMP SET H14 BLACK MESH	-
8050521	NUT 3/8-16 NYLOCK	-	10970058	TRAMP SET H14 TURQ MESH	-
8050540	NUT 3/8-16 HX NYLOCK-LP	-	10990010	SAIL H14 MAIN WHITE	-
8050601	NUT 1/2-13 NYLON HEX FIN	-	10990099	SAIL H14 MAIN - CUSTOM	-
8050631	NUT 1/2-13 NYLOCK LO-PRO SS	-	10992511	SAIL H14 JIB WHITE	-
8050801	NUT 8-32 MACH/SCREW SS	-	11070000	BLOCK, H16 JIB HALYARD	-
8051301	NUT 10-32 SQUARE SS	-	11110005	MAST BEARING, PKG OF 3	-
8060001	COTTER PIN 1/16 X 1/2 SS	-	11110100	MAST BEARING, PKG OF 100	-
8060101	COTTER PIN 3/32 X 1/2 SS	-	11140011	TURBO STRIKER CASTING *	-
8060111	COTTER PIN 3/32 X 3/4 SS	-	11170000	DOLPHIN STRIKER-WIRE H14	-
8060121	COTTER PIN 3/32 X 2 SS	-	11170030	DOLPHIN STRIKER ROD H14	-
8060151	RETAINING CLIP, "E" TYPE	-	11220000	SHACKLE STND "D" 4.7 MM	-
8061011	NYLINER 3/8 D X 3/8 L	-	11322011	BATTEN CAP-LUFF	-
8061101	NYLINER 1" ID X 1.094 LG	-	11323000	BATTEN CAP-LEACH (2 holes)	-

INDEX Continued...

11470000	DEAD EYE	-	20991090	SAIL H16 MAIN CAYMAN	-
11510000	TILLER CONN, HALF SPHERE	-	20991991	SAIL H16 MAIN - CUSTOM	-
11520005	TILLER CONNECTOR KIT	-	20992010	SAIL H16 JIB WHITE	-
11540000	TILLER CONNECTOR,SPRING	-	20992089	SAIL H16 JIB TORTOLA	-
11840100	TRAVELER HINGE	-	20992090	SAIL H16 JIB (CAYMAN)	-
11850000	TRAVELER,HINGE WIRE	-	20992310	SAIL H16 JIB WHITE - VELCRO RA	-
11860000	TRAVELER SPACER	-	20992991	SAIL H16 JIB - CUSTOM	-
11870000	TRAVELER,DECK PLATE	-	20999020	SPIN KIT H16 / GTWY SNUFFER, P	OS
11880000	TRAVELER SHEAVE	-	20999201	GENNAKER KIT - H16 WHITE	-
11901010	PAD FOR 240/241 SWVL BASE	-	20999210	GENNAKER - H16 WHITE	-
11952021	FAIRLEAD REPLACEMENT KIT	-	21000001	BATTEN SET H16 MAIN	OS
12240000	TACK/CLEW PLATE SET	-	21090001	MAST SEAL PLATE,H16	-
12430001	DECAL, SAIL HOBIE "H"-WHT	-	21180000	HOG RING 1/2" S/S, BLUNT, 14 G	-
12430011	DECAL HOBIE SAIL"H" BLACK	-	21180010	HOG RING 5/8" SS,BLUNT, 14 GA	-
12440000	DECAL, SAIL H14	-	21230000	CAR JIBSHEET W/BLOCK H16	-
12450016	DECAL BRAVO	-	21310000	BAG SAIL & BOOM STANDARD	-
12451031	DECAL "HOBIE" DIAMOND-TURQ/SLV	-	21333000	BATTEN CAP JIB-SINGLE	-
12451050	DECAL "HOBIE" SCRIPT BLACK	-	21380001	MAST STEP LINK KIT H14/16	-
12451051	DECAL "HOBIE" SCRIPT WHT	-	21900030	BRIDLE WIRE H16 ROLLER FUR	-
12451061	DECAL "HOBIE" DIAMOND-SLVR/GRA	-	22080905	LUFF BATTEN PROTECTOR KIT- JIB	-
12452121	DECAL HOBIE CAT 16 (BLK/SLVR)	-	22090001	JIB HANK W/ SCREW	-
12453023	DECAL, HOBIE SCRIPT CHROME/BLK	-	22240000	JIB CLEW PLATE (5 HOLE)	-
12453024	DECAL, 12" HOBIE FISHING BLACK	-	22330000	DECAL SAIL - H16 CLASS INSIGNI	-
12453026	DECAL 12" HOBIE SAILING BL/RD/	-	23450000	ASSEMBLY MANUAL H16	-
12453031	DECAL - HOBIE CAT TEQ	-	25131910	XBAR H16 FWD W/STEP	OS
12480000	MAIN BATTEN POCKET PROTECTOR (-	25191911	XBAR H16 AFT	OS
12480001	HOBIE POCKET PROTECTOR KIT	-	25231051	JIB CAR STOP H16 (INT TRACK)	-
12700030	SAIL NUMBER 14" #0 BLACK	-	25232201	JIB TRAV CAR LT - BRASS WHEELS	-
12710030	SAIL NUMBER 14" #1 BLACK	-	25232211	JIB TRAV CAR RT - BRASS WHEELS	-
12720030	SAIL NUMBER 14" #2 BLACK	-	25243003	JIB CAR SLIDE-ONLY W/ WHEELS	-
12730030	SAIL NUMBER 14" #3 BLK.	-	25244001	JIB CAR - PLATE ONLY	-
12740030	SAIL NUMBER 14" #4 BLK.	-	30110001	MAST STEP BALL-GTWY/20/21	-
12750030	SAIL NUMBER 14" #5 BLK.	-	30740001	RUDDER PIN H21/SC	-
12760030	SAIL NUMBER 14" #6/9 BLK.	-	31110001	COMPRESSION SLEEVE,H21/SC	-
12770030	SAIL NUMBER 14" #7 BLK.	-	31800001	TRAVELER CAR ASSY H20/21SC	-
12780030	SAIL NUMBER 14" #8 BLACK	-	36601000	DECAL FLYING "H" SMALL BLK	-
13001001	DECAL BOW - FLYING "H" BLK	-	36601011	DECAL FLYING "H" SMALL WHT	-
13440000	DECAL, MAST CAUTION. BLK	-	36970000	TRAMP SET H21SC MAIN - WHITE	-
13440010	DECAL, MAST CAUTION/ORNG	-	36980055	TRAMP H21SC FWD-BLACK MESH	-
13450000	ASSEMBLY MANUAL H14	-	37001020	GTWY SUS MESH WING ASSY, TURQ	OS
13780000	TRAMP LACE STRIP H14/16 WHITE	-	37001030	GTWY SUS MSH WNG ASSY '17+, GR	OS
13780055	TRAMP LACE STRIP H14/16 BLACK	-	37016001	BATTEN SET GETAWAY	OS
20060000	MAST FOAM PLUG - H16	-	37091001	WING TENSION LEG GETAWAY	-
20100000	ANCHOR PIN	-	37101001	WING LEG GTWY	-
20120000	BOW TANG H14/16	-	37131710	XBAR GETAWAY FWD ASSY 17+	OS
20132031	SHEAVE H16 JIB TRAV	-	37131910	XBAR GETAWAY FWD ASSY	OS
20140001	DOLPH STRIKER POST H16/14	-	37140001	TRAPEZE RIG KIT GETAWAY	-
20170001	DOLPHIN STRIKER ROD H16	OS	37151041	END CAP FWD XBAR CSTG PIS GTWY	-
20200011	MAST STEP,H14/16 BLACK	-	37170001	STUD MAST STEP GETAWAY	-
20210000	TWIST TOGGLE	-	37191710	XBAR GETAWAY AFT ASSY 17+	OS
20240001	BLOCK H16/18 JIB HALYARD	-	37191910	XBAR GETAWAY AFT ASSY	OS
20250000	TRACK - H16 JIBSHEET BLOCK	-	37201021	CSTG AFT XBAR END CAP GETAWAY	-
20260000	TRACK END CAP 5/8"	-	37312000	GETAWAY EZ LOC RUDDER ASSY -A	OS
20270011	SIDE BAR H16 BLACK	OS	37321111	TILLER ARM GETAWAY	-
20352000	RUDDER CAM STOP PLATE	-	37341011	TRAMP TRACK MAIN GETAWAY	OS
20382011	TILLER ARM H16 STR BLACK	-	37342011	TRAMP TRCK FWD GETAWAY	OS
20400001	BATTEN SET H16 JIB	OS	37370036	TUBE FITTING, NYLON MULTI-BARB	-
20490030	RUDDER BLADE EPO-3	-	37371038	PLUG ASSY - GETAWAY COOLER	-
20491000	RUDDER BLADE EZ LOC w/INDENTS	-	37380001	CLAMCLEAT MINI CL204	-
20492021	EZ LOC PLUNGER - LWR RDR HOUSI	-	37382011	TILLER ARM GETAWAY EZLOC	-
20493000	RUDDER BLADE - WHITE NYLON	-	37450011	ASSEMBLY MANUAL GETAWAY	-
20520011	TILLER XBAR H16/17/18 BLK	OS	37500001	BOW SPREADER GETAWAY	OS
20521001	TILLER XBAR H16/17/18 '95	OS	37500021	PLATE GTWY BOW SPRDR	-
20550001	TILLER EXTENSION H14/16 (84")	OS	37500031	END BLOCK GTWY BOW SPRDR	-
20610000	MAST ASSY H16 BLACK	OST	37501701	BOW SPREADER GETAWAY 17+	OS
20611100	COMPTIP H16	OS	37521701	TILLER XBAR GTWY EZ LOC 17+	OS
20614001	MAST HEAD H16 COMPTIP	-	37522001	TILLER XBAR GTWY - TENDON/ALUM	OS
20614210	SHEAVE 2-1/4" OD BLACK DELRIN	-	37523001	TILLER XBAR GTWY - TENDON/EZ L	OS
20614231	SPACER MSTD SHEAVE-16	-	37524001	TILLER XBAR GTWY - '07/EZ LOC	OS
20616001	LUFF TRACK 92-7/8"-H16	OS	37561001	TILLER END CAP (TENDON STYLE)	-
20617001	HALYARD - H16 MAIN (COMPTIP)	-	37561011	TENDON GTWY/WV - KIT	-
20640011	MAST BASE H16 BLACK	-	37561200	TLR END CAP, w/HOLE (UAI)	-
20651011	HALYARD - H16 MAIN (NON COMPTI	-	37561203	TLR END CAP, PIN ASSY (UAI)	-
20661001	WIRE JIB HALYARD ASSY H16	-	37583141	MAST GETAWAY LOWER TIF	OST
20680000	SHEET BLOCK	-	37601001	MAST HEAD ASSY GTWY	-
20690000	MAST TANG H16/17/18	-	37610000	MAST ASSY GETAWAY	OST
20700001	SHACKLE BOW 5/16 PIN	-	37611001	SHEAVE GTWY MAST HEAD	-
20710000	BLOCK, H16 MAST CHEEK	-	37611100	COMPTIP GETAWAY	OS
20720011	BOOM H16 BLACK	OS	37611151	LUFF TRACK GTWY 102.0"	OS
20730001	TRAPEZE SHOCKCORD H14/16	-	37641001	MAST BASE CSTG GETAWAY	-
20730002	TRAP SHCKCD W/HOOK H14/16	-	37651001	HALYARD MAIN GETAWAY	-
20742001	WIRE H16 TRAPEZE W/ BLOCK (EA)	-	37660031	WING END CAP LF/RR GTWY	-
20760000	THIMBLE 5/32"	-	37660041	WING END CAP RF/LR GTWY	-
20781001	LINE PKG, H16	-	37661050	BRACKET WING LEG	-
20782002	JIBSHEET H16 32 7mm MAGIC LIT	-	37661091	LANYARD GTWY WING LEG	-
20792011	WIRE SHROUD H16/17/SPT BLK	-	37760041	CAM CLEAT PLT- GTWY (BENT)	-
20800000	THIMBLE 1/8"	-	37790001	WIRE SHROUD GETAWAY	-
20810011	WIRE FORESTAY H16 UPR	-	37810001	WIRE FORESTAY ASSY GETAWAY	-
20810021	WIRE FORESTAY H16 LWR BAR	-	37810021	WIRE FORESTAY LWR GETAWAY	-
20810031	WIRE FORESTAY - H16 AUSSIE	-	37810030	YOKE GETAWAY FORESTAY	-
20810041	WIRE FORESTAY UPPER - H16 AUS	-	37822011	WIRE BRIDLE GETAWAY	-
20812011	WIRE FORESTAY H16 LWR BLK	-	37830020	FORESTAY ADJ, 1/4" 10 HOLE GT	-
20820011	WIRE BRIDLE H16 WHITE	-	37880001	LACING ROD GTWY FWD 68.0"	OS
20822011	WIRE BRIDLE H16 BLACK	-	37880011	LACING ROD GTWY MAIN 64-3/4"	-
20830010	ADJUSTER 1/4" 7 HOLE - SHROUD/	-	37900011	BLOCK RATCHET LWR GTWY	-
20830020	ADJUSTER 1/4" 10 HOLE - SHROUD	-	37900021	BLOCK DOUBLE SWVL w/BKT GTWY	-
20840000	SAILMAKERS THIMBLE 5/32	-	37970055	TRAMP GETAWAY BLACK MESH	-
20860000	LARGE CLEVIS RING	-	37970058	TRAMP GETAWAY TURQ MESH	-
20860100	LARGE CLEVIS RING / 100 PACK	-	37970059	TRAMP GETAWAY GRAY MESH	-
20880001	RUDDER PIN ALUM - H14/16	-	37971058	WING COVER GETAWAY TURQ MSH PR	-
20880011	RUDDER PIN S.STEEL - H14/16	-	37971758	TRAMP GETAWAY GRAY MESH 17+	-
20970000	TRAMP SET H16 WHITE	-	37977058	WING COVER GTW GRAY MSH PR 17+	-
20970055	TRAMP SET H16 BLACK MESH	-	37980055	TRAMP GETAWAY FWD BLACK MESH	-
20970058	TRAMP SET H16 TURQ MESH	-	37981755	TRAMP GETAWAY FWD BLK MESH 17+	-
20970059	TRAMP SET H16 GRAY MESH	-	37991001	SAIL GETAWAY MAIN "H" WHT RESO	-
20991011	SAIL H16 MAIN WHITE	-	37991077	SAIL GETAWAY MAIN "V" MARTINI	-
20991089	SAIL H16 MAIN TORTOLA	-	37991099	SAIL GETAWAY MAIN "V" CUSTOM	-

INDEX

37992072	SAIL GETAWAY JIB ORANGE	-	40700541	DOWNHAUL SHEAVE H20	-
37992099	SAIL GETAWAY JIB - CUSTOM	-	40792001	WIRE SHROUD H20	-
38010061	SEAT PAD LT BLUE	-	40810011	WIRE FORESTAY H20 UPR	-
38010071	SEAT PAD GRAY	-	40822001	WIRE BRIDLE H20	-
38016001	BATTEN SET WAVE	OS	40822121	WIRE FORESTAY H20 (5/16" END)	-
38040011	BACKREST SET WAVE - BLUE	OST	40880011	RUDDER PIN H20 SS	-
38040012	BACKREST SET WAVE - GRAY	OST	40970001	HIKING STRAP SET - H20	-
38041001	COVER - BACKREST PAD BLUE (1)	-	40970055	TRAMP H20 BLACK MESH	-
38041002	COVER - BACKREST PAD GRAY (1)	-	40991000	SAIL H20 MAIN WHITE	OS
38101301	PINTLE WAVE UPPER	-	40992010	SAIL H20 JIB WHITE	OS
38101401	PINTLE WAVE LOWER	-	41150001	FWD OUTBOARD SUPPORT TUBE H20	-
38120011	EYESTRAP WAVE BRIDLE	-	41220001	EYELET POST	-
38120031	NYLON PUSH-IN PANEL RIVET	-	41370001	HATCH SCREW-IN -WHITE 5"	-
38120041	TANG HW BOW SPREADER	-	50101301	GUDGEON UPPER	-
38131041	XBAR WAVE CLB/SE FWD NEW STEP	OS	50101401	GUDGEON LWR	-
38132001	XBAR STOP WAVE	-	50101701	ANCHOR BAR - SHROUD	-
38140001	TRAPEZE RIGGING KIT WAVE	-	50102011	GUDGEON CASTING H16	-
38170001	STUD HW MAST STEP	-	50212301	DOLPHIN STRIKER BALL 17 / WAVE	-
38171001	MAST STEP/HW (BALL STYLE)	-	50252021	TRACK H17 TRAVELER DEEP	-
38190021	END CAP AFT WAVE BLACK	-	50253001	B/U PLATE H17 REAR XBAR	-
38191031	XBAR WAVE AFT	OS	50262101	XBAR CAP H-17 PKG OF 4	-
38191041	SEAL CAP-BLACK 5/8"	-	50312201	PLUNGER RUDDER H17/18	-
38321111	TILLER ARM, WAVE ORIGINAL STYL	-	50312301	PIN RUDDER CAM H17/18	-
38360001	BUSHING WAVE LWR PINTLE	-	50313001	EZ LOC RDR HOUSING	-
38370001	HULL SEAL CAP (UNDER SEATPAD)	-	50313201	LINKAGE EZ LOC RDR HOUSING	-
38450000	ASSEMBLY MANUAL WAVE	-	50313301	RIVET LWR RDR HOUSING	-
38490011	KEEPER PIN W/LANYARD WAVE	-	50314001	EZ LOC - UP-LOCK PIN KIT	-
38581041	MAST ASSY WAVE 2-PC T/F	OST	50321001	RUDDER CASTING UPR LT BLK	-
38582100	COMPTIP WAVE	OS	50322001	RUDDER CASTING LWR BLACK	-
38583141	MAST WAVE LOWER, NEWER TYPE T/	OST	50341001	RUDDER CASTING UPR RT BLK	-
38584001	LUFFTRACK 87.0"-HW-EXCPT H16 /	OS	50350140	CENTERBOARD SPRING H17	-
38641001	MAST BASE CSTG WAVE (FOR BALL	-	50351001	CENTERBOARD H17	-
38651000	TRAILER ALUM HOBIE WAVE/BRAVO	OST	50404101	LUFF TRACK UPDATE (12.5")	-
38651001	HALYARD, WAVE MAIN	-	50404111	LUFF TRACK UPDATE (14.8") H17	-
38651100	MAST STAND ALUMINUM FORWARD	OST	50406301	PIN H17/20/TIGER MAST STEP	-
38651200	MAST STAND ALUMINUM REAR	OST	50416011	MAST BASE H17/20/TIGER BLACK	-
38653000	TRAILER ALUM HOBIE 16-20"	OST	50502201	ROLL PIN, GOOSENECK BOOM PIN	-
38653100	DOUBLE ROLLER KIT - TRAILER AL	-	50611101	COMPTIP H17	OS
38653200	CRADLE MOUNT KIT - TRAILER ALU	-	50650900	WING TRAMP H17 SET BLACK	-
38660011	BACKREST COLLAR FWD WAVE	-	50650958	WING TRAMP H17 SET TURQ MESH	-
38660031	BACKREST COLLAR AFT WAVE	-	50663001	WING CASTING H17 FWD BLK	-
38670011	"S" HOOK,WAVE HALYD DWNHL	-	50665001	WING CAP H17	-
38760021	TUBE SE WAVE TRAMPOLINE	-	50670091	TRAMP SET H17 BLACK MESH	-
38760031	TRAMP ANCHOR HOOK SE WAVE	-	50670391	TRAMP LACING AFT H17 BLK	-
38760041	CAM CLEAT PLT-CLUB/SE	-	50701101	WIRE BRIDLE H17 SE BLACK	-
38760061	TENSION HOOK WAVE SE TRAMP	-	50701201	WIRE FORESTAY H17 SE BLACK	-
38760071	HOOK WAVE SE TRAMP (SLIDE)	-	50701501	TRAPEZE SHOCKCORD H17	-
38790001	WIRE SHROUD SE WAVE W/HOOKS	-	50772031	HINGE VERTEX.GOOSENECK	-
38822011	WIRE BRIDLE WAVE SE W/HOOK-1/8	-	52009001	SPREADER POLE END CAP SPORT	-
38881011	TRAMP LACING ROD WAVE	OS	52410011	HOOK-SPORT DOWNHAUL	-
38900031	"S" HOOK, WAVE MAIN SHEET	-	52411001	WASHER MAST BASE H17/20	-
38900061	BLOCK, STD FIDDLE W/BEARING	-	52500001	SPREADER POLE ASSY SPORT	OS
38900071	BLOCK, 40MM FIDDLE W/CAM, BKT,	-	52500101	BRIDLE LWR SPORT (SS)	-
38950011	END CAP WAVE JIB SPREADER	-	52500201	WIRE BRIDLE UPR SPORT	-
38970000	TRAMP SET WAVE SE WHITE	-	52661001	WIRE JIB HALYARD SPORT	-
38970051	WIRE WAVE SE TRAMP	-	52721111	BALL MEDIUM 6 MM BLACK	-
38970055	TRAMP WAVE SE BLACK MESH	-	52722011	SPORT SAIL FOOT "BOOMLET"	-
38970058	TRAMP WAVE SE TURQ MESH	-	52812001	WIRE SPORT FORESTAY LWR	-
38970061	STRAP WAVE SE TRAMP AFT TENSIO	-	52812011	WIRE SPORT FORESTAY UPR	-
38990050	SAIL BAG WAVE	-	52991000	SAIL H17SE/SPT MAIN WHITE	OS
38991000	SAIL WAVE MAIN "V" WHITE	OS	52992006	SAIL SPORT JIB WHITE DACR	-
38991050	SAIL WAVE MAIN "H" WHITE RESOR	OS	53180011	HOG RING 3/8" S/S FOR 3/16" BU	-
38991079	SAIL WAVE MAIN "V" MARTINQ	OS	53790141	HOOK JIB GTW / TRIFOILER	-
38991950	SAIL WAVE MAIN "H" CUSTOM RESO	OS	60060000	MAST FOAM PLUG H18	-
38991991	SAIL WAVE MAIN "V" - CUSTOM	OS	60102011	GUDGEON H18 CASTING KIT	-
38992007	SAIL WAVE JIB YELLOW 25sq ft	-	60110000	MAST BEARING H18	-
38992010	SAIL WAVE JIB WHITE (25 sq ft)	-	60120000	TANG H18 BOW	-
38992071	SAIL WAVE JIB TURQUOISE (25 sq	-	60140001	DOLPHIN STRIKER H18 POST	-
38992072	SAIL WAVE JIB ORANGE (25 sq ft	-	60170011	MAST H18 STEP BLACK	-
38999000	SPIN POLE & HRDWR KIT WAV	-	60180011	MAST H18 STEP ASSY BLACK	-
38999001	WAVE JIB SPDR & HRDWR KIT	OS	60210011	XBAR H18 CSTG AFT LT BLK	-
38999021	BOW SPREADER - WAVE	OS	60220001	BOOM H18 OUTHAUL SLASY	-
38999052	SPINNAKER WAVE (60 sq ft)	-	60240000	BOOM H18 OUTHAUL BEARING	-
39100011	ANCHOR PLATE CLUB WAVE SHROUD	-	60250000	BOOM PIN H18 OUTHAUL BRNG	-
39130021	END CAP FWD BLACK	-	60270000	FAIRLEAD H18 THRU-DECK	-
39250000	MAIN TRAVELER KIT - CLUB WAVE	-	60309001	DAGGER WELL NEOPRENE KIT	-
39312000	WAVE EZ LOC RUDDER ASSY - ADD	OS	60330031	JIB SLIDE H18/20 (WITH 1/4-20	-
39341011	TRAMP TRACK WAVE CLUB	OS	60330041	BLOCK HARKEN JIBSHEET	-
39382011	TILLER ARM WAVE EZ LOC	-	60400011	RUDDER ADJUSTER KIT	-
39522001	TILLER XBAR WAVE "TENDON"	OS	60450000	SCREW DELRIN RUDDER	-
39524001	TILLER XBAR WAVE "EZ LOC"	OS	60550001	TILLER EXTENSION H18/21 (106")	OS
39550001	HIKING STICK KIT - WAVE EZ LOC	OS	60611000	COMPTIP H18	OS
39640020	MAST FLT PLT	-	60620000	SHEAVE 1"	-
39790001	WIRE SHROUD WAVE CLUB	-	60641031	MAST BASE CASTING H18	-
39810001	WIRE FORESTAY WAVE CLUB	-	60650011	MAST BASE HINGE CSTG H18	-
39822011	WIRE BRIDLE WAVE CLUB	-	60670000	SHACKLE,TWIST 3/16 PIN	-
39870000	BEACH DOLLY - WAVE	OS	60680001	COMPRESSION PLATE ASSY - MAST	-
39970000	TRAMP CLUB WAVE WHITE	-	60710000	GOOSENECK YOKE	-
39970055	TRAMP CLUB WAVE BLACK MESH	-	60730001	TRAPEZE SHOCK CORD H18	-
39970058	TRAMP CLUB WAVE TURQ MESH	-	60730002	TRAPEZE SHOCKCORD W/HKS	-
39970059	TRAMP SET WV-CLUB GRAY MESH	-	60751010	BOOM CAP H18 FWD BLACK	-
40240001	OUTHAUL ROLLER	-	60790001	SHROUD H18/21SC WHITE	-
40340001	RUDDER PIN BUSHING H20 UPPER	-	60792001	SHROUD H18/21SC BLACK	-
40360001	RUDDER PIN BUSHING H20 LOWER	-	60810011	WIRE H18/21SC FSTAY UPR	-
40380011	TILLER ARM H20	-	60810021	WIRE H18/21SC FSTAY WHT	-
40401210	COMPTIP H20	OS	60812021	WIRE H18/21SC FSTAY BLK	-
40504501	WIRE TRAPEZE H20 PR.	-	60820001	WIRE H18 BRIDLE WHITE	-
40530001	TILLER CONNECTER POST	-	60822001	WIRE H18 BRIDLE BLACK	-
40530021	TLR CONNECTER SCREW/CLUB	-	60830000	STAY ADJUSTER (FOR JIB FURLER)	-
40540001	TILLER CONN ADJUSTER THREADED	-	60880001	RUDDER PIN H17/18	-
40550001	TILLER CONN END CAP - THREADED	-	60880011	RUDDER PIN, ST. STEEL H17/18	-
40561001	END CAP TILLER CONNECT FIXED	-	60970000	TRAMP SET H18 WHITE	-
40590001	TILLER CONNECTOR RETAINER	-	60970055	TRAMP SET, H18 BLK MESH	-
40600001	TILLER EXTENSION BUSHING	-	60970058	TRAMP SET H18 TURQ MESH	-
40650001	END CAP,TILLER ARM SWIVEL	-	60991011	SAIL H18 MAIN WHITE	-
40660001	TILLER ARM INSERT	-	60991991	SAIL H18 MAIN - CUSTOM	-
40680001	INSERT BEARING TILLER CONNECTO	-	60992011	SAIL H18 JIB WHITE	-

INDEX Continued...

60992991	SAIL H18 JIB - CUSTOM	-	90382011	TILLER ARM - BRAVO EZ LOC	-
61020001	INSERT NUT - INBD SUPT CSTG H1	-	90440011	PAD HIKING STRAP - BRAVO	-
61040001	INBOARD SUPPORT CSTG H18 REAR	-	90440021	HIKING STRAP ADJUST - BRAVO	-
61070000	CLAMCLEAT JUNIOR CL203	-	90440050	BLOCK LARGE BULLET	-
61070010	CLAMCLEAT RACE JUNIOR	-	90500021	MAST KEEPER GATE ASSY	-
61080000	MAST SEAL PLATE H18	-	90500022	MAST KEEPER HINGED GATE ASSY	-
61210001	MAST ROTATION BAR	-	90501031	CSTG A-FRM CONNECTOR	-
61230000	SWIVEL JIB FURLER-EYE/EYE	-	90501036	FURLER LINE KEEPER STRAP ASSY	-
61260000	SHEAVE - JIB HALYARD BLOCK	-	90502031	KNOB ASSY - MAST GATE	-
61290011	RING SS 3/16 X 1-3/16" ID	-	90502041	KNOB ASSY - MAST GATE / NEWER	-
61290021	HALYARD RING W/LOOP	-	90550011	BRAVO TILLER EXT - EZ LOC	-
61370001	HATCH SCREW-IN -WHITE 6"	-	90560041	TILLER END CAP BRAVO - EZ LOC	-
61510000	EYE STRAP	-	90600012	MAST FLOAT BRAVO (UNIVERSAL)	-
61530000	ROPE LOCK	-	90600021	SADDLE STRAP/BRAVO FLOAT	-
61570000	THIMBLE 1/16" SS HVY DUTY	-	90600041	MAST FLOAT WEB STRAP/BUCKLE	-
61610101	HALYARD HOOK H18/20 COMPTIP	-	90610101	COLLAR BRAVO MAST	-
61661001	WIRE JIB HALYARD ASSY H18	-	90610111	DELNRN BALL 3/8 DIA - FURLERS	-
61670000	BALL BEARING (18 PER FURLER)	-	90610112	DELNRN BALL 3/8 DIA (PKG OF 12)	-
61740000	ROLLER DIAMOND WIRE H18	-	90610121	FURLER LINE - BRAVO	-
61750001	WIRE DIAMOND H18 W/TURNBUCKLE	-	90611001	COMPTIP HOBIE BRAVO	OS
61770000	TURNBUCKLE 1/8" FLAT JAW	-	90612111	MAST BEARING - INJ MOLD	-
61800001	TRAVELER ASSEMBLY - MAIN	-	90613000	MAST BRAVO LOWER T/F	OST
61810000	ROLLER SKID - TRAVELER	-	90640011	MAST BASE BRAVO	-
61830000	BUSHING SHAFT - TRAVELER	-	90640021	BALL - MAST ROTATION	-
61852000	BEARING SET (2 CYLINDERS)	-	90700011	WIRE BRAVO MAINSHEET ATTACHMEN	-
61870000	TRAVELER DECK PLATE	-	90700050	COVER BRAVO A-FRAME	-
61880000	SPACER,H18 TRAVELER CAR	-	90700121	BLOCK SINGLE w/BCKET BLACK	-
61890000	SHEAVE TRAVELER CAR	-	90700131	BLOCK RATCHET LOWER BRAVO (EZ	-
61900000	JIB FURLER ASSY	-	90700201	BRACKET MAINSHEET ATTACH - BRA	-
61900900	FURLER TUNE UP KIT	-	90701001	A-FRAME REPLACEMENT KIT 2-PC	-
61920000	FURLER BEARING RACE	-	90710000	A-FRAME SUPPORT w/STRAP -NEWER	-
61930000	FURLER BEARING CAGE	-	90710009	END CAP, VERT SPRT 5/16 - 18	-
61940000	FURLER NYLON SLEEVE 1" ID X.1.	-	90710010	END CAP, VERT SPRT 5/16-18	-
61950001	FURLER SLEEVE	-	90710011	A-FRAME SUPPORT w/STRAP -OLDER	-
61960001	FURLER SPOOL&HOUSING	-	90711001	A FRAME ATTACH-OLD STYLE 1/4-2	-
61980000	FURLER BRIDLE YOKE	-	90711011	A FRAME ATTACH-NEW STYLE 5/16-	-
62260001	CLAMCLEAT LEECHLINE CLEAT	-	90720000	BOOM ASSY BRAVO	OS
62270000	CLEW PLATE (3 HOLE)	-	90720101	GSNK BOOM CLIP - BRAVO	-
62300000	ZIPPER JIB LUFF	-	90870000	BEACH DOLLY - BRAVO	OS
62330000	DECAL H18 SAIL - CLASS INSIG	-	90880211	PINTLE UPR - EZ LOC	-
68190001	ANCHOR PLATE, SX WINGS	-	90880221	PINTLE LWR - EZ LOC	-
68330011	HEADBOARD ALUM W/RIVETS	-	90880231	RETAINER CLIP EZ LOC RDR HOUSI	-
68503501	TRAPEZE WIRE SX18 BLACK	-	90990021	SAIL BRAVO 3.8 OZ-SEABREEZE	-
68661001	WIRE H18SX JIB HALYARD	-	90990022	SAIL BRAVO 3.8 OZ-MARTINIQ	-
68793501	WIRE H18SX SHROUD BLACK	-	90991000	BAG MAST/SAIL BRAVO	-
70001111	BEACH DOLLY EURO H16	OST	90992000	BAG SAIL BRAVO (SAIL ONLY)	-
70060001	HOBIE UV PROTECTANT-12oz	-	91011001	BATTEN CAP 3/16 DIA	-
71175001	HATCH BAG 6.0 DIA.-RED	-	91011011	BRAVO BATTEN #1 (5' 6 1/2")	-
71190011	HANDLE - LIFTING (WEB - BRAVO)	-	91021111	BRAVO BATTEN #2 (11' 6 5/8")	-
71190021	HANDLE - LIFTING '08 (WEB - B	-	91031011	BRAVO BATTEN #3 (10')	-
71220001	PAD EYE - CHROME	-	91050010	HOOK WHT NYLON SEW-ON	-
71321001	GASKET KAYAK HATCH 6"	-	91050020	HOOK BLK NYLON SEW-ON	-
71331001	GASKET KAYAK HATCH 8"	-	91281000	DRAIN SCREW W/WASHER W/WTF/20'	-
71701001	HATCH 6" TWIST-N-SEAL KIT	-	92870000	SHACKLE HEADBOARD 3/16	-
71701011	HATCH 6" TWIST-N-SEAL	-	96280000	SLUG SLIDE 5/16" NYLON	-
71701021	O RING 6" TWIST-N-SEAL	-	1470B	TRAP WIRES WAVE BLK	-
71702001	HATCH 8" TWIST-N-SEAL KIT	-	1471B	TRAP WIRES H16/17 BLK	-
71702011	HATCH 8" TWIST-N-SEAL	-	1472B	TRAP WIRES H16 BLK W/SHCK	-
71702021	O RING 8" TWIST-N-SEAL	-	1473B	TRAP WIRES H18 BLK (ONE SIDE)	-
71703001	HOBIE DRY BAG 8.0"	-	1473W	TRAP WIRES H18 WHITE	-
71707001	RECTANGULAR HATCH BLACK	-	1474B	TRAP WIRES H18 BLK W/SHCK	-
71707002	GASKET - RECTANGULAR HATCH	-	1475B	TRAP WIRES H14 BLK	-
71707003	RECTANGULAR HATCH KIT, HORIZON	-	1476B	TRAP WIRES H14 BLK W/SHCK	-
71708001	TACKLE MANAGEMENT RACK KIT	-	1476LG	HARNESS AUTOMATIC LG	-
71710001	RECTANGULAR HATCH ASSY WHITE	-	1476MD	HARNESS AUTOMATIC MD	-
71950001	WATER BOTTLE - STAINLESS	-	1476SM	HARNESS AUTOMATIC SM	-
72020000	HOBIE GEAR KEEPER SMALL 36"	-	1476XL	HARNESS AUTOMATIC XL	-
72020001	HOBIE GEAR KEEPER LARGE 36"	-	1478B	TRAP WIRES GETAWAY BLK	-
72020003	HYDRO STAR SOS DLX LIGHT	-	1478LG	HARNESS CONVERTIBLE LG	-
72020010	HOBIE SAFETY KIT	-	1478SM	HARNESS CONVERTIBLE S/MD	-
72020030	TEAR-AID / TYPE A (POLY)	-	1478XL	HARNESS CONVERTIBLE XL	-
72020031	TEAR-AID / TYPE B (VINYL)	-	1488LG	HARNESS SKIPPERS LARGE	-
72020032	BILGE - HAND PUMP	-	1488MD	HARNESS SKIPPERS MEDIUM	-
72020078	HOBIE FIRST AID KIT	-	1488SM	HARNESS SKIPPERS SMALL	-
72020087	COOLER - PA BUCKET / ALL CARGO	-	1488XL	HARNESS SKIPPERS XLARGE	-
72020092	RESCUE STEP - KAYAK	-	1521H	BATTEN CAP KIT, H14/17 LEACH	-
72020120	TROLLING MOTOR X16 50" FRESH	OS	1522H	BATTEN CAP KIT, H16 MAIN LEACH	-
72020123	BATTERY CHARGER 12 / 6 VOLT	-	1523H	BATTEN CAP KIT, H18 LEACH	-
72020124	PROP WEEDLESS 2 BLADE 3.5"	-	1531H	BATTEN CAP KIT, H16 JIB	-
72020125	PROP NUT / WRENCH / PINS	-	1552CR	CROAKIES "HOBIE" BLACK	-
72020127	NMEA2000 STARTER KIT	-	1553CR	CROAKIES "HOBIE" BLUE	-
72021015	MARINE GOOP 3.7oz CLEAR	-	1553L	LID LATCH MULTI-COLOR	-
72026103	SPEAKER BLUE TOOTH AND 4GB	-	1554CR	CROAKIES "FISHING" BLACK	-
72042001	TIE DOWN STRAPS HOBIE- 12 FOOT	-	1555CR	CROAKIES "FISHING" BLUE	-
72043001	TIE DOWN STRAPS HOBIE- 15 FOOT	-	1671BLK	RAIL RUG KIT BLACK - H14/16	-
72410001	DAGGERBOARD COVER TIGER/FOX/FX	-	1825LID	LID TOYBOX FWD - FIBERGLASS	-
79050211	DRAIN PLUG - 3/8" W O-RING&KEE	-	1825WHT	TOYBOX	OST
79545001	DECAL, HOBIE DOME, GOLD 2.75"	-	2004BLK	J & H HANDLES-BLACK	-
80100501	SAIL FEEDER - HOBIE	-	2004WHT	J & H HANDLES-WHITE	-
80181001	YOKE TILLER CONNECTOR	-	314-13ALL	COVER UNIVERSAL UP TO 13' WAVE	-
80200000	TURBO H14 JIB RIGGING KIT	-	314-14TO17	COVER UNIVERSAL 14'-17'	-
80200010	DOLPHIN STRIKER KIT H14	-	314-16-GTWY2	COVER GETAWAY UNIVERSAL (V2)	-
80201300	TURBO JIB BLOCK SUPPORT WIRE	-	314-17TO18	COVER UNIVERSAL 17'-18'	-
80550005	BATTEN MAIN PKT PROTECTOR KIT	-	314-19TO20	COVER UNIVERSAL 19'-20'	-
80660000	AUSSIE H16 JIB HALYARD KIT W/	-	3188LG	GLOVES HOBIE LARGE	-
82010001	BATTEN UNIVERSAL 107-7/8"	OS	3188MD	GLOVES HOBIE MEDIUM	-
82020001	BATTEN UNIVERSAL 82-3/8"	OS	3188SM	GLOVES HOBIE SMALL	-
82030001	BATTEN UNIVERSAL 90-1/8"	OS	3188XL	GLOVES HOBIE X LARGE	-
82040001	BATTEN UNIVERSAL 42-11/16"	-	3252W	WIRE COVERS 1/8" WHITE	-
82060001	BATTEN UNIVERSAL 100 9/16"	OS	3253W	WIRE COVERS 5/32" WHITE	-
82070001	BATTEN UNIVERSAL 67-1/2" JIB (OS	3261B	SHROUD ADJ COVERS BLK 12" PAIR	-
82080001	BATTEN UNIVERSAL 43 3/4" JIB	-	72000B	POUCH GUSSETED 6x12	-
82420000	COVERS - RUDDER (PAIR)	-	72005B	POUCH SUPER GUSSETED 8x15	-
84430128	DVD - GETAWAY RIGGING	-	72210L	VIEW DRY BAG VENTED 10L	-
87369116	BOOK, HOBIE-MASTER OF WATER,	-	72230L	VIEW DRY BAG VENTED 30L	-
90170011	MAST STEP ASSY / BRAVO NEWER	-	80000R	ROLLING DUFFLE/GEAR BAG	-
90312000	BRAVO EZ LOC RUDDER ASSY - REQ	OS	80035A	ANCHOR w/BAG & LINE (3.5 LB)	-

INDEX

B094	SWIVEL SHACKLE	-	RH018WHT	LINE 1/8" NYLON BRAID WHITE	-
B323	BULLSEYE W/FERRULE	-	RH038WHT	LINE 3/8" STRAIT-CORE POLY	-
BAJA-010108	SATIN BLK/GREY PC	-	RH112WHT	LINE 1/12" BRAID WHITE	-
BAJA-010139	SATIN BLACK CPR / SEA GRN MIR	-	RH316WHT	LINE 3/16" STRAIT-CORE POLY	-
BAJA-010168	SATIN BLK/GREY/COBALT MIR PC	-	RH516WHT	LINE 5/16" STRAIT-CORE POLY	-
BAYSIDE-010108	SATIN BLK/GREY PC	-	RL012BLU	LINE 1/2" HOLLOW BRAID BLU/WHT	-
BROAD-909008	SHINY GUNMETAL/GREY PC	-	RLH4BS	LINE 4MM MAGIC EDGE BLK/SLVR	-
BROAD-949468	SHINY GOLD/GREY/COBALT MIR PC	-	RLH5BLU	LINE 5MM HERCULES COLOUR BLU	-
CABO-48PGY	SATIN BLK/GREY PC	-	RLH5RYB	LINE 5MM MAGIC GOLD RED/YEL/BL	-
CABO-50PGY	SHINY BLK/GREY PC	-	RLH5YEL	LINE 5MM MAGIC D PRO YELLOW	-
CABO-58PCP	SHINY BRN WD GRAIN/COPPER PC	-	RLH5YRB	LINE 5MM MAGIC GOLD YEL/RED/BL	-
CM7703	BRIDLE VANE - STANDARD	-	RLM10YEL	LINE 10MM NAUTIC YELLOW	-
CM7704	VANE REPLACEMENT	-	RLM70W	LINE 7MM MAGIC SHEET ORG/WHT F	-
CM7705	BRIDLE VANE ADAPTOR - FURLER	-	RLM9SW	LINE 9MM MAGIC SHEET SILV/WHT	-
CM7732	L'IL SISTER CLIPS	-	RLS4BLK	SHOCKCORD 4MM BLACK	-
COASTAL-8010126	SATIN BLACK COPPER / SEA GREEN	-	RLS5BLK	SHOCKCORD 5MM BLACK	-
COASTAL-8010168	SATIN BLACK GREY / COBALT	-	RM014BLK	LINE 1/4" SPUN DACRON - BLACK	-
CRUZ-010168	SATIN BLK/GREY/COBALT MIR PC	-	RM014BLU	LINE 1/4" SPUN DACRON - BLUE	-
DANA-000008	SHINY BLACK / GREY	-	RM014RED	LINE 1/4" SPUN DACRON - RED	-
DANA-222228	SHINY CRYSTAL BROWN / COPPER	-	RM014WHT	LINE 1/4" SPUN DBL BRD - WHITE	-
ELMATADOR-01010	SATIN BLACK / GREY PC	-	RM038BLK	LINE 3/8" SPUN DACRON - BLACK	-
ELMATADOR-97813	SATIN BROWN TORT / SGTMSTR PC	-	RM038BLU	LINE 3/8" SPUN DACRON - BLUE	-
EVGLADE-010126	SATIN BLACK / COP W/SEA GRN	-	RM038RED	LINE 3/8" SPUN DACRON - RED	-
EVGLADE-010138	SATIN BLACK / SIGHTMASTER	-	RM038WHT	LINE 3/8" SPUN DBL BRD - WHITE	-
F99502360	TILLER EXT CARBON WC/TIGER	OS	RM516BLK	LINE 5/16" SPUN DACRON - BLK	-
H001	BLOCK SINGLE 2.25"	-	RM516BLU	LINE 5/16" SPUN DACRON - BLUE	-
H071	SPRING-STANDUP	-	RM516RED	LINE 5/16" SPUN DACRON - RED	-
H072	SHACKLE-3/16" W/PIN & RING	-	RM716BLK	LINE 7/16" SPUN DACRON - BLACK	-
H082	BLOCK-SINGLE BULLET	-	RM716BLU	LINE 7/16" SPUN DACRON - BLUE	-
H083	BLOCK-BULLET W/BECKET	-	RM716RED	LINE 7/16" SPUN DACRON - RED	-
H084	BLOCK-BULLET DOUBLE	-	RM716WHT	LINE 7/16" SPUN DACRON - WHITE	-
H092	BLOCK-BULLET CHEEK	-	RS014BLK	SHOCKCORD 1/4" BLACK	-
H093	SPRING, MICRO CAM CLEAT MS-093	-	RS018BLK	SHOCKCORD 1/8" BLACK	-
H097	STAND UP SPRING-SMALL	-	RS038BLK	SHOCKCORD 3/8" BLACK	-
H099	BLOCK-BULLET W/BCKT (HI LOAD)	-	RS316BLK	SHOCKCORD 3/16" BLACK	-
H125	BLOCK-BIG BULLET	-	RS516BLK	SHOCKCORD 5/16" BLACK	-
H126	BLOCK-BIG BULLET W/BECKET	-	RS716BLK	SHOCKCORD 7/16" BLACK	-
H137	EYESTRAP-LARGE SS	-	S6103XL	PFD THINBACK MEN SUN L/XL	-
H138	SHACKLE ASSY-1/4" SS	-	S6103SM	PFD THINBACK MEN SUN S/M	-
H145	CAM-MATIC WEDGE KIT	-	S6103XXL	PFD THINBACK MEN SUN XXL	-
H150	CAM CLEAT-CAM MATIC ALUMINUM	-	S6104XL	PFD THINBACK MEN SLATE L/XL	-
H160	SHEAVE-BULLET	-	S6104SM	PFD THINBACK MEN SLATE S/M	-
H166	BLOCK-BULLET SWIVEL	-	S6104XXL	PFD THINBACK MEN SLATE XXL	-
H167	BLOCK-BULLET SWIVEL W/BECKET	-	S6105ML	PFD THINBACK WMN SUN M/L	-
H168	BLOCK-BIG BULLET SWIVEL	-	S6105PL	PFD THINBACK WMN SUN PLUS	-
H194	BLK-2.25" LO PRO TRIPLE HEX	-	S6105XS	PFD THINBACK WMN SUN XS/S	-
H201	EYESTRAP-LO PRO SS	-	S6106ML	PFD THINBACK WMN SLATE M/L	-
H2139	BLK 2.25" CARBO RATCHET/CAMMAT	-	S6106PL	PFD THINBACK WMN SLATE PLUS	-
H224	BLOCK-MICRO SINGLE	-	S6106XS	PFD THINBACK WMN SLATE XS/S	-
H225	BLOCK-MICRO W/BECKET	-	S6107XL	PFD FISH THINBACK STGRN L/XL	-
H226	BLOCK-MICRO DOUBLE	-	S6107SM	PFD FISH THINBACK STGRN S/M	-
H227	BLOCK MICRO DOUBLE W/BKT	-	S6107XL	PFD FISH THINBACK STGRN XXL	-
H228	BLOCK-MICRO TRIPLE	-	S6108XL	PFD EDGE BLKGRY L/XL	-
H231	BLOCK-MICRO TRIPLE W/CAM	-	S6108SM	PFD EDGE BLKGRY S/M	-
H232	BLOCK-MICRO TRAVELER	-	S6108XXL	PFD EDGE BLKGRY XXL	-
H233	BLOCK-MICRO CHEEK	-	S6771CLG	PFD CHILD LIME GREEN 30-50#	-
H237	BULLSEYE FAIRLEAD	-	S6771ILG	PFD INFANT LIME GREEN -30#	-
H244	BLOCK MICRO FIDDLE W/V-JAM	-	S6771YLG	PFD YOUTH LIME GREEN 50-90#	-
H2640	TRIPLE 40mm CARBO BLOCK	-	S6779R	PFD INFLATABLE REARM KIT 24g	-
H281	EYESTRAP-MICRO SS	-	S6780R	PFD INFLATABLE REARM KIT 16g	-
H284	KIT-MICRO WIRE FAIRLEAD	-	S6782BL	PFD INFLATABLE BLUE - 24g	-
H285	SAIL CHAFE PROTECTOR SET	-	S6782GR	PFD INFLATABLE GREEN - 24g	-
H297	WEDGE KIT-MICRO CAM	-	S6782RD	PFD INFLATABLE RED - 24g	-
H344	29mm CARBO TRIPLE SWIVEL	-	S6782TN	PFD INFLATABLE TAN - 24g	-
H347	29mm CARBO TRIPLE w/CLEAT	-	S6783BL	PFD BELT PACK INFLATABLE BLUE	-
H353	BLOCK-BULLET TRAVELER	-	S6783YL	PFD BELT PACK INFLATABLE YELLO	-
H365	CAM CLEAT-PL HI PERFORMANCE LP	-	S6800MLG	PFD MIRAGE GRAY - MEDIUM/LG	-
H404	BLOCK-16MM AIR FXD SGL	-	S6800SMD	PFD MIRAGE GRAY - SMALL/MED	-
H406	BLOCK-16MM AIR FIXED DOUBLE	-	S9000LG	PET PFD LG MANGO 60-90#	-
H407	BLOCK-16MM AIR FIXED DBL W/BKT	-	S9000MD	PET PFD MD MANGO 24-60#	-
H424B	FAIRLEAD MICRO CAM - BLK	-	S9000SM	PET PFD SM MANGO 12-24#	-
H471	CAM CLEAT-MICRO CARBO	-	S9000XL	PET PFD XL MANGO -90#	-
HFS100	SCREW 8-32 X .188 18-8 S-THMS	-	S9000XS	PET PFD XS MANGO <12#	-
HSB56	CAM SPRING-150 & 200	-	SANDCUT-000008	SHINY BLK/GREY PC	-
HSPAP	SCREW 1/4-20 X 3/4 THMS-P SS	-	SNOOK-010126	SATIN BLACK / COP W/ SEA GRN	-
HUNTING-L0108	SATIN BLACK ENTRAPPED / GREY	-	SNOOK-010138	SATIN BLACK / SIGHTMASTER	-
HUNTING-L0128	SATIN BLACK ENTRAPPED / COP	-	SP150041	SHACKLE 5/32 - 3/8 X 5/8	-
HUNTING-L9926	UNENTRAPPED COPPER / SEA GRN	-	SP150051	SHACKLE 3/16 - 1/2 x 11/16	-
HUNTING-L9968	UNENTRAPPED GREY / COBALT	-	SP150052	SHACKLE 3/16 - 5/8 x 1"	-
IMPE200-000128	SHINY BLACK / COPPER +2.0	-	SP150061	SHACKLE 1/4 - 9/16 x 1"	-
KAYLEE-000008	SHINY BLACK / GREY	-	SP150081	SHACKLE 5/16 - 11/16 x 13/16	-
KAYLEE-282828	SHINY BROWN TORT / COPPER	-	SP180005	SHACKLE W/SAFETY KEY PIN 3/16"	-
MAVERIC-920008	SHINY SILVER / BLACK / GRE	-	SP180006	SHACKLE W/SAFETY KEY PIN 1/4"	-
MAVERIC-940027	SHINY GOLD / BLACK / COP GRAD	-	SP180008	SHACKLE SAFETY 5/16	-
MK0046	HOBIE CAUTION FLAG	-	SP185205	SHACKLE W/ SAFETY KEY PIN 3/16	-
MK0053	SAFTEY WHISTLES	-	WOODY-010108	SATIN BLK/GREY PC	-
MOJO-B010168	SATIN BLK/GREY/COBALT MIRROR	-	WOODY-282808	SHINY LEOPARD TORTOISE/GRY PC	-
MOJO-B010188	SATIN BLK/BRN/GREEN MIRROR	-	WOODY-94PCP	SHINY TORTOISE/COPPER PC	-
R359P	LANCE CLEAT PORT	-	WRIGHTS-000008	SHINY BLK/GREY PC	-
R359S	LANCE CLEAT STBD	-	WRIGHTS-949428	SHINY BRN TORTOISE/COPPER PC	-
RF4850LG	GLOVES-FINGERLESS LG STICKY	-			
RF4850MD	GLOVES-FINGERLESS MD STICKY	-			
RF4850SM	GLOVES-FINGERLESS SM STICKY	-			
RF4850XL	GLOVES-FINGERLESS XL STICKY	-			
RF4850XS	GLOVES-FINGERLESS XS STICKY	-			
RF4851LG	GLOVES-3 FINGER LG STICKY	-			
RF4851MD	GLOVES-3 FINGER MD STICKY	-			
RF4851SM	GLOVES-3 FINGER SM STICKY	-			
RF4851XL	GLOVES-3 FINGER XL STICKY	-			
RF4851XS	GLOVES-3 FINGER XS STICKY	-			
RF5001	CAM CLEAT SM RED	-			
RF5005	SMALL "FAST TRACK" FAIRLEAD	-			
RF5011	CLEAT CAM RONSTAN	-			
RF5015	MEDIUM "FAST TRACK" FAIRLEAD	-			
RF5404	SMALL ROPE GUIDE	-			
RF56100	BLOCK SERIES 55 AUTO RATCHET	-			
RH014WHT	LINE 1/4" STRAIT-CORE POLY	-			

Hobie

HOBBIE CAT COMPANY
Holding Company
Oceanside, CA, U.S.A.
1-800-HOBIE-49
hobie.com

HOBBIE CAT AUSTRALASIA
Subsidiary
Huskisson, NSW, Australia
1-800-4-HOBIE
hobie.com

HOBBIE CAT EUROPE
Subsidiary
Toulon, France
+33 (0) 494 08 78 78
hobie.com

HOBBIE KAYAK EUROPE
Independent Distributor
Stellendam, The Netherlands
+31 (0) 187 499 440
hobie.com

HOBBIE CAT BRASIL
Independent Distributor
Porto Belo, Santa Catarina, Brasil
+55 (47) 9746-9735
hobie.com



SAILING PARTS & ACCESSORIES

INTERNATIONAL 87367257