



**LEICA SL2**  
Instruction manual

## FOREWORD

Dear Customer,

We wish you a great deal of fun and success taking photographs with your new Leica SL2. Please read this manual thoroughly to familiarize yourself with the full scope of functions your camera has to offer. You can find all information about the Leica SL2 whenever you need it at [sl2.leica-camera.com](http://sl2.leica-camera.com).

Your Leica Camera AG

## SCOPE OF DELIVERY

Before using your camera for the first time, please check that the accessories supplied are complete.

- Leica SL2
- Lithium-ion battery Leica BP-SCL4
- Leica BC-SCL4 charger, incl. mains cable (US, EU)
- Camera bayonet cover
- Carry strap
- Quick Start Guide
- CE flyer
- Creative Cloud flyer
- Test certificate

Subject to changes in design and production.

## REPLACEMENT PARTS/ACCESSORIES

Please contact Leica Customer Care or visit the Leica Camera AG website for information on the extensive range of Leica replacement parts/accessories:

[en.leica-camera.com/Photography/Leica-SL/Accessories](http://en.leica-camera.com/Photography/Leica-SL/Accessories)

Only the accessories specified and described in this manual or by Leica Camera AG must be used with the camera (battery, charger, mains plug, mains cable, etc.). These accessories should only be used with this product. Third-party accessories may result in malfunctions or damage to the product.

Please read the chapters “Legal information”, “Safety remarks”, and “General information” before using your camera for the first time. Knowledge of the content will prevent inadvertent damage to the product, possible injuries and other risks.

## LEGAL INFORMATION

### LEGAL INFORMATION

- Compliance with copyright laws is mandatory. The recording and publication of pre-recorded media like tapes, CDs or other published or broadcast material may breach copyright laws.
- The same applies for all software supplied in the scope of delivery.
- The following applies for all video material created with this camera: This product is governed by the AVC Patent Portfolio license and is meant for private use by a consumer only. The device may furthermore be used for purposes for which the consumer receives no remuneration, e.g. (i) encoding in accordance with the AVC Standard (“AVC Video”) and/or (ii) decoding of AVC Video that was encoded by a consumer in accordance with the AVC Standard within the scope of personal use and/or which the consumer has received from the provider, who is in possession of a license to offer AVC Video. No license is granted or implied for any other use. Any other use, specifically the provision of AVC video in exchange for remuneration, may require a separate license agreement with MPEG LA, L.L.C. Please visit the MPEG LA, L.L.C. website at: [www.mpegla.com](http://www.mpegla.com) for more information.

The device-specific license information can be found in the camera menu.

- ▶ Select **Camera Information** in the main menu
- ▶ Select **License Informations**

## REGULATORY INFORMATION

You will find the manufacturing date of your camera on the stickers in the Warranty Card and/or on the packaging.  
The date format is year/month/day.

Specific regional approvals for this device can be found in the camera menu.

- ▶ Select **Camera Information** in the main menu
- ▶ Select **Regulatory Information**

### CE mark

The CE mark on our products documents compliance with the fundamental requirements of applicable EU guidelines. Please read the CE flyer provided for more information.



### DISPOSAL OF ELECTRICAL AND ELECTRONIC EQUIPMENT

(Applies within the EU and for other European countries with active waste separation policies.)

This device contains electric and/or electronic components which must not be disposed of in general household waste. Instead, it should be disposed of at a recycling collection point provided by your local authority.

This service is free of charge. Any standard or rechargeable batteries used in this device must be removed and disposed of separately in accordance with local regulations.

Please contact your local authorities, waste disposal collection point or the retailer, from whom you purchased the device for more information on correct waste disposal.



## IMPORTANT NOTES REGARDING THE USE OF WLAN/BLUETOOTH® (LEICA FOTOS)

Please read the important notes on specific functions of Leica FOTOS on p. 194.

- Appropriate measures must be taken to ensure security and protect against disruptions to the systems in place where devices or computer systems are in use that require more stringent security than WLAN devices.
- Leica Camera AG shall not accept liability for damages arising from the use of the camera for purposes other than as a WLAN device.
- It is assumed that the WLAN function will be used in countries where this camera is sold. There may be a risk of breaching statutory wireless communication regulations when using the camera in other countries. Leica Camera AG shall not accept liability for such breaches.
- Please note that there is a risk of unauthorized third party interception of wirelessly communicated data. We highly recommend that you activate encryption in the wireless access point settings to ensure data safety.
- Avoid using the camera in areas where it can be exposed to magnetic fields, static electricity or other interferences, e.g. near a microwave oven. RF transmissions may otherwise not reach the camera.
- Using the camera near devices like microwave ovens or wireless phones that use the 2.4 GHz RF band may negatively affect the performance of both devices.
- Do not attempt to connect to wireless networks you are not authorized to use.
- The device will automatically search for wireless networks, once the WLAN function is enabled. A list, including networks you are not authorized to access, will be displayed (SSID: Network

identifier for a WLAN network). Do not attempt to connect to such a network, as this could be construed as unauthorized access.

- We recommend disabling the WLAN function while on an aircraft.
- The use of the WLAN-RF band between 5150 MHz and 5350 MHz is permitted only in enclosed spaces.

## SAFETY REMARKS

### GENERAL INFORMATION

- Do not use your camera in the immediate vicinity of devices that generate powerful magnetic, electrostatic or electromagnetic fields (e.g. induction ovens, microwave ovens, television sets or computer screens, video game consoles, cell phones, broadcasting equipment). Their electromagnetic fields can interfere with recordings.
- Strong magnetic fields, e.g. from speakers or large electric motors can damage the stored picture data or disrupt recording.
- Switch off the camera, remove the battery briefly, replace it and switch the camera back on in case of a camera malfunction due to the effects of electromagnetic fields.
- Do not use the camera in the immediate vicinity of radio transmitters or high-voltage power lines. Their electromagnetic fields may interfere with recordings.
- Always store small parts e.g. the accessory shoe cover as follows:
  - out of the reach of children
  - in a safe location, where they will not get lost or stolen
- State-of-the-art electronic components are sensitive to static discharge. Since people can easily pick up charges of several 10,000 volts by walking on synthetic carpets, a discharge can occur when you touch the camera, and especially it is placed on a conductive surface. A static discharge on the camera housing poses no risk for the electronics. Despite built-in safety circuits, you should avoid direct contact with external camera contacts like those in the flash shoe.
- Take care not to soil or scratch the sensor for lens detection in the bayonet. You must similarly prevent direct contact of the bayonet with grains of sand or similar particles, as these could cause irreparable damage. This component must only be cleaned with a dry cloth (in system cameras).
- Use a cotton or linen cloth instead of a microfiber cloth from an optician's (synthetic) when cleaning the contacts. Make sure to discharge any electrostatic charge by deliberately touching a heating or water pipe (conductive, grounded material). Dirt deposits and oxidation on the contacts can be avoided by storing your camera in a dry location with the lens cap and the flash shoe/viewfinder cap (in system cameras) attached.
- Only use accessories specified for this model to prevent faults, short circuits or electric shock.
- Do not attempt to remove parts of the housing (covers) yourself. Repairs must be done at authorized service centers only.
- Protect the camera against contact with insect sprays and other aggressive chemicals. Petroleum spirit, thinner and alcohol must not be used for cleaning. Some chemicals and liquids can damage the camera housing or the surface finish.
- Rubber and plastics are known to expel aggressive chemicals and should therefore not be kept in contact with the camera for extended periods of time.
- Prevent any sand or dust or water penetration into the camera, e.g. during snowfall or rain or on the beach. Be extra careful when changing the lens (in system cameras) and when inserting or removing the memory card and rechargeable battery. Sand and dust can damage the camera, the lens, the memory card and the battery. Moisture can cause malfunctions and irreparable damage to the camera and memory card.

## LENS

- A camera lens can have the effect of a magnifying glass when exposed to direct frontal sunlight. The camera must therefore be protected against extended exposure to direct sunlight.
- Attaching the lens cap and keeping the camera in the shade or ideally in its camera case, will help prevent damage to the interior of the camera.

## RECHARGEABLE BATTERY

- Improper use of the batteries or the use of unapproved battery types may result in an explosion!
- Do not expose the rechargeable battery to sunlight, heat, humidity or moisture for prolonged periods of time. Likewise, the batteries must not be placed in a microwave oven or a high-pressure container as this would pose a fire or explosion hazard.
- Do not under any circumstances charge or insert a damp or wet battery into the camera!
- A safety valve in the battery ensures that any excess pressure caused by improper handling is discharged safely. It is nevertheless important to dispose of a bloated battery immediately. It may pose an explosion hazard!
- Keep the battery contacts clean and easily accessible. Although lithium-ion batteries are secured against short circuits, they should still be protected against contact with metal objects like paper clips or jewelry. A short-circuited battery can get very hot and cause severe burns.

- When a battery is accidentally dropped, make sure to check the housing and the contacts immediately for any damage. A damaged battery can damage the camera.
- The battery must be removed from the camera or charger and must be replaced immediately in case of a strange smell, discoloration, deformation, overheating or leakage. Continued use of the battery may result in overheating, which can cause fire and/or explosion!
- Never throw batteries into a fire as they may explode.
- Keep the battery away from sources of heat in case of leakage or if you smell burning. Leaked fluid can catch fire!
- The use of other chargers not approved by Leica Camera AG can cause damage to the batteries – and in extreme cases – cause serious or life-threatening injuries.
- Make sure that the power socket is freely accessible at all times.
- Do not attempt to open the battery or the charger. Repairs must only be carried out by authorized service centers.
- Keep batteries out of the reach of children. Batteries can cause suffocation when swallowed.

### FIRST AID

- Battery fluid may cause blindness if it comes into contact with the eyes. Rinse the eyes thoroughly with clean water immediately. Avoid rubbing. Seek medical attention immediately.
- Leaked battery fluid poses an injury hazard when it comes in contact with clothing or skin. Rinse the affected areas thoroughly with clean water.

## CHARGER

- Using the charger in the vicinity of broadcasting receivers may interfere with reception. Ensure a distance of at least 1 m (3 ft) between the charger and the receiver.
- When the charger is in use, it may emit a buzzing sound – this is normal and not a malfunction.
- Disconnect the charger from the mains when it is not in use, as it consumes electricity (a very small amount), even if no battery is inserted.
- Always keep the charger contacts clean, and never short circuit them.

## MEMORY CARD

- Never remove the memory card during a datasave or card reading process. The camera must not be switched off or be subjected to impact or vibrations while working.
- Do not open the cover/remove the memory card or the battery while the status LED is lit, which indicates memory access. Data on the card may otherwise be destroyed and camera malfunctions may occur.
- Do not drop or bend memory cards as this will cause damage and result in the loss of stored data.
- Do not touch the connections on the reverse of the memory card and keep them clean and dry.
- Keep memory cards out of the reach of children. Swallowing a memory card may cause suffocation.

## SENSOR

- Cosmic radiation (e.g. during flights) may cause pixel defects.

## CARRY STRAP

- Carry straps are usually made of very robust material. You should therefore keep it out of the reach of children. A carry strap is not a toy and poses a strangulation risk.
- Use the carry strap only for its intended purpose on a camera or on binoculars. Any other use poses the risk of injury and may possibly result in damage to the carry strap and is therefore not permitted.
- Carry straps should also not be used for cameras/binoculars during sports activities that pose a risk of entanglement (e.g. when mountain climbing and similar outdoor activities).

## TRIPOD

- When using a tripod, make sure it is standing securely and turn the camera only by turning the tripod, not the actual camera. Ensure that the tripod screw is hand-tightened only. Avoid transporting the camera while the tripod is attached. You might injure yourself or others and the camera could get damaged.

## FLASH

- The use of incompatible flash units with your Leica SL2 may result in irreparable damage to the camera and/or the flash unit.



## GENERAL INFORMATION

Please read the section about “Care/Maintenance” for more information about what to do in case of problems.

### CAMERA/LENS

#### (For system cameras)

- Make a note of the serial numbers of your camera (engraved in the base of the camera housing) and lenses, as this information will be extremely important in case of loss.
- Make sure to always have a lens or the camera bayonet cover attached to prevent dust or other foreign bodies penetrating the camera.
- That is why you should always replace lenses quickly and in a dust-free environment.
- Never store the camera bayonet cover or the lens back cover in a pants pocket, as they will attract lint and dust, which could then be accidentally introduced into the camera.

### LCD PANEL

- Condensation may form on the LCD panel if the camera is exposed to great temperature fluctuations. Wipe the screen carefully with a soft, dry cloth.
- The screen image will initially be slightly darker than normal if the camera is very cold when it is switched on. The normal level of brightness will be reached as soon as the LCD panel warms up.

## RECHARGEABLE BATTERY

- The battery must have a temperature between + 0°C and + 35°C for charging (otherwise the charger will not switch on or will switch off again immediately).
- Lithium-ion batteries can be charged at any time, regardless of their current charge level. A partially charged battery will charge to full capacity faster than a fully discharged one.
- The rechargeable batteries come only partly charged ex works and should therefore be charged fully before their first use.
- A new battery only reaches its full capacity after it has been fully charged and – by using it in the camera – depleted 2 to 3 times. This depletion process should be repeated roughly every 25 cycles.
- Battery and charger heat up during the charging process. That is normal and not a malfunction.
- Rapid flashing of the two LEDs (> 2 Hz) when charging commences indicates a charging error (e.g. maximum charging time exceeded, voltages or temperatures outside permitted ranges or a short circuit). Disconnect the charger from the mains and remove the battery. Ensure that the above temperature conditions are met and then restart the charging process. Please contact your dealer, the Leica office in your country or Leica Camera AG if the problem persists.
- Rechargeable lithium-ion batteries generate power by way of internal chemical reactions. These reactions are influenced by ambient temperature and humidity. To ensure a maximum service life of the battery, it should not be exposed to extreme temperatures (high or low) for extended periods of time (e.g. in a parked car in the summer or winter).
- However, every battery has a limited service life! After several hundred charging cycles, this limitation will become evident as the operating times get significantly shorter.

- The replaceable battery supplies power to a backup battery, which is permanently installed in the camera. This backup battery retains the date and time for some weeks. Once the backup battery is depleted, it must be replenished by inserting a charged main battery. The time and date will have to be set again after a full depletion of both batteries.
- As the battery capacity deteriorates or if using an older battery, warning messages may appear and some functions may be restricted or blocked entirely.
- Remove the battery if the camera will not be used for an extended period of time. Make sure to switch the camera off via the main switch before removing the battery. Leaving the battery in the camera will result in a deep discharge after a few weeks. Voltage levels will decrease significantly, as the camera uses a low idle current to maintain settings.
- Dispose of damaged batteries in accordance with the relevant regulations at an approved collection point for proper recycling.
- The date of manufacture can be found on the battery. The date format is week/year.

## MEMORY CARD

- The range of available SD/SDHC/SDXC cards on the market is too extensive for Leica Camera AG to test for compatibility and quality. Generally, any type of memory card may be used without any damage to the camera or memory card. As some "no name" cards may not fully comply with the SD/SDHC/SDXC standards, Leica Camera AG cannot provide any guarantee of function.
- We recommend formatting memory cards from time to time, because fragmented residual data from deleted files may block some of the storage capacity.
- Generally, it is not necessary to format (initialize) memory cards that have been previously used. Formatting will, however, be

necessary if you insert an unformatted memory card or a card that was formatted in another device (e.g. a computer) for the first time.

- We recommend backing up your data on a PC, because electromagnetic fields, static electricity and any damage to the memory card or camera defects may result in irretrievable damage or loss of your data.
- SD, SDHC, and SDXC memory cards come with a write protection slider to prevent accidental overwriting. This slider is located on the non-beveled side of the card. All data on the card is protected when the slider is set to its lower position, marked LOCK.
- All data stored on a memory card will be lost during formatting. Formatting will not be prevented by the deletion protection set for individual pictures.

## SENSOR

- Any dust or dirt particles stuck to the glass cover of the sensor may result in noticeable dark stains or specks on the pictures (in system cameras). Alternatively, send your camera to the Leica Customer Care department for sensor cleaning (see p. 220). This service is not part of the warranty offering and will therefore incur charges.

## DATA

- All data, including personal information, may be changed or deleted due to incorrect or accidental operation, static discharge, accidents, malfunctions, repairs and other measures.
- Please note that Leica Camera AG does NOT accept liability for direct or consequential damage due to the manipulation or destruction of data and personal information.

## FIRMWARE UPDATE

Leica is continuously working on the further development and optimization of Leica SL2. As digital cameras have many functions that are controlled electronically, improvements and enhancements to the functions can be installed on the camera retroactively. Leica releases what are known as firmware updates at irregular intervals. Cameras are always supplied from the factory with the latest firmware. Otherwise you can download it from our website yourself and transfer it to your camera.

You will receive a newsletter informing you of the availability of a new firmware update if you register your camera on the Leica Camera homepage.

Visit the download section or the "Customer Area" for information about how to register or how to get firmware updates for your Leica SL2. Additionally, you can find information about changes or additions to the manual at:

[club.leica-camera.com](http://club.leica-camera.com)

Leica releases firmware updates for lenses at irregular intervals. You can download any new firmware version from our homepage and transfer it to your lens. Please see p. 191 for more information.

Select the menu item **Camera Information** (see p. 191) to check whether your camera and lenses are running the latest firmware version.



## WARRANTY

In addition to your statutory warranty rights regarding your dealer, you will receive an additional Leica Camera AG product warranty valid from the date of purchase at an authorized Leica retailer. Previously, the product warranty was included with the product in the packaging. From now on, the product warranty will only be available online as a new service. You will be able to review the warranty conditions for your product at any time, without having to search for the document. Please note that this new policy applies only for products that are no longer delivered with a hardcopy product warranty included in the packaging. Any products still delivered with the warranty document in the packaging remain governed exclusively by that document. For more information regarding the warranty scope, warranty services and limitations, please visit:

[warranty.leica-camera.com](http://warranty.leica-camera.com)

### **Leica SL2 comes with splash water and dust protection.**

The camera was tested under controlled laboratory conditions and is classified as IP54 in accordance with DIN EN 60529. Please note: The splash water and dust protection coating is not permanent and will diminish over time. Please read the section on camera care and storage for detailed instructions on how to clean and dry the camera. The warranty does not cover liquid damage. Any attempt to open the camera casing by an unauthorized retailer or service partner will cause an immediate expiration of the splash water and dust warranty.

## TABLE OF CONTENT

FOREWORD .....	2
SCOPE OF DELIVERY .....	2
REPLACEMENT PARTS/ACCESSORIES .....	3
LEGAL INFORMATION .....	4
SAFETY REMARKS .....	6
GENERAL INFORMATION .....	10
<b>SENSOR</b> .....	11
WARRANTY.....	13
TABLE OF CONTENT .....	14
PART DESIGNATIONS .....	20
DISPLAYS.....	24
<b>PHOTO</b> .....	24
<b>VIDEO/CINE</b> .....	26
<b>DISPLAYS IN THE TOP DISPLAY</b> .....	28
PREPARATION .....	30
<b>ATTACHING THE CARRY STRAP</b> .....	30
<b>PREPARING THE CHARGER</b> .....	30
<b>CHARGING THE BATTERY</b> .....	31
CHARGING VIA USB.....	32
<b>INSERTING/REMOVING THE BATTERY</b> .....	32
<b>INSERTION/REMOVAL OF MEMORY CARDS</b> .....	33
<b>LENS</b> .....	35
COMPATIBLE LENSES .....	35
CHANGING THE LENS.....	37
<b>DIOPTR SETTINGS</b> .....	40
<b>MULTIFUNCTION HAND GRIP SL</b> .....	41

CAMERA OPERATION.....	46
<b>CONTROL ELEMENTS</b> .....	46
MAIN SWITCH .....	46
SHUTTER BUTTON .....	47
FRONT SETTING WHEEL.....	48
THUMBWHEEL .....	48
JOYSTICK .....	49
PLAY BUTTON/MENU BUTTON .....	49
FN BUTTONS .....	50
LCD PANEL (TOUCH SCREEN) .....	51
TOP DISPLAY.....	52
<b>MENU CONTROL</b> .....	52
CONTROL ELEMENTS .....	52
MENU SECTIONS .....	53
STATUS SCREEN .....	55
MENU NAVIGATION .....	58
SUBMENU .....	60
KEYBOARD/NUMBER PAD .....	60
MENU BAR .....	61
SCALE MENU.....	62
DATE/TIME MENU .....	62
COMBI MENU .....	63
<b>USER-DEFINED OPERATION</b> .....	64
<b>FAVORITES MENU</b> .....	64
MANAGING THE FAVORITES MENU .....	64
<b>FN BUTTONS</b> .....	65
CHANGING AN ASSIGNMENT .....	65
ACCESSING THE ASSIGNED MENU FUNCTION .....	65
<b>SETTING WHEEL ASSIGNMENTS</b> .....	66
WHEN USING AF LENSES.....	66
WHEN USING MF LENSES.....	67
<b>ROTATION DIRECTION OF THE SETTING WHEELS</b> .....	68
<b>JOYSTICK FUNCTIONS</b> .....	68
<b>LOCKING THE OPERATING ELEMENTS</b> .....	69

<b>CAMERA BASIC SETTINGS</b> .....	<b>70</b>	DEACTIVATING INDIVIDUAL INFO PROFILES.....	81
<b>MENU LANGUAGE</b> .....	<b>70</b>	CUSTOMIZING THE INFO PROFILES .....	81
<b>DATE/TIME</b> .....	<b>70</b>	<b>SHOW AVAILABLE</b> .....	<b>82</b>
RECEIVING THE SETTINGS FROM A MOBILE DEVICE.....	70	INFO BARS .....	82
MANUAL SETTINGS .....	71	GRID.....	82
<b>DISTANCE UNIT</b> .....	<b>71</b>	FOCUS PEAKING.....	82
<b>POWER SAVE MODE (STANDBY MODE)</b> .....	<b>72</b>	CLIPPING/ZEBRA .....	83
<b>LCD PANEL/VIEWFINDER (EVF) SETTINGS</b> .....	<b>72</b>	LEVEL GAUGE.....	84
LCD PANEL/EVF USE.....	73	HISTOGRAM .....	85
EYE SENSOR SENSITIVITY.....	73	<b>RECORDING – BASIC SETTINGS (PICTURE)</b> .....	<b>86</b>
BRIGHTNESS .....	74	<b>SENSOR FORMAT</b> .....	<b>86</b>
LCD PANEL .....	74	<b>FILE FORMAT</b> .....	<b>87</b>
EVF.....	74	<b>JPG SETTINGS</b> .....	<b>88</b>
<b>COLOR RENDERING</b> .....	<b>74</b>	RESOLUTION.....	88
LCD PANEL .....	74	NOISE REDUCTION .....	88
EVF.....	74	<b>IMAGE PROPERTIES</b> .....	<b>89</b>
<b>EVF FRAME RATE</b> .....	<b>75</b>	COLOR PROFILE .....	89
<b>AUTOMATIC LCD PANEL AND EVF SHUTDOWN</b> .....	<b>75</b>	MONOCHROME PROFILE.....	89
<b>ACOUSTIC SIGNALS</b> .....	<b>75</b>	CUSTOMIZING PHOTO PROFILES .....	90
VOLUME .....	75	<b>MEMORY CARD MANAGEMENT</b> .....	<b>90</b>
ACOUSTIC SIGNALS.....	75	<b>NOISE SUPPRESSION FUNCTION</b>	
ELECTRONIC SHUTTER SOUND .....	75	<b>FOR LONG-TERM EXPOSURE</b> .....	<b>91</b>
AUTOFOCUS CONFIRMATION .....	76	<b>SHUTTER TYPE</b> .....	<b>91</b>
SILENT PHOTOGRAPHY .....	76	<b>ASPECT RATIO</b> .....	<b>92</b>
<b>RECORDING – BASIC SETTINGS (PICTURE &amp; VIDEO)</b> .....	<b>78</b>	<b>IMAGE STABILIZATION</b> .....	<b>92</b>
<b>TOUCH AF</b> .....	<b>78</b>	SETTING THE STABILIZATION DIRECTION.....	92
TOUCH AF IN EVF MODE.....	79	<b>MF ASSIST FUNCTIONS</b> .....	<b>93</b>
<b>FOCUS LIMIT</b> .....	<b>79</b>	AF ASSIST LIGHT .....	93
<b>EV INCREMENT</b> .....	<b>79</b>	ACOUSTIC AF CONFIRMATION .....	93
<b>AUXILIARY DISPLAYS</b> .....	<b>80</b>	<b>RECORDING – BASIC SETTINGS (VIDEO)</b> .....	<b>94</b>
INFO PROFILES .....	80	<b>SENSOR FORMAT</b> .....	<b>94</b>
CHANGING THE INFO PROFILES .....	81	<b>FILE FORMAT</b> .....	<b>95</b>

<b>VIDEO FORMAT</b> .....	<b>95</b>	<b>AF SETTINGS</b> .....	<b>107</b>
AVAILABLE RESOLUTIONS .....	96	AF-PROFILES .....	107
AVAILABLE FRAME RATES .....	96	PRE FOCUS .....	108
SETTING THE VIDEO FORMAT .....	96	<b>AF QUICK SETTING</b> .....	<b>109</b>
<b>IMAGE PROPERTIES</b> .....	<b>97</b>	ACCESSING AF QUICK SETTING.....	109
VIDEO PROFILES.....	97	ADJUSTING THE METERING FIELD SIZE .....	109
CUSTOMIZING VIDEO PROFILES .....	97	CHANGING THE AF METERING METHOD.....	109
<b>MICROPHONE</b> .....	<b>97</b>	<b>MF ASSIST FUNCTIONS</b> .....	<b>110</b>
<b>WIND NOISE REDUCTION</b> .....	<b>98</b>	ENLARGEMENT IN AF MODE.....	110
<b>TIME CODE</b> .....	<b>98</b>	AF ASSIST LIGHT .....	110
TIME CODE MODE.....	98	ACOUSTIC AF CONFIRMATION.....	110
START TIME .....	99	<b>MANUAL FOCUSING (MF)</b> .....	<b>111</b>
<b>VIDEO GAMMA</b> .....	<b>99</b>	<b>MF SETTINGS*</b> .....	<b>111</b>
<b>VIDEO STABILIZATION</b> .....	<b>100</b>	<b>MF ASSIST FUNCTIONS</b> .....	<b>112</b>
<b>HDMI OUTPUT</b> .....	<b>100</b>	FOCUS PEAKING.....	112
<b>VIDEO AUXILIARY DISPLAYS</b> .....	<b>101</b>	ENLARGEMENT IN MF MODE.....	112
ASPECT RATIO DISPLAY.....	101	DISTANCE DISPLAY.....	114
SAFETY AREA.....	101	USING AUTOFOCUS IN MF MODE.....	115
<b>PICTURE MODE</b> .....	<b>102</b>	<b>ISO SENSITIVITY</b> .....	<b>115</b>
<b>DRIVE MODE</b> .....	<b>102</b>	FIXED ISO VALUES.....	116
<b>FOCUSING</b> .....	<b>103</b>	AUTOMATIC SETTING.....	116
AUTOFOCUS MODES .....	103	LIMITING SETTING RANGES .....	116
INTELLIGENT AF.....	103	FLOATING ISO .....	117
AFs (single).....	103	<b>WHITE BALANCE</b> .....	<b>118</b>
AFc (continuous).....	103	AUTOMATIC CONTROL/FIXED SETTINGS .....	118
AUTOFOCUS METERING METHODS .....	104	MANUAL SETTING VIA METERING .....	119
MULTI-FIELD.....	104	GRAY CARD .....	119
SPOT/FIELD .....	104	GRAY CARD LIVE VIEW.....	120
ZONE.....	105	DIRECT SETTING OF THE COLOR TEMPERATURE.....	120
TRACKING .....	105	<b>EXPOSURE</b> .....	<b>121</b>
START POSITION FOR TRACKING .....	106	EXPOSURE METERING METHODS.....	122
PERSON DETECTION.....	106	SPOT METERING .....	122
		CENTER-WEIGHTED METERING.....	122
		MULTI-FIELD METERING.....	122

<b>EXPOSURE MODES</b> .....	<b>123</b>	<b>CONTROLLING THE AUTOFOCUS</b> .....	<b>145</b>
SELECTING A MODE .....	123	TOUCH AF .....	145
<b>FULLY AUTOMATIC EXPOSURE SETTING - P</b> .....	<b>124</b>	SUPPRESSING CONTINUOUS FOCUSING .....	145
AUTOMATIC PROGRAM - P .....	124	<b>AUTOFOCUS METERING METHODS</b> .....	<b>146</b>
CHANGING THE PRESET SHUTTER SPEED/APERTURE COMBINATIONS (SHIFT) .....	124	<b>TRACKING</b> .....	<b>147</b>
<b>SEMI-AUTOMATIC EXPOSURE SETTING - A/S</b> .....	<b>125</b>	PERSON DETECTION .....	148
APERTURE PRIORITY - A .....	125	<b>AF SETTINGS</b> .....	<b>149</b>
SHUTTER SPEED PRIORITY - S .....	125	<b>AF QUICK SETTING</b> .....	<b>149</b>
<b>MANUAL EXPOSURE SETTING - M</b> .....	<b>126</b>	<b>MF ASSIST FUNCTIONS</b> .....	<b>150</b>
<b>LONG-TERM EXPOSURE</b> .....	<b>126</b>	<b>MANUAL FOCUSING (MF)</b> .....	<b>151</b>
<b>EXPOSURE CONTROL</b> .....	<b>127</b>	<b>MF SETTINGS*</b> .....	<b>151</b>
EXPOSURE PREVIEW .....	127	<b>MF ASSIST FUNCTIONS</b> .....	<b>152</b>
EXPOSURE LOCK .....	128	<b>ISO SENSITIVITY</b> .....	<b>153</b>
EXPOSURE COMPENSATION .....	130	FIXED ISO VALUES .....	154
<b>PICTURE RECORDING MODES</b> .....	<b>131</b>	AUTOMATIC SETTING .....	154
<b>SERIAL EXPOSURES</b> .....	<b>131</b>	FLOATING ISO .....	155
<b>INTERVAL SHOOTING</b> .....	<b>132</b>	<b>ASA SENSITIVITY</b> .....	<b>155</b>
SPECIFYING THE NUMBER OF PICTURES .....	132	<b>WHITE BALANCE</b> .....	<b>156</b>
SPECIFYING THE INTERVALS BETWEEN SHOTS .....	132	AUTOMATIC CONTROL/FIXED SETTINGS .....	156
<b>EXPOSURE BRACKETING</b> .....	<b>133</b>	MANUAL SETTING VIA METERING .....	157
<b>SELF-TIMER</b> .....	<b>135</b>	DIRECT SETTING OF THE COLOR TEMPERATURE .....	158
<b>FLASH PHOTOGRAPHY</b> .....	<b>135</b>	<b>EXPOSURE</b> .....	<b>159</b>
<b>COMPATIBLE FLASH UNITS</b> .....	<b>135</b>	EXPOSURE METERING METHODS .....	160
<b>FLASH EXPOSURE METERING (TTL METERING)</b> .....	<b>136</b>	EXPOSURE MODES .....	161
<b>FLASH CONTROL</b> .....	<b>137</b>	FULLY AUTOMATIC EXPOSURE SETTING - P .....	162
SYNC POINT .....	137	SEMI-AUTOMATIC EXPOSURE SETTING - A/S .....	163
<b>FLASH RANGE</b> .....	<b>138</b>	MANUAL EXPOSURE SETTING - M .....	163
<b>FLASH EXPOSURE COMPENSATION</b> .....	<b>139</b>	EXPOSURE COMPENSATION .....	164
<b>VIDEO MODE</b> .....	<b>142</b>	<b>PLAYBACK/REVIEW MODE</b> .....	<b>166</b>
<b>VIDEO MODE AND CINE MODE</b> .....	<b>142</b>	CONTROL ELEMENTS IN PLAYBACK/REVIEW MODE .....	166
<b>START/EXIT VIDEO MODE</b> .....	<b>143</b>	INITIATE/EXIT PLAYBACK/REVIEW MODE .....	168
<b>START/END VIDEO RECORDING</b> .....	<b>144</b>	SELECTING/SCROLLING THROUGH RECORDINGS .....	168
<b>FOCUSING</b> .....	<b>144</b>	INFO DISPLAYS IN PLAYBACK/REVIEW MODE .....	169
<b>AUTOFOCUS MODES</b> .....	<b>145</b>		

<b>CROPPED SECTION ZOOM</b> .....	170	<b>CARE/STORAGE</b> .....	198
<b>DISPLAYING MULTIPLE RECORDINGS AT ONCE</b> .....	171	<b>FAQ</b> .....	200
<b>TAGGING/RATING OF RECORDINGS</b> .....	173	<b>MENU OVERVIEW</b> .....	208
<b>DELETING RECORDINGS</b> .....	173	<b>INDEX</b> .....	210
DELETING INDIVIDUAL RECORDINGS.....	174	<b>TECHNICAL DATA</b> .....	216
DELETING MULTIPLE RECORDINGS.....	174	<b>LEICA CUSTOMER CARE</b> .....	220
DELETING ALL RECORDINGS .....	175	<b>LEICA ACADEMY</b> .....	220
DELETING UNRATED RECORDINGS .....	176		
<b>PREVIEW OF LATEST RECORDING</b> .....	176		
<b>SLIDESHOW</b> .....	177		
<b>VIDEO PLAYBACK</b> .....	178		
VIDEO EDITING .....	181		
<b>OTHER FUNCTIONS</b> .....	184		
<b>USER PROFILES</b> .....	184		
<b>DATA MANAGEMENT</b> .....	186		
DATA STRUCTURE ON THE MEMORY CARD.....	186		
EDIT FILE NAMES.....	187		
CREATING A NEW FOLDER .....	187		
ADDING COPYRIGHT INFORMATION.....	187		
RECORDING THE IMAGE LOCATION WITH GPS .....	188		
FORMATTING A MEMORY CARD.....	188		
<b>DATA TRANSFER</b> .....	189		
<b>USING RAW DATA (DNG)</b> .....	190		
<b>RESETTING THE CAMERA TO FACTORY SETTINGS</b> .....	190		
<b>FIRMWARE UPDATES</b> .....	191		
UPDATING THE CAMERA FIRMWARE .....	191		
UPDATING THE LENS FIRMWARE.....	192		
UPDATING THE ADAPTER FIRMWARE .....	192		
<b>LEICA FOTOS</b> .....	194		
<b>CONNECTION</b> .....	194		
<b>REMOTE CAMERA CONTROL</b> .....	196		
REMOTE CAMERA ACTIVATION .....	196		

**Definition of the various categories of information found in this manual****Note**

Additional information

**Important**

Failure to observe the instructions may result in damage to the camera, the accessories or the pictures.

**Attention**

Non-compliance may result in personal injury

## PART DESIGNATIONS

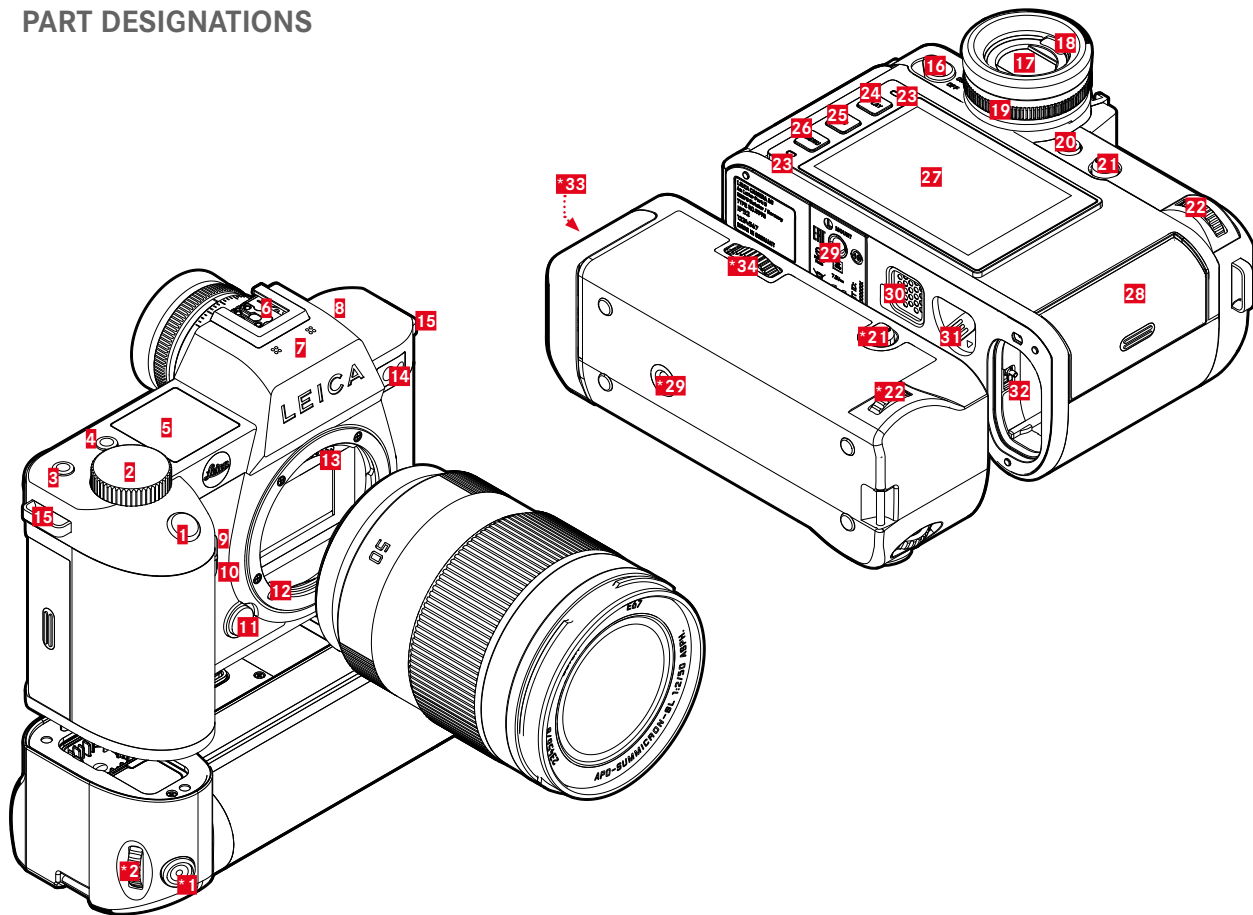

\* optional accessory: Multifunction hand grip SL, lens



## Leica SL2

- 1** Shutter button
- 2** Front setting wheel
- 3** FN button
- 4** FN button
- 5** Top display
- 6** Accessory shoe
- 7** Microphone
- 8** Speaker
- 9** FN button
- 10** FN button
- 11** Lens release button
- 12** Leica L bayonet
- 13** Contact strip
- 14** Self-timer LED / AF Assist Lamp / Sensor for exposure metering
- 15** Strap lugs
- 16** Main switch
- 17** Viewfinder eyepiece
- 18** Eye sensor
- 19** Diopter setting ring
- 20** FN button
- 21** Joystick
- 22** Thumbwheel
- 23** Status LED

- 24** PLAY button
- 25** FN button
- 26** MENU button
- 27** LCD panel
- 28** Memory card slot
- 29** Tripod thread
- 30** Contact for multifunction hand grip
- 31** Battery release lever
- 32** Battery compartment

## MULTIFUNCTION HAND GRIP SL

- \*1** Shutter button
- \*2** Front setting wheel
- \*21** Joystick
- \*22** Thumbwheel
- \*29** Tripod thread
- \*33** Hand grip-integrated battery compartment
- \*34** Hand grip lock

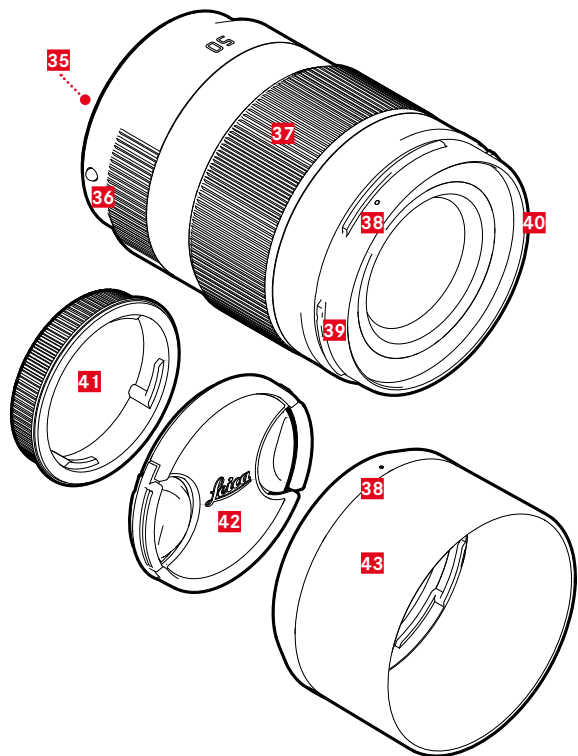
**LENS\***

- 35** Contact strip
- 36** Alignment points for lens replacement
- 37** Focus ring
- 37** poss. zoom setting ring
- 38** Alignment point for lens hood mounting
- 39** Male bayonet for lens hood
- 40** Internal thread for filters
- 41** Bayonet cover
- 42** Lens cap
- 43** Lens hood

\* Not included in the delivery package. Representative image. Technical features may vary depending on model.



## DISPLAYS

The images displayed on the LCD panel and in the viewfinder are identical.

## PHOTO

### STATUS SCREEN



### WHEN TAKING A PICTURE

All displays/values refer to the actual settings.

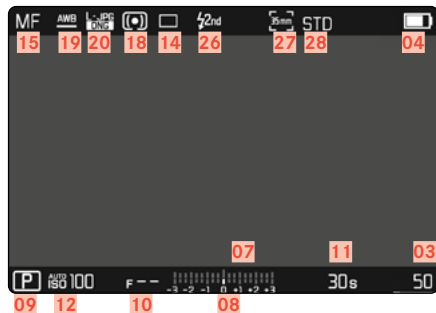

## IN PLAYBACK MODE

All displays/values refer to the displayed image.

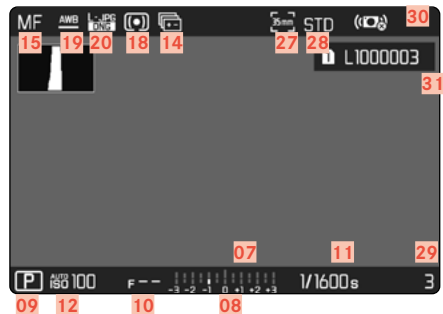

Activated Capture Assistants

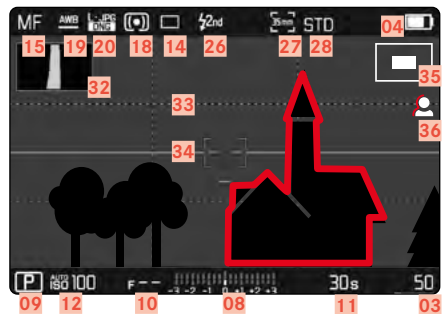

- 01 Focal length
- 02 Memory card used
- 03 Remaining memory capacity
- 04 Battery capacity
- 05 Menu section **PHOTO**
- 06 Menu sections **VIDEO**
- 07 Light balance
- 08 Exposure compensation scale
- 09 Exposure mode
- 10 Exposure value
- 11 Shutter speed
- 12 ISO Sensitivity
- 13 Exposure compensation value
- 14 Picture mode (**Drive Mode**)
- 15 Focus mode
- 16 Autofocus metering method
- 17 Autofocus settings
- 18 Exposure metering method
- 19 White balance mode
- 20 File format/compression level/resolution
- 21 Formatting a memory card
- 22 User profile
- 23 Locking/unlocking the setting wheels
- 24 Leica FOTOS
- 25 Main menu
- 26 Flash mode
- 27 Aspect ratio (sensor)
- 28 Color rendering (**Film Style**)
- 29 File number of the picture shown
- 30 Stabilization activated
- 31 File name
- 32 Histogram
- 33 Grid lines
- 34 Level Gauge
- 35 Display of cropped section size and position
- 36 Focus peaking  
(identification of in sharp edges in the object)

## VIDEO/CINE

### STATUS SCREEN

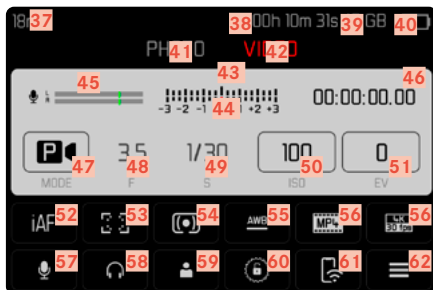

### WHEN TAKING A PICTURE

All displays/values refer to the actual settings

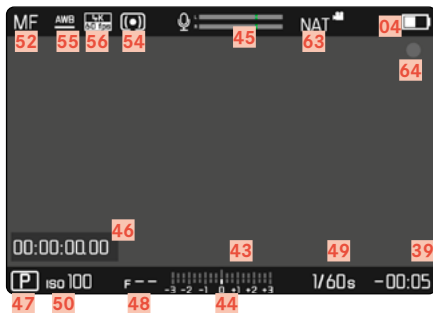

## IN PLAYBACK MODE

All displays/values refer to the displayed image

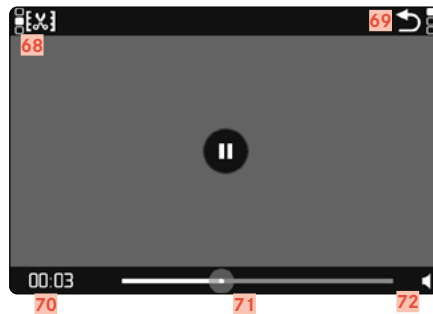

37 Focal length  
38 Memory card used  
39 Remaining memory capacity  
40 Battery capacity  
41 Menu section PHOTO  
42 Menu sections VIDEO  
43 Light balance  
44 Exposure compensation scale  
45 Microphone recording level  
46 Recording time (time code)  
47 Exposure mode  
48 Exposure value  
49 Shutter speed  
(Cine: shutter angle)  
50 ISO Sensitivity  
(Cine: ASA indication)  
51 Exposure compensation value  
52 Focus mode  
53 Autofocus metering method  
54 Exposure metering method  
55 White balance mode  
56 File format/compression level/resolution  
57 Recording level  
58 Headphone volume  
59 User profile  
60 Locking/unlocking the setting wheels  
61 Leica FOTOS  
62 Main menu

63 Color rendering (Video Style)  
64 Indicates recording in progress  
65 Stabilization activated  
66 File name  
67 File number of the picture shown  
68 Video editing function  
69 Exiting video playback  
70 Current time of the playback  
71 Playback status bar  
72 Playback volume

## DISPLAYS IN THE TOP DISPLAY

## Home screen



## DEFAULT VIEW



## MODE CHANGE



- <sup>73</sup> Camera name
- <sup>74</sup> Date
- <sup>75</sup> Time
- <sup>76</sup> Handgrip battery capacity
- <sup>77</sup> Camera battery capacity
- <sup>78</sup> Exposure mode
- <sup>79</sup> Set flash exposure compensation
- <sup>80</sup> Program shift
- <sup>81</sup> Exposure value
- <sup>82</sup> Shutter speed  
(<sup>Circle</sup>: shutter angle)
- <sup>83</sup> ISO Sensitivity  
(<sup>Circle</sup>: ASA indication)
- <sup>84</sup> Memory card used
- <sup>85</sup> Remaining memory capacity
- <sup>86</sup> Leica FOTOS
- <sup>87</sup> GPS
- <sup>88</sup> USB charging function
- <sup>89</sup> Depth of field threshold values
- <sup>90</sup> Sharp distance focus



## CHARGE STATUS INDICATOR ON THE LCD PANEL

The battery charge status is displayed in the status pane and in the header line (Info Bars) at the top right.



Display	Charge status
	approx. 75 - 100%
	approx. 50 - 75%
	approx. 25 - 50%
	approx. 0 - 25%
	approx. 0% The battery needs charging or replacing

## PREPARATION

### ATTACHING THE CARRY STRAP

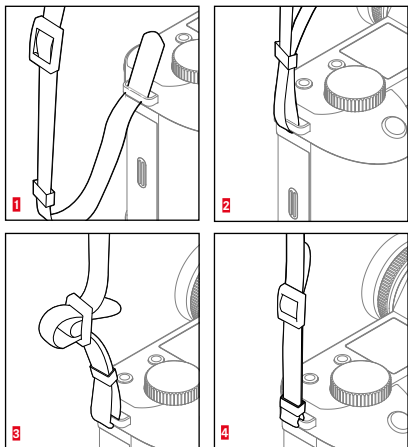

#### Attention

- Once you have attached the carry strap, please make sure that the clips are mounted correctly to prevent the camera from falling.

### PREPARING THE CHARGER

Use the mains cable with the matching regional plug to connect the charger to mains electricity.

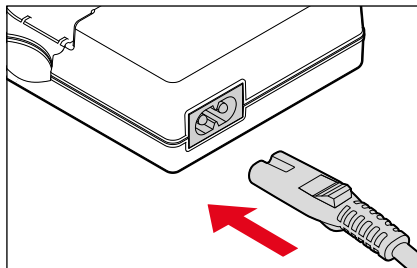

#### Note

- The charger will automatically adapt to local mains voltage.

## CHARGING THE BATTERY

The camera is powered by a lithium-ion battery.

### INSERTING THE BATTERY IN THE CHARGER

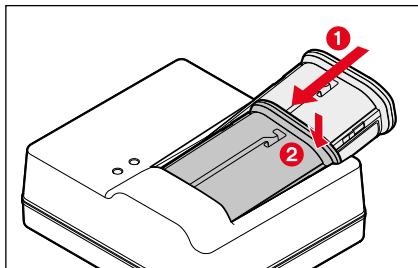

- ▶ Slide the battery into the charger with the groove facing up until the contacts meet
- ▶ Press down on the battery until you can hear and feel it clicking into place
- ▶ Ensure that the battery is fully inserted into the charger

### REMOVING THE BATTERY FROM THE CHARGER

- ▶ Tilt the battery up and lift it out at an angle

## CHARGE STATUS INDICATORS ON THE CHARGER

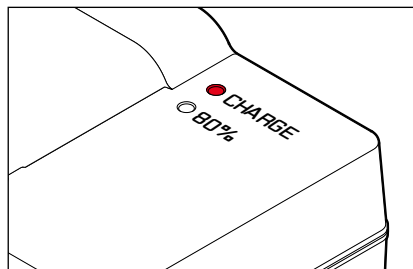

The status LED indicates a correct charging process.

Display	Charge status	Charge time*
<b>CHARGE</b> flashes green	battery is charging	
<b>80%</b> lights up orange	80%	approx. 2 hours
<b>CHARGE</b> continuous green light	100%	approx. 3½ h

Disconnect the charger from mains electricity when the charging process is complete. There is no risk of overcharging.

\* for a completely discharged battery

## CHARGING VIA USB

The rechargeable battery in the camera can be automatically charged when the camera is connected to a computer or another suitable power source via USB cable.

Factory setting: **On**

- ▶ Select **Camera Settings** in the main menu
- ▶ Select **USB Charging**
- ▶ Select **On/Off**

### Notes

- The camera will only charge while it is switched off. The charging process will be interrupted as soon as the camera is switched on. The camera will be displayed as a USB storage medium if an SD card is inserted (see p. 189).
- Charging does start automatica.

## INSERTING/REMOVING THE BATTERY

- ▶ Ensure that the camera is switched OFF (see p. 46)

### INSERTION

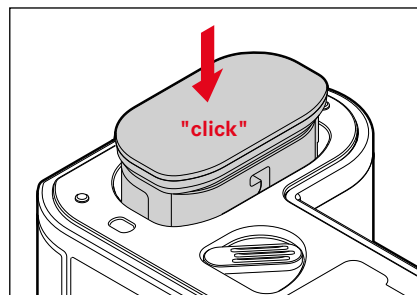

- ▶ Insert the battery into the slot with the groove pointing towards the LCD panel and gently push until you hear and feel it clicking into place

## REMOVAL

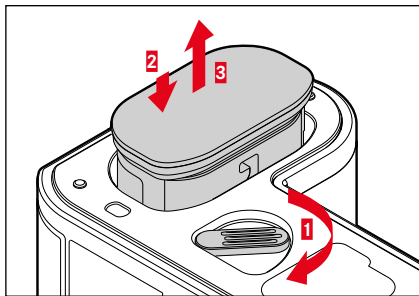

- ▶ Turn the battery release lever
  - Battery is pushing out slightly.
- ▶ Press down on the battery lightly
  - The battery unlocks and pushes out fully.
- ▶ Removing the battery

### Important

- Removing the battery while the camera is switched on may result in the loss of custom settings or damage to the memory card.

## INSERTION/REMOVAL OF MEMORY CARDS

Leica SL2 offers slots for two memory cards. There are various options for use, see p. 90.

The camera will save exposures to an SD (Secure Digital), SDHC (High Capacity) or SDXC (eXtended Capacity) memory card.

### Notes

- SD/SDHC/SDXC memory cards are available from various suppliers in various sizes and with differing read/write speeds. Memory cards with high storage capacities and high read/write speeds offer quick storage and rendering.
- The memory card may not be supported (capacity) or will have to be formatted before first use (see p. 188). The camera will in that case display a relevant message. Please see the section "Technical Data" for information about supported cards.
- Check the memory card for correct alignment if you are having difficulties inserting it into the camera.
- Video recordings require a high write speed.
- See p. 8 and p. 11 for additional information.

- ▶ Ensure that the camera is switched OFF (see p. 46)

### OPENING THE COVER OVER THE MEMORY CARD SLOT

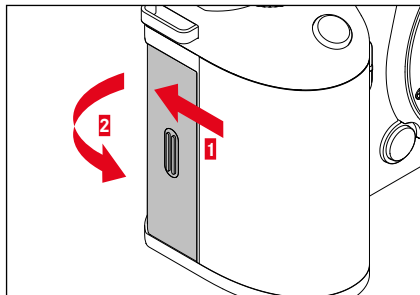

- ▶ Slide the cover as shown in the illustration
  - The cover lifts automatically.

### CLOSING THE COVER OVER THE MEMORY CARD SLOT

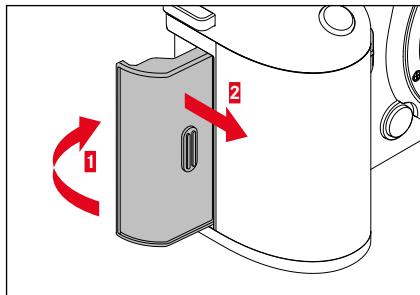

- ▶ Close and hold down the cover
- ▶ Slide the cover as shown in the illustration until it audibly clicks into place

### INSERTION

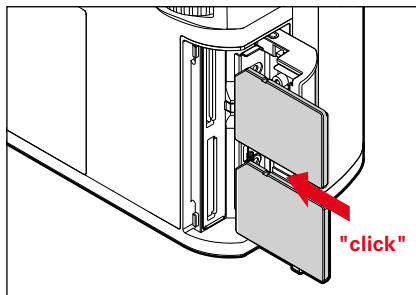

- ▶ Push the memory card into the slot until you hear and feel it clicking into place
  - The beveled corner of the card must be at the top left.

### REMOVAL

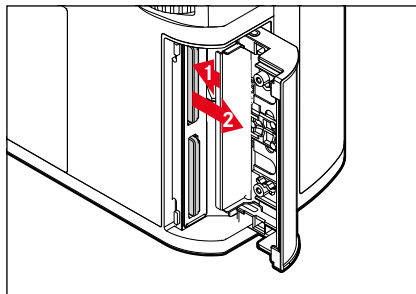

- ▶ Push down on the card until you hear a click
  - The card pushes out slightly.
- ▶ Remove the memory card

## LENS

### COMPATIBLE LENSES

In addition to Leica SL lenses, the Leica SL2 can also accommodate Leica TL lenses with full functionality via the L bayonet. Leica M and R lenses can also be used in conjunction with Leica M/R L adapters.

### L-MOUNT LENSES

Sophisticated optical systems guarantee the excellent imaging performance of the SL lenses. In the design phase for the optics, a homogeneous performance across all focal lengths, aperture and focus settings is a high priority. That is how SL lenses can be used for optimally creative results in any situation.

### EXPOSURE METERING AND EXPOSURE CONTROL USING VARIO LENSES

Some Leica TL and SL Vario lenses have a variable speed, which means that the effective aperture opening depends on the configured focal length. Make sure to set the desired focal length before storing the meter value or changing the shutter speed/aperture combination to prevent incorrect exposure. Please read the sections on "Exposure" starting on page 121 for more information. Make sure that the aperture setting on the flash unit matches the camera aperture if you are using a non-system compatible flash unit.

## LEICA M AND R LENSES

Leica M and R lenses can be attached via Leica M or R L adapters. There are lens profiles stored in the camera, which allow the following functions:

- The flash exposure and flash reflector controls utilize the stored lens data (see “Compatible flash units”).
- The lens data is furthermore written to the EXIF data of the recordings, provided the lens is relevantly encoded. The focal length of the lens is additionally displayed when rendering the extended picture data.

The camera will automatically select the appropriate lens type settings if the Leica M lens used comes with 6 bit encoding, or the Leica R lens has an ROM contact strip. You will have to enter the lens model manually if the lenses are not relevantly equipped.

### Using automatic detection

- ▶ Select **Camera Information** in the main menu
- ▶ Select **Lens Profiles**
- ▶ Activate automatic lens detection (**Auto**) or deactivate the feature (**Off**)

### Setting the lens type manually

- ▶ Select **Camera Information** in the main menu
- ▶ Select **Lens Profiles**
- ▶ Select **M-Lenses** or **R-Lenses**

### Sorting the lens type lists

- ▶ Select **Camera Information** in the main menu
- ▶ Select **Lens Profiles**
- ▶ Select **M-Lenses** or **R-Lenses**
- ▶ Select **Edit List of M-Lenses** or **Edit List of R-Lenses**
- ▶ Activate (**On**) or deactivate (**Off**) the lens types you will be using



## CHANGING THE LENS

### Important

- Make sure to always have a lens or the camera bayonet cover attached to prevent dust or other foreign bodies penetrating the camera.
- That is why you should always replace lenses quickly and in a dust-free environment.

## L-MOUNT LENSES

### ATTACHING THE LENS

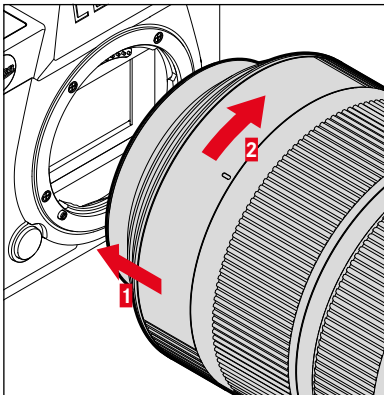

- ▶ Ensure that the camera is switched OFF
- ▶ Hold the lens on the fixed ring
- ▶ Position the alignment point on the lens opposite the alignment point on the camera housing
- ▶ Attach the lens in this position
- ▶ Turn the lens clockwise until you hear and feel it click into place

### DETACHING THE LENS

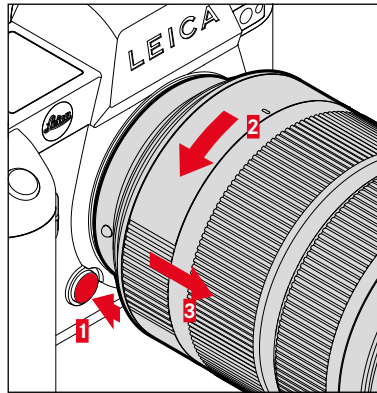

- ▶ Ensure that the camera is switched OFF
- ▶ Hold the lens on the fixed ring
- ▶ Press and hold the release button on the camera housing
- ▶ Turn the lens counter-clockwise until the alignment point is opposite the release button
- ▶ Remove the lens

## OTHER LENSES

### (e.g. Leica M lenses)

Other lenses can be used by inserting an adapter for L bayonets (e.g. Leica-M adapter L).

#### ATTACHING THE ADAPTER

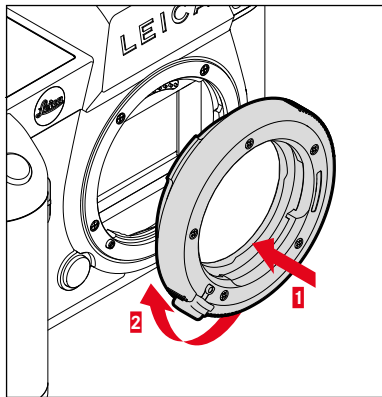

- ▶ Ensure that the camera is switched OFF
- ▶ Position the alignment point on the adapter opposite the alignment point on the camera housing
- ▶ Attach the lens in this position
- ▶ Turn the adapter clockwise until you hear and feel it click into place
- ▶ Attach the lens immediately

#### DETACHING THE ADAPTER

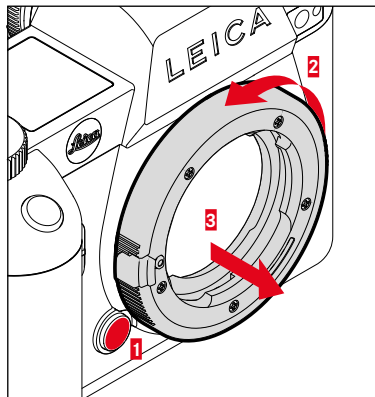

- ▶ Ensure that the camera is switched OFF
- ▶ Detaching the lens
- ▶ Press and hold the release button on the camera housing
- ▶ Turn the adapter counter-clockwise until the alignment point is opposite the release button
- ▶ Remove the adapter

## ATTACHING THE LENS TO THE ADAPTER

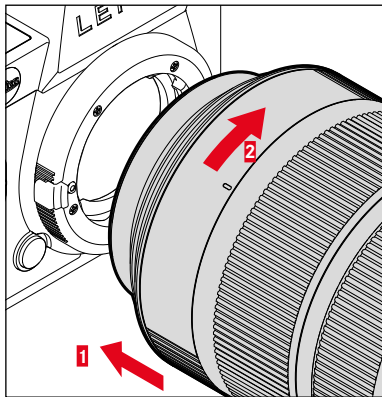

- ▶ Ensure that the camera is switched OFF
- ▶ Hold the lens on the fixed ring
- ▶ Position the alignment point on the lens opposite the alignment point on the adapter
- ▶ Attach the lens in this position
- ▶ Turn the lens clockwise until you hear and feel it click into place

## DETACHING THE LENS FROM THE ADAPTER

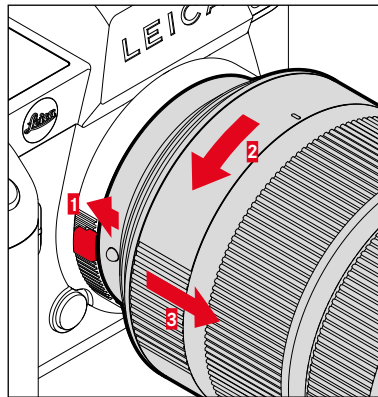

- ▶ Ensure that the camera is switched OFF
- ▶ Hold the lens on the fixed ring
- ▶ Press and hold the release button on the adapter
- ▶ Turn the lens counter-clockwise until its alignment point is opposite the release button
- ▶ Remove the lens

## DIOPTER SETTINGS

The viewfinder has a diopter setting function with a range between +4 and -2 diopter to allow glasses wearers the use of the camera without eyeglasses (diopter adjustment).

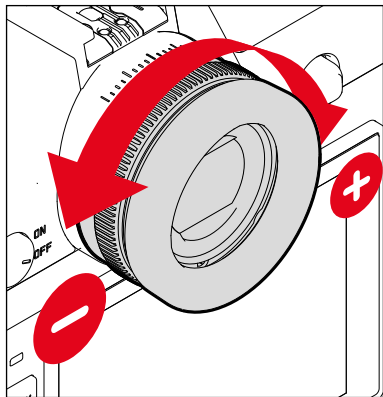

- ▶ Look through the viewfinder
- ▶ Aiming at and focusing on an object
- ▶ Turn the diopter setting wheel until you see the image in the viewfinder and the displays in perfect focus

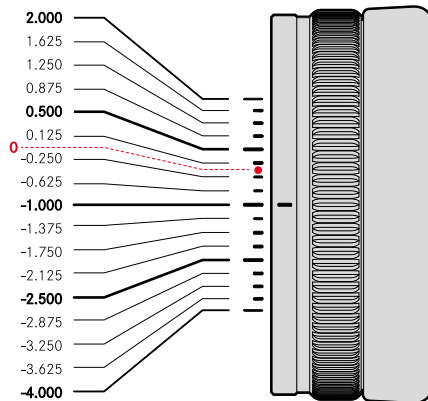

## MULTIFUNCTION HAND GRIP SL (optional accessory)

The Multifunction Handgrip SL is an optional accessory and comes with additional operating elements (shutter button, joystick, thumbwheel and front setting wheel) positioned specifically for easy portrait photography. The handgrip is therefore particularly useful for one-handed photography. It also offers space for a second rechargeable battery.

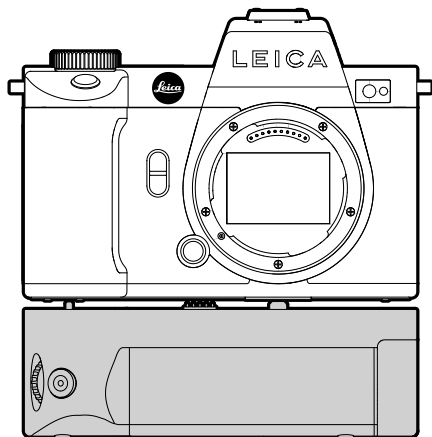

## PHOTOGRAPHY WITH THE HANDGRIP

The operating elements of the handgrip are positioned in such a way as to be in easy reach when using the camera for portrait photography.

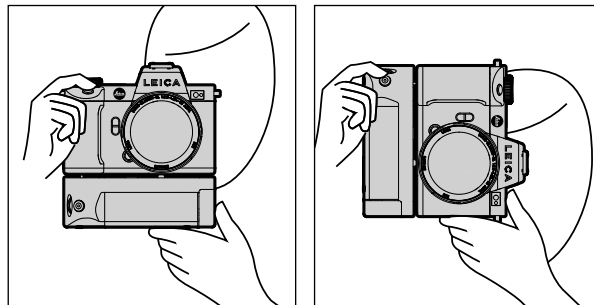

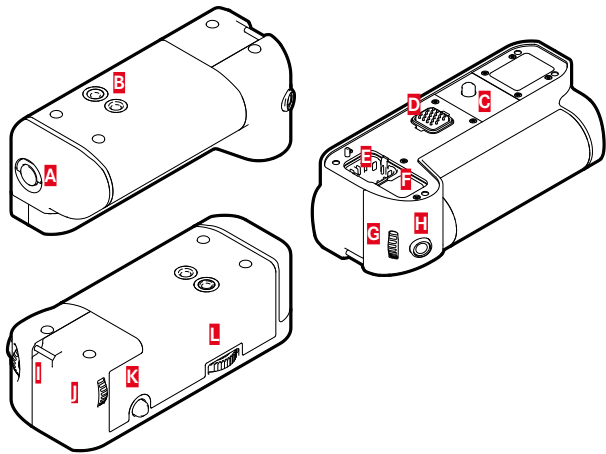

- A** Locking toggle
- B** Tripod thread
- C** Attachment screw
- D** Interface with the camera
- E** Storage compartment for the contact cover of the handgrip
- F** Storage compartment for the contact cover of the camera
- G** Front setting wheel
- H** Shutter button
- I** Strap lug
- J** Thumbwheel
- K** Joystick
- L** Hand grip lock

## ATTACHING THE HANDGRIP

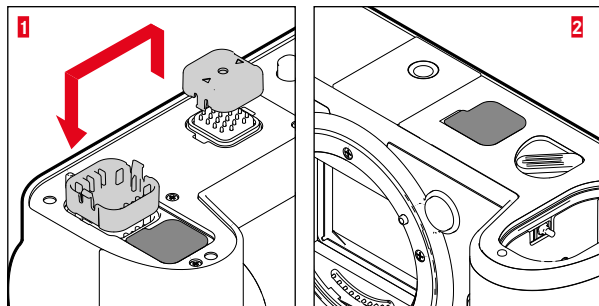

- ▶ Squeeze the contact cover of the handgrip on the two sides marked with triangles and lift it off
- ▶ Store the contact cover in its designated compartment in the handgrip
- ▶ Remove the contact cover in the base of the camera housing
- ▶ Store the contact cover in its designated compartment in the handgrip

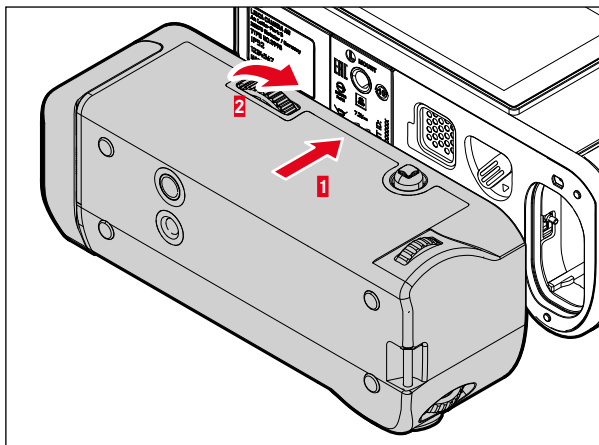

## DETACHING THE HANDGRIP

- ▶ Turn the handgrip to the left to unlock the connection
  - Make sure to hold the camera and the handgrip securely while doing so.
- ▶ Replace both cover caps over the connections

### Important

Make sure that the contact covers are securely in place on the camera and on the handgrip whenever the handgrip is not attached to the camera. The highly sensitive contacts could otherwise easily be damaged.

- ▶ Align the handgrip with the base of the camera
  - Make sure not to damage the contacts.
- ▶ Turn the Handgrip lock to the right and hand tighten

### Important

- Make sure to check regularly whether the connection is still tight when using the camera with the handgrip attached and re-tighten it as needed.

## MOUNTING THE WRIST LOOP/CARRY STRAP ON THE MULTIFUNCTION HANDGRIP

The high quality wrist loop is available as an optional ergonomic accessory for the handgrip to ensure more stability for the camera. The hand loop is recommended in particular for landscape photography.

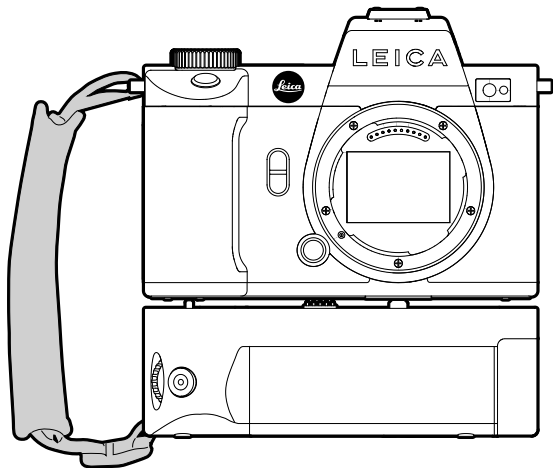

When using the handgrip for portrait photography for extended periods of time, we recommend attaching the carry strap on the strap lug of the camera on the right-hand side and on the strap lug of the handgrip. This will always maintain the camera in the correct position. See p. 30 for instructions on how to attach the carry strap.

## CHANGING THE BATTERY

The multifunction handgrip offers space for a second rechargeable battery. This will significantly increase operating time.

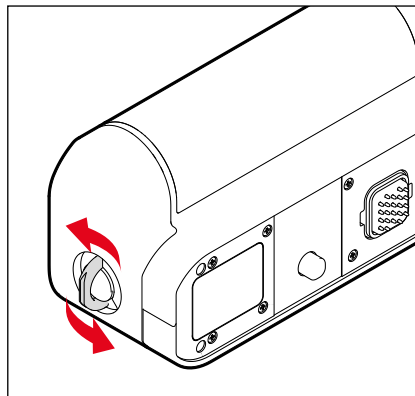

- ▶ Click up the locking toggle
- ▶ Turn the locking toggle in anti-clockwise direction
  - The battery cover lifts automatically.



## REMOVING THE BATTERY

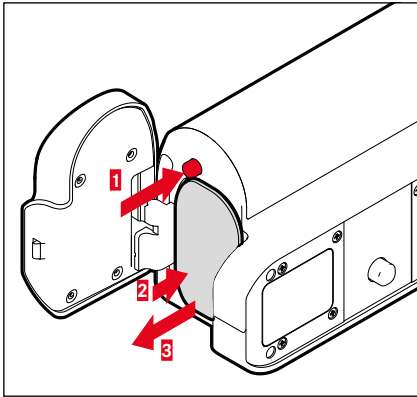

- ▶ Push down the ejector pin
  - Battery is pushing out slightly.
- ▶ Press down on the battery lightly
  - The battery unlocks and pushes out fully.
- ▶ Removing the battery

## INSERTING THE BATTERY

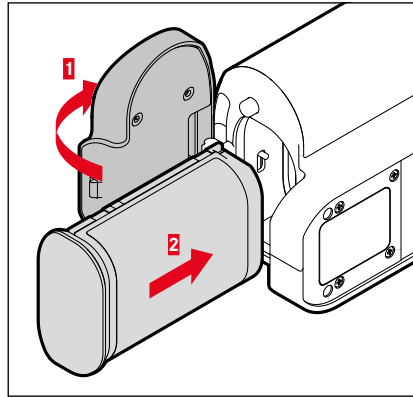

- ▶ Insert the battery into the slot with the groove pointing towards until you hear and feel it clicking into place

### CLOSE THE BATTERY COMPARTMENT

- ▶ Close the cover over the battery compartment
  - It will click to signify it is locked.
- ▶ Click down the locking toggle

### Note

- The camera must have a battery with at least minimal charge inserted to utilize a rechargeable battery in the handgrip.

## CAMERA OPERATION

### CONTROL ELEMENTS

#### MAIN SWITCH

The main switch switches the camera on and off.

#### SWITCHING THE CAMERA ON

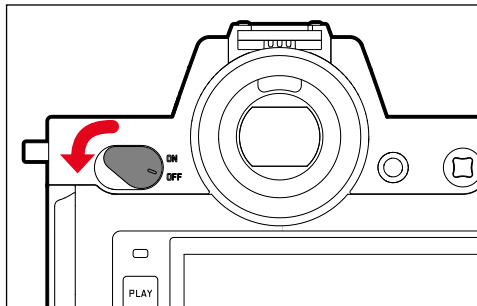

#### Notes

- Once switched on, the camera will be ready to use after approx. 1 s.
- Displays in the viewfinder appear

#### SWITCHING THE CAMERA OFF

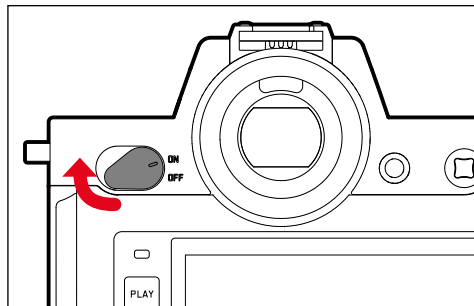

#### Note

- The function **Auto Power Off** (see p. 72) deactivates the camera automatically if no operation occurs within a preset time. Use the main switch to deactivate the camera if this function is **Off** to prevent inadvertent exposures and battery discharge when the camera is not in use.

## SHUTTER BUTTON

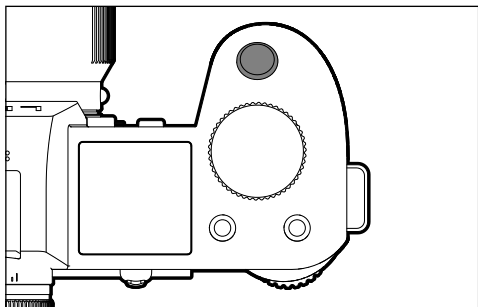

The shutter button works in two stages.

1. **Tapping** (= Pressing the shutter button to the 1st pressure point)
  - Activating the camera electronics and displays
  - Metering memory lock (metering & saving):
    - AF mode: range measurement (AF-L)
    - (semi) automatic exposure mode: exposure metering (AE-L)
  - Canceling a running self-timer delay time
  - Return to picture mode
    - from review/playback mode
    - from menu control
    - from standby mode

2. **Press down fully**

- Shutter release
  - The data is then transferred to the memory card.
- Starting a video recording
- Starting a preselected self-timer delay
- Starting a picture series or interval shooting

### Notes

- Press down the shutter button in a smooth motion until you hear the click of the shutter to prevent camera shake.
- The shutter button remains locked:
  - if the memory card inserted and/or the internal buffer memory are (temporarily) full
  - if the battery has exceeded its performance limits (capacity, temperature, age)
  - if the memory card is write-protected or damaged
  - if the sensor is too hot

## FRONT SETTING WHEEL

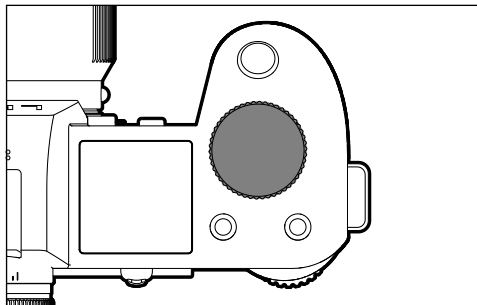

- Menu navigation
- Setting the shutter speeds
- Exposure compensation value selection
- Enlarging/reducing viewed pictures

## THUMBWHEEL

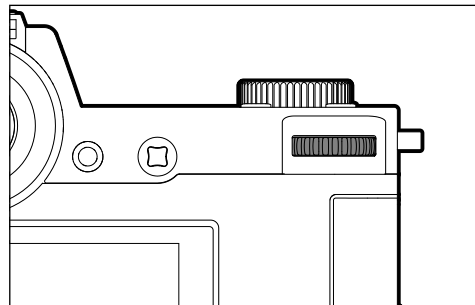

- Menu navigation
- Accessing the submenu
- Applying menu settings
- Setting selected menu items/functions
- Setting the exposure value
- Exposure compensation value selection
- Setting the program shift
- Scrolling through the picture memory
- Playback of video recordings
- Confirming the prompts

## JOYSTICK

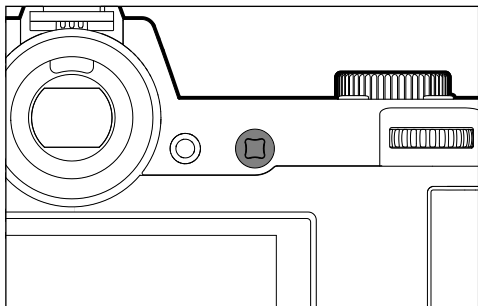

- Menu navigation
- Accessing the submenu
- Applying menu settings
- Setting selected menu items/functions
- Scrolling through the picture memory
- Shifting the metering field (Field or Spot AF)
- Exposure lock
- Playback of video recordings
- Confirming the prompts

## PLAY BUTTON/MENU BUTTON

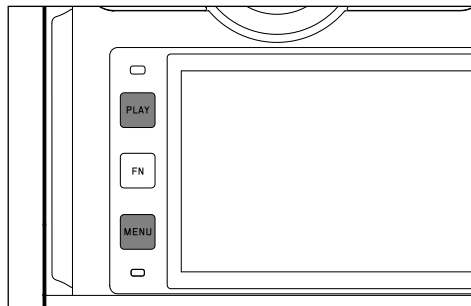

### PLAY BUTTON

- Activation and deactivation of the (continuous) review/playback mode
- Return to full-screen display

### MENU BUTTON

- Accessing the menu (incl. status screen)
- Accessing the Playback/Review menu
- Exiting the currently displayed (sub) menu

## FN BUTTONS

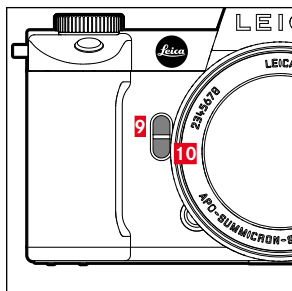
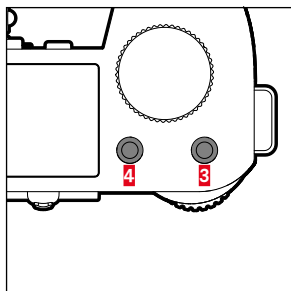
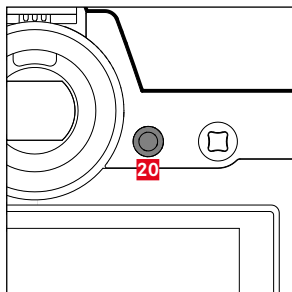
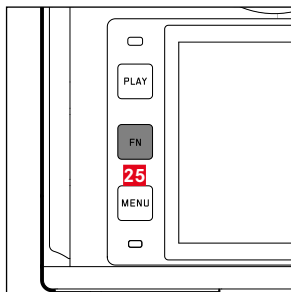

Direct access to various menus and functions. All FN buttons can be custom configured (see p. 65).

## FACTORY SETTINGS

in picture mode

in playback/review mode

FN button **25**

Toggle info profiles

FN button **20**

LCD panel/EVF switchover

FN button **4**

Mode change (photo/video)

Marking/rating a recording

FN button **3**

- Photo: ISO
- Video: ISO
- (Cine: Exposure Index)









FN button **9**

- Photo: Magnification
- Video: Microphone Gain

FN button **10**

Autofocus metering method

## LCD PANEL (TOUCH SCREEN)

TOUCH CONTROL*		in picture mode	in playback/review mode
	tap briefly	Shifting the AF metering field and focusing (while Touch AF is activated)	Select the recording Marking/rating a recording
	double tap	Resetting the AF metering field (while Touch AF is activated)	Enlarging/reducing viewed pictures
	swipe		Shifts the enlarged image section
	horizontal swipe (full length)	Mode change (photo/video)	Scrolling through the picture memory
	vertical swipe (full length)	Switch to playback/review mode	Switch to picture mode
	touch and hold	Accessing the AF quick setting	
	two-finger pinch/ spread		Enlarging/reducing viewed pictures
	swipe and hold/ hold and swipe	Shifting the AF metering field and focusing (while Touch AF is activated)	Continuous scrolling

\* A light touch is enough, don't apply pressure.

## TOP DISPLAY

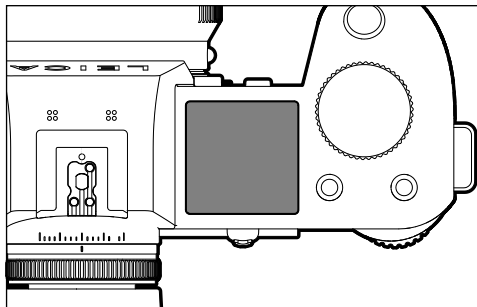

- Display of the active mode
- Display of recording data
- Display of camera information

## MENU CONTROL

### CONTROL ELEMENTS

The following elements are used for menu control.

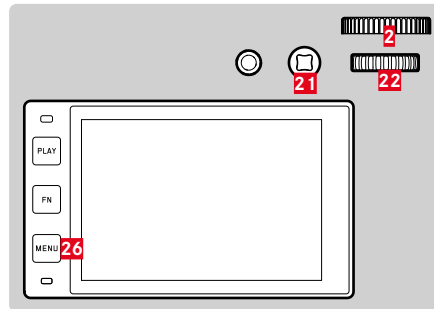

**21** Joystick

**2** Front setting wheel

**26** MENU button

**22** Thumbwheel



## MENU SECTIONS

The following menu sections are available: Status Screen, **Main Menu** and **Favorites**. At this top level, the menu sections in picture and video mode are easily recognizable by their color:

Status-Screen:

- quick access to the most important settings

**Favorites**:

- your custom list (see p. 64 for details on how to manage this list)

**Main Menu**:

- offers access to **all** menu items
- contains various submenus

### Note

- The favorites menu can only be displayed if it has at least one menu item assigned.

SECTION	PHOTO	VIDEO
Status screen	dark background	bright background
Favorites		
Main menu (top level)	dark header line	bright header line
Main menu (Submenus)	black header line	

Status screen

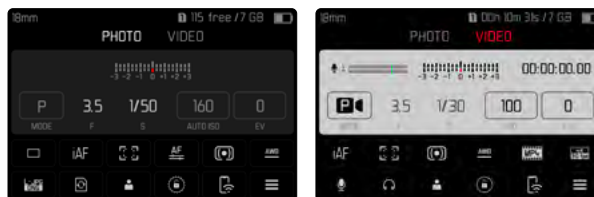

Favorites



Main menu

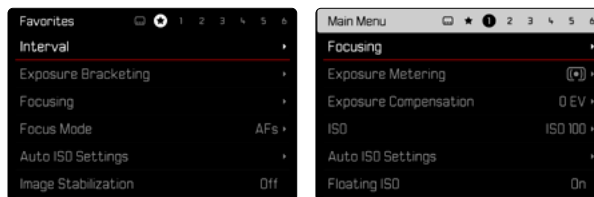

## SWITCHING MENU SECTIONS

The status screen will always be displayed as the first menu section. The top menu level is organized into pages, which are displayed in the header line: Status Screen, Favorites Menu (up to 2 pages) and six subsections of the main menu. You can switch between menu sections by scrolling through the pages. Alternatively, the status screen and the favorites menu offer access to the main menu as their respectively last menu item.

### Scrolling forward

- ▶ Press the **MENU** button

or

- ▶ Turn the front setting wheel in clockwise direction
  - The status screen will appear again after page 6 of the main menu.

### Scrolling backward

- ▶ Turn the front setting wheel in anti-clockwise direction
  - Page 6 of the main menu will appear again after the status screen.

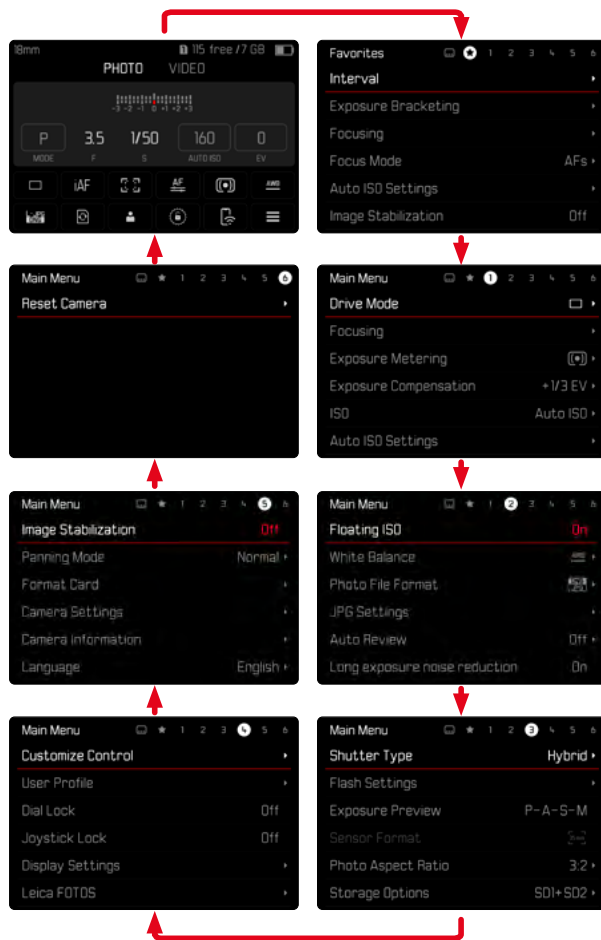

## STATUS SCREEN

The status screen offers an overview of the most important information regarding the current camera status and active settings.

It furthermore allows direct access to important settings. The status screen is optimized for touch control.

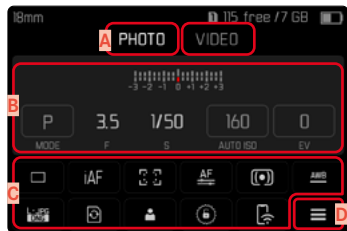

- A** Mode: picture/video (see p. 143)
- B** Exposure settings (see p. 121 and p. 159)
- C** Menu items
- D** Access to the main menu

## Notes

- Where touch control is not possible or not desirable (e.g. in EV mode), the status screen can alternatively be controlled via the joystick and/or the thumbwheel.
- The settings become effective immediately.
- The framed control panels can be selected. Unframed values are added in automatically (depending on the active exposure mode).
- The available menu items in picture and video mode differ (see p. 24 and p. 26).

## SELECTING SETTINGS

Settings can be selected in various ways from within the status screen. The setting types vary from menu to menu.

- ▶ Briefly touch the desired control panel
  - The relevant menu appears.

## DIRECT SETTINGS

A version of the menu bar appears in the lower area of the status screen (see p. 61).



- ▶ Select the desired function directly or swipe

## ACCESSING A STANDARD SUBMENU

These menus behave as if they were accessed from within the main menu (see p. 60). Touch control is therefore unavailable. From there, you return to the status screen and not to the next higher menu item.

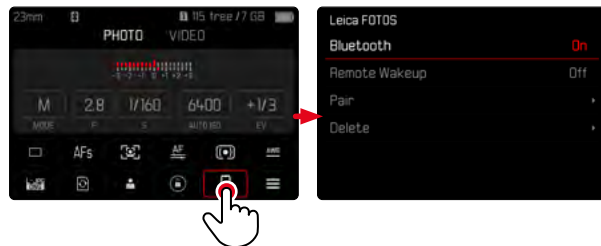

- ▶ Select the desired setting

## FAVORITES MENU

The favorites menu offers quick access to the most frequently used menu items. It can contain up to 11 menu items. These can be assigned individually (see p. 64).

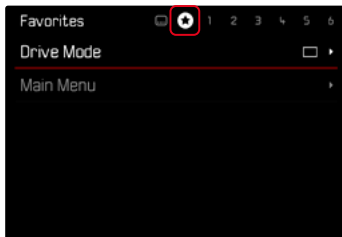

## MAIN MENU

The main menu offers access to all settings. Most of these are organized in submenus.

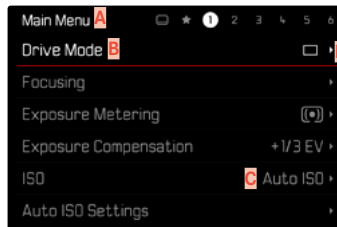

**A** Menu sections: **Main Menu** and **Favorites**





**B** Menu item name

**C** Menu item setting

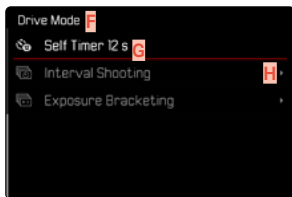
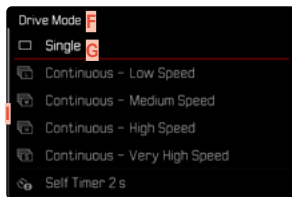
**D** Submenu reference

## SUBMENU



-  Current menu item
-  Submenu item
-  References to other submenus
-  Scrollbar

There are various types of submenus available. The following pages describe their operation.

## MENU NAVIGATION

### SCREEN BY SCREEN NAVIGATION

#### Scrolling forward

- ▶ Press the **MENU** button (repeatedly if needed)
- or
- ▶ Turn the front setting wheel in clockwise direction
  - The status screen will appear again after page 6 of the main menu.

#### Scrolling backward

- ▶ Turn the front setting wheel in anti-clockwise direction
  - Page 6 of the main menu will appear again after the status screen.

### LINE BY LINE NAVIGATION

(Function/function option selection)

- ▶ Press the joystick up/down
- or
- ▶ Turn the thumbwheel  
(to the right = down, to the left = up)
  - Once the last menu item has been reached scrolling up or down, the display will automatically jump to the previous or next screen. The currently active menu section (Favorites, Main Menu) is not exited.

#### Note

- Some menu items can only be accessed under specific circumstances. The text in the relevant line is displayed in gray to signify the existence of a submenu.

## SHOW SUBMENU

- ▶ Press the joystick/thumbwheel  
or
- ▶ Press the joystick to the right

## CONFIRM SELECTION

- ▶ Press the joystick/thumbwheel
  - The screen image changes back to the active menu item. The set function variant is shown on the right in the relevant menu line.

### Note

- No confirmation is needed for the selection of **On** or **Off**. An automatic save is done.

## GO BACK ONE STEP

### (Return to the superordinate menu item)

- ▶ Press the joystick to the left
  - This option is only available for list-type submenus.

## GO BACK TO TOP MENU LEVEL

- ▶ Press the **MENU** button 1x
  - The top level of the currently selected menu section is displayed.

## EXITING THE MENU

You can exit the menus and submenus at any time – with/without applying the settings selected there.

### go to picture mode

- ▶ Tap the shutter button

### go to playback mode

- ▶ Press the **PLAY** button

## SUBMENU

## KEYBOARD/NUMBER PAD

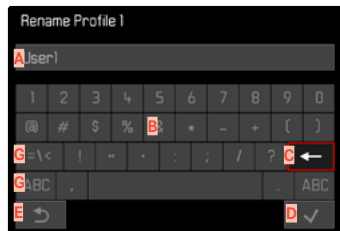

- A** Entry line
- B** Keyboard/Number pad
- C** "Delete" button (deletes the last character entered)
- D** "Confirm" button  
(to apply individual values and existing settings)
- E** Return to previous menu level
- F** Shift key (toggles between upper and lower case letters)
- G** Changing the character type



## SELECTING A BUTTON (ICON/FUNCTION BUTTON)

### Using button control

- ▶ Press the joystick in the relevant direction
    - The currently active button will be highlighted.
  - ▶ Press the joystick/thumbwheel
- or
- ▶ Turn the thumbwheel
    - The currently active button will be highlighted.
    - There will be an automatic jump to the next/previous line when the end/beginning of the line is reached.
  - ▶ Press the joystick/thumbwheel

### Using touch control

- ▶ Press the button of your choice

## SAVE

- ▶ Select button **D**

## CANCEL

- ▶ Select button **E**

## MENU BAR



### Using button control

- ▶ Press the joystick left/right
- or
- ▶ Turn the thumbwheel

### Using touch control

- ▶ Select the desired function directly or swipe

## Notes

- The currently active setting displayed in the center is highlighted in red.
- The set value is displayed above the scale/below the menu bar.
- The following applies for direct access: The selected function requires no additional confirmation and will be active immediately.

## SCALE MENU

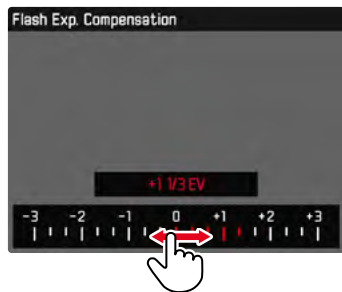

### Using button control

- ▶ Press the joystick left/right
- or
- ▶ Turn the thumbwheel

### Using touch control

- ▶ Select the desired function directly or swipe

### Notes

- The currently active setting displayed in the center is highlighted in red.
- The set value is displayed above the scale/below the menu bar.
- The following applies for direct access: The selected function requires no additional confirmation and will be active immediately.

## DATE/TIME MENU

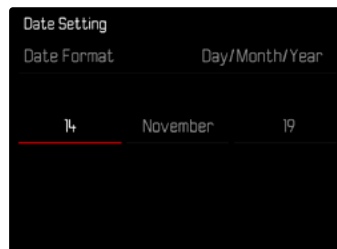

### To move to the next settings field

- ▶ Press the joystick left/right
- or
- ▶ Turn the thumbwheel

### To set values

- ▶ Press the joystick up/down

### To save and return to superordinate menu item

- ▶ Press the joystick/thumbwheel

## COMBI MENU



The setting of the individual menu items is done via a setting bar in the lower display area.

### To access individual menu items

- ▶ Press the joystick in the relevant direction

or

- ▶ Turn the thumbwheel

### To set individual items

- ▶ Press the joystick/thumbwheel
  - The set value displayed next to the menu item is highlighted.
- ▶ Press the joystick left/right

or

- ▶ Turn the thumbwheel

### To apply the setting

- ▶ Press the joystick/thumbwheel

### To return to the superordinate menu item

- ▶ Press the joystick to the left

## USER-DEFINED OPERATION

### FAVORITES MENU

Assign your most frequently used menu items to a favorites menu (up to 11 items) for quick and easy access. The available functions are shown in the list on p. 208.

As there are separate menu sections for picture and video mode, the associated favorite menus can also be assigned individually. The favorites menu in video mode applies for both video modes (Video and Cine). The menu item **ISO** in Cine mode accesses the associated **Exposure Index** function.

The favorites menu will be represented by an asterisk in the header line, provided it contains at least one menu item.

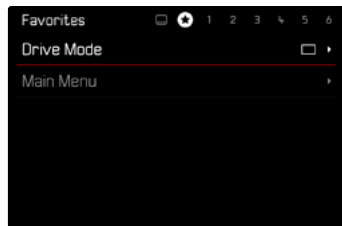

### MANAGING THE FAVORITES MENU

- ▶ Switch to the desired mode (picture or video)
- ▶ Select **Customize Control** in the main menu
- ▶ Select **Edit Favorites**
- ▶ Select the desired menu item

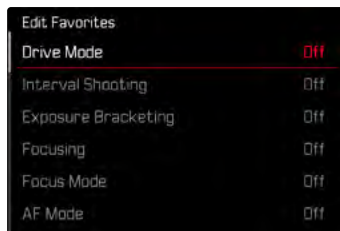

- ▶ Select **On/Off**
  - A warning message appears when the favorites menu has reached the maximum of 11 menu items and no further items can be added.

#### Note

- The favorites menu will be deleted completely if all menu items are set to **Off**.

## FN BUTTONS

You can assign specific menu functions to the FN buttons for extra quick direct access to menu items in recording mode. The assignments in picture and video mode are completely independent of each other.

The available functions are shown in the list on p. 208. For factory settings see p. 50

## CHANGING AN ASSIGNMENT

All FN buttons permit a quick and easy reassignment in addition to access to their currently assigned menu function.

- ▶ Switch to the desired mode (picture or video)
- ▶ Press the desired FN button longer
  - The direct access appears on the LCD panel.

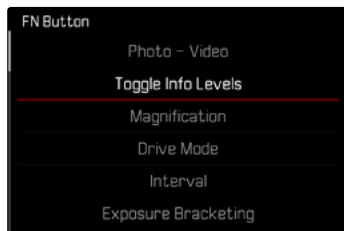

- ▶ Select the desired menu item

## ACCESSING THE ASSIGNED MENU FUNCTION

- ▶ Press the desired FN button briefly
  - The assigned function is accessed, or a submenu appears on screen.

### Notes

- The submenus accessed via direct access may look differently than when they are accessed via the main menu. Specifically, they often appear as menu bars to allow quick settings.
- The settings can be done via key control or using touch control on the LCD panel. The operating mode depends on the type of submenu.

## SETTING WHEEL ASSIGNMENTS (IN PICTURE MODE)

The function of the two setting wheels depends on the active exposure mode. Wheel assignments can be specified independently for picture and video mode and for every exposure mode.

### WHEN USING AF LENSES

#### FACTORY SETTINGS

Picture mode

	Thumbwheel	Front setting wheel
<b>P</b>	Program shift	Exposure compensation
<b>S</b>	Exposure compensation	Shutter speed
<b>A</b>	Aperture	Exposure compensation
<b>M</b>	Aperture	Shutter speed

Video mode

	Thumbwheel	Front setting wheel
<b>P</b>	Exposure compensation	Microphone Gain
<b>S</b>	Exposure compensation	Shutter speed
<b>A</b>	Aperture	Exposure compensation
<b>M</b>	Aperture	Shutter speed

## CUSTOMIZING THE SETTING WHEELS

The functions of the two setting wheels can be swapped.

Picture mode

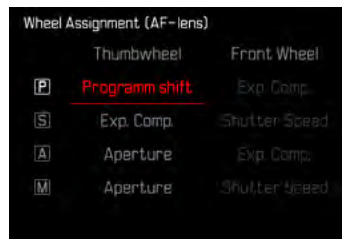

Video mode

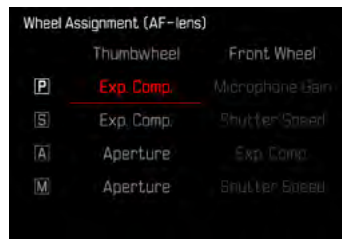

- ▶ Switch to the desired mode (picture or video)
- ▶ Select **Customize Control** in the main menu
- ▶ Select **Wheel Assignment (AF-lens)**
- ▶ Select the desired setting

## WHEN USING MF LENSES

### FACTORY SETTINGS

Picture mode

	Thumbwheel	Front setting wheel
<b>A</b>	Magnification	Exposure compensation
<b>M</b>	Magnification	Shutter speed

Video mode

	Thumbwheel	Front setting wheel
<b>A</b>	Magnification	Exposure compensation
<b>M</b>	Magnification	Shutter speed

## CUSTOMIZING THE SETTING WHEELS

The functions of the two setting wheels can be swapped.

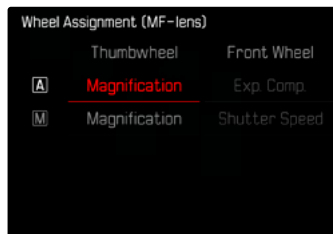

- ▶ Switch to the desired mode (picture or video)
- ▶ Select **Customize Control** in the main menu
- ▶ Select **Wheel Assignment [MF Lens]**
- ▶ Select the desired setting

## ROTATION DIRECTION OF THE SETTING WHEELS

You can specify any rotation direction for exposure settings via the setting wheels. You specify the rotation direction, which will result in an exposure reduction (shorter shutter times/smaller aperture). The assignments for the two setting wheels are done separately independent of each other in picture and video mode.

### THUMBWHEEL

Factory setting: **Stop Down →**

- ▶ Switch to the desired mode (picture or video)
- ▶ Select **Customize Control** in the main menu
- ▶ Select **Thumbwheel Direction**
- ▶ Select **Stop Down →** or **← Stop Down**

### FRONT SETTING WHEEL

Factory setting: **← Stop Down**

- ▶ Switch to the desired mode (picture or video)
- ▶ Select **Customize Control** in the main menu
- ▶ Select **Front Wheel Direction**
- ▶ Select **Stop Down →** or **← Stop Down**

## JOYSTICK FUNCTIONS (IN PICTURE MODE)

You can assign various functions to the joystick in picture mode. The settings for AF and MF mode are done separately. See p. 112, p. 115 and p. 128 for the various functions.

### AF MODE

- ▶ Select **Customize Control** in the main menu
- ▶ Select **Joystick**
- ▶ Select **AF Mode**
- ▶ Select the desired setting  
(**AF-L**, **AE-L**, **AF-L + AE-L**)

### MF MODE

- ▶ Select **Customize Control** in the main menu
- ▶ Select **Joystick**
- ▶ Select **MF Mode**
- ▶ Select the desired setting  
(**AFs**, **AFs + AE-L**, **AFc**, **AFc + AE-L**, **AE-L**, **Magnification**)



## LOCKING THE OPERATING ELEMENTS

Various operating elements can optionally be locked in recording mode.

### Note

-  Appears on screen when a operating element is used while the lock is active.

## LOCKING THE SETTING WHEELS

- ▶ Select **Dial Lock** in the main menu
- ▶ Select **On/Off**

## LOCKING THE JOYSTICK

- ▶ Select **Joystick Lock** in the main menu
- ▶ Select **On/Off**

## CAMERA BASIC SETTINGS

The settings described in this chapter apply for picture and video mode alike. They are therefore available in the picture and video menu (see chapter "Camera Operation" under "Menu Control"). A setting selected in one of the modes will also apply to the other.

### Note

- The two menu items **Language** and **Date & Time** appear automatically when switching the camera on for the first time, when activating the camera after a factory reset (see p.190) or after a firmware update.

## MENU LANGUAGE

Factory setting: English

Available menu languages: German, French, Italian, Spanish, Russian, Japanese, Korean, Traditional or Simplified Chinese

- ▶ Select **Language** in the main menu
- ▶ Select your language
  - Aside from a few exceptions, the language will be changed for all information.

## DATE/TIME

### RECEIVING THE SETTINGS FROM A MOBILE DEVICE

The date and time settings can be automatically received from the mobile device.

Factory setting: **On**

- ▶ Select **Camera Settings** in the main menu
- ▶ Select **Date & Time**
- ▶ Select **via Smartphone**
  - The settings will be re-synched each time the device is paired again.

### Note

- The pairing process is described in the chapter "Leica FOTOS" (see p. 194).

## MANUAL SETTINGS

### DATE

You can choose one of 3 options.

- ▶ Select **Camera Settings** in the main menu
- ▶ Select **Date & Time**
- ▶ Select **Date Setting**
- ▶ Select the desired date format  
(**Day/Month/Year**, **Month/Day/Year**, **Year/Month/Day**)
- ▶ Set the date

### TIME

- ▶ Select **Camera Settings** in the main menu
- ▶ Select **Date & Time**
- ▶ Select **Time Setting**
- ▶ Select the desired brightness  
(**12 Hours**, **24 Hours**)
- ▶ Set the time  
(Select **am** or **pm** for the 12-hour format)

### TIME ZONE

- ▶ Select **Camera Settings** in the main menu
- ▶ Select **Date & Time**
- ▶ Select **Time Zone**
- ▶ Select your time zone/current location

### DAYLIGHT SAVING TIME

- ▶ Select **Camera Settings** in the main menu
- ▶ Select **Date & Time**
- ▶ Select **Daylight Saving Time**
- ▶ Select **On/Off**

## DISTANCE UNIT

The distance can be displayed in meters or in feet (see p. 114).

Factory setting: **Meter (m)**

- ▶ Select **Camera Settings** in the main menu
- ▶ Select **Distance Unit**
- ▶ Select the desired setting  
(**Meter (m)**, **Feet (ft.)**)

## POWER SAVE MODE (STANDBY MODE)

The camera will switch to the power-saving standby mode after a preset time to extend battery life if this function is activated.

The device has two power save levels.

– Standard Save mode:

Activates device standby mode in

3 s/5 s/10 s/2 min/5 min/10 min

– Automatic LCD panel shutdown (see p. 75)

## STANDARD SAVE MODE

Factory setting: 2 min

▶ Select **Camera Settings** in the main menu

▶ Select **Power Saving**

▶ Select **Auto Power Off**

▶ Select the desired setting

(Off, 3 s, 5 s, 10 s, 2 min, 5 min, 10 min)

### Note

- The camera can be woken from standby mode at any time by pressing the shutter button or by switching the main switch off and on again.

## LCD PANEL/VIEWFINDER (EVF) SETTINGS

The camera comes equipped with a 3.2” liquid crystal color panel, which is protected by a glass cover made of extremely hard and scratch-resistant Gorilla® glass.

The following functions can be configured and used individually:

– Use of the LCD panel and EVF (electronic viewfinder)

– Eye sensor sensitivity

– Brightness

– Color rendering

– EVF Frame Rate

– Automatic LCD panel and EVF shutdown

## LCD PANEL/EVF USE

You can preset the situations in which EVF and LCD panel should be used. The displays appearing on screen and in the viewfinder are identical.

Factory setting: **Auto**

	EVF	LCD panel
Auto	The eye sensor in the viewfinder automatically toggles the camera between LCD panel and EVF. <ul style="list-style-type: none"> <li>• Recording</li> <li>• Playback/Review</li> <li>• Menu control</li> </ul>	
LCD		<ul style="list-style-type: none"> <li>• Recording</li> <li>• Playback/Review</li> <li>• Menu control</li> </ul>
EVF	<ul style="list-style-type: none"> <li>• Recording</li> <li>• Playback/Review</li> <li>• Menu control</li> </ul>	
EVF extended	<ul style="list-style-type: none"> <li>• Recording</li> <li>• Playback/Review</li> <li>• Menu control</li> </ul>	

- ▶ Select **Display Settings** in the main menu
- ▶ Select **EVF-LCD**
- ▶ Select the desired setting  
(**LCD**, **Auto**, **EVF Extended**, **EVF**)

### Note

- Select **EVF** if you want to keep the LCD panel switched off (e.g. on dark environments).

## EYE SENSOR SENSITIVITY

You can adjust the eye sensor sensitivity to ensure that the changeover functions reliably if you wear eyeglasses.

Factory setting: **Low**

- ▶ Select **Display Settings** in the main menu
- ▶ Select **Eye Sensor Sensitivity**
- ▶ Select the desired setting  
(**Low**, **High**)

## BRIGHTNESS

You can adjust brightness for best visibility in various lighting conditions. Brightness is set individually for the LCD panel and the viewfinder. Selection occurs via key control or touch control.

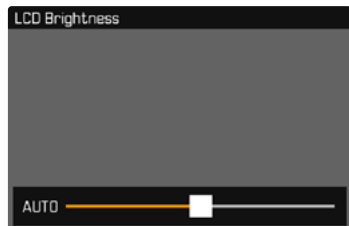

### LCD PANEL

- ▶ Select **Display Settings** in the main menu
- ▶ Select **LCD Brightness**
- ▶ Select the desired brightness of **Auto**
- ▶ Confirm selection

### EVF

- ▶ Select **Display Settings** in the main menu
- ▶ Select **EVF Brightness**
- ▶ Look through the viewfinder
- ▶ Select the desired brightness
- ▶ Confirm selection

## COLOR RENDERING

Color rendering can also be adjusted. Brightness is set individually for the LCD panel and the viewfinder. Selection occurs via key control or touch control.

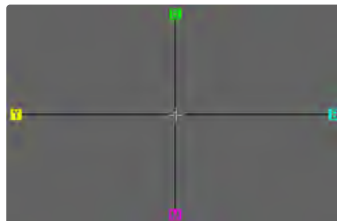

### LCD PANEL

- ▶ Select **Display Settings** in the main menu
- ▶ Select **LCD Color Adjustment**
- ▶ Select the desired color setting
- ▶ Confirm selection

### EVF

- ▶ Select **Display Settings** in the main menu
- ▶ Select **EVF Color Adjustment**
- ▶ Look through the viewfinder
- ▶ Select the desired color setting
- ▶ Confirm selection

## EVF FRAME RATE

The image frequency of the EVF can be set.

- ▶ Select **Display Settings** in the main menu
- ▶ Select **EVF Frame Rate**
- ▶ Select the desired setting  
(60 fps, 120 fps)

## AUTOMATIC LCD PANEL AND EVF SHUTDOWN

The LCD panel and EVF deactivate automatically to save power

Factory setting: 1 min

- ▶ Select **Camera Settings** in the main menu
- ▶ Select **Power Saving**
- ▶ Select **All Displays Auto Off**
- ▶ Select the desired setting  
(30 s, 1 min, 5 min)

### Note

- The top display is not affected by the automatic shutdown.

## ACOUSTIC SIGNALS

Some functions can be acknowledged with acoustic signals. The following special functions can be configured separately:

- Electronic shutter sound
- AF Confirmation

## VOLUME

The volume of active signals can be set.

- ▶ Select **Camera Settings** in the main menu
- ▶ Select **Acoustic Signal**

## ACOUSTIC SIGNALS

This setting specifies, whether the camera should output general notification signals, e.g. during the delay time of the self-timer or as a warning signal, when the memory card is full.

- ▶ Select **Camera Settings** in the main menu
- ▶ Select **Acoustic Signal**
- ▶ Select **Acoustic Signals**
- ▶ Select **On**

## ELECTRONIC SHUTTER SOUND

- ▶ Select **Camera Settings** in the main menu
- ▶ Select **Acoustic Signal**
- ▶ Select **Electronic Shutter Sound**
- ▶ Select **On**

## AUTOFOCUS CONFIRMATION

A signal sound can be selected for successful AF settings.

- ▶ Select **Camera Settings** in the main menu
- ▶ Select **Acoustic Signal**
- ▶ Select **AF Confirmation**
- ▶ Select **On**
- ▶ Select **Volume**
- ▶ Select **Low/high**

## SILENT PHOTOGRAPHY

When pictures should be taken as quietly as possible.

- ▶ Select **Camera Settings** in the main menu
- ▶ Select **Acoustic Signal**
- ▶ Select **Electronic Shutter Sound/AF Confirmation/Acoustic Signals**
- ▶ Select **Off** for each of these menu items





## RECORDING – BASIC SETTINGS (PICTURE & VIDEO)

The settings described in this chapter apply for picture and video mode alike. They are therefore available in the picture and video menu (see chapter "Camera Operation" under "Menu Control"). A setting selected in one of the modes will also apply to the other.

### TOUCH AF

Touch AF allows a direct placement of the AF metering field. Factory setting: **On**

- ▶ Select **Camera Settings** in the main menu
- ▶ Select **Touch AF**
- ▶ Select **On/Off**

#### Positioning the AF Metering Field

- ▶ Briefly tap the LCD panel in the desired position
- or
- ▶ Swipe at desired position

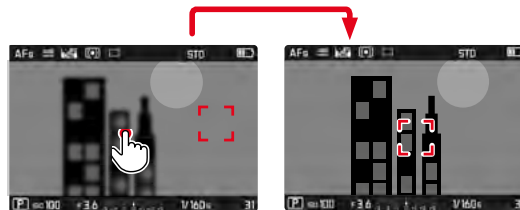

To move the metering field back to the center of the screen

- ▶ Double tap the LCD panel

#### Notes

- This function is available in conjunction with the following AF metering methods: **Spot**, **Field**, **Zone** and **Tracking**.
- With **Spot**, **Field** or **Zone** metering selected, the camera will immediately focus again automatically. If the metering method **Tracking** is selected, the metering field will remain at the selected position and autofocus commences when the shutter button is tapped.

## TOUCH AF IN EVF MODE

Touch AF is deactivated by default when EVF is in use to prevent any inadvertent altering of the AF metering field. Touch AF can, however, also be used in EVF mode.

Factory setting: **Off**

- ▶ Select **Camera Settings** in the main menu
- ▶ Select **Touch AF in EVF**
- ▶ Select **On/Off**

### Note

- In this case, you can change the position of the AF metering field by swiping.

## FOCUS LIMIT

The focusing range can be limited by excluding the macro range. This will speed up automatic focusing considerably.

Factory setting: **Off**

- ▶ Select **Camera Settings** in the main menu
- ▶ Select **Focus Limit (Macro)**
- ▶ Select **On/Off**

### Notes

- The focusing range differs depending on the lens used (see relevant instructions).
- This function is not available for specific lenses:
  - lenses mounted via an adapter (e.g. Leica M lenses with L adapter M)
  - specific Leica SL lenses

## EV INCREMENT

You can choose between 1/2 EV or 1/3 EV graduations. This will allow you to choose between stronger or more subtle effects for your relevant settings.

This setting doesn't just apply for exposure compensation settings. It also specifies the sensitivity of the setting wheels in standard recording mode, i.e. the increment width with which the shutter speeds and the aperture will be set. A setting to **1/2** will change the shutter speeds and aperture values that much faster each time the setting wheel is moved one click further and the correct setting is achieved quicker. A setting to **1/3** facilitates a more precise setting.

Factory setting: **1/3**

- ▶ Select **Camera Settings** in the main menu
- ▶ Select **EV Increment**
- ▶ Select the desired setting (**1/2**, **1/3**)

## AUXILIARY DISPLAYS

The Leica SL2 has 4 independent info profiles, which contain differing combinations of the available auxiliary displays. The following functions are available:

- Info Bars (see p. 82)
- Grid (only picture mode, see p. 82)
- Focus Peaking (see p. 82)
- Clipping / Zebra (see p. 83)
- Level Gauge (only picture mode, see p. 84)
- Histogram (see p. 84)

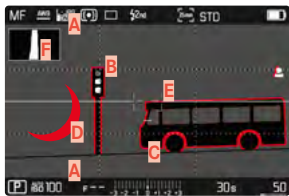

- A** Info Bars (= header and footer line)
- B** Grid
- C** Focus peaking
- D** Clipping / Zebra
- E** Level gauge
- F** Histogram

## INFO PROFILES

Up to 4 independent profiles can be used. The desired function can be selected and adjusted individually for each profile. During operation, the switch between info profiles is done via direct access (see p. 65). In factory settings, that will be the **FN** button at the back left, next to the LCD panel (25). It allows quick switches between various views.

The following profiles are predefined in the factory settings:

Profile	Factory settings
1	Only info Bars (header and footer lines)
2	Full screen view (all auxiliary displays Off)
3	Info Bars    Clipping/Zebra    Focus Peaking    Histogram
4	Info Bars    Clipping/Zebra    Grid    Level Gauge



## CHANGING THE INFO PROFILES

- ▶ Press the FN button with the function assignment **Toggle Info Profiles**
  - In factory settings, that will be the **FN** button at the back left, next to the LCD panel (25).

### Note

- The same info profiles are available in Playback/Review mode as in recording mode. The actual info profile currently in use, however, is saved separately.

## DEACTIVATING INDIVIDUAL INFO PROFILES

You can limit the number of info profiles by activating/deactivating individual profiles. At least one profile must always be active, but that can be an "empty" profile.

- ▶ Select **Camera Settings** in the main menu
- ▶ Select **Capture Assistants**
- ▶ Select a profile
- ▶ Select **On/Off**

## CUSTOMIZING THE INFO PROFILES

- ▶ Select **Camera Settings** in the main menu
- ▶ Select **Capture Assistants**
- ▶ Select **Setting**
- ▶ Select a profile
- ▶ Select the desired function
- ▶ Select the desired setting

Function	Available settings
Info Bars	On, Off
Grid	3 x 3, 6 x 4, Off
Focus Peaking	On, Off Color (Red, Blue, Green, White) & sensitivity (settings apply to <u>all</u> info profiles)
Clipping/Zebra	Off, Upper limit (value between 200 and 255)
Level Gauge	On, Off
Histogram	On, Off

### Note

- It is advisable to reserve one info profile as "empty", in which all functions are set to **Off**. It allows you to temporarily hide all displays. In effect, you get an unobstructed view of the full screen image.

## SHOW AVAILABLE

### INFO BARS

The header and footer lines show the currently active settings and exposure values. See chapter "Displays" for a full list of the various displays (see p. 24).



### GRID

The grids divide the image frame into multiple fields. They facilitate picture composition and an exact camera orientation. The grid line distribution can be adjusted to fit the object.

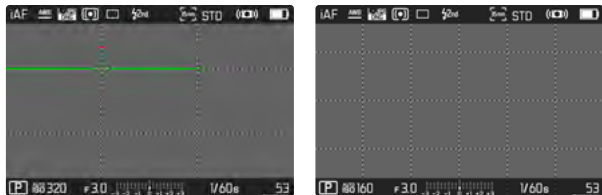

You can choose one of two grid displays. They divide the frame into 3 x 3 or 6 x 4 fields.

## FOCUS PEAKING

This assist function highlights the edges of in focus subject elements in color.



When Focus Peaking is activated,  will appear to the right of the frame with a display of the color used.

### TAG COLOR

The color can be user-specified. This setting will apply for all info profiles.

Factory setting: **Red**

- ▶ Select **Focusing** in the main menu
- ▶ Select **Focus Assist**
- ▶ Select **Focus Peaking**
- ▶ Select the desired setting  
(**Red**, **Green**, **Blue**, **White**)

## ISO SENSITIVITY

The sensitivity can be additionally adjusted. This setting will apply for all info profiles.

Factory setting: **Low**

- ▶ Select **Focusing** in the main menu
- ▶ Select **Focus Assist**
- ▶ Select **Peaking Sensitivity**
- ▶ Select the desired setting  
(**Low**, **High**)

### Note

- Focus peaking is based on subject contrast, i.e. differences between light and dark. As a result, high contrast subject parts could be marked, even if they are not completely in focus.

## CLIPPING/ZEBRA

The Clipping/Zebra display marks very bright image areas. This function is a very easy and exact tool for checking the correct exposure setting. The two displays differ as follows:

- In picture mode: Clipping (flashes black)
- In video mode: Zebra (black/white striped pattern)



### SETTING THE LIMIT VALUE

You can set a threshold value for these displays, i.e. define a value at what degree of overexposure they will appear, so that you can adjust these displays to specific conditions or in line with your own composition ideas.

- ▶ Select **Camera Settings** in the main menu
- ▶ Select **Capture Assistants**
- ▶ Select **Setting**
- ▶ Select a profile
- ▶ Select **Clipping / Zebra**
- ▶ Select **Upper limit**
- ▶ Select the desired value  
(**200** to **255**)

## LEVEL GAUGE

The integrated sensors of the camera show its orientation. These indicators ensure exact camera orientation along the longitudinal and transverse axes of critical objects, e.g. architecture.



Two long lines to the left and right of the image center indicate the transverse axis on screen.

- in zero position = green
- in tilted position = red



The longitudinal axis is indicated in level position by two green double-lines immediately left and right of the image center. When the camera is tilted, these lines are white and a short red line appears above or below them.



### Note

- The camera will switch the aspect of the level gauge autonomously for pictures taken in portrait format.



## HISTOGRAM

Histogram represents the brightness distribution in the picture. The horizontal axis shows the graduated values from black (left) through gray to white (right). The vertical axis corresponds to the number of pixels at each brightness level.

This type of rendering allows an additional quick and easy assessment of the exposure setting.



### Notes

- The histogram is always based on the brightness displayed; depending on the settings used, it may not represent the final exposure.
- In picture mode, the histogram should be regarded as a "trend indicator".
- The histogram during rendering may differ slightly from the one during exposure.
- Histogram is available only in full screen mode.

## RECORDING – BASIC SETTINGS (PICTURE)

The settings described in this chapter only apply for picture mode. They are therefore part of the picture menu and must always be accessed and configured from within picture mode (see chapter "Camera operation" in the section "Menu Control"). Any menu items of the same name in the video menu are entirely independent of these.

### SENSOR FORMAT

The picture data of the entire 35 mm sensor can be used or only a cropped section, which corresponds to the APS-C format. This can be helpful, e.g. when only limited storage capacity remains or a lens developed specifically for APS-C is used.

The max. available resolution is dependent on the setting of the sensor format.

Sensor format	DNG resolution
35 mm	8368 x 5584 pixels (46.7 MP)
APS-C	5504 x 3664 pixels (20 MP)

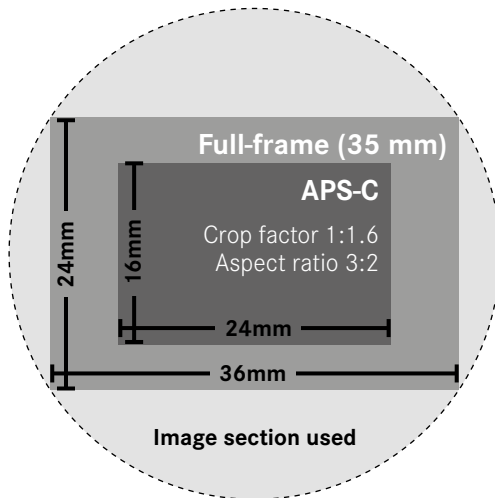

Factory setting: 35 mm

- ▶ Select **Sensor Format** in the main menu
- ▶ Select the desired setting  
(35 mm, APS-C)

The set sensor format is shown in the header line.



#### Note

- The setting switches automatically to APS-C when an APS-C-specific lens is mounted.

## FILE FORMAT

Choose the JPG format **JPG** or the standardized raw data format **DNG** (= digital negative). These can be used individually or simultaneously. Factory setting: **DNG + JPG**

- ▶ Select **Photo File Format** in the main menu
- ▶ Select a value  
(**DNG**, **DNG + JPG**, **JPG**)

#### Notes

- The standardized DNG (Digital Negative) format is generally used for the storage of raw data.
- When picture data is saved in **DNG** and in **JPG** format simultaneously, then the camera will use the resolution setting for the **JPG** format is used for the JPG file.
- The **DNG** format always works with the highest available resolution, no matter what **JPG** setting is selected.
- The remaining number of pictures shown in the LCD panel will not necessarily change after every picture taken. A counter change depends on the subject; very fine image structures result in higher data quantities, while homogeneous surfaces mean less data.

## JPG SETTINGS

The functions and settings described in this section apply for pictures taken in **JPG** format only.

### RESOLUTION

The **JPG** format setting offers 3 image resolution (number of pixels) options. The following file formats are available: **L-JPG**, **M-JPG** and **S-JPG**. You can therefore adjust your settings to the intended use and available memory card capacity. The resolution also depends on the selected sensor format. The set sensor format is shown in the header line.

RESOLUTION	Sensor format	
	35 mm	APS-C
L-JPG	47 MP	20 MP
M-JPG	24 MP	10 MP
S-JPG	12 MP	5 MP

Factory setting: **L-JPG**

- ▶ Select **JPG Settings** in the main menu
- ▶ Select **JPG Resolution**
- ▶ Select the desired resolution

(**L-JPG** (47 MP / 20 MP), **M-JPG** (24 MP / 10 MP), **S-JPG** (12 MP / 5 MP))

## NOISE REDUCTION

In digital photography, the appearance of flawed pixels that can be white, red, blue and green is called noise. Except when high sensitivities are used, noise is luckily negligible. Nevertheless, noise reduction is a component of data processing when JPG files are generated. On the other hand, since it also has an effect on the focus review, you can optionally weaken or strengthen this noise reduction in comparison to the standard setting.

Factory setting: **Low**

- ▶ Select **JPG Settings** in the main menu
- ▶ Select **Noise Reduction**
- ▶ Select the desired setting

(**Low**, **Medium**, **High**)

## IMAGE PROPERTIES

One of the many advantages of digital photography is that it is very easy to change key image properties.

You can manipulate contrast, sharpness and color saturation before recording.

### CONTRAST

The contrast setting, i.e. the difference between light and dark image sections, determines whether an image comes across as "flat" or "brilliant". Increasing or decreasing this difference impacts on contrast, meaning that some image sections are rendered with more or less light.

### SHARPNESS

The impression of sharpness in a picture is largely determined by edge sharpness, i.e. by how slight the transition area between light and dark is at edges in the picture. Expanding or reducing these areas will therefore change the impression of sharpness.

### COLOR SATURATION

The saturation factor in color images determines, whether colors in the picture appear "pale" and pastel-like or "bright" and colorful. While you can't do anything about weather conditions (clear/misty), you can change the way an image is rendered.

## COLOR PROFILE

Three pre-configured color profiles are available:

Factory setting: **Standard**

- **STD** **Standard**
- **VIV** **Vivid**
- **NAT** **Natural**

- ▶ Select **JPG Settings** in the main menu
- ▶ Select **Film Style**
- ▶ Select a profile

## MONOCHROME PROFILE

Two pre-configured monochrome profiles are available:

- **BW** **Monochrome**
- **BW** **Monochrome High Contrast**

- ▶ Select **JPG Settings** in the main menu
- ▶ Select **Film Style**
- ▶ Select a profile

## CUSTOMIZING PHOTO PROFILES

Additionally, you can adjust the values for contrast, sharpness and saturation (saturation only for color pictures) for each profile separately.

- ▶ Select **JPG Settings** in the main menu
- ▶ Select **Film Style**
- ▶ Select **Film Style Settings**
- ▶ Select a profile
- ▶ **Contrast**, **Sharpness**, **Saturation**
- ▶ Select the desired level

## MEMORY CARD MANAGEMENT

There are a number of options for saving data when two memory cards are inserted.

- DNG+JPG on SD1=SD2 (Backup)
- DNG+JPG on SD1+SD2 (Standard)
- DNG on SD1 / JPG on SD2 (Split)

SD1=SD2 (Backup)	All files are saved to SD1 and SD2. One of the cards therefore serves as backup.
SD1+SD2 (Standard)	Files are saved to SD1 first, until its capacity is reached. Subsequent files will then be saved to SD2.
SD1 /SD2 (Split)	Files are saved separately depending on their format: JPG files are saved to SD1 and DNG files to SD2.

An icon in the status screen denotes the selected setting.

Factory setting: **SD1+SD2**

- ▶ Select **Storage Options** in the main menu
- ▶ Select the desired setting  
(**SD1=SD2**, **SD1+SD2**, **SD1/SD2**)

## NOISE SUPPRESSION FUNCTION FOR LONG-TERM EXPOSURE

Image noise becomes apparent when using higher sensitivities, particularly on uniform dark areas. In order to reduce this annoying phenomenon, the camera will take a second “black picture” (taken with the shutter closed) automatically after pictures taken with slow shutter speeds and high ISO values. The noise metered in this parallel picture is then digitally “subtracted” from the data for the actual picture. In such cases the message **Noise reduction in progress** will appear with a relevant time value. The doubling of the “exposure” time must be taken into account for long exposure times. The camera must not be switched off during that time.

Factory setting: **On**

- ▶ Select **Long exposure noise reduction** in the main menu
- ▶ Select **On/Off**

## SHUTTER TYPE

The Leica SL2 comes equipped with a mechanical shutter and a purely electronic shutter function. The electronic shutter expands the available shutter area and functions completely noiseless, which may be important in some work environments.

Factory setting: **Hybrid**

- ▶ Select **Shutter Type** in the main menu
- ▶ Select the desired setting

(**Mechanical**, **Electronic**, **Hybrid**)

<b>Mechanical</b>	Only the mechanical shutter is used. Working range: 30 min to 1/8000 s
<b>Electronic</b>	Only the electronic shutter function is used. Working range: 1 s to 1/40000 s
<b>Hybrid</b>	You can add in the electronic shutter functions if you need faster shutter speeds than can be achieved with the mechanical shutter. Working range: 30 min to 1/8000 s + 1/8000 s to 1/40000 s

## ASPECT RATIO

You have a choice of aspect ratios to select in addition to the basic 3:2 (e.g. 1:1). The relevant cropped section will be displayed. Recordings made in JPG format are saved with the relevant aspect ratio. DNG recordings will always have the natural sensor format (3:2), the set aspect ratio is only in aid of the image composition. In review mode, DNG recordings will be displayed with horizontal or vertical auxiliary lines showing the cropped section seen when recording.

Factory setting: **3:2**

- ▶ Select **Photo Aspect Ratio** in the main menu
- ▶ Select the desired setting  
(**3:2**, **7:5**, **4:3**, **1:1**, **3:1**, **16:9**)

## IMAGE STABILIZATION

The less favorable the lighting conditions during recording, the slower will be the required shutter speeds for correct exposure. Visual image stabilization is a great tool for preventing out-of-focus images due to blurring.

Factory setting: **On**

- ▶ Select **Image Stabilization** in the main menu
- ▶ Select **On/Off**

## SETTING THE STABILIZATION DIRECTION

For camera pans it can be useful to only correct camera shake in specific directions.

Factory setting: **Normal**

Normal	Camera shake in all directions (horizontal, vertical, rotational) will be corrected automatically.
Automatic	The camera recognizes the panning direction automatically and corrects orthogonal camera shake autonomously.
Vertical panning	Only horizontal camera shake will be corrected.
Horizontal panning	Only vertical camera shake will be corrected.

- ▶ Select **Panning Mode** in the main menu
- ▶ Select the desired setting  
(**Normal**, **Auto Panning**, **Vertical Panning**, **Horizontal Panning**)



## MF ASSIST FUNCTIONS

### AF ASSIST LIGHT

The integrated AF assist light allows operation of the AF system in unfavorable lighting conditions. This light comes on while metering is performed, provided the function is activated.

Factory setting: **On**

- ▶ Select **Camera Settings** in the main menu
- ▶ Select **AF Assist Lamp**
- ▶ Select **On/Off**

#### Notes

- The AF assist light illuminates an area of up to approx. 5 m.
- The AF assist light switches off automatically, once focusing was successful (AF metering field is green) or has failed (AF metering field is red).

### ACOUSTIC AF CONFIRMATION

You can set an acoustic confirmation signal for successful focus metering in AF mode.

Factory setting: **Off**

- ▶ Select **Camera Settings** in the main menu
- ▶ Select **Acoustic Signal**
- ▶ Select **AF Confirmation**
- ▶ Select **On**
- ▶ Select **Volume**
- ▶ Select **Low/High**

## RECORDING – BASIC SETTINGS (VIDEO)

The settings described in this chapter only apply for video operations. They are therefore part of the video menu and must always be accessed and configured from within video mode (see chapter "Camera operation" in the section "Menu Control"). Any menu items of the same name in the picture menu are entirely independent of these.

## SENSOR FORMAT

The picture data of the entire 35 mm sensor can be used or only a cropped section, which corresponds to the APS-C format. This can be helpful, e.g. when only limited storage capacity remains or a lens developed specifically for APS-C is used.

Factory setting: 35 mm

- ▶ Select **Sensor Format** in the main menu
- ▶ Select the desired setting  
(35 mm, APS-C)

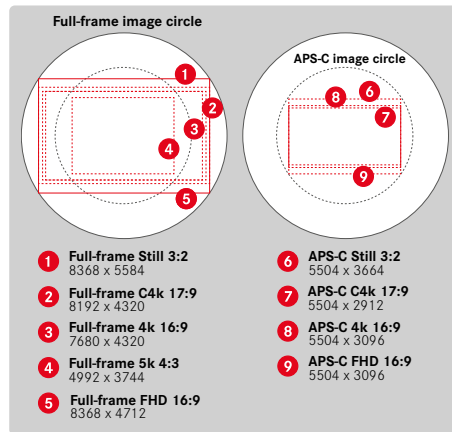

### Note

- The setting switches automatically to APS-C when an APS-C-specific lens is mounted.

## FILE FORMAT

Video can be recorded in the file formats MOV or MP4. Various combinations of resolution and frame rate can be configured depending on the file format chosen. The settings are done separately. You could therefore select the combination **C4K/29.97 fps** for the MOV format or **FHD/59.94 fps** for MP4. The preset video format settings are then accessed automatically, when one of the two file formats is selected.

### Note

- You can toggle between video file formats via the status screen without having to (re)configure the settings.

## VIDEO FORMAT

The following combinations of resolution and frame rate are available:

Frame rate	Resolution (file format)			
	5K	C4K	4K	FHD
23.98 fps	MOV	MOV	MOV + MP4	MOV + MP4
25 fps	MOV	MOV	MOV + MP4	MOV + MP4
29.97 fps	MOV	MOV	MOV + MP4	MOV + MP4
50 fps		MOV	MOV + MP4	MOV + MP4
59.94 fps		MOV	MOV + MP4	MOV + MP4
100 fps				MOV + MP4
120 fps				MOV + MP4
150 fps				MOV + MP4
180 fps				MOV + MP4

## AVAILABLE RESOLUTIONS

You can choose from up to 4 resolutions with the associated aspect ratios (depending on file format and recording mode).

Sensor format	File format	Available resolutions	
35 mm	MOV	5K	4992 x 3744
		C4K	4096 x 2160
	MOV + MP4	4K	3840 x 2160
		Full HD	2790 x 1572
APS-C	MOV	C4K	5504 x 2912
		4K	5504 x 3096
	MOV + MP4	Full HD	2752 x 1548

## AVAILABLE FRAME RATES

Up to 9 different frame rates between 23.98 fps and 180 fps are available depending on the selected resolution. The frame rates 100 fps to 180 fps allow slow motion recordings in varying speeds.

## SETTING THE VIDEO FORMAT

Factory setting: file format MP4, resolution FHD, frame rate 59.94 fps

### MOV

- ▶ Select **Video Format / Resolution** in the main menu
- ▶ Select **MOV**
- ▶ Select the desired resolution  
(5K, C4K, 4K, Full HD)
- ▶ Select the desired frame rate:

### MP4

- ▶ Select **Video Format / Resolution** in the main menu
- ▶ Select **MP4**
- ▶ Choose the desired combination of resolution and frame rate

### Note

- The list of available resolutions for this camera also contains additional information, e.g. on video compression.

## IMAGE PROPERTIES

The image properties for video recordings are easy to customize. You can manipulate contrast, sharpness and color saturation before recording.

## VIDEO PROFILES

3 pre-configured color profiles are available:

- STD  Standard
- VIV  Vivid
- NAT  Natural

There are two additional profiles available for monochrome video recordings:

- BW  Monochrome
- BW  Monochrome High Contrast

- ▶ Select **Video Style** in the main menu
- ▶ Select a profile

## CUSTOMIZING VIDEO PROFILES

Additionally, you can adjust the values for contrast, sharpness and saturation (saturation only for color pictures) for each profile separately.

- ▶ Select **Video Style** in the main menu
- ▶ Select **Video Style Settings**
- ▶ Select a profile
- ▶ **Contrast**, **Sharpness**, **Saturation**
- ▶ Select the desired level  
(-2, -1, 0, +1, +2)

## MICROPHONE

The sensitivity of the integrated microphone can be set. Factory setting: 0 dB

- ▶ Select **Video Settings** in the main menu
- ▶ Select **Microphone Gain**
- ▶ Select the desired level  
(Off, +6 dB, +5 dB, +4 dB, +3 dB, +2 dB, +1 dB, 0 dB, -1 dB, -2 dB, -3 dB, -4 dB, -5 dB, -6 dB, -7 dB, -8 dB, -9 dB, -10 dB, -11 dB, -12 dB)

### Notes

- The Autofocus function and manual focal length adjustments generate noise that may be picked up in the recording.
- There will be no audio recorded if this setting is Off. As notification, the icon for the recording level changes as shown here .

## WIND NOISE REDUCTION

Wind noise reduction can be adjusted individually for the internal and the external microphone.

### INTERNAL MICROPHONE

Factory setting: **Low**

- ▶ Select **Video Settings** in the main menu
- ▶ Select **Wind Elimination**
- ▶ Select **Internal Microphone**
- ▶ Select the desired setting  
(**High**, **Low**, **Off**)

### EXTERNAL MICROPHONE

Factory setting: **Off**

- ▶ Select **Video Settings** in the main menu
- ▶ Select **Wind Elimination**
- ▶ Select **External Microphone**
- ▶ Select the desired setting  
(**High**, **Low**, **Off**)

## TIME CODE

The time code is a data record that is generated and recorded alongside the image and audio data. It ensures the correct time assignment of picture and audio signals after cutting or after later separate processing. Time code mode and start time can be selected.

### TIME CODE MODE

Time information is written to the recorded video file if the time code setting is activated.

Factory setting: **Off**

<b>Off</b>	Timekeeping begins at 00:00:00.00 for every recording.
<b>Free Run</b>	The timer continues running regardless of whether the camera is currently recording video.
<b>Rec Run</b>	The timer only runs while a video is being recorded. The timer will stop when recording ends and will continue when the next recording starts.

Select **Video Settings** in the main menu

- ▶ Select **Time Code**
- ▶ Select **Mode**
- ▶ Select the desired setting  
(**Off**, **Free Run**, **Rec Run**)

## START TIME

The start time can be reset manually or can be set to a specific value if multiple cameras are used for recording. Alternatively, the current time set in the camera can be specified as the time code.

- ▶ Select **Video Settings** in the main menu
- ▶ Select **Time Code**
- ▶ Select **Start Time**
- ▶ Select the desired setting  
(**Reset Timecode**, **Manual**, **Camera Time**)

The desired start time can be set in the format hour:minute:second:frame if **Manual** is selected.

## VIDEO GAMMA

Video gamma can be set to HLG and L-Log or can be deactivated altogether.

Off	Optimization for playback compatible with all screen/TV devices in compliance with the BT.709 standard.
HLG	Optimization for HDR-capable UHD-TV devices.
L-Log	Optimization for professional reworking, e.g. color grading.

Factory setting: **Low**

- ▶ Select **Video Settings** in the main menu
- ▶ Select **Video Gamma**
- ▶ Select the desired setting  
(**Off**, **HLG**, **L-Log**)

## SHARPNESS AND SATURATION SETTINGS

Sharpness and saturation can be set individually for HLG and sharpness only for L-Log. The factory setting in all these cases is a median value 0.

### HLG

- ▶ Select **Video Settings** in the main menu
- ▶ Select **Video Gamma**
- ▶ Select **Settings**
- ▶ Select **HLG**
- ▶ Select **Sharpness** or **Saturation**
- ▶ Select the desired setting  
(**-2**, **-1**, **0**, **+1**, **+2**)

### L-LOG

- ▶ Select **Video Settings** in the main menu
- ▶ Select **Video Gamma**
- ▶ Select **Settings**
- ▶ Select **L-Log**
- ▶ Select **Sharpness**
- ▶ Select the desired setting  
(**-2**, **-1**, **0**, **+1**, **+2**)

## VIDEO STABILIZATION

With video recording - in addition to optical stabilization by means of appropriately equipped lenses - a independent digital stabilization function is available that can be used with any lens. This function is particularly useful in conjunction with lenses that do not feature an OIS function.

Factory setting: **On**

- ▶ Select **Image Stabilization** in the main menu
- ▶ Select **On/Off**

### Note

- The function **Panning Mode** is permanently set to **Normal** in video mode. Camera shake in all directions (horizontal, vertical, rotational) will be corrected automatically.

## HDMI OUTPUT

HDMI output is available with or without audio.

Factory setting: **With Audio**

- ▶ Select **HDMI Output** in the main menu
- ▶ Select the desired setting  
(**With Audio**, **Without Audio**)

### Note

- An output with audio may result in some negligible delays. We recommend the setting **Without Audio** to avoid this effect (if, for example HDMI Live View is required for a recording with an external recorder).

## VIDEO ASSIST FUNCTIONS

### AF ASSIST LIGHT

The AF assist light could be a visible disturbance in video recordings and is therefore always without function in video mode, no matter the setting for **AF assist light**.

### ACOUSTIC AF CONFIRMATION

You can set an acoustic confirmation signal for successful focus metering in AF mode.

- ▶ Select **Camera Settings** in the main menu
- ▶ Select **Acoustic Signal**
- ▶ Select **AF Confirmation**
- ▶ Select **On**
- ▶ Select **Volume**
- ▶ Select **Low/High**

### Note

- The signal only appears during the focusing for a recording, not during recording.



## VIDEO AUXILIARY DISPLAYS

### ASPECT RATIO DISPLAY

The actually recorded aspect ratio depends on the set resolution (see p. 96). It is possible, however, to have colored auxiliary lines displayed to show other aspect ratios (e.g. 4:3). Multiple auxiliary lines can be displayed at the same time. No auxiliary lines are displayed in factory settings.

- ▶ Select **Video Aspect Ratio** in the main menu
- ▶ Select the desired setting  
(1.33:1 [4:3], 1.66:1 [5:3], 1.78:1 [16:9], 1.85:1 [37:20], 2.35:1, 2.40:1)
- ▶ Select **On/Off**

### Notes

- The format limits of a wider aspect ratio (than that of the recorded video) are indicated by horizontal green lines, those of a narrower one by vertical red lines.
- The auxiliary lines are labeled with the relevant aspect ratio.

### SAFETY AREA

Depending on the playback device used, a small area of the image borders may be invisible. It is therefore possible to display a "safety area" in a configurable width. The image is displayed with a relevantly proportioned frame around the desired image section. Multiple safety area frames can be displayed at the same time. No safety area frames are displayed in factory settings.

- ▶ Select **Video Safety Area** in the main menu
- ▶ Select the desired setting  
(00%, 90%, 92.5%, 95%)
- ▶ Select **On/Off**

## PICTURE MODE

The settings described in this chapter only apply for picture mode. They are therefore part of the picture menu and must always be accessed and configured from within picture mode (see chapter "Camera operation" in the section "Menu Control"). Any menu items of the same name in the video menu are entirely independent of these.

Picture data is shown in the top display and on the LCD panel (EVF). For display settings see p. 103. See chapter "Displays" for details about the various displays.

## DRIVE MODE

The functions and settings described in the following generally refer to the exposure of individual pictures. In addition to single frame shots, the Leica SL2 offers a number of other picture modes. Please read the relevant sections for information about functionalities and setting options.

- ▶ Select **Drive Mode** in the main menu
- ▶ Select the desired function options

Mode	Setting options/Variants
Single frame exposure	<b>Single</b>
Serial exposures (see p. 131)	Speed: - <b>Continuous - Low Speed</b> - <b>Continuous - Medium Speed</b> - <b>Continuous - High Speed</b> - <b>Continuous - Very High Speed</b>
Self-timer (see p. 135)	Delay time: - <b>Self Timer 2 s</b> - <b>Self Timer 12 s</b>
Interval shooting (see p. 132)	<b>Number of Frames</b> Interval between the pictures ( <b>Interval</b> ) Delay time ( <b>Countdown</b> )
Exposure bracketing (see p. 133)	<b>Number of Frames</b> (3 or 5) <b>EV Steps</b> <b>Exposure Compensation</b>

## FOCUSING

Your Leica SL2 allows automatic as well as manual focusing. There are 3 operating modes and 4 metering methods available for AF photography. Only manual setting options are available for MF lenses.

### AF PHOTOGRAPHY

- ▶ Select the desired AF mode (see p. 103)
- ▶ Position the AF metering field as needed
- ▶ Tap and hold the shutter button
  - Focusing occurs one time (AFs) or continuously (AFc).
  - Metering was successful: The AF metering field lights up green.
  - Metering was unsuccessful: The AF metering field lights up red.
  - Alternatively, focusing and/or exposure settings can be done and saved via the joystick (see "Metering memory lock" on p.128).
- ▶ Shutter release

### MF PHOTOGRAPHY

- ▶ Select as focus mode **MF** (see p. 111)
- ▶ Use the focus ring to manually focus on the object
- ▶ Shutter release

Please read the following chapters for more information.

## AUTOFOCUS MODES

The following AF modes are available: **AFs**, **AFc** and **Intelligent AF**. The currently selected AF mode is shown in the header line.

Factory setting: **Intelligent AF**

- ▶ Select **Focusing** in the main menu
- ▶ Selecting **Focus Mode**
- ▶ Select the desired setting  
**(Intelligent AF, AFs, AFc)**

### INTELLIGENT AF

Suitable for all objects. The camera automatically selects between AFs and AFc.

#### AFs (single)

Suitable for objects with little or no movement. Focusing is done only once and the setting remains as long as the shutter button is held at the pressure point. That also applies if the AF metering field is pointed at another object.

(exposure only after successful focusing)

#### AFc (continuous)

Suitable for objects in motion. As long as the shutter button is held at the 1st pressure point, focusing is continuously adjusted to the object in the AF metering field.

(anytime exposure)

## AUTOFOCUS METERING METHODS

The AF mode offers various metering methods for focusing. A successful focus setting is identified by a green metering field, an unsuccessful one is shown in red.

Factory setting: **Multi-Field**

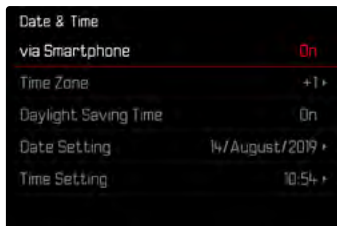

- ▶ Select **Focusing** in the main menu
- ▶ Select **AF Mode**
- ▶ Select the desired setting  
(**Multi-Field**, **Spot**, **Field**, **Zone**, **Tracking**, **Face/Body Detection**)

### Note

- AF focusing can be unsuccessful:
  - If the distance to the object is too great (macro mode) or too small
  - If the object is not sufficiently illuminated

## MULTI-FIELD

Several metering fields are detected automatically. This function is particularly useful for snapshots.

## SPOT/FIELD

Both methods detect only those parts of the object that are within the relevant AF metering fields. The metering fields are indicated by a small frame (field metering) or a cross (spot metering). The very small measuring range for spot metering allows focusing on tiny details of the subject.

The slightly larger measuring range in field metering is less critical for focusing, but still permits selective metering.

These metering methods can also be used for serial exposures in which the part of the object you want to focus on will always be at the same off-center position in the image.

Simply move the AF metering field to another position.

- ▶ Press the joystick in the relevant direction
- or
- ▶ Briefly tap the LCD panel  
(while Touch AF is activated)

### Notes

- In both cases, the metering fields remain at their last positions set, even if the metering method is changed or the camera is switched off.
- The metering fields are joined together when the exposure metering method **Spot** is combined with the AF metering methods **Spot** and **Field**. Exposure metering will then occur at the point specified by the AF metering field, even if it is moved.

## ZONE

With this metering method, subject sections are recorded with a coherent group comprising 5 x 5 fields. This function combines some security for snapshots with the option of aiming at larger objects reliably.



After the setting has been made, the metering fields are displayed in which the subject sections are displayed in focus.

## TRACKING

This field metering variant helps in the capture of moving objects. The focus on the object in the metering field is continuously adjusted, once it is detected.

- ▶ Aim the metering field at the desired subject  
(by panning the camera shifting the metering field)
  - ▶ Tap and hold the shutter button
- or
- ▶ Press and hold the joystick  
(provided it was assigned the function **AF-L** or **AF-L + AE-L**, see p. 128)
    - The camera focuses on the object.
  - ▶ Pan the camera to the desired cropped section
    - The metering field "tracks" the saved object and focus is continuously adjusted.

### Note

- This metering method focuses continuously, even if the AF mode **AFs** was set.

## START POSITION FOR TRACKING

Factory setting: **Center**

You can specify the starting point for tracking.

<b>Center</b>	Center of the screen
<b>Last Position</b>	Ending position of the most recent tracking Example: A car drives through the picture from left to right. The picture is taken on the right edge of the frame. The subsequent measurement is taken at the right edge of the frame
<b>Recall</b>	Starting position of the most recent tracking Example: A car drives through the picture from left to right. The picture is taken on the right edge of the frame. The subsequent measurement is taken at the left edge of the frame.

- ▶ Select **Focusing** in the main menu
- ▶ Select **AF Setup**
- ▶ Select **AF Tracking Start Position**
- ▶ Select the desired setting  
(**Last Position**, **Recall**, **Center**)

## PERSON DETECTION

Person detection is an expansion of the face recognition feature. In addition to biometric patterns of faces, the camera also detects body patterns and uses them for focusing. Tracking will therefore continue, once a person is detected and measured, even if the face may not be in view at some point. This feature prevents inadvertent "jumps" to other faces if several persons are in the frame.

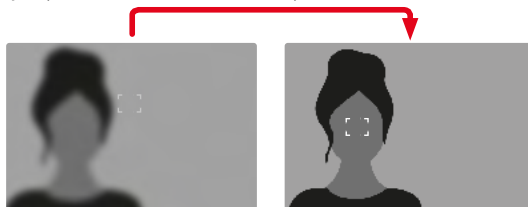

## AF SETTINGS

### AF-PROFILES

AF profiles allow optimal adjustments to the autofocus behavior depending on the type of object. You specify the sensitivity of the autofocus response to changes in the object.

There are 4 pre-defined AF profiles:

AF Profile	Typical situation
Children / Pets	Standard movements
Team sports	Fast and unexpected change in direction
Runner	Constant movements
Wildlife	Sudden appearance, change in direction

Each of these profiles contains three parameters: **Depth Sensitivity**, **Field Movement** and **Shift in Direction**.

higher values:	lower values:
<b>Depth Sensitivity</b>	
Changes in the distance to the object are tracked immediately	the adjustment is delayed slightly to prevent unwanted focus jumps, should e.g. an object pass in front of the object
<b>Field Movement</b>	
in case of movement from within the active focus field, the camera will switch as quickly as possible to the next focus field	gradual change to adjacent focus fields to prevent errors due to slight movements
<b>Shift in Direction</b>	
the focus will track sudden changes to the movement of the object immediately	more robust focusing during steady movements

### ACCESSING THE ACTIVE PROFILE

- ▶ Select **Focusing** in the main menu
- ▶ Select **AF Setup**
- ▶ Select **AF Profiles**

### CHANGING THE ACTIVE PROFILE

- ▶ Accessing the active profile
- ▶ Press the joystick/thumbwheel
  - The currently selected profile is marked as changeable by red lettering and two small white triangles on either side.
- ▶ Press the joystick left/right  
or
- ▶ Turn the thumbwheel

### ADJUSTING THE ACTIVE PROFILE

- ▶ Accessing the active profile
- ▶ Select desired parameter
- ▶ Press the joystick/thumbwheel
- ▶ Set the desired value

### RESETING THE ACTIVE PROFILE

- ▶ Accessing the active profile
- ▶ Press the joystick to the right
- ▶ Press the joystick/thumbwheel

### PRE FOCUS

When the function is active, the camera carries out a continuous depth mapping in realtime before the actual focusing. That allows a pre-identification of possible focus points in a scene. It speeds up the autofocus function significantly.

The pre-focus function is compatible with all AF modes and AF metering methods.

Factory setting: **On**

- ▶ Select **Focusing** in the main menu
- ▶ Select **AF Setup**
- ▶ Select **Pre Focus**
- ▶ Select **On/Off**



## AF QUICK SETTING

AF Quick Setting offers the following functions:

- quick switches of the AF metering methods
- Adjusting the metering field size during field metering

The viewfinder image remains visible continuously during setting adjustments.

### ACCESSING AF QUICK SETTING

- ▶ Touch and hold the LCD panel
  - All auxiliary displays are hidden.
  - Red triangles appear at two corners of the metering field if the metering method **Field** is set.



### ADJUSTING THE METERING FIELD SIZE

(only **Field**)

- ▶ Turn the thumbwheel
- or
- ▶ Pinch or spread
    - The size of the AF-metering field is adjustable in 3 increments.

#### Note

- AF Quick Setting can only be accessed if the function **Touch AF** is active (see p. 78).

## CHANGING THE AF METERING METHOD

- ▶ Turn the front setting wheel
  - A menu bar appears at the bottom of the screen.

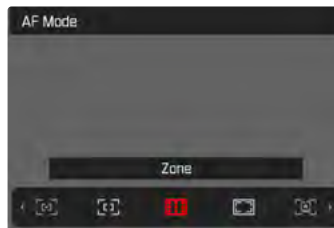

- ▶ Select a metering method
  - Alternatively, you can use the front setting wheel for the setting.
  - The setting is applied automatically after 3 seconds, the menu bar disappears.

## MF ASSIST FUNCTIONS

### ENLARGEMENT IN AF MODE

You can access the enlargement function independent of focusing for a better assessment of the settings.

The enlargement function must be assigned to one of the FN buttons to use this feature (see p. 65).

#### Assigning the function to one of the FN buttons

- ▶ See p. 65

#### Accessing the enlargement function

- ▶ Press the FN button
  - A enlarged image section appears The position of the enlargement depends on the position of the AF metering field.
  - The rectangle within the frame at the top right represents the current magnification, as well as its position in the displayed cropped section.
  - The enlargement starts at the 2nd of 3 enlargement increments.

#### Adjusting the enlargement function

- ▶ Turn the thumbwheel/front setting wheel

#### Changing the position of the enlarged section

- ▶ Swiping will allow you to move the position of an enlarged cropped section

or

- ▶ Press the joystick in the relevant direction

#### Exiting the enlargement function

- ▶ Tap the shutter button

#### Note

- The enlargement function remains active until it is exited.

### AF ASSIST LIGHT

The integrated AF assist light allows operation of the AF system in unfavorable lighting conditions. This light comes on while metering is performed, provided the function is activated.

For settings see p. 93.

### ACOUSTIC AF CONFIRMATION

You can set an acoustic confirmation signal for successful focus metering in AF mode (see p. 93).

## MANUAL FOCUSING (MF)

Focusing manually may in some situations be a better choice than autofocus.

- the same setting is used for several exposures
  - it would take longer to use the metering memory lock function
  - the setting is to be kept at infinity for landscape pictures
  - poor, i.e. very dark lighting conditions prevent AF operation or would slow it down
- ▶ Select **Focusing** in the main menu
  - ▶ Selecting **Focus Mode**
  - ▶ Select **MF**
- ▶ Turn the focus ring until the desired part of the object is in clear focus

## MF SETTINGS\*

Factory setting: **0n**

The speed of the MF setting is adjustable. Example: for a setting to **90°**, the entire focus range will be run through when the focus setting ring is turned by one quarter. A full turn of the focus setting ring will be needed for a setting to **360°**. Smaller angles allow faster adjustments, while larger angles offer more precise settings.

- ▶ Select **Focusing** in the main menu
- ▶ Select **MF Setup**
- ▶ Select the desired setting

(Standard MF, **90°**, **120°**, **150°**, **180°**, **210°**, **240°**, **270°**, **300°**, **330°**, **360°**,  
Maximum)

\* This function will become available with the 2020 firmware update. Registered users will be automatically notified about updates, see p. 12 and p. 191. Subject to changes.

## MF ASSIST FUNCTIONS

The following assist functions are available in MF mode.

### FOCUS PEAKING

This assist function highlights the edges of in focus subject elements in color.



When Focus Peaking is activated,  will appear to the right of the frame with a display of the color used. The color can be user-specified. The sensitivity can be additionally adjusted. The activation of this function is controlled vis the info profiles (see p. 80).

### Note

- Focus peaking is based on subject contrast, i.e. differences between light and dark. As a result, high contrast subject parts could be marked, even if they are not completely in focus.

## ENLARGEMENT IN MF MODE

The larger the details of the subject are shown, the better you can assess their sharpness and the more accurately you can focus. This function can be automatically activated during manual focusing or can be accessed independently.

### ACCESS VIA THE FOCUS SETTING RING

Turning the focus ring will automatically enlarge a image section.

- ▶ Select **Focusing** in the main menu
- ▶ Select **Focus Assist**
- ▶ Select **Auto Magnification**
- ▶ Select **On**
- ▶ Turn the focus ring
  - A enlarged image section appears The position of the enlargement depends on the position of the AF metering field.
  - The rectangle within the frame at the top right represents the current magnification, as well as its position in the displayed cropped section.
  - The enlargement starts at the 1st of 3 enlargement increments.

### Adjusting the enlargement function

- ▶ Turn the thumbwheel/front setting wheel

### Changing the position of the enlarged section

- ▶ Swiping will allow you to move the position of an enlarged cropped section

or

- ▶ Press the joystick in the relevant direction

### Exiting the enlargement function

- ▶ Tap the shutter button

or

- ▶ Decrease the enlargement, until the full image is visible again

### Note

- The enlargement will automatically return to normal viewing size about 5 s after the last turn of the focus ring.

### ACCESSING WITH THE FN BUTTON/JOYSTICK

This function can be assigned to an FN button or the joystick.

### Assigning the function to one of the FN buttons

- ▶ See p. 65

### Assigning the function to the joystick

- ▶ Select **Customize Control** in the main menu
- ▶ Select **Joystick**
- ▶ Select **Magnification**

### Accessing the enlargement function

- ▶ Press FN button/joystick
  - A enlarged image section appears The position of the enlargement depends on the position of the AF metering field.
  - The rectangle within the frame at the top right represents the current magnification, as well as its position in the displayed cropped section.
  - The enlargement starts at the 2nd of 3 enlargement increments.

**Adjusting the enlargement function**

- ▶ Turn the thumbwheel/front setting wheel

**Changing the position of the enlarged section**

- ▶ Swiping will allow you to move the position of an enlarged cropped section

or

- ▶ Press the joystick in the relevant direction

**Exiting the enlargement function**

- ▶ Tap the shutter button

**Note**

- The enlargement function remains active until it is exited.

**DISTANCE DISPLAY**

Distance information is shown in the top display during manual focusing.

- Focus Mode MF: when the shutter button is pressed to the first pressure point
- Focus Mode AF: when the shutter button is pressed and held at the first pressure point, followed by a turning of the focus setting ring

The unit of measure ( or ) can be selected, see p. 71.

## USING AUTOFOCUS IN MF MODE

The joystick can be used as needed for automatic focusing. The AF modes AFs and AFc are available.

You can also concurrently carry out exposure metering and save the resulting value (see p. 128).

- ▶ Select **Customize Control** in the main menu
- ▶ Select **Joystick**
- ▶ Select **MF Mode**
- ▶ Select the desired setting  
(**AFs**, **AFs + AE-L**, **AFc**, **AFc + AE-L**)

The metering functions are distributed as follows while the joystick is pressed and held:

Menu settings	Joystick	Shutter button
AFs + AE-L AFc + AE-L	Exposure and focus	-
AFs AFc	Sharpness	Exposure

- ▶ Aim at the object
- ▶ Press and hold the joystick
  - The measurement is taken and saved.
- ▶ Store more measurements via the shutter button as needed
- ▶ Select the final image section
- ▶ Shutter release

## ISO SENSITIVITY

The ISO setting covers a range between ISO 50 and ISO 50000, allowing you to adapt to the relevant situation as required.

There is more leeway for the use of preferred shutter speed and aperture combinations when setting the exposure manually. You can set priorities within the scope of the automatic setting, e.g. for reasons of picture composition.

Factory setting: **Auto ISO**

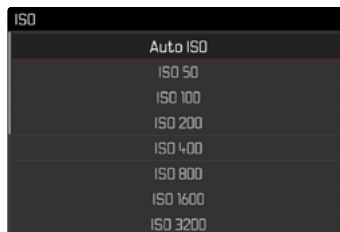

## FIXED ISO VALUES

ISO values between 50 and 50000 can be selected in 11 increments.

- ▶ Select **ISO** in the main menu
- ▶ Select the desired setting

(**ISO 50**, **ISO 100**, **ISO 200**, **ISO 400**, **ISO 800**, **ISO 1600**, **ISO 3200**, **ISO 6400**,  
**ISO 12500**, **ISO 25000**, **ISO 50000**)

### Note

- When high ISO values are used or the image is edited later, image noise, as well as vertical and horizontal stripes may become visible, particularly in larger, evenly lit areas of the object.

## AUTOMATIC SETTING

The camera automatically adjusts the sensitivity to ambient brightness and/or to the configured shutter speed/aperture settings combination. In conjunction with aperture priority mode, this function extends the range for automatic exposure control.

- ▶ Select **ISO** in the main menu
- ▶ Select **Auto ISO**

## LIMITING SETTING RANGES

A max. ISO value can be set, which will then limit the automatic setting range (**Maximum ISO**). A max. exposure time can also optionally be configured. There are automatic settings and fixed max. shutter speeds **1/2** s and **1/2000** s available for that purpose. Separate settings are available for flash photography.

### LIMITING ISO VALUES

Factory setting: **6400**

- ▶ Select **Auto ISO Settings** in the main menu
- ▶ Select **Maximum ISO**
- ▶ Select the desired value

(**100**, **200**, **400**, **800**, **1600**, **3200**, **6400**, **12500**, **25000**, **50000**)



## LIMITING SHUTTER SPEED RANGES

Factory setting: **Auto**

- ▶ Select **Auto ISO Settings** in the main menu
- ▶ Select **Shutter Speed Limit**
- ▶ Select the desired value  
(**Auto**, **1/2000**, **1/1000**, **1/500**, **1/250**, **1/125**, **1/60**, **1/30**, **1/15**, **1/8**, **1/4**, **1/2**)

## LIMITING ISO VALUES (FLASH)

- ▶ Select **Auto ISO Settings** in the main menu
- ▶ Select **Maximum ISO with Flash**
- ▶ Select the desired value  
(**100**, **200**, **400**, **800**, **1600**, **3200**, **6400**, **12500**, **25000**, **50000**)

## LIMITING SHUTTER SPEED RANGES (FLASH)

Factory setting: **1/15**

- ▶ Select **Auto ISO Settings** in the main menu
- ▶ Select **Shutter Speed Limit with Flash**
- ▶ Select the desired value  
(**Auto**, **1/250**, **1/125**, **1/60**, **1/30**, **1/15**, **1/8**, **1/4**, **1/2**)

## FLOATING ISO

This function complements Auto ISO. Light strength changes with many zoom lenses when the focal length is changed. Floating ISO will in this situation adjust the sensitivity in fine graduations and will simultaneously ensure that the selected settings of exposure value and shutter speed remain constant in (semi) automatic exposure modes. This will specifically in video recordings prevent visible jumps in brightness.

Factory setting: **On**

- ▶ Select **Floating ISO** in the main menu
- ▶ Select **On**

### Note

- **Floating ISO** can work only if the original ISO setting allows scope for change, i.e. the highest/lowest ISO setting is not already being used. The **Floating ISO** warning icon will be displayed in that case.

## WHITE BALANCE

In digital photography, white balance ensures neutral color rendering in any light. White balance is based on the camera being preset to render a particular light color as white.

Four methods are available:





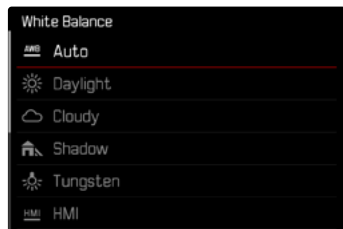



- automatic control
- fixed presets
- manual setting via metering
- direct setting of the color temperature

Factory setting: **Auto**



## AUTOMATIC CONTROL/FIXED SETTINGS

- **Auto**: for automatic control, which delivers neutral results in most situations
- Various fixed presets for most frequently encountered light sources:

 Daylight	for outdoor pictures in sunlight
 Cloudy	for outdoor pictures in cloudy conditions
 Shadow	for outdoor pictures with the main subject in shadow
 Tungsten	for indoor pictures with (predominantly) incandescent lamp light
 HMI	for indoor pictures with (predominantly) light from metal halide lamps
 Fluorescent (warm)	for indoor pictures with (prevailing) light from fluorescent tubes with warm light color
 Fluorescent (cool)	for indoor pictures with (prevailing) light from fluorescent tubes with cool light color
 Flash	for flash photography

- ▶ Select **White Balance** in the main menu
- ▶ Select the desired setting

## MANUAL SETTING VIA METERING

( Graycard /  **Graycard Live View**)

The variant  **Graycard** is suited best for subjects in which you can clearly identify a neutral gray or pure white area. If not, or should you base your metering on an off-center detail, then

 **Graycard Live View** will be a better choice.

### Note

- A value configured using this method will remain unchanged (i.e. it will be used for all subsequent photographs) until new measurements are taken or one of the other white balance settings is selected.

## GRAY CARD

This metering variant captures all color hues in the metering field and uses these to calculate a mean gray value.

- ▶ Select **White Balance** in the main menu
- ▶ Select  **Graycard**
  - The following will appear on the LCD panel:
    - the image based on automatic white balance
    - a frame in the center of the image



- ▶ Aim the metering field at a white or neutral gray area
  - The screen image changes dynamically in line with the reference area in the frame.

### Taking measurements

- ▶ Shutter release
- or
- ▶ Press the joystick/thumbwheel
    - The measurement is taken.

### Canceling the measurement

- ▶ Press the **FN** button **(25)**

## GRAY CARD LIVE VIEW

This metering variant captures only the color hue metered within the metering field and calculates the mean gray value from it.

- ▶ Select **White Balance** in the main menu
- ▶ Select **Graycard Live View**
  - The following will appear on the LCD panel:
    - the image based on automatic white balance
    - cross in the center of the image

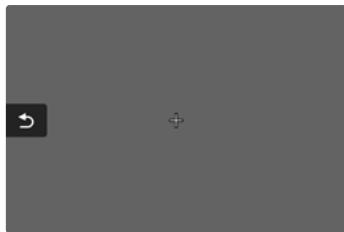

- ▶ Aim the metering field at a white or neutral gray area

### Moving the metering field

- ▶ Press the joystick in the relevant direction

### Taking measurements

- ▶ Shutter release
- or
- ▶ Press the joystick/thumbwheel
  - The measurement is taken.

### Canceling the measurement

- ▶ Press the **FN** button (**25**)

## DIRECT SETTING OF THE COLOR TEMPERATURE

Values between 2000 and 11,500 K (Kelvin) can be set directly. That gives you a very wide range, which covers virtually all color temperatures occurring in real life and within which you can adapt color rendering to any light color and your personal preferences with incredible detail.

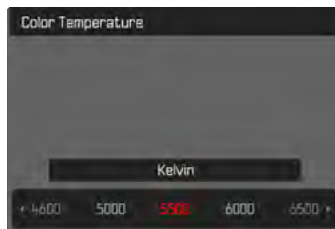

- ▶ Select **White Balance** in the main menu
- ▶ Select **Color Temperature**
- ▶ Select the desired value

## EXPOSURE

The exposure setting is done dynamically via the two setting wheels. As a rule, the thumbwheel controls the aperture and the front setting wheel the shutter speed. The "free" setting wheel is used for quick access to exposure compensation during semi automatic exposure setting. Function assignments can be modified, see p. 66.

Exposure settings can be done quickly and easily via the status screen.

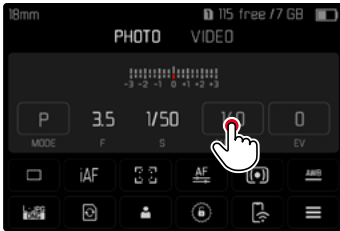

- ▶ Briefly touch the desired control panel
  - The active control panel is highlighted in red.
  - A setting band appears instead of the light balance. A dot marks the current setting. The current setting value is displayed above the dot.

- ▶ Tap the setting band briefly in the desired position or drag the dot to the desired position

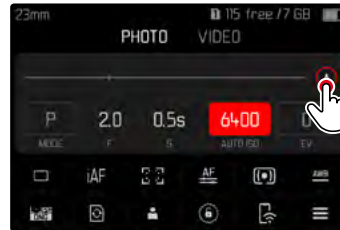

## EXPOSURE METERING METHODS

Optional methods are Spot metering, Center-Weighted and Multi-Field metering.

Factory setting: **(Multi-Field)**

- ▶ Select **(Exposure Metering)** in the main menu
- ▶ Select a metering method  
**(Spot, Center-Weighted, Multi-Field)**
  - The selected metering method is displayed in the header line of the screen image.

### Notes

- The exposure information (ISO value, aperture, shutter speed and light balance with exposure compensation scale) will help to determine the settings required for correct exposure.
- The most important displays (ISO value, aperture and shutter speed) will also appear in the top display.

## SPOT METERING –

This metering method is concentrated exclusively on a small area in the center of the image. The metering fields are joined together when the exposure metering method **(Spot)** is combined with the AF metering methods **(Spot)** and **(Field)**. Exposure metering will then occur at the point specified by the AF metering field, even if it is moved.

## CENTER-WEIGHTED METERING –

This method considers the entire image field. The subject elements captured in the center will, however, impact on the calculation of the exposure value more so than areas around the edges.

## MULTI-FIELD METERING –

This metering method is based on the detection of multiple values. These values are used in an algorithm to calculate an exposure value appropriate for a good rendering of the assumed main subject.

## EXPOSURE MODES

There are four exposure modes available to adjust the rendering of the object or to create the desired picture composition:

- Automatic program (**P**)
- Aperture priority mode (**A**)
- Shutter priority mode (**S**)
- Manual setting (**M**)

## SELECTING A MODE

### Via the thumbwheel

- ▶ Press the thumbwheel
  - The currently selected mode is shown in the top display. The currently selected mode is marked in red on screen.
- ▶ Turn the thumbwheel to select the desired mode.
  - The mode display changes in the top display and on screen.
  - All modes can be reached by turning the wheel in either direction.
  - The selected mode will be applied automatically approx. 2 s after the thumbwheel is moved the last time.



### To apply the selected mode immediately

- ▶ Press thumbwheel/joystick
- or
- ▶ Tap the shutter button

### Via the status screen

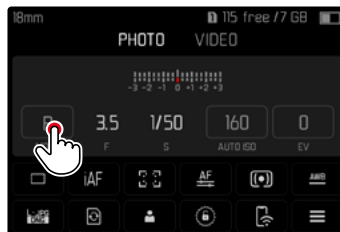

- ▶ Touch the control panel briefly

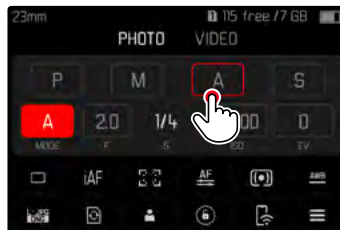

- ▶ Tap the desired exposure mode

### Note

- When using a lens with an aperture setting ring (e.g. Leica M lenses), only the exposure modes **A** (aperture priority) and **M** (manual setting) will be available. Where that is the case, **F0.0** is displayed as the aperture value.

## FULLY AUTOMATIC EXPOSURE SETTING – P

### AUTOMATIC PROGRAM – P

The automatic program mode facilitates fast and fully automatic photography. The exposure is controlled by an automatic shutter speed and aperture setting.

- ▶ Selecting the operating mode **P** (see p. 123)
  - ▶ Tap and hold the shutter button
    - Exposure information is displayed at the bottom of the screen. This contains the automatically set value pair of aperture setting and shutter speed.
    - All other visible displays of the info bars will be hidden.
  - ▶ Shutter release
- or
- ▶ Adjusting the automatically set value pair

## CHANGING THE PRESET SHUTTER SPEED/ APERTURE COMBINATIONS (SHIFT)

Changing the preset values using the Shift function combines the reliability and speed of fully automatic exposure control with the opportunity to vary the speed/aperture combination selected by the camera at any time to fit in with your own ideas and intentions. The overall exposure, i.e. the brightness of the image, remains unchanged. Faster shutter speeds are a good choice for e.g. sports pictures, while longer speeds will offer more depth of field for e.g. landscape pictures.

- ▶ Turn the thumbwheel to the left/right  
(right = greater depth of field with slower shutter speed, left = faster shutter speed with less depth of field)
  - Shifted value pairs are marked with an asterisk next to the . The icon in the top display changes from **P** to **Ps**.

### Notes

- The adjustment range is limited to guarantee correct exposure.



## SEMI-AUTOMATIC EXPOSURE SETTING – A/S

### APERTURE PRIORITY - A

Aperture priority mode sets the exposure automatically according to the manually selected aperture. This mode is suitable for pictures in which the depth of field is a critical compositional element.

By selecting an appropriately low aperture value, you can reduce the depth of field range, for example to make a face “stand out” in sharp focus against an unimportant or distracting background. Conversely, you can use a higher aperture value to increase the depth of field range, so that everything from the foreground to the background will be in full focus in a landscape shot.

- ▶ Select the operating mode **A** (see p. 123)
- ▶ Set the desired exposure value
- ▶ Tap and hold the shutter button
  - Exposure information is displayed at the bottom of the screen. This contains the automatically set value pair of aperture setting and shutter speed.
  - All other visible displays of the info bars will be hidden.
- ▶ Shutter release

### SHUTTER SPEED PRIORITY – S

Shutter speed priority mode will set exposure automatically according to the manually selected shutter speed. It is therefore particularly suitable for pictures of moving objects, where the sharpness of the movement depicted is a critical picture composition element.

An appropriately fast shutter speed can help to avoid e.g. unwanted motion blurring and will “freeze” the object. Conversely, an appropriately longer shutter speed can help create a better feeling of motion in the image with targeted “tracer effects”.

- ▶ Select the operating mode **S** (see p. 123)
- ▶ Select the desired shutter speed
  - Exposure information is displayed at the bottom of the screen. This contains the automatically set value pair of aperture setting and shutter speed.
  - All other visible displays of the info bars will be hidden.
- ▶ Shutter release



## MANUAL EXPOSURE SETTING – M

The following manual settings for shutter speed and aperture are a good choice:

- to create a special image mood that can only be achieved with a very specific type of exposure
- to ensure a perfectly identical exposure for multiple images with different cropped sections

- ▶ Select the operating mode **M** (see p. 123)
- ▶ Tap and hold the shutter button
  - Exposure information is displayed at the bottom of the screen.
  - All other visible displays of the info bars will be hidden.
- ▶ Select desired exposure
  - The exposure compensation is done using the scale of the light balance.
- ▶ Shutter release

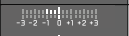
Displays on the light balance:

	correct exposure
	Under/over exposure by the displayed value
	Under or overexposure by more than 3 EV (Exposure Value)

### Note

- The screen image will show an exposure preview if **P-A-S-M** is selected in the menu item **Exposure Preview** (after exposure metering, see p. 127).

## LONG-TERM EXPOSURE

In the modes **S** and **M**, the Leica SL2 allows shutter speeds up to 30 minutes.

The remaining exposure time after shutter release is counted down in seconds on the display for shutter speeds greater than 1 s. Image noise becomes apparent when using higher sensitivities, particularly on uniform dark areas. In order to reduce this annoying phenomenon, the camera will take a second “black picture” (taken with the shutter closed) automatically after pictures taken with slow shutter speeds and high ISO values. The noise metered in this parallel picture is then digitally “subtracted” from the data for the actual picture. In such cases the message **Noise reduction in progress** will appear with a relevant time value. The doubling of the “exposure” time must be taken into account for long exposure times. The camera must not be switched off during that time.

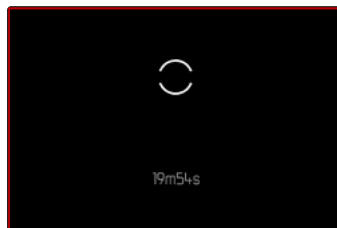

## EXPOSURE CONTROL (FUNCTIONS FOR AUTOMATIC EXPOSURE)

### EXPOSURE PREVIEW

The brightness of the screen image mirrors the effects of the selected exposure settings when pressing and holding the shutter button on the first pressure point. You can now assess and control the effect of the relevant exposure setting on the image before taking the picture. This will apply as long as the subject brightness and the set exposure don't result in excessively low or high brightness values.

This function can be disabled for the manual exposure setting (**M**):

Factory setting: **P-A-S-M**

- ▶ Select **Exposure Preview** in the main menu
- ▶ Select **P-A-S** (only in automatic, aperture priority and shutter speed priority mode) or **P-A-S-M** (also for manual setting)

### Notes

- Depending on ambient lighting conditions, the brightness of the screen image may differ from that of the actual pictures, despite the settings described above. The screen image will appear considerably darker than the – correctly exposed – picture. That is particularly the case in long-term exposures.
- The exposure preview will also be displayed if exposure metering is done via another control element (e.g. using the joystick, provided it was assigned the **AE-L** function).

## EXPOSURE LOCK

We often want to arrange important subject elements outside the center of the picture for reasons of picture composition and these elements may sometimes be very bright or very dark. Center-weighted metering and spot metering, however, mainly capture an area in the center of the image and are calibrated to an average gray scale value. In that case the metering memory lock initially allows a metering of the main object and to store the relevant settings until the final image section is set.

The same applies for focusing (AF-L) in any autofocus mode.

Usually both lock functions (focusing and exposure) are done at the same time with the shutter button. You can, however, divide the lock functions between the shutter button and the joystick or assign both to the joystick. The functions include settings and storage

## AF-L (AUTO FOCUS LOCK)

The camera stores the focus setting. That makes it easier to change the image section when focusing is fixed.

## AE-L (AUTO EXPOSURE LOCK)

The camera stores the exposure value. The focus can therefore be set on another object, no matter which exposure value is selected.

## AF-L + AE-L

This option allows the camera to store the exposure value and the focus setting when the joystick is pressed and held.

## Notes

- A metering memory lock doesn't make much sense in conjunction with multi-field metering, because a targeted capture of an individual object element will not be possible.
- A change in the aperture setting after the metering memory lock is set will not result in an adjustment of the shutter speed, i.e. the end result would be an incorrect exposure.

## METERING MEMORY LOCK IN AF MODE

The metering functions are distributed as follows while the joystick is pressed and held:

Menu settings	Joystick	Shutter button
AF-L + AE-L	Exposure and focus	-
AF-L	Sharpness	Exposure
AE-L	Exposure	Sharpness

The shutter button will store both measured values if the joystick is not pressed.

### Via the shutter button

- ▶ Aim at the key part of the object or at a similar detail
- ▶ Tap and hold the shutter button
  - The measurement is taken and saved.
- ▶ Select the final image section
- ▶ Shutter release

### Via the Joystick

- ▶ Select **Customize Control** in the main menu
- ▶ Select **Joystick**
- ▶ Select **AF Mode**
- ▶ Select the desired setting
- ▶ Press and hold the joystick
  - The measurement is taken and saved.
- ▶ Store more measurements via the shutter button as needed
- ▶ Select the final image section
- ▶ Shutter release

## METERING MEMORY LOCK IN AF MODE

In NF mode, only the exposure can be locked via the shutter button. This function can also be assigned to the joystick.

The exposure value is saved via the shutter button independent of the setting if the joystick is not pressed.

### Via the shutter button

- ▶ Aim at the key part of the object or at a similar detail
- ▶ Tap and hold the shutter button
  - The measurement is taken and saved.
- ▶ Select the final image section
- ▶ Shutter release

### Via the Joystick

- ▶ Select **Customize Control** in the main menu
- ▶ Select **Joystick**
- ▶ Select **MF Mode**
- ▶ Select **AE-L**
- ▶ Press and hold the joystick
  - The measurement is taken and saved.
- ▶ Select the final image section
- ▶ Shutter release

## EXPOSURE COMPENSATION

Exposure meters are calibrated for a medium gray scale value, which matches a standard, i.e. average image object. Should the measured image detail not fulfill that requirement, then the a relevant exposure compensation can be effected.

Specifically where several pictures are taken in sequence, for example if for a series a slightly lesser or greater exposure is desired for a particular reason, then exposure compensation can be a very useful function: Once set, the setting remains active – unlike the metering memory lock – until it is reset.

Exposure compensation can be set in the range  $\pm 3$  EV (EV: Exposure Value). The available values depend on the global setting **EV Increment** (see p. 79).

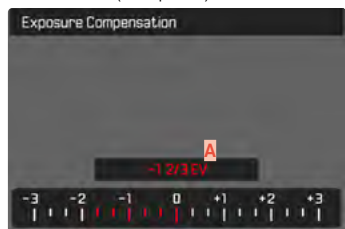

**A** Set compensation value (marks at 0 = Off)

- ▶ Select **Exposure Compensation** in the main menu
  - A scale appears as a submenu item.
- ▶ Set the value on the scale
  - The set value is displayed above the scale.
  - While setting the value, you can see the effect on the screen image, which becomes darker or lighter.

### Notes

- This function is assigned to one of the setting wheels in the three (semi) automatic exposure modes and therefore quickly accessible (see p. 66).
- The set exposure compensation is indicated by a mark on the exposure compensation scale in the footer line (see p. 24).
- The following applies for set compensation values, no matter how they were initially set: They remain effective until they are manually reset to 0, i.e. even if the camera is switched off and on again in the meantime.
- Changes to the **EV Increment** setting (see p. 79) lead to the cancellation of a compensation that has been set, i.e. in such cases it is automatically reset to 0.

## PICTURE RECORDING MODES

### SERIAL EXPOSURES

The camera is set to single shot exposures by default (**Single**). Serial exposures can also be created to e.g. capture motion sequences at various stages.

- ▶ Select **Drive Mode** in the main menu
- ▶ Select the desired setting  
**(Continuous - Low Speed, Continuous - Medium Speed, Continuous - High Speed, Continuous - Very High Speed)**

Once you have finalized your settings, the camera will take serial exposures as long as you keep the shutter button pressed down fully (and you have sufficient space on your memory card).

#### Notes

- We recommend deactivating the preview review mode (**Auto Playback/Review**) when using this function.
- The specified picture sequence stated in the technical information refers to a default setting (**ISO 200**, JPG format **L-JPG**). The picture sequence may differ in conjunction with other settings or depending on the picture content, **White Balance** setting and the memory card used.
- Regardless of how many pictures were taken in a series, the last picture in the series or the last picture saved on the memory card while the save process is ongoing will be displayed first in both review modes.
- Serial exposures with **Continuous - High Speed** set are taken at a frequency of max. 10 fps, provided shutter speeds of 1/60 s or faster are used.
- Serial exposures are not possible if a flash is used. Only a single picture will be taken if the flash function is activated.

- Serial exposures are not available in combination with the self-timer function.
- The buffer memory of the camera only allows a limited number of exposures in series and in the selected exposure frequency. The exposure frequency is reduced, once the capacity limit of the camera is reached. The remaining number of exposures is displayed at the bottom right.
- **Continuous - Low Speed/Continuous - Medium Speed**:  
 With **AFs**, **AFc** and **MF**, exposure and White Balance settings will be performed individual for every shot. Focusing is done additionally in the modes **AFs** and **AFc**.
- **Continuous - High Speed/Continuous - Very High Speed**:  
 With **AFs**, **AFc** and **MF**, exposure, focusing and White Balance settings determined for the first shot are used for all following shots.

## INTERVAL SHOOTING

This camera allows you to capture motion sequences over extended periods of time automatically using the interval shooting function. You specify the number of pictures, the intervals between pictures, and the start time of the series.

The exposure and focus settings are no different from those for normal pictures, but you should remember that the lighting conditions may change during the course of the picture series.

### SPECIFYING THE NUMBER OF PICTURES

- ▶ Select **Drive Mode** in the main menu
- ▶ Select **Interval Shooting**
- ▶ Select **Number of Frames**
- ▶ Enter the desired value

### SPECIFYING THE INTERVALS BETWEEN SHOTS

- ▶ Select **Drive Mode** in the main menu
- ▶ Select **Interval Shooting**
- ▶ Select **Interval**
- ▶ Enter the desired value

## SETTING THE DELAY TIME

- ▶ Select **Drive Mode** in the main menu
- ▶ Select **Interval Shooting**
- ▶ Select **Countdown**
- ▶ Enter the desired value

### To get started

- ▶ Press the shutter button
  - The remaining time until the next exposure and its number is displayed at the top right.
  - The LCD panel will switch off automatically between recordings. Tapping the shutter button reactivates the LCD panel before the next exposure.

### To cancel a running serial exposure

- ▶ Press the joystick
  - A small menu appears.
- ▶ Select **End**



## Notes

- The use of autofocus in interval shooting may result in not all exposures having their focus on the same object.
- Interval shooting over an extended period of time in a cold location or in a place with high temperature and humidity may result in malfunctions.
- Interval shooting will be interrupted or canceled in the following situations:
  - if the battery is depleted
  - if the camera is switched off

Make sure to check the battery for sufficient charge. A warning will be displayed when the battery reaches a critically low level.

- Interrupted or canceled interval shooting can be resumed by switching the camera off, replacing the battery or memory card as needed and then switching the camera back on. A prompt will be displayed on screen if the camera is switched off and on again while the **Interval Shooting** shooting function is active.
- The interval function remains active after a picture series is completed, and also after the camera is switched off and on again, until another exposure mode (picture series) is set.
- The availability of this function does not mean that the camera is suitable for use as a monitoring device.
- Regardless of how many pictures were taken in a series, the last picture in the series or the last picture in the series or the last picture saved on the memory card while the saving process is ongoing will be displayed first in both review modes.
- The camera may under some circumstances be unable to take good pictures. That may happen if, for example, focusing was unsuccessful. In that case, the camera will not take a picture and the series will continue with the next interval. The message **Some Frames are dropped** appears on screen.

## EXPOSURE BRACKETING

Many attractive objects are rich in contrast, which means they have very bright and very dark areas. The image effect can be dramatically different, depending on which of these areas you choose to align your exposure with. The automatic bracketing function in aperture priority mode allows you to produce several alternatives with graduated exposure values and varying shutter speeds. You can then select the picture you like best or use relevant picture editing software to calculate an image with a particularly broad contrast spectrum (HDR).

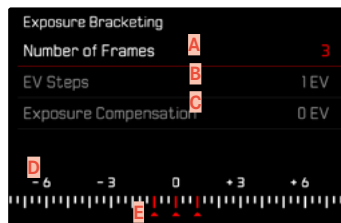

- A** Number of pictures
- B** Exposure difference between the pictures
- C** Exposure compensation
- D** Light value scale
- E** Exposure values of the images marked in red

(The scale will be offset by the relevant value if exposure compensation is set concurrently.)

You can select the desired number of exposures (3 or 5). The exposure difference, which can be set via **EV Steps**, can be up to 3 EV. The available values depend on the global setting **EV Increment** (see p. 79).

- ▶ Select **Drive Mode** in the main menu
- ▶ Select **Exposure Bracketing**
- ▶ Select the desired number of pictures under **Number of Frames** in the sub menu
- ▶ Select the desired exposure offset under **EV Steps** in the sub menu
- ▶ Select the desired **Exposure Compensation** value in the sub menu
  - The marked exposure values change positions according to the settings selected. In the case of exposure compensation, the scale also shifts.
  - The selected exposure compensation value will be applied to the entire exposure series.
- ▶ Shutter release

## Notes

-  Appears on the LCD panel if the bracketing function is activated. You can watch the effect of the function on screen while the pictures are taken (brighter or darker).
- Depending on the exposure mode, the exposure gradations are produced by changing the shutter speed and/or aperture value:
  - Shutter speed (**A/M**)
  - Aperture (**S**)
  - Shutter speed and aperture value (**P**)
- The picture sequence: underexposed/correct exposure/overexposure.
- The working range for automatic bracketing may be limited depending on the available shutter speed/aperture combination.
- With automatic ISO sensitivity control enabled, the sensitivity calculated by the camera automatically for the raw picture will also be applied to all other pictures in a series, i.e. the ISO value will not change during bracketing. This may mean that the slowest shutter speed specified under **Shutter Speed Limit** is exceeded.
- The focus range for automatic bracketing may be limited (depending on the originally set shutter speed). The specified numbers of pictures will be taken regardless. Several pictures in a series may consequently be taken with the same exposure values.
- The function remains active until another function is selected in the **Drive Mode** sub menu or the camera is switched off and on again. If no other function is selected, another series of pictures is taken each time the shutter button is pressed.

## SELF-TIMER

The self-timer function allows taking pictures with a preset time delay. We recommend that the camera is placed on a tripod.

- ▶ Select **Self Timer** in the main menu
- ▶ Select **Self Timer 2 s**/**Self Timer 12 s**
- ▶ Shutter release
  - The remaining time until exposure is counted down on screen. The self-timer LED at the front of the camera counts down the delay time. It flashes slowly during the first 10 s, then fast for the last 2 s.
  - The self-timer delay time can be canceled at any time by tapping the shutter button; the relevant settings remain intact.

### Notes

- In self-timer mode, the exposure value is set just before the picture is taken and not when the shutter button is pressed.
- The self-timer function remains active until it is deactivated via the menu or the camera is switched off.
- Exposure metering is done first; in autofocus mode, focusing is first. The delay time only starts after this.

## FLASH PHOTOGRAPHY

The camera determines the necessary flash intensity by firing one or more pre-flashes before taking the actual picture. The main flash fires immediately after, i.e. during exposure

### COMPATIBLE FLASH UNITS

The entire scope of functions described in this instruction manual, incl. TTL flash metering, is available only for Leica system flash units like the SF 40. Other flash units, which only have a positive center contact, can be safely fired via the Leica SL2, but cannot be controlled via the camera. Correct function cannot be guaranteed when using any other flash unit.

### Note

- When using flash units that are not specifically designed for the camera and can therefore not automatically switch over the white balance of the camera should be used in the **fwb** flash setting.

### Important

- The use of incompatible flash units with your Leica SL2 may result in irreparable damage to the camera and/or the flash unit.

## ATTACHING THE FLASH UNIT

- ▶ Switch off the camera and flash unit
- ▶ Slide the foot of the flash unit all the way into the accessory shoe and use the clamping nut (where available) to secure it against accidental movement
  - Movement inside the accessory shoe can interrupt required contacts and therefore cause malfunctions.

## DETACHING THE FLASH UNIT

- ▶ Switch off the camera and flash unit
- ▶ Detaching the flash unit

## FLASH EXPOSURE METERING (TTL METERING)

The camera offers a fully automated, camera-controlled flash mode in conjunction with system-compatible flash units (see p. 135) and for the auto modes aperture priority and manual setting. In aperture priority mode and with manual setting, the camera furthermore allows the use of other interesting flash techniques like flash synchronization and firing with slower shutter speeds than the max. sync time.

The camera additionally communicates the sensitivity setting to the flash unit. The flash unit can use this information to automatically adjust its range data, provided the device comes with these displays and the aperture setting selected on the lens is also entered manually on the flash unit. The ISO sensitivity setting cannot be altered via the flash unit on system-compatible units, because the information is received from the camera.

## SETTINGS ON THE FLASH UNIT

Operating mode	
<b>TTL</b>	Automatic camera control
<b>A</b>	Aperture priority
<b>M</b>	The flash exposure must be set to an output level to match the aperture and shutter speed settings determined by the camera.

Set the flash unit to **TTL** mode to allow automatic control of the unit by the camera.

When set to **A**, subjects with above or below average brightness may not be exposed correctly.

In **M** mode, the flash exposure must be set to an output level to match the aperture and shutter speed settings determined by the camera by setting an appropriate partial light power level.

### Note

- Please read the relevant manual provided with third party flash units regarding their various operating modes.

## FLASH CONTROL

The settings and functions described in the following sections only apply to settings and functions available in this camera and in system-compatible flash units.

### SYNC POINT

Flash exposures are lit by two light sources:

- ambient light
- Flash

Any subject elements lit primarily by the flash will almost always be rendered in perfect focus by the short burst of light, provided the focus is set correctly. All other subject elements in the same frame lit by ambient light or lit from within will be rendered with varying degrees of sharpness. Whether or not these object elements will be rendered in sharp focus or blurred, as well as the degree of "blurriness" depends on two interdependent factors:

- the shutter speeds
- the speed of movement of the subject elements or camera during recording

The longer the shutter speed and the faster the motion, the greater the difference between the two superimposed partial images.

A flash is usually fired at the start of exposure (**Start of Exp.**), right after the first shutter curtain has completely opened the image window. This may result in apparent contradictions, e.g. the picture of a vehicle being overtaken by its own light trail. This camera allows you to synchronize the flash firing with the end of exposure (**End of Exp.**), right before the second shutter curtain closes the image window. The sharp image will in this case be a rendering of the end of the captured motion. This flash technique creates a more natural impression of movement and dynamics in the image. This function is available with all camera and flash unit settings.

Factory setting: **End of Exp**

- ▶ Select **Flash Settings** in the main menu
- ▶ Select **Flash Sync**
- ▶ Select the desired setting  
(**Start of Exp.**, **End of Exp.**)
  - The set sync point is shown in the header line.

### Notes

- Do not use synch cables that are longer than 3 m/10 feet.
- When using the flash with faster shutter speeds, a difference between the two flash times will be barely discernible or only noticeable for very fast movements.

## FLASH RANGE

The usable flash range depends on the aperture and sensitivity values set manually or calculated by the camera. It is important to ensure that the subject is within the relevant flash range for sufficient illumination. A permanent setting to the shortest available shutter speed for flash mode (sync time) may often result in unnecessary underexposure of those subject elements that are not lit sufficiently by the flash.

This camera allows the fine tuning of the shutter speed used in flash mode in combination with aperture priority depending on the conditions of the object or your own picture composition ideas.

## FLASH EXPOSURE COMPENSATION

This function can be used to selectively reduce or enhance flash exposure regardless of ambient light, e.g. to brighten the face of a person in the foreground when taking a picture outdoors in the evening while retaining the same general lighting mood.

Factory setting: 0 EV

- ▶ Select **Flash Settings** in the main menu
- ▶ Select **Flash Exp. Compensation**
  - The sub menu displays a scale with a red setting mark. The function is deactivated if the value is set to 0.
- ▶ Set the value on the scale
  - The set value is displayed above the scale.
  - The available values depend on the global setting **EV Increment** (see p. 79).



## Notes

- The following applies for set compensation values, no matter how they were initially set: They remain effective until they are manually reset to 0, i.e. even if the camera is switched off and on again in the meantime.
- Changes to the **EV Increment** setting (see p. 79) lead to the cancellation of a compensation that has been set, i.e. in such cases it is automatically reset to 0.
- **Flash Exp. Compensation** is not available if flash units with an integrated compensation function are used, e.g. Leica SF 58.
- A compensation value configured on the camera will be overruled when a relevantly equipped flash unit is attached, e.g. a Leica SF 60 and a compensation value is entered on that flash unit.
- The menu item **Flash Exp. Compensation** can only be used in conjunction with flash units on which the compensation value cannot be set manually (e.g. Leica SF 26).
- A brighter flash illumination with Plus compensation will require a greater flash intensity. Flash exposure compensation will therefore impact on the flash range: A Plus correction will decrease it, a Minus correction will increase it.
- An exposure compensation set on the camera will only affect the measurement of ambient light. If a simultaneous TTL flash exposure metering compensation is desired in flash mode, then it must be additionally set on the flash unit. (Exception: On the Leica SF 26, the compensation value must be set on the camera via menu control.)

## FLASH PHOTOGRAPHY

- ▶ Switch on the flash unit
- ▶ Set the desired guide number control mode (e.g. TTL or GNC = Guide Number Control) on the flash unit
- ▶ Switching the camera on
- ▶ Set the desired exposure mode, shutter speed and/or aperture setting
  - It is imperative to take note of the shortest flash sync speed, as it determines whether a "normal" flash or an HSS flash is fired.
- ▶ Tap the shutter button before each flash exposure to activate exposure metering
  - The flash unit may not fire if this step is missed by pressing the shutter button down completely and skipping these settings.

## Notes

- A flash unit that is not ready to flash may cause incorrect exposures or error messages.
- Studio flash systems may have a very long flash firing duration. It may therefore be advantageous to select a slower shutter speed than 1/180 s when using such a system. The same applies for RF-controlled flash firing for so-called "off-camera" flashes, as the transmission time may cause a delay.
- Serial exposures and automatic bracketing with flash are not available.
- Depending on the setting selected in the **Auto ISO Settings** menu, the camera may not support slower shutter speeds, because an increase in ISO sensitivity takes priority.
- Use a tripod to prevent blurring at slow shutter speeds. Alternatively, you can select a higher sensitivity.





## VIDEO MODE

The settings described in this chapter only apply for video operations. They are therefore part of the video menu and must always be accessed and configured from within video mode (see chapter "Camera operation" in the section "Menu Control"). Any menu items of the same name in the picture menu are entirely independent of these.

### Notes

- You can record up to 29 minutes of uninterrupted video.
- The maximum file size for the uninterrupted video recording is 96 GB. Once a recording exceeds this file size, the overrun will be automatically stored in a new file (but cannot be longer than 29 min).
- As only part of the sensor area is used in video recordings, the relevantly effective focal length is increased, which slightly reduces the size of the image sections.
- Some menu items are unavailable in Video mode. The text in the relevant line is displayed in gray to signify the existence of a submenu.
- Unlike in picture mode, the joystick is used exclusively for focusing (metering and saving). A coupling of exposure metering and focusing is not done, no matter which metering method is selected.

## VIDEO MODE AND CINE MODE

Cine mode is optimized for use by cinematography professionals. The mode is reduced to the most important points and the use of terminology from cinematography ensure a seamless user experience.

(Semi) automatic exposure programs (P, A, S) and the automatic control of light sensitivity (Auto ISO, Floating ISO) remain disabled. Light sensitivity is stated as an ASA value.

Unlike other video modes, the shutter speeds are not set as absolutes, but as shutter angles, relative to the selected frame rate.

In conjunction with suitable lenses, the Cine mode allows the Leica SL2 the use of T-stops to ensure exact same exposure scenarios independent of camera settings.

Factory setting: Video

- ▶ Select Recording Mode in the main menu
- ▶ Select the desired setting  
(Video, Cine)

### Note

- The settings for light sensitivity (ISO/ASA), aperture and shutter speeds are saved separately for Video and Cine mode.

## START/EXIT VIDEO MODE

The camera will always be in Picture mode after an initial activation or a reset to factory settings. There are two methods for toggling between Picture and Video mode:

### Using touch control

Variant 1

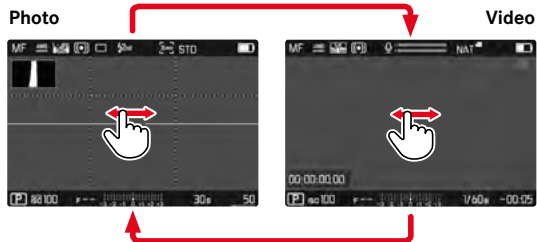

Variant 2



- The color of the status screen changes accordingly.

### Using button control

- ▶ Press the FN button with the function assignment **Photo - Video**
  - In factory settings, that will be the **FN** button at the back left, next to the LCD panel **(25)**.

### Note

- The camera switches to the most recently set photo or video mode.

## START/END VIDEO RECORDING



- ▶ Press the shutter button
  - Video recording begins.
  - The dot flashes red.
  - Recording time is running.
- ▶ Press the shutter button again
  - Video recording ends.
  - The dot lights in gray.

### Notes

- The current recording is shown in the top display with a dot below the mode.
- Basic recording settings (see p. 94) must be configured before recording.
- No direct access to menu functions is possible during video recording.

## FOCUSING

Your Leica SL2 allows automatic as well as manual focusing. There are 3 operating modes and 4 metering methods available for automatic focusing. Only manual setting options are available for MF lenses.

### TAKING VIDEOS WITH AF

Focusing is done as needed when **AFs** is in use. The area in the AF metering field will be focused continuously if **AFc** and **Intelligent AF** are in use. Continuous focusing can be suppressed by using a metering memory lock.

### TAKING VIDEOS WITH MF

Focusing is done manually via the focus setting ring. The joystick can be used as needed to do an AF metering (in **AFs** mode).

### Note

- Autofocus can be overridden manually at any time by turning the focus setting ring, while pressing and holding the shutter button at the first pressure point. The set focus will remain unchanged until the shutter button is released.

## AUTOFOCUS MODES

The following AF modes are available: **AFs**, **AFc** and **Intelligent AF**. The currently selected AF mode is shown in the header line.

Factory setting: **Intelligent AF**

- ▶ Select **Focusing** in the main menu
- ▶ Selecting **Focus Mode**
- ▶ Select the desired setting  
(**Intelligent AF**, **AFs**, **AFc**)

### INTELLIGENT AF

Suitable for all objects. The camera automatically selects between AFs and AFc.

#### AFs (single)

A meaningful option if the focus setting should remain constant for an extended period of time. Allows greater control over focusing and helps to avoid incorrect focusing.

#### AFc (continuous)

Suitable for objects in motion. Focusing is continuously adjusted to the object in the AF metering field.

Facilitates an intuitive focus control, specifically in conjunction with Touch AF.

## CONTROLLING THE AUTOFOCUS

### TOUCH AF

During video recordings, Touch AF facilitates a more intuitive focus control, even if the main object moves outside the center of the frame.

#### With AFs

- ▶ Briefly tap the LCD panel at the desired point
  - Focusing is done after the touch.

#### With AFc

- ▶ Keep your finger on the LCD panel and move it dynamically
  - The focus will adapt dynamically to the relevant position of the AF metering field.

### SUPPRESSING CONTINUOUS FOCUSING

Continuous focus adjustments can be suppressed by initiating a metering memory lock.

Use the following control elements depending on the currently selected mode:

Intelligent AF	Shutter button (tap and hold)
	Joystick (press and hold)
AFc	Joystick (press and hold)

The camera stores the focus setting. That makes it easier to change the image section when focusing is fixed. The focus remains constant as long as the control element is held. Automatic focusing will only resume after the control element is released.

## AUTOFOCUS METERING METHODS

The AF mode offers various metering methods for focusing. A successful focus setting is identified by a green metering field, an unsuccessful one is shown in red.

Factory setting: **Multi-Field**

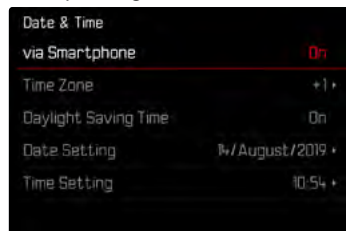

- ▶ Select **Focusing** in the main menu
- ▶ Select **AF Mode**
- ▶ Select the desired setting

(**Multi-Field**, **Spot**, **Field**, **Zone**, **Tracking**, **Face/Body Detection**)

### Note

- AF focusing can be unsuccessful:
  - If the distance to the object is too great (macro mode) or too small
  - If the object is not sufficiently illuminated

## MULTI-FIELD

Several metering fields are detected automatically.

## SPOT/FIELD

Both methods detect only those parts of the object that are within the relevant AF metering fields. The metering fields are indicated by a small frame (field metering) or a cross (spot metering). The very small measuring range for spot metering allows focusing on tiny details of the subject. Simply move the AF metering field to another position.

The slightly larger measuring range in field metering is less critical for focusing, but still permits selective metering.

- ▶ Press the joystick in the relevant direction

or

- ▶ Briefly tap the LCD panel  
(while Touch AF is activated)

### Notes

- In both cases, the metering fields remain at their last positions set, even if the metering method is changed or the camera is switched off.
- The metering fields are joined together when the exposure metering method **Spot** is combined with the AF metering methods **Spot** and **Field**. Exposure metering will then occur at the point specified by the AF metering field, even if it is moved.

## ZONE

With this metering method, subject sections are recorded with a coherent group comprising 5 x 5 fields.



After the setting has been made, the metering fields are displayed in which the subject sections are displayed in focus.

## TRACKING

This field metering variant helps in the capture of moving objects. The focus on the object in the metering field is continuously adjusted, once it is detected.

- ▶ Aim the metering field at the desired subject  
(by panning the camera shifting the metering field)
- ▶ Tap and hold the shutter button

or

- ▶ Press and hold the joystick
  - The camera focuses on the object.
  - The metering field "tracks" the saved object and focus is continuously adjusted.

### Note

- This metering method focuses continuously, even if the AF mode **AFs** was set.

## START POSITION FOR TRACKING

Factory setting: **Center**

You can specify the starting point for tracking.

Center	Center of the screen
Last Position	Ending position of the most recent tracking
Recall	Starting position of the most recent tracking

- ▶ Select **Focusing** in the main menu
- ▶ Select **AF Setup**
- ▶ Select **AF Tracking Start Position**
- ▶ Select the desired setting  
(**Last Position**, **Recall**, **Center**)

## PERSON DETECTION

Person detection is an expansion of the face recognition feature. In addition to biometric patterns of faces, the camera also detects body patterns and uses them for focusing. Tracking will therefore continue, once a person is detected and measured, even if the face may not be in view at some point. This feature prevents inadvertent "jumps" to other faces if several persons are in the frame.

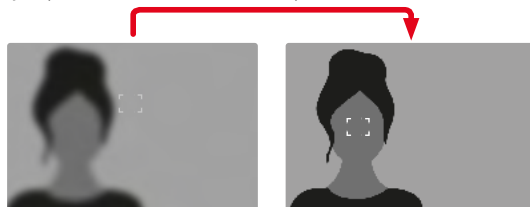



## AF SETTINGS

### ISO SENSITIVITY

Specifies the sensitivity of contrast metering.

Factory setting: 0

- ▶ Select **Focusing** in the main menu
- ▶ Select **AF Setup**
- ▶ Select **AF Sensitivity**
- ▶ Select the desired setting  
(-3, -2, -1, 0, +1, +2, +3)

### SPEED

Where objects are not as fast-moving, it is advisable to set AF Speed to a slightly lower value. This will prevent overly abrupt focus changes. For very fast-moving objects, a high setting will guarantee a correct focus.

Factory setting: 0

- ▶ Select **Focusing** in the main menu
- ▶ Select **AF Setup**
- ▶ Select **AF Speed**
- ▶ Select the desired setting  
(-5, -4, -3, -2, -1, 0, +1, +2, +3, +4, +5)

## AF QUICK SETTING

AF Quick Setting offers the following functions:

- quick switches of the AF metering methods
- Adjusting the metering field size during field metering

The viewfinder image remains visible continuously during setting adjustments.

### ACCESSING AF QUICK SETTING

- ▶ Touch and hold the LCD panel
  - All auxiliary displays are hidden.
  - Red triangles appear at two corners of the metering field if the metering method **Field** is set.



### ADJUSTING THE METERING FIELD SIZE

(only **Field**)

- ▶ Turn the thumbwheel
- or
- ▶ Pinch or spread
    - The size of the AF-metering field is adjustable in 3 increments.

### Note

- AF Quick Setting can only be accessed if the function **Touch AF** is active (see p. 78).

## CHANGING THE AF METERING METHOD

- ▶ Turn the front setting wheel
  - A menu bar appears at the bottom of the screen.



- ▶ Select a metering method
  - Alternatively, you can use the front setting wheel for the setting.
  - The setting is applied automatically after 3 seconds, the menu bar disappears.

### Note

- This function is unavailable while recording.

## MF ASSIST FUNCTIONS

### ENLARGEMENT IN AF MODE

You can access the enlargement function independent of focusing for a better assessment of the settings.

The enlargement function must be assigned to one of the FN buttons to use this feature (see p. 65).

#### Assigning the function to one of the FN buttons

- ▶ See p. 65

#### Accessing the enlargement function

- ▶ Press the FN button
  - A enlarged image section appears The position of the enlargement depends on the position of the AF metering field.
  - The rectangle within the frame at the top right represents the current magnification, as well as its position in the displayed cropped section.
  - The enlargement starts at the 2nd of 3 enlargement increments.

#### Adjusting the enlargement function

- ▶ Turn the thumbwheel/front setting wheel

#### Changing the position of the enlarged section

- ▶ Swiping will allow you to move the position of an enlarged cropped section

or

- ▶ Press the joystick in the relevant direction

#### Exiting the enlargement function

- ▶ Tap the shutter button

## Notes

- The enlargement function remains active until it is exited.
- This function is unavailable while recording.

## AF ASSIST LIGHT

The AF assist light is not active in video mode.

## ACOUSTIC AF CONFIRMATION

You can set an acoustic confirmation signal for successful focus metering in AF mode (see p. 76).

## Note

- This function is unavailable while recording.

## MANUAL FOCUSING (MF)

Manual focusing offers more control and is less prone to incorrect settings than the AF modes.

- ▶ Select **Focusing** in the main menu
- ▶ Selecting **Focus Mode**
- ▶ Select **MF**
- ▶ Start video recording
- ▶ Turn the focus setting ring to select the desired focusing.

## MF SETTINGS\*

Factory setting: **On**

The speed of the MF setting is adjustable. Example: for a setting to **90°**, the entire focus range will be run through when the focus setting ring is turned by one quarter. A full turn of the focus setting ring will be needed for a setting to **360°**. Smaller angles allow faster adjustments, while larger angles offer more precise settings.

- ▶ Select **Focusing** in the main menu
- ▶ Select **MF Setup**
- ▶ Select the desired setting  
(**Standard MF**, **90°**, **120°**, **150°**, **180°**, **210°**, **240°**, **270°**, **300°**, **330°**, **360°**, **Maximum**)

\* This function will become available with the 2020 firmware update. Registered users will be automatically notified about updates, see p. 12 and p. 191. Subject to changes.

## MF ASSIST FUNCTIONS

The following assist functions are available in MF mode.

### FOCUS PEAKING

This assist function highlights the edges of in focus subject elements in color.



When Focus Peaking is activated,  will appear to the right of the frame with a display of the color used. The color can be user-specified. The sensitivity can be additionally adjusted. The activation of this function is controlled vis the info profiles (see p. 80).

### Note

- Focus peaking is based on subject contrast, i.e. differences between light and dark. As a result, high contrast subject parts could be marked, even if they are not completely in focus.

## ENLARGEMENT IN MF MODE

The larger the details of the subject are shown, the better you can assess their sharpness and the more accurately you can focus. This function can be automatically activated during manual focusing or can be accessed independently.

### ACCESS VIA THE FOCUS SETTING RING

Turning the focus ring will automatically enlarge a image section.

- ▶ Select **Focusing** in the main menu
- ▶ Select **Focus Assist**
- ▶ Select **Auto Magnification**
- ▶ Select **On**
- ▶ Turn the focus ring
  - A enlarged image section appears The position of the enlargement depends on the position of the AF metering field.
  - The rectangle within the frame at the top right represents the current magnification, as well as its position in the displayed cropped section.
  - The enlargement starts at the 1st of 3 enlargement increments.

### Adjusting the enlargement function

- ▶ Turn the thumbwheel/front setting wheel

### Changing the position of the enlarged section

- ▶ Swiping will allow you to move the position of an enlarged cropped section

or

- ▶ Press the joystick in the relevant direction

### Exiting the enlargement function

- ▶ Tap the shutter button
- or
- ▶ Decrease the enlargement, until the full image is visible again

### Notes

- The enlargement will automatically return to normal viewing size about 5 s after the last turn of the focus ring.
- This function is unavailable while recording.

### DISTANCE DISPLAY

Distance information is shown in the top display during manual focusing.

- Focus Mode MF: when the shutter button is pressed to the first pressure point
- Focus Mode AF: when the shutter button is pressed and held at the first pressure point, followed by a turning of the focus setting ring

The unit of measure (m or ft) can be selected, see p. 71.

## ISO SENSITIVITY (Video mode)

The ISO setting covers a range between ISO 50 and ISO 50000, allowing you to adapt to the relevant situation as required. There is more leeway for the use of preferred shutter speed and aperture combinations when setting the exposure manually. You can set priorities within the scope of the automatic setting. Factory setting: ISO 100

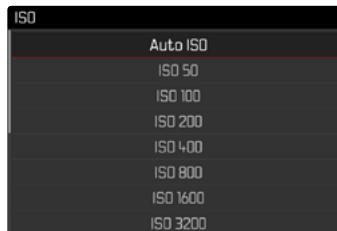

## FIXED ISO VALUES

ISO values between 50 and 50000 can be selected in 11 increments.

- ▶ Select **ISO** in the main menu
- ▶ Select the desired setting

(**ISO 50**, **ISO 100**, **ISO 200**, **ISO 400**, **ISO 800**, **ISO 1600**, **ISO 3200**, **ISO 6400**,  
**ISO 12500**, **ISO 25000**, **ISO 50000**)

### Note

- When high ISO values are used or the image is edited later, image noise, as well as vertical and horizontal stripes may become visible, particularly in larger, evenly lit areas of the object.

## AUTOMATIC SETTING

The camera automatically adjusts the sensitivity to ambient brightness and/or to the configured shutter speed/aperture settings combination. In conjunction with aperture priority mode, this function extends the range for automatic exposure control.

- ▶ Select **ISO** in the main menu
- ▶ Select **Auto ISO**

### Note

- This function is not available in Cine mode.

## LIMITING SETTING RANGES

A max. ISO value can be set, which will then limit the automatic setting range (**Maximum ISO**). A max. exposure time can also optionally be configured. There are automatic settings and fixed max. shutter speeds **1/30** s and **1/2000** s available for that purpose.

### LIMITING ISO VALUES

Factory setting: **6400**

- ▶ Select **Auto ISO Settings** in the main menu
- ▶ Select **Maximum ISO**
- ▶ Select the desired value

(**100**, **200**, **400**, **800**, **1600**, **3200**, **6400**, **12500**, **25000**, **50000**)

### LIMITING SHUTTER SPEED RANGES

Factory setting: **Auto**

- ▶ Select **Auto ISO Settings** in the main menu
- ▶ Select **Shutter Speed Limit**
- ▶ Select the desired value

(**Auto**, **1/2000**, **1/1000**, **1/500**, **1/250**, **1/125**, **1/60**, **1/30**)

## FLOATING ISO

This function complements Auto ISO. Light strength changes with many zoom lenses when the focal length is changed. Floating ISO will in this situation adjust the sensitivity in fine graduations and will simultaneously ensure that the selected settings of exposure value and shutter speed remain constant in (semi) automatic exposure modes. This will specifically in video recordings prevent visible jumps in brightness.

Factory setting: **On**

- ▶ Select **Floating ISO** in the main menu
- ▶ Select **On**

### Notes

- **Floating ISO** can work only if the original ISO setting allows scope for change, i.e. the highest/lowest ISO setting is not already being used. The **Floating ISO** warning icon will be displayed in that case.
- This function is not available in Cine mode.

## ASA SENSITIVITY (Cine-Mode)

The sensitivity setting in Cine mode is always done manually. The menu item **Exposure Index** replaces the menu item **ISO**. The value is stated in ASA units. Automatic settings (Auto ISO/Floating ISO) are unavailable.

Factory setting: **400 ASA**

- ▶ Select **ISO** in the main menu
- ▶ Select the desired setting

**(50 ASA, 100 ASA, 200 ASA, 400 ASA, 800 ASA, 1600 ASA, 3200 ASA, 6400 ASA, 12500 ASA, 25000 ASA, 50000 ASA)**

## WHITE BALANCE

In white balance ensures neutral color rendering in any light. White balance is based on the camera being preset to render a particular light color as white.

Four methods are available:





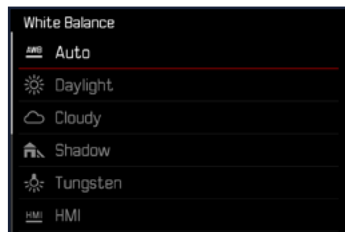



- automatic control
- fixed presets
- manual setting via metering
- direct setting of the color temperature

Factory setting: **Auto**



## AUTOMATIC CONTROL/FIXED SETTINGS

- **Auto**: for automatic control, which delivers neutral results in most situations
- Various fixed presets for most frequently encountered light sources:



 Daylight	for outdoor pictures in sunlight
 Cloudy	for outdoor pictures in cloudy conditions
 Shadow	for outdoor pictures with the main subject in shadow
 Tungsten	for indoor pictures with (predominantly) incandescent lamp light
 HMI	for indoor pictures with (predominantly) light from metal halide lamps
 Fluorescent (warm)	for indoor pictures with (prevailing) light from fluorescent tubes with warm light color
 Fluorescent (cool)	for indoor pictures with (prevailing) light from fluorescent tubes with cool light color
 Flash	for flash photography

- ▶ Select **White Balance** in the main menu
- ▶ Select the desired setting



## MANUAL SETTING VIA METERING

( Graycard /  **Graycard Live View**)

The variant  **Graycard** is suited best for subjects in which you can clearly identify a neutral gray or pure white area. If not, or should you base your metering on an off-center detail, then  **Graycard Live View** will be a better choice.

### Note

- A value configured using this method will remain unchanged (i.e. it will be used for all subsequent photographs) until new measurements are taken or one of the other white balance settings is selected.

## GRAY CARD

This metering variant captures all color hues in the metering field and uses these to calculate a mean gray value.

- ▶ Select **White Balance** in the main menu
- ▶ Select  **Graycard**
  - The following will appear on the LCD panel:
    - the image based on automatic white balance
    - a frame in the center of the image



- ▶ Aim the metering field at a white or neutral gray area
  - The screen image changes dynamically in line with the reference area in the frame.

### Taking measurements

- ▶ Shutter release
- or
- ▶ Press the joystick/thumbwheel
    - The measurement is taken.

### Canceling the measurement

- ▶ Press the **FN** button **(25)**

## GRAY CARD LIVE VIEW

This metering variant captures only the color hue metered within the metering field and calculates the mean gray value from it.

- ▶ Select **White Balance** in the main menu
- ▶ Select **Graycard Live View**
  - The following will appear on the LCD panel:
    - the image based on automatic white balance
    - cross in the center of the image

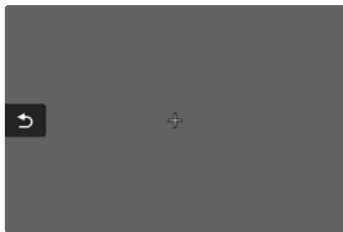

- ▶ Aim the metering field at a white or neutral gray area

### Moving the metering field

- ▶ Press the joystick in the relevant direction

### Taking measurements

- ▶ Shutter release
- or
- ▶ Press the joystick/thumbwheel
  - The measurement is taken.

### Canceling the measurement

- ▶ Press the **FN** button (**25**)

## DIRECT SETTING OF THE COLOR TEMPERATURE

Values between 2000 and 11,500 K (Kelvin) can be set directly. That gives you a very wide range, which covers virtually all color temperatures occurring in real life and within which you can adapt color rendering to any light color and your personal preferences with incredible detail.

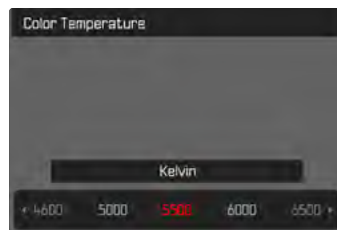

- ▶ Select **White Balance** in the main menu
- ▶ Select **Color Temperature**
- ▶ Select the desired value

## EXPOSURE

The exposure setting is done dynamically via the two setting wheels. As a rule, the thumbwheel controls the aperture and the front setting wheel the shutter speed. The "free" setting wheel is used for quick access to exposure compensation during semi automatic exposure setting. Function assignments can be modified, see p. 66.

Exposure settings can be done quickly and easily via the status screen.

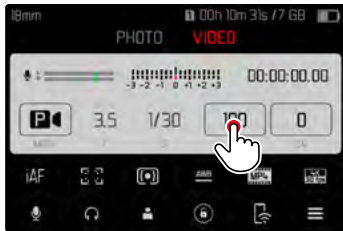

- ▶ Briefly touch the desired control panel
  - The active control panel is highlighted in red.
  - A setting band appears instead of the light balance. A dot marks the current setting. The current setting value is displayed above the dot.

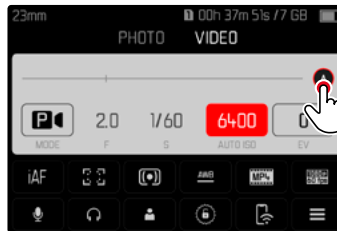
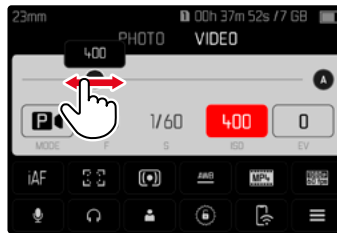

- ▶ Tap the setting band briefly in the desired position or drag the dot to the desired position

## EXPOSURE METERING METHODS

Optional methods are Spot metering, Center-Weighted and Multi-Field metering.

Factory setting: **Multi-Field**

- ▶ Select **Exposure Metering** in the main menu
- ▶ Select a metering method  
(**Spot**, **Center-Weighted**, **Multi-Field**)
  - The selected metering method is displayed in the header line of the screen image.

### Notes

- The exposure information (ISO value, aperture, shutter speed and light balance with exposure compensation scale) will help to determine the settings required for correct exposure.
- The most important displays (ISO value, aperture and shutter speed) will also appear in the top display.

## SPOT METERING –

This metering method is concentrated exclusively on a small area in the center of the image. The metering fields are joined together when the exposure metering method **Spot** is combined with the AF metering methods **Spot** and **Field**. Exposure metering will then occur at the point specified by the AF metering field, even if it is moved.

## CENTER-WEIGHTED METERING –

This method considers the entire image field. The subject elements captured in the center will, however, impact on the calculation of the exposure value more so than areas around the edges.

## MULTI-FIELD METERING –

This metering method is based on the detection of multiple values. These values are used in an algorithm to calculate an exposure value appropriate for a good rendering of the assumed main subject.

## EXPOSURE MODES

You can choose one of four video recording modes:

- Automatic program (**P**)
- Aperture priority mode (**A**)
- Shutter priority mode (**S**)
- Manual setting (**M**)

Cine mode also offers another, fully manual mode.

### Notes

- When using a lens with an aperture setting ring (e.g. Leica M lenses), only the exposure modes **A** (aperture priority) and **M** (manual setting) will be available.
- Where that is the case, **F0.0** is displayed as the aperture value.
- The following applies for all exposure modes: the available shutter speeds for custom settings or those available for automatic settings depend on the selected frame rate (see p. 96).
- When Auto ISO is active, the camera uses the dynamic adjustment function for the ISO value for the exposure setting. Depending on the exposure mode selected, the automatic ISO setting interacts with automatically controlled aperture and/or shutter speed settings.

## SELECTING A MODE

### Via the thumbwheel

- ▶ Press the thumbwheel
  - The currently selected mode is shown in the top display. The currently selected mode is marked in red on screen.
- ▶ Turn the thumbwheel to select the desired mode.
  - The mode display changes in the top display and on screen.
  - All modes can be reached by turning the wheel in either direction.
  - The selected mode will be applied automatically approx. 2 s after the thumbwheel is moved the last time.



### To apply the selected mode immediately

- ▶ Press thumbwheel/joystick
- or
- ▶ Tap the shutter button

Via the status screen

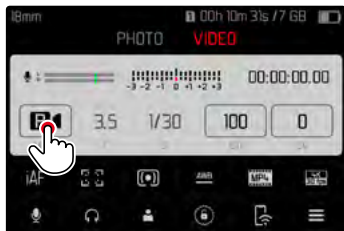

- ▶ Touch the control panel briefly

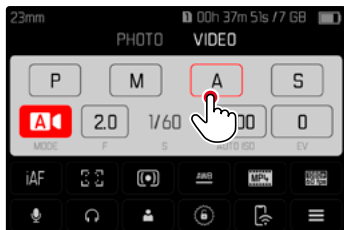

- ▶ Tap the desired exposure mode

## FULLY AUTOMATIC EXPOSURE SETTING – P

### AUTOMATIC PROGRAM – P

The exposure is controlled by an automatic shutter speed and aperture setting.

The exposure compensation and recording level are controlled directly via the setting wheels.

- ▶ Selecting the operating mode **P** (see p. 161)
- ▶ Set exposure compensation as needed
- ▶ Start video recording

## SEMI-AUTOMATIC EXPOSURE SETTING – A/S

### APERTURE PRIORITY - A

Aperture priority mode sets the exposure automatically according to the manually selected aperture. It is therefore specifically suitable for recordings in which the depth of field is a critical compositional element.

The range of the depth of field can be diminished with an accordingly small exposure value. This will set off the focused area against the unfocused background. Conversely, a greater exposure value will increase the range of the depth of field. Such a setting is advisable if the foreground and background should be rendered in sharp focus.

The selected aperture setting will be maintained for the duration of the recording.

- ▶ Select the operating mode **A** (see p. 161)
- ▶ Set the desired exposure value
- ▶ Start video recording

### SHUTTER SPEED PRIORITY – S

Shutter speed priority mode will set exposure automatically according to the manually selected shutter speed. The selected shutter speed will be maintained for the duration of the recording.



- ▶ Select the operating mode **S** (see p. 161)
- ▶ Select the desired shutter speed
- ▶ Start video recording

## MANUAL EXPOSURE SETTING – M

The following manual settings for shutter speed and aperture are a good choice:

- to maintain constant exposure settings between multiple recordings
- to maintain constant exposure settings while recording, specifically in conjunction with fixed ISO settings
- ▶ Select the operating mode **M** (see p. 161)
- ▶ Select desired exposure
  - The exposure compensation is done using the scale of the light balance.
- ▶ Shutter release

Displays on the light balance:

	correct exposure
	Under/over exposure by the displayed value
	Under or overexposure by more than 3 EV (Exposure Value)

## EXPOSURE COMPENSATION

Exposure compensation can be set in the range  $\pm 3$  EV (EV: Exposure Value). The available values depend on the global setting **EV Increment** (see p. 79).



**A** Set compensation value (marks at 0 = Off)

- ▶ Select **Exposure Compensation** in the main menu
  - A scale appears as a submenu item.
- ▶ Set the value on the scale
  - The set value is displayed above the scale.
  - While setting the value, you can see the effect on the screen image, which becomes darker or lighter.

## Notes

- This function is assigned to one of the setting wheels in the three (semi) automatic exposure modes and therefore quickly accessible (see p. 66).
- The set exposure compensation is indicated by a mark on the exposure compensation scale in the footer line (see p. 26).
- The following applies for set compensation values, no matter how they were initially set: They remain effective until they are manually reset to 0, i.e. even if the camera is switched off and on again in the meantime.
- Changes to the **EV Increment** setting (see p. 79) lead to the cancellation of a compensation that has been set, i.e. in such cases it is automatically reset to 0.





## PLAYBACK/REVIEW MODE

There are two completely independent playback/review functions available:

- short-term rendering directly after exposure (Preview)
- normal Review mode, in which the stored recordings can be viewed and managed for any length of time

The switchover between recording and playback/review mode, as well as most other actions can be completed using gesture or key control. Please see p. 51 for more information about the available gestures.

### Notes

- Recorded pictures are not automatically rotated in Review mode to utilize the full screen area.
- It may not be possible to render files with this camera that were not recorded with this device.
- In some cases, the screen image may not have the expected quality, or the LCD panel will remain blank and only display the file name.
- You can toggle back from playback mode to recording mode at any time by tapping the shutter button.

## CONTROL ELEMENTS IN PLAYBACK/REVIEW MODE

### CONTROL ELEMENTS ON THE CAMERA

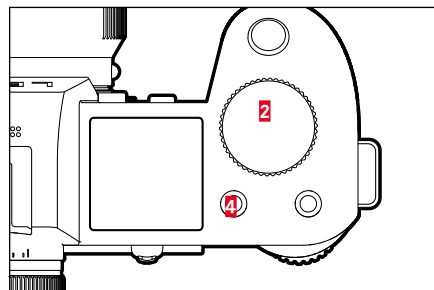
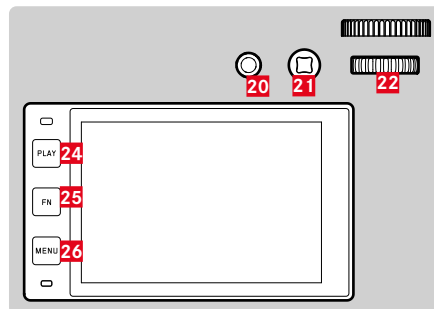

- |                                     |   |
|-------------------------------------|---|
| <b>2</b> Front setting wheel        | <b>22</b> Thumbwheel                                  |
| <b>4</b> FN button at the top left  | <b>24</b> <b>PLAY</b> button                          |
| <b>20</b> FN button at the rear top | <b>25</b> Press the <b>FN</b> button at the rear left |
| <b>21</b> Joystick                  | <b>26</b> <b>MENU</b> button                          |

## FN BUTTONS IN PLAYBACK/REVIEW MODE

In Playback/Review mode, the FN buttons either have permanently assigned functions or are without function.

The following FN buttons have assigned functions:

FN button at the rear left <b>(25)</b>	Toggle Info Profiles
FN button at the rear top <b>(20)</b>	EVF-LCD
FN button at the top left <b>(4)</b>	Tag recordings (Rate / Unrate)

## CONTROL ELEMENTS ON THE LCD PANEL

On-screen control elements generally function by intuitively by touch. Many can also be selected by pressing one of the three buttons to the left of the LCD panel. A control element in the header is accompanied by an icon denoting the relevant button. A control element on the edge of the screen will be positioned directly next to the relevant button.

Example: The "Go back" icon  can be selected in one of two ways:

- Tap the "Go back" icon briefly right away
- press the relevant button  
(top button = **PLAY**)



- A** Control element "Go back"
- B** Control element "Delete"
- C** Display of the relevant button

## INITIATE/EXIT PLAYBACK/REVIEW MODE

### Using touch control

- ▶ Swipe up or down

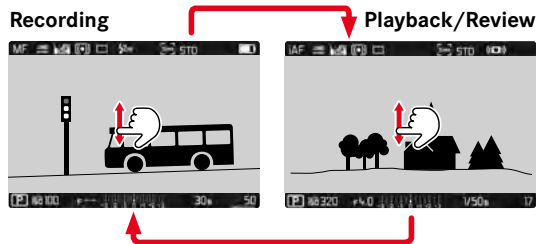

### Using button control

- ▶ Press the **PLAY** button
  - The last picture taken appears on the screen.
  - The following message appears if the inserted memory card does not contain any picture data: **No valid picture to play.**
  - The **PLAY** button function differs, depending on the current camera setting:

Initial situation	After pressing the PLAY button
Full screen display of a recording	Recording mode
Display of an enlarged cropped section/or several thumbnails	Full screen display of the recording

## SELECTING/SCROLLING THROUGH RECORDINGS

The recordings are visually arranged in a horizontal reel. When the end of an image series is reached, the display automatically jumps back to the first image in the series. All recordings can therefore be reached by scrolling either right or left.

### SINGLE

#### Using touch control

- ▶ Swipe to the left or right

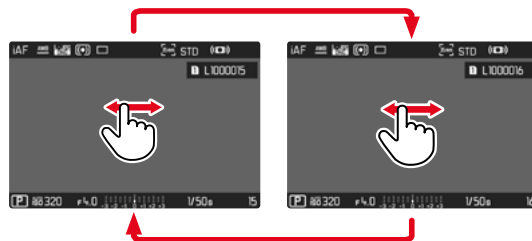

#### Using button control

- ▶ Press the joystick left/right
- or
- ▶ Turn the thumbwheel

## CONTINUOUS

- ▶ Swipe to the left or right and hold the finger on the edge of the screen
  - The subsequent recordings will move past continuously.

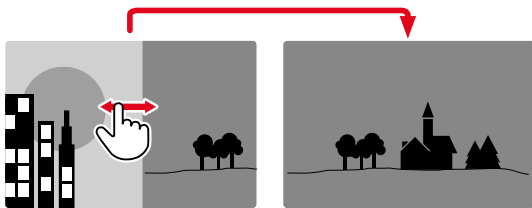

## INFO DISPLAYS IN PLAYBACK/REVIEW MODE

The same info profiles are available in Playback/Review mode as in recording mode. The actual info profile currently in use, however, is saved separately. It is therefore possible to use an empty info profile completely without assist function icons in Playback/Review mode, without having to set them again when switching to recording mode. See S. 80 for setting options and additional information. The assist functions **Grid** and **Level Gauge** are not available in Playback/Review mode.

## DISPLAYING ASSIST FUNCTIONS

To switch between info profiles

- ▶ Press the **FN** button at the rear left (25)



Empty info profile



Recording data only  
(Info Bars)



Clipping / Zebra + Info Bars



Info Bars, Focus Peaking, Histogram

## CROPPED SECTION ZOOM

You can zoom in to any section of an image for closer inspection. Zooming via the front setting wheel is done in four increments; zooming is stepless via touch control.

### Using touch control

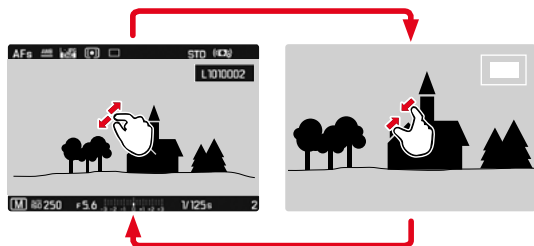

- ▶ Two-finger pinch/spread
  - The central cropped section of the picture is enlarged.

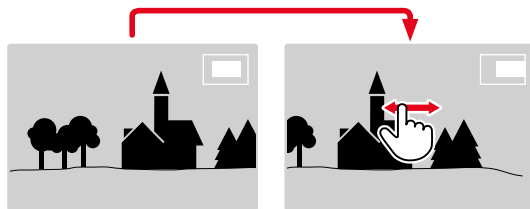

- ▶ Swiping will allow you to move the position of an enlarged cropped section
  - The rectangle within the frame at the top right represents the current magnification, as well as its position in the displayed cropped section.

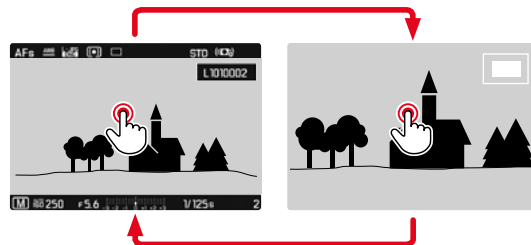

- ▶ Double tap
  - Toggles between max. zoom at the tap position and full screen view.

### Using button control

- ▶ Turn the front setting wheel  
(in clockwise direction: increase magnification, anti-clockwise: decrease magnification)
- ▶ Press thumbwheel/joystick
  - Toggles between max. magnification and standard full screen view.
- ▶ Use the joystick to move the position of the cropped section while the image is magnified
  - The rectangle within the frame at the top right represents the current magnification, as well as its position in the displayed cropped section.

You can move directly from one picture to the next in magnification mode, which will then also be displayed with the same magnification.

- ▶ Turn the thumbwheel to the left/right

### Notes

- It may not be possible to enlarge pictures taken with other camera types.
- Video recordings cannot be enlarged.

## DISPLAYING MULTIPLE RECORDINGS AT ONCE

The camera offers an overview function in which several thumbnail images can be viewed on one screen, which makes it easier to find a specific image. You can choose 12 or 30 images per overview.

### Using touch control

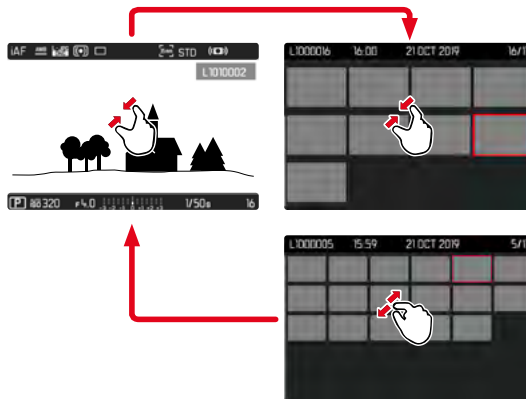

- ▶ Two-finger pinch
  - The display toggles from 12 to 30 thumbnails.

### To view other recordings

- ▶ Swipe up or down

### Using button control

- ▶ Turn the front setting wheel in anti-clockwise direction
  - 12 thumbnails are shown at the same time. Another turn on the thumbwheel increases the number of displayed recordings to 30.

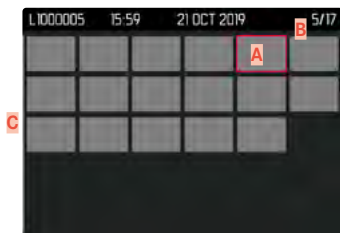

- A** Currently selected recording
- B** Number of the currently selected recording
- C** Scrollbar

The currently viewed recording is framed in red and can be selected for a closer look.

### To navigate between recordings

- ▶ Press the joystick in the relevant direction  
or
- ▶ Turn the thumbwheel

### To display the recording in full size

#### Using touch control

- ▶ Two-finger spread  
or
- ▶ Briefly touch the image

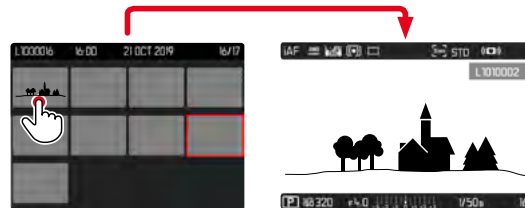

#### Using button control



- ▶ Turn the front setting wheel in clockwise direction  
or
- ▶ Press joystick, thumbwheel or **PLAY** button





## TAGGING/RATING OF RECORDINGS

Recordings can be tagged as favorites to find them quicker or to simplify the later deletion of multiple recordings. Tagging can be done in regular view mode or in the overviews.

### Tagging a recording

- ▶ Press the FN button at the top left 
  - The recording is marked with . The icon will appear in the header line on the far right when viewing images in full size, and in the top left corner of the thumbnail in overview mode.

### Removing a tag

- ▶ Press the FN button at the top left 
  - The  marking disappears.

## DELETING RECORDINGS

There are several methods available to delete recordings:

- deleting individual recordings
- deleting multiple recordings
- deleting all recordings without a tag/ranking
- deleting all recordings

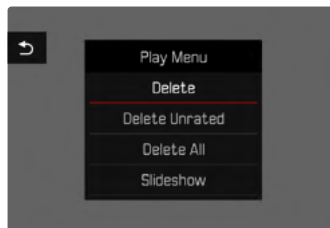

### Important note

- Once deleted, recordings are no longer retrievable.

## DELETING INDIVIDUAL RECORDINGS

- ▶ Press the **MENU** button
- ▶ Select **Delete** in the Playback/Review menu
  - The Delete screen appears.



- ▶ Select the Delete icon 
  - The LED will flash during the delete process. The process may take a few seconds.
  - The next recording will be displayed once deletion is complete. The following message appears if no other recordings are saved on the card: *No valid picture to play.*

To cancel deletion and return to the normal Playback/Review mode

- ▶ Select the "Go back" icon 

### Notes

- The Delete screen can not be called up when in overview mode, because the menu function **Delete** of the Review menu is not available in this context.
- The "Scroll" and "Magnify" functions continue to be available when the "Delete" screen is active.

## DELETING MULTIPLE RECORDINGS

Several recordings can be marked in a Delete overview with twelve thumbnails and can then be deleted all at once. This overview can be reached in two ways.

- ▶ Turn the front setting wheel in anti-clockwise direction
  - The overview screen appears.
- ▶ Press the **MENU** button
- ▶ Select **Delete Multi** in the Review menu
  - The Delete overview appears.

or

- ▶ Press the **MENU** button
- ▶ Select **Delete** in the Playback/Review menu
  - The Delete screen appears.
- ▶ Turn the front setting wheel in anti-clockwise direction
  - The Delete overview appears.

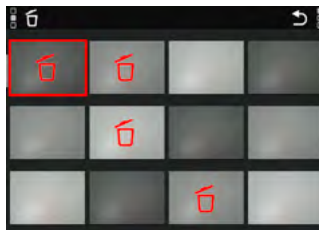

Any number of recordings can be selected in this view.

### Selecting recordings for deletion

- ▶ Select a recording
  - ▶ Press the joystick/thumbwheel
- or
- ▶ Briefly touch the image
    - The recordings selected for deletion are marked with a red Delete icon .

### To delete the selected recordings

- ▶ Select the Delete icon 
  - The prompt `Do you want to delete all marked files?` appears.
- ▶ Select `Yes`

### To cancel deletion and return to the normal Playback/Review mode

- ▶ Select the "Go back" icon 

## DELETING ALL RECORDINGS

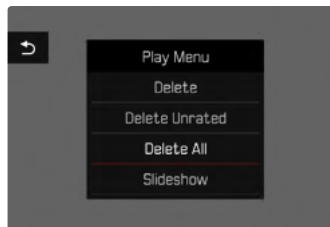

- ▶ Press the **MENU** button
- ▶ Select `Delete All` in the Review menu
  - The prompt `Do you want to delete all files?` appears.
- ▶ Select `Yes`

### Note

- The message `No valid picture to play.` appears after successful deletion. The same picture is displayed again if deletion was unsuccessful. When deleting several or all pictures/recordings, a notification screen may appear for the time needed to process the data.

## DELETING UNRATED RECORDINGS

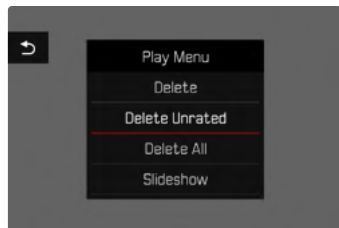

- ▶ Press the **MENU** button
- ▶ Select **Delete unrated** in the Review menu
  - The prompt **Do you really want to delete all not rated files?** appears.
- ▶ Select **Yes**

### Note

- The LED will flash during the deletion process. The next marked recording appears once deletion is complete. The message **No valid picture to play.** appears if no other recordings are saved on the card.

## PREVIEW OF LATEST RECORDING

Photo recordings can be displayed automatically directly after they are taken to e.g. check the success of the recording quickly and easily. A duration for the automatic display can be configured.

- ▶ Select **Auto Review** in the main menu
- ▶ Select the desired function or duration  
(**Off**, **1 s**, **3 s**, **5 s**, **Permanent**, **Shutter pressed**)

**Permanent:** The most recent recording is displayed until automatic review is ended by pressing the **PLAY** button or by tapping the shutter button.

**Shutter pressed:** The most recent recording is displayed for as long as the shutter button is pressed down.

### Notes

- Various control elements change back to regular Review mode to execute their normal functions while automatic review is selected. The camera will remain in Review mode until it is exited.
- Tagging and deleting can only be done in regular Review mode and not during automatic review.
- When pictures were taken with the functions Serial exposures or Interval shooting, then the last image in the series will be displayed or – if the save process is still incomplete – the last image in the series saved to the memory card.
- Where display times were configured (**1 s**, **3 s**, **5 s**) automatic review can be ended immediately by pressing the **PLAY** button or tapping the shutter button.

## SLIDESHOW

A slide show function is available in Review mode, in which the saved images are shown automatically in series. Choose to see all recordings (**Play All**), only photos (**Pictures Only**) or only videos (**Videos Only**) should be displayed. For photos, select how long each image should be displayed (**Duration**).

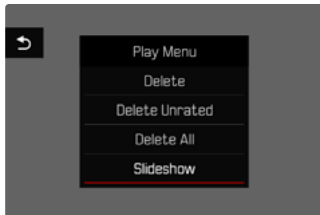

## SETTING THE DURATION

- ▶ Press the **MENU** button
- ▶ Select **Slideshow** in the Review menu
- ▶ Select **Duration**
- ▶ Select the desired duration (**1 s**, **2 s**, **3 s**, **5 s**)

## STARTING THE SLIDE SHOW

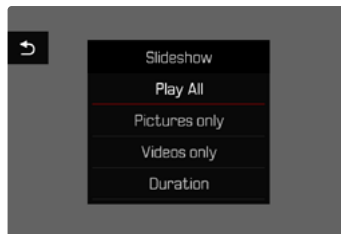

- ▶ Press the **MENU** button
- ▶ Select **Slideshow** in the Review menu
- ▶ Select the desired setting (**Play All**, **Pictures only**, **Videos only**)
  - The slide show will start automatically with the selected recordings and runs in an endless loop until it is exited.

## ENDING THE SLIDE SHOW

- ▶ Press the **PLAY** button
- or
- ▶ Tap the shutter button
    - The camera switches to the relevant mode.

## Notes

- An intermediate screen may appear while the data is prepared for playback.
- The settings in **Duration** remain intact even after the camera is switched off and on again.

## VIDEO PLAYBACK

### ACCESSING CONTROL ELEMENTS

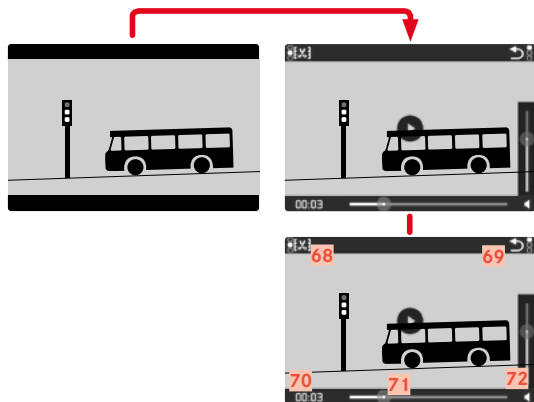

- 68** Video editing function
  - 69** Exiting video playback
  - 70** Current time of the playback
  - 71** Playback status bar
  - 72** Playback volume
- ▶ Briefly tap the LCD panel
- or
- ▶ Press the joystick/thumbwheel

#### Notes

- A running playback will be interrupted if a control element is accessed.
- The control elements disappear after about 3 s. Touching the LCD panel or pressing a button will make them reappear.

## START PLAYBACK

**PLAY** ▶ Appears on screen if you have selected a video file in playback mode.

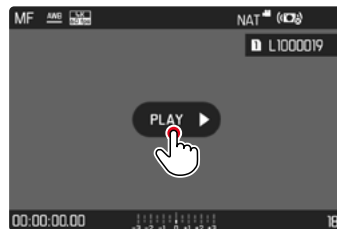

- ▶ Press the joystick/thumbwheel
- or
- ▶ touch **PLAY** ▶ briefly

## PAUSE PLAYBACK

- ▶ Briefly tap the LCD panel
- or
- ▶ Press the joystick/thumbwheel

## RESUMING PLAYBACK/REVIEW

While control elements are visible:

### Using touch control

- ▶ Touch the LCD panel briefly anywhere in the picture

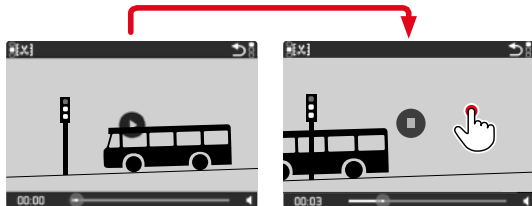

### Using button control

- ▶ Press the joystick/thumbwheel

## NAVIGATE TO ANY POINT IN THE FILE

### QUICK JUMP

### Using touch control

While control elements are visible:

- ▶ Touch the playback status bar briefly at the desired position

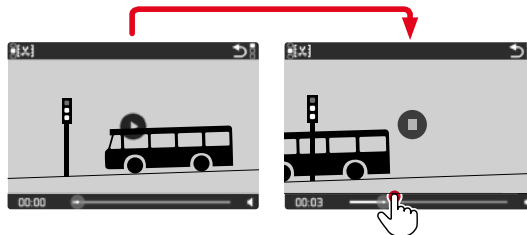

### Using button control

- ▶ Press and hold the joystick left/right

### PRECISE SELECTION

- ▶ Turn the thumbwheel

## END PLAYBACK

### Using touch control

While control elements are visible:

- ▶ Select the "Go back" icon ↶

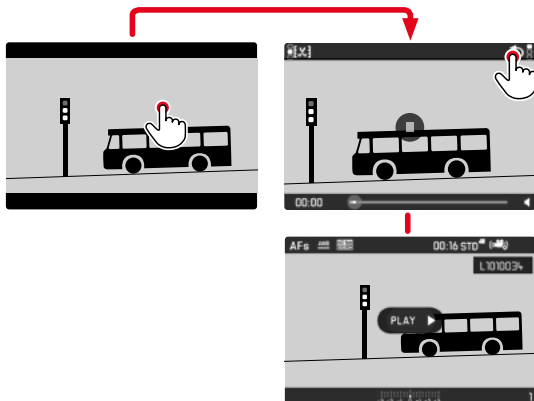

### Using button control

- ▶ Press the **PLAY** button

## SETTING THE VOLUME

### Using touch control

While control elements are visible:

- ▶ Tap the volume icon briefly
- ▶ Touch the volume status bar briefly at the desired position

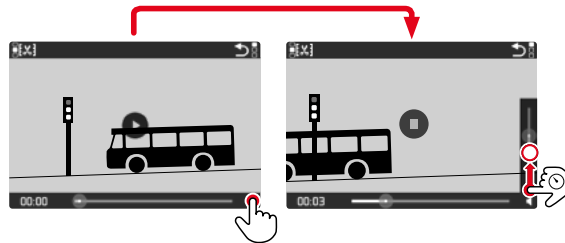

### Using button control

- ▶ Press the joystick up/down
  - The volume status bar appears.
- ▶ Press the joystick up (louder) or down (quieter)

### Note

- Sound is switched off at the lowest part of the bar and the volume icon changes to .



## VIDEO EDITING

### Using touch control

While control elements are visible:

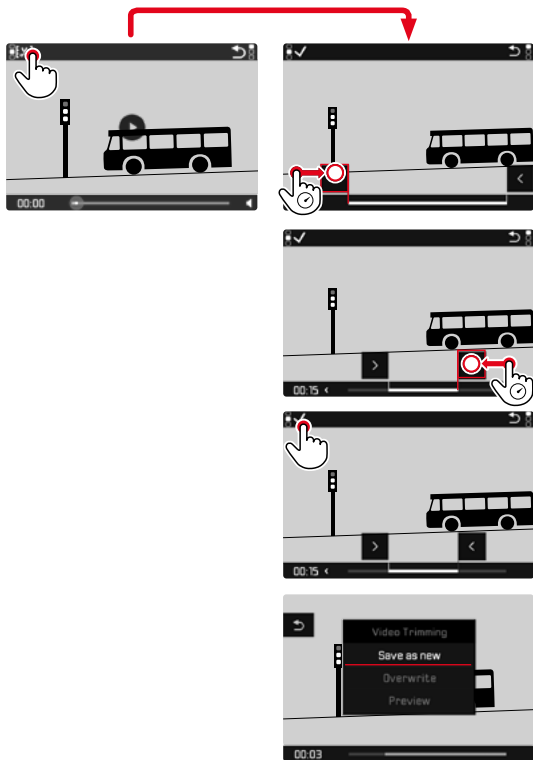

### Using button control

#### ACCESSING THE VIDEO EDITING FUNCTION

- ▶ Press the FN button at the rear left (25)
  - The video editing screen appears, the left cutting mark is highlighted in red (= active).

#### CHANGING THE CURRENT CUTTING POINT

- ▶ Press the joystick left/right
  - The selected cutting point is highlighted in red (= active).

#### MOVING THE ACTIVE CUTTING POINT

- ▶ Turn the thumbwheel
  - The currently selected time of the relevant cutting point is displayed at the bottom left of the footer line. A still of the video sequence at that point is displayed in the background.

**CUTTING**

- ▶ Press the **FN** button at the rear left (25) to confirm the cuts
  - The **Video Trimming** menu appears.
- ▶ Select a function from the **Video Trimming** menu  
(**Save as new**, **Overwrite**, **Auto Review**)

<b>Save as new</b>	The new video is <u>additionally</u> saved, the original video remains unchanged.
<b>Overwrite</b>	The newly cut video is saved and the original one is deleted.
<b>Auto Review</b>	The new video is played. The newly cut video is not saved and the original remains unchanged.

The editing function can be canceled at any time, provided no selection was made in the **Video Trimming** menu.

- ▶ Press the **PLAY** button
  - The video playback screen reappears.

**Notes**

- In all three cases, a notification screen appears while the data is being processed. Then the new video is played back.
- The numbering of existing recordings will not be changed when **New Video** is selected. The newly created video will be added to the end of the series of videos.



## OTHER FUNCTIONS

The settings described in this chapter apply for picture and video mode alike. They are therefore available in the picture and video menu (see chapter "Camera Operation" under "Menu Control"). A setting selected in one of the modes will also apply to the other.

## USER PROFILES

This camera allows the permanent storage of any menu settings, to e.g. access them quickly and easily for recurring conditions/image objects. Six memory slots are provided to store custom settings, plus the factory setting, which is always available and cannot be modified (**Default Profile**). You can assign names for the saved profiles yourself.

Any profiles configured for the camera can be saved to a memory card for use on another camera. Similarly, profiles saved on a memory card can be transferred to the camera.

## SAVING CURRENT SETTINGS AS A USER PROFILE

### CREATING PROFILES

Saving settings/Creating a profile

- ▶ Create custom settings for the desired functions via menu control
- ▶ Select **User Profile** in the main menu
- ▶ Select **Manage Profiles**
- ▶ Select **Save as Profile**
- ▶ Select a memory slot
- ▶ Confirm the selection

### Notes

- Existing profiles are overwritten with the latest settings.
- A memory slot can only be deleted via the function **Reset Camera** described in the section "Resetting the camera to factory settings" (see p. 190).

### RENAMING PROFILES

- ▶ Select **User Profile** in the main menu
- ▶ Select **Manage Profiles**
- ▶ Select **Rename Profiles**
- ▶ Select a profile
- ▶ Enter a name for the profile via the associated submenu keyboard and confirm your input (see p. 60)
  - Profile names must be between 3 and 10 characters in length.

## APPLY/ACTIVATE PROFILES

Factory setting: `Default Profile`

- ▶ Select `User Profile` in the main menu
  - A list of profile names is displayed.
  - Free memory slots appear in gray.
  - Only assigned memory slots can be selected.
- ▶ Select a profile
  - The selected profile is marked as `Active`.

## EXPORTING/IMPORTING PROFILES TO/FROM THE MEMORY CARD

- ▶ Select `User Profile` in the main menu
- ▶ Select `Manage Profiles`
- ▶ Select `Export Profiles` or `Import Profiles`
- ▶ Confirm the selection

### Notes

- When importing and exporting, all profile slots are transferred to the card, i.e. including any empty slots. Any existing profiles stored in the camera will be overwritten, during the profile import. Individual profiles cannot be imported or exported.
- Any existing set of profiles will be replaced on the memory card during an export without an acknowledgment prompt.

## DATA MANAGEMENT

### DATA STRUCTURE ON THE MEMORY CARD

#### FOLDER STRUCTURE

The files (= pictures) on the memory cards are saved in automatically generated folders. The first three characters signify the folder number (numerals), the last five the folder name (letters). The first folder is assigned the name "100LEICA", the second "101LEICA". A folder will always be created with the next available number; you can have max. 999 folders.

#### FILE STRUCTURE

The file names in these folders consist of eleven characters. In the factory settings, the first file is named "L1000001.XXX", the second "L1000002.XXX", etc. The first letter can be selected, the "L" from the factory settings denotes the camera brand. The first three characters signify the folder number (numerals). The next four digits denote the sequential file number. Once file number 9999 is reached, then a new folder will be automatically created, in which the file numbering begins at 0001 again. The last three places after the dot denote the file format (DNG or JPG).

#### Notes

- When using memory cards that were not formatted with this camera, the file numbering will begin with 0001 again. Should the memory card already contain a file with a higher number, then numbering will be continued from that number.
- A relevant message will be displayed on the LCD panel once folder number 999 and file number 9999 are reached, and all numbering must be reset.
- Format the memory card and reset the picture number right after to reset the folder number to 100.

## EDIT FILE NAMES

- ▶ Select **Camera Settings** in the main menu
- ▶ Select **Edit File Names**
  - A keyboard submenu is displayed.
  - The input line contains the factory setting "L" as the first letter of the file name. Only this letter can be changed.
- ▶ Enter a letter of your choice (see p. 60)
- ▶ Confirm

### Notes

- The change to a file name applies to all subsequent pictures or until a new change is made. The sequential number will not be affected; but it will be reset when a new folder is created.
- During a reset to factory settings, the first letter will always be reset to "L".

## CREATING A NEW FOLDER

- ▶ Select **Camera Settings** in the main menu
- ▶ Select **Reset Image Numbering**
  - A relevant prompt is displayed.
- ▶ Confirm the creation of a new folder (**Yes**) or cancel the new folder (**No**).

### Note

- The name part (first letter) of a new folder created this way remains unchanged. The file numbers in that folder will start again at 0001.

## ADDING COPYRIGHT INFORMATION

This camera allows you to enter letters and other characters as a copyright mark for your picture files. You can enter up to 20 characters of information under 2 headings per picture.

- ▶ Select **Camera Information** in the main menu
- ▶ Select **Copyright Information** in the submenu
- ▶ Activate the **Copyright** function (**On**)
- ▶ Select **Information/Artist** in the submenu
  - A keyboard submenu is displayed.
- ▶ Enter the desired information (see p. 60)
- ▶ Confirm

## RECORDING THE IMAGE LOCATION WITH GPS (ONLY IN CONNECTION WITH THE LEICA FOTOS APP)

The GPS (global positioning system) allows the pinpointing of a receiver anywhere in the world. The GPS function is activated automatically when a connection to the Leica FOTOS app is active and if the GPS function is active on the mobile device. The camera will then continuously receive the current GPS data (latitude and longitude, elevation above sea level) and writes this information into the Exif data of the images.

- ▶ Activate the GPS function on the mobile device
- ▶ Activate Leica FOTOS and connect to the camera
  - This function is available only as long as the camera is on line with the Leica FOTOS app.

## FORMATTING A MEMORY CARD

Memory cards that have already been in use with this camera will usually not require formatting. An unformatted memory card that is inserted into the camera for the first time must be formatted. We recommend formatting memory cards from time to time, because residual data traces (data pertaining to individual pictures) may reduce the card's memory capacity. The two memory cards will be formatted separately.

- ▶ Select **Format Card** in the main menu
- ▶ Select **Format SD Card 1** or **Format SD Card 2**
- ▶ Confirm the selection
  - The lower status LED will flash during that process.



## Notes

- Never switch off the camera while data transfer is in progress.
- All data stored on a memory card will be lost during formatting. Formatting will not be prevented by the deletion protection set for individual pictures.
- All images should therefore be regularly transferred to a safe mass storage medium, e.g. the hard disk of a computer.
- A simple formatting process will initially not irretrievably destroy existing data on the card. Only the directory will be deleted, which means the data will no longer be directly accessible. Data access can be restored with appropriate software. Only data that is overwritten when new data is saved will actually be irretrievable.
- A memory card should be formatted again in the camera if it was formatted in another device, e.g. a computer.
- Contact your retailer or Leica Customer Care if the memory card cannot be formatted/overwritten (see p. 220).

## DATA TRANSFER

Data can be conveniently transferred to mobile devices via Leica FOTOS (see p. 194). Alternatively, a card reader or USB cable can be used for the transfer.

### ABOUT LEICA FOTOS

- ▶ See chapter "Leica FOTOS" (p. 194)

### VIA USB CABLE

The camera supports multiple data transfer options (PTP and mass storage mode). A transfer mode can be permanently selected or chosen every time a connection is established.

Factory setting: **PTP**

- ▶ Select **Camera Settings** in the main menu
- ▶ Select **USB-Mode**
- ▶ Select the desired setting  
(**Mass Storage**, **PTP**, **Select on connection**)

### Notes

- We recommend using a card reader for the transfer of large files (e.g. video recordings).
- The USB connection must not be interrupted while data is being transferred, as the computer or the camera could otherwise "crash" and irreparable damage could occur on the memory card.
- The camera must not be turned off or automatically shut itself down due to a lack of battery power while data is being transferred, as this can cause the computer to crash. For the same reason, the battery must never be removed from the camera while the connection is active.

## USING RAW DATA (DNG)

You will need specific software for editing data in DNG format, e.g. the professional raw data converter Adobe® Photoshop® Lightroom®.

It allows high-quality conversions of stored raw data. It furthermore provides quality-optimized algorithms for digital color processing, delivering exceptionally low-noise photographs with incredible resolution. During editing, you can adjust parameters like gradation, sharpness etc. in retrospect to achieve the best possible image quality.

You will receive a temporary membership for the Adobe Creative Cloud Foto subscription with the purchase of this camera. You will have to register the camera online to take advantage of this membership:

[club.leica-camera.com](http://club.leica-camera.com)

## RESETTING THE CAMERA TO FACTORY SETTINGS

This function allows you to reset all your custom menu settings back to the factory settings. You can optionally exclude the user profiles, WiFi and Bluetooth settings, as well as the image numbering from the reset individually.

- ▶ Select **Reset Camera** in the main menu
  - The prompt **Reset Camera Settings?** appears.
- ▶ Confirm or reject the reset to factory settings **(Yes)** / **(No)**
  - Selecting **No** will cancel the reset and the display will return to the main menu. Selecting **Yes** will trigger additional prompts regarding the settings you can opt to keep.
- ▶ Confirm or reject the reset of the user profiles **(Yes)** / **(No)**
- ▶ Confirm or reject the reset of the WiFi and Bluetooth settings **(Yes)** / **(No)**
- ▶ Confirm or reject the reset of the image numbering **(Yes)** / **(No)**
  - The message **Please Restart the Camera** appears.
- ▶ Switch the camera off and on again

### Notes

- Data & time, as well as the preferred language will have to be set up again after the restart. Relevant prompts will appear on screen.
- You reset the image file numbering separately via the menu item **Reset Image Numbering** (see p. 187)

## FIRMWARE UPDATES

Leica is continuously working on the further improvement and optimization of your camera. Since many camera functions are entirely controlled by software, some of these improvements and additions to the functional scope can be installed in retrospect. Leica offers firmware updates at irregular intervals, which you can download from our website.

Leica will notify you of any new updates, once you have registered your camera.

### Find out which firmware version is currently installed

- ▶ Select **Camera Information** in the main menu
  - The current firmware versions are displayed.

More information about registering, firmware updates and how to download them to your camera, as well as any amendments and additions to this manual can be found in the customer area of our website at:

[club.leica-camera.com](http://club.leica-camera.com)

## UPDATING THE CAMERA FIRMWARE

- ▶ Download the latest firmware version
- ▶ Save the download to the memory card
- ▶ Insert the memory card into the camera
- ▶ Switching the camera on
- ▶ Select **Camera Information** in the main menu
- ▶ Select **Camera Firmware Version**
- ▶ Select **Start Update**
  - A prompt with information about the camera is displayed.
- ▶ Check the version information
- ▶ Select **Yes**
  - The prompt **Save profiles on SD Card?** appears.
- ▶ Select the desired setting
  - The update will start automatically.
  - The lower status LED will flash during this process.
  - Once the process has completed successfully, a relevant on-screen message and prompt to restart the device will appear on screen.
- ▶ Switch the camera off and on again

### Notes

- The camera must not be switched off before the update is completed.
- Data & time, as well as the preferred language will have to be set up again after the restart. Relevant prompts will appear on screen.
- The message **Low battery status** will appear if the battery is not sufficiently charged. Recharge the battery and then repeat the process described above.

## UPDATING THE LENS FIRMWARE

Where available, you can optionally carry out firmware updates for lenses. The instructions provided for camera firmware updates apply.

- ▶ Download the latest firmware version
- ▶ Save the download to the memory card
- ▶ Insert the memory card into the camera
- ▶ Switching the camera on
- ▶ Select **Camera Information** in the main menu
- ▶ Select **Lens Firmware Version**
- ▶ Select **Start Update**
- ▶ Select **Yes**

## UPDATING THE ADAPTER FIRMWARE

Where available, you can optionally carry out firmware updates for adapters. The instructions provided for camera firmware updates apply.

- ▶ Download the latest firmware version
- ▶ Save the download to the memory card
- ▶ Insert the memory card into the camera
- ▶ Switching the camera on
- ▶ Select **Camera Information** in the main menu
- ▶ Select **Adaptor Firmware Version**
- ▶ Select **Start Update**
- ▶ Select **Yes**

### Note

- The relevant menu item will only be visible if an adapter is mounted and active.



## LEICA FOTOS

The camera can be controlled remotely using a smartphone/tablet PC. This will require an installation of the Leica FOTOS app on the mobile device.

- ▶ Scan the following QR code with the mobile device



or

- ▶ The app is available from Apple App Store™/Google Play Store™

## CONNECTION

### FIRST-TIME CONNECTION TO A MOBILE DEVICE

The connection is established via Bluetooth. A pairing of the camera and the mobile device is required for a first-time connection to a mobile device.

### CONNECTION WIZARD

The connection wizard appears at initial startup of the camera or after a camera reset. These settings are also available via the menu item **Leica FOTOS**.



## USING THE MENU TO

### ON THE MOBILE DEVICE

- ▶ Activate Bluetooth
- ▶ Launch the Leica FOTOS app
- ▶ Select the camera model

### IN THE CAMERA

- ▶ Select **Leica FOTOS** in the main menu
- ▶ Select **Bluetooth**
  - Bluetooth is activated.
- ▶ Follow the Leica FOTOS instructions
  - The relevant icons appear on the LCD panel and the status LED lights in blue once a connection is established successfully.

### Notes

- The pairing process may take a few minutes to complete.
- Each mobile device only needs to be paired with the camera once. The process adds the device to the list of known devices.
- GPS data will be automatically determined and written to the Exif data when pictures are taken while the camera is connected to the Leica FOTOS app.

## CONNECTING TO KNOWN DEVICES

- ▶ Select **Leica FOTOS** in the main menu
- ▶ Select **Bluetooth**
- ▶ Select **On**
  - Activate the Bluetooth function.
  - The camera connects to the mobile device automatically.

### Notes

- Should there be more than one known device in the vicinity of the camera, then it will automatically connect to the first device responding. A favorite mobile device cannot be specified.
- We recommend removing rarely used devices from the list of known devices to prevent unwanted connections.
- Disconnect and reconnect (i.e. deactivating and reactivating Bluetooth in the camera) if the wrong device was connected.

## REMOVING DEVICES FROM THE LIST OF KNOWN DEVICES

- ▶ Select **Leica FOTOS** in the main menu
- ▶ Select **Delete**
- ▶ Select the relevant device
  - A security prompt appears on the LCD panel.
- ▶ Select **Yes**

### Note

- The pairing process will have to be repeated to reconnect a deleted device to the camera.

## FIND THE MAC ADDRESS

You can find the MAC address of the Leica SL2 in the camera menu.

- ▶ Select **Camera Information** in the main menu

## REMOTE CAMERA CONTROL

You can take pictures and record video remotely via the mobile device, and can also change image settings or transfer data to the mobile device. A list of available functions and instructions for their use can be found in the Leica FOTOS app.

## REMOTE CAMERA ACTIVATION

The camera can be activated remotely from off or standby if this function is activated in the camera. The Bluetooth function must be active.

- ▶ Select **Leica FOTOS** in the main menu
- ▶ Select **Remote Wakeup**
- ▶ Select **On**
  - The camera will scan for known devices and automatically establishes a connection.



**Important information**

- Remote activation will activate the camera even if it was switched off via the main switch.
- Accidental remote camera activation may result in unwanted pictures taken and excessive power consumption.
- A third-party device can – provided it has been paired with the camera – access the camera remotely if your own mobile device is not currently connected or its Bluetooth function is deactivated. This poses a danger of unauthorized access to your data or camera functions.

**Solution**

- Only activate this function just before you want to use it.
- Disable the function as soon as it is no longer needed.

## CARE/STORAGE

We recommend the following if the camera will not be used for an extended period of time:

- Switching the camera off
- Remove the memory card
- Remove the battery (after approx. 2 months the set date and time will be lost)

## CAMERA HOUSING

- Keep your equipment meticulously clean, as any kind of dirt residue presents a breeding ground for micro organisms.
- Only clean the camera with a soft, dry cloth. Stubborn dirt should first be moistened with a watered-down detergent and can then be wiped away with a dry cloth.
- Wet a soft cloth with tap water, wring it out thoroughly and use it to wipe down the camera. Then wipe it down thoroughly with a dry cloth.
- Wipe the camera with a clean, lint-free cloth to remove stains and fingerprints. Tougher dirt in hard to reach corners of the camera housing can be removed with a small brush. Take care not to touch the shutter blades.
- Store the camera in a closed and padded container to prevent friction damage and protect it against dust accumulation.
- Keep the camera in a dry, sufficiently ventilated place, where it will not be subjected to high temperatures and humidity. Make sure to remove all moisture from the camera if it was used in humid conditions.
- Do not store the camera in a leather case for extended periods of time to prevent fungal contamination.

- Empty your camera bag completely if it ever gets wet during use. Your equipment might otherwise be subjected to moisture and tanning residue released by the moist leather.
- All mechanical bearings and sliding surfaces on your camera are lubricated. Remember to press the shutter button several times every three months to prevent the lubrication points hardening if the camera will not be used for an extended period of time. We also recommend repeated adjustment and use of all the other operating elements.
- When using your camera in tropical climates, make sure to expose the equipment to sunlight and fresh air as much as possible to prevent fungal growth. Storage in airtight containers or cases is recommended only in conjunction with a desiccant like silica gel.

## LENS

- A soft-bristle brush will usually suffice to remove dust from the outer lenses. Remove more severe soiling with a clean, soft cloth that is completely free of foreign matter. Wipe the lens in a circular motion from the center outward. We recommend using microfiber cloths that come in a protective container and are available from photography shops and other optical retailers. These cloths are machine-washable at 40°C. Do not use fabric softener and do not iron them. Never use spectacle lens cleaning cloths, as these are soaked in chemicals, which could damage the glass of the camera lenses.
- Attach a transparent UVA filter for optimal front lens protection in unfavorable conditions (e.g. sand, salt water spray). Please remember that the filter may create unwanted light reflections in some backlight situations and in case of high contrasts.
- The lens caps supplied protect the lens against accidental fingerprint smudges and rain.

- All mechanical bearings and sliding surfaces on your lens are lubricated. Make sure to periodically move the focus ring and the aperture setting ring to prevent seizing if the lens will not be used for an extended period of time.

## **VIEWFINDER/LCD PANEL**

- Switch off your camera and leave it to stand at room temperature for around 1 hour if condensation has formed on or in the camera. The condensation will disappear, once the camera temperature has reached room temperature.

## **RECHARGEABLE BATTERY**

- Lithium-ion rechargeable batteries should only be stored partially charged, i.e. not fully depleted or fully charged. The camera LCD panel will show the current charge level of the battery. Charge the battery twice a year for around 15 minutes to avoid deep discharge in case of very long storage periods.

## **MEMORY CARDS**

- Make sure to store memory cards in their anti-static container when not in use.
- Do not store memory cards where they will be exposed to high temperatures, direct sunlight, magnetic fields or static electricity. Always remove the memory card if the camera will not be used for an extended period of time.
- We recommend formatting the memory card from time to time, because fragmented residual data from deleted files may block some of its storage capacity.

## FAQ

Problem	possible cause to be verified	Troubleshooting suggestions
<b>Battery issues</b>		
Battery is depleted too quickly	Battery too cold	Warm the battery (e.g. in pants pocket) and only insert directly before use
	Battery too hot	Allow battery to cool down
	LCD panel or EVF set too bright	Reduce brightness
	Power save mode deactivated	Activate power save mode
	AF mode permanently activated	Select other mode
	Permanent WLAN connection	Deactivate WLAN when not in use
	Continuous use of LCD panel (e.g. in Live View mode)	Deactivate the function
	Battery has been recharged too many times	The battery has reached the end of its operating time, replace battery
	Third-party lens with high power consumption connected	Change battery, use handgrip, use external power supply via USB
Charging process not starting	Tracking-AF with AFc activated	Use AFs or MF
	Preview of the recorded images (Auto Review) activated	Deactivate Auto Review
Charging takes too long	Incorrect battery polarization or faulty charger connection	Check polarization and connection
Charging pilot light is on, but battery isn't charging	Battery too hot or too cold	Charge the battery at room temperature
	The battery contacts are dirty	Clean the contacts with a soft, dry cloth
Battery not charging via USB	Battery has been recharged too many times	The battery has reached the end of its operating time Replace battery
	The battery can only be charged via USB when the camera is off	Switching the camera off
<b>Camera problems</b>		
The camera suddenly switches itself off	Battery is depleted	Charge or replace the battery
The camera won't switch on	Battery is depleted	Charge or replace the battery
	Battery too cold	Warm the battery (e.g. in pants pocket)
The camera doesn't respond	The camera is connected to the Leica FOTOS app	Terminate the connection
Camera is heating up	Heat development due to high-res video recording (4K) or serial exposures with DNG	Not a fault; allow camera to cool down if it gets too hot

Camera does not recognize the memory card	The memory card is not compatible or defective	Check the compatibility of the memory card (See "Technical Data")
	Memory card is incorrectly formatted	Format the memory card (Caution: Loss of data!)
<b>Menus and displays</b>		
Viewfinder is dark	EVF brightness is set too low	Set the EVF brightness
Display language is not English	-	Select <b>English</b> in the <b>Language</b> menu
The LCD panel is too dark or too bright/not clear	The brightness setting is incorrect	Adjust the display brightness
<b>Favorites</b> menu does not appear	The favorites menu is empty	Add at least one function
Live View stops suddenly or doesn't start	The camera is hot due to high ambient temperature, extended Live View operation, extended video recording or serial exposures	Allow camera to cool down
The brightness in Live View mode is not the same as in the pictures	The brightness settings for the LCD panel have no influence over the exposures	Adjust the brightness settings as needed
The number of remaining exposures does not count down after a picture is taken	The exposure requires only very little memory space	This is not a fault; the number of remaining exposures is calculated as approximations
<b>Recording</b>		
The camera won't take a picture/shutter button is deactivated	Memory card is full	Replace the memory card
	The memory card is not formatted	Reformat the memory card (Caution: Loss of data!)
	The memory card is write protected	Deactivate the write protection on the memory card (small lever on the side of the memory card)
	Dirt on the memory card contacts	Clean the contacts with a soft cotton or linen cloth
	The memory card is damaged	Replace the memory card
	The sensor is overheating	Allow camera to cool down
	The camera has switched off automatically (automatic shutdown)	Switch the camera on again deactivate auto shutdown as needed
	Picture data is being written to the memory card and the cache is full	Wait
	Noise reduction function is working (e.g. after night photography with long exposure times)	Wait or deactivate noise reduction
	Battery is depleted	Charge or replace the battery
	Camera is processing a picture	Wait
No picture is taken	The camera is connected to the Leica FOTOS app	End connection and reconnect

Image noise appears on the LCD panel/in the viewfinder when the shutter button is pressed to the first pressure point	The gain is increased to aid image composition if the object is insufficiently lit with reduced aperture opening	Not a fault – picture quality will not be impacted
LCD panel/viewfinder deactivates after a very short time	Power Save settings are activated	Change the settings as needed
The display switches off after the picture is taken/ the LCD panel goes dark after the picture is taken	Flash loads after picture is taken, LCD panel deactivates during load time	Wait until the flash is loaded
Camera does not focus	Desired object part is too close to the camera	Select Macro mode
	Desired object part is very far away	Exit Macro mode
	Object not suitable for AF	Use Focus lock or select manual focus
Flash won't fire	The flash cannot be used with the current settings	Refer to the list of flash function-compatible settings
	Flash is deactivated	Select other flash mode
	Battery is depleted	Charge or replace the battery
	Pressing the shutter button while flash is still loading	Wait until the flash is loaded
	Electronic shutter function is selected	Change the setting
	Automatic bracketing or Picture series is activated	Select other mode
The flash does not fully illuminate the object	Object is outside the flash range	Move object into flash range
	Flash is covered	Make sure the th flash unit is not covered by your finger or some object
Image does not sharpen automatically	AF is deactivated	Activate AF
No face detection/faces are not recognized	Face is covered (sunglasses, hat, long hair, etc.)	Remove distracting objects
	Face takes up to little space in the picture composition	Change image composition
	Face is tilted or horizontal	Keep face straight
	Camera not held straight	Hold camera straight
	Face is insufficiently lit	Use flash, improve illumination
Camera selects incorrect object	The incorrectly selected object is closer to the image center than the main object	Change the image section or take picture using the focus lock
	The incorrectly selected object is a face	Deactivate face detection
No continuous recording available	The camera is overheated and the function was temporarily disabled to protect the camera	Allow camera to cool down
The image on the LCD panel displays lots of noise	Light enhancement function of the LCD panel in dark surroundings	Not a fault – picture quality will not be impacted
Image storage takes a long time	Noise Suppression is activated for long-term exposures	Deactivate the function

Manual white balance is unavailable	The image object is too bright or too dark	
Viewfinder is out of focus		Check the diopter setting and adjust as needed
Viewfinder is dark	Switchover between EVF and LCD incorrectly set	Select the setting <b>Auto</b> , <b>EVF Extended</b> or <b>EVF</b> under <b>EVF-LCD</b>
AF metering field is framed in red with activated AF; images out of focus	Focusing was unsuccessful	Try to focus again
No AF metering field selectable	Automatic Metering Field Control or Face Detection in AF Mode is selected	Select other control mode
	Image Review is activated	Deactivate Image Review
	Camera is in Standby mode	Press the shutter button to the first pressure point
AF assist light does not light up	Camera is in video recording mode	Change the mode
	Function is deactivated	Activate AF
<b>MF Setup</b> is grayed out	The mounted lens does not support this setting	Use another lens
Focus mode <b>MF</b> is unavailable	A lens with AF/MF switch is mounted	An AF selection in the menu will not be available if the lens switch is set to MF
<b>Focus Limit (Macro)</b> is grayed out in the camera settings	The mounted lens does not support this setting	Use another lens
<b>Lens Profiles</b> is grayed out in the camera settings	No M-adapter L or R-adapter L attached	This menu is available only for Leica M and Leica R lenses
<b>Video recording</b>		
No video is recorded	The camera is overheated and the function was temporarily disabled to protect the camera	Allow camera to cool down
Video recording stops	Maximum length of individual video sequence was reached	
	The memory card's write speed is too low for the selected video resolution/compression	Insert another memory card or change the storage method
<b>L-Log</b> is not selectable in video mode	A 10 bit format was not selected as the video format	Switch to 10 bit format for the video format
In video mode, I see <b>ASA</b> instead of <b>ISO</b> , angle instead shutter speed and T-exposure values instead of F-values	<b>Cine</b> was selected as recording mode	Switch from <b>Cine</b> to <b>Video</b> mode
There are visible exposure jumps during zooming	The camera is set to <b>Auto ISO</b>	Switch to <b>Floating ISO</b>

<b>Review/playback and video/image management</b>		
Pictures taken in portrait format are displayed in landscape format	-	Adjust the display options
Selected images cannot be deleted	Some of the selected images are write protected	Remove write protection (using the device with which the file was originally set to write protected)
File numbering does not start at 1	The memory card contains previously stored images	
The time and date settings are incorrect or are not displayed	The camera has not been in use for an extended period of time (the battery was removed)	Insert a charged battery and configure the correct settings
The time and date stamp on images are incorrect	Time settings are incorrect	Set the time correctly Caution: Time settings will be lost if the camera is not used/remains in storage with a depleted battery over an extended period of time
The time and date stamp on images are unwanted	Setting was ignored	Cannot be removed in retrospect Deactivate the function as needed
Pictures/recordings are damaged or missing	The memory card was removed while the readiness indicator was flashing	Never remove the memory card while the readiness indicator is flashing. Charge the battery.
	The memory card formatting is faulty or the card is damaged	Reformat the memory card (Caution: Loss of data!)
Parts of my video scenes are not fully in the picture	Difference of aspect ratios between camera and playback medium	Set the correct aspect ratio on the camera
Review/playback unavailable	The camera is connected to the Leica FOTOS app	Terminate the connection
<b>Picture quality</b>		
The picture is too bright	Light sensor was covered while picture was taken	Make sure that the light sensor is not obstructed
Image noise	Long exposure times (>1 s)	Activate the noise suppression function for long exposure times
	ISO sensitivity set too high	Decrease ISO sensitivity
Unnatural colors	White balance not or incorrectly set	Adjust white balance to light source or adjust manually
Round white stains, similar to soap bubbles	Flash photography in very dark environment: Reflection of dust particles	Deactivate the flash
Images are out of focus	Lens is dirty	Clean the lens
	Lens is obstructed	Make sure that lens is unobstructed
	Camera moved during exposure	Use flash or mount camera on a tripod
	Macro Function	Select the appropriate mode



Images are overexposed	Flash is activated in bright surroundings	Change the flash mode
	Strong light source in the image	Avoid strong light sources in picture composition
	(Half) backlight falling into the lens (also from light sources outside the image range)	Use the lens hood or change to another subject
Out of focus/picture stabilizer not functioning	Exposure at a dark location without flash	Use a tripod
The image is grainy or there is image noise	ISO sensitivity set too high	Decrease ISO sensitivity
Horizontal stripes	Picture was taken with electronic shutter under a light source like a fluorescent lamp	Try shorter shutter speeds
Unnatural colors and brightness	Picture taken in artificial light or extreme brightness	Set white balance or select correct lighting presets
No images are displayed	Memory card is empty or not inserted	
Images cannot be displayed	File name of the image was changed on a PC	Use appropriate software for image transfers from a PC to the camera; available from the Leica AG website
<b>Video quality</b>		
Video recordings show flickering/stripes	Light source interference in artificial lighting	Select a different frame rate (suitable for the local AC grid frequency) under <b>Video Resolution</b>
Camera noise in video recording	The setting dials were used	Avoid using the setting dials during video recordings
No sound on video recording	Playback volume is set too low	Increase playback volume
	Microphone was covered during recording	Make sure the microphone is not obstructed while recording video
	Speakers are covered	Make sure that speakers are unobstructed during playback
	Microphone was deactivated while recording	Activate the microphone
Flickering or horizontal stripes in the video recording	CMOS sensors will display this phenomenon when light sources like LED lamps or fluorescent tubes are used	Quality may be improved by selecting a manual shutter speed (e.g. 1/100 s)

<b>Smartphones/WLAN</b>		
WLAN connection gets interrupted	Camera deactivates when it overheats (safety feature)	Allow camera to cool down
Cannot pair with a mobile device	The camera was already paired with the mobile device	Delete the camera registration from the Bluetooth settings in the mobile device and repeat pairing process
Mobile device connection/image transfer not working	The mobile device is too far away	Bring the devices closer to each other
	Interference from other devices in the vicinity, e.g. other smartphones or a microwave oven	Increase distance to interfering devices
	Interference from multiple mobile devices in the vicinity	Re-establish the connection/remove other mobile devices
	Mobile device is currently connected to another device	Check connection
Camera does not appear on the WLAN configuration screen of the mobile device	Mobile device does not recognize camera	Switch the WLAN function of the mobile device off and on again



# MENU OVERVIEW

## DIRECT ACCESS

Function	PHOTO			VIDEO/CINE			Page
	Favorites	FN buttons		Favorites	FN buttons		
Photo – Video		●	● (top left)		●	● (top left)	143
Toggle Info Profiles		●	● (rear left)		●	● (rear left)	80, 169
Magnification		●	● (front top)		●		110, 112, 150
Drive Mode	★	●					102
Interval Shooting	★	●					132
Exposure Bracketing	★	●					134
Focusing	★	●		★	●		103–108, 145–149
Focus Mode	★	●		★	●		103, 111, 145
AF Mode	★	●	● (front bottom)	★	●	● (front bottom)	104–106, 146–148
Focus Assist	★	●		★	●		112, 152
Exposure Metering	★	●		★	●		122, 160
Exposure Compensation	★	●		★	●		130, 164
ISO (PHOTO & Video)* Exposure Index (Cine)*	★	●	● (top right)	★	●	● (top right)	115–117, 153–155, 156
Auto ISO Settings	★	●		★	● (only in video mode)		116, 154

Function	PHOTO			VIDEO/CINE			Page
	Favorites	FN buttons		Favorites	FN buttons		
White Balance	★	●		★	●		118-120, 156-158
Graycard	★	●		★	●		119-120, 157-158
Photo File Format	★	●					87
JPG Resolution	★	●					88
Film Style	★	●					89-90
Image Stabilization	★	●		★	●		92, 100
Shutter Type	★	●					91
Flash Settings	★	●					138-140
Flash Exp. Compensation	★	●					139-140
User Profile	★	●		★	●		184-185
Video Format / Resolution				★	●		95-96
Video Style				★	●		97
EVF-LCD	★	●	● (rear top)	★	●	● (rear top)	73, 167
Format Card	★	●		★	●		188-189
Dial Lock	★	●		★	●		69
Joystick Lock	★	●		★	●		69
Lens Profiles	★	●		★	●		36
Audio Levels					●	● (front top)	97

★ = Available for the favorites menu

● = Available for FN buttons

● = Factory settings of the FN buttons

## INDEX

## Symbole

4K .....	96
5K .....	96

## A

A (Aperture priority) .....	125, 163
Accessory .....	3
Acoustic signals .....	75
Adapter .....	38, 192
AE-L .....	128
AF assist light .....	93
AFc .....	103, 145
AF Confirmation .....	76, 93
AF-L .....	128
AF mode .....	103, 145
AF Mode .....	104, 146
AFs .....	103, 145
Akademie, Leica .....	220
Aperture .....	123, 161
Aperture priority .....	125, 163
App .....	194
ASA .....	155
Aspect ratio .....	92, 96, 101
Assist function .....	80, 100
Assist functions, AF .....	93, 110, 150
Assist functions, MF .....	112, 152
Autofocus .....	103, 107, 145
Auto ISO .....	116, 154
Automatic program .....	124, 162
Automatic review .....	176, 177

Auto Review .....	176
Auxiliary displays .....	80, 101, 169

## B

Basic recording settings .....	78, 86, 94
Basic settings, camera .....	70
Basic settings, recording .....	78, 86, 94
Bluetooth .....	5, 194
Brightness, EVF .....	74
Brightness, LCD panel .....	74
Button assignment .....	65

## C

C4K .....	96
Camera information .....	191
Care .....	198
Carry strap .....	8, 30
Center-weighted metering .....	122, 160
Charger .....	8, 30
Charge status, charger .....	31
Charge status, LCD panel .....	29
Charging the battery .....	31
Cine .....	142
Clipping .....	83
Color profile .....	89, 97
Color rendering, EVF .....	74
Color rendering, LCD panel .....	74
Color saturation, image properties .....	89, 97
Color settings, EVF .....	74
Color settings, LCD panel .....	74
Color temperature .....	120, 158
Connection, mobile devices .....	194
Contact, Leica .....	220

- Contrast, image properties..... 89, 97
- Copyright..... 187
- Customer service..... 220
- D**
- Data management..... 186
- Data structure..... 186
- Data transfer..... 189
- Date ..... 62, 71
- Deletion, recordings..... 173
- Deletion, user profiles ..... 184
- Diopter adjustment ..... 40
- Direct access..... 65, 208
- Displays..... 24, 26, 28, 80, 169
- Display, settings..... 72
- Display, standby..... 75
- Disposal..... 4
- Distance display..... 114, 153
- Distance unit ..... 71
- DNG ..... 87, 190
- Drive Mode ..... 102, 131, 132
- E**
- Editing, video ..... 181
- Electronic shutter..... 75, 91
- Electronic shutter sound ..... 75
- EVF..... 72, 75
- EV Increment ..... 79
- Exposure..... 121, 159
- Exposure, automatic..... 124, 162
- Exposure bracketing..... 133
- Exposure compensation ..... 130, 164
- Exposure compensation, flash ..... 139
- Exposure, long-term ..... 91, 126
- Exposure, manual..... 126, 163
- Exposure metering, flash ..... 136
- Exposure, metering methods ..... 122, 160
- Exposure, modes ..... 123, 161
- Exposure preview ..... 127
- Exposure simulation ..... 127
- Exposure time, max..... 126
- Eye sensor ..... 73
- F**
- Face detection ..... 106, 148
- Factory settings ..... 190
- FAQ ..... 200
- Favorites, menu ..... 57, 64, 208
- Favorites, pictures..... 173
- FHD ..... 96
- Field metering..... 104, 146
- File format ..... 87, 95
- File name..... 187
- File structure ..... 186
- Film Style..... 89
- Firing point, flash ..... 137
- Firmware ..... 12, 191
- Fixed ISO value ..... 116, 154
- Flash..... 135
- Flash, control..... 137
- Flash, exposure compensation ..... 139
- Flash, exposure metering ..... 136
- Flash, firing point ..... 137
- Flash, range ..... 138
- Flash, setting ..... 137
- Flash, synchronization..... 137

Flash units, compatible .....	135	Image numbering .....	186
Floating ISO .....	117, 155	Image properties .....	89, 97
FN button .....	50, 65, 208	Image stabilization .....	92, 100
Focus assist .....	112, 152	Individual button assignment .....	65
Focusing .....	103, 144	Info Bars .....	82
Focusing, automatic .....	103, 145	Info profiles .....	80
Focusing, manual .....	111, 151	Information displays .....	80
Focusing, metering methods .....	104, 146	Information, regulatory .....	4
Focus Limit .....	79	Inserting/removing the battery .....	32
Focus mode .....	103, 144	Intelligent AF .....	103, 145
Focus peaking .....	82, 112, 152	Interval shooting .....	132
Folders .....	186	ISO Sensitivity .....	115, 153
Folder structure .....	186	ISO value, greatest .....	116, 154
Format .....	87, 95		
Formatting, memory card .....	188	<b>J</b>	
Frame rate .....	96	Joystick .....	49, 68
Front setting wheel .....	48, 66	JPG .....	87, 88
Full HD .....	96	JPG settings .....	88
<b>G</b>		<b>K</b>	
General information .....	10	Keyboard .....	60
GPS .....	188	Keylock .....	69
Gray Card .....	119, 157		
Grid .....	82	<b>L</b>	
		Language .....	70
<b>H</b>		LCD panel .....	72
hand grip .....	41	LCD panel, setting .....	72
HDMI .....	100	Legal information .....	4
HDR .....	133	Leica Academy .....	220
Histogram .....	85	Leica Customer Care .....	220
Horizon .....	84	Leica FOTOS .....	5, 194
		Lens .....	7, 35, 192, 198
<b>I</b>			



Level Gauge .....	84	Navigation, menu .....	54, 58
Lock .....	69	Noiseless .....	76
Long-term exposure .....	91, 126	Noise reduction .....	88, 91, 126
<b>M</b>		Notes, legal.....	4
Magnification, picture mode .....	110, 112, 150, 152	Number pad.....	60
Magnification, Playback/Review mode .....	170	<b>O</b>	
Main menu.....	57	Operating mode, exposure .....	123, 161
Main switch .....	46	Operation, customized .....	64
Manual exposure setting .....	126, 163	<b>P</b>	
Manual focusing.....	111, 151	Part Designations.....	20
Maximum exposure time .....	126	Parts, overview .....	20
Memory card .....	8, 11, 33, 90, 188, 199	P (automatic program).....	124, 162
Menu bar .....	61	Person detection.....	106, 148
Menu control .....	52	Picture, interval.....	132
Menu language .....	70	Picture mode .....	102
Menu navigation.....	54, 58	Picture series.....	131, 132, 133
Metering method, AF.....	104, 146	Playback/Review, automatic .....	176, 177
Metering method, exposure.....	122, 160	Playback/Review mode.....	166
MF.....	111, 151	Playback, video .....	178
Microphone .....	97	PLAY button .....	49
M (Manual exposure setting) .....	126, 163	Power off, automatic .....	72, 75
Mode, switching.....	143, 168	Power save .....	72
Monochrome photography .....	89, 97	Power save mode.....	72
MOV .....	95	Pre Focus .....	108
MP4.....	95	Problems .....	200
Multi-field metering, exposure .....	122, 160	Profile, user .....	184
Multi-field metering, focusing .....	104, 146	<b>Q</b>	
<b>N</b>		Quick access .....	64, 65
Name, file .....	186, 187		
Name, folder .....	186		

<b>R</b>	
Rating, recording.....	173
Raw data.....	190
Rechargeable battery, capacity.....	29
Rechargeable battery, notes.....	7, 10, 199
Recording, delete.....	173
Recording, marking.....	173
Recording mode.....	142
Recording, rating.....	173
Regulatory information.....	4
Remote control.....	196
Repair.....	220
Replacement parts.....	3
Reset, camera.....	190
Reset Camera.....	190
Reset, image numbering.....	187
Reset Image Numbering.....	187
Resolution.....	88, 96
Restriction, focus area.....	79
<b>S</b>	
Safety remarks.....	6
Saturation, image properties.....	89, 97
Saving, energy.....	72
Scale.....	62
Scope of delivery.....	2
SD card.....	8, 11, 33, 90, 188, 199
Self-timer.....	135
Sensitivity, ASA.....	155
Sensitivity, eye sensor.....	73
Sensitivity, ISO.....	115, 153
Sensor.....	8, 11
Sensor format.....	86, 94
Serial exposures.....	131
Service.....	220
Settings, LCD panel/EVF.....	72
Settings, store.....	184
Setting wheel, front.....	48, 66
Sharpness, image properties.....	89, 97
Shift.....	124
Shortcut.....	64, 65
Shutdown, LCD panel.....	75
Shutter button.....	47
Shutter, electronic.....	75, 91
Shutter priority mode.....	125, 163
Shutter release.....	47
Shutter speed/aperture combination.....	123, 161
Signals, acoustic.....	75
Silent.....	76
Silent operation.....	76
Slideshow.....	177
Smartphone.....	194
Sound.....	75, 180
Sounds.....	75
Spot metering, exposure.....	122, 160
Spot metering, focusing.....	104, 146
S (Shutter speed priority mode).....	125, 163
Standby mode.....	72
Status screen.....	24, 26, 55
Storage.....	198
Switching, mode.....	143, 168
Switching off, camera.....	46
Switching on, camera.....	46

Sync point ..... 137

## T

Tagging, recordings ..... 173

Technical Data ..... 216

Thumbwheel ..... 48, 66

Time ..... 62, 71

Time code ..... 98

Time lapse ..... 132

Time zone ..... 71

Touch AF ..... 78

Touch control ..... 51, 78

Tracking ..... 105, 147

Transfer, data ..... 189

Troubleshooting ..... 200

TTL metering ..... 135, 136

## U

Update, firmware ..... 12, 191

USB ..... 32

User-defined operation ..... 64

User profiles ..... 184

## V

Video ..... 142, 178

Video format ..... 95

Video Gamma ..... 99

Video mode ..... 142

Video stabilization ..... 100

Video Style ..... 97

Volume ..... 75

Volume, playback ..... 180

## W

Warning signal ..... 75

Warranty ..... 13

White balance ..... 118, 156

Wi-Fi/WLAN ..... 5

Wind noise reduction ..... 98

WLAN ..... 5

## Z

Zebra ..... 83

Zone ..... 147

Zone, focusing ..... 105

## TECHNICAL DATA

### CAMERA

#### Designation

Leica SL2

#### Camera type

Mirrorless full-frame system camera

#### Type no.

2998

#### Order No.

10 854 EU/JP/US (black), 10 856 ROW (black)

#### Buffer memory

4 GB

DNG™: 78 recordings

JPG: > 100 recordings

#### Storage medium

UHS-II (recommended), UHS-I, SD/SDHC/SDXC memory card

#### Material

Full-metal housing made of aluminum and magnesium, leatherette cover, splash-water protected in compliance with IEC standard 60529 (protection type IP54).

#### Lens mount

Leica L bayonet with contact strip for communication between lens and camera

#### Operating conditions

-10 to +40°C

#### Interfaces

ISO accessory shoe with additional control contacts, HDMI jack 2.0b Type A, USB 3.1 Gen1 Type C, Audio-Out 3.5 mm/Audio-In 3.5 mm, communication interface in the base cover for multifunction hand grip

#### Tripod thread

A 1/4 DIN 4503 (1/4") with stainless steel in the base

#### Dimensions (WxHxD)

146 x 107 x 42 mm

#### Weight

approx. 835 g (without battery)

### SENSOR

#### Sensor size

CMOS sensor, pixel pitch: 4.3 µm

35 mm: 8368 x 5584 pixels (47.3 MP)

APS-C: 5504 x 3664 pixels (20.2 MP)

#### Image stabilization

5 axis Body Image Stabilization. Camera stabilizes up to 5.5 stops.

#### Filter

RGB color filter, UV/IR filter, no low-pass filter

#### Processor

Leica Maestro series (Maestro III)

#### File formats

Photo: DNG™ (raw data), DNG + JPG, JPG (DCF, Exif 2.31)

Video: MP4: H.264/MPEG-4 AVC (Audio Format: 2ch 48 kHz/16-Bit,

AAC), MOV: H.264/MPEG-4 AVC (Audio Format: 2ch

48kHz/16-Bit, AC-3)

#### Picture resolution

DNG™: 8368 x 5584 pixels (46.7 MP)

JPG: 8368 x 5584 pixels (46.7 MP), 6000 x 4000 pixels (24 MP),

4272 x 2848 pixels (12 MP)

#### Color depth

DNG™: 14 bit

JPG: 8 bit

**Color space**

Foto: sRGB

Video: Rec. 709/Rec. 2020 (HLG)/L-Log

**File size**

DNG™: 84.4 MB

JPG: depending on resolution and image content

Video: max. length: 29 min, max. file size: 96 GB

**Recording Mode Video**

Video mode: P - A - S - M

Cine mode: M

**Video Resolution**

Sensor format	Sensor area in use	Resolution
35 mm - 5K	8368 x 5584 (Full scan)	4992 x 3744
35 mm - C4K	8192 x 4320 (Pixel mix)	4096 x 2160
35 mm - 4K	7680 x 4320 (Pixel mix)	3840 x 2160
35 mm - Full HD	8368 x 4712 (Pixel mix)	2790 x 1572
APS-C - C4K	5504 x 3096 (Full scan)	5504 x 2912
APS-C - 4K	5504 x 3096 (Full scan)	5504 x 3096
APS-C - Full HD	5504 x 3096 (Pixel mix)	2752 x 1548

**Video Frame rate**

MOV 5K	29.97 fps, 25 fps, 23.98 fps
MOV C4K	59.94 fps, 50 fps, 29.97 fps, 25 fps, 23.98 fps
MOV 4K	59.94 fps, 50 fps, 29.97 fps, 25 fps, 23.98 fps
MOV FHD	180 fps, 150 fps, 120 fps, 100 fps, 59.94 fps, 50 fps, 29.97 fps, 25 fps, 23.98 fps
MP4 4K	59.94 fps, 50 fps, 29.97 fps, 25 fps, 23.98 fps
MP4 FHD	180 fps, 150 fps, 120 fps, 100 fps, 59.94 fps, 50 fps, 29.97 fps, 25 fps, 23.98 fps

**Bit Rate**

8/10 bit for recordings on SD card, 10 bit via HDMI output

**Video Gamma**

Rec. 709, L-Log Rec. 2020, HLG Rec. 2020

**VIEWFINDER/LCD PANEL****Viewfinder (EVF)**

Resolution: 5,760,000 pixels (dots), 120 fps, magnification: 0.78x, aspect ratio: 4:3, frame coverage: 100%, exit pupil position: 21 mm, setting range +2/-4 diopters, with eye sensor for automatic switchover between viewfinder and LCD panel, time delay 0.005 s

**LCD panel**

3.2" (backlight LED) with anti-fingerprint and anti-scratch coating, 2,100,000 pixels (dots), format 3:2, touch control available

**Top display**

1.28" highly reflective trans-reflective monochrome LCD, 128 x 128 pixels, viewing angle 120°; anti-fingerprint coating

**SHUTTER****Shutter type**

Electronically controlled focal plane shutter/electronic shutter

**Shutter speeds**

Mech. shutter: 30 min to 1/8000 s

Electr. shutter function: 1 s to 1/40000 s

Flash Synch: up to 1/250 s

**Shutter button**

Two-stage

(1st stage: Activation of the camera electronics including autofocus and exposure metering, 2nd stage: Taking the picture)

**Self-timer**

Delay time: 2 s or 12 s

**Drive Mode****Single**

**Continuous – Low Speed** (3 fps)

**Continuous – Medium Speed** (6 fps)

**Continuous – High Speed** (10 fps without AFc/AE/WB)

**Continuous – Very High Speed** (20 fps with electr. shutter function without AFc/AE/WB)

**Interval Shooting****Exposure Bracketing****FOCUSING****Working range**

30cm to ∞

With macro setting: from 17 cm

**Focus Mode**

Automatic (Autofocus in modes iAF/AFs/AFc/Touch AF) or manual  
With manual setting: **Auto Magnification** and **Focus Peaking** optionally available as focus aids

**Autofocus system**

Based on contrast metering and depth mapping

**Autofocus modes**

**Intelligent AF** (autonomously selects **AFs** and **AFc**), **AFs** (picture taken only after successful focusing), **AFd** (picture can be taken at any time), AF setting can be saved

**Autofocus metering methods**

**Spot** (can be shifted), **Field** (can be shifted), **Multi-Field**, **Zone**, **Face/Body Detection**, object **Tracking**, optional **Touch AF**

**Autofocus Metering Fields**

225

**EXPOSURE****Exposure metering**

TTL (exposure metering through the lens)

**Exposure Metering Methods**

**Spot**, **Center-Weighted**, **Multi-Field**

**Exposure modes**

Automatic program (P)

Aperture priority (A): manual aperture setting

Shutter priority mode (S): manual shutter speed setting

Manual (M): manual setting for shutter speed and aperture

**Exposure Compensation**

±3 EV in 1/3 EV increments or 1/2 EV increments

**Automatic bracketing**

3 or 5 exposures, up to ±3 EV, in 1/3 EV increments

Shift function: up to ±3 EV, additional JPG-HDR

**ISO sensitivity range**

**Auto ISO**: ISO 100 to ISO 50000

Manual: ISO 50 to ISO 50000

**White balance**

Automatic (**Auto**), **Daylight** 5200 K, **Cloudy** 6000 K, **Shadow** 7000 K, **Tungsten** 3200 K, **HMI** 5600 K, **Fluorescent (warm)** 4000 K, **Fluorescent (cool)** 4500 K, **Flash** 5400 K, **Graycard Live View**, **Graycard**, **Color Temperature** 2000 K to 11500 K

## FLASH

### Flash unit connector

About the accessory shoe

### Flash sync time

↔: 1/250 s, slower shutter speeds available, automatic changeover to TTL linear flash mode with HSS-compatible Leica flash units if sync time is undercut

### Flash exposure metering

Using center-weighted TTL pre-flash metering with Leica flash units (SF 26, 40, 40MkII, 58, 60, 64) or with system-compatible flash units, flash remote control SF C1

### Flash exposure compensation

SF 40:  $\pm 2$  EV in 1/2 EV increments

SF 60:  $\pm 2$  EV in 1/3 EV increments

## EQUIPMENT

### Microphone

Stereo internal + microphone input 3.5 mm stereo jack

### Speaker

Mono internal + headphones output 3.5 mm stereo jack

### WLAN

The Leica FOTOS app is required to use the WLAN function. The Leica app is available from the Apple App Store™ or the Google Play Store™. Compliant with Wi-Fi IEEE802.11b/g/n, 2.4 GHz, channel 1-11 (2412-2462 MHz) and Wi-Fi IEEE802.11ac, 2.4 GHz & 5 GHz, channel 39-48 (5180-5240 MHz), channel 52-64 (5260-5320 MHz), channel 100-140 (5500-5700 MHz) (standard WLAN protocol), encryption method: WLAN-compatible WPA™/WPA2™

### Bluetooth

Bluetooth v4.2 (Bluetooth Low Energy (BLE)), 2402 to 2480 MHz

## GPS

Via Leica FOTOS app

### Menu languages

English, German, French, Italian, Spanish, Russian, Japanese, Simplified Chinese, Traditional Chinese, Korean

## POWER SUPPLY

### Rechargeable battery (Leica BP-SCL4)

Lithium-ion rechargeable battery, rated voltage: 7.2 V (DC); capacity: 1860 mAh (min.), approx. 370 recordings (based on CIPA standard, without EVF); charging time: approx. 140 min (after deep discharge); manufacturer: Panasonic Energy (Wuxi) Co. Ltd., Made in China

### USB Power Supply

USB charger function in standby mode or when switched off, USB power supply when switched on

### Charger (Leica BC-SCL4)

Input: AC 100–240 V, 50/60 Hz, 0.25 A, automatic switchover; Output: DC 8.4 V 0.85 A; Manufacturer: Salom Electric (Xiamen) Co., Ltd., Made in China

## LEICA CUSTOMER CARE

Please contact the Customer Care department of Leica Camera AG for the maintenance of your Leica equipment and for help and advice regarding Leica products and how to order them. You can also contact the Customer Care department or the repair service provided by your regional Leica subsidiary for repairs or warranty claims.

### **Leica Camera AG**

Leica Customer Care  
Am Leitz-Park 5  
35578 Wetzlar  
Germany

**Phone:** +49 (0)6441 2080-189

**Fax:** +49 (0)6441 2080-339

**Email:** [customer.care@leica-camera.com](mailto:customer.care@leica-camera.com)

[www.leica-camera.com](http://www.leica-camera.com)

## LEICA ACADEMY

Have a look at our full seminar program with many interesting workshops on the topic of photography at:  
[us.leica-camera.com/Leica-Akademie/Global-Leica-Akademie](http://us.leica-camera.com/Leica-Akademie/Global-Leica-Akademie)