

HG-T Configuration Tool **User's Manual**

(MEMO)

Introduction

Thank you for using **HG-T Configuration Tool**.

This user's manual explains how to set up and operate the **HG-T Configuration Tool** software, which is used in combination with the **HG-T** series thru-beam type digital displacement sensor and compatible communication unit.

Before using this product, read and understand this user's manual. Use the product correctly and in the optimum manner.

Keep this manual in a safe location for reference whenever necessary.

Types of Manuals

The following user's manuals are available for the **HG-T**. Refer to the appropriate manual according to your need.

The user's manuals are also available for download from our website (<https://panasonic.net/id/pidsx/global>).

Unit name or purpose of use	Manual name	Manual code
HG-T Control Unit	HG-T User's Manual	WUME-HGTM
Tool software for the HG-T series HG-T Configuration Tool	HG-T Configuration Tool User's Manual	WUME-HGTCT
RS-485 Communication Unit for Digital Displacement Sensors	SC-HG1-485 User's Manual	WUME-SCHG1485

Notes

1. No part of this manual may be reproduced or reprinted in any form or by any means without prior written permission from Panasonic.
2. The contents of this manual are subject to change without notice for future improvement.
3. This manual has undergone strict quality control; but should you discover any dubious information or mistakes, please contact your local dealer or our call center.

Manual Configuration

Chapter 1	Before Using This Product	This chapter explains safety and handling precautions and license agreements for this software.
Chapter 2	System Configuration	This chapter explains the system configuration and recommended environment for using HG-T Configuration Tool .
Chapter 3	System Requirements Specification	This chapter explains the system requirements specification.
Chapter 4	Installing HG-T Configuration Tool	This chapter explains how to install HG-T Configuration Tool .
Chapter 5	Starting and Exiting HG-T Configuration Tool	This chapter explains how to start and exit HG-T Configuration Tool .
Chapter 6	Name and Function of Each Window	This chapter explains the name and function of each window.
Chapter 7	Setting up the Main Unit	This chapter explains how to set up the main unit using HG-T Configuration Tool .
Chapter 8	Using Convenient Functions	This chapter explains the convenient functions of HG-T Configuration Tool .
Chapter 9	Troubleshooting	This chapter explains error messages and alarm messages.

Table of Contents

1 Before Using This Product	1-1
1.1 Meaning of Icons Used in this Manual	1-2
1.2 Terminology.....	1-3
1.3 Software Version and Setting Functions	1-4
1.4 Software License Agreement.....	1-5
2 System Configuration	2-1
2.1 System Configuration.....	2-2
2.2 Tool Software “HG-T Configuration Tool”	2-3
2.3 HG-T Control Unit	2-4
3 System Requirements Specification	3-1
3.1 System Requirements Specification	3-2
4 Installing HG-T Configuration Tool	4-1
4.1 Installation.....	4-2
4.2 Uninstallation	4-5
5 Starting and Exiting HG-T Configuration Tool	5-1
5.1 Starting HG-T Configuration Tool	5-2
5.2 Starting by Loading the Settings from Communication Unit	5-3
5.2.1 Starting by loading the settings from USB communication unit	5-3
5.2.2 Starting by loading the settings from RS-485 communication unit ..	5-4
5.3 Exiting HG-T Configuration Tool	5-19
6 Name and Function of Each Window	6-1
6.1 Main Window	6-2
6.2 Menu bar.....	6-3
6.2.1 File Menu	6-3
6.2.2 Edit Menu.....	6-5
6.2.3 Help Menu.....	6-6
6.3 Quick Access Toolbar	6-8
6.4 Connected Units Window.....	6-10
6.4.1 Connection State	6-12
6.4.2 Product Image Icons	6-12
6.4.3 Error Icons	6-13
6.4.4 Output State.....	6-13
6.4.5 Add and Delete Buttons for Communication Unit	6-14
6.5 "Monitor" tab	6-17
6.5.1 Monitor Tab Window	6-17
6.5.2 Received Light Waveform Monitor	6-17
6.5.3 Measured Value Monitor	6-18

6.5.4	Export as Image / Export as CSV	6-19
6.5.5	I/O Monitor	6-22
6.5.6	Device Information Notification Dialog	6-22
6.6	"Settings" tab	6-24
6.6.1	Settings Tab Window	6-24
6.6.2	List of Configuration Parameters	6-25
6.7	"Device information" tab.....	6-28
7	Setting up the Main Unit.....	7-1
7.1	Flow of Operations up to Setup Completion	7-2
7.2	Adjusting the Beam Axis and Registering Reference Waveforms	7-3
7.3	Adjusting Sensitivity	7-6
7.4	Performing Measurement Settings	7-8
7.4.1	Operation Mode	7-8
7.5	Performing Teaching	7-10
7.5.1	1-point Teaching.....	7-11
7.5.2	2-point Teaching.....	7-12
7.5.3	3-point Teaching.....	7-13
7.6	Performing Calibration	7-16
7.7	Writing Parameters to Main Unit.....	7-19
7.7.1	Writing Procedure	7-19
7.7.2	If Parameters Cannot be Written.....	7-20
7.8	Performing Bank Operation	7-22
7.9	Initialization	7-24
8	Using Convenient Functions	8-1
8.1	Monitoring Multiple Controllers	8-2
8.2	Labeling	8-5
8.3	Offline Setting	8-7
8.3.1	Creating New Configuration Files	8-7
8.3.2	Writing Configuration Files to Controller	8-10
8.3.3	Opening Existing Configuration Files	8-12
8.3.4	Editing Connection Configuration	8-13
8.4	Copying Settings.....	8-15
8.4.1	Copying Settings.....	8-15
8.4.2	Pasting Copied Settings.....	8-15
8.4.3	Selecting and Pasting Copied Settings.....	8-16
8.5	Protecting Settings with Password.....	8-18
8.5.1	Setting a Password	8-18
8.5.2	Initializing a Password	8-19
9	Troubleshooting.....	9-1
9.1	Error Messages.....	9-2
9.2	Alarm Messages	9-3





1 Before Using This Product

1.1 Meaning of Icons Used in this Manual	1-2
1.2 Terminology.....	1-3
1.3 Software Version and Setting Functions	1-4
1.4 Software License Agreement.....	1-5

1.1 Meaning of Icons Used in this Manual

1.1 Meaning of Icons Used in this Manual

- In this manual, the following symbols are used to indicate safety information that must be observed.

	Indicates an action that is prohibited or a matter that requires caution.
	Indicates an action that must be taken.
	Indicates supplemental information.
	Indicates details about the subject in question or information useful to remember.
	Indicates operation procedures.

1.2 Terminology

Term	Description
Software "HG-T Configuration Tool"	HG-T Configuration Tool is tool software dedicated to the HG-T series controllers. This software enables the user to set up the HG-T series controllers connected via the compatible communication unit, display received light waveforms, and perform other operations.
USB communication unit "SC-HG1-USB"	An interface unit that enables measurement data and other data of connected controllers to be monitored. ^(Note 1)
RS-485 communication unit "SC-HG1-485"	
HG-T series controller - Master unit	A controller that can be used on a standalone basis
HG-T series controller - Slave unit	A controller that is used by connecting to a master unit
End plate or commercially available fitting	A part that is used to secure both edges of a connector to prevent the connector from coming off and causing a communication failure when controllers are connected

(Note 1) For details on each communication unit, refer to the instruction manual supplied with the product.

1.3 Software Version and Setting Functions

■ HG-TConfiguration Tool Ver.1.30 (Released in November 2020)

Functions added

Added function	Description	
User assigned edge detection	Measurement settings	Operation mode setting
Tab cancel function	Correction settings	
Hold state output	Operation setting	Digital I/O
Measured value reversal selection function	Measurement settings	

(Note 1) For details on each function, refer to the *HG-T User's Manual*.

The above functions are available only when the HG-TC□ series controller is combined with the HG-T□ series sensor head, both of which are manufactured in November 2020 onwards.

Those functions cannot be used with the controllers and sensor heads manufactured in October 2020 or earlier.

Other changes

Some screen layouts and screen user interface designs

Please be careful when using this Software with version earlier than Ver.1.30. It is recommended to upgrade to Ver.1.30 or later.

This Software with Ver.1.30 or later can also be used with the controllers combined with the sensor heads, both of which are manufactured in October 2020 or earlier.

Please download the latest version from our website (<https://panasonic.net/id/pidsx>).

1.4 Software License Agreement

Panasonic Industrial Devices SUNX Co., Ltd. ("PIDSX") grants to you a license to use this Software on condition that you accept this Agreement. You must read this Software License Agreement (this "Agreement") carefully before using this Software. Only in case that you accept this Agreement, you may start your use of this Software.

Your unsealing the package of this Software, or your downloading, installing or launching this Software or the like shall be deemed as your acceptance of this Agreement.

The Software includes not only proprietary computer programs owned by PIDSX or licensed to PIDSX but also open source software programs. As for the open source software programs, refer to the detailed terms and conditions thereof shown in the installation package of the Software. Should a discrepancy arise between any of the terms of this Agreement and any open source software program license statement, the open source software program license statement shall take precedence over this Agreement.

Article 1 Grant of License

PIDSX hereby grants to you a non-exclusive license to use this Software only in combination with PIDSX product(s) specified in the manual of this Software (the "Product") in accordance with the terms of this Agreement. You may not use this Software in connection with products of any third party other than PIDSX.

Article 2 Restrictions

You may NOT:

- (1) Modify, reverse engineer, decompile, or disassemble this Software,
- (2) Use this Software by methods or for purposes other than those specified in the manual of this Software provided by PIDSX, nor
- (3) Distribute, rent, lease or otherwise transfer this Software to any third party; provided, however, that you may assign the rights to use this Software under this Agreement along with the Product on the condition that the assignee agrees to be bound by all the terms of this Agreement. In the case of such assignment, you must deliver any and all the copies of this Software and all the accompanying materials to the assignee and you may not retain any copies of this Software including backups.

Article 3 Disclaimer

1. PIDSX HEREBY DISCLAIMS ALL OTHER WARRANTIES ON THIS SOFTWARE, EITHER EXPRESS OR IMPLIED, INCLUDING BUT NOT LIMITED TO THE IMPLIED WARRANTIES OF MERCHANTABILITY, FITNESS FOR PARTICULAR PURPOSE, AND NON-INFRINGEMENT OF THIRD PARTY RIGHTS.

2. UNDER NO CIRCUMSTANCES SHALL PIDSX BE LIABLE FOR ANY DAMAGES (INCLUDING DIRECT, INDIRECT, INCIDENTAL, CONSEQUENTIAL OR SPECIAL OR WHATSOEVER) ARISING OUT OF THE USE OF THIS SOFTWARE, INABILITY TO USE THIS SOFTWARE, DEFECTS IN THIS SOFTWARE (e.g., BUGS, SECURITY HOLES, AND MALFUNCTION), OR OTHERWISE IN CONNECTION WITH THIS SOFTWARE.

Article 4 Term

1. This Agreement shall come into effect upon your unsealing the package of this Software, or your downloading, installing or launching this Software or the like.
2. PIDSX may terminate this Agreement immediately, if you breach any of the provisions of this Agreement.
3. You shall, at your own costs, return, delete or destroy this Software and any of its copies within four (4) weeks after termination of this Agreement.

Article 5 Export Control

You shall comply with all laws and regulations regarding export control under any competent jurisdiction, including but not limited to the Japanese Foreign Exchange & Foreign Trade

1.4 Software License Agreement

Control Law, the export control regulations based on resolutions of the United Nations Security Council, etc. If any license or appropriate approval from a governmental authority is required under the applicable laws, you may not export this Software without such approval to any countries either directly or indirectly. Furthermore, you shall neither use nor sell this Software for military purposes either directly or indirectly.

Article 6 Intellectual Property Rights

Except for the open source software programs, all intellectual property rights in this Software, including the copyright, belong to PIDSX and/or the licensors of PIDSX.

Article 7 Upgrade of this Software

1. Release of future upgrades or updates of this Software is not guaranteed and left to the sole discretion of PIDSX. Furthermore, PIDSX may charge fees for upgrading or updating of this Software.

2. If any upgrades or updates are provided to you either for fees or for free, such upgrades or updates shall be deemed as a part of this Software and shall be governed by this Agreement, unless PIDSX designates otherwise at the time of provision of such upgrades or updates.

Article 8 Limitation on Liability

AGGREGATE LIABILITIES OF PIDSX IN CONNECTION WITH THIS AGREEMENT OR THIS SOFTWARE SHALL IN NO EVENT EXCEED TEN THOUSAND (10,000) YEN.

Article 9 Governing Law and Jurisdiction

1. This Agreement shall be governed by the laws of Japan.

2. Should any dispute arise from or in connection with this Agreement, Nagoya District Court, Japan shall exclusively have the jurisdiction over such dispute.

This Software consists of the following types of software.

(1) Software developed independently by PIDSX

(2) Software owned by and licensed by the third party

(3) Open source software licensed on the license terms

Software in categories (3) above is distributed with the expectation of effectiveness as a single piece of software, but there is no guarantee provided, including implied guarantees regarding viability as a product and/or suitability for specific purposes.

For details, please refer to the license statements included in the install package of this Software.

2 System Configuration

2.1 System Configuration.....	2-2
2.2 Tool Software “ HG-T Configuration Tool ”	2-3
2.3 HG-T Control Unit	2-4

2.1 System Configuration

2.1 System Configuration

- Tool software **HG-T Configuration Tool** is used in combination with compatible communication unit.

For USB communication unit

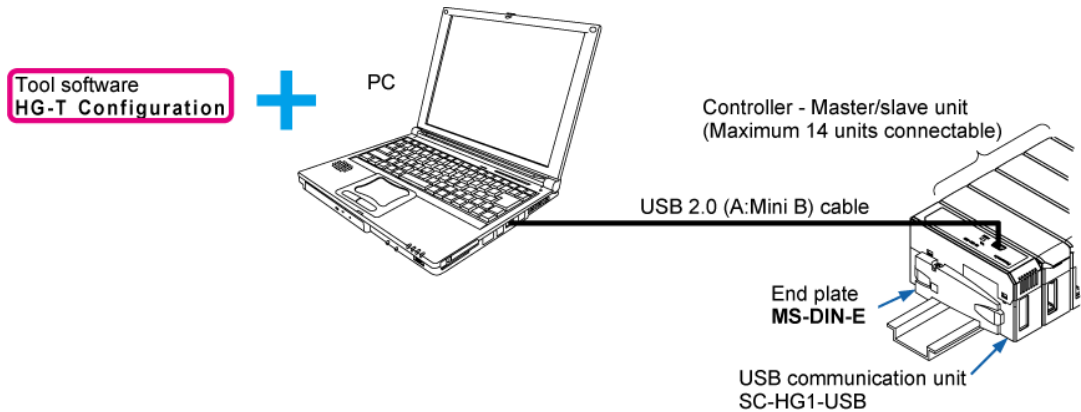

For details on the communication unit, refer to the instruction manual supplied with the **SC-HG1-USB**.

For RS-485 communication unit

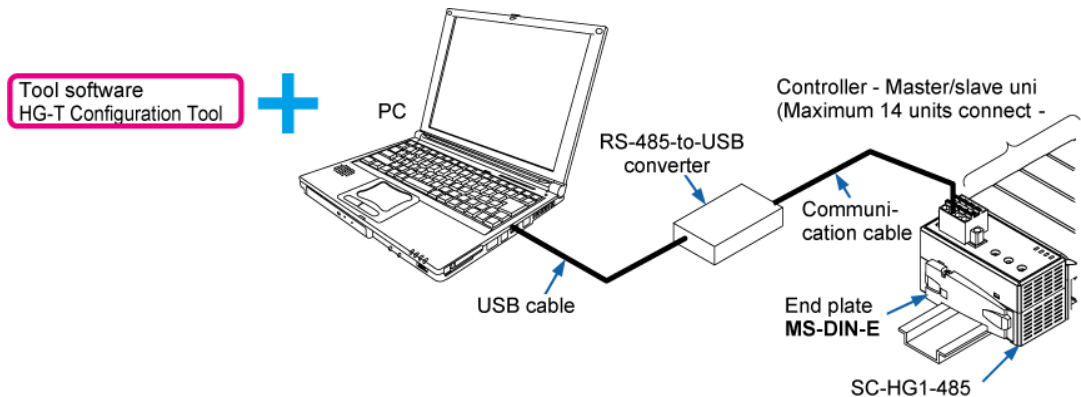

To connect the RS-485 communication unit and PC, an RS-485-to-USB converter is required. For details, refer to the instruction manual of the RS-485-to-USB converter to be used and the **SC-HG1-485** User's Manual.

Versions of **HG-T Configuration Tool** that are earlier than Ver. 1.2 do not recognize RS-485 communication units.

Download the latest version of HG-T Configuration Tool from our website (<https://panasonic.net/id/pidsx/global>).

2.2 Tool Software “HG-T Configuration Tool”

HG-T Configuration Tool is tool software dedicated to the **HG-T** series controllers. Installing this tool software on a PC enables the user to set up the connected **HG-T** series controllers, display received light waveforms, and perform other operations.

2.3 HG-T Control Unit

2.3 HG-T Control Unit

HG-T control units are connected to the compatible communication units.
Compatible controller models are shown below.

Compatible models

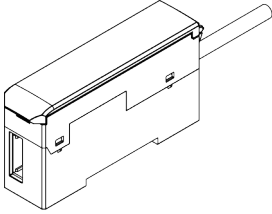
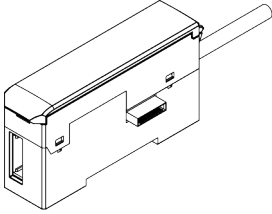
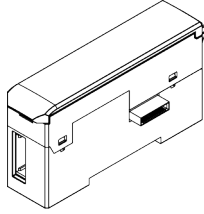
<p>HG-TC101 / Master unit of high-performance NPN output type HG-TC101-P / Master unit of high-performance PNP output type</p> 	<p>HG-TC111 / Slave unit of high-performance NPN output type HG-TC111-P / Slave unit of high-performance PNP output type</p> 
<p>HG-TC113 / Slave unit of wire-saving type</p> 	

Note: For details on control units, refer to the user's manual for each control unit.

Compatible communication units

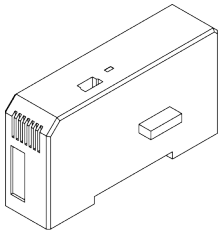
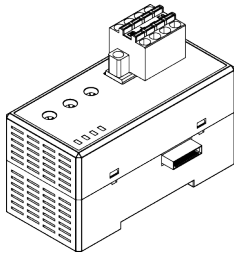
<p>SC-HG1-USB / USB communication unit</p> 	<p>SC-HG1-485 / RS-485 communication unit</p> 
---	---

Note: For details on compatible communication units, refer to the user's manual for each communication unit.

3 System Requirements Specification

3.1 System Requirements Specification3-2

3.1 System Requirements Specification

3.1 System Requirements Specification

The following operating conditions are required to use the tool software. Check whether the system to be used meets the conditions and the necessary devices are prepared.

Item	Specifications
OS ^(Note 1)	Windows ^(R) 7 (32-bit / 64-bit) SP1 or later Windows ^(R) 8 (8.1) (32 bit / 64 bit) Windows ^(R) 10 (32 bit / 64 bit)
CPU ^(Note 2)	Intel ^(R) Core™ i3 1 GHz or faster
Memory	2 GB or more
Available hard disk space	200 MB or more
Screen size	1,280 × 1,024 or higher (recommended)
Screen language	Japanese, English, and Chinese (Simplified), Korean
Communication interface	USB 2.0
Operating conditions	.NET Frameworks 4.5.2 or later must be installed.

(Note 1) Windows is a registered trademark or trademark of Microsoft Corporation in the United States and/or other countries.

(Note 2) Intel^(R) and Core™ are registered trademarks or trademarks of Intel Corporation and its subsidiaries in the United States and/or other countries.

To connect the PC on which the tool software is installed to the compatible communication unit, it is necessary to install the USB driver on the PC.

The USB driver can be downloaded from our website (<https://panasonic.net/id/pidsx/global>).

4 Installing HG-T Configuration Tool

4.1 Installation.....	4-2
4.2 Uninstallation	4-5

4.1 Installation

4.1 Installation

This section explains the procedure for installation on a PC.

i Info.

- Windows warning messages such as "User Account Control" and "Windows can't verify the publisher of this driver software" may be displayed, but there is no problem and you can proceed to the next step.

1 2 Procedure

1. Open the folder containing the downloaded file and double-click [setup.exe].
2. Select the target language and click the [OK] button.

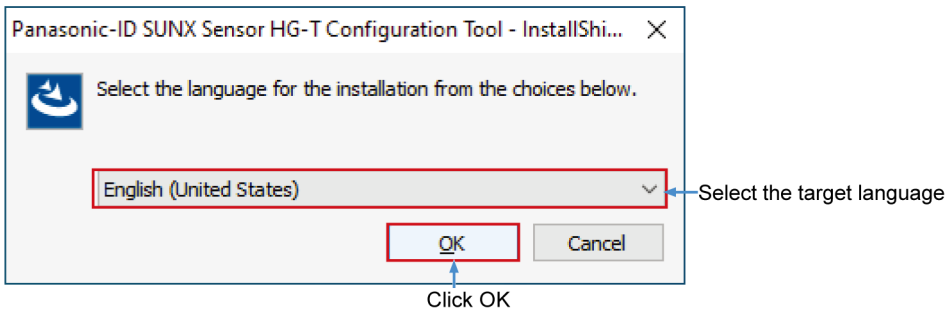

3. Click the [Next] button.

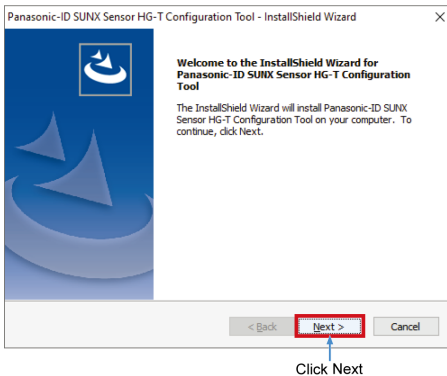

4. The "License Agreement" window will be displayed. Carefully read the agreement, select "I accept the terms in the license agreement", and then click [Next] button.

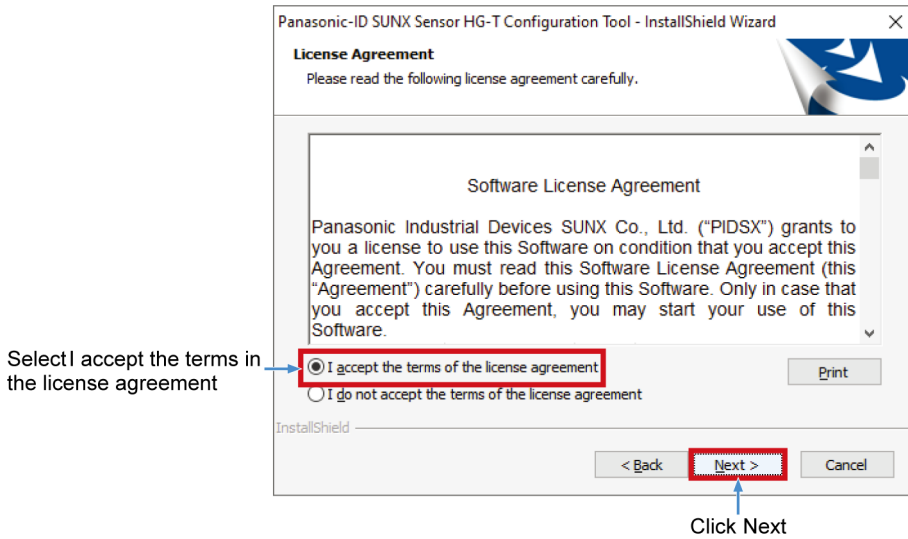

5. If you do not change the installation folder, click the [Next] button. If you change the installation folder, specify a desired folder and then click the [Next] button.

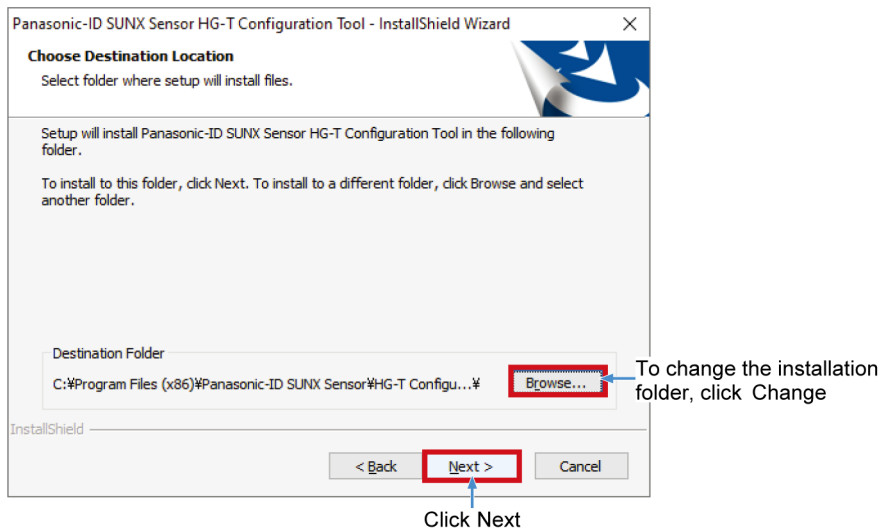

6. Click the [Install] button.

4.1 Installation

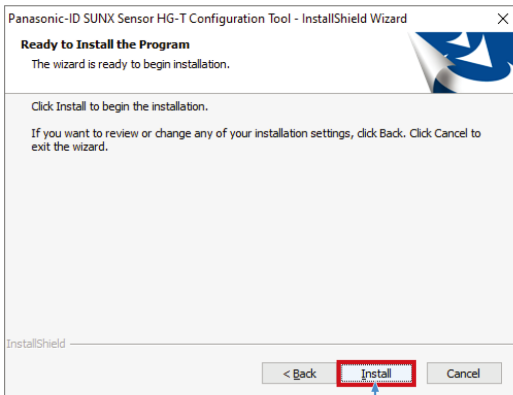

Click Install

7. Click the [Finish] button.

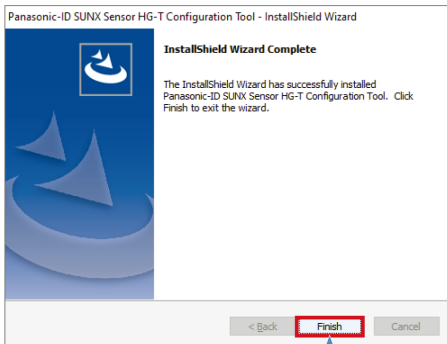

Click Finish

8. The **HG-T Configuration Tool** icon will be displayed on the desktop.

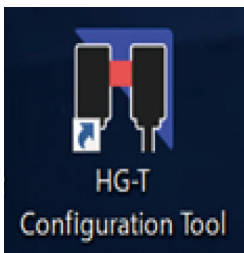

4.2 Uninstallation

Uninstall the following two items.

Windows 8.1 or earlier (32-bit / 64-bit)

1. HG-T_USB_Driver
[32bit]HG-T_USB_Driver_x64
[64bit]HG-T_USB_Driver_x86
2. Panasonic-ID SUNX Sensor HG-T Configuration Tool

Windows 10 (32-bit / 64-bit)

1. HG-T_USB_Driver_Win10
[32bit]HG-T_USB_Driver_Win10_x64
[64bit]HG-T_USB_Driver_Win10_x86
2. Panasonic-ID SUNX Sensor HG-T Configuration Tool

In Windows, select **Start>Control Panel>Programs and Features** in this order and then uninstall the specified items.

(MEMO)

5 Starting and Exiting HG-T Configuration Tool

5.1 Starting HG-T Configuration Tool	5-2
5.2 Starting by Loading the Settings from Communication Unit	5-3
5.2.1 Starting by loading the settings from USB communication unit	5-3
5.2.2 Starting by loading the settings from RS-485 communication unit ..	5-4
5.3 Exiting HG-T Configuration Tool	5-19

5.1 Starting HG-T Configuration Tool

5.1 Starting HG-T Configuration Tool

This section explains the procedure for starting **HG-T Configuration Tool**.

Use the following procedure to start HG-T Configuration Tool.

1 2 Procedure

1. Double-click the **HG-T Configuration Tool** icon on the desktop. Alternatively, click the Windows [Start] button and, from all the programs, select **Panasonic -ID Sensor>HG-T Configuration Tool**.
2. When **HG-T Configuration Tool** is started, the "Start menu" dialog box is displayed.

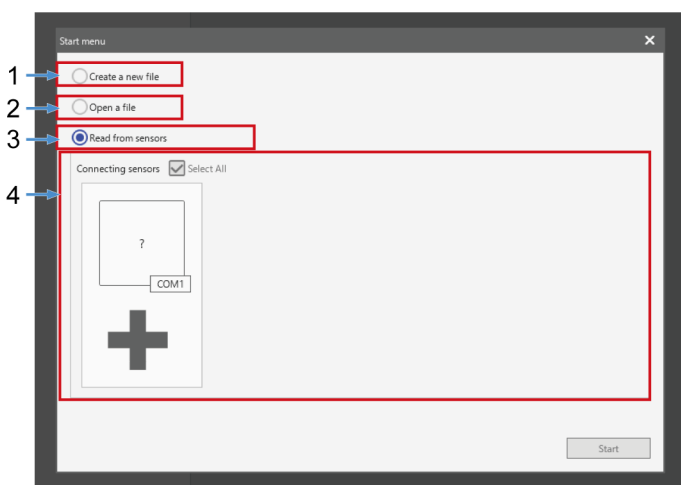

No.	Item	Description
1	"Create a new file"	Allows the user to create a new HG-T configuration file
2	"Open a file"	Allows the user to open an existing HG-T configuration file
3	"Read from sensors"	Allows the user to load the settings of the HG-T main unit (sensor) from the HG-T main unit via the communication unit
4	"Communication unit being connected" display area	This area displays the communication unit that is currently connected. If "Read from sensors" is selected, this area will be enabled.

5.2 Starting by Loading the Settings from Communication Unit

Use the following procedure to start HG-T Configuration Tool.



- Before selecting "Read from sensors", check that the PC and the compatible communication unit are connected correctly.
- Check that the connected **HG-TC** controller (master unit) is turned ON.

5.2.1 Starting by loading the settings from USB communication unit

1 2

Procedure

1. On the "Start menu" dialog box, select "Read from sensors" and, after selecting the connected communication unit in the "Communication unit being connected" display area, click the [Start] button.

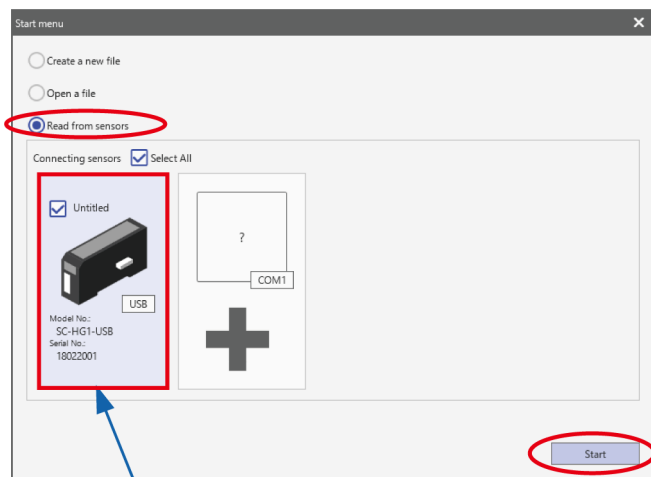

Select the connected communication unit

2. After configuration information and other settings are loaded from each **HG-T** series controller, the main window is displayed.

5.2 Starting by Loading the Settings from Communication Unit

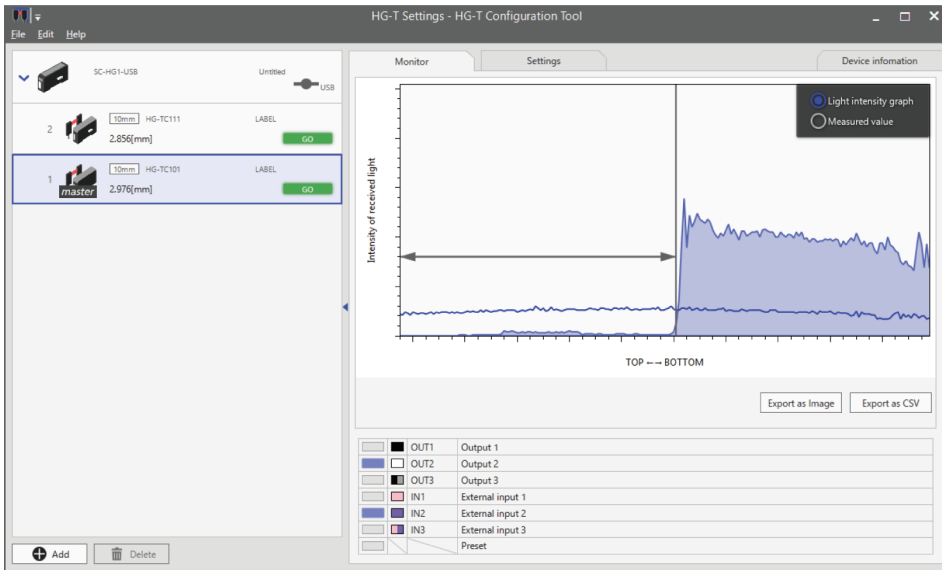

3. The startup procedure is completed.

5.2.2 Starting by loading the settings from RS-485 communication unit

No address is set for the **SC-HG1-485** communication unit connected to the PC, so you must conduct serial communication unit searches. The procedure is as below.

Communication Protocol Setting: Starting by Loading Settings through MODBUS

1 2 Procedure

1. A question mark is displayed in the “Communication unit being connected” area as an unknown COM port. Click “+”.

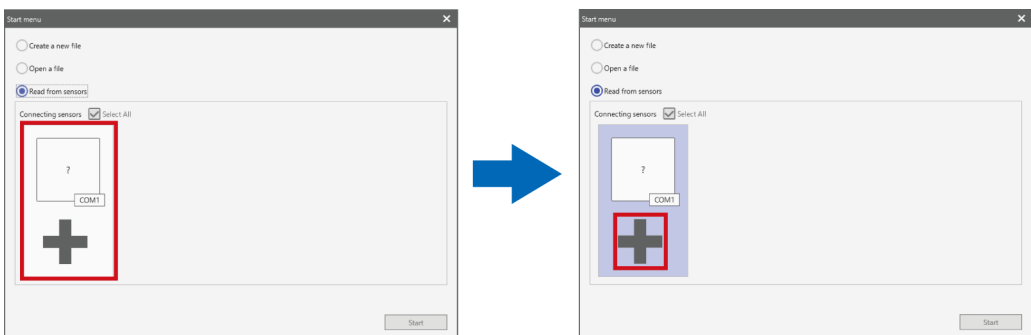

5.2 Starting by Loading the Settings from Communication Unit

- The "Serial communication unit search" dialog box will be displayed.

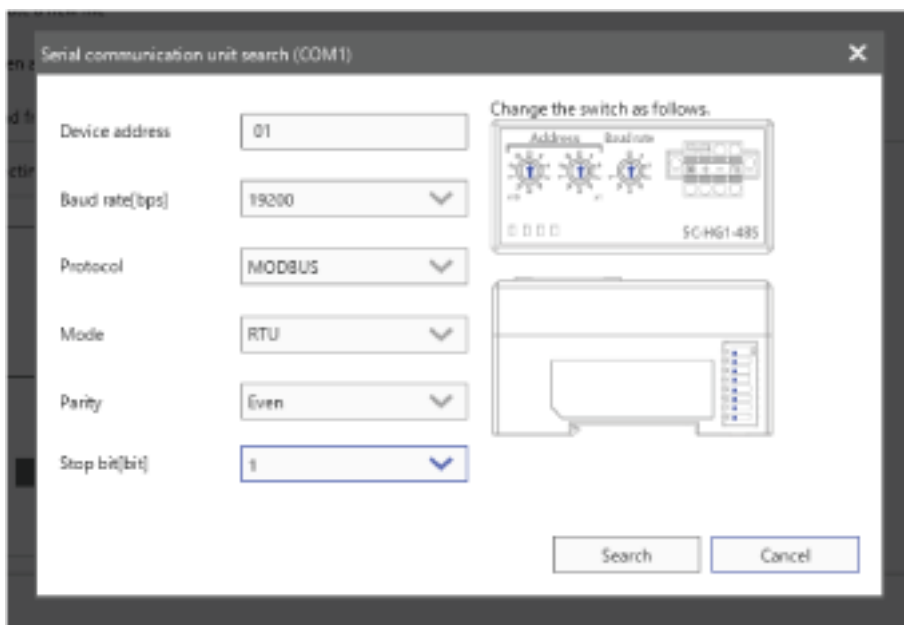

Note

- Set the communication protocol between the **SC-HG1-485** communication unit and PC to the MODBUS communication protocol. This setting can be confirmed by the communication switch located on the side of the target **SC-HG1-485** communication unit.

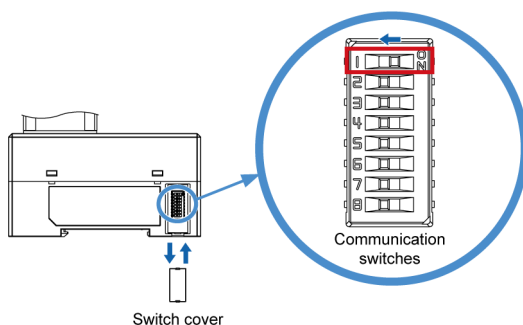

SW No.	Name	Function
1	Communication protocol setting	0: MODBUS 1: MEWTOCOL

- Click the [Address] button on the right of "Device address", and the "Detect address" dialog box will be displayed. Select the check box of the address to be specified and then click anywhere outside the dialog box.

5.2 Starting by Loading the Settings from Communication Unit

Select the detection address of a communication unit with the same settings as the unit to be detected

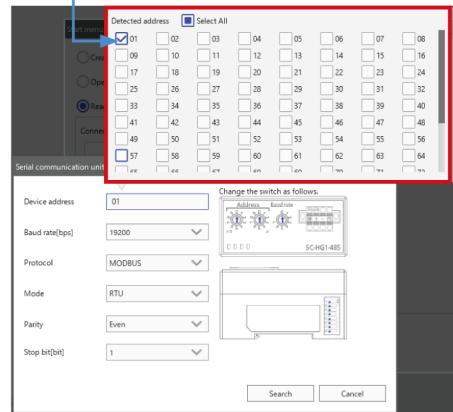
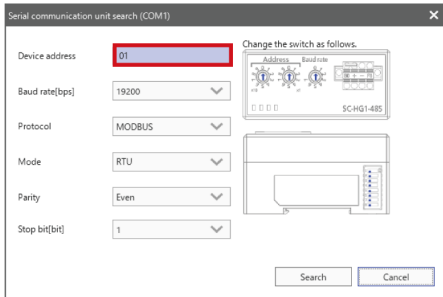

Use the “Address” setting switch on the target **SC-HG1-485** communication unit to check the address setting of the communication unit.

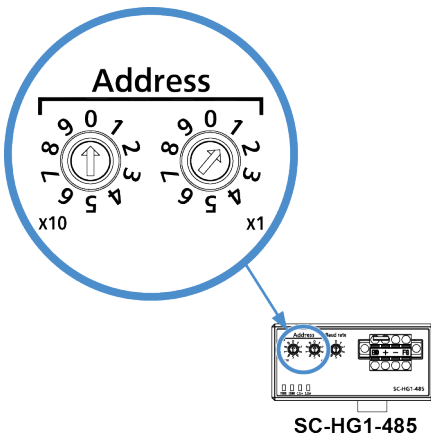

4. Set a desired baud rate by selecting it from the drop-down list.

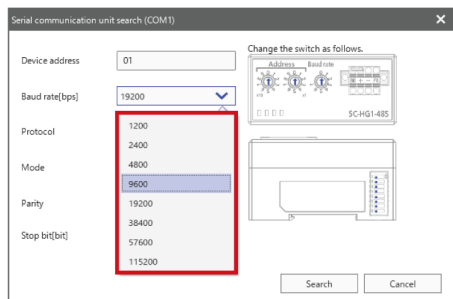
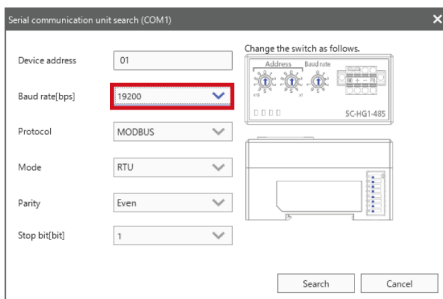

Use the “Baud rate” setting switch on the target **SC-HG1-485** communication unit to check the baud rate setting of the communication unit.

5.2 Starting by Loading the Settings from Communication Unit

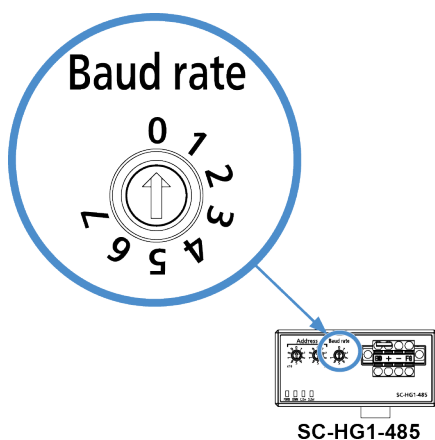

Name	Function
Baud rate setting switch	0: 19,200 bps 1: 38,400 bps 2: 57,600 bps 3: 115,200 bps 4: 1,200 bps 5: 2,400 bps 6: 4,800 bps 7: 9,600 bps

5. Set a desired transfer mode by selecting it from the drop-down list.

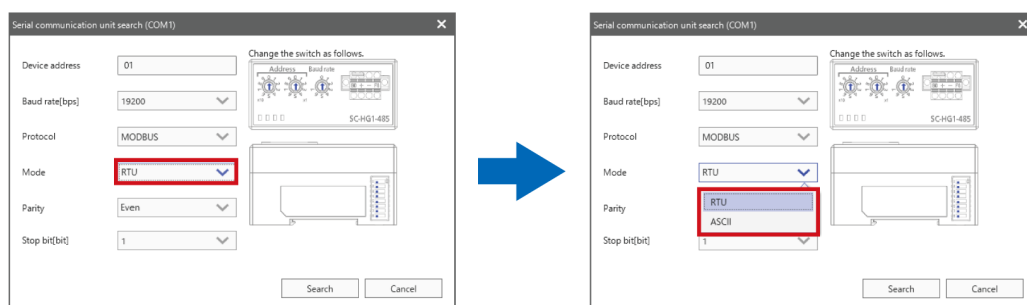

Use communication switch [2] on the target **SC-HG1-485** communication unit to check the transfer mode setting of the communication unit.

5.2 Starting by Loading the Settings from Communication Unit

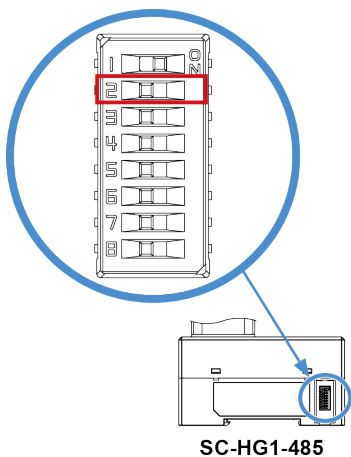

SW NO.	Name	Function
2	Transfer mode setting	0: RTU 1: ASCII

6. Set a desired parity check value by selecting it from the drop-down list.

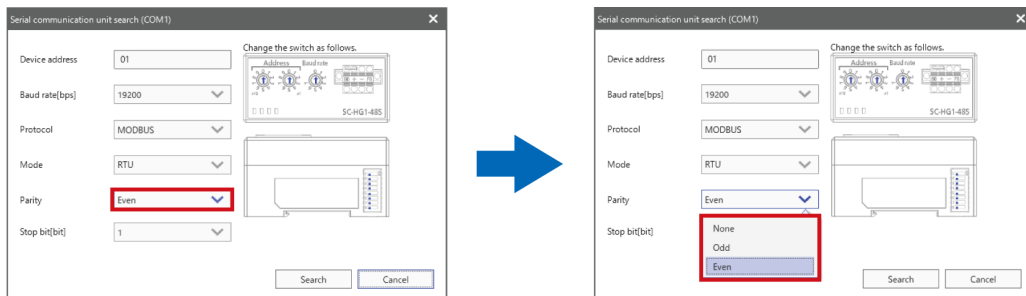

Use communication switches [3] and [4] on the target **SC-HG1-485** communication unit to check the parity check setting of the communication unit.

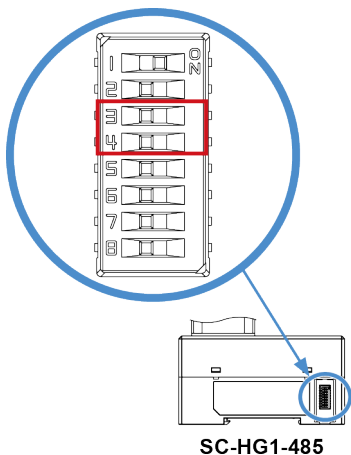

5.2 Starting by Loading the Settings from Communication Unit

SW NO.	Name	Function
3	Parity check setting (SW3: High order SW4: Low order)	00: EVEN
4		01: ODD 10: NONE 11: Setting prohibited

7. Set a desired stop bit length by selecting it from the drop-down list.

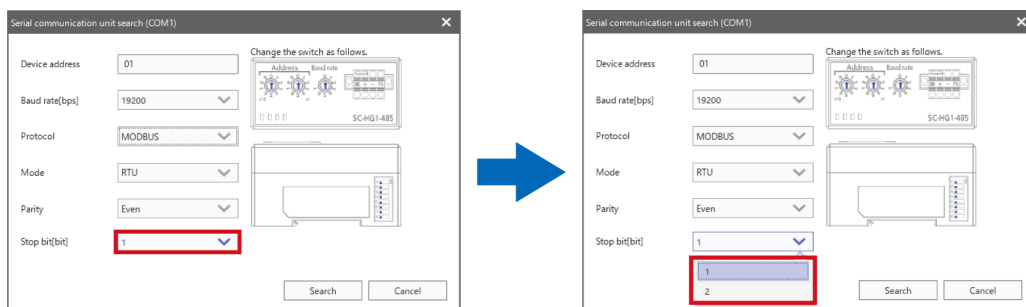

Use communication switch [5] on the target **SC-HG1-485** communication unit to check the stop bit length setting of the communication unit.

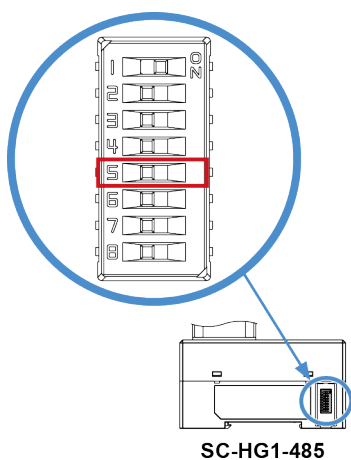

SC-HG1-485

SW NO.	Name	Function
5	Stop bit length setting	0: 1bit 1: 2bit

8. When you have finished setting up the tool software, click the [Search] button. A confirmation message will be displayed. Click the [Yes] button.

5.2 Starting by Loading the Settings from Communication Unit

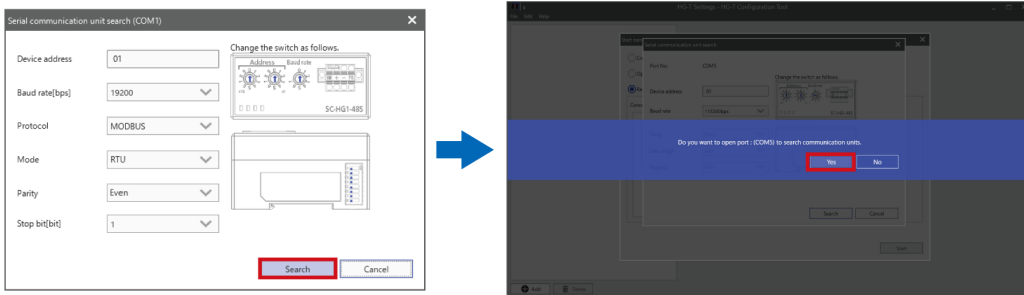

9. If the communication is successful, a completion message will be displayed. Click the [OK] button.

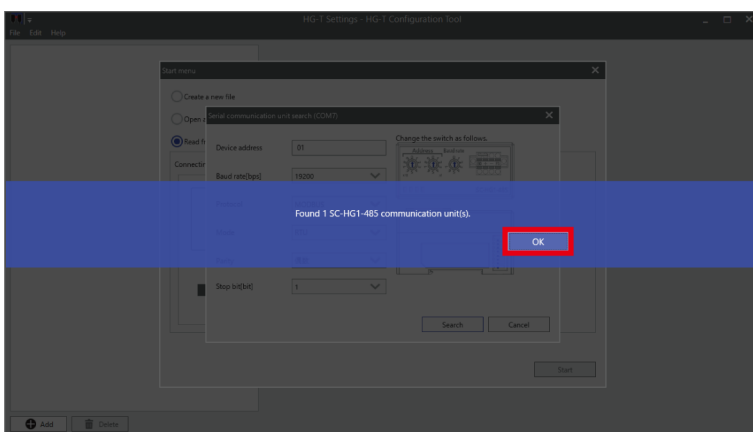

10. The target **SC-HG1-485** communication unit will be displayed in the “Sensor being connected” area. Select the communication unit by clicking it and then click the [Start] button.

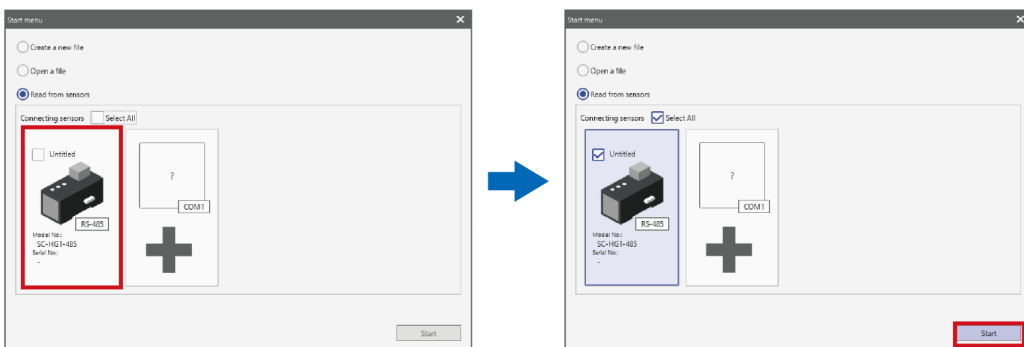

11. After configuration information and other settings are loaded from each **HG-T** series controller, the main window is displayed.

5.2 Starting by Loading the Settings from Communication Unit

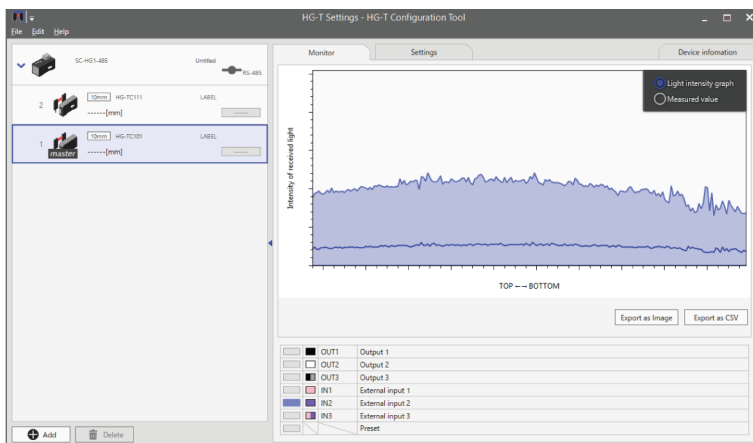

12. The startup procedure is completed.

Communication Protocol Setting: Starting by Loading Settings through MEWTOCOL

12 Procedure

1. The SC-HG1-485 communication unit will be displayed as an unknown COM port in the "Communication unit being connected" area. Click "+".

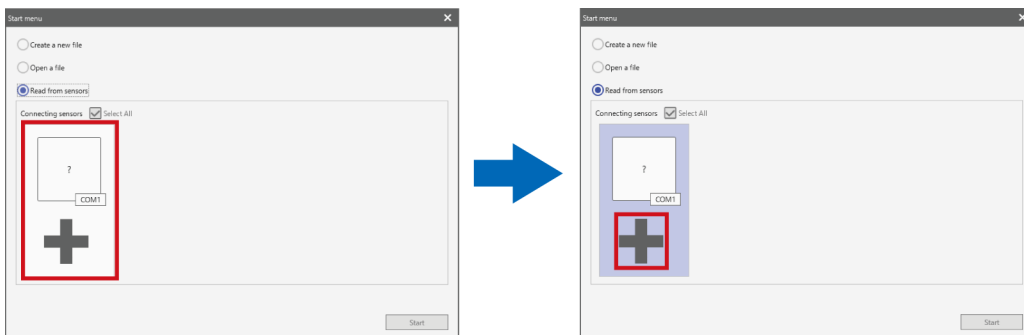

2. The "Serial communication unit search" dialog box will be displayed.

5.2 Starting by Loading the Settings from Communication Unit

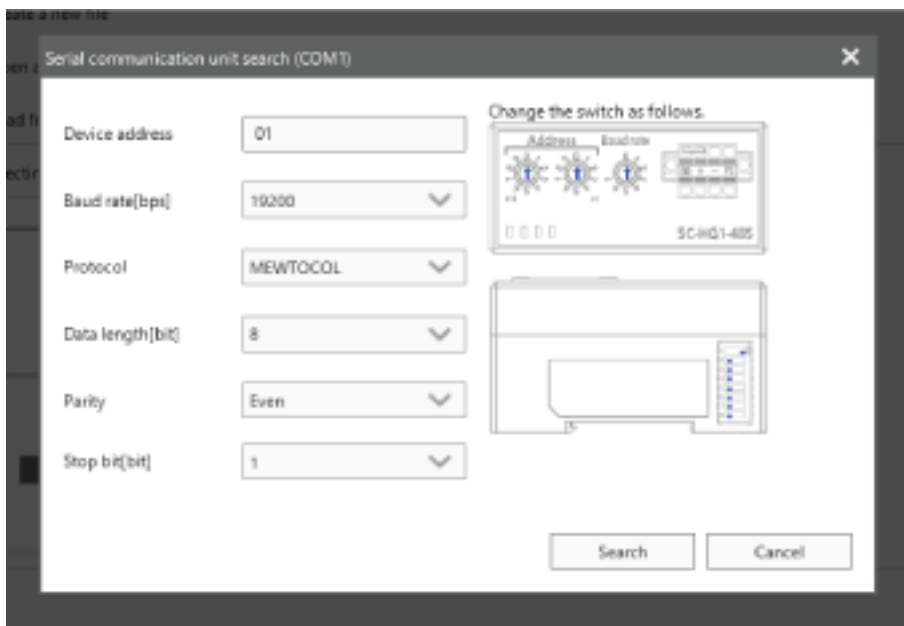

Note

- Set the communication protocol between the **SC-HG1-485** communication unit and PC to "MEWTOCOL". This setting can be confirmed by the communication switch located on the side of the target **SC-HG1-485** communication unit.

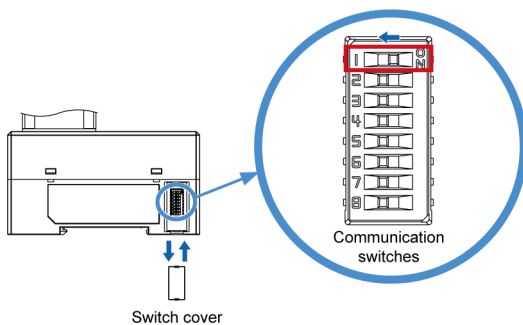

SW No.	Name	Function
1	Communication protocol setting	0: MODBUS 1: MEWTOCOL

- Click the [Address] button on the right of "Device address" to display the "Detect address" dialog box. Select the check box of the address to be specified and then click anywhere outside the dialog box.

5.2 Starting by Loading the Settings from Communication Unit

Select the detection address of a communication unit with the same settings as the unit to be detected

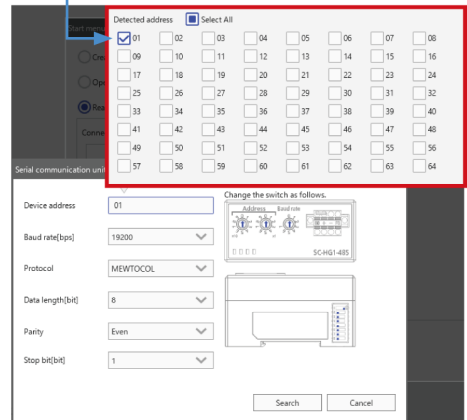
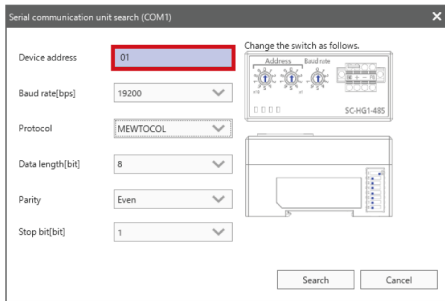

Use the “Address” setting switch on the target **SC-HG1-485** communication unit to check the address setting of the communication unit.

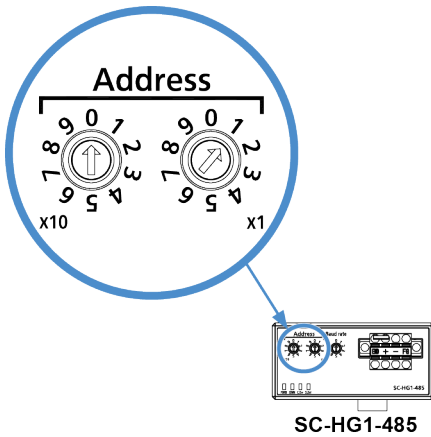

4. Set a desired baud rate by selecting it from the drop-down list.

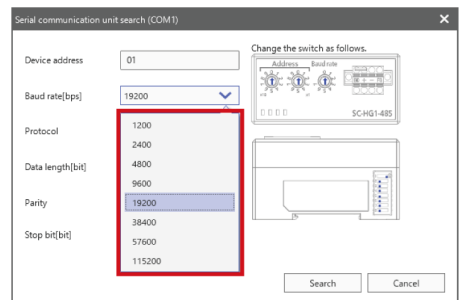
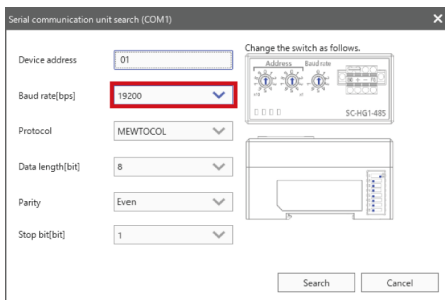

Use the “Baud rate” setting switch on the target **SC-HG1-485** communication unit to check the baud rate setting of the communication unit.

5.2 Starting by Loading the Settings from Communication Unit

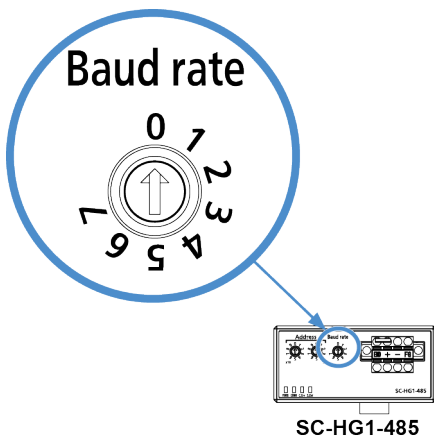

Name	Function
Baud rate setting switch	0: 19,200 bps 1: 38,400 bps 2: 57,600 bps 3: 115,200 bps 4: 1,200 bps 5: 2,400 bps 6: 4,800 bps 7: 9,600 bps

5. Set a desired data length by selecting it from the drop-down list.

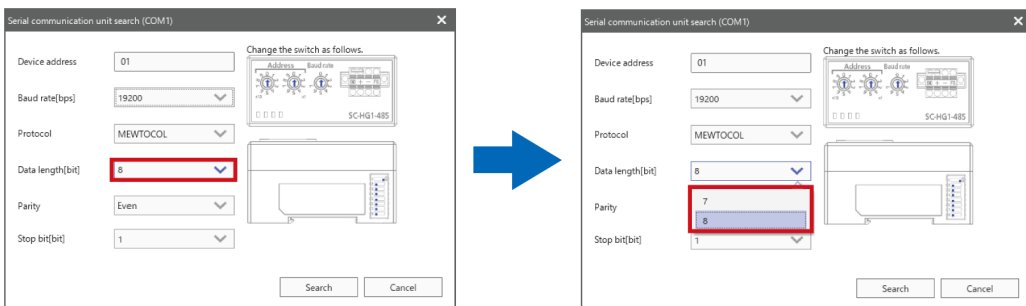

Use communication switch [2] on the target **SC-HG1-485** communication unit to check the data length setting of the communication unit.

5.2 Starting by Loading the Settings from Communication Unit

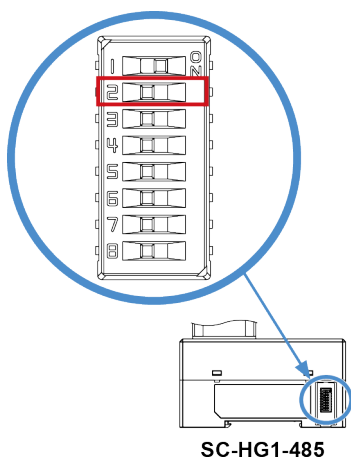

SW NO.	Name	Function
2	Data bit setting	0: 8bit 1: 7bit

6. Set a desired parity check value by selecting it from the drop-down list.

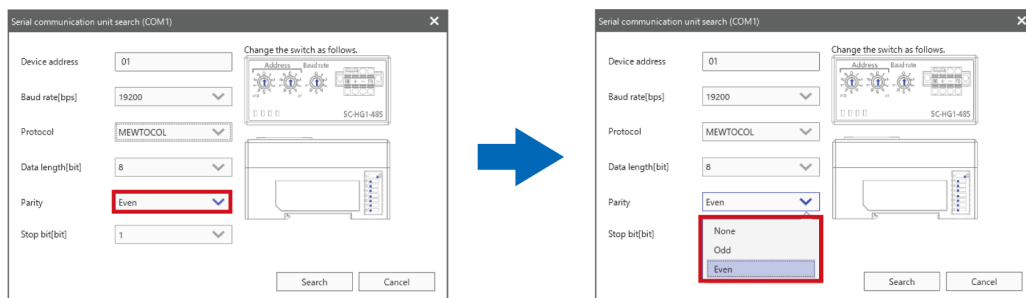

Use communication switches [3] and [4] on the target **SC-HG1-485** communication unit to check the parity check setting of the communication unit.

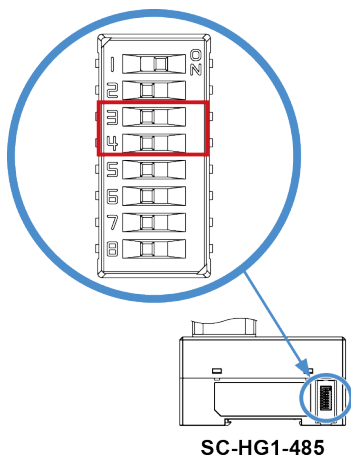

5.2 Starting by Loading the Settings from Communication Unit

SW NO.	Name	Function
3	Parity check setting (SW3: High order SW4: Low order)	00: EVEN
4		01: ODD 10: NONE 11: Setting prohibited

7. Set a desired stop bit length by selecting it from the drop-down list.

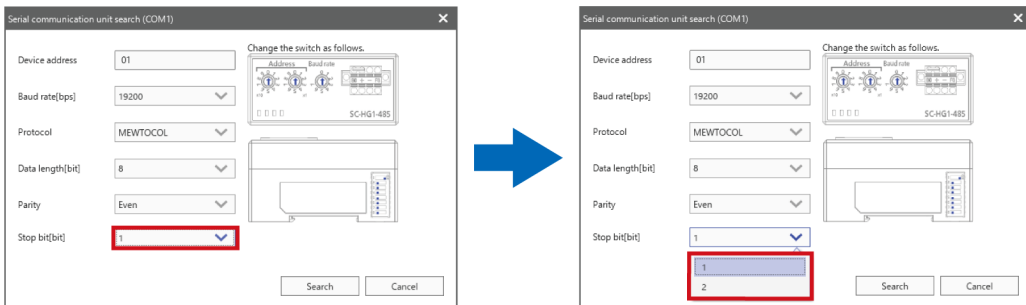

Use communication switch [5] on the target **SC-HG1-485** communication unit to check the stop bit length setting of the communication unit.

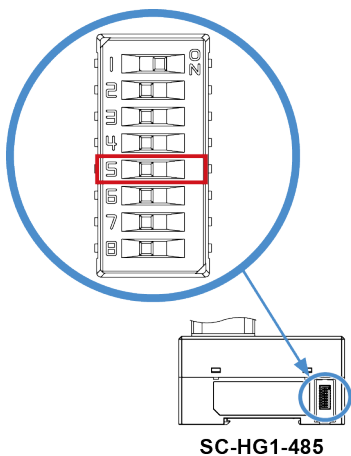

SW NO.	Name	Function
5	Stop bit length setting	0: 1bit 1: 2bit

8. When you have finished setting up the tool software, click the [Search] button. A confirmation message will be displayed. Click the [Yes] button.

5.2 Starting by Loading the Settings from Communication Unit

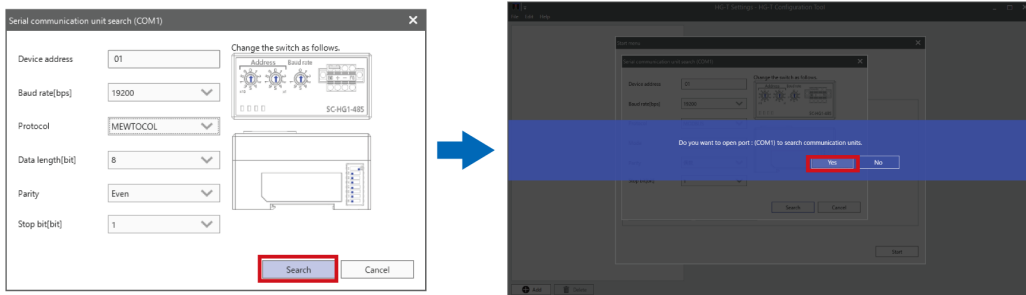

9. If the communication is successful, a completion message will be displayed. Click the [OK] button.

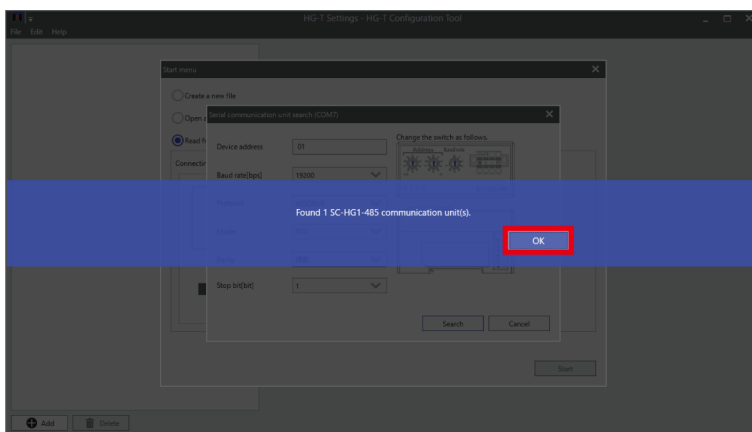

10. The target **SC-HG1-485** communication unit will be displayed in the “Connecting sensors” area. Select the communication unit by clicking it and then click the [Start] button.

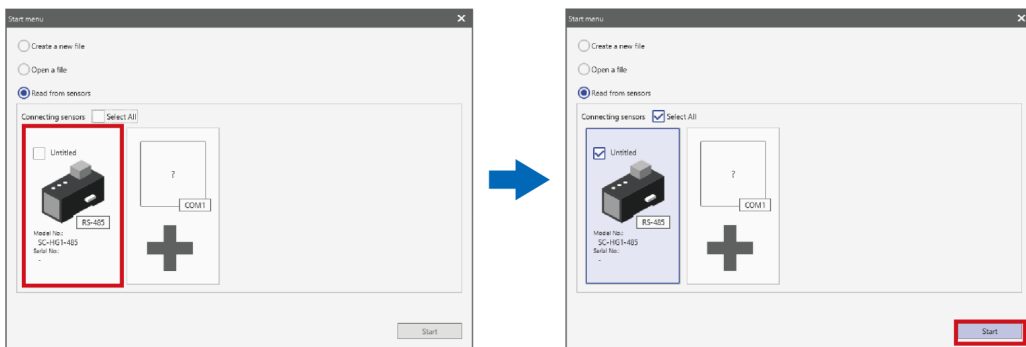

11. After configuration information and other settings are loaded from each **HG-T** series controller, the main window is displayed.

5.2 Starting by Loading the Settings from Communication Unit

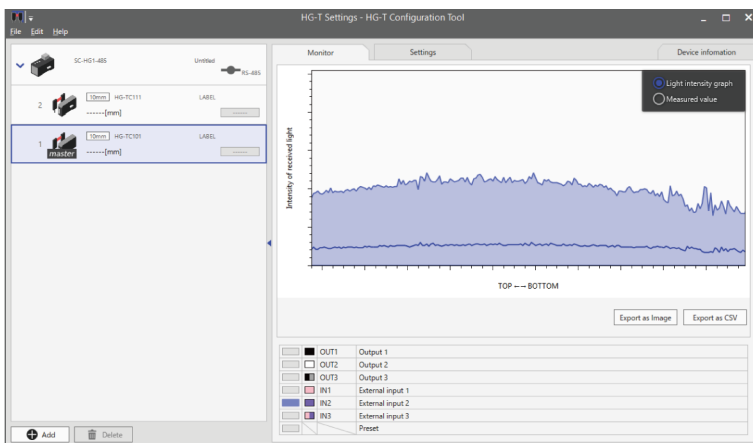

12. The startup procedure is completed.

5.3 Exiting HG-T Configuration Tool

Use one of the following methods to exit **HG-T Configuration Tool**.



- If the settings have been changed, be sure to save the configuration file before exiting the software. If the software is exited without saving the configuration file, the changes will be discarded.

- Click the [Close] button in the top right corner of the tool software window.

(Note 1) If the configuration file has not been saved, a confirmation window like the one shown above will be displayed, asking whether to save the configuration file. If [No] button is clicked, the software will be exited without saving the configuration file.

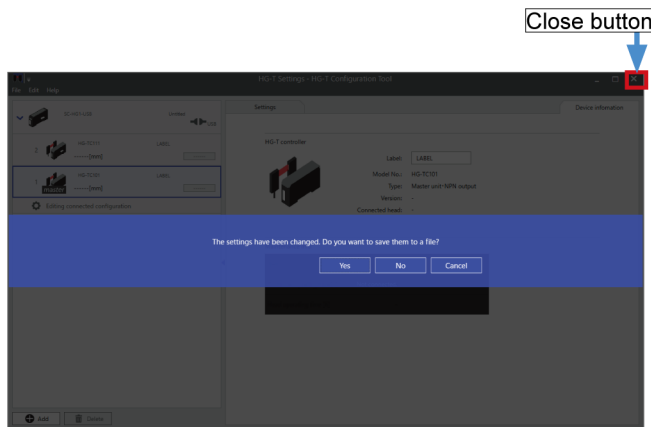

5.3 Exiting HG-T Configuration Tool

Note

- The following methods can also be used to exit HG-T Configuration Tool.

- Using the menu bar

On the menu bar, select **File>Exit**.

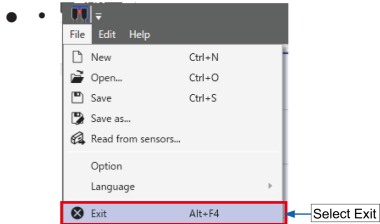

- - Using the Quick Access Toolbar

On the Quick Access Toolbar, click the **HG-T Configuration Tool** icon and then select "Close".

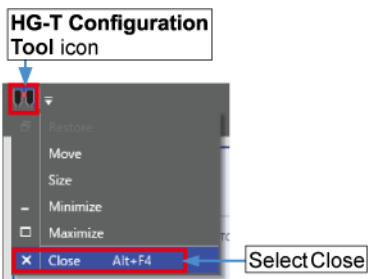

6 Name and Function of Each Window

6.1	Main Window	6-2
6.2	Menu bar	6-3
6.2.1	File Menu	6-3
6.2.2	Edit Menu	6-5
6.2.3	Help Menu	6-6
6.3	Quick Access Toolbar	6-8
6.4	Connected Units Window	6-10
6.4.1	Connection State	6-12
6.4.2	Product Image Icons	6-12
6.4.3	Error Icons	6-13
6.4.4	Output State	6-13
6.4.5	Add and Delete Buttons for Communication Unit	6-14
6.5	"Monitor" tab	6-17
6.5.1	Monitor Tab Window	6-17
6.5.2	Received Light Waveform Monitor	6-17
6.5.3	Measured Value Monitor	6-18
6.5.4	Export as Image / Export as CSV	6-19
6.5.5	I/O Monitor	6-22
6.5.6	Device Information Notification Dialog	6-22
6.6	"Settings" tab	6-24
6.6.1	Settings Tab Window	6-24
6.6.2	List of Configuration Parameters	6-25
6.7	"Device information" tab	6-28

6.1 Main Window

6.1 Main Window

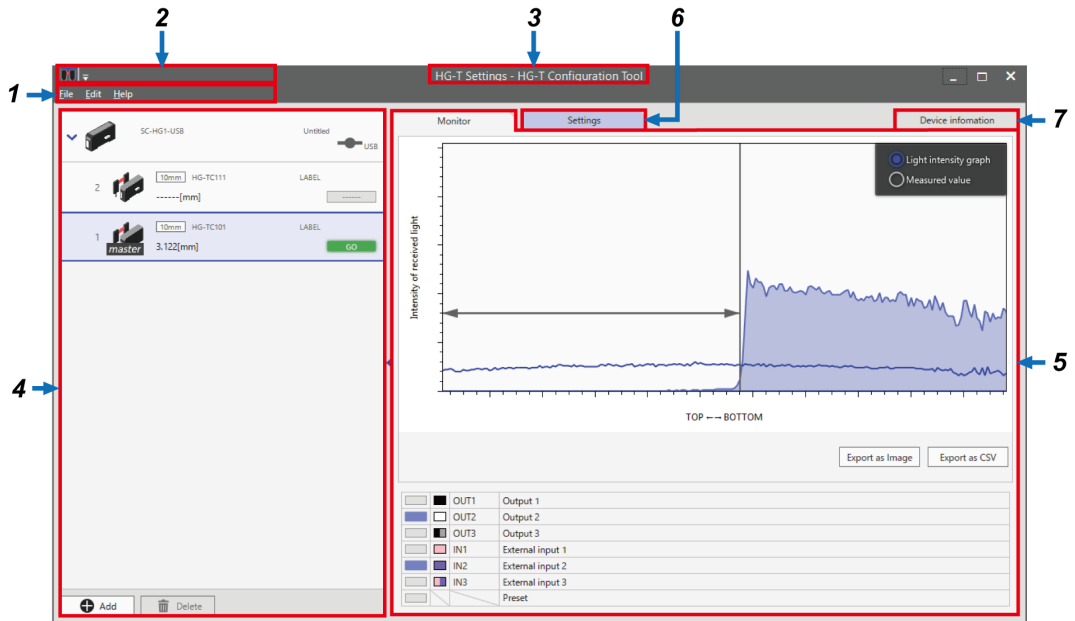

	Name	Function	Reference section
1	Menu bar	Displays the menus of each function used by HG-T Configuration Tool	"6.2 Menu bar"
2	Quick Access Toolbar	Allows the user to place operation icons for various functions in order to quickly execute frequently used functions such as "New", "Save", and "Copy"	"6.3 Quick Access Toolbar"
3	Title bar	Shows the name of the tool software. When a configuration file is saved or opened, the name of the configuration file is indicated.	—
4	Connected units window	Displays a list of communication units and controllers that are being connected or edited	"6.4 Connected Units Window"
5	"Monitor" tab	Allows the user to monitor the light waveforms received by the selected controller and the status of each input terminal	"6.5 "Monitor" tab"
6	"Settings" tab	Allows the user to set up the selected controller	"6.6 "Settings" tab"
7	"Device information" tab	Displays device information for the selected communication unit and controllers	"6.7 "Device information" tab"

6.2 Menu bar

This section introduces the functions that can be set on the menu bar.

6.2.1 File Menu

This menu allows the user to set operations and options related to configuration files, and language.

The following items can be selected.

New

This item allows the user to create a new configuration file.

On the menu bar, select **File>New**. (Shortcut key: Ctrl + N)

For details on the operating procedure, refer to "[8.3.1 Creating New Configuration Files](#)".

Open

This item allows the user to open an existing configuration file.

On the menu bar, select **File>Open**. (Shortcut key: Ctrl + O)

For details on the operating procedure, refer to "[8.3.3 Opening Existing Configuration Files](#)".

Save

This item allows the user to overwrite an existing configuration file.

On the menu bar, select **File>Save**.

The current configuration file will be overwritten. (Shortcut key: Ctrl + S)

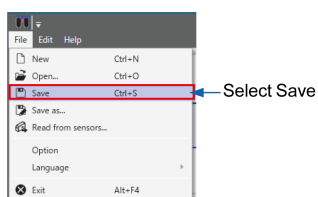

Save as

This item allows the user to rename and save the specified file. The operating procedure is as below.

1 2 Procedure

1. On the menu bar, select **File>Save as**.

6.2 Menu bar

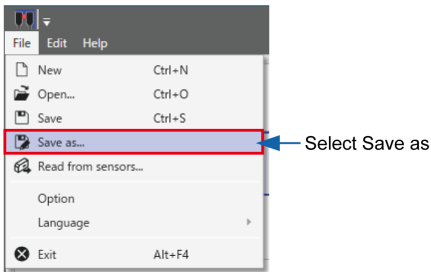

2. The "Save as" dialog box will be displayed.

Specify a storage location and file name and then click the [Save] button. [Storage format: hgt file format (extension : .hgt)]

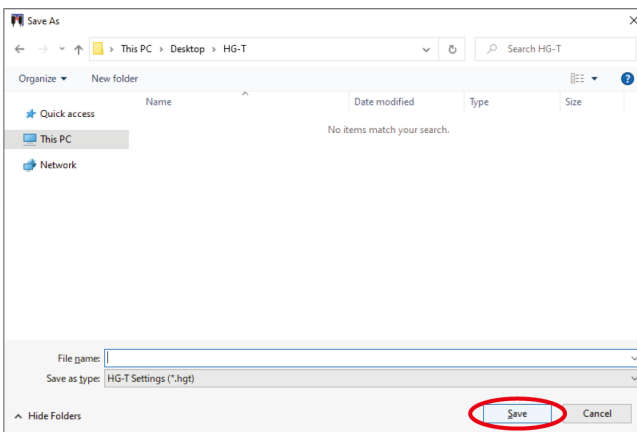

Read from sensors

The **HG-T** series configuration information and other settings in the main unit can be read from the communication unit connected to the PC.

On the menu bar, select **File>Read from sensors (R)**.

In the displayed menu, select the connected communication unit in the "Communication unit being connected" display area, then click the [Add] button.

For details, refer to ["5.2 Starting by Loading the Settings from Communication Unit"](#).

Option

This item allows the user to specify a password when writing the settings to the controller.

Specifying a password prevents functions from being set or changed for the controller.

For details on the operating procedure, refer to ["8.5.1 Setting a Password"](#).

Note

- If you have forgotten the password specified in "Option", you can initialize the password. For details on the operating procedure, refer to ["8.5.2 Initializing a Password"](#).

Language

This item allows you to switch the display language for HG-T Configuration Tool.
The operating procedure is as below.

1 2 Procedure

1. On the menu bar, select **File>Language**. (Default: 日本語)

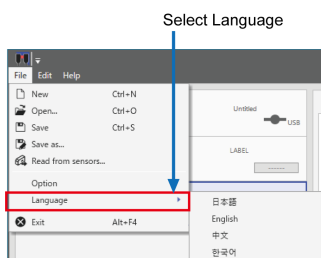

2. You can select "日本語", "English", "中文" or "한국어".
When **HG-T Configuration Tool** is restarted, the settings will take effect.

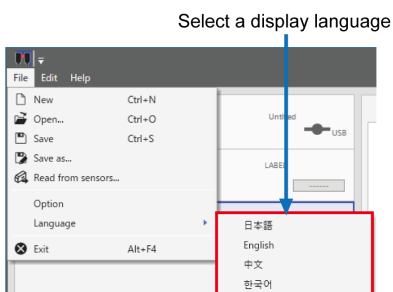

Exit

On the menu bar, select **File>Exit** to close **HG-T Configuration Tool**. (Shortcut key: Alt + F4)

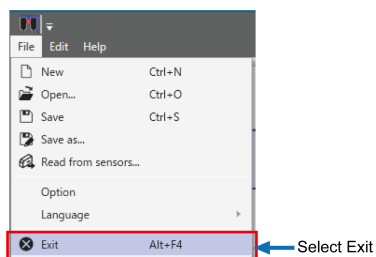

6.2.2 Edit Menu

This menu allows you to copy the settings of each function set up for a controller or paste a copied configuration file to another controller.

6.2 Menu bar

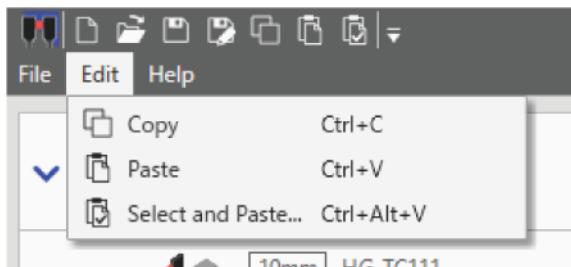

Copy / Paste

The Copy item allows you to copy all the settings of a particular controller and the Paste item allows you to paste them to another controller.

For details on the operating procedure, refer to ["8.4.1 Copying Settings"](#).

Select and Paste

This item allows you to select any desired settings from a particular controller and paste them to another controller.

For details on the operating procedure, refer to ["8.4.3 Selecting and Pasting Copied Settings"](#).

6.2.3 Help Menu

This menu allows you to refer to the manual and check the software version of **HG-T Configuration Tool**.

Manual

This item allows you to refer to the manual of **HG-T Configuration Tool**.

Version information

Select **Help>About**.

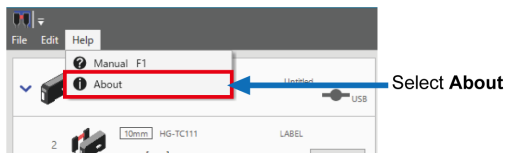



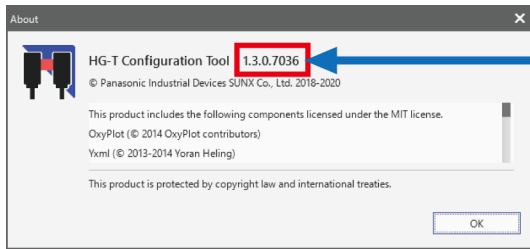





Version information for **HG-T Configuration Tool** will be displayed.



Version information

6.3 Quick Access Toolbar

The menu items of functions that are frequently used with **HG-T Configuration Tool** can be registered on the Quick Access Toolbar.

Item	Name	Reference section
	"New"	"8.3.1 Creating New Configuration Files"
	"Open"	"8.3.3 Opening Existing Configuration Files"
	"Save"	"Save"
	"Save as"	"Save as"
	"Read from communication unit"	"5.2 Starting by Loading the Settings from Communication Unit"
	"Copy"	"8.4.1 Copying Settings"
	"Paste"	"8.4.2 Pasting Copied Settings"
	"Select and Paste"	"8.4.3 Selecting and Pasting Copied Settings"
	"Manual"	"6.2.3 Help Menu"

1 2 Procedure

1. Click the  button on the Quick Access Toolbar.

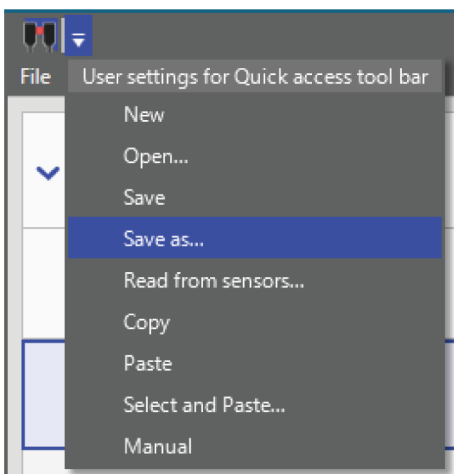

2. Clicking "Save as" displays a tick mark on the left of "Save as " and adds the  icon on the right side of HG-T Configuration Tool.

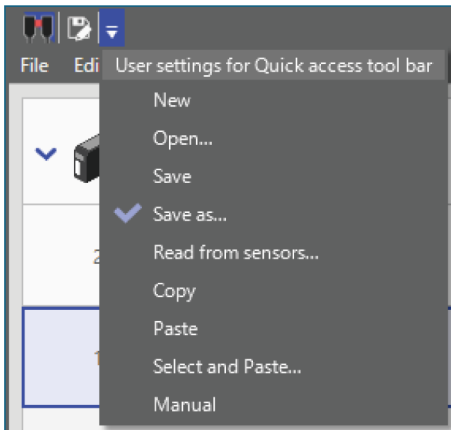

6.4 Connected Units Window

6.4 Connected Units Window

This window displays a list of communication units and controllers that are being connected or edited.

Communication units, slave controllers, and master controllers are displayed as connected units on the tree in this order. If you select a master controller or slave controller in the connected units window when they are in an online state, "Monitor" tab, "Settings" tab, and "Device information" tab for the selected controller will be enabled.

The connected units window consists of the following components.

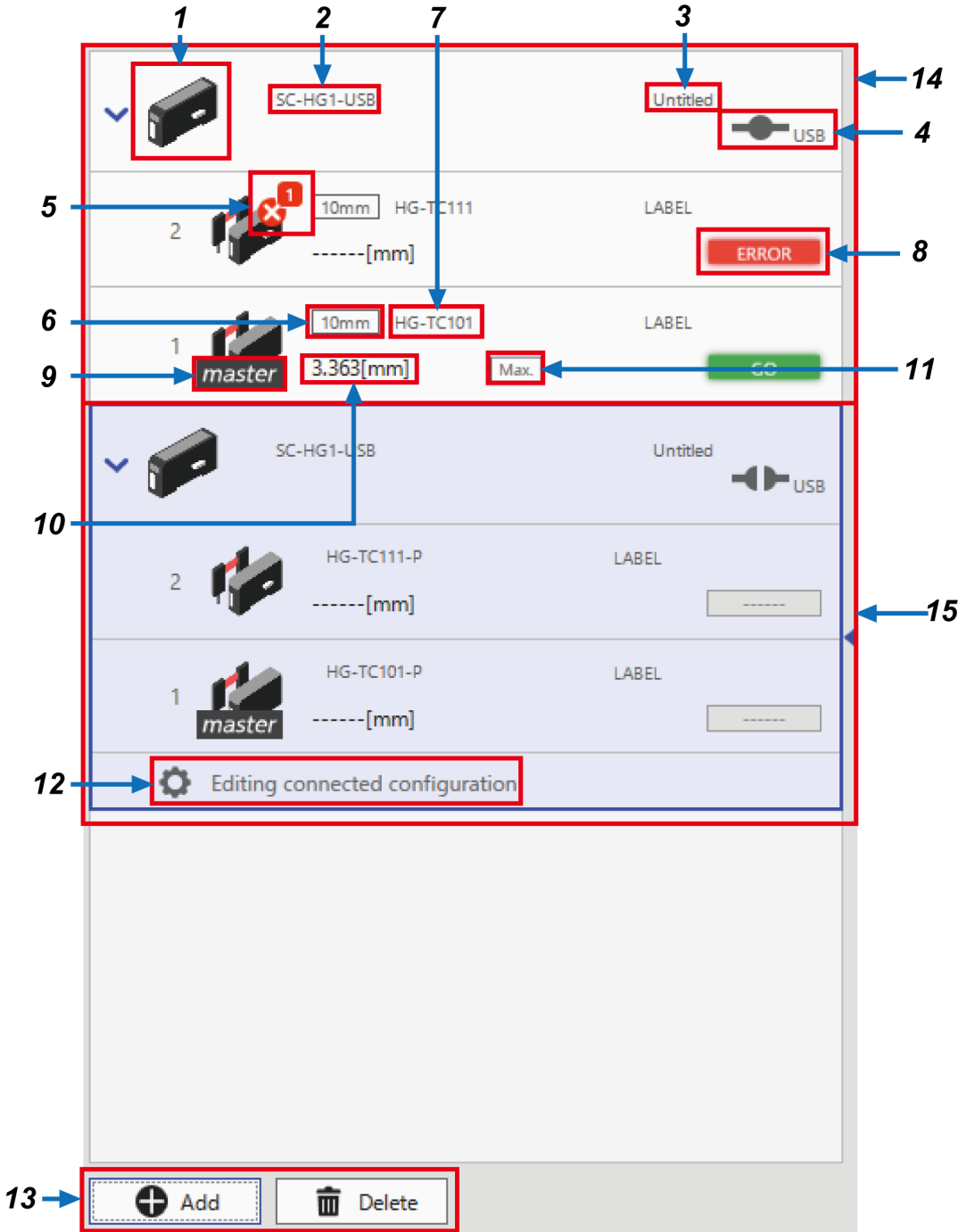

	Name	Description	Reference section
1	Product image icon	The image of the connected product is displayed.	"6.4.2 Product Image Icons"

6.4 Connected Units Window

	Name	Description	Reference section
2	Communication unit model	The model of the connected product is displayed.	-
3	Communication unit label	The label entered in the Device Information tab window is displayed.	-
4	Connection state	The connection state of the communication unit and the PC is displayed.	"6.4.1 Connection State"
5	Error icon	An error or alarm that has occurred on the controller and the number of errors or alarms are displayed. Click to pop up the device information notification dialog.	"6.4.3 Error Icons" "6.5.6 Device Information Notification Dialog"
6	Connected head type	The measurement width of the connected sensor head is displayed.	-
7	Controller model	The model of the controller is displayed.	-
8	Output state	The output state of the controller is displayed.	"6.4.4 Output State"
9	Master unit identification	This is only displayed for master controllers.	-
10	Measured value	The measured value of the controller is displayed.	-
11	Calculation type (for master units only)	The application set in calculation mode for the master controller is displayed.	-
12	[Edit connected configuration] button	This button is used to add or remove controllers to be connected. Use this button only in offline setting mode.	"8.3.4 Editing Connection Configuration"
13	[Add] button/[Delete] button	These buttons are used to add and delete communication units in the connected units window, respectively.	"6.4.5 Add and Delete Buttons for Communication Unit"
14	Online unit list	This list indicates a state in which the communication unit and the PC are actually communicating with each other.	—
15	Offline unit list	This list indicates a state in which there are only settings in the PC and there is no actual machine.	-

6.4.1 Connection State



The connection state of the communication unit and the PC is displayed as below.

Connected	Disconnected	Offline
 Can communicate with communication unit	 Cannot communicate with communication unit	 Only settings in the PC and no actual machine

6.4.2 Product Image Icons

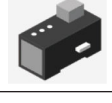

The connected controllers and communication unit are displayed as product images.

If an alarm or error is detected, the corresponding icon will be displayed within the image of the unit.

Display	Description
	HG-T master controller HG-TC101 / HG-TC101-P
	HG-T slave controller HG-T111 / HG-T111-P / HG-T113
	USB communication unit SC-HG1-USB
	RS-485 communication unit SC-HG1-485



6.4.3 Error Icons

If an error occurs on the controller or the specified alarm conditions are satisfied, one of the following error icons will be displayed. The number of errors or alarms that occur at the same time is also displayed inside the red square on the top right of the icon. Click the icon to start the "Device information notification dialog".

Display	Description
	An error has occurred on the controller.
	The specified alarm has been detected in the controller.
	The number of generated errors/alarms is displayed.

6.4.4 Output State

The output states of connected controllers are displayed as below.

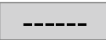
Display	State	Condition
	LOW	The measured value falls below the LOW set value.
	GO	The measured value falls within the set value range.
	HIGH	The measured value exceeds the HIGH set value.
	Data indeterminate	Correct measurements cannot be made (there is no abnormality).

6.4 Connected Units Window

Display	State	Condition
+OVER	Out of display range (+)	The measured value exceeds +199.999.
-OVER	Out of display range (-)	The measured value falls below -199.999.
ALARM	Alarm	An alarm has occurred.
ERROR	Error	An error has occurred.

6.4.5 Add and Delete Buttons for Communication Unit

Add

This button is used to add communication units to the connected units window.

Clicking [Add] displays a sensor addition menu.

For details on how to add communication units, refer to ["8.3.1 Creating New Configuration Files"](#).

Delete

This button is used to delete communication units from the connected units window.

The procedure for deleting communication units is as described below.

1 Procedure

1. Select a connection configuration to be deleted from the connected units window and then click [Delete].

Select a connection configuration

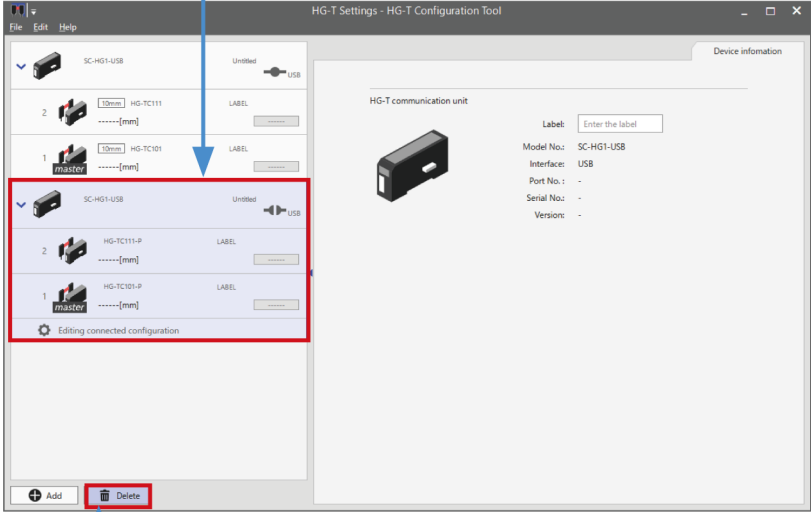

Click Delete

2. A confirmation message will be displayed. Click [Yes].

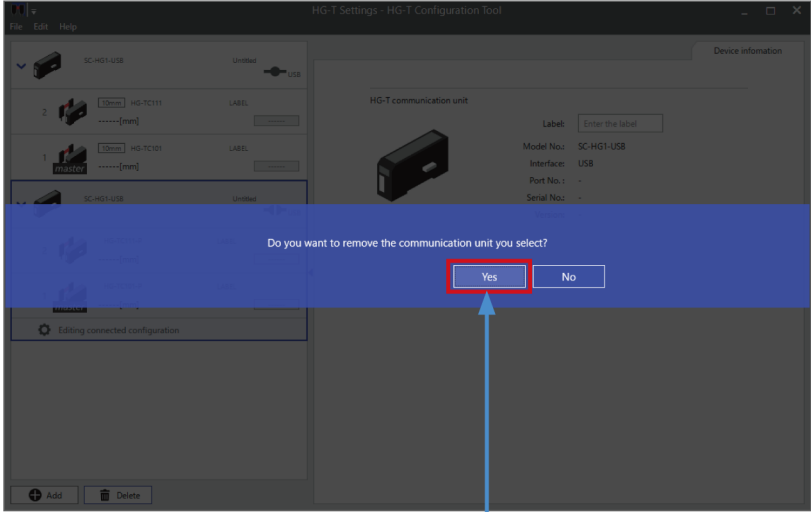

Click Yes

3. The selected connection configuration has been deleted.

6.4 Connected Units Window

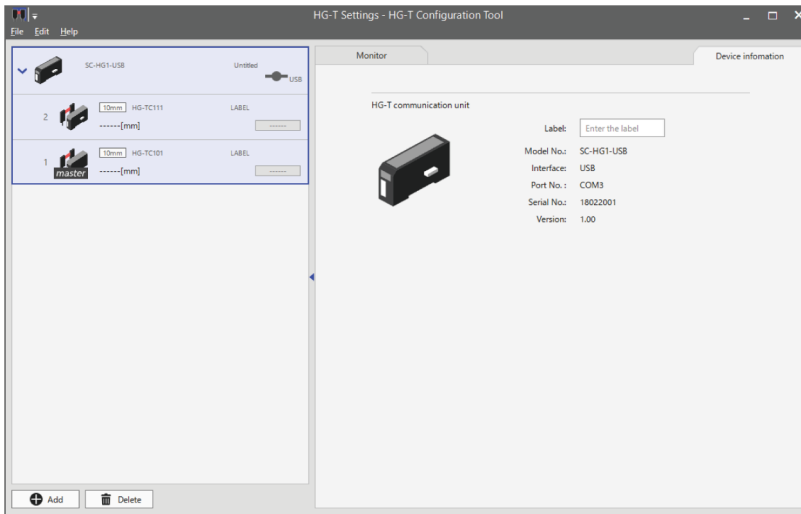

6.5 "Monitor" tab

This tab allows the user to monitor the light waveforms received by the selected controller or the status of each I/O terminal.

6.5.1 Monitor Tab Window

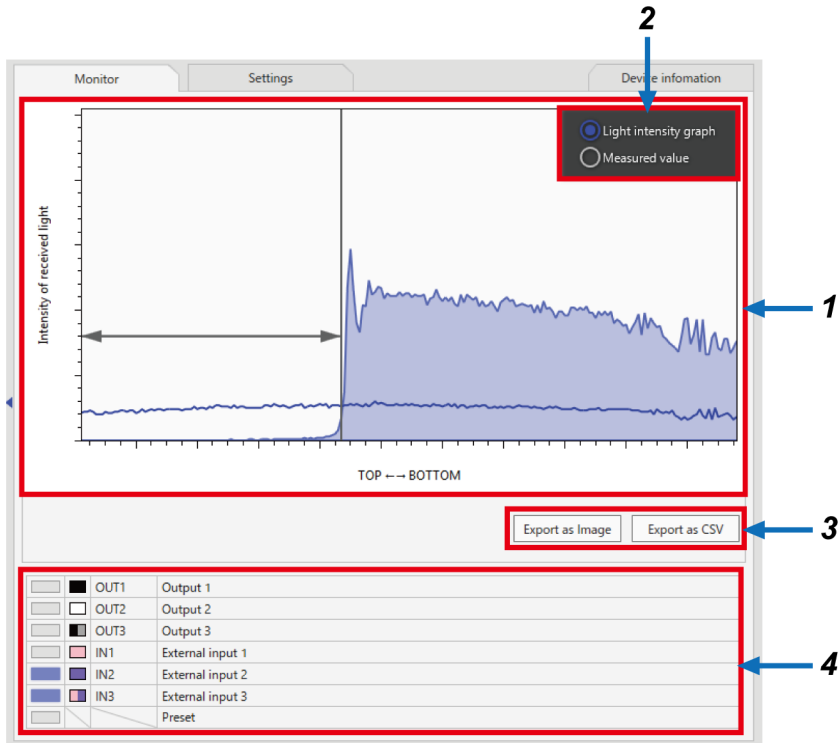

	Name	Description	Reference section
1	Received light waveform monitor / measured value monitor	Received light waveform monitor or measured value logging monitor is displayed.	"6.5.2 Received Light Waveform Monitor" "6.5.3 Measured Value Monitor"
2	Monitor selector	The display can be changed to the received light waveform monitor or measured value monitor.	—
3	[Export as Image] / [Export as CSV]	Received light waves or measured values are output as image or CSV data.	"6.5.4 Export as Image / Export as CSV"
4	I/O monitor	The ON/OFF state of each function is displayed.	"6.5.5 I/O Monitor"

6.5.2 Received Light Waveform Monitor

This area displays the state of the light waveforms received by the selected controller, judgment level waveforms, and edge positions.

6.5 "Monitor" tab

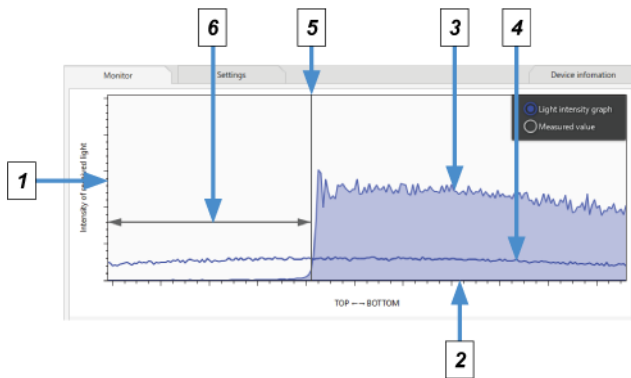

	Name	Description
1	Vertical axis	The amount of light received is displayed.
2	Horizontal axis	The measurement range of the sensor head is displayed.
3	Received light waveform	Waveforms are displayed by connecting each measured amount of received light with a line.
4	Judgment level waveform	Waveforms are displayed by connecting each measured amount of received light at the specified judgment level with a line. If the amount of light received falls below the judgment level, the light will be judged to be intercepted and the edge position will be calculated.
5	Edge position	The edge position of the measured object that is inserted is displayed as a straight line.
6	Measured value	The area from the top or bottom to the edge position is displayed as an arrow line. The area indicated by the arrow line is the value measured by the sensor head.

6.5.3 Measured Value Monitor

The measured value in the selected controller is displayed. The update cycle can be changed to a desired cycle setting. This monitor can be used for measured value logging.

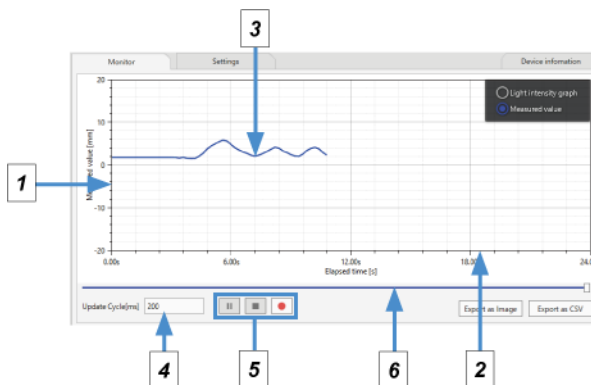

	Name	Description
1	Vertical axis	Measured values are indicated.

	Name	Description
2	Horizontal axis	The elapsed time from the start of logging is shown. The graph scrolls horizontally as the elapsed time increases.
3	Measured value waveform	The waveform is created by connecting measured values with a line.
4	Update cycle setting	The interval of the measured value logging can be set.
5	Logging operation	Used to perform measured value logging operations. <input type="checkbox"/> : Pauses logging. <input type="checkbox"/> : Stops logging. (Note 1) <input checked="" type="checkbox"/> : Starts logging. (Pressing this while logging is paused resumes logging.)
6	Slider	By moving the slider, you can check the past measurement waveform outside the display area.

(Note 1) When logging is stopped, a confirmation message appears and the data can be output as CSV. If CSV data is not output, the logging data will not be saved.

Note

- If an abnormality occurs during logging, the following will be displayed.

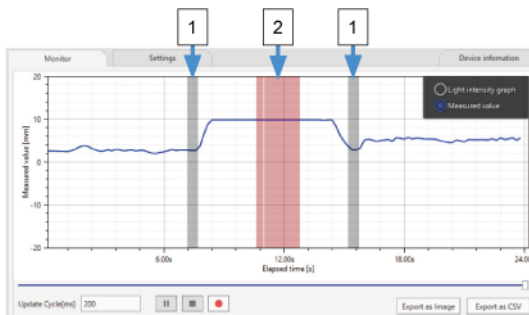

	Name	Description
1	Data loss Indeterminate data	When data is lost or becomes indeterminate, the zone where such a problem has occurred is displayed as a gray background.
2	Error / alarm occurrence Out of display range	When an error or alarm occurs on the device or data goes beyond or falls below the display range, the zone where such a problem has occurred is displayed as a red background.

6.5.4 Export as Image / Export as CSV

Information displayed in the graph window can be output as image or CSV.

Export as Image

The graph displayed in the window can be output as image data (format: PNG).

6.5 "Monitor" tab

1 2 Procedure

1. Click [Export as Image].



2. The "Save as" dialog box will be displayed.
Specify a storage location and file name and then click [Save].

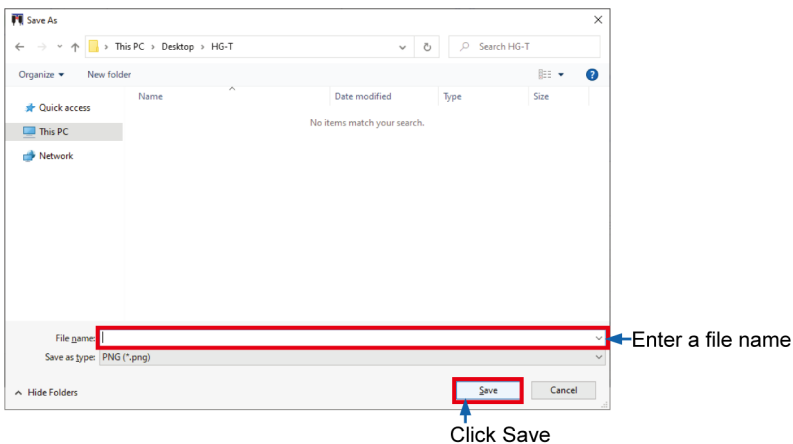

3. Images will be output in PNG format to the specified storage location.

Export as CSV

Information of the graph displayed in the window can be output as CSV data.

When the received light waveform monitor has been selected, the "array number" and the "amount of received light" are output.

When the measured value monitor has been selected, the "refreshing interval," the "acquisition time" and "measured value" are output.

1 2 Procedure

1. Click [Export as CSV].

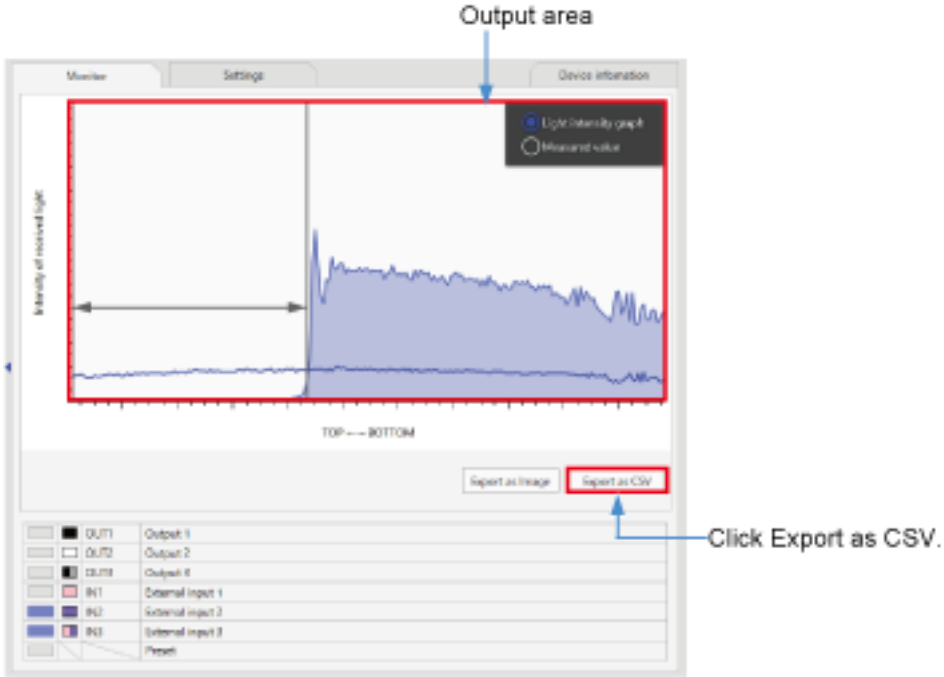

2. The "Save as" dialog box will be displayed. Specify a storage location and file name and then click [Save].

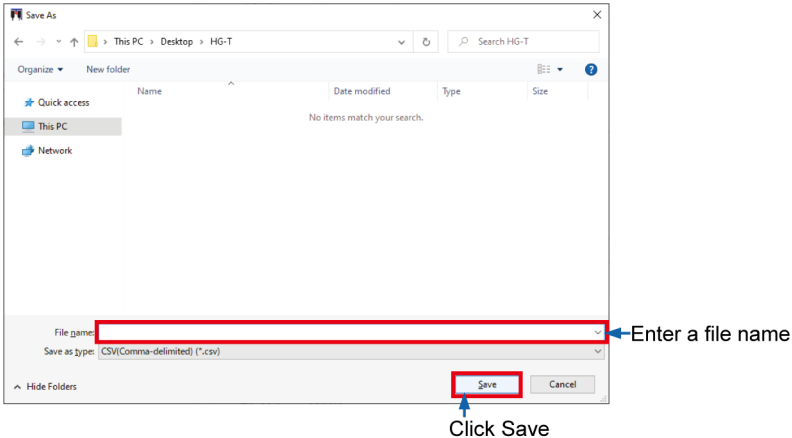

3. Data will be output in CSV format to the specified storage location.

6.5 "Monitor" tab

6.5.5 I/O Monitor

The I/O monitor displays the ON/OFF state of each function or the preset ON/OFF state for the connected controller.

Each indicator turns ON when the output or input turns ON. The icon on the right side of the indicator indicates the color of the cable.

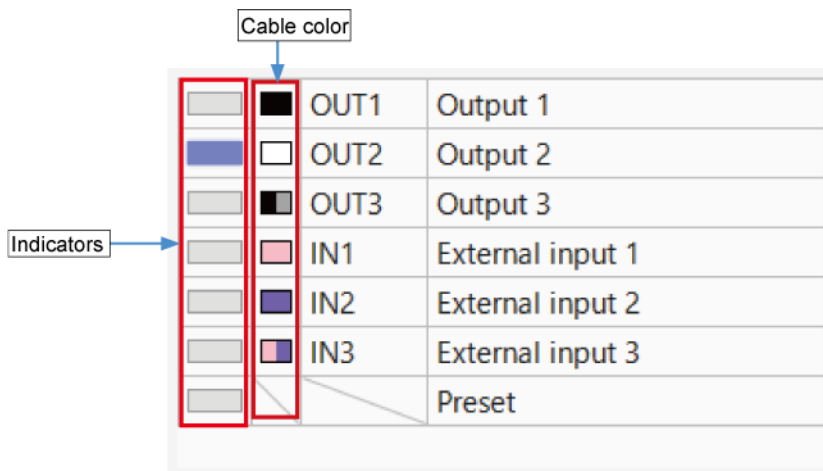

i Info.

- The monitor is not influenced by output operation settings.

6.5.6 Device Information Notification Dialog

■ Error

If an error occurs on the controller, error information like the following example will be displayed.

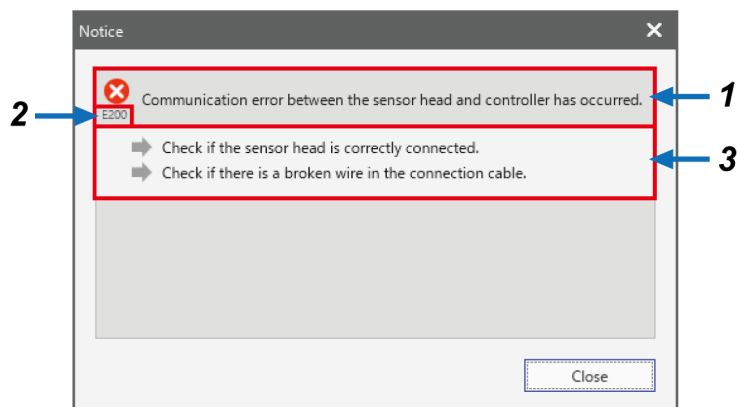

	Name	Description
1	Error message	Indicates an error that has occurred on the current controller

	Name	Description
2	Error code	Indicates the error code of the error that has occurred
3	Action	Indicates the action to resolve the error that has occurred

For details on error messages and action methods, refer to "9.1 Error Messages".

■ Alarm

If an alarm occurs on the controller, alarm indication like the following example will be displayed.

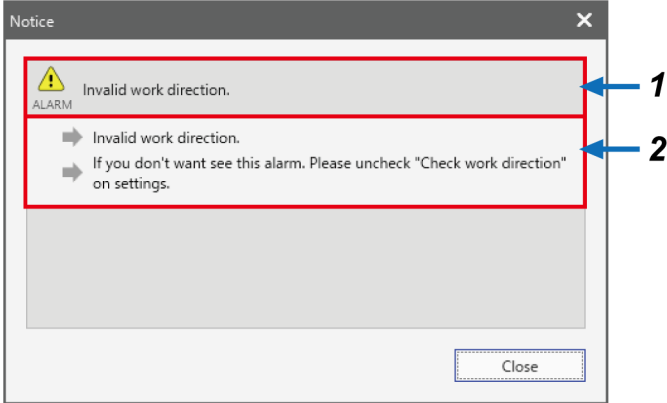

	Name	Description
1	Alarm message	Indicates an alarm that has occurred on the current controller
2	Action	Indicates the action to resolve the alarm that has occurred

For details on alarm messages and action methods, refer to "9.2 Alarm Messages".

6.6 "Settings" tab

6.6 "Settings" tab

This tab allows the user to set up each parameter for the selected controller.

6.6.1 Settings Tab Window

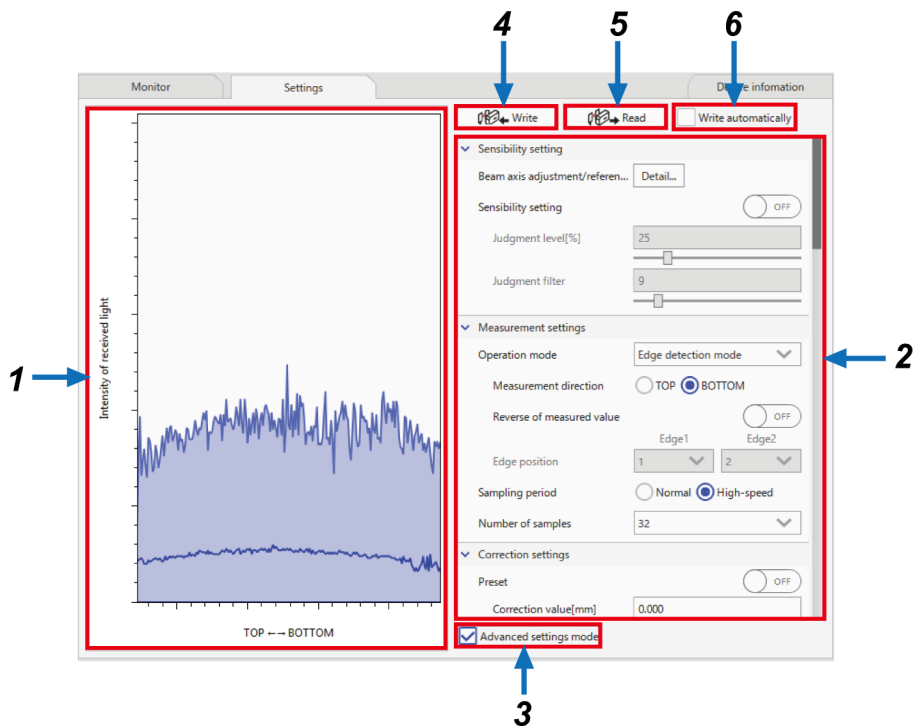

	Name	Function	Reference section
1	Received light waveform monitor	The state of received light waveforms is displayed. The vertical axis indicates the amount of light received and the horizontal axis indicates the measurement range of the sensor head.	"6.5.2 Received Light Waveform Monitor"
2	Configuration parameter area	This area displays the parameters that can be set for the HG-T series controllers. Each parameter can be checked and edited. When the tool software is started, this area is displayed in simple setting mode (in which only general parameters are displayed).	-
3	"Advanced settings mode" check box	Selecting this check box displays all settable parameters in the configuration parameter area so that more detailed settings can be specified.	"6.6.2 List of Configuration Parameters"
4	[Write] button	Clicking this button writes the parameter settings in the configuration parameter area to the controller.	"7.7.1 Writing Procedure"
5	[Read] button	Clicking this button reads the parameter settings from the controller and reflects them into the configuration parameter area.	-

	Name	Function	Reference section
6	"Write automatically" check box	Selecting this check box reads the parameter settings from the controller and reflects them into the configuration parameter area. When any parameter in the configuration parameter area is changed, the changed settings are automatically written to the main unit.	-

6.6.2 List of Configuration Parameters

The following list shows the parameters and items that can be set with **HG-T Configuration Tool**.

For details on each parameter, refer to the *HG-T User's Manual*.

Configuration parameter		Outline	Advanced settings mode (Note 2)
Sensitivity setting	Beam axis adjustment / Reference waveform registration	This parameter allows the user to adjust the beam axis and register reference waveforms.	
	Manual sensitivity adjustment	ON: User setting / OFF: Default value	
	Judgment level [%]	This item allows the user to set a judgment level when manual sensitivity adjustment is set to ON.	
	Judgment filter	This item allows the user to set a judgment filter when manual sensitivity adjustment is set to ON.	
Measurement settings	Operation mode	This parameter allows the user to set the operation mode.	
	Measurement direction	This item sets the direction in which the measured object is inserted when the operation mode requires direction settings.	
	Measured value reversal	This item turns ON when the measured value reversal function is used. Default : OFF	
	Edge position	This item is used when the user assigned edge detection mode is selected. Assigned edge 1 and edge 2.	
	Sampling cycle	This parameter sets the sampling cycle of the sensor head.	○
	Average count	This parameter sets an average count (response time).	
Correction settings	Preset	This parameter sets ON / OFF for preset.	
	Correction value ^(Note 1)	This item sets a preset value when Preset is set to ON.	
	Preset data selection	This parameter sets target data for preset.	○
	Value calculation	This parameter sets ON / OFF for calculation.	○
	Calculation method	This item is used to select from five methods such as the minimum value and maximum value.	○

6.6 "Settings" tab

Configuration parameter		Outline	Advanced settings mode (Note 2)
	Tab cancel	This parameter turns ON when the tab cancel function is specified.	
	Tab judgment threshold	This is one of the setting parameters of the tab cancel function. Default: 1.000 mm	
	Tab detection count	This is one of the setting parameters of the tab cancel function. Default: 17	
	Hold settings	This parameter sets each hold function.	<input type="radio"/>
	Trigger mode	This item sets trigger mode for each hold function.	<input type="radio"/>
	Calibration	This parameter performs a calibration.	
Operation setting	Threshold		
	HIGH set value [mm]	This item sets the HIGH set value to any desired value.	
	LOW set value [mm]	This item sets the LOW set value to any desired value.	
	Teaching	This item performs teaching.	
	Hysteresis [mm]	This item sets the hysteresis to be used for teaching.	<input type="radio"/>
	Digital I/O		
	IN1 / IN2 / IN3	This item sets the input terminal function.	
	Simultaneous input	This item sets ON / OFF for simultaneous input.	<input type="radio"/>
	OUT1 / OUT2 / OUT3	This item sets the output terminal function.	
	Output type	This item sets N.O. or N.C.	
	Output delay timer	This item sets an output delay timer.	<input type="radio"/>
	Timeout value	This item sets a timeout value for the output delay timer.	<input type="radio"/>
	Analog output		
	Output type	This item sets voltage output or current output.	
	Scaling	ON: User setting / OFF: Default value	<input type="radio"/>
	Upper limit value [mm] This item sets the upper limit value of analog scaling when scaling is set to ON.		<input type="radio"/>
	Lower limit value [mm] This item sets the lower limit value of analog scaling when scaling is set to ON.		<input type="radio"/>
	Alarm		<input type="radio"/>
	Alarm delay count [number]	This item sets an alarm delay count.	<input type="radio"/>

Configuration parameter		Outline	Advanced settings mode (Note 2)
	Alarm output	This item sets the output state at the time of measurement alarm 1 occurrence.	<input type="radio"/>
	Dirt check	This item sets the dirt check function.	<input type="radio"/>
	Threshold	This item sets threshold values for the dirt check function when user settings are specified.	<input type="radio"/>
	Connected units count check	This item sets the connected units count check function.	<input type="radio"/>
	Reverse insertion check	This item sets the reverse insertion check function.	<input type="radio"/>
Configuratio n	Bank settings		
	Item to be read and written	This item sets the item to be saved to or loaded from each bank.	
	Bank operation	This item saves or loads the set item to or from the bank.	
	EEPROM storage		<input type="radio"/>
	Preset save	This item sets ON / OFF for preset storage in EEPROM.	<input type="radio"/>
	Reference waveform save	This item sets reference waveform storage in EEPROM through host communication.	<input type="radio"/>
	Interference prevention	This parameter sets ON / OFF for the interference prevention function.	<input type="radio"/>
	Number of digits displayed	This parameter sets the number of digits to be displayed.	<input type="radio"/>
	Eco mode	This parameter sets ON / OFF for Eco mode.	<input type="radio"/>
	Auto key lock	ON: Manual / OFF: Auto setting	<input type="radio"/>

(Note 1) The parameter name changes according to the preset ON / OFF setting. (ON: Target value / OFF: Correction value)

(Note 2) Parameters where is marked in the "Advanced settings mode" column are displayed and can be set when the "Advanced settings mode" check box at the bottom of the "Settings" tab window is selected.

6.7 "Device information" tab

6.7 "Device information" tab

Clicking the "Device information" tab allows the user to check device information for the selected controller and communication unit and to initialize the controller and set a label.

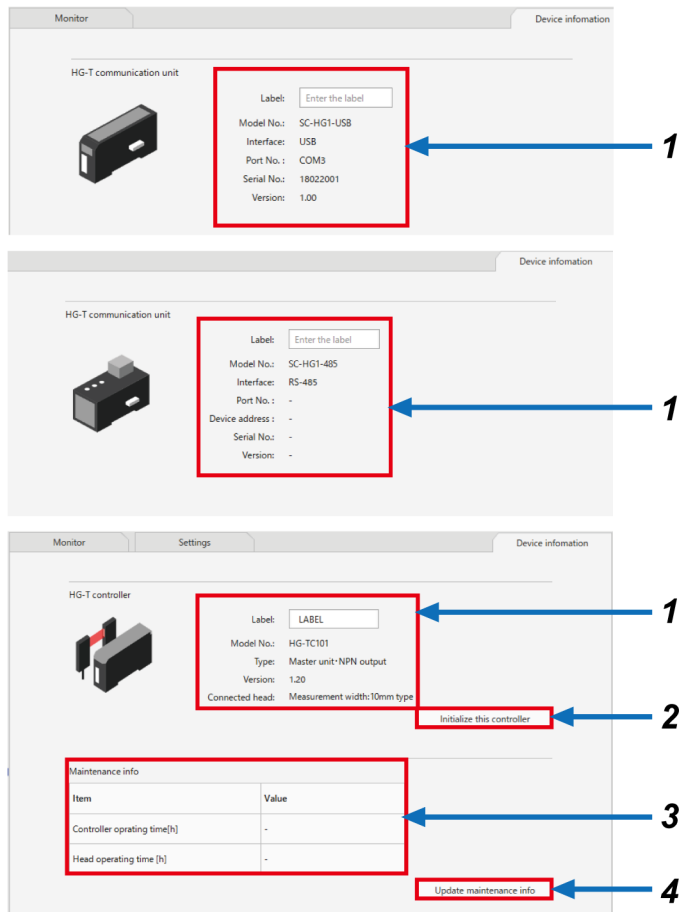

	Name	Description
1	Device information (Note 1)	<p>[Controller] Label, model name, type, software version, and connected head</p> <p>[Communication unit]</p> <ul style="list-style-type: none"> • SC-HG1-USB Label, model name, interface, serial number, and software version • SC-HG1-485 Label, model, interface, port number, device address, serial number, and software version
2	[Initialization] button (Note 2)	This button resets the controller to its factory default state. (Note 2)
3	Maintenance information	The cumulative operating hours of the controller and sensor head are displayed.
4	[Information update] button	Maintenance information is updated to the latest information.

(Note 1) For details on how to set a label, refer to ["8.2 Labeling"](#).

(Note 2) For details on how to initialize a controller, refer to ["7.9 Initialization"](#).

(MEMO)

7 Setting up the Main Unit

The "Settings" tab can be used to set up the main unit.

7.1 Flow of Operations up to Setup Completion	7-2
7.2 Adjusting the Beam Axis and Registering Reference Waveforms	7-3
7.3 Adjusting Sensitivity	7-6
7.4 Performing Measurement Settings	7-8
7.4.1 Operation Mode	7-8
7.5 Performing Teaching	7-10
7.5.1 1-point Teaching	7-11
7.5.2 2-point Teaching	7-12
7.5.3 3-point Teaching	7-13
7.6 Performing Calibration	7-16
7.7 Writing Parameters to Main Unit	7-19
7.7.1 Writing Procedure	7-19
7.7.2 If Parameters Cannot be Written	7-20
7.8 Performing Bank Operation	7-22
7.9 Initialization	7-24

7.1 Flow of Operations up to Setup Completion

7.1 Flow of Operations up to Setup Completion

This section explains the flow of **HG-T Configuration Tool** operations up to the completion of main unit setup.

1. Preparation

Download the tool software from our website, and install the software by following the installation procedure.

"4.1 Installation"



2. Start

Start up HG-T Configuration Tool.

"5.1 Starting **HG-T Configuration Tool**"



3. Read

Using the compatible communication tool, load the **HG-T** series main unit settings to the PC.

"5.2 Starting by Loading the Settings from Communication Unit"



4. Confirming the waveform

Using the "Monitor" tab or "Settings" tab, confirm the waveform.

"6.5 "Monitor" tab"

"6.6 "Settings" tab"



5. Setting up the functions

Using the "Settings" tab, set or change the parameters in the HG-T series main unit.

"6.6.2 List of Configuration Parameters"



6. Write

After completing the function setting, write the settings to the controller by following the specified procedure.

"7.7 Writing Parameters to Main Unit"



7. Saving the configuration file

After completing the setting, save the configuration file in the PC for safekeeping.

"6.2.1 File Menu"

"Save as"

7.2 Adjusting the Beam Axis and Registering Reference Waveforms

Use this procedure to check the beam axis of the connected controller and register reference waveforms.

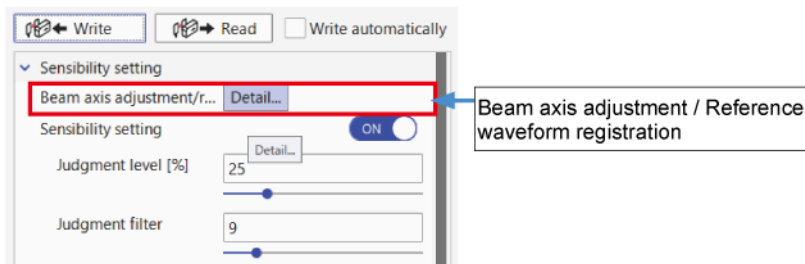

The operating procedure is as below.

1 2 Procedure

1. Click the [Detail] button on the right side of Beam axis adjustment / reference waveform registration to display the following window.

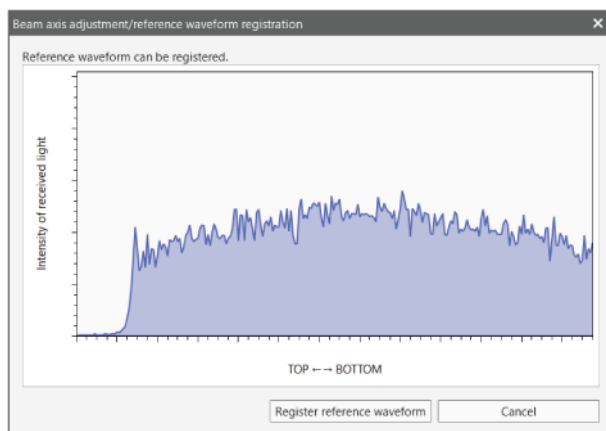

If the beam axis is misaligned, the waveform will be displayed in red. The adjustment method is displayed on the top left of the window. Move the emitter or receiver upward, downward, rightward, or leftward according to the instruction displayed in the dialog box. For details on how to adjust the beam axis, refer to "Adjusting the Beam Axis" in the **HG-T** series User's Manual.

7.2 Adjusting the Beam Axis and Registering Reference Waveforms

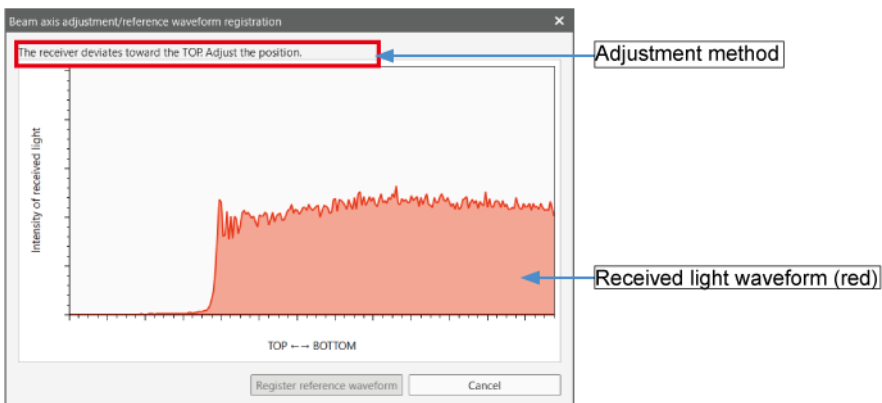

2. If the beam axis is aligned according to the displayed adjustment method, the waveform will be displayed in blue and the message "Reference waveform can be registered" will be displayed.

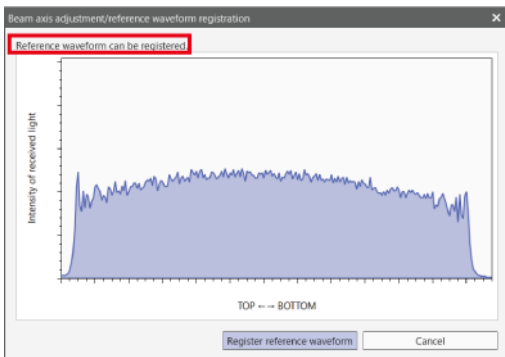

3. If you successively register a reference waveform, click the [Register reference waveform] button. The received light waveform displayed in the graph window will be registered as the reference waveform.
(If you do not register a reference waveform, click the [Cancel] button. The display will be returned to the main window.)

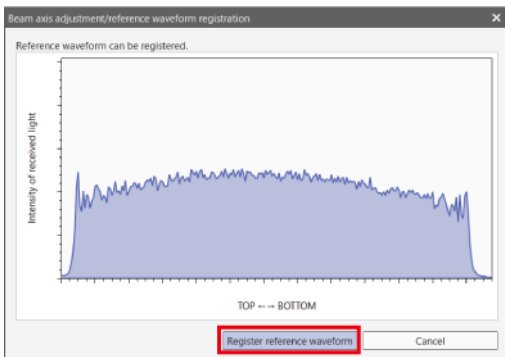

When the registration is completed, the message "Reference waveform has been registered" will be displayed. Clicking [OK] button closes the message window.

7.2 Adjusting the Beam Axis and Registering Reference Waveforms

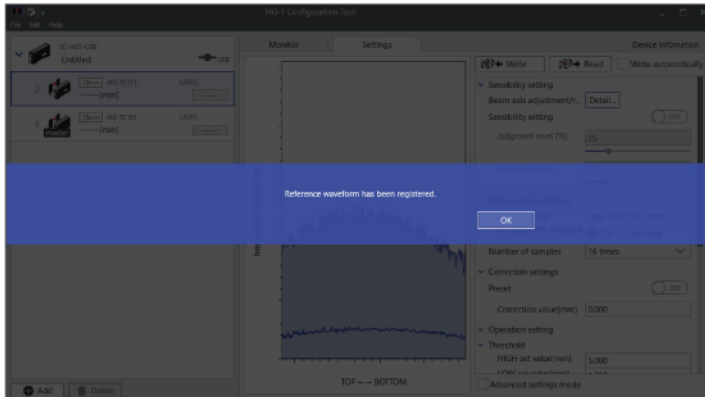

7.3 Adjusting Sensitivity

7.3 Adjusting Sensitivity

If the measured object that is inserted is a transparent body or if there is a risk of foreign objects contamination in the environment, you can change the judgment level and judgment filter for the sensor head that is connected.

If Sensitivity setting is set to OFF, the judgment level and judgment filter are set to their respective default values. To adjust them, set Sensitivity setting to ON, so that you can change the judgment level and judgment filter.

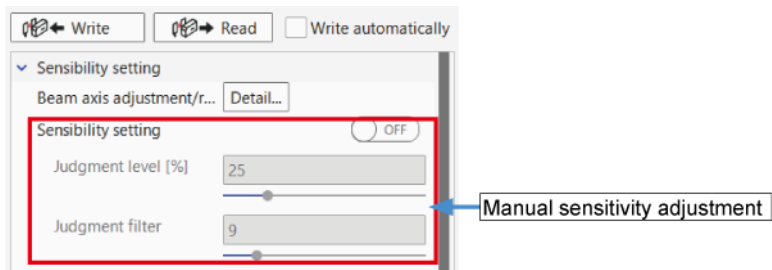

1 2 Procedure

- Slide the "Sensitivity setting" switch from OFF to ON. (Default: OFF)

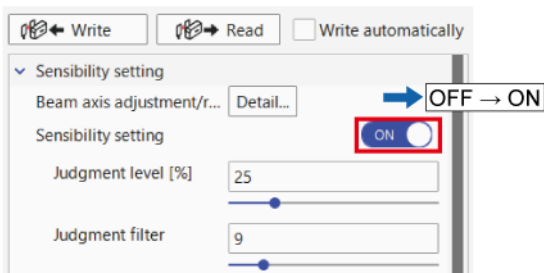

- For stable measurement of objects with high transmittance, you must increase the judgment level. For the judgment level, you can use either numerical input or slider input.

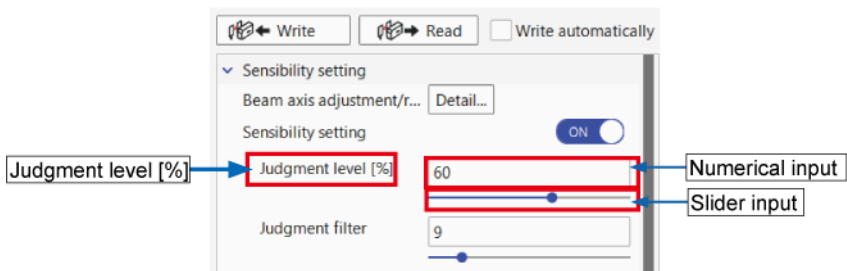

Configuration parameter	Setting range	Default value
Judgment level [%]	10 to 90 (%)	25

- To prevent malfunctions due to foreign objects contamination or other problems, you must increase the value of the judgment filter. For the judgment filter, you can use either numerical input or slider input.

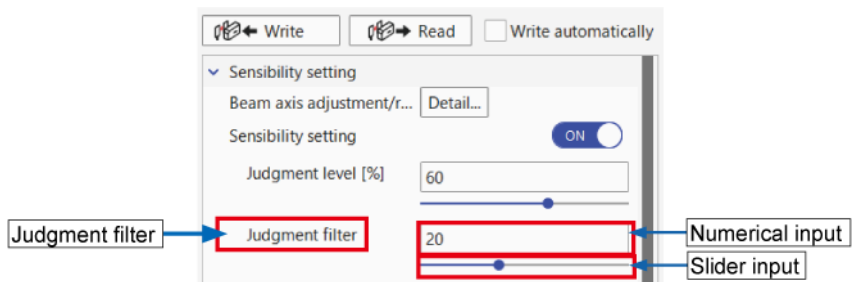

For stable measurement of small objects, you can measure them stably by reducing the value of the judgment filter.

Configuration parameter	Setting range	Default value
Filter strength	3 to 50	9

7.4 Performing Measurement Settings

7.4 Performing Measurement Settings

You can set the operation mode, insertion direction and average count according to the shape of the measured object or application.

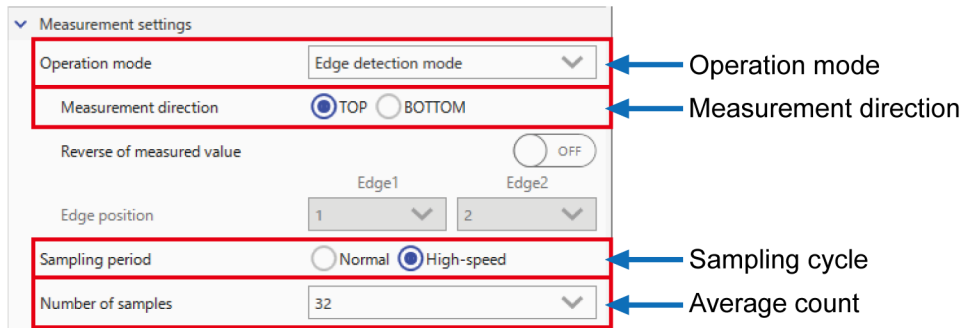

7.4.1 Operation Mode

Set the operation mode according to the method of measuring the workpieces.
(Default: Auto edge detection mode)

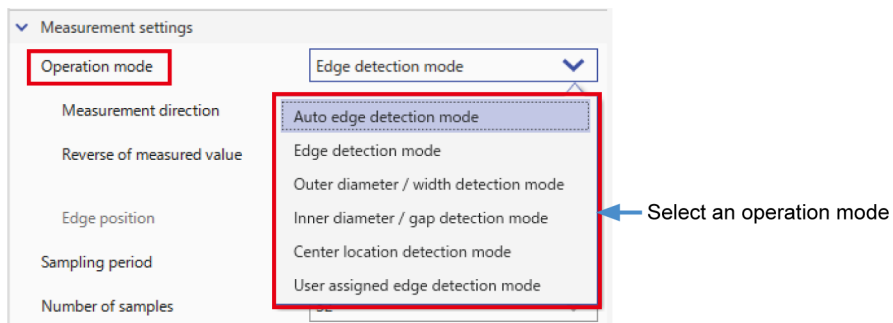

Setting item	Description
"Auto edge detection mode"	This mode automatically recognizes the direction in which the measured object enters the measurement area of the sensor head (TOP or BOTTOM side). The distance from the edge of the side where the measured object enters the measurement area to the edge of the measured object is measured.
"Edge detection mode"	When the direction in which the measured object enters the measurement area of the sensor head is specified as the TOP or BOTTOM side, this mode measures the distance from the TOP or BOTTOM side of the measurement area to the edge of the measured object.
"Outer diameter / width detection mode"	This mode measures the outer diameter or width of the measured object.
"Inner diameter/gap detection mode"	This mode measures the inner diameter or gap of the measured object.
"Center location detection mode"	When an object such as a pin is measured, this mode measures the distance from either the TOP or BOTTOM side edge to the center of the measured object.
"User assigned edge detection mode"	This mode measures the distance between the edges of the two points that are optionally selected from a number of detected edges or the distance from the TOP or BOTTOM position to the optionally assigned edge position.

 **Note**

- When "Edge detection mode" is selected, the "reverse insertion check" function can be used. The reverse insertion check function generates an alarm when the measured object is inserted in a direction different from the specified insertion direction.

7.5 Performing Teaching

7.5 Performing Teaching

This function allows you to set HIGH and LOW set values automatically.

For the teaching method, you can select 1-point teaching, 2-point teaching, or 3-point teaching.

1 2 Procedure

1. Click the [Teaching] button.

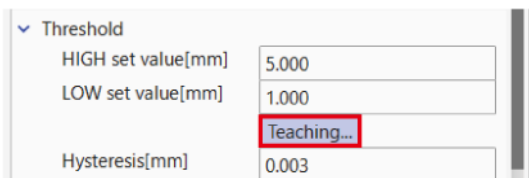

2. The "Teaching" dialog box will be displayed. Select a teaching method to be set.

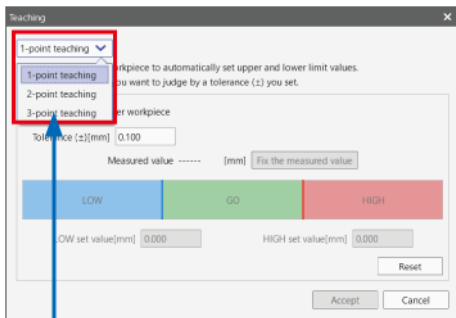

Select a teaching method

When performing teaching, check the setting for the direction of insertion by viewing "Measurement settings"—"Measurement direction".

Note

- When the operation mode has been set to "Auto edge detection mode", the "Threshold" parameter will be displayed as shown below.

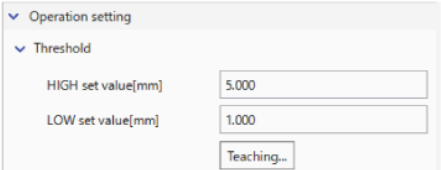
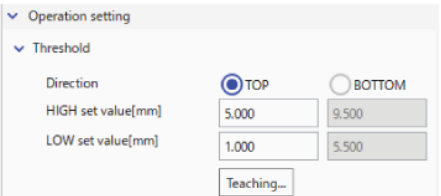
Mode other than auto edge detection mode	Auto edge detection mode
	

(Note 1) If the threshold values are changed using the threshold setting, it is necessary to set either TOP or BOTTOM as the reference point.

7.5.1 1-point Teaching

1.2 Procedure

1. Enter a tolerance to be set.

The judgment value of the master workpiece plus the tolerance can be set as the HIGH set value and the judgment value of the master workpiece minus the tolerance can be set as the LOW set value.

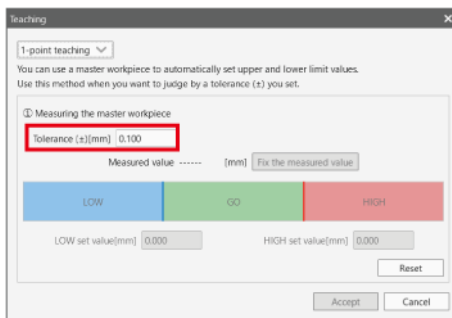

2. With the master workpiece measured, click the [Fix the measured value] button.

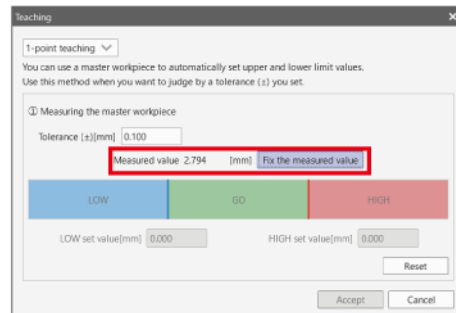
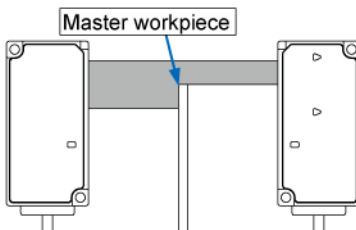

3. The HIGH and LOW set values will be set. By entering a numerical value, you can adjust the HIGH or LOW set value within the range (between the HIGH and LOW set values).



4. If you click the [Accept] button, the values set for teaching will be reflected in the configuration parameters.

7.5 Performing Teaching

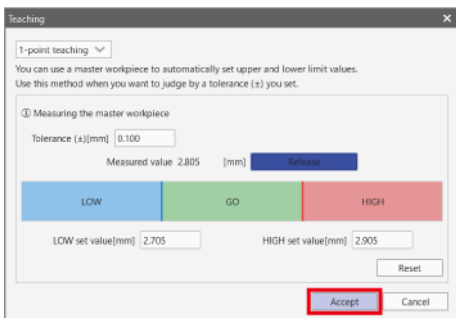

Note

- To reset the HIGH and LOW set values that have been set, click the [Reset] button in the lower right part of the "Teaching" window. The HIGH and LOW set values will be reset.

7.5.2 2-point Teaching

1 2 Procedure

1. Measure the first workpiece and click the [Fix the measured value] button for the first workpiece.

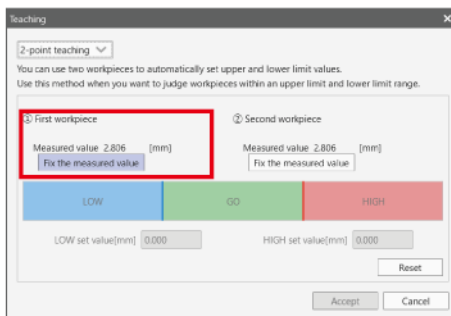
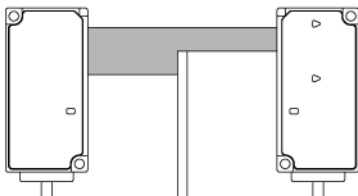

2. Measure the second workpiece and click the [Fix the measured value] button for the second workpiece.

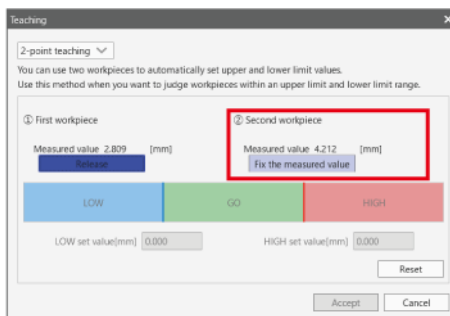
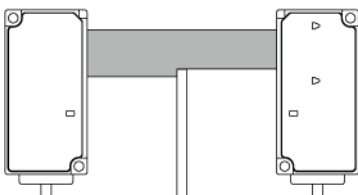

3. The HIGH and LOW set values will be set. By entering a numerical value, you can adjust the HIGH or LOW set value within the range (between the HIGH and LOW set values).

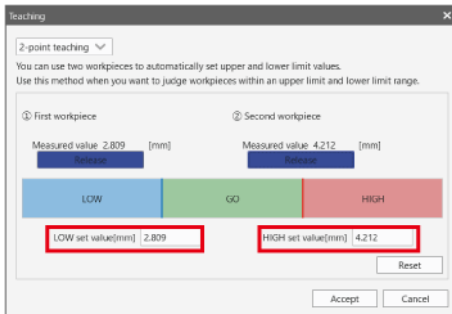

4. If you click the [Accept] button, the values set for teaching will be reflected in the configuration parameters.

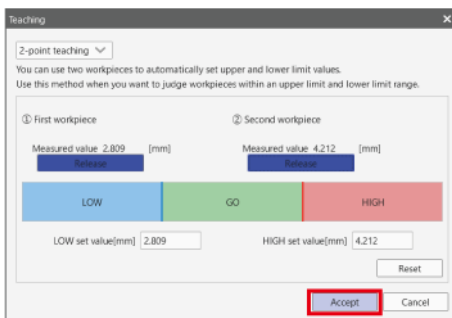

7.5.3 3-point Teaching

1 2 Procedure

1. Measure a LOW defective workpiece and click the [Fix the measured value] button.

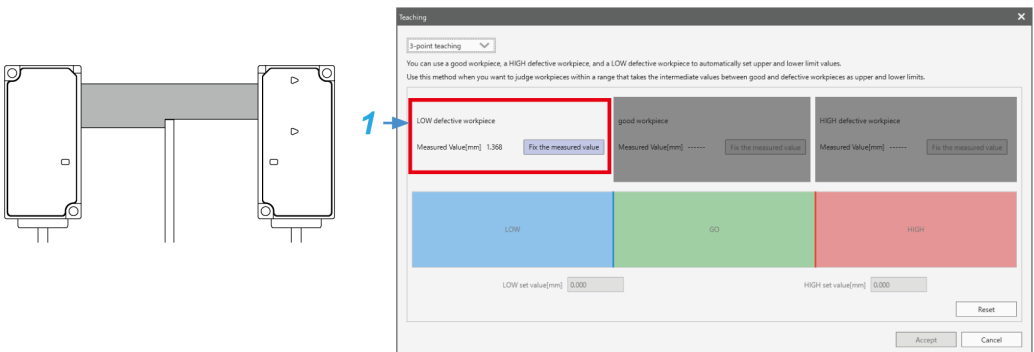

2. Measure a good workpiece and click the [Fix the measured value] button.

7.5 Performing Teaching

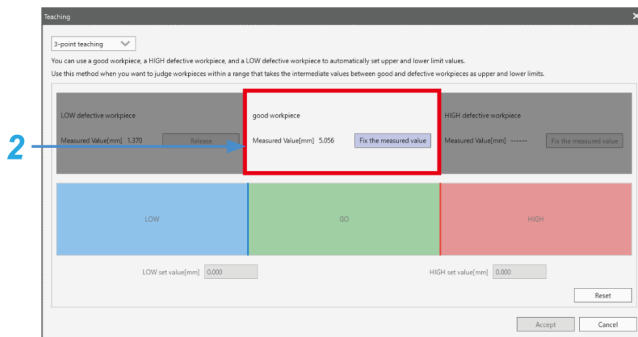
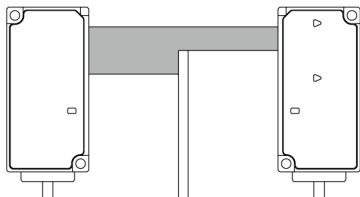

3. Measure a HIGH defective workpiece and click the [Fix the measured value] button.

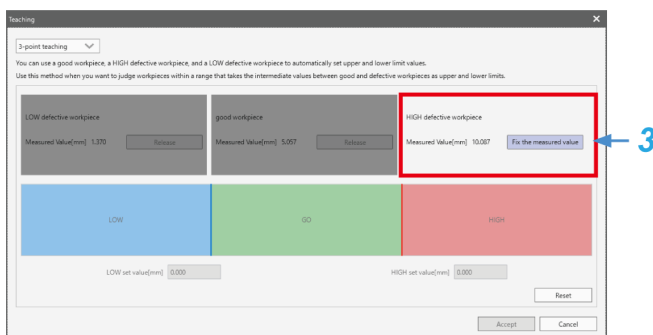
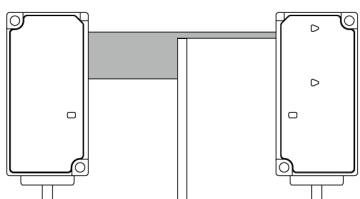

4. The HIGH and LOW set values will be set. By entering a numerical value, you can adjust the HIGH or LOW set value within the range (between the HIGH and LOW set values).

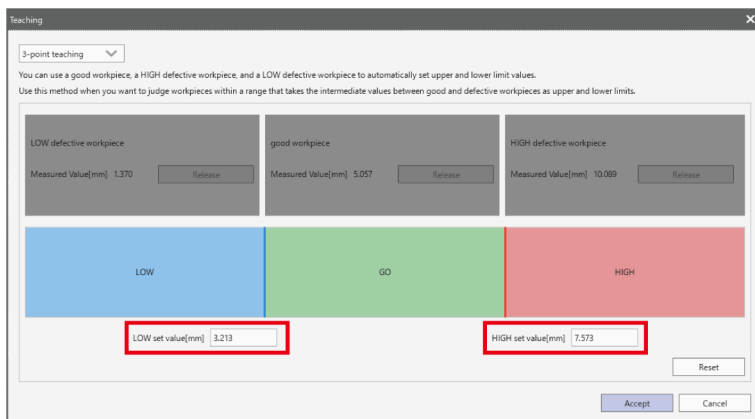

5. If you click the [Accept] button, the values set for teaching will be reflected in the configuration parameters.

7.5 Performing Teaching

Teaching

3-point teaching

You can use a good workpiece, a HIGH defective workpiece, and a LOW defective workpiece to automatically set upper and lower limit values.
Use this method when you want to judge workpieces within a range that takes the intermediate values between good and defective workpieces as upper and lower limits.

Workpiece Type	Measured Value(mm)	Release
LOW defective workpiece	1.370	Release
good workpiece	5.057	Release
HIGH defective workpiece	10.069	Release

LOW GO HIGH

LOW set value(mm) 3.213 HIGH set value(mm) 7.573

Reset

Accept Cancel

7.6 Performing Calibration

7.6 Performing Calibration

By performing a calibration, you can reduce installation errors when replacing the sensor head, for example.

1 2 Procedure

1. Select the "Advanced settings mode" check box.

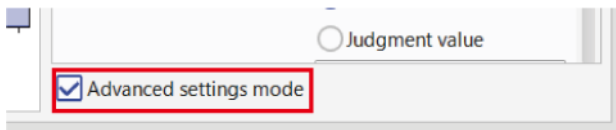

2. Set the "Calibration" switch from OFF to ON. (Default: OFF)

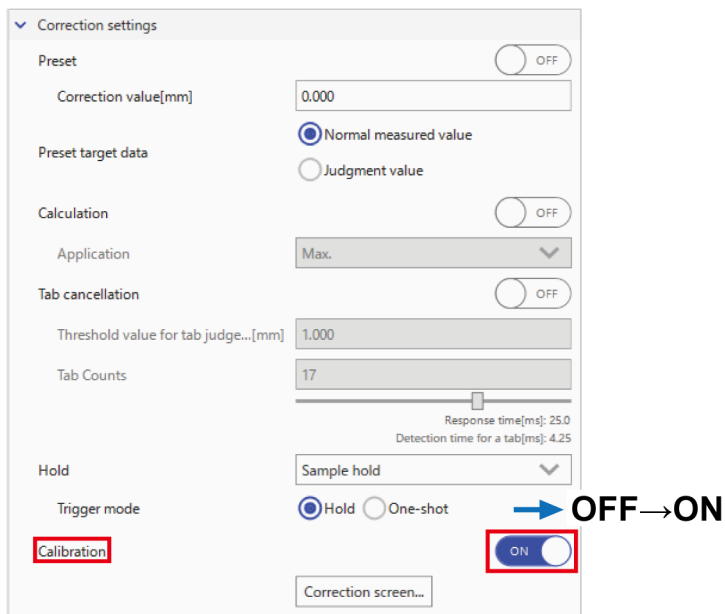

3. The "Calibration settings" window will be displayed. Insert the first workpiece between the emitter and receiver of the sensor head, and click the [Fix the measured value] button when the workpiece is at any desired position.

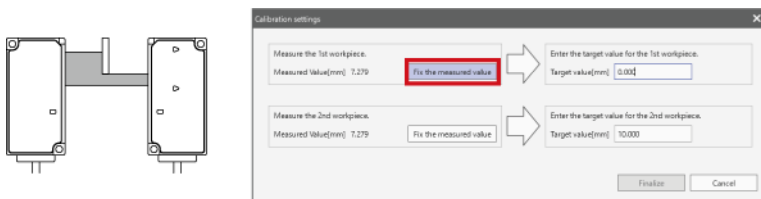

4. Enter a target value for the first workpiece.



Item	Setting range	Default value
Target value	-199.999 to 199.999 (mm)	0.000

5. Insert the second workpiece between the emitter and receiver of the sensor head, and click the [Fix the measured value] button when the workpiece is at any desired position.

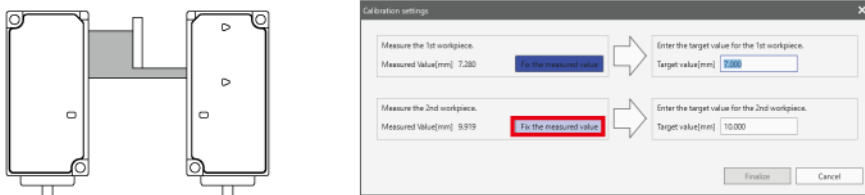

To change the measured value, click [Fix the measured value] button and cancel the value. After changing the position of the workpiece, click the [Fix the measured value] button.



6. Enter a target value for the second workpiece.



Item	Setting range	Default value
Target value	-199.999 to 199.999 (mm)	10.000

7. Click the [Finalize] button. A calibration will be executed.

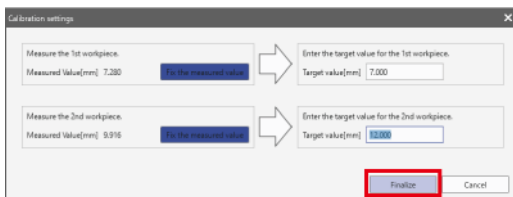

8. A message is displayed while a calibration is being executed. When the message disappears, the calibration is completed.

7.6 Performing Calibration

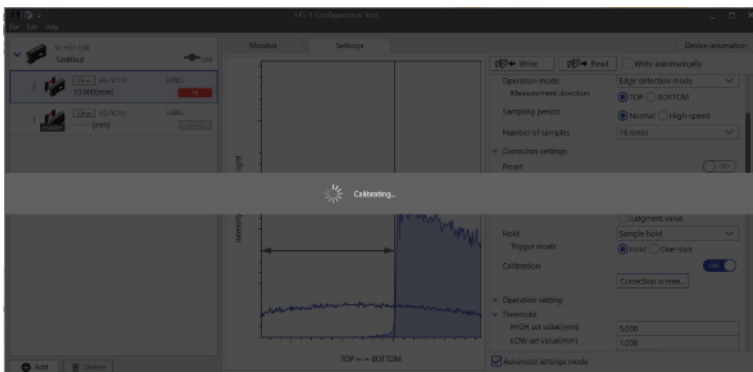

9. After the calibration is complete, check that the Calibration switch is set to ON.

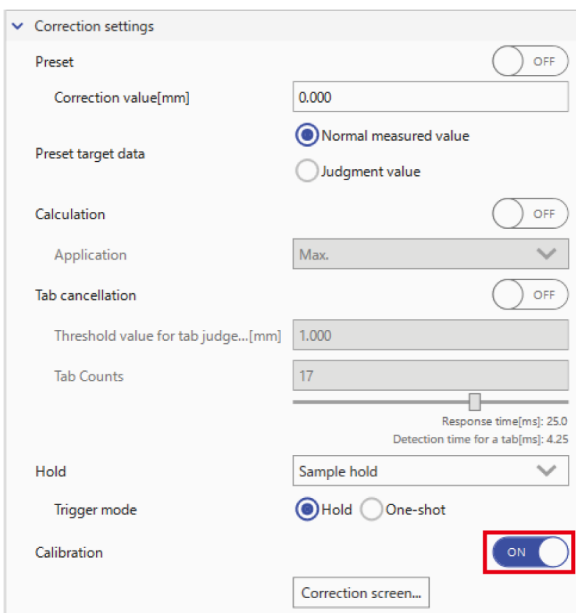

Note: Clicking the [Correction screen] button displays the "Calibration" dialog box again, so that you can perform a calibration again. (The dialog box will be reset to the default state.)

7.7 Writing Parameters to Main Unit

If settings have been changed with **HG-T Configuration Tool**, the settings can be written to the **HG-T** series controller.



- Before writing the settings, check if the PC and the **HG-T** series controller are correctly connected.

Info.

- If the "Write automatically" check box is selected, the settings will be sent to the specified controller at the same time as when the settings are changed.

7.7.1 Writing Procedure

1 2 Procedure

1. In the connected units window, select the controller to which the setting data is to be written.



2. Click the [Write] button.

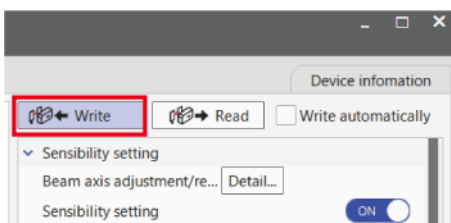

3. The following confirmation window will be displayed. Clicking [OK] writes the setting data to the specified controller.

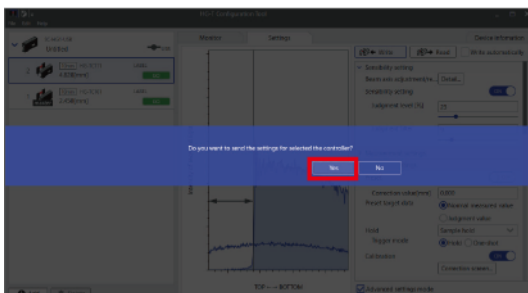

7.7 Writing Parameters to Main Unit

7.7.2 If Parameters Cannot be Written

■ Situation

If you click the [Write] button when the controller write-protection function is enabled, a message will be displayed, indicating that the setting data cannot be written to the controller.

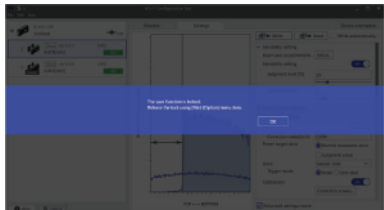

■ Action method

Disabling the write lock function enables the data to be written. The procedure is explained below.

1. On the menu bar, click **File>Option** to display the "Option" window. In the "Option" window, clear the "Enable write lock function" check box.

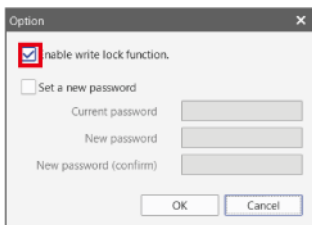

2. The "Password input" window will be displayed. Enter a password and click the [OK] button.

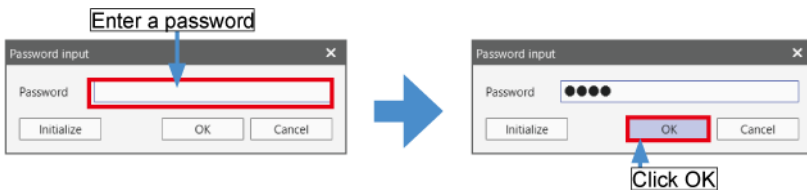

3. The display will be returned to the "Option" window. Check that the "Enable write lock function" check box is not selected and then click the [OK] button.



4. A completion message will be displayed, indicating that the write lock function has been disabled.

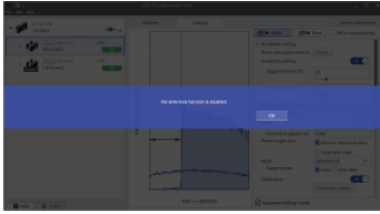

If you have disabled the write lock function, we recommend that this function be enabled again.

7.8 Performing Bank Operation

7.8 Performing Bank Operation

You can write and read the HIGH and LOW set values (or other setting data) to / from the specified bank (1 to 3) for the selected controller. You can use the bank function to write settings for an object to be measured to a bank beforehand and easily read the settings when needed.

The operating procedure is as below.

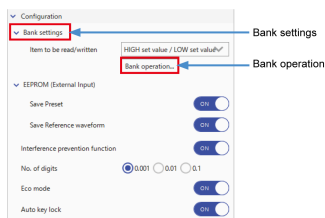

1 2

Procedure

1. Select a setting item to be loaded or saved from / to a bank.

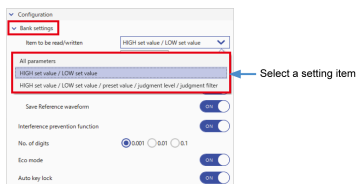

Bank save selection	Function
HIGH set value and LOW set value (THRS)	Selects the HIGH set value and LOW set value
HIGH set value, LOW set value, preset value, sensitivity adjustment, judgment level, and judgment filter (THRS.PR)	Selects the HIGH set value, LOW set value, preset value, sensitivity adjustment, judgment level, and judgment filter
All items (ALL)	Selects all items

2. Click the [Bank operation] button.

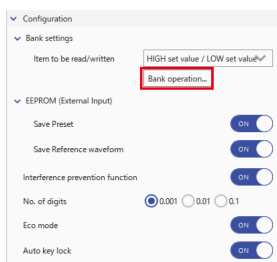

3. The "Bank operation" window will be displayed. Select a bank that data is to be read from or written to.

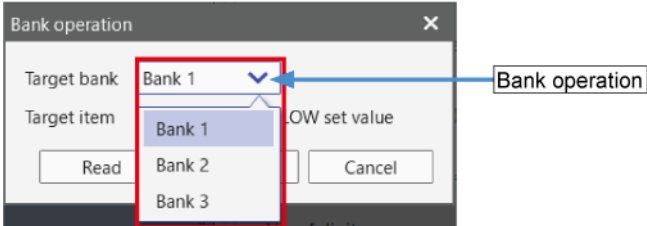

4. Check the selected bank and click the [Read] button or [Write] button.



7.9 Initialization

If a controller is selected, the [Initialize the controller] button will be displayed in the "Device information" tab. Clicking the [Initialize the controller] button initializes the controller to the factory default settings.

1 2 Procedure

1. Select a desired controller in the sensor list and click the "Device information" tab.

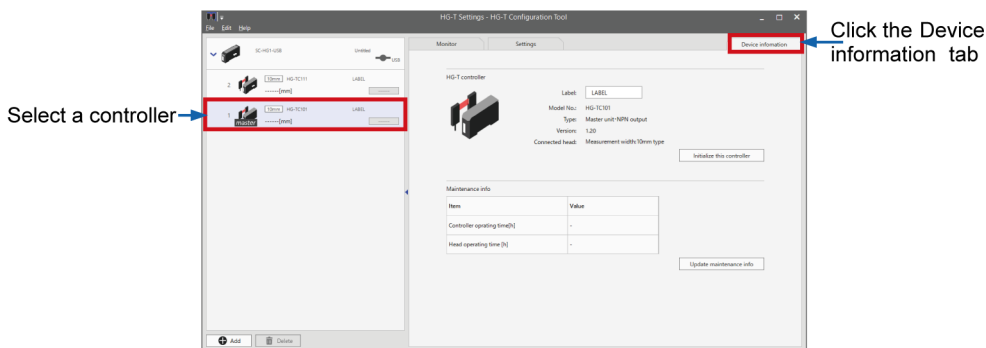

2. Click the [Initialize the controller] button.

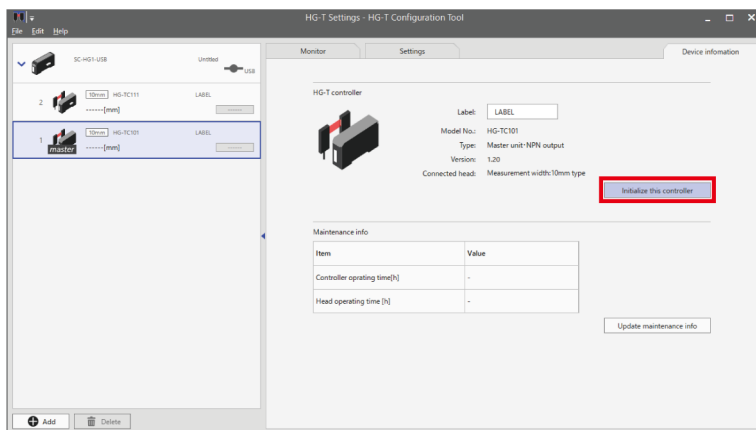

3. A confirmation message will be displayed. Click the [Yes] button.

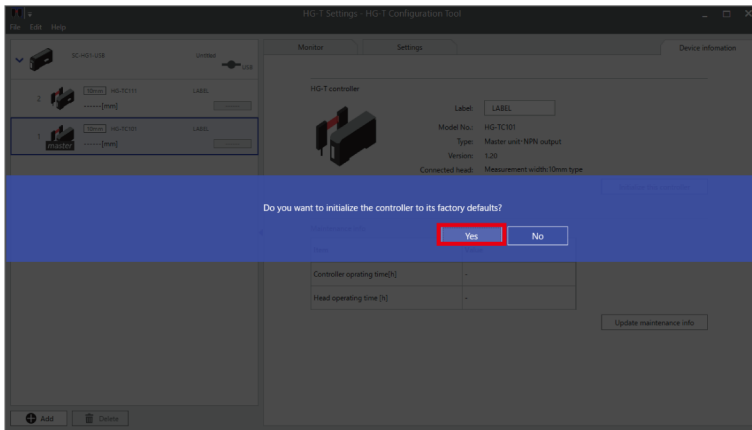

4. When the controller has been initialized, the following completion window is displayed.

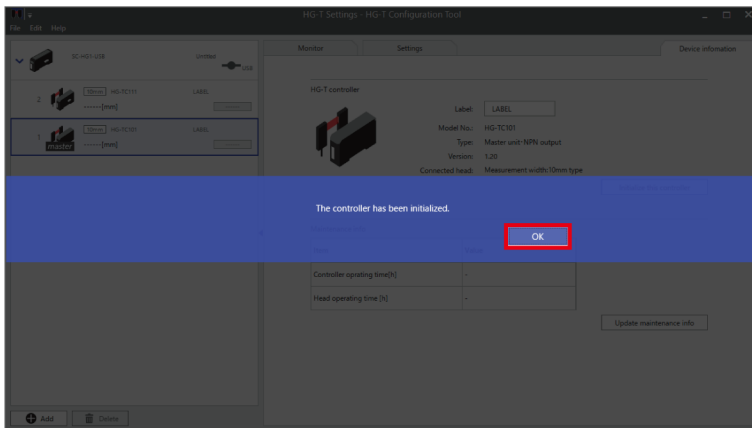

(MEMO)

8 Using Convenient Functions

8.1 Monitoring Multiple Controllers	8-2
8.2 Labeling	8-5
8.3 Offline Setting	8-7
8.3.1 Creating New Configuration Files	8-7
8.3.2 Writing Configuration Files to Controller	8-10
8.3.3 Opening Existing Configuration Files	8-12
8.3.4 Editing Connection Configuration	8-13
8.4 Copying Settings.....	8-15
8.4.1 Copying Settings.....	8-15
8.4.2 Pasting Copied Settings.....	8-15
8.4.3 Selecting and Pasting Copied Settings.....	8-16
8.5 Protecting Settings with Password.....	8-18
8.5.1 Setting a Password	8-18
8.5.2 Initializing a Password	8-19

8.1 Monitoring Multiple Controllers

8.1 Monitoring Multiple Controllers

Light waveforms received by multiple controllers can be monitored simultaneously. The operating procedure is as below.

1 2 Procedure

1. In the "connected units window", click the communication unit connected to multiple controllers to be monitored.

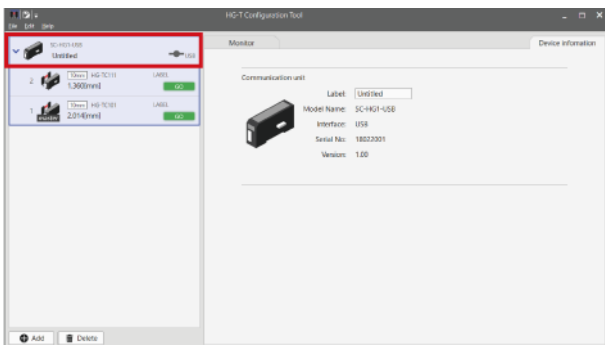

2. Click "Monitor" tab.

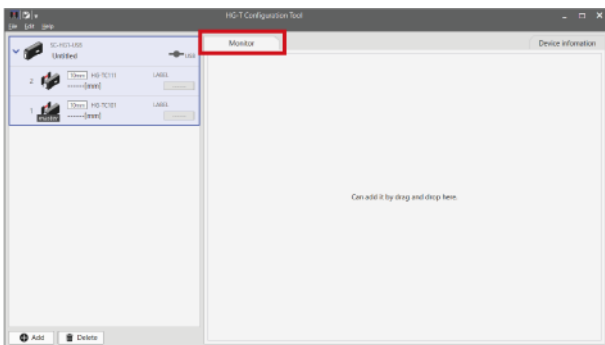

3. Click the first controller to be monitored and drag and drop it into the area in the "Monitor" tab window.

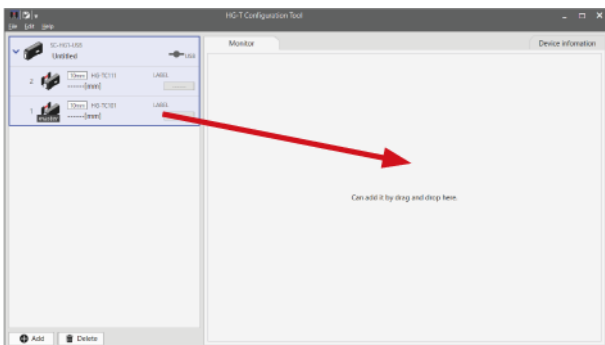

4. The monitor screen of the first controller will be displayed in the "Monitor" tab window.

8.1 Monitoring Multiple Controllers

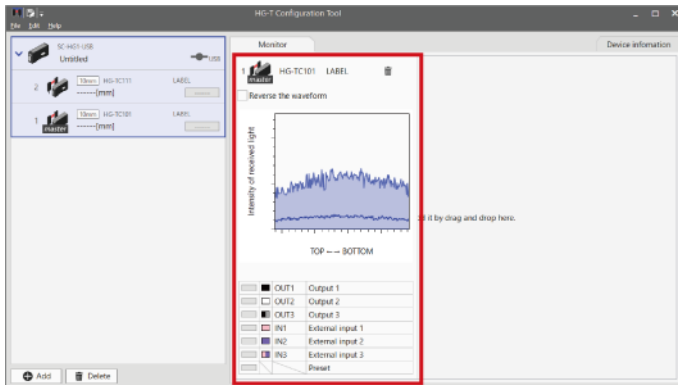

5. Click the second controller to be monitored and drag and drop it into the area in the "Monitor" tab window in the same way as above.

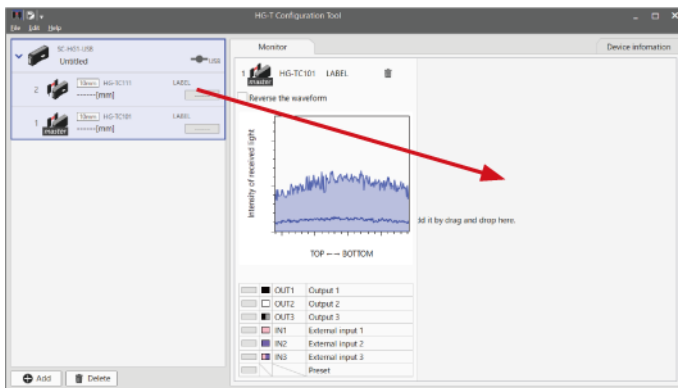

6. The monitor screens of the two controllers will be displayed in the "Monitor" tab window.

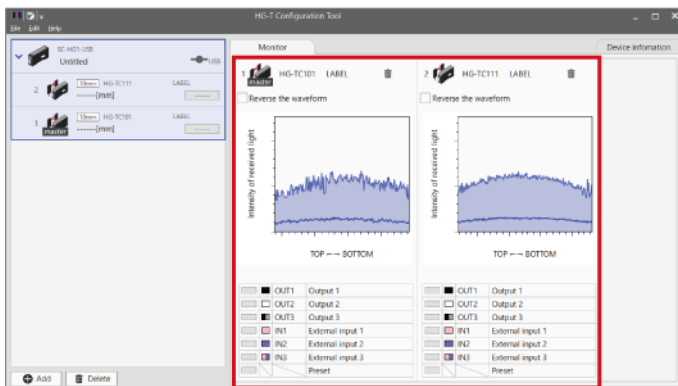

- When multiple controllers are monitored, the display of received light waveforms can be reversed. Clicking the "Reverse the waveform" check box in each monitor screen reverses the display of the received light waveform.

8.1 Monitoring Multiple Controllers

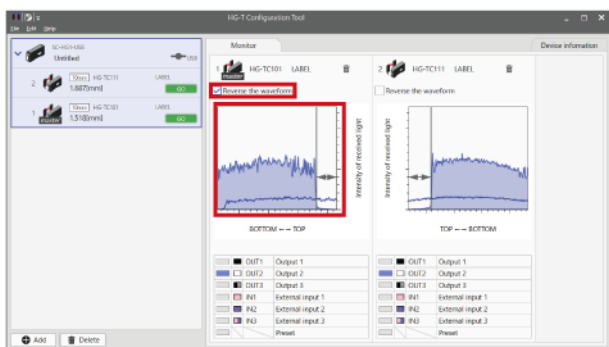
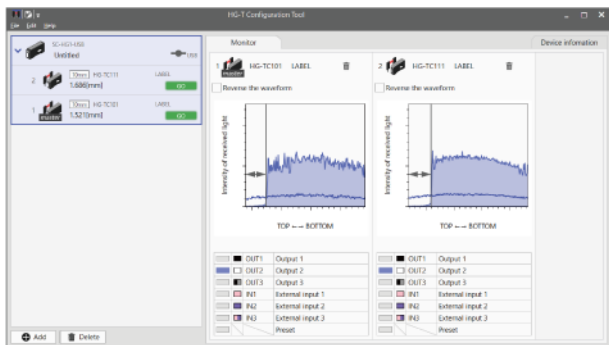

- Clicking the trash icon in the screen of the monitored controller displays a confirmation message. Selecting [Yes] deletes the monitor screen of the target controller.

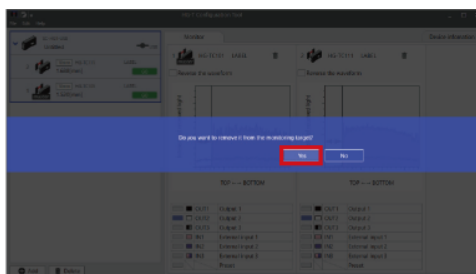
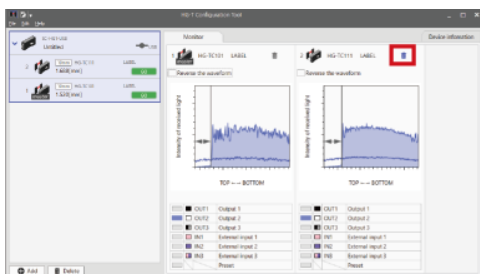

- Notes: 1) Simultaneously monitoring a number of controllers delays monitor updating.
 2): Multiple controllers cannot be monitored simultaneously between different communication units.

8.2 Labeling

The label of the controller or communication unit selected in the connected units window can be changed.

1 2 Procedure

1. In the connected units window, select a desired communication unit or controller and click the "Device information" tab.

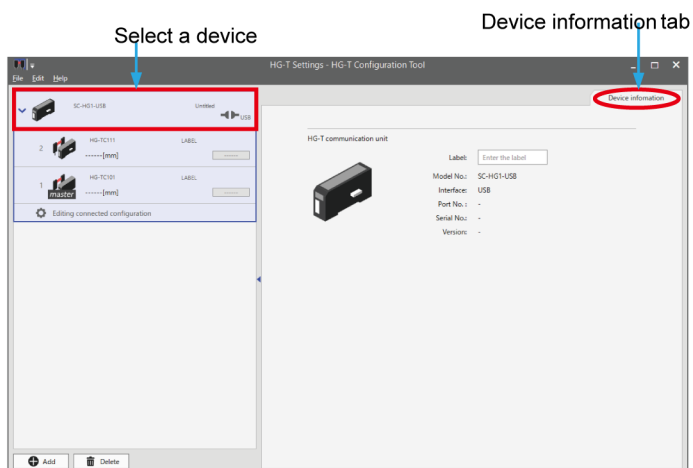

2. Information for the selected device will be displayed. If necessary, enter a label name.

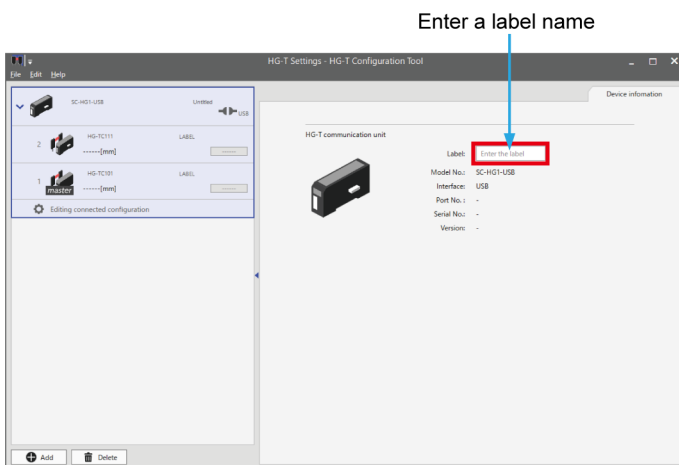

3. After entering any desired label name, press the Enter key. A confirmation message window will be displayed. Click the [Yes] button.

8.2 Labeling

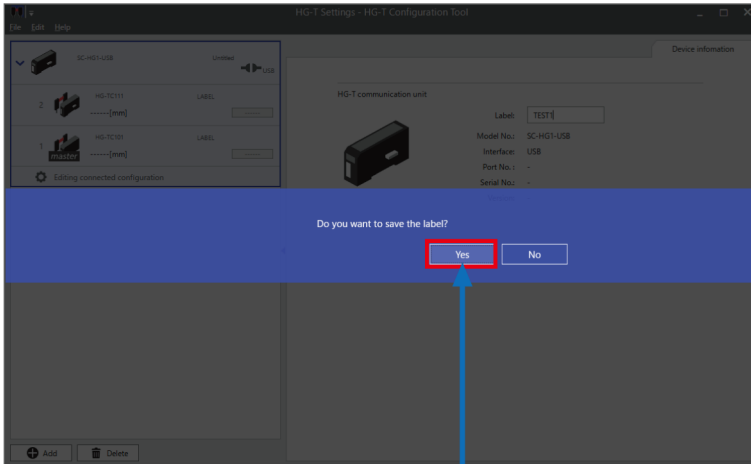

Click Yes

4. When processing is complete, the label field of the controller or communication unit in the sensor list will be changed to the name that was entered.

Optionally entered label

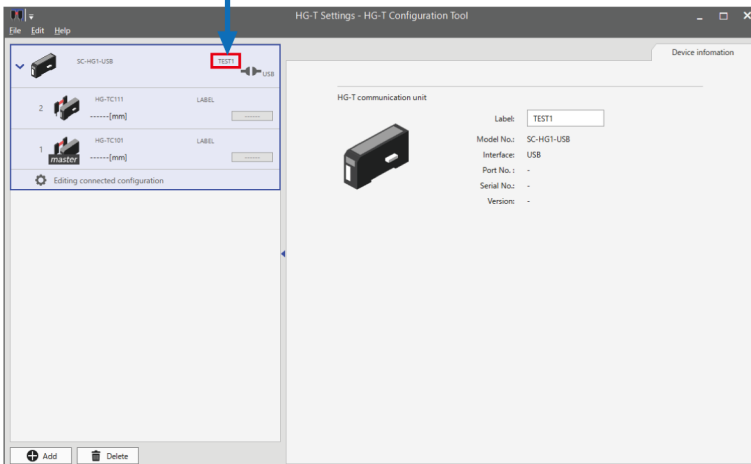

Note: Labels of communication units are managed by the tool software in the PC. If the tool software is reinstalled or the communication unit is connected to another PC, the set label will not be retained.

Note

- When changing the label name of a controller, you can enter the following characters:
<Characters that can be entered: A to Z, 0 to 9, *, +, -, <, >, \, <space>> (Number of characters that can be entered: Six half-width characters)

8.3 Offline Setting

Settings can be specified on a PC (offline) that is not connected to HG-T series controllers. This section explains how to create a new configuration file in offline setting mode and how to open and edit an existing configuration file in offline setting mode.

8.3.1 Creating New Configuration Files

Use the following procedure to create a new configuration file.

1 2 Procedure

1. In the "Start menu" dialog box, select "Create a new file" and then click the [Start] button.

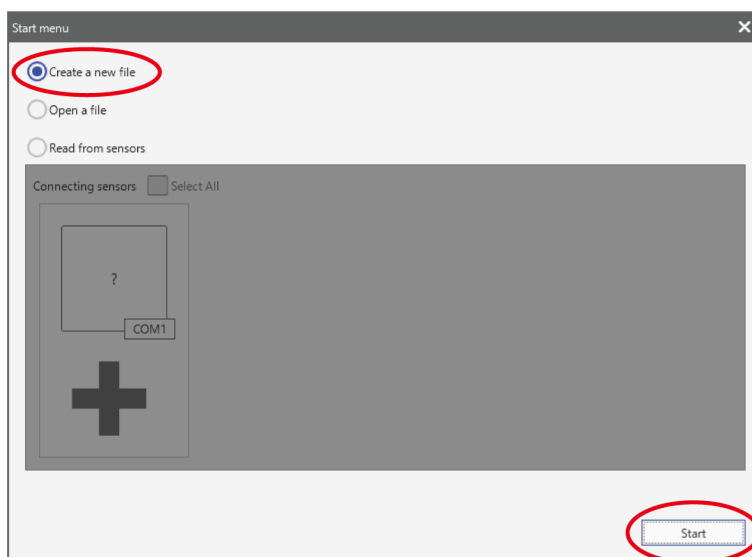

2. A communication unit addition menu will be displayed. Select a communication unit to be used and click the [Add] button. Note: A communication unit can also be added by double-clicking the icon of a communication unit to be added.

8.3 Offline Setting



3. A controller addition menu will be displayed. Select a controller (master unit) to be used and then drag and drop it into the "Connected configuration" area.

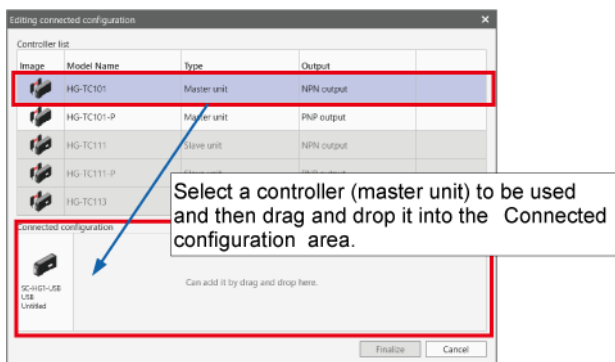

4. After selecting the master unit, select a slave unit and then drag and drop it into the "Connected configuration" area.

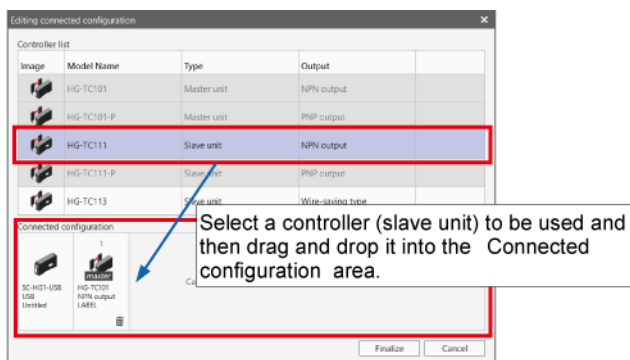

- Up to 14 controllers (slave units) can be dragged and dropped into the "Connected configuration" area.
- To delete a selected controller from the configuration, click the "X" icon for the controller. Deleting a master unit from the configuration also deletes all the slave units connected to the master unit.

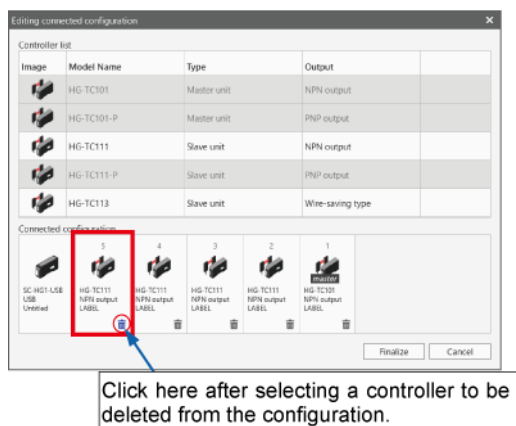

5. After selecting all the controllers to be used, click the [Finalize] button..

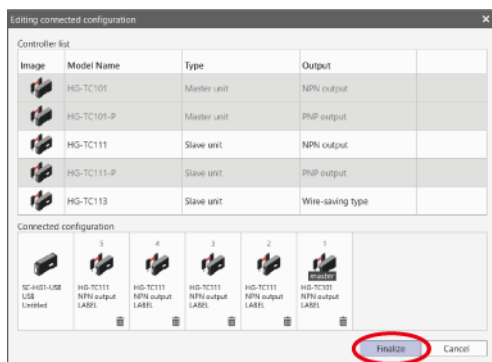

6. The main window will be displayed in offline setting mode.

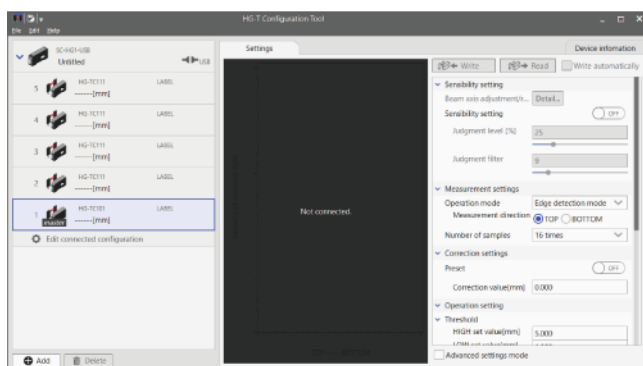

7. After all the controllers to be used have been set up, click **File>Save as** on the menu bar and save the configuration file.

8.3 Offline Setting

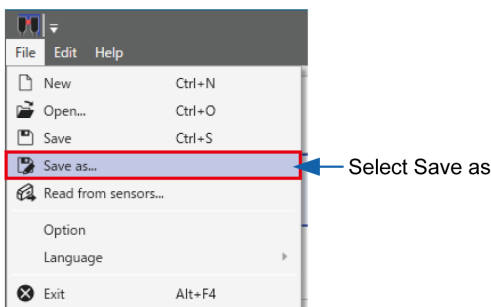

8.3.2 Writing Configuration Files to Controller

If a configuration file that has been created in offline setting mode is reflected in a **HG-T** series controller, you must write the configuration file to the HG-T series controller. The procedure is explained below.

1 2 Procedure

1. Connect the HG-T series controller and the PC. After connecting them, turn ON the HG-T series controller, select a desired communication unit in the connected units window, and click the connection state icon.

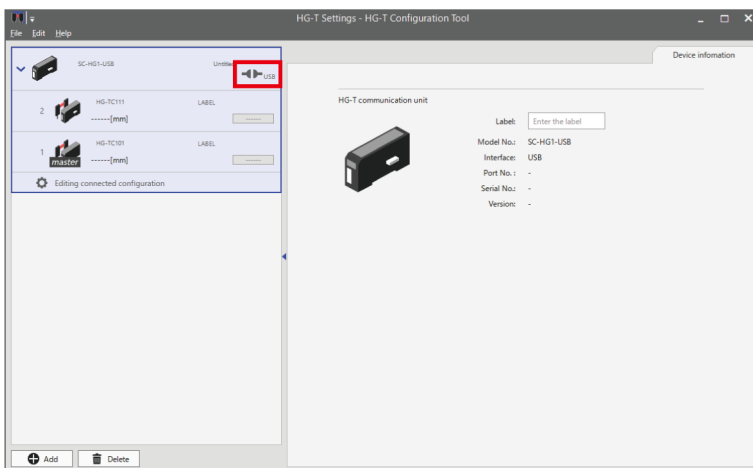

2. When the connection state icon is clicked, the "Connection" dialog box will be displayed. The communication units that are currently connected are displayed. Select a desired communication unit. Then, click the [Finalize] button.

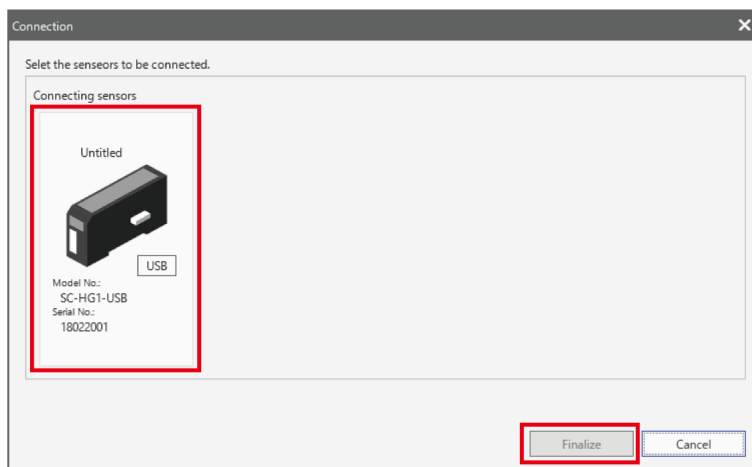

Note : If the communication unit addition menu is used to select the SC-HG1-485 as the communication unit to be used, a different operating method will be used. For details on the operating procedure, "5.2.2 Starting by loading the settings from RS-485 communication unit".

3. "The confirmation message "Do you want to write the settings?" "will be displayed. Click the [Yes] button. The settings will be written to and reflected in the **HG-T** series controller.

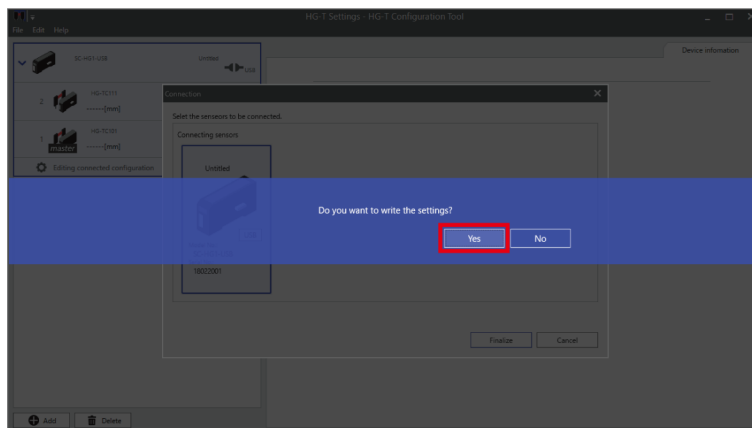

8.3 Offline Setting

Note

- When the settings are written, if the number of controllers that is specified in the configuration file in offline mode differs from the actual number of **HG-T** series controllers connected to the communication unit, the following confirmation message will be displayed.

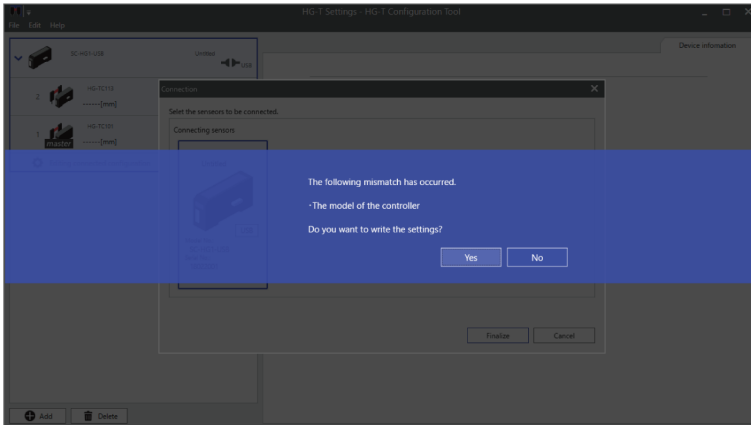

Recheck the number of controllers that is specified in the configuration file in offline mode and the actual number of **HG-T** series controllers.

If you do not write the settings, click the [No] button.

If you write the settings, click the [Yes] button.

If you write the settings when the number of controllers specified in the configuration file differs from the actual number of **HG-T** series controllers, note the following points.

- If the number of controllers that is specified in the configuration file is greater than the number of **HG-T** series controllers connected, the settings will be written to the **HG-T** series master unit and only the actual slave units sequentially connected to the master unit. The settings in the configuration file that are for controllers exceeding the actual number of **HG-T** series controllers will not be written.
- If the number of controllers that is specified in the configuration file is fewer than the number of **HG-T** series controllers connected, the settings will be written to the **HG-T** series master unit and the slave units sequentially connected to the master unit that are the same number as the number of controllers in the configuration file. The settings will not be written to **HG-T** series controllers that exceed the number of controllers that is specified in offline setting mode.

8.3.3 Opening Existing Configuration Files

You can load configuration files created in the past. The procedure is as below.

1.2 Procedure

1. In the "Start menu" dialog box, select "Open a file" and then click the [Start] button.

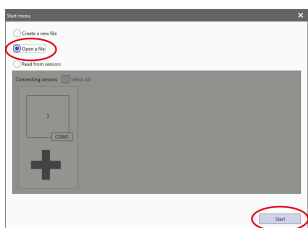

2. A "file selection" dialog box will be displayed. Select a file to be used and click the [Open] button.

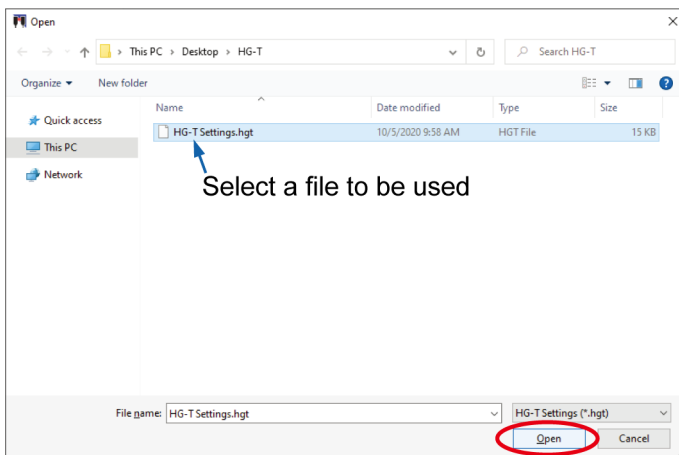

3. The main window will be displayed in offline setting mode.

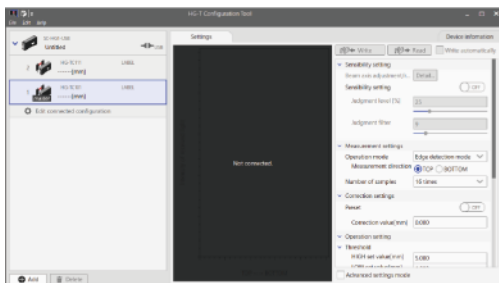

8.3.4 Editing Connection Configuration

1 2 Procedure

1. In the connected units window, click the [Edit connected configuration] button.

8.3 Offline Setting

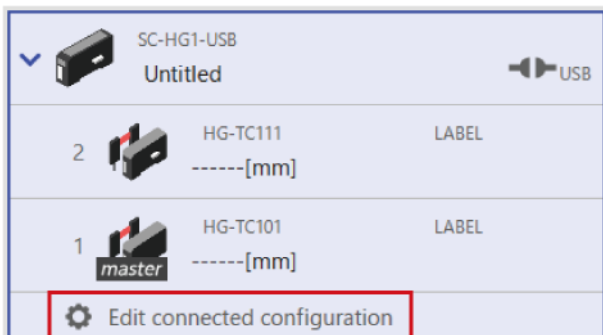

2. The "Editing connected configuration" dialog box will be displayed.

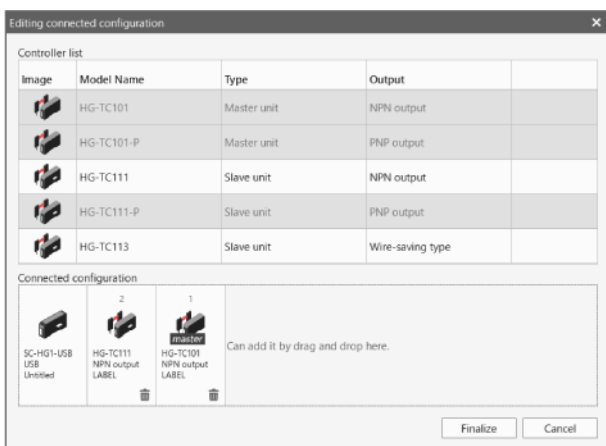

3. Edit the connection configuration by adding or deleting controllers. After editing the connection configuration, click the [Finalize] button to reflect the configuration in the connected units window.

Example: Window with a slave unit (HG-TC111) deleted

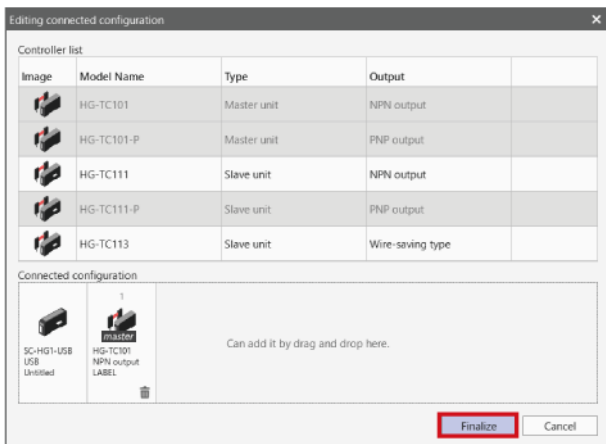

8.4 Copying Settings

You can copy the settings of each function set up for a controller and paste the copied settings to another main unit. (Copying settings)

8.4.1 Copying Settings

1 2 Procedure

1. In the connected units window, select the controller from which you want to copy the settings.



2. Copy the settings of the controller as below. On the menu bar, select **Edit>Copy**. Alternatively, you can right-click and then select "Copy" from the context menu that appears.

Shortcut key: Ctrl+C

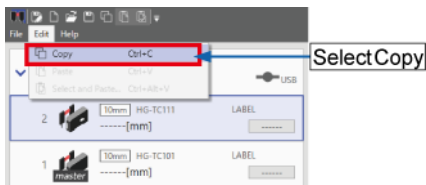

8.4.2 Pasting Copied Settings

1 2 Procedure

1. In the connected units window, select the controller to which you want to paste the copied settings.



2. Paste the settings of the controller as below. On the menu bar, select **Edit>Paste**. Alternatively, you can right-click and then select "Paste" from the context menu that appears.

Shortcut key: Ctrl+V

8.4 Copying Settings

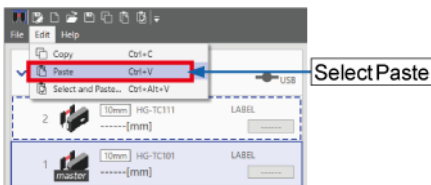

8.4.3 Selecting and Pasting Copied Settings

1 2 Procedure

1. Select and paste the copied settings of the controller as below. On the menu bar, select **Edit>Select and Paste**.

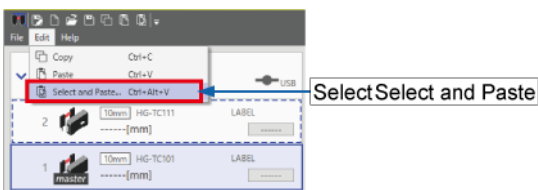

2. The "Select and Paste" window will be displayed. "In Items to be pasted," select items that you want to set.

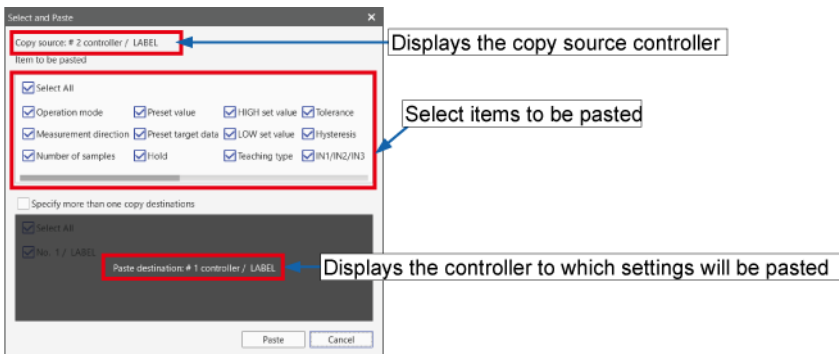

3. The settings can be pasted to multiple controllers at one time. Select the "Specify more than one copy destination" check box and select applicable controllers.

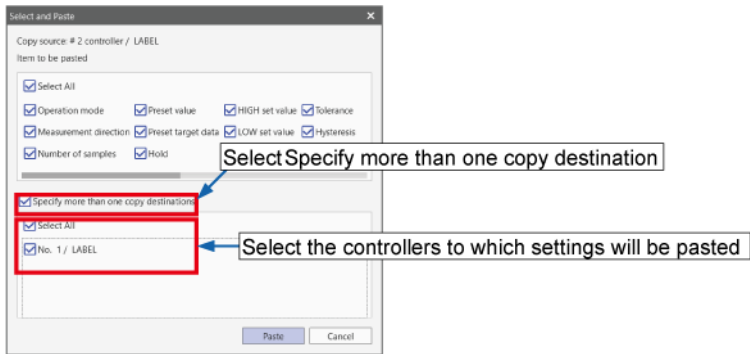

4. Clicking the [Paste] button copies the parameters selected in the Settings tab window of the copy source to the Settings tab window of the copy destination controller.
5. For details on how to write the settings to the **HG-T** series controller without making any changes, refer to "7.7 Writing Parameters to Main Unit".

8.5 Protecting Settings with Password

8.5.1 Setting a Password

You can specify a password that is required to write settings to a controller. Specifying a password prevents functions from being set or changed for the controller.

i Info.

- When the controller write-protection function is disabled, there is a risk that settings could be changed by third parties. We recommend that users specify passwords and enable the write-protection function to prevent third parties from changing the settings.
- Implement strict management to prevent passwords from being forgotten.

1 2 Procedure

1. On the menu bar, select **File>Option**.

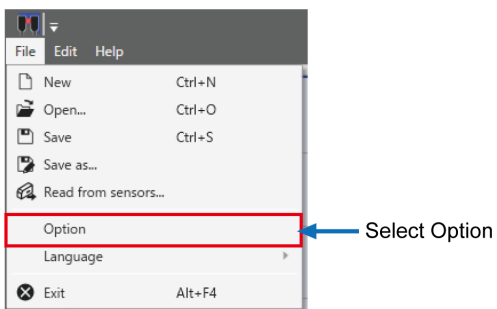

2. The "Option" window will be displayed. Select the "Enable the write lock function" check box and the "Set a new password" check box and then enter the current password and a new password. When setting a password for the first time, enter a new password only.
 - For passwords, use four half-width alphanumeric characters.
 - English alphabets are case-sensitive.

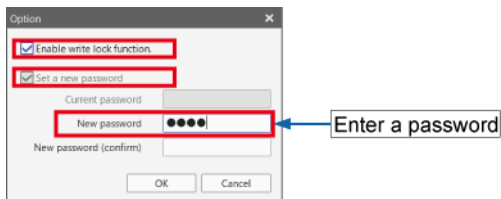

3. For confirmation, enter the password again in the "New password (confirm)" field and then click the [OK] button.

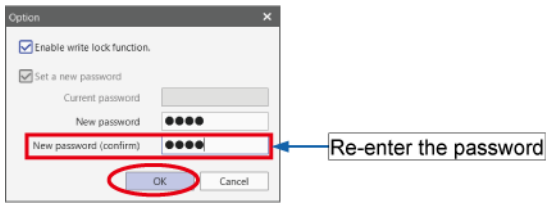

When a password has been set, the controller write-protection function is enabled. (No password is set at the time of shipping.)

8.5.2 Initializing a Password

If you have forgotten your password, initialize the password using the following procedure.

1 2 Procedure

1. In the "Password input" window, click the [Initialize] button.

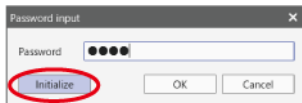

2. The "Password initialization" window will be displayed. Notify your local dealer of the request code displayed in the window. Your local dealer will notify you of an initialization code.

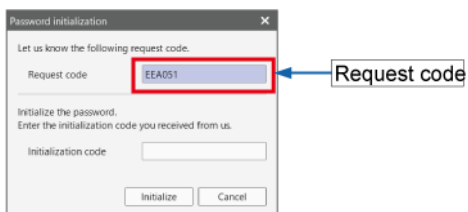

3. After receiving an initialization code, enter the initialization code in the "Password initialization" window. After entering the code, click the [Initialize] button. The password will be initialized and the write-protection function will be disabled.

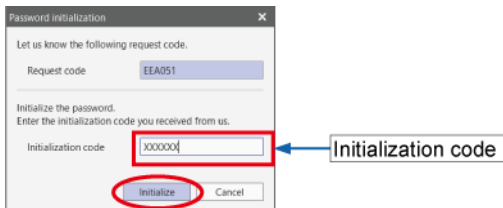

(MEMO)

9 Troubleshooting

9.1 Error Messages.....	9-2
9.2 Alarm Messages	9-3

9.1 Error Messages

9.1 Error Messages

One of the messages shown below is displayed in the device notification information section when an error occurs during setting or measurement.

For the details of the device notification information, refer to ["6.5.6 Device Information Notification Dialog"](#).



Note

- When the **HG-T** controller manufactured prior to January 2019 is used, some functions will be restricted. For details, consult your Panasonic representative.

Message	Error code	Action method
"EEPROM of the controller is damaged."	E600 / 610 / 620	Replace the controller.
"EEPROM of the sensor head is damaged."	E630 / 640	Replace the sensor head.
"The detection output load has short-circuited and excessive current is flowing."	E700	Turn OFF the power and check the load.
"Laser of the emitter is damaged."	E240	Replace the sensor head.
"Communication error between the sensor head and controller has occurred."	E200	Check if the sensor head is correctly connected. Check if there is a broken wire in the connection cable.
"The combination of emitter and receiver is incorrect."	E230	Check the connection state of the sensor head and controller.
"An error has occurred inside the controller."	E900 / 911 / 912 / 920	Turn the power OFF and then ON to initialize the controller.
"Communication error between connected controllers has occurred."	E120 / 130	Check if the controllers are correctly connected.
"Number of connected controllers is changed."	E160	Check the number of controllers connected.
"NPN output type and PNP output type controllers are mixed."	E100	Standardize the controller type as the NPN output type or PNP output type.
"Number of slave units is insufficient for the calculation."	E140 / 150	Connect the necessary number of slave units. Check the settings of the calculation application. Set the calculation function to OFF.
"Maximum number of connectable controllers is exceeded."	E110	Check the number of controllers connected.

Important

If an error occurs again after you cleared it, check if excessive vibration is transmitted to the controller or the sensor head.

If the product still does not operate normally after you check the above, consult our technical support center.

9.2 Alarm Messages

One of the messages shown below is displayed in the device notification information section when an alarm occurs during setting or measurement.

For details on the device information notification, refer to ["6.5.6 Device Information Notification Dialog"](#).

Note

- When the **HG-T** controller manufactured prior to January 2019 is used, some functions will be restricted. For details, consult your Panasonic representative.

Message	Action method
"Maximum number of detectable edges is exceeded."	<ul style="list-style-type: none"> • Check the condition of the workpiece. • Clean the lenses on the emitter and receiver of the sensor head.
"Measurement setting: The direction of workpiece insertion is different from the setting of measurement direction."	<ul style="list-style-type: none"> • Match the setting and the direction of workpiece insertion. • When inserting workpieces in the reverse direction, set the reverse insertion check function to OFF.
"The intensity of received light is too much."	Check if ambient light hits the light receiving section of the sensor head.
"Intensity of received light is reduced."	<ul style="list-style-type: none"> • Check the condition of the workpiece. • Clean the lenses on the emitter and receiver of the sensor head. • Install the emitter and receiver of the sensor head correctly. • Check the settings of the alarm / dirt check function.
"The master unit executed the copy operation, but a copy cannot be produced due to a slave unit malfunction."	Turn the power OFF and then ON and check that the slave unit operates normally.
"Communication error between connected controllers has occurred."	Turn OFF the power, check whether the controllers are connected correctly, and then turn ON the power again.

Important

If the product still does not operate normally after you cleared the above, consult our technical support center.

(MEMO)

Revision History

Revision history	Revision date	Revision item
First edition	October 7, 2018	
Second edition	December 7, 2018	<ul style="list-style-type: none"> • Correction of mistakes • “7.1 Flow of Operations up to Setup Completion” has been added. • “Chapter 9 Troubleshooting” has been added.
Third edition	February 12, 2019	<ul style="list-style-type: none"> • “6.5.3 Measured Value Monitor” has been added. • “7.4 Performing Measurement Settings” has been added.
Fourth edition	November 22, 2019	<p><Added></p> <ul style="list-style-type: none"> • “5.2 Starting by Loading the Settings from Communication Unit” • “■ Starting by loading the settings from RS-485 communication unit” <p><Removed></p> <ul style="list-style-type: none"> • “2.3 USB Communication Unit SC-HG1-USB” • “2.4 USB Cable”
Fifth edition	April 22, 2020	<ul style="list-style-type: none"> • Changed the document format.
Sixth edition	October 30, 2020	<p>Supports software Ver.1.30.</p> <p><Added></p> <ul style="list-style-type: none"> • “1.3 Software Version and Setting Functions”.

Contact us

Please contact

Panasonic Corporation

Panasonic Industrial Devices SUNX Co., Ltd.
<https://panasonic.net/id/pidsx/global>

Please visit our website for inquiries and about our sales network.