

# KickStart

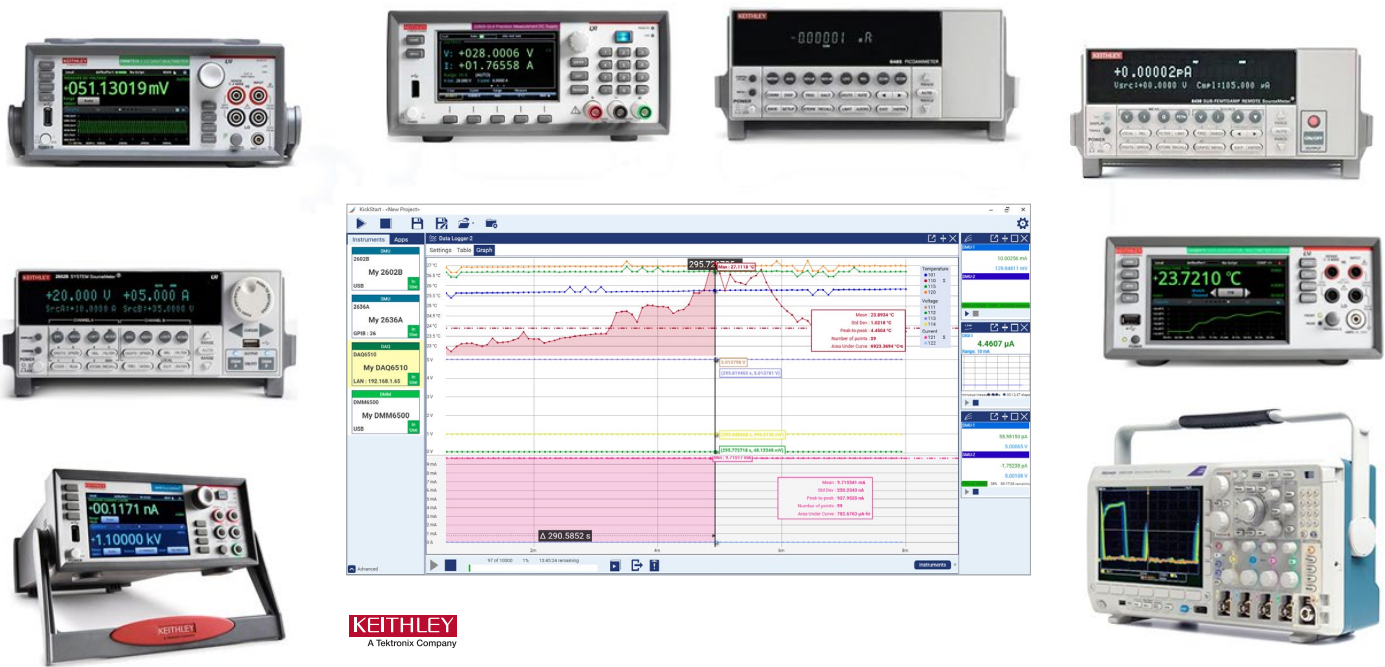

**KEITHLEY**  
A Tektronix Company



Accelerate the path to the measurements you want with KickStart Software. KickStart simplifies what you need to know about the instrument so that in just minutes you can take the instrument out of the box and get real data on your device. By plotting data immediately and offering quick statistical summaries of the data in the reading table, KickStart allows you to gather insights faster and make the decisions you need to move on to the next stage of device and product development. KickStart saves you time by facilitating quick replication of tests and comparison of results using convenient export features. With KickStart, you can focus on interpreting the test results so that your team can meet their innovation goals.

## Key Features

KickStart Software for the PC enables quick test setup and data visualization when using multiple instruments.

- Save time by automating data collection of millions of readings.
- Set up a multi-instrument test with the ability to independently control up to eight instruments.
- Supports source measure unit (SMU) instruments, DMMs, power supplies, oscilloscopes, dataloggers, and sensitive instruments.
- Replicate tests quickly using saved test configurations.
- Use built-in plotting and comparison tools to quickly discover measurement anomalies and trends.
- Auto-export data in ready-to-use .csv and .xlsx formats for reports and additional analysis.

## Applications

- Device characterization: Characterize materials and discrete components and verify design of electronic modules.
- Datalogging: Reliably log data to the PC; useful for testing device compliance to regulatory or industrial standards.

## Minimized Time to Results

Connect your instrument to your PC and have KickStart discover your instrument in seconds. KickStart supports instruments connected using GPIB, LAN, and USB interfaces. With a simple drag of the mouse, launch an app to control and collect data from an instrument. KickStart can collect millions of readings from each instrument, which makes it a great solution for your long-term datalogging needs, for capturing transient events with a digitizing DMM, I-V characterization with SMUs, and now for capturing waveforms with oscilloscopes. KickStart presents the data in tabular and graphical formats. In the table, KickStart presents a statistical summary of the data in each column. You can hide non-essential data, and the statistics automatically update to reflect only data visible in the table. This can be quite useful for applications in which you want to monitor devices after they have reached thermal stabilization.

KickStart provides a test solution even when your tests involve the control of multiple instruments. You can launch and run up to eight apps at the same time. You can see results from multiple instruments in a single easy-to-view format.

	101	102	103	104	105
56	15.876371	1.028459e+6	1.003070e+3	205.2355	4.751286e+3
57	16.164916	1.029070e+6	1.003070e+3	205.2350	4.751270e+3
58	16.453456	1.029685e+6	1.003070e+3	205.2344	4.751263e+3
59	16.741992	1.028453e+6	1.003071e+3	205.2349	4.751286e+3
60	17.030523	1.028414e+6	1.003071e+3	205.2348	4.751278e+3
61	17.319517	1.029278e+6	1.003071e+3	205.2348	4.751288e+3
62	17.608509	1.028830e+6	1.003071e+3	205.2348	4.751287e+3
63	17.897051	1.028494e+6	1.003071e+3	205.2351	4.751267e+3
64	18.185590	1.028752e+6	1.003070e+3	205.2343	4.751284e+3
65	18.474579	1.028564e+6	1.003071e+3	205.2353	4.751285e+3
66	18.763116	1.028138e+6	1.003071e+3	205.2340	4.751275e+3
67	19.051650	1.029005e+6	1.003071e+3	205.2348	4.751285e+3
68	19.340190	1.028797e+6	1.003070e+3	205.2350	4.751280e+3
69	19.628730	1.028879e+6	1.003070e+3	205.2347	4.751285e+3
70	19.917255	1.028752e+6	1.003072e+3	205.2348	4.751283e+3
71	20.205789	1.028891e+6	1.003072e+3	205.2352	4.751282e+3
Min	0.00000	1.028138e+6	1.003069e+3	205.2340	4.751267e+3
Max	20.2058	1.031195e+6	1.003075e+3	205.2395	4.751303e+3
Mean	10.1031	1.029230e+6	1.003070e+3	205.2352	4.751282e+3
StdDev	5.95789	468.1030	888.3387e-6	797.2339e-6	119.1363e-3

View data in the reading table in an easy to read format. Hide rows or columns to show only relevant data

<b>Min</b>	0.00000	1.028138e+6	1.003069e+3	205.2340
<b>Max</b>	20.2058	1.031195e+6	1.003075e+3	205.2395
<b>Mean</b>	10.1031	1.029230e+6	1.003070e+3	205.2352
<b>StdDev</b>	5.95789	468.1030	888.3387e-6	797.2339e-6

KickStart calculates basic statistics for each column of data visible in the table.

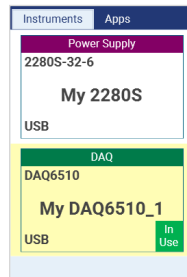

KickStart quickly discovers all connected instruments and allows you to create tests and view data even when instruments are not connected to the PC.

## Faster Insights into Data

KickStart plots your data immediately so that you can quickly discover anomalies or trends and make the needed decisions to get you to the next phase of development of your material, device, or module. Getting insights quickly is most important, so a large portion of the viewing area is dedicated to the graph. There are built-in tools to compare and overlay data from previous test runs. You can mark or highlight points of interest in the graph and use cursors to view detail on multiple data series at once.

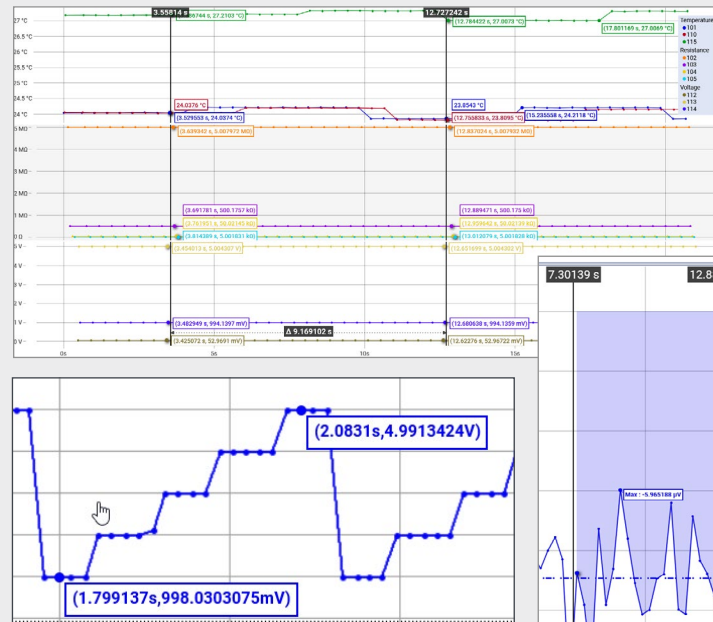

Data always gets prime focus in KickStart. Use the graph to discover measurement trends or anomalies.

Use markers to highlight points of interest on the graph.

Use cursors to get information on multiple data series or to calculate differences on the horizontal scale.

## Peace of Mind. Confidence. Reliability.

Proving that your device or module complies with industrial and regulatory standards is an important part of ensuring that your device or electronic module will meet your customer's requirements. Safe archival of test data is essential in compliance testing. KickStart streams and auto-exports data in .csv and .xlsx formats from the instrument to PC storage media, so, even in the event of a power outage, your data-logging data is preserved.

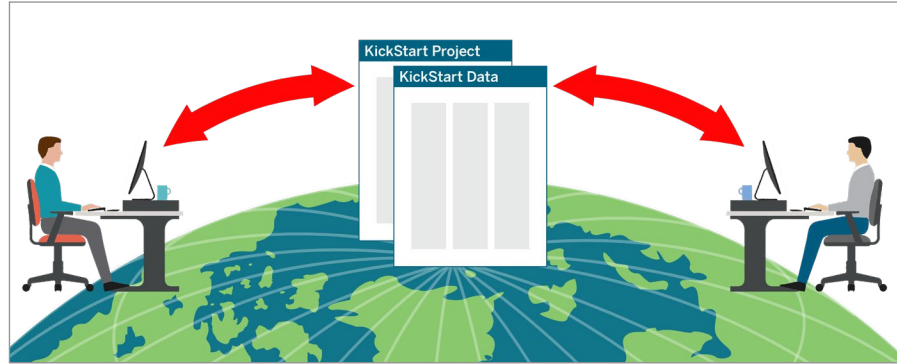





Save tests and share data for easy collaboration between multiple development sites.



Additionally, you can save any test project that you create to re-use later or to share with others. This allows you to replicate tests easily at other locations, which is essential when you work on a global development team.

KickStart even allows you to prepare your tests using simulated instruments so that you are ready to test once the actual instrument arrives. You can quickly swap the actual instrument in your test configuration later. The use of simulated instruments also allows offline viewing of the data and test setup.

### Available KickStart Apps

#### Base Apps

-  Data Logger
-  1.946 DMM
-  IV Characterizer
-  Power Supply
-  Scope

-  High Resistivity
-  Curve Tracer

### Power Supply App

This app simplifies supplying power to your device or system.

- Quickly set up automated tests using bias or list sweep mode.
- Interactively control bias conditions while monitoring measurements on another instrument.
- Use along with the Precision Multimeter App for an application such as power consumption analysis or monitoring load current stability.
- Supports Keithley 2280S-32-6 and 22380S-60-3 Precision Measurement DC Power Supplies. Supports 222x and 223x DC power supplies. Also supports 2281S-20-6 as a power supply only.

V : +1.999 V  
I : +1.998 mA

Index	Voltage (V)	Current Limit (A)
1	1	0.1
2	1.5	0.1
3	1.5	0.2
4	2	0.2
5	2	0.3

Source Mode: List Sweep  
List Hold Time: Points  
Use List Number: 1  
Sample Count: 1

Overvoltage Protection: 21 V  
NPLC: 1  
Measure Range: Auto

Timing: Source to Measure Delay: 1 s, Output Turn On Delay: 0 s, Output Turn Off Delay: 0 s, Rising Slew Rate: 100 V/s, Falling Slew Rate: 100 V/s

Triggering: Trigger Source Output: Immediate, Measure Complete Trigger after: Each Step

Channel 1

+5.000 V  
+4.999 mA

5 V 0.1 A



Create and download list sweeps of up to 99 points on the power supply.

View and set the most essential parameters on the power supply in KickStart's minimized view.

## Precision Digital Multimeter App

This app affords you a simple way to log data using your Keithley DMM or sensitive measurement instrument.

- Automate long-term datalogging.
- Plot and inspect waveforms from the digitizer built into the DMM.

- Trigger digitizer on digital events or programmed analog levels.
- Continuous data streaming for digitizer operation using DMM7510 and DMM6500.
- Supports Keithley DMM7510 7½-Digit and DMM6500

6½-Digit DMMs, DAQ6510 Data Acquisition and Logging Multimeter System, and 2001, 2010, 2100, and 2110 DMMs.

- Supports 6485 and 6487 Picoammeters, and 6514 and 6517B Electrometers.

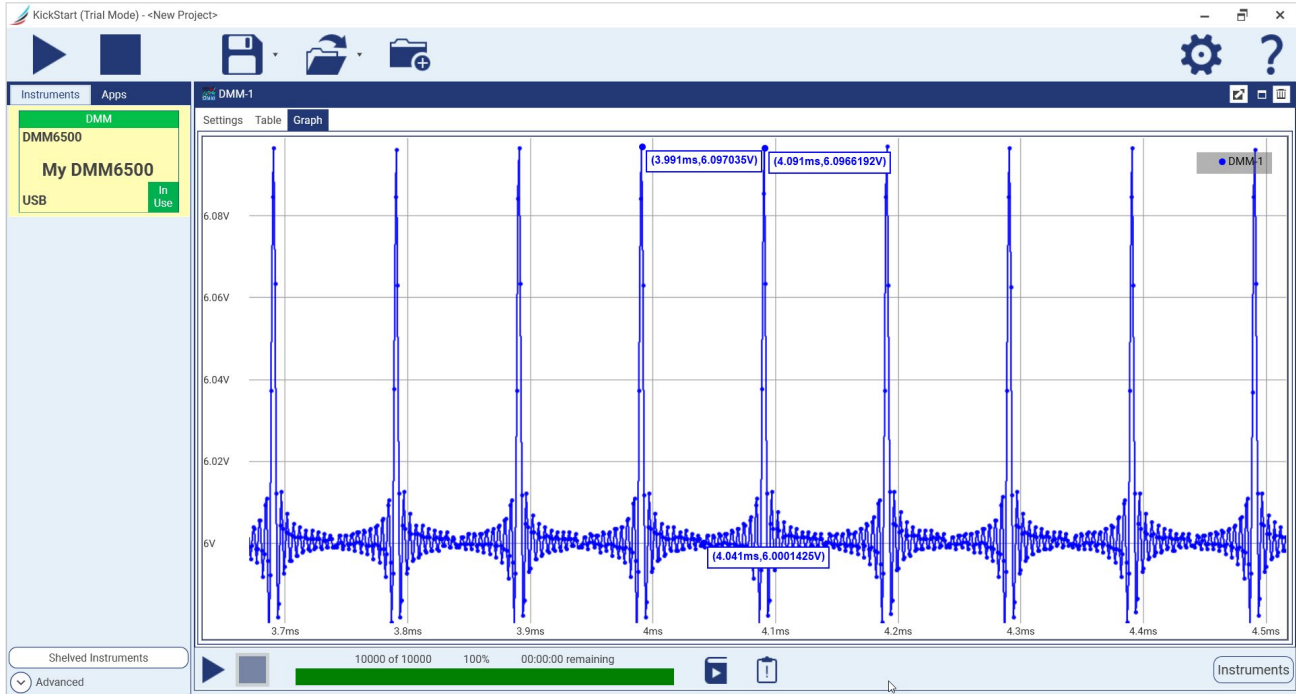

Capture waveforms with the DMM6500 Digitizing DMM using KickStart's Precision Multimeter App.

## Data Logger App

Use the KickStart Data Logger App to set up and control your multi-channel data acquisition instrument. This app is designed to help you configure all your channels very quickly and even validate your connections during test configuration. It allows you to set up multiple channels with the same configuration but give each channel a meaningful label so that you can quickly scan your results and grab the information you need. Configure pass/fail limits for each channel in order to set alarm conditions and obtain quick visual verification of test results.

- Stream millions of readings to PC storage media for safe data archival.
- View multiple measurement functions in a single data window using stacked graphs.
- Plot measurement data versus another channel or versus time.
- Automatically export data in ready-to-use formats for reports and additional analysis even while the test is running.
- Supports Keithley DAQ6510, DMM6500 (with scan card), 2700, 2701, 2750, and 3706A.

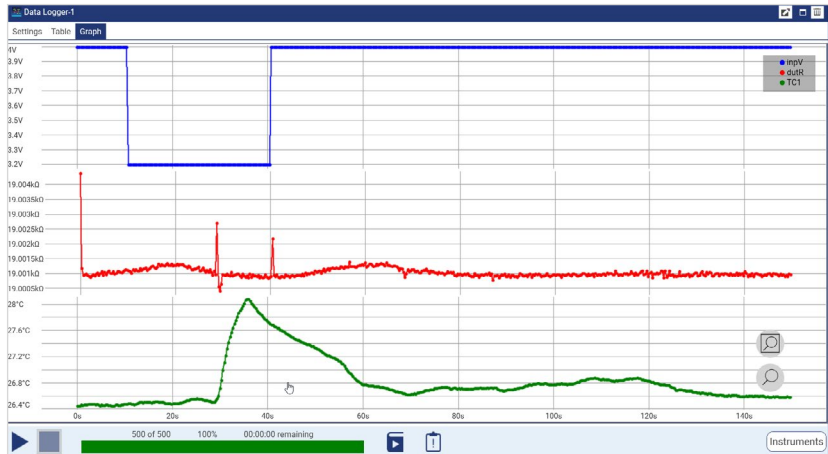

Plot and view multiple channels in a single graph with KickStart's Data Logger App.

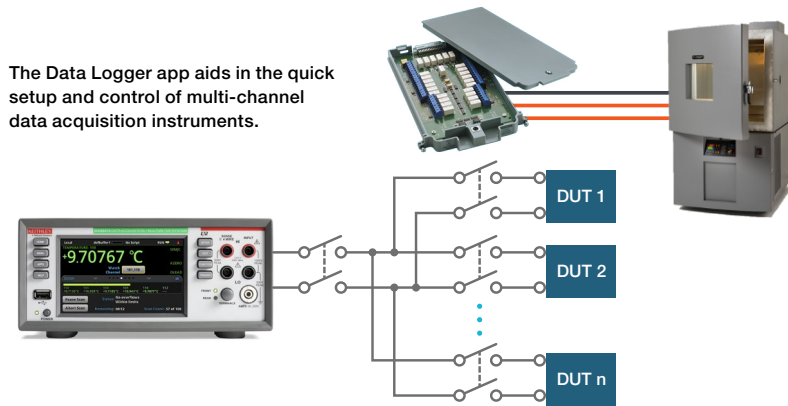

The Data Logger app aids in the quick setup and control of multi-channel data acquisition instruments.

Channels E	
<input checked="" type="checkbox"/> 101	inpV
<input type="checkbox"/> 102	102
<input type="checkbox"/> 103	103
<input type="checkbox"/> 104	104
<input checked="" type="checkbox"/> 105	dutR

Create personalized labels for each channel of your data logging switch card.



## I-V Characterizer App

Use the I-V Characterizer App to perform current vs. voltage (I-V) test on a variety of materials, two-terminal and multi-terminal semiconductor devices, solar cells, and much more. You can configure each SMU for a variety of bias and sweep sourcing operations, including linear, log, list, and dual sweeps.

- Configure and control up to four SourceMeter SMU instruments with independent sweeps or multi-level sweeps.
- Differentiate SMU instrument channels and their measurement data using labels that are relevant to your device or module.
- Use built-in comparison tools to compare and overlay multiple test runs in a single graph.
- Create tests by mixing any of these SMU instruments: Series 2400, Series 2400 Graphical, Series 2600B, 2606B, 2657A, and 6430 SourceMeter SMU instruments.
- KickStart I-V Characterizer App supports the 2601B-Pulse with PulseMeter technology for outputting pulses as short as 10  $\mu\text{s}$  at 10 A and 10 V. This performance makes it perfect for testing:

- Vertical cavity surface emitting lasers (VCSEL) used in LIDAR and facial recognition
- LEDs for lighting and displays
- Semiconductor device characterization
- Surge protection testing

See the 2601B-Pulse datasheet for additional tests, details, and specifications.

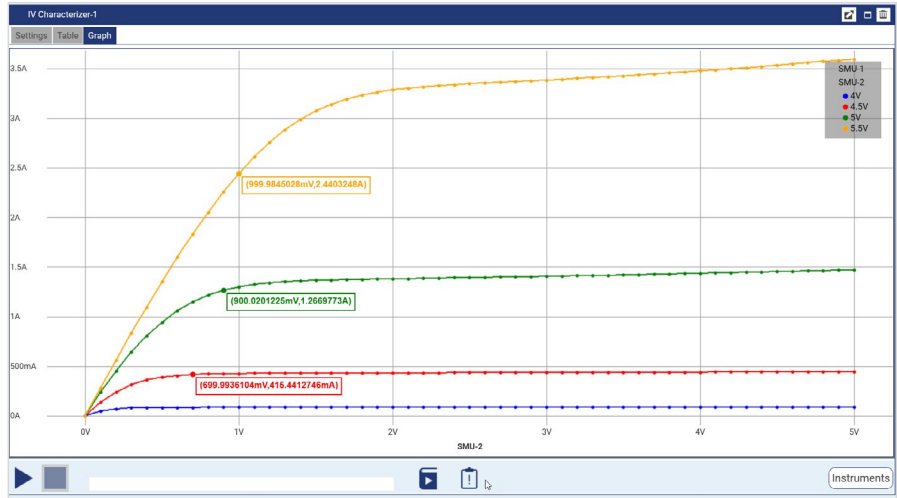

Create current vs. voltage characteristics for 2-terminal, 3-terminal, and 4-terminal devices.

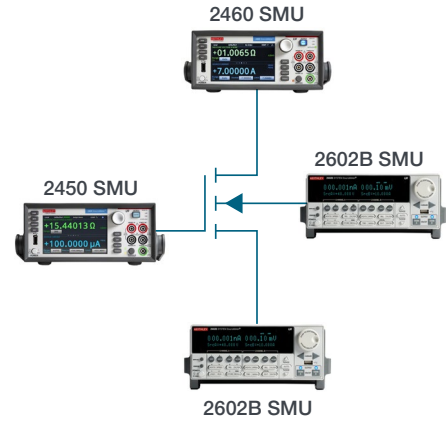
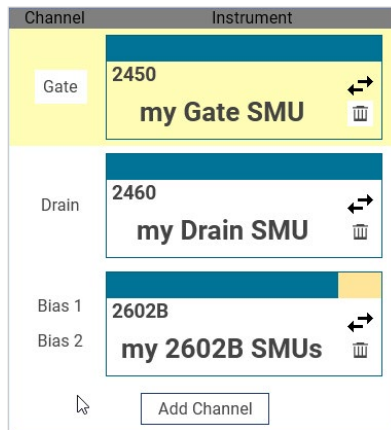

Characterize devices using up to four of Keithley's SourceMeter SMU instruments.

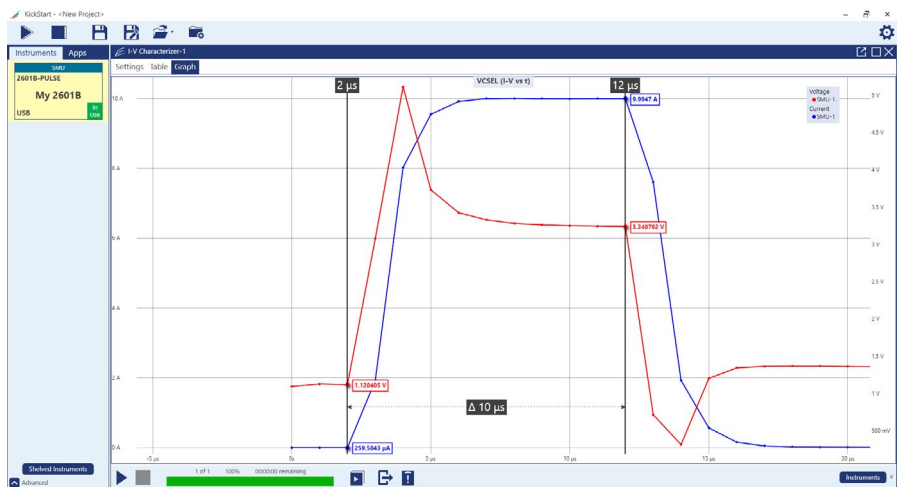

VCSEL Screenshot I-V-T for pulsing capability added as part of Slingshot project on the 2601B-Pulse SMU.

# Scope App

Use the Scope app for data capture and datalogging of waveforms, measurements, and screenshots. This app offers three modes of operation.

- **Waveforms Mode:** KickStart retrieves the x-y data of each desired channel from the scope. It lists the data in the Table tab and a data plot in the Graph tab for the user to verify that the data retrieved is desired. Only data from analog channels is retrieved.
- **Measurements Mode:** The user can select up to 8 measurements to retrieve from the scope. The measurements are made by the oscilloscope and logged into the KickStart Table. The user can use the Graph tab in KickStart to view the measurement data and easily note trends or spot anomalies.
- **Screenshot Mode:** Capture the screen image of the oscilloscope.

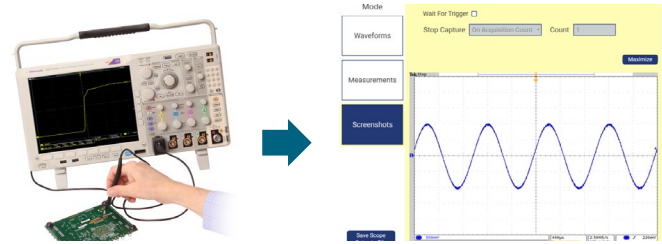

Saved screen capture of scope with KickStart.

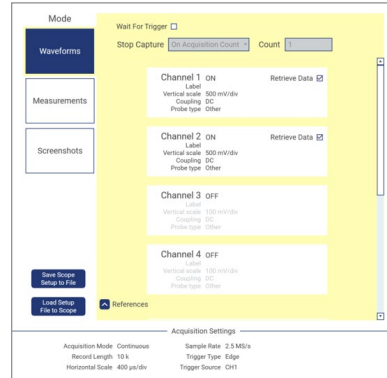

The setup window enables the selection of the Waveforms, Measurements, or Screenshots mode.

The Scope app supports data retrieval from Analog Channels, Reference Channels and Math Channels. The app will either capture present data (without waiting for a trigger) or will arm the scope to wait for a trigger, stop the capture to gather data once scope has been triggered and re-arm scope to wait for next trigger after data is captured.

- Supports Tektronix 3 Series MDO, MDO3000 Series, MDO4000 Series, MSO3000 Series, MSO4000 Series, DPO3000 Series, DPO4000 Series, TBS1000 Series, TBS2000 Series, TDS1000 Series, TDS2000 Series, and TDS200 Series scope models.

Time (s)	Channel 1 Voltage (V)	Channel 2 Voltage (V)
-2.00000e-3	160.000e-3	60.0000e-3
-1.99990e-3	160.000e-3	20.0000e-3
-1.99920e-3	240.000e-3	140.000e-3
-1.99850e-3	200.000e-3	60.0000e-3
-1.99780e-3	200.000e-3	60.0000e-3
-1.99710e-3	240.000e-3	180.000e-3
-1.99640e-3	280.000e-3	100.000e-3
-1.99570e-3	120.000e-3	60.0000e-3
-1.99500e-3	160.000e-3	100.000e-3
-1.99430e-3	200.000e-3	20.0000e-3
-1.99360e-3	240.000e-3	100.000e-3
-1.99290e-3	240.000e-3	140.000e-3
-1.99220e-3	240.000e-3	140.000e-3
-1.99150e-3	240.000e-3	140.000e-3
-1.99080e-3	280.000e-3	180.000e-3
-1.99010e-3	240.000e-3	100.000e-3
-1.98940e-3	-1.20000e-3	-1.30000e-3
-1.98870e-3	1.00000e-3	580.000e-3
-2.00e-9	-64.1040e-3	-157.4320e-3
1.56738e-3	719.4994e-3	722.6684e-3

Data collected from the scope can be displayed in Table View with statistics.

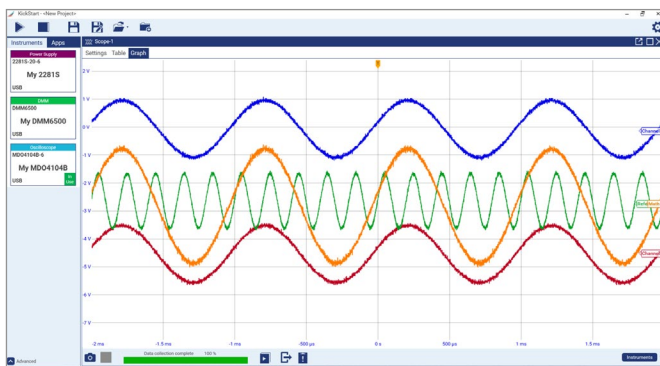

Display up to 4 channels of analog data, including Reference and Math channels.

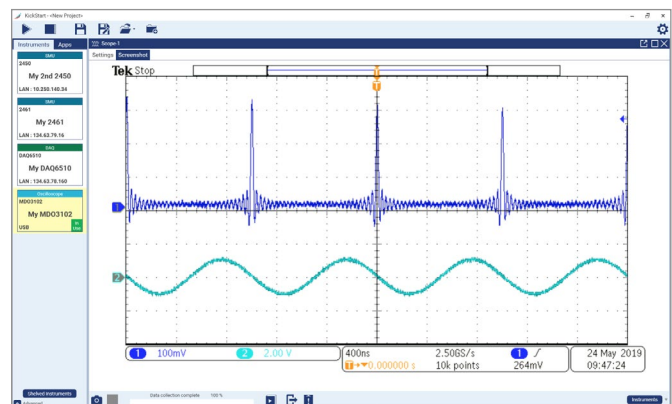

Capture and save a screenshot image for use in reports and journal.

## High Resistivity App for 6517B Electrometer

The optional high resistivity application (HRMA) for KickStart is designed for use with Keithley's 6517B Electrometer/ High Resistance Meter. The 6517B along with the 8009 Resistivity Test Fixture is a laboratory standard for volume and surface resistivity measurements on insulating materials. Together, they can be used to measure resistance up to  $10^{18} \Omega$  at up to 1000 V.

The KickStart high resistance measurement option makes it easier for you to:

- Quickly and reliably determine resistivity of material using tests that conform to ASTM D257 standard.
- Perform a Step Response test to identify electrification time appropriate to the material's time constant.
- Observe resistivity dependence on temperature and relative humidity of environment using optional probes 6517-TP and 6517-RH.
- Use the alternating polarity measurement technique to eliminate inherent background currents for the most accurate resistivity measurements.

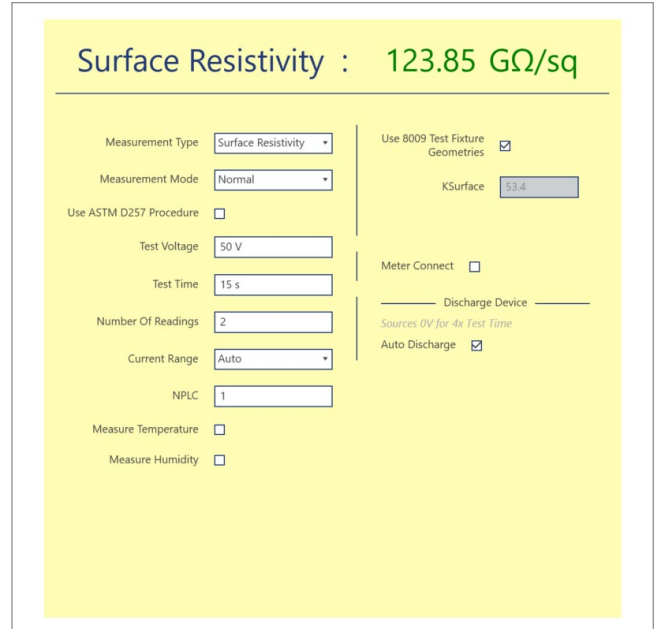

Set up a High Resistivity Test from a single window.

The KickStart High Resistivity Application requires a license: either the KICKSTARTFL-HRMA2 floating perpetual license or the KICKSTARTFL-HRMA2-AN 1-year time-based license. A floating license allows selected users to manage transfer of individual license to different PCs.

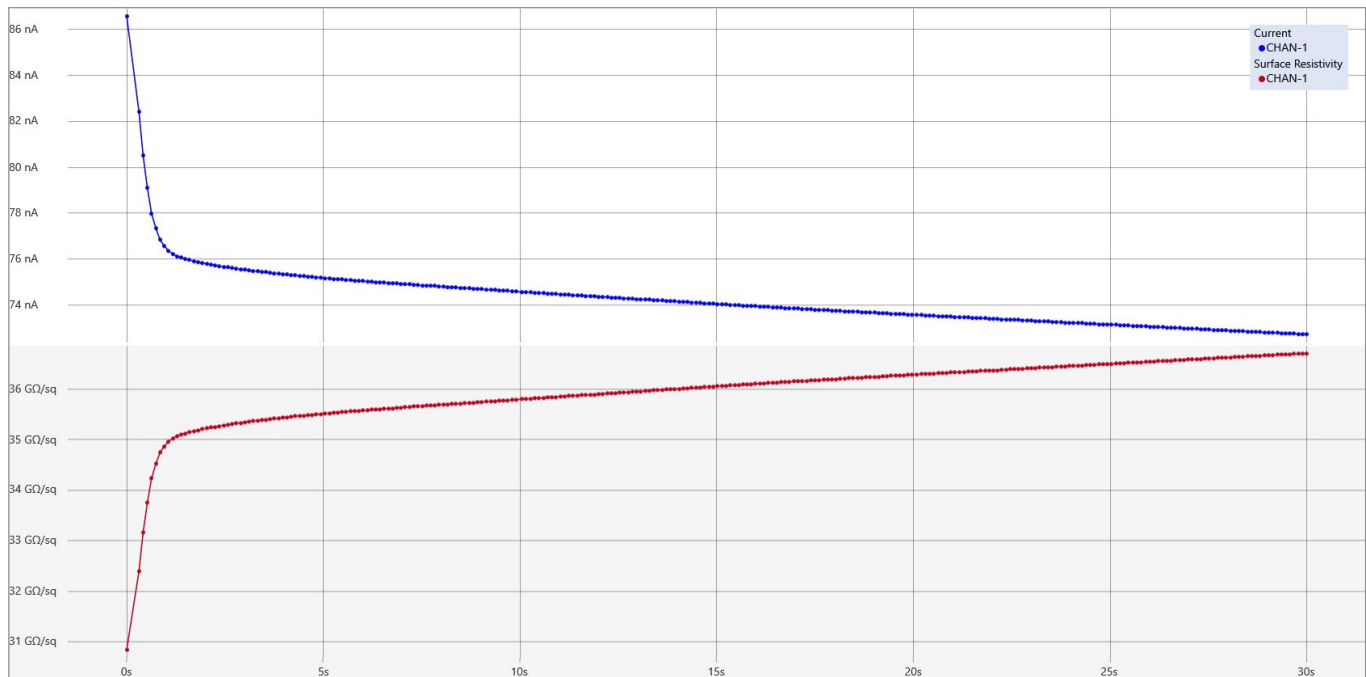

View Step Response in real time.



## I-V Tracer App

Keithley I-V Tracer Software leverages the unique touchscreen interface of the Graphical 2400 Series SourceMeter SMU instruments to recreate the familiar user experience of a curve tracer for two-terminal devices. Adding the I-V Tracer software to your SourceMeter instrument gives you a dedicated user interface for tracing the characteristics of your devices through both current and voltage. With a range of compatible instruments, I-V Tracer can utilize the full capabilities of each source measure unit, including the dual high-speed digitizers of the 2461 to perform tracing with AC polarity and pulsed DC in addition to standard DC polarity.



- Compatible with Keithley 2450, 2460, 2461, and 2470 Graphical SourceMeter SMUs
- +DC, -DC, AC polarity modes (AC mode only compatible with the 2461 SMU)
- Compare mode to display a reference device next to a measured curve
- Save curve data to disk with KickStart for analysis in Excel
- Screen capture curves
- Pinch and zoom on the touchscreen to analyze data immediately
- Current sourcing capabilities allowing the user to sweep current across the device and plot current versus voltage

I-V Tracer Software is a specialty KickStart App and is sold separately. Please refer to Ordering Information on page 9 for details on single, three, or five license packs.

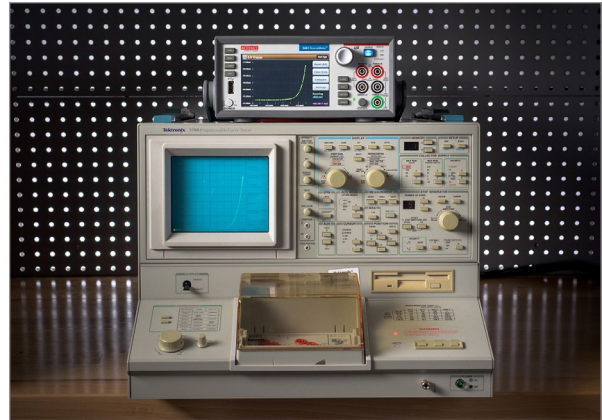

I-V Tracer Software offers a modern alternative to traditional curve tracers.



Use the front panel knob to see your data more clearly.



Using I-V Tracer Software means engineers no longer need to share outdated equipment.

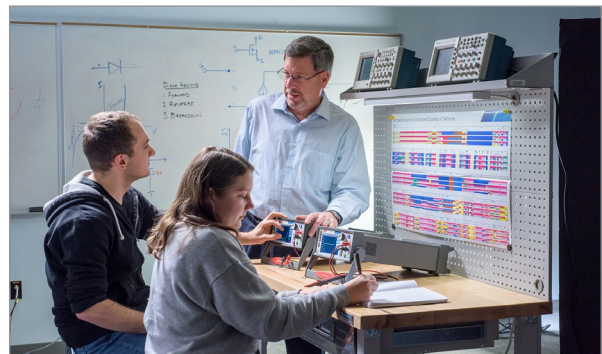

I-V Tracer offers an ideal engineering teaching solution.

## Ordering Information

### Suite Applications

KICKSTARTFL-SUITE	KickStart Instrument Control Software; Perpetual Floating License Option*
KICKSTARTFL-SUITE-UP	KickStart Instrument Control Software; Annual Maintenance License for extending the Perpetual Floating License Option*
KICKSTARTFL-SUITE-AN	KickStart Instrument Control Software; 1 year Time-Based Floating License Option**
KICKSTARTFL-DL	KickStart Data Logger Application Software; Perpetual Floating License Option*
KICKSTARTFL-DL-UP	KickStart Data Logger Application Software; Maintenance License for extending the Perpetual Floating License Option*
KICKSTARTFL-DL-AN	KickStart Data Logger Application Software; 1 year Time-Based Floating License Option**
KICKSTARTFL-DMM	KickStart Precision Digital Multimeter Application Software; Perpetual Floating License Option*
KICKSTARTFL-DMM-UP	KickStart Precision Digital Multimeter Application Software; Maintenance License for extending the Perpetual Floating License Option*
KICKSTARTFL-DMM-AN	KickStart Precision Digital Multimeter Application Software; 1 year Time-Based Floating License Option**
KICKSTARTFL-IVC	KickStart I-V Characterizer Application Software; Perpetual Floating License Option*
KICKSTARTFL-IVC-UP	KickStart I-V Characterizer Application Software; Maintenance License for extending the Perpetual Floating License Option*
KICKSTARTFL-IVC-AN	KickStart I-V Characterizer Application Software; 1 year Time-Based Floating License Option**
KICKSTARTFL-PS	KickStart Power Supply Application Software; Perpetual Floating License Option*
KICKSTARTFL-PS-UP	KickStart Power Supply Application Software; Maintenance License for extending the Perpetual Floating License Option*
KICKSTARTFL-PS-AN	KickStart Power Supply Application Software; 1 year Time-Based Floating License Option**
KICKSTARTFL-SCOPE	KickStart Scope Application Software; Perpetual Floating License Option*
KICKSTARTFL-SCOPE-UP	KickStart Scope Application Software; Maintenance License for extending the Perpetual Floating License Option*
KICKSTARTFL-SCOPE-AN	KickStart Scope Application Software; 1 year Time-Based Floating License Option**

### Specialty Applications

KICKSTARTFL-HRMA2	KickStart High Resistivity Application Software; Perpetual Floating License Option*
KICKSTARTFL-HRMA2-UP	KickStart High Resistivity Application Software; Annual Maintenance License for extending the Perpetual Floating License Option*
KICKSTARTFL-HRMA2-AN	KickStart High Resistivity Application Software; 1 year Time-Based Floating License Option**
KICKSTARTNL-ACT1	Single license I-V Tracer App pack for one source measure unit
KICKSTARTNL-ACT3	Single license I-V Tracer App pack for three source measure units
KICKSTARTNL-ACT5	Single license I-V Tracer App pack for five source measure units

\* Perpetual Licenses: The software can be used indefinitely; license does not expire but updates/support only available for the first 12 months. Support can be extended by purchasing a maintenance license. If a perpetual license goes out of support, all features will be frozen to the last released version before the support expired. The software will continue to work, but you cannot get any updates newer than the support expiration date.

- Maintenance Licenses – Apply to perpetual licenses only. Maintenance license is an extension license that extends the period of support of an original perpetual license for 12 months.

\*\* Time-based Licenses: The software can be used throughout the term of the license only. Software updates and support through the term of the license are included. When the Time-Based license expires, all features will no longer work, but a new Time-Based license may be purchased.

## Download the latest version of KickStart today from [www.tek.com/keithley-kickstart](http://www.tek.com/keithley-kickstart)

KickStart allows you to create tests and view, manipulate and export data without a license. To communicate with and control an instrument, KickStart requires a license. KickStart installs with a one-time 60-day trial license. Visit [www.tek.com](http://www.tek.com) to get a quote for KICKSTARTFL-BASE, a floating license that unlocks all the base KickStart apps. A floating license allows selected users to manage transfer of individual license files to different PCs. License management is done through the Tektronix Asset Management System (TekAMS).

For more info on TekAMS, visit <https://www.tek.com/products/product-license>. Each valid license entitles you to unlimited support by Tektronix' worldwide technical support centers and field applications engineers.

## Learn More about KickStart

Visit [www.tek.com/keithley-kickstart](http://www.tek.com/keithley-kickstart) for the latest information about KickStart.

For questions, please visit Tektronix Technical Forums at <http://forum.tek.com> or contact your local Tektronix sales office noted on the back of this datasheet.

## Recommended System Requirements

- CPU: Dual-core processor 2 GHz or better
- Memory: 8GB RAM
- Disk Drive: 8GB of free space
- Windows 10, 8, 7 64-bit
- Instrument communication interfaces: USB, GPIB, LAN
- Display resolution: Minimum 1920x1080 recommended

## Contact Information:

**Australia** 1 800 709 465  
**Austria\*** 00800 2255 4835  
**Balkans, Israel, South Africa and other ISE Countries** +41 52 675 3777  
**Belgium\*** 00800 2255 4835  
**Brazil** +55 (11) 3759 7627  
**Canada** 1 800 833 9200  
**Central East Europe / Baltics** +41 52 675 3777  
**Central Europe / Greece** +41 52 675 3777  
**Denmark** +45 80 88 1401  
**Finland** +41 52 675 3777  
**France\*** 00800 2255 4835  
**Germany\*** 00800 2255 4835  
**Hong Kong** 400 820 5835  
**India** 000 800 650 1835  
**Indonesia** 007 803 601 5249  
**Italy** 00800 2255 4835  
**Japan** 81 (3) 6714 3010  
**Luxembourg** +41 52 675 3777  
**Malaysia** 1 800 22 55835  
**Mexico, Central/South America and Caribbean** 52 (55) 56 04 50 90  
**Middle East, Asia, and North Africa** +41 52 675 3777  
**The Netherlands\*** 00800 2255 4835  
**New Zealand** 0800 800 238  
**Norway** 800 16098  
**People's Republic of China** 400 820 5835  
**Philippines** 1 800 1601 0077  
**Poland** +41 52 675 3777  
**Portugal** 80 08 12370  
**Republic of Korea** +82 2 565 1455  
**Russia / CIS** +7 (495) 6647564  
**Singapore** 800 6011 473  
**South Africa** +41 52 675 3777  
**Spain\*** 00800 2255 4835  
**Sweden\*** 00800 2255 4835  
**Switzerland\*** 00800 2255 4835  
**Taiwan** 886 (2) 2656 6688  
**Thailand** 1 800 011 931  
**United Kingdom / Ireland\*** 00800 2255 4835  
**USA** 1 800 833 9200  
**Vietnam** 12060128

\* European toll-free number. If not accessible, call: +41 52 675 3777



Find more valuable resources at [TEK.COM](http://TEK.COM)

Copyright © Tektronix. All rights reserved. Tektronix products are covered by U.S. and foreign patents, issued and pending. Information in this publication supersedes that in all previously published material. Specification and price change privileges reserved. TEKTRONIX and TEK are registered trademarks of Tektronix, Inc. All other trade names referenced are the service marks, trademarks or registered trademarks of their respective companies.  
031821 SBG 1KW-60965-7

