

# tekmar® Installation & Operation Manual

## Boiler Control 275

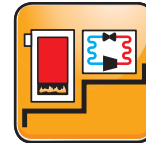

**D 275**

01/12

Multi-Staging Replaces:03/09

The Boiler Control 275 is designed to stage up to four condensing or non-condensing, modulating or on-off boilers using P.I.D. staging to accurately maintain temperature. The control supports hybrid boiler plants that contain both condensing and non-condensing boiler groups. Water temperature is controlled by outdoor reset for space heating applications or a fixed setpoint for Domestic Hot Water (DHW) tank heating or industrial process heating applications. The control will also accept an analog signal from an Energy Management System (EMS) to control the water temperature. Boiler equal run-time rotation, pump exercising and stand-by system pump operation increase boiler plant reliability. The control is tekmarNet® communication compatible allowing for internet connectivity using an optional Gateway 483.

**Additional functions include:**

- tN4 Compatible
- BTC I Compatible
- 24 Hour, 5-11, 5-2, 7 Day Schedule
- Flow or Combustion Air Proof
- Four Modulating or On/Off Boilers
- Equal Run Time Rotation
- Primary Pump Sequencing
- DHW Operation
- Optional DHW Sensor
- Setpoint Operation

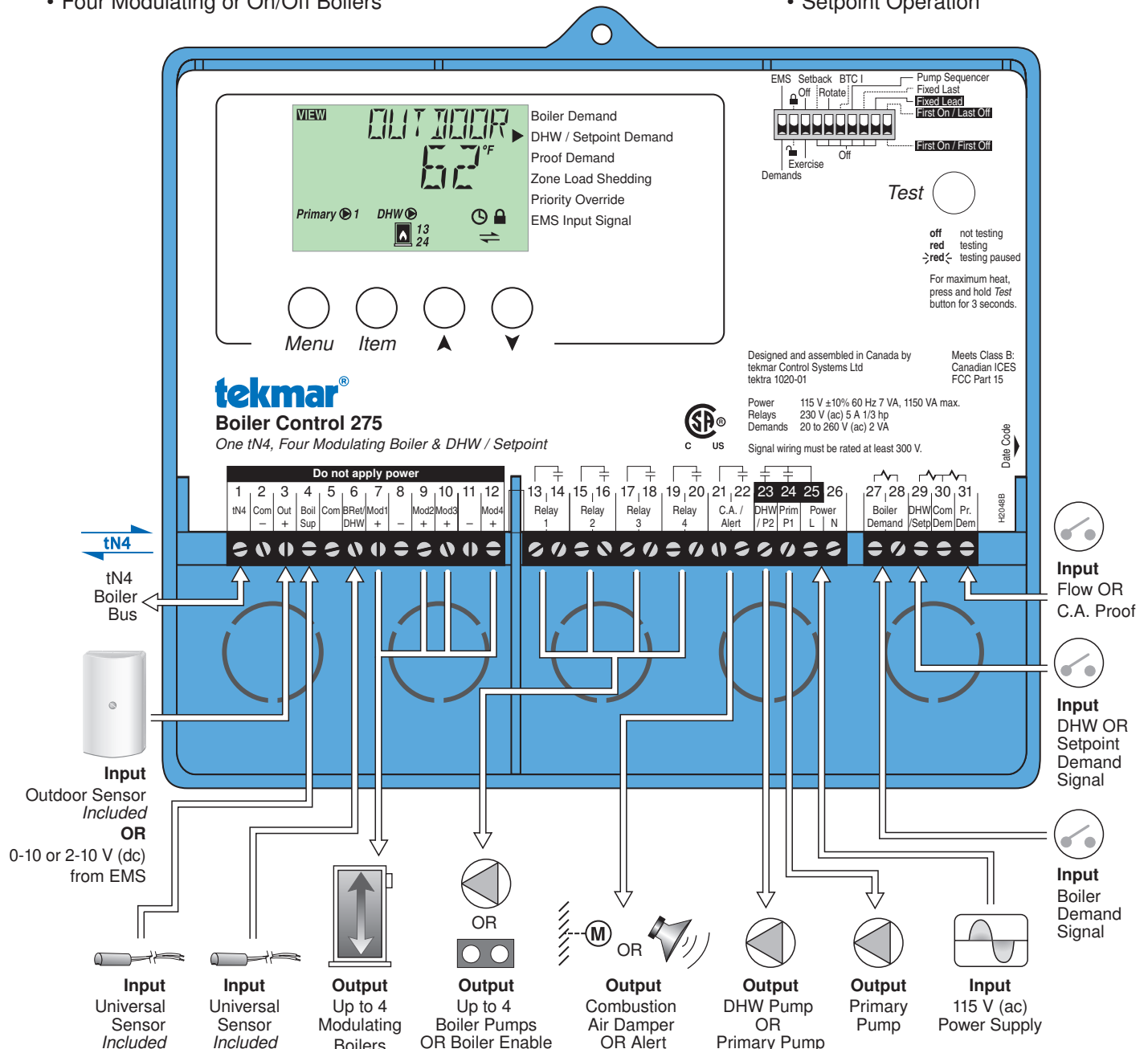

## How to Use the Data Brochure

This brochure is organized into three main sections.

- They are:
- 1) Sequence of Operation,
  - 2) Installation,
  - 3) Control Settings and
  - 4) Testing and Troubleshooting.

The Control Settings section of this brochure describes the various items that are adjusted and displayed by the control. The control functions of each adjustable item are described in the Sequence of Operation.

## Table of Contents

User Interface.....	2	Section O: Time Clock .....	20
Display and Symbol Description.....	3	Section P: Boost.....	20
Access Level.....	4	Section Q: Exercising.....	20
Sequence of Operation.....	4	Section R: tekmarNet®4 Communication.....	20
Section A: Boiler Demand .....	4	Section S: Scene Operation.....	21
Section B: Outdoor Reset.....	4	Installation .....	22
Section C: Boiler Operation.....	6	Control Settings .....	28
Section D: Modulating Boilers.....	8	Cleaning the Control .....	28
Section E: On / Off Boilers .....	10	DIP Switch Settings.....	28
Section F: OEM Boilers Equipped With A BTC I....	10	VIEW Menu .....	30
Section G: Fixed Lead and Fixed Last .....	10	ADJUST Menu .....	32
Section H: Condensing and Non-Condensing Boiler Groups .....	10	TIME Menu.....	39
Section I: Domestic Hot Water Operation .....	11	SCHEDULE Menu.....	40
Section J: Setpoint Operation .....	14	MISC Menu .....	43
Section K: Energy Management System (EMS) ....	16	Testing the Control.....	44
Section L: Pump Operation .....	17	Error Messages .....	45
Section M: Combustion Air and Alert Settings .....	18	Technical Data.....	48
Section N: Setting the Schedule .....	19	Limited Warranty .....	48

## User Interface

The control uses a Liquid Crystal Display (LCD) as the method of supplying information. You use the LCD in order to setup and monitor the operation of your system. The control has four push buttons (Menu, Item, ▲, ▼) for selecting and adjusting settings. As you program your control, record your settings in the ADJUST menu table, which is found in the second half of this brochure.

### Menu

All of the items displayed by the control are organized into five menus (View, Adjust, Time, Schedule, and Misc). These menus are listed on the top left hand side of the display (Menu Field). To select a menu, use the Menu button. By pressing and releasing the Menu button, the display sequences between the five menus. Once a menu is selected, there will be a group of items that can be viewed within the menu.

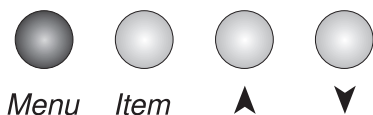

### Item

The abbreviated name of the selected item will be displayed in the item field of the display. To view the next available item, press and release the Item button. Once you have reached the last available item in a menu, pressing and

releasing the Item button will return the display to the first item in the selected menu.

The items can be quickly scrolled through by holding the Item button and then pressing the ▼ button. To rapidly scroll through the items in the reverse order, hold the Item button and press the ▲ button.

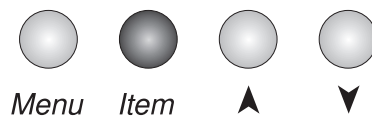

### Adjust

To make an adjustment to a setting in the control, begin by selecting the ADJUST, TIME, SCHEDULE or MISC menu using the Menu button. Then select the desired item using the Item button. Finally, use the ▲, and / or ▼ button to make the adjustment.



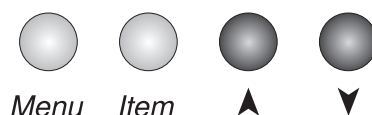



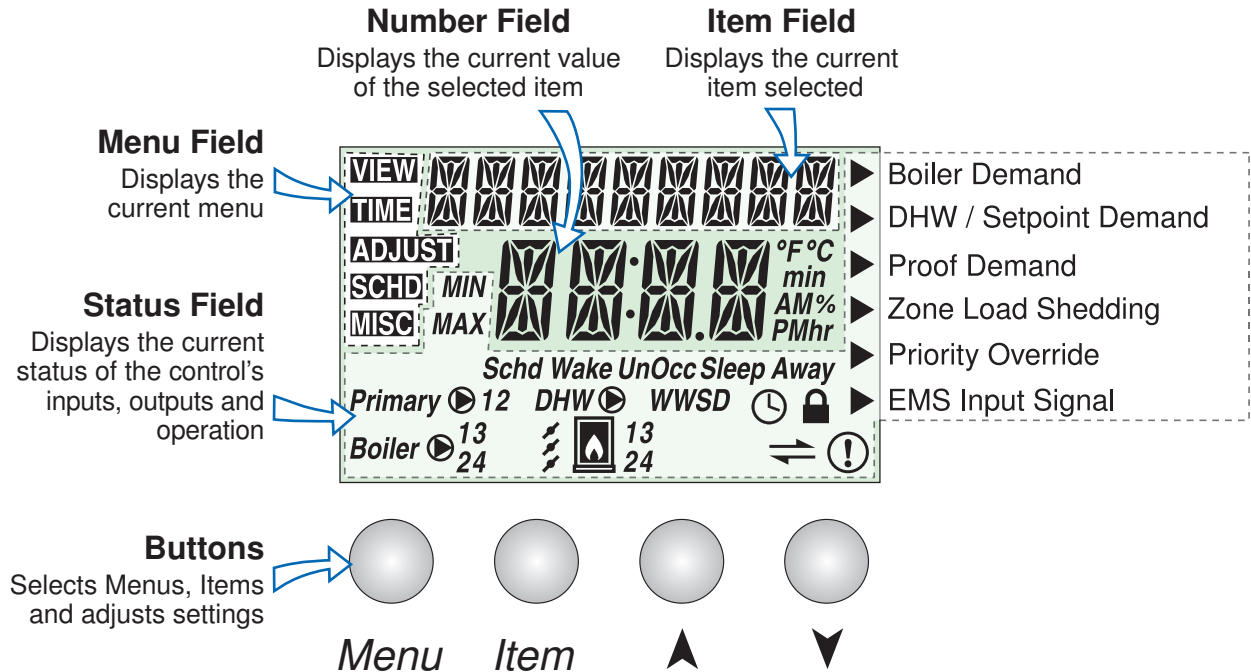



Additional information can be gained by observing the Status field of the LCD. The status field will indicate which of the control's outputs are currently active. Most symbols in the status field are only visible when the VIEW menu is selected.



## Display



## Symbol Description

<b>Primary</b>  <b>12</b>	<b>PRIMARY PUMP</b> Displays when primary pump 1 or primary pump 2 is in operation	<b>Boiler</b>  <b>13 24</b>	<b>BOILER PUMP</b> Displays when the boiler pump 1, 2, 3, or 4 are operating
 <b>13 24</b>	<b>BOILER</b> Displays which modulating output is operating		<b>COMBUSTION AIR DAMPER</b> Displays when the combustion air damper relay is closed
	<b>LOCK</b> Displays when adjusting Access level if Switch is set to lock.		<b>SCHEDULE MASTER</b> Displays when the 275 is a schedule master
	<b>WARNING</b> Displays when an error exists.	<b>WWSD</b>	<b>WARM WEATHER SHUT DOWN</b> Displays when the control is in warm weather shut down
	<b>COMMUNICATION BUS</b> Displays when tN4 thermostats are connected.	<b>MIN MAX</b>	<b>MINIMUM &amp; MAXIMUM</b> Displays when the boil target or the boil supply is at a minimum or maximum
<b>DHW</b> 	<b>DHW PUMP</b> Displays when the DHW Pump is operating	<b>Schd Wake UnOcc Sleep Away</b>	<b>Schd, Wake, UnOcc, Sleep, Away</b> Displays the current event of a schedule or scene
<b>°F °C min AM% PMhr</b>	<b>°F, °C, MINUTES, AM, %, PM, HOURS</b> Units of measurement.		<b>POINTER</b> Displays the control operation as indicated by the text

## Access Level

The access level restricts the number of Menus, Items, and Adjustments that can be accessed by the user. The Access Level setting is found in the Miscellaneous (MISC) Menu. Select the appropriate access level for the people who work with the control on a regular basis. There are three Access Level Settings:

- User (USER): Select this access level for building supervisors and other non-technical staff to prevent unauthorized access to installer and advanced level settings.

- Installer (INST): Select this access level to limit some of the settings available to the installer. This is the factory default access level.
- Advanced (ADV): Select this access level to have complete access to all of the control settings. In the display menu tables, the appropriate access level needed to view each item is shown in the Access column.

**Note:** the Lock / Unlock switch on the front of the control must be set to unlock to change the access level.

## Sequence of Operation

In order for the control to have a target water temperature there must be a demand. There are three different demands the control can have: boiler demand, DHW demand, and setpoint demand.

### Boiler Demand

### Section A

Once the control receives a boiler demand it calculates a target water temperature based on the characterized heating curve to provide outdoor reset for space heating. The control can receive a boiler demand three different ways:

1. By applying 20-260 V (ac) to the boiler demand terminals (27 & 28) when the DIP switch is set to Demands.
2. From an Energy Management System (EMS) by applying a 0-10 or 2-10 V (dc) signal to terminals 2 & 3 when the DIP switch is set to EMS.
3. From a tN4 device. This requires a tN4 thermostat to be wired to terminals 1 & 2 so that the call for heat can go over the communication bus.

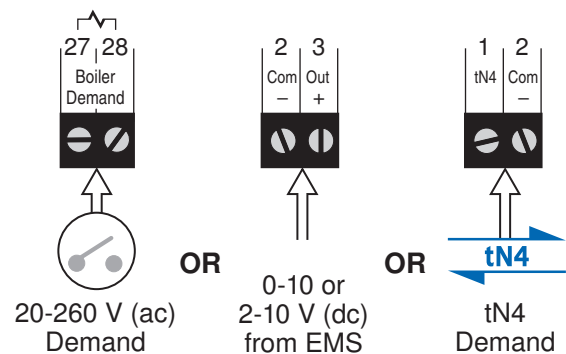

### Outdoor Reset

### Section B

In a heating system, the rate of heat supplied to the building must equal the rate at which heat is lost. If the two rates are not equal, the building will either cool off or over heat.

The rate of building heat loss depends mostly on the outdoor temperature. Outdoor Reset allows a hot water heating system to increase the water temperature, adding heat to the building, as the outdoor temperature drops. The rate at which the water temperature is changed as a function of outdoor temperature is defined by the characterized heating curve.

#### Characterized Heating Curve

A characterized heating curve determines the amount the target water temperature is raised for every 1° drop in outdoor air temperature.

The characterized heating curve takes into account the type of terminal unit that the system is using. Since different types of heating terminal units transfer heat to a space using

different proportions of radiation, convection and conduction, the supply water temperature must be controlled differently. The control uses the terminal unit setting to vary the supply water temperature to suit the terminal unit being used. This improves the control of the air temperature in the building.

#### Boiler Characterized Heating Curve

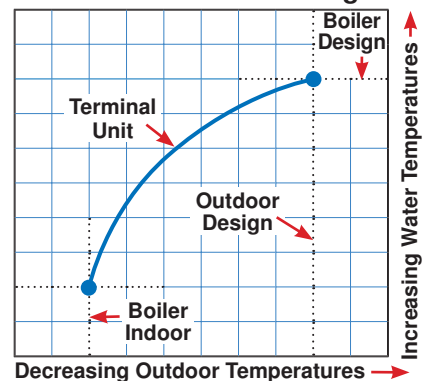

## Terminal Unit Setting in Adjust Menu

Select the appropriate terminal unit in the adjust menu. This will change the shape of the characterized heating curve to better match the heat transfer properties of that specific terminal unit.

### Hydronic Radiant Floor (HRF1)

A heavy or high mass, hydronic radiant floor system. This type of a hydronic radiant floor is embedded in either a thick concrete or gypsum pour. This heating system has a large thermal mass and is slow acting.

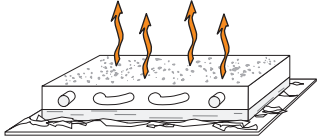

### Hydronic Radiant Floor (HRF2)

A light or low mass, hydronic radiant floor system. Most commonly, this type of radiant heating system is attached to the bottom of a wood sub floor, suspended in the joist space, or sandwiched between the subfloor and the surface. This type of radiant system has a relatively low thermal mass and responds faster than a high mass system.

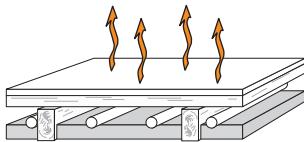

### Fancoil (COIL)

A fancoil terminal unit or air handling unit (AHU) consisting of a hydronic heating coil and either a fan or blower. Air is forced across the coil at a constant velocity by the fan or blower and is then delivered into the building space.

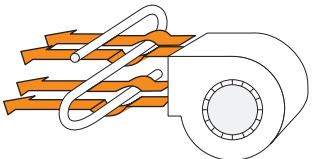

### Fin-tube Convectector (CONV)

A convectector terminal unit is made up of a heating element with fins on it. This type of terminal unit relies on the natural convection of air across the heating element to deliver heated air into the space. The amount of natural convection is dependant on the supply water temperature to the heating element and the room air temperature.

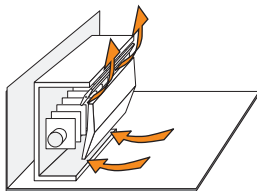

### Radiator (RAD)

A radiator terminal unit has a large heated surface that is exposed to the room. A radiator provides heat to the room through radiant heat transfer and natural convection.

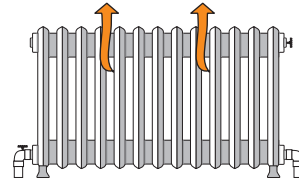

### Baseboard (BASE)

A baseboard terminal unit is similar to a radiator, but has a low profile and is installed at the base of the wall. The proportion of heat transferred by radiation from a baseboard is greater than that from a fin-tube convectector.

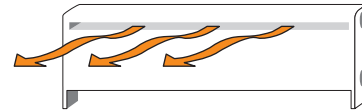

## Boiler Terminal Unit Defaults

When a terminal unit is selected for boiler zones, the control loads default values for the boiler design, boiler maximum supply, and boiler minimum supply temperatures. The factory defaults can be changed to better match the installed system. Locate the Terminal Unit setting in the Adjust menu.

Terminal Unit	BOIL DSGN	BOIL MAX	BOIL MIN
High Mass Radiant	120°F (49°C)	140°F (60°C)	OFF
Low Mass Radiant	140°F (60°C)	160°F (71°C)	OFF
Fancoil	190°F (88°C)	210°F (99°C)	140°F (60°C)
Fin-Tube Convectector	180°F (82°C)	200°F (93°C)	140°F (60°C)
Radiator	160°F (71°C)	180°F (82°C)	140°F (60°C)
Baseboard	150°F (76°C)	170°F (77°C)	140°F (60°C)

## Room Setting in Adjust Menu

The Room setting is the desired room air temperature, according to the outdoor reset heating curve. The Room setting parallel shifts the heating curve up or down to change the target water temperature. Adjust the Room setting to increase or decrease the amount of heat available to the building. Once the heating curve has been set up properly, the Room setting is the only setting that needs to be adjusted. The default Room setting is 70°F (21°C), and it can be adjusted for both the occupied and unoccupied periods.

## Outdoor Design Setting in Adjust Menu

The outdoor design temperature is typically the coldest outdoor air temperature of the year. This temperature is used when doing the heat loss calculations for the building and is used to size the heating system equipment. If a cold outdoor design temperature is selected, the supply water temperature rises gradually as the outdoor temperature drops. If a warm outdoor design temperature is selected, the supply water temperature rises rapidly as the outdoor temperature drops.

## Boiler Indoor Setting in Adjust Menu

The boiler indoor design temperature is the indoor temperature the heating designer chose while calculating the heat loss for the boiler water heated zones. This temperature is typically 70°F (21.0°C). This setting establishes the beginning of the boiler characterized heating curve.

## Boiler Design Setting in Adjust Menu

The boiler design supply temperature is the boiler water temperature required to heat the zones at the outdoor design temperature, or on the typical coldest day of the year.

(Default automatically changes based on terminal unit setting)

## Warm Weather Shut Down (WWSD) Setting in Adjust Menu

Warm Weather Shut Down disables the heating system when the outdoor air temperature rises above this programmable setting. When the control enters into WWSD, the LCD will indicate this in the status field. WWSD is only available when the DIP switch = Demands. The boilers will operate when a Domestic Hot Water (DHW) demand or a Setpoint Demand is present.

## Boiler Operation

## Section C

The 275 is able to operate up to four modulating or on-off boilers as a heat source. For proper operation of the boilers, the 275 must be the only control that determines when a boiler is to fire.

**\*Important note:** The boiler operator, or aquastat, remains in the burner circuit and acts as a secondary upper limit on the boiler temperature. The boiler aquastat temperature setting must be adjusted above the 275's boiler maximum setting in order to prevent short cycling of the burner.

## Boiler Target Temperature

The boiler target temperature is determined by connected tN4 devices or by a Boiler, DHW or Setpoint demand received by the control. An Energy Management System (EMS) can also give a boiler target. The tN4 devices determine the highest water temperature required and then request this temperature on the tN4 boiler bus. The temperature request creates a Boiler Demand and this is indicated on the display. A DHW demand and a Setpoint demand have temperature settings to which the boilers are operated to meet and are able to override the tN4 bus temperature if required. The control displays the temperature that it is currently trying to maintain as the boiler supply temperature in the View menu. If the control does not presently have a requirement for heat, it does not show a boiler target temperature. Instead, “— —” is displayed in the LCD.

## Boiler Minimum Setting in Adjust Menu

The boiler minimum is the lowest temperature that the control is allowed to use as a boiler target temperature. During mild conditions, if the control calculates a boiler target temperature that is below the boiler minimum setting, the boiler target temperature is adjusted to at least the boiler minimum setting. The MIN segment is displayed in the LCD while viewing the boiler supply or target and when the boiler target is boiler minimum and the boiler supply is less than boiler minimum plus 5°F (2.5°C). Set the Boiler Minimum setting to the boiler manufacturer's recommended temperature.

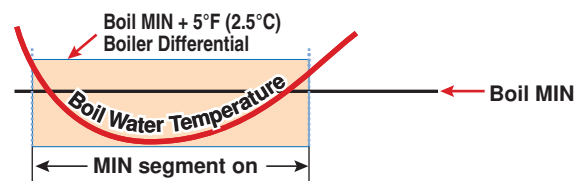

## Boiler Maximum Setting in Adjust Menu

The boiler maximum is the highest temperature that the control is allowed to use as a boiler target temperature. The MAX segment is displayed in the LCD while viewing the boiler supply or target and when the boiler target is boiler maximum and the boiler supply is greater than boiler maximum minus 5°F (2.5°C). Set the boiler maximum setting below the boiler operator or aquastat temperature. At no time does the control operate the boiler above 248°F (120°C).

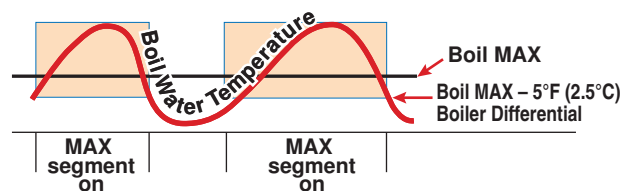

## Stage Delay Setting in Adjust Menu

The Stage Delay is the minimum time delay between the firing of each stage. After this delay has expired the control can fire the next stage if it is required. This setting can be adjusted manually or set to an automatic setting. When the automatic setting is used, the control determines the best stage delay based on the operation of the system.

## Boiler Relay Setting in Adjust Menu (per boiler)

The 275 provides a dry contact for either burner ignition or boiler pump. Selection is made through the Boiler RELAY setting in the adjust menu. Select 'burner' for boilers that require a boiler enable signal as well as a modulating signal in order to operate. Select pump to operate a boiler pump with post purge capabilities.

## Boiler Mass Setting in Adjust Menu (per boiler)

Match the boiler mass setting with the thermal mass characteristics of each boiler. The modulation of the boiler can become unstable if the incorrect Boiler Mass setting is chosen. A key sign of unstable boiler modulation is that the flame will continue to increase and then decrease in short periods of time. By choosing a lower boiler mass setting, the boiler response will become more stable.

### LO

The LO setting is selected if the boiler that is used has a low thermal mass. This means that the boiler has very small water content and has very little metal in the heat exchanger. A boiler that has a low thermal mass comes up to temperature quite rapidly when fired. This is typical of many copper fin-tube boilers.

The Lo mass setting provides a fast response to the heating system.

### MED

The MED setting is selected if the boiler that is used has a medium thermal mass. This means that the boiler either has a large water content and a low metal content or a low water content and a high metal content. This is typical of many modern residential cast iron boilers or steel tube boilers.

The Med mass setting provides a moderate response to the heating system.

### HI

The HI setting is selected if the boiler that is used has a high thermal mass. This means that the boiler has both large water content and a large metal content. A boiler that has a high thermal mass is relatively slow in coming up to temperature. This is typical of many commercial cast iron and steel tube boilers.

The Hi mass setting provides a slow response to the heating system.

## Boiler Differential Setting in Adjust Menu

A modulating boiler must be operated with a differential while operating at Minimum Modulation. When the boiler is modulating above Minimum Modulation, the differential does not apply. Instead, the modulation output signal is determined using Proportional, Integral, and Derivative (PID) logic in order to satisfy the boiler target temperature.

The boiler differential can be fixed or automatically determined by the control. The Auto Differential setting balances the amount of temperature swing in the boiler supply temperature with boiler on times, off times, and cycle times. This reduces potential short cycling during light load conditions.

## Manual Differential

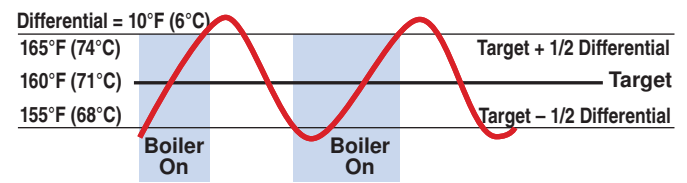

## Automatic Differential

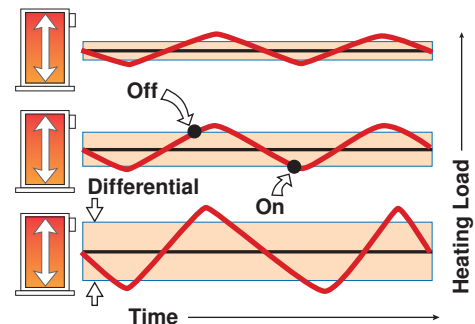

## Rotation

The Rotate feature changes the firing order of the boilers whenever one boiler accumulates 48 hours more run time than any other boiler. Rotation will be forced if any boiler accumulates 60 hours more run time. After each rotation, the boiler with the least running hours is the first to fire and the boiler with the most running hours is the last to fire. This function ensures that all of the boilers receive equal amounts of use. When the Rotate / Off DIP switch is set to the Off position, the firing sequence always begins with lowest boiler to the highest boiler.

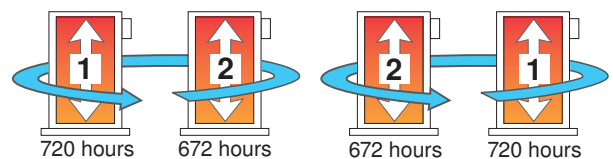

To reset the rotation sequence (without regard to historical running hours), toggle the Rotation DIP Switch Off for 3 seconds and on again. Note that the running hours (see Run Time) in the View menu also need to be reset if you want the rotation sequence and running hours display to be synchronized.

## Boiler Run Time in View Menu

The running time of each boiler is logged in the view menu. To reset the running time, select the appropriate Boiler Run Time in the View menu and press and hold the Up and Down buttons together until CLR is displayed.

The 275 can operate up to four modulating boilers. The control also provides dry contacts for either burner ignition or boiler pump. Selection is made through Boiler Relay setting in the Adjust menu.

Once a boiler is required to operate, the control outputs an analog signal corresponding to the Start Modulation setting and then turns on the boiler relay. Once the Fire Delay time has elapsed, the modulating output is adjusted to the Minimum Modulation setting. The control then holds the modulating output at Minimum Modulation until the Minimum Modulation Delay time has elapsed. Proportional, Integral and Derivative (PID) logic is used in order to satisfy the boiler target temperature.

**Modulation Mode Setting in Adjust Menu**

The control includes a Modulation Mode setting that selects either Sequential or Parallel Modulation. Sequential modulation should be used on boilers that are more efficient when operating at high fire. Parallel modulation should be used on boilers that are more efficient when operating at low fire.

**Sequential Modulation**

In sequential modulation, the first boiler is turned on and is modulated to satisfy light loads. Once the first boiler does not have enough capacity to satisfy the load, the first boiler reduces its modulation to provide a smooth transition when the second boiler fires at low fire. The first boiler then modulates up to maximum modulation as the load increases. Only then is the second boiler able to increase its output as the load continues to increase. When the third boiler is required, the second boiler reduces its modulation to allow the third boiler to operate at low fire. As the load continues to increase, the second boiler is modulated to its maximum and then the third boiler is modulated. The operation is reversed when shutting off the boilers.

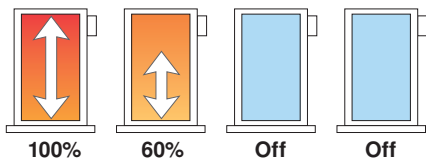

**Parallel Modulation**

In parallel modulation, the first boiler turns on at low fire and begins to increase its modulation. Once the first boiler's output is greater than the combined output of the first and second boiler's low fire, the first boiler is modulated down to low fire and the second boiler is fired at low fire. The two boilers now modulate together. Once the two boiler's combined output is greater than the combined output of all three boilers operating at low fire, the first and second boilers are modulated down to low fire, and all three boilers are operated at low fire. The boilers are then modulated as the load increases. The operation is reversed when shutting off the boilers.

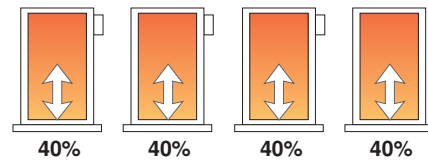

**Boiler Start Modulation Setting in Adjust Menu**

*(per boiler)*

The Start Modulation setting is the lowest modulation output required to obtain proper ignition. Whenever boiler operation is required, the control outputs an analog signal corresponding to the Start Modulation setting and closes the boiler contact to turn on the burner. After the Fire Delay has elapsed and the burner is ignited, the control modulates the firing rate between the Minimum Modulation setting and the Maximum Modulation setting.

**Boiler Fire Delay Setting in Adjust Menu**

*(per boiler)*

The Boiler Fire Delay sets the time it takes for the boiler to generate flame from the time the boiler turns on.

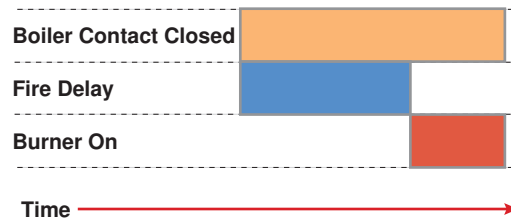

**Boiler Motor Speed Setting in Adjust Menu**

*(per boiler)*

The Motor Speed is the amount of time the boiler requires to go from 0% modulation to 100% modulation.

Gas valve actuating motors have a design time from fully closed to fully opened which can be found in the manufacturer's manual. The Motor Speed should be set to this time.

The Motor Speed setting for a Variable Frequency Drive (VFD) is the amount of time required to go from a stopped position to 100% fan speed. Since a VFD has a very quick response rate, it may be necessary to increase the Motor Speed setting in order to increase the stability of the boiler modulation.



**Boiler % Modulation in View Menu**

View the current % modulation of each boiler in the View menu.



## Boiler Minimum Modulation Setting in Adjust Menu

(per boiler)

The Minimum Modulation setting is the lowest modulation output to obtain low fire. The Minimum Modulation setting is typically based on the turndown ratio of the boiler. The control adjusts the modulating output signal from Minimum Modulation to 0% after the burner turns off and boiler operation is not required.

To calculate the Minimum Modulation, use the following formula:

### For 0 to 10 V (dc):

$$\text{Minimum Modulation} = \frac{0\text{V}(\text{dc}) - \text{Boiler's Minimum Input Signal}}{0 - 10\text{V}(\text{dc})} \times 100\%$$

Example:

A boiler requires a 1.8 V (dc) signal to fire the boiler at low fire. The boiler can be modulated to 10 V (dc) where it reaches high fire. This means the boiler's input signal range is 1.8 to 10 V (dc). The 275 control has an output signal range of 0 to 10 V (dc).

To make the two signal ranges the same, the Minimum Modulation required is:

$$\text{Minimum Modulation} = (0 - 1.8) \div (0 - 10) \times 100\% = 18\%$$

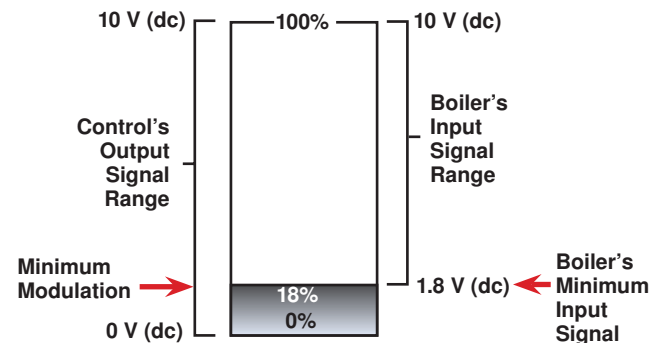

## Minimum Modulation Delay Setting in Adjust Menu

(per boiler)

The Minimum Modulation Delay is the time that the boiler burner must hold the modulation of the boiler at a minimum before allowing it to modulate any further.

## Boiler Maximum Modulation Setting in Adjust Menu

(per boiler)

The Maximum Modulation defines the maximum output signal from the control to the boiler burner. It is based on a percentage of the control's output signal range. The maximum modulation setting for boilers with power burners is typically set to 100%.

For boilers with electronic operators, the boiler's input signal range may not match the output signal range of the 275 control. The Maximum Modulation setting limits the control output range in order to match the boiler's input range.

To calculate the Maximum Modulation, use the following formula:

### For 0 to 10 V (dc):

$$\text{Maximum Modulation} = \frac{0\text{V}(\text{dc}) - \text{Boiler's Maximum Input Signal}}{0 - 10\text{V}(\text{dc})} \times 100\%$$

Example:

A boiler's input signal range is 0 to 9 V (dc). The 275 control has an output signal range of 0 to 10 V (dc). To make the two signal ranges the same, the Maximum Modulation required is:

$$\text{Maximum Modulation} = (0 - 9) \div (0 - 10) \times 100\% = 90\%$$

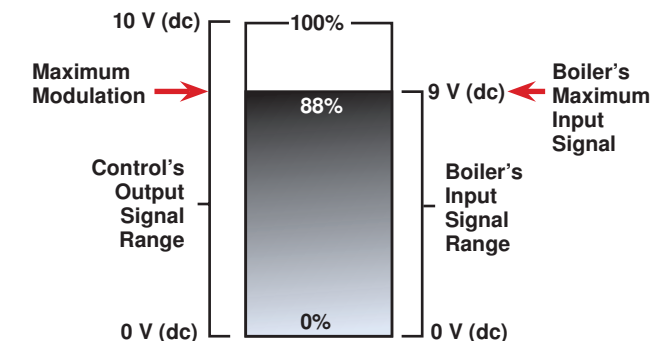

## Minimum and Maximum Boiler Outputs (MBH) Setting in Adjust Menu

(per boiler)

In order to accommodate different boiler capacities in the same system, a minimum and maximum boiler output for each boiler can be set. This allows the control to properly operate the boilers using either sequential or parallel modulation. Each boiler typically has a rating plate that specifies the minimum and maximum output. This information is also available in the boiler manual.

The minimum and maximum boiler output is expressed in MBH. 1 MBH = 1,000 BTU / hour. The range is from 1 MBH to 1,999 MBH.

For example, if a boiler has a maximum output of 100,000 BTU / hr and a minimum output of 20,000 BTU / hr (turn down ratio of 5):

$$\text{Maximum Boiler Output} = \frac{100,000}{1,000} = 100 \text{ MBH}$$

$$\text{Minimum Boiler Output} = \frac{20,000}{1,000} = 20 \text{ MBH}$$

The 275 can operate up to four modulating or on/off boilers in any combination. Each boiler stage has a Boiler Mode setting in the the Adjust menu that allows the selection of either modulating (Mod) or on/off (OnOF). By selecting a

boiler stage to on/off, the 275 then uses sequential boiler staging, the stage relay is set to operate a burner, and settings related to modulation are removed from the boiler settings.

**OEM Boilers Equipped With A BTC I Control****Section F**

The 275 can sequence up to four boilers equipped with an integral BTC I control. Boilers that include the BTC I control may have multi-stage or modulating burners. Each boiler is connected to the 275 using two wires connected to the Mod + and - wiring terminals for each boiler stage. The 275

also allows combinations of multi-stage boilers together with modulating boilers. In total, the 275 is able to control up to 16 stages. For information on BTC I equipped boilers and how to installed with the 275, please see tekmar Service Bulletin SB 055.

**Fixed Lead and Fixed Last****Section G****Fixed Last**

In some applications, it may be desirable to have the last boiler fire last at all times while the firing sequence of the remaining boilers is changed using Equal Run Time Rotation. This configuration is typical of installations where the boiler plant includes higher efficient boilers and a single lesser efficient boiler. The lesser efficient boiler is only desired to be operated when all other boilers in the plant are on and the load cannot be satisfied. This rotation option is selected by setting the Fixed Last / Off DIP switch to Fixed Last. With a fixed last rotation, the last boiler is the last to stage on and the first to stage off. The Fixed Last is always applied to the boiler 4 output.

Lead / Off DIP switch to the Fixed Lead position. The Fixed Lead is always applied to the boiler 1 output.

When using the Fixed Lead rotation option, a selection must be made between First On / Last Off and First On / First Off using the DIP switch.

When First On / First Off is selected, the lead boiler is always staged on first and staged off first. This configuration is typical of installations where the boiler plant includes similar boilers but the first boiler is required to be the first to fire in order to establish sufficient draft for venting.

**Fixed Lead & First On / First Off**

In some applications, it may be desirable to have the first boiler fire first at all times while the firing sequence of the remaining boilers is changed using Equal Run Time Rotation. This rotation option is selected by setting the Fixed

**Fixed Lead & First On / Last Off**

When First On / Last Off is selected, the lead boiler is always staged on first and staged off last. This configuration is typical of installations where the boiler plant includes a single higher efficient boiler with lesser efficient boilers. The lead boiler is the high efficiency boiler, therefore it the last boiler to be sequenced off.

**Condensing and Non-Condensing Boiler Groups****Section H**

Operating a boiler plant that contains both condensing (high initial cost) and non-condensing (lower initial cost) boilers allows the boiler plant to achieve nearly the same operating efficiencies as operating all condensing boilers but at a much lower installed cost to the building owner. High system efficiency can be achieved as long as the condensing boilers are the first to operate in the firing sequence. During mild weather, the lead condensing boilers operate at lower boiler temperatures and achieve their peak boiler efficiencies while the non-condensing boilers are rarely operated. During very cold weather, the boiler target is often above the boiler's condensation point and the condensing and non-condensing boilers operate together at roughly the same efficiency level.

applied to the boiler target to prevent damage to the non-condensing boiler heat exchanger from sustained flue gas condensation.

To operate one to three condensing boilers as the lead boiler group, and operate a single non-condensing boiler as the lag boiler, set the Fixed Last / Off DIP switch to the Fixed Last position and select the Condensing Lead (COND LEAD) setting to on. The boilers within the condensing lead group can be operated using Equal Run Time Rotation to balance running hours.

To operate a single condensing boiler as the lead boiler, and operate one to three non-condensing boilers as the lag group, set the Fixed Lead / Off DIP switch to the Fixed Lead position and select the Condensing Lead (COND LEAD) setting to on. The boilers within the non-condensing lag group can be operated using Equal Run Time Rotation to balance running hours.

In the event that Fixed Lead or Fixed Last is selected and all boiler are non-condensing, select the Condensing Lead (COND LEAD) setting to off.

The 275 supports the operation of condensing and non-condensing boilers as separate groups through either the Fixed Lead or Fixed Last options. When a condensing boiler is operating, it is desirable to operate the boilers without a boiler minimum temperature being applied to the boiler target. This allows the condensing boiler to operate at its maximum efficiency. When a non-condensing boiler is operating, a boiler minimum temperature should be

DHW operation is only available when the Pump Sequencer DIP Switch is set to Off.

### DHW Demand

DHW Demands come from one of three sources: an external aquastat, a DHW tank sensor, or a tN4 Setpoint Control.

Once the control detects a DHW Demand, the DHW Demand segment is displayed in the LCD. If an External Powered DHW Demand is applied while the DHW sensor is enabled in the 275, an error message is generated and both demands are ignored.

A DHW demand from a tN4 Setpoint Control can coexist with another DHW demand without generating an error message. The 275 will then use the higher of the two targets.

### Powered DHW Demand

The control registers a DHW Demand when a voltage between 20 and 260 V (ac) is applied across the DHW Demand terminals 29 and 30. An aquastat or setpoint control is used to switch the DHW Demand circuit. Program a DHW Exchange temperature for the Occupied and UnOccupied events in the Adjust Menu.

- DHW Sensor must be set to Off.

### DHW Sensor

The control can register a DHW Demand when a DHW Sensor is wired to terminals 5 and 6. Once the DHW Sensor drops 1/2 of the DHW Differential setting below the DHW Setpoint, the control registers a DHW Demand. Program a DHW Tank temperature for the Occupied and UnOccupied events in the Adjust Menu.

- The DHW Sensor must be set to On. There cannot be an externally powered DHW demand when using a DHW sensor.

### tN4 Setpoint Control in DHW Mode

The control can register a DHW Demand when a tN4 Setpoint Control in DHW Mode is wired to terminals 1 and 2. The DHW Demand is sent over the tN4 communication bus when the Setpoint Control calls for heat. Program a DHW tank temperature for the Occupied and UnOccupied events and the desired supply water temperature required on the tN4 bus in the Adjust Menu of the tN4 Setpoint Control.

### DHW Differential Setting in Adjust Menu

Due to large differences between the heating load and the DHW load, a separate DHW differential should be used whenever a DHW Demand is present. This will improve staging and boiler cycling. When using a DHW Sensor, a DHW Demand is registered when the DHW sensor drops 1/2 of the DHW Differential setting below the DHW setting. The DHW Demand is satisfied once the DHW Sensor rises 1/2 of the DHW Differential setting above the DHW setting.

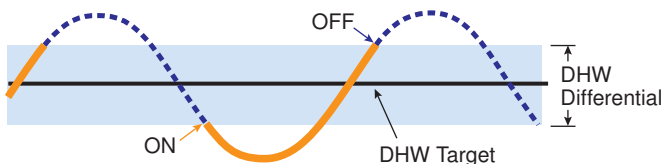

### Boiler Target Temperature during a DHW Demand

If a Powered DHW Demand is present, the boilers are operated to maintain the DHW Exchange temperature. If a DHW sensor demand is present, the boilers are operated to maintain a temperature of 40°F (22°C) above the DHW tank temperature. If a tN4 demand is present, the primary pump is turned on according to the device's reported requirements and the boilers are operated to maintain the devices requested target on the bus. The DHW Demand overrides the boiler reset target temperature, except when the boiler reset target is higher than the DHW target. Regardless of DHW settings and requested targets, the boilers will maintain a target temperature no higher than the Boil MAX setting.

### DHW During UnOccupied

When using a Powered DHW Demand, the control has a DHW Exchange UnOccupied setting that allows the installer to select On or Off. When set to On, and the control receives a DHW Demand during an UnOccupied or Sleep period, the control continues operation of the DHW system as it would during the Occupied and Wake periods. When set to Off, the control will ignore a DHW Demand for the duration of the UnOccupied and Sleep periods.

When using a DHW Sensor, a second DHW temperature setting is available for the UnOccupied or Sleep period.

DIP Switch must be set to Setback to view UnOccupied items.

During the Away Scene, DHW demands are ignored.

### DHW Mode Setting in the Adjust Menu

The control has six different DHW Modes that affect pump operation. The required DHW Mode setting will depend on the piping arrangement of the DHW tank and whether or not priority for DHW is necessary. DHW Priority stops or limits the delivery of heat to the building heating system while the DHW tank calls for heat. This allows for quick recovery of the DHW tank.

### Mode OFF / No DHW Generation

All DHW demands are ignored. If this mode is selected while DHW generation is underway, all DHW operation ceases.

### Mode 1 - DHW in Parallel with No Priority

When a valid DHW Demand is present, the DHW relay (terminal 23) turns on. The primary pump can operate when a Boiler Demand is present. It is assumed that the DHW pump will provide adequate flow through the heat exchanger and the boiler. Heating zones are unaffected by DHW operation.

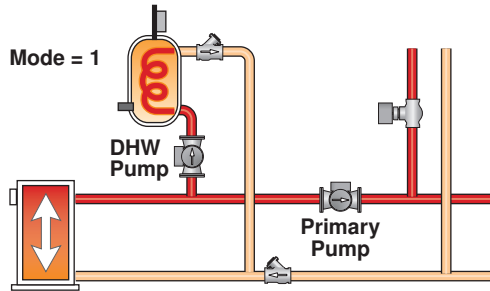

### Mode 4 - DHW in Primary/Secondary with Priority

When a valid DHW Demand is present, the DHW relay (terminal 23) and Primary Pump relay (terminal 24) turn on. If the boilers are unable to maintain the boiler target temperature, space heating zones are shut off sequentially using tN4 communication in order to provide priority to the DHW tank. For non-tN4 systems, priority requires the use of an external relay to force the heating zones off.

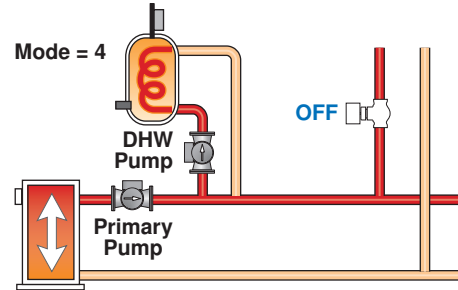

### Mode 2 - DHW in Parallel with Priority

When a valid DHW Demand is present, the DHW relay (terminal 23) turns on. The primary pump can operate when a Boiler Demand is present. If the boilers are unable to maintain the boiler target temperature, space heating zones are shut off sequentially using tN4 communication in order to provide priority to the DHW tank. For non-tN4 systems, the primary pump shuts off to provide priority. It is assumed that the DHW pump will provide adequate flow through the heat exchanger and the boiler.

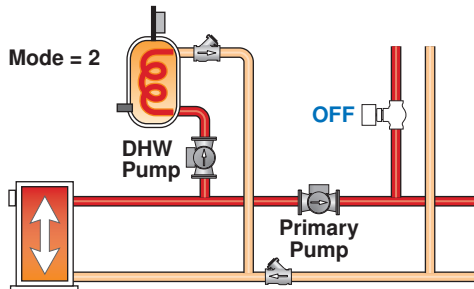

### Mode 5 - DHW in Parallel / Last Boiler with Priority

When a valid DHW Demand is present, the DHW relay (terminal 23) turns on and boiler pump 4 turns off. The control uses the DHW Exchange Supply Sensor in order to measure the boiler supply temperature supplied to the indirect tank. There are two boiler target temperatures, one for the heating system (BOIL TARGET) and one for the indirect DHW system (BOIL DHW TARGET). In this mode, the DHW Demand can only be provided from an External Powered Demand or tN4 Setpoint Control in DHW mode.

- All boilers are used for space heating requirements
- Boiler 4 is used for DHW when there is a DHW demand
- **The dedicated DHW boiler is always boiler 4 (relay 4), even if there are less than 4 boilers.**
- **If boiler 4 is disabled and mode 5 is selected then the dedicated DHW boiler (boiler 4) will not operate.**

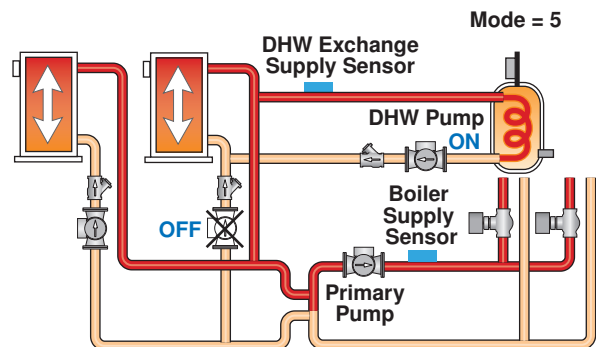

### Mode 3 - DHW in Primary/Secondary with No Priority

When a valid DHW Demand is present, the DHW relay (terminal 23) and Primary Pump relay (terminal 24) turn on. Heating zones are unaffected by DHW operation. This mode can be used if the DHW tank is piped in parallel and a DHW valve is installed (need to use an external relay to power the valve with 24 V (ac) since the DHW pump output is a 120 V (ac) powered output).

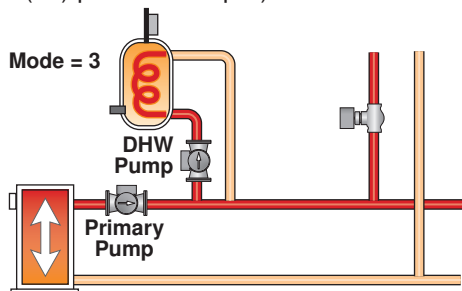

## Mode 6 – Dedicated DHW

When a valid DHW Demand is present from the DHW Sensor, the primary pump relay turns on. The DHW Relay in this mode is used as the DHW recirculation pump and operates continuously in the Occupied period and cycles with the primary pump in the UnOccupied period. The boiler plant is sequenced based only on the DHW Sensor.

- All boilers are used for DHW requirements
- Requires DHW demand from DHW sensor
- DHW Pump Relay is used for DHW recirculation pump
- Boiler Supply Sensor Not Required

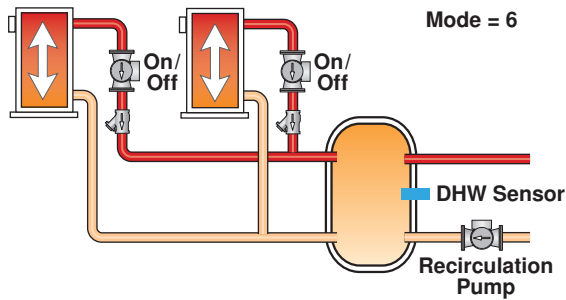

## DHW Priority Override Setting in Adjust Menu

DHW Priority Override applies to DHW MODE 2 and 4, as well as Mode 5 if there is a tN4 device with DHW. It prevents the building from cooling off too much or the possibility of a potential freeze up during DHW priority.

When set to auto, the priority time is calculated based on outdoor temperature. At or below the design outdoor temperature, 15 minutes are allowed for DHW priority. At or above 70°F (21°C), 2 hours are allowed for DHW priority. The time allowed for DHW priority varies linearly between the above two points. There is a manual setting also available in the adjust menu.

The priority timer does not start timing until priority is selected and both a DHW Demand and a Boiler Demand exist together. Once the allowed time for priority has elapsed, the control overrides the DHW priority and resumes space heating.

### Automatic Priority Override

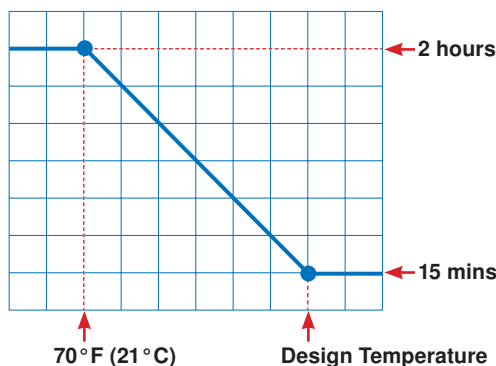

## Conditional DHW Priority

If the boiler supply temperature is maintained at or above the required temperature during DHW generation, this indicates that the boilers have enough capacity for DHW and possibly heating as well. As long as the boiler supply temperature is maintained near the target, DHW and heating occurs simultaneously.

## DHW Post Purge

After the DHW Demand is removed, the control performs a purge. The control shuts off the boilers and continues to operate the DHW Pump and the primary pump if applicable. This purges the residual heat from the boilers into the DHW tank. The control continues this purge until one of the following occurs:

1. A Boiler Demand is detected
2. The boiler supply drops 20°F (11°C) below the DHW target temperature
3. The DHW tank temperature rises above the DHW setpoint plus 1/2 DHW Differential
4. Two minutes elapse

## DHW Mixing Purge

After DHW operation, the boiler is extremely hot. At the same time, the heating zones may have cooled off considerably after being off for a period of time. When restarting the heating system after a DHW demand with priority, the control shuts off the boiler and continues to operate the DHW pump while the primary pump is turned on. This allows some of the DHW return water to mix with the cool return water from the zones and temper the boiler return water.

## DHW with Low Temperature Boilers

If DHW heating is to be incorporated into a low temperature system such as a radiant floor heating system, a mixing device is often installed to isolate the high DHW supply temperature from the lower system temperature. If a mixing device is not installed, high temperature water could be supplied to the low temperature system while trying to satisfy the DHW demand. This may result in damage to the low temperature heating system.

The control is capable of providing DHW heating in such a system while minimizing the chance that the temperature in the heating system exceeds the design supply water temperature. In order to do this, the following must be true:

- tN4 Present
- DHW MODE 2 or 4
- Boil MIN OFF

On a call for DHW, the control provides DHW priority by sending a message on the boiler temperature bus to the tN4 thermostats to shut off the heating zones for a period of time. The length of time is based on the outdoor air temperature as described in the DHW Priority Override section. However, if the DHW Demand is not satisfied within the allotted time, the boiler shuts off and the heat of the boiler is purged into the DHW tank. A DHW mixing purge occurs in order to reduce the boiler water temperature and once the boiler supply temperature is sufficiently reduced, the DHW Pump contact shuts off. The heating system zones are allowed to turn on for a period of time to prevent the building from cooling off. After a period of heating, and if the DHW Demand is still present, the control shuts off the heating system and provides heat to the DHW tank once again.

## DHW Boilers Setting in Adjust Menu

Select the number of boilers to use for DHW generation.

Setpoint operation is only available when DHW Mode is set to Off.

The control can operate to satisfy the requirements of a setpoint load in addition to a space heating load. A setpoint load overrides the current outdoor reset temperature in order to provide heat to the setpoint load.

**Setpoint Demand**

Setpoint Demands come from one of two sources: a Powered Setpoint Demand, or a tN4 Setpoint Control.

**Powered Setpoint Demand**

The control registers a Setpoint Demand when a voltage between 20 and 260 V (ac) is applied across the Setpoint Demand terminals 29 and 30. An aquastat or setpoint control is used to switch the Setpoint Demand circuit. Program a Setpoint target for the Occupied and UnOccupied events in the Adjust Menu.

- DHW Mode must be set to Off.

**tN4 Setpoint Control**

The control can register a Setpoint Demand when a tN4 Setpoint Control is wired to terminals 1 and 2. The Setpoint Demand is sent over the tN4 communication bus when the Setpoint Control calls for heat. Program a Setpoint temperature for the Occupied and UnOccupied events and the desired supply water temperature required on the tN4 bus in the Adjust Menu of the tN4 Setpoint Control.

- DHW Mode must be set to Off.

A demand from a tN4 Setpoint Control can coexist with another setpoint demand without generating an error message. The 275 will then use the higher of the two targets.

**Boiler Target Temperature during a Setpoint Demand**

If a Powered Setpoint Demand is present, the boilers are operated to maintain the Setpoint target. If a tN4 demand is present, the primary pump is turned on according to the device's reported requirements and the boilers are operated to maintain the devices requested target on the bus. The Setpoint Demand overrides the boiler reset target temperature, except when the boiler reset target is higher than the Setpoint target. Regardless of Setpoint settings and requested targets, the boilers will maintain a target temperature no higher than the Boil MAX setting.

**Setpoint During UnOccupied**

When using a Powered Setpoint Demand, the control has a Setpoint UnOccupied setting that allows the installer to select On or Off. When set to On, and the control receives a Setpoint Demand during an UnOccupied or Sleep period, the control continues operation of the Setpoint system as it would during the Occupied and Wake periods. When set to Off, the control will ignore a Setpoint Demand for the duration of the UnOccupied and Sleep periods.

DIP Switch must be set to Setback to view UnOccupied items.

During the Away Scene, Setpoint demands are ignored.

**Setpoint Mode Setting in the Adjust Menu**

The control has four different Setpoint Modes that affect pump operation. The required Setpoint Mode setting will depend on the piping arrangement and whether or not priority is necessary. Setpoint Priority stops or limits the delivery of heat to the building heating system while the Setpoint load calls for heat. This allows for quick recovery of the Setpoint load.

**Mode OFF - No Setpoint Operation**

All Setpoint demands are ignored. If this mode is selected while Setpoint operation is underway, all Setpoint operation ceases.

**Mode 1 - Setpoint in Parallel with No Priority**

Whenever a Setpoint Demand is present, the boilers are operated to maintain the setpoint target. The primary pump does not turn on, but may operate based on a Boiler Demand. It is assumed that the Setpoint pump will provide adequate flow through the heat exchanger and the boiler.

Mode = 1

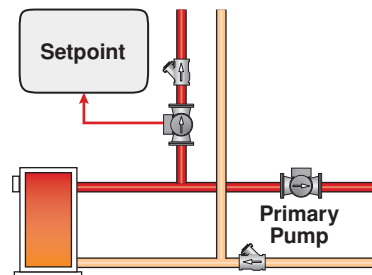

**Mode 2 - Setpoint in Parallel with Priority**

When a Setpoint Demand is present, the boilers are operated to maintain the setpoint target. The primary pump can operate when a Boiler Demand is present. If the boilers are unable to maintain the boiler target temperature, space heating zones are shut off sequentially using tN4 communication in order to provide priority to the Setpoint Load. For non-tN4 systems, the primary pump shuts off to provide priority. It is assumed that the Setpoint pump will provide adequate flow through the heat exchanger and the boiler.

Mode = 2

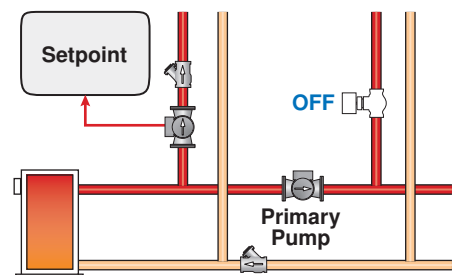

### Mode 3 - Setpoint in Primary/Secondary with No Priority

Whenever a Setpoint Demand is present, the primary pump is turned on and the boilers are operated to maintain the setpoint target.

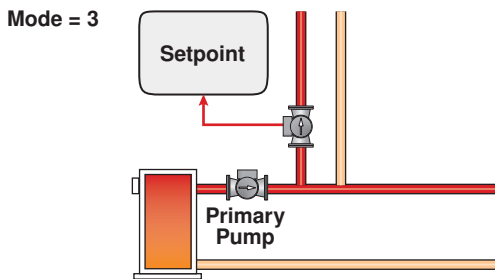

### Mode 4 - Setpoint in Primary/Secondary with Priority

Whenever a Setpoint Demand is present, the primary pump is turned on and the boilers are operated to maintain the setpoint target. Space heating zones will be shut off if the boilers are unable to maintain the boiler target temperature using tN4 communication. For non-tN4 systems, an external relay is required to force off the heating zones.

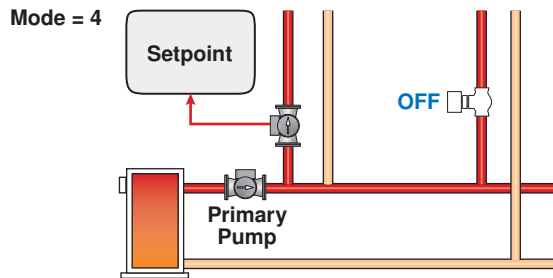

### Setpoint Priority Override Setting in Adjust Menu

Setpoint Priority Override applies to SETPOINT MODE 2 and MODE 4. To prevent the building from cooling off too much or the possibility of a potential freeze up during setpoint priority, the control limits the amount of time for setpoint priority.

When set to auto, the priority time is calculated based on outdoor temperature. At or below the design outdoor temperature, 15 minutes are allowed for Setpoint priority. At or above 70°F (21°C), 2 hours are allowed for Setpoint priority. The time allowed for Setpoint priority varies linearly between the above two points. There is a manual setting also available in the adjust menu.

The priority timer does not start timing until priority is selected and both a Setpoint Demand and a Boiler Demand exist together. Once the allowed time for priority has elapsed, the control overrides the Setpoint priority and resumes space heating.

### Automatic Priority Override

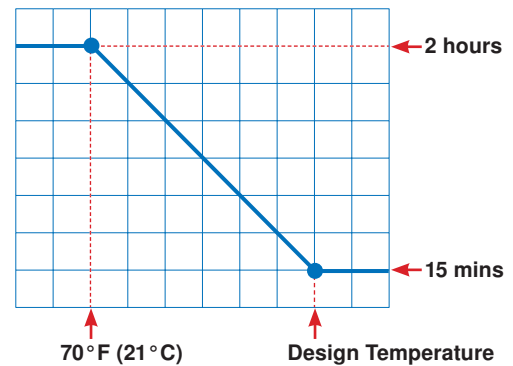

### Conditional DHW Priority

If the boiler supply temperature is maintained at or above the required temperature during setpoint generation, this indicates that the boiler has enough capacity for setpoint and possibly heating as well. As long as the boiler target temperature is maintained, setpoint and heating occur at the same time.

### Setpoint Post Purge

After a tN4 Setpoint Demand is removed, the control performs a purge. The control shuts off the boilers and continues to operate the Setpoint Pump and the primary pump if applicable. This purges the residual heat from the boilers into the Setpoint load. The control continues this purge until one of the following occurs:

1. A Boiler Demand is detected
2. The boiler supply drops 20°F (11°C) below the Setpoint target temperature
3. Two minutes elapse

The control can accept an external DC signal from an Energy Management System (EMS) in place of the outdoor sensor. The control converts the DC signal into the appropriate boiler target temperature between 50°F (10°C) and 210°F (99°C) based on the EMS Input Signal and Offset settings. To use the external input signal, the EMS / Demands DIP switch must be set to EMS.

An external signal is generated by applying a voltage between 0 V (dc) and 10 V (dc) across the Out + and Com – terminals (3 and 2). Voltages that exceed 10 V (dc) will still be considered a 10 V (dc) signal.

Once voltage is applied, the EMS Input Signal pointer is displayed in the LCD and the control calculates a boiler target and closes the primary pump contact. The control then modulates the boiler(s), if required, to maintain the target supply temperature.

If the EMS signal goes below the minimum voltage, the EMS Input Signal pointer is turned off in the display. The boiler target temperature is displayed as “--” to indicate that there is no longer a call for heating.

**Input Signal**

The control can accept either a 0 - 10 V (dc) signal or a 2 - 10 V (dc) signal. The External Input Signal setting must be set to the proper setting based on the signal that is being sent to the control.

**0 - 10 V (dc) or 0 - 20 mA**

When the 0 - 10 V (dc) signal is selected, an input voltage of 1 V (dc) corresponds to a boiler target temperature of 50°F (10°C). An input voltage of 10 V (dc) corresponds to a boiler target temperature of 210°F (99°C). As the voltage varies between 1 V (dc) and 10 V (dc) the boiler target temperature varies linearly between 50°F (10°C) and 210°F (99°C). If a voltage below 0.5 V (dc) is received the boiler target temperature is displayed as “--” indicating that there is no longer a call for heating.

A 0 - 20 mA signal can be converted to a 0 - 10 V (dc) signal by installing a 500 Ω resistor between the Out + and Com – terminals (3 and 2).

**2 - 10 V (dc) or 4 - 20 mA**

When the 2 - 10 V (dc) signal is selected, an input voltage of 2 V (dc) corresponds to a boiler target temperature of 50°F (10°C). An input voltage of 10 V (dc) corresponds to a boiler target temperature of 210°F (99°C). As the voltage varies between 2 V (dc) and 10 V (dc) the boiler target temperature varies linearly between 50°F (10°C) and 210°F (99°C). If a voltage below 1.5 V (dc) is received the boiler target temperature is displayed as “--” indicating that there is no longer a call for heating.

A 4 - 20 mA signal can be converted to a 2 - 10 V (dc) signal by installing a 500 Ω resistor between the Out + and Com – terminals (3 and 2).

CONVERSION TABLE 0 - 10		
0 - 20 mA*	0 - 10 V (dc)	Boiler Target
0	0	--- (OFF)
2	1	50°F (10°C)
4	2	68°F (20°C)
6	3	86°F (30°C)
8	4	103°F (39°C)
10	5	121°F (49°C)
12	6	139°F (59°C)
14	7	157°F (69°C)
16	8	174°F (79°C)
18	9	192°F (89°C)
20	10	210°F (99°C)

\*Requires 500 Ω Resistor in Parallel

CONVERSION TABLE 2 - 10		
4 - 20 mA*	2 - 10 V (dc)	Boiler Target
0	0	--- (OFF)
4	2	50°F (10°C)
6	3	70°F (21°C)
8	4	90°F (32°C)
10	5	110°F (43°C)
12	6	130°F (54°C)
14	7	150°F (66°C)
16	8	170°F (77°C)
18	9	190°F (88°C)
20	10	210°F (99°C)

\*Requires 500 Ω Resistor in Parallel

**Offset Setting in Adjust Menu**

For external input operation, the boiler target (determined from the external input signal) may be fine tuned. The Offset setting is used to provide the fine tuning. The Offset setting may be adjusted ±10°F. When set to 0°F, if the temperature determined from the external signal is 140°F, the boiler target will be 140°F. When set to +5°F and with the same external signal represents 140°F, the boiler target will be 145°F.

Example		
Range	= 0 - 10 V (dc)	└─┬─> 157°F (69°C)
Input	= 7 V (dc)	
Offset	= +5°F (3°C)	─┬─> +5°F (3°C)
Boiler Target	=	162°F (72°C)

The minimum and maximum settings also apply for external input operation. For example, if a boiler minimum of 140°F is set and the external signal received represents 80°F, the boiler target will be 140°F. The MIN segment will also be displayed to indicate that a limiting condition is in effect. This also applies for the MAX segment limit.

Whenever an external signal is used, the control can still provide all DHW OR Setpoint functions.



**Primary Pump Operation**

The control includes two primary pump outputs with capability for sequencing. Primary pump sequencing is activated through a DIP switch. Only primary pump 1 is operated when pump sequencing is turned off, while primary pumps 1 and 2 are operated in stand-by mode when pump sequencing is turned on.

The running times of the primary pumps are logged in the view menu. To reset these values back to zero, press and hold the up and down button while viewing this item.

**Note:** Once primary pump sequencing is selected, DHW operation is not available. Setpoint operation, however, is available if primary pump sequencing is selected.

The primary pump(s) will operate when the control receives an appropriate demand:

- External Boiler Demand
- tN4 Boiler Demand and that zone's thermostat has H1 Pump set to On.
- DHW Demand and the control is set to DHW Mode 3, 4, or 6.
- Setpoint Demand and the control is set to Setpoint Mode 3 or 4.

The primary pump also operates when the control is completing a DHW Purge.

tN4 thermostats can select whether the primary pump is required to operate or not. tN4 thermostats also include a thermal actuator setting which can delay the primary pump for 3 minutes to allow thermal actuators to open.

**Flow Proof**

The control includes a flow proof demand in order to prove flow once a primary pump has turned on. In order for boiler operation to commence, the proof demand must be present. A flow proof signal is required at all times during pump operation. A flow proof is generated by applying a voltage between 20 and 260 V (ac) across the Flow Proof terminals (30 and 31). Once voltage is applied, the Proof Demand indicator is turned on in the LCD.

Once a pump contact is turned on, a flow proof signal must be present before the flow proof delay has expired.

The flow proof demand is selected by setting the Proof Demand item in the Adjust menu to F P (flow proof).

A flow proof demand can come from a flow switch, pressure differential switch, current sensing or power sensing device.

	ΔP	Pressure Differential Switch
	FS	Flow Switch
	KW	Power Sensing Device
	Amp	Current Sensing Device

**Stand-by Operation**

The control only operates one primary pump at a time. A flow proof device can be used to detect when stand-by pump operation is required.

- When a demand is registered, the lead pump is activated, and the control waits for flow to be established within the flow proof delay time.
- If no flow is established, the lead pump is de-activated, the lag pump is activated and the control waits again for the flow to establish within the flow proof delay time.
- If again no flow is established, the lag pump is de-activated and the control stops operation until the error is cleared. Verify that the pumps and flow proof device are working correctly before clearing the error.
- If the lead pump establishes flow, and fails during operation, the lag pump is activated.
- If at any time, one or both pumps fail to prove flow, an error message is displayed.

**Normal Operation**

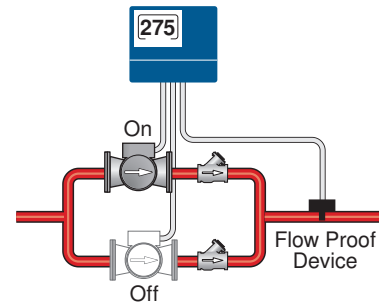

**Stand-by Pump Operation**

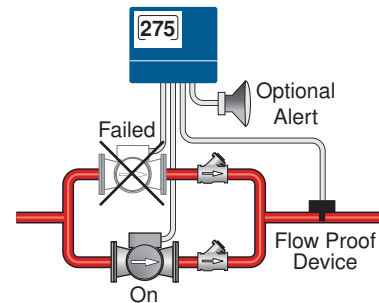

**Flow Proof Delay Setting in Adjust Menu**

The control waits a period of time to receive a flow proof demand from the time the primary pump turns on. If the control does not receive a flow proof demand within that period of time, the primary pump turns off and the stand-by primary pump (if active) turns on. The control then waits that period of time again for the stand-by primary pump to prove flow. If flow is not proven, the stand-by pump turns off. The period of time is set through the Proof Demand 'Pump' DLY item in the Adjust menu and it is adjustable between 10 seconds and 3 minutes.

## **Flow Proof Demand Test**

The control includes a flow proof demand test in order to determine if the flow/pressure device has failed. A flow proof failure is detected if a flow proof is present after the pumps have been shut off for more than four minutes. This can occur if the flow proof device sticks in the on position even when flow has stopped in the system. A proof demand error will latch when this condition exists.

## **Primary Pump Rotation Setting in Adjust Menu**

The control rotates the pumps based on the Rotate item in the Adjust menu. Frequency of Rotation is based on the running time of the pumps. Rotation is done when the lead pump is off. If the lead pump runs continuously, the rotation is delayed for up to 12 hours. If the pump runs continuously and rotation is required, the control shuts off the lead pump and 1 second later the stand-by pump is turned on. This eliminates overloading the pump electrical circuit. Upon turning on the stand-by pump the flow proof input is checked after the flow proof demand delay time.

## **Primary Pump Purge**

After the last valid demand is removed, the primary pump is operated for an additional purging time of at least 20 seconds. If the last demand came from a tN4 zone, the control sends out a purge message to override the zone open for the duration of the boiler purge. At the end of

the purge, the zone override is removed so the zone is allowed to close and turn off the primary pump. If the last demand came from a non-tN4 zone, the purge period for the primary pump is adjustable between 10 seconds and 19:55 minutes.

## **Boiler Pump Operation**

The control is capable of operating individual boiler pumps. This feature is available by setting the Boiler relays to pump in the Adjust Menu.

The control includes a boiler pump pre-purge which operates the respective boiler pump for a period of time before the boiler is ignited in order to purge potential residual heat out of the boiler. The pre-purge time is determined from the boiler mass setting. As the boiler mass setting is increased, the boiler pump pre-purge time is also increased. The pre-purge time is fixed at 4 seconds whenever a DHW / Setpoint demand is provided in order to reduce boiler pick-up times.

The control includes a boiler pump post-purge feature that operates the respective boiler pump for a period of time after the boiler is turned off. This feature will purge heat out of the boiler and aid in reducing “kettling”. The amount of time for the boiler pump post purge is adjustable between 10 seconds and 19:55 minutes. See the boiler pump purge setting in the adjust menu.

## **Combustion Air and Alert Settings**

## **Section M**

### **Relay Setting in Adjust Menu (C.A. / Alert)**

The control includes an auxiliary relay that can be used either for a combustion / venting device or an Alert. Selection is made through the Relay item in the Adjust menu.

#### **Alert**

When the Relay is set to Alert, terminals 21 and 22 close whenever a control or sensor error is detected, or when a warning or limiting condition is detected. When the alert contact closes, refer to the Error Messages section of this brochure to determine the cause of the alert and how to clear the error.

#### **Boiler Alarm**

For the Boiler Alarm item to appear in the Adjust menu, the Relay must be set to Alert. If no temperature increase is detected at the boiler supply sensor within this delay period, the Alert relay will close and the control will display the Boiler Alarm error message. To clear the error, press and hold the up and down buttons together for 5 seconds while viewing the error message in the View menu.

### **Combustion Air (C.A.)**

When the Relay is set to C.A., terminals 21 and 22 operate a combustion air damper / fan motor or power vent motor. The Relay closes once a demand is received and the control has determined that one or more boilers need to be turned on.

### **Combustion Air Proof Demand Setting in Adjust Menu**

The proof demand can be used to prove a combustion air or venting device if set to C.A. Boiler operation cannot occur until the proof demand is present. If the proof demand is lost during operation, the boiler plant is sequenced off.

### **Combustion Air Proof Demand Delay Setting in Adjust Menu**

The control includes a time delay that is associated with the proof demand feature in order to determine if the proof device is functional. Once the C.A. relay closes, the control allows for this delay to receive the proof demand. If the proof demand is not received within the delay time, the control will display an error message.

### **Combustion Air Delay Setting in Adjust Menu**

If the Proof Demand function is set to F P (flow proof) or OFF, sequencing only occurs once a user adjustable time delay elapses.

### **Combustion Air Post Purge**

There is a fixed 15 second post purge of the C.A. relay after the last boiler has turned off, or demand is removed. If there is a heat demand still present once the last boiler has turned off, the control can look at the error and determine if sequencing is to occur in a “short” period of time. If the control does anticipate staging, the C.A. relay will remain on. Otherwise, the C.A. relay will be turned off once the 15 second post purge elapses.

## Combustion Air Proof Demand Test

The control includes a C.A. proof demand test in order to determine if the proving device has failed. If the C.A. damper contacts are opened, the flow proof demand should not be present after 4 minutes. If the flow proof demand remains, the control will display an error message.

## Setting the Schedule

## Section N

To provide greater energy savings, you can operate the control on a programmable schedule. The schedule is stored in memory and is not affected by loss of power to the control. If a tN4 network is detected the control can become either a schedule member or schedule master.

### Control (CTRL) Schedule (tN4 present)

The schedule only applies to the control. The control follows its own schedule and the events are not communicated to tN4 thermostats.

### Master Schedule (tN4 present)

If the control is connected to tN4 thermostats, then the control can operate on a master schedule. You can set up a maximum of four master schedules on the tN4 Network. A master schedule is available to all devices on the tN4 network. Master schedules simplify installation since one master schedule may be used by multiple devices.

#### To create a master schedule:

- Assign the control to be a schedule master by setting the Heat Schedule item in the Schedule menu to Master (MST) 1 to 4. After a master schedule is selected, a clock symbol will appear in the View menu display.

**Note:** The 275 Setback/Off DIP Switch must be set to Setback to access the Schedule Menu.

#### To follow a master schedule:

- Assign the control to follow a master schedule by setting the Heat Schedule in the Schedule menu to Member (MBR) 1 to 4.

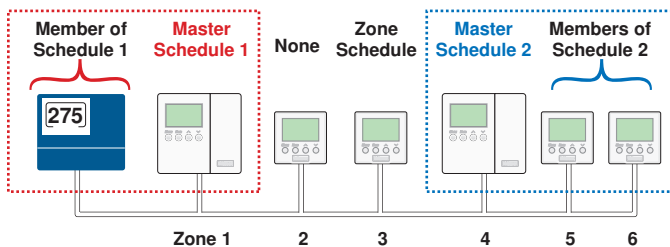

### Schedule Types

The schedule type determines when the schedule repeats itself. This control includes three schedule types:

- 24 Hour:** Repeats every 24 hours.
- 5-11:** Repeats on a weekly basis. However, it breaks the week into Saturday and Sunday followed by the weekdays. This reduces the amount of schedule event settings.
- 7 Day:** Repeats on a weekly basis and allows for separate event times for each day.

Day	Schedule Type		
	24 Hour	5-11	7 day
Saturday		•	•
Sunday		•	•
Monday			•
Tuesday	•		•
Wednesday		•	•
Thursday			•
Friday			•

### Schedule Mode

The schedule mode can have either 4 or 2 events per day. An event is a time at which the control changes the target temperature. The event time can be set to the nearest 10 minutes. If you wish to have the thermostat skip the event, enter "--:--" as the time. The "--:--" time is found between 11:50 PM and 12:00 AM. See the table, Schedule Mode, for more details regarding types of events.

Schedule Mode	Event	24Hr	Sat	Sun	Mon	Tue	We	Thu	Fri
4 events per day	Wake	6:00 AM	6:00 AM	6:00 AM	6:00 AM	6:00 AM	6:00 AM	6:00 AM	6:00 AM
	Unoccupied	8:00 AM	8:00 AM	8:00 AM	8:00 AM	8:00 AM	8:00 AM	8:00 AM	8:00 AM
	Occupied	6:00 PM	6:00 PM	6:00 PM	6:00 PM	6:00 PM	6:00 PM	6:00 PM	6:00 PM
	Sleep	10:00 PM	10:00 PM	10:00 PM	10:00 PM	10:00 PM	10:00 PM	10:00 PM	10:00 PM
or									
2 events per day	Occupied	6:00 AM	6:00 AM	6:00 AM	6:00 AM	6:00 AM	6:00 AM	6:00 AM	6:00 AM
	Unoccupied	10:00 PM	10:00 PM	10:00 PM	10:00 PM	10:00 PM	10:00 PM	10:00 PM	10:00 PM

## Time Clock

## Section O

The control will exercise the Combustion Air Damper, all pumps, and tN4 zones (zone valves and zone pumps) for 10 seconds every three days of inactivity to prevent seizure. To enable exercising, switch the Exercise / Off DIP to the Exercise position.

The control has a built-in time clock to allow the control to operate on a schedule. A battery-less backup allows the control to keep time for up to 4 hours without power. The time clock supports automatic adjustment for Daylight Saving Time (DST) once the day, month, and year are entered. Use the Time menu to set the correct time, day, month, and year.

**Note:** The Setback / Off DIP Switch must be set to Setback before the Time menu can be accessed.

### Daylight Savings Time Modes

Mode	DST Start	DST End
1	1st Sunday in April	Last Sunday in October
2	2nd Sunday in March	1st Sunday in November

## Boost

## Section P

When the control changes from the UnOccupied mode to the Occupied mode, it enters into a boosting mode. In this mode, the supply water temperature to the system is raised above its normal values for a period of time to provide a faster recovery from the setback temperature of the building. The maximum length of the boost is selected using the BOOST setting in the Adjust menu.

Typical settings for the boost function vary between 30 minutes and two hours for buildings that have a fast responding heating system. For buildings that have a slow responding heating system, a setting between four hours and eight hours is typical. After a boost time is selected, the setback timer must be adjusted to come out

of setback some time in advance of the desired occupied time. This time in advance is normally the same as the BOOST setting.

If the building is not up to temperature at the correct time, the BOOST setting should be lengthened and the setback timer should be adjusted accordingly. If the building is up to temperature before the required time, the BOOST setting should be shortened and the setback timer should be adjusted accordingly. If the system is operating near its design conditions or if the supply water temperature is being limited by settings made in the control, the time required to bring the building up to temperature may be longer than expected.

## Exercising

## Section Q

The control will exercise the Combustion Air Damper, all pumps, and tN4 zones (zone valves and zone pumps) for 10 seconds every three days of inactivity to prevent seizure.

To enable exercising, switch the Exercise / Off DIP to the Exercise position.

## tekmarNet®4 Communication

## Section R

tekmarNet®4 (tN4) communicates between tN4 devices (thermostats, Reset Module and Expansion Modules). Each tN4 device is connected to a tN4 communication bus using two wires. Each tN4 bus adjusts a single water temperature in the system using indoor temperature feedback. The Boiler Control 275 allows for one tN4 bus. This allows you to control a system with one water temperature. A system that has more than one tN4 bus is referred to as a tN4 network.

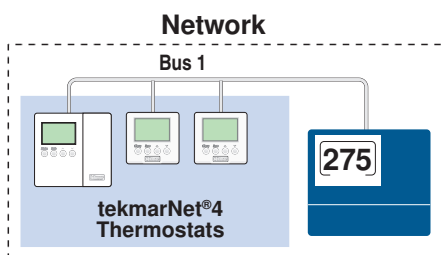

### Boiler Control 275

The Boiler Control 275 is the system control for a hydronic heating system. The 275 operates up to 4 modulating boilers, a domestic hot water tank, and responds to other heating requirements such as pool heating and snow melting. The 275 also coordinates and optimizes the operation of all the tN4 thermostats.

### tN4 Thermostat

The tN4 thermostat operates heating, cooling, and or ventilation equipment for a zone. Several tN4 thermostats may work in a group when operating a cooling system. Up to 24 tN4 devices can connect to a single tN4 bus.

## Zone Load Shedding (tN4)

Zone load shedding helps protect non-condensing boilers from sustained flue gas condensation damage. Zone load shedding starts when the boiler supply temperature is below the boiler minimum setting and all boilers are operating at 100% output. Zones are shut off in order of their tN4 address.

Second stage heat zones are the first to shut off starting with thermostat address b:24, continuing downward until the last to shut off is b:01.

Once all second stage heat zones are shut off, first stage zones shut off starting with highest thermostat address b:24 and ending at the lowest b:01.

When the boiler supply temperature reaches the boiler minimum, the first stage heating zones turn back on in order from b:01 to b:24, and then the second stage in order from b:01 to b:24.

## Cycle Length Setting in Adjust Menu (tN4)

The control includes an adjustment for the cycle length. The cycle length adjustment allows for synchronization of tN4 zones. An Auto setting allows for the cycle length to be automatically calculated to balance equipment cycling and comfort.

In the tekmarNet<sup>®</sup>4 system, all of the tekmarNet<sup>®</sup>4 Thermostats determine the best cycle length for their zone. The thermostats look at trying to maintain the longest possible cycle length while keeping temperature swings to a minimum. The Thermostats do this every cycle and send their ideal cycle length time to the 275.

In order to operate the system as efficiently as possible, all of the zones must operate based on the same cycle. In order to do this, the 275 listens to all of the cycle length requests from all of the tekmarNet<sup>®</sup>4 Thermostats. The 275 then determines the average cycle length and sends this information to all of the tekmarNet<sup>®</sup>4 Thermostats, allowing them to operate on the same cycle.

## Indoor Temperature Feedback (tN4)

Indoor feedback applies when the 275 is connected to a tN4 Thermostat network operating on a boiler bus. Indoor temperature feedback fine tunes the water temperature of the system based on the requirements of the thermostats. Each thermostat tells the tN4 System Control the water temperature that it requires to heat its zone.

- If the zone is becoming too cool, the thermostat asks for a higher water temperature.
- If the zone is becoming too warm, the thermostat asks for a cooler water temperature.

The 275 provides the highest water temperature required by all of the thermostats.

- The thermostat with the highest water temperature requirement stays on 100% of its cycle.
- The remaining thermostats stay on for a percentage of their cycles.

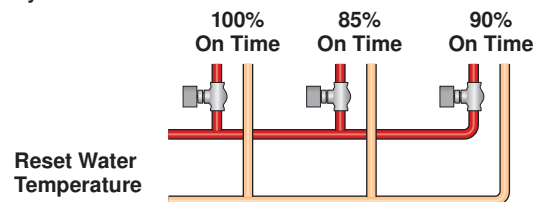

## Device Count (tN4)

The control includes a device count of all the tN4 devices connected to the boiler bus. This item is always found in the Miscellaneous Menu called NUM DEV. Use this to confirm that the correct number of devices are connected to the boiler bus.

## Scene Operation

## Section S

The 275 can be connected to a User Switch using tekmarNet<sup>®</sup> communication and responds to the following scenes.

Scene	Response
1	Occupied or Schedule
2	Away, operates Room at 62° F (16.5° C) and there is no DHW heating
3	Permanent Unoccupied
4	Occupied or Schedule
5	Occupied or Schedule
6	Temporary 3 hour Occupied
7	Temporary 3 hour Occupied
8	Temporary 3 hour Occupied

# Installation

## Caution

Improper installation and operation of this control could result in damage to the equipment and possibly even personal injury or death. It is your responsibility to ensure that this control is safely installed according to all applicable codes and standards. This electronic control is not intended for uses as a primary limit control. Other controls that are

intended and certified as safety limits must be placed into the control circuit. Do not attempt to service the control. Refer to qualified personnel for servicing. Opening voids warranty and could result in damage to the equipment and possibly even personal injury or death.

## Step One — Getting Ready

Check the contents of this package. If any of the contents listed are missing or damaged, please contact your wholesaler or tekmar sales representative for assistance.

### **Type 275 includes:**

One Boiler Control 275, One Outdoor Sensor 070, Two Universal Sensors 082, One 500 Ohm resistor, Data Brochures D 275, D 070, D 001, Application Brochure A 275.

**Note:** Carefully read the details of the Sequence of Operation to ensure the proper control was chosen for the application.

## Step Two — Mounting the Base

Remove the control from its base by pressing on the release clip in the wiring chamber and sliding the control away from it. The base is then mounted in accordance with the instructions in the Data Brochure D 001.

## Step Three — Rough-in Wiring

All electrical wiring terminates in the control base wiring chamber. The base has standard 7/8" (22 mm) knockouts, which accept common wiring hardware and conduit fittings. Before removing the knockouts, check the wiring diagram and select those sections of the chamber with common voltages. Do not allow the wiring to cross between sections as the wires will interfere with safety dividers which should be installed at a later time.

Power must not be applied to any of the wires during the rough-in wiring stage.

- All wires are to be stripped to a length of 3/8" (9 mm) to ensure proper connection to the control.
- Install the Outdoor Sensor 070 according to the installation instructions in the Data Brochure D 070 and run the wiring back to the control.

- Install the Boiler Supply Sensor 082 according to the installation instructions in the Data Brochure D 070 and run the wiring back to the control.
- Install the Boiler Return or DHW Sensor 082 according to the installation instructions in the Data Brochure D 070 and run the wiring back to the control.
- Run wires from any security system, alarm panel, or telephone dialer back to the control.
- Run wires from other system components (boilers, pumps, flow switch, etc.) to the control.
- Run wires from the 115 V (ac) power to the control. Use a clean power source with a 15 A circuit to ensure proper operation. Multi-strand 16 AWG wire is recommended for all 115 V (ac) wiring due to its superior flexibility and ease of installation into the terminals.

## Step Four — Electrical Connections to the Control

### General

The installer should test to confirm that no voltage is present at any of the wires. Push the control into the base and slide it down until it snaps firmly into place.

### ⚠ Powered Input Connections

Terminals 25 - 31

#### 115 V (ac) Power

Connect the 115 V (ac) power supply to the Power L and Power N terminals (25 and 26). This connection provides power to the microprocessor and display of the control.

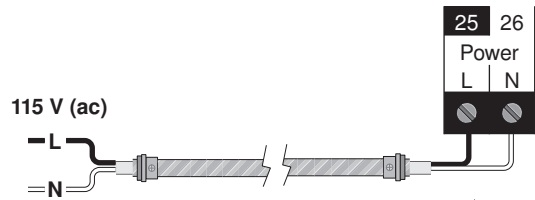

#### Boiler Demand

To generate a Boiler Demand, a voltage between 20 V (ac) and 260 V (ac) must be applied across the Boiler Demand terminals (27 and 28).

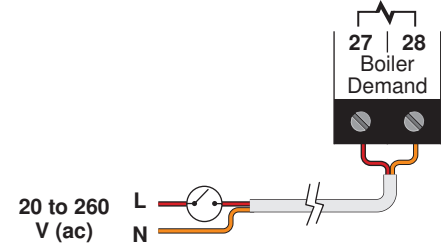

#### DHW Demand

To generate a DHW Demand, a voltage between 20 V (ac) and 260 V (ac) must be applied across the DHW/Setp and Com Dem terminals (29 and 30). The Pump Sequencer DIP Switch must be set to Off and DHW MODE must be set to 1 through 5.

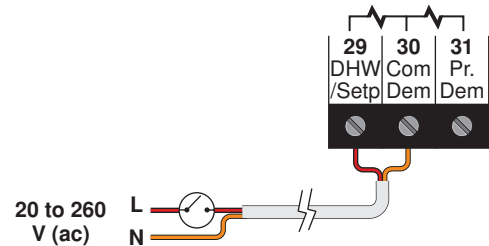

#### Setpoint Demand

To generate a Setpoint Demand, a voltage between 20 V (ac) and 260 V (ac) must be applied across the DHW/Setp and Com Dem terminals (29 and 30). The DHW MODE must be set to OFF.

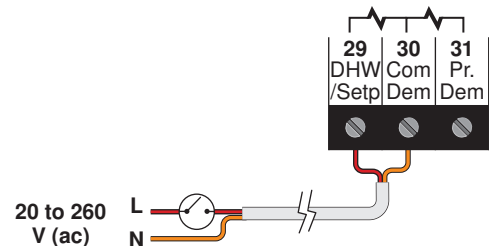

#### Proof Demand

To generate a Proof Demand, a voltage between 20 V (ac) and 260 V (ac) must be applied across the Pr. Dem and Com Dem terminals (31 and 30).

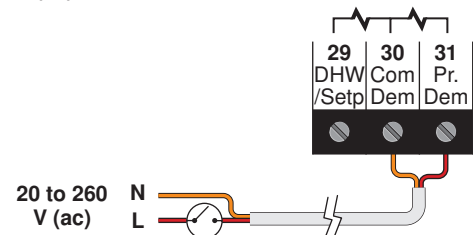

#### Energy Management System (EMS)

To generate an external input signal from an Energy Management System (EMS), either a 0 to 10 V (dc) or 2 to 10 V (dc) signal must be applied to the Com - and Out + terminals (2 and 3).

A 0 - 20 mA signal can be converted to a 0 - 10 V (dc) signal by installing a 500  $\Omega$  resistor in parallel between the Com - and Out + terminals (2 and 3).

A 4 - 20 mA signal can be converted to a 2 - 10 V (dc) signal by installing a 500  $\Omega$  resistor in parallel between the Com - and Out + terminals (2 and 3).

**Note:** DIP Switch must be set to EMS.

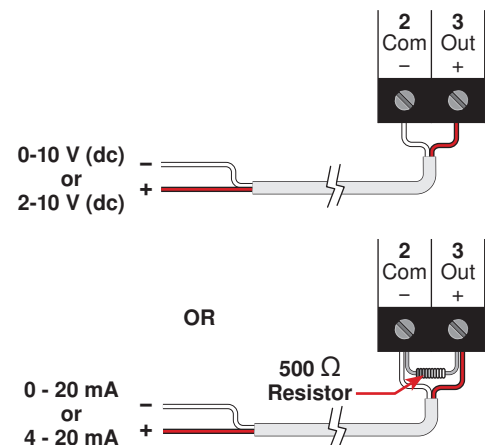

**tN4**

Terminals 1 and 2 provide a tN4 connection for tN4 devices on the tN4 bus. Connect terminals 1 (tN4) and 2 (Com) to the corresponding terminals on the tN4 devices that are to be connected.

**Note:** The connection is polarity sensitive. Ensure that terminal 1 (tN4) is connected to the tN4 terminal on the tN4 device and that terminal 2 (C) is connect to the C terminal on the tN4 device.

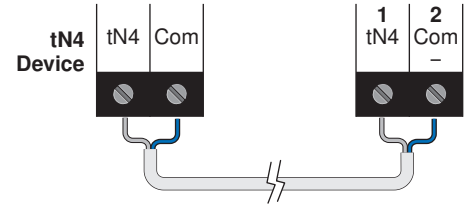

**Outdoor Sensor (tekmar 070)**

Connect the two wires from the Outdoor Sensor 070 to the Com and Out (2 and 3) terminals. The outdoor sensor is used by the control to measure the outdoor air temperature.

**Note:** If an Outdoor Sensor 070 is connected to a tekmarNet®4 thermostat in the system, it is not required to be connected to the control.

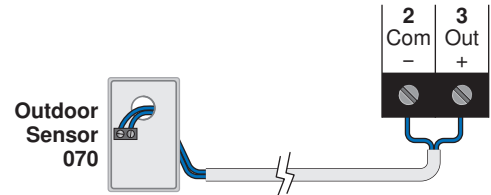

**Boiler Supply Sensor (tekmar 082)**

Connect the two wires from the Boiler Supply Sensor 082 to the Com and Boil (5 and 4) terminals. The Boiler Supply Sensor is used by the control to measure the boiler supply water temperature.

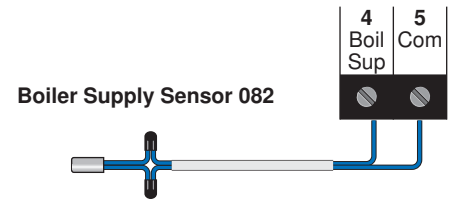

**DHW or Boiler Return Sensor (tekmar 082)**

Connect the two wires from the DHW Sensor 082 to the Com and BRet / DHW (5 and 6) terminals. The DHW Sensor is used by the control to measure the DHW water temperature or the DHW Exchange Supply Temperature.

OR

Connect the two wires from the Boiler Return Sensor 082 to the Com and BRet / DHW (5 and 6) terminals. The Boiler Return Sensor is used by the control to measure the boiler return temperature.

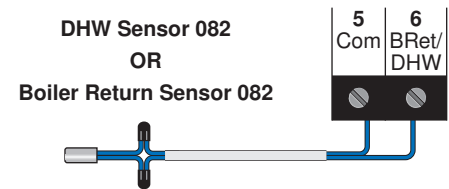

**⚠ Powered Output Connections**

**Primary Pump P1**

The Prim P1 output on terminal (24) is a powered output. When the relay in the control closes, 115 V (ac) is provided to the Prim P1 terminal (24) from the Power L terminal (25). To operate the primary pump P1, connect one side of the primary pump circuit to terminal (24) and the second side of the pump circuit to the neutral (Power N) side of the 115 V (ac) power supply.

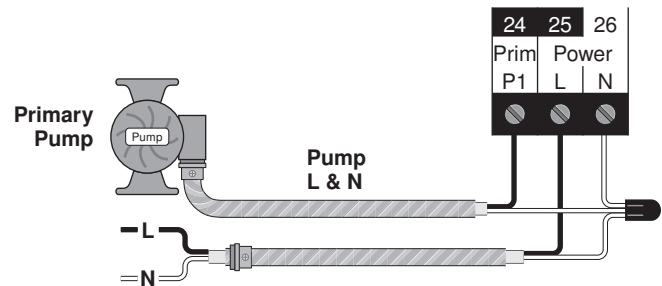

**Primary Pump P2**

The DHW / P2 output on terminal (23) is a powered output. When the relay in the control closes, 115 V (ac) is provided to the DHW / P2 terminal (23) from the Power L terminal (25). To operate the primary pump P2, connect one side of the primary pump circuit to terminal (23) and the second side of the pump circuit to the neutral (Power N) side of the 115 V (ac) power supply.

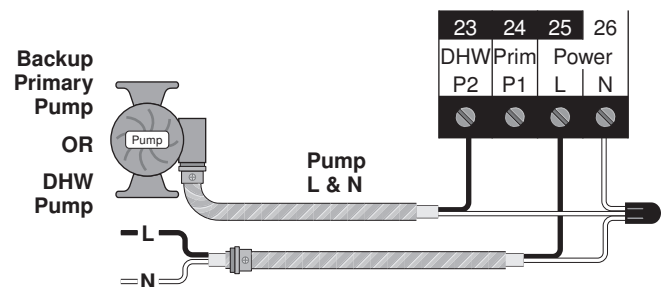



**Wiring the Modulating Boiler Outputs**

The control provides a 0-10 V (dc) modulating output to four modulating boilers.

- Polarity is important.
- Connect the + wire from boilers 1, 2, 3 and 4 to terminals 7, 9, 10 and 12 respectively.
- Connect the – wire from boilers 1 and 2 to terminal 8 and from boilers 3 and 4 to terminal 11.

**Note:** Some modulating boilers may also require an on / off signal in addition to the modulating signal. See terminals 13 to 20.

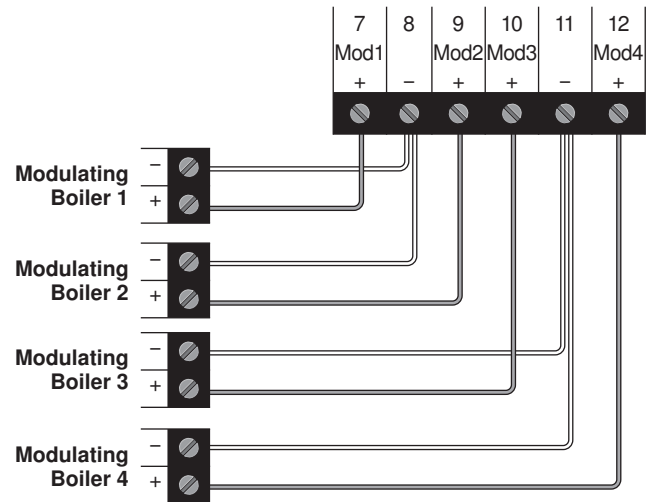

**Wiring the T-T**

(RELAY TYPE = Boiler  13/24)

Terminals 13-14, 15-16, 17-18 and 19-20 are dry contacts. No power is available from these terminals. These contacts can be used to enable the modulating or on/off boiler. The boiler must be wired to power as per the manufacturers' directions.

These terminals are typically connected to the boiler's control circuit (commonly labeled as T-T). Connect these terminals directly to the boiler T-T connections.

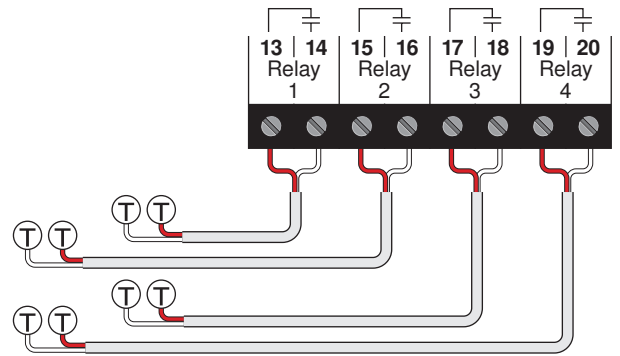

**Wiring the Boiler Pumps**

(RELAY TYPE = Boiler pump  13/24)

Terminals 13-14, 15-16, 17-18 and 19-20 are dry contacts. No power is available from these terminals. These contacts can be used to turn on individual boiler pumps. Wire line voltage to one side of the relay. The other side of the relay goes to one side of the boiler pump and the remaining side of the boiler pump goes to neutral.

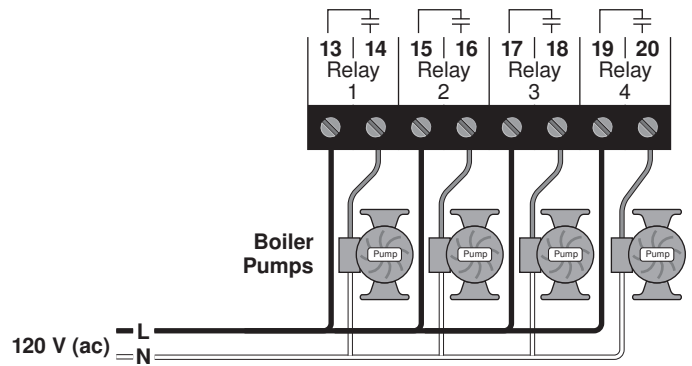

**Combustion Air / Alert Contact (C.A./Alert)**

Terminals 21 and 22 are an isolated output in the control. There is no power available on these terminals from the control. These terminals are to be used as a switch to either make or break power to the combustion air damper or alert device. Since this is an isolated contact, it may switch a voltage between 24 V (ac) and 230 V (ac).

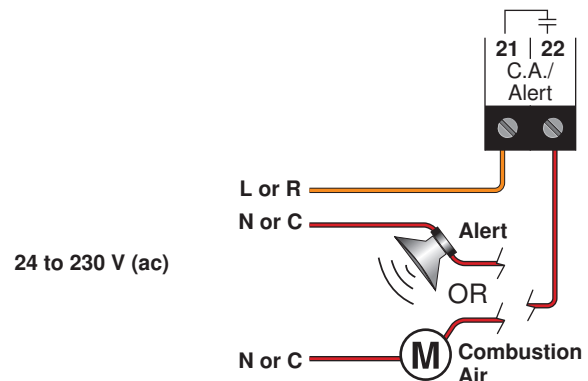

## Step Five — Testing the Wiring

### General

The following tests are to be performed using standard testing practices and procedures and should only be carried out by properly trained and experienced persons.

A good quality electrical test meter, capable of reading from at least 0-300 V (ac), 0-30 V (dc), 0-2,000,000 Ohms, and testing for continuity is essential to properly test the wiring and sensors.

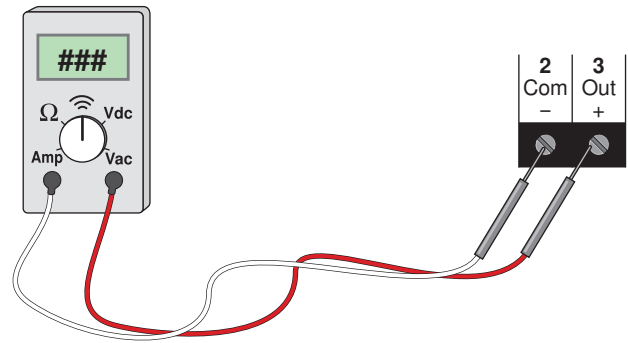

### Testing tN4 Network

Terminals 1 – 2

To test the tN4 Network, check the wires for continuity.

1. Disconnect the two wires (tN4 and Com) at one end and connect them together.
2. Go to the other end of the wires and disconnect them.
3. Using an electrical test meter, check for continuity.

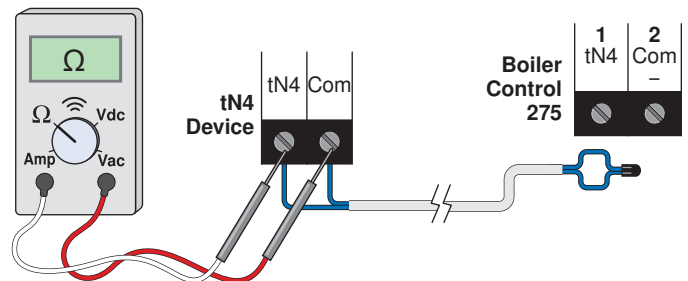

### Testing the EMS output

Terminals 2 – 3

If an Energy Management System is used, measure the voltage (dc) between the Com – and the Out + terminals (2 and 3). When the EMS calls for heat, a voltage between 0 – 10 V (dc) or 2 – 10 V (dc) should be measured at the terminals.

### Testing the Sensor Wiring

Terminals 2 – 6

To test the sensors, the actual temperature at each sensor location must be measured.

- Use a good quality digital thermometer with a surface temperature probe for ease of use and accuracy. Where a digital thermometer is not available, strap a spare sensor alongside the one to be tested and compare the readings.
- Disconnect each sensor from the control.
- Test the sensors resistance according to the instructions in the sensor Data Brochure D 070.

### Testing Modulating Outputs (0-10 V dc)

Terminals 7 – 12

1. Ensure that the control can operate the modulating output by setting at least one boiler to Auto
2. Remove the front cover from the control.
3. Press the Test Button.
4. When the % output and the boiler symbol are displayed in the LCD, use an electrical test meter to measure the (dc) voltage between the appropriate Mod + and the - terminals (7-8, 8-9, 10-11, 11-12). The reading should vary between 0 V (dc) and 10 V (dc).

1. Shut off power to the control and the boiler circuit or boiler pump circuit.
2. Remove the bottom cover from the control. Disconnect the wiring from the Relay contacts (terminals 13 – 20).
3. Apply power to the control and press the Test button.
4. Use an electrical test meter and check for continuity between terminals 13 - 14, 15 - 16, 17 - 18, and 19 - 20.

**If the relay is set to boiler ignition:**

- When the appropriate boiler symbol is displayed in the LCD, there should be continuity.
- When the appropriate boiler symbol is not displayed in the LCD, there should be no continuity.

- If the relay is set to boiler pump:
  - When the appropriate boiler pump symbol is displayed in the LCD, there should be continuity.
  - When the appropriate boiler pump symbol is not displayed in the LCD, there should be no continuity.
5. Reconnect the wires to the Relay contacts, install the bottom cover on the control and reapply power to the boiler circuit or boiler pump circuit.

## Testing C.A. / Alert Relay

1. Shut off power to the control and the boiler circuit or boiler pump circuit.
2. Remove the bottom cover from the control. Disconnect the wiring from the C.A. / Alert contact (terminals 21 – 22).
3. Apply power to the control and press the Test button.
4. Use an electrical test meter and check for continuity between terminals 21 – 22.

**If the relay is set to Combustion Air Damper:**

- When the Combustion Air Damper symbol is displayed in the LCD, there should be continuity.

- When the Combustion Air Damper symbol is not displayed in the LCD, there should be no continuity.

**If the relay is set to Alert:**

- When the Alert symbol is displayed in the LCD, there should be continuity.
  - When the Alert symbol is not displayed in the LCD, there should be no continuity.
5. Reconnect the wires to the C.A. / Alert contacts, install the bottom cover on the control and reapply power to the Combustion Air Damper or Alert circuit.

## Testing DHW and Primary Pumps

1. Remove the front and bottom covers from the control.
2. Press the Test Button.
3. When the Primary Pump 1 symbol is displayed in the LCD, use an electrical test meter to measure the (ac) voltage between the Primary Pump 1 terminal and Neutral (24-26). The reading should be 115 V (ac) + / – 10%.

**If DHW Mode is enabled:**

When the DHW Pump symbol is displayed in the LCD, use

an electrical test meter to measure the (ac) voltage between the DHW Pump terminal and Neutral (23-26). The reading should be 115 V (ac) + / – 10%.

**If Pump Sequencer is enabled:**

When the Primary Pump 2 symbol is displayed in the LCD, use an electrical test meter to measure the (ac) voltage between the Primary Pump 2 terminal and Neutral (23-26). The reading should be 115 V (ac) + / – 10%.

## Testing the Input Power

1. Remove the front and bottom cover from the control.
2. Use an electrical test meter to measure (ac) voltage between the Input Power L and N terminals (25 and 26). The reading should be 115 V (ac) + / – 10% and the LCD should be lit and show some segments.

3. If power is not present and the LCD is off:

- Check the circuit that supplies power to the Control.
- Make sure exposed wires and bare terminals are not in contact with other wires or grounded surfaces.

## Testing the Demands

1. Remove the front and bottom cover from the control.
2. Use an electrical test meter to measure (ac) voltage between the Boiler Demand terminals (27-28) or the DHW / Setpoint Demand terminals (29-30) or the Proof Demand terminals (30-31).

- When the demand device is on, a voltage between 20 and 260 V (ac) should be measured between the appropriate demand terminals and the LCD should display an indicator arrow pointing to Boiler Demand, DHW / Setpoint Demand, or Proof Demand.
- When the demand device is off, less than 5 V (ac) should be measured between the terminals.

# Control Settings

## Cleaning the Control

The control's exterior can be cleaned using a damp cloth. Moisten the cloth with water and wring out prior to wiping control. Do not use solvents or cleaning solutions.

## DIP Switch Settings

Set the DIP switch settings prior to making adjustments to the control through the user interface. Setting the DIP switches determines which menu items are displayed in the user interface.

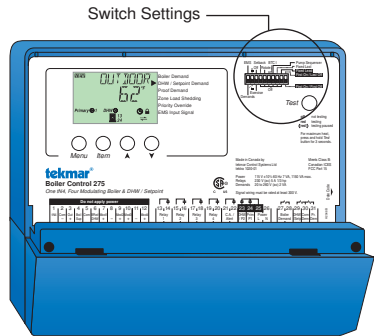

### EMS / Demands

The EMS / Demands DIP switch selects whether a tekmar outdoor sensor 070 or an external 0-10 or 2-10 V (dc) input signal is to be connected to the com - and Out+ terminals (2 & 3).

Set the EMS / Demands DIP switch to EMS if an Energy Management System is providing an external analog input signal to the control.

Set the EMS / Demands DIP switch to Demands if the control is accepting a boiler demand and using the outdoor sensor for outdoor reset.

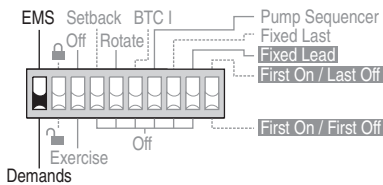

### Lock / Unlock

Use this DIP switch to lock and unlock the Access Level of the 275 and all connected tN4 devices, including tN4 thermostats. For details, see "Access Level".

- Once locked, the access level in all devices cannot be viewed or changed.
- When the control is locked, a small segment representing a padlock is shown in the bottom right hand corner of the display (except in View and Time Menu)

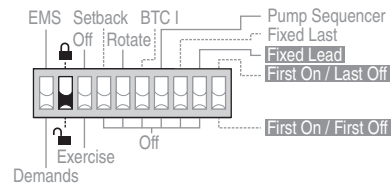

### Off / Exercise

Use the Off / Exercise DIP switch to select whether or not the control is to exercise all pumps, and hydronic zones (zone valves and zone pumps) for 10 seconds every three days of inactivity to prevent seizure.

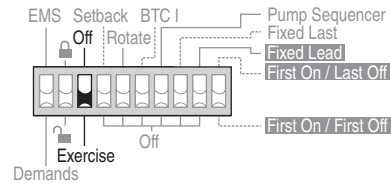

### Setback / Off

Use the Setback / Off DIP switch to select whether or not the control is to follow a schedule.

- If the 275 is to be a schedule member or schedule master, set the DIP switch to Setback to enable the Time and Schedule menus and the Unocc items in the Adjust menu.
- If the 275 does not follow a schedule, set the DIP switch to Off to disable the Time and Schedule menus and the Unocc items in the Adjust menu.

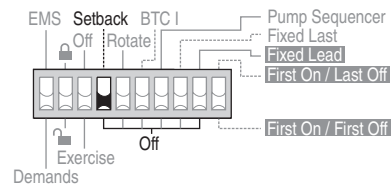

## Rotate / Off

Use the Rotate / Off DIP switch to enable the Equal Run Time Rotation feature. This feature Changes the firing order of the boilers in order to maintain a similar amount of running time on each boiler. If set to Off, the firing sequence if fixed starting with boiler 1 to boiler 4.

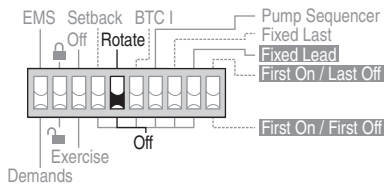

## BTC I / Off

Use the BTC I / Off DIP switch when the 275 is wired to boilers with BTC I (Boiler Temperature Control series I) controls.

- If wired to BTC I controls, set the DIP switch to BTC I.
- If not wired to BTC I controls, set the DIP switch to Off.

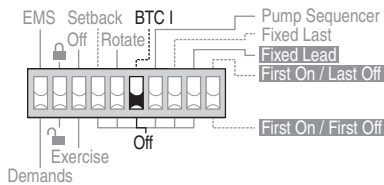

## Pump Sequencer / Off

Use the Pump Sequencer / Off DIP switch to activate primary pump sequencing. DHW operation is not available when Pump Sequencer is selected.

- If set to Pump Sequencer, the control operates primary pumps 1 & 2 in stand-by mode.
- If set to Off, the control operates primary pump 1 and the pump 2 relay is then available for a DHW pump.

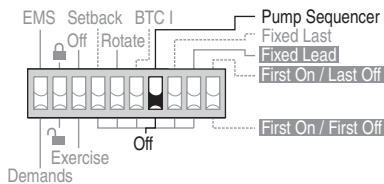

## Fixed Last / Off

Use the Fixed Last / Off DIP switch to exclude the last boiler in the rotation sequence. This DIP is only active when the Rotate / Off DIP is set to Rotate.

- If set to Fixed Last, the last boiler is always the last to fire.
- Fixed Last will only work for boilers wired to the Relay 4 terminals (19 and 20).

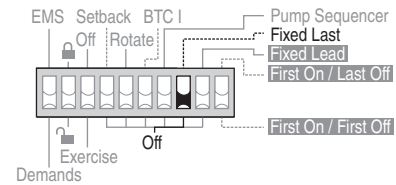

## Fixed Lead / Off

- Use the Fixed Lead / Off switch to exclude the first boiler in the rotation sequence. This DIP is only active when the Rotate / Off DIP is set to Rotate.
- If set to Fixed Lead, the first boiler is always the first to fire.
- Fixed Lead will only work for boilers wired to the Relay 1 terminals (13 and 14).

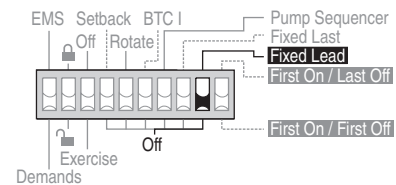

## First On / Last Off or First On / First Off.

- The First On / Last Off or First On / First Off DIP switch selects whether the first boiler is the first to fire and the last to shut off or the first to fire and the first to shut off. This DIP switch is only active when the Rotate / Off DIP switch is set to Rotate and the Fixed Lead / Off DIP switch is set to Fixed Lead.

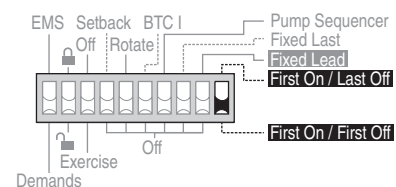

# Display Menus

## View Menu (1 of 2)

Menu



Item



The View menu items display the current operating temperatures and status information of the system.





VIEW MENU

Item Field	Range	Access	Description
	-76 to 149°F (-60.0 to 65.0°C)	USER INST ADV	<b>OUTDOOR</b> Current outdoor air temperature as measured by the outdoor sensor. <b>Note:</b> This item is only available when the EMS/ Demands DIP is set to Demands.
	-22 to 266°F (-30.0 to 130.0°C)	USER INST ADV	<b>BOILER SUPPLY</b> Current boiler supply water temperature as measured by the boiler sensor. <b>Note:</b> This item is not available when DHW Mode is 6.
	---, 35 to 230°F (---, 1.5 to 110.0°C)	ADV	<b>BOILER TARGET</b> <a href="#">SECTION C</a> The boiler target is the temperature the control is currently trying to maintain at the boiler supply sensor. "---" is displayed when no heat is required. <b>Note:</b> This item is not available when DHW Mode is 6.
	---, 35 to 230°F (---, 1.5 to 110.0°C)	ADV	<b>DHW EXCHANGE TARGET</b> <a href="#">SECTION I</a> The DHW exchange target is the temperature the control is currently trying to maintain at the DHW Exchange Supply Sensor. "---" is displayed when no heat is required. <b>Note:</b> This item is only available when DHW Mode is 5.
	-22 to 266°F (-30.0 to 130.0°C)	USER INST ADV	<b>DHW</b> <a href="#">SECTION I</a> Current DHW tank temperature as measured by the DHW sensor. <b>Note:</b> This item is only available if DHW Sensor is On and Pump Sequencing DIP is Off, or DHW Mode is 6.
	-22 to 266°F (-30.0 to 130.0°C)	ADV	<b>BOILER RETURN</b> Current boiler return water temperature as measured by the boiler return sensor. <b>Note:</b> This item is only available if DHW Sensor is Off and a boiler return sensor is present.
	0 to 252°F (-18.0 to 122.5°C)	ADV	<b>BOILER ΔT</b> Current temperature difference between the boiler supply and boiler return sensors. <b>Note:</b> This item is only available if DHW Sensor is Off and a boiler return sensor is present.
	0 to 100 % or 1 to 4	ADV	<b>BOILER 1 MODULATION / STG</b> <a href="#">SECTION D</a> Current percent modulation of the boiler 1 burner. If the BTC I / Off DIP is set to BTC I, the BTC I number of stages is displayed. <b>Note:</b> This item is only available when boiler 1 is set to Auto.

Continued on next page.

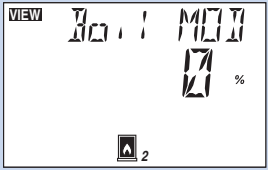
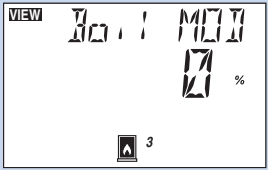
## View Menu (2 of 2)

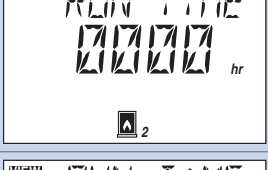
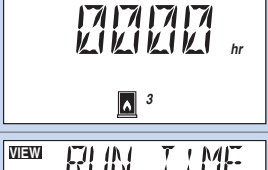
VIEW MENU

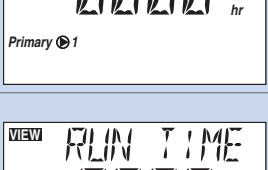
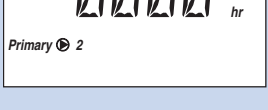
Item Field	Range	Access	Description
	0 to 100 % or 1 to 4	ADV	<b>BOILER 2 MODULATION / STG</b> <a href="#">SECTION D</a> Current percent modulation of the boiler 2 burner. If the BTC I / Off DIP is set to BTC I, the BTC I number of stages is displayed. <b>Note:</b> This item is only available when boiler 2 is set to Auto or CP1.
	0 to 100% or 1 to 4	ADV	<b>BOILER 3 MODULATION / STG</b> <a href="#">SECTION D</a> Current percent modulation of the boiler 3 burner. If the BTC I / Off DIP is set to BTC I, the BTC I number of stages is displayed. <b>Note:</b> This item is only available when boiler 3 is set to Auto or CP1.
	0 to 100% or 1 to 4	ADV	<b>BOILER 4 MODULATION / STG</b> <a href="#">SECTION D</a> Current percent modulation of the boiler 4 burner. If the BTC I / Off DIP is set to BTC I, the BTC I number of stages is displayed. <b>Note:</b> This item is only available when boiler 4 is set to Auto or CP1.
	0 to 9999 hours	ADV	<b>BOILER 1 RUNNING TIME</b> <a href="#">SECTION C</a> The total running time of boiler 1 since this item was last cleared. To clear this item, press the up and down buttons together while viewing this item. <b>Note:</b> This item is only available when boiler 1 is set to Auto.
	0 to 9999 hours	ADV	<b>BOILER 2 RUNNING TIME</b> <a href="#">SECTION C</a> The total running time of boiler 2 since this item was last cleared. To clear this item, press the up and down buttons together while viewing this item. <b>Note:</b> This item is only available when boiler 2 is set to Auto or CP1.
	0 to 9999 hours	ADV	<b>BOILER 3 RUNNING TIME</b> <a href="#">SECTION C</a> The total running time of boiler 3 since this item was last cleared. To clear this item, press the up and down buttons together while viewing this item. <b>Note:</b> This item is only available when boiler 3 is set to Auto or CP1.
	0 to 9999 hours	ADV	<b>BOILER 4 RUNNING TIME</b> <a href="#">SECTION C</a> The total running time of boiler 4 since this item was last cleared. To clear this item, press the up and down buttons together while viewing this item. <b>Note:</b> This item is only available when boiler 4 is set to Auto or CP1.
	0 to 9999 hours	ADV	<b>PRIMARY PUMP 1 RUNNING TIME</b> <a href="#">SECTION L</a> The total running time of pump 1 since this item was last cleared. To clear this item, press the up and down buttons together while viewing this item.
	0 to 9999 hours	ADV	<b>PUMP 2 RUNNING TIME</b> <a href="#">SECTION L</a> The total running time of pump 2 since this item was last cleared. To clear this item, press the up and down buttons together while viewing this item. <b>Note:</b> This item is only available when the Pump Sequencer / Off DIP Switch is set to Pump Sequencer.

• After the last item, the control returns to the first item in the menu.

## Adjust Menu (1 of 7)

Menu







Item

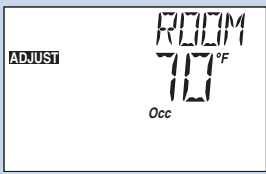
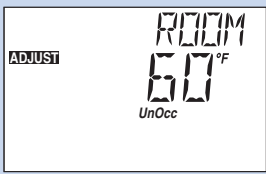
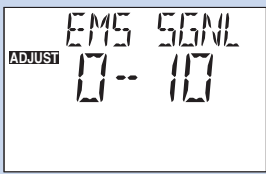
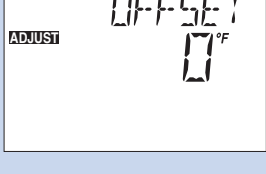
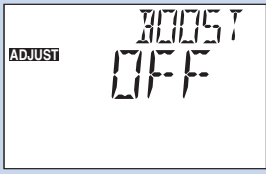

The Adjust Menu items are the programmable settings used to operate the mechanical equipment.

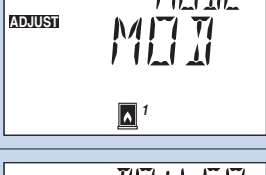
ADJUST MENU



Item Field	Range	Access	Description	Actual Setting
	35 to 100°F (2.0 to 38.0°C) Default = 70°F (21.0°C)	<b>INST ADV</b>	<b>ROOM OCCUPIED</b> <a href="#">SECTION B</a> The desired room air temperature during the occupied period. <b>Note:</b> This item is only available when EMS / Demands DIP is set to Demands and Outdoor Design is set to a temperature.	
	35 to 100°F (2.0 to 38.0°C) Default = 70°F (21.0°C)	<b>INST ADV</b>	<b>ROOM UNOCCUPIED</b> <a href="#">SECTION B</a> The desired room air temperature during the unoccupied period. <b>Note:</b> This item is only available when EMS / Demands DIP is set to Demands and Outdoor Design is set to a temperature. and the Setback / Off DIP switch is set to Setback.	
	0-10, 2-10 Default = 0-10	<b>ADV</b>	<b>EMS SIGNAL</b> <a href="#">SECTION K</a> Selects the range of the Energy Management System (EMS) input signal. <b>Note:</b> This item is only available when the EMS / Demands DIP switch is set to EMS.	
	-10 to 10°F (-5.6 to 5.6°C) Default = 0°F (°C)	<b>ADV</b>	<b>OFFSET</b> <a href="#">SECTION K</a> Selects the range of the Energy Management System input signal. <b>Note:</b> This item is only available when the EMS / Demands DIP switch is set to EMS.	
	OFF, 0:20 to 8:00 hr (5 minute increments) Default = OFF)	<b>ADV</b>	<b>BOOST</b> <a href="#">SECTION P</a> The maximum amount of morning boost when changing from the unoccupied to the occupied period. <b>Note:</b> This item is only available when EMS / Demands DIP is set to Demands and Setback / Off DIP is set to Setback.	
	Auto, OFF Default = Auto	<b>INST ADV</b>	<b>BOILER 1</b> <a href="#">SECTION C</a> Selects whether boiler 1 is operational or not.	
	Mod, OnOF or 1, 2, 3, 4, Mod Default = Mod	<b>ADV</b>	<b>BOILER 1 MODE</b> <a href="#">SECTION D, E, F</a> Select whether boiler 1 is modulating (Mod) or on-off (OnOF). If the BTC I / Off DIP switch is set to BTC I, then select the number of boiler stages for boiler 1.	
	CP1, Auto, OFF Default = Auto	<b>INST ADV</b>	<b>BOILER 2</b> <a href="#">SECTION C</a> Selects whether boiler 2 is operational or not. CP1 copies the settings of boiler 1 to boiler 2 and selects boiler 2 to be operational.	

Continued on next page.



## Adjust Menu (2 of 7)

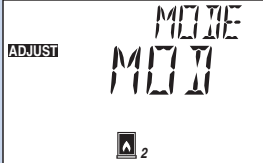
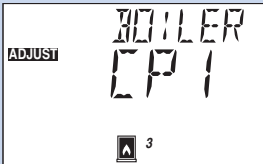

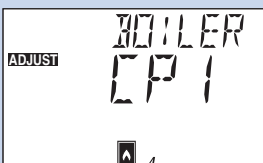
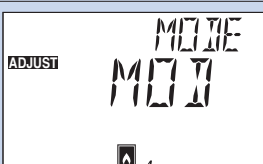
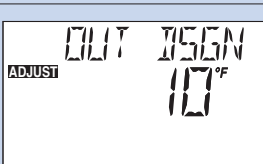
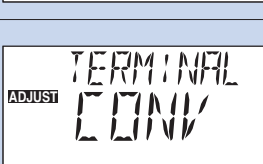
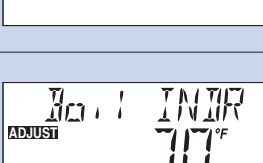
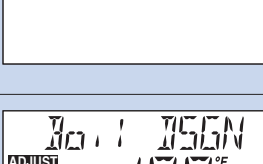
### ADJUST MENU

Item Field	Range	Access	Description	Actual Setting
	Mod, OnOF or 1, 2, 3, 4, Mod Default = Mod	ADV	<b>BOILER 2 MODE</b> SECTION D, E, F Select whether boiler 2 is modulating (Mod) or on-off (OnOF). If the BTC I / Off DIP switch is set to BTC I, then select the number of boiler stages for boiler 2.	
	CP1, Auto, OFF Default = Auto	INST ADV	<b>BOILER 3</b> SECTION C Selects whether boiler 3 is operational or not. CP1 copies the settings of boiler 1 to boiler 3 and selects boiler 3 to be operational.	
	Mod, OnOF or 1, 2, 3, 4, Mod Default = Mod	ADV	<b>BOILER 3 MODE</b> SECTION D, E, F Select whether boiler 3 is modulating (Mod) or on-off (OnOF). If the BTC I / Off DIP switch is set to BTC I, then select the number of boiler stages for boiler 3.	
	CP1, Auto, OFF Default = Auto	INST ADV	<b>BOILER 4</b> SECTION C Selects whether boiler 4 is operational or not. CP1 copies the settings of boiler 1 to boiler 4 and selects boiler 4 to be operational.	
	Mod, OnOF or 1, 2, 3, 4, Mod Default = Mod	ADV	<b>BOILER 4 MODE</b> SECTION D, E, F Select whether boiler 4 is modulating (Mod) or on-off (OnOF). If the BTC I / Off DIP switch is set to BTC I, then select the number of boiler stages for boiler 4.	
	OFF, -60 to 45°F (OFF, -51 to 7.0°C) Default = 10°F (-12°C)	INST ADV	<b>OUTDOOR DESIGN</b> SECTION B The design outdoor air temperature used in the heat loss calculations for the heating system. Typically set to the outdoor temperature of the coldest day of the year. When set to OFF, the boiler target is fixed to 180°F (82.0°C).	
	HRF1 HRF2 COIL CONV RAD BASE Default = CONV	INST ADV	<b>TERMINAL</b> SECTION B The type of heating terminal units that are being used. <b>Note:</b> This item is only available when the EMS / Demands DIP switch is set to Demands and outdoor design is set to a temperature.	
	35 to 100°F (2.0 to 38.0°C) Default = 70°F (21.0°C)	ADV	<b>BOILER INDOOR</b> SECTION B The design indoor air temperature used in the heat loss calculation for the boiler zones. Typically set to 70°F (21.0°C). <b>Note:</b> This item is only available when the EMS / Demands DIP switch is set to Demands and outdoor design is set to a temperature.	
	70 to 220°F (21.0 to 104.5°C) Default = 180°F (82.0°C)	ADV	<b>BOILER DESIGN</b> SECTION B The supply water temperature required for boiler zones on the typical coldest day of the year. <b>Note:</b> This item is only available when the EMS / Demands DIP switch is set to Demands and outdoor design is set to a temperature.	

Continued on next page.

## Adjust Menu (3 of 7)

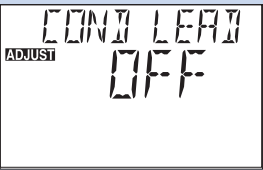
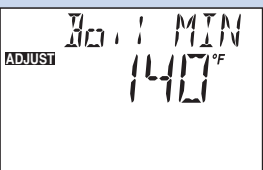
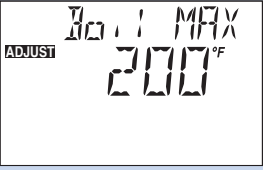
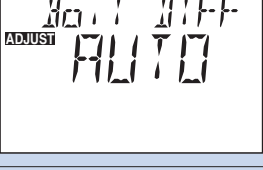

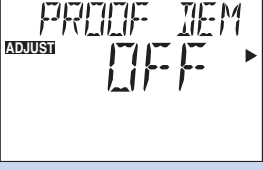
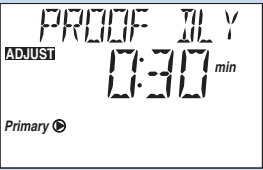
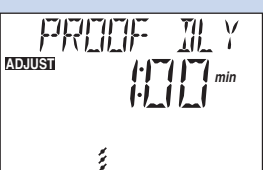





ADJUST MENU

Item Field	Range	Access	Description	Actual Setting
	OFF or On Default = OFF	ADV	<b>CONDENSING LEAD</b> <a href="#">SECTION H</a> Select whether or not the lead group of boilers are condensing or not. When set to On, the boiler minimum setting is not applied to the lead group of boilers. <b>Note:</b> Only available when Fixed Lead / Off DIP switch is set to Fixed Lead, or when Fixed Last / Off DIP switch is set to Fixed Last.	
	OFF, 80 to 180°F (OFF, 26.5 to 82.0°C) Default = 140°F (60.0°C)	ADV	<b>BOIL MINIMUM</b> <a href="#">SECTION C</a> The minimum allowed boiler target temperature and boiler return protection temperature. Check the boiler manufacturer's manual for recommended supply water temperatures.	
	120 to 225°F, OFF (49.0 to 107.0°C, OFF) Default = 200°F (93.5°C)	ADV	<b>BOILER MAXIMUM</b> <a href="#">SECTION C</a> The maximum allowed boiler target temperature.	
	Au (Auto), 2 to 42°F (Au, 1 to 23.5°C) Default = Au	ADV	<b>BOILER DIFFERENTIAL</b> <a href="#">SECTION C</a> The temperature differential that the control is to use to cycle the boiler on and off (half above and half below target).	
	DMPR 'Damper', ALRT 'Alert' Default = DMPR	ADV	<b>RELAY</b> <a href="#">SECTION M</a> Selects the operation of the relay to be either combustion air or alert.	
	OFF, Flow Proof (FP), Combustion Air (CA) Default = OFF	ADV	<b>PROOF DEMAND</b> <a href="#">SECTION M</a> Selects the operation of the Proof Demand to be either off, flow proof, or combustion air damper. <b>Note:</b> Only available when Relay is set to Damper (DMPR).	
	0:10 to 3:00 minutes Default = 0:30	ADV	<b>PUMP PROOF DEMAND DELAY</b> <a href="#">SECTION L</a> The time allowed for the control to receive a proof demand once the primary pump turns on. <b>Note:</b> Only available when Proof Demand is set to Flow Proof (FP).	
	0:10 to 3:00 minutes Default = 1:00	ADV	<b>CA PROOF DEMAND DELAY</b> <a href="#">SECTION M</a> The time allowed for the control to receive a proof demand once the Combustion Air (CA) contact turns on. <b>Note:</b> Only available when Relay is set to Damper and Proof Demand is set to Combustion Air (CA).	

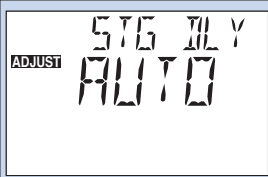
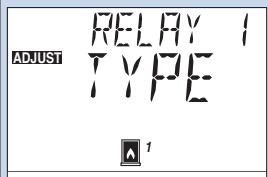
Continued on next page.

## Adjust Menu (4 of 7)

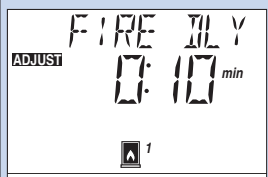

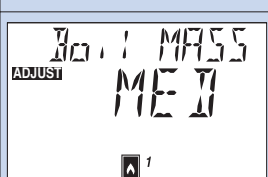
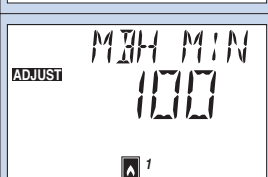
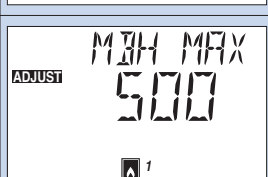
ADJUST MENU

Item Field	Range	Access	Description	Actual Setting
	0:10 to 3:00 minutes Default = 1:00	ADV	<b>DAMPER DELAY</b> <a href="#">SECTION M</a> The time delay for the boiler to operate once the combustion air damper relay closes. <b>Note:</b> Only available when Relay is set to Damper and Proof Demand is set to Combustion Air (CA).	
	SEQ (Sequential) PAR (Parallel) Default = SEQ	ADV	<b>MODULATION MODE</b> <a href="#">SECTION D</a> Selects either sequential or parallel modulation. <b>Note:</b> This item is only available when the BTC I / Off DIP is set to Off and DHW Mode is set to 1 to 5.	
	Au (Auto), 0:30 to 40:00 minutes Default = Au	ADV	<b>STAGE DELAY</b> <a href="#">SECTION C</a> The minimum delay between the operation of stages. <b>Note:</b> This item is only available when at least two boilers are set to Auto or CP1.	
	 (Burner),  (Pump) Default = 	ADV	<b>BOILER 1 RELAY</b> <a href="#">SECTION C</a> Selects whether the boiler relay is for a burner or a boiler pump. <b>Note:</b> This item is only available when Boiler 1 is set to Auto.	
	0:00 to 3:00 minutes Default = 0:10	ADV	<b>BOILER 1 FIRE DELAY</b> <a href="#">SECTION D</a> Delay from turn-on of ignition (Start Modulation) until the burner fires. <b>Note:</b> This item is only available when Boiler 1 is set to Auto.	
	0:00 to 3:00 minutes Default = 0:10	ADV	<b>BOILER 1 MIN MODULATION DELAY</b> <a href="#">SECTION D</a> Delay between the burner firing and the boiler releasing to modulation. <b>Note:</b> This item is only available when Boiler 1 is set to Auto and Boiler 1 Mode is set to Mod.	
	Lo, Med, Hi Default = Med	INST ADV	<b>BOILER 1 MASS</b> <a href="#">SECTION C</a> The thermal mass characteristics of the boiler. <b>Note:</b> This item is only available when Boiler 1 is set to Auto.	
	1 to 1999 Default = 100	ADV	<b>BOILER 1 MINIMUM MBH</b> <a href="#">SECTION D</a> Minimum (low fire) heat output in BTU/hr/1000. <b>Note:</b> This item is only available when Boiler 1 is set to Auto and Boiler 1 Mode is set to Mod.	
	1 to 1999 Default = 500	ADV	<b>BOILER 1 MAXIMUM MBH</b> <a href="#">SECTION D</a> Maximum (high fire) heat output in BTU/hr/1000. <b>Note:</b> This item is only available when Boiler 1 is set to Auto.	

Continued on next page.

## Adjust Menu (5 of 7)

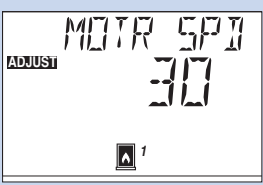
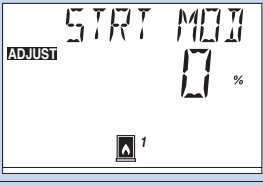
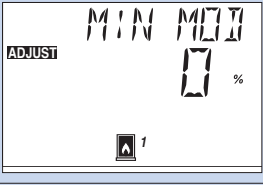
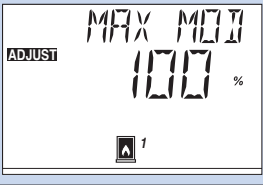
ADJUST MENU

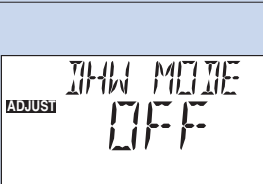
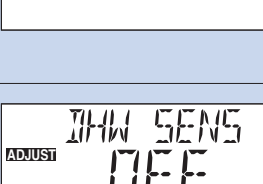
Item Field	Range	Access	Description	Actual Setting
	10 to 230 seconds Default = 30 seconds	ADV	<b>BOILER 1 MOTOR SPEED</b> SECTION D The amount of time required for the modulating actuating motor to fully open the gas valve or operate the fan speed from a stopped position to full speed. <b>Note:</b> This item is only available when Boiler 1 is set to Auto and Boiler 1 Mode is set to Mod.	
	0 to 100% Default = 0%	ADV	<b>BOILER 1 START MODULATION</b> SECTION D The percent modulation required to obtain ignition. <b>Note:</b> This item is only available when Boiler 1 is set to Auto and Boiler 1 Mode is set to Mod.	
	0 to 50% Default = 0%	ADV	<b>BOILER 1 MINIMUM MODULATION</b> SECTION D The minimum percent modulation of the burner. <b>Note:</b> This item is only available when Boiler 1 is set to Auto and Boiler 1 Mode is set to Mod.	
	50 to 100% Default = 100%	ADV	<b>BOILER 1 MAXIMUM MODULATION</b> SECTION D The maximum percent modulation of the burner. <b>Note:</b> This item is only available when Boiler 1 is set to Auto and Boiler 1 Mode is set to Mod.	
	OFF, 0:10 to 19:55 minutes Default = 0:20 min	ADV	<b>BOILER PUMP 1 PURGE</b> SECTION L The time the boiler pump remains on once the boiler is turned off. <b>Note:</b> This item is only available when Boiler 1 is set to Auto and Boiler 1 relay is set to 'Pump'.	
<b>Note:</b> The previous 11 menu items will repeat for up to four boilers.				
	AUTO, 5 to 30 minutes Default = Auto	ADV	<b>CYCLE LENGTH</b> SECTION R The cycle length to which all tN4 devices will synchronize. <b>Note:</b> This item is only available when a tN4 device is present.	
	OFF, 1 (parallel, no priority) 2 (parallel, priority) 3 (pri-sec, no priority) 4 (pri-sec, priority) 5 (parallel with last boiler, priority) 6 (dedicated DHW) Default = OFF	ADV	<b>DHW MODE</b> SECTION I This determines the operation of the primary pump in combination with the DHW pump and whether or not DHW priority is required. <b>Note:</b> This item is only available when the Pump Sequencer / Off DIP is set to Off.	
	OFF, ON Default = OFF	ADV	<b>DHW SENSOR</b> SECTION I Selects if a DHW sensor is to be used for DHW generation. <b>Note:</b> This item is only available when the Pump Sequencer / Off DIP is set to Off and DHW Mode is set to 1, 2, 3 or 4.	

Continued on next page.

## Adjust Menu (6 of 7)

ADJUST MENU

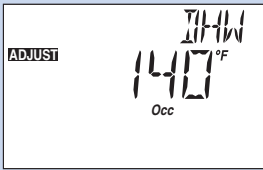
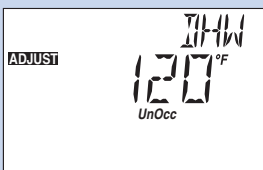
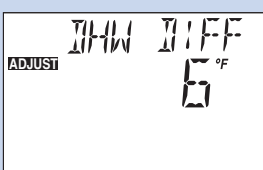
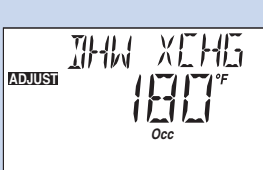
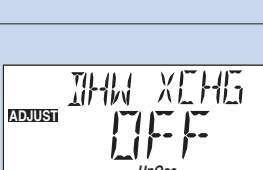
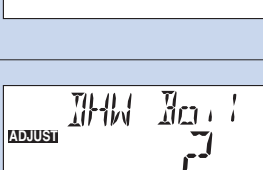
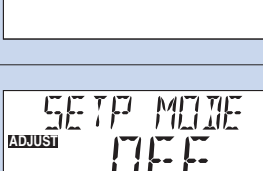
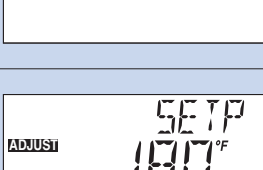
Item Field	Range	Access	Description	Actual Setting
	OFF, 70 to 190°F (OFF, 21.0 to 87.5°C) Default = 140°F (60.0°C)	<b>INST ADV</b>	<b>DHW OCCUPIED</b> SECTION I The temperature of the DHW tank during the wake and occupied periods. <i>Note:</i> This item is only available when DHW Mode is 1, 2, 3 or 4, the DHW Sensor is set to On, and the Pump Sequencer / Off DIP is Off.	
	OFF, 70 to 190°F (OFF, 21.0 to 87.5°C) Default = 120°F (49.0°C)	<b>ADV</b>	<b>DHW UNOCCUPIED</b> SECTION I The temperature of the DHW tank during the sleep and unoccupied periods. <i>Note:</i> This item is only available when DHW Mode is 1, 2, 3 or 4, the DHW Sensor is set to On, the Pump Sequencer / Off DIP is Off, and the Setback / Off DIP is set to Setback.	
	1 to 42°F (0.5 to 23.5°C) Default = 6°F (3.0°C)	<b>ADV</b>	<b>DHW DIFFERENTIAL</b> SECTION I The temperature differential (swing up and down) of the DHW tank from the DHW setting. <i>Note:</i> This item is only available when DHW Mode = 1, 2, 3, 4 or 6, the DHW Sensor is set to On, and the Pump Sequencer / Off DIP is Off.	
	100 to 220°F (38.0 to 104.5°C) Default = 180°F (82.0°C)	<b>ADV</b>	<b>DHW EXCHANGE OCCUPIED</b> SECTION I The boiler supply temperature to the DHW heat exchanger during the Occupied and Wake periods. <i>Note:</i> This item is only available when DHW Mode is set to 1, 2, 3, 4 or 5, the DHW Sensor is set to OFF, and the Pump Sequencer / Off DIP is set to Off.	
	OFF, On Default = OFF	<b>ADV</b>	<b>DHW EXCHANGE UNOCCUPIED</b> SECTION I Selects whether the control should respond to DHW Demands during the Sleep and Unoccupied periods. <i>Note:</i> This item is only available when DHW Mode is set to 1, 2, 3, 4 or 5, the DHW Sensor is set to OFF, the Pump Sequencer / Off DIP is set to Off, and the Setback / Off DIP is Off.	
	1, 2, 3, 4 Default = 2	<b>ADV</b>	<b>DHW BOILER</b> SECTION I The number of boilers used for indirect DHW generation. <i>Note:</i> This item is only available when DHW Mode = 1, 2, 3, or 4 and the Pump Sequencer / Off DIP is set to Off.	
	OFF, 1 (parallel, no priority) 2 (parallel, priority) 3 (pri-sec, no priority) 4 (pri-sec, priority) Default = 1)	<b>ADV</b>	<b>SETPoint MODE</b> SECTION J Selects the Setpoint mode of operation. This determines the operation of the primary pump and whether or not priority is required. <i>Note:</i> This item is only available when DHW Mode is set to Off.	
	OFF, 60 to 220°F (15.5 to 104.5°C) Default = 180°F (82°C)	<b>ADV</b>	<b>SETPoint OCCUPIED</b> SECTION J The minimum boiler target temperature when a Setpoint Demand is present during the Wake and Occupied periods. <i>Note:</i> This item is only available when DHW Mode is set to Off.	

Continued on next page.

## Adjust Menu (7 of 7)

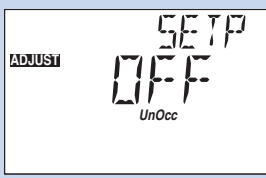
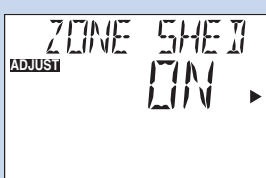
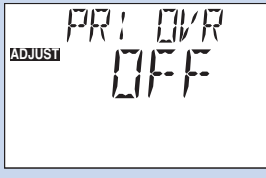
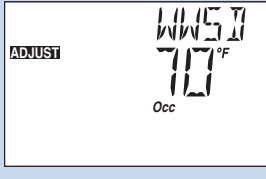
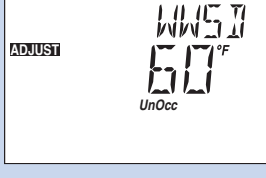
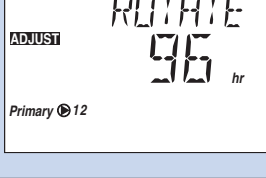
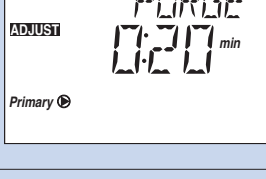
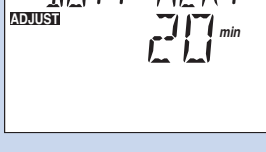
Item Field	Range	Access	Description	Actual Setting
	OFF, On Default = OFF	ADV	<b>SETPOINT UNOCCUPIED</b> SECTION J Selects whether the control should respond to Setpoint demands while in unoccupied mode. <b>Note:</b> This item is only available when DHW Mode is set to Off, and Setback / Off DIP is set to On.	
	OFF, On Default = On	ADV	<b>ZONE LOAD SHEDDING</b> SECTION R Selects whether Zone Load Shedding is active or not. <b>Note:</b> This item is only available when a tN4 device is present and Boiler Minimum is set to a temperature.	
	OFF, AUTO, 0:20 to 4:00 hours Default = OFF	ADV	<b>PRIORITY OVERRIDE</b> SECTION I, J The amount of time priority is given for DHW or Setpoint operation before space heating resumes. <b>Note:</b> This item is only available when DHW Mode is set to 2, 4, or 5, or Setpoint mode is set to 2 or 4.	
	35 to 100°F, OFF (2.0 to 38.0°C, OFF) Default = 70°F (21.0°C)	INST ADV	<b>WWSD OCCUPIED</b> SECTION B The system's warm weather shut down temperature during the wake and occupied periods. The WWSD applies to the space heating loads only. It does not affect DHW or Setpoint heating loads. <b>Note:</b> This item is only available when EMS / Demands DIP is set to Demands.	
	35 to 100°F, OFF (2.0 to 38.0°C, OFF) Default = 60°F (15.5°C)	ADV	<b>WWSD UNOCCUPIED</b> SECTION B The system's warm weather shut down temperature during the sleep and unoccupied period. <b>Note:</b> This item is only available when EMS / Demands DIP is set to Demands and Setback / Off DIP is set to Off.	
	12 to 180 hours, OFF Default = 96 hours	ADV	<b>ROTATE PRIMARY PUMPS</b> SECTION L Select the frequency of rotation of the primary pumps. <b>Note:</b> This item is only available when Pump Sequencer DIP is set to Pump Sequencer.	
	OFF, 0:10 to 19:55 minutes Default = 0:20 min	ADV	<b>PURGE PRIMARY PUMP</b> SECTION L Time the primary pump remains on once the demand is removed to purge heat from the boiler.	
	OFF, 3 to 40 minutes Default = 20 minutes	ADV	<b>BOILER ALERT</b> SECTION M Alert signal if boiler supply does not increase in temperature within the selected time. <b>Note:</b> This item is only available when RELAY is set to Alert (ALRT).	

ADJUST MENU

After the last item, the control returns to the first item in the menu.

## Time Menu (1 of 2)

**Note:** The Setback / Off switch setting must be in the Setback position in order to have access to the TIME menu.



TIME MENU

Item Field	Range	Access	Description
	Default = MONDAY 12:00 AM	USER INST ADV	<b>CURRENT TIME AND DAY</b> <a href="#">SECTION 0</a> Displays the current time and day of the week. The time and date flash if the time is not set.
	Default = JAN 01 2005	USER INST ADV	<b>CURRENT DATE</b> <a href="#">SECTION 0</a> Display the current month, day, and year. Use this date to determine daylight savings time. <b>Note:</b> This item is only available when Daylight Savings Time (DST) is set to On.
	12:00 to :59 Default = 12:00 AM	USER INST ADV	<b>CLOCK MINUTES</b> <a href="#">SECTION 0</a> Set the minutes.
	12:00 AM to 11:59 PM or 00:00 to 23:59 Default = 12:00 AM	USER INST ADV	<b>CLOCK HOURS</b> <a href="#">SECTION 0</a> Set the hours.
	SUNDAY ... WEDNESDAY ... SATURDAY Default = SUNDAY	USER INST ADV	<b>DAY OF THE WEEK</b> <a href="#">SECTION 0</a> Set the day of the week.
	OFF, 1, 2 Default = OFF	INST ADV	<b>DAYLIGHT SAVINGS TIME</b> <a href="#">SECTION 0</a> Selects whether to use Daylight Savings Time. The time is automatically adjusted if set to Mode 1 or 2. <b>Note:</b> See page 18 for a description of DST Modes.
	JAN, FEB, MAR ... DEC Default = JAN	INST ADV	<b>MONTH</b> <a href="#">SECTION 0</a> Set the current month of the year. <b>Note:</b> This item is only available when Daylight Savings Time is set to Mode 1 or 2.
	01 ... 31 (number of days is dependent on month) Default = 01	INST ADV	<b>DAY OF THE MONTH</b> <a href="#">SECTION 0</a> Set the day of the month. <b>Note:</b> This item is only available when Daylight Savings Time is set to Mode 1 or 2.

Continued on next page.

## Time Menu (2 of 2)

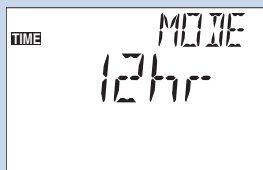
Item Field	Range	Access	Description
	2000 ... 2255 Default = 2005	INST ADV	<b>YEAR</b> <span style="float: right;">SECTION O</span> Set the current year. <b>Note:</b> This item is only available when Daylight Savings Time is set to Mode 1 or 2.
	12 hr OR 24 hr Default = 12 hr	INST ADV	<b>MODE</b> <span style="float: right;">SECTION O</span> Select whether time should be displayed using a 12 or a 24 hour clock.

After the last item, the control returns to the first item in the menu.

## Schedule Menu (1 of 3)

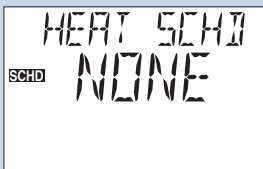
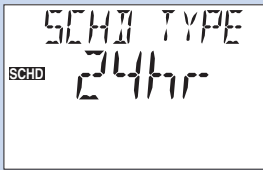
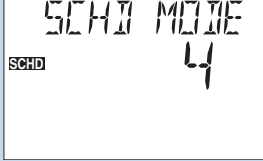

Item Field	Range	Access	Description
	NONE, CTRL, MST1, MST2, MST3, MST4, MBR1, MBR2, MBR3, MBR4 Default = NONE	USER INST ADV	<b>HEAT SCHEDULE</b> <span style="float: right;">SECTION N</span> If a schedule is not required, select NONE. If the schedule is only used by this control, select CTRL. If the schedule is shared with other tN4 devices, select MST1 to MST4. If the schedule is set on another tN4 device, select MBR1 to MBR4. <b>Note:</b> This item is only available if the Setback DIP is set to On and a tN4 device is present. This item can be viewed in the USER and INST access levels but can only be adjusted in the ADV access level.
	24 hr, 5-11, 7dAY Default = 24 hr	USER INST ADV	<b>SCHEDULE TYPE</b> <span style="float: right;">SECTION N</span> Select the type of schedule. <b>Note:</b> This item is only available when the Setback / Off DIP is set to On and the Heat Schedule is set to Control (CTRL) or Master (MST) 1 to 4.
	2 (Occ, UnOcc), 4 (Wake, UnOcc, Occ, Sleep) Default = 4	USER INST ADV	<b>SCHEDULE MODE</b> <span style="float: right;">SECTION N</span> Select the number of events per day. <b>Note:</b> This item is only available when the Setback / Off DIP is set to On and the Heat Schedule is set to Control (CTRL) or Master (MST) 1 to 4.

Continued on next page.



## Schedule Menu (2 of 3)

SCHEDULE MENU

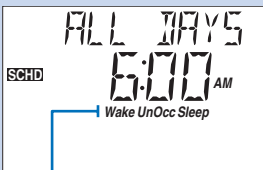
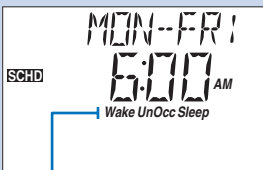
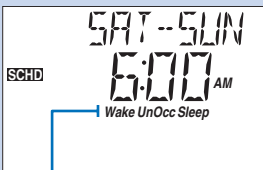
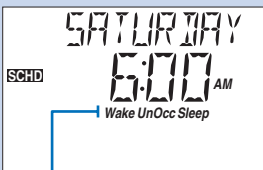
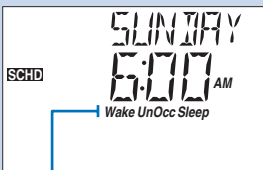
Item Field	Range	Access	Description
	--:-- to 11:50 PM or --:-- to 23:50	<b>USER</b> <b>INST</b> <b>ADV</b>	<b>ALL DAYS OF THE WEEK</b> <a href="#">SECTION N</a> Select the times for the scheduled events.  <b>Note:</b> This item is only available when the Setback / Off DIP is set to On and the Heat Schedule is set to Control (CTRL) or Master (MST) 1 to 4 and the Schedule Type is set to 24 hr.
Wake	Default = 6:00 AM		
UnOccupied	Default = 8:00 AM		
Occupied	Default = 6:00 PM		
Sleep	Default = 10:00 PM		
	--:-- to 11:50 PM or --:-- to 23:50	<b>USER</b> <b>INST</b> <b>ADV</b>	<b>MONDAY THROUGH FRIDAY</b> <a href="#">SECTION N</a> Select the times for the scheduled events.  <b>Note:</b> This item is only available when the Setback / Off DIP is set to On and the Heat Schedule is set to Control (CTRL) or Master (MST) 1 to 4 and the Schedule Type is set to 5-2 or 5-11.
Wake	Default = 6:00 AM		
UnOccupied	Default = 8:00 AM		
Occupied	Default = 6:00 PM		
Sleep	Default = 10:00 PM		
	--:-- to 11:50 PM or --:-- to 23:50	<b>USER</b> <b>INST</b> <b>ADV</b>	<b>SATURDAY AND SUNDAY</b> <a href="#">SECTION N</a> Select the times for the scheduled events.  <b>Note:</b> This item is only available when the Setback / Off DIP is set to On and the Heat Schedule is set to Control (CTRL) or Master (MST) 1 to 4 and the Schedule Type is set to 5-2.
Wake	Default = 6:00 AM		
UnOccupied	Default = 8:00 AM		
Occupied	Default = 6:00 PM		
Sleep	Default = 10:00 PM		
	--:-- to 11:50 PM or --:-- to 23:50	<b>USER</b> <b>INST</b> <b>ADV</b>	<b>SATURDAY</b> <a href="#">SECTION N</a> Select the times for the scheduled events.  <b>Note:</b> This item is only available when the Setback / Off DIP is set to On and the Heat Schedule is set to Control (CTRL) or Master (MST) 1 to 4 and the Schedule Type is set to 5-11 or 7 Day.
Wake	Default = 6:00 AM		
UnOccupied	Default = 8:00 AM		
Occupied	Default = 6:00 PM		
Sleep	Default = 10:00 PM		
	--:-- to 11:50 PM or --:-- to 23:50	<b>USER</b> <b>INST</b> <b>ADV</b>	<b>SUNDAY</b> <a href="#">SECTION N</a> Select the times for the scheduled events.  <b>Note:</b> This item is only available when the Setback / Off DIP is set to On and the Heat Schedule is set to Control (CTRL) or Master (MST) 1 to 4 and the Schedule Type is set to 5-11 or 7 Day.
Wake	Default = 6:00 AM		
UnOccupied	Default = 8:00 AM		
Occupied	Default = 6:00 PM		
Sleep	Default = 10:00 PM		

Continued on next page.

## Schedule Menu (3 of 3)

# SCHEDULE MENU

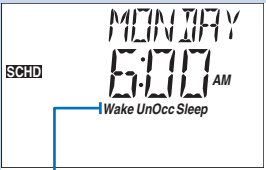
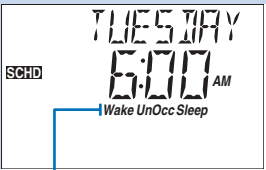
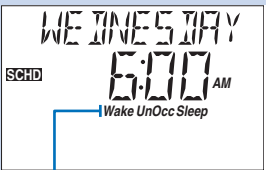
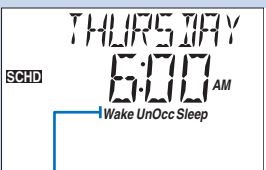
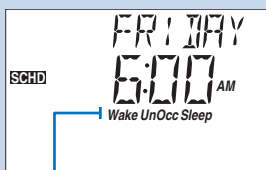
Item Field	Range	Access	Description
	--:-- to 11:50 PM or --:-- to 23:50	<b>USER</b> <b>INST</b> <b>ADV</b>	<b>MONDAY</b> <span style="float: right;">SECTION N</span> Select the times for the scheduled events. <b>Note:</b> This item is only available when the Setback / Off DIP is set to On and the Heat Schedule is set to Control (CTRL) or Master (MST) 1 to 4 and the Schedule Type is set to 7 Day.
Wake	Default = 6:00 AM		
UnOccupied	Default = 8:00 AM		
Occupied	Default = 6:00 PM		
Sleep	Default = 10:00 PM		
	--:-- to 11:50 PM or --:-- to 23:50	<b>USER</b> <b>INST</b> <b>ADV</b>	<b>TUESDAY</b> <span style="float: right;">SECTION N</span> Select the times for the scheduled events. <b>Note:</b> This item is only available when the Setback / Off DIP is set to On and the Heat Schedule is set to Control (CTRL) or Master (MST) 1 to 4 and the Schedule Type is set to 7 Day.
Wake	Default = 6:00 AM		
UnOccupied	Default = 8:00 AM		
Occupied	Default = 6:00 PM		
Sleep	Default = 10:00 PM		
	--:-- to 11:50 PM or --:-- to 23:50	<b>USER</b> <b>INST</b> <b>ADV</b>	<b>WEDNESDAY</b> <span style="float: right;">SECTION N</span> Select the times for the scheduled events. <b>Note:</b> This item is only available when the Setback / Off DIP is set to On and the Heat Schedule is set to Control (CTRL) or Master (MST) 1 to 4 and the Schedule Type is set to 7 Day.
Wake	Default = 6:00 AM		
UnOccupied	Default = 8:00 AM		
Occupied	Default = 6:00 PM		
Sleep	Default = 10:00 PM		
	--:-- to 11:50 PM or --:-- to 23:50	<b>USER</b> <b>INST</b> <b>ADV</b>	<b>THURSDAY</b> <span style="float: right;">SECTION N</span> Select the times for the scheduled events. <b>Note:</b> This item is only available when the Setback / Off DIP is set to On and the Heat Schedule is set to Control (CTRL) or Master (MST) 1 to 4 and the Schedule Type is set to 7 Day.
Wake	Default = 6:00 AM		
UnOccupied	Default = 8:00 AM		
Occupied	Default = 6:00 PM		
Sleep	Default = 10:00 PM		
	--:-- to 11:50 PM or --:-- to 23:50	<b>USER</b> <b>INST</b> <b>ADV</b>	<b>FRIDAY</b> <span style="float: right;">SECTION N</span> Select the times for the scheduled events. <b>Note:</b> This item is only available when the Setback / Off DIP is set to On and the Heat Schedule is set to Control (CTRL) or Master (MST) 1 to 4 and the Schedule Type is set to 7 Day.
Wake	Default = 6:00 AM		
UnOccupied	Default = 8:00 AM		
Occupied	Default = 6:00 PM		
Sleep	Default = 10:00 PM		

After the last item, the control returns to the first item in the menu.





## Misc (Miscellaneous) Menu (1 of 1)

Menu  
○

Item  
○

^  
○    ○  
v

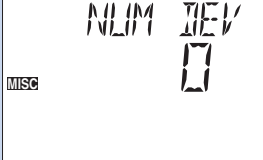
The Miscellaneous menu items set display and control options such as access level and temperature units.

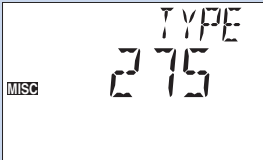
Item Field	Range	Access	Description
	USER, INST, ADV Default = INST	<b>USER</b> <b>INST</b> <b>ADV</b>	<b>ACCESS LEVEL</b> <span style="float: right;">PAGE 4</span> The access level of the control. The access column shows which items are visible in each access level. <b>Note:</b> This item is only available when the Lock / Unlock DIP switch on the control is set to Unlock
	°F, °C Default = °F	<b>USER</b> <b>INST</b> <b>ADV</b>	<b>UNITS</b> Select Fahrenheit or Celsius as the temperature units.
	1 to 24	<b>ADV</b>	<b>NUMBER OF DEVICES</b> <span style="float: right;">SECTION R</span> Number of tN4 devices connected to this tN4 bus.
	OFF, SEL Default = OFF	<b>ADV</b>	<b>DEFAULT</b> Press and hold the up and down buttons together for 1 second to display DEFAULT SEL and load the default settings. Does not load defaults for items in the miscellaneous menu.
	275, Software Version	<b>USER</b> <b>INST</b> <b>ADV</b>	<b>TYPE</b> Product number of this control. Hold the Up button to view the software version.

MISC MENU

• After the last item, the control returns to the first item in the menu.

# Testing the Control

The control has a built-in test routine that tests the main control functions. The control continually monitors the sensors and displays an error message whenever a fault is found. The individual outputs and relays are tested using a test sequence.

## Test Sequence

Each step in the test sequence lasts 10 seconds.

- Start the test sequence by pressing the Test button.
- Pause the test sequence by pressing the Test button again. To advance to the next step, press the Test button again.
- If the test sequence is paused for more than five minutes, the control exits the entire test routine.
- To advance to a particular step, repeatedly press and release the Test button to display the appropriate device.

### HAZARD

Access to the Test button requires the removal of the front cover and exposes hazardous voltage while the control is powered. Only trained, qualified and competent personnel should operate the Test button.



**Step 1** IF the RELAY item is set to 'Damper' or 'Alert' the C.A. / Alert relay is closed.

IF the RELAY item is set to 'Alert', the C.A. / Alert relay is opened after 10 seconds

**Step 2** The Primary Pump 1 relay is closed.

IF Pump Sequencer DIP is set to On, the Primary Pump 1 relay is opened after 10 seconds.

### IF Pump Sequencer DIP = On

**Step 3** The Primary Pump 2 relay is closed.

### IF Boiler 1 = Auto

(repeat for each boiler set to Auto or CP1)

**Step 4** Relay 1 is closed for Boiler 1 Pump or Boiler 1 Ignition. Boiler 1 modulates up to the STRT MOD 1 setting according to the MOTR SPD 1 setting. The boiler is operated for the Fire Delay 1 time or at least 10 seconds.

### IF a demand is present

**Step 5** Boiler 1 modulates up to the MAX MOD 1 setting according to the MOTR SPD 1 setting.

**Step 6** Boiler 1 modulates down to 0% according to the MOTR SPD 1 setting, and then Relay 1 is opened.

### IF DHW mode = 1, 2, 5, or 6, the primary pump is turned off

**Step 7** The DHW relay is closed.  
The C.A. / Alert relay is opened  
The primary pump is turned off  
The control exits the test sequence.

If a device fails to operate during the test sequence, refer to the installation section of this brochure to check the operation of the control. If the control works properly, refer to any troubleshooting information supplied by the equipment manufacturer.

## Max Heat

The control has a function called Max Heat. As long as there is a demand for heat the control operates in this mode for up to 24 hours or until the Test button is pressed. tN4 devices operate to meet their occupied setting +5°F (3°C) and display the MAX segment to indicate the Max Heat mode. Use this mode to run the circulators during system start-up to purge air from the piping.

- When a boiler demand is present the control targets Boiler Maximum. If Boiler Minimum = Off, the control then targets Boiler Design. This allows the Boiler Maximum setting to be set higher for DHW generation.
- When a DHW demand is present the control targets the lower of Boiler Maximum or DHW Exchange.
- The Boil Maximum setting and DHW Exchange setting are always available in the Adjust Menu when in Max Heat. The Boiler Design setting is also available in the Adjust Menu when in Max Heat and the Boiler Minimum is set to Off.
- DHW priority and WWSD are disabled.

### To enable Max Heat:

Press and hold the Test button for more than 3 seconds and less than 6 seconds and the test LED will begin to flash rapidly. MAX HEAT and TEST are displayed on screen. No outputs are turned on until there is a demand for heat present.



### To Cancel Max Heat:

Press the Test button to cancel Max Heat manually or wait 24 hours and the control will automatically leave the Max Heat mode.

## Zone Test

In Zone Test mode, each tN4 device can be individually turned on one at a time. The control tests each zone for up to 5 minutes of no button activity. Use this feature to purge air out of each zone and assist in troubleshooting. No items are available in the user interface of the control.

## To Enable Zone Test:

1. Press and hold the Test button for more than 6 seconds. The control displays ZONE TEST OFF and the Test LED remains on.



2. Press the Up button to change the display to ZONE TEST ON. After 3 seconds, the boiler and all pumps are shut off.
3. The control operates stage one of the tN4 device with the lowest address number. Device number one (b:01) has the lowest address number and device 24 (b:24) has the highest address number. All other tN4 zones are shut off.

4. Pressing the Up button will turn off stage 1, and turn on stage 2 of the same device (if that device has a second stage) or turn on stage 1 of the device with the next lowest address. The Down button can be pressed to move to a device with a lower address number. The second stage of a two stage zone is indicated with a small 2 in the display.



5. The Up and Down buttons can then be used to move through the devices and the heating stages of each device on the boiler bus.

To cancel the Zone Test press the Test button. Once the Zone Test ends or is cancelled, the control resumes normal operation.

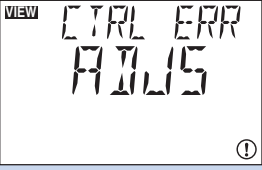
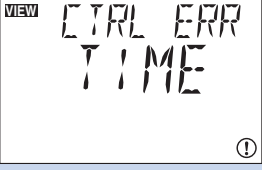
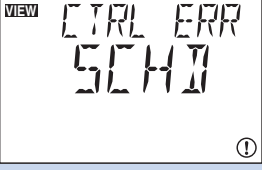
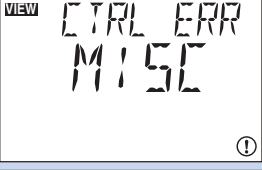
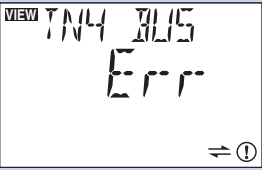
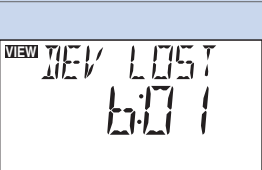
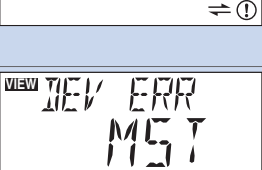

## Error Messages (1 of 3)

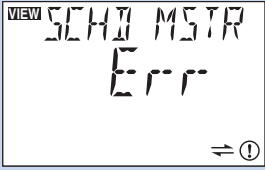
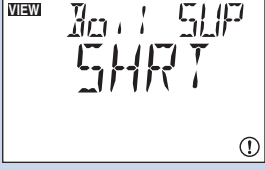
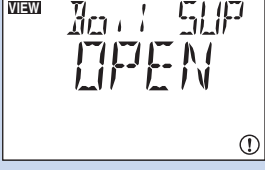
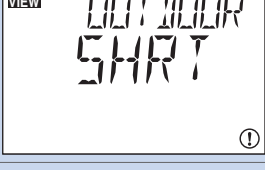
Error Message	Description
	<p><b>CONTROL ERROR ADJUST</b></p> <p>The control failed to read the Adjust Menu settings, and reloaded the factory default settings. Operation stops until you check all the Adjust Menu settings.</p> <p><b>Note:</b> To clear the error, the access level must be set to Advanced and the settings in the Adjust menu must be checked.</p>
	<p><b>CONTROL ERROR TIME</b></p> <p>The control failed to read the Time Menu settings, and reloaded the factory default settings. Operation continues normally.</p> <p><b>Note:</b> To clear the error, the access level must be set to Advanced and the settings in the Time menu must be checked.</p>
	<p><b>CONTROL ERROR SCHEDULE</b></p> <p>The control failed to read the Schedule Menu settings, and reloaded the factory default settings. Operation continues normally.</p> <p><b>Note:</b> To clear the error, the access level must be set to Advanced and the settings in the Schedule menu must be checked.</p>
	<p><b>CONTROL ERROR MISCELLANEOUS</b></p> <p>The control failed to read the Miscellaneous Menu settings, and reloaded the factory default settings. Operation continues normally.</p> <p><b>Note:</b> To clear the error, the access level must be set to Advanced and the settings in the Miscellaneous menu must be checked.</p>
	<p><b>TN4 BUS ERROR</b></p> <p>Communication has been lost on the boiler bus due to a short or open circuit. Check the tN4, C and R wires for each tN4 device. Check the polarity of the C and R wires. Check for loose or broken wires. The error message self clears once the error condition is corrected.</p> <p>To clear the error code, press and hold the up and down buttons together for 5 seconds while viewing this error message.</p>
	<p><b>DEVICE LOST</b></p> <p>Communication is lost to a tekmarNet® device on the boiler bus. The number shown is the address of the lost device. The LCD on the lost device displays the tekmarNet® communication symbol and OPEN. Ensure that there is power to the lost device. Trace the wires from the control to the lost device looking for loose or damaged wires. The error message self clears when the error condition is corrected.</p> <p><b>Note:</b> If you deliberately remove a tekmarNet® device, hold the up and down buttons together for 5 seconds to clear the error.</p>
	<p><b>MASTER DEVICE ERROR</b></p> <p>More than one tN4 System Control has been detected on the tN4 bus. This generally indicates that two tN4 buses are wired together. Check the tN4 bus wiring. The error message clears once the error condition is corrected.</p>

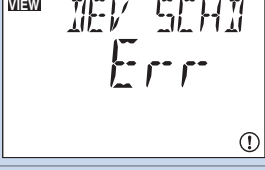
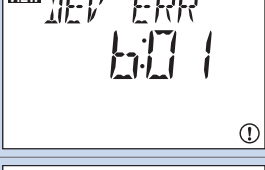
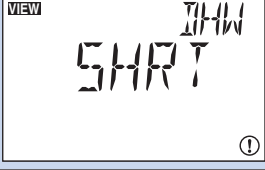
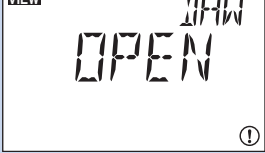
## Error Messages (2 of 3)

Error Message	Description
 <p>VIEW SCHED MSTR Err</p>	<p><b>SCHEDULE MASTER ERROR</b> More than one tekmarNet® device has been assigned the same master number.</p>
 <p>VIEW BOIL SUP SHRT</p>	<p><b>BOILER SUPPLY SENSOR SHORT CIRCUIT</b> Due to a short circuit, the control failed to read the boiler supply sensor. When there is a call for heat, the control no longer controls the boiler(s). Instead, the control provides a boiler enable to the boiler's aquastat or boiler control until the sensor is repaired. The control will not operate the boiler contact if the Boil Minimum setting is less than 100°F (38.0°C). Locate and repair the problem as described in the data brochure D 070. The error message self clears once the error condition is corrected.</p>
 <p>VIEW BOIL SUP OPEN</p>	<p><b>BOILER SUPPLY SENSOR OPEN CIRCUIT</b> Due to an open circuit, the control failed to read the boiler supply sensor. The control no longer controls the boiler. Instead, the control provides a boiler enable to the boiler's aquastat or boiler control until the sensor is repaired. The control will not operate the boiler contact if the Boil Minimum setting is less than 100°F (38.0°C). Locate and repair the problem as described in the data brochure D 070. The error message self clears once the error condition is corrected. <b>Note:</b> If you deliberately remove the boiler supply sensor, power down for 10 seconds then restart the control.</p>
 <p>VIEW OUTDOOR SHRT</p>	<p><b>OUTDOOR SENSOR SHORT CIRCUIT</b> Due to a short circuit, the control failed to read the outdoor sensor. As a result, the control assumes an outdoor temperature of 32°F (0.0°C) and continues operation. Locate and repair the problem as described in the data brochure D 070. The error message self clears once the error condition is corrected.</p>
 <p>VIEW OUTDOOR OPEN</p>	<p><b>OUTDOOR SENSOR OPEN CIRCUIT</b> Due to an open circuit, the control failed to read the outdoor sensor. As a result, the control assumes an outdoor temperature of 32°F (0.0°C) and continues operation. Locate and repair the problem as described in the data brochure D 070. The error message self clears once the error condition is corrected.</p>
 <p>VIEW DEV SCHED Err</p>	<p><b>DEVICE SCHEDULE ERROR</b> The selected system schedule is no longer available. Either the system schedule master is no longer connected to the network or the system schedule number has been changed on the schedule master. The error message self clears once the error condition is corrected.</p>
 <p>VIEW DEV ERR 601</p>	<p><b>DEVICE ERROR AT THERMOSTAT</b> There is an error on a thermostat or setpoint control that is connected to the 275. Find the thermostat with this address to locate the source of the error. Once the error on the thermostat or setpoint control is corrected, this error message will self clear.</p>
 <p>VIEW DHW SHRT</p>	<p><b>DHW SHORT CIRCUIT</b> Due to a short circuit, the control failed to read the DHW sensor. As a result, the control no longer heats the DHW tank. Locate and repair the problem as described in the data brochure D 070. DHW tank heating will resume once the sensor problem is corrected. The error message self clears once the error condition is corrected.</p>
 <p>VIEW DHW OPEN</p>	<p><b>DHW OPEN CIRCUIT</b> Due to an open circuit, the control failed to read the DHW sensor. As a result, the control no longer heats the DHW tank. Locate and repair the problem as described in the data brochure D 070. DHW tank heating will resume once the sensor problem is corrected. The error message self clears once the error condition is corrected.</p>

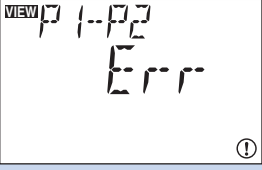
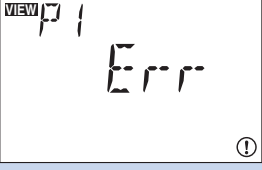
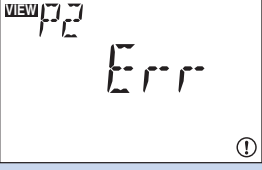
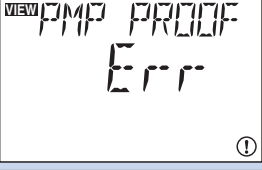
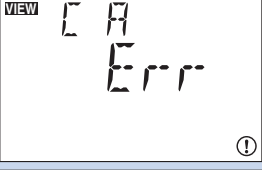
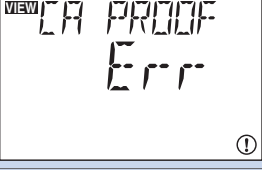
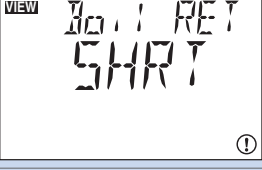
## Error Messages (3 of 3)

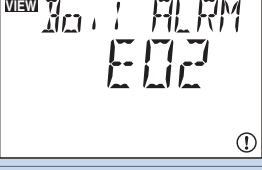
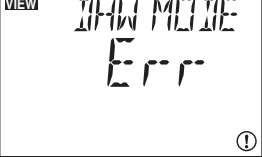
Error Message	Description
	<p><b>PRIMARY PUMP P1 &amp; P2 FAILURE</b></p> <p>Both the primary pump P1 and P2 have failed or the flow proof demand signal was not detected before the proof demand delay time elapsed.</p> <p>To clear the error code, press and hold the up and down buttons together for 5 seconds while viewing this error message.</p>
	<p><b>PRIMARY PUMP P1 FAILURE</b></p> <p>The primary pump P1 has failed. The primary pump 1 relay closed, but a flow proof demand was not detected before the proof demand delay time elapsed.</p> <p>To clear the error code, press and hold the up and down buttons together for 5 seconds while viewing this error message.</p>
	<p><b>PRIMARY PUMP P2 FAILURE</b></p> <p>The primary pump P2 has failed. The pump 2 relay closed, but a flow proof demand was not detected before the proof demand delay time elapsed.</p> <p>To clear the error code, press and hold the up and down buttons together for 5 seconds while viewing this error message.</p>
	<p><b>PUMP PROOF DEMAND ERROR</b></p> <p>The primary pump has been turned off, but the pump proof demand remains after 4 minutes.</p> <p>To clear the error code, press and hold the up and down buttons together for 5 seconds while viewing this error message.</p>
	<p><b>COMBUSTION AIR DAMPER FAILURE</b></p> <p>The Combustion Air (C.A.) damper has failed. The C.A. relay closed, but the control did not detect a damper proof demand before the proof demand delay time elapsed.</p> <p>To clear the error code, press and hold the up and down buttons together for 5 seconds while viewing this error message.</p>
	<p><b>DAMPER PROOF DEMAND ERROR</b></p> <p>The Combustion Air (C.A.) damper has been turned off, but the damper proof demand remains after 4 minutes.</p> <p>To clear the error code, press and hold the up and down buttons together for 5 seconds while viewing this error message.</p>
	<p><b>BOILER RETURN SENSOR SHORT CIRCUIT</b></p> <p>Due to an short circuit, the control failed to read the boiler return sensor. The control will continue to operate normally. Locate and repair the problem as described in the data brochure D 070. The error message self clears once the error condition is corrected.</p>
	<p><b>BOILER RETURN SENSOR OPEN CIRCUIT</b></p> <p>Due to an open circuit, the control failed to read the boiler return sensor. The control will continue to operate normally. Locate and repair the problem as described in the data brochure D 070. The error message self clears once the error condition is corrected.</p>
	<p><b>BOILER ALARM ERROR</b></p> <p>The boiler supply temperature did increase within the boiler alarm time. To reset the alarm, press and hold the up and down buttons together for 5 seconds while viewing this error message.</p>
	<p><b>DHW ERROR</b></p> <p>A DHW sensor and a DHW demand have been applied at the same time. The DHW tank will not be heated until the DHW Demand signal is removed. The error message self clears once the condition is corrected.</p>

# Technical Data

<b>Boiler Control 275 One tN4, Four Modulating Boiler &amp; DHW / Setpoint</b>	
Literature	D275, A275, D001, D070
Control	Microprocessor control. This is not a safety (limit) control.
Packaged weight	3.3 lbs (1500 g)
Dimensions	6-5/8" H x 7-9/16" W x 2-13/16" D (170 x 193 x 72 mm)
Enclosure	Blue PVC plastic, NEMA type 1
Approvals	CSA C US, meets class B: ICES & FCC Part 15
Ambient conditions	Indoor use only, 32 to 122°F (0 to 50°C), RH ≤ 90% Non-condensing
Power supply	115 V (ac) ±10% 60 Hz, 7 VA, 1150 VA max
Relays	230 V (ac) 5 A, 1/3 hp
Modulating output	0 - 10 V (dc), Minimum 2500 Ω
Demands	20 to 260 V (ac) 2 VA
Sensors	NTC thermistor, 10k Ω @ 77°F (25°C ± 0.2°C) β=3892
- Included	Outdoor Sensor 070, 2 of Universal Sensors 082, and 500 Ω resistor
Warranty	Limited 3 Year

## Limited Warranty and Product Return Procedure

**Limited Warranty** *The liability of tekmar under this warranty is limited. The Purchaser, by taking receipt of any tekmar product ("Product"), acknowledges the terms of the Limited Warranty in effect at the time of such Product sale and acknowledges that it has read and understands same.*

The tekmar Limited Warranty to the Purchaser on the Products sold hereunder is a manufacturer's pass-through warranty which the Purchaser is authorized to pass through to its customers. Under the Limited Warranty, each tekmar Product is warranted against defects in workmanship and materials if the Product is installed and used in compliance with tekmar's instructions, ordinary wear and tear excepted. The pass-through warranty period is for a period of twenty-four (24) months from the production date if the Product is not installed during that period, or twelve (12) months from the documented date of installation if installed within twenty-four (24) months from the production date.

The liability of tekmar under the Limited Warranty shall be limited to, at tekmar's sole discretion: the cost of parts and labor provided by tekmar to repair defects in materials and/or workmanship of the defective product; or to the exchange of the defective product for a warranty replacement product; or to the granting of credit limited to the original cost of the defective product, and such repair, exchange or credit shall be the sole remedy available from tekmar, and, without limiting the foregoing in any way, tekmar is not responsible, in contract, tort or strict product liability, for any other losses, costs, expenses, inconveniences, or damages, whether direct, indirect, special, secondary, incidental or consequential, arising from ownership or use of the product, or from defects in workmanship or materials, including any liability for fundamental breach of contract.

The pass-through Limited Warranty applies only to those defective Products returned to tekmar during the warranty period. This Limited Warranty does not cover the cost of the parts or labor to remove or transport the defective Product, or to reinstall the repaired or replacement Product, all such costs and expenses being subject to Purchaser's agreement and warranty with its customers.

Any representations or warranties about the Products made by Purchaser to its customers which are different from or in excess of the tekmar Limited Warranty are the Purchaser's sole responsibility and obligation. Purchaser shall indemnify and hold tekmar harmless from and against any and all claims, liabilities and damages of any kind or nature which arise out of or are related to any such representations or warranties by Purchaser to its customers.

The pass-through Limited Warranty does not apply if the returned Product has been damaged by negligence by persons other than tekmar, accident, fire, Act of God, abuse or misuse; or has been damaged by modifications, alterations or attachments made subsequent to purchase which have not been authorized by tekmar; or if the Product was not installed in compliance with tekmar's instructions and/or the local codes and ordinances; or if due to defective installation of the Product; or if the Product was not used in compliance with tekmar's instructions.

THIS WARRANTY IS IN LIEU OF ALL OTHER WARRANTIES, EXPRESS OR IMPLIED, WHICH THE GOVERNING LAW ALLOWS PARTIES TO CONTRACTUALLY EXCLUDE, INCLUDING, WITHOUT LIMITATION, IMPLIED WARRANTIES OF MERCHANTABILITY AND FITNESS FOR A PARTICULAR PURPOSE, DURABILITY OR DESCRIPTION OF THE PRODUCT, ITS NON-INFRINGEMENT OF ANY RELEVANT PATENTS OR TRADEMARKS, AND ITS COMPLIANCE WITH OR NON-VIOLATION OF ANY APPLICABLE ENVIRONMENTAL, HEALTH OR SAFETY LEGISLATION; THE TERM OF ANY OTHER WARRANTY NOT HEREBY CONTRACTUALLY EXCLUDED IS LIMITED SUCH THAT IT SHALL NOT EXTEND BEYOND TWENTY-FOUR (24) MONTHS FROM THE PRODUCTION DATE, TO THE EXTENT THAT SUCH LIMITATION IS ALLOWED BY THE GOVERNING LAW.

**Product Warranty Return Procedure** All Products that are believed to have defects in workmanship or materials must be returned, together with a written description of the defect, to the tekmar Representative assigned to the territory in which such Product is located. If tekmar receives an inquiry from someone other than a tekmar Representative, including an inquiry from Purchaser (if not a tekmar Representative) or Purchaser's customers, regarding a potential warranty claim, tekmar's sole obligation shall be to provide the address and other contact information regarding the appropriate Representative.



tekmar Control Systems Ltd., Canada, tekmar Control Systems, Inc., U.S.A. **Head Office: 5100 Silver Star Road, Vernon, B.C. Canada V1B 3K4, 250-545-7749, Fax. 250-545-0650 Web Site: www.tekmarcontrols.com**

