

Operating Instructions <Basics>

Remote Operation Panel

Model No. **AK-HRP200G**

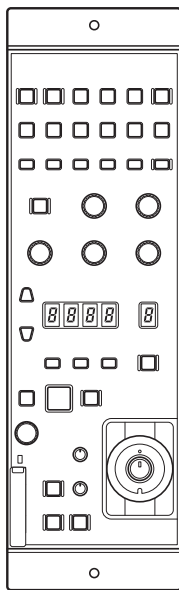

- How the operating instructions are organized
 - **Basics (this manual):**
This manual describes how to connect the unit to the required equipment and set it up.
Before installing the unit, be sure to read the <Basics> manual to ensure that you know how to install it correctly.
The <Basics> manual is provided as a PDF file on the CD-ROM supplied with the unit.
 - **Operations and Settings:**
Operations and Settings describe how to operate and set up the unit.
The <Operations and Settings> manual is provided as a PDF file on the CD-ROM supplied with the unit.
- **To read PDF files, you will need Adobe® Reader®.**
You can download it from Adobe Systems' website.



DEUTSCH

Für Erläuterungen in Deutsch, konsultieren Sie bitte die mitgelieferte CD-ROM.
(→ Seite 4)

FRANÇAIS

Pour des explications en français, veuillez vous reporter au CD-ROM fourni.
(→ page 4)

ITALIANO

Per le istruzioni in italiano, vedere il CD-ROM in dotazione. (→ pagina 4)

ESPAÑOL

Para la explicación en español, consulte el CD-ROM suministrado. (→ página 4)

日本語

日本語版の取扱説明書は付属のCD-ROMに納められています。(→4ページ)

This manual is also contained as a PDF file on the CD-ROM supplied with the unit. (→page 4)

Before operating this product, please read the instructions carefully and save this manual for future use.

Read this first!

■ DO NOT REMOVE PANEL COVERS BY UNSCREWING THEM.

No user serviceable parts inside.
Refer servicing to qualified service personnel.

WARNING:

- To reduce the risk of fire, do not expose this equipment to rain or moisture.
- To reduce the risk of fire, keep this equipment away from all liquids. Use and store only in locations which are not exposed to the risk of dripping or splashing liquids, and do not place any liquid containers on top of the equipment.

WARNING:

Always keep memory cards (optional accessory) out of the reach of babies and small children.

CAUTION:

Do not remove panel covers by unscrewing.
To reduce the risk of electric shock, do not remove the covers. No user serviceable parts inside.
Refer servicing to qualified service personnel.

CAUTION:

To reduce the risk of fire or electric shock and annoying interference, use the recommended accessories only.

 indicates safety information.

FCC NOTICE(USA)

This device complies with part 15 of the FCC Rules. Operation is subject to the following two conditions:

(1) This device may not cause harmful interference, and (2) this device must accept any interference received, including interference that may cause undesired operation

CAUTION:

This equipment has been tested and found to comply with the limits for a class A digital device, pursuant to Part 15 of the FCC Rules. These limits are designed to provide reasonable protection against harmful interference when the equipment is operated in a commercial environment. This equipment generates, uses, and can radiate radio frequency energy and, if not installed and used in accordance with the instruction manual, may cause harmful interference to radio communications. Operation of this equipment in a residential area is likely to cause harmful interference in which case the user will be required to correct the interference at his own expense.

FCC Warning:

To assure continued FCC emission limit compliance, follow the attached installation instructions and the user must use only shielded interface cables when connecting to host computer or peripheral devices.
Also, any unauthorized changes or modifications to this equipment could void the user's authority to operate this device.

NOTIFICATION(Canada)

This class A digital apparatus complies with Canadian ICES-003.

 indicates safety information.

EEE Yönetmeliğine Uygundur.
EEE Complies with Directive of Turkey.

Note:

The rating plate (serial number plate) is on the bottom of the unit.

Importer's name and address of pursuant to EU rules:

Panasonic Testing Centre
Panasonic Marketing Europe GmbH
Winsbergring 15, 22525 Hamburg, Germany

EMC NOTICE FOR THE PURCHASER/USER OF THE APPARATUS

1. Applicable standards and operating environment (AK-HRP200)

The apparatus is compliant with:

- standards EN55103-1 and EN55103-2 2009, and
- electromagnetic environments E1 - E5.

2. Pre-requisite conditions to achieving compliance with the above standards

<1> Peripheral equipment to be connected to the apparatus and special connecting cables

- The purchaser/user is urged to use only equipment which has been recommended by us as peripheral equipment to be connected to the apparatus.
- The purchaser/user is urged to use only the connecting cables described below.

<2> For the connecting cables, use shielded cables which suit the intended purpose of the apparatus.

- Video signal connecting cables
Use double shielded coaxial cables, which are designed for 75-ohm type high-frequency applications, for SDI (Serial Digital Interface). Coaxial cables, which are designed for 75-ohm type high-frequency applications, are recommended for analog video signals.
- Audio signal connecting cables
If your apparatus supports AES/EBU serial digital audio signals, use cables designed for AES/EBU.
Use shielded cables, which provide quality performance for high-frequency transmission applications, for analog audio signals.
- Other connecting cables (LAN, RS-422)
Use shielded cables, which provide quality performance for high-frequency applications, as connecting cables.
- When connecting to the DVI signal terminal, use a cable with a ferrite core.
- If your apparatus is supplied with ferrite core(s), they must be attached on cable(s) following instructions in this manual.

3. Performance level

The performance level of the apparatus is equivalent to or better than the performance level required by these standards.

However, the apparatus may be adversely affected by interference if it is being used in an EMC environment, such as an area where strong electromagnetic fields are generated (by the presence of signal transmission towers, cellular phones, etc.). In order to minimize the adverse effects of the interference on the apparatus in cases like this, it is recommended that the following steps be taken with the apparatus being affected and with its operating environment:

1. Place the apparatus at a distance from the source of the interference.
2. Change the direction of the apparatus.
3. Change the connection method used for the apparatus.
4. Connect the apparatus to another power outlet where the power is not shared by any other appliances.

Декларація про Відповідність

Вимогам Технічного Регламенту Обмеження Використання деяких Небезпечних Речовин в електричному та електронному обладнанні (затвердженого Постановою №1057 Кабінету Міністрів України)

Виріб відповідає вимогам Технічного Регламенту Обмеження Використання деяких Небезпечних Речовин в електричному та електронному обладнанні (ТР ОБНР).

Вміст небезпечних речовин у випадках, не обумовлених в Додатку №2 ТР ОБНР, :

1. свинець(Pb) – не перевищує 0,1 % ваги речовини або в концентрації до 1000 частин на мільйон;
2. кадмій (Cd) – не перевищує 0,01 % ваги речовини або в концентрації до 100 частин на мільйон;
3. ртуть(Hg) – не перевищує 0,1 % ваги речовини або в концентрації до 1000 частин на мільйон;
4. шестивалентний хром (Cr6+) – не перевищує 0,1 % ваги речовини або в концентрації до 1000 частин на мільйон;
5. полібромбіфеноли (PBB) – не перевищує 0,1% ваги речовини або в концентрації до 1000 частин на мільйон;
6. полібромдифенілові ефіри (PBDE) – не перевищує 0,1 % ваги речовини або в концентрації до 1000 частин на мільйон.

IMPORTANT SAFETY INSTRUCTIONS

- 1) Read these instructions.
- 2) Keep these instructions.
- 3) Heed all warnings.
- 4) Follow all instructions.
- 5) Do not use this apparatus near water.
- 6) Clean only with dry cloth.
- 7) Do not block any ventilation openings. Install in accordance with the manufacturer's instructions.
- 8) Do not install near any heat sources such as radiators, heat registers, stoves, or other apparatus (including amplifiers) that produce heat.
- 9) Do not defeat the safety purpose of the polarized or grounding-type plug. A polarized plug has two blades with one wider than the other. A grounding-type plug has two blades and a third grounding prong. The wide blade or the third prong are provided for your safety. If the provided plug does not fit into your outlet, consult an electrician for replacement of the obsolete outlet.
- 10) Protect the power cable from being walked on or pinched particularly at plugs, convenience receptacles, and the point where they exit from the apparatus.
- 11) Only use attachments/accessories specified by the manufacturer.
- 12) Use only with the cart, stand, tripod, bracket, or table specified by the manufacturer, or sold with the apparatus. When a cart is used, use caution when moving the cart/apparatus combination to avoid injury from tip-over.
- 13) Unplug this apparatus during lightning storms or when unused for long periods of time.
- 14) Refer all servicing to qualified service personnel. Servicing is required when the apparatus has been damaged in any way, such as power-supply cord or plug is damaged, liquid has been spilled or objects have fallen into the apparatus, the apparatus has been exposed to rain or moisture, does not operate normally, or has been dropped.



S3125A

ENGLISH

■ **How to open the operating instruction manual PDF files**

Discontinue installation if the installation screen of the software opens as a result of inserting the CD-ROM.

When [INDEX.pdf] on the CD-ROM is opened, a list of the operating instruction manuals will be displayed.

Click on the document name of the manual to be opened.

■ **Adobe® Reader® is required to read PDF files.**

It can be downloaded from the home page of Adobe Systems.

DEUTSCH

■ **Öffnen der PDF-Dateien der Bedienungsanleitung**

Brechen Sie die Installation ab, falls beim Einlegen der CD-ROM der Installationsbildschirm der Software erscheint.

Wenn [INDEX.pdf] auf der CD-ROM geöffnet wird, erscheint eine Liste der Bedienungsanleitungen.

Klicken Sie auf den Dokumentennamen der zu öffnenden Anleitung.

■ **Zum Lesen der PDF-Dateien benötigen Sie Adobe® Reader®.**

Dieses Programm kann von der Homepage von Adobe Systems heruntergeladen werden.

FRANÇAIS

■ **Comment ouvrir les fichiers PDF des manuels du mode d'emploi**

Arrêter l'installation si l'écran d'installation du logiciel s'ouvre quand le CD-ROM est inséré.

Quand [INDEX.pdf] sur le CD-ROM s'ouvre, la liste des manuels du mode d'emploi s'affiche.

Cliquer sur le nom du document correspondant au manuel à consulter.

■ **Adobe® Reader® est nécessaire pour lire les fichiers PDF.**

Ce logiciel peut être téléchargé depuis la page d'accueil d'Adobe Systems.

ITALIANO

■ **Come aprire i file dei manuali di istruzioni per l'uso**

Se inserendo il CD-ROM si apre la schermata di installazione del software, interrompere l'installazione.

Aperto [INDEX.pdf] sul CD-ROM, viene visualizzato un elenco di manuali di istruzioni per l'uso.

Fare clic sul nome del documento corrispondente al manuale da aprire.

■ **Per leggere i file PDF è necessario Adobe® Reader®.**

Il programma può essere scaricato dal sito Web di Adobe Systems.

ESPAÑOL

■ **Modo de abrir los archivos PDF que contienen el manual de las instrucciones de funcionamiento**

Interrumpa la instalación si la pantalla de instalación del software se abre como resultado de insertar el CD-ROM.

Cuando se abra [INDEX.pdf] en el CD-ROM se visualizará una lista de los manuales de instrucciones de funcionamiento.

Haga clic en el nombre de documento del manual que va a abrir.

■ **Para leer los archivos PDF se necesita el programa Adobe® Reader®.**

Este programa se puede descargar de la página inicial de Adobe Systems.

日本語

■ **取扱説明書PDFファイルの聞き方**

CD-ROMを挿入してソフトウェアのインストール画面が立ち上がる場合は、インストールを中止してください。

CD-ROM内の[INDEX.pdf]を聞くと取扱説明書の一覧が表示されません。

開きたい取扱説明書のドキュメント名をクリックしてください。

■ **PDFファイルをご覧いただくには、Adobe® Reader® が必要です。**

アドビシステムズ社のホームページからダウンロードしてください。

About this instruction manual

■ About trademarks and registered trademarks

- Adobe® and Reader® are either registered trademarks or trademarks of Adobe Systems Incorporated in the United States and other countries.
- SDHC logo is a trademark of SD-3C and LLC.
- Other names of companies or products in this manual are either registered trademarks or trademarks of their respective owners.

■ About copyright

Distributing, copying, disassembling, reverse compiling, reverse engineering and also exporting in violation of export laws of the software provided with this unit are expressly prohibited.

■ Abbreviations

The following abbreviations are used in this manual.

- The AK-HRP200G is referred to as the AK-HRP200 in this manual.
- The term memory card will be used below as a generic term for both SD and SDHC memory cards.
SD or SDHC will be used in descriptions that refer to only one of the two card types.
- A studio handy camera is referred to as a camera in this manual.
- A camera control unit is referred to as a CCU in this manual.
- A remote operation panel is referred to as an ROP in this manual.

■ Illustrations and screen displays in this manual

- Illustrations and screen displays in the manual may differ from those actually displayed.

Regarding the Protection of Personal Information

削除します

Images of clearly identifiable individuals that are recorded using this unit are subject to the Act on the Protection of Personal Information.*
Be sure to handle image information in accordance with the law.

* Please refer to "Cases corresponding to personal information" in the "Guidelines Targeting Economic and Industrial Sectors Pertaining to the Act on the Protection of Personal Information" published by the Ministry of Economy, Trade and Industry.

• Images recorded by this product and stored on the SD memory cards it uses may be classified as personal information. Make sure that such information is handled appropriately such as when this product is disposed of, transferred, handed in for repair or otherwise comes into the hands of a third person. Remove the SD memory card and store it in a safe place.

Table of Contents

Read this first!	2	Rack installation (rack mounting)	8
About this instruction manual	5	System component connections	9
Introduction	6	Outside dimension drawing	9
Features	7	Parts and their functions	10
Accessories	7	Operation panel	10
Precautions for use	7	Connector Panel	18
Precautions for installation	8	Dip Switches	18
Setting up the unit	8	Specifications	19
Installing and removing rack mount brackets.....	8	Index	19

Introduction

■ Overview

This unit is a remote operation panel for controlling a studio handy camera (AK-HC3800) and a camera controller unit (AK-HCU200). Use a dedicated optical fiber cable to connect a studio handy camera to a camera controller unit and use an ROP cable to connect this unit to the camera controller unit.

■ Memory Cards

Use only memory cards that comply with the SD and SDHC specifications in this unit.

Be sure to format memory cards in this unit.

This unit supports the following memory card capacities.

It does not support SDXC memory cards.

SD memory cards: 8 MB to 2 GB

SDHC memory cards: 4 GB to 32 GB

For the latest information not available in the Operating Instructions, visit the following Web site.

<http://pro-av.panasonic.net/>

Pay attention to the following when using and storing the unit.

- Avoid locations exposed to high temperature and humidity
- Avoid exposure to condensation
- Avoid static electricity.

■ Software upgrades

For upgrades, visit Support & Download on the Panasonic website.

<http://panasonic.biz/sav/>

Follow the instructions included in the download file to perform the upgrade.

■ Disclaimer

Panasonic Corporation will not accept any liability whatsoever for any of the following.

- (1) Any direct, indirect, accidental, special or consequential damage or loss related to this unit
- (2) Personal injury or equipment damage caused by inappropriate use or negligent operation of the user
- (3) Disassembly, repair or modification of the unit by the user
- (4) Inconvenience, loss or damage when images cannot be displayed for whatever reason including unit failure or defects
- (5) Any defect or inconvenience, loss or damage resulting from such a defect arising when the unit is combined with the device of a third party
- (6) Loss of recorded data for whatever reason

Features

- This unit is a remote operation panel for controlling a studio handy camera (AK-HC3800) and a camera controller unit like the AK-HCU200.
- A simple button layout and an IRIS control lever ensure intuitive and stable operation.
- Scene files, user files and lens files can be stored on memory cards.

Accessories

Make sure that the following accessories are supplied.

- Be sure to appropriately dispose of the packing material when you have unpacked the product.

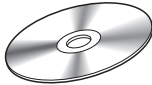
CD-ROM..... 1

• Operating Instructions <Basics>
• Operating Instructions <Operations and Settings>

Precautions for use

Observe the following in addition to the information included in “Read this first!”.

■ Handle carefully

Do not drop the unit or expose it to strong impacts or vibrations. Do not carry the unit by the iris lever. The unit could be damaged or cause an accident.

■ Use the unit within a temperature range of 0°C to 40°C (32°F to 104°F).

Exposure to temperatures below 0°C (32°F) or above 40°C (104°F) could adversely affect internal components.

■ Power off before connecting or disconnecting cables

Connect and disconnect cables when the unit is turned off (when the CCU is off, the ROP cable is disconnected and an external DC power supply is not connected).

■ Avoid humidity and dust

Avoid using the unit in an excessively humid or dusty location to prevent damage to internal components.

■ Maintenance

Turn the unit off and wipe it with a dry cloth. To remove stubborn soiling, immerse a cloth in a solution of a neutral kitchen detergent and water, wring it out thoroughly and wipe the unit gently. Then wipe it with a dry cloth to remove any moisture.

<Note>

- Do not use benzine, paint thinner or other volatile fluids.
- If you use a chemical cloth for cleaning, read through the precautions before use.

■ Avoid exposure to water

Make sure that the unit is not directly exposed to water. Exposure to water could damage it.

■ Disposal

When the unit reaches the end of its service life, ask a special contractor to dispose of it properly according to environmental regulations.

Precautions for installation

Observe the following in addition to the information included in “Read this first!”.

Have your supplier install the unit and handle connections.

■ Cable connections

- Be sure to use dedicated remote operation panel (ROP) cables.
- If the unit will not be used for an extended period of time, disconnect the ROP cables to save electricity.

■ Handle carefully

- Make sure you do not drop or expose the unit to strong impacts or vibrations that could damage the product or cause accidents.

■ Do not insert foreign material in the unit.

- Foreign materials such as water, metal objects, food or drink that enter the unit could cause a fire or electrical shock.

■ Installation location

- This unit is designed for indoor use.
- Use the unit on a stable and horizontal surface that is sufficiently capable of supporting its weight.
- When the unit will be recessed into a panel or table, make sure that enough space is provided for ventilation and cables.
- Do not install the unit in a location where it and the cables can be easily damaged.
- Do not install the unit in a location where the temperature drops to 0°C (32°F) or lower or reaches 40°C (104°F) or higher.
- Do not install the unit in a location exposed to direct sunlight or near exhaust vents that expel hot air.
- Do not install the unit in a location exposed to excessive humidity, dust or vibrations to prevent malfunction.

Setting up the unit

Installing and removing rack mount brackets

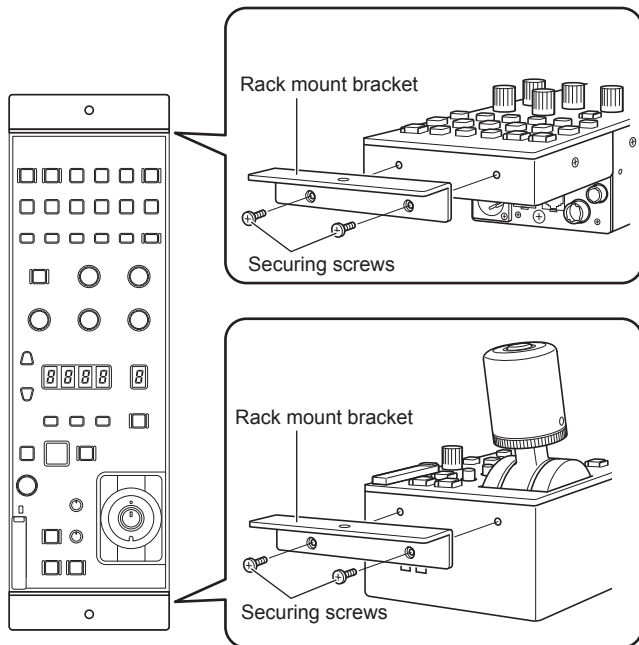

The unit is shipped from the factory with the rack mount brackets installed.

The customer can remove the four screws that hold the rack mount brackets in place using a Phillips screwdriver.

<Note>

- After detaching, store the rack mount brackets and the screws in a location easily accessible when required.
- Next time you use the rack mount brackets to secure the unit, tighten the four screws to a torque of 50 N•cm or more.

Rack installation (rack mounting)

Securing screw (commercially available)

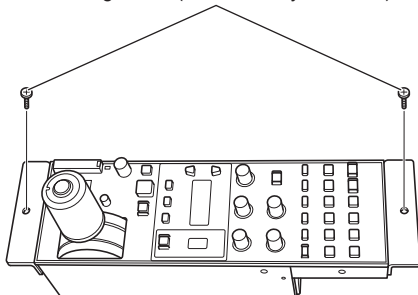

Secure the unit to the rack using two screws.

<Note>

- The securing screws are not supplied with the unit. Purchase screws that will fit the 5 mm (3/16 inch) in diameter holes before rack mounting.
- The temperature in the rack must be between 0 °C (32°F) and 40 °C (104°F).

System component connections

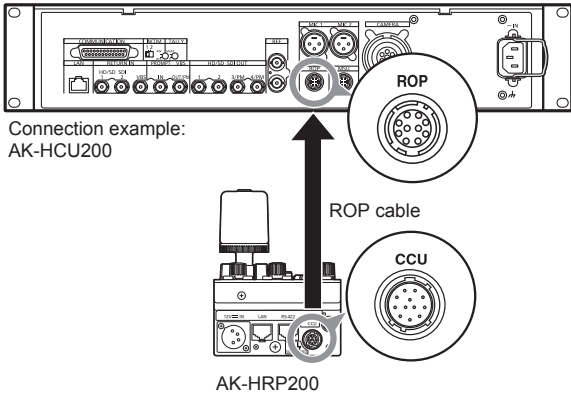

1. Connect the CCU connector on this unit to the ROP connector on the CCU rear panel using a dedicated ROP cable (sold separately).

2. After having connected all the components, turn the CCU main power on, and then turn the camera on.

<Note>

- If no camera is connected, the number of CCU functions that this unit can control is limited.
- Turn off the CCU before disconnecting the ROP cable.

Outside dimension drawing

Unit: mm (inch)

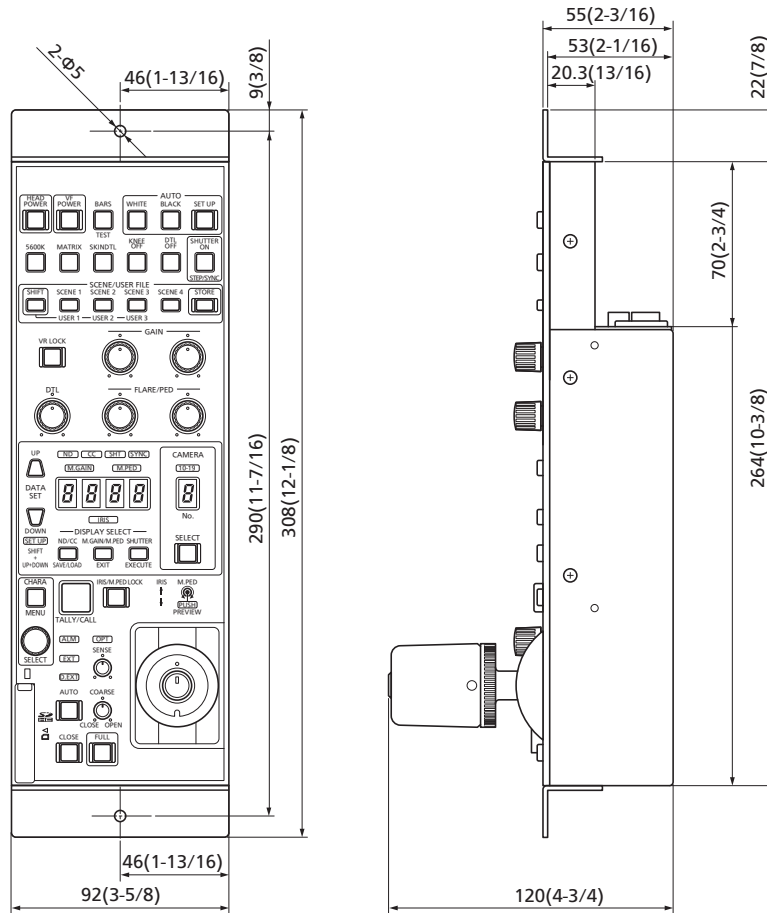

Parts and their functions

Operation panel

A beep (buzzer) sounds when a button is pressed. However, buttons do not beep when the buzzer is set to Off in setup mode.

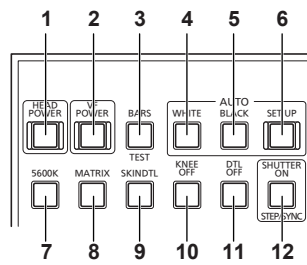

1. Camera power button <HEAD POWER>

Use this button to control camera power remotely. However, it will not function unless the CCU and the camera are turned on.

Each press of the button turns the power on and off.

On (green):	The camera is turned on.
On (red):	The camera is turned off.
Flashing (red):	The unit is off.

When the camera is powered from an external DC power supply, the button lights green and the camera power supply cannot be remotely controlled from this unit.

2. Viewfinder power button <VF POWER>

Use this button to control camera viewfinder power remotely. It lights when the unit is ON.

When the camera is turned on by the unit, the viewfinder is also turned on.

Each press of the button turns the power On (power on) and Off (power off).

On (green):	Both the camera and viewfinder are On.
Off:	The viewfinder has been turned off from the unit

<Note>

The button lights (green) or goes off with each press of the button also when the viewfinder is turned off.

3. Color Bar Signal Output button <BARS/TEST>

Use this button to output the camera color bar signal from the camera via the camera video output on the CCU rear panel.

To select a CCU color bar type, choose [SYSTEM(1/2)] → [HD COLOR BAR] in the ROP menu. (For details, refer to Operations and Settings on the supplied CD-ROM)

Select the camera color bar from the camera menu. (Refer to the operating instructions supplied with the camera.)

When the video signal is a camera signal or a color bar signal, press and hold the Color Bar Signal Output <BARS/TEST> button to select the TEST signal. To switch from TEST signal output, press the Color Bar Signal Output button <BARS/TEST> to select camera video output.

On (yellow):	CCU color bar and camera color bar On
On (green):	TEST signal On
Off:	Camera video

4. Auto White Balance button <WHITE>

Use this button to automatically adjust the white balance.

On:	This indicates that the auto white balance adjustment has started.
Flashing:	This warns that the automatic white balance adjustment ended without being completed. When highlights and lowlights are lost, white balance is returned to its previous value. When correct white balance cannot be obtained, adjustment stops at the last obtained value.
Off:	This indicates that the white balance has been adjusted correctly.

Pressing the Auto White Balance button <WHITE> during white balance adjustment (lamp on) cancels adjustment and turns the lamp off. Then the white balance value returns to the value it had prior to auto white balance adjustment.

<Note>

If the auto white balance adjustment is not completed, check the message on the picture monitor (PM) on the CCU.

5. Auto Black Balance button <BLACK>

Use this button to automatically adjust the black balance.

Automatic white spot correction is performed simultaneously.

On:	This indicates that the automatic black balance adjustment has started.
Flashing:	This warns that the automatic black balance adjustment ended without being completed. Auto black balance returns to the value it had prior to adjustment.
Off:	This indicates that the black balance has been adjusted correctly.

Pressing the Auto Black Balance button <BLACK> during black balance adjustment (lamp on) cancels adjustment and turns the lamp off. Then the black balance value returns to the value it had prior to auto black balance adjustment.

<Note>

If the auto black balance adjustment is not completed, check the message on the picture monitor (PM) on the CCU.

6. Auto Setup button <SETUP>

Use this button to start auto setup.

The setup status is output to the picture monitor.

Choose [FUNCTION] → [ASU SETUP] in the ROP menu to select [OUT FULL] or [OUT EASY] mode. (For details, refer to Operations and Settings on the supplied CD-ROM)

	Standard setup based on an outdoor shooting chart
OUT FULL:	<Sequence of operation execution> AWB→ABB→BSHD→ABB→AWB→FLARE→AWB
	Easy setup based on an outdoor shooting chart
OUT EASY:	<Sequence of operation execution> AWB→ABB→AWB→FLARE→AWB

Align the position of the gray scale wedge with the angle of view in the vertical direction of the viewfinder. Be sure to correctly select the position from which you shoot the chart since some positions may not enable a satisfactory auto setup.

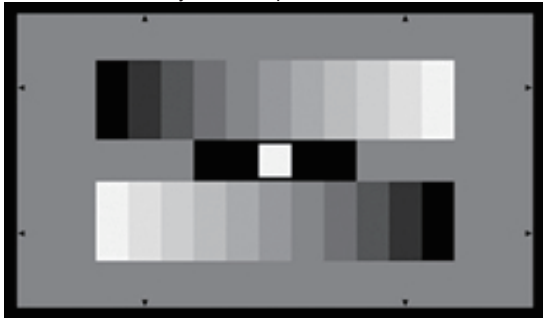

(Recommended gray scale)

● Starting auto setup

1. Press <SETUP>.

<SETUP> flashes at about 2-second intervals while the auto setup start preparation mode is established, and a square marker appears in the center of the camera viewfinder. Align the white at the center of the gray scale with this square marker. (To cancel setup button, press and hold the switch.)

2. Press <SETUP> again.

<SETUP> lights as auto setup starts. (Pressing <SETUP> during the auto setup operation will abort auto setup.)

<SETUP> goes off when auto setup ends successfully.

If <SETUP> flashes at approximately 1-second intervals, auto setup has ended without being completed. During the auto setup operation, the picture monitor (PM) displays characters to indicate operation status.

<Note>

If auto setup is not completed, check the message on the picture monitor (PM) on the CCU.

7. 5600 K button <5600K>

Use this function to change the amplification rate of the RB signals by an electrical circuit to achieve a white balance that corresponds to a 5600K color temperature. When the 5600K button <5600K> is set to On, the B video signal is attenuated by about -6 dB, the R video signal is boosted by about 3 dB while the G video signal is not attenuated.

Select this setting for shooting under a 5600K light source or when shooting outdoors.

On:	ON
Off:	OFF

8. Matrix button <MATRIX>

Use this function to correct saturation and color phase according to the gain setting of each color component in matrix memory. Each press of the button turns the function on or off.

On:	ON
Off:	OFF

9. Skin Detail button <SKINDTL>

Use this button to apply coring to the detail enhancement of the skin tone areas in the HDTV video output signals to soften or increase the enhancement of skin tone details. Each press of the button turns the function on or off.

On:	ON
Off:	OFF

10. Knee OFF button <KNEE OFF>

Use this button to cancel the knee function that attenuates those areas of the video signals where a particular level (knee point) has been exceeded so that they will not become saturated as easily.

On:	Knee function is canceled. (Knee OFF)
Off:	Knee function is on.

11. Detail OFF button <DTL OFF>

Use this button to cancel contour enhancement (hard/soft) (detail enhancer) of image output.

On:	Turns off contour enhancement (detail enhancer off)
Off:	Turns on contour enhancement (detail enhancer on)

12. Shutter On/Off button <SHUTTER ON> STEP/SYNC select button <STEP/SYNC>

Use this button to turn the SHUTTER on or off. Press and hold the button to switch between STEP and SYNCRO. In SHUTTER ON mode, the SHUTTER display select button <SHUTTER> and the SHUTTER display <SHT> goes on, and the setting appears on the setting display for about 2 seconds.

On:	SHUTTER ON (STEP/SYNCRO setting is available)
Off:	SHUTTER OFF (STEP/SYNCRO setting is available)

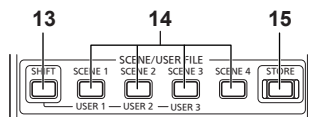

13. Scene/User File selector button <SHIFT>

Use this button to determine whether the SCENE/USER FILE select button will be used for selecting scene files or user files. Simultaneously pressing this button and a SCENE/USER FILE select button 1 to 3 <SCENE1/USER1> to <SCENE3/USER3> allows you to select user files 1 to 3.

Scene file	Scene files are mainly used by video engineers (VE) to create the required image characteristics.
User file	A user file is system setting data (reference file) composed of scene files and operation data. The user can record user files.

For details on scene files and user files, refer to Operations and Settings on the supplied CD-ROM and also Operating Instructions of studio handy camera (AK-HC3800).

14. SCENE/USER FILE select buttons

<SCENE 1/USER1> to <SCENE 3/USER 3> <SCENE 4>

Use these buttons to open previously saved scene files (1 to 4) or user files (1 to 3) when needed. You can also use them to store your own scene files (1 to 4) or user files (1 to 3).

On:	A scene file is selected
Off:	A scene file is not selected

The button lights for about 1 second before going off: A user file is selected

● Opening a scene file

Press the SCENE/USER FILE select button <SCENE1/USER1> to <SCENE3/USER3> or <SCENE4> for the number of the scene file (1 to 4) you want to open.

The pressed button lights and the scene file opens.

The button remains lit even after the file has opened.

To cancel opening a scene file, press the SCENE/USER FILE select button that is on to turn it off.

The setting information that was temporarily saved before the scene file was opened is now restored, and the settings made prior to the scene file call are also restored.

Pressing a SCENE/USER FILE select button other than the lit scene/user file select button lights the button of that scene/user file and opens it.

<Note>

Settings that are adjusted while the scene file is being opened or after it has opened will persist when the power is turned off.

● Opening a user file

Hold down <SHIFT> while pressing the SCENE/USER FILE select button <SCENE1/USER1> to <SCENE3/USER3> for the number of the scene file (1 to 3) you want to open.

The pressed button lights and the user file opens in about 1 second. About a second later the button goes off.

<Note>

Opening a user file will cancel a previously selected scene file.

- Hold down <TALLY/CALL> and press <SHIFT> and <SCENE4> to return camera scene files and user files to their factory default settings. Then turn off the CCU.
- To return the CCU scene files and user files to their factory default settings, choose [MAINTENANCE] > [SYSTEM] > [INITIALIZE] in the CCU menu.

15. Scene/user file store button <STORE>

Use this button to store your own scene files (1 to 4) or user files (1 to 3).

On:	Indicates that a scene or user file can be stored
Off:	Indicates that the scene or user file has been stored or canceled

● Storing scene files to buttons 1 to 4

1. Press <STORE>.

The button lights.

2. Press the SCENE/USER FILE select button <SCENE1/USER1> to <SCENE3/USER3> or <SCENE4> for the number of the scene file or user file you want to store.

The button lights and scene file storage starts.

The button goes off when storage ends.

When the file has been stored, it is selected and the SCENE/USER FILE select button lights.

<Note>

Adjustments made after opening a scene file that is later stored will be stored with the adjustments. The stored scene file is then selected and the corresponding SCENE/USER FILE select button lights.

● Storing settings to user files 1 to 3

1. Adjust and set up the camera to the status you want to store in a file.

2. Press <STORE>.

The button lights.

3. In this condition, hold down <SHIFT> and press the SCENE/USER FILE select button <SCENE1/USER1> to <SCENE3/USER3> for the number of the user file you want to store the settings in.

The button lights and file storage starts.

When storage is completed, the scene/user file <STORE> button goes off. The SCENE/USER FILE select button also goes off.

<Note>

A scene file that is open or about to open will remain selected when stored in a user file.

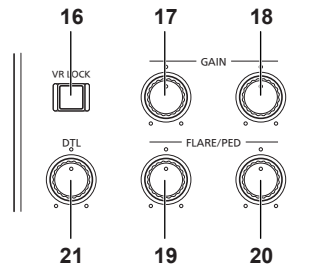

16.Control lock button <VR LOCK>

Use this button to lock (disable) the paint control operation. It controls GAIN (R, B), PED/FLARE (R,B) and DTL paint. Each press of the button turns the function on or off.

On:	ON (locks the paint control value)
Off:	OFF (the paint control value changes)

● **Using the control lock button <VR LOCK>**

1. Use the controls (17 to 21) to make adjustments.

2. Press <VR LOCK>.

The button lights.

The unit will register this paint control value.

3. Turn the control to its center position.

4. Press <VR LOCK> again.

The button goes off and the control lock is released.

Then the control is set to the paint control value stored in step 2.

17.R gain control <GAIN R>

Use this control to adjust the red (R) components of the white balance.

It is controlled by control lock (VR LOCK).

18.B gain control <GAIN B>

Use this control to adjust the blue (B) components of the white balance.

It is controlled by the control lock (VR LOCK).

19.R flare/pedestal control <FLARE/PED R>

Use this control to adjust the red (R) components in pedestal or flare.

Setup mode determines whether it controls pedestal or flare.

It is controlled by the control lock (VR LOCK).

20.B flare/pedestal control <FLARE/PED B>

Use this control to adjust the blue (B) components in pedestal or flare.

Setup mode determines whether it controls pedestal or flare.

It is controlled by the control lock (VR LOCK).

21.DTL control <DTL>

Use this control to adjust detail enhancer effects.

It is controlled by the control lock (VR LOCK).

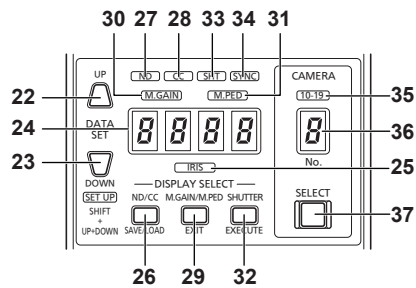

22.DATA SET button <UP>

Use this button to increase set values when ND filter/CC filter, M.GAIN or SHUTTER/SYNCRO is displayed. Each press of the button increases the set value.

On:	Enabled
Off:	Disabled

<Note>

The CC filter cannot be used on the AK-HC3800 studio handy camera.

23.DATA SET button <DOWN>

Use this button to decrease set values when ND filter/CC filter, M.GAIN or SHUTTER/SYNCRO is displayed. Each press of the button decreases the set value.

On:	Enabled
Off:	Disabled

<Note>

The CC filter cannot be used on the AK-HC3800 studio handy camera.

24.Setting display (4 digits)

This function indicates settings.

It indicates IRIS values when the power is on. Pressing one of the display select buttons displays the selected setting. It displays the range of settings and standard position (default setting).

Item	Adjustable range	Display	Standard position
IRIS		_■■■	
ND	1 to 4 1: Clear 2: 1/4 3: 1/16 4: 1/64	■_	1
CC	Not supported by the AK-HC3800 studio handy camera.	■_	1
M.GAIN	-3 to 12 (in 3 dB steps), 18, 27, 36 • Depends on camera setting.	■■_	0
M.PED		_■■■	0
SHUTTER	- At 59.94 Hz STEP: 1/100 to 1/2000 SYNCRO: 61.7 to 6130 - At 50 Hz STEP: 1/60 to 1/2000 SYNCRO: 51.5 to 6250	■■■■	-

25.IRIS display <IRIS>

The setting display lights green when an IRIS setting is displayed. It indicates IRIS values when the power is on. Operating the Iris lever when the setting display shows something other than IRIS will replace this indication with the IRIS value for about 2 seconds.

26.ND filter/CC filter DISPLAY SELECT button <ND/CC>

SAVE/LOAD button <SAVE/LOAD> (In setup mode)

Press this button to display and change set values for the ND or CC filters.

On (white):	Displays the ND filter and CC filter settings
Off:	Displays settings other than the ND filter and CC filter settings

<Note>

The CC filter cannot be used on the AK-HC3800 studio handy camera.

● Setting and displaying the ND filter and CC filter

1. Press <ND/CC> when IRIS or other (M.GAIN/M.PED or SHUTTER) DISPLAY SELECT status is displayed.

The button lights and the ND filter display <ND> lights green. (However, when the ND filter or CC filter is not at the standard position, the display always lights yellow)

2. Press the lit DATA SET button <UP> <DOWN>.

This allows you to change the ND filter setting.

3. Press <ND/CC> again.

The ND filter display <ND> goes off, the CC filter display <CC> lights green and the setting display indicates the CC setting. Press the lit DATA SET button <UP> <DOWN> to change the CC filter setting.

Since the AK-HC3800 is not equipped with a CC filter function, a bar display appears.

4. Press <ND/CC> again.

The button goes off and the ND filter display <ND> and CC filter display <CC> go off. (However, when the ND filter or CC filter is not at the standard position, the display stays yellow) Then the setting display returns to IRIS indication. Pressing another DISPLAY SELECT button (<M.GAIN/M.PED> or <SHUTTER>) turns off the button and lights the selected button.

In setup mode, use it to switch submenus.

For details on setup mode, refer to Operations and Settings on the supplied CD-ROM.

27.ND filter display <ND>

The setting display lights green when ND filter settings are displayed. When the ND filter setting is not at the standard position, the setting display always lights yellow regardless of what it shows. (Standard position: 1)

28.CC filter display <CC>

The setting display lights green when CC filter settings are displayed. When the CC filter setting is not at the standard position, the setting display always lights yellow regardless of what it shows. (Standard position: 1)

<Note>

The CC filter cannot be used on the AK-HC3800 studio handy camera.

29.M.GAIN/M.PED DISPLAY SELECT button <M.GAIN/M.PED>

EXIT button <EXIT> (In setup mode)

Press this button to display and change M.GAIN or M.PED settings.

M.PED settings are only displayed, the DATA SET buttons <UP> <DOWN> cannot be used to make settings. Use the Master pedestal control <M.PED> to adjust the iris lever.

● **Setting and Displaying M.GAIN/M.PED**

1. Press <M.GAIN/M.PED> when IRIS or other (ND/CC, SHUTTER) DISPLAY SELECT status is displayed.

The button lights and the M.GAIN display <M.GAIN> lights green. (However, when M.GAIN is not at the standard position, the display always lights yellow)

2. Press the lit DATA SET button <UP> <DOWN>.

This allows you to change the M.GAIN setting.

3. Press <M.GAIN/M.PED> again.

The M.GAIN display <M.GAIN> goes off and the M.PED display <M.PED> lights green. (However, when M.PED is not at the standard position, the display always lights yellow)

4. Press <M.GAIN/M.PED> again.

The button goes off and the M.PED display <M.PED> goes off. (However, when M.GAIN or M.PED is not at the standard position, the display stays yellow)

Then the setting display returns to IRIS indication.

<Note>

Use the master pedestal control to adjust M.PED. (This setting is always available regardless of display status)

Pressing another Display Select button (<ND/CC> or <SHUTTER>) turns off the button and lights the selected button.

To exit setup mode, hold down this button for about 2 seconds.

For details on setup mode, refer to Operations and Settings on the supplied CD-ROM.

30.M.GAIN display <M.GAIN>

The setting display lights green when a M.GAIN setting is displayed.

When the M.GAIN setting is not at the standard position, the setting display always lights yellow regardless of what it shows.

(Standard position: 0)

When a M.GAIN setting is selected, the M.GAIN display lights.

31.M.PED display <M.PED>

The setting display lights green when an M.PED setting is displayed.

When the M.PED setting is not at the standard position, the setting display always lights yellow regardless of what it shows.

(Standard position: 0)

Operating the master pedestal control <M.PED> when the setting display shows something other than M.PED will replace this indication with the M.PED value for about 2 seconds.

<Note>

Use the master pedestal control <M.PED> to adjust M.PED. (This setting is always available regardless of display status)

32.SHUTTER DISPLAY SELECT button <SHUTTER>

EXECUTE button <EXECUTE> (In setup mode)

Press this button to display and change SHUTTER settings.

<Note>

When the Shutter On/Off button <SHUTTER ON> is set to Off, the SHUTTER DISPLAY SELECT button <SHUTTER> is available and the SHUTTER can be adjusted. (Adjustments can be made prior to operation)

● **Setting and displaying the SHUTTER**

Hold down the STEP/SYNC select button <STEP/SYNC> for about 2 seconds to switch between STEP and SYNC settings. When SYNCRO is selected, the SYNCRO display lights green.

1. Press <SHUTTER> when IRIS or other (ND/CC, M.GAIN/M.PED) DISPLAY SELECT status is displayed.

The button lights and the SHUTTER display <SHT> where STEP/SYNC is selected lights green.

Then the setting display shows the SHUTTER setting of STEP or SYNCHRO selected using the STEP/SYNC select button <STEP/SYNC>.

2. Press the lit DATA SET button <UP> <DOWN>.

This allows you to change the SHUTTER setting.

3. Press <SHUTTER> again.

The button goes off and the SHUTTER display <SHT> goes off. Then the setting display returns to IRIS indication.

Pressing another Display Select button (<ND/CC> or <M.GAIN/M.PED>) turns off the button and lights the selected button.

In setup mode, it confirms menus and set values.

For details on setup mode, refer to Operations and Settings on the supplied CD-ROM.

33.SHUTTER display <SHT>

The setting display lights green when a SHUTTER setting is displayed.

<Note>

Hold down the STEP/SYNC select button <STEP/SYNC> for about 2 seconds to switch between STEP and SYNC settings. When SYNCRO is selected, the SYNCRO display <SYNC> lights green.

34.SYNCR0 display <SYNC>

The setting display lights green when a SHUTTER (SYNC) setting is displayed. The STEP display light goes off.

Off:	SHUTTER is in STEP mode
On:	SHUTTER is in SYNCRO mode

<Note>

Hold down the STEP/SYNC select button <STEP/SYNC> for about 2 seconds to switch between the STEP and SYNCRO settings.

35.Camera number tens' place digit display <10 to 19>

This LED lights when the camera number is a number between 10 and 19. Use setup mode to set camera number.

On:	The camera number is a number between 10 and 19.
Off:	The camera number is a number between 1 and 9.

36.Camera number display <No.>

This function displays the camera number. Indicates the one's digit of a camera number between 10 to 19. The ten's digit is indicated by the ten's digit display.

Use setup mode to set the camera number.

37.Camera select button <SELECT>

For future use.

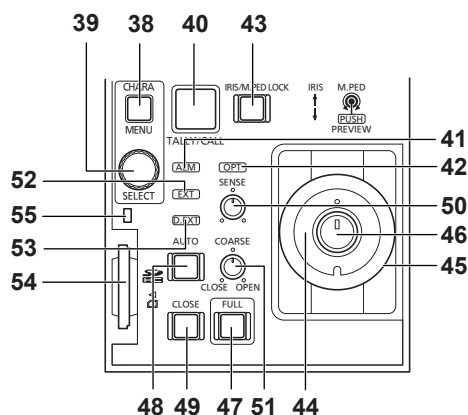

38.Character/Menu button <CHARA/MENU>

Use this function to switch on and off the characters (status screen) displayed on the picture monitor (PM).

Press and hold (for 2 seconds) to display the ROP menu on the picture monitor.

For details on the ROP menu, refer to Operations and Settings on the supplied CD-ROM.

Short press (On):	Displays characters on the PM
	Each short press changes the display data.
Press and hold (Off):	Turns off the PM character display

To open the ROP menu when characters are displayed on the PM, hold down the button to turn off the character display.

Press and hold (On):	Displays the ROP menu on the PM.
Press and hold (Off):	Turns off the ROP menu display on the PM

To display characters when the ROP menu is open, hold down the button to close the ROP menu.

<Note>

When characters do not appear, the video output has not been set to PM. Since characters appear in SDI 3&4 or VBS output from the CCU, make the settings that your operating environment requires.

39.Select dial <SELECT>

Perform the following menu operations when the ROP menu is displayed on the picture monitor (PM).

For details on the ROP menu, refer to Operations and Settings on the supplied CD-ROM.

Turn clockwise:	Increases the selected value and selects the bottom of the menu
Turn counterclockwise:	Decreases the selected value and selects the top of the menu
Press:	Confirms the selected value and the menu

40.Red/green tally display, Call button <TALLY/CALL>

The tally lights red when the red tally is input to the CCU communication connector.

The tally lights green when the green tally is input. When both are input, the tally lights red.

Press this button to use it as a Call switch. Pressing the button when it is not on will light it. Pressing it when it is on will light turn it off.

Pressing it when it is on or off will light the Call lamp on the CCU and the indicator (TALLY) on the camera.

Pressing the call switch on the camera or CCU sounds the unit buzzer. It stays on as long as the switch is depressed (when the buzzer is set to On). The tally also lights red when the button is off, but goes off if the button is lit red or green.

41.Alarm display <ALM>

This indicator displays alarms.

Consult your supplier if a failure occurs.

On:	Lights when the camera fan stops due to a failure. • Alarm data can be displayed on the CCU PM. • When an alarm occurs, the Character/Menu button <CHARA/MENU> on the unit lights and an alarm display appears like an interrupt on the CCU PM.
Flashing:	Indicates that the power voltage of the unit has decreased
Off:	Normal operating status

42.Optical alarm display <OPT>

This is the optical transmission warning indicator light.

When camera/CCU reception strength level is low, the display lights yellow or red.

When the optical fiber cable has not been properly connected or seated, disconnect the camera/CCU optical cable. Then connect the cable again making sure that it is properly seated. If this does not remedy the problem, turn off the CCU, disconnect the optical fiber cable between the camera and the CCU and clean the optical connectors. Use a cotton swab moistened in alcohol to gently clean the fiber surfaces.

Off:	Normal operating status (optical reception strength level is 5)
Lights yellow:	Optical reception level 3 or 4
Lights red:	Optical reception level is 1 or 2, or the cable is disconnected
Flashes red:	The cable is connected but is short-circuited

43.Iris/master pedestal lock button <IRIS/M.PED LOCK>

Use this function to disable iris and M.PED operation.

The button lights red when they are disabled.

Press the button again to release the lock.

Off:	Iris and M.PED can be controlled
Lights red:	Disabled (locked)
Flashes red:	Indicates that the Iris lever was operated when the function was disabled (locked). When the Iris lever is returned to lock position, the button goes off and normal control is available.

44.Iris lever <IRIS (↑ ↓)>

Use this to control the iris level.
 This function is enabled when the iris/master pedestal lock is released.
 If the auto iris is not on, the iris can be controlled manually.
 When the auto iris is on, the iris level (standard value for automatic aperture adjustment) is automatically adjusted.
 Press the button at the front end of the lever to connect the preview signal from the preview connector.

During manual iris adjustments (when the <IRIS/M.PED LOCK>, <AUTO>, <FULL> buttons are all off)

Front position:	Adjusts the iris in the CLOSE direction within the range set by the sense and range control.
Rear position:	Adjusts the iris in the OPEN direction within the range set by the sense and range control.

In auto iris adjustment mode

Front position:	Adjusts the auto iris level in the CLOSE direction
Rear position:	Adjusts the auto iris level in the OPEN direction

45.Master pedestal control <M.PED>

Use this function to control the master pedestal level. Turn it clockwise to increase the master pedestal.
 Turning the master pedestal control <M.PED> will display the setting on the setting display for about 2 seconds.
 The master pedestal and the R, G and B pedestal can be adjusted independently. A master pedestal adjustment does not affect the R, G and B pedestal values.
 Pressing the M.GAIN/M.PED DISPLAY SELECT button twice displays the setting on the setting display.

46.Preview button <PREVIEW>

Use this function to output the preview signal from the preview output connector. (→page 18)

On (press):	Preview output is On
OFF:	Preview output is Off

47.Fader full button <FULL>

Use this button to set the range of the iris lever all the way from OPEN to CLOSE. To use the SENSE and COARSE controls, press the Fader Full button again to turn it off.

On:	Iris lever range is full (all the way from OPEN to CLOSE)
Off:	Iris lever range depends on the SENSE and COARSE control settings.

48.Auto iris button <AUTO>

Use this button to activate the auto iris function.
 Moving the Iris lever forward adjusts the auto iris level in CLOSE direction. Moving it to the rear adjusts it in the OPEN direction.

On:	The auto iris mode is enabled.
Off:	Manual (manual) adjustment using the iris bar is possible

For details on auto iris settings, refer to "ROP menu setting" in Operations and Settings on the supplied CD-ROM.

49.Iris close button <CLOSE>

Use this button to forcibly set the iris to CLOSE.

On:	Forcibly sets the iris to CLOSE.
Off:	Cancel iris CLOSE

50.Sense control <SENSE>

Use this control to adjust the iris range when the iris lever is moved from the center to the upper and lower edges.
 The aperture at the control center position is about ±1 f-stop

Turn clockwise:	Widens the range (iris lever sensitivity increases) The aperture at the rightmost control position is about ±2 f-stops
Turn counterclockwise:	Narrows the range (iris lever sensitivity decreases) The aperture at the leftmost control position is about ±2 f-stops

51.Coarse control <COARSE>

Use this control to adjust the iris value when the iris lever is moved to the center.

Turn clockwise (OPEN):	Increases the IRIS value At the rightmost position, the aperture is 3 f-stops higher than at the control center position.
Turn counterclockwise (CLOSE):	Decreases the IRIS value At the leftmost position, the aperture is 3 f-stops lower than at the control center position.

52.Lens extender indicator <EXT>

This indicator lights to warn that the lens extender is set to something other than 1x.

On:	The lens extender is set to something other than 1x.
Off:	This indicates that the lens extender is not being used or that it is not available.

53.Digital extender indicator <D.EXT>

This indicator lights to warn that the digital extender is set to something other than 1x.

On:	The digital extender is set to something other than 1x.
Off:	This indicates that the digital extender is not being used or that it is not available.

<Note>

Set to 2x on the AK-HC3800 studio handy camera.

54.Memory card slot

Insert a memory card in this slot. You can save scene files, user files and other files to a memory card.
 For details on what memory cards can be used with the unit, refer to page 6.

55.Memory card access indicator

This indicator lights when data is read from or loaded to a memory card.

Connector Panel

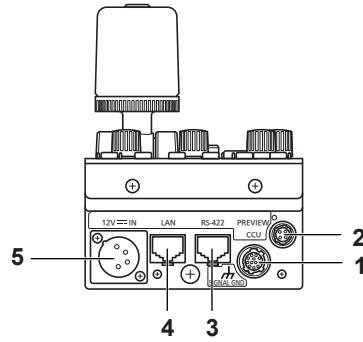

1. CCU connector <CCU>

(Hirose Electric: HR10A-10R-10P (71))

Connect this connector to the CCU of a camera.

Pin number	Function	Polarity	Signal flow
1	CAM DATA(H)	+	CAM→ROP
2	CAM DATA(L)	-	CAM→ROP
3	CAM CONT(H)	+	ROP→CAM
4	CAM CONT(L)	-	ROP→CAM
5	CAM No.A		
6	CAM No.B		
7	CAM No.C		
8	CAM No.D		
9	12V		
10	GND		

2. Preview connector <PREVIEW>

(Hirose Electric: HR10A-7R-4PC(73))

This connector outputs the preview signal. It provides contact output when the iris lever is depressed.

This is a dry contact.

Pin number	Function	Signal flow	Remarks
1	P.VIEW1	ROP → external control	Dry contact
2	P.VIEW2	ROP → external control	Dry contact
3	EXTRA1	External control → ROP	For future connections
4	EXTRA2	External control → ROP	For future connections

3. RS-422 connector <RS-422> (RJ-45 connector)

This connector is designed for future use. Do not use this connector.

4. IP connector <LAN> (RJ-45 connector)

This connector is designed for future use. Do not use this connector.

5. 12 V DC connector <12 V IN>

(Hirose Electric: HA16RA-4P (77))

A 12 V DC connector for connecting an AC adapter.

Pin number	Function
1	GND
2	NC
3	NC
4	+12V

<Note>

An external power supply is used when the unit is connected to LAN (and the CCU is not connected). (For future use)

Dip Switches

The dip switches (4 pins) on the side panel are for factory adjustments and should not be touched.

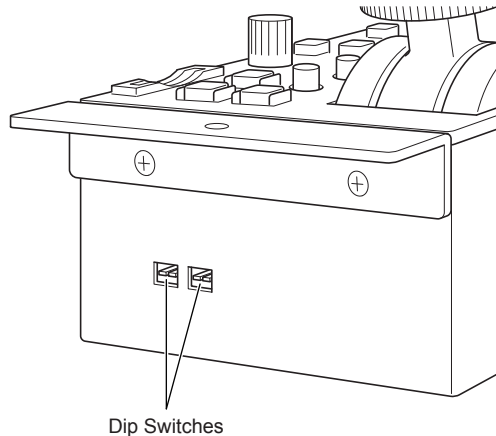

Specifications

■ General

Power input

Power supply: 12 V DC, 0.35 A (DC input range; 10 V DC - 16 V DC)
Power consumption: 4.2 W

 indicates safety information.

CCU control	- Control signals (camera, CCU control)
	- Power supply (12 V DC)*1
	*1 Can be provided from CCU or AC adapter

PREVIEW control	: Contact output
Maximum cable length	: 50 m (164 ft)
Operating temperature	: 0 °C to 40 °C (32 °F to 104 °F)
Storage temperature	: -20 °C to 60 °C (-4 °F to 140 °F)
Humidity	: 90 % or less
Dimensions (W x H x D)	: 92 mm x 308 mm x 55 mm (3-5/8 inches x 12-1/8 inches x 2-3/16 inches) (excluding protrusions)
Mass	: approx. 1.3 kg (approx. 2.87lb)

Index

Numerics

12 DC V connector	18
5600 K button	11

A

Accessories	7
Alarm display	16
Auto Black Balance button	10
Auto iris button	17
Auto setup	11
Auto Setup button	11
Auto White Balance button	10

B

B flare/pedestal control	13
B gain control	13

C

Call button	16
Camera number display	15
Camera number tens' place digit display	15
Camera power button	10
Camera select button	15
CC filter	14
CC filter display	14
CCU connector	18
Character/Menu button	16
Coarse control	17
Color Bar Signal Output button	10
Connection	9
Control lock	13
Control lock button	13

D

DATA SET button	14
Detail OFF button	11
Digital extender indicator	17
Dip Switches	18
DTL control	13

E

EXECUTE button	15
EXIT button	15

F

Fader full button	17
-------------------	----

I

IP connector	18
Iris close button	17
IRIS display	14
Iris lever	17
Iris/master pedestal lock button	16

K

Knee OFF button	11
-----------------	----

L

Lens extender indicator	17
-------------------------	----

M

Master pedestal control	17
Matrix button	11
Memory card access indicator	17
Memory card slot	17
M.GAIN display	15
M.GAIN/M.PED	15
M.GAIN/M.PED DISPLAY SELECT button	15
M.PED display	15

N

ND filter	14
ND filter/CC filter DISPLAY SELECT button	14
ND filter display	14

O

Optical alarm display	16
Outside dimension drawing	9

P

Preview button	17
Preview connector	18

R

Rack mount brackets	8
Rack mounting	8
Red/green tally display	16
R flare/pedestal control	13
R gain control	13
RS-422 connector	18

S

Scene file	
Opening	12
Storing	12
SCENE/USER FILE select buttons	12
Scene/User File selector button	12
Scene/user file store button	12
Select dial	16
Sense control	17
Setting display	14
SHUTTER	15
SHUTTER display	15
SHUTTER DISPLAY SELECT button	15
Shutter On/Off button	11
Skin Detail button	11
Specifications	19
STEP/SYNC select button	11
SYNCHRO display	15

U

User file	
Opening	12
Storing	12

V

Viewfinder power button	10
-------------------------	----

Information on Disposal for Users of Waste Electrical & Electronic Equipment (private households)



This symbol on the products and/or accompanying documents means that used electrical and electronic products should not be mixed with general household waste.

For proper treatment, recovery and recycling, please take these products to designated collection points, where they will be accepted on a free of charge basis. Alternatively, in some countries you may be able to return your products to your local retailer upon the purchase of an equivalent new product.

Disposing of this product correctly will help to save valuable resources and prevent any potential negative effects on human health and the environment which could otherwise arise from inappropriate waste handling. Please contact your local authority for further details of your nearest designated collection point.

Penalties may be applicable for incorrect disposal of this waste, in accordance with national legislation.

For business users in the European Union

If you wish to discard electrical and electronic equipment, please contact your dealer or supplier for further information.

Information on Disposal in other Countries outside the European Union

This symbol is only valid in the European Union.

If you wish to discard this product, please contact your local authorities or dealer and ask for the correct method of disposal.

Panasonic Corporation

Web Site: <http://panasonic.net>

パナソニック株式会社 プロフェッショナルAVビジネスユニット

〒571-8503 大阪府門真市松葉町2番15号 ☎ (06) 6901-1161

© Panasonic Corporation 2012