

AUTONOMIC

A  **Snap** COMPANY
av

MMS 1E/3E/5E

Multi-Source Music Streamer with eAudioCast™



eSERIES

Table of Contents

Important Safety Instructions	1
New Dealers - What to know	3
Get to Know the MMS.....	3
Features.....	5
MMS - Connections.....	7
MMS - Application Diagrams	8
MMS - Web Configuration.....	9
Using the MMS with Third-Party Amplifiers	15
Using AirPlay.....	15
Content Tab.....	16
Adding Digital Content and Configuring Cloud Services.....	18
Streaming Music Services.....	19
Schedules	22
Control Systems.....	22
Firmware Updates.....	23
Safety Information	24
CE - European Conformity Information	24
Appendix.....	25
Specifications.....	26

Important Safety Instructions

1. Read these instructions.
2. Keep these instructions.
3. Heed all warnings.
4. Follow all instructions.
5. Do not use this apparatus near water.
6. Clean only with dry cloth.
7. Do not block any ventilation openings. Install in accordance with the manufacturer's instructions.
8. Do not install near any heat sources such as radiators, heat registers, stoves, or other apparatus (including other amplifiers) that produce heat.
9. Use the apparatus only in Moderate climates (not in tropical climates).
10. Do not defeat the safety purpose of the polarized or grounding type plug. A polarized plug has two blades with one wider than the other, a grounding type plug has two blades and a third grounding prong, the wide blade or the third grounding prong are provided for your safety. If the provided plug does not fit onto your outlet, consult an electrician for replacement of the obsolete outlet.
11. Protect the power cord from being walked on or pinched particularly at plugs, convenience receptacles, and the point where they exit from the apparatus.
12. Only use attachments / accessories specified by the manufacturer.
13. Unplug this apparatus during lightning storms or when unused for long periods of time.
14. If you install the apparatus in a built-in installation, such as a bookcase or rack, ensure that there is adequate ventilation. Leave 20cm (8") of free space at the top and sides and 10cm (4") at the rear. The rear edge of the shelf or board above the apparatus shall be set 10cm (4") away from the rear panel or wall, creating a flue like gap for warm air to escape. Good airflow is necessary to help ensure proper operation. Not only should you

provide enough free space around the unit, but also ensure that air can flow freely and escape from the amplifier surroundings. Failure to do so may cause thermal shutdown of the unit, and reduced life expectancy.

15. Refer all servicing to qualified service personnel. Servicing is required when the apparatus has been damaged in any way, such as:
 - a. When the power supply cord or plug is damaged.
 - b. If liquid has been spilled, or objects have fallen into the apparatus.
 - c. If the apparatus has been exposed to rain or water.
 - d. If the apparatus has been dropped or damaged in any way.
 - e. If the apparatus does not operate normally by following the instructions. Adjust only those controls that are covered by the operating instructions.
 - f. When the apparatus exhibits distinct change in performance this indicates a need for a service.

WARNING!

Do not expose the apparatus to dripping or splashing. Do not place objects filled with liquids near the apparatus.

WARNING!

To reduce the risk of fire or electric shock, do not expose this apparatus to rain or moisture.

WARNING!

Equipment must be connected to a Mains socket outlet with a protective earthing connection.

WARNING!

Never push objects of any kind into the apparatus through openings as they may touch dangerous voltage points or short-out parts that could result in a fire or electric shock.

IMPORTANT!

Ensure adequate ventilation. Do not install in a cabinet that is smaller than 60cm (24") wide x 45cm (18") deep x 20cm (8") high. If you do the device may overheat.

Precautions

1. AC Fuse

The AC fuse inside the unit is not user-serviceable. If you cannot turn on the unit, contact the dealer from whom you purchased this unit.

2. Care

Occasionally you should dust the unit all over with a soft cloth. For stubborn stains, use a soft cloth dampened with a weak solution of mild detergent and water. Dry the unit immediately afterwards with a clean cloth. Don't use abrasive cloths, thinners, alcohol, or other chemical solvents, because they may damage the finish or remove the panel lettering.

3. POWER WARNING: Before plugging in this device for the first time, read the following section carefully.

AC outlet voltages vary from country to country. Make sure that the voltage in your area meets the voltage requirements printed on the unit's rear panel. e.g. ~ 110V / 240V, 50/60HZ. The power cord is used to disconnect this unit from the AC power source. Make sure that the plug is readily operable (easily accessible) at all times. If you do not intend to use the unit for an extended period, remove the power cord from the AC outlet.

4. Earth

The unit is defined as Class1 in EN60065 (low voltage directive) and MUST BE EARTHED. Connect only to a mains socket outlet with protective earth, and only use the power cord supplied.

Finland: "Laite on Liitettävä suojamaadoituskoskettimillä varustettun pistorasiaan"

Norway: "Apparatet må tilkoples jordet stikkontakt."

Sweden: "Apparaten skall anslutas till jordat uttag."

5. Never Touch This Unit with Wet Hands

Never handle this unit or its power cord while your hands are wet or damp. If water or any other liquid gets inside this unit, have it checked by your Autonomic dealer.

6. Handling Notes

- a. If you need to transport this unit, use the original packaging.
- b. Do not leave rubber or plastic items on this unit for a long time; they may leave marks on the case.
- c. This unit's top and rear panels may get warm after prolonged use. This is normal.

7. Speaker Shorts

Under no circumstances should the speaker output terminals of the unit be short circuited, grounded or connected to another output.

WARNING:

TO REDUCE THE RISK OF FIRE OR ELECTRIC SHOCK, DO NOT EXPOSE THIS APPARATUS TO RAIN OR MOISTURE.

CAUTION:

TO REDUCE THE RISK OF ELECTRIC SHOCK, DO NOT REMOVE COVER (OR BACK). NO USER-SERVICEABLE PARTS INSIDE. REFER SERVICING TO QUALIFIED SERVICE PERSONNEL.



WARNING
RISK OF ELECTRIC SHOCK
DO NOT OPEN

AVIS
RISQUE DE CHOC ELECTRIQUE
NE PAS OUVRIR



The lightning flash with arrowhead symbol, within an equilateral triangle, is intended to alert the user to the presence of uninsulated "dangerous voltage" within the product's enclosure that may be sufficient magnitude to constitute a risk of electric shock to persons.



The exclamation point within an equilateral triangle is intended to alert the user to the presence of important operating and maintenance (servicing) instructions in the literature accompanying the appliance.

8. Direct Sun light

Avoid installing the amplifier in positions where the front panel is exposed to direct sunlight – may cause control to become sluggish

9. Controller Connection

Never connect more than eight Autonomic controllers. The supply is internally fused (self-resetting) and may open circuit. Never connect the unit's 12VDC terminal ("Bus Run" port) to an external power supply.

Declaration of Conformity

We declare under our sole responsibility that this product, to which this declaration relates, is in conformity with the following standards:

- EN60065
- EN55013
- EN55020
- EN61000-3-2
- EN61000-3-3

Following the provisions of Low Voltage Directive 2006/95/EC and EMC Directive 2004/108/EC, the EC regulation 1275/2008 and its frame work Directive 2009/125/EC for Energy-related Products (ErP).

TUV Certification

This product has been certified and conforms to UL60065 and certified to CAN/SSA, IEC 60065.

For North American Models

FCC interference statement

This device complies with Part 15 of the FCC Rules. Operation is subject to the following two conditions: (1) This device may not cause

harmful interference, and (2) this device must accept any interference received, including interference that may cause undesired operation.

IMPORTANT!

Changes or modifications not expressly approved by the party responsible for compliance could void the user's authority to operate the equipment.

NOTE: This equipment has been tested and found to comply with the limits for a Class B digital device, pursuant to Part 15 of the FCC Rules. These limits are designed to provide reasonable protection against harmful interference in a residential installation. This equipment generates, uses, and can radiate radio frequency energy and, if not installed and used in accordance with the instructions, may cause harmful interference to radio communications. However, there is no guarantee that interference will not occur in a particular installation. If this equipment does cause harmful interference to radio or television reception, which can be determined by turning the equipment off and on, the user is encouraged to try to correct the interference by one of the following measures:

- Reorient or relocate the receiving antenna.
- Increase the separation between the equipment and receiver.
- Connect the equipment into an outlet on a circuit different from that to which the receiver is connected.
- Consult the dealer or an experienced radio / TV technician for help.

For Canadian Models

NOTE: THIS CLASS B DIGITAL APPARATUS COMPLIES WITH CANADIAN ICES-003.

For models having a power cord with a polarized plug:

CAUTION: TO PREVENT ELECTRIC SHOCK, MATCH WIDE BLADE OF PLUG TO WIDE SLOT FULLY INSERT.

Modèle pour les Canadiens

REMARQUE: CET APPAREIL NUMÉRIQUE DE LA CLASSE B EST CONFORME À LA NORME NMB-003 DU CANADA.

Sur les modèles dont la fiche est polarisée:

ATTENTION: POUR ÉVITER LES CHOCS ÉLECTRIQUES, INTRODUIRE LA LAME LA PLUS LARGE DE LA FICHE DANS LA BORNE CORRESPONDANTE DE LA PRISE ET POUSSER JUSQU'AU FOND.

A Note About Recycling

This product's packaging materials are recyclable and can be reused. Please dispose of any materials in accordance with the local recycling regulations.



When discarding the unit, comply with local rules or regulations. Batteries should never be thrown away or incinerated but disposed of in

accordance with the local regulations concerning battery disposal.

This product and the supplied accessories constitute the applicable product according to the WEEE directive.

New Dealers - What to know

We strongly recommend performing setup and configuration prior to installing at the customer site. This is especially important if this is your first time working with the product. Please retain this manual for future reference.

Important Tools and Resources

Resources

- OvrC – <http://www.ovrc.com/>
- DealerZone – <https://dealerzone.autonomic-controls.com/>
- Knowledge Base – www.autonomic-controls.com/kb

Tools

- a display monitor or laptop or tablet connected to the internet
- audio/network cables,
- a voltmeter,
- headphones,
- powered speakers

Get to Know the MMS

Overview

The MMS product line offers state-of-the-art, high resolution audio with the convenience of accessing all local audio content and streaming Internet services with a single device.

Multiple independent streams of audio (five on the MMS-5e, or three on the MMS-3e, and 2 on the MMS-1e) can be played using analog, digital, or pristine jitter-free high definition USB audio for audiophile DACs and high-end amplifiers that have digital USB inputs.

The MMS has one video output that can be configured to display Now Playing information for any of the audio outputs.

MMS Capabilities

- Control of multiple discreet audio channels throughout the home.
- Play back of audiophile grade uncompressed, lossless 24-bit/192kHz audio files through analog, digital coax or USB outputs.
- Browse music and control playback from around the home using any iOS or Android device, web browser, or control system including Crestron, AMX, Control4, RTI, URC, Savant, ELAN, Command Fusion and BitWise.
- Access an online library of tens of thousands of albums with Napster®, Spotify or Slacker Premium.
- Access SiriusXM online without having to install an antenna.

- Create custom radio stations via Pandora or Slacker Radio.
- Browse thousands of AM and FM radio broadcasts around the world using TuneIn Internet Radio service.
- Synchronize with Apple iCloud. (Requires the Media Sync and iTunes software to be installed). This synchronization allows access to media anywhere in the world using any iOS or Android device or web browser.
- Synchronize the content of multiple MMS Servers located anywhere on the planet using Google Drive.
- Play content from any iOS device through a home audio system using the built-in Airplay receiver available on each audio output on the MMS.

Streaming Services

NOTE: This product incorporates Spotify software which is subject to 3rd party licenses found here:

<https://developer.spotify.com/esdk-third-party-licenses/>

The MMS provides access to several online music services via an Internet connection, such as PANDORA®, SiriusXM, Spotify, Slacker, Napster and TuneIn.

Autonomic is constantly working to develop partnerships with content service providers to bring even more of the best Internet-delivered media through future firmware updates.



Local Content

To keep libraries organized, the MMS comes preloaded with software to install onto a Mac or PC that automatically keeps music files and playlists synchronized with the server. This software can be downloaded from the server onto the computers once the MMS is setup on the home network. Whenever new content is added to the computer, the MMS Media Sync software automatically catalogs it and sends it to the MMS server for on-demand playback. The MMS can be configured to stream content from a NAS device or other shared network storage as well.

Cloud Synchronization Features

The MMS can synchronize with Google Drive™ and Apple iCloud™ (iCloud requires the MMS Media Sync and iTunes software to be installed). This unique feature provides several distinct benefits:

1. All content can be bidirectionally synchronized with MMS servers at multiple locations by entering the same credentials at each site.
2. All content is securely backed up off site on Google or Apple servers. [\(Confirm\)](#)
3. The entire library can be accessed in nearly any location using a number of different applications available on Android and Apple iOS mobile devices or with your laptop.
4. The MMS can be configured so that any time new music is purchased either in the home or with a mobile device, it is automatically added to the home library (or other connected locations).

TuneBridge

TuneBridge™ technology can easily switch between online services and purchased music in a library. Mixed queues and playlists can be created with content from Napster, Spotify and the local music collection. TuneBridge can instantly queue up an entire album with Napster or Spotify, or play a custom Pandora or Slacker radio station with similar music from a song played from the local library, online radio or streaming service.

Control System Integration

The MMS Media Server is designed to work seamlessly in an automated home environment. Autonomic works closely with all leading control system manufacturers to ensure the smoothest operation and access to all features of the MMS on control system touch panels or automation applications. Autonomic has partnered with Crestron, AMX, Control4, URC, RTI, Savant, Elan, Command Fusion, Bitwise Controls, and Key Digital to provide modules, UI templates and other tools needed for a successful integration.



Features

Thank you for purchasing an MMS. Please read this manual thoroughly before making connections and plugging in the device. Following the instructions in this manual will enable you to obtain optimum performance and listening enjoyment from your new Media System. Please retain this manual for future reference.



MMS-1e

- 1. Infra-Red Receiver (5e and 1e Only)**
Receiver for front panel IR control (Used only for amplifier control, not IR pass through). A remote not supplied, however an IRC profile is located at:
www.Autonomic-Controls.com/Support/
- 2. Power Indicator (5e and 1e Only)**
Lights blue when AC power is supplied.
Note: The power button lights blue on the 3e when power is supplied.
- 3. Chassis Feet**
Provide unrestricted air-flow through the chassis for convection cooling.
- 4. Power Button**
Press to manually power on and off the server. Illuminates when powered on.
- 5. Rack Mount Ears (Optional)**
To mount the server in a rack. (Not pictured)

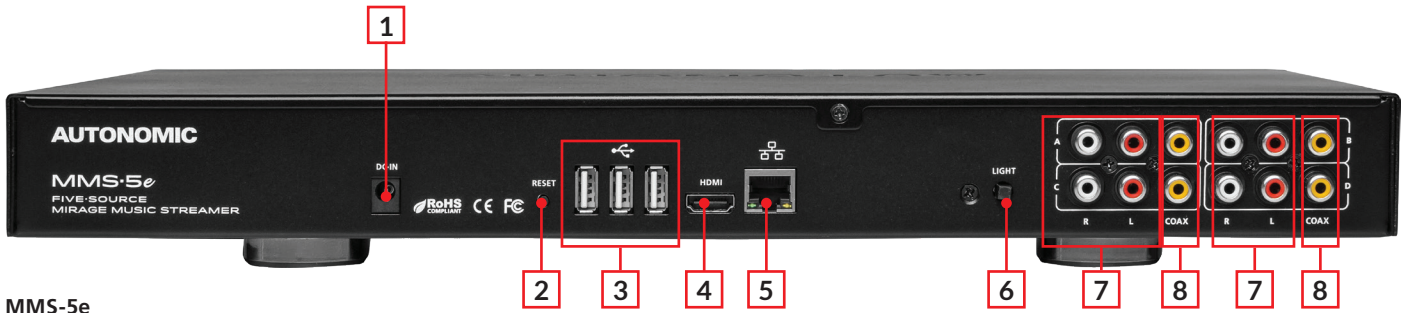

MMS-5e

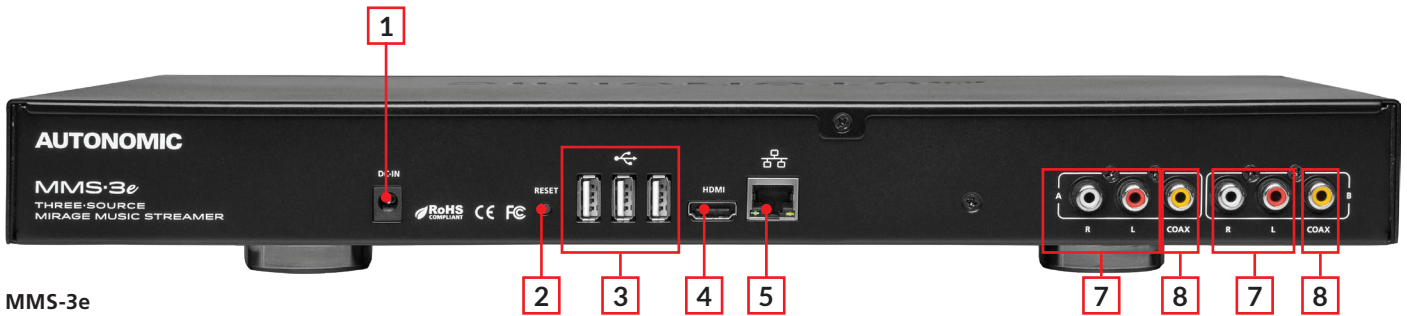

MMS-3e



MMS-1e

1. **AC Inlet**
Connect power source to this port.
2. **Reset Button**
Press to soft reset the server.
Note: Press and hold the reset button for 10 seconds while the server powers on to factory reset. Progress of the reset can be displayed on screen via the HDMI output.
3. **USB Ports**
To connect an external hard drive for additional storage.
4. **HDMI Port**
To connect a display for set up and "Now Playing" information.
5. **Ethernet Port**
Ethernet port for connection to the Home network.
6. **Light Switch (5e only)**
Press to turn on the light bar.
7. **Zone Pre Amplifier Out**
Analog Audio L/R zone outputs
8. **Coax Digital Source Output Terminals** Coax digital outputs for expansion to further amplifier zones.

MMS - Connections

See below for a basic connection diagram for an MMS setup.

This section provides an overview of powering up the server for the first time and using the MMS Configuration Utility to configure the device.

NOTE Plug everything in and connect all wires before powering up. It is recommended to attach a display when first powering up the server as the IP address will be on screen.

Once all necessary connections are made, press the power button located on the front of the unit once to turn on the MMS. The power button will illuminate.

Wait 2-3 minutes for the server to completely boot up. If the server is connected to a video display, wait until the Now Playing screen shows on the display.

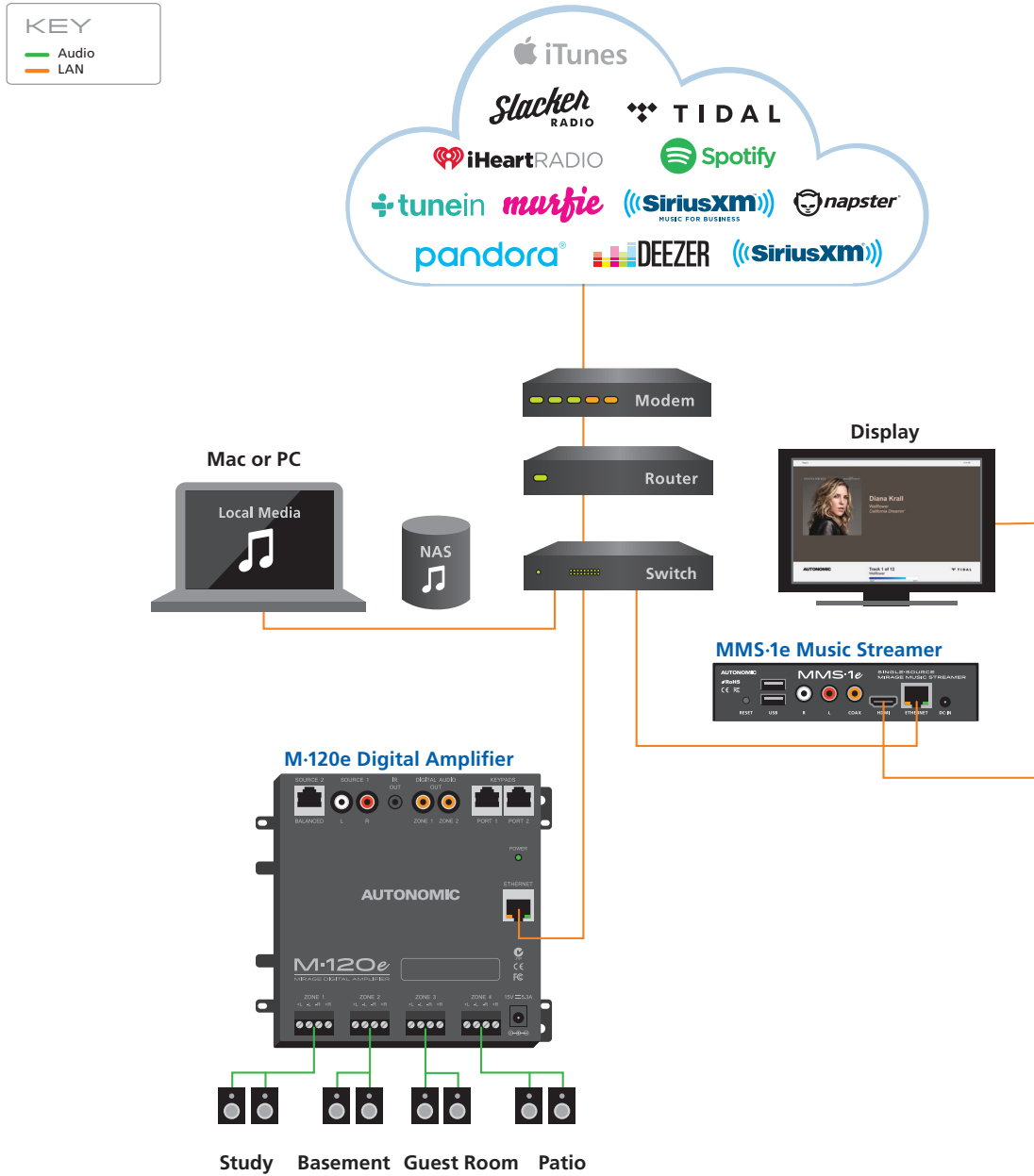

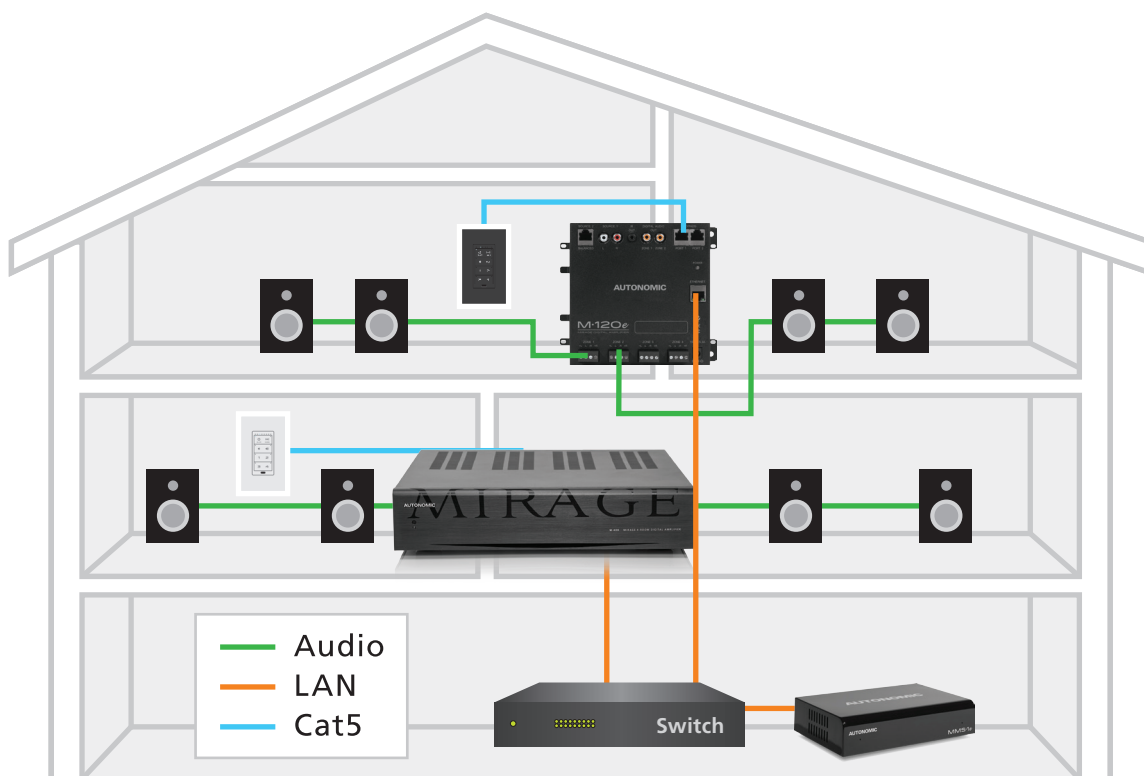

Recommended **WIRED** Configuration for Distributed Audio Installation

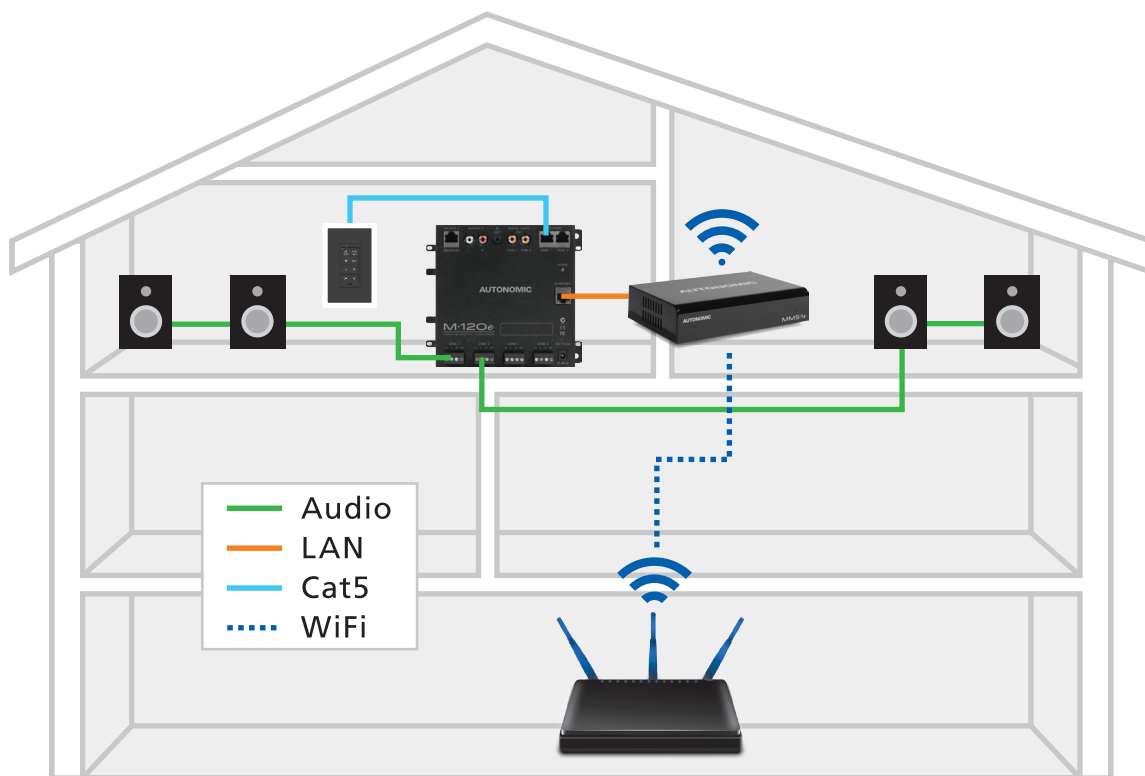

Recommended **WIRELESS** Configuration for Distributed Audio Installation

MMS - Web Configuration

Initial configuration of the MMS is accomplished through a web browser using the MMS web interface. Launch Internet Explorer or Google Chrome and enter the URL as such: **http://<Server-IP>/config**. For example, if the IP address of the MMS is 192.168.1.10, the URL for accessing the Web Configuration is **http://192.168.1.10/config**.

Configuration is broken up into Tabs (Machine, System, Content, Schedule, Control Systems and Firmware).

Machine Tab

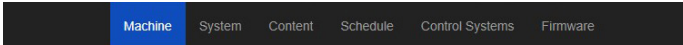

Figure 1

The Machine tab allows setup for important functions such as server identification, remote management, access security, time zone and IP network settings.

1. Server Identification:
 - a. Name: Displays the MMS network name.
 - b. Description: Provide an optional text description for the server.

TIP: For easier remote management through the OvrC interface, it is recommended that an identifying Name and Description are added.

2. Reboot Server: Restarts the system
3. Remote Management: Grant remote access via DealerZone or OvrC to the third party indicated. If access is toggled off, remote management is disabled.

TIP: Register this device with an OvrC account by entering your credentials in a separate window.

4. Configuration Security: Optionally password protect the MMS configuration page to prevent unauthorized/unintended configuration changes. This is desirable when the system is installed in a commercial or public location.
 - a. User/Password: Enter the user name and password to gain access to the config page.
 - b. Recovery email address: Password recovery emails are sent to this email address after 3 unsuccessful login attempts.
5. Control Security: Optionally password protect the MMS Web Player. This prevents unauthorized audio playback and may be desirable in a commercial or public location.
 - a. User/Password: The user name and password to gain access to the web player.
 - b. Recovery email address: Password recovery emails will be sent to this email address after 3 unsuccessful login attempts.

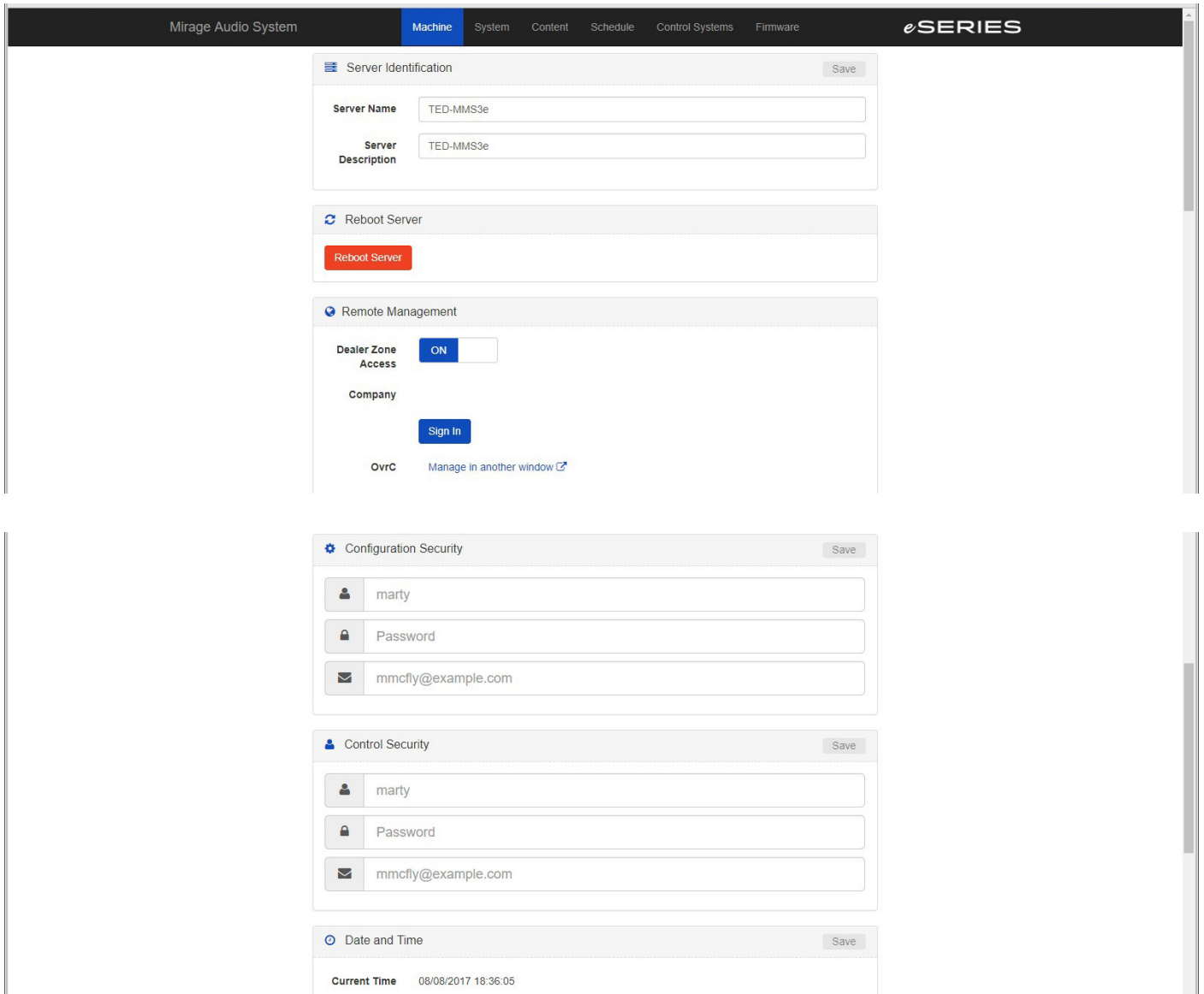

6. Date and Time
 - a. Date: Current time and date
 - b. Time Zone: Select the time zone for your device.
 - c. Time Server: Select a preferred NTP server in reasonable geographic proximity.

TIP: The time zone must be set prior to pressing the NTP sync button for accurate timekeeping. Failure to configure time or time zone properly may result in some features not functioning correctly.
7. Wired Networking: Displays the device's network configuration.
 - a. Connection: Configure the device for either DHCP or static IP address. The device must be properly configured with an IP address, gateway, subnet mask and DNS to allow connection to the Internet.

TIP: Configure the server network connection to automatically use a network DHCP server to obtain its IP address and network settings, or manually specify a static IP setting.
8. The following details must be entered if using a static address:
 - a. IP Address: The unique address of the server on the local network.
 - b. Subnet mask: The subnet mask for the local network (commonly 255.255.255.0).

- c. Gateway: The IP address for the router. This is necessary for the MMS to access the Internet.
 - d. DNS 1 & 2: IP addresses providing Domain Name Services.
 - i. DNS 1: Suggested server: OpenDNS [208.67.222.222]
 - ii. DNS 2: Suggested server: Google's DNS [8.8.8.8]
9. Wireless Networking – Enter WiFi settings here for models with wireless support. It is recommended to use a wired connection for optimal network performance and reliability whenever possible.
 - a. SSID: Choose from the available SSIDs from the drop-down list.
 - b. Encryption: Select the configured encryption for the WiFi network.
 - c. Password: Enter the wireless password for the SSID device
 - d. Configure for DHCP or Static IP address as directed in the Wired Network instructions above.
 - e. Select Go Wireless to save the settings.
 - f. If configuring the MMS with an eSeries amplifier, connect an Ethernet cable directly from the network port of the MMS to the network port of the eSeries Amplifier.

🕒 **Date and Time** Save

Current Time 08/08/2017 18:36:54

Time Zone

Time Server

🔌 **Wired Networking** Save

MAC Address D4:6A:91:60:0A:AA

DHCP

IP Address 192.168.1.102

Gateway 192.168.1.1

Subnet Mask 255.255.255.0

DNS 1 192.168.1.1

DNS 2

📶 **Wireless Networking**

MAC Address B0:F1:EC:1F:1C:D9

SSID

Encryption

Password

DHCP

IP Address 0.0.0.0

Gateway 0.0.0.0

Subnet Mask 0.0.0.0

DNS 1 0.0.0.0

DNS 2 0.0.0.0

Configure Wireless Network

You are about to activate Wireless mode. A direct Cat5 connection from MMS to eSeries amplifier is required *after activation*. Upon successful activation, data will be received wirelessly on the MMS.

Warning: Wireless mode requires the MMS and eSeries amplifier to use a direct, hardwired Cat5 connection. Once wireless mode is activated, **access to the configuration page will use the assigned wireless IP address.**

In order to revert back to a Wired Networking configuration, the MMS and amplifier(s) will require a direct network connection **before** exiting Wireless mode. **Please see the Wireless Networking knowledgebase article for details**

System Tab

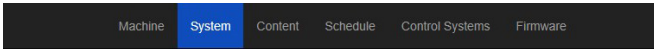

The System tab contains configuration for audio settings and system outputs on the MMS and connected devices.

1. System

- a. System Id: The ID of the MMS device **group**. Communication between eSeries devices (servers and amplifiers) is enabled when sharing the same System ID. By default, eSeries devices are configured for System ID 1 and therefore will automatically link together.

TIP: Leaving the system ID at 1 (auto-join) will allow new eSeries devices to be visible when added to the system. Changing the System ID will create an isolated music system **

- b. Add system component: Discover additional network connected devices on another System ID. Adding the device will reconfigure it with your System ID.

- c. Clear Queue – When set to “on” empties the queue when the last zone listening to an audio source is turned off. When toggled off, the MMS queues remain intact, even if the zones are powered off.

- 2. Streamers: Lists all MMS devices sharing the same System Id. Click the gear icon to edit a device’s configuration or remove the device from this System Id.

TIP: When using System Id 1 (auto-join), eSeries devices can only be removed if they are offline. Otherwise, removing an eSeries device will reset its System Id back to 1 (default).

- a. Server Details: Lists information such as Model, Serial Number and Firmware version of the device
- b. Click on the Name field to edit the System name of the selected device.
- c. Click on the Output name to modify its default label. (e.g. Player A). When used with eSeries amplifiers, sources are automatically managed and generally not exposed in control clients (except in the MMS Web Client). Therefore when using eSeries amplifier(s) editing the default Output names is unnecessary.

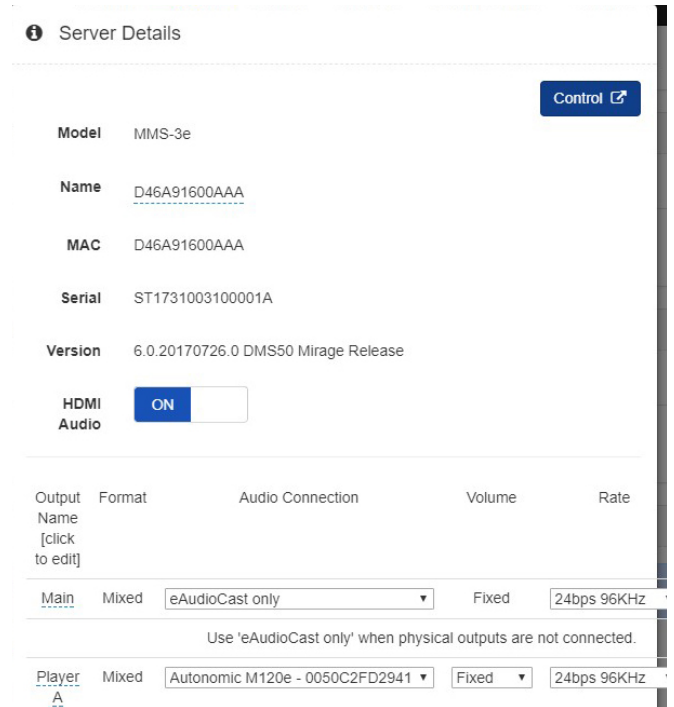
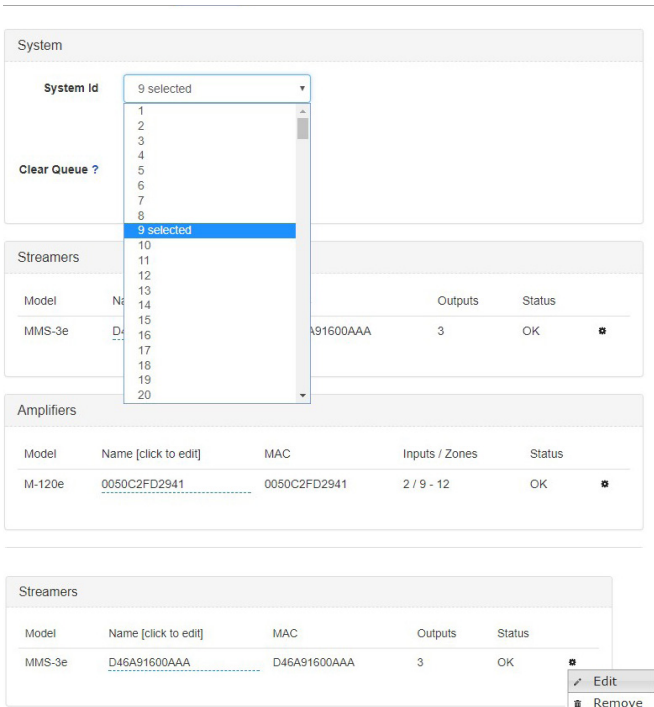
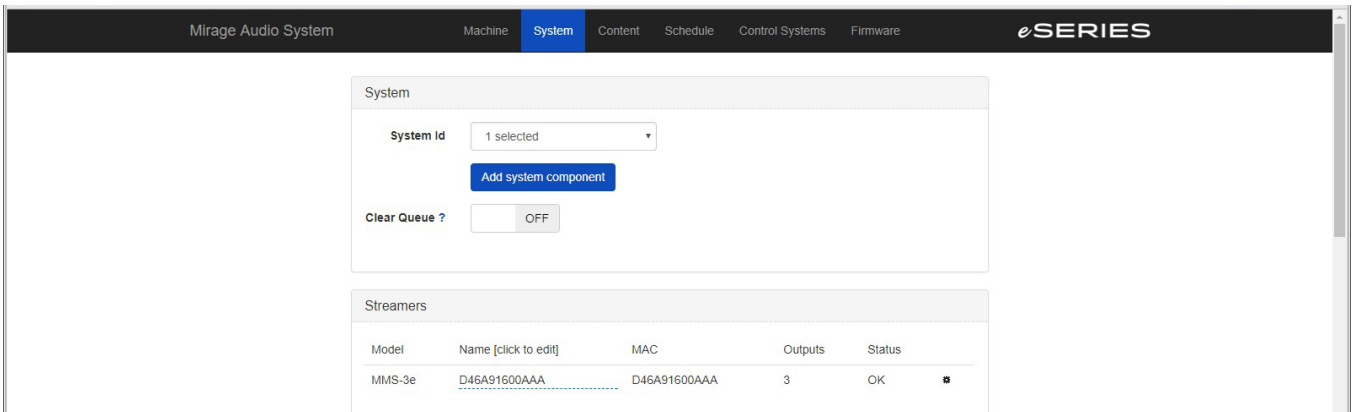

TIP: The HDMI output of the MMS servers can be assigned to whatever output necessary for the system design.

Click the gear on the system tab, then choose the zone for the HDMI output port. Select "Done" when finished.

Model	Name [click to edit]	MAC	Outputs	Status
MMS-1e	D46A91600987	D46A91600987	2	OK

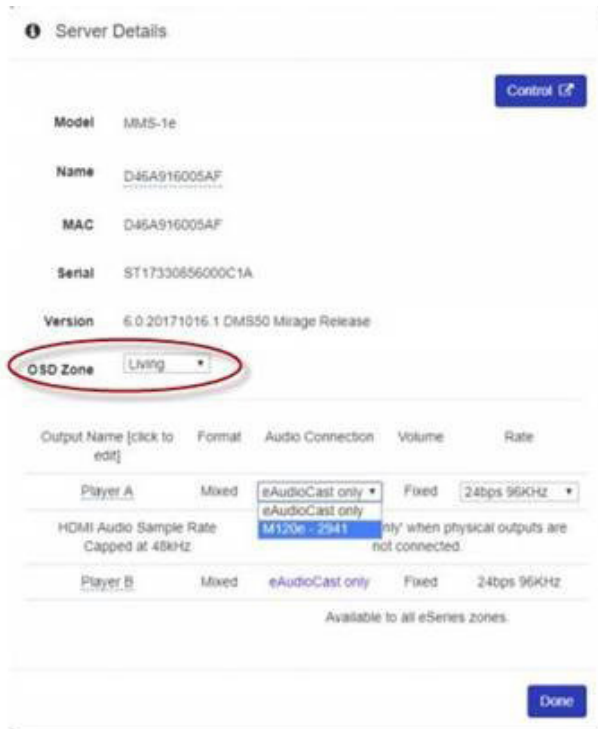

TIP: For controlThe HDMI OUT system programming, the server will respond to commands issued using the default output names, as well as commands issued using custom names.

- d. Configure audio details for each configured MMS output by following the below guidance.
 - i. Output Name: Editable text label for the source output (Player)
 - ii. Format: Displays output type
 01. Mixed - Physical and eAudioCast
 02. eAudioCast - output available on the network
 - iii. Audio Connection
 01. Zone Player - Treats the output as a controllable audio endpoint.
 02. eAudioCast Only
 03. Amplifier (displays grouped amplifiers)
 - iv. Volume - Sets the gain as Fixed or Variable.
 01. Fixed: The MMS gain is preset and volume is adjusted at the amplifier.
 02. Variable: The gain can be adjusted by the MMS Player or other control system.
 - v. Rate - The bit depth and sample rate resolution of the source output signal.)

Note: When a 1e is paired with a 120e amplifier, Player B will only have an option for an eAudioCast Audio Connection.

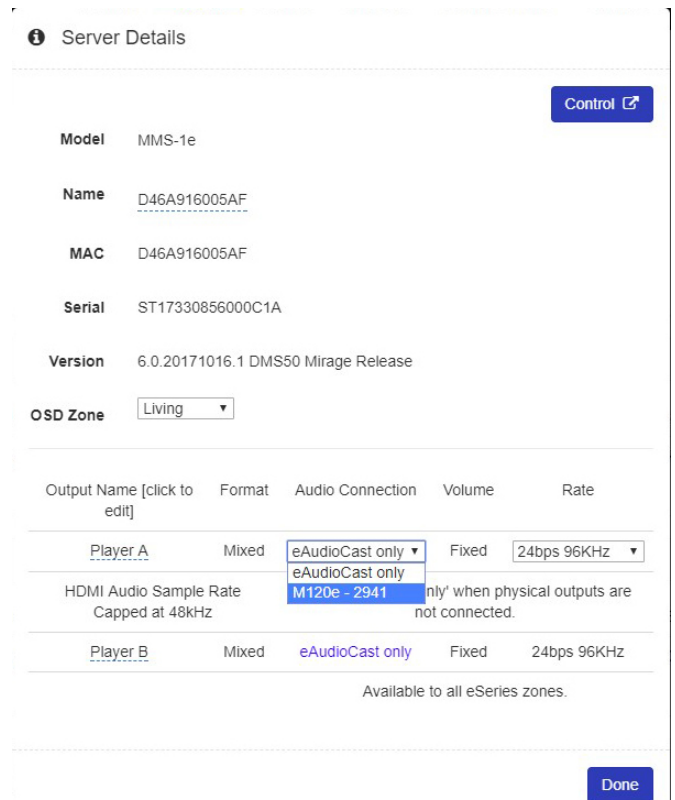

Bit Depth and Sample Rate Resolution

Bit depth and sample rate of the digital audio outputs can be set to values from 16-bit/44 kHz, up to 24-bit/192 kHz.

Set this value to the highest setting that the connected amplifier or AV receiver can support. If the highest supported bit depth and sample rate on the connected equipment is not known, the MMS will play a sample sound in each speaker whenever this setting is changed. If the test tone is audible, that setting is supported by the amplifier. If the test tone is not audible, lower this setting until the test signal is audible.

Audio Player Screen

The Audio Player Screen is accessible by entering the streamer IP address in a web browser, or by clicking the "Control" button on the "Server Details" screen in the streamer configuration screen on the System Tab.

Note: The MMS player requires flash to operate.



Using the MMS with eSeries Amplification

Audio can be delivered to the eSeries amplifier either via eAudioCast or a traditional physical cable connection (e.g. Digital Coax). Audio rates up to 24bps/192KHz are supported when physically connected (e.g. using RCA digital coax cables) to eSeries amplifiers.

TIP: Review the "System Tab" section on page 11 to bring one or more eSeries amplifiers into the System ID group for configuration.

Physical cable connection: Connect the MMS to an available amplifier source input. For each MMS Player output, identify the amplifier and the specific source input connected on the amplifier config page.

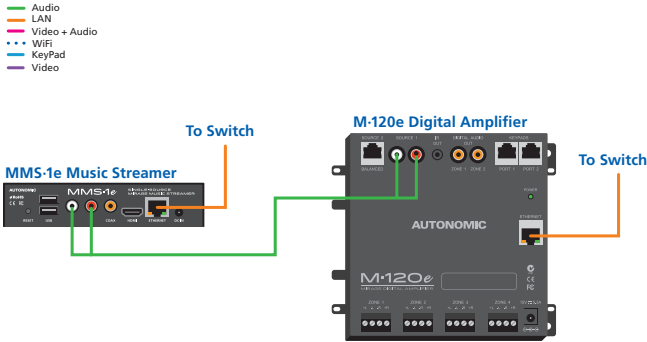

eAudioCast: Connect a Player from the MMS to playback to an available amplifier with audio quality up to 24bps/96KHz output.

TIP: Sources can be “eAudioCast only” or “Mixed” format. “eAudioCast only” means that the audio source is available over Ethernet to be received by an eAudioCast capable device. “Mixed” format means the source is available on a physical MMS output as well as (mirrored) over Ethernet to eAudiocast capable devices.

Amplifiers: Lists any supported amplifiers sharing the same System ID. Click the gear icon to edit device configuration.

Streamers				
Model	Name [click to edit]	MAC	Outputs	Status
MMS-3e	D46A91600AAA	D46A91600AAA	3	OK

Amplifiers				
Model	Name [click to edit]	MAC	Inputs / Zones	Status
M-120e	0050C2FD2941	0050C2FD2941	2 / 9 - 12	OK

- Name the device by clicking on the Name field.
- Click the Zone Names field to rename.

[Configure](#)

Model M120e

Name [0050C2FD2941](#)

MAC 0050C2FD2941

Version 5.4.2

Zone Name [click to edit]

[Zone 9](#)

[Zone 10](#)

[Zone 11](#)

[Zone 12](#)

Source Name [click to edit]

[S1](#)

[S2](#)

TIP: When one or more zones are renamed, any remaining zones with default names are assumed unused and hidden from user

Amp Details

[Configure](#)

Model M120e

Name [0050C2FD2941](#)

MAC 0050C2FD2941

Version 5.4.2

Zone Name [click to edit]

[Living](#)

[Dining](#)

[Basement](#)

[Patio](#)

Source Name [click to edit]

[Iphone](#)

- Name any of the local sources in use on the amplifier (e.g. iPhone). Click “Done to save.

Source Name [click to edit]

[Iphone](#)

[Radio](#)

AirPlay: iOS devices will be able to AirPlay directly to selected zones. A password may be set to prevent unauthorized AirPlay to all enabled zones.

AirPlay & Spotify

Changes to these settings may take up to a minute to be reflected on your iOS/Android device.

Click [here](#) to add an Airplay password.

Select the zones where you wish to have Airplay and/or Spotify Connect reception.

- ALL
- Living
- Dining
- Basement
- Patio

Amplifier Configuration

Click the Gear icon under the Amplifier field, click “Edit”, then click the “Configure” button on the Amp Details screen to configure the connected amplifiers.

Amplifier Tab

Device Information: Displays the device information for the connected amplifier. The System ID field notes the system ID which is assigned to the amplifier. Changing the system ID will change the system to which this amplifier is assigned. This is useful when there are two or more streamer and amplifier systems set up in one residence.

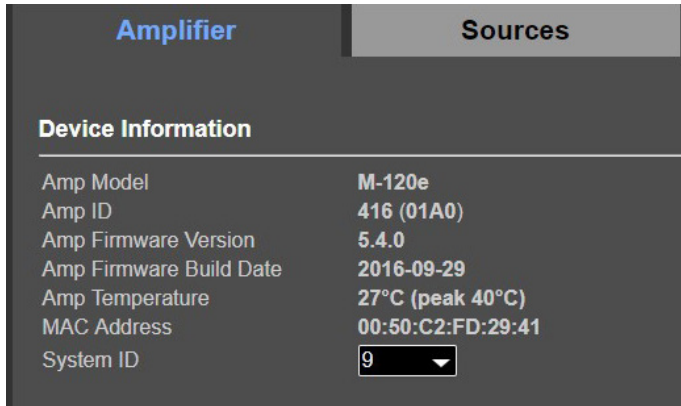

Wired Ethernet: Network to which the amp is assigned is displayed here. Choose whether to configure the amplifier to use a static IP or DHCP. Use a static IP to reserve the IP address for devices on the network. This can help reduce opportunity for connectivity errors. Improperly setting up IP settings can lead to connectivity issues.

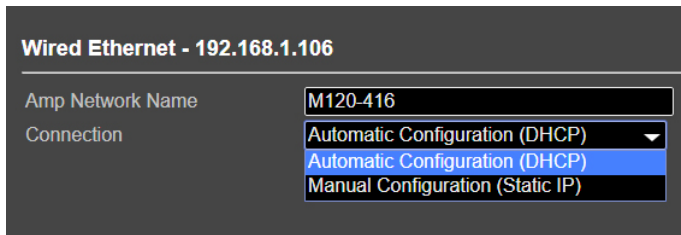

Important: Clicking "Save Changes" for each tab is necessary to save all changes.

Sources Tab

Physical Source: Displays the actual source of the connected amplifier. The number of sources available for name assignments depends on how many are available on the amplifier connected.



Source Name: Displays the name assigned to each source connected to the amplifier. The name chosen here will display on all keypads connected. Keep device names to a maximum of 15 characters.



Source Gain: Set the gain for sources connected to the amplifier via analog inputs.



Zones Tab

Zone Settings: Rename the zones for any linked amplifiers as they appear on keypads. Names here also have a 15 character limit. Zones appear grouped to the corresponding amplifier. Amps and their zones are displayed in the order as discovered by the server on the network.

Note: It is not necessary to connect all amplifiers in a chain (loopout connected amps) to the network. Only connect the first amplifier via Ethernet. The server will locate the zones from the connected amplifier.

Click the configure button to configure each zone.



Amplifier Zone Configuration

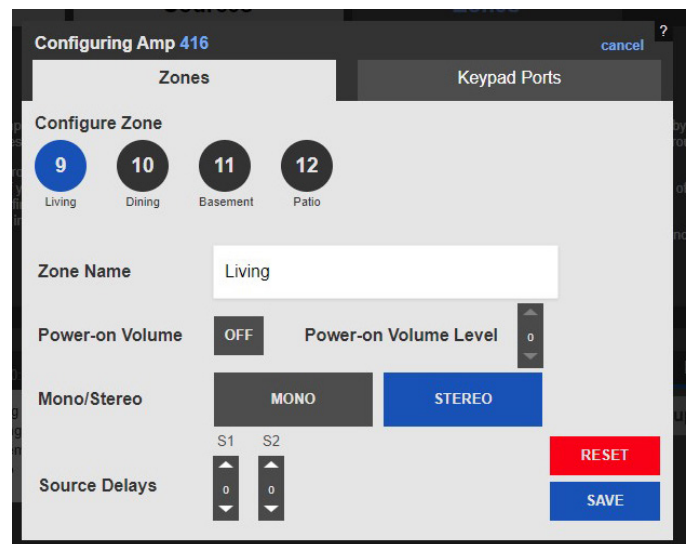

Configure Zone: Choose which zone to configure.

Zone Name: The zone name can be changed here as well as on the initial Amplifier configuration screen. Changing the zone name here will also change the zone name where ever else it is displayed, provided the save button is pressed.

Power On Volume: Set the volume level of that zone when powered on. Default state for this option is set to "Off". Click to set to "ON" then click the arrows next to "Power on Volume Level" to set the volume level.

Mono/Stereo: Set the Zone to Mono or Stereo Output.

Source Delays: Set the number of seconds to delay playback from a source.

Note: Click "Save" before navigating away from this page to ensure all changes are saved.

Keypad Ports Tab

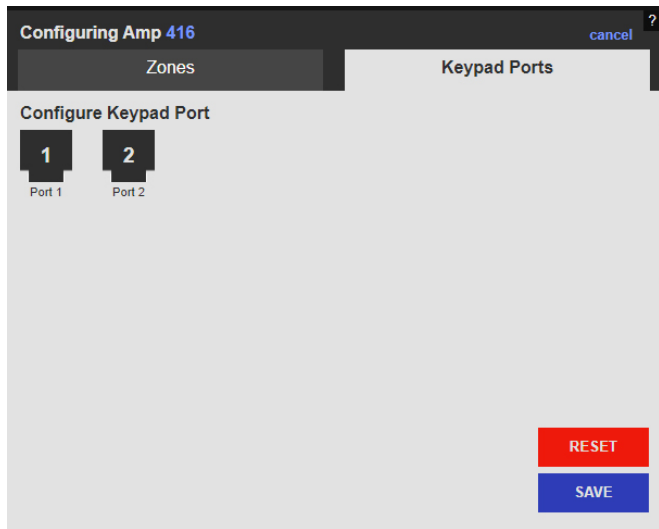

Configure Keypad Port: Configure any keypads connected to the amplifier. (Look up options). Unresponsive keypads can be reset from this screen.

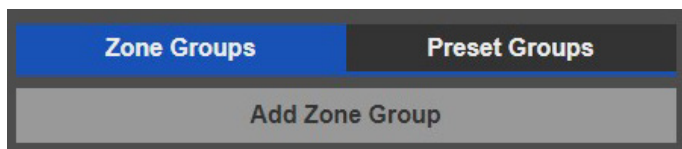

Zone Groups: Zone Groups can be configured to be linked by power, Volume or both. Zones in a group are unlimited, however a single zone can only be included in a single group.

Click "Add Zone Group", then click on the zone to add it to the new zone group. Click "Save" once all desired zones have been added to the group.

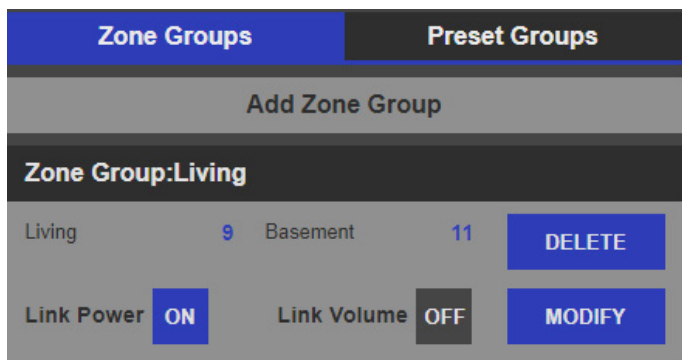

Once the zone group is created, it will be named after the lowest numbered zone in the group. Choose to link power, volume or both. Click "Modify" to add or remove zones from the group, then click "Save" to retain changes. Clicking "Delete" will remove the zone group.

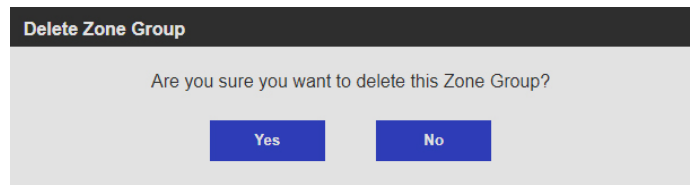

Click "Delete" then click "Yes" to confirm and remove the zone group.

Preset Groups: Preset groups assign zones to the same preset slots on connected Servers. Assign Preset Groups with easily identifiable names, and set to read only to prevent end user changes. Zone group inclusion does not exclude a zone from being included in a Preset group.

Click "Add Preset Group", then click on the zone to add it to the new zone group. Click "Save" once all desired zones have been added to the group.

Click "Read/Write" to change the property of the Preset group to "Read Only" Conversely, Click "Read Only" To set the property to "Read/Write".

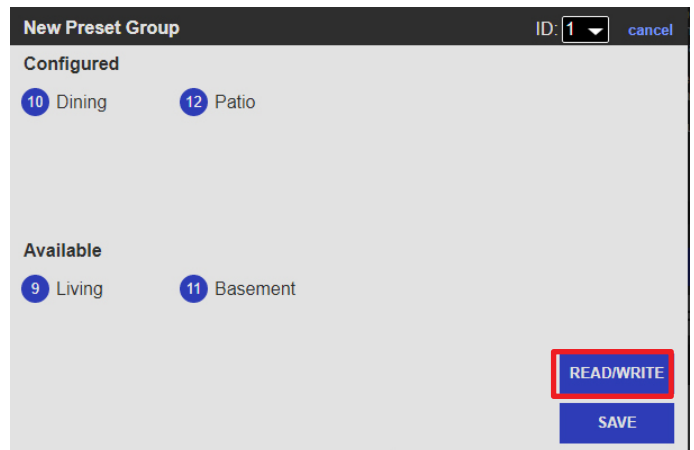

Once the zone group is created, it will be named "Group 1".

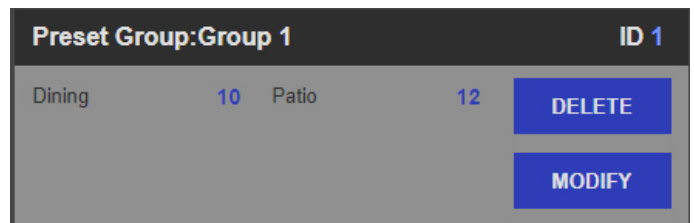

Click "Modify" to add or remove zones from the group, then click "Save" to retain changes. Clicking "Delete" will remove the zone group.

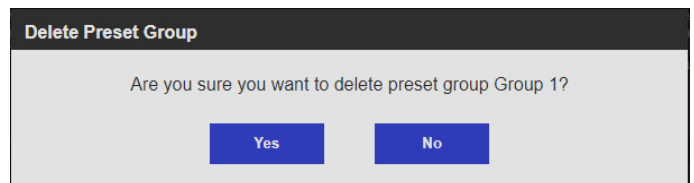

Click "Delete" then click "Yes" to confirm and remove the preset group.

Using the MMS with Third-Party Amplifiers

Audio Connection: Set to "Zone Player" when connecting to a third-party amplifier or control system.

Fixed Volume: The MMS output will be fixed at 100% volume. Control the volume using the available methods from the third-party amplifier or control system vendor.

Variable Volume: Set the volume to variable only if using the MMS without a control system or controllable amplifier and require volume to be adjusted on the MMS.

TIP: Verify the maximum supported audio rate of the third-party amplifier when connecting it to the MMS via digital audio.

Using AirPlay

The AirPlay section allows assignment of outputs on the MMS to be Airplay receivers. When enabled, the MMS is displayed on the AirPlay menu of any device or software that supports AirPlay (iOS devices and iTunes running on a Mac or PC).

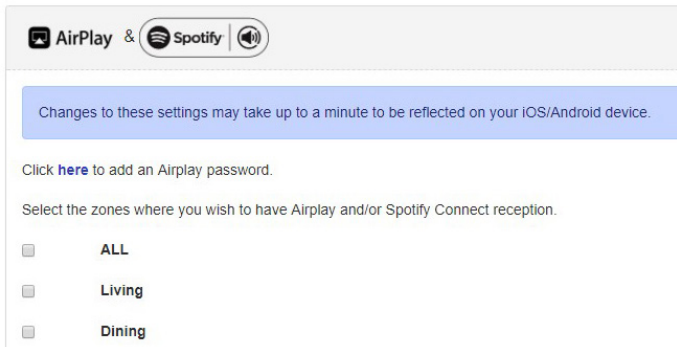

NOTE: In a MMS Audio System configuration, Airplay will be displayed on the AirPlay menu of any device or software that supports AirPlay (iOS devices and iTunes running on a Mac or PC) as zone names.

When the MMS is selected, any currently playing content will be interrupted and the server will begin to wirelessly stream the content from the connected device.

This can be overridden by selecting any other content for playback through the MMS web interface, mobile applications, or IP control.

The optional AirPlay password allows a password to be set that the user of the mobile device (or iTunes) will be prompted for before the MMS will accept a stream from the device. This will prevent uninvited transmissions from being broadcast to the amplifier.

[Click here to add an Airplay password.](#)

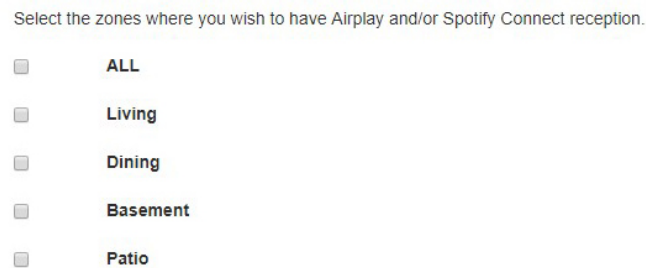

Click in the link to add a password. The password pop-up window will appear. Enter the new password and click "OK" to save.

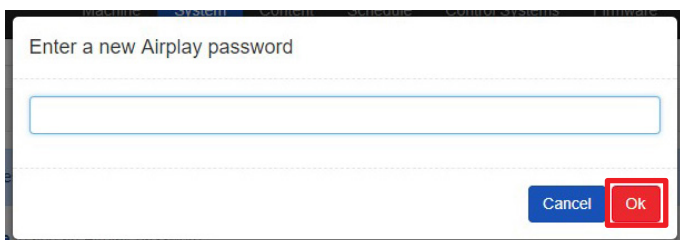

Party Mode: "Party Mode" is a predefined zone group which enables a listener to quickly and easily start playing music throughout the house. By default, all zones are grouped together when using the Party Mode feature. De-select any zones you wish to exclude from participating in Party Mode.

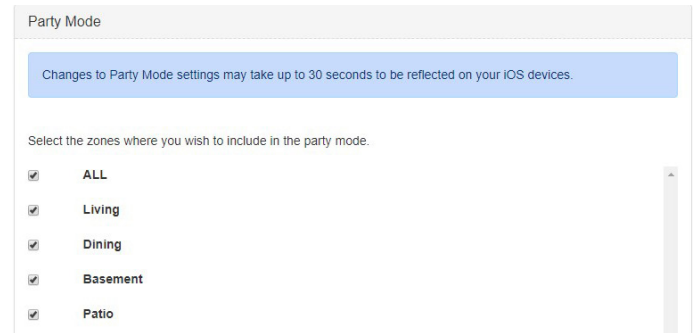

Content Tab

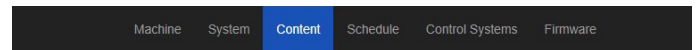

The Content tab contains configuration for accessing local and streaming music content.

1. Media Options
 - a. Overlay on Albums - By default, the album art is displayed unadulterated. Select the check box to overlay the artwork with the artist and album name.
 - b. Export Media Catalog - Downloads a .csv file with local library catalog details, such as Name, Artist, Album, Genre, etc.



2. Synchronized Computers - The MMS Media Sync software allows synchronization of music libraries on another device with the MMS. This software is provided for both Windows and Macintosh and must be installed on the device in the home containing the source music. Clicking on either link will download the software to your PC to be installed. Double click the file to install.



- a. Once Media Sync is installed, select the server which will synchronize content, and select the option to synchronize with that server if desired.

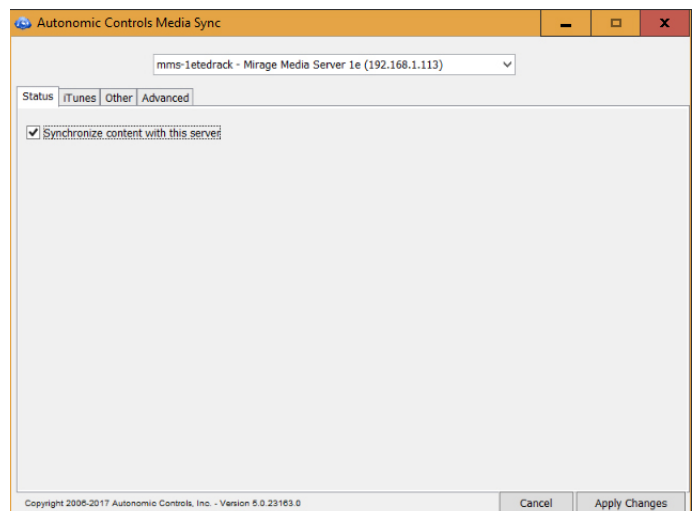

- b. Select options to synchronize all music, or selected playlists in iTunes if available.

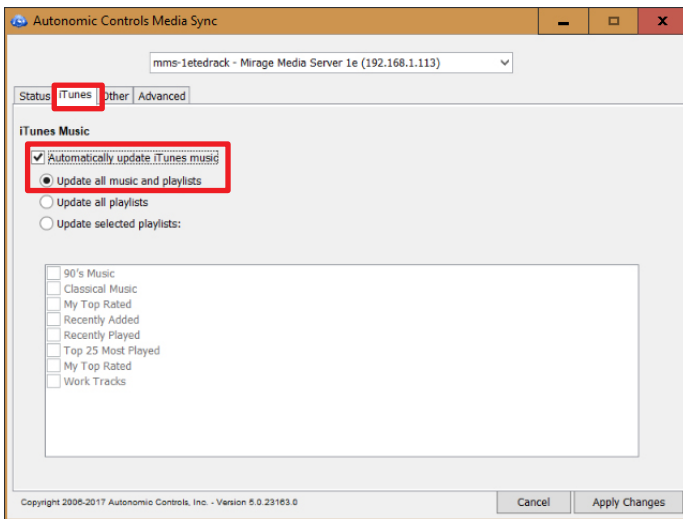

- c. Other locations on the network can also be synchronized. Click the "+" to add an other location from which to synchronize more music.

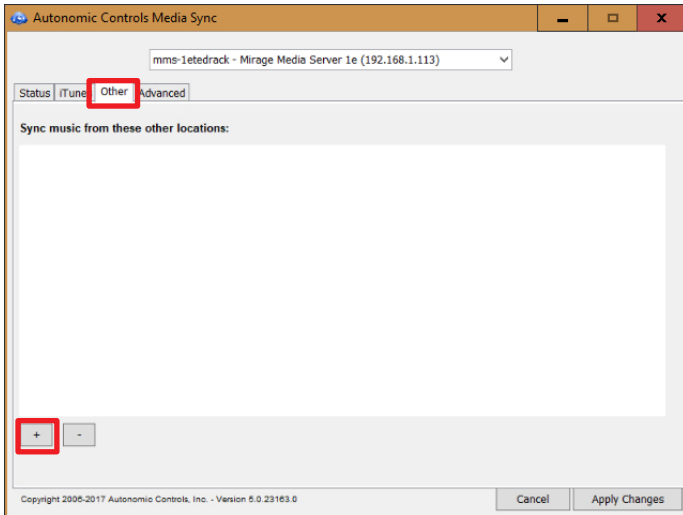

- d. Navigate to the appropriate folder location on the network, then click "save", to synchronize that network folder location.

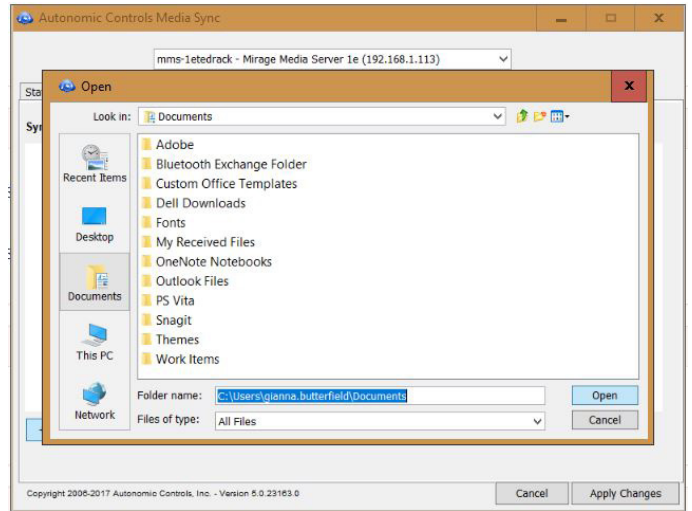

- e. Click on the "Advanced Tab" to see server information, export diagnostics and change Media Sync startup options.

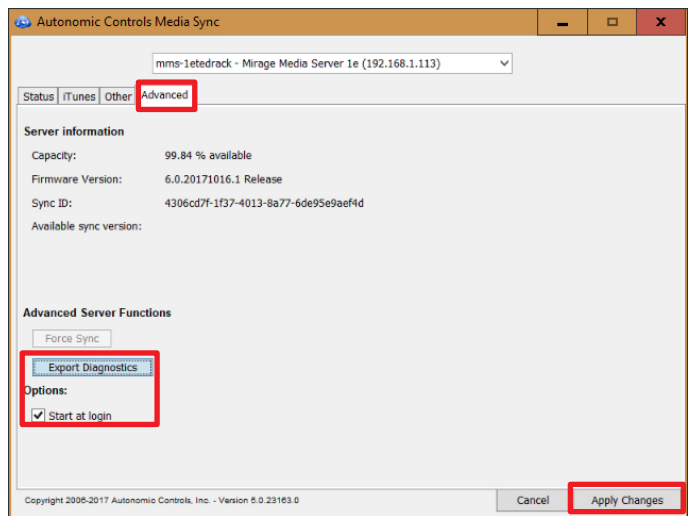

- f. Click "Apply Changes" to save.

7. Network Storage - complete this section to allow the streamer to access music stored on a network location.

NOTE: This method has a few caveats for consideration.

- This content will only be available for playback when the NAS device or computer hosting the files is online.
- The MMS cannot read playlists from iTunes or Windows Media Player using this method since those playlists reside inside special databases that are only accessible to the MMS when the files are transferred.
- Playback can be affected by local network performance.

For these reasons, synchronizing the content to the MMS rather than streaming it may provide a more stable experience.

If a local library is too large to fit on the MMS internal hard drive, use the MMS Media Sync software to selectively synchronize selected playlists, then use the NAS streaming method to provide access to the rest of the content, or attach an external USB.

- a. Click "Add Network Drive" to add storage from a NAS drive or a network folder.

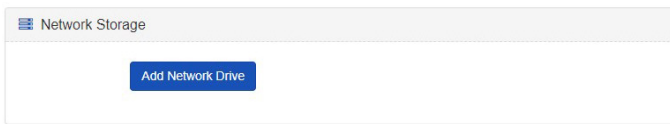

- b. Click the path of the selected server at the top of the page.
- c. Click on a folder to select it or, enter the full path in the field.
- d. Click "Add" once the desired folder is selected. The user name and password must be added if the folder requires authentication.

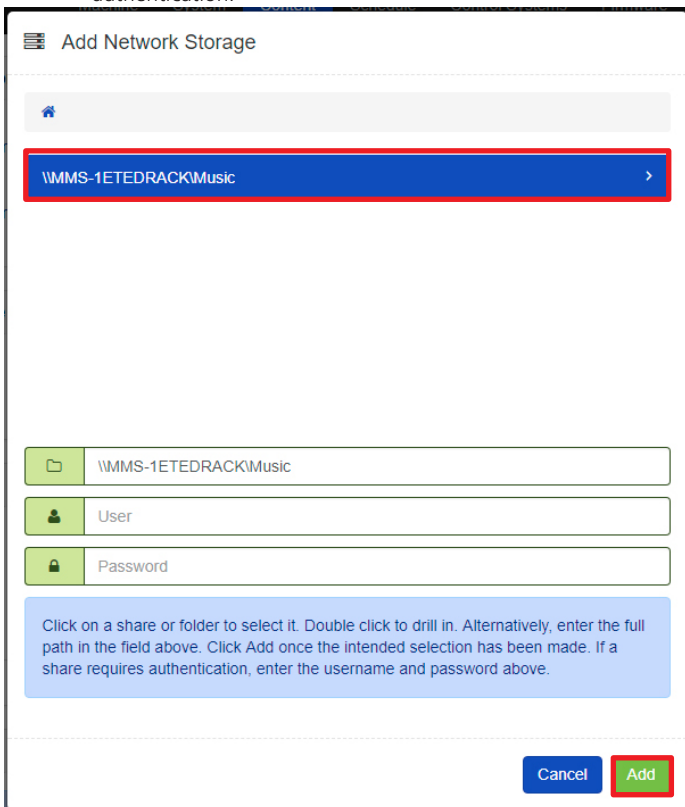

8. Local Storage. This section details the available storage on the device.

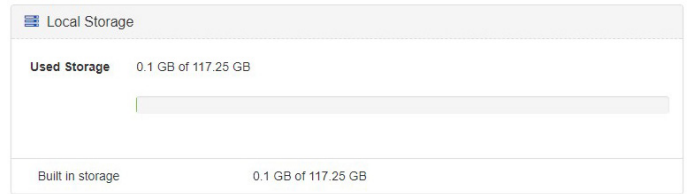

9. Location. Certain online services use the location of the server for location based content. Change the default location in this section.

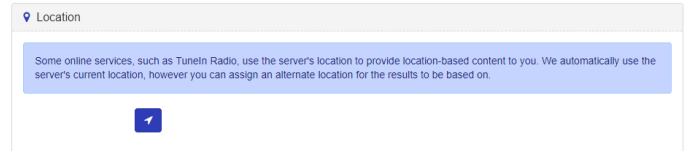

- a. Add the postal code to the "Address Lookup" section and click "Get Coordinates".
- b. Click "Set Location" once done.

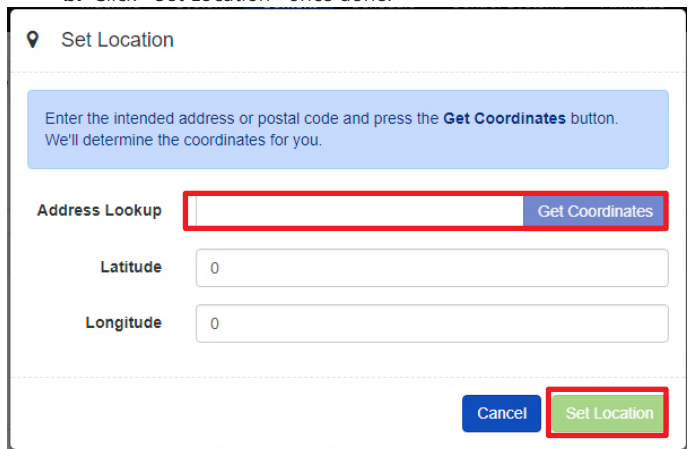

Adding Digital Content and Configuring Cloud Services

The Content tab allows account credentials to be entered for streaming media services and cloud services supported by the MMS.

Google Drive

The MMS can interface with a Google account to synchronize content to and from the cloud from multiple locations.

To enable this feature, click the gear in the right side, and select "Add account". Enter a Google user ID and password, and select one or both options for copying content to or from Google online storage.

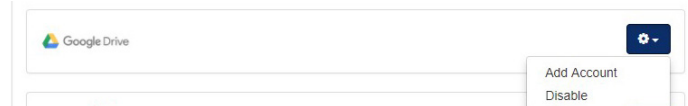

The MMS will synchronize all music files with Google online storage, even uncompressed FLAC or WAV files. These files will be stored in the Google account and will be available for multi-location synchronization.

Synchronizing Multiple Servers Via Google

MMS synchronization does not require any one unit to be designated as the master. The server accomplishes bidirectional synchronization with all locations.

To create a master/slave relationship between one master and one or more slaves enable only the "Copy To my Google Online Storage Account" option on the server acting as a master, and only the "Copy From my Google Online Storage Account" on the server acting as a slave.

Changes to the files synchronized to the MMS hard drive in the shared Music folder are copied to a hidden location on the MMS in order to maintain the integrity of the synchronization. These files must be modified at the source, or on Google Online storage.

iCloud Synchronization

Apple's iCloud service allows synchronization of music stored on multiple computers and devices via an iCloud account. This service is supported on the MMS via MMS Media Sync software.

NOTE: Only content downloaded to the Mac or PC will synchronize with the MMS.

The following settings are recommended for the most seamless experience:

1. Turn on iTunes Match. This allows synchronization of content from other computers and devices, which in turn is synchronized to the MMS via the MMS Media Sync software.
2. Enable automatic downloads of Music purchases. This setting can be found under iTunes > Preferences > Store.

When configuring the MMS Media Sync software, select the "Synchronize content with this server" option.

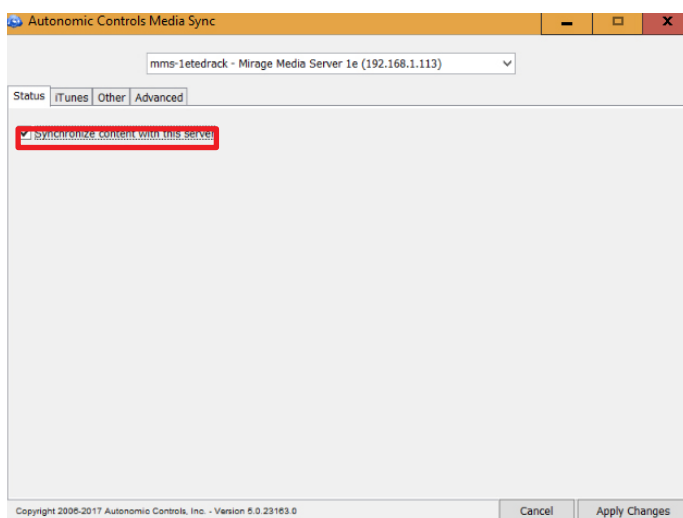

Synchronizing Files and Playlists To The MMS with iCloud

To automatically synchronize content with iCloud, configure iCloud using iTunes on any computer that will host the MMS Media Sync software.

The synchronization software can be configured to synchronize all music, or individual playlists can be selected and copied to the MMS.

All content synchronized with this utility is physically copied to the MMS to provide for backup and high availability. This means that once synchronized, content on the MMS can still be played even when the computer is off.

To stop synchronizing with one of the computers, click the "X" next to the computer name to remove it from the list and remove all content contributed by that computer to the MMS library.

Streaming Music Services

Configuration of streaming music services is accomplished on the Content tab of the configuration utility in a web browser.

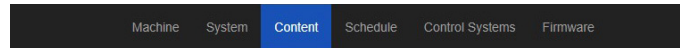

The information on these services changes frequently. Please check with the service provider for most current info.

[Link to appendix with a chart for music services here](#)

Pandora Internet Radio

Pandora is a service that allows creation of custom radio stations based on chosen albums or artists while including similar music from other artists and albums.

Subscribing to Pandora Paid Services will yield additional benefits on the MMS such as higher bitrate content, and commercial-free playback.

Select the gear to the right of the Pandora section under "Online Credentials" and click "Add Account". Enter Pandora credentials to associate the MMS with an online Pandora Internet Radio account.



When valid credentials are supplied, all online Pandora radio stations are available for playback on the MMS, and any new stations that created on the MMS will be saved in the online account.

The MMS supports multiple Pandora accounts, which can be created through the MMS Application (app) for iOS and Android, the MMS Web Interface and most third party control interfaces. Additionally, an existing Pandora account can be accessed through the interfaces by entering credentials when prompted.

New Pandora radio stations can be created using the MMS app, MMS Web Interface, and most third party interfaces.

The MMS TuneBridge™ technology allows creation of new Pandora stations based on any song or artist heard while playing back music from any streaming service or the local music collection. This feature can be accessed in the "Actions" menu of the MMS Web Interface and on third party control system touch panel interfaces or the TuneBridge™ icon in the iOS and Android MMS Media Controller app.

Pandora allows listening to up to six simultaneous streams with a single user ID and password on the MMS-5e, or three on the MMS-3e.

More information about Pandora Internet Radio can be found at www.Pandora.com

Napster®

Select the gear to the right of the Napster section under "Online Credentials" and click "Add Account". Enter Napster credentials to associate the MMS with a Napster online music account.

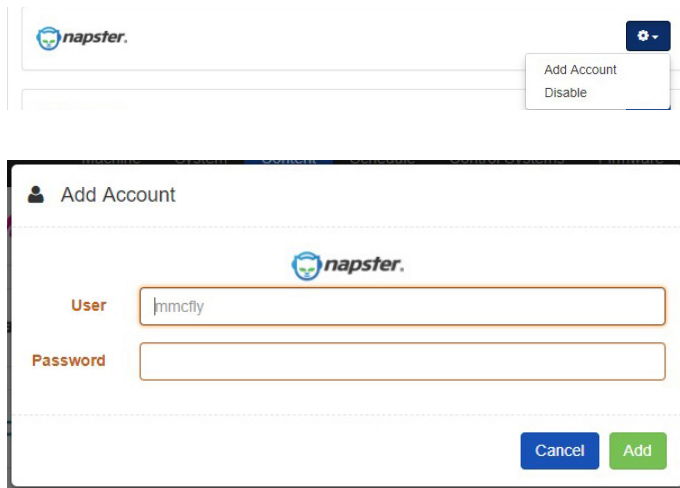

Napster is a digital music service that allows listening to all the music on the MMS and create cloud-based libraries from millions of songs available for on-demand playback.

Music can be browsed or searched by Album, Artist, Genre, and Popular Playlists via the Music Guide.

The Actions button on the MMS Web Interface or control system or the TuneBridge™ icon on the MMS Media Controller can be used to add the Album, Artist, or Track to your virtual collection.

Napster allows you to listen to one stream with a single user ID and password. The MMS supports multiple Napster accounts. Simultaneous streaming playback is supported using multiple accounts.

Additional accounts can be created via a new Napster account through the MMS Media Controller for iOS and Android, the MMS Web Interface, and most third party control system interfaces.

More information about Napster can be found at us.napster.com

SiriusXM Internet Radio

Select the gear to the right of the SiriusXM section under "Online Credentials" and click "Add Account". Enter the credentials to associate the MMS with an online SiriusXM Internet Radio account.

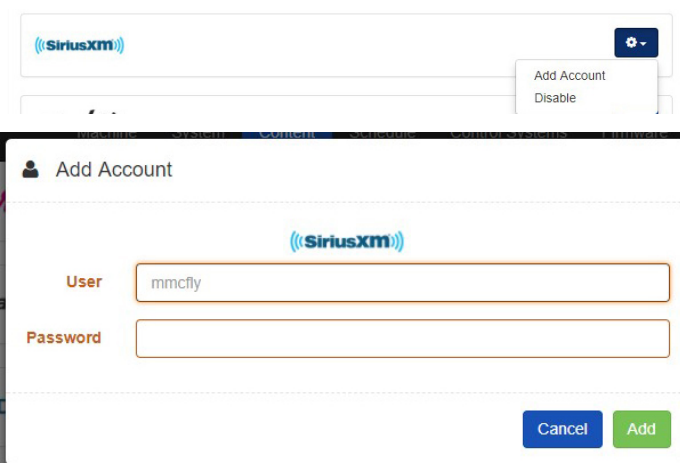

The MMS can access SiriusXM Radio subscriptions through an Internet connection. This eliminates the need for an external antenna or line of sight access to SiriusXM satellite transmitters.

NOTE: This information does not apply to the Auto radio subscription accounts.

IMPORTANT: While a single SiriusXM account can be used on any of the multiple MMS outputs, SiriusXM radio subscribers must provide one account ID and password, for each simultaneous stream that is listened to on any of the audio outputs.

SiriusXM will provide additional SiriusXM Internet Radio accounts for a reduced monthly fee.

More information about SiriusXM can be found at www.SiriusXM.com

Spotify

To activate the Spotify service on the MMS, select the gear to the right of the Spotify section under "Online Credentials" and click "Add Account". Enter the credentials to associate the MMS with an online Spotify account.

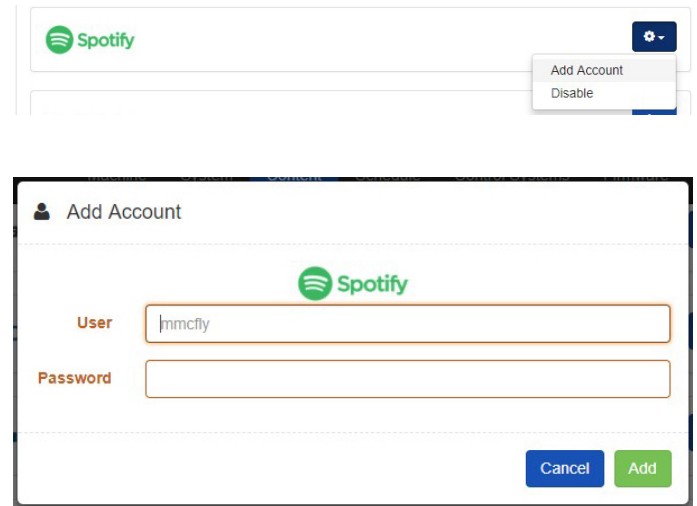

Spotify is a music streaming service offering streaming of selected music from a range of major and independent record labels. Music can be searched by artist, album, genre, or playlists, and searches can be saved as custom playlists. Most Spotify content is streamed at 320 Kbps, one of the highest bitrates offered by streaming music services.

Spotify allows for multiple accounts that can be added through the MMS Player app for iOS and Android, the MMS Web and most third party control system interfaces. While a single Spotify account can be used on any of the multiple MMS outputs, Spotify subscribers must provide one account ID and password for each simultaneous stream that is listened to on any of the audio outputs.

NOTE: Login must be from the account name, and not through a Facebook account.

More information about Spotify can be found at www.Spotify.com

This product incorporates Spotify software which is subject to 3rd party licenses found here:

<https://developer.spotify.com/esdk-third-party-licenses/>

Slacker

To activate Slacker services on the MMS, select the gear to the right of the Slacker section under "Online Credentials" and click "Add Account". Enter the credentials to associate the MMS with an online Spotify account.

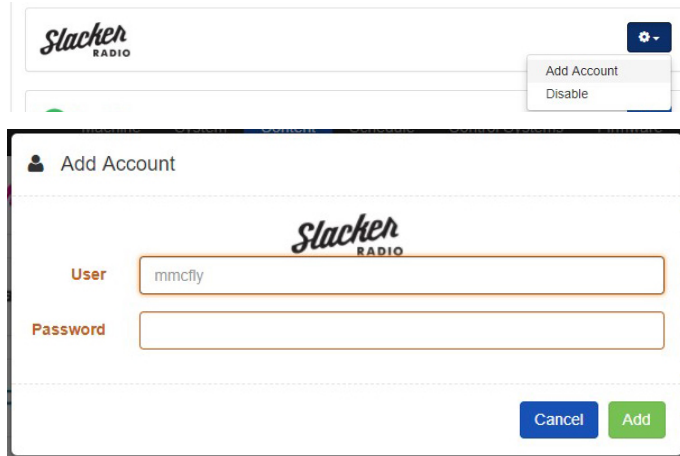

Slacker gives listeners access to music and entertainment. Listeners can personalize Slacker with talk, sports, news, and entertainment. Stations are updated daily based on trending and real-time user feedback.

Slacker supports multiple accounts that can be added or created through the MMS app for iOS, Android, and the MMS Web Player and most third party control interfaces. While a single Slacker account can be used on any of the multiple MMS outputs, Slacker radio subscribers must provide one account ID and password for each simultaneous stream that listened to on any of the audio outputs.

More information about Slacker can be found at www.Slacker.com.

TuneIn

To activate TuneIn services on the MMS, select the gear to the right of the TuneIn section under "Online Credentials" and click "Add Account". Enter the credentials to associate the MMS with an online TuneIn account.

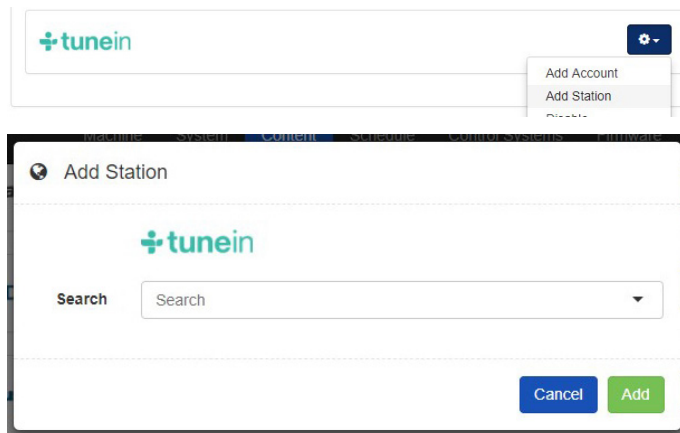

TuneIn is a free service that brings AM, FM, and Internet radio stations to the home. This service provides a directory of the world's radio stations that broadcast over the Internet. Many, if not all local AM and FM radio stations are available for crystal clear online streaming through the MMS without an over the air antenna. Thousands of radio stations world-wide can be browsed by genre or program name.

IMPORTANT: TuneIn allows for multiple streams. No account is required, however a TuneIn account allows favorite titles to be saved.

More information about TuneIn Radio can be found at www.TuneIn.com

Murfie HiFi

To activate Murfie services on the MMS, select the gear to the right of the Murfie section under "Online Credentials" and click "Add Account". Enter the credentials to associate the MMS with an online Murfie account.

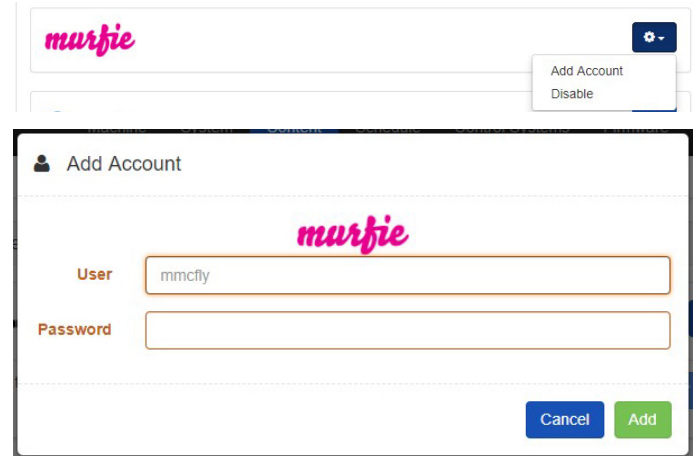

Murfie is a cloud-based service that allows listeners to upload their entire physical music collection, and purchase digital or physical copies of music from other collections of uploaded libraries.

Collections are uploaded daily, and hosted in an online account in the cloud. For a Monthly fee, once music is added to a library hosted on Murfie, it can be played on any compatible device.

Most Murfie content is streamed at 320 kbps, one of the highest bitrates offered by streaming music services.

Murfie HiFi allows for multiple accounts that can be added through the MMS Player app for iOS and Android, the MMS Web and most third party control system interfaces. While a single Murfie account can be used on any of the multiple MMS outputs, HiFi subscribers must provide one account ID and password for each simultaneous stream that is listened to on any of the audio outputs.

More information about Murfie can be found at www.Murfie.com/hifi

Deezer

To activate Deezer services on the MMS, select the gear to the right of the Deezer section under "Online Credentials" and click "Add Account". Enter the credentials to associate the MMS with an online Deezer account.

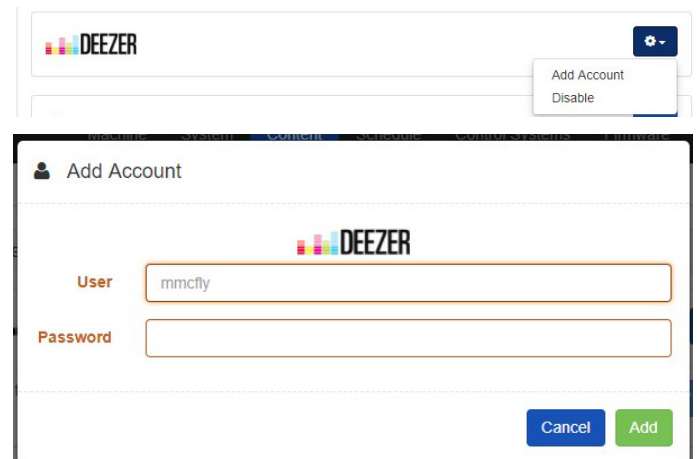

Deezer is a music streaming service offering streaming of selected music from a large range of major and independent record labels. Music can be searched by artist, album, genre, or playlist, and searches can be

saved as custom playlists. With the Premium Plus membership, music can be downloaded to any device for playback without an internet connection.

Deezer allows for multiple accounts that can be added through the MMS Player app for iOS and Android, the MMS Web and most third party control system interfaces. While a single Deezer account can be used on any of the multiple MMS outputs, Deezer subscribers must provide one account ID and password for each simultaneous stream that is listened to on any of the audio outputs.

NOTE: More information about Deezer can be found at www.Deezer.com.

iHeartRadio

To activate iHeartRadio services on the MMS, select the gear to the right of the iHeartRadio section under "Online Credentials" and click "Add Account". Enter the credentials to associate the MMS with an online iHeartRadio account.

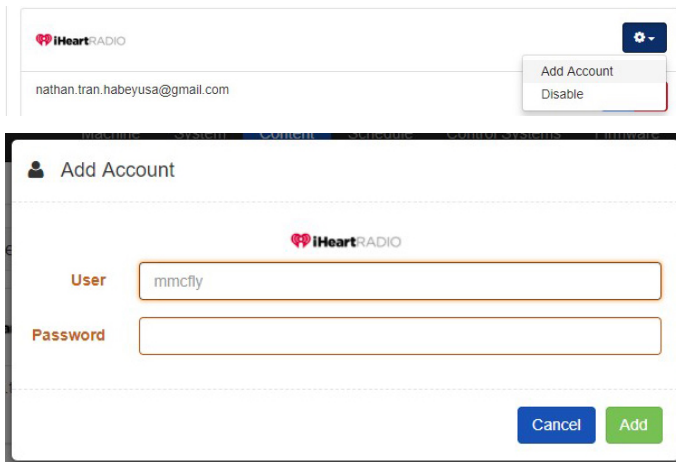

iHeartRadio is a free broadcast and internet radio platform that aggregates thousands of radio stations and podcasts. A paid subscription allows on demand playback of saved songs from live broadcasts

More information about iHeartRadio can be found at www.iHeart.com.

Tidal HiFi

To activate Tidal services on the MMS, select the gear to the right of the Tidal section under "Online Credentials" and click "Add Account". Enter the credentials to associate the MMS with an online Tidal account.

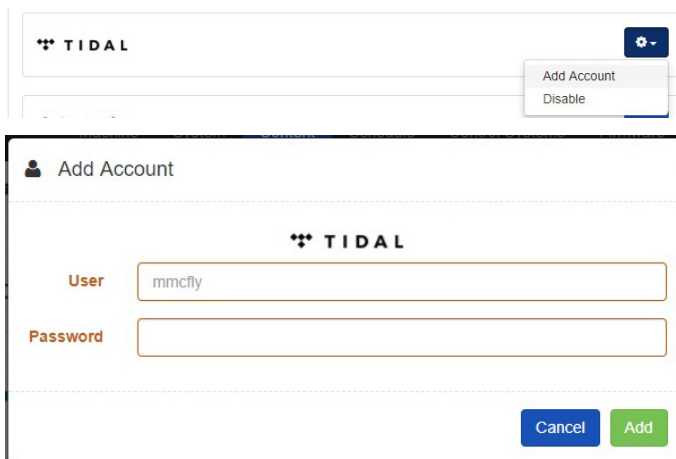

Tidal is a subscription based music streaming service offering high-definition lossless audio and music videos. Master Quality Authenticated technology provides subscribers with premium quality audio not matched by other online subscription services.

More information about Tidal can be found at Tidal.com/us.

Schedules

The Schedule tab allows creation and modification schedules for content playback. Click the Schedule Tab to get started.

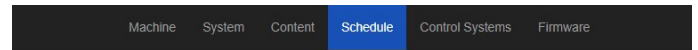

1. Click on "Add Schedule" to open the Schedule window and add options.

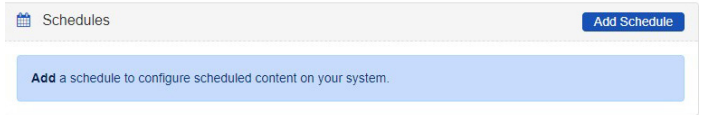

2. Add a title to the "Name" field.
3. Select the days on which to apply the scheduled start and stop time for content playback.
4. Select the start and stop time.
5. Type a preset name in the "Preset" field
6. Set the volume levels for each of the zones that will apply to the scheduled playback.
7. Click Add to complete the schedule.

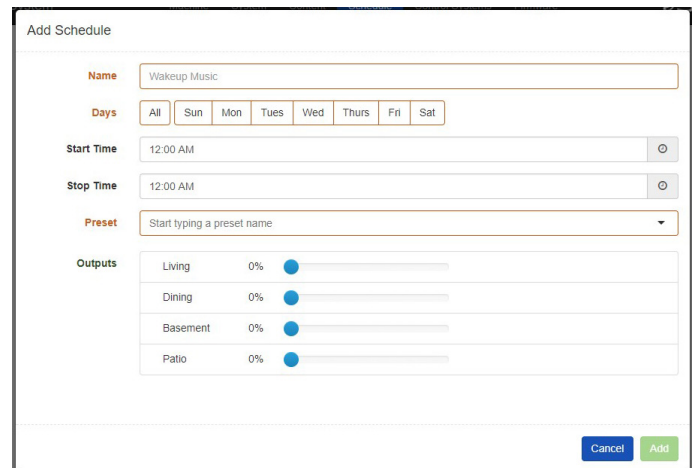

Control Systems

The Control Systems tab allows configuration of compatible control systems. Please note that some control systems do not need additional configuration beyond installation of the control system module. Visit http://www.autonomic-controls.com/support_downloads.php to download.

Crestron

Drivers for the streamers and SystemBuilder along with a guide to installation and programming is available on the product support tab on the SnapAV [website](http://www.snapav.com). A link is also available in the top right corner of the Crestron field on the Control Systems tab. Click "Save" to keep any changes.

Control4

Drivers, a sample installation guide and an MMS programming guide are available on the product support tab on the SnapAV [website](http://www.snapav.com). Install the driver and follow the instructions for configuration to set up and use the MMS with a Control 4 system.

ELAN

A driver for the MMS is only available on the ELAN Dealer Portal. This driver is limited to control of a single device.

Savant

A driver for Savant control of the MMS is only available from Savant. Visit the website at www.Savant.com.

Lutron

RadioRa® integration can be done via the Control System tab on the streamer configuration page. A guide for installation is available on the product support tab on the SnapAV [website](#).

RTI* (Not compatible with eAudiocast at this time)

An MMS programming guide and the RTI driver are available on the product support tab on the SnapAV [website](#). Install the driver and follow the instructions for configuration to set up and use the MMS with an RTI system.

URC

An MMS programming guide and the URC driver are available on the product support tab on the SnapAV [website](#). Install the driver and follow the instructions for configuration to set up and use the MMS with a URC system.

Firmware Updates

View the current firmware version on the MMS, update the software in the MMS, download utility and control software for controlling the server and synchronizing content, and contact remote technical support on the Firmware Tab.

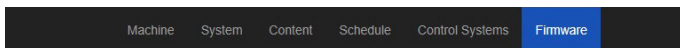

From time to time, new software is released to add new services, features, and correct any reported issues. If there is an update available, a button will appear in this section that allows download and application of the update.

After clicking the Update Firmware button, the MMS automatically downloads the latest version, installs the new operating firmware, and restarts the MMS. This process can take several minutes depending on the size of the update and internet speed.

WARNING: Do not power off the MMS during a firmware update. Doing so could require factory service to restore the MMS. The MMS should become available within a few minutes, at which point the update is complete and the MMS is available for normal use.

Other Software

This section contains links for starting the standalone app or Web player for the MMS.



License and Hardware

This section displays the product license information and serial number. Software serial number and hardware serial number are also printed on the bottom of the unit.

License and Hardware	
Model	MMS-3e
Serial Number	ST1731003100001A
ID	efea3d61-69c1-4b0f-8071-4e1c0c19a964
Ethernet MAC Address	D46A91600AAA
License	Licensed for general PolyTune streaming use by MMS-1e CM
CPU Speed	1.6GHz
CPU Temp	43.2°C

Logging

Internal server logs and media databases can be uploaded here. Enter your contact information and a description of the issue. These log files are sent directly to Tech Support.

Logging

Logs are sent to our support team. Please provide a contact email along with a description of the issue you're experiencing so that we may get back to you.

Contact Email

Comments

Remote Support

Tech Support may request remote access to a server through the Internet in order to check the operation of a server during service calls.

In that event, a security code will be provided that can be entered into this field to grant Technical Support remote access to the MMS.

Call 866.838.5052 or visit www.SnapAV.com for technical support.

Support

Safety Information

FCC - Federal Communications Commission Information

CAUTION: User changes or modifications not expressly approved by the party responsible for compliance could void the user's authority to operate the equipment.

NOTE: This equipment has been tested and found to comply with the limits for a Class B digital devices, pursuant to Part 15 of the FCC Rules. These limits are designed to provide reasonable protection against harmful interference in a residential installation.

This equipment generates, uses and can radiate radio frequency energy and, if not installed and used in accordance with the instructions, may cause harmful interference to radio communications. However, there is no guarantee that interference will not occur in a particular installation. If this equipment does cause harmful interference to radio or television reception, which can be determined by turning the equipment off and on, the user is encouraged to correct the interference by one or more of the following measures:

- Reorient or relocate the receiving antenna.
- Increase the separation between the equipment and receiver.
- Connect the equipment into an outlet on a circuit different from that to which the receiver is connected.
- Consult the dealer or an experienced radio/TV technician for help.

CE - European Conformity Information

This equipment bears the CE marking of conformity that indicates a product complies with the essential requirements of the applicable European laws or directives with respect to safety, health, environment and consumer protection. Generally, this conformity to the applicable directives is done through self-declaration. The CE Marking is required on products in the countries of the European Economic Area (EEA) to facilitate trade among the member countries. The manufacturer or their authorized representative established in the EEA is responsible for affixing the CE Marking to their product. The CE Marking provides a means for a manufacturer to demonstrate that a product complies with a common set of laws required by all of the countries in the EEA to allow free movement of trade within the EEA countries.













Our Promise

Autonomic is committed to updating and supporting our products to provide dealers with maximum value and the best digital media control solutions.

If there's any way we can serve your needs, please email Techsupport@SnapAV.com, visit www.SnapAV.com or contact our support team at 866.838.5052.

MMS OS STREAMING SERVICES

The MMS and MAS operating system (OS) provides playback of the most popular online streaming music services. Many of the services support multiple accounts that can be entered and accessed directly from the UI controlling the MMS or MAS. Service terms vary per streaming service, and although one account may suffice for playback on one player of the MMS, multiple accounts may be required to play simultaneous streams of the service. Below is a comprehensive list of streaming services available through the MMS, highlighting account types required and number of accounts needed to support simultaneous streams of playback per service.

SUPPORTED STREAMING SERVICES				
Streaming Service*	Account Type / Subscription Supported	Number of Accounts	Number of Simultaneous Streams per Account	Additional Information
 iCloud	Free or Premium	(1) One	Not Applicable	Sync multiple MMS content
 iHeartRADIO	Free	Unlimited	Not Applicable	...
 iTunes	Free or Premium	Unlimited	Unlimited	...
PANDORA	Free or Premium	Multiple	Unlimited	...
 napster	Premium	Multiple	(1) One	Napster offers a family plan, for more information visit: us.napster.com/family
 ((SiriusXM))	Premium	Multiple	(1) One	SiriusXM offers a family plan, for more information visit: www.SiriusXM.com
 ((SiriusXM)) MUSIC FOR BUSINESS	Premium	Multiple	(1) One	No timeout restrictions. For more information, visit: https://www.siriusxm.com/siriusxmfor-business
 Spotify	Premium	Multiple	(1) One	Spotify offers a family plan, for more information visit: www.Spotify.com
 Slacker RADIO	Free or Premium	Multiple	(1) One	Limits of 200 track starts on free accounts in Canada
 TIDAL	Premium	Multiple	(1) One	TIDAL offers a family plan, for more information visit: www.Tidal.us
 DEEZER	Free or Premium	Multiple	(1) One	International; Premium tier US available
 tunein	Free	(1) One (optional)	Unlimited	Account only required to browse presets
 murfie	Premium	Multiple	Unlimited	...

*To see which countries support each service, please reference: <http://www.pro-music.org/legal-music-services.php>

For additional questions or information, please contact Autonomic Technical Support at 914-598-1647, option 2, or email support@autonomic-controls.com

Specifications



High Resolution Output

As with the premium music servers in the lineup, the MMS-1e supports full High Resolution Audio (HRA) at 24bit/192kHz.

Flexible Output Options

The MMS-1e supports one analog output through its on board HRA 24bit/192kHz DAC, plus mirrored High Resolution PCM digital outputs in both Coax and HDMI formats.

eAudioCast™

The MMS-1e will support one physical stream mirrored to Analog, PCM, and HDMI outputs. Our proprietary eAudioCast™ technology enables two network streams of audio to be played back on the MMS-1e versus usage of the single stream available with use of one of the physical outputs. eAudioCast™ network streams are only available for use when the MMS-1e is paired with a complementing eSeries MMS Digital Amplifier.

All Solid State

All eSeries products are completely solid state. Autonomic has eliminated all moving parts from its entire lineup with solid state storage and re-engineered passive cooling systems, which translates to years of trouble free and silent performance, lower power consumption, and snappier responsiveness.

WiFi Support

The MMS-1e supports both wired and bi-directional WiFi connections for convenient placement.

MMS-1e	
Streaming Services	Deezer, iHeartRadio, Murfie, Napster, PANDORA® Internet Radio, SiriusXM Internet Radio, Slacker Radio, Spotify, TIDAL, TuneIn, AirPlay
Audio Formats	.aif, .aifc, .aiff, .au, .cda, .flac, .m4a, .m4p, .mp2, .mp3, .mpa, .rmi, .snd, .wav, .wma, .wpl
Internal Storage	32 GB Flash Memory; holds approximately 10,000 songs
External Storage	Expandable via USB external hard drives or network shared storage
Pre-Amp Audio Output	(1) analog, unbalanced, stereo RCA type, line level audio output
Digital Audio Output	(1) Stereo Coaxial, RCA type, PCM (1) Stereo USB for connection to external DAC PCM (1) Stereo HDMI PCM
Digital-to-Analog Conversion	High-resolution 24bit/192kHz
Supported Sample Rates	44.1/48/96/192 kHz at 16-bit or 24-bit resolution
S/N Ratio	96db, A weighted
Video Outputs for OSD	HDMI (Max Resolution of 1920 X 1080)
Local Synchronization	MMS Media Sync for both Mac and Windows: download from web-based configuration under Firmware tab
Cloud-based Synchronization	Google Drive Cloud Sync (fees for online storage may apply)
Control System Protocols	IP, 2-way documented API
Control Interfaces	AMX, Command Fusion, Control4, Crestron, Elan, KNX, Leviton, Lutron, ON Controls, RTI, Savant, URC, Windows/Mac, on-screen display (OSD), mobile devices and computers, MMS Media Controller for Apple iPad, iPhone/iPod Touch, Android and Amazon Kindle
LAN Connection	(1) 8-wire RJ45 with 2 LED indicators; 10/100/1000 Mbps/sec BaseT Ethernet port; green LED indicates link status; yellow LED indicates Ethernet activity
Wireless LAN	802.11 a/b/g/n/ac; Dual-band 2.4 GHz/5GHz
USB	(2) USB 2.0
Power Connection	100V–240V AC ~ 50-60Hz: External DC 5 V @ 2A (included)
Main Power Consumption	10W @ 100–240 V AC, 50–60Hz
Environmental Requirements	Humidity: 10% to 90% RH (non-condensing) Temperature: 32°F to 104°F (0°C to 40°C)
Dimensions	With feet: 6" x 3.9" x 1.4"; with brackets: 6.5" x 3.9" x 1.3" (With feet: 153mm x 100mm x 36mm; with brackets: 165mm x 100mm x 33mm)
Net Weight	1 lb (0.5 kg)
Mounting	(4) feet included; (2) brackets for structured wire cabinet / wall mount included
Warranty	2-year limited warranty

INTEGRATE ANY STREAMING SERVICE WITH YOUR CONTROL SYSTEM





Audiophile Quality Sound

Supports reference quality, High Resolution Audio (HRA) 24-bit/192kHz content, perfectly rendered through analog, coaxial digital and USB outputs, in addition to eAudioCast™ network streams.

Flexible Output Options

The MMS-3e supports two analog outputs through its on board HRA 24-bit/192kHz DAC, plus mirrored High Resolution PCM coax digital outputs and one output mirrored to both HDMI and USB (to DAC) formats.

eAudioCast

Our innovative, proprietary eAudioCast technology enables audio-over-Ethernet to compatible eSeries devices. The MMS-3e will support three eAudioCast streams, including both physical streams mirrored to eAudioCast, as well as a third eAudioCast-only stream available when paired with MMS eSeries amplifiers.

All Solid State

All eSeries products are completely solid state and use passive cooling systems. All moving parts have been eliminated from the entire Autonomic lineup, which translates to years of trouble free and silent performance, lower power consumption, and quick responsiveness.

MMS-3e

Streaming Services	Deezer, iHeartRadio, Murfie, Napster, PANDORA® Internet Radio, SiriusXM Internet Radio, Slacker Radio, Spotify, TIDAL, TuneIn, AirPlay			
Audio Formats	.aif, .aifc, .aiff, .alac, .au, .cda, .flac, .m4a, .m4p, .mp2, .mp3, .mpa, .rmi, .snd, .wav, .wma, .wpl			
Internal Storage	120 GB SSD; holds approximately 25,000 songs			
External Storage	Expandable via USB external hard drives or network shared storage			
Audio Outputs (3 Total)	Supported Format	Output 1	Output 2	Output 3
	Analog ¹	✓	✓	
	COAX ²	✓	✓	
	USB ³			✓
	HDMI ⁴			✓
	eAudioCast ⁵	✓	✓	✓
Analog¹:	unbalanced, stereo RCA type, line level audio output			
COAX²:	Stereo Coaxial, RCA type, PCM			
USB³:	Stereo USB for connection to external DAC PCM			
HDMI⁴:	Stereo HDMI, Type A, PCM			
eAudioCast⁵:	Provides audio-over-Ethernet technology when paired with eSeries devices			
Digital-to-Analog Conversion	High-resolution 24-bit/192kHz			
Supported Sample Rates	44.1/48/96/192 kHz at 16-bit or 24-bit resolution			
S/N Ratio	96db, A weighted			
Video Outputs for OSD	HDMI (Max Resolution of 1920 X 1080)			
Local Synchronization	MMS Media Sync for both Mac and Windows: download from web-based configuration under Firmware tab			
Cloud-based Synchronization	Google Drive Cloud Sync (fees for online storage may apply)			
Control System Protocols	IP, 2-way documented API			
Control Interfaces	AMX, Command Fusion, Control4, Crestron, Elan, KNX, Leviton, Lutron, ON Controls, RTI, Savant, URC, Windows/Mac, on-screen display (OSD), mobile devices and computers, MMS Media Controller for iOS and/or Android devices			
LAN Connection	(1) 8-wire RJ45 with 2 LED indicators; 10/100/1000 Mbits/sec BaseT Ethernet port; green LED indicates link status; yellow LED indicates Ethernet activity			
USB	(3) USB 2.0			
Power Connection	110V-240V external DC 12 V @ 5 A with removable IEC 60320-1 C13/C14 power cord (included)			
Main Power Consumption	10W @ 100–240 V AC, 50–60Hz			
Environmental Requirements	(Humidity: 10% to 90% RH (non-condensing) Temperature: 32°F to 104°F (0°C to 40°C)			
Dimensions	2.25" H (with included feet installed) x 17" W x 10" D (5.7cm x 43cm x 25cm); 1RU rack-mount chassis			
Net Weight	5 lbs (2.27 kg)			
Mounting	Four (4) screw on feet included; two rack ears included			
Warranty	2-year limited warranty			

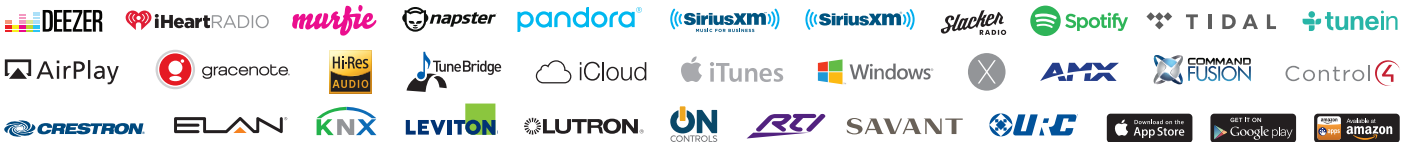



Audiophile Quality Sound

Supports reference quality, High Resolution Audio (HRA) 24-bit/192kHz content, perfectly rendered through analog, coaxial digital and USB outputs, in addition to eAudioCast™ network streams.

Flexible Output Options

The MMS-5e supports four analog outputs through its on board HRA 24-bit/192kHz DAC, plus mirrored High Resolution PCM coax digital outputs and one output mirrored to both HDMI and USB (to DAC) formats.

eAudioCast

Our innovative, proprietary eAudioCast technology enables audio-over-Ethernet to compatible eSeries devices. The MMS-5e will support five eAudioCast streams, including all four physical streams mirrored to eAudioCast, as well as a fifth eAudioCast-only stream available when paired with MMS eSeries amplifiers.

All Solid State

All eSeries products are completely solid state and use passive cooling systems. All moving parts have been eliminated from the entire Autonomic lineup, which translates to years of trouble free and silent performance, lower power consumption, and quick responsiveness.

MMS-5e																																					
Streaming Services	Deezer, iHeartRadio, Murfie, Napster, PANDORA® Internet Radio, SiriusXM Internet Radio, Slacker Radio, Spotify, TIDAL, TuneIn, AirPlay																																				
Audio Formats	.aif, .aifc, .aiff, .alac, .au, .cda, .flac, .m4a, .m4p, .mp2, .mp3, .mpa, .rmi, .snd, .wav, .wma, .wpl																																				
Internal Storage	256 GB SSD; holds approximately 50,000 songs																																				
External Storage	Expandable via USB external hard drives or network shared storage																																				
Audio Outputs (5 Total)	<table border="1"> <thead> <tr> <th>Supported Format</th> <th>Output 1</th> <th>Output 2</th> <th>Output 3</th> <th>Output 4</th> <th>Output 5</th> </tr> </thead> <tbody> <tr> <td>Analog¹</td> <td>✓</td> <td>✓</td> <td>✓</td> <td>✓</td> <td></td> </tr> <tr> <td>COAX²</td> <td>✓</td> <td>✓</td> <td>✓</td> <td>✓</td> <td></td> </tr> <tr> <td>USB³</td> <td></td> <td></td> <td></td> <td></td> <td>✓</td> </tr> <tr> <td>HDMI⁴</td> <td></td> <td></td> <td></td> <td></td> <td>✓</td> </tr> <tr> <td>eAudioCast⁵</td> <td>✓</td> <td>✓</td> <td>✓</td> <td>✓</td> <td>✓</td> </tr> </tbody> </table>	Supported Format	Output 1	Output 2	Output 3	Output 4	Output 5	Analog ¹	✓	✓	✓	✓		COAX ²	✓	✓	✓	✓		USB ³					✓	HDMI ⁴					✓	eAudioCast ⁵	✓	✓	✓	✓	✓
	Supported Format	Output 1	Output 2	Output 3	Output 4	Output 5																															
	Analog ¹	✓	✓	✓	✓																																
	COAX ²	✓	✓	✓	✓																																
	USB ³					✓																															
	HDMI ⁴					✓																															
eAudioCast ⁵	✓	✓	✓	✓	✓																																
Analog¹: unbalanced, stereo RCA type, line level audio output COAX²: Stereo Coaxial, RCA type, PCM USB³: Stereo USB for connection to external DAC PCM HDMI⁴: Stereo HDMI, Type A, PCM eAudioCast⁵: Provides audio-over-Ethernet technology when paired with eSeries devices																																					
Digital-to-Analog Conversion	High-resolution 24-bit/192kHz																																				
Supported Sample Rates	44.1/48/96/192 kHz at 16-bit or 24-bit resolution																																				
S/N Ratio	96db, A weighted																																				
Video Outputs for OSD	HDMI (Max Resolution of 1920 X 1080)																																				
Local Synchronization	MMS Media Sync for both Mac and Windows: download from web-based configuration under Firmware tab																																				
Cloud-based Synchronization	Google Drive Cloud Sync (fees for online storage may apply)																																				
Control System Protocols	IP, 2-way documented API																																				
Control Interfaces	AMX, Command Fusion, Control4, Crestron, Elan, KNX, Leviton, Lutron, ON Controls, RTI, Savant, URC, Windows/Mac, on-screen display (OSD), mobile devices and computers, MMS Media Controller for iOS and/or Android devices																																				
LAN Connection	(1) 8-wire RJ45 with 2 LED indicators; 10/100/1000 Mbits/sec BaseT Ethernet port; green LED indicates link status; yellow LED indicates Ethernet activity																																				
USB	(3) USB 2.0																																				
Power Connection	110V-240V external DC 12 V @ 5 A with removable IEC 60320-1C13/C14 power cord (included)																																				
Main Power Consumption	10W @ 100–240 V AC, 50–60Hz																																				
Environmental Requirements	(Humidity: 10% to 90% RH (non-condensing) Temperature: 32°F to 104°F (0°C to 40°C)																																				
Dimensions	2.25" H (with included feet installed) x 17" W x 10" D (5.7cm x 43cm x 25cm); 1RU rack-mount chassis																																				
Net Weight	5 lbs (2.27 kg)																																				
Mounting	Four (4) screw on feet included; two rack ears included																																				
Warranty	2-year limited warranty																																				

