



Service Manual

Induction Slide-in Range



 **Electrolux**

318 202 124 (1004)

Table of Contents

SAFE SERVICING PRACTICES	1
FEATURE OVERVIEW	2-8
WIRING DIAGRAM	9-10
INSTALLATION INSTRUCTIONS.....	11-21
CLEARANCE AND DIMENSIONS	11-12
TO AVOID BREAKAGE: DO NOT HANDLE OR MANIPULATE THE UNIT BY THE COOKTOP	13
IMPORTANT NOTES TO THE INSTALLER	14
IMPORTANT NOTE TO THE CONSUMER.....	14
IMPORTANT SAFETY INSTRUCTIONS.....	15
1. FACTORY CONNECTED POWER SUPPLY CORD (CANADA ONLY)	15
2. POWER SUPPLY CORD KIT (U.S.A.)	15
3. ACCESS TO TERMINAL BLOCK & GROUNDING STRAP (USA)	15
4. ELECTRICAL CONNECTION TO RANGE (U.S.A.).....	16-17
5. CABINET CONSTRUCTION	18
6. RANGE INSTALLATION.....	19
7. LEVELING THE RANGE	20
8. CHECK OPERATION	20
9. ANTI-TIP BRACKET INSTALLATION INSTRUCTIONS.....	21
NOTES	22
ELECTRONIC OVEN CONTROL	23-46
SETTING THE CLOCK AT POWER UP	23
CONTROL PANEL DISPLAY MODES.....	23
TEMPERATURE VISUAL DISPLAY	23
OVEN LIGHT.....	24
CONTROL LOCK	24
SETTING THE KITCHEN TIMER.....	24
BAKING	25
COOK TIME	26
END TIME	26
BROILING	27
CONVECTION BAKING.....	28
CONVECTION CONVERT	29
RAPID PREHEAT.....	29
CONVECTION ROASTING.....	30
CONVECTION BROILING	31
KEEP WARM.....	32
SLOW COOK	33
DEHYDRATING.....	34

Table of Contents

DEFROSTING	34
BREAD PROOFING	35
PERFECT TURKEY	36
TEMPERATURE PROBE	37
MULTI STAGE	38-39
USER PREFERENCES.....	40-42
MY FAVORITES	43
SABBATH FEATURE.....	44-45
STARTING SELF-CLEAN CYCLE.....	46

INDUCTION COOKTOP CONTROLS 47-52

ABOUT THE CERAMIC GLASS COOKTOP	47
USE THE CORRECT COOKWARE TYPE.....	47
MINIMUM PAN SIZE REQUIREMENTS	47
COOKWARE RECOMMENDATIONS	48
USE QUALITY COOKWARE IN GOOD CONDITION.....	49
SETTING THE COOKTOP	50-51
SETTING POWER BOOST FEATURE	52
POWER SHARING.....	52
OPERATIONAL NOISES.....	52

SERVICE DATA 53

ELECTRONIC OVEN CONTROL.....	53
ELECTRONIC OVEN CONTROL RELAY BOARD	53
ELECTRONIC CONTROL DISPLAY BOARD	54
POWER SUPPLY BOARD FOR ELECTRONIC CONTROL DISPLAY BOARD	54
CONVECTION FAN AND OVEN LIGHTS CONTROL BOARD.....	54
ELECTRONIC OVEN CONTROL (FAULT CODES) DESCRIPTIONS.....	55
RTD SCALE	56
ELECTRICAL RATING FOR ELECTRIC OVENS	56
ELECTRIC SLIDE-IN OVEN CIRCUIT ANALYSIS MATRIX	56
LOWER OVEN ANALYSIS MATRIX.....	56
MEAT PROBE RESISTANCE.....	56
OVEN LIGHT.....	57
ELECTRONIC SURFACE CONTROL (ESEC) USER INTERFACE BOARD (UIB)	58
POWER SUPPLY BOARD FOR ESEC UIB	58
INDUCTION COOKTOP ELECTRONIC ERROR (FAULT) CODE DESCRIPTIONS.....	59-60
ADDITIONAL INDUCTION COOKTOP ERROR (FAULT) CONDITIONS	60-61
INDUCTION HOUSING ASSEMBLY	61
BLOCK DIAGRAM.....	62

III Table of Contents

DISASSEMBLY	63
1. HOW TO ACCESS THE CONTROL PANEL AREA	63
2. CONTROL PANEL'S COMPONENTS IDENTIFICATION AND REPLACEMENT	66
3. AUTOMATED DOOR LIGHT SWITCH (PLUNGER) & DOOR LOCK ASSEMBLY	67
4. INDUCTION COOKTOP	68
5. COOLING FAN AND SAFETY THERMOSTAT	72
6. HALOGEN LIGHT SOCKET, HINGE RECEPTACLE AND OVEN RACK SENSOR	73
7. OVEN RACKS, LADDER RACKS AND HALOGEN LIGHT COVER AND LENS	75
8. MEAT PROBE	77
9. OVEN TEMPERATURE SENSOR	78
10. BROIL ELEMENT	79
11. CONVECTION ELEMENT. MOTOR AND COOLING FAN	79
12. UNIT BACK VIEW AND COMPONENTS	83
13. HIDDEN BAKE AND MINI OVEN ELEMENT	83
14. MINI OVEN LIGHT AND GLIDES	87
15. MINI OVEN DRAWER ASSEMBLY	88
16. MAIN OVEN DOOR ASSEMBLY	90

EXPLODED VIEW DRAWINGS - TO COME

SAFE SERVICING PRACTICES 1

To avoid personal injury and/or property damage, it is important that **Safe Servicing Practices** be observed. The following are some limited examples of safe practices:

1. **DO NOT** attempt a product repair if you doubt your ability to complete it in a safe and satisfactory manner.
2. Before servicing or moving an appliance:
 - Remove power cord from electrical outlet, trip circuit breaker to the **OFF** position, or remove fuse.
 - Turn off gas supply
 - Turn off water supply
3. Never interfere with the proper operation of any safety device.
4. **Use The Correct Replacement Parts Cataloged For This Appliance. Substitutions May Defeat Compliance With Safety Standards Set For Home Appliances.**
5. **GROUNDING:** The standard color code for safety ground wires is **GREEN**, or **GREEN** with **YELLOW STRIPES**. **DO NOT** use ground leads as current carrying conductors. It is **EXTREMELY** important that the service technician reestablish all safety grounds prior to completion of service. Failure to do so will create a hazard.
6. Prior to returning the product to service, ensure that:
 - All electrical connections are correct and secure.
 - All electrical leads are properly dressed and secured away from sharp edges, high-temperature components, and moving parts
 - All non-insulated electrical terminals, connectors, heaters, etc. are adequately spaced away from all metal parts and panels
 - All safety grounds (both internal and external) are correctly and securely connected
 - All panels are properly and securely reassembled

©2010 Electrolux Home Products, Inc.

WARNING

This service manual is intended for use by persons having electrical and mechanical training and a level of knowledge of these subjects generally considered acceptable in the appliance repair trade. Electrolux Home Products cannot be responsible, nor assume any liability, for injury or damage of any kind arising from the use of this manual.

2

Feature Overview

YOUR SLIDE-IN RANGE

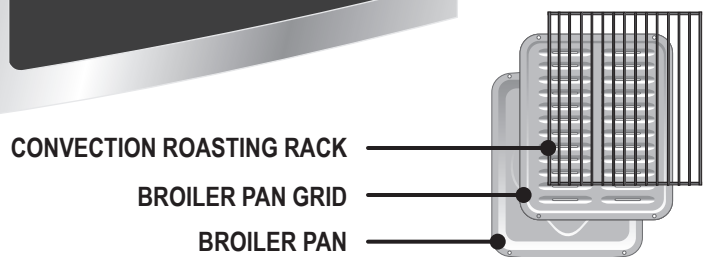
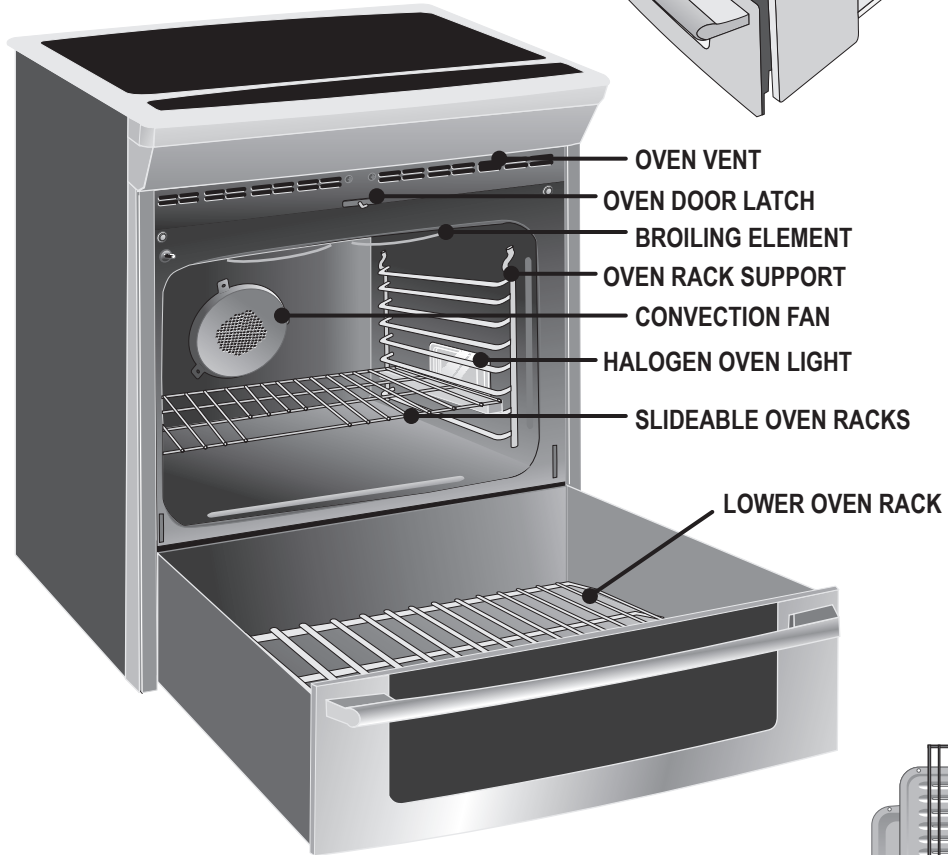
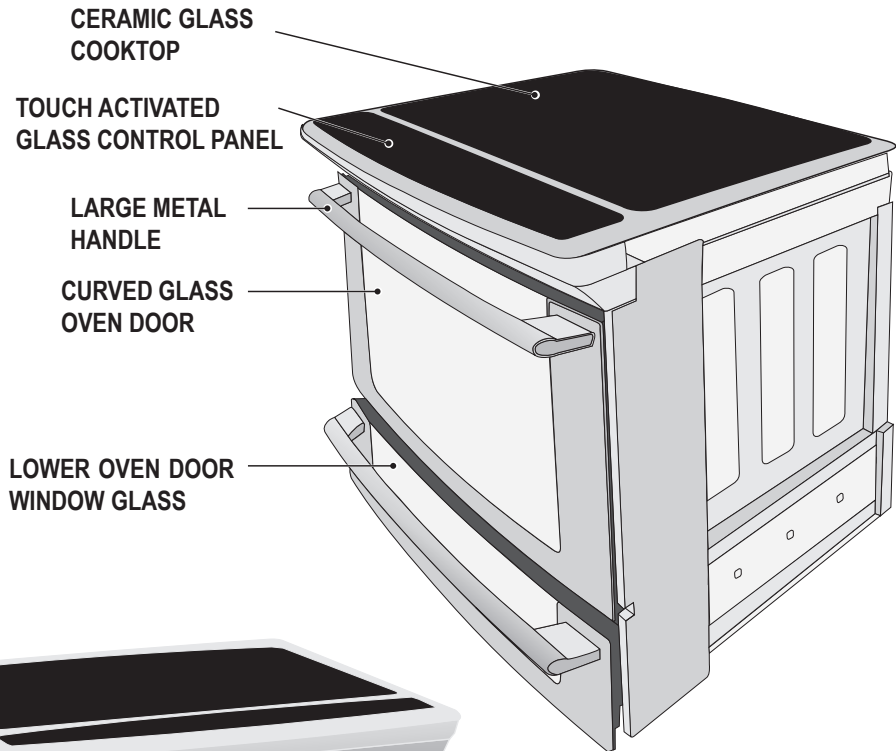

INDUCTION COOKTOP FEATURES

READ THESE INSTRUCTIONS CAREFULLY BEFORE USING THE COOKTOP

A COOLER COOKTOP - A unique feature of the Induction Cooktop is whether turned ON or OFF, the cooktop surface remains cooler than standard ceramic cooktops.

CAUTION

The Cooking Zones may appear to be cool while turned ON and after they have been turned OFF. **The glass surface may be HOT** from residual heat transferred from the cookware and burns may occur.

MAGNETIC DETECTOR - The coil sensor automatically detects whether the pan is magnetic and eliminates accidental “turn-ONs.”

PAN SIZE DETECTION - The pan recognition sensor automatically detects and adapts the Cooking Zones to the pan sizes in use.

EFFICIENT - Induction cooking heats faster while using less energy. Induction power levels are quick to boil and delicate when simmering.

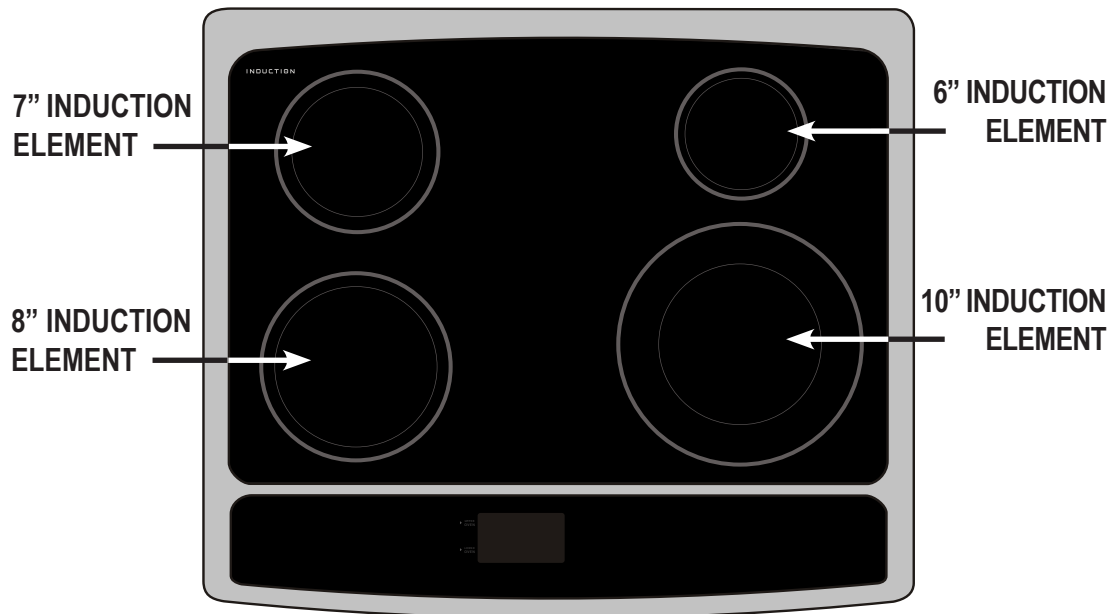

4 Feature Overview

OVEN RACK SUPPORTS & OVEN VENTS



Installing Oven Rack Supports

ALWAYS INSTALL OVEN RACK SUPPORT BEFORE TURNING ON THE OVEN (WHEN THE OVEN IS COOL).

To install oven rack support, insert the supports by pushing them downward into the two brackets on each side of the oven interior, as shown below.

To remove the oven rack support for a self-clean cycle, pull up the support to disengage them from the brackets. If the rack supports are not removed, the self-clean cycle won't start.

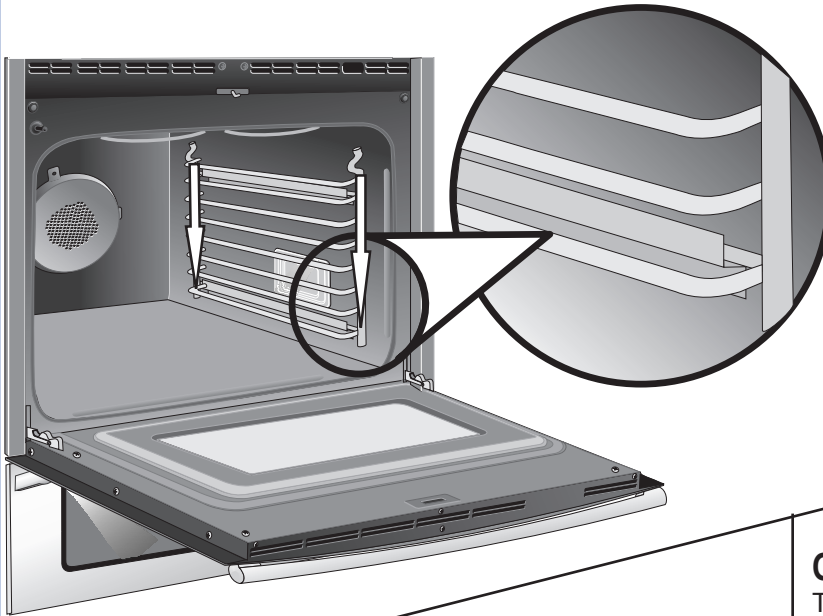

Oven Rack Positions

This oven is equipped with ladder rack supports with 7 positions to accommodate precisely every mode of cooking.

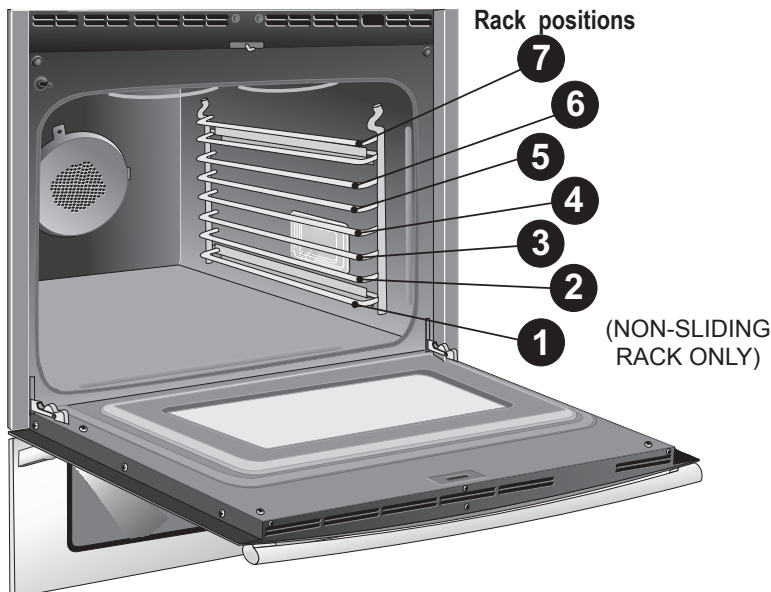

Oven Vents Location

The oven is vented **above each door**. When the oven is on, warm air is released through the vents. This venting is necessary for proper air circulation in the oven and good baking results.

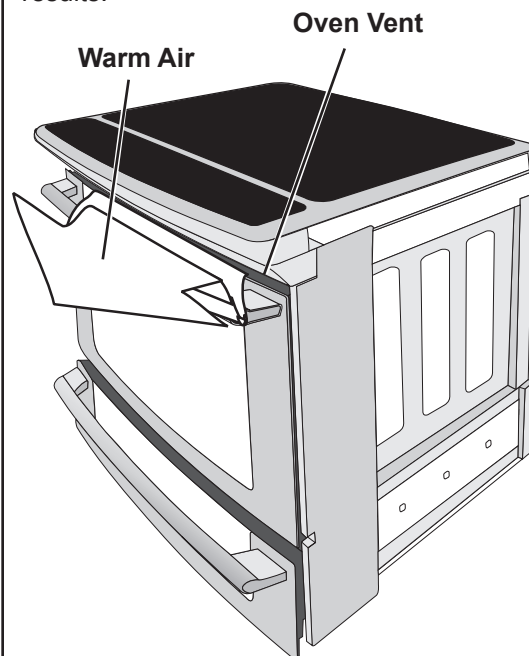

REMOVING AND REPLACING OVEN RACKS

Removing Sliding Oven Racks

1. With the rack in its closed position; grasp the rack and the sliders at once.
2. Slightly lift the rack and sliders and pull it to clear the first bracket.
3. Pull the rack and sliders until the second bracket stops the rack.
4. Lift the rack and sliders and carefully remove them from the oven.

Refer to the care and cleaning section for directions on how to clean the racks.

Replacing Sliding Oven Racks

To replace the oven racks, follow the instructions above in reverse order.

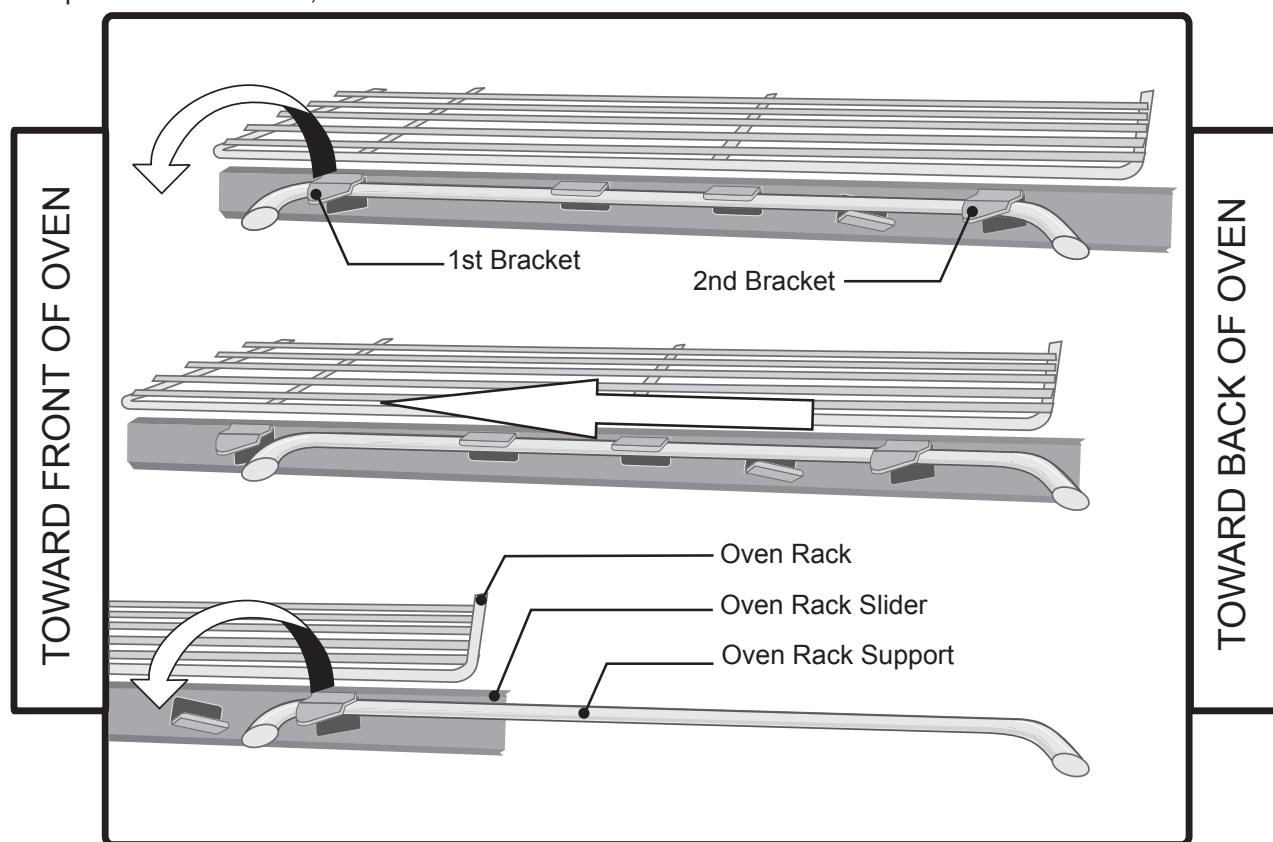

Removing Non-Sliding Oven Rack

Simply pull the rack and slightly tilt it upward when the rack hits its stop position.

Replacing Non-Sliding Oven Rack

Insert the rack into the oven rack supports by inserting the rack openings into the rack supports. Be sure the rack is at the same position on each oven rack support on both sides.

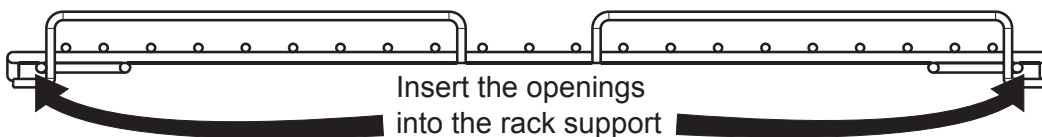

⚠ WARNING Always arrange the oven racks when the oven is cool (prior to operating the oven). Always use oven mitts when using the oven.

6 Feature Overview

OVEN CONTROL PAD FUNCTIONS

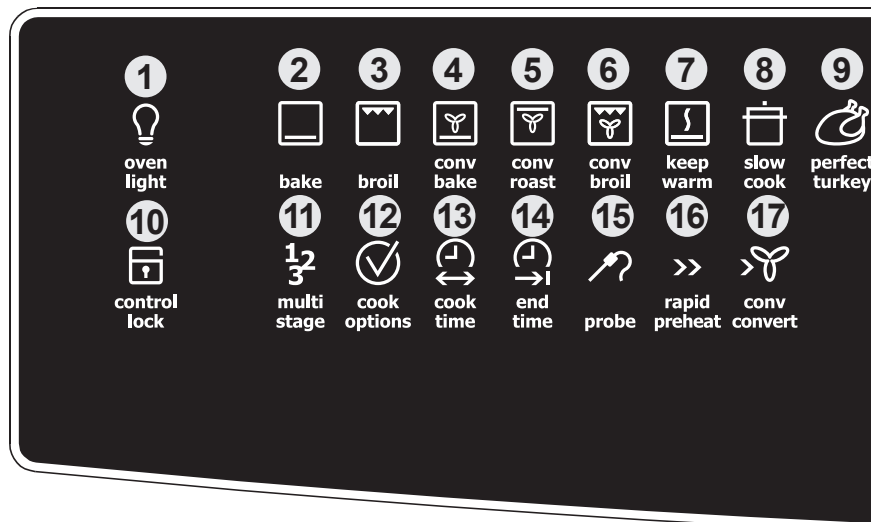

- 1 Light Pad**- Used to turn the oven light on and off.
- 2 Bake Pad**- Used to enter the normal baking mode temperature.
- 3 Broil Pad**- Used to select the variable broil mode.
- 4 Convection Bake Pad**- Used to select the convection baking mode.
- 5 Convection Roast Pad**- Used to select the convection roasting mode.
- 6 Convection Broil Pad**- Used to select the convection broil mode.
- 7 Keep Warm Pad**- Used to select the keep warm mode.
- 8 Slow Cook Pad**- Used to select the slow cook mode.
- 9 Perfect Turkey Pad**- Used to select the perfect turkey cooking mode.
- 10 Control Lock Pad**- Used to disable all oven function.
- 11 Multi Stage Pad**- Used to enter up to three subsequent modes.
- 12 Cook Options Pad**- Used to light up the cooking options pads.
- 13 Cook Time Pad**- Used to set a cooking duration time.
- 14 End Time Pad**- Used to select the time at which the cooking will end.
- 15 Probe Pad**- Used to activate the meat probe mode.
- 16 Rapid Preheat Pad**- Used to preheat the oven to the desired temperature.
- 17 Conv. Convert Pad**- Used to convert a standard temperature to a convection temperature.

OVEN CONTROL PAD FUNCTIONS (CONTINUED)

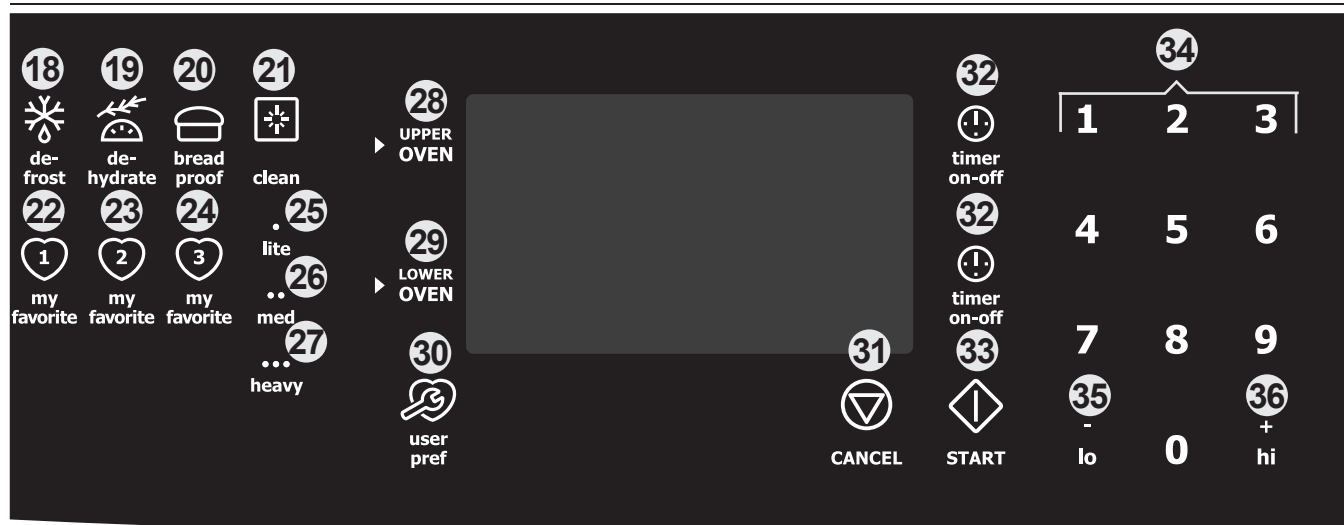

- 18** **Defrost Pad-** Used to select the defrost mode.
- 19** **Dehydrate Pad-** Used to select the dehydrate mode.
- 20** **Bread Proof Pad-** Used to select the bread proof mode.
- 21** **Clean Pad-** Used to select the self-cleaning mode.
- 22** **My Favorite 1 Pad-** Used to save or recall the favorite 1 cooking mode.
- 23** **My Favorite 2 Pad-** Used to save or recall the favorite 2 cooking mode.
- 24** **My Favorite 3 Pad-** Used to save or recall the favorite 3 cooking mode.
- 25** **Lite Pad-** Used to start a 2 hours self-clean cycle.
- 26** **Med Pad-** Used to start a 3 hours self-clean cycle.
- 27** **Heavy Pad-** Used to start a 4 hours self-clean cycle.
- 28** **Upper Oven Pad-** Used to activate the upper oven for cooking operation.
- 29** **Lower Oven Pad-** Used to activate the lower oven for cooking operation.
- 30** **User Preference Pad-** Used to bring the user preference menu in the display.
- 31** **Cancel Pad-** Used to cancel any function previously entered except the time of day and minute timer. Push **Cancel pad** to stop cooking.
- 32** **Timer Pads-** Used to set or cancel the minute timer. The minute timer does not start or stop cooking.
- 33** **Start Pad-** Used to start all oven functions.
- 34** **0 Thru 9 Number Pads-** Used to enter temperature and times.
- 35** **- lo Pad-** Used to lower the temperature and times.
- 36** **+ hi Pad-** Used to raise the temperature and times.

8 Feature Overview

COOKTOP CONTROL PAD FUNCTIONS

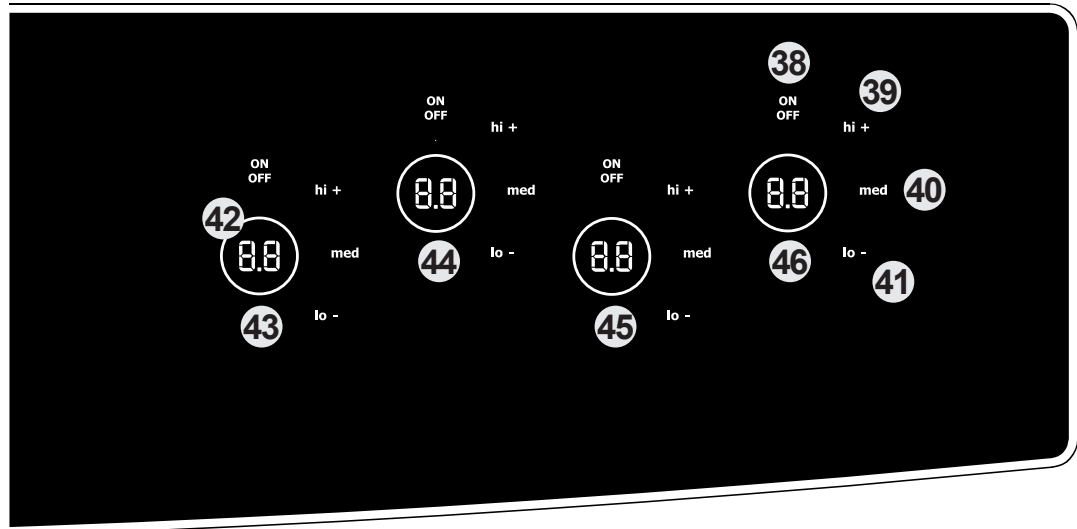

- 38** **ON / OFF Pad-** Used to toggle ON and OFF the associated induction element.
- 39** **HI + Pad-** Used to select the “Power Boost” temperature or raise the temperature currently displayed.
- 40** **MED Pad-** Used to select the medium temperature.
- 41** **LO - -** Used to select the lowest temperature or lower the temperature currently displayed.
- 42** **Pan Detection Indicator Ring-** Will light up when a pan made of magnetic material is placed in a cooking zone.
- 43** **Left Front Zone Controls and Display-** Used to set the left front cooking zone power levels.
- 44** **Left Rear Zone Controls and Display-** Used to set the left rear cooking zone power levels.
- 45** **Right Front Zone Controls and Display-** Used to set the right front cooking zone power levels.
- 46** **Right Rear Zone Controls and Display-** Used to set the right rear cooking zone power levels.

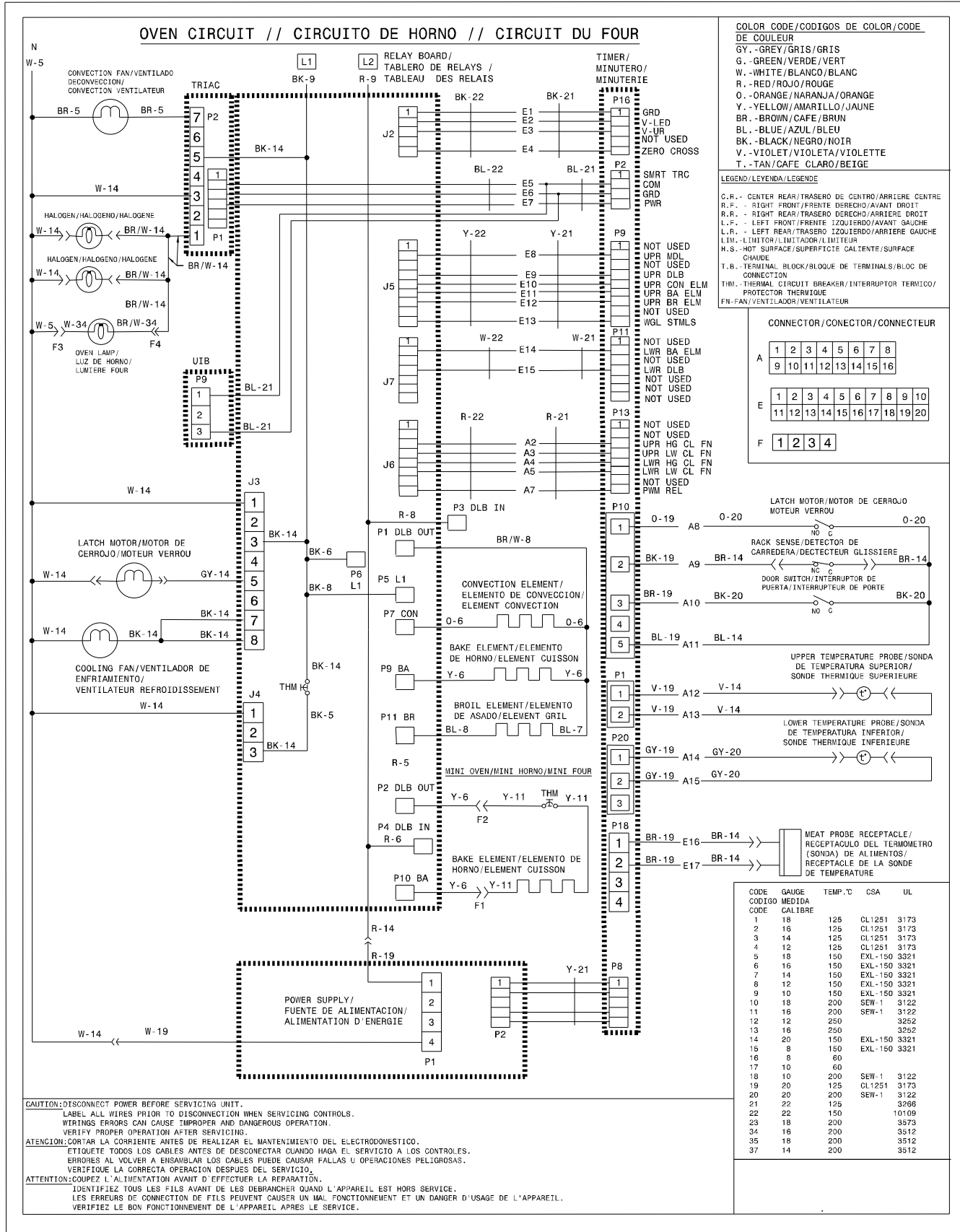

Installation Instructions

11

United States



INSTALLATION AND SERVICE MUST BE PERFORMED BY A QUALIFIED INSTALLER.

**IMPORTANT: SAVE FOR LOCAL ELECTRICAL INSPECTOR'S USE.
READ AND SAVE THESE INSTRUCTIONS FOR FUTURE REFERENCE.**

⚠ WARNING FOR YOUR SAFETY: Do not store or use gasoline or other flammable vapors and liquids in the vicinity of this or any other appliance.

Canada



For existing 29" (73,7 cm) cutout wide opening, you must call the Service Center for optional thinner side trims. Also you must prepare the countertop edge as shown in the "Countertop Preparation" section (see page 8).

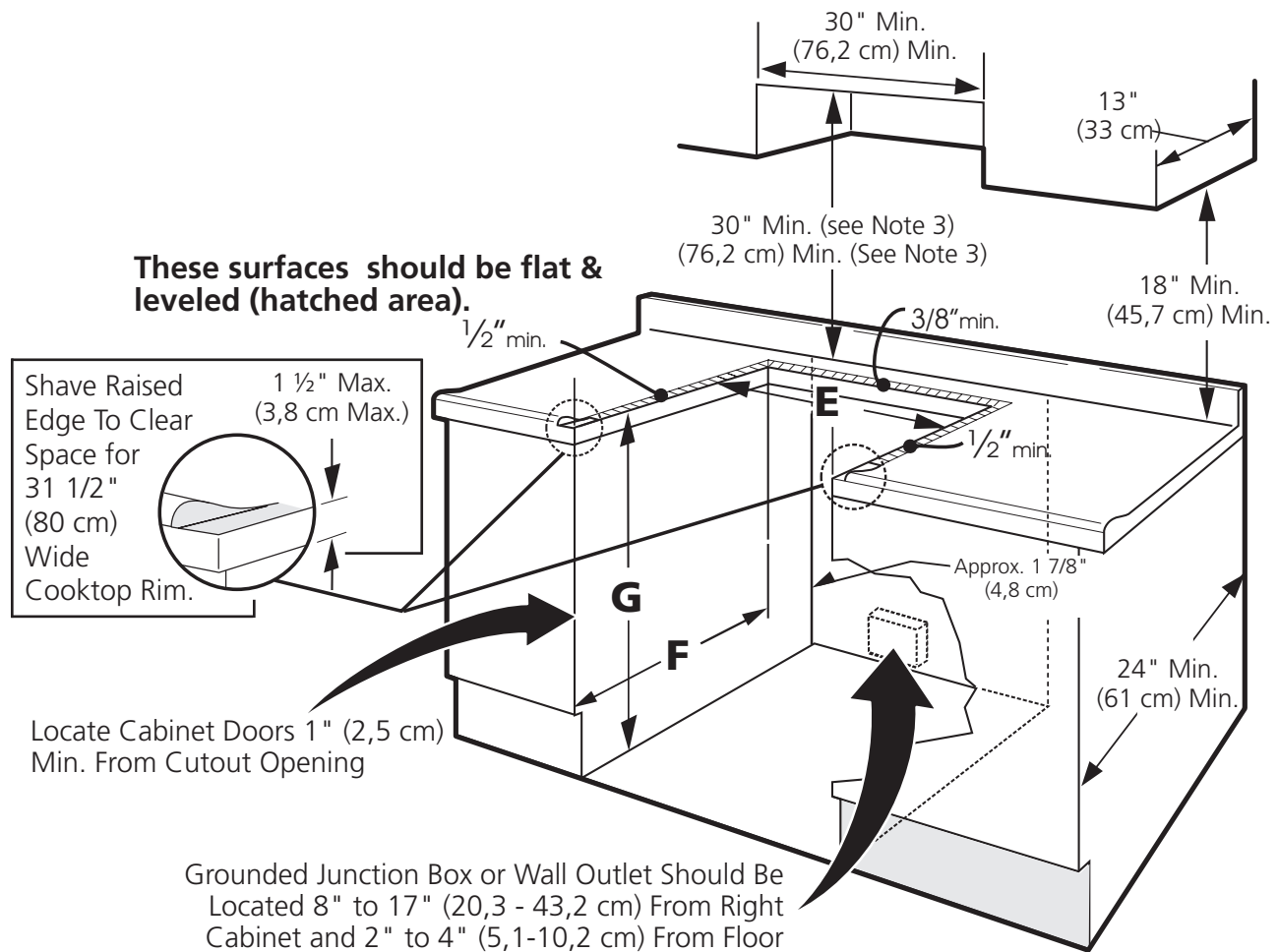

⚠ WARNING Do not install the unit in the cabinet before reading next two pages.

A. HEIGHT (Under Cooktop)	B. WIDTH	C. COOKTOP WIDTH	D. TOTAL DEPTH TO FRONT OF RANGE	E. CUTOUT WIDTH*** (Countertop and cabinet)	F. CUTOUT DEPTH	G. HEIGHT OF COUNTERTOP
35 3/4" (90,8 cm) 36 5/8" (93 cm)	30" (76,2 cm)	31 1/2" (80 cm)	28 5/16" (71,9 cm)	30±1/16" (76,2±0,15 cm)	21 3/4" (55,2 cm) Min. 22 1/8" (56,2 cm) Max 24" (61 cm) Min. with backguard	35 3/4" (90,8 cm) Min. 36 5/8" (93 cm) Max.

12 Installation Instructions

NOTE:

1. Do not pinch the power supply cord or the flexible gas conduit between the range and the wall.
2. Do not seal the range to the side cabinets.
3. 24" (61 cm) minimum clearance between the cooktop and the bottom of the cabinet when the bottom of wood or metal cabinet is protected by not less than ¼" (0,64 cm) flame retardant millboard covered with not less than No. 28 MSG sheet metal, 0,015" (0,4 mm) stainless steel, 0,024" (0,6 mm) aluminum, or 0,020" (0,5 mm) copper. 30" (76,2 cm) minimum clearance when the cabinet is unprotected.
4. For cutouts below 22 7/8" (58,1 cm), appliance will slightly show out of the cabinet.
5. Allow at least 19 ¼" (48,9 cm) clearance for door depth when it is open.

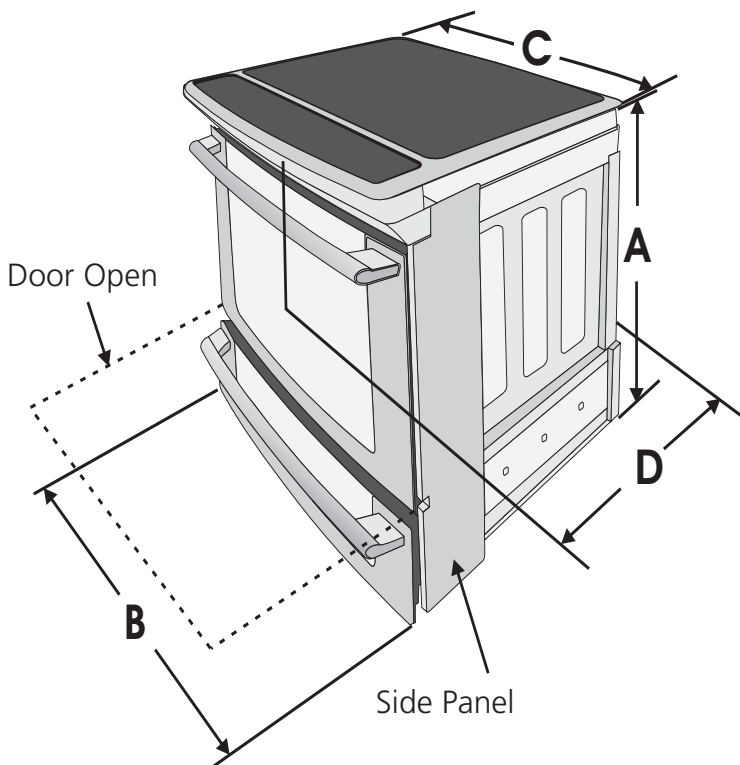

***** IMPORTANT: To avoid cooktop breakage for cutout width (E dimension) of more than 30 1/16" (76,4 cm), make sure the appliance is centered in the counter opening while pushing into it. Raise leveling legs and the rear adjustable wheels at a higher position than the cabinet height (see page 3), insert the appliance in the counter and then level. Make sure the unit is supported by the leveling legs at the front and the wheels at the back and NOT by the cooktop itself.**

IMPORTANT: Cabinet and countertop width should match the cutout width.

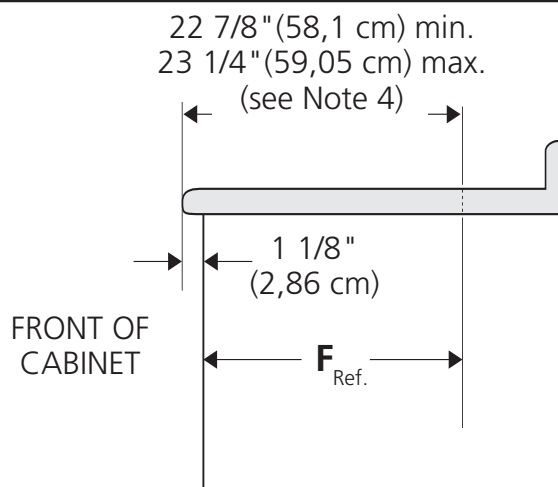
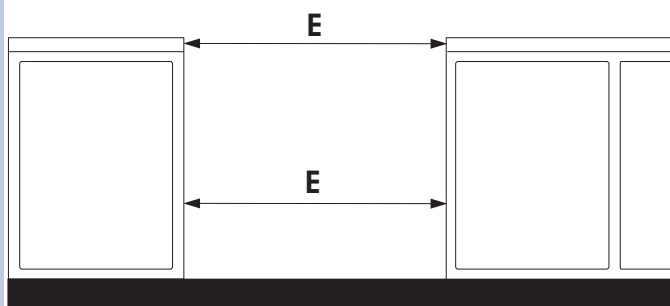

A. HEIGHT (Under Cooktop)	B. WIDTH	C. COOKTOP WIDTH	D. TOTAL DEPTH TO FRONT OF RANGE	E. CUTOUT WIDTH*** (Countertop and cabinet)	F. CUTOUT DEPTH	G. HEIGHT OF COUNTERTOP
35 3/4" (90,8 cm) 36 5/8" (93 cm)	30" (76,2 cm)	31 1/2" (80 cm)	28 5/16" (71,9 cm)	30±1/16" (76,2±0,15 cm)	21 3/4" (55,2 cm) Min. 22 1/8" (56,2 cm) Max 24" (61 cm) Min. with backguard	35 3/4" (90,8 cm) Min. 36 5/8" (93 cm) Max.

To avoid breakage: DO NOT handle or manipulate the unit by the cooktop.

- 1 The counter-top around the cut-out should be flat and leveled (see hatched area on illustration 1).
- 2 Before installing the unit, measure the heights of the two (2) cabinet sides (H1-4), front and back (see illustration 1) from the floor to the top of the counter.



- 3 Level the range using the two (2) front leveling legs and the two (2) adjustable leveling wheel, so that the height from the floor to the underside of the metal flange is greater than the tallest cabinet measurement by at least 1/16" (see illustration 2).

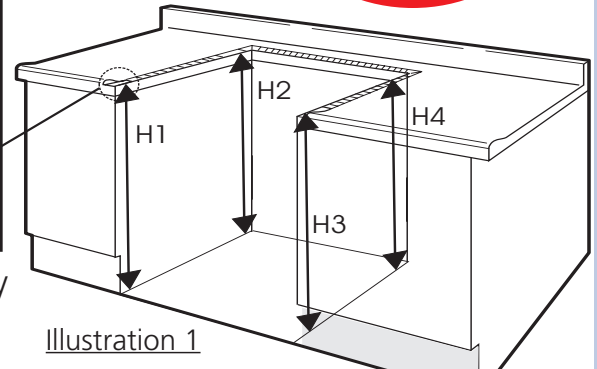
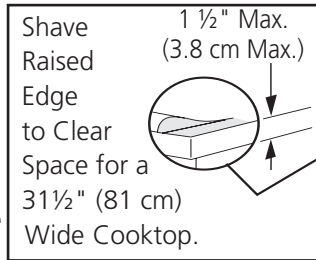
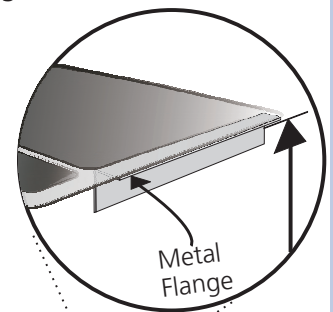
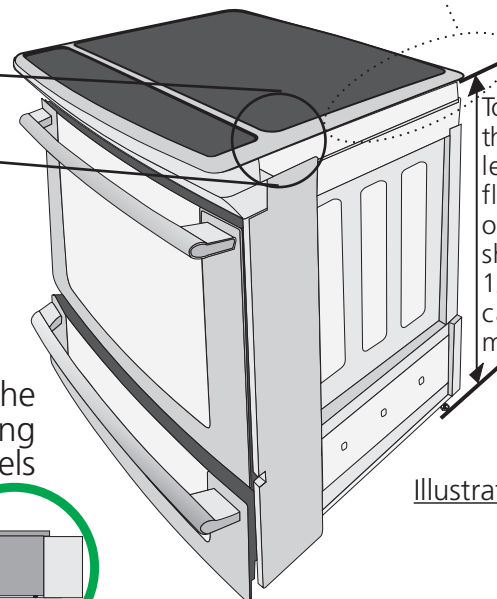
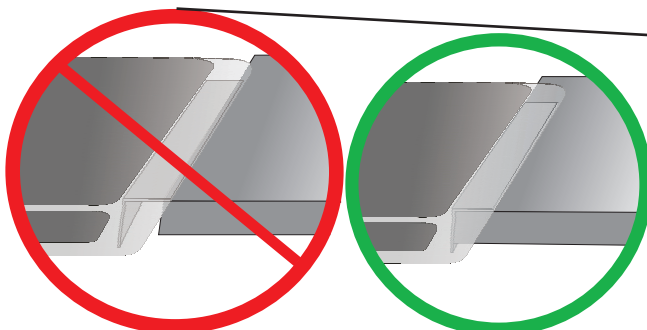

Illustration 1

- 4 Remove and discard the two rear leveling legs, they are only in place to solidify the unit for the transport.
- 5 Slide the unit into the cabinet. Make sure the center of the unit is aligned with the center of the cabinet cut-out.
- 6 Remove the protective channels on each side of the cooktop (if provided).



- 7 The metal flange under each side of the cooktop **MUST** be placed over the cabinet countertop for proper unit support. The cooktop should **NOT** rest directly on the countertop (see illustration 2) or else it could cause damage to the cooktop voiding the warranty. Level the unit if needed.



To successfully install the range, the initial level height from floor to underside of cooktop frame should be at least 1/16" taller than cabinet sides as measured in step 2.

Illustration 2

- 8 After the installation, **MAKE SURE** that the unit is supported by the two front leveling legs and the two adjustable leveling wheels and **NOT** by the cooktop.

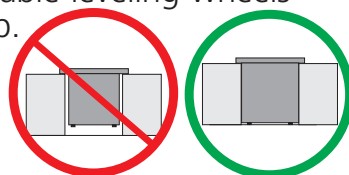

14

Installation Instructions

Important Notes to the Installer

1. Read all instructions contained in these installation instructions before installing range.
2. Remove all packing material from the oven compartments before connecting the electrical supply to the range.
3. Observe all governing codes and ordinances.
4. Be sure to leave these instructions with the consumer.

Important Note to the Consumer

Keep these instructions with your Owner's Guide for the local electrical inspector's use and future reference.

IMPORTANT SAFETY INSTRUCTIONS

⚠ CAUTION Cold temperatures can damage the electronic control. When using the appliance for the first time, or when the appliance has not been used for an extended period of time, be certain the unit has been in temperatures above 32°F (0°C) for at least 3 hours before turning on the power to the appliance.

- **Be sure your range is installed and grounded properly by a qualified installer or service technician.**
- **This range must be electrically grounded in accordance with local codes or, in their absence, with the National Electrical Code ANSI/NFPA No. 70—latest edition in United States or with CSA Standard C22.1, Canadian Electrical Code, Part 1 in Canada.**
- The installation of appliances designed for manufactured (mobile) home installation must conform with Manufactured Home Construction and Safety Standard, title 24CFR, part 3280 [Formerly the Federal Standard for Mobile Home Construction and Safety, title 24, HUD (part 280)] or when such standard is not applicable, the Standard for Manufactured Home Installation 1982 (Manufactured Home Sites, Communities and Setups), ANSI Z225.1/NFPA 501A—latest edition, or with local codes in United States and with CAN/CSA-Z240 MH in Canada.

- **Make sure the wall coverings around the range can withstand the heat generated by the range.**
- **Before installing the range in an area covered with linoleum or any other synthetic floor covering, make sure the floor covering can withstand heat at least 90°F (32.2°C) above room temperature without shrinking, warping or discoloring.** Do not install the range over carpeting unless you place an insulating pad or sheet of ¼" (0.64 cm) thick plywood between the range and carpeting.

⚠ WARNING Never leave children alone or unattended in the area where an appliance is in use. As children grow, teach them the proper, safe use of all appliances. Never leave the oven door open when the range is unattended.

⚠ WARNING Stepping, leaning or sitting on the door or drawer of this range can result in serious injuries and can also cause damage to the range.

- **Do not store items of interest to children in the cabinets above the range.** Children could be seriously burned climbing on the range to reach items.
- **To eliminate the risk of burns or fire by reaching over heated surface units, cabinet storage space above the surface unit should be avoided.** If cabinet storage is to be provided the risk can be reduced by installing a range hood that projects horizontally a minimum of 5 inches beyond the bottom of the cabinet.
- **Do not use the oven as a storage space.** This creates a potentially hazardous situation.
- **Never use your range for warming or heating the room.** Prolonged use of the range without adequate ventilation can be dangerous.
- **Do not store or use gasoline or other flammable vapors and liquids near this or any other appliance.** Explosions or fires could result.
- **Reset all controls to the "off" position after using a programmable timing operation.**

FOR MODELS WITH SELF-CLEAN FEATURE:

- **Remove oven racks, broiler pan, food and other utensils before self-cleaning the oven.** Wipe up excess spillage. Follow the precleaning instructions in the Owner's Guide.

	⚠ WARNING <ul style="list-style-type: none">• All ranges can tip.• Injury to persons could result.• Install anti-tip device packed with range.	To reduce the risk of tipping of the range, the range must be secured by properly installed anti-tip bracket(s) provided with the range. To check if the bracket(s) is installed properly, grasp the top rear edge of the range and carefully tilt it forward to make sure the range is anchored.
---	---	---

Serial Plate Location

You will find the model and serial number printed on the serial plate. The serial plate is located as shown.

Remember to record the serial number for future reference.

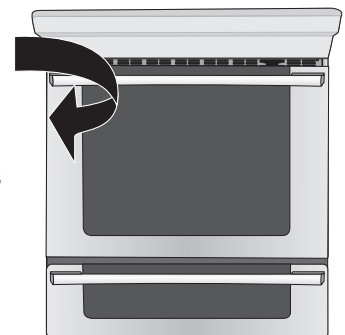

1. Factory Connected Power Supply Cord (Canada only)

This range is equipped with a factory-connected power cord (see Figure 1). Cord must be connected to a grounded 120/240 volt or 120/208 volt range outlet with a 50A recommended circuit. If no outlet is available, have one installed by a qualified electrician.

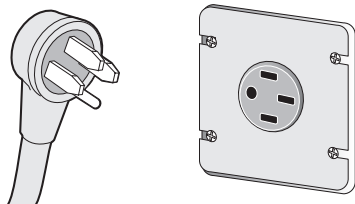

Canada Style
Figure 1

2. Power Supply Cord Kit (U.S.A.)

The user is responsible for connecting the power supply cord to the connection block located behind the back panel access cover.

This appliance may be connected by means of permanent "hard wiring"; flexible armored or nonmetallic shielded copper cable (when local code allow it) or by means of a power supply cord kit (**only use 50A cord kits for use with 1³/₈ inch connections**). See chart (on next page) for the minimum wire size (general UL listing, local code may differ).

NOTE: Electric Slide-in Range is shipped from factory with 1 1/8" (2.9 cm) dia. hole as shown on figure 4. If a larger hole is required, punch out the knockout.

⚠ WARNING Risk of fire or electrical shock exists if an incorrect size range cord kit is used, the Installation Instructions are not followed, or the strain relief bracket is discarded.

For mobile homes, new installations or recreational vehicles, use only a power supply kit designed for a range at 125V/250V 50A. Cord must have either 3 (when local code permits grounding through neutral) or 4 conductors. Terminal on end of wires must be either closed loop or open spade lug with upturned ends. Cord must have strain-relief clamp.

⚠ CAUTION Do not loosen the nuts which secure the factory-installed range wiring to terminal block while connecting range. Electrical failure or loss of electrical connection may occur.

⚠ WARNING

Electrical Shock Hazard

- Electrical ground is required on this appliance.
- Do not connect to the electrical supply until appliance is permanently grounded.
- Disconnect power to the circuit breaker or fuse box before making the electrical connection.
- This appliance must be connected to a grounded, metallic, permanent wiring system, or a grounding connector should be connected to the grounding terminal or wire lead on the appliance.

Failure to do any of the above could result in a fire, personal injury or electrical shock.

3. Access to Terminal Block & Grounding Strap (U.S.A.)

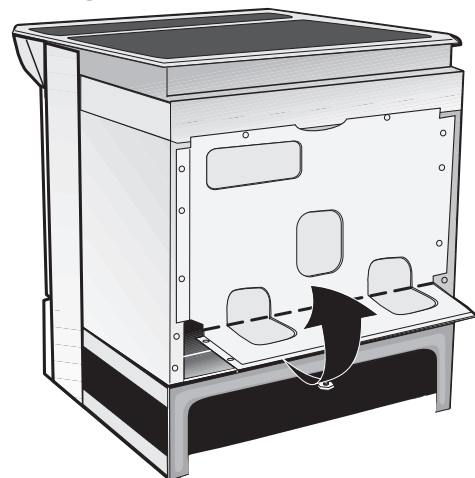

BEND REAR WIRE COVER HERE
FOR ACCESS TO TERMINAL BLOCK

Figure 2

⚠ WARNING This appliance is manufactured with the frame grounded by connection of a grounding strap between the neutral power supply terminal and the frame. If used in USA, in a new branch circuit installation (1996 NEC), mobile home or recreational vehicle, where local code do not permit grounding through neutral (white) wire or in Canada; remove the grounding strap from the frame and cut the other end, near the neutral terminal. Connect the appliance in usual manner.

16

Installation Instructions

4. Electrical Connection to the Range (U.S.A.)

Three Conductor Wire Connection to Range

If local codes permit connection of the frame grounding conductor to the neutral wire of the copper power supply cord (see Figure 3):

1. Remove the 3 screws at the lower end of the rear wire cover, then bend the lower end of the rear wire cover (access cover) upward to expose range terminal connection block (see Figure 2).
2. Using the nuts supplied in the literature package, connect the neutral of the copper power supply cord to the center silver-colored terminal of the terminal block, and connect the other wires to the outer terminals. Match wires and terminals by color (red wires connected to the right terminal, black wires connected to the left terminal) (see figure 3).
3. Lower the terminal cover and replace the 3 screws.

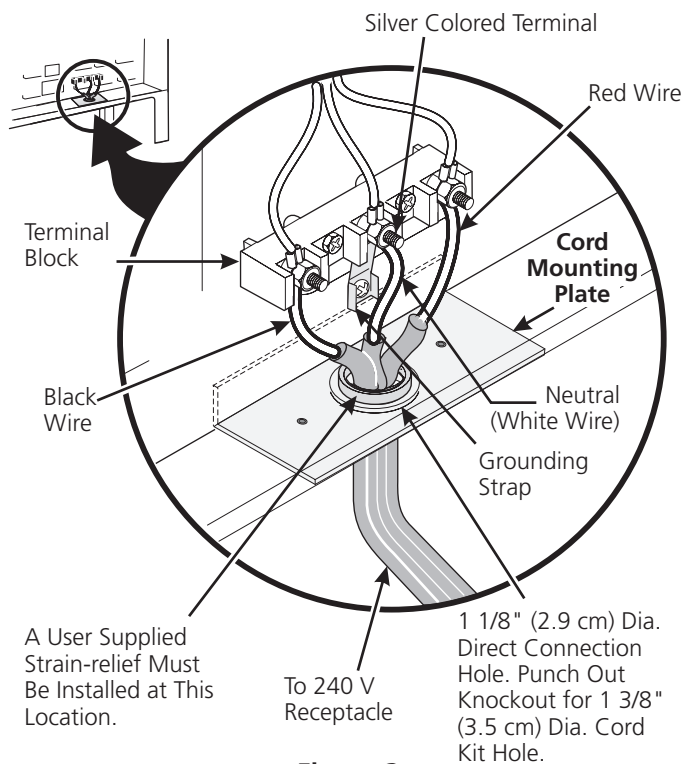
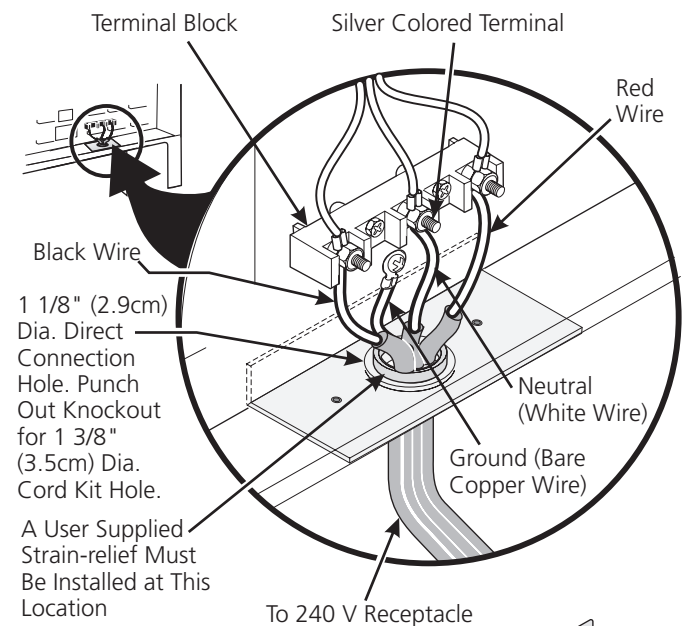

Figure 3

Four Conductor Wire Connection to Range

Where local codes does NOT permit connection of the frame grounding conductor to the neutral wire of the copper power supply cord (see Figure 4):

1. Remove the 3 screws at the lower end of the rear wire cover, then raise the lower end of the rear wire cover (access cover) upward to expose range terminal connection block (see figure 2).
2. Remove the grounding strap from the terminal block and from the appliance frame.
3. Using the nuts supplied with the literature package, connect the ground wire (green) of the copper power supply cord to the frame of the appliance with the ground screw, using the hole in the frame where the ground strap was removed (see Figure 4).
4. Connect the neutral of the copper power supply cord to the center silver-colored terminal of the terminal block, and connect the other wires to the outer terminals. Match wires and terminals by color (red wires connected to the right terminal, black wires connected to the left terminal).
5. Lower the terminal cover and replace the 3 screws.



NOTE: Be sure to remove the supplied grounding strap.

Figure 4

Direct Electrical Connection to the Circuit Breaker, Fuse Box or Junction Box

If the appliance is connected directly to the circuit breaker, fuse box or junction box, use flexible, armored or nonmetallic sheathed copper cable (with grounding wire). Supply a U.L. listed strain-relief at each end of the cable. At the appliance end, the cable goes through the Direct Connection Hole (see Figure 5) on the Cord Mounting Plate. Wire sizes (**copper wire only**) and connections must conform to the rating of the appliance.

Where local codes permit connecting the appliance-grounding conductor to the neutral (white) wire (see Figure 5):

1. Be sure that no power is supplied on the cable from residence.
2. Remove the grounding strap from the terminal block and from the appliance frame.
3. In the circuit breaker, fuse box or junction box:
 - a) Connect the green (or bare copper) wire, the white appliance cable wire, and the neutral (white) wire together.
 - b) Connect the 2 black wires together.
 - c) Connect the 2 red wires together.

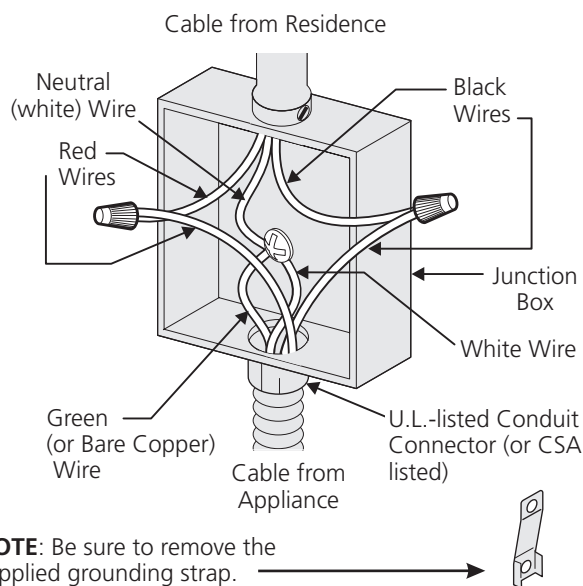

Figure 5
3-Wire (Grounded Neutral) Electrical System
(Example: Junction Box)

Where local codes DO NOT permit connecting the appliance-grounding conductor to the neutral (white) wire, or if connecting to 4-wire electrical system (see Figure 6):

1. Be sure that no power is supplied on the cable from residence.
2. Remove the grounding strap from the terminal block and from the appliance frame.
3. In the circuit breaker, fuse box or junction box:
 - a) Connect the white appliance cable wire to the neutral (white) wire.
 - b) Connect the 2 black wires together.
 - c) Connect the 2 red wires together.
 - d) Connect the green (or bare copper) grounding wire to the grounding wire of the circuit breaker, fuse box or junction box.

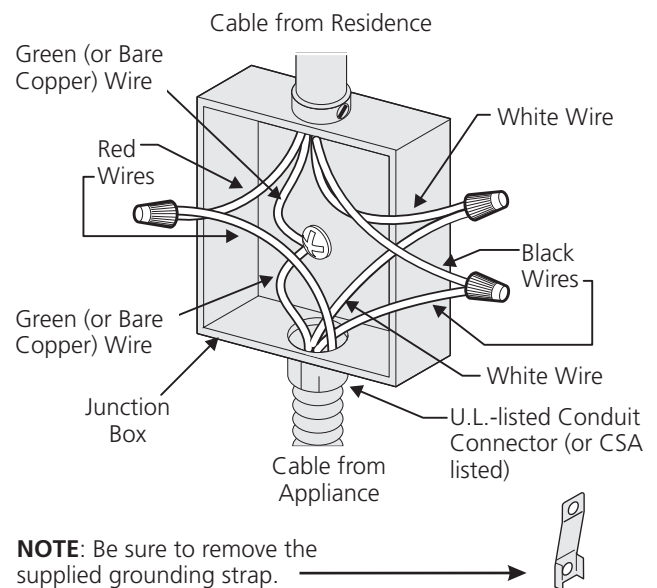

Figure 6 – 4-Wire Electrical System
(Example: Junction Box)

18 Installation Instructions

5. Cabinet Construction

4.1 CAUTION To eliminate the risk of burns or fire by reaching over heated surface units, do not have cabinet storage space above the range. If there is cabinet storage space above range, reduce risk by installing a range hood that projects horizontally a minimum of 5" (12.7 cm) beyond the bottom of the cabinet.

4.2 Countertop Preparation

- The cooktop sides of the range fit over the cutout edge of your countertop.
- If you have a **square finish (flat) countertop**, no countertop preparation is required. Cooktop sides lay directly on edge of countertop.
- **Formed front-edged countertops** must have molded edge shaved flat $\frac{3}{4}$ " (1.9 cm) from each front corner of opening (Figure 7).
- **Tile countertops** may need trim cut back $\frac{3}{4}$ " (1.9 cm) from each front corner and/or rounded edge flattened (Figure 7).

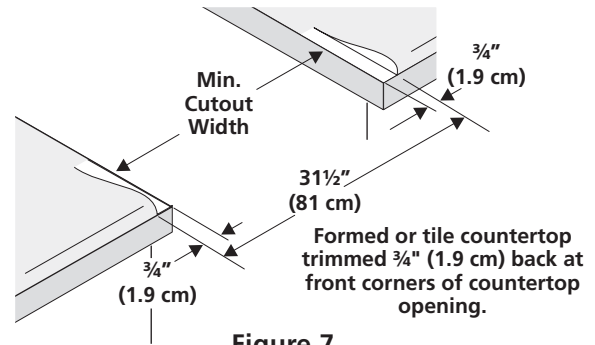

Figure 7

- **If the existing cutout width is greater than $30 \frac{1}{16}$ " (76,4 cm)**, reduce the $\frac{3}{4}$ " (1.9 cm) dimension.
- **Countertop must be level.** Place a level on the countertop, first side to side, then front to back. If the countertop is not level, the range will not be level. The oven must be level for satisfactory baking results. Cooktop sides of range fit over edges of countertop opening

4.3 IMPORTANT For existing cutout width of 29" (73.7 cm) :

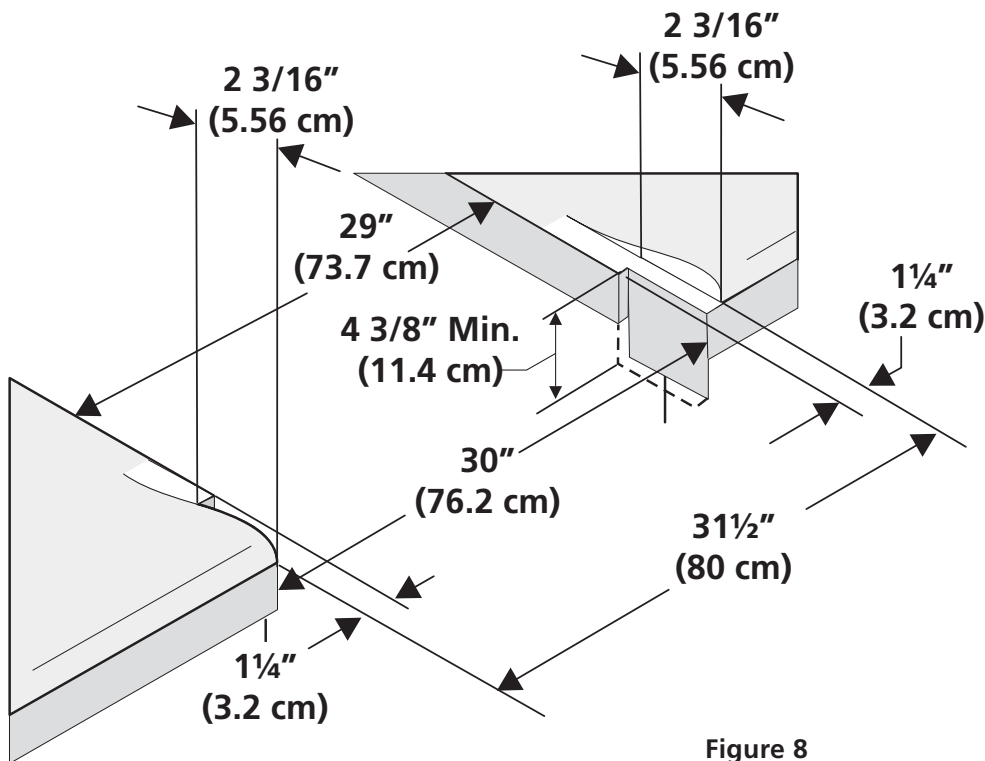
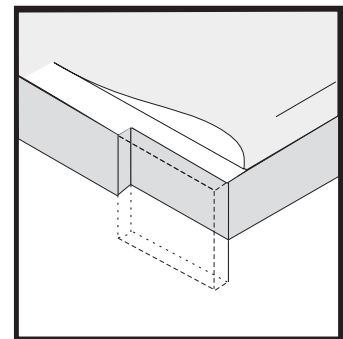

Figure 8

You must also clear $2 \frac{3}{16}$ " (5.56cm) of material from front of countertop.



Formed or tile countertop trimmed $\frac{1}{4}$ " (3.2 cm) back at front corners of countertop opening.

6. Range Installation

Important Note: Door removal is not a requirement for installation of the range, but is an added convenience. Refer to the Use and Care Guide for oven door removal instructions.



Standard Installation

1 The range cooktop overlaps the countertop at the sides and the range rests on the floor. The cooktop is 31½" (80 cm) wide.

2 Install base cabinets 30" (76.2 cm) apart. Make sure they are plumb and level before attaching cooktop. Shave raised countertop edge to clear 31½" (80 cm) wide range top rim.

3 Install cabinet doors 32" (81.3 cm) min. apart so as not to interfere with range door opening.

4 Cutout countertop exactly as shown on page 1.

5 Make sure the two front leveling legs and the rear leveling wheels (see page 11) are setup higher than the height of the cabinet (shown on page 3).

6 Remove and discard the two rear leveling legs, they are only in place to solidify the unit for the transport.

7 **CAUTION** Install the anti-tip bracket at this point before placing the range at its final position. Follow the installation instructions on page 11 or on the anti-tip bracket template supplied with the range.

8 To provide an optimum installation, the top surface of the countertop must be level and flat (lie on the same plane) around the 3 sides that are adjacent to range cooktop. Proper adjustments to make the top flat should be made or gaps between the countertop and the range cooktop may occur.

9 **CAUTION** To reduce the risk of damaging your appliance, do not handle or manipulate it by the cooktop. Manipulate with care.

10 Position range in front of the cabinet opening.

11 Make sure that the underside of the cooktop clears the countertop. If necessary, raise the unit by lowering the front leveling legs and the back leveling wheels.

12 **Level the range** (see section 6). The floor where the range is to be installed must be level. Follow the instructions under "Leveling the Range".

13 Slide the range into the cutout opening.

IMPORTANT If Accessories Needed :

Installation For 29" Existing Cutout Wide Opening

1. You must replace the actual side trims by new and smaller side trims. These new side trims can be ordered through a Service Center.
2. Follow instructions supplied with your new side trims to replace the actual side trims with the new ones.
3. Check if the countertop and cabinet opening are prepared for 29" cutout wide opening in "**Countertop Preparation**" section (see page 8).
4. Install range as in the "**Installation without side panels**" section.

Installation With Backguard

The cutout depth of (21 3/4" (55.2 cm)Min., 22 1/8" (56.2cm) Max.) needs to be increased to 24" (61 cm) when installing a backguard.

Installation With End Panel

A End Panel kit can be ordered through a Service Center.

Installation With Side Panels

A Side Panels kit can be ordered through a Service Center. Note: Install cabinet doors 32" (81.3 cm) min. apart so as not to interfere with range door opening.

7. Leveling the Range

Models Equipped with Leveling Device

Level the range after installation in the cutout opening.

1. Open the range drawer. The leveling screws control the height of the rear leg.
2. Adjust the appliance legs and wheels as follows until the underside of the cooktop surface is sitting level on the countertop (Figure 9).
 - a. To adjust the front legs, use a wrench on the leg base and turn clockwise to lower or counterclockwise to raise.
 - b. Remove the rear legs using a wrench on the leg base and turn counterclockwise until the legs are removed from the unit. You can discard those legs, they are only in place to solidify the unit for the transport.
 - c. To adjust the rear wheels, use a ratchet or a nutdriver and turn the leveling screws counterclockwise to lower or clockwise to raise.
3. Check if the range is level by installing an oven rack in the center of the oven and placing a level on the rack (Figure 10).
4. Take 2 readings with the level placed diagonally in one direction and then the other. Level the range, if necessary, by adjusting the leveling legs and wheels.
5. If the range cannot be level, contact a carpenter to correct sagging or sloping floor.

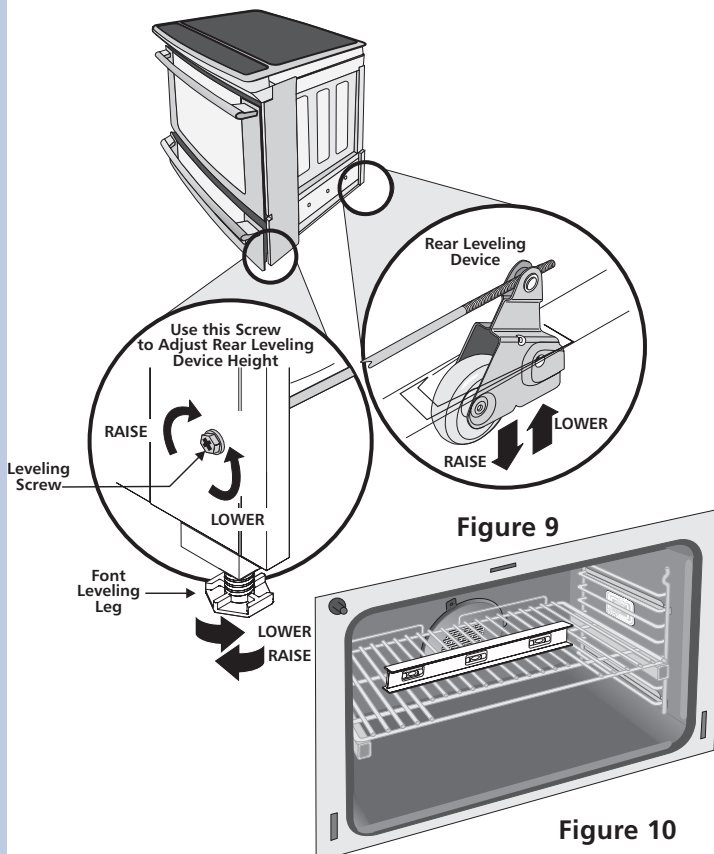

Figure 9

Figure 10

8. Check Operation

Refer to the Use and Care Manual packaged with the range for operating instructions and for care and cleaning of your range.

CAUTION Do not touch the elements. They may be hot enough to cause burns.

Remove all packaging from the oven before testing.

1. Operation of Surface Elements

Turn on each of the four surface elements and check to see that they heat. Check the surface element indicator light(s), if equipped.

2. Operation of Oven Elements

The oven is equipped with an electronic oven control. Each of the functions has been factory checked before shipping. However, it is suggested that you verify the operation of the electronic oven controls once more. Refer to the Use and Care Manual for operation. Follow the instructions for the Clock, Timer, Bake, Broil, Convection (some models) and Clean functions.

Bake—After setting the oven to 350°F (177°C) for baking, the lower element in the oven should become red.

Broil—When the oven is set to BROIL, the upper element in the oven should become red.

Clean—When the oven is set for a self-cleaning cycle, the upper element should become red during the preheat portion of the cycle.

Convection (some models)—When the oven is set to CONV. BAKE/ROAST at 350°F (177°C), both elements cycle on and off alternately and the convection fan will turn. The convection fan will stop turning when the oven door is opened during convection baking or roasting.

Warmer Drawer (some models)—Set the control knob to HI and check to see the drawer is heating.

When All Hookups are Complete

Make sure all controls are left in the OFF position.

Before You Call for Service

Read the Before you call list and operating instructions in your Use and Care Manual . It may save you time and expense. The list includes common occurrences that are not the result of defective workmanship or materials in this appliance.

Refer to the warranty and service information in your Use and Care Manual for our phone number and address. Please call or write if you have inquiries about your range product and/or need to order parts.

9. Anti-Tip Brackets Installation Instructions

⚠ WARNING To reduce the risk of tipping of the range, the range must be secured to the floor by properly installed anti-tip bracket and screws packed with the range. These parts are located in the oven. Failure to install the anti-tip bracket will allow the range to tip over if excessive weight is placed on an open door or if a child climbs upon it. Serious injury might result from spilled hot liquids or from the range itself.

Follow the instructions below to install the anti-tip brackets.

If range is ever moved to a different location, the anti-tip brackets must also be moved and installed with the range.

Tools Required:

Adjustable Wrench
Ratchet
Drill & 1/8" (0,32 cm) bit
5/16" (0,8 cm) Nutdriver
Level

The anti-tip bracket attaches to the floor at the back of the range to prevent range from tipping. When fastening bracket to the floor, be sure that screws do not penetrate electrical wiring or plumbing. The screws provided will work in either wood or concrete.

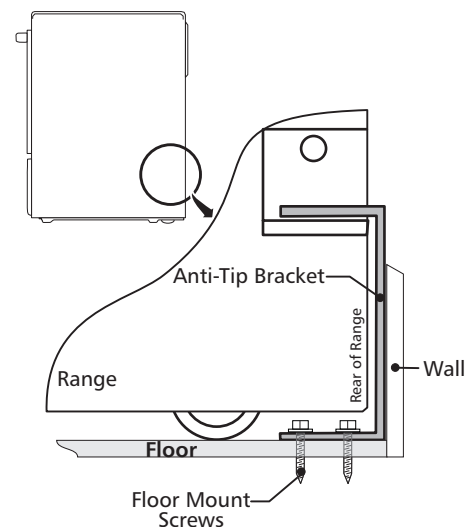
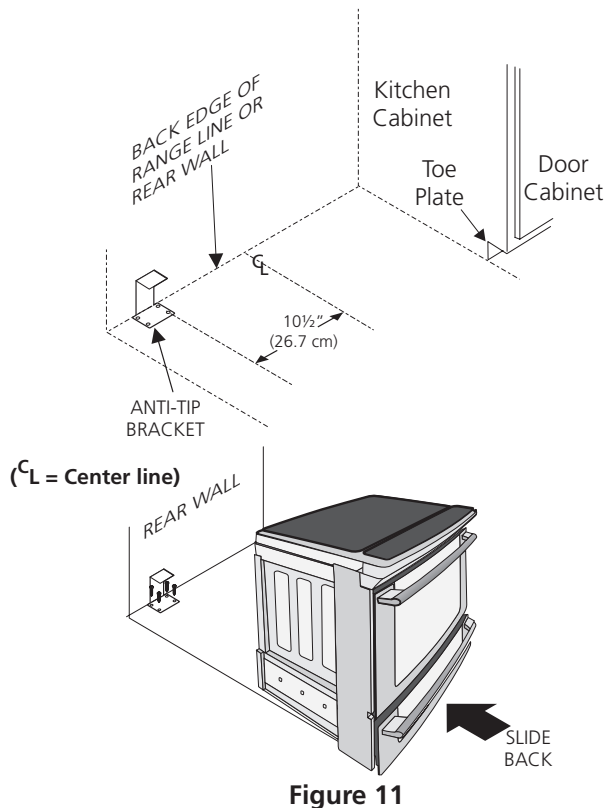

1. Draw a center line (CL) on the floor where the range should be installed. Also draw a line on the floor at the range back position if there is no wall.
2. Unfold paper template and place it flat on the floor with the right rear corner positioned exactly on the intersection of the center and back lines you just drew before. (Use the diagram below to locate brackets if template is not available. (Figure 11))
3. Mark on the floor the location of the 4 mounting holes shown on the template. For easier installation, 3/16" (0,48 cm) diameter pilot holes 1/2" (1,27 cm) deep can be drilled into the floor.
4. Remove template and place bracket on floor. Line up holes in bracket with marks on floor and attach with 4 screws provided. Bracket must be secured to solid floor (Figure 12). If attaching to concrete floor, first drill 3/16" (0,48 cm) dia. pilot holes using masonry drill bit.
5. Be sure the 4 levelling legs are at the highest position they can be.
6. Slide range into place making sure structure of the range is trapped by the anti-tip bracket (Figure 11). Lower the range by adjusting the 4 levelling legs until the underside of the cooktop is sitting level on the countertop. Refer to "Levelling the Range" section.
7. After installation, verify that the anti-tip bracket is engaged by grasping the top rear edge of the range and carefully attempt to tilt it forward to make sure range is properly anchored.



SETTING CLOCK AT POWER UP

When the unit is first plugged in, or when the power supply to the range has been interrupted, the timer in the display will flash with “12:00”. The clock cannot be set when the oven is on. If an invalid time of day is entered, the control will triple beep to prompt you to re-enter a valid time of day.

To set the clock (example for 1:30):

1. Press **1** **3** **0** pads to set the time of day to 1:30. The pads **+** or **-** can also be pressed to raise or lower the actual time displayed.
2. Press **START**  to accept the changes or **CANCEL**  to start with a time of 12:00.

CONTROL PANEL DISPLAY MODES

Sleep Mode:

Your control will remain in a sleep mode when not in use. Only the clock will display during this mode. You will need to wake the control to begin any function.

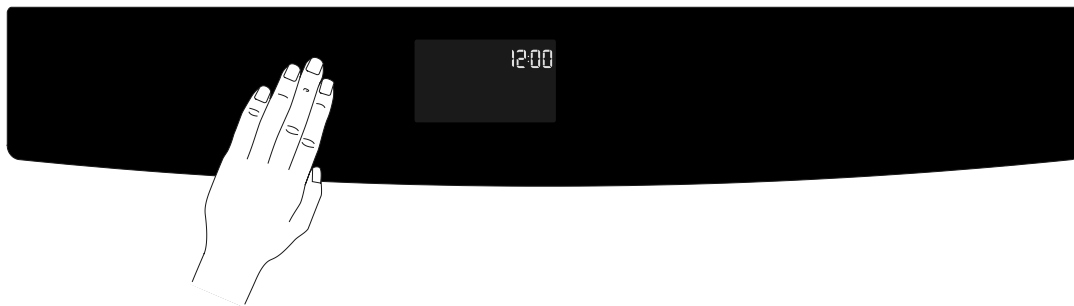

Wake Mode:

To wake the control, touch within the display panel. After 2 minutes without activity the control will beep and go back into sleep mode.

To start a cooking feature you must select either the upper oven or the lower oven. User preferences will be available during this mode as well as timers, oven light and the control lock.

TEMPERATURE VISUAL DISPLAY

Your oven is equipped with a temperature visual display for each oven. When a cooking mode is set, the actual temperature will be shown in the display and will rise as the unit preheat. When the unit has reached its target temperature, a chime will sound to remind you to place the food in the oven. This feature will be active with some cooking modes; bake, convection bake, convection roast and perfect turkey. The cooking modes which does not feature the temperature visual display will be noted in their descriptions.

NOTE: The lowest temperature that can be displayed is 100°F.

OVEN LIGHT



Your appliance includes “theater” style oven lighting feature that gradually lights both the upper and lower oven interiors to full brightness. The upper oven is equipped with 2 halogen lights and the lower oven is equipped with 1 incandescent light. The oven lights will turn on automatically when the oven door is opened. The oven light may be turned on when the door is closed by using the oven light pad located on the control panel. The oven light key will toggle the lights in both ovens at the same time at full intensity.

To toggle the Oven Lights ON and OFF:

1. Press **OVEN LIGHT** .

CONTROL LOCK



The Control Lock feature automatically locks the upper oven door, control panel and the cooktop. The Control Lock is only allowed when the oven and the cooktop are turned OFF (not active). DOOR LOCK will flash in the display for 20 seconds or until the door has finished locking. Once the door has been locked, **Loc** message will appear in the upper display and “- -” will appear in the cooktop displays. Do not attempt to open the oven door while DOOR LOCK is flashing.

To toggle the Control Lock ON and OFF:





1. Keep **CONTROL LOCK**  pressed for 3 seconds.

SETTING THE KITCHEN TIMER



This unit is equipped with 2 Kitchen Timers which serves as extra timers in the kitchen that will beep when the set time has run out. It does not start or stop cooking. The Timer feature can be used during any of the other oven control functions and cooking modes.

To set the Timer (example for 5 minutes):

1. Press **TIMER** . “00:00” will appear in the display.
2. Press **5** pad to set the timer to 5 minutes. The pads **hi** or **lo** can also be pressed to raise or lower the actual time displayed.
3. Press again **TIMER**  to accept and start the countdown.
4. When the set time has run out, “00:00” will be displayed and the **TIMER**  pad will flash. The clock will sound a chime that will be repeated at regular intervals until the **TIMER**  pad is pressed.

To cancel the Timer before the set time has run out:

Press **TIMER** . The display will return to the time of day.

BAKING

This mode is best used for your standard recipes. The hidden bake element is used to heat the air and maintain temperature. The temperature probe can be used in this cooking mode. The upper oven can be programmed to bake at any temperature from 170°F to 550°F with a default temperature of 350°F. The lower oven can be programmed to bake at any temperature from 170°F to 450°F with a default temperature of 350°F.



Upper Oven Baking Tips:

- Always preheat your oven before using the bake mode.
- During preheat, the 3 elements and the convection fan are used in cycle to quickly heat the oven.
- Use only one rack and center the pans as much as possible.
- If using two racks, place the oven racks in positions 2 and 6.
- Allow 2" to 4" (5,1 to 10,2cm) around the utensil(s) for proper air circulation.
- Be sure the pans do not touch each other, the door, sides or back of the oven.

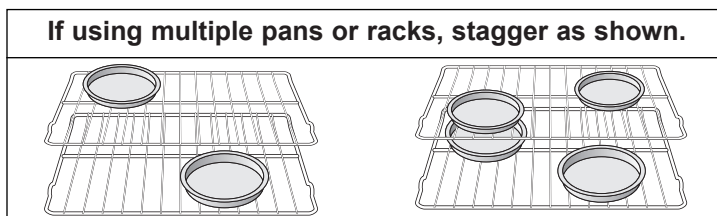

Lower Oven Baking Tips:

- Follow recommendations for lower oven cooking modes in the **Lower Oven Operation** section of this manual.

To set a Bake Temperature of 350°F:

1. Arrange interior oven racks.
2. Select oven by pressing **UPPER OVEN** ^{UPPER} _{OVEN} or **LOWER OVEN** ^{LOWER} _{OVEN}.
3. Press **BAKE**
4. Press **START**
5. Place food in the oven when the chime signals and temperature display shows that the oven has reached the set target temperature and the **PRE-HEATING** message disappear.
6. Cook Time, Timer and End Time features can be set to control your cooking time in both ovens (read their sections for directions). The Temperature Probe and Rapid Preheat features can be used only with the upper oven.
7. Remove food. Always use oven mitts when removing hot pans from the oven.
8. Press **CANCEL**

To change to a Bake Temperature of 425°F:

1. Select oven by pressing **UPPER OVEN** ^{UPPER} _{OVEN} or **LOWER OVEN** ^{LOWER} _{OVEN}.
2. Press the **HI hi** or **LO lo** pads to get to the desired temperature.
3. Press **START** .

Baking Problems

Refer to the Baking Problems Table in the Solutions to Common Problems section of this manual.







COOK TIME



Cook Time allows the oven to be set to cook for a set length of time and shut off automatically.

The time remaining will always be shown in the timer section of the display. The oven will shut off and will beep when the countdown is finished. This feature can be used with Bake, Convection Bake, Convection Roast, Slow Cook, Keep Warm, Defrost, Bread Proof, Dehydrate and Perfect Turkey cooking modes. It can also be part of a Multi-Stage sequence.

To set a timed cooking (example is a 450°F Bake for 30 minutes):







1. Select oven by pressing **UPPER OVEN** .
2. Press **BAKE** . The temperature numbers will blink in the display.
3. Enter temperature needed; **4 5 0**.
4. Press **COOK OPTIONS**  to bring up the cook options items.
5. Press **COOK TIME** .
6. Enter time needed; **3 0**.
7. Press **START** . The oven will start heating. The cook time will start counting down for the set time.
8. Press **CANCEL**  to stop the audible alarm or to cancel cooking at anytime.

END TIME



End Time allows the oven to be set to shut off automatically at a set time of day. The oven control will calculate the remaining time by itself. The time remaining will always be shown in the timer section of the display. The oven will shut off and will beep when the countdown is finished. This feature can be used with Bake, Convection Bake, Convection Roast, Slow Cook, Keep Warm, Defrost, Dehydrate, Clean and Bread Proof cooking modes. This oven can be programmed with Cook Time and End Time to start and stop by itself at the right time.

To set a delayed timed cooking (example is a 450°F Bake for 30 minutes which will end at 6:00PM):

1. Select oven by pressing **UPPER OVEN** .
2. Press **BAKE** . The temperature numbers will blink in the display.
3. Enter temperature needed; **4 5 0**.
4. Press **COOK OPTIONS**  to bring up the cook options items.
5. Press **COOK TIME** .
6. Enter time needed; **3 0**.
7. Press **END TIME** .
8. Enter time of day needed; **6 0 0**.
9. Press **START** . The time remaining will be shown in the display.
10. Press **CANCEL**  to stop the audible alarm or to cancel cooking at anytime.

CAUTION Use caution with the **COOK TIME** or **END TIME** features. Use the automatic timer when cooking cured or frozen meats and most fruits and vegetables. Foods that can easily spoil such as milk, eggs, fish, meat or poultry, should be chilled in the refrigerator first. Even when chilled, they should not stand in the oven for more than 1 hour before cooking begins, and should be removed promptly when cooking is completed. Eating spoiled food can result in sickness from food poisoning.

BROILING





This mode is best for meats, fish and poultry up to 1" thick. Broiling is a method of cooking tender cuts of meat by direct heat under the broil element of the oven. The high heat cooks quickly and gives a rich, brown outer appearance. The temperature probe cannot be used with this mode. The oven can be programmed to broil at any temperature from 300°F to 550°F with a default temperature of 550°F.



Broiling Tips:

- For optimum browning, preheat the broil element for 2 minutes.
- Broil one side until the food is browned; turn and cook on the second side. Season and serve.
- Always pull the rack out to the "stop" position before turning or removing food.
- Always use the broiler pan and its grid when broiling. It allows the dripping grease to be kept away from the high heat of the broil element (see Figure 1).
- For best broiling results, broil with the oven door slightly open.
- **DO NOT** use the broil pan without the insert. **DO NOT cover the broil pan insert with foil.** The exposed grease could catch fire. **DO NOT** use the roasting rack when broiling.

To set a Broil Temperature of 550°F:

1. Arrange interior oven racks.
2. Select oven by pressing **UPPER OVEN** .
3. Press **BROIL** .
4. Press **START** .
5. Place food in the oven after 2 minutes.
6. Turn food when the top side is browned and cook on the second side.
7. Remove food. Always use oven mitts when removing hot pans from the oven.
8. Press **CANCEL**  to stop or cancel the Broil feature at any time.

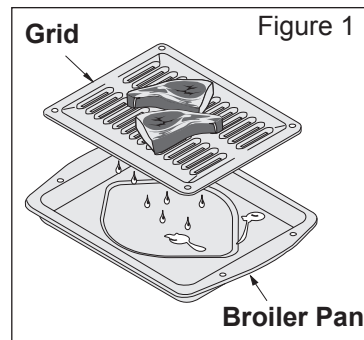

Broiling Times

Electric Wall Oven Broiling Table Recommendations					
Food Item	Rack Position	Temp Setting	Cook Time		Doneness
			1st side	2nd side	
Steak 1" thick	7	550° F	6:00	4:00	Rare
	7	550° F	7:00	5:00	Medium
Pork Chops 3/4" thick	7	550° F	8:00	6:00	Well
Chicken - Bone In	5	450° F	20:00	10:00	Well
Chicken - Boneless	7	450° F	8:00	6:00	Well
Fish	7	500° F	13:00	0:00	Well
Shrimp	5	550° F	5:00	0:00	Well
Hamburger 1" thick	7	550° F	9:00	7:00	Medium
	5	550° F	10:00	8:00	Well

⚠ WARNING Should an oven fire occur, close the oven door and turn off the oven. If the fire continues, throw baking soda on the fire or use a fire extinguisher. **DO NOT** put water or flour on the fire. Flour may be explosive and water can cause a grease fire to spread and cause personal injury.

CONVECTION BAKING



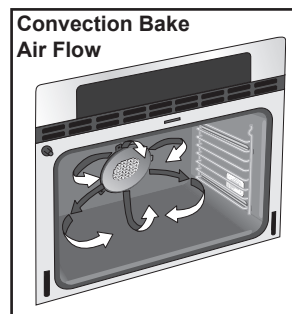

This mode of cooking enables you to obtain the best culinary results when baking with multiple pans and racks. Multiple rack baking may slightly increase cook time for some foods but the overall result is time saved. Most foods cooked in a standard oven will cook faster and more evenly with Convection Bake. Convection baking uses the three elements and a fan to circulate the oven's heat evenly and continuously within the oven. The temperature probe can be used in this cooking mode. The oven can be programmed for Convection baking at any temperature between 170°F to 550°F with a default temperature of 350°F.







Convection Baking Tips:

- Always preheat your oven before using the Convection Bake mode.
- If your recipe cooking temperature has already been converted for convection baking there is no need to reduce your oven temperature. If your recipe has not had the temperature converted for convection baking you can easily reduce the temperature using the Convection Convert feature. Please see Convection Convert section on next page for further instruction on temperature conversion.
- Use tested recipes with times adjusted for convection baking when using this mode. With single rack convection baking some foods may have as much as a 25% reduction in cook time; check food at minimum time. Time reductions will vary depending on the amount and type of food to be cooked.
- When using Convection Bake with a single rack, place oven rack in position 3 or 4. If cooking on multiple racks, place the oven racks in positions 2 and 6 or 1, 4 and 7.
- Most bakeries (except cakes) should be baked on pans with no sides or very low sides to allow heated air to circulate around the food.
- Food baked on pans with a dark finish will cook faster.

To set a Convection Bake Temperature of 350°F:





1. Arrange interior oven racks.
2. Select oven by pressing **UPPER OVEN** UPPER OVEN.
3. Press **CONVECTION BAKE** .
4. Press **START** . The oven display shows **PRE-HEATING**.
5. Place food in the oven when the chime signals and temperature display shows that the oven has reached the set target temperature and the **PRE-HEATING** message disappear.
6. The Temperature Probe, Cook Time, Timer, End Time and Rapid Preheat features can be set to control your cooking time (read their sections for directions).
7. Remove food. Always use oven mitts when removing hot pans from the oven.
8. Press **CANCEL**  to stop or cancel the Convection Bake feature at any time.

CONVECTION CONVERT

The Convection Convert pad is used to automatically convert a standard baking recipe for convection baking. When set properly, this feature is designed to display the actual converted (reduced) temperature in the display. Convection Convert may ONLY be used with a Convection Bake cooking mode. It can be used with the features End Time and Cook Time (see their sections for directions). If convection conversion is used with the cook time and end time features, "CF" (check food) will be displayed when 75% of the bake time is complete. At this time the oven control will sound 3 long beeps at regular intervals until baking had finished. When the bake time has completely finished the control will beep at regular interval until the **CANCEL**  pad is pressed. **NOTE:** To use this feature with the **COOK TIME**  option, the **COOK TIME**  pad must be pressed before the **CONVECTION CONVERT**  pad.



Changing from a normal bake temperature to a convection bake temperature:

1. Select oven by pressing **UPPER OVEN**  **UPPER OVEN**.
2. Press **CONVECTION BAKE** .
3. Press **COOK OPTIONS** . The cook options items will light up.
4. Press **CONVECTION CONVERT** . The temperature displayed will be 25°F lower than what it used to be.
5. Press **START**  to begin the convection baking (see Convection Baking section for more informations).





RAPID PREHEAT

The Preheat feature will bring the oven up to temperature faster than a regular preheat and then indicate when to place the food in the oven. Preheating is not necessary when roasting or cooking casseroles. The oven can be programmed to preheat at any temperature between 170°F to 550°F with some of the cooking modes; Bake, Convection Bake and Convection Roast.



IMPORTANT: The rapid preheat feature is for single rack ONLY. The heat distribution with multiple rack will be uneven.

To set a rapid preheat (example is for a 350°F Bake):

1. Select oven by pressing **UPPER OVEN**  **UPPER OVEN**.
2. Press **BAKE** .
3. Press **COOK OPTIONS** . The cook options items will light up.
4. Press **RAPID PREHEAT** .
5. Press **START**  to begin the baking with the rapid preheat feature enabled.
6. Place food in the oven when the chime signals and temperature display shows that the oven has reached the set target temperature.

CONVECTION ROASTING







This mode is best for cooking tender cuts of beef, lamb, pork and poultry. Use this mode when cooking speed is desired. The Convection Roasting gently browns the exterior and seals in the juices. Convection roasting uses the hidden bake element, the hidden convection element, the broil element and a fan to circulate the oven's heat evenly and continuously within the oven. The temperature probe can be used in this cooking mode. The oven can be programmed for Convection Roasting at any temperature between 170°F to 550°F with a default temperature of 350°F.

Convection Roasting Tips:

- Use the broiler pan and grid, and the roasting rack (Figure 1). The broiler pan will catch grease spills and the grid will help prevent spatters. The roasting rack will hold the meat.
- Place an oven rack on rack position 2 (next-bottom).
- Make sure the roasting rack is securely seated on the grid in the broiler pan. The roasting rack fits on the grid allowing the heated air to circulate under the food for even cooking and helps to increase browning on the underside.
- There is no need to reduce the convection temperature or to use the Convection Convert feature with this cooking mode.
- **DO NOT** use the broiler pan without the grid or cover the grid with aluminum foil.
- Always pull the rack out to the stop position before removing food.
- Position food (fat side up) on the roasting rack.

To set a Convection Roast Temperature of 350°F:

1. Arrange interior oven racks.
2. Select oven by pressing **UPPER OVEN** .
3. Press **CONVECTION ROAST** .
4. Press **START** .
5. The Temperature Probe, Cook Time, Timer, End Time and Rapid Preheat features can be set to control your cooking time (read their sections for directions).
6. Remove food. Always use oven mitts when removing hot pans from the oven.
7. Press **CANCEL**  to stop or cancel the Convection Roast feature at any time.

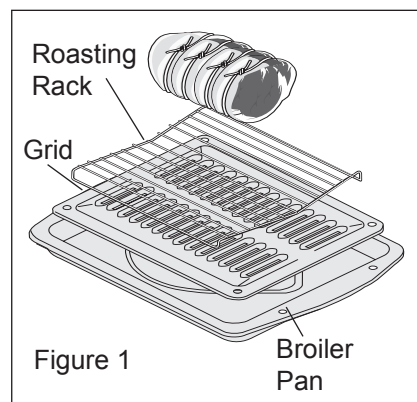

Convection Roasting Chart

Meat	Weight	Oven Temp	Internal Temp	Min per lb.	
Beef	Standing rib roast	4 to 6 lbs.	350° F	*	25-30
	Rib eye roast	4 to 6 lbs.	350° F	*	25-30
	Tenderloin roast	2 to 3 lbs.	400° F	*	15-25
Poultry	Turkey, whole**	12 to 16 lbs.	325° F	180° F	8-10
	Turkey, whole**	16 to 20 lbs.	325° F	180° F	10-15
	Turkey, whole**	20 to 24 lbs.	325° F	180° F	12-16
	Chicken	3 to 4 lbs.	350-375° F	180° F	12-16
Pork	Ham roast, fresh	4 to 6 lbs.	325° F	160° F	30-40
	Shoulder blade roast	4 to 6 lbs.	325° F	160° F	20-30
	Loin	3 to 4 lbs.	325° F	160° F	20-25
	Pre-cooked ham	5 to 7 lbs.	325° F	160° F	30-40

* For beef: med rare 145°F, med 160°F, well done 170°F

** Stuffed turkey requires additional roasting time. Shield legs and breast with foil to prevent overbrowning and drying of the skin.

CONVECTION BROILING

Use this mode for thicker cuts of meat, fish and poultry. The Convection Broiling gently browns the exterior and seals in the juices. Convection broiling uses the broil element and a fan to circulate the oven's heat evenly and continuously within the oven. The temperature probe cannot be used in this cooking mode. The oven can be programmed for Convection Broiling at any temperature between 300°F to 550°F with a default temperature of 550°F.





Convection Broiling Tips:

- For optimum browning, preheat the broil element for 2 minutes.
- Broil one side until the food is browned; turn and cook on the second side. Season and serve.
- Always pull the rack out to the “stop” position before turning or removing food.
- Always use the broiler pan and its grid when broiling. It allows the dripping grease to be kept away from the high heat of the broil element (see Figure 1).
- **DO NOT** use the broil pan without the insert. **DO NOT cover the broil pan insert with foil.** The exposed grease could catch fire. **DO NOT** use the roasting rack when broiling.
- Convection broiling is generally faster than conventional broiling. Check for doneness at the minimum recommended time.

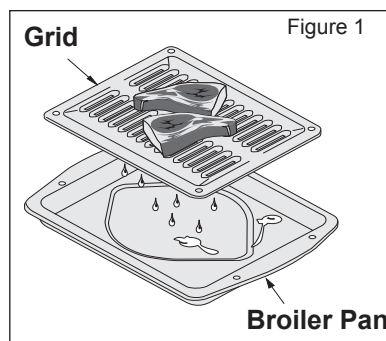
IMPORTANT: Always use this cooking mode with the oven door closed or the fan will not turn on.



To set a Convection Broil Temperature of 550°F:

1. Arrange interior oven racks.
2. Select oven by pressing **UPPER OVEN** UPPER OVEN.
3. Press **CONVECTION BROIL** .
4. Press **START** .
5. Place food in the oven after 2 minutes.
6. Turn food when the top side is browned and cook on the second side.
7. Remove food. Always use oven mitts when removing hot pans from the oven.
8. Press **CANCEL**  to stop or cancel the Convection Broil feature at any time.

⚠ WARNING Should an oven fire occur, leave the oven door closed and turn off the oven. If the fire continues, throw baking soda on the fire or use a fire extinguisher. **DO NOT** put water or flour on the fire. Flour may be explosive and water can cause a grease fire to spread and cause personal injury.

KEEP WARM



This mode is best for keeping oven baked foods warm for serving after cooking has finished. The Keep Warm feature uses the hidden bake element to maintain the temperature within the oven. The Keep Warm feature may be used with Multi-Stage (refer to its section for directions) if you wish to have the Keep Warm feature turn ON automatically when cooking has finished. The oven can be programmed for Keep Warm at any temperature between 150°F to 190°F with a default temperature of 170°F.



Keep Warm Tips for Upper Oven:

- Always start with hot food.
- Do not use the Keep Warm feature to heat cold food.
- Food in heat-safe glass and glass ceramic containers may need higher temperature settings compared to food in regular containers.
- Avoid repeated openings of the oven, it will allow hot air to escape and the food to cool.
- Aluminum foil may be used to cover food to increase moisture content.

Keep Warm Tips for Lower Oven:

- Follow recommendations for lower oven cooking modes in the **Setting Lower Oven** section of this manual.

To set a Keep Warm Temperature of 170°F:

1. Arrange interior oven racks (for upper oven only).
2. Select oven by pressing **UPPER OVEN** UPPER OVEN or **LOWER OVEN** LOWER OVEN.
3. Press **KEEP WARM** .
4. Press **START** .
5. The Multi-Stage, Cook Time, Timer and End Time features can be set to control your warming time (read their sections for directions).
6. Remove food. Always use oven mitts when removing hot pans from the oven.
7. Press **CANCEL**  to stop or cancel the Keep Warm feature at any time.

SLOW COOK



This mode may be used to cook foods more slowly, at lower oven temperatures and provide cooking results much the same way as a Slow Cooker or Crock-Pot. The Slow Cook feature is ideal for roasting beef, pork & poultry. Slow Cooking meats may result in the exterior of meats becoming dark but not burnt. This is normal. The Slow Cook mode uses the hidden bake element to maintain a low temperature in the oven. The temperature probe cannot be used in this cooking mode. There are 2 settings available, high (HI) or low (LO). The maximum cook time for the Slow Cook feature is 12 hours unless the oven control has been changed to the Continuous Bake mode or the Sabbath mode has been activated.



Slow Cook Tips:

- Completely thaw all frozen foods before cooking with the Slow Cook feature.
- When using a single rack, position it in the center of the oven.
- Position multiple racks to accommodate size of cooking utensils when cooking multiple food items.
- Do not open the oven door often or leave the door open when checking foods. If the oven heat escapes often, the Slow Cook time may need to be extended.
- Cover the foods to keep them moist or use a loose or vented type cover to allow foods to turn crisp or brown.
- Cook times will vary; depending on the weight, fat content, bone & the shape of the meat.
- Use the recipe's recommended food temperature and a food thermometer to determine when the food is done.
- Preheating the oven will not be necessary when using the Slow Cook feature.
- Add any cream or cheese sauces during the last hour of cooking.

To set a Slow Cook:

1. Arrange interior oven racks and place food in the oven.
2. Select oven by pressing **UPPER OVEN** UPPER OVEN or **LOWER OVEN** LOWER OVEN.
3. Press **SLOW COOK** .
4. Press $\overset{+}{hi}$ for high (**HI**) setting or $\overset{-}{lo}$ low (**Lo**) setting.
5. Press **START** .
6. The Cook Time, Timer and End Time features can be set to control your Slow Cook time (read their sections for directions).
7. Remove food. Always use oven mitts when removing hot pans from the oven.
8. Press **CANCEL**  to stop or cancel the Slow Cook feature at any time.

DEHYDRATING





This mode dries foods with heat from the bake and the convection element. The heat is circulated throughout the oven by the convection fan. Dehydrating is used to dry and/or preserve foods such as fruits, meats, vegetables and herbs. This mode holds an optimum low temperature while circulating the heated air to slowly remove moisture. The oven can be programmed for Dehydrating at any temperature between 100°F to 225°F with a default temperature of 120°F.

Dehydrating Tips:

- Do not preheat the oven.
- Multiple racks can be used simultaneously.
- Drying times vary depending on the moisture and sugar content of the food, the size of the pieces, the amount being dried and the humidity in the air.
- Check food at the minimum drying time.
- Treat fruits with antioxidants to avoid discoloration.
- Consult a food preservation book or a library for additional information.

To set a Dehydrate Temperature of 120°F:



1. Arrange interior oven racks and place food.
2. Select oven by pressing **UPPER OVEN** UPPER OVEN.
3. Press **DEHYDRATE** .
4. Press **START**  to begin dehydrating.
5. Remove food. Always use oven mitts when removing hot pans from the oven.
6. Press **CANCEL**  to stop or cancel the Dehydrate feature at any time.

DEFROSTING



Use the defrost feature to thaw small portions of delicate items such as cream cakes, frozen cream pies and cheesecake, at room temperature. While in the defrost mode, the convection fan will operate to circulate room temperature air around the food slowly, accelerating the natural defrosting of the food without heat.

To set a Defrost:

1. Arrange interior oven racks and place food in the oven.
2. Select oven by pressing **UPPER OVEN** UPPER OVEN.
3. Press **DEFROST** .
4. Press **START**  to start the defrosting. A “dEF” message is displayed when active.
5. The Cook Duration, End Time and Timer features can be set to control your Defrost time (read their sections for directions).
6. Press **CANCEL**  to stop or cancel the Defrost feature at any time.

Note: This feature is not meant for thawing frozen meats, poultry, seafood or other foods that need to be cooked before serving. Follow USDA recommendations for thawing foods. Only frozen foods that can be defrosted and served without cooking should be used with this feature.

BREAD PROOFING



Proofing bread prepares the dough for baking by activating the yeast. This feature is ideal for proofing, or rising bread dough. The oven can be programmed for Bread Proofing at any temperature between 85°F to 100°F with a default temperature of 100°F. The temperature visual display is not available for this function.



Bread Proofing Tips:

- No need to preheat for this feature.
- Proof bread until dough has doubled in bulk.
- For best results, place a shallow pan with 1 to 3 cups of boiling hot water on the lowest rack position to keep the air moist inside the oven cavity.
- Allow at least 1" between edge of pan and walls of the oven.
- Limit frequent door openings to prevent losing heat and lengthening proofing time.

To set a Bread Proof temperature of 100°F:

1. Arrange interior oven racks and place bread dough in the oven.
2. Select oven by pressing **UPPER OVEN** UPPER OVEN.
3. Press **BREAD PROOF** .
4. Press **START**  to begin the bread proofing.
5. The Cook Time, Timer and End Time features can be set to control your Bread Proof time (read their sections for directions).
6. Remove food.
7. Press **CANCEL**  to stop or cancel the Bread Proof feature at any time.

To change a Bread Proof temperature while the function is active:

1. Select oven by pressing **UPPER OVEN** UPPER OVEN.
2. Press the **HI** ⁺_{hi} or **LO** ⁻_{lo} pads to get to the desired temperature.
3. Press **START**  to continue the bread proofing with the new setting.

PERFECT TURKEY





This mode uses the temperature probe to control precisely the cooking of a perfect turkey. The convection system gently browns the turkey's exterior and seals in the juices. The temperature probe is **required** with this cooking mode (read its section on next page for more details). The oven can be programmed for Perfect Turkey at any temperature between 170°F to 550°F with a default temperature of 325°F. The probe default temperature for the perfect turkey feature is 180°F.



Perfect Turkey Tips:

- Thaw the turkey in the refrigerator at least 24 hours per 5 lbs before cooking the bird.
- Use the broiler pan and grid, and the roasting rack. The broiler pan will catch grease spills and the grid will help prevent spatters. The roasting rack will hold the turkey.
- Place an oven rack on rack position 2 (next-bottom).
- Make sure the roasting rack is securely seated on the grid in the broiler pan. The roasting rack fits on the grid allowing the heated air to circulate under the food for even cooking and helps to increase browning on the underside.

To set a Perfect Turkey of 325°F:

1. Arrange interior oven racks and place food in the oven.
2. Insert the meat probe into the bird and connect it in the oven (read the probe section on next page for more details).
3. Select oven by pressing **UPPER OVEN** ^{UPPER} _{OVEN}.
4. Press **PERFECT TURKEY** . A temperature can be entered if another value than the default is needed.

Optional : Press **PROBE**  if you wish to change the probe target temperature (see PROBE section).

5. Press **START** .
6. Remove food from the oven when the temperature probe chime signals that the oven has reached the set target temperature.
7. Press **CANCEL**  to stop or cancel the Perfect Turkey feature at any time.

Perfect Turkey Chart

	Weight	Oven Temp	Internal Temp	Min per lb.
Poultry Turkey, whole*	12 to 16 lbs.	325° F	180° F	8-10
Turkey, whole*	16 to 20 lbs.	325° F	180° F	10-15
Turkey, whole*	20 to 24 lbs.	325° F	180° F	12-16
Chicken	3 to 4 lbs.	350-375° F	180° F	12-16

* Stuffed turkey requires additional roasting time. Shield legs and breast with foil to prevent overbrowning and drying of the skin.

TEMPERATURE PROBE

For many foods, especially roasts and poultry, testing the internal temperature is the best method to insure properly cooked food. The Temperature Probe gets the exact temperature you desire without having to guess. This feature can be used with Bake, Convection Bake, Convection Roast and Perfect Turkey cooking modes. The oven can be programmed for Probe at any temperature between 130°F to 210°F with a default temperature of 170°F. This unit is equipped with one temperature probe entry in the upper oven.



IMPORTANT:

1. Use only the probe supplied with your appliance; any other may result in damage to the probe or the appliance.
2. Handle the Temperature Probe carefully when inserting and removing it from the food and outlet.
3. Do not use tongs to pull the cable when inserting or removing the Probe. It could damage the Probe.
4. Defrost your food completely before inserting the Probe to avoid breaking it.
5. Never leave or store the Temperature Probe inside the oven when not in use.
6. To prevent the possibility of burns, carefully unplug the Temperature Probe using hot pads.

Proper Temperature Probe Placement:

1. Always insert the probe so that the tip rests in the center of the thickest part of the meat. Do not allow probe to touch bone, fat, gristle or pan.
2. For bone-in ham or lamb, insert the Probe into the center of the lowest large muscle or joint. For dishes such as meat loaf or casseroles, insert the Probe into the center of the food. When cooking fish, insert the Probe from just above the gill into the meatiest area, parallel to the backbone.
3. For whole poultry (chicken, turkey, etc.), insert the probe into the thickest part of the inner thigh from below and parallel to the leg (see figure 1).

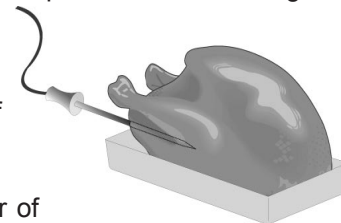

Figure 1

Setting the Oven when using the Temperature Probe:

1. Insert the Temperature Probe into the food (see Proper Temperature Probe Placement above).
2. Plug the Temperature Probe into its outlet in the oven. (**The outlet is located on the top left hand side of the cavity wall, near front of the oven**). Always insert the probe into a cool oven. Make sure it is pushed all the way into the outlet. Close the oven door.
3. Select oven by pressing either **UPPER OVEN** UPPER OVEN.
4. Select a cooking mode. A target temperature must be set to trigger the buzzer when the food reaches the set temperature. Press **COOK OPTIONS** to bring up the cook options items and press **PROBE** pad to enter the temperature. Adjust temperature to the desired setting using the numeric pads or just press **START** to use the default target temperature of 170°F. The pads **hi** or **lo** can also be pressed to raise or lower the temperature. The target temperature setting will be accepted after the **START** pad is pressed.
5. At any time during the cooking, the **PROBE** pad can be pressed once to display the actual meat temperature or pressed twice to display the target temperature. When on the target temperature display, a new temperature can be entered. After 5-8 seconds, the display will go back to showing the oven temperature.
6. When the food reach the target temperature, the oven will go into a **KEEP WARM** mode until you press **CANCEL** .

The probe can be damaged by very high temperature. To protect the probe against this damage, the oven control will not allow you to start a self-clean, broil or convection broil while the probe is connected.

MULTI STAGE



1
2
3

This feature enables you to perform sequential cooking at the touch of a button. Its purpose is to program a queue of up to three cooking modes with individual cooking time and temperatures in a sequence. This feature can be used with most cooking modes; Baking, Broiling, Convection Baking, Convection Roasting, Convection Broiling, Keep Warm and Bread Proof. A Cook Time can be programmed with your cooking mode and then queued. An auto-suggested set temperature outputs in the display as a default value during the set temperature programming. Any stage programmed with Broil or Convection Broil cannot last longer than 10 minutes. A proper cook time and a set temperature are required for every stage programming. At least two stages must be programmed before a Multi-Stage cooking operation starts. During stage 1 cooking the electronic control provides temperature visual output in the display. During stage 2 and 3, the electronic control displays the set temperature only.





To set a Multi Stage sequence (*Timed Convection Bake, Timed Broil, Keep Warm*):

1. Arrange interior oven racks and place food.
2. Select oven by pressing **UPPER OVEN** UPPER OVEN.
3. Press **MULTI STAGE** $\frac{1}{2}$.

Stage 1

4. Press **CONVECTION BAKE** . "350" will flash in the display prompting to enter a temperature.
5. Enter a temperature using the numeric pads **0** to **9**.
6. Press **START** . "00:00" will start flashing in the display prompting to enter a cook time.
7. Enter a cook time using the numeric pads **0** to **9**.
8. Press **START** . The Multi-Stage indicator will now display the 2nd stage.



Stage 2

9. Press **BROIL** . "550" will start flashing in the display prompting to enter a temperature.
10. Enter a temperature using the numeric pads **0** to **9**.
11. Press **START** . "00:00" will start flashing in the display prompting to enter a cook time.
12. Enter a cook time using the numeric pads **0** to **9**.
13. Press **START** . The Multi-Stage indicator will now display the 3rd stage. If a third stage is not needed, press **START**  a second time. This will start the cooking sequence.

Read next page for stage 3 and canceling details

MULTI STAGE (CONTINUED)

Stage 3

14. Press **KEEP WARM** . "170" will start flashing in the display prompting to enter a temperature.
15. Enter a temperature using the numeric pads **0** to **9**.
16. Press **START** . "00:00" will start flashing in the display prompting to enter a cook time.
17. Enter a cook time using the numeric pads **0** to **9**.
18. Press **START** . The cooking sequence will begin.

12
3

Canceling

19. At the end of the sequence, the display will show "End" and a chime will sound.
20. Remove food.
21. Press **CANCEL**  to stop or cancel the Multi-Stage sequence at any time (see below for further details).

To cancel a Multi Stage sequence:

A multi stage cooking can be canceled any time while it is in progress (or during its programming) by the Cancel  key.





If the key is pressed during a multi-stage programming, the electronic control returns to Idle mode.

USER PREFERENCES



The User Preferences menu includes all user defined options. This feature enables you to control the various options of the electronic controls. This menu features the Time of Day, Celsius or Fahrenheit display mode, Continuous Bake or 12 Hour Energy Saving modes, Clock display or No-Clock display, 12 Hours Time of Day or 24 Hours Time of Day, Audio Control, and Adjusting the oven temperature. The User Preferences menu is only available when the oven is not being used (not cooking).

To browse through the User Preferences menu:

1. Press **USER PREF**  to bring up the User Preferences menu.
2. Press **USER PREF**  again to browse through the menu pages.
3. Press $\overset{+}{hi}$ or $\overset{-}{lo}$ to toggle between the available options.
4. Press **START**  while the chosen option is on display to change.
5. Press **CANCEL**  when finished to get back to the standard oven display.

User Preferences menu items:



- **CLO 12:00**; Setting the clock.
- **CLO on**; Clock on/off.
- **CLO 12hr**; 12/24 hour time of day display.
- **UPO**; Adjusting oven temperature.
- **F-C F**; Fahrenheit / Celsius display.
- **AUd**; Audio on/off and volume.
- **E S on**; 12 hour Energy Saving on/off.
- **rSt**; Reset to default factory settings.

SETTING THE CLOCK - TIME OF DAY

The clock may be set for 12 or 24 hour time of day operation (see advanced settings section). The clock has been preset at the factory for the 12 hour operation. When the range is first plugged in, or when the power supply to the range has been interrupted, the display will show “**CLO 12:00**”. The clock must be set before the oven can be used.

When power to the unit has been interrupted, “**12:00**” appears and flashes in the display. To set the Clock in this case, skip step 1 in the example below and follow steps 2 and 3.

To set the clock (example for 1:30):

1. Press **USER PREF**  until you get to the **CLO 12:00** menu page.
2. Press **1 3 0** pads to set the time of day to 1:30. The pads $\overset{+}{hi}$ or $\overset{-}{lo}$ can also be pressed to raise or lower the actual time displayed.
3. Press **START**  to accept the changes and go back to user preferences menu display.



USER PREFERENCES (CONTINUED)

SETTING CLOCK DISPLAY — ON OR OFF

The oven control can be programmed to display the time of day or not. The oven has been preset at the factory to display the time of day.





Changing clock display between ON and OFF:

1. Press **USER PREF**  until you get to the **CLO on** menu page.
- +
2. Press **lo** or **hi** to toggle between displaying or hiding the clock.
3. Press **START**  to accept the changes and go back to user preferences menu display.

SETTING TIME OF DAY DISPLAY — 12 OR 24 HOURS

The oven control can be programmed to display time of day in 12 hours or 24 hours mode. The oven has been preset at the factory to display in 12 hours mode.



Changing between 12 or 24 hour time of day display:

1. Press **USER PREF**  until you get to the **CLO 12hr** menu page.
- +
2. Press **lo** or **hi** to toggle the display of the clock in 12 or 24 hours.
3. Press **START**  to accept the changes and go back to user preferences menu display.
4. Remember to set your clock after changing the time of day display mode.

ADJUSTING OVEN TEMPERATURE

The temperature in the oven has been pre-set at the factory. When first using the oven, be sure to follow recipe times and temperatures. If you think the oven is too hot or too cool, the temperature in the oven can be adjusted. Before adjusting, test a recipe by using a temperature setting that is higher or lower than the recommended temperature. The baking results should help you to decide how much of an adjustment is needed. Each oven can be individually adjusted.

To adjust the oven temperature:

1. Press **USER PREFERENCES**  until you get to the **UPO** menu page.
2. To select the oven you want to adjust, press **USER PREFERENCES**  again to toggle between the upper and the lower display.
3. Enter the temperature by pressing the **hi** ⁺ or **lo** ⁻ pads. The temperature can only be adjusted by $\pm 35^{\circ}\text{F}$.
4. Press **START**  to accept the changes and go back to user preferences menu display.



USER PREFERENCES (CONTINUED)



SETTING TEMPERATURE DISPLAY — FAHRENHEIT OR CELSIUS

The oven control can be programmed to display temperatures in Fahrenheit or Celsius. The oven has been preset at the factory to display in Fahrenheit.



To change display from Fahrenheit to Celsius or Celsius to Fahrenheit:

1. Press **USER PREF**  until you get to the **F-C F** menu page.
2. Press $\overset{+}{hi}$ or $\overset{-}{lo}$ to toggle between the °C and °F display options.
3. Press **START**  to accept the changes and go back to user preferences menu display.

AUDIO CONTROL

The Audio Control feature allows the oven control to be operated without sounds or beeps whenever necessary. If desired the control can be programmed for silent operation and later returned to operating with all the default sounds and beeps. The volume of the beeps can also be adjusted.



To change the audio mode or audio volume:

1. Press **USER PREF**  until you get to the **AUd** menu page.
2. Press $\overset{+}{hi}$ or $\overset{-}{lo}$ to toggle between the available volume settings. **AUd 5** for the highest volume setting to **AUd 1** for the lowest volume. **AUd OFF** to disable the beeps.
3. Press **START**  to accept the changes and go back to user preferences menu display.

SETTING CONTINUOUS BAKE OR 12 HOUR ENERGY SAVING

The oven control has a factory preset built-in 12 Hour Energy Saving feature that will shut off the oven if the oven control is left on for more than 11 hours and 59 minutes. The oven can be programmed to override this feature for Continuous Baking.



Changing between 12 hour energy saving and continuous bake:

1. Press **USER PREF**  until you get to the **E S** menu page.
2. Press $\overset{+}{hi}$ or $\overset{-}{lo}$ to toggle the energy saving setting on and off.
3. Press **START**  to accept the changes and go back to user preferences menu display.

RE-SETTING TO DEFAULT FACTORY SETTINGS

The oven control can be set to return to its original factory settings. This includes: Setting the Clock ON/OFF to ON, Setting the clock display mode to 12h, Display mode to Fahrenheit, Setting the oven temperature adjustment to zero, Setting audio level to 5 and Enabling the 12h energy saving mode. Resetting the control also erases the My Favorite recipes.

To reset the oven control to its original settings:

1. Press **USER PREF**  until you get to the **rSt no** menu page.
2. Press $\overset{+}{hi}$ or $\overset{-}{lo}$ to select **YES**.
3. Press **START**  to reset to default factory settings.





MY FAVORITES

The Favorites settings allows you to save your most frequently used or most complex cooking sequences. This feature will save the cooking mode, the target temperature and the cooktime (if any). The oven can recall up to six cooking sequences from its internal memory, three for each oven, which are easily accessible from a one touch button. These functions can be used with all cooking modes and features.



To save a Favorite (example is a 450°F Bake for 30 minutes):



- Saving a Favorite can only be done for an oven which is currently in operation.

1. Select oven by pressing either **UPPER OVEN** ^{UPPER}_{OVEN} or **LOWER OVEN** ^{LOWER}_{OVEN}.
2. Press **BAKE** . The default temperature will appear in the display.
3. Enter temperature needed; **4 5 0**.
4. Press **COOK OPTIONS**  to bring up the cook options items.
5. Press **COOK TIME** .
6. Enter time needed; **3 0**.
7. Press **START** .
8. Press and hold for 3 seconds any **MY FAVORITE**  pad. Notice that the red indicator above the key will light up.



To recall a Favorite:

- Recalling a Favorite can only be done for an oven which is not currently in operation.

1. Select oven by pressing either **UPPER OVEN** ^{UPPER}_{OVEN} or **LOWER OVEN** ^{LOWER}_{OVEN}.
2. Press any **MY FAVORITE**  pad which is currently lighted up.
3. Press **START** .

To overwrite a Favorite:

1. To overwrite a My Favorite simply start a new cooking sequence and save it into the same My Favorite location (1, 2 or 3) for the selected oven as shown in example above. The new My Favorite settings will overwrite the old ones.

To delete a Favorite:

1. Select oven by pressing either **UPPER OVEN** ^{UPPER}_{OVEN} or **LOWER OVEN** ^{LOWER}_{OVEN}.
2. Press the currently lighted up **MY FAVORITE**  pad you wish to delete for **3 seconds**.

SABBATH FEATURE

(FOR USE ON THE JEWISH SABBATH & HOLIDAYS)









The **HI**⁺_{hi} and **LO**⁻_{lo} pads are used to set the Sabbath feature. The Sabbath feature may only be used with the **BAKE**  pad. The oven temperature may be set higher or lower after setting the Sabbath feature (the oven temperature adjustment feature should be used only during Jewish Holidays), however the display will not visibly show or provide any audible tones indicating whether the change occurred correctly. Once the oven is properly set using Bake with the Sabbath feature active, the oven will remain continuously ON until cancelled. This will override the factory preset 12-Hour Energy Saving feature.

If the oven light will be needed during the Sabbath, press **OVEN LIGHT**  before activating the Sabbath feature. Once the oven light is turned ON and the Sabbath feature is active, the oven light will remain ON until the Sabbath feature is turned OFF. If the oven light needs to be OFF, be sure to turn the oven light OFF before activating the Sabbath feature.

IMPORTANT NOTES: It is not advised to attempt to activate any other program feature other than **BAKE** while the Sabbath feature is active. ONLY the following key pads will function after setting the Sabbath feature; **CANCEL** , **HI**⁺_{hi} and **LO**⁻_{lo}.

ALL OTHER KEYPADS will not function once the Sabbath feature is properly activated.

To Program the Upper Oven to Begin Baking Immediately & Activate the Sabbath feature (example: baking at 350°F)

1. Place the food in the oven.
2. Select oven by pressing either **UPPER OVEN**  or **LOWER OVEN** .
3. Press **BAKE** .
4. If you desire to set the oven control for a **COOK TIME**  do so at this time. If not, skip this step and continue to step 5. Refer to their section for complete instructions. Remember the oven will shut down after using **COOK TIME**  and therefore may only be used once during the Sabbath/Jewish Holidays.
5. Press **START** .
6. The oven will turn ON and begin heating immediately.
7. Press and hold both the **HI**⁺_{hi} and **LO**⁻_{lo} pads for at least 3 seconds. **SAb** will appear in the oven display and **Sb** in the cooktop displays. Once SAb appears in the display the oven control will no longer beep or display any further changes and the oven is properly set for the Sabbath feature.

SABBATH FEATURE (CONTINUED)

Note: You may change the oven temperature once baking has started. The **HI**_{hi}⁺ key pad will increase the temperature by 5°F (2°C) at each key press. The **LO**_{lo}⁻ key pad will decrease the temperature by 5°F (2°C) at each key press. Remember that **the oven control will no longer beep or display any further changes** once the oven is set for the Sabbath feature.



8. The oven may be turned OFF at any time by pressing **CANCEL**  pad (this will turn the oven OFF only). To turn OFF the Sabbath feature press and hold both the **HI**_{hi}⁺ and **LO**_{lo}⁻ pads for at least 3 seconds. **SAb** will disappear from the display.

Should you experience a power failure or interruption, the oven will shut off. When power is returned the oven will not turn back on automatically. **SF** (Sabbath Failure) will be displayed in the oven control display and the surface element displays. The oven will remember that it is set for the Sabbath and the food may be safely removed from the oven while still in the Sabbath feature, however the oven cannot be turned back on until after the Sabbath. After the Sabbath observance turn OFF the Sabbath feature. Press and hold both the **HI**_{hi}⁺ and **LO**_{lo}⁻ pads for at least 3 seconds. **SAb** will disappear from the display and the oven may be used with all normal functions. For further assistance, guidelines for proper usage, and a complete list of models with the Sabbath feature, please visit the web at <http://www.star-k.org>.

Notes for the use of the cooktop in Sabbath mode:





- No Sabbath mode is available for induction cooktops. When Sabbath mode is enabled, the cooktop will lock and it will not be possible to turn a cooking zone ON. If a cooking zone is ON when Sabbath is set, it will turn off.

STARTING SELF-CLEAN CYCLE









A self-cleaning oven cleans itself with high temperatures (well above cooking temperatures) which eliminate soil completely or reduce it to a fine powdered ash you can whisk away with damp cloth. If you are planning to use the oven directly after a self-clean cycle remember to allow time for the oven to cool down and the oven door to unlock. This normally takes about one hour.

To set the controls for a Self-Cleaning cycle:



1. Remove the oven racks and the racks supports.
2. Be sure the clock is set with the correct time of day and the oven door is closed.
3. Press **CLEAN** .
4. Press **LITE** ● for a 2 hour self-clean, or press **MEDIUM** ●● for 3 hours, or press **HEAVY** ●●● for 4 hours.
5. Press **START** . The “**DOOR**  ” icon will flash.
6. As soon as the control is set, the motor driven oven door lock will begin to close automatically. Once the door has been locked the “**DOOR**  ” indicator light will stop flashing and remain on.

Note: Allow about 15 seconds for the oven door lock to close.

To set the controls for a delayed Self-Cleaning cycle:



1. Follow the instructions above.
2. Press **COOK OPTIONS**  to bring up the cook options items.
3. Press **END TIME** .
4. Enter time of day needed for the end of the cycle (example for “6:00”;   ).
5. Press **START** .

When the Self-Clean Cycle is Completed:

1. The time of day and “**DOOR**  ” will remain ON.
2. The display will show an “**Hot**” message while the oven is still too hot to open door.
3. Once the oven has cooled down for 1 HOUR, and the “**DOOR**  ” icon is no longer displayed, the oven door can then be opened.

Stopping or Interrupting a Self-Cleaning Cycle:

If it becomes necessary to stop or interrupt a self-cleaning cycle due to excessive smoke:

1. Press **CANCEL** .
2. Once the oven has cooled down for approximately 1 HOUR and the “**DOOR**  ” icon is no longer displayed, the oven door can then be opened.

⚠ WARNING During the self-cleaning cycle, the outside of the wall oven can become very hot to the touch. **DO NOT** leave small children unattended near the appliance; they may be burned if they touch the hot oven door surfaces.

⚠ CAUTION **DO NOT** force the oven door open. This can damage the automatic door locking system. Use care when opening the oven door after the self-cleaning cycle. Stand to the side of the oven when opening the door to allow hot air or steam to escape. The oven may still be VERY HOT.

ABOUT THE CERAMIC GLASS COOKTOP

The ceramic cooktop has inductor elements located below the surface of the glass. The design of the ceramic cooktop outlines the area of the inductor element underneath. **Make sure** the diameter of the pan matches the diameter of the element outline on the cooktop. Only flat-bottom cookware should be used. Heat may be transferred from the cookware to the ceramic glass and the areas surrounding the elements may become **hot enough to cause burns**. The type and size of cookware, the number of inductor elements in use and the settings, are all factors that will affect the amount of heat that will spread to areas beyond the surface elements.

USE THE CORRECT COOKWARE TYPE

The magnetic Cooking Zone sensors located below the cooktop surface require the use of cookware made with magnetic material in order to start the heating process on any of the Cooking Zones.

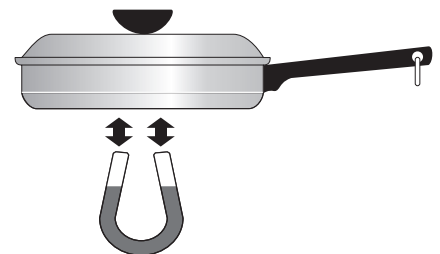

When purchasing pans, look for cookware specifically identified by the manufacturer for use with Induction cooktops. If you are not sure, use a magnet to test whether the cookware type will work. If a magnet sticks to the bottom of the cookware, the material type is correct for Induction cooking.

It is recommended to always use heavier high quality stainless steel cookware on your Induction Cooktop surface. This will greatly reduce the possibility of developing scratches on the ceramic surface. Even quality cookware can scratch the cooktop surface, especially if cookware is slid over the ceramic cooktop surface without being lifted up. Over time sliding **ANY** type of cookware over the ceramic cooktop will likely alter the overall appearance of the cooktop. Eventually the buildup of scratches will make cleaning the surface difficult and degrade the overall appearance of the cooktop.

MINIMUM PAN SIZE REQUIREMENTS

USE THE CORRECT SIZE COOKWARE - The Cooking Zones available on the Induction Cooktop require a **MINIMUM** pan size to be used at each location. The inner ring of each Cooking Zone is your guide to the correct **MINIMUM** pan size. The pan bottom must **FULLY** cover the inner ring for proper cooking to occur.

The thicker outer ring at each Cooking Zone is helpful to determine the pan **MAXIMUM** size. After centering the cookware on the cooktop, make sure the cookware does not extend more than 1/2" beyond the thicker line on the Cooking Zone. The pan must make **FULL** contact on the glass surface without the bottom of the pan touching the metal cooktop trims.

NOTE: If a pan made of the correct material is centered properly on any of the active Cooking Zones but is **TOO SMALL**, the circle around the digital part of the display will stay off and the pan will not heat.

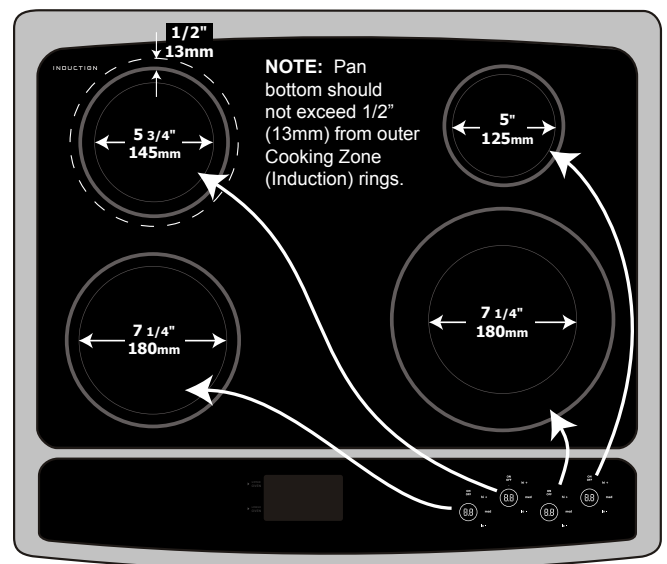

COOKWARE RECOMMENDATIONS

INCORRECT



- Cookware not centered on Cooking Zone surface.

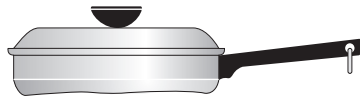

- Curved or warped pan bottoms or sides.

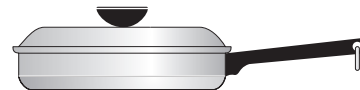

- Pan does not meet the minimum size required for the Cooking Zone used.



- Pan bottom rests on cooktop trim or does not rest completely on the cooktop surface.



- Heavy handle tilts pan.

CORRECT



- Cookware centered correctly on Cooking Zone surface.

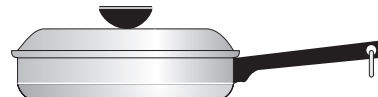

- Flat pan bottom & straight sides.



- Pan size meets or exceeds the recommended minimum size for the Cooking Zone.



- Pan rests completely on the Cooktop surface.



- Pan is properly balanced.

Fig. 1

PLEASE NOTE - ANY one of the incorrect conditions listed above in Fig. 1 may be detected by the sensors located below the ceramic cooktop surface. If the cookware does not meet any of these conditions, one or more of the Cooking Zones will not heat indicated by the turned off circle surrounding the digital display for that affected zone. Correct the problems before attempting to reactivate the cooktop.

USE QUALITY COOKWARE IN GOOD CONDITION

The cookware used with the Induction Cooktop should have flat bottoms that make good contact with the entire surface of the Cooking Zone. Check for flatness by rotating a ruler across the bottom of the cookware (See Fig. 1). Be sure to follow all the recommendations for using cookware.

Also remember to:

- Use cookware made with the correct material type for Induction Cooking.
- Use quality cookware with heavier bottoms for better heat distribution allowing for more even cooking results.
- The pan size should match the amount of food being prepared.
- **Do not let pans boil dry.** This may cause permanent damage in the form of breakage, fusion, or marring that can affect the ceramic cooktop. (This type of damage is not covered by your warranty).
- Do not use dirty pans with grease buildup. Always use pans that are easy to clean after cooking.

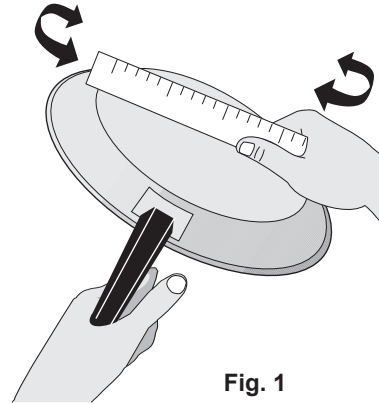

Fig. 1

⚠ CAUTION

The Cooking Zones may appear to be cool while turned ON and after they have been turned OFF. **The glass surface may be HOT** from residual heat transferred from the cookware and burns may occur.

⚠ CAUTION

DO NOT TOUCH HOT COOKWARE or PANS directly with hands. Always use oven mitts or pot holders to protect hands from burns.

⚠ CAUTION

DO NOT SLIDE Cookware across the cooktop surface. Doing so may permanently damage the appearance of the ceramic cooktop.

Prior to using your cooktop for the first time, apply the recommended cooktop cleaning creme to the ceramic surface. Buff with a non-abrasive cloth or pad. This will make cleaning easier when soiled from cooking. The special cooktop cleaning cream leaves a protective finish on the glass to help prevent scratches and abrasions.

SETTING THE COOKTOP

The cooktop control provides 4 digital display windows to help set power levels for the heating zones located on the cooktop. These settings work the same way as normal knob settings except the settings are displayed in LCD style displays.

Available cooktop settings

Your control provides 23 different settings for each cooking zone. Some of these power levels include **Lo** (1%) *Fig. 1*, **5.0** (medium 50%) *Fig. 2*, **Hi** (100%) *Fig. 3*, **Pb** (Power Boost) *Fig. 4*.

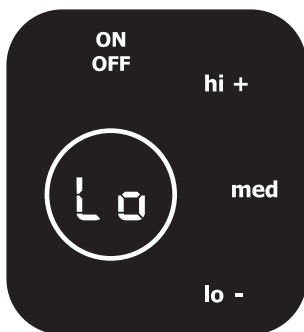

Fig. 1



Fig. 2

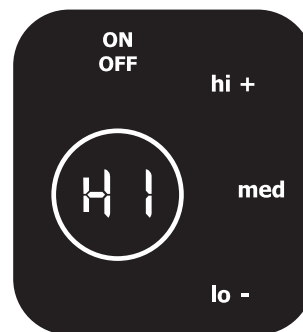

Fig. 3

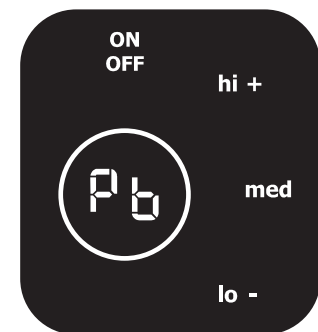

Fig. 4

- The **ON OFF** key pad is used to power-up or power-off the cooking zone.
- The **hi+** key pad is used to set the cooking zone at Power Boost (Fig. 4) if used after the **ON OFF** key pad. It can also be used at any moment to raise the power setting of the cooking zone.
- The **med** key pad is used to set the cooking zone at 5.0 (Fig. 2).
- The **lo-** key pad is used to set the cooking zone at Lo (Fig. 1) if used after the **ON OFF** key pad. It can also be used at any moment to lower the power setting of the cooking zone.

The **hi+** and **lo-** keys provide incremental adjustments for more precise control when changing settings between the lower heat levels (Lo to 3.0 power levels). Higher heat level setting changes (between 3.0 to HI) will change much faster.

Display Settings Changes	
Setting / Power	Incremental change
Lo to 3.0 (1-30%)	0.2
3.0 to HI (30-100%)	0.5

SETTING THE COOKTOP (CONTINUED)

Setting cooktop elements

- If needed, wake the control panel.
- Touch the **ON OFF** key for the desired heating zone.
- Press the desired power level key (**hi+**, **med** or **lo-**) or for more precise level settings use the **hi+** or **lo-** keys to make specific level changes.

Hot Element (HE) Message

After using any of the induction heating zones, the ceramic cooktop will become very hot from heat transferred by the cookware. Even after turning the control off, the cooktop will remain hot for some time.

The cooktop control monitors the temperature of the cooktop surface and displays a message “**HE**” (hot element) and flashes the burner ring when the cooktop is still too hot to touch -Fig. 1-. If the **HE** message remains displayed in the LCD, the heating zone may be set again and used for cooking.



Fig. 1

Suggested cooktop power settings

Use the chart below to determine the suggested setting for the type of food you are preparing when using the cooktop.

Recommended Surface Settings Chart	
Setting	Type of Cooking
POWER BOOST (Pb)	Start most foods; bring water to a boil and pan broiling.
HIGH (8-HI)	Continue a rapid boil; frying, deep fat frying.
MEDIUM (6)	Maintain a slow boil; thicken sauces and gravies; steaming vegetables.
MEDIUM LOW (4- 5)	Keep foods cooking; poaching and stewing.
LOW (Lo-3)	Keep warm, melting and simmering.

CAUTION

Heat may be transferred from the cookware to the ceramic glass and the areas surrounding the elements may become **hot enough to cause burns**. The **Hot Element Message Light will turn ON and will continue to glow until the glass cooktop has cooled down to a moderate level**. The glass surface may still be hot and burns may occur if the glass surface is touched before the indicator light has turned OFF.

Do not place plastic items such as salt and pepper shakers, spoon holders or plastic wrappings on top of the range when it is in use. These items could melt or ignite. Potholders, towels or wooden spoons could catch fire if placed too close to the surface elements.

SETTING POWER BOOST FEATURE

Your induction cooktop is equipped with a Power Boost feature on each cooking zone. The Power Boost feature is used to bring large quantities of water or food to cooking temperature at the fastest speed possible. The Power Boost feature will give you up to 139% power output for a maximum of 10 minutes.

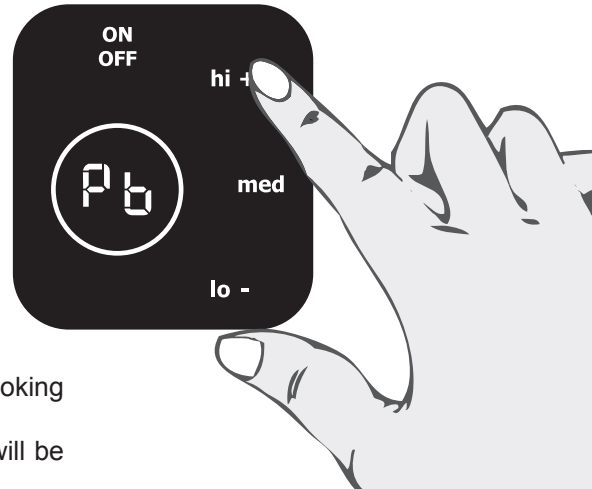

To Turn ON the Power Boost Feature:

- Press the **ON OFF** pad to turn on the cooking zone you want to set to Power Boost.
- Press the "**hi +**" key pad and the **PB** will be shown in the display (figure 1).

Figure 1

To set the Power Boost, press **hi +** when the zone is first turned on.

POWER SHARING

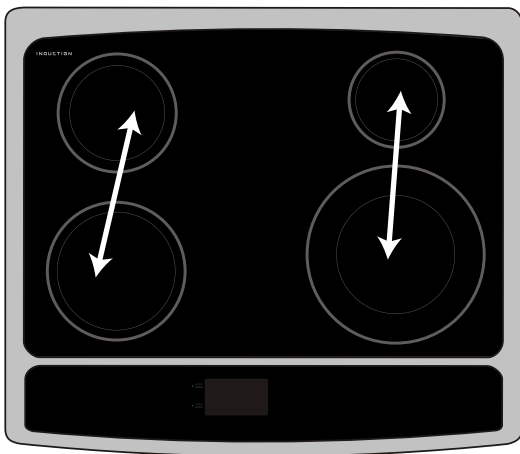

Fig. 2

Your cooktop is equipped with four cooking zones within two heating sections: right and left. Each section is powered by one induction inverter. The two cooking zones in the right and left section share the power of one inverter.

If you are cooking in both zones of a heating section, the last zone that began to heat will cook at the power setting you selected. The other zone will experience a slight decrease from its power setting.

POWER SHARING TIPS: Remember to select the power setting last for the cooking zone you want to maintain at full setting heat. To maintain full setting heat for two items, place one item on a zone in one section (left side), and the other item on a zone in another section (right side).

OPERATIONAL NOISES

The electronic processes involved with Induction Cooking create some unusual background noises. These noises are normal and part of the Induction Cooking process.

Please note that these noises are more noticeable while cooking at the Power BOOST level. Very loud noises are not part of normal Induction Cooking.

ELECTRONIC OVEN CONTROL

1. This self-cleaning controller offers Bake, Broil, Convection Bake, Convection Roasting and Convection Broil modes, Dehydrating, Defrosting, Temperature Probe, Perfect Turkey, Bread Proof, Keep Warm and Cleaning functions.
2. Convection operates with an element and a fan dedicated to convection.
3. This controller includes a display board, a relay board, and a convection fan and oven light control board.

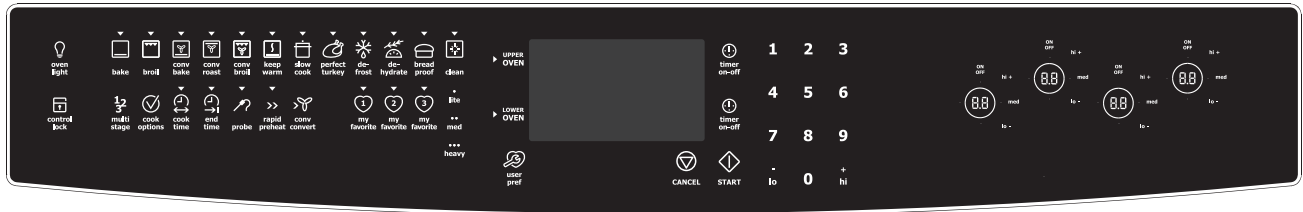

NOTE: The controllers are not field repairable. Only temperature settings can be changed. See oven calibration.

ELECTRONIC OVEN CONTROL RELAY BOARD

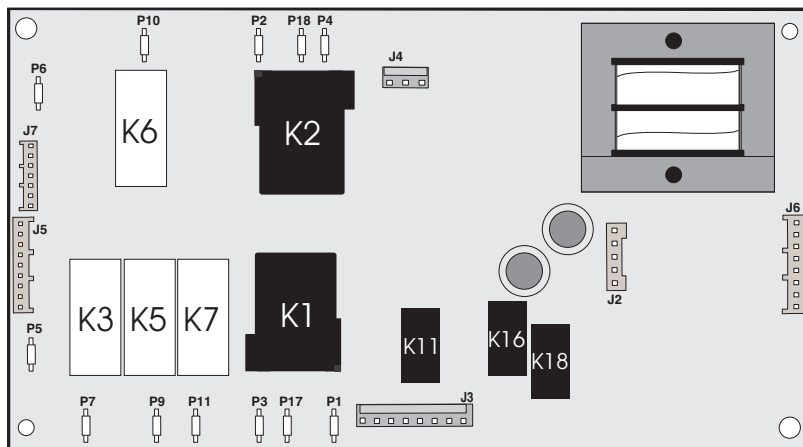

Relay Board Legend:

- K1. Double Line Break - Upper Oven
- K2. Double Line Break - Lower Oven
- K3. Broil Relay - Upper Oven
- K5. Bake Relay - Upper Oven
- K6. Bake Relay - Lower Oven
- K7. Convection Element Relay - Upper Oven
- K11. Motor Door Latch - Upper Oven
- K16. Cooling Fan Relay Low Speed - Upper Oven
- K18. Cooling Fan Relay High Speed - Upper Oven

This relay board serves to energize the upper and lower oven heating elements, door lock motor and cooling fan.

- P1 - L2 Out, Upper Oven
- P2 - L2 Out, Lower Oven
- P3 - L2 In, Upper Oven
- P4 - Not Used
- P5 - L1, Upper Oven
- P6 - L1, Lower Oven
- P7 - Broil, Upper Oven
- P9 - Bake, Upper Oven
- P10 - Bake, Lower Oven
- P11 - Convection Element, Upper Oven
- P17 - Not Used
- P18 - L2 In, Lower Oven

- J2 - DC Power Output To Display Board
- J3 - AC Power Output (motor door latch, cooling fan) For Upper Oven
- J4 - Power Input (L1, Neutral)
- J5 - Relay Control Inputs (bake, broil and convection elements, motor door latch, DLB) For Upper Oven
- J6 - Relay Control Inputs (cooling fan) For Upper Oven
- J7 - Relay Control Inputs (bake element and DLB) For Lower Oven

ELECTRONIC CONTROL DISPLAY BOARD

Electronic oven display board for electric ranges

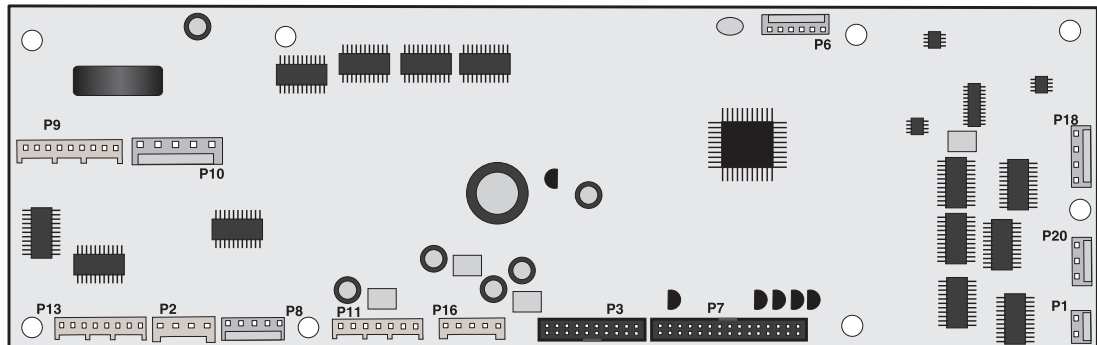

Connector Legend:

- P1 - Upper Oven Probe Input
- P2 - Communication with Convection Fan and Oven Light Control Board, Communication with ESEC UIB
- P3 - Keyboard (touch panel)
- P6 - Microprocessor Programming (not used)
- P7 - Touch Panel LEDs
- P8 - Power Supply Input for Display LEDs
- P9 - Relay Control Output (heating elements, DLB, motor door latch) for Upper Oven
- P10 - Switches Input (motor door latch switch, door switch, rack switch) for Upper Oven
- P11 - Relay Control Output (heating element, DLB) for Lower Oven
- P13 - Relay Control Output (cooling fan)
- P16 - DC Power Supply Input (from Electronic Oven Control Relay Board)
- P18 - Meat Probe Input
- P20 - Lower Oven Probe Input

POWER SUPPLY BOARD FOR ELECTRONIC CONTROL DISPLAY BOARD

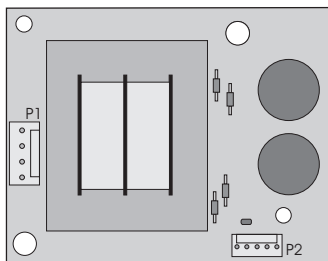

This board provides power to the electronic control display board.

- P1 - AC Power Input (L2 and Neutral)
- P2 - DC Power Output

CONVECTION FAN AND OVEN LIGHTS CONTROL BOARD

This board control the power output of the convection fan and oven lights.

- P1 - Communication with display board and power supply input
- P2 - AC power output for convection fan and oven lights, power inputs (L1, neutral)
- P6 - Microprocessor programming (not used)

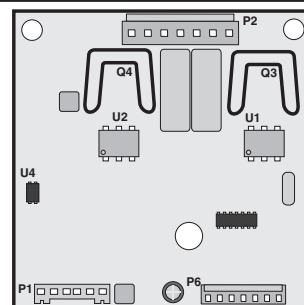

ELECTRONIC OVEN CONTROL (FAULT CODES) DESCRIPTIONS

Note: Generally speaking "F1X" implies a control failure, "F3X" an oven probe problem, and "F9X" a latch motor problem.

F10 Control has sensed a potential runaway oven condition. Control may have shorted relay, RTD sensor probe may have a gone bad. **1)** Check RTD sensor probe and replace if necessary. If oven is overheating, disconnect power. If oven continues to overheat when power is reapplied, replace relay board and/or display board.

F11 Shorted Key: a key has been detected as pressed for a long period and will be considered a shorted key alarm and will terminate all oven activity. **1)** Press any key to clear the error. **2)** If fault returns, replace the keyboard (touch panel). **3)** If the problem persists, replace the display board.

F13 Control's internal checksum may have become corrupted. **1)** Press any key to clear the error. **2)** Disconnect power, wait 30 seconds and reapply power. If fault returns upon power-up, replace display board.

F14 Misconnected keyboard cable. **1)** Verify connection between display board and touch panel (2 ribbon cables). Make sure the cables are well connected at both ends. **2)** If the cables are good, replace the touch panel. **3)** If the problem persists, replace the display board.

F15 Controller self check failed or terminal cutoff open. **1)** If the oven controller displays an F15 error code and the ESEC controller displays an E15 error code at the same time, this is a strong indication that the safety thermostat (thermal cutoff) inside the front console opened. The primary reason for a safety thermostat to open is a deficiency of the cooling fan. With a ohmmeter, verify if the thermostat tripped. Reset the thermostat is needed and verify operation of the cooling fan. Note: the safety thermostat, when open, cuts AC power to the oven relay board (connector J4, pin 1 and 3) and the ESEC relay board (connector J1, pin and 3). **2)** An F15 error code on the oven controller may indicate the oven controller is not receiving a synchronization signal from the relay board. One easy way to determine this is to power off the unit, power it on and start a Timer for 1 minute before the F15 error code appears. If the timer counts-down normally then the synchronization signal is okay. If the timer stays at 1:00 and does not countdown, then the synchronization signal is missing. If the synchronization signal is missing, check first if the oven relay board is receiving 120VAC correctly (J4 pin 1 and 3). Then check the wiring between connector J2 on the relay board and connector P16 on the oven controller. If AC power and wiring looks good and the problem is still there, replace the relay board. If problem persists, replace the oven controller. **3)** The F15 error code may be caused by an oven controller failure. If the safety thermostat and synchronization signal have been verified and tested good, replace the oven controller.

F20 The oven controller has detected a problem with the communication link to the surface element controller (ESEC). **1)** Is the ESEC User Interface Board powered on (are the surface element displays showing something)? If not, that is the reason why the oven control cannot communicate with it (ESEC has no power). Check the 120VAC voltage going in to the ESEC power supply board located in the front console (connector P1) and the low voltage supply going from the power supply board (connector P2) to the ESEC UIB (connector P8). **2)** Check connections between connector P2 on the oven controller and P9 on the ESEC User Interface Board. This is the communication link. Verify for continuity. Refer to the wiring diagram. **3)** If the above steps failed to solve the problem, replace the ESEC UIB board. **4)** If problem persists replace the oven controller.

F23 The controller failed to communicate with the convection fan and oven lights control board. **1)** Verify wiring between P2 on the display board and P2 on the convection fan and oven lights control board. **2)** If wiring is good, replace convection fan and oven lights board. **3)** If the problem persists, replace the display board.

F25 No zero cross signal detected on the convection fan and oven lights control board. **1)** Make sure L1 and Neutral are connected to the convection fan and oven lights control board on connector P2 (P2 pin 3 = neutral / P2 pin 5 = L1). **2)** If problem persists, replace the oven convection fan and oven lights control board.

F30 Open RTD sensor probe/ wiring problem. Note: EOC may initially display an "F10", thinking a runaway condition exists. F31 Shorted RTD sensor probe / wiring problem. Note: F30 or F31 is displayed when oven is in active mode or an attempt to enter an active mode is made. **1)** Check wiring in probe circuit for possible open condition. **2)** Check RTD resistance at room temperature (compare to probe resistance chart). If resistance does not match the chart, replace the RTD sensor probe. **3)** Let the oven cool down and restart the function. **4)** If the problem persists, replace the display board.

F90 Door motor mechanism failure. **1)** Press any key to clear the error. **2)** If it does not eliminate the problem, turn off power for 30 seconds, then turn on power. **3)** Check wiring of Lock Motor, Lock Switch and Door Switch circuits. **4)** Unplug the lock motor from the board and apply power (L1) directly to the Lock Motor. If the motor does not rotate, replace Lock Motor Assembly. **5)** Check Lock Switch for proper operation (do they open and close, check with ohmmeter). The Lock Motor may be powered as in above step to open and close Lock Switch. If the Lock Switch is defective, replace Motor Lock Assembly. **6)** If all above steps fail to correct situation, replace the display board and/or the relay board in the event of a motor that does not rotate. **7)** If all the above steps fail to correct the situation, replace the display board in the event of a motor that rotates endlessly.

56 Data Sheets

RTD SCALE		
Temp. °F	Temp. °C	Resistance (ohms)
32 ± 1.9	0.0 ± 1.1	1000 ± 4.0
75 ± 2.5	23.9 ± 1.4	1091 ± 5.3
250 ± 4.4	121.1 ± 2.4	1453 ± 8.9
350 ± 5.4	176.7 ± 3.0	1654 ± 10.8
450 ± 6.9	232.2 ± 3.8	1852 ± 13.5
550 ± 8.2	287.8 ± 4.6	2047 ± 15.8
650 ± 9.6	343.3 ± 5.3	2237 ± 18.5
900 ± 13.6	482.2 ± 7.6	2697 ± 24.4

ELECTRICAL RATING FOR ELECTRIC OVENS			
Kw Rating 240/208 V	See Nameplate	Bake Element Wattage	2500W / 1879W
Broil Element Wattage	4000W / 3004W	Convection Element Wattage	2500W / 1879W

OVEN
TEMPERATURE
SENSOR

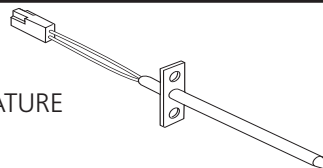

	ELECTRIC SLIDE-IN OVEN CIRCUIT ANALYSIS MATRIX									
	On Relay Board ELEMENTS				On Convection Fan and Oven Lights Control Board		On Display Board	On Relay Board		
	Bake P9	Broil P7	Conv. P13	Door Motor J3-5	Light P2-1	Convection Fan P2-7	Door Switch P8-3 / P8-5	DLB L2 out P1	Cooling Fan Low speed J3-7	Cooling Fan High speed J3-8
Bake	X	X	X*			X*		X	X	
Keep Warm	X							X	X	
Broil		X						X		X
Conv. Bake	X	X	X			X		X	X	
Conv. Roast	X	X	X			X		X	X	
Conv. Broil		X				X		X		X
Clean	X	X						X	X	X
Locking				X						
Locked										
Unlocking				X						
Unlocked										
Light					X					
Door Open							X			
Door Closed										
Bread Proof	X				X				X	X

Relay will operate in this condition only

* Convection element and fan are used for the first rise of temperature.

	LOWER OVEN ANALYSIS MATRIX	
	On Relay Board ELEMENTS	On Relay Board DLB
	Bake P10	L2 out P2
Bake	X	X
Keep Warm	X	X

MEAT PROBE RESISTANCE

Meat Probe Temperature VS Resistance Table		
Temp. Celsius	Temp. Fahrenheit	Probe Resistance
25°C	77°F	49.478 Kohm +/- 7%
50°C	122°F	17.737 Kohm +/- 4.9%
80°C	176°F	6.107 Kohm +/- 3.3%
100°C	212°F	3.264 Kohm +/- 4.6%

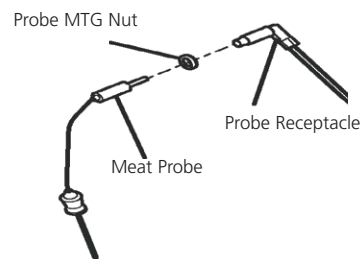

OVEN LIGHT

This appliance is equipped with electronics that control the intensity of the oven lights. This is done with the Convection Fan and Oven Lights Control Board that modulates the AC voltage going to the 120V halogen lamps. When the light key is pressed or when the oven door is opened the display board communicates with the Convection Fan and Oven Lights Control Board to specify the required light intensity. The Convection Fan and Oven Lights Control Board also add a “theater-like” effect on the light: the light intensity is gradually ramp-up or ramp-down as the light is turned on or off.

The lights of the upper and lower oven (warmer oven) are connected together and will turn on or off at the same time, they cannot be controlled individually.

If the oven lights do not operate, check the following:

- If you are getting an F23 error code it means the display board is not able to communicate with the Convection Fan and Oven Lights Control Board, thus the oven light will not operate. Check connections between the display board and the Convection Fan and Oven Lights Control Board. Refer to the fault code section for corrective actions.
- If the lights are always ON (even with the door closed), it could be because the control mistakenly thinks the door is opened. Verify door switch and its wiring.
- Check connections on the Convection Fan and Oven Lights Control Board. On connector P2: pin 3 should be Neutral, pin 5 should be L1 (120VAC) and pin 1 should go to the oven lights. The other terminal of the light should be connected to Neutral.
- Verify if light bulbs need to be replaced.
- If there is no error code, the wiring is good and still the oven lights are not working then replace the Convection Fan and Oven Lights Control Board.

58 Data Sheets

NOTICE - This service data sheet is intended for use by persons having electrical and mechanical training and a level of knowledge of these subjects generally considered acceptable in the appliance repair trade. The manufacturer cannot be responsible, nor assume any liability for injury or damage of any kind arising from the use of this data sheet.

SAFE SERVICING PRACTICES

To avoid the possibility of personal injury and/or property damage, it is important that safe servicing practices be observed. The following are examples, but without limitation, of such practices.

1. Before servicing or moving an appliance remove power cord from electrical outlet, trip circuit breaker to OFF, or remove fuse.
2. Never interfere with the proper installation of any safety device.
3. **GROUNDING:** The standard color coding for safety ground wires is **GREEN** or **GREEN WITH YELLOW STRIPES**. Ground leads are not to be used as current carrying conductors. **It is extremely important that the service technician reestablish all safety grounds prior to completion of service. Failure to do so will create a potential safety hazard.**
4. Prior to returning the product to service, ensure that:
 - All electric connections are correct and secure.
 - All electrical leads are properly dressed and secured away from sharp edges, high-temperature components, and moving parts.
 - All uninsulated electrical terminals, connectors, heaters, etc. are adequately spaced away from all metal parts and panels.
 - All safety grounds (both internal and external) are correctly and securely reassembled.

BASIC COOKING ZONE WIRING

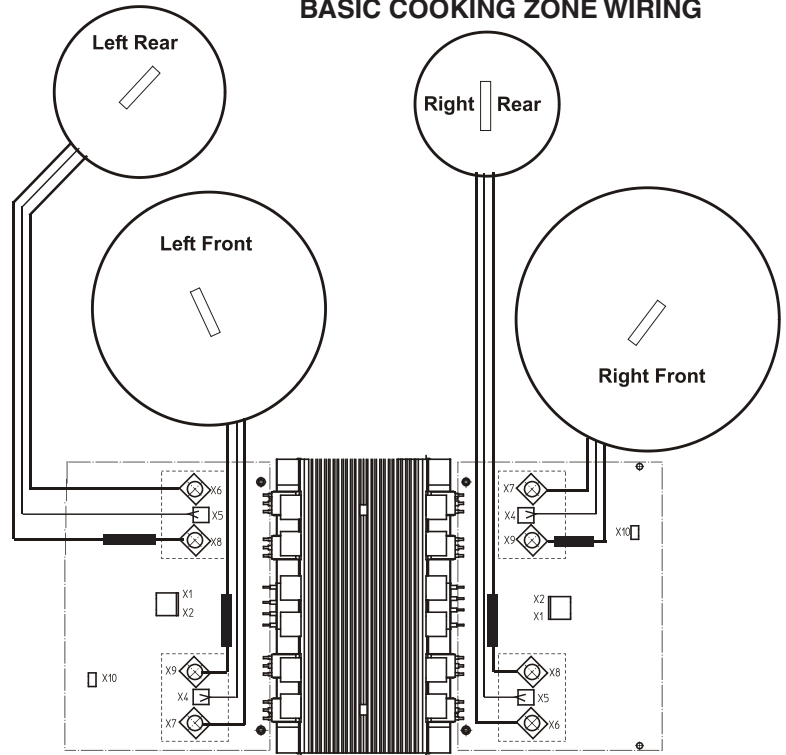

NOTE: Connect inductor wire identified by a red sleeve (shortest) to X8 or X9 connectors.

POWER LEVEL EXPLANATION TABLE

Displayed Power Level	LH	Lo	1.2	1.4	1.6	1.8	2.0	2.2	2.4	2.6	2.8	3.0	3.5
Power Level %	3.0	3.0	3.5	4.0	4.5	5.0	5.5	6.0	7.0	8.0	9.0	10.5	13.0
Displayed Power Level	4.0	4.5	5.0	5.5	6.0	6.5	7.0	8.0	9.0	Hi	PB		
Power Level %	15.5	18.0	21.0	25.0	31.0	38.0	45.0	54.0	64.0	100	130-153		

ELECTRONIC SURFACE ELEMENT CONTROL (ESEC) USER INTERFACE BOARD (UIB)

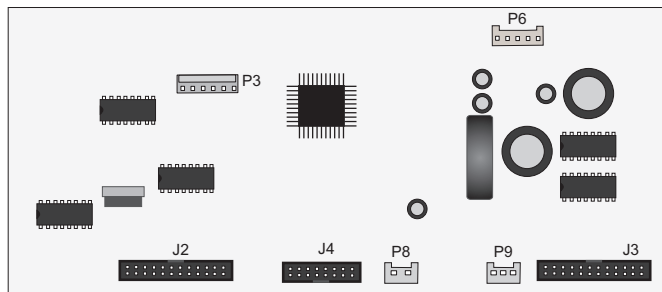

User Interface Board (UIB)

User Interface Board (UIB) Legend:

- J2. Connector for Touch Panel LEDs and Display Indicators
- J3. Connector for Touch Panel LEDs and Display Indicators
- J4. Connector for Keyboard (Touch Panel)
- P3. Micro Programming Header (Not Used)
- P6. Power Supply Input (from Power Supply Board for ESEC)
- P8. Communication with the Induction
- P9. Communication with Oven Control

POWER SUPPLY BOARD FOR ESEC UIB

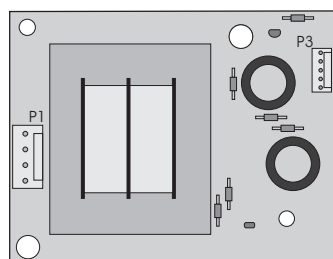

This board provides power to the Electronic Surface Element Control (ESEC).

P1 - AC Power Input (L1 and Neutral)

P3 - DC Power Output

INDUCTION COOKTOP ELECTRONIC ERROR (FAULT) CODE DESCRIPTIONS

Error Code - Possible Cause or Condition	Suggested Corrective Action
11- Jammed key.	1) Verify if there is no mechanical interference in the <i>Touch Panel</i> area (utensil, wire, etc...) Disconnect power, wait 30 seconds and reapply power. If fault returns: 2) Verify harnesses between the <i>ESEC-UIB</i> and the <i>Touch Panel</i> . 3) Replace <i>ESEC-UIB</i> . 4) Replace the <i>Touch Panel</i> .
14 - <i>Touch Panel</i> Tail missing	Disconnect power, wait 30 seconds and reapply power. If fault returns: 1) Verify harnesses between <i>ESEC-UIB</i> and the <i>Touch Panel</i> . 2) Replace <i>ESEC-UIB</i> . 3) Replace the <i>Touch Panel</i> .
15 - ESEC Self test fail.	1) Check harness going to <i>ESEC-UIB</i> connection. 2) Replace <i>ESEC-UIB</i> .
21- Lin (Local Interconnect Network) error, no communications, shorted bus.	1) Verify the Lin Bus communication harness at <i>ESEC-UIB</i> , P8 connector is well connected and not damaged. 2) Replace <i>ESEC-UIB</i> . 3) Replace <i>Filter Circuit Board</i> .
30/70- AC input voltage too high, <i>Induction Housing Assembly</i> 35/75- AC input voltage too low, <i>Induction Housing Assembly</i>	1) Measure the house voltage at the main incoming connections on the <i>Filter Circuit Board</i> , between terminals X1,X2 and X4,X5 the voltage should be 240 Volts AC \pm 10%. 2) Inspect electrical jumpers from X1 to X2 and X4 to X5. 3) Terminal X6 is your chassis ground wire. 4) If proper voltage is present, replace the <i>Filter Circuit Board</i> .
31- Internal generator error, sync <i>Induction Housing Assembly</i> / Left side cooking zones.	1) Verify cables & connections on the <i>Left Side Generator Circuit Board</i> . 2) Replace the <i>Left Side Generator Circuit Board</i> .
32/33- Power Supply defect, <i>Induction Housing Assembly</i> / Left side cooking zones	1) Test all cables & connections on <i>Filter Circuit Board</i> . 2) Replace the <i>Filter Circuit Board</i> . 3) Replace the <i>Left Side Generator Circuit Board</i> .
34- Internal generator error, communication, <i>Induction Housing Assembly</i> / Left side cooking zones.	1) Check cable between <i>Filter Circuit Board</i> , X12 connector and <i>Left Side Generator Circuit Board</i> , X10 connector. 2) Replace <i>Left Side Generator Circuit Board</i> . 3) Replace <i>Filter Circuit Board</i> .
36- Communication error, <i>Induction Housing Assembly</i> / Left side cooking zones	1) Verify communication harness between <i>ESEC-UIB</i> , P9 connector and <i>Filter Circuit Board</i> , X14/X20 connectors. 2) Verify communication harness going between <i>Filter Circuit Board</i> , connector X12 and <i>Left Side Generator Circuit Board</i> , connector X10. Replace if defective. 3) Replace <i>Filter Circuit Board</i> . 4) Replace <i>Left Side Generator Circuit Board</i> . 5) Replace <i>ESEC-UIB</i> .
37- Heat sink temperature sensor break, <i>Induction Housing Assembly</i> / Left side cooking zones	1) Replace <i>Left Side Generator Circuit Board</i> .
39- Configuration mismatch between the <i>ESEC-UIB</i> and the <i>Induction Housing Assembly</i> .	1) Disconnect power, wait 30 seconds and reapply power. If fault returns: 2) Activate simultaneous both right front and right rear On/Off keys for 5 seconds (approx.), the error code should be replaced by "8.8". 3) When "8.8" are shown on both left and right displays, release right side On/Off keys simultaneous active both left side front and rear On/Off keys for 5 seconds (approx.). 4) Displays should show walking dashes when the re configuration is executing. When displays turn off, the unit is ready to operate. 5) If the reconfiguration described in steps 2 to 4 did not resolve the problem, replace the induction generator housing in the cooktop.
51- Inductor temperature sensor break (LF). 52- Inductor temperature sensor break (LR). 54- Inductor temperature sensor break (RR). 55- Inductor temperature sensor break (RF).	1) Verify element temperature sensor is correctly connected to the good <i>Induction Housing Assembly</i> connector (refer to wiring diagram). 2) Replace Inductor if temperature sensor resistor value is not approximately 1000 ohms (blue wires) at room temperature. 3) Replace associated <i>Generator Circuit Board</i> .
61- LF Inductor temperature sensor too hot. 62- LR Inductor temperature sensor too hot. 64- RR Inductor temperature sensor too hot. 65- RF Inductor temperature sensor too hot.	1) Verify cooktop ventilation is correct (airway & fan). 2) Verify Inductor white isolation material is complete and cover the whole Inductor. 3) Verify Inductor temperature sensor is correctly connected to the <i>Induction House Assembly</i> . 4) Replace Inductor if temperature sensor resistor value is not approximately 1000 ohms (blue wires) at room temperature. 5) Replace associated <i>Generator Circuit Board</i> .
71- Internal generator error. Sync, <i>Induction Housing Assembly</i> / Right side cooking zones.	1) Check all cables and connectors on the <i>Right Side Generator Circuit Board</i> , replace if defective. 2) Replace the <i>Right Side Generator Circuit Board</i> .

INDUCTION COOKTOP ELECTRONIC ERROR (FAULT) CODE DESCRIPTIONS (continued)

Error Code - Possible Cause or Condition	Suggested Corrective Action
72/73- Power Supply defect. <i>Induction Housing Assembly / Right side cooking zones.</i>	1) Test all cables & connections on <i>Filter Circuit Board</i> . 2) Replace the <i>Filter Circuit Board</i> . 3) Replace the <i>Right Side Generator Circuit Board</i> .
74- Internal generator error. Communication, <i>Induction Housing Assembly / Right side cooking zones.</i>	1) Check cable between <i>Filter Circuit Board</i> , connector X13 and the <i>Right Side Generator Circuit Board</i> , connector X10. 2) Replace the <i>Filter Circuit Board</i> . 3) Replace the <i>Right Side Generator Circuit Board</i> .
76- Communication error. <i>Induction Housing Assembly / Right side cooking zones.</i>	1) Verify communication harness between <i>ESEC-UIB P9</i> connector and <i>Filter Circuit Board X20/X14</i> , replace if damaged. 2) Verify communication harness going between <i>Filter Circuit Board</i> , connector X13 and <i>Right Side Generator Circuit Board</i> , X10 connector. Replace if defective. 3) Replace <i>Filter Circuit Board</i> . 4) Replace the <i>Right Side Generator Circuit Board</i> . 5) Replace <i>ESEC-UIB</i> .
77- Heat sink temperature sensor break, <i>Induction Housing Assembly / Right side cooking zones.</i>	1) Replace the <i>Right Side Generator Circuit Board</i> .

ADDITIONAL INDUCTION COOKTOP ERROR (FAULT) CONDITIONS

SYMPTOM OR FAILURE	CONTROL DISPLAY	POSSIBLE CAUSE OR CONDITION	SUGGESTED CORRECTIVE ACTION
Pan does not heat up.	Normal operation	Pan too small for proper pan detection and only works with low power.	Use larger pan or this pan on a smaller cooking zone. Refer to owners guide for proper pan selection.
	Red circle does not light or is flashing and pan does not heat.	Pan not detected.	Check whether the pots or pans are suitable for induction. Refer to owners guide for proper pan selection.
		Induction Coil not correctly connected or Induction Coil open.	Check the coil wire terminal connections. Ensure that they are properly connected and tightened. Test continuity of coil (should be less than 1 ohm).
Distance between coil and glass ceramic too large.	None	Individual buttons cannot be used or cannot always be used.	1) Follow instructions for proper use of touch controls. 2) Verify harness going between <i>ESEC-UIB J4</i> and <i>Touch Panel/J3</i> connectors (16 pins). Replace if defective or damaged. 3) Verify there is no mechanical interference close to the <i>Touch Panel</i> (wires, utensils, etc...) 4) Replace <i>ESEC-UIB</i> 5) Replace <i>Touch Panel</i>
		Cooking power too low or shuts down prematurely.	Fluids spilled or object lying on <i>Touch Panel</i> keypads. Clean up spills or remove objects. Restart cooktop in normal manner.
		Normal operation	Ventilation slots obstructed. Clean up spills or remove objects. Restart cooktop in normal manner.
Cooking power too low or shuts down prematurely.	None	Unsuitable pots (bottom bent).	Follow owners guide for proper pan selection.
		Distance between coil and glass ceramic too large.	Check whether the glass ceramic was pushed down when being screwed in position and the coil has been correctly positioned.
		Fan does not start.	1) When setting a cooking phase >0, the fan runs at a slow speed. If not, check the fan for foreign objects, remove these where appropriate. 2) If necessary, replace fan. 3) Replace the <i>Filter Circuit Board</i> .
		Oven Cooling Fan does not operate.	1) Check oven cooling fan for correct operation when cooktop zones are heating. If necessary, replace fan.

INDUCTION COOKTOP ELECTRONIC ERROR (FAULT) CODE DESCRIPTIONS (continued)

SYMPTOM OR FAILURE	CONTROL DISPLAY	POSSIBLE CAUSE OR CONDITION	SUGGESTED CORRECTIVE ACTION
Steady "HE" in display when cooking zone is cold and switched off.	"HE"	Temperature sensor defect.	1) Test coil RTD approx. 1K ohms at room temperature. Replace coil if resistance is not correct. 2) Replace generator circuit board.
Cooktop does not initialize/operate.	Blank No Display No Beep	Unit not powered	- Verify unit installation.
		Defective ESEC power supply.	1) Measure voltage at the power supply input P1 pins 1&4 should be 120VAC. Verify harness if voltage is not present. 2) Measure voltage at power supply output P3 pins 1&2 should app. 8VDC. Replace ESEC power supply if voltage is not present. 3) Measure voltage at power supply output P3 pins 1&3 should be app. 16VDC. Replace ESEC power supply if voltage is not present.
		Defective ESEC-UIB.	Replace ESEC-UIB.

INDUCTION HOUSING ASSEMBLY

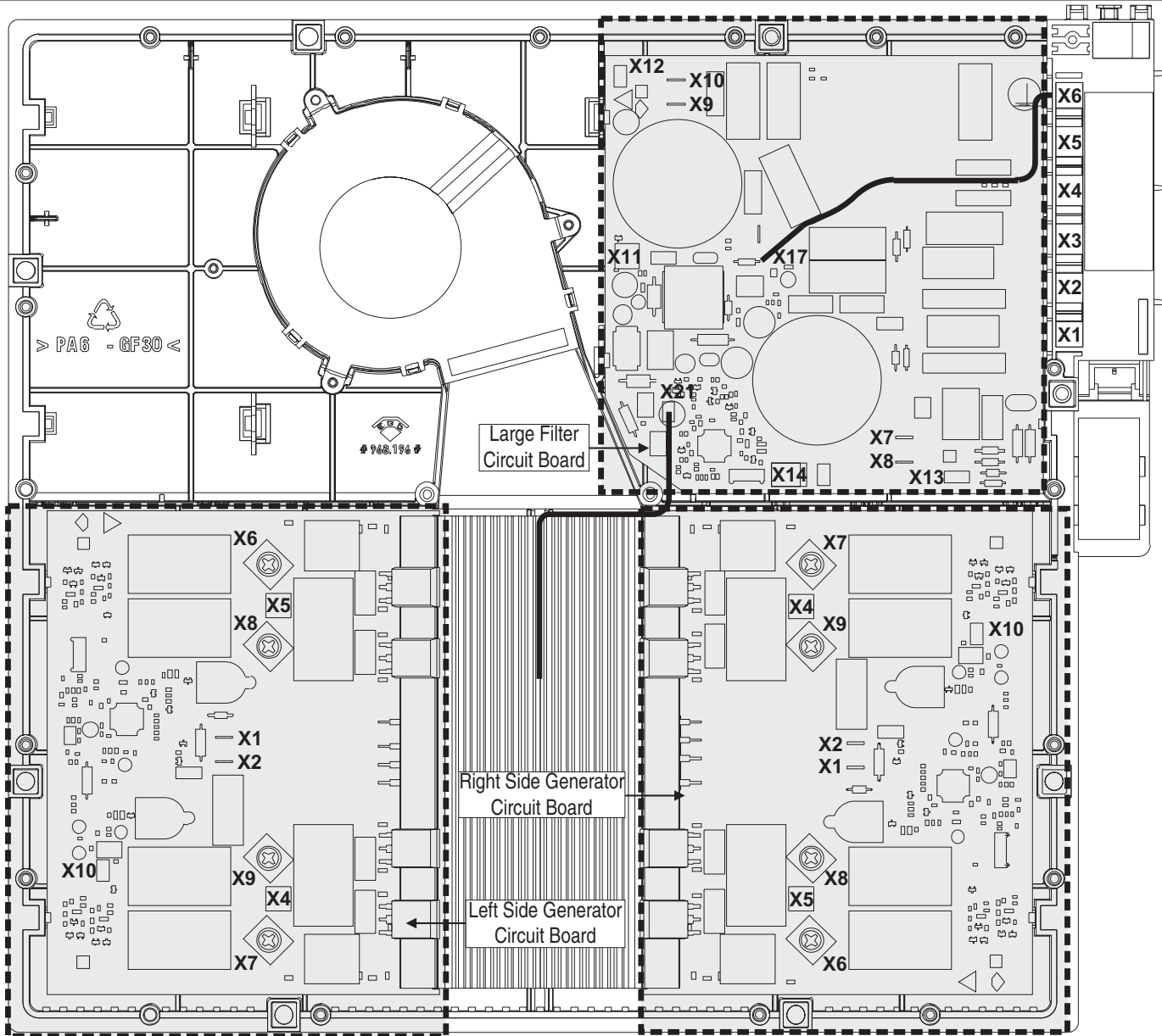

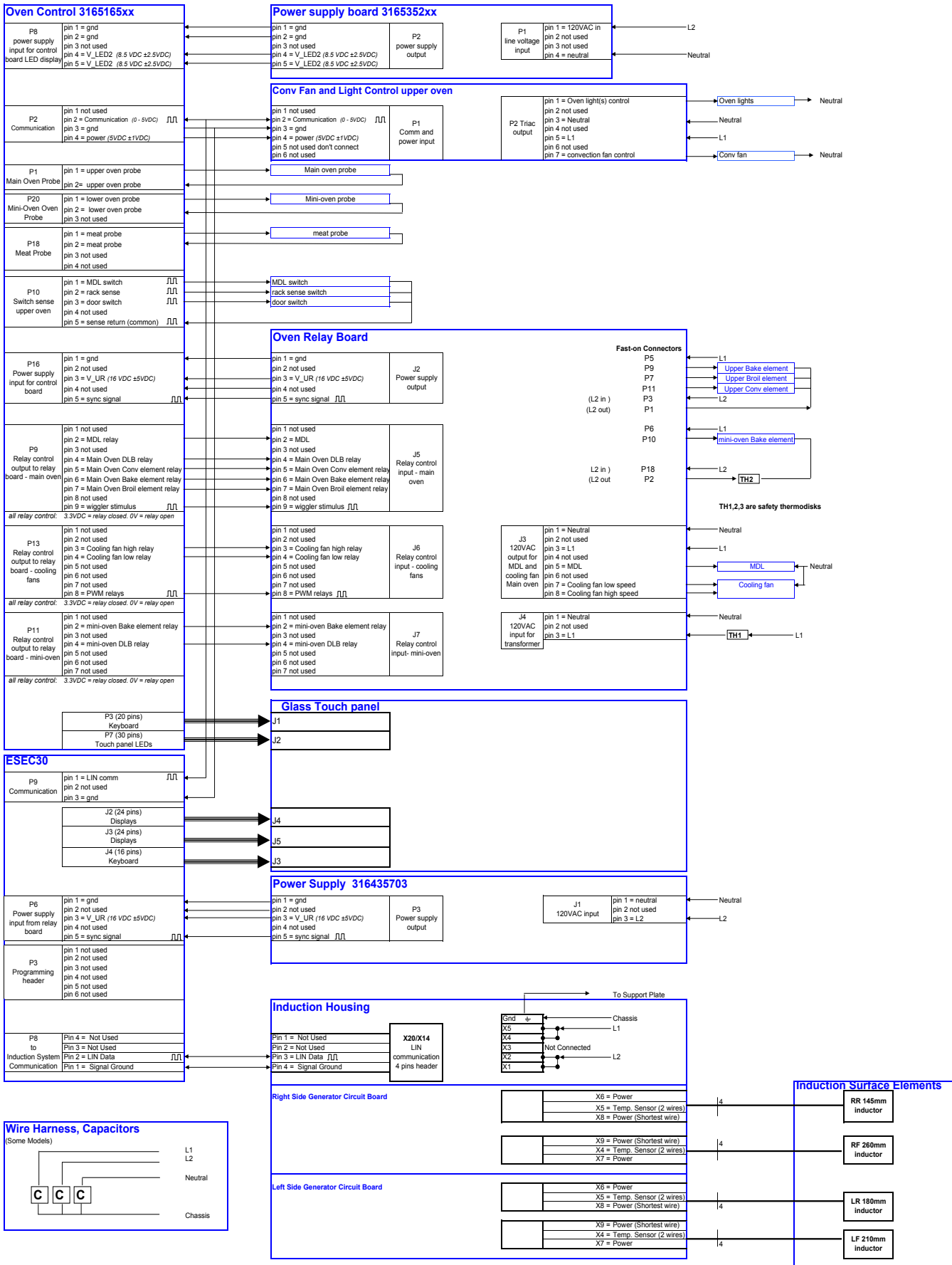

1. How to access the control panel area.

NOTE: Always turn the house breaker or fuses to the off position, or unplug the unit from the wall outlet before working on the unit.

Note: It is suggested to always remove the oven door prior to working on the unit. This will lighten the unit and prevent damaging the unit and the oven door assembly.

1.1 Fully open the oven door and locate hinge lock lever.



1.2 After locating the hinge lock lever, pull it to the lock position as shown.



1.3 Pull the oven door up at roughly 45° as shown; this will lock the oven door hinges, and pull the oven door out of its hinge receptacles and away from the unit.



64 Disassembly

1.4 Gently pull the unit out of its cutouts.

1.5 Remove the 2 screws from the decorative side panel.

IMPORTANT: If ever you need to replace the left hand side trim, it is imperative to remove the name plate off the trim and to glue it back on the new trim or store it in a safe place.

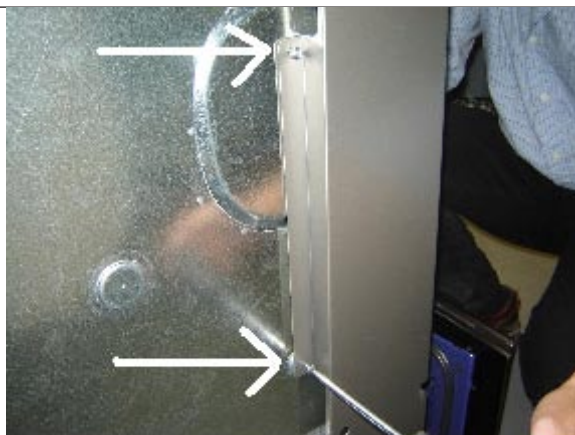

1.6 Pull out the drawer and pull the lower end of this decorative side panel frontward, lift the top up and remove from the unit.



1.7 Remove the 6 screws from the control panel as shown.

NOTE: The far left and right hand screws are #1 square bit. (Robertson)



1.8 Gently pull the control panel down and off of the unit.



1.9 Remove the 2 screws that hold the front of the burner box to the upper side panel.
You will locate these 2 screws after removing the left and right hand side decorative side panels.
(One screw on each side as shown)

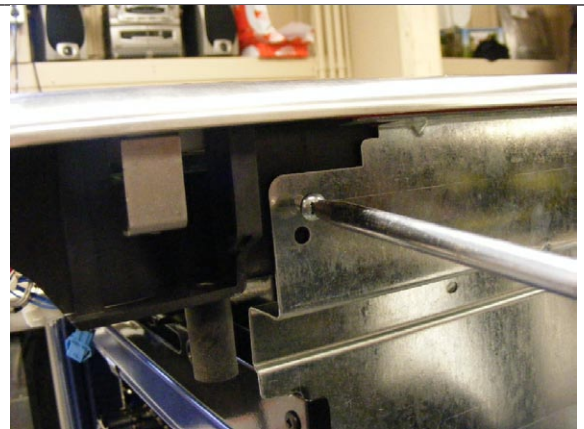

1.10 Unplug the 3 “idiot proof” quick connections from under the control panel.

NOTE: Do not unplug the blue and white “A” connection can stay plugged.

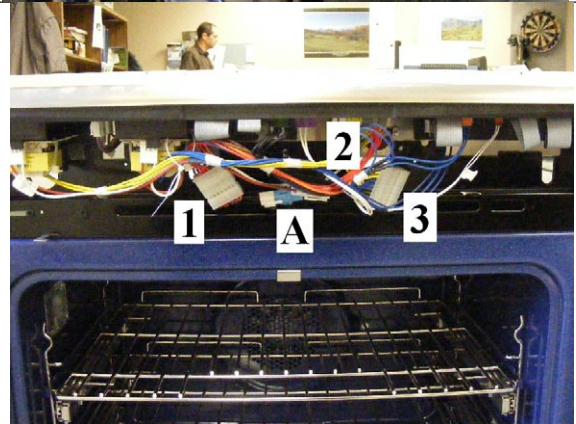

1.11 Remove the 3 screws that hold the front of the burner box to the center trim.



1.12 Pull the cooktop and console up (at the front) and pull it 6” toward you in order to unlock it from its 2 anchorage point at the back of the burner box.



View of cooktop locked



View of the cooktop unlocked

66 Disassembly

1.13 By doing so, you will access the Molex quick connector that you will disconnect.

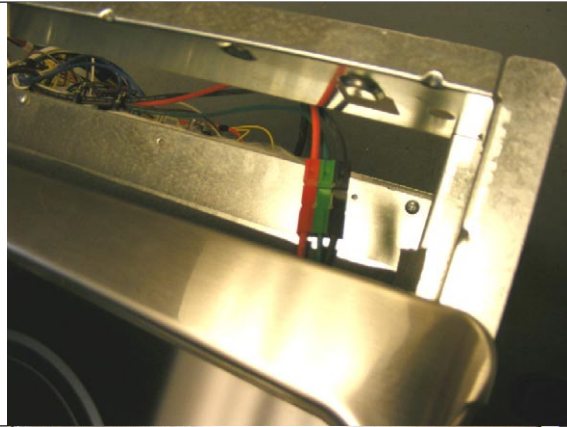

1.14 Remove the complete burner box and console assembly out of the unit and flip it upside down making sure to protect the customer's table or countertop and for sure, the face of the cooktop.

NOTE: You can access the Electronic Oven Control, power supply and UIB by doing so or simply by leaving the cooktop in place and working on it looking upwards.



2. Control panel's components identification and replacement

View of the Electronic Oven Control

2.1 Remove 2 flex connectors (AB)

2.2 Remove 10 quick connectors (1 / 10)

2.3 Remove 6 screws* (circles)

* There are only 5 visible screws: you will need to remove the power supply that is over the EOC (2 screws) which is over this 6th screw.



2.4 Remove the 2 screws that hold the power supply that is over the EOC

2.5 Remove the hidden 6th screw that hold the EOC

NOTE: Both power supplies have 2 screws and 2 quick connectors.

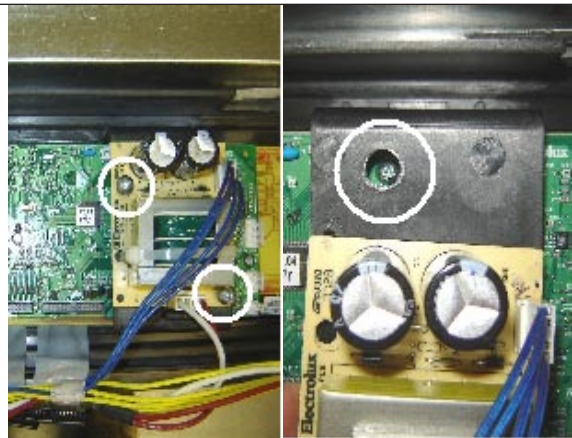

User Interface Board (UIB) for the surface elements.

2.6 Remove 3 flex connectors (1 2 3)

2.7 Remove 3 quick connectors (A B C)

2.8 Remove 4 screws that hold the UIB.

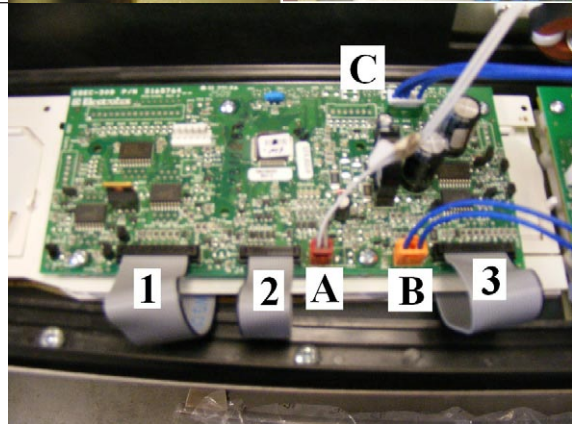

3. Automated door light switch (plunger) & Door lock assembly.

3.1 Gently pull on the automated door light switch and remove from the unit.

3.2 Remove the 2 wires.



With the oven door locked

3.3 Remove the right hand side screw.

3.4 Loosen the left hand side screw and with the screwdriver still in the left hand side screw, slide the door lock assembly to the left.

With the oven door unlocked.

3.5 Follow steps 1.1 through 1.14 in order to have access to the door lock assembly service panel.



68

Disassembly

3.6 Follow section 1. in order to remove the cooktop section from the range

3.7 Unplug the blue and white quick connection and the 2 orange wires.

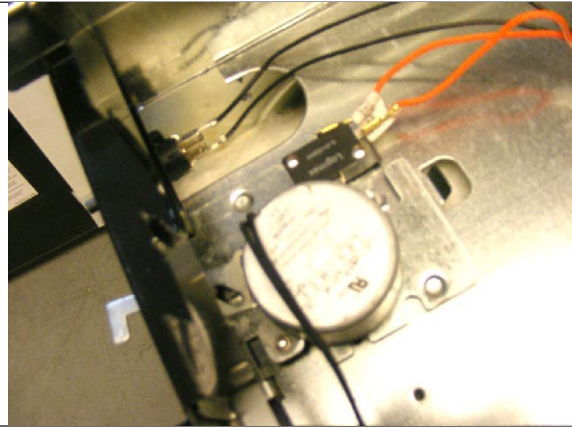
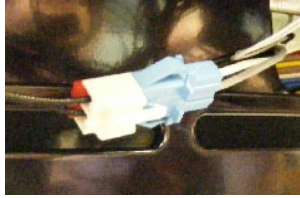

4. Induction cooktop.

4.1 Follow section 1. in order to remove the cooktop section from the range.

IMPORTANT: The cooktop stays on its upright side. Do not flip upside down to access the inner cooktop components.

4.2 Remove the 2 screws that hold the cooktop at the rear.
(One bracket on each LH & RH side)

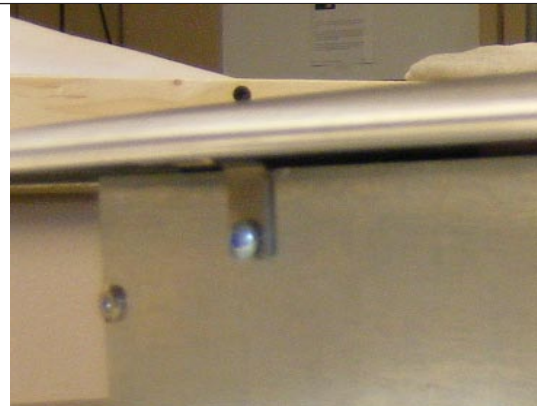

4.3 Remove the front center screw located under the control panel dead center.

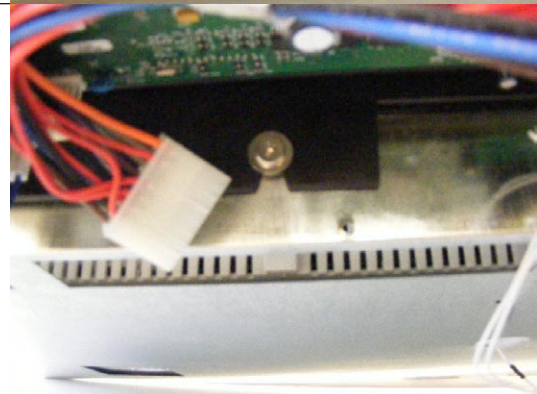

4.4 Lift and remove the main top from the burner box.



4.5 Lift the insulation, locate service panel screw and remove it. Remove the service panel.



4.6 Lift the second layer of insulation and unplug the small blue wire then unscrew the 2 large wires.

4.7 Remove element from its supports.

NOTE: You will need a #20 torque screwdriver for these screws.

IMPORTANT: When removing more than one induction element, refer to the wiring diagram in order to wire the proper element to the proper induction output.

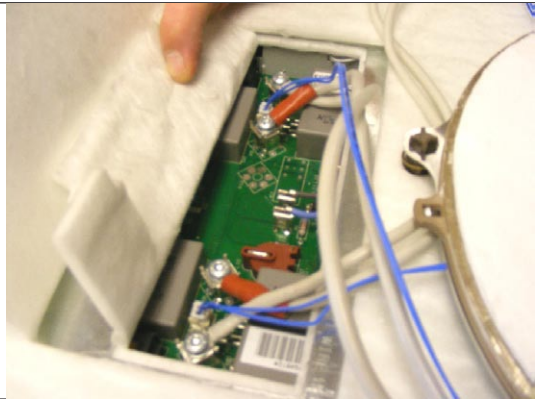

4.8 Remove the 12 springs, lift and remove the 1st layer of insulation.

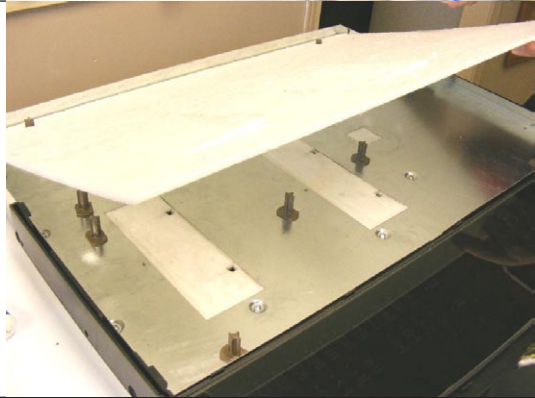

4.9 Remove the 12 screws (1 to 12) and the one ground wire nut (A).

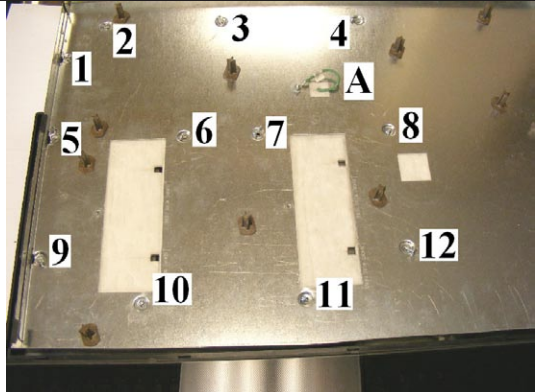

70 Disassembly

4.10 Lift the middle panel by pulling on the induction element rear pin guide.



4.11 Pull the black plastic of the sub frame console away at the center (L&H sides) of the burner box in order to lift and clear the middle panel.



4.12 Insert a flat heat screwdriver between the burner box and the middle panel in order to lift and clear the black plastic of the sub frame console (L&H sides).

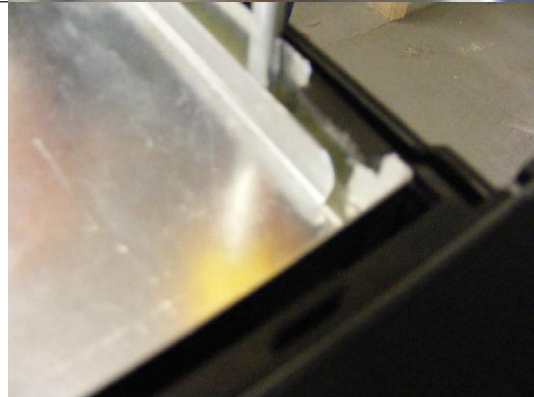

4.13 Complete the removal of this center panel.

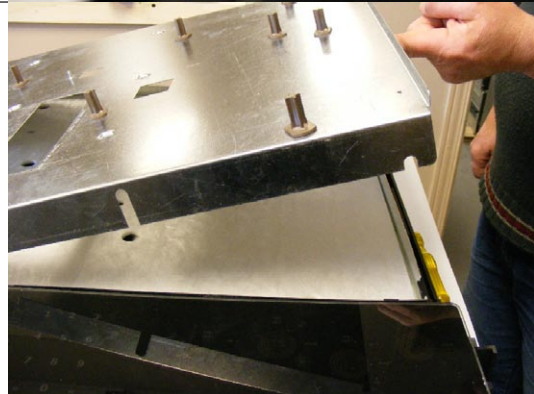

4.14 Lift and remove the inner insulation.

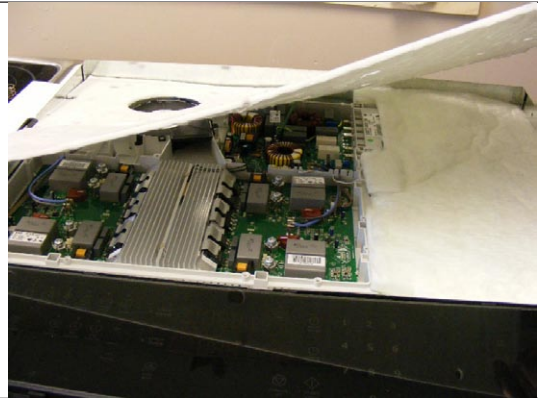

4.15 Lift and remove the side insulation.



4.16 Unplug the white wire from the induction housing X14 terminal.

NOTE: This white wire comes through the hole located on the RH side of the induction housing.

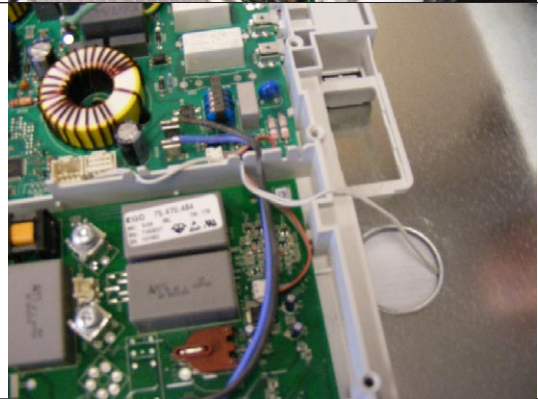

4.17 View of this white wire that runs under the burner box and is screwed at its Magnetic Core to the front portion of the burner box.

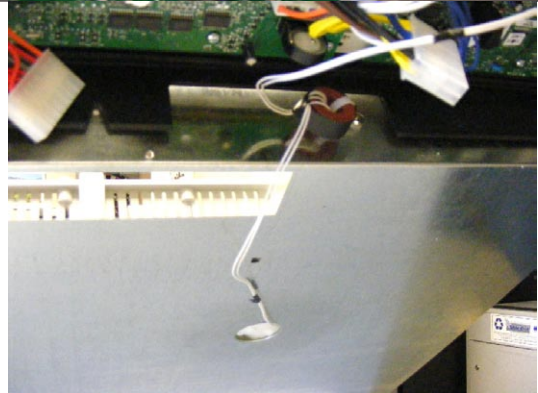

72 Disassembly

4.18 IMPORTANT: When replacing the housing assembly, make sure that the 2 cooper jumpers have been re-introduced at position 1 & 2 and 4 & 5.

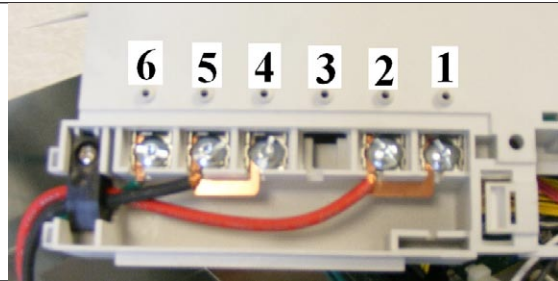

4.19 When placing the housing assembly back into the burner box, align the housing with the lift-up tab at the bottom of the burner box as shown.

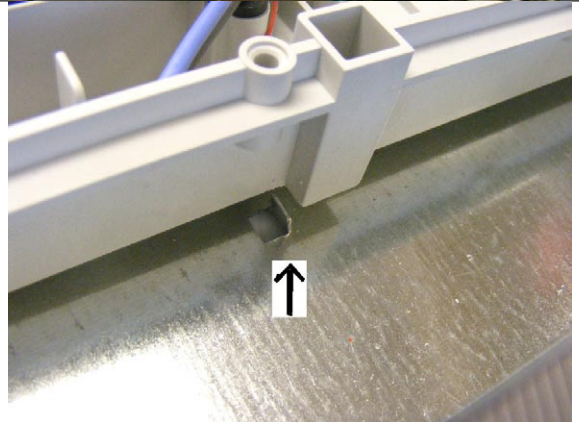

5. Cooling fan and safety thermostat.

5.1 Follow section 1. in order to remove the cooktop section from the range.

5.2 Remover the 2 wires.

5.3 Turn the cooling fan counterclockwise and remove it from its slotted area.

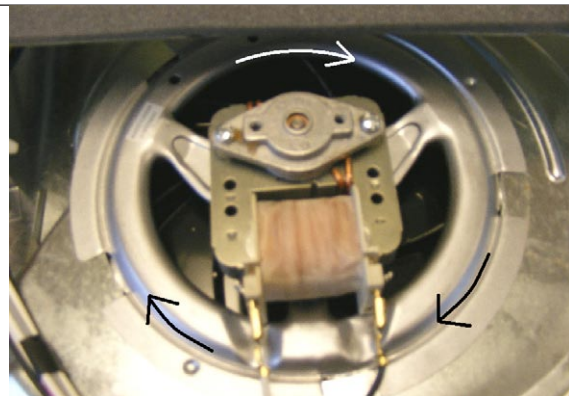

5.4 When installing the new cooling fan, properly align the 5 circled slotted areas and turn the cooling fan clock wise.

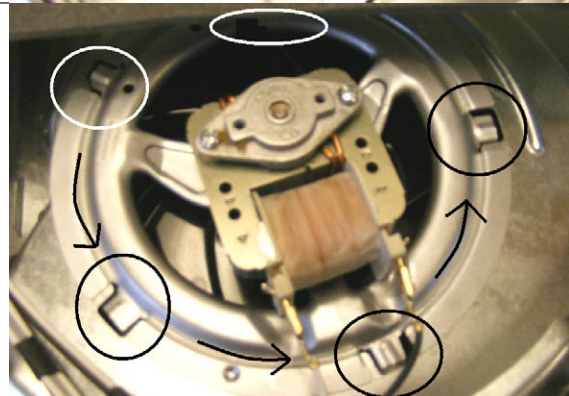

5.5 Remove the 2 wires and the 2 screws that hold the safety thermostat.

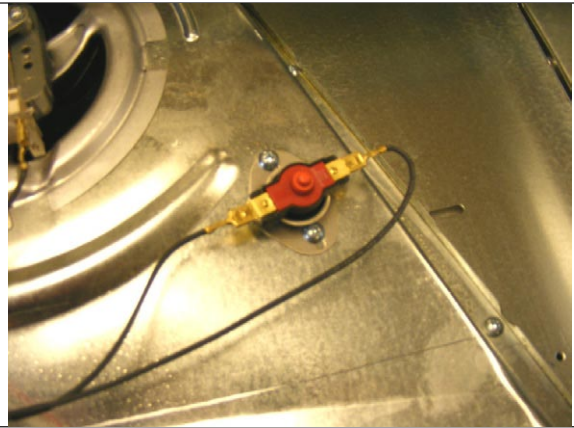

6. Halogen light socket, hinge receptacle and oven rack sensor

NOTE: Always turn the house breaker or fuses to the off position, or unplug the unit from the wall outlet before working on the unit.

6.1 Remove the oven door and the decorative side panel as shown in section 1.1 through 1.6

6.2 Pull the unit out of its cutouts.

6.3 Remove the 9 screws which hold the left or right hand side panel.

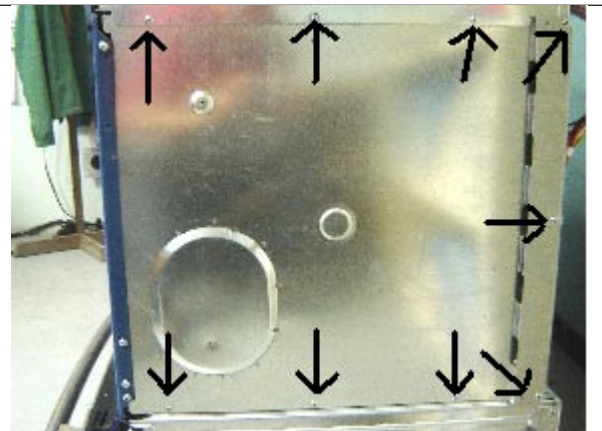

6.4 Pull the insulation up and locate the right hand side halogen light socket.

6.5 Press the push-pins in, in order to remove the halogen light socket

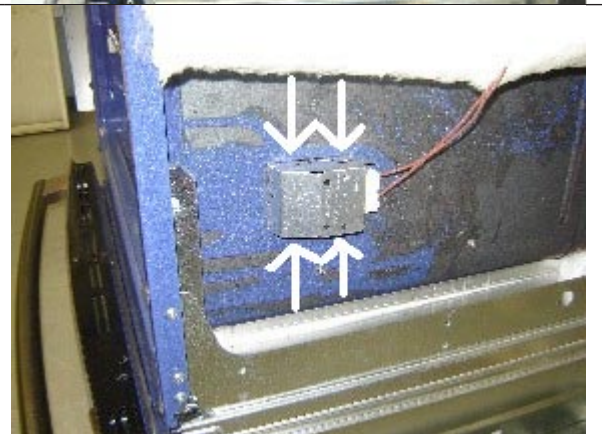

74 Disassembly

6.6 Pull the insulation up and locate the left hand side halogen light socket and the oven rack sensor.

6.7 Gently pull the 2 wires off the oven rack sensor.

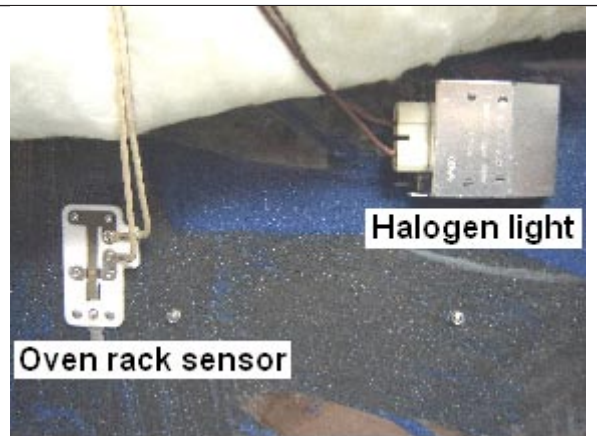

6.8 Remove the 1 screw that holds the oven rack swivel arm to the outer side of the oven liner.

6.9 Remove oven and ladder rack as shown in section 7.1 through 7.42

NOTE: This screw is located on the rear of the upper ladder rack bracket; inner side of the oven liner.



6.10 Remove the 2 screws which hold the hinge receptacle.

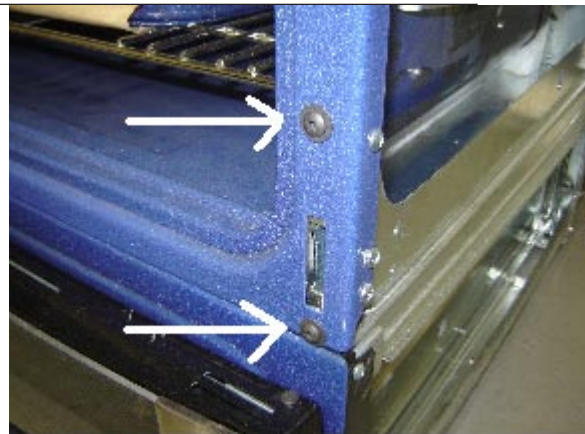

6.11 Locate hinge receptacle from the side and remove from the back of the front frame

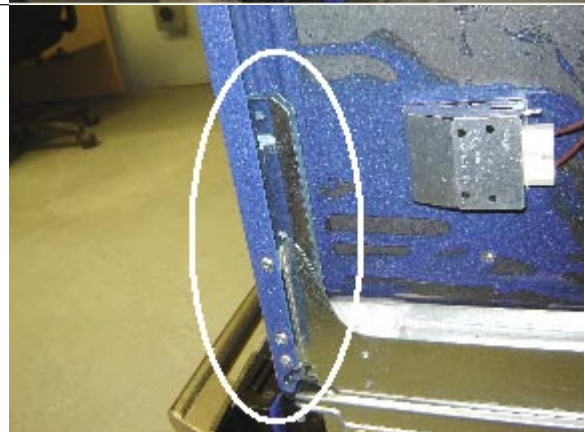

6.12 Push the insulation back into its original emplacement making sure that it's properly tucked in behind the lower panels.



6.13 Upon replacing the side panel, make sure that it will be inserted between the frame and the upper side panel as shown.



7. Oven racks, ladder racks and halogen light cover and lens

NOTE: Always turn the house breaker or fuses to the off position, or unplug the unit from the wall outlet before working on the unit.

7.1 Remove the oven door as shown in section 1.1 through 1.3

7.2 Pull the oven rack all the way out



76 Disassembly

7.3 Lift the oven rack up from both sides in order to free the glide from the ladder racks.

Note: There is another “L” shape bracket at the back of the glide that needs to be lifted upwards...



5.41 To remove the ladder rack from the oven liner, push the ladder racks up in order to free them from their holders.

View of the ladder rack in its holder.



7.42 View of the ladder rack out and ready to be removed from its holder.

IMPORTANT: Oven and ladder racks have to be removed from the oven in self-clean mode.



7.5 Gently pull on the light cover in order to have access to the halogen lamp.



7.6 Gently pull on the halogen lamp in order to remove it from its socket.

IMPORTANT

Upon installing a new halogen lamp into its socket, the halogen lamp manufacturer suggests not to touch the lamp with your bare hands.

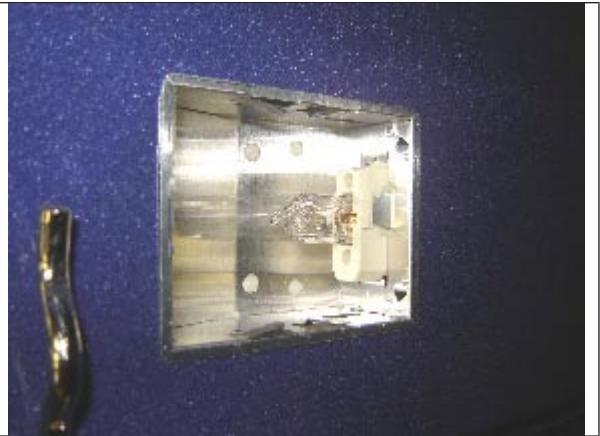

8. Meat probe

NOTE: Always turn the house breaker or fuses to the off position, or unplug the unit from the wall outlet before working on the unit.

8.1 Unscrew the two screws which hold the meat probe receptacle to the upper portion of the oven liner.

NOTE: In order to facilitate the removal of the meat probe receptacle, you may remove the oven racks.



8.2 Gently pull the meat probe receptacle down and remove the two wires from the meat probe receptacle.

Note: There is long enough wire in order to replace the meat probe receptacle without removing the unit from its cutouts.



78 Disassembly

8.3 Unscrew the nut which hold the meat probe receptacle to its mounting panel



9. Oven temperature sensor.

NOTE: Always turn the house breaker or fuses to the off position, or unplug the unit from the wall outlet before working on the unit.

7.1 Remove the 2 screws which hold the oven temperature sensor to the oven liner.

NOTE: In order to facilitate the removal of the oven temperature sensor, you may remove the oven racks.

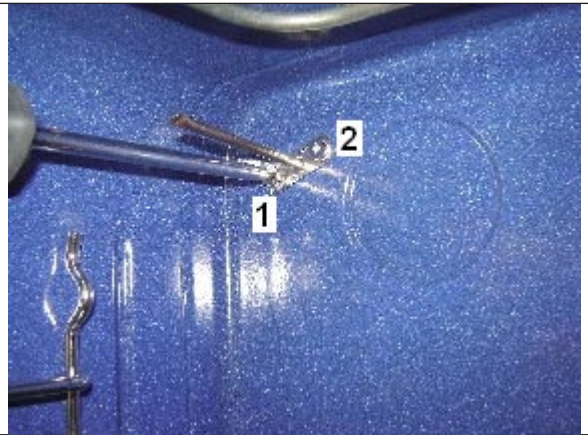

9.2 Gently pull the oven temperature sensor out.

NOTE: There is long enough wire in order to replace the oven temperature sensor without removing the unit from its cutouts.



10. Broil element

NOTE: Always turn the house breaker or fuses to the off position, or unplug the unit from the wall outlet before working on the unit.

10.1 Remove the 4 screws from the broil element

NOTE: In order to facilitate the removal of the broil element, you may remove the oven racks.



10.2 Pull the broil element out and unplug the two blue wires.

NOTE: There is long enough wire in order to service by the front without having to move the unit out of its cutouts.

IMPORTANT: Gently push the broil element back in place taking care not to pinch the wires between the oven cavity and the broil element.



11. Convection element, motor and cooling fan.

NOTE: Always turn the house breaker or fuses to the off position, or unplug the unit from the wall outlet before working on the unit.

11.1 Remove the 3 screws that hold the convection fan cover to the back of the oven liner

NOTE: In order to facilitate the removal of the convection fan cover, you may remove the oven racks.

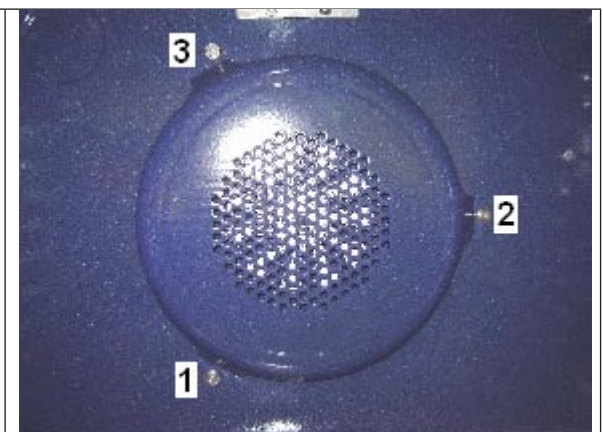

11.2 Remove the 3 screws which hold the convection element to the back of the oven liner.



11.3 Pull the convection element out and unplug the two orange wires.

NOTE: There is long enough wire in order to service by the front without having to move the unit out of its cutouts.

IMPORTANT: Gently push the convection element back in place taking care not to pinch the wires between the oven cavity and the convection element.



11.4 Remove the convection fan cover as shown in section 11.1

11.5 Hold the convection fan with one hand and unscrew the nut with a pair of pliers.(clockwise)



11.6 Remove the convection fan.

Note: Be careful, there is a small washer on the shaft behind the fan.

IMPORTANT: Do not remove the 2 screws on the left and right and side of the convection motor shaft, they hold the oven liner to the back side of the unit.



11.7 Remove the 4 screws from the convection motor and remove from the unit.

Important: The #4 screw holds the convection motor mounting plate.

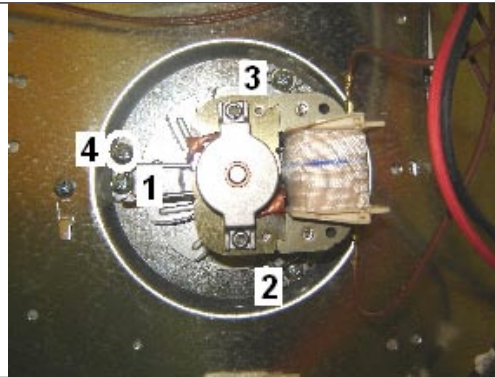

11.8 Remove the rubber washer from the convection shaft.



11.9 Properly align the mounting holes from the mounting plate and the convection motor. From the front side of the convection motor...



...and from the back side of the convection motor.



82 Disassembly

11.10 Make sure that the rubber washer is properly installed; laying flat on the convection motor mounting plate.



11.11 Pull the unit out and remove the back cover.

11.12 Remove the 2 screws which hold the cooling fan in place.

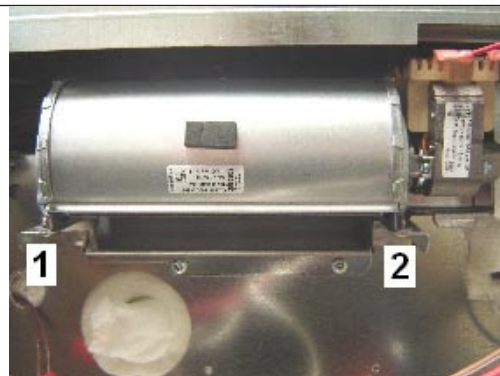

11.13 Pull the cooling fan away from the unit and remove the 3 wires.

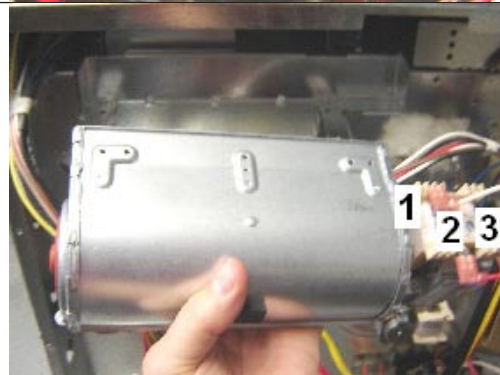

12. Units back view and components...

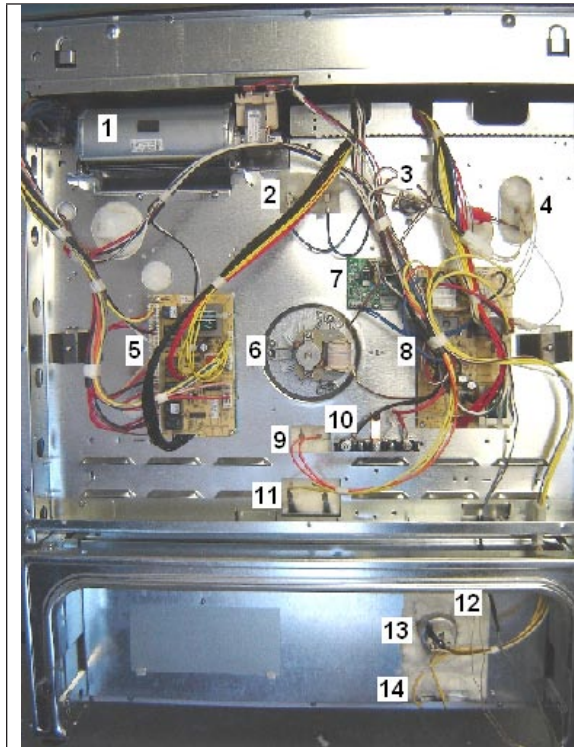

- 1 Cooling fan
- 2 Broil element
- 3 Safety thermostat
- 4 Oven temperature sensor
- 5 Cooktop relay board
- 6 Convection motor
- 7 Triac
- 8 Oven relay board
- 9 Convection element
- 10 Terminal block
- 11 Hidden bake element
- 12 Mini oven temperature sensor
- 13 Mini oven light socket
- 14 Mini oven element

13. Hidden bake and mini oven element

NOTE: Always turn the house breaker or fuses to the off position, or unplug the unit from the wall outlet before working on the unit.

13.1 Pull the mini oven drawer out and remove the 4 screws (3 screws on each side, screws 1 & 2 are visible here and the 3rd one is closer to the back) from its left and right hand side glides the remove the drawer body.

NOTE: The glides will be completely removed from the drawer assembly.



84 Disassembly

13.2 Remove the 10 screws from the lower front frame and remove the front frame from the unit.



13.3 Remove the 2 screws that hold the side of the mini oven to the frame of the unit
These screws are located one on each side in front of the drawer glide.

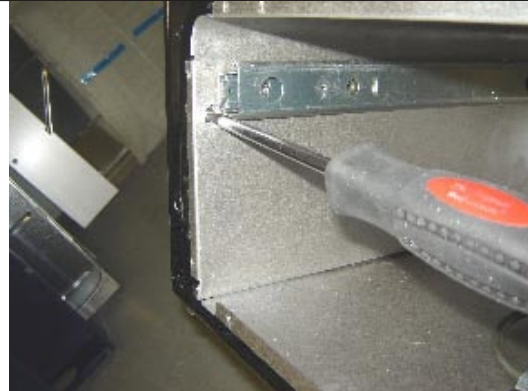

13.4 Remove the 2 screws from the mini oven bake element



13.5 Remove the 2 screws (one on each side) of the lower back side of the mini oven.



13.6 Remove the 3 screws from under the back panel of the mini oven.

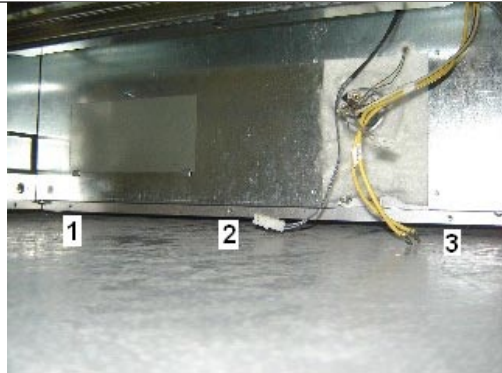

13.7 Remove the wires from the mini oven sensor, mini oven light and mini oven element.



13.8 Insert these wires between the upper and lower frame as shown.



13.9 Pull the back panel off from the mini oven starting by pulling the lower portion away as shown.



13.10 Remove the 2 screws (one on each side) that hold the side wall of the mini oven to the bottom brackets.

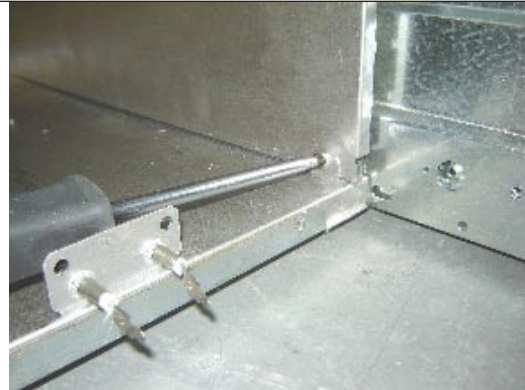

13.11 Pull the mini oven out from the back of the unit as shown.

NOTE: Only the side and top portion will move out



13.12 Remove the main back cover and remove the hidden bake element wires.

Refer to section 12. Item 11 for its location.

13.13 Remove the 3 screws from under the front portion of the hidden bake cover.

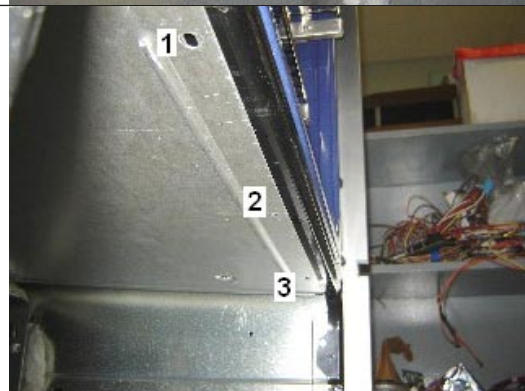

13.14 After having removed these 3 screws, the hidden bake element will lower itself as shown.



13 15 Remove the four screws that hold the hidden bake element to its service panel.

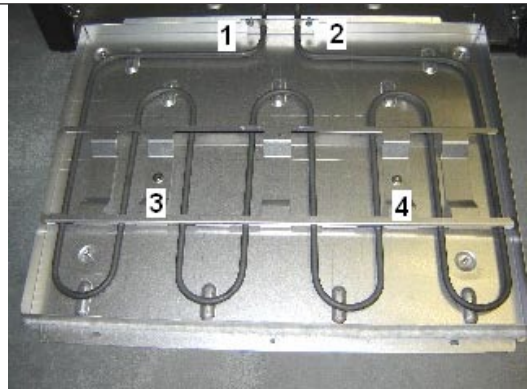

14. Mini oven light and glides

NOTE: Always turn the house breaker or fuses to the off position, or unplug the unit from the wall outlet before working on the unit.

14.1 Remove the mini oven drawer as shown in section 13.1

14.2 Locate the spring clip holder, move it either to the left or right hand side, remove the light cover and replace the light bulb.



14.3 Remove the mini oven drawer as shown in section 13.1

14.4 Remove the 1 screw which holds the trim to the inner portion of the mini oven.



14.5 Slide the glide out and pull on it in order for the glide to “unlock” from its bracket mounting system.



15. Mini oven drawer assembly

15.1 Pull and remove the mini oven drawer out as shown in section 13.1

15.2 Remove the 7 screws that hold the drawer to the front panel assembly.

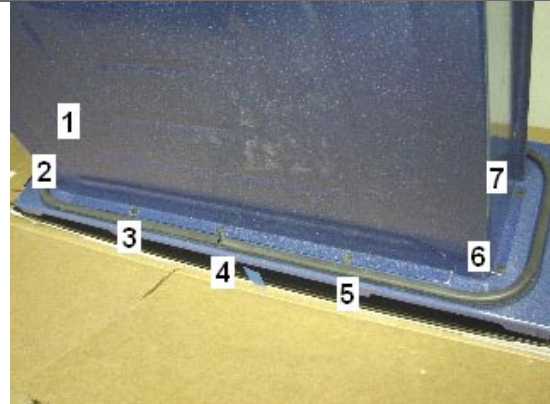

15.3 Remove the 6 screws from the upper trim, turn the mini oven door and also remove the 6 ones from the lower trim.



15.4 Remove the 2 screws which hold the mini oven door handle.

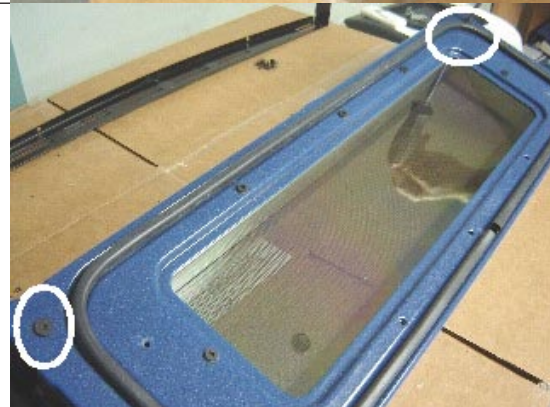

15.5 Pull the mini oven door apart.



15.6 Remove the 5 screws that hold the inner mini oven door liner to the inner glass frame assembly.

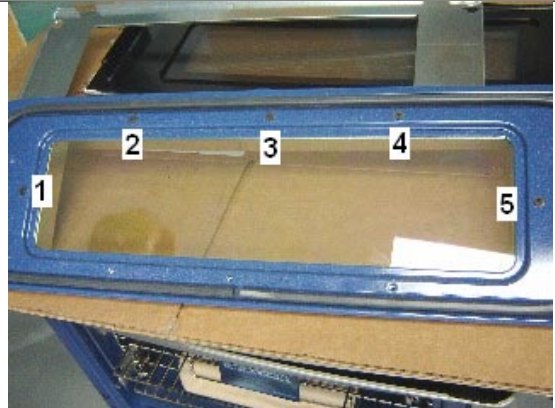

15.7 Pull the 2 sections apart in order to access the inner door glass and frame.

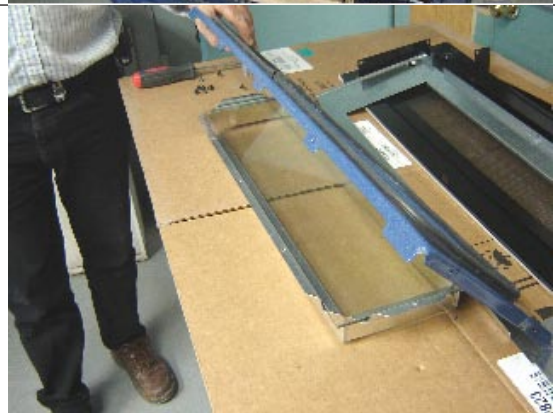

15.8 Apply pressure (squeeze) on the spring clip of the mini oven door gasket in order to remove it.



15.9 Upon installing the mini oven door back together, notice the way that the oven door handle screw spacer has to be installed.

NOTE: Small hole towards the liner side and large hole towards the handle side.

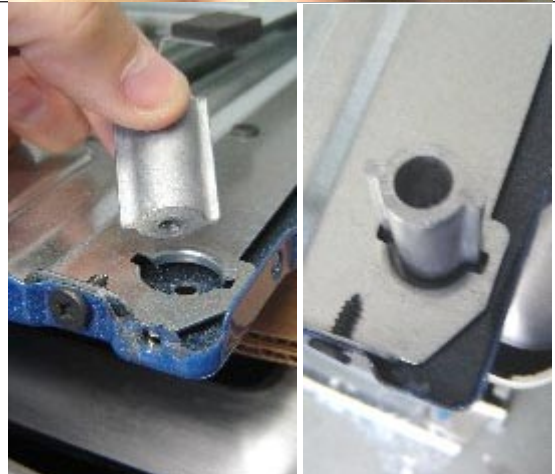

90 Disassembly

16. Main oven door assembly

16.1 Remove the oven door as shown in section 1.1 through 1.3

16.2 Remove the 2 screws that hold the oven door handle.



16.3 Remove the center screw of the lower trim; the one closest from the oven door glass.



16.4 Remove the 10 screws that hold the front decorative glass assembly; 4 at the top and 3 on each of the left and right hand side.

IMPORTANT: Upon installing the decorative glass assembly back on the door, remember that the smallest screw goes on the lower left and ring hand side through the side and lower trim as well as into the hinge assembly.

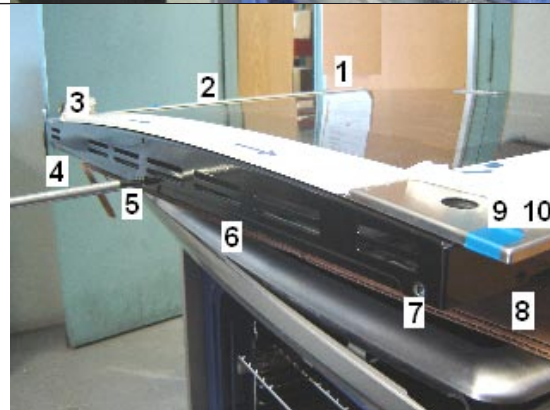

16.5 Pull the decorative glass assembly off of the oven door.

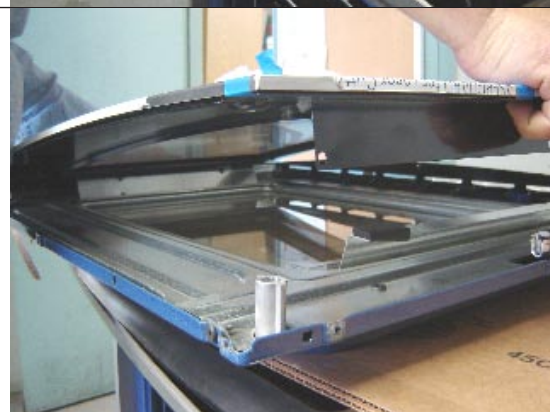

16.6 Remove the 3 screws that hold the lower trim.



16.7 The side screw being already removed, remove the 1 screw left on the lower hinge.



16.8 Turn the oven door upside down and remove the screw that holds the oven door hinge to the inner door liner.



16.9 Remove the 9 screws that hold the inner door baffle.

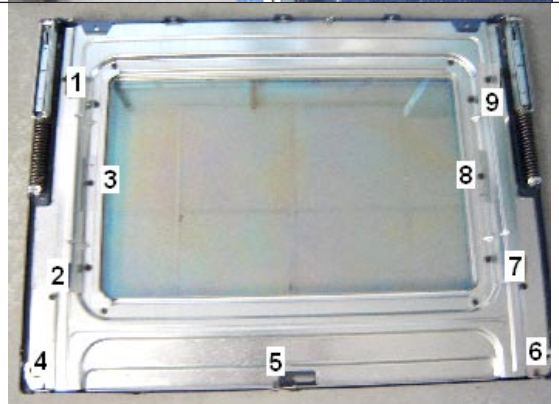

92 Disassembly

16.10 Once the inner baffle has been removed, remove the 4 screws that hold the inner door glass pack assembly in place.



16.11 Remove the glass holders and insulation.

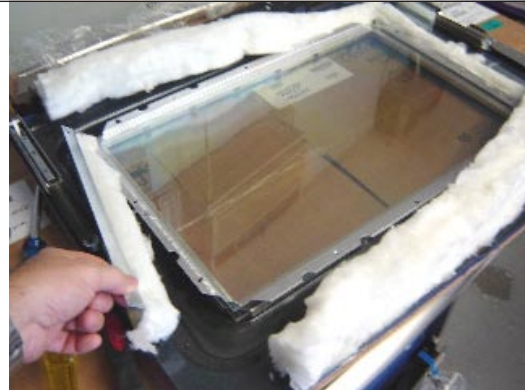

16.12 Remove the 2nd inner glass from the glass pack assembly.

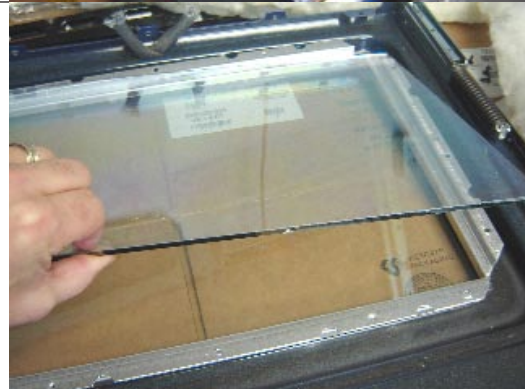

16.13 Remove the inner glass pack frame.



16.14 Remove the first inner door glass.

16.15 In order to remove the oven door gasket, refer to section **15.8**

Refer to section **15.9** in order to properly install the oven door handle screw spacer

