

DS4608

Imaging Scanner



Product Reference Guide



ZEBRA

Copyright

ZEBRA and the stylized Zebra head are trademarks of Zebra Technologies Corporation, registered in many jurisdictions worldwide. All other trademarks are the property of their respective owners. ©2019-2020 Zebra Technologies Corporation and/or its affiliates. All rights reserved.

COPYRIGHTS & TRADEMARKS: For complete copyright and trademark information, go to www.zebra.com/copyright.

WARRANTY: For complete warranty information, go to www.zebra.com/warranty.

END USER LICENSE AGREEMENT: For complete EULA information, go to www.zebra.com/eula.

For Australia Only

For Australia Only. This warranty is given by Zebra Technologies Asia Pacific Pte. Ltd., 71 Robinson Road, #05-02/03, Singapore 068895, Singapore. Our goods come with guarantees that cannot be excluded under the Australia Consumer Law. You are entitled to a replacement or refund for a major failure and compensation for any other reasonably foreseeable loss or damage. You are also entitled to have the goods repaired or replaced if the goods fail to be of acceptable quality and the failure does not amount to a major failure.

Zebra Technologies Corporation Australia's limited warranty above is in addition to any rights and remedies you may have under the Australian Consumer Law. If you have any queries, please call Zebra Technologies Corporation at +65 6858 0722. You may also visit our website: www.zebra.com for the most updated warranty terms.

Terms of Use

- Proprietary Statement

This manual contains proprietary information of Zebra Technologies Corporation and its subsidiaries ("Zebra Technologies"). It is intended solely for the information and use of parties operating and maintaining the equipment described herein. Such proprietary information may not be used, reproduced, or disclosed to any other parties for any other purpose without the express, written permission of Zebra Technologies.

- Product Improvements

Continuous improvement of products is a policy of Zebra Technologies. All specifications and designs are subject to change without notice.

- Liability Disclaimer

Zebra Technologies takes steps to ensure that its published Engineering specifications and manuals are correct; however, errors do occur. Zebra Technologies reserves the right to correct any such errors and disclaims liability resulting therefrom.

- Limitation of Liability

In no event shall Zebra Technologies or anyone else involved in the creation, production, or delivery of the accompanying product (including hardware and software) be liable for any damages whatsoever (including, without limitation, consequential damages including loss of business profits, business interruption, or loss of business information) arising out of the use of, the results of use of, or inability to use such product, even if Zebra Technologies has been advised of the possibility of such damages. Some jurisdictions do not allow the exclusion or limitation of incidental or consequential damages, so the above limitation or exclusion may not apply to you.

Revision History

Changes to the original guide are listed below:

Change	Date	Description
-01 Rev A	6/2019	Initial Release
-02 Rev A	7/2019	Changes from various Jira issues
-03EN Rev A	1/2020	- Added the fast blinking red LED indication in Table 4. - Updated the USB Cert information in Table 8, Table 9, and Table 10.

Table of Contents

Copyright	2
For Australia Only	2
Terms of Use	2
Revision History	3
About This Guide	
Introduction	22
Configurations	22
Accessories	23
Chapter Descriptions	24
Notational Conventions	25
Related Documents and Software	25
Service Information	26
Getting Started	
Introduction	27
Interfaces	27
Unpacking	27
Features	28
Setting Up the Scanner	28
Inserting the Interface Cable	28
Removing the Interface Cable	29
Connecting Power (if required)	30
Configuring the Scanner	30
123Scan and Software Tools	
Introduction	31
123Scan	31
Communication with 123Scan	32
123Scan Requirements	32
123Scan Information	32
Scanner SDK, Other Software Tools, and Videos	33
Advanced Data Formatting (ADF)	33
Multicode Data Formatting (MDF)	34
Preferred Symbol	34

Data Capture

Introduction 35

Beeper Definitions 35

LED Definitions 37

Scanning 38

 Scanning in Hands-Free (Presentation) Mode 38

 Assemble the Stand 38

 Mounting the Stand (optional) 39

 Scanning with the Stand 39

 Scanning in Hand-Held Mode 40

 Aiming 41

Decode Ranges 42

Maintenance, Troubleshooting, & Technical Specifications

Introduction 44

Maintenance 44

 Known Harmful Ingredients 44

 Approved Cleaners for the Imaging Scanner 44

 Approved Disinfectant Cleaners for Healthcare Configurations of the DS4608 Scanners 45

 Cleaning Agents Containing Active Ingredients 45

 Brand Name Disinfectants 45

 Cleaning the Imaging Scanner 45

Troubleshooting 46

Send Versions 49

 Software Version 49

 Serial Number 49

 Manufacturing Information 49

Technical Specifications 50

Imaging Scanner Signal Descriptions 57

USB Interface

Introduction 59

Setting Parameters 59

 Scanning Sequence Examples 59

 Errors While Scanning 60

Connecting a USB Interface 60

USB Parameter Defaults 61

USB Host Parameters 62

 USB Device Type 62

 Symbol Native API (SNAPI) Status Handshaking 64

 USB Keystroke Delay 65

 USB Caps Lock Override 65

 Barcodes with Unknown Characters 66

 USB Convert Unknown to Code 39 66

 USB Fast HID 67

 USB Polling Interval 68

 Keypad Emulation 70

 Quick Keypad Emulation 70

 Keypad Emulation with Leading Zero 71

Table of Contents

USB Keyboard FN1 Substitution	71
Function Key Mapping	72
Simulated Caps Lock	72
Convert Case	73
USB Static CDC	74
CDC Beep on <BEL>	74
TGCS (IBM) USB Direct I/O Beep	75
TGCS (IBM) USB Beep Directive	75
TGCS (IBM) USB Barcode Configuration Directive	76
TGCS (IBM) USB Specification Version	76
ASCII Character Sets	77

SSI Interface

Introduction	78
Communication	78
SSI Commands	79
SSI Transactions	80
General Data Transactions	80
ACK/NAK Handshaking	80
Decoded Data Transmission	81
ACK/NAK Enabled and Packeted Data	81
ACK/NAK Enabled and Unpacketed ASCII Data	81
ACK/NAK Disabled and Packeted DECODE_DATA	82
ACK/NAK Disabled and Unpacketed ASCII Data	82
Communication Summary	83
RTS/CTS Lines	83
ACK/NAK Option	83
Number of Data Bits	83
Serial Response Timeout	83
Retries	83
Baud Rate, Stop Bits, Parity, Response Timeout, ACK/NAK Handshaking	83
Errors	83
SSI Communication Notes	84
Using Time Delay to Low Power Mode with SSI	84
Encapsulation of RSM Commands/Responses over SSI	85
Command Structure	85
Response Structure	85
Example Transaction	86
Command from Host to Query Packet Size Supported by Device	86
Response from Device with Packet Size Information	86
Command from Host to Retrieve Diagnostic Information	86
Response from Device with Diagnostic Information	86
Setting Parameters	87
Scanning Sequence Examples	87
Errors While Scanning	87
Simple Serial Interface Parameter Defaults	88
SSI Host Parameters	89
Select SSI Host	89
Baud Rate	89
Parity	91

Table of Contents

Check Parity	91
Stop Bits	92
Software Handshaking	93
Host RTS Line State	94
Decode Data Packet Format	94
Host Serial Response Timeout	95
Host Character Timeout	96
Multipacket Option	97
Interpacket Delay	98
Event Reporting	99
Decode Event	99
Boot Up Event	100
Parameter Event	100
RS-232 Interface	
Introduction	101
Setting Parameters	101
Scanning Sequence Examples	102
Errors While Scanning	102
Connecting an RS-232 Interface	102
RS-232 Parameter Defaults	103
RS-232 Host-Specific Parameter Settings	104
RS-232 Host-Specific Code ID Characters	105
RS-232 Host Types	107
Baud Rate	109
Parity	111
Stop Bits	112
Data Bits	112
Check Receive Errors	113
Hardware Handshaking	113
Software Handshaking	115
Host Serial Response Timeout	117
RTS Line State	118
Beep on <BEL>	118
Intercharacter Delay	119
Nixdorf Beep/LED Options	120
Barcodes with Unknown Characters	120
ASCII Character Sets	121
IBM 468X / 469X Interface	
Introduction	122
Setting Parameters	122
Scanning Sequence Examples	122
Errors While Scanning	122
Connecting an IBM 468X/469X Host	123
IBM Parameter Defaults	124
IBM Host Parameters	125
Port Address	125
Convert Unknown to Code 39	126

Table of Contents

RS-485 Beep Directive	126
RS-485 Barcode Configuration Directive	127
IBM-485 Specification Version	127
Keyboard Wedge Interface	
Introduction	128
Setting Parameters	128
Scanning Sequence Examples	128
Errors While Scanning	129
Connecting a Keyboard Wedge Interface	129
Keyboard Wedge Parameter Defaults	130
Keyboard Wedge Host Parameters	131
Keyboard Wedge Host Types	131
Barcodes with Unknown Characters	131
Keystroke Delay	132
Intra-keystroke Delay	132
Alternate Numeric Keypad Emulation	133
Quick Keypad Emulation	133
Simulated Caps Lock	134
Caps Lock Override	134
Convert Case	135
Function Key Mapping	136
FN1 Substitution	136
Send Make and Break	137
Keyboard Map	137
ASCII Character Sets	137
User Preferences & Miscellaneous Options	
Introduction	138
Setting Parameters	138
Scanning Sequence Examples	138
Errors While Scanning	138
User Preferences/Miscellaneous Options Parameter Defaults	139
User Preferences	142
Default Parameters	142
Write to Custom Defaults	142
Parameter Barcode Scanning	143
Beep After Good Decode	144
Beeper Volume	145
Beeper Tone	146
Beeper Duration	147
Suppress Power Up Beeps	148
LED on Good Decode	149
Direct Decode Indicator	149
Decode Pager Motor (DS4608-HC Only and DS4608-DPE)	150
Decode Pager Motor Duration (DS4608-HC Only)	151
Night Mode (DS4608-HC and DS4608-DPE Only)	153
Night Mode Trigger (DS4608-HC and DS4608-DPE Only)	154
Night Mode Toggle (DS4608-HC and DS4608-DPE Only)	154

Table of Contents

Low Power Mode	155
Time Delay to Low Power Mode	156
Hand-held Trigger Mode	158
Hand-held Decode Aiming Pattern	159
Hands-free (Presentation) Decode Aiming Pattern	160
Hands-free Mode	161
Picklist Mode	162
Continuous Barcode Read	163
Unique Barcode Reporting	164
Decode Session Timeout	164
Timeout Between Decodes, Same Symbol	165
Timeout Between Decodes, Different Symbols	165
Triggered Timeout, Same Symbol	166
Mobile Phone/Display Mode	167
PDF Prioritization	168
PDF Prioritization Timeout	169
Presentation Mode Field of View	170
Decoding Illumination	171
Illumination Brightness	172
Motion Tolerance (Hand-held Trigger Modes Only)	173
Product ID (PID) Type	174
Product ID (PID) Value	174
ECLevel	175
DPM Parameters (DS4608-DPE Only)	176
DPM Illumination Control	176
DPM Mode	177
Miscellaneous Scanner Parameters	178
Enter Key	178
Tab Key	178
Transmit Code ID Character	179
Prefix/Suffix Values	180
Scan Data Transmission Format	181
FN1 Substitution Values	183
Transmit "No Read" Message	184
Unsolicited Heartbeat Interval	185
securPharm Decoding	186
securPharm Output Formatting	187
Sample GS1 Format	187
Sample IFA Format	188
securPharm Output Formatting Barcodes	189
Image Capture Preferences	
Introduction	190
Setting Parameters	190
Scanning Sequence Examples	191
Errors While Scanning	191
Image Capture Preferences Parameter Defaults	191
Image Capture Preferences	193
Operational Modes	193
Decode Mode	193

Table of Contents

Snapshot Mode	193
Video Mode	193
Image Capture Illumination	194
Image Capture Autoexposure	194
Fixed Exposure	195
Analog and Digital Gain	196
Analog Gain	196
Digital Gain	196
Snapshot Mode Timeout	197
Snapshot Aiming Pattern	198
Silence Operational Mode Changes	198
Image Cropping	199
Crop to Pixel Addresses	199
Image Size (Number of Pixels)	201
Image Brightness (Target White)	202
JPEG Image Options	202
JPEG Quality Value	203
JPEG Size Value	203
Image Enhancement	204
Image File Format Selector	205
Image Rotation	206
Bits Per Pixel	207
Signature Capture	208
Signature Capture File Format Selector	209
Signature Capture Bits Per Pixel	210
Signature Capture Width	211
Signature Capture Height	211
Signature Capture JPEG Quality	212
Video Mode Format Selector	212
Video View Finder	213
Target Video Frame Size	213
Video View Finder Image Size	214
Video Resolution	214
Symbologies	
Introduction	215
Setting Parameters	215
Scanning Sequence Examples	216
Errors While Scanning	216
Symbology Parameter Defaults	216
Enable/Disable All Code Types	223
UPC/EAN/JAN	224
UPC-A	224
UPC-E	224
UPC-E1	225
EAN-8/JAN-8	225
EAN-13/JAN-13	226
Bookland EAN	226
Bookland ISBN Format	227
ISSN EAN	228

Table of Contents

Decode UPC/EAN/JAN Supplementals	229
User-Programmable Supplementals	232
UPC/EAN/JAN Supplemental Redundancy	232
UPC/EAN/JAN Supplemental AIM ID Format	233
Transmit UPC-A Check Digit	234
Transmit UPC-E Check Digit	234
Transmit UPC-E1 Check Digit	235
UPC-A Preamble	236
UPC-E Preamble	237
UPC-E1 Preamble	238
Convert UPC-E to UPC-A	239
Convert UPC-E1 to UPC-A	239
EAN/JAN Zero Extend	240
UCC Coupon Extended Code	240
Coupon Report	241
UPC Reduced Quiet Zone	242
Code 128	242
Set Lengths for Code 128	243
GS1-128 (formerly UCC/EAN-128)	244
ISBT 128	245
ISBT Concatenation	246
Check ISBT Table	247
ISBT Concatenation Redundancy	247
Code 128 <FNC4>	248
Code 128 Security Level	249
Code 128 Reduced Quiet Zone	250
Code 39	250
Trioptic Code 39	251
Convert Code 39 to Code 32	251
Code 32 Prefix	252
Set Lengths for Code 39	252
Code 39 Check Digit Verification	254
Transmit Code 39 Check Digit	254
Code 39 Full ASCII Conversion	255
Code 39 Security Level	256
Code 39 Reduced Quiet Zone	258
Code 93	258
Set Lengths for Code 93	259
Code 11	261
Set Lengths for Code 11	261
Code 11 Check Digit Verification	263
Transmit Code 11 Check Digits	264
Interleaved 2 of 5 (ITF)	264
Set Lengths for Interleaved 2 of 5	265
I 2 of 5 Check Digit Verification	267
Transmit I 2 of 5 Check Digit	267
Convert I 2 of 5 to EAN-13	268
Febraban	268
I 2 of 5 Security Level	269
I 2 of 5 Reduced Quiet Zone	270
Discrete 2 of 5 (DTF)	270

Table of Contents

Set Lengths for Discrete 2 of 5	271
Codabar (NW - 7)	273
Set Lengths for Codabar	273
CLSI Editing	275
NOTIS Editing	275
Codabar Security Level	276
Codabar Upper or Lower Case Start/Stop Characters	277
Codabar Mod 16 Check Digit Verification	277
Transmit Codabar Check Digit	278
MSI	278
Set Lengths for MSI	279
MSI Check Digits	280
Transmit MSI Check Digit(s)	281
MSI Check Digit Algorithm	281
MSI Reduced Quiet Zone	282
Chinese 2 of 5	282
Matrix 2 of 5	283
Set Lengths for Matrix 2 of 5	283
Matrix 2 of 5 Check Digit	285
Transmit Matrix 2 of 5 Check Digit	285
Korean 3 of 5	286
Inverse 1D	287
GS1 DataBar	288
GS1 DataBar Omnidirectional (formerly GS1 DataBar-14)	288
GS1 DataBar Limited	288
GS1 DataBar Expanded	289
Convert GS1 DataBar to UPC/EAN/JAN	289
GS1 DataBar Security Level	290
GS1 DataBar Limited Margin Check	291
GS1 DataBar Expanded Security Level	292
Symbology-Specific Security Features	293
Redundancy Level	293
Security Level	295
1D Quiet Zone Level	296
Intercharacter Gap Size	297
Composite	298
Composite CC-C	298
Composite CC-A/B	298
Composite TLC-39	299
Composite Inverse	299
UPC Composite Mode	300
Composite Beep Mode	301
GS1-128 Emulation Mode for UCC/EAN Composite Codes	302
2D Symbologies	303
PDF417	303
MicroPDF417	303
Code 128 Emulation	304
Data Matrix	305
GS1 Data Matrix	305
Data Matrix Inverse	306
Decode Data Matrix Mirror Images	307

Table of Contents

Maxicode	308
QR Code	309
GS1 QR	309
MicroQR	310
Linked QR Mode	311
Aztec	312
Aztec Inverse	313
Han Xin	314
Han Xin Inverse	315
Grid Matrix	316
Grid Matrix Inverse	317
Grid Matrix Mirror	318
DotCode	319
DotCode Inverse	320
DotCode Mirrored	321
DotCode Prioritize	322
Macro PDF Features	322
Escape Characters	323
Flush Macro PDF Buffer	323
Abort Macro PDF Entry	323
Postal Codes	324
US Postnet	324
US Planet	324
Transmit US Postal Check Digit	325
UK Postal	325
Transmit UK Postal Check Digit	326
Japan Postal	326
Australia Post	327
Australia Post Format	328
Netherlands KIX Code	329
USPS 4CB/One Code/Intelligent Mail	329
UPU FICS Postal	330
Mailmark	330
OCR Programming	
Introduction	331
Setting Parameters	331
Scanning Sequence Examples	331
Errors While Scanning	332
OCR Parameter Defaults	332
OCR Programming Parameters	333
OCR-A	333
OCR-A Variant	334
OCR-B	336
OCR-B Variant	337
MICR E13B	341
US Currency Serial Number	342
OCR Orientation	342
OCR Lines	344
OCR Minimum Characters	344

Table of Contents

OCR Maximum Characters	345
OCR Subset	345
OCR Quiet Zone	346
OCR Template	347
Required Digit (9)	347
Required Alpha (A)	347
Require and Suppress (0)	348
Optional Alphanumeric (1)	348
Optional Alpha (2)	348
Alpha or Digit (3)	349
Any Including Space & Reject (4)	349
Any except Space & Reject (5)	349
Optional Digit (7)	350
Digit or Fill (8)	350
Alpha or Fill (F)	350
Optional Space ()	351
Optional Small Special (.)	351
Other Template Operators	351
Repeat Previous (R)	355
Multiple Templates	356
Template Examples	356
OCR Check Digit Modulus	356
OCR Check Digit Multiplier	357
OCR Check Digit Validation	359
None	359
Product Add Left to Right	359
Digit Add Left to Right	360
Digit Add Right to Left	361
Product Add Right to Left Simple Remainder	361
Digit Add Right To Left Simple Remainder	362
Health Industry - HIBCC43	363
Inverse OCR	364
OCR Redundancy	365
Intelligent Document Capture (IDC)	
Introduction	366
The IDC Process	366
Barcode Acceptance Test	367
Capture Region Determination	367
IDC Operating Mode = Anchored	367
IDC Operating Mode = Free-Form or Linked	368
Image Post Processing	368
Data Transmission	368
PC Application and Programming Support	368
Setting Parameters	368
Scanning Sequence Examples	369
Errors While Scanning	369
Image Document Capture Parameter Defaults	370
IDC Operating Mode	371
IDC Symbology	372

Table of Contents

IDC X Coordinate	373
IDC Y Coordinate	373
IDC Width	374
IDC Height	374
IDC Aspect	375
IDC File Format Selector	375
IDC Bits Per Pixel	376
IDC JPEG Quality	377
IDC Find Box Outline	377
IDC Minimum Text Length	378
IDC Maximum Text Length	378
IDC Captured Image Brighten	379
IDC Captured Image Sharpen	380
IDC Border Type	381
IDC Delay Time	382
IDC Zoom Limit	382
IDC Maximum Rotation	383
Quick Start	384
Sample IDC Setup	384
IDC Demonstrations	385
Anchored Mode Demo	385
Free-Form Mode Demo	385
Linked Mode Demo	385
Other Suggestions	386
Quick Start Form	386
Data Formatting: ADF, MDF, Preferred Symbol	
Introduction	387
Advanced Data Formatting (ADF)	387
Multicode Data Formatting (Hand-held Mode Only)	387
Programming a Scanner	388
Preferred Symbol	388
Driver's License Set Up (DSXXXX-DL)	
Introduction	389
Driver's License Parsing	390
Parsing Driver's License Data Fields (Embedded Driver's License Parsing)	391
Embedded Driver's License Parsing Criteria - Code Type	391
Driver's License Parse Field Barcodes	392
AAMVA Parse Field Barcodes	395
Parser Version ID Barcode	405
User Preferences	405
Set Default Parameter	405
Output Gender as M or F	405
Date Format	406
No Separator	408
Send Keystroke (Control Characters and Keyboard Characters)	409
Control Characters	409
Keyboard Characters 414	

Parsing Rule Example	430
Embedded Driver's License Parsing ADF Example	434
Standard Parameter Defaults	
Introduction	436
Numeric Barcodes	
Numeric Barcodes	450
Cancel	452
Alphanumeric Barcodes	
Cancel	453
Alphanumeric Barcodes	454
ASCII Character Sets	
Programming Reference	
Symbol Code Identifiers	482
AIM Code Identifiers	484
Communication Protocol Functionality	
Functionality Supported via Communication (Cable) Interface	489
Country Codes	
Introduction	491
USB and Keyboard Wedge Country Keyboard Types (Country Codes)	491
Country Code Barcodes	492
Country Code Pages	
Introduction	509
Country Code Page Defaults	509
Country Code Page Barcodes	513
CJK Decode Control	
Introduction	533
CJK Control Parameters	534
Unicode Output Control	534
CJK Output Method to Windows Host	535
Non-CJK UTF Barcode Output	541
Country Keyboard Type Missing Characters	542
Unicode/CJK Decode Setup with Windows Host	543
Setting Up the Windows Registry Table for Unicode Universal Output	543

Adding CJK IME on Windows	543
Selecting the Simplified Chinese Input Method on the Host	544
Selecting the Traditional Chinese Input Method on the Host	545
Signature Capture Code	
Introduction	546
Code Structure	546
Signature Capture Area	546
CapCode Pattern Structure	547
Start / Stop Patterns	547
Dimensions	548
Data Format	548
Additional Capabilities	548
Signature Boxes	549
Non-Parameter Attributes	
Introduction	550
Attributes	550
Model Number	550
Serial Number	550
Date of Manufacture	551
Date of First Programming	551
Configuration Filename	551
Beeper/LED	552
Parameter Defaults	553
Beep on Next Bootup	553
Reboot	553
Host Trigger Session	553
Firmware Version	554
Scankit Version	554
Sample Barcodes	
UPC/EAN	555
UPC-A, 100%	555
UPC-A with 2-digit Add-on	555
UPC-A with 5-digit Add-on	556
UPC-E	556
UPC-E with 2-digit Add-on	556
UPC-E with 5-digit Add-on	557
EAN-8	557
EAN-13, 100%	557
EAN-13 with 2-digit Add-on	558
EAN-13 with 5-digit Add-on	558
Code 128	558
GS1-128	559
Code 39	559
Code 93	559
Code 11 with 2 Check Digits	560

Table of Contents

Interleaved 2 of 5	560
MSI with 2 Check Digits	560
Chinese 2 of 5	561
Matrix 2 of 5	561
Korean 3 of 5	561
GS1 DataBar	562
GS1 DataBar Omnidirectional (formerly GS1 DataBar-14)	562
GS1 DataBar Truncated	562
GS1 DataBar Stacked	562
GS1 DataBar Stacked Omnidirectional	563
GS1 DataBar Limited	563
GS1 DataBar Expanded	563
GS1 DataBar Expanded Stacked	564
2D Symbolologies	564
PDF417	564
Data Matrix	564
GS1 Data Matrix	565
Maxicode	565
QR Code	565
GS1 QR	565
MicroQR	566
Aztec	566
Grid Matrix	566
Han Xin	567
Postal Codes	567
US Postnet	567
UK Postal	567
Japan Postal	567
Australian Post	568
OCR	568
OCR-A	568
OCR-B	568
MICR E13B	568
US Currency	569

List of Figures

Figure 1. Parts of the Scanner	28
Figure 2. Inserting the Cable	29
Figure 3. Removing the Cable	29
Figure 4. Assembling the Stand	38
Figure 5. Mounting the Stand	39
Figure 6. Inserting the Scanner in the Gooseneck Intellistand	40
Figure 7. Centering the Aiming Dot on the Barcode	40
Figure 8. Aiming Dot	41
Figure 9. Scanning Orientation with Aiming Dot	41
Figure 10. Acceptable Aiming	41
Figure 11. Incorrect Aiming	42
Figure 12. Imaging Scanner Cable Pinouts	57
Figure 13. USB Connection	60
Figure 14. RS-232 Connection	102
Figure 15. IBM Connection	123
Figure 16. Keyboard Wedge Connection	129
Figure 17. IBM PS2 Type Keyboard	137
Figure 18. Quick Start Form	386
Figure 19. CapCode	546
Figure 20. CapCode Structure	547
Figure 21. Acceptable Signature Boxes	549

List of Tables

Table 1. Scanner Configurations	22
Table 2. Scanner Accessories	23
Table 3. Beeper Definitions	35
Table 4. Standard LED Definitions	37
Table 5. DS4608SR/DL/HD/HC Decode Ranges	42
Table 6. DS4608-DPE Decode Ranges	43
Table 7. Troubleshooting	46
Table 8. Technical Specifications - DS4608-SR/DS4608-DL/DS4608-HD/DS4608-HL	50
Table 9. Technical Specifications - DS4608-HC	52
Table 10. Technical Specifications - DS4608-DPE	55
Table 11. DS4608 Imaging Scanner Signal Pin-outs	58
Table 12. USB Interface Parameter Defaults	61
Table 13. SSI Commands	79
Table 14. Values for Selecting Time Delay to Low Power.	84
Table 15. Command Structure	85
Table 16. Response Structure	85
Table 17. SSI Interface Default Table	88
Table 18. Event Codes	99
Table 19. RS-232 Interface Parameter Defaults	103
Table 20. RS-232 Host-Specific Settings	104
Table 21. RS-232 Host-Specific Settings	104
Table 22. RS-232 Host-Specific Code ID Characters	105
Table 23. RS-232 Host-Specific Code ID Characters	106
Table 24. IBM 468X/469X Interface Parameter Defaults	124
Table 25. Keyboard Wedge Interface Parameter Defaults	130
Table 26. User Preferences Parameter Defaults.	139
Table 27. Image Capture Preferences Parameter Defaults	191
Table 28. Image Size.	201
Table 29. Output File Format.	209
Table 30. Resolution and Video Image Sizes	214
Table 31. Symbology Parameter Defaults.	216
Table 32. OCR Programming Default Table	332
Table 33. Table of Numeric Value Assignments for Computing HIBC LIC Data Format Check Digit	363
Table 34. Intelligent Document Capture (IDC) Parameter Defaults	370
Table 35. IDC Symbologies.	372
Table 36. DL Parsing Parameter Table	389
Table 37. Parameter Defaults	436
Table 38. ASCII Character Set.	471
Table 39. ALT Key Character Set	476
Table 40. GUI Key Character Set	477
Table 41. PF Key Character Set	478
Table 42. F Key Character Set	479

List of Tables

Table 43. Numeric Key Character Set	480
Table 44. Extended Key Character Set	480
Table 45. Symbol Code Characters	482
Table 46. Aim Code Characters	484
Table 47. Modifier Characters	485
Table 48. Communication Interface Functionality	489
Table 49. Country Code Page Defaults	509
Table 50. Start / Stop Pattern Definitions	547
Table 51. User Defined CapCode Parameters	547
Table 52. Data Format.	548
Table 53. Beeper/LED Values	552

About This Guide

Introduction

The DS4608 scanner Product Reference Guide provides general instructions for setting up, operating, maintaining, and troubleshooting the DS4608 scanner.

Configurations

This guide includes the DS4608 scanner configurations listed in [Table 1](#).

Table 1 Scanner Configurations

Part Number	Description
DS4608-SR00006ZZWW	Area Imager, Standard Range, White (Scanner Only)
DS4608-SR00007ZZWW	Area Imager, Standard Range, Twilight Black (Scanner Only)
DS4608-SR00007ZZAP	Area Imager, Standard Range, Twilight Black, APAC Only (Scanner Only)
DS4608-SR00007ZZY	Area Imager, Standard Range, Twilight Black, India Only (Scanner Only)
DS4608-DL00006ZZWW	Area Imager, Standard Range, White, Driver's License Parsing U.S. Only (Scanner Only)
DS4608-DL00007ZZWW	Area Imager, Standard Range, Twilight Black, Driver's License Parsing U.S. Only (Scanner Only)
DS4608-HD00007ZZWW	Area Imager, High Density, Twilight Black (Scanner Only)
DS4608-HD00007ZZAP	Area Imager, High Density, Twilight Black, APAC Only (Scanner Only)
DS4608-HD00007ZCWW	Area Imager, High Density, Twilight Black, Checkpoint EAS (Scanner Only)
DS4608-HC4000BZZWW	Area Imager, Healthcare, HC White (Scanner Only)
DS4608-HC4000BZZWW	Area Imager, Healthcare, HC White, APAC Only (Scanner Only)
DS4608-HL00007ZZWW	Area Imager, High Density, Twilight Black, Driver's License Parsing U.S. Only (Scanner Only)

Table 1 Scanner Configurations (Continued)

Part Number	Description
DS4608-TT00007ZZJP	Area Imager, Standard Range, Twilight Black, Toshiba TEC (Scanner Only)
DS4608-DPE0007VZRW	Area Imager, Electronics DPM, Corded, White Illumination, Twilight Black, Vibration Motor - NA, LA, EMEA Only

Accessories



NOTE: Check Solution Builder for additional information regarding all available accessories, and the latest available configurations.

The scanner ships with the DS4608 Quick Start Guide. The following required accessories must be ordered:

- Interface cable for the appropriate interface. For example, a shielded connector cable when connecting via USB.
- Universal power supply, if the interface requires this.
- Gooseneck Intellistand for hands-free operation of the DS4608.

The product configurations related to the DS4608 scanner are listed in [Table 2](#).

Table 2 Scanner Accessories

Product Type	Part Number	Description
Cables	For information about cables, cable compatibility, and the full list of supported cables go to the Zebra Partner Portal at: https://partnerportal.zebra.com/PartnerPortal/product_services/downloads_z/barcode_scanners/Universal-Cable-Guide-Bar-Code-Scanners.xlsx .	
Stands and Holders (optional)	20-71043-04R (Black) 20-71043-0BR (HC White)	Gooseneck Intellistand
	STND-GS00UNC-04 (Black)	Universal Gooseneck Intellistand
	21-71043-04R (Black) 21-71043-0BR (HC White)	Cup
	STND-DC0081-04 (Black)	Document capture stand
	11-66553-06R (Twilight Black)	Wall Mount Hook
	20-70777-01R (Twilight Black)	Desk Holder

Table 2 Scanner Accessories (Continued)

Product Type	Part Number	Description
Power Supplies (if required)	PWR-WUA5V4W0WW	5.2VDC, 1.1A, All WW Adapter Plugs, Level 6 Compliant
	PWR-WUA5V4W0US	5.2VDC, 1.1A, US Adapter Plug, Level 6 Compliant
	PWR-WUA5V4W0EU	5.2VDC, 1.1A, EU and UK Adapter Plug, Level 6 Compliant
	PWR-WUA5V4W0BR	5.2VDC, 1.1A, Brazil Adapter Plug, Level 6 Compliant
	PWR-WUA5V4W0CN	5.2VDC, 1.1A, China Adapter Plug, Level 6 Compliant
	PWR-WUA5V4W0IN	5.2VDC, 1.1A, India Adapter Plug, Level 6 Compliant
	PWR-WUA5V4W0AU	5.2VDC, 1.1A, Australia Adapter Plug, Level 6 Compliant

Chapter Descriptions

Topics covered in this guide are as follows:

- [Getting Started](#) provides a product overview, unpacking instructions, and cable connection information.
- [123Scan and Software Tools](#) describes the Zebra software tools available for customizing scanner operation.
- [Data Capture](#) provides beeper and LED definitions, scanning instructions and tips, and decode ranges.
- [Maintenance, Troubleshooting, & Technical Specifications](#) provides suggested scanner maintenance, troubleshooting, technical specifications, and signal descriptions (pinouts).
- [USB Interface](#) describes how to set up the scanner with a USB host.
- [SSI Interface](#) describes the system requirements of the Simple Serial Interface (SSI), which provides a communications link between Zebra decoders and a serial host.
- [RS-232 Interface](#) describes how to set up the scanner with an RS-232 host.
- [IBM 468X / 469X Interface](#) describes how to set up the scanner with an IBM 468X/469X host.
- [Keyboard Wedge Interface](#) describes how to set up a keyboard wedge interface with the scanner.
- [User Preferences & Miscellaneous Options](#) describes each user preference feature and provides programming barcodes for selecting these features.
- [Image Capture Preferences](#) describes imaging preference features and provides programming barcodes for selecting these features.
- [Symbologies](#) describes all symbology features and provides programming barcodes for selecting these features.
- [OCR Programming](#) describes how to set up the scanner for OCR programming.
- [Intelligent Document Capture \(IDC\)](#) describes IDC, an advanced image processing firmware, including IDC functionality, parameter barcodes to control its features, and a quick start procedure.
- [Data Formatting: ADF, MDF, Preferred Symbol](#) describes the Zebra software tools available for customizing scanner operation.
- [Driver's License Set Up \(DSXXXX-DL\)](#) describes how to program the DSXXXX-DL scanner to read and use the data contained in the 2D barcodes on US driver's licenses and AAMVA compliant ID cards.
- [Standard Parameter Defaults](#) provides a table of all host and miscellaneous scanner defaults.

- [Numeric Barcodes](#) includes the numeric barcodes to scan for parameters requiring specific numeric values.
- [Alphanumeric Barcodes](#) includes the alphanumeric barcodes to scan for parameters requiring specific alphanumeric values.
- [ASCII Character Sets](#) provides tables for ASCII character values and other character sets.
- [Programming Reference](#) provides tables for Symbol code identifiers, AIM code identifiers, and modifier characters.
- [Communication Protocol Functionality](#) lists supported scanner functionality by communication protocol.
- [Country Codes](#) provides barcodes for programming the country keyboard type for the USB keyboard (HID) device and the keyboard wedge host.
- [Country Code Pages](#) provides barcodes for selecting code pages for the country keyboard type.
- [CJK Decode Control](#) describes control parameters for Unicode/CJK (Chinese, Japanese, Korean) barcode decode through USB HID Keyboard Emulation mode.
- [Signature Capture Code](#) describes CapCode, a special pattern that encloses a signature area on a document and allows the scanner to capture a signature.
- [Non-Parameter Attributes](#) defines non-parameter attributes.
- [Sample Barcodes](#) includes sample barcodes of various code types.

Notational Conventions

The following conventions are used in this document:

- **Bold** text is used to highlight the following:
 - Parameter names and options
 - Parameter barcode captions
 - Dialog box, window and screen names
 - Drop-down list and list box names
 - Check box and radio button names
 - Icons on a screen
 - Key names on a keypad
 - Button names on a screen.
- Bullets (•) indicate:
 - Action items
 - Lists of alternatives
 - Lists of required steps that are not necessarily sequential.
- Sequential lists (e.g., those that describe step-by-step procedures) appear as numbered lists.

Related Documents and Software

The following documents provide more information about the DS4608 scanner.

- DS4608 Quick Start Guide, p/n MN-003599-xx, provides general information for getting started with the DS4608 scanner, and includes basic set up and operation instructions.

- Advanced Data Formatting Programmer Guide, p/n 72E-69680-xx, provides information on ADF, a means of customizing data before transmission to a host.
- MDF and Preferred Symbol User Guide, p/n MN-002895-xx, provides information on Multicode Data Formatting (MDF), which enables a 2D imaging scanner to scan all barcodes on a label, and then modify and transmit the data to meet host application requirements.
- Attribute Data Dictionary, p/n 72E-149786-xx defines attribute numbers (device configuration parameters, monitored data, and born-on information) and describes management of various attribute domains for barcode scanners and OEM engines.
- Plural Stage Programmer's Guide, p/n 72E-67113-xx, provides the barcodes necessary to program the DS4608 scanner to decode Plural Stage barcodes and enable Supplemental Recognition Characters.
- Toshiba TEC Programmer's Guide, p/n MN-002707-xx, provides information on programming the Toshiba TEC USB device type.

For the latest version of this guide and all guides, go to: zebra.com/support.

Service Information

If you have a problem with your equipment, contact Zebra Global Customer Support for your region. Contact information is available at: zebra.com/support.

When contacting support, please have the following information available:

- Serial number of the unit
- Model number or product name
- Software type and version number.

Zebra responds to calls by email, telephone or fax within the time limits set forth in support agreements.

If your problem cannot be solved by Zebra Customer Support, you may need to return your equipment for servicing and will be given specific directions. Zebra is not responsible for any damages incurred during shipment if the approved shipping container is not used. Shipping the units improperly can possibly void the warranty.

If you purchased your Zebra business product from a Zebra business partner, contact that business partner for support.

Provide Documentation Feedback

If you have comments, questions, or suggestions about this guide, send an email to EVM-Techdocs@zebra.com.

Getting Started

Introduction

Whether at your point of sale, on your production line, or in your hospital or other healthcare facility, the DS4600 Series has a scanner that meets your needs; capture a wide range of barcodes and data, on different surfaces, in different conditions, from different distances - all instantly and flawlessly. The DS4600 Series combines performance with versatility, focusing on the task at hand without worrying about capturing data. With the right DS4600 scanner for your environment, let the DS4608 capture your data.

Interfaces

The DS4608 scanner supports:

- USB connection to a host. The scanner autodetects a USB host and defaults to the HID keyboard interface type. Select other USB interface types by scanning programming barcode menus. This interface supports the international keyboards (for Windows® environment) included in the chapter [Country Codes](#).
- Standard RS-232 connection to a host. Scan barcode menus to set up communication of the scanner with the host.
- Connection to IBM 468X/469X hosts. Scan barcode menus to set up communication of the scanner with the IBM terminal.
- Keyboard Wedge connection to a host. The host interprets scanned data as keystrokes. Scan barcode menus to set up communication of the scanner with the host. This interface supports the international keyboards (for Windows® environment) included in the chapter [Country Codes](#).

Unpacking

Remove the digital scanner from its packing and inspect it for damage. If the scanner was damaged in transit, contact support. See [26](#) for information. **KEEP THE PACKING**. It is the approved shipping container; use this to return the equipment for servicing.

Features

Figure 1 Parts of the Scanner

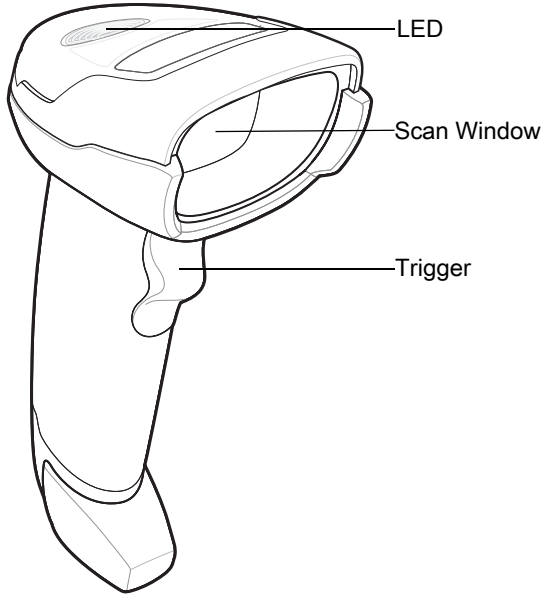

Setting Up the Scanner

Inserting the Interface Cable



NOTE: Different hosts require different cables. The connectors illustrated in each host chapter are examples only. Connectors vary from those illustrated, but the steps to connect the scanner are the same.

1. Insert the interface cable modular connector into the interface cable port on the rear of the digital scanner until you hear a click. Low/medium/high beeps sound, indicating the scanner is operational.

Figure 2 Inserting the Cable

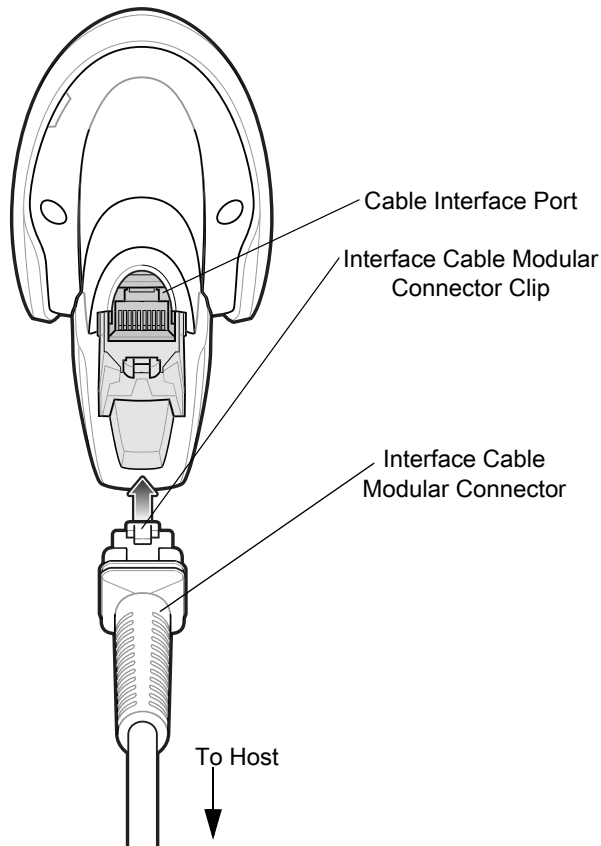

2. Gently tug the cable to ensure the connector is secure.
3. Connect the other end of the interface cable to the host (see the specific host chapter for information on host connections).

Removing the Interface Cable

1. Press the cable's modular connector clip through the access slot in the digital scanner's base.

Figure 3 Removing the Cable

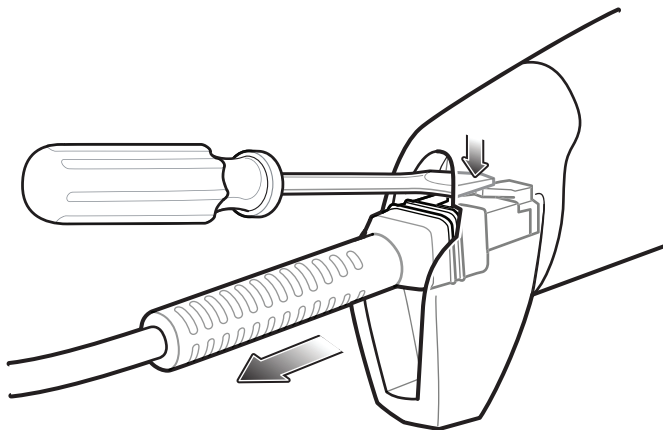

2. Carefully slide out the cable.
3. Follow the steps for [Inserting the Interface Cable](#) to connect a new cable.

Connecting Power (if required)

If the host does not provide power to the digital scanner, connect an external power supply.

1. Connect the interface cable to the base of the scanner, as described in [Inserting the Interface Cable on page 28](#).
2. Connect the other end of the interface cable to the host (refer to the host manual to locate the correct port).
3. Plug the power supply into the power jack on the interface cable. Plug the other end of the power supply into an AC outlet.

Configuring the Scanner

To configure the scanner use the barcodes included in this manual or use the 123Scan configuration program. See each host-specific chapter to set up a connection to a specific host type.

123Scan and Software Tools

Introduction

This chapter briefly describes the Zebra software tools available for customizing scanner operation.

123Scan

123Scan is a software tool that simplifies scanner setup and more.

Intuitive enough for first time users, the 123Scan wizard guides users through a streamlined setup process. Settings are saved in a configuration file that can be printed as a single programming barcode for scanning, emailed to a smart phone for scanning from its screen, or downloaded to the scanner using a USB cable.

Through 123Scan a user can:

- Configure a scanner using a wizard.
 - Program the following scanner settings.
 - Beeper tone / volume settings.
 - Enable / disable symbologies.
 - Communication settings.
 - Modify data before transmission to a host using:
 - Advanced Data Formatting (ADF) - Scan one barcode per trigger pull.
 - Multicode Data Formatting (MDF) - Scan many barcodes in one trigger pull (select scanners).
 - Preferred Symbol - Single out one barcode on label of many (select scanners).
- Load parameter settings to a scanner via the following.
 - Barcode scanning.
 - Scan a paper barcode.
 - Scan a barcode from a PC screen.
 - Scan a barcode from a smart phone screen.
 - Download over a USB cable.
 - Load settings to one scanner.
 - Stage up to 10 scanners simultaneously (Powered USB Hub recommended with 0.5 amp / port).

- Validate scanner setup.
 - View scanned data within the utility's **Data** view screen.
 - Capture an image and save to a PC within the utility's **Data** view screen.
 - Review settings using the Parameter Report.
 - Clone settings from an already deployed scanner from the **Start** screen.
- Upgrade scanner firmware.
 - Load settings to one scanner.
 - Stage up to 10 scanners simultaneously (Powered USB Hub recommended with 0.5 amp / port).
- View statistics such as:
 - Asset tracking information.
 - Time and usage information.
 - Barcodes scanned by symbology.
 - Battery diagnostics (select scanners).
- Generate the following reports.
 - Barcode Report - Programming barcode, included parameter settings, and supported scanner models.
 - Parameter Report - Parameters programmed within a configuration file.
 - Inventory Report - Scanner asset tracking information.
 - Validation Report - Scanned data from the **Data** view.
 - Statistics Report - All statistics retrieved from the scanner.

For more information go to: <http://www.zebra.com/123Scan>.

Communication with 123Scan

Use a USB cable to connect the scanner to a Windows host computer running 123Scan.

123Scan Requirements

- Host computer running Windows XP, 7, 8, and 10
- Scanner
- USB cable.

123Scan Information

For more information on 123Scan, go to: <http://www.zebra.com/123Scan>

For a 1 minute tour of 123Scan, go to: <http://www.zebra.com/ScannerHowToVideos>

To see a list of all of our software tools, go to: <http://www.zebra.com/scannersoftware>

Scanner SDK, Other Software Tools, and Videos

Tackle all your scanner programming needs with our diversified set of software tools. Whether you need to simply stage a device, or develop a fully featured application with image and data capture as well as asset management, these tools help you every step of the way.

To download any of the following free tools, go to: <http://www.zebra.com/scannersoftware>.

- 123Scan configuration utility
- SDKs
 - Scanner SDK for Windows
 - Scanner SDK for Linux
 - Scanner SDK for Android
 - Scanner SDK for iOS
- Drivers
 - OPOS driver
 - JPOS driver
 - USB CDC driver
 - TWAIN driver
- Scanner Management Service (SMS) for Remote Management
 - Windows
 - Linux
- How-To-Videos



NOTE: For a list of SDK supported scanner functionality by communication protocol, see [Communication Protocol Functionality](#).

Advanced Data Formatting (ADF)

Advanced Data Formatting (ADF) allows customizing data before transmission to the host device. Use ADF to edit scanned data to suit the host application's requirements. With ADF you scan one barcode per trigger pull. ADF is programmed using 123Scan.

For a video on Creating an Advanced Data Formatting (ADF) Rule using 123Scan, go to: <http://www.zebra.com/ScannerHowToVideos>.

For additional information, refer to the Advanced Data Formatting Programmer Guide.

Multicode Data Formatting (MDF)

Multicode Data Formatting (MDF) enables a 2D imaging scanner to scan all barcodes on a label with a single trigger pull, and then modify and transmit the data to meet host application requirements. MDF supports programming up to nine unique labels into one scanner. MDF also supports scanning multiple barcodes on opposite sides of a box by holding the trigger.

Programming options include:

- Output all or specific barcodes.
- Control the barcode output sequence.
- Apply unique multicode data formatting (MDF) to each output barcode.
- Discard scanned data if all required barcodes are not present.

For more information, refer to the Multicode Data Formatting and Preferred Symbol User Guide, p/n MN-002895-xx.

For a video on Creating an Multicode Data Formatting (MDF) Rule using 123Scan, go to: www.zebra.com/ScannerHowToVideos.

Preferred Symbol

Preferred Symbol is a barcode prioritization technique that enables favored decoding of high priority barcode(s). The Preferred Symbol is the only barcode that is decoded and output within the preset Preferred Symbol Timeout. During this time, the scanner attempts to decode the prioritized barcode and reports only this barcode.

For more information, refer to the Multicode Data Formatting and Preferred Symbol User Guide, p/n MN-002895-xx.

To program Preferred Symbol via 123Scan, select 123Scan > Configuration Wizard > Symbologies screen, and then select Preferred Symbol from the drop-down menu. Preferred Symbol programming is saved in the 123Scan configuration file.

Data Capture

Introduction

This chapter provides beeper and LED definitions, techniques involved in scanning barcodes, general instructions and tips about scanning, and decode ranges.

Beeper Definitions

The digital scanner issues different beep sequences and patterns to indicate status. [Table 3](#) defines beep sequences that occur during both normal scanning and while programming the digital scanner.

Table 3 Beeper Definitions

Beeper Sequence	Indication
Standard Use	
Low/medium/high beeps	Power up.
Short beep, tone programmable	A barcode symbol was decoded (if decode beeper is enabled).
4 long low beeps	Transmission error.
5 low beeps	Conversion or format error.
Low/low/low/extra low beeps	RS-232 receive error.
High beep	The digital scanner detected a <BEL> character over RS-232.
Parameter Menu Scanning	
Low/high beeps	Input error; incorrect barcode, programming sequence, or Cancel scanned.
High/low beeps	Keyboard parameter selected. Enter value using numeric barcodes.
High/low/high/low beeps	Successful program exit with change in parameter setting.
ADF Programming	
Low/low beeps	Enter another alphabetic character or scan the End of Message barcode.
Low/high/high beeps	All rules are deleted.
Low/high/low/high beeps	Out of rule memory. Erase some existing rules, then try to save rule again.

Table 3 Beeper Definitions (Continued)

Beeper Sequence	Indication
Low/high/low beeps	Cancel rule entry. Rule entry mode exited because of an error or the user asked to exit rule entry.
Low/high beeps	Entry error, wrong barcode scanned, or criteria/action list is too long for a rule. Re-enter criterion or action.
Low beep	Delete last saved rule. The current rule is left intact.
High/high beeps	ADF criteria or action is expected. Enter another criterion or action, or scan the Save Rule barcode.
High/low/low beeps	All criteria or actions cleared for current rule, continue entering rule.
High/low/high/low beeps	Rule saved. Rule entry mode exited.
Macro PDF	
2 low beeps	MPDF sequence buffered.
2 long low beeps	File ID error. A barcode not in the current MPDF sequence was scanned.
3 long low beeps	Out of memory. There is not enough buffer space to store the current MPDF symbol.
4 long low beeps	Bad symbology. Scanned a 1D or 2D barcode in a MPDF sequence, a duplicate MPDF label, a label in an incorrect order, or trying to transmit an empty or illegal MPDF field.
5 long low beeps	Flushing MPDF buffer.
Low/high beeps	Flushing an already empty MPDF buffer.
Fast warble beep	Aborting MPDF sequence.
Host Specific	
USB only	
Low/medium/high beeps upon scanning a USB device type	Communication with the host must be established before the digital scanner can operate at the highest power level.
Low/medium/high beeps occur more than once	The USB host can put the digital scanner in a state where power to the scanner is cycled on and off more than once. This is normal and usually happens when the PC cold boots.
RS-232 only	
1 short high beep	A <BEL> character is received and Beep on <BEL> is enabled.

LED Definitions

In addition to beep sequences, the digital scanner uses a two-color LED to indicate status. [Table 4](#) defines LED colors that display during scanning.

Table 4 Standard LED Definitions

LED	Indication
Hand-Held Scanning Standard Use	
Green	A barcode was successfully decoded.
Red	Transmission error, conversion or format error, or RS-232 receive error.
Off	No power is applied to the digital scanner, or the scanner is on and ready to scan.
Fast Blinking Red	The scanner is disabled by a host command to the scanner.
Hands-Free (Presentation) Scanning Standard Use	
Green	The scanner is on and ready to scan.
Momentarily Off	A barcode was successfully decoded.
Red	Transmission error, conversion or format error, or RS-232 receive error.
Off	No power is applied to the digital scanner, or the scanner is in low power mode.
Parameter Programming	
Green	Number expected. Enter value using numeric barcodes. Successful program exit with change in parameter setting.
Red	Input error: incorrect barcode, programming sequence, or Cancel scanned.
Firmware Update	
Red, alternating between solid and fast blinking	Firmware download is completing (user should wait for this indicator to complete before using the scanner). This indicator is followed by a low/medium/high power up beep.
ADF Programming	
Green	Enter another digit. Add leading zeros to the front if necessary. Enter another alphabetic character or scan the End of Message barcode. All criteria or actions cleared for current rule, continue entering rule. Delete last saved rule. The current rule is left intact. All rules deleted.
Blinking Green	Enter another criterion or action, or scan the Save Rule barcode.
Green after Blinking	Rule saved. Rule entry mode exited. Cancel rule entry. Rule entry mode exited because of an error or the user asked to exit rule entry.
Red	Out of rule memory. Erase some existing rules, then try to save rule again. Entry error, wrong barcode scanned, or criteria/action list is too long for a rule. Re-enter criterion or action.

Scanning

The DS4608 digital scanner is in hands-free (presentation) mode when it is placed in the gooseneck Intellistand. In this mode, the digital scanner operates in continuous (constant-on) mode, where it automatically decodes a barcode presented in its field of view.

When the digital scanner is not used for a user-definable period of time, it enters a low power mode in which the LEDs are turned off or illumination blinks at a low duty cycle until the digital scanner detects an image change (e.g. motion).

Scanning in Hands-Free (Presentation) Mode

The optional stand adds greater flexibility to DS4608 scanning operation. When the scanner is seated in the stand's "cup," the scanner's built-in sensor places the scanner in hands-free (presentation) mode. When the scanner is removed from the stand, it automatically switches to its programmed hand-held triggered mode.

Assemble the Stand

To assemble the stand:

1. Unscrew the wing nut from the bottom of the one piece scanner "cup."

Figure 4 Assembling the Stand

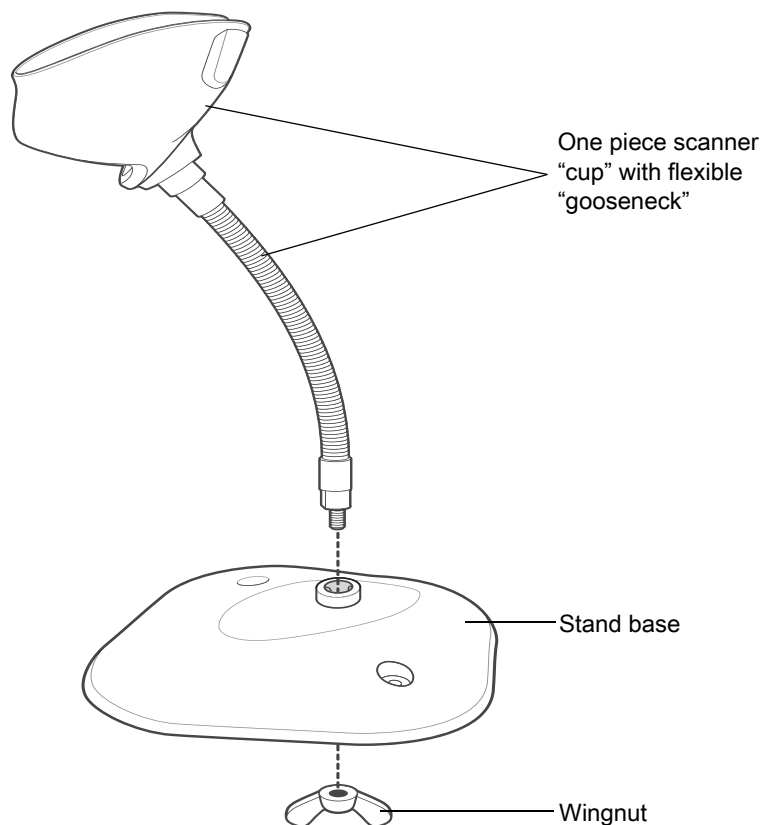

2. Fit the bottom of the gooseneck piece into the opening on the top of the stand base.
3. Tighten the wing nut underneath the base to secure the cup and neck piece to the base.
4. Bend the neck to the desired position for scanning.

Mounting the Stand (optional)

You can attach the base of the scanner's stand to a flat surface using two screws or double-sided tape (not provided).

Figure 5 Mounting the Stand

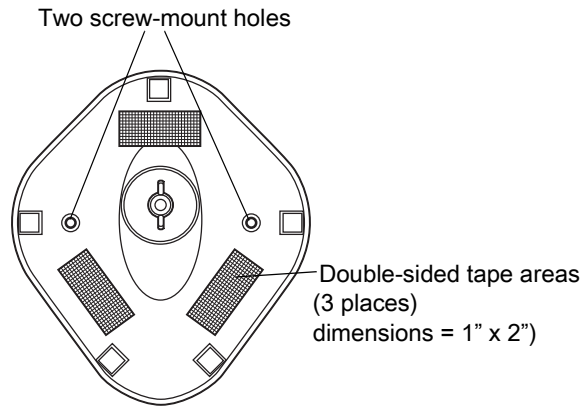

Screw Mount

1. Position the assembled base on a flat surface.
2. Screw one #10 wood screw into each screw-mount hole until the base of the stand is secure (see [Figure 5](#)).

Tape Mount

1. Peel the paper liner off one side of each piece of tape and place the sticky surface over each of the three rectangular tape holders.
2. Peel the paper liner off the exposed sides of each piece of tape and press the stand on a flat surface until it is secure (see [Figure 5](#)).

Scanning with the Stand

When the digital scanner is placed in the gooseneck Intellistand it operates in continuous (constant-on) mode, where it automatically decodes a barcode presented in its field of view.

To operate the scanner in the stand:

1. Ensure the scanner is properly connected to the host (see the appropriate host chapter for information on host connections).
2. Insert the scanner in the gooseneck Intellistand by placing the front of the scanner into the stand's "cup."

Figure 6 Inserting the Scanner in the Gooseneck Intellistand

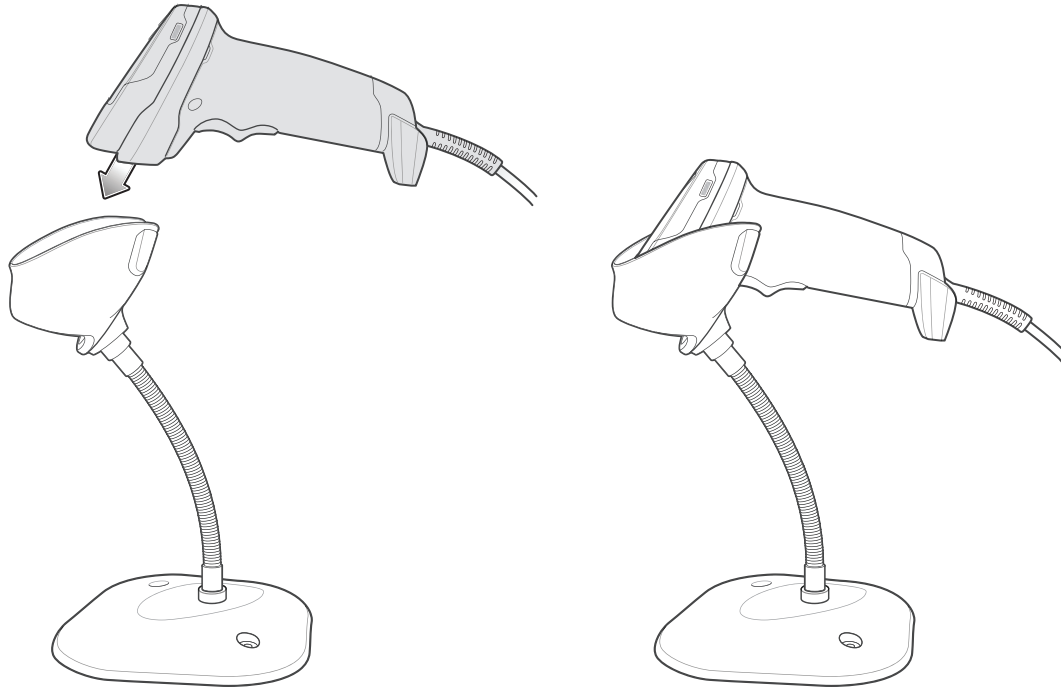

3. Adjust the scan angle by bending the stand's flexible "gooseneck" body.
4. Present the barcode. Upon successful decode, the scanner beeps and the LED momentarily shuts off. For more information about beeper and LED definitions, see [Table 3](#) and [Table 4](#).

Scanning in Hand-Held Mode

Pick up the digital scanner. The aiming dot displays.

1. Ensure the aiming dot is centered on the barcode. See [Aiming](#) below

Figure 7 Centering the Aiming Dot on the Barcode

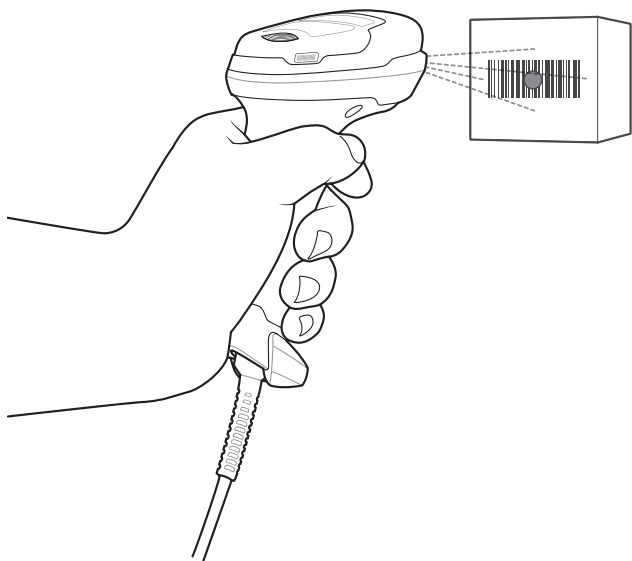

2. Press and hold the trigger until either:
 - a. The digital scanner reads the barcode. The digital scanner beeps, the LED flashes, and the aiming dot turns off.
 - Or
 - b. The digital scanner does not read the barcode and the aiming dot turns off.
3. Release the trigger.

Aiming

When scanning, the digital scanner projects an LED dot which allows positioning the barcode within its field of view. See [Decode Ranges on page 42](#) for the proper distance to achieve between the digital scanner and a barcode.

Figure 8 Aiming Dot

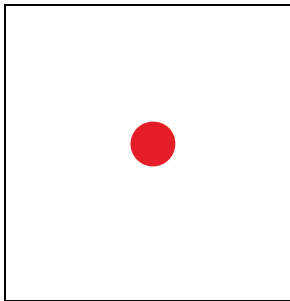

If necessary, the digital scanner turns on its illumination LEDs to illuminate the target barcode.

To scan a barcode, center the symbol and ensure the entire symbol is within the rectangular area formed by the illumination LEDs.

Figure 9 Scanning Orientation with Aiming Dot

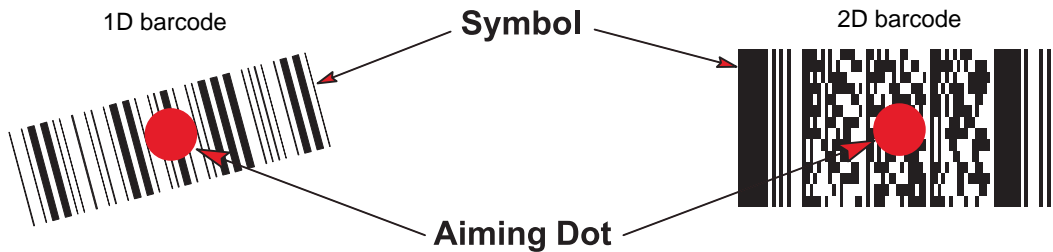

The digital scanner can also read a barcode presented within the aiming dot not centered. The top examples in [Figure](#) show acceptable aiming options, while the bottom examples can not be decoded.

Figure 10 Acceptable Aiming

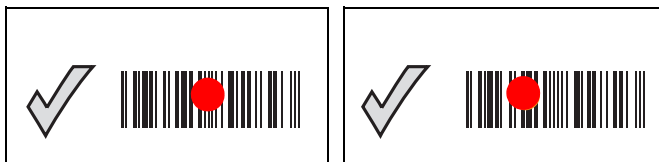
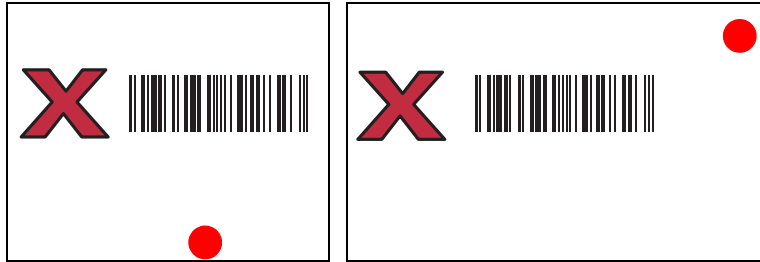

Figure 11 Incorrect Aiming



The aiming dot is smaller when the digital scanner is closer to the symbol and larger when it is farther from the symbol. Scan symbols with smaller bars or elements (mil size) closer to the digital scanner, and those with larger bars or elements (mil size) farther from the digital scanner.

The digital scanner beeps to indicate that it successfully decoded the barcode. For more information on beeper and LED definitions, see [Table 3](#) and [Table 4](#).

Decode Ranges

Table 5 DS4608SR/DL/HD/HC Decode Ranges

Barcode Type	Symbol Density	DS4608SR/DL Typical Working Ranges		DS4608HD/HC Typical Working Ranges	
		Near (in / cm)	Far (in / cm)	Near (in / cm)	Far (in / cm)
Code 128	3.0 mil	2.7 / 6.8	5.4 / 13.7	1.7 / 4.3	5.0 / 12.7
Code 39	3.0 mil	2.2 / 5.5	5.4 / 13.7	1.3 / 3.3	6.0 / 15.2
	5.0 mil	0.7 / 1.8	11.0 / 27.9	0.1 / 0.2	11.5 / 29.2
	20.0 mil	0.0 / 0.0	44.0 / 111.7	0.6 / 1.5	29.0 / 73.6
100% UPC	13.0 mil	0.0 / 0.0	28.0 / 71.1	0.0 / 0.0	18.0 / 45.7
PDF417	6.6 mil	1.3 / 3.3	10.0 / 25.4	0.6 / 1.5	9.3 / 23.6
Data Matrix	5 mil	2.8 / 7.1	5.0 / 12.7	1.8 / 4.5	5.0 / 12.7
	7.5 mil	2.0 / 5.0	8.5 / 21.5	1.0 / 2.5	8.0 / 20.3
	10.0 mil	1.0 / 2.5	11.5 / 29.2	0.2 / 0.5	9.5 / 24.1
QR Code	10.0 mil	1.0 / 2.5	9.0 / 22.8	0.2 / 0.5	8.5 / 21.5
	20.0 mil	0.0 / 0.0	17.5 / 44.4	0.0 / 0.0	13.5 / 34.3

Table 6 DS4608-DPE Decode Ranges

Barcode Type	Symbol Density	DS4608-DPE Typical Working Ranges	
		Near (in / cm)	Far (in / cm)
Code 128	2.0 mil	0.3 / 0.8	2.3 / 5.8
	3.0 mil	0.0 / 0.0	3.5 / 8.8
	15 mil	4.2 / 10.7	8.6 / 21.8
Code 39	2.0 mil	0.2 / 0.5	3.0 / 7.6
	3.0 mil	0.0 / 0.0	3.8 / 9.6
	5.0 mil	0.0 / 0.0	5.2 / 13.2
100% UPC	13.0 mil	0.0 / 0.0	8.5 / 21.5
PDF417	4.0 mil	0.0 / 0.0	3.3 / 8.4
	5.0 mil	0.0 / 0.0	3.8 / 9.6
	6.6 mil	0.0 / 0.0	4.5 / 11.4
Data Matrix	4.0 mil	0.2 / 0.5	2.8 / 7.1
	5 mil	0.0 / 0.0	3.4 / 8.6
	10.0 mil	0.0 / 0.0	4.8 / 12.2
QR Code	10.0 mil	0.0 / 0.0	4.5 / 11.4

Maintenance, Troubleshooting, & Technical Specifications

Introduction

This chapter provides suggested imaging scanner maintenance, troubleshooting, technical specifications, and signal descriptions (pinouts).

Maintenance

Known Harmful Ingredients

The following chemicals are known to damage the plastics on Zebra scanners and should not come in contact with the device:

- Acetone
- Ammonia solutions
- Aqueous or alcoholic alkaline solutions
- Aromatic and chlorinated hydrocarbons
- Benzene
- Carboric acid
- Compounds of amines or ammonia
- Ethanolamine
- Ethers
- Ketones
- TB-lysoform
- Toluene
- Trichloroethylene.

Approved Cleaners for the Imaging Scanner

- Isopropyl alcohol 70% (including pre-moistened wipes).

Approved Disinfectant Cleaners for Healthcare Configurations of the DS4608 Scanners

Only use cleaning agents from the following lists and follow the manufacturer's instructions, where applicable.

Cleaning Agents Containing Active Ingredients

- Bleach 10% (Sodium Hypoclorite 0.55%) and Water 90% Solution
- Hydrogen Peroxide 3% and Water 97%
- Mild Dish Soap

Brand Name Disinfectants

- 409® Glass and Surface Cleaner from Clorox
- Clorox Healthcare® Bleach Germicidal Disinfectant Wipes
- Dispatch® Wipes from Clorox
- Sani-Cloth® Bleach Wipes
- Windex® Blue, Windex® with Ammonia D and Windex® Cleansers: Antimicrobial from SC Johnson

Cleaning the Imaging Scanner

Routinely cleaning the exit window is required. A dirty window may affect scanning accuracy. Do not allow any abrasive material to touch the window.

To clean the scanner:

1. Dampen a soft cloth with one of the approved cleaning agents listed above or use pre-moistened wipes.
2. Gently wipe all surfaces, including the front, back, sides, top and bottom. Never apply liquid directly to the scanner. Be careful not to let liquid pool around the scanner window, trigger, cable connector or any other area on the device.
3. Be sure to clean the trigger and in between the trigger and the housing (use a cotton-tipped applicator to reach tight or inaccessible areas).
4. Do not spray water or other cleaning liquids directly into the exit window.
5. Wipe the scanner exit window with a lens tissue or other material suitable for cleaning optical material such as eyeglasses.
6. Immediately dry the scanner window after cleaning with a soft non-abrasive cloth to prevent streaking.
7. Allow the unit to air dry before use.
8. Scanner connectors:
 - a. Dip the cotton portion of a cotton-tipped applicator in isopropyl alcohol.
 - b. Rub the cotton portion of the cotton-tipped applicator back-and-forth across the connector on the Zebra scanner at least 3 times. Do not leave any cotton residue on the connector.
 - c. Use the cotton-tipped applicator dipped in alcohol to remove any grease and dirt near the connector area.
 - d. Use a dry cotton tipped applicator and rub the cotton portion of the cotton-tipped applicator back-and-forth across the connectors at least 3 times. Do not leave any cotton residue on the connectors.

Troubleshooting



NOTE: If after performing the possible solutions in [Table 7](#) the imaging scanner still experiences problems, contact the distributor or call support.

Table 7 Troubleshooting

Problem	Possible Causes	Possible Solutions
The illumination does not appear when pressing the trigger.	No power to the imaging scanner.	If the configuration requires a power supply, re-connect the power supply.
	Incorrect host interface cable is used.	Connect the correct host interface cable.
	Interface/power cables are loose.	Re-connect cables.
	Imaging scanner is disabled.	For IBM 468x and USB IBM hand-held, IBM table-top, and OPOS modes, enable the imaging scanner via the host interface. Otherwise, see the technical person in charge of scanning.
	If using RS-232 Nixdorf B mode, CTS is not asserted.	Assert CTS line.
	Illumination is disabled.	Enable the illumination. See Decoding Illumination on page 171 .
Imaging scanner emits illumination, but does not decode the barcode.	Imaging scanner is not programmed for the correct barcode type.	Program the imaging scanner to read that type of barcode. See Symbologies .
	Barcode symbol is unreadable.	Scan test symbols of the same barcode type to determine if the barcode is defaced.
	The symbol is not completely inside illumination.	Move the symbol completely within the illumination. Move the symbol completely within the field of view (AIM pattern does NOT define FOV)
	Distance between imaging scanner and barcode is incorrect.	Move the scanner closer to or further from the barcode. See Decode Ranges on page 42 .

Table 7 Troubleshooting (Continued)

Problem	Possible Causes	Possible Solutions
Imaging scanner decodes barcode, but does not transmit the data to the host.	Imaging scanner is not programmed for the correct host type.	Scan the appropriate host type programming barcode. See the chapter corresponding to the host type.
	Interface cable is loose.	Re-connect the cable.
	If the imaging scanner emits four long low beeps, a transmission error occurred. This occurs if a unit is not properly configured or connected to the wrong host type.	Set the scanner's communication parameters to match the host's setting.
	If the imaging scanner emits 5 low beeps, a conversion or format error occurred.	Configure the imaging scanner's conversion parameters properly.
	If the imaging scanner emits low/high/low beeps, it detected an invalid ADF rule.	Program the correct ADF rules. Refer to the Advanced Data Formatting Programmer Guide.
Host displays scanned data incorrectly.	Imaging scanner is not programmed to work with the host.	Scan the appropriate host type programming barcode.
		For RS-232, set the imaging scanner's communication parameters to match the host's settings.
		For a Keyboard Wedge configuration, program the system for the correct keyboard type, and turn off the CAPS LOCK key.
		Program the proper editing options (e.g., UPC-E to UPC-A Conversion).
Imaging scanner emits short low/short medium/short high beep sequence (power-up beep sequence) more than once.	The USB bus may put the imaging scanner in a state where power to the scanner is cycled on and off more than once.	Normal during host reset.
Imaging scanner emits 4 short high beeps during decode attempt.	Imaging scanner has not completed USB initialization.	Wait several seconds and scan again.
Imaging scanner emits Low/low/low/extra low beeps when not in use.	RS-232 receive error.	Normal during host reset. Otherwise, set the imaging scanner's RS-232 parity to match the host setting.
Imaging scanner emits low/high beeps during programming.	Input error, incorrect barcode or Cancel barcode was scanned.	Scan the correct numeric barcodes within range for the parameter programmed.

Table 7 Troubleshooting (Continued)

Problem	Possible Causes	Possible Solutions
Imaging scanner emits low/high/low/high beeps during programming.	Out of host parameter storage space.	Scan Default Parameters on page 142 .
	Out of memory for ADF rules.	Reduce the number of ADF rules or the number of steps in the ADF rules.
	During programming, indicates out of ADF parameter storage space.	Erase all rules and re-program with shorter rules.
Imaging scanner emits low/high/low beeps.	ADF transmit error.	Refer to the Advanced Data Formatting Guide for information.
	Invalid ADF rule is detected.	Refer to the Advanced Data Formatting Guide for information.
Imaging scanner emits a power-up beep after changing USB host type.	The USB bus re-established power to the imaging scanner.	Normal when changing USB host type.
Imaging scanner emits one high beep when not in use.	In RS-232 mode, a <BEL> character was received and Beep on <BEL> option is enabled.	Normal when Beep on <BEL> is enabled and the imaging scanner is in RS-232 mode.
Imaging scanner emits frequent beeps.	Incorrect host interface cable is used.	Verify that the correct host interface cable is used. If not, connect the correct host interface cable.
	Interface/power cables are loose.	Check for loose cable connections and re-connect cables.
Imaging scanner emits five long low beeps after a barcode is decoded.	Conversion or format error was detected. The scanner conversion parameters are not properly configured.	Ensure the scanner conversion parameters are properly configured.
	Conversion or format error was detected. An ADF rule was set up with characters that can't be sent for the host selected.	Change the ADF rule, or change to a host that can support the ADF rule.
	Conversion or format error was detected. A barcode was scanned with characters that can't be sent for that host.	Change the barcode, or change to a host that can support the barcode.

Send Versions

Software Version

Scan the following barcode to send the version of software installed in the scanner.



Software Version

Serial Number

Scan the following barcode to send the scanner serial number to the host.

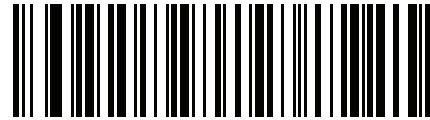

Serial Number

Manufacturing Information

Scan the following barcode to send the scanner manufacturing information to the host.

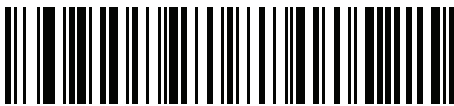

Manufacturing Information

Technical Specifications

Table 8 Technical Specifications - DS4608-SR/DS4608-DL/DS4608-HD/DS4608-HL

Item	Description
Physical Characteristics	
Dimensions	6.5 in. H x 2.6 in. W x 3.9 in. D 16.5 cm H x 6.7 cm W x 9.8 cm D
Weight	5.7 oz. /161.9 g
Input Voltage Range	4.5 to 5.5 VDC Host Powered; 4.5 to 5.5 VDC External Power Supply
Operating Current at Nominal Voltage (5.0V)	340 mA (typical)
Standby Current (Idle) at Nominal Voltage (5.0V)	150 mA (typical)
Color	Nova White, Twilight Black
Supported Host Interfaces	USB, RS232, TGCS (IBM) 46XX over RS485
USB Certification	DS4608 is USB2.0 Full Speed Compliant, visit USB.org for more details.
Keyboard Support	Supports over 90 international keyboards
Electronic Article Surveillance	Compatible with Checkpoint EAS deactivation system
User Indicators	Direct Decode Indicator, Good Decode LEDs, rear view LEDs, beeper (adjustable tone and volume)
Performance Characteristics	
Light Source	Aiming Pattern: circular 617nm amber LED
Illumination	(2) 660nm Red LEDs
Imager Field of View	36.1° H x 22.6° V nominal
Image Sensor	1280 x 800 pixels
Minimum Print Contrast	15% minimum reflective difference
Skew Tolerance	+/- 60°
Pitch Tolerance	+/- 60°
Roll Tolerance	0°-360°
Imaging Characteristics	
Graphics Format Support	Images can be exported as Bitmap, JPEG or TIFF
Image Quality	96PPI on an A4 document (DS4608-SR)
¹ Printing resolution, contrast, and ambient light dependent	

Table 8 Technical Specifications - DS4608-SR/DS4608-DL/DS4608-HD/DS4608-HL (Continued)

Item	Description
Environmental	
Operating Temperature	32.0° to 122.0° F / 0.0° to 50.0° C
Storage Temperature	-40.0° to 158.0° F / -40.0° to 70.0° C
Humidity	5% to 95% RH, non-condensing
Drop Specification	Designed to withstand multiple drops at 6.0 ft./1.8 m to concrete
Tumble Specification	Designed to withstand 2,000 tumbles in 1.5 ft./0.5 m tumbler
Environmental Sealing	IP52
Electrostatic Discharge (ESD)	ESD per EN61000-4-2, +/-15 KV Air, +/-8 KV Direct, +/-8 KV Indirect
Ambient Light Immunity	0 to 10,000 foot candles/0 to 107,000 Lux
Accessories	
Gooseneck Intellistand, Cup	
Symbol Decode Capability	
1D	Code 39, Code 128, Code 93, Codabar/NW7, Code 11, MSI Plessey, UPC/EAN, I 2 of 5, Korean 3 of 5, GS1 DataBar, Base 32 (Italian Pharma)
2D	PDF417, Micro PDF417, Composite Codes, TLC-39, Aztec, DataMatrix, MaxiCode, QR Code, Micro QR, Han Xin, Postal Codes, SecurPharm, DotCode, Dotted DataMatrix
OCR	OCR-A, OCR-B, MICR, US Currency
Minimum Element Resolution	Code 39 - 3.0 mil (DS4608-SR)
	DataMatrix - 5.0 mil (DS4608-SR)
	Code 39 - 2.0 mil (DS4608-HD)
	DataMatrix - 4.0 mil (DS4608-HD)
DS4608-SR/DL Decode Ranges (Typical) ¹	
Symbology/Resolution	Near/Far
Code 39: 3 mil	2.2 in./5.6 cm to 5.4 in./13.7 cm
Code 39: 5 mil	0.7 in./1.8 cm to 11.0 in./27.9 cm
Code 39: 20 mil	0 in./0 cm to 44.0 in./111.8 cm
Code 128: 5 mil	2.7 in./6.9 cm to 5.4 in./13.7 cm
PDF 417: 6.7 mil	1.3 in./3.3 cm to 10.0 in./25.4 cm
UPC: 13 mil (100%)	0 in./0 cm to 28.0 in./71.1 cm
DataMatrix: 10 mil	1.0 in./2.5 cm to 11.5 in./29.2 cm
QR: 20 mil	0 in./0 cm to 17.5 in./44.5 cm
¹ Printing resolution, contrast, and ambient light dependent	

Table 8 Technical Specifications - DS4608-SR/DS4608-DL/DS4608-HD/DS4608-HL (Continued)

Item	Description
DS4608-HD/HL Decode Ranges (Typical) ¹	
Symbology/Resolution	Near/Far
Code 39: 3 mil	1.3 in./3.3 cm to 6.0 in./15.2 cm
Code 39: 5 mil	0 .1 in./0.3 cm to 11.5 in./29.2 cm
Code 39: 20 mil	0.6 in./1.5 cm to 29.0 in./73.7 cm
Code 128: 5 mil	1.7 in./4.3 cm to 5.0 in./12.7 cm
PDF 417: 6.7 mil	0.6 in./1.5 cm to 9.3 in./23.6 cm
UPC: 13 mil (100%)	0 in./0 cm to 18.0 in./45.7 cm
DataMatrix: 10 mil	0.2 in./0.5 cm to 9.5 in./24.1 cm
QR: 20 mil	0 in./0 cm to 13.5 in./34.3 cm
Utilities and Management	
123Scan	Programs scanner parameters, upgrades firmware, provides scanned barcode data and prints reports. See 123Scan and Software Tools . www.zebra.com/123Scan
Symbol Scanner SDK	Generates a fully-featured scanner application, including documentation, drivers, test utilities and sample source code. www.zebra.com/ScannerSDKforWindows
Scanner Management Service (SMS)	Remotely manages your Zebra scanner and queries its asset information. www.zebra.com/sms
¹ Printing resolution, contrast, and ambient light dependent	

Table 9 Technical Specifications - DS4608-HC

Item	Description
Physical Characteristics	
Dimensions	6.5 in. H x 2.6 in. W x 3.9 in. D 16.5 cm H x 6.7 cm W x 9.8 cm D
Weight	5.7 oz. /161.9 g
Input Voltage Range	4.5 to 5.5 VDC Host Powered; 4.5 to 5.5 VDC External Power Supply
Operating Current at Nominal Voltage (5.0V)	375 mA (typical)
Standby Current (Idle) at Nominal Voltage (5.0V)	150 mA (typical)
Color	Healthcare White
Supported Host Interfaces	USB, RS232, TGCS (IBM) 46XX over RS485
¹ Printing resolution, contrast, and ambient light dependent	

Table 9 Technical Specifications - DS4608-HC (Continued)

Item	Description
USB Certification	DS4608 is USB2.0 Full Speed Compliant, visit USB.org for more details.
Keyboard Support	Supports over 90 international keyboards
User Indicators	Direct Decode Indicator, Good Decode LEDs, rear view LEDs, beeper (adjustable tone and volume), haptic/vibration
Performance Characteristics	
Light Source	Aiming Pattern: circular 528nm true green LED
Illumination	(2)warm white LEDs
Imager Field of View	35° H x 22° V nominal
Image Sensor	1280 x 800 pixels
Minimum Print Contrast	15% minimum reflective difference
Skew Tolerance	+/- 60°
Pitch Tolerance	+/- 60°
Roll Tolerance	0° - 360°
Imaging Characteristics	
Graphics Format Support	Images can be exported as Bitmap, JPEG or TIFF
Environmental	
Operating Temperature	32.0° to 122.0° F / 0.0° to 50.0° C
Storage Temperature	-40.0° to 158.0° F / -40.0° to 70.0° C
Humidity	5% to 95% RH, non-condensing
Drop Specification	Designed to withstand multiple drops at 6.0 ft./1.8 m to concrete
Tumble Specification	Designed to withstand 2,000 tumbles in 1.5 ft./0.5 m tumbler
Environmental Sealing	IP52
Approved Cleaners	Disinfectant Ready. See Approved Disinfectant Cleaners for Healthcare Configurations of the DS4608 Scanners on page 45.
Electrostatic Discharge (ESD)	ESD per EN61000-4-2, +/-15 KV Air, +/-8 KV Direct, +/-8 KV Indirect
Ambient Light Immunity	0 to 10,000 foot candles/0 to 107,000 Lux
Accessories	
Gooseneck Intellistand, Cup	
¹ Printing resolution, contrast, and ambient light dependent	

Table 9 Technical Specifications - DS4608-HC (Continued)

Item	Description																		
Symbol Decode Capability																			
1D	Code 39, Code 128, Code 93, Codabar/NW7, Code 11, MSI Plessey, UPC/EAN, I 2 of 5, Korean 3 of 5, GS1 DataBar, Base 32 (Italian Pharma)																		
2D	PDF417, Micro PDF417, Composite Codes, TLC-39, Aztec, DataMatrix, MaxiCode, QR Code, Micro QR, Han Xin, Postal Codes, SecurPharm																		
OCR	OCR-A, OCR-B, MICR, US Currency																		
Minimum Element Resolution	Code 39 - 2.0 mil DataMatrix - 4.0 mil																		
DS4608-HC Decode Ranges (Typical) ¹																			
<table border="1"> <thead> <tr> <th data-bbox="198 690 631 724">Symbology/Resolution</th> <th data-bbox="639 690 1521 724">Near/Far</th> </tr> </thead> <tbody> <tr> <td data-bbox="198 724 631 758">Code 39: 3 mil</td> <td data-bbox="639 724 1521 758">1.3 in./3.3 cm to 6.0 in./15.2 cm</td> </tr> <tr> <td data-bbox="198 758 631 791">Code 39: 5 mil</td> <td data-bbox="639 758 1521 791">0.1 in./0.3 cm to 11.5 in./29.2 cm</td> </tr> <tr> <td data-bbox="198 791 631 825">Code 39: 20 mil</td> <td data-bbox="639 791 1521 825">0.6 in./1.5 cm to 29.0 in./73.7 cm</td> </tr> <tr> <td data-bbox="198 825 631 858">Code 128: 5 mil</td> <td data-bbox="639 825 1521 858">1.7 in./4.3 cm to 5.0 in./12.7 cm</td> </tr> <tr> <td data-bbox="198 858 631 892">PDF 417: 6.7 mil</td> <td data-bbox="639 858 1521 892">0.6 in./1.5 cm to 9.3 in./23.6 cm</td> </tr> <tr> <td data-bbox="198 892 631 926">UPC: 13 mil (100%)</td> <td data-bbox="639 892 1521 926">0 in./0 cm to 18.0 in./45.7 cm</td> </tr> <tr> <td data-bbox="198 926 631 959">DataMatrix: 10 mil</td> <td data-bbox="639 926 1521 959">0.2 in./0.5 cm to 9.5 in./24.1 cm</td> </tr> <tr> <td data-bbox="198 959 631 993">QR: 20 mil</td> <td data-bbox="639 959 1521 993">0 in./0 cm to 13.5 in./34.3 cm</td> </tr> </tbody> </table>	Symbology/Resolution	Near/Far	Code 39: 3 mil	1.3 in./3.3 cm to 6.0 in./15.2 cm	Code 39: 5 mil	0.1 in./0.3 cm to 11.5 in./29.2 cm	Code 39: 20 mil	0.6 in./1.5 cm to 29.0 in./73.7 cm	Code 128: 5 mil	1.7 in./4.3 cm to 5.0 in./12.7 cm	PDF 417: 6.7 mil	0.6 in./1.5 cm to 9.3 in./23.6 cm	UPC: 13 mil (100%)	0 in./0 cm to 18.0 in./45.7 cm	DataMatrix: 10 mil	0.2 in./0.5 cm to 9.5 in./24.1 cm	QR: 20 mil	0 in./0 cm to 13.5 in./34.3 cm	
Symbology/Resolution	Near/Far																		
Code 39: 3 mil	1.3 in./3.3 cm to 6.0 in./15.2 cm																		
Code 39: 5 mil	0.1 in./0.3 cm to 11.5 in./29.2 cm																		
Code 39: 20 mil	0.6 in./1.5 cm to 29.0 in./73.7 cm																		
Code 128: 5 mil	1.7 in./4.3 cm to 5.0 in./12.7 cm																		
PDF 417: 6.7 mil	0.6 in./1.5 cm to 9.3 in./23.6 cm																		
UPC: 13 mil (100%)	0 in./0 cm to 18.0 in./45.7 cm																		
DataMatrix: 10 mil	0.2 in./0.5 cm to 9.5 in./24.1 cm																		
QR: 20 mil	0 in./0 cm to 13.5 in./34.3 cm																		
Utilities and Management																			
123Scan	Programs scanner parameters, upgrades firmware, provides scanned barcode data and prints reports. See 123Scan and Software Tools . www.zebra.com/123Scan																		
Symbol Scanner SDK	Generates a fully-featured scanner application, including documentation, drivers, test utilities and sample source code. www.zebra.com/ScannerSDKforWindows																		
Scanner Management Service (SMS)	Remotely manages your Zebra scanner and queries its asset information. www.zebra.com/sms																		
¹ Printing resolution, contrast, and ambient light dependent																			

Table 10 Technical Specifications - DS4608-DPE

Item	Description
Physical Characteristics	
Dimensions	6.5 in. H x 2.6 in. W x 3.9 in. D 16.5 cm H x 6.7 cm W x 9.8 cm D
Weight	5.7 oz. /161.9 g
Input Voltage Range	4.5 to 5.5 VDC Host Powered; 4.5 to 5.5 VDC External Power Supply
Operating Current at Nominal Voltage (5.0V)	375 mA (typical)
Standby Current (Idle) at Nominal Voltage (5.0V)	150 mA (typical)
Color	Twilight Black
Supported Host Interfaces	USB, RS232, TGCS (IBM) 46XX over RS485
USB Certification	DS4608 is USB2.0 Full Speed Compliant, visit USB.org for more details.
Keyboard Support	Supports over 90 international keyboards
User Indicators	Direct Decode Indicator, Good Decode LEDs, rear view LEDs, beeper (adjustable tone and volume), haptic/vibration
Performance Characteristics	
Light Source	Aiming Pattern: circular 528nm true green LED
Illumination	(2) warm white LEDs
Imager Field of View	34° H x 21.6° V nominal
Image Sensor	1280 x 800 pixels
Minimum Print Contrast	15% minimum reflective difference
Skew Tolerance	+/- 60°
Pitch Tolerance	+/- 60°
Roll Tolerance	0°- 360°
Imaging Characteristics	
Graphics Format Support	Images can be exported as Bitmap, JPEG or TIFF
Environmental	
Operating Temperature	32.0° to 122.0° F / 0.0° to 50.0° C
Storage Temperature	-40.0° to 158.0° F / -40.0° to 70.0° C
¹ Printing resolution, contrast, and ambient light dependent	

Table 10 Technical Specifications - DS4608-DPE (Continued)

Item	Description
Humidity	5% to 95% RH, non-condensing
Drop Specification	Designed to withstand multiple drops at 6.0 ft./1.8 m to concrete
Tumble Specification	Designed to withstand 2,000 tumbles in 1.5 ft./0.5 m tumbler
Environmental Sealing	IP52
Electrostatic Discharge (ESD)	ESD per EN61000-4-2, +/-15 KV Air, +/-8 KV Direct, +/-8 KV Indirect
Ambient Light Immunity	0 to 10,000 Foot Candles / 0 to 107,600 Lux
Accessories	
Gooseneck Intellistand, Cup	
Symbol Decode Capability	
1D	Code 39, Code 128, Code 93, Codabar/NW7, Code 11, MSI Plessey, UPC/EAN, I 2 of 5, Korean 3 of 5, GS1 DataBar, Base 32 (Italian Pharma)
2D	PDF417, Micro PDF417, Composite Codes, TLC-39, Aztec, DataMatrix, DotCode, Dotted DataMatrix, MaxiCode, QR Code, Micro QR, Han Xin, Postal Codes, SecurPharm
Minimum Element Resolution	Code 39 - 2.0 mil DataMatrix - 4.0 mil
DS4608-HC Decode Ranges (Typical) ¹	
Symbology/Resolution	Near/Far
Code 128: 2 mil	0.3 in./0.8 cm to 2.3 in./5.8 cm
Code 128: 3 mil	0 in./0 cm to 3.5 in./8.8 cm
Code 128: 15 mil	4.2 in./10.7 cm to 8.6 in./21.8 cm
Code 39: 2 mil	0.2 in./0.5 cm to 3.0 in./7.6 cm
Code 39: 3 mil	0 in./0 cm to 3.8 in./9.6 cm
Code 39: 5 mil	0 in./0 cm to 5.2 in./13.2 cm
PDF 417: 4 mil	0 in./0 cm to 3.3 in./8.4 cm
PDF 417: 5 mil	0 in./0 cm to 3.8 in./9.6 cm
PDF 417: 6.6 mil	0 in./0 cm to 4.5 in./11.4 cm
UPC: 13 mil (100%)	0 in./0 cm to 8.5 in./21.5 cm
Data Matrix: 4 mil	0.2 in./0.5 cm to 2.8 in./7.1 cm
Data Matrix: 5 mil	0 in./0 cm to 3.4 in./8.6 cm
Data Matrix: 10 mil	0 in./0 cm to 4.8 in./12.2 cm
QR Code: 10 mil	0 in./0 cm to 4.5 in./11.4 cm
Utilities and Management	
¹ Printing resolution, contrast, and ambient light dependent	

Table 10 Technical Specifications - DS4608-DPE (Continued)

Item	Description
123Scan	Programs scanner parameters, upgrades firmware, provides scanned barcode data and prints reports. See 123Scan and Software Tools . www.zebra.com/123Scan
Symbol Scanner SDK	Generates a fully-featured scanner application, including documentation, drivers, test utilities and sample source code. www.zebra.com/ScannerSDKforWindows
Scanner Management Service (SMS)	Remotely manages your Zebra scanner and queries its asset information. www.zebra.com/sms
¹ Printing resolution, contrast, and ambient light dependent	

Imaging Scanner Signal Descriptions

Figure 12 Imaging Scanner Cable Pinouts

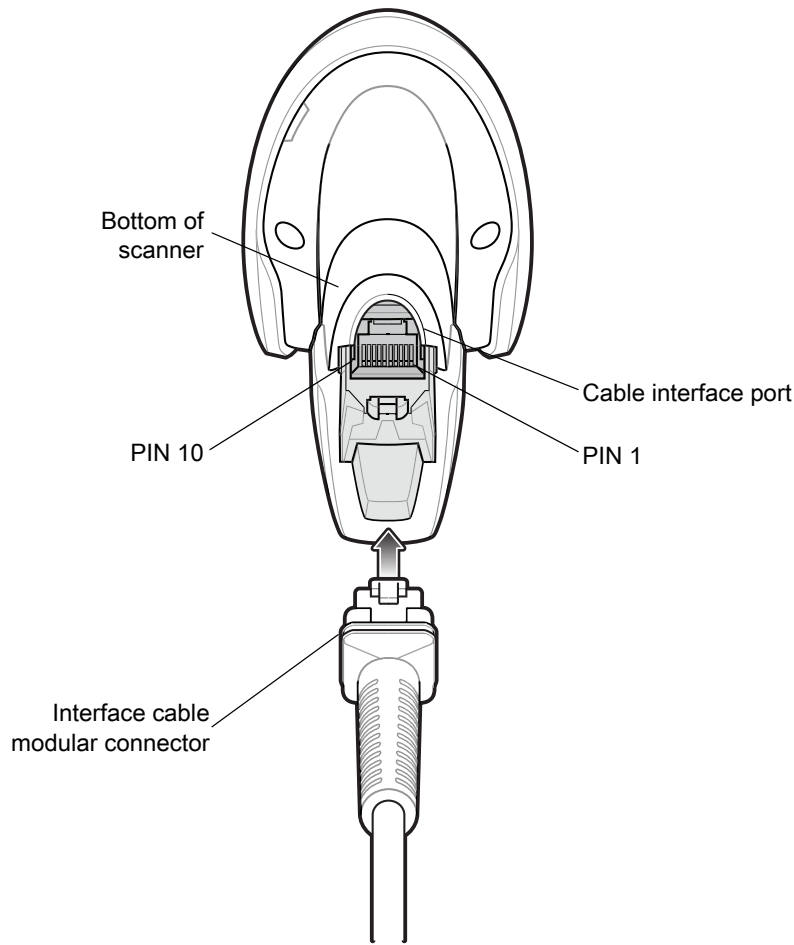

The signal descriptions in [Table 11](#) apply to the connectors on the DS4608 imaging scanner and are for reference only.

Table 11 DS4608 Imaging Scanner Signal Pin-outs

Pin	IBM	RS-232	Keyboard Wedge	USB
1	Cable ID	Cable ID	Cable ID	Cable ID
2	Power (+5V)	Power (+5V)	Power (+5V)	Power (+5V)
3	Ground	Ground	Ground	Ground
4	IBM_OUT	TxD	KeyClock	Reserved
5	IBM_IN	RxD	TermData	D +
6	IBM_T/R	RTS	KeyData	Reserved
7	Reserved	CTS	TermClock	D -
8	Reserved	Reserved	Reserved	Reserved
9	See note			
10	See note			

Note: EAS configurations use pins 9 and 10 for an EAS antenna. For other configurations pins 9 and 10 are open.

USB Interface

Introduction

This chapter describes how to set up the scanner with a USB host. The scanner connects directly to a USB host, or a powered USB hub, which powers it. No additional power supply is required.

The scanner ships with the settings shown in [Table 12 on page 61](#) (also see [Standard Parameter Defaults](#) for all defaults). If the default values suit requirements, programming is not necessary.

Setting Parameters

To set feature values, scan a single barcode or a short barcode sequence. The settings are stored in non-volatile memory and are preserved even when the scanner powers down.



NOTE: Most computer monitors allow scanning barcodes directly on the screen. When scanning from the screen, be sure to set the document magnification to a level where you can see the barcode clearly, and bars and/or spaces do not merge.

To return all features to default values, scan [Set Factory Defaults on page 142](#). Throughout the programming barcode menus, asterisks (*) indicate default values.



* Indicates default *Enable Parameter Feature/option

Scanning Sequence Examples

In most cases scanning one barcode sets the parameter value. For example, to set the USB keystroke delay to medium, scan the **Medium Delay (20 msec)** barcode under [USB Keystroke Delay on page 65](#). The scanner issues a fast warble beep and the LED turns green, signifying a successful parameter entry.

Other parameters require scanning several barcodes. See the parameter descriptions for this procedure.

Errors While Scanning

Unless otherwise specified, to correct an error during a scanning sequence, just re-scan the correct parameter.

Connecting a USB Interface

Figure 13 USB Connection

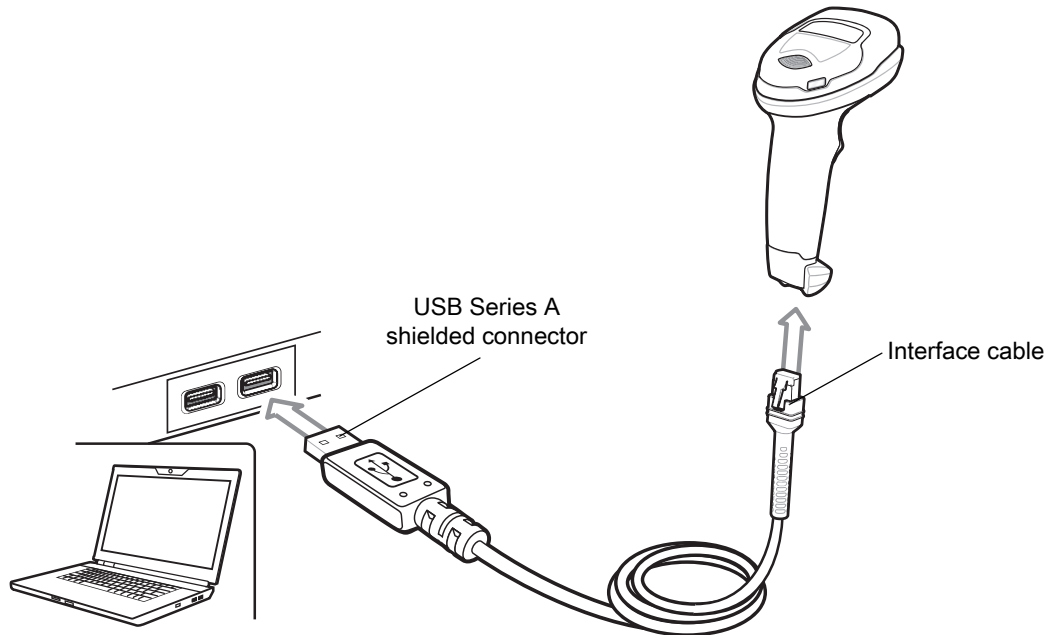

NOTE: When connecting via USB use the shielded connector cable (e.g., p/n CBA-U21-S07ZAR). Refer to Solution Builder for guidance about cables.

The scanner connects to USB-capable hosts including:

- TGCS (IBM) terminals
- Apple™ desktop and notebooks
- Other network computers that support more than one keyboard.

The following operating systems support the scanner through USB:

- Windows® XP, 7, 8, 10
- MacOS 8.5 - MacOS 10.6
- IBM 4690 OS.

The scanner also interfaces with other USB hosts that support USB Human Interface Devices (HID).

To set up the scanner:



NOTE: Interface cables vary depending on configuration. The connectors illustrated in [Figure 13](#) are examples only. The connectors may be different than those illustrated, but the steps to connect the scanner are the same.

1. Connect the modular connector of the USB interface cable to the cable interface port on the scanner. See [Inserting the Interface Cable on page 28](#).
2. Plug the series A connector in the USB host or hub, or plug the Plus Power connector in an available port of the IBM SurePOS terminal.
3. The scanner automatically detects the host and uses the default USB device type. If the default (*) does not meet your requirements, select another USB device type by scanning the appropriate barcode from [USB Device Type on page 62](#).
4. On first installation when using Windows, the software may prompt to select or install the Human Interface Device driver. To install this driver, provided by Windows, click **Next** at all choices and click **Finished** on the last choice. The scanner powers up during this installation.
5. To modify any other parameter options, scan the appropriate barcodes in this chapter.

If problems occur with the system, see [Troubleshooting on page 46](#).

USB Parameter Defaults

[Table 12](#) lists defaults for USB host parameters. Change these values in one of two ways:

- Scan the appropriate barcodes in this chapter. The new value replaces the standard default value in memory. To recall default parameter values, see [Default Parameters on page 142](#).
- Configure the scanner using the 123Scan configuration program. See [123Scan and Software Tools](#).



NOTE: See [Standard Parameter Defaults](#) for all user preference, host, symbology, and miscellaneous default parameters.

Table 12 USB Interface Parameter Defaults

Parameter	Default	Page Number
USB Host Parameters		
USB Device Type	USB HID Keyboard	62
Symbol Native API (SNAPI) Status Handshaking	Enable	64
USB Keystroke Delay	No Delay	65
USB Caps Lock Override	Do Not Override (Disable)	65
Barcodes with Unknown Characters	Send Barcodes with Unknown Characters	66
USB Convert Unknown to Code 39	Disable	66
USB Fast HID	Enable	67
USB Polling Interval	3 msec	68
Keypad Emulation	Enable	70
Quick Keypad Emulation	Enable	70
Keypad Emulation with Leading Zero	Enable	71
USB FN1 Substitution	Disable	71
Function Key Mapping	Disable	72

Table 12 USB Interface Parameter Defaults (Continued)

Parameter	Default	Page Number
Simulated Caps Lock	Disable	72
Convert Case	None	73
USB Static CDC	Enable	74
CDC Beep on <BEL>	Enable	74
TGCS (IBM) USB Direct I/O Beep	Honor	75
TGCS (IBM) USB Beep Directive	Ignore	75
TGCS (IBM) USB Barcode Configuration Directive	Ignore	76
TGCS (IBM) USB Specification Version	Version 2.2	76

USB Host Parameters

USB Device Type

Scan one of the following barcodes to select the USB device type. To select a country keyboard type for the **USB HID Keyboard** host, see [Country Codes](#).



NOTES

- When changing USB Device Types, the scanner resets and issues the standard startup beep sequences.
- When connecting two scanners to a host, IBM does not allow selecting two of the same device type. If you require two connections, select **IBM Table-top USB** for one scanner and **IBM Hand-held USB** for the second scanner.
- Select **IBM Hand-held USB** to transmit data only once when an IBM register issues a Scan Disable command. If the register issues a Scan Enable command before the timeout expires, scanning can continue. If a Scan Enable does not occur within the timeout, the scanner issues 4 long low transmission error beeps, and data does not transmit. You can then scan again under the same criteria.

Select **OPOS (IBM Hand-held with Full Disable)** to completely shut off the scanner when an IBM register issues a Scan Disable command, including aim, illumination, decoding, and data transmission.

- Before selecting **USB CDC Host**, install the Zebra USB CDC driver located at <https://www.zebra.com/us/en/support-downloads/software/drivers/usb-cdc-driver.html> on the host.
 - If using Windows XP, this self-contained driver provides functionality but prompts with a warning message as Microsoft no longer re-certifies drivers for this operating system.
 - Windows 10 includes a native CDC driver that supports Zebra scanners. Use this to provide CDC functionality in the Windows 10 environment.
 - To recover a stalled scanner:
 - Install the Zebra USB CDC driver, or,
 - After power-up, hold the trigger for 10 seconds, which allows the scanner to power up using an alternate USB configuration. Upon power-up, scan another USB Device Type.
- To select the Toshiba TEC device type, refer to the Toshiba TEC Programmer's Guide.

USB Device Type (continued)



***USB HID Keyboard**



IBM Table-top USB

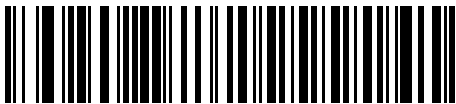

IBM Hand-held USB



**OPOS
(IBM Hand-held with Full Disable)**

USB Device Type (continued)



USB CDC Host

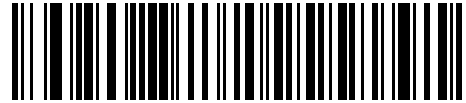

SSI over USB CDC



Symbol Native API (SNAPI) with Imaging Interface



Symbol Native API (SNAPI) without Imaging Interface

Symbol Native API (SNAPI) Status Handshaking

After selecting a SNAPI interface as the USB device type, scan one of the following barcodes to select whether to enable or disable status handshaking.



***Enable SNAPI Status Handshaking**



Disable SNAPI Status Handshaking

USB Keystroke Delay

Scan one of the following barcodes to set the delay, in milliseconds, between emulated keystrokes. Select a longer delay for hosts that require slower data transmission.



***No Delay**

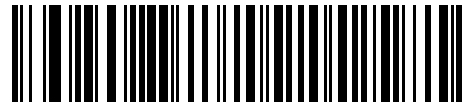

Medium Delay (20 msec)

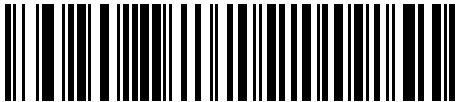

Long Delay (40 msec)

USB Caps Lock Override

This option applies only to the USB HID Keyboard device. Scan **Override Caps Lock Key** to preserve the case of the data regardless of the state of the **Caps Lock** key. This setting is always enabled for the Japanese Windows (ASCII) keyboard type and can not be disabled.



**Override Caps Lock Key
(Enable)**



***Do Not Override Caps Lock Key
(Disable)**

Barcodes with Unknown Characters

This option applies only to the USB HID Keyboard and IBM devices. Unknown characters are characters the host does not recognize. Scan **Send Barcodes With Unknown Characters** to send all barcode data except for unknown characters. The scanner issues no error beeps.

Scan **Do Not Send Barcodes With Unknown Characters** for IBM devices to prevent sending barcodes containing at least one unknown character to the host, or for USB HID Keyboard devices to send the barcode characters up to the unknown character. The scanner issues an error beep.

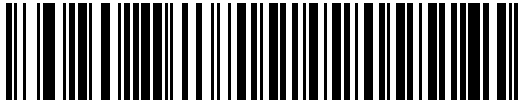

***Send Barcodes with Unknown Characters**



Do Not Send Barcodes with Unknown Characters

USB Convert Unknown to Code 39

This option applies only to the IBM hand-held, IBM table-top, and OPOS devices. Scan one of the following barcodes to enable or disable converting unknown barcode type data to Code 39.



Enable Convert Unknown to Code 39



***Disable Convert Unknown to Code 39**

USB Fast HID

Scan **Enable USB Fast HID** to transmit USB HID data at a faster rate.



NOTE: Disable this if there are problems with transmission.

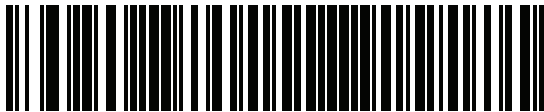

***Enable USB Fast HID**

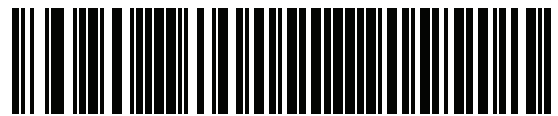

Disable USB Fast HID

USB Polling Interval

Scan one of the following barcodes to set the polling interval, which is the rate at which data transmits between the scanner and host computer. A lower number indicates a faster data rate.



NOTE: When changing the USB polling interval, the scanner restarts and issues a power-up beep sequence.



IMPORTANT: Ensure the host supports the selected data rate.



1 msec

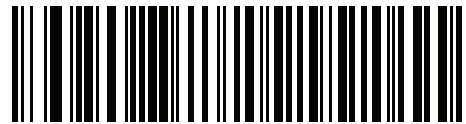

2 msec

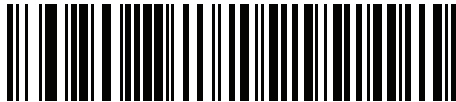

*3 msec

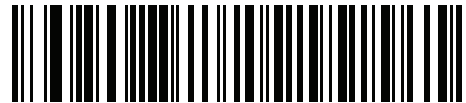

4 msec

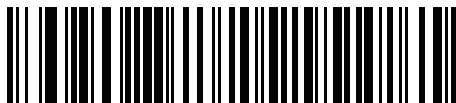

5 msec

USB Polling Interval (continued)



6 msec



7 msec



8 msec

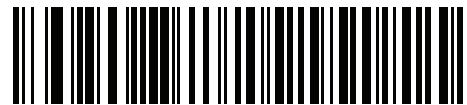

9 msec

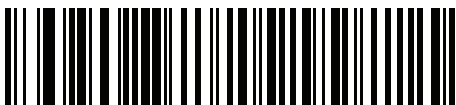

10 msec

Keypad Emulation

Scan **Enable Keypad Emulation** to send all characters as ASCII sequences over the numeric keypad. For example, ASCII A transmits as “ALT make” 0 6 5 “ALT Break”.



NOTE: If your keyboard type is not listed in the country code list (see [Country Codes on page 491](#)), disable [Quick Keypad Emulation](#) and enable **Keypad Emulation**.

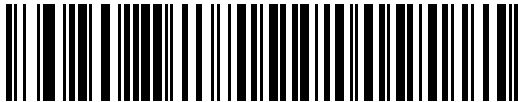

***Enable Keypad Emulation**



Disable Keypad Emulation

Quick Keypad Emulation

This option applies only to the USB HID Keyboard device when [Keypad Emulation](#) is enabled. Scan **Enable Quick Keypad Emulation** for a quicker method of emulation using the numeric keypad where ASCII sequences are only sent for ASCII characters not found on the keyboard.



***Enable Quick Keypad Emulation**



Disable Quick Keypad Emulation

Keypad Emulation with Leading Zero

Scan **Enable Keypad Emulation with Leading Zero** to send character sequences sent over the numeric keypad as ISO characters which have a leading zero. For example, ASCII A transmits as “ALT MAKE” 0 0 6 5 “ALT BREAK”.



***Enable Keypad Emulation with Leading Zero**



Disable Keypad Emulation with Leading Zero

USB Keyboard FN1 Substitution

This option applies only to the USB HID Keyboard device. Scan **Enable USB Keyboard FN1 Substitution** to replace any FN1 character in a GS1 128 barcode with a user-selected Key Category and value. See [FN1 Substitution Values on page 183](#) to set the Key Category and Key Value.



Enable USB Keyboard FN1 Substitution



***Disable USB Keyboard FN1 Substitution**

Function Key Mapping

ASCII values under 32 are normally sent as a control-key sequence (see [Table 38 on page 471](#)). Scan **Enable Function Key Mapping** to send the keys in bold in place of the standard key mapping. Table entries that do not have a bold equivalent remain the same regardless of whether you enable this parameter.



Enable Function Key Mapping

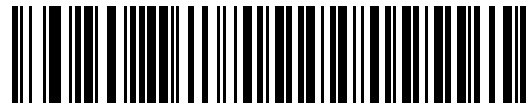

***Disable Function Key Mapping**

Simulated Caps Lock

Scan **Enable Simulated Caps Lock** to invert upper and lower case characters on the barcode as if the Caps Lock state is enabled on the keyboard. This inversion occurs regardless of the keyboard's **Caps Lock** state.



NOTE: Simulated Caps Lock applies to ASCII characters only.

Do not enable this if [USB Caps Lock Override on page 65](#) is enabled.

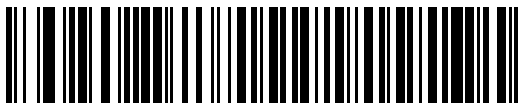

Enable Simulated Caps Lock

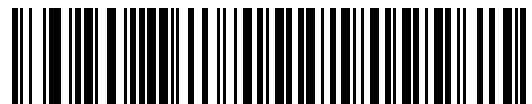

***Disable Simulated Caps Lock**

Convert Case

Scan one of the following barcodes to convert all barcode data to the selected case.



NOTE: Convert Case applies to ASCII characters only.

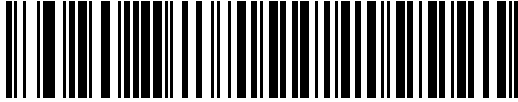

***No Case Conversion**

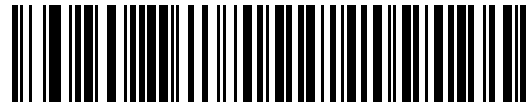

Convert All to Upper Case

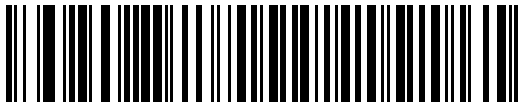

Convert All to Lower Case

USB Static CDC

When disabled, each device connected consumes another COM port (first device = COM1, second device = COM2, third device = COM3, etc.)

When enabled, each device connects to the same COM port.



***Enable USB Static CDC**



Disable USB Static CDC

CDC Beep on <BEL>

If you enable this parameter, the scanner issues a beep when it detects a <BEL> character in USB CDC communications. <BEL> indicates an illegal entry or other important event.

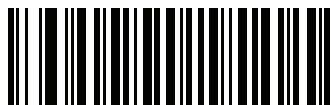

***Enable CDC Beep on <BEL>**



Disable CDC Beep on <BEL>

TGCS (IBM) USB Direct I/O Beep

The host can send a direct I/O beep request to the scanner. If you select **Ignore Direct I/O Beep**, the scanner does not sound beeps on this command. All directives are still acknowledged to the USB host as if they were processed.



***Honor Direct I/O Beep
(1)**



**Ignore Direct I/O Beep
(0)**

TGCS (IBM) USB Beep Directive

The host can send a beeper configuration request to the scanner. Scan **Ignore Beep Directive** to prevent the scanner from processing the host request. All directives are still acknowledged to the USB host as if they were processed.



Honor Beep Directive



***Ignore Beep Directive**

TGCS (IBM) USB Barcode Configuration Directive

The host can enable and disable code types. Scan **Ignore Barcode Configuration Directive** to prevent the scanner from processing the host request. All directives are still acknowledged to the USB host as if they were processed.



Honor Barcode Configuration Directive



***Ignore Barcode Configuration Directive**

TGCS (IBM) USB Specification Version

Select **IBM Specification Level Version 0 (Original)** to send the following code types as Unknown:

- Data Matrix
- GS1 Data Matrix
- QR Code
- GS1 QR
- MicroQR Code
- Aztec

Select **IBM Specification Level Version 2.2** to send the code types with the appropriate IBM identifiers.



IBM Specification Level Version 0 (Original)



***IBM Specification Level Version 2.2**

ASCII Character Sets

See [ASCII Character Sets](#) for the following information:

- [ASCII Character Set on page 471](#)
- [ALT Key Character Set on page 476](#)
- [GUI Key Character Set on page 477](#)
- [PF Key Character Set on page 478](#)
- [F Key Character Set on page 479](#)
- [Numeric Key Character Set on page 480](#)
- [Extended Key Character Set on page 480](#)

SSI Interface

Introduction

This chapter describes the system requirements of the Simple Serial Interface (SSI), which provides a communications link between Zebra decoders (e.g., scan engines, slot scanners, hand-held scanners, two-dimensional scanners, hands-free scanners, and RF base stations) and a serial host. It provides the means for the host to control the decoder or scanner.

Communication

All communication between the scanner and host occurs over the hardware interface lines using the SSI protocol. Refer to the Simple Serial Interface Programmer's Guide, p/n 72E-40451-xx, for more information on SSI.

The host and the scanner exchange messages in packets. A packet is a collection of bytes framed by the proper SSI protocol formatting bytes. The maximum number of bytes per packet that the SSI protocol allows for any transaction is 257 (255 bytes + 2 byte checksum).

Depending on the configuration, the scanner can send decode data as ASCII data (unpacketed), or as part of a larger message (packeted).

SSI performs the following functions for the host device:

- Maintains a bi-directional interface with the scanner
- Allows the host to send commands that control the scanner
- Passes data from the scanner to a host device in SSI packet format or straight decode message.

The SSI environment consists of a scanner, a serial cable which attaches to the host device, and if required, a power supply.

SSI transmits all decode data including special formatting (e.g., AIM ID). Parameter settings can control the format of the transmitted data.

The scanner can also send parameter information, product identification information, or event codes to the host.

All commands sent between the scanner and host must use the format described in the SSI Message Formats section. [SSI Transactions on page 80](#) describes the required sequence of messages in specific cases.

SSI Commands

Table 13 lists all the SSI opcodes the scanner supports. The host transmits opcodes designated type H. The scanner (decoder) transmits type D opcodes, and either can transmit Host/Decoder (H/D) types.

Table 13 SSI Commands

Name	Type	Opcode	Description
AIM_OFF	H	0xC4	Deactivate aiming pattern.
AIM_ON	H	0xC5	Activate aiming pattern.
BEEP	H	0xE6	Sound the beeper.
CAPABILITIES_REPLY	D	0xD4	Reply to CAPABILITIES_REQUEST; contains a list of the capabilities and commands the decoder supports.
CAPABILITIES_REQUEST	H	0xD3	Request capabilities report from the decoder.
CMD_ACK	H/D	0xD0	Positive acknowledgment of received packet.
CMD_NAK	H/D	0xD1	Negative acknowledgment of received packet.
DECODE_DATA	D	0xF3	Decode data in SSI packet format.
EVENT	D	0xF6	Event indicated by associated event code.
LED_OFF	H	0xE8	De-activate LED output.
LED_ON	H	0xE7	Activate LED output.
PARAM_DEFAULTS	H	0xC8	Set parameter default values.
PARAM_REQUEST	H	0xC7	Request values of certain parameters.
PARAM_SEND	H/D	0xC6	Send parameter values.
REPLY_REVISION	D	0xA4	Reply to REQUEST_REVISION, contains the decoder's software/hardware configuration.
REQUEST_REVISION	H	0xA3	Request the decoder's configuration.
SCAN_DISABLE	H	0xEA	Prevent the operator from scanning barcodes.
SCAN_ENABLE	H	0xE9	Permit barcode scanning.
SLEEP	H	0xEB	Request to place the decoder into low power.
START_DECODE	H	0xE4	Tell the decoder to attempt to decode a barcode.
STOP_DECODE	H	0xE5	Tell the decoder to abort a decode attempt.
WAKEUP	H	N/A	Wake the decoder from low power mode.

For details of the SSI protocol, refer to the *Simple Serial Interface Programmer's Guide*.

SSI Transactions

General Data Transactions

ACK/NAK Handshaking

If you enable ACK/NAK handshaking (the default), all packeted messages must have a CMD_ACK or CMD_NAK response, unless the command description states otherwise. Zebra recommends leaving this handshaking enabled to provide feedback to the host. Raw decode data and WAKEUP do not use ACK/NAK handshaking since they are not packeted data.

Following is an example of a problem which can occur if you disable ACK/NAK handshaking:

- The host sends a PARAM_SEND message to the scanner to change the baud rate from 9600 to 19200.
- The scanner cannot interpret the message.
- The scanner does not implement the change the host requested.
- The host assumes that the parameter change occurred and acts accordingly.
- Communication is lost because the change did not occur on both sides.

If you enable ACK/NAK handshaking, the following occurs:

- The host sends a PARAM_SEND message.
- The scanner cannot interpret the message.
- The scanner CMD_NAKs the message.
- The host resends the message.
- The scanner receives the message successfully, responds with CMD_ACK, and implements parameter changes.

Decoded Data Transmission

The [Decode Data Packet Format](#) parameter controls how decode data is sent to the host. Set this parameter to send the data in a DECODE_DATA packet. Clear this parameter to transmit the data as raw ASCII data.



NOTE: When transmitting decode data as raw ASCII data, ACK/NAK handshaking does not apply regardless of the state of the ACK/NAK handshaking parameter.

ACK/NAK Enabled and Packeted Data

The scanner sends a DECODE_DATA message after a successful decode. The scanner waits for a programmable timeout for a CMD_ACK response. If it does not receive the response, the scanner tries to send two more times before issuing a host transmission error. If the scanner receives a CMD_NAK from the host, it may attempt a retry depending on the cause field of the CMD_NAK message.

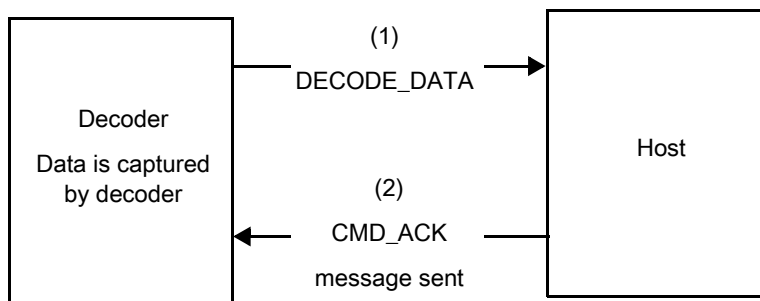

ACK/NAK Enabled and Unpacketed ASCII Data

Even if ACK/NAK handshaking is enabled, no handshaking occurs because handshaking applies only to packeted data. In this example the packeted_decode parameter is disabled.

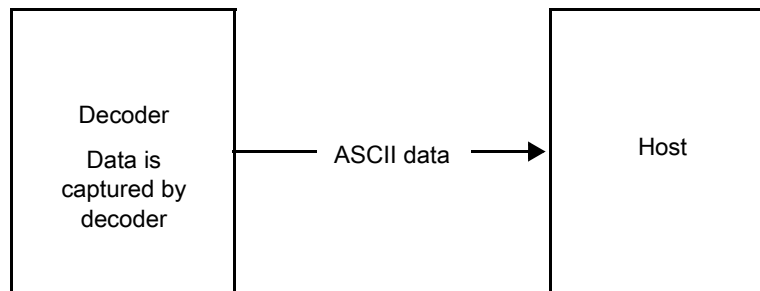

ACK/NAK Disabled and Packeted DECODE_DATA

In this example ACK/NAK does not occur even though packeted_decode is enabled because the ACK/NAK handshaking parameter is disabled.

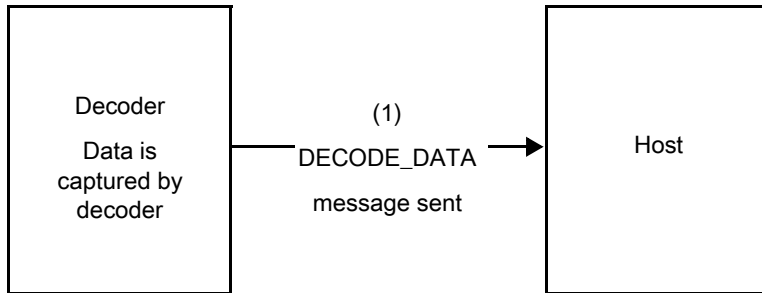

ACK/NAK Disabled and Unpacketed ASCII Data

The decoder sends captured data to the host.

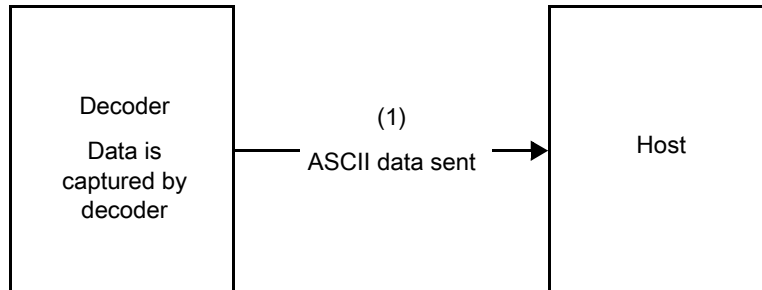

Communication Summary

RTS/CTS Lines

All communication must use RTS/CTS handshaking as described in the *Simple Serial Interface Programmer's Guide*, p/n 72E-40451-xx. If bypassing hardware handshaking, the host must send the WAKEUP command before all other communication or the first byte of a message can be lost during the scanner wakeup sequence. Zebra recommends not bypassing RTS/CTS hardware handshaking.

ACK/NAK Option

ACK/NAK handshaking is enabled by default and Zebra recommends leaving it enabled. Disabling this can cause communication problems, as handshaking is the only acknowledgment that a message was received correctly. ACK/NAK is not used with unpacked decode data regardless of whether it is enabled.

Number of Data Bits

All communication with the scanner must use 8-bit data.

Serial Response Timeout

The [Host Serial Response Timeout](#) parameter determines how long to wait for a handshaking response before trying again or aborting further attempts. Set the same value for both the host and scanner.



NOTE: You can temporarily change the [Host Serial Response Timeout](#) when the host takes longer to process an ACK or longer data string. Zebra does not recommend frequent permanent changes due to limited write cycles of non-volatile memory.

Retries

The host resends data twice after the initial send if the scanner does not respond with an ACK or NAK (if ACK/NAK handshaking is enabled), or response data (e.g., PARAM_SEND, REPLY_REVISION). If the scanner replies with a NAK RESEND, the host resends the data. All resent messages must have the resend bit set in the Status byte.

The scanner resends data two times after the initial send if the host fails to reply with an ACK or NAK (if ACK/NAK handshaking is enabled).

Baud Rate, Stop Bits, Parity, Response Timeout, ACK/NAK Handshaking

If you use PARAM_SEND to change these serial parameters, the ACK response to the PARAM_SEND uses the previous values for these parameters. The new values then take effect for the next transaction.

Errors

The scanner issues a communication error when:

- The CTS line is asserted when the scanner tries to transmit, and is still asserted on each of two successive retries
- The scanner does not receive an ACK or NAK after initial transmit and two resends.

SSI Communication Notes

- When not using hardware handshaking, space messages sufficiently apart. The host must not communicate with the scanner if the scanner is transmitting.
- When using hardware handshaking, frame each message properly with handshaking signals. Do not try to send two commands within the same handshaking frame.
- There is a permanent/temporary bit in the PARAM_SEND message. Removing power from the scanner discards temporary changes. Permanent changes are written to non-volatile memory. Frequent changes shorten the life of the non-volatile memory.

Using Time Delay to Low Power Mode with SSI

[Time Delay to Low Power Mode on page 156](#) provides options to select a general time delay. To program a more specific delay value, use an SSI command according to [Table 14](#).

Table 14 Values for Selecting Time Delay to Low Power

Value	Timeout	Value	Timeout	Value	Timeout	Value	Timeout
0x00	15 Min	0x10	1 Sec	0x20	1 Min	0x30	1 Hour
0x01	30 Min	0x11	1 Sec	0x21	1 Min	0x31	1 Hour
0x02	60 Min	0x12	2 Sec	0x22	2 Min	0x32	2 Hours
0x03	90 Min	0x13	3 Sec	0x23	3 Min	0x33	3 Hours
N/A	N/A	0x14	4 Sec	0x24	4 Min	0x34	4 Hours
N/A	N/A	0x15	5 Sec	0x25	5 Min	0x35	5 Hours
N/A	N/A	0x16	6 Sec	0x26	6 Min	0x36	6 Hours
N/A	N/A	0x17	7 Sec	0x27	7 Min	0x37	7 Hours
N/A	N/A	0x18	8 Sec	0x28	8 Min	0x38	8 Hours
N/A	N/A	0x19	9 Sec	0x29	9 Min	0x39	9 Hours
N/A	N/A	0x1A	10 Sec	0x2A	10 Min	0x3A	10 Hours
N/A	N/A	0x1B	15 Sec	0x2B	15 Min	0x3B	15 Hours
N/A	N/A	0x1C	20 Sec	0x2C	20 Min	0x3C	20 Hours
N/A	N/A	0x1D	30 Sec	0x2D	30 Min	0x3D	30 Hours
N/A	N/A	0x1E	45 Sec	0x2E	45 Min	0x3E	45 Hours
N/A	N/A	0x1F	60 Sec	0x2F	60 Min	0x3F	60 Hours



CAUTION: With hardware handshaking disabled, the scanner wakes from low power mode upon receiving a character. However, the scanner does not process this character or any others it receives during the 10 ms period following wakeup. Wait at least 10 ms after wakeup to send valid characters.

Encapsulation of RSM Commands/Responses over SSI

The SSI protocol allows the host to send a command that is variable in length up to 255 bytes. Although there is a provision in the protocol to multi-packet commands from the host, the scanner does not support this. The host must fragment packets using the provisions in the RSM protocol.

Command Structure

Table 15 Command Structure

Byte	7	6	5	4	3	2	1	0
0	Length (not including the checksum)							
1	SSI_MGMT_COMMAND (0x80)							
2	Message Source (4 - Host)							
3	Reserved (0)			Reserved (0)		Reserved (0)	Cont'd packet	Retransmit
4	Payload data (see the following example)							
...								
Length -1								
Length	2's complement checksum (MSB)							
Length +1	2's complement checksum (LSB)							

The expected positive response is SSI_MGMT_COMMAND which can be a multi-packet response. Devices that do not support this command respond with the standard SSI_NAK.

Response Structure

Table 16 Response Structure

Byte	7	6	5	4	3	2	1	0
0	Length (not including the checksum)							
1	SSI_MGMT_COMMAND (0x80)							
2	Message Source (0 - Decoder)							
3	Reserved (0)			Reserved (0)		Reserved (0)	Cont'd packet	Retransmit
4	Payload data (see the following example)							
...								
Length -1								
Length	2's complement checksum (MSB)							
Length +1	2's complement checksum (LSB)							

Example Transaction

The following example illustrates how to retrieve diagnostic information (Diagnostic Testing and Reporting (Attribute #10061) decimal) from the scanner using encapsulation of RSM commands over SSI. Before sending an RSM command, the host must send the RSM Get Packet Size command to query the packet size supported by the device.

Command from Host to Query Packet Size Supported by Device

```
0A 80 04 00 00 06 20 00 FF FF FD 4E
```

Where:

- 0A 80 04 00 is encapsulation of RSM commands over SSI command header
- 00 06 20 00 FF FF is RSM Get Packet Size command
- FD 4E is SSI command checksum

Response from Device with Packet Size Information

```
0C 80 00 00 00 08 20 00 00 F0 00 F0 FD 6C
```

Where:

- 0C 80 00 00 is encapsulation of RSM command over SSI command header
- 00 08 20 00 00 F0 00 F0 is RSM Get Packet Size response
- FD 6C is SSI response checksum

Command from Host to Retrieve Diagnostic Information

```
0C 80 04 00 00 08 02 00 27 4D 42 00 FE B0
```

Where:

- 0C 80 04 00 is encapsulation of RSM commands over SSI command header
- 00 08 02 00 27 4D 42 00 is attribute Get command requesting attribute 10061 decimal
- FE B0 is SSI command checksum

Response from Device with Diagnostic Information

```
21 80 00 00 00 1D 02 00 27 4D 41 01 42 00 0E 00 00 00 00 01 03 02 03 03 03 04 03 05 03 06 03 FF FF FC 15
```

Where:

- 21 80 00 00 00 1D 02 00 27 4D 41 01 42 00 0E 00 00 is encapsulation of RSM responses over SSI command header
- 00 00 01 03 02 03 03 03 04 03 05 03 06 03 is attribute Get response which includes diagnostic report value
- FF FF is attribute Get response, packet termination
- FC 15 is SSI response checksum

Setting Parameters

This section describes how to set up the scanner with an SSI host. When using SSI, program the scanner via barcode menu or SSI hosts commands.

The scanner ships with the settings shown in [Table 17 on page 88](#) (also see [Standard Parameter Defaults](#) for all defaults). If the default values suit requirements, programming is not necessary.

To set feature values, scan a single barcode or a short barcode sequence. The settings are stored in non-volatile memory and are preserved even when the scanner powers down.



NOTE: Most computer monitors allow scanning barcodes directly on the screen. When scanning from the screen, be sure to set the document magnification to a level where you can see the barcode clearly, and bars and/or spaces do not merge.

To return all features to default values, scan [Set Factory Defaults on page 142](#). Throughout the programming barcode menus, asterisks (*) indicate default values.

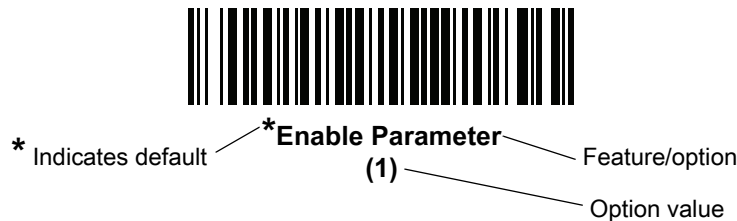

Scanning Sequence Examples

In most cases scanning one barcode sets the parameter value. For example, to set the baud rate to 19,200, scan the **Baud Rate 19,200** barcode under [Baud Rate on page 89](#). The scanner issues a fast warble beep and the LED turns green, signifying a successful parameter entry.

Other parameters require scanning several barcodes. See the parameter descriptions for this procedure.

Errors While Scanning

Unless otherwise specified, to correct an error during a scanning sequence, just re-scan the correct parameter.

Simple Serial Interface Parameter Defaults

Table 13 lists defaults for SSI host parameters. Change these values in one of two ways:

- Scan the appropriate barcodes in this chapter. The new value replaces the standard default value in memory. To recall default parameter values, see [Default Parameters on page 142](#).
- Download data through the device’s serial port using SSI. Hexadecimal parameter numbers appear in this chapter below the parameter title, and option values appear in parenthesis beneath the accompanying barcodes. Refer to the Simple Serial Interface (SSI) Programmer’s Guide for detailed instructions for changing parameters using this method.



NOTE: See [Standard Parameter Defaults](#) for all user preference, host, symbology, and miscellaneous default parameters.

Table 17 SSI Interface Default Table

Parameter	Parameter Number	SSI Number	Default	Page Number
SSI Host Parameters				
Select SSI Host	N/A	N/A	N/A	89
Baud Rate	156	9Ch	9600	89
Parity	158	9Eh	None	91
Check Parity	151	97h	Disable	91
Stop Bits	157	9Dh	1	92
Software Handshaking	159	9Fh	Enable ACK/NAK	93
Host RTS Line State	154	9Ah	Low	94
Decode Data Packet Format	238	EEh	Send Raw Decode Data	94
Host Serial Response Timeout	155	9Bh	2 Seconds	95
Host Character Timeout	239	EFh	200 msec	96
Multipacket Option	334	F0h 4Eh	Option 1	97
Interpacket Delay	335	F0h 4Fh	0 msec	98
Event Reporting				
Decode Event	256	F0h 00h	Disable	99
Boot Up Event	258	F0h 02h	Disable	100
Parameter Event	259	F0h 03h	Disable	100



NOTE: SSI interprets Prefix, Suffix1, and Suffix2 values listed in [Table 38 on page 471](#) differently than other interfaces. SSI does not recognize key categories, only the 3-digit decimal value. The default value of 7013 is interpreted as CR only.

SSI Host Parameters

Select SSI Host

To select SSI as the host interface, scan the following barcode.



SSI Host

Baud Rate

Parameter # 156

SSI # 9Ch

Baud rate is the number of bits of data transmitted per second. Scan one of the following barcodes to set the scanner's baud rate to match the baud rate setting of the host device. Otherwise, data may not reach the host device or may reach it in distorted form.



***Baud Rate 9600
(6)**



**Baud Rate 19,200
(7)**



**Baud Rate 38,400
(8)**

Baud Rate (continued)



**Baud Rate 57,600
(10)**



**Baud Rate 115,200
(11)**



**Baud Rate 230,400
(13)**



**Baud Rate 460,800
(14)**



**Baud Rate 921,600
(15)**

Parity

Parameter # 158

SSI # 9Eh

A parity check bit is the most significant bit of each ASCII coded character. Scan one of the following barcodes to select the parity type according to host device requirements:

- **Odd** - This sets the parity bit value to 0 or 1, based on data, to ensure that the coded character contains an odd number of 1 bits.
- **Even** - This sets the parity bit value to 0 or 1, based on data, to ensure that the coded character contains an even number of 1 bits.
- **None** - No parity bit is required.



**Odd
(2)**



**Even
(1)**



***None
(0)**

Check Parity

Parameter # 151

SSI # 97h

Scan one of the following barcodes to select whether to check the parity of received characters. See [Parity](#) to select the type of parity.



***Do Not Check Parity
(0)**



**Check Parity
(1)**

Stop Bits

Parameter # 157

SSI # 9Dh

The stop bit(s) at the end of each transmitted character marks the end of transmission of one character and prepares the receiving device for the next character in the serial data stream. Scan one of the following barcodes to set the number of stop bits (one or two) based on the number the receiving host can accommodate.



***1 Stop Bit
(1)**



**2 Stop Bits
(2)**

Software Handshaking

Parameter # 159

SSI # 9Fh

This parameter offers control of data transmission in addition to the control hardware handshaking offers. Hardware handshaking is always enabled; you cannot disable it.

Options:

- **Disable ACK/NAK Handshaking** - The scanner neither generates nor expects ACK/NAK handshaking packets.
- **Enable ACK/NAK Handshaking** - After transmitting data, the scanner expects either an ACK or NAK response from the host. The scanner also ACKs or NAKs messages from the host.

The scanner waits up to the programmable [Host Serial Response Timeout](#) to receive an ACK or NAK. If the scanner does not get a response in this time, it resends its data up to two times before discarding the data and declaring a transmission error.



**Disable ACK/NAK
(0)**



***Enable ACK/NAK
(1)**

Host RTS Line State

Parameter # 154

SSI # 9Ah

Scan one of the following barcodes to set the expected idle state of the Serial Host RTS line.

The SSI interface is used with host applications which also implement the SSI protocol. However, you can use the scanner in a "scan-and-transmit" mode to communicate with any standard serial communication software on a host PC (see [Decode Data Packet Format on page 94](#)). If transmission errors occur in this mode, the host PC may be asserting hardware handshaking lines which interfere with the SSI protocol. Scan the **High** barcode to address this problem.



***Low
(0)**



**High
(1)**

Decode Data Packet Format

Parameter # 238

SSI # EEh

Scan one of the following barcodes to select whether to transmit decoded data in raw format (unpacked), or with the packet format defined by the serial protocol.

Selecting the raw format disables ACK/NAK handshaking for decode data.



***Send Raw Decode Data
(0)**



**Send Packeted Decode Data
(1)**

Host Serial Response Timeout

Parameter # 155

SSI # 9Bh

Scan one of the following barcodes to specify how long the scanner waits for an ACK or NAK before resending. Also, if the scanner wants to send, and the host has already been granted permission to send, the scanner waits for the designated timeout before declaring an error.



NOTE: Other values are available via SSI command.



***Low - 2 Seconds
(20)**



**Medium - 5 Seconds
(50)**



**High - 7.5 Seconds
(75)**



**Maximum - 9.9 Seconds
(99)**

Host Character Timeout

Parameter # 239

SSI # EFh

Scan one of the following barcodes to specify the maximum time the scanner waits between characters transmitted by the host before discarding the received data and declaring an error.



NOTE: Other values are available via SSI command.



***Low - 200 msec
(20)**



**Medium - 500 msec
(50)**



**High - 750 msec
(75)**



**Maximum - 990 msec
(99)**

Multipacket Option

Parameter # 334

SSI # F0h 4Eh

Scan one of the following barcodes to control ACK/NAK handshaking for multi-packet transmissions:

- **Multi-Packet Option 1** - The host sends an ACK/NAK for each data packet during a multi-packet transmission.
- **Multi-Packet Option 2** - The scanner sends data packets continuously, with no ACK/NAK handshaking to pace the transmission. The host, if overrun, can use hardware handshaking to temporarily delay scanner transmissions. At the end of transmission, the scanner waits for a CMD_ACK or CMD_NAK.
- **Multi-Packet Option 3** - This is the same as option 2 with the addition of a programmable interpacket delay. See [Interpacket Delay on page 98](#) to set this delay.



***Multipacket Option 1
(0)**



**Multipacket Option 2
(1)**



**Multipacket Option 3
(2)**

Interpacket Delay

Parameter # 335

SSI # F0h 4Fh

Scan one of the following barcodes to specify the interpacket delay if you selected **Multipacket Option 3**.



NOTE: Other values are available via SSI command.



***Minimum - 0 msec**
(0)



Low - 25 msec
(25)



Medium - 50 msec
(50)



High - 75 msec
(75)



Maximum - 99 msec
(99)

Event Reporting

The host can request the scanner to provide certain information (events) relative to scanner behavior. Scan the following barcodes to enable or disable the events listed in [Table 18](#) and on the following pages.

Table 18 Event Codes

Event Class	Event	Code Reported
Decode Event	Non-parameter decode	0x01
Boot Up Event	System power-up	0x03
Parameter Event	Parameter entry error	0x07
	Parameter stored	0x08
	Defaults set (and parameter event is enabled by default)	0x0A
	Number expected	0x0F

Decode Event

Parameter # 256

SSI # F0h 00h

Scan one of the following barcodes to enable or disable Decode Event.

- **Enable Decode Event** - The scanner generates a message to the host upon a successful barcode decode.
- **Disable Decode Event** - No notification is sent.

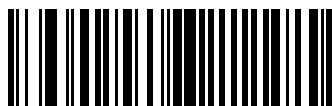

**Enable Decode Event
(1)**



***Disable Decode Event
(0)**

Boot Up Event

Parameter # 258

SSI # F0h 02h

Scan one of the following barcodes to enable or disable Boot Up Event:

- **Enable Boot Up Event** - The scanner generates a message to the host whenever power is applied.
- **Disable Boot Up Event** - No notification is sent.

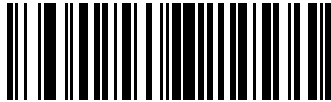

**Enable Boot Up Event
(1)**



***Disable Boot Up Event
(0)**

Parameter Event

Parameter # 259

SSI # F0h 03h

Scan one of the following barcodes to enable or disable Parameter Event:

- **Enable Parameter Event** - The scanner generates a message to the host when one of the events specified in [Table 18 on page 99](#) occurs.
- **Disable Parameter Event** - No notification is sent.



**Enable Parameter Event
(1)**

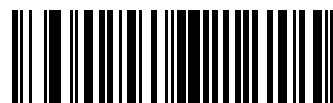

***Disable Parameter Event
(0)**

RS-232 Interface

Introduction

This chapter describes how to set up the scanner with an RS-232 host. The scanner uses the RS-232 interface to connect to point-of-sale devices, host computers, or other devices with an available RS-232 port (e.g., com port).

The scanner ships with the settings shown in [Table 19 on page 103](#) (also see [Standard Parameter Defaults](#) for all defaults). If the default values suit requirements, programming is not necessary.

If your host does not appear in [Table 20](#), refer to the documentation for the host device to set communication parameters to match the host.



NOTE: The scanner uses TTL RS-232 signal levels, which interface with most system architectures. For system architectures requiring RS-232C signal levels, Zebra offers different cables providing TTL-to-RS-232C conversion. Contact support for more information.

Setting Parameters

To set feature values, scan a single barcode or a short barcode sequence. The settings are stored in non-volatile memory and are preserved even when the scanner powers down.



NOTE: Most computer monitors allow scanning barcodes directly on the screen. When scanning from the screen, be sure to set the document magnification to a level where you can see the barcode clearly, and bars and/or spaces do not merge.

To return all features to default values, scan [Set Factory Defaults on page 142](#). Throughout the programming barcode menus, asterisks (*) indicate default values.



* Indicates default *Enable Parameter Feature/option

Scanning Sequence Examples

In most cases scanning one barcode sets the parameter value. For example, to set the baud rate to 19,200, scan the **Baud Rate 19,200** barcode under [Baud Rate on page 109](#). The scanner issues a fast warble beep and the LED turns green, signifying a successful parameter entry.

Other parameters require scanning several barcodes. See the parameter descriptions for this procedure.

Errors While Scanning

Unless otherwise specified, to correct an error during a scanning sequence, just re-scan the correct parameter.

Connecting an RS-232 Interface

Connect the scanner directly to the host computer.

Figure 14 RS-232 Connection

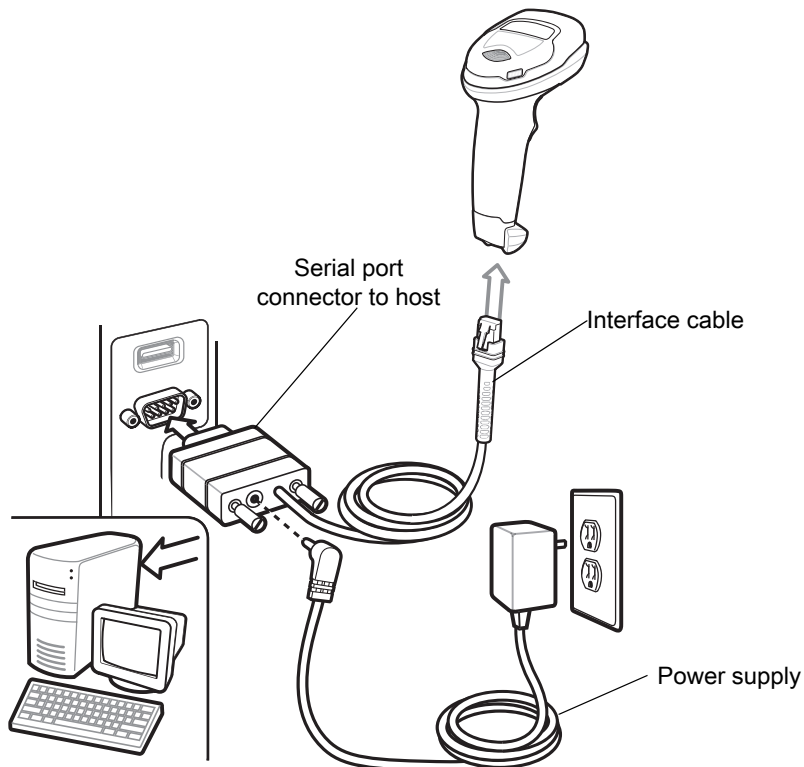

NOTE: Interface cables vary depending on configuration. The connectors can be different than those illustrated in [Figure 14](#), but the steps to connect the scanner are the same.

1. Attach the modular connector of the RS-232 interface cable to the cable interface port on the scanner. See [Inserting the Interface Cable on page 28](#).
2. Connect the other end of the RS-232 interface cable to the serial port on the host.
3. If required, connect the power supply to the serial connector end of the RS-232 interface cable. Plug the power supply into an appropriate outlet.

4. The scanner automatically detects the host interface type and uses the default setting. If the default (*) does not meet your requirements, select another RS-232 host type by scanning the appropriate barcode from [RS-232 Host Types on page 107](#).
5. To modify any other parameter options, scan the appropriate barcodes in this chapter.

If problems occur with the system, see [Troubleshooting on page 46](#).

RS-232 Parameter Defaults

[Table 19](#) lists defaults for RS-232 host parameters. Change these values in one of two ways:

- Scan the appropriate barcodes in this chapter. The new value replaces the standard default value in memory. To recall default parameter values, see [Default Parameters on page 142](#).
- Configure the scanner using the 123Scan configuration program. See [123Scan and Software Tools](#).



NOTE: See [Standard Parameter Defaults](#) for all user preference, host, symbology, and miscellaneous default parameters.

Table 19 RS-232 Interface Parameter Defaults

Parameter	Default	Page Number
RS-232 Host Parameters		
RS-232 Host Types	Standard	107
Baud Rate	9600	109
Parity	None	111
Stop Bits	1 Stop Bit	112
Data Bits	8-bit	112
Check Receive Errors	Enable	113
Hardware Handshaking	None	113
Software Handshaking	None	115
Host Serial Response Timeout	2 Seconds	117
RTS Line State	Low RTS	118
Beep on <BEL>	Disable	118
Intercharacter Delay	0 msec	119
Nixdorf Beep/LED Options	Normal Operation	120
Barcodes with Unknown Characters	Send Barcode With Unknown Characters	120

RS-232 Host-Specific Parameter Settings

Various RS-232 hosts use their own parameter default settings. Selecting standard, ICL, Fujitsu, Wincor-Nixdorf Mode A or B, OPOS/JPOS, Olivetti, Omron, or Common Use Terminal Equipment (CUTE-LP/LG barcode readers) sets the defaults listed in [Table 20](#) and [Table 21](#).

Table 20 RS-232 Host-Specific Settings

Parameter	ICL	Fujitsu	Wincor-Nixdorf Mode A	Wincor-Nixdorf Mode B/ OPOS/JPOS
Baud Rate	9600	9600	9600	9600
Parity	Even	None	Odd	Odd
Stop Bits	One	One	One	One
Data Bits	8-bit	8-bit	8-bit	8-bit
Hardware Handshaking	RTS/CTS Option 3	None	RTS/CTS Option 3	RTS/CTS Option 3
Software Handshaking	None	None	None	None
Serial Response Timeout	9.9 Seconds	2 Seconds	None	None
RTS Line State	High	Low	Low	Low = No data to send
Beep On <BEL>	Disable	Disable	Disable	Disable
Transmit Code ID	Yes	Yes	Yes	Yes
Data Transmission Format	Data/Suffix	Data/Suffix	Data/Suffix	Data/Suffix
Prefix	None	None	None	None
Suffix	CR (1013)	CR (1013)	CR (1013)	CR (1013)

In the Wincor-Nixdorf Mode A/B, when CTS is low, scanning is disabled and when CTS is high, scanning is enabled.

If you scan Wincor-Nixdorf RS-232 Mode A/B without connecting the scanner to the proper host, it may appear unable to scan. In this case, scan a different RS-232 host type within 5 seconds of cycling power to the scanner.

Table 21 RS-232 Host-Specific Settings

Parameter	Olivetti	Omron	CUTE
Baud Rate	9600	9600	9600
Parity	Even	None	None
Stop Bits	One	One	One
Data Bits	7-bit	8-bit	8-bit

The CUTE host disables all parameter scanning, including Set Defaults. If you inadvertently select CUTE, scan [*Enable Parameter Barcode Scanning \(1\)](#) on page 143, and then change the host selection.

Table 21 RS-232 Host-Specific Settings (Continued)

Parameter	Olivetti	Omron	CUTE
Hardware Handshaking	None	None	None
Software Handshaking	ACK/NAK	None	None
Serial Response Timeout	9.9 Seconds	9.9 Seconds	9.9 Seconds
RTS Line State	Low	High	High
Beep On <BEL>	Disable	Disable	Disable
Transmit Code ID	Yes	Yes	Yes
Data Transmission Format	Prefix/Data/ Suffix	Data/Suffix	Prefix/Data/ Suffix
Prefix	STX (1003)	None	STX (1002)
Suffix	ETX (1002)	CR (1013)	CR (1013) ETX (1003)

The CUTE host disables all parameter scanning, including Set Defaults. If you inadvertently select CUTE, scan [*Enable Parameter Barcode Scanning \(1\) on page 143](#), and then change the host selection.

RS-232 Host-Specific Code ID Characters

Selecting ICL, Fujitsu, Wincor-Nixdorf Mode A or B, OPOS/JPOS, Olivetti, Omron, or CUTE transmits the code ID characters listed in [Table 22](#) and [Table 23](#). These characters are not programmable and are separate from the Transmit Code ID feature. Do not enable the Transmit Code ID feature for these hosts.

Table 22 RS-232 Host-Specific Code ID Characters

Code Type	ICL	Fujitsu	Wincor-Nixdorf Mode A	Wincor-Nixdorf Mode B/ OPOS/JPOS
UPC-A	A	A	A	A
UPC-E	E	E	C	C
EAN-8/JAN-8	FF	FF	B	B
EAN-13/JAN-13	F	F	A	A
Bookland EAN	F	F	A	A
Code 128	L <len>	None	K	K
GS1-128	L <len>	None	P	P
Code 39	C <len>	None	M	M
Code 39 Full ASCII	None	None	M	M
Trioptic	None	None	None	None
Code 32	None	None	None	None
Code 93	None	None	L	L

Table 22 RS-232 Host-Specific Code ID Characters (Continued)

Code Type	ICL	Fujitsu	Wincor-Nixdorf Mode A	Wincor-Nixdorf Mode B/ OPOS/JPOS
I 2 of 5	I <len>	None	I	I
D 2 of 5	H <len>	None	H	H
IATA	H<len>	None	H	H
Codabar	N <len>	None	N	N
MSI	None	None	O	O
GS1 DataBar Variants	None	None	E	E
PDF417	None	None	Q	Q
MicroPDF417	None	None	S	S
Data Matrix	None	None	R	R
GS1 Data Matrix	None	None	W	W
Maxicode	None	None	T	T
QR Code	None	None	U	U
GS1 QR	None	None	X	X
Aztec/Aztec Rune	None	None	V	V

Table 23 RS-232 Host-Specific Code ID Characters

Code Type	Olivetti	Omron	CUTE
UPC-A	A	A	A
UPC-E	C	E	None
EAN-8/JAN-8	B	FF	None
EAN-13/JAN-13	A	F	A
Bookland EAN	A	F	None
Code 128	K <len>	L <len>	5
GS1-128	P <len>	L <len>	5
Code 39	M <len>	C <len>	3
Code 39 Full ASCII	None	None	3
Trioptic	None	None	None
Code 32	None	None	None
Code 93	L <len>	None	None

*This host does not support 2D barcodes.

Table 23 RS-232 Host-Specific Code ID Characters (Continued)

Code Type	Olivetti	Omron	CUTE
I 2 of 5	I <len>	I <len>	1
D 2 of 5	H <len>	H <len>	2
IATA	H<len>	H<len>	2
Codabar	N <len>	N <len>	None
MSI	O <len>	None	None
GS1 DataBar Variants	None	None	None
PDF417	None	None	6
MicroPDF417	None	None	6
Data Matrix	None	None	4
QR Code	None	None	7
Aztec/Aztec Rune	None	None	8

*This host does not support 2D barcodes.

RS-232 Host Types

To select an RS-232 host interface, scan one of the following barcodes.



NOTES 1 For a list of supported scanner functionality by communication protocol, see [Communication Protocol Functionality](#).

2. Scanning **Standard RS-232** activates the RS-232 driver, but does not change port settings (e.g., parity, data bits, handshaking). Selecting another RS-232 host type barcode changes these settings.

3. The CUTE host disables all parameter scanning, including Set Defaults. If you inadvertently select **CUTE**, scan [*Enable Parameter Barcode Scanning \(1\) on page 143](#), and then change the host selection.

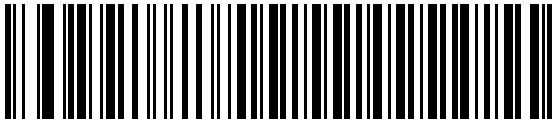

*Standard RS-232

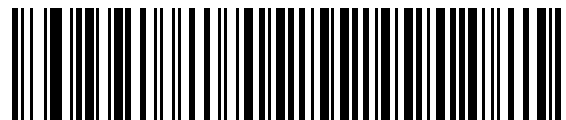

ICL RS-232

RS-232 Host Types (continued)

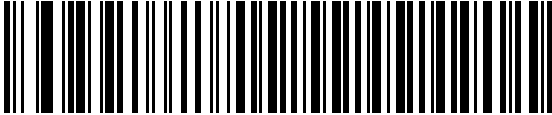

Wincor-Nixdorf RS-232 Mode A

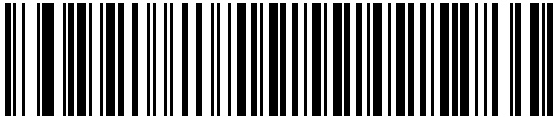

Wincor-Nixdorf RS-232 Mode B

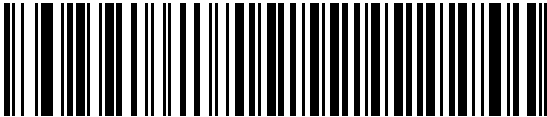

Olivetti ORS4500

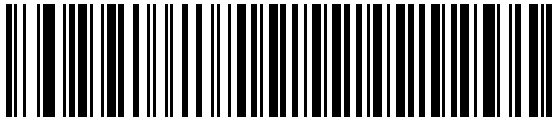

Omron



OPOS/JPOS

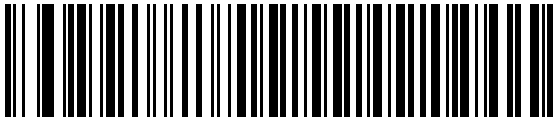

Fujitsu RS-232



CUTE

Baud Rate

Baud rate is the number of bits of data transmitted per second. Scan one of the following barcodes to set the scanner's baud rate to match the baud rate setting of the host device. Otherwise, data may not reach the host device or may reach it in distorted form.



NOTE: The scanner does not support baud rates below 9600.



***Baud Rate 9600**



Baud Rate 19,200



Baud Rate 38,400



Baud Rate 57,600

Baud Rate (continued)



Baud Rate 115,200

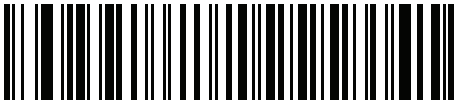

Baud Rate 230,400

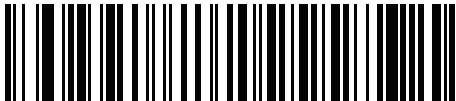

Baud Rate 460,800

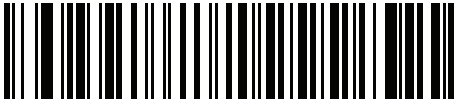

Baud Rate 921,600

Parity

A parity check bit is the most significant bit of each ASCII coded character. Scan one of the following barcodes to select the parity type according to host device requirements:

- **Odd** - This sets the parity bit value to 0 or 1, based on data, to ensure that the coded character contains an odd number of 1 bits.
- **Even** - This sets the parity bit value to 0 or 1, based on data, to ensure that the coded character contains an even number of 1 bits.
- **None** - No parity bit is required.



Odd

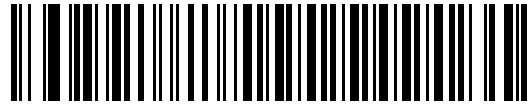

Even



***None**

Stop Bits

The stop bit(s) at the end of each transmitted character marks the end of transmission of one character and prepares the receiving device for the next character in the serial data stream. Scan one of the following barcodes to set the number of stop bits (one or two) based on the number the receiving host can accommodate.

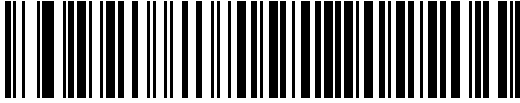

***1 Stop Bit**

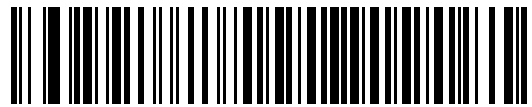

2 Stop Bits

Data Bits

This parameter allows the scanner to interface with devices requiring a 7-bit or 8-bit ASCII protocol.

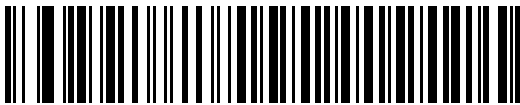

7-bit

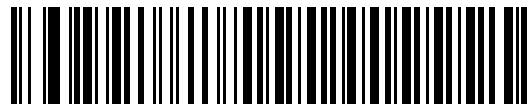

***8-bit**

Check Receive Errors

Scan one of the following barcodes to set whether to check the parity, framing, and overrun of received characters. The parity value of received characters is verified against the value set for [Parity on page 111](#).

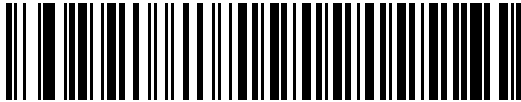

***Check For Received Errors**

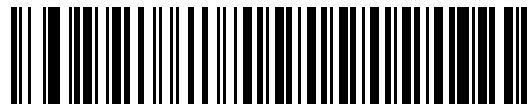

Do Not Check For Received Errors

Hardware Handshaking

The data interface consists of an RS-232 port designed to operate either with or without the hardware handshaking lines Request to Send (RTS) and Clear to Send (CTS).

If hardware handshaking and software handshaking are both enabled, hardware handshaking takes precedence.



NOTE: The DTR signal is jumpered to the active state.

Options:

- **None** - This disables hardware handshaking and transmits scan data as it becomes available.
- **Standard RTS/CTS** - This sets standard RTS/CTS hardware handshaking and transmits scanned data according to the following sequence:
 - a. The scanner reads the CTS line for activity:
 - If the CTS line is de-asserted, the scanner asserts the RTS line and waits up to [Host Serial Response Timeout on page 117](#) for the host to assert CTS, and then transmits data when asserted. If, after the timeout, the CTS line is not asserted, the scanner sounds a transmit error and discards the data.
 - If CTS is asserted, the scanner waits up to [Host Serial Response Timeout](#) for the host to de-assert CTS. If after this timeout the CTS line is still asserted, the scanner sounds a transmit error and discards the scanned data.
 - b. The scanner de-asserts RTS after sending the last character of data.
 - c. The host negates CTS. The scanner checks for a de-asserted CTS upon the next data transmission.

During data transmission, if CTS is deasserted for more than 50 ms between characters, the scanner sounds a transmit error and discards the data. The data must be re-scanned.

- **RTS/CTS Option 1** - The scanner asserts RTS before transmitting and ignores the state of CTS. The scanner de-asserts RTS when transmission completes.
- **RTS/CTS Option 2** - RTS is always high or low (user-programmed logic level). However, the scanner waits for the host to assert CTS before transmitting data. If CTS is not asserted within the [Host Serial](#)

Response Timeout, the scanner sounds a transmit error and discards the data. During data transmission, if CTS is deasserted for more than 50 ms between characters, the scanner sounds a transmit error and discards the data.

- **RTS/CTS Option 3** - This transmits scanned data according to the following sequence:
 - d. The scanner asserts RTS before data transmission, regardless of the state of CTS.
 - e. The scanner waits up to the **Host Serial Response Timeout** for the host to assert CTS, and then transmits data when asserted. If, after the timeout, the CTS line is not asserted, the scanner sounds a transmit error and discards the data.
 - f. The scanner de-asserts RTS after sending the last character of data.
 - g. The host negates CTS. The scanner checks for a de-asserted CTS upon the next data transmission.

During data transmission, if CTS is deasserted for more than 50 ms between characters, the scanner sounds a transmit error and discards the data. The data must be re-scanned.

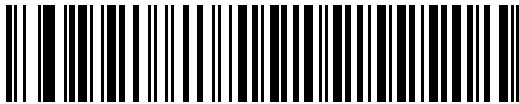

***None**



Standard RTS/CTS

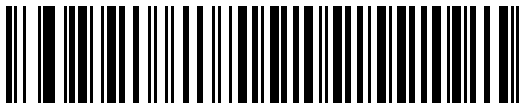

RTS/CTS Option 1



RTS/CTS Option 2



RTS/CTS Option 3

Software Handshaking

This parameter offers control of data transmission in addition to, or instead of, that offered by hardware handshaking. If software handshaking and hardware handshaking are both enabled, hardware handshaking takes precedence.

Options:

- **None** - This transmits data immediately. The scanner expects no response from the host.
- **ACK/NAK** - After transmitting data, the scanner waits for an ACK or NAK response from the host. If it receives a NAK, the scanner transmits the data again and waits for an ACK or NAK. After three unsuccessful attempts to send data after receiving NAKs, the scanner sounds a transmit error and discards the data.

The scanner waits up to the programmable [Host Serial Response Timeout](#) to receive an ACK or NAK. If the scanner does not get a response in this time, it sounds a transmit error and discards the data. There are no reattempts.

- **ENQ** - The scanner waits for an ENQ character from the host before transmitting data. If it does not receive an ENQ within the [Host Serial Response Timeout](#), the scanner sounds a transmit error and discards the data. The host must transmit an ENQ character at least every [Host Serial Response Timeout](#) to prevent transmission errors.
- **ACK/NAK with ENQ** - This combines the two previous options. An additional ENQ is not required to re-transmit data due to a NAK from the host.
- **XON/XOFF** - An XOFF character stops data transmission until the scanner receives an XON character. There are two situations for XON/XOFF:
 - The scanner receives an XOFF before it has data to send. When the scanner has data, it waits up to the [Host Serial Response Timeout](#) for an XON character before transmitting. If it does not receive the XON within this time, the scanner sounds a transmit error and discards the data.
 - The scanner receives an XOFF during data transmission and stops transmission after sending the current byte. When the scanner receives an XON character, it sends the rest of the data. The scanner waits indefinitely for the XON.

Software Handshaking (continued)



*None



ACK/NAK



ENQ



ACK/NAK with ENQ



XON/XOFF

Host Serial Response Timeout

Scan one of the following barcodes to specify how long the scanner waits for an ACK, NAK, or CTS before determining that a transmission error occurred. This only applies when in one of the ACK/NAK software handshaking modes, or RTS/CTS hardware handshaking mode,



***Minimum: 2 Seconds**

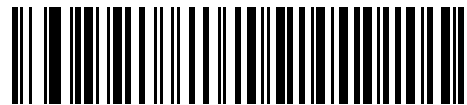

Low: 2.5 Seconds

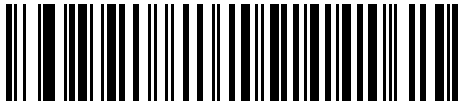

Medium: 5 Seconds

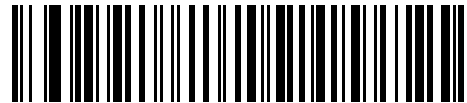

High: 7.5 Seconds

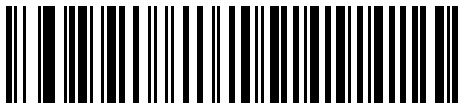

Maximum: 9.9 Seconds

RTS Line State

Scan one of the following barcodes to set the idle state of the serial host RTS line to **Low RTS** or **High RTS**.

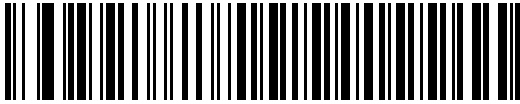

***Host: Low RTS**

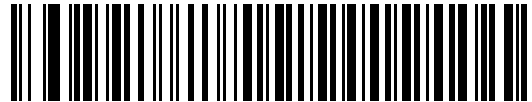

Host: High RTS

Beep on <BEL>

Scan one of the following barcodes to set whether the scanner issues a beep when it detects a <BEL> character on the RS-232 serial line. <BEL> indicates an illegal entry or other important event.

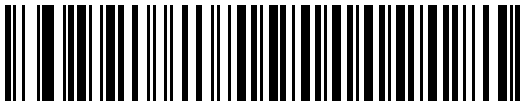

**Beep On <BEL> Character
(Enable)**

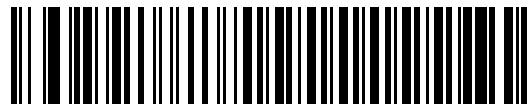

***Do Not Beep On <BEL> Character
(Disable)**

Intercharacter Delay

Scan one of the following barcodes to specify the intercharacter delay inserted between character transmissions.



***Minimum: 0 msec**



Low: 25 msec

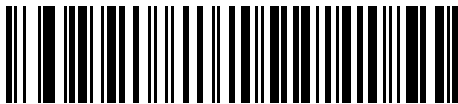

Medium: 50 msec



High: 75 msec

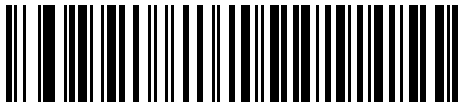

Maximum: 99 msec

Nixdorf Beep/LED Options

If you selected Nixdorf Mode B, scan one of the following barcodes to indicate when the scanner beeps and turns on its LED after a decode.



***Normal Operation**
(Beep/LED Immediately After Decode)

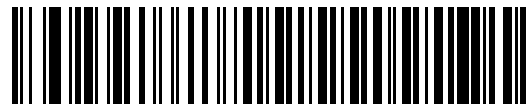

Beep/LED After Transmission

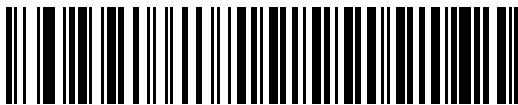

Beep/LED After CTS Pulse

Barcodes with Unknown Characters

Unknown characters are characters the host does not recognize. Scan **Send Barcodes With Unknown Characters** to send all barcode data except for unknown characters. The scanner issues no error beeps.

Scan **Do Not Send Barcodes With Unknown Characters** to send barcode data up to the first unknown character. The scanner issues an error beep.

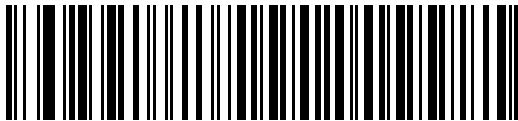

***Send Barcodes With Unknown Characters**

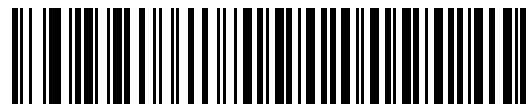

Do Not Send Barcodes With Unknown Characters

ASCII Character Sets

See [ASCII Character Set on page 471](#) for prefix/suffix values.

IBM 468X / 469X Interface

Introduction

This chapter describes how to set up the scanner with an IBM 468X/469X host.

The scanner ships with the settings shown in [Table 24 on page 124](#) (also see [Standard Parameter Defaults](#) for all defaults). If the default values suit requirements, programming is not necessary.

Setting Parameters

To set feature values, scan a single barcode or a short barcode sequence. The settings are stored in non-volatile memory and are preserved even when the scanner powers down.



NOTE: Most computer monitors allow scanning barcodes directly on the screen. When scanning from the screen, be sure to set the document magnification to a level where you can see the barcode clearly, and bars and/or spaces do not merge.

To return all features to default values, scan [Set Factory Defaults on page 142](#). Throughout the programming barcode menus, asterisks (*) indicate default values.

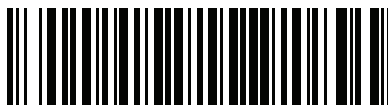

* Indicates default *Enable Parameter Feature/option

Scanning Sequence Examples

In most cases scanning one barcode sets the parameter value. For example, to select the Port 9B address, scan the **Hand-held Scanner Emulation (Port 9B)** barcode under [Port Address on page 125](#). The scanner issues a fast warble beep and the LED turns green, signifying a successful parameter entry.

Other parameters require scanning several barcodes. See the parameter descriptions for this procedure.

Errors While Scanning

Unless otherwise specified, to correct an error during a scanning sequence, just re-scan the correct parameter.

Connecting an IBM 468X/469X Host

Connect the scanner directly to the host computer.

Figure 15 IBM Connection

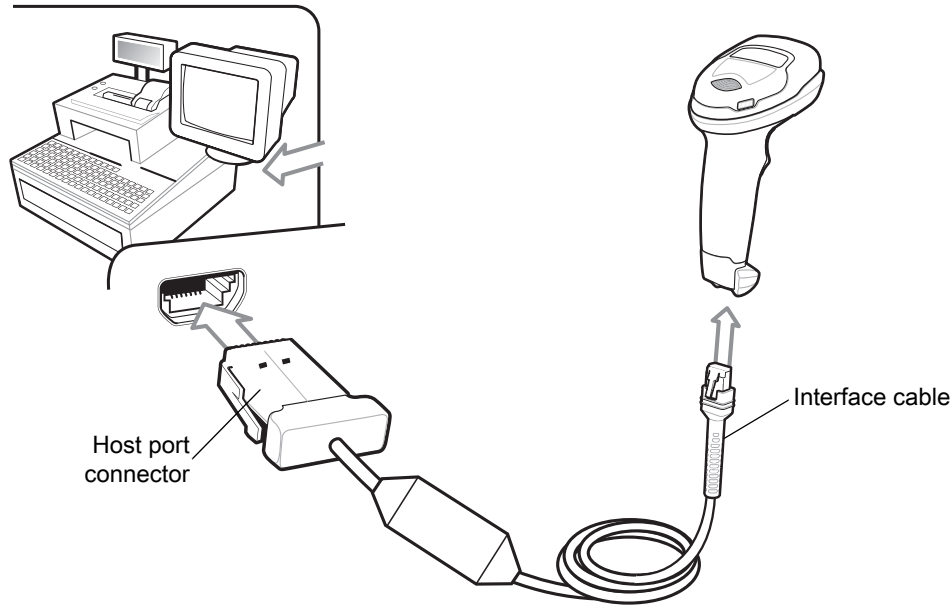

NOTE: Interface cables vary depending on configuration. The connectors can be different than those illustrated in [Figure 15](#), but the steps to connect the scanner are the same.

1. Attach the modular connector of the IBM 46XX interface cable to the cable interface port on the scanner. See [Inserting the Interface Cable on page 28](#).
2. Connect the other end of the IBM 46XX interface cable to the appropriate port on the host (typically Port 9).
3. The scanner automatically detects the host interface type, but there is no default setting. Scan the appropriate barcode from [Port Address on page 125](#) to select the port address.
4. To modify any other parameter options, scan the appropriate barcodes in this chapter.



NOTE: The only required configuration is the port address. The IBM system typically controls other scanner parameters.

If problems occur with the system, see [Troubleshooting on page 46](#).

IBM Parameter Defaults

Table 24 lists defaults for IBM host parameters. Change these values in one of two ways:

- Scan the appropriate barcodes in this chapter. The new value replaces the standard default value in memory. To recall default parameter values, see [Default Parameters on page 142](#).
- Configure the scanner using the 123Scan configuration program. See [123Scan and Software Tools](#).



NOTE: See [Standard Parameter Defaults](#) for all user preference, host, symbology, and miscellaneous default parameters.

Table 24 IBM 468X/469X Interface Parameter Defaults

Parameter	Default	Page Number
IBM 468X/469X Host Parameters		
Port Address	None	125
Convert Unknown to Code 39	Disable	126
RS-485 Beep Directive	Ignore	126
RS-485 Barcode Configuration Directive	Ignore	127
IBM-485 Specification Version	Original Specification	127

IBM Host Parameters

Port Address

Scan one of the following barcodes to select the IBM 468X/469X port.



- NOTES**
- 4 Scanning a Port Address barcode enables the RS-485 interface on the scanner.
 5. For a list of supported scanner functionality by communication protocol, see [Communication Protocol Functionality](#).

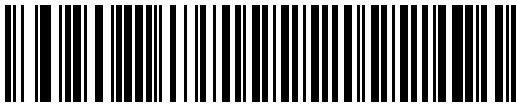

*None

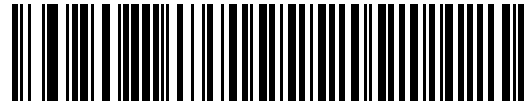

Hand-held Scanner Emulation (Port 9B)



Non-IBM Scanner Emulation (Port 5B)

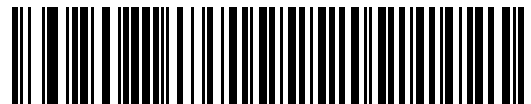

Table-top Scanner Emulation (Port 17)

Convert Unknown to Code 39

Scan one of the following barcodes to enable or disable converting unknown barcode type data to Code 39.



Enable Convert Unknown to Code 39

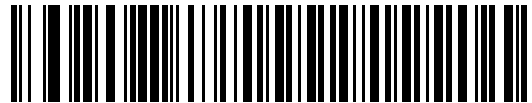

***Disable Convert Unknown to Code 39**

RS-485 Beep Directive

The IBM RS-485 host can send a beeper configuration request to the scanner. Scan **Ignore Beep Directive** to prevent the scanner from processing the host request. All directives are still acknowledged to the host as if they were processed.

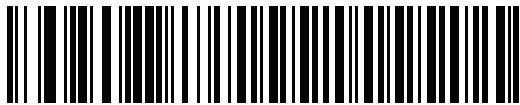

Honor Beep Directive



***Ignore Beep Directive**

RS-485 Barcode Configuration Directive

The IBM RS-485 host can enable and disable code types. Scan **Ignore Barcode Configuration Directive** to prevent the scanner from processing the host request. All directives are still acknowledged to the IBM RS-485 host as if they were processed.



Honor Barcode Configuration Directive

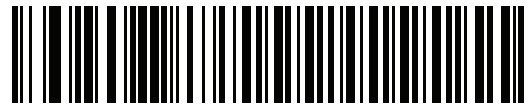

***Ignore Barcode Configuration Directive**

IBM-485 Specification Version

Parameter # 1729

SSI # F8h 06h C1h

Select **IBM-485 Original Specification** to report only symbologies historically supported on each port as known.

Select **IBM-485 Version 2.2** to report all symbologies supported in the new IBM specification as known with the respective code types.

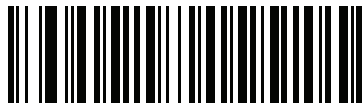

***IBM-485 Original Specification
(0)**

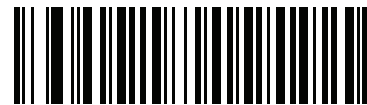

**IBM-485 (Version 2.2)
(1)**

Keyboard Wedge Interface

Introduction

This chapter describes how to set up a keyboard wedge interface with the scanner. The scanner connects between the keyboard and host computer and translates barcode data into keystrokes, which the host accepts as if they originated from the keyboard. This mode adds barcode reading functionality to a system designed for manual keyboard input. Keyboard keystrokes are simply passed through.

The scanner ships with the settings shown in [Table 25 on page 130](#) (also see [Standard Parameter Defaults](#) for all defaults). If the default values suit requirements, programming is not necessary.

Setting Parameters

To set feature values, scan a single barcode or a short barcode sequence. The settings are stored in non-volatile memory and are preserved even when the scanner powers down.



NOTE: Most computer monitors allow scanning barcodes directly on the screen. When scanning from the screen, be sure to set the document magnification to a level where you can see the barcode clearly, and bars and/or spaces do not merge.

To return all features to default values, scan a barcode in [Default Parameters on page 142](#). Throughout the programming barcode menus, asterisks (*) indicate default values.



* Indicates default *Enable Parameter Feature/option

Scanning Sequence Examples

In most cases, scanning one barcode sets the parameter value. For example, to select a medium keystroke delay, scan the **Medium Delay (20 msec)** barcode under [Keystroke Delay on page 132](#). The scanner issues a fast warble beep and the LED turns green, signifying a successful parameter entry.

Other parameters require scanning several barcodes. See the parameter descriptions for this procedure.

Errors While Scanning

Unless otherwise specified, to correct an error during a scanning sequence, just re-scan the correct parameter.

Connecting a Keyboard Wedge Interface

Figure 16 Keyboard Wedge Connection

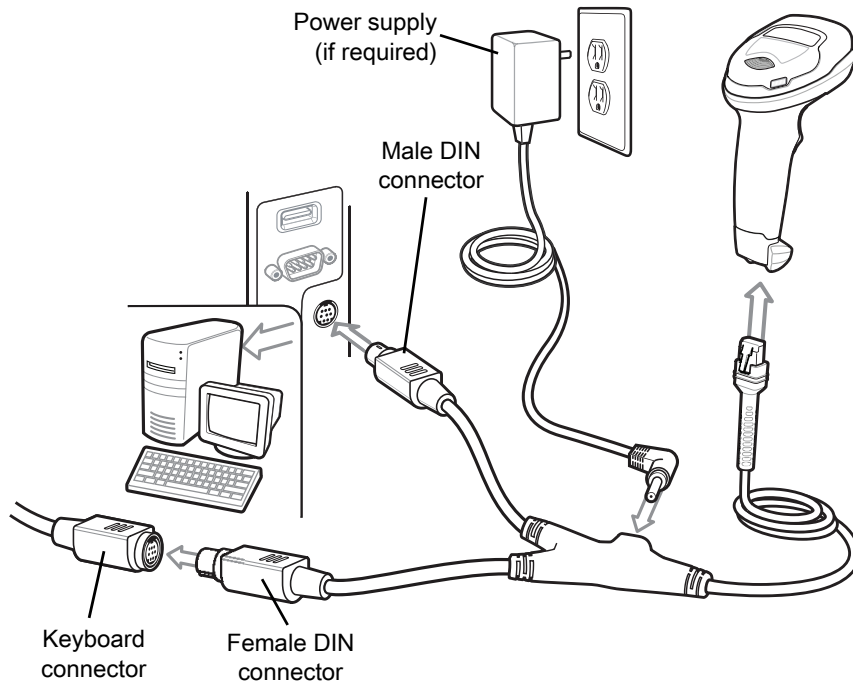

NOTE: Interface cables vary depending on configuration. The connectors can be different than those illustrated in [Figure 16](#), but the steps to connect the scanner are the same.

1. Turn off the host and unplug the keyboard connector.
2. Attach the modular connector of the Y-cable to the cable interface port on the scanner. See [Inserting the Interface Cable on page 28](#).
3. Connect the round male DIN host connector of the Y-cable to the keyboard port on the host device.
4. Connect the round female DIN keyboard connector of the Y-cable to the keyboard connector.
5. If required, attach the optional power supply to the connector in the middle of the Y-cable.
6. Ensure that all connections are secure.
7. Turn on the host system.
8. The scanner automatically detects the host interface type and uses the default setting. If the default (*) does not meet your requirements, scan [IBM PC/AT & IBM PC Compatibles on page 131](#).
9. To modify other parameter options, scan the appropriate barcodes in this guide.

If problems occur with the system, see [Troubleshooting on page 46](#).

Keyboard Wedge Parameter Defaults

Table 25 lists defaults for keyboard wedge host parameters. Change these values in one of two ways:

- Scan the appropriate barcodes in this chapter. The new value replaces the standard default value in memory. To recall default parameter values, see [Default Parameters on page 142](#).
- Configure the scanner using the 123Scan configuration program. See [123Scan and Software Tools](#).



NOTE: See [Standard Parameter Defaults](#) for all user preference, host, symbology, and miscellaneous default parameters.

Table 25 Keyboard Wedge Interface Parameter Defaults

Parameter	Default	Page Number
Keyboard Wedge Host Parameters		
Keyboard Wedge Host Type	IBM AT Notebook	131
Barcodes with Unknown Characters	Send Barcodes with Unknown Characters	131
Keystroke Delay	No Delay	132
Intra-keystroke Delay	Disable	132
Alternate Numeric Keypad Emulation	Enable	133
Quick Keypad Emulation	Enable	133
Simulated Caps Lock	Disable	134
Caps Lock Override	Disable	134
Convert Case	Do Not Convert	135
Function Key Mapping	Disable	136
FN1 Substitution	Disable	136
Send Make and Break	Send	137

Keyboard Wedge Host Parameters

Keyboard Wedge Host Types

Scan one of the following barcodes to select the keyboard wedge host.



NOTE: For a list of supported scanner functionality by communication protocol, see [Communication Protocol Functionality](#).

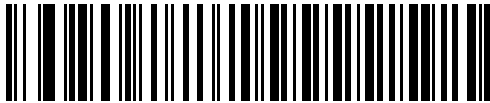

IBM PC/AT & IBM PC Compatibles

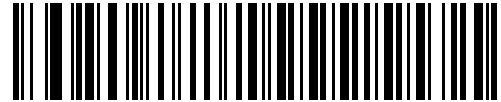

***IBM AT Notebook**

Barcodes with Unknown Characters

Unknown characters are characters the host does not recognize. Scan **Send Barcodes With Unknown Characters** to send all barcode data except for unknown characters. The scanner issues no error beeps.

Scan **Do Not Send Barcodes With Unknown Characters** to send barcode data up to the first unknown character. The scanner issues an error beep.

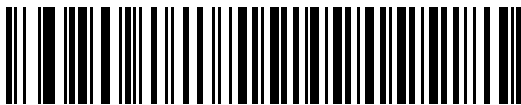

***Send Barcodes with Unknown Characters**



Do Not Send Barcodes with Unknown Characters

Keystroke Delay

This is the delay in milliseconds between emulated keystrokes. Scan one of the following barcodes to increase the delay when hosts require a slower data transmission.



***No Delay**



Medium Delay (20 msec)

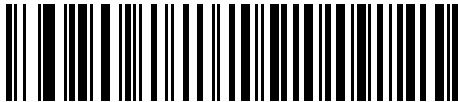

Long Delay (40 msec)

Intra-keystroke Delay

Scan **Enable Intra-keystroke Delay** to insert an additional delay between each emulated key press and release. This also sets [Keystroke Delay](#) to a minimum of 5 msec.

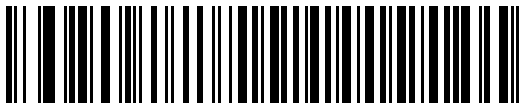

Enable Intra-keystroke Delay



***Disable Intra-keystroke Delay**

Alternate Numeric Keypad Emulation

This allows emulation of most other country keyboard types not listed in [Country Codes](#) in a Microsoft® operating system environment.



NOTE: If your keyboard type is not listed in the country code list (see [Country Codes on page 491](#)), disable [Quick Keypad Emulation on page 133](#) and ensure [Alternate Numeric Keypad Emulation on page 133](#) is enabled.

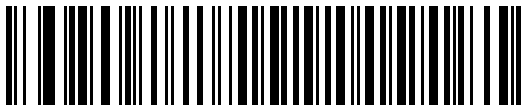

***Enable Alternate Numeric Keypad**



Disable Alternate Numeric Keypad

Quick Keypad Emulation

This enables faster keypad emulation where character value sequences are only sent for characters not found on the keyboard.



NOTE: This option applies only when [Alternate Numeric Keypad Emulation](#) is enabled.

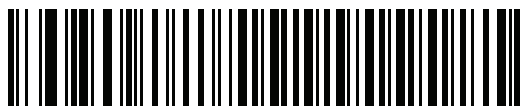

***Enable Quick Keypad Emulation**



Disable Quick Keypad Emulation

Simulated Caps Lock

Scan **Enable Caps Lock** to invert upper and lower case characters on the barcode as if the Caps Lock state is enabled on the keyboard. This inversion occurs regardless of the keyboard's Caps Lock state. Note that this only applies to alpha characters.

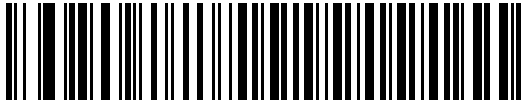

Enable Caps Lock

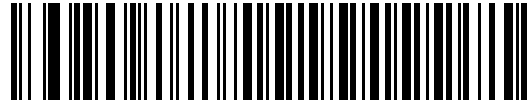

***Disable Caps Lock**

Caps Lock Override

Scan **Enable Caps Lock Override** for AT or AT Notebook hosts to preserve the case of the data regardless of the state of the Caps Lock key. Therefore, an 'A' in the barcode transmits as an 'A' regardless of the setting of the keyboard's Caps Lock key.



Enable Caps Lock Override



***Disable Caps Lock Override**



NOTE: If both Simulated Caps Lock and Caps Lock Override are enabled, Caps Lock Override takes precedence.

Convert Case

Scan one of the following barcodes to convert all barcode data to the selected case.



NOTE: Convert Case applies to ASCII characters only.

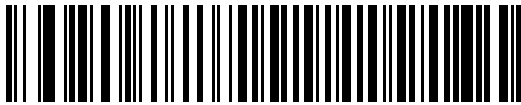

Convert to Upper Case

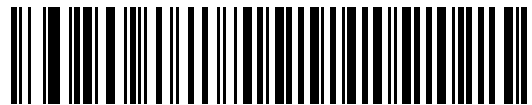

Convert to Lower Case



***Do Not Convert**

Function Key Mapping

ASCII values under 32 are normally sent as control key sequences (see [Table 38 on page 471](#)). Scan **Enable Function Key Mapping** to send the keys in bold in place of the standard key mapping. Table entries that do not have a bold entry remain the same whether or not you enable this parameter.

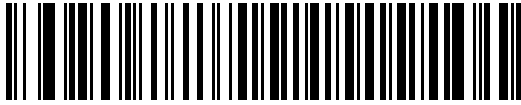

Enable Function Key Mapping

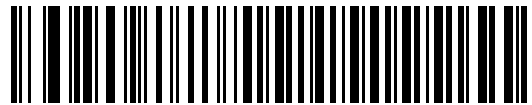

***Disable Function Key Mapping**

FN1 Substitution

Scan **Enable FN1 Substitution** to replace FN1 characters in an EAN128 barcode with a user-selected keystroke (see [FN1 Substitution Values on page 183](#)).

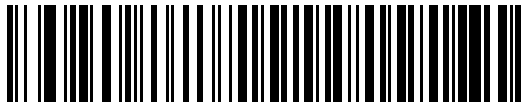

Enable FN1 Substitution

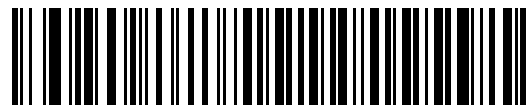

***Disable FN1 Substitution**

Send Make and Break

Scan **Send Make and Break Scan Codes** to prevent sending the scan codes for releasing a key.

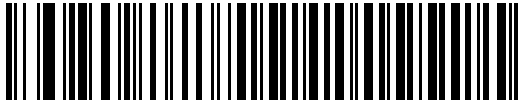

*Send Make and Break Scan Codes

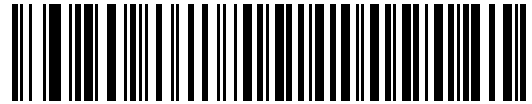

Send Make Scan Code Only



NOTE: Windows-based systems must use **Send Make and Break Scan Codes**.

Keyboard Map

The following keyboard map is a reference for prefix/suffix keystroke parameters. To program the prefix/suffix values, see the barcodes on [page 180](#).

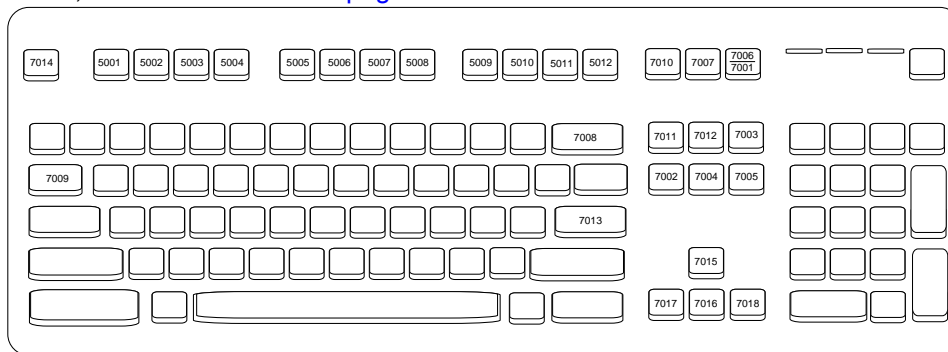

Figure 17 IBM PS2 Type Keyboard

ASCII Character Sets

See [ASCII Character Sets](#) for the following information:

- [ASCII Character Set on page 471](#)
- [ALT Key Character Set on page 476](#)
- [GUI Key Character Set on page 477](#)
- [PF Key Character Set on page 478](#)
- [F Key Character Set on page 479](#)
- [Numeric Key Character Set on page 480](#)
- [Extended Key Character Set on page 480](#)

User Preferences & Miscellaneous Options

Introduction

You can program the scanner to perform various functions, or activate different features. This chapter describes user preference features and provides programming barcodes for selecting these features.

The scanner ships with the settings shown in [Table 26 on page 139](#) (also see [Standard Parameter Defaults](#) for all defaults). If the default values suit requirements, programming is not necessary.

Setting Parameters

To set feature values, scan a single barcode or a short barcode sequence. The settings are stored in non-volatile memory and are preserved even when the scanner powers down.



NOTE: Most computer monitors allow scanning barcodes directly on the screen. When scanning from the screen, be sure to set the document magnification to a level where you can see the barcode clearly, and bars and/or spaces do not merge.

If not using the default host, select the host type (see each host chapter for specific host information) after the power-up beeps sound. This is only necessary upon the first power-up when connected to a new host.

To return all features to default values, see [Default Parameters on page 142](#). Throughout the programming barcode menus, asterisks indicate (*) default values.

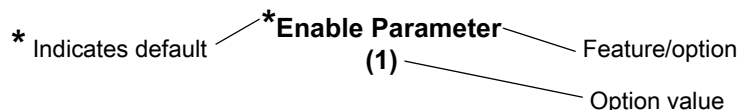
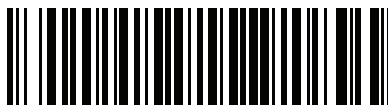

Scanning Sequence Examples

In most cases, scanning one barcode sets the parameter value. For example, to set the beeper tone to high, scan the **High Frequency** (beeper tone) barcode listed under [Beeper Tone on page 146](#). The scanner issues a fast warble beep and the LED turns green, signifying a successful parameter entry.

Other parameters require scanning several barcodes. See the parameter descriptions for this procedure.

Errors While Scanning

Unless otherwise specified, to correct an error during a scanning sequence, just re-scan the correct parameter.

User Preferences/Miscellaneous Options Parameter Defaults

Table 26 lists defaults for user preferences parameters. Change these values in one of two ways:

- Scan the appropriate barcodes in this chapter. The new value replaces the standard default value in memory. To recall default parameter values, see [Default Parameters on page 142](#).
- Configure the scanner using the 123Scan configuration program. See [123Scan and Software Tools](#).



NOTE: See [Standard Parameter Defaults](#) for all user preference, host, symbology, and miscellaneous default parameters.

Table 26 User Preferences Parameter Defaults

Parameter	Parameter Number ¹	SSI Number ²	Default	Page Number
User Preferences				
Set Default Parameter	N/A	N/A	N/A	142
Parameter Barcode Scanning	236	ECh	Enable	143
Beep After Good Decode	56	38h	Enable	144
Beeper Volume	140	8Ch	High	145
Beeper Tone	145	91h	Medium	146
Beeper Duration	628	F1h 74h	Medium	147
Suppress Power Up Beeps	721	F1h D1h	Do Not Suppress	148
LED on Good Decode	744	F1h E8h	Enable	149
Direct Decode Indicator	859	F2h 5Bh	Disable	149
Decode Pager Motor (DS4608-HC and DS4608-DPE Only)	613	F1h 65h	Enable	150
Decode Pager Motor Duration (DS4608-HC Only)	626	F1h 72h	150 msec	151
Night Mode Trigger (DS4608-HC and DS4608-DPE Only)	1215	F8h 04h BFh	DS4608-HC: Enable DS4608-DPE: Disable	154
Night Mode Toggle (DS4608-HC Only DS4608-DPE)	N/A	N/A	N/A	154
Low Power Mode	128	80h	Disable	155
Time Delay to Low Power Mode	146	92h	1 Hour	156
Trigger Mode (or Hand-held Trigger Mode)	138	8Ah	Auto Aim	158
Hand-held Decode Aiming Pattern	306	F0h 32h	Enable	159

1. Parameter number decimal values are used for programming via RSM commands.

2. SSI number hex values are used for programming via SSI commands.

Table 26 User Preferences Parameter Defaults (Continued)

Parameter	Parameter Number ¹	SSI Number ²	Default	Page Number
Hands-free (Presentation) Decode Aiming Pattern	590	F1h 4Eh	Disable Hands-free (Presentation) Decode Aiming Pattern	160
Hands-free Mode	630	F1h 76h	Enable	161
Picklist Mode	402	F0h 92h	Disable Picklist Mode Always	162
Continuous Barcode Read	649	F1h 89h	Disable	163
Unique Barcode Reporting	723	F1h D3h	Enable	164
Decode Session Timeout	136	88h	9.9 Seconds	164
Timeout Between Decodes, Same Symbol	137	89h	0.5 Seconds	165
Timeout Between Decodes, Different Symbols	144	90h	0.1 Seconds	165
Triggered Timeout, Same Symbol	724	F1h D4h	Disable	166
Mobile Phone/Display Mode	716	F1h CCh	Normal	167
PDF Prioritization	719	F4h F1h CFh	Disable	168
PDF Prioritization Timeout	720	F1h D0h	200 ms	168
Presentation Mode Field of View	609	F1h 61h	Full	170
Decoding Illumination	298	F0h 2Ah	Enable	171
Illumination Brightness	669	F1h 9Dh	High	172
Motion Tolerance (Hand-held Trigger Mode Only)	858	F2h 5Ah	Less	173
Product ID (PID) Type	1281	F8h 05h 01h	Host Type Unique	174
Product ID (PID) Value	1725	F8h 06h BDh	0	174
ECLevel	1710	F8h 06h AEh	0	175
DPM Parameters (DS4608-DPE Only)				
DPM Illumination	429	F0h ADh	Cycle Illumination	176

1. Parameter number decimal values are used for programming via RSM commands.
2. SSI number hex values are used for programming via SSI commands.

Table 26 User Preferences Parameter Defaults (Continued)

Parameter	Parameter Number ¹	SSI Number ²	Default	Page Number
DPM Mode	1438	F8h 05h 9Eh	Enable	177
Miscellaneous Options				
Enter Key	N/A	N/A	N/A	178
Tab Key	N/A	N/A	N/A	178
Transmit Code ID Character	45	2Dh	None	179
Prefix Value	99, 105	63h, 69h	7013 <CR><LF>	180
Suffix 1 Value	98, 104	62h, 68h	7013 <CR><LF>	180
Suffix 2 Value	100, 106	64h, 6Ah		
Scan Data Transmission Format	235	EBh	Data As Is	181
FN1 Substitution Values	103, 109	67h, 6Dh	7013 <CR><LF>	183
Transmit “No Read” Message	94	5E	Disable	184
Unsolicited Heartbeat Interval	1118	F8h 04h 5Eh	Disable	185
securPharm Decoding	1752	F8h 06h D8h	Disable	186
securPharm Output Formatting	1753	F8h 06h D9h	No Formatting	187

1. Parameter number decimal values are used for programming via RSM commands.
2. SSI number hex values are used for programming via SSI commands.

User Preferences

Default Parameters

Scan one of the following barcodes to reset the scanner to its default settings as follows:

- **Restore Defaults** resets all default parameters as follows:
 - If you configured custom default parameter values via the **Write to Custom Defaults** barcode, scanning the **Restore Defaults** barcode restores these custom values.
 - If you did not configure custom default parameter values, scanning the **Restore Defaults** barcode restores the factory default values. See [Standard Parameter Defaults](#) for these values.
- **Set Factory Defaults** clears all custom default values and sets the factory default values. See [Standard Parameter Defaults](#) for these values.

Write to Custom Defaults

To create a set of custom defaults, select the desired parameter values in this guide, and then scan **Write to Custom Defaults**.



Restore Defaults



Set Factory Defaults



Write to Custom Defaults

Parameter Barcode Scanning

Parameter # 236

SSI # ECh

Scan one of the following barcodes to select whether to enable or disable the decoding of parameter barcodes, including the **Set Defaults** barcodes.



***Enable Parameter Barcode Scanning
(1)**



**Disable Parameter Barcode Scanning
(0)**

Beep After Good Decode

Parameter # 56

SSI # 38h

Scan one of the following barcodes to select whether or not the scanner beeps after a good decode. If you select **Disable Beep After Good Decode**, the beeper still operates during parameter menu scanning and to indicate error conditions.



***Enable Beep After Good Decode**
(1)

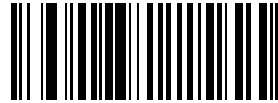

Disable Beep After Good Decode
(0)

Beeper Volume

Parameter # 140

SSI # 8Ch

Scan one of the following barcodes to select a beeper volume.



Low Volume
(2)



Medium Volume
(1)



***High Volume**
(0)

Beeper Tone

Parameter # 145

SSI # 91h

Scan one of the following barcodes to select a beeper tone for the good decode beep.



Disable Tone
(3)

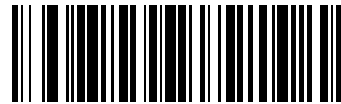

Low Tone
(2)

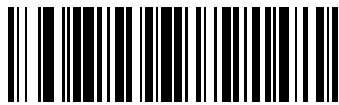

***Medium Tone**
(1)

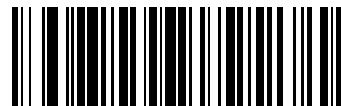

High Tone
(0)



Medium to High Tone (2-tone)
(4)

Beeper Duration

Parameter # 628

SSI # F1h 74h

Scan one of the following barcodes to select the duration for the good decode beep.

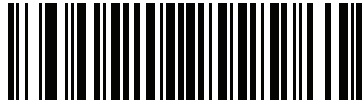

**Short Duration
(0)**

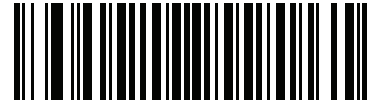

***Medium Duration
(1)**

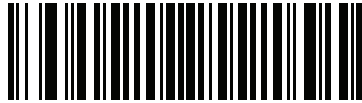

**Long Duration
(2)**

Suppress Power Up Beeps

Parameter # 721

SSI # F1h D1h

Scan one of the following barcodes to select whether or not to suppress the scanner's power-up beeps.



***Do Not Suppress Power Up Beeps**
(0)



Suppress Power Up Beeps
(1)

LED on Good Decode

Parameter # 744

SSI # F1h E8h

Scan one of the following barcodes to select whether or not the LED blinks on a good decode.



***Enable LED on Good Decode
(2)**



**Disable LED on Good Decode
(0)**

Direct Decode Indicator

Parameter # 859

SSI # F2h 5Bh

This parameter is only supported in Auto Aim and Standard (Level) [Hand-held Trigger Mode](#). Scan one of the following barcodes to select optional blinking of the illumination on a successful decode if you continue to hold the trigger. If you release the trigger upon decode, the blinking does not occur. This allows you to choose additional feedback for a successful decode by holding the trigger, or to continue to scan as normal.

- ***Disable Direct Decode Indicator** - Illumination does not blink on a successful decode.
- **1 Blink** - Illumination blinks once upon a successful decode.
- **2 Blinks** - Illumination blinks twice upon a successful decode.

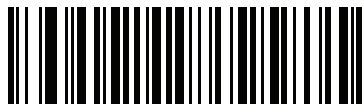

***Disable Direct Decode Indicator
(0)**



**1 Blink
(1)**



**2 Blinks
(2)**

Decode Pager Motor (DS4608-HC Only and DS4608-DPE)

Parameter # 613

SSI # F1h 65h

The scanner includes a pager motor which, when enabled, vibrates the scanner for a period of time when a successful decode occurs.



NOTE: While the scanner is in the Intellistand, the pager motor is disabled.

Scan one of the following barcodes to enable or disable the pager motor. If enabled, scan a [Decode Pager Motor Duration \(DS4608-HC Only\)](#) barcode to set the duration of the pager motor vibration.



***Enable Pager Motor
(1)**

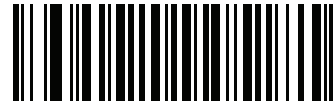

**Disable Pager Motor
(0)**

Decode Pager Motor Duration (DS4608-HC Only)

Parameter # 626

SSI # F1h 72h

If you enabled [Decode Pager Motor \(DS4608-HC Only and DS4608-DPE\)](#), scan one of the following barcodes to set the duration of the pager motor vibration.

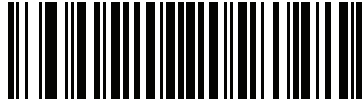

***150 msec
(15)**

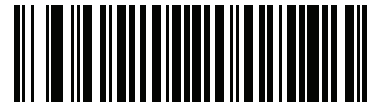

**200 msec
(20)**

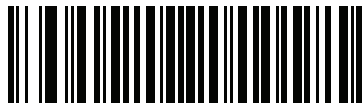

**250 msec
(25)**



**300 msec
(30)**

Decode Pager Motor Duration (continued)



400 msec
(40)

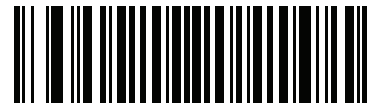

500 msec
(50)

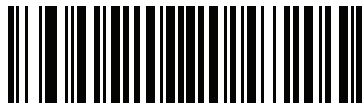

600 msec
(60)



750 msec
(75)

Night Mode (DS4608-HC and DS4608-DPE Only)

The Night Mode feature allows you to easily switch to a “quiet mode” in order to use the pager motor with the beeper off. Enter and exit Night Mode in one of two ways:

- If [Night Mode Trigger \(DS4608-HC and DS4608-DPE Only\)](#) is enabled, you can use the trigger to toggle between entering and exiting Night Mode. To do this, point the scanner away from a barcode and press the trigger until the beam goes off. Hold the trigger for an additional 5 seconds.



NOTE: After decoding a barcode, holding the trigger an additional 5 seconds has no affect.

- Scan the [Night Mode Toggle \(DS4608-HC and DS4608-DPE Only\)](#) barcode to enter or exit Night Mode, regardless of the state of the [Night Mode Trigger \(DS4608-HC and DS4608-DPE Only\)](#) parameter.

Entering Night Mode enables [Decode Pager Motor \(DS4608-HC Only and DS4608-DPE\)](#), and disables [Beep After Good Decode](#).

Also note the following scanner behavior regarding Night Mode:

- Exiting Night Mode returns the scanner to the previously programmed states for the three parameters changed. For example, if [Beep After Good Decode](#) was enabled before entering Night Mode, it returns to enabled upon exiting Night Mode.
- When entering Night Mode, the pager motor vibrates. When exiting Night Mode, the scanner emits two short beeps.
- Scanning a [Default Parameters](#) barcode causes the scanner to exit Night Mode.
- For scanners that do not use a pager motor, scanning any of the Night Mode parameters or the pager motor parameters results in an error beep.
- If the scanner loses power while in Night Mode because a cable is disconnected, on the next power up the scanner exits Night Mode and resumes normal operation.

Night Mode Trigger (DS4608-HC and DS4608-DPE Only)

Parameter # 1215

SSI # F8h 04h BFh

Scan **Enable Night Mode Trigger** to use the trigger to toggle between entering and exiting Night Mode. To toggle, point the scanner away from a barcode, press the trigger until the beam goes off, and then hold the trigger for an additional 5 seconds. Note that pressing the trigger an additional 5 seconds after decoding a barcode has no affect.

When entering Night Mode, the pager motor vibrates. When exiting Night Mode, the scanner emits two short beeps.



***Enable Night Mode Trigger DS4608-HC
(1)**



***Disable Night Mode Trigger DS4608-DPE
(0)**

Night Mode Toggle (DS4608-HC and DS4608-DPE Only)

Scan this barcode to toggle between entering and exiting Night Mode without using the trigger. This functions regardless of the state of the **Night Mode Trigger** parameter.

When entering Night Mode, the pager motor vibrates. When exiting Night Mode, the scanner emits two short beeps.



Toggle Night Mode

Low Power Mode

Parameter # 128

SSI # 80h



NOTE: The Low Power Mode parameter only applies for non-USB and non-RS485 host interfaces, and when [Hand-held Trigger Mode on page 158](#) is set to **Level (Standard)**.

Scan one of the following barcodes to select whether or not the scanner enters low power mode after a decode attempt or host communication. This applies to serial and keyboard wedge connections. If disabled, power remains on after each decode attempt.

If you enable this, see [Time Delay to Low Power Mode](#) to set the inactivity time period.



**Enable Low Power Mode
(1)**



***Disable Low Power Mode
(0)**

Time Delay to Low Power Mode

Parameter # 146

SSI # 92h



NOTE: This parameter only applies when [Low Power Mode](#) is enabled.

Scan one of the following barcodes to set the time the scanner remains active before entering low power mode. The scanner wakes upon trigger press or when the host attempts to communicate with the scanner.



1 Second
(17)



10 Seconds
(26)



1 Minute
(33)



5 Minutes
(37)



15 Minutes
(43)

Time Delay to Low Power Mode (continued)



**30 Minutes
(45)**

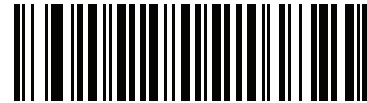

**45 Minutes
(46)**



***1 Hour
(49)**

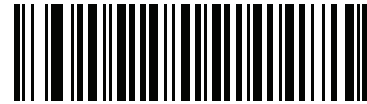

**3 Hours
(51)**

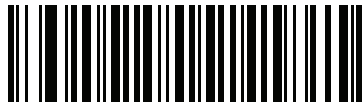

**6 Hours
(54)**

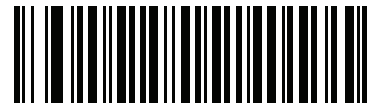

**9 Hours
(57)**

Hand-held Trigger Mode

Parameter # 138

SSI # 8Ah

Scan one of the following barcodes to select a trigger mode for the scanner:

- **Standard (Level)** - A trigger press activates decode processing. Decode processing continues until the barcode decodes, you release the trigger, or the [Decode Session Timeout on page 164](#) occurs.
- **Presentation (Blink)** - The scanner activates decode processing when it detects a barcode in its field of view. After a period of non-use, the LEDs turn off until the scanner senses motion.
- ***Auto Aim** - The scanner projects the aiming pattern when lifted. A trigger press activates decode processing. After a period of inactivity the aiming pattern shuts off.

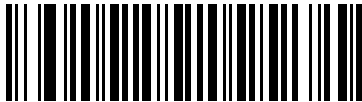

Standard (Level)
(0)

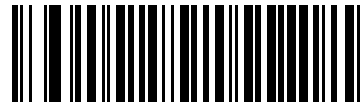

Presentation (Blink)
(7)



***Auto Aim**
(9)

Hand-held Decode Aiming Pattern

Parameter # 306

SSI # F0h 32h

Scan one of the following barcodes to select when to project the aiming pattern in hand-held mode:

- **Enable Hand-held Decode Aiming Pattern** - This projects the aiming pattern during barcode capture.
- **Disable Hand-held Decode Aiming Pattern** - This turns the aiming pattern off.
- **Enable Hand-held Decode Aiming Pattern on PDF** - This projects the aiming pattern when the scanner detects a PDF barcode.



NOTE: With [Picklist Mode on page 162](#) enabled, the decode aiming pattern flashes even if you disable the **Hand-held Decode Aiming Pattern**.



***Enable Hand-held Decode Aiming Pattern
(2)**

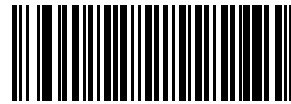

**Disable Hand-held Decode Aiming Pattern
(0)**



**Enable Hand-held Decode Aiming Pattern on PDF
(3)**

Hands-free (Presentation) Decode Aiming Pattern

Parameter # 590

SSI # F1h 4Eh

Scan one of the following barcodes to select when to project the aiming pattern in hands-free mode:

- **Enable Hands-free (Presentation) Decode Aiming Pattern** - This projects the aiming pattern during barcode capture.
- **Disable Hands-free (Presentation) Decode Aiming Pattern** - This turns the aiming pattern off.
- **Enable Hands-free (Presentation) Decode Aiming Pattern on PDF** - This projects the aiming pattern when the scanner detects a PDF barcode.



NOTE: With [Picklist Mode on page 162](#) enabled, the decode aiming pattern flashes even when you disable the **Hands-free Decode Aiming Pattern**.



**Enable Hands-free (Presentation)
Decode Aiming Pattern
(1)**



***Disable Hands-free (Presentation)
Decode Aiming Pattern
(0)**



**Enable Hands-free (Presentation)
Decode Aiming Pattern on PDF
(2)**

Hands-free Mode

Parameter # 630

SSI # F1h 76h

Scan one of the following barcodes to enable or disable hands-free mode:

- **Enable Hands-free Mode** - When you place the scanner in a hands-free stand, it automatically triggers when presented with a barcode. Removing the scanner from the stand or pulling the trigger causes it to behave according to the setting of the [Hand-held Trigger Mode on page 158](#).
- **Disable Hands-free Mode** - The scanner behaves according to the setting of the [Hand-held Trigger Mode on page 158](#) regardless of whether it is hand-held or in a stand.



***Enable Hands-free Mode
(1)**



**Disable Hands-free Mode
(0)**

Picklist Mode

Parameter # 402

SSI # F0h 92h

Scan one of the following barcodes to select a Picklist Mode. In this mode, you can pick out and decode a barcode from a group of barcodes that are printed close together by placing the aiming pattern on the barcode you want to decode.



NOTE: Enabling Picklist Mode overrides the Disable Decode Aiming Pattern options. You can not disable the decode aiming pattern when Picklist Mode is enabled.

Enabling Picklist Mode can slow decode speed and hinder the ability to decode longer barcodes.

- **Enable Picklist Mode Always** - Picklist Mode is always enabled.
- **Enable Picklist Mode in Hand-held Mode** - Picklist Mode is enabled when the scanner is out of hands-free mode and disabled when the scanner is in presentation mode.
- **Enable Picklist Mode in Hands-free Mode** - Picklist Mode is enabled when the scanner is in hands-free mode only.
- **Disable Picklist Mode Always** - Picklist Mode is always disabled.

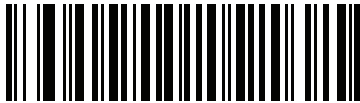

Enable Picklist Mode Always
(2)

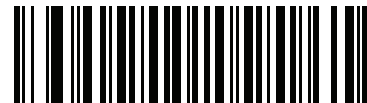

Enable Picklist Mode in Hand-held Mode
(1)



Enable Picklist Mode in Hands-free Mode
(3)



***Disable Picklist Mode Always**
(0)

Continuous Barcode Read

Parameter # 649

SSI # F1h 89h

Scan **Enable Continuous Barcode Read** to report every barcode while the trigger is pressed.



NOTE: We strongly recommend enabling [Picklist Mode on page 162](#) with this parameter. Disabling Picklist Mode can cause accidental decodes when more than one barcode is in the scanner's field of view.



Enable Continuous Barcode Read
(1)

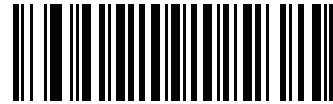

***Disable Continuous Barcode Read**
(0)

Unique Barcode Reporting

Parameter # 723

SSI # F1h D3h

Scan **Enable Continuous Barcode Read Uniqueness** to report only unique barcodes while the trigger is pressed. This option only applies when [Continuous Barcode Read](#) is enabled.



***Enable Unique Barcode Reporting
(1)**



**Disable Unique Barcode Reporting
(0)**

Decode Session Timeout

Parameter # 136

SSI # 88h

This parameter sets the maximum time decode processing continues during a scan attempt. It is programmable in 0.1 second increments from 0.5 to 9.9 seconds. The default timeout is 9.9 seconds.

To set a Decode Session Timeout, scan the following barcode, and then scan two barcodes from [Numeric Barcodes](#) that correspond to the desired on time. Enter a leading zero for single digit numbers. For example, to set a Decode Session Timeout of 0.5 seconds, scan this barcode, and then scan the **0** and **5** barcodes. To correct an error or change the selection, scan [Cancel on page 452](#).



Decode Session Timeout

Timeout Between Decodes, Same Symbol

Parameter # 137

SSI # 89h

Use this option in presentation mode or [Continuous Barcode Read](#) mode to prevent the scanner from continuously decoding the same barcode when it is left in the scanner's field of view. The barcode must be out of the field of view for the timeout period before the scanner reads the same consecutive symbol. It is programmable in 0.1 second increments from 0.0 to 9.9 seconds. The default interval is 0.5 seconds.

To select the timeout between decodes for the same symbol, scan the following barcode, and then scan two barcodes from [Numeric Barcodes](#) that correspond to the desired interval, in 0.1 second increments.



Timeout Between Decodes, Same Symbol

Timeout Between Decodes, Different Symbols

Parameter # 144

SSI # 90h

Use this option in presentation mode or [Continuous Barcode Read](#) to control the time the scanner waits before decoding a different symbol. It is programmable in 0.1 second increments from 0.1 to 9.9 seconds. The default is 0.1 seconds.

To select the timeout between decodes for different symbols, scan the following barcode, and then scan two barcodes from [Numeric Barcodes](#) that correspond to the desired interval, in 0.1 second increments.



NOTE: Timeout Between Decodes, Different Symbols cannot be greater than or equal to the [Decode Session Timeout](#).



Timeout Between Decodes, Different Symbols

Triggered Timeout, Same Symbol

Parameter # 724

SSI # F1h D4h



NOTE: This feature does not apply to Timeout Between Decodes, Different Symbols.



NOTE: Timeout Between Decodes, Same Symbol cannot be greater than or equal to the Time Delay to Low Power Mode (parameter #146 on page 156).

Scan **Enable Triggered Timeout, Same Symbol** below to apply **Timeout Between Decodes, Same Symbol** (parameter #137 on page 165) in hand-held trigger mode. Subsequent scans of **Enable Triggered Timeout, Same Symbol** are ignored until **Timeout Between Decodes, Same Symbol** expires.



Enable Triggered Timeout, Same Symbol
(1)



*** Disable Triggered Timeout, Same Symbol**
(0)

Mobile Phone/Display Mode

Parameter # 716

SSI # F1h CCh

This mode improves barcode reading performance off mobile phones and electronic displays. Scan one of the following barcodes to select the desired mode.



***Normal Mobile Phone/Display Mode
(0)**

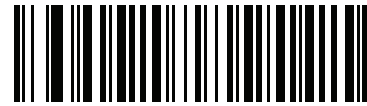

**Enhanced in Hand-held Mode
(1)**

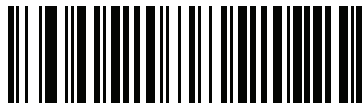

**Enhanced in Hands-free Mode
(2)**



**Enhanced in Both Modes
(3)**

PDF Prioritization

Parameter # 719

SSI # F4h F1h CFh

Scan **Enable PDF Prioritization** to delay decoding certain 1D barcodes (see Note below) by the value specified in **PDF Prioritization Timeout**. During that time the scanner attempts to decode a PDF417 symbol (e.g., on a US driver's license), and if successful, reports this only. If it does not decode (can not find) a PDF417 symbol, it reports the 1D symbol after the timeout. The 1D symbol must be in the device's field of view for the scanner to report it. This parameter does not affect decoding other symbologies.



NOTE: The 1D Code 128 barcode lengths include the following:

- 7 to 10 characters
- 14 to 22 characters
- 27 to 28 characters

In addition, a Code 39 barcode with the following lengths are considered to potentially be part of a US driver's license:

- 8 characters
- 12 characters



**Enable PDF Prioritization
(1)**



***Disable PDF Prioritization
(0)**

PDF Prioritization Timeout

Parameter # 720

SSI # F1h D0h

If you enabled [PDF Prioritization](#), set this timeout to indicate how long the scanner attempts to decode a PDF417 symbol before reporting the 1D barcode in the field of view.

Scan the following barcode, and then scan four barcodes from [Numeric Barcodes](#) that specify the timeout in milliseconds. For example, to enter 400 ms, scan the following barcode, and then scan 0400. The range is 0 to 5000 ms, and the default is 200 ms.



PDF Prioritization Timeout

Presentation Mode Field of View

Parameter # 609

SSI # F1h 61h

In presentation mode, by default the scanner searches the larger area of the aiming pattern (**Full Field of View**).

Select **Small Field of View** or **Medium Field of View** to search for a barcode in a smaller region around the aiming pattern's center in order to speed search time.

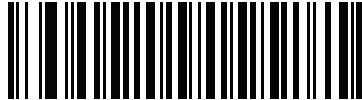

Small Field of View
(0)

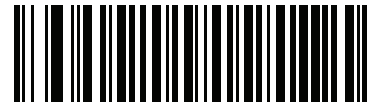

Medium Field of View
(1)

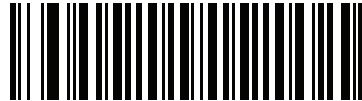

***Full Field of View**
(2)

Decoding Illumination

Parameter # 298

SSI # F0h 2Ah

Scan one of the following barcodes to determine whether the scanner turns on illumination to aid decoding. Enabling illumination usually results in superior images and better decode performance. The effectiveness of the illumination decreases as the distance to the target increases.



***Enable Decoding Illumination
(1)**



**Disable Decoding Illumination
(0)**

Illumination Brightness

Parameter # 669

SSI # F1h 9Dh

Scan one of the following barcodes to set the illumination brightness used during an active decode session. This only applies in hand-held mode (not in presentation mode).



NOTE: Selecting a lower brightness level can affect decode performance.



**Low Illumination Brightness
(0)**



**Medium Illumination Brightness
(3)**



***High Illumination Brightness
(10)**

Motion Tolerance (Hand-held Trigger Modes Only)

Parameter # 858

SSI # F2h 5Ah

Scan one of the following barcodes to select a motion tolerance option:

- **Less Motion Tolerance** - This provides optimal decoding performance on 1D barcodes.
- **More Motion Tolerance** - This increases motion tolerance and speeds decoding when scanning a series of 1D barcodes in rapid progression.



***Less Motion Tolerance
(0)**

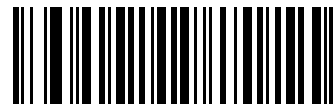

**More Motion Tolerance
(1)**

Product ID (PID) Type

Parameter # 1281

SSI # F8h 05h 01h

Scan one of the following barcodes to define the PID value reported in USB enumeration.

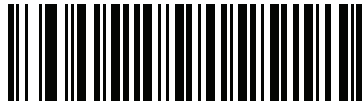

*Host Type Unique
(0)



Product Unique
(1)

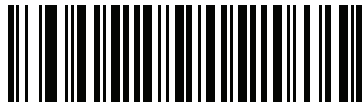

IBM Unique
(2)

Product ID (PID) Value

Parameter # 1725

SSI # F8h 06h BDh

To set a Product ID value, scan **Set PID Value**, and then scan four numeric barcodes in [Numeric Barcodes](#) that correspond to the value. Enter a leading zero for single digit numbers. To correct an error, or change a selection, scan [Cancel on page 452](#). The range is (0,1600-1649).



NOTE: This parameter applies to customers using a Firmware Flash Update per the Toshiba Global Commerce Solutions (TGCS) Universal Serial Bus OEM Point-of-Sale Device Interface.



Set PID Value

ECLevel

Parameter # 1710

SSI # F8h 06h AEh

To set an ECLevel value, scan **Set ECLevel**, and then scan five numeric barcodes in [Numeric Barcodes](#) that correspond to the desired level. Enter a leading zero for single digit numbers. To correct an error, or change a selection, scan [Cancel on page 452](#).



NOTE: This parameter applies to customers using a Firmware Flash Update per the Toshiba Global Commerce Solutions (TGCS) Universal Serial Bus OEM Point-of-Sale Device Interface. It allows defining an ECLevel value to manage and control Flash Update operations on the 4690 operating system.

Contact the Zebra Customer Support Center online at: www.zebra.com/support for more information.



Set ECLevel

DPM Parameters (DS4608-DPE Only)

DPM Illumination Control

Parameter # 429

SSI # F0h ADh

This parameter controls the Illumination for DPM barcode reading.

- Direct Illumination - scanner uses only the direct illumination.
- Indirect Illumination - scanner uses only the Diffused illumination.
- Cycle Illumination - scanner cycles alternately between direct and indirect illumination. The scanner starts with the illumination used during the last successful decode.



Direct Illumination
(0)



Indirect Illumination
(1)



*** Cycle Illumination**
(3)

DPM Mode

Parameter # 1438

SSI # F8h 05h 9Eh

Unlike barcodes typically printed on labels, a direct part mark (DPM) is a symbol that is marked, using methods such as laser etching and dot peening, directly on an item surface for permanent identification. A DPM reader can scan these types of symbols. Scan one of the following barcodes to select a DPM mode:

- **Disable DPM Mode** - No special processing occurs.



NOTE: If you enable a **DPM Mode**, disable [Picklist Mode on page 162](#) when scanning a DPM barcode. Picklist performance is not guaranteed for DPM barcodes.

If you enable a **DPM Mode**, the decoder behaves as if the **Data Matrix Inverse Autodetect** setting is selected. If you disable DPM, the previous (user-selected) **Data Matrix Inverse** setting remains in effect. See [Data Matrix Inverse on page 306](#).



**Disable DPM Mode
(0)**



***Enable DPM Mode
(1)**

Miscellaneous Scanner Parameters

Enter Key

Scan the following barcode to add an Enter key (carriage return/line feed) after scanned data. To program other prefixes and/or suffixes, see [Prefix/Suffix Values on page 180](#).

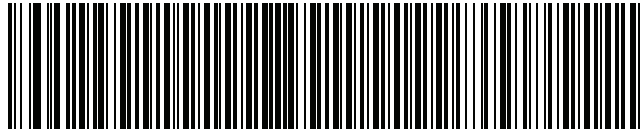

Add Enter Key (Carriage Return/Line Feed)

Tab Key

Scan the following barcode to add a Tab key after scanned data.

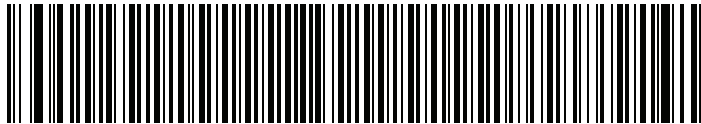

Tab Key

Transmit Code ID Character

Parameter # 45

SSI # 2Dh

A Code ID character identifies the code type of a scanned barcode. This is useful when decoding more than one code type. In addition to any single character prefix selected, the Code ID character is inserted between the prefix and the decoded symbol.

Select no Code ID character, a Symbol Code ID character, or an AIM Code ID character. For Code ID characters, see [Symbol Code Identifiers on page 482](#) and [AIM Code Identifiers on page 484](#).



NOTE: If you enable Symbol Code ID Character or AIM Code ID Character, and enable [Transmit "No Read" Message on page 184](#), the scanner appends the code ID for Code 39 to the NR message.

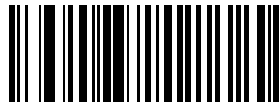

Symbol Code ID Character
(2)

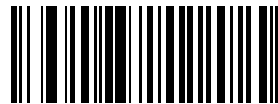

AIM Code ID Character
(1)

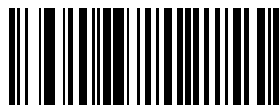

*None
(0)

Prefix/Suffix Values

Key Category Parameter # P = 99, S1 = 98, S2 = 100

SSI # P = 63h, S1 = 62h, S2 = 64h

Decimal Value Parameter # P = 105, S1 = 104, S2 = 106

SSI # P = 69h, S1 = 68h, S2 = 6Ah

You can append a prefix and/or one or two suffixes to scan data for use in data editing. To set a value for a prefix or suffix, scan one of the following barcodes, and then scan four barcodes from [Numeric Barcodes](#) that correspond to that value. See [ASCII Character Sets](#) for the four-digit codes.

When using host commands to set the prefix or suffix, set the key category parameter to 1, and then set the 3-digit decimal value. See [ASCII Character Sets](#) for the four-digit codes.

The default prefix and suffix value is 7013 <CR><LF> (Enter key). To correct an error or change a selection, scan [Cancel on page 452](#).



NOTE: To use Prefix/Suffix values, first set the [Scan Data Transmission Format on page 181](#).

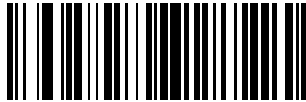

**Scan Prefix
(7)**

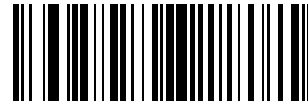

**Scan Suffix 1
(6)**



**Scan Suffix 2
(8)**



Data Format Cancel

Scan Data Transmission Format

Parameter # 235

SSI # EBh

To change the scan data format, scan one of the following barcodes corresponding to the desired format.



NOTE: If using this parameter do not use ADF rules to set the prefix/suffix.

To set values for the prefix and/or suffix, see [Prefix/Suffix Values on page 180](#).



***Data As Is**
(0)



<DATA> <SUFFIX 1>
(1)



<DATA> <SUFFIX 2>
(2)



<DATA> <SUFFIX 1> <SUFFIX 2>
(3)

Scan Data Transmission Format (continued)



<PREFIX> <DATA >
(4)



<PREFIX> <DATA> <SUFFIX 1>
(5)



<PREFIX> <DATA> <SUFFIX 2>
(6)



<PREFIX> <DATA> <SUFFIX 1> <SUFFIX 2>
(7)

FN1 Substitution Values

Key Category Parameter # 103

Key Category SSI # 67h

Decimal Value Parameter # 109

Decimal Value SSI # 6Dh

Keyboard wedge and USB HID keyboard hosts support a FN1 substitution feature. Enabling this substitutes any FN1 character (0x1b) in an EAN128 barcode with a value. This value defaults to 7013 <CR><LF> (Enter key).

When using host commands to set the FN1 substitution value, set the key category parameter to 1, and then set the 3-digit keystroke value. See the ASCII Character Set table for the current host interface for the desired value.

To select a FN1 substitution value via barcode menus:

1. Scan the following barcode.

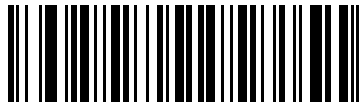

Set FN1 Substitution Value

2. Locate the keystroke desired for FN1 Substitution in the ASCII Character Set table for the current host interface, and enter the 4-digit ASCII value by scanning four barcodes from [Numeric Barcodes](#).

To correct an error or change the selection, scan **Cancel**.

To enable FN1 substitution for USB HID keyboard, scan the **Enable FN1 Substitution** barcode on page [183](#).

Transmit “No Read” Message

Parameter # 94

SSI # 5Eh

Scan one of the following barcodes to set an option for transmitting the No Read (NR) characters:



NOTES 1 If you enable **Transmit No Read**, and also enable Symbol Code ID Character or AIM Code ID Character for [Transmit Code ID Character on page 179](#), the scanner appends the code ID for Code 39 to the NR message.

2. This does not apply in presentation mode.

- **Enable No Read** - This transmits the characters NR when a successful decode does not occur before trigger release or the **Decode Session Timeout** expires. See [Decode Session Timeout on page 164](#).
- **Disable No Read** - This sends nothing to the host if a symbol does not decode.



**Enable No Read
(1)**



***Disable No Read
(0)**

Unsolicited Heartbeat Interval

Parameter # 1118

SSI # F8h 04h 5Eh

The scanner can send unsolicited heartbeat messages to assist in diagnostics. To enable this parameter and set the desired unsolicited heartbeat interval, scan one of the following time interval barcodes, or scan **Set Another Interval** followed by four barcodes from [Numeric Barcodes](#) that correspond to the desired number of seconds. The range is 0 - 9999.

Scan **Disable Unsolicited Heartbeat Interval** to turn off the feature.

The heartbeat event is sent as decode data (with no decode beep) in the form of:

MOTEVTHB:nnn

where **nnn** is a three-digit sequence number starting at 001 and wrapping after 100.

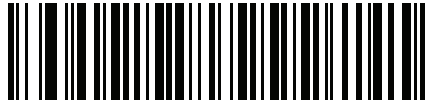

10 Seconds
(10)



1 Minute
(60)



Set Another Interval



***Disable Unsolicited Heartbeat Interval**
(0)

securPharm Decoding

Parameter # 1752

SSI # F8h 06h D8h

securPharm implements the IFA and GS1 Coding System for the European pharmaceutical industry. securPharm code is used to prevent pharmaceutical counterfeiting.

When this feature is enabled, if a GS1 symbol is decoded and includes any aspects of the Application Identifier associated with the securPharm GS1 specifications, the entire GS1 symbol is processed as a securPharm symbol. For this reason, it is expected that under certain circumstances, a GS1 barcode that is a securPharm symbol may not be processed properly; if the GS1 symbol is not created as per the specification. The output cannot be guaranteed as valid.

Although the GS1-128 type and the GS1 DataBar family are not specifically indicated in the IFA specification, they are supported.

The securPharm output is in XML format and can include the product number, serial number, lot number, expiration and Date of Manufacturing. The XML tags can be arranged in any order. Tags that are not in the barcode are omitted. For example:

```
<content dfi="value_dfi" >
<Daten_1>value_Daten_1</Daten_1>
<Daten_2>value_Daten_2</Daten_2>
<Daten_n>value_Daten_n</Daten_n>
</content>
```

Where:

value_dfi = IFA or GS1

Daten_1 to Daten_n is the production number, serial number, etc.

Scan a barcode below to enable or disable the ability to process pharmaceutical type barcodes.



***Disable securPharm Decoding
(0)**



**Enable securPharm Decoding
(1)**

securPharm Output Formatting

Parameter # 1753

SSI # F8h 06h D9h



NOTE: securPharm output formatting is effective only when [securPharm Decoding on page 186](#) is enabled.

securPharm Output Formatting parameter options represent bit positions. Therefore, any combination of formatting can be used.

When you scan a securPharm Output Formatting barcode, the securPharm output is formatted in a number of ways.

Sample GS1 Format

Product Number: GTIN Data Identifier DI Data Format Identifier: GS1

Data Carrier

*FNC1*04150123456782

101A234B5*FNC1*

1717231



> Scanned Barcode >

```
<content dfi="GS1">
<gtin>04150123456782</gtin>
  <lot>1A234B5</lot>
  <exp>151231</exp>
  <sn>1234567890123456</sn>
</content>
```

Sample GS1 Output - Feature Disabled

The output has no format:

0104150123456782101A234B517151231211234567890123456

Sample GS1 Output - No Formatting (0)

The output is a single line of characters:

```
<content
dfi="GS1"><gti n>04150123456782</gti n><l ot>1A234B5</l ot><exp>151231</exp><sn>1234567890123456</sn></content>
```

Sample GS1 Output - Insert Tab (1)

The output is a single line of characters with a tab inserted in the XML body:

```
<content
dfi="GS1">[tab]<gti n>04150123456782</gti n>[tab]<l ot>1A234B5</l ot>[tab]<exp>151231</exp>[tab]<sn>12345
67890123456</sn></content>
```

Sample GS1 Output - Insert New Line (2)

The output consists of multiple lines of characters with a new line character at the end of each line.

```
<content dfi="GS1">
<gti n>04150123456782</gti n>
<l ot>1A234B5</l ot>
<exp>151231</exp>
<sn>1234567890123456</sn>
</content>
```

Sample GS1 Output - Insert Tab and New Line (3)

The output consists of multiple lines of characters with tabs and a new line character at the end of each line.

```
<content dfi="GS1">
[tab]<gt;n>04150123456782</gti n>
[tab]<l ot>1A234B5</l ot>
[tab]<exp>151231</exp>
[tab]<sn>1234567890123456</sn>
</content>
```

Sample IFA Format

Product Number: PPNData Identifier DI Data Format Identifier: IFA

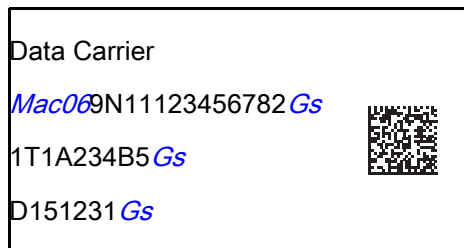

> Scanned Barcode >

```
<content dfi="IFA">
<ppn>111234567842</ppn>
<l ot>1A234B5</l ot>
<sn>1234567890123456</sn>
</content>
```

Sample GS1 Output - Feature Disabled

The output has no format:

```
[ ]>069N1112345678421T1A234B5S1234567890123456
```

Sample GS1 Output - No Formatting (0)

The output is a single line of characters:

```
<content
dfi="IFA"><ppn>111234567842</ppn><l ot>1A234B5</l ot><sn>1234567890123456</sn></content>
```

Sample GS1 Output - Insert Tab (1)

The output is a single line of characters with a tab inserted in the XML body:

```
<content
dfi="IFA">[tab]<ppn>111234567842</ppn>[tab]<l ot>1A234B5</l ot>[tab]<sn>1234567890123456</sn></content>
```

Sample GS1 Output - Insert New Line (2)

The output consists of multiple lines of characters with a new line character at the end of each line.

```
<content dfi="IFA">
<ppn>111234567842</ppn>
<l ot>1A234B5</l ot>
<sn>1234567890123456</sn>
</content>
```

Sample GS1 Output - Insert Tab and New Line (3)

The output consists of multiple lines of characters with tabs and a new line character at the end of each line.

```
<content dfi="IFA">  
[tab]<ppn>111234567842</ppn>  
[tab]<l ot>1A234B5</l ot>  
[tab]<sn>1234567890123456</sn>  
</content>
```

securPharm Output Formatting Barcodes

Scan a barcode below to format the securPharm output.



***No Formatting
(0)**



**Insert Tab
(1)**



**Insert New Line
(2)**



**Insert Tab and New Line
(3)**

Image Capture Preferences

Introduction

You can program the imager to perform various functions, or activate different features. This chapter describes image capture preference features and provides programming barcodes for selecting these features.



NOTE: Only the Symbol Native API (SNAPI) with Imaging interface supports image capture. See [USB Device Type on page 62](#) to enable this host.

The imager ships with the settings shown in [Table 27 on page 191](#) (also see [Standard Parameter Defaults](#) for all defaults). If the default values suit requirements, programming is not necessary.

Setting Parameters

To set feature values, scan a single barcode or a short barcode sequence. The settings are stored in non-volatile memory and are preserved even when the imager powers down.



NOTE: Most computer monitors allow scanning barcodes directly on the screen. When scanning from the screen, be sure to set the document magnification to a level where you can see the barcode clearly, and bars and/or spaces do not merge.

To return all features to default values, scan the [Set Factory Defaults on page 142](#). Throughout the programming barcode menus, asterisks (*) indicate default values.

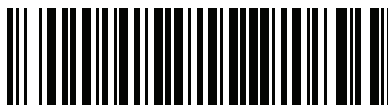

* Indicates default — *Enable Parameter — Feature/option
(1) — Option value

Scanning Sequence Examples

In most cases scanning one barcode sets the parameter value. For example, to disable image capture illumination, scan the **Disable Image Capture Illumination** barcode under [Image Capture Illumination on page 194](#). The imager issues a fast warble beep and the LED turns green, signifying a successful parameter entry.

Other parameters require scanning several barcodes. See the parameter descriptions for this procedure.

Errors While Scanning

Unless otherwise specified, to correct an error during a scanning sequence, just re-scan the correct parameter.

Image Capture Preferences Parameter Defaults

[Table 27](#) lists defaults for image capture preference parameters. Change these values in one of two ways:

- Scan the appropriate barcodes in this chapter. The new value replaces the standard default value in memory. To recall default parameter values, see [Default Parameters on page 142](#).
- Configure the scanner using the 123Scan configuration program. See [123Scan and Software Tools](#).



NOTE: See [Standard Parameter Defaults](#) for all user preference, host, symbology, and miscellaneous default parameters.

Table 27 Image Capture Preferences Parameter Defaults

Parameter	Parameter Number ¹	SSI Number ²	Default	Page Number
Image Capture Preferences				
Operational Modes	N/A	N/A	N/A	193
Image Capture Illumination	361	F0h 69h	Enable	194
Image Capture Autoexposure	360	F0h 68h	Enable	194
Fixed Exposure	567	F4h F1h 37h	100	195
Analog Gain	1232	F4h D0h	Analog Gain x 2	196
Digital Gain	1233	F4h D1h	32	196
Snapshot Mode Timeout	323	F0h 43h	0 (30 seconds)	197
Snapshot Aiming Pattern	300	F0h 2Ch	Enable	198
Silence Operational Mode Changes	1293	F8h 05h 0Dh	Disable (do not silence)	198
Image Cropping	301	F0h 2Dh	Disable	199

1. Parameter number decimal values are used for programming via RSM commands.

2. SSI number hex values are used for programming via SSI commands.

Image Capture Preferences

Table 27 Image Capture Preferences Parameter Defaults (Continued)

Parameter	Parameter Number ¹	SSI Number ²	Default	Page Number
Crop to Pixel Addresses	315 316 317 318	F4h F0h 3Bh F4h F0h 3Ch F4h F0h 3Dh F4h F0h 3Eh	0 top 0 left 799 bottom 1279 right	199
Image Size (Number of Pixels)	302	F0h 2Eh	Full	201
Image Brightness (Target White)	390	F0h 86h	180	202
JPEG Image Options	299	F0h 2Bh	Quality	202
JPEG Quality Value	305	F0h 31h	65	203
JPEG Size Value	561	F1h 31h	160 kB	203
Image Enhancement	564	F1h 34h	Low (1)	204
Image File Format Selection	304	F0h 30h	JPEG	205
Image Rotation	665	F1h 99h	0	206
Bits per Pixel (BPP)	303	F0h 2Fh	8 BPP	207
Signature Capture	93	5Dh	Disable	208
Signature Capture Image File Format Selection	313	F0h 39h	JPEG	209
Signature Capture Bits per Pixel (BPP)	314	F0h 3Ah	8 BPP	210
Signature Capture Width	366	F4h F0h 6Eh	400	211
Signature Capture Height	367	F4h F0h 6Fh	100	211
Signature Capture JPEG Quality	421	F0h A5h	65	212
Video Mode Format Selector	916	F2h 94h	JPEG	212
Video View Finder	324	F0h 44h	Disable	213
Target Video Frame Size	328	F0h 48h	2200 bytes	213
Video View Finder Image Size	329	F0h 49h	1700 bytes	214
Video Resolution	667	F1h 9Bh	1/4 resolution	214

1. Parameter number decimal values are used for programming via RSM commands.

2. SSI number hex values are used for programming via SSI commands.

Image Capture Preferences

The parameters in this chapter control image capture characteristics.

Operational Modes

The imager has three modes of operation:

- Decode Mode
- Snapshot Mode
- Video Mode.

Decode Mode

By default, when you press the trigger the imager attempts to locate and decode enabled barcodes within its field of view. The imager remains in this mode until it decodes a barcode or you release the trigger.

Snapshot Mode

Use Snapshot Mode to capture a high-quality image and transmit it to the host. Scan the **Snapshot Mode** barcode to temporarily enter this mode. While in this mode the imager blinks the green LED at one-second intervals to indicate it is not in standard operating (decode) mode.

In Snapshot Mode, the imager turns on its aiming pattern to highlight the area to capture in the image. The next trigger press instructs the imager to capture a high quality image and transmit it to the host. A short time may pass (less than two seconds) between when the trigger is pressed and the image is captured as the imager adjusts to lighting conditions. Hold the imager steady until a single beep indicates that it captured the image.

If you do not press the trigger within the Snapshot Mode Timeout period, the imager returns to Decode Mode. Use [Snapshot Mode Timeout on page 197](#) to adjust this timeout period. The default timeout period is 30 seconds.

To disable the aiming pattern during Snapshot Mode, see [Snapshot Aiming Pattern on page 198](#).



Snapshot Mode

Video Mode

In this mode the imager behaves as a video camera as long as you press the trigger. Release the trigger to return to Decode Mode. Scan this barcode to temporarily enter Video Capture Mode.



Video Mode

Image Capture Illumination

Parameter # 361

SSI # F0h 69h

Scan **Enable Image Capture Illumination** to turn on illumination during every image capture. This usually results in superior images. The effectiveness of illumination decreases as the distance to the target increases.

Scan **Disable Image Capture Illumination** to prevent the imager from using illumination.

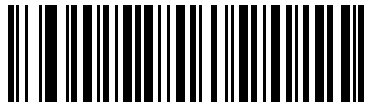

***Enable Image Capture Illumination
(1)**

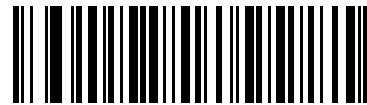

**Disable Image Capture Illumination
(0)**

Image Capture Autoexposure

Parameter # 360

SSI # F0h 68h

Scan **Enable Image Capture Autoexposure** to allow the imager to control gain settings and exposure (integration) time to best capture an image for the selected operation mode.

Scan **Disable Image Capture Autoexposure** to manually adjust the gain and exposure time (see the following pages). This option is only recommended for advanced users with difficult image capture situations.

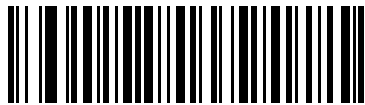

***Enable Image Capture Autoexposure
(1)**

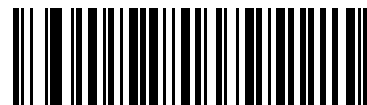

**Disable Image Capture Autoexposure
(0)**

Fixed Exposure

Parameter # 567

SSI # F4h F1h 37h

Type: Word

Range: 1 - 1000

This parameter configures the exposure used in manual mode for Snapshot and Video modes.

Each integer value represents 100 μ s of exposure. The default value is 100 which results in an exposure setting of 10 ms.

To set the exposure, scan the **Fixed Exposure** barcode, and then scan four numeric barcodes from [Numeric Barcodes](#) representing the value. Leading zeros are required. For example, to set a Fixed Exposure value of 99, scan 0, 0, 9, 9.



Fixed Exposure
(4 digits)

Analog and Digital Gain

If you disable [Image Capture Autoexposure](#) you can modify the engine's analog and digital gain using these parameters. Total gain = analog gain x digital gain.

Analog Gain

Parameter # 1232

SSI # F4h D0h

Select an option to set an analog gain value.



Analog Gain x 1
(00h)

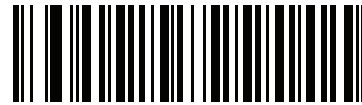

*Analog Gain x 2
(01h)



Analog Gain x 4
(02h)

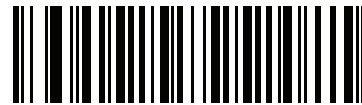

Analog Gain x 8
(03h)

Digital Gain

Parameter # 1233

SSI # F4h D1h

To set the digital gain, scan the following barcode, then scan two barcodes from [Numeric Barcodes](#) to enter a 2-digit value for the digital gain. The default is 32.

A value of 32 = x 1 digital gain; i.e., digital gain = 1/32 x digital gain parameter value.



Digital Gain

Snapshot Mode Timeout

Parameter # 323

SSI # F0h 43h

This parameter sets the amount of time the imager remains in Snapshot Mode. The imager exits Snapshot Mode when you press the trigger, or when the Snapshot Mode Timeout elapses. To set this timeout value, scan the **Set Snapshot Mode Timeout** barcode, and then scan a barcode from [Numeric Barcodes](#). The default value is 0 which represents 30 seconds; values increment by 30. For example, 1 = 60 seconds, 2 = 90 seconds.

To quickly re-set the default timeout to 30 seconds, scan the **30 Seconds** barcode.

If you scan **No Timeout**, the imager remains in Snapshot Mode until you press the trigger.



Set Snapshot Mode Timeout

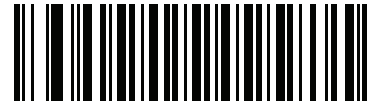

***30 Seconds**

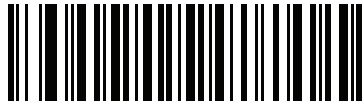

No Timeout

Snapshot Aiming Pattern

Parameter # 300

SSI # F0h 2Ch

Scan one of the following barcodes to select whether or not to project the aiming pattern when in Snapshot Mode.



NOTE: If enabled, the aiming pattern frames the image for aiming purposes and does not appear in the captured image.



***Enable Snapshot Aiming Pattern
(1)**



**Disable Snapshot Aiming Pattern
(0)**

Silence Operational Mode Changes

Parameter # 1293

SSI # F8h 05h 0Dh

Scan **Silence Operational Mode Changes** to silence the beeper when switching between operational modes (e.g., from Decode Mode to Snapshot Mode).



**Silence Operational Mode Changes (Enable)
(1)**



***Do Not Silence Operational Mode Changes
(Disable)
(0)**

Image Cropping

Parameter # 301

SSI # F0h 2Dh

Scan the **Enable Image Cropping** barcode to crop a captured image to the pixel addresses set in [Crop to Pixel Addresses on page 199](#). Scan **Disable Image Cropping** to present the full 1280 x 800 pixels.



**Enable Image Cropping
(1)**



***Disable Image Cropping
(Use Full 1280 x 800 Pixels)
(0)**

Crop to Pixel Addresses

Parameter # 315

SSI # F4h F0h 3Bh (Top)

Parameter # 316

SSI # F4h F0h 3Ch (Left)

Parameter # 317

SSI # F4h F0h 3Dh (Bottom)

Parameter # 318

SSI # F4h F0h 3Eh (Right)

If you enabled [Image Cropping](#), set the pixel addresses from (0,0) to (1279 x 799) to crop to.

Columns are numbered from 0 to 1279, rows from 0 to 799. Specify values for Top, Left, Bottom, and Right, where Top and Bottom correspond to row pixel addresses, and Left and Right correspond to column pixel addresses. For example, for a 4 row x 8 column image in the extreme bottom-right section of the image, set the following values:

Top = 796, Bottom = 799, Left = 1272, Right = 1279

To set the pixel addresses, scan each of the following barcodes, and then scan four numeric barcodes from [Numeric Barcodes](#) representing the value. Leading zeros are required. For example, to crop the top pixel address to 3, scan 0, 0, 0, 3. The defaults are:

Top = 0, Bottom = 799, Left = 0, Right = 1279



NOTE: The imager has a cropping resolution of 4 pixels. Setting the cropping area to less than 4 pixels (after resolution adjustment, see [Image Size \(Number of Pixels\) on page 201](#)) transfers the entire image.

Crop to Pixel Address (continued)



Top Pixel Address
(0 - 799 Decimal)



Left Pixel Address
(0 - 1279 Decimal)

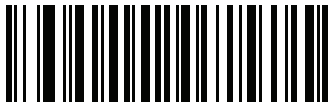

Bottom Pixel Address
(0 - 799 Decimal)

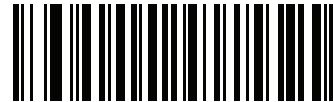

Right Pixel Address
(0 - 1279 Decimal)

Image Size (Number of Pixels)**Parameter # 302****SSI # F0h 2Eh**

This option alters image resolution before compression. Multiple pixels are combined to one pixel, resulting in a smaller image containing the original content with reduced resolution.

Scan one of the following barcodes to select an image size.

Table 28 Image Size

Resolution Value	Uncropped Image Size
Full	1280 x 800
1/2	640 x 400
1/4	320 x 200



***Full Resolution
(0)**



**1/2 Resolution
(1)**



**1/4 Resolution
(3)**

Image Brightness (Target White)

Parameter # 390

SSI # F0h 86h

Type: Byte

Range: 1 - 240

This parameter sets the Target White value used in Snapshot and Video Viewfinder modes when using autoexposure. White and black are defined as 240 decimal and 1, respectively. Setting the value to the factory default of 180 sets the white level of the image to ~180.

Scan the **Image Brightness** barcode, and then scan three numeric barcodes from [Numeric Barcodes](#) representing the value. Leading zeros are required. For example, to set an Image Brightness value of 99, scan 0, 9, 9.



*180



Image Brightness
(3 digits)

JPEG Image Options

Parameter # 299

SSI # F0h 2Bh

Scan one of the following barcodes to optimize JPEG images for either size or quality:

- **JPEG Quality Selector** - Enter a quality value via the [JPEG Quality Value](#) parameter; the imager then selects the corresponding image size.
- **JPEG Size Selector** - Enter a size value via the [JPEG Size Value](#) parameter; the imager then selects the best image quality.



*JPEG Quality Selector
(1)



JPEG Size Selector
(0)

JPEG Quality Value

Parameter # 305

SSI # F0h 31h

If you selected **JPEG Quality Selector**, scan the **JPEG Quality Value** barcode, and then scan three barcodes from [Numeric Barcodes](#) corresponding to a value from 5 to 100, where 100 represents the highest quality image. Leading zeros are required. For example, to set an image quality value of 55, scan 0, 5, 5.



JPEG Quality Value
(Default: 065)
(5 - 100 Decimal)

JPEG Size Value

Parameter # 561

SSI # F1h 31h

Type: Word

Range: 5-350

If you selected **JPEG Size Selector**, scan the **JPEG Size Value** barcode, and then scan three numeric barcodes from [Numeric Barcodes](#) representing the target JPEG file size in kilobytes (KB). Leading zeros are required. For example, to set an image file size value of 99, scan 0, 9, 9.



CAUTION: JPEG compression may take 10 to 15 seconds based on the amount of information in the target image. Scanning **JPEG Quality Selector** (default setting) on [page 202](#) produces a compressed image that is consistent in quality and compression time.



JPEG Size Value
(Default: 160)
(3 digits)

Image Enhancement

Parameter # 564

SSI # F1h 34h

This parameter uses a combination of edge sharpening and contrast enhancement to produce an image that is visually pleasing.

Scan one of the following barcodes to select the level of image enhancement:

- Off (0)
- Low (1) - Default
- Medium (2)
- High (3)



**Off
(0)**



***Low
(1)**



**Medium
(2)**



**High
(3)**

Image File Format Selector

Parameter # 304

SSI # F0h 30h

Scan one of the following barcodes to select an image format appropriate for the system (BMP, TIFF, or JPEG). The imager stores captured images in the selected format.



**BMP File Format
(3)**



***JPEG File Format
(1)**



**TIFF File Format
(4)**

Image Rotation

Parameter # 665

SSI # F1h 99h

Scan one of the following barcodes to rotate the image 0, 90, 180, or 270 degrees.



***Rotate 0°**
(0)



Rotate 90°
(1)



Rotate 180°
(2)

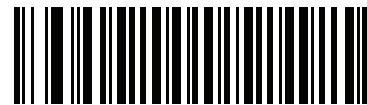

Rotate 270°
(3)

Bits Per Pixel

Parameter # 303

SSI # F0h 2Fh

Scan one of the following barcodes to select the number of significant bits per pixel (BPP) to use when capturing an image:

- **1 BPP** - For a black and white image.
- **4 BPP** - Assigns 1 of 16 levels of grey to each pixel.
- **8 BPP** - Assigns 1 of 256 levels of grey to each pixel.



NOTE: The imager ignores these settings for JPEG file formats, which only support **8 BPP**. TIFF file formats only support **4 BPP** and **8 BPP**. Selecting **1 BPP** for TIFF applies the **4 BPP** option.



1 BPP
(0)



4 BPP
(1)



***8 BPP**
(2)

Signature Capture

Parameter # 93

SSI # 5Dh

A signature capture barcode is a special-purpose symbology which delineates a signature capture area in a document with a machine-readable format. The recognition pattern is variable so it can optionally provide an index to various signatures. The region inside the barcode pattern is considered the signature capture area. See [Signature Capture Code](#) for more information.

Scan one of the following barcodes to enable or disable Signature Capture.



**Enable Signature Capture
(1)**



***Disable Signature Capture
(0)**

Signature Capture File Format Selector

Parameter # 313

SSI # F0h 39h

Decoding a signature capture barcode de-skews the signature image and converts the image to a BMP, JPEG, or TIFF file format. The output data includes the file descriptor followed by the formatted signature image.

Table 29 Output File Format

File Descriptor			Signature Image
Output Format (1 byte)	Signature Type (1 byte)	Signature Image Size (4 bytes) (BIG Endian)	
JPEG - 1	1-8	0x00000400	0x00010203....
BMP - 3			
TIFF - 4			

Scan one of the following barcodes to select a signature file format appropriate for the system (BMP, TIFF, or JPEG). The imager stores captured signatures in the selected format.



**BMP Signature Format
(3)**



***JPEG Signature Format
(1)**



**TIFF Signature Format
(4)**

Signature Capture Bits Per Pixel

Parameter # 314

SSI # F0h 3Ah

Scan one of the following barcodes to select the number of significant bits per pixel (BPP) to use when capturing a signature:

- **1 BPP** - For a black and white image.
- **4 BPP** - Assigns 1 of 16 levels of grey to each pixel.
- **8 BPP** - Assigns 1 of 256 levels of grey to each pixel.



NOTE: The imager ignores these settings for JPEG file formats, which only support **8 BPP**.



1 BPP
(0)



4 BPP
(1)



***8 BPP**
(2)

Signature Capture Width

Parameter # 366

SSI # F4h F0h 6Eh

The aspect ratio of the Signature Capture Width and Signature Capture Height parameters must match that of the signature capture area. For example, a 4 x 1 inch signature capture area requires a 4 to 1 aspect ratio of width to height.

To set the width of the signature capture box, scan the **Signature Capture Width** barcode, and then scan four barcodes from [Numeric Barcodes](#) corresponding to a value in the range of 001 to 1280 decimal.



Signature Capture Width (Default: 400)
(001 - 1280 Decimal)

Signature Capture Height

Parameter # 367

SSI # F4h F0h 6Fh

To set the height of the signature capture box, scan the **Signature Capture Height** barcode, and then scan three barcodes from [Numeric Barcodes](#) corresponding to a value in the range of 001 to 800 decimal.



Signature Capture Height (Default: 100)
(001 - 800 Decimal)

Signature Capture JPEG Quality

Parameter # 421

SSI # F0h A5h

Scan the **JPEG Quality Value** barcode, and then scan three barcodes from [Numeric Barcodes](#) corresponding to a value from 005 to 100, where 100 represents the highest quality image.



JPEG Quality Value (Default: 065)
(5 - 100 Decimal)

Video Mode Format Selector

Parameter # 916

SSI # F2h 94h

When the imager is in Video Mode, scan one of the following barcodes to select whether to send data in BMP or JPEG format.

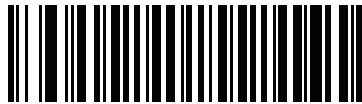

BMP File Format
(3)



***JPEG File Format**
(1)

Video View Finder

Parameter # 324

SSI # F0h 44h

Scan one of the following barcodes to select whether to project the video view finder while in Snapshot Mode.

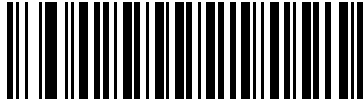

Enable Video View Finder
(1)

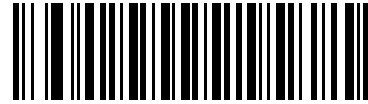

*Disable Video View Finder
(0)

Target Video Frame Size

Parameter # 328

SSI # F0h 48h

This parameter sets the number of 100-byte blocks to transmit per second. A smaller value transmits more frames per second but reduces video quality, while a larger value increases video quality but slows transmission.

Scan the **Target Video Frame Size** barcode, and then scan three barcodes from [Numeric Barcodes](#) corresponding to the 100-byte value from 800 to 20,000 bytes. For example, to select 1500 bytes, enter 0, 1, 5. To select 900 bytes, enter 0, 0, 9. The default is 2200 bytes.

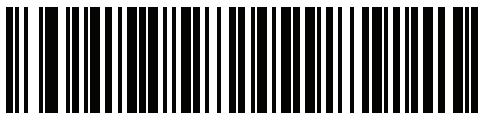

Target Video Frame Size

Video View Finder Image Size

Parameter # 329

SSI # F0h 49h

This parameter sets the number of 100-byte blocks. Values range from 800 to 12,000 bytes. A smaller value transmits more frames per second, while a larger value increases video quality.

Scan the **Video View Finder Image Size** barcode, and then scan three barcodes from [Numeric Barcodes](#) corresponding to the 100-byte value from 800 to 12,000 bytes. For example, to select 1500 bytes, enter 0, 1, 5. To select 900 bytes, enter 0, 0, 9. The default is 1700 bytes.



Video View Finder Image Size

Video Resolution

Parameter # 667

SSI # F1h 9Bh

This parameter alters the video resolution before transmission. Rows and columns are removed from the image, resulting in a smaller video image containing the original content with reduced resolution.

Scan one of the following barcodes to select a value:

Table 30 Resolution and Video Image Sizes

Resolution Value	Video Image Size
Full	1280 x 800
1/2	640 x 400
1/4	320 x 200



Full Resolution
(0)



1/2 Resolution
(1)



*1/4 Resolution
(3)

Symbologies

Introduction

You can program the scanner to perform various functions, or activate different features. This chapter describes symbology features and provides programming barcodes for selecting these features.

The scanner ships with the settings shown in [Table 31 on page 216](#) (also see [Standard Parameter Defaults](#) for all defaults). If the default values suit requirements, programming is not necessary.

Setting Parameters

To set feature values, scan a single barcode or a short barcode sequence. The settings are stored in non-volatile memory and are preserved even when the scanner powers down.



NOTE: Most computer monitors allow scanning barcodes directly on the screen. When scanning from the screen, be sure to set the document magnification to a level where you can see the barcode clearly, and bars and/or spaces do not merge.

If not using a USB cable, select a host type (see each host chapter for specific host information) after the power-up beeps sound. This is only necessary upon the first power-up when connected to a new host.

To return all features to default values, see [Default Parameters on page 142](#). Throughout the programming barcode menus, asterisks (*) indicate default values.



* Indicates default — ***Enable Parameter** — Feature/option
(1) — Option value

Scanning Sequence Examples

In most cases, scanning one barcode sets the parameter value. For example, to transmit barcode data without the UPC-A check digit, scan the **Do Not Transmit UPC-A Check Digit** barcode under [Transmit UPC-A Check Digit on page 234](#). The scanner issues a fast warble beep and the LED turns green, signifying a successful parameter entry.

Other parameters require scanning several barcodes. See the parameter descriptions for this procedure.

Errors While Scanning

Unless otherwise specified, to correct an error during a scanning sequence, just re-scan the correct parameter.

Symbology Parameter Defaults

[Table 31](#) lists defaults for all symbology parameters. Change these values in one of two ways:

- Scan the appropriate barcodes in this chapter. The new value replaces the standard default value in memory. To recall the default parameter values, see [Default Parameters on page 142](#).
- Configure the scanner using the 123Scan configuration program. See [123Scan and Software Tools](#).



NOTE: See [Standard Parameter Defaults](#) for all user preference, host, symbology, and miscellaneous default parameters.

Table 31 Symbology Parameter Defaults

Parameter	Parameter Number ¹	SSI Number ²	Default	Page Number
Enable/Disable All Code Types				223
1D Symbologies				
UPC/EAN/JAN				
UPC-A	1	01h	Enable	224
UPC-E	2	02h	Enable	224
UPC-E1	12	0Ch	Disable	225
EAN-8/JAN 8	4	04h	Enable	225
EAN-13/JAN 13	3	03h	Enable	226
Bookland EAN	83	53h	Disable	226
Bookland ISBN Format	576	F1h 40h	ISBN-10	227
ISSN EAN	617	F1h 69h	Disable	228
Decode UPC/EAN/JAN Supplementals (2 and 5 digits)	16	10h	Ignore	229

1. Parameter number decimal values are used for programming via RSM commands.

2. SSI number hex values are used for programming via SSI commands.

Table 31 Symbology Parameter Defaults (Continued)

Parameter	Parameter Number ¹	SSI Number ²	Default	Page Number
User-Programmable Supplementals			000	232
Supplemental 1:	579	F4h F1h 43h		
Supplemental 2:	580	F4h F1h 44h		
UPC/EAN/JAN Supplemental Redundancy	80	50h	10	232
Decode UPC/EAN/JAN Supplemental AIM ID	672	F1h A0h	Combined	233
Transmit UPC-A Check Digit	40	28h	Enable	234
Transmit UPC-E Check Digit	41	29h	Enable	234
Transmit UPC-E1 Check Digit	42	2Ah	Enable	235
UPC-A Preamble	34	22h	System Character	236
UPC-E Preamble	35	23h	System Character	237
UPC-E1 Preamble	36	24h	System Character	238
Convert UPC-E to A	37	25h	Disable	239
Convert UPC-E1 to A	38	26h	Disable	239
EAN/JAN Zero Extend	39	27h	Disable	240
UCC Coupon Extended Code	85	55h	Disable	240
Coupon Report	730	F1h DAh	New Coupon Format	241
UPC Reduced Quiet Zone	1289	F8h 05h 09h	Disable	242
Code 128				
Code 128	8	08h	Enable	242
Set Length(s) for Code 128	209, 210	D1h, D2h	Any Length	243
GS1-128 (formerly UCC/EAN-128)	14	0Eh	Enable	244
ISBT 128	84	54h	Enable	245
ISBT Concatenation	577	F1h 41h	Disable Enable for DS4608-HC	246
Check ISBT Table	578	F1h 42h	Enable	247
ISBT Concatenation Redundancy	223	DFh	10	247
Code 128 <FNC4>	1254	F8h 04h E6h	Honor	248

1. Parameter number decimal values are used for programming via RSM commands.

2. SSI number hex values are used for programming via SSI commands.

Table 31 Symbology Parameter Defaults (Continued)

Parameter	Parameter Number ¹	SSI Number ²	Default	Page Number
Code 128 Security Level	751	F1h EFh	Security Level 1 Security Level 2 for DS4608-HC	249
Code 128 Reduced Quiet Zone	1208	F8h 04h B8h	Disable	250
Code 39				
Code 39	0	00h	Enable	250
Trioptic Code 39	13	0Dh	Disable	251
Convert Code 39 to Code 32 (Italian Pharmacy Code)	86	56h	Disable	251
Code 32 Prefix	231	E7h	Disable	252
Set Length(s) for Code 39	18, 19	12h, 13h	1 to 55	252
Code 39 Check Digit Verification	48	30h	Disable	254
Transmit Code 39 Check Digit	43	2Bh	Disable	254
Code 39 Full ASCII Conversion	17	11h	Disable	255
Code 39 Security Level	750	F1h EEh	Security Level 1	256
Code 39 Reduced Quiet Zone	1209	F8h 04h B9h	Disable	258
Code 93				
Code 93	9	09h	Enable	258
Set Length(s) for Code 93	26, 27	1Ah, 1Bh	1 to 55	259
Code 11				
Code 11	10	0Ah	Disable	261
Set Lengths for Code 11	28, 29	1Ch, 1Dh	4 to 55	261
Code 11 Check Digit Verification	52	34h	Disable	263
Transmit Code 11 Check Digit(s)	47	2Fh	Disable	264
Interleaved 2 of 5 (ITF)				
Interleaved 2 of 5 (ITF)	6	06h	Enable	264
Set Lengths for I 2 of 5	22, 23	16h, 17h	6 to 55	265
I 2 of 5 Check Digit Verification	49	31h	Disable	267
Transmit I 2 of 5 Check Digit	44	2Ch	Disable	267
Convert I 2 of 5 to EAN 13	82	52h	Disable	268

1. Parameter number decimal values are used for programming via RSM commands.

2. SSI number hex values are used for programming via SSI commands.

Table 31 Symbology Parameter Defaults (Continued)

Parameter	Parameter Number ¹	SSI Number ²	Default	Page Number
Febraban	1750	F8h 06h D6h	Disable	268
I 2 of 5 Security Level	1121	F8h 04h 61h	Security Level 1	269
I 2 of 5 Reduced Quiet Zone	1210	F8h 04h BAh	Disable	270
Discrete 2 of 5 (DTF)				
Discrete 2 of 5	5	05h	Disable	270
Set Length(s) for D 2 of 5	20, 21	14h 15h	1 to 55	271
Codabar (NW - 7)				
Codabar	7	07h	Enable	273
Set Lengths for Codabar	24, 25	18h, 19h	4 to 55	273
CLSI Editing	54	36h	Disable	275
NOTIS Editing	55	37h	Disable	275
Codabar Security Level	1776	F8h 06h F0h	Security Level 1	276
Codabar Upper or Lower Case Start/ Stop Characters Detection	855	F2h 57h	Upper Case	277
Codabar Mod 16 Check Digit Verification	1784	F8h 06h F8h	Disable	277
Transmit Codabar Check Digit	704	F1h C0h	Disable	278
MSI				
MSI	11	0Bh	Disable	278
Set Length(s) for MSI	30, 31	1Eh, 1Fh	4 to 55	279
MSI Check Digits	50	32h	One	280
Transmit MSI Check Digit	46	2Eh	Disable	281
MSI Check Digit Algorithm	51	33h	Mod 10/Mod 10	281
MSI Reduced Quiet Zone	1392	F8h 05h 70h	Disable	282
Chinese 2 of 5				
Chinese 2 of 5	408	F0h 98h	Disable	282
Matrix 2 of 5				
Matrix 2 of 5	618	F1h 6Ah	Disable	283
Matrix 2 of 5 Lengths	619 620	F1h 6Bh F1h 6Ch	4 to 55	283
Matrix 2 of 5 Check Digit	622	F1h 6Eh	Disable	285

1. Parameter number decimal values are used for programming via RSM commands.

2. SSI number hex values are used for programming via SSI commands.

Table 31 Symbology Parameter Defaults (Continued)

Parameter	Parameter Number ¹	SSI Number ²	Default	Page Number
Transmit Matrix 2 of 5 Check Digit	623	F1h 6Fh	Disable	285
Korean 3 of 5				
Korean 3 of 5	581	F1h 45h	Disable	286
Inverse 1D	586	F1h 4Ah	Regular	287
GS1 DataBar				
GS1 DataBar Omnidirectional	338	F0h 52h	Enable	288
GS1 DataBar Limited	339	F0h 53h	Enable	288
GS1 DataBar Expanded	340	F0h 54h	Enable	289
Convert GS1 DataBar to UPC/EAN/JAN	397	F0h 8Dh	Disable	289
GS1 DataBar Security Level	1706	F8h 06h AAh	Level 1	290
GS1 DataBar Limited Margin Check	728	F1h D8h	Level 3	291
Symbology-Specific Security Features				
Redundancy Level	78	4Eh	1	293
Security Level	77	4Dh	1	295
1D Quiet Zone Level	1288	F8h 05h 08h	1	296
Intercharacter Gap Size	381	F0h 7Dh	Normal	297
Composite Codes				
Composite CC-C	341	F0h 55h	Disable	298
Composite CC-A/B	342	F0h 56h	Disable	298
Composite TLC-39	371	F0h 73h	Disable	299
Composite Inverse	1113	F8h 04h 59h	Regular	299
UPC Composite Mode	344	F0h 58h	UPC Never Linked	300
Composite Beep Mode	398	F0h 8Eh	Beep As Each Code Type is Decoded	301
GS1-128 Emulation Mode for UCC/EAN Composite Codes	427	F0h ABh	Disable	302
<p>1. Parameter number decimal values are used for programming via RSM commands.</p> <p>2. SSI number hex values are used for programming via SSI commands.</p>				

Table 31 Symbology Parameter Defaults (Continued)

Parameter	Parameter Number ¹	SSI Number ²	Default	Page Number
2D Symbologies				
PDF417	15	0Fh	Enable	303
MicroPDF417	227	E3h	Disable	303
Code 128 Emulation	123	7Bh	Disable	304
Data Matrix	292	F0h 24h	Enable	305
GS1 Data Matrix	1336	F8h 05h 38h	Disable	305
Data Matrix Inverse	588	F1h 4Ch	Inverse Autodetect	306
Decode Data Matrix Mirror Images	537	F1h 19h	Auto	307
Maxicode	294	F0h 26h	Disable	308
QR Code	293	F0h 25h	Enable	309
GS1 QR	1343	F8h 05h 3Fh	Enable	309
MicroQR	573	F1h 3Dh	Enable	310
Linked QR Mode	1847	737h	Linked QR Only	311
Aztec	574	F1h 3Eh	Enable	312
Aztec Inverse	589	F1h 4Dh	Inverse Autodetect	313
Han Xin	1167	F8h 04h 8Fh	Disable	314
Han Xin Inverse	1168	F8h 04h 90h	Regular	315
Grid Matrix	1718	F8h 06h B6h	Disable	316
Grid Matrix Inverse	1719	F8h 06h B7h	Regular	317
Grid Matrix Mirror	1736	F8h 06h C8h	Regular Only	318
DotCode	1906	F8 07 72h	Disable	319
DotCode Inverse	1907	F8 07 73h	Inverse Autodetect	320
DotCode Mirrored	1908	F8 07 74h	Autodetect	321
DotCode Prioritize	1937	F8 07 91h	Enable	322
Macro PDF				
Flush Macro PDF Buffer	N/A	N/A	N/A	323
Abort Macro PDF Entry	N/A	N/A	N/A	323
Postal Codes				
US Postnet	89	59h	Disable	324
1. Parameter number decimal values are used for programming via RSM commands.				
2. SSI number hex values are used for programming via SSI commands.				

Table 31 Symbology Parameter Defaults (Continued)

Parameter	Parameter Number ¹	SSI Number ²	Default	Page Number
US Planet	90	5Ah	Disable	324
Transmit US Postal Check Digit	95	5Fh	Enable	325
UK Postal	91	5Bh	Disable	325
Transmit UK Postal Check Digit	96	60h	Enable	326
Japan Postal	290	F0h 22h	Disable	326
Australia Post	291	F0h 23h	Disable	327
Australia Post Format	718	F1h CEh	Autodiscriminate	328
Netherlands KIX Code	326	F0h 46h	Disable	329
USPS 4CB/One Code/Intelligent Mail	592	F1h 50h	Disable	329
UPU FICS Postal	611	F1h 63h	Disable	330
Mailmark	1337	F8h 05h 39h	Disable	330

1. Parameter number decimal values are used for programming via RSM commands.
2. SSI number hex values are used for programming via SSI commands.

Enable/Disable All Code Types

Scan the **Disable All Code Types** barcode to disable all symbologies. This is useful when enabling only a few code types.

Scan **Enable All Code Types** to enable all symbologies. This is useful if you need to disable only a few code types.

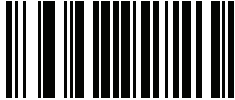

Disable All Code Types



Enable All Code Types

UPC/EAN/JAN

UPC-A

Parameter # 1

SSI # 01h

Scan one of the following barcodes to enable or disable UPC-A.

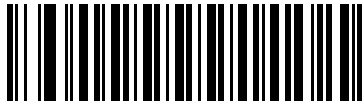

***Enable UPC-A
(1)**

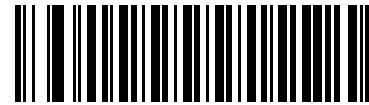

**Disable UPC-A
(0)**

UPC-E

Parameter # 2

SSI # 02h

Scan one of the following barcodes to enable or disable UPC-E.

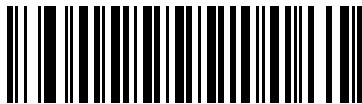

***Enable UPC-E
(1)**

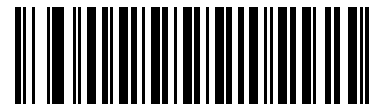

**Disable UPC-E
(0)**

UPC-E1

Parameter # 12

SSI # 0Ch

Scan one of the following barcodes to enable or disable UPC-E1.



NOTE: UPC-E1 is not a UCC (Uniform Code Council) approved symbology.

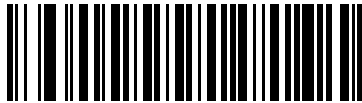

Enable UPC-E1
(1)

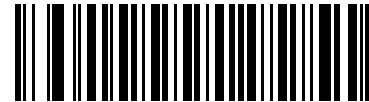

*Disable UPC-E1
(0)

EAN-8/JAN-8

Parameter # 4

SSI # 04h

Scan one of the following barcodes to enable or disable EAN-8/JAN-8.



*Enable EAN-8/JAN-8
(1)



Disable EAN-8/JAN-8
(0)

EAN-13/JAN-13

Parameter # 3

SSI # 03h

Scan one of the following barcodes to enable or disable EAN-13/JAN-13.

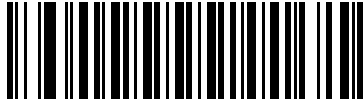

***Enable EAN-13/JAN-13
(1)**

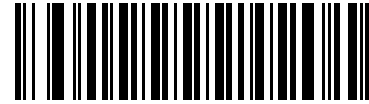

**Disable EAN-13/JAN-13
(0)**

Bookland EAN

Parameter # 83

SSI # 53h

Scan one of the following barcodes to enable or disable Bookland EAN.

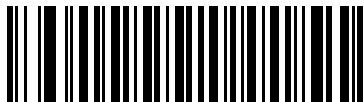

**Enable Bookland EAN
(1)**



***Disable Bookland EAN
(0)**



NOTE: If you enable Bookland EAN, select a [Bookland ISBN Format](#). Also set [Decode UPC/EAN/JAN Supplementals on page 229](#) to either Decode UPC/EAN/JAN with Supplementals Only, Autodiscriminate UPC/EAN/JAN With Supplementals, or Enable 978/979 Supplemental Mode.

Bookland ISBN Format

Parameter # 576

SSI # F1h 40h

If you enabled Bookland EAN using [Bookland EAN on page 226](#), select one of the following formats for Bookland data:

- **Bookland ISBN-10** - The scanner reports Bookland data starting with 978 in traditional 10-digit format with the special Bookland check digit for backward-compatibility. Data starting with 979 is not considered Bookland in this mode.
- **Bookland ISBN-13** - The scanner reports Bookland data (starting with either 978 or 979) as EAN-13 in 13-digit format to meet the 2007 ISBN-13 protocol.



*Bookland ISBN-10
(0)



Bookland ISBN-13
(1)



NOTE: For Bookland EAN to function properly, first enable Bookland EAN using [Bookland EAN on page 226](#), and then set [Decode UPC/EAN/JAN Supplementals on page 229](#) to either Decode UPC/EAN/JAN with Supplementals Only, Autodiscriminate UPC/EAN/JAN With Supplementals, or Enable 978/979 Supplemental Mode.

ISSN EAN

Parameter # 617

SSI # F1h 69h

Scan one of the following barcodes to enable or disable ISSN EAN.



Enable ISSN EAN
(1)

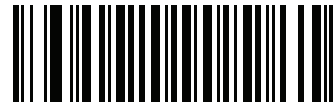

*Disable ISSN EAN
(0)

Decode UPC/EAN/JAN Supplementals

Parameter # 16

SSI # 10h

Supplementals are barcodes appended according to specific format conventions (e.g., UPC A+2, UPC E+2, EAN 13+2). The following options are available:

- **Decode UPC/EAN/JAN with Supplementals Only** - The scanner only decodes UPC/EAN/JAN symbols with supplemental characters, and ignores symbols without supplementals.
- **Ignore UPC/EAN/JAN Supplementals** - When presented with a UPC/EAN/JAN plus supplemental symbol, the scanner decodes UPC/EAN/JAN and ignores the supplemental characters.
- **Autodiscriminate UPC/EAN/JAN with Supplementals** - The scanner decodes UPC/EAN/JAN symbols with supplemental characters immediately. If the symbol does not have a supplemental, the scanner must decode the barcode the number of times set via [UPC/EAN/JAN Supplemental Redundancy on page 232](#) before transmitting its data to confirm that there is no supplemental.

Select one of the following **Supplemental Mode** options to immediately transmit EAN-13 barcodes starting with that prefix that have supplemental characters. If the symbol does not have a supplemental, the scanner must decode the barcode the number of times set via [UPC/EAN/JAN Supplemental Redundancy on page 232](#) before transmitting the data to confirm that there is no supplemental. The scanner transmits UPC/EAN/JAN barcodes that do not have that prefix immediately.

- **Enable 378/379 Supplemental Mode**
- **Enable 978/979 Supplemental Mode**



NOTE: If you select 978/979 Supplemental Mode and are scanning Bookland EAN barcodes, see [Bookland EAN on page 226](#) to enable Bookland EAN, and select a format using [Bookland ISBN Format on page 227](#).

- **Enable 977 Supplemental Mode**
- **Enable 414/419/434/439 Supplemental Mode**
- **Enable 491 Supplemental Mode**
- **Enable Smart Supplemental Mode** - This applies to EAN-13 barcodes starting with any prefix listed previously.
- **Supplemental User-Programmable Type 1** - This applies to EAN-13 barcodes starting with a 3-digit user-defined prefix. Set this using [User-Programmable Supplementals on page 232](#).
- **Supplemental User-Programmable Type 1 and 2** - This applies to EAN-13 barcodes starting with either of two 3-digit user-defined prefixes. Set the prefixes using [User-Programmable Supplementals on page 232](#).
- **Smart Supplemental Plus User-Programmable 1** - This applies to EAN-13 barcodes starting with any prefix listed previously or the prefix set using [User-Programmable Supplementals on page 232](#).
- **Smart Supplemental Plus User-Programmable 1 and 2** - This applies to EAN-13 barcodes starting with any prefix listed previously or one of the two user-defined prefixes set using [User-Programmable Supplementals on page 232](#).



NOTE: To minimize the risk of invalid data transmission, select either to decode or ignore supplemental characters.

Decode UPC/EAN/JAN Supplementals (continued)



**Decode UPC/EAN/JAN With Supplementals Only
(1)**



***Ignore UPC/EAN/JAN Supplementals
(0)**



**Autodiscriminate UPC/EAN/JAN with
Supplementals
(2)**

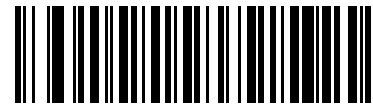

**Enable 378/379 Supplemental Mode
(4)**



**Enable 978/979 Supplemental Mode
(5)**



**Enable 977 Supplemental Mode
(7)**

Decode UPC/EAN/JAN Supplementals (continued)



Enable 414/419/434/439 Supplemental Mode
(6)



Enable 491 Supplemental Mode
(8)



Enable Smart Supplemental Mode
(3)



Supplemental User-Programmable Type 1
(9)



Supplemental User-Programmable Type 1 and 2
(10)



Smart Supplemental Plus User-Programmable 1
(11)



Smart Supplemental Plus
User-Programmable 1 and 2
(12)

User-Programmable Supplementals

Supplemental 1: Parameter # 579

SSI # F4h F1h 43h

Supplemental 2: Parameter # 580

SSI # F4h F1h 44h

If you selected a Supplemental User-Programmable option from [Decode UPC/EAN/JAN Supplementals on page 229](#), scan **User-Programmable Supplemental 1**, and then scan three barcodes from [Numeric Barcodes](#) to set the 3-digit prefix. To set a second 3-digit prefix, scan **User-Programmable Supplemental 2**, and then scan three barcodes from [Numeric Barcodes](#). The default is 000 (zeroes).



User-Programmable Supplemental 1



User-Programmable Supplemental 2

UPC/EAN/JAN Supplemental Redundancy

Parameter # 80

SSI # 50h

If you selected **Autodiscriminate UPC/EAN/JAN with Supplementals**, this option sets the number of times to decode a symbol without supplementals before transmission. The range is from two to 30. Five or above is recommended when decoding a mix of UPC/EAN/JAN symbols with and without supplementals. The default is 10.

To set a redundancy value, scan the following barcode, and then scan two barcodes from [Numeric Barcodes](#). Enter a leading zero for single digit numbers. To correct an error or change a selection, scan [Cancel on page 452](#).



UPC/EAN/JAN Supplemental Redundancy

UPC/EAN/JAN Supplemental AIM ID Format

Parameter # 672

SSI # F1h A0h

If [Transmit Code ID Character on page 179](#) is set to **AIM Code ID Character**, scan one of the following barcodes to select an output format when reporting UPC/EAN/JAN barcodes with supplementals:

- **Separate** - Transmit UPC/EAN/JAN with supplementals with separate AIM IDs but one transmission, i.e.,
]E<0 or 4><data>]E<1 or 2>[supplemental data]
- **Combined** – Transmit UPC/EAN/JAN with supplementals with one AIM ID and one transmission, i.e.,
]E3<data+supplemental data>
- **Separate Transmissions** - Transmit UPC/EAN/JAN with supplementals with separate AIM IDs and separate transmissions, i.e.,

]E<0 or 4><data>

]E<1 or 2>[supplemental data]



**Separate
(0)**

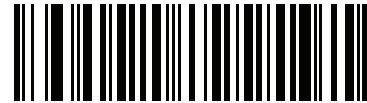

***Combined
(1)**



**Separate Transmissions
(2)**

Transmit UPC-A Check Digit

Parameter # 40

SSI # 28h

The check digit is the last character of the symbol used to verify the integrity of the data. Scan one of the following barcodes to transmit the barcode data with or without the UPC-A check digit. It is always verified to guarantee the integrity of the data.

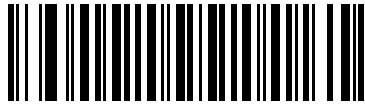

***Transmit UPC-A Check Digit
(1)**

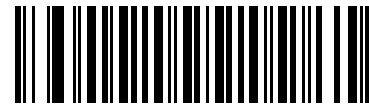

**Do Not Transmit UPC-A Check Digit
(0)**

Transmit UPC-E Check Digit

Parameter # 41

SSI # 29h

The check digit is the last character of the symbol used to verify the integrity of the data. Scan one of the following barcodes to transmit the barcode data with or without the UPC-E check digit. It is always verified to guarantee the integrity of the data.

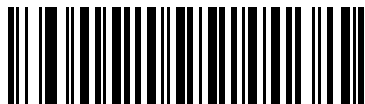

***Transmit UPC-E Check Digit
(1)**

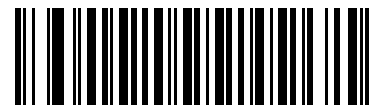

**Do Not Transmit UPC-E Check Digit
(0)**

Transmit UPC-E1 Check Digit

Parameter # 42

SSI # 2Ah

The check digit is the last character of the symbol used to verify the integrity of the data. Scan one of the following barcodes to transmit the barcode data with or without the UPC-E1 check digit. It is always verified to guarantee the integrity of the data.



***Transmit UPC-E1 Check Digit
(1)**



**Do Not Transmit UPC-E1 Check Digit
(0)**

UPC-A Preamble

Parameter # 34

SSI # 22h

Preamble characters are part of the UPC symbol, and include Country Code and System Character. Select the appropriate option for transmitting a UPC-A preamble to match the host system:

- Transmit System Character only
- Transmit System Character and Country Code ("0" for USA)
- Transmit no preamble.

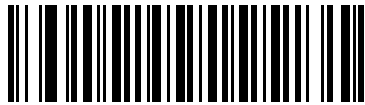

No Preamble (<DATA>)
(0)

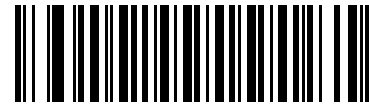

***System Character**
(<SYSTEM CHARACTER> <DATA>)
(1)

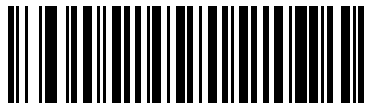

System Character & Country Code
(<COUNTRY CODE> <SYSTEM CHARACTER> <DATA>)
(2)

UPC-E Preamble

Parameter # 35

SSI # 23h

Preamble characters are part of the UPC symbol, and include Country Code and System Character. Select the appropriate option for transmitting a UPC-E preamble to match the host system:

- Transmit System Character only
- Transmit System Character and Country Code ("0" for USA)
- Transmit no preamble.

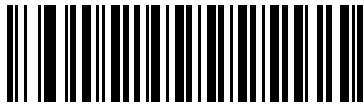

No Preamble (<DATA>)
(0)



***System Character**
(<SYSTEM CHARACTER> <DATA>)
(1)

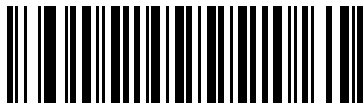

System Character & Country Code
(<COUNTRY CODE> <SYSTEM CHARACTER> <DATA>)
(2)

UPC-E1 Preamble

Parameter # 36

SSI # 24h

Preamble characters are part of the UPC symbol, and include Country Code and System Character. Select the appropriate option for transmitting a UPC-E1 preamble to match the host system:

- Transmit System Character only
- Transmit System Character and Country Code ("0" for USA)
- Transmit no preamble.

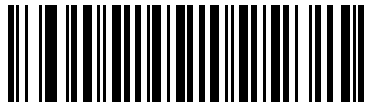

No Preamble (<DATA>)
(0)

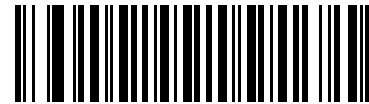

***System Character**
(<SYSTEM CHARACTER> <DATA>)
(1)

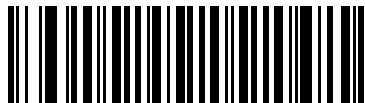

System Character & Country Code
(< COUNTRY CODE> <SYSTEM CHARACTER> <DATA>)
(2)

Convert UPC-E to UPC-A**Parameter # 37****SSI # 25h**

Enable this to convert UPC-E (zero suppressed) decoded data to UPC-A format before transmission. After conversion, the data follows UPC-A format and is affected by UPC-A programming selections (e.g., Preamble, Check Digit).

Disable this to transmit UPC-E decoded data as UPC-E data, without conversion.

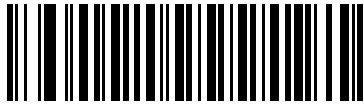

Convert UPC-E to UPC-A (Enable)
(1)

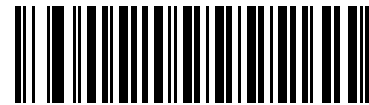

***Do Not Convert UPC-E to UPC-A (Disable)**
(0)

Convert UPC-E1 to UPC-A**Parameter # 38****SSI # 26h**

Scan **Convert UPC-E1 to UPC-A (Enable)** to convert UPC-E1 decoded data to UPC-A format before transmission. After conversion, the data follows UPC-A format and is affected by UPC-A programming selections (e.g., Preamble, Check Digit).

Scan **Do Not Convert UPC-E1 to UPC-A (Disable)** to transmit UPC-E1 decoded data as UPC-E1 data, without conversion.

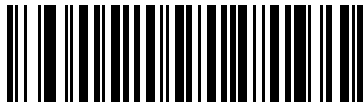

Convert UPC-E1 to UPC-A (Enable)
(1)

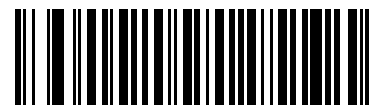

***Do Not Convert UPC-E1 to UPC-A (Disable)**
(0)

EAN/JAN Zero Extend

Parameter # 39

SSI # 27h

Scan **Enable EAN/JAN Zero Extend** to add five leading zeros to decoded EAN-8 symbols to make them compatible in length to EAN-13 symbols. Scan **Disable EAN/JAN Zero Extend** to transmit EAN-8 symbols as is.



Enable EAN/JAN Zero Extend
(1)

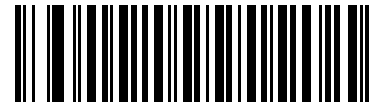

*Disable EAN/JAN Zero Extend
(0)

UCC Coupon Extended Code

Parameter # 85

SSI # 55h

Scan **Enable UCC Coupon Extended Code** to decode UPC-A barcodes starting with digit '5', EAN-13 barcodes starting with digit '99', and UPC-A/GS1-128 coupon codes. UPC-A, EAN-13, and GS1-128 must be enabled to use this feature.

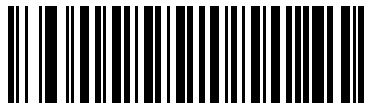

Enable UCC Coupon Extended Code
(1)



*Disable UCC Coupon Extended Code
(0)



NOTE: See [UPC/EAN/JAN Supplemental Redundancy on page 232](#) to control autodiscrimination of the GS1-128 portion (right half) of a coupon code.

Coupon Report

Parameter # 730

SSI # F1h DAh

Scan one of the following barcodes to select the type of coupon format to support.

- **Old Coupon Format** - Support UPC-A/GS1-128 and EAN-13/GS1-128.
- **New Coupon Format** - An interim format to support UPC-A/GS1-DataBar and EAN-13/GS1-DataBar.
- **Autodiscriminate Format** - Support both **Old Coupon Format** and **New Coupon Format**.



Old Coupon Format
(0)



***New Coupon Format**
(1)



Autodiscriminate Coupon Format
(2)

UPC Reduced Quiet Zone

Parameter # 1289

SSI # F8h 05h 09h

Scan one of the following barcodes to enable or disable decoding UPC barcodes with reduced quiet zones (the margins on either side of the barcode). If you select **Enable**, select a [1D Quiet Zone Level on page 296](#).



Enable UPC Reduced Quiet Zone
(1)

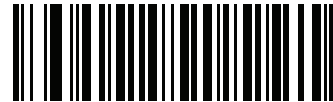

*Disable UPC Reduced Quiet Zone
(0)

Code 128

Parameter # 8

SSI # 08h

Scan one of the following barcodes to enable or disable Code 128.

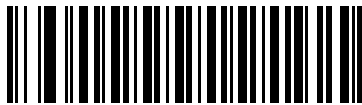

*Enable Code 128
(1)



Disable Code 128
(0)

Set Lengths for Code 128

L1 = Parameter # 209

SSI # D1h

L2 = Parameter # 210

SSI # D2h

The length of a code refers to the number of characters (i.e., human readable characters), including check digit(s) the code contains. Set lengths for Code 128 to any length, one or two discrete lengths, or lengths within a specific range. The maximum range is 128. The default is **Any Length**.



NOTE: When setting lengths, enter a leading zero for single digit numbers.

Scan one of the following barcodes to select a length option:

- **One Discrete Length** - Decode only Code 128 symbols containing a selected length. Select the length using the barcodes in [Numeric Barcodes](#). For example, to decode only Code 128 symbols with 14 characters, scan **Code 128 - One Discrete Length**, and then scan **1, 4**. To correct an error or change the selection, scan [Cancel on page 452](#).
- **Two Discrete Lengths** - Decode only Code 128 symbols containing either of two lengths. Select lengths using the barcodes in [Numeric Barcodes](#). For example, to decode only Code 128 symbols containing either 2 or 14 characters, scan **Code 128 - Two Discrete Lengths**, and then scan **0, 2, 1, 4**. To correct an error or change the selection, scan [Cancel on page 452](#).
- **Length Within Range** - Decode Code 128 symbols with a specific length range. Select lengths using the barcodes in [Numeric Barcodes](#). For example, to decode Code 128 symbols containing between 4 and 12 characters, scan **Code 128 - Length Within Range**, and then scan **0, 4, 1, 2**. To correct an error or change the selection, scan [Cancel on page 452](#).
- **Any Length** - Decode Code 128 symbols containing any number of characters within the scanner's capability.

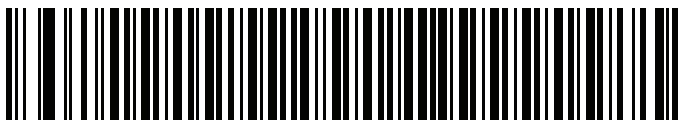

Code 128 - One Discrete Length

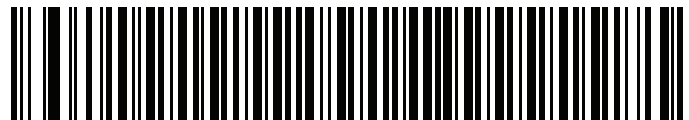

Code 128 - Two Discrete Lengths

Set Lengths for Code 128 (continued)

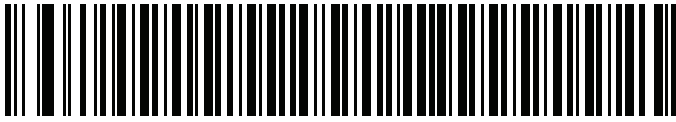

Code 128 - Length Within Range

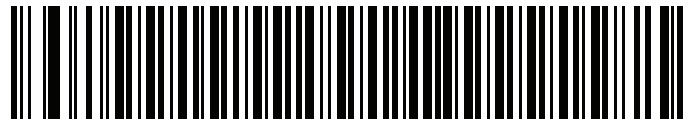

*Code 128 - Any Length

GS1-128 (formerly UCC/EAN-128)

Parameter # 14

SSI # 0Eh

Scan one of the following barcodes to enable or disable GS1-128.

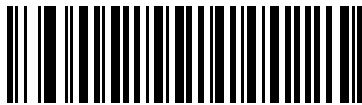

*Enable GS1-128
(1)



Disable GS1-128
(0)

ISBT 128

Parameter # 84

SSI # 54h

ISBT 128 is a variant of Code 128 used in the blood bank industry. Scan one of the following barcodes to enable or disable ISBT 128.



***Enable ISBT 128**
(1)



Disable ISBT 128
(0)

ISBT Concatenation

Parameter # 577

SSI # F1h 41h

Select an option for concatenating pairs of ISBT code types:

- **Enable ISBT Concatenation** - There must be two ISBT codes in order for the scanner to decode and perform concatenation. The scanner does not decode single ISBT symbols.
- **Disable ISBT Concatenation** - The scanner does not concatenate pairs of ISBT codes it encounters.
- **Autodiscriminate ISBT Concatenation** - The scanner decodes and concatenates pairs of ISBT codes immediately. If only a single ISBT symbol is present, the scanner must decode the symbol the number of times set via [ISBT Concatenation Redundancy on page 247](#) before transmitting its data to confirm that there is no additional ISBT symbol.



NOTE: When enabling ISBT Concatenation or Autodiscriminate ISBT Concatenation set Code 128 Security Level to Level 2.

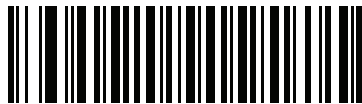

***Enable ISBT Concatenation
(1)
(Default for DS4608-HC only)**

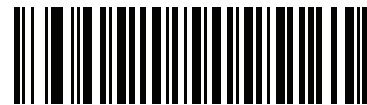

***Disable ISBT Concatenation
(0)**

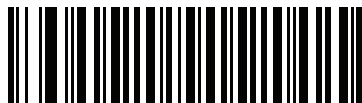

**Autodiscriminate ISBT Concatenation
(2)**

Check ISBT Table

Parameter # 578

SSI # F1h 42h

The ISBT specification includes a table that lists several types of ISBT barcodes that are commonly used in pairs. If you set **ISBT Concatenation** to **Enable**, enable **Check ISBT Table** to concatenate only those pairs found in this table. Other types of ISBT codes are not concatenated.



*Enable Check ISBT Table
(1)

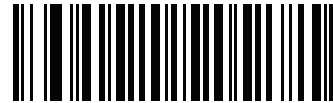

Disable Check ISBT Table
(0)

ISBT Concatenation Redundancy

Parameter # 223

SSI # DFh

If you set [ISBT Concatenation on page 246](#) to **Autodiscriminate** (the default), use this parameter to set the number of times the scanner must decode an ISBT symbol before determining that there is no additional symbol.

Scan the following barcode, and then scan barcodes in [Numeric Barcodes](#) to set a value between 2 and 20. Enter a leading zero for single digit numbers. To correct an error or change a selection, scan [Cancel on page 452](#). The default is 10.



ISBT Concatenation Redundancy

Code 128 <FNC4>**Parameter # 1254****SSI # F8h 04h E6h**

This feature applies to Code 128 barcodes with an embedded <FNC4> character. Select **Ignore Code 128 <FNC4>** to strip the <FNC4> character from the decode data. The remaining characters are sent to the host unchanged. When disabled, the <FNC4> character is processed normally as per Code 128 standard.



***Honor Code 128 <FNC4>**
(0)



Ignore Code 128 <FNC4>
(1)

Code 128 Security Level

Parameter # 751

SSI # F1h EFh

Code 128 barcodes are vulnerable to misdecodes, particularly when Code 128 Lengths is set to **Any Length**. The scanner offers four levels of decode security for Code 128 barcodes. There is an inverse relationship between security and scanner aggressiveness. Increasing the level of security can reduce scanning aggressiveness, so select only the level of security necessary.

- **Code 128 Security Level 0** - The scanner operates in its most aggressive state, while providing sufficient security in decoding most in-spec barcodes.
- **Code 128 Security Level 1** - This option eliminates most misdecodes while maintaining reasonable aggressiveness.
- **Code 128 Security Level 2** - This option applies greater barcode security requirements if **Security Level 1** fails to eliminate misdecodes.
- **Code 128 Security Level 3** - If you selected **Security Level 2**, and misdecodes still occur, select this security level to apply the highest safety requirements.



NOTE: Selecting this option is an extreme measure against mis-decoding severely out-of-spec barcodes, and significantly impairs the decoding ability of the scanner. If this level of security is required, try to improve the quality of the barcodes.

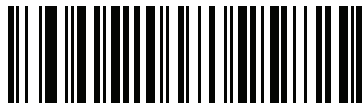

Code 128 Security Level 0
(0)



***Code 128 Security Level 1**
(1)



***Code 128 Security Level 2**
(2)
(Default for DS4608-HC only)



Code 128 Security Level 3
(3)

Code 128 Reduced Quiet Zone

Parameter # 1208

SSI # F8h 04h B8h

Scan one of the following barcodes to enable or disable decoding Code 128 barcodes with reduced quiet zones (the margins on either side of the barcode). If you select **Enable**, select a [1D Quiet Zone Level on page 296](#).



Enable Code 128 Reduced Quiet Zone
(1)



*Disable Code 128 Reduced Quiet Zone
(0)

Code 39

Parameter # 0

SSI # 00h

Scan one of the following barcodes to enable or disable Code 39.

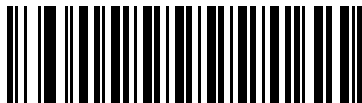

*Enable Code 39
(1)



Disable Code 39
(0)

Trioptic Code 39

Parameter # 13

SSI # 0Dh

Trioptic Code 39 is a variant of Code 39 used in the marking of computer tape cartridges. Trioptic Code 39 symbols always contain six characters. Scan one of the following barcodes to enable or disable Trioptic Code 39.

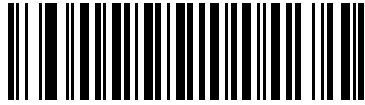

Enable Trioptic Code 39
(1)

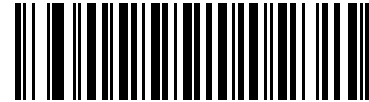

*Disable Trioptic Code 39
(0)



NOTE: You cannot enable Trioptic Code 39 and Code 39 Full ASCII simultaneously.

Convert Code 39 to Code 32

Parameter # 86

SSI # 56h

Code 32 is a variant of Code 39 used by the Italian pharmaceutical industry. Scan one of the following barcodes to enable or disable converting Code 39 to Code 32.



NOTE: Code 39 must be enabled for this parameter to function.

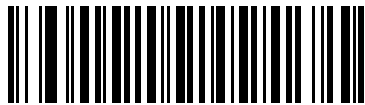

Enable Convert Code 39 to Code 32
(1)

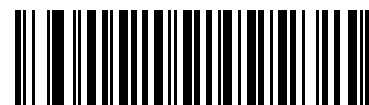

*Disable Convert Code 39 to Code 32
(0)

Code 32 Prefix

Parameter # 231

SSI # E7h

Scan one of the following barcodes to enable or disable adding the prefix character “A” to all Code 32 barcodes.



NOTE: Convert Code 39 to Code 32 must be enabled for this parameter to function.

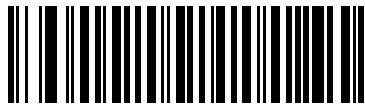

Enable Code 32 Prefix
(1)

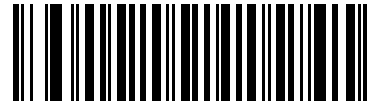

*Disable Code 32 Prefix
(0)

Set Lengths for Code 39

L1 = Parameter # 18

SSI # 12h

L2 = Parameter # 19

SSI # 13h

The length of a code refers to the number of characters (i.e., human readable characters), including check digit(s) the code contains. Set lengths for Code 39 to any length, one or two discrete lengths, or lengths within a specific range. If Code 39 Full ASCII is enabled, **Length Within Range** or **Any Length** are the preferred options. The maximum range is 80. The default is **Length Within Range: 1 to 55**.



NOTE: When setting lengths, enter a leading zero for single digit numbers.

Scan one of the following barcodes to select a length option:

- **One Discrete Length** - Decode only Code 39 symbols containing a selected length. Select the length using the barcodes in [Numeric Barcodes](#). For example, to decode only Code 39 symbols with 14 characters, scan **Code 39 - One Discrete Length**, and then scan **1, 4**. To correct an error or change the selection, scan [Cancel on page 452](#).
- **Two Discrete Lengths** - Decode only Code 39 symbols containing either of two lengths. Select lengths using the barcodes in [Numeric Barcodes](#). For example, to decode only Code 39 symbols

containing either 2 or 14 characters, scan **Code 39 - Two Discrete Lengths**, and then scan **0, 2, 1, 4**. To correct an error or change the selection, scan [Cancel on page 452](#).

- **Length Within Range** - Decode Code 39 symbols with a specific length range. Select lengths using the barcodes in [Numeric Barcodes](#). For example, to decode Code 39 symbols containing between 4 and 12 characters, scan **Code 39 - Length Within Range**, and then scan **0, 4, 1, 2**. To correct an error or change the selection, scan [Cancel on page 452](#).
- **Any Length** - Decode Code 39 symbols containing any number of characters within the scanner's capability.



Code 39 - One Discrete Length



Code 39 - Two Discrete Lengths



***Code 39 - Length Within Range**
(Default: 1 to 55)



Code 39 - Any Length

Code 39 Check Digit Verification

Parameter # 48

SSI # 30h

Scan **Enable Code 39 Check Digit** to check the integrity of all Code 39 symbols to verify that the data complies with specified check digit algorithm. Only Code 39 symbols which include a modulo 43 check digit are decoded. Enable this feature if the Code 39 symbols contain a Modulo 43 check digit.

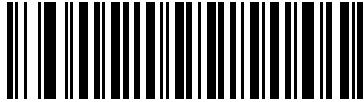

**Enable Code 39 Check Digit
(1)**

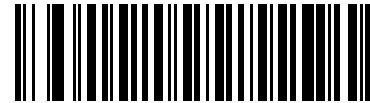

***Disable Code 39 Check Digit
(0)**

Transmit Code 39 Check Digit

Parameter # 43

SSI # 2Bh

Scan one of the following barcodes to transmit Code 39 data with or without the check digit.

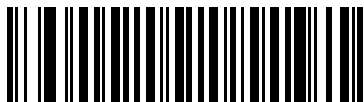

**Transmit Code 39 Check Digit (Enable)
(1)**



***Do Not Transmit Code 39 Check Digit (Disable)
(0)**



NOTE: [Code 39 Check Digit Verification](#) must be enabled for this parameter to function.

Code 39 Full ASCII Conversion

Parameter # 17

SSI # 11h

Code 39 Full ASCII is a variant of Code 39 which pairs characters to encode the full ASCII character set. Scan one of the following barcodes to enable or disable Code 39 Full ASCII.



Enable Code 39 Full ASCII
(1)

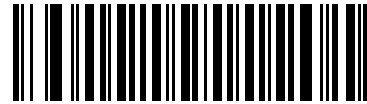

*Disable Code 39 Full ASCII
(0)



NOTES 1 You cannot enable Trioptic Code 39 and Code 39 Full ASCII simultaneously.

2. Code 39 Full ASCII to Full ASCII Correlation is host-dependent, and is therefore described in the ASCII character set table for the appropriate interface. See [Table 38 on page 471](#).

Code 39 Security Level

Parameter # 750

SSI # F1h EEh

The scanner offers four levels of decode security for Code 39 barcodes. There is an inverse relationship between security and scanner aggressiveness. Increasing the level of security can reduce scanning aggressiveness, so select only the level of security necessary.

- **Code 39 Security Level 0:** The scanner operates in its most aggressive state, while providing sufficient security in decoding most in-spec barcodes.
- **Code 39 Security Level 1:** This default setting eliminates most misdecodes.
- **Code 39 Security Level 2:** This option applies greater barcode security requirements if **Security Level 1** fails to eliminate misdecodes.
- **Code 39 Level 3:** If you selected **Security Level 2**, and misdecodes still occur, select this security level to apply the highest safety requirements.



NOTE: Selecting this option is an extreme measure against mis-decoding severely out-of-spec barcodes, and significantly impairs the decoding ability of the scanner. If this level of security is required, try to improve the quality of the barcodes

Code 39 Security Level (continued)



**Code 39 Security Level 0
(0)**



***Code 39 Security Level 1
(1)**



**Code 39 Security Level 2
(2)**



**Code 39 Security Level 3
(3)**

Code 39 Reduced Quiet Zone

Parameter # 1209

SSI # F8h 04h B9h

Scan one of the following barcodes to enable or disable decoding Code 39 barcodes with reduced quiet zones (the margins on either side of the barcode). If you select **Enable**, select a [1D Quiet Zone Level on page 296](#).



Enable Code 39 Reduced Quiet Zone
(1)

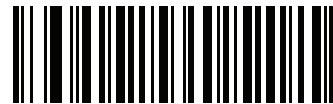

*Disable Code 39 Reduced Quiet Zone
(0)

Code 93

Parameter # 9

SSI # 09h

Scan one of the following barcodes to enable or disable Code 93.

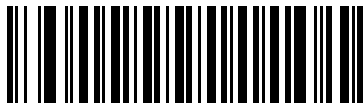

*Enable Code 93
(1)

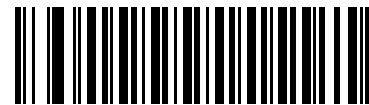

Disable Code 93
(0)

Set Lengths for Code 93

L1 = Parameter # 26

SSI # 1Ah

L2 = Parameter # 27

SSI # 1Bh

The length of a code refers to the number of characters (i.e., human readable characters), including check digit(s) the code contains. Set lengths for Code 93 to any length, one or two discrete lengths, or lengths within a specific range. The maximum range is 80. The default is **Length Within Range: 1 to 55**.



NOTE: When setting lengths, enter a leading zero for single digit numbers.

Scan one of the following barcodes to select a length option:

- **One Discrete Length** - Decode only Code 93 symbols containing a selected length. Select the length using the barcodes in [Numeric Barcodes](#). For example, to decode only Code 93 symbols with 14 characters, scan **Code 93 - One Discrete Length**, and then scan **1, 4**. To correct an error or change the selection, scan [Cancel on page 452](#).
- **Two Discrete Lengths** - Decode only Code 93 symbols containing either of two lengths. Select lengths using the barcodes in [Numeric Barcodes](#). For example, to decode only Code 93 symbols containing either 2 or 14 characters, scan **Code 93 - Two Discrete Lengths**, and then scan **0, 2, 1, 4**. To correct an error or change the selection, scan [Cancel on page 452](#).
- **Length Within Range** - Decode Code 93 symbols with a specific length range. Select lengths using the barcodes in [Numeric Barcodes](#). For example, to decode Code 93 symbols containing between 4 and 12 characters, scan **Code 93 - Length Within Range**, and then scan **0, 4, 1, 2**. To correct an error or change the selection, scan [Cancel on page 452](#).
- **Any Length** - Decode Code 93 symbols containing any number of characters within the scanner's capability.

Set Lengths for Code 93 (continued)



Code 93 - One Discrete Length



Code 93 - Two Discrete Lengths



***Code 93 - Length Within Range
(Default: 1 to 55)**



Code 93 - Any Length

Code 11

Parameter # 10

SSI # 0Ah

Scan one of the following barcodes to enable or disable Code 11

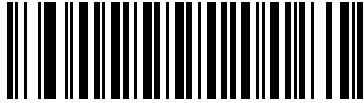

Enable Code 11
(1)

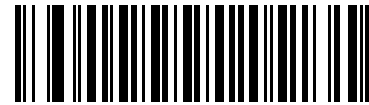

***Disable Code 11**
(0)

Set Lengths for Code 11

L1 = Parameter # 28

SSI # 1Ch

L2 = Parameter # 29

SSI # 1Dh

The length of a code refers to the number of characters (i.e., human readable characters), including check digit(s) the code contains. Set lengths for Code 11 to any length, one or two discrete lengths, or lengths within a specific range. The maximum range is 80. The default is **Length Within Range: 4 to 55**.



NOTE: When setting lengths, enter a leading zero for single digit numbers.

Scan one of the following barcodes to select a length option:

- **One Discrete Length** - Decode only Code 11 symbols containing a selected length. Select the length using the barcodes in [Numeric Barcodes](#). For example, to decode only Code 11 symbols with 14 characters, scan **Code 11 - One Discrete Length**, and then scan **1, 4**. To correct an error or change the selection, scan [Cancel on page 452](#).
- **Two Discrete Lengths** - Decode only Code 11 symbols containing either of two lengths. Select lengths using the barcodes in [Numeric Barcodes](#). For example, to decode only Code 11 symbols containing either 2 or 14 characters, scan **Code 11 - Two Discrete Lengths**, and then scan **0, 2, 1, 4**. To correct an error or change the selection, scan [Cancel on page 452](#).
- **Length Within Range** - Decode Code 11 symbols with a specific length range. Select lengths using the barcodes in [Numeric Barcodes](#). For example, to decode Code 11 symbols containing between 4 and 12 characters, scan **Code 11 - Length Within Range**, and then scan **0, 4, 1, 2**. To correct an error or change the selection, scan [Cancel on page 452](#).
- **Any Length** - Decode Code 11 symbols containing any number of characters within the scanner's capability.

Set Lengths for Code 11 (continued)



Code 11 - One Discrete Length



Code 11 - Two Discrete Lengths



***Code 11 - Length Within Range
(Default: 4 to 55)**



Code 11 - Any Length

Code 11 Check Digit Verification

Parameter # 52

SSI # 34h

This feature allows the scanner to check the integrity of all Code 11 symbols to verify that the data complies with the specified check digit algorithm.

Scan one of the following barcodes to specify the number of check digits encoded in the Code 11 symbols, or to disable this feature.

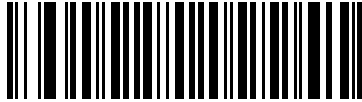

***Disable
(0)**



**One Check Digit
(1)**

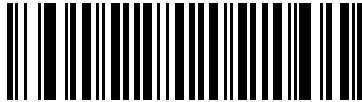

**Two Check Digits
(2)**

Transmit Code 11 Check Digits

Parameter # 47

SSI # 2Fh

Scan one of the following barcodes to select whether or not to transmit the Code 11 check digit(s).

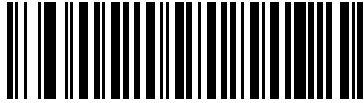

Transmit Code 11 Check Digit(s) (Enable)
(1)

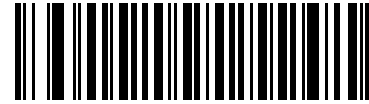

*Do Not Transmit Code 11 Check Digit(s) (Disable)
(0)



NOTE: [Code 11 Check Digit Verification](#) must be enabled for this parameter to function.

Interleaved 2 of 5 (ITF)

Parameter # 6

SSI # 06h

Scan one of the following barcodes to enable or disable Interleaved 2 of 5.

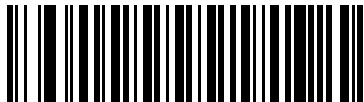

*Enable Interleaved 2 of 5
(1)



Disable Interleaved 2 of 5
(0)

Set Lengths for Interleaved 2 of 5

L1 = Parameter # 22

SSI # 16h

L2 = Parameter # 23

SSI # 17h

The length of a code refers to the number of characters (i.e., human readable characters), including check digit(s) the code contains. Set lengths for I 2 of 5 to any length, one or two discrete lengths, or lengths within a specific range. The maximum range is 80. The default is **Length Within Range: 6 to 55**.



NOTE: When setting lengths, enter a leading zero for single digit numbers.

Scan one of the following barcodes to select a length option:

- **One Discrete Length** - Decode only I 2 of 5 symbols containing a selected length. Select the length using the barcodes in [Numeric Barcodes](#). For example, to decode only I 2 of 5 symbols with 14 characters, scan **I 2 of 5 - One Discrete Length**, and then scan **1, 4**. To correct an error or change the selection, scan [Cancel on page 452](#).
- **Two Discrete Lengths** - Decode only I 2 of 5 symbols containing either of two lengths. Select lengths using the barcodes in [Numeric Barcodes](#). For example, to decode only I 2 of 5 symbols containing either 2 or 14 characters, scan **I 2 of 5 - Two Discrete Lengths**, and then scan **0, 2, 1, 4**. To correct an error or change the selection, scan [Cancel on page 452](#).
- **Length Within Range** - Decode I 2 of 5 symbols with a specific length range. Select lengths using the barcodes in [Numeric Barcodes](#). For example, to decode I 2 of 5 symbols containing between 4 and 12 characters, scan **I 2 of 5 - Length Within Range**, and then scan **0, 4, 1, 2**. To correct an error or change the selection, scan [Cancel on page 452](#).

Set Lengths for Interleaved 2 of 5 (continued)

- **Any Length** - Decode 1 2 of 5 symbols containing any number of characters within the scanner's capability.



NOTE: Due to the construction of the 1 2 of 5 symbology, it is possible for a scan line covering only a portion of the code to transmit as a complete scan, yielding less data than is encoded in the barcode. To prevent this, select specific lengths (1 2 of 5 - One Discrete Length, Two Discrete Lengths) for 1 2 of 5 applications, or increase the [1 2 of 5 Security Level on page 269](#).



1 2 of 5 - One Discrete Length



1 2 of 5 - Two Discrete Lengths



***1 2 of 5 - Length Within Range
(Default: 6 to 55)**



1 2 of 5 - Any Length

I 2 of 5 Check Digit Verification

Parameter # 49

SSI # 31h

Scan one of the following barcodes to check the integrity of all I 2 of 5 symbols to verify the data complies with either the specified Uniform Symbology Specification (USS), or the Optical Product Code Council (OPCC) check digit algorithm.



***Disable
(0)**



**USS Check Digit
(1)**



**OPCC Check Digit
(2)**

Transmit I 2 of 5 Check Digit

Parameter # 44

SSI # 2Ch

Scan one of the following barcodes to transmit I 2 of 5 data with or without the check digit.



**Transmit I 2 of 5 Check Digit (Enable)
(1)**



***Do Not Transmit I 2 of 5 Check Digit (Disable)
(0)**

Convert I 2 of 5 to EAN-13

Parameter # 82

SSI # 52h

Scan **Convert I 2 of 5 to EAN-13 (Enable)** to convert 14-character I 2 of 5 codes to EAN-13, and transmit to the host as EAN-13. To accomplish this, the I 2 of 5 code must be enabled, and the code must have a leading zero and a valid EAN-13 check digit.



Convert I 2 of 5 to EAN-13 (Enable)
(1)

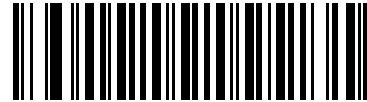

*Do Not Convert I 2 of 5 to EAN-13 (Disable)
(0)

Febraban

Parameter # 1750

SSI # F8h 06h D6h

Febraban is an Interleaved 2 of 5 barcode of length 44 that requires inserting special check characters in the transmitted data stream. Enabling this disables the I 2 of 5 internal check digit calculation and transmission.

Recommendations for length settings:

- **Interleaved 2 of 5 Length 1:** Larger of the fixed length and the Febraban length (==44).
- **Interleaved 2 of 5 Length 2:** Smaller of the fixed length and the Febraban length (==44).



Enable Febraban
(1)



*Disable Febraban
(0)

I 2 of 5 Security Level

Parameter # 1121

SSI # F8h 04h 61h

Interleaved 2 of 5 barcodes are vulnerable to misdecodes, particularly when I 2 of 5 Lengths is set to **Any Length**. The scanner offers four levels of decode security for Interleaved 2 of 5 barcodes. There is an inverse relationship between security and scanner aggressiveness. Increasing the level of security can reduce scanning aggressiveness, so select only the level of security necessary.

- **I 2 of 5 Security Level 0:** The scanner operates in its most aggressive state, while providing sufficient security in decoding most in-spec barcodes.
- **I 2 of 5 Security Level 1:** A barcode must be successfully read twice, and satisfy certain safety requirements before being decoded. This default setting eliminates most misdecodes.
- **I 2 of 5 Security Level 2:** This option applies greater barcode security requirements if **Security Level 1** fails to eliminate misdecodes.
- **I 2 of 5 Security Level 3:** If you selected **Security Level 2**, and misdecodes still occur, select this security level. The highest safety requirements are applied. A barcode must be successfully read three times before being decoded.



NOTE: Selecting this option is an extreme measure against mis-decoding severely out-of-spec barcodes, and significantly impairs the decoding ability of the scanner. If this level of security is required, try to improve the quality of the barcodes.

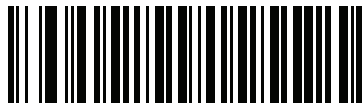

I 2 of 5 Security Level 0
(0)

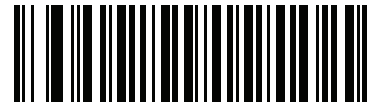

*I 2 of 5 Security Level 1
(1)



I 2 of 5 Security Level 2
(2)



I 2 of 5 Security Level 3
(3)

I 2 of 5 Reduced Quiet Zone

Parameter # 1210

SSI # F8h 04h BAh

Scan one of the following barcodes to enable or disable decoding I 2 of 5 barcodes with reduced quiet zones (the margins on either side of the barcode). If you select **Enable**, select a [1D Quiet Zone Level on page 296](#).



Enable I 2 of 5 Reduced Quiet Zone
(1)



*Disable I 2 of 5 Reduced Quiet Zone
(0)

Discrete 2 of 5 (DTF)

Parameter # 5

SSI # 05h

Scan one of the following barcodes to enable or disable Discrete 2 of 5.

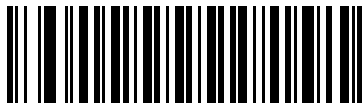

Enable Discrete 2 of 5
(1)



*Disable Discrete 2 of 5
(0)

Set Lengths for Discrete 2 of 5

L1 = Parameter # 20

SSI # 14h

L2 = Parameter # 21

SSI # 15h

The length of a code refers to the number of characters (i.e., human readable characters), including check digit(s) the code contains. Set lengths for D 2 of 5 to any length, one or two discrete lengths, or lengths within a specific range. The maximum range is 55. The default is **Length Within Range: 1 to 55**.



NOTE: When setting lengths, enter a leading zero for single digit numbers.

Scan one of the following barcodes to select a length option:

- **One Discrete Length** - Decode only D 2 of 5 symbols containing a selected length. Select the length using the barcodes in [Numeric Barcodes](#). For example, to decode only D 2 of 5 symbols with 14 characters, scan **D 2 of 5 - One Discrete Length**, and then scan **1, 4**. To correct an error or change the selection, scan [Cancel on page 452](#).
- **Two Discrete Lengths** - Decode only D 2 of 5 symbols containing either of two lengths. Select lengths using the barcodes in [Numeric Barcodes](#). For example, to decode only D 2 of 5 symbols containing either 2 or 14 characters, scan **D 2 of 5 - Two Discrete Lengths**, and then scan **0, 2, 1, 4**. To correct an error or change the selection, scan [Cancel on page 452](#).
- **Length Within Range** - Decode D 2 of 5 symbols with a specific length range. Select lengths using the barcodes in [Numeric Barcodes](#). For example, to decode D 2 of 5 symbols containing between 4 and 12 characters, scan **D 2 of 5 - Length Within Range**, and then scan **0, 4, 1, 2**. To correct an error or change the selection, scan [Cancel on page 452](#).

Set Lengths for Discrete 2 of 5 (continued)

- **Any Length** - Decode D 2 of 5 symbols containing any number of characters within the scanner's capability.



NOTE: Due to the construction of the D 2 of 5 symbology, it is possible for a scan line covering only a portion of the code to transmit as a complete scan, yielding less data than is encoded in the barcode. To prevent this, select specific lengths (D 2 of 5 - One Discrete Length, Two Discrete Lengths) for D 2 of 5 applications.



D 2 of 5 - One Discrete Length



D 2 of 5 - Two Discrete Lengths



***D 2 of 5 - Length Within Range
(Default: 1 to 55)**



D 2 of 5 - Any Length

Codabar (NW - 7)

Parameter # 7

SSI # 07h

Scan one of the following barcodes to enable or disable Codabar.

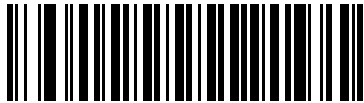

*Enable Codabar
(1)

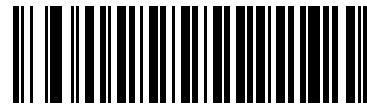

Disable Codabar
(0)

Set Lengths for Codabar

L1 = Parameter # 24

SSI # 18h

L2 = Parameter # 25

SSI # 19h

The length of a code refers to the number of characters (i.e., human readable characters), including check digit(s) the code contains. Set lengths for Codabar to any length, one or two discrete lengths, or lengths within a specific range. The maximum range is 60. The default is **Length Within Range: 4 to 55**.



NOTE: When setting lengths, enter a leading zero for single digit numbers.

Scan one of the following barcodes to select a length option:

- **One Discrete Length** - Decode only Codabar symbols containing a selected length. Select the length using the barcodes in [Numeric Barcodes](#). For example, to decode only Codabar symbols with 14 characters, scan **Codabar - One Discrete Length**, and then scan **1, 4**. To correct an error or change the selection, scan [Cancel on page 452](#).
- **Two Discrete Lengths** - Decode only Codabar symbols containing either of two lengths. Select lengths using the barcodes in [Numeric Barcodes](#). For example, to decode only Codabar symbols containing either 2 or 14 characters, scan **Codabar - Two Discrete Lengths**, and then scan **0, 2, 1, 4**. To correct an error or change the selection, scan [Cancel on page 452](#).
- **Length Within Range** - Decode Codabar symbols with a specific length range. Select lengths using the barcodes in [Numeric Barcodes](#). For example, to decode Codabar symbols containing between 4 and 12 characters, scan **Codabar - Length Within Range**, and then scan **0, 4, 1, 2**. To correct an error or change the selection, scan [Cancel on page 452](#).
- **Any Length** - Decode Codabar symbols containing any number of characters within the scanner's capability.

Set Lengths for Codabar (continued)



Codabar - One Discrete Length



Codabar - Two Discrete Lengths



***Codabar - Length Within Range
(Default: 4 to 55)**



Codabar - Any Length

CLSI Editing

Parameter # 54

SSI # 36h

Scan **Enable CLSI Editing** to strip the start and stop characters and insert a space after the first, fifth, and tenth characters of a 14-character Codabar symbol if the host system requires this data format.



NOTE: Symbol length does not include start and stop characters.

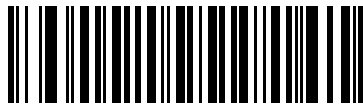

Enable CLSI Editing
(1)

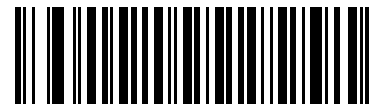

*Disable CLSI Editing
(0)

NOTIS Editing

Parameter # 55

SSI # 37h

Scan **Enable NOTIS Editing** to strip the start and stop characters from a decoded Codabar symbol if the host system requires this data format.



Enable NOTIS Editing
(1)

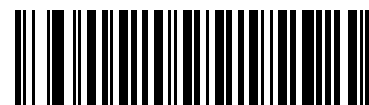

*Disable NOTIS Editing
(0)

Codabar Security Level

Parameter # 1776

SSI # F8h 06h F0h

The scanner offers four levels of decode security for Codabar barcodes. There is an inverse relationship between security and scanner aggressiveness. Increasing the level of security can reduce scanning aggressiveness, so select only the level of security necessary.

- **Codabar Security Level 0:** This setting allows the scanner to operate in its most aggressive state, while providing sufficient security in decoding most in-spec barcodes.
- **Codabar Security Level 1:** This default setting eliminates most misdecodes.
- **Codabar Security Level 2:** Select this option with greater barcode security requirements if **Security Level 1** fails to eliminate misdecodes.
- **Codabar Security Level 3:** If you selected **Security Level 2**, and misdecodes still occur, select this security level to apply the highest safety requirements.



NOTE: Selecting this option is an extreme measure against mis-decoding severely out-of-spec barcodes, and significantly impairs the decoding ability of the scanner. If this level of security is required, try to improve the quality of the barcodes.

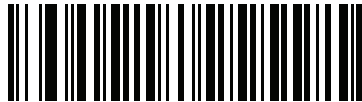

Codabar Security Level 0
(0)



*Codabar Security Level 1
(1)

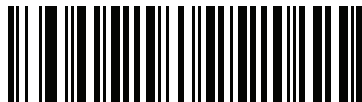

Codabar Security Level 2
(2)



Codabar Security Level 3
(3)

Codabar Upper or Lower Case Start/Stop Characters

Parameter # 855

SSI # F2h 57h

Scan one of the following barcodes to select whether to transmit upper case or lower case Codabar start/stop characters.



Lower Case
(1)

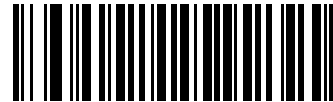

*Upper Case
(0)

Codabar Mod 16 Check Digit Verification

Parameter # 1784

SSI # F8h 06h F8h

Enable this feature to check the Codabar Mod 16 Check Digit to verify that the data complies with the specified check digit algorithm.



Enable Codabar Mod 16 Check Digit
(1)



* Disable Codabar Mod 16 Check Digit
(0)

Transmit Codabar Check Digit

Parameter # 704

SSI # F1h C0h

Scan one of the following barcodes to select whether or not to transmit the Codabar check digit(s).



NOTE: [Codabar Mod 16 Check Digit Verification](#) must be enabled for this parameter to function.



Enable Codabar Check Digit Transmission
(1)



* Disable Codabar Check Digit Transmission
(0)

MSI

Parameter # 11

SSI # 0Bh

Scan one of the following barcodes to enable or disable MSI.

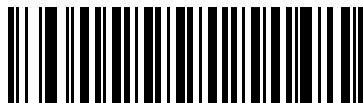

Enable MSI
(1)

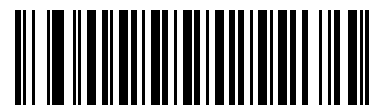

*Disable MSI
(0)

Set Lengths for MSI

L1 = Parameter # 30

SSI # 1Eh

L2 = Parameter # 31

SSI # 1Fh

The length of a code refers to the number of characters (i.e., human readable characters), including check digit(s) the code contains. Set lengths for MSI to any length, one or two discrete lengths, or lengths within a specific range. The maximum range is 55. The default is **Length Within Range: 4 to 55**.



NOTE: When setting lengths, enter a leading zero for single digit numbers.

Scan one of the following barcodes to select a length option:

- **One Discrete Length** - Decode only MSI symbols containing a selected length. Select the length using the barcodes in [Numeric Barcodes](#). For example, to decode only MSI symbols with 14 characters, scan **MSI - One Discrete Length**, and then scan **1, 4**. To correct an error or change the selection, scan [Cancel on page 452](#).
- **Two Discrete Lengths** - Decode only MSI symbols containing either of two lengths. Select lengths using the barcodes in [Numeric Barcodes](#). For example, to decode only MSI symbols containing either 2 or 14 characters, scan **MSI - Two Discrete Lengths**, and then scan **0, 2, 1, 4**. To correct an error or change the selection, scan [Cancel on page 452](#).
- **Length Within Range** - Decode MSI symbols with a specific length range. Select lengths using the barcodes in [Numeric Barcodes](#). For example, to decode MSI symbols containing between 4 and 12 characters, scan **MSI - Length Within Range**, and then scan **0, 4, 1, 2**. To correct an error or change the selection, scan [Cancel on page 452](#).
- **Any Length** - Decode MSI symbols containing any number of characters within the scanner's capability.



NOTE: Due to the construction of the MSI symbology, it is possible for a scan line covering only a portion of the code to transmit as a complete scan, yielding less data than is encoded in the barcode. To prevent this, select specific lengths (**MSI - One Discrete Length, Two Discrete Lengths**) for MSI applications.

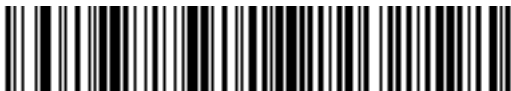

MSI - One Discrete Length



MSI - Two Discrete Lengths

Set Lengths for MSI (continued)



*MSI - Length Within Range
(Default: 4 to 55)

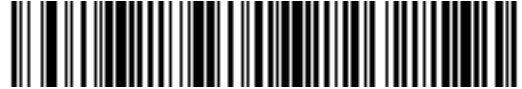

MSI - Any Length

MSI Check Digits

Parameter # 50

SSI # 32h

With MSI symbols, one check digit is mandatory and always verified by the reader. The second check digit is optional. If the MSI codes include two check digits, scan the **Two MSI Check Digits** barcode to enable verification of the second check digit.

- 0 - Does not check the MSI check digit; decodes MSI with no check digit.
- 1 - This is for MSI barcodes with one check digit. This is the default.
- 2 - This is for MSI barcodes with two check digits.

See [MSI Check Digit Algorithm on page 281](#) to select second digit algorithms.

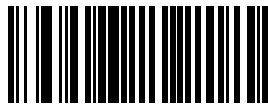

No MSI Check Digit
(0)

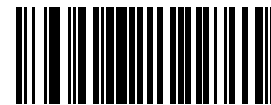

*One MSI Check Digit
(1)

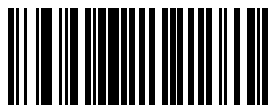

Two MSI Check Digits
(2)

Transmit MSI Check Digit(s)**Parameter # 46****SSI # 2Eh**

Scan one of the following barcodes to transmit MSI data with or without the check digit.



Transmit MSI Check Digit(s) (Enable)
(1)

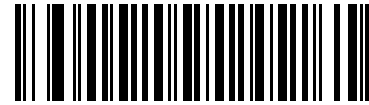

***Do Not Transmit MSI Check Digit(s) (Disable)**
(0)

MSI Check Digit Algorithm**Parameter # 51****SSI # 33h**

Two algorithms are available for verifying the second MSI check digit. Scan one of the following barcodes to select the algorithm used to encode the check digit.

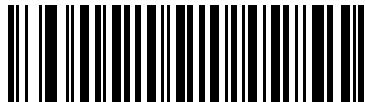

MOD 11/MOD 10
(0)

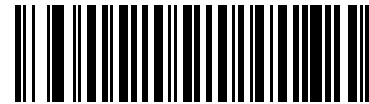

***MOD 10/MOD 10**
(1)

MSI Reduced Quiet Zone

Parameter # 1392

SSI # F8h 05h 70h

Scan one of the following barcodes to enable or disable decoding MSI barcodes with reduced quiet zones. If you select **Enable**, select a [1D Quiet Zone Level on page 296](#).

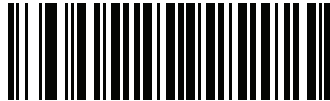

***Disable MSI Reduced Quiet Zone
(0)**



**Enable MSI Reduced Quiet Zone
(1)**

Chinese 2 of 5

Parameter # 408

SSI # F0h 98h

Scan one of the following barcodes to enable or disable Chinese 2 of 5.



**Enable Chinese 2 of 5
(1)**

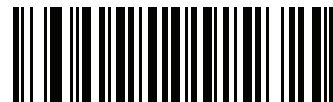

***Disable Chinese 2 of 5
(0)**

Matrix 2 of 5

Parameter # 618

SSI # F1h 6Ah

Scan one of the following barcodes to enable or disable Matrix 2 of 5.



**Enable Matrix 2 of 5
(1)**



***Disable Matrix 2 of 5
(0)**

Set Lengths for Matrix 2 of 5

L1 = Parameter # 619

SSI # F1h 6Bh

L2 = Parameter # 620

SSI # F1h 6Ch

The length of a code refers to the number of characters (i.e., human readable characters), including check digit(s) the code contains. Set lengths for Matrix 2 of 5 to any length, one or two discrete lengths, or lengths within a specific range. The maximum range is 80. The default is **Length Within Range: 4 to 55**.



NOTE: When setting lengths, enter a leading zero for single digit numbers.

Scan one of the following barcodes to select a length option:

- **One Discrete Length** - Decode only Matrix 2 of 5 symbols containing a selected length. Select the length using the barcodes in [Numeric Barcodes](#). For example, to decode only Matrix 2 of 5 symbols with 14 characters, scan **Matrix 2 of 5 - One Discrete Length**, and then scan **1, 4**. To correct an error or change the selection, scan [Cancel on page 452](#).
- **Two Discrete Lengths** - Decode only Matrix 2 of 5 symbols containing either of two lengths. Select lengths using the barcodes in [Numeric Barcodes](#). For example, to decode only Matrix 2 of 5 symbols containing either 2 or 14 characters, scan **Matrix 2 of 5 - Two Discrete Lengths**, and then scan **0, 2, 1, 4**. To correct an error or change the selection, scan [Cancel on page 452](#).
- **Length Within Range** - Decode Matrix 2 of 5 symbols with a specific length range. Select lengths using the barcodes in [Numeric Barcodes](#). For example, to decode Matrix 2 of 5 symbols containing between 4 and 12 characters, scan **Matrix 2 of 5 - Length Within Range**, and then scan **0, 4, 1, 2**. To correct an error or change the selection, scan [Cancel on page 452](#).

Set Lengths for Matrix 2 of 5 (continued)

- **Any Length** - Decode Matrix 2 of 5 symbols containing any number of characters within the scanner's capability.



Matrix 2 of 5 - One Discrete Length



Matrix 2 of 5 - Two Discrete Lengths



***Matrix 2 of 5 - Length Within Range
(Default: 4 to 55)**



Matrix 2 of 5 - Any Length

Matrix 2 of 5 Check Digit

Parameter # 622

SSI # F1h 6Eh

The check digit is the last character of the symbol used to verify the integrity of the data. Scan one of the following barcodes to determine whether to include the Matrix 2 of 5 check digit with the barcode data.



Enable Matrix 2 of 5 Check Digit
(1)



*Disable Matrix 2 of 5 Check Digit
(0)

Transmit Matrix 2 of 5 Check Digit

Parameter # 623

SSI # F1h 6Fh

Scan one of the following barcodes to transmit Matrix 2 of 5 data with or without the check digit.



Transmit Matrix 2 of 5 Check Digit
(1)



*Do Not Transmit Matrix 2 of 5 Check Digit
(0)

Korean 3 of 5

Parameter # 581

SSI # F1h 45h

Scan one of the following barcodes to enable or disable Korean 3 of 5.



NOTE: The length for Korean 3 of 5 is fixed at 6.



**Enable Korean 3 of 5
(1)**

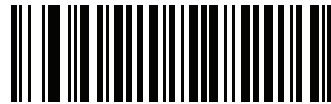

***Disable Korean 3 of 5
(0)**

Inverse 1D

Parameter # 586

SSI # F1h 4Ah

Scan one of the following barcodes to set the 1D inverse decoder setting:

- **Regular Only** - The scanner decodes regular 1D barcodes only.
- **Inverse Only** - The scanner decodes inverse 1D barcodes only.
- **Inverse Autodetect** - The scanner decodes both regular and inverse 1D barcodes.



NOTES 1 This parameter does not apply to GS1 DataBarcode types.
2. The Inverse 1D setting may impact Composite or Inverse Composite decoding.
See [Composite Inverse on page 299](#).



***Regular
(0)**



**Inverse Only
(1)**



**Inverse Autodetect
(2)**

GS1 DataBar

The variants of GS1 DataBar are DataBar Omnidirectional, DataBar Limited, and DataBar Expanded. The limited and expanded versions have stacked variants. Scan the appropriate barcodes to enable or disable each variant of GS1 DataBar.

GS1 DataBar Omnidirectional (formerly GS1 DataBar-14)

Parameter # 338

SSI # F0h 52h

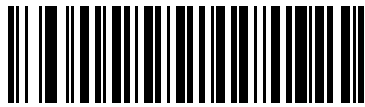

***Enable GS1 DataBar Omnidirectional
(1)**



**Disable GS1 DataBar Omnidirectional
(0)**

GS1 DataBar Limited

Parameter # 339

SSI # F0h 53h

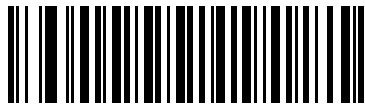

***Enable GS1 DataBar Limited
(1)**

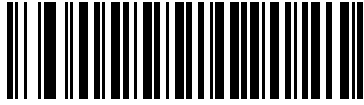

**Disable GS1 DataBar Limited
(0)**

GS1 DataBar Expanded**Parameter # 340****SSI # F0h 54h**

***Enable GS1 DataBar Expanded
(1)**

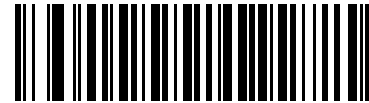

**Disable GS1 DataBar Expanded
(0)**

Convert GS1 DataBar to UPC/EAN/JAN**Parameter # 397****SSI # F0h, 8Dh**

This parameter only applies to GS1 DataBar Omnidirectional and GS1 DataBar Limited symbols not decoded as part of a Composite symbol. Scan **Enable Convert GS1 DataBar to UPC/EAN/JAN** to strip the leading '010' from DataBar Omnidirectional and DataBar Limited symbols encoding a single zero as the first digit, and report the barcode as EAN-13.

For barcodes beginning with between two and five zeros, this strips the leading '0100' and reports the barcode as UPC-A. The [UPC-A Preamble](#) option that transmits the system character and country code applies to converted barcodes. Note that neither the system character nor the check digit can be stripped.

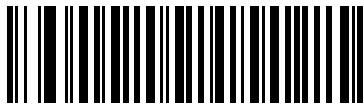

**Enable Convert GS1 DataBar to UPC/EAN/JAN
(1)**



***Disable Convert GS1 DataBar to UPC/EAN/JAN
(0)**

GS1 DataBar Security Level

Parameter # 1706

SSI # F8h 06h AAh

The scanner offers four levels of decode security for GS1 DataBar (GS1 DataBar Omnidirectional, GS1 DataBar Limited, GS1 DataBar Expanded) barcodes.

- **Security Level 0** - The scanner operates in its most aggressive state, while providing sufficient security decoding most in-spec barcodes.
- **Security Level 1** - This setting eliminates most misdecodes while maintaining reasonable aggressiveness.
- **Security Level 2** - Select this option with greater barcode security requirements if Security Level 1 fails to eliminate misdecodes.
- **Security Level 3** - If you selected Security Level 2 and misdecodes still occur, select this security level to apply the highest safety requirements.



GS1 DataBar Security Level 0
(0)



***GS1 DataBar Security Level 1**
(1)



GS1 DataBar Security Level 2
(2)



GS1 DataBar Security Level 3
(3)

GS1 DataBar Limited Margin Check

Parameter # 728

SSI # F1h D8h

The scanner offers four levels of decode security for GS1 DataBar Limited barcodes. There is an inverse relationship between the level of margin check and scanner aggressiveness. Increasing the level of margin check can reduce scanning aggressiveness, so select only the level of margin check necessary.

- **Margin Check Level 1** – No clear margin required. This complies with the original GS1 standard, yet can result in erroneous decoding of a DataBar Limited barcode when scanning some UPC symbols that start with digits **9** and **7**.
- **Margin Check Level 2** – Automatic risk detection. This level of margin check can result in erroneous decoding of DataBar Limited barcodes when scanning some UPC symbols. If a misdecode is detected, the scanner operates in Level 3 or Level 1.
- **Margin Check Level 3** – Margin check level reflects the newly proposed GS1 standard that requires a five times trailing clear margin.
- **Margin Check Level 4** – Margin check level extends beyond the standard required by GS1. This level of margin check requires a five times leading and trailing clear margin.



GS1 DataBar Limited Margin Check Level 1
(1)



GS1 DataBar Limited Margin Check Level 2
(2)



*GS1 DataBar Limited Margin Check Level 3
(3)



GS1 DataBar Limited Margin Check Level 4
(4)

GS1 DataBar Expanded Security Level

Parameter # 1707

SSI # F8h 06h ABh

The scanner offers four levels of decode security for GS1 DataBar Expanded barcodes.

- **Security Level 0** - The scanner operates in its most aggressive state, while providing sufficient security decoding most in-spec barcodes.
- **Security Level 1** - This setting eliminates most misdecodes while maintaining reasonable aggressiveness.
- **Security Level 2** - Select this option with greater barcode security requirements if Security Level 1 fails to eliminate misdecodes.
- **Security Level 3** - If you selected Security Level 2 and misdecodes still occur, select this security level to apply the highest safety requirements.



GS1 DataBar Expanded Security Level 0
(0)



*GS1 DataBar Expanded Security Level 1
(1)



GS1 DataBar Expanded Security Level 2
(2)



GS1 DataBar Expanded Security Level 3
(3)

Symbology-Specific Security Features

Redundancy Level

Parameter # 78

SSI # 4Eh

The scanner offers four levels of decode redundancy. Select higher redundancy levels for decreasing levels of barcode quality. As redundancy levels increase, the scanner's aggressiveness decreases.

Scan one of the following barcodes to select the redundancy level appropriate for the barcode quality:

- **Redundancy Level 1** - The scanner must read the following code types twice before decoding:
 - Codabar (8 characters or less)
 - MSI (4 characters or less)
 - D 2 of 5 (8 characters or less)
 - I 2 of 5 (8 characters or less)
- **Redundancy Level 2** - The scanner must read all code types twice before decoding.
- **Redundancy Level 3** - The scanner must read code types other than the following twice before decoding, but must read the following codes three times:
 - Codabar (8 characters or less)
 - MSI (4 characters or less)
 - D 2 of 5 (8 characters or less)
 - I 2 of 5 (8 characters or less)
- **Redundancy Level 4** - The scanner must read all code types three times before decoding.

Redundancy Level (continued)



***Redundancy Level 1
(1)**



**Redundancy Level 2
(2)**

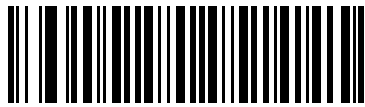

**Redundancy Level 3
(3)**

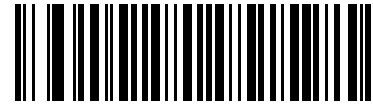

**Redundancy Level 4
(4)**

Security Level

Parameter # 77

SSI # 4Dh

The scanner offers four levels of decode security for delta barcodes, which include the Code 128 family, UPC/EAN/JAN, and Code 93. Select increasing levels of security for decreasing levels of barcode quality. There is an inverse relationship between security and scanner aggressiveness, so choose only that level of security necessary for the application.

- **Security Level 0** - The scanner operates in its most aggressive state, while providing sufficient security decoding most in-spec barcodes.
- **Security Level 1** - This default setting eliminates most misdecodes.
- **Security Level 2** - Select this option if Security Level 1 fails to eliminate misdecodes.
- **Security Level 3** - If you selected Security Level 2 and misdecodes still occur, select this security level.



NOTE: Selecting this option is an extreme measure against mis-decoding severely out-of-spec barcodes, and significantly impairs the decoding ability of the scanner. If this level of security is required, try to improve the quality of the barcodes.

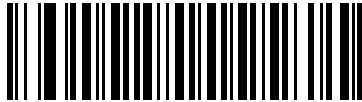

Security Level 0
(0)



***Security Level 1**
(1)

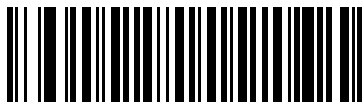

Security Level 2
(2)



Security Level 3
(3)

1D Quiet Zone Level

Parameter # 1288

SSI # F8h 05h 08h

This feature sets the level of aggressiveness when decoding barcodes with a reduced quiet zone (the margin on either side of a barcode), and applies to symbologies enabled by a Reduced Quiet Zone parameter. Because higher levels increase the decoding time and risk of misdecodes, Zebra strongly recommends enabling only the symbologies which require higher quiet zone levels, and leaving Reduced Quiet Zone disabled for all other symbologies. Options are:

- **1D Quiet Zone Level 0** - The scanner performs normally in terms of quiet zone.
- **1D Quiet Zone Level 1** - The scanner performs more aggressively in terms of quiet zone.
- **1D Quiet Zone Level 2** - The scanner only requires a quiet zone at the end of barcode for decoding.
- **1D Quiet Zone Level 3** - The scanner decodes anything in terms of quiet zone or end of barcode.

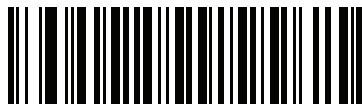

1D Quiet Zone Level 0
(0)

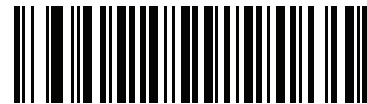

*1D Quiet Zone Level 1
(1)

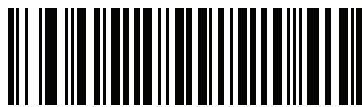

1D Quiet Zone Level 2
(2)



1D Quiet Zone Level 3
(3)

Intercharacter Gap Size

Parameter # 381

SSI # F0h, 7Dh

The Code 39 and Codabar symbologies have an intercharacter gap that is typically quite small. Due to various barcode printing technologies, this gap can grow larger than the maximum size allowed, preventing the scanner from decoding the symbol. If this problem occurs, scan the **Large Intercharacter Gaps** parameter to tolerate these out-of-specification barcodes.



***Normal Intercharacter Gaps
(6)**



**Large Intercharacter Gaps
(10)**

Composite

Composite CC-C

Parameter # 341

SSI # F0h 55h

Scan one of the following barcodes to enable or disable Composite barcodes of type CC-C.

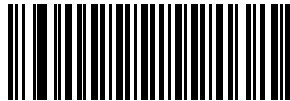

Enable CC-C
(1)



*Disable CC-C
(0)

Composite CC-A/B

Parameter # 342

SSI # F0h 56h

Scan one of the following barcodes to enable or disable Composite barcodes of type CC-A/B.

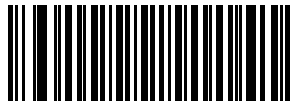

Enable CC-A/B
(1)



*Disable CC-A/B
(0)

Composite TLC-39**Parameter # 371****SSI # F0h 73h**

Scan one of the following barcodes to enable or disable Composite barcodes of type TLC-39.

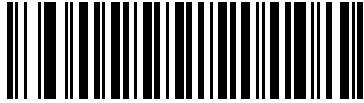

**Enable TLC39
(1)**



***Disable TLC39
(0)**

Composite Inverse**Parameter # 1113****SSI # F8h 04h 59h**

Select an option to set Composite for either regular decode or inverse decode.

- **Regular Only** - The scanner decodes regular Composite barcodes only. Before selecting this, set [Inverse 1D on page 287](#) to **Regular Only** or **Inverse Autodetect**.
- **Inverse Only** - The scanner decodes inverse Composite barcodes only. This mode only supports Composite Inverse that includes DataBar combined with CCAB, and does not support other 1D/2D combinations. Before selecting this, first enable [Composite CC-A/B on page 298](#), and set [Inverse 1D on page 287](#) to **Inverse Only** or **Inverse Autodetect**.



***Regular Only
(0)**



**Inverse Only
(1)**

UPC Composite Mode

Parameter # 344

SSI # F0h 58h

Select an option for linking UPC symbols with a 2D symbol during transmission as if they were one symbol:

- **UPC Never Linked** - Transmit UPC barcodes regardless of whether a 2D symbol is detected.
- **UPC Always Linked** - Transmit UPC barcodes and the 2D portion. If 2D is not present, do not transmit the barcode.
- **Autodiscriminate UPC Composites** - The scanner determines if there is a 2D portion, then transmits the UPC, as well as the 2D portion if present.



***UPC Never Linked
(0)**

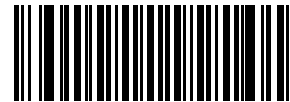

**UPC Always Linked
(1)**



**Autodiscriminate UPC Composites
(2)**

Composite Beep Mode

Parameter # 398

SSI # F0h, 8Eh

Scan one of the following barcodes to select the number of decode beeps that sound upon decoding a Composite barcode.

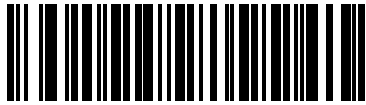

Single Beep After Both are Decoded
(0)

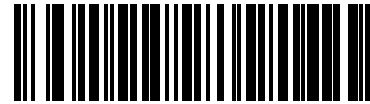

*Beep as Each Code Type is Decoded
(1)

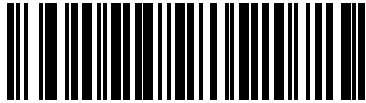

Double Beep After Both are Decoded
(2)

GS1-128 Emulation Mode for UCC/EAN Composite Codes

Parameter # 427

SSI # F0h, ABh

Scan one of the following barcodes to enable or disable this mode.



**Enable GS1-128 Emulation Mode for
UCC/EAN Composite Codes
(1)**



***Disable GS1-128 Emulation Mode for
UCC/EAN Composite Codes
(0)**

2D Symbologies

PDF417

Parameter # 15

SSI # 0Fh

Scan one of the following barcodes to enable or disable PDF417.



***Enable PDF417
(1)**



**Disable PDF417
(0)**

MicroPDF417

Parameter # 227

SSI # E3h

Scan one of the following barcodes to enable or disable MicroPDF417.



**Enable MicroPDF417
(1)**



***Disable MicroPDF417
(0)**

Code 128 Emulation

Parameter # 123

SSI # 7Bh

Enable this parameter to transmit data from certain MicroPDF417 symbols as Code 128. You must enable [AIM Code ID Character \(1\)](#) on page 179 for this parameter to work.

Enable Code 128 Emulation to transmit these MicroPDF417 symbols with one of the following prefixes:

]C1if the first codeword is 903-905

]C2if the first codeword is 908 or 909

]C0if the first codeword is 910 or 911

Disable Code 128 Emulation to transmit these MicroPDF417 symbols with one of the following prefixes:

]L3if the first codeword is 903-905

]L4if the first codeword is 908 or 909

]L5if the first codeword is 910 or 911

Scan one of the following barcodes to enable or disable Code 128 Emulation.



NOTE: Linked MicroPDF codewords 906, 907, 912, 914, and 915 are not supported. Use GS1 Composites instead.



**Enable Code 128 Emulation
(1)**



***Disable Code 128 Emulation
(0)**

Data Matrix

Parameter # 292

SSI # F0h, 24h

Scan one of the following barcodes to enable or disable Data Matrix.



***Enable Data Matrix
(1)**



**Disable Data Matrix
(0)**

GS1 Data Matrix

Parameter # 1336

SSI # F8h 05h 38h

Scan one of the following barcodes to enable or disable GS1 Data Matrix.

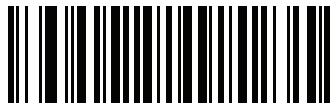

**Enable GS1 Data Matrix
(1)**



***Disable GS1 Data Matrix
(0)**

Data Matrix Inverse

Parameter # 588

SSI # F1h 4Ch

Scan one of the following barcodes to select the Data Matrix inverse decoder setting:

- **Regular Only** - The scanner decodes regular Data Matrix barcodes only.
- **Inverse Only** - The scanner decodes inverse Data Matrix barcodes only.
- **Inverse Autodetect** - The scanner decodes both regular and inverse Data Matrix barcodes.



Regular Only
(0)



Inverse Only
(1)



***Inverse Autodetect**
(2)

Decode Data Matrix Mirror Images

Parameter # 537

SSI # F1h 19h

Scan one of the following barcodes to select an option for decoding mirror image Data Matrix barcodes:

- **Never** - Do not decode Data Matrix barcodes that are mirror images.
- **Always** - Decode only Data Matrix barcodes that are mirror images.
- **Auto** - Decode both mirrored and unmirrored Data Matrix barcodes.



Never
(0)



Always
(1)



***Auto**
(2)

Maxicode

Parameter # 294

SSI # F0h, 26h

Scan one of the following barcodes to enable or disable Maxicode.



**Enable Maxicode
(1)**



***Disable Maxicode
(0)**

QR Code

Parameter # 293

SSI # F0h, 25h

Scan one of the following barcodes to enable or disable QR Code.



NOTE: Enabling this also enables [Linked QR Mode](#).



***Enable QR Code
(1)**



**Disable QR Code
(0)**

GS1 QR

Parameter # 1343

SSI # F8h 05h 3Fh

Scan one of the following barcodes to enable or disable GS1 QR.



***Enable GS1 QR
(1)**



**Disable GS1 QR
(0)**

MicroQR

Parameter # 573

SSI # F1h 3Dh

Scan one of the following barcodes to enable or disable MicroQR.



***Enable MicroQR**
(1)



Disable MicroQR
(0)

Linked QR Mode

Parameter # 1847

SSI # 737h

Scan one of the following barcodes to select a linked QR mode:

- **Linked QR Only** - The scanner does not decode individual QR symbols from a set of linked QR codes.
- **Individual QR With Headers** - The scanner decodes individual QR symbols from a set of linked QR codes and retains the header information and data.
- **Individual QR No Headers** - The scanner decodes individual QR symbols from a set of linked QR codes and transmits the data without header information.

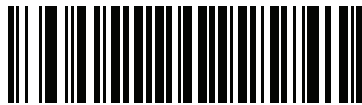

*Linked QR Only
(0)



Individual QR With Headers
(1)

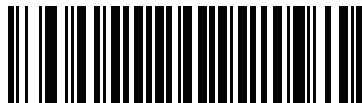

Individual QR No Headers
(2)

Aztec

Parameter # 574

SSI # F1h 3Eh

Scan one of the following barcodes to enable or disable Aztec.



NOTE: Enabling this also enables Linked Aztec.



***Enable Aztec
(1)**



**Disable Aztec
(0)**

Aztec Inverse

Parameter # 589

SSI # F1h 4Dh

Scan one of the following barcodes to select the Aztec inverse decoder setting:

- **Regular Only** - The scanner decodes regular Aztec barcodes only.
- **Inverse Only** - The scanner decodes inverse Aztec barcodes only.
- **Inverse Autodetect** - The scanner decodes both regular and inverse Aztec barcodes.



Regular Only
(0)



Inverse Only
(1)



***Inverse Autodetect**
(2)

Han Xin

Parameter # 1167

SSI # F8h 04h 8Fh

Scan one of the following barcodes to enable or disable Han Xin.



**Enable Han Xin
(1)**



***Disable Han Xin
(0)**

Han Xin Inverse

Parameter # 1168

SSI # F8h 04h 90h

Scan one of the following barcodes to select a Han Xin inverse decoder setting:

- **Regular Only** - The scanner decodes Han Xin barcodes with normal reflectance only.
- **Inverse Only** - The scanner decodes Han Xin barcodes with inverse reflectance only.
- **Inverse Autodetect** - The scanner decodes both regular and inverse Han Xin barcodes.



***Regular Only
(0)**

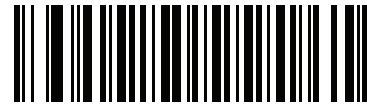

**Inverse Only
(1)**



**Inverse Autodetect
(2)**

Grid Matrix

Parameter # 1718

SSI # F8h 06h B6h

To enable or disable Grid Matrix, scan one of the following barcodes.



**Enable Grid Matrix
(1)**



***Disable Grid Matrix
(0)**

Grid Matrix Inverse

Parameter # 1719

SSI # F8h 06h B7h

Select a Grid Matrix inverse decoder setting:

- **Regular Only** - the imager decodes Grid Matrix barcodes with normal reflectance only.
- **Inverse Only** - the imager decodes Grid Matrix barcodes with inverse reflectance only.
- **Inverse Autodetect** - the imager decodes both regular and inverse Grid Matrix barcodes.



***Regular**
(0)

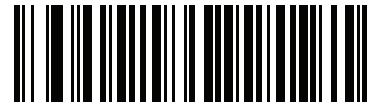

Inverse Only
(1)

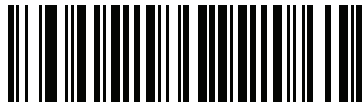

Inverse Autodetect
(2)

Grid Matrix Mirror

Parameter # 1736

SSI # F8h 06h C8h

Select a mirror image Grid Matrix setting:

- **Regular Only** - the imager decodes non-mirrored Grid Matrix barcodes only.
- **Mirrored Only** - the imager decodes mirrored Grid Matrix barcodes only.
- **Autodiscriminate** - the imager decodes both mirrored and non-mirrored Grid Matrix barcodes.

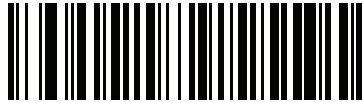

***Regular Only**
(0)

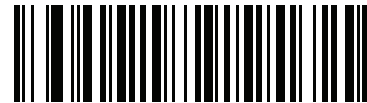

Mirrored Only
(1)

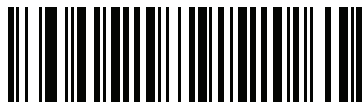

Autodiscriminate
(2)

DotCode

Parameter # 1906

SSI # F8 07 72h

Scan one of the following barcodes to enable or disable DotCode.

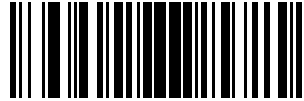

*** Disable DotCode
(0)**

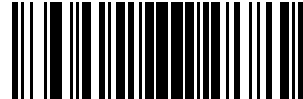

**Enable DotCode
(1)**

DotCode Inverse

Parameter # 1907

SSI # F8 07 73h

Scan one of the following barcodes to select a DotCode Inverse decoder setting. Setting options are:

- **Regular Only** - Decoder decodes DotCode barcodes with normal reflectance only.
- **Inverse Only** - Decoder decodes DotCode barcodes with inverse reflectance only.
- **Inverse Autodetect** - Decoder decodes both regular and inverse DotCode barcodes.

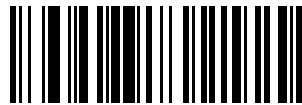

**Regular
(0)**



**Inverse Only
(1)**

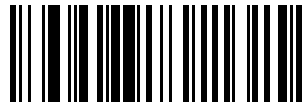

*** Inverse Autodetect
(2)**

DotCode Mirrored

Parameter # 1908

SSI # F8 07 74h

Scan one of the following barcodes to select a DotCode Mirror decoder setting:

- **Non-Mirrored Only** - Digital scanner decodes non-mirrored DotCode barcodes only.
- **Mirrored Only** - Digital scanner decodes mirrored DotCode barcodes only.
- **Autodetect** - Digital scanner decodes both mirrored and non-mirrored DotCode barcodes.



**Non-Mirrored Only
(0)**

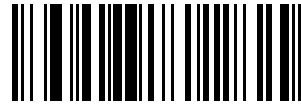

**Mirrored Only
(1)**

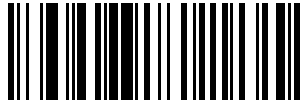

*** Autodetect
(2)**

DotCode Prioritize

Parameter # 1937

SSI # F8 07 91h

Enable DotCode Prioritize to give priority to DotCode decoding as compared to other symbologies.

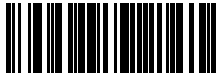

Disable



* Enable

Macro PDF Features

Macro PDF is a special feature for concatenating multiple PDF symbols into one file. The scanner can decode symbols encoded with this feature, and can store more than 64 Kb of decoded data from up to 50 MacroPDF symbols.



CAUTION: When printing, keep each Macro PDF sequence separate, as each sequence has unique identifiers. Do not mix barcodes from several Macro PDF sequences, even if they encode the same data. When scanning a Macro PDF sequence, scan the entire sequence without interruption. When scanning a mixed sequence, two long low beeps (low / low) indicate an inconsistent file ID or inconsistent symbology error.

Escape Characters

Parameter # 233

SSI # E9h

This enables the backslash (\) character as an Escape character for systems that can process transmissions containing special data sequences. Scan one of the following barcodes to either format special data according to the GLI (Global Label Identifier) protocol, or to disable this parameter. This parameter only affects the data portion of a Macro PDF symbol transmission; the Macro PDF Control Header (if enabled) is always sent with GLI formatting.



**GLI Protocol
(2)**



***None
(0)**

Flush Macro PDF Buffer

Scan the following barcode to flush the buffer of all decoded Macro PDF data stored to that point, transmit it to the host device, and abort from Macro PDF mode.



Flush Macro PDF Buffer

Abort Macro PDF Entry

Scan the following barcode to clear all currently-stored Macro PDF data in the buffer without transmission and abort from Macro PDF mode.



Abort Macro PDF Entry

Postal Codes

US Postnet

Parameter # 89

SSI # 59h

Scan one of the following barcodes to enable or disable US Postnet.



Enable US Postnet
(1)



*Disable US Postnet
(0)

US Planet

Parameter # 90

SSI # 5Ah

Scan one of the following barcodes to enable or disable US Planet.



Enable US Planet
(1)



*Disable US Planet
(0)

Transmit US Postal Check Digit

Parameter # 95

SSI # 5Fh

Scan one of the following barcodes to select whether to transmit US Postal data, which includes both US Postnet and US Planet, with or without the check digit.



***Transmit US Postal Check Digit
(1)**

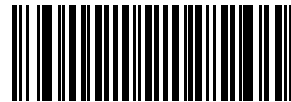

**Do Not Transmit US Postal Check Digit
(0)**

UK Postal

Parameter # 91

SSI # 5Bh

Scan one of the following barcodes to enable or disable UK Postal.



**Enable UK Postal
(1)**

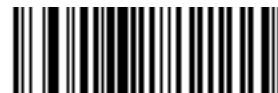

***Disable UK Postal
(0)**

Transmit UK Postal Check Digit

Parameter # 96

SSI # 60h

Scan one of the following barcodes to select whether to transmit UK Postal data with or without the check digit.



***Transmit UK Postal
Check Digit
(1)**



**Do Not Transmit UK Postal Check Digit
(0)**

Japan Postal

Parameter # 290

SSI # F0h, 22h

Scan one of the following barcodes to enable or disable Japan Postal.



**Enable Japan Postal
(1)**



***Disable Japan Postal
(0)**

Australia Post

Parameter # 291

SSI # F0h, 23h

Scan one of the following barcodes to enable or disable Australia Post.



**Enable Australia Post
(1)**



***Disable Australia Post
(0)**

Australia Post Format

Parameter # 718

SSI # F1h, CEh

Scan one of the following barcodes to select a format for Australia Post:

- **Autodiscriminate** (or Smart mode) - Decode the Customer Information Field using the N and C Encoding Tables.



NOTE: This option increases the risk of misdecodes because the encoded data format does not specify the Encoding Table used for encoding.

- **Raw Format** - Output raw bar patterns as a series of numbers 0 through 3.
- **Alphanumeric Encoding** - Decode the Customer Information Field using the C Encoding Table.
- **Numeric Encoding** - Decode the Customer Information Field using the N Encoding Table.

For more information on Australia Post Encoding Tables, refer to the Australia Post Customer Barcoding Technical Specifications available at <http://www.auspost.com.au>.



***Autodiscriminate
(0)**

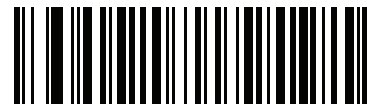

**Raw Format
(1)**



**Alphanumeric Encoding
(2)**



**Numeric Encoding
(3)**

Netherlands KIX Code

Parameter # 326

SSI # F0h, 46h

Scan one of the following barcodes to enable or disable Netherlands KIX Code.



Enable Netherlands KIX Code
(1)



*Disable Netherlands KIX Code
(0)

USPS 4CB/One Code/Intelligent Mail

Parameter # 592

SSI # F1h 50h

Scan one of the following barcodes to enable or disable USPS 4CB/One Code/Intelligent Mail.



Enable USPS 4CB/One Code/Intelligent Mail
(1)



*Disable USPS 4CB/One Code/Intelligent Mail
(0)

UPU FICS Postal

Parameter # 611

SSI # F1h 63h

Scan one of the following barcodes to enable or disable UPU FICS Postal.



Enable UPU FICS Postal
(1)



*Disable UPU FICS Postal
(0)

Mailmark

Parameter # 1337

SSI # F8h 05h 39h

Scan one of the following barcodes to enable or disable Mailmark.

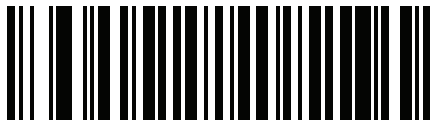

*Disable Mailmark
(0)

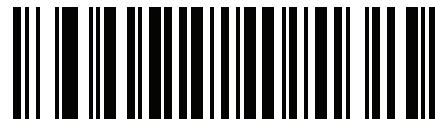

Enable Mailmark
(1)

OCR Programming

Introduction

This chapter describes how to set up the scanner for OCR programming. The scanner can read 6 to 60 point OCR typeface. It supports font types OCR-A, OCR-B, MICR-E13B, and US Currency Serial Number.

OCR is not as secure as a barcode. To decrease OCR misdecodes and speed OCR reading, set an accurate OCR template and character subset, and use a check digit.

All OCR fonts are disabled by default. You can enable OCR-A and OCR-B at the same time, but not other combined font types.

Setting Parameters

To set feature values, scan a single barcode or a short barcode sequence. The settings are stored in non-volatile memory and are preserved even when the imager powers down.



NOTE: Most computer monitors allow scanning barcodes directly on the screen. When scanning from the screen, be sure to set the document magnification to a level where you can see the barcode clearly, and bars and/or spaces do not merge.

To return all features to default values, scan the [Set Factory Defaults on page 142](#). Throughout the programming barcode menus, asterisks (*) indicate default values.

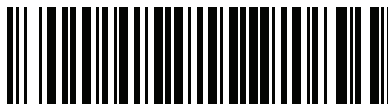

* Indicates default *Enable Parameter Feature/option
(1) Option value

Scanning Sequence Examples

In most cases scanning one barcode sets the parameter value. For example, to enable OCR-B, scan the **Enable OCR-B** barcode under [OCR-B on page 336](#). The scanner issues a fast warble beep and the LED turns green, signifying a successful parameter entry.

Other parameters require scanning several barcodes. See the parameter descriptions for this procedure.

Errors While Scanning

Unless otherwise specified, to correct an error during a scanning sequence, just re-scan the correct parameter.

OCR Parameter Defaults

Table 32 lists the defaults for OCR parameters. Change these values in one of two ways:

- Scan the appropriate barcodes in this chapter. The new value replaces the standard default value in memory. To recall default parameter values, see [Default Parameters on page 142](#).
- Configure the scanner using the 123Scan configuration program. See [123Scan and Software Tools](#).



NOTE: See [Standard Parameter Defaults](#) for all user preference, host, symbology, and miscellaneous default parameters.

Table 32 OCR Programming Default Table

Parameter	Parameter Number	SSI Number	Default	Page Number
OCR Programming Parameters				
OCR-A	680	F1h A8h	Disable	333
OCR-A Variant	684	F1h ACh	Full ASCII	334
OCR-B	681	F1h A9h	Disable	336
OCR-B Variant	685	F1h ADh	Full ASCII	337
MICR E13B	682	F1h AAh	Disable	341
US Currency	683	F1h ABh	Disable	342
OCR Orientation	687	F1h AFh	0°	342
OCR Lines	691	F1h B3h	1	344
OCR Minimum Characters	689	F1h B1h	3	344
OCR Maximum Characters	690	F1h B2h	100	345
OCR Subset	686	F1h AEh	Selected font variant	345
OCR Quiet Zone	695	F1h B7h	50	346
OCR Template	547	F1h 23h	99999999	347
OCR Check Digit Modulus	688	F1h B0h	1	356
OCR Check Digit Multiplier	700	F1h BCh	121212121212	357
OCR Check Digit Validation	694	F1h B6h	None	359
Inverse OCR	856	F2h 58h	Regular	364
OCR Redundancy	1770	F8h 06h EAh	Level 1	365

OCR Programming Parameters

OCR-A

Parameter # 680

SSI # F1h A8h

Scan one of the following barcodes to enable or disable OCR-A.



NOTES 1 OCR is not as secure as a barcode. To decrease OCR misdecodes and speed OCR reading, set an accurate OCR template and character subset, and use a check digit. See [OCR Subset on page 345](#) and [OCR Template on page 347](#).

2. All OCR fonts are disabled by default.



Enable OCR-A
(1)

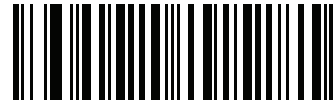

*Disable OCR-A
(0)

OCR-A Variant

Parameter # 684

SSI # F1 ACh

The font variant sets a processing algorithm and default character subset for the given font. To choose a variant, scan one of the following barcodes. Select the most appropriate font variant to optimize performance and accuracy.

OCR-A supports the following variants:

- OCR-A Full ASCII

!"#\$()*+,-./0123456789<>ABCDEFGHIJKLMNOPQRSTUVWXYZ^

- OCR-A Reserved 1

\$*+,-./0123456789ABCDEFGHIJKLMNOPQRSTUVWXYZ

- OCR-A Reserved 2

\$*+,-./0123456789<>ABCDEFGHIJKLMNOPQRSTUVWXYZ

- OCR-A Banking

-0123456789<> Ψ ϣ ϣ

Special banking characters output as the following representative characters:

Ψ outputs as f

ϣ outputs as c

ϣ outputs as h



NOTE: Enable OCR-A before setting this parameter. If disabling OCR-A, set the variant to its default (OCR-A Full ASCII).

OCR-A Variant (continued)



***OCR-A Full ASCII
(0)**

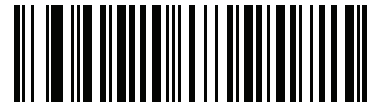

**OCR-A Reserved 1
(1)**



**OCR-A Reserved 2
(2)**



**OCR-A Banking
(3)**

OCR-B

Parameter # 681

SSI # F1h A9h

Scan one of the following barcodes to enable or disable OCR-B.



NOTES 1 OCR is not as secure as a barcode. To decrease OCR misdecodes and speed OCR reading, set an accurate OCR template and character subset, and use a check digit. See [OCR Subset on page 345](#) and [OCR Template on page 347](#).

2. All OCR fonts are disabled by default.



Enable OCR-B
(1)



***Disable OCR-B**
(0)

OCR-B Variant

Parameter # 685

SSI # F1h ADh

OCR-B has the following variants. Select the most appropriate font variant to optimize performance and accuracy.

- OCR-B Full ASCII

!#\$%()*+,-./0123456789<>ABCDEFGHIJKLMNOPQRSTUVWXYZ^|~

- OCR-B Banking

#+-0123456789<>JNP|

- OCR-B Limited

+,-./0123456789<>ACENPSTVX

- OCR-B ISBN 10-Digit Book Numbers

-0123456789>BCEINPSXz

- OCR-B ISBN 10 or 13-Digit Book Numbers

-0123456789>BCEINPSXz

- OCR-B Travel Document Version 1 (TD1) 3-Line ID Cards

-0123456789<ABCDEFGHIJKLMNOPQRSTUVWXYZ

- OCR-B Travel Document Version 2 (TD2) 2-Line ID Cards

-0123456789<ABCDEFGHIJKLMNOPQRSTUVWXYZ

- OCR-B Travel Document 2 or 3-Line ID Cards Auto-Detect

!#\$%()*+,-./0123456789<>ABCDEFGHIJKLMNOPQRSTUVWXYZ^|~

- OCR-B Passport

-0123456789<ABCDEFGHIJKLMNOPQRSTUVWXYZÑ

- OCR-B Visa Type A

-0123456789<ABCDEFGHIJKLMNOPQRSTUVWXYZ

- OCR-B Visa Type B

-0123456789<ABCDEFGHIJKLMNOPQRSTUVWXYZÑ

- OCR-B ICAO Travel Documents

This allows reading either TD1, TD2, Passport, Visa Type A, or Visa Type B without switching between these options. It automatically recognizes the travel document read.

Selecting one of the ISBN Book Numbers automatically applies the appropriate ISBN checksum, so setting this is not required.

OCR-B Variant (continued)

To choose a variant, scan one of the following barcodes. Selecting the following OCR-B variants automatically sets the appropriate [OCR Lines on page 344](#). These five variants invoke extensive special algorithms and checking for that particular document type:

Passport	2
TD1 ID Cards	3
TD2 ID Cards	2
Visa Type A	2
Visa Type B	2

If you set one of these variants with both OCR-A and OCR-B enabled, only the specified travel document is read without reading OCR-A. Returning OCR-B variant to its default (Full ASCII) allows reading OCR-A.

For the best performance in passport reading, fix the target passport and the scanner in place (6.5 - 7.5”).



NOTE: Enable OCR-B before setting this parameter. If disabling OCR-B, set the variant to its default (OCR-B Full ASCII).



***OCR-B Full ASCII
(0)**

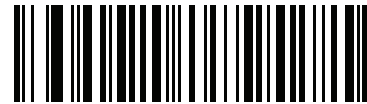

**OCR-B Banking
(1)**



**OCR-B Limited
(2)**



**OCR-B ISBN 10-Digit Book Numbers
(6)**

OCR-B Variant (continued)



OCR-B ISBN 10 or 13-Digit Book Numbers
(7)



OCR-B Travel Document Version 1 (TD1)
3 Line ID Cards
(3)



OCR-B Travel Document Version 2 (TD2)
2-Line ID Cards
(8)



Travel Document 2 or 3-Line ID Cards Auto-Detect
(20)



OCR-B Passport
(4)



OCR-B Visa Type A
(9)

OCR-B Variant (continued)



**OCR-B Visa Type B
(10)**



**OCR-B ICAO Travel Documents
(11)**

MICR E13B

Parameter # 682

SSI # F1h AAh

Scan one of the following barcodes to enable or disable MICR E13B.

MICR E 13B uses the following characters:

0 1 2 3 4 5 6 7 8 9 t a o d

TOAD characters (Transit, On Us, Amount, and Dash) output as the following representative characters:

t outputs as t

a outputs as a

o outputs as o

d outputs as d



NOTES 1 OCR is not as secure as a barcode. To decrease OCR misdecodes and speed OCR reading, set an accurate OCR template and character subset, and use a check digit. See [OCR Subset on page 345](#) and [OCR Template on page 347](#).

2. All OCR fonts are disabled by default.



Enable MICR E13B
(1)



*Disable MICR E13B
(0)

US Currency Serial Number

Parameter # 683

SSI # F1h ABh

Scan one of the following barcodes to enable or disable US Currency Serial Number.



NOTES 1 OCR is not as secure as a barcode. To decrease OCR misdecodes and speed OCR reading, set an accurate OCR template and character subset, and use a check digit. See [OCR Subset on page 345](#) and [OCR Template on page 347](#).

2. All OCR fonts are disabled by default.



**Enable US Currency
(1)**

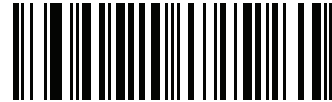

***Disable US Currency
(0)**

OCR Orientation

Parameter # 687

SSI # F1h AFh

Select one of five options to specify the orientation of the OCR to read:

- 0° to the imaging engine (default)
- 270° clockwise (or 90° counterclockwise) to the imaging engine
- 180° (upside down) to the imaging engine
- 90° clockwise to the imaging engine
- Omnidirectional

Setting an incorrect orientation can cause misdecodes.

OCR Orientation (continued)



*OCR Orientation 0°
(0)



OCR Orientation 270° Clockwise
(1)



OCR Orientation 180° Clockwise
(2)



OCR Orientation 90° Clockwise
(3)



OCR Orientation Omnidirectional
(4)

OCR Lines

Parameter # 691

SSI # F1h B3h

To select the number of OCR lines to decode, scan one of the following barcodes. Selecting Visas, TD1, or TD2 ID cards automatically sets the appropriate **OCR Lines**. Also see [OCR-B Variant on page 337](#).



***OCR 1 Line
(1)**



**OCR 2 Lines
(2)**



**OCR 3 Lines
(3)**

OCR Minimum Characters

Parameter # 689

SSI # F1h B1h

To select the minimum number of OCR characters (not including spaces) per line to decode, scan the following barcode, then scan a three-digit number between 003 and 100 using the barcodes in [Numeric Barcodes](#) representing the number of OCR characters to decode. Strings of OCR characters less than the minimum are ignored. The default is 003.



OCR Minimum Characters

OCR Maximum Characters

Parameter # 690

SSI # F1h B2h

To select the maximum number of OCR characters (including spaces) per line to decode, scan the following barcode, then scan a three-digit number between 003 and 100 using the barcodes in [Numeric Barcodes](#) representing the number of OCR characters to decode. Strings of OCR characters greater than the maximum are ignored. The default is 100.



OCR Maximum Characters

OCR Subset

Parameter # 686

SSI # F1h AEh

Create an OCR subset to define a custom group of characters in place of a preset font variant. For example, if scanning only numbers and the letters A, B, and C, create a subset of just these characters to speed decoding. This applies a designated OCR Subset across all enabled OCR fonts.

To set or modify the OCR font subset:

1. Enable the appropriate OCR font(s).
2. Scan the **OCR Subset** barcode.
3. Scan numbers and letters to form the OCR Subset from [Alphanumeric Barcodes](#).
4. Scan [End of Message on page 460](#).

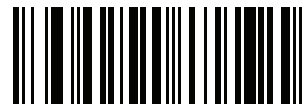

OCR Subset

To cancel an OCR subset, for OCR-A or OCR-B, scan OCR-A variant **Full ASCII**, or OCR-B variant **Full ASCII**.

For MICR E13B or US Currency Serial Number, create a subset which includes all allowed characters in that character set, or scan an option from the [Default Parameters on page 142](#) and re-program the scanner.

OCR Quiet Zone

Parameter # 695

SSI # F1h B7h

This option sets the OCR quiet zone. The scanner stops scanning a field when it detects a sufficiently wide blank space. The width of this space is defined by the End of Field option. Used with parsers that tolerate slanted characters, the End of Field count is approximately a count of 8 for a character width. For example, if set to 15, then two character widths are an end of line indicator for the parser. Larger end of field numbers require bigger quiet zones at each end of text line.

To set a quiet zone, scan the following barcode, then scan a two-digit number using the numeric keypad in [Alphanumeric Barcodes](#). The range of the quiet zone is 20 - 99 and the default is 50, indicating a six character width quiet zone.



OCR Quiet Zone

OCR Template

Parameter # 547

SSI # F1h 23h

This option creates a template for precisely matching scanned OCR characters to a desired input format. Carefully constructing an OCR template eliminates scanning errors.

To set or modify the OCR decode template, scan the [OCR Template](#) barcode, and then scan barcodes on the following pages that correspond to numbers and letters to form the template expression. Then scan **End of Message**. The default is **99999999** which accepts OCR strings containing any character.



OCR Template



End of Message

Required Digit (9)

Only a numeric character is allowed in this position.

Template	Valid data	Valid data	Invalid data
99999	12987	30517	123AB



9

Required Alpha (A)

Only an alpha character is allowed in this position.

Template	Valid data	Valid data	Invalid data
AAAAA	ABCDE	UVWXY	12FGH



A

Require and Suppress (0)

Any character in this position, including space or reject, is suppressed from the output.

Template	Incoming data	Output
990AA	12QAB	12AB

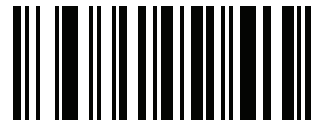

0

Optional Alphanumeric (1)

An alphanumeric character is accepted in this position if present. Optional characters are not allowed as the first character(s) in a field of like characters.

Template	Valid data	Valid data	Invalid data
99991	1234A	12345	1234<



1

Optional Alpha (2)

An alpha character is accepted in this position if present. Optional characters are not allowed as the first character(s) in a field of like characters.

Template	Valid data	Valid data	Invalid data
AAAA2	ABCDE	WXYZ	ABCD6



2

Alpha or Digit (3)

An alphanumeric character is required in this position to validate the incoming data.

Template	Valid data	Valid data	Invalid data
33333	12ABC	WXY34	12AB<



3

Any Including Space & Reject (4)

Any character is accepted in this position, including space and reject. An underscore (_) represents rejects in the output. This is a good selection for troubleshooting.

Template	Valid data	Valid data
99499	12\$34	34 98



4

Any except Space & Reject (5)

Any character is accepted in this position, except a space or reject.

Template	Valid data	Valid data	Invalid data
55999	A.123	*Z456	A BCD



5

Optional Digit (7)

A numeric character is accepted if present. Optional characters are not allowed as the first character(s) in a field of like characters.

Template	Valid data	Valid data	Invalid data
99977	12345	789	789AB



7

Digit or Fill (8)

Any numeric or fill character is accepted in this position.

Template	Valid data	Valid data	Valid data
88899	12345	>>789	<<789



8

Alpha or Fill (F)

Any alpha or fill character is accepted in this position.

Template	Valid data	Valid data	Valid data
AAFF	ABCXY	LMN>>	ABC<5



F

Optional Space ()

A space is accepted if present. Optional characters are not allowed as the first character(s) in a field of like characters.

Template	Valid data	Valid data	Invalid data
99 99	12 34	1234	67891



Space

Optional Small Special (.)

A special character is accepted if present. Optional characters are not allowed as the first character(s) in a field of like characters. Small special characters are - , and .

Template	Valid data	Valid data	Invalid data
AA.99	MN.35	XY98	XYZ12



.

Other Template Operators

These template operators assist in capturing, delimiting, and formatting scanned OCR data.

Literal String (" and +)

Use either of these delimiting characters surrounding characters from the alphanumeric keyboard in [Alphanumeric Barcodes](#) to define a literal string within a template that must be present in scanned OCR data. There are two

characters used to delimit required literal strings; if one of the delimiter characters is present in the desired literal string, use the other delimiter.

Template	Valid data	Invalid data
"35+BC"	35+BC	AB+22



“



+

New Line (E)

To create a template of multiple lines, add **E** between the template of each single line.

Template	Valid data	Valid data	Invalid data
999EAAAA	321	987	XYZW
	BCAD	ZXYW	12



E

String Extract (C)

This operator combined with others defines a string of characters to extract from the scanned data. The string extract is structured as follows:

CbPe

Where:

- **C** is the string extract operator
- **b** is the string begin delimiter
- **P** is the category (one or more numeric or alpha characters) describing the string representation
- **e** is the string end delimiter

Values for *b* and *e* can be any scannable character. They are included in the output stream.

Template	Incoming data	Output
C>A>	XQ3>ABCDE>	>ABCDE>
	->ATHRUZ>123	>ATHRUZ>
	1ABCZXYZ	No Output



C

Ignore to End of Field (D)

This operator causes all characters after a template to be ignored. Use this as the last character in a template expression. Examples for the template 999D:

Template	Incoming data	Output
999D	123-PED	123
	357298	357
	193	193



D

Skip Until (P1)

This operator skips over characters until a specific character type or a literal string is detected. It can be used in two ways:

P1ct

Where:

- P1 is the Skip Until operator
- c is the type of character that triggers the start of output
- t is one or more template characters

P1"s"t

Where:

- P1 is the Skip Until operator

- "s" is one or more literal string characters (see [Literal String \(" and +\) on page 351](#)) that trigger the start of output
- t is one or more template characters

The trigger character or literal string is included in output from a Skip Until operator, and the first character in the template should accommodate this trigger.

Template	Incoming data	Output
P1"PN"AA9999	123PN9876	PN9876
	PN1234	PN1234
	X-PN3592	PN3592



P



1

Skip Until Not (P0)

This operator skips over characters until a specific character type or a literal string is not matched in the output stream. It can be used in two ways:

P0ct

Where:

- P0 is the Skip Until Not operator
- c is the type of character that triggers the start of output
- t is one or more template characters

P0"s"t

Where:

- P0 is the Skip Until Not operator
- "s" is one or more literal string characters (see [Literal String \(" and +\) on page 351](#)) that trigger the start of output
- t is one or more template characters

The trigger character or literal string is not included in output from a Skip Until Not operator.

Template	Incoming data	Output
P0A9999	BPN3456	3456
	PN1234	1234
	5341	No output

Template	Incoming data	Output
P0"PN"9999	PN3456	3456
	5341	No output
	PNPN7654	7654



P



0

Repeat Previous (R)

This operator allows a template character to repeat one or more times, allowing the capture of variable-length scanned data. The following examples capture two required alpha characters followed by one or more required digits:

Template	Incoming data	Output
AA9R	AB3	AB3
	PN12345	PN12345
	32RM52700	No output



R

Scroll Until Match (S)

This operator steps through scanned data one character at a time until the data matches the template.

Template	Incoming data	Output
S99999	AB3	No Output
	PN12345	12345
	32RM52700	52700



S

Multiple Templates

This feature sets up multiple templates for OCR decoding. To do this, follow the procedure described in [OCR Template on page 347](#) (scan the [OCR Template](#) barcode, and then barcodes corresponding to numbers and letters to form the template expression, and then **End of Message**) for each template in the multiple template string, using a capital letter **X** as a separator between templates.

For example, set the [OCR Template](#) as **99999XAAAAA** to decode OCR strings of either **12345** or **ABCDE**.

Template Examples

Following are sample templates with descriptions of valid data for each definition.

Field Definition	Description
"M"99977	M followed by three digits and two optional digits.
"X"997777"X"	X followed by two digits, four optional digits, and an X .
9959775599	Two digits followed by any character, a digit, two optional digits, any two characters, and two digits.
A55"-"999"-"99	A letter followed by two characters, a dash, three digits, a dash, and two digits.
33A"."99	Two alphanumeric characters followed by a letter, a period, and two digits.
999992991	Five digits followed by an optional alpha, two digits, and an optional alphanumeric.
"PN98"	Literal field - PN98

OCR Check Digit Modulus

Parameter # 688

SSI # F1h B0h

The check digit is the last digit (in the right-most position) in an OCR string and improves the accuracy of the collected data. This option sets OCR module check digit calculation. The calculation is performed on incoming data

to determine this check digit, based on the numeric weight of the alpha and numeric characters. See [OCR Check Digit Multiplier on page 357](#). If the incoming data does not match the check digit, the data is considered corrupt.

The selected check digit option does not take effect until you set [OCR Check Digit Validation on page 359](#).

To choose the Check Digit Modulus, such as 10 for Modulus 10, scan the following barcode, and then scan a three-digit number from 001 to 099 representing the check digit using the numeric keypad in [Alphanumeric Barcodes](#). The default is 1.



OCR Check Digit

OCR Check Digit Multiplier

Parameter # 700

SSI # F1h BCh

This option sets OCR check digit multipliers for character positions. For check digit validation, each character in scanned data has an assigned weight to use in calculating the check digit. The scanner OCR ships with the following weight equivalents:

0 = 0	A = 10	K = 20	U = 30
1 = 1	B = 11	L = 21	V = 31
2 = 2	C = 12	M = 22	W = 32
3 = 3	D = 13	N = 23	X = 33
4 = 4	E = 14	O = 24	Y = 34
5 = 5	F = 15	P = 25	Z = 35
6 = 6	G = 16	Q = 26	Space = 0
7 = 7	H = 17	R = 27	
8 = 8	I = 18	S = 28	
9 = 9	J = 19	T = 29	

All other characters are equivalent to one (1).

You can define the multiplier string if it is different from the default.

121212121212 (default)

123456789A (for ISBN, Product Add Right to Left. See [OCR Check Digit Validation on page 359](#))

For example:

ISBN	0	2	0	1	1	8	3	9	9	4	
Multiplier	10	9	8	7	6	5	4	3	2	1	
Product	0	18	0	7	6	40	12	27	18	4	
Product add	0+	18+	0+	7+	6+	40+	12+	27+	18+	4=	132

ISBN uses Modulus 11 for the check digit. In this case, 132 is divisible by 11, so it passes the check digit.

To set the check digit multiplier, scan the following barcode, and then scan numbers and letters to form the multiplier string from [Alphanumeric Barcodes](#). Then scan [End of Message on page 460](#).



OCR Check Digit Multiplier

OCR Check Digit Validation

Parameter # 694

SSI # F1h B6h

Use the following options to protect against scanning errors by applying a check digit validation scheme.

None

No check digit validation, indicating no check digit is applied. This is the default.



***No Check Digit
(0)**

Product Add Left to Right

Each character in the scanned data is assigned a numeric value (see [OCR Check Digit Multiplier on page 357](#)). Each digit representing a character in the scanned data is multiplied by its corresponding digit in the multiplier, and the sum of these products is computed. The check digit passes if this sum modulo Check Digit Modulus is zero.

Example:

Scanned data numeric value is 132456 (check digit is 6)

Check digit multiplier string is 123456

Digit	1	3	2	4	5	6	
Multiplier	1	2	3	4	5	6	
Product	1	6	6	16	25	36	
Product add	1+	6+	6+	16+	25+	36=	90

The Check Digit Modulus is 10. It passes because 90 is divisible by 10 (the remainder is zero).



**Product Add Left to Right
(3)**

Product Add Right to Left

Each character in the scanned data is assigned a numeric value (see [OCR Check Digit Multiplier on page 357](#)). The check digit multiplier is reversed in order. Each value representing a character in the scanned data is multiplied by its corresponding digit in the reversed multiplier, resulting in a product for each character in the scanned data. The sum of these products is computed. The check digit passes if this sum modulo Check Digit Modulus is zero.

Example:

Scanned data numeric value is 132459 (check digit is 9)

Check digit multiplier string is 123456

Digit	1	3	2	4	5	9	
Multiplier	6	5	4	3	2	1	
Product	6	15	8	12	10	9	
Product add	6+	15+	8+	12+	10+	9=	60

The Check Digit Modulus is 10. It passes because 60 is divisible by 10 (the remainder is 0).



**Product Add Right to Left
(1)**

Digit Add Left to Right

Each character in the scanned data is assigned a numeric value (see [OCR Check Digit Multiplier on page 357](#)). Each value representing a character in the scanned data is multiplied by its corresponding digit in the multiplier, resulting in a product for each character in the scanned data. The sum of each individual digit in all of the products is then calculated. The check digit passes if this sum modulo Check Digit Modulus is zero.

Example:

Scanned data numeric value is 132456 (check digit is 6)

Check digit multiplier string is 123456

Digit	1	3	2	4	5	6	
Multiplier	1	2	3	4	5	6	
Product	1	6	6	16	25	36	
Digit add	1+	6+	6+	1+6+	2+5+	3+6=	36

The Check Digit Modulus is 12. It passes because 36 is divisible by 12 (the remainder is 0).



**Digit Add Left to Right
(4)**

Digit Add Right to Left

Each character in the scanned data is assigned a numeric value (see [OCR Check Digit Multiplier on page 357](#)). The check digit multiplier is reversed in order. Each value representing a character in the scanned data is multiplied by its corresponding digit in the reversed multiplier, resulting in a product for each character in the scanned data. The sum of each individual digit in all of the products is then calculated. The check digit passes if this sum modulo Check Digit Modulus is zero.

Example:

Scanned data numeric value is 132456 (check digit is 6)

Check digit multiplier string is 123456

Digit	1	3	2	4	5	6	
Multiplier	6	5	4	3	2	1	
Product	6	15	8	12	10	6	
Digit add	6+	1+5+	8+	1+2+	1+0+	6=	30

The Check Digit Modulus is 10. It passes because 30 is divisible by 10 (the remainder is 0).



**Digit Add Right to Left
(2)**

Product Add Right to Left Simple Remainder

Each character in the scanned data is assigned a numeric value (see [OCR Check Digit Multiplier on page 357](#)). The check digit multiplier is reversed in order. Each value representing a character in the scanned data is multiplied by its corresponding digit in the reversed multiplier, resulting in a product for each character in the scanned data. The sum of these products **except for the check digit's product** is computed. The check digit passes if this sum modulo Check Digit Modulus is equal to the check digit's product.

Example:

Scanned data numeric value is 122456 (check digit is 6)

Check digit multiplier string is 123456

Digit	1	2	2	4	5		6
Multiplier	6	5	4	3	2		1
Product	6	10	8	12	10		6
Product add	6+	10+	8+	12+	10=	46	6

The Check Digit Modulus is 10. It passes because 46 divided by 10 leaves a remainder of 6.



**Product Add Right to Left Simple Remainder
(5)**

Digit Add Right To Left Simple Remainder

Each character in the scanned data is assigned a numeric value (see [OCR Check Digit Multiplier on page 357](#)). The check digit multiplier is reversed in order. Each value representing a character in the scanned data is multiplied by its corresponding digit in the reversed multiplier, resulting in a product for each character in the scanned data. The sum of each individual digit in all of the products **except for the check digit's product** is then calculated. The check digit passes if this sum modulo Check Digit Modulus is equal to the check digit's product.

Example:

Scanned data numeric value is 122459 (check digit is 6)

Check digit multiplier string is 123456

Digit	1	2	2	4	5		9
Multiplier	6	5	4	3	2		1
Product	6	10	8	12	10		9
Digit add	6+	1+0+	8+	1+2+	1+0=	19	9

The Check Digit Modulus is 10. It passes because 19 divided by 10 leaves a remainder of 9.



**Digit Add Right to Left Simple Remainder
(6)**

Health Industry - HIBCC43

This is the health industry module 43 check digit standard. The check digit is the modulus 43 sum of all the character values in a given message, and is printed as the last character in a given message.

Example:

Supplier Labelling Data Structure: + A 1 2 3 B J C 5 D 6 E 7 1

Sum of values: $41+10+1+2+3+11+19+12+5+13+6+14+7+1 = 145$

Divide 145 by 43. The quotient is 3 with a remainder of 16. The check digit is the character corresponding to the value of the remainder (see Table 33), which in this example is 16, or **G**. The complete Supplier Labeling Data Structure, including the check digit, therefore is:

A 1 2 3 B J C 5 D 6 E 7 1 G

Table 33 Table of Numeric Value Assignments for Computing HIBC LIC Data Format Check Digit

0 = 0	9 = 9	I = 18	R = 27	- = 36
1 = 1	A = 10	J = 19	S = 28	. = 37
2 = 2	B = 11	K = 20	T = 29	Space = 38
3 = 3	C = 12	L = 21	U = 30	\$ = 39
4 = 4	D = 13	M = 22	V = 31	/ = 40
5 = 5	E = 14	N = 23	W = 32	+ = 41
6 = 6	F = 15	O = 24	X = 33	% = 42
7 = 7	G = 16	P = 25	Y = 34	
8 = 8	H = 17	Q = 26	Z = 35	



Health Industry - HIBCC43
(9)

Inverse OCR

Parameter # 856

SSI # F2h 58h

Inverse OCR is white or light words on a black or dark background. Select an option for decoding inverse OCR:

- **Regular Only** - Decode regular OCR (black on white) strings only.
- **Inverse Only** - Decode inverse OCR (white on black) strings only.
- **Autodiscriminate** - Decode both regular and inverse OCR strings.



***Regular Only**
(0)



Inverse Only
(1)



Autodiscriminate
(2)

OCR Redundancy

Parameter # 1770

SSI # F8h 06h EAh

This option adjusts the number of times to decode an OCR text string before transmission. There are three levels of OCR decode redundancy. There is an inverse relationship between the redundancy level and OCR decoding aggressiveness. Increasing the level of the redundancy can reduce OCR scanning aggressiveness, so select only the level of redundancy necessary.

- **OCR Redundancy Level 1:** This default setting allows the scanner to operate in its most aggressive state while providing sufficient accuracy in decoding most in-spec OCR text strings.
- **OCR Redundancy Level 2:** This setting eliminates most misdecodes while maintaining reasonable aggressiveness.
- **OCR Redundancy Level 3:** Select this option with greater redundancy requirements if OCR Redundancy Level 2 fails to eliminate misdecodes.



***OCR Redundancy Level 1**
(1)



OCR Redundancy Level 2
(2)



OCR Redundancy Level 3
(3)

Intelligent Document Capture (IDC)

Introduction

Intelligent Document Capture (IDC) is Zebra advanced image processing firmware for select imager based scanners. This chapter describes the IDC functionality, provides parameter barcodes to control IDC features, and includes a quick start procedure.

The IDC Process

Intelligent Document Capture:

1. Verifies a barcode is appropriate to use as an IDC anchor or link. See [Barcode Acceptance Test](#).
2. Determines the rectangular region to capture as an image. See [Capture Region Determination on page 367](#).
3. Processes the captured image. See [Image Post Processing on page 368](#).
4. Transmits the data. See [Data Transmission on page 368](#).

Barcode Acceptance Test

Upon decoding a barcode, the scanner checks that the barcode fits the description of a barcode that anchors or links to an IDC form. To be accepted as an IDC barcode:

- The symbology must be enabled for decode, and also enabled via [IDC Symbology on page 372](#). The IDC firmware allows enabling between zero and eight symbologies simultaneously: Code 128, Code 39, Interleaved 2 of 5, Discrete 2 of 5, Codabar, PDF417, Data Matrix, and EAN-128.
- The decoded data must satisfy the values set in the [IDC Minimum Text Length](#) and [IDC Maximum Text Length](#) parameters. To disable either of these checks, set the value to zero.

If the barcode does not satisfy both requirements, it is sent as a normal (non-IDC) decode.

An IDC barcode is required when [IDC Operating Mode on page 371](#) is set to **Anchored** or **Linked**.

Free-Form operating mode does not require a barcode, but transmits decoded data if one is found and satisfies the requirements. If no barcode is decoded, the document capture process starts but may require specifying a non-zero value for the [IDC Delay Time on page 382](#). The scanner must wait for at least this amount of time after trigger pull before capturing a document, unless a barcode is decoded before the time expires.

If [Picklist Mode on page 162](#) is enabled, the barcode must be directly under the aiming pattern and within the scanner's decode range, and the region to capture must be completely within the scanner's field-of-view.

Capture Region Determination

After accepting an IDC barcode, the firmware establishes the region to capture as an image. The method used depends on the setting of the [IDC Operating Mode](#) as follows.

The IDC firmware emits a single low beep after successfully capturing a region. The scanner is then no longer capturing images and can be moved without disturbing the IDC output. Be sure to hold the trigger button until the decode beep, otherwise the IDC process may be aborted.

IDC Operating Mode = Anchored

A coordinate system is built based on the barcode in its rectified (de-skewed) form. The origin is the center of the barcode, and the x-axis is set toward the right, from the barcode's point of view. The unit module width of the barcode is the unit for x. Similarly, the y-axis is set toward the up direction. The unit for the y-axis is specified via the parameter [IDC Aspect on page 375](#). This is the aspect ratio of a thin bar or space - the barcode's height is divided by this value to get this unit. Set [IDC Aspect](#) to zero to automatically calculate the aspect ratio. The barcode can be of different sizes for the same form, as long as the center of the barcode is the same when the barcode's length changes.

From this coordinate system, the IDC area is determined using four parameters: offsets in x and y ([IDC X Coordinate](#), [IDC Y Coordinate](#)) to the region's top-left corner, and width and height ([IDC Width](#), [IDC Height](#)).

If the capture area is relatively large as compared to the barcode area, the calculation to obtain the capture area is prone to significant errors. A recommended solution is to enclose the form with a single black-lined rectangular border (a box), which is not in contact with any other line on the outside of the form (although it can be connected to lines on the inside of the form). When the [IDC Find Box Outline](#) is set, the firmware searches for the box, and does not decode if any edges are broken (such as by a protruding thumb).

The [IDC Zoom Limit](#) parameter controls the quality of the captured form. The IDC firmware rejects capturing a form unless the width is at least the [IDC Zoom Limit](#) percentage of the [IDC Width](#) parameter. For example, if [IDC Zoom Limit](#) is set to 100 and [IDC Width](#) is set to 150, the form must be at least 300 pixels wide before it is captured (each unit module is scaled to two pixels).

The [IDC Maximum Rotation](#) parameter controls the maximum rotation any edge of the form can have in relation to the scanner's horizontal or vertical axis.

IDC Operating Mode = Free-Form or Linked

The document capture region is a rectangular piece of paper, or a portion of it enclosed by a rectangular border. In either case, all four sides of the capture region must be completely within the scanner's field-of-view, and there must be sufficient contrast at the border of the capture region. For example, if a piece of white paper contains the document to capture, it must be put in front of a dark background.

By default, the scanner captures the largest rectangular region within the field-of-view. To specify a particular border type, use the [IDC Border Type](#) parameter.

The region must contain at least 10% of the field-of-view in two dimensions.

If an IDC barcode is decoded, IDC uses its location to start the search for the capture region. Otherwise, it searches the capture region from the center of the field-of-view. IDC also uses the orientation of a decoded IDC barcode to orient the output image.

Image Post Processing

After determining the document capture region, the firmware de-skews and re-samples the region as follows. Enabling [IDC Captured Image Brighten](#) calls normalization, which makes the brightness of the image uniform, and enhances contrast as a large percent of background pixels is made completely white (a smaller percent of pixels is made completely black if the firmware determines there is no danger of enhancing the contrast of a very bland area). Enabling [IDC Captured Image Sharpen](#) enhances the sharpness of the image.

IDC re-samples the image about one output pixel per input pixel for **Free-Form** or **Linked** modes and two pixels-per-module in **Anchored** mode.

IDC compresses and transmits the image in one of the standard image formats selected by the [IDC File Format Selector](#), [IDC Bits Per Pixel](#), and [IDC JPEG Quality](#) parameters.

Note that it may take several seconds for post processing to complete, depending on the size of the captured region, the options enabled, and the scanner model.

Data Transmission

After processing the captured image, IDC assembles the image with the decoded barcode data (if applicable) into an ISO/IEC 15434 style packet and transmits it to the host. The scanner issues the standard decode beep and the trigger can be released. Be sure to set the [USB Device Type on page 62](#) to **Symbol Native API (SNAPI) with Imaging Interface**.

PC Application and Programming Support

For a sample application running on the Microsoft Windows operating system, contact your Zebra representative. This application displays barcode data and/or captured images from Intelligent Document Capture enabled scanners and allows setting and reading IDC parameters. Complete source code and documentation are also provided for developing custom applications. The application includes documentation for the ISO/IEC 15434 format as used by the IDC firmware and C# code to process it.

Setting Parameters

This section describes the parameters controlling the IDC firmware and provides programming barcodes for setting them.

The scanner ships with the settings shown in [Table 34 on page 370](#) (also see [Standard Parameter Defaults](#) for all defaults). If the default values suit requirements, programming is not necessary.

To set feature values, scan a single barcode or a short barcode sequence. The settings are stored in non-volatile memory and are preserved even when the imager powers down.



NOTE: Most computer monitors allow scanning barcodes directly on the screen. When scanning from the screen, be sure to set the document magnification to a level where you can see the barcode clearly, and bars and/or spaces do not merge.

To return all features to default values, scan the [Set Factory Defaults on page 142](#). Throughout the programming barcode menus, asterisks (*) indicate default values.

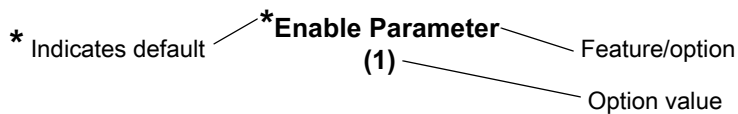

Scanning Sequence Examples

In most cases scanning one barcode sets the parameter value. For example, to set the document capture file format to BMP, scan the **BMP** barcode under [IDC File Format Selector on page 375](#). The scanner issues a fast warble beep and the LED turns green, signifying a successful parameter entry.

Other parameters require scanning several barcodes. See the parameter descriptions for this procedure.

Errors While Scanning

Unless otherwise specified, to correct an error during a scanning sequence, just re-scan the correct parameter.

Image Document Capture Parameter Defaults

Table 34 lists defaults for IDC parameters. Change these values in one of two ways:

- Scan the appropriate barcodes in this chapter. The new value replaces the standard default value in memory. To recall default parameter values, see [Default Parameters on page 142](#).
- Configure the scanner using the 123Scan configuration program. See [123Scan and Software Tools](#).



NOTE: See [Standard Parameter Defaults](#) for all user preference, host, symbology, and miscellaneous default parameters.

Alternatively, use the sample application to set parameters using the parameter name. The application provides prompts and error checking to assist in setting the parameters correctly and easily. You must use an application to set a parameter to a negative value, as the [IDC X Coordinate](#) can require.

Table 34 Intelligent Document Capture (IDC) Parameter Defaults

Parameter	Parameter Name	Parameter Number ¹	SSI Number ²	Default	Page Number
Intelligent Document Capture (IDC) Parameters					
IDC Operating Mode	DocCap_MODE	594	F1h 52h	Off	371
IDC Symbology	DocCap_SYMBLOGY	655	F1h 8Fh	001	372
IDC X Coordinate	DocCap_X	596	F4h F1h 54h	-151	373
IDC Y Coordinate	DocCap_Y	597	F4h F1h 55h	-050	373
IDC Width	DocCap_WIDTH	598	F1h 56h	0300	374
IDC Height	DocCap_HEIGHT	599	F1h 57h	0050	374
IDC Aspect	DocCap_ASPECT	595	F1h 53h	000	375
IDC File Format Selector	DocCap_FMT	601	F1h 59h	JPEG	375
IDC Bits Per Pixel	DocCap_BPP	602	F1h 5Ah	8 BPP	376
IDC JPEG Quality	DocCap_JPEG_Qual	603	F1h 5Bh	065	377
IDC Find Box Outline	Sig_FINDBOX	727	F1h D7h	Disable	377
IDC Minimum Text Length	DocCap_MIN_TEXT	656	F1h 90h	00	378
IDC Maximum Text Length	DocCap_MAX_TEXT	657	F1h 91h	00	378
IDC Captured Image Brighten	Sig_BRIGHTEN	654	F1h 8Eh	Enable	379
IDC Captured Image Sharpen	Sig_SHARPEN	658	F1h 92h	Enable	380
IDC Border Type	DocCap_BORDER	829	F2h 3Dh	None	381
IDC Delay Time	DocCap_DELAY	830	F2h 3Eh	000	382
IDC Zoom Limit	Sig_MIN_PERCENT	651	F1h 8Bh	000	382
IDC Maximum Rotation	Sig_MAX_ROT	652	F1h 8Ch	00	383

1. Parameter number decimal values are used for programming via RSM commands.

2. SSI number hex values are used for programming via SSI commands.

IDC Operating Mode

Parameter Name: DocCap_MODE

Parameter # 594

SSI # F1h 52h

Select the operating mode of the Intelligent Document Capture firmware:

- **Off** - Disables the IDC feature.
- **Anchored** - Requires a barcode decode. The image capture region is based off this barcode.
- **Free-Form** - A printed border or page edge defines the image capture region. A barcode is optional.
- **Linked** - A printed border or page edge defines the image capture region. A barcode is required.



*Off
(0)



Anchored
(1)



Free-Form
(2)

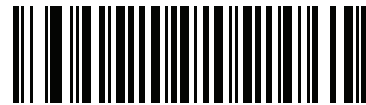

Linked
(3)

IDC Symbology

Parameter Name: DocCap_SYMBOLOGY

Parameter # 655

SSI # F1h 8Fh

Select the barcode type(s) to use when Document Capture mode is not set to **Off**. To enable more than one symbology at a time, simply add the values together. For example, to enable PDF417, Data Matrix, and Code 39 write a value of 98 (32 + 64 + 2).

Scan the following barcode, and then scan three barcodes from [Numeric Barcodes](#) in the range of 000 to 255 decimal. The default is 001.

Table 35 IDC Symbologies

Symbology	Value (Decimal)
Code 128	1
Code 39	2
I 2 of 5	4
D 2 of 5	8
Codabar	16
PD 417	32
Data Matrix	64
EAN 128	128
Aztec	256



IDC Symbology

IDC X Coordinate

Parameter Name: DocCap_X

Parameter # 596

SSI # F4h F1h 54h

This parameter only applies when [IDC Operating Mode](#) is set to **Anchored**. Specify the horizontal offset to the top left corner of the region to capture relative to the center of the barcode. Negative values move toward the left.

Scan the following barcode, and then scan four barcodes from [Numeric Barcodes](#) in the range of +/- 1279. The default is -151. Note that you must use an application to set a negative value.



IDC X Coordinate

IDC Y Coordinate

Parameter Name: DocCap_Y

Parameter # 597

SSI # F4h F1h 55h

This parameter only applies when [IDC Operating Mode](#) is set to **Anchored**. Specify the vertical offset to the top left corner of the region to capture relative to the center of the barcode. Negative values move toward the top.

Scan the following barcode, and then scan four barcodes from [Numeric Barcodes](#) in the range of +/- 1023. The default is -050. Note that you must use an application to set a negative value.



IDC Y Coordinate

IDC Width

Parameter Name: DocCap_WIDTH

Parameter # 598

SSI # F1h 56h

This parameter only applies when [IDC Operating Mode](#) is set to **Anchored**. Specify the width of the region to capture.

Scan the following barcode, and then scan four barcodes from [Numeric Barcodes](#) in the range of 0000 to 1279. The default is 0300.



IDC Width

IDC Height

Parameter Name: DocCap_HEIGHT

Parameter # 599

SSI # F1h 57h

This parameter only applies when [IDC Operating Mode](#) is set to **Anchored**. Specify the height of the region to capture.

Scan the following barcode, and then scan four barcodes from [Numeric Barcodes](#) in the range of 0000 to 1279. The default is 0050.



IDC Height

IDC Aspect

Parameter Name: DocCap_ASPECT

Parameter # 595

SSI # F1h 53h

This parameter only applies when [IDC Operating Mode](#) is set to **Anchored**. Specify the barcode's aspect ratio of a thin bar or space. The barcode's height is divided by this value to obtain the unit in the y-axis. Set this parameter to zero to calculate the aspect value automatically.

Scan the following barcode, and then scan three barcodes from [Numeric Barcodes](#) in the range of 000 to 255. The default is 000.



IDC Aspect

IDC File Format Selector

Parameter Name: DocCap_FMT

Parameter # 601

SSI # F1h 59h

Select a document capture file format appropriate for your system (BMP, TIFF, or JPEG). The scanner stores captured areas in the selected format.

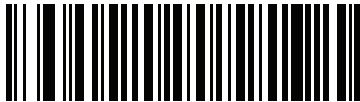

***JPEG
(1)**



**BMP
(3)**



**TIFF
(4)**

IDC Bits Per Pixel

Parameter Name: DocCap_BPP

Parameter # 602

SSI # F1h 5Ah

Select the number of significant bits per pixel (BPP) to use when capturing an image. Select 1 BPP for a black and white image, 4 BPP to assign 1 of 16 levels of grey to each pixel, or 8 BPP to assign 1 of 256 levels of grey to each pixel.



NOTE: The scanner ignores these settings for JPEG file formats, which only support 8 BPP.



1 BPP
(0)

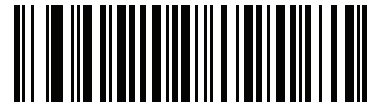

4 BPP
(1)



***8 BPP**
(2)

IDC JPEG Quality

Parameter Name: DocCap_JPEG_Qual

Parameter # 603

SSI # F1h 5Bh

Set the amount of JPEG compression to perform on the captured image. Higher numbers produce a better quality image but larger files.

Scan the following barcode, and then scan three barcodes from [Numeric Barcodes](#) in the range of 005 to 100 decimal. The default is 065.

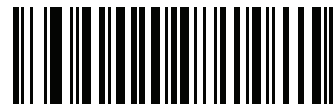

IDC JPEG Quality

IDC Find Box Outline

Parameter Name: Sig_FINDBOX

Parameter # 727

SSI # F1h D7h

This parameter only applies when [IDC Operating Mode](#) is set to **Anchored**. Scan **Enable Find Box Outline** to search for a rectangular border during document capture.



**Enable Find Box Outline
(1)**

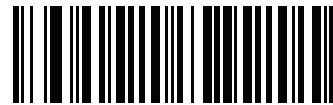

***Disable Find Box Outline
(0)**

IDC Minimum Text Length

Parameter Name: DocCap_MIN_TEXT

Parameter # 656

SSI # F1h 90h

Specify the minimum number of characters encoded in a barcode for the IDC firmware to use it as an anchored or linked barcode. Set this to zero (the default) to disable all checking and use all barcodes.

Scan the following barcode, and then scan two barcodes from [Numeric Barcodes](#) in the range of 00 to 55 decimal. The default is 00.



IDC Minimum Text Length

IDC Maximum Text Length

Parameter Name: DocCap_MAX_TEXT

Parameter # 657

SSI # F1h 91h

Specify the maximum number of characters encoded in a barcode for the IDC firmware to use it as an anchored or linked barcode. Set this to zero (the default) to disable all checking and use all barcodes.

Scan the following barcode, and then scan two barcodes from [Numeric Barcodes](#) in the range of 00 to 55 decimal. The default is 00.



IDC Maximum Text Length

IDC Captured Image Brighten

Parameter Name: Sig_BRIGHTEN

Parameter # 654

SSI # F1h 8Eh

Enable **Captured Image Brighten** to make image brightness uniform and enhance contrast such that a large percent of the background pixels is made completely white (a smaller percent of pixels is made completely black if the program determines there is no danger of enhancing the contrast of a very bland area).



NOTE: This parameter is also used for Signature Capture.

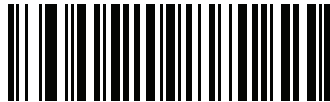

***Enable Captured Image Brighten
(1)**



**Disable Captured Image Brighten
(0)**

IDC Captured Image Sharpen

Parameter Name: Sig_SHARPEN

Parameter # 658

SSI # F1h 92h

Enable this to enhance the sharpness of the image.



NOTE: This parameter is also used for Signature Capture.



***Enable Captured Image Sharpen
(1)**



**Disable Captured Image Sharpen
(0)**

IDC Border Type

Parameter Name: DocCap_BORDER

Parameter # 829

SSI # F2h 3Dh

This parameter only applies when [IDC Operating Mode](#) is set to **Free-Form** or **Linked**. Select the style of border used to determine the outline of the capture region:

- **None** - Capture the largest rectangular region within the field-of-view.
- **Black** - The border must be black (such as a printed rectangular border).
- **White** - The border must be white (e.g., paper edge on a dark background).
- **Advanced Edge Detection (AED)** - Capture a region defined by edges of any color and potentially broken.

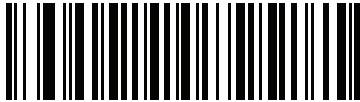

***None**
(0)



Black
(1)



White
(2)



Advanced Edge Detection (AED)
(3)

IDC Delay Time

Parameter Name: DocCap_DELAY

Parameter # 830

SSI # F2h 3Eh

This parameter only applies when [IDC Operating Mode](#) is set to **Free-Form**. Set the delay for capturing a document after a trigger pull. Decoding a barcode aborts this delay.

Scan the following barcode, and then scan three barcodes from [Numeric Barcodes](#) in the range of 000 to 200 decimal in units of 10 msec. The default is 000.



IDC Delay Time

IDC Zoom Limit

Parameter Name: Sig_MIN_PERCENT

Parameter # 651

SSI # F1h 8Bh

This parameter only applies when [IDC Operating Mode](#) is set to **Anchored**. Set the minimal "zoom" percentage value of a form for it to be considered for capture. This controls the quality of the captured form. The IDC firmware rejects capturing a form unless the width is at least the [IDC Zoom Limit](#) percentage of the [IDC Width](#) parameter. For example, if you set this parameter to 100 and [IDC Width](#) to 150, the form must be at least 300 pixels wide before it is captured (each unit module is scaled to two pixels).

Set this to zero (the default) to disable all checking.

Scan the following barcode, and then scan three barcodes from [Numeric Barcodes](#) in the range of 000 to 100 percent. The default is 000.



IDC Zoom Limit

IDC Maximum Rotation

Parameter Name: Sig_MAX_ROT

Parameter # 652

SSI # F1h 8Ch

This parameter only applies when [IDC Operating Mode](#) is set to **Anchored**. Set the maximum rotation any edge of the form can have in relation to the scanner's horizontal or vertical axis for it to be considered for capture. Set this to zero (the default) to disable all checking.

Scan the following barcode, and then scan two barcodes from [Numeric Barcodes](#) in the range of 00 to 45 decimal. The default is 00.

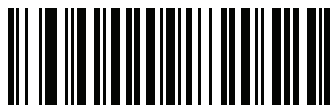

IDC Maximum Rotation

Quick Start

This section familiarizes you with some of the Intelligent Document Capture features. [IDC Demonstrations on page 385](#) includes instructions to demonstrate the Anchored, Free-Form, and Linked modes using a sample form to provide an understanding of how to use IDC. These examples do not illustrate all capabilities of the advanced IDC firmware. Build upon these using different parameter settings and forms.

Sample IDC Setup

To set up IDC:

1. Connect a scanner equipped with IDC to the host computer's USB port.
2. To set the scanner to the default settings and proper USB host type, scan **Set Defaults** followed by the **Symbol Native API (SNAPI) with Imaging Interface** barcode. Allow time for the scanner to reset and the USB connection to remunerate after each scan before continuing.



Set Defaults



Symbol Native API (SNAPI) with Imaging Interface

3. Start the sample application and select the scanner in the **SNAPI Scanners** drop-down menu.
4. Set parameters as specified in [IDC Demonstrations on page 385](#) using the sample application or by scanning parameter barcodes in this guide. The barcode in the sample form is Code 128, which is enabled by default for decoding and as a Document Capture symbology. You can change these settings for your IDC application.
5. Perform each demo. When scanning, aim the scanner at the barcode in the center of the rectangle. Pull the scanner back so the rectangle is fully contained in the aiming pattern. When you pull the trigger, the scanner emits a low tone to indicate that the IDC firmware identified and captured an image, then a decode beep to indicate that the data transmitted. There may be several seconds between the two beeps, depending on the size of the captured image and options selected (de-skew, brighten, etc). You can move the scanner after the first beep, but continue to hold the trigger or the scanner may end the session before sending the data.

IDC Demonstrations

Anchored Mode Demo

- Set [IDC Operating Mode on page 371](#) to **Anchored**.
- Set parameters to these values:
 - Set [IDC Height on page 374](#) to **100**.
 - Set [IDC Width on page 374](#) to **90**.
 - Set [IDC X Coordinate on page 373](#) to **-175**.
 - Set [IDC Y Coordinate on page 373](#) to **-50**.
- Pull the trigger. The scanner decodes the barcode and captures an image of the text scroll.
- Rotate the form clockwise so the word **Capture** is along the bottom edge, and pull the trigger. The scanner decodes the barcode and captures the same image, including orientation. (This example also works with the form rotated counter-clockwise or upside down).
- Modify the values for height, width, x, and y. Pull the trigger. The captured area changes in size and location.
- Cover the barcode with a small piece of paper (or your finger) and pull the trigger. The scanner does not decode the barcode or capture an image.

What This Demonstrates

Anchored mode captures an image of fixed size and location relative to a barcode on the page. Parameters control the height, width, and location. The IDC firmware requires that a barcode is present in order to capture an image. It decodes the barcode and uses it to adjust the image to the upright orientation.

Free-Form Mode Demo

- Set [IDC Operating Mode on page 371](#) to **Free-Form**.
- Pull the trigger. The scanner decodes the barcode and captures an image of the entire rectangle, including the contents.
- Modify the values for height, width, x, and y. Pull the trigger. Note that the captured image is not affected.
- Rotate the form clockwise so the word **Capture** is along the bottom edge, and pull the trigger. The scanner decodes the barcode and captures the same image, including orientation. (This example also works with the form rotated counterclockwise or upside down).
- Cover the barcode with a small piece of paper and pull the trigger. The scanner does not decode the barcode and does not re-orient the captured image to the normal position, i.e., with the logo in the upper-left corner.

What This Demonstrates

Free-Form mode captures an image where a rectangular border on the page determines the size and position. It adjusts the image to the upright orientation if a barcode is found and decoded in the image.

Linked Mode Demo

Set [IDC Operating Mode on page 371](#) to **Linked**.

Use the examples from the [Free-Form Mode Demo](#), noting that the last item (covering the barcode) does not decode the barcode or capture an image.

What This Demonstrates

Linked mode captures an image where a rectangular border on the page determines the size and position. The IDC firmware requires that a barcode is present in order to capture an image. It decodes the barcode and uses it to adjust the image to the upright orientation.

Other Suggestions

Hold the scanner at an angle (up/down or side to side) to the page instead of perpendicular to it. The IDC firmware de-skews and adjusts the brightness (enabled by default) to produce a quality image when the scanner is held at less than ideal conditions.

Quick Start Form

Figure 18 Quick Start Form

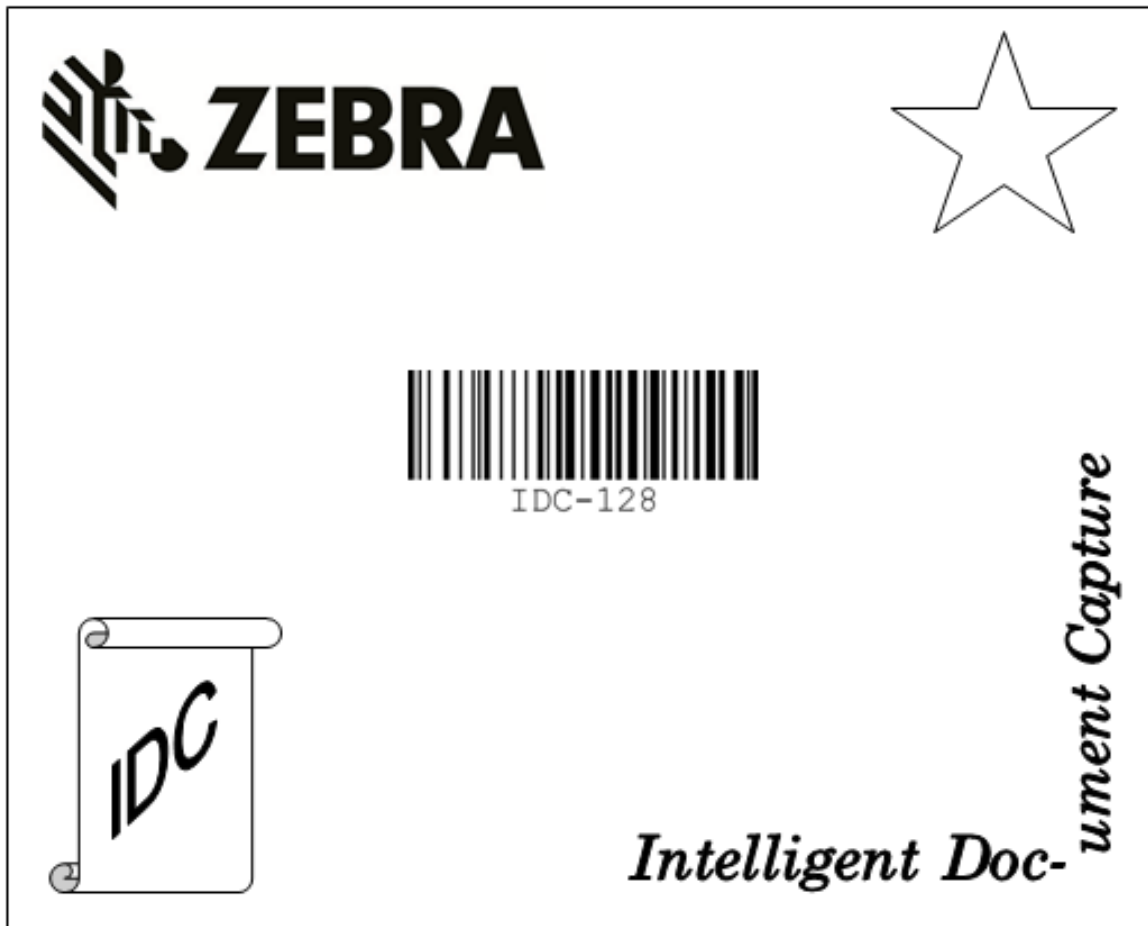

Data Formatting: ADF, MDF, Preferred Symbol

Introduction

This chapter briefly describes the Zebra features available for customizing scanner operation.

Advanced Data Formatting (ADF)

Advanced Data Formatting (ADF) allows customizing data before transmission to the host device. Use ADF to edit scanned data to suit the host application's requirements. With ADF you scan one barcode per trigger pull. ADF is programmed using 123Scan.

For a video on Creating an Advanced Data Formatting (ADF) Rule using 123Scan, go to: www.zebra.com/ScannerHowToVideos.

For additional information, refer to the Advanced Data Formatting Programmer Guide.

Multicode Data Formatting (Hand-held Mode Only)

Multicode Data Formatting (MDF) enables a 2D scanner to scan all barcodes on a label with a single trigger pull, and then modify and transmit the data to meet host application requirements. MDF supports programming up to nine unique labels into one scanner. MDF also supports scanning multiple barcodes on opposite sides of a box by holding the trigger.

MDF options include:

- Output all or specific barcodes.
- Control the barcode output sequence.
- Apply unique multicode data formatting (MDF) to each output barcode.
- Discard scanned data if all required barcodes are not present.

Programming a Scanner

- Using 123Scan, programming an MDF is similar to programming an ADF rule. MDF programming is saved in a 123Scan configuration file.
- MDF can be deployed to a fleet of 2D scanners using the Scanner Management Service (SMS) through a traditional SMS package.

For more information, refer to the Multicode Data Formatting and Preferred Symbol User Guide, p/n MN-002895-xx.

For a video on Creating an Multicode Data Formatting (MDF) Rule using 123Scan, go to: www.zebra.com/ScannerHowToVideos.

Preferred Symbol

Preferred Symbol is a barcode prioritization technique that enables favored decoding of high priority barcode(s). The Preferred Symbol is the only barcode that is decoded and output within the preset Preferred Symbol Timeout. During this time, the scanner attempts to decode the prioritized barcode and reports only this barcode.

For more information, refer to the Multicode Data Formatting and Preferred Symbol User Guide, p/n MN-002895-xx.

To program Preferred Symbol via 123Scan, select 123Scan > Configuration Wizard > Symbologies screen, and then select Preferred Symbol from the drop-down menu. Preferred Symbol programming is saved in the 123Scan configuration file.

Driver's License Set Up (DSXXX-DL)

Introduction

The scanner uses internally embedded algorithms to parse out barcode information from standard US driver's licenses and certain other American Association of Motor Vehicle Administrators (AAMVA) compliant ID cards. Scanning these barcodes produces formatted data for use in age verification, credit card application information, and more.

[Set Factory Defaults on page 142](#). Throughout the programming barcode menus, asterisks (*) indicate default values.



This chapter describes how to program the scanner to read and use the data contained in the 2D barcodes on US driver's licenses and AAMVA compliant ID cards.

Table 36 DL Parsing Parameter Table

Parameter			Default	Page Number
DL Parsing Parameters				
Driver's License Parsing			No Driver's License Parsing	390
Parsing Driver's License Data Fields			N/A	391
Driver's License Parse Field Barcodes			N/A	392
AAMVA Parse Field Barcodes			N/A	395
Set Default Parameter			N/A	405
Output Gender as M or F			N/A	405

Table 36 DL Parsing Parameter Table (Continued)

Parameter			Default	Page Number
Date Format			CCYYMMDD	406
No Separator			N/A	408
Send Keystroke			N/A	409
Control Characters				409
Keyboard Characters				414
Parsing Rule Example			N/A	430
Embedded Driver's License Parsing ADF Example			N/A	434

Driver's License Parsing

To enable driver's license parsing on the scanner, scan the **Embedded Driver's License Parsing** barcode. This does not require Zebra software (.DLL).

Scan the barcodes on the following pages in the order indicating the sequence of data fields that the scanner outputs. See [Parsing Driver's License Data Fields \(Embedded Driver's License Parsing\) on page 391](#) for more information.

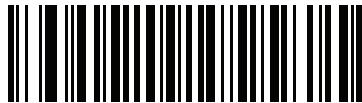

***No Driver's License Parsing**



Embedded Driver's License Parsing

Parsing Driver's License Data Fields (Embedded Driver's License Parsing)

To program a parsing rule:

1. Scan [Begin New Driver's License Parse Rule on page 392](#).
2. Scan any of the field barcodes on the following pages, or [Send Keystroke \(Control Characters and Keyboard Characters\) on page 409](#).
3. After entering the entire rule, scan [Save Driver's License Parse Rule on page 392](#) to save the rule.



NOTE: The scanner stores only one driver's license parsing rule in memory at a time. Saving a new rule replaces the prior rule.

To abort the programming sequence at any time during programming, scan [Quit Entering Driver's License Rule on page 392](#). Any previously saved rule is retained.

To erase a saved rule, scan [Erase Driver's License Parse Rules on page 392](#).

Embedded Driver's License Parsing Criteria - Code Type

After specifying the fields and their order for the parsed driver's license, you can also apply standard ADF rules to the parsed data using the **Parsed Driver's License** criterion barcode in the Advanced Data Formatting Programmer Guide.



NOTE: Only create standard ADF rules on parsed driver's license data when configured for Embedded Driver's License Parsing.

See [Embedded Driver's License Parsing ADF Example on page 434](#) for a sample ADF rule using this code type criterion.

Driver's License Parse Field Barcodes



Begin New Driver's License Parse Rule



Save Driver's License Parse Rule



Quit Entering Driver's License Rule



Erase Driver's License Parse Rules

Driver's License Parse Field Barcodes (continued)

The supported parse fields begin below. Not all IDs present data in the same format. For example, some IDs can have separate fields for first name, last name, and middle initial, while others have a single field with the entire name. Also, some IDs expire on the subject's birth date while the expiration date field only indicates the year. To present data in a consistent format, use the following nine barcodes to return data calculated from the actual data contained in the ID barcode.



First Name

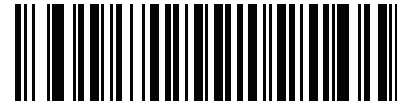

Middle Name/Initial



Last Name



Name Suffix



Name Prefix



Expiration Date

Driver's License Parse Field Barcodes (continued)



Birth Date

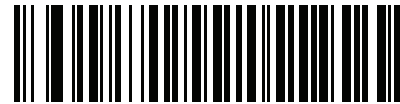

Issue Date



ID Number (Formatted)

AAMVA Parse Field Barcodes



AAMVA Issuer ID

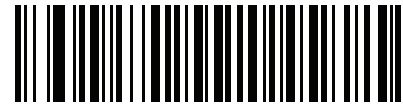

Full Name



Last Name

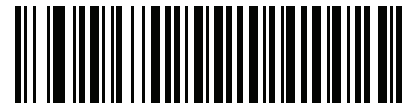

First Name

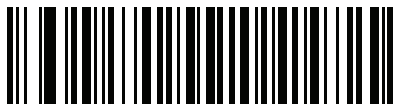

Middle Name / Initial



Name Suffix



Name Prefix

AAMVA Parse Field Barcodes (continued)



Mailing Address Line 1

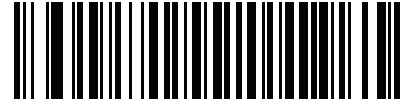

Mailing Address Line 2



Mailing Address City



Mailing Address State



Mailing Address Postal Code



Home Address Line 1



Home Address Line 2

AAMVA Parse Field Barcodes (continued)



Home Address City

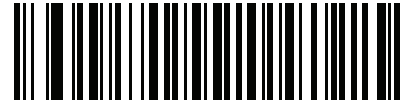

Home Address State



Home Address Postal Code

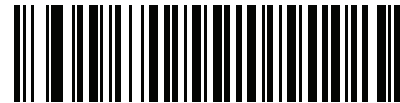

License ID Number



License Class



License Restrictions



License Endorsements

AAMVA Parse Field Barcodes (continued)



Height (Feet and/or Inches)

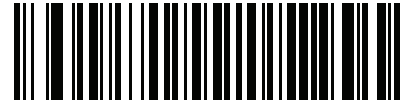

Height (Centimeters)



Weight (Pounds)

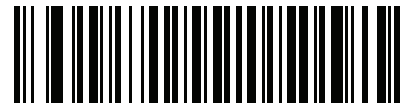

Weight (Kilograms)



Eye Color

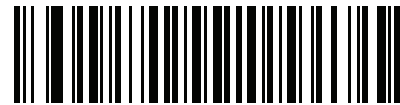

Hair Color



License Expiration Date

AAMVA Parse Field Barcodes (continued)



Birth Date

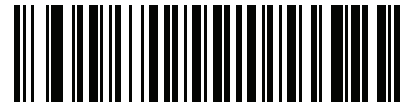

Gender



License Issue Date



License Issue State



Social Security Number



Permit Class



Permit Expiration Date

AAMVA Parse Field Barcodes (continued)



Permit ID Number



Permit Issue Date



Permit Restrictions

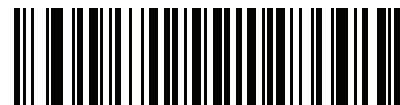

Permit Endorsements



AKA Social Security Name



AKA Full Name



AKA Last Name

AAMVA Parse Field Barcodes (continued)



AKA First Name

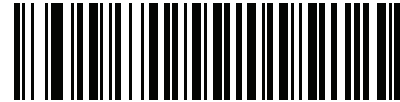

AKA Middle Name / Initial

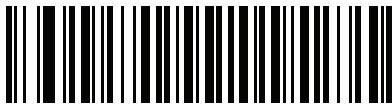

AKA Name Suffix

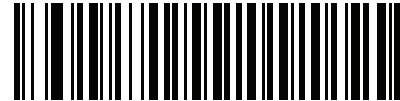

AKA Name Prefix

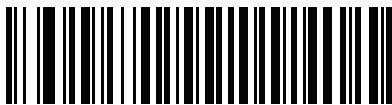

AKA Birth Date



Issue Timestamp



Number of Duplicates

AAMVA Parse Field Barcodes (continued)



Medical Codes

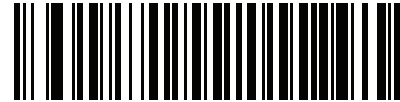

Organ Donor



Nonresident

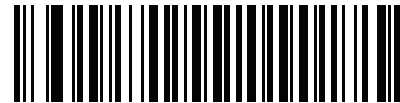

Customer ID



Weight Range

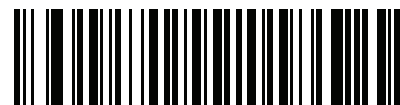

Document Discriminator



Country

AAMVA Parse Field Barcodes (continued)



Federal Commission Codes

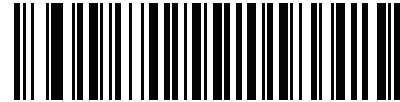

Place of Birth



Audit Information

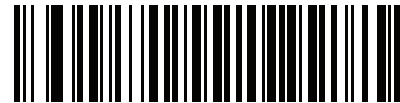

Inventory Control



Race / Ethnicity



Std Vehicle Class



Std Endorsements

AAMVA Parse Field Barcodes (continued)



Std Restrictions

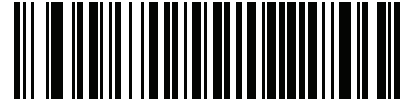

Class Description



Endorsement Description

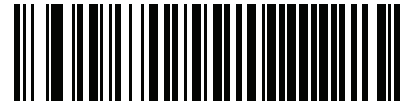

Restrictions Description



Height in Inches

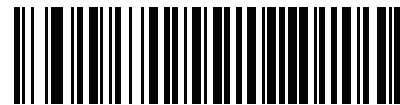

Height in Centimeters



Std Endorsements

Parser Version ID Barcode

Include this field to emit embedded parser software version identification.



Parser Version ID

User Preferences

Set Default Parameter

Scan this barcode to return all parameters to the default values listed in [Table 37 on page 436](#).



*Set All Defaults

Output Gender as M or F

Scan this barcode to report the gender as **M** or **F** instead of a numeric value.



Output gender as M or F

Date Format

Use these barcodes to select the date format to display. Date fields include the following:

- **CCYY** = 4-digit year (**CC**=2-digit century [00-99], **YY**=2-digit year in the century [00-99])
- **MM** = 2-digit month [01-12]
- **DD** = 2-digit day of the month [00-31]

The default is **CCYYMMDD**.



NOTE: To specify a date separator, i.e., a character separating each field of the date, scan the **Send <character>** barcode that corresponds to the alphanumeric character to use as the date separator immediately following the date format barcode. To select no date separator, scan the **No Separator DL** parsing rule immediately following the date format barcode.

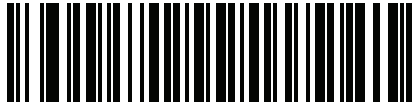

*CCYYMMDD



CCYYDDMM



MMDDCCYY



MMCCYYDD

Date Format (continued)



DDMMCCYY

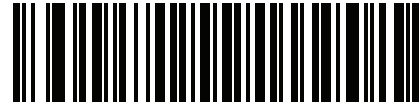

DDCCYYMM

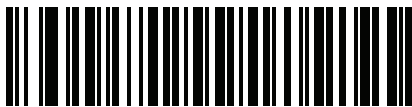

YYMMDD



YYDDMM



MMDDYY



MMYYDD

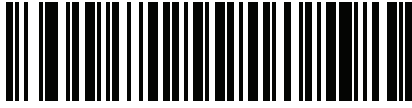

DDMMYY



DDYYMM

No Separator

Scan this barcode immediately following a date format barcode to use no separator character between the date fields.

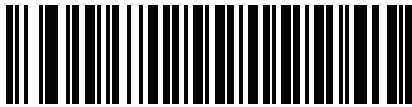

No Separator

Send Keystroke (Control Characters and Keyboard Characters)

Control Characters

Scan a **Send** barcode for the keystroke to send.



Send Control A



Send Control B



Send Control C



Send Control D



Send Control E



Send Control F



Send Control G

Control Characters (continued)



Send Control H



Send Control I



Send Control J



Send Control K



Send Control L



Send Control M



Send Control N

Control Characters (continued)



Send Control O



Send Control P



Send Control Q



Send Control R



Send Control S



Send Control T



Send Control U

Control Characters (continued)



Send Control V



Send Control W



Send Control X



Send Control Y



Send Control Z



Send Control [

Control Characters (continued)



**Send Control **



Send Control]



Send Control 6



Send Control -

Keyboard Characters

Scan a **Send** barcode for the keyboard characters to send.



Send Space



Send !



Send "



Send #



Send \$



Send %

Keyboard Characters (continued)



Send &



Send ‘



Send (



Send)



Send *



Send +

Keyboard Characters (continued)



Send ,



Send -



Send .



Send /



Send 0



Send 1

Keyboard Characters (continued)



Send 2



Send 3



Send 4



Send 5



Send 6



Send 7

Keyboard Characters (continued)



Send 8



Send 9



Send :



Send ;



Send <



Send =

Keyboard Characters (continued)



Send >



Send ?



Send @



Send A



Send B



Send C

Keyboard Characters (continued)



Send D



Send E



Send F



Send G



Send H



Send I

Keyboard Characters (continued)



Send J



Send K



Send L



Send M



Send N



Send O

Keyboard Characters (continued)



Send P



Send Q



Send R



Send S



Send T



Send U

Keyboard Characters (continued)



Send V



Send W



Send X



Send Y



Send Z



Send [

Keyboard Characters (continued)



Send \



Send]



Send ^

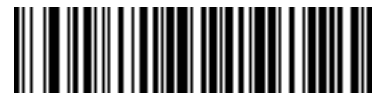

Send _



Send `



Send a

Keyboard Characters (continued)



Send b



Send c



Send d



Send e



Send f



Send g

Keyboard Characters (continued)



Send h



Send i



Send j



Send k



Send l



Send m

Keyboard Characters (continued)



Send n



Send o



Send p



Send q



Send r



Send s

Keyboard Characters (continued)



Send t



Send u



Send v



Send w



Send x



Send y

Keyboard Characters (continued)



Send z



Send {



Send |



Send }



Send ~



Send Tab Key



Send Enter Key

Parsing Rule Example

Scan the following barcodes in sequence to program the scanner to extract and transmit first, middle, and last names; mailing address line 1; mailing address line 2; mailing address city; mailing address state; mailing address postal code; and, date of birth. Then, scan a driver's license barcode.



NOTE: This example applies to RS-232. To use this example with a USB interface, enable [Function Key Mapping on page 72](#) to send the Enter key properly.

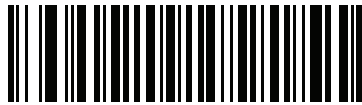

1 - Embedded Driver's License Parsing



2 - Begin New Driver's License Parse Rule



3 - First Name



4 - Send Space



5 - Middle Name / Initial



6 - Send Space

Parsing Rule Example (continued)



7 - Last Name



8 - Send Enter Key

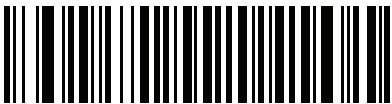

9 - Mailing Address Line 1



10 - Send Space

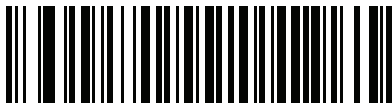

11 - Mailing Address Line 2



12 - Send Enter Key

Parsing Rule Example (continued)

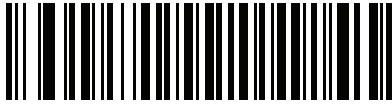

13 - Mailing Address City



14 - Send Space

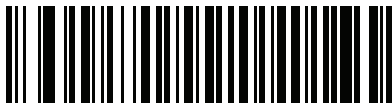

15 - Mailing Address State



16 - Send Space



17 - Mailing Address Postal Code



18 - Send Enter Key

Parsing Rule Example (continued)

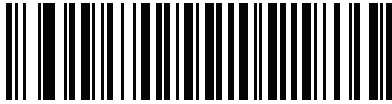

19 - Birth Date



20 - Send Enter Key



21 - Save Driver's Licence Parse Rule

Embedded Driver's License Parsing ADF Example

This example creates a parsing rule for parsed data configured to result in the format:

Last Name, First Name



1 - Begin New Driver's License Parse Rule

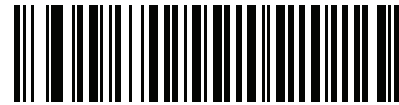

2 - Last Name



3 - Send ,



4 - Send Space



5 - First Name

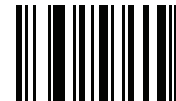

6 - Save Driver's License Parse Rule

Then, in order to limit the full name to 15 characters, create the following ADF rule:



1 - Begin New Rule

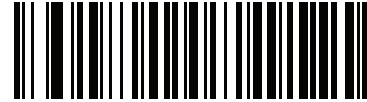

2 - Criterion: Parsed Driver's License



3 - Action: Send Next 15 Characters



4 - Save Rule

For a license belonging to Michael Williams, the parsed data is Williams, Michael and Williams, Micha after applying the previous ADF rule.

Standard Parameter Defaults

Introduction

Table 37 Parameter Defaults

Parameter	Parameter Number ¹	SSI Number ²	Default	Page #
Send Versions				
Software Version	N/A	N/A	N/A	49
Serial Number	N/A	N/A	N/A	49
Manufacturing Information	N/A	N/A	N/A	49
USB Host Parameters				
USB Device Type	N/A	N/A	USB HID Keyboard	62
Symbol Native API (SNAPI) Status Handshaking	N/A	N/A	Enable	64
USB Keystroke Delay	N/A	N/A	No Delay	65
USB Caps Lock Override	N/A	N/A	Do Not Override (Disable)	65
Barcodes with Unknown Characters	N/A	N/A	Send Barcodes with Unknown Characters	66
USB Convert Unknown to Code 39	N/A	N/A	Disable	66
USB Fast HID	N/A	N/A	Enable	67
USB Polling Interval	N/A	N/A	3 msec	68
Keypad Emulation	N/A	N/A	Enable	70
Quick Keypad Emulation	N/A	N/A	Enable	70
Keypad Emulation with Leading Zero	N/A	N/A	Enable	71
USB FN1 Substitution	N/A	N/A	Disable	71
Function Key Mapping	N/A	N/A	Disable	72

1. Parameter number decimal values are used for programming via RSM commands.

2. SSI number hex values are used for programming via SSI commands.

Table 37 Parameter Defaults (Continued)

Parameter	Parameter Number ¹	SSI Number ²	Default	Page #
Simulated Caps Lock	N/A	N/A	Disable	72
Convert Case	N/A	N/A	None	73
USB Static CDC	N/A	N/A	Enable	74
CDC Beep on <BEL>	N/A	N/A	Enable	74
TGCS (IBM) USB Direct I/O Beep	N/A	N/A	Honor	75
TGCS (IBM) USB Beep Directive	N/A	N/A	Ignore	75
TGCS (IBM) USB Barcode Configuration Directive	N/A	N/A	Ignore	76
TGCS (IBM) USB Specification Version	N/A	N/A	Version 2.2	76
SSI Host Parameters				
Select SSI Host	N/A	N/A	N/A	89
Baud Rate	156	9Ch	9600	89
Parity	158	9Eh	None	91
Check Parity	151	97h	Disable	91
Stop Bits	157	9Dh	1	92
Software Handshaking	159	9Fh	Enable ACK/NAK	93
Host RTS Line State	154	9Ah	Low	94
Decode Data Packet Format	238	EEh	Send Raw Decode Data	94
Host Serial Response Timeout	155	9Bh	2 Seconds	95
Host Character Timeout	239	EFh	200 msec	96
Multipacket Option	334	F0h 4Eh	Option 1	97
Interpacket Delay	335	F0h 4Fh	0 msec	98
Event Reporting				
Decode Event	256	F0h 00h	Disable	99
Boot Up Event	258	F0h 02h	Disable	100
Parameter Event	259	F0h 03h	Disable	100
RS-232 Host Parameters				
RS-232 Host Types	N/A	N/A	Standard	107
Baud Rate	N/A	N/A	9600	109

1. Parameter number decimal values are used for programming via RSM commands.

2. SSI number hex values are used for programming via SSI commands.

Table 37 Parameter Defaults (Continued)

Parameter	Parameter Number ¹	SSI Number ²	Default	Page #
Parity	N/A	N/A	None	111
Stop Bits	N/A	N/A	1 Stop Bit	112
Data Bits	N/A	N/A	8-bit	112
Check Receive Errors	N/A	N/A	Enable	113
Hardware Handshaking	N/A	N/A	None	113
Software Handshaking	N/A	N/A	None	115
Host Serial Response Timeout	N/A	N/A	2 Seconds	117
RTS Line State	N/A	N/A	Low RTS	118
Beep on <BEL>	N/A	N/A	Disable	118
Intercharacter Delay	N/A	N/A	0 msec	119
Nixdorf Beep/LED Options	N/A	N/A	Normal Operation	120
Barcodes with Unknown Characters	N/A	N/A	Send Barcode With Unknown Characters	120
IBM 468X/469X Host Parameters				
Port Address	N/A	N/A	None	125
Convert Unknown to Code 39	N/A	N/A	Disable	126
RS-485 Beep Directive	N/A	N/A	Ignore	126
RS-485 Barcode Configuration Directive	N/A	N/A	Ignore	127
IBM-485 Specification Version	N/A	N/A	Original Specification	127
Keyboard Wedge Host Parameters				
Keyboard Wedge Host Type	N/A	N/A	IBM AT Notebook	131
Barcodes with Unknown Characters	N/A	N/A	Send Barcodes with Unknown Characters	131
Keystroke Delay	N/A	N/A	No Delay	132
Intra-keystroke Delay	N/A	N/A	Disable	132
Alternate Numeric Keypad Emulation	N/A	N/A	Enable	133
Quick Keypad Emulation	N/A	N/A	Enable	133
Simulated Caps Lock	N/A	N/A	Disable	134
Caps Lock Override	N/A	N/A	Disable	134
Convert Case	N/A	N/A	Do Not Convert	135

1. Parameter number decimal values are used for programming via RSM commands.

2. SSI number hex values are used for programming via SSI commands.

Standard Parameter Defaults

Table 37 Parameter Defaults (Continued)

Parameter	Parameter Number ¹	SSI Number ²	Default	Page #
Function Key Mapping	N/A	N/A	Disable	136
FN1 Substitution	N/A	N/A	Disable	136
Send Make and Break	N/A	N/A	Send	137
User Preferences				
Set Default Parameter	N/A	N/A	N/A	142
Parameter Barcode Scanning	236	ECh	Enable	143
Beep After Good Decode	56	38h	Enable	144
Beeper Volume	140	8Ch	High	145
Beeper Tone	145	91h	Medium	146
Beeper Duration	628	F1h 74h	Medium	147
Suppress Power Up Beeps	721	F1h D1h	Do Not Suppress	148
LED on Good Decode	744	F1h E8h	Enable	149
Direct Decode Indicator	859	F2h 5Bh	Disable	149
Decode Pager Motor (DS4608-HC Only)	613	F1h 65h	Enable	150
Decode Pager Motor Duration (DS4608-HC Only)	626	F1h 72h	150 msec	151
Night Mode Trigger (DS4608-HC Only)	1215	F8h 04h BFh	Enable	154
Night Mode Toggle (DS4608-HC Only)	N/A	N/A	N/A	154
Low Power Mode	128	80h	Disable	155
Time Delay to Low Power Mode	146	92h	1 Hour	156
Trigger Mode (or Hand-held Trigger Mode)	138	8Ah	Auto Aim	158
Hand-held Decode Aiming Pattern	306	F0h 32h	Enable	159
Hands-free (Presentation) Decode Aiming Pattern	590	F1h 4Eh	Disable Hands-free (Presentation) Decode Aiming Pattern	160
Hands-free Mode	630	F1h 76h	Enable	161
Picklist Mode	402	F0h 92h	Disable Picklist Mode Always	162
Continuous Barcode Read	649	F1h 89h	Disable	163
Unique Barcode Reporting	723	F1h D3h	Enable	164

1. Parameter number decimal values are used for programming via RSM commands.

2. SSI number hex values are used for programming via SSI commands.

Table 37 Parameter Defaults (Continued)

Parameter	Parameter Number ¹	SSI Number ²	Default	Page #
Decode Session Timeout	136	88h	9.9 Seconds	164
Timeout Between Decodes, Same Symbol	137	89h	0.5 Seconds	165
Timeout Between Decodes, Different Symbols	144	90h	0.1 Seconds	165
Triggered Timeout, Same Symbol	724	F1h D4h	Disable	166
Mobile Phone/Display Mode	716	F1h CCh	Normal	167
PDF Prioritization	719	F4h F1h CFh	Disable	168
PDF Prioritization Timeout	720	F1h D0h	200 ms	169
Presentation Mode Field of View	609	F1h 61h	Full	170
Decoding Illumination	298	F0h 2Ah	Enable	171
Illumination Brightness	669	F1h 9Dh	High	172
Motion Tolerance (Hand-held Trigger Mode Only)	858	F2h 5Ah	Less	173
Product ID (PID) Type	1281	F8h 05h 01h	Host Type Unique	174
Product ID (PID) Value	1725	F8h 06h BDh	0	174
ECLevel	1710	F8h 06h AEh	0	175
DPM Parameters (DS4608-DPE Only)				
DPM Illumination	429	F0h ADh	Cycle Illumination	176
DPM Mode	1438	F8h 05h 9Eh	Enable	177
Miscellaneous Options				
Enter Key	N/A	N/A	N/A	178
Tab Key	N/A	N/A	N/A	178
Transmit Code ID Character	45	2Dh	None	179
Prefix Value	99, 105	63h, 69h	7013 <CR><LF>	180
Suffix 1 Value	98, 104	62h, 68h	7013 <CR><LF>	180
Suffix 2 Value	100, 106	64h, 6Ah		
Scan Data Transmission Format	235	EBh	Data As Is	181
FN1 Substitution Values	103, 109	67h, 6Dh	7013 <CR><LF>	183
Transmit "No Read" Message	94	5E	Disable	184
Unsolicited Heartbeat Interval	1118	F8h 04h 5Eh	Disable	185

1. Parameter number decimal values are used for programming via RSM commands.

2. SSI number hex values are used for programming via SSI commands.

Standard Parameter Defaults

Table 37 Parameter Defaults (Continued)

Parameter	Parameter Number ¹	SSI Number ²	Default	Page #
securPharm Decoding	1752	F8h 06h D8h	Disable	186
securPharm Output Formatting	1753	F8h 06h D9h	No Formatting	187
Image Capture Preferences				
Operational Modes	N/A	N/A	N/A	193
Image Capture Illumination	361	F0h 69h	Enable	194
Image Capture Autoexposure	360	F0h 68h	Enable	194
Fixed Exposure	567	F4h F1h 37h	100	195
Analog Gain	1232	F4h D0h	Analog Gain x 2	196
Digital Gain	1233	F4h D1h	32	196
Snapshot Mode Timeout	323	F0h 43h	0 (30 seconds)	197
Snapshot Aiming Pattern	300	F0h 2Ch	Enable	198
Silence Operational Mode Changes	1293	F8h 05h 0Dh	Disable (do not silence)	198
Image Cropping	301	F0h 2Dh	Disable	199
Crop to Pixel Addresses	315 316 317 318	F4h F0h 3Bh F4h F0h 3Ch F4h F0h 3Dh F4h F0h 3Eh	0 top 0 left 799 bottom 1279 right	199
Image Size (Number of Pixels)	302	F0h 2Eh	Full	201
Image Brightness (Target White)	390	F0h 86h	180	202
JPEG Image Options	299	F0h 2Bh	Quality	202
JPEG Quality Value	305	F0h 31h	65	203
JPEG Size Value	561	F1h 31h	160 kB	203
Image Enhancement	564	F1h 34h	Low (1)	204
Image File Format Selector	304	F0h 30h	JPEG	205
Image Rotation	665	F1h 99h	0	206
Bits per Pixel (BPP)	303	F0h 2Fh	8 BPP	207
Signature Capture	93	5Dh	Disable	208
Signature Capture Image File Format Selection	313	F0h 39h	JPEG	209
Signature Capture Bits per Pixel (BPP)	314	F0h 3Ah	8 BPP	210

1. Parameter number decimal values are used for programming via RSM commands.

2. SSI number hex values are used for programming via SSI commands.

Table 37 Parameter Defaults (Continued)

Parameter	Parameter Number ¹	SSI Number ²	Default	Page #
Signature Capture Width	366	F4h F0h 6Eh	400	211
Signature Capture Height	367	F4h F0h 6Fh	100	211
Signature Capture JPEG Quality	421	F0h A5h	65	212
Video Mode Format Selector	916	F2h 94h	JPEG	212
Video View Finder	324	F0h 44h	Disable	213
Target Video Frame Size	328	F0h 48h	2200 bytes	213
Video View Finder Image Size	329	F0h 49h	1700 bytes	214
Video Resolution	667	F1h 9Bh	1/4 resolution	214

Symbologies

Enable/Disable All Code Types				223
1D Symbologies				
UPC/EAN/JAN				
UPC-A	1	01h	Enable	224
UPC-E	2	02h	Enable	224
UPC-E1	12	0Ch	Disable	225
EAN-8/JAN 8	4	04h	Enable	225
EAN-13/JAN 13	3	03h	Enable	226
Bookland EAN	83	53h	Disable	226
Bookland ISBN Format	576	F1h 40h	ISBN-10	227
ISSN EAN	617	F1h 69h	Disable	228
Decode UPC/EAN/JAN Supplementals (2 and 5 digits)	16	10h	Ignore	229
User-Programmable Supplementals			000	232
Supplemental 1:	579	F4h F1h 43h		
Supplemental 2:	580	F4h F1h 44h		
UPC/EAN/JAN Supplemental Redundancy	80	50h	10	232
UPC/EAN/JAN Supplemental AIM ID Format	672	F1h A0h	Combined	233
Transmit UPC-A Check Digit	40	28h	Enable	234
Transmit UPC-E Check Digit	41	29h	Enable	234

1. Parameter number decimal values are used for programming via RSM commands.

2. SSI number hex values are used for programming via SSI commands.

Standard Parameter Defaults

Table 37 Parameter Defaults (Continued)

Parameter	Parameter Number ¹	SSI Number ²	Default	Page #
Transmit UPC-E1 Check Digit	42	2Ah	Enable	235
UPC-A Preamble	34	22h	System Character	236
UPC-E Preamble	35	23h	System Character	237
UPC-E1 Preamble	36	24h	System Character	238
Convert UPC-E to A	37	25h	Disable	239
Convert UPC-E1 to A	38	26h	Disable	239
EAN/JAN Zero Extend	39	27h	Disable	240
UCC Coupon Extended Code	85	55h	Disable	240
Coupon Report	730	F1h DAh	New Coupon Format	241
UPC Reduced Quiet Zone	1289	F8h 05h 09h	Disable	242
Code 128				
Code 128	8	08h	Enable	242
Set Length(s) for Code 128	209, 210	D1h, D2h	Any Length	243
GS1-128 (formerly UCC/EAN-128)	14	0Eh	Enable	244
ISBT 128	84	54h	Enable	245
ISBT Concatenation	577	F1h 41h	Disable Enable for DS4608-HC	246
Check ISBT Table	578	F1h 42h	Enable	247
ISBT Concatenation Redundancy	223	DFh	10	247
Code 128 <FNC4>	1254	F8h 04h E6h	Honor	248
Code 128 Security Level	751	F1h EFh	Security Level 1 Security Level 2 for DS4608-HC	249
Code 128 Reduced Quiet Zone	1208	F8h 04h B8h	Disable	250
Code 39				
Code 39	0	00h	Enable	250
Trioptic Code 39	13	0Dh	Disable	251
Convert Code 39 to Code 32 (Italian Pharmacy Code)	86	56h	Disable	251

1. Parameter number decimal values are used for programming via RSM commands.

2. SSI number hex values are used for programming via SSI commands.

Standard Parameter Defaults

Table 37 Parameter Defaults (Continued)

Parameter	Parameter Number ¹	SSI Number ²	Default	Page #
Code 32 Prefix	231	E7h	Disable	252
Set Length(s) for Code 39	18, 19	12h, 13h	1 to 55	252
Code 39 Check Digit Verification	48	30h	Disable	254
Transmit Code 39 Check Digit	43	2Bh	Disable	254
Code 39 Full ASCII Conversion	17	11h	Disable	255
Code 39 Security Level	750	F1h EEh	Security Level 1	256
Code 39 Reduced Quiet Zone	1209	F8h 04h B9h	Disable	258
Code 93				
Code 93	9	09h	Enable	258
Set Length(s) for Code 93	26, 27	1Ah, 1Bh	1 to 55	259
Code 11				
Code 11	10	0Ah	Disable	261
Set Lengths for Code 11	28, 29	1Ch, 1Dh	4 to 55	261
Code 11 Check Digit Verification	52	34h	Disable	263
Transmit Code 11 Check Digit(s)	47	2Fh	Disable	264
Interleaved 2 of 5 (ITF)				
Interleaved 2 of 5 (ITF)	6	06h	Enable	264
Set Lengths for I 2 of 5	22, 23	16h, 17h	6 to 55	265
I 2 of 5 Check Digit Verification	49	31h	Disable	267
Transmit I 2 of 5 Check Digit	44	2Ch	Disable	267
Convert I 2 of 5 to EAN-13	82	52h	Disable	268
Febraban	1750	F8h 06h D6h	Disable	268
I 2 of 5 Security Level	1121	F8h 04h 61h	Security Level 1	269
I 2 of 5 Reduced Quiet Zone	1210	F8h 04h BAh	Disable	270
Discrete 2 of 5 (DTF)				
Discrete 2 of 5	5	05h	Disable	270
Set Length(s) for D 2 of 5	20, 21	14h 15h	1 to 55	271

1. Parameter number decimal values are used for programming via RSM commands.

2. SSI number hex values are used for programming via SSI commands.

Standard Parameter Defaults

Table 37 Parameter Defaults (Continued)

Parameter	Parameter Number ¹	SSI Number ²	Default	Page #
Codabar (NW - 7)				
Codabar	7	07h	Enable	273
Set Lengths for Codabar	24, 25	18h, 19h	4 to 55	273
CLSI Editing	54	36h	Disable	275
NOTIS Editing	55	37h	Disable	275
Codabar Security Level	1776	F8h 06h F0h	Security Level 1	276
Codabar Upper or Lower Case Start/ Stop Characters Detection	855	F2h 57h	Upper Case	277
Codabar Mod 16 Check Digit Verification	1784	F8h 06h F8h	Disable	277
Transmit Codabar Check Digit	704	F1h C0h	Disable	278
MSI				
MSI	11	0Bh	Disable	278
Set Length(s) for MSI	30, 31	1Eh, 1Fh	4 to 55	279
MSI Check Digits	50	32h	One	280
Transmit MSI Check Digit	46	2Eh	Disable	281
MSI Check Digit Algorithm	51	33h	Mod 10/Mod 10	281
MSI Reduced Quiet Zone	1392	F8h 05h 70h	Disable	282
Chinese 2 of 5				
Chinese 2 of 5	408	F0h 98h	Disable	282
Matrix 2 of 5				
Matrix 2 of 5	618	F1h 6Ah	Disable	283
Matrix 2 of 5 Lengths	619 620	F1h 6Bh F1h 6Ch	4 to 55	283
Matrix 2 of 5 Check Digit	622	F1h 6Eh	Disable	285
Transmit Matrix 2 of 5 Check Digit	623	F1h 6Fh	Disable	285
Korean 3 of 5				
Korean 3 of 5	581	F1h 45h	Disable	286
Inverse 1D	586	F1h 4Ah	Regular	287

1. Parameter number decimal values are used for programming via RSM commands.

2. SSI number hex values are used for programming via SSI commands.

Standard Parameter Defaults

Table 37 Parameter Defaults (Continued)

Parameter	Parameter Number ¹	SSI Number ²	Default	Page #
GS1 DataBar				
GS1 DataBar Omnidirectional	338	F0h 52h	Enable	288
GS1 DataBar Limited	339	F0h 53h	Enable	288
GS1 DataBar Expanded	340	F0h 54h	Enable	289
Convert GS1 DataBar to UPC/EAN/JAN	397	F0h 8Dh	Disable	289
GS1 DataBar Security Level	1706	F8h 06h AAh	Level 1	290
GS1 DataBar Limited Margin Check	728	F1h D8h	Level 3	291
Symbology-Specific Security Features				
Redundancy Level	78	4Eh	1	293
Security Level	77	4Dh	1	295
1D Quiet Zone Level	1288	F8h 05h 08h	1	296
Intercharacter Gap Size	381	F0h 7Dh	Normal	297
Composite Codes				
Composite CC-C	341	F0h 55h	Disable	298
Composite CC-A/B	342	F0h 56h	Disable	298
Composite TLC-39	371	F0h 73h	Disable	299
Composite Inverse	1113	F8h 04h 59h	Regular	299
UPC Composite Mode	344	F0h 58h	UPC Never Linked	300
Composite Beep Mode	398	F0h 8Eh	Beep As Each Code Type is Decoded	301
GS1-128 Emulation Mode for UCC/EAN Composite Codes	427	F0h ABh	Disable	302
2D Symbologies				
PDF417	15	0Fh	Enable	303
MicroPDF417	227	E3h	Disable	303
Code 128 Emulation	123	7Bh	Disable	304
Data Matrix	292	F0h 24h	Enable	305
GS1 Data Matrix	1336	F8h 05h 38h	Disable	305
Data Matrix Inverse	588	F1h 4Ch	Inverse Autodetect	306

1. Parameter number decimal values are used for programming via RSM commands.

2. SSI number hex values are used for programming via SSI commands.

Table 37 Parameter Defaults (Continued)

Parameter	Parameter Number ¹	SSI Number ²	Default	Page #
Decode Data Matrix Mirror Images	537	F1h 19h	Auto	307
Maxicode	294	F0h 26h	Disable	308
QR Code	293	F0h 25h	Enable	309
GS1 QR	1343	F8h 05h 3Fh	Enable	309
MicroQR	573	F1h 3Dh	Enable	310
Linked QR Mode	1847	737h	Linked QR Only	311
Aztec	574	F1h 3Eh	Enable	312
Aztec Inverse	589	F1h 4Dh	Inverse Autodetect	313
Han Xin	1167	F8h 04h 8Fh	Disable	314
Han Xin Inverse	1168	F8h 04h 90h	Regular	315
Grid Matrix	1718	F8h 06h B6h	Disable	316
Grid Matrix Inverse	1719	F8h 06h B7h	Regular	317
Grid Matrix Mirror	1736	F8h 06h C8h	Regular Only	318
DotCode	1906	F8 07 72h	Disable	319
DotCode Inverse	1907	F8 07 73h	Inverse Autodetect	320
DotCode Mirrored	1908	F8 07 74h	Autodetect	321
DotCode Prioritize	1937	F8 07 91h	Enable	322
Macro PDF				
Flush Macro PDF Buffer	N/A	N/A	N/A	323
Abort Macro PDF Entry	N/A	N/A	N/A	323
Postal Codes				
US Postnet	89	59h	Disable	324
US Planet	90	5Ah	Disable	324
Transmit US Postal Check Digit	95	5Fh	Enable	325
UK Postal	91	5Bh	Disable	325
Transmit UK Postal Check Digit	96	60h	Enable	326
Japan Postal	290	F0h 22h	Disable	326
Australia Post	291	F0h 23h	Disable	327
Australia Post Format	718	F1h CEh	Autodiscriminate	328

1. Parameter number decimal values are used for programming via RSM commands.

2. SSI number hex values are used for programming via SSI commands.

Standard Parameter Defaults

Table 37 Parameter Defaults (Continued)

Parameter	Parameter Number ¹	SSI Number ²	Default	Page #
Netherlands KIX Code	326	F0h 46h	Disable	329
USPS 4CB/One Code/Intelligent Mail	592	F1h 50h	Disable	329
UPU FICS Postal	611	F1h 63h	Disable	330
Mailmark	1337	F8h 05h 39h	Disable	330

OCR Programming Parameters

OCR-A	680	F1h A8h	Disable	333
OCR-A Variant	684	F1h ACh	Full ASCII	334
OCR-B	681	F1h A9h	Disable	336
OCR-B Variant	685	F1h ADh	Full ASCII	337
MICR E13B	682	F1h AAh	Disable	341
US Currency	683	F1h ABh	Disable	342
OCR Orientation	687	F1h AFh	0°	342
OCR Lines	691	F1h B3h	1	344
OCR Minimum Characters	689	F1h B1h	3	344
OCR Maximum Characters	690	F1h B2h	100	345
OCR Subset	686	F1h AEh	Selected font variant	345
OCR Quiet Zone	695	F1h B7h	50	346
OCR Template	547	F1h 23h	99999999	347
OCR Check Digit Modulus	688	F1h B0h	1	356
OCR Check Digit Multiplier	700	F1h BCh	121212121212	357
OCR Check Digit Validation	694	F1h B6h	None	359
Inverse OCR	856	F2h 58h	Regular	364
OCR Redundancy	1770	F8h 06h EAh	Level 1	365

Intelligent Document Capture (IDC) Parameters

IDC Operating Mode	594	F1h 52h	Off	371
IDC Symbology	655	F1h 8Fh	001	372
IDC X Coordinate	596	F4h F1h 54h	-151	373
IDC Y Coordinate	597	F4h F1h 55h	-050	373
IDC Width	598	F1h 56h	0300	374

1. Parameter number decimal values are used for programming via RSM commands.

2. SSI number hex values are used for programming via SSI commands.

Table 37 Parameter Defaults (Continued)

Parameter	Parameter Number ¹	SSI Number ²	Default	Page #
IDC Height	599	F1h 57h	0050	374
IDC Aspect	595	F1h 53h	000	375
IDC File Format Selector	601	F1h 59h	JPEG	375
IDC Bits Per Pixel	602	F1h 5Ah	8 BPP	376
IDC JPEG Quality	603	F1h 5Bh	065	377
IDC Find Box Outline	727	F1h D7h	Disable	377
IDC Minimum Text Length	656	F1h 90h	00	378
IDC Maximum Text Length	657	F1h 91h	00	378
IDC Captured Image Brighten	654	F1h 8Eh	Enable	379
IDC Captured Image Sharpen	658	F1h 92h	Enable	380
IDC Border Type	829	F2h 3Dh	None	381
IDC Delay Time	830	F2h 3Eh	000	382
IDC Zoom Limit	651	F1h 8Bh	000	382
IDC Maximum Rotation	652	F1h 8Ch	00	383
DL Parsing Parameters				
Driver's License Parsing	N/A	N/A	No Driver's License Parsing	390
Parsing Driver's License Data Fields	N/A	N/A	N/A	391
Driver's License Parse Field Barcodes	N/A	N/A	N/A	392
AAMVA Parse Field Barcodes	N/A	N/A	N/A	395
Set Default Parameter	N/A	N/A	N/A	405
Output Gender as M or F	N/A	N/A	N/A	405
Date Format	N/A	N/A	CCYYMMDD	406
No Separator	N/A	N/A	N/A	408
Send Keystroke Control Characters Keyboard Characters	N/A	N/A	N/A	409
Parsing Rule Example	N/A	N/A	N/A	430
Embedded Driver's License Parsing ADF Example	N/A	N/A	N/A	434

1. Parameter number decimal values are used for programming via RSM commands.

2. SSI number hex values are used for programming via SSI commands.

Numeric Barcodes

Numeric Barcodes

For parameters requiring specific numeric values, scan the appropriately numbered barcode(s).



0



1

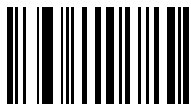

2



3

Numeric Barcodes (continued)



4



5



6

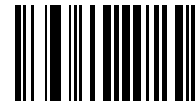

7



8



9

Cancel

To correct an error or change a selection, scan the barcode below.



Cancel

Alphanumeric Barcodes

Cancel

To correct an error or change a selection, scan the following barcode.



Cancel

Alphanumeric Barcodes



Space



#



\$



%



*



+

Alphanumeric Barcodes (continued)



-



.



/

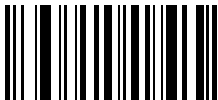

!



“



&

Alphanumeric Barcodes (continued)



€

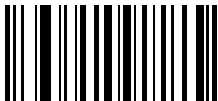

(



)



:



;



<

Alphanumeric Barcodes (continued)



=

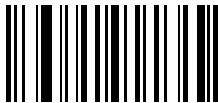

>



?



@



[



\

Alphanumeric Barcodes (continued)



J

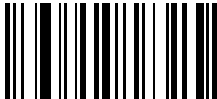

^

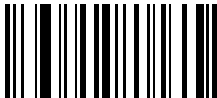

-



,

Alphanumeric Barcodes (continued)



NOTE: Do not confuse the following barcodes with those on the numeric keypad.



0



1



2



3



4



5

Alphanumeric Barcodes (continued)



6



7



8



9



End of Message



Cancel

Alphanumeric Barcodes (continued)



A



B



C



D



E



F

Alphanumeric Barcodes (continued)



G



H



I



J



K



L

Alphanumeric Barcodes (continued)



M



N



O



P

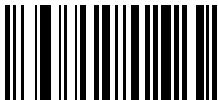

Q

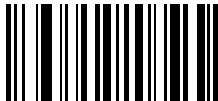

R

Alphanumeric Barcodes (continued)



S



T

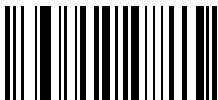

U

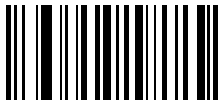

V

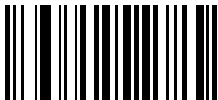

W



X

Alphanumeric Barcodes (continued)

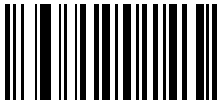

Y



Z

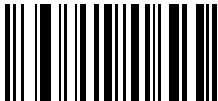

a



b



c



d

Alphanumeric Barcodes (continued)



e



f

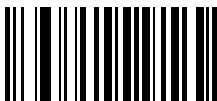

g



h



i



j

Alphanumeric Barcodes (continued)

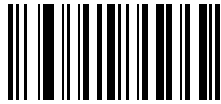

k

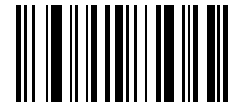

l

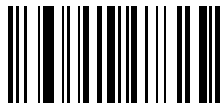

m



n

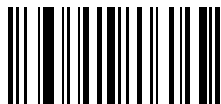

o

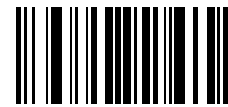

p

Alphanumeric Barcodes (continued)



q



r



s



t



u



v

Alphanumeric Barcodes (continued)



w

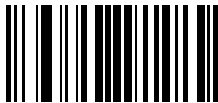

x



y

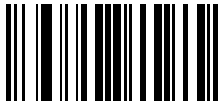

z



{



|

Alphanumeric Barcodes (continued)

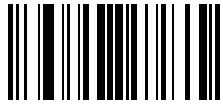

}

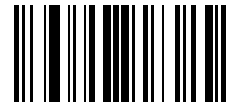

~

ASCII Character Sets



NOTE: For the Keyboard Wedge Interface, Code 39 Full ASCII interprets the barcode special character (\$ + % /) preceding a Code 39 character and assigns an ASCII character value to the pair. For example, if you enable Code 39 Full ASCII and scan **+B**, it transmits as **b**, **%J** as **?**, and **%V** as **@**. Scanning **ABC%I** outputs the keystroke equivalent of **ABC >**.

Table 38 ASCII Character Set

ASCII Value (Prefix/Suffix Value)	Full ASCII Code 39 Encode Char	Keystroke	ASCII Character (Applies to RS-232 Only)
1000	%U	CTRL 2	NUL
1001	\$A	CTRL A	SOH
1002	\$B	CTRL B	STX
1003	\$C	CTRL C	ETX
1004	\$D	CTRL D	EOT
1005	\$E	CTRL E	ENQ
1006	\$F	CTRL F	ACK
1007	\$G	CTRL G	BELL
1008	\$H	CTRL H/ BACKSPACE ¹	BCKSPC
1009	\$I	CTRL I/ HORIZONTAL TAB ¹	HORIZ TAB
1010	\$J	CTRL J	LF/NW LN
1011	\$K	CTRL K	VT
1012	\$L	CTRL L	FF
1013	\$M	CTRL M/ ENTER ¹	CR/ENTER
1014	\$N	CTRL N	SO

¹The keystroke in bold transmits only if you enabled Function Key Mapping on page 72 or page 136. Otherwise, the unbold keystroke transmits.

ASCII Character Sets

Table 38 ASCII Character Set (Continued)

ASCII Value (Prefix/Suffix Value)	Full ASCII Code 39 Encode Char	Keystroke	ASCII Character (Applies to RS-232 Only)
1015	\$O	CTRL O	SI
1016	\$P	CTRL P	DLE
1017	\$Q	CTRL Q	DC1/XON
1018	\$R	CTRL R	DC2
1019	\$S	CTRL S	DC3/XOFF
1020	\$T	CTRL T	DC4
1021	\$U	CTRL U	NAK
1022	\$V	CTRL V	SYN
1023	\$W	CTRL W	ETB
1024	\$X	CTRL X	CAN
1025	\$Y	CTRL Y	EM
1026	\$Z	CTRL Z	SUB
1027	%A	CTRL [ESC
1028	%B	CTRL \	FS
1029	%C	CTRL]	GS
1030	%D	CTRL 6	RS
1031	%E	CTRL -	US
1032	Space	Space	Space
1033	/A	!	!
1034	/B	"	"
1035	/C	#	#
1036	/D	\$	\$
1037	/E	%	%
1038	/F	&	&
1039	/G	'	'
1040	/H	((
1041	/I))
1042	/J	*	*
1043	/K	+	+

¹The keystroke in bold transmits only if you enabled Function Key Mapping on page 72 or page 136. Otherwise, the unbold keystroke transmits.

ASCII Character Sets

Table 38 ASCII Character Set (Continued)

ASCII Value (Prefix/Suffix Value)	Full ASCII Code 39 Encode Char	Keystroke	ASCII Character (Applies to RS-232 Only)
1044	/L	,	,
1045	-	-	-
1046	.	.	.
1047	/o	/	/
1048	0	0	0
1049	1	1	1
1050	2	2	2
1051	3	3	3
1052	4	4	4
1053	5	5	5
1054	6	6	6
1055	7	7	7
1056	8	8	8
1057	9	9	9
1058	/Z	:	:
1059	%F	;	;
1060	%G	<	<
1061	%H	=	=
1062	%I	>	>
1063	%J	?	?
1064	%V	@	@
1065	A	A	A
1066	B	B	B
1067	C	C	C
1068	D	D	D
1069	E	E	E
1070	F	F	F
1071	G	G	G
1072	H	H	H

¹The keystroke in bold transmits only if you enabled Function Key Mapping on page 72 or page 136. Otherwise, the unbold keystroke transmits.

ASCII Character Sets

Table 38 ASCII Character Set (Continued)

ASCII Value (Prefix/Suffix Value)	Full ASCII Code 39 Encode Char	Keystroke	ASCII Character (Applies to RS-232 Only)
1073	I	I	I
1074	J	J	J
1075	K	K	K
1076	L	L	L
1077	M	M	M
1078	N	N	N
1079	O	O	O
1080	P	P	P
1081	Q	Q	Q
1082	R	R	R
1083	S	S	S
1084	T	T	T
1085	U	U	U
1086	V	V	V
1087	W	W	W
1088	X	X	X
1089	Y	Y	Y
1090	Z	Z	Z
1091	%K	[[
1092	%L	\	\
1093	%M]]
1094	%N	^	^
1095	%O	_	_
1096	%W	`	`
1097	+A	a	a
1098	+B	b	b
1099	+C	c	c
1100	+D	d	d
1101	+E	e	e

¹The keystroke in bold transmits only if you enabled Function Key Mapping on page 72 or page 136. Otherwise, the unbold keystroke transmits.

ASCII Character Sets

Table 38 ASCII Character Set (Continued)

ASCII Value (Prefix/Suffix Value)	Full ASCII Code 39 Encode Char	Keystroke	ASCII Character (Applies to RS-232 Only)
1102	+F	f	f
1103	+G	g	g
1104	+H	h	h
1105	+I	i	i
1106	+J	j	j
1107	+K	k	k
1108	+L	l	l
1109	+M	m	m
1110	+N	n	n
1111	+O	o	o
1112	+P	p	p
1113	+Q	q	q
1114	+R	r	r
1115	+S	s	s
1116	+T	t	t
1117	+U	u	u
1118	+V	v	v
1119	+W	w	w
1120	+X	x	x
1121	+Y	y	y
1122	+Z	z	z
1123	%P	{	{
1124	%Q	 	
1125	%R	}	}
1126	%S	~	~
1127			Undefined
7013			ENTER

¹The keystroke in bold transmits only if you enabled Function Key Mapping on page 72 or page 136. Otherwise, the unbold keystroke transmits.

Table 39 ALT Key Character Set

ALT Keys	Keystroke
2045	ALT -
2050	ALT 2
2054	ALT 6
2064	ALT @
2065	ALT A
2066	ALT B
2067	ALT C
2068	ALT D
2069	ALT E
2070	ALT F
2071	ALT G
2072	ALT H
2073	ALT I
2074	ALT J
2075	ALT K
2076	ALT L
2077	ALT M
2078	ALT N
2079	ALT O
2080	ALT P
2081	ALT Q
2082	ALT R
2083	ALT S
2084	ALT T
2085	ALT U
2086	ALT V
2087	ALT W
2088	ALT X
2089	ALT Y
2090	ALT Z

Table 39 ALT Key Character Set (Continued)

ALT Keys	Keystroke
2091	ALT [
2092	ALT \
2093	ALT]

Table 40 GUI Key Character Set

GUI Key	Keystroke
3000	Right Control Key
3048	GUI 0
3049	GUI 1
3050	GUI 2
3051	GUI 3
3052	GUI 4
3053	GUI 5
3054	GUI 6
3055	GUI 7
3056	GUI 8
3057	GUI 9
3065	GUI A
3066	GUI B
3067	GUI C
3068	GUI D
3069	GUI E
3070	GUI F
3071	GUI G
3072	GUI H
3073	GUI I
3074	GUI J
3075	GUI K
3076	GUI L

Note: GUI Shift Keys - The Apple™ iMac keyboard has an apple key on either side of the space bar. Windows-based systems have a GUI key to the left of the left ALT key, and to the right of the right ALT key.

Table 40 GUI Key Character Set (Continued)

GUI Key	Keystroke
3077	GUI M
3078	GUI N
3079	GUI O
3080	GUI P
3081	GUI Q
3082	GUI R
3083	GUI S
3084	GUI T
3085	GUI U
3086	GUI V
3087	GUI W
3088	GUI X
3089	GUI Y
3090	GUI Z

Note: GUI Shift Keys - The Apple™ iMac keyboard has an apple key on either side of the space bar. Windows-based systems have a GUI key to the left of the left ALT key, and to the right of the right ALT key.

Table 41 PF Key Character Set

PF Keys	Keystroke
4001	PF 1
4002	PF 2
4003	PF 3
4004	PF 4
4005	PF 5
4006	PF 6
4007	PF 7
4008	PF 8
4009	PF 9
4010	PF 10
4011	PF 11
4012	PF 12

Table 41 PF Key Character Set (Continued)

PF Keys	Keystroke
4013	PF 13
4014	PF 14
4015	PF 15
4016	PF 16

Table 42 F Key Character Set

F Keys	Keystroke
5001	F 1
5002	F 2
5003	F 3
5004	F 4
5005	F 5
5006	F 6
5007	F 7
5008	F 8
5009	F 9
5010	F 10
5011	F 11
5012	F 12
5013	F 13
5014	F 14
5015	F 15
5016	F 16
5017	F 17
5018	F 18
5019	F 19
5020	F 20
5021	F 21
5022	F 22
5023	F 23
5024	F 24

Table 43 Numeric Key Character Set

Numeric Keypad	Keystroke
6042	*
6043	+
6044	Undefined
6045	-
6046	.
6047	/
6048	0
6049	1
6050	2
6051	3
6052	4
6053	5
6054	6
6055	7
6056	8
6057	9
6058	Enter
6059	Num Lock

Table 44 Extended Key Character Set

Extended Keypad	Keystroke
7001	Break
7002	Delete
7003	Pg Up
7004	End
7005	Pg Dn
7006	Pause
7007	Scroll Lock
7008	Backspace
7009	Tab

Table 44 Extended Key Character Set (Continued)

Extended Keypad	Keystroke
7010	Print Screen
7011	Insert
7012	Home
7013	Enter
7014	Escape
7015	Up Arrow
7016	Dn Arrow
7017	Left Arrow
7018	Right Arrow

Programming Reference

Symbol Code Identifiers

Table 45 Symbol Code Characters

Code Character	Code Type
A	UPC-A, UPC-E, UPC-E1, EAN-8, EAN-13
B	Code 39, Code 32
C	Codabar
D	Code 128, ISBT 128, ISBT 128 Concatenated
E	Code 93
F	Interleaved 2 of 5
G	Discrete 2 of 5, or Discrete 2 of 5 IATA
H	Code 11
J	MSI
K	GS1-128
L	Bookland EAN
M	Trioptic Code 39
N	Coupon Code
R	GS1 DataBar Family
S	Matrix 2 of 5
T	UCC Composite, TLC 39
U	Chinese 2 of 5
V	Korean 3 of 5
X	ISSN EAN, PDF417, Macro PDF417, Micro PDF417
z	Aztec, Aztec Rune

Table 45 Symbol Code Characters (Continued)

Code Character	Code Type
P00	Data Matrix
P01	QR Code, MicroQR
P02	Maxicode
P03	US Postnet
P04	US Planet
P05	Japan Postal
P06	UK Postal
P08	Netherlands KIX Code
P09	Australia Post
P0A	USPS 4CB/One Code/Intelligent Mail
P0B	UPU FICS Postal
P0C	Mailmark
P0D	Grid Matrix
P0G	GS1 Data Matrix
P0H	Han Xin
P0Q	GS1 QR
P0X	Signature Capture

AIM Code Identifiers

Each AIM Code Identifier contains the three-character string **Jcm** where:

- J = Flag Character (ASCII 93)
- c = Code Character (see [Table 46](#))
- m = Modifier Character (see [Table 47](#))

Table 46 Aim Code Characters

Code Character	Code Type
A	Code 39, Code 39 Full ASCII, Code 32
C	Code 128, ISBT 128, ISBT 128 Concatenated, GS1-128, Coupon (Code 128 portion)
d	Data Matrix, GS1 Data Matrix
E	UPC/EAN, Coupon (UPC portion)
e	GS1 DataBar Family
F	Codabar
G	Code 93
g	Grid Matrix
H	Code 11
h	Han Xin
I	Interleaved 2 of 5
L	PDF417, Macro PDF417, Micro PDF417
L2	TLC 39
M	MSI
Q	QR Code, MicroQR, GS1 QR
S	Discrete 2 of 5, IATA 2 of 5
U	Maxicode
z	Aztec, Aztec Rune
X	Bookland EAN, ISSN EAN, Trioptic Code 39, Chinese 2 of 5, Matrix 2 of 5, Korean 3 of 5, US Postnet, US Planet, UK Postal, Japan Postal, Australia Post, Netherlands KIX Code, USPS 4CB/One Code/ Intelligent Mail, UPU FICS Postal, Mailmark, Signature Capture

The modifier character is the sum of the applicable option values based on [Table 47](#).

Table 47 Modifier Characters

Code Type	Option Value	Option
Code 39	0	No check character or Full ASCII processing.
	1	Reader has checked one check character.
	3	Reader has checked and stripped check character.
	4	Reader has performed Full ASCII character conversion.
	5	Reader has performed Full ASCII character conversion and checked one check character.
	7	Reader has performed Full ASCII character conversion and checked and stripped check character.
	Example: A Full ASCII barcode with check character W, A+I+MI+DW , is transmitted as JA7AIMID where 7 = (3+4).	
Trioptic Code 39	0	No option specified at this time. Always transmit 0.
	Example: A Trioptic barcode 412356 is transmitted as JX0412356	
Code 128	0	Standard data packet, no Function code 1 in first symbol position.
	1	Function code 1 in first symbol character position.
	2	Function code 1 in second symbol character position.
	Example: A Code (EAN) 128 barcode with Function 1 character ^{FNC1} in the first position, AIMID is transmitted as JC1AIMID	
I 2 of 5	0	No check digit processing.
	1	Reader has validated check digit.
	3	Reader has validated and stripped check digit.
	Example: An I 2 of 5 barcode without check digit, 4123, is transmitted as J104123	
Codabar	0	No check digit processing.
	1	Reader has checked check digit.
	3	Reader has stripped check digit before transmission.
	Example: A Codabar barcode without check digit, 4123, is transmitted as JF04123	
Code 93	0	No options specified at this time. Always transmit 0.
	Example: A Code 93 barcode 012345678905 is transmitted as JG0012345678905	
MSI	0	Check digits are sent.
	1	No check digit is sent.
	Example: An MSI barcode 4123, with a single check digit checked, is transmitted as JM14123	

Table 47 Modifier Characters (Continued)

Code Type	Option Value	Option
D 2 of 5	0	No options specified at this time. Always transmit 0.
	Example: A D 2 of 5 barcode 4123, is transmitted as JS0 4123	
UPC/EAN	0	Standard data packet in full EAN format, i.e., 13 digits for UPC-A, UPC-E, and EAN-13 (not including supplemental data).
	1	Two digit supplemental data only.
	2	Five digit supplemental data only.
	3	Combined data packet comprising 13 digits from EAN-13, UPC-A or UPC-E symbol and 2 or 5 digits from supplemental symbol.
	4	EAN-8 data packet.
	Example: A UPC-A barcode 012345678905 is transmitted as JE00 12345678905	
Bookland EAN	0	No options specified at this time. Always transmit 0.
	Example: A Bookland EAN barcode 123456789X is transmitted as JX0 123456789X	
ISSN EAN	0	No options specified at this time. Always transmit 0.
	Example: An ISSN EAN barcode 123456789X is transmitted as JX0 123456789X	
Code 11	0	Single check digit
	1	Two check digits
	3	Check characters validated but not transmitted.
GS1 DataBar Family		No option specified at this time. Always transmit 0. GS1 DataBar Omnidirectional and GS1 DataBar Limited transmit with an Application Identifier "01". Note: In GS1-128 emulation mode, GS1 DataBar is transmitted using Code 128 rules (i.e., JC1).
	Example: A GS1 DataBar Omnidirectional barcode 0110012345678902 is transmitted as Je00 110012345678902.	

Table 47 Modifier Characters (Continued)

Code Type	Option Value	Option
EAN.UCC Composites (GS1 DataBar, GS1-128, 2D portion of UPC composite)		Native mode transmission. Note: UPC portion of composite is transmitted using UPC rules.
	0	Standard data packet.
	1	Data packet containing the data following an encoded symbol separator character.
	2	Data packet containing the data following an escape mechanism character. The data packet does not support the ECI protocol.
	3	Data packet containing the data following an escape mechanism character. The data packet supports the ECI protocol.
		GS1-128 emulation Note: UPC portion of composite is transmitted using UPC rules.
	1	Data packet is a GS1-128 symbol (i.e., data is preceded with JJC1).
PDF417, Micro PDF417	0	Reader set to conform to protocol defined in 1994 PDF417 symbology specifications. Note: When this option is transmitted, the receiver cannot reliably determine whether ECIs have been invoked or whether data byte 92 _{DEC} has been doubled in transmission.
	1	Reader set to follow the ECI protocol (Extended Channel Interpretation). All data characters 92 _{DEC} are doubled.
	2	Reader set for Basic Channel operation (no escape character transmission protocol). Data characters 92 _{DEC} are not doubled. Note: When decoders are set to this mode, unbuffered Macro symbols and symbols requiring the decoder to convey ECI escape sequences cannot be transmitted.
	3	The barcode contains a GS1-128 symbol, and the first codeword is 903-907, 912, 914, 915.
	4	The barcode contains a GS1-128 symbol, and the first codeword is in the range 908-909.
	5	The barcode contains a GS1-128 symbol, and the first codeword is in the range 910-911.
Example: A PDF417 barcode ABCD, with no transmission protocol enabled, is transmitted as JL2ABCD.		

Table 47 Modifier Characters (Continued)

Code Type	Option Value	Option
Data Matrix	0	ECC 000-140, not supported.
	1	ECC 200.
	2	ECC 200, FNC1 in first or fifth position.
	3	ECC 200, FNC1 in second or sixth position.
	4	ECC 200, ECI protocol implemented.
	5	ECC 200, FNC1 in first or fifth position, ECI protocol implemented.
	6	ECC 200, FNC1 in second or sixth position, ECI protocol implemented.
GS1 Data Matrix	2	ECC 200, FNC1 in first or fifth position.
MaxiCode	0	Symbol in Mode 4 or 5.
	1	Symbol in Mode 2 or 3.
	2	Symbol in Mode 4 or 5, ECI protocol implemented.
	3	Symbol in Mode 2 or 3, ECI protocol implemented in secondary message.
QR Code	0	Model 1 symbol.
	1	Model 2 / MicroQR symbol, ECI protocol not implemented.
	2	Model 2 symbol, ECI protocol implemented.
	3	Model 2 symbol, ECI protocol not implemented, FNC1 implied in first position.
	4	Model 2 symbol, ECI protocol implemented, FNC1 implied in first position.
	5	Model 2 symbol, ECI protocol not implemented, FNC1 implied in second position.
	6	Model 2 symbol, ECI protocol implemented, FNC1 implied in second position.
GS1 QR	3	Model 2 symbol, ECI protocol not implemented, FNC1 implied in first position.
Aztec	0	Aztec symbol.
	C	Aztec Rune symbol.
Han Xin	0	Generic data, no special features are set. The transmitted data does not follow the AIM ECI protocol.
	1	ECI protocol enabled. There is at least one ECI mode encoded. Transmitted data must follow the AIM ECI protocol.
Mailmark	0	No option specified at this time. Always transmit 0.

Communication Protocol Functionality

Functionality Supported via Communication (Cable) Interface

Table 48 lists supported scanner functionality by communication protocol.

Table 48 Communication Interface Functionality

Communication Interfaces	Functionality		
	Data Transmission	Remote Management	Image and Video Transmission
USB			
HID Keyboard Emulation	Supported	Not Available	Not Available
Simple COM Port Emulation	Supported	Not Available	Not Available
CDC COM Port Emulation	Supported	Not Available	Not Available
SSI over CDC COM Port Emulation	Supported	Supported	Supported
IBM Table-top USB	Supported	Supported	Not Available
IBM Hand-held USB	Supported	Supported	Not Available
USB OPOS Hand-held	Supported	Supported	Not Available
Symbol Native API (SNAPI) without Imaging Interface	Supported	Supported	Not Available
Symbol Native API (SNAPI) with Imaging Interface	Supported	Supported	Supported
RS-232			
Standard RS-232	Supported	Not Available	Not Available
ICL RS-232	Supported	Not Available	Not Available
Fujitsu RS-232	Supported	Not Available	Not Available
Wincor-Nixdorf RS-232 Mode A	Supported	Not Available	Not Available
Wincor-Nixdorf RS-232 Mode B	Supported	Not Available	Not Available
Olivetti ORS4500	Supported	Not Available	Not Available

Table 48 Communication Interface Functionality (Continued)

Communication Interfaces	Functionality		
	Data Transmission	Remote Management	Image and Video Transmission
Omron	Supported	Not Available	Not Available
CUTE	Supported	Not Available	Not Available
OPOS/JPOS	Supported	Not Available	Not Available
SSI	Supported	Supported	Supported
IBM 4690			
Hand-held Scanner Emulation (Port 9B)	Supported	Not Available	Not Available
Table-top Scanner Emulation (Port 17)	Supported	Supported	Not Available
Non-IBM Scanner Emulation (Port 5B)	Supported	Supported	Not Available
Keyboard Wedge			
IBM PC/AT & IBM PC Compatibles	Supported	Not Available	Not Available
IBM AT Notebook	Supported	Not Available	Not Available

Country Codes

Introduction

This chapter provides instructions for programming the keyboard to interface with a USB or keyboard wedge host. The host powers the scanner. For host setup information, see [USB Interface](#) and [Keyboard Wedge Interface](#).

To select a code page for the country keyboard type, see [Country Code Pages](#).

Throughout the programming barcode menus, default values are indicated with asterisks (*).

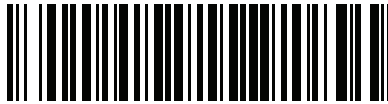

* Indicates default *Enable Parameter Feature/option

USB and Keyboard Wedge Country Keyboard Types (Country Codes)

Scan the barcode corresponding to the keyboard type. For a USB host, this setting applies only to the USB Keyboard (HID) device. If the keyboard type is not listed, see [Keypad Emulation on page 70](#) for the USB HID host. For a keyboard wedge host, see [Alternate Numeric Keypad Emulation on page 133](#).



- NOTES**
- 1When changing USB country keyboard types the scanner automatically resets and issues the standard startup beep sequences.
 2. For best results when using international keyboards, enable [Quick Keypad Emulation on page 70](#).



IMPORTANT: Some country keyboard barcode types are specific to certain Windows operating systems (i.e., XP and Windows 7 or higher). Barcodes requiring a specific Windows OS are noted in the barcode captions.

Use the **French International** barcode for Belgian French keyboards.

Country Code Barcodes



***US English (North American)**

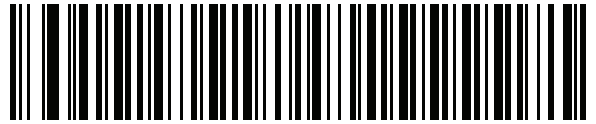

US English (Mac)



Albanian

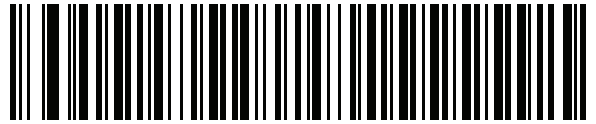

Arabic (101)

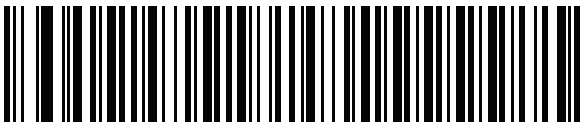

Arabic (102)

Country Code Barcodes (continued)

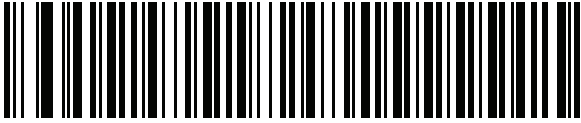

Arabic (102) AZERTY

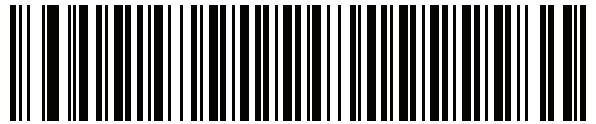

Azeri (Latin)

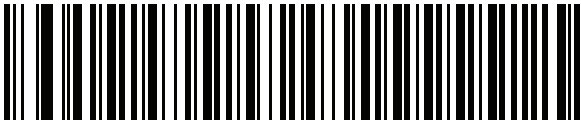

Azeri (Cyrillic)

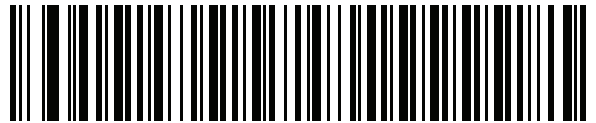

Belarusian



Bosnian (Latin)



Bosnian (Cyrillic)

Country Code Barcodes (continued)

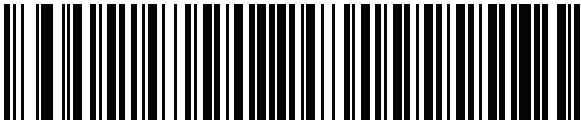

Bulgarian (Latin)

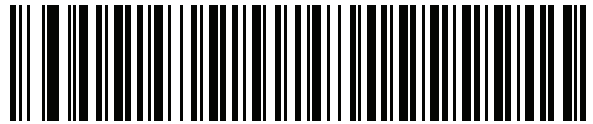

**Bulgarian Cyrillic (Typewriter)
(Bulgarian -Windows XP
Typewriter - Windows 7 or higher)**

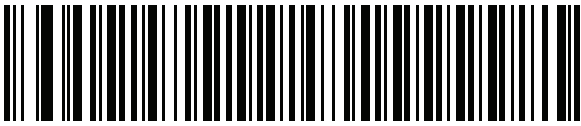

Canadian French Win7

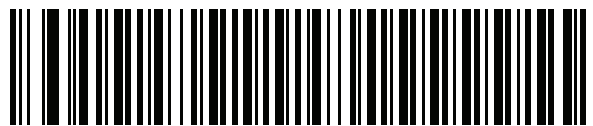

Canadian French (Legacy)

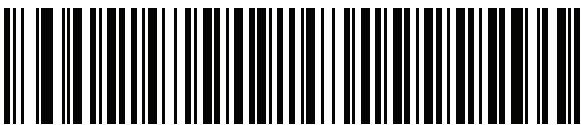

Canadian Multilingual Standard

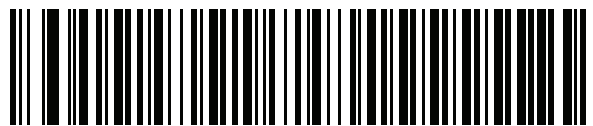

Chinese (ASCII)

Country Code Barcodes (continued)

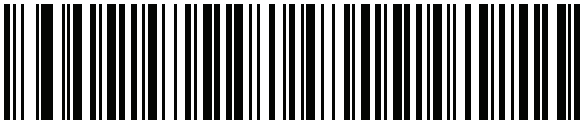

Chinese (Simplified)*

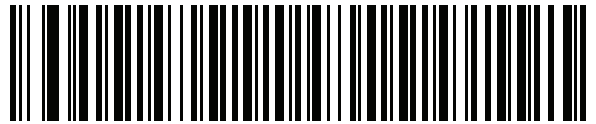

Chinese (Traditional)*

*For CJK keyboard types, see [CJK Decode Control](#).



Croatian

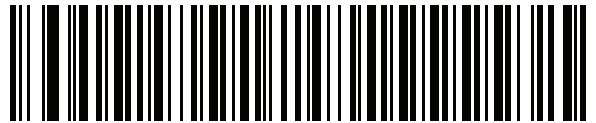

Czech



Czech (Programmer)



Czech (QWERTY)

Country Code Barcodes (continued)

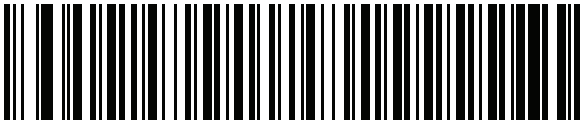

Danish

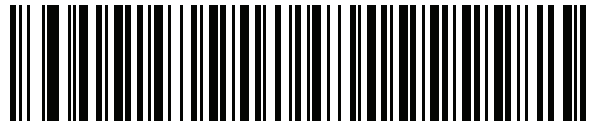

Dutch (Netherlands)

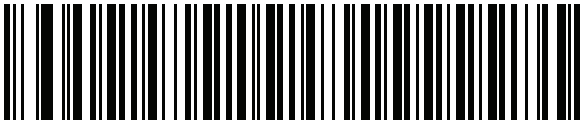

Estonian

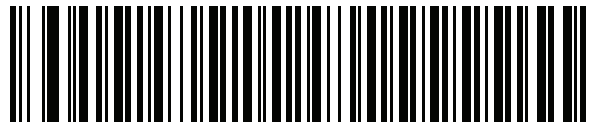

Faeroese



Finnish



French (France)

Country Code Barcodes (continued)

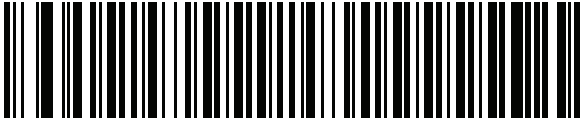

**French International
(Belgian French)**

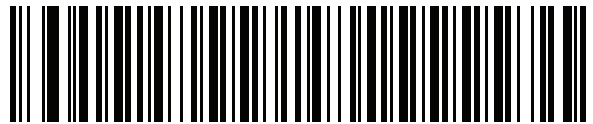

French (Canada) 95/98

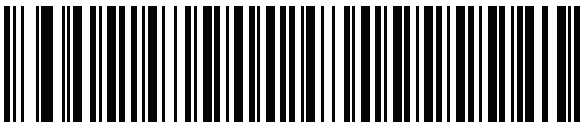

French (Canada) 2000/XP*

*There is also a country code barcode for [Canadian Multilingual Standard on page 494](#). Be sure to select the appropriate barcode for your host system.

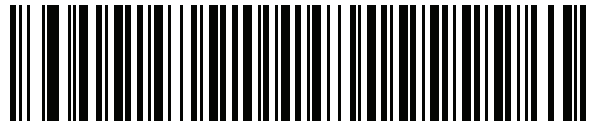

Galician

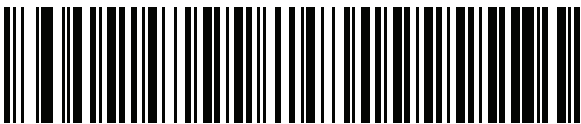

German



Greek Latin

Country Code Barcodes (continued)

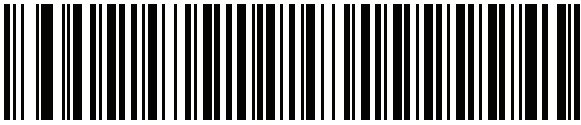

Greek (220) Latin

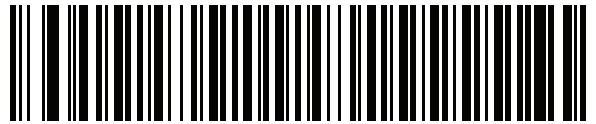

Greek (319) Latin

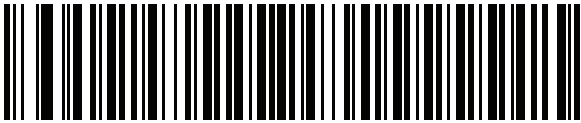

Greek

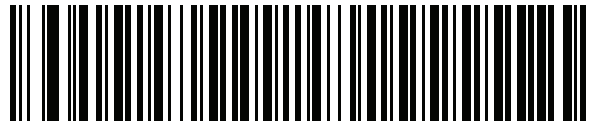

Greek (220)



Greek (319)



Greek Polytonic

Country Code Barcodes (continued)

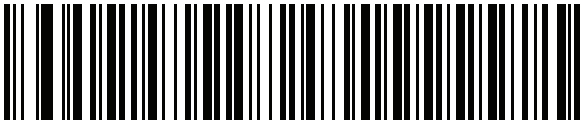

Hebrew Israel

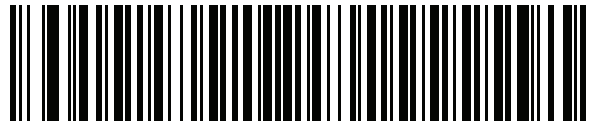

Hungarian

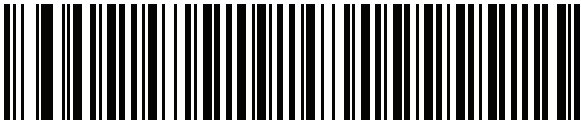

Hungarian_101KEY

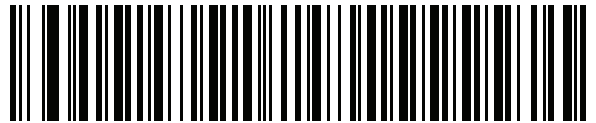

Icelandic



Irish



Italian

Country Code Barcodes (continued)

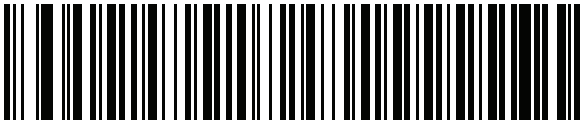

Italian (142)

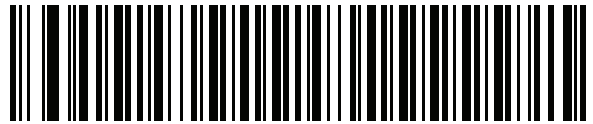

Japanese (ASCII)

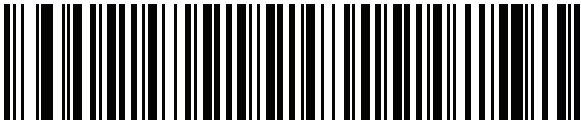

Japanese (SHIFT-JIS)*

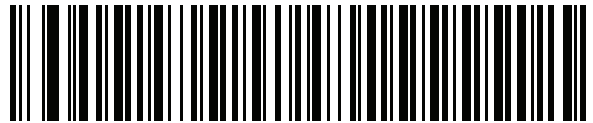

Kazakh



Korean (ASCII)



Korean (Hangul)*

*For CJK keyboard types, see [CJK Decode Control](#).

Country Code Barcodes (continued)

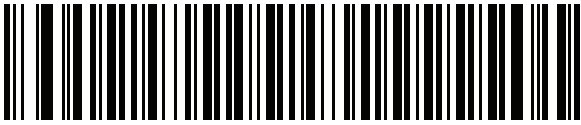

Kyrgyz

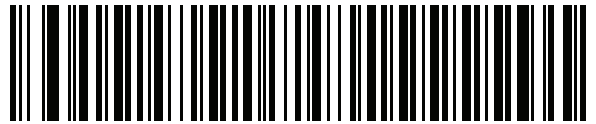

Latin American

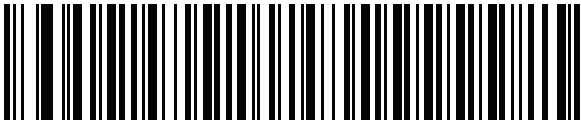

Latvian

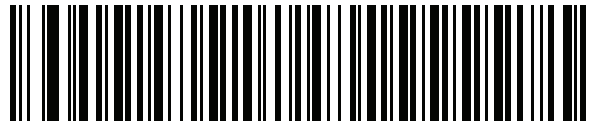

Latvian (QWERTY)



Lithuanian

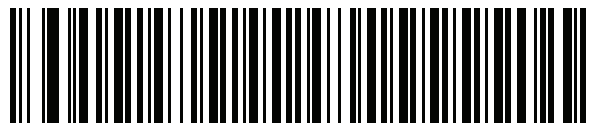

Lithuanian (IBM)

Country Code Barcodes (continued)

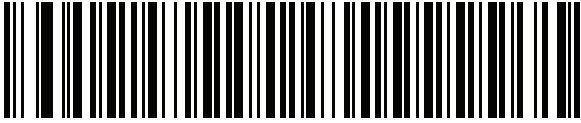

Macedonian (FYROM)

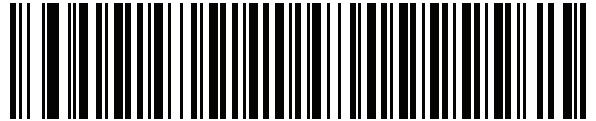

Maltese_47KEY

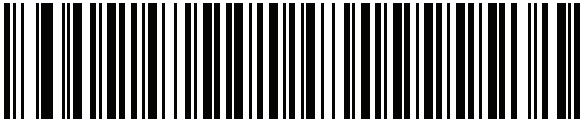

Mongolian

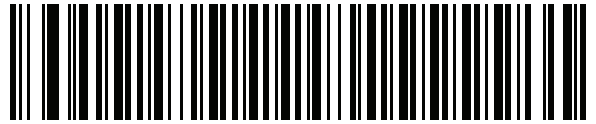

Norwegian

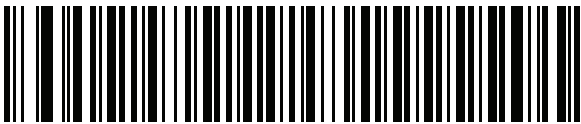

Polish (214)

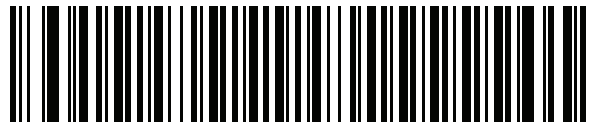

Polish (Programmer)

Country Code Barcodes (continued)

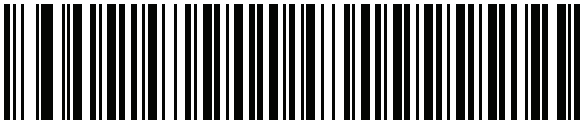

**Portuguese (Brazil)
(Windows XP)**

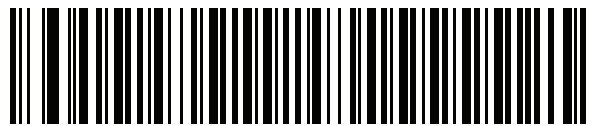

Portuguese (Brazilian ABNT)

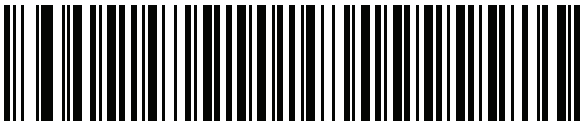

Portuguese (Brazilian ABNT2)

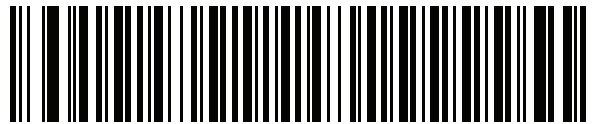

Portuguese (Portugal)

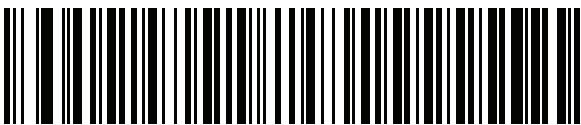

**Romanian
(Windows XP)**



**Romanian (Legacy)
(Windows 7 or higher)**

Country Code Barcodes (continued)

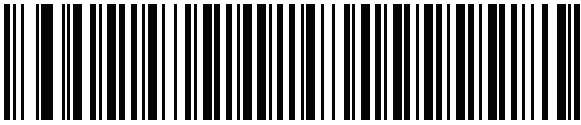

**Romanian (Standard)
(Windows 7 or higher)**

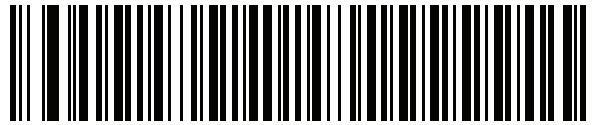

**Romanian (Programmer)
(Windows 7 or higher)**

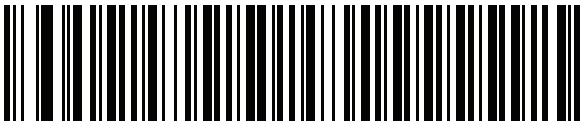

Russian

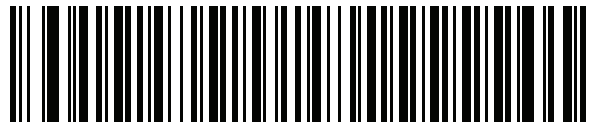

Russian (Typewriter)

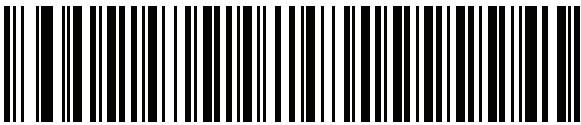

Serbian (Latin)

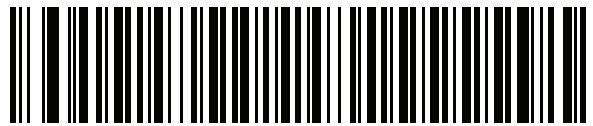

Serbian (Cyrillic)

Country Code Barcodes (continued)

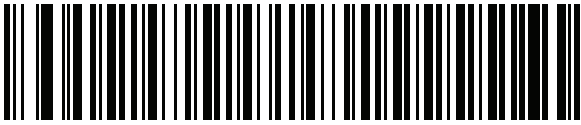

Slovak

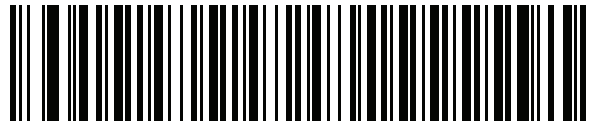

Slovak (QWERTY)

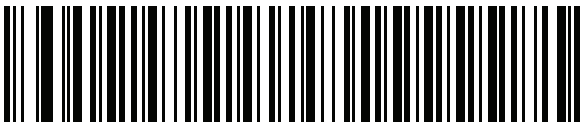

Slovenian

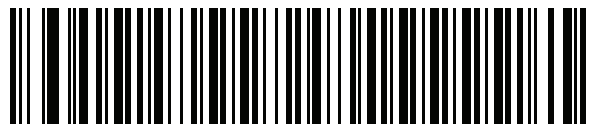

Spanish



Spanish (Variation)



Swedish

Country Code Barcodes (continued)

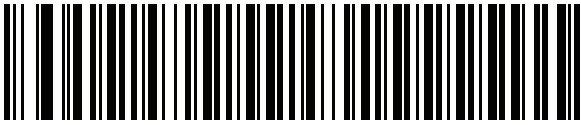

Swiss French

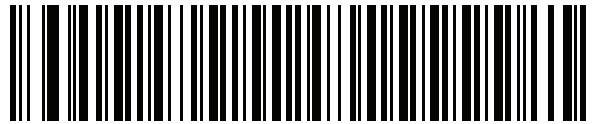

Swiss German

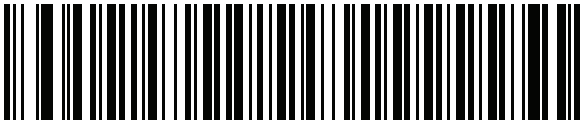

Tatar

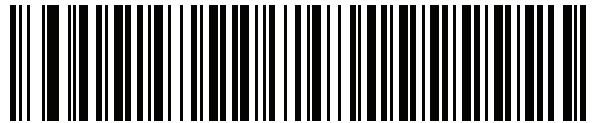

Thai (Kedmanee)



Turkish F



Turkish Q

Country Code Barcodes (continued)

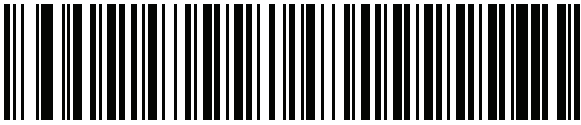

UK English

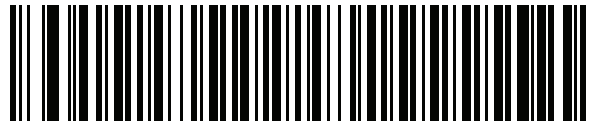

Ukrainian

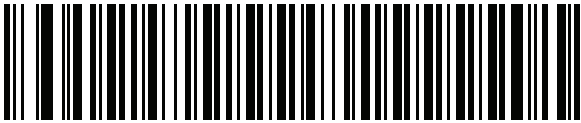

US Dvorak

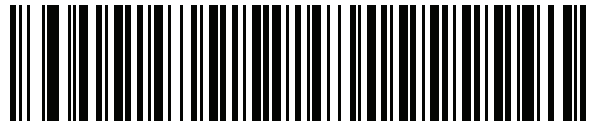

US Dvorak Left



US Dvorak Right



US International

Country Code Barcodes (continued)

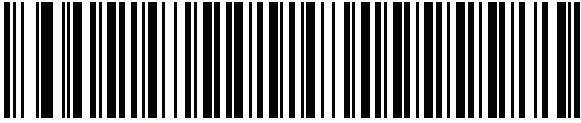

Uzbek

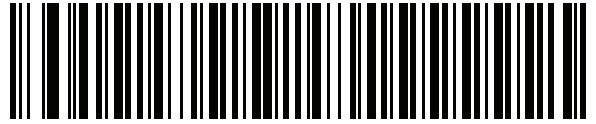

Vietnamese

Country Code Pages

Introduction

This chapter provides barcodes for selecting code pages for the country keyboard type selected in [Country Codes](#). If the default code page in [Table 49](#) is appropriate for your selected country keyboard type, you do not need to scan a country code page barcode.



NOTE: ADF rules can also specify a code page based on the symbology and other ADF criteria. Refer to the [Advanced Data Formatting Programmer Guide](#).

Country Code Page Defaults

[Table 49](#) lists the code page default for each country keyboard.

Table 49 Country Code Page Defaults

Country Keyboard	Code Page Default
US English (North American)	Windows 1252
US English (Mac)	Mac CP10000
Albanian	Windows 1250
Arabic 101	Windows 1256
Arabic 102	Windows 1256
Arabic 102 AZERTY	Windows 1256
Azeri Latin	Windows 1254
Azeri Cyrillic	Windows 1251
Belarusian	Windows 1251
Bosnian Latin	Windows 1250
Bosnian Cyrillic	Windows 1251
Bulgarian Latin	Windows 1250
Bulgarian Cyrillic	Windows 1251

Table 49 Country Code Page Defaults (Continued)

Country Keyboard	Code Page Default
Canadian French Win7	Windows 1252
Canadian French (Legacy)	Windows 1252
Canadian Multilingual	Windows 1252
Croatian	Windows 1250
Chinese ASCII	Windows 1252
Chinese (Simplified)	Windows 936, GBK
Chinese (Traditional)	Windows 950, Big5
Czech	Windows 1250
Czech Programmers	Windows 1250
Czech QWERTY	Windows 1250
Danish	Windows 1252
Dutch Netherland	Windows 1252
Estonian	Windows 1257
Faeroese	Windows 1252
Finnish	Windows 1252
French (France)	Windows 1252
French (Canada) 95/98	Windows 1252
French (Canada) 2000/XP	Windows 1252
French International (Belgian French)	Windows 1252
Galician	Windows 1252
German	Windows 1252
Greek Latin	Windows 1252
Greek220 Latin	Windows 1253
Greek319 Latin	Windows 1252
Greek	Windows 1253
Greek220	Windows 1253
Greek319	Windows 1253
Greek Polytonic	Windows 1253
Hebrew Israel	Windows 1255
Hungarian	Windows 1250
Hungarian_101KEY	Windows 1250

Table 49 Country Code Page Defaults (Continued)





Country Keyboard	Code Page Default
Icelandic	Windows 1252
Irish	Windows 1252
Italian	Windows 1252
Italian_142	Windows 1252
Japanese ASCII	Windows 1252
Japanese (Shift-JIS)	Windows 932, Shift-JIS
Kazakh	Windows 1251
Korean ASCII	Windows 1252
Korean (Hangul)	Windows 949, Hangul
Kyrgyz Cyrillic	Windows 1251
Latin America	Windows 1252
Latvian	Windows 1257
Latvian QWERTY	Windows 1257
Lithuanian	Windows 1257
Lithuanian IBM	Windows 1257
Macedonian -FYROM	Windows 1251
Maltese_47KEY	Windows 1252
Mongolian-Cyrillic	Windows 1251
Norwegian	Windows 1252
Polish_214	Windows 1250
Polish Programmer	Windows 1250
Portuguese Brazil	Windows 1252
Portuguese Brazilian ABNT	Windows 1252
Portuguese Brazilian ABNT2	Windows 1252
Portuguese Portugal	Windows 1252
Romanian	Windows 1250
Romanian Legacy	Windows 1250
Romanian Standard	Windows 1250
Romanian Programmer	Windows 1250
Russian	Windows 1251
Russian Typewriter	Windows 1251

Table 49 Country Code Page Defaults (Continued)

Country Keyboard	Code Page Default
Serbian Latin	Windows 1250
Serbian Cyrillic	Windows 1251
Slovak	Windows 1250
Slovak QWERTY	Windows 1250
Slovenian	Windows 1250
Spanish	Windows 1252
Spanish Variation	Windows 1252
Swedish	Windows 1252
Swiss French	Windows 1252
Swiss German	Windows 1252
Tatar	Windows 1251
Thai-Kedmanee	Windows 874
Turkish F	Windows 1254
Turkish Q	Windows 1254
Ukrainian	Windows 1251
United Kingdom	Windows 1252
United States	Windows 1252
US Dvorak	Windows 1252
US Dvorak Left Hand	Windows 1252
US Dvorak Right Hand	Windows 1252
US International	Windows 1252
Uzbek Cyrillic	Windows 1251
Vietnamese	Windows 1258

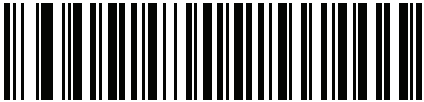
Country Code Page Barcodes

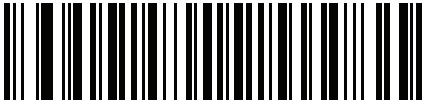
Scan the barcode corresponding to the country keyboard code page.

 <p>Windows 1250 Latin 2, Central European</p>	
	 <p>Windows 1251 Cyrillic, Slavic</p>
 <p>Windows 1252 Latin 1, Western European</p>	
	 <p>Windows 1253 Greek</p>
 <p>Windows 1254 Latin 5, Turkish</p>	



Windows 1250
Latin 2, Central European



Windows 1251
Cyrillic, Slavic

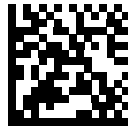

Windows 1252
Latin 1, Western European



Windows 1253
Greek



Windows 1254
Latin 5, Turkish

Country Code Page Barcodes (continued)

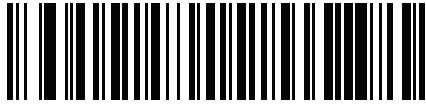

**Windows 1255
Hebrew**

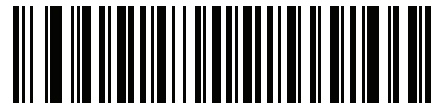

**Windows 1256
Arabic**



**Windows 1257
Baltic**



**Windows 1258
Vietnamese**

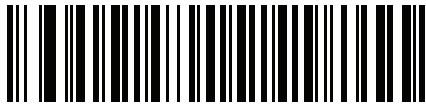

**Windows 874
Thai**

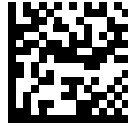

Windows 1255
Hebrew



Windows 1256
Arabic

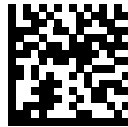

Windows 1257
Baltic



Windows 1258
Vietnamese



Windows 874
Thai

Country Code Page Barcodes (continued)



**Windows 20866
Cyrillic KOI8-R**

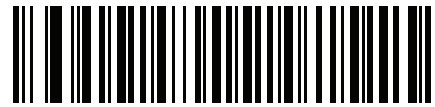

**Windows 932
Japanese Shift-JIS**



**Windows 936
Simplified Chinese GBK**

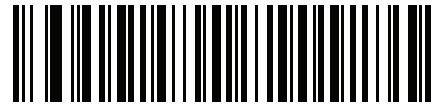

**Windows 54936
Simplified Chinese GB18030**

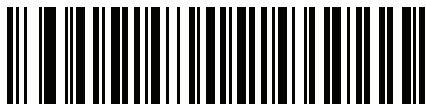

**Windows 949
Korean Hangul**



**Windows 20866
Cyrillic KOI8-R**



**Windows 932
Japanese Shift-JIS**

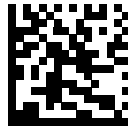

**Windows 936
Simplified Chinese GBK**



**Windows 54936
Simplified Chinese GB18030**



**Windows 949
Korean Hangul**

Country Code Page Barcodes (continued)

 <p>Windows 950 Traditional Chinese Big5</p>	
	 <p>MS-DOS 437 Latin US</p>
 <p>MS-DOS 737 Greek</p>	
	 <p>MS-DOS 775 Baltic</p>
 <p>MS-DOS 850 Latin 1</p>	

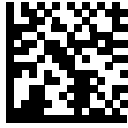

Windows 950
Traditional Chinese Big5



MS-DOS 437
Latin US



MS-DOS 737
Greek

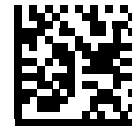





MS-DOS 775
Baltic

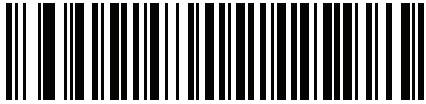

MS-DOS 850
Latin 1

Country Code Page Barcodes (continued)

 <p>MS-DOS 852 Latin 2</p>	
	 <p>MS-DOS 855 Cyrillic</p>
 <p>MS-DOS 857 Turkish</p>	
	 <p>MS-DOS 860 Portuguese</p>
 <p>MS-DOS 861 Icelandic</p>	

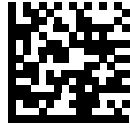

MS-DOS 852
Latin 2

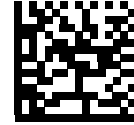

MS-DOS 855
Cyrillic



MS-DOS 857
Turkish



MS-DOS 860
Portuguese



MS-DOS 861
Icelandic

Country Code Page Barcodes (continued)

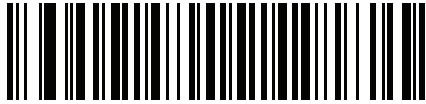

**MS-DOS 862
Hebrew**

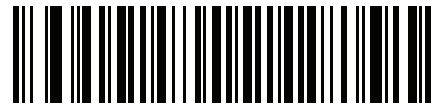

**MS-DOS 863
French Canada**

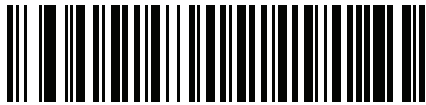

**MS-DOS 865
Nordic**

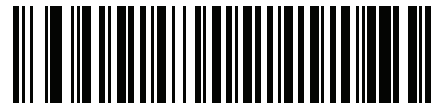

**MS-DOS 866
Cyrillic**

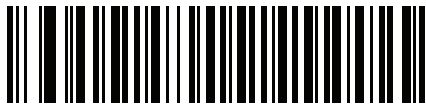

**MS-DOS 869
Greek 2**

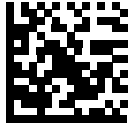

MS-DOS 862
Hebrew



MS-DOS 863
French Canada

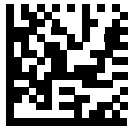

MS-DOS 865
Nordic



MS-DOS 866
Cyrillic

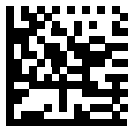

MS-DOS 869
Greek 2

Country Code Page Barcodes (continued)



ISO 8859-1
Latin 1, Western European

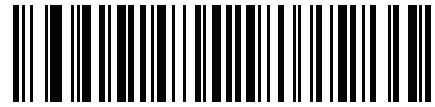

ISO 8859-2
Latin 2, Central European



ISO 8859-3
Latin 3, South European

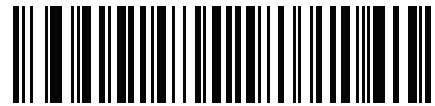

ISO 8859-4
Latin 4, North European



ISO 8859-5
Cyrillic



ISO 8859-1
Latin 1, Western European



ISO 8859-2
Latin 2, Central European



ISO 8859-3
Latin 3, South European







ISO 8859-4
Latin 4, North European



ISO 8859-5
Cyrillic

Country Code Page Barcodes (continued)

 <p>ISO 8859-6 Arabic</p>	
	 <p>ISO 8859-7 Greek</p>
 <p>ISO 8859-8 Hebrew</p>	
	 <p>ISO 8859-9 Latin 5, Turkish</p>
 <p>ISO 8859-10 Latin 6, Nordic</p>	

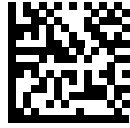

ISO 8859-6
Arabic



ISO 8859-7
Greek

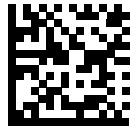

ISO 8859-8
Hebrew





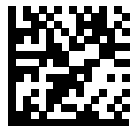

ISO 8859-9
Latin 5, Turkish



ISO 8859-10
Latin 6, Nordic

Country Code Page Barcodes (continued)

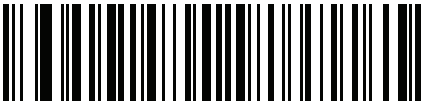
 <p>ISO 8859-11 Thai</p>	
	 <p>ISO 8859-13 Latin 7, Baltic</p>
 <p>ISO 8859-14 Latin 8, Celtic</p>	
	 <p>ISO 8859-15 Latin 9</p>
 <p>ISO 8859-16 Latin 10, South-Eastern European</p>	



ISO 8859-11
Thai



ISO 8859-13
Latin 7, Baltic

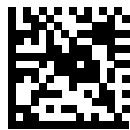

ISO 8859-14
Latin 8, Celtic





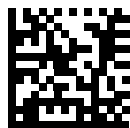



ISO 8859-15
Latin 9

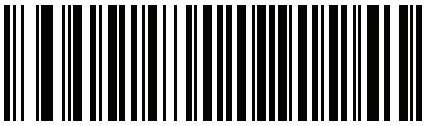

ISO 8859-16
Latin 10, South-Eastern European

Country Code Page Barcodes (continued)

 <p>UTF-8</p>	
	 <p>UTF-16LE UTF-16 Little Endian</p>
 <p>UTF-16BE UTF-16 Big Endian</p>	
	 <p>Mac CP10000 Roman</p>
 <p>UTF-8</p>	

	 <p>UTF-16LE UTF-16 Little Endian</p>
 <p>UTF-16BE UTF-16 Big Endian</p>	
	 <p>Mac CP10000 Roman</p>

CJK Decode Control

Introduction

This appendix describes control parameters for CJK (Chinese, Japanese, Korean) barcode decode through USB HID Keyboard Emulation mode.



NOTE: Because ADF does not support CJK character processing, there is no format manipulation for CJK output.

CJK Control Parameters

Unicode Output Control

Parameter # 973



For a Unicode encoded CJK barcode, select one of the following options for unicode output:

- **Universal Output to Unicode and MBCS Application** - This default method applies to Unicode and MBCS expected applications, such as MS Word and Notepad on a Windows host.

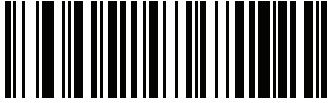

NOTE: To support Unicode universal output, set up the registry table for the Windows host. See [Unicode/CJK Decode Setup with Windows Host on page 543](#).

- **Output to Unicode Application Only** - This method applies only to Unicode expected applications, such as MS Word and WordPad, but not Notepad.

 <p>*Universal Output (0)</p>	
	 <p>Unicode Application Only (1)</p>
 <p>*Universal Output (0)</p>	
	 <p>Unicode Application Only (1)</p>

CJK Output Method to Windows Host

Parameter # 972

For a national standard encoded CJK barcode, select one of the following options for CJK output to a Windows host:

- **Universal CJK Output** - This is the default universal CJK output method for US English IME or Chinese/Japanese/Korean ASCII IME on a Windows host. This method converts CJK characters to Unicode and emulates the characters when transmitting to the host. Use the [Unicode Output Control](#) parameter to control Unicode output.





NOTE: To support universal CJK output, set up the registry table for the Windows host. See [Unicode/CJK Decode Setup with Windows Host on page 543](#).

- **Other options for CJK output** - With the following methods, the scanner sends the CJK character hexadecimal internal code (Nei Ma) value to the host, or converts the CJK character to Unicode and sends the hexadecimal Unicode value to the host. When using these methods, the Windows host must select the corresponding IME to accept the CJK character. See [Unicode/CJK Decode Setup with Windows Host on page 543](#).
 - **Japanese Unicode Output**
 - **Simplified Chinese GBK Code Output**
 - **Simplified Chinese Unicode Output**
 - **Korean Unicode Code Output**
 - **Traditional Chinese Big5 Code Output** (Windows XP)
 - **Traditional Chinese Big5 Code Output** (Windows 7)
 - **Traditional Chinese Unicode Code Output** (Windows XP)
 - **Traditional Chinese Unicode Code Output** (Windows 7)

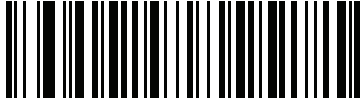

NOTE: The Unicode emulate output method depends on the host system (Windows XP or Windows 7).

 <p>*Universal CJK Output (0)</p>	
	 <p>Japanese Unicode Output (34)</p>
	<p>(For Japanese Unicode Output, select Simplified Chinese Unicode IME on the Windows host)</p>

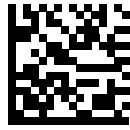







***Universal CJK Output
(0)**



**Japanese Unicode Output
(34)**

(For Japanese Unicode Output, select Simplified Chinese Unicode IME on the Windows host)

CJK Output Method to Windows Host (continued)

 <p>Chinese (Simplified) GBK Output (1)</p>	
	 <p>Chinese (Simplified) Unicode Output (2)</p>
 <p>Korean Unicode Output (50)</p>	
<p>(for Korean Unicode Output, select Simplified Chinese Unicode IME on the Windows host)</p>	 <p>Chinese (Traditional) Big5 Output (Windows XP) (17)</p>
 <p>Chinese (Simplified) GBK Output (1)</p>	
	 <p>Chinese (Simplified) Unicode Output (2)</p>







**Korean Unicode Output
(50)**



(for Korean Unicode Output, select Simplified Chinese Unicode IME on the Windows host)



**Chinese (Traditional) Big5 Output (Windows XP)
(17)**

CJK Output Method to Windows Host (continued)

 <p>Chinese (Traditional) Big5 Output (Windows 7) (19)</p>	
	 <p>Chinese (Traditional) Unicode Output (Windows XP) (18)</p>
 <p>Chinese (Traditional) Unicode Output (Windows 7) (20)</p>	
 <p>Chinese (Traditional) Big5 Output (Windows 7) (19)</p>	

	 <p>Chinese (Traditional) Unicode Output (Windows XP) (18)</p>
 <p>Chinese (Traditional) Unicode Output (Windows 7) (20)</p>	

Non-CJK UTF Barcode Output

Parameter # 960

Some country keyboard type layouts contain characters that do not exist in the default code page (see [Country Keyboard Type Missing Characters on page 542](#)). Although the default code page can not encode these characters in a barcode, they can be encoded in the UTF-8 barcode. Scan the following barcode to output the Unicode values by emulation mode.



NOTE: Use this special country keyboard type to decode the non-CJK UTF-8 barcode. After decoding, re-configure the scanner to use the original country keyboard type.

Use US English IME on Windows. See [Unicode Output Control on page 534](#).

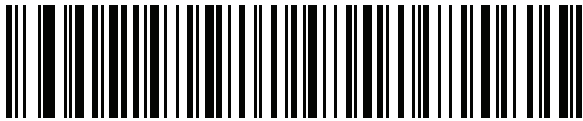

Non-CJK UTF-8 Emulation Output

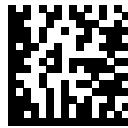

Non-CJK UTF-8 Emulation Output

Country Keyboard Type Missing Characters

Country keyboard type: **Tatar, Uzbek, Mongolian, Kyrgyz, Kazakh and Azeri**

Default code page: CP1251

Missing characters:

ƒ	F
х	X
κ	K
h	h
ө	Ө
ә	Ә
Y	Y
Һ	Ҥ
ж	Ж
ƒ	
Һ	Ҥ
Y	Y
κ	K
ч	Ч
κ	K

Country keyboard type: **Romanian (Standard)**

Default code page: CP1250

Missing characters:

ș	Ș
ț	Ț

Country keyboard type: **Portuguese-Brazilian (ABNT), Portuguese-Brazilian (ABNT2)**

Default code page: CP1252

Missing character: **Ꞣ**

Country keyboard type: **Azeri-Latin**

Default code page: CP1254

Missing characters: ə, Ə

Unicode/CJK Decode Setup with Windows Host

This section describes how to set up CJK decode with a Windows host.

Setting Up the Windows Registry Table for Unicode Universal Output

To support the Unicode universal output method, set up the Windows host registry table as follows:

1. Select **Start > Run > regedt32** to start the registry editor.
2. Under **HKEY_Current_User\Control Panel\Input Method**, set **EnableHexNumpad** to **1** as follows:

```
[HKEY_CURRENT_USER\Control Panel\Input Method]
```

```
"EnableHexNumpad"="1"
```

If this key does not exist, add it as type **REG_SZ** (string value).

3. Reboot the computer to implement the registry change.

Adding CJK IME on Windows

To add the desired CJK input language:

1. Click **Start > Control Panel**.
2. If the Control Panel opens in category view, select **Switch to Classic View** in the top left corner.
3. Select **Regional and Language Options**.
4. Click the **Language** tab.
5. Under **Supplemental Language Support**, select the **Install Files for East Asian Languages** check box if not already selected, and click **Apply**. This may require a Windows installation CD to install the required files. This step ensures that the East Asian Languages (CJK) are available.
6. Under **Text Services and Input Language**, click **Details**.
7. Under **Installed Services**, click **Add**.
8. In the **Add Input Language** dialog box, choose the CJK input language and keyboard layout or Input Method Editor (IME) to add.
9. Click **OK** twice. The language indicator appears in the system tray (at bottom right corner of the desktop by default). To switch between input languages (keyboard languages) select the language indicator in the system tray.
10. Select the language indicator in the system tray to select the desired country keyboard type.
11. Verify that the characters displayed on each country's keyboard appear.

Selecting the Simplified Chinese Input Method on the Host

To select the Simplified Chinese input method:

- Select Unicode/GBK input on Windows XP: **Chinese (Simplified) - NeiMa**, then click the input bar to select **Unicode** or **GBK NeiMa** input.

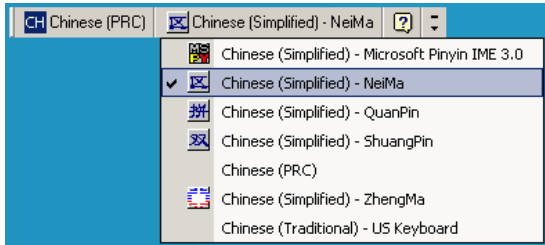

Or



- Select Unicode/GBK input on Windows 7: **Chinese (Simplified) - Microsoft Pinyin New Experience Input Style**, then select **Tool Menu > Secondary Inputs > Unicode Input** or **GB Code Input**.

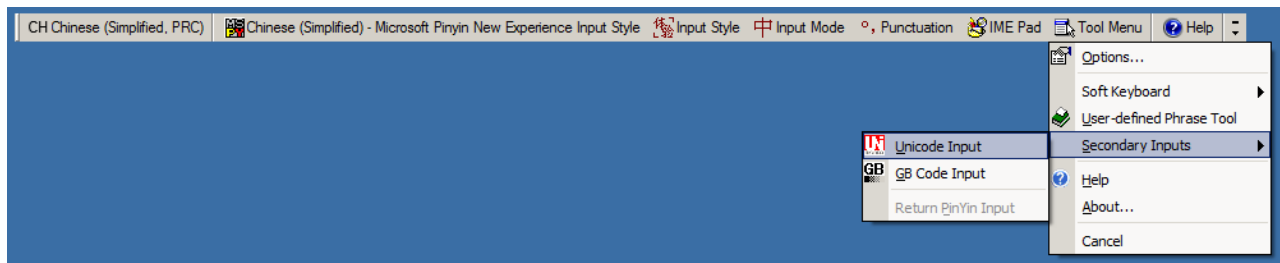

Selecting the Traditional Chinese Input Method on the Host

To select the Traditional Chinese input method:

- Select Unicode input on Windows XP: **Chinese (Traditional) - Unicode**

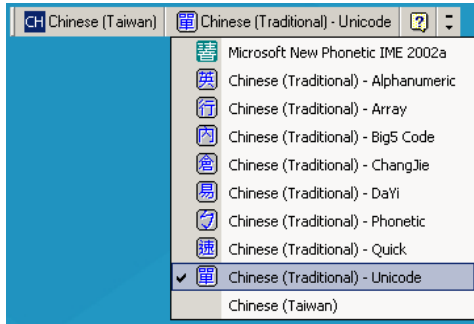

- Select Big5 input on Windows XP: **Chinese (Traditional) - Big5 Code**

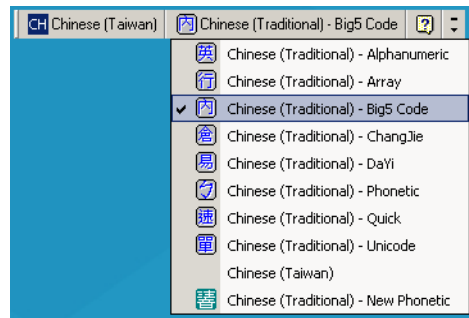

- Select Unicode/Big5 input on Windows 7: **Chinese (Traditional) - New Quick**. This option support both Unicode and Big5 input.



Signature Capture Code

Introduction

CapCode, a signature capture code, is a special pattern that encloses a signature area on a document and allows a scanner to capture a signature.

There are several accepted patterns that allow automatic identification of different signatures on the same form. For example, on the federal tax return 1040 form there are three signature areas, one each for two joint filers, and one for a professional preparer. By using different patterns, a program can correctly identify all three, so they can be captured in any sequence and still be identified correctly.

Code Structure

Signature Capture Area

A CapCode is printed as two identical patterns on either side of a signature capture box, as shown in [Figure 19](#). Each pattern extends the full height of the signature capture box.

The box is optional, so you can omit it, replace it with a single baseline, or print a baseline with an "X" on top of it towards the left, as is customarily done in the US to indicate a request for signature. However, if an "X" or other markings are added in the signature box area, these are captured with the signature.

Figure 19 CapCode



CapCode Pattern Structure

A CapCode pattern structure consists of a start pattern followed by a separator space, a signature capture box, a second separator space, and then a stop pattern. Assuming that X is the dimension of the thinnest element, the start and stop patterns each contains $9X$ total width in 4 bars and 3 spaces. A $7X$ quiet zone is required to the left and to the right of the CapCode pattern.

Figure 20 CapCode Structure

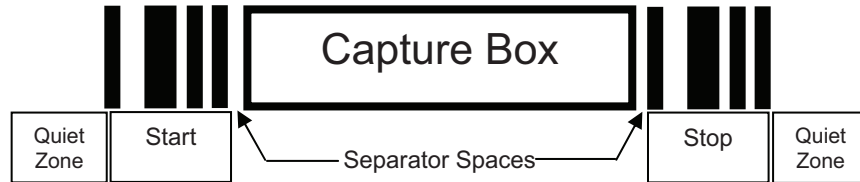

The separator spaces on either side of the signature capture box can be between $1X$ and $3X$ wide.

Start / Stop Patterns

Table 50 lists the accepted start / stop patterns. The bar and space widths are expressed as multiples of X . You must use the same pattern on either side of a signature capture box. The type value is reported with the captured signature to indicate the purpose of the signature captured.

Table 50 Start / Stop Pattern Definitions

Bar/Space Patterns							Type
B	S	B	S	B	S	B	
1	1	2	2	1	1	1	2
1	2	2	1	1	1	1	5
2	1	1	2	1	1	1	7
2	2	1	1	1	1	1	8
3	1	1	1	1	1	1	9

Table 51 lists selectable parameters used to generate the image of the captured signature.

Table 51 User Defined CapCode Parameters

Parameter	Defined
Width	Number of pixels
Height	Number of pixels
Format	JPEG, BMP, TIFF
JPEG quality	1 (most compression) to 100 (best quality)
Bits Per Pixel (not applicable to JPEG format)	1 (2 levels)
	4 (16 levels)
	8 (256 levels)

BMP format does not use compression, JPEG and TIFF formats do.

Dimensions

The size of the signature capture box is determined by the height and separation of the start and stop patterns. The line width of the signature capture box is insignificant.

The thinnest element width, referred to here as X, is nominally 10 mils (1 mil = 0.0254 mm). Select this as an exact multiple of the pixel pitch of the printer used. For example, when using a 203 DPI (dots-per-inch) printer and printing 2 dots per module, the resulting X dimension is 9.85 mils.

Data Format

The decoder output is formatted according to [Table 52](#). Zebra decoders allow different user options to output or inhibit barcode type. Selecting "Symbol ID" as the barcode type for output identifies the CapCode with letter "i".

Table 52 Data Format

File Format (1 byte)	Type (1 byte)	Image Size (4 bytes, BIG Endian)	Image Data
JPEG - 1 BMP - 3 TIFF - 4	See Table 50 , last column		(Same bytes as in a data file)

Additional Capabilities

Regardless of how the signature is captured, the output signature image is de-skewed and right-side up.

A scanner that captures signatures automatically determines whether it is scanning a signature or a barcode. You can disable the signature capturing capability in a decoder.

Signature Boxes

Figure 21 illustrates the five acceptable signature boxes:

Figure 21 Acceptable Signature Boxes

Type 2:



Type 5:

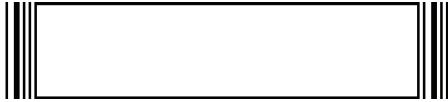

Type 7:



Type 8:



Type 9:



Non-Parameter Attributes

Introduction

This appendix defines non-parameter attributes.

Attributes

Model Number

Attribute #533

Model number of the scanner. This electronic output matches the printout on the physical device label, for example **SA4608-SR00006ZZWW**.

Type	S
Size (Bytes)	18
User Mode Access	R
Values	Variable

Serial Number

Attribute #534

Unique serial number assigned in the manufacturing facility. This electronic output matches the printout on the physical device label, for example **M1J26F45V**.

Type	S
Size (Bytes)	16
User Mode Access	R
Values	Variable

Date of Manufacture

Attribute #535

Date of device manufacture assigned in the manufacturing facility. This electronic output matches the printout on the physical device label, for example **30APR19** (which reads the 30th of April 2019).

Type	S
Size (Bytes)	7
User Mode Access	R
Values	Variable

Date of First Programming

Attribute #614

Date of first electronic programming represents the first time settings were electronically loaded to the scanner either by 123Scan or via SMS, for example **18MAY19** (which reads the 18th of May 2019).

Type	S
Size (Bytes)	7
User Mode Access	R
Values	Variable

Configuration Filename

Attribute #616

The name assigned to the configuration settings loaded electronically to the device either by 123Scan or via SMS.



NOTE: Scanning the **Set Defaults** barcode automatically changes the configuration filename to factory defaults.

To indicate the configuration settings loaded to the device were changed, the configuration filename changes to **Modified** upon scanning any parameter barcode.

Type	S
Size (Bytes)	17
User Mode Access	RW
Values	Variable

Beeper/LED

Attribute #6000

Activates the beeper and/or LED.

Type X
Size (Bytes) N/A
User Mode Access W

Values:

Table 53 Beeper/LED Values

Beep / LED Action	Value	Beep / LED Action	Value
1 high short beep	0	1 low long beep	15
2 high short beeps	1	2 low long beeps	16
3 high short beeps	2	3 low long beeps	17
4 high short beeps	3	4 low long beeps	18
5 high short beeps	4	5 low long beeps	19
1 low short beep	5	Fast warble beep	20
2 low short beeps	6	Slow warble beep	21
3 low short beeps	7	High-low beep	22
4 low short beeps	8	Low-high beep	23
5 low short beeps	9	High-low-high beep	24
1 high long beep	10	Low-high-low beep	25
2 high long beeps	11	High-high-low-low beep	26
3 high long beeps	12	Green LED off	42
4 high long beeps	13	Green LED on	43
5 high long beeps	14	Red LED on	47
		Red LED off	48

Parameter Defaults

Attribute #6001

This attribute restores all parameters to their factory defaults.

Type	X
Size (Bytes)	N/A
User Mode Access	W
Values	0 = Restore Defaults 1 = Restore Factory Defaults 2 = Write Custom Defaults

Beep on Next Bootup

Attribute #6003

This attribute configures (enables or disables) beep on next boot up of scanner.

Type	X
Size (Bytes)	N/A
User Mode Access	W
Values	0 = Disable beep on next bootup 1 = Enable beep on next bootup

Reboot

Attribute #6004

This attribute initiates a device reboot.

Type	X
Size (Bytes)	N/A
User Mode Access	W
Values	N/A

Host Trigger Session

Attribute #6005

This attribute triggers a decode session similar to manually depressing the scanner trigger button.

Type	X
Size (Bytes)	N/A
User Mode Access	W
Values	1 = Start Host Trigger Session 0 = Stop Host Trigger Session

Firmware Version

Attribute #20004

The scanner's operating system version. For example, **NBRFMAAC** or **PAAAABS00-007-R03D0**.

Type	S
Size (Bytes)	Variable
User Mode Access	R
Values	Variable

Scankit Version

Attribute #20008

Identifies the 1D decode algorithms resident on the device, for example **SKIT4.33T02**.

Type	S
Size (Bytes)	Variable
User Mode Access	R
Values	Variable

Sample Barcodes



IMPORTANT: To read a sample barcode the parameter must be enabled. To enable a parameter scan the appropriate **Enable** barcode in [Symbologies](#).

UPC/EAN

UPC-A, 100%



UPC-A with 2-digit Add-on

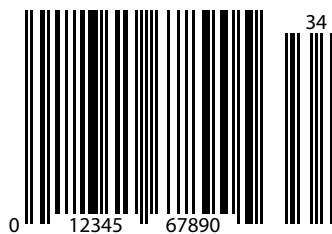

UPC-A with 5-digit Add-on



UPC-E



UPC-E with 2-digit Add-on



UPC-E with 5-digit Add-on



EAN-8

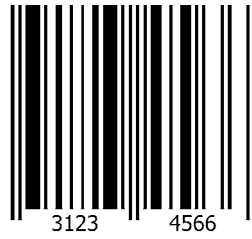

EAN-13, 100%

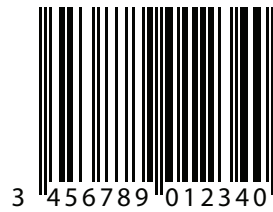

EAN-13 with 2-digit Add-on



EAN-13 with 5-digit Add-on



Code 128



GS1-128



Code 39



Code 93

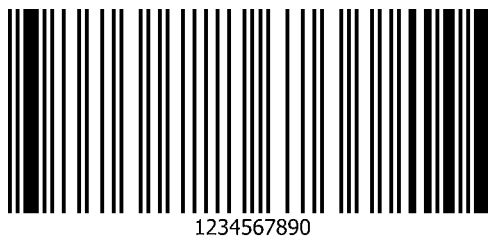

Code 11 with 2 Check Digits



Interleaved 2 of 5



MSI with 2 Check Digits



Chinese 2 of 5

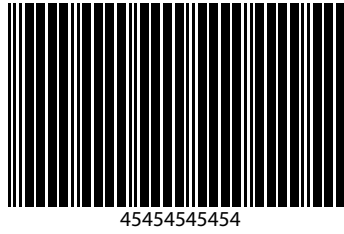

Matrix 2 of 5



Korean 3 of 5



GS1 DataBar

GS1 DataBar Omnidirectional (formerly GS1 DataBar-14)



7612341562341

GS1 DataBar Truncated

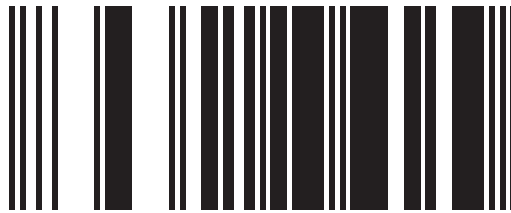

(01)00614141999996

GS1 DataBar Stacked



GS1 DataBar Stacked Omnidirectional



GS1 DataBar Limited



GS1 DataBar Expanded



GS1 DataBar Expanded Stacked



2D Symbologies

PDF417

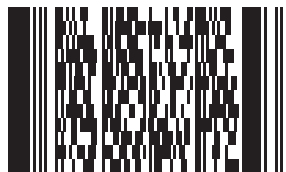

Data Matrix



GS1 Data Matrix



Maxicode

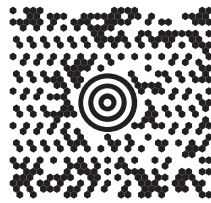

QR Code



GS1 QR



MicroQR



Aztec

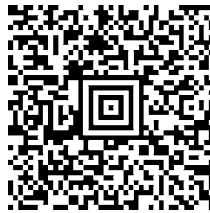

0123456789ABCDEFGHIJKLMNOPQRSTUVWXYZ0123456789ABCDEFGHIJKLMNOPQRSTUVWXYZ0123456
7890123456789ABCDEFGHIJKLMNOPQRSTUVWXYZ0123456789ABCDEFGHIJKLMNOPQRSTUVWXYZ0123
456789

Grid Matrix

✓ **NOTE** Grid Matrix must be enabled to read the following barcode (see [Grid Matrix on page 316](#)).

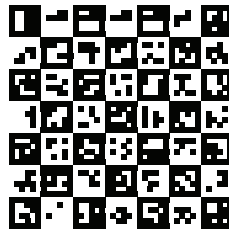

Han Xin



Postal Codes

US Postnet



UK Postal



Japan Postal



Australian Post



OCR

OCR-A

WFSGH67890

OCR-B

12345ABMKP

MICR E13B

! : 0 1 2 3 || 4 5 6 ... 7 8 9 0 , ' !

US Currency

A barcode consisting of the alphanumeric string "F 01840626 D" printed in green ink on a light-colored background.

F 01840626 D

Index

Numerics

123Scan	31
requirements	32
2D barcodes	
aztec	312
aztec inverse	313
code 128 emulation	304
data matrix	305
data matrix inverse	306
data matrix mirror images	307
grid matrix	316
grid matrix inverse	317
grid matrix mirrored	318
GS1 data matrix	305
GS1 QR	309
han xin	314
han xin inverse	315
linked QR mode	311
maxicode	308
microPDF417	303
microQR	310
PDF417	303
QR code	309

A

accessories	
cables	23
configurations	23
interface cable	23
partner portal	23
power supplies	24
stands and holders	23
ADF	33, 387
invalid rule	48
transmit error	48
advanced data formatting	33, 48, 387
aiming	
orientation	41
pattern, hand-held	159
pattern, hands-free	160

pattern, snapshot	198
snapshot mode timeout	197
video view finder	213
aiming pattern	41
orientation	42
ASCII character sets	471
assembling the stand	38
attributes, non-parameter	
beep on next bootup	553
configuration filename	551
date of first programming	551
date of manufacture	551
firmware version	554
host trigger session	553
model number	550
parameter defaults	553
reboot	553
scankit version	554
serial number	550
autoexposure	194
aztec bar codes	
sample	566
aztec barcodes	312
inverse	313

B

bar codes	
analog gain	196
digital gain	196
samples	555
securPharm	186
securPharm output formatting	187
triggered timeout, same symbol	166
barcodes	
1D quiet zone level	296
alphanumeric	454
autoexposure	194
aztec	312
inverse	313
beep after good decode	144
beeper duration	147

- beeper tone 146
- beeper volume 145
- bits per pixel 207
- cancel 452
- Chinese 2 of 5 282
- CJK
 - non-CJK UTF barcode output 541
 - output method 535
 - unicode output control 534
- codabar 273
 - CLSI editing 275
 - lengths 273
 - NOTIS editing 275
 - security level 276
 - start and stop characters 277
- code 11 261
 - check digit verification 263
 - lengths 261
 - transmit check digits 264
- code 128 242
 - check ISBT table 247
 - code 128 fnc4 248
 - GS1-128 244
 - ISBT 128 245
 - ISBT concatenation 246
 - ISBT concatenation redundancy 247
 - lengths 243
 - reduced quiet zone 250
 - security level 249
- code 128 emulation 304
- code 39 250
 - check digit verification 254
 - code 32 prefix 252
 - convert code 39 to code 32 251
 - full ASCII conversion 255
 - lengths 252
 - reduced quiet zone 258
 - security level 256
 - transmit check digit 254
 - trioptic code 39 251
- code 93 258
 - lengths 259
- composite
 - beep mode 301
 - composite CC-A/B 298
 - composite CC-C 298
 - composite inverse 299
 - composite TLC-39 299
 - GS1-128 emulation mode 302
 - UPC composite mode 300
- continuous barcode read 163
- country code page defaults 509
- country code pages . . 513, 515, 517, 519, 521, 523, 525, 527, 529, 531
- country codes 491
- country keyboard types (country codes) 491
- crop to address 199
- data matrix 305
 - data matrix inverse 306
 - GS1 data matrix 305
 - mirror images 307
- decode pager motor 150
- decode pager motor duration 151
- decode session timeout 164
- direct decode indicator 149
- disable all code types 223
- discrete 2 of 5 270
 - lengths 271
- DPM illumination control 176
- DPM mode 177
- driver's license parsing 390
 - driver's license date format 406
 - driver's license gender format 405
 - no separator 408
 - parser version ID 405
 - parsing field 392, 393, 394
 - send control characters 409
 - send keyboard characters 414
 - set defaults 405
- elevel 175
- enable all code types 223
- enter 178
- febraban 268
- fixed exposure 195
- FN1 substitution values 183
- grid matrix 316
- grid matrix inverse 317
- grid matrix mirrored 318
- GS1 databar 288
 - convert to UPC/EAN/JAN 289
 - GS1 databar expanded 289
 - GS1 databar expanded security level 292
 - GS1 databar limited 288
 - GS1 databar limited margin check 291
 - GS1 databar omnidirectional 288
 - security level 290
- han xin 314
 - inverse 315
- hand-held decode aiming pattern 159
- hand-held trigger mode 158
- hands-free decode aiming pattern 160
- hands-free mode 161
- IBM
 - barcode configuration directive 127
 - beep directive 126
 - convert unknown to code 39 126
 - default table 124
 - port address 125
 - specification version 127
- IDC

- aspect 375
- bits per pixel 376
- border type 381
- captured image brighten 379
- captured image sharpen 380
- default table 370
- delay time 382
- file format selector 375
- find box outline 377
- height 374
- JPEG quality 377
- maximum rotation 383
- maximum text length 378
- minimum text length 378
- operating mode 371
- symbology 372
- width 374
- X coordinate 373
- Y coordinate 373
- zoom limit 382
- illumination 171, 194
- illumination brightness 172
- image brightness (target white) 202
- image capture
 - default table 191
- image cropping 199
- image enhancement 204
- image file format 205
- image rotation 206
- image size 201
- intercharacter gap size 297
- interleaved 2 of 5 264
 - check digit verification 267
 - convert to EAN-13 268
 - lengths 265
 - reduced quiet zone 270
 - security level 269
 - transmit check digit 267
- inverse 1D 287
- JPEG image options 202
- JPEG quality 203
- JPEG size 203
- keyboard wedge
 - alternate numeric keypad emulation 133
 - caps lock override 134
 - convert case 135
 - default table 130
 - FN1 substitution 136
 - function key mapping 136
 - host types 131
 - intra-keystroke delay 132
 - keystroke delay 132
 - quick keypad emulation 133
 - send make and break 137
 - simulated caps lock 134
 - unknown characters 131
- Korean 3 of 5 286
- LED on good decode 149
- linked QR mode 311
- low power mode 155
- macro PDF
 - abort entry 323
 - escape characters 323
 - flush buffer 323
- manufacturing information 49
- matrix 2 of 5 283
 - check digit 285
 - lengths 283
 - transmit check digit 285
- maxicode 308
- microPDF417 303
- mobile phone/display mode 167
- motion tolerance 173
- MSI 278
 - check digit algorithm 281
 - check digits 280
 - lengths 279
 - reduced quiet zone 282
 - transmit check digit 281
- night mode 153
- night mode toggle 154
- night mode trigger 154
- numeric 450, 451
- numeric barcodes 452
- OCR
 - check digit 356
 - check digit multiplier 357
 - check digit validation 359
 - default table 332
 - inverse OCR 364
 - lines 344
 - maximum characters 345
 - MICR E13B 341
 - minimum character 344
 - OCR-A 333
 - OCR-A variant 334
 - OCR-B 336
 - OCR-B variant 337
 - orientation 342
 - parameters 333
 - quiet zone 346
 - redundancy 365
 - subset 345
 - template 347
 - US currency serial number 342
- operational modes 193
- pager motor 150
- parameter scanning 143
- PDF prioritization 168
- PDF prioritization timeout 169

- PDF417 303
- picklist mode 162
- pid type 174
- pid value 174
- postal 324
 - Australia post 327
 - Australia post format 328
 - Japan postal 326
 - mailmark 330
 - Netherlands KIX code 329
 - transmit UK postal check digit 326
 - transmit US postal check digit 325
 - UK postal 325
 - UPU FICS postal 330
 - US planet 324
 - US postnet 324
 - USPS 4CB/One Code/Intelligent Mail 329
- prefix/suffix values 180
- presentation mode field of view 170
- QR code 309
 - GS1 QR 309
 - microQR 310
- redundancy level 293
- RS-232
 - baud rate 109
 - beep on bel 118
 - check receive errors 113
 - data bits 112
 - default table 103
 - hardware handshaking 113
 - host serial response timeout 117
 - host types 107
 - intercharacter delay 119
 - nixdorf beep LED options 120
 - parity 111
 - RTS line state 118
 - software handshaking 115, 116
 - stop bits 112
 - unknown characters 120
- scan data options 181
- security level 295
- send versions 49
- serial number 49
- set defaults 142
- signature capture 208
- signature capture bits per pixel 210
- signature capture file format 209
- signature capture height 211
- signature capture JPEG quality 212
- signature capture width 211
- silence operational mode changes 198
- snapshot aiming pattern 198
- snapshot mode timeout 197
- software version 49
- SSI
 - baud rate 89
 - boot up event 100
 - check parity 91
 - data packet format 94
 - decode event 99
 - host character timeout 96
 - host RTS line state 94
 - host serial response timeout 95
 - interpacket delay 98
 - multipacket option 97
 - parameter event 100
 - parity 91
 - selecting 89
 - software handshaking 93
 - stop bits 92
 - suppress power up beeps 148
 - symbolologies
 - default table 216
 - tab key 178
 - time delay to low power mode 156
 - timeout between decodes, different symbols 165
 - timeout between decodes, same symbol 165
 - transmit code ID character 179
 - transmit no read message 184
 - unique barcode reporting 164
 - unsolicited heartbeat interval 185
- UPC/EAN/JAN
 - bookland EAN 226
 - bookland ISBN 227
 - convert UPC-E to UPC-A 239
 - convert UPC-E1 to UPC-A 239
 - coupon report 241
 - EAN/JAN zero extend 240
 - EAN-13/JAN-13 226
 - EAN-8/JAN-8 225
 - ISSN EAN 228
 - supplemental AIM ID format 233
 - supplemental redundancy 232
 - supplementals 229
 - transmit UPC-A check digit 234
 - transmit UPC-E check digit 234
 - transmit UPC-E1 check digit 235
 - UCC coupon extended code 240
 - UPC reduced quiet zone 242
 - UPC-A 224
 - UPC-A preamble 236
 - UPC-E 224
 - UPC-E preamble 237
 - UPC-E1 225
 - UPC-E1 preamble 238
 - user programmable supplementals 232
- USB
 - barcode configuration directive 76
 - beep directive 75
 - caps lock override 65

- CDC beep on bel 74
- convert case 73
- convert unknown to code 39 66
- default table 61
- device type 62
- direct I/O beep 75
- fast HID 67
- function key mapping 72
- IBM specification version 76
- keyboard FN1 substitution 71
- keypad emulation 70
- keypad emulation with leading zero 71
- keystroke delay 65
- polling interval 68
- quick keypad emulation 70
- simulated caps lock 72
- SNAPI handshaking 64
- static CDC 74
- unknown characters 66
- user preferences
 - default table 139
- video frame size 213
- video image size 214
- video mode format selector 212
- video resolution 214
- video view finder 213
- beeper
 - beep after good decode 144
 - definitions 35
 - duration 147
 - suppress on power up 148
 - tone adjustment 146
- bullets 25
- C**
- cables
 - installing 28
 - interface 23
 - removing 29
 - signal descriptions 57
- character sets
 - ALT key 476
 - ASCII 471
 - extended key 480
 - F key 479
 - GUI key 477
 - numeric key 480
 - PF key 478
- Chinese 2 of 5 bar codes
 - sample 561
- Chinese 2 of 5 barcodes 282
- CJK 533
 - control parameters 534
 - country keyboard missing characters 542
 - decode setup 543
 - input method 544
- cleaning the devices
 - approved disinfectant cleaners for healthcare devices 45
 - approved for standard devices 44
 - how to 45
 - known harmful ingredients 44
- codabar barcodes 273
 - CLSI editing 275
 - lengths 273
 - NOTIS editing 275
 - security level 276
 - start and stop characters 277
- code 11 bar codes
 - sample 560
- code 11 barcodes 261
 - check digit verification 263
 - lengths 261
 - transmit check digits 264
- code 128 bar codes
 - sample 558
- code 128 barcodes 242
 - check ISBT table 247
 - fnc4 248
 - GS1-128 244
 - ISBT 128 245
 - ISBT concatenation 246
 - ISBT concatenation redundancy 247
 - lengths 243
 - reduced quiet zone 250
 - security level 249
- code 128 emulation barcodes 304
- code 39 bar codes
 - sample 555, 559
- code 39 barcodes 250
 - check digit verification 254
 - code 32 prefix 252
 - code 39 security level 256
 - convert code 39 to code 32 251
 - full ASCII conversion 255
 - lengths 252
 - reduced quiet zone 258
 - transmit check digit 254
 - trioptic 251
- code 93 bar codes
 - sample 559
- code 93 barcodes 258
 - lengths 259
- code identifiers
 - AIM 484
 - modifier characters 485
 - Symbol 482
 - transmitting 179
- communication protocol

cable interface	489
composite barcodes	
beep mode	301
composite CC-A/B	298
composite CC-C	298
composite inverse	299
composite TLC-39	299
GS1-128 emulation mode	302
UPC composite mode	300
configurations	
accessories	23
cables	23
stands and holders	23
connecting	
IBM interface	123
interface cable	28
keyboard wedge interface	129
power	30
RS-232 interface	102
USB interface	60
conventions	
notational	25
country code pages	513, 515, 517, 519, 521, 523, 525, 527, 529, 531
defaults	509
country codes	491
cropping images	199
D	
data matrix bar codes	
sample	566, 567, 568
data matrix barcodes	305
data matrix inverse	306
GS1 data matrix	305
mirror images	307
decode zones	
ranges	42, 43
default parameters	139
all	436
DL parsing	389
IBM	124
IDC	370
image capture	191
keyboard wedge	130
OCR	332
RS-232	103
setting	142
SSI	88
USB	61
user preferences	139
digital scanner	
parts	28
discrete 2 of 5 barcodes	270
lengths	271

driver's license parsing	
ADF example	434
barcodes	390
control characters	409
data fields	391
date format	406
default parameters	389
field parsing barcodes	392, 393, 394
gender format	405
keyboard characters	414
no separator	408
parser version ID	405
rule example	430

E

ecllevel	175
error indications	
ADF	48
format	48
input	47
exposure options	
analog gain	196
autoexposure	194
digital gain	196
fixed exposure	195
illumination	171, 194
presentation mode field of view	170

G

gain	
analog	196
digital	196
gooseneck Intellistand	38, 39
grid matrix bar codes	
sample	566
gs1 data matrix bar codes	
sample	565
GS1 databar bar codes	
sample	562
GS1 databar barcodes	288
convert GS1 databar to UPC/EAN/JAN	289
GS1 databar expanded	289
GS1 databar expanded security level	292
GS1 databar limited	288
GS1 databar limited margin check	291
GS1 databar omnidirectional	288
security level	290
GS1 QR bar codes	
sample	565

H

han xin bar codes	
-------------------	--

sample	567
han xin barcodes	314
inverse	315
host types	
IBM	125
keyboard wedge	131
RS-232	107
SSI	89
USB	62

I

IBM	
barcodes	125
connection	123
default parameters	124
IDC	366
barcode acceptance test	367
barcodes	371
capture region	367
data transmission	368
default parameters	370
demonstrations	385
image post processing	368
operating mode	368
quick start	384
quick start form	386
sample setup	384
support	368
illumination	171, 194
brightness	172
image capture	
default parameters	191
operational modes	193
image options	
bits per pixel	207
cropping	199
file formats	205
image brightness (target white)	202
image enhancement	204
image rotation	206
image size	201
JPEG image options	202
JPEG quality	203
JPEG size	203
signature capture	208
signature capture file format	209
information, service	26
interface	
cables	23, 24
interleaved 2 of 5 bar codes	
sample	560
interleaved 2 of 5 barcodes	264
check digit verification	267
convert to EAN-13	268

febraban	268
lengths	265
reduced quiet zone	270
security level	269
transmit check digit	267

J

JPEG image options	202
quality	203
size	203

K

keyboard types (country codes)	
Albanian	492
Arabic (101)	492
Arabic (102)	492
Arabic (102) Azerty	493
Azeri (Cyrillic)	493
Azeri (Latin)	493
Belarusian	493
Bosnian (Cyrillic)	493
Bosnian (Latin)	493
Bulgarian (Latin)	494
Bulgarian Cyrillic (Typewriter)	494
Canadian French (Legacy)	494
Canadian French Win7	494
Canadian Multilingual Standard	494
Chinese (ASCII)	494
Chinese (Simplified)	495
Chinese (Traditional)	495
Croatian	495
Czech	495
Czech (Programmer)	495
Czech (QWERTY)	495
Danish	496
Dutch (Netherlands)	496
Estonian	496
Faeroese	496
Finnish	496
French (Canada) 2000/XP	497
French (Canada) 95/98	497
French (France)	496
French International	497
Galician	497
German	497
Greek	498
Greek (220) Latin	498
Greek (319) Latin	498
Greek 220	498
Greek 319	498
Greek Latin	497
Greek Polytonic	498
Hebrew Israel	499

Hungarian	499
Hungarian_101KEY	499
Irish	499
Islandic	499
Italian	499
Italian (142)	500
Japanese (ASCII)	500
Japanese (SHIFT-JIS)	500
Kazakh	500
Korean (ASCII)	500
Korean (Hangul)	500
Kyrgyz	501
Latin American	501
Latvian	501
Latvian (QWERTY)	501
Lithuanian	501
Lithuanian (IBM)	501
Macedonian (FYROM)	502
Maltese_47KEY	502
Mongolian	502
Norwegian	502
Polish (214)	502
Polish (Programmer)	502
Portuguese (Brazil)	503
Portuguese (Brazilian ABNT)	503
Portuguese (Brazilian ABNT2)	503
Portuguese (Portugal)	503
Romanian	503
Romanian (Legacy)	503
Romanian (Programmer)	504
Romanian (Standard)	504
Russian	504
Russian (Typewriter)	504
Serbian (Cyrillic)	504
Serbian (Latin)	504
Slovak	505
Slovak (QWERTY)	505
Slovenian	505
Spanish	505
Spanish (Variation)	505
Swedish	505
Swiss French	506
Swiss German	506
Tatar	506
Thai (Kedmanee)	506
Turkish F	506
Turkish Q	506
UK English	507
Ukrainian	507
US Dvorak	507
US Dvorak Left	507
US Dvorak Right	507
US English	492
US International	507
Uzbek	508
Vietnamese	508
keyboard wedge	
barcodes	131
connection	129
default parameters	130
keyboard map	137
Korean 2 of 5 bar codes	
sample	561
Korean 3 of 5 barcodes	286
L	
LED definitions	37
M	
macro PDF	322
abort entry	323
escape characters	323
flush buffer	323
maintenance	44
approved cleaners for standard devices	44
approved disinfectant cleaners for healthcare devices	45
how to clean the devices	45
known harmful ingredients	44
matrix 2 of 5 bar codes	
sample	561
matrix 2 of 5 barcodes	283
check digit	285
lengths	283
transmit check digit	285
maxicode barcodes	308
MDF	34, 387
microPDF417 barcodes	303
microQR code bar codes	
sample	566
mounting	
wall	23
mounting the stand	39
MSI bar codes	
sample	560
MSI barcodes	278
check digit algorithm	281
check digits	280
lengths	279
reduced quiet zone	282
transmit check digit	281
multicode data formatting	34, 387
N	
night mode	153
non-parameter attributes	
beep on next bootup	553

configuration filename	551
date of first programming	551
date of manufacture	551
firmware version	554
host trigger session	553
model number	550
parameter defaults	553
reboot	553
scankit version	554
serial number	550

O

OCR	
barcodes	333
default parameters	332

P

page	
motor	150
partner portal	23
parts	28
PDF417 bar codes	
sample	564
PDF417 barcodes	303
PDF prioritization	168
pinouts	
scanner signal descriptions	57
postal code bar codes	
sample	567
postal code barcodes	324
Australia post	327
Australia post format	328
Japan postal	326
mailmark	330
Netherlands KIX code	329
transmit UK postal check digit	326
transmit US postal check digit	325
UK postal	325
UPU FICS postal	330
US planet	324
US postnet	324
USPS 4CB/One Code/Intelligent Mail	329
power supplies	24
power supply	
connecting	30
preferred symbol	34, 388
presentation mode	38, 39
field of view	170
product id (pid) value	174
product id type	174

Q

QR code bar codes	
sample	566, 567, 568
QR code barcodes	309
GS1 QR	309
microQR	310

R

related documents	25
related software	25
RS-232	
barcodes	107
connection	102
default parameters	103
host parameters	104
RSM	
commands and responses over SSI	85

S

sample bar codes	
aztec	566
Chinese 2 of 5	561
code 11	560
code 128	558
code 39	555, 559
code 93	559
data matrix	566, 567, 568
grid matrix	566
gs1 data matrix	565
GS1 databar	562
GS1 QR	565
han xin	567
interleaved 2 of 5	560
Korean 2 of 5	561
matrix 2 of 5	561
microQR code	566
MSI	560
PDF417	564
QR code	566, 567, 568
UK postal	567
UPC/EAN	555
US postnet	567
scanning	
aiming	41
hand-held mode	38, 40
hands-free mode	38, 39
security	
1D quiet zone level	296
intercharacter gap size	297
redundancy level	293
security level	295
setting defaults	142

- setup
 - connecting a keyboard wedge host 129
 - connecting a USB interface 60
 - connecting an IBM most 123
 - connecting an RS-232 interface 102
 - connecting power 30
 - installing interface cable 28
 - unpacking 27
- signal descriptions 57
- signature capture 208
 - bits per pixel 210
 - code structure 546
 - data format 548
 - dimensions 548
 - file format selector 209
 - height 211
 - JPEG quality 212
 - signature boxes 549
 - start and stop patterns 547
 - width 211
- software tools
 - 123Scan 31
 - ADF 33, 387
 - MDF 34, 387
 - preferred symbol 34, 388
- specifications
 - DS4608-DPE 55
 - DS4608-HC 52
 - DS4608-SR/DS4608-DL/DS4608-HD/DS4608-HL 50
- SSI
 - barcodes 89
 - commands 79
 - communications 78, 83
 - data transmission 81
 - default parameters 88
 - event reporting 99
 - handshaking 80, 83
 - low power mode 84
 - RSM commands and responses 85
 - RTS CTS 83
 - transactions 80
- stand
 - assembling 38
 - mounting 39
- symbolologies
 - barcodes 223
 - default parameters 216
- T
 - technical specifications
 - DS4608-DPE 55
 - DS4608-HC 52
 - DS4608-SR/DS4608-DL/DS4608-HD/DS4608-HL 50
 - trigger mode, hand-held 158
- troubleshooting 46
- U
 - unicode
 - output control 534
 - unpacking 27
 - UPC/EAN/JAN bar codes
 - samples 555
 - UPC/EAN/JAN barcodes
 - bookland EAN 226
 - bookland ISBN 227
 - convert UPC-E to UPC-A 239
 - convert UPC-E1 to UPC-A 239
 - coupon report 241
 - decode supplementals 229
 - EAN/JAN zero extend 240
 - EAN-13/JAN-13 226
 - EAN-8/JAN-8 225
 - ISSN EAN 228
 - supplemental AIM ID format 233
 - supplemental redundancy 232
 - transmit UPC-A check digit 234
 - transmit UPC-E check digit 234
 - transmit UPC-E1 check digit 235
 - UCC coupon extended code 240
 - UPC reduced quiet zone 242
 - UPC-A 224
 - UPC-A preamble 236
 - UPC-E 224
 - UPC-E preamble 237
 - UPC-E1 225
 - UPC-E1 preamble 238
 - user programmable supplementals 232
- USB
 - barcodes 62
 - connection 60
 - default parameters 61
- V
 - version
 - barcodes 49
 - video
 - formats 212
 - frame size 213
 - image size 214
 - resolution 214
 - view finder 213

