

# TM 11-5820-358-10

DEPARTMENT OF THE ARMY TECHNICAL MANUAL

---

OPERATOR'S MANUAL,

RADIO RECEIVER R-390A/URR



*HEADQUARTERS, DEPARTMENT OF THE ARMY  
16 JANUARY 1961*

## **WARNING**

### **DANGEROUS VOLTAGES EXIST IN THIS EQUIPMENT**

Be careful when working on the 240-volt power supply and the circuits connected to it, or on the 115/230-volt ac line connections. Before connecting the receiver to an ac source, be sure that the chassis is connected to the same ground as the ac source.

**DON'T TAKE CHANCES!**

CHANGED TO  
C-2  
JAN 15/65.

\*TM 11-5820-358-10

TECHNICAL MANUAL }  
No. 11-5820-358-10 }

HEADQUARTERS,  
DEPARTMENT OF THE ARMY  
WASHINGTON 25, D. C., 16 January 1961

## RADIO RECEIVER R-390A/URR

			Paragraph	Page
CHAPTER	1.	INTRODUCTION		
Section	I.	General		
		Scope .....	1	3
		Forms and records .....	2	3
	II.	Description and data		
		Purpose and use .....	3	3
		System application .....	4	3
		Technical characteristics .....	5	5
		Components of Radio Receiver R-390A/URR .....	6	5
		Description .....	7	5
		Additional equipment required .....	8	6
CHAPTER	2.	OPERATING INSTRUCTIONS		
Section	I.	Controls and instruments		
		General .....	9	8
		Receiver controls and indicators .....	10	8
	II.	Operation		
		Preparing receiver for reception .....	11	9
		Calibration .....	12	9
		Tuning receiver for voice reception .....	13	9
		Mcw or cw reception .....	14	9
		Reception of frequency-shift signals .....	15	9
		Single-sideband reception .....	16	9
		Stopping procedure .....	17	24
		Antijamming instructions .....	18	24
CHAPTER	3.	MAINTENANCE INSTRUCTIONS		
		Scope of operator's maintenance .....	19	26
		Preventive maintenance .....	20	26
		Checking fuses .....	21	26
		Visual inspection .....	22	26
		Operational checklist .....	23	26
CHAPTER	4.	SHIPMENT AND LIMITED STORAGE AND DEMOLITION TO PREVENT ENEMY USE		
Section	I.	Shipment and limited storage		
		Disassembly .....	24	30
		Repacking for shipment or limited storage .....	25	30
	II.	Demolition of materiel to prevent enemy use		
		Authority for demolition .....	26	30
		Methods of destruction .....	27	30
APPENDIX	I.	REFERENCES .....		31
	II.	BASIC ISSUE ITEMS LIST, RADIO RECEIVER R-390A/URR .....		32

\*This manual supersedes so much of TM 11-856A, 20 January 1956, including C1, 19 March 1956; C2, 17 May 1956; C3, 23 November 1956; C4, 7 June 1957; C5, 23 July 1958, and C6, 13 November 1958, as pertains to the operation of the equipment.

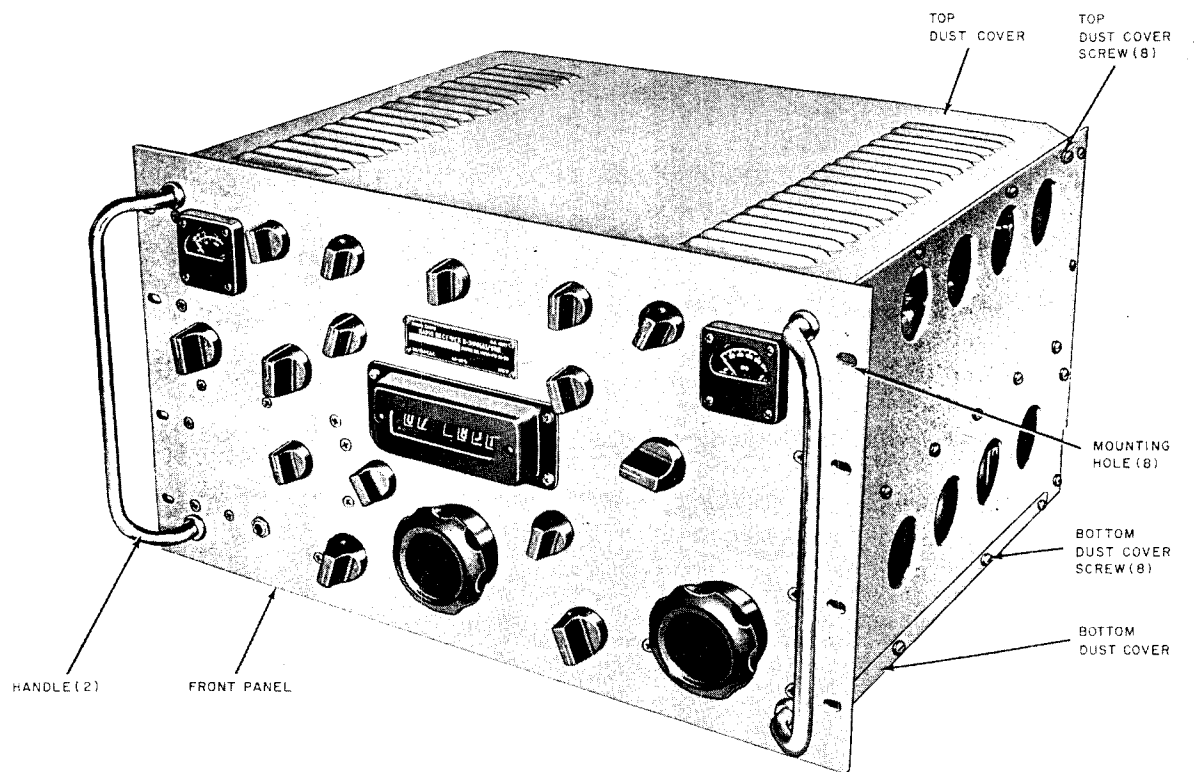

TM 5820-358-10-1

Figure 1. Radio Receiver R-390A/URR.

# CHAPTER 1

## INTRODUCTION

### Section I. GENERAL

#### 1. Scope

This manual describes Radio Receiver R-390A/URR (fig. 1) and covers its operation, and operator's maintenance. It includes cleaning and inspection of the equipment and replacement of parts available to first echelon maintenance. Throughout this manual, Radio Receiver R-390A/URR is referred to as the receiver.

#### 2. Forms and Records

##### a. *Unsatisfactory Equipment Reports.*

- (1) Fill out and forward DA Form 468 (Unsatisfactory Equipment Report) to the Commanding Officer, U. S. Army Signal Materiel Support Agency, ATTN: SIGMS-ML, Fort Monmouth, N. J., as prescribed in AR 700-38.
- (2) Fill out and forward AF TO Form 29 (Unsatisfactory Report) to the Commander, Air Materiel Command, Wright-Patterson Air Force Base, Ohio, as prescribed in AF TO 00-35D-54.

b. *Report of Damaged or Improper Shipment.* Fill out and forward DD Form 6 (Report of Damaged or Improper Shipment) as prescribed in AR 700-58 (Army), Navy Shipping Guide, Article 1850-4 (Navy), and AFR 71-4 (Air Force).

c. *Preventive Maintenance Form.* Prepare DA Form 11-238 (fig. 15), (Maintenance Check List for Signal Equipment (Sound Equipment, Radio, Direction Finding, Radar, Carrier, Radiosonde, and Television)) in accordance with instructions on the form.

d. *Parts List Form.* Forward DA FORM 2028, (Recommended Changes to DA Technical Parts Lists or Supply Manuals 7, 8, or 9) directly to the Commanding Officer, U. S. Army Signal Materiel Support Agency, ATTN: SIGMS-ML, Fort Monmouth, N. J., with comments on parts listings in Appendix II.

e. *Comments on Manual.* Forward all other comments on this publication directly to the Commanding Officer, U. S. Army Signal Materiel Support Agency, ATTN: SIGMS-PA2d, Fort Monmouth, N. J.

### Section II. DESCRIPTION AND DATA

#### 3. Purpose and Use

a. The receiver (fig. 1) is a general-purpose receiver for use in both fixed and mobile applications. The receiver provides reception of continuous-wave (cw), modulated-continuous-wave (mcw), amplitude-modulated (am.), frequency-shift keyed (fsk), and single-sideband (ssb) signals.

b. The receiver furnishes audiofrequency (af) output power to a local loudspeaker and headset or a balanced line. An intermediate frequency (if.) output is also provided so that received radio teletypewriter signals may be fed to other equipment for conversion into signals usable by teletypewriter printers.

c. The calibration of the receiver is ac-

curate to within 300 cps; this permits use of the receiver as a frequency meter.

#### 4. System Application

##### a. *Space-Diversity Receiving System.*

- (1) Two or three receivers can be connected as a space-diversity receiving system for reception of voice signals (fig. 2). This system provides substantially uniform audio output to a loudspeaker or headset, minimizing the effect of fading signals.

- (2) Rhombic or doublet antennas spaced at least 600 feet apart are connected to the two receivers.

##### b. *Space-Diversity Radio Teletypewriter*

*System.* Figure 3 shows two receivers connected in a space-diversity radio teletypewriter system. The doublet or rhombic antennas feed the incoming frequency-shift signals to the receivers. The outputs of the receivers are applied to a converter which provides diversity combining and produces direct current (dc) signals for the operation of teletypewriter equipment.

*c. Single-Sideband Radio Teletypewriter System.* A receiver and a single sideband converter may be connected as shown in figure 4.

This system permits the reception of single-sideband (ssb) signals, occupying 12 kc of rf spectrum space divided into two 6-kc sidebands, one 6-kc sideband on each side of a reduced carrier. A double-sideband signal, either am. or phase-modulated (pm), occupying up to a total of 12 kc of spectrum space also can be received. This system is used primarily for the reception of multichannel radio-teletypewriter transmissions. For additional information, refer to TM 11-649.

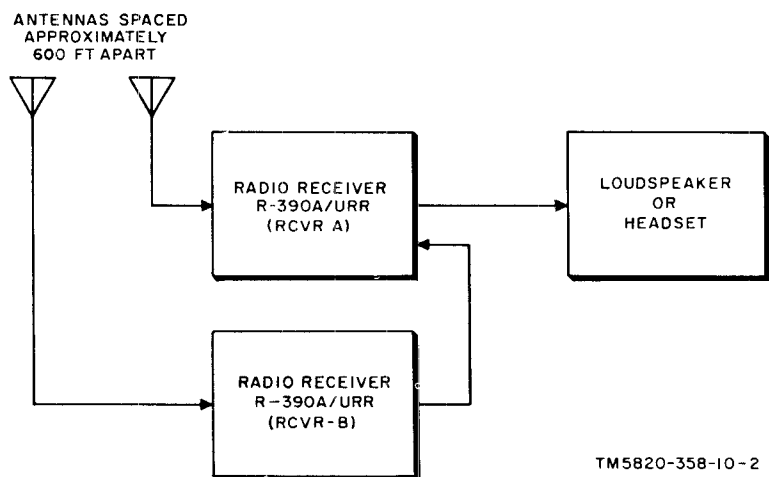

Figure 2. Space-diversity receiving system, block diagram.

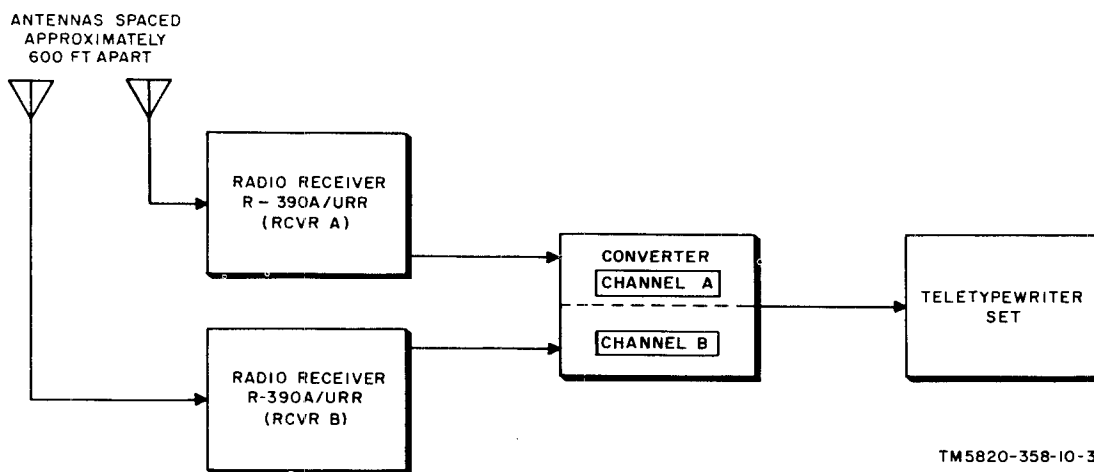

Figure 3. Space-diversity radio teletypewriter receiving system, block diagram.

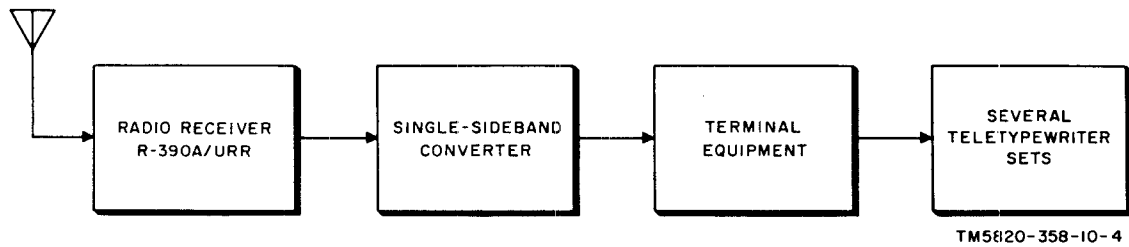

Figure 4. Single-sideband radio teletypewriter receiving system, block diagram.

### 5. Technical Characteristics

Frequency range .... 0.5 to 32 mc.  
 Type of signals Cw, mcw, voice, ssb, fsk.  
 received  
 Type of tuning ..... Continuous; frequency  
 read directly on coun-  
 tertype indicator.  
 Method of Built-in crystal-controlled.  
 calibration  
 Calibration points .. Every 100 kc.  
 Power source ..... 115 or 230 volts ac  $\pm 10\%$ ,  
 48 to 62 cps.  
 Power input ..... 250 watts total; 140 watts  
 with OVENS switch  
 turned to OFF.

### Antenna

requirements:

Unbalanced .... Straight wire of random  
 length or vehicular-  
 mounted whip.

Balanced ..... 125-ohm terminating im-  
 pedance; matches 50- to  
 200-ohm balanced or  
 unbalanced transmis-  
 sion line by use of adap-  
 ters.

### 6. Components of Radio Receiver R-390A/URR

a. *Components.* The components of Radio Receiver R-390A/URR are listed in the following table:

Quantity	Item	Fig. No.	Height (in.)	Depth (in.)	Width (in.)	Unit weight (lb)
1	Radio Receiver R-390A/URR	1	10 15/32	16 19/32	19	75
2	TM 11-5820-358-10					
1 set	Running spares (b below)	5				1

b. *Running Spares.* (fig. 5). The following is a list of running spares except as noted.

Quantity	Item
1	Electron tube, OA2
1	Electron tube, 6AK6
1	Electron tube, 6C4
1	Electron tube, 6DC6
1	Electron tube, 26Z5W
1	Electron tube, 5654/6AK5W
2	Electron tube, 5749/6BA6W
2	Electron tube, 5814A
5	Fuses, 3-ampere, 250-volt
1	Lamp, incandescent, 6-volt, 0.2-ampere, Federal Spec. No. W-L-11
1	Resistor, current-regulating
5	<sup>a</sup> Fuses, 1/4-ampere, 250-volt
5	<sup>a</sup> Fuses, 1/8-ampere, 250-volt

<sup>a</sup> Only on receivers bearing Order No. 15-PHILA-56, serial numbers 2683 and above, and Order No. 14385-PHILA-58.

### 7. Description

a. The receiver (fig. 1 and 6) is designed for mounting in a standard 19-inch rack or a table-top cabinet.

b. All operating controls, indicators, and a PHONES jack are located on the front panel. Two handles are provided to aid in removal of the receiver from the rack or cabinet. The chassis is enclosed by dust covers which may be removed when the receiver is installed in a cabinet.

c. Antenna connectors, operating and spare fuses, a power cord, an if. connector, an OVENS switch, terminal boards, and special tools are mounted on the rear panel (fig. 7).

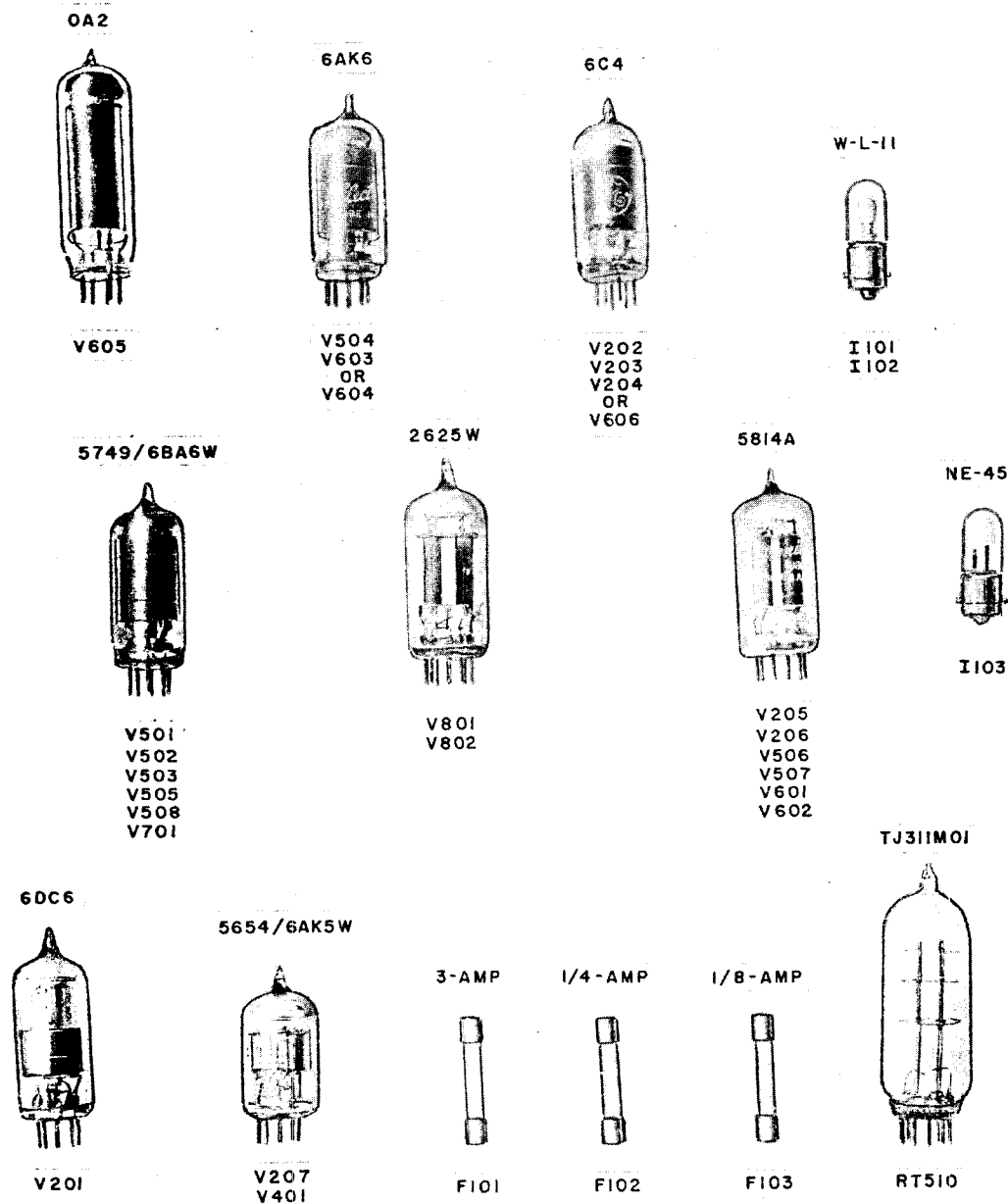

TM5820-358-10-5

Figure 5. Running spares.

Cutouts are provided to permit access to internal controls.

### 8. Additional Equipment Required

The following material is *not* supplied as a part of Radio Receiver R-390A/URR but is required for its operation. The connectors required will depend on the particular installation.

Antenna:

- Balanced ..... Doublet or rhombic.
- Unbalanced .... Random-length straight-wire or whip.

Low-impedance transmission line:

- Balanced ..... 50 to 200 ohms.
- Unbalanced .... 70-ohm coaxial cable.



Connector .....	Connector Plug UG-573/U or Connector Plug PL-259.		917/URR (Mobile) CY-1216/U or CY-979/URR
Headset .....	Headset Navy type CW-49507 or equivalent 600-ohm headset.	Adapter Connector UG-970/U .....	Adapts Connector Plug PL-259 on unbalanced antenna lead-in to balanced antenna input.
Cord .....	Headset Cord CX-1334/U, or equivalent.		
Loudspeaker .....	LS-166/U, or equivalent.	Adapter Connector UG-971/U .....	Adapts Connector Plug UG-573/U on unbalanced antenna lead-in to balanced antenna input.
Mounting and housing facilities	Standard 19-inch rack or cabinet such as: (Fixed) CY-1119/U or CY-		

*CHANGE C 2*

4. TO PREVENT DAMAGE TO THE RCVR, BE SURE TO TURN THE DIAL LOCK CONTROL COUNTERCLOCKWISE UNTIL IT STOPS BEFORE TURNING THE KILOCYCLE CHANGE CONTROL. DO NOT FORCE THE DIAL LOCK CONTROL BEYOND THE NORMAL STOP POSITION IN EITHER DIRECTION.
5. WHEN TURNING THE ZERO ADJ CONTROL KNOB, BE CAREFUL NOT TO FORCE THE KNOB COUNTERCLOCKWISE BEYOND THE STOP. THE SHAFT CAN BE TURNED TO A POINT AT WHICH THE PLATE ON THE END OF THE SHAFT IS FORCED OFF.



Control or indicator	Function
	AGC Receiver operative, with gain controlled automatically.
	MGC Receiver operative, with gain controlled by RF GAIN control or by an external control.
	<i>Sw Pos</i> <i>Effect</i> Cal Permits calibration of the tuning system at 100-kc checkpoints.
ANT TRIM control .....	Permits peaking of received signal to maximum value.
DIAL LOCK .....	When turned clockwise, locks KILOCYCLE CHANGE control to prevent accidental change of setting.
ZERO ADJ .....	When turned clockwise, disengages frequency indicator from KILOCYCLE CHANGE control for calibration purposes.
LOCAL GAIN control .....	Controls level of af signal applied to local headset or loudspeaker.
RF GAIN control .....	Manual control of amplification of received signal.
MEGACYCLE CHANGE control .....	Selects any one of 32 tuning bands in steps of 1 megacycle; changes reading of first two digits of frequency indicator.
KILOCYCLE CHANGE control .....	Tunes receiver to any frequency within a 1-megacycle band; changes reading of last three digits of frequency indicator.
PHONES jack .....	Provides means of connecting headset to receiver.

## Section II. OPERATION

### 11. Preparing Receiver for Reception

A sample frequency of 07.275 megacycles will be used in paragraphs 11 through 15; it is understood that the operator will substitute the desired frequency. For preparatory procedure, refer to figure 8.

### 12. Calibration

The receiver is now ready for calibration. To maintain maximum tuning accuracy, calibrate the frequency indicator at the 100-kc point nearest the desired frequency. Recalibrate whenever the MEGACYCLE CHANGE control is turned. Start with the controls set as in paragraph 11. For calibration procedure, refer to figure 9.

### 13. Tuning Receiver for Voice Reception

Start with controls set as in paragraph 11. For voice reception tuning procedure, refer to figure 10.

### 14. Mcw or Cw Reception

Set up the controls the same as for voice reception (para 13). For mcw or cw reception, refer to figure 11.

### 15. Reception of Frequency-Shift Signals

The following procedure can be used for tuning the receiver to frequency-shift signals, unless another procedure is given in the technical manual covering the particular receiving system. The receiver requires exact tuning for this type of operation. The entire procedure applies only to systems that use the audio output of the receiver, such as Radioteletype Terminal Equipment AN/FGC-1. Omit the procedure given in step 4, figure 12, with equipments that use the if. output of the receiver, such as Frequency Shift Converter CV-116/URR. Set up the receiver the same as for mcw or cw reception (para 14). For reception of frequency-shift signals, refer to figure 12.

### 16. Single-sideband Reception

Tuning the receiver for ssb reception must be done accurately if this type of signal is to be received. Calibrate the receiver as shown in paragraph 12. Start with the receiver set up as in paragraph 14. For ssb tuning procedure refer to figure 13.

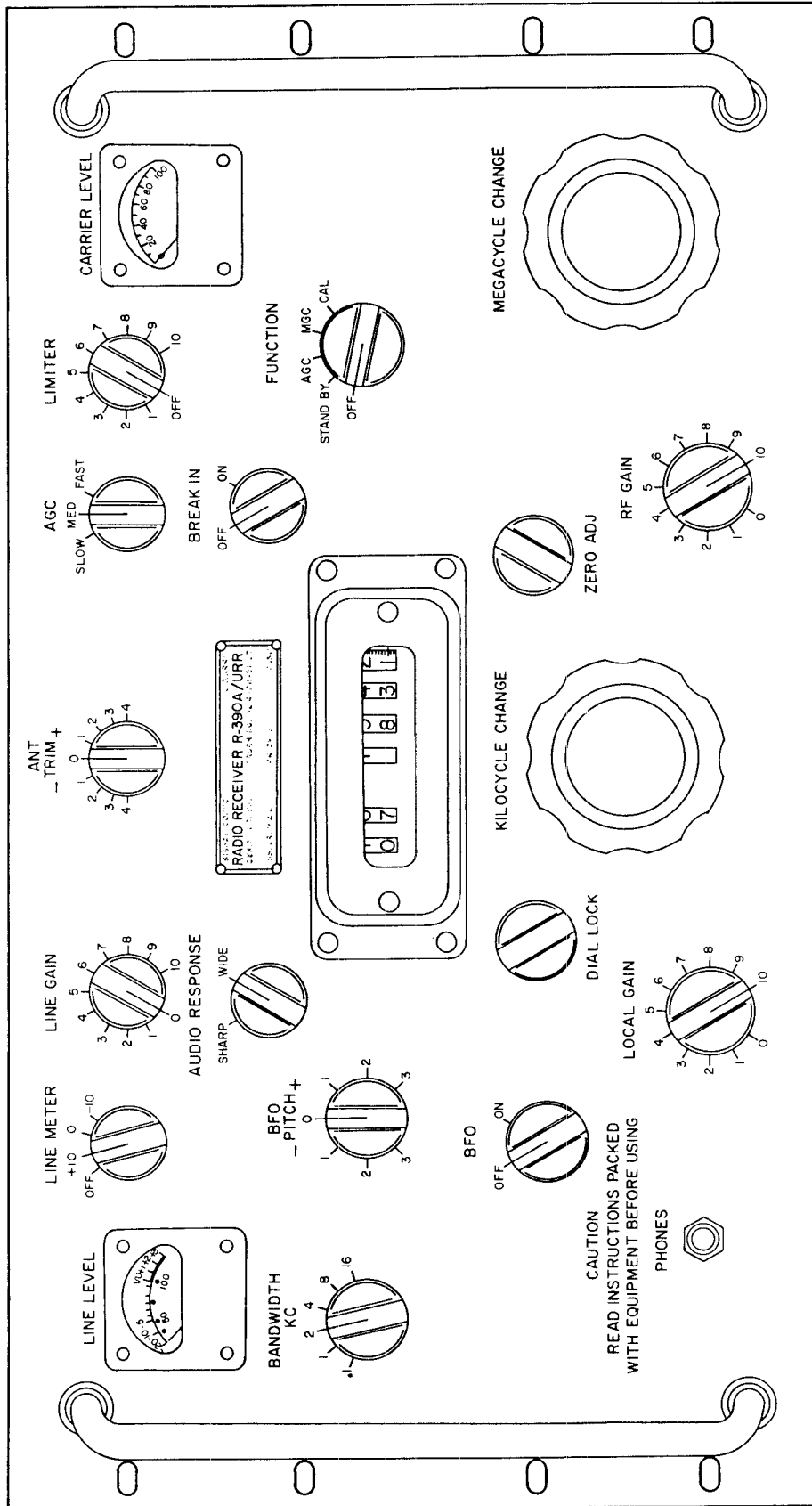

TM5820-358-10-9

Figure 6. Front panel.

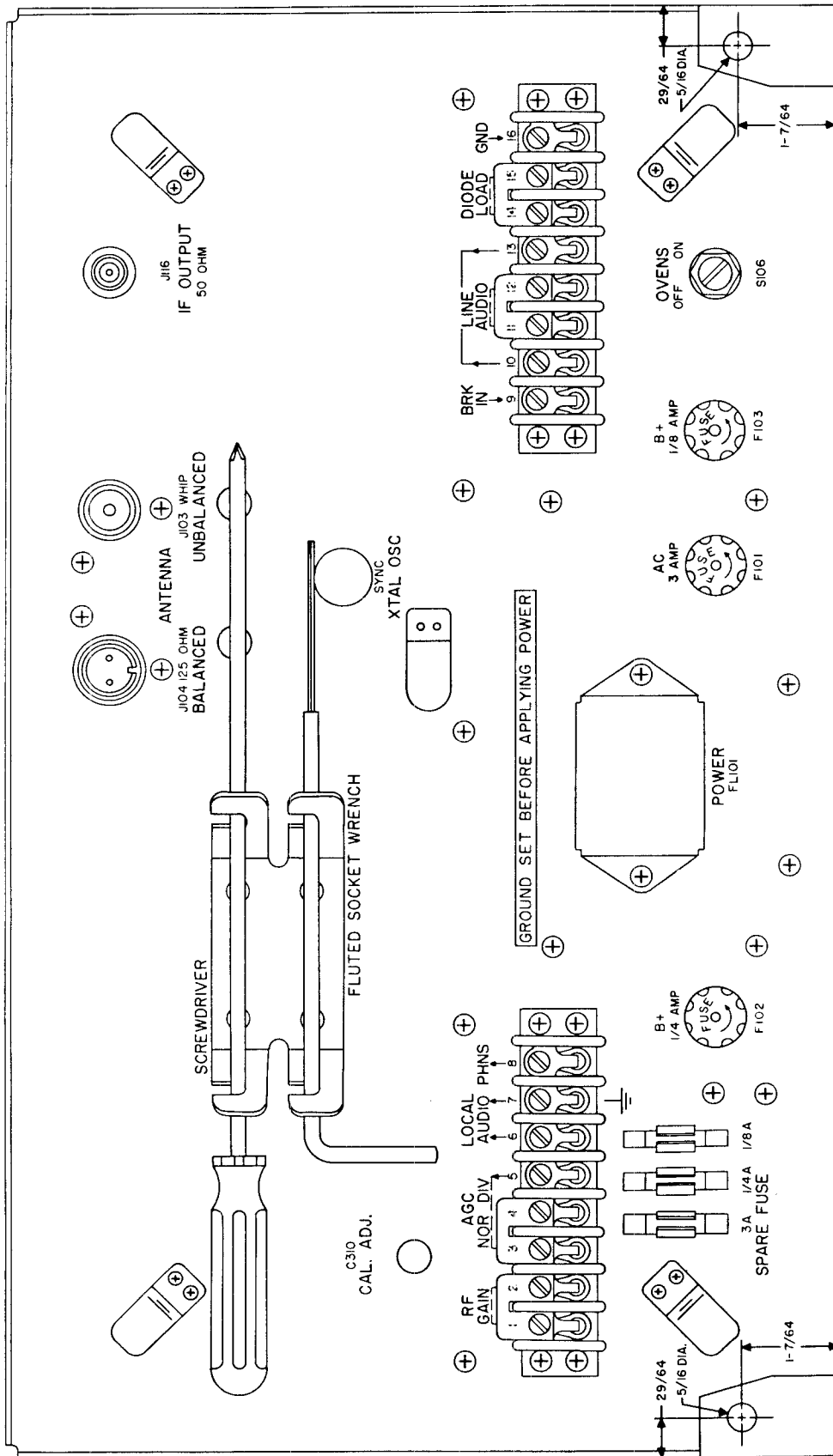

NOTE:  
 FUSES F102 AND F103 APPEAR ONLY  
 IN RECEIVERS BEARING ORDER NO.  
 14 - PHILA-56 SERIAL NUMBERS 2683  
 AND ABOVE, AND ORDER NO. 14365 -  
 PHILA-58.

TM5620-358-10-10

Figure 7. Rear panel.

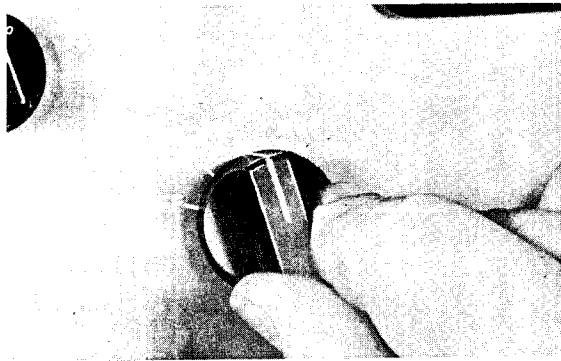

**1** Turn the FUNCTION switch to AGC. Allow the receiver to warm up for several minutes before operating it.

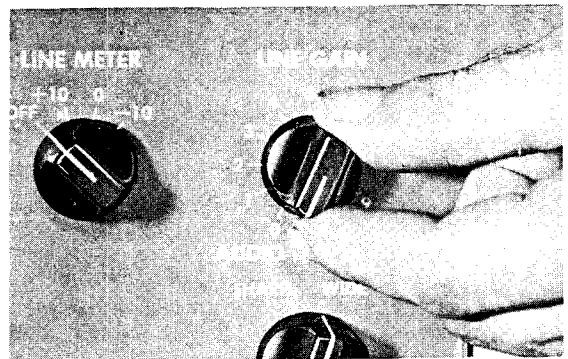

**3** Turn the LINE GAIN to 0.

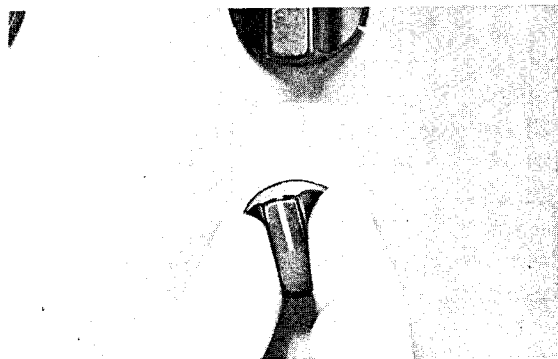

**2** Turn the BFO switch to OFF.

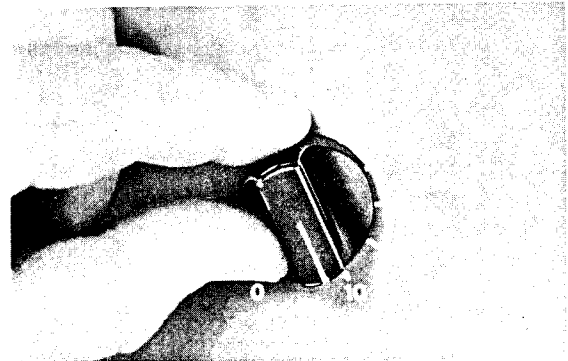

**4** Turn the RF GAIN control to 10.



**5** Turn the LOCAL GAIN control to 6.

TM5820-358-10-14 ①

Figure 8①. Preparing receiver for reception (part 1 of 2).

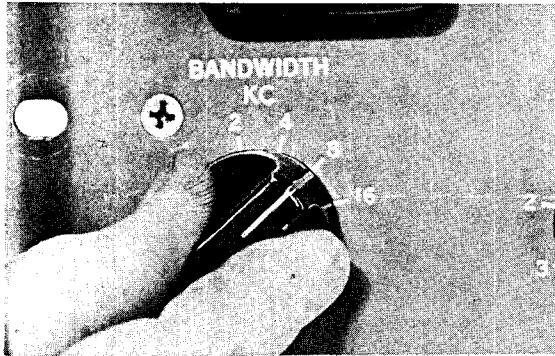

**6** Turn the BANDWIDTH switch to 8.



**8** Turn the AGC switch to MED.

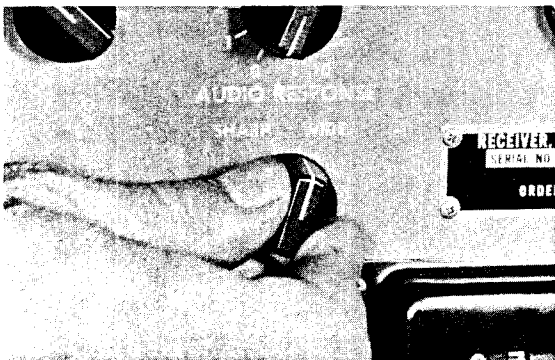

**7** Turn the AUDIO RESPONSE switch to WIDE.

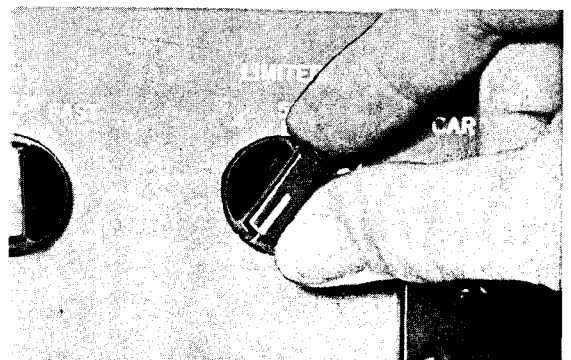

**9** Turn the LIMITER control to OFF.

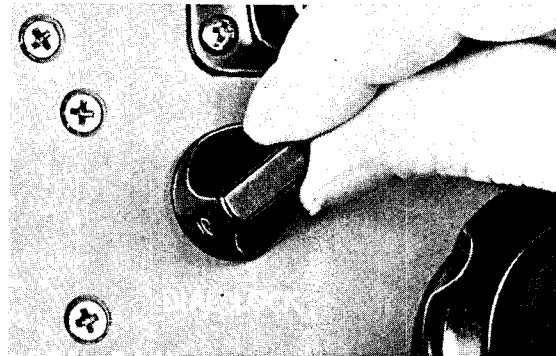

**10** Turn the DIAL LOCK to the left until it stops.

TM5820-358-10-14 (2)

Figure 8(2). Preparing receiver for reception (part 2 of 2).

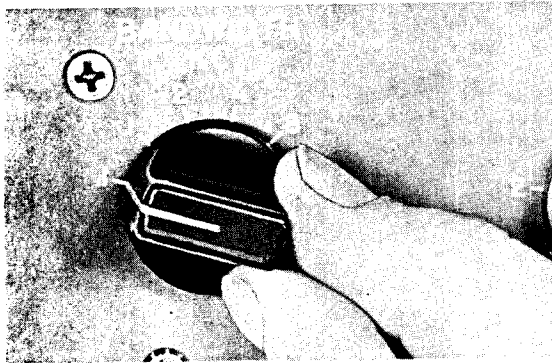

**1** Turn the BANDWIDTH switch to .1.

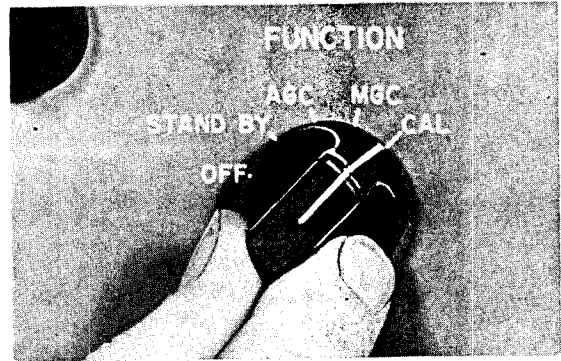

**4** Turn the FUNCTION switch to CAL.

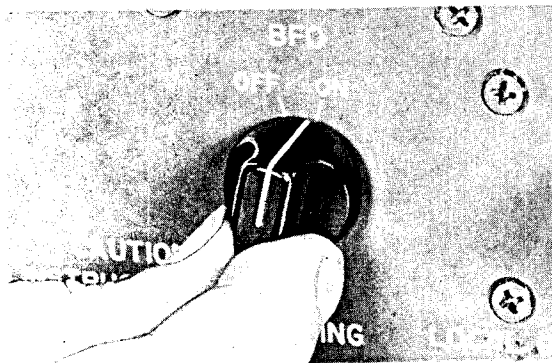

**2** Turn the BFO switch to ON.

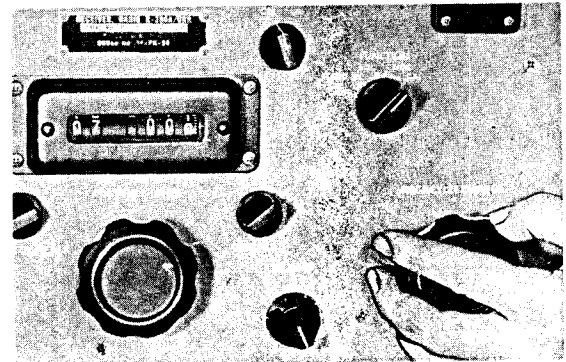

**5** Turn the MEGACYCLE CHANGE control to the desired band.

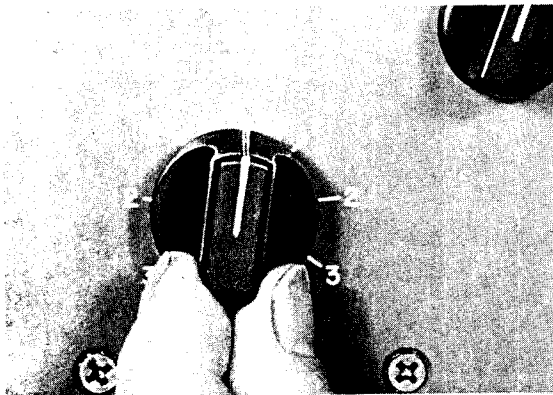

**3** Turn the BFO PITCH control to 0.

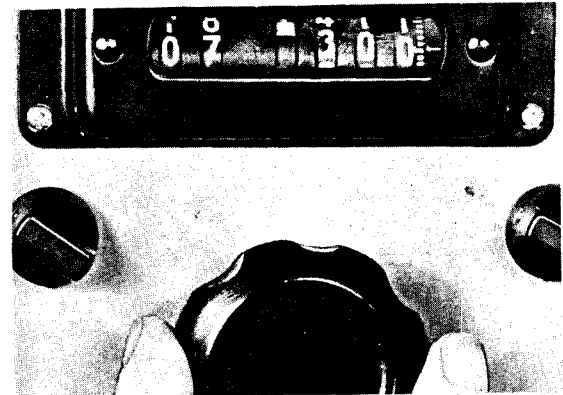

**6** Turn the KILOCYCLE CHANGE control to the 100-kc point nearest the desired frequency.

TM5820-358-10-15 ①

Figure 9①. Calibration (part 1 of 2).



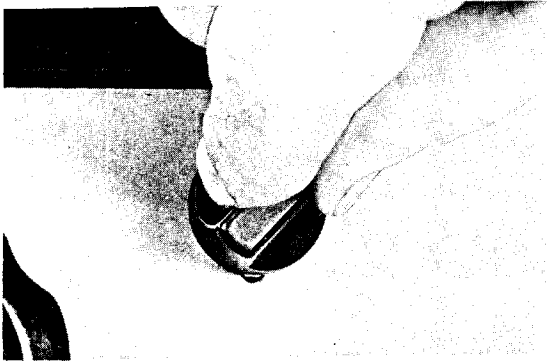

**7** Turn the ZERO ADJ knob to the right until it stops.

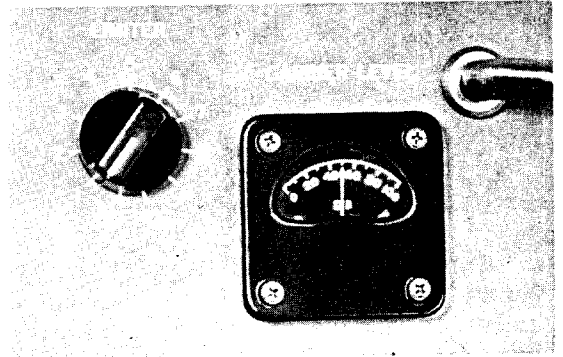

**9** Adjust the KILOCYCLE CHANGE control for a maximum indication of the CARRIER LEVEL meter (step 6).

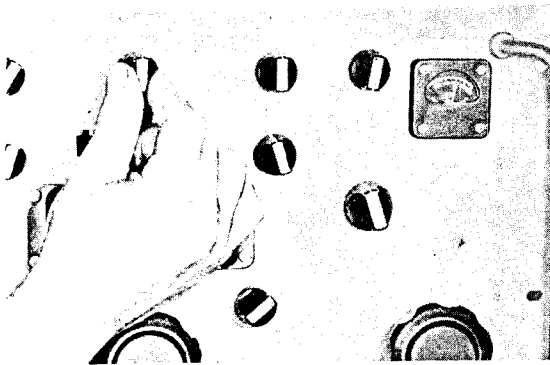

**8** Adjust the ANT TRIM knob to obtain a maximum indication of the CARRIER LEVEL meter.

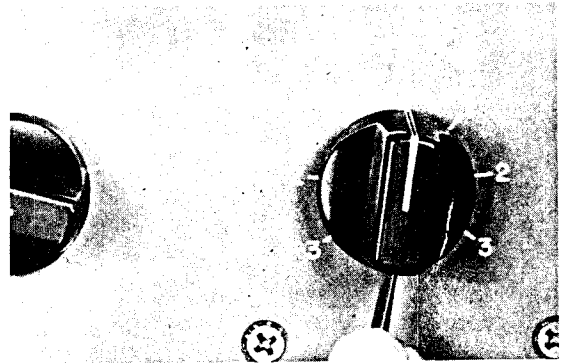

**10** If the BFO PITCH control does not produce a zero beat at 0, tune it for zero beat, loosen the knob screw, and adjust the knob to zero without turning the shaft. Tighten the knob screw.

**11** Turn the ZERO ADJ knob to the left until it stops. The dial is now calibrated accurately (step 7).

TM5820-358-10-15 ②

Figure 9②. Calibration (part 2 of 2).

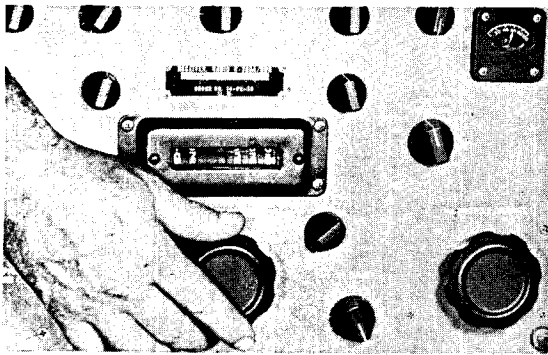

**1** Turn the KILOCYCLE CHANGE control slightly toward the left or right of the desired station for a maximum CARRIER LEVEL meter indication (the MEGACYCLE CHANGE control has been set during calibration).

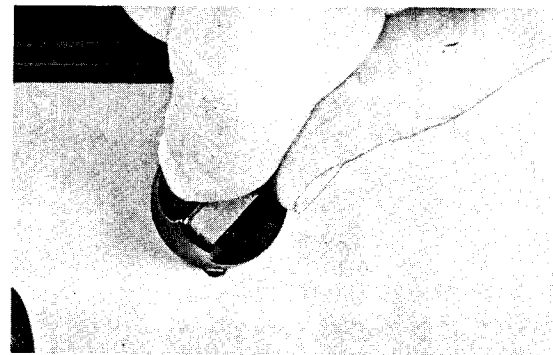

**3** Turn the DIAL LOCK knob to the right until it stops.

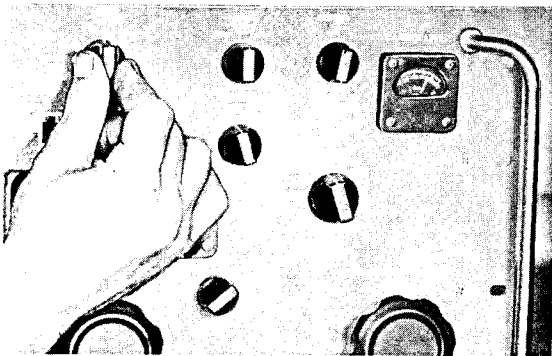

**2** Adjust the ANT TRIM control for a maximum CARRIER LEVEL meter indication.

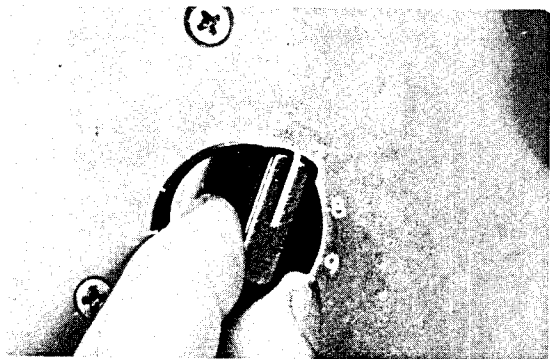

**4** Adjust the LOCAL GAIN control for a comfortable volume level.

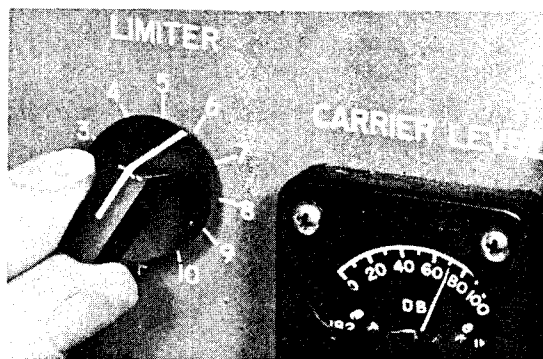

**5** If there is excessive noise, turn the LIMITER control to the right as needed.

TM 5820-358-10-16①

Figure 10①. Tuning receiver for voice reception (part 1 of 2).

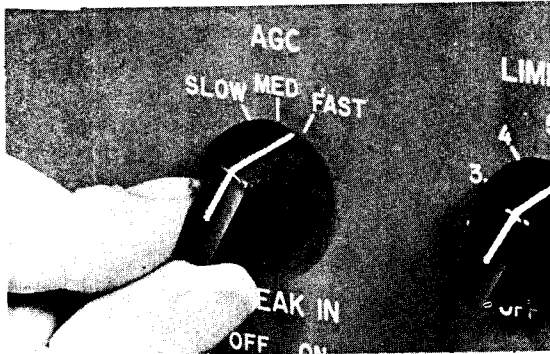

**6** If the signal fades rapidly, turn the AGC control to FAST.

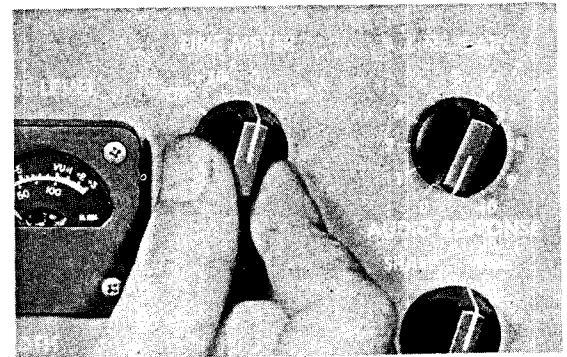

**8** The LINE METER switch (when used) is usually set at 0.

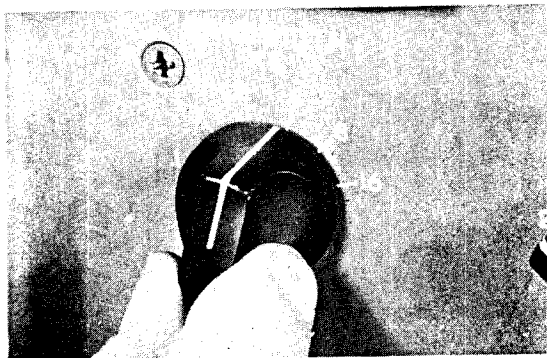

**7** If another station is interfering, turn the BANDWIDTH switch to 4, or if necessary to 2.

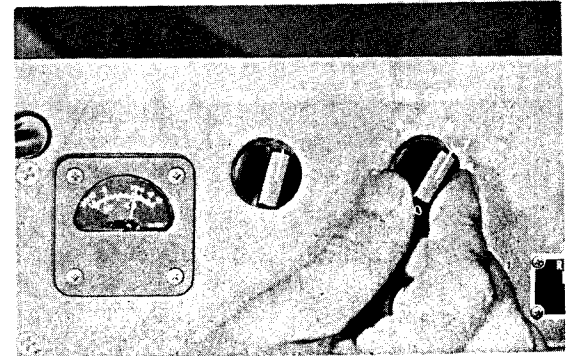

**9** When the LINE METER switch is set at 0, the LINE GAIN control is usually adjusted for a LINE LEVEL meter indication at the VU mark.

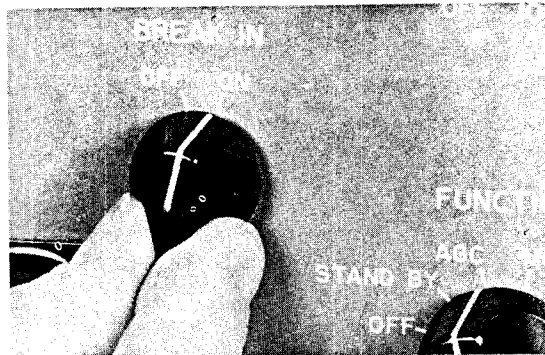

**10** If the receiver is to be disabled during periods of transmission, turn the BREAK IN switch to ON.

TM5820-358-10-16 (2)

Figure 10(2). Tuning receiver for voice reception (part 2 of 2).

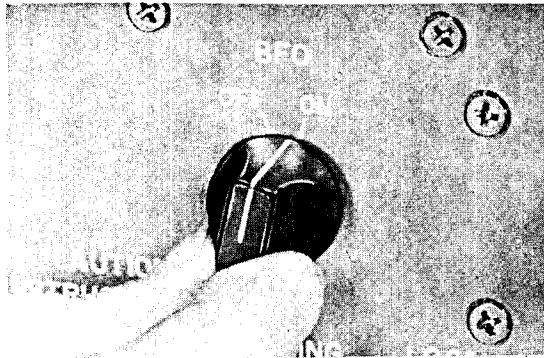

**1** Turn the BFO switch to ON.

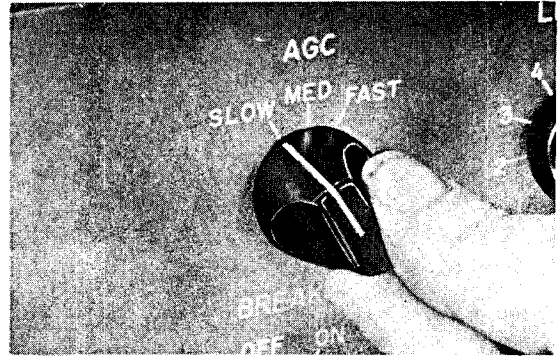

**4** Turn the AGC switch to SLOW. If keying is at such a slow speed that noise is heard between characters, perform steps 5 and 6.



**2** Adjust the BFO PITCH control for a comfortable tone.

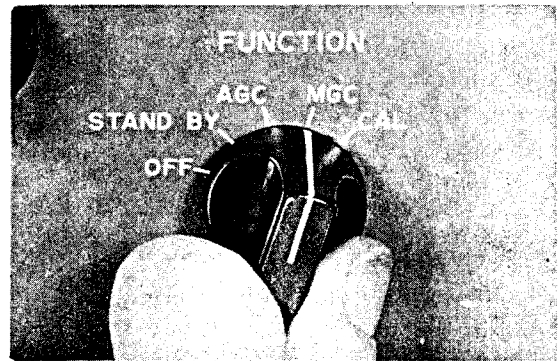

**5** Turn the FUNCTION switch to MGC.



**3** Turn the BANDWIDTH switch to 2, or if necessary to a lower position, to reduce adjacent channel interference.

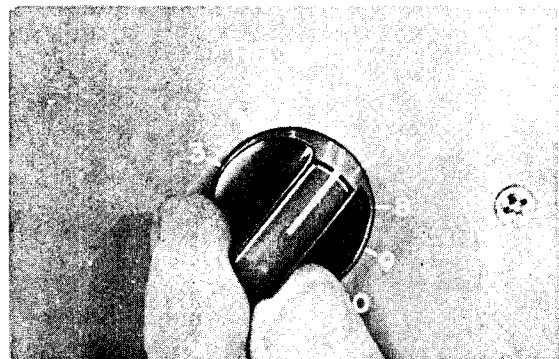

**6** Reduce the RF GAIN control setting to prevent blocking. For greater selectivity during cw reception, perform steps 7, 8, 9, 10, and 11.

TM5820-358-10-17①

Figure 11①. *Mcw or cw reception (part 1 of 2).*

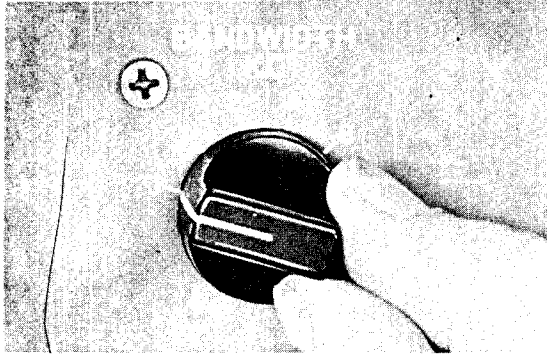

**7** Turn the BANDWIDTH switch to .1.



**9** Tune the KILOCYCLE CHANGE control for zero beat.

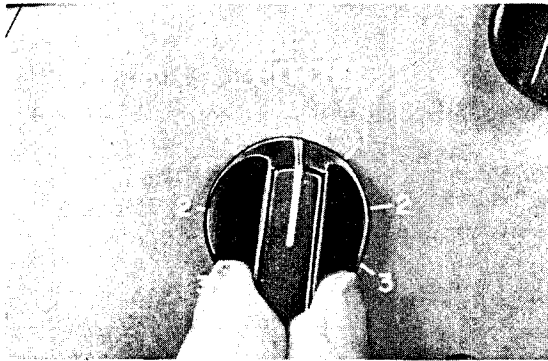

**8** Turn the BFO PITCH control to 0.



**10** Adjust the BFO PITCH control for a comfortable tone.

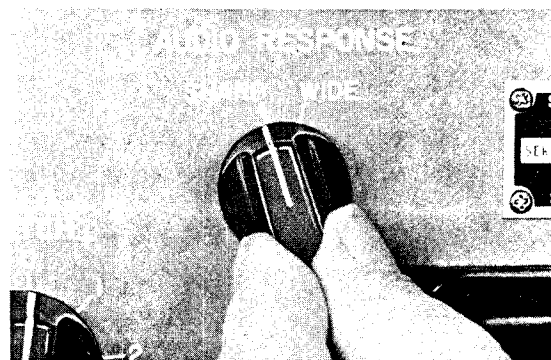

**11** Turn the AUDIO RESPONSE switch to SHARP.

TM5820-358-10-17 (2)

Figure 11 (2). Mcw or cw reception (part 2 of 2).

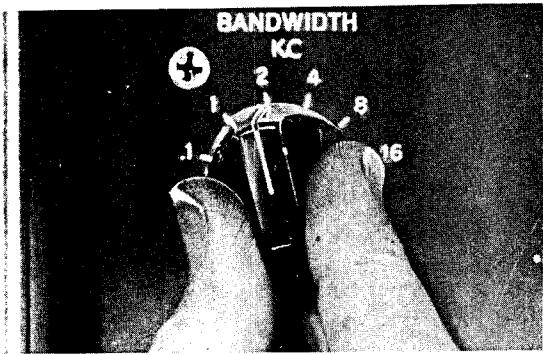

**1** Turn the BANDWIDTH switch to 2. (For filter-type equipment, such as Radioteletype Terminal Equipment AN/FGC-1, where audio frequencies of 2,125 and 2,975 cps are used, turn the BANDWIDTH switch to 4.)

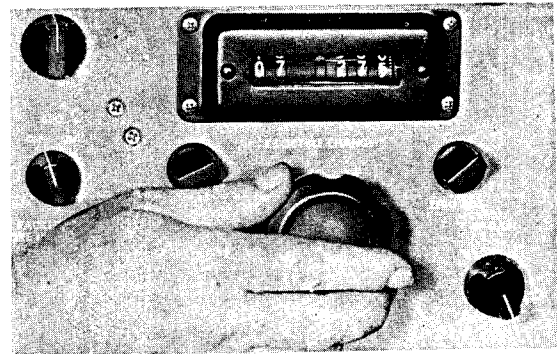

**3** Tune the KILOCYCLE CHANGE control to the desired frequency; then readjust it slightly until mark and space signals with the same tone are heard.

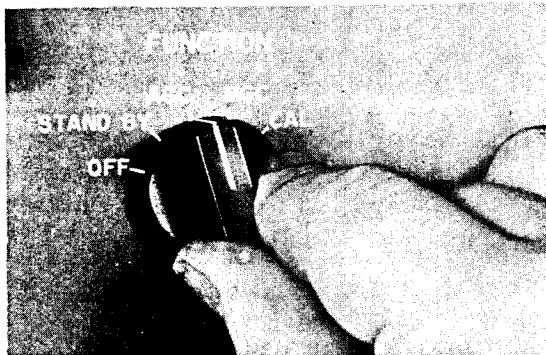

**2** Turn the FUNCTION switch to AGC.



**4** Adjust the BFO PITCH control until the teletypewriter prints good copy.

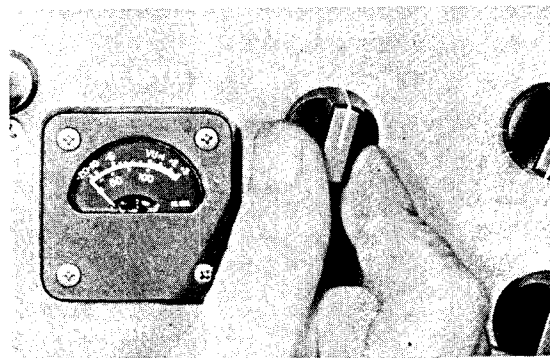

**5** Turn the LINE METER switch to 0.

TM 5820-358-10-18 ①

Figure 12①. Reception of frequency-shift signals (part 1 of 2).

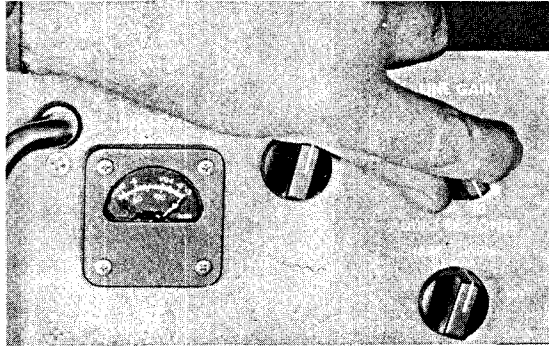

**6** Turn the LINE GAIN control to 10. The LINE LEVEL meter should deflect fully to the right.

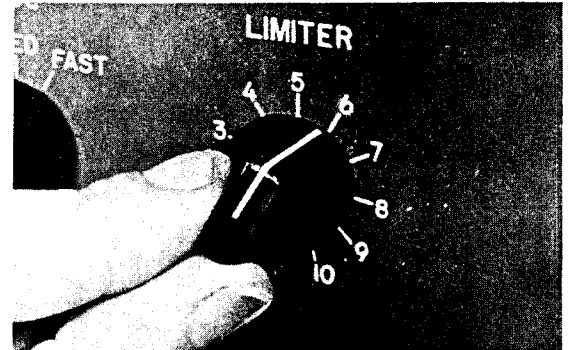
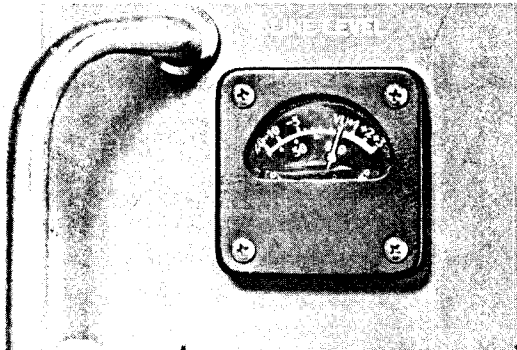

**7** Adjust the LIMITER control for a LINE LEVEL meter indication at the VU mark.

TM5820-358-10-18 (2)

Figure 12(2). Reception of frequency-shift signals (part 2 of 2).

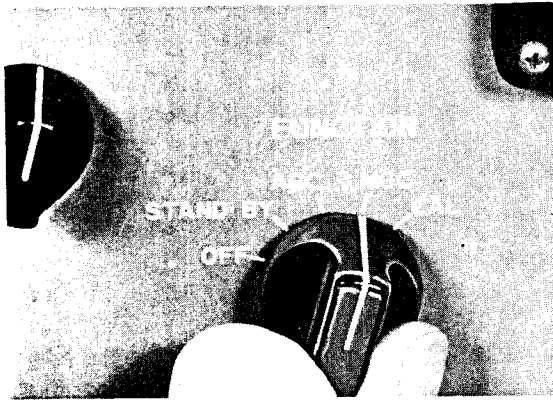

**1** Turn the FUNCTION switch to MGC.

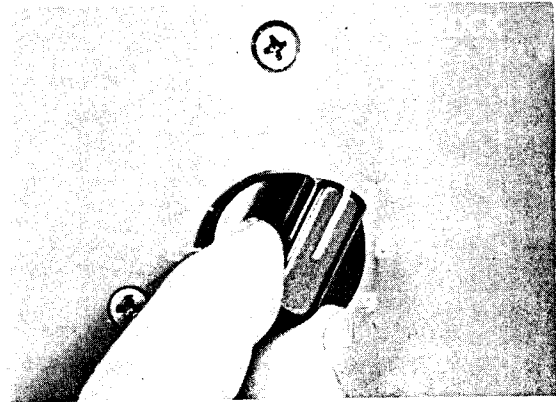

**3** Turn the LOCAL GAIN control to 6.

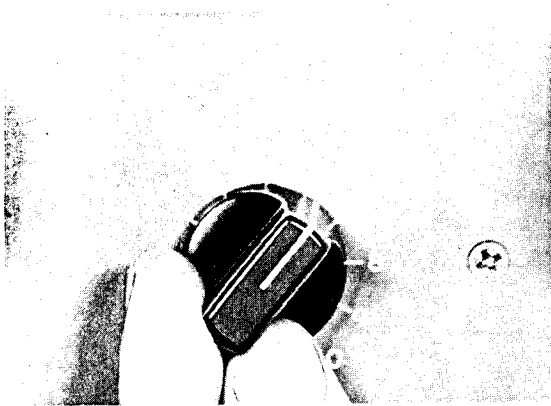

**2** Turn the RF GAIN control to 6.

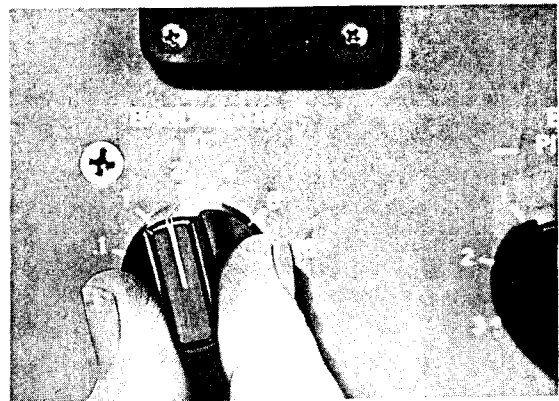

**4** Turn the BANDWIDTH switch to 2 for a 2-kc bandwidth, or to 4 for a 4-kc bandwidth.

TM5820-358-10-19 ①

Figure 13①. Single-sideband reception (part 1 of 2).





- 5** Turn the BFO switch to ON.

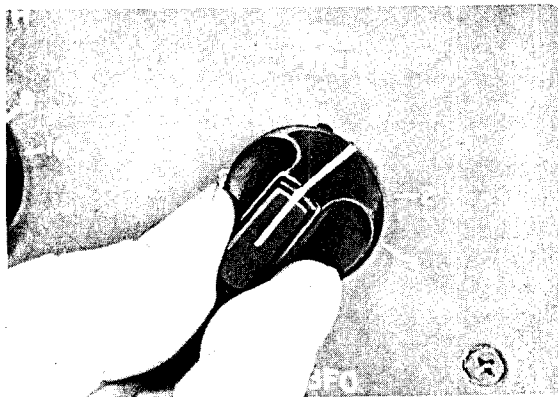

- 6** Set the BFO PITCH control at  $-1$  for upper sideband reception with a signal 2-kc wide, or  $-2$  for a 4-kc signal width ( $+1$  or  $+2$  respectively for lower sideband reception).

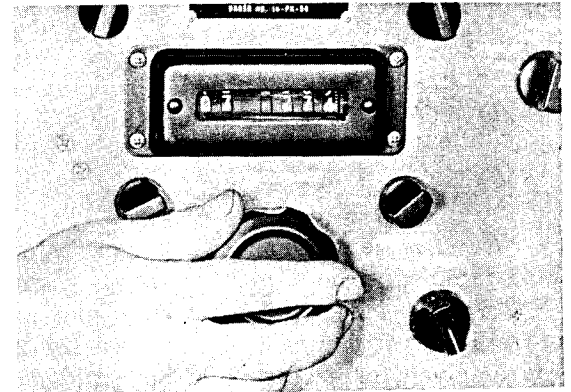

- 7** Tune the KILOCYCLE CHANGE control to the carrier frequency  $+1$  kc for a 2-kc bandwidth, or  $+2$  kc for a 4-kc bandwidth if the upper sideband is used ( $-1$  kc or  $-2$  kc respectively if the lower sideband is used).

- 8** Adjust the BFO PITCH and/or KILOCYCLE CHANGE control slightly for the most intelligible reception (steps 6 and 7).

- 9** Adjust the LOCAL GAIN and RF GAIN controls for the desired audio level (steps 2 and 3).

TM5820-358-10-19 ②

Figure 13②. Single-sideband reception (part 2 of 2).

## 17. Stopping Procedure

When the receiver is not to be used but is to be maintained in a state of readiness, turn the FUNCTION switch to STAND BY.

**Caution:** The FUNCTION switch should not be left in STAND BY for more than 30 minutes. Under this condition, the life of certain vacuum tubes may be shortened. For stopping procedure, refer to figure 14.

## 18. Antijamming Instructions

When it is determined that the receiver is being jammed, promptly inform your immediate superior officer. To provide maximum intelligibility of jammed signals, use the procedures given for each type of operation.

a. When receiving jammed voice signals, follow the procedures in the order indicated below until the signal is heard with the least amount of interference.

- (1) Turn the KILOCYCLE CHANGE control very slowly through several dial markings on either side of the desired signal. Some separation of the desired signal from the jamming signal may be achieved.

- (2) Turn the BANDWIDTH switch to 4 or 2, whichever gives better results. Slowly tune as described in (1) above.
- (3) Adjust the ANT TRIM control to the point where the signal is heard with the least amount of interference.
- (4) If the noise is severe, adjust the LIMITER control as required.
- (5) When the jamming signal is weak, turn the FUNCTION switch to MGC and the RF GAIN control counterclockwise. The interfering signal may be reduced enough to permit the desired signal to come through.
- (6) If these steps do not provide a readable signal, request a change of frequency and call sign.
- (7) Request the use of cw operation, if permissible (b below).
- (8) If possible, change the direction, length, and height of the antenna. This may reduce the jamming effectiveness so that some degree of satisfactory reception is obtained.
- (9) If the jamming prevents communication, report this fact to your immedi-

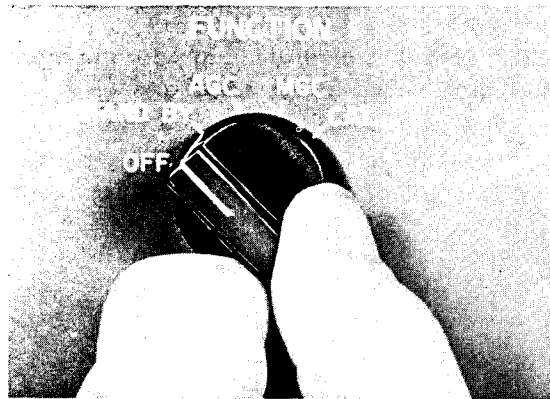

- 1** When the receiver is not to be used but is to be maintained in a state of instant readiness, turn the FUNCTION switch to STAND BY.

**Caution:** Do not leave the FUNCTION switch in STAND BY for more than 30 minutes, because the life of certain vacuum tubes may be shortened.

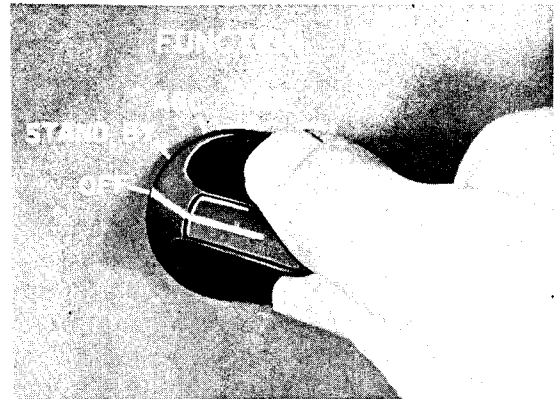

- 2** To shut the receiver off, turn the FUNCTION switch to OFF.

TM 5820-358-10-20

Figure 14. Stopping procedure.

ate superior. Keep your receiver tuned to the desired signal; continue to operate.

*b.* When receiving jammed cw or mcw signals, follow the procedures in the order indicated below until satisfactory reception is established.

- (1) Turn the KILOCYCLE CHANGE control very slowly through a few dial markings on either side of the desired signal. Some separation of the desired signal from the jamming may be achieved.

- (2) Turn the BANDWIDTH switch to 1 or .1 and turn the AUDIO RESPONSE switch to SHARP. Slowly tune as described in (1) above.

- (3) Reset the BFO PITCH control; it may be possible to separate the tone of the desired signal from the jamming signal to provide readability.

- (4) Perform the procedures indicated in *a*(3) through (6), (8), and (9) above.

*c.* When receiving frequency-shift signals, refer to the technical manual on the particular receiving system for antijamming instructions.

## CHAPTER 3

### MAINTENANCE INSTRUCTIONS

#### 19. Scope of Operator's Maintenance

a. The following is a list of maintenance duties normally performed by the operator of Radio Receiver R-390A/URR. These procedures do not require special tools or test equipment.

b. Operator's maintenance for Radio Receiver R-390A/URR consists of the following:

- (1) Preventive maintenance (para 20).
- (2) Visual inspection (para 22).
- (3) Operational check (para 23).
- (4) Replacement of defective fuses (para 21).

#### 20. Preventive Maintenance

a. *DA Form 11-238*. DA Form 11-238 (fig. 15) is a preventive maintenance checklist to be used by the operator. Items not applicable to the receiver are lined out in the figure. References in the ITEM block in the figure are to paragraphs that contain additional maintenance information pertinent to the particular item. Instructions for the use of the form appear on the form.

b. *Items*. The information shown in the chart below is supplementary to DA Form 11-238. The item numbers correspond to the ITEM numbers on the form.

Item	Maintenance procedures
2	Use a clean cloth to remove dust, dirt, moisture, and grease from the exteriors of cases, racks, mounts, transmission lines, headsets, and front panel controls. If necessary, wet the cloth with Cleaning Compound (Federal stock No. 7930-395-9542) and then wipe the parts with a dry clean cloth.
3	All control knobs should work smoothly, be tight on the shaft, and should not bind. Tighten all loose knobs and be sure that the knobs do not rub against the panel.
7	Report to the higher echelon repairman any cut, worn, or broken cables, wires, or transmission lines.

**Warning:** Cleaning compound is flammable and its fumes are toxic. Do not use near a flame; provide adequate ventilation.

#### 21. Checking Fuses

(fig. 7)

a. Remove the fuses from the rear panel. See that they are of the proper value. If the receiver is to be operated from a 115-volt source with the OVENS switch at OFF, replace the AC 3 AMP fuse with a 2-ampere fuse. If the receiver is to be operated from a 230-volt source with the OVENS switch at ON, use a 1½-ampere fuse; use a 1-ampere fuse with the OVENS switch at OFF.

*Note.* Receivers bearing Order No. 14-Phila-56, serial numbers 2683 and above, and Order No. 14385-Phila-58 have a ½-ampere and a ¼-ampere fuse on the rear panel in addition to the AC 3 AMP fuse.

b. If you replace a burned-out fuse with a new one and the new fuse burns out, notify a higher echelon repairman.

**Caution:** To avoid serious damage to the receiver, do not use any fuse other than the value specified.

#### 22. Visual Inspection

a. When the equipment fails to perform properly, turn the power off and check all the items listed below. *Do not check any item with the power on.*

- (1) Wrong settings of switches and controls (para 9 and 10).
- (2) Cables, headset cord, or antenna lead-in wire improperly connected.
- (3) Disconnected cables, plugs, or headset cord.
- (4) Grounded or broken antenna lead-in wire.
- (5) Burned-out fuses (usually indicate some other faults) (para 21).

b. If the above checks do not locate the trouble, proceed to the operational checklist (para 23).

#### 23. Operational Checklist

a. *General.* The operational checklist will help the operator to locate trouble quickly. The corrective measures are used to repair this



trouble. If the measures suggested do not restore normal operation, troubleshooting is required by a higher echelon repairman. Note on the repair tag what corrective measures were taken and how the equipment performed at the time of failure.

*b. Procedure.* Place the set in operation (para 13). After the equipment has had time to warm up, perform the steps shown in *c* below, in the order given. Observe the equipment operation and perform any corrective measures necessary.

*c. Checklist*

Action	Normal indication	Corrective measure
FUNCTION switch at AGC.	Dial lamps lighted.	Check power cord and fuses (para 21).
	Rushing noise or signal heard in headset.	Check headset cord and plug.
Turn MEGACYCLE CHANGE control to each band.	Proper numbers appear in frequency-indicator window.	Higher echelon repair required.
Tune KILOCYCLE CHANGE control to a desired station.	Desired station is heard.	Higher echelon repair required.
Adjust ANT TRIM control for a maximum indication on CARRIER LEVEL meter.	A maximum deflection of meter is obtained.	Higher echelon repair required.
Turn LOCAL GAIN control from minimum to maximum.	Volume at loudspeaker or headset will increase.	Higher echelon repair required.
Turn LINE GAIN control from minimum to maximum.	Output level to 600-ohm line or headset and LINE LEVEL meter will increase.	Higher echelon repair required.
Turn RF GAIN control from minimum to maximum.	Audio output and CARRIER LEVEL meter indication will increase.	Higher echelon repair required.
Turn FUNCTION switch to MGC.	With no signal being received, noise level should increase slightly and CARRIER LEVEL not indicate.	Higher echelon repair required.
Tune KILOCYCLE CHANGE control to several different signals with FUNCTION switch at AGC.	Output volume nearly constant.	Higher echelon repair required.
Turn FUNCTION switch to CAL and operate KILOCYCLE CHANGE control.	Deflection on CARRIER LEVEL meter at each 100 kc reading.	Higher echelon repair required.
Turn LIMITER control to the right.	Noise peaks are reduced in amplitude.	Higher echelon repair required.
Turn LINE METER switch to 0 and adjust LINE GAIN control for LINE LEVEL meter reading at VU mark.	LINE LEVEL meter reads at VU mark.	Higher echelon repair required.
LINE METER switch at -10.	LINE LEVEL meter reads completely to right.	Higher echelon repair required.
LINE METER switch at +10.	LINE LEVEL meter reads -10.	Higher echelon repair required.
LINE METER switch at OFF.	LINE LEVEL meter reads completely to left.	Higher echelon repair required.
Turn BFO switch to ON.		
Turn KILOCYCLE CHANGE control.	A whistle-like tone is heard as each station is tuned in.	Higher echelon repair required.
Turn BFO PITCH control.	The pitch of the tone changes.	Higher echelon repair required.

Action	Normal indication	Corrective measure
Turn BANDWIDTH KC switch to each position from 16 to .1.	Selectivity becomes sharper and noise decreases. Only low frequency audio tones are heard in the .1 position.	Higher echelon repair required.
Turn FUNCTION switch to STAND BY.	No noise or signal is heard, dial lamps remain lighted.	Higher echelon repair required.
Turn FUNCTION switch to OFF.	Dial lamps go out.	Higher echelon repair required.

## CHAPTER 4

### SHIPMENT AND LIMITED STORAGE AND DEMOLITION TO PREVENT ENEMY USE

---

#### Section I. SHIPMENT AND LIMITED STORAGE

##### 24. Disassembly

The following instructions are recommended for preparing the receiver for transportation and storage:

- a. Disconnect the antenna lead-in cable.
- b. Remove all connections to the rear-panel terminal strips of the receiver.
- c. Unplug the headphone cord from the front panel PHONES jack.

d. Disconnect the power cable from the ac outlet. Wind the cable around the clips provided on the receiver rear panel.

##### 25. Repacking for Shipment or Limited Storage

Repacking for shipment or limited storage is normally done at a higher echelon level.

#### Section II. DEMOLITION OF MATERIEL TO PREVENT ENEMY USE

##### 26. Authority for Demolition

The receiver and its accessories will be demolished only upon the order of the commander. The destruction procedures outlined in paragraph 28 will be used to prevent the enemy from using or salvaging the equipment.

##### 27. Methods of Destruction

Use any or all of the methods listed in *a* through *f* below to make the equipment completely useless.

a. *Smash*. Smash the controls, tuning mechanism, tubes, coils, switches, capacitors, transformers, filters, and meters; use sledges,

axes, handaxes, pickaxes, hammers, crowbars, or other heavy tools.

b. *Cut*. Cut the power cord, the antenna lead-in cable, and the headset cord; use an axe, a handaxe, or a machete.

c. *Burn*. Burn cords, cables, and manuals; use gasoline, kerosene, oil, flamethrowers, or incendiary grenades.

d. *Bend*. Bend the panel, the cabinet, and the main frame.

e. *Explosives*. If explosives are necessary, use firearms, grenades, or TNT.

f. *Disposal*. Bury or scatter the destroyed parts in slit trenches or foxholes, or throw them into streams.



## APPENDIX I REFERENCES

---

Following is a list of applicable references that are available to the operator of Radio Receiver R-390A/URR:

DA PAM 108-1	Index of Army Motion Pictures, Film Strips, Slides, and Phono Recordings.	FM 21-5 FM 21-6	Military Training. Techniques of Military Instruction.
DA PAM 310-4	Index of Technical Manuals, Technical Bulletins, Supply Bulletins, Lubrication Orders, and Modification Work Orders.	FM 21-30 SR 320-5 SR 320-50 TM 11-649	Military Symbols. Dictionary of United States Army Terms. Authorized Abbreviations and Brevity Codes. Radio Receiving Sets AN/FRR-40 and AN/FRR-41.

**APPENDIX II**  
**BASIC ISSUE ITEMS LIST**  
**RADIO RECEIVER R-390A/URR**

---

**Section I. INTRODUCTION**

**I. Scope**

a. This appendix lists items supplied for initial operation and for running spares. The list includes tools, accessories, parts, and material issued as *part of* the major end item. The list includes all items authorized for basic operator maintenance of the equipment. End items of equipment are issued on the basis of allowances prescribed in equipment authorization tables and other documents that are a basis for requisitioning.

b. The columns are as follows:

- (1) *Source, maintenance, and recoverability code.* Not used.
- (2) *Federal stock number.* This column lists the 11-digit Federal stock number.
- (3) *Designation by model.* Not used.
- (4) *Description.* Nomenclature or the standard item name and brief identifying data for each item are listed in this column. When requisitioning, enter the nomenclature and description on the requisition.
- (5) *Unit of issue.* The unit of issue is the supply term by which the individual item is counted for procurement, storage, requisitioning, allowance, and issue purposes.

(6) *Expendability.* Expendable items are indicated by the letter X; nonexpendable items are indicated by NX.

(7) *Quantity authorized.* Under "Items Comprising an Operable Equipment" the column lists the quantity of items supplied for the initial operation of the equipment. Under "Running Spares and Accessory Items" the quantities listed are those issued initially with the equipment as spare parts. The quantities are authorized to be kept on hand by the operator for maintenance of the equipment.

(8) *Illustrations.* The "Figure No." column lists the illustrations in which the items appear. The "Item No." column lists the reference designations that appear on the part in the equipment. These designations are also used on any illustrations of the equipment.

**2. Critical Items**

A zero slash ( $\phi$ ) in the "Description" column indicates items that are expected to fail during the first year or items that will make the equipment inoperative if they fail.

## Section II. FUNCTIONAL PARTS LIST

(1) SOURCE MAINTENANCE AND RECOVERABILITY CODE	(2) FEDERAL STOCK NUMBER	(3) DESIGNATION BY MODEL	(4) DESCRIPTION	(5) UNIT OF ISSUE	(6) EXPERIANCE AUTHORIZED	(7) QUANTITY AUTHORIZED	(8) ILLUSTRATIONS FIGURE NO	(9) ITEM NO
			ITEMS COMPRISING AN OPERABLE EQUIPMENT					
			RECEIVER RADIO R-390A/URR					
	5820-538-7535		RECEIVER RADIO R-390A/URR	ea	X	1		V605
	Ord thru AGC		TECHNICAL MANUAL TM 11-3820-339-10	ea	X	1		V604
			RUNNING SPARES AND ACCESSORY ITEMS					
			RECEIVER RADIO R-390A/URR					
	5960-188-3564		0 ELECTRON TUBE: MIL type 6A2	ea	X	1		V605
	5960-188-3551		0 ELECTRON TUBE: MIL type 6AK6	ea	X	1		V604
	5960-188-8315		0 ELECTRON TUBE: MIL type 6C1 Item Nos. V202, V203, V201, V606	ea	X	1		V603
	5960-548-5068		0 ELECTRON TUBE: MIL type 6DC6	ea	X	1		See desc column
	5960-262-0221		0 ELECTRON TUBE: MIL type 2A25A	ea	X	1		V201
	5960-262-1357		0 ELECTRON TUBE: MIL type 5A23 6AK5A	ea	X	1		V801
	5960-264-2089		0 ELECTRON TUBE: MIL type 5710 6AV9W; (When V701 is replaced sub-assembly must be adjusted) Item Nos. V501, V503, V503, V505, V508, V701	ea	X	1		V802
	5960-262-0210		0 ELECTRON TUBE: MIL type 5811A Item Nos. V203, V206, V506, V707, V509, V601, V602	ea	X	2		V207
	5920-010-6652		0 FUSE, CARTRIDGE: MIL type F026R091	ea	X	2		V101
	5920-543-0425		0 FUSE, CARTRIDGE: MIL type F026R25B	ea	X	5		See desc column
	5920-356-2188		0 FUSE, CARTRIDGE: MIL type F026R125A	ea	X	5		F101
	6240-155-7857		0 LAMP, INCANDESCENT: Fed Spec No. W-1-11, Trade No. 328; Collins part # 9 No. 265 0023 00	ea	X	5		F102
			0 LAMP, GLOW: 1 1/2, GE type No. NE-45 g210-170-1811 (Eng Stk No.)	ea	X	1		F103
	59 05 - 502 - 4840		RESISTOR, CURRENT REGULATING MIL TYPE T431M01	ea	X	1		I102
				ea	X	1		I103
				ea	X	1		RT510

R-390A/URR

TM 5820-358-10-21

By Order of *Wilber M. Brucker*, Secretary of the Army:

G. H. DECKER,  
*General, United States Army,*  
*Chief of Staff.*

Official:

R. V. LEE,  
*Major General, United States Army,*  
*The Adjutant General.*

Distribution:

*Active Army:*

To be distributed in accordance with DA Form 12-7 requirements for TM 11 Series (UNCL) plus the following formula:

USASA (2)	11-57
CNGB (1)	11-85
Tech Stf, DA (1) except CSigO (18)	11-86
DASA (5)	11-98
US ARADCOM (2)	11-117
US ARADCOM Rgn (2)	11-155
MDW (1)	11-500 (AA-AE) (4)
Seventh US Army (2)	11-557
EUSA (2)	11-587
Units org under fol TOE: (2 copies each	11-592
except as inde)	11-597
11-7	32-51
11-16	32-56
11-32	32-57

NG: State AG (3); Units — Same as Active Army except allowance is one copy for each unit.

USAR: None.

For explanation of abbreviations used, see AR 320-50.



