

CE73JD

# Microwave Oven

## Owner's Instructions & Cooking Guide

imagine the possibilities

Thank you for purchasing this Samsung product.

Please be advised that the Samsung warranty does NOT cover service calls to explain product operation, correct improper installation, or perform normal cleaning or maintenance.

**SAMSUNG**

# Contents

<b>Safety instructions</b> .....	<b>3</b>
<b>Installation</b> .....	<b>8</b>
Accessories .....	8
Installation site .....	8
Turntable.....	8
<b>Maintenance</b> .....	<b>9</b>
Cleaning .....	9
Replacement (repair).....	9
Care against an extended period of disuse .....	9
<b>Oven features</b> .....	<b>10</b>
Oven.....	10
Control panel .....	10
<b>Oven use</b> .....	<b>11</b>
How a microwave oven works .....	11
Setting the time .....	11
Cooking/Reheating .....	12
Checking that your oven is operating correctly.....	12
Adjusting the cooking time.....	13
Power levels .....	13
Stopping the cooking.....	13
Using the keep warm Feature .....	14
Using the keep warm settings.....	14
Using the power defrost feature .....	15
Using the power defrost settings.....	15
Using the india's best feature .....	16
India's best settings .....	16
Using the cafeteria feature .....	18
The cafeteria settings.....	18
Using the tikka series feature .....	20
The tikka series settings.....	20
Using the healthy cook feature.....	22

The healthy cook settings .....	22
Using the kid's nutrition feature.....	24
The kid's nutrition settings .....	24
Using the veggie feature .....	26
The veggie settings.....	26
Fast preheating the oven.....	28
Cooking by convection .....	28
Choosing the accessories.....	29
Grilling .....	29
Combining microwaves and the grill.....	30
Combining microwaves and convection.....	30
Safety-locking your microwave oven .....	31
Switching the beeper off .....	31
Multistage cooking.....	32
<b>Cookware guide</b> .....	<b>33</b>
<b>Cooking guide</b> .....	<b>34</b>
Microwaves .....	34
Cooking.....	34
Reheating .....	36
Reheating baby food .....	36
Manual defrosting .....	37
Grill .....	38
Microwave + Grill .....	38
Convection .....	39
Microwaves + Convection.....	39
Tips and tricks .....	40
<b>Troubleshooting</b> .....	<b>41</b>
What to do if you are in doubt or have a problem.....	41
<b>Technical specifications</b> .....	<b>42</b>

## Safety instructions

### **IMPORTANT SAFETY INSTRUCTIONS**

READ CAREFULLY AND KEEP FOR FUTURE REFERENCE.

### **MICROWAVE FUNCTION ONLY**

**WARNING:** If the door or door seals are damaged, the oven must not be operated until it has been repaired by a competent person.

**WARNING:** It is hazardous for anyone other than a competent person to carry out any service or repair operation that involves the removal of a cover which gives protection against exposure to microwave energy.

**WARNING:** Liquids and other foods must not be heated in sealed containers since they are liable to explode.

**WARNING:** Only allow children to use the oven without supervision when adequate instructions have been given so that the child is able to use the oven in a safe way and understands the hazards of improper use.

This appliance is intended to be used in household only and it is not intended to be used such as:

- staff kitchen areas in shops, offices and other working environments;
- farm houses;

- by clients in hotels, motels and other residential environments;
- bed and breakfast type environments.

Only use utensils that are suitable for use in microwave ovens.

When heating food in plastic or paper containers, keep an eye on the oven due to the possibility of ignition.

Metallic containers for food and beverages are not allowed during microwave cooking.

The microwave oven is intended for heating food and beverages. Drying of food or clothing and heating of warming pads, slippers, sponges, damp cloth and similar may lead to risk of injury, ignition or fire.

If smoke is observed (emitted), switch off or unplug the appliance and keep the door closed in order to stifle any flames.

Microwave heating of beverages can result in delayed eruptive boiling, therefore care must be taken when handling the container.

The contents of feeding bottles and baby food jars shall be stirred or shaken and the temperature checked before consumption, in order to avoid burns.

Eggs in their shell and whole hard-boiled eggs should not be heated in microwave ovens since they may explode, even after microwave heating has ended.

The oven should be cleaned regularly and any food deposits removed.

Failure to maintain the oven in a clean condition could lead to deterioration of the surface that could adversely affect the life of the appliance and possibly result in a hazardous situation.

The microwave oven is intended to be used on the counter top (freestanding) use only, the microwave oven shall not be placed in a cabinet.

The appliance should not be cleaned with a water jet.

The appliance is not intended for installing in road vehicles, caravans and similar vehicles etc.

This appliance is not intended for use by persons (including children) with reduced physical, sensory or mental capabilities, or lack of experience and knowledge, unless they have been given supervision or instruction concerning use of the appliance by a person responsible for their safety.

Children should be supervised to ensure that they do not play with the appliance.

This appliance can be used by children aged from 8 years and above and persons with reduced physical, sensory or mental capabilities or lack of experience and knowledge if they have been given supervision or instruction concerning use of the appliance in a safe way and understand the hazards involved. Children shall not play with the appliance. Cleaning and user maintenance shall not be made by children without supervision.

If the supply cord is damaged, it must be replaced by the manufacturer, its service agent or similarly qualified persons in order to avoid a hazard.

This oven should be positioned proper direction and height permitting easy access to cavity and control area.

Before using the your oven first time, oven should be operated with the water during 10 minute and then used.

If the oven generates a strange noise, a burning smell, or smoke is emitted, unplug the power plug immediately and contact your nearest service center.

The microwave oven has to be positioned so that plug is accessible.

## OVEN FUNCTION ONLY - OPTIONAL

**WARNING:** When the appliance is operated in the combination mode, children should only use the oven under adult supervision due to the temperatures generated.

During use the appliance becomes hot. Care should be taken to avoid touching heating elements inside the oven.

**WARNING:** Accessible parts may become hot during use. Young children should be kept away.

A steam cleaner is not to be used.

Do not use harsh abrasive cleaners or sharp metal scrapers to clean the oven door glass since they can scratch the surface, which may result in shattering of the glass.

**WARNING:** Ensure that the appliance is switched off before replacing the lamp to avoid the possibility of electric shock.

Do not use harsh abrasive cleaners or sharp metal scrapers to clean the oven door glass since they can scratch the surface, which may result in shattering of the glass.

**WARNING:** The appliance and its accessible parts become hot during use.

Care should be taken to avoid touching heating elements.

Children less than 8 years of age shall be kept away unless continuously supervised.

This appliance can be used by children aged from 8 years and above and persons with reduced physical, sensory or mental capabilities or lack of experience and knowledge if they have been given supervision or instruction concerning use of the appliance in a safe way and understand the hazards involved. Children shall not play with the appliance. Cleaning and user maintenance shall not be made by children without supervision.

The door or the outer surface may get hot when the appliance is operating.

The temperature of accessible surfaces may be high when the appliance is operating.

The appliances are not intended to be operated by means of an external timer or separate remote-control system.

This appliance can be used by children aged from 8 years and above and persons with reduced physical, sensory or mental capabilities or lack of experience and knowledge if they have been given supervision or instruction concerning use of the appliance in a safe way and understand the hazards involved. Children shall not play with the appliance. Cleaning and user maintenance shall not be made by children unless they are older than 8 and supervised.

Keep the appliance and its cord out of reach of children less than 8 years.

English - 5

## General safety

Any modifications or repairs must be performed by qualified personnel only. Do not heat food or liquids sealed in containers for the microwave function. Do not use benzene, thinner, alcohol, or steam or high-pressure cleaners to clean the oven.

Do not install the oven: near a heater or flammable material; locations that are humid, oily, dusty or exposed to direct sunlight or water; or where gas may leak; or an uneven surface.

This oven must be properly grounded in accordance with local and national codes.

Regularly use a dry cloth to remove foreign substances from the power plug terminals and contacts.

Do not pull, excessively bend, or place heavy objects on the power cord. If there is a gas leak (propane, LP, etc) ventilate immediately. Do not touch the power cord.

Do not touch the power cord with wet hands.

While the oven is operating, do not turn it off by unplugging the power cord.

Do not insert fingers or foreign substances. If foreign substances enter the oven, unplug the power cord and contact a local Samsung service centre. Do not apply excessive pressure or impact to the oven.

Do not place the oven over fragile objects.

Ensure the power voltage, frequency, and current matches the product specifications.

Firmly plug the power plug into the wall socket. Do not use multiple plug adapters, extension cords, or electric transformers.

Do not hook the power cord on metal objects. Make sure the cord is between objects or behind the oven.

Do not use a damaged power plug, power cord, or loose wall socket. For damaged power plugs or cords, contact a local Samsung service centre.

Do not pour or directly spray water onto the oven.

Do not place objects on the oven, inside, or on the oven door.

Do not spray volatile materials such as insecticide on the oven.

Do not store flammable materials in the oven. Because alcohol vapours can contact hot parts of the oven, use caution when heating food or drinks containing alcohol.

Children may bump themselves or catch their fingers on the door. When opening/closing the door, keep children away.

## Microwave warning

Microwave heating of beverages may result in delayed eruptive boiling; always use caution when handling the container. Always allow beverages to stand at least 20 seconds before handling. If necessary, stir during heating. Always stir after heating.

In the event of scalding, follow these First Aid instructions:

1. Immerse the scalded area in cold water for at least 10 minutes.
2. Cover with a clean, dry dressing.
3. Do not apply any creams, oils, or lotions.

To avoid damaging the tray or rack, do not put the tray or rack in water shortly after cooking.

Do not use the oven for deep fat frying because the oil temperature cannot be controlled. This could result in a sudden boil over of hot oils.

## Microwave oven precautions

Only use microwave-safe utensils. Do not use metallic containers, gold or silver trimmed dinnerware, skewers, etc.

Remove wire twist ties. Electric arcing may occur.

Do not use the oven to dry papers or clothes.

Use shorter times for small amounts of food to prevent overheating or burning.

Keep the power cord and power plug away from water and heat sources.

To avoid the risk of explosion, do not heat eggs with shells or hard-boiled eggs. Do not heat airtight or vacuum-sealed containers, nuts, tomatoes, etc.

Do not cover the ventilation slots with cloth or paper. This is a fire hazard.

The oven may overheat and turn off automatically and will remain off until it cools sufficiently.

Always use oven mitts when removing a dish.

Stir liquids halfway during heating or after heating ends and allow the liquid stand at least 20 seconds after heating to prevent eruptive boiling.

Stand at arms length from the oven when opening the door to avoid getting scalded by escaping hot air or steam.

Do not operate the oven when it is empty. The oven will automatically shut down for 30 minutes for safety purposes. We recommend placing a glass of water inside the oven at all times to absorb microwave energy in case the oven is started accidentally.

Install the oven in compliance with the clearances in this manual. (See Installing your microwave oven.)

Use caution when connecting other electrical appliances to sockets near the oven.

### Microwave operation precautions

Failure to observe the following safety precautions may result in harmful exposure to microwave energy.

- Do not operate the oven with the door open. Do not tamper with the safety interlocks (door latches). Do not insert anything into the safety interlock holes.
- Do not place any object between the oven door and front face or allow food or cleaner residue to accumulate on sealing surfaces. Keep the door and door sealing surfaces clean by wiping with a damp cloth and then with a soft, dry cloth after each use.
- Do not operate the oven if it is damaged. Only operate after it has been repaired by a qualified technician.

**Important:** the oven door must close properly. The door must not be bent; the door hinges must not be broken or loose; the door seals and sealing surfaces must not be damaged.

- All adjustments or repairs must be done by a qualified technician.

### Limited warranty

Samsung will charge a repair fee for replacing an accessory or repairing a cosmetic defect if the damage to the unit or accessory was caused by the customer. Items this stipulation covers include:

- Door, handles, out-panel, or control panel that are dented, scratched, or broken.
- A broken or missing tray, guide roller, coupler, or wire rack.

Use this oven only for its intended purpose as described in this instruction manual. Warnings and Important Safety Instructions in this manual do not cover all possible conditions and situations that may occur. It is your responsibility to use common sense, caution, and care when installing, maintaining, and operating your oven.

Because these following operating instructions cover various models, the characteristics of your microwave oven may differ slightly from those described in this manual and not all warning signs may be applicable. If you have any questions or concerns, contact a local Samsung service centre or find help and information online at [www.samsung.com](http://www.samsung.com).

Use this oven for heating food only. It is intended for domestic use only. Do not heat any type of textiles or cushions filled with grains. The manufacturer cannot be held liable for damage caused by improper or incorrect use of the oven.

To avoid deterioration of the oven surface and hazardous situations, always keep the oven clean and well maintained.

# Installation

## ACCESSORIES

Depending on the model that you have purchased, you are supplied with several accessories that can be used in a variety of ways.

1. **Roller ring**, to be placed in the centre of the oven.

**Purpose :** The roller ring supports the turntable.

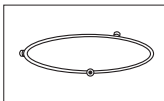

2. **Turntable**, to be placed on the roller ring with the centre fitting to the coupler.

**Purpose :** The turntable serves as the main cooking surface; it can be easily removed for cleaning.

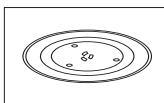

3. **High rack, Low rack**, to be placed on the turntable.

**Purpose :** The metal racks can be used to cook two dishes at the same time. A small dish may be placed on the turntable and a second dish on the rack. **The metal racks can be used in grill, convection and combination cooking.**

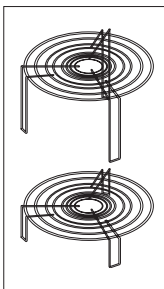

## INSTALLATION SITE

- Select a flat, level surface approx. 85 cm above the floor. The surface must support the weight of the oven.
- Secure room for ventilation, at least 10 cm from the rear wall and both sides, and 20 cm from above.
- Do not install the oven in hot or damp surroundings, such as next to other microwave ovens or radiators.
- Conform to the power supply specifications of this oven. Use only approved extension cables if you need to use.
- Wipe the interior and the door seal with a damp cloth before using your oven for the first time.

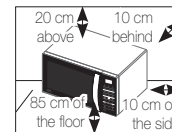

## TURNTABLE

Remove all packing materials inside the oven. Install the roller ring and turntable. Check that the turntable rotates freely.

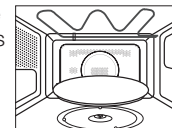



# Maintenance

## CLEANING

Clean the oven regularly to prevent impurities from building up on or inside the oven. Also pay special attention to the door, door sealing, and turntable and roller ring (applicable models only).

If the door won't open or close smoothly, first check if the door seals have built up impurities. Use a soft cloth in soapy water to clean both the inner and outer sides of the oven. Rinse and dry well.

### To remove stubborn impurities with bad smells from inside the oven

1. With an empty oven, put a cup of diluted lemon juice on the centre of the turntable.
2. Heat the oven for 10 minutes at max power.
3. When the cycle is complete, wait until the oven cools down. Then, open the door and clean the cooking chamber.

### To clean inside swing-heater models

To clean the upper area of the cooking chamber, lower the top heating element by 45° as shown. This will help clean the upper area. When done, reposition the top heating element.

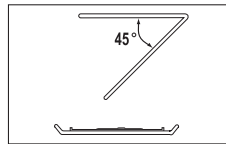

## CAUTION

- Keep the door and door sealing clean and ensure the door opens and closes smoothly. Otherwise, the oven's lifecycle may be shortened.
- Take caution not to spill water into the oven vents.
- Do not use any abrasive or chemical substances for cleaning.
- After each use of the oven, use a mild detergent to clean the cooking chamber after waiting for the oven to cool down.

## REPLACEMENT (REPAIR)

### WARNING

This oven has no user-removable parts inside. Do not try to replace or repair the oven yourself.

- If you encounter a problem with hinges, sealing, and/or the door, contact a qualified technician or a local Samsung service centre for technical assistance.
- If you want to replace the light bulb, contact a local Samsung service centre. Do not replace it yourself.
- If you encounter a problem with the outer housing of the oven, first unplug the power cord from the power source, and then contact a local Samsung service centre.

## CARE AGAINST AN EXTENDED PERIOD OF DISUSE

If you don't use the oven for an extended period of time, unplug the power cord and move the oven to a dry, dust-free location. Dust and moisture that builds up inside the oven may affect the performance of the oven.

# Oven features

## OVEN

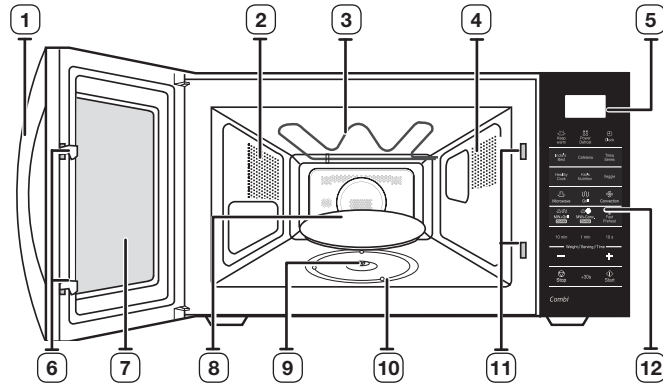

- |                      |                            |
|----------------------|----------------------------|
| 1. DOOR HANDLE       | 7. DOOR                    |
| 2. VENTILATION HOLES | 8. TURNTABLE               |
| 3. GRILL             | 9. COUPLER                 |
| 4. LIGHT             | 10. ROLLER RING            |
| 5. DISPLAY           | 11. SAFETY INTERLOCK HOLES |
| 6. DOOR LATCHES      | 12. CONTROL PANEL          |

## CONTROL PANEL

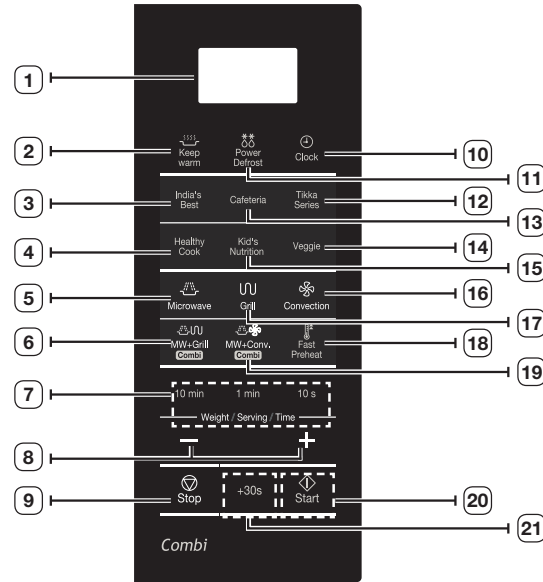

- |  |   |
|--|---|
| 1. DISPLAY   | 11. POWER DEFROST BUTTON                |
| 2. KEEP WARM BUTTON  | 12. TIKKA SERIES BUTTON                 |
| 3. INDIA'S BEST SELECTION  | 13. CAFETERIA BUTTON                    |
| 4. HEALTHY COOK SELECTION  | 14. VEGGIE BUTTON                       |
| 5. MICROWAVE BUTTON  | 15. KID'S NUTRITION BUTTON              |
| 6. MICROWAVE+GRILL (COMBI) BUTTON                                | 16. CONVECTION BUTTON                   |
| 7. TIME SETTING BUTTON   | 17. GRILL BUTTON                        |
| 8. UP (+) / DOWN (-) BUTTON (Cook time, Weight and serving size) | 18. FAST PREHEAT BUTTON                 |
| 9. STOP / CANCEL BUTTON  | 19. MICROWAVE+CONVECTION (COMBI) BUTTON |
| 10. CLOCK SETTING BUTTON   | 20. START BUTTON                        |
|  | 21. +30s BUTTON                         |

# Oven use

## HOW A MICROWAVE OVEN WORKS

Microwaves are high-frequency electromagnetic waves; the energy released enables food to be cooked or reheated without changing either the form or the colour.

You can use your microwave oven to:

- Defrost
- Reheat
- Cook

### Cooking Principle

1. The microwaves generated by the magnetron reflected at cavity and are distributed uniformly as the food rotates on the turntable. The food is thus cooked evenly.
2. The microwaves are absorbed by the food up to a depth of about 1 inch (2.5 cm). Cooking then continues as the heat is dissipated within the food.
3. Cooking times vary according to the container used and the properties of the food:
  - Quantity and density
  - Water content
  - Initial temperature (refrigerated or not)

As the centre of the food is cooked by heat dissipation, cooking continues even when you have taken the food out of the oven.

Standing times specified in recipes and in this booklet must therefore be respected to ensure:

- Even cooking of the food right to the centre
- The same temperature throughout the food

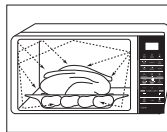

## SETTING THE TIME

Your microwave oven has an inbuilt clock. When power is supplied, “:0”, “88:88” or “12:00” is automatically displayed on the display. Please set the current time. The time can be displayed in either the 24- hour or 12-hour notation. You must set the clock:

- When you first install your microwave oven
- After a power failure

 Do not forget to reset the clock when you switch to and from summer and winter time.

### 1. To display the time in the...

24-hour notation  
12-hour notation



### 2. Press the (−) and (+) buttons to set the hour.

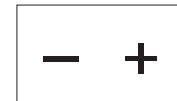

### 3. Press the **Clock** (⌚) button.



### 4. Press the (−) and (+) buttons to set the minute.

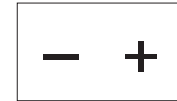

### 5. When the right time is displayed, press the **Clock** (⌚) button to start the clock.

**Result:** The time is displayed whenever you are not using the microwave oven.



## CHECKING THAT YOUR OVEN IS OPERATING CORRECTLY

The following simple procedure enables you to check that your oven is working correctly at all times. Open the oven door by pushing the large button in the bottom right-hand corner of the control panel.

First, place a bowl of water on the turntable. Then, close the door.

1. Press the **Microwave** (  ) button and set the time to 4-5 minutes by pressing the **1 min** button the appropriate number of times.

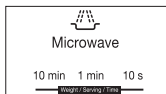

2. Press the **Start** (  ) button.

**Result :** The oven heats the water for 4 to 5 minutes. The water should then be boiling.



-  The oven must be plugged into an appropriate wall socket. The turntable must be in position in the oven. If a power level other than the maximum is used, the water takes longer to boil.

## COOKING/REHEATING

The following procedure explains how to cook or reheat food.

Always check your cooking settings before leaving the oven unattended. First, place the food in the centre of the turntable. Then, close the door

1. Press the **Microwave** (  ) button.

**Result :** The following indications are displayed: (  ) (microwave mode).



2. Select the appropriate power level by pressing the Microwave (  ) button again until the corresponding output power is displayed. Refer to the power level table below for further details.



3. Set the cooking time by pressing the 10min, 1min and 10s buttons.

**Result:** The cooking time is displayed.



4. Press the **Start** (  ) button.

**Result :** The oven light comes on and the turntable starts rotating. Cooking starts and when it has finished:

- The oven will beep and flash "0" four times. The oven will then beep one time per minute.



## ADJUSTING THE COOKING TIME

You can increase the cooking time by pressing the +30 s button once for each 30 seconds to be added.

1. Press the **+30 s** button once for each 30 seconds to be added.

+30 s

2. Press the **Start** (◊) button.

Start

## POWER LEVELS

You can choose among the power levels and temperature below.

Power level	Output		
	MWO	GRILL	CONVECTION
HIGH	800 W	-	-
MEDIUM HIGH	600 W	-	-
MEDIUM	450 W	-	-
MEDIUM LOW	300 W	-	-
DEFROST (❄️)	180 W	-	-
LOW/KEEP WARM	100 W	-	-
GRILL	-	1100 W	-
COMBI (🔥🍷)	600 W 450 W 300 W	1100 W	-
CONVECTION	-	-	MAX:1700 W
COMBI I (🔥🍷🌀)	600 W 450 W 300 W 180 W 100 W	-	MAX:1700 W (200 - 40 °C)

The cooking times given in recipes and in this booklet correspond to the specific power level indicated.

If you select a...	Then the cooking time must be...
Higher power level	Decreased
Lower power level	Increased

## STOPPING THE COOKING

You can stop cooking at any time so that you can:

- Check the food
- Turn the food over or stir it
- Leave it to stand

To stop the cooking...	Then...
Temporarily	Open the door. <b>Result:</b> Cooking stops. To resume cooking, close the door again and press the <b>Start</b> (◊) button.
Completely	Press the Stop button. <b>Result:</b> Cooking stops. If you wish to cancel the cooking settings, press the <b>Start</b> (◊) button again.

## USING THE KEEP WARM FEATURE

Place the keep food warm in the centre of the turntable and close the door.

1. Press the **Keep Warm** (🔥) button.



2. Set the keep warm time by pressing the 10min, 1min and 10s buttons.



**Result:** The keep warm time is displayed.

3. Press the **Start** (⏮) button.  
The max keep warm time is 90 mins





**Result :** When keep warm time has finished, the oven will beep and flash "0" four times.  
The oven will then beep one time per minute.

## USING THE KEEP WARM SETTINGS

The following table presents 4 items. It contains food, drink, bread/pastries and ovenware. The convection heater operates only and it will cycle on and off to keep food warm. Use oven gloves while taking out!

Item	Example & Recommendations
Food	roast meat, chicken, gratin, pizza, potatoes and plated meal
Drink	water, milk and coffee
Bread and pastries	bread, toast, rolls, muffins and cake
Dishes/ Crockery	cup and ovenware Distribute the crockery over the whole area of turn table. Do not overload the oven. (Maximum load 5kg)

-  Do not use this function to reheat cold foods. This programmes are for keeping food warm that has just been cooked.
-  Do not recommend food being kept warm for too long (more than 1 hour), as it will continue to cook. Warm food spoils more quickly.
-  Cover liquids and foods which are high moisture contents. But if you want to keep crisp roast or fried foods, do not cover it.

## USING THE POWER DEFROST FEATURE

The Power Defrost feature enables you to defrost meat, poultry, fish. The defrost time and power level are set automatically. You simply select the programme and the weight.

 Use only dishes that are microwave-safe.

First, place the frozen food in the centre of the turntable and close the door.

1. Press the **Power Defrost** (☼☼) button.

**Result :** The following indication is displayed:

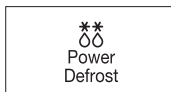

2. Select the type of food that you are cooking by pressing the **Power Defrost** (☼☼) button. Refer to the table on the following page for a description of the various preprogrammed settings.

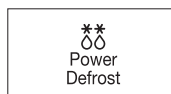

3. Select the food weight by pressing the (−) and (+) buttons.

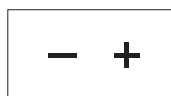

4. Press the **Start** (◊) button.

**Result :**

- Defrosting begins.
- The oven beeps through defrosting to remind you to turn the food over.



5. Press the **Start** (◊) again to finish defrosting.

**Result :** When cooking has finished, the oven will beep and flash "0" four times. The oven will then beep one time per minute.









 You can also defrost food manually. To do so, select the microwave cooking/reheating function with a power level of 180 W. Refer to the section entitled "**Cooking/Reheating**" on page 12 for further details.

## USING THE POWER DEFROST SETTINGS

The following table presents the various Power Defrost programmes, quantities, standing times and appropriate recommendations. Remove all kind of package material before defrosting.

Place meat, poultry and fish on a flat glass plate or on a ceramic plate, arrange bread and cake on kitchen paper.

Code	Food	Serving Size	Standing Time	Recommendations
1	Meat 	200-1500 g	20-90 min.	Shield the edges with aluminium foil. Turn the meat over, when the oven beeps. This programme is suitable for beef, lamb, pork, steaks, chops, minced meat.
2	Poultry 	200-1500 g	20-90 min.	Shield the leg and wing tips with aluminium foil. Turn the poultry over, when the oven beeps. This programme is suitable for whole chicken as well as for chicken portions.
3	Fish 	200-1500 g	20-80 min.	Shield the tail of a whole fish with aluminium foil. Turn the fish over, when the oven beeps. This programme is suitable for whole fishes as well as for fish fillets.
4	Bread / Cake 	125-625 g	10-60 min.	Put bread horizontally on a piece of kitchen paper and turn over, as soon as the oven beeps. Place cake on a ceramic plate and if possible, turn over, as soon as the oven beeps. (Oven keeps operating and is stopped, when you open the door). This programme is suitable for all kinds of bread, sliced or whole, as well as for bread rolls and baguettes. Arrange bread rolls in a circle. This programme is suitable for all kinds of yeast cake, biscuit, cheese cake and puff pastry. It is not suitable for short/crust pastry, fruit and cream cakes as well as for cake with chocolate topping.
5	Fruit 	100-500 g	5-20 min.	Spread fruits evenly into a flat glass dish. This programme is suitable for all kind of fruits.

 Select the Manual Defrosting function with a power level of 180 W if you want to defrost food manually. For further details on manual defrosting and defrosting time, refer to the page 37.

## USING THE INDIA'S BEST FEATURE

The Auto India's Best feature has 10 pre-programmed cooking time. You do not need to set either the cooking times or the power level. First, place the food in the centre of the turntable and close the door. Open the door. Place the food in the centre of the turntable. Close the door.

1. Select the type of food that you are cooking by pressing the **India's best** button once or more times.

India's  
Best

2. Press the **Start** (◊) button.

- Result :** Cooking starts. When it has finished:
- 1) The oven beeps four times.
  - 2) The end reminder signal will beep 3 times. (once every minute)
  - 3) The current time is displayed again.

Start

-  Use only recipients that are microwave-safe.

## INDIA'S BEST SETTINGS

The following table presents the various India's Best Programmes and appropriate recommendations.

Food	Ingredients
<b>1. Fish Curry</b>  Serving Size 400-500 gm	Surmai - 200 gm, Onions (Chopped) - 1, Tomato (Chopped) - 1, Water - 1 Cup, Coconut + Milk - ½ Cup, Ginger Garlic Paste, Turmeric Powder, Red Chilli , Powder, Garam Masala, Salt - As per your taste, Oil - As required.
	<b>Recommendations</b>  In microwave safe bowl take oil, chopped onions, ginger garlic paste and cook. When beeps, add all ingredients. Mix well and after that put the microwave safe bowl and cook.
<b>2. Stuffed Tomato</b>  Serving Size 200-300 gm	Tomato - 4, Onion (Chopped) - 1, Paneer - ½ Cup, Coriander, Cumin Powder, Salt & Sugar - As per your test, Butter - 1 tbsp
	<b>Recommendations</b>  Cut tomatoes and scoop out the pulp to have plain tomato cups. Grate paneer then mix coriander, cumin powder and the stuff the mixture with tomatoes. In Microwave safe Glass bowl add butter and chopped onions and press the start. When beeps, add tomatoes and cover it. Mix well and after that put the microwave safe bowl in microwave and cook.
<b>3. Chicken Kali Mirch</b>  Serving Size 400-500 gm	Bone Less Chicken - 350 gm, Chopped onion - 1, Ginger Garlic Paste - 1 tsp, Kali Mirch Powder (Pepper Powder) - 1 tsp, Salt , Lemon Juice, Oil -As per your taste
	<b>Recommendations</b>  Marinate chicken with salt, lemon juice and kali mirch powder and keep for 1 hour. In microwave safe bowl take oil, chopped onions, ginger garlic paste and put the microwave safe bowl in Microwave and then press start. When beeps, add marinated chicken, little water and salt and put the microwave safe bowl in Microwave and cook.
<b>4. Sweet Rice</b>  Serving Size 400-500 gm	Soaked Rice - 100 gm, Sugar - ½ cup, Lemon Juice - 1 tsp, Dry Fruits - (As per your taste), Cardamom Powder - (As per your taste), Edible Yellow Color - ¼ tsp, Ghee - 2 tbsp, Water - 200ml
	<b>Recommendations</b>  In microwave safe bowl take ghee and soaked rice, water and cover with lid then press start. When beeps, add sugar, dry fruits, color and cardamom powder. Mix well and cook.



Food	Ingredients
<b>5. Sambhar</b>  Serving Size 400-500 gm	Arhar Dal/ Red Gram - 100 gm, Oil - 2 Tb. Sp ,Onion Chopped - 1, Tomato (Chopped) - 1, Mix Vegetables (drumsticks, Ghia / Bottle Gourd Red Pumpkin, Brinjal, Ladies Finger) - 1 cup, Mustard Seeds - 1 tbsp, Asafetida - ¼ tsp, Tamarind Pulp, Cumin Seeds, Green Chili, Sambhar Masala, Salt - As required  <b>Recommendations</b>  In microwave safe bowl put dal, turmeric powder, onions, green chillies, tomatoes, mixed vegetables and add some water, cover it in microwave and then press start. When beeps, take microwave safe bowl take oil, safetida, and cumin, curry leaves, red chillies, dal, sambhar masala, tamrind pulp, salt, water and put the microwave safe bowl in microwave then cook.
<b>6. Chicken Biryani</b>  Serving Size 400-500 gm	Basmati rice (Soaked for 1 hour) - 200 gm, Water - 500 ml, Ghee - 3 tbsp Cloves, Cardamom, Pepper Cinnamon, Tej Patta, Salt - As per your taste, Chicken - 200 gm, Onion (chopped) - 1, Tomato (chopped) - 1  <b>Recommendations</b>  In microwave safe glass bowl add ghee, chicken, onions, tomatoes and all masala and soaked rice and put the microwave safe bowl in microwave and then press start.  When beeps, add salt and water mix well, cover it and put the microwave safe bowl in microwave and then cook. When beeps, serve hot with salads.
<b>7. Kashmiri Aloo</b>  Serving Size 300-400 gm	Small Pealed Potato - 8/10, Onion Grind - 2 No, Tomato Puri - 2, Ginger, Garlic Paste - 2 tbsp, Coriander Powder, Cumin Powder, Turmeric Powder, Red Chili Powder, Garam Masala, Salt - As per your taste, Oil - 3 tbsp, Cream - ¼ Cup, Water - ½ Cup  <b>Recommendations</b>  In microwave safe bowl take water add prick potatoes then press start. When beeps, in another bowl add oil, onions and ginger-garlic paste, potato and all other ingredients and cook.
<b>8. Kheema Masala</b>  Serving Size 400-500 gm	Kheema (chicken) - 200 gm, Chopped Onion – 1, Chopped Tomato – 1, Ginger Garlic Paste - 1 tsp, Turmeric, Salt, Red Chili, Cumin Powder, Garam Masala - As per taste, Oil and Water - As required, Dhaniya - For Garnishing  <b>Recommendations</b>  In microwave safe glass bowl take kheema with water, After that put the microwave safe bowl in microwave and press start.  When beeps, in microwave safe glass bowl take oil, chopped onion, tomato, ginger garlic paste and all the masala. After that put the microwave safe bowl in microwave and cook. When beep, add boiled kheema to this microwave safe bowl mix well and serve.

Food	Ingredients
<b>9. Carrot Halwa</b>  Serving Size 400-500 gm	Grated Carrot - 300 gm, Ghee - 2 tbsp, Milk Powder - 4 tbsp, Khoya - 5 tbsp, Sugar - 4 tbsp, Milk - ½ Cup, Cardamom Powder and Dry Fruit - As per your taste  <b>Recommendations</b>  In microwave safe uncovered glass bowl take grated carrot and ghee. Mix it well and press the start.  When beeps, add milk powder, milk, khoya and sugar. Mix it well and cook. Again when beeps, add dry fruits and cardamom powder and serve.
<b>10. Machchi Patiala</b>  Serving Size 400-500 gm	Fish (preferably skinless & boneless) – 500 gm (cut into 2" pieces (but fish with skin and bones can also be used)) Oil - 4 tbsp, Large Onion , (Chopped very fine) - 1 (1 cup), Green Chillies -2 to 3, Garlic Paste - ½ tsp, Ginger Paste - ½ tsp, Turmeric Powder - ½ tsp, Red Chili Powder - ½ tsp, Salt - ½ tsp, Medium Tomatoes (chopped very fine) - 3 (2 ½ cups), Water - ¾ cup, Corn Flour - 2 heaped tsp  <b>Recommendations</b>  In a glass bowl take oil. Add powdered muster seeds, cumin and ajwain and press start.  Add turmeric, onion, ginger, garlic and green chillies. Mix well. Add Fish pieces, red chili powder, salt, tomatoes and ¾ cup water. Mix well with a spoon. Add corn flour dissolved in 2 tbsp water. Mix well and covered then cook.

## USING THE CAFETERIA FEATURE

The Auto Cafeteria feature has 10 pre-programmed cooking time. You do not need to set either the cooking times or the power level. First, place the food in the centre of the turntable and close the door. Open the door. Place the food in the centre of the turntable. Close the door.

1. Select the type of food that you are cooking by pressing the **Cafeteria** button once or more times.



2. Press the **Start** (◊) button.

- Result :** Cooking starts. When it has finished:
- 1) The oven beeps four times.
  - 2) The end reminder signal will beep 3 times. (once every minute)
  - 3) The current time is displayed again.



-  Use only recipients that are microwave-safe.

## THE CAFETERIA SETTINGS

The following table presents the various Cafeteria Programmes and appropriate recommendations.

Food	Ingredients
<b>1. Brownie</b>  Serving Size 300 - 400 gm	Plain Flour - 100 gm, Powdered Sugar - 80 gm, Butter - 75 gm, Eggs - 2 no, Chopped Almonds - 3 tbsp, Baking Powder - 1 tsp, Chocolate Essence - 1 tsp, Coco Powder - 3 tbsp
	<b>Recommendations</b>  Sieve plain flour, baking powder, mix coco powder with ½ cup water. In a bowl beat butter with powder sugar. Add eggs and essence and beat it well. Add maida and almonds to this mixture and mix well. Add coco solution to this mixture and mix well. For spoon dropping consistency add milk or water. Pour this mixture in greased metal tin.  Preheat the 200°C Convection using the fast preheat button. When beeps, put this cake tin in microwave and cook.
<b>2. Garlic Bread</b>  Serving Size 300-400 gm	Bread (French) - 3 slices, Butter - 3 tbsp, Garlic - 2 tbsp, Grated Cheese - 3 tbsp, Salt, Pepper, Oregano, Chili Flakes - As per taste
	<b>Recommendations</b>  Mix butter, garlic, salt, pepper, oregano and make a paste. Apply this paste on both sides of the bread and sprinkle grated cheese and chilli flakes. Keep these breads on metal tray on low rack.  Preheat the 200°C Convection using the fast preheat button. When beeps, put this metal tray in microwave and cook.
<b>3. Chocolate Muffin</b>  Serving Size 6 Muffin's	Plain Flour - 100 gm, Butter - 75 gm, Powdered Sugar - 75 gm, Eggs - 1 Nos, Baking Powder - 1/2 tsp, Almond Essence - 1/2 tsp, Almonds, Walnuts (As per your taste)
	<b>Recommendations</b>  Sieve plain flour with baking powder beat butter with sugar, add eggs. Beat well and add essence, mix maida in it keep on adding milk and water till the tin is filled to the brim, grease the Muffin tin in with butter and pour the cake mixture in it.  Preheat the 200°C Convection using the fast preheat button. When beeps, keep in low rack and cook.

Food	Ingredients
<b>4. Veg. Pizza</b>  Serving Size 200-250 gm	Pizza Base - 100 gm, Pizza Topping - 3 tbsp, Mixed Vegetables (Tomato, capsicum, Onion) - 1 cup, Grated Cheese - ½ cup, Chili Flakes - As per your taste, Oregano - seasoning
	<p style="text-align: center;"><b>Recommendations</b></p> Preheat the 200°C convection using the fast preheat button. When beeps, add pizza topping mixed vegetable and Cheese on Pizza base, and After that put the pizza in lower and then press start. Serve with oregano and chili flakes on top.
<b>5. Dhokla</b>  Serving Size 200 gm	Gram Flour - 200 gm, Warm Water - 75 ml, Curd - 3 tbsp, Green Chili-Ginger - 1 ½ tsp, Fruit Salt - 1 ½ tsp, Salt & Sugar - As per your taste
	<p style="text-align: center;"><b>Recommendations</b></p> Grease the microwave safe flat dish, with little oil. Mix gram flour curd, sugar, salt, water, ginger, green chili paste, yellow color, fruit, and salt together. Pour the mixture in greased dish, then put the bowl in dhokla maker and then press start. Cut it into pieces, garnish with grated coconut and coriander and serve with sauce or chutney.
<b>6. Marble Cake</b>  Serving Size 450-500 gm	Plain Flour - 150 gm, Condensed Milk - 200 gm, Butter - 100 gm, Baking Powder - 1 tsp, Soda bi carb - ½ tsp, Vanilla Essence - 1 tsp, Coco Powder - 2 tbsp
	<p style="text-align: center;"><b>Recommendations</b></p> Sieve plain flour with baking powder and soda, in a bowl beat butter with milkmaid, Beat well and add essence, mix maida in it for spoon dropping consistency add milk and water. Divide the mixture in 2 parts. Add coco powder in one part put the plain batter and coco batter alternately in the tin. Run a spoon through the batter only once. Select menu and after that put the microwave safe bowl in microwave.  Preheat the 200°C Convection using the fast preheat button. When beeps, put the tin on lower rack, Put the tin in lower rack on microwave and then press start to bake.

Food	Ingredients
<b>7. Lazeez Paneer Toast</b>  Serving Size 2 Egg's	Butter - 1 ½ tbsp, Brown or White Bread - 4 slices, Garlic (5-6 Flakes, crushed and chopped) - 1 tsp, Leaves of Palak (Spinach + washed & shredded) - 100 gm, Paneer - 150 gm, Basil or Coriander - 1 tbsp (chopped), Mozzarella Cheese (grated) - 5 tbsp, Salt & Pepper - ¼ tsp, Red Chili Flakes - (As per test)
	<p style="text-align: center;"><b>Recommendations</b></p> Wash and shred the spinach leaves into thin ribbons. In microwave bowl add butter, garlic, spinach and press the start.  When beeps, remove and add grated paneer, basil cheese, mozzarella cheese & mix it well. Spread the mixer on the toast. In a low rack take spread bread slice at low rack and cook.
<b>8. Cheese Straw</b>  Serving Size 200-250 gm	Plain Flour - 100 gm, Grated Cheese - 25 gm, Butter - 50 gm, Baking Powder - 1/8 tsp, Pepper Powder - ¼ tsp, Chili Powder - ½ tsp, Salt - ¼ tsp, Water - As required
	<p style="text-align: center;"><b>Recommendations</b></p> Sieve plain flour with baking powder, chili powder and pepper. In a bowl add butter, maida, and cheese and rub with fingertips till it resembles like bread crump's, add little water to make soft dough in thin roti and cut into small pieces, Twist them and put on Metal tray.  Preheat the 200°C Convection using the fast preheat button. When beeps, keep this tray on low rack and cook. Serve cold.
<b>9. Fish Cutlet</b>  Serving Size 300 gm	Fish Fillet (Cut in small pieces) - 250 gm, Boiled Potato - 2 no, Bread crumbs - 1 cup, Oil - 2 tbsp, Chili Powder, Turmeric, Ginger-Garlic Paste, Salt - As per your taste, Garam Masala Powder - 1 tbsp, Coriander - 2 tbsp
	<p style="text-align: center;"><b>Recommendations</b></p> In a bowl take fish fillet and all the other ingredients except oil and mix well. Make cutlets. Put them on a metal tray; put some oil around the cutlets. Keep this on high rack and cook.  When beeps, remove and turn them over. Put it in a microwave and cook. When it gives a beep remove and garnish with coriander.
<b>10. Omelet</b>  Serving Size 2 eggs	Eggs - 2 Nos, Chopped Onions - ¼ cup, Chopped Tomatoes - ¼ cup, Chopped Green Chili - 1 Nos, Chopped Coriander - 1 tbsp, Milk - 2 tbsp, Salt and Pepper - As per your taste
	<p style="text-align: center;"><b>Recommendations</b></p> Beat the eggs and add chopped onions, tomatoes, green chillies, coriander, salt, pepper and milk and mix well. Apply some oil to microwave safe flat dish and add egg mixture and cook.  When beeps, turn and cook. Stand for 1 minute.

## USING THE TIKKA SERIES FEATURE

The Auto Tikka Series feature has 10 pre-programmed cooking time. You do not need to set either the cooking times or the power level. First, place the food in the centre of the turntable and close the door. Open the door. Place the food in the centre of the turntable. Close the door.

1. Select the type of food that you are cooking by pressing the **Tikka Series** button once or more times.

Tikka  
Series

2. Press the **Start** (◊) button.

- Result :** Cooking starts. When it has finished:
- 1) The oven beeps four times.
  - 2) The end reminder signal will beep 3 times. (once every minute)
  - 3) The current time is displayed again.

Start

-  Use only recipients that are microwave-safe.

## THE TIKKA SERIES SETTINGS

The following table presents the various Tikka Series Programmes and appropriate recommendations.

Food	Ingredients
<b>1. Harabhara Kabab</b>  Serving Size 300 - 400 gm	Boiled Potato (mashed) - 200 gm, Mix Veg (mashed) - 100 gm, Ginger Garlic Paste - 1 tsp, Chili Paste - 1 tsp, Salt, Garam Masala, Oil and Bread Crump's - As required.
	<b>Recommendations</b>  Mix all the ingredients and make cutlets in desired shape. Keep high rack inside and place cutlets on metal flat dish, Keep this on high rack and then cook. When beeps, turn the cutlets and keep this on high rack and cook. Serve with sauce.
<b>2. Chicken Tikka</b>  Serving Size 300-350 gm	Boneless Chicken - 225 gm, Thick Curd - 1 cup, Chat Masala - 1 tbsp, Ginger Garlic Paste - 1 ½ tbsp, Eatable Orange - A Pinch, Oil - 2 tbsp, Salt & Lemon Juice - As per your taste, Cream - 2 tbsp
	<b>Recommendations</b>  Mix all the ingredients together and keep in the refrigerator for 1 hour. After marinating add chicken pieces in a greased metal tray. Sprinkle some oil on it and cook on the high rack. When beeps, turn pieces of side down and cook. Serve hot with green Chutney.
<b>3. Paneer Tikka</b>  Serving Size 250-300 gm	Paneer - 200 gm, Lemon Juice - 1 tbsp, Edible Red Color - 1 pinch, Oil - 1 tbsp Marinate : Hung Curd - 4 tbsp, Ginger Garlic Paste - 1 ½ tbsp, Red Chili Powder, Garam Masala - As per your taste
	<b>Recommendations</b>  Mix all the ingredients of marinate thoroughly. Add paneer pieces and keep it for 2 hrs in a refrigerator. Keep the pieces in metal tray on high rack. Apply little oil on it. After that put the metal tray on high rack and then start cooking. When beeps, turn the pieces and again put the metal tray on high rack and then press start. Serve hot with chutney.

Food	Ingredients
4. Fish Tikka  Serving Size 400-500 gm	Fish Fillet - 400 gm Marinate : Hung Curd - ½ cup, Lemon juice - 1 tbsp, Salt, Turmeric, Red Chili Powder, Chat Masala, Garam Masala, Ginger Garlic Paste - As per your taste
	<b>Recommendations</b>
	Wash the Fish Fillet. Mix all the ingredients of marinating and pour this mixture to fish fillet evenly. Keep for 1 hr in a refrigerator. Arrange the fish fillet on greased metal tray. Apply little oil on each piece. Keep the metal tray on high rack and start cooking. When beeps turn the pieces and take on high rack and cook.
5. Aloo Tikka  Serving Size 400-500 gm	Baby Potato (peeled) - 400 gm, Curd - ½ cup, Ginger garlic paste - ½ tsp, Coriander Powder, Cumin Powder, Red Chili Powder, Kasoori Methi, Salt & Oil - As per your test
	<b>Recommendations</b>
	Take peeled Aloo, add curd, ginger garlic paste and other spices and salt mix them well and put on high rack metal tray sprinkle oil, and start to cook. When beeps, turn potato and cook again. Serve hot.
6. Tandoori Gobhi  Serving Size 250-300 gm	Gobhi (Cut big flowers) - 200 gm, Lemon Juice - 1 tbsp, Edible Red Color - 1 pinch, Oil - 1 tbsp Marinate : Hung Curd - 4 tbsp, Ginger Garlic Paste - 1 ½ tsp, Red Chili Powder, Garam Masala - As per your taste
	<b>Recommendations</b>
	Mix all the ingredients of marinate thoroughly. Add Gobhi pieces and keep it for 2 hrs in a refrigerator. Keep the pieces in metal tray on high rack. Apply little oil on it. After that put the metal tray on high rack and then press start. When beeps, turn the pieces and again after that put the metal tray on high rack and cook. Serve hot with chutney.
7. Murg Malai Kabab  Serving Size 400-500 gm	Chicken - 300 gm (Cut-Boneless (skinless), Cut in 1 1/2" - 2" pieces (pieces should be of even size)) Saunf (aniseed) , powder - 1 tsp, Salt - 1 tsp, Amchoor (dry mango) Powder - 1 tsp, Red Chili Powder - 1 tsp, Nutmeg powder - ¼ tsp, Cream or Malai - 4 tbsp
	<b>Recommendations</b>
	In microwave safe glass bowl take all the ingredients. Marinate in refrigerator for 1 hr. In metal tray arrange the pieces, sprinkle oil, and cook at high rack. When beeps, turn the pieces and cook.

Food	Ingredients
8. Mutton Tikka  Serving Size 400-500 gm	Mutton (Boneless) - 400 gm, Salt, Red Chili Powder, Turmeric, Garam Masala, Chat Masala, Oil - As per your taste Marinate : Hung Curd - 1 cup, Ginger Garlic Paste - 2 tsp
	<b>Recommendations</b>
	In microwave safe glass bowl take all the ingredients. Marinate in refrigerator for 1 hr. In metal tray arrange the pieces, sprinkle oil and cook at the high rack. When beeps, turn the pieces and cook again.
9. Pepper Chicken  Serving Size 400-500 gm	Boneless chicken - 500 gm, Pepper powder - 1 tbsp, Oil - 1 tsp, Soya sauce - 1 tsp, Salt - As per your taste
	<b>Recommendations</b>
	In microwave safe bowl take chicken with all other ingredients mix well, after that put the microwave safe bowl in Microwave and then press start. When beep, stir well and after that put the microwave safe bowl and cook. Serve hot.
10. Tandoori Arvi  Serving Size 400-500 gm	Arvi (peeled) - 400 gm, Curd - ½ cup, Ginger Garlic Paste, Dhaniya Powder, Cumin Powder, Red Chili Powder, Kasoori Methi, Salt & Oil - As per your taste
	<b>Recommendations</b>
	Take peeled Arvi, add curd ginger garlic paste and other spices and salt mix them well and put on high rack and cook. When beeps, turn the Arvi and cook. Serve hot.

## USING THE HEALTHY COOK FEATURE

The Auto Healthy Cook feature has 10 pre-programmed cooking time. You do not need to set either the cooking times or the power level. First, place the food in the centre of the turntable and close the door. Open the door. Place the food in the centre of the turntable. Close the door.

1. Select the type of food that you are cooking by pressing the **Healthy Cook** button once or more times.

Healthy  
Cook

2. Press the **Start** (◊) button.

- Result :** Cooking starts. When it has finished:
- 1) The oven beeps four times.
  - 2) The end reminder signal will beep 3 times. (once every minute)
  - 3) The current time is displayed again.

Start

-  Use only recipients that are microwave-safe

## THE HEALTHY COOK SETTINGS

The following table presents the various Healthy Cook Programmes and appropriate recommendations.

Food	Ingredients
<b>1. Lemon Chicken</b>  Serving Size 300 - 400 gm	Chicken (Boneless) - 300 gm, Lemon Juice - 3 tbsp, Honey - 3 tbsp, Pepper - 1 tbsp, Olive Oil - 2 tbsp, Salt - As required
	<b>Recommendations</b>  Marinate chicken with pepper, salt and lemon juice and put in refrigerator for one hour. In microwave safe bowl take olive oil and marinate chicken mix well and cover it and After that put the microwave safe bowl in Microwave and then cook.  When beeps, turn the chicken pieces and after that put the microwave safe bowl in microwave and then press start. After cooking, remove bowl and add honey after 5 minutes mix and serve.
<b>2. Poha</b>  Serving Size 300-400 gm	Poha - 0.3 kg, Oil - 3 tbsp, Onion Chopped - 1 cup, Green Chili - 4 Nos, Mustered, Cumin, Asafetida, Turmeric, Curry Leaves - For Tempering, Grated Coconut & Coriander - For Garnishing.
	<b>Recommendations</b>  In microwave safe bowl put oil mustered, cumin, green chili, onions, turmeric powder curry leaves. After that put the microwave safe bowl in microwave and then press start.  When beeps, add washed Poha, salt and sugar to taste. Mix well and cook again. Garnish coconut and coriander. Serve hot.
<b>3. Upma</b>  Serving Size 300-400 gm	Rava Suji (Semolina) - one cup or 100 gm, Oil - 2 tbsp, Mustered, Cumin - 2 tsp, Urad Dal (Black Gram) - 1/2 tsp, Green Chilies - 2 nos, Curry Leaves - 7 to 8, Water - 200 ml, Sugar & Salt - as per your taste, Lemon Juice - 1 tsp
	<b>Recommendations</b>  In microwave safe bowl put oil, muster seeds, cumin, black gram, green chilies, curry leaves, and rava suji/semolina. After that put the microwave safe bowl in microwave and then press start.  When beeps, add water, sugar and salt to taste, lemon juice, mix well and keep inside. And then put the bowl in microwave and cook again. Garnish with coriander and bhujia.

Food	Ingredients
4. <b>Daliya</b>  Serving Size 300-400 gm	Daliya - 100 gm, Sugar - 75 gm, Milk + Water (equal) - 200 ml, Ghee - 1 tbsp, Cardamom Powder, Kishmish and Cashew Nuts - As per your taste
	<p style="text-align: center;"><b>Recommendations</b></p> <p>Soaked daliya for 1 hr. Drained water &amp; keep it side, microwave safe bowl a daliya &amp; ghee and then cook. When beeps, add milk, water, sugar mix well, cover it and cook again. When beeps, add cardamom powder, kishmish and cashew nuts mix well.</p>
5. <b>Chili Honey Veg.</b>  Serving Size 200 gm	Mix Veg - 200 gm (Carrot, Muter, Corn, Cornflower, French Beans etc - Cut small pieces), Honey - 2 tbsp, Salt, Lemon Juice, Pepper Powder - As per your test, Water - As required
	<p style="text-align: center;"><b>Recommendations</b></p> <p>In microwave safe bowl take vegetable and cook. When beeps, drain water add honey, salt, lemon juice, pepper powder mix well and cook again.</p>
6. <b>Hot and Sour Soup</b>  Serving Size 300 gm	Chopped Mix Veg (Carrot, Cabbage, Capsicum) - 1 cup, Chopped Ginger - 1 tbsp, Chopped Garlic - 1 tbsp, Con Flower - 2 tbsp, Oil / Butter - 2 tbsp, Water - 200 ml, Chili Sauce, Soya Sauce, Vinegar, Salt, Sugar - As per your test
	<p style="text-align: center;"><b>Recommendations</b></p> <p>In microwave safe glass bowl add oil and mix veg., ginger, garlic. After that put the bowl in microwave and cook. When beeps, grind and strain the whole and add water, chili sauce, soya sauce, vinegar, salt, sugar as your requirement &amp; mix well, bowl in microwave and cook again.</p>
7. <b>Idli</b>  Serving Size 8 Idly	Instant Idly Mix - 2 cups, Curd - 1 cup, Ginger Garlic Chili Paste and Salt - As per your taste, Water - As required
	<p style="text-align: center;"><b>Recommendations</b></p> <p>Mix all the ingredients and make a batter, pour this batter to greased microwave and cook. Serve hot with Chutney &amp; Sambhar.</p>
8. <b>Steamed Veg.</b>  Serving Size 200 gm	Mix Veg (Cauliflower, Carrot, Capsicum Muter Corn, French Beans) - 200 gm (Cut in small pieces), Sugar, Pepper Powder, Salt - As per your taste, Water - 3 cup
	<p style="text-align: center;"><b>Recommendations</b></p> <p>In microwave safe glass bowl take mix veg. and water, after that put the bowl in microwave and cook. When beeps, drain water in another bowl take veg., sugar, peper powder, salt mix well and serve hot.</p>

Food	Ingredients
9. <b>Atta Ladoo</b>  Serving Size 300-350 gm	Atta -2 cup, Ghee - 100 gm, Powder Sugar - 75 gm, Cardamom Powder - 1 tbsp, Almonds (Chopped) - ¼ cup
	<p style="text-align: center;"><b>Recommendations</b></p> <p>In microwave safe glass bowl add Atta and ghee and mix well and cook. When beeps, stir well and cook again. When cool and cardamom powder, sugar powder, mix well and make Ladoo.</p>
10. <b>Sukhi Moong Dal</b>  Serving Size 300-400 gm	Moong dal - 150 gm, Onion (chopped) - 2 nos, Water - 1 cup, Ginger Garlic Paste, Salt, Turmeric Powder, Chili Garam Masala, Coriander Powder, Cumin Powder & Pepper Powder
	<p style="text-align: center;"><b>Recommendations</b></p> <p>In microwave safe glass bowl take oil onion and ginger-garlic paste and cook. When beeps, add moong dal and all other ingredients along with water and cook again.</p>

## USING THE KID'S NUTRITION FEATURE

The Auto Kid's Nutrition feature has 10 pre-programmed cooking time. You do not need to set either the cooking times or the power level. First, place the food in the centre of the turntable and close the door. Open the door. Place the food in the centre of the turntable. Close the door.

1. Select the type of food that you are cooking by pressing the **Kid's Nutrition** button once or more times.



Kid's  
Nutrition

2. Press the **Start** (◊) button.

- Result :** Cooking starts. When it has finished:
- 1) The oven beeps four times.
  - 2) The end reminder signal will beep 3 times. (once every minute)
  - 3) The current time is displayed again.



Start

-  Use only recipients that are microwave-safe.

## THE KID'S NUTRITION SETTINGS

The following table presents the various Kid's Nutrition Programmes and appropriate recommendations.

Food	Ingredients
<b>1. Veg. Pasta</b>  Serving Size 200-250 gm	Pasta - 200 gm, Oil - 1 tbsp, Grated Cheese - 3 tbsp, Pizza Pasta Sauce Spring Onion Water - As per your taste, Salt - As required
	<b>Recommendations</b>  In microwave safe bowl add pasta and water and cook. When beeps, strain pasta and mix the pasta with all the ingredients and cook again. Serve hot.
<b>2. Noodles</b>  Serving Size 150-300 gm	Noodles - 0.3 kg, Oil - 3 tbsp, Vinegar - 1 tbsp, Soya Sauce - 1 tbsp, Chili Sauce - 1 tbsp, Mix vegetables - 1 cup (Cabbage, Carrot, Capsicum, French, Beans, etc)
	<b>Recommendations</b>  In microwave safe bowl take noodles, water, oil and salt and put the bowl in microwave and cook. When beeps, strain noodles and pour cold water over it. In the bowl put some oil and finally chopped vegetables, add vinegar, soya sauce, chili sauce, MSG salt and paper to taste and ¼ cup water and After that put the bowl in microwave and cook again. Add noodles and mix well.
<b>3. Chana Chat</b>  Serving Size 200-250 gm	Soaked Chana - 100 gm, Water - 250 ml, Boiled Potato - 1 No, Ginger paste - 1 tbsp, Green Chili Paste - 1 tbsp, Oil - 1 tbsp, Salt, Red Chili Powder, Pepper, Garam Masala, Chat Masala and Lemon Juice - As per taste, Mustar Seeds, Cumin, and Asafetida - For tempering
	<b>Recommendations</b>  In bowl take water and soaked chana, after that put the bowl in microwave then start cooking. When beeps drain the remaining water. In another microwave safe bowl take mustar seeds, cumin, asafetida, oil, green chili paste and ginger paste and after that put the microwave safe bowl in microwave and cook. When beeps add boiled chana, boiled potato, salt, garam masala, chat, masala, lemon juice and mix well.
<b>4. Suji Halwa</b>  Serving Size 200-250 gm	Suji - 150 gm, Ghee - 4 tbsp, Sugar - ¾ cup, Water - 3 cup, Dry Fruit, Cardamom Powder - As per your test
	<b>Recommendations</b>  In microwave safe glass bowl take suji & ghee and cook. When beeps, add water, sugar, dry fruit & cardamom powder mix well and cook again.



Food	Ingredients
5. <b>Chicken Pizza</b>	Pizza Base - 100 gm, Pizza Topping - 3 tbsp, Boiled Chicken (Shredded) - ½ cup, Grated Cheese - ½ cup, Flakes, Oregano - As per your taste
	<b>Recommendations</b>
Serving Size 200-250 gm	Preheat the 200°C Convection using the fast preheat button. When beeps, add pizza topping boiled chicken and cheese on pizza base, and after that put on lower rack and then press start. Serve with oregano and chili flakes on top.
6. <b>Corn Chat</b>	Sweet Corn - 300 gm, Water - 100 ml, Salt, Sugar, Butter, Chat Masala, Pepper Powder - As required
	<b>Recommendations Recommendations</b>
Serving Size 200-250 gm	In microwave safe glass bowl take sweet corn with water and start cooking. When beeps, drain water and add salt, sugar, butter, chat masala and pepper powder mix well and serve hot.
7. <b>Veg. Cutlet</b>	Boiled Vegetables (Potato, Cauliflower Carrots, Green Peas) - 200 gm, Corn flour - 2 tbsp, Bread Crumbs - 1 cup, Ginger Garlic Paste - 2 tbsp, Chili Paste - 2 tbsp, Garam Masala - 1 tbsp, Lemon Juice, Salt, Sugar - As per your taste.
	<b>Recommendations</b>
Serving Size 200-250 gm	In a bowl take mix vegetables, boiled potato, bread crumbs and all the other ingredients except oil and mix well and smash properly. Make cutlets. Put them on a metal tray and put some oil around the cutlets. Keep this on high rack and start cook. When it gives a beep, remove and turn them over. Put it in a microwave and keep this on high rack and cook again. When it gives a beep remove and garnish with coriander.
8. <b>Macaroni</b>	Macaroni - 150 gm, Hot Water - 400 ml, Butter - 4 tbsp, Spring Onion (chopped) - 4 tbsp, Garlic (Chopped) - 6 tbsp, Mushrooms (Chopped) - 6 Nos, Tomato Sauce - 6 tbsp, Chili Sauce - 4 tbsp, Salt, Sugar, Pepper & Oregano - As per your taste
	<b>Recommendations</b>
Serving Size 200-250 gm	In microwave safe bowl take macaroni with hot water. After that put the microwave safe bowl and start cook. When beeps, drain water from it. In bowl add all the ingredients with boiled macaroni mix well and after that put the bowl in microwave and cook again.

Food	Ingredients
9. <b>Pasta Salad</b>	Pasta (Penne) - 150 gm, Hot Water -400 ml, Butter - 4 tbsp, Spring Onion (chopped) - 4 tbsp, Garlic (Chopped) - 6 tbsp, Tomato Sauce - 6 tbsp, Salt, Sugar, Pepper & Oregano - As per your taste, White Sauce - ½ cup, Cheese - ¼ cup
	<b>Recommendations</b>
Serving Size 200-250 gm	In microwave safe bowl take pasta with hot water. After that put the bowl in microwave and start cooking. When beeps, drain water from it. In bowl add all the ingredients with boiled pasta, mix well and after that put the bowl in microwave and cook again.
10. <b>Maggie</b>	Maggie - 200 gm, Water - 400 ml, Maggie Masala - 1 packet, Salt - As per your taste
	<b>Recommendations</b>
Serving Size 200-250 gm	In microwave safe bowl take maggie with water and maggie masala. After that put the bowl in microwave and start cooking.

## USING THE VEGGIE FEATURE

The Auto Veggie feature has 10 pre-programmed cooking time. You do not need to set either the cooking times or the power level. First, place the food in the centre of the turntable and close the door. Open the door. Place the food in the centre of the turntable. Close the door.

1. Select the type of food that you are cooking by pressing the **Veggie** button once or more times.



2. Press the **Start** (◊) button.

- Result :** Cooking starts. When it has finished:
- 1) The oven beeps four times.
  - 2) The end reminder signal will beep 3 times. (once every minute)
  - 3) The current time is displayed again.

-  Use only recipients that are microwave-safe.



## THE VEGGIE SETTINGS

The following table presents the various Veggie Programmes and appropriate recommendations.

Food	Ingredients
<b>1. Pav. Bhaji</b>  Serving Size 400-500 gm	Vegetables (Potato, Cauliflower, Capsicum, Green Peas, Carrot, Beans etc) - 300 gm, Oil - 3 tbsp, Onion (Chopped) - 2 nos, Tomato (Chopped) - 2 Nos, Pav Bhaji Masala, Ginger Garlic Paste, Red Chili Powder, Salt, Lemon juice, Butter, Hara Dhaniya, Water - As per your taste.
	<b>Recommendations</b>  In microwave safe take all the vegetables, after that put the bowl in microwave and start to cook. When beeps, in another bowl add oil, ginger garlic paste, chopped onion, chopped tomato, mix well and add masala, lemon juice, smashed vegetables, salt, pav bhaji masala and water as required. Mix well and that put bowl in microwave and cook again.
<b>2. Mutter Paneer</b>  Serving Size 400-500 gm	Boiled Mutter - 100 gm, Paneer - 200 gm, Onions (paste) - 2 no, Tomato (puree) - 2 no, Garlic Ginger Paste - 1 tsp, Oil - 2 tbsp, Red Chili Powder, Garam Masala
	<b>Recommendations</b>  In microwave safe bowl add oil, onions and ginger garlic paste and put the bowl in microwave and start cooking. When beeps, add tomato puree, cream, and all masala except, salt and sugar boiled mutter, paneer salt and sugar and put the bowl in microwave and cook again.
<b>3. Aloo Ghobi</b>  Serving Size 300-400 gm	Cut Potatoes - 200 gm, Cut Cauliflower - 200 gm, Cut Tomatoes - 100 gm, Oil - 2 tbsp, Turmeric Powder, Coriander Powder, Red Chili Powder, Cumin Seeds, Salt, Garam Masala, Water - As per your taste, Fresh Cream, Salt, Turmeric, Sugar, Kasoori Methi, Coriander - As per your taste, Cream - 2 tbsp
	<b>Recommendations</b>  In microwave safe glass bowl take oil, potatoes and cauliflower and mix well. Put the bowl in microwave and start cooking. When beeps, add tomatoes, other ingredients, and water and put in microwave then cook again.

Food	Ingredients
<b>4. Karela Masala</b>  Serving Size 300-400 gm	Karela (Cut small Pieces) - 8/10, Onion Grind - 2 No, Tomato Puri - 2 No, Ginger, Garlic Pest - 2 Tbsp, Coriander Powder, Cumin Powder, Turmeric Powder, Red chili powder, Garam Masala, Salt - As per your test, Oil - 3 tbsps, Cream - ¼ Cup, Water - ½ Cup  <b>Recommendations</b>  In microwave safe bowl take oil and add onions and start cooking. When beeps, add ginger garlic paste, karela pieces and all the spices and add tomato puree, half cup water, cream and cover it and cook again. Serve hot with rice.
<b>5. Aloo Methi</b>  Serving Size 150-200 gm	Aloo (Boiled) - 2 nos, Methi - 1 bunch, Green Chillies - 2 to 3 nos, Oil - 2 tbsp, Salt, Turmeric, Musters Seeds, Cumin - As required  <b>Recommendations</b>  In microwave safe bowl take oil, muster, cumin, green chillies. After that put the microwave safe bowl in microwave and start to cook. When beeps, add methi leaves, turmeric and salt mix well and after that put the bowl in microwave and cook again. After the cooking, add boiled aloo mix with rice.
<b>6. Kadhi Pakoda</b>  Serving Size 400-500 gm	Ghee - 2 tbsp, Gram Flour - 3 tbsp, Curd - 200 gm, Water - 300 ml, Salt, Sugar, Cumin, Green Chilli, Ginger, Curry Leaves - As per your taste, Gram flour for Pakoda - 100 gm, Red Chili Powder, Turmeric, Ajwain & Salt - As per your taste  <b>Recommendations</b>  In microwave safe glass bowl add ghee, cumin and curry leave curd with water add gram flour, sugar, salt, green chilli and ginger mix it well and start cooking. In another bowl take gram flour. Add salt, ajwain, red chili powder, little oil to it and make soft dough and make small ball form it. When beeps, add to this ball to Kadhi mixture and cook again. Serve hot with rice.
<b>7. Dal Tadka</b>  Serving Size 400-500 gm	Soaked Arhar Dal (Soaked for 1 hr) -200 gm, Water - 300 gm, Oil - 2 tbsp, Cumin - 1 tbsp, Green Chillies - 2 to 3 nos, Curry Leaves - 5 to 6 nos, Salt, Coriander, Cumin Powder, Turmeric, Asafetida, Kasoori Methi, Lemon Juice - As per your taste  <b>Recommendations</b>  In microwave safe bowl take dal. Add water, turmeric and asafetida and cover it. After that put the bowl in microwave and start to cook. When beeps, take another bowl and add oil, cumin, chopped green chillies, curry leaves cooked dal, salt, coriander, cumin powder, kasurimethi, lemon juice, water. After that put the bowl in microwave and cook again. Garnish with tomato.

Food	Ingredients
<b>8. Lazeez Bhindi</b>  Serving Size 400-500 gm	Bhindi (Cut into pieces) - 400 gm, Onion (Chopped) - 2 Nos, Tomato (Chopped) - 2 Nos, Ginger Garlic Paste - 2 tbsp, Coriander Powder, Cumin Powder, Turmeric, Red Chili Powder, Garam Masala, Salt - As per your taste, Oil - As required, Cream - 2 tbsp  <b>Recommendations</b>  In microwave safe glass bowl take oil, add chopped onion & ginger garlic paste. After that put the bowl in microwave and start cooking. When beeps, add powder masala. Chopped tomato and bhindi, salt and cream and after that put the bowl in microwave and cook again.
<b>9. Palak Paneer</b>  Serving Size 400-500 gm	Palak Leaves (Spinach) - 300 gm (Boiled & Grinded), Onion (Chopped) - 2 Nos, Tomato (Chopped) - 2 Nos, Ginger Garlic Paste - 2 tbsps, Paneer - 150 gm, Oil - 3 tbsps, Garam Masala, Coriander Cumin, Powder, Salt, Fresh Cream - As per your taste  <b>Recommendations</b>  In microwave safe glass bowl take oil, add chopped onion & ginger garlic paste. After that put the bowl in microwave and start cooking. When beeps, add tomato and all the masala, palak paste, paneer and cream. Mix it well and after that put the bowl in microwave and cook again.
<b>10. Mixed Masala</b>  Serving Size 400-500 gm	Mix Vegetables (Yam, Custer Beans, White Ash Guard, White Pumpkin, Red Pumpkin, Raw Banana, Carrots) - 400 gm (Peeled and Cut into), Fresh coconut - 1 cup (2" pieces), Green Chilli - 2 to 3 Nos, Cumin - ½ tsp, Curry Leaves - 7 to 8 Nos, Turmeric - ¼ tsp, Curd - ¼ cup, Coconut oil - 1 tsp, Salt & Sugar - As per taste  <b>Recommendations</b>  Make paste of coconut, green chill and cumin with little water and keep aside. In microwave safe bowl, take all the vegetables, with some water and start to cook. When beeps, in another microwave safe bowl, take coconut oils, curry leaves, turmeric and boiled vegetables mix well and cook again. After cooking, add curd and paste of coconut and mix well.

## FAST PREHEATING THE OVEN

For convection cooking, it is recommended that you preheat the oven to the appropriate temperature before placing the food in the oven.

When the oven reaches the requested temperature, it is maintained for approximately 10 minutes; it is then switched off automatically.

1. Press the **Fast Preheat** (🔥) button.

**Result :** The following indications are displayed:  
200°C (temperature)

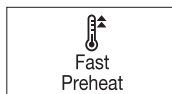

2. Press the **Fast Preheat** (🔥) button one or more times to set the temperature.  
(Temperature : 200, 180, 160, 140, 100, 40°C)

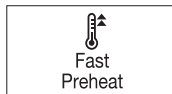

3. Press the **Start** (▶) button.

**Result :** The oven is preheated to the requested temperature.



- The display times are 8 seconds for the selected cooking mode and 2 seconds for the preset temperature in sequence.  
Ex) In fast preheat mode at 200°C



(displayed for 8 seconds)



(displayed for 2 seconds)

- Upon arrival at the preset temperature, the oven beeps 6 times and the temperature is kept for 10 minutes.
- After 10 minutes, the beeps 4 times and the operation stops.

☑ In case the inner temperature has reached the preset temperature, the beeps 6 times when temperature and the preset temperature is kept for 10 minutes.

☑ If you would like to know the current temperature of oven cavity, press Fast Preheat button.

## COOKING BY CONVECTION

The convection mode enables you to cook food in the same way as in a traditional oven. The microwave mode is not used. You can set the temperature, as required, in a range varying from 40°C to 200°C in eight preset levels. The maximum cooking time is 60 minutes.

☑ If you wish to Fast Preheat the oven, see the left side .

- Always use oven gloves when touching the recipients in the oven, as they will be very hot.
- You can get better cooking and browning, if you use the low rack.

Open the door and place the recipient on the low rack and set on turntable.

1. Press the **Convection** (🌀) button.

**Result :** The following indications are displayed:  
🌀(convection mode) 200°C  
(temperature)



2. Press the **Convection** (🌀) button once or more times to set the temperature.  
(Temperature : 200, 180, 160, 140, 100, 40°C)

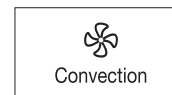

3. Select the cooking time by pressing the 10min, 1min and 10s buttons.



☑ Be careful, Grill heater may work intermittently while the convection mode is operating.

4. Press the **Start** (◊) button.

**Result :**

Cooking starts:

- The display times are 8 seconds for the preset cooking time and 2 seconds for the preset temperature in sequence.Ex) 30 minutes of cooking time at 200°C



(displayed for 8 seconds)



(displayed for 2 seconds)

- When cooking has finished, the oven will beep and flash "0" four times. The oven will then beep one time per minute.

-  If you would like to know the current temperature of oven cavity, press **Fast Preheat** (⚡) button.

## CHOOSING THE ACCESSORIES

Traditional convection cooking does require cookware. You should, however, use only cookware that you would use in your normal oven.

Microwave-safe containers are not usually suitable for convection cooking; don't use plastic containers, dishes, paper cups, towels, etc.

If you wish to select a combined cooking mode (microwave and grill or convection), use only recipients that are microwave-safe and oven-proof.

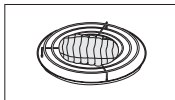

- For further details on suitable cookware and utensils, refer to the "**Cookware guide**" on page 33.

## GRILLING

The grill enables you to heat and brown food quickly, without using microwaves.

- Always use oven gloves when touching the recipients in the oven, as they will be very hot.
- You can get better cooking and grilling results, if you use the high rack.

1. Open the door and place the food on the rack.

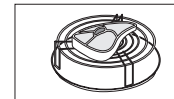

2. Press the **Grill** (⌋) button.

**Result:**

The following indications are displayed:  
(⌋) (grill mode)

- You cannot set the temperature of the grill.



3. Set the grilling time by pressing the 10min, 1min and 10s buttons.

- The maximum grilling time is 60 minutes.



4. Press the **Start** (◊) button.

**Result :**

Grilling starts:

- When cooking has finished, the oven will beep and flash "0" four times. The oven will then beep one time per minute.



## COMBINING MICROWAVES AND THE GRILL

You can also combine microwave cooking with the grill, to cook quickly and brown at the same time.

- ☑ **ALWAYS** use microwave-safe and oven-proof cookware. Glass or ceramic dishes are ideal as they allow the microwaves to penetrate the food evenly.
- ☑ **ALWAYS** use oven gloves when touching the recipients in the oven, as they will be very hot.
- ☑ You can improve cooking and grilling, if you use the high rack. Open the door. Place the food on the rack best suited to the type of food to be cooked. Place the rack on the turntable. Close the door.

- Press the **Microwave + Grill** (☑) button.  
**Result :** The following indications are displayed:  
☑ (microwave & grill combi mode)  
**600 W** (output power)



- Select the appropriate power level by pressing the **Microwave + Grill** (☑) button until the corresponding output power is displayed (300-600W).



- Set the cooking time by pressing the **10min, 1min** and **10s** buttons.



- Press the **Start** (◊) button.  
**Result :** Cooking starts:
  - Combination cooking starts.
  - When cooking has finished, the oven will beep and flash "0" four times. The oven will then beep one time per minute.



## COMBINING MICROWAVES AND CONVECTION

Combination cooking uses both microwave energy and convection heating. No preheating is required as the microwave energy is immediately available.

Many foods can be cooked in combination mode, particularly:

- Roast meats and poultry
- Pies and cakes
- Egg and cheese dishes

- ☑ **ALWAYS** use microwave-safe and oven-proof cookware. Glass or ceramic dishes are ideal as they allow the microwaves to penetrate the food evenly.

- ☑ **ALWAYS** use oven gloves when touching the recipients in the oven, as they will be very hot.

Open the door . Place the food on the turntable or on the low rack which should then be placed on the turntable. Close the door. You can get better cooking and browning, if you use the low rack.

- Press the **Microwave + CONV.** (☑) button.

- Result :** The following indications are displayed:  
☑ (microwave & convection combi mode)  
**200°C** 200°C (temperature)

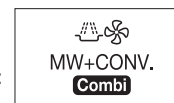

- Select the temperature by pressing the **Microwave + CONV.** (☑) button.  
(Temperature : 200, 180, 160, 140, 100, 40°C)

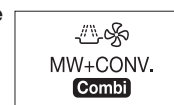

- Set the cooking time by pressing the **10min, 1min** and **10s** buttons.



4. Set the appropriate power level by pressing the **Microwave + CONV.** (MW+CONV.) button until the corresponding output power is displayed (600, 450, 300, 180, 100W).

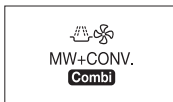

5. Press the **Start** (Start) button.

**Result :**

- Combination cooking starts.
- The oven is heated to the required temperature and then microwave cooking continues until the cooking time is over.
- The display times are 8 seconds for the preset cooking time and 2 seconds for the preset temperature in sequence. Ex) 30 minutes of cooking time at 200°C



(displayed for 8 seconds)



(displayed for 2 seconds)

- When cooking has finished, the oven will beep and flash "0" four times. The oven will then beep one time per minute.

- If you would like to know the current temperature of the oven cavity, press the **Fast Preheat** button.



## SAFETY-LOCKING YOUR MICROWAVE OVEN

Your microwave oven is fitted with a special Child Safety programme, which enables the oven to be "locked" so that children or anyone unfamiliar with it cannot operate it accidentally. The oven can be locked at any time.

1. Press the **Grill** (Grill) and **Microwave + CONV.** (MW+CONV.) buttons at the same time (about three second).

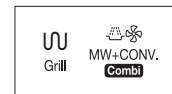

**Result:**

- The oven is locked.
- The follow indication is display "L".

2. To unlock the oven, press the **Grill** (Grill) and **Microwave + CONV.** (MW+CONV.) buttons again at the same time (about three second).

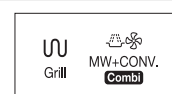

**Result:**

The oven can be used normally.

## SWITCHING THE BEEPER OFF

You can switch the beeper off whenever you want.

1. Press the **Fast Preheat** (Fast Preheat) and **Microwave Grill** (MW+Grill) buttons at the same time (about one second).

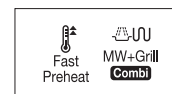

**Result:**

The oven does not beep to indicate the end of a function.

2. To switch the beeper back on, press the **Fast Preheat** (Fast Preheat) and **Microwave Grill** (MW+Grill) buttons again at the same time (about one second).

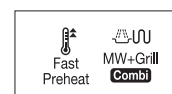

**Result:**

The oven operates normally.

## MULTISTAGE COOKING

Your microwave oven can be programmed to cook food in up to three stages (the Convection, Microwave+Convection and Fast Preheat mode can not be used in Multistage cooking). Example: You wish to Power defrost food and cook it without having to reset the oven after each stage.

You can thus defrost and cook a 1.5 kg chicken in three stages:

If you want to cook some food

- Defrosting
- Microwave cooking for 25 minutes
- Grill for 10 minutes



 Defrosting must be the first stage. Combination and Grill can only be used once during the remaining two stages, However microwave can be used twice (at two different power levels).

1. Press the **Power Defrost** () button.

  
Power  
Defrost

2. Select the type of food that you are cooking by pressing the Power Defrost () button. (refer to **15** page)

  
Power  
Defrost

3. Set the weight by pressing the () and () buttons the appropriate number of times (1500 g in the example).

4. Press the **Microwave** () button.

  
Microwave

5. Set the microwave power level by pressing the **Microwave** () button to select the appropriate Power Level (450W in the example).

  
Microwave

6. Set the cooking time by 10min, 1min and 10s buttons. (30 minutes in the example)

10 min 1 min 10 s  

7. Press the **Grill** () button.

  
Grill

8. Pressing the 10min, 1min and 10s appropriate number of times (15 minutes in the example).

10 min 1 min 10 s  

9. Press the **Start** () button.

### Result :

Cooking starts.  
When cooking has finished, the oven will beep and flash "0" four times.  
The oven will then beep one time per minute.

  
Start



## Cookware guide

To cook food in the microwave oven, the microwaves must be able to penetrate the food, without being reflected or absorbed by the dish used. Care must therefore be taken when choosing the cookware. If the cookware is marked microwave-safe, you do not need to worry.

The following table lists various types of cookware and indicates whether and how they should be used in a microwave oven.

Cookware	Microwave-Safe	Comments
<b>Aluminium foil</b>	✓ X	Can be used in small quantities to protect areas against overcooking. Arcing can occur if the foil is too close to the oven wall or if too much foil is used
<b>Browning plate</b>	✓	Do not preheat for more than eight minutes.
<b>China and earthenware</b>	✓	Porcelain, pottery, glazed earthenware and bone china are usually suitable, unless decorated with a metal trim.
<b>Disposable polyester cardboard dishes</b>	✓	Some frozen foods are packaged in these dishes.
<b>Fast-food packaging</b>		
• Polystyrene cups containers	✓	Can be used to warm food. Overheating may cause the polystyrene to melt.
• Paper bags or newspaper	X	May catch fire.
• Recycled paper or metal trims	X	May cause arcing.

Cookware	Microwave-Safe	Comments
<b>Glassware</b>		
• Oven-to-table ware	✓	Can be used, unless decorated with a metal trim.
• Fine glassware	✓	Can be used to warm foods or liquids. Delicate glass may break or crack if heated suddenly.
• Glass jars	✓	Must remove the lid. Suitable for warming only.
<b>Metal</b>		
• Dishes	X	May cause arcing or fire.
• Freezer bag twist ties	X	
<b>Paper</b>		
• Plates, cups, napkins and Kitchen paper	✓	For short cooking times and warming. Also to absorb excess moisture.
• Recycled paper	X	May cause arcing.
<b>Plastic</b>		
• Containers	✓	Particularly if heat-resistant thermoplastic. Some other plastics may warp or discolour at high temperatures. Do not use Melamine plastic.
• Cling film	✓	Can be used to retain moisture. Should not touch the food. Take care when removing the film as hot steam will escape.
• Freezer bags	✓ X	Only if boilable or oven-proof. Should not be airtight. Prick with a fork, if necessary.
<b>Wax or grease-proof paper</b>	✓	Can be used to retain moisture and prevent spattering.

✓ : Recommended    ✓X : Use Caution    X : Unsafe

# Cooking guide

## MICROWAVES

Microwave energy actually penetrates food, attracted and absorbed by its water, fat and sugar content.

The microwaves cause the molecules in the food to move rapidly. The rapid movement of these molecules creates friction and the resulting heat cooks the food.

## COOKING

### Cookware for microwave cooking:

Cookware must allow microwave energy to pass through it for maximum efficiency. Microwaves are reflected by metal, such as stainless steel, aluminium and copper, but they can penetrate through ceramic, glass, porcelain and plastic as well as paper and wood. So food must never be cooked in metal containers.

### Food suitable for microwave cooking:

Many kinds of food are suitable for microwave cooking, including fresh or frozen vegetables, fruit, pasta, rice, grains, beans, fish, and meat. Sauces, custard, soups, steamed puddings, preserves, and chutneys can also be cooked in a microwave oven. Generally speaking, microwave cooking is ideal for any food that would normally be prepared on a hob. Melting butter or chocolate, for example (see the chapter with tips, techniques and hints).

### Covering during cooking

To cover the food during cooking is very important, as the evaporated water rises as steam and contributes to cooking process.

Food can be covered in different ways: e.g. with a ceramic plate, plastic cover or microwave suitable cling film.

### Standing times

After cooking is over food the standing time is important to allow the temperature to even out within the food.

## Cooking Guide for frozen vegetables

Use a suitable glass pyrex bowl with lid. Cook covered for the minimum time – see table. Continue cooking to get the result you prefer.

Stir twice during cooking and once after cooking. Add salt, herbs or butter after cooking. Cover during standing time.

Food	Portion	Power	Time (min.)	Standing time (min.)
Spinach	150 g	600 W	5-6	2-3
	<b>Instructions</b>			
	Add 15 ml (1 tablespoon) cold water.			
Broccoli	300 g	600 W	9-10	2-3
	<b>Instructions</b>			
	Add 30 ml (2 tbsp.) cold water.			
Peas	300 g	600 W	7-8	2-3
	<b>Instructions</b>			
	Add 15 ml (1 tbsp.) cold water.			
Green Beans	300 g	600 W	8-9	2-3
	<b>Instructions</b>			
	Add 30 ml (2 tbsp.) cold water.			
Mixed Vegetables (carrots/peas/corn)	300 g	600 W	7 ½ -8 ½	2-3
	<b>Instructions</b>			
	Add 15 ml (1 tbsp.) cold water.			
Mixed Vegetables (Chinese style)	300 g	600 W	8-9	2-3
	<b>Instructions</b>			
	Add 15 ml (1 tbsp.) cold water.			

## Cooking Guide for fresh vegetables

Use a suitable glass pyrex bowl with lid. Add 30-45 ml cold water (2-3 tbsp.) for every 250 g unless another water quantity is recommended – see table. Cook covered for the minimum time – see table. Continue cooking to get the result you prefer. Stir once during and once after cooking. Add salt, herbs or butter after cooking.

Cover during a standing time of 3 minutes.

**Hint :** Cut the fresh vegetables into even sized pieces. The smaller they are cut, the quicker they will cook.

All fresh vegetables should be cooked using full microwave power (800 W).

Food	Portion	Time (min.)	Standing time (min.)	Instructions
Broccoli	250 g 500 g	4 -5 7-8	3	Prepare even sized florets. Arrange the stems to the centre.
Brussels Sprouts	250 g	6-7	3	Add 60-75 ml (5-6 tbsp.) water.
Carrots	250 g	4½-5	3	Cut carrots into even sized slices.
Cauliflower	250 g 500 g	5-6 8 -9	3	Prepare even sized florets. Cut big florets into halves. Arrange stems to the centre.
Courgettes	250 g	3-4	3	Cut courgettes into slices. Add 30 ml (2 tbsp.) water or a knob of butter. Cook until just tender.
Egg Plants	250 g	3½-4	3	Cut egg plants into small slices and sprinkle with 1 tablespoon lemon juice.
Leeks	250 g	4 ½-5	3	Cut leeks into thick slices.
Mushrooms	125 g 250 g	1½-2 3-3 ½	3	Prepare small whole or sliced mushrooms. Do not add any water. Sprinkle with lemon juice. Spice with salt and pepper. Drain before serving.
Onions	250 g	5 ½-6	3	Cut onions into slices or halves. Add only 15 ml (1 tbsp.) water.
Pepper	250 g	4½-5	3	Cut pepper into small slices.
Potatoes	250 g 500 g	4-5 7 ½ -8 ½	3	Weigh the peeled potatoes and cut them into similar sized halves or quarters.
Turnip Cabbage	250 g	5½-6	3	Cut turnip cabbage into small cubes.

## Cooking Guide for rice and pasta

**Rice :** Use a large glass pyrex bowl with lid – rice doubles in volume during cooking. Cook covered. After the cooking time is over, stir before standing time and salt or add herbs and butter.

Remark: the rice may not have absorbed all water after the cooking time is finished.

**Pasta :** Use a large glass pyrex bowl. Add boiling water, a pinch of salt and stir well. Cook uncovered. Stir occasionally during and after cooking. Cover during standing time and drain thoroughly afterwards.

Food	Portion	Power	Time (min.)	Standing time (min.)	Instructions
White Rice (parboiled)	250 g	800 W	16-18	5	Add 500 ml cold water.
Brown Rice (parboiled)	250 g	800 W	21-23	5	Add 500 ml cold water.
Mixed Rice (rice + wild rice)	250 g	800 W	17-19	5	Add 500 ml cold water.
Mixed Corn (rice + grain)	250 g	800 W	12-14	2	Add 500 ml cold water.
Pasta	250 g	800 W	10-12	5	Add 1000 ml hot water.

## REHEATING

Your microwave oven will reheat food in a fraction of the time that conventional ovens hobs normally take. Use the power levels and reheating times in the following chart as a guide. The times in the chart consider liquids with a room temperature of about +18 to +20°C or a chilled food with a temperature of about +5 to +7°C.

### ARRANGING AND COVERING

Avoid reheating large items such as joint of meat – they tend to overcook and dry out before the centre is piping hot. Reheating small pieces will be more successful.

### POWER LEVELS AND STIRRING

Some foods can be reheated using 800 W power while others should be reheated using 600 W, 450 W or even 300 W. Check the tables for guidance. In general, it is better to reheat food using a lower power level, if the food is delicate, in large quantities, or if it is likely to heat up very quickly (mince pies, for example). Stir well or turn food over during reheating for best results. When possible, stir again before serving.

Take particular care when heating liquids and baby foods. To prevent eruptive boiling of liquids and possible scalding, stir before, during and after heating. Keep them in the microwave oven during standing time. We recommend putting a plastic spoon or glass stick into the liquids. Avoid overheating (and therefore spoiling) the food.

It is preferable to underestimate cooking time and add extra heating time, if necessary.

### HEATING AND STANDING TIMES

When reheating food for the first time, it is helpful to make a note of the time taken – for future reference.

Always make sure that the reheated food is piping hot throughout. Allow food to stand for a short time after reheating - to let the temperature even out.

The recommended standing time after reheating is 2-4 minutes, unless another time is recommended in the chart..

Take particular care when heating liquids and baby food. See also the chapter with the safety precautions.

### REHEATING LIQUIDS

Always allow a standing time of at least 20 seconds after the oven has been switched off to allow the temperature to even out. Stir during heating, if necessary, and ALWAYS stir after heating. To prevent eruptive boiling and possible scalding, you should put a spoon or glass stick into the beverages and stir before, during and after heating.

## REHEATING BABY FOOD

**BABY FOOD:** Empty into a deep ceramic plate. Cover with plastic lid. Stir well after reheating! Let stand for 2-3 minutes before serving. Stir again and check the temperature.

Recommended serving temperature: between 30-40 °C.

**BABY MILK:** Pour milk into a sterilised glass bottle. Reheat uncovered.

Never heat a baby's bottle with teat on, as the bottle may explode if overheated. Shake well before standing time and again before serving ! Always carefully check the temperature of baby milk or food before giving it to the baby. Recommended serving temperature: ca. 37 °C.

**REMARK:** Baby food particularly needs to be checked carefully before serving to prevent burns. Use the power levels and times in the next table as a guide lines for reheating.

### Reheating Liquids and Food

Use the power levels and times in this table as a guide lines for reheating.

Food	Portion	Power	Time (min.)	Standing time (min.)
Drinks (coffee, tea and water)	150 ml(1 cup)	800 W	1-1½	1-2
	250 ml(1 mug)		2-2½	
<b>Instructions</b>				
Pour into cup and reheat uncovered. Put cup/ mug in the centre of turntable. Keep in microwave oven during standing time and stir well.				
Soup (chilled)	250-350 g	800 W	3-4	2-3
	<b>Instructions</b>			
Pour into a deep ceramic plate or deep ceramic bowl. Cover with plastic lid. Stir well after reheating. Stir again before serving.				
Stew (chilled)	350 g	600 W	4½-5½	2-3
	<b>Instructions</b>			
Put stew in a deep ceramic plate. Cover with plastic lid. Stir occasionally during reheating and again before standing and serving.				
Pasta with sauce (chilled)	350 g	600 W	4-5	3
	<b>Instructions</b>			
Put pasta (e.g. spaghetti or egg noodles) on a flat ceramic plate. Cover with microwave cling film. Stir before serving.				

Food	Portion	Power	Time (min.)	Standing time (min.)
Filled pasta with sauce (chilled)	350 g	600 W	5-6	3
	<b>Instructions</b>			
Put filled pasta (e.g. ravioli, tortellini) in a deep ceramic plate. Cover with plastic lid. Stir occasionally during reheating and again before standing and serving.				
Plated meal (chilled)	350 g	600 W	5 ½ -6 ½ 6 ½ - 7 ½	3
	<b>Instructions</b>			
Plate a meal of 2-3 chilled components on a ceramic dish. Cover with microwave cling-film.				

### Reheating Baby Food and Milk

Use the power levels and times in this table as guide lines for reheating.

Food	Portion	Power	Time	Standing time (min.)
Baby food (vegetables + meat)	190 g	600 W	30 sec.	2-3
	<b>Instructions</b>			
Empty into ceramic deep plate. Cook covered. Stir after cooking time. Stand for 2-3 minutes. Before serving, stir well and check the temperature carefully.				
Baby porridge (grain + milk + fruit)	190 g	600 W	20 sec.	2-3
	<b>Instructions</b>			
Empty into ceramic deep plate. Cook covered. Stir after cooking time. Stand for 2-3 minutes. Before serving, stir well and check the temperature carefully.				
Baby milk	100 ml	300 W	30-40 sec.	2-3
	200 ml		1 min. to 1 min. 10 sec.	
<b>Instructions</b>				
Stir or shake well and pour into a sterilized glass bottle. Place into the centre of turn-table. Cook uncovered. Shake well and stand for at least 3 minutes. Before serving, shake well and check the temperature carefully.				

## MANUAL DEFROSTING

Microwaves are an excellent way of defrosting frozen food. Microwaves gently defrost frozen food in a short period of time. This can be of great advantage, if unexpected guests suddenly show up.

Frozen poultry must be thoroughly thawed before cooking. Remove any metal ties and take it out of any wrapping to allow thawed liquid to drain away.

Put the frozen food on a dish without cover. Turn over half way, drain off any liquid and remove any giblets as soon as possible.

Check the food occasionally to make sure that it does not feel warm.

If smaller and thinner parts of the frozen food start to warm up, they can be shield by wrapping very small strips of aluminium foil around them during defrosting.

Should poultry start to warm up on the outer surface, stop thawing and allow it to stand for 20 minutes before continuing.

Leave the fish, meat and poultry to stand in order to complete defrosting.

The standing time for complete defrosting will vary depending on the quantity defrosted. Please refer to the table below.

**Hint :** Flat food defrosts better than thick and smaller quantities need less time than bigger ones. Remember this hint while freezing and defrosting food.

For defrosting of frozen food with a temperature of about -18 to -20 °C, use the following table as a guide.

All frozen food should be defrosted using defrosting power level (180 W).

Food	Portion	Time (min.)	Standing time (min.)
<b>Meat</b>			
Minced meat	250 g	5-6	15-30
	500 g	10-12	
Pork steaks	250 g	5-7	
	<b>Instructions</b>		
Place the meat on a flat ceramic plate. Shield thinner edges with aluminium foil. Turn over after half of defrosting time!			
<b>Poultry</b>			
Chicken pieces	500 g (2 pcs)	12-14	15-60
	1200 g	28-32	
Whole chicken	<b>Instructions</b>		
	First, put chicken pieces first skin-side down, whole chicken first breast-side-down on a flat ceramic plate. Shield the thinner parts like wings and ends with aluminium foil. Turn over after half of defrosting time!		
<b>Fish</b>			
Fish fillets	200 g	5-7	10-25
	400 g	10-12	
<b>Instructions</b>			
Put frozen fish in the middle of a flat ceramic plate. Arrange the thinner parts under the thicker parts. Shield narrow ends with aluminium foil. Turn over after half of defrosting time!			
<b>Fruits</b>			
Berries	300 g	5-7	5-10
<b>Instructions</b>			
Distribute fruits on a flat, round glass dish (with a large diameter).			
<b>Bread</b>			
Bread rolls (each about 50 g)	2 pcs	1-1½	5-20
	4 pcs	2½-3	
Toast/Sandwich	250 g	4-4½	
	500 g	8-10	
German bread (wheat+rye flour)	<b>Instructions</b>		
	Arrange rolls in a circle or bread horizontally on kitchen paper in the middle of turntable. Turn over after half of defrosting time!		

## GRILL

The grill-heating element is located underneath the ceiling of the cavity. It operates while the door is closed and the turntable is rotating. The turntable's rotation makes the food brown more evenly. Preheating the grill for 3-5 minutes will make the food brown more quickly.

### Cookware for grilling:

Should be flameproof and may include metal. Do not use any type of plastic cookware, as it can melt.

### Food suitable for grilling:

Chops, sausages, steaks, hamburgers, bacon and gammon rashers, thin fish portions, sandwiches and all kinds of toast with toppings.

### Important remark:

Whenever the grill only mode is used, please remember that food must be placed on the high rack, unless another instruction is recommended.

## MICROWAVE + GRILL

This cooking mode combines the radiant heat that is coming from the grill with the speed of microwave cooking. It operates only while the door is closed and the turntable is rotating. Due to the rotation of the turntable, the food browns evenly. Three combination modes are available with this model: 600W + Grill, 450W + Grill and 300W + Grill.

### Cookware for cooking with microwave + grill:

Please use cookware that microwaves can pass through. Cookware should be flameproof. Do not use metal cookware with combination mode. Do not use any type of plastic cookware, as it can melt.

### Food suitable for microwave + grill cooking:

Food suitable for combination mode cooking include all kinds of cooked food which need reheating and browning (e.g. baked pasta), as well as foods which require a short cooking time to brown the top of the food. Also, this mode can be used for thick food portions that benefit from a browned and crispy top (e.g. chicken pieces, turning them over half way through cooking). Please refer to the grill table for further details.

### Important remark:

Whenever the combination mode (microwave + grill) is used, the food should be placed on the high rack, unless another instruction is recommended. Please refer to the instructions in the following chart.

The food must be turned over, if it is to be browned on both sides.

## Grill Guide

Preheat the grill with the grill-function for 3-4 minutes.  
Use the power levels and times in this table as guide lines for grilling. Use oven gloves when taking out.

Fresh food	Portion	Power	1st side time (min.)	2nd side time (min.)
Toast Slices	4 pcs (each 25 g)	Grill only	2-3	2-3
	<b>Instructions</b>			
Put the toast slices side by side on the rack.				
Grilled Tomatoes	400 g (2 pcs)	300 W+ Grill	5-6	-
	<b>Instructions</b>			
Cut tomatoes into halves. Put some cheese on top. Arrange in a circle in a flat glass pyrex dish. Place it on the high rack. Stand for 2-3 minutes.				
Tomato-Cheese Toast	4 pcs (300 g)	300W+ Grill	6-7	-
	<b>Instructions</b>			
Toast the bread slices first. Put the toast with topping on the high rack. Stand for 2-3 minutes.				
Toast Hawaii (ham, pineapple, cheese slices)	4 pcs (500 g)	300 W + Grill	5-6	-
	<b>Instructions</b>			
Toast the bread slices first. Put the toast with topping on the high rack. Stand for 2-3 minutes.				
Baked Potatoes	500 g	600 W + Grill	8-10	-
	<b>Instructions</b>			
Cut potatoes into halves. Put them in a circle on the high rack with the cut side to the grill.				
Gratin Potatoes / vegetables (chilled)	450 g	450W+ Grill	10-12	-
	<b>Instructions</b>			
Put the fresh gratin into a small glass pyrex dish. Put the dish on the high rack. After cooking stand for 2-3 minutes.				
Baked Apples	2 apples (ca.400 g)	300W + Grill	7-8	-
	<b>Instructions</b>			
Brush the lamb chops with oil and spices. Lay them in a circle on the rack. After grilling stand for 2-3 minutes.				

Fresh food	Portion	Power	1st side time (min.)	2nd side time (min.)
Chicken Pieces	500 g (2 pcs)	300W+ Grill	12-14	10-13
	<b>Instructions</b>			
Brush chicken pieces with oil and spices. Put them in a circle on the high rack. After grilling stand for 2-3 minutes				
Roast Fish	400-500 g	300W+ Grill	5-7	5½-6½
	<b>Instructions</b>			
Brush skin of whole fish with oil and add herbs and spices. Put two fishes side by side (head to tail) on the high rack. After grilling stand for 2-3 minutes.				

## CONVECTION

Cooking with convection is the traditional and well known method of cooking food in a traditional oven with hot air.

### Cookware for convection cooking:

All conventional ovenproof cookware, baking tins and sheets – anything you would normally use in a traditional convection oven – can be used.

### Food suitable for convection cooking:

All biscuits, individual scones, rolls and cakes should be made by this mode as well as rich fruit cakes, choux pastry and soufflés.

## MICROWAVES + CONVECTION

This mode combines the microwave energy with the hot air and is therefore reducing the cooking time while giving the food a brown and crispy surface. Cooking with convection is the traditional and well known method of cooking food in an oven with hot air circulated by a fan on the back-wall.

### Cookware for cooking with microwaves + convection:

Should be able to let the microwaves pass through. Should be ovenproof (like glass, pottery or china without metal trims); similar to the cookware described under MW + Grill.

### Food suitable for microwave + convection cooking:

All kinds of meats and poultry as well as casseroles and gratin dishes, sponge cakes and light fruit cakes, pies and crumbles, roast vegetables, scones and breads.

### Convection Guide for fresh and frozen food

Preheat the convection with the auto pre-heat function to the desired temperature.

Use the power levels and times in this table as guide lines for convection cooking. Use oven gloves when taking out.

Fresh food	Portion	Power	Time
PIZZA Frozen Pizza (ready baked)	300-400 g	450 W + 200 °C	11-14
	<b>Instructions</b> Place the pizza on the high rack. After baking stand for 2-3 minutes		
PASTA Frozen Lasagne	400 g	1st stage: 450 W + 200°C  2nd stage: Only grill	1st stage: 22-25  2nd stage: 3-5
	<b>Instructions</b> Put into a suitable sized glass pyrex dish or leave in the original packaging (take care that this is suitable for microwaves and oven heat). Put frozen lasagne on the low rack. After cooking stand for 2-3 minutes.		
MEAT Roast Beef/ Roast Lamb (medium)	1000-1200 g	600W + 160 °C	1st side: 15-20 2nd side: 10-13
	<b>Instructions</b> Brush beef/ lamb with oil and spice it with pepper, salt and paprika. Put it on the low rack, first with the fat side down. After cooking wrap in aluminium foil and stand for 10-15minutes.		
Roast Chicken	1000-1300 g	450 W + 200 °C	1st side : 20-25 2nd side: 18-23
	<b>Instructions</b> Brush chicken with oil and spices. Put chicken first breast side down, second side breast side up on the low rack. Stand for 5 minutes.		
BREAD Frozen Bread Rolls	4-5 pcs (250 g)	100 W + 180 °C	9-11
	<b>Instructions</b> Put bread rolls in a circle on the low rack. Stand 2-3 minutes.		
Garlic Bread (chilled, prebaked)	200 g (1 pc)	100 W + 200 °C	10-12
	<b>Instructions</b> Put the chilled baguette on baking paper on the low rack. After baking stand for 2-3 minutes.		

Fresh food	Portion	Power	Time
CAKE	500 g	Only 180 °C	40-45
Apple Cake (fresh dough)	<b>Instructions</b> Put the fresh dough in a small rectangular black metal baking dish (length 25 cm). Put the cake on the low rack. After baking stand for 5-10 minutes.		
Mini Muffins (fresh dough)	8 x 30 g (200-250g)	Only 180 °C	17-23
	<b>Instructions</b> Fill the fresh dough evenly in paper muffin dishes. Put the dishes on the low rack. After baking stand for 5 minutes.		
Frozen Puff pastries, filled	250-300 g	Only 180 °C	23-28
	<b>Instructions</b> Put the pastry snacks on the low rack.		
Frozen Cake	500 g	180 W + 160 °C	12-15
	<b>Instructions</b> Put the frozen cake directly on the low rack. After defrost and warming stand for 15-20 minutes.		

### TIPS AND TRICKS

#### MELTING BUTTER

Put 50 g butter into a small deep glass dish. Cover with plastic lid. Heat for 30-40 seconds using 800 W, until butter is melted.

#### MELTING CHOCOLATE

Put 100 g chocolate into a small deep glass dish. Heat for 3-5 minutes, using 450 W until chocolate is melted. Stir once or twice during melting. Use oven gloves while taking out!

#### MELTING CRYSTALLIZED HONEY

Put 20 g crystallized honey into a small deep glass dish. Heat for 20-30 seconds using 300 W, until honey is melted.

#### MELTING GELATINE

Lay dry gelatine sheets (10 g) for 5 minutes into cold water. Put drained gelatine into a small glass pyrex bowl. Heat for 1 minute using 300 W. Stir after melting.



### COOKING GLAZE/ICING (FOR CAKE AND GATEAUX)

Mix instant glaze (approximately 14 g) with 40 g sugar and 250 ml cold water.

Cook uncovered in a glass pyrex bowl for 3 ½ to 4 ½ minutes using 800 W, until glaze/icing is transparent. Stir twice during cooking.

### COOKING JAM

Put 600 g fruits (for example mixed berries) in a suitable sized glass pyrex bowl with lid. Add 300 g preserving sugar and stir well.

Cook covered for 10-12 minutes using 800 W.

Stir several times during cooking. Empty directly into small jam glasses with twist-off lids. Stand on lid for 5 minutes.

### COOKING PUDDING/ CUSTARD

Mix pudding powder with sugar and milk (500 ml) by following the manufacturers instructions and stir well. Use a suitable sized glass pyrex bowl with lid. Cook covered for 6 ½ to 7 ½ minutes using 800 W.

Stir several times well during cooking.

### BROWNING ALMOND SLICES

Spread 30 g sliced almonds evenly on a medium sized ceramic plate.

Stir several times during browning for 3 ½ to 4 ½ minutes using 600 W. Let it stand for 2-3 minutes in the oven. Use oven gloves while taking out!

## Troubleshooting

### WHAT TO DO IF YOU ARE IN DOUBT OR HAVE A PROBLEM

If you have any of the problems listed below try the solutions given.

#### This is normal.

- Condensation inside the oven
- Air flow around the door and outer casing.
- Light reflection around the door and outer casing.
- Steam escaping from around the door or vents.

#### The oven does not start when you press the button.

- Is the door completely closed?

#### The food is not cooked at all.

- Have you set the timer correctly and/or pressed the  button?
- Is the door closed?
- Have you overloaded the electric circuit and caused a fuse to blow or a breaker to be triggered?

#### The food is either overcooked or undercooked.

- Was the appropriate cooking length set for the type of food?
- Was an appropriate power level chosen?

#### Sparking and cracking occur inside the oven (arcing).

- Have you used a dish with metal trimmings?
- Have you left a fork or other metal utensil inside the oven?
- Is aluminium foil too close to the inside walls?

#### The oven causes interference with radios or televisions.

- Slight interference may be observed on televisions or radios when the oven is operating. This is normal. To solve this problem, install the oven away from televisions, radios and aerials.
- If interference is detected by the oven's microprocessor, the display may be reset. To solve this problem, disconnect the power plug and reconnect it. Reset the time.

 If the above guidelines do not enable you to solve the problem, contact your local dealer or SAMSUNG after-sales service.

# Technical specifications

SAMSUNG strives to improve its products at all times. Both the design specifications and these user instructions are thus subject to change without notice.

## Technical specifications

<b>Model</b>	<b>CE73JD</b>
<b>Power source</b>	230V ~ 50 Hz AC
<b>Power consumption</b>	
Maximum power	2350 W
Microwave	1200 W
Grill (heating element)	1100 W
Convection (heating element)	Max. 1700 W
<b>Output power</b>	100 W / 800 W - 6 levels (IEC-705)
<b>Operating frequency</b>	2450 MHz
<b>Magnetron</b>	OM75P(31)
<b>Cooling method</b>	Cooling fan motor
<b>Dimensions (W x H x D)</b>	
Outside	489 x 282 x 444 mm
Oven cavity	330 x 211 x 309 mm
<b>Volume</b>	0.7 Cubic feet /21L
<b>Weight</b>	
Net	15 kg approx.

## MEMO

**MEMO**

---

**MEMO**

---



## QUESTIONS OR COMMENTS?

COUNTRY	CALL	OR VISIT US ONLINE AT
AUSTRALIA	1300 362 603	<a href="http://www.samsung.com/au/support">www.samsung.com/au/support</a>
NEW ZEALAND	0800 726 786	<a href="http://www.samsung.com/nz/support">www.samsung.com/nz/support</a>
CHINA	400-810-5858	<a href="http://www.samsung.com/cn/support">www.samsung.com/cn/support</a>
HONG KONG	3698 4698	<a href="http://www.samsung.com/hk/support">www.samsung.com/hk/support</a> (Chinese) <a href="http://www.samsung.com/hk_en/support">www.samsung.com/hk_en/support</a> (English)
INDIA	1800 40 SAMSUNG (1800 40 7267864) (Toll-Free)	<a href="http://www.samsung.com/in/support">www.samsung.com/in/support</a>
BANGLADESH	09612300300 08000300300 (Toll free)	<a href="http://www.samsung.com/in/support">www.samsung.com/in/support</a>
INDONESIA	021-5699-7777 0800-112-8888 (Toll Free)	<a href="http://www.samsung.com/id/support">www.samsung.com/id/support</a>
JAPAN	0120-363-905	<a href="http://www.galaxymobile.jp/jp/support">www.galaxymobile.jp/jp/support</a>
MALAYSIA	1800-88-9999 +603-7713 7420 (Overseas contact)	<a href="http://www.samsung.com/my/support">www.samsung.com/my/support</a>
PHILIPPINES	1-800-10-726-7864 [ PLDT Toll Free ] 1-800-8-726-7864 [ Globe Landline and Mobile ] 02-422-2111 [ Standard Landline ]	<a href="http://www.samsung.com/ph/support">www.samsung.com/ph/support</a>
SINGAPORE	1800-SAMSUNG (726-7864)	<a href="http://www.samsung.com/sg/support">www.samsung.com/sg/support</a>
THAILAND	0-2689-3232 1800-29-3232 (Toll free)	<a href="http://www.samsung.com/th/support">www.samsung.com/th/support</a>
TAIWAN	0800-329-999 (All Product)	<a href="http://www.samsung.com/tw/support">www.samsung.com/tw/support</a>
VIETNAM	1800 588 889	<a href="http://www.samsung.com/vn/support">www.samsung.com/vn/support</a>
MYANMAR	+95-1-2399-888 VIP HHP +95-1-2399-990	<a href="http://www.samsung.com/th/support">www.samsung.com/th/support</a>
MACAU	0800 333	<a href="http://www.samsung.com/support">www.samsung.com/support</a>
SRI LANKA	+9411SAMSUNG (+94117267864) +94117540540 +94115900000	<a href="http://www.samsung.com/in/support">www.samsung.com/in/support</a>

**This product is RoHS compliant**

DE68-03995B-05

