

# Indian<sup>®</sup>

MOTORCYCLE

*Chief Dark Horse<sup>®</sup>*

*Chieftain<sup>®</sup> Dark Horse<sup>™</sup>*

*Chief<sup>®</sup> Classic*

*Chieftain<sup>®</sup>*

*Chief<sup>®</sup> Vintage*

*Roadmaster<sup>™</sup> Classic*

*Indian Springfield<sup>™</sup>*

*Roadmaster<sup>™</sup>*

**2017 RIDER'S MANUAL**

**California Proposition 65 Warning**

This product contains or emits  
chemicals known to the state of  
California to cause cancer and birth  
defects or other reproductive harm.



## **2017 Rider's Manual**

Chief Dark Horse®

Chief® Classic

Chief® Vintage

Indian Springfield™

Chieftain® Dark Horse™

Chieftain®

Roadmaster™ Classic

Roadmaster™

Copyright 2016 Indian Motorcycle International, LLC

All information contained within this publication is based on the latest product information available at the time of publication. Product improvements or other changes may result in differences between this manual and the motorcycle. Depictions and/or procedures in this publication are intended for reference use only.

No liability can be accepted for omissions or inaccuracies. Indian Motorcycle Company reserves the right to make changes at any time, without notice and without incurring obligation to make the same or similar changes to motorcycles previously built. Any reprinting or reuse of the depictions and/or procedures contained within, whether whole or in part, is expressly prohibited.

INDIAN®, INDIAN MOTORCYCLE®, INDIAN CHIEF®, CHIEF®, CHIEF DARK HORSE®, SPRINGFIELD™, CHIEFTAIN® DARK HORSE™ , CHIEFTAIN®, ROADMASTER™ CLASSIC, and ROADMASTER™ are trademarks of Indian Motorcycle Company.

iPhone®, iPod®, iPod nano®, and iPod touch® are trademarks of Apple Inc., registered in the U.S. and other countries.

The Bluetooth® word mark and logos are registered trademarks owned by Bluetooth SIG, Inc. and any use of such marks by INDIAN MOTORCYCLE is under license. Other trademarks and trade names are those of their respective owners.

Pandora, the Pandora logo, and the Pandora trade dress are trademarks or registered trademarks of Pandora Media, Inc. Used with permission.

Garmin® and zumo® are registered trademarks of Garmin Ltd. or its subsidiaries.

JCASE® is a registered trademark of Littelfuse, Inc.

9927621

## CONGRATULATIONS!

---

Congratulations on your purchase of a new INDIAN motorcycle. You have joined an elite family of motorcycle riders who have acquired a celebrated piece of American history by choosing to own an INDIAN motorcycle.

Your new motorcycle is the end result of true dedication and craftsmanship by our engineering, design and assembly teams. It was designed and manufactured to meet our goal of providing you with a high quality motorcycle that you can ride trouble-free for many years to come. We hope you will take as much pride in riding your new motorcycle as our team did in building it for you.

We urge you to read this rider's manual thoroughly. It contains information essential to safe riding and proper maintenance of your motorcycle.

Your authorized INDIAN MOTORCYCLE dealer knows your motorcycle best and should be consulted for service and assistance. Skilled technicians using advanced equipment and methods are best qualified to perform all major repairs and service your motorcycle may require.

INDIAN motorcycles comply with all federal, state and local safety and emission regulations for the area of intended sale.

## SAFETY SYMBOLS AND SIGNAL WORDS

---

The following signal words and symbols appear throughout this manual. Your safety and the safety of others is involved when these words and symbols are used. Become familiar with their meanings before reading the manual.



The safety alert symbol indicates a potential personal injury hazard.

### **DANGER**

A **DANGER** indicates a hazardous situation that, if not avoided, **will** result in death or serious injury.

### **WARNING**

A **WARNING** indicates a hazardous situation that, if not avoided, **could** result in death or serious injury.

### **CAUTION**

A **CAUTION** indicates a hazardous situation that, if not avoided, could result in minor or moderate injury.

### **NOTICE**

A **NOTICE** indicates a situation that could result in property damage.

### **NOTE**

A **NOTE** indicates information that helps clarify procedures.

**Introduction.** . . . . . **7**

**Safety** . . . . . **11**

    Reporting Safety Defects . . . . . 21

**Component Identification** . . . . . **25**

**Instruments, Features and Controls** . . . . . **31**

**Pre-Ride Inspections** . . . . . **81**

**Operation** . . . . . **93**

**Maintenance** . . . . . **105**

**Cleaning and Storage** . . . . . **155**

**Specifications** . . . . . **165**

**Warranty** . . . . . **173**

**Maintenance Log** . . . . . **185**

**Audio System** . . . . . **187**

**RIDE COMMAND™** . . . . . **225**





---

# INTRODUCTION

## IDENTIFICATION NUMBER RECORDS

Record important identification numbers below:

<b>Vehicle Identification Number (VIN)</b> (see page 22)	
<b>Engine Identification Number</b> (see page 9)	
<b>Master PIN</b>	
<b>Rider PIN</b>	
<b>Key Fob #1 Serial Number</b>	
<b>Key Fob #2 Serial Number</b>	
<b>Key Fob #3 Serial Number</b>	
<b>Key Fob #4 Serial Number</b>	

### **SERVICE AND WARRANTY INFORMATION**

Some procedures are beyond the scope of this manual. See your dealer to purchase an *INDIAN MOTORCYCLE Service Manual*. Some procedures provided in the service manual require specialized knowledge, equipment, and training. Be sure you have the required technical skills and tools that are needed before you attempt ANY service on your motorcycle. Please contact your authorized dealer before attempting any service work that is beyond your level of technical knowledge or experience, or if the work requires specialized equipment.

### **OPERATING YOUR MOTORCYCLE OUTSIDE THE U.S.A.**

If you plan to operate your motorcycle in countries other than the USA and Canada:

- Service facilities or replacement parts may not be readily available.
- Unleaded gasoline may not be available. The use of leaded fuels will cause engine damage, damage to your emissions systems and voiding of your warranty.
- Gasoline may have a considerably lower octane rating. Improper fuel can cause engine damage.

---

## ENGINE IDENTIFICATION NUMBER

The engine number ① is stamped into the right crankcase beneath the balance shaft cover. The engine number is positioned behind the right floorboard with the engine installed in the frame. Record the number in the space provided on page 7.



①



## SAFETY

### ABOUT THE RIDER'S MANUAL

---

**WARNING!** Failure to follow all recommended precautions and procedures could result in severe injury or death. Always heed all safety precautions and follow all operation, inspection and maintenance procedures outlined in this manual.

---

All references to RIGHT, LEFT, FRONT or REAR are from the operator's perspective when seated in a normal riding position. If you have questions about the operation or maintenance of your motorcycle after you've read this manual, please see your authorized dealer. To locate the nearest authorized INDIAN MOTORCYCLE dealer, visit the INDIAN MOTORCYCLE web site at [www.indianmotorcycle.com](http://www.indianmotorcycle.com).

Carefully read and understand the information found in the *Safety* section beginning on this page. To keep your motorcycle in peak condition on the road or in storage, understand and follow the procedures outlined in the *Maintenance* section beginning on Maintenance.

Bring the manual along when you ride. Following the precautions and procedures in the manual will add to your enjoyment and help keep you safe. If you lose or damage this manual, please purchase a new one through any authorized INDIAN MOTORCYCLE dealer. This rider's manual should be considered part of the motorcycle and should remain with the motorcycle when ownership changes.

### SAFE RIDING PRACTICES

---

**WARNING!** Improper use of a motorcycle can result in serious injury or death to you, your passenger and others. To minimize the risk of injury, read and understand the information contained in this section before operating the motorcycle. This section contains safety information specific to the INDIAN motorcycle, as well as information about general motorcycle safety. Anyone who rides the motorcycle (operators and passengers) must follow these safety precautions.

---

#### MOTORCYCLING HAS INHERENT RISKS

You can minimize those risks, but you can't eliminate them completely. Even if you're an experienced motorcycle operator or passenger, read all of the safety information in this manual before operating the motorcycle.

- Take a rider education course from the Motorcycle Safety Foundation or another qualified instructor. The course will help you develop or refresh your expertise in safe riding habits through instruction and riding. For information on Motorcycle Safety Foundation rider education courses in your area, call 1-800-446-9227 or visit [www.msf-usa.org](http://www.msf-usa.org).
- Read and understand all information in this rider's manual.
- Observe all maintenance requirements specified in this manual. See the *INDIAN MOTORCYCLE Service Manual* or an authorized INDIAN MOTORCYCLE dealer.

#### DESIGN CHARACTERISTICS AFFECT HOW YOU SHOULD RIDE THE MOTORCYCLE

- The motorcycle is designed for on-road use with one rider (and one passenger if the motorcycle is equipped with a passenger seat). *Never exceed the GVWR or the GAWR.* Refer to the *Specifications* section, or the Manufacturing Information/VIN label on the motorcycle frame for model-specific information.
- Riding off-road, riding with more than one passenger, or carrying weight exceeding the maximum weight rating can make handling difficult, which could cause loss of control.
- During the first 500 miles (800 km) of operation, follow all break-in procedures as outlined on page 93. Failure to do so can result in serious engine damage.
- If your motorcycle is equipped with saddlebags, a windshield or a passenger backrest, be prepared to reduce operating speed to maintain stability.

---

## FOLLOW THESE GENERAL SAFE RIDING PRACTICES

- Before each ride, perform the Pre-Ride Inspections. Failure to do so may result in damage to the motorcycle or an accident.
  - Until you're thoroughly familiar with the motorcycle and all of its controls, practice riding where there is little or no traffic. Practice riding at a moderate speed on various road surfaces and in different weather conditions.
  - Know your skills and limits, and ride within them.
  - Allow only licensed, experienced operators to ride your motorcycle, and then only after they have become familiar with its controls and operation. Make sure all riders read and understand this rider's manual before riding.
  - Do not ride when you're fatigued, ill or under the influence of alcohol, prescription drugs, over-the-counter drugs or any other drugs. Fatigue, illness, alcohol and drugs can cause drowsiness, loss of coordination and loss of balance. They can also affect your awareness and judgment.
  - If your motorcycle operates abnormally, correct the problem immediately. See the *INDIAN MOTORCYCLE Service Manual* or an authorized INDIAN MOTORCYCLE dealer.
  - Ride defensively, as if you are invisible to other motorists, even in broad daylight. *A motorist's failure to see or recognize a motorcycle is the leading cause of automobile/motorcycle accidents.* Ride where you're clearly visible to other motorists, and observe their behavior carefully.
  - Be especially cautious at intersections, as these are the most likely places for an accident.
  - To prevent loss of control, keep your hands on the handlebars and your feet on the footrests.
  - Be aware that a highway bar is not designed to protect the rider from injury in a collision.
  - Obey the speed limit and adjust your speed and riding technique based on road, weather and traffic conditions. As you travel faster, the influence of all other conditions increases, which can affect the motorcycle's stability and increase the possibility of losing control.
  - Do not move or operate the motorcycle with the steering locked (if equipped), as the severely restricted steering could result in loss of control.
  - Reduce speed when:
    - The road has potholes or is otherwise rough or uneven.
    - The road contains sand, dirt, gravel or other loose substances.
    - The road is wet, icy or oily.
    - The road contains painted surfaces, manhole covers, metal grating, railway crossings or other slippery surfaces.
    - The weather is windy, rainy or otherwise causing slippery or rapidly changing conditions.
    - Traffic is heavy, congested, not allowing sufficient space between vehicles or otherwise not flowing smoothly.
    - You are being passed in either direction by a large vehicle that may produce a wind blast in its wake.
  - When approaching a curve, choose a speed and lean angle that allows you to pass through the curve in your own lane without applying the brakes. Excessive speed, improper lean angle or braking in a curve can cause loss of control.
  - Ground clearance is reduced when the motorcycle leans. Do not allow components to contact the road surface when leaning the motorcycle in a curve, as this could cause loss of control.
-

## SAFETY

---

- Do not tow a trailer. Towing a trailer can make the motorcycle hard to handle.
- Retract the sidestand fully before riding. If the sidestand is not fully retracted, it could contact the road surface and cause loss of control.
- To maximize braking effectiveness, *use the front and rear brakes together*. Be aware of the following braking facts and practices:
  - The rear brake provides 40% of the motorcycle's stopping power, at most. Use the front and rear brakes together.
  - To avoid skidding, apply the brakes gradually when the road is wet or rough, or contains loose or other slippery substances.
  - If possible, avoid applying the brakes while making a turn. Motorcycle tires have less traction during turns, so braking will increase the possibility of skidding. Bring the motorcycle to the upright position before applying the brakes.
  - With new pads and rotors, allow up to 250 miles (500 km) of operation in urban driving conditions (not highway cruising) to allow pads to mate with new rotors. Brakes should be used frequently. During this time brake performance will be less effective. Avoid using brakes harshly unless in an emergency. Brake efficiency will gradually increase during this seating period.

### ANTI-LOCK BRAKE SYSTEM RESPONSE

When the anti-lock brakes engage during a braking event, the rider will feel pulsing at the brake levers. *Continue to apply steady pressure to the brakes for the best stopping performance.*

## CARRYING A PASSENGER

---

**WARNING!** Do not carry a passenger unless the motorcycle is equipped with passenger seat and passenger footrests.

---

### TO CARRY A PASSENGER SAFELY

- Do not exceed the gross vehicle weight rating (GVWR) for your motorcycle. Refer to the *Specifications* section of this manual (Specifications) or the Manufacturing Information/VIN label on the motorcycle frame for model-specific information.
- Adjust ride height as needed. See page 120–page 121.
- Direct the passenger to hold onto you or to the passenger hand strap with both hands and to keep both feet on the passenger footrests. Do not carry a passenger who cannot place both feet firmly on the passenger footrests. A passenger who is not holding on properly, or who cannot reach the passenger footrests, can shift their body erratically, which can make the motorcycle hard to handle and cause loss of control.
- Before riding, be sure your passenger knows safe riding procedures. Discuss any safety information unfamiliar to your passenger. A passenger who is unaware of safe riding procedures may distract you or make movements that make the motorcycle hard to handle.
- Adjust your riding style to compensate for the differences in handling, acceleration and braking caused by the additional weight of the passenger. Failure to do so can cause loss of control.



---

## PROTECTIVE APPAREL

*Wear protective apparel to decrease the risk of injury and increase riding comfort.*

- Always wear a helmet that meets or exceeds established safety standards. Approved helmets in the USA and Canada bear a U.S. Department of Transportation (DOT) label. Approved helmets in Europe, Asia and Oceania bear the ECE 22.05 label. The ECE mark consists of a circle surrounding the letter E, followed by the distinguishing number of the country which has granted approval. The approval number and serial number will also be displayed on the label. Laws in some areas *require* that you wear an approved helmet. Head injuries are the leading cause of fatalities in accidents involving motorcycles. Statistics prove that an approved helmet is the most effective protection in preventing or reducing head injuries.
- Wear eye protection to protect eyes from wind or airborne particles and objects. Laws in some areas *require* that you wear eye protection. We recommend that you wear approved Personal Protective Equipment (PPE) bearing markings such as VESC 8, V-8, Z87.1, or CE. Make sure protective eyewear is kept clean.
- All riders should wear bright or light-colored and/or reflective clothing to improve visibility to other motorists. *A motorist's failure to see or recognize a motorcycle is the leading cause of automobile/motorcycle accidents.*
- Wear gloves, a jacket, heavy boots and long pants to prevent or reduce injury from abrasions, lacerations or burns should the motorcycle fall. Wear boots with low heels, as high heels can catch on pedals or footrests. The combination of boots and pants should completely cover legs, ankles and feet, protecting skin from engine and exhaust system heat.

- Do not wear loose, flowing clothing or long boot laces, as they can catch on handlebars, levers or footrests, or they can become entangled in the wheels, causing loss of control and serious injury.

## USE OF ACCESSORIES

Because INDIAN MOTORCYCLE cannot test and make specific recommendations concerning every accessory or combination of accessories sold, the operator is responsible for determining that the motorcycle can be safely operated with any accessories or additional weight. Use the following guidelines when choosing and installing accessories:

- Do not install accessories that impair operator visibility or the stability, handling or operation of the motorcycle. Before installing an accessory, be sure that it does not:
  - reduce ground clearance when the motorcycle is either leaned or in a vertical position;
  - limit suspension or steering travel or your ability to operate controls;
  - displace you from your normal riding position;
  - obscure lights or reflectors.
- Bulky, heavy or large accessories can cause instability (due to the lifting or buffeting effects of wind) and loss of control.
- Do not install electrical accessories that exceed the capacity of the motorcycle's electrical system. Never install higher wattage light bulbs than those supplied as original equipment. An electrical failure could result and cause hazardous loss of engine power or lights, or damage to the electrical system. See page 149.

## SAFETY

---

- Use only genuine INDIAN MOTORCYCLE accessories designed for your model.
- Do not exceed the gross vehicle weight rating (GVWR) for your motorcycle.
- Adjust ride height as needed. See page 120-page 121.

## MODIFICATIONS

Modifying the motorcycle by removing any equipment or by adding equipment not approved by the manufacturer may void your warranty. Such modifications could make the motorcycle unsafe to ride and could result in severe injury to operator or passenger, as well as damage to the motorcycle. Some modifications may not be legal in your area of operation. If in doubt, contact your authorized INDIAN MOTORCYCLE dealer.

## PARKING THE MOTORCYCLE

When leaving the motorcycle unattended, turn the engine off. Remove the ignition key to prevent unauthorized use.

Park the motorcycle where people are not likely to touch the hot engine or exhaust system or place combustible materials near these hot areas. Do not park near a flammable source such as a kerosene heater or an open flame, where hot components could ignite combustible materials.

Park the motorcycle on a firm, level surface. Sloped or soft surfaces may not support the motorcycle. If you must park on a slope or soft surface, follow the precautions outlined on page 104.

## SADDLEBAGS, TRUNK AND OTHER STORAGE

Whenever operating a motorcycle equipped with cargo storage features such as saddlebags, a trunk, racks, glove boxes or other storage compartments:

- Never ride at excessive speeds. Storage features and cargo, combined with the lifting or buffeting effects of wind, can make a motorcycle unstable and cause loss of control.
- Distribute weight evenly on each side of the motorcycle.
- Do not exceed the individual weight limit of any saddlebag, trunk or other storage compartment. Refer to the storage capacity label located on or near the storage feature. See page 22.
- NEVER EXCEED the GROSS VEHICLE WEIGHT RATING (GVWR) or the GROSS AXLE WEIGHT RATING (GAWR), regardless of whether or not any storage feature is loaded to capacity. Exceeding the weight rating can reduce stability and handling and cause loss of control.
- Adjust ride height as needed. See page 120-page 121.

---

## CARRYING CARGO

Use the following guidelines when attaching cargo or accessories to the motorcycle. Where applicable, these guidelines also refer to the contents of any accessories.

- Keep cargo and accessory weight to a minimum, and keep items as close to the motorcycle as possible to minimize a change in the motorcycle's center of gravity. Changing the center of gravity can cause loss of stability and handling and could cause loss of control.
  - Adjust ride height as needed. See page 120-page 121.
  - Do not exceed the gross vehicle weight rating (GVWR) for your motorcycle.
  - Distribute weight evenly on both sides of the motorcycle. Maintain even weight distribution by checking accessories and cargo to make sure they're securely attached to the motorcycle before riding and whenever you take a break from riding. Uneven weight distribution or sudden shifting of accessories or cargo while you're riding may cause difficult handling, loss of control and driving hazards for other motorists (if cargo falls from the motorcycle).
  - For riding comfort and to ensure proper ground clearance, adjust rear shock air pressure (if equipped) as specified on the label located under the left side cover. See page 121.
- Do not attach large or heavy cargo such as sleeping bags, duffel bags or tents to the handlebars, front fork area or front fender. Cargo or accessories placed in these areas can cause instability (due to improper weight distribution or aerodynamic changes) and could cause loss of control. Such items can also block air flow to the engine and cause overheating that can damage the engine.
  - Do not exceed the maximum cargo weight limit of any accessory (see accessory instructions and labels). Do not attach cargo to an accessory not designed for that purpose. Either circumstance could result in an accessory failure that could cause loss of control.
  - Always obey posted speed limits.
  - Do not attach anything to the motorcycle unless specifically designed for that purpose by INDIAN MOTORCYCLE.

## SAFETY

---

### TRANSPORTING THE MOTORCYCLE

If you must transport the motorcycle:

- Use a truck or trailer. Do not tow the motorcycle with another vehicle, as towing will impair the motorcycle's steering and handling.
- Position and restrain the motorcycle in an upright position. If the motorcycle leans to one side, gasoline may leak from the fuel tank and result in a fire hazard or damage to the finish.
- Do not restrain the motorcycle using the handlebars.
- Loop tiedown straps (from the front) up and over the lower triple clamp, using care to not interfere with wiring and brake lines. Place tiedowns as wide apart as possible on the truck or trailer bed for best stability.

### FUEL AND EXHAUST SAFETY

Always heed these fuel safety warnings when refueling or servicing the fuel system. For fueling procedures, see page 95.

---

**WARNING!** Gasoline is highly flammable and explosive under certain conditions.

- Always exercise extreme caution whenever handling gasoline.
- Always turn off the engine before refueling.
- Always refuel outdoors or in a well-ventilated area.
- Open the fuel cap slowly. Do not overfill the tank. Do not fill the tank neck.
- Do not smoke or allow open flames or sparks in or near the area where refueling is performed or where gasoline is stored.

Gasoline and gasoline vapors are poisonous and can cause severe injury.

- Do not swallow gasoline, inhale gasoline vapors, or spill gasoline. If you swallow gasoline, inhale more than a few breaths of gasoline vapor, or get gasoline in your eyes, see a physician immediately.
  - If gasoline spills on your skin or clothing, immediately wash it off with soap and water and change clothing.
  - Exhaust gases contain carbon monoxide, a colorless, odorless gas that can cause loss of consciousness or death in a short time.
  - Never start the engine or let it run in an enclosed area.
  - Never inhale exhaust gases.
-

---

## SAFETY MAINTENANCE

---

**WARNING!** Failure to perform safety maintenance as recommended can result in difficult handling and loss of control, which could result in serious injury or death. Always perform the safety maintenance procedures as recommended in this manual. Perform maintenance and repairs promptly. See the INDIAN MOTORCYCLE Service Manual or an authorized INDIAN MOTORCYCLE dealer or other qualified dealer.

---

- Before each ride, perform the *Pre-Ride Inspections*.
  - Perform all periodic maintenance at the recommended intervals outlined in the *Periodic Maintenance* section.
  - Always maintain proper tire pressure, tread condition and wheel and tire balance. Inspect tires regularly and replace worn or damaged tires promptly. Use only approved replacement tires. See the *Specifications* section.
- Always ensure proper steering head bearing adjustment. Regularly inspect the rear shock absorber and the front forks for fluid leaks or damage. Make any necessary repairs promptly. See page 124.
- Clean the motorcycle thoroughly to reveal items in need of repair.
  - Fasteners must meet original specifications for quality, finish and type to ensure safety. Use only genuine INDIAN MOTORCYCLE replacement parts, and ensure that all fasteners are tightened to the proper torque.

## SAFETY

---

### ELECTROMAGNETIC INTERFERENCE

This vehicle complies with UN ECE Regulation 10 requirements and Canadian ICES-002.

### KEY FOB AND VEHICLE CONTROL MODULE FCC/IC COMPLIANCE STATEMENT

FCC: W99PI01, W99PI02

IC: 8296A-PI01; 8296A-PI02

This device complies with Part 15 of the FCC Rules and Canada license-exempt RSS-210 standard. Operation is subject to the following two conditions:

1. THIS DEVICE MAY NOT CAUSE HARMFUL INTERFERENCE
2. THIS DEVICE MUST ACCEPT ANY INTERFERENCE RECEIVED, INCLUDING INTERFERENCE THAT MAY CAUSE UNDESIREDD OPERATION.

### GROSS VEHICLE WEIGHT RATING (GVWR)

---

**WARNING!** Exceeding the gross vehicle weight rating of your motorcycle can reduce stability and handling and could cause loss of control. NEVER exceed the GVWR of your motorcycle.

---

The *maximum load capacity* of your motorcycle is the maximum weight you may add to your motorcycle *without exceeding the GVWR*. This capacity is determined by calculating the difference between your motorcycle's GVWR and wet weight.

Refer to the *Specifications* section of this manual (Specifications) or the Manufacturing Information/VIN label on the motorcycle frame for model-specific information.

When determining the weight you will be adding to your motorcycle, and to ensure you do not exceed the maximum load capacity, include the following:

- operator body weight
- passenger body weight
- weight of all riders' apparel and items in or on apparel
- weight of any post-production accessories *and their contents*
- weight of any additional cargo on the motorcycle

---

## REPORTING SAFETY DEFECTS

If you believe that your vehicle has a defect that could result in a crash or cause injury or death, you should immediately inform the National Highway Traffic Safety Administration (NHTSA) in addition to notifying INDIAN MOTORCYCLE in writing.

If NHTSA receives similar complaints, it may open an investigation, and if it finds that a safety defect exists in a group of vehicles, it may order a recall and remedy campaign. However, NHTSA cannot become involved in individual problems between you, your INDIAN MOTORCYCLE dealer or Indian Motorcycle Company.

To contact NHTSA, or obtain other information about motor vehicle safety, you may either call the Vehicle Safety Hotline toll-free at 1-888-327-4236 (TTY: 1-800-424-9153), visit the NHTSA web site at [www.safercar.gov](http://www.safercar.gov), or write to:

ADMINISTRATOR, NHTSA  
1200 New Jersey Avenue, SE  
West Building  
Washington, DC 20590

## SAFETY

### SAFETY AND INFORMATION LABELS

Labels are model-specific and market-specific. Some of the following labels will be present only if your motorcycle is equipped with the feature.

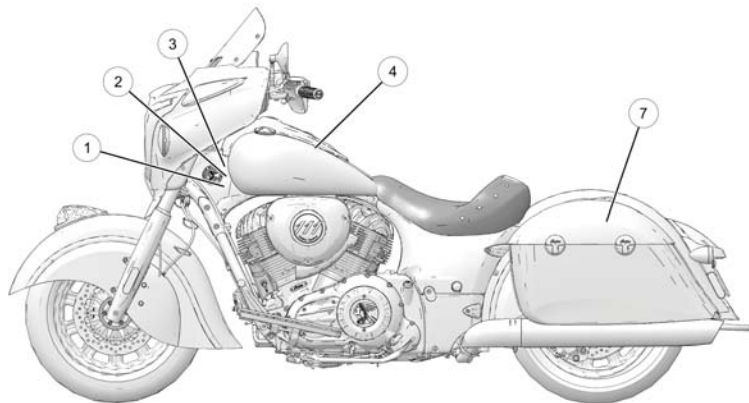

**CHIEFTAIN DARK HORSE shown**

- ① Vehicle Identification Number (VIN) (side of steering head)
- ② Vehicle Emission Control Information (VECI)
- ③ Noise Emission Control Information (NECI)
- ④ Operator Warning/Fuel Recommendation

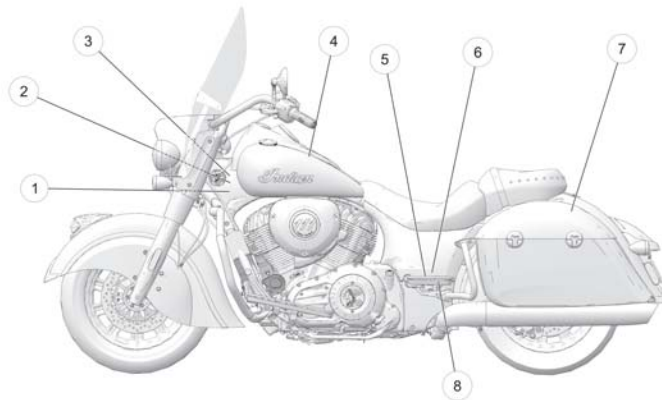

**SPRINGFIELD shown**

- ⑤ Shock Air Pressure Warning (under side cover)
- ⑥ Rear Wheel Service Warning (under side cover)
- ⑦ Saddlebag / Cargo Warning
- ⑧ Rear Tip-Over Bar Warning



## SAFETY AND INFORMATION LABELS

Labels are model-specific and market-specific. Some of the following labels will be present only if your motorcycle is equipped with the feature.

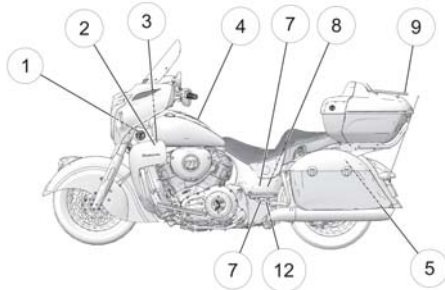

**ROADMASTER shown**

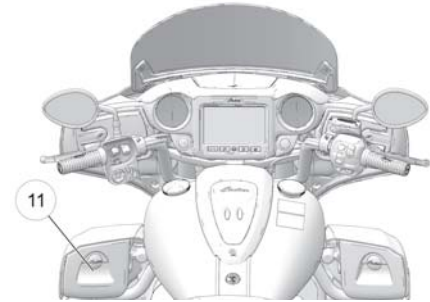
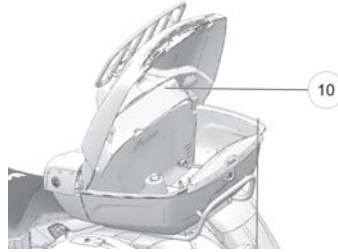

- ① Vehicle Identification Number (VIN) (side of steering head)
- ② Vehicle Emission Control Information (VECI)
- ③ Noise Emission Control Information (NECI)
- ④ Operator Warning/Fuel Recommendation
- ⑤ Saddlebag/Cargo Warning
- ⑥ Highway Bar Warning

- ⑦ Shock Air Pressure Warning (under side cover)
- ⑧ Rear Wheel Service Warning (under side cover)
- ⑨ Trunk Rack Capacity Label
- ⑩ Trunk Capacity Label
- ⑪ Lower Fairing Glove Box Cargo Capacity Labels (inside covers)
- ⑫ Rear Tip-Over Bar Warning



## COMPONENT IDENTIFICATION CONSOLE

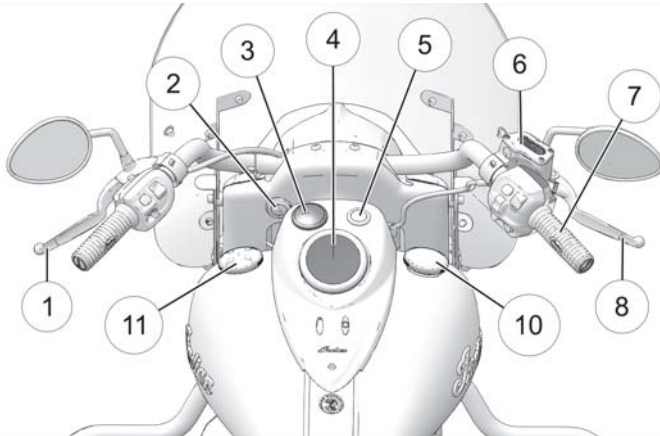

**CHIEF DARK HORSE/CHIEF CLASSIC/CHIEF VINTAGE/  
SPRINGFIELD (SPRINGFIELD shown)**

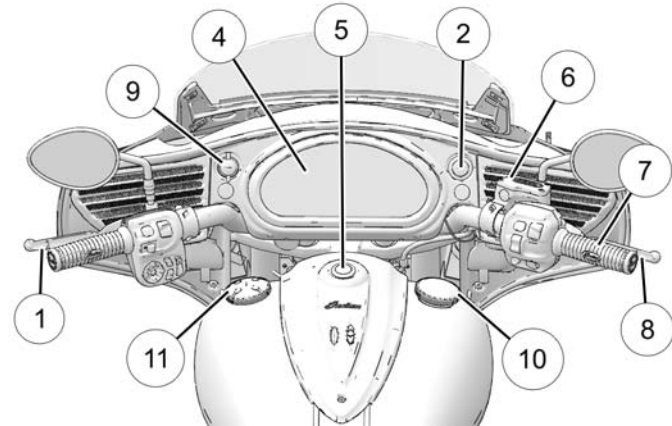

**CHIEFTAIN DARK HORSE**

- ① Clutch Lever
- ② Auxiliary Light Switch (if equipped)
- ③ Fuel Gauge (CHIEF VINTAGE/SPRINGFIELD)
- ④ Instrument Cluster
- ⑤ Power Switch/Security Light
- ⑥ Front Brake Master Cylinder

- ⑦ Throttle Control Grip
- ⑧ Front Brake Lever
- ⑨ 12-Volt Outlet (CHIEFTAIN DARK HORSE)
- ⑩ Fuel Cap
- ⑪ Ornamental Cap (Do not remove)

## COMPONENT IDENTIFICATION

---

### CONSOLE

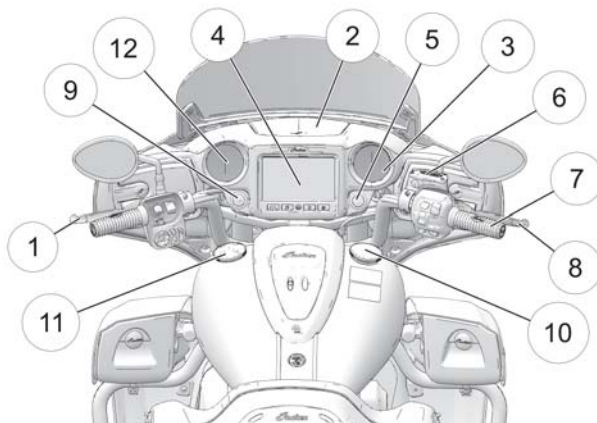

**CHIEFTAIN/ROADMASTER CLASSIC/ROADMASTER (ROADMASTER shown)**

- |   |  |
|---|--|
| ① Clutch Lever                                  | ⑦ Throttle Control Grip                |
| ② Phone Storage Compartment                     | ⑧ Front Brake Lever                    |
| ③ Tachometer                                    | ⑨ Auxiliary Light Switch (if equipped) |
| ④ Infotainment Instrument Cluster (if equipped) | ⑩ Fuel Cap                             |
| ⑤ Power Switch/Security Light                   | ⑪ Ornamental Cap (Do not remove)       |
| ⑥ Front Brake Master Cylinder                   | ⑫ Fuel Gauge                           |

**COMPONENT IDENTIFICATION**

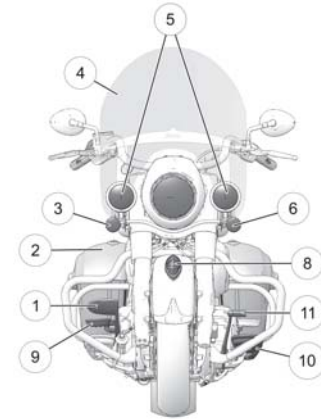
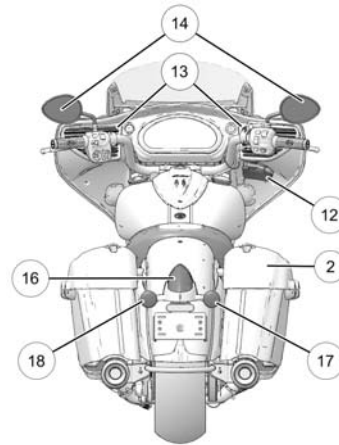
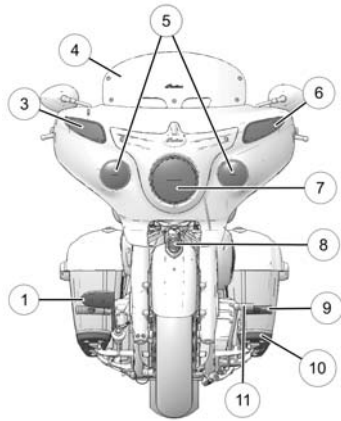

**CHIEFTAIN DARK HORSE shown**

**SPRINGFIELD shown**

- ① Rear Brake Pedal
- ② 12-Volt Outlet (if equipped)
- ③ Right Front Turn Signal
- ④ Windshield (if equipped)
- ⑤ Auxiliary Lights (if equipped)
- ⑥ Left Front Turn Signal

- ⑦ Headlight
- ⑧ INDIAN MOTORCYCLE Headdress
- ⑨ Passenger Foot Peg (if equipped)
- ⑩ Driver's Footrest
- ⑪ Gear Shifter
- ⑫ Glove Box Storage (if equipped)

- ⑬ Speakers
- ⑭ Mirror
- ⑮ USB Cord (not shown)
- ⑯ Taillight
- ⑰ Right Rear Turn Signal
- ⑱ Left Rear Turn Signal

## COMPONENT IDENTIFICATION

---

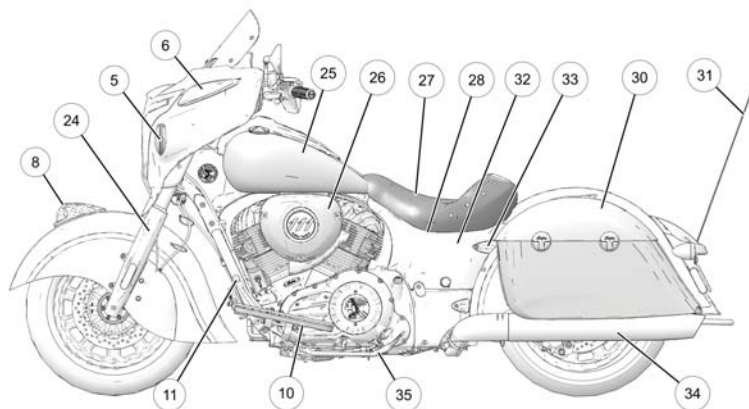

**CHIEFTAIN DARK HORSE shown**

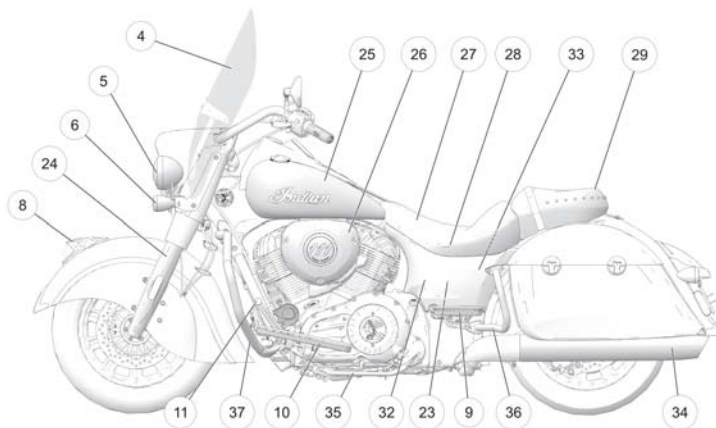

**SPRINGFIELD shown**

- ⑱ Trunk Cargo Rack (if equipped)
- ⑳ Trunk (if equipped)
- ㉑ Lower Fairing Wind Deflector (if equipped)
- ㉒ Lower Fairing (if equipped)
- ㉓ 12-Volt Batter Tender Terminal (Under cover, if equipped)
- ㉔ Front Fork
- ㉕ Fuel Tank

- ㉖ Air Box Cover (left)
- ㉗ Driver's Seat
- ㉘ Battery (under seat)
- ㉙ Passenger Seat (if equipped)
- ㉚ Saddlebag (if equipped)
- ㉛ Radio Antenna (if equipped)
- ㉜ Side Cover (Left)

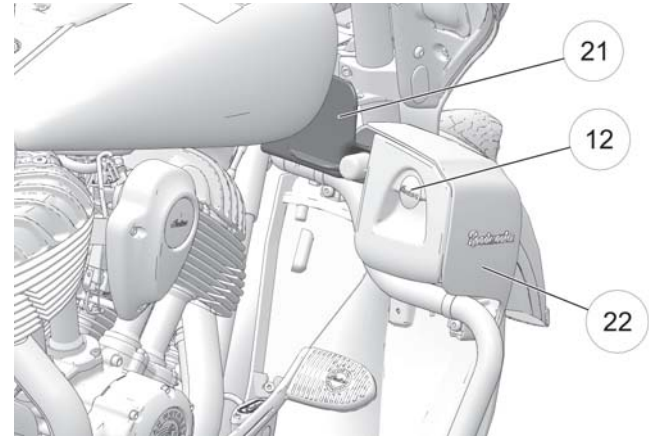
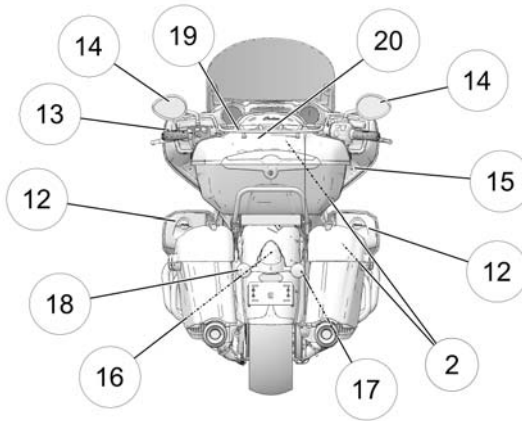

### ROADMASTER shown

- ③ Shock Air Fill (under cover) (SPRINGFIELD/CHIEFTAIN DARK HORSE/CHIEFTAIN/ROADMASTER CLASSIC/ROADMASTER)
- ③④ Muffler
- ③⑤ Sidestand
- ③⑥ Rear Tipover Bar (if equipped)
- ③⑦ Front Tipover Bar (if equipped)





# INSTRUMENTS, FEATURES AND CONTROLS

## SWITCH LOCATIONS

### LEFT CONTROL

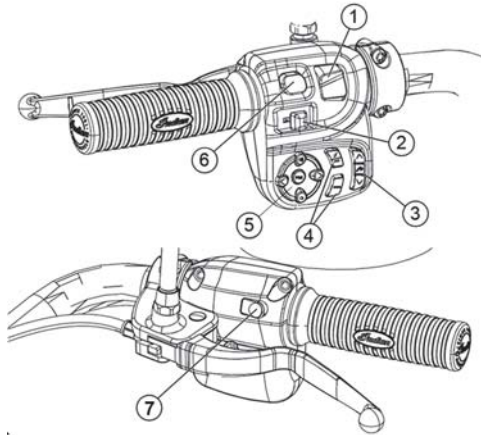

- ① High/Low Light Switch
- ② Turn Signal Switch
- ③ Windshield Switches (if equipped)
- ④ Infotainment Switches (if equipped)
- ⑤ Audio Control Switches (if equipped)
- ⑥ Horn Switch
- ⑦ LEFT-TOGGLE Switch

### RIGHT CONTROL

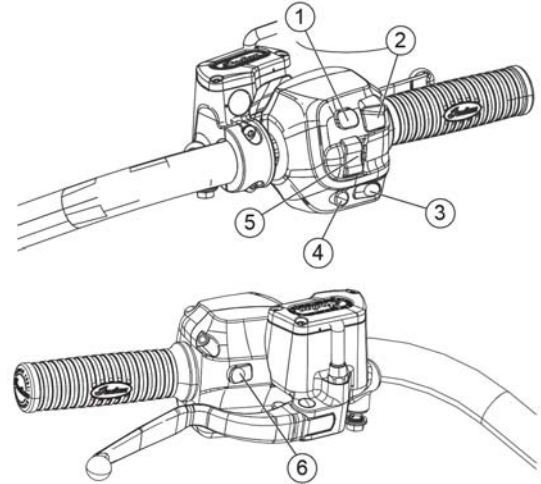

- ① Flasher (Hazard) Switch
- ② Engine Stop/Run Switch
- ③ Engine Starter Switch
- ④ Cruise On/Off Switch
- ⑤ Cruise Control Switch
- ⑥ RIGHT-TOGGLE Switch

## CHIEF MODELS/SPRINGFIELD



① Auxiliary Light Switch (if equipped)

② Power Switch

## CHIEFTAIN DARK HORSE

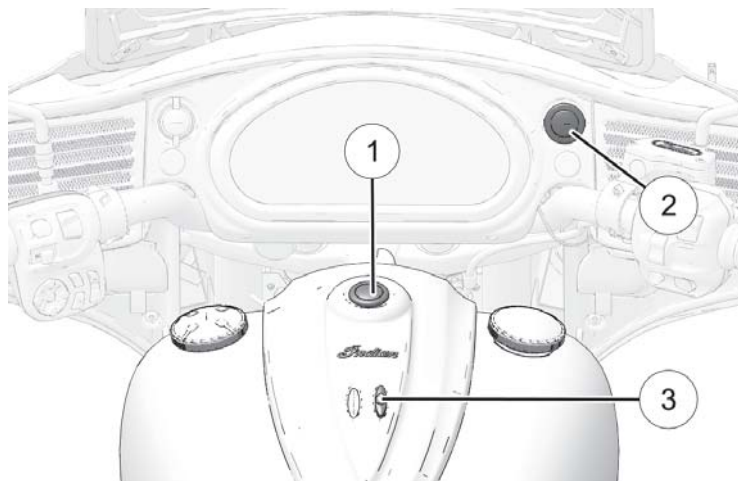

① Power Switch

② Auxiliary Light Switch

③ Saddlebag/Trunk Lock Switch

**CHIEFTAIN/ROADMASTER**

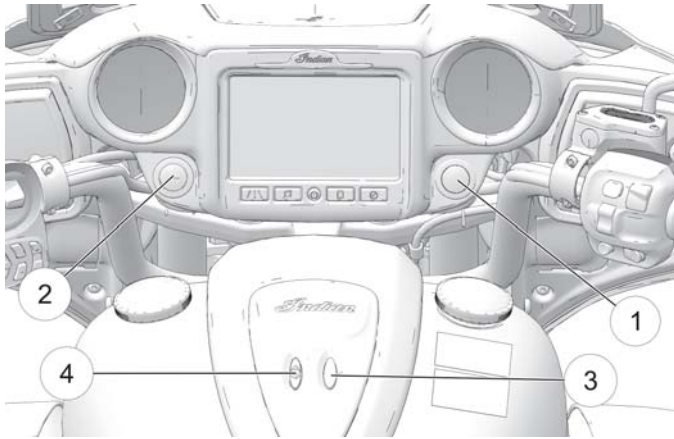







**ROADMASTER shown**

- ① Power Switch
- ② Auxiliary Light Switch
- ③ Power Locks
- ④ Heated Handgrips (if equipped)

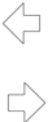
## INSTRUMENTS, FEATURES AND CONTROLS

### SWITCH SYMBOLS

SYMBOL	SWITCH	DESCRIPTION
	Emergency Flasher Switch (Hazard Switch)	The hazard switch activates and cancels the emergency flashers. See page 35.
	High/Low Headlight Beam Switch	The high/low headlight beam switch toggles the headlight between high beam and low beam. See page 37.
-	Auxiliary Light Switch (if equipped)	Press the auxiliary light switch to turn the auxiliary lights off or on. See page 37.
	Horn Switch	Press the horn switch to sound the horn.
	Turn Signal Switch	Move the switch to the left to activate the left turn signals. Move the switch to the right to activate the right turn signals. A signal will deactivate automatically when speed or distance reach predetermined levels. To cancel a signal manually, move the switch to the center position and push it inward. <i>Momentary Feature: Move the turn signal switch left or right and hold it in that position for at least one second. The momentary feature will activate and the signal will then cancel when the switch is released.</i>
	Stop/Run Switch	Press the bottom of the switch (RUN) to allow the engine to start and run. Press the top of the switch (STOP) to stop the engine. See page 35.
	Starter Switch	Use the starter switch to start the engine. The engine stop/run switch must be in the RUN position. See page 36.
	Power Switch	The power switch is located above the instrument gauge. Press and release the power switch to enable or disable all electrical power to the vehicle. See page 35.
-	Saddlebag/Trunk Lock Switch (if equipped)	Press the lock switch to lock or unlock the saddlebags and trunk (if equipped). The key fob can also be used to lock or unlock the saddlebags and trunk.
-	Heated Grip Switch	Use the hand grip heater switch to turn the grip heaters on or off and to adjust the heat level. See page 38.

## SWITCHES

### POWER SWITCH

The power switch is located on the console for all non-fairing motorcycles. The power switch is located on the dash for all models equipped with the infotainment dash. Press and release the power switch to enable or disable all electrical power to the vehicle. The power switch does not have to be on to start the engine. See page 36.

To disable all electrical power if the motorcycle is moving and the engine is running, press and hold the power switch for more than three (3) seconds.

**TIP:** To save battery power, the vehicle will automatically power off after five minutes of inactivity. Automatic power down can be overridden on bikes with RIDE COMMAND™ through the settings menu.

### HAZARD SWITCH

The power switch must be ON to activate the flashers, but once activated, the flashers will continue to flash when the power switch is turned off. When the flashers are active, all four turn signals flash.

- Press the switch to activate the flashers.
- Press the switch again to cancel the flashers.

### ENGINE STOP/RUN SWITCH

Use the engine stop/run switch to turn the engine off quickly.

- Press the top of the switch (STOP) ① to interrupt the circuits and stop the engine. The engine should not start or run when the switch is in the STOP position.
- Press the bottom of the switch (RUN) ② to complete the circuits and allow the engine to start and run.

**TIP:** The headlights and any accessories plugged into power ports will remain on until the power switch is turned off.

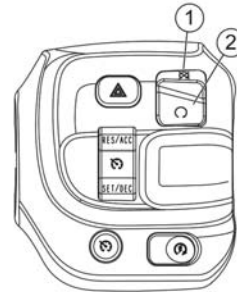

**Right Control**

## INSTRUMENTS, FEATURES AND CONTROLS

### ENGINE STARTER SWITCH

Read the engine starting procedures before starting the engine. See page 96.

The power switch ① does not have to be on to start the engine. Press and hold the starter switch to engage the one-touch starting feature, which activates the electrical system and starts the engine. The engine stop/run switch must be in the RUN position and the transmission must be in neutral.

#### Right Control

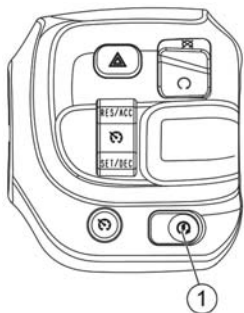

### KEYLESS IGNITION

#### STARTING KEY FOB OPERATION:

When the electrical system is activated with either the power switch or the starter switch, the key fob must be within range. If the key fob is not detected, the security light and/or power switch will flash. The electrical system will automatically shut down.

The starter motor will not engage during this time. If a key fob is not available, your personal identification number (PIN) can be entered using the turn signal switches to unlock the security system. See page 149.

#### DRIVING KEY FOB OPERATION:

After starting the engine, the Vehicle Control Module (VCM) will verify that the key fob is within range again when shifting from neutral into gear. The security light may turn on during this check. The VCM will not search for the key fob again after the vehicle has moved. If the key fob is lost during riding, the PIN will be needed to restart the vehicle.

If the key fob is not detected when shifting into gear:

- The horn will sound and the security light and/or power switch will flash.
- The engine will then turn off.
- The electrical system will then automatically shut down.

#### KEY FOB STORAGE:

The key fob should not be stored near devices that can interfere with radio waves, such as cell phones, power supplies, or magnets.

### AUDIO SYSTEM SWITCHES (IF EQUIPPED)

See page 187 for audio systems operation.

### CRUISE CONTROL SWITCHES

Refer to the Cruise Control section of this manual (beginning on page 102) for cruise control operation.

### HIGH/LOW HEADLIGHT BEAM SWITCH

The headlights automatically come on when the engine is started. See page 67.

The high/low headlight beam switch toggles the headlight between high beam and low beam. To activate the high beam, press the upper portion of the switch. To activate the low beam, press the lower portion of the switch.

### AUXILIARY LIGHT SWITCH (IF EQUIPPED)

The auxiliary lights provide additional lighting on each side of the headlight. Some drivers prefer using the auxiliary lights when operating in foggy conditions or when passing a vehicle to help improve visibility to other motorists.

Press the auxiliary light switch ① to turn the auxiliary lights on or off. The switch background light changes color to indicate whether lights are on or off.

OFF: Red Light

ON: Green Light

The auxiliary lights turn off when the power switch is turned off. The auxiliary lights automatically turn on when the engine starts if they were on when the engine was shut down.

The switch background light flashes if a fault exists with either auxiliary light.

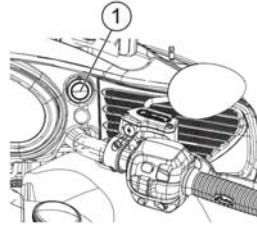

**CHIEFTAIN DARK HORSE**

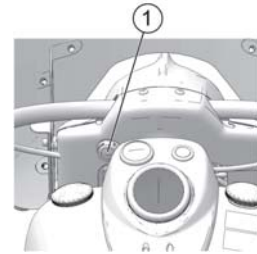

**CHIEF MODELS/SPRINGFIELD**



**CHIEFTAIN / ROADMASTER**

## INSTRUMENTS, FEATURES AND CONTROLS

### TOGGLE SWITCHES

All models are equipped with toggle switches on the front side of the left and right handlebar controls. The **LEFT-TOGGLE** switch ① is active for all models. The **RIGHT-TOGGLE** switch ② is active only for CHIEFTAIN DARK HORSE, CHIEFTAIN, and ROADMASTER models. See page 244.

The power switch must be ON. Use the switches to toggle through the modes of the multi-function display and to change settings in the display.

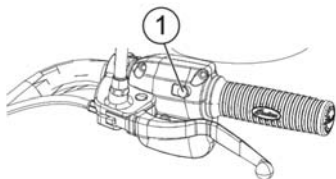

**Left Control**

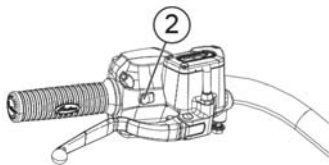

**Right Control**

### HAND GRIP HEATER SWITCH (IF EQUIPPED)

Press the top or bottom of the switch to turn the hand grip heaters on. The center of the switch illuminates when heaters are on. Press the center of the switch to turn the heaters off ②.

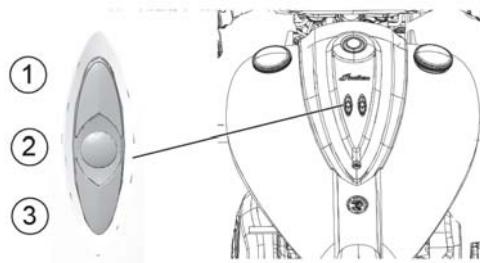

The heaters have 10 heat levels, ranging from OFF (level 0) to highest heat (level 10). Press and release the top of the switch ① to increase the heat level by one increment. Press and release the bottom of the switch ③ to decrease heat by one increment.

The heaters turn off when the engine is turned off. When the engine is restarted the heaters turn on at the previous heat level setting.

If the center of the switch flashes, the heaters may not be working properly. Please see your dealer.



### SADDLEBAG/TRUNK LOCK SWITCH (IF EQUIPPED)

Use the key fob or the lock switch on the console to lock ① and unlock ② the electric saddlebag and trunk locks. When using the console lock switch, the key fob must be within range. If the key fob is not detected, the security light and/or power switch will flash. The system will not perform the lock or unlock command.

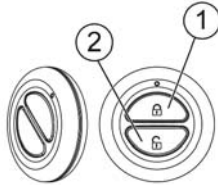

### SEAT HEATER SWITCHES (IF EQUIPPED)

The seat heater toggle switches ① are located on the lower left edge of the seat. The driver's switch ② is the left switch, the passenger's switch ③ (if equipped) is on the right.

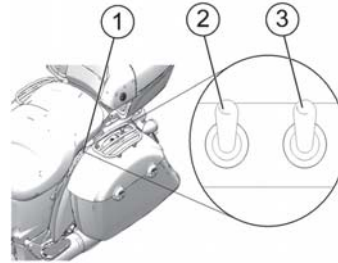

Toggle Position	Heat Setting
Top	HIGH
Center	OFF
Down	LOW

### INSTRUMENT CLUSTER (CHIEF MODELS/SPRINGFIELD)

The instrument cluster includes the speedometer, indicator lamps and Multi-Function Display (MFD).

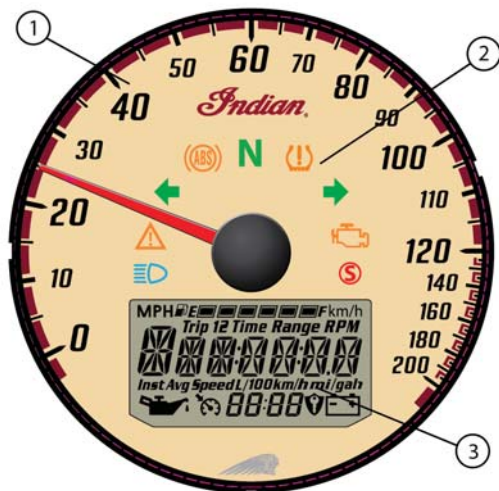









- ① Speedometer
- ② Indicator Lamps
- ③ MFD

### SPEEDOMETER

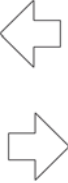
The speedometer displays forward vehicle speed in either miles per hour or kilometers per hour.





**INDICATOR LAMPS**

LAMP	INDICATES	CONDITION
	Chassis Fault	The alert symbol illuminates if a chassis fault occurs.
	Tire Pressure Monitoring System (TPMS)	If equipped, the TPMS indicator illuminates if low tire pressure is detected. It will also illuminate along with the Low Battery Voltage indicator when TPMS battery power is low, requiring service.
	Neutral	The transmission is in neutral.
	High Beam	The headlight switch is set to high beam. This indicator will flash if there is a problem with the low or high beam light.
	Turn Signals	The turn signal indicators flash when the left, right, or both turn signals (hazard) are active. <i>If there is a problem in the signal system, the lamps will flash at twice the normal rate.</i>
	Check Engine	<i>If this lamp illuminates while the engine is running, see your dealer promptly.</i> The light will remain on if the tilt sensor shuts down the engine. If abnormal sensor or engine operation is detected the light will remain on as long as the fault condition exists. Retrieve the error codes for diagnosis. See page 45.
	Anti-Lock Brakes Not Activated	The indicator remains on until the anti-lock system activates, which occurs when vehicle speed exceeds 6 MPH (10 km/h). When the lamp is illuminated, the anti-lock brakes will not activate, but the conventional brake system will continue to operate normally.
	Vehicle Speed	When standard mode is selected, speed displays in miles per hour. When metric mode is selected, speed displays in kilometers per hour.

## INSTRUMENTS, FEATURES AND CONTROLS

### MULTI-FUNCTION DISPLAY (MFD)

#### MFD INDICATORS

LAMP	INDICATES	CONDITION
	Cruise Control Status	<i>Amber Lamp:</i> Cruise control is enabled, but not set. When flashing, a cruise control related fault exists. <i>Green Lamp:</i> Cruise control is set to the desired speed. <i>Read the safety and operation procedures before using cruise control. See page 102.</i>
	Low Oil Pressure	This lamp illuminates when oil pressure drops below a safe operating pressure while the engine is running. If this lamp illuminates while the engine is running above idle speed, turn the engine off as soon as safely possible and check the oil level. <i>If the oil level is correct and the lamp remains on after the engine is restarted, turn the engine off immediately. See your dealer.</i>
	Security System Locked	This indicator lamp illuminates while the security system is searching for the key fob signal and when the security system is locked. The lamp flashes if the key fob is not detected within range or if the fob is not programmed properly. It also illuminates with the low battery voltage indicator when the key fob battery is low.
	Low Battery Voltage	This lamp illuminates when battery voltage is low. Turn non-essential accessories off to conserve power. Make sure the charging system is operating properly. See page 154. This lamp also illuminates with the security light and/or power switch when the key fob battery is low, and with the TPMS lamp when the TPMS sensor battery is low.

#### FUEL GAUGE DISPLAY (CHIEF DARK HORSE/CLASSIC)

The segments of the fuel gauge ① show the level of fuel in the fuel tank. When the last segment clears, a low fuel warning is activated. All segments including the fuel icon will flash. Refuel promptly.

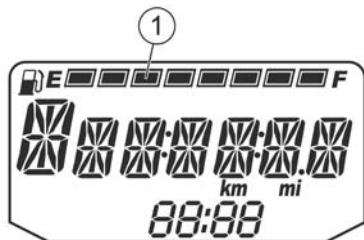

## MULTI-FUNCTION DISPLAY (MFD) MODES

### CHIEF/SPRINGFIELD MODELS ONLY

The power switch must be ON to access the MFD. Use the mode switches ① to toggle through the modes of the multi-function display and to change settings in the display.

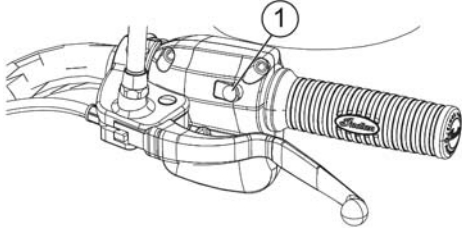

#### MODES AVAILABLE

Odometer	Engine Speed
Trip Odometer 1	Average Fuel Economy
Trip Odometer 2	DC Voltage
Clock	Ambient Air Temperature
Gear Indicator	Fuel Range

## ODOMETER

The odometer displays total distance traveled.

## TRIP ODOMETERS

The trip odometers (Trip 1 and Trip 2) display total distance traveled since being reset. To reset a trip odometer, toggle to the trip odometer, then press and hold the LEFT-TOGGLE switch until the trip odometer resets to zero.

## ENGINE SPEED

Engine speed displays in revolutions per minute (RPM).

## DC VOLTAGE

The volt meter displays battery voltage. If the engine is not running, approximate *battery* voltage displays. If the engine is running, approximate *charging* voltage displays.

## GEAR POSITION

Gear position displays at all times while the engine is running, unless a fault occurs with the gear position sensor.

## TEMPERATURE

The temperature area displays ambient air temperature.

## FUEL RANGE

The fuel range displays the distance the motorcycle can travel on the remaining fuel in the fuel tank.

## AVERAGE FUEL ECONOMY

Average Fuel Economy displays as of the last time the mode was reset. To reset, press and hold LEFT-TOGGLE while viewing the fuel economy display.

## INSTRUMENTS, FEATURES AND CONTROLS

---

### HEATED GRIPS HEAT LEVEL SETTING (IF EQUIPPED)

The heated grips heat level displays if the heat level is above zero.

### DISPLAY UNITS (STANDARD/METRIC)

The display can be changed to display either standard or metric units of measurement.

	STANDARD DISPLAY	METRIC DISPLAY	
<b>Distance</b>	Miles	Kilometers	
<b>Fuel</b>	U.S. Gallons	I = Imperial Gallons	Liter = Liters
<b>Temperature</b>	Fahrenheit	Celsius	
<b>Time</b>	12-Hour Clock	24-Hour Clock	

1. Stop the engine.
2. Wait 10 seconds.
3. Press and *hold* the LEFT-TOGGLE switch while pressing the power switch.
4. When the display flashes the distance setting, tap the LEFT-TOGGLE switch to advance to the desired setting.
5. Press and *hold* the LEFT-TOGGLE switch to save the setting and advance to the next display option.
6. Repeat the procedure to change remaining display settings.

### CLOCK

---

**TIP:** The clock must be reset any time the battery has been disconnected or discharged.

---

1. Use the LEFT-TOGGLE switch to toggle to the odometer display.
2. Press and *hold* the LEFT-TOGGLE switch until the hour segment flashes. Release the switch.
3. With the segment flashing, tap the LEFT-TOGGLE switch to advance to the desired setting.
4. Press and *hold* the LEFT-TOGGLE switch until the next segment flashes. Release the switch.
5. Repeat steps 3–4 twice to set the 10-minute and 1-minute segments. After completing the 1-minute segment, step 4 will save the new settings and exit the clock mode.

**DIAGNOSTIC FUNCTIONALITY**

Certain conditions will cause an error message to display in the screen. If this occurs, please see your authorized dealer.

MESSAGE	LOCATION	INDICATES
ERROR	All	Checksum error (gauge malfunction)
LO (CHIEF/SPRINGFIELD)	DC Voltage Screen	Voltage remains below 11.0 volts for more than 10 seconds
OV (CHIEF/SPRINGFIELD)	DC Voltage Screen	Voltage remains above 15.0 volts for more than 10 seconds

**ENGINE ERROR CODES**

The error screen displays only when the CHECK ENGINE light is on or when it goes on and off during one ignition cycle. Error codes display only during the current ignition cycle. When the power switch is turned OFF, the code and message is lost, but will reappear if the fault reoccurs after restarting the engine.

If the CHECK ENGINE indicator lamp illuminates, retrieve the error codes from the display.

1. If the error codes are not displayed, use the LEFT-TOGGLE switch to toggle until "Ck ENG" displays on the main line of the display.
2. Press and hold the LEFT-TOGGLE switch to enter the diagnostics code menu.
3. Record the three numbers displayed in the gear position, clock and odometer displays.
4. See an authorized dealer for code details and diagnosis.

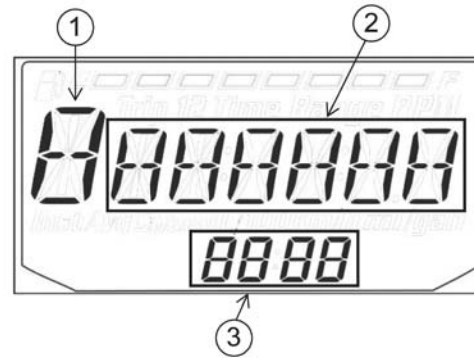

- ① Error Code Number (0-9)
- ② Failure Mode Indicator (FMI)
- ③ Suspect Parameter Number (SPN)

## INSTRUMENTS, FEATURES AND CONTROLS

### MISFIRE DETECTION

If a misfire is detected, the check engine indicator lamp will begin to flash and fuel will be cut to the affected cylinder(s). The check engine indicator lamp will continue to flash until the ignition switch has been moved to the off position. Restarting the engine will clear the flashing indicator and restore fuel to both cylinders. If another misfire occurs, the check engine indicator lamp will resume flashing and fuel will once again be cut to the affected cylinder(s). After the 3<sup>rd</sup> misfire, P0314 misfire fault is determined & set, the check engine light will remain on and fuel will be cut to the affected cylinder(s). If this occurs, your INDIAN dealer can assist.

### LOW OIL PRESSURE DISPLAY (CHIEF MODELS/SPRINGFIELD)

“LO OIL” displays under the following conditions.

CONDITION	INDICATES	ACTION REQUIRED
Engine oil pressure has dropped while the engine is running.	Oil pressure is below a safe operating pressure.	Stop the engine as soon as safely possible and check the oil level. If the oil level is sufficient, but “LO OIL” continues to display after restarting the engine, stop the engine immediately.

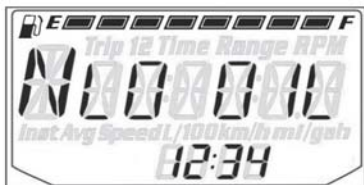



## INSTRUMENT CLUSTER (CHIEFTAIN DARK HORSE)

The instrument cluster includes the speedometer, tachometer, fuel gauge, indicator lamps and multi-function display (MFD).

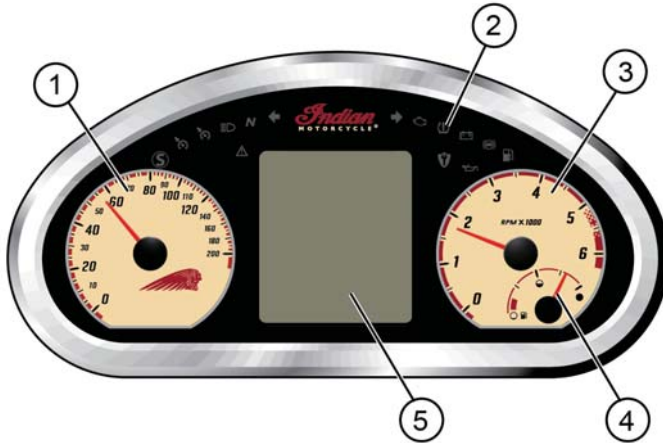

① Speedometer

② Indicator Lamps

③ Tachometer

④ Fuel Gauge

⑤ Multi-Function Display

### SPEEDOMETER

The speedometer displays forward vehicle speed in either miles per hour or kilometers per hour.

### TACHOMETER

The tachometer displays engine speed in revolutions per minute (RPM). A red line on the face of the gauge indicates the maximum safe engine speed.









Excessive engine speed can cause engine damage or failure, which could result in serious injury or death. Do not allow engine speed to exceed the red line.

### FUEL GAUGE







The fuel gauge displays fuel level. For the most accurate reading, sit on the motorcycle and bring it to the upright position.

## INSTRUMENTS, FEATURES AND CONTROLS

### INDICATOR LAMPS

LAMP	INDICATES	CONDITION
	Neutral	The transmission is in neutral and the power switch is ON.
	Vehicle Speed	When standard mode is selected, speed displays in miles per hour.
		When metric mode is selected, speed displays in kilometers per hour.
	High Beam	The headlight switch is set to high beam. This indicator will flash if there is a problem with the low or high beam light.
	Low Oil Pressure	This lamp illuminates when oil pressure drops below a safe operating pressure while the engine is running. If this lamp illuminates while the engine is running above idle speed, turn the engine off as soon as safely possible and check the oil level. <i>If the oil level is correct and the lamp remains on after the engine is restarted, turn the engine off immediately. See your dealer.</i>
	Low Fuel	This lamp illuminates when approximately one gallon (3.8 liters) of fuel remains in the fuel tank. The LCD Display will switch into a Low Fuel Mileage Counter Mode to provide the rider with mileage tracking from the time the indicator was activated.
	Turn Signals	One arrow flashes when the corresponding turn signal is activated. Both arrows flash when the hazard signal is activated. <i>If there is a problem in the signal system, the lamps will flash at twice the normal rate.</i>
	Sidestand Light	The sidestand light will turn on anytime the sidestand is down.

**INDICATOR LAMPS**

LAMP	INDICATES	CONDITION
	Low Battery Voltage	This lamp illuminates when battery voltage is low. Turn non-essential accessories off to conserve power. Make sure the charging system is operating properly. See page 154. This lamp also illuminates with the security light and/or power switch when the key fob battery is low, and with the TPMS lamp when the TPMS sensor battery is low.
	Cruise Control Status	When cruise control is enabled the speedometer lamp will illuminate. When flashing, a cruise control related fault exists. When cruise control is set to the desired speed, the arrow will illuminate. <i>Read the safety and operation procedures before using cruise control. See page 102</i>
	ABS Not Activated	The indicator remains on until the anti-lock system activates, which occurs when vehicle speed exceeds 6 MPH (10 km/h). When the lamp is illuminated, the anti-lock brakes will not activate, but the conventional brake system will continue to operate normally.
	Check Engine	This lamp illuminates briefly when the power switch is turned ON. This indicates proper function. <i>If this lamp illuminates while the engine is running, see an authorized dealer promptly.</i> The light will remain on if the tilt sensor shuts down the engine. If abnormal sensor or engine operation is detected the light will remain on as long as the fault condition exists. Retrieve the error codes for diagnosis. See page 55.
	Tire Pressure Monitoring System (TPMS)	The TPMS indicator illuminates if low tire pressure is detected. It will also illuminate along with the Low Battery Voltage indicator when TPMS battery power is low, requiring service.
	Security System Locked	This indicator lamp illuminates while the security system is searching for the key fob signal and when the security system is locked. The lamp flashes if the key fob is not detected within range or if the fob is not programmed properly. It also illuminates with the low battery voltage indicator when the key fob battery is low.

## INSTRUMENTS, FEATURES AND CONTROLS

### MULTI-FUNCTION DISPLAY (MFD)

The power switch must be on or the engine must be running to view or change settings in the MFD. Use the **LEFT-TOGGLE** ① and **RIGHT-TOGGLE** ② switches to toggle through the modes of the multi-function display and to change settings in the display. See page 38.

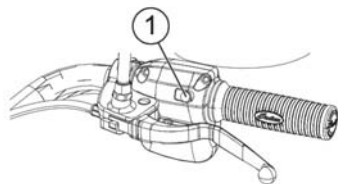

**Left Control**

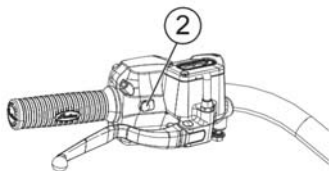

**Right Control**

### INFOTAINMENT DISPLAY SETTINGS

See the Infotainment chapter at the end of this manual for information on the Infotainment display, page 225.

There are four zones in the center display.

**ZONE ONE** (1) provides the time and outside air temperature. While the units for time and temperature can be changed, these items cannot be adjusted by the rider.

**ZONE TWO** (2) will always display audio system information.

**ZONES THREE** (3) and **FOUR** (4) will display vehicle/engine information.

---

**TIP:** Zone three can be set to display expanded audio information. See page 54.

---

You can modify the items in zone four by changing the settings in the **SET BOTTOM SCREEN** menu. See page 61.

(1)	7:30	75F
(2)	USB ARTIST SONG TITLE	
(3)	TRIP 1 MI	205.5
	HR	3.5
(4)	RANGE 25680 mi	250 <b>6</b>

## INFOTAINMENT DISPLAY SETTINGS

The following items can be displayed in Zone Three on the infotainment display:

- Trip 1 Hours/Distance
- Trip 2 Hours/Distance
- Fuel Economy
- Front/Rear Tire Pressure
- Engine Hours/Oil Life
- Average Speed & Battery Voltage
- Expanded Radio Information
- Heated Grip Power Level (if equipped)
- Diagnostic Trouble Codes (DTCs)

Press **LEFT-TOGGLE** repeatedly to cycle through the Zone Three displays.

## TRIP 1 HOURS/DISTANCE

Trip 1 Hours/Distance will display the total hours and distance in miles or kilometers.

1. Press and hold **LEFT-TOGGLE** to reset Trip 1 hours and distance to zero.
2. Press **LEFT-TOGGLE** to cycle to the Trip 2 display.

7:30	75F
FM	93.7
TRIP 1	
MI	205.5
HR	3.5
RANGE 250	<b>6</b>
25680 mi	

## INSTRUMENTS, FEATURES AND CONTROLS

---

### TRIP 2 HOURS/DISTANCE

Trip 2 Hours/Distance will display the total hours and distance in miles or kilometers.

1. Press and hold **LEFT-TOGGLE** to reset Trip 2 hours and distance to zero.
2. Press **LEFT-TOGGLE** to cycle to Fuel Economy display.

7:30	75F
FM	93.7
TRIP 2 MI	900.2
HR	21.2
RANGE 250 25680 mi	<b>6</b>

### FUEL ECONOMY

This screen will display the current instant and average miles per gallon (MPG) or liters per 100 kilometers.

1. Press and hold **LEFT-TOGGLE** to reset the average.
2. Press **LEFT-TOGGLE** to cycle to the Front/Rear Tire Pressure display.

7:30	75F
FM	93.7
INSTANT MPG	27.5
AVERAGE	34.5
RANGE 250 25680 mi	<b>6</b>

## FRONT/REAR TIRE PRESSURE

This screen will display the current front and rear tire pressure in PSI or kPa.

- Press **LEFT-TOGGLE** to cycle to the Engine Hours/Oil Life display.

7:30	75F	
FM	93.7	
FRONT	36.1	
PSI	40.2	
REAR	40.2	
RANGE	250	6
25680 mi		

## ENGINE HOURS/OIL LIFE

This screen will display the total engine hours accumulated when the engine is running.



Engine oil life is also displayed. The rate at which oil life is reduced to 0% is determined by the following:

- Engine break-in period: 0-500 miles or 804 km
- Routine oil change intervals: Every 5,000 miles or 8,046 km

**TIP:** When engine oil life reaches 0%, change the engine oil and filter.

After changing the engine oil and filter:

- Press and hold **LEFT-TOGGLE** until the value begins to flash.
- Press and hold **LEFT-TOGGLE** to reset the engine oil life to 100%.
- Press **LEFT-TOGGLE** to display Average Speed/Battery Voltage screen.

7:30	75F	
FM	93.7	
	2.5 HR	
ENGINE OIL		 100%
RANGE	250	6
25680 mi		

## INSTRUMENTS, FEATURES AND CONTROLS

---

### AVERAGE SPEED/BATTERY VOLTAGE

This screen displays the average motorcycle speed and current battery voltage.

1. Press and hold **LEFT-TOGGLE** to reset the average speed.
2. Press **LEFT-TOGGLE** to cycle to Expanded Audio Information.

7:30	75F
FM	93.7
AVG SPEED	55 MPH
	12.9 VOLTS
RANGE	250
25680 mi	<b>6</b>

### EXPANDED AUDIO INFORMATION

In this mode, the display screen will dedicate zone three to the audio system and allow for up to six lines of audio system information.

Press **LEFT-TOGGLE** to cycle to:

- Heated Grips (if equipped)
- Diagnostic Trouble Codes (if present)
- Trip 1 (top of menu)

7:30	75F
iPOD	
ARTIST	
SONG TITLE	
ALBUM TITLE	
RANGE	250
25680 mi	<b>6</b>



**HEATED GRIPS (IF EQUIPPED)**

This screen displays the heated grip heat level setting. The screen does not display if heaters are set at zero or if heated grips are not installed.

Press **LEFT-TOGGLE** to cycle to:

- Diagnostic Trouble Codes (if present)
- Trip 1 (top of menu)

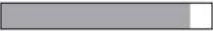
7:30	75F
FM	93.7
HEATED GRIPS	
	
Power Level	9
RANGE	250
25680 mi	<b>6</b>

**DIAGNOSTIC TROUBLE CODES (DTCs)**

If the CHECK ENGINE indicator is illuminated on the instrument cluster, this screen will display, indicating there are Diagnostic Trouble Codes (DTCs).

The error screen displays only when the CHECK ENGINE light is on and only during the current ignition cycle. DTCs will reappear only if the fault reoccurs after restarting the engine.

7:30	75F
FM	93.7
DTC	
SPN	598
FMI	2
RANGE	250
25680 mi	<b>6</b>

## INSTRUMENTS, FEATURES AND CONTROLS

---

### RETRIEVING ERROR CODES

If the CHECK ENGINE indicator illuminates, you can retrieve the error codes from the DTC display.

1. Press and hold **LEFT-TOGGLE** to enter the display screen.

---

**TIP:** The CHECK ENGINE icon will appear on the screen when in the DTC display mode.

---

2. Press **LEFT-TOGGLE** to cycle through the list of available codes.
3. Record the SPN and FMI numbers.
4. See an authorized INDIAN MOTORCYCLE dealer for code details and diagnosis.
5. Press and hold **LEFT-TOGGLE** to exit.

7:30	75F
FM	93.7
DTC	
SPN	 598
FMI	2
RANGE	250
25680 mi	<b>6</b>

## INSTRUMENT CLUSTER SETUP

The clock is found in the Settings section of the Infotainment display. See the Infotainment Display chapter at the end of this manual, page 225.

The instrument cluster setup menus allow the following actions:

- Set clock
- Set units (volume, temperature, clock type, pressure)
- Set bottom screen display (trip 1 distance, instant fuel economy, average fuel economy, and range)
- View instrument cluster software/hardware information
- Set Tire Pressure Monitoring System (TPMS) (dealer only)
- Adjust infotainment display brightness

To access the instrument cluster setup menus:

1. Place the transmission in neutral.
2. Press and hold **LEFT-TOGGLE** and **RIGHT-TOGGLE** simultaneously until the **SETUP** menu appears on the display.
3. Press **RIGHT-TOGGLE** repeatedly to cycle through the setup menu.
4. Press **LEFT-TOGGLE** to enter the desired menu.

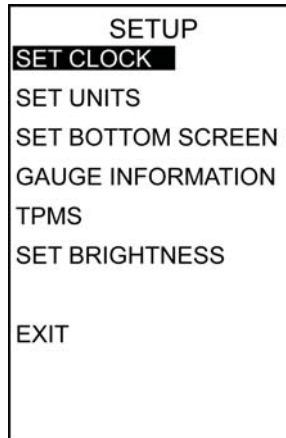

## SETTING THE CLOCK

1. With **SET CLOCK** highlighted on the setup menu, press **LEFT-TOGGLE**.
2. Press **LEFT-TOGGLE** repeatedly to set the hours.
3. Press **RIGHT-TOGGLE** to move to tens of minutes.
4. Press **LEFT-TOGGLE** repeatedly to set the tens of minutes.
5. Press **RIGHT-TOGGLE** to move to minutes.
6. Press **LEFT-TOGGLE** repeatedly to set the minutes.
7. Press **RIGHT-TOGGLE** to enter the time and move to **EXIT**.
8. Press **LEFT-TOGGLE** to exit.

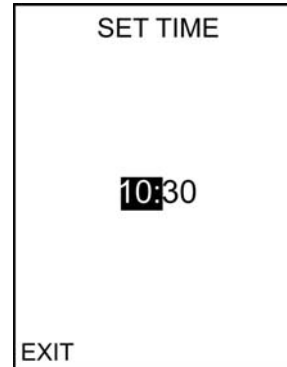

## INSTRUMENTS, FEATURES AND CONTROLS

---

### SET UNITS

Use the SET UNITS menu to set the following items:

- DISTANCE: Miles or kilometers
  - VOLUME: Gallon, Imperial Gallon or Liter
  - TEMPERATURE: Fahrenheit or Celsius
  - CLOCK TYPE: 12-hour or 24-hour
  - PRESSURE: PSI or kPa
1. With SET UNITS highlighted on the setup menu, press **LEFT-TOGGLE**.
  2. Press **RIGHT-TOGGLE** repeatedly to cycle through menu items.
  3. Press **LEFT-TOGGLE** to enter the desired SET UNITS menu.

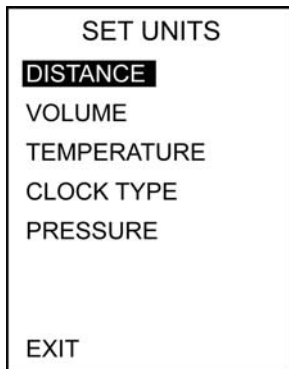
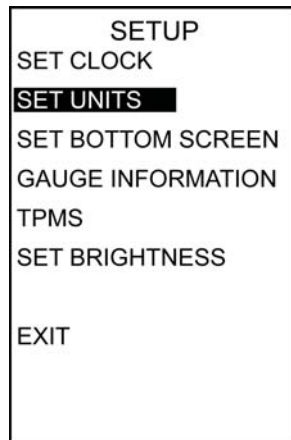

### SET UNITS - DISTANCE SETTING

Use the DISTANCE menu to change the speedometer and distance units. Select either miles or kilometers.

1. With DISTANCE highlighted in the SET UNITS menu, press **LEFT-TOGGLE**.
2. Press **RIGHT-TOGGLE** to select miles or kilometers.
3. Press **LEFT-TOGGLE** to set the desired setting.
4. Press **RIGHT-TOGGLE** to select EXIT.
5. Press **LEFT-TOGGLE** to exit.

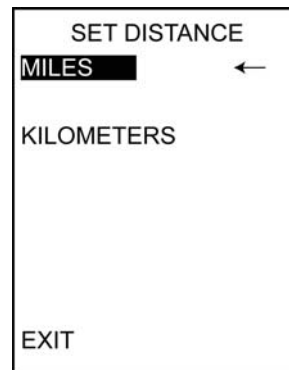
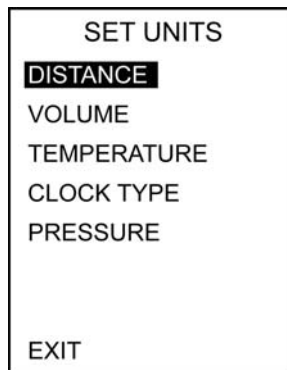

### SET UNITS - VOLUME SETTINGS

Use the VOLUME menu to change the instrument cluster volume units. Select gallon, imperial gallon or liter.

1. With VOLUME highlighted in the SET UNITS menu, press **LEFT-TOGGLE**.
2. Press **RIGHT-TOGGLE** to select gallon, imperial gallon, or liter.
3. Press **LEFT-TOGGLE** to set the desired setting.
4. Press **RIGHT-TOGGLE** to select EXIT.
5. Press **LEFT-TOGGLE** to exit.

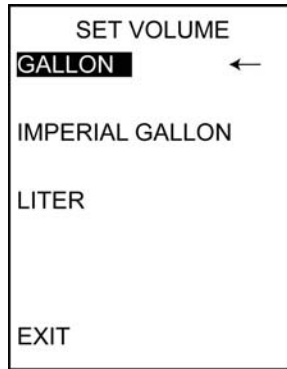
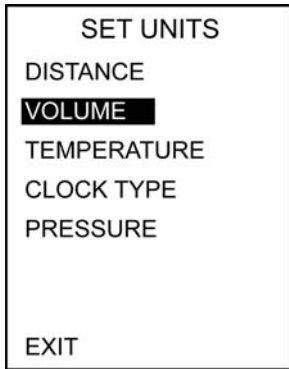

### SET UNITS - TEMPERATURE SETTINGS

Use the TEMPERATURE menu to change the instrument cluster temperature units. Select Fahrenheit or Celsius.

1. With TEMPERATURE highlighted in the SET UNITS menu, press **LEFT-TOGGLE**.
2. Press **RIGHT-TOGGLE** to select fahrenheit or Celsius.
3. Press **LEFT-TOGGLE** to set the desired setting.
4. Press **RIGHT-TOGGLE** to select EXIT.
5. Press **LEFT-TOGGLE** to exit.

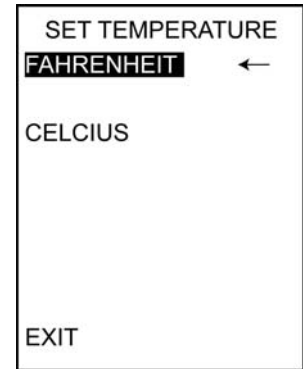
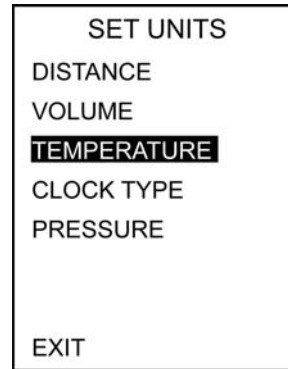

## INSTRUMENTS, FEATURES AND CONTROLS

---

### SET UNITS - CLOCK TYPE

Use the CLOCK TYPE menu to change the clock format. Select 12-hour or 24-hour format.

1. With CLOCK TYPE highlighted in the SET UNITS menu, press **LEFT-TOGGLE**.
2. Press **RIGHT-TOGGLE** to select 12 hour or 24 hour.
3. Press **LEFT-TOGGLE** to set the desired clock format.
4. Press **RIGHT-TOGGLE** to select EXIT.
5. Press **LEFT-TOGGLE** to exit.

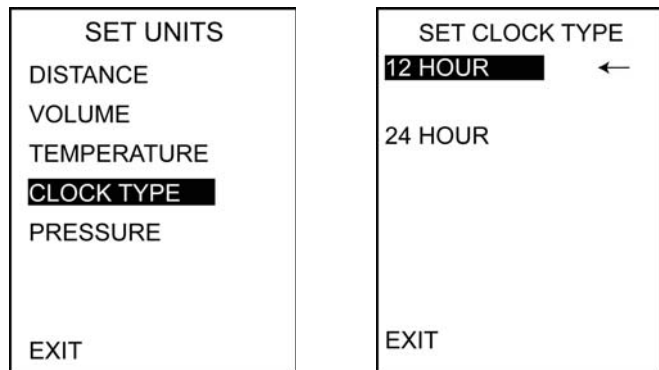

### SET UNITS - PRESSURE

Use the PRESSURE menu to change the pressure display format. Select PSI or KPA.

1. With PRESSURE highlighted in the SET UNITS menu, press **LEFT-TOGGLE**.
2. Press **RIGHT-TOGGLE** to select PSI or KPA.
3. Press **LEFT-TOGGLE** to set the desired pressure display format.
4. Press **RIGHT-TOGGLE** to select EXIT.
5. Press **LEFT-TOGGLE** to exit.

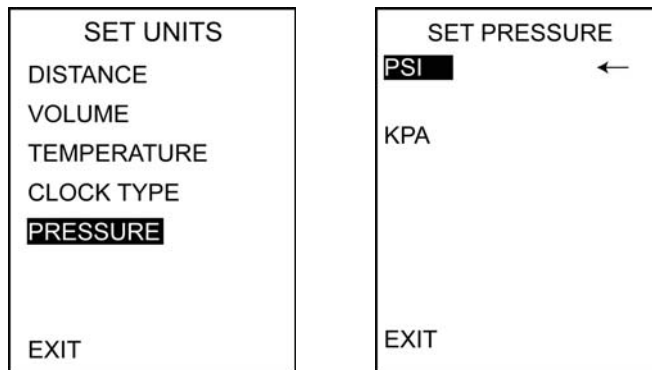

## SET BOTTOM SCREEN MENU

Use the SET BOTTOM SCREEN menu to display one of the following items in ZONE FOUR of the display screen:

- Trip 1 Distance
- Average Fuel
- Instant Fuel
- Range

1. With SET BOTTOM SCREEN highlighted on the setup menu, press **LEFT-TOGGLE**.
2. Press **RIGHT-TOGGLE** repeatedly to cycle through menu items.
3. Press **LEFT-TOGGLE** to enter the desired SET UNITS menu.
4. Press **RIGHT-TOGGLE** to select EXIT.
5. Press **LEFT-TOGGLE** to exit.

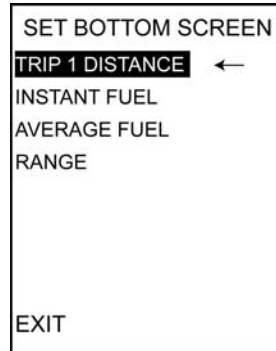

## DISPLAY

### TRIP 1 DISTANCE DISPLAY

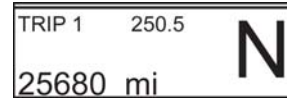

### INSTANT FUEL DISPLAY

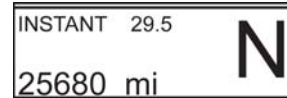

### AVERAGE FUEL DISPLAY



### RANGE DISPLAY

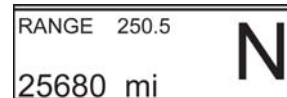

## INSTRUMENTS, FEATURES AND CONTROLS

---

### GAUGE INFORMATION

The instrument cluster hardware and software part and serial numbers are displayed on the Gauge Information menu.

1. With **GAUGE INFORMATION** highlighted on the setup menu, press **LEFT-TOGGLE**.
2. Press **RIGHT-TOGGLE** to select EXIT.
3. Press **LEFT-TOGGLE** to exit.

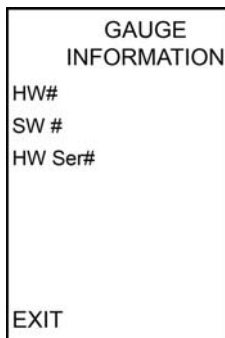
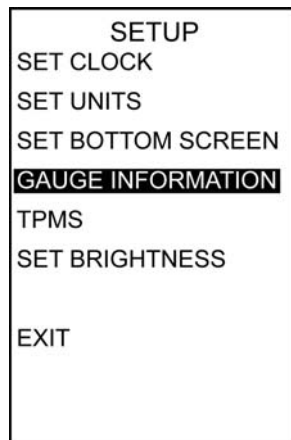

### TIRE PRESSURE MONITORING SYSTEM (TPMS) SETUP

Do not attempt to access the TPMS menu. Without the proper training and tools, you may inadvertently erase the sensor identification numbers from system memory, which would disable the TPMS.

The TPMS setup menu allows your authorized INDIAN MOTORCYCLE dealer to register new tire pressure sensors and to relearn erased sensors using the TPMS tool.

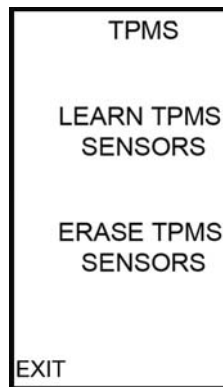



## SET BRIGHTNESS

The brightness level of the instrument cluster and display screen can be adjusted. There are two methods to enter the Set Brightness menu.

### METHOD 1:

This method bypasses the instrument cluster setup menu. The transmission does not have to be in neutral using this method.

1. Press and hold **RIGHT-TOGGLE** until the SET BRIGHTNESS menu appears.
2. Press **RIGHT-TOGGLE** repeatedly to adjust the instrument cluster brightness.
3. The menu will close after the desired brightness level is set.

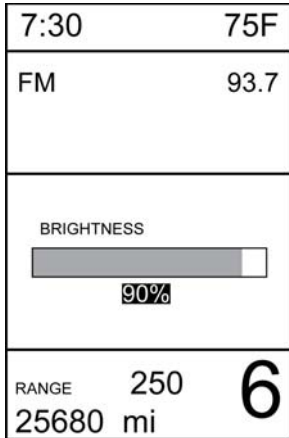

### METHOD 2:

1. With SET BRIGHTNESS highlighted on the setup menu, press **LEFT-TOGGLE**.
2. Press **LEFT-TOGGLE** repeatedly to adjust the brightness level from 0% to 100%.
3. When the desired brightness level is set, press **RIGHT-TOGGLE** to select EXIT.
4. Press **LEFT-TOGGLE** to exit.

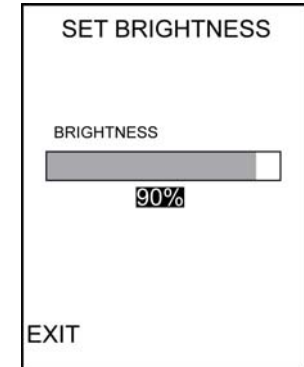
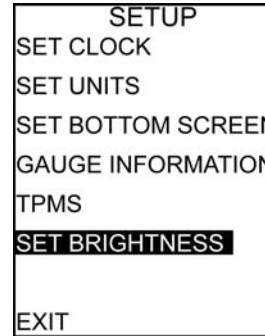

### INSTRUMENT CLUSTER (CHIEFTAIN/ROADMASTER)

The instrument cluster includes the speedometer, tachometer, fuel gauge, indicator lamps and Infotainment display. For information on the RIDE COMMAND™ display, please see the RIDE COMMAND™ chapter at the end of this manual, on page 225.



- ① Speedometer
- ② Fuel Gauge / Fuel Range
- ③ RIDE COMMAND™
- ④ Tachometer / Gear / Odometer
- ⑤ Indicator Lamps
- ⑥ Infotainment Buttons

#### SPEEDOMETER

The speedometer displays forward vehicle speed in either miles per hour or kilometers per hour.

#### TACHOMETER







The tachometer displays engine speed in revolutions per minute (RPM). A red line on the face of the gauge indicates the maximum safe engine speed.

Excessive engine speed can cause engine damage or failure, which could result in serious injury or death. Do not allow engine speed to exceed the red line.

#### FUEL GAUGE







The fuel gauge displays fuel level. For the most accurate reading, sit on the motorcycle and bring it to the upright position.

## INDICATOR LAMPS

LAMP	INDICATES	CONDITION
	Neutral	The transmission is in neutral and the power switch is ON.
	Vehicle Speed	When standard mode is selected, speed displays in miles per hour.
		When metric mode is selected, speed displays in kilometers per hour.
	High Beam	The headlight switch is set to high beam. This indicator will flash if there is a problem with the low or high beam light.
	Low Oil Pressure	This lamp illuminates when oil pressure drops below a safe operating pressure while the engine is running. If this lamp illuminates while the engine is running above idle speed, turn the engine off as soon as safely possible and check the oil level. <i>If the oil level is correct and the lamp remains on after the engine is restarted, turn the engine off immediately. See your dealer.</i>
	Low Fuel	This lamp illuminates when approximately one gallon (3.8 liters) of fuel remains in the fuel tank. The LCD Display will switch into a Low Fuel Mileage Counter Mode to provide the rider with mileage tracking from the time the indicator was activated.
	Turn Signals	One arrow flashes when the corresponding turn signal is activated. Both arrows flash when the hazard signal is activated. <i>If there is a problem in the signal system, the lamps will flash at twice the normal rate.</i>
	Sidestand Light	The sidestand light will turn on anytime the sidestand is down.

## INSTRUMENTS, FEATURES AND CONTROLS

### INDICATOR LAMPS

LAMP	INDICATES	CONDITION
	Low Battery Voltage	This lamp illuminates when battery voltage is low. Turn non-essential accessories off to conserve power. Make sure the charging system is operating properly. See page 154. This lamp also illuminates with the security light and/or power switch when the key fob battery is low, and with the TPMS lamp when the TPMS sensor battery is low.
	Cruise Control Status	When cruise control is enabled the speedometer lamp will illuminate. When flashing, a cruise control related fault exists. When cruise control is set to the desired speed, the arrow will illuminate. <i>Read the safety and operation procedures before using cruise control. See page 102</i>
	ABS Not Activated	The indicator remains on until the anti-lock system activates, which occurs when vehicle speed exceeds 6 MPH (10 km/h). When the lamp is illuminated, the anti-lock brakes will not activate, but the conventional brake system will continue to operate normally.
	Check Engine	This lamp illuminates briefly when the power switch is turned ON. This indicates proper function. <i>If this lamp illuminates while the engine is running, see an authorized dealer promptly.</i> The light will remain on if the tilt sensor shuts down the engine. If abnormal sensor or engine operation is detected the light will remain on as long as the fault condition exists. Retrieve the error codes for diagnosis. See page 55.
	Tire Pressure Monitoring System (TPMS)	The TPMS indicator illuminates if low tire pressure is detected. It will also illuminate along with the Low Battery Voltage indicator when TPMS battery power is low, requiring service.
	Security System Locked	This indicator lamp illuminates while the security system is searching for the key fob signal and when the security system is locked. The lamp flashes if the key fob is not detected within range or if the fob is not programmed properly. It also illuminates with the low battery voltage indicator when the key fob battery is low.

### HEADLIGHTS

The headlights automatically come on when the engine is started.

**WARNING!** Motorcycle riders must remain as visible as possible at all times. To aid in this, the headlight must be on at all times. Do not modify the ignition/headlight wiring to circumvent the automatic headlight feature.

The headlights operate only when the engine is running. You can use the high/low headlight beam switch to override this function and allow the headlights to operate when the engine is not running. Turn the power switch on, then toggle the high/low headlight beam switch to turn the headlights on.

### THROTTLE CONTROL GRIP

The throttle control grip is located on the right handlebar. Use the throttle control grip to control engine speed.

While seated in the proper riding position:

- Roll the grip rearward ① to open the throttle (increase engine speed and power).
- Roll the grip forward ② to close the throttle (decrease engine speed and power).

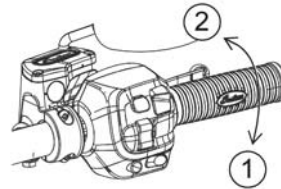

The control grip is spring loaded. When you release the grip, the throttle returns to the idle position.

### CLUTCH LEVER

The clutch lever ① is located on the left handlebar. Disengage the clutch before shifting gears. For smooth clutch operation, pull the lever quickly and release it in a brisk but controlled manner.

- To disengage the clutch, pull the lever toward the handlebar.
- To engage the clutch, release the lever in a brisk but controlled manner.

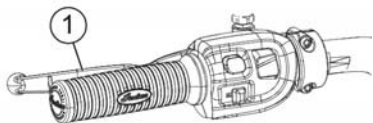

### GEAR SHIFT LEVER

The gear shift lever is located on the left side of the motorcycle. Operate the lever with your foot.

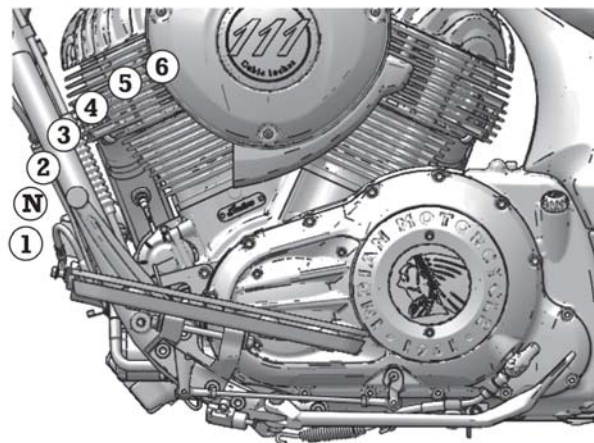

- Press downward on the toe lever to shift to a lower gear.
- Lift upward on the toe lever to shift to a higher gear.
- Release the lever after each gear shift.
- See page 98, for gear shifting procedures.

## TIRE PRESSURE MONITORING SYSTEM (TPMS) (IF EQUIPPED)

**NOTICE:** On models equipped with a TPMS, the sensors are located 180° from the valve stem. Use caution when servicing tires. To avoid damaging a sensor, break the bead at the valve stem, then at 90° and 270° from the valve stem as required.

With a TPMS, the pressure of each tire can be viewed in the MFD and in the display for Infotainment motorcycles on rider screens. If dashes display instead of a pressure value while traveling above 15 MPH (24 km/h), the system may not be functioning properly. See your dealer for service.

The TPMS warning indicator will illuminate if low tire pressure is detected. Always correct low tire pressure promptly. Always inspect tire pressure and condition before each ride. See page 86.

The TPMS display may indicate an increase in tire pressure while riding, a normal occurrence as tires warm up. Riding into colder conditions may result in a drop in tire pressure as tires cool down. Regardless of conditions, low tire pressures should always be corrected promptly.

## TRUNK (IF EQUIPPED)

Do not exceed the cargo capacity of a trunk, a cargo rack or a trunk/cargo rack combination. The capacity for the trunk alone, as well as for any trunk/cargo rack combination, is listed in the table below. The capacity for a rack alone is 5 lbs. (2.2 kg). If you load a rack with 5 lbs. (2.2 kg) of cargo, do not add more than 25 lbs. (11.3 kg) to a hard trunk, or 20 lbs (9 kg) to a leather trunk.

Hard Trunk	30 lbs (13.6 kg)
Leather Trunk	25 lbs (11.3 kg)
Cargo Rack (Alone)	5 lbs (2.2 kg)

### **HARD TRUNK REMOVAL (IF EQUIPPED)**

1. If applicable, remove the left and right saddlebags and remove the trunk lock fastener ① from each trunk latch.

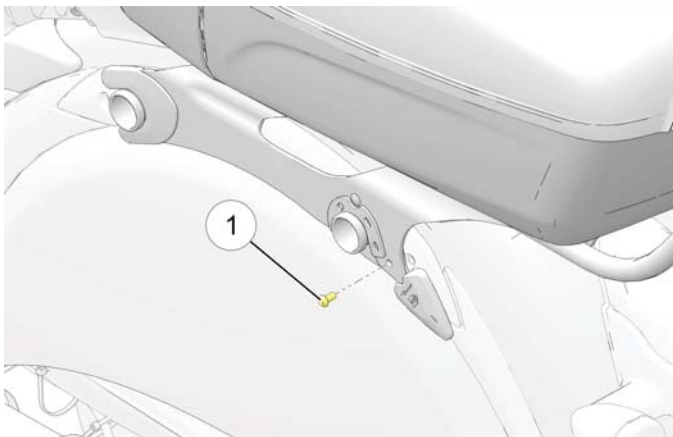

2. Disconnect the trunk harness multi-plug ②.

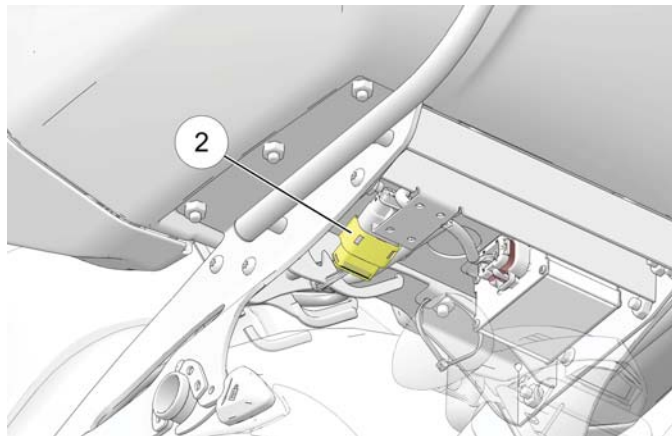



3. Lift the trunk latches ③ to unlock the trunk from the mount.

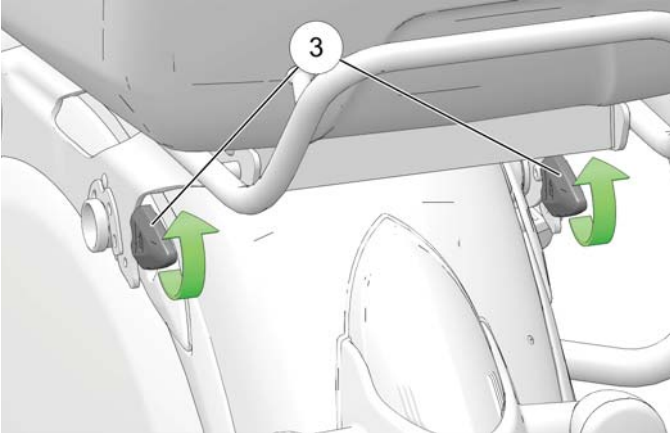

4. Lift up on the rear of the trunk ④ and slide rearward ⑤ to release the trunk from the motorcycle.

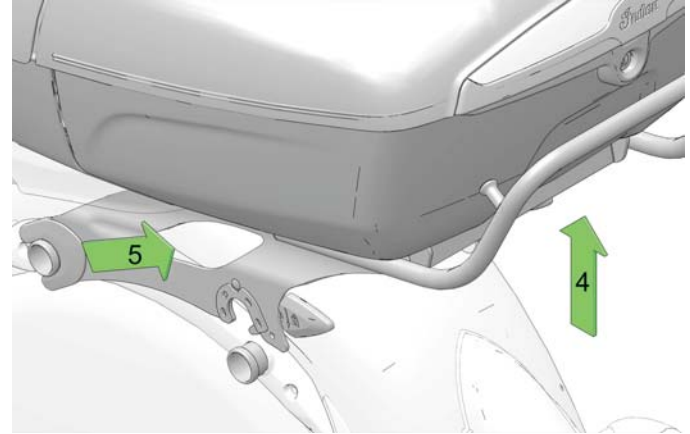

### SOFT TRUNK REMOVAL

1. If applicable, remove the left and right saddlebags and remove the trunk lock fastener ① from each trunk latch.

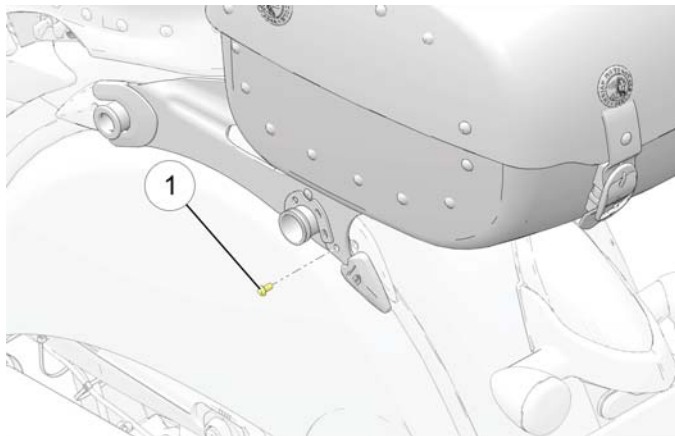

2. Lift the trunk latches ② to unlock the trunk from the mount.

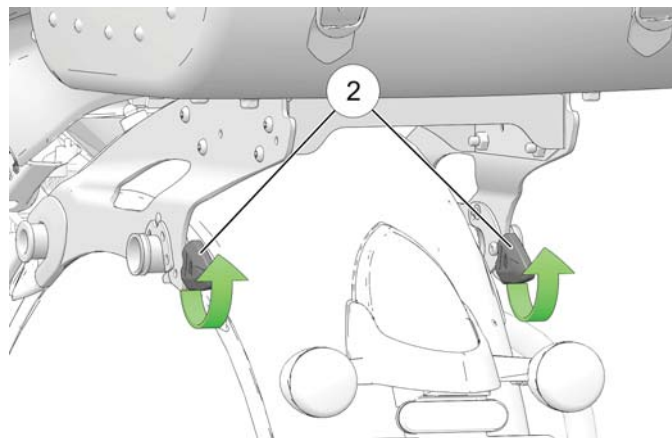

3. Lift up on the rear of the trunk ③ and slide rearward ④ to release the trunk from the motorcycle.

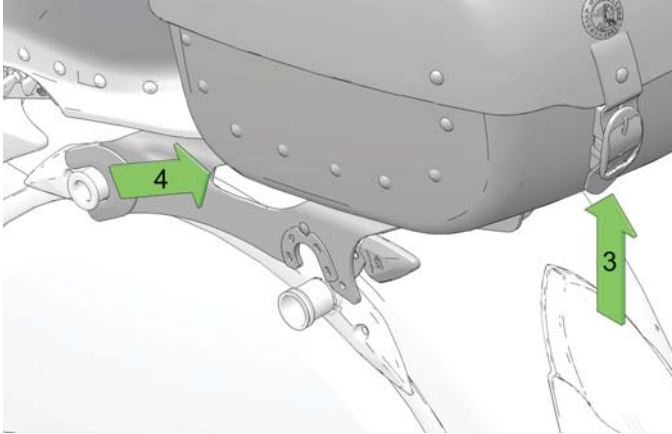

### SADDLEBAGS (IF EQUIPPED)

Do not exceed the weight limit of each saddlebag. Always distribute weight evenly in each of the saddlebags. Refer to the saddlebag/cargo warning label on or near the saddlebag for cargo capacity.

Hard bag capacity is 22 lbs. (10 kg) of cargo per side.

Soft bag capacity is 15 lbs. (6.8 kg) of cargo per side.

### HARD BAG REMOVAL

1. Unlock the electric saddlebag locks ① (if equipped).

**TIP:** The provided key can also be used in the latch release buttons to unlock the saddlebag lids.

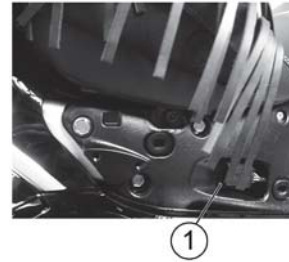

2. Remove the side cover.
3. Disconnect the saddlebag lock wiring near the seat.
4. Press the lid latch release button and lift the lid.
5. Flip the two quick-release latches upward.
6. Tilt the saddlebag away from the frame of the vehicle to remove it.
7. To reinstall, place the hard bag in a fully seated position on the muffler.

**NOTICE:** To prevent damage to components, always make sure saddlebags are fully seated onto the muffler before engaging the latches.

## INSTRUMENTS, FEATURES AND CONTROLS

---

8. Make sure the rubber bushings ⑤ on the latch pins ③ are fully engaged in the spools ④. Engage the quick-release latches ② and flip them fully downward.

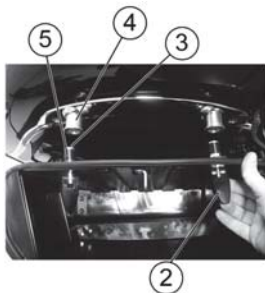

9. Reconnect the electrical wiring.
10. Reinstall the side cover, using care to avoid damaging electrical wires.

### SOFT BAG REMOVAL

1. Unbuckle the saddlebag lid clasps and open the lid.
2. Flip the two quick-release latches upward.
3. Tilt the saddlebag away from the fender and lift upward to remove it from the spools.

---

**WARNING!** Improper saddlebag installation can result in loss of control, accident and driving hazards for other motorists (if saddlebag falls from the motorcycle). Always make sure saddlebag mounting brackets are fully seated onto the spools before engaging latches.

---

4. To reinstall, place the soft bag in position. Make sure the mounting bracket ② is seated fully on the spool ①. Make sure the rubber bushings on the latch pins are fully engaged in the spools.

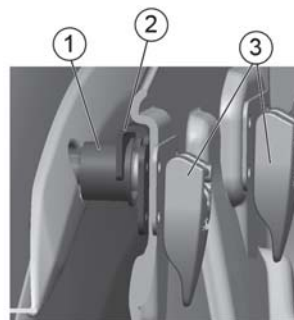

5. Engage the quick-release latches ③ and flip them fully downward.

### SIDESTAND

The sidestand is equipped with a safety switch that prevents operation of the motorcycle if the sidestand is deployed.

---

**WARNING!** An improperly retracted sidestand could contact the ground and cause a loss of control resulting in serious injury or death. Always retract the sidestand fully before operating the motorcycle.

---

To park the motorcycle, swing the end of the sidestand downward and away from the motorcycle until it is fully extended. Always

turn the handlebars to the left for maximum stability. Lean the motorcycle to the left until the sidestand firmly supports the motorcycle.

---

**CAUTION!** If the motorcycle weight is not resting on the sidestand, it will not lock. In this situation, any movement of the motorcycle could cause the sidestand to retract slightly. If the sidestand is not in the full forward position when the motorcycle weight is rested on it, the motorcycle could fall over, possibly causing injury and damage to the motorcycle.

---

To retract the sidestand, straddle the motorcycle and bring it to the fully upright position. Swing the end of the sidestand upward and toward the motorcycle until it is fully retracted.

## WINDSHIELD (IF EQUIPPED)

### WINDSHIELD REMOVAL

#### APPLIES TO: CHIEF/SPRINGFIELD

1. If equipped with a quick-latch windshield, rotate the two latches ① upward.

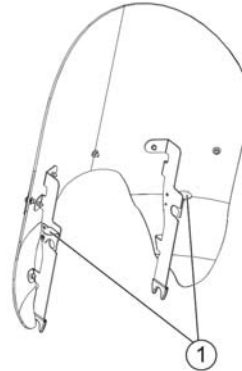

2. From the front of the motorcycle, pull firmly on the upper windshield to remove the windshield from the upper mounts, then pull the windshield upward and away from motorcycle.
3. Reverse this procedure to reinstall the windshield. Rotate the latches fully downward to secure the windshield.

---

**WARNING!** Improper windshield installation can result in loss of control, accident and driving hazards for other motorists (if windshield falls from the motorcycle). Always make sure the windshield is fully seated before engaging latches.

---

### WINDSHIELD ADJUSTMENT

#### APPLIES TO: CHIEFTAIN DARK HORSE / ROADMASTER

Use the windshield switch to adjust windshield height for the best wind deflection.

- Press the top of the switch to adjust the windshield upward.
- Press the bottom of the switch to adjust the windshield downward.



### WINDSHIELD CARE (IF EQUIPPED)

Clean the windshield with a soft cloth and plenty of warm water. Dry with a soft clean cloth. Remove minor scratches with a high-quality polishing compound designed for use on polycarbonate surfaces.

---

**NOTICE:** Brake fluid and alcohol will permanently damage the windshield. Do not use glass cleaners, water or soil repellents, and petroleum or alcohol based cleaners on the windshield, as these products can damage the windshield.

---

## BRAKES

### ANTI-LOCK BRAKE SYSTEM (ABS)

The anti-lock brake system automatically reduces or increases brake pressure as needed to provide optimum braking control, reducing the chance of wheel lock-up during hard braking events or when braking on rough, uneven, slippery or loose surfaces. See page 14.

1. The anti-lock brake system cannot be turned off.
  2. The ABS indicator always illuminates when vehicle power is turned on. It remains illuminated until the anti-lock system activates, which occurs when vehicle speed exceeds 6 MPH (10 km/h).
  3. When the lamp is illuminated, the anti-lock brakes will not activate, but the conventional brake system will continue to operate normally.
  4. When the anti-lock brakes engage during a braking event, the rider will feel pulsing at the brake levers. *Continue to apply steady pressure to the brakes for the best stopping performance.*
  5. If the ABS light does not come on when the key is turned to the ON or PARK position, your authorized INDIAN MOTORCYCLE dealer can assist.
- If the lamp continues to illuminate after vehicle speed exceeds 6 MPH (10 km/h), the ABS system is not functioning. See your INDIAN MOTORCYCLE dealer or other dealer promptly for service.
  - Operating with non-recommended tires or improper tire pressure may reduce the effectiveness of the anti-lock brake system. Always use the recommended size and type of tires specified for your vehicle. Always maintain the recommended tire pressure.
  - The anti-lock brake system will not prevent wheel lockup, loss of traction or loss of control *under all conditions*. Always adhere to all safe motorcycle-riding practices as recommended.
  - It is not unusual to leave tire marks on the road surface during a hard braking event.
  - The anti-lock brake system does not compensate for or reduce the risks associated with:
    - excessive speed
    - reduced traction on rough, uneven or loose surfaces
    - poor judgment
    - improper operation

## MIRRORS

Your vehicle is equipped with convex mirrors. Objects seen in a mirror may be closer than they appear. Always adjust mirrors before riding.

To adjust the mirrors, sit on the motorcycle in the anticipated riding position. Adjust the mirrors so that you can see a small portion of your shoulders in each mirror.

### BRAKES

The front brake lever activates the front brake calipers. The rear brake pedal activates the rear brake caliper. For maximum brake effectiveness, apply the front brake lever and the rear brake pedal together.

#### FRONT BRAKE LEVER

The front brake lever is located on the right handlebar. This lever controls only the front brakes. The front brakes should be applied simultaneously with the rear brakes. To apply the front brake, pull the lever toward the handlebar. See page 101 for braking procedures.

Front brake lever reach (distance to the hand grip) is adjustable.

1. *Gently push and hold* the lever away from the hand grip. The adjuster wheel ② is located between the lever and the switch cube.
2. To increase reach distance, rotate the adjuster to align a lower number of hash marks with the pin ③.
3. To decrease the reach distance, rotate the adjuster to align a higher number of hash marks with the pin.
4. Make sure the pin is fully seated into the selected hole ①.

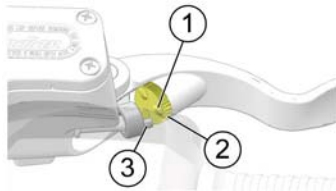

#### REAR BRAKE PEDAL

The rear brake pedal ① is located on the right side of the motorcycle. Press downward on the rear brake pedal to apply the rear brake.

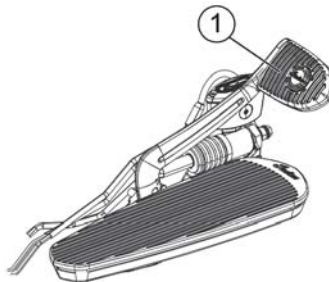

**WARNING!** Resting your foot on the brake pedal will cause excessive and premature wear of brake pads and reduced braking efficiency, which could result in severe injury or death.

See page 101 for braking procedures.



## PASSENGER FLOORBOARD SUPPORTS (IF EQUIPPED)

The passenger floorboard height and angle can be adjusted.

To adjust the angle, loosen both attachment screws ①. Rotate the floorboard to the desired position using the indicator mark on the rear-facing support as a guide, then tighten the screws.

**TORQUE:** 18 ft-lbs (24.4 Nm)

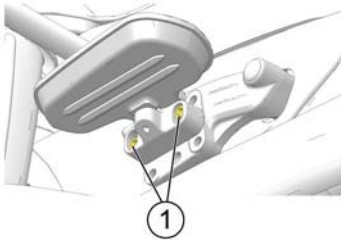

To adjust the height, remove both attachment screws. Move the floorboard assembly to the next hole position, then reinstall the fasteners, adjust the angle and tighten the fasteners.

**TORQUE:** 18 ft-lbs (24.4 Nm)

## FUEL CAP

The fuel filler cap ① is located on the right side of the console. An ornamental cap ② is located on the left side of the console. Do not attempt to remove the ornamental cap.

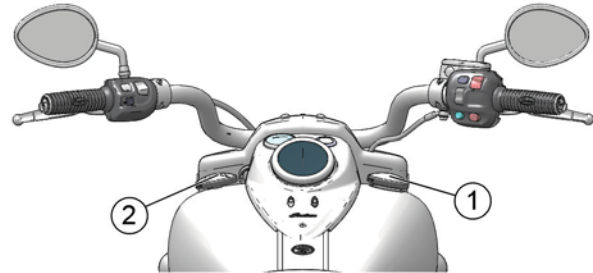

1. Turn the fuel cap counter-clockwise to remove it.
2. See page 95 for fueling instructions.
3. To tighten the cap, turn it clockwise until the seal compresses onto the tank, then continue to tighten until the cap ratchets several times.



## PRE-RIDE INSPECTIONS

To keep your motorcycle in safe operating condition, always perform the recommended pre-ride inspections before each ride. This is especially important before making a long trip and when removing the motorcycle from storage.

---

**WARNING!** Failure to perform the recommended pre-ride inspections could result in component failure while riding, which could result in serious injury or death. Always perform the pre-ride inspections before each ride. When inspection reveals the need for adjustment, replacement or repair, perform the service promptly, or your authorized INDIAN MOTORCYCLE can assist.

---

**WARNING!** Read the entire Instruments, Features and Controls section of this manual before riding your motorcycle. A complete understanding of the features and capabilities of your motorcycle is essential to its safe operation. Anything less may result in serious injury or death.

---

You must be familiar with all instruments and controls to perform the pre-ride inspections.

---

**TIP:** During the pre-ride inspections you may use products that are potentially hazardous, such as oil or brake fluid. When using any of these products, always follow the instructions and warnings on the product packaging.

---

When inspections reveal the need for adjustment, replacement or repair:

- refer to the maintenance section of this manual ( page 105)
- refer to the INDIAN MOTORCYCLE Service Manual
- or see your authorized INDIAN MOTORCYCLE dealer or other dealer

## PRE-RIDE INSPECTIONS

---

### ELECTRICAL INSPECTIONS

Turn the power switch on and move the stop/run switch to RUN before performing the following electrical inspections. Turn the power switch off after completing these inspections. If inspection of any electrical item reveals component failure, repair or replace the component before operating the motorcycle.

ITEM	INSPECTION PROCEDURE
Headlamp	Move the headlight switch from low beam to high beam to turn the lights on and verify operation of both beams. Start the engine. Switch to high beam. Verify that the high beam indicator comes on and that lamp brightness increases.
Taillights/Brakelight	Verify that the taillights and license plate light illuminate. Verify that the taillight lamps increase in brightness when the front brake lever is applied and also when the rear brake pedal is applied.
Turn Signals	Move the turn signal switch to the left. Verify that front and rear left turn signals flash, as well as the corresponding light on the indicator panel. Move the switch to the center position and push it inward to cancel the signal. Verify that the signals and the indicator light stop flashing. Repeat the procedure for the right turn signals.
Emergency Flashers	Press the hazard switch to activate the flashers. Verify that all four turn signals flash, as well as the lamps on the indicator panel. Turn the flashers off. Verify that all signals and indicator lamps stop flashing.
Horn	Press the horn switch. Verify that the horn sounds loudly.
Neutral Indicator	Place the transmission in neutral. Verify that the neutral indicator lamp illuminates and that the letter "N" displays in the gear position display.
Low Oil Pressure Display	Start the engine. CHIEF MODELS/SPRINGFIELD: Verify that "LO OIL" is not displayed in the MFD. CHIEFTAIN DARK HORSE / ROADMASTER: Verify that the low oil pressure indicator is not illuminated.
Engine Stop/Run Switch	Start the engine. Move the stop/run switch to the STOP position. Verify that the engine stops. Attempt to restart the engine to verify that the engine WILL NOT start.

**GENERAL INSPECTIONS**

ITEM	INSPECTION PROCEDURE
Engine Oil	Check the oil level. See page 84.
Fuel	Check the fuel level. See page 91.
Fluid Leaks	Check the vehicle and the ground/floor for any fuel, oil or hydraulic fluid leaks.
Tires	Inspect condition, pressure and tread depth. See page 86.
Brake Operation	Inspect pedal and lever movement.
Brake Fluid Levels	Check front and rear brake fluid levels.
Brake Components	Inspect hoses and connections.
Throttle	Inspect hand grip and throttle movement.
Clutch	Check lever operation and freeplay.
Front Suspension	Check for leaks, debris and damage.
Steering	Check for smooth operation by turning handlebars full left and full right.
Rear Suspension	Check mounting and inspect for leaks. CHIEFTAIN DARK HORSE/ROADMASTER/SPRINGFIELD: Check shock movement and air pressure, verify ground clearance.
Ride Height	Make sure preload is adjusted properly for load. See page 120.
Rear Drive Belt	Check for wear or damage. Check drive belt tension. See page 116- page 116.
Sidestand	Verify smooth operation, inspect pivot bolt and spring.
Fasteners	Inspect for loose, damaged or missing fasteners.
Mirrors	Adjust for proper rear view.
Trunk/Saddlebags	If equipped, make sure the trunk and saddlebags are properly installed and that lids are securely closed.

## PRE-RIDE INSPECTIONS

---

### ENGINE OIL LEVEL

With the semi-dry sump lubrication system, the engine oil level on the dipstick will fluctuate, depending on the motorcycle's position and engine speed when the engine is turned off. To ensure a proper reading of the engine oil level, follow all inspection procedures closely.

---

**WARNING!** Operating with insufficient, deteriorated or contaminated engine oil will cause accelerated wear and may result in engine or transmission seizure, which could result in loss of control and serious injury or death. Check the oil level frequently. We recommended checking the oil each time you refuel.

---

The engine must be at normal operating temperature when checking the oil level.

---

**NOTICE:** Oil level will NOT be accurate if checked on a cold engine. DO NOT ADD oil to bring level to the FULL mark on a cold engine, as this can result in overfilling.

---

The oil fill cap/dipstick is located on the left side of the motorcycle. A special tool is provided in the tool kit to assist with dipstick removal. Always use the recommended oil. See page 171.

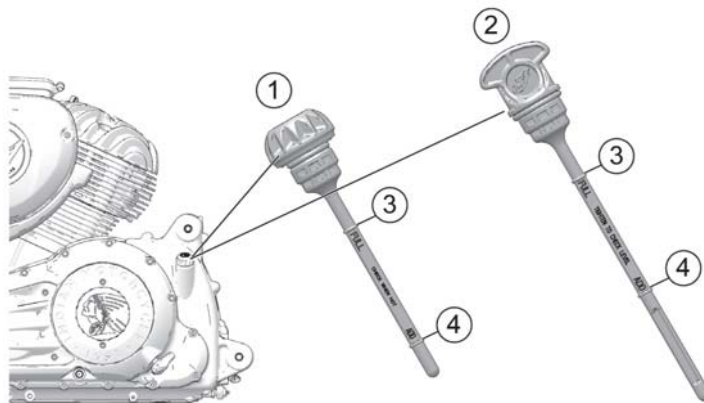

① Dipstick (All Other)

③ FULL Mark

② Dipstick (Dark Horse)

④ ADD Mark

---

## CHECKING THE ENGINE OIL LEVEL

1. Start the engine and allow it to run until it reaches normal operating temperature.
2. Stop the engine and wait one minute before checking the oil level.

---

**TIP:** If the oil level is not checked within 3 minutes, repeat steps 1–2.

---

3. Position the motorcycle on level ground in the fully upright and centered position.
4. Remove the dipstick and wipe it clean.
5. Reinstall the dipstick until fully seated.
6. Remove the dipstick and view the oil level.
7. Add the recommended oil as needed to bring the level within the safe operating range (anywhere between the two marks on the dipstick with engine at operating temperature). ***If the oil level on the dipstick is anywhere in the safe range, do not add oil.*** Oil should be added only if the proper oil check procedure is followed AND the level is below the safe mark.
8. Do not overfill. Overfilling can result in loss of engine performance and an oil-saturated air filter. Use a suction device to remove excess oil if overfilled.

---

**TIP:** The approximate volume between the ADD and FULL marks on the dipstick is 32 oz. (.94 l).

---

9. Repeat steps 1–7 to ensure the level is within the safe operating range.
10. Reinstall the dipstick securely.

## PRE-RIDE INSPECTIONS

---

### TIRES

---

**WARNING!** Operating the motorcycle with incorrect tires, incorrect tire pressure or excessively worn tires could cause loss of control or accident. Underinflation can cause a tire to overheat and result in a tire failure. Always use the correct size and type of tires specified by INDIAN MOTORCYCLE for your vehicle. Always maintain proper tire pressure as recommended in the rider's manual and on safety labels.

---

### TIRE PRESSURE

Improper tire pressure can result in irregular tire wear, tire failure, reduced fuel economy and a poor riding experience. It can also affect handling and stopping ability.

Slow tire pressure loss over time is normal for a functional tire. Although a tire pressure monitoring system (TPMS) will alert the user to a low pressure condition (if equipped), always inspect tire pressure and condition before each ride.

Check tire pressure before riding, when the tires are cold. This will provide the most accurate reading, as riding warms the tires and increases tire air pressure. Tires remain warm for at least 3 hours after a ride. Do not adjust tire pressure immediately after riding. As tires cool, the pressure will drop and result in underinflation. Always check and adjust tire pressure when tires are cold.

Using a good quality pocket-style gauge, adjust tire pressure to the recommended pressure. See page 136.

### TIRE CONDITION

Inspect the tire sidewalls, road contact surface and tread base. If inspection reveals cuts, punctures, cracks or other wear or damage, replace the tire before riding. Always use the correct size and type of tires specified by INDIAN MOTORCYCLE for your vehicle.

### TIRE TREAD DEPTH

Measure the tread depth near the center of the tread on both tires. See page 135. Replace any tire with a tread depth of less than 1/16 inch (1.6 mm).



## FRONT BRAKE FLUID LEVEL

1. Straddle the motorcycle and bring it to the fully upright position. Position the handlebars so that the fluid reservoir is level.
2. View the fluid level through the sight glass ①. The fluid should be clear. Replace cloudy or contaminated fluid.

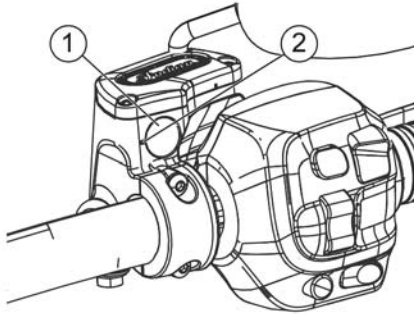

3. The fluid level should be above the minimum indicator mark ② in the sight glass.
4. If the fluid level is low, inspect brake pads as outlined on page 131-page 132. If pads are not worn beyond the service limit, inspect the brake system for leaks. Check for signs of brake fluid leaks around hoses, fittings, reservoir, and brake calipers.
5. Add brake fluid if necessary. See page 130.

## FRONT BRAKE LEVER

1. Pull the front brake lever toward the handlebar and hold it. The lever should move freely and smoothly. The lever should feel firm and continue to feel firm until released.
2. Release the lever. It should return to its rest position quickly when released.
3. If the front brake lever fails to perform as stated, service the brake lever before riding.

## REAR BRAKE PEDAL

1. Press downward on the rear brake pedal. It should move freely and smoothly. The pedal should feel firm and continue to feel firm until released.
2. Release the pedal. It should return to its rest position quickly when released.
3. If the rear brake pedal fails to perform as stated or travels too far before beginning to engage the brake, service the brakes before riding.

## PRE-RIDE INSPECTIONS

---

### REAR BRAKE FLUID LEVEL

The rear brake fluid reservoir is located near the rear brake pedal. View the reservoir level from the right side of the vehicle.

1. Position the motorcycle on level ground in the fully upright position.
2. View the brake fluid through the reservoir ①.
3. The fluid should be clear. Replace cloudy or contaminated fluid.
4. The fluid level should be above the minimum indicator mark ② on the reservoir body. Add brake fluid as needed.

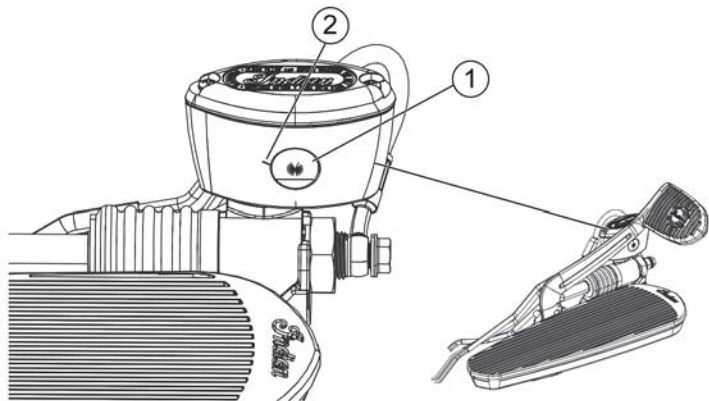

### BRAKE LINES

Inspect all brake hoses and connections for dampness or stains from leaking or dried fluid. Tighten any leaking connections to the proper torque values and replace components as necessary. See the *INDIAN MOTORCYCLE Service Manual* or an authorized INDIAN MOTORCYCLE dealer or other qualified dealer.

---

**WARNING!** Brake fluid leaks or low brake fluid levels could cause brake system failure, which could result in serious injury or death. Do not operate the vehicle with low brake fluid levels or when leaks are evident (dampness or stains from dried fluid). See your authorized INDIAN MOTORCYCLE dealer or other qualified dealer.

---

## THROTTLE

Rotate the throttle control grip. It should rotate smoothly from the rest position to the completely open position. It should return to the rest position quickly when released.

## SIDESTAND

1. On level ground, straddle the motorcycle and bring it to the fully upright position.
2. Move the sidestand up to the stored position and down to the fully extended position several times. It should move smoothly and quietly. Make sure the return spring holds the sidestand tightly in place when the sidestand is in the stored position. Adjust or replace a loose spring.
3. Inspect the sidestand pivot bolt for looseness or wear. Tighten or replace a loose or worn bolt.
4. Periodically test the sidestand safety switch for proper operation. With the transmission in gear and brakes applied, attempt to start the engine while the sidestand is down. The engine should NEVER start in any gear except neutral if the sidestand is down. If the engine starts during this test, see your dealer for service.

## MECHANICAL CLUTCH

1. Squeeze the clutch lever ① toward the handlebar and release it. It should move freely and smoothly, and it should return to the rest position quickly when released. If the lever fails to perform as stated, service the clutch lever before riding.

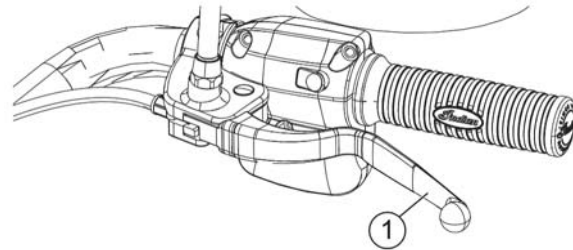

2. Freeplay (gap) is the amount of lever movement from the rest position to the point of cable resistance. Clutch lever freeplay should be 0.5-1.5 mm. Measure the gap between the clutch lever and the lever housing. See page 126. Adjust clutch lever freeplay if necessary.

**TIP:** The starter interlock switch is dependent on the clutch lever freeplay being set correctly to ensure activation of the clutch safety switch.

## PRE-RIDE INSPECTIONS

---

### FASTENERS

1. Inspect the entire motorcycle chassis and engine for loose, damaged or missing fasteners.
2. Tighten loose fasteners to the proper torque. See the *INDIAN MOTORCYCLE Service Manual* or an authorized INDIAN MOTORCYCLE dealer or other qualified dealer.

---

**TIP:** Always replace stripped, damaged or broken fasteners before riding. Use genuine INDIAN MOTORCYCLE fasteners of equal size and strength.

---

### FRONT SUSPENSION

Inspect the front forks for oil leaks or damage, and verify smooth suspension operation. See page 123.

### STEERING

1. On level ground, straddle the motorcycle and bring it to the fully upright position. Turn the handlebars from stop to stop. The action should be smooth, but not loose.
2. Make sure wires, hoses and control cables do not interfere with smooth steering.

### REAR SUSPENSION

Check the rear shock absorber mounting and inspect for leaks. See your dealer for service if you discover leaks or malfunction of any kind. See page 118.

*SPRINGFIELD/CHIEFTAIN DARK HORSE/CHIEFTAIN/ROADMASTER CLASSIC/ROADMASTER only:* Check rear shock absorber movement and air pressure to ensure the correct amount of suspension travel and ground clearance. See page 121.

---

**WARNING!** Inadequate ground clearance could result in components contacting the ground, causing loss of control and serious injury or death. Always ensure ground clearance is at specification.

---

### REAR DRIVE BELT

1. Check drive belt tension. See page 116

---

**TIP:** The drive belt system must be cool, clean and dry to accurately measure belt tension (deflection). Do not measure belt tension when the belt or drive system is wet or when it is hot (such as immediately after riding).

---

2. Check the drive belt teeth for stones or other debris.
3. Inspect drive belt condition. See page 116. If you discover cracks, broken teeth or frayed edges, replace the drive belt before riding. See the *INDIAN MOTORCYCLE Service Manual* or an authorized INDIAN MOTORCYCLE dealer can assist.

## FUEL LEVEL

For the most accurate reading, sit on the motorcycle and bring it to the upright position.

### CHIEF VINTAGE/SPRINGFIELD

The tank fuel gauge ① displays the fuel level.



### CHIEFTAIN DARK HORSE

The fuel level displays in the instrument cluster gauge ②.

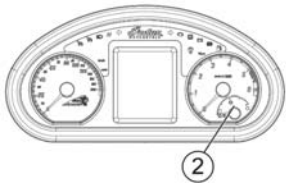

### CHIEF CLASSIC/CHIEF DARK HORSE

The fuel level displays in the Multi-Function Display ③. See page 42.

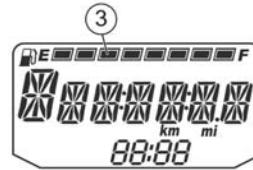

### CHIEFTAIN/ROADMASTER CLASSIC/ROADMASTER

The fuel level displays in the Speedometer CPI ④ and Infotainment Display. Both the left-hand speedometer LCD and the Infotainment display will say LOW in the Fuel Range area.





---

## OPERATION

The operation section of this manual describes how to ensure maximum performance and longevity through the proper care and operation of your motorcycle.

Important areas covered by the operation section include:

- Engine Break-In
- Fueling
- Starting the Engine
- Shifting Gears
- Using Cruise Control (if equipped)
- Accelerating
- Braking
- Stopping the Engine
- Parking

---

**TIP:** Even if you're an experienced motorcycle operator or passenger, read all of the safety information in this manual before operating the motorcycle. See page 12.

---

## ENGINE BREAK-IN

The engine break-in period for your motorcycle is the first 500 miles (800 km) of operation. During this break-in period, critical engine parts require special wear-in procedures so they seat and mate properly. Read, understand and follow all break-in procedures to ensure the long-term performance and durability of your engine.

---

**NOTICE:** Failure to properly follow the engine break-in procedures outlined in this manual can result in serious damage to the engine. Follow all break-in procedures carefully. Avoid full throttle operation and other conditions that may place an excessive load on the engine during the break-in period.

---

The more cautiously you treat your motorcycle during the break-in period, the more satisfied you will be with its performance later on. Overloading the engine at low RPM and/or running the engine prematurely at high RPM may result in damage to the pistons and/or other engine components.

Observe the following precautions during the break-in period:

- Upon initial start-up, do not allow the engine to idle for long periods as overheating can occur. See page 96.
- Avoid fast starts with wide open throttle. Drive slowly until the engine warms up.
- Avoid running the engine at extremely low RPM in higher gears (lugging the engine).
- Drive within the recommended operating speeds and gears. See page 94.

## OPERATION

---

### OPERATING SPEEDS AND GEARS

ODOMETER		BREAK-IN PROCEDURE
MILES	KM	
0-90	0-145	Do not operate for extended periods above 1/3 throttle or at any one throttle position. Vary engine speed frequently.
91-300	146-483	Do not operate for extended periods above 1/2 throttle or at any one throttle position. Vary engine speed frequently.
301-500	484-800	Do not operate for extended periods above 3/4 throttle.
At 500	At 800	Perform the break-in maintenance outlined in the maintenance section of this manual. Break-in maintenance should be performed by a dealership. Break-in maintenance must include inspection, adjustments, fastener tightening and an engine oil and filter change. Performing break-in maintenance at the required odometer reading helps ensure peak engine performance, minimal exhaust emissions and maximum service life of the engine.



---

## FUELING

Always dismount the motorcycle and refuel on level ground with the sidestand down. Review the fuel warnings. See page 18. Use only the recommended fuel. See page 171. Hold the nozzle while filling. Do not rest the weight of the nozzle and hose on the filler neck. Do not leave the nozzle unattended.

---

**WARNING!** Overflows or spilled gasoline could contact a hot engine or exhaust system and cause a fire, which could result in serious injury or death. Do not allow gasoline to contact hot components.

---

---

**WARNING!** Always remove the fuel cap slowly and fill the fuel tank slowly to prevent spillage. Do not overfill the fuel tank. Leave space in the tank to allow for the fuel to expand.

---

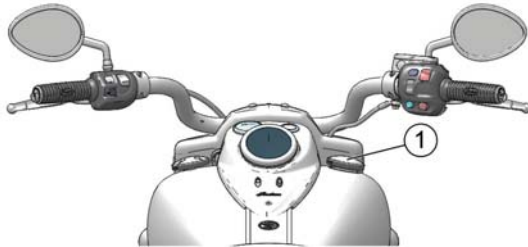

1. Turn the fuel cap ① counter-clockwise to remove it.
2. Insert the fuel nozzle into the fuel tank filler neck. The nozzle-stop at the bottom of the filler neck will prevent over-insertion.

3. Add fuel to the tank until it touches the bottom edge of the filler neck. The tank is full at this level.
4. Always securely install the fuel cap before remounting the motorcycle. To tighten the cap, turn it clockwise until the seal compresses onto the tank, then continue to tighten until the cap ratchets several times.

---

**NOTICE:** Fuel can damage painted surfaces and plastic parts. If gasoline spills on the any part of the motorcycle, immediately rinse it off with water or wipe it dry with a clean cloth.

---

## OPERATION

---

### PRIMING THE FUEL SYSTEM

If the motorcycle runs out of fuel, prime the fuel system before attempting to restart the engine.

1. Fill the fuel tank.
2. Turn the power switch on.
3. Move the engine stop/run switch to the RUN position.

### STARTING THE ENGINE

The starter interlock system allows the engine to be started only when the transmission is in neutral, or when the transmission is in gear with the clutch disengaged (clutch lever pulled in). The engine should NEVER start in any gear except neutral if the sidestand is down. See page 74.

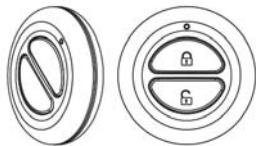

---

**TIP:** If the motorcycle runs out of fuel, prime the system before attempting to restart the engine. See page 96.

---

1. Perform the Pre-Ride Inspections. See page 81. Properly secure any cargo.

4. Allow the fuel pump to run until it stops (about 2 seconds).
5. Move the engine stop/run switch to the STOP position.
6. Repeat steps 3–5 four to five times.
7. Move the engine stop/run switch to the RUN position.
8. Start the engine. See page 96.

2. Straddle the motorcycle and bring it to the fully upright position. Retract the sidestand.

---

**TIP:** When the electrical system is activated with either the power switch or the starter switch, the key fob must be within range. See page 36.

---

3. Move the engine stop/run switch to the RUN position.
4. Shift the transmission to neutral.
5. Apply the front brakes. Disengage the clutch (pull the clutch lever fully toward the handlebar).
6. Press and hold the starter switch to engage the one-touch starting feature, which activates the electrical system and starts the engine. Another option is to turn the power switch on, and with the throttle closed, press and release the starter switch to start the engine. The starter motor will crank until the engine starts, but no more than 3 seconds. If the engine does not start, wait five seconds, then try again.

7. If starting a COOL engine, DO NOT open the throttle while starting. Idle speed is computer controlled and idle speed will adjust automatically depending on engine temperature and air temperature. Allow the engine to warm up for 30 seconds minimum at low RPM after starting. Do not run the engine above 2500 RPM. If starting a WARM engine, DO NOT open the throttle while starting.
  8. If either the check engine indicator or the low oil pressure indicator (or display) remains on after the engine starts, stop the engine *immediately*. Refer to the low oil pressure indicator/display information in page 46 or page 65.
- 

**NOTICE:** Operating an engine with a misfire or non-firing cylinder can overheat the catalytic converter, which could result in catalytic converter damage and loss of emission control. DO NOT OPERATE the motorcycle if a misfire or non-firing cylinder exists.

---

9. Leave the throttle closed and allow the engine to idle. Idle speed will gradually slow to normal as the engine warms to operating temperature.
- 

**TIP:** Do not rev the engine or put the transmission in gear immediately after starting the engine. Allow the engine to idle for about 30 seconds after a warm start or at least one minute after a cold start (longer in cold weather). This will allow oil to reach all areas before the engine is put under load.

---

**NOTICE:** Do not run the engine at high RPM with the clutch disengaged or the transmission in neutral. Maximum safe engine speed is 5400 RPM. Never exceed the maximum safe RPM as this could result in serious engine damage.

---

**NOTICE:** The engine is air-cooled and requires unrestricted air flow to ensure proper operating temperature. Long periods of idling or traveling at very low speeds (such as during a parade) may overheat the engine, resulting in serious engine damage.

---

## OPERATION

---

### SHIFTING GEARS

---

**WARNING!** Forced shifting (with clutch engaged) could cause damage to the engine, transmission and drive train. Such damage could cause loss of control, which could result in serious injury or death. Always pull the clutch lever fully toward the handlebars to disengage the clutch before shifting gears.

---

This motorcycle is equipped with a six-speed transmission. Neutral is located between first and second gear.

Press downward on the toe lever to shift to a lower gear. Lift upward on the toe lever to shift to a higher gear. Release the clutch lever after each gear shift.

Shifting to neutral is easiest if the motorcycle is rolling slowly. To shift from first gear to neutral, gently lift the toe lever a half stroke.

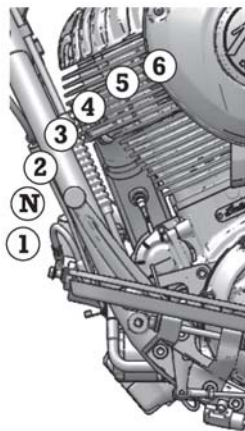

**TIP:** The transmission is in neutral if you can move the motorcycle forward or rearward freely without disengaging the clutch. If the power switch is ON, the neutral indicator illuminates when the transmission is in neutral.

---

### SHIFTING GEARS WHILE STATIONARY

To locate neutral when the motorcycle is stationary, use one of the following techniques to load and unload the transmission shift dogs, which allows them to disengage:

1. With the clutch disengaged (lever pulled inward), shift into neutral while rocking the motorcycle forward and rearward.
2. With the transmission in first gear, gently release the clutch until it just begins to engage. Apply upward pressure on the toe lever and quickly pull the clutch inward.

**NOTE:** There is a Neutral indicator light on the instrument cluster.

---

To shift gears when the motorcycle is stationary (engine may be running or stopped), disengage the clutch and apply slight pressure on the shift lever while rocking the motorcycle forward and rearward.

---

## SHIFTING GEARS WHILE DRIVING

1. Start the engine. See page 96.
2. With the engine at idle speed, apply the front brakes.
3. Disengage the clutch (pull the clutch lever fully toward the handlebar).
4. Push the toe lever downward until you feel it stop in first gear.
5. Release the brake lever.
6. Simultaneously release the clutch lever while opening the throttle (rolling the throttle control grip rearward) in one smooth motion. As the clutch begins to engage, the motorcycle will move forward.
7. To shift to a higher gear, accelerate smoothly to the recommended shift point. See *Recommended Shift Points* chart. With a quick motion, simultaneously close the throttle completely and disengage the clutch. Raise the toe shift lever until you feel it stop at the next gear. Simultaneously release the clutch lever and open the throttle in one smooth motion.

---

**TIP:** Within the recommended speed ranges (see Recommended Shift Points chart), you can downshift to slow the motorcycle or to increase power. You may want to downshift when climbing a hill or passing. Downshifting also helps to decrease speed when combined with closing the throttle.

---

8. To shift to a lower gear (downshift), simultaneously pull the clutch lever toward the handlebar and close the throttle. Move the toe shift lever downward until you feel it stop at the next gear. Simultaneously release the clutch lever while opening the throttle.

---

**WARNING!** Downshifting improperly could cause transmission damage, loss of traction and loss of control, which could result in serious injury or death.

---

- Reduce speed before downshifting. Always downshift within the recommended shift points.
- Use extreme caution when downshifting on wet, slippery or other low traction surfaces. Release the clutch lever very gradually in these conditions.
- Avoid downshifting in a curve. Downshift before entering the curve.

## OPERATION

---

### RECOMMENDED SHIFT POINTS

UPSHIFTING (ACCELERATING)			DOWNSHIFTING (DECELERATING)	
GEAR CHANGE	RECOMMENDED SPEED		GEAR CHANGE	RECOMMENDED SPEED
1 to 2	15 MPH (24 km/h)		6 to 5	40 MPH (64 km/h)
2 to 3	25 MPH (40 km/h)		5 to 4	35 MPH (56 km/h)
3 to 4	35 MPH (56 km/h)		4 to 3	25 MPH (40 km/h)
4 to 5	45 MPH (72 km/h)		3 to 2	15 MPH (24 km/h)
5 to 6	50 MPH (80 km/h)		2 to 1	10 MPH (16 km/h)

---

## BRAKING

Always allow sufficient stopping distance so that brakes can be applied gradually.

---

**TIP:** Applying slightly more front brake than rear brake generally provides the best braking performance.

---

1. To slow the motorcycle with the brakes, close the throttle and apply the front and rear brakes evenly and gradually.

---

**TIP:** When the anti-lock brakes engage during a braking event, the rider will feel pulsing at the brake levers. Continue to apply steady pressure to the brakes for the best stopping performance.

---

2. As the motorcycle slows, disengage the clutch, or downshift each time vehicle speed reaches a downshift point.

---

**WARNING!** Braking improperly could result in loss of control, which could result in serious injury or death. Avoid braking abruptly. Always apply the brakes gradually, especially on wet, slippery or other low traction surfaces. Avoid braking in a curve or turn. Bring the motorcycle to the upright position before applying the brakes.

---

---

## ACCELERATING

Accelerate by opening the throttle (rolling the throttle control grip rearward). For even acceleration, open the throttle with a smooth, continuous motion. When you reach the recommended speed for upshifting, shift up one gear.

---

**WARNING!** Accelerating abruptly could cause your body to shift rearward suddenly, which could result in loss of control. Accelerating abruptly could also cause loss of control on low traction surfaces. Loss of control could result in serious injury or death. Always accelerate gradually, especially on wet, slippery or other low traction surfaces.

---

---

## STOPPING THE ENGINE

Before stopping the engine, bring the motorcycle to a complete stop. Shift to neutral or disengage the clutch.

---

**WARNING!** Stopping the engine with the transmission in gear while the motorcycle is moving could cause loss of rear wheel traction or engine and transmission damage, which could cause loss of control and serious injury or death. Always stop the engine after the motorcycle is fully stopped and the transmission is in neutral. If the engine stops unexpectedly while the motorcycle is moving, guide the motorcycle to a safe location off the road and away from traffic. Turn the power switch off.

---

1. When fully stopped, shift into neutral.
2. Move the engine stop/run switch to the STOP position.
3. Turn the power switch off.

## OPERATION

### USING CRUISE CONTROL

The cruise control switches are located on the right handlebar. Read this section and understand how to safely operate this feature before using the cruise control.

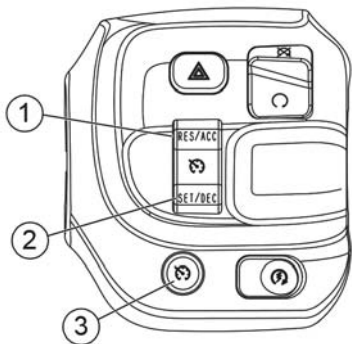

① Resume/Accelerate Switch

③ Cruise On/Off Switch

② Set/Decelerate Switch

**WARNING!** Improper operation of cruise control could cause loss of control and result in serious injury or death. Follow all cruise operation procedures carefully. Never use cruise control when roads are wet or slippery. Do not use cruise control when riding in heavy or congested traffic.

### CRUISE CONTROL TIPS

- Cruise control can be set in gears 4-6.
- Vehicle speed must be above 20 MPH (32 km/h).
- Set speed will vary slightly in hilly terrain.
- Cruise control will not resume a pre-set speed if the resulting acceleration or deceleration rate is too high or too low. For example, resuming a set speed from 40 MPH (64 km/h) while in 6th gear may cause cruise to disengage.
- Cruise control will not engage if brake lights are not operating properly.
- The clutch or either brake must have been activated at least once since the engine was started for the cruise control to function.

### SET SPEED

1. Press and release the cruise on/off switch ①. The amber cruise control indicator will illuminate in the instrument cluster. Cruise control is enabled, but not set.
2. Accelerate to the desired speed and press the SET/DEC switch ②. The green cruise control indicator lamp will illuminate. Cruise control is set to the desired speed.

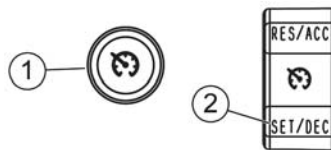



## RESUME SPEED

After disengaging the cruise control with the brake, throttle or clutch, press the RES/ACC switch ① to return to the set speed.

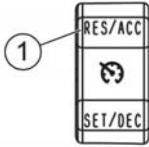

## ACCELERATE

While cruise control is engaged, tap and release the RES/ACC switch to increase speed in approximately 1 MPH (1-2 km/h) increments. Press and hold the RES/ACC switch to accelerate to a new set speed (resets when switch is released).

---

**TIP:** If you use the throttle to accelerate and then release it, the cruise control will resume the previously set speed.

---

## DECELERATE

While cruise control is engaged, tap and release the SET/DEC switch to decrease speed in approximately 1 MPH (1-2 km/h) increments. Press and hold the SET/DEC switch to decelerate to a new set speed (resets when switch is released), or to the minimum cruise speed of 20 MPH (32 km/h).

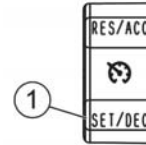

## CANCEL CRUISE CONTROL

To temporarily cancel the cruise control and allow use of the resume feature:

- apply the brakes or
- close the throttle
- disengage the clutch

To cancel the cruise control and erase the set speed from memory, press the cruise on/off switch.

## OPERATION

---

### PARKING

Choose a firm level surface to park the motorcycle.

1. When fully stopped, shift into neutral.
2. Stop the engine.
3. Fully extend the sidestand.
4. Turn the handlebars to the left and lean the motorcycle to the left until the sidestand firmly supports the motorcycle.
5. Turn the power switch off.

### PARKING ON A SLOPE

If parking on a slope is unavoidable, park with the front wheel uphill from the rear wheel. Place the transmission in first gear and position the motorcycle so that it is stable when it rests on the sidestand.

### PARKING ON A SOFT SURFACE

If parking on a soft surface is unavoidable, place a sidestand footrest under the foot of the sidestand to provide a firm surface. The sidestand footrest must be strong enough and large enough to support the motorcycle's weight without sinking into the parking surface.

Asphalt becomes soft in hot weather. A sidestand can sink into soft asphalt and the motorcycle may fall. When parking on asphalt in hot weather, use a sidestand footrest.

---

**CAUTION!** Hot engine and exhaust components can cause burns to skin and can ignite a fire if exposed to flammable materials. Always park the motorcycle clear of flammable materials and where people are not likely to contact hot components.

---

## MAINTENANCE

### SAFETY DURING SERVICE PROCEDURES

---

**WARNING!** Failure to follow all recommended precautions and procedures could result in severe injury or death. Always heed all safety precautions and follow all operation, inspection and maintenance procedures outlined in this manual.

- Improperly installed or adjusted components can make the motorcycle unstable or hard to handle. Improperly installed electrical components can cause engine or electrical system failure. In either event, damage or serious injury could result. If you do not have the time, tools and expertise necessary to complete a procedure properly, please see your dealer for service.
  - Review the safety-related maintenance information on page 19.
  - Before beginning any maintenance procedure, read the instructions for the entire procedure.
  - Always position the motorcycle on a firm level surface before performing service. Make sure the motorcycle will not tip or fall while elevated or while on the sidestand. See page 151.
  - Hot engine and exhaust components can cause burns to skin and can ignite a fire if exposed to flammable materials. Always park the motorcycle clear of flammable materials and where people are not likely to contact hot components.
  - Wear eye and face protection when using pressurized air.
  - Never start the engine or let it run in an enclosed area. Engine exhaust fumes are poisonous and can cause loss of consciousness or death in a short time.
  - During some procedures you may use potentially hazardous products such as oil or brake fluid. Always follow the instructions and warnings on the product packaging.
-

### ROAD TESTS

Before returning the motorcycle to regular use after performing service, road test it in a safe environment. Pay special attention to the proper fit and operation of all serviced components. Make any corrections or additional adjustments necessary to ensure safe vehicle performance.

### BREAK-IN MAINTENANCE

Perform the break-in maintenance procedures when the motorcycle's odometer registers 500 miles (800 km). Please see your authorized dealer for this service.

Performing the break-in maintenance will help ensure optimum engine performance for the entire service life of the engine. Your dealer will change engine oil, inspect all fluids and serviceable components, ensure that all fasteners are tightened and make other adjustments as needed.

### MAJOR MAINTENANCE

Major repairs typically require technical skills and specially designed tools. Emission system service requires special tools and training and should be performed by your dealer. See the *INDIAN MOTORCYCLE Service Manual* or an authorized INDIAN MOTORCYCLE dealer or other qualified dealer.

### PERIODIC MAINTENANCE

Inspect, clean, lubricate, adjust and replace parts as necessary. When inspection reveals the need for replacement parts, use genuine INDIAN MOTORCYCLE parts available from your dealer. Record service and maintenance information in the Maintenance Log beginning on page 185.

---

**NOTICE:** Use of non-recommended lubricants and components can result in damage to the motorcycle. Damage resulting from the use of non-recommended products is not covered by warranty.

---

Perform maintenance at the intervals specified in the Periodic Maintenance Table beginning on page 107. *Vehicles subjected to severe use must be inspected and serviced more frequently.*

### SEVERE USE DEFINITION

- high speed operation for extended periods
- low speed operation for extended periods
- operation in dusty or otherwise adverse conditions
- operation in cold weather (temperatures below freezing)

**PERIODIC MAINTENANCE TABLE**

		Odometer Reading in Miles (Kilometers)															
Component See table key below		500 (800)	2,500 (4,000) & every 5,000 (8,000) thereafter	5,000 (8,000)	10,000 (16,000)	15,000 (24,000)	20,000 (32,000)	25,000 (40,000)	30,000 (48,000)	35,000 (56,000)	40,000 (64,000)	45,000 (72,000)	50,000 (80,000)				
Engine	Key Fob Battery *	-	-	-	-	-	-	-	-	-	-	-	-	-	-	-	-
	Engine Compression See page 151	I	-	-	I	-	I	-	I	-	I	-	I	-	I	-	I
	Engine Oil & Filter* See page 113	R	-	R	R	R	R	R	R	R	R	R	R	R	R	R	R
	Crankcase Vent See page 124	I	I	I	I	I	I	I	I	I	I	I	I	I	I	I	I
	Engine Mount Fasteners	I	-	-	-	-	-	-	-	-	-	-	-	-	-	-	-
	Oil Lines/Oil System Inspection (if equipped)	I	I	I	I	I	I	I	I	I	I	I	I	I	I	I	I
	Air Filter See page 115	I	I	I	I	R	I	I	R	I	I	I	R	I	I	R	I
	Exhaust System See page 151	I	I	I	I	I	I	I	I	I	I	I	I	I	I	I	I
	Spark Plugs See page 137	I	-							R						I	
<p><b>Maintenance Key:</b> <b>I</b> = Inspect, clean, adjust, correct or replace if necessary; <b>P</b> = Perform; <b>R</b> = Replace/Rebuild  <b>L</b> = Lubricate w/ proper lubricant; * = Replace at specified interval or annually; ** = Replace as specified or every 2 years</p>																	

# MAINTENANCE

Component See table key below		500 (800)	2,500 (4,000) & every 5,000 (8,000) thereafter	5,000 (8,000)		10,000 (16,000)		15,000 (24,000)		20,000 (32,000)		25,000 (40,000)		30,000 (48,000)		35,000 (56,000)		40,000 (64,000)		45,000 (72,000)		50,000 (80,000)
Chassis	Battery/Connections See page 144	I	I	I		I		I		I		I		I		I		I		I		I
	Brake Fluid** See page 129	I	I	I		R		I		R		I		R		I		R		I		R
	Brake Lines/Brake Pads See page 88	I	I	I		I		I		I		I		I		I		I		I		I
	Clutch Cable See page 127	I	-	I		L		I		L		I		L		I		L		I		L
	Clutch Lever (Mechanical) See page 126	L	-	I		L		I		L		I		L		I		L		I		L
	Diagnostic Codes	I	I	I		I		I		I		I		I		I		I		I		I
	Drive Belt (Rear) See page 90	I	I	I		I		I		I		I		R		I		I		I		I
	Drive Belt Tension Adjustment	I	-	I	See dealer or service manual for adjustment at indicated intervals and with each tire change thereafter.																	
<p><b>Maintenance Key:</b> <b>I</b> = Inspect, clean, adjust, correct or replace if necessary; <b>P</b> = Perform; <b>R</b> = Replace/Rebuild  <b>L</b> = Lubricate w/ proper lubricant; * = Replace at specified interval or annually; ** = Replace as specified or every 2 years</p>																						

Component See table key below		500 (800)	2,500 (4,000) & every 5,000 (8,000) thereafter	5,000 (8,000)		10,000 (16,000)		15,000 (24,000)		20,000 (32,000)		25,000 (40,000)		30,000 (48,000)		35,000 (56,000)		40,000 (64,000)		45,000 (72,000)		50,000 (80,000)	
Chassis	Electrical Equipment/Switches	I	I	I		I		I		I		I		I		I		I		I		I	
	Evaporative Emission Control System (if equipped) See page 125	I	I	I		I		I		I		I		I		I		I		I		I	
	Fasteners See page 151	I	I	I		I		I		I		I		I		I		I		I		I	
	Front Brake Lever See page 130	L	I	L		L		L		L		L		L		L		L		L		L	
	ABS Components See page 133	I	I	I		I		I		I		I		I		I		I		I		I	
	Front Fork Oil** See page 123	I		I		I		R		I		I		R		I		I		R		I	
<p><b>Maintenance Key:</b> <b>I</b> = Inspect, clean, adjust, correct or replace if necessary; <b>P</b> = Perform; <b>R</b> = Replace/Rebuild  <b>L</b> = Lubricate w/ proper lubricant; * = Replace at specified interval or annually; ** = Replace as specified or every 2 years</p>																							

# MAINTENANCE

Component See table key below		500 (800)	2,500 (4,000) & every 5,000 (8,000) thereafter	5,000 (8,000)	10,000 (16,000)	15,000 (24,000)	20,000 (32,000)	25,000 (40,000)	30,000 (48,000)	35,000 (56,000)	40,000 (64,000)	45,000 (72,000)	50,000 (80,000)
Chassis	Front Fork/Axle See page 123	I	I	I	I	I	I	I	I	I	I	I	I
	Fuel System/Lines/Fittings See page 125	I	I	I	I	I	I	I	I	I	I	I	I
	Fuel Filter See page 114	-	-	-	-	-	-	-	-	-	-	-	R
	Gear Shift Lever	I	I	I	I	I	I	I	I	I	I	I	I
	Headlamp See page 140	I	I	I	I	-	I	-	I	-	I	-	I
	Rear Suspension Rocker	I	I	I	I	L	I	I	L	I	I	L	I
	Rear Shock Unit See page 90 and page 118	I	I	I	I	I	I	I	I	I	I	I	R
<p><b>Maintenance Key:</b> <b>I</b> = Inspect, clean, adjust, correct or replace if necessary; <b>P</b> = Perform; <b>R</b> = Replace/Rebuild  <b>L</b> = Lubricate w/ proper lubricant; * = Replace at specified interval or annually; ** = Replace as specified or every 2 years</p>													



Component See table key below		500 (800)	2,500 (4,000) & every 5,000 (8,000) thereafter	5,000 (8,000)		10,000 (16,000)		15,000 (24,000)		20,000 (32,000)		25,000 (40,000)		30,000 (48,000)		35,000 (56,000)		40,000 (64,000)		45,000 (72,000)		50,000 (80,000)	
Chassis	Rear Wheel Alignment See page 133	I	I	I		I		I		I		I		I		I		I		I		I	
	Rear Brake Pedal See page 128	I	I	I		I		I		I		I		I		I		I		I		I	
	Road Test See page 151	P	P	P		P		P		P		P		P		P		P		P		P	
	Sidestand/Sidestand Safety Switch See page 89	L	I	I		I		I		I		I		I		I		I		I		I	
	Steering Bearings See page 124	I	I	I		I		I		I		I		I		I		I		I		I	
	Suspension Linkage, Rear	I	I	I		I		I		I		I		I		I		I		I		I	
<p><b>Maintenance Key:</b> <b>I</b> = Inspect, clean, adjust, correct or replace if necessary; <b>P</b> = Perform; <b>R</b> = Replace/Rebuild  <b>L</b> = Lubricate w/ proper lubricant; * = Replace at specified interval or annually; ** = Replace as specified or every 2 years</p>																							

## MAINTENANCE

Component See table key below	500 (800)	2,500 (4,000) & every 5,000 (8,000) thereafter	5,000 (8,000)		10,000 (16,000)		15,000 (24,000)		20,000 (32,000)		25,000 (40,000)		30,000 (48,000)		35,000 (56,000)		40,000 (64,000)		45,000 (72,000)		50,000 (80,000)
	Swingarm/Rear Axle See page 122	I	I	I		I		I		I		I		I		I		I		I	
Throttle Body	I	I	I		I		I		I		I		I		I		I		I		I
Throttle Control Grip	L	I	L		L		L		L		L		L		L		L		L		L
Tires/Wheels/Spokes See page 133	I	I	I		I		I		I		I		I		I		I		I		I
<p><b>Maintenance Key:</b> <b>I</b> = Inspect, clean, adjust, correct or replace if necessary; <b>P</b> = Perform; <b>R</b> = Replace/Rebuild  <b>L</b> = Lubricate w/ proper lubricant; * = Replace at specified interval or annually; ** = Replace as specified or every 2 years</p>																					

## ENGINE OIL/FILTER CHANGE

Change the engine oil at the intervals specified in the Periodic Maintenance Table beginning on page 107. Change the oil more frequently if the motorcycle is subjected to severe use, especially operation in cold weather. See page 106.

**NOTICE:** Failure to perform frequent oil changes during cold weather operation can result in condensation forming. Freezing condensation can result in plugged oil lines and serious engine damage.

The total amount of oil required for the oil and filter change is approximately 5.5 qts. (5.2 l). Follow all instructions carefully. Do not overfill.

**NOTICE:** After an oil change, the low oil pressure indicator may illuminate when the engine is started. If this occurs, do not increase RPM above idle speed until the indicator turns off. Operating above idle speed could result in damage to the engine.

1. Change the oil and filter when the engine is warm. If the engine is cold, start the engine and allow it to run at idle for at least 5 minutes.
2. Park the motorcycle with the sidestand down on a firm, level surface. If using a service lift, the motorcycle should be centered.

3. Clean the area around the scavenge area drain plug ① and the storage area drain plug ②. Place a drain pan under both drain plugs.

**CAUTION!** Hot oil can cause burns to skin. Do not allow hot oil to contact skin.



4. Remove the drain plugs. Allow the oil to drain completely.
5. Install new sealing washers on the drain plugs. The sealing surfaces on drain plugs and engine should be clean and free of burrs, nicks or scratches.

## MAINTENANCE

---

6. Reinstall the drain plugs. Torque to 15 ft. lbs. (20 Nm).

**CAUTION!** Hot oil can cause burns to skin. Do not allow hot oil to contact skin. Wear leather gloves when handling hot components.

---

7. Place shop towels beneath the oil filter. Using an oil filter wrench, turn the filter counter-clockwise to remove it.
8. Using a clean dry cloth, clean the filter sealing surface on the engine.
9. Lubricate the o-ring on the new filter with a film of fresh engine oil. Check to make sure the o-ring is in good condition.
10. Install the new filter and rotate it clockwise by hand until the filter gasket contacts the sealing surface, then turn it an additional 3/4 to one full turn.
11. Remove the dipstick. Add only 4.5 qts. (4.25 l) of the recommended oil at this step. *Do not overfill.*
12. Reinstall the dipstick securely.
13. With the motorcycle in an upright, centered position, start the engine and run it at varied speeds up to 2500 RPM for approximately 3 minutes.
14. Stop the engine and add an additional one quart (.95 l) of engine oil. Do not overfill. Overfilling can result in loss of engine performance and an oil-saturated air filter. Use a suction device to remove excess oil if overfilled.

15. To ensure the oil level is within the safe operating range, recheck the oil level as outlined in page 84.
- 

**NOTICE:** After an oil change, the low oil pressure indicator may illuminate when the engine is started. If this occurs, do not increase RPM above idle speed until the indicator turns off. Operating above idle speed could result in damage to the engine.

---

16. Dispose of used filter and oil properly.

17. *CHIEFTAIN DARK HORSE / CHIEFTAIN / ROADMASTER:* Reset the oil change life in the instrument gauge. See page 55.

## FUEL FILTER

The fuel filter is attached to the electric fuel pump located inside the fuel tank. See your authorized INDIAN MOTORCYCLE dealer or other qualified dealer for replacement.

## AIR FILTER

The air box is located on the left side of motorcycle. Inspect the air filter often if riding in unusually wet or dusty conditions. Replace the filter at the intervals specified in the Periodic Maintenance Table on page 107.

1. Remove the three air box cover screws ① and washers. Remove the cover ②.



2. Remove the three air filter screws ③ and remove the air filter assembly.
3. Remove the air filter ④.

4. Clean the filter sealing surface on the backing plate ⑤.

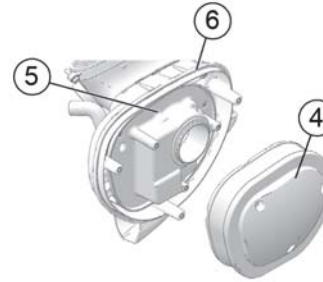

5. Verify that the air box cover seal ⑥ is properly seated in the groove around the outer edge of the air box backing plate.
6. Position the air filter assembly against the air box backing plate.
7. Reinstall the three screws. Torque to specification.

---

**TORQUE:** 5 ft-lbs (7 Nm)

---

8. Reinstall the external air box cover and screws. Torque to specification.

---

**TORQUE:** 7.4 ft-lbs (10 Nm)

---

## MAINTENANCE

---

### REAR DRIVE BELT CLEANING

Cleaning the drive belt will maximize belt and sprocket life and minimize drive line noise. Clean the belt at every tire change. Clean the belt more often if riding in dirty, dusty or high debris environments.

1. Mix a few drops of mild dish soap with a cup of warm water.
2. Use a soft nylon brush to clean the belt and sprocket teeth with the soapy water. Clean well in corner areas where road debris and belt dust can collect.
3. Rinse the belt with clear water, then dry thoroughly.

---

**TIP:** Do not inspect or adjust drive belt tension when the belt or drive system is wet or hot. Improper adjustment will result.

---



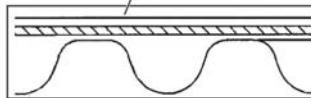

### REAR DRIVE BELT CONDITION

Inspect the rear drive belt at the intervals specified in the Periodic Maintenance Table on page 107. Replace the drive belt if it is cracked or has broken teeth or frayed edges. No matter its condition, the drive belt should be replaced at periodic intervals. See the *INDIAN MOTORCYCLE Service Manual* or an authorized INDIAN MOTORCYCLE dealer can assist.

DO NOT attempt to check belt tension if the belt has been exposed to rain or washing within a 24 hour period or if the vehicle has been run at operating temperature within the last four hours. Allow the vehicle to cool down to ambient temperature before measuring belt tension. Replace the drive belt and both sprockets as a set if the drive belt has over 5,000 miles (8,000 km) of service at the time of damage or failure.

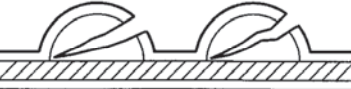

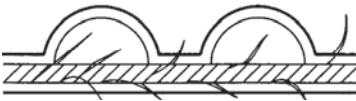
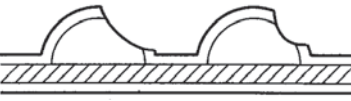
**REAR DRIVE BELT WEAR ANALYSIS**

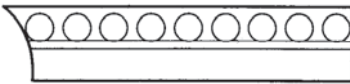
			
<p>Internal tooth cracks (hairline): OK to run, but monitor condition</p>	<p>External tooth cracks: Replace belt</p>	<p>Missing teeth: Replace belt</p>	<p>Chipping (not serious): OK to run, but monitor condition</p>
			
<p>Fuzzy edge cord: OK to run, but monitor condition</p>	<p>Hook wear: Replace belt</p>	<p>Stone damage: Replace belt if damage is on edge</p>	<p>Bevel wear (outboard edge only): OK to run, but monitor condition</p>

### REAR SHOCK PRELOAD (RIDE HEIGHT) INSPECTION

Periodically inspect rear shock preload. For the most comfortable ride and proper ground clearance, adjust preload if ride height is out of specification.

1. Verify that tire pressure is at specification. See page 136.
2. Secure the motorcycle in an upright position by clamping the front wheel in a wheel vise.
3. Remove the saddlebag (if equipped).
4. Apply a strip of tape ① to the rear fender directly over the center of the rear axle.

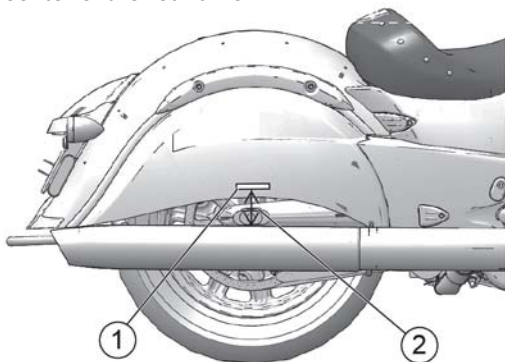

5. Using a suitable lift, raise the motorcycle until the rear shock is completely extended.
6. Measure the distance ② (*in millimeters*) from the center of the rear axle to the bottom of the tape. Record the results as measurement M1.
7. Lower the motorcycle and remove the lift.
8. Load the motorcycle with all intended cargo. Wearing your riding gear, bring the motorcycle to the upright position and sit on the operator's seat. If you plan to carry a passenger, have the passenger (with riding gear) sit on the passenger seat.
9. Have an assistant measure in the same location. Record the results as measurement M2.
10. Subtract measurement M2 from M1. The result is the measured rider sag. ( $M1-M2=Sag$ ). Adjust preload as needed.



RECOMMENDED SUSPENSION SAG		ADJUSTMENT PROCEDURE
CHIEF DARK HORSE	35mm	See page 120.
CHIEF CLASSIC	35mm	See page 120.
CHIEF VINTAGE	35mm	See page 121.
SPRINGFIELD	45mm	See page 121.
CHIEFTAIN DARK HORSE	45mm	See page 121.
CHIEFTAIN	45mm	See page 121.
ROADMASTER	45mm	See page 121.
ROADMASTER CLASSIC	45mm	See page 121.
ROADMASTER	45mm	See page 121.

### REAR SHOCK PRELOAD (RIDE HEIGHT) ADJUSTMENT

#### APPLIES TO: CHIEF MODELS

1. Park the motorcycle with the sidestand down on a firm, level surface. Remove all riders and cargo.
2. Remove the seat. See page 138.

---

**TIP:** Using the INDIAN MOTORCYCLE spanner wrench PV-46993 will make rear suspension adjustment significantly easier.

---

3. The upper spanner nut on the shock is the lock nut ①. The lower spanner nut is the adjuster nut ②. Loosen the lock nut by turning it counter-clockwise (as viewed from the top of shock) with the spanner wrench.
4. Spray a light lubricant on the adjuster nut where it contacts the spring.
5. Adjust shock preload by rotating the adjuster clockwise ③ (as viewed from the top of shock) to INCREASE preload (firm) or counter-clockwise ④ to DECREASE preload (softer).
6. Recheck the preload measurement after adjusting.
7. Tighten the lock nut securely against the adjuster nut.
8. Reinstall the seat.

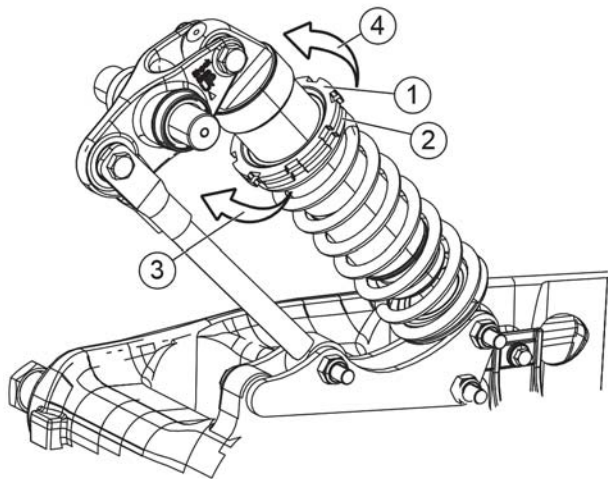

## SHOCK AIR PRESSURE (RIDE HEIGHT) ADJUSTMENT

### APPLIES TO: SPRINGFIELD/CHIEFTAIN MODELS/ROAD-MASTER CLASSIC/ROADMASTER

For riding comfort and to ensure proper ground clearance, adjust rear shock air pressure. Refer to the label located on the inside of the left side cover. The label shows recommended pressures based on potential load weights. Always inspect and adjust shock preload (ride height) based on your actual load weight, in addition to adjusting shock air pressure. See page 120.

Follow these guidelines when adjusting:

- Park the motorcycle with the sidestand down on a firm, level surface. Remove all riders and cargo.
- DO NOT exceed 150 PSI (1034 kPa) in the shock.
- Use the INDIAN MOTORCYCLE Air Pump and Gauge (P/N PV-48909). Follow the instructions on the following pages.

If the recommended air pump is not available, use a gauge and a pressurized air source with a maximum line and gauge pressure of 150 PSI (1034 kPa). After using the alternate gauge, remove it quickly to minimize leakage. Expect to lose up to 5 PSI (34 kPa) with each pressure check. *Use only a dry air source*, such as a system with a water separator or air line dryer, to prevent moisture from entering the shock.

**CAUTION!** Air pressure increases VERY quickly when using pressurized air. Wear eye and face protection.

AIR SUSPENSION ADJUSTMENT				
TOTAL CARGO & OCCUPANT WEIGHT (lbs)	AIR PRESSURE (psi)			MAX PRESSURE: 150 PSI
	NO TRUNK	LEATHER TRUNK	PAINTED TRUNK	
0	0	0	0	SELECT PRESSURE CORRESPONDING TO TOTAL CARGO AND OCCUPANT WEIGHT. REMOVE ALL PASSENGERS AND CARGO BEFORE SETTING/CHECKING SHOCK PRESSURE. SET PRESSURE WITH BIKE ON SIDE STAND.
150	0	0	0	
175	0	0	10	
200	0	10	23	
225	10	23	30	
250	23	30	38	
275	30	38	48	
300	38	48	60	
325	48	60	71	
350	60	71	85	
375	71	85	100	
400	85	100	122	
425	100	122	134	
450	122	134	145	
475	134	145	N/A	
500	145	N/A	N/A	
				7183758

### SHOCK AIR PRESSURE (RIDE HEIGHT) ADJUSTMENT

#### APPLIES TO: SPRINGFIELD/CHIEFTAIN MODELS/ROAD- MASTER CLASSIC/ROADMASTER

1. Park the motorcycle with the sidestand down on a firm, level surface. Remove all riders and cargo.
2. Remove the left side cover. Remove the cap from the air fitting ①.



3. Determine the recommended rear shock air pressure. Refer to the label located on the inside of the left side cover.
4. Install the hose fitting of the recommended gauge securely onto the air fitting. Read the air pressure on the gauge.
5. To *reduce* air pressure, push the bleed button on the gauge. Bleed pressure in small amounts until the desired pressure is attained.

6. To *increase* pressure, pump the handle until pressure increases to the desired amount.

---

**CAUTION!** DO NOT exceed 150 PSI (1034 kPa) in the shock.

---

7. Remove the hose from the air fitting and reinstall the cap.

---

**TIP:** Expect to lose up to 5 PSI (34 kPa) with each pressure check.

---

8. Repeat the preload inspection to verify proper preload. See page 118.

### SWING ARM/REAR AXLE INSPECTION

1. Sit in the operator's seat and slowly bounce the rear suspension a few times. Make sure the suspension moves freely without binding. Listen for abnormal noises.
2. Elevate and support the motorcycle with the rear tire slightly off the floor. See page 151.

---

**CAUTION!** Make sure the motorcycle is stable when elevated. Injury may occur if the motorcycle tips or falls.

---

3. Grasp the rear wheel and attempt to move the wheel side-to-side. If there is movement at the front of the swingarm or in the axle area, see your dealer for service.
4. With the transmission in neutral, slowly rotate the rear wheel. If the wheel does not rotate smoothly, see your dealer for service.

---

## FRONT FORK/SUSPENSION INSPECTION

1. Place the motorcycle on the sidestand and inspect the front forks. If fork oil is present on the outer tube, *do not ride the motorcycle*. See your dealer for service before operating. If fork oil is present around the fork seals ① or inner tubes ②, replace the fork seals.

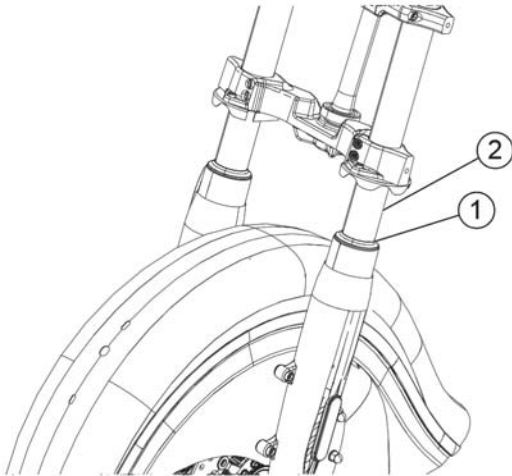

**General Representation**

2. Clean the fork tubes to remove bugs, tar or buildup which may cause seal wear or leakage. Inspect the outer surfaces of the inner fork tubes for scratches or damage from foreign objects.
3. Straddle the motorcycle and bring it to the fully upright position. Apply the front brake and push downward (hard) on the handlebars several times. The front suspension should operate smoothly and quietly.
4. Fork oil condition and level affects front suspension performance and internal component wear. Replace fork oil at the recommended intervals. Special tools are required to perform this procedure. See the *INDIAN MOTORCYCLE Service Manual* or an authorized INDIAN MOTORCYCLE dealer can assist.

### STEERING HEAD INSPECTION

1. Elevate and support the motorcycle with the front tire slightly off the floor. See page 151.

**CAUTION!** Make sure the motorcycle is stable when elevated. Injury may occur if the motorcycle tips or falls.

---

2. Turn the handlebars from stop to stop. The action should be smooth but not loose. Make sure wires, hoses and control cables do not interfere with smooth steering.
3. Position the front wheel straight ahead. Grasp the front forks near the front axle and attempt to move the wheel front-to-back. If there is front-to-back movement at the steering head, see your dealer for service.
4. If steering binds, feels rough or uneven, or if movement is detected at the steering stem, see your dealer for service.
5. Rotate the front wheel and inspect for smooth rotation of front wheel bearings. If roughness or unusual sounds are present, see your dealer for service.
6. Turn handle bars full right or left and hold against the fork stop. Attempt to move front wheel side-to-side. If movement is observed, see your dealer for service.

### CRANKCASE BREATHER HOSES

Inspect both breather hoses along their length and at both ends. Make sure hoses are not restricted, kinked, cracked or otherwise damaged. Replace any worn or damaged hoses.

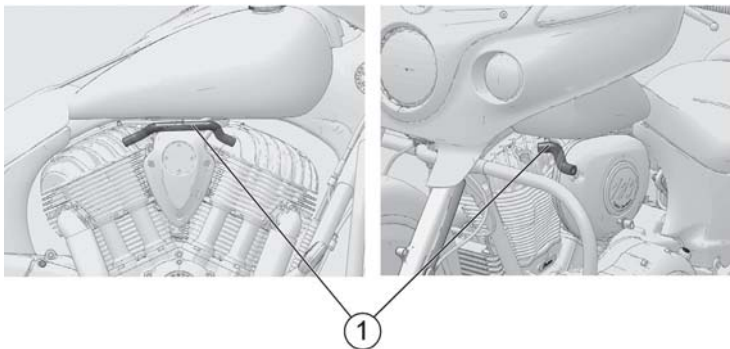

## EVAPORATIVE EMISSION CONTROL SYSTEM (CALIFORNIA AND INTERNATIONAL MODELS)

1. Inspect all evaporative emission control system hoses and connections. Make sure all connections are tight and locked.
2. The canister ① is located under the rear fender. Make sure it is securely fastened to the mounting bracket.
3. Inspect connections at the evaporative emissions canister to be sure they are secure. The vent line coming from the tank should be connected to the black port. The purge line should be connected to the gray or natural-colored port.

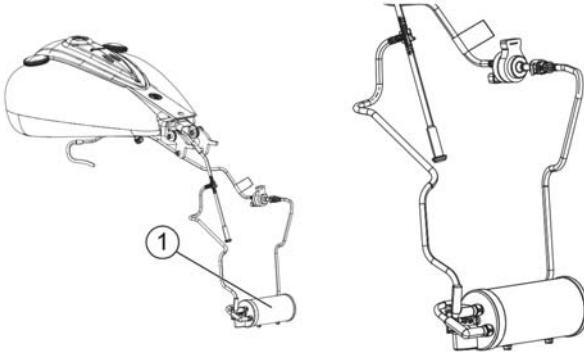

## FUEL SYSTEM COMPONENTS

1. Inspect fuel hoses for cracks or damage.
2. Inspect hose connections at the fuel tank ① and at the fuel rail for dampness or stains from leaks. The tank connection for the fuel line is under the tank console.
3. The fuel system is under pressure and caution must be used when inspecting and servicing the fuel system. See the *INDIAN MOTORCYCLE Service Manual* or an authorized INDIAN MOTORCYCLE dealer can assist.

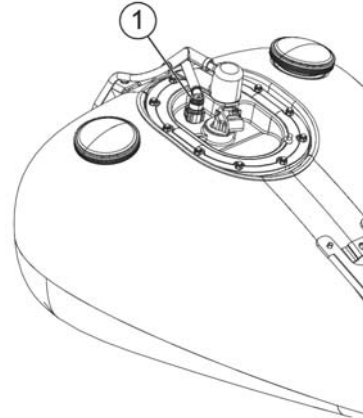

### THROTTLE CONTROL INSPECTION

1. With the engine OFF, rotate the throttle control grip fully open and then release it. It should rotate smoothly from the rest position to the completely open position. It should return to the rest position quickly when released.
2. Repeat the twist and release process with the handlebars turned fully *right* and fully *left*.
3. Service the throttle system if throttle operation is not smooth or if throttle grip does not return properly. See the *INDIAN MOTORCYCLE Service Manual* or an authorized *INDIAN MOTORCYCLE* dealer can assist.

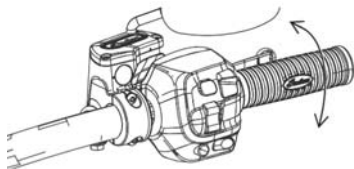

### SIDESTAND LUBRICATION

Periodically lubricate the sidestand bushing. See page 89 for sidestand inspections.

### MECHANICAL CLUTCH LEVER FREEPLAY

1. Position the handlebars in the straight-ahead position before measuring clutch lever freeplay.
2. The clutch cable adjuster nut is located alongside the left down-tube. Hold the clutch cable. Slide the rubber protective cover away from the lock nut. Loosen the lock nut.
3. Turn the cable adjuster inward or outward until clutch lever freeplay is 0.5-1.5 mm.

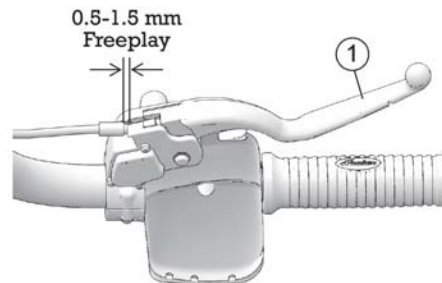

4. While holding the cable, tighten the adjuster lock nut securely.
5. Verify that the safety switch activates properly. The engine should not start in gear with the clutch lever ① released.

---

**TIP:** The starter interlock switch is dependent on the clutch lever freeplay being set correctly to ensure activation of the clutch safety switch.

---



## MECHANICAL CLUTCH LEVER LUBRICATION

1. The clutch cable adjuster nut is located alongside the left down-tube. Slide the rubber protective cover away from the adjuster. Loosen the lock nut.
2. Turn the cable adjuster completely inward to provide maximum lever freeplay.
3. Remove the clutch lever c-clip ① and pin ②. Disconnect the clutch cable ③ from the clutch lever.

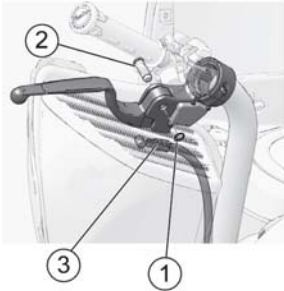

4. Remove any old grease and dirt from the lever and housing. Lubricate the clutch lever and pin with moly assembly grease or all-purpose grease.

**NOTICE:** During installation of the lever, be aware of the internal clutch switch. Improper assembly can cause damage to the switch.

5. Reconnect the clutch cable. Reinstall the lever C-clip and pin.
6. Adjust clutch lever freeplay. See page 126.

7. Tighten the adjuster nut and slide the protective cover over the adjuster.

## MECHANICAL CLUTCH CABLE LUBRICATION

Lubricate control cable ends at the intervals recommended in the Periodic Maintenance Table beginning on page 107.

**NOTICE:** External casings are factory-lubricated. Additional lubrication could be detrimental to cable performance.

Verify proper routing and smooth movement. Inspect for damage to the external casing, and inspect exposed cable wire for fraying, kinks or corrosion. Replace any damaged, sticky or sluggish cable.

1. Disconnect the cable at the clutch lever and at the primary cover.
2. Lubricate the barrel ends with all-purpose grease.
3. Reconnect the cable and adjust freeplay as needed.

### REAR BRAKE PEDAL

1. Lubricate the pivot bushing at the intervals recommended in the Periodic Maintenance Table beginning on page 107. Also lubricate any time binding is evident. Use all-purpose grease.
2. Inspect brake pads as outlined on page 132.

### BRAKE HOSES/CONNECTIONS

Inspect all brake hoses and connections for dampness or stains from leaking or dried fluid. Tighten any leaking connections and replace components as necessary. See the *INDIAN MOTORCYCLE Service Manual* or an authorized INDIAN MOTORCYCLE dealer can assist.

### BRAKE FLUID PRECAUTIONS

---

#### **WARNING!**

Using the wrong fluid or allowing air or contaminants into the fluid system can damage the system seals or result in a malfunction that could lead to serious injury or death. Use only DOT 4 brake fluid from a sealed container.

Do not operate the front brake with the reservoir cover removed. Fluid could overflow from the reservoir and allow air to enter the system. Air in the brake system could cause the brakes to malfunction.

An over-full reservoir may cause brake drag or brake lock-up, which could result in serious injury or death. Maintain brake fluid at the recommended level. Do not overfill.

---

**NOTICE:** Brake fluid will damage painted surfaces and plastic parts. Always clean spilled brake fluid immediately with water and a mild detergent.

---

## REAR BRAKE FLUID

Change the brake fluid at the intervals recommended in the page 107. Always add brake fluid from a new, unopened container. Always use the recommended fluid. See page 171.

1. Position the motorcycle on level ground in the fully upright position.
2. The rear brake fluid reservoir is located near the rear brake pedal. View the reservoir from the right side of the vehicle.
3. Wipe the fluid container and the area around the reservoir cover with a clean cloth.
4. If the fluid level is low, inspect brake pads as outlined in page 132. If pads are not worn beyond the service limit, inspect the brake system for leaks.

5. Remove the cover and diaphragm. The fluid level should be above the minimum indicator mark ② on the reservoir body ①. Add brake fluid as needed. *Do not overfill.*

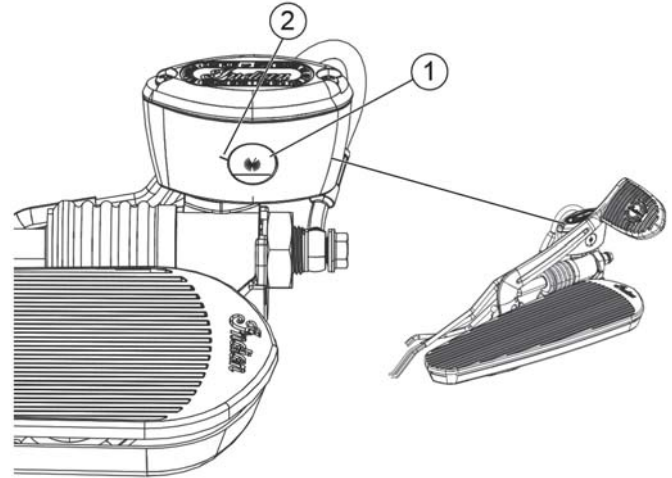

6. Reinstall the cover and diaphragm.
7. Wipe away any fluid spills. Check for signs of brake fluid leaks around hoses, fittings, reservoir, and brake calipers.

### FRONT BRAKE LEVER

1. See page 78 for front brake lever reach adjustments.
2. Lubricate the pivot pin ① and brake lever hinge points at the intervals recommended in the Periodic Maintenance Table beginning on page 107. Also lubricate any time binding is evident. Use all-purpose grease.
3. Inspect brake pads as outlined in page 132.

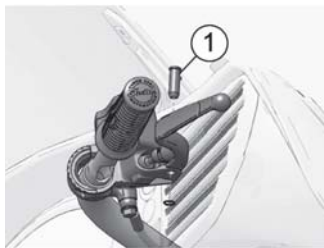

### FRONT BRAKE FLUID

Change the brake fluid at the intervals recommended in the Periodic Maintenance Table beginning on page 107. Do not attempt to change the anti-lock brake system fluid. Please see your dealer for this service. Always add brake fluid from a new, unopened container. Always use the recommended fluid. See page 171.

1. Position the motorcycle on level ground in the fully upright position. Position the handlebars so that the fluid reservoir is level. Wipe the fluid container and the area around the reservoir cover with a clean cloth.

2. If the fluid level is low, inspect brake pads as outlined in page 132. If pads are not worn beyond the service limit, inspect the brake system for leaks.
3. To add fluid, remove the reservoir cover screws. Remove the cover and diaphragm.
4. The fluid level should be above the minimum indicator mark ① in the sight glass ②. Add brake fluid as needed. *Do not overfill.*

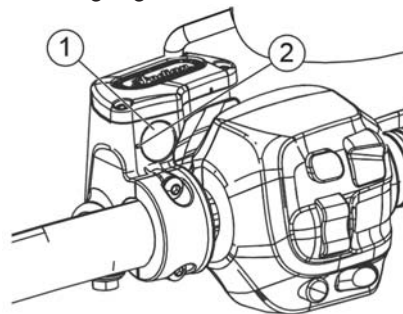

5. Reinstall the diaphragm, cover and screws.

---

**TORQUE:** 13 in-lbs (1.4 Nm)

---

6. Wipe away any fluid spills. Check for signs of brake fluid leaks around hoses, fittings, reservoir and brake calipers. Check for deterioration of hoses.

## BRAKE DISC INSPECTION/CLEANING

1. Inspect brake discs for nicks, scratches, cracks or other damage ①. Inspect the thickness of each brake disc at four or more locations around the disc. If any disc is worn to the minimum thickness at the thinnest point, or if a disc is damaged, see your dealer for replacement.

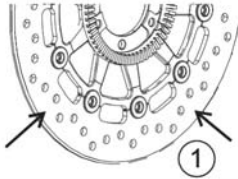

2. Clean discs if minor squeaks develop due to dirt or dust. Apply brake cleaner to a clean shop towel and wipe the discs. DO NOT allow brake cleaner to contact painted or plastic parts. Read all precautions on the label.



### **Minimum Thickness**

Front: 4.5mm; Rear 6.5mm

## MAINTENANCE

---

### BRAKE PADS

Inspect each front brake pad on both sides of the front disc. Inspect each rear brake pad on both sides of the rear disc. Replace brake pads when the thinnest point of the friction material ① has worn to 1.0 mm. Please see your dealer for this service.

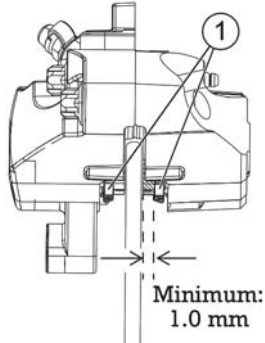

---

**TIP:** After replacing pads, allow up to 250 miles (500 km) of operation in urban driving conditions (not highway cruising) to allow pads to mate with new rotors. Brakes should be used frequently. During this time brake performance will be less effective. Avoid using brakes harshly unless in an emergency. Brake efficiency will gradually increase during this seating period.

---

When checking brake pad friction material thickness, check each brake caliper for dampness or stains from leaking or dried brake fluid. If inspection reveals signs of fluid leakage, do not operate the vehicle. See your dealer for service.

---

### FRONT BRAKE PAD INSPECTION

1. Remove the two acorn nuts ① and one screw securing the protective caliper covers. Remove the covers.

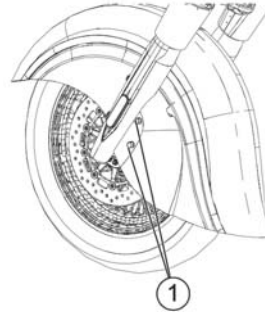

2. Use an inspection mirror, positioned at the front side of the caliper, to view the friction material.
3. Reinstall the caliper covers.

---

**TORQUE:** 18 ft-lbs (24 Nm)

---

### REAR BRAKE PAD INSPECTION

1. Position the motorcycle on the sidestand with the handlebars turned to the left.
2. Use an inspection mirror, positioned at the front side of the caliper, to view the friction material.

## ANTI-LOCK BRAKE SYSTEM (ABS) TONE RING/SENSOR INSPECTION

1. Visually inspect for damaged teeth ① on the front and rear ABS tone rings. Inspect for nicks and dents on the face of the teeth. The teeth edges should be consistent in appearance. If a tone ring is damaged, see your dealer for replacement as soon as possible.
2. Inspect for debris adhering to the end of the wheel speed sensors ②. If contamination is observed, or if you are unable to visually inspect, slide a thin towel across the face of the sensor between the sensor and the tone ring to remove any potential debris.

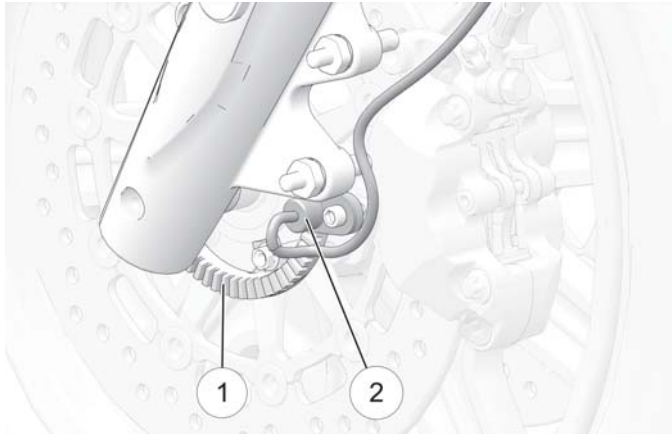

## WHEEL SPOKES (IF EQUIPPED)

Inspect both wheels for loose, bent, broken or missing spokes (if equipped). To identify loose spokes, grasp each spoke and try to move it side to side or up and down. All spokes should be equally tight and have the same amount of flex. Tighten loose spokes and replace bent, broken or missing spokes (see an authorized dealer).

---

**WARNING!** Spokes adjusted or replaced improperly could distort the wheel, make the motorcycle difficult to handle, and cause loss of control.

---

## WHEEL INSPECTION

Inspect both wheels for cracks or damage and replace damaged wheels promptly. Do not operate the motorcycle if wheels are damaged or cracked. See the *INDIAN MOTORCYCLE Service Manual* or an authorized INDIAN MOTORCYCLE dealer can assist.

## WHEEL ALIGNMENT

Inspect rear wheel alignment at regular service intervals, whenever the rear wheel is removed and when the rear drive belt is adjusted. Please see your dealer for this service.

## MAINTENANCE

---

### FRONT WHEEL INSTALLATION

If the front wheel is removed for any reason, it must be reinstalled in the correct rotating direction.

Clean all wheel components before installation. Apply a light coat of all-purpose grease to the axle and both spacers.

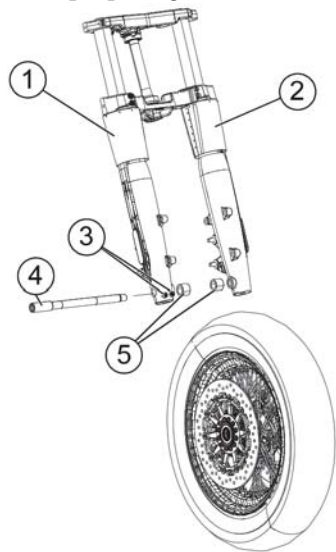

① Right Fork Tube

④ Axle Bolt 52 ft-lbs. (70 Nm)

② Left Fork Tube

⑤ Wheel Spacers 0.925 in. (23.5 mm)

③ Pinch Bolt 18–19 ft-lbs. (24.4–25.7 Nm)



---

## TIRES

---

**WARNING!** Operating the motorcycle with incorrect tires, incorrect tire pressure or excessively worn tires could cause loss of control or accident. Underinflation can cause a tire to overheat and result in a tire failure. Always use the correct size and type of tires specified by INDIAN MOTORCYCLE for your vehicle. Always maintain proper tire pressure as recommended in the rider's manual and on safety labels.

---

## TIRE REPLACEMENT

---

**NOTICE:** On models equipped with a TPMS, the sensors are located 180° from the valve stem. Use caution when servicing tires. To avoid damaging a sensor, break the bead at the valve stem, then at 90° and 270° from the valve stem as required.

---

Tires, rims, innertubes and air valves must be correctly matched to wheel rims. Use only the proper size tires specified with the same or higher load ratings. INDIAN MOTORCYCLE-recommended tires provide proper clearance between fenders, swingarm, drive belts and other components. See the Specifications section beginning on Specifications.

On models equipped with innertubes, innertubes **MUST** be replaced with new innertubes when tires are replaced. Use only the proper size innertubes.

---

**WARNING!** Mismatched tires, rims and air valves may result in damage to the tire bead during mounting or may allow the tire to slip off the rim, possibly resulting in tire failure.

---

## TIRE CONDITION

Inspect the tire sidewalls, road contact surface, and tread base for cuts, punctures, and cracking. Replace damaged tires immediately. See the *INDIAN MOTORCYCLE Service Manual* or an authorized INDIAN MOTORCYCLE dealer can assist.

## TIRE TREAD DEPTH

Replace any tire with a tread depth of less than 1/16 inch (1.6 mm).

Tread wear indicators are located in at least six places on the tread circumference and become visible at a tread depth of approximately 1/16 inch (1.6 mm). The tread wear indicators appear as a solid band across the tread.

You may also use a depth gauge or an accurate ruler to measure the depth of the center tire tread on both front and rear tires.

## MAINTENANCE

### TIRE PRESSURE

Always check and adjust tire pressure when tires are cold. Do not adjust tire pressure immediately after riding. Wait at least 3 hours after riding to check pressure. If pressure checked and adjusted while tires are warm, the pressure will drop as tires cool and result in under inflation. Adjust tire pressure as recommended for the total weight of your intended load (see chart below). For more information, refer to the manufacturing information label located on the front frame down tube. See page 22.

**WARNING!** Do not exceed the maximum recommended inflation pressure to seat the bead. Tire or rim failure may result.

LOCATION	SIZE	BRAND	TYPE	RECOMMENDED PRESSURE	
				LOADS UP TO 200 LBS. (91 KG)	LOADS UP TO VEHICLE'S MAXIMUM LOAD CAPACITY
<b>Black Tires - CHIEFTAIN DARK HORSE/CHIEFTAIN/ROADMASTER CLASSIC/ROADMASTER</b>					
Front	130/90-B16 73H	Dunlop	Elite 3	36 psi (248 kPa)	36 psi (248 kPa)
Rear	180/60-R16 80H	Dunlop	Elite 3	41 psi (283 kPa)	41 psi (283 kPa)
<b>White Wall Tires - CHIEF VINTAGE</b>					
Front	130/90-B16 67H	Dunlop	American Elite	36 psi (248 kPa)	36 psi (248 kPa)
Rear	180/65-B16 81H	Dunlop	American Elite	40 psi (276 kPa)	40 psi (276 kPa)
<b>Black Tires - SPRINGFIELD</b>					
Front	130/90-B16 73H	Dunlop	Elite 3	46 psi (317 kPa)	46 psi (317 kPa)
Rear	180/60-R16 80H	Dunlop	Elite 3	41 psi (283 kPa)	41 psi (283 kPa)
<b>Black Tires - CHIEF CLASSIC/CHIEF DARK HORSE</b>					
Front	130/90-B16 73H	Dunlop	Elite 3	36 psi (248 kPa)	36 psi (248 kPa)
Rear	180/65-B16 81H	Dunlop	American Elite	40 psi (276 kPa)	40 psi (276 kPa)
<b>Black Tires - CHIEFTAIN LIMITED/CHIEFTAIN ELITE</b>					
Front: 19" x 3.5" Cast Aluminum	130/60 - B19 61H	Dunlop	American Elite	36 psi (248 kPa)	36 psi (248 kPa)
Rear: 16" x 5" Cast Aluminum	180/60 - R16 80H	Dunlop	Elite 3	40 psi (276 kPa)	40 psi (276 kPa)

## SPARK PLUGS

Inspect spark plugs ① after the break-in period and every 15,000 miles (24,000 km) thereafter. Replace spark plugs every 30,000 miles (48,000 km). Always replace spark plugs in pairs.

SPARK PLUG SPECIFICATIONS	
Spark Plug Type	NGK DCPR8E
Spark Plug Gap	.036 inch (.9 mm)
Spark Plug Torque	12 ft-lbs (16.3 Nm)

1. Make sure the engine has cooled to room temperature.
2. Turn the power switch off.
3. Pull upward on the spark plug boots (not the wires) to remove the boots.

**CAUTION!** Wear eye and face protection when using pressurized air.

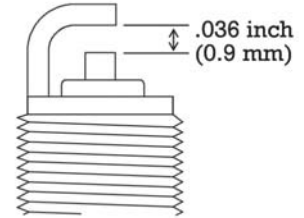
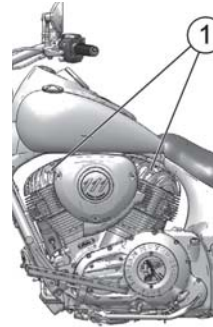

4. To prevent debris from entering the spark plug holes, use compressed air to clean the area around the plugs before removing them.

**Tool:** 12 mm plug socket

5. Reinstall the spark plugs or install new plugs.
6. Reinstall the spark plug boots.

### SIDE COVERS

Remove the left side cover to access the tool kit, shock air fitting (if equipped), fuse box and diagnostic connector.

Remove both side covers to access the seat mounting fasteners and the electrical connections for the saddlebags (if equipped).

1. Pull outward at each corner of the side cover to disengage the three darts.
2. Remove the side cover from the motorcycle.
3. To reinstall the side cover, make sure each rubber grommet is properly positioned. Align each dart with the appropriate grommet and press inward firmly to secure each dart.

### SEAT REMOVAL

Remove the seat to access the battery.

1. Remove the left side cover to access the tool kit.
2. Locate the seat mount brackets under the edge of the driver's seat. Remove the seat mount bolt ① from each side of the seat.
3. Remove the rear bracket bolt ②, washer and nylon grommet from the passenger portion of the seat (if equipped).
4. Lift the rear of the seat and pull rearward to disengage the front mounting tab of the seat from the frame mount. Do not allow the seat mount brackets to contact the rear fender.

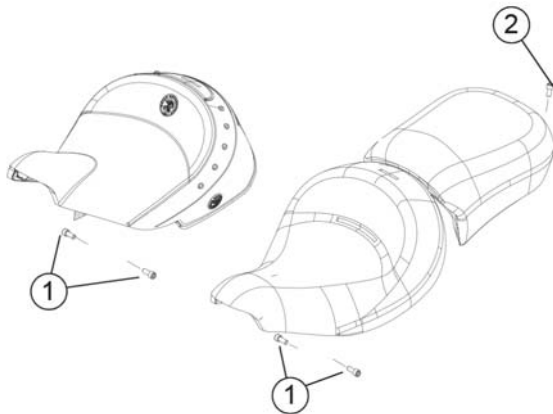

## SEAT INSTALLATION

1. Position the seat by inserting the seat mounting tab from rear to front into the mount on the top of the frame.
2. Rotate the rear of the seat downward and position the side mount seat brackets onto the frame. Do not allow the seat mount brackets to contact the rear fender.
3. On each side, thread the seat mount bolt through the seat mount bracket and into the frame. Torque seat bolts to specification.

---

**TORQUE:** 18 ft-lbs (13.5 Nm)

---

4. Secure the passenger seat (if equipped). Gently raise the rear bracket and reinstall the nylon grommet. Thread the rear bracket bolt and washer through the bracket and nylon grommet. Torque the bolt to specification.

---

**TORQUE:** 96 in-lbs (10.8 Nm)

---

## SEAT REMOVAL (ROADMASTER CLASSIC/ ROADMASTER)

1. Remove the left side cover to access the tool kit.
2. Remove the trunk.
3. Disconnect the trunk harness from the main harness.
4. Locate the seat mount brackets under the edge of the driver's seat. Remove the seat mount bolt ① from each side of the seat.
5. Remove the rear bracket bolt ②, washer and nylon grommet from the passenger portion of the seat.
6. Lift the rear of the seat and unplug the seat heater.
7. Pull the seat rearward to disengage the front mounting tab of the seat from the frame mount. Do not allow the seat mount brackets to contact the rear fender.



### SEAT INSTALLATION (ROADMASTER CLASSIC/ROADMASTER)

1. Position the seat by inserting the seat mounting tab from rear to front into the mount on the top of the frame.
2. Reconnect the seat heater.
3. Rotate the rear of the seat downward and position the side mount seat brackets onto the frame. Do not allow the seat mount brackets to contact the rear fender.
4. On each side, thread the seat mount bolt through the seat mount bracket and into the frame. Torque seat bolts to specification.

**TORQUE:** 18 ft-lbs (13.5 Nm)

5. Gently raise the rear bracket and reinstall the nylon grommet. Thread the rear bracket bolt and washer through the bracket and nylon grommet. Torque the bolt to specification.

**TORQUE:** 96 in-lbs (10.8 Nm)

6. Reconnect the trunk harness to the main harness.
7. Reinstall the trunk.

### HEADLIGHT AIM INSPECTION CHIEF MODELS/SPRINGFIELD/CHIEFTAIN MODELS:

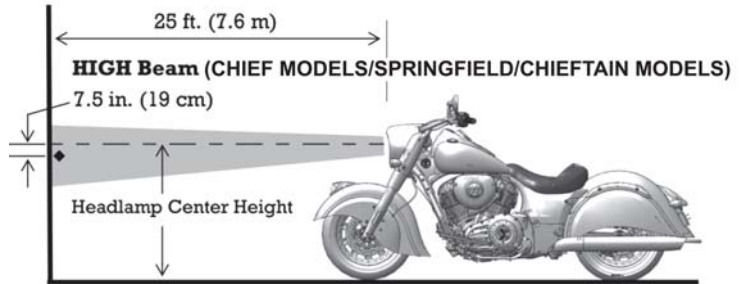

On HIGH beam, the center of highest intensity (appearing as a diamond shape) should be 7.5 in. (19 cm) lower than the headlamp and centered straight ahead at 25 feet (7.6 m).

### ROADMASTER CLASSIC/ ROADMASTER:

On LOW beam, the top of the low beam cut-off (appearing as a diamond shape) should be 3 in. (7.6 cm) lower than the headlamp center height at 25 feet (7.6 m).

1. Verify that tire pressure is at specification. See page 136.
2. Verify that rear suspension ride height (preload) is at specification. See page 118.
3. Position the motorcycle on a level surface with the headlight 25 feet (7.6 m) from a wall.
4. With the operator and passenger (if applicable) on board, bring the motorcycle to the fully upright position.

5. Start the engine and switch the headlamp to high beam. Observe the headlight aim on the wall.
6. Make any necessary adjustments to headlight aim. See page 141.

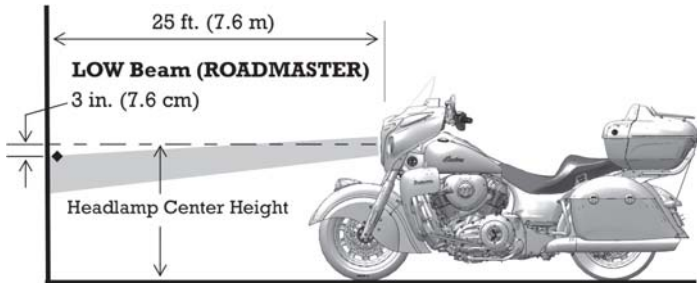

## HEADLIGHT AIM ADJUSTMENT

The headlamp adjustment screws ① are located inside the headlamp housing.

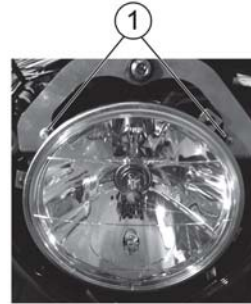

1. Remove the two headlight bezel screws (*CHIEFTAIN DARK HORSE only*) and remove the bezel from the fairing. Reinstall the bezel after adjusting the headlamp.

**Tool:** M4 hex wrench or universal tool

2. To adjust the headlamp vertically, tighten both top adjustment screws equally to adjust the beam downward. Loosen both screws equally to adjust the beam upward.

**Tool:** M4 hex wrench or universal tool

3. To adjust the headlamp horizontally, loosen the left side screw to adjust the beam to the left. Loosen the right side screw to adjust the beam to the right.

## MAINTENANCE

### HEADLIGHT LAMP REPLACEMENT

**NOTE:** For vehicles equipped with LED headlights, the headlight is not serviceable. If the headlight becomes damaged or inoperable, the entire headlight assembly must be replaced. See your authorized INDIAN MOTORCYCLE dealer.

#### APPLIES TO: CHIEF MODELS/SPRINGFIELD

1. Remove the six bolts securing the front nacelle headlight shroud. Pull this piece forward to access the headlight.
2. Remove the sealing boot. Press the looped end of the wire bulb retainer clip and swing the end toward the center of the bulb to release it from the latch tab.
3. With the wire connector attached, pull the bulb out. Disconnect the wire harness.
4. Install the new bulb and secure the retainer.

**TIP:** Avoid touching a halogen lamp with bare fingers. Oil from your skin leaves a residue, causing a hot spot that will shorten the life of the lamp. If a lamp is touched, clean it thoroughly with denatured alcohol.

5. Reinstall the sealing boot. Make sure it seals tightly around the bulb base and lens to prevent condensation.
6. Reinstall the front nacelle headlight shroud.
7. Tighten the two (2) top bolts.

**TORQUE:** 36 in-lbs (4 Nm)

8. Tighten the four (4) rear bolts.

**TORQUE:** 84 in-lbs (9.5 Nm)

### HEADLIGHT LAMP REPLACEMENT (CHIEF-TAIN MODELS)

1. Remove the two bolts securing the front trim bezel to the fairing. Pull this piece forward to access the headlight.
2. Remove the four screws ① securing the headlamp retaining ring ②. Remove the retaining ring.

**Tool:** Phillips screwdriver or universal tool

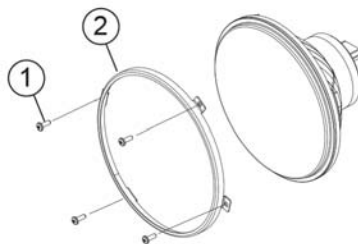

3. Remove the headlight assembly from the headlight carrier.
4. Remove the sealing boot. Press the looped end of the wire bulb retainer clip and swing the end toward the center of the bulb to release it from the latch tab.
5. With the wire connector attached, pull the bulb out. Disconnect the wire harness.



- 
6. Install the new bulb and secure the retainer.

**TIP:** Avoid touching a halogen lamp with bare fingers. Oil from your skin leaves a residue, causing a hot spot that will shorten the life of the lamp. If a lamp is touched, clean it thoroughly with denatured alcohol.

---

7. Reinstall the sealing boot. Make sure it seals tightly around the bulb base and lens to prevent condensation.
8. Reinstall the headlight assembly into the carrier, being sure to index the assembly properly.
9. Reinstall the retaining ring with the four screws.

---

**TORQUE:** 12 in-lbs (1.4 Nm)

---

10. Reinstall the front trim bezel and bolts.

---

**TORQUE:** 36 in-lbs (4 Nm)

---

## HEADLIGHT LAMP REPLACEMENT (ROAD-MASTER CLASSIC/ROADMASTER)

The LED headlight is not serviceable. If the headlight becomes damaged or inoperable, the entire headlight assembly must be replaced. See your authorized INDIAN MOTORCYCLE dealer.

## TAILLIGHT/BRAKE LIGHT REPLACEMENT

The LED taillight and brake lights are not serviceable. If the taillight or a brake light becomes damaged or inoperable, the entire light assembly must be replaced. See your authorized INDIAN MOTORCYCLE dealer or other authorized dealer.

## MAINTENANCE

---

### BATTERY

The motorcycle battery is a sealed, maintenance-free battery. Do not remove the battery cap strip for any reason. Keep the battery connections clean and tight at all times.

---

#### **WARNING!**

Battery electrolyte is poisonous. It contains sulfuric acid. Serious burns can result from contact with skin, eyes or clothing.

#### **Antidote:**

**External:** Flush with water.

**Internal:** Drink large quantities of water or milk. Follow with milk of magnesia, beaten egg, or vegetable oil. Call physician immediately.

**Eyes:** Flush with water for 15 minutes and get prompt medical attention.

Batteries may produce explosive gases.

---

- Keep sparks, flame, cigarettes, etc. away.
- Ventilate when charging or using in an enclosed space.
- Always shield eyes when working near batteries.
- **KEEP OUT OF REACH OF CHILDREN.**

### KEY FOB BATTERY LIFE:

Key fob battery life is approximately 1-2 years depending on fob type and usage patterns. Battery changes recommended yearly. Multi-Function (Two Button) Key Fob battery life will decrease with frequent use of the LOCK / UNLOCK buttons.

Low Battery Indicators:

- Decreased fob authentication range
- Horn honks 5 seconds after startup
- Security light stays illuminated for up to 20 seconds
- Both Battery Light and Security Light are illuminated

Key Fob performance can be affected by the following conditions:

- Close proximity of ferrous materials (e.g. money clip or pocket knife)
- Key Fob stuck to saddlebag speaker magnet
- Key Fob held in ferrous container (metal cup holder or glasses case)
- Cold temperatures (Key Fob should be kept above 45°F / 7°C)

Key Fob Replacement Battery Part Number: 4014675 or CR2032

---

## BATTERY REMOVAL

1. Remove the seat. See page 138

---

**WARNING!** Improperly connecting or disconnecting battery cables can result in an explosion and cause serious injury or death. When removing the battery, always disconnect the negative (black) cable first. When reinstalling the battery, always connect the negative (black) cable last.

---

2. Remove the negative (-) battery cable ① from the battery terminal. Position the cable well clear of the terminal.

**Tool:** 10 mm wrench

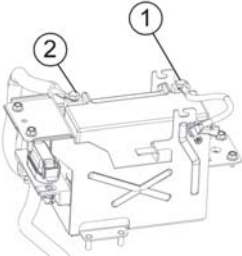

3. Remove the fastener securing the battery cover to the frame crossmember.

4. Lift the cover, with the attached electronic module in place, folding the wires toward the fuel tank.

**Tool:** 5 mm hex key wrench

---

**NOTICE:** Do not allow the Electronic Control Unit (ECU) to touch the battery terminals or it will damage the ECU instantly.

---

5. Remove the rubber cover from the positive (+) battery cable ② and remove the cable from the terminal. Position the cable well clear of the terminal.
6. Remove the battery.

---

**WARNING!** If the VCM touches the positive battery post or wire the VCM can short out.

---

## MAINTENANCE

---

### BATTERY INSTALLATION

---

**WARNING!** Improperly connecting or disconnecting battery cables can result in an explosion and cause serious injury or death. When removing the battery, always disconnect the negative (black) cable first. When reinstalling the battery, always connect the negative (black) cable last.

---

**NOTICE:** Do not remove the battery cables while the engine is running. Doing so may damage the Electronic Control Unit (ECU). Take great care not to reverse the battery leads when installing the battery. Reverse power applied to the ECU will damage it instantly.

---

1. Inspect the battery box and cover for damage. Be sure pads are in good condition and properly located.
2. Make sure cable ends and battery terminals are clean. Apply a light film of dielectric grease to the terminal bolt threads.
3. Carefully position the battery into the battery box with the negative (-) terminal toward the front of the motorcycle.

4. Make sure the positive (+) cable ① is routed horizontally and perpendicular to the long side of the battery. Connect the positive (+) cable to the positive (+) battery terminal.
- 

**TORQUE:** 45 in-lbs (5 Nm)

---

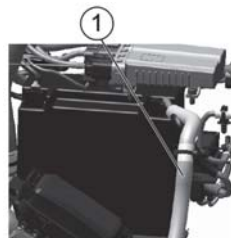

5. Install the negative (-) cable last. Route the starter ground cable beneath the frame ground cable on the negative battery terminal.
- 

**TORQUE:** 45 in-lbs (5 Nm)

---

6. Reinstall the battery cover and fastener.
- 

**TORQUE:** 84 in-lbs (9.5 Nm)

---

7. Reinstall the seat. See page 139.

---

## BATTERY CHARGING

If your motorcycle will not be used for a period of four (4) weeks or longer, a maintenance charger should be connected to the battery. A maintenance charger can be purchased through your authorized INDIAN MOTORCYCLE dealer.

1. Following the charger manufacturer's instructions, use a battery charger designed for use with 12-volt batteries. The charger should have a maximum charging rate of 1.8 amps. Charge the battery for approximately 10 hours at a rate of 1.8 amps. If you use a taper or trickle charger, it will take longer to charge the battery.
2. After charging the battery, allow the battery to sit 1-2 hours before checking the state of charge with a DC volt meter. The charge should be a minimum of 12.5 DC volts. Repeat the charging cycle if the charge is less than 12.5 DC volts. Replace the battery if it fails to reach 12.5 volts after the second charge.



### FUSE REPLACEMENT

---

**NOTICE:** Use fuses with the recommended amperage to avoid damage to the electrical system.

---

#### STANDARD FUSES

The standard fuse box is located under the left side cover. This fuse box houses all standard service fuses and the automatic circuit breakers. Fuse application and size are provided on a label on the fuse box cover.

---

**TIP:** Use the fuse puller provided in the tool kit to remove a fuse.

---

1. Remove the left side cover. See page 138.
2. Release the locking tabs, then squeeze the upper and lower cover clips ① to remove the fuse box cover.
3. After replacing a fuse, reinstall the fuse box cover and side cover.

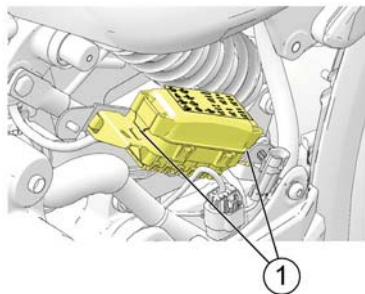

#### HIGH-CURRENT FUSES

The JCASE® fuse box ① contains the high-current fuses for the chassis, vehicle control module and anti-lock brake system. This fuse box is located next to the battery box.

Fuse application and size are provided on a label on the fuse box cover.

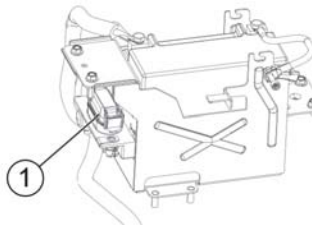

## ELECTRICAL PRECAUTIONS

Be aware of the following precautions regarding the electrical system to avoid disruption of electrical signals and possible system malfunction.

- DO use **ONLY** genuine INDIAN MOTORCYCLE parts and accessories designed for your model, and follow the instructions provided.
- DO use the accessory power jack provided (if equipped).
- If it is necessary to provide power to an item that does not use one of the previously mentioned power jacks, connect to the load side of the main circuit breaker and connect the ground wire to the engine ground at the front left side of the crankcase (near the circuit breaker). On DARK HORSE models the circuit breaker is located under the cover next to the oil filter adapter. On all other models it's located under the cover behind the oil cooler.
- DO NOT splice or cut any wires.
- DO NOT tap in to any power or ground on the motorcycle unless specifically directed to do so by the INDIAN MOTORCYCLE instructions that come with the kit.
- DO NOT back-probe electrical connectors on the vehicle unless directed to do so by the *INDIAN MOTORCYCLE Service Manual*.
- DO NOT power any accessories from the diagnostic connector (under left side cover).

## UNLOCKING THE SECURITY SYSTEM

Your dealer will provide the master personal identification number (PIN) for the security system. Your dealer may also change the master PIN to a new rider PIN on your behalf.

Record both PINs on page 7.

Change the dealer-provided PIN to a PIN of your own choosing as soon as possible after receiving delivery of your new motorcycle. See page 150.

If a key fob is not available, your rider PIN can be entered using the turn signal switches to unlock the security system. Use the following guide to enter your valid rider PIN.

DIGIT TO ENTER	TURN SIGNAL FEATURE USED	PROCEDURE
The number "0"	CANCEL switch	Press and release
First digit (1-9)	LEFT turn switch	Move and release once per digit value. See example below.
Second digit (1-9)	RIGHT turn switch	
Third digit (1-9)	LEFT turn switch	
Fourth digit (1-9)	RIGHT turn switch	
<b>Example for entering the number 1024:</b> LEFT - CANCEL - LEFT - LEFT - RIGHT - RIGHT - RIGHT - RIGHT		

## MAINTENANCE

---

### CHANGING YOUR SECURITY SYSTEM PIN

To change your PIN, you must have either the key fob or your existing valid PIN available to gain access to the security system. If the key fob is not detected or is not available and you cannot remember your PIN, please see your INDIAN MOTORCYCLE dealer.

Please read the entire procedure before beginning.

1. Turn the power switch on. Do NOT start the engine. The security light and/or power switch will turn on briefly until the key fob is detected or until the valid, current PIN is entered.
2. Push or hold the turn signal CANCEL switch for 10 seconds until the security light and/or power switch turn on.

---

**NOTE:** On models with Infotainment Display, a pop-up window will appear during this procedure stating that the key fob is out of range.

---

3. Enter either the master PIN (see page 7) or your current 4-digit rider PIN within 20 seconds. If the PIN is successfully entered, the security light and/or power switch will remain on and the horn will sound briefly.

---

**TIP:** If the valid PIN is not entered within 20 seconds, the security light and/or power switch will flash for 10 seconds, then the system will shut down. Return to step 1 to try again.

---

#### Entering Your New Rider PIN

4. Enter a new 4-digit security PIN of your own choosing. If the PIN is successfully entered, the security light and/or power switch will remain on and the horn will sound briefly. Proceed to step 5.

---

**TIP:** If the 4-digit PIN is NOT successfully entered within 20 seconds, the security light and/or power switch will flash for 10 seconds, then the system exits the procedure. Return to step 1 to try again.

---

5. Re-enter the new 4-digit PIN. If this entry matches the first entry, the security light and/or power switch will turn off and the horn will sound briefly. The new rider PIN has been saved. *Record your new rider PIN on page 7.*

---

**TIP:** If the second entry is not entered within 20 seconds or does not match the first entry, the security light and/or power switch will flash for 10 seconds, then the system exits the procedure. The new PIN was NOT saved. Continue to use your former valid PIN. Return to step 1 to try again.

---



---

## ENGINE COMPRESSION TEST

An engine compression test can be performed to monitor general engine condition. See the *INDIAN MOTORCYCLE Service Manual* or an authorized INDIAN MOTORCYCLE dealer can assist.

## EXHAUST SYSTEM INSPECTION

Check the exhaust system for stains from leaking exhaust gasses. Replace damaged or leaking exhaust gaskets. Check all exhaust system fasteners. Tighten loose clamps and fasteners. Do not overtighten. See the *INDIAN MOTORCYCLE Service Manual* or an authorized INDIAN MOTORCYCLE dealer can assist.

## ELEVATING THE MOTORCYCLE

**WARNING!** Serious injury or death can occur if the motorcycle tips or falls. Make sure the motorcycle will not tip or fall while elevated or while on the sidestand.

Some procedures require raising the motorcycle to remove weight from the component being inspected. Elevate the motorcycle by placing a stable, flat platform jack or lift mechanism on a firm, flat surface and lifting under the engine crankcase. The platform should be a minimum of 12 inches (30 cm) square. DO NOT attempt to lift the motorcycle without proper equipment. Always secure the motorcycle properly before lifting so it cannot tip or fall when elevated.

## ROAD TEST

Before returning the motorcycle to regular use, perform a road test in a safe area. Pay special attention to the proper fit and operation of all serviced components.

Make any corrections or additional adjustments promptly to ensure safe, reliable and enjoyable vehicle performance.

## FASTENER INSPECTION

1. Inspect the entire motorcycle chassis and engine for loose, damaged or missing fasteners. Tighten loose fasteners to the proper torque. See the *INDIAN MOTORCYCLE Service Manual* or an authorized INDIAN MOTORCYCLE dealer can assist.
2. Always replace stripped, damaged or broken fasteners before riding. Use genuine INDIAN MOTORCYCLE fasteners of equal size and strength.

## FASTENER TORQUES

Some procedures and fastener torques are not listed in this manual. See the *INDIAN MOTORCYCLE Service Manual* or an authorized INDIAN MOTORCYCLE dealer can assist.

## MAINTENANCE

---

### TROUBLESHOOTING

For your personal safety, do not attempt inspection or repairs not fully described in this rider's manual. Contact an authorized dealer for service if you cannot determine the cause of a problem or if the inspection/repair exceeds your mechanical ability or tool resources. Do not perform any inspection or repair with the engine running.

#### ENGINE CRANKS BUT WILL NOT START

POSSIBLE CAUSE	POSSIBLE REMEDY/ACTION
Low Fuel	Verify fuel level
Fuel Pump Inoperative	Turn engine STOP switch to RUN. Turn the power switch on. The fuel pump should run momentarily and then stop. Check the fuel pump/ignition circuit breaker. See page 148.
Battery Voltage Too Low	Fully charge the battery. See page 147.
Spark Plug(s) Fouled	Inspect spark plugs. See page 137.
Spark Plug Wire(s) Disconnected or Loose	Be sure spark plug wires are securely fastened.
Low Compression	Please see your dealer for an engine compression test.

#### STARTER MOTOR CLICKS, DOES NOT TURN OR TURNS SLOWLY

POSSIBLE CAUSE	POSSIBLE REMEDY/ACTION
Engine Stop/Run Switch in Stop Position	Place switch in RUN position.
Battery Discharged	Fully charge the battery. See page 147.
Battery Cables Loose or Corroded	Inspect battery cables.
Transmission In Gear	Shift transmission into neutral or pull the clutch lever in to disengage the clutch. See starting procedures in page 96.
Key Fob Not Authenticated	Make sure key fob is within range and that key fob battery voltage is not low.
Sidestand is Down With Transmission in Gear	Shift to neutral or retract the sidestand fully.

## ENGINE STARTS BUT MISSES OR RUNS POORLY

**TIP:** Turn engine OFF before inspecting any of these items.

POSSIBLE CAUSE	POSSIBLE REMEDY/ACTION
Battery Discharged	Fully charge the battery. See page 147.
Battery Cables Loose or Corroded	Inspect battery cables and connections.
Spark Plug(s) Fouled	Inspect spark plugs. See page 137.
Spark Plug Wire(s) Loose or Wet	Inspect spark plug wires, ensure dry/secure.
Contaminated Fuel	Inspect fuel for water/contamination. Please see your dealer.
Engine Oil Level Incorrect Or Wrong Type	Inspect level and quality of oil. See page 84.
Loose, Broken, Shorted Ignition Coil Wires	Inspect coil primary wires. Please see your dealer.
Air Intake Restricted	Inspect air filter. See page 115.
Intake Leaks	Inspect air box, throttle body and intake boot joints.

## SHIFTING DIFFICULTIES OR HARD TO FIND NEUTRAL

POSSIBLE CAUSE	POSSIBLE REMEDY/ACTION
Shift Linkage Bushings Dry Or Worn	Lubricate shift linkage.
Clutch Damage	Replace clutch.
Clutch Cable Not Adjusted Properly	Please see your dealer for inspection and adjustment.
Shift Linkage Not Adjusted Properly	Please see your dealer for inspection and adjustment.

## MAINTENANCE

---

### BATTERY CHARGING RATE LOW OR BATTERY DISCHARGES

POSSIBLE CAUSE	POSSIBLE REMEDY/ACTION
Loose/Corroded Charging Circuit Connection	Check/clean battery cable connections. Check/clean charging circuit connections. Please see your dealer.
Accessory Load Exceeds Charge Rate	Limit accessory operation when the engine is off.
Improperly Wired Accessory (Current Draw)	Please see your dealer to check charging system output and current draw.

### BRAKE NOISE/POOR BRAKE PERFORMANCE

**TIP:** See your dealer if brake performance does not return after these inspections.

---

POSSIBLE CAUSE	POSSIBLE REMEDY/ACTION
Dust/Dirt On Brake Disc(s)	Clean disc. See page 131.
Worn Pads Or Disc/Brake Disc Damage	Inspect pads. See page 131.
Brake Fluid Level Low Or Fluid Contaminated	Inspect fluid level/fluid condition. See page 87.

### ANTI-LOCK BRAKE LIGHT REMAINS ILLUMINATED OR ILLUMINATES INTERMITTENTLY

POSSIBLE CAUSE	POSSIBLE REMEDY/ACTION
Blown fuse	Check the fuses. See page 148.
Loose or damaged pulse ring	Inspect pulse ring for looseness or chipped teeth.
Debris lodged in components	Inspect wheel speed sensor and pulse ring for debris.
Damage caused by debris	Inspect wheel speed sensor for cracked housing.
Damaged components	See service manual or authorized dealer.

---

## CLEANING AND STORAGE

### CLEANING PRODUCTS

This section provides tips on the very best way to clean, polish and preserve every surface of your beautiful new INDIAN motorcycle. We recommend the use of our new INDIAN MOTORCYCLE cleaning and polishing products and accessories, which have been specially designed to offer the best care possible for your INDIAN motorcycle.

In addition to the products recommended in this section for cleaning and polishing, INDIAN MOTORCYCLE also has specialty products for:

- enhancing black and silver engines
- cleaning engines, tires and wheels
- removing brake dust

After cleaning the motorcycle, inspect for damage to the painted surfaces. Chips or scratches should be repaired promptly to prevent corrosion.

For Matte Clear Coat Finish Care, see page 156.

For Gloss Clear Coat Finish Care, see page 157.

For more information, or for answers to your cleaning and detailing questions, please see your INDIAN MOTORCYCLE dealer.

---

## WASHING THE MOTORCYCLE

**NOTICE:** Do not use pressurized water to wash the motorcycle. Water may seep in and deteriorate wheel bearings, brake caliper assemblies, brake master cylinders, electrical connectors, steering head bearings, and transmission seals. Do not direct any water stream at air intakes, exhaust outlets, electrical connectors or audio system speakers. Electrical components may be damaged by water. Do not allow water to contact electrical components or connectors.

---

1. Before washing, make sure exhaust pipes are cool. Cover each pipe opening with a plastic bag secured with a strong rubber band. Check that the spark plugs, spark plug wire caps, oil fill cap and fuel caps are properly seated.
2. Do not use abrasive cleaners.
3. Rinse off as much dirt and mud as possible with water running at low pressure. Use as little water as possible when washing near the air intake or the exhaust pipe openings. Dry these components thoroughly before using the motorcycle.
4. Clean the front fork tubes thoroughly to reduce fork seal wear and leakage.
5. After washing, remove the rubber bands and plastic bags from the exhaust pipes. Start the engine and let it idle for a few minutes.
6. Make sure the brakes are functioning properly before riding.

## CLEANING AND STORAGE

---

### WINDSHIELD CARE (IF EQUIPPED)

Clean the windshield with a soft cloth and plenty of warm water. Dry with a soft clean cloth. Remove minor scratches with a high-quality polishing compound designed for use on polycarbonate surfaces.

---

**NOTICE:** Brake fluid and alcohol will permanently damage the windshield. Do not use glass cleaners, water or soil repellents, and petroleum or alcohol based cleaners on the windshield, as these products can damage the windshield.

---

### MATTE CLEAR COAT FINISH CARE

Matte finish products are prone to trapping dirt, oils and other contaminants. Always clean this type of finish with warm water and a mild dish-washing detergent. Use a soft sponge to gently rub the surface, then rinse with clean warm water. For stubborn stains such as grease or oil, use a citrus-based cleaner. Spray the cleaner onto the area and rub gently with a soft sponge. Allow the cleaner to sit for a couple of minutes, then rinse well with clean warm water. Repeat as needed.

---

**NOTICE:** Never use a polishing/buffing wax or any sponge that has an abrasive surface when cleaning a matte finish. These products will buff the matte surface of the finish and result in a glossy finish. Never clean matte finishes with a pressure washer, as this will further imbed contaminants into the clear coat and may damage labels and decals.

---

## GLOSS CLEAR COAT FINISH CARE

The Axalta Sports and Equipment Finish System was used to provide the original gloss finish on your motorcycle. This finish system provides superior protection against the elements. To maximize the benefits of this system, use the following guide to care for the gloss finish on your motorcycle.

- During the first 30 days, when the finish is still fresh, clean the motorcycle with a water rinse only.
- Do not wax the motorcycle for the first 60 days. Doing so can cause loss of the gloss. After 60 days, use only waxes designed for new clear coat finishes.
- Do not use pressurized water to wash the motorcycle. When paint is still fresh, pressurized water could damage the finish. If using a pressure washer is unavoidable, keep the spray nozzle at least 24 inches (60 cm) away from the surface of the motorcycle.
- Wash your motorcycle often, especially when exposed to salty, dusty, acidic or alkaline environments.
- Use warm or cool water and a soft cloth for cleaning.
- Use soaps that are non-abrasive and have a neutral pH (non acidic/non alkaline detergents).

- Do not use solvent-based solutions.
- Do not use a dry cloth to remove dust.
- Do not use a stiff bristle brush, which can scratch the surface.
- Do not wash with extremely hot water.
- Do not wash the motorcycle while the surface is hot and avoid washing the motorcycle in the hot sun. Minerals in the water may be difficult to remove once dried on the surface of the motorcycle.
- Do not allow spilled gasoline, motor oil or brake fluid to stand on the paint. Remove these substances immediately by rinsing with water. Use a soft cloth to absorb any remaining residue and dab dry.
- To remove bug remnants or road tar, use only products that are specifically designed for this purpose. Follow the product manufacturer's recommendations to prevent potential damage to the finish. Follow with a wash using the methods described in this section.
- Always brush away any ice or snow, do not scrape off.
- Chips or scratches should be repaired promptly to prevent corrosion.

## INFOTAINMENT TOUCHSCREEN CARE

We recommend using a gentle detergent and water to clean your touchscreen. Wash and dry with a lint free cloth.

- Do not expose to brake fluid.
- Do not expose to gasoline.
- Do not expose to DEET.

## CLEANING AND STORAGE

---

### LEATHER CARE

#### LEATHER FACTS

Leather is a natural product and will exhibit qualities inherent in a natural material. Fading, wrinkles, grain changes, creases and small marks are assurance that this material is not man-made. As the product is used, each leather product will exhibit tarnish from use. Regular care will help keep premium leather products looking their best.

#### EXPOSURE TO SUN

There are many environmental elements that will contribute to the aging of leather products. Regular exposure to the sun, along with heat from the sun and exhaust system or engine components, may rapidly fade the leather. Heat from the sun will dry the leather, potentially causing it to crack. Periodic application of the INDIAN MOTORCYCLE Leather Care Dressing Kit will replace the oils, maintaining the leather's natural surface. Periodic use of the Leather Care Dressing Kit will help restore and maintain the oil-tanned color and finish to help keep it looking its best.

#### EXPOSURE TO MOISTURE

If leather is exposed to moisture, wipe down the leather products and allow them to dry naturally at room temperature. Do not attempt to accelerate the drying process by using heat. Heating the leather will remove the natural oils and cause it to dry out and crack. Whenever possible, take steps to protect the leather from exposure to moisture.

---

**NOTICE:** The leather used on INDIAN motorcycles is an all-natural product; exposure to moisture will result in structural changes to the material, causing permanent damage. Regular usage of INDIAN MOTORCYCLE Leather Care Dressing will help prevent this type of damage.

---

#### EXPOSURE TO DIRT/DUST

Leather items on motorcycles can get extremely dirty with normal use. It is acceptable to wipe down leather products with a sponge and clean water, especially after a long ride. If extremely dirty, use a small amount of mild soap in the water and follow with a clean water rinse.



### LEATHER CARE DRESSING

INDIAN MOTORCYCLE Leather Care Dressing is a leather conditioner formulated to restore many of the oils that are lost from leather due to exposure to environmental elements. This conditioner is suitable for all oil-tanned leather on your INDIAN motorcycle, but it should never be used on suede.

This leather care dressing will also restore some of the color lost through natural aging and now includes UV protection. The rate of aging depends on how often the motorcycle is used, how it is stored, and weather conditions. While visible signs of aging are more noticeable on natural leather, lack of care may cause non-warrantable damage to both natural and black leather.

### LEATHER CARE DRESSING APPLICATION

Apply Leather Care Dressing as part of a regular maintenance regime, such as polishing chrome and washing painted surfaces. Apply this treatment at least one time per month. Apply more often if the motorcycle is regularly exposed to the elements or parked in the sun.

1. Wipe down leather with a sponge and clean water.
2. Wipe down leather with a dry towel and allow it dry at room temperature. Do not use heat to accelerate drying time.
3. With a clean cloth, lightly rub the dressing into the leather and wipe off any excess. Be cautious not to allow droplets or globs of the treatment to sit on an area of the leather as that area will darken. For better results, use a straight wiping motion rather than a tight swirling motion. Lighter areas may need more treatment applied to darken them.
4. Allow the treatment to dry before riding (typically one hour).

### FREQUENTLY ASKED QUESTIONS

#### **Q. CAN I USE SHOE POLISH TO RESTORE LEATHER COLOR?**

A. Shoe polish should not be used on the leather items on your INDIAN motorcycle. Shoe polish contains a dye that can damage the leather and may leave residue on clothing.

#### **Q. WHAT SHOULD I USE TO TREAT THE BLACK LEATHER THAT CAME ON MY INDIAN MOTORCYCLE?**

A. INDIAN MOTORCYCLE Leather Care Dressing is suitable for all oil-tanned leather on your INDIAN motorcycle. Black leather uses a different tanning process and may not require application of the dressing as often.

#### **Q. WHAT SHOULD I USE ON MY LEATHER ACCESSORIES?**

A. INDIAN MOTORCYCLE Leather Care Dressing is suitable for all oil-tanned leather on your INDIAN motorcycle, including accessories.

#### **Q. WHERE CAN I PURCHASE A TAN LEATHER RESTORE KIT OR THE INDIAN MOTORCYCLE LEATHER CARE DRESSING?**

A. Please see your authorized INDIAN MOTORCYCLE dealer for these products and for all of your motorcycle care needs.

#### **Q. CAN I USE THE LEATHER CARE DRESSING AFTER USING THE TAN LEATHER RESTORE KIT?**

A. Yes. The leather care dressing should be applied at least once per month (more often in extreme conditions) to maintain the desired finish. Apply leather care dressing as part of a regular exterior maintenance plan (e. g. polishing chrome and washing painted surfaces).

#### **Q. HOW MANY APPLICATIONS CAN I GET OUT OF ONE TAN LEATHER RESTORE KIT?**

A. Each kit contains enough product for two applications.

### STORAGE AREA PREPARATION

If you will not operate the motorcycle for more than 60 days, store the motorcycle to prevent damage to the fuel system and the battery and to protect components from corrosion or deterioration. During storage preparation you might use products that are potentially hazardous; such as fuel stabilizer. When using any of these products, follow the instructions and warnings on the product packaging.

Choose a dry, well-ventilated storage location, inside a garage or other structure if possible. The location should have a firm, flat surface and allow enough space for the motorcycle.

---

**WARNING!** Gasoline is highly flammable and explosive under certain conditions. Do not store the motorcycle in any area (in home or garage) where it could be near open flames, pilot lights, sparks or electric motors. Do not smoke in the storage area.

---

To best preserve tire condition:

- The storage area should have a relatively constant and moderate temperature.
- The storage surface should be free of oil and gasoline.
- The motorcycle should not be near a radiator or other heat source, or any type of electric motor.

## CLEANING AND STORAGE

---

### CLEAN AND PROTECT THE MOTORCYCLE

To prepare the motorcycle for storage, begin by cleaning and polishing the motorcycle as outlined beginning on page 155. Polish chromed and other metal surfaces. Apply protectant to exposed rubber, vinyl and plastic parts. *Do not apply rubber protectant to the tire tread surfaces.*

### FUEL STABILIZER

Add fresh fuel to fill the fuel tank and add fuel stabilizer. Do not overfill.

Ride the motorcycle or start and run the engine for 15 minutes in a well ventilated area to distribute the stabilizer throughout the fuel system.

### TIRE INFLATION

Inflate the tires to normal pressure. See page 136.

### ENGINE PROTECTION

Change the engine oil. See page 113.

### BATTERY CARE

1. Remove the battery. See page 145.
2. Clean the battery terminals first with a wire brush to remove any loose deposits.
3. Wash the posts and the ends of the battery cables with a solution of one part baking soda to 16 parts water. Rinse with clean water and wipe dry.
4. Apply a thin film of dielectric grease to the posts and cable connectors.
5. Clean the outside of the battery with a solution of mild detergent and warm water.
6. Store the battery in a dry area with a temperature of 32° to 90° F (0° to 32° C).
7. While in storage, fully charge the battery once a month. See page 147.

### MAINTENANCE DURING STORAGE

During extended storage periods, maintain tire pressure and battery voltage at the recommended levels.

## RODENTS

Mice and other rodents are often the worst enemy of a stored motorcycle. If the motorcycle will be stored in an area where mice are a concern (particularly in rural areas, barns, sheds, etc.) be sure to take extra measures to deter their infestation. This may include placing a screen mesh over any intake or exhaust openings (remember to remove them when you remove the motorcycle from storage).

## PARK AND COVER THE MOTORCYCLE

1. Park the motorcycle in its storage location. Block the frame to take some of the weight off the front and rear wheels.

---

**TIP:** Starting the motorcycle periodically during storage is NOT recommended. Water vapor is a by-product of the combustion process, and corrosion may result unless the engine is operated long enough to bring the oil and exhaust system to normal operating temperature.

---

2. Secure a plastic bag over the (cooled) exhaust outlets to prevent moisture from entering the exhaust system.
3. Cover the motorcycle with a cover made from a durable, breathable material designed for storage. Covering the motorcycle helps protect it from dust and other airborne materials. The cover must be of a breathable material to prevent moisture from building up on the motorcycle which can cause oxidation of metal surfaces.

## REMOVAL FROM STORAGE

1. Install a fully charged battery.
2. Check the oil level. If the motorcycle was stored in an area subject to wide swings in temperature and humidity (such as outdoors), change the engine oil before starting the engine.

---

**NOTICE:** During storage, temperature and humidity changes can cause condensation to form in the crankcase and mix with engine oil. Running the engine with oil that contains condensation can cause engine damage.

---

3. Inspect the storage area for signs of fluid leaks. Identify and perform service to any leaking components.
4. Remove any intake or exhaust mesh covers installed for rodent protection.
5. Install new spark plugs if necessary.
6. Perform the pre-ride inspections. See page 81.
7. Perform a road test. See page 151.
8. Wash and polish the motorcycle. Wax, polish or apply protectant to appropriate components.



**SPECIFICATIONS**  
**DIMENSIONS**

Dimensions and specifications may vary with features, options and accessories.

MODEL YEAR 2017	CHIEF	SPRINGFIELD	CHIEFTAIN / CHIEFTAIN DARK HORSE	ROADMASTER CLASSIC	ROADMASTER	CHIEFTAIN LIMITED / CHIEFTAIN ELITE
Overall Length	103.5 in. (2630 mm) Classic / Dark Horse 103.7 in. (2634 mm) Vintage	101.7 in. (2583 mm)	101.2 in. (2571 mm)	103.5 in. (2630 mm)	104.6 in. (2656 mm)	98.7 in. (250.6 cm)
Overall Width	39.4 in. (1000 mm)	39 in. (990 mm)	39.4 in. (1000 mm)	39.4 in. (1000 mm)	39.4 in. (1000 mm)	39.4 in. (100 cm)
Overall Height	46.3 in. (1176 mm) Classic / Dark Horse 58.7 in. (1491 mm) Vintage	56.6 in. (1438 mm)	54.6 in. (1512 mm)	58.7 in. (1491 mm)	58.7 in. (1491 mm)	54.3 in. (137.9 cm) CHIEFTAIN LIMITED 57 in. (144.7 cm) CHIEFTAIN ELITE
Seat Height	26 in. (660 mm)	26 in. (660 mm)	26 in. (660 mm)	26.5 in. (673 mm)	26.5 in. (673 mm)	26 in. (66 cm)
Wheelbase	68.1 in. (1730 mm)	67 in (1701 mm)	65.7 in. (1668 mm)	65.7 in. (1668 mm)	65.7 in. (1668 mm)	65.7 in. (166.9 cm)
Ground Clearance	5.5 in. (140 mm)	5.6 in. (142 mm)	5.6 in. (142 mm)	5.5 in. (140 mm)	5.5 in. (140 mm)	5.6 in. (14.2 cm)
Rake (frame)/Trail	29°/6.1 in. (155 mm)	25°/5.2 in. (133 mm)	25°/5.9 in. (150 mm)	25°/5.9 in. (150 mm)	25°/5.9 in. (150 mm)	25°/5.9 in. (150 mm)

## SPECIFICATIONS

### WEIGHT

MODEL YEAR 2017	CHIEF	SPRINGFIELD	CHIEFTAIN / CHIEFTAIN DARK HORSE	ROADMASTER CLASSIC	ROADMASTER	CHIEFTAIN LIMITED / CHIEFTAIN ELITE
Dry Weight (without fuel/fluids)	751 lbs. (341 kg) Classic / Dark Horse 824 lbs. (374 kg) Vintage	830 lbs. (376 kg)	Chieftain Dark Horse 799 lbs. (362 kg) Chieftain 828 lbs. (376 kg)	864 lbs. (392 kg)	912 lbs. (414 kg)	817 lbs. (371 kg) CHIEFTAIN LIMITED 831 lbs. (377 kg) CHIEFTAIN ELITE
Wet Weight (with fuel/fluids)	783 lbs. (356 kg) Classic / Dark Horse 856 lbs. (388 kg) Vintage	862 lbs. (391 kg)	Chieftain Dark Horse 831 lbs. (377 kg) Chieftain 860 lbs. (391 kg)	896 lbs. (406 kg)	944 lbs. (428 kg)	849 lbs (385 kg) CHIEFTAIN LIMITED 863 lbs (392kg) CHIEFTAIN ELITE
Gross Vehicle Weight Rating (GVWR)	1260 lbs. (573 kg)	1385 lbs. (628 kg)	1385 lbs. (628 kg)	1385 lbs. (630 kg)	1385 lbs. (630 kg)	1385 lbs (628 kg)
Gross Axle Weight Rating (GAWR)	Front 485 lbs. (220 kg) Rear 775 lbs. (352 kg)	Front 500 lbs. (227 kg) Rear 885 lbs. (401 kg)	Front 500 lbs. (227 kg) Rear 885 lbs. (401 kg)	Front 500 lbs. (227 kg) Rear 885 lbs. (403 kg)	Front 500 lbs. (227 kg) Rear 885 lbs. (403 kg)	Front: 500 lbs (227 kg) Rear: 885 lbs (401 kg)
Maximum Load Capacity (riders, cargo, accessories)	477 lbs. (216 kg) Classic / Dark Horse 404 lbs. (183 kg) Vintage	523 lbs. (237 kg)	545 lbs. (247 kg) Chieftain 554 lbs. (251 kg) Chieftain Dark Horse	489 lbs. (222 kg)	441 lbs. (200 kg)	536 lbs (243 kg) CHIEFTAIN LIMITED 522 lbs (236 kg) CHIEFTAIN ELITE

### CAPACITIES

MODEL YEAR 2017	CHIEF	SPRINGFIELD / CHIEFTAIN DARK HORSE / CHIEFTAIN MODELS/ ROADMASTER CLASSIC / ROADMASTER
Engine Oil	5.5 qts. (5.2 l) with filter at oil change	5.5 qts. (5.2 l) with filter at oil change
Fuel	5.5 gal. (20.8 l)	5.5 gal. (20.8 l)
Fuel Reserve (fuel light on)	1.0 gal. (3.8 l)	1.0 gal. (3.8 l)
Fork Oil	20.3 oz. (599 cc)	18.8 oz. (557 cc)



**ENGINE**

<b>MODEL YEAR 2017</b>	<b>ALL MODELS</b>
Engine Type	ThunderStroke 111, Air Cooled
Configuration	V-Twin
Displacement	111 cu. in. (1811 cc)
Cooling System	Air Cooled (CHIEF, SPRINGFIELD) Air/Oil Cooler (CHIEFTAIN DARK HORSE)
Compression Ratio	9.5:1
Valve Train	2 Valves Per Cylinder, Hydraulic Lifters
Bore and Stroke	3.976" x 4.449" (101mm x 113mm)
Fuel System/Throttle Body Bore	Closed Loop Fuel Injection/54 mm
Exhaust System	1 into 2 with Catalytic Converter Split Dual Exhaust with Cross-over
Rev Limit	5400 RPM
Idle RPM	800 +/- 50 RPM Fully Warm
Lubrication System	Semi-Dry Sump
Spark Plug/Gap	NGK DCPR8E/.034 inch (0.90 mm)

## SPECIFICATIONS

### DRIVE SYSTEM

<b>MODEL YEAR 2017</b>	<b>ALL MODELS</b>
Primary Drive	Gear Drive Wet Clutch
Crank Gear	55 Teeth
Clutch Gear	86 Teeth
Clutch Type	Wet, Multi-Plate
Primary Reduction Ratio	1.564:1
Transmission Type	6 Speed/Constant Mesh/Foot Shift
1st Gear Ratio	2.733:1
2nd Gear Ratio	1.864:1
3rd Gear Ratio	1.385:1
4th Gear Ratio	1.103:1
5th Gear Ratio	0.943:1
6th Gear Ratio	0.811:1
Gear Shift Pattern	1 Down/5 Up
Final Drive Type	Belt Drive, 152-Tooth
Transmission	30-Tooth
Rear Wheel	66-Tooth
Ratio	2.2:1
Overall Gear Ratio	
1st Gear	9.403:1
2nd Gear	6.411:1
3rd Gear	4.763:1
4th Gear	3.796:1
5th Gear	3.243:1
6th Gear	2.789:1

**CHASSIS**

<b>MODEL YEAR 2017</b>	<b>CHIEF MODELS</b>	<b>SPRINGFIELD</b>	<b>CHIEFTAIN DARK HORSE / CHIEFTAIN / ROADMASTER CLASSIC / ROADMASTER</b>
Front Suspension Type/Travel	Telescopic Fork/4.7 in. (119 mm)		
Front Fork Tube Diameter	46 mm		
Rear Suspension Type/Travel	Single Shock/3.7 in. (94mm)	Single Shock w/ Air Adjust/4.5 in. (114mm)	
Swing-arm	Cast Aluminum		
Front Brakes	Dual/4 Caliper/Floating Rotor		
Rear Brakes	Single/2 Caliper/Floating Rotor		

**WHEELS AND TIRES**

<b>MODEL YEAR 2017</b>	<b>CHIEF MODELS</b>	<b>SPRINGFIELD</b>	<b>CHIEFTAIN DARK HORSE / CHIEFTAIN / ROADMASTER CLASSIC / ROADMASTER</b>	<b>CHIEFTAIN LIMITED / CHIEFTAIN ELITE</b>
Front Wheel Size/Type	3.5 in. x 16 in. Cast Aluminum (Classic) 3.5 in. x 16 in. Spoked (Vintage)	3.5 in. x 16 in. Cast Aluminum		3.5 in. x 19 in. Cast Aluminum
Rear Wheel Size/Type	5 in. x 16 in. Cast Aluminum (Classic) 5 in. x 16 in. Spoked (Vintage)	5 in. x 16 in. Cast Aluminum		5 in. x 16 in. Cast Aluminum
Front Tire Type/Size	130/90-B16 73H Dunlop Elite 3 (Classic) 130/90-B16 67H American Elite (Vintage)	130/90-B16 73H Dunlop Elite 3		130/60-B19 61H Dunlop American Elite
Rear Tire Type/Size	180/65B16 81H Dunlop American Elite	180/60R16 80H Dunlop Elite 3 Multi-Compound		

## SPECIFICATIONS

### ELECTRICAL

MODEL YEAR 2017	CHIEF / SPRINGFIELD / CHIEFTAIN DARK HORSE / CHIEFTAIN / ROADMASTER
Alternator	710W @ 2000 RPM 610W @2000 RPM (Chief Dark Horse)
Battery	12 Volt, 18 amp/hour, 310 CCA, Sealed Glass Mat
Power Points	Front - 10 amp maximum Rear - 10 amp maximum (Combined - 10 amp maximum)
Voltage Regulator	14.4 volts/42 amp
Lamps (all bulbs are 12 volt)	
Headlight	H4 12V 60/55W LL Roadmaster Classic/Roadmaster/Chieftain Elite: Non-Serviceable LED
Auxiliary Light	Chief Vintage/Springfield/Chief Dark Horse/Chieftain/Chieftain Limited: H8 35W Roadmaster Classic/Roadmaster/Chieftain Elite: Non-Serviceable LED
Tail/Brake Light	Non-Serviceable LED
Turn Signal	Non-Serviceable LED
License Plate	Non-Serviceable LED
Front Fender Light	Non-Serviceable LED
Speedometer	Non-Serviceable LED
Indicator Lights	Non-Serviceable LED

---

## FUEL RECOMMENDATION

For best performance, use only unleaded gasoline with a 91 pump octane minimum (R+M/2 Method). DO NOT USE E-85 GASOLINE OR GASOLINE CONTAINING METHANOL. Using E85 or gasoline/methanol blends can result in poor starting and driveability, engine damage and damage to critical fuel system components.

- *Gasoline containing up to 15% Ethanol can be used.*
- *Gasoline containing up to 15% Methyl Tertiary Butyl Ether (MTBE) can be used.*

In the event that the recommended premium unleaded gasoline is not available and low octane fuel must be used, fill the fuel tank only partially with unleaded regular gasoline, then fill the tank fully with premium unleaded gasoline as soon as possible.

## ENGINE OIL RECOMMENDATION

We recommend the use of INDIAN MOTORCYCLE Premium Synthetic Blend 20W-40 Engine Oil for your motorcycle. This oil is formulated with synthetic-based oil and premium engine additive which have physical properties that meet API SM and ILSAC GF-4 specifications.

Do not blend oil additives with engine oil.

If oil must be added in an emergency and the recommended oil is not available, choose only a high-quality 20W-40 motorcycle oil. Change back to the recommended oil at the first opportunity.

---

**NOTICE:** Use of non-recommended lubricants can result in engine damage. Damage resulting from the use of non-recommended lubricants is not covered by warranty.

---

## FORK OIL

We recommend the use of INDIAN MOTORCYCLE Fork Oil for your motorcycle.

## BRAKE FLUID

We recommend the use of INDIAN MOTORCYCLE DOT 4 Brake Fluid for both brake master cylinders. *DO NOT use DOT 5 silicone fluid.*



## **WARRANTY**

### **INDIAN MOTORCYCLE WARRANTY POLICY**

#### **LIMITED WARRANTY**

INDIAN MOTORCYCLE COMPANY, 2100 Highway 55, Medina, MN 55340 (INDIAN MOTORCYCLE) gives a TWO YEAR LIMITED WARRANTY on all components of your INDIAN motorcycle against defects in material or workmanship. This warranty covers parts and labor charges for repair or replacement of defective parts and begins on the date of purchase by the original retail purchaser. This warranty is transferable to another owner during the warranty period through an INDIAN MOTORCYCLE dealer, but any such transfer will not extend the original term of the warranty. The duration of this warranty may vary by international region based upon local laws and regulations.

#### **REGISTRATION**

At the time of sale, the Warranty Registration Form must be completed by your dealer and submitted to INDIAN MOTORCYCLE within ten days of purchase. Upon receipt of this registration, INDIAN MOTORCYCLE will record the registration for warranty. No verification of registration will be sent to the purchaser as the copy of the Warranty Registration Form will be your proof of warranty coverage. If you have not signed the original registration and received the customer copy, please contact your dealer immediately. **NO WARRANTY COVERAGE WILL BE ALLOWED UNLESS YOUR MOTORCYCLE IS REGISTERED WITH INDIAN MOTORCYCLE.** Initial dealer preparation and set-up of your motorcycle is very important in ensuring trouble-free operation. Purchasing a vehicle in the crate or without proper dealer set-up will void your warranty coverage.

## WARRANTY

---

### LIMITATIONS OF WARRANTIES AND REMEDIES

This INDIAN MOTORCYCLE limited warranty excludes any failures that are not caused by a defect in material or workmanship. THIS WARRANTY DOES NOT COVER CLAIMS OF DEFECTIVE DESIGN. This warranty also does not cover acts of God, accidental damage, normal wear and tear, abuse or improper handling. This warranty also does not cover any motorcycle, component, or part that has been altered structurally, modified, neglected, improperly maintained or used for racing, competition, or purposes other than for which it was designed.

This warranty excludes damages or failures resulting from: improper lubrication; improper engine timing; improper fuel; surface imperfections caused by external stress, heat, cold or contamination; operator error or abuse; improper component alignment, tension, adjustment or altitude compensation; snow, water, dirt or other foreign substance ingestion/contamination; improper maintenance; modified components; use of aftermarket or unapproved components, accessories, or attachments; unauthorized repairs; or repairs made after the warranty period expires or by an unauthorized repair center.

This warranty excludes damages or failures caused by abuse, accident, fire, or any other cause other than a defect in materials or workmanship and provides no coverage for consumable components, general wear items, or any parts exposed to friction surfaces, stresses, environmental conditions and/or contamination for which they were not designed or not intended, including but not limited to the following items:

- Wheels and tires
- Suspension components
- Brake components
- Seat components
- Clutches and components
- Steering components
- Batteries
- Light bulbs/Sealed beam lamps
- Filters
- Lubricants
- Bushings
- Sealants
- Coolants
- Bearings
- Finished and unfinished surfaces
- Fuel Injectors/Throttle body components
- Engine components
- Drive belts
- Hydraulic components and fluids
- Circuit breakers/Fuses
- Electronic components
- Spark plugs



## LUBRICANTS AND FLUIDS

1. Mixing oil brands or using non-recommended oil may cause engine damage. We recommend the use of INDIAN MOTORCYCLE engine oil.
2. Damage or failure resulting from the use of non-recommended lubricants or fluids is not covered by this warranty.

This warranty provides no coverage for personal loss or expense, including mileage, transportation costs, hotels, meals, shipping or handling fees, motorcycle pick-up or delivery, replacement rentals, loss of vehicle use, loss of profits, or loss of vacation or personal time.

The exclusive remedy for breach of this warranty shall be, at INDIAN MOTORCYCLE's option, repair or replacement of any defective materials, components, or products. THE REMEDIES SET FORTH IN THIS WARRANTY ARE THE ONLY REMEDIES AVAILABLE TO ANY PERSON FOR BREACH OF THIS WARRANTY. INDIAN MOTORCYCLE SHALL HAVE NO LIABILITY TO ANY PERSON FOR INCIDENTAL, CONSEQUENTIAL OR SPECIAL DAMAGES OF ANY DESCRIPTION, WHETHER ARISING OUT OF EXPRESS OR IMPLIED WARRANTY OR ANY OTHER CONTRACT, NEGLIGENCE, OR OTHER TORT OR OTHERWISE. THIS EXCLUSION OF CONSEQUENTIAL, INCIDENTAL, AND SPECIAL DAMAGES IS INDEPENDENT FROM AND SHALL SURVIVE ANY FINDING THAT THE EXCLUSIVE REMEDY FAILED OF ITS ESSENTIAL PURPOSE.

THE IMPLIED WARRANTY OF FITNESS FOR A PARTICULAR PURPOSE IS EXCLUDED FROM THIS LIMITED WARRANTY. ALL OTHER IMPLIED WARRANTIES (INCLUDING BUT NOT LIMITED TO THE IMPLIED WARRANTY OF MERCHANTABILITY) ARE LIMITED IN DURATION TO THE ABOVE one year WARRANTY PERIOD. INDIAN MOTORCYCLE DISCLAIMS ALL EXPRESS WARRANTIES NOT STATED IN THIS WARRANTY. SOME STATES DO NOT PERMIT THE EXCLUSION OR LIMITATION OF INCIDENTAL OR CONSEQUENTIAL DAMAGES OR ALLOW LIMITATIONS ON THE DURATION OF IMPLIED WARRANTIES, SO THE ABOVE LIMITATIONS MAY NOT APPLY TO YOU IF INCONSISTENT WITH CONTROLLING STATE LAW.

## WARRANTY

---

### **HOW TO OBTAIN WARRANTY SERVICE**

If your motorcycle requires warranty service, you must take it to an INDIAN MOTORCYCLE Servicing Dealer. When requesting warranty service you must present your copy of the Warranty Registration Form to the dealer. (THE COST OF TRANSPORTATION TO AND FROM THE DEALER IS YOUR RESPONSIBILITY). INDIAN MOTORCYCLE suggests that you use your original selling dealer; however, you may use any INDIAN MOTORCYCLE Servicing Dealer to perform warranty service.

### **IN THE COUNTRY WHERE YOUR MOTORCYCLE WAS PURCHASED:**

Warranty or Service Bulletin repairs must be done by an authorized INDIAN MOTORCYCLE dealer. If you move or are traveling within the country where your motorcycle was purchased, Warranty and Service Bulletin repairs may be requested from any authorized INDIAN MOTORCYCLE dealer.

### **OUTSIDE THE COUNTRY WHERE YOUR MOTORCYCLE WAS PURCHASED:**

If you are traveling temporarily outside the country where your motorcycle was purchased, you should take your motorcycle to an authorized INDIAN MOTORCYCLE dealer. You must show the dealer photo identification from the country of the selling dealer's authorized location as proof of residence. Upon residence verification, the servicing dealer will be authorized to perform the warranty repair.

### **IF YOU MOVE:**

If you move to another country, be sure to contact INDIAN MOTORCYCLE Customer Assistance and the customs department of the destination country before you move. Vehicle importation rules vary considerably from country to country. You may be required to present documentation of your move to INDIAN MOTORCYCLE in order to continue your warranty coverage. You may also be required to obtain documentation from INDIAN MOTORCYCLE in order to register your motorcycle in your new country. You should warranty register your motorcycle at a local INDIAN MOTORCYCLE dealer in your new country immediately after you move to continue your warranty coverage and to ensure that you receive information and notices regarding your motorcycle.

### **IF YOU PURCHASE FROM A PRIVATE PARTY:**

If you purchase an INDIAN motorcycle from a private party, to be kept and used outside of the country in which the motorcycle was originally purchased, all warranty coverage will be denied. You must nonetheless register your motorcycle under your name and address with a local INDIAN MOTORCYCLE dealer in your country to ensure that you receive safety information and notices regarding your motorcycle.

### **EXPORTED VEHICLES**

EXCEPT WHERE SPECIFICALLY REQUIRED BY LAW, THERE IS NO WARRANTY OR SERVICE BULLETIN COVERAGE ON THIS VEHICLE IF IT IS SOLD OUTSIDE THE COUNTRY OF THE SELLING DEALER'S AUTHORIZED LOCATION. This policy does not apply to vehicles that have received authorization for export from INDIAN MOTORCYCLE. Dealers may not give authorization for export. You should consult an authorized dealer to determine this vehicle's warranty or service coverage if you have any questions. This policy does not apply to vehicles registered to government officials or military personnel on assignment outside the country of the selling dealer's authorized location. This policy does not apply to Safety Bulletins.

### **NOTICE**

If your vehicle is registered outside of the country where it was purchased and you have not followed the procedure set above, your vehicle will no longer be eligible for warranty or service bulletin coverage of any kind, other than safety bulletins. Vehicles registered to Government officials or military personnel on assignment outside of the country where the vehicle was purchased will continue to be covered by the Limited Warranty.

Please work with your dealer to resolve any warranty issues. Should your dealer require any additional assistance, they will contact the appropriate person at INDIAN MOTORCYCLE.

This warranty gives you specific legal rights, and you may also have other rights which vary from state to state or in different countries. If any of the above terms are void because of federal, state, local law, all other warranty terms will remain in effect.

***For questions call INDIAN MOTORCYCLE Customer Assistance:***

United States & Canada: 1-877-204-3697

French: 1-800-268-6334

## WARRANTY

---

### **MOTORCYCLE NOISE REGULATION**

Tampering with noise control systems is prohibited. Federal law prohibits the following acts or causing thereof:

- The removal or rendering inoperative by any person other than for the purposes of maintenance, repair, or replacement, of any device or element of design incorporated into any new vehicle for the purpose of noise control prior to its sale or delivery to the ultimate purchaser or while it is in use, or
- The use of the vehicle after such device or element of design has been removed or rendered inoperative by any person.

Among those acts presumed to constitute tampering are:

- Removal or puncturing of the muffler, baffles, header pipes, or any other component which conducts exhaust gasses.
- Removal or puncturing of any part of the intake system.
- Lack of proper maintenance.
- Replacing any moving part of the vehicle, or parts of the exhaust system or intake system, with parts other than those specified by the manufacturer.

This product should be checked for repair or replacement if the motorcycle noise has increased significantly through use. Otherwise, the owner may become subject to penalties under state and local ordinances.

### **NOISE EMISSION WARRANTY**

INDIAN MOTORCYCLE warrants that this exhaust system, at the time of sale, meets all applicable U.S. EPA Federal noise standards. This warranty extends to the first person who buys this exhaust system for purposes other than resale, and to all subsequent buyers.

Warranty claims should be directed to:

- *An authorized INDIAN MOTORCYCLE dealer, or*
- *INDIAN MOTORCYCLE COMPANY, 2100 Highway 55, Medina, MN 55340*

## **EMISSIONS CONTROL SYSTEM WARRANTY**

### **INDIAN MOTORCYCLE COMPANY - EMISSION CONTROL SYSTEM WARRANTY STATEMENT**

#### **YOUR WARRANTY RIGHTS AND OBLIGATIONS**

The California Air Resources Board and INDIAN MOTORCYCLE COMPANY (hereinafter INDIAN MOTORCYCLE) are pleased to explain the emission control system warranty on your 2015 or later INDIAN motorcycle. In California, new motor vehicles must be designed, built and equipped to meet the state's stringent anti-smog standards. INDIAN MOTORCYCLE must warrant the emission control system on your motorcycle for the periods of time listed below provided there has been no abuse, neglect or improper maintenance of your motorcycle. Your emission control system may include parts such as the fuel-injection system, the ignition system, catalytic converter and engine computer. Also included may be hoses, belts, connectors and other emission related assemblies. Where a warrantable condition exists, INDIAN MOTORCYCLE will repair your motorcycle at no cost to you, including diagnosis, parts and labor.

#### **MANUFACTURER'S WARRANTY COVERAGE**

Class III motorcycles (280cc and larger): for a period of use of five (5) years or 30,000 kilometers (18,641 miles), whichever first occurs.

If an emission-related part on your motorcycle is defective, the part will be repaired or replaced by INDIAN MOTORCYCLE. This is your emission control system DEFECTS WARRANTY.

## WARRANTY

---

### **OWNER'S WARRANTY RESPONSIBILITIES**

As the motorcycle owner, you are responsible for the performance of the required maintenance listed in your Rider's manual. INDIAN MOTORCYCLE recommends that you retain all receipts covering maintenance on your motorcycle, but INDIAN MOTORCYCLE cannot deny warranty solely for the lack of receipts or for your failure to ensure the performance of all scheduled maintenance. You are responsible for presenting your motorcycle to an INDIAN MOTORCYCLE dealer as soon as a problem exists. The warranty repairs should be completed in a reasonable amount of time, not to exceed 30 days. As the motorcycle owner, you should be aware that INDIAN MOTORCYCLE may deny your warranty coverage if your motorcycle or part has failed due to abuse, neglect, improper maintenance or unapproved modifications.

If you have any questions regarding your warranty rights and responsibilities, you should contact INDIAN MOTORCYCLE COMPANY, 2100 Highway 55, Medina, MN 55340, or the California Air Resources Board, P.O. Box 8001, 9528 Telstar Avenue, El Monte, CA 91734-8001.

INDIAN MOTORCYCLE COMPANY., (hereinafter INDIAN MOTORCYCLE) warrants that each new 2015 and later INDIAN motorcycle that includes as standard equipment a headlight, taillight and stoplight, and is street legal:

- A. is designed, built and equipped so as to conform at the time of initial retail purchases with all applicable regulations of the United States Environmental Protection Agency, and the California Air Resources Board; and
- B. is free from defects in material and workmanship which cause such motorcycle to fail to conform with applicable regulations of the United States Environmental Protection Agency or the California Air Resources Board for a period of use, depending on the engine displacement, of 12,000 kilometers (7,456 miles), if the motorcycle's engine displacement is less than 170 cubic centimeters; of 18,000 kilometers (11,185 miles), if the motorcycle's engine displacement is equal or greater than 170 cubic centimeters but less than 280 cubic centimeters; or of 30,000 kilometers (18,641 miles), if the motorcycle's engine displacement is 280 cubic centimeters or greater; or 5 (five) years from the date of initial retail delivery, whichever occurs first.

## **I. COVERAGE**

Warranty defects shall be remedied during customary business hours at any authorized INDIAN MOTORCYCLE dealer located within the United States of America in compliance with the Clean Air Act and applicable regulations of the United States Environmental Protection Agency and the California Air Resources Board. Any part or parts replaced under this warranty shall become the property of INDIAN MOTORCYCLE.

In the State of California only, emission-related warranted parts are specifically defined by the state's Emission Warranty Parts List. These warranted parts are: carburetor and internal parts; intake manifold; fuel tank; fuel injection system; spark advance mechanism; crankcase breather; air cutoff valves; fuel tank cap for evaporative emission controlled vehicles; oil filler cap; pressure control valve; fuel/vapor separator; canister; igniters; breaker governors; ignition coils; ignition wires; ignition points; condensers, and spark plugs if failure occurs prior to the first scheduled replacement; and hoses, clamps, fittings and tubing used directly in these parts. Since emission related parts may vary from model to model, certain models may not contain all of these parts and certain models may contain functionally equivalent parts. In the State of California only, Emission Control System emergency repairs, as provided for in the California Administrative Code, may be performed by other than an authorized INDIAN MOTORCYCLE dealer. An emergency situation occurs when an authorized INDIAN MOTORCYCLE dealer is not reasonably available, a part is not available within 30 days or a repair is not complete within 30 days. Any replacement part can be used in an emergency repair. INDIAN MOTORCYCLE will reimburse the owner for expenses, including diagnosis, not to exceed INDIAN MOTORCYCLE's suggested retail price for all warranted parts replaced and labor charges based on INDIAN MOTORCYCLE'S recommended time allowance for the warranty repair and the geographically appropriate hourly labor rate. The owner may be required to keep receipts and failed parts in order to receive compensation.

## WARRANTY

---

### II. LIMITATIONS

The Emission Control System Warranty shall not cover any of the following:

A. Repair or replacement required as a result of:

- Accident
- Misuse
- Repairs improperly performed or replacements improperly installed
- Use of replacement parts or accessories not conforming to INDIAN MOTORCYCLE specifications which adversely affect performance and/or
- Use in competitive racing or related events.

B. Inspections, replacement of parts, and other services and adjustments necessary for required maintenance

C. Any motorcycle on which the odometer mileage has been changed so that actual mileage cannot be readily determined.



### III. LIMITED LIABILITY

- A. The liability of INDIAN MOTORCYCLE under this Emission Control System Warranty is limited solely to the remedying of defects in material or workmanship by an authorized INDIAN MOTORCYCLE dealer at its place of business during customary business hours. This warranty does not cover inconvenience or loss of use of the motorcycle or transportation of the motorcycle to or from the INDIAN MOTORCYCLE dealer. INDIAN MOTORCYCLE SHALL NOT BE LIABLE FOR ANY OTHER EXPENSES, LOSS OR DAMAGE, WHETHER DIRECT, INCIDENTAL, CONSEQUENTIAL OR EXEMPLARY ARISING IN CONNECTION WITH THE SALE OR USE OF OR INABILITY TO USE THE INDIAN MOTORCYCLE FOR ANY PURPOSE. SOME STATES DO NOT ALLOW THE EXCLUSION OR LIMITATION OF ANY INCIDENTAL OR CONSEQUENTIAL DAMAGES, SO THE ABOVE LIMITATIONS MAY NOT APPLY TO YOU.
- B. NO EXPRESS EMISSION CONTROL SYSTEM WARRANTY IS GIVEN BY INDIAN MOTORCYCLE EXCEPT AS SPECIFICALLY SET FORTH HEREIN. ANY EMISSION CONTROL SYSTEM WARRANTY IMPLIED BY LAW, INCLUDING ANY WARRANTY OF MERCHANTABILITY OR FITNESS FOR A PARTICULAR PURPOSE, IS LIMITED TO THE EXPRESS EMISSION CONTROL SYSTEM WARRANTY TERMS STATED IN THIS WARRANTY. THE FOREGOING STATEMENTS OF WARRANTY ARE EXCLUSIVE AND IN LIEU OF ALL OTHER REMEDIES. SOME STATES DO NOT ALLOW LIMITATIONS ON HOW LONG AN IMPLIED WARRANTY LASTS SO THE ABOVE LIMITATIONS MAY NOT APPLY TO YOU.
- C. No dealer is authorized to modify this INDIAN MOTORCYCLE Limited Emission Control System Warranty.

## WARRANTY

---

### **IV. LEGAL RIGHTS**

THIS WARRANTY GIVES YOU SPECIFIC LEGAL RIGHTS, AND YOU MAY ALSO HAVE OTHER RIGHTS WHICH VARY FROM STATE TO STATE.

### **V. THIS WARRANTY IS IN ADDITION TO THE INDIAN MOTORCYCLE LIMITED MOTORCYCLE WARRANTY**

### **VI. ADDITIONAL INFORMATION**

Any replacement part that is equivalent in performance and durability may be used in the performance of any maintenance or repairs. However, INDIAN MOTORCYCLE is not liable for these parts. The owner is responsible for the performance of all required maintenance. Such maintenance may be performed at a service establishment or by any individual. The warranty period begins on the date the motorcycle is delivered to an ultimate purchaser.

INDIAN MOTORCYCLE COMPANY

2100 Highway 55

Medina, MN 55340

ATTN: Warranty Department

**MAINTENANCE LOG**

MAINTENANCE PERFORMED	MILES/KM	NOTES	PERFORMED BY



---

## AUDIO SYSTEM

### AUDIO SYSTEM INTRODUCTION

#### CHIEFTAIN DARK HORSE

Not all motorcycles are equipped with an audio system. Motorcycles equipped with an audio system may not be equipped with all components discussed in the audio section of this manual. Components not installed at the factory can be purchased from and installed by your INDIAN MOTORCYCLE dealer.

---

**WARNING!** Distracted driving can result in loss of control, collision or accident, which may result in serious injury or death. Avoid using any features and devices while driving that may take your attention away from the road and safe driving habits, even for a moment. Always keep both hands on the handlebars. When device operation is necessary, please use voice-activated devices.

---



#### IPOD / IPHONE DEVICE COMPATIBILITY

Your radio will connect with the following iPod and iPhone models. Update your iPod and iPhone devices to the latest software before use.

Made for:

## AUDIO SYSTEM

---

- iPhone 5 and newer
- iPhone 4s and newer
- iPhone 4 and newer
- iPhone 3GS and newer
- iPhone 3G and newer
- iPod touch (5th generation and newer)
- iPod touch (4th generation and newer)
- iPod touch (3rd generation and newer)
- iPod touch (2nd generation and newer)
- iPod nano (7th generation and newer)
- iPod nano (6th generation and newer)
- iPod nano (5th generation and newer)
- iPod nano (4th generation and newer)

“Made for iPod” and “Made for iPhone” mean that an electronic accessory has been designed to connect specifically to iPod or iPhone, respectively, and has been certified by the developer to meet Apple performance standards. Apple is not responsible for the operation of this device or its compliance with safety and regulatory standards. Please note that the use of this accessory with iPod or iPhone may affect wireless performance.

## RADIO FREQUENCIES

### NORTH AMERICA

- AM 520 to 1720 kHz
- FM 87.9 to 107.9 MHz
- WX 7 NOAA Channels (162.400 to 162.550 MHz)

### EUROPE

- FM 87.5 to 108.00 MHz (100 kHz steps)
- MW 531 to 1602 kHz
- LW 153 to 279 kHz

### EUROPE 50

- FM 87.5 to 108.00 MHz (50 kHz steps)
- MW 531 to 1602 kHz
- LW 153 to 279 kHz

### AUSTRALIA

- FM 87.5 to 108.0 MHz
- AM 531 to 1701 kHz

### JAPAN

- FM 76.1 to 89.9 MHz
- AM 522 to 1629 kHz

### TAIWAN

- FM 87.5 to 108.0 MHz
- AM 531 to 1701 kHz

## RADIO SOURCES

### NORTH AMERICA SOURCES

- FM
- AM
- WX
- USB
- NAV
- Bluetooth

### EUROPE/EUROPE 50 SOURCES

- FM
- MW
- LW
- USB
- NAV
- Bluetooth

### JAPAN/TAIWAN SOURCES

- FM
- AM
- USB
- NAV
- Bluetooth

### AUSTRALIA SOURCES

- FM
- AM
- USB
- NAV
- Bluetooth

## AUDIO SYSTEM

---

### AUDIO MENU OPTIONS

- Audio Output
- Bass
- Mid
- Treble
- Fader
- Automatic Volume Control (AVC)
- Bluetooth Setup
- Driver Device
- NAV Audio
- AM/FM Clear Preset
- Radio Broadcast Data System (RBDS)



## AUDIO CONTROLS

The audio controls are located on the left handlebar.

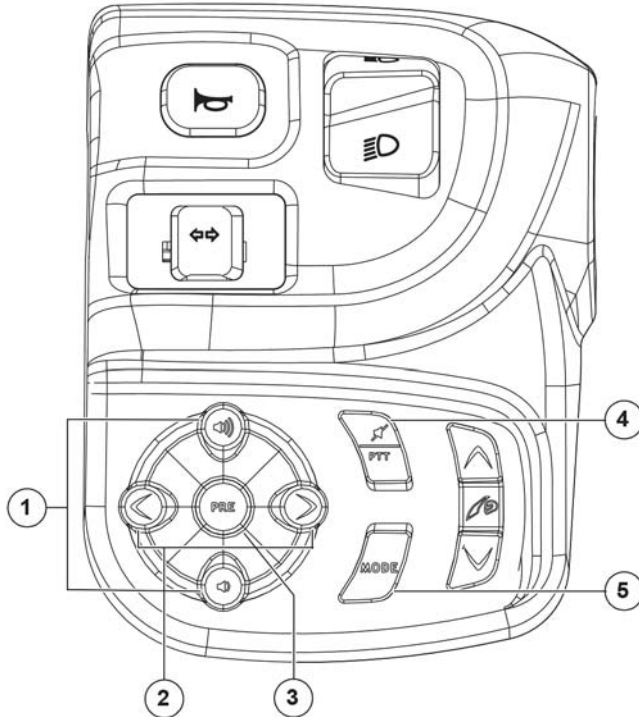

- |  |   |
|--|---|
| 1. Radio On/Off<br>Volume +/-<br>Menu Scroll |  VOL (+) |
|  |  VOL (-) |

- |   |  |
|---|--|
| 2. Tuner<br>Music Track Select<br>Menu Navigation |  TUNE (+) |
|   |  TUNE (-) |

- |  |  |
|--|--|
| 3. Preset Button<br>(Select/Enter Menus) |  PRESET |
|--|--|

- |  |  |
|--|--|
| 4. Mute<br>Push-to-Talk (PTT)<br>Voice Recognition |  MUTE |
|  |  PTT  |

- |                |  |
|----------------|--|
| 5. Mode Button |  MODE |
|----------------|--|

**TIP:** Some mode menu options have sub-menus. Sources and menu options will be displayed only for installed components.

## AUDIO SYSTEM

---

### INSTRUMENT CLUSTER AUDIO DISPLAY

The audio system information is displayed in the center display on the instrument cluster. All audio system information is displayed in zones two (2) and three (3).

<b>ZONE 2</b>	7:30	75F
	FM	93.7
<b>ZONE 3</b>	TRIP 1	
	MI	210.3
	HR	3.5
	RANGE 250	<b>6</b>
	25680 mi	

## USB CONNECTOR

A USB connector cord is located on the right side of the lower front fairing. A pouch is provided to hold your device while operating. This pouch is padded and tethered to the fairing to securely hold your device.

**TIP:** Device-to USB adapters are not supplied with the motorcycle and must be purchased separately. Reference device owner's manual for USB accessory adapter information.

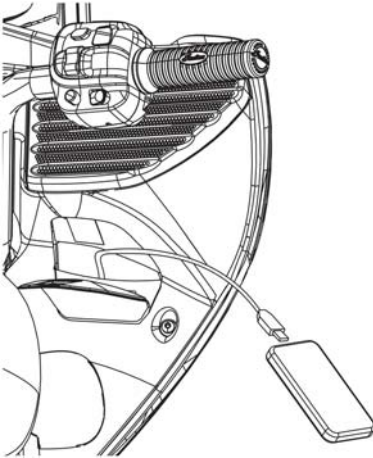

## POWER AND VOLUME CONTROLS

### AUDIO SYSTEM POWER

Turn the power switch ON to use the audio system. The screen will display "RADIO OFF".



**TIP:** To prevent battery drain when the engine is not running, power will automatically turn off after 5 minutes.

To turn the audio system on, press and release MODE or one of the volume buttons.

The screen will display the last active entertainment source. The volume level when power is turned on will default to the level in use when power was last turned off (limited to level 15).



## AUDIO SYSTEM

---

### AUDIO SYSTEM VOLUME

Audio is active in either the speakers or the headsets. The volume controls will adjust the volume in the speakers or in the driver's Bluetooth headset.

**TIP:** On some headsets, the user must press (+) or (-) or rotate the volume dial on the headset controls to raise or lower volume.

---

Press  or  to adjust volume.

7:30	75F
VOLUME	8



### TURN THE RADIO OFF

Press and hold  until the radio turns off.

7:30	75F
RADIO OFF	

### MUTE/PUSH-TO-TALK (PTT)

Press  once to mute the audio system volume.

Press  or  or  to un-mute the audio system volume.

Double press  to activate voice recognition feature on a paired phone.

### LOW VOLTAGE MUTE

If the battery voltage drops to 10.5 +/- 0.5 volts, the radio will mute to reduce voltage drain on the battery. Full volume will be restored when the battery voltage returns to 11.5-12.5 volts. If battery voltage drops below 8.5 volts, the radio will turn off. Radio function will not be available until the battery is charged.

7:30	75F
MUTE LOW VOLTAGE	

## SELECTING AUDIO SOURCES

Press **MODE** repeatedly to choose the desired audio source. Each press changes the audio source as follows:

- FM
- AM
- MW (Europe only)
- LW (Europe only)
- WX (Weather) (North America only)
- USB
- NAV (If enabled)
- Bluetooth Driver (if enabled)

### FM SOURCE:

All models (shown with RBDS FULL)

7:30	75F
FM	93.7
93X	
ARTIST	

### AM SOURCE:

All models excluding Europe

7:30	75F
AM	1500

### MW (MEDIUM WAVE) SOURCE:

Europe models only

7:30	75F
MW	531

### LW (LONG WAVE) SOURCE:

Europe models only

7:30	75F
LW	153

### WX (WEATHER) SOURCE:

North America models only

7:30	75F
WX	1

## AUDIO SYSTEM

---

### USB SOURCES:

All models

Flash memory connected

7:30	75F
USB	
ARTIST	
SONG TITLE	

iPhone / iPod connected

7:30	75F
iPod	
ARTIST	
SONG TITLE	

Pandora® on iPhone / iPod only (Pandora is currently available only in the United States, Australia and New Zealand.)

7:30	75F
PANDORA	
ARTIST	
SONG TITLE	

### NAV SOURCE:

All models (skipped if not enabled)

7:30	75F
NAV	

### BLUETOOTH DRIVER SOURCE:

All models (skipped if not enabled)

---

**TIP:** Pandora® is available on some Bluetooth devices.

---

7:30	SW	75F
STACY'S PHONE		

## FM/AM/MW/LW TUNING

MW and LW radio sources are in Europe only.



1. Press **MODE** repeatedly to choose the desired audio source.
2. Use the tune buttons on the left control to tune radio stations. Press and release **<** or **>** to locate stations in single-step increments.
3. Press and hold **<** or **>** to seek for radio stations. The radio will slew until the tune button is released. At that time, the radio will seek to the next strong radio station signal.

7:30	75F
FM	93.7
93X	
ARTIST	

FM station shown with RBDS FULL on

## MEMORY PRESETS

The audio system features 15 user-defined presets for each tuner source for storing favorite stations.

1. To set a preset, press **MODE** repeatedly until the desired source is active (FM, AM, MW, LW).
2. Use **<** or **>** to tune a radio station.
3. Press and hold **PRE**.
4. Press  or  to cycle to an available preset location.

The preset location displays on the screen.

**TIP:** Saving a radio station without picking a location will save the station in the next available location.

5. When the desired location is displayed, press **PRE**.

7:30	SW	75F
SAVING 93.7		
P1	--.	
P2	--.	
P3	--.	
P4	--.	
P5	--.	

## AUDIO SYSTEM

---

6. The station will be stored.

7:30	75F
P2	93.7

---

**TIP:** If the desired preset location already contains a stored radio station, it will be overwritten by the new selection.

---

7. Press **PRE** repeatedly to scroll through the list of radio presets.

7:30	75F
FM	93.7

## WEATHER BAND (WX)

Weather band channels are broadcast by the National Oceanic and Atmospheric Administration (NOAA). NOAA operates more than 940 transmitters covering the United States, Puerto Rico, the U.S. Virgin Islands, the U. S. Pacific Territories and adjacent coastal waterways.

1. Press **MODE** repeatedly button until WX source is selected.

---

**TIP:** Typically, only one weather band channel will be available for a given location. When traveling, if a channel becomes unavailable, search for another active channel.

---

2. Press **<** or **>** to select a channel.



## USB AUDIO SOURCE - FLASH / MEMORY STICK

The USB flash drive must be formatted using the FAT32 file system. For assistance, search the web for “How to format FAT32”.

Connect the USB memory stick to the USB connector cable. The following music files are recognized by the radio:

- WAV
- OGG
- MP3
- FLAC

Music files not recognized by the radio will be ignored.

1. Press and release **MODE** until USB is active. When USB is active, the console screen will display “USB” as the active source.

7:30	75F
USB	
ARTIST	
SONG TITLE	

2. Press and hold **<** or **>** to select the next or the previous music folder. The folders are arranged in alphabetical order.
3. Press and release **<** or **>** to select the next or previous song.

## USB AUDIO SOURCE - IPOD / IPHONE CONNECTED



1. Connect a compatible iPod or iPhone device to the USB connector cable.
2. Press and release **MODE** until iPod is the active source. When iPod is active, the console screen will display “iPod” as the active source.

7:30	75F
iPod	
ARTIST	
SONG TITLE	

### TUNING/FF - RW

1. Press and release < or > to select the next or previous song.
2. Press and hold < or > to fast forward or rewind.

### DIRECT SONG SELECTION



1. Press and release **PRE** to display currently playing track list.
2. Press and release  or  to scroll track list.
3. Press and release **PRE** or > to select the new song choice and exit to active source display.
4. Press < to exit without selecting a new song track.

## CATEGORY SELECT

1. Press and hold **PRE** until the category list appears.

**TIP:** Pandora® will appear only if device is connected via USB and is capable of running Pandora.





2. To navigate the categories, press and release  or . Press and hold to continuously scroll through the list.
3. Press and release **PRE** or  to select new category.
4. Press and release **MODE** to exit to the main menu.

5. To navigate from the category menu to the sub-category menu,

press **PRE** or .



6. Press and release  or  to scroll.
7. Press and release **PRE** to select new subcategory and play the first song found. Press  to browse the list of songs available.

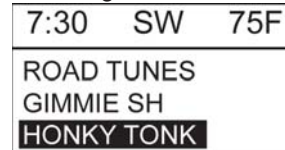

8. Press  to navigate back to the subcategory or category selection.

## AUDIO SYSTEM

---

### USB AUDIO SOURCE - IPOD/IPHONE WITH PANDORA

When using the Pandora app on an iPod or iPhone, connect the device to the USB connector. Using the USB connection will enable Pandora functions like: skip track, thumbs up, and thumbs down, through the left-hand control.

**TIP:** Pandora is intended for use only in the United States, Australia and New Zealand. If licensing restrictions prevent Pandora from playing, "NOT AVAILABLE" displays.

---

7:30	SW	75F
PANDORA NOT AVAILABLE		

1. Turn on the Pandora app. Connect a compatible iPhone or iPod device to the USB connector.

7:30	75F
PANDORA ARTIST SONG TITLE	

2. Press and release **MODE** until Pandora is displayed in the screen.

**TIP:** If Pandora is the currently playing app on the device, the USB source displays information and enables features specific to the app. If it is not, you must select Pandora from the category menu. Press and hold **PRE**.

---

CATEGORY
PLAYLIST
ARTIST
ALBUM
<b>PANDORA</b>

3. To give a "THUMBS UP" for the current song, press and hold **>**.

7:30	75F
THUMBS UP ARTIST SONG TITLE	

4. To give a "THUMBS DOWN" for the current song, press and hold **<**.

7:30	75F
THUMBS DOWN ARTIST SONG TITLE	

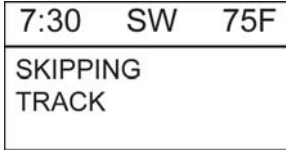

5. To skip forward to the next song, press and release **>**.

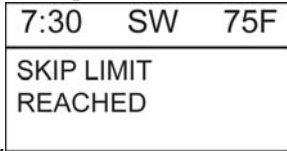

6. When the skip limit is reached, "SKIP LIMIT REACHED"



displays.

7. Press and release **PRE** to display the station list. Use  or  to scroll through the list and then press **PRE** or **>** to select a new station.

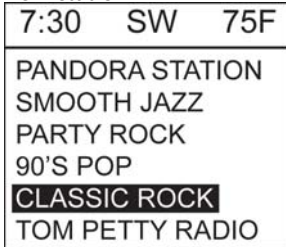

## NAV SOURCE

Please read this manual and the GARMIN ZUMO 660 NAV MP3 information provided with your player to become familiar with all unit features and operation.

The audio integration kit must be installed to enable outputs from the NAV MP3 (such as navigation instructions or user-loaded MP3 media files) to play through the headsets or speakers. The unit is fully functional without the kit installed, but there will be no interface with the vehicle's audio system.

## AUDIO SYSTEM

---

### NAVIGATION MP3 OPERATION TIPS

- Signals coming from the NAV MP3 unit will override any source of the motorcycle's audio system to ensure navigation instructions are communicated when needed. The signals will also override the MP3 player.
- You must set volume levels within the NAV MP3 unit. Volume settings in the motorcycle's audio system control NAV MP3 volume, but navigation instructions may be difficult to hear if volume levels in the unit are set too low. See the GARMIN information for setting procedures. The recommended initial settings are 100/80/80: MASTER 100%, NAVIGATION 80%, MEDIA 80%.
- Pause or stop the MP3 player to play audio from radio source.
- If playing MP3 files from the GARMIN ZUMO 660 unit, you may need to turn down the "media volume" on the GARMIN unit to avoid distortion.
- NAV audio must be turned on in the mode menu in order to play MP3 music files from the GARMIN ZUMO 660 NAV unit.
- While in NAV source, only MP3 music stored on the GARMIN ZUMO 660 will play on the radio.

The power switch must be ON to use the audio system. Press and release **MODE** until NAV is the active source.

When navigation instructions are given, the music volume will be muted and "NAV" will be displayed on the line below the active source.

7:30	75F
NAV	

### BLUETOOTH SOURCES

Press and release **MODE** until "DRIVE DEVICE" is displayed on the screen.

#### TIP:

If a Bluetooth compatible device is paired to the DRIVE DEVICE, the radio will automatically turn on the DRIVE DEVICE in the audio source loop.

Make sure the Bluetooth volume on your device is turned all the way up.

### BLUETOOTH SOURCE - DRIVER

When a device is paired and connected to the Driver Device location, selecting this mode will stream music to the radio.

7:30	SW	75F
STACY'S PHONE		

When a device is paired but not connected to a Bluetooth source location, the display will alternate between "SEARCHING" and "NOT CONNECTED".

7:30	SW	75F
STACY'S PHONE SEARCHING		

7:30	SW	75F
DRIVE DEVICE NOT CONNECTED		

When a device is paired to a Bluetooth source and is in the process of connecting to the radio, "CONNECTING" will be displayed.



When Driver Device is turned on, "NO AUDIO" will be displayed as the radio resumes connection with the device.





## BLUETOOTH DEVICE MUSIC MODE SETTINGS

The DRIVE DEVICE source will play the music source that is active on the connected device. Some Bluetooth devices allow the radio to access additional features and controls when using the Pandora® app.



The MUSIC MODE menu offers two settings:

- **DEFAULT** - Radio streams active music source from device with limited left-hand control functions (even if Pandora is the active music source on the device).
- **PANDORA** - Radio always commands device to use Pandora when DRIVE DEVICE is on. Left-hand control features expanded Pandora functionality: skip track, thumbs up, and thumbs down.

## MUSIC MODE SETTING - BLUETOOTH SETUP MENU

1. Press and hold **MODE** Until the system enters the audio system mode menus.
2. Press and release **MODE** to cycle through the menu items until **BLUETOOTH SETUP** is displayed. Press and release to access the Bluetooth Setup Menu options.
3. In the Bluetooth Setup Menu, press  or  to navigate through selections. Select **DRIVE DEVICE**.



4. Press  or  to navigate through selections until the device you want to configure is highlighted. Press and release **PRE** to select the device.



## AUDIO SYSTEM

---

5. Press  or  to navigate to MUSIC. Press and release **PRE**.





STACY'S PHONE  
CONNECTED  
RECONNECT  
**MUSIC**  
UNPAIR  
EXIT

6. Press  or  to navigate to either DEFAULT or PANDORA. Press and release **PRE** to make the selection.



MUSIC MODE  
DEFAULT  
**PANDORA**

## MUSIC MODE SETTING - BLUETOOTH DRIVE SOURCE

1. When the Bluetooth device audio source is active and playing, press and hold **PRE** until the system enters the MUSIC MODE menu.
2. Press  or  to navigate to either DEFAULT or PANDORA. Press and release **PRE** to make the selection.

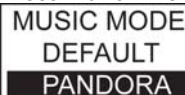

MUSIC MODE  
DEFAULT  
**PANDORA**



## VOICE RECOGNITION MODE

The radio features voice recognition when a driver headset is connected and turned on. Radio Bluetooth functionality is dependent on the capabilities of the device. Please see your device's user manual.

**TIP:** Make sure the Bluetooth volume on your device is turned all the way up.

The device's signal and battery strength are shown on the display with a range of zero to five (0-5), with "5" representing maximum strength.

## INITIATING A PHONE CALL

To initiate a phone call, double-press  to request voice recognition mode.

7:30	SW	75F
ALEX PHONE VOICE COMMAND		
ACTIVATE: PRESET CANCEL: MODE SIGNAL 5 BATT 5		

**Full screen mode shown**

Speak phone commands into microphone. Press and release **PRE** or press and release  while in voice recognition mode to re-send or resume voice recognition request.

When the phone call is initiated, "DIALING" and either the caller ID or "OUTGOING CALL" will be displayed.

7:30	SW	75F
ALEX PHONE OUTGOING CALL DIALING		

## AUDIO SYSTEM

---

Press **MODE** to cancel outgoing call if desired.

When the call is answered, the screen will display "CONNECTED".

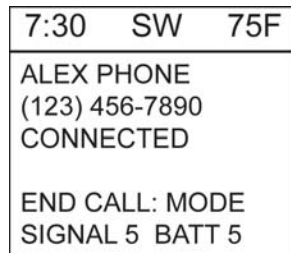

**Full screen mode shown**

Press and release **MODE** to end the phone call.

## RECEIVING/ANSWERING PHONE CALLS

When a phone is paired to DRIVER DEVICE, the audio system will allow the driver to either answer or reject an incoming phone call.

When an incoming phone call is received, the screen will display the information of the caller.

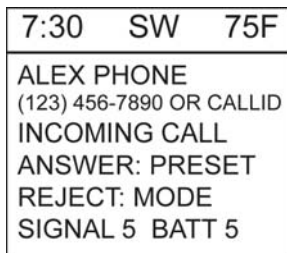

**Full screen mode shown**

Press **PRE** to answer the call.

Press **MODE** to reject the call.

To end the phone call, press **MODE**.

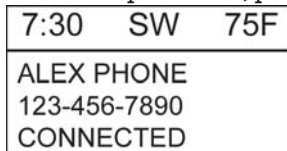

## ERROR MESSAGES

If your phone receives an incoming call, but you do not have your headsets connected, the incoming call information and “CANNOT ANSWER” displays.

7:30 SW 75F
ALEX PHONE (123) 456-7890 INCOMING CALL CANNOT ANSWER DRIVER HEADSET NOT CONNECTED

Press **PRE** or **MODE** to send the incoming call to voice mail.

If you attempt to initiate a phone call, but you do not have your headsets connected, “HEADSET NOT CONNECTED” displays.

7:30 SW 75F
ALEX PHONE VOICE COMMAND ERROR DRIVER HEADSET NOT CONNECTED

## SIRI EYES FREE

Your radio’s voice command mode supports the Siri Eyes Free feature on select iPhone models so you can use Siri without having to look at the screen. For example:

“Play songs by..”

“Get directions to...”

“Read my notifications”

“Send a message to...”

For additional commands, consult your device’s owner’s manual.

Siri is available on iPhone 4s, iPhone 5, iPad (3rd and 4th generations), iPad mini and iPod touch (5th generation), and requires internet access. Siri may not be available in all languages or in all areas, and features may vary by area. Cellular data charges may apply.

For more information about Siri Eyes Free, visit: [www.apple.com/ios/siri/](http://www.apple.com/ios/siri/).

## AUDIO SYSTEM

---

### AUDIO MODE MENUS

#### ENTERING MODE MENU

1. Press and hold **MODE** until the system enters the audio system mode menus.
2. Press and release **MODE** to cycle through the following menu items, shown in order of display:
  - Audio Output Select
  - Bass
  - Mid
  - Treble
  - Fader
  - Automatic Volume Control (AVC)
  - Bluetooth Setup
  - Bluetooth Drive Device
  - NAV Audio
  - FM/AM Tuner Clear Presets
  - Radio Broadcast Data System (RBDS)
3. At the RBDS screen, press and release **MODE** to return to the beginning of the mode menu list.

#### EXITING MODE MENU

Exit the screen and return to the default display in one of two ways:



1. Wait 10 seconds. The system will automatically exit.
2. Press **<** or **>** to exit.

### AUDIO OUTPUT SELECT

Use the audio output select menu to direct the audio output to either the external speakers or headsets.

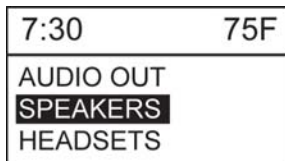
- Speakers • Headsets



1. Press  or  to adjust.
2. Press and release **MODE** to move to the next selection.

### BASS SETTING

Press  or  to adjust.

Press and release **MODE** to move to next selection.

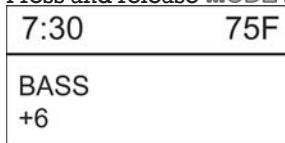

## MID SETTING

Press  or  to adjust.

Press and release **MODE** to move to next selection.

7:30	75F
MID	
-1	



## TREBLE SETTING

Press  or  to adjust.

Press and release **MODE** to move to next selection.

7:30	75F
TREBLE	
+4	

## FADER SETTING

1. Press  or  to adjust speaker fader balance.
2. Use the fader adjustment menu to control audio sound balance between front and rear speakers.

7:30	75F
FADER	
0	

**TIP:** Fader setting menu not shown if headsets are selected as the output.

3. Press and release **MODE** to move to next selection.

## AUDIO SYSTEM



---

### AUTOMATIC VOLUME CONTROL (AVC)

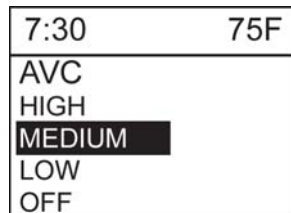
When set, this feature will lower or raise the speaker/headset volume automatically, based on vehicle speed.



- Off: No Adjustment
- Low: Least aggressive setting
- Medium: Moderate setting
- High: Most aggressive setting

1. Press  or  to adjust the automatic volume settings.
2. Press and release **MODE** to move to next selection.

### BLUETOOTH SETUP

Bluetooth Setup allows the user to pair and unpair the headset and devices.

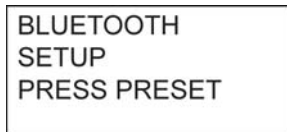

1. To access Bluetooth Setup, Press and hold **MODE** to access the audio menu.
2. Press and release **MODE** until “BLUETOOTH SETUP” is displayed.
3. Press and release **PRE** to access the Bluetooth Setup Menu options.

---

**TIP:** The Bluetooth setup menu is not available when the motorcycle is moving or when the screen is set to display Diagnostic Trouble Codes (DTCs).

---

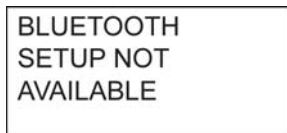

## BLUETOOTH SETUP MENU

The Bluetooth Setup Menu provides the following selections:

- DRIVE H-SET: Pair/unpair driver headset(s)
- DRIVE DEVICE: Pair/unpair driver device(s)
- EXIT: Exit Bluetooth Setup Menu



1. Press and release  or  to scroll through the list.
2. Press and release **PRE** or **>** to select an item.

## BLUETOOTH SETUP NOTES

- The Bluetooth Setup Menu will display “C” next to each position when there is either a headset or device connected.



- Each Bluetooth position can have a maximum of three devices paired to that location. To add another device, you must remove one or all of the paired devices.
- Only one device can be connected at any given time.
- During audio system power-up, the radio will search through the list of paired devices and make connections to one of each pairing position.

**TIP:** Turning the source off in the MODE MENU will not prevent the device from connecting; it only prevents it from appearing on the audio source loop. This allows a device to be paired and connected only for the purpose of receiving phone calls.

- Left hand audio controls are limited to basic functions when devices are connected via Bluetooth.
- To maintain full left hand audio controls, connect the device to the USB cable.
- To enable maximum functionality when streaming Pandora® over a device, select Pandora from the MUSIC MODE menu. See Bluetooth Device Music Mode Settings.
- To enable maximum functionality when playing Pandora on an iPod or iPhone, connect the device using the USB cable.

## AUDIO SYSTEM



---

### DRIVER HEADSET PAIRING

---

**TIP:** Incoming phone calls cannot be answered if driver headset is not connected. Press and release **PRE** or **MODE** to send the calls to voice mail.

---

1. Press and hold **MODE** to access the audio menu.
2. Press and release **MODE** until “BLUETOOTH SETUP” is displayed.
3. Press and release **PRE** to access the Bluetooth Setup Menu options.
4. In the Bluetooth Setup Menu, press  or  to navigate through selections. Select **DRIVE H-SET**.

BLUETOOTH
<b>DRIVE H-SET</b>
DRIVE DEVICE
EXIT

5. Press and release **PRE**.

6. Press **PRE** to select **ADD H-SET**.
- 

**TIP:** Sena SMH10 motorcycle Bluetooth headsets are recommended. Reference the headset user manual to enable Bluetooth pairing.

---

DRIVE H-SET
<b>ADD H-SET</b>
EXIT

The radio will search for the headset.

7:30	75F
ADD HEADSET	
SEARCHING	

7. When the headset is found, its name will be displayed.

7:30	75F
ADD HEADSET	
<b>SENA SMH10</b>	
EXIT	

8. Press and release **PRE** to pair the headset with the radio.

7:30	75F
SENA SMH10	
PAIRING	





9. The radio will display “PAIRING” during the pairing process.

**TIP:**

If prompted to enter a pairing code, find the code in the headset user's manual.

PAIRING CODE ----
----------------------

Use  or  to enter the digits 0-9.



Press and release **PRE** to enter the number and move to the next digit. Default codes are typically: “0000” or “1234”.

“PAIRED” is displayed on the screen when the radio has successfully paired the headset.

7:30	75F
SENA SMH10	
PAIRED	

## DRIVER DEVICE PAIRING

The radio can be paired with Bluetooth devices such as smart phones.

1. In the Bluetooth Setup Menu, press  or  to scroll.
2. Set device to “Discoverable Mode” before starting the pairing procedure.
3. Select **DRIVE DEVICE**.

BLUETOOTH DRIVE H-SET <b>DRIVE DEVICE</b> EXIT
---

4. Press and release **PRE**.
5. Use  or  to scroll to **ADD DEVICE**.

DRIVE DEVICE STACY'S PHONE <b>ADD DEVICE</b> UNPAIR ALL EXIT
--

6. Press and release **PRE** to select.

ADD DEVICE SEARCHING
-------------------------

## AUDIO SYSTEM



---

The radio will search for the device. When the device is found, its name will display.

ADD DEVICE  
ALEX'S PHONE

7. Press and release **PRE** to pair the device with the radio.

ALEX'S PHONE  
PAIRING

8. After pressing **PRE**, a confirmation screen will appear. Verify the code on the device matches the code displayed on the screen. Use  or  to scroll to YES. Push to **PRE** enter key.

CONFIRM: 123456  
NO  
YES

---

**TIP:** Select “NO” if the codes do not match. Perform steps 1-8 again to pair the device.



---

9. “PAIRED” is displayed on the screen when the radio has successfully paired the device.

ALEX'S PHONE  
PAIRED



## UNPAIRING/RECONNECTING DEVICES

**TIP:** The following steps reference the DRIVE H-SET as an example. Unpairing other devices follows the same procedures.

1. In the Bluetooth Setup Menu, use  or  to make a selection. Select DRIVE H-SET.



```

BLUETOOTH
DRIVE H-SET
DRIVE DEVICE
EXIT
  
```

2. Press and release **PRE**.
3. To unpair ALL of the devices in the DRIVE H-SET location, press  or  to select UNPAIR ALL, and then press **PRE**.

```



DRIVE H-SET
SCALA RIDER G9
SENA SMH10
UNPAIR ALL
EXIT
  
```

4. Press  or  to select NO or YES. Select YES, and then press and release **PRE** to unpair all devices.

```



UNPAIR ALL
DRIVE H-SET
NO
YES
  
```

*The radio will unpair all of the devices from this location and return to the Bluetooth Setup Menu.*

5. To unpair individual devices in the DRIVE H-SET location, press and release  or  to select the device you want to unpair.

```

DRIVE H-SET
C SCALA RIDER G9
SENA SMH10
SCALA RIDER G9
UNPAIR ALL
EXIT
  
```

6. Press and release **PRE** to select the device.
7. Press and release  or  to select UNPAIR.

```

SCALA RIDER G9
RECONNECT
UNPAIR
EXIT
  
```

## AUDIO SYSTEM

---

8. Push and release **PRE** to unpair the device.

SCALA RIDER G9  
UNPAIRING

*“UNPAIRED” will be displayed after the device is removed from the list.*

SCALA RIDER G9  
UNPAIRED



*The radio will return to the DRIVE H-SET device location.*

DRIVE H-SET  
SENA SMH10  
UNPAIR ALL  
EXIT

9. To connect a different paired device at a location, select that device and press **PRE** to select it. Select RECONNECT. Press **PRE**.



SCALA RIDER G9  
RECONNECT  
UNPAIR  
EXIT

## BLUETOOTH DRIVER DEVICE

1. Press  or  to turn the DRIVER Bluetooth device source ON or OFF.
  - SOURCE ON
  - SOURCE OFF
2. Press and release **MODE** to move to the next selection.



7:30	SW	75F
DRIVE DEVICE SOURCE OFF <b>SOURCE ON</b>		

## NAV AUDIO

1. Press  or  to turn the NAV AUDIO source ON or OFF.
2. Press and release **MODE** to move to the next selection.

7:30	SW	75F
NAV AUDIO OFF <b>ON</b>		

## TUNER CLEAR PRESETS

1. To clear all FM or AM radio station presets, press  or  to select FM or AM clear presets.

7:30	75F
FM CLEAR PRESETS	



2. Press **PRE** to clear the presets for the desired tuner band.
3. Press and release **MODE** to move to the next selection.

7:30	75F
FM PRESETS CLEARED	

## AUDIO SYSTEM

---

### RADIO BROADCAST DATA SYSTEM (RBDS)

1. Press  or  to turn the Radio Broadcast Data System (RBDS). When on, the screen will display artist, song title, etc. (if available in the radio signal).
  - OFF
  - ON (Station name only)
  - FULL (Station name + radio text)
2. Press and release **MODE** to move to the top of the MODE menu list.

7:30	SW	75F
RBDS		
FULL		
ON		
OFF		

## AUDIO SYSTEM DIAGNOSTICS

The audio system diagnostic menu allows the following actions for you or your INDIAN MOTORCYCLE dealer:

- View radio software version
- Perform left hand audio control key pad tests
- Set radio tuner location
- View vehicle speed

### DIAGNOSTIC MENU

To access the diagnostic menu:

1. Press and hold  to turn the radio off.
2. Turn the power switch OFF.
3. Turn the power switch ON.
4. Press and hold **PRE** for several seconds.
5. This screen will appear if steps 1-4 were performed correctly.

7:30	75F
RADIO	
BOOT V 1.00A	

**TIP:** If you do not see this screen, perform steps 1-4 again.

6. Press and release **MODE** to move to Key Pad Diagnostics.

## KEY PAD DIAGNOSTICS

Key pad diagnostics allows the user to test the function of each button on the left hand audio control block.

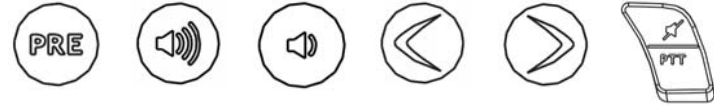

1. Press and release each of the audio control buttons to test the function of each button.
2. Observe the display after each button is pressed. The screen will display the button name by its function. If nothing displays, the button is not working. See your authorized dealer for

7:30	75F
VOL UP	

service.

3. Press and release **MODE** to move to Tuner Location Settings.

## AUDIO SYSTEM

---

### TUNER LOCATION SETTINGS

---

**TIP:** Partial screen shown. Full list will appear on screen if DTC display mode is inactive.

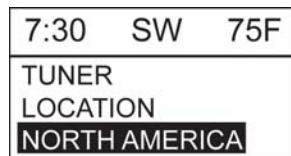

---

The radio tuner can be set to the geographical location where the motorcycle will be driven.



The following settings can be chosen under the Tuner Location Settings menu:

- NORTH AMERICA (USA/CANADA/MEXICO)
- EUROPE
- EUROPE 50
- JAPAN
- AUSTRALIA
- TAIWAN

1. Press and release  or  to make a new selection.
2. Turn the power switch OFF, then ON to save the new tuner location.



**SPEED DIAGNOSTIC**

The Speed Diagnostic menu displays vehicle speed.

7:30	75F
SPEED	
0 MPH	
0 KPH	

Use this menu to verify the radio system is receiving a speed signal from the vehicle control module.

1. Press and release **MODE** to return to the radio hardware/version display screen.
2. To exit the audio system diagnostics menu, press and release **<** or **>** to return to the RADIO OFF screen.

**AUDIO COMPLIANCE INFORMATION****FCC AND INDUSTRY CANADA COMPLIANCE STATEMENT**

This equipment complies with FCC radiation exposure limits set forth for an uncontrolled environment. This equipment should be installed and operated with minimum distance of 20 cm between the radiator and your body.

This device complies with Industry Canada license-exempt RSS standard(s). Operation is subject to the following two conditions: (1) this device may not cause interference, and (2) this device must accept any interference, including interference that may cause undesired operation of the device.

**JAPAN COMPLIANCE STATEMENT**

This device contains a radio module with certification number:

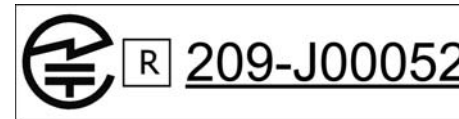



## RIDE COMMAND™ OVERVIEW



## RIDER SCREEN



The Rider Screen is a customizable split screen menu system that provides unique access to ride data, vehicle status, and vehicle information. The Rider Screen also provides easy access to other often used features, such as Audio controls, Bluetooth features, and Maps.

### **CUSTOMIZE YOUR RIDER SCREENS**

RIDE COMMAND™ has three customizable screens.

To customize the left or right-hand side of the Rider Screens, do the following:

RIDE COMMAND™ is found on Chieftain and Roadmaster models.

The RIDE COMMAND™ Display has 5 buttons:

- Rider Screen Button
- Audio Button
- Display On/Off Button
- Bluetooth Button
- Navigation Button

## RIDE COMMAND™

---

1. Press the Rider button to access the rider screen.

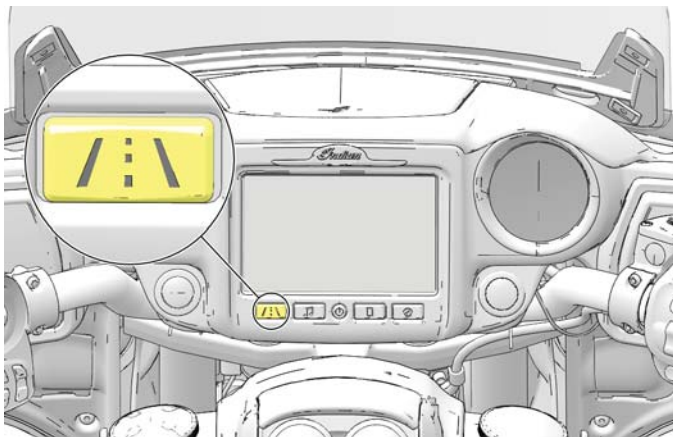

2. Press the menu icon ①, located in the lower right corner of the display screen.



3. From the options shown on the left side of the display screen ②, select the option you want displayed on the left side of your Rider Screen.



4. From the options shown on the right side of the display screen ③, select the option you want displayed on the right side of your Rider Screen.



5. When you have finished, press the return icon on the display screen ④ to save and return.

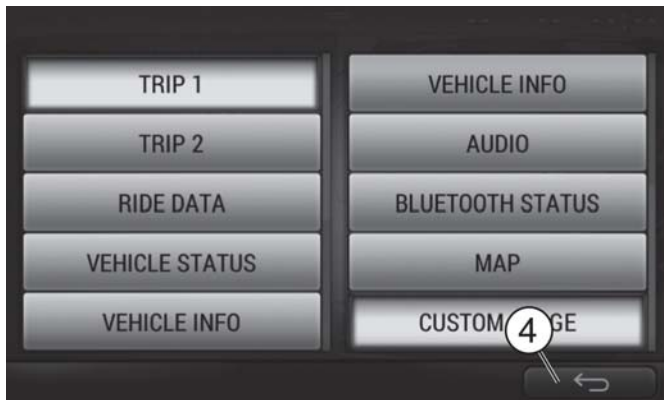

## AUDIO



The Audio Section of RIDE COMMAND™ allows you to change the audio source, adjust volume level, and set radio presets.

### AUDIO SOURCE

To select audio source, do the following:

1. Press the Audio button to access the Audio Section

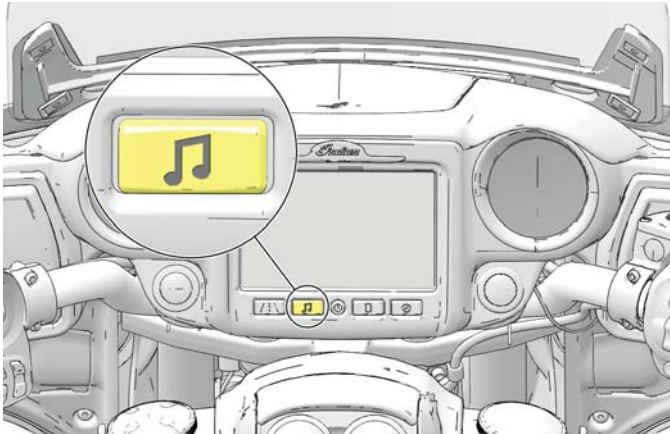

2. Press the Audio button again, or press the Source button ① in the upper left corner of your display screen.



3. Choose audio source from available options.



**NOTE:** Current audio source is shown inside red circle on display screen.

---



## TUNER

If you select FM or AM as your audio source, a tuner will show on the RIDE COMMAND™ display.

1. Press the Seek button ② to advance to the next station with a strong signal.



2. Press the Scan button ③ to toggle through stations. The tuner will stop at each station with a strong signal and play for a limited time, before moving on to the next station.



3. Press the Scan button again to stop scanning.

## RIDE COMMAND™

---

4. To save a station to your presets, be on the station you wish to save and press and hold on an empty preset button ④.



## DISPLAY ON/OFF SCREEN



The Display On/Off button allows you to turn your display on and off while your motorcycle is in use.

1. Press the power button once to display the INDIAN logo screen.

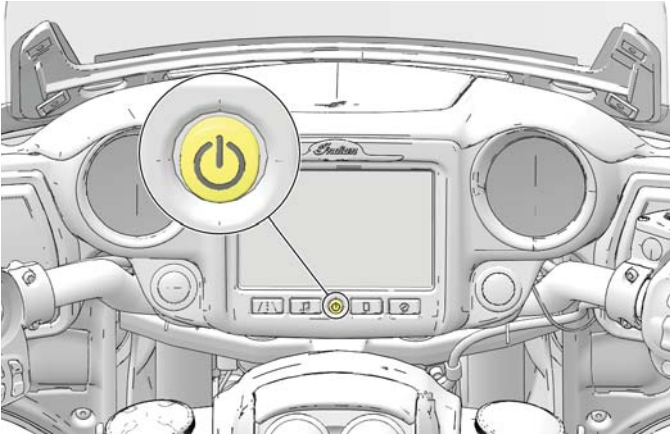

2. Hold the power button for 3 seconds to shut down the display.



3. Hold the power button for 6 seconds to shut down display and audio.
4. Press any button to turn on display.

## BLUETOOTH



Press the Bluetooth button to access the Bluetooth section on the RIDE COMMAND™ display.

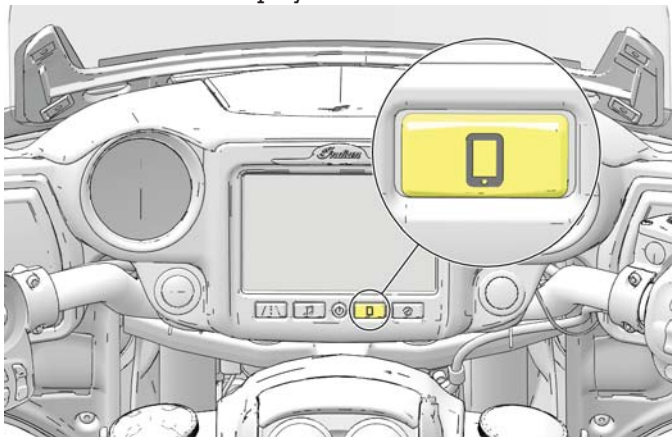

**NOTE:** You must enable Bluetooth on your phone and make it visible to complete this process.

## PAIR PHONE TO RIDE COMMAND™

To pair phone to touchscreen display, do the following:

1. Enable Bluetooth on your phone.
2. Make phone visible.
3. Press the Bluetooth button to access the Bluetooth section on your RIDE COMMAND™ display.
4. Press the Bluetooth icon on the left side of your display.

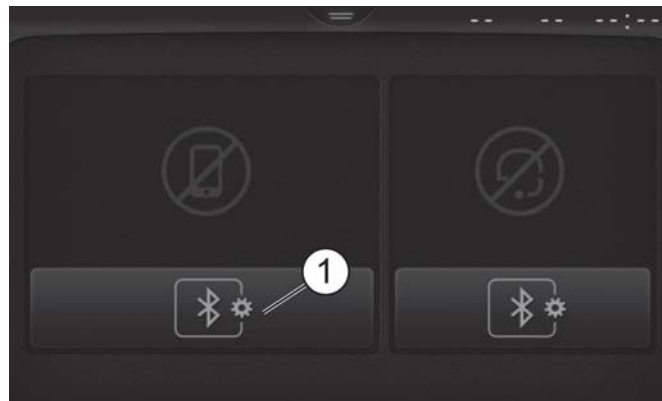

5. Press OK, and select your phone on the RIDE COMMAND™ display screen.
6. Agree to all notifications on your phone.

**NOTE:** While accepting notifications on your phone, remember to select the “Do Not Show Again” box if applicable.

---

## PAIR HEADSET TO RIDE COMMAND™

---

**NOTE:** For the Bluetooth features of RIDE COMMAND™ to work properly both the phone and the headset need to be paired with the RIDE COMMAND™ display. If the phone is paired directly with the headset, the Bluetooth features of the RIDE COMMAND™ display will not function.

---

To pair your headset to RIDE COMMAND™, do the following:

1. Enable Bluetooth on your headset.
2. Follow the manufacture's instructions to put your headset into pairing mode.
3. Press the Bluetooth icon on the right side of the display.

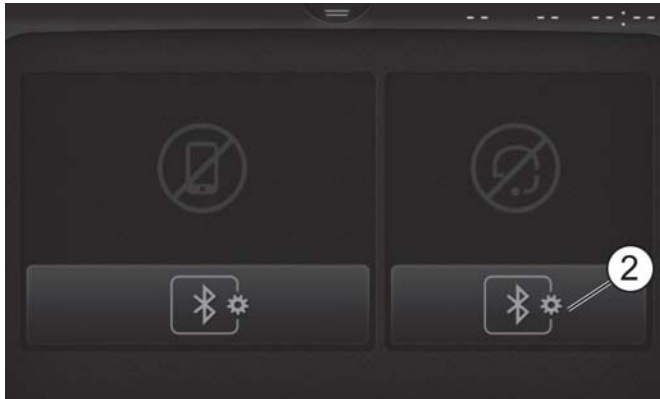

4. Press OK, and select your headset on the RIDE COMMAND™ display screen.

## NAVIGATION



The Navigation Screen provides you with directions to your destinations. You can easily find addresses, gas stations, and other points of interest.

Press the Navigation button to access the Navigation Section on the RIDE COMMAND™ display.

### SEARCH FOR AN ADDRESS

To search for an address, do the following:

1. Press the Navigation button to access the Navigation section.

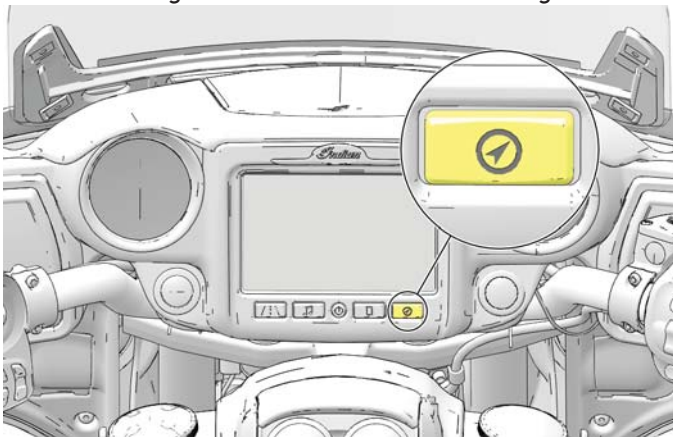

2. Press the Search button ① in the lower right of the RIDE COMMAND™ display.

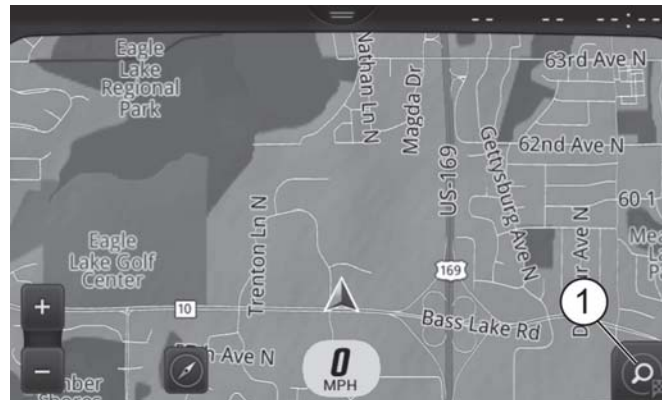

3. Press the Address Search button ②.

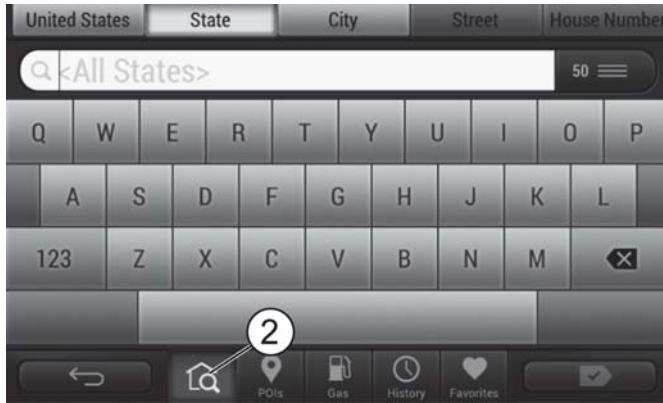

4. Press the Country button at the top of the display screen ③ and enter the name of the country you are searching for into the search field, then press the confirm button ④.



5. Enter the name of the City into the search field and press the confirm button.

6. The display will ask you if you want to travel to the city center. Select City Center if you wish to navigate to the city center, or press Enter Address if you want to continue entering the address.

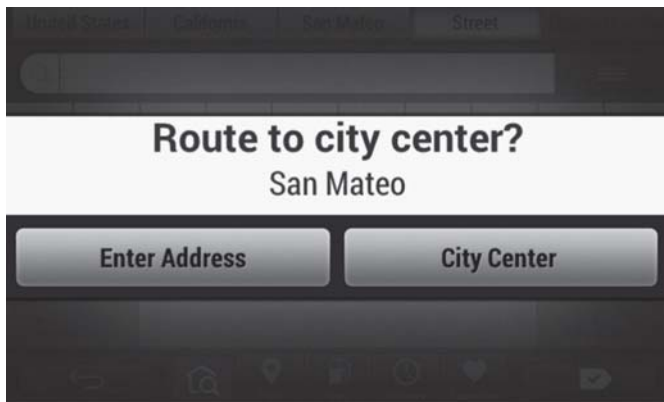

7. If you selected Enter Address, enter the street name of the address you are searching for into the search field, and press the confirm button.
8. Enter the street address of the address you are searching for into the search field and press confirm.

---

**NOTE:** You must enter the street name for where you are going, and then the number for the address in that order when entering an address.

---

9. The RIDE COMMAND™ display will show an overview of the route. For additional route options, press the Options button located in the upper right corner of the display screen (5). Options include Fastest route, Shortest route, or Scenic route. You can also choose to avoid highways or avoid tolls.





10. Press the confirm button ⑥ to confirm selection and begin navigation.

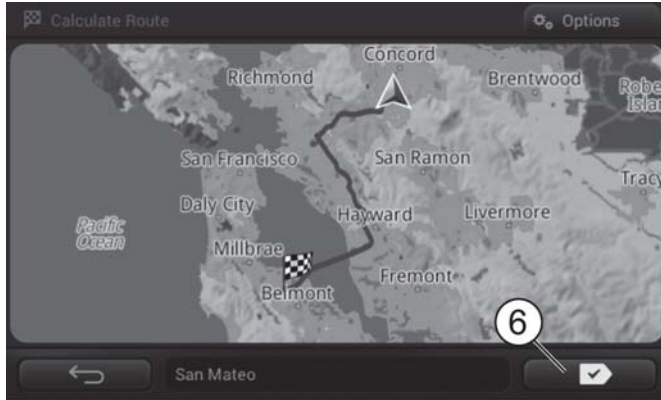

## NAVIGATION OPTIONS

1. Press the Menu button ① to view a detailed view of each step on your route.



2. Press the Audio icon on the Navigation screen ② to bring up a list of audio options, such as volume controls and mute.

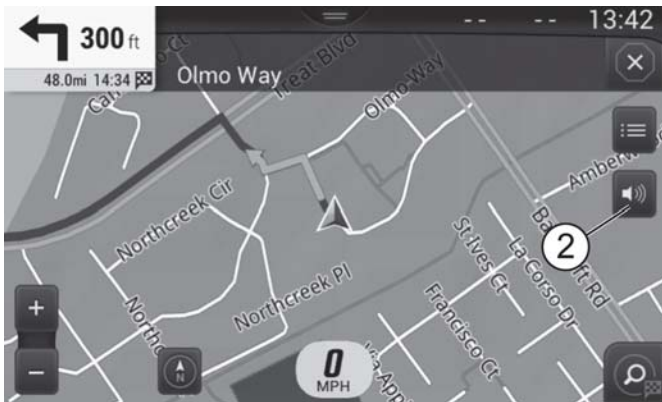

3. Press the X icon ③ to pause the navigation, or stop navigation.



4. Pinch the screen with 2 fingers to zoom out of your map, pinch your fingers outward to zoom in.

5. You can also use the + and - buttons ④ located in the lower left corner of the touchscreen to zoom in and out of your map.



7. Press the re-center button ⑤ to re-center your map.



6. Swipe your finger across the touchscreen display to pan around the map.

## POINT OF INTEREST (POI)

1. To access the POI menu, press the Search button in the lower right corner of the RIDE COMMAND™ display.

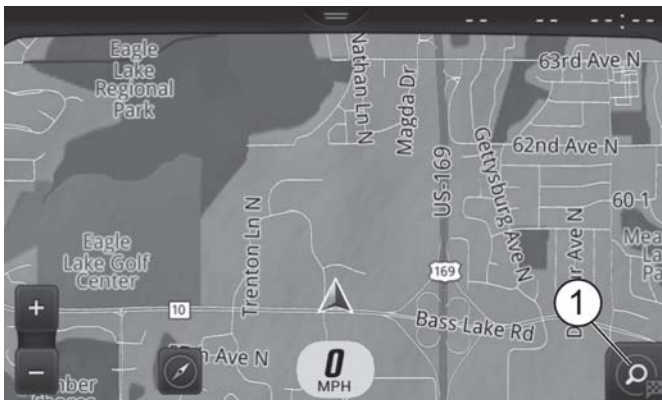

2. Select the POI icon from the available search options. This will bring up a menu that displays commonly visited places, such as restaurants, and fuel stations.



3. Select from the categories listed on the left side of the touchscreen to display points of interest near you.
4. Select your POI.

5. When prompted to Calculated Route, press Yes.

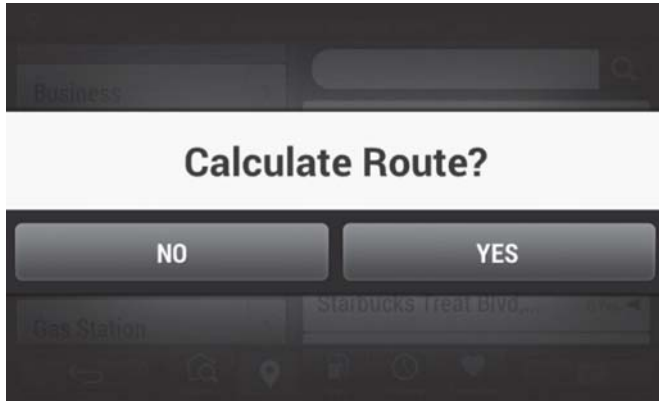

6. Press the Confirm button ③ located in the lower right of the RIDE COMMAND™ display.

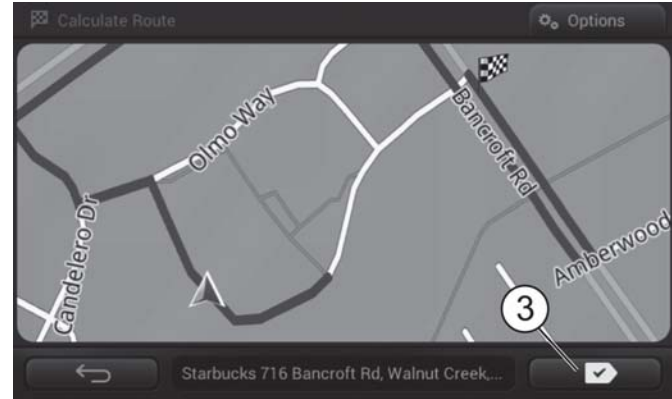

## HAND CONTROLS

### TRIGGER CONTROLS

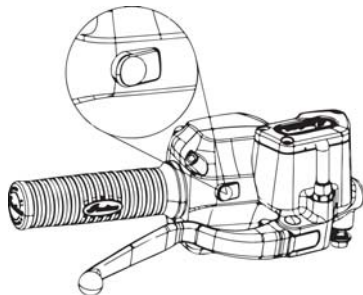

1. Use the left-hand trigger to decline selection, or switch Ride Command screens.
2. Use right-hand trigger to accept selection (shown above).

## AUDIO CONTROLS

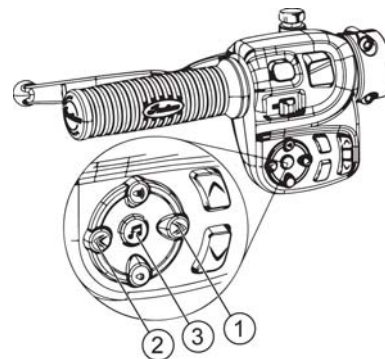

Use the controls on the left control block to affect audio features.

- ① Press the right button to advance.



- ② Press the left button to go back.



- ③ Press the center button to mute, play, or pause audio.



## MAP CONTROLS

Press the up and down buttons on the left hand control block to zoom in and out of the map.

## RIDE COMMAND™ SETTINGS

The Settings Menu is where you can personalize your Navigation System. You can configure settings, such as Language, Speed Units, Time Formats, as well as audio and vehicle settings.

To access the settings menu on your RIDE COMMAND™ display, press the button at the top of the touchscreen display ①, and then press the settings button ②.



The Settings Menu is composed of 4 categories that allow you to customize your screens; General, Time, Audio, and Vehicle.

## GENERAL

Press the General button ③ to access the General Settings.

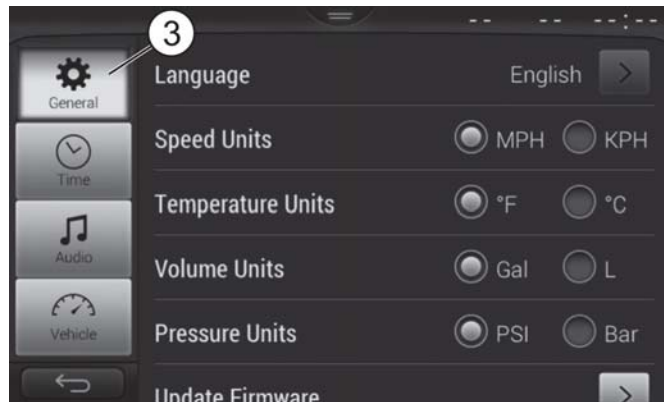

From the General settings menu you can do the following:

- Change the Language
- Set the Speed Units (MPH or KPH)
- Set the Temperature Units (F or C)
- Set the Volume Units (Gal or L)
- Set the Pressure Units (PSI or Bar)
- Update Software
- Update Maps

## TIME

Press the Time button to access the Time Settings.

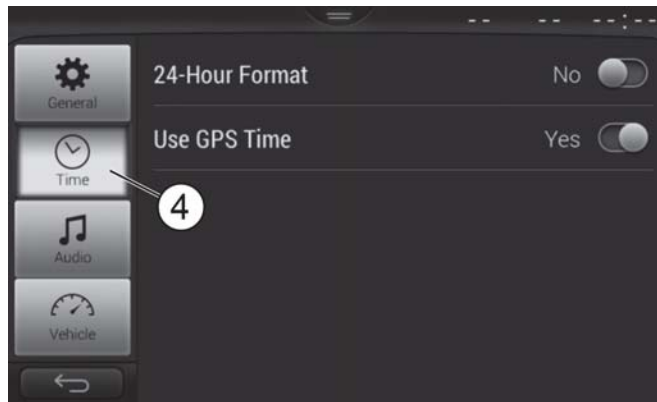

From the Time Settings you can do the following:

- Set the Time Format (12 hour or 24 hour)
- Enable GPS Time, which automatically sets the time to the time zone you are currently in
- Set the time
- Enable/Disable Daylight Saving Time



## AUDIO

Press the Audio button within the settings menu to access the Audio Settings.



From the Audio Settings you can do the following:

- Enable Automatic Volume Control
- Set the Equalizer settings
- Adjust the Fade and Balance
- Clear AM/FM Presets
- Set the Radio Tuner Region

## VEHICLE

Press the Vehicle button to access the Vehicle Settings.

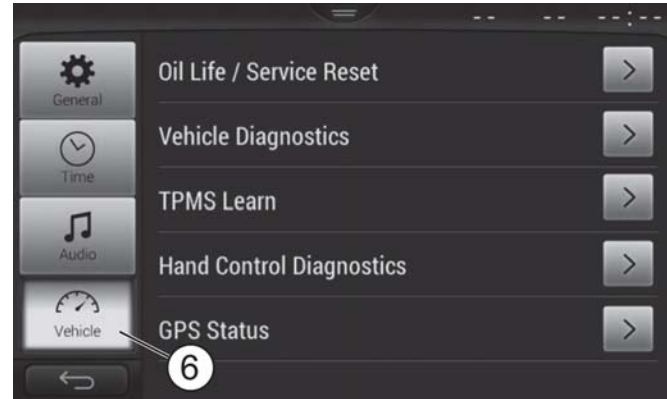

From the Vehicle Settings you can do the following:

- Oil Life/ Service Reset
- Access Vehicle Diagnostics
- TPMS Learn
- Access Hand Control Diagnostics
- View GPS Status

### DOWNLOAD NEW SOFTWARE

To download new software for RIDE COMMAND™, do the following:

#### ON YOUR PERSONAL COMPUTER

1. Go to [www.my.indianmotorcycle.com](http://www.my.indianmotorcycle.com)
2. Log into your account, or create a new account.
3. Using the Vehicle Identification Number (VIN), add your new Indian Motorcycle to your Garage.
4. Locate and download the latest software to the USB flash drive (8 GB).

---

**NOTE:** File cannot be in a folder.

---

5. Properly eject USB flash drive from your personal computer.

#### ON YOUR MOTORCYCLE

1. Connect the USB flash drive to the USB cable located within the storage area above the display.
2. Power up your Indian Motorcycle.

#### ON YOUR RIDE COMMAND™ DISPLAY SCREEN

1. Navigate to the Settings Menu of your RIDE COMMAND™ display.

2. Select General Settings ①.

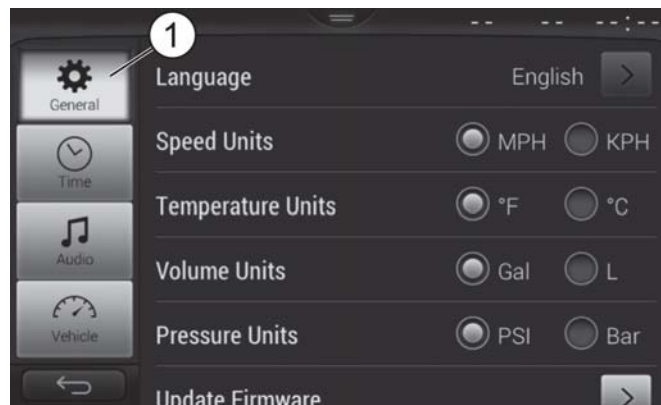

3. Select Update Software.
4. Select Continue.
5. Select the file you wish to load.

---

**NOTE:** Use the date listed in the file name to determine most recent file.

---

6. Select Yes to restart display.

---

**NOTE:** Restart is required for new software to become active.

---

---

## DOWNLOAD NEW MAPS

To download new maps for RIDE COMMAND™, do the following:

### ON YOUR MOTORCYCLE

1. Connect the USB flash drive to the USB cable located within the storage area above the RIDE COMMAND™ display.

### ON YOUR RIDE COMMAND™ DISPLAY SCREEN

1. Navigate to the Settings Menu of your RIDE COMMAND™ display.
2. Select General Settings.
3. Select Update Maps.
4. Select the Create Key button.
5. Once the key has finished loading, power down your motorcycle and remove the USB flash drive.

### ON YOUR PERSONAL COMPUTER

1. Go to [www.my.indianmotorcycle.com](http://www.my.indianmotorcycle.com)
2. Log into your account, or create a new account.
3. Using the Vehicle Identification Number (VIN), add your new Indian Motorcycle to your Garage.
4. Locate and download the latest maps to the USB flash drive.

---

**NOTE:** File cannot be in a folder.

---

5. Properly eject USB flash drive from your personal computer.

### ON YOUR MOTORCYCLE

1. Connect the USB flash drive to the USB cable located within the storage area above the display.
2. Power up your Indian Motorcycle.

### ON YOUR RIDE COMMAND™ DISPLAY SCREEN

1. Navigate to the Settings Menu of your RIDE COMMAND™ display.
2. Select General Settings.
3. Select Update Maps.
4. Select Continue.
5. Select Yes to restart display.

---

**NOTE:** Restart is required for new maps to become active.

---

---

**NOTE:** Your Ride Command display comes with a 3 year care map. This includes all of the original maps that came with your display, plus 2 additional years of free map updates.

---



**A**

About the Rider's Manual ..... 11

ABS Sensor Inspection ..... 133

ABS Tone Ring Inspection ..... 133

Accelerating ..... 101

Accessories

    Use ..... 15

Air Filter ..... 115

Anti-Lock Brake System (ABS) ..... 77

Anti-Lock Brake System Response ..... 14

Audio Compliance Information ..... 223

Audio Controls ..... 191

Audio Menu Options ..... 190

Audio Mode Menus ..... 210

Audio System Diagnostics ..... 221

Audio System Introduction ..... 187

Audio System Power ..... 193

Audio System Switches ..... 37

Audio System Volume ..... 194

Automatic Volume Control ..... 212

Auxiliary Light Switch ..... 37

Average Fuel Economy ..... 43

Average Speed ..... 54

**B**

Battery ..... 144

Battery Care, Storage ..... 162

Battery Charging ..... 147

Battery Installation ..... 146

Battery Removal ..... 145

Battery Voltage ..... 54

Bluetooth Music Mode Settings ..... 205

Bluetooth Setup ..... 212

Bluetooth Sources ..... 204

Brake Disc Inspection/Cleaning ..... 131

Brake Fluid ..... 171

Brake Fluid Precautions ..... 128

Brake Hoses/Connections ..... 128

Brake Light Replacement ..... 143

Brake Pads ..... 132

Brakes ..... 78

    Front Brake Lever ..... 78

    Rear Brake Pedal ..... 78

Braking ..... 101

Break-In Maintenance ..... 106

**C**

Capacities ..... 166

Carrying a Passenger ..... 14

    To Carry A Passenger Safely ..... 14

Carrying Cargo ..... 17

Changing Your Security System PIN ..... 150

Chassis ..... 169

Clean and Protect the Motorcycle ..... 162

Cleaning Products ..... 155

Clock ..... 44

Clutch Lever ..... 68

Component Identification ..... 27–29

Console ..... 25–26

Control

    Left Control ..... 31

    Right Control ..... 31

Crankcase Breather Hoses ..... 124

Cruise Control ..... 102

    Accelerate ..... 103

    Cruise Control Tips ..... 102

    Cruise Control, Cancel ..... 103

    Decelerate ..... 103

    Resume Speed ..... 103

    Set Speed ..... 102

Cruise Control Switches ..... 37

**D**

DC Voltage ..... 43

Diagnostic Functionality ..... 45

Diagnostic Trouble Codes ..... 55

Dimensions ..... 165

Display ..... 61

Display Units (Standard/Metric) ..... 44

Drive System ..... 168

**E**

Electrical ..... 170

Electrical Precautions ..... 149

Electromagnetic Interference ..... 20

Elevating the Motorcycle ..... 151

# INDEX

---

Engine .....	167
Engine Break-In .....	93
Engine Compression Test .....	151
Engine Error Codes .....	45
Engine Hours .....	53
Engine Identification Number .....	9
Engine Oil Recommendation .....	171
Engine Oil/Filter Change .....	113
Engine Protection .....	162
Engine Run Switch .....	35
Engine Speed .....	43
Engine Starter Switch .....	36
Engine Stop Switch .....	35
Evaporative Emission Control System .....	125
Exhaust System Inspection .....	151
Expanded Audio Information .....	54
Exposure to Dirt/Dust .....	158
Exposure to Moisture .....	158
Exposure to Sun .....	158

## F

Fastener Inspection .....	151
Fastener Torques .....	151
FCC and Industry Canada Compliance Statement .....	223
FM/AM/MW/LW Tuning .....	197
Fork Oil .....	171
Frequently Asked Questions .....	160
Front Brake Fluid .....	130

Front Brake Lever .....	130
Front Brake Pad Inspection .....	132
Front Fork Inspection .....	123
Front Tire Pressure, Display .....	53
Front Wheel Installation .....	134
Fuel and Exhaust Safety .....	18
Fuel Cap .....	79
Fuel Economy Display .....	52
Fuel Filter .....	114
Fuel Gauge .....	47, 64
Fuel Gauge Display .....	42
Fuel Level Chief Classic Dark Horse .....	91, 93
Chief/Springfield .....	91
CHIEFATAIN/ROADMASTER .....	91
CHIEFTAIN DARK HORSE .....	91
Fuel Range .....	43
Fuel Recommendation .....	171
Fuel Stabilizer .....	162
Fuel System Components .....	125
Fueling .....	95
Fuse Replacement .....	148

## G

Gauge Information .....	62
Gear Position .....	43
Gear Shift Lever .....	68
Gloss Clear Coat Finish Care .....	157
Gross Vehicle Weight Rating .....	20
GVWR .....	20

## H

Hand Grip Heater Switch .....	38
Headlight Aim Adjustment .....	141
Headlight Aim Inspection .....	140
Headlight Beam Switch .....	37
Headlight Lamp Replacement .....	142–143
Headlights .....	67
Heated Grips .....	55
Heated Grips Setting .....	44
High-Current Fuses .....	148

## I

Identification Number Records .....	7
Indicator Lamps .....	41, 48–49, 65–66
Information Labels .....	23
Infotainment Care .....	157
Infotainment Display Settings .....	50–56
Instrument Cluster .....	40–52, 64–66
Speedometer .....	40
Instrument Cluster (CHIEFTAIN DARK HORSE) .....	47
Instrument Cluster Audio Display .....	192
Instrument Cluster Setup .....	57–63
Method 1 .....	63
Method 2 .....	63
iPod / iPhone Compatibility .....	187

**K**

Key Fob Compliance Statement .....	20
Keyless Ignition .....	36

**L**

Leather Care .....	158
Leather Care Dressing .....	159
Leather Care Dressing Application .....	159
Low Oil Pressure Display .....	46
LUBRICANTS AND FLUIDS .....	175

**M**

Maintenance	
Periodic Maintenance Table .....	107
Maintenance During Storage.....	162
Maintenance Log .....	185
Maintenance, Major.....	106
Matte Clear Coat Finish Care .....	156
Mechanical Clutch Cable	
Lubrication.....	127
Mechanical Clutch Lever Freeplay .....	126
Mechanical Clutch Lever Lubrication .....	127
Memory Presets.....	197
MFD Indicators .....	42
Mirrors .....	77
Misfire Detection.....	46
Modifications .....	16

Motorcycle Noise Regulation .....	178
Multi-Function Display (MFD).....	43, 50
Mute .....	194
Mute, Low Voltage .....	194

**N**

Navigation MP3 Operation.....	204
Noise Emission Warranty.....	178

**O**

Odometer .....	43
Oil Life .....	53
Operating Speeds and Gears .....	94
Operating Your Motorcycle Outside the U.S.A. ....	8

**P**

Parking .....	104
Parking on a Slope .....	104
Parking on a Soft Surface .....	104
Parking the Motorcycle .....	16
Passenger Floorboard Supports .....	79
Periodic Maintenance .....	106
Severe Use Definition.....	106
Periodic Maintenance Table .....	107

Phone Call, Initiating .....	207
Phone Calls, Receiving .....	208
Pre-Ride Inspections.....	81
Brake Lines .....	88
Electrical Inspections .....	82
Engine Oil Level .....	84–85
Fasteners .....	90
Front Brake Fluid Level .....	87
Front Brake Lever, Inspection .....	87
Front Suspension .....	90
Fuel Level .....	91
General Inspections .....	83
Mechanical Clutch .....	89
Rear Brake Fluid Level .....	88
Rear Brake Pedal, Inspection.....	87
Rear Drive Belt .....	90
Rear Suspension .....	90
Sidestand.....	89
Steering .....	90
Throttle .....	89
Tire Condition .....	86
Tire Pressure .....	86
Tire Tread Depth.....	86
Tires .....	86
Priming the Fuel System.....	96
Protective Apparel .....	15
PTT .....	194
Push-To-Talk .....	194

# INDEX

---

## R

Radio, Turn Off .....	194
Rear Brake Fluid .....	129
Rear Brake Pad Inspection .....	132
Rear Brake Pedal .....	128
Rear Drive Belt Cleaning .....	116
Rear Drive Belt Condition .....	116
Rear Drive Belt Wear Analysis .....	117
Rear Shock Preload (Ride Height) Adjustment .....	120
Rear Shock Preload Inspection .....	118
Rear Tire Pressure, Display .....	53
Removal From Storage .....	163
Reporting Safety Defects .....	21
Retrieving Error Codes .....	56
RIDE COMMAND™ .....	64, 225, 233
Audio .....	229
Bluetooth .....	234
Download Maps .....	249
Download Software .....	248
Hand Controls .....	244
Navigation .....	236
Rider Screen .....	225
Settings .....	245
Ride Height Adjustment .....	121
Ride Height Inspection .....	118
Road Test .....	151
Road Tests .....	106
Rodents .....	163

## S

Saddlebag Lock Switch .....	39
Saddlebags .....	73
Hard Bag Removal .....	73
Soft Bag Removal .....	74
Saddlebags, Trunk and Other Storage ..	16
Safe Riding Practices .....	12
Follow These General Safe Riding Practices .....	12–13
Motorcycling Has Inherent Risks .....	12
Safety and Information Labels .....	22
Safety During Service Procedures .....	105
Safety Labels .....	23
Safety Maintenance .....	19
Safety Symbols and Signal Words .....	4
Seat Heater Switches .....	39
Seat Installation .....	139–140
Seat Removal .....	138–139
Security System .....	149–150
Selecting Audio Sources .....	195
Service Information .....	8
Set Bottom Screen Menu .....	61
Set Brightness .....	63
Set Units .....	58
Set Units, Clock Type .....	60
Set Units, Distance Setting .....	58
Set Units, Pressure .....	60
Set Units, Temperature Settings .....	59
Set Units, Volume Settings .....	59
Setting the Clock .....	57
Shifting Gears .....	98

Recommended Shift Points .....	100
Shifting Gears While Driving .....	99
Shifting Gears While Stationary .....	98
Shock Air Pressure (Ride Height) Adjustment .....	122
Shock Air Pressure Adjustment .....	121–122
Side Covers .....	138
Sidestand .....	74
Sidestand Lubrication .....	126
Siri Eyes Free .....	209
Spark Plugs .....	137
Specifications .....	165–171
Speedometer .....	47, 64
Standard Fuses .....	148
Starting the Engine .....	96
Steering Head Inspection .....	124
Stopping the Engine .....	101
Storage Area Preparation .....	161
Storage, Park and Cover .....	163
Suspension Inspection .....	123
Swing Arm/Rear Axle Inspection .....	122
Switches .....	31–39
Hazard Switch .....	35
Power Switch .....	35

## T

Tachometer .....	47, 64
Taillight Replacement .....	143
Temperature .....	43
Throttle Control Grip .....	67



Throttle Control Inspection ..... 126  
 Tire Condition ..... 135  
 Tire Inflation..... 162  
 Tire Pressure ..... 136  
 Tire Pressure Monitoring System ..... 69  
 Tire Pressure Monitoring System  
   Setup ..... 62  
 Tire Replacement ..... 135  
 Tire Tread Depth..... 135  
 Tires ..... 135  
 Toggle Switches..... 38  
 Transporting the Motorcycle ..... 18  
 Trip 1 Hours ..... 51  
 Trip 2 Hours ..... 52  
 Trip Odometers ..... 43  
 Troubleshooting ..... 152–154  
 Trunk ..... 69  
 Trunk Lock Switch ..... 39  
 Trunk, Removal ..... 70  
 Trunk, Removal (Soft) ..... 72

**U**

USB Connector ..... 193

**V**

Vehicle Control Module FCC/IC  
 Compliance Statement ..... 20

Voice Recognition Mode ..... 207

**W**

Warranty ..... 173  
 Warranty Information..... 8  
 Washing the Motorcycle ..... 155  
 Weight ..... 166  
 Wheel Alignment ..... 133  
 Wheel Inspection ..... 133  
 Wheel Spokes ..... 133  
 Wheels And Tires..... 169  
 Windshield Adjustment..... 76  
 Windshield Care ..... 76, 156  
 Windshield Removal..... 75





To locate your nearest dealer,  
visit [www.indianmotorcycle.com](http://www.indianmotorcycle.com)

**Indian Motorcycle Company**  
2100 Highway 55  
Medina, MN 55340  
Phone: 1-877-204-3697  
French: 1-800-268-6334

**Part No. 9927621 Rev 02 Printed  
in USA**

