

PageWriter TC70/TC50 Cardiograph INSTRUCTIONS FOR USE

Notice

About This Edition

Published by Philips
Medical Systems

Printed in USA

Publication number
453564164431

Edition History

Edition 1, June 2009
Software Revision
A.03.00 and higher

Edition 2, March 2010
Software Revision
A.04.01 and higher

Warranty

Philips Medical Systems reserves the right to make changes to both this *Instructions for Use* and to the product that it describes. Product specifications are subject to change without notice.

Nothing contained within this *Instructions for Use* is intended as any offer, warranty, promise, or contractual condition, and must not be taken as such.

Copyright

© 2010 Koninklijke Philips Electronics N.V. All rights are reserved. All other product names are the property of their respective owners.

Reproduction in whole or in part in any form, or by any means, electrical, mechanical or otherwise, is prohibited without the written consent of the copyright holder.

Philips Medical Systems
3000 Minuteman Road
Andover, MA 01810 USA
(978) 687-1501

Unauthorized copying of this publication may not only infringe copyright laws, but may also reduce the ability of Philips Medical Systems to provide accurate and current information to users.

Compliance

The Philips Medical Systems PageWriter TC70 cardiograph and PageWriter TC50 cardiograph comply with all relevant international and national standards and laws. Information on compliance will be supplied on request by a local Philips Medical Systems representative, or by the manufacturer.

Intended Use of this Instructions for Use

This Philips product is intended to be operated only in accordance with the safety procedures and operating instructions provided in this *Instructions for Use*, and in accordance with the purposes for which it was designed. Installation, use, and operation of this product is subject to the laws in effect in the jurisdiction(s) in which the product is being used. Users must only install, use, and operate this product in such a manner that does not conflict with applicable laws or regulations that have the force of law. Use of this product for purposes other than the express intended purpose provided by the manufacturer, or incorrect use and operation, may relieve the manufacturer (or agent) from all or some responsibility for resultant non-compliance, damage, or injury.

United States federal law restricts this device to use by or on the order of a physician. THIS PRODUCT IS NOT INTENDED FOR HOME USE.

Training

Users of this product must receive adequate clinical training on its safe and effective use before attempting to operate the product as described in this *Instructions for Use*.

Training requirements vary by country. Users must ensure that they receive adequate clinical training in accordance with local laws or regulations.

For further information on available training on the use of this product, please contact a Philips Medical Systems representative, or the manufacturer.

Medical Device Directive

The PageWriter TC70 cardiograph and PageWriter TC50 cardiograph comply with the requirements of the Medical Device Directive 93/42/EEC and carries the **CE**₀₁₂₃ mark accordingly.

Authorized EU-representative:

Philips Medizin Systeme
Böblingen GmbH
Hewlett Packard Str. 2
71034 Böblingen
Germany

Contents

About the PageWriter TC70 and PageWriter TC50 Cardiographs

About the Instructions for Use	i-i
Safety Summary	i-i
Symbols Marked on the Cardiograph or Patient Interface Module (PIM)	i-i
Safety Symbols Marked on the Cardiograph Packaging	i-iv
Safety and Regulatory Symbols Marked on the PageWriter TC70 Cardiograph Cart.	i-v
Safety and Regulatory Symbols Marked on the PageWriter TC50 Cardiograph Cart.	i-v
Safety and Regulatory Symbols Marked on the PageWriter TC70 Cardiograph AC Power Adapter	i-vi
Important Patient and Safety Information	i-vii
Accessories and Supplies	i-vii
AC Power Adapter and AC Power Cord	i-viii
Analog ECG Output Signal Port	i-ix
Batteries	i-ix
PageWriter TC50 Cardiograph One Battery Operation	i-x
Cart	i-x
Defibrillation	i-x
Diagrams	i-x
Display Accuracy	i-x
ECG Interpretation	i-xi
Electrodes	i-xi
Faxed ECGs	i-xi
General Cardiograph Use	i-xi
IEC 60601-2-51	i-xii
Lead Wires	i-xii
Main Waveform Display Screen	i-xii
Modem Card and Fax Feature	i-xii
Pacemaker	i-xiii
Patient Data Cable	i-xiii
Patient Interface Module (PIM)	i-xiii
Printer	i-xiv
Servicing the Cardiograph	i-xiv
Software	i-xiv
Touch Screen	i-xiv
USB Memory Stick	i-xv
The PageWriter TC70 Cardiograph and PageWriter TC50 Cardiograph	i-xv
Intended Use	i-xv
Indications for Use	i-xvi
The Philips ECG Algorithm	i-xvi
Intended Use	i-xvi
Indications for Use	i-xvi

Chapter 1 Getting Started

PageWriter TC70/TC50 Cardiograph Learning Kit	1-2
About the PageWriter TC70/TC50 Cardiograph Learning Kit	1-2
Philips ECG XML Information	1-4
Using the Philips InCenter Site	1-5
About Adobe Acrobat Versions	1-5
PageWriter TC70 Cardiograph Components	1-5
PageWriter TC50 Cardiograph Components	1-9
Assembling the PageWriter TC70 Cardiograph Cart	1-11
Assembling the PageWriter TC50 Cardiograph Cart	1-14
Using the Cart Wheel Positioners and Brake	1-19
Patient Interface Module (PIM)	1-20
About Class A and Class B Patient Data Cables and PIMs	1-21
Attaching the Patient Data Cable to the PIM and Cardiograph	1-22
Special Note about Patient Interface Module (PIM)	1-24
PIM ECG Button	1-25
Configuring the 16-Lead PIM	1-26
Recommended 16-Lead Configurations	1-28
Installing the Batteries	1-29
Notes about Battery Installation	1-29
Charging the Batteries	1-32
Calibrating the Batteries	1-33
Battery Power Indicator	1-33
Using the Wireless LAN Card	1-35
Using the Modem Card	1-36
Using the USB Memory Stick	1-36
Using the Barcode Reader	1-37
Using the Cardiograph Touch Screen	1-38
Touch Screen Overview	1-39
Using the Main ECG Screen	1-42
The Status Bar	1-43
Supplies and Ordering Information	1-45
Ordering Supplies	1-45
Special Note about Welsh Bulb Electrodes	1-46
PageWriter TC70 and PageWriter TC50 Cardiograph Supply Part Numbers	1-46
PIM Patient Data Cable	1-46
Complete Lead Sets	1-47
Lead Accessories	1-47
Disposable and Reusable Electrodes	1-48
Printer Paper	1-49
Batteries	1-49
Keyboard Covers	1-49
Replacement Fuse	1-49
USB Memory Stick	1-49
Ordering Options and Upgrades	1-50

Product Troubleshooting	1-51
Contacting a Philips Response Center	1-51
North America Response Centers	1-51
South America Response Centers	1-51
Europe Response Centers	1-52
Asia Response Centers	1-53
Africa and Middle East	1-54

Chapter 2 Configuring Default Clinical Settings

Configuring the Wireless LAN Card	2-1
Password Access	2-1
Tips for Creating Secure Passwords	2-1
Configuration with a Philips TraceMaster ECG Management System	2-1
Configuration with a Third Party ECG Management System	2-2
Restoring Custom Configuration Settings	2-2
Configuring Multiple Cardiographs	2-2
Opening the Setup Screens	2-3
Using Online Help	2-4
Configuring 12-Lead and 16-Lead Exam Settings	2-5

Chapter 3 The Patient Session

Introduction	3-1
Patient Preparation	3-4
Instructing the Patient	3-4
Preparing the Skin	3-4
Electrode Placement	3-5
Attaching Disposable Electrodes	3-12
Attaching Welsh Bulb and Limb Clamp Electrodes	3-13
Attaching the Lead Wires	3-14
Using the On/Standby Button	3-15
Entering Patient Information	3-16
Required ID Information	3-16
Navigating on the ID Screen	3-16
Entering ID Information with the Keyboard	3-17
Selecting an Order from the Worklist	3-17
Searching for Orders	3-17
Editing ID Information	3-18
Checking Signal Quality	3-19
Color-coded waveforms	3-19
Leads Map	3-20
Troubleshooting Signal Quality	3-20
Urgent (STAT) ECGs	3-24
Main ECG Screen	3-24
Changing the Lead Format on the Main ECG Screen	3-24

Taking an Auto ECG	3-25
Using the Preview Screen	3-26
Using the Last ECG Feature on the Preview Screen	3-28
Viewing Event Markers on the Preview Screen	3-29
Critical Values on Preview Screen	3-29
Very High Heart Rate Critical Value	3-30
Rhythm ECG Acquisition	3-30
Special Note about Artifact Filter	3-31
Disclose ECG Acquisition	3-33
Event Marker Warning	3-33
Capturing Events from the Main or Rhythm Screens	3-33
Reviewing Events on the Disclose Screen	3-34
Reviewing Previous Events	3-37
Using Timed ECG	3-37
Transferring ECGs from the Archive	3-38
Downloading ECGs from TraceMaster	3-39

Chapter 4 Reading the Printed ECG Report

Interpretive, Reason, and Severity Statements	4-3
Severity Statement	4-3
Critical Values	4-4
Basic Measurements	4-5
About the Fridericia and Bazett's Formula Rate-Corrected QT Interval Setting	4-5
Patient ID Clinical Information	4-6
Patient ID Information	4-7
Institution Information	4-8
Configurable Clinical Information	4-9
ECG Order Information	4-11
Physician Information	4-12
Report Information	4-12
Calibration Information	4-13
Time Separator	4-15
Pacing Detection Settings	4-15
Algorithm Version Number	4-17
Filter Settings	4-18
Artifact Filter	4-18
AC Filter	4-19
Frequency Response Filters	4-19
Baseline Wander Filter	4-20
Speed and Sensitivity Settings	4-21
Device Identification Number	4-21
12-Lead ECG Report Examples	4-22
15 and 16-Lead ECG Report Examples	4-29
ST Map Reports	4-34

12-Lead ST Map Reports	4-34
Extended Lead ST Map Reports	4-34
Rhythm Report	4-39
1-Minute Disclose Report	4-42
Extended Measurements Report	4-43

Chapter 5 Cardiograph Care and Maintenance

Cardiograph and PIM Cleaning	5-2
Approved Cleaning Solutions	5-3
Patient Data Cable and Lead Wire Cleaning	5-3
Approved Cleaning Solutions	5-3
Reusable Electrode Cleaning	5-4
Cleaning the Print Head	5-5
Printer Paper	5-7
Battery Maintenance and Care	5-8
Replacing the Batteries	5-9
Battery Calibration	5-12
Patient Interface Module (PIM) Test	5-14
Ping Test	5-14
Lead Wire Performance Test	5-15
Cardiograph and Accessory Disposal	5-15
Maintaining the Touch Screen	5-16
Touch Screen Calibration	5-16
Touch Screen Cleaning	5-16
Changing the Date and Time	5-16
Replacing the PageWriter TC50 Cardiograph Fuse	5-17

Appendix A Suppressed Borderline Interpretive Statements

Philips 12-Lead Algorithm Version PH090A	
Exclude Low Certainty Suppressed Statements	A-1
Philips 12-Lead Algorithm Version PH090A	
Exclude All Suppressed Statements	A-3
Philips DXL ECG Algorithm Version PH100B	
Exclude Low Certainty Suppressed Statements	A-6
Philips DXL ECG Algorithm Version PH100B	
Exclude All Suppressed Statements	A-8

Appendix B Critical Value Statements

Philips 12-Lead Algorithm Version PH090A	
Acute Myocardial Infarction Critical Value Statements	B-2
Philips 12-Lead Algorithm Version PH090A	
Tachycardia Critical Value Statements	B-4

Philips 12-Lead Algorithm Version PH090A	
Complete Heart Block Critical Value Statements	B-4
Philips DXL ECG Algorithm Version PH100B	
Acute Myocardial Infarction Critical Value Statements	B-5
Philips DXL ECG Algorithm Version PH100B	
Tachycardia Critical Value Statements	B-7
Philips DXL ECG Algorithm Version PH100B	
Complete Heart Block Critical Value Statements	B-7
Philips DXL ECG Algorithm Version PH100B	
Acute Ischemia Critical Value Statements	B-8

Appendix C Specifications

Technical Specifications	C-1
ECG Acquisition	C-1
PageWriter TC70 Keyboard	C-1
PageWriter TC50 Keyboard	C-1
PageWriter TC70 Touchscreen Display	C-1
PageWriter TC50 Touchscreen Display	C-1
Patient Interface Module	C-1
Patient Interface Module Signal Acquisition	C-2
Signal Processing/Acquisition	C-2
Sampling Rate	C-2
Auto Frequency Response	C-2
Rhythm Frequency Response	C-2
Minimum Amplitude or Value of Patient Physiological Signal	C-2
Filters	C-2
Printer	C-2
Printer Resolution	C-2
Report Formats	C-3
Exam Profiles	C-3
12 Lead Report Formats	C-3
16 Lead Report Formats	C-3
Rhythm Report Formats	C-3
Battery Operation	C-3
Voltage	C-3
Current	C-3
Power	C-3
PageWriter TC70/TC50 Two Battery Operating Capacity	C-4
PageWriter TC50 One Battery Operating Capacity	C-4
Status Display	C-4
Recharge	C-4
Network Connection	C-4
FAX Capability (optional)	C-4
Modem	C-4
Barcode Reader (optional)	C-4
Magnetic Card Reader (optional)	C-5

Smart Card Reader (optional)	C-5
ECG Storage	C-5
Orders	C-5
ECG File Formats	C-5
Power and Environment	C-5
PageWriter TC70 Cardiograph AC Adapter	C-5
PageWriter TC50 Cardiograph AC Input Voltage	C-5
PageWriter TC50 Cardiograph AC Output Voltage	C-5
PageWriter TC70 Cardiograph Dimensions	C-6
PageWriter TC70 Cardiograph Weight	C-6
PageWriter TC50 Cardiograph Dimensions	C-6
PageWriter TC50 Cardiograph Weight	C-7
Safety and Performance	C-7
Classification (IEC 60601-1)	C-7
PageWriter TC50 Cardiograph Class I (Internally Powered)	C-7
PageWriter TC70 Cardiograph Class II (Internally Powered)	C-7
Electromagnetic Compatibility (EMC)	C-8
Reducing Electromagnetic Interference	C-9
Wireless LAN Card Specifications	C-14
Summit SDC-CF20G Wireless Adapter (Option D21)	C-14
Summit SDC-CF22AG Wireless Adapter (Option D22)	C-18

Index

About the PageWriter TC70 and PageWriter TC50 Cardiographs

About the Instructions for Use

This *PageWriter TC70 and PageWriter TC50 Cardiograph Instructions for Use* is intended to assist users in the safe and effective use of the product.

Before attempting to operate this product, read this *Instructions for Use*, and note and strictly observe all Warning and Cautions as described in this document.

Pay special attention to all of the safety information provided in the Safety Summary section. For more information, see page i-i.

WARNING Warning statements describe conditions or actions that may result in a potentially serious outcome, adverse event, or a safety hazard. Failure to follow a Warning may result in death or serious injury to the user or to the patient.

CAUTION Caution statements describe when special care is necessary for the safe and effective use of the product. Failure to follow a caution may result in minor to moderate personal injury or damage to the product or other property, a remote risk of more serious injury, or may cause environmental pollution.



NOTE Notes contain additional important information about a topic.

TIP A Tip contains suggested information on using a particular feature.











Menu items and button names appear in bold no-serif font. Example: Touch the **Setup** button.

Safety Summary





Symbols Marked on the Cardiograph or Patient Interface Module (PIM)

Symbol	Name	Description
	Attention; read the <i>Instructions for Use</i>	See the <i>PageWriter TC70 and PageWriter TC50 Cardiograph Instructions for Use</i> .
	Type CF Defibrillator Proof	ECG physio isolation is type CF, defibrillator proof. Suitable for all patient applications including direct cardiac application. System is in continuous operation.
	DC Polarity	Indicates the polarity of the DC power connector.





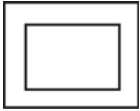

Symbols Marked on the Cardiograph or Patient Interface Module (PIM)

Symbol	Name	Description
	Direct Current	Indicates that the equipment is suitable for direct current only.
	Disposal	Dispose of in accordance with the requirements of your country.
	ECG output signal	The connector near this symbol provides access to an analog ECG signal that can be used as a synchronization signal for external devices, such as an imaging device. This analog ECG signal is not diagnostic quality and should not be used for ECG analysis purposes.
	Local Area Network (LAN) Connector	Connect the Ethernet RJ45 LAN cable to the connector directly above this symbol to establish LAN connectivity.
	Modem Connector	Connect an analog phone line to the connector directly above this symbol.
	Attention; read the <i>Instructions for Use</i>	See the <i>PageWriter TC70 and PageWriter TC50 Cardiograph Instructions for Use</i> .
	Patient Interface Module (PIM) Connector	Connect the PIM patient data cable to the connector located directly above this symbol.
	PCMCIA icon	Insert the wireless LAN card into the slot located directly above this symbol.
	PS/2 Connector	Connect the Magnetic Card Reader or Barcode Reader to the connector located directly above this symbol.
	Serial Number	The number next to this symbol is the serial number of the cardiograph.
	Standby	Pressing the button with this symbol on it puts the cardiograph into Standby (power saving mode).

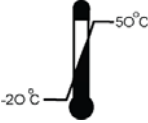
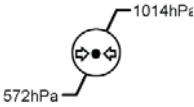
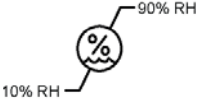

Symbols Marked on the Cardiograph or Patient Interface Module (PIM)

Symbol	Name	Description
	USB Connector	The connector near this symbol is used with a USB device.
	Non-ionizing electromagnetic radiation	Interference may occur in the vicinity of equipment marked with this symbol.
	Equipotential Grounding Post	Equipotential grounding post used for establishing common ground between instruments.
	Class II	Protection against electric shock (PageWriter TC70 Cardiograph only).
	Fuse	The PageWriter TC50 Cardiograph contains a 1.6 amp (250V) time-delay fuse.



Safety Symbols Marked on the Cardiograph Packaging

Symbol	Description
	Keep dry.
	Ambient temperature range of -20 °C (-4° F) to 50 °C (122° F) (non-condensing) for transport and storage. Note: the batteries will discharge at a rapid rate if the cardiograph is stored at a high temperature.
	Atmospheric pressure range of 0 to 4572 meters (15,000 feet), 572 hPa above sea level for transport and storage.
	Relative humidity range of 10% to 90% (non-condensing) for transport and storage.
	Made from recycled materials.
	Fragile.
	Lithium ion battery. Do not dispose of in trash. Follow local regulations for disposing of as small chemical waste.
	This product consists of devices that may contain mercury, which must be recycled or disposed of in accordance with local, state, or federal laws. (Within this system, the backlight lamps in the monitor display contain mercury.)
	Dispose of in accordance with the requirements of your country.

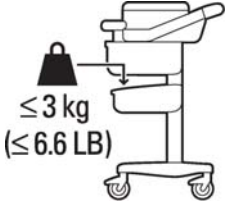

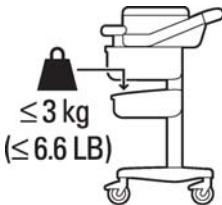

Safety and Regulatory Symbols Marked on the PageWriter TC70 Cardiograph Cart

Symbol	Name	Description
	Cart Transport	Do not transport the cart with the drawer open.
	Cart Drawer Weight Limit	Do not place more than 3 kilograms or 6.6 pounds of weight into the cart drawer.
	Cart Storage Bin Weight Limit	Do not place more than 3 kilograms or 6.6 pounds of weight into the cart storage bin.

Safety and Regulatory Symbols Marked on the PageWriter TC50 Cardiograph Cart

Symbol	Name	Description
	Cart Storage Bin Weight Limit	Do not place more than 3 kilograms or 6.6 pounds of weight into the cart storage bin.
	Optional Patient Cable Arm	Do not transport the cart with the patient cable arm positioned to the side. Only transport the cart with the patient cable arm positioned to the front of the cart.

Safety and Regulatory Symbols Marked on the PageWriter TC70 Cardiograph AC Power Adapter

Symbol	Name	Description
	No serviceable parts inside	There are no serviceable parts inside the AC adapter. Do not open the AC adapter case.
	Indoor, dry location use only	The AC adapter is only intended for indoor use in a dry location.
	Attention; read the <i>Instructions for Use</i>	See the <i>PageWriter TC70 and PageWriter TC50 Cardiograph Instructions for Use</i> for information on the AC power adapter.
	AC adapter disposal	Dispose of in accordance with the requirements of your country.

Important Patient and Safety Information

The PageWriter TC70 cardiograph and PageWriter TC50 cardiograph isolate all connections to the patient from electrical ground and all other conductive circuits in the cardiograph. This reduces the possibility of hazardous currents passing from the cardiograph through the patient's heart to ground.

WARNING Failure to follow these warnings could affect both patient and operator safety.

Accessories and Supplies

WARNING Always clean and disinfect reusable electrodes before patient use. Failure to properly clean and disinfect reusable electrodes before patient use may cause infectious materials to be transferred between patients.

WARNING The Welsh bulb electrodes (available as an accessory for the cardiograph) do not meet the requirements of IEC 60601-2-25 for defibrillation recovery time, and cannot be reliably used for patient diagnosis immediately following defibrillation.

WARNING When using additional peripheral equipment powered from an electrical source other than the cardiograph, the combination is considered to be a medical system. It is the responsibility of the operator to comply with IEC 60601-1-1 and test the medical system according to the requirements. For additional information contact Philips Medical Systems.

WARNING Do not use non-medical peripherals within 6 feet of a patient unless the non-medical peripherals receive power from the cardiograph or from an isolation transformer that meets medical safety standards.

CAUTION The Welsh bulb electrodes contain natural rubber latex which may cause allergic reactions.

CAUTION The use of equipment that applies high frequency voltages to the patient (including electrosurgical equipment and some respiration transducers) is not supported and may produce undesired results.

CAUTION Only use Philips Medical Systems replacement parts and supplies with the cardiograph. The use of non-approved replacement parts and supplies with the cardiograph is strictly prohibited. Cardiograph safety and performance are not guaranteed when non-approved replacement parts and supplies are used with the cardiograph.

- Using accessories, peripherals, or cables that are not supplied with the cardiograph or that are not recommended by Philips Medical Systems can result in increased emissions or decreased immunity of the cardiograph.
- Connect other equipment in accordance with IEC 60601-1-1 Medical Electrical Systems Standard or IEC 60601-1: 2005 (3rd Edition) Medical Electrical Equipment Standard Clause 16 Medical Electrical Systems.
- When connecting the cardiograph to other AC powered equipment, only connect equipment approved to IEC 60601-1 Medical Electrical Equipment or IEC 60950-1 Information Technology Equipment.
- Only use patient electrodes that are approved by Philips Medical Systems. The use of non-approved patient electrodes may degrade cardiograph performance.
- To prevent burns to the patient, remove all ECG electrodes and lead wires prior to the use of high frequency surgical equipment (including electrosurgical equipment and some respiration transducers).

AC Power Adapter and AC Power Cord

WARNING Only use the external power supply with part number 453564094411 with the PageWriter TC70 cardiograph in order to prevent electrical safety hazards. The use of any other power supply is not approved by Philips Medical Systems.

WARNING Whenever the AC power cord is connected to a live power outlet, ensure that it is also securely attached to the cardiograph. Always disconnect the AC power cord from the power outlet when it is not connected to the cardiograph.

WARNING Only use grounded power cords (three-wire power cords with grounded plugs) and grounded electrical outlets that are labeled as *Hospital Only* or *Hospital Grade*. **NEVER** adapt a grounded plug to fit an ungrounded outlet by removing the ground prong. Use the equipotential post when redundant earth ground is necessary according to IEC 60601-1-1.

CAUTION The power supply could feel warm to the touch.

- The PageWriter TC70 cardiograph external power supply, part number 453564094411, is designed with a three wire supply system. The ground only serves a functional purpose for EMC and not protective earth for electrical safety. Use of an appropriate three-wire power cord is necessary to provide proper EMC operation.

- Only use the AC power adapter designed to be used with the PageWriter TC70 cardiograph, part number 453564094411, in order to ensure continued compliance with the requirements of IEC 60601-1.
- To disconnect the cardiograph from AC power, unplug the cardiograph AC power cord from the mains power supply.
- This equipment complies with the earth leakage current limits as specified in UL 60601-1:2003 Medical Electrical Equipment - General Requirements for Safety, only when connected to a 120 Volt mains power supply.
- Periodically inspect the patient data cable, lead wires, and AC power cord for any worn or cracked insulation. Ensure that no exposed wires are visible on the AC power cord.
- Only use the Philips Medical Systems AC power cord (part number 453564094411) supplied with the cardiograph. Use of any other power supply has not been verified and may lead to operator or patient harm, including electrical shock. Periodically inspect the AC power cord and AC power connector to ensure that both are in a safe and operable condition. If the AC power cord or AC power connector is not in a safe or operable condition, operate the cardiograph on battery power and contact Philips Medical Systems for service.

Analog ECG Output Signal Port

- Do not use the analog ECG output signal port (not supported on cardiograph) for diagnostic purposes and do not use this signal for critical synchronization timing.
- Do not connect any equipment to the cardiograph analog ECG output signal port that does not meet medical safety requirements and that has not been evaluated by local safety personnel.

Batteries

-
- CAUTIONS**
- Before removing and replacing batteries from the cardiograph, press down and hold the On/Standby button () (located on the front of the cardiograph), to shut down the cardiograph. Ensure that the cardiograph is shut down. When the cardiograph is fully shut down, the screen is black, and the On/Standby button is not illuminated. Once the cardiograph is shut down, proceed to remove and replace the batteries.
 - When removing batteries from the cardiograph, the batteries could feel warm to the touch.
-

- The battery capacity for the PageWriter TC50 cardiograph with a single battery installed using the battery with Philips part number 989803170371, is 30 minutes of continuous Rhythm printing, or 30 total ECG reports.
- When operating the PageWriter TC50 cardiograph with one battery installed, only use the Philips battery with part number 989803170371. Do not use the battery with Philips part number 989803160981 for one battery operation.
- When operating the PageWriter TC70 or the PageWriter TC50 cardiograph with two batteries installed, ensure that both batteries contain the same Philips part number. The

battery part number identification label is found on the bottom of the battery. The cardiograph cannot operate with two batteries that contain different part numbers. If the cardiograph is operated with two batteries with different part numbers, the cardiograph will display an error message and will not operate.

PageWriter TC50 Cardiograph One Battery Operation

- The PageWriter TC50 cardiograph with installed software version A.04.00 and higher can operate on a single battery with Philips part number 989803170371.
- The battery capacity for the PageWriter TC50 cardiograph with a single battery installed using the battery with Philips part number 989803170371, is 30 minutes of continuous Rhythm printing, or 30 total ECG reports.
- When operating the PageWriter TC50 cardiograph with one battery installed, only use the Philips battery with part number 989803170371. Do not use the battery with Philips part number 989803160981 for one battery operation.
- When operating the PageWriter TC50 cardiograph with one battery installed, the single battery may be inserted into either battery compartment.

Cart

- Ensure that the cardiograph is securely attached to the cardiograph cart before use.

Defibrillation

WARNING Do not touch the patient, patient data cable, leads, or the cardiograph during defibrillation. Death or injury may occur from the electrical shock delivered by the defibrillator.

Diagrams

- Upon customer request, Philips Medical Systems will make available circuit diagrams, component part lists, descriptions, calibration instructions and other technical information.

Display Accuracy

- The accuracy of the ECG signals are within +/- 5% (or +/- 40 uV whichever is greater), over a range of 0 to 5 mV, in the presence of differential and common mode DC offset voltages of +/- 300 mV. The cardiograph performance is tested to comply with the accuracy requirements over the dynamic ranges and frequency ranges specified in the IEC 60601-2-51 and AAMI EC-11 standards.
- For additional details regarding accuracy and precision, refer to the *Physician's Guide* and the Manufacturer's Disclosure Statement.

ECG Interpretation

CAUTION Always enter accurate patient information (including age and gender) if using the Philips DXL ECG Algorithm or Philips 12-Lead Algorithm for ECG interpretation.

Electrodes

- Philips recommends the use of disposable electrodes at all times for all patient applications. Choose either adult or pediatric disposable electrodes based on the age and size of the patient. See “Disposable and Reusable Electrodes” on page 1-48 for information on ordering disposable electrodes.

Faxed ECGs

CAUTION No guarantee is made as to the suitability of a faxed ECG for any particular purpose, due to the variability inherent in fax technology.

CAUTION Faxed ECGs should only be sent to secure recipient fax machines.

General Cardiograph Use

WARNING Electrical shock hazard. Keep the cardiograph, Patient Interface Module (PIM), and all cardiograph accessories away from liquids. Do not immerse the cardiograph, PIM, or other accessories in any liquids.

WARNING Do not use this cardiograph near flammable anesthetics. It is not intended for use in explosive environments or in operating rooms. The disconnection or connection of AC power, or electrostatic discharge (ESD) may result in an electrical spark.

CAUTION The cardiograph may generate electromagnetic interference (EMI) that may cause nearby equipment to fail.

CAUTION The use of equipment that applies high frequency voltages to the patient (including electrosurgical equipment and some respiration transducers) is not supported and may produce undesired results. Disconnect the patient data cable from the cardiograph, or detach the leads from the patient prior to performing any procedure that uses high frequency surgical equipment.

- The use of non-Philips equipment connected to, or operating with, the PageWriter TC70 cardiograph or the PageWriter TC50 cardiograph is not tested or supported, and may produce undesired results.
- Connecting multiple cardiographs to the same patient may pose a safety hazard due to the summation of leakage currents. Any combination of instruments should be evaluated by local safety personnel before being put into service.

IEC 60601-2-51

- For information on the standard IEC 60601-2-51, please go to the Philips InCenter web site (incenter.medical.philips.com). For information on using the Philips InCenter site, see page 1-5.

Lead Wires

WARNING Electrical shock hazard. Do not touch accessible connector pins and the patient simultaneously.

WARNING Do not touch any loose or exposed leads during defibrillation. Death or injury may occur from the electrical shock delivered by the defibrillator.



WARNING Ensure that the electrodes or lead wires do not come in contact with any other conductive materials (including earth-grounded materials) especially when connecting or disconnecting electrodes to or from a patient.

Main Waveform Display Screen

- Manual measurements of ECG intervals and magnitudes should be performed on printed ECG reports only. Do not make manual measurements of ECG intervals and magnitudes on the main waveform display screen since these ECG representations are scaled.

Modem Card and Fax Feature

WARNING Do not connect the modem card to a phone line when the cardiograph is connected to a patient.

WARNING Only connect the phone line to the modem connector () located on the rear panel of the cardiograph. Never attach the phone line to the LAN connector ().

- No guarantee is made as to the suitability of a faxed ECG report for any particular purpose, due to the variability inherent in fax technology.

Pacemaker

- Pace pulses may not be visible on a printed ECG report that uses simultaneous acquisition.

Patient Data Cable

WARNING The Philips Medical Systems patient data cable (supplied with cardiograph) is an integral part of the cardiograph safety features. Use of any other patient data cable may lead to the distortion or corruption of patient ECG data, may compromise defibrillation protection and degrade cardiograph performance, and overall cardiograph safety may be seriously degraded.

WARNING Ensure that the patient data cable is securely connected to the PIM Connector () on the rear panel of the cardiograph.

- The PageWriter TC50 cardiograph with installed software version A.03.00 and higher are only compatible with the Class B patient data cable (Philips part number 989803164281).
- Keep the patient data cable away from power cords and any other electrical equipment. Failure to do so can result in AC power line frequency interference on the ECG trace.
- Periodically inspect the patient data cable for any cracks or breaks in the cable insulation. If the integrity of the patient data cable is not assured, replace the patient data cable. Contact Philips Medical Systems for further assistance, see "Contacting a Philips Response Center" on page 1-51.

Patient Interface Module (PIM)

WARNING Always clean and disinfect the Patient Interface Module (PIM) after patient use, if the PIM comes into direct contact with the patient's skin. Failure to properly clean and disinfect the PIM after direct contact with the patient's skin may cause infectious materials to be transferred between patients.

CAUTION If using the optional, 16-lead PIM, always ensure that the leads connected to the Patient Interface Module (PIM) are the same leads that are displayed on the cardiograph screen.

- The PageWriter TC50 cardiograph with installed software version A.03.00 and higher is only compatible with the Class B 12-lead PIM (Philips part number 453564150741, AAMI and 453564150761, IEC) or the Class B 16-lead PIM (Philips part number 453564150751, AAMI and 453564150771, IEC).
- Always put the cardiograph in Standby before replacing the Patient Interface Module (PIM). Do not change the PIM while the cardiograph is in active use.

Printer

CAUTION Do not pull on the paper while an ECG report is being printed. This can cause distortion of the waveform and can lead to potential misdiagnosis.

Servicing the Cardiograph

- Only qualified personnel may service the cardiograph or may open the cardiograph housing to access internal cardiograph components. Do not open any covers on the cardiograph. There are no internal cardiograph components that are serviced by the operator.
- The Philips Medical Systems warranty is applicable only if you use Philips Medical Systems approved accessories and replacement parts. See “Supplies and Ordering Information” on page 1-45 for more information.

Software

WARNING Only install Philips Medical Systems software on the cardiograph. The installation or use of software not approved by Philips Medical Systems is strictly prohibited and cardiograph safety and performance are not guaranteed.

Touch Screen

WARNING Do not use sharp objects with the touch screen or apply excessive force to the touch screen. Applying excessive force to the touch screen may result in breaking the touch screen display and can cause sharp, jagged parts to expel to persons nearby.

- Manual measurements of ECG intervals and magnitudes should be performed on printed ECG reports only. Do not make manual measurements of ECG intervals and magnitudes on the touchscreen display since these ECG representations are scaled.

USB Memory Stick

WARNING Do not use the USB memory stick to import ECGs from other cardiographs, or other non-Philips devices onto the PageWriter TC70 cardiograph or PageWriter TC50 cardiograph.

CAUTIONS Only use the USB memory stick that is available for purchase as an optional accessory from Philips Medical Systems with the PageWriter TC cardiograph.

Do not insert a USB memory stick into the cardiograph, or remove a USB memory stick from the cardiograph when the cardiograph is acquiring ECG data from the patient.

Only use the USB memory stick to transfer data between the cardiograph and a computer. Do not use the USB memory stick with other devices.

Keep all USB memory sticks that contain patient data in a secure location where they cannot be accessed by unauthorized personnel. Always delete patient data from a USB memory stick promptly after use.

Affix a label to all USB memory sticks that contain patient data notifying users that unauthorized access of patient data on the USB memory stick is punishable by law.

- Periodically inspect the USB connectors (side and rear of cardiograph) for any cracks or breaks. If the integrity of a USB connectors is not assured, do not use the USB connector, and contact Philips Medical Systems for further assistance, see "Contacting a Philips Response Center" on page 1-51.

The PageWriter TC70 Cardiograph and PageWriter TC50 Cardiograph

These Philips products are intended to be used and operated only in accordance with the safety procedures and operating instructions provided in this *Instructions for Use*, and for the purposes for which it was designed. The purposes for which the product is intended are provided below. However, nothing stated in this *Instructions for Use* reduces the responsibility of the user for sound clinical judgment and best clinical procedures.

Intended Use

The intended use of the cardiograph is to acquire multi-channel ECG signals from adult and pediatric patients from body surface ECG electrodes and to record, display, analyze, and store these ECG signals for review by the user. The cardiograph is to be used in healthcare facilities by trained healthcare professionals. Analysis of the ECG signals is accomplished with algorithms that provide measurements, data presentations, graphical presentations, and interpretations for review by the user.

The interpreted ECG with measurements and interpretive statements is offered to the clinician on an advisory basis only. It is to be used in conjunction with the clinician's knowledge of the patient, the results of the physical examination, the ECG tracings, and other clinical findings.

A qualified physician is asked to overread and validate (or change) the computer-generated ECG interpretation.

Indications for Use

The cardiograph is to be used where the clinician decides to evaluate the electrocardiogram of adult and pediatric patients as part of decisions regarding possible diagnosis, potential treatment, effectiveness of treatment, or to rule out causes for symptoms.

The Philips ECG Algorithm

The PageWriter TC70 cardiograph and PageWriter TC50 cardiograph software uses the Philips ECG Algorithm. The algorithm in the software analyzes the morphology and rhythm on each of the 16 leads and summarizes the results. The set of summarized measurements is then analyzed by the clinically-proven ECG Analysis Program.

16-lead reports may include or exclude ECG measurements, reasons, or analysis statements.

Intended Use

The intended use of the Philips ECG Algorithm is to analyze multi-channel ECG signals from adult and pediatric patients with algorithms that provide measurements, data presentations, graphical presentations, and interpretations for review by the user.

The interpreted ECG with measurements and interpretive statements is offered to the clinician on an advisory basis only. It is to be used in conjunction with the clinician's knowledge of the patient, the results of the physical examination, the ECG tracings, and other clinical findings. A qualified physician is asked to overread and validate (or change) the computer-generated ECG interpretation.

Indications for Use

The Philips ECG Algorithm is to be used where the clinician decides to evaluate the electrocardiogram of adult and pediatric patients as part of decisions regarding possible diagnosis, potential treatment, effectiveness of treatment, or to rule out causes for symptoms.

Getting Started

Welcome to the PageWriter TC70 and TC50 cardiographs, a versatile and powerful addition to your cardiac care patient workflow. The PageWriter TC cardiographs help to simplify patient cardiac care through easy-to-use 1-2-3 touch screen operation, color-coded signal quality indicators, and integrated connectivity with the TraceMaster ECG Management System for one touch patient order download and ECG transmission. The PageWriter TC70 and TC50 cardiographs also support integrated connectivity with an ADT Order Update system. Powerful clinical features include the Philips DXL ECG Algorithm that provides comprehensive measurement and interpretive analysis for up to 16 leads, and includes full pediatric interpretation, enhanced pacemaker pulse detection, lead reversal detection notification, and the *Critical Values* feature that provides an alert to caregivers of a silent MI or other conditions that require immediate treatment, an integral tool for acute care environments. Other time-sensitive clinical tools include ST Map reports that indicate ST elevation, along with optional culprit artery identification that locates the probable anatomical site of a coronary artery occlusion responsible for an ischemia. Support for up to 16 leads assists in the precise detection of right sided or posterior myocardial injury in adults, conditions that are difficult to diagnosis or detect in standard 12-lead ECGs. For pediatric patients, the use of 15 leads provides full information on the electrical activity of the right ventricle of the heart, crucial information for the accurate diagnosis of pediatric patients.

This *PageWriter TC70 and PageWriter TC50 Cardiograph Instructions for Use* and the other components provided in the Learning Kit describe all aspects of setting up, using, and maintaining your cardiograph.

NOTE Read and complete the materials included in the PageWriter TC70/TC50 Cardiograph Learning Kit before using the cardiograph. Pay close attention to all warnings and cautions.

PageWriter TC70/TC50 Cardiograph Learning Kit

Philips Medical Systems provides detailed instructional and reference materials in the PageWriter TC70/TC50 Cardiograph Learning Kit.

The PageWriter TC70/TC50 Cardiograph Learning Kit contains the *Quick Help Guide*, User Skills Checklists, and the User Documentation and Training DVD.

Figure 1-1 The PageWriter TC70/TC50 Cardiograph Learning Kit

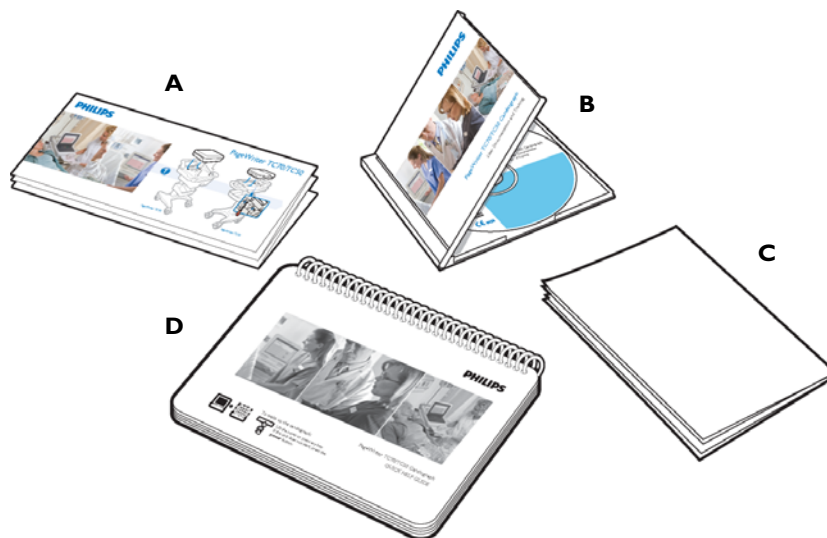

About the PageWriter TC70/TC50 Cardiograph Learning Kit

- *Getting Started Guide (A)*
This fold out guide Guide provides out-of-the-box instructions for setting up the cardiograph. It is intended to be used with the instructions provided in this chapter.

- **User Documentation and Training DVD (B)**

The user documentation and training DVD includes many useful files including:

- *Philips DXL ECG Algorithm Physician's Guide*

This Physician's Guide provides a comprehensive description of the Philips DXL ECG Algorithm version PH100B, and lists all of the interpretive statements included in the 0B criteria.

- *Philips 12-Lead Algorithm Physician's Guide*

This Physician's Guide provides a comprehensive description of the Philips 12-Lead Algorithm version PH090A, and lists all of the interpretive statements included in the 0A criteria.

- *PageWriter TC Cardiograph Network Configuration Guide (only available in English)*

This Network Configuration Guide provides detailed instructions on installing and configuring wired or wireless network connectivity between the cardiograph and the TraceMaster ECG Management System (including the OrderVue order handling option), or other third party ECG management system.

- *PageWriter TC Cardiograph Service Manual (only available in English)*

This document provides comprehensive information on product troubleshooting, performance verification and safety tests, using the Service Utilities accessed from the Setup menu, and installing software upgrades.

- *Metrologic Scanner Instructions for Use (only available in English)*

This document provides comprehensive information on using and configuring the optional barcode scanner available with the cardiograph, and also provides detailed calibration sequences for configuring the barcode scanner for use with extended Code 39 barcode standards.

- *PageWriter TC70 and PageWriter TC50 Cardiograph Interactive Training Program for software version A.02.00 (only available in English)*

This training program provides detailed information on the purpose of 12 and 16-lead ECGs, the different views of the heart that the ECG represents, electrode placement for 12 or 16 leads, effective patient preparation, basic cardiograph operation, and how to troubleshoot various ECG signal quality problems. The training program also includes interactive, hands-on training exercises to test users on information provided in the training program. Updates to this training program will be available on a periodic basis, and may be downloaded from the Philips InCenter site. For more information on accessing and using the Philips InCenter site, see "Using the Philips InCenter Site" on page 1-5.

To open the User Documentation and Training DVD:

- 1 Insert the DVD into a DVD-compatible drive on a standard PC.

The main menu opens automatically. Click on a blue button or on the file name to open a file.

NOTE

If you save PDF files from the DVD to a PC hard drive, Acrobat Reader 9.0 will need to be installed on the PC in order to view the files. For a free install, go to: www.adobe.com.

- 2 If the main menu does not automatically appear, open the DVD in Windows Explorer.

- 3 Double-click the file **menu.pdf** on the DVD. The main menu appears. Any of the files on the DVD may be printed or saved to a PC hard drive
- *User Skills Checklists (C)* (only available in English)

These checklists provide a comprehensive list of all of the tasks associated with patient preparation, taking an ECG, and using the cardiograph features. These checklists provide the basis for all critical tasks recommended for inclusion in a clinical training program. These checklists can be copied as necessary, and retained as an official record of clinical training at your facility. The checklists are also included as PDF files on the User Documentation and Training DVD.
 - *Quick Help Guide (D)*

The Quick Help Guide is presented as an easy-to-use flip book that can be left at the cardiograph in order to provide clear and simple instructions to users on using cardiograph features. Included are instructions on proper patient preparation and electrode placement, signal quality indicators, taking STAT or urgent ECGs, how to retrieve orders, and using other cardiograph features. The guide is included as a PDF file on the User Documentation and Training DVD, and additional copies may be printed if necessary. The PDF file is sized appropriately for printing on standard sized paper.

Philips ECG XML Information

The PageWriter TC70 cardiograph and PageWriter TC50 cardiograph export ECG data in XML (Extensible Markup Language) format. There are three available XML schema versions on the cardiograph: version 1.03, version 1.04, and version 1.04.01. Version 1.03 exports ECG data in 12-lead format only, version 1.04 exports ECG data for up to 16 leads, and version 1.04.01 exports ECG data for up to 16 leads and includes full interpretation from the Philips DXL Algorithm.

Information regarding the Philips ECG XML schema can be obtained directly from Philips Medical Systems by sending an email request to: ecg@philips.com. Please include your name, facility, and the serial number of your PageWriter TC cardiograph in the email request.

NOTE The default XML version setting on the cardiograph must be coordinated with the XML version compatibility of the TraceMaster ECG Management System, or other third party ECG management system used by your facility. For more information on configuring your cardiograph for use with an external ECG management system, see the *PageWriter TC Network Configuration Guide* included on the User Documentation and Training DVD, or download the file from the Philips InCenter site.

Using the Philips InCenter Site

The Philips InCenter site provides frequent updates to all Philips Cardiac Systems product documentation and product software, including the PageWriter TC70 and PageWriter TC50 cardiographs.

The Philips InCenter site requires an active registration and password. To register, go to the InCenter site at: incenter.medical.philips.com and click on the **Need help?** link on the main page (located under the user login and password fields). On the following page, under **Software Updates** (lower right corner of page), click the **Click here for account registration** link. The Cardiac Systems InCenter Registration page appears. Complete all of the information fields on the page to receive a login and password for the InCenter site.

Registration for the InCenter site requires the serial number of at least one PageWriter TC70 or PageWriter TC50 cardiograph in active use at your facility. The serial number is found on the product identification label. The product identification label is located on the rear panel of the cardiograph.

About Adobe Acrobat Versions

Adobe Acrobat Reader version 9.0 must be installed on the PC that is used to access the Philips InCenter site. Previous versions of Acrobat Reader are not compatible with the Philips InCenter site, and attempting to access InCenter with a previous version of Acrobat Reader will result in error messages when opening documents. Uninstall all previous versions of Acrobat Reader, and then proceed for a free install of Acrobat Reader 9.0 at: www.adobe.com.

Any version of Adobe Acrobat Professional or Acrobat Elements are also not compatible with the Philips InCenter site, and error messages will appear when opening documents with these applications. Acrobat Reader 9.0 must be installed in addition to Acrobat Professional or Acrobat Elements.

Follow this procedure when accessing documents on the Philips InCenter site.

To access documents on the Philips InCenter site:

- 1 Exit Acrobat Professional or Acrobat Elements (if open).
- 2 Start Acrobat Reader 9.0.
- 3 Open Internet Explorer, and go to the Philips InCenter site. Keep Acrobat Reader 9.0 open the entire time while accessing the InCenter site.

PageWriter TC70 Cardiograph Components

The following sections include a description of all of the components of the PageWriter TC70 cardiograph, including the connection ports on the cardiograph, the Patient Interface Module (PIM), and optional accessories available with the cardiograph. For more information on using the cardiograph features, see "The Patient Session" on page 3-1. For information on ordering any of the optional accessories for the cardiograph, see "Supplies and Ordering Information" on page 1-45.

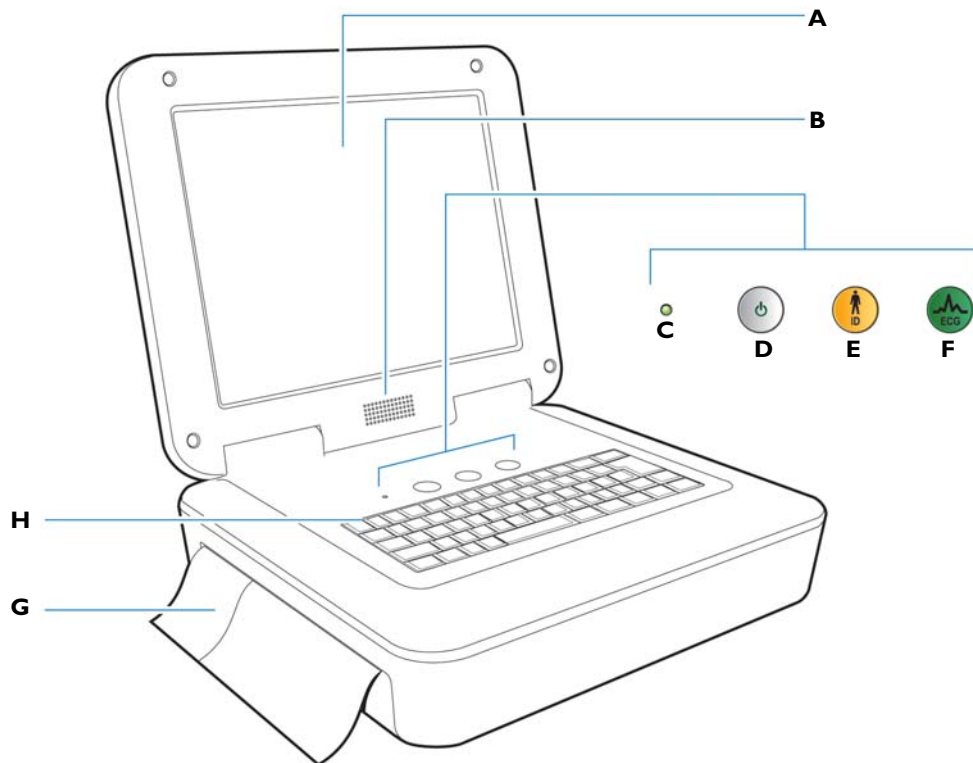
Figure 1-2 PageWriter TC70 Cardiograph (left front view)

- | | |
|--------------------------------------|---------------------|
| A Touch screen | F ECG button |
| B Audio speaker | G Paper tray |
| C AC power on indicator light | H Keyboard |
| D Power/Standby button | |
| E ID button | |

Figure 1-3 PageWriter TC70 Cardiograph (right front view)

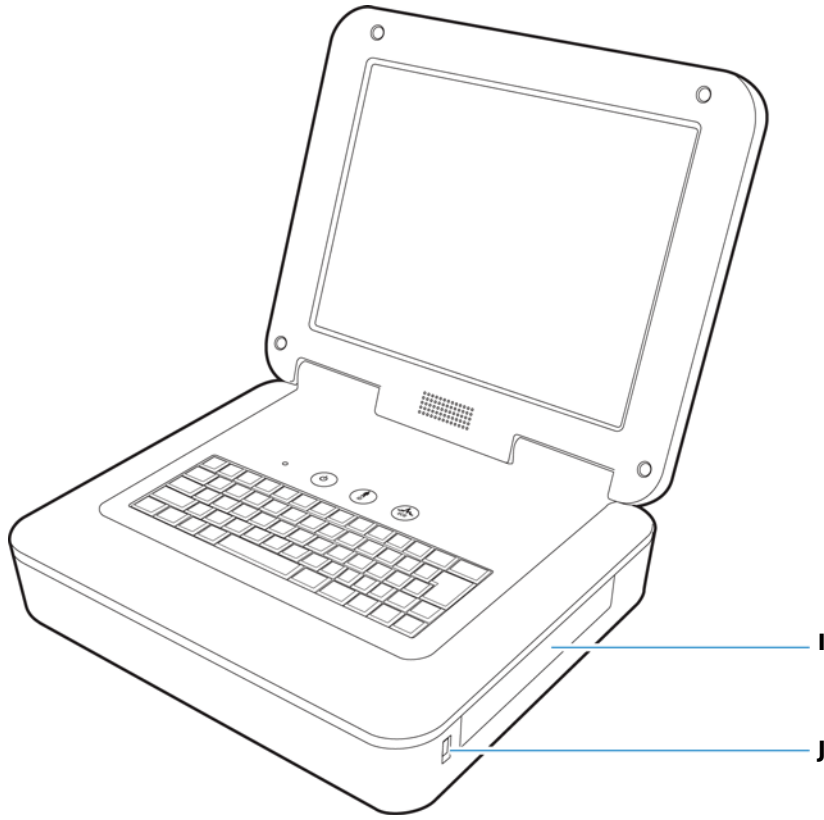

- I Battery compartment
- J USB memory stick connector

Figure 1-4 PageWriter TC70 Cardiograph (rear view)

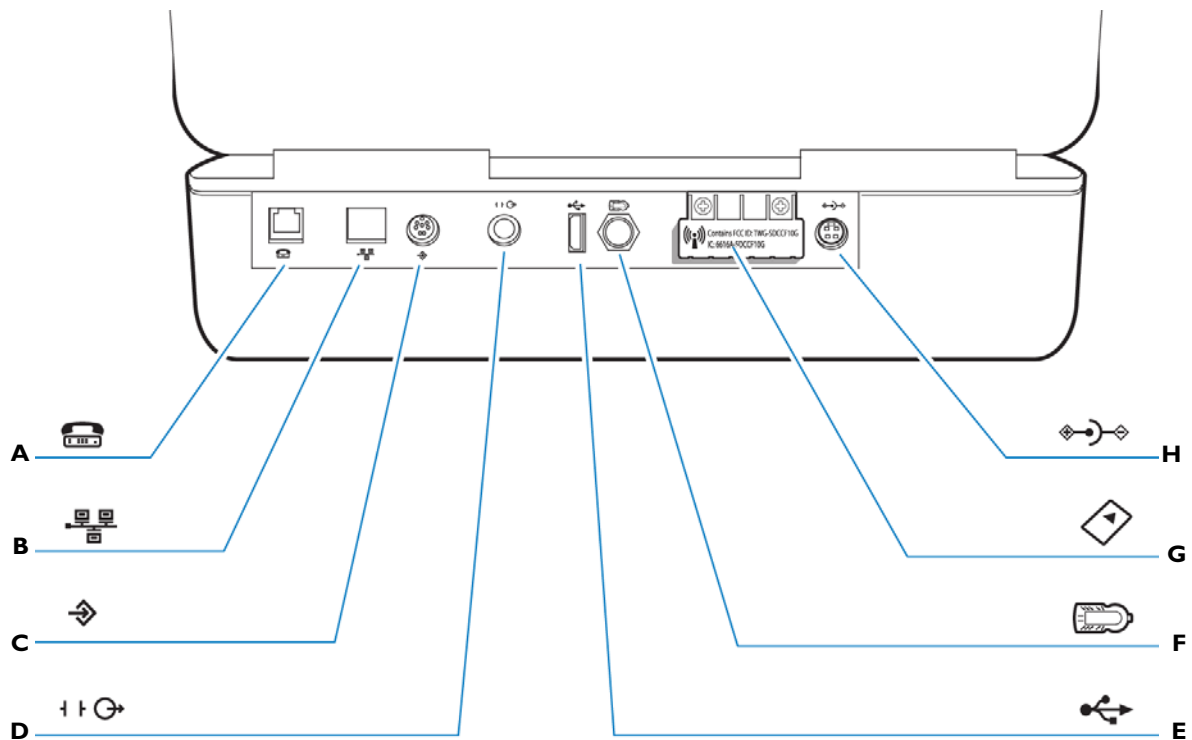

- | | |
|---|---|
| A Modem connector | G Wireless LAN card slot (with protective cover installed) |
| B LAN connector | H AC power connector |
| C Barcode reader or magnetic card reader connector | |
| D Analog ECG output signal connector (not supported) | |
| E USB connector | |
| F PIM connector | |

WARNING Do not connect the modem card to a phone line when the cardiograph is connected to a patient.

CAUTION Do not insert a USB memory stick into the cardiograph, or remove a USB memory from the cardiograph when the cardiograph is acquiring ECG data from a patient.

PageWriter TC50 Cardiograph Components

The following sections include a description of all of the components of the PageWriter TC50 cardiograph, including the connection ports on the cardiograph, the Patient Interface Module (PIM), and optional accessories available with the cardiograph. For more information on using the cardiograph features, see “The Patient Session” on page 3-1. For information on ordering any of the optional accessories for the cardiograph, see “Supplies and Ordering Information” on page 1-45.

Figure 1-5 PageWriter TC50 Cardiograph (right front view)

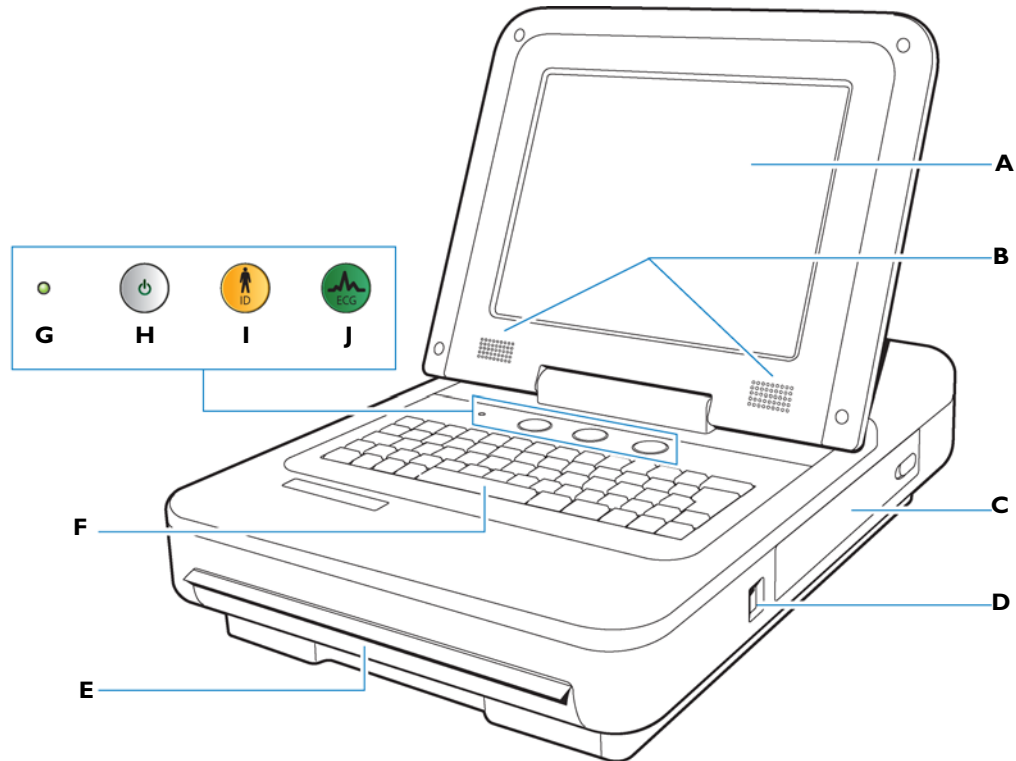

- | | |
|-------------------------------------|--------------------------------------|
| A Touch screen | F Keyboard |
| B Audio speakers | G AC power on indicator light |
| C Battery compartment | H Power/Standby button |
| D USB memory stick connector | I ID button |
| E Paper tray | J ECG button |

Figure 1-6 PageWriter TC50 Cardiograph (rear view)

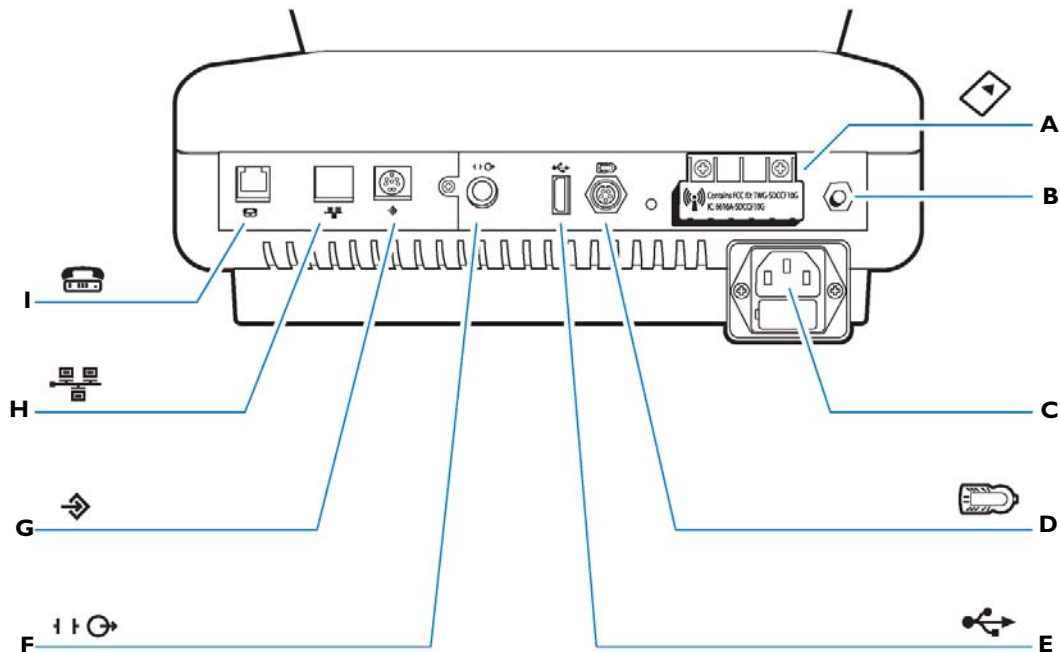

- | | |
|---|---|
| A Wireless LAN card slot (with protective cover installed) | G Barcode reader or magnetic card reader connector |
| B Equipotential grounding post | H LAN connector |
| C AC power cord connector | I Modem connector |
| D PIM connector | |
| E USB connector | |
| F Analog ECG output signal connector (not supported) | |

WARNING Do not connect the modem card to a phone line when the cardiograph is connected to a patient.

CAUTIONS Do not insert a USB memory stick into the cardiograph, or remove a USB memory from the cardiograph when the cardiograph is acquiring ECG data from a patient.

Only use grounded power cords (three-wire power cords with grounded plugs) and grounded electrical outlets that are labelled as *Hospital Only* or *Hospital Grade*. **Never** adapt a grounded plug to fit an ungrounded outlet by removing the ground prong. Use the equipotential post when redundant earth ground is necessary according to IEC 60601-1-1.

Assembling the PageWriter TC70 Cardiograph Cart

The PageWriter TC70 cardiograph is available with an optional cart that includes a locking storage drawer, storage bin, and a built-in holder for the PIM (patient interface module). The instructions in this section describe the unassembled cart option. For information on ordering the cart, see “PageWriter TC70 and PageWriter TC50 Cardiograph Supply Part Numbers” on page 1-46.

To attach the cardiograph to a fully assembled cart, see Step 7 on page 1-13 .

CAUTION Follow the procedure below to ensure that the cardiograph is securely fastened to the cart before use.

Figure 1-7 TC70 Unassembled Cart Kit Contents

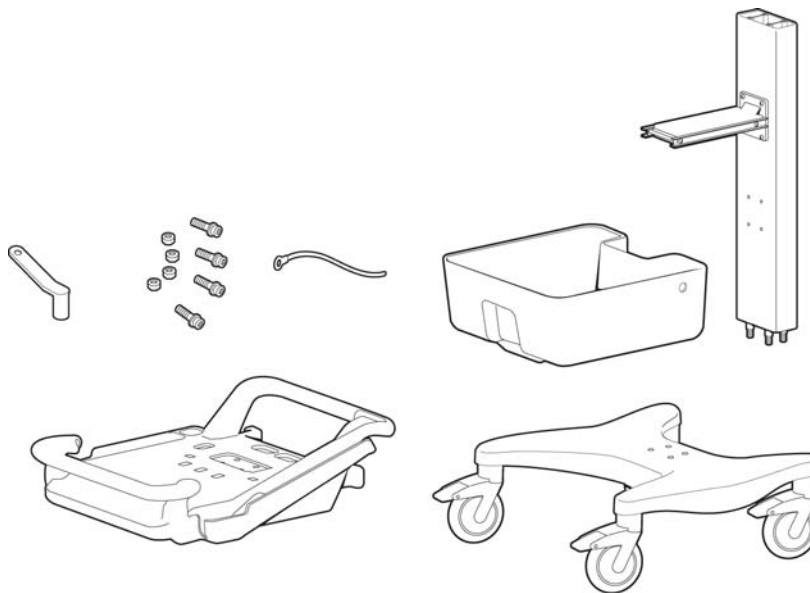

To attach the cardiograph to the cart:

- 1 Insert the beam into the cart base.

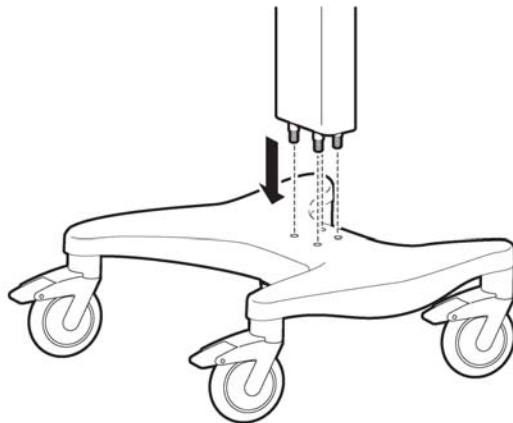

- 2 Hold the beam steadily. Turn the cart onto the side to expose the bottom of the cart.

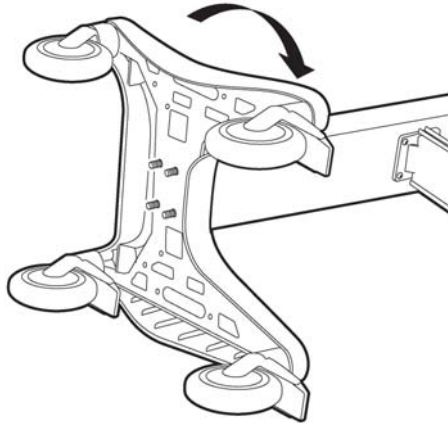

- 3 Place the ground strap onto the screw end.

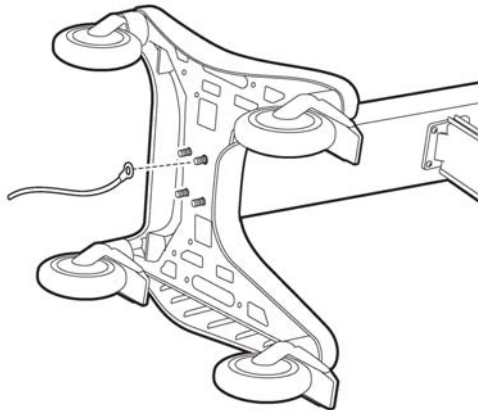

- 4 Attach the bolt screws and tighten using the provided wrench. Ensure that the bolt screws are tightened to 80-100 in lbs.

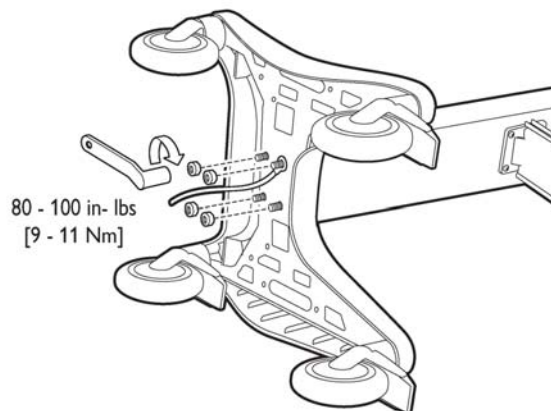

- 5 Turn the cart upright.
- 6 Attach the top shelf to the beam using the provided bolts and wrench. Tighten the bolts to 80-100 in lbs.

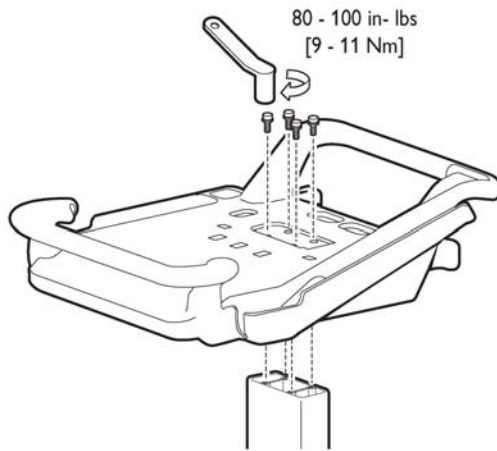

- 7 Align the rear feet of the cardiograph with the rear locking holes on the cart. Align the front feet of the cardiograph with the front screw holes on the cart. Lower the cardiograph onto the cart and snap into place.

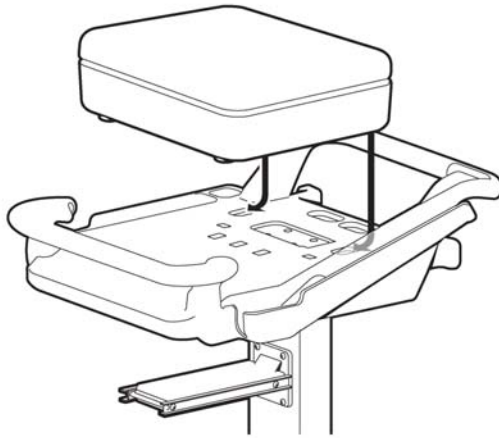

- 8 Insert the front screws through the bottom of the base, and tighten.

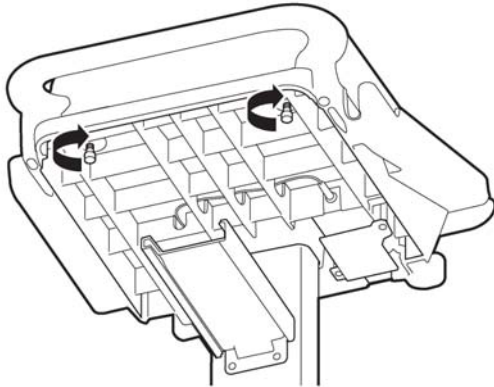

- 9 Slide the drawer onto the cart as shown.

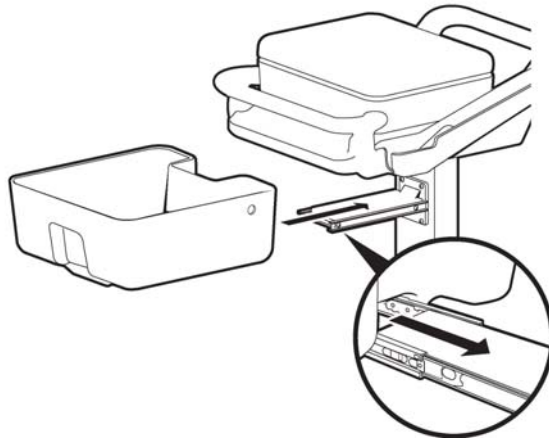

Assembling the PageWriter TC50 Cardiograph Cart

The PageWriter TC50 cardiograph is available with an optional cart that includes a storage bin and a built-in holder for the PIM (patient interface module). A second storage bin is available as an optional accessory. The instructions in this section describe the unassembled cart option. For information on ordering the cart, see "PageWriter TC70 and PageWriter TC50 Cardiograph Supply Part Numbers" on page 1-46.

To attach the cardiograph to a fully assembled cart, see Step 10 on page 1-18 .

CAUTION Follow the procedure below to ensure that the cardiograph is securely fastened to the cart before use.

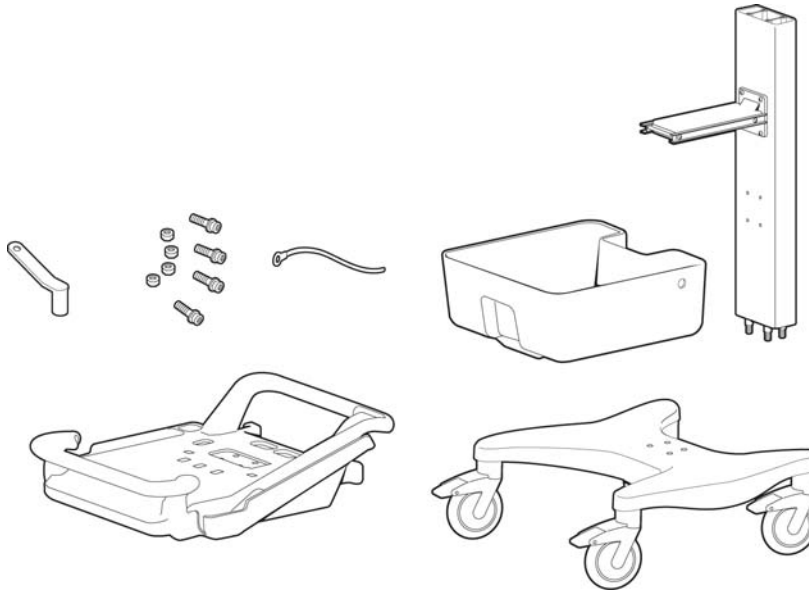
Figure 1-8 Unassembled Cart Kit Contents**To attach the cardiograph to the cart:**

- 1 Insert the beam into the cart base.

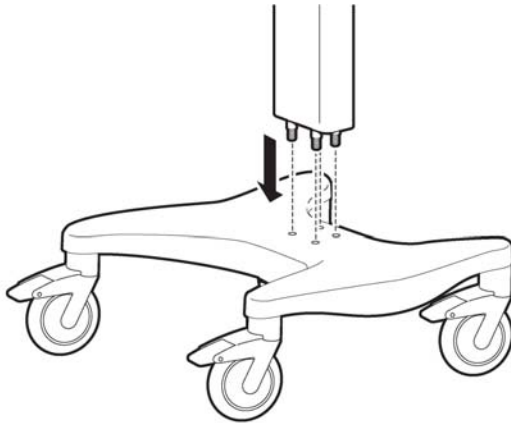

- 2 Hold the beam steadily. Turn the cart onto the side to expose the bottom of the cart.

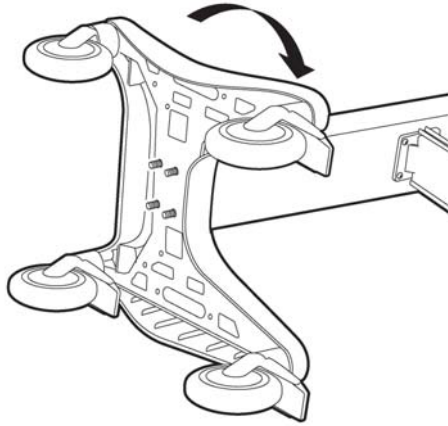

- 3 Place the ground strap onto the screw end.

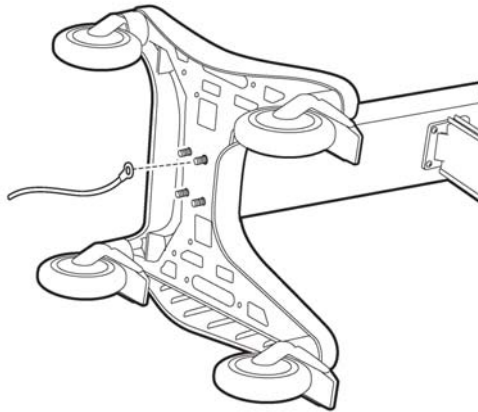

- 4 Attach the bolt screws and tighten using the provided wrench. Ensure that the bolt screws are tightened to 80-100 in lbs.

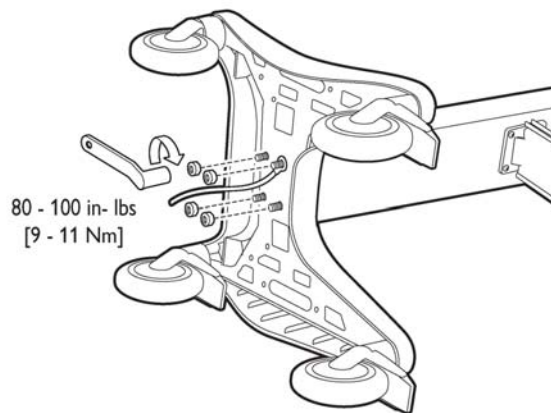

- 5 Turn the cart upright.
- 6 Attach the bin to the beam.

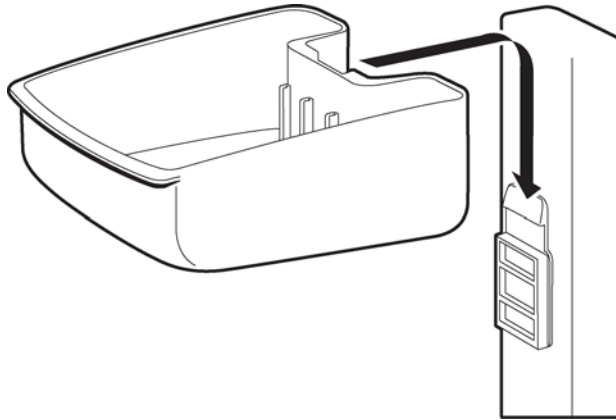

- 7 Insert the bin dividers as shown.

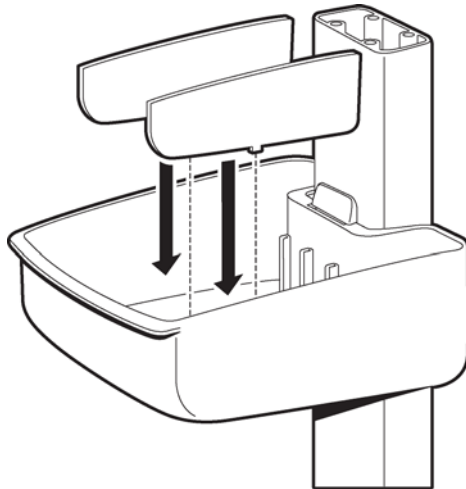

- 8 Slide out the tray on the top shelf.

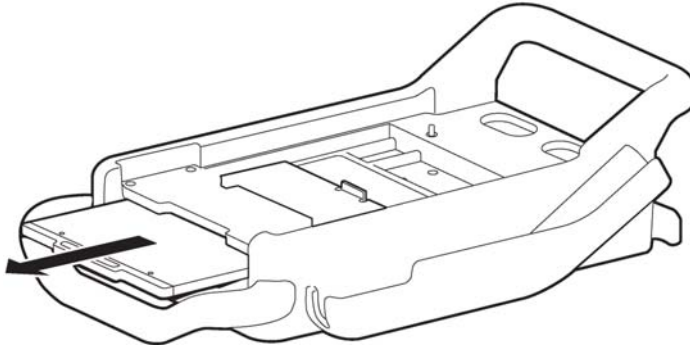

- 9 Attach the top shelf to the beam using the bolt screws. Tighten the bolts using the provided wrench. Ensure that the bolt screws are tightened to 80-100 in lbs.

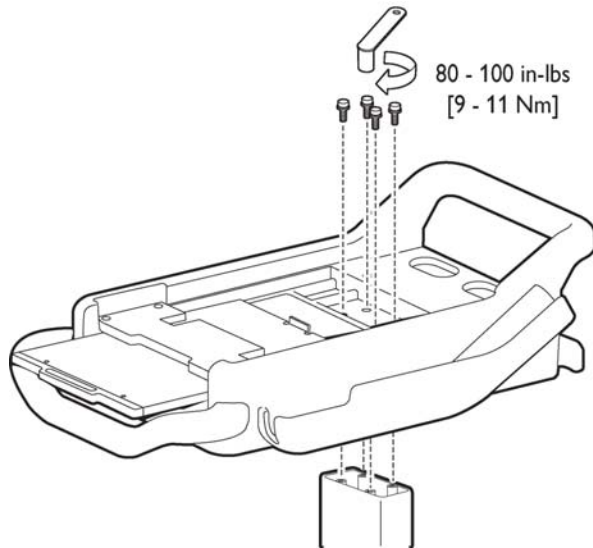

- 10 Align the rear feet of the cardiograph with the rear holes on the cart. Lower the front feet of the cardiograph into the front holes on the cart and push the cardiograph into place. Ensure that the cardiograph is locked into the slot on the front right of the cart.

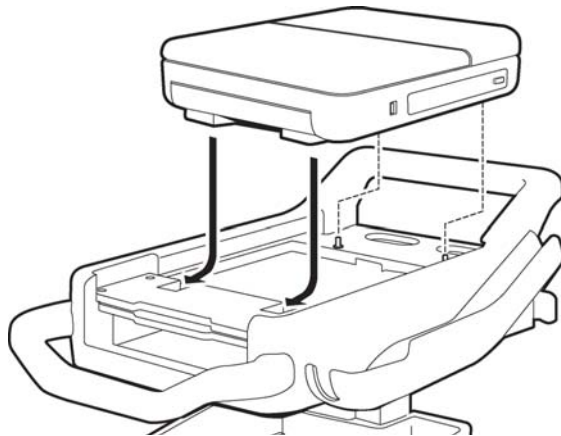

- 11 Insert the screws through the bottom of the base, and tighten.

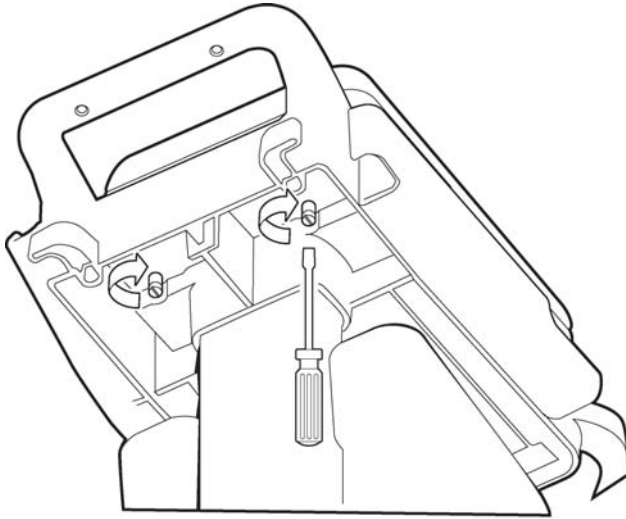

Using the Cart Wheel Positioners and Brake

Both cart models include one wheel brake and two wheel positioners. Lock the wheel positioners at all times when using the cart. The wheel positioners keep the cart straight when moving forward or backward, or when turning corners. The wheel positioners also help the cart maneuver in tight spaces.

To use the cart wheel positioners and brake:

- 1 Align the front wheels so that they are straight. Step on both wheel positioners. Move the cart forward until the wheels lock into position. The cart will move forward or backward in a straight line.

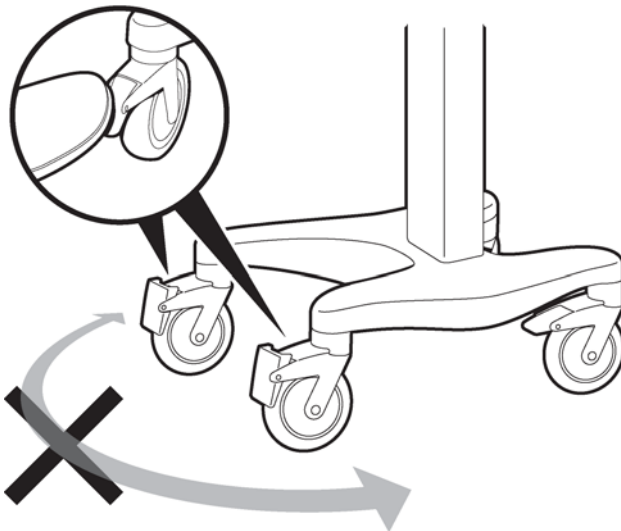

- Step on the gray rear wheel brake to lock the cart wheels. The cart will not move. Step on the wheel brake again to unlock the wheels.

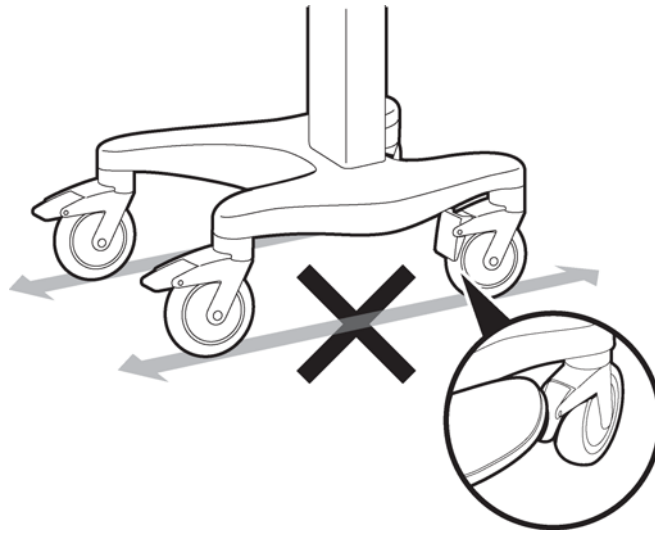

Patient Interface Module (PIM)

The same Patient Interface Module (PIM) is used on both the TC70 and TC50 model cardiographs. The PIM is a hand-held device that connects to the patient data cable. The PIM is available in a standard 12-lead, or an optional 16-lead model. For information on configuring the optional 16-lead PIM, see “Configuring the 16-Lead PIM” on page 1-26.

NOTE Figure 1-9 shows AAMI version PIMs.

Figure 1-9 16-lead (left) and 12-lead (right) Patient Interface Module (PIM)

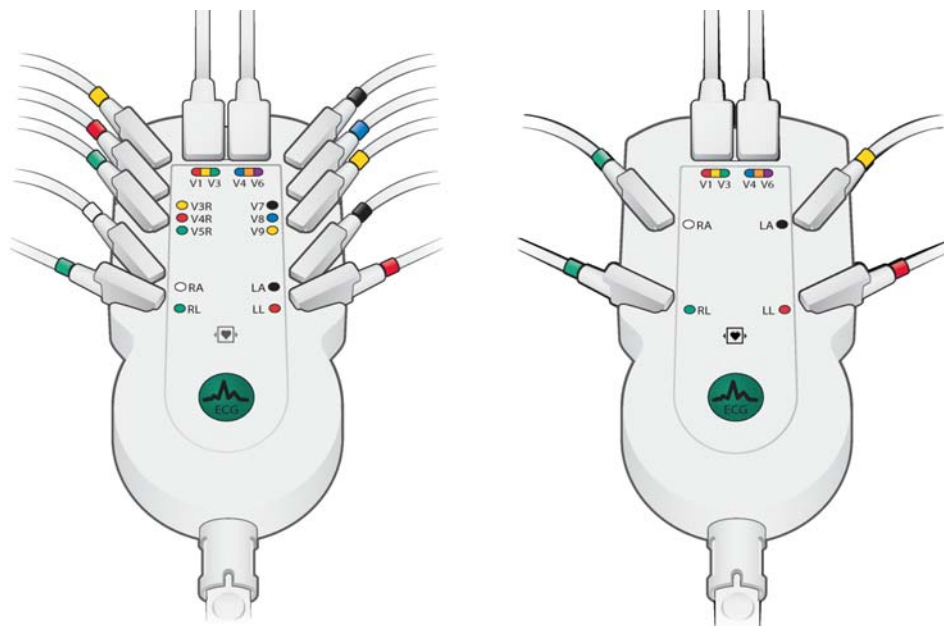

About Class A and Class B Patient Data Cables and PIMs

Prior to August, 2009, PageWriter TC70 cardiographs with installed software version A.02.00 and lower were shipped from Philips Medical Systems with Class A patient data cables and Class A PIMs. All PageWriter TC70 cardiographs and PageWriter TC50 cardiographs with installed software version A.03.00 and higher are shipped from Philips Medical Systems with Class B patient data cables and Class B PIMs.

The only visual difference between a Class A and a Class B PIM or patient data cable is the number of connectors on the PIM, and the number of pins on the PIM connector end of the patient data cable. All Class A devices have 5 connectors/pins on the PIM connector, and on the PIM connector end of the patient data cable. All Class B devices have 8 connectors/pins on the PIM connector, and on the PIM connector end of the patient data cable.

NOTE Both Class A and Class B patient data cables have 5 pins on the connector end that attaches to the cardiograph.

Class A patient data cables can only be used with a Class A PIM on the PageWriter TC70 cardiograph. Class B patient data cables can only be used with a Class B PIM on either a PageWriter TC70 or a PageWriter TC50 cardiograph. When ordering replacement patient data cables or PIMs from Philips Medical Systems, check the number of connectors on the PIM, and also check the number of pins on the PIM connector end of the patient data cable to ensure that you are ordering the correct Class A or Class B device.

NOTE If you are unable to connect a patient data cable to a PIM connector, check that both devices are compatible. You cannot connect a Class A patient data cable to a Class B PIM.

Figure 1-10 Class A and Class B Patient Data Cable Connectors

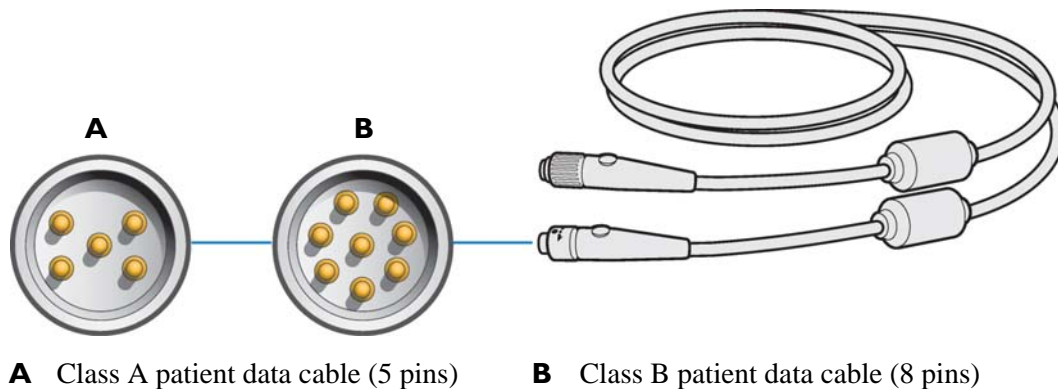
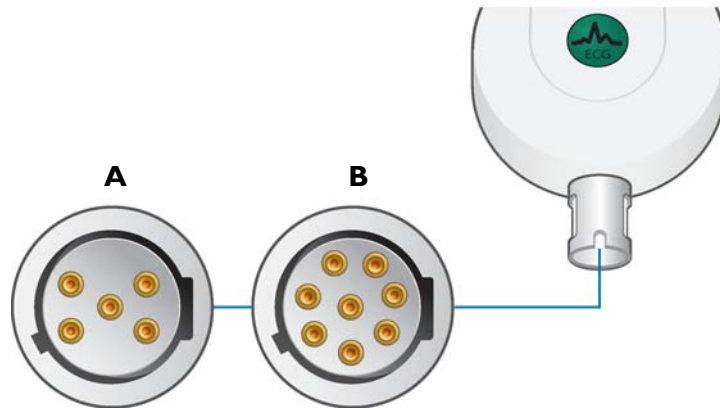

Figure 1-11 Class A and Class B Patient Interface Module (PIM) Connectors



A Class A PIM (5 connectors)

B Class B PIM (8 connectors)

Attaching the Patient Data Cable to the PIM and Cardiograph

The patient data cable must be attached to the PIM connector before use. Once attached to the PIM, the patient data cable is then attached to the cardiograph through the appropriate PIM connector on the rear of the cardiograph.

WARNING Ensure that the patient data cable is securely connected to the PIM connector () on the rear panel of the cardiograph.

WARNING The Philips Medical Systems patient data cable (supplied with cardiograph) is an integral part of the cardiograph safety features. Use of any other patient data cable may lead to the distortion or corruption of patient ECG data, may compromise defibrillation protection and degrade cardiograph performance, and overall cardiograph safety may be seriously degraded.

NOTE The PageWriter TC50 cardiograph with installed software version A.03.00 and higher is only compatible with the Class B patient data cable (Philips part number 989803164281).

To attach the patient data cable to the PIM and to the cardiograph:

- 1 Align the raised dot on the top of the patient data cable connector with the front of the PIM. Insert the patient data cable connector through the metal housing. Push the patient data cable connector firmly into the PIM connector. The connector *clicks* when it is locked into position.

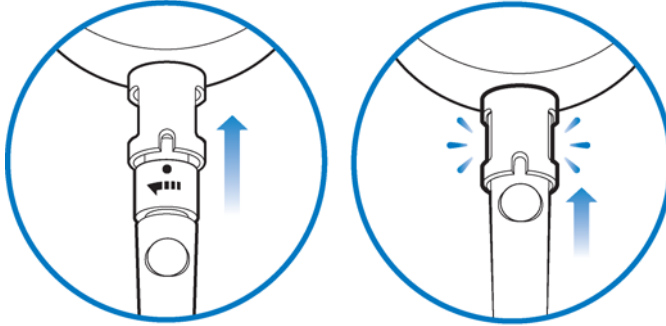
**NOTE**

If you are unable to connect a patient data cable to a PIM connector, check that both devices are compatible. You cannot connect a Class A patient data cable to a Class B PIM. For more information, see page 1-21.

- 2 Connect the other end of the patient data cable to the PIM connector port () located on the rear panel of the cardiograph. Align the raised circle on the cable connector upright as shown in the figure. Turn the cable connector to the right to lock it into position.

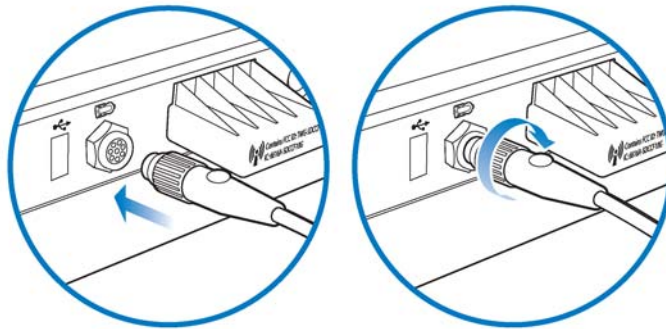

- 3 Drape the patient data cable over the top of the rear handle on the cart to help ensure that the patient data cable does not drag on the ground.

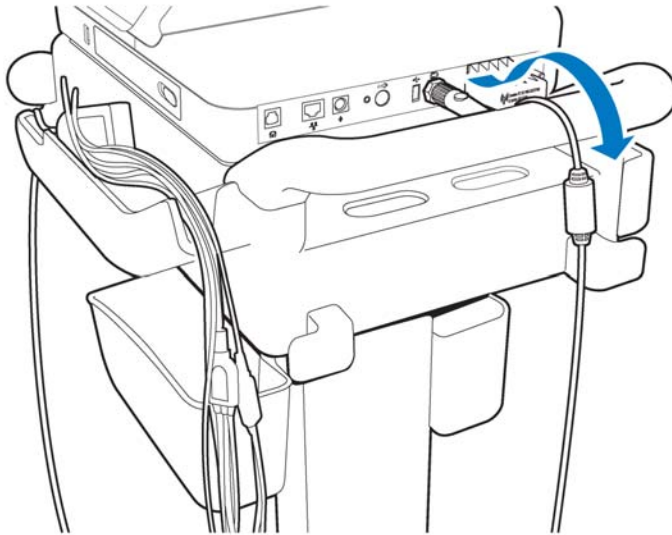

To disconnect the patient data cable from the PIM:

- ▶ Twist the end of the patient cable connector inside the metal housing and pull the connector out.

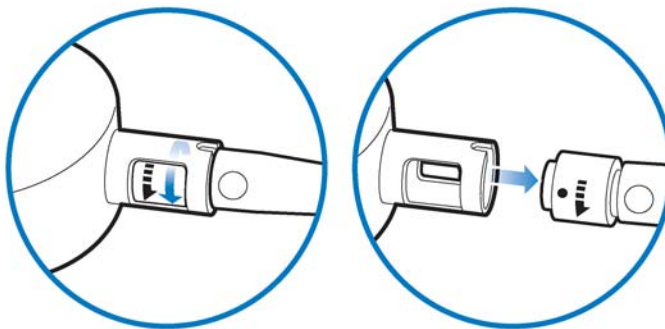

Special Note about Patient Interface Module (PIM)

The PIM is an electronic device and can feel warm if placed on bare skin.

CAUTION If the PIM is placed on the patient's bare skin, always place a sheet or cloth between the PIM and the patient. If the PIM is left on the patient's skin for an extended period of time while the cardiograph is being used for monitoring purposes, the PIM could reach a maximum temperature of 46 °C (114.8 °F) in a room environment with a temperature of 40 °C (104 °F).

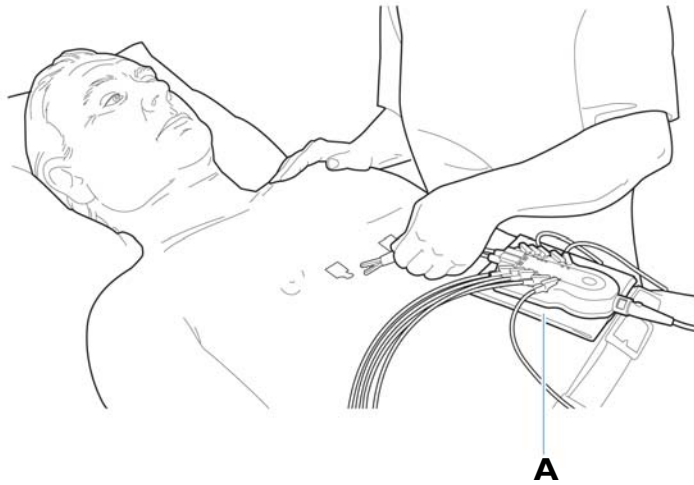
Figure 1-12 Placing PIM on patient's skin

A Cloth placed between PIM and patient

PIM ECG Button

The PIM has an **ECG** button that is used to take ECGs from the bedside. For information on connecting the PIM to the patient, or on using the PIM ECG button, see “The Patient Session” on page 3-1.

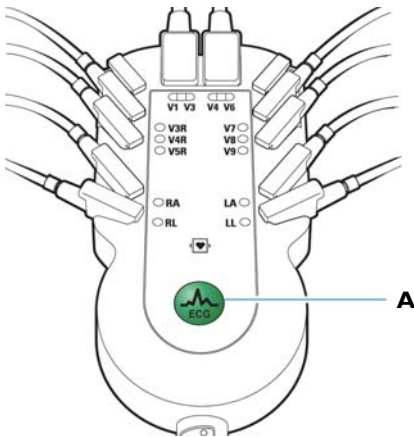
Figure 1-13 The 16-Lead PIM with ECG button

A PIM ECG button

Configuring the 16-Lead PIM

The optional 16-lead PIM may be configured to support up to 16 optional leads for adult and pediatric application. The 16-lead PIM is shipped with four optional leads, color clip identifiers, and shorting plugs. For information on ordering the 16-lead PIM option, see “PageWriter TC70 and PageWriter TC50 Cardiograph Supply Part Numbers” on page 1-46.

CAUTION When using the 16-lead PIM, always ensure that the leads connected to the Patient Interface Module (PIM) are the same leads that are displayed on the cardiograph screen.

Figure 1-14 16-Lead PIM Kit

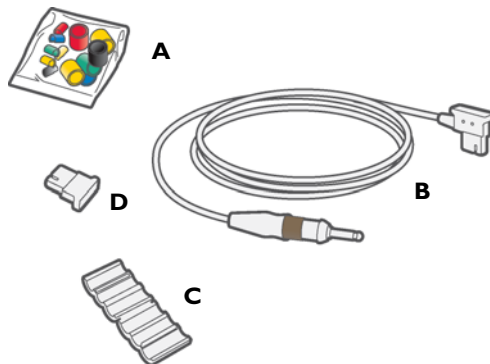

- | | |
|-------------------------------------|----------------------------------|
| A Color identification clips | C Lead separator |
| B Optional leads (4 total) | D Shorting plug (6 total) |

To configure the 16-lead PIM:

- 1 Press the On/Standby button to put the cardiograph into Standby.

CAUTION Always put the cardiograph in Standby before connecting or disconnecting the Patient Interface Module (PIM). Do not disconnect or connect the PIM to the cardiograph while the cardiograph is in active use.

- 2 Disconnect the PIM from the cardiograph, if necessary.
- 3 There are six optional lead connectors available on the PIM. These optional lead connectors include: **C3R/V3R**, **C4R/V4R**, **C5R/V5R**, **C7/V7**, **C8/V8** and **C9/V9**. Any of these optional leads (up to a maximum of four) may be configured for use with the cardiograph.

NOTE The cardiograph does not support the configuration of 18 leads. Any of the optional leads, up to a maximum of 4, may be configured for use with the cardiograph.

Figure 1-15 16-Lead PIM Optional Lead Connectors (AAMI/IEC)

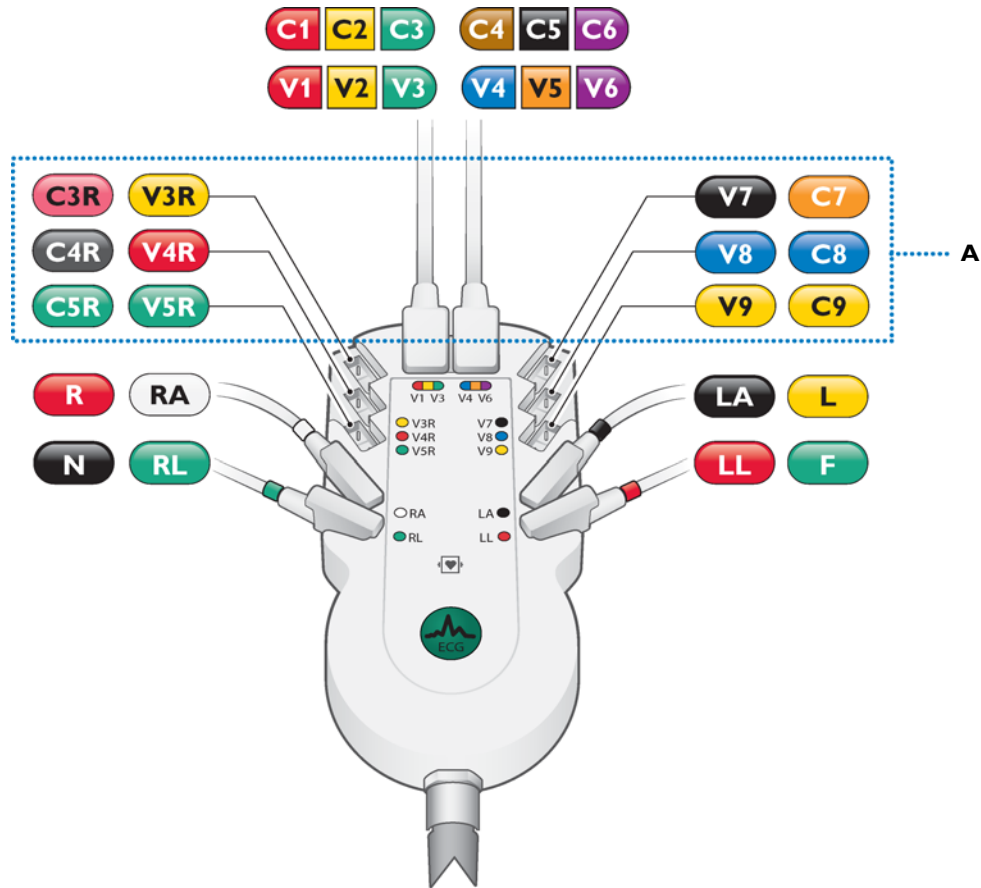

A Optional lead connectors

- 4 Attach the appropriate color-coded identification clip (included in the lead kit) to the lead, and attach the small color clip near the connector end of the lead wire.

Figure 1-16 Attaching the color clips to the lead

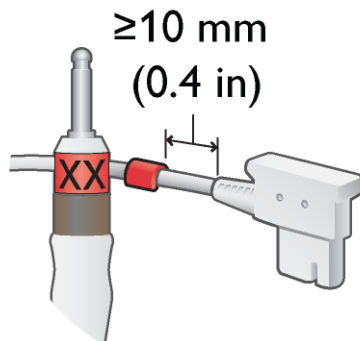

- Attach the lead to the correct lead connector on the PIM. If any lead connectors on the PIM are left empty, insert a shorting plug (included in kit).

Figure 1-17 Shorting Plug (included in Lead Kit)



NOTE To configure the 16-lead PIM for standard 12 leads, insert shorting plugs into all of the optional lead connectors.

- Ensure that each lead is firmly connected to the PIM.

Recommended 16-Lead Configurations

Table 1-1 provides some suggested configurations of the 16-lead Patient Interface Module (PIM) for adult and pediatric application.

NOTE The recommended 16-lead configuration options described in Table 1-1 are the only 16-lead options that are compatible with the TraceMaster ECG Management System.

Table 1-1 15 and 16-Lead PIM Configuration Options

Lead Option	Standard 12-leads plus extended leads (AAMI/IEC)	Lead Placement
Pediatric (15 leads)	V3R (C3R), V4R (C4R), V7 (C7)	
Posterior (15 leads)	V7 (C7), V8 (C8), V9 (C9)	

Table 1-1 15 and 16-Lead PIM Configuration Options (continued)

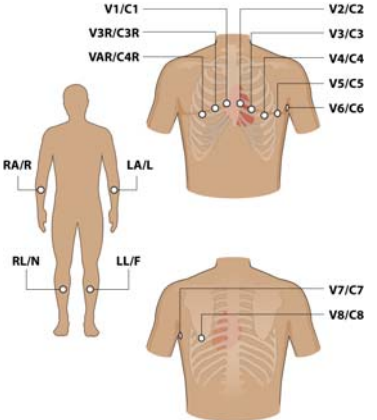
Lead Option	Standard 12-leads plus extended leads (AAMI/IEC)	Lead Placement
Balanced (16 leads)	V3R (C3R), V4R (C4R), V7 (C7), V8 (C8)	

Installing the Batteries

The PageWriter TC70 cardiograph is shipped with two batteries, and the PageWriter TC50 cardiograph is shipped with one or an optional two batteries that are used to power the cardiograph when AC power is not available.

CAUTION Insert the batteries into the cardiograph before plugging the cardiograph into AC power.

Notes about Battery Installation

- NOTES**
- If operating the PageWriter TC50 cardiograph with one battery installed, the battery may be inserted into either battery compartment.
 - When operating the PageWriter TC50 cardiograph with one battery installed, only use the Philips battery with part number 989803170371. Do not use the battery with Philips part number 989803160981 for one battery operation.
 - When operating the PageWriter TC70 or PageWriter TC50 cardiograph with two batteries installed, ensure that both batteries contain the same Philips part number. The battery part number identification label is found on the bottom of the battery. The cardiograph cannot operate with two batteries that contain different part numbers. If the cardiograph is operated with two batteries with different part numbers, the cardiograph will display an error message and will not operate.

To install the batteries:

- 1 Open the battery door.

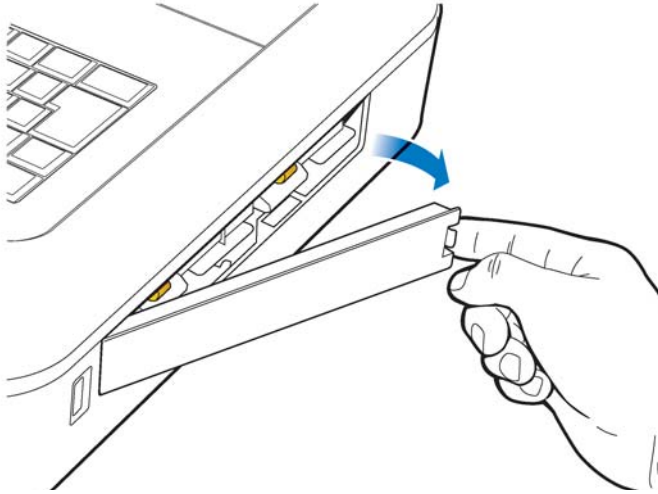

- 2 Locate the two gold pull tabs inside of the battery compartment. Pull the tabs straight out of the battery compartment and lay flat.

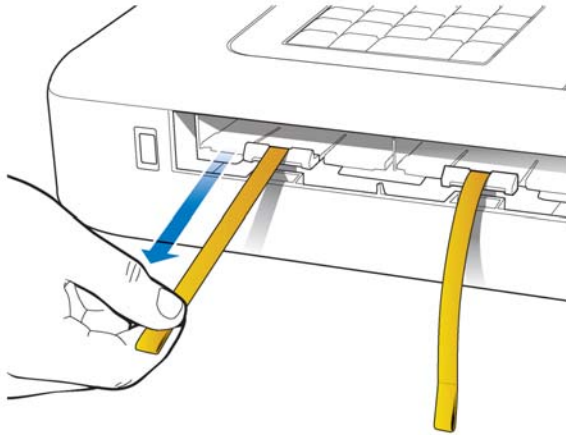

- 3 Insert the battery with the external connector facing the bottom rear of the compartment.

NOTE If operating the PageWriter TC50 cardiograph with one battery installed, the battery may be inserted into either battery compartment.

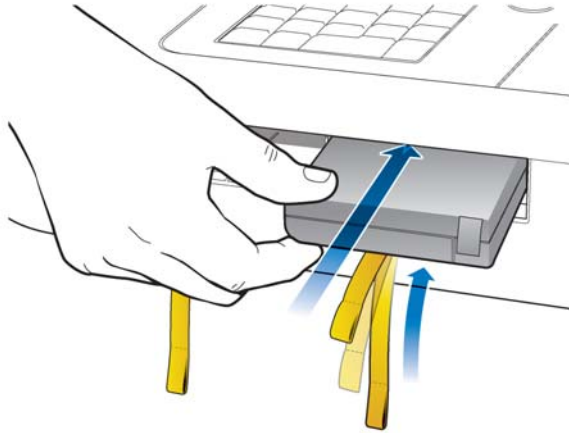

- 4 Push in the battery and ensure that the battery is fully inserted into the slot. The pull tab will insert along with the battery. Insert the second battery following the same procedure.

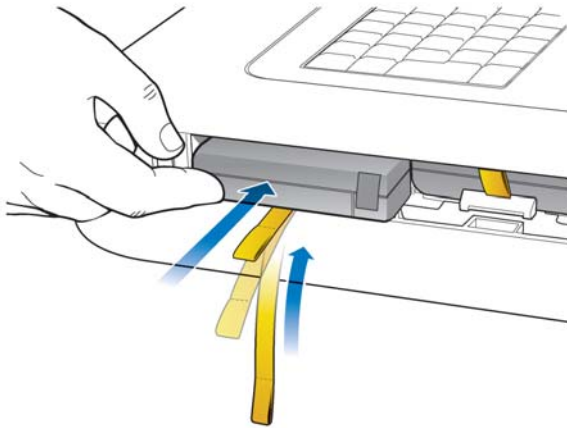

- 5 Reinstall the battery door.

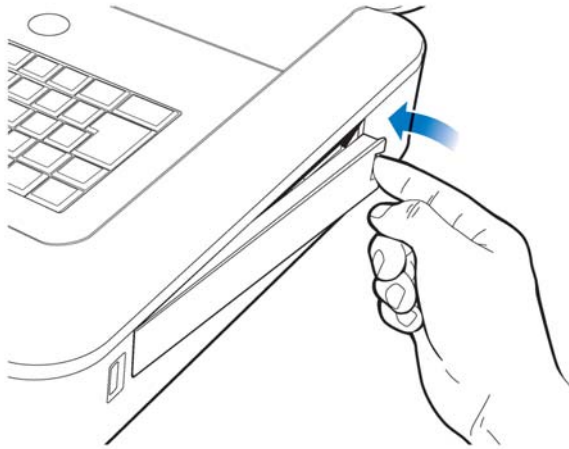

- 6 Connect the AC power cord to the cardiograph. Charge the batteries for five hours before operating the cardiograph on battery power only.

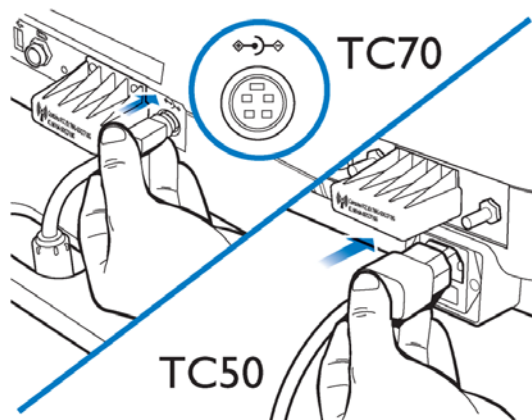

Charging the Batteries

Charge the batteries for five hours prior to initial use. Plug the cardiograph into AC power whenever possible, and fully charge the batteries. Proper battery maintenance and care, including frequent and full charging of the batteries, will help to prolong battery life.

There are configurable power saving features available on the cardiograph. These features are used to help prolong overall battery life, and to optimize battery power use between battery charges.

CAUTION When removing the batteries from the cardiograph, the batteries could feel warm to the touch.

Calibrating the Batteries

The batteries may require periodic calibration to ensure the continued accuracy of the battery power and overall battery status information displayed on the cardiograph. When battery calibration is required, a message appears on the Battery Status window. For more information on battery calibration, see “Battery Calibration” on page 5-12.

Battery Power Indicator

The battery power indicator () appears on the Status Bar and is always visible. The indicator displays the current battery power level. The cardiograph can operate on AC power while the batteries are charging, but the batteries will charge at a slower rate.

Figure 1-18 Battery Power Indicator on the Status Bar



A Battery level indicator

To check the battery power level:

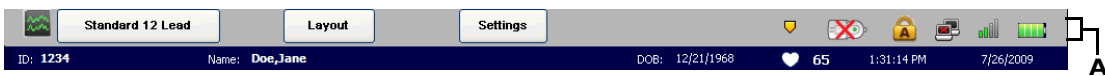





- 1 From any screen, tap on the battery icon on the Status Bar (). The Battery Status window appears. This window provides detailed information on the status of the cardiograph batteries. The battery icon indicates the overall charge status of the battery.

Table 1-2 Battery Icon (on Status Bar or Battery Status window)

Icon on Status Bar	Battery Level
	Fully Charged Battery
	75% power capacity
	50% power capacity
	<p>Low Battery Power:</p> <ul style="list-style-type: none"> ■ red battery icon appears when power level is below 25% ■ cardiograph <i>beeps</i> and an error message appears until the unit is plugged into AC power (audio feature may be disabled) ■ tap the icon to see how many minutes are left of operating battery power ■ If overall battery power is below 15% and the cardiograph is in Standby, when the On/Standby button is pressed it will flash green five times and the cardiograph will be unable to return to active use. Plug the cardiograph into AC power to recharge the batteries.
	No or Dead Battery

NOTE If the **Plug in the Cardiograph** message appears, the cardiograph needs to be plugged into AC power immediately.

Figure 1-19 Battery Status Information with *Plug in the Cardiograph* message

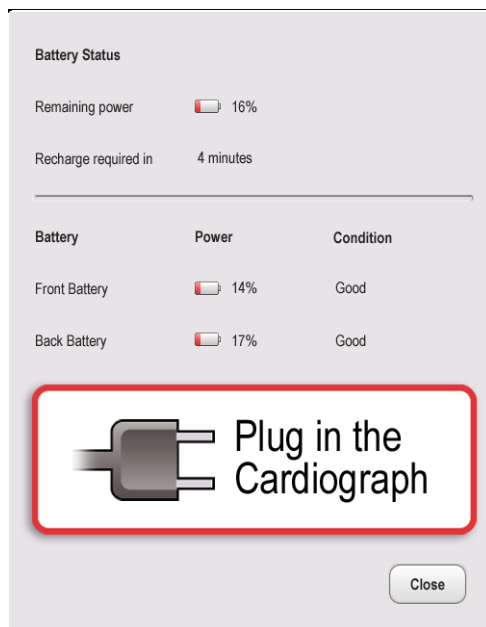

- 2 Touch the **Close** button to close the window.

Using the Wireless LAN Card

The PageWriter TC70 cardiograph and PageWriter TC50 cardiograph both support the Summit Wireless LAN card. The wireless LAN card is used to transfer ECG and order data between the cardiograph and a TraceMaster ECG Management System. The cardiograph can also be configured to transfer ECG data using a wireless connection to a third party ECG management system. For information on configuring cardiograph connectivity with a TraceMaster or other third party ECG management system, see the *PageWriter TC70/TC50 Cardiograph Network Configuration Guide* available on the User Documentation and Training DVD, or the file can be downloaded from the Philips InCenter site.

CAUTION Only use wireless LAN cards with the PageWriter TC70 or PageWriter TC50 cardiographs that have been purchased from Philips Medical Systems. The use of non-approved wireless LAN cards with either model cardiograph is not tested or supported, and Philips Medical Systems does not guarantee cardiograph operation or wireless LAN connectivity.

For information on installing the card and configuring the cardiograph for wireless transmission, see the *PageWriter TC Cardiograph Wireless LAN Installation Instructions*. The file is available for download from the Philips InCenter site (incenter.medical.philips.com).

For information on ordering the wireless card, see "Supplies and Ordering Information" on page 1-45.

Using the Modem Card

The modem card is an optional accessory that is used to fax ECGs to a configured receiving fax machine, or is used to transfer ECGs or orders by modem between the cardiograph and a TraceMaster ECG Management System. The cardiograph can also be configured to transfer ECG data by modem to a third party ECG management system. For information on configuring cardiograph connectivity with a TraceMaster or other third party ECG management system, see the *PageWriter TC70/TC50 Cardiograph Network Configuration Guide* available on the User Documentation and Training DVD, or the file can be downloaded from the Philips InCenter site.

For information on ordering the modem card, see “Supplies and Ordering Information” on page 1-45.

WARNING Do not connect the modem card to a phone line when the cardiograph is connected to a patient.

Using the USB Memory Stick

The USB memory stick is an optional accessory that is used to transfer orders to the cardiograph from a computer that has the WebSelect Utility installed, and can also be used to transfer completed ECGs from the cardiograph to a TraceMaster ECG Management System for reconciliation and processing. The USB memory stick can also be used to save custom settings specified on the Setup screens as a *Custom Settings* file. This Custom Settings file can then be transferred to additional cardiographs to help speed up the configuration process.

For information on using the WebSelect Utility, see the *Using OrderVue with PageWriter Cardiographs* guide. This guide is available for download from the Philips InCenter site. For information on the Philips InCenter site, see “Using the Philips InCenter Site” on page 1-5.

CAUTION The PageWriter TC70 and TC50 cardiographs only support the USB memory stick that is available for purchase as an optional accessory from Philips Medical Systems. Philips does not guarantee that other USB memory sticks are compatible with the PageWriter TC70 or TC50 cardiographs.

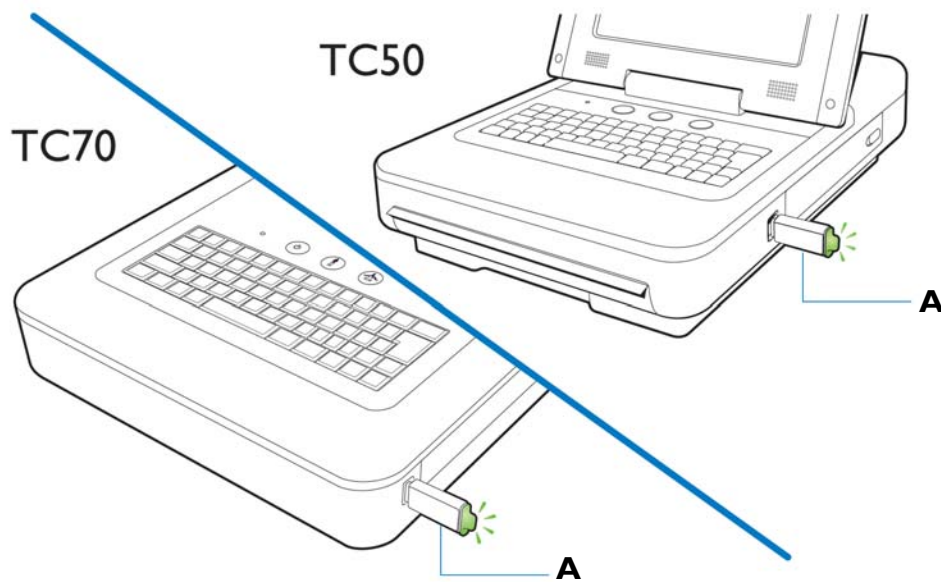
Figure 1-20 USB memory stick inserted into USB connector

A USB memory stick inserted into USB connector (tip illuminates when properly inserted)

The USB memory stick can store up to 200 ECGs and 200 orders. Ensure that the USB memory stick is firmly inserted into the USB connector located on the front right side of the cardiograph (next to the battery door). The tip of the USB memory stick illuminates when it is properly inserted into the USB connector.

CAUTION Do not insert a USB memory stick into the cardiograph, or remove a USB memory stick from the cardiograph when the cardiograph is acquiring ECG data from a patient.

CAUTION Only use the USB memory stick to transfer data between a PageWriter TC70 or TC50 cardiograph and a computer. Do not use the memory stick with other devices.

Using the Barcode Reader

The barcode reader is an optional accessory that is used to quickly enter ID information by scanning a barcode.

The barcode reader attaches to the barcode reader connector (↔) on the rear panel of the cardiograph. Attach the barcode reader to the cardiograph before turning on AC power. For information on ordering the barcode reader, see “Supplies and Ordering Information” on page 1-45.

NOTE The *Metrologic Scanner Instructions for Use*, which provides complete information on configuring and using the barcode scanner, is included on the User Documentation and Training DVD.

Figure 1-21 The Barcode Reader

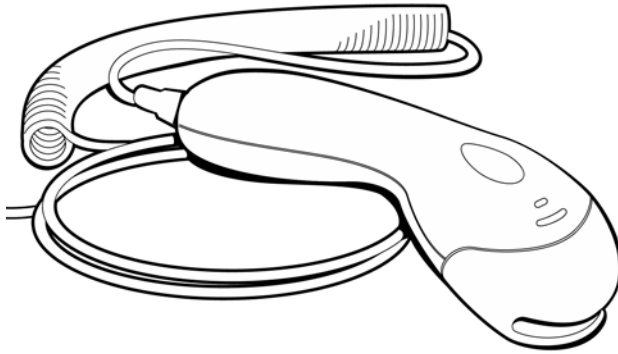

Using the Cardiograph Touch Screen

The touch screen provides access to all of the cardiograph features. Simply touch the buttons on the screen to open the different screens and to perform different functions.

Touch Screen Overview

The touch screen is organized into different areas that are grouped by function. The following sections provide an overview of each area of the touch screen.

Figure 1-22 Touch Screen Overview

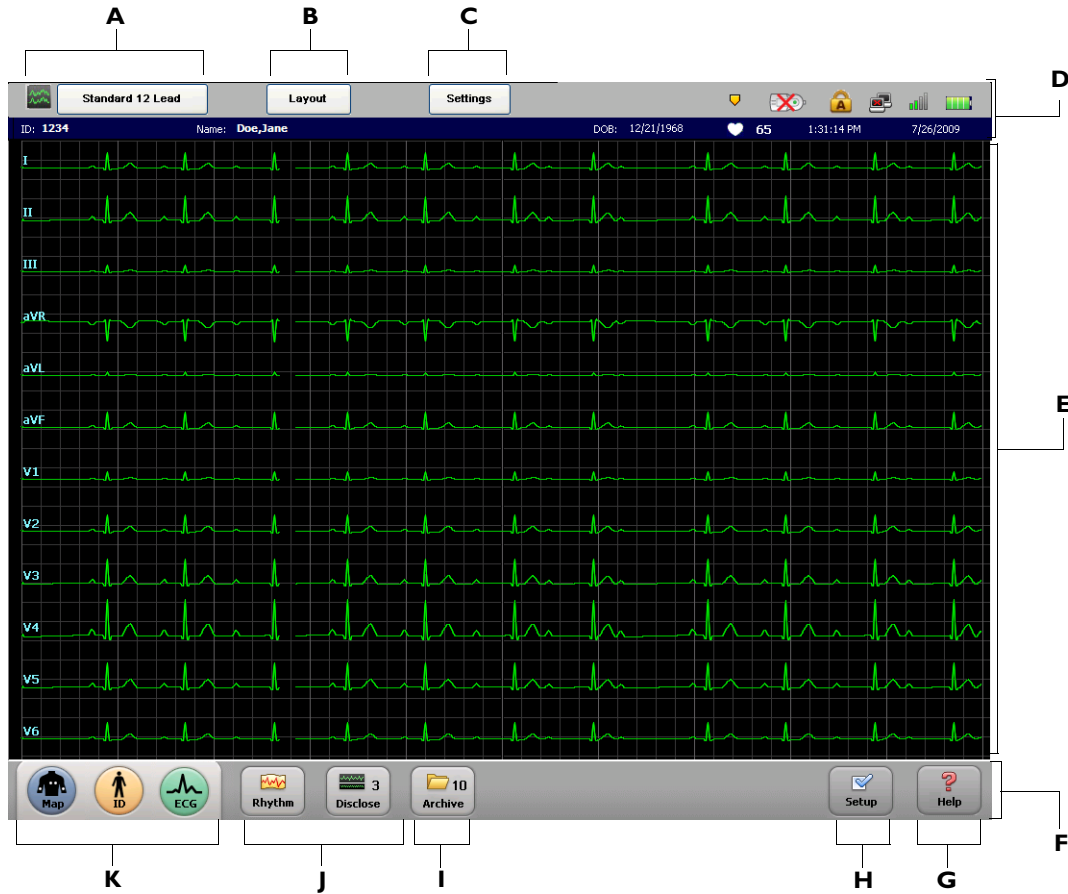

Table 1-3 Touch Screen Overview

Touch Screen Item	Feature	Description
A	<p>Selected Exam Type</p> 	<ul style="list-style-type: none"> ■ The Exam Type selected for the current patient session. ■ The available Exam Types are: Resting 12-Lead, Resting Extended Lead, and Timed ECG. ■ Touch the button to change the selected Exam Type.

Table 1-3 Touch Screen Overview (continued)







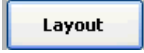

Touch Screen Item	Feature	Description
B	Exam Layout 	<ul style="list-style-type: none"> The settings underneath this button include the selected ECG report layout settings, and the level of interpretation generated by the Philips 12 or 16-lead algorithm that are being applied to the selected Exam Type. Any of the settings on this screen may be edited, and the new settings are applied to the current patient session.
C	Current Operating Settings 	<ul style="list-style-type: none"> The settings underneath this button include the selected filters (Artifact, Baseline Wander), pacing detection setting, and report scaling settings being applied to the current patient session. The Unknown pacing setting is recommended for most ECGs.
D	Status Bar	Displays information about the current cardiograph settings, including selected Exam Type, current patient name, network connectivity status, PIM status, and the current date and time.
E	Waveform Display	Display area for ECG waveforms. Lead connection quality is indicated by the color of the waveform. Press the up arrow () or the down arrow () key (on keyboard) to change the displayed lead format.
F	Toolbar	All cardiograph ECG acquisition modes and ECG management features.
G	Help 	Provides information on how to use the cardiograph.
H	Setup 	The settings underneath this button are used to configure or change cardiograph settings, or to access the service utilities. Access to these screens may require entering a password.

Table 1-3 Touch Screen Overview (continued)

Touch Screen Item	Feature	Description
I	ECG Storage and Management Features 	<ul style="list-style-type: none"> ■ Provides access to the ECG Archive, which is used as temporary storage for all ECGs acquired on the cardiograph. ■ From the Archive, ECGs may be transferred to a TraceMaster ECG Management System, or a third party ECG management system. ■ From the Archive, a TraceMaster server may be searched for previous ECGs to view and print on the cardiograph. ■ The number on the button (9) displays the number of ECGs currently stored in the Archive.
J	Rhythm and Disclose Features 	<ul style="list-style-type: none"> ■ The Rhythm feature is used to print continuous rhythm strips of up to 12 or 16 selected leads until the Stop button is touched. ■ The Disclose feature is used to review captured Events, to view continuous data from one selected lead, or to print ECG reports in a variety of formats. ■ The number on the Disclose button (0) displays the number of Events currently stored in Disclose.
K	1-2-3 Operation Features 	<p>The Map, ID, and ECG buttons are used in sequence to acquire and print a standard 12-lead or 16-lead ECG.</p>

Using the Main ECG Screen

The main screen displays 10 seconds of continuous ECG waveform data for each lead on one single screen, or can display a split screen view with various views of continuous ECG waveform data for each lead.

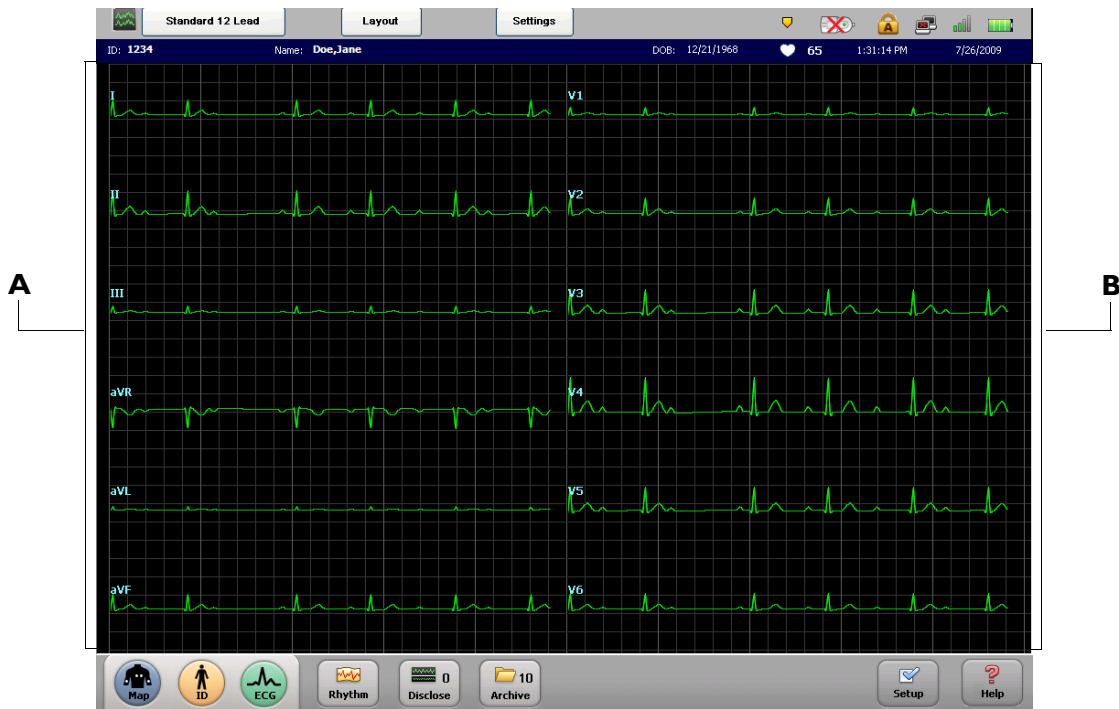

Figure 1-23 Main Screen with Split Screen View (12 Leads Displayed)



A Limb Leads

B Precordial Leads

To change the lead display on the main screen:

- 1 Press the down arrow key (on keyboard)  to display all leads on a split screen view. The split screen view provides five seconds of continuous ECG waveform data for each lead. The left side of the split screen displays the limb leads, and the right side displays all precordial leads. Press the down arrow key (on keyboard)  again to view additional lead configurations.
- 2 Press the up arrow key (on keyboard)  to change the display back to a standard 12, 15, or 16-lead view with no split screen. The standard view provides ten seconds of continuous ECG waveform data for each lead.

The Status Bar

The Status Bar (top of the screen) provides information about the current cardiograph settings. The Status Bar is always visible.

Figure 1-24 The Status Bar

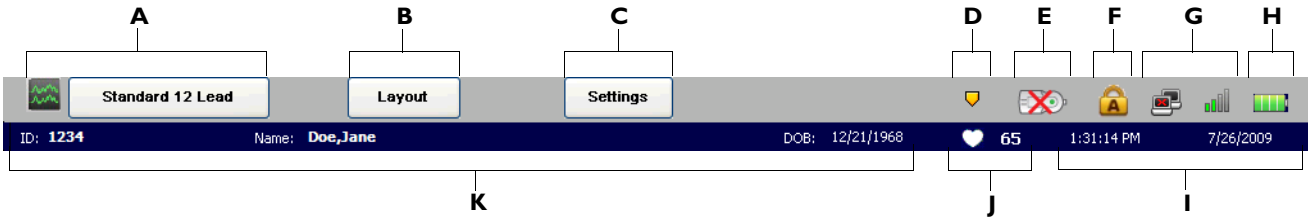

Table 1-4 The Status Bar





Status Bar Item	Feature	Description
A	Selected Exam Type 	<ul style="list-style-type: none"> The Exam Type selected for the current patient session. The available Exam Types are: Resting 12-Lead, Resting Extended Lead, and Timed ECG.
B	ECG Layout 	<ul style="list-style-type: none"> The current ECG report layout settings, including the level of interpretation generated by the Philips 12 or 16-lead algorithm. Any of the settings on this screen may be edited for the current patient session.
C	Operating Settings 	<ul style="list-style-type: none"> The current selected filters (Artifact, Baseline Wander), pacing detection setting, and report scaling settings. The Unknown pacing setting is recommended for most ECGs.
D	Event Marker Alert 	<ul style="list-style-type: none"> If this flashing icon appears, saved Event markers () have not yet been reviewed on the Disclose screen, and will be deleted within the next 5 minutes (TC70 cardiograph), or the next 2 minutes (TC50 cardiograph). Touch the Disclose button on the toolbar to review saved Events.

Table 1-4 The Status Bar (continued)









Status Bar Item	Feature	Description
E	PIM Disconnected 	<ul style="list-style-type: none"> ■ If this icon appears, the Patient Interface Module (PIM) is not connected to the cardiograph, or that a Class A PIM is connected to a PageWriter TC50 cardiograph. ■ Check that the PIM cable is firmly attached to the connector on the cardiograph, and that there are no breaks or cracks in the cable. Ensure that a Class B PIM is only used with a PageWriter TC50 cardiograph, see “About Class A and Class B Patient Data Cables and PIMs” on page 1-21.
F	Caps Lock 	<ul style="list-style-type: none"> ■ Indicates that the Caps Lock setting is enabled (keyboard types in all capital letters). ■ Touch the <i>Caps Lock</i> key (on keyboard) to disable the setting.
G	LAN and Wireless LAN Connectivity 	<p>LAN connectivity:</p> <ul style="list-style-type: none"> ■ Indicates if the cardiograph is connected to a live Ethernet connection through the LAN connector () on the rear of the cardiograph. ■ If no LAN connection is detected, a red “x” mark appears on the icon (). <p>Wireless LAN connectivity:</p> <ul style="list-style-type: none"> ■ Indicates the signal strength of a the wireless LAN connection. ■ Green bars indicate that the wireless adapter is associated to an access point. The higher the number of green bars, the better the connection. ■ No bars indicates that the cardiograph is losing the wireless LAN signal and that the cardiograph should be moved to an area with a stronger signal. ■ Gray solid bars () indicate that the wireless adapter is unable to associate to an access point.

Table 1-4 The Status Bar (continued)

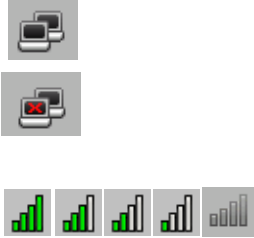
Status Bar Item	Feature	Description
H	Battery Power Indicator 	<ul style="list-style-type: none"> Displays the available battery power. For more information, see “Battery Power Indicator” on page 1-33.
I	Date and Time 	<ul style="list-style-type: none"> Displays the current date and time. The date and time can be set manually, or the cardiograph can be configured to automatically synchronize the date and time with a TraceMaster ECG Management server. Go to the Archive or Setup screens to manually change the date and time (accessing these screens may require entering a password.) Tap the displayed date and time to edit the settings.
J	Heart Rate Indicator 	<ul style="list-style-type: none"> Displays the patient heart rate in beats per minute. The icon appears in white when no patient is attached to the cardiograph <p>Note: The heart rate indicator measurement has been verified with a simulator that can generate ECG waveforms up to 240 bpm (beats per minute). Accuracy of this measurement beyond 240 bpm has not been verified.</p>
K	Patient Date of Birth, Name, and ID Number 	Displays the date of birth, patient name, and patient ID number for the current patient session.

Supplies and Ordering Information

The part numbers for all supplies for the PageWriter TC70 and PageWriter TC50 cardiographs are listed in this section.

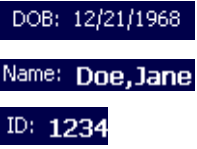
Ordering Supplies

All supplies may be ordered on the web at:

<http://shop.medical.philips.com>

Use the part numbers listed in this section to ensure that the correct supplies are ordered.

Special Note about Welsh Bulb Electrodes

Figure 1-25 Welsh Bulb Electrode



Welsh Bulb electrodes are offered as an optional supply part with the PageWriter TC70 and PageWriter TC50 cardiographs. Special care is necessary when using these electrodes. Pay special attention to all warnings associated with these electrodes. For information on cleaning the reusable Welsh Bulb electrodes, see “Reusable Electrode Cleaning” on page 5-4. Philips Medical Systems recommends the use of disposable electrodes with the PageWriter TC70 or PageWriter TC50 cardiograph.

WARNING The Welsh bulb electrodes (available as an accessory for the cardiograph) do not meet the requirements of IEC 60601-2-25 for defibrillation recovery time, and cannot be reliably used for patient diagnosis immediately following defibrillation.

WARNING Always clean and disinfect reusable electrodes before patient use. See “Reusable Electrode Cleaning” on page 5-4 for information on cleaning and disinfecting reusable electrodes. Failure to properly clean and disinfect reusable electrodes before patient use may cause infectious materials to be transferred between patients.

CAUTION The Welsh bulb electrodes contain natural rubber latex which may cause allergic reactions.

PageWriter TC70 and PageWriter TC50 Cardiograph Supply Part Numbers

PIM Patient Data Cable

Part Number	Description
989803158481	Class A Patient Data Cable, 5-pin (2.0 meters/6.56 feet length) Note: this patient data cable is <i>only</i> compatible with a Class A PIM for the PageWriter TC70 cardiograph, see page 1-21.
989803164281	Class B Patient Data Cable, 8-pin (2.0 meters/6.56 feet length) Note: this patient data cable is <i>only</i> compatible with a Class B PIM, see page 1-21.

Complete Lead Sets

Part Number	Description
989803151631	Complete AAMI Lead Set for Standard 12 Leads (arm lead 99 cm/39 in, leg lead 104.1 cm/41 in, chest leads 69.8 cm/27.5 in)
989803151641	Complete IEC Lead Set for Standard 12 Leads (arm lead 99 cm/39 in, leg lead 104.1 cm/41 in, chest leads 69.8 cm/27.5 in)
989803151711	Limb Lead Set (AAMI/IEC) (arm lead 99 cm/39 in, leg lead 104.1 cm/41 in)
989803151671	Complete Chest Lead Set (AAMI/IEC) (chest leads 69.8 cm/27.5 in)
989803151651	Long Complete AAMI Lead Set for Standard 12 Leads (arm lead 137.1cm/54 in, leg lead 142.2 cm/56 in, chest leads 69.8 cm/27.5 in)
989803151661	Long Complete IEC Lead Set for Standard 12 Leads (arm lead 137.1cm/54 in, leg lead 142.2 cm/56 in, chest leads 106.6 cm/42 in)
989803151731	Long Limb Lead Set (AAMI and IEC) (arm lead 137.1cm/54 in, leg lead 142.2 cm/56 in)
989803151691	Long Chest Lead Set (AAMI/IEC) (chest leads 106.6 cm/42 in)
989803151751	16-Lead Kit for AAMI Leads (arm lead 99 cm/39 in, leg lead 104.1 cm/41 in, chest leads 69.8 cm/27.5 in, extended leads 83.8 cm/33 in)
989803151761	16-Lead Kit for IEC Leads (arm lead 99 cm/39 in, leg lead 104.1 cm/41 in, chest leads 69.8 cm/27.5 in, extended leads 83.8 cm/33 in)
989803151771	Long 16-Lead Kit for AAMI Leads (arm lead 137.1cm/54 in, leg lead 142.21 cm/56 in, chest leads 106.6cm/42 in, extended leads 121.9cm/48 in)
989803151781	Long 16-Lead Kit for IEC Leads (arm lead 137.1cm/54 in, leg lead 142.21 cm/56 in, chest leads 106.6cm/42 in, extended leads 121.9cm/48 in)

Lead Accessories

Part Number	Description
989803129231	Alligator Clips for Disposable Tab Electrodes (AAMI) (10 total per pack)
989803129241	Alligator Clips for Disposable Tab Electrodes (IEC) (10 total per pack)

Lead Accessories

Part Number	Description
989803101361	Alligator Clip Extender (Pediatric) for Disposable Tab Electrodes (10 total per pack) (AAMI)
989803101371	Alligator Clip Extender (Pediatric) for Disposable Tab Electrodes (10 total in pack) (IEC)
989803106061	Wide Disposable Tab Electrode Connector (10 total per pack) (AAMI/IEC)
989803166031	Clear Tab with Snap Adapter (AAMI) (10 total electrodes)
989803101701	IEC Snap Lead Adapter (converts IEC connector to grabber connector for use with snap disposable electrodes and 4mm banana plug termination cables)
989803151701	16-Lead Spare Parts Kit (includes color rings, shorting plugs, lead separators and banana post adapters)

Disposable and Reusable Electrodes

Part Number	Description
989803100441	Solid gel tab disposable cardiography electrode, resting diagnostic ECG (35 mm x 22 mm, 1.37 x .86 in) (1000 total electrodes)
989803106051	Solid gel tab disposable cardiography electrode, resting diagnostic ECG (33 mm x 20 mm, 1.29 x .78 in) (1000 total electrodes)
989803149901	Pediatric disposable tab electrode (14 mm x 34 mm, .55 x 1.33 in) (1000 total electrodes)
989803101311	Reusable Welsh Bulb Electrode 15 mm diameter (AAMI) (6 total electrodes)
989803101651	Reusable Welsh Bulb Electrode 15 mm diameter (IEC) with banana plug adapter (1 total electrode)
989803101281	Reusable Welsh Bulb Electrode (IEC) with side screw connection (6 total electrodes)
989803101661	Reusable Adult Limb Plate Electrode (IEC) (4 total electrodes)
989803101691	Reusable Adult Limb Clamp Electrode (4 total electrodes) (AAMI/IEC)
989803101341	Reusable Adult Limb Plate Electrode for push-in type connection, nickel-silver (4 total electrodes) (AAMI/IEC)
989803100601	Rubber Strap for Reusable Limb Plate Electrodes (38 cm/15 in) (4 total straps) (AAMI/IEC)

Printer Paper

Part Number	Description
989803106261	Z-fold, with header, A size (21.6 x 28 cm/8.5 x 11 in)
989803106271	Z-fold, with header, A4 size (21 x 29.69 cm/8.27 x 11.69 in)
989803106281	Anti-fade, A size (21.6 x 28 cm/8.5 x 11 in)
989803106291	Anti-fade, A4 size (21 x 29.69 cm/8.27 x 11.69 in)

Batteries

Part Number	Description
989803160981	Lithium-ion replacement battery (2 battery operation only for PageWriter TC70 and TC50 cardiographs)
989803170371	Lithium-ion replacement battery (1 battery operation for PageWriter TC50 only, or for 2 battery operation for both PageWriter TC70 and TC50 cardiographs)

Keyboard Covers

Part Number	Description
989803166511	PageWriter TC70 Cardiograph Keyboard Cover (5 per pack)
989803166501	PageWriter TC50 Cardiograph Keyboard Cover (5 per pack)

Replacement Fuse

Part Number	Description
453564131221	PageWriter TC50 Cardiograph 1.6 amp (250 V) Replacement Fuse

USB Memory Stick

Part Number	Description
989803145331	USB Memory Stick

Ordering Options and Upgrades

For more information on ordering any of the following cardiograph upgrades or options, please contact your Philips Sales Representative or your local distributor.

Table 1-5 Data Input Options

Option Number	Description
H12	Barcode Reader
H13	Magnetic Card Reader
H14	Smart Card Reader

Table 1-6 Patient Interface Module (PIM) Options

Option Number	Description
H21	12-Lead Patient Interface Module (PIM) (AAMI or IEC)
H22	16-Lead Patient Interface Module (PIM) (AAMI or IEC)

Table 1-7 Software Upgrades

Option Number	Description
D01	Orders support (order system connectivity)
D07	Manual order entry support (user entered orders)
D12	Last ECG and Interactive Query support (requires TraceMaster ECG Management System)
D21	Wireless LAN support (802.11b/g)
D22	Wireless LAN support (802.11a, 802.11b/g)
H11	Global Modem support

Table 1-8 Cardiograph Cart and Accessories

Option Number	Description
B01	Partially Assembled Cardiograph Cart
B02	Fully Assembled Cardiograph Cart (only available in USA)
C01	TC70 Cardiograph Cart Drawer
C02	TC50 Cardiograph Additional Cart Storage Bin/TC70 Cardiograph Additional Wire Storage Bin
C03	Patient Cable Arm

Table 1-9 Keyboard Cover

Option Number	Description
H16	Keyboard Cover

Product Troubleshooting

For information on product troubleshooting, see the *PageWriter TC Cardiograph Service Manual* included on the User Documentation and Training DVD, or the file may be downloaded from the Philips InCenter site. For information on using the InCenter site, see page 1-5. This document provides comprehensive information on product troubleshooting, performance verification and safety tests, using the Service Utilities accessed from the Setup menu, and installing software upgrades. The *Service Manual* is only available in English. For more comprehensive information on product troubleshooting, contact the nearest Philips Response Center for further assistance.

Contacting a Philips Response Center

The Philips Response Center can assist with product troubleshooting and provide technical expertise to help with any issue with the PageWriter TC cardiographs or any of its accessories.

For more information on the Philips Response Center go to:

www.medical.philips.com/main/services/response_center

North America Response Centers

Country	Telephone Number
Canada	(800) 323 2280
Mexico	01 800 710 8128
Puerto Rico	1 787 754 6811
United States	(800) 722 9377

South America Response Centers

Country	Telephone Number
Argentina	54 11 4546 7698
Brazil	0800 701 7789
Chile	0800 22 3003
Columbia	01 8000 11 10 10
Peru	51 1 620 6440

Europe Response Centers

Country	Telephone Number
United Kingdom	44 0870 532 9741 Fax: 44 01737 23 0550
Austria	43 1 60101 820
Belgium	32 2 525 7102 (French) 32 2 525 7103 (Flemish)
Czech Republic MCR Response Center (located in The Netherlands)	31 40 2781619
Denmark	45 80 30 30 35
Finland	358 615 80 400
France	0 810 835 624
Germany	0180 5 47 5000
Greece MCR Response Center (located in The Netherlands)	31 40 2781619
Hungary MCR Response Center (located in The Netherlands)	31 40 2781619
Italy	0800 232100
Netherlands	31 40 27 211 27
Norway	47 800 84 080
Poland MCR Response Center (located in The Netherlands)	31 40 2781619
Rumania MCR Response Center (located in The Netherlands)	31 40 2781619

Europe Response Centers

Country	Telephone Number
Russia MCR Response Center (located in The Netherlands)	31 40 2781619
Slovak Republic MCR Response Center (located in The Netherlands)	31 40 2781619
Spain	34 90 230 4050
Sweden	46 200 81 00 10
Switzerland	0800 80 3000 (German) 0800 80 3001 (French)

Asia Response Centers

Country	Telephone Number
Australia	1800 251 400
China	800 810 0038
Hong Kong	852 2876 7578
India	1600 112 444
Indonesia	62 21 7910040, ext 8610
Japan	81 (0)120 095 205
Korea	82 (0)2 3445 9010
Malaysia	1800 886 188
New Zealand	0800 251 400
Philippines	63 2 8162617 ext. 875
Singapore	1800 Philips
Taiwan	0800 005 616
Thailand	66 (0)2 614 3569

Africa and Middle East

Country	Telephone Number
All countries MCR Response Center (located in The Netherlands)	31 40 2781619

Configuring Default Clinical Settings



All of the settings on the PageWriter TC70 cardiograph or PageWriter TC50 cardiograph may be customized to meet the needs of a specific clinical environment. The cardiograph is shipped with factory default settings, and any of these settings may be changed. All configuration of the cardiograph is completed on the **Setup** screens.

Configuring the Wireless LAN Card

For information on configuring the wireless LAN option, see the *PageWriter TC Cardiograph Wireless LAN Installation Instructions* provided with the wireless adapter, or download the file from the Philips InCenter web site (incenter.medical.philips.com). For information on using the Philips InCenter web site, see page 1-5.

Password Access

Access to all functions that are used to configure the cardiograph may be set to be password access controlled.

Tips for Creating Secure Passwords

Use the following guidelines when creating passwords used on the cardiograph:

- Include at least one upper case character
- Include at least one number
- Create passwords at least eight characters in length
- Do not use common words, names, or other easily identified terms

Configuration with a Philips TraceMaster ECG Management System

For information on configuring networking and other settings on the cardiograph that are used with a TraceMaster ECG Management System (including the OrderVue order handling option), see the *PageWriter TC Cardiograph Network Configuration Guide* (only available in English) included on the User Documentation and Training DVD, or download the file from the Philips InCenter web site (incenter.medical.philips.com). For information on the Philips InCenter site, see "Using the Philips InCenter Site" on page 1-5.

For more comprehensive information on configuring the PageWriter TC cardiograph, or other Philips PageWriter cardiographs with a TraceMaster ECG Management System, see the *Installing TraceMaster and Configuring Communication Guide* (only available in English) available for download from the Philips InCenter web site (incenter.medical.philips.com). For information on using the Philips InCenter web site, see page 1-5.

Configuration with a Third Party ECG Management System

For information on configuring networking and other settings on the cardiograph that are used with a third party ECG management system, see the *PageWriter TC Cardiograph Network Configuration Guide* (only available in English) included on the User Documentation and Training DVD, or download the file from the Philips InCenter web site (incenter.medical.philips.com). For information on the Philips InCenter site, see "Using the Philips InCenter Site" on page 1-5.

Restoring Custom Configuration Settings

After configuring the cardiograph, save the settings to a USB memory stick in case of system failure. If the cardiograph loses custom settings, the settings may be quickly and easily restored by loading them onto the cardiograph from a USB memory stick.

Configuring Multiple Cardiographs

When configuring multiple cardiographs with the same TraceMaster and OrderVue settings, you can save all settings to a USB memory stick, and then upload them to additional PageWriter TC70 or PageWriter TC50 cardiographs.

NOTE You cannot transfer custom settings between different models of cardiographs. For example, you can only transfer custom settings from a PageWriter TC70 cardiograph to another PageWriter TC70 cardiograph, and not to a PageWriter TC50 cardiograph.

NOTE Wireless LAN card settings specified in the Summit WLAN Adapter are saved with the custom settings file.

Opening the Setup Screens



To open the setup screens:

- ▶ Touch the **Setup** button on the Toolbar. The Setup menu appears.

Figure 2-1 The Setup and Service Utilities Menu

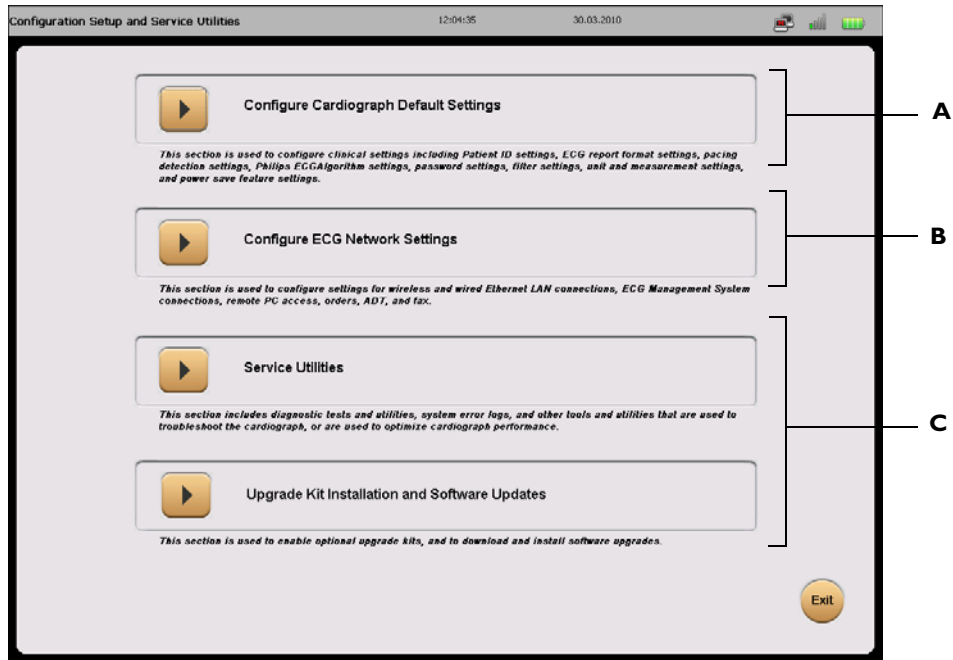

Table 2-1 Setup and Service Utilities Menu

Menu Item	Feature	Description
A	Configure Cardiograph Default Settings	<ul style="list-style-type: none"> ■ Touch to configure all clinical settings used on the cardiograph ■ Touch to configure password and power save features ■ Includes Maintenance Tests that can be used to troubleshoot or to optimize cardiograph performance. For more information, see "Cardiograph Care and Maintenance" on page 5-1.

Table 2-1 Setup and Service Utilities Menu (continued)

Menu Item	Feature	Description
B	Configure ECG Network Settings	<ul style="list-style-type: none"> ■ Touch to configure TraceMaster and OrderVue settings, or to configure the PDF Export option for a remote PC or server, or to configure settings for a third party (non-Philips) ECG Management System ■ For more information, see the <i>PageWriter TC Cardiograph Network Configuration Guide</i> (only available in English)
C	Service Utilities	<ul style="list-style-type: none"> ■ Touch to access the Service Utilities, including all maintenance and performance tests, and software upgrades ■ For more information on using the Service Utilities, see the <i>PageWriter TC Cardiograph Service Manual</i> (only available in English)

Using Online Help

Each configuration screen within the cardiograph software application provides Help that describes the currently selected option or field. Use the Help when configuring cardiograph settings, or to learn more about a specific feature or item.

When a configuration screen is opened, Help displays in the blue *Information box* located at the bottom of the screen. Touch a tab, or touch the name of any field or option displayed on the screen to change the Help for that specific item. A highlighted field or option appears in blue type.

To view help for a tab or field:

- ▶ Touch a tab or touch the name of the field or option so that it is highlighted in blue. Help for the selected item displays in the blue Information box at the bottom of the screen (see Figure 2-2 on page 2-5).

Figure 2-2 The Information Box on a Setup screen

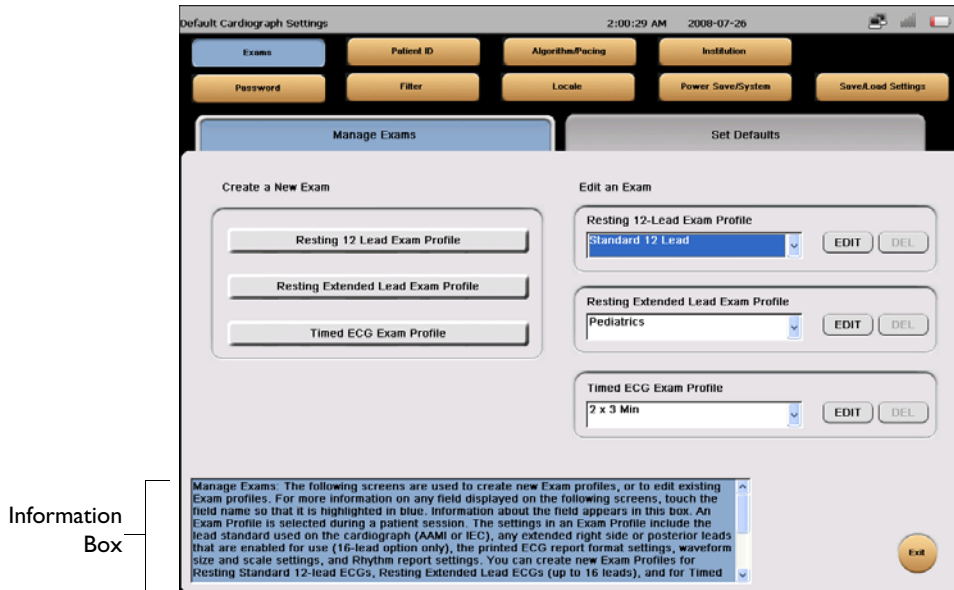

Configuring 12-Lead and 16-Lead Exam Settings

The Exam setup wizard is used to specify ECG operating settings for 12 and for 16-lead ECGs. Each set of defined settings is saved as an individual *Exam Profile* that can be selected during a patient session.

NOTES The 16-lead Exams settings will only appear if a 16-lead Patient Interface Module (PIM) is connected to the cardiograph.

For information on configuring the 16-lead PIM for use with the PageWriter TC70 cardiograph, see "Configuring the 16-Lead PIM" on page 1-26.

To configure 12 or 16-lead Exams settings:

- 1 Touch the **Exams** button (top left of screen) on the Default Cardiograph Settings screen.
- 2 The Exams setup screens appear. The **Manage Exams** tab is selected (in blue).

Figure 2-3 The Exams Setup screens

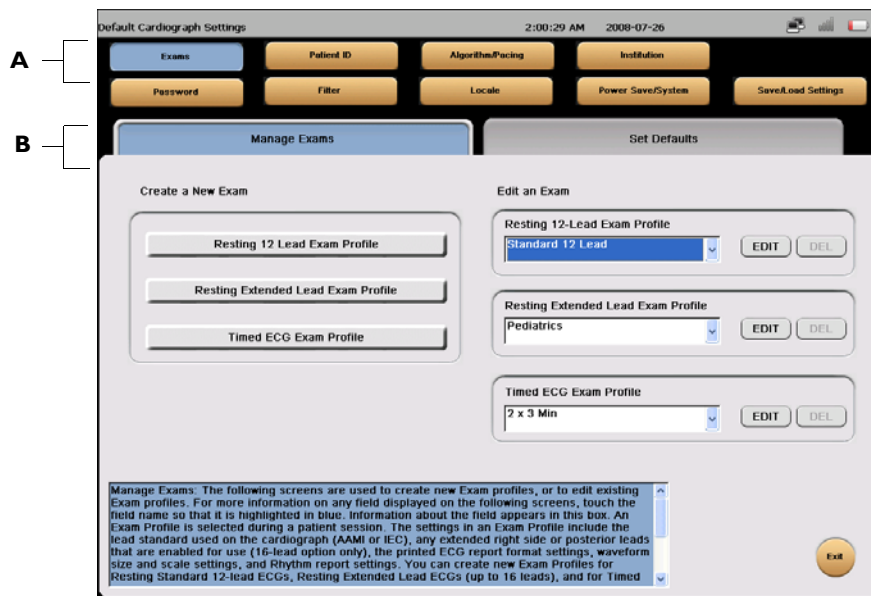

A Exams button selected

B Manage Exams tab selected

- 3 Touch a button under **Create a New Exam** to begin creating a new Exam for Resting 12-lead, Resting Extended (16-lead), or Timed ECG.
- 4 On the following screen select a lead sequence (**Standard** or **Cabrera**) and a lead standard (**AAMI** or **IEC**). Touch the **Next** button (bottom right of screen) to continue.
- 5 On the following screen, select a report format to specify for this Exam. Select the Rhythm leads for the selected report format (if necessary). Touch the **Next** button to continue.
- 6 Select the settings for the selected report format, these settings include the waveform scale and size settings, and if the ECG data shown on the report is captured simultaneously, or time sequentially. On the right side of the screen, select an interpretation level for the Philips 12-lead or 16-lead algorithm. Touch the **Next** button to continue.

NOTES

The **Print Severity** setting enables the printing of the ECG severity on the ECG report. For more information on the Severity setting, see "Interpretive, Reason, and Severity Statements" on page 4-3.

The **Extended Measurements** setting enables the printing of the full Extended Measurements Report with each ECG. For information on the Extended Measurements Report, see "Extended Measurements Report" on page 4-43.

- 7 The following screen specifies the Rhythm leads and the waveform speed and scale settings for all Rhythm reports printed using the specified Exams setting.
- 8 Touch the **Back** button to return to any previous screen and make edits. Touch the **Save** button when complete.

- 9 The Create New Exam profile window appears. Enter a name for the Exam. Touch **OK**.

The Patient Session

Introduction

A patient session is the period of time when waveform data is acquired and processed from a single patient. A patient session begins by entering accurate patient information. Patient information is then linked with all waveform data acquired during the patient session.

CAUTION Entering accurate patient information (age, gender) is highly recommended if using the Philips 12-Lead Algorithm, version PH090A, or the Philips DXL ECG Algorithm, version PH100B, for ECG interpretation. For more information see the applicable *Physician's Guide* on the PageWriter TC Cardiograph User Documentation and Training DVD, or download the file from the Philips InCenter site (incenter.medical.philips.com).

The steps in a typical patient session are described below.

Table 3-1 The Patient Session

The Patient Session		
Prepare the Patient		
Step	Description	More Information See...
1	Prepare the patient for the procedure.	"Patient Preparation" on page 3-4.
2	Prepare the electrode sites and attach the electrodes.	<ul style="list-style-type: none"> ■ "Preparing the Skin" on page 3-4. ■ "Electrode Placement" on page 3-5. ■ "Attaching Disposable Electrodes" on page 3-12. ■ "Attaching Welsh Bulb and Limb Clamp Electrodes" on page 3-13.
3	Attach the lead wires.	"Attaching the Lead Wires" on page 3-14.

Table 3-1 The Patient Session (continued)

The Patient Session		
Enter Patient Information or Take a STAT ECG		
Step	Description	More Information See...
1	Return the cardiograph to active use.	<ul style="list-style-type: none"> ■ “Using the On/Standby Button” on page 3-15.
2	<ul style="list-style-type: none"> ■ Take an urgent/STAT ECG ■ Enter patient information or select an order from the Worklist 	<ul style="list-style-type: none"> ■ “Urgent (STAT) ECGs” on page 3-24. ■ “Entering Patient Information” on page 3-16.
Check the Signal Quality		
Step	Description	More Information See...
1	When the patient is connected to the cardiograph, color-coded ECG waveforms appear on the Main screen. Check the signal quality.	“Checking Signal Quality” on page 3-19.
2	Touch the Map button on the cardiograph to check electrode connection.	“Leads Map” on page 3-20.
Select an ECG Acquisition Mode		
Step	Description	More Information See...
1	Do any of the following:	
	<ul style="list-style-type: none"> ■ Capture Events for review on the Disclose screen 	“Capturing Events from the Main or Rhythm Screens” on page 3-33.
	<ul style="list-style-type: none"> ■ Print an Auto ECG 	“Main ECG Screen” on page 3-24.
	<ul style="list-style-type: none"> ■ Print a Rhythm report 	“Rhythm ECG Acquisition” on page 3-30.
	<ul style="list-style-type: none"> ■ Use the Disclose feature to: <ul style="list-style-type: none"> – review Events captured on the Main or Rhythm screens – print a 12 or 16-lead ECG of captured Event data – view continuous waveform data for a selected Disclose lead – print a 1-minute report of a selected Disclose lead – view live waveform data for a selected Disclose lead 	“Disclose ECG Acquisition” on page 3-33.

Table 3-1 The Patient Session (continued)

The Patient Session		
Step	Description	More Information See...
	<ul style="list-style-type: none"> ■ Use the Timed ECG feature to: <ul style="list-style-type: none"> – Take ECGs at preset intervals 	“Using Timed ECG” on page 3-37.
View, Print, Save, and Transfer ECG(s) from the Preview Screen		
Step	Description	More Information See...
1	Compare the most recent ECG from the same patient using the Last ECG feature (requires an active TraceMaster connection)	<ul style="list-style-type: none"> ■ “Using the Last ECG Feature on the Preview Screen” on page 3-28. ■ “Critical Values on Preview Screen” on page 3-29.
End the Patient Session		
Step	Description	More Information See...
1	Disconnect the patient.	
Transfer ECGs from the Archive		
Step	Description	More Information See...
1	Transfer completed ECGs from the Archive as a PDF file or as an XML file using a USB memory stick, or a network or modem connection.	■ “Transferring ECGs from the Archive” on page 3-38.
2	Download ECGs from TraceMaster to the cardiograph using a network or modem connection.	■ “Downloading ECGs from TraceMaster” on page 3-39.
<p>The patient session ends when:</p> <ul style="list-style-type: none"> ■ New patient information is entered or a pending order is selected ■ The cardiograph enters Standby or is shut down ■ Archive or Setup are selected 		

Patient Preparation

Thorough patient preparation techniques are essential for a good quality ECG. Follow the procedures listed in this section to ensure a quality ECG for each patient.

TIP Good ECG technique is very important to achieve the best quality results.

Instructing the Patient

Before attaching the electrodes, greet the patient and explain the procedure. Explaining the procedure decreases anxiety and informs the patient about what to expect.

- Privacy is important to relaxation. When possible, take the ECG in a quiet room or area where others can't see the patient. Draw the curtains around the bed when taking the ECG in a room with other people.
- Reassure the patient that the procedure is painless.
- Make sure the patient is lying down and is comfortable. The patient's arms and hands must be relaxed. If the table is too narrow, place the patient's hands under the buttocks to prevent muscle tension in the arms.

Once the electrodes and lead wires are attached, instruct the patient to:

- Remain still and do not talk
- Breathe normally
- Try not to shiver
- Do not chew or clench teeth

The more relaxed the patient, the less the ECG will be affected by noise.

Preparing the Skin

Thorough skin preparation is very important. The skin is a poor conductor of electricity and frequently creates artifact that distorts the ECG signal. There is a natural resistance on the skin surface due to dry, dead epidermal cells, oils, and dirt.

TIP The area of the skin where the electrodes are applied must be clean and free of skin oil.

To prepare the skin:

- 1 Clip hair from electrode sites if necessary (excessive hair prevents a good connection).
- 2 Wash thoroughly with soap and water.
- 3 Dry the skin vigorously to increase capillary blood flow to the tissues and to remove the dead, dry skin cells and oil.

TIP **Do not use alcohol** to clean the skin because it dries the skin. If there is no time to follow the procedure above, rub the site with gauze to remove dead, dry skin and to increase capillary flow.

Electrode Placement

Review the following lead wire labeling and electrode placement information to ensure a quality ECG.

Table 3-2 AAMI and IEC Lead Labeling and Electrode Placement

AAMI Lead	IEC Lead	Electrode Position
RL	N	On the right leg (inside calf, midway between knee and ankle)
LL	F	On the left leg (inside calf, midway between knee and ankle)
RA	R	On the right arm (on the inside)
LA	L	On the left arm (on the inside)
V1	C1	Right side of the sternum in the 4th intercostal space
V2	C2	Left side of the sternum in the 4th intercostal space
V3	C3	Midway between V2 and V4
V4	C4	Left midclavicular line in the 5th intercostal space
V5	C5	Anterior axillary line at the same level as V4
V6	C6	Left midaxillary line at the same level as V4
V3R	C3R	Midway between V1 and V4R, right side of chest
V4R	C4R	Midclavicular line in the fifth intercostal space, right side of chest
V7	C7	Left posterior axillary line at the same level as V6
V8	C8	Under the left mid-scapular line at the same level as V6

Table 3-2 AAMI and IEC Lead Labeling and Electrode Placement *(continued)*

AAMI Lead	IEC Lead	Electrode Position
V9	C9	Left paraspinal border at the same level as V6

Figure 3-1 Male Standard 12-Lead Electrode Placement (AAMI/IEC)

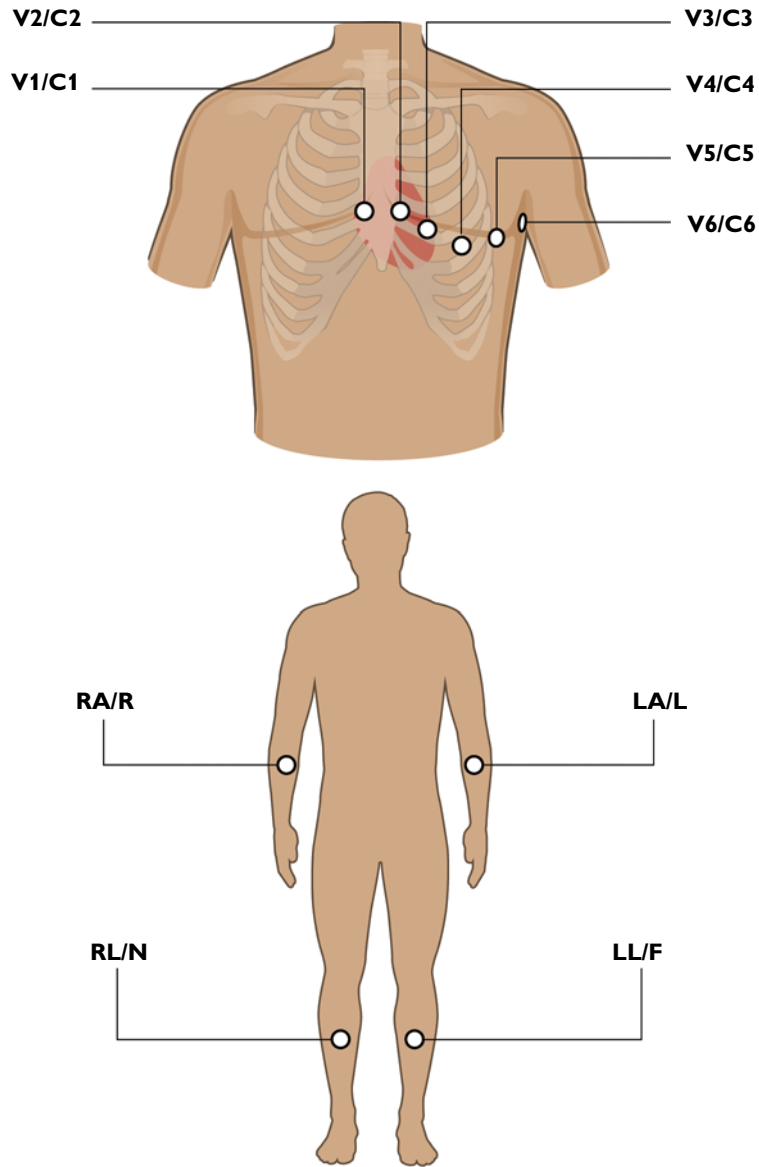

Figure 3-2 Female Standard 12-Lead Electrode Placement (AAMI/IEC)

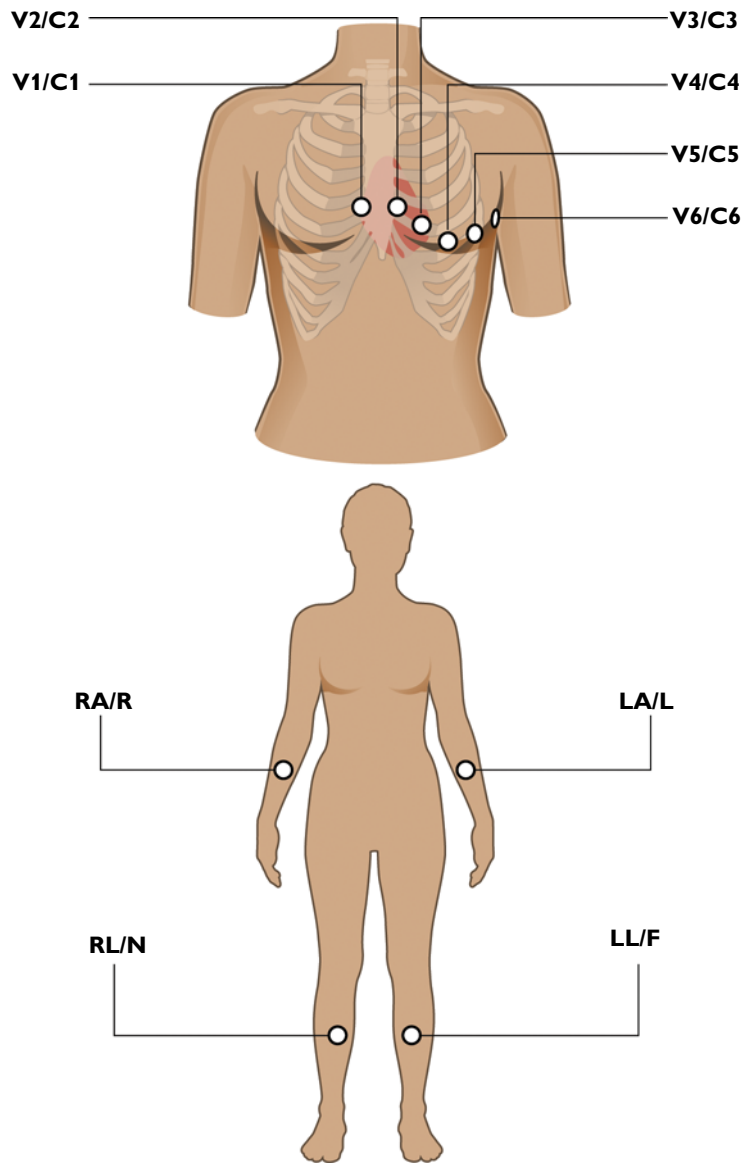

Figure 3-3 Pediatric 15-Lead Electrode Placement (AAMI/IEC)

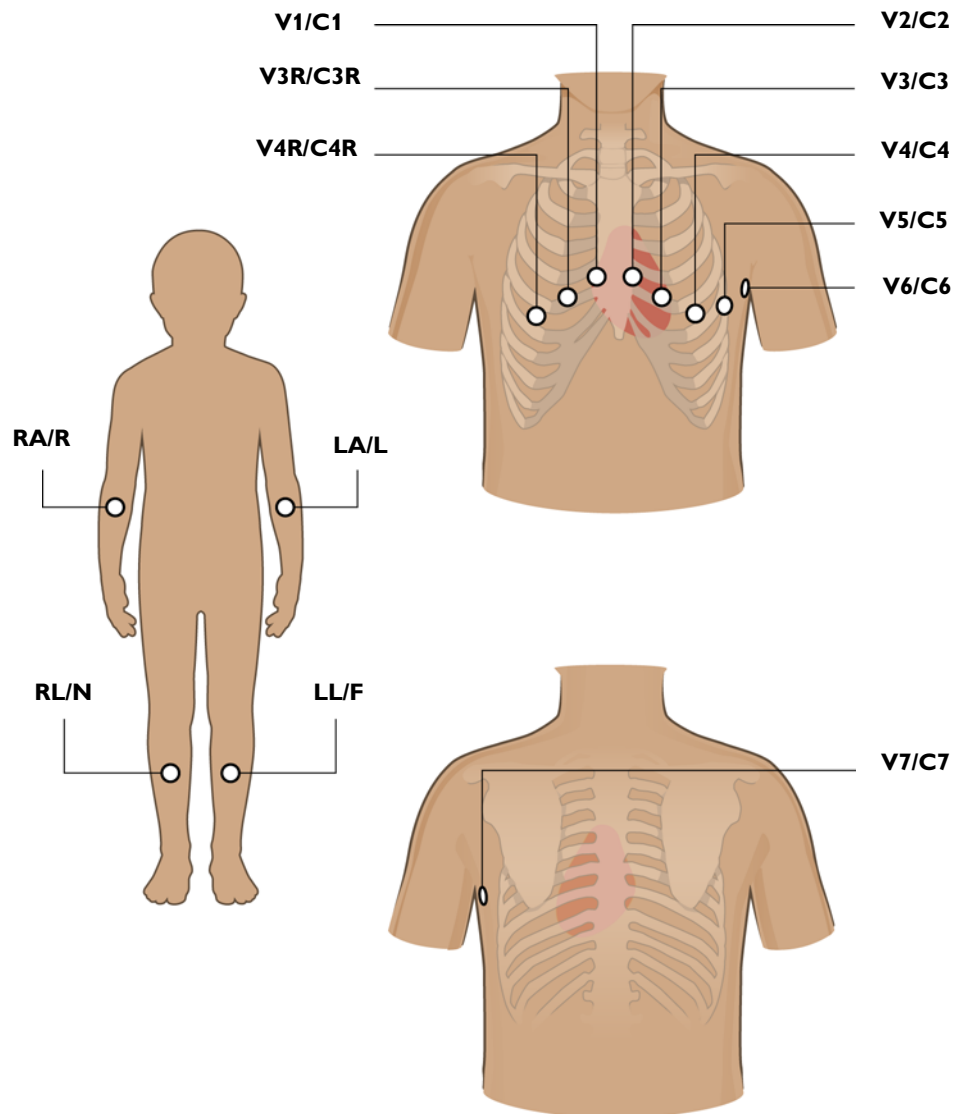

Figure 3-4 Male Balanced 16-Lead Electrode Placement (AAMI/IEC)

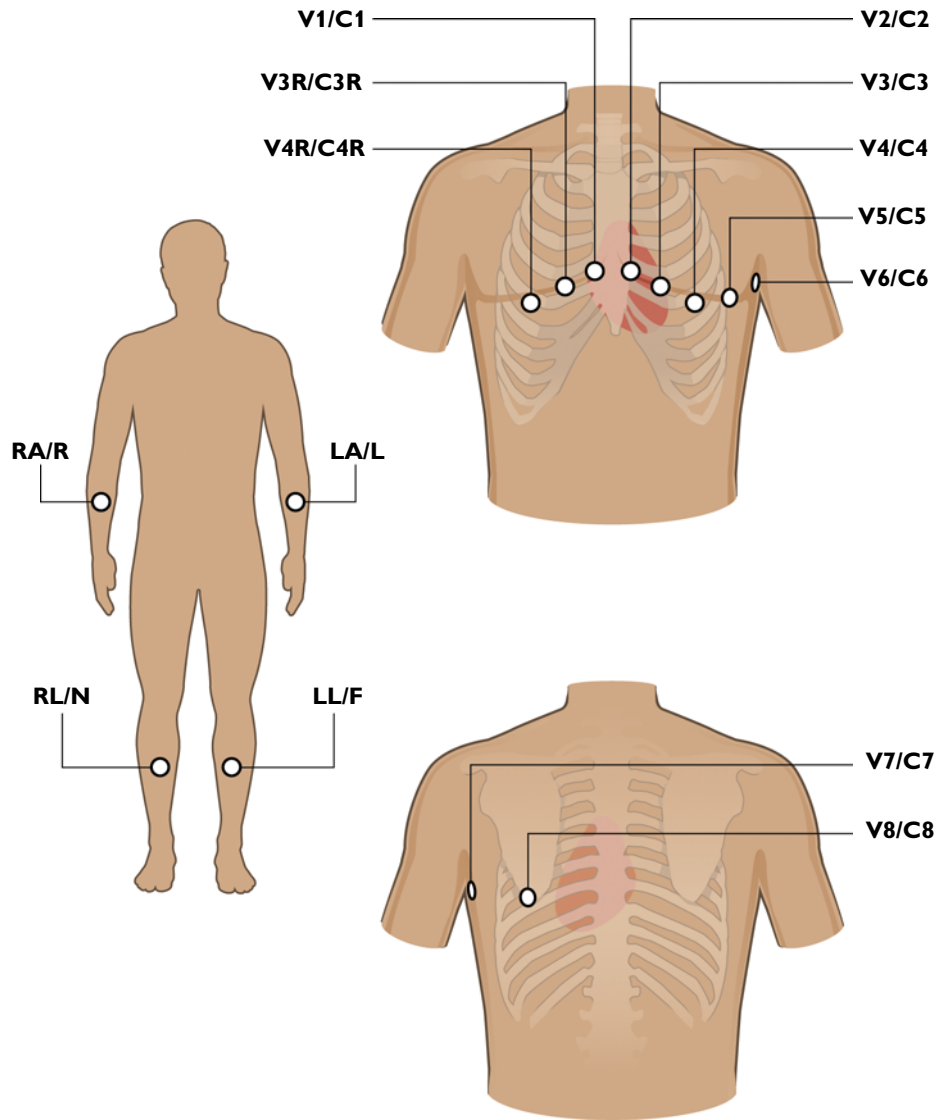

Figure 3-5 Female Balanced 16-Lead Electrode Placement (AAMI/IEC)

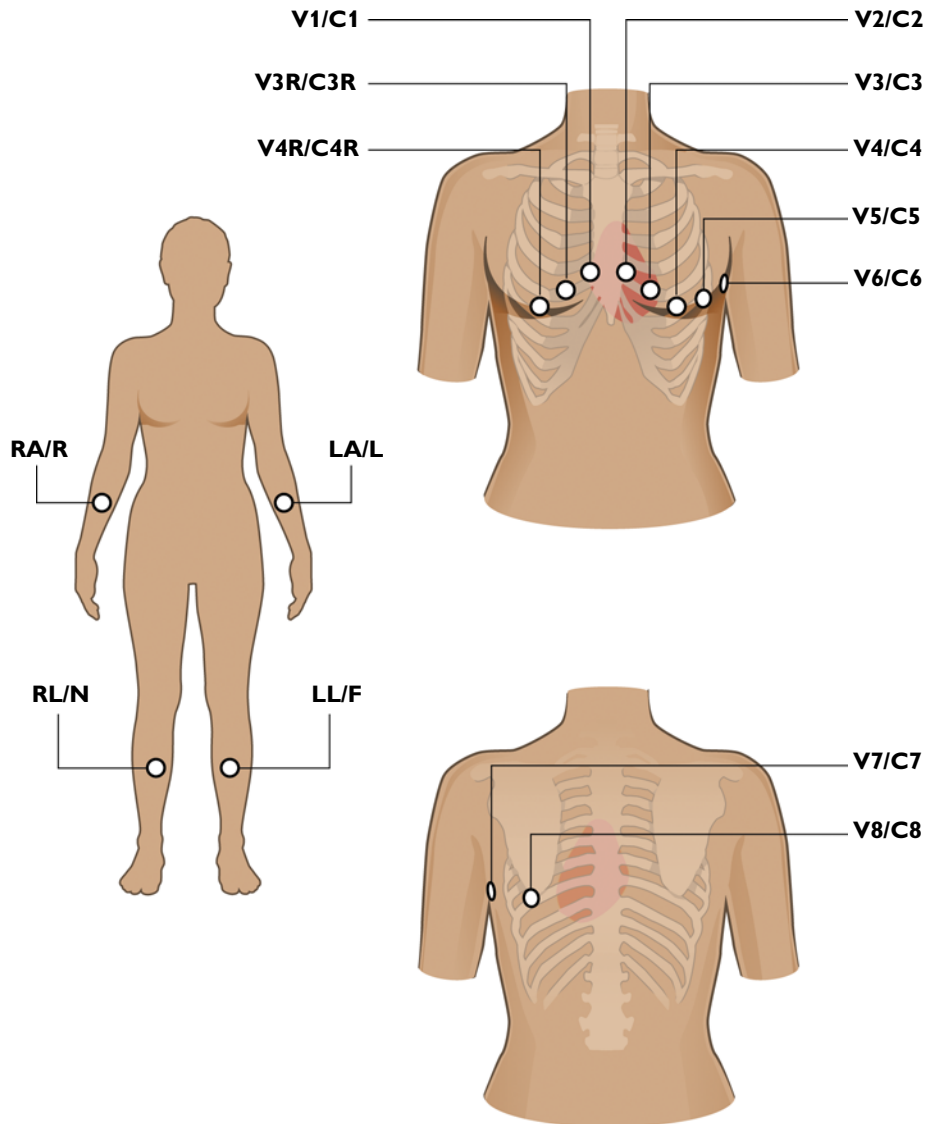

Figure 3-6 Male Posterior 15-Lead Electrode Placement (AAMI/IEC)

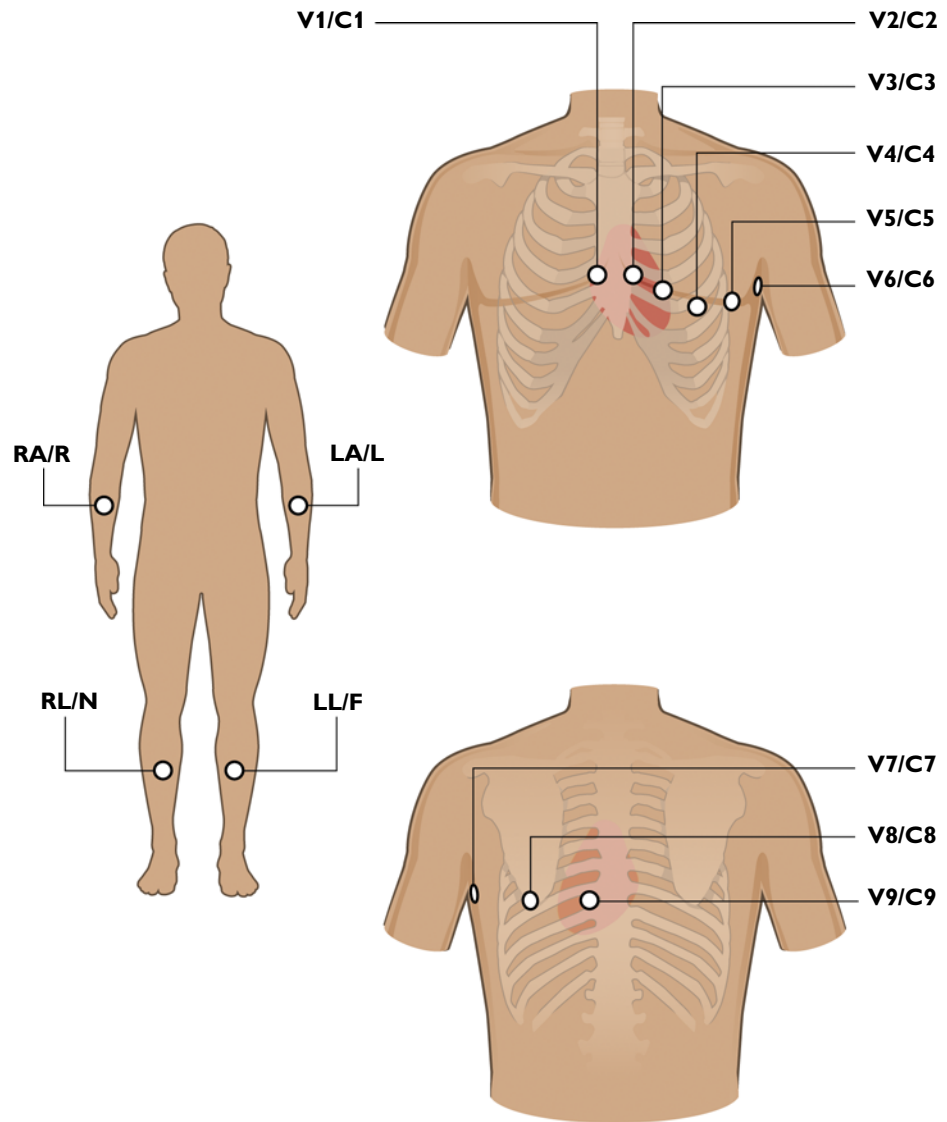
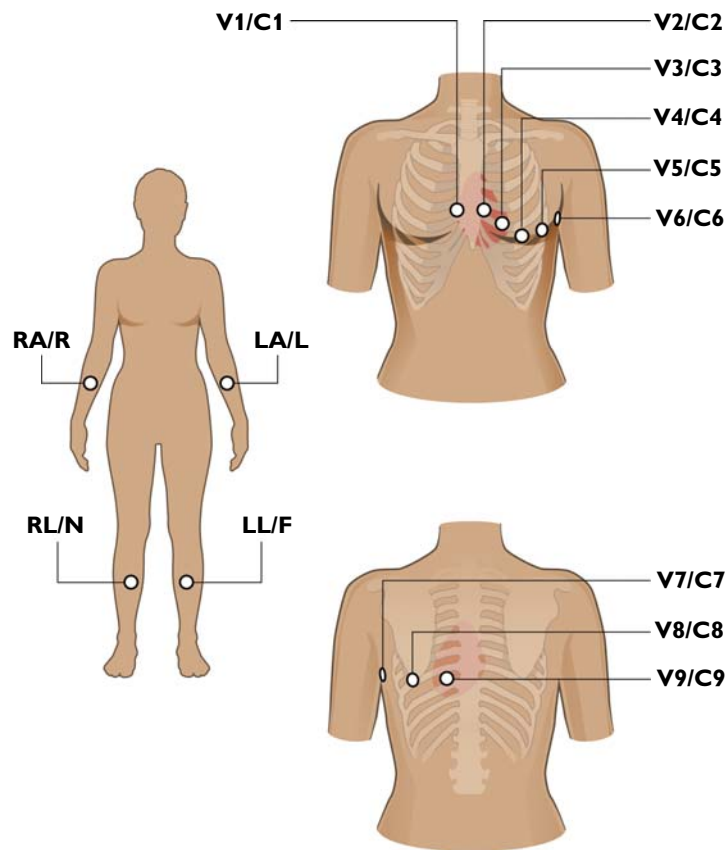

Figure 3-7 Female Posterior 15-Lead Electrode Placement (AAMI/IEC)

Attaching Disposable Electrodes

For the best quality ECG, ensure that all skin preparation procedures described in “Preparing the Skin” on page 3-4 have been followed.

To attach disposable electrodes:

- 1 Expose the arms and legs of the patient (to place the limb electrodes).
- 2 Place the electrodes on flat, fleshy parts of the arms and legs.
- 3 Place the electrodes on the inside of each arm (between the wrists and elbows).
- 4 Place the electrodes on the inside of each calf (between the knee and the ankle).
- 5 Place the limb electrodes equal distance from the heart. Position the electrodes at the same place on each limb.
- 6 If a limb site is not available (amputation, injury) place the electrodes closer to the torso.
- 7 Attach the electrodes to the skin. A good test for firm electrode contact is to try to move it. If it moves easily, the electrode connection is too loose. Do not allow the electrodes to move in any way.

Attaching Welsh Bulb and Limb Clamp Electrodes

Special Note about Welsh Bulb Electrodes

Special care is necessary when using Welsh Bulb electrodes. Pay special attention to all warning associated with these electrodes. For information on cleaning the reusable Welsh Bulb electrodes, see "Reusable Electrode Cleaning" on page 5-4. Philips Medical Systems recommends the use of disposable electrodes at all times with the PageWriter TC cardiographs.

WARNING The Welsh bulb electrodes (available as an accessory for the cardiograph) do not meet the requirements of IEC 60601-2-25 for defibrillation recovery time, and cannot be reliably used for patient diagnosis immediately following defibrillation.

WARNING Always clean and disinfect reusable electrodes before patient use. See "Reusable Electrode Cleaning" on page 5-4 for information on cleaning and disinfecting reusable electrodes. Failure to properly clean and disinfect reusable electrodes before patient use may cause infectious materials to be transferred between patients.

CAUTION The Welsh bulb electrodes contain natural rubber latex which may cause allergic reactions.

The Welsh Bulb electrode is a self-restraining electrode that consists of a rubber squeeze bulb and a metal cup. The rubber squeeze bulb provides sufficient suction to hold the electrode firmly on the patient without causing discomfort. This electrode is used on the chest or back. The limb clamp electrodes are used on the arms and legs. Philips recommends the application of highly conductive multipurpose electrolyte gel to the electrode site whenever Welsh Bulb and limb clamp electrodes are used.

Figure 3-8 Welsh Bulb and Limb Clamp Electrode

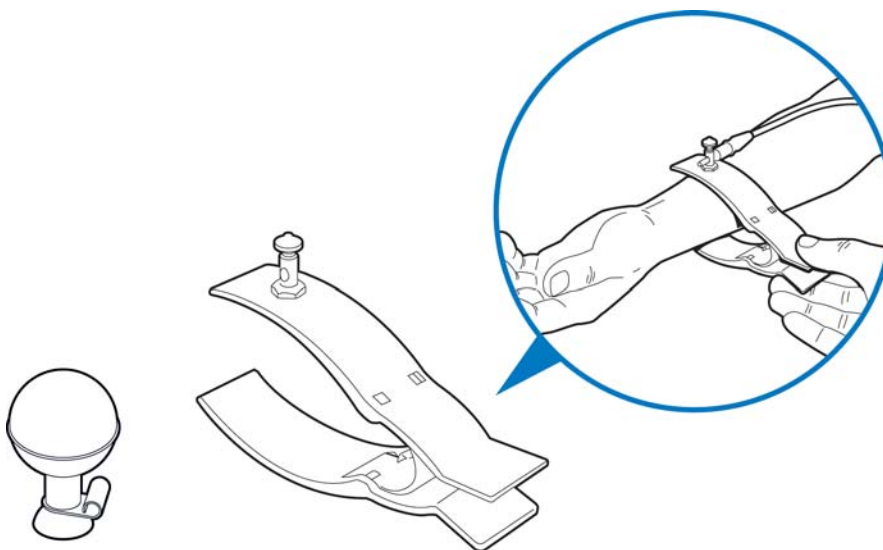

For the best quality ECG, ensure that all skin preparation procedures described in “Preparing the Skin” on page 3-4 have been followed.

To attach limb clamp and welsh bulb electrodes:

- 1 Expose the arms and legs of the patient (to place the limb plate electrodes).
- 2 Inspect both the limb clamp and the Welsh Bulb electrodes to ensure that both are clean. For information on cleaning reusable electrodes, see “Reusable Electrode Cleaning” on page 5-4.
- 3 Ensure that the patient data cable and the lead wires are not twisted, and lay the Patient Interface Module (PIM) flat.
- 4 Connect the lead wire to the corresponding electrode, this may be done one electrode at a time for convenience.
- 5 Apply a thin layer of electrolyte gel to the area of the skin where the electrode will be applied. The skin area covered by the electrolyte gel should not exceed the diameter of the electrode.
- 6 Rub the electrode on the skin with a circular motion to apply and spread the electrolyte gel to the electrode surface and skin. This is very important if the patient’s skin is extremely dry. If the patient’s skin is excessively hairy, follow the procedure “Preparing the Skin” on page 3-4 to remove hair from electrode sites.

CAUTION

When applying the precordial electrodes, do not overlap the electrolyte gel of adjacent electrode sites. Overlapping electrolyte gel will cause interaction between electrode sites, and may result in distortion of the ECG signal.

- 7 Hold the electrode on the patient’s skin and depress the top of the rubber bulb.
- 8 Release the rubber bulb, and the electrode attaches to the patient. A good test for firm electrode contact is to try to move it. If it moves easily, the electrode connection is too loose. Do not allow the electrodes to move in any way.

TIPS

- Place the electrodes on flat, fleshy parts of the arms and legs.
- Place the electrodes on the inside of each arm (between the wrists and elbows).
- Place the electrodes on the inside of each calf (between the knee and the ankle).
- Place the limb electrodes equal distance from the heart. Position the electrodes at the same place on each limb.
- If a limb site is not available (amputation, injury) place the electrodes closer to the torso.

To remove limb clamp and welsh bulb electrodes:

- ▶ Detach the rubber bulb from the metal cup by pulling. Follow the procedure “Reusable Electrode Cleaning” on page 5-4 to clean reusable electrodes after each use.

Attaching the Lead Wires

Each lead wire tip is labeled and color-coded for easy identification.

To attach the lead wires:

- ▶ Attach the lead wire to the corresponding electrode.

Using the On/Standby Button

The On/Standby button is used to:

- put the cardiograph into Standby when not in active use in order to conserve battery power
- shut down all power to the cardiograph for extended periods of inactivity
- return the cardiograph to active use

CAUTION

Ensure that all patient data from an active patient session is saved before entering Standby, or shutting down the cardiograph. Unsaved patient data (patient identification information, unreviewed Event Markers, unsaved ECGs) is deleted when the cardiograph enters Standby.

Figure 3-9 The On/Standby button

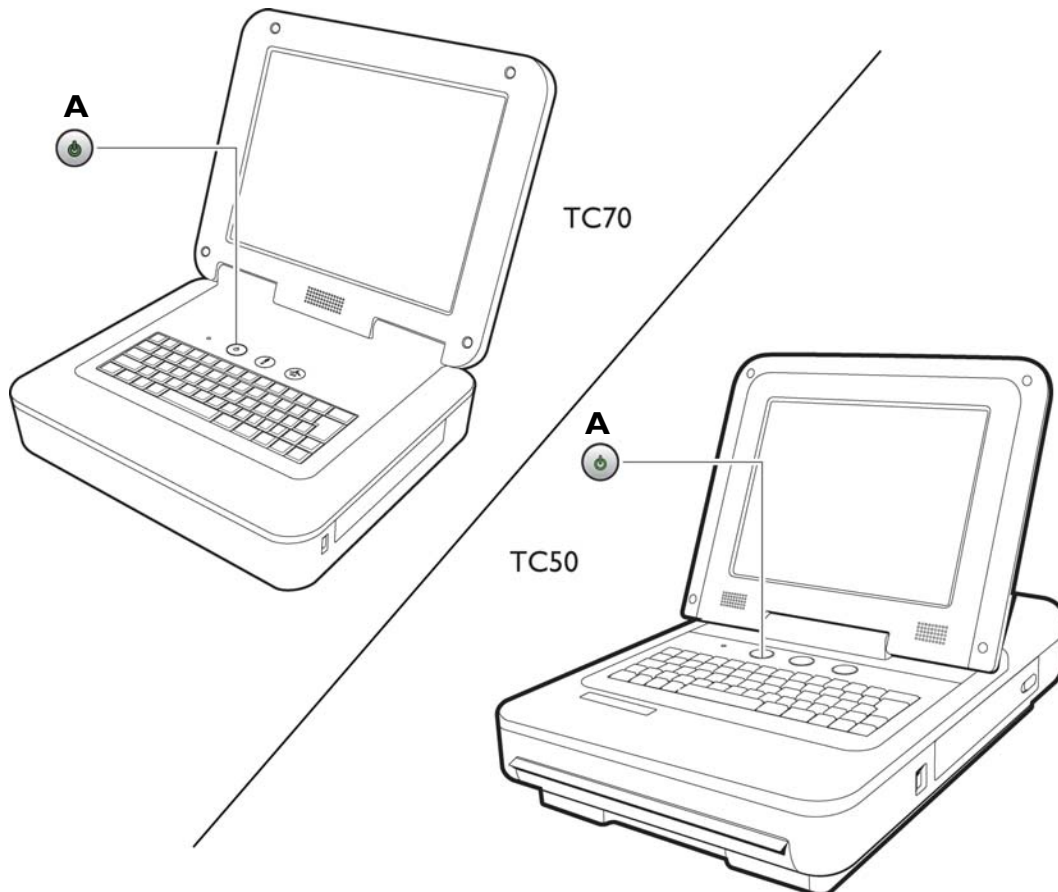

A On/Standby button

To put the cardiograph into Standby (power save):

- 1 Press the On/Standby button gently to put the cardiograph into Standby. When the cardiograph is in Standby, the screen is black.

TIP Plug the cardiograph into AC power whenever possible to recharge the batteries.

- 2 Press the On/Standby button again to return the cardiograph to active use. The previously viewed screen (prior to entering Standby) appears.

NOTES If overall battery power is below 15% and the cardiograph is in Standby, when the On/Standby button is pressed it will flash green five times and the cardiograph will be unable to return to active use. Plug the cardiograph into AC power to recharge the batteries.

If the Disclose or Rhythm screens are viewed prior to entering Standby, the Main screen will appear when the cardiograph is returned to active use.

To shut down the cardiograph:

- 1 Press and hold the On/Standby button for 3 seconds to shut down the cardiograph. When the cardiograph is shut down, any unsaved patient data is lost.
- 2 Press the On/Standby button to return the cardiograph to active use. The cardiograph fully restarts and the Main screen appears.

Entering Patient Information

ID information is entered by:

- Keyboard
- Selecting a pending order
- Barcode reader (optional)
- Magnetic card reader (optional)
- Smart card reader (optional)

Required ID Information

Required patient information is indicated in blue type on the ID screen. This information must be complete in order to transmit an ECG from the Archive to a TraceMaster ECG Management System, or to a USB memory stick. The ID fields that are required are designated by your supervisor.

Navigating on the ID Screen

- To move to the next field on the screen, press the *Tab* key (on keyboard).
- To move to the previous field on the screen, press and hold the *Shift* key (on keyboard) and then press the *Tab* key.

Entering ID Information with the Keyboard

To enter ID information with the keyboard:



- 1 Touch the **ID** button on the Toolbar. The ID screen appears. The New Patient tab (top of screen) is selected. Patient information is entered under this tab. Fields in blue are required (if configured) and must be completed.

NOTE A message appears if the ID screen is exited before completing the required patient information fields.

- 2 Enter the information. Press the *Tab* key (on keyboard) to scroll between the different fields.

NOTE Do not add any spaces to the **ID** number field if transferring ECGs to a TraceMaster ECG Management System.

- 3 Touch **OK** when done.

Selecting an Order from the Worklist

Any order contained in the Worklist may be selected for a patient session. Orders are downloaded to the cardiograph from a specified TraceMaster Remote Site through an inbox configured for use on the cardiograph.



To select a pending order for a patient session:

- 1 Touch the **ID** button.
- 2 Touch the **Worklist** tab (top of screen). The selected tab is highlighted in blue. The Worklist screen appears.

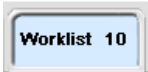

NOTE The number that displays on the Worklist tab (**10**) indicates how many pending orders are available in the Worklist.

- 3 The orders available in the Worklist appear on the screen. Touch an order to select it. The selected order is highlighted in blue.
- 4 Touch the **Select** button (lower right corner of screen) to select the highlighted order for the current patient session. The Main screen appears with the patient information for the selected order appearing on the Status Bar (top of screen).

Searching for Orders

You can search for orders in any inbox that is available on the cardiograph.

Or, you can search for an order during an active patient session by using data scanned from a barcode reader, magnetic card reader, or from a Smart Card reader.

The cardiograph must be connected to the network in order to use the order search feature.

To search for orders:

- 1 Touch the **ID** button. The ID screen appears.
- 2 Touch the **Find Patient** tab (top of screen). The selected tab is highlighted in blue.

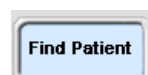

- The **Location** dropdown list (top left of screen) contains all of the available search locations for the cardiograph. Touch the dropdown arrow button to open the list. Touch a location to select it. The selected location appears highlighted in blue and the list closes.

NOTE **Worklist** is the internal cardiograph pending order list.

- Enter order search data into the available fields including **Patient ID**, **Last Name**, **First Name**, **Date of Birth**, and **Room** (number). The entered information will be used to search for orders. To search using data entered from an external device (barcode reader, magnetic card reader, Smart Card reader) place the cursor in the field in which the data is to be scanned. Scan the data. The data appears in the field.

TIP Enter the wildcard character (*) into any field to broaden the search information. For example, to search for orders for all patients with the last name of Doe, enter **Doe*** into the **Last Name** field.

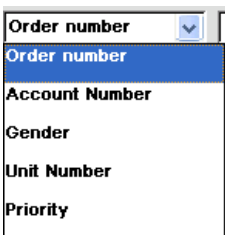

- The selectable optional search field is located at the upper right of the screen. This available optional search field includes the following options: **Order Number**, **Account Number**, **Gender**, **Unit Number** or **Priority** (STAT). Touch the dropdown arrow to open the list of optional search fields. Touch an optional search field to select it. Then, enter search data into the field.
- When all patient information to be used in the search is entered, touch the **Find** button (bottom of screen). The Message Bar (bottom of screen) displays the search status. Any orders that match the entered search data appear in the orders list.
- Touch an order to select it. The selected order appears highlighted in blue. To select the highlighted order for the current patient session, touch the **Select** button (bottom of screen).

NOTE Touch the **Cancel** button to exit the screen without saving the Order.

Editing ID Information

Patient information may be edited at any time during a patient session, or may be edited for a single ECG on the Archive screen. A message appears if changes made to patient information could affect ECG interpretation.

Changes to patient information are applied to all ECGs taken during an active patient session, or to a single ECG stored in the Archive.

To edit ID information:

- From the Archive only, touch the saved ECG that you wish to edit. The selected item is highlighted in blue.
- From the Main screen, or from the Archive, touch the **ID** button. The ID screen appears.
- From the Archive, the **Edit Patient ID** tab is automatically selected, or touch this tab to select it. The selected tab is highlighted in blue.
- Edit the ID information displayed on the screen. Press the *Tab* key (on keyboard) to scroll between the different fields.

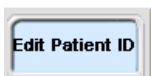

- 5 Touch **OK** to save the edits.
Touch **Cancel** to exit without saving the edits.

Checking Signal Quality



The signal quality of each lead is indicated by the color of the lead as displayed on the screen. In addition to the color-coded signal quality indicators, there are additional signal quality features available on the cardiograph. If the signal quality of all leads is good, and all required patient information has been entered, the **ECG** button (front panel of cardiograph, or on the PIM) illuminates, indicating that the ECG is ready to be taken. Also, the **Map** button can be used to check for any loose or disconnected leads or electrodes. When the **Map** button is touched, a lead diagram appears and any loose or disconnected leads are indicated with a red x mark (✗).

For information on troubleshooting signal quality issues, see "Troubleshooting Signal Quality" on page 3-20.

Color-coded waveforms

When the lead wires are attached to the patient (with the cardiograph turned on), waveforms appear on the Main ECG screen. The color of the waveform indicates the ECG signal quality.

Table 3-3 Waveform Quality Indicators

Waveform Color	Indicates...	Possible Causes
Green waveform	<ul style="list-style-type: none"> ■ Good connection 	
Yellow waveform	<ul style="list-style-type: none"> ■ Moderate noise level, artifact, electrical interference, or a poor electrode connection ■ ECG quality will be affected 	<ul style="list-style-type: none"> ■ Inadequate patient preparation ■ Electrical interference from another device ■ Moderate patient movement, tense patient ■ Improperly gelled electrode (dried gel)
Orange waveform	<ul style="list-style-type: none"> ■ Severe artifact, electrical interference, or a poor electrode connection ■ One or more limb leads are disconnected (chest leads display in orange) 	<ul style="list-style-type: none"> ■ Electrical interference from another device ■ Patient tremors, shivering patient, inadequate preparation ■ Very poor electrode contact, dry electrodes

Table 3-3 Waveform Quality Indicators (continued)

Waveform Color	Indicates...	Possible Causes
Red dotted line	<ul style="list-style-type: none"> ■ Loose electrode connection ■ ECG waveform data that cannot be analyzed 	<ul style="list-style-type: none"> ■ Inoperative electrode, electrode that has fallen off the patient ■ Defibrillation has been performed too recently to take ECG measurements ■ Other cause that renders waveform data useless

Leads Map

The Leads Map is a graphical representation of a patient that shows the location of loose or inoperative electrode(s).

Leads Map is available with:

- Main screen



To open the Leads Map:

- 1 Touch the **Map** button on the Toolbar.
- 2 The location of a loose or inoperative electrode is indicated with a red x mark (✖).

Troubleshooting Signal Quality

Always follow good skin and patient preparation techniques prior to taking an ECG. Proper skin preparation helps to ensure a good quality ECG. Skin is a poor conductor of electricity and frequently creates artifact that distorts the ECG signal. For more information, see "Patient Preparation" on page 3-4.

Table 3-4 Signal Acquisition Issues

Symptom	Possible Cause & Investigation Step	Solution
All leads show leads off (red dashed line) <i>continuously</i>	PIM communications have been lost due to USB patient data cable connection failure, or defective leads are connected to the PIM	<ol style="list-style-type: none"> 1 Check to see if the RL/N lead and electrode are firmly attached. 2 Check to see if the PIM disconnected icon () appears at the top right of the screen. If this icon appears, check that the patient data cable is firmly connected to the PIM, and to the PIM connector port on the rear of the cardiograph. For more information, see “Attaching the Patient Data Cable to the PIM and Cardiograph” on page 1-14. 3 If the PIM is firmly attached, perform the PIM test as described in “Patient Interface Module (PIM) Test” on page 5-13. If the PIM Test fails, replace the patient data cable. If the PIM Test continues to fail with a new patient data cable attached, replace the PIM. 4 If the PIM test passes, ensure that all lead wires are fully seated in the PIM lead connectors. 5 Ensure that all lead wires are intact and that there are no cracks visible in any of the lead wires. 6 Run the lead wire open and short tests, as described in “Lead Wire Performance Test” on page 5-14. 7 If the lead wire open and short tests fail, contact the Philips Response Center. See “Contacting a Philips Response Center” on page 1-39.
One or more leads show leads off (red dashed line) <i>periodically</i>	Improper or incomplete patient and skin preparation techniques	Ensure that good patient preparation and skin preparation techniques have been followed as described in “Patient Preparation” on page 3-4.
	Improperly attached electrodes or lead wires; expired disposable gel electrodes	<ol style="list-style-type: none"> 1 Ensure that the lead adapters are clean and have a tight fit. 2 Ensure that the electrodes are within their shelf life and are firmly attached to the patient.

Table 3-4 Signal Acquisition Issues *(continued)*



Symptom	Possible Cause & Investigation Step	Solution
	Defib or high noise event	<p>Observe frequency and recovery behavior.</p> <p>The PIM performs an automatic ranging action when input signals vary significantly. If this behavior persists in the absence of electrode movement or defib events, the cardiograph should be serviced to inspect and possibly replace the PIM or lead cables. Contact the Philips Response Center. See “Contacting a Philips Response Center” on page 1-39.</p>
	PIM reset (up to ten second duration)	<p>It is normal for the PIM to reset under the following conditions:</p> <ul style="list-style-type: none"> ■ power on/wakeup ■ screen changes ■ insertion/removal of a USB device (USB memory stick) <p>When the PIM resets, it is normal for all leads to display red dashed lines for up to ten seconds. The PIM disconnected icon () is displayed during the PIM reset.</p>

Table 3-4 Signal Acquisition Issues (continued)

Symptom	Possible Cause & Investigation Step	Solution
<p>One or more leads show leads off (red dashed line) <i>periodically</i></p>	<p>PIM communications have been lost due to USB patient data cable connection failure, or defective leads are connected to the PIM</p>	<ol style="list-style-type: none"> 1 Check to see if the RL/N lead and electrode are firmly attached. 2 Check to see if the PIM disconnected icon () appears at the top right of the screen. If this icon appears, check that the patient data cable is firmly connected to the PIM, and to the PIM connector port on the rear of the cardiograph. For more information, see “Attaching the Patient Data Cable to the PIM and Cardiograph” on page 1-14. 3 If the PIM is firmly attached, perform the PIM test as described in “Patient Interface Module (PIM) Test” on page 5-13. If the PIM Test fails, replace the patient data cable. If the PIM Test continues to fail with a new patient data cable attached, replace the PIM. 4 If the PIM test passes, ensure that all lead wires are fully seated in the PIM lead connectors. 5 Ensure that all lead wires are intact and that there are no visible cracks in the lead wires. 6 Run the lead wire open and short tests, as described on page 5-14. 7 If the lead wire open and short tests fail, contact the Philips Response Center. See “Contacting a Philips Response Center” on page 1-39.

Urgent (STAT) ECGs

Patient information does not have to be entered in an emergency situation in order to take an ECG.

Complete all patient information after the urgent ECG is taken, but before the patient session ends. All required patient information fields must be completed in full in order to transfer an ECG to a TraceMaster ECG Management System.



To take an emergency or STAT ECG:

- 1 From the Main screen, check that all leads have a good connection.
- 2 When all leads have a good connection, touch the green **ECG** button on the front of the cardiograph twice rapidly, or press the green **ECG** button on the PIM twice rapidly.
- 3 The ECG prints and appears on the Preview screen.

NOTE If no ID information is entered a statement is included on the ECG that interpretation used a default age (50 years) and gender (male).

Main ECG Screen

The Main ECG screen displays live patient data in a variety of formats. The Main ECG screen is the default screen that appears when the cardiograph is taken out of Standby or is restarted.

Changing the Lead Format on the Main ECG Screen

The format of the waveforms that display on the Main screen can be changed at any time. The available lead formats are described in Table 3-5.



Table 3-5 Main Screen Lead Formats

Lead Format	Description
16x1 or 12x1	<ul style="list-style-type: none"> ■ This view provides ten seconds of continuous ECG waveform data for each lead ■ This is the default lead format that appears on the Main screen each time that the cardiograph is taken out of Standby or is restarted
Split Screen view	<ul style="list-style-type: none"> ■ This view provides five seconds of continuous ECG waveform data for each lead on a split screen ■ See Figure 3-10 on page 3-25 ■ In the split screen display, the limb and augmented leads on the left, and the precordial leads are on the right

Table 3-5 Main Screen Lead Formats

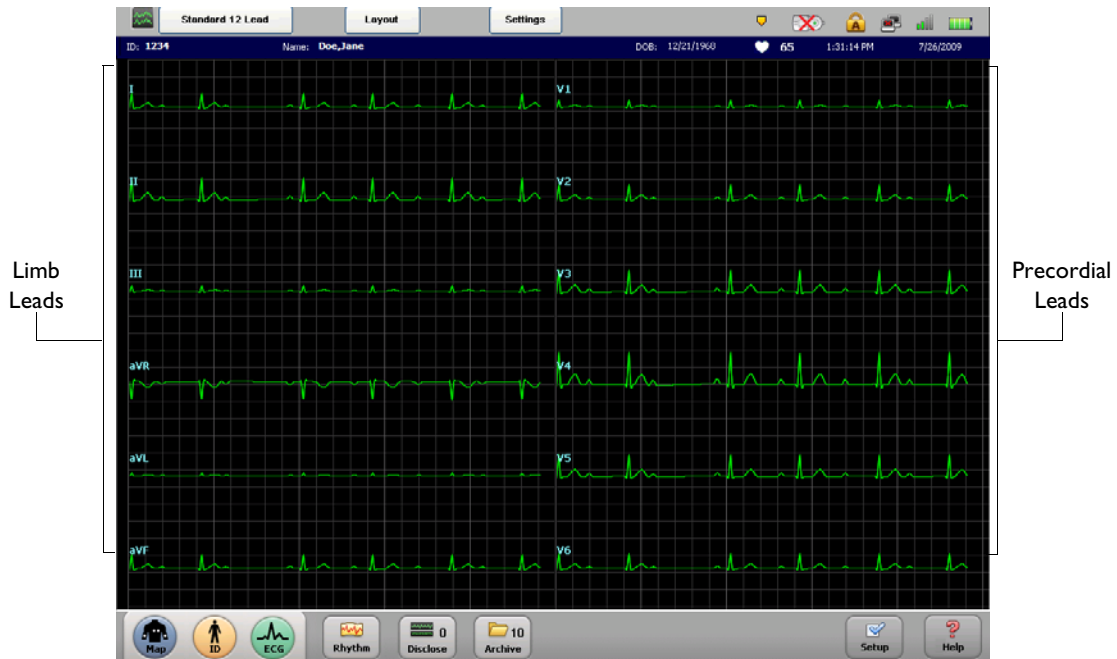
Lead Format	Description
3x4	<ul style="list-style-type: none"> This view provides 2.5 seconds of waveform data for each lead, with 3 total rows with 4 leads in each row In this view, the limb and augmented leads are on the left, and the precordial leads are on the right

Figure 3-10 Main Screen Split Screen View with 12 Leads Displayed**To change the lead format on the Main display:**

- 1 Press the down arrow key (on keyboard)  or the up arrow key  to scroll through the available Main screen lead formats.
- 2 The default lead format (16x1 or 12x1) appears on the Main screen each time that the cardiograph is returned to active use.

Taking an Auto ECG

Once all waveforms are of good quality, and all patient information is complete, the ECG button illuminates. When the ECG button illuminates, it means that the ECG is ready to be taken.

**To take an Auto ECG:**

- ▶ When the **ECG** button is lit, press it to take an Auto ECG.

Using the Preview Screen

The Preview screen displays the ECG exactly as it looks when printed. The **ECG** button can be touched at any time from the Main screen to display a full-screen preview of an ECG. The ECG captures the most recent 10-seconds of waveform data.

Depending on how the Preview screen is configured to operate, the ECG once it appears on the Preview screen may automatically print, be saved to the Archive, or may be transferred to TraceMaster, and the cardiograph can be configured to automatically retrieve the most recent ECG from the same patient for direct comparison purposes at the cardiograph.

To preview an ECG from the Main ECG screen:



- 1 On the Main ECG screen, or on the Patient Interface Module (PIM), touch the **ECG** button to see a previewed ECG of the most recent 10-seconds of waveform data. If no patient information has been entered, touch the **ECG** button twice rapidly.

NOTE

As shown in Figure 3-11 on page 3-26, the **Print, Save, Transfer, or Last ECG** buttons may not appear on your individual cardiograph, or may appear grayed out (cannot be selected), depending on how your cardiograph is configured. If the buttons are grayed out, your cardiograph is configured to automatically perform these functions. If the buttons do not appear, your cardiograph is not configured to support these functions.

Figure 3-11 The Preview Screen

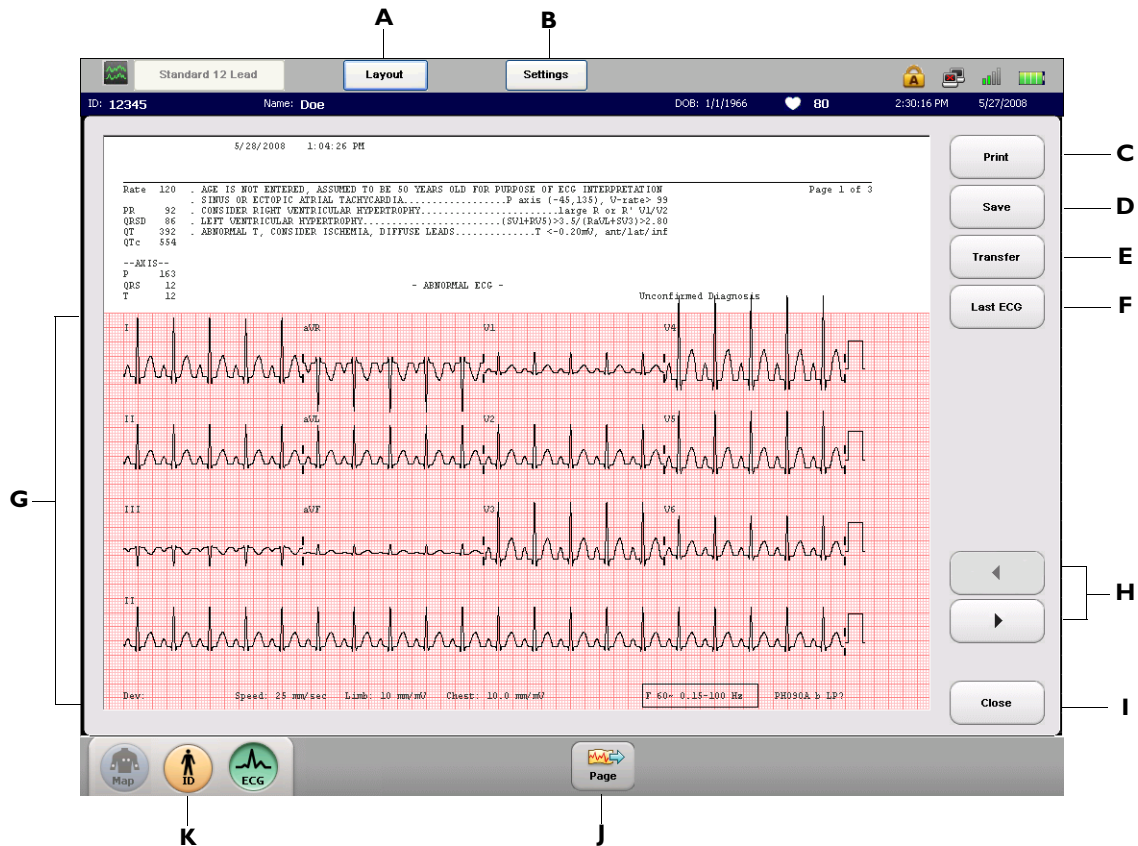

Table 3-6 Preview Screen Description

Preview Screen Item	Feature Name	Description
A	Layout Button	<p>Touch to:</p> <ul style="list-style-type: none"> ■ change the layout/format of the ECG report displayed on the screen ■ change whether the waveforms are displayed simultaneously or time sequentially ■ change the rhythm lead ■ change the amount of interpretation that appears on the ECG report <p>The new settings are immediately applied.</p>
B	Settings Button	<p>Touch to:</p> <ul style="list-style-type: none"> ■ change the optional filter settings (Artifact, Baseline Wander) ■ change pacing detection setting ■ change waveform speed and scale settings <p>The new settings are immediately applied.</p>
C	Print Button	Touch to print the displayed ECG.
D	Save Button	Touch to save the displayed ECG.
E	Transfer Button	<p>Touch to send the displayed ECG to TraceMaster</p> <p>Note: Only ECGs with complete required patient information can be sent to TraceMaster. Touch the ID button to complete any missing required patient information.</p>
F	Last ECG	<p>Touch to:</p> <ul style="list-style-type: none"> ■ review on the Preview screen and print from the cardiograph the most recent previous ECG from the same patient ■ use of this feature requires an active connection to the specified TraceMaster server
G	ECG Report	<ul style="list-style-type: none"> ■ The displayed ECG report. ■ Press the down arrow key (↓) or the up arrow key (↑) to change the displayed report format. Touch the ECG button to print out an ECG report. ■ Press and hold the <i>Shift</i> key (on keyboard) and then press the down arrow key (↓) or the up arrow key (↑) to change the level of interpretation displayed on the ECG.

Table 3-6 Preview Screen Description (continued)

Preview Screen Item	Feature Name	Description
H	Page forward and page back button	Touch to view additional pages of the displayed ECG report.
I	Close Button	Touch to close the Preview screen and to return to the Main screen
J	Page Advance Button	Touch to advance the printer paper to the beginning of the next page
K	ID Button	Touch to enter missing patient information for the displayed ECG (not available with the Last ECG feature) Note: This feature is not used to enter patient information for a new patient.

Using the Last ECG Feature on the Preview Screen

When a previous patient ECG is printed at the cardiograph using the **Last ECG** feature, a watermark appears on the ECG report specifying that this is a previously recorded ECG.

Figure 3-12 Previous ECG Watermark on ECG Report

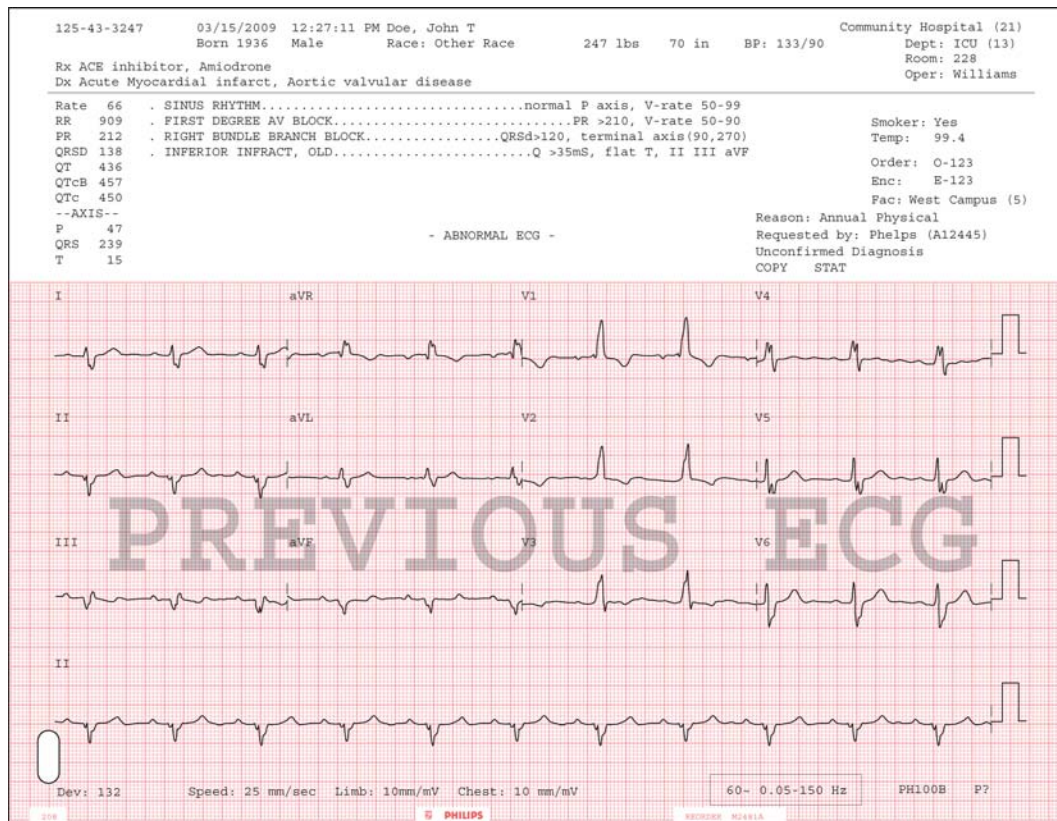

Viewing Event Markers on the Preview Screen

If any Event Markers are captured within the 10-seconds of ECG data that appear on the Preview screen or on the printed ECG report, an Event Marker symbol () will appear directly above the waveform. For information on capturing Events on the Main or Rhythm screens, see "Capturing Events from the Main or Rhythm Screens" on page 3-33.

Figure 3-13 Event Marker Symbol on Preview Screen



A Event Marker Symbol on ECG Report

Critical Values on Preview Screen

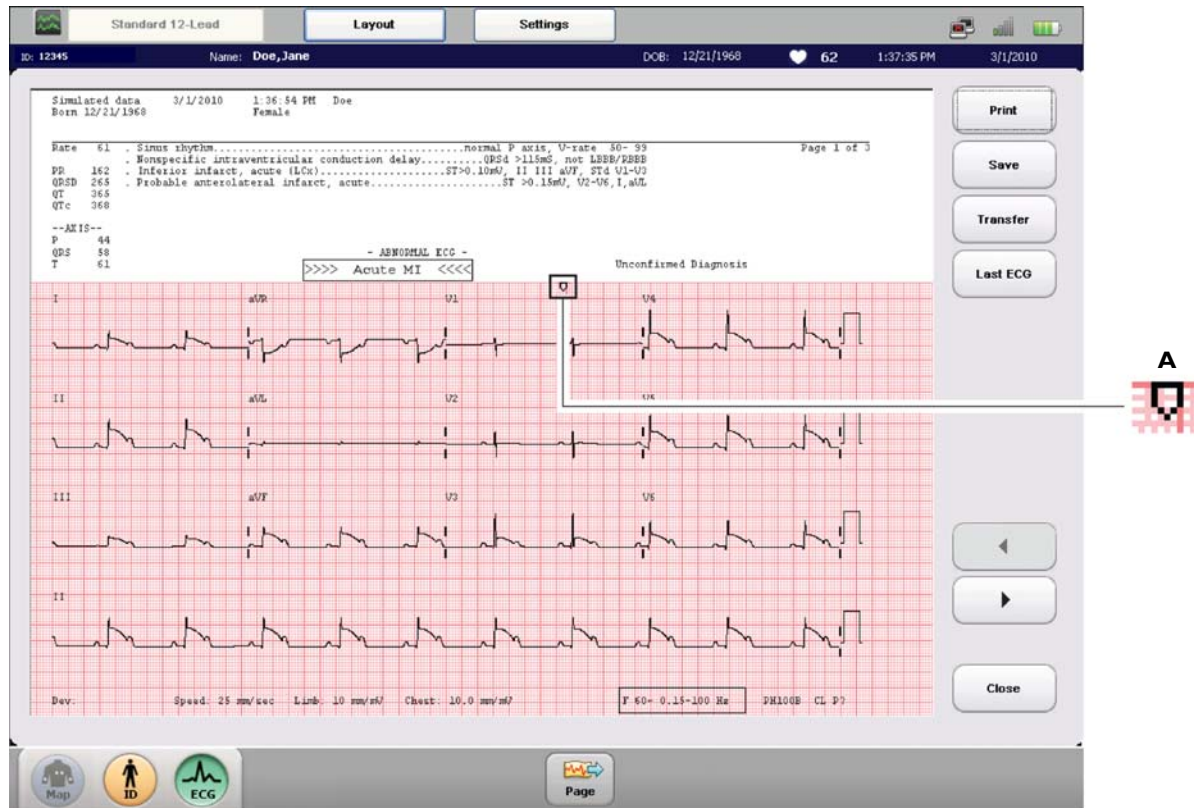
The algorithm offers a feature called *Critical Values*, that when enabled will display an ECG message on the Preview screen, and print the message on the ECG report, in order to notify caregivers of an ongoing or imminent cardiac event, such as a silent MI, that requires immediate treatment. The notification statement displays prominently on the Preview screen. If any of these Critical Values appear on the Preview screen, obtain help immediately.

The messages are triggered by a defined set of interpretive statements that are listed in "Critical Value Statements" on page B-1. These Critical Values include the statements **ACUTE MI**, **VERY HIGH HEART RATE**, **COMPLETE HEART BLOCK**, and for the Philips DXL ECG Algorithm version PH100B, the statement **ACUTE ISCHEMIA** is supported.

Very High Heart Rate Critical Value

For the Philips DXL ECG Algorithm version PH100B, the statement **VERY HIGH HEART RATE** is generated by the following formula: the measured heart rate in beats per minute, minus the patient age in years. For patients 80 years old and younger, if this value is 220 bpm or higher, the **VERY HIGH HEART RATE** statement will appear on the ECG. For patients who are older than 80 years, if this value is 140 bpm or higher, the **VERY HIGH HEART RATE** statement will appear on the ECG.

For the Philips 12-Lead Algorithm version PH090A, the statement **Very High Heart Rate** is generated by the following formula: the measured heart rate in beats per minute, minus the patient age in years. If this value is 150 bpm or higher, the **Very High Heart Rate** statement will appear on the ECG.

Figure 3-14 Critical Value Message on Preview Screen

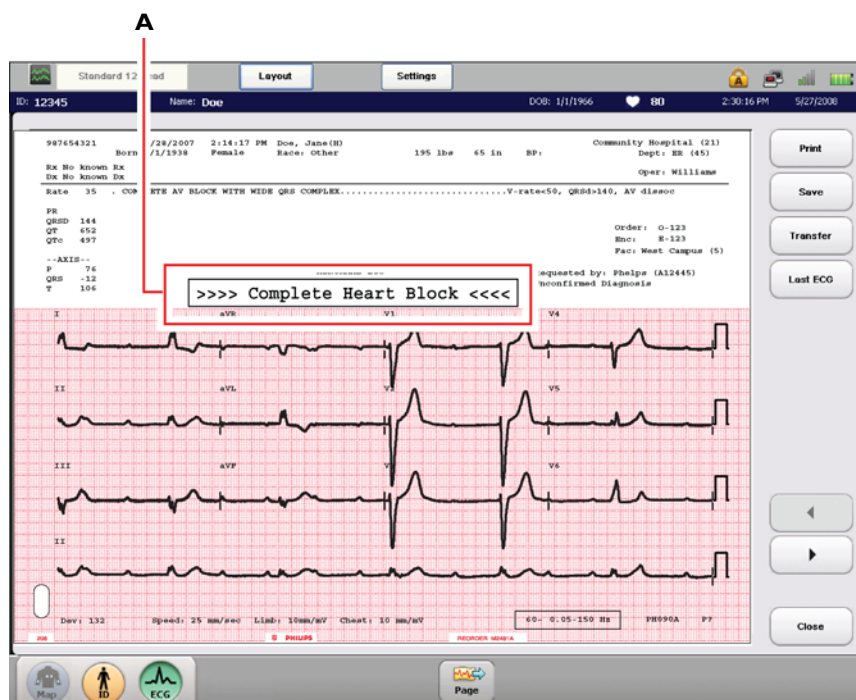

A Complete Heart Block Critical Value Message on Preview Screen

Rhythm ECG Acquisition

Rhythm ECG acquisition is used to print continuous rhythm strips of selected leads until the **Stop** button is touched. The selected Rhythm leads, the size and scale of the waveforms on the printed report, pacing detection settings, and the optional Artifact filter settings may be changed at any time during the recording.

NOTE Rhythm reports are not analyzed.

To record a rhythm ECG:

- 1 Touch the **Rhythm** button on the toolbar.
- 2 Touch the **Stop** button on the toolbar to stop printing.
- 3 Touch the **Page** button on the toolbar to advance the paper to the top of the next page.

**To change the rhythm leads:**

- 1 Touch the **Leads** button on the toolbar to select a predefined group of leads, or select the leads individually by touching the lead label.
- 2 Touch the **Select All** button to select all available rhythm leads.
- 3 Touch the **OK** button to apply the new settings. Touch the **Cancel** button to exit the screen without changing leads.



The new rhythm lead settings are immediately applied, and the report continues to print with the selected rhythm leads.

To change rhythm report settings:

- 1 Touch the **Settings** button on the Status Bar (top of screen). The Settings window appears.
- 2 Touch the **ON/OFF** button next to **Artifact** to enable or to disable the Artifact filter.
- 3 Touch settings for waveform speed and scale as desired.

NOTE The **Chest Leads** setting scales the precordial leads to the same size as the limb leads (**Full**) or to half the size of the limb leads (**Half**).

- 4 Touch a setting next to **Pacing** to change the pacing detection setting.

NOTE The **Unknown** setting is recommended for most ECGs.

- 5 Touch the **OK** button to close the window and to apply the settings. Touch the **Cancel** button to close the window and to discard the settings.

Special Note about Artifact Filter

The purpose of the Artifact filter is to remove skeletal muscle artifact from the ECG signal. Skeletal muscle artifact is the most difficult noise source to eliminate due to the fact that it contains the same frequencies as actual patient ECG signals. The Artifact filter will eliminate skeletal muscle artifact, but it will also reduce all high frequency components of the ECG signal. Due to this fact, use of the Artifact filter may make it impossible to detect pacemaker pulses, and may affect P waves, and the entire QRS-T complex. Only use the Artifact filter for ECGs that otherwise would be unreadable due to significant levels of muscle artifact.

Figure 3-15 The Rhythm Screen with rhythm report printing

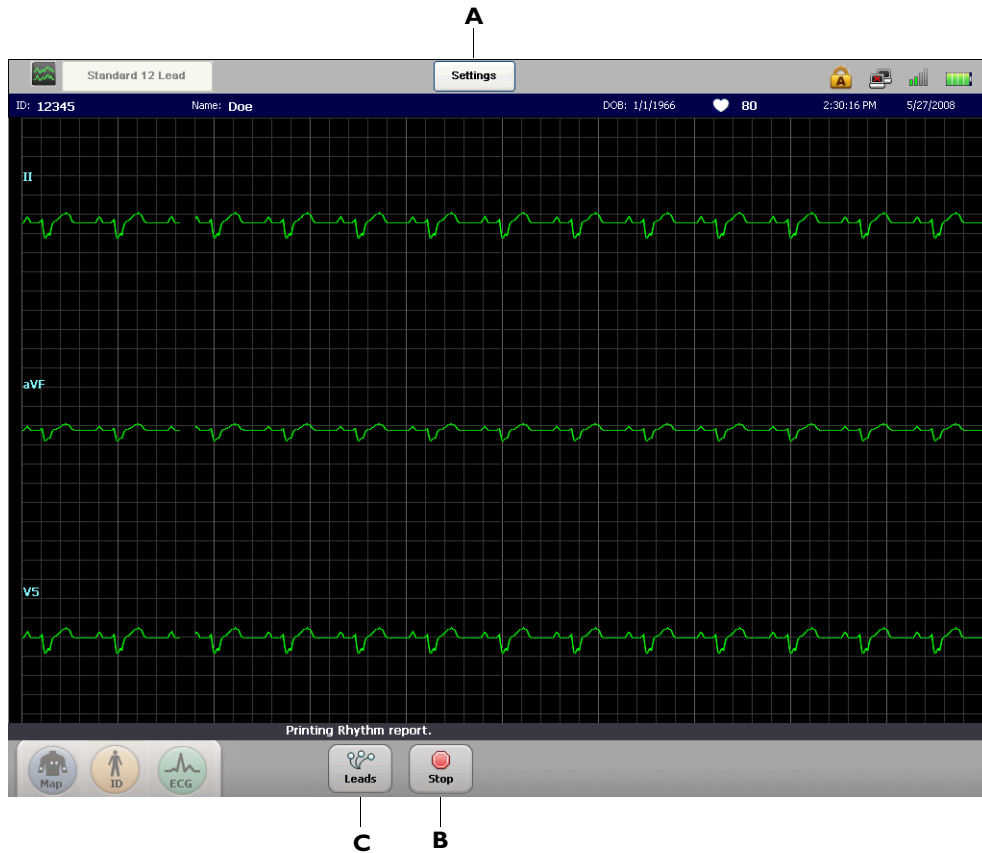

Figure 3-16 Rhythm Toolbar with no report actively printing

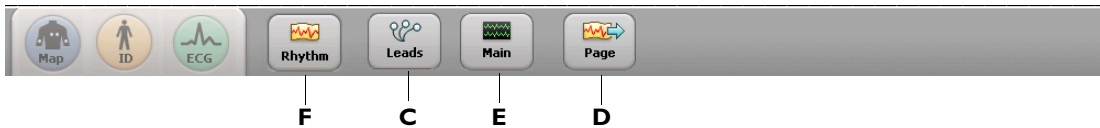

Table 3-7 Rhythm Screen

Rhythm Screen Item	Feature Name	Description
A	Settings Button	Touch to: <ul style="list-style-type: none"> ■ change Artifact filter settings ■ change pacing setting ■ change waveform speed setting ■ change waveform scale setting The new settings are immediately applied.

Table 3-7 Rhythm Screen (continued)

Rhythm Screen Item	Feature Name	Description
B	Stop Button	<ul style="list-style-type: none"> Touch to stop printing the rhythm report When the rhythm report is stopped the toolbar shown in Figure 3-16 appears
C	Leads Button	<ul style="list-style-type: none"> Touch to change the rhythm leads This button appears whether or not a rhythm report is printing
D	Page Button	<ul style="list-style-type: none"> Touch to advance the printer paper to the beginning of the next page This button only appears when no rhythm report is printing
E	Main Screen Button	<ul style="list-style-type: none"> Touch to exit the Rhythm screen and return to the Main screen This button only appears when no rhythm report is printing
F	Rhythm Button	<ul style="list-style-type: none"> Touch this button to resume printing a rhythm report This button only appears when no rhythm report is printing

Disclose ECG Acquisition

Disclose ECG acquisition is used to review Events captured on the Main or Rhythm screens. For the PageWriter TC70 cardiograph, up to 20 minutes of continuous ECG waveform data for a selected lead can be reviewed, in either a static or in a live view. For the PageWriter TC50 cardiograph, up to 12 minutes of continuous ECG waveform data for a selected lead can be reviewed in either a static or in a live view. Any data viewed on the screen may be selected and printed as a standard 12-lead or optional 16-lead report.

Event Marker Warning

A flashing icon () appears on the Status Bar (top of screen) if Event Markers captured during an individual patient session have not yet been reviewed on the Disclose screen, and are about to be deleted. For more information, see "The Status Bar" on page 1-43.

Capturing Events from the Main or Rhythm Screens

If a clinically significant event is viewed on either the Main or Rhythm screens, this clinically significant data can be captured for future review and processing on the Disclose screen. This captured data is called an *Event* and is marked on the screen with a white arrow symbol (). This white arrow symbol is called an *Event Marker*, and appears directly above the waveform.



The number of Events captured for the current patient session displays as a number on the **Disclose** button located on the toolbar.

As the waveform data on the screen refreshes, additional Events can be captured as necessary. Even though an Event scrolls off of the screen, it is saved for review on the Disclose screen.

To capture an Event on the Main or Rhythm screens:

- 1 If a clinically significant event is viewed, touch and press down on the screen directly above the waveform for two seconds in order to capture the significant data for future review and processing.
- 2 Once the data is captured, a white Event Marker appears above the waveform. For the PageWriter TC70 cardiograph, a maximum of 15 Events can be captured for an individual patient session. For the PageWriter TC50 cardiograph, a maximum of 10 Events can be captured for an individual patient session. After the Event is captured, the number that appears on the **Disclose** button increases by 1.



Figure 3-17 Disclose Button with 4 Captured Events



Continue to capture Events as necessary, or proceed to review Events on the Disclose screen. Even though an Event scrolls off of the screen, it is saved for future review and processing. Wait 15 seconds after capturing an Event, and then touch the **Disclose** button to view Events.

Reviewing Events on the Disclose Screen

Captured Events can be reviewed on the Disclose screen. When the **Disclose** button is touched, the Disclose screen appears in a static view. The most recent Events appear at the lower right corner of the screen.

Figure 3-18 Disclose Screen, Static View with Captured Event

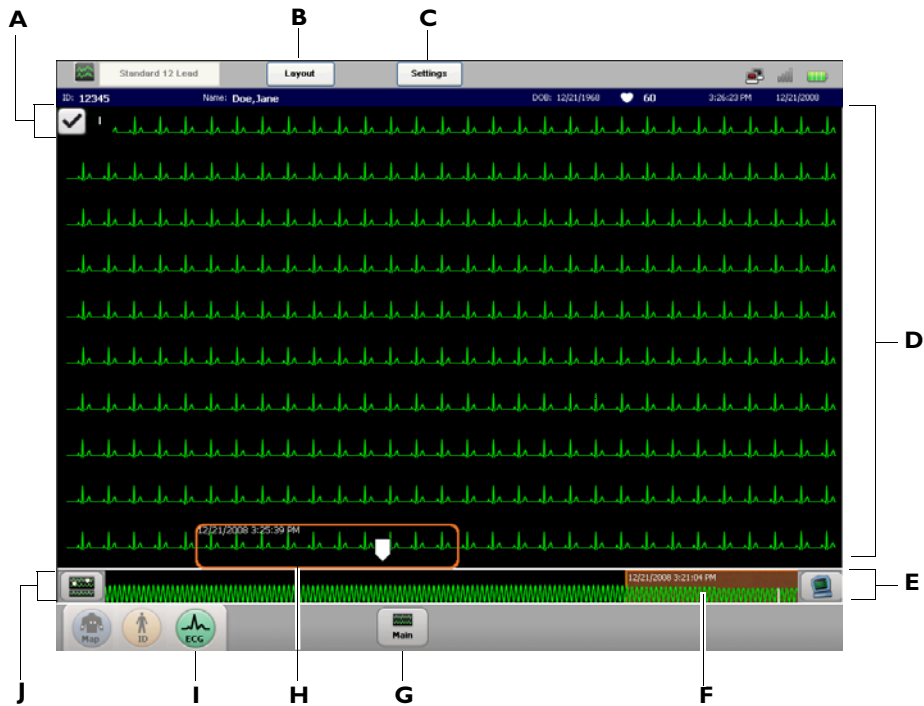

Table 3-8 Disclose Screen, Static View with Captured Events

Disclose Screen Item	Feature Name	Description
A	Selected Disclose Lead	<ul style="list-style-type: none"> Touch to change the displayed Disclose lead Only one lead may be selected as the Disclose lead
B	Layout Button	<ul style="list-style-type: none"> Touch to change ECG report settings, including report layout, time sequential settings, and any rhythm leads that appear on the 12-lead or 16-lead ECG report Touch the change the amount of interpretive information generated by the algorithm that appears on the ECG report The ECG report is derived from the 10-seconds of data that is captured inside the orange Focus box  <p>The new settings are immediately applied.</p>

Table 3-8 Disclose Screen, Static View with Captured Events

Disclose Screen Item	Feature Name	Description
C	Settings Button	<p>Touch to:</p> <ul style="list-style-type: none"> ■ change Artifact filter settings ■ change pacing setting ■ change waveform speed setting ■ change waveform scale setting <p>The new settings are immediately applied.</p>
D	Waveform Display Area	<ul style="list-style-type: none"> ■ The area where Disclose lead waveforms appear ■ Touch any area on the screen to move the orange Focus box 
E	Live View Button	<ul style="list-style-type: none"> ■ Touch to enter Live View that displays live waveforms ■ In this view, live waveforms scroll across the screen; the most recent data is seen at the top of the screen, and the oldest data is seen at the bottom of the screen
F	Disclose Timeline	<ul style="list-style-type: none"> ■ This is a data timeline that displays up to 20 minutes of waveform data for the TC70 cardiograph, and up to 12 minute for the TC50 cardiograph ■ The orange shaded area in the timeline captures the data that is displayed above in the waveform area ■ Tap anywhere on the timeline to move the orange shaded area and to display different ECG waveform data ■ White upright lines in the timeline are saved Events
G	Main Screen Button	Touch to exit the Disclose screen and return to the Main screen
H	Focus Box	<ul style="list-style-type: none"> ■ The Focus Box captures 10-seconds of ECG data that can be printed as a 12-lead or 16-lead ECG report ■ Tap any area of the waveform display area to move the Focus Box ■ The time and date at the upper left corner of the Focus Box is the beginning time and date of the waveform data captured inside the Focus Box

Table 3-8 Disclose Screen, Static View with Captured Events

Disclose Screen Item	Feature Name	Description
I	ECG Button	<ul style="list-style-type: none"> ■ Touch to print a 12-lead or 16-lead ECG report of the data captured inside the orange Focus Box ■ Touch the ECG button on the front panel of the cardiograph or on the PIM twice rapidly to take a STAT ECG ■ The ECG report appears on the Preview screen
J	Previous Events Button	<ul style="list-style-type: none"> ■ Touch this button to view Events captured more than 20 minutes in the past for the TC70 cardiograph, and more than 12 minutes in the past for the TC50 cardiograph

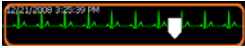
Reviewing Previous Events

While within the same patient session, Events that occurred more than 20 minutes in the past for the PageWriter TC70 cardiograph, or more than 12 minutes in the past for the PageWriter TC50 cardiograph, are saved as 30-second segments that can be reviewed on the Previous Events screen. Any portion of these 30-second segments can be reviewed and printed as Standard 12-Lead or 16-lead ECG reports.

To open the previous events screen and print an ECG report:



- 1 On any Disclose screen, touch the Previous Events button (lower left corner of screen).
- 2 The Previous Events screen appears. Each saved Event appears on the screen as a 30-second segment. The orange Focus Box on the screen captures 10-seconds of the 30-second segment. The 10-seconds captured inside the Focus Box can be printed as a 12-lead or 16-lead ECG. Touch the **ECG** button to print out an ECG of the 10-seconds of data captured inside the Focus Box.

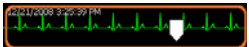

Using Timed ECG

The Timed ECG feature is used to take ECGs at pre-defined intervals, most commonly as part of a stress test protocol. The number of total ECGs recorded, and the interval between ECGs can be defined as a Timed ECG Exam in Setup. For more information on configuring Exams settings, see “Configuring 12-Lead Exam Settings” on page 2-5.

To take ECGs using the Timed ECG feature:

1 When all patient information has been entered, and all leads are of good quality, touch the Exams button on the Status Bar (upper left corner of screen). By default, the Exams button will display **Standard 12-Lead**.



2 On the Exams dropdown, touch **Timed ECG**. The available Timed ECG protocols then appear as side buttons. Touch a Timed ECG profile to select it for the current patient session. **2x3 Minutes** is the factory default Timed ECG profile.

3 The dropdown list closes with the selected Timed ECG profile appearing on the Exams button. The Timed ECG protocol begins.

4 A progress bar on the bottom of the screen provides a status update on the number of ECGs remaining, and the number of seconds remaining until the next ECG is taken. Touch the **Stop** button (bottom of screen) at any time to stop the Timed ECG protocol.



Transferring ECGs from the Archive



ECG reports may be transferred during a patient session from the Preview screen (if the cardiograph is configured to support this feature). Or, saved ECGs may be transferred from the Archive after the patient session ends as a:

- PDF file to a USB memory stick
- XML file to a USB memory stick
- XML file to configured TraceMasterVue or other third party ECG management system using a network or modem connection

For information on using a USB memory stick with the cardiograph, see "Using the USB Memory Stick" on page 1-36.

**To transfer ECGs from the Archive:**

- 1 Touch the **Archive** button on the main toolbar. The number on the button (**9**) indicates how many ECGs are currently saved to the **Main Archive** (internal cardiograph storage).
- 2 Ensure that **Main Archive - ID Complete** is selected (top left of screen). This directory contains all ECGs that may be transferred from the cardiograph.

NOTES

Only ECGs that contain all required patient information may be transferred from the cardiograph. Required patient information fields are specified by your individual facility. For information on editing or completing patient information from the Archive screen, see "Editing ID Information" on page 3-18.

To review ECGs that are saved as XML files to a USB memory stick (inserted into the USB connector on the cardiograph) select **USB memory stick** from the dropdown list.

- 3 Touch an ECG displayed in the directory to select it for transfer. A selected ECG is highlighted in blue. To select or to deselect all ECGs in the directory, touch the **Select** column header (top of screen).

- When all ECGs have been selected, touch the **Transfer Destination** dropdown (top center of screen). Select an option from the dropdown list.

NOTE ECGs saved as XML files are saved to the default XML schema version specified in **Setup, Configure ECG Network Settings, ECG Management System**. The XML schema version is dependent upon the selected TraceMasterVue version or third party ECG management system that is selected on this screen. For more information, see the *PageWriter TC Cardiograph Network Configuration Guide*, which is available for download from the Philips InCenter site. For information on using the Philips InCenter site, see "Using the Philips InCenter Site" on page 1-5.

- Touch the **Transfer** button (lower right corner of screen) to transfer the selected ECGs as PDF files to the specified destination.

NOTE Touch the **Print List** button to print a list of all ECGs saved to the selected Archive. Touch the **Delete** button to delete the selected (highlighted) ECGs on the screen. A message then appears confirming that you wish to delete the selected ECGs from the Archive.

Downloading ECGs from TraceMaster

Downloading ECGs from TraceMaster requires an active network or modem connection, and at least one configured TraceMaster Remote Site.

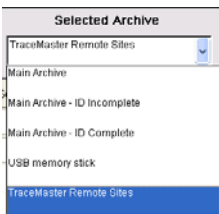

To download ECGs from TraceMaster to the cardiograph:

- Select **TraceMaster Remote Sites** from the Selected Archive dropdown (top left of screen).
- The available TraceMaster Remote Sites configured for use on the cardiograph appear under the **Query From** dropdown (top center of screen). Select a TraceMaster Remote Site.
- Touch the **Get ECGs** button (top right of screen).
- The Remote Site search screen appears. Enter information into the available search fields to use to search for ECGs on the specified TraceMaster Remote Site. To scan barcode data into a search field, place the cursor in the field. Scan the barcode data. Enter % into any field to search using a wildcard for that field. If a field is left blank it will not be used in the search.
- When all search information has been entered, touch the **Search** button. A message appears (bottom of screen) with the search status. Touch the **Stop** button to cancel the search once it is in process.
- When the search is complete, any ECGs that match the entered search criteria appear on the screen. Touch an ECG to select it for download. A selected ECG appears highlighted in blue.
- Touch the **Download** button (bottom of screen) to download the selected ECGs from the TraceMaster Remote Site for viewing on the cardiograph.

Reading the Printed ECG Report

The ECG report formats described in this chapter are available on the PageWriter TC70 or TC50 cardiograph with installed software version A.03.00 and higher.

Figure 4-1 A 12-Lead 3x4, 1R Report (page one)

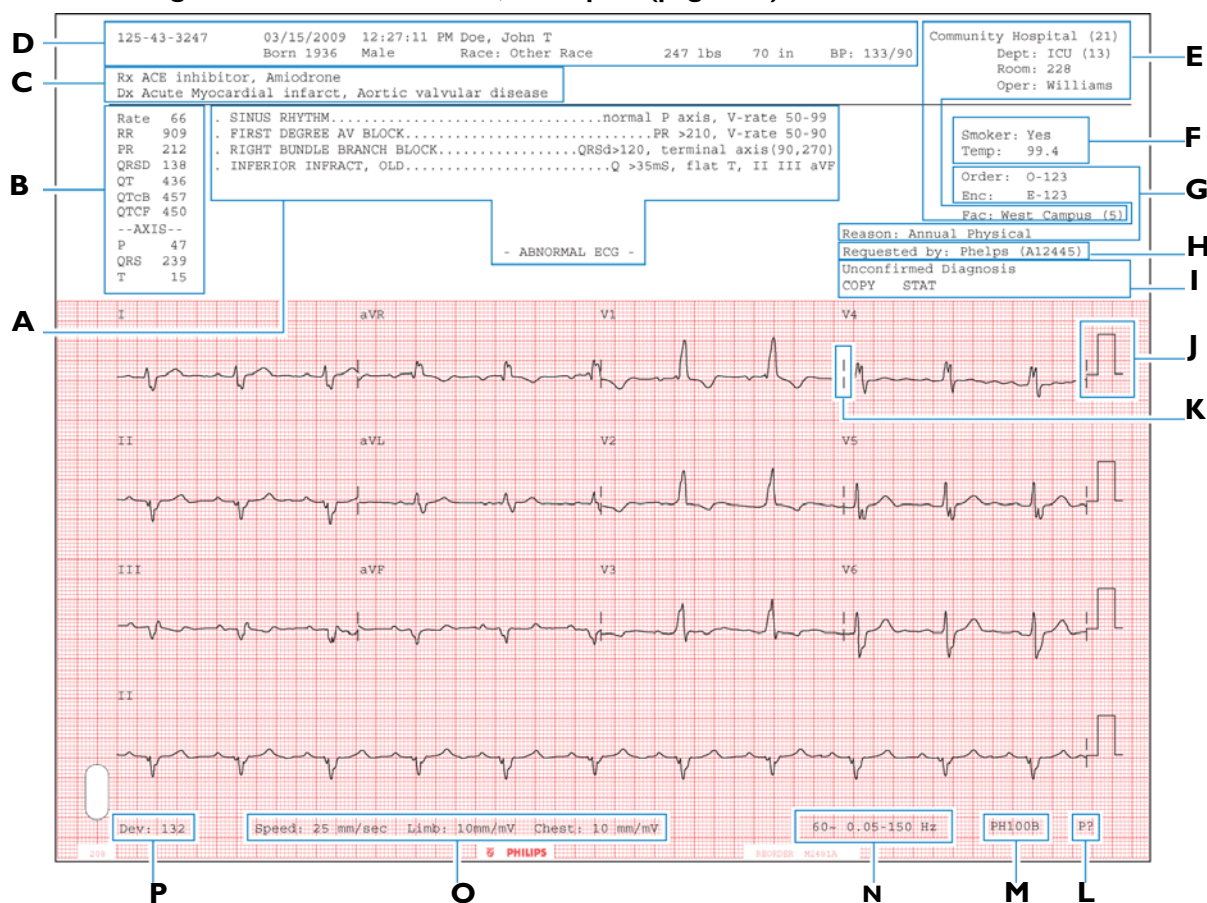

- A** Interpretive, Reason, and Severity Statements (see page 4-3)
- B** Basic Measurements (see page 4-5)
- C** Patient ID Clinical Information (see page 4-6)
- D** Patient ID Information (see page 4-7)
- E** Institution Information (see page 4-8)
- F** Configurable Clinical Information (see page 4-9)
- G** ECG Order Information (see page 4-11)
- H** Physician Information (see page 4-12)
- I** Report Information (see page 4-12)
- J** Calibration Information (see page 4-13)
- K** Time Separator (see page 4-15)
- L** Pacing Detection Setting (see page 4-15)
- M** Algorithm Version (see page 4-17)
- N** Filter Settings (see page 4-18)
- O** Speed and Sensitivity Settings (see page 4-21)
- P** Device Identification Number (page 4-21)

Additional patient information fields may appear on the top of a second page of the ECG report if more than two clinical fields (Rx, Dx, Sx, Hx) are entered with the Patient ID information.

Additional configurable clinical information fields may also appear on the top of a second page of the ECG report if more than four fields are configured.

Figure 4-2 A 12-Lead 3x4, 1R Report (page two)



Q Additional Patient Clinical Information Fields (see page 4-6)

R Additional Configurable Clinical Information (see page 4-9)

Interpretive, Reason, and Severity Statements

This area of the report contains the interpretive, reason, and severity statements generated by the Philips DXL ECG Algorithm.

Figure 4-3 Interpretive, Reason, and Severity Statements on the ECG Report

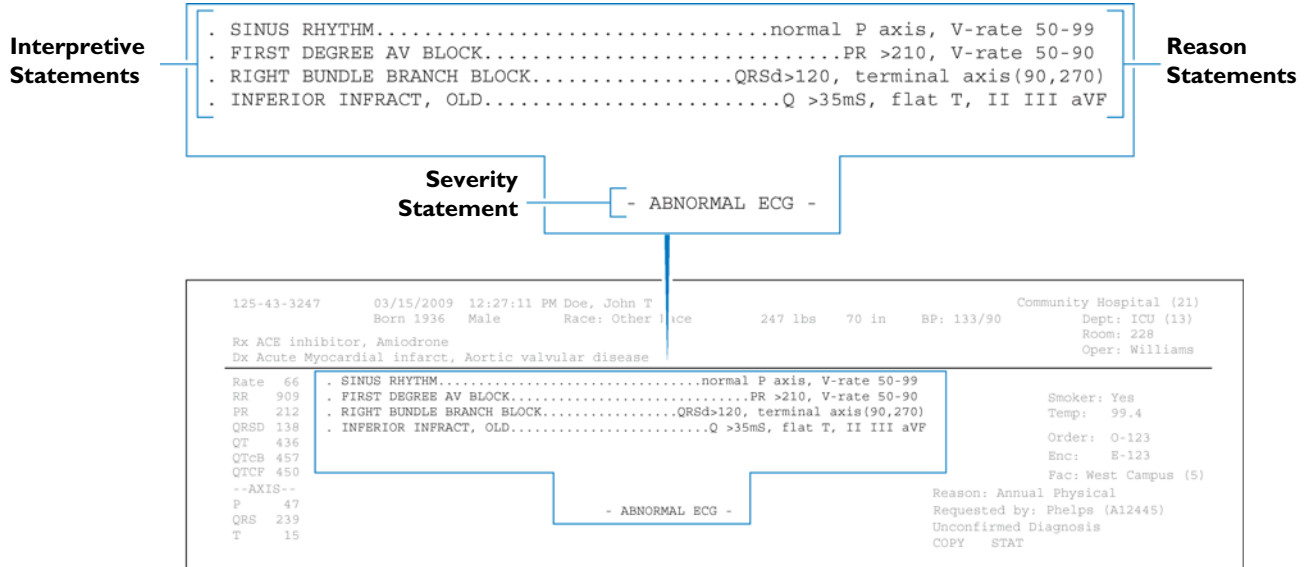

Interpretive statements may include a reason statement that summarizes the criteria that generated the interpretive statement.

NOTE The interpretive statements may include quality statements that describe a signal quality problem that occurred during recording, such as **ARTIFACT IN LEAD(S) I, III, aVL**.

Severity Statement

Each interpretive statement included on the ECG report has an associated severity. Severities that are more abnormal override lesser severities. The severities of all selected interpretive statements are combined to determine the overall severity of the ECG. This severity code is printed on the front page of the ECG report.

Table 4-1 Overall ECG Severity with Code

Severity	Code
No Severity	NS
Normal ECG	NO
Otherwise Normal ECG	ON
Borderline ECG	BO
Abnormal ECG	AB
Defective ECG	DE

Critical Values

When the **Critical Values** setting is enabled on the acquisition equipment, statements may appear on the ECG report if specific interpretive statements are generated by the Philips DXL ECG Algorithm. These statements are intended to alert caregivers of an ongoing or imminent cardiac event, such as a silent MI, that require immediate clinical treatment. This feature is provided in part to help satisfy Section 2C of Goal 2 of the 2009 National Patient Safety Goals of the United States of America, as defined by the Joint Commission on Accreditation of Healthcare Organizations.

There are four Critical Value statements that may appear on the ECG report. These statements are shown in Figure 4-4 through Figure 4-7.

Figure 4-4 Acute Myocardial Infarction Statement on ECG Report

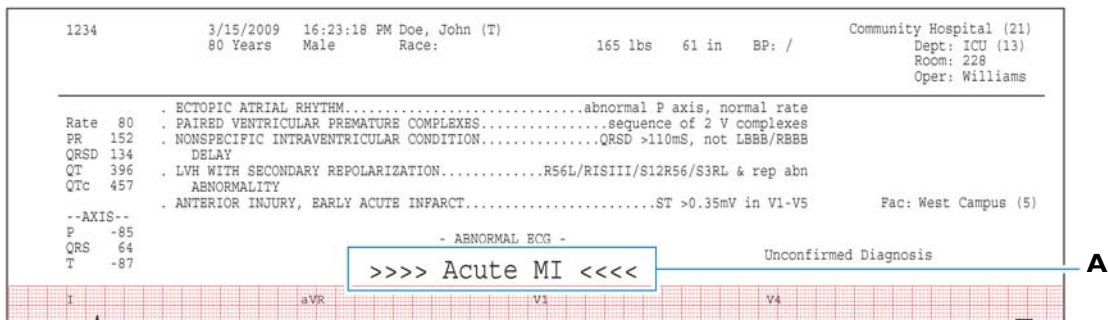

A Acute Myocardial Infarction Statement on ECG Report

Figure 4-5 Very High Heart Rate Statement on ECG Report

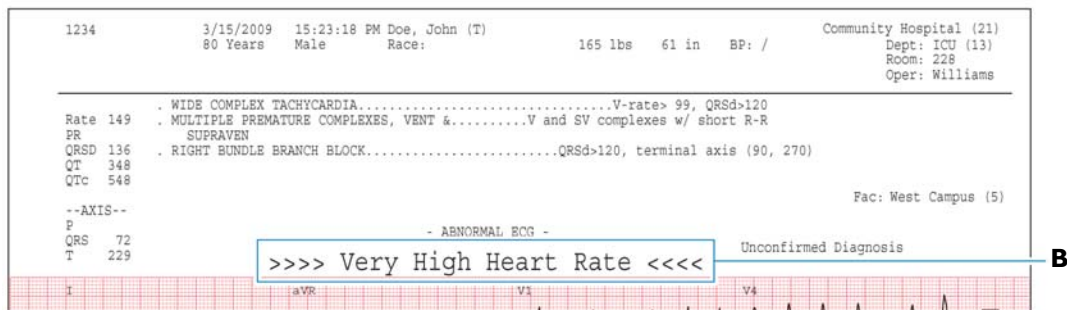

B Very High Heart Rate Statement on ECG Report

Figure 4-6 Complete Heart Block Statement on ECG Report



C Complete Heart Block Statement on ECG Report

Figure 4-7 Acute Ischemia Statement on ECG Report (algorithm version PH100B only)

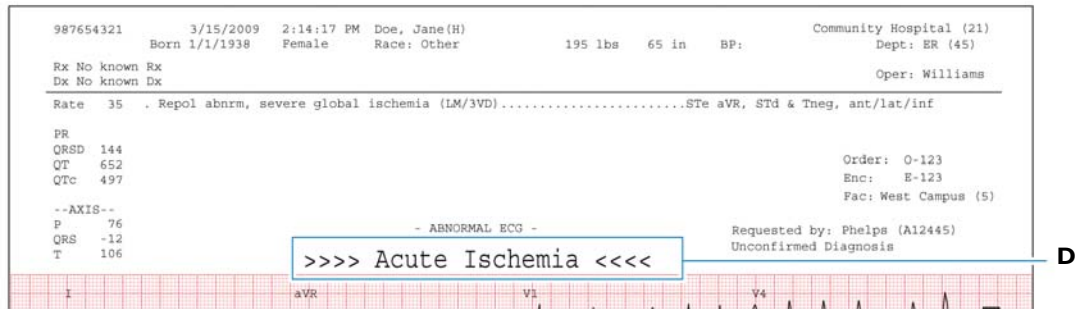

D Acute Ischemia Statement on ECG Report

Basic Measurements

These measurements provide standard interval and duration measurements in milliseconds, and limb lead axis measurements in degrees. These are the values measured from the representative beat pattern in the ECG.

About the Fridericia and Bazett’s Formula Rate-Corrected QT Interval Setting

The Fridericia rate-corrected QT interval setting can be enabled on the acquisition device. The default QT rate correction formula available on the acquisition device is Bazett’s formula. Bazett’s formula is calculated by dividing the QT interval by the square root of the average RR interval (expressed in seconds). The Fridericia rate-corrected QT interval is calculated by dividing the QT interval by the cube root of the average RR interval. Both calculations provide a corrected QT interval that represents the QT interval normalized for a heart rate of 60 beats per minute. For certain clinical situations, the Fridericia corrected QT interval may be preferable over Bazett’s, and this additional measurement may be configured to appear in the measurements section of the printed ECG report.

Figure 4-8 The Bazett's (QTcB) and Fredericia (QTcF) Rate-Corrected QT interval on the printed ECG report

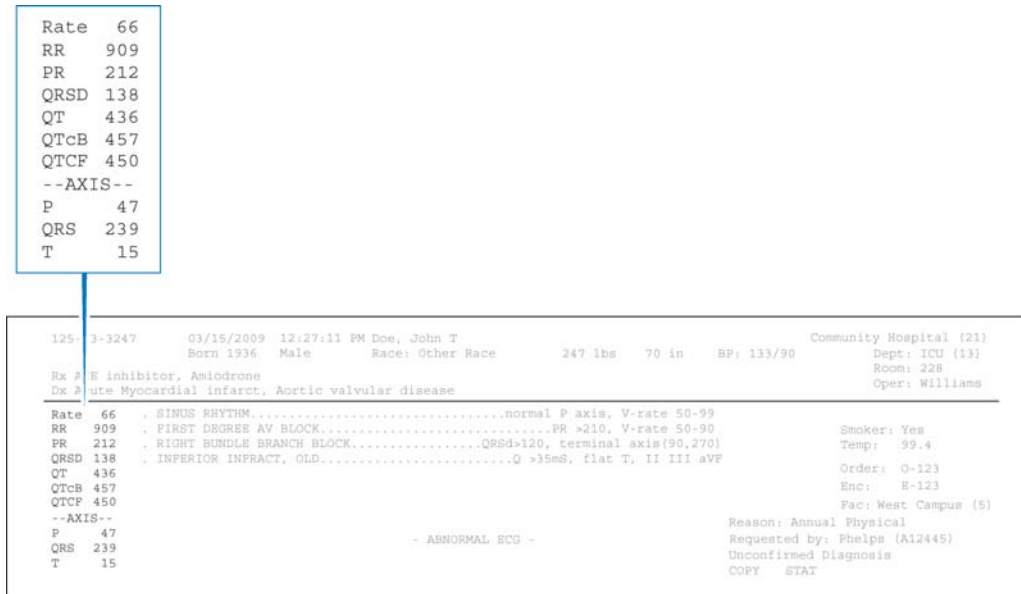

NOTE Some reports do not include the heart rate (RATE) in Basic Measurements, but do include a heart rate above the interpretive statements. This rate may be edited.

Table 4-1 Basic Measurements

Label	Description	Units
RATE	Heart rate	beats per minute
RR	RR interval	milliseconds
PR	PR interval	milliseconds
QRSD	QRS duration	milliseconds
QT	QT interval	milliseconds
QTcB	Bazett's Rate-Corrected QT interval	milliseconds
QTcF	Fridericia Rate-Corrected QT interval	milliseconds
P	Frontal P axis	degrees
QRS	Frontal QRS axis	degrees
T	Frontal T axis	degrees

Patient ID Clinical Information

This area of page one or page two of the ECG report contains clinical patient information that is entered on the patient information entry screen, or that is contained in the order associated with the ECG. This includes information about the patient's Medications (Rx), Diagnoses

(Dx), Symptoms (Sx), History (Hx), and a Diagnosis Related Group (DRG) code. The example below is for informational purposes only.

Figure 4-9 Patient ID Clinical Information on the ECG Report (page one)

Rx ACE inhibitor, Amiodrone
 Dx Acute Myocardial infarct, Aortic valvular disease

125-43-3247	03/15/2009 12:27:11 PM Doe, John T	Community Hospital (21)
Born 1936 Male Race: Other Race	247 lbs 70 in BP: 133/90	Dept: ICU (13)
Rx ACE inhibitor, Amiodrone		Room: 228
Dx Acute Myocardial infarct, Aortic valvular disease		Oper: Williams

Rate 66	. SINUS RHYTHM.....normal P axis, V-rate 50-99	Smoker: Yes
RR 909	. FIRST DEGREE AV BLOCK.....PR >210, V-rate 50-90	Temp: 99.4
PR 212	. RIGHT BUNDLE BRANCH BLOCK.....QRSd>120, terminal axis(90,270)	Order: O-123
QRSD 138	. INFERIOR INFRACT, OLD.....Q >35mS, flat T, II III aVF	Enc: E-123
QT 436		Fac: West Campus (5)
QTcB 457		Reason: Annual Physical
QTcP 450		Requested by: Phelps (A12445)
--AXIS--		Unconfirmed Diagnosis
P 47	- ABNORMAL ECG -	COPY STAT
QRS 239		
T 15		

If more than two Patient ID Clinical Information fields are entered, the third and subsequent fields appear at the top of a second page of the report.

Figure 4-10 Patient ID Clinical Information on the ECG Report (page two)

Sx: Arm Pain, Indigestion
 Hx: Cardiac Arrhythmia, Coronary artery bypass graph
 DRG: 139

125-43-3247	03/15/2009 12:27:11 PM Doe, John T	Community Hospital (21)
Sx: Arm Pain, Indigestion		Order: O-123
Hx: Cardiac Arrhythmia, Coronary artery bypass graph		Enc: E-123
DRG: 139		Page 2 of 2
		Outpatient: Yes

Patient ID Information

This section contains patient identification information. The example below is for informational purposes only.

Figure 4-11 Patient ID Information on the ECG Report

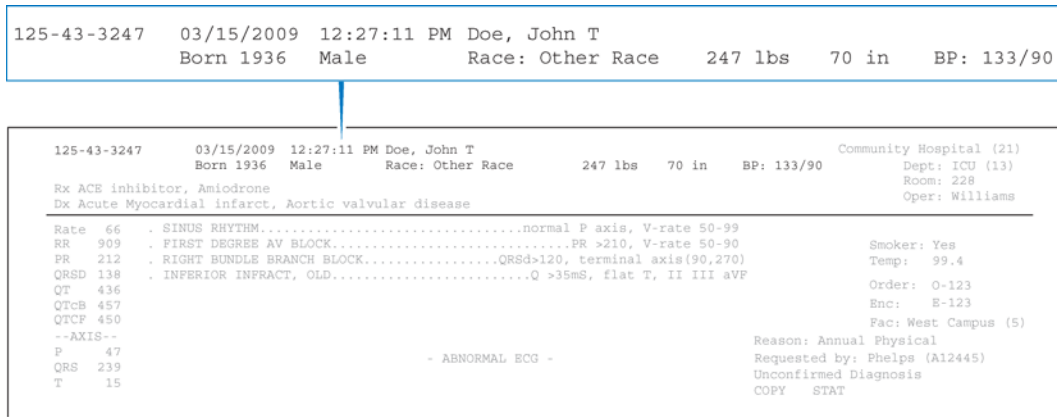

Table 4-2 Patient ID Information

Label	Description
123456789	<ul style="list-style-type: none"> ■ Patient identification number
09/06/2006; 12:27:11 PM	<ul style="list-style-type: none"> ■ Date and time of ECG acquisition ■ Cannot be edited
Doe, John T.	<ul style="list-style-type: none"> ■ Patient name
70 Years	<ul style="list-style-type: none"> ■ Patient age (may be configured to display date of birth)
Male	<ul style="list-style-type: none"> ■ Patient gender
Race	<ul style="list-style-type: none"> ■ Patient ethnicity
247 lbs, 70 in.	<ul style="list-style-type: none"> ■ Patient weight and height
BP: 133/90	<ul style="list-style-type: none"> ■ Patient blood pressure (mm/Hg)

Institution Information

This block of identification information is optional and is fully configurable. The example below is for informational purposes only.

Figure 4-12 Institution Information on the ECG Report

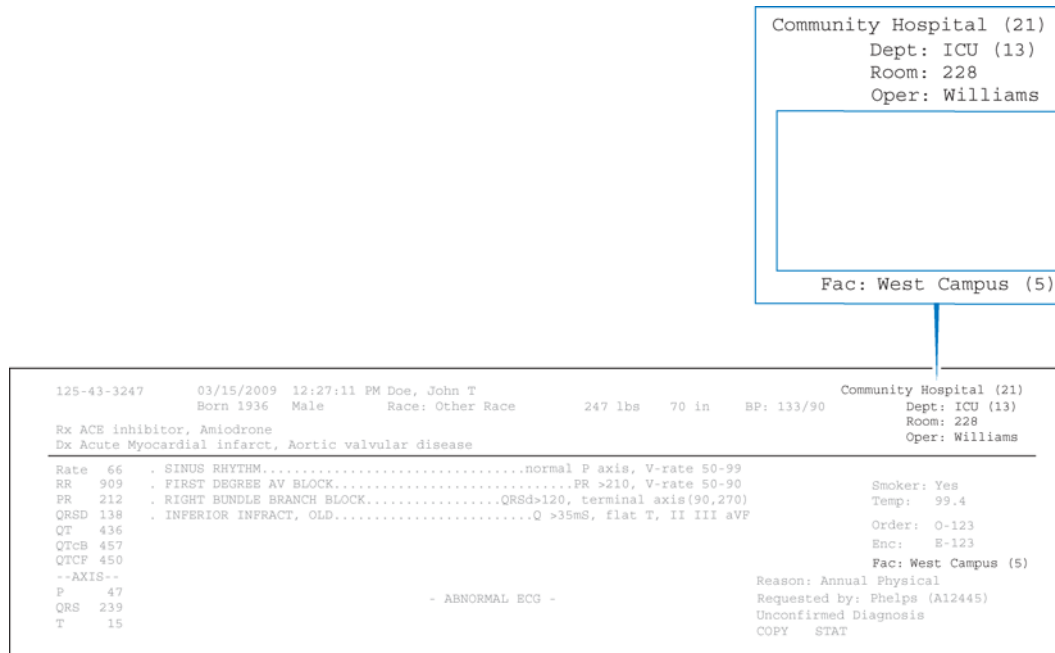

Table 4-3 Institution Information

Label	Description
Community Hospital (21)	■ Name and ID number of institution
Dept: ICU (13)	■ Name and ID number of department
Room: 228	■ Room number of patient or room number where ECG was acquired
Oper: Williams	■ Operator identification
Fac: West Campus (5)	■ Name and ID number of facility or other unit within an institution

Configurable Clinical Information

This information is configurable to fit specific clinical needs. Up to eight configurable clinical information fields may be available for use on the acquisition device.

The first four clinical fields appear on page one of the ECG report. The fifth and subsequent fields appear on page two of the ECG report. The examples below are for informational purposes only.

Figure 4-13 Configurable Clinical Information on the ECG Report (page one)

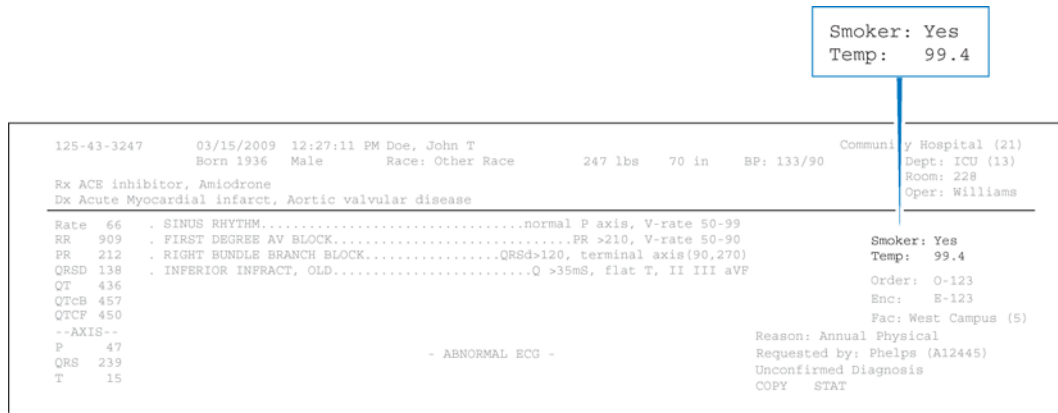

Figure 4-14 Configurable Clinical Information on the ECG Report (page two)



ECG Order Information

This area of the ECG report is optional and fully configurable, and is intended to meet the requirements of an order management system.

Figure 4-15 ECG Order Information on the ECG Report

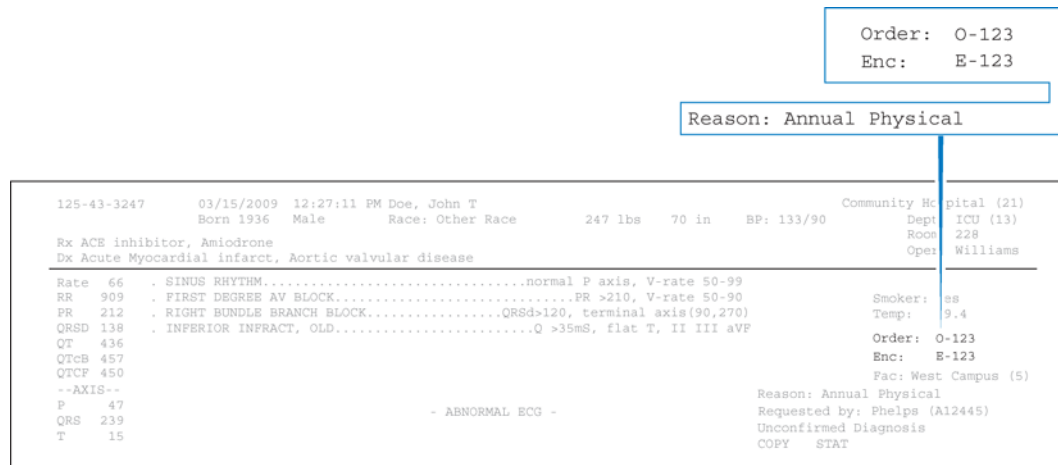

Table 4-4 ECG Order Information

Label	Description
Order: 0-123	<ul style="list-style-type: none"> ■ Institution-defined order number, part of order management system.
Enc: E-123	<ul style="list-style-type: none"> ■ Institution-defined encounter number, part of order management system.
Reason: Annual Physical	<ul style="list-style-type: none"> ■ The reason for acquiring the ECG, may be part of an order management system.

Physician Information

This information block is optional, and contains physician identification information, including the name of the ordering physician, and may include the NPI (National Provider Identifier) number in parenthesis. The NPI is only applicable to providers inside the United States.

Figure 4-16 Physician Information on the ECG report

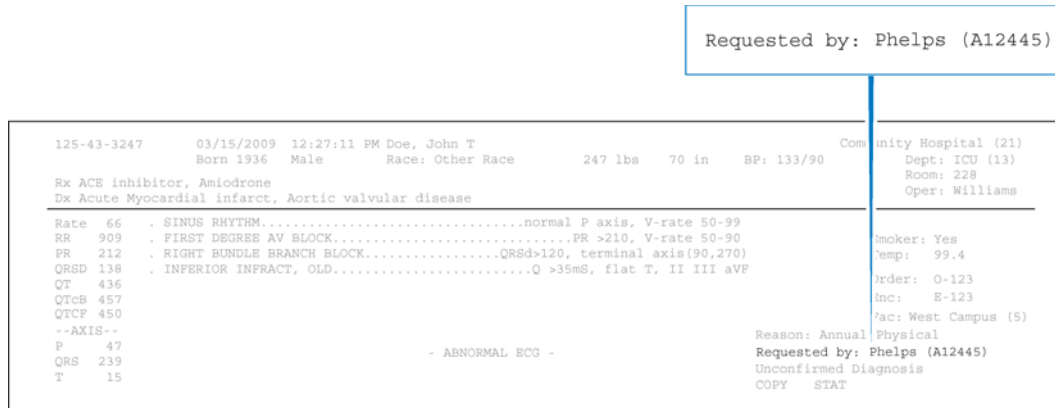

Report Information

Information about the status of the ECG report is included in this section, and may include a statement indicating that the ECG report has not yet been overread by a qualified physician.

Figure 4-17 Report Information on the ECG Report

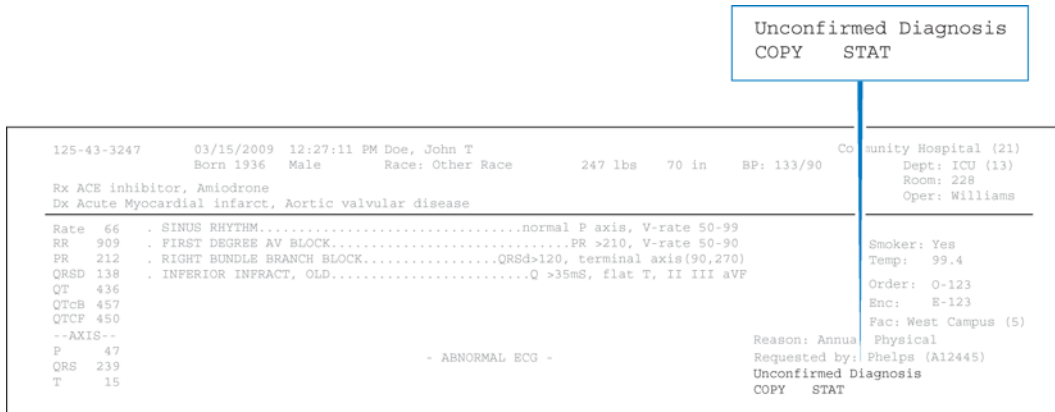

Table 4-5 Report Information

Label	Description
Unconfirmed Diagnosis	<ul style="list-style-type: none"> Indicates that the ECG report has not been overread by a qualified physician. This statement may be customized by an institution.
COPY	The ECG report is a printed copy of an original.

Table 4-5 Report Information (continued)

Label	Description
STAT	The ECG report is designated as STAT.
Non-standard lead gains	<ul style="list-style-type: none"> ■ The limb leads or precordial leads were recorded at a gain other than the standard 10mm/mV. ■ see “Calibration Information” on page 4-13..

Calibration Information

The calibration pulse is the rectangular waveform shown in each line of ECG trace. It shows the hypothetical deflection of the trace in response to a 1 mV calibration pulse applied to the acquisition circuitry.

Figure 4-18 Calibration Pulse on the ECG Report





The shape of the calibration pulse reflects the scaling of the trace.

- If the calibration pulse is square the precordial leads and limb leads were recorded at the same scale.
- If the calibration pulse is stepped the precordial leads were recorded at half the scale of the limb leads.

Table 4-6 Calibration Pulse Shapes

Calibration Pulse Shape	Limb (mm/mV)	Precordial (mm/mV)
	5	5
	5	2.5
	10	10

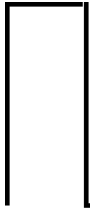
Table 4-6 Calibration Pulse Shapes (continued)

Calibration Pulse Shape	Limb (mm/mV)	Precordial (mm/mV)
	10	5
	20	20
	20	10

NOTE For ECG recordings where the precordial leads or limb leads were recorded at a gain other than 10mm/mV, the statement **Non-standard lead gains** appears in the Report Information section on the printed report.

Figure 4-19 Calibration information on the ECG report

Unconfirmed Diagnosis
COPY STAT Non-Standard lead gains

```

125-43-3247    03/15/2009 12:27:11 PM Doe, John T    Community Hospital (21)
                Born 1936   Male      Race: Other Race    247 lbs  70 in  BP: 133/90    Dept:  U (13)
Rx ACE inhibitor, Amiodrone
Dx Acute Myocardial infarct, Aortic valvular disease
-----
Rate 66 . SINUS RHYTHM.....normal P axis, V-rate 50-99
RR 909 . FIRST DEGREE AV BLOCK.....PR >210, V-rate 50-90    Smoker: Yes
PR 212 . RIGHT BUNDLE BRANCH BLOCK.....QRSd>120, terminal axis(90,270)    Temp: 99.
QRSd 138 . INFERIOR INFRACT, OLD.....Q >35ms, flat T, II III aVF
QT 436
QTcB 457
QTcF 450
--AXIS--
P 47
QRS 239
T 15
                - ABNORMAL ECG -
Reason: Annual Physical
Requested by: Phelps (A12 45)
Unconfirmed Diagnosis
COPY STAT Non-standard lead gains
    
```

Time Separator

The time separator marks indicate whether the ECG data is displayed on the printed ECG report simultaneously or time-sequentially. The data for each lead is always acquired simultaneously.

Figure 4-20 Simultaneous time separator on ECG report



The double line indicates that the ECG data for each lead is displayed simultaneously. The starting point of each lead is the same time even though they may appear to start at different times on the printed ECG report.

Figure 4-21 Time sequential separator on ECG report

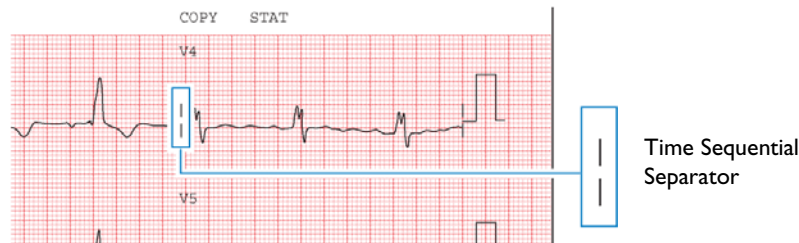

The single line indicates that the ECG data for each lead is displayed over a continuous period of time. For example, on a 3x4 grid all signals start at 0 in the first column, 2.5 seconds in the second column, 5.0 seconds in the third column, and 7.5 seconds in the fourth column.

Pacing Detection Settings

This area of the report contains information about the pacing detection settings that were selected when the ECG report was printed.

Pacemaker pulses that are detected by the acquisition device are marked on the ECG report with small vertical tick marks. These marks enable the overreader to identify false pacemaker pulse detections, or if true pulses are not being detected.

Figure 4-22 Pacing Detection Setting on the ECG report

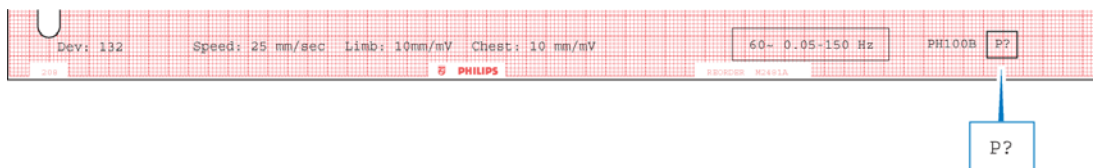

The table below describes the possible Pacing Detection Settings available on the acquisition device, along with the setting code that appears on the printed ECG report.

Table 4-7 Pacing Detection Settings

Setting	Description	ECG Report Code
Paced Unknown	<ul style="list-style-type: none"> ■ This is the default setting and normally is used for both paced and non-paced patients. ■ Pacemaker pulse detection is on and is at normal sensitivity. ■ Occasional false pacemaker pulse detections may occur in ECGs with excessive noise. ■ False detections may result in an incorrect interpretive statement appearing on the report. ■ Small amplitude pacemaker pulses may not be detected using this setting. 	P?
Non-paced	<ul style="list-style-type: none"> ■ Pacemaker pulse detection is off. ■ Use this setting if there are false pacemaker pulse detections from noise, or if incorrect interpretive statements or inappropriate paced ECG complexes appear on the report. 	<ul style="list-style-type: none"> ■ No code appears on the ECG report if the Non-paced setting is selected.
Paced	<ul style="list-style-type: none"> ■ Pacemaker pulse detection is on and is set at a higher sensitivity. ■ Use this setting if small amplitude pacemaker pulses are not being detected at the default (Not Known if Paced) setting. ■ False pacemaker pulse detections may occur if the ECG is noisy. 	P

Table 4-7 Pacing Detection Settings (continued)

Setting	Description	ECG Report Code
Paced (magnet)	<ul style="list-style-type: none"> ■ Use this setting if the ECG is acquired with an active pacemaker magnet or programmer in place. ■ Pacemaker pulse detection is on and is at a higher sensitivity. ■ Magnets or programmers often put the pacemaker in a fixed-rate, non-sensing mode. ■ The statement ECG ACQUIRED WITH MAGNET IN PLACE is printed on the ECG report. This statement notifies the overreader that a magnet or programmer was used and would explain the fixed rate behavior of the pacer. 	PM

Algorithm Version Number

The algorithm version number is printed at the bottom of the ECG Report. The algorithm version number appears as either **PH090A** (Philips 12-Lead Algorithm), or as **PH100B** (Philips DXL ECG Algorithm). A Critical Values (**C**), or lead reversal detection symbol (**L?**) can also appear in this area of the ECG report if these optional features are enabled.

Figure 4-23 Algorithm Version Information on ECG report

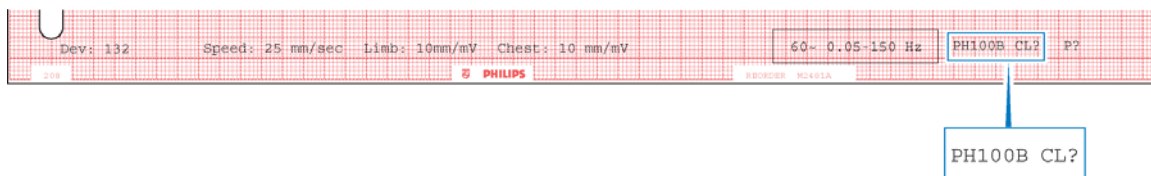

Table 4-8 Algorithm Version Information

Label	Description
PH100B or PH090A	<ul style="list-style-type: none"> ■ PH refers to Philips ■ 09 or 10 refers to the version of the measurement program ■ 0A or 0B refers to the criteria version installed on the cardiograph
C	<ul style="list-style-type: none"> ■ This symbol appears on the report if the optional Critical Values feature is enabled on the cardiograph

Table 4-8 Algorithm Version Information(continued)

Label	Description
L?	<ul style="list-style-type: none"> ■ This symbol may appear with the algorithm version number ■ If this symbol appears, it designates that the optional lead reversal detection feature is enabled on the cardiograph, and that the cardiograph detected a lead reversal that the operator overrode when printing the ECG

Filter Settings

The filter settings applied to the ECG report are displayed in filter information box that is located at the bottom of the ECG report. These filters are used to optimize the displayed or printed ECG waveform.

With the exception of the AC filter, which is highly selective, there is trade off between fidelity and clarity of the ECG trace when a filter is applied. The more filtering that is applied, the greater the possibility of removing ECG signal details.

NOTE While all filters affect displayed and printed ECGs, the interpretive algorithms always receive, store, and analyze data at 0.05 to 150 Hz.

Figure 4-24 Filter Information Box on the Printed ECG Report

Artifact Filter

The Artifact filter removes skeletal muscle artifact. This noise source is the most difficult to eliminate because it possesses the same frequencies as legitimate ECG signals. While this filter eliminates skeletal muscle artifact, it also reduces all high frequency components of the ECG. This effect may make it impossible to detect pacemaker pulses, can cause visual underestimation of signal amplitudes, and can also render QRS notching invisible.

The filter removes up to 50 μ V of signals in the 5 Hz to 150 Hz frequency range. This may affect P waves and the entire QRS-T complex.

Use the Artifact filter *only* for ECGs that would be unreadable due to significant levels of muscle artifact. Using the filter should provide at least rhythm information, although paced pulses may only be evident by looking at the markers that are produced on the ECG reports.

When the Artifact filter is used, the **F** symbol is included in the filter information box at the lower right corner of the printed ECG report.

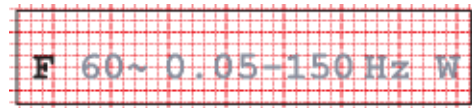
Figure 4-25 Artifact Filter Symbol on Printed ECG Report

AC Filter

The AC filter removes interference created by the magnetic fields associated with electrical power interacting with the lead wires. The frequency of the AC interference is stable at 60 or 50 Hz. The AC filter removes the AC noise and leaves the ECG signal intact. The line frequency of 60 or 50 Hz is selected during the configuration of the acquisition device.

When the AC filter is used, the AC filter symbol is included in the filter information box at the lower right corner of the printed ECG report.

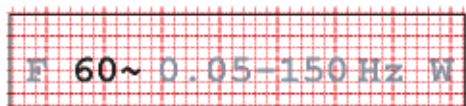
Figure 4-26 AC Filter Symbol on Printed ECG Report

Frequency Response Filters

These filters suppress frequencies at the high and low ends of the ECG signal spectrum. The available low frequency response filter settings are 40, 100, and 150 Hz.

In 1989, the American Heart Association recommended that frequencies up to 125 Hz be recorded for adult ECGs, and that frequencies up to 150 Hz be recorded for pediatric ECGs¹.

Changing the low-pass frequency filter to 40 or 100 Hz permits frequencies below these values to remain in the report and results in a smoother-looking ECG waveform, but eliminates some fine detail in the signal. Small deflections, notches, and slurs may be distorted or may disappear if one of these filters is applied.

The high-pass frequency response filter settings are 0.05, 0.15, and 0.5 Hz. Using this filter permits frequencies above the selected value to appear in the ECG report. That is, this filter suppress frequencies below the selected value.

NOTE When the baseline wander filter is enabled, the high-frequency response filter is automatically set to 0.5. It is recommended that the 0.15 high frequency response filter setting be used for all other ECGs.

The frequency response of the ECG is included in the filter information box at the lower right corner of the printed ECG. The interpretive algorithms always use 0.05 to 150 Hz bandwidth for maximum fidelity. The maximum fidelity waveform is always stored in the permanent record.

1. Bailey JJ, Berson AS, Garson A, Horan LG, Macfarlane PW, Mortara DW, Zywietsz C. "Recommendations for Standardization and Specifications in Automated Electrocardiography: Bandwidth and Digital Signal Processing." *Circulation* 81:730-739 (1990).

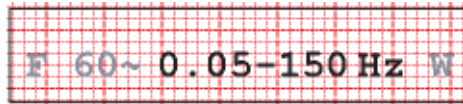
Figure 4-27 Frequency Response Filter on the ECG Report

Baseline Wander Filter

Baseline wander is the slow (typically 0.1 – 0.2 Hz) drifting of the ECG baseline up or down during ECG recording. Baseline wander may result from patient respiration or from other sources. Severe baseline wander may make it difficult to determine the true wave shapes in the ECG.

Effective baseline wander suppression techniques do not distort the ST segment. While the highest frequency response limit of 0.05 Hz (recommended for normal use) eliminates baseline wander from most ECGs, additional suppression may be required. Enabling the baseline wander filter suppresses all frequencies below 0.5.

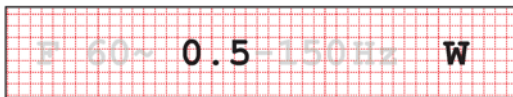
Figure 4-28 Baseline Wander Filter on the ECG Report

NOTE If contour analysis is important in Rhythm mode, use the 0.05 Hz Rhythm high-pass frequency response setting that minimizes the ST segment distortion. Rhythm characteristics of the ECG are accurately recorded, regardless of the low-pass frequency setting in Rhythm mode.

Speed and Sensitivity Settings

This area contains information about the speed and sensitivity settings that were used for the ECG recording.

Figure 4-29 Speed and Sensitivity Settings on the ECG Report

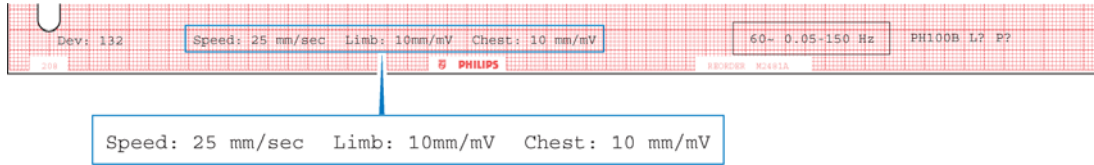

Table 4-9 Speed and Sensitivity Settings

Label	Description
Speed	<ul style="list-style-type: none"> ■ The speed at which the ECG was printed ■ Available settings: <ul style="list-style-type: none"> – 25mm/sec – 50 mm/sec
Limb	<ul style="list-style-type: none"> ■ The limb lead sensitivity setting ■ Available settings: <ul style="list-style-type: none"> – 5, 10, or 20 mm/mV
Chest	<ul style="list-style-type: none"> ■ Precordial lead sensitivity setting ■ Available settings: <ul style="list-style-type: none"> – 2.5, 5, 10, or 20 mm/mV

NOTE For ECG recordings where the precordial leads or limb leads were recorded at a gain other than 10mm/mV, the statement **Non-standard lead gains** appears in the Report Information section on the printed report.

Device Identification Number

This identification number may be entered at the acquisition device. This number is used to identify the individual device that acquired the ECG.

Figure 4-30 Device ID on the ECG Report

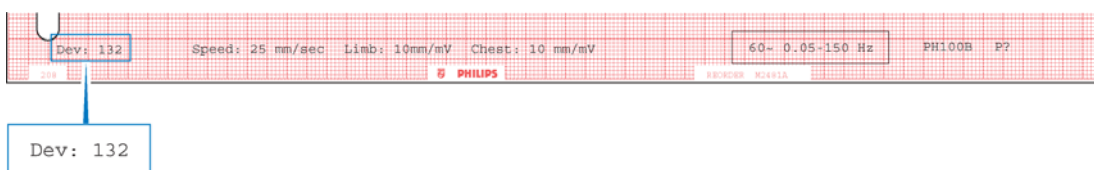

12-Lead ECG Report Examples

The following section includes examples of other 12-lead ECG formats.

- 3x4, 1R report with Standard Leads
- 3x4, 1R report with Cabrera Leads
- 6x2 report (5-second waveform segments) with Cabrera Leads
- 12x1 report with Cabrera Leads. The 12x1 report shows 10 seconds of continuous waveform data for 12 leads and includes a second page with interpretive, reason, and severity statements (if configured).
- Panoramic (Pan-12) report with Cabrera Leads. The Pan-12 report shows a one-second representative complex for each Cabrera Lead and three pre-selected rhythm strips at the bottom (aVF, V2, V5).

Figure 4-31 3x4, 1R Report with Standard Leads

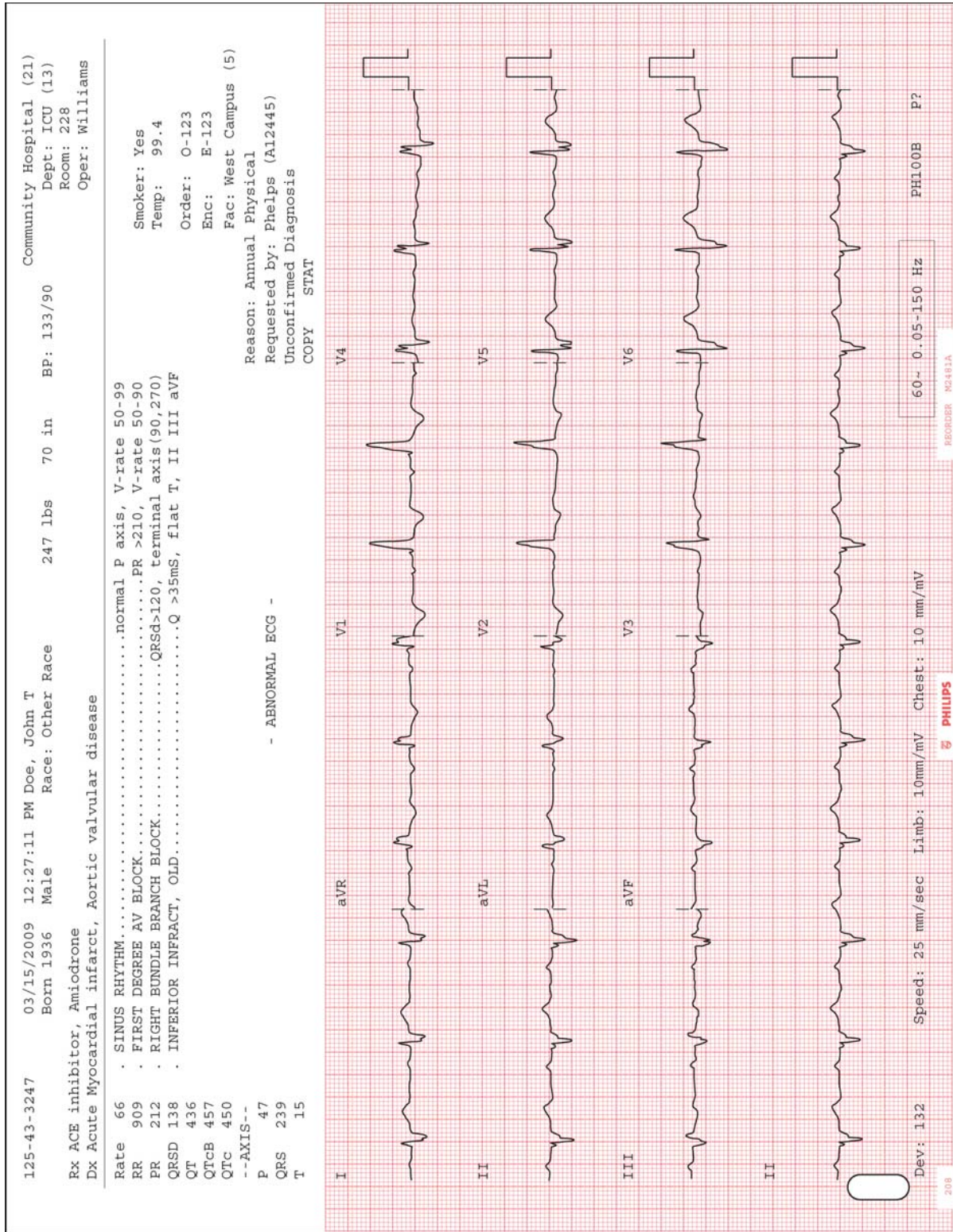

Figure 4-32 3x4, 1R Report with Cabrera Leads and Simultaneous Acquisition

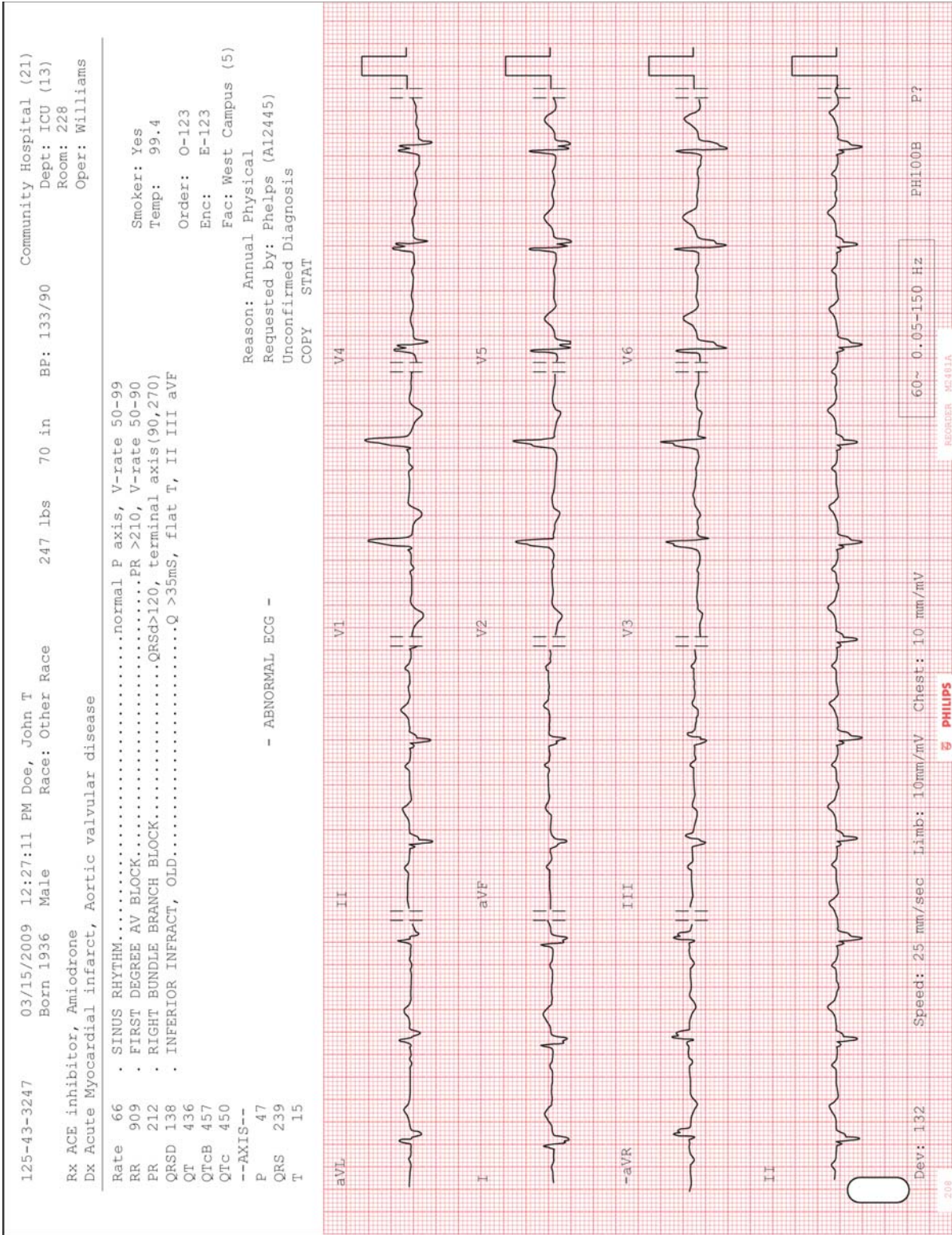

Figure 4-33 6x2 Report with Cabrera Leads

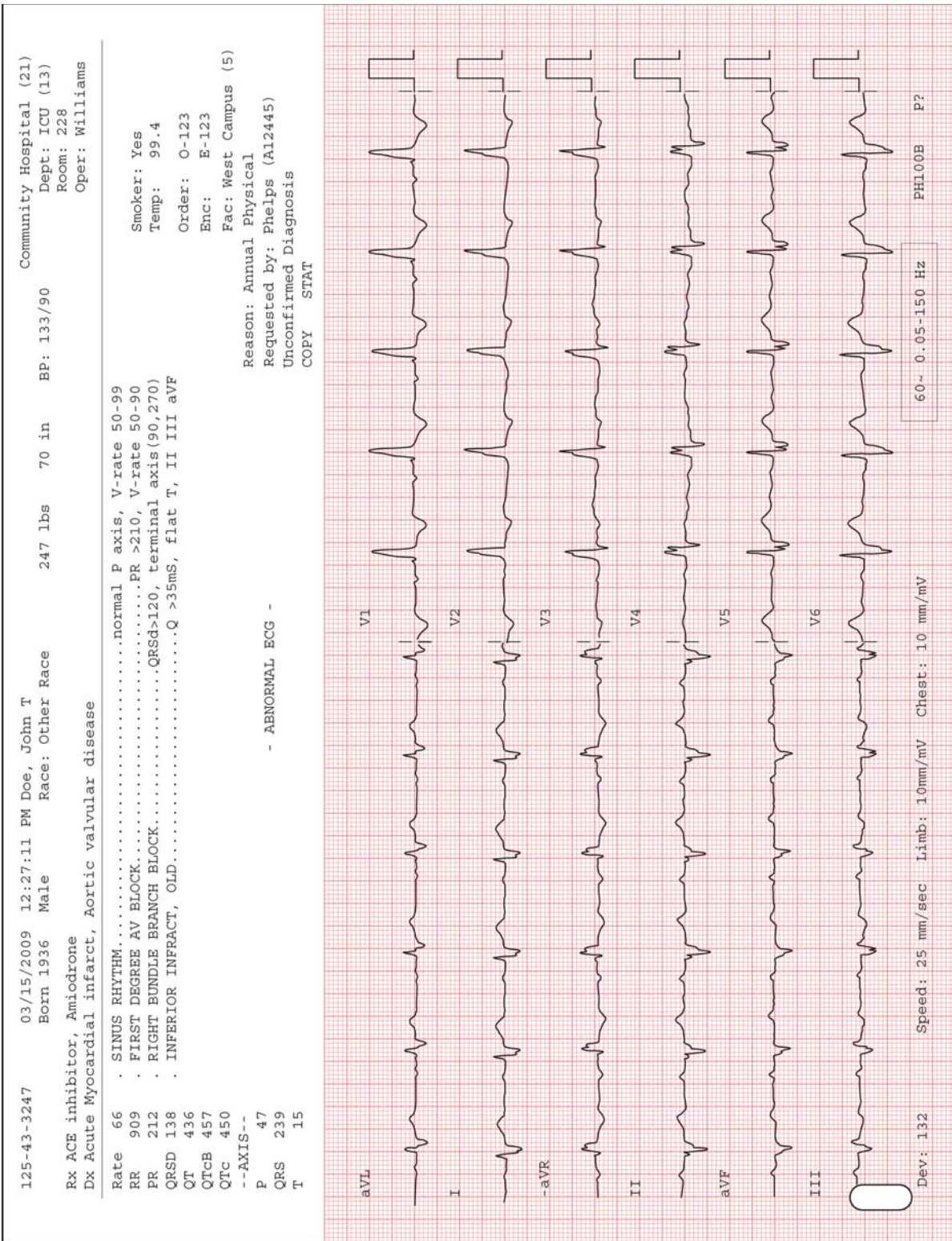

Figure 4-34 12x1 Report with Cabrera Leads (page one)

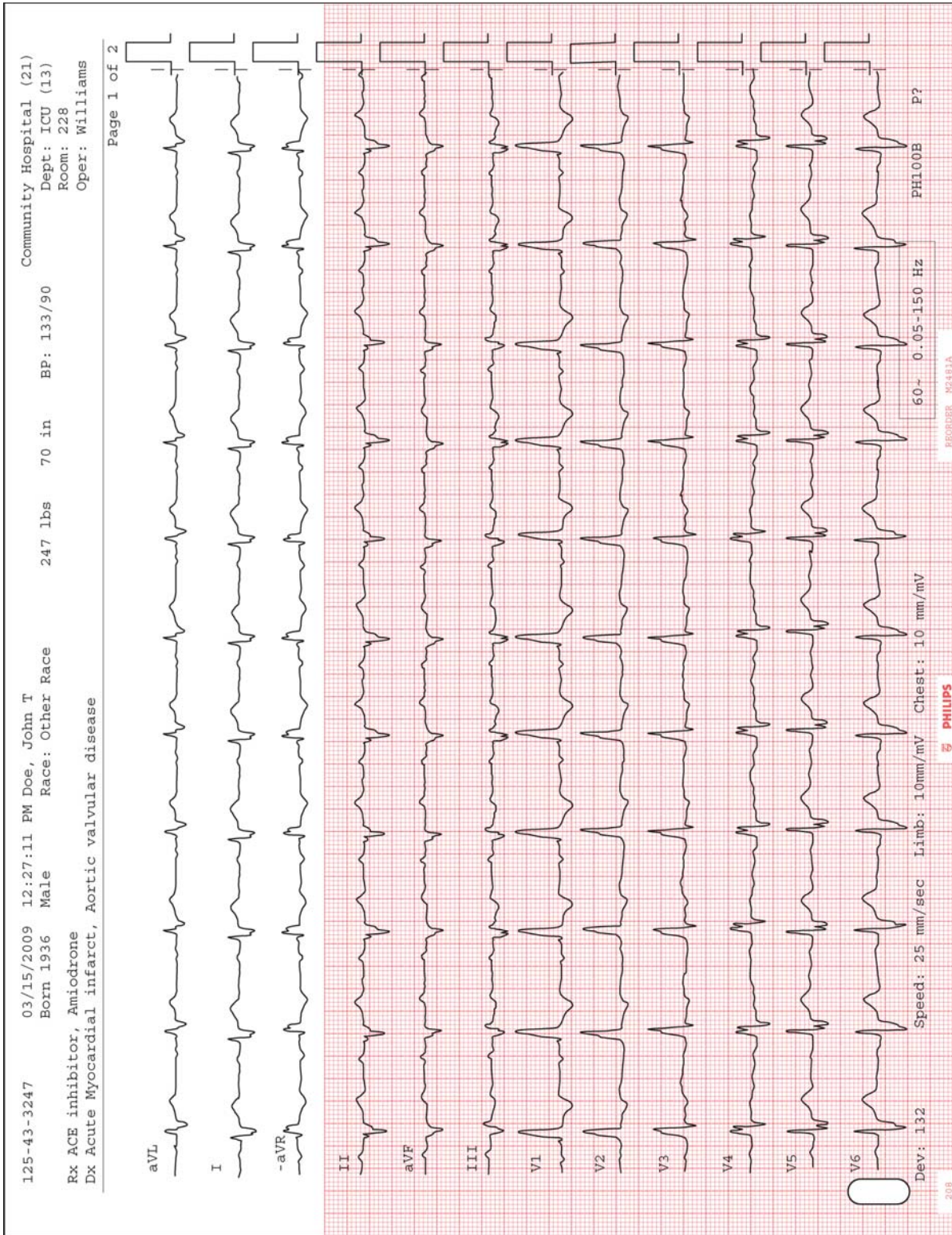

Figure 4-35 12x1 Report with Cabrera Leads (page two)

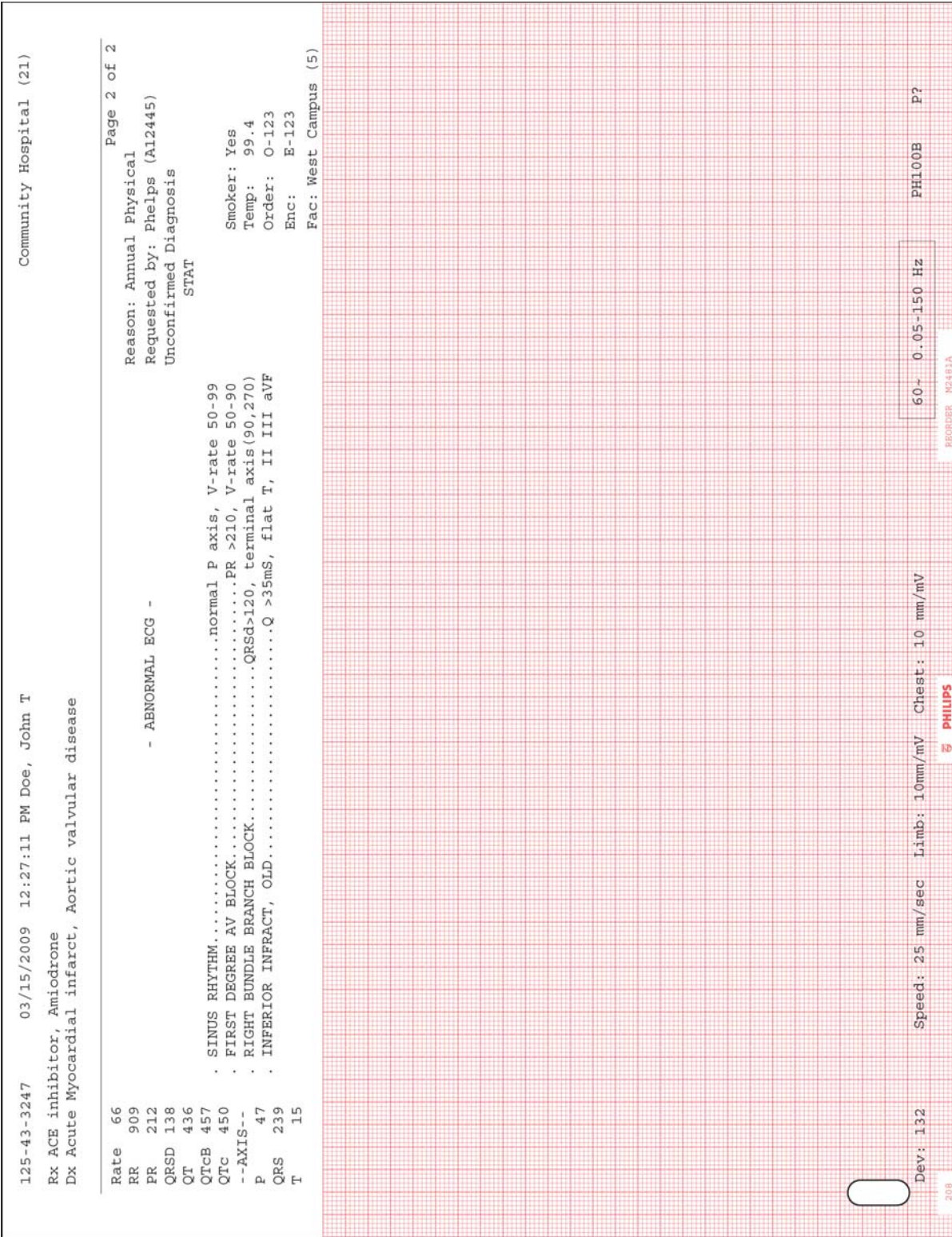
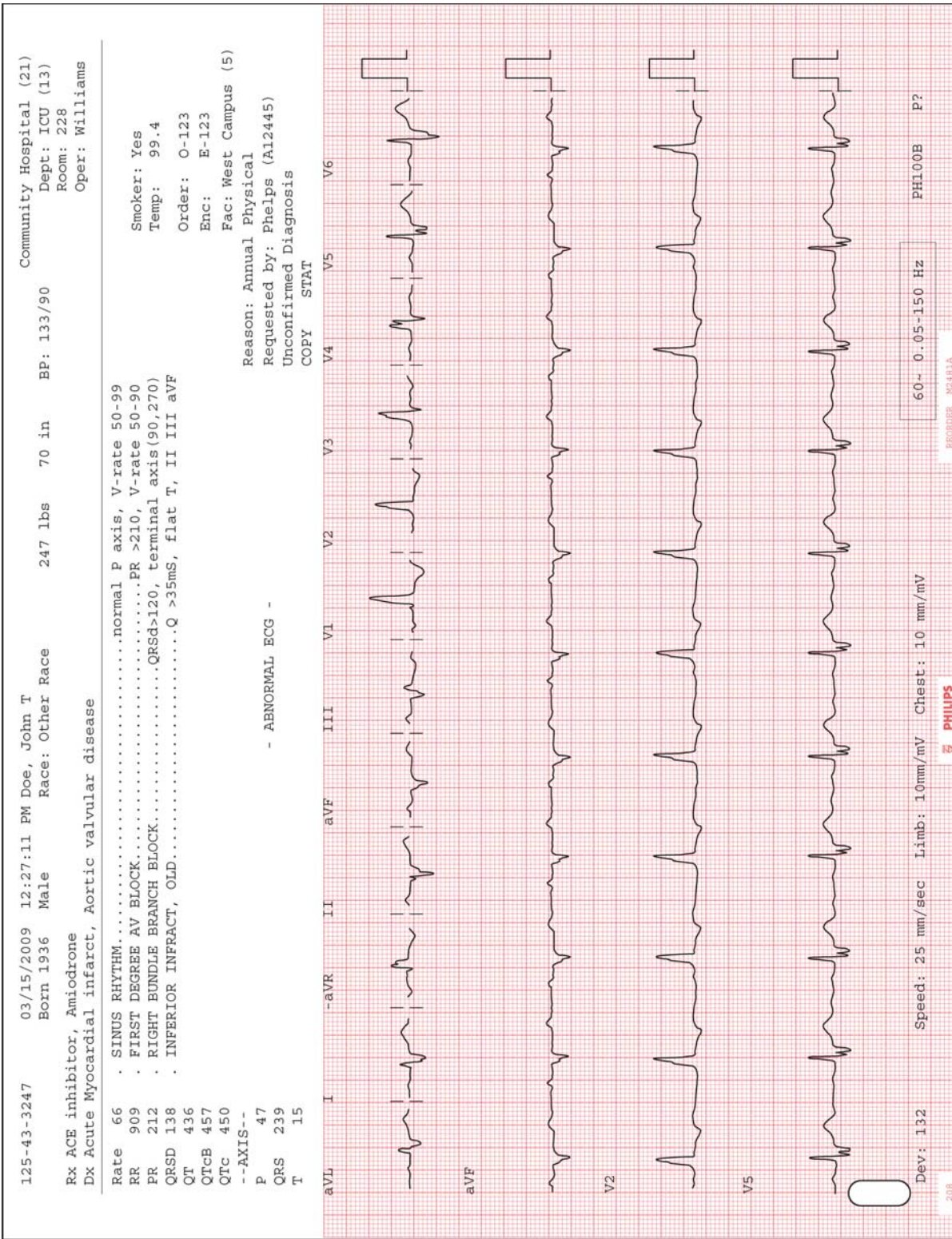

Figure 4-36 Panoramic (Pan-12) Report



NOTE Leads are displayed in Cabrera sequence on the Panoramic (Pan-12) Report regardless of the selected lead standard on the acquisition device.

15 and 16-Lead ECG Report Examples

The following section provides examples of 15 and 16-lead format ECG report formats available on the cardiograph including:

- Pediatric 3x5, 1R report with Standard Leads
- Pediatric 3x5, 3R report with Standard Leads
- Balanced 4x4, 1R report with Standard Leads
- Adult Posterior 3x5 3R report with Standard Leads

Figure 4-37 Pediatric 3x5, 1R Report with Standard Leads

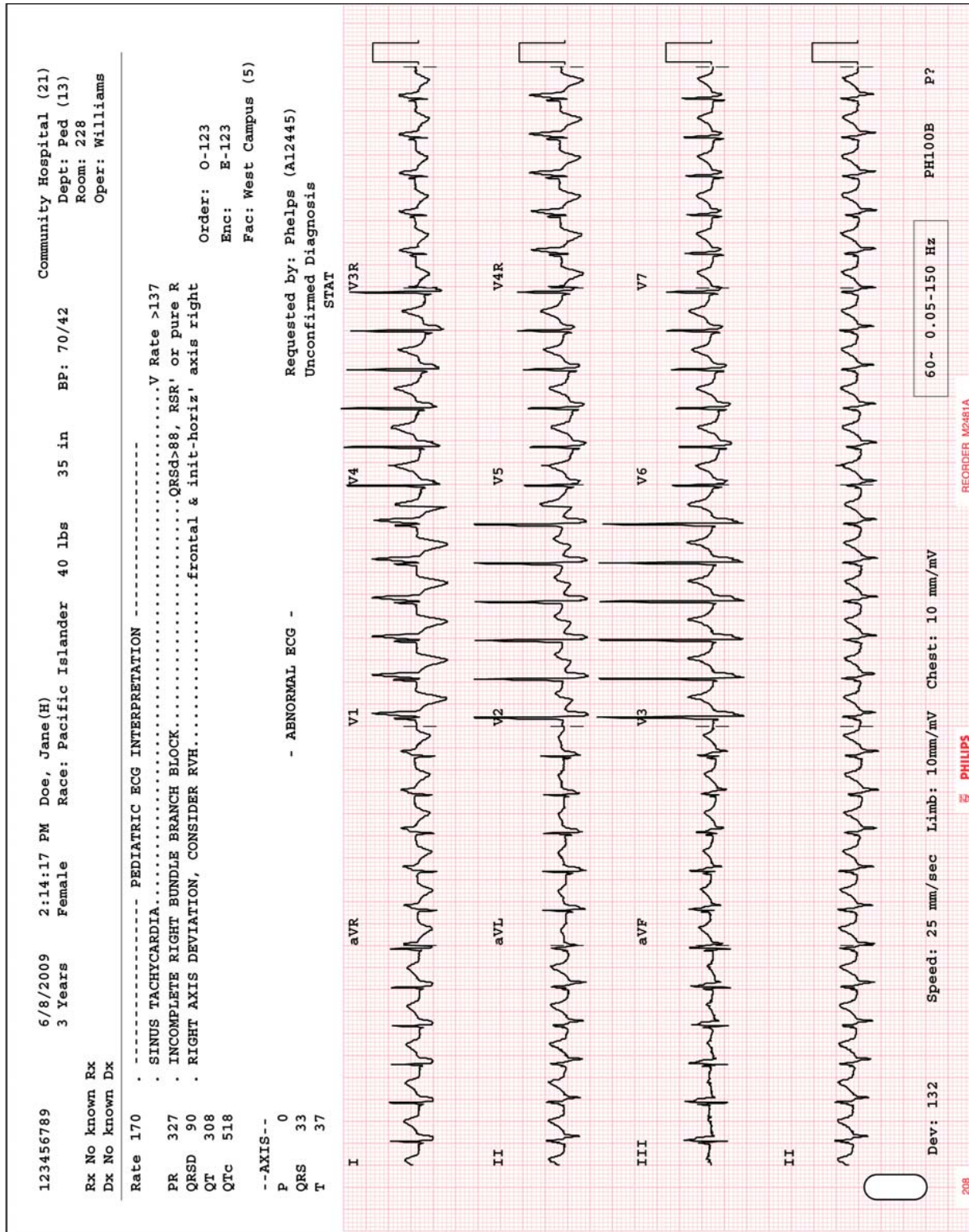

Figure 4-38 Pediatric 3x5, 3R Report with Standard Leads

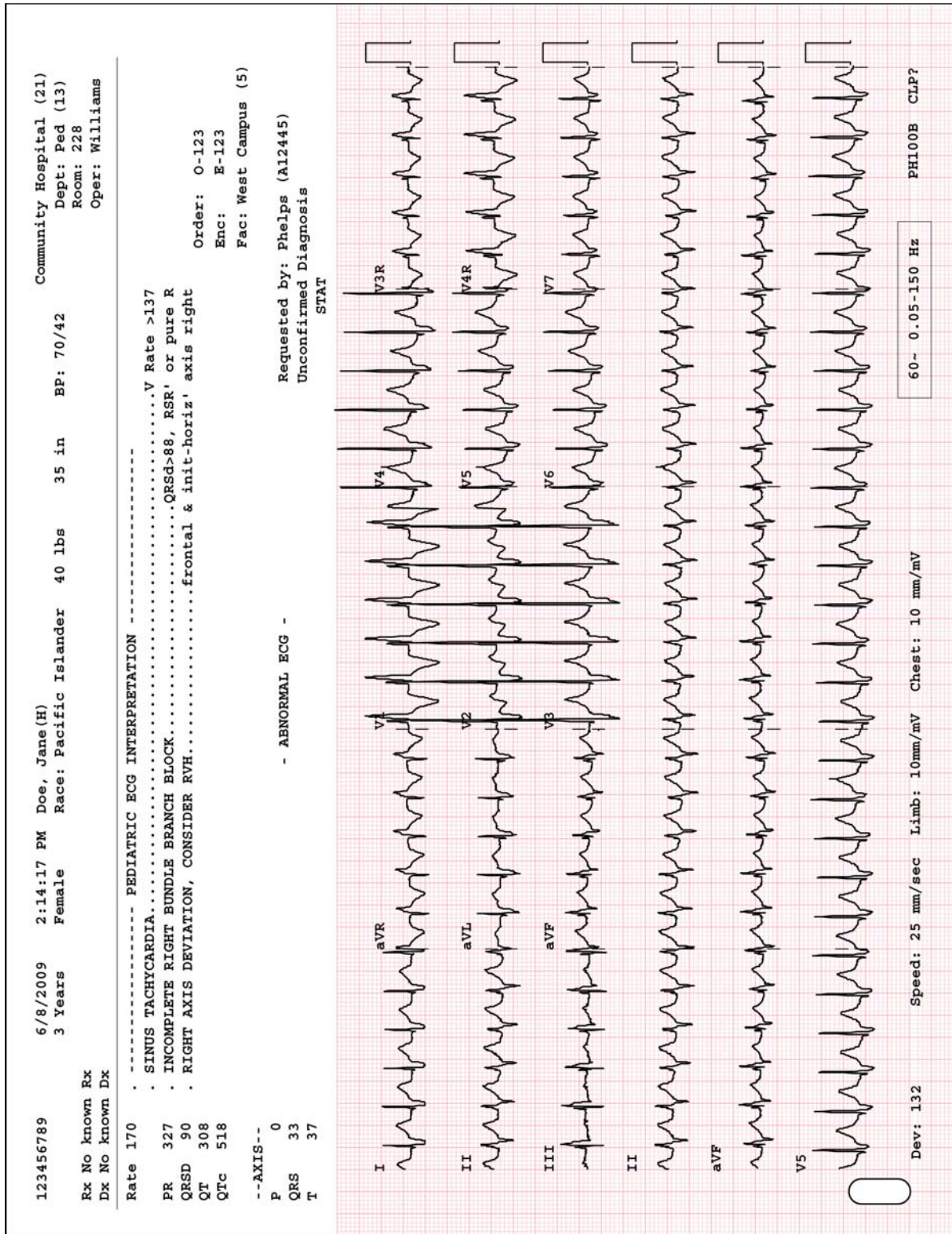

Figure 4-39 Adult Balanced 4x4, 1R with Standard Leads

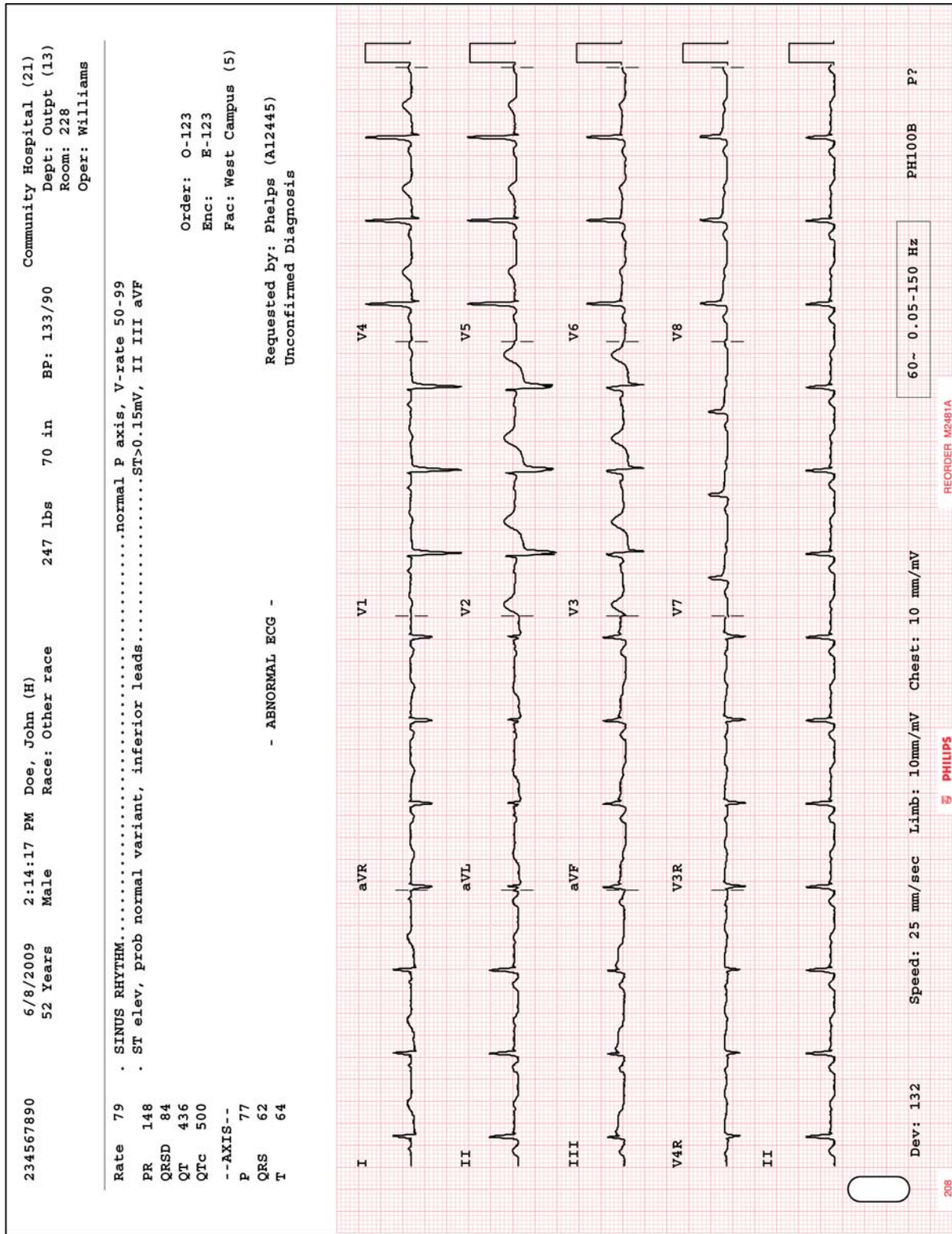
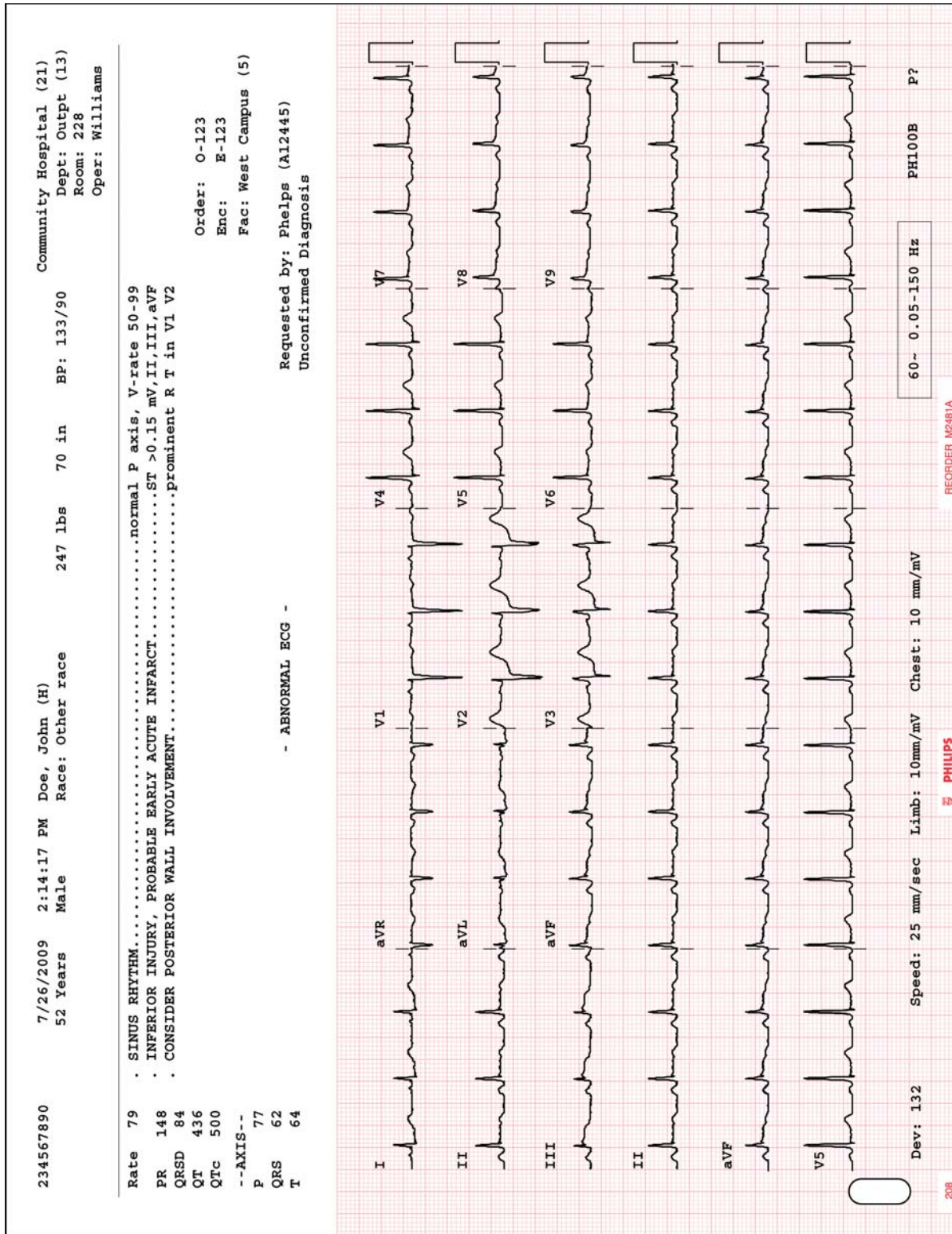

Figure 4-40 Adult Posterior 3x5, 3R Report with Standard Leads



ST Map Reports

ST Map reports are available for both 12 leads, and for optional 15 and 16 leads. The ST Map displays the ST values for each of the leads as derived by the interpretive algorithm (either version PH090A or version PH100B). These ST values enable the clinician to accurately detect ST elevation or ST depression, and also allow the clinician to identify the anatomical location of the ST elevation or depression. The ST segment is the portion of the ECG tracing that can indicate myocardial ischemia.

These ST values are shown graphically in two separate diagrams, or “maps.” The first diagram depicts ST values for the limb leads, and the second diagram depicts the ST values for the chest leads. Each of these diagrams depict a multi-axis orthogonal plane, and each individual axis within this plane represents the ST value at the J point for an individual lead.

12-Lead ST Map Reports

For Standard 12 leads, two ST-related reports are provided. The 3x4 1R 10ST report displays three rows of four 2.5-second waveform segments, with 1 ten-second rhythm strip and the ST Maps at the bottom of the report. The 3x4 1R 8ST report displays three rows of four 2-second waveform segments, with 1 eight-second rhythm strip at the bottom, and the ST Maps at the right side of the report.

NOTE For the 3x4 1R 8ST report, if the ST value of a lead exceeds $\pm 0.30\text{mV}$, the value displayed for leads in the ST Map will not exceed $\pm 0.30\text{mV}$, regardless of their actual value.

Extended Lead ST Map Reports

For 15 leads, the 3x5 1R ST report displays three rows of five 2-second waveform segments, with 1 ten-second rhythm strip and the ST Maps at the bottom of the report.

For 16 leads, the 4x4 1R ST report displays four rows of 2.5 second waveform segments with 1 eight-second rhythm strip at the bottom, and the ST Maps at the right side of the report.

NOTE Extended leads are not included in the ST Map, however, the lead values for all extended leads are listed next to, or underneath the ST Map.

Figure 4-41 3x4 1R 8ST Report

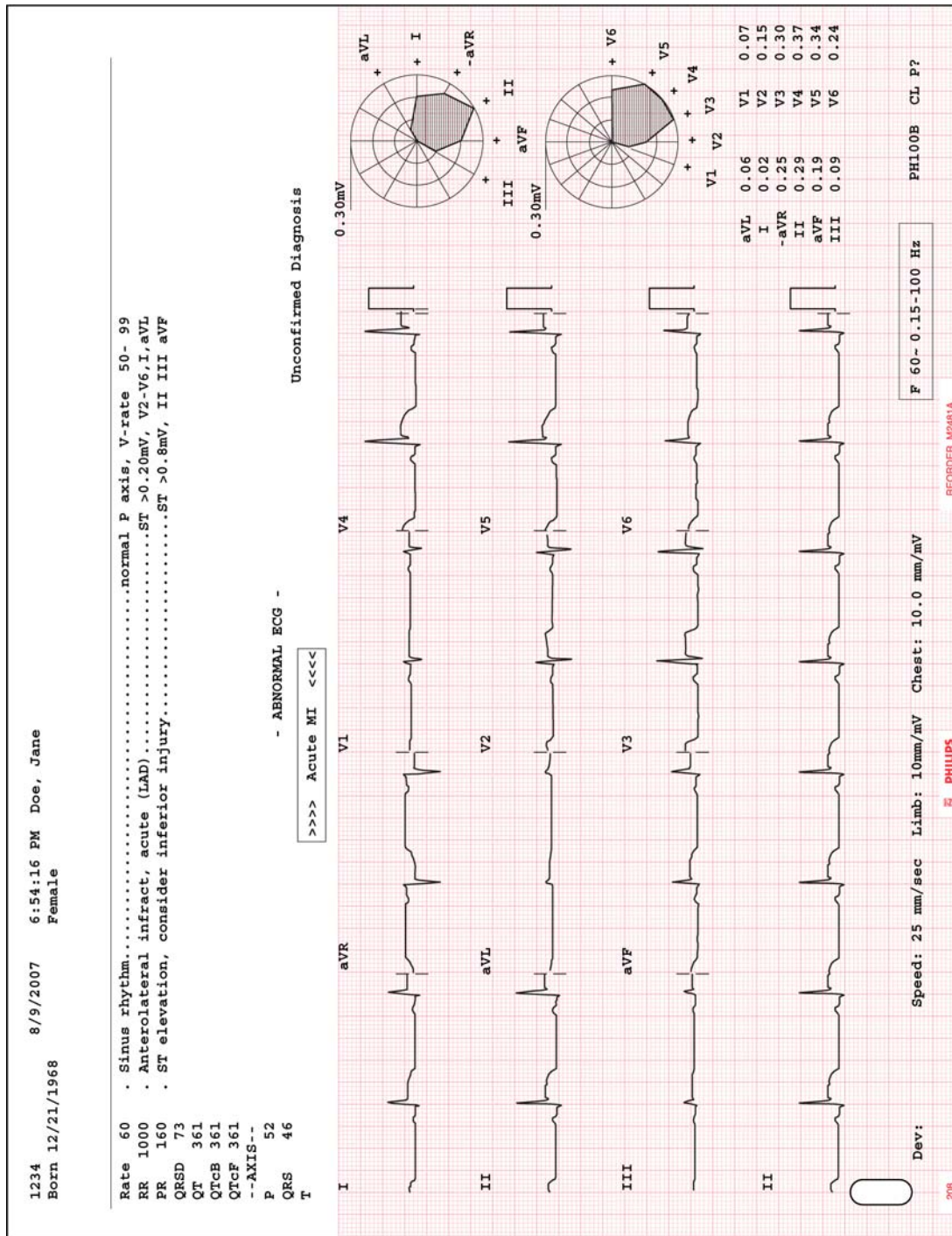

Figure 4-42 3x4 1R 10ST Report

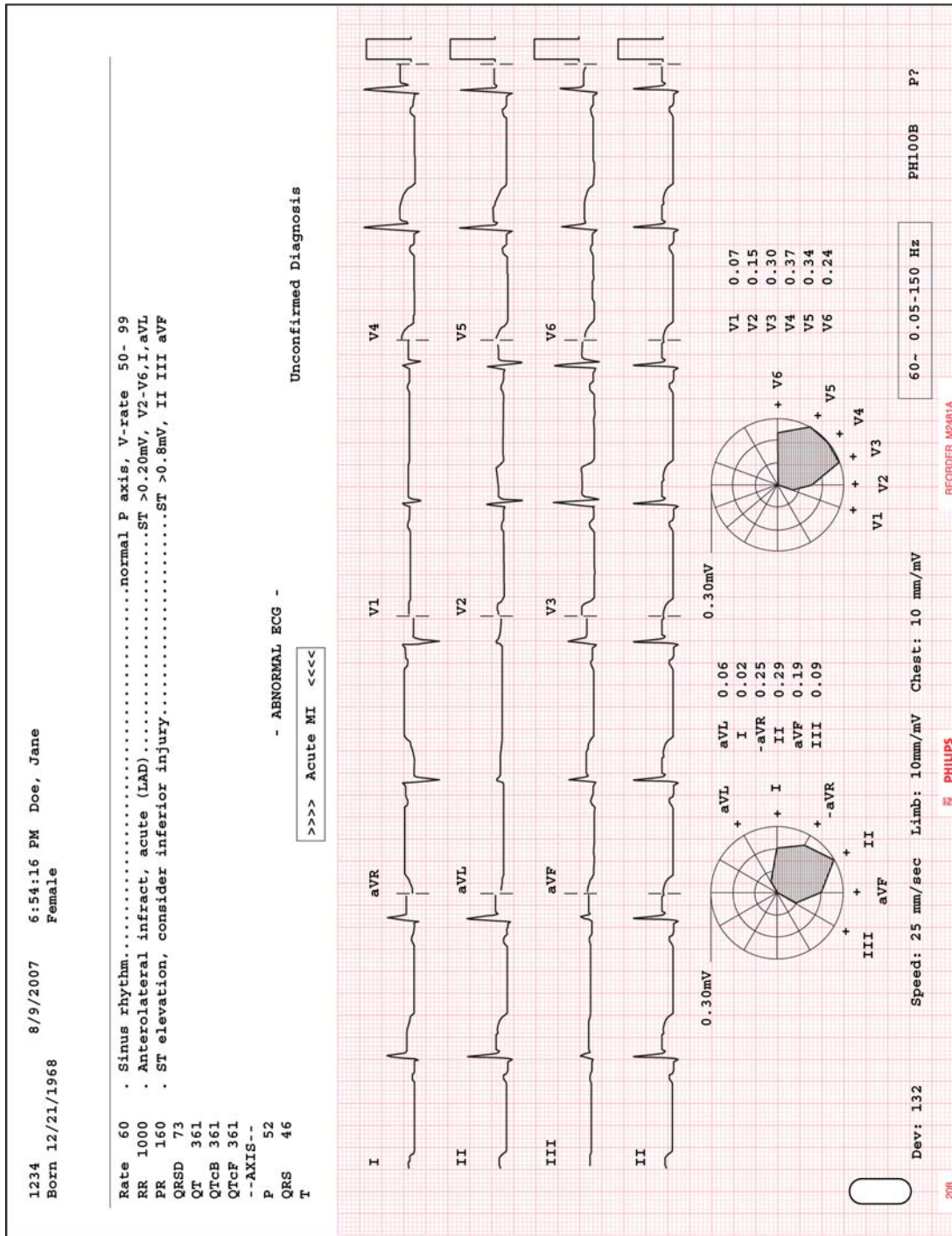

Figure 4-43 3x5 1R ST Report

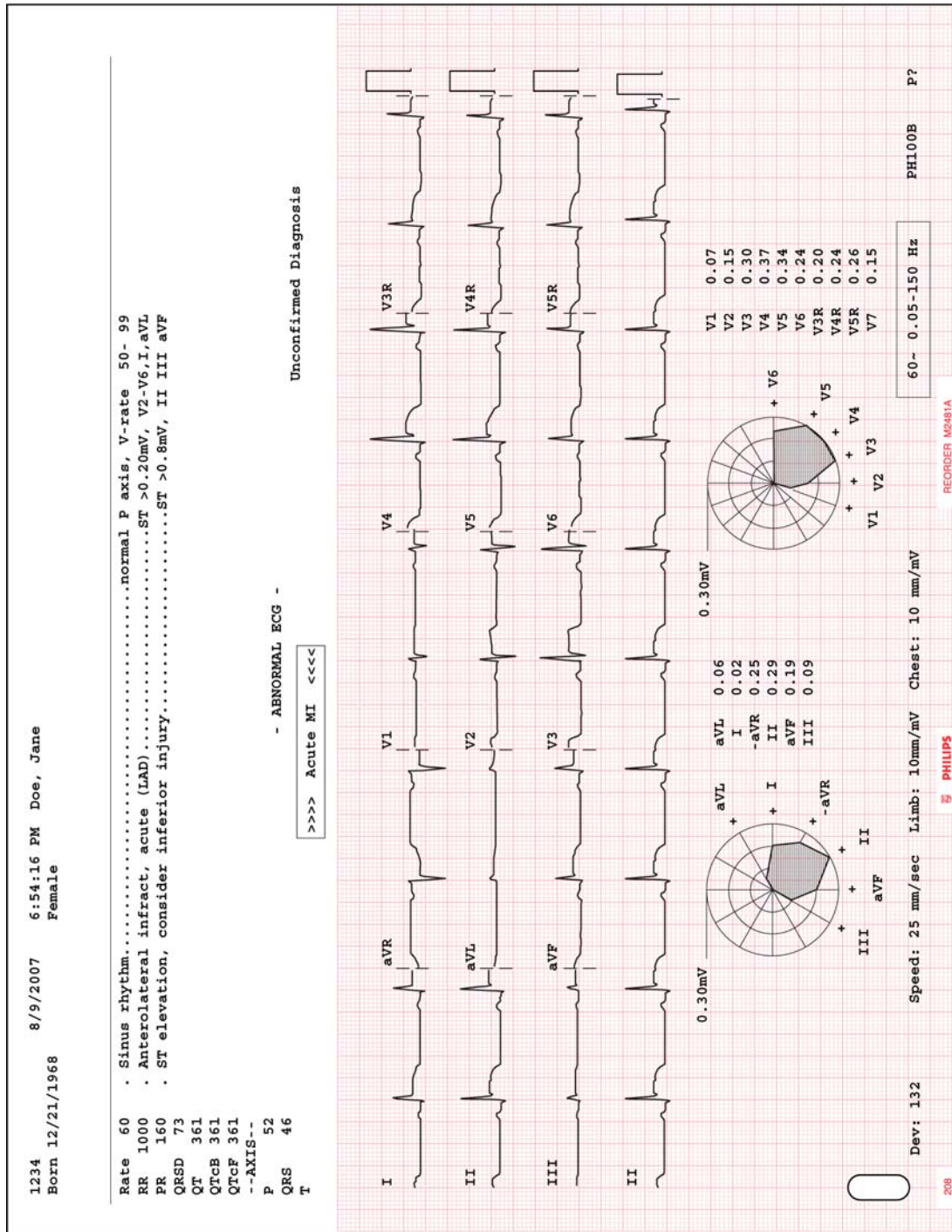
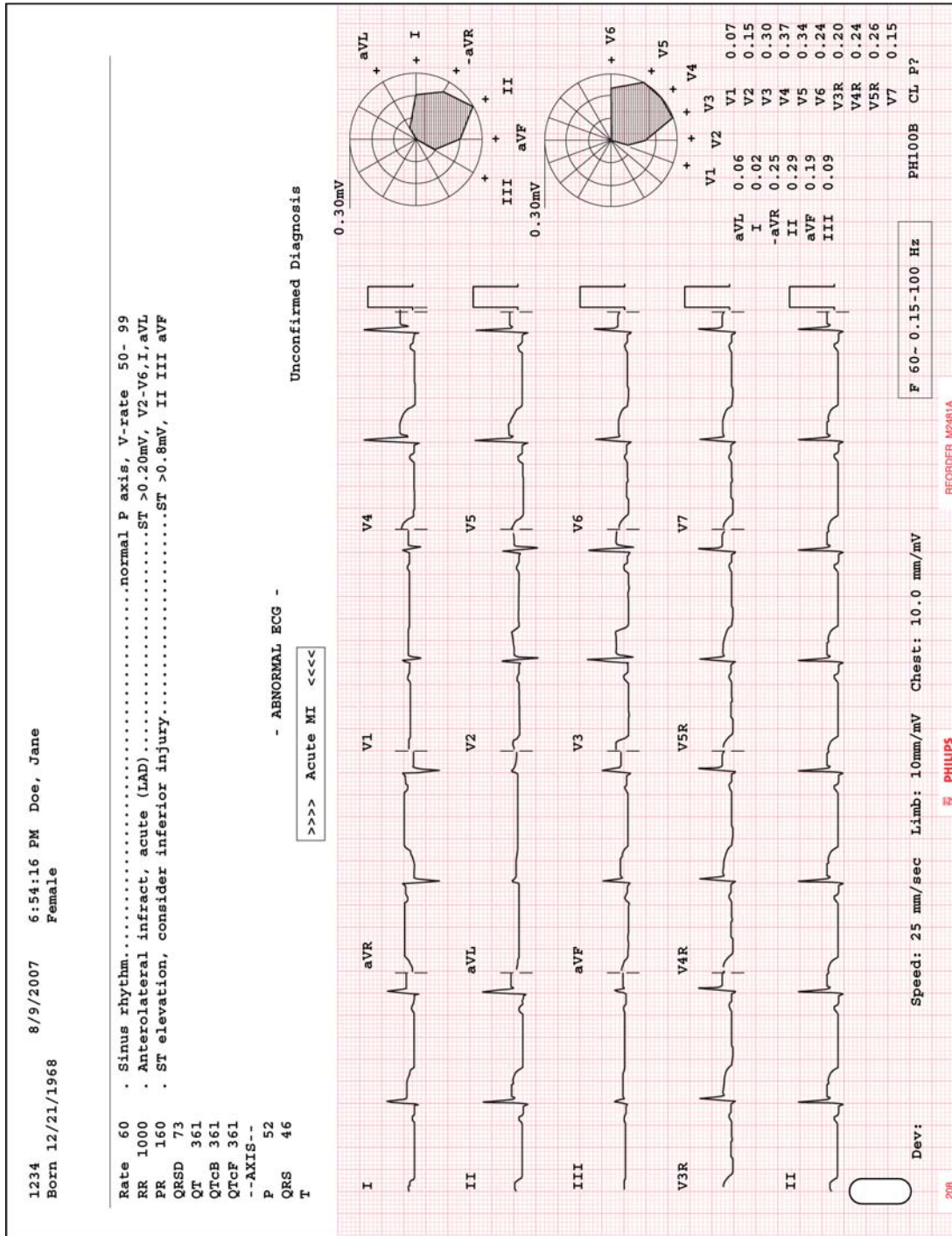

Figure 4-44 4x4 1R ST Report



Rhythm Report

Rhythm reports show up to 12 or 16 leads of continuous waveform data. The amount of report information that is included on the report is dependent upon the number of leads selected for recording. Information on the report may include:

- Patient information
- Data and time of recording
- Settings information (scale and sensitivity, filter settings)

Rhythm reports are not analyzed, so they do not provide measurement information or interpretive statements, and they are not saved to the Archive. The calibration pulse appears at the beginning of each ECG trace.

Figure 4-45 Rhythm Report with 6 Leads

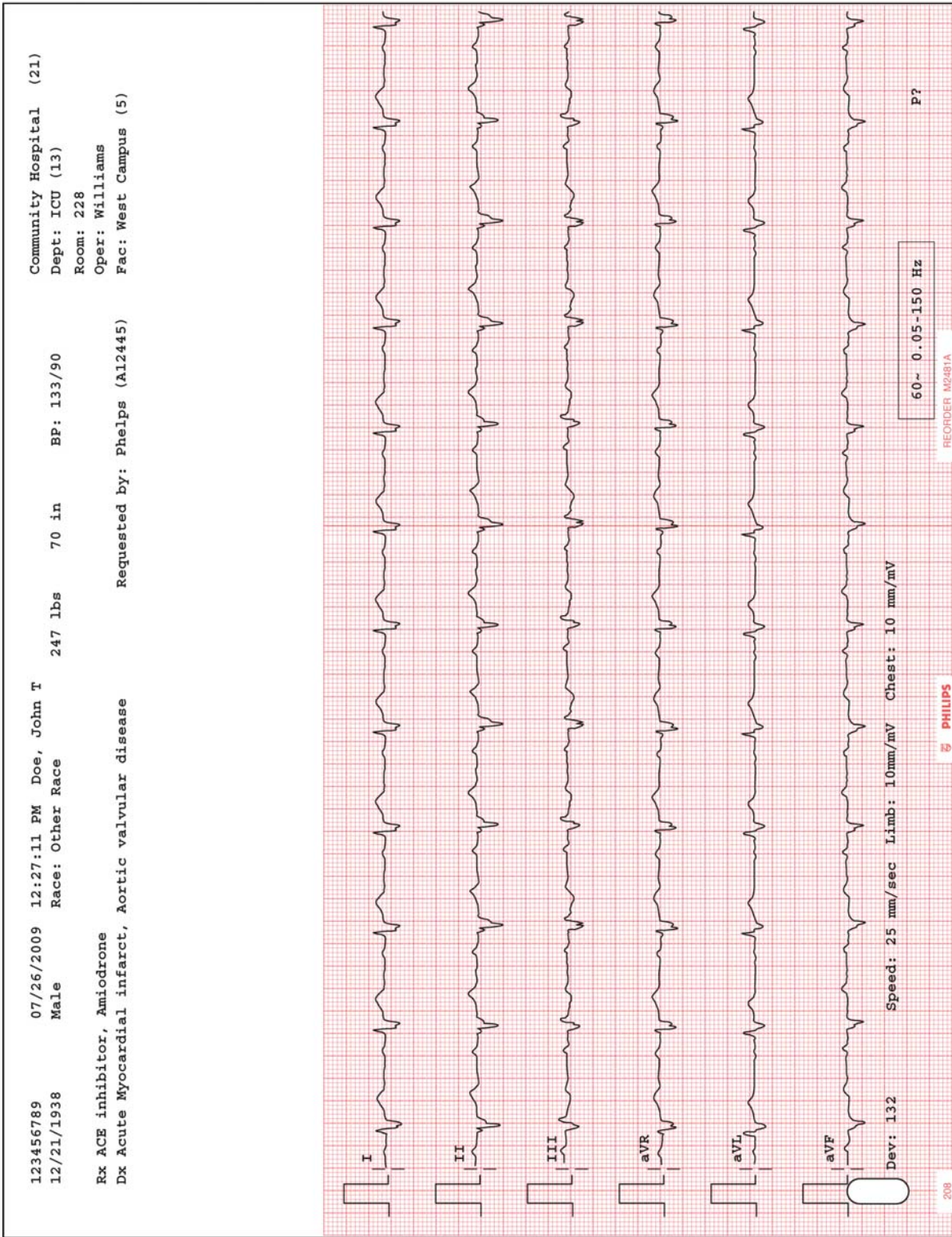
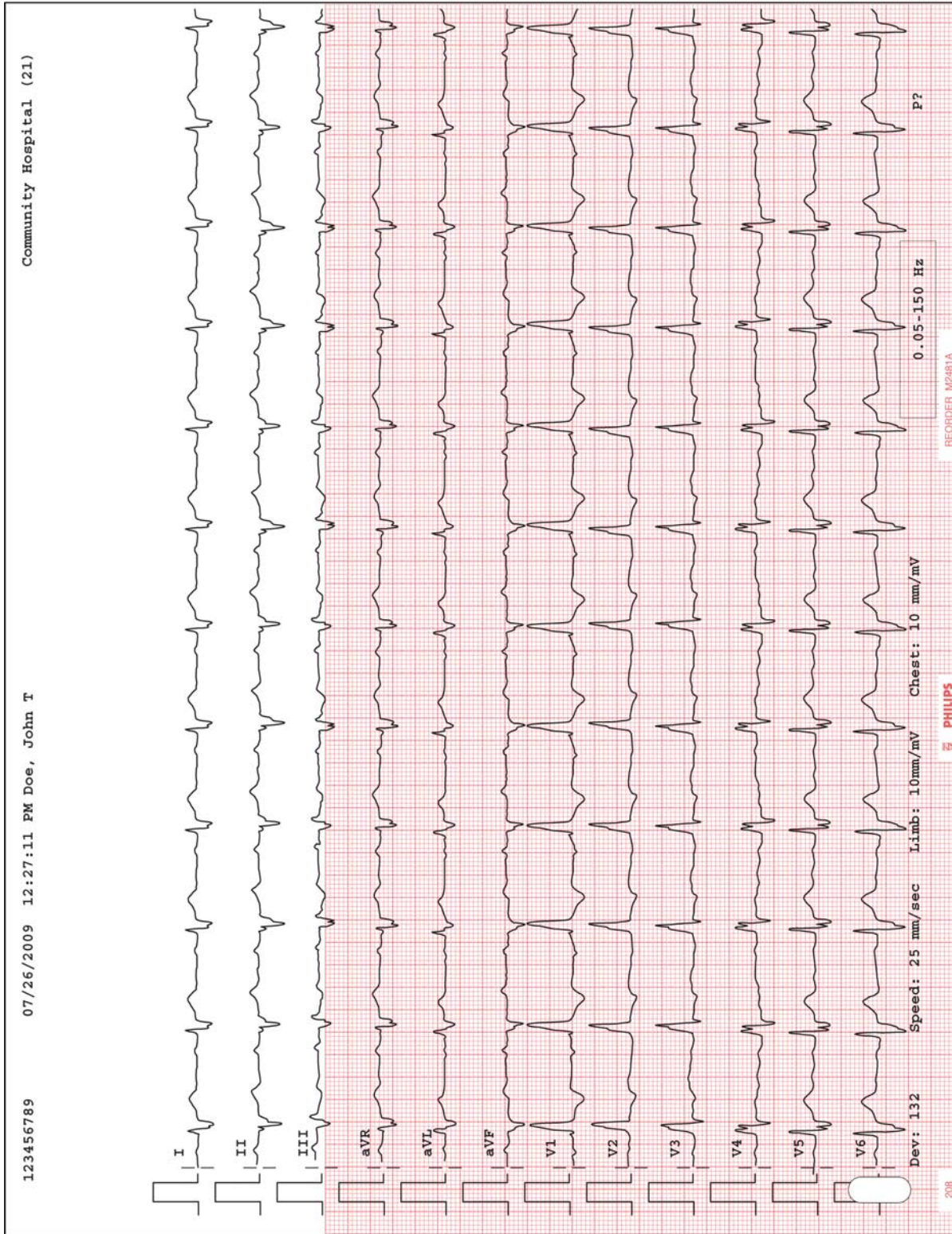

Figure 4-46 Rhythm Report with 12 Leads



1-Minute Disclose Report

The 1-Minute Disclose Report displays up to one minute of continuous ECG waveform data for the selected Disclose lead. Disclose reports are not analyzed, so they do not provide measurement information or interpretive statements, and they are not saved to the Archive. Each 10-second waveform segment on the report is labeled next to the lead name.

Figure 4-47 1-Minute Disclose Report

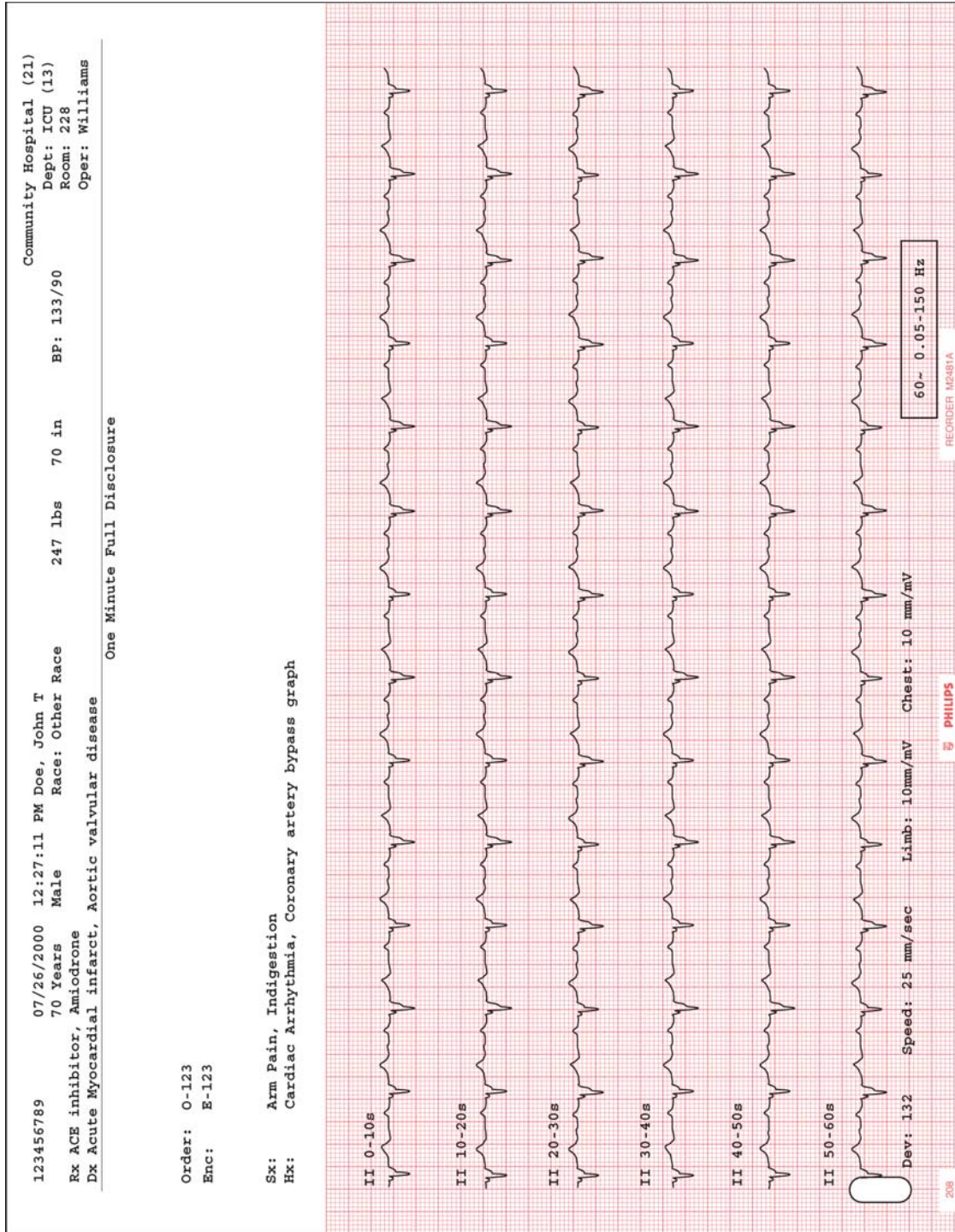

Extended Measurements Report

The Extended Measurements Report summarizes the output of the Philips 12-Lead Algorithm version PH090A, or of the Philips DXL ECG Algorithm version PH100B. The report includes the morphology characteristics for the individual leads, and the rhythm characteristics for the rhythm groups. The algorithm uses this measurement information to generate interpretive statements. The Extended Measurements Report is especially useful if you want to examine the measurements used to generate an interpretation.

For more information on the Extended Measurements Report, see Chapter 5 of the *Philips DXL ECG Algorithm Physician's Guide* on the User Documentation and Training DVD, or download the file from the InCenter site (incenter.medical.philips.com). For information on using the InCenter site, see page 1-5.

NOTE The extended right side (V3R/C3R, and V4R/C4R) and posterior leads (V7/C7 - V9/C9) available on the cardiograph will not appear in the Morphology Analysis section of the Extended Measurements report.

Cardiograph Care and Maintenance

The following chapter contains information about basic cardiograph care, and periodic cardiograph maintenance that may be required. If further technical assistance is required, contact the nearest Philips Response Center, see page 1-51.

Table 5-1 Recommended Frequency of Maintenance Tasks

Component	Recommended Frequency	Maintenance Task and page number
Cardiograph and Patient Interface Module (PIM) Cleaning	Weekly, or after patient use if patient's skin comes into contact with PIM	"Cardiograph and PIM Cleaning" on page 5-2
Patient Data Cable and Lead Wire Cleaning	Weekly	"Patient Data Cable and Lead Wire Cleaning" on page 5-3
Reusable Electrode Cleaning	After each patient use	"Reusable Electrode Cleaning" on page 5-4
Print Head Cleaning	When necessary due to uneven print quality	"Cleaning the Print Head" on page 5-5
Battery Calibration	When necessary, due to inaccurate battery status information displayed on cardiograph	"Battery Calibration" on page 5-12
Patient Interface Module (PIM) Test	When necessary, to confirm that the PIM is communicating with the cardiograph	"Patient Interface Module (PIM) Test" on page 5-14
Ping Test	When necessary, to confirm that the cardiograph can successfully communicate with an entered IP address	"Ping Test" on page 5-14
Lead Wire Performance Test	Weekly	"Lead Wire Performance Test" on page 5-15

Table 5-1 Recommended Frequency of Maintenance Tasks *(continued)*

Component	Recommended Frequency	Maintenance Task and page number
Touch screen calibration	When necessary, due to decreased touch screen performance	“Touch Screen Calibration” on page 5-16
Touch screen cleaning	Weekly	“Touch Screen Cleaning” on page 5-16
Cardiograph Overall Sensitivity Test	Once per year	The overall sensitivity test is used to test the calibration voltage. According to <i>IEC 60601-2-51</i> , this test should be run regularly. Taking an ECG using a 12-lead simulator allows you to verify areas of operation that the extended self tests cannot check, and allows you to verify the accuracy of the sensitivity settings. See the <i>PageWriter TC70/TC50 Cardiograph Service Manual</i> for detailed instructions on the performance of this test.
Replacing the PageWriter TC50 Cardiograph Fuse	When the cardiograph is plugged into AC power, but the green AC power indicator light does not illuminate	“Replacing the PageWriter TC50 Cardiograph Fuse” on page 5-17

Cardiograph and PIM Cleaning

WARNING Electrical shock hazard. Keep the cardiograph, Patient Interface Module (PIM), and all cardiograph accessories away from liquids. Do not immerse the cardiograph, PIM, or other accessories in any liquids.

WARNING Always clean and disinfect the Patient Interface Module (PIM) after patient use, if the PIM comes into direct contact with the patient’s skin. Failure to properly clean and disinfect the PIM after direct contact with the patient’s skin may cause infectious materials to be transferred between patients.

To clean the cardiograph and PIM:

- 1 Unplug the AC power cord.
- 2 Ensure that the AC power indicator light (next to power button) is not lit.

- 3 Wipe the external surfaces of the cardiograph and the PIM with a soft cloth dampened in any of the approved cleaning solutions listed below.

CAUTION When cleaning, avoid the lead wire connectors and patient data cable connectors.

Approved Cleaning Solutions

- Mild soap and water
- Isopropyl alcohol (consisting of 70% solution)
- Chlorine bleach (5.25% sodium hypochlorite content) mixed as 3% solution in water
- Quaternary ammonium compounds such as *Steris Coverage Plus NPD*, mixed as one half fluid ounce per gallon water, or one part *Coverage Plus NPD* to 256 parts water

CAUTIONS Do not use strong solvents or abrasive cleaning materials.

Do not use any of the following to clean the cardiograph:

- Acetone
- Iodine-based cleaners
- Phenol-based cleaners
- Ethylene oxide sterilization
- Ammonia-based cleaners

The cardiograph, PIM, lead wires, and patient data cable should not be autoclaved, ultrasonically cleaned, or immersed.

Patient Data Cable and Lead Wire Cleaning

Prior to cleaning the patient data cable, inspect the patient data cable for any cracks or breaks in the cable insulation. If the integrity of the patient data cable is not assured, replace the patient data cable. Contact Philips Medical Systems for further assistance, see “Contacting a Philips Response Center” on page 1-39.

Approved Cleaning Solutions

- Mild soap and water
- Isopropyl alcohol (consisting of 70% solution)
- Chlorine bleach (5.25% sodium hypochlorite content) mixed as 3% solution in water
- Quaternary ammonium compounds such as *Steris Coverage Plus NPD*, mixed as one half fluid ounce per gallon water, or one part *Coverage Plus NPD* to 256 parts water

CAUTIONS Do not use strong solvents or abrasive cleaning materials.

Do not use any of the following to clean the cardiograph:

- Acetone
- Iodine-based cleaners
- Phenol-based cleaners
- Ethylene oxide sterilization
- Ammonia-based cleaners

The cardiograph, PIM, lead wires, and patient data cable should not be autoclaved, ultrasonically cleaned, or immersed.

To clean the patient data cable and lead wires:

- 1 Dampen a soft cloth with soapy water or with one of the disinfectants or cleaning agents listed in “Approved Cleaning Solutions” on page 5-3.
 - 2 Wring excess moisture from the cloth before cleaning.
-

CAUTION Do not:

- Autoclave the patient data cable or lead wires or use ultrasonic cleaners
 - Immerse
 - Use abrasive materials
 - Wet the connectors
-

Reusable Electrode Cleaning

Reusable limb clamp and Welsh Bulb electrodes must be cleaned after each use.

WARNING Always clean and disinfect reusable electrodes before patient use. Failure to properly clean and disinfect reusable electrodes before patient use may cause infectious materials to be transferred between patients.

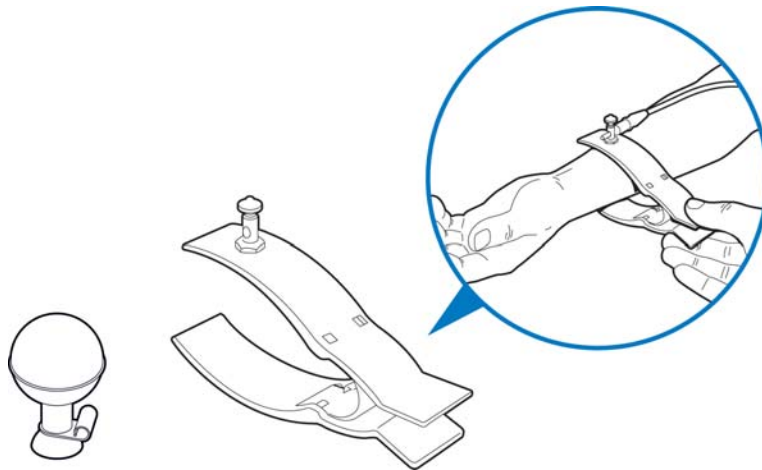
Figure 5-1 Welsh Bulb and Limb Clamp Electrode**To clean reusable electrodes:**

- 1 For Welsh Bulb electrodes only: detach the rubber bulb from the metal cup by pulling. Wash the rubber bulb in warm water. Remove all electrolyte gel residue, check inside the rubber bulb to ensure that all residue is removed.
- 2 For all reusable electrodes: dampen a soft cloth with one of the disinfectants or cleaning agents listed below.
 - Cidex Ortho Phthaladehyde
 - Cetylcide
 - Vesphene 2 Aqueous Phenolic Germicidal Agent

CAUTION Do not:

- Use isopropyl alcohol
 - Autoclave the reusable electrodes or use ultrasonic cleaners
 - Use abrasive materials
-

- 3 Wring excess moisture from the cloth before cleaning.
- 4 Dry the bulb and cup of the Welsh Bulb electrode thoroughly before use.
- 5 Store the reusable electrodes away from direct sunlight and excessive heat when not in use.

Cleaning the Print Head

Clean the print head periodically, as a dirty print head may cause poor or uneven print quality. Clean the print head more frequently when printing large volumes of ECGs.

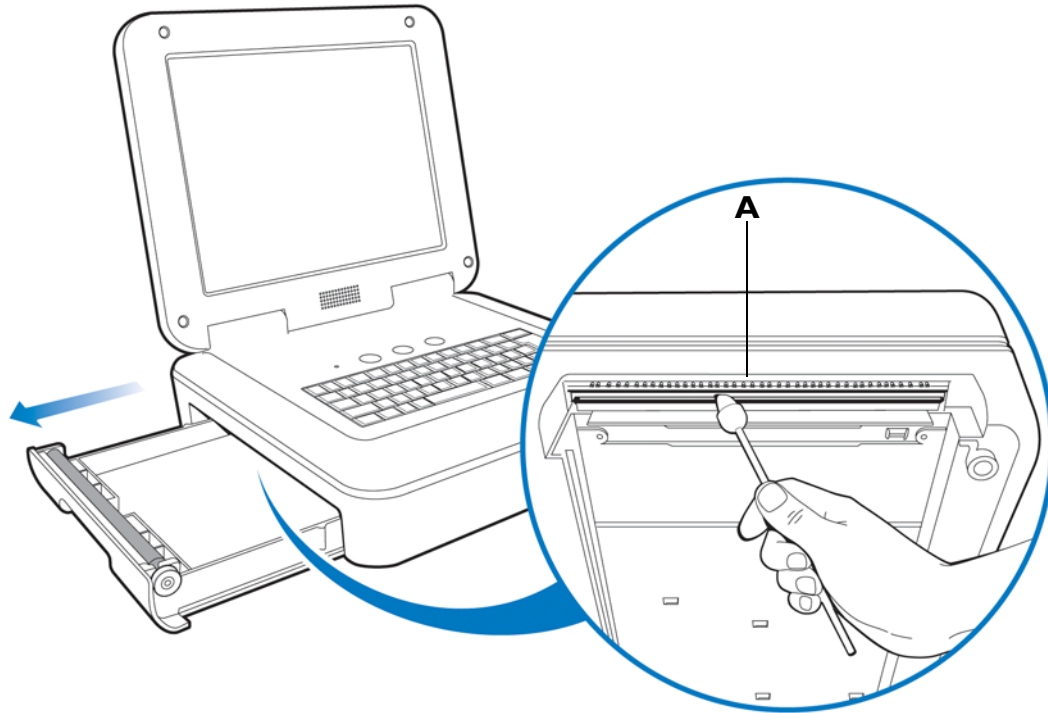
Figure 5-2 PageWriter TC70 Cardiograph Cleaning the Print Head

A Print head

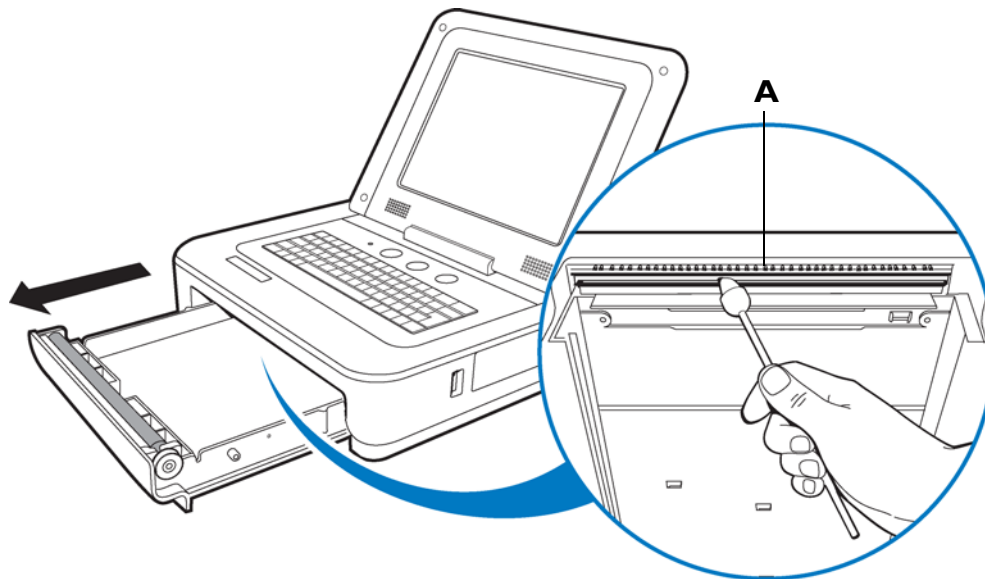
Figure 5-3 PageWriter TC50 Cardiograph Cleaning the Print Head

A Print head

To clean the print head:

- 1 Open the paper drawer.
- 2 Wipe the print head lightly with a foam swab dipped in 90% alcohol.

- 3 Allow the print head to dry.

Printer Paper

Replace the printer paper when a red stripe appears on the printed ECG report. Only use Philips Medical Systems replacement printer paper. For part ordering information, see “Supplies and Ordering Information” on page 1-45.

To change the printer paper:

- 1 Open the paper drawer and remove any remaining sheets. Lift up the paper hold down bar.

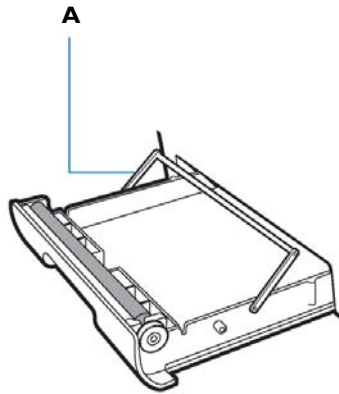

A Paper hold down bar

- 2 Insert a new pack of printer paper with the printed side facing up. Make sure that the hole for the paper sensor is positioned as shown below.

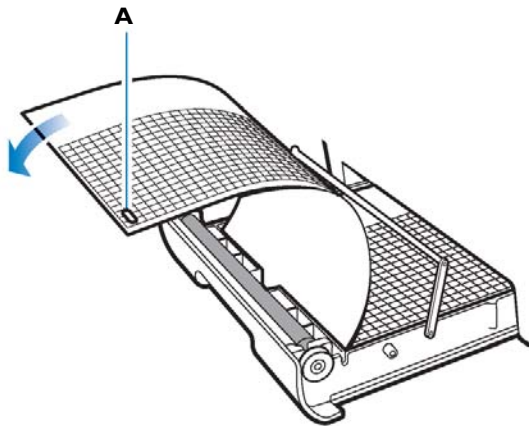

A Paper sensor hole

- 3 Drape the first sheet over the roller and place the paper hold down bar on top of the paper.

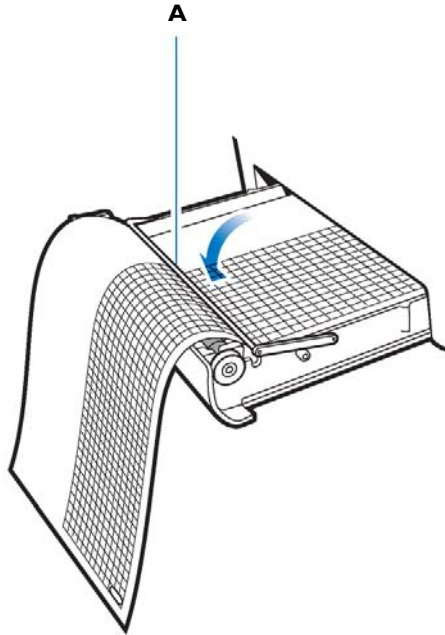

A Paper hold down bar

- 4 Close the paper drawer.

Battery Maintenance and Care

The PageWriter TC70 cardiograph operates with two removable lithium ion batteries that supply power to the cardiograph during mobile use, and power the cardiograph printer while it is plugged into AC power. The PageWriter TC50 cardiograph uses either one or two removable lithium ion batteries that supply power to the cardiograph during mobile use, and power the cardiograph printer while it is plugged into AC power.

For optimal battery performance:

- When operating the PageWriter TC50 cardiograph with one battery installed, only use the Philips battery with part number 989803170371. Do not use the battery with Philips part number 989803160981 for one battery operation.
- When operating the PageWriter TC50 cardiograph with two batteries installed, ensure that both batteries contain the same Philips part number. The battery part number identification label is found on the bottom of the battery. The cardiograph cannot operate with two batteries that contain different part numbers. If the cardiograph is operated with two batteries with different part numbers, the cardiograph will display an error message. Before initial use, fully charge the batteries for five hours before operating the cardiograph without AC power. Regularly and consistently charging the batteries will prolong battery life.

- Charging, storing, or using the batteries at temperatures above 50 °C (122° F) can damage the batteries and reduce overall battery life.
- Check the battery power indicator on the Status Bar. Tap the battery icon on the Status Bar for information on remaining battery power, see Figure 5-4 on page 5-12.
- Always charge the batteries when the cardiograph is not in use. Plug the cardiograph into AC power. Ensure that the green AC power indicator light on the front of the cardiograph is lit. The batteries will charge while the cardiograph is in use, but will charge at a slower rate.
- Operate the cardiograph, charge the batteries, and store the batteries at a room temperature of 25 °C (77° F) or lower. Exposure to higher temperatures may reduce battery life, damage the batteries, and degrade overall cardiograph performance.
- If the cardiograph will be stored for more than sixty days without use, fully charge the batteries, and then remove AC power from the cardiograph, and remove the batteries from the cardiograph. Store the batteries in a cool, dry location. A set of fully charged batteries stored outside the cardiograph will need to be recharged every sixty days.

Replacing the Batteries

WARNING Properly dispose of or recycle depleted batteries according to local regulations. Do not disassemble, puncture, or incinerate the disposed batteries.

WARNING Carefully follow the instructions for replacing the batteries. Only use batteries with Philips part number 989803160981 or Philips part number 989803170371.

- CAUTIONS**
- Before removing and replacing batteries from the cardiograph, press down and hold the On/Standby button () (located on the front of the cardiograph), to shut down the cardiograph. Ensure that the cardiograph is shut down. When the cardiograph is fully shut down, the screen is black, and the On/Standby button is not illuminated. Once the cardiograph is shut down, proceed to remove and replace the batteries.
 - When removing batteries from the cardiograph, the batteries could feel warm to the touch.
-

How often batteries need to be replaced depends on how well the battery is maintained and how much it is used. If the batteries are fully charged but lose significant power after only a few ECGs, consider replacement. For information on ordering replacement batteries, see “PageWriter TC70 and PageWriter TC50 Cardiograph Supply Part Numbers” on page 1-46.

To install the batteries:

- 1 Unplug the cardiograph from AC power.

- 2 Open the battery door.

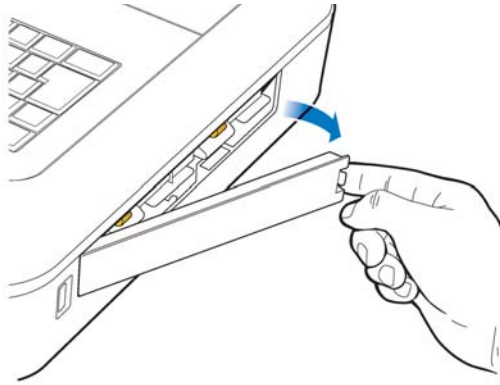

- 3 Remove both batteries from the battery compartment by pulling on the gold straps.

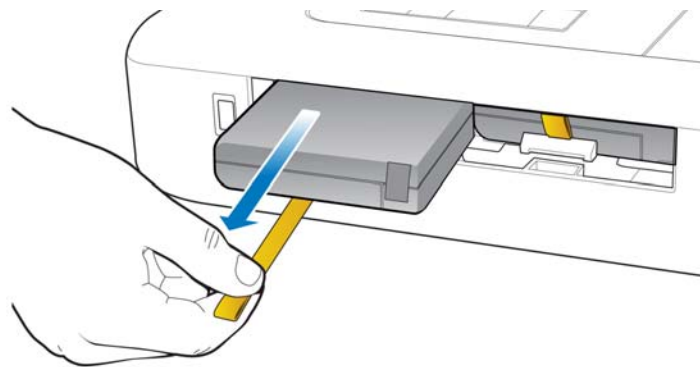

- 4 Insert the battery with the external connector facing the bottom rear of the compartment.

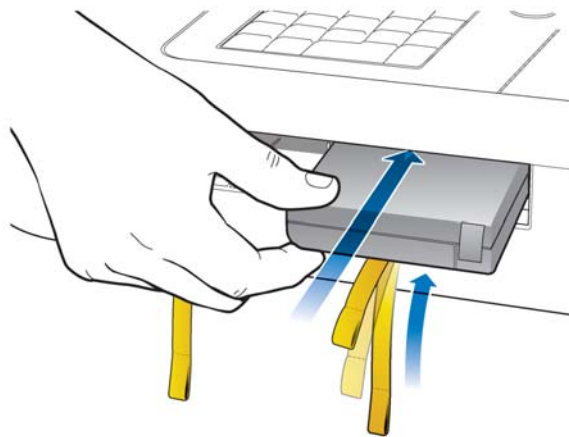

- 5 Ensure that the battery is fully inserted into the slot. The pull tab will insert along with the battery. Insert the second battery following the same procedure.

NOTE If operating the PageWriter TC50 cardiograph with one battery installed, the battery may be inserted into either battery compartment.

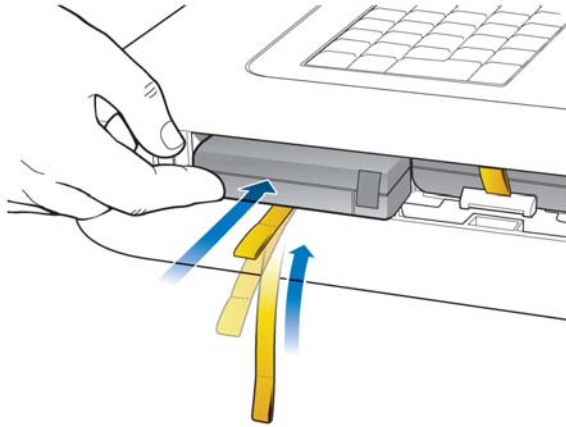

- 6 Reinstall the battery door.

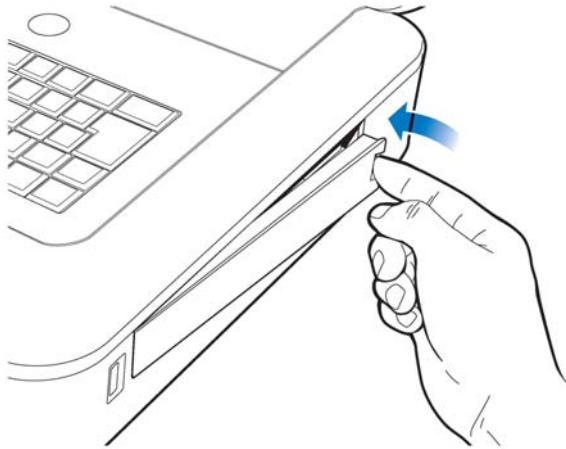

- 7 Connect the AC power cord to the cardiograph. Charge the batteries for five hours before operating the cardiograph on battery power only.

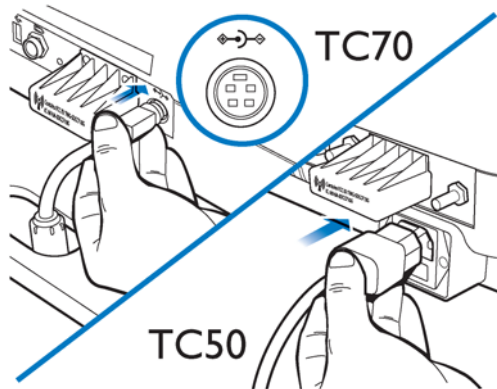

Battery Calibration

Battery calibration may be necessary in order to enhance the accuracy of the battery level indicator that displays on the Status Bar. If the accuracy of this indicator is affected, the other battery indicators included on the Battery Status window that is opened by tapping the battery icon on the Status Bar may also be less accurate.

Figure 5-4 Battery Power Indicator on the Status Bar

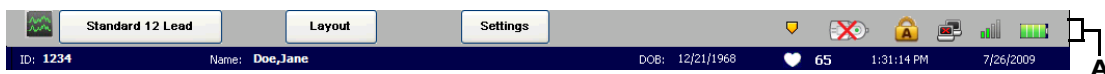

A Battery level indicator

The **Estimated Remaining Runtime** and Power (bar indicators) may not be accurate. The recommended intervals for battery calibration are dependent upon factors in your clinical use model. When the battery power indicators are not functioning so that they are useful in your daily work environment, Philips recommends calibrating the batteries following the procedure described in this section.

The battery calibration procedure requires that the cardiograph be taken out of active use for up to 8 hours.

To calibrate the batteries on the cardiograph:

- 1 Attach the AC power cord to the cardiograph. Ensure that the AC power supply is connected to a grounded electrical outlet and that the cardiograph is receiving AC power. Check that the AC power indicator light (located next to the power button) is lit.
- 2 Fully charge the batteries.
- 3 To ensure that the batteries are fully charged, view the **Charge Current** field in the Service Utility. Touch the **Setup** button on the toolbar. Select the Service Utility from the Setup main menu.



- NOTE** Accessing the Service Utility may require entering a password. If a password is lost and cannot be retrieved, contact the Philips Response Center for assistance (see page 1-51).
- 4 From the Service Utility screen, ensure that the **About the Cardiograph** button is selected (top of screen). A selected button is highlighted in blue.
 - 5 Underneath the **Battery Status** column (middle of screen), check that the **Charge Current** field for both batteries display **0 mA**, ensuring that both batteries are fully charged.
 - 6 Touch the **Print** button (top of screen) to print out a report of the cardiograph settings displayed on this screen.
 - 7 Touch the **Exit** button (lower right hand corner of screen). Touch the **Exit** button again on the Setup main menu.
 - 8 Once the Main screen appears, touch the **ID** button to open the ID entry screen. Ensure that the ID screen remains open.
 - 9 Unplug the cardiograph from AC power. Ensure that the AC power indicator light (located next to the power button) is *not* lit.
 - 10 Keep the ID screen displayed and allow the batteries to deplete of all battery power. This process will take approximately 8 hours to complete. When the batteries are depleted of all power, the screen is black and the cardiograph cannot be returned to active use by touching the power button.
 - 11 Once the batteries are fully depleted, reconnect the cardiograph to AC power. Press the On/Standby button to power on the cardiograph in order to confirm successful calibration. Afterwards, charge the batteries fully before returning it to active use.
 - 12 On the Main screen, touch the **Setup** button.
 - 13 Select the Service Utility from the Setup main menu.
 - 14 From the Service Utility screen, ensure that the **About the Cardiograph** button is selected (top of screen). A selected button is highlighted in blue.
 - 15 Underneath the **Battery Status** column, check the **Expected Max Error (%)** and **Full Capacity (mAh)** values as viewed on the screen are different than the values printed on the report generated from the Service Utility screen. If the values are different, the battery calibration procedure is complete.

- NOTE** If the **Expected Max Error (%)** field has not been reset to 2%, another calibration procedure may be necessary. The max error value may not change if the full charge capacity has been decreased by more than 256 mAh or increased by more than 512 mAh. If this occurs, another calibration procedure is recommended as soon as it is convenient to further improve the accuracy of displayed battery status information. For batteries with more than 8% of error, the maximum error will remain unchanged if a limited calibration cycle occurs.

Patient Interface Module (PIM) Test

This test is used to confirm that the Patient Interface Module (PIM) is communicating with the cardiograph. This test can be performed when the cardiograph displays PIM error messages, or when the cardiograph is unable to acquire data from the PIM. Be sure that the PIM patient data cable is securely attached to the PIM connector on the rear of the cardiograph before performing the test.

If this test fails, it may indicate a problem with the PIM or with the PIM patient data cable.

To perform the PIM Test:



- 1 Ensure that the patient data cable is securely attached to the PIM connector () on the rear of the cardiograph.
- 2 Touch the **Setup** button on the bottom toolbar. The Configuration Setup and Service Utilities menu appears.
- 3 Touch **Configure Cardiograph Default Settings**. On the Default Cardiograph Settings screen, touch the **Maintenance Test** button (upper right side of screen).
- 4 The Maintenance Test screen appears. Touch the **Patient Interface Module (PIM) Test** button. The PIM test automatically starts and the results appear on the screen. The **Patient Interface Module (PIM) Test** window reports the **PIM Option** (with a note that a Class A or Class B PIM is installed), the currently installed software **PIM Kernel Version**, and if the PIM Test has failed or passed. If the message **PIM Test Passed** appears, the PIM is communicating properly with the cardiograph.

NOTE The PageWriter TC50 cardiograph with installed software version A.03.00 and higher is *only* compatible with the Class B 12-lead PIM (Philips part number 453564150741, AAMI and 453564150761, IEC) or the Class B 16-lead PIM (Philips part number 453564150751, AAMI and 453564150771, IEC) and the Class B patient data cable (Philips part number 989803164281).

- NOTE** 5 Touch the **Close** button to close the window.
- 6 If the message **PIM Test Failed** appears, check that the PIM patient data cable is securely attached to the PIM connector on the rear of the cardiograph, and that the patient data cable and PIM are Class B devices (PageWriter TC50 cardiograph only). If the error message persists, contact the Philips Response Center for assistance.

Ping Test

The Ping Test is used with a wireless or wired network connection to verify that the cardiograph can successfully communicate over a network connection to an entered IP address.

To perform the Ping Test:

- 1 Ensure that the LAN cable is securely attached to the LAN connector () on the rear of the cardiograph, or that the wireless LAN connection is associated to an access point



and that green bars appear on the Status bar (top of screen), indicating a live wireless connection.

- 2 Touch the **Setup** button on the bottom toolbar. The Configuration Setup and Service Utilities menu appears.
- 3 Touch **Configure Cardiograph Default Settings**. On the Default Cardiograph Settings screen, touch the **Maintenance Test** button (upper right side of screen).
- 4 On the Maintenance Test screen, touch the **Ping Test** button. The Ping Test window appears.
- 5 Enter the IP address to ping. Touch the **Ping** button.
- 6 The Ping Test results window appears and reports the test results.

Lead Wire Performance Test

The Lead Wire Performance Test should be run on a weekly basis. This test examines all of the lead wires for shortages and reports the results. Lead wire shortages can often be subtle and appear as intermittent ECG signal loss, signal noise, or reduced signal amplitude. Any lead that is reported as having a shortage must be replaced.

To perform the Lead Wire Performance Test:

- 1 Ensure that the patient data cable is securely attached to the PIM connector () on the rear of the cardiograph.
- 2 Ensure that all leads are securely attached to the lead connectors on the PIM.
- 3 Disconnect the PIM from a patient or patient simulator before starting the test.
- 4 Touch the **Setup** button on the bottom toolbar. The Configuration Setup and Service Utilities menu appears.
- 5 Touch **Configure Cardiograph Default Settings**. On the Default Cardiograph Settings screen, touch the **Lead Wire Performance Test** button.
- 6 The Lead Wire Performance Test window appears with the message **Checking Leadwires...** At the conclusion of the test, any lead wire shortages are identified on the same window.
- 7 Replace any leads that are identified as having a lead wire shortage. Touch the **Close** button when done.



Cardiograph and Accessory Disposal

When the cardiograph has reached the end of its product life, dispose of it according to local ordinances. When any of the cardiograph accessories reach the end of their product life, dispose of these items in accordance with manufacturer instructions and local ordinances.

Maintaining the Touch Screen

The touch screen may require occasional maintenance, including calibration and cleaning.

Touch Screen Calibration

The touch screen may be calibrated at any time. Calibration is recommended if it requires many attempts to select an item on the screen, or if selecting items on a specific area of the screen is difficult.

The touch screen may also require calibration if the cardiograph is used in different settings (seated instead of standing) or by users of significantly different height. The touch screen may need to be recalibrated to work optimally in the new setting or with the new user.

To calibrate the touch screen:



- 1 From any screen, touch the **Ctrl + Alt + C** keys (on keyboard) at the same time. Or, touch the **Setup** button on the Toolbar (accessing the Setup screens may require entering a password). On the following screen, touch **Configure Cardiograph Default Settings**. Touch the **Maintenance Test** button (top right of screen), and then touch **Touch Screen Calibration and Test**.
- 2 A white screen appears with a cross hair (center of screen). Touch the middle of the cross hair where the two lines intersect. When the cross hair is touched it moves to a new location. Continue to touch the center of the cross hair.
- 3 Tap the screen (when a message appears) to end the test.

Touch Screen Cleaning

The touch screen may require occasional cleaning.

To clean the touch screen:

- 1 Dampen a soft cloth with water or with isopropyl alcohol.
- 2 Wring excess moisture from the cloth.
- 3 Wipe the touch screen area clean. Allow the touch screen to dry completely before use.
- 4 Perform the Barcode Test to verify performance.

Changing the Date and Time

The date and time that displays on the cardiograph may be changed manually, or may be configured to automatically synchronize with a specified TraceMaster server using the Time Synchronization feature. For more information on configuring the Time Synchronization feature on the cardiograph, see the *PageWriter TC70/TC50 Cardiograph Network Configuration Guide* on the User Documentation and Training DVD.

Follow the procedure below to manually set the date or time.

NOTE Opening the Setup screens may require entering a password. If a password is lost and cannot be retrieved, call the Philips Response Center for further assistance. See "Contacting a Philips Response Center" on page 1-51.



To set the date and time:

- 1 Touch the Setup button on the main toolbar.
- 2 The Configuration Setup and Service Utilities menu appears. Touch the button next to **Configure TraceMaster and OrderVue Settings**.
- 3 The Configure Network Settings screens appear. Touch the **TraceMaster/OrderVue** button (top of screen).
- 4 The TraceMaster settings screens appear. The **Create TraceMaster Connection** tab is selected. Touch the **Edit/Delete TraceMaster Connection** tab (top of screen).
- 5 Under **Time Synchronization Settings** (middle of screen), touch the **Set** button next to **Manual Time Set**.
- 6 The Date and Time Settings window appears with the current specified date and time displayed. To change the current date, touch the back or forward arrows next to the name of the displayed month (to change the month), or touch a date on the calendar to change the date within the displayed month.
- 7 To change the displayed time, touch the hour and minutes displayed under **Current Time**, or touch the up or down arrow buttons next to the displayed time to manually change the time. Touch the time designator to change it to **AM** or to **PM**.
- 8 Touch the dropdown arrow button under **Time Zone** to change the selected time zone.

- NOTES**
- The time displayed on the cardiograph automatically adjusts for Daylight Savings Time, if applicable.
- Touch the **Time Sync** button to manually synchronize the cardiograph date and time with a specified TraceMaster server.
- 9 Touch the **OK** button when done. Touch the **Exit** button (lower right corner of screen) to exit the Setup screen. The new time and date is immediately applied.

Replacing the PageWriter TC50 Cardiograph Fuse

The AC fuse needs to be replaced when the cardiograph is plugged into AC power, but the green AC power indicator light does not illuminate.

NOTE The PageWriter TC70 cardiograph does not have a replaceable fuse.

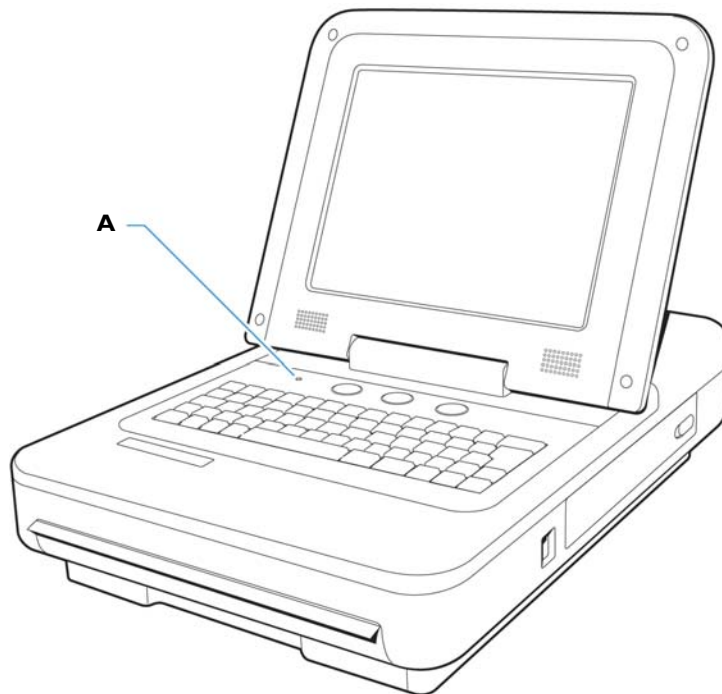
Figure 5-5 AC power indicator light on TC50 cardiograph

A AC power on indicator light

Only use replacement AC fuses with Philips part number 453564131221, or use a 1.6 amp (250V) time-delay fuse the same size and configuration as the original fuse.

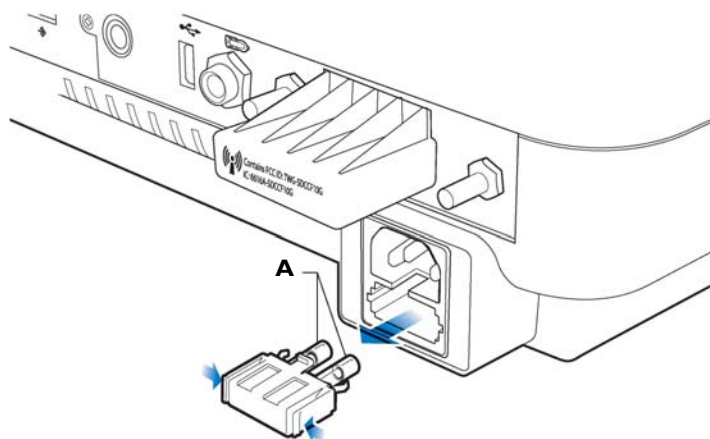
Figure 5-6 Replacing the AC Fuse

A AC fuse

To replace the AC fuse:

- 1 Unplug the cardiograph from AC power. Pull out the AC power cord from the AC power connector on the rear of the cardiograph.
- 2 Locate the AC fuse, which is directly below the AC power connector.
- 3 Push on both ends of the fuse and pull out the fuse from the fuse holder slot.

- 4 Insert the new fuse using the same orientation.
- 5 Push the fuse all the way into the fuse holder slot. The fuse snaps into place.

Suppressed Borderline Interpretive Statements

Introduction

This Appendix includes a listing of all borderline interpretive statements that are suppressed using the *Borderline Statement Suppression* feature that is available with both the Philips 12-Lead Algorithm version PH090A, and with the Philips DXL ECG Algorithm version PH100B. This feature is used to exclude interpretive statements that indicate a borderline or otherwise normal condition from appearing on the ECG report. Borderline interpretive statements are generated by measurements that are above an abnormal threshold, but may in fact indicate a non-pathological condition. These statements indicate to the clinician that a condition may be present, but there is no decisive indicator. These statements often include the terms “minimal,” “consider,” or “borderline.”

For more information on the Philips 12-lead Algorithm version PH090A, see the *Philips 12-Lead Algorithm Physician's Guide*. For more information on the Philips DXL Algorithm version PH100B, see the *Philips DXL ECG Algorithm Physician's Guide*. Both *Physician's Guides* are available on the User Documentation and Training DVD, or may be downloaded from the Philips InCenter web site (incenter.medical.philips.com). For information on using the Philips InCenter web site, see page 1-5.

NOTE The symbol *** in an interpretive statement is replaced with a numeric value on the ECG report.

Philips 12-Lead Algorithm Version PH090A Exclude Low Certainty Suppressed Statements

The following interpretive statements listed in Table A-1 are suppressed when the **Exclude Low Certainty** setting is selected under the **Algorithm/Pacing** button on the Setup, Default Cardiograph Settings screen.

**Table A-1 Philips 12-Lead Algorithm Version PH090A
Exclude Low Certainty - Suppressed Statements**

Statement Code	Interpretive Statement
BAVCD	Borderline Av Conduction Delay...PR >**, V-rate **_**
BIVCD	Borderline Intraventricular Conduction Delay.....QRSd >*** mS
CLAA	Consider Left Atrial Abnormality.....wide or notched P waves

Table A-1 Philips 12-Lead Algorithm Version PH090A
Exclude Low Certainty - Suppressed Statements (continued)

Statement Code	Interpretive Statement
CRAA	Consider Right Atrial Abnormality.....P >0.24mV limb lead
ET	Early Precordial R/s Transition.....QRS area positive in V2
ETRSR1	RSR' In V1 Or V2, Right VCD Or RVH.....QRS area positive & R' V1/V2
LOWT	BOrderline T Wave Abnormalities.....flat T
LT	Late Precordial R/S Transition.....QRS area negative in V5/V6
LVHQ	Consider Left Ventricular Hypertrophy.....deep Q in V5-6 or II III aVF
LVOLFB	Borderline Low Voltage In Frontal Leads.....all frontal leads <0.6mV
NFAD	No Further Analysis Attempted Due To Paced Rhythm
NFRA	No Further Rhythm Analysis Attempted Due To Paced Rhythm
QMAB	Artifact In Lead(S) And Baseline Wander In Lead(S)
QMART	Artifact In Lead(S)
QMBW	Baseline Wander In Lead(S)
REPB	Borderline Repolarization Abnormality.....ST dep & abnormal T
RSR1	RSR' In V1 Or V2, Probably Normal Variant.....small R' only
RSRNv	RSR' In V1, Normal Variation.....term-vector post-rightward
SDALP	Nonspecific ST Depression, Anterolateral Lds.....ST <-0.10mV, I aVL V2-V6
SDANP	Nonspecific ST Depression, Anterior Leads.....ST <-0.10mV, V2-V5
SDCU	Minimal ST Depression.....ST concave upward
SDINP	Nonspecific ST Depression, Inferior Leads.....ST <-0.10mV, II III aVF
SDJ	Junctional ST Depression.....ST <-0.10mV any 3 leads
SDM	Minimal ST Depression.....ST <-0.05mV in 2 leads
SEALP	ST Elevation, Prob Normal Variation, Ant-lat.....ST >0.15 mV, I aVL V2-V6

**Table A-1 Philips 12-Lead Algorithm Version PH090A
Exclude Low Certainty - Suppressed Statements (continued)**

Statement Code	Interpretive Statement
SEANP	ST Elev, Probably Normal Variation, Ant Leads.....ST>0.15mV, V2-V5
SEINP	ST Elevation, Probably Normal Variation, Inf.....ST>0.15mV, II III aVF
SPRB	Borderline Short PR Interval.....PR int < ** mS
TAXAB	Borderline T Wave Abnormalities.....T axis not between (-10,100)
TAXQT	Borderline T Wave Abnormalities.....QRS-T axis angle (91,180)
TTW1	Tall T, Probably Normal Variant, Ant-lat Lds.....T >1.0mV, I aVL V2-V6

Philips 12-Lead Algorithm Version PH090A Exclude All Suppressed Statements

The interpretive statements listed in Table A-1, “Philips 12-Lead Algorithm Version PH090A Exclude Low Certainty - Suppressed Statements,” on page A-1, and the interpretive statements listed in Table A-2, “Philips 12-Lead Algorithm Version PH090A Exclude All Setting - Suppressed Statements,” on page A-3, are suppressed when the **Exclude All** setting is selected under the **Algorithm/Pacing** button on the Setup, Default Cardiograph Settings screen.

**Table A-2 Philips 12-Lead Algorithm Version PH090A
Exclude All Setting - Suppressed Statements**

Statement Code	Interpretive Statement
AMI1	Borderline R Wave Progression, Anterior Leads.....R < 0.15mV
AMI3	Q Wave In V1.....Q >15mS in V1
AXL	Borderline Left Axis Deviation.....QRS axis (**, **)
AXR	Borderline Right Axis Deviation.....QRS axis (**, **)
BIVCDL	Borderline IVCD With LAD.....QRSd > ** mS, axis (-90,-30)
CRHPI	Consider RVH Or Posterior Infarct.....large R in V1
CRHPIR	Consider RVH Or PMI W/ Sec Repol Abnormality.....large R V1, repol abnormality

Table A-2 Philips 12-Lead Algorithm Version PH090A
Exclude All Setting - Suppressed Statements (continued)

Statement Code	Interpretive Statement
CRPMI	Tall R Wave In V2, Consider RVH OR PMI..... R/S ratio >3, T >0.30mV V1 V2
CRVH	Consider Right Ventricular Hypertrophy.....large R or R' V1/ V2
IMI3	Borderline Inferior Q Waves.....Qs add to 80 mS in II III aVF
IMI4	Consider LAFB Or Inferior Infarct.....Qs add to 65mS II III aVF & LAD
IMI18	Inferior Q Waves, Probably Normal Variation.....Q >30mS, age<31 male, <40 female
IRBBRV	IRBBB, The RSR' Pattern May Also Reflect RVH.....IRBBB, R or R' >0.5mV in V1-V3
LMI10	Borderline Lateral Q Waves.....Q >35mS, I aVL V5 V6
LMI49	Lateral Q Waves, Probably Normal Variation.....Q >35mS, age<31 male, <40 female
LQTB	Borderline Prolonged QT Interval.....QTc > ** mS
LVHR56	LVH By Voltage.....R > ** mV in V5 or V6
LVHR6	LVH By Voltage.....R > ** mV in V6
LVHRS	Consider Left Ventricular Hypertrophy.....RV6+SV1 > ** mV
LVHRSI	LVH By Voltage.....(R I+S III) > ** mV
LVHS12	LVH By Voltage.....S < ** in V1 or ** in V2
LVHTA	Consider Left Ventricular Hypertrophy.....prominent leftward forces
LVHV	LVH By Voltage.....R > ** in aVL
MSTEA	Minimal ST Elevation, Anterior Leads.....ST >0.08mV, V1-V4
MSTEAL	Minimal ST Elevation, Anterolateral Leads.....ST >0.06mV, I aVL V2-V6
MSTEI	Minimal ST Elevation, Inferior Leads.....ST >0.06mV, II III aVF
MSTEL	Minimal ST Elevation, Lateral Leads.....ST >0.07mV, I aVL V5 V6S

Table A-2 Philips 12-Lead Algorithm Version PH090A
Exclude All Setting - Suppressed Statements (continued)

Statement Code	Interpretive Statement
PLAA	Probable Left Atrial Abnormality.....P >50mS, <-0.10mV V1
PQAL	Borderline Q Wave In Anterolateral Leads.....Q >35mS, I aVL V3-V6
PQAN	Borderline Q Wave In Anterior Leads.....Q >30mS in V2-V5
PQIN	Borderline Q Waves In Inferior Leads.....Qs add to 80 mS in II III aVF
PQLA	Borderline Q Waves In Lateral Leads.....Q >35mS in I aVL V5 V6
PRAA	Probable Right Atrial Abnormality.....biphasic P >0.20 mV in V1
REPBAL	Borderline Repol Abnormality, Ant-lat Leads.....ST dep, T flat/neg, I aVL V2-V6
REPBAN	Borderline Repol Abnormality, Ant Leads.....ST dep, T flat/neg, V2-V4
REPBIL	Borderline Repol Abnormality, Inf-lat Leads.....ST dep, T flat/neg, inf/lat
REPBIN	Borderline Repol Abnormality, Inferior Leads.....ST dep, T flat/neg, II III aVF
REPBLA	Borderline Repol Abnormality, Lateral Leads.....ST dep, T flat/neg, I aVL V5 V6
RVHS5	Consider Right Ventricular Hypertrophy.....S < ** mV in V5
RVHS6	Consider Right Ventricular Hypertrophy.....S < ** mV in V6
SD0AL	Minimal ST Depression, Anterolateral Leads.....ST <-0.03mV, I aVL V2-V6
SD0AN	Minimal ST Depression, Anterior Leads.....ST <-0.03mV, V2-V4
SD0IN	Minimal St Depression, Inferior Leads.....ST <-0.03mV, II III aVF
SD0LA	Minimal St Depression, Lateral Leads.....ST <-0.03mV, I aVL V5 V6
SD0NS	Minimal St Depression.....ST <-0.03mV, T neg, any 2 leads

Table A-2 Philips 12-Lead Algorithm Version PH090A
Exclude All Setting - Suppressed Statements (continued)

Statement Code	Interpretive Statement
SPR	Short PR Interval, Accelerated Av Conduction.....PR < ** mS
SQT	Short QT Interval.....QTc <340mS
T0AL	Borderline T Abnormalities, Ant-lat Leads.....T flat/neg, I aVL V2-V6
T0AN	Borderline T Abnormalities, Anterior Leads.....T flat or neg, V2-V4
T0IN	Borderline T Abnormalities, Inferior Leads.....T flat/neg, II III aVF
T0LA	Borderline T Abnormalities, Lateral Leads.....T flat/neg, I aVL V5 V6
T0NS	Borderline T Wave Abnormalities.....T/QRS ratio < 1/20 or flat T
TTW30	Tall T Waves, Probably Normal Variant.....T >1.2mV, age 16-30

Philips DXL ECG Algorithm Version PH100B

Exclude Low Certainty Suppressed Statements

The following interpretive statements listed in Table A-3 are suppressed when the **Exclude Low Certainty** setting is selected under the **Algorithm/Pacing** button on the Setup, Default Cardiograph Settings screen.

Table A-3 Philips DXL ECG Algorithm Version PH100B
Exclude Low Certainty - Suppressed Statements

Statement Code	Interpretive Statement
BAVCD	Borderline prolonged PR interval.....PR > **, V-rate ** - **
BIVCD	Borderline intraventricular conduction delay.....QRSd > ** mS
CLAE	Consider left atrial enlargement.....wide or notched P waves
CRAE	Consider right atrial enlargement.....P >0.24mV limb lead
ET	Abnormal R-wave progression, early transition.....QRS area>0 in V2
ETRSR1	RSR' in V1 or V2, right VCD or RVH.....QRS area positive & R' V1/V2
LOWT	Borderline T wave abnormalities.....flat T

Table A-3 Philips DXL ECG Algorithm Version PH100B
Exclude Low Certainty - Suppressed Statements (continued)

Statement Code	Interpretive Statement
LT	Abnormal R-wave progression, late transition.....QRS area <0 in V5/V6
LVHQ	Consider left ventricular hypertrophy.....deep Q in V5-6 or II III aVF
LVOLFB	Borderline low voltage, extremity leads.....all extremity leads <0.6mV
NFAD	No further analysis attempted due to paced rhythm
NFRA	No further rhythm analysis attempted due to paced rhythm
QMAB	Artifact in lead(s) ** and baseline wander in lead(s) **
QMART	Artifact in lead(s) **
QMBW	Baseline wander in lead(s) **
REPB	Borderline repolarization abnormality....ST dep & abnormal T
RSR1	RSR' in V1 or V2, probably normal variant.....small R' only
RSRNV	RSR' in V1, normal variation.....term-vector post-rightward
SDALP	Nonspecific ST depression, anterolateral lds.....ST <-0.10mV, I aVL V2-V6
SDANP	Nonspecific ST depression, anterior leads.....ST <-0.10mV, V2-V5
SDCU	Minimal ST depression.....ST concave upward
SDINP	Nonspecific ST depression, inferior leads.....ST <-0.10mV, II III aVF
SDJ	Junctional ST depression.....ST <-0.10mV any 3 leads
SDM	Minimal ST depression.....ST <-0.05mV in 2 leads
SEALP	ST elevation, prob normal variation, ant-lat.....ST >0.15 mV, I aVL V2-V6
SEANP	ST elev, probably normal variation, ant leads.....ST>0.15mV, V2-V5
SEINP	ST elevation, probably normal variation, inf.....ST>0.15mV, II III aVF
SPRB	Borderline short PR interval.....PR int < ** mS
TAXAB	Borderline T wave abnormalities...T axis not between (-10,100)

**Table A-3 Philips DXL ECG Algorithm Version PH100B
Exclude Low Certainty - Suppressed Statements (continued)**

Statement Code	Interpretive Statement
TAXQT	Borderline T wave abnormalities.....QRS-T axis angle (91,180)
TTW1	Tall T, probably normal variant, ant-lat lds.....T >1.0mV, I aVL V2-V6

Philips DXL ECG Algorithm Version PH100B Exclude All Suppressed Statements

The interpretive statements listed in Table A-3, “Philips DXL ECG Algorithm Version PH100B Exclude Low Certainty - Suppressed Statements,” on page A-6, and the interpretive statements listed in Table A-4, “Philips DXL ECG Algorithm Version PH100B Exclude All Setting - Suppressed Statements,” on page A-8, are suppressed when the **Exclude All** setting is selected under the **Algorithm/Pacing** button on the Setup, Default Cardiograph Settings screen.

**Table A-4 Philips DXL ECG Algorithm Version PH100B
Exclude All Setting - Suppressed Statements**

Statement Code	Interpretive Statement
ANTQ	Abnormal Q wave in V1.....Q >15mS in V1
AXL	Borderline left-axis deviation.....QRS axis (** , **)
AXR	Borderline right-axis deviation.....QRS axis (** , **)
BIVCDL	Borderline IVCD with LAD.....QRSd > ** mS, axis(-90,-30)
CRHPI	Consider RVH or posterior infarct.....large R in V1
CRHPIR	Consider RVH or PMI w/ sec repol abnormality....large R V1, repol abnormality
RPMIC	Tall R wave in V2, consider RVH or PMI.....R/S ratio >3, T >0.30mV V1 V2
CRVH	Consider right ventricular hypertrophy.....large R or R' V1/V2
INFQ	Abnormal inferior Q waves.....Qs add to 80 mS in II III aVF
IQNV	Inferior Q waves, probably normal variation.... Q >30mS, age<21 male, <30 female
IRBBRV	IRBBB, the RSR' pattern may also reflect RVH...IRBBB, R or R' >0.5mV in V1-V3
LATQ	Abnormal lateral Q waves.....Q >35mS, I aVL V5 V6

Table A-4 Philips DXL ECG Algorithm Version PH100B
Exclude All Setting - Suppressed Statements (continued)

Statement Code	Interpretive Statement
LQNV	Lateral Q waves, probably normal variation...Q >35mS, age<31 male, <40 female
LQTB	Borderline prolonged QT interval.....QTc > ** mS
LVHR56	LVH by voltage.....R >*.***mV in V5 or V6
LVHR6	LVH by voltage.....R >*.***mV in V6
LVHRS	Consider left ventricular hypertrophy.....RV6+SV1 >*.***mV
LVHRSI	LVH by voltage.....(R I+S III) >*.***mV
LVHS12	LVH by voltage.....S <*.*** in V1 or *.*** in V2
LVHTA	Consider left ventricular hypertrophy...prominent leftward forces
LVHV	LVH by voltage.....R >*.*** in aVL
MSTEA	Minimal ST elevation, anterior leads.....ST >0.10mV, V1-V4
MSTEAL	Minimal ST elevation, anterolateral leads.....ST >0.08mV, I aVL V2-V6
MSTEI	Minimal ST elevation, inferior leads....ST >0.06mV, II III aVF
MSTEL	Minimal ST elevation, lateral leads...ST >0.06mV, I aVL V5 V6
PLAE	Probable left atrial enlargement....P >50mS, <-0.10mV V1
PQAL	Borderline Q wave in anterolateral leads.....Q >35mS, I aVL V3-V6
PQAN	Borderline Q wave in anterior leads.....Q >30mS in V2-V5
PQIN	Borderline Q waves in inferior leads.....Qs add to 80 mS in II III aVF
PQLA	Borderline Q waves in lateral leads...Q >35mS in I aVL V5 V6
PRAE	Probable right atrial enlargement....biphasic P >0.20 mV in V1
REPBAL	Borderline repol abnormality, ant-lat leads.....ST dep, T flat/neg, I aVL V2-V6
REPBAN	Borderline repol abnormality, ant leads.....ST dep, T flat/neg, V2-V4
REPBIL	Borderline repol abnormality, inf-lat leads.....ST dep, T flat/neg, inf/lat

Table A-4 Philips DXL ECG Algorithm Version PH100B
Exclude All Setting - Suppressed Statements (continued)

Statement Code	Interpretive Statement
REPBIN	Borderline repol abnormality, inferior leads.....ST dep, T flat/neg, II III aVF
REPBLA	Borderline repol abnormality, lateral leads...ST dep, T flat/neg, I aVL V5 V6
RVHS5	Consider right ventricular hypertrophy.....deep S in V5
RVHS6	Consider right ventricular hypertrophy.....deep S in V6
SD0AL	Minimal ST depression, anterolateral leads.....ST <-0.04mV, I aVL V2-V6
SD0AN	Minimal ST depression, anterior leads....ST <-0.03mV, V2-V4
SD0IN	Minimal ST depression, inferior leads...ST <-0.04mV, II III aVF
SD0LA	Minimal ST depression, lateral leads.....ST <-0.04mV, I aVL V5 V6
SD0NS	Minimal ST depression.....ST <-0.04mV, T neg, any 2 leads
SPR	Short PR interval.....PR < ** mS
SQT	Short QT interval.....QTc <340mS
T0AL	Borderline T abnormalities, ant-lat leads.....T flat/neg, I aVL V2-V6
T0AN	Borderline T abnormalities, anterior leads...T flat or neg, V2-V4
T0IN	Borderline T abnormalities, inferior leads.....T flat/neg, II III aVF
T0LA	Borderline T abnormalities, lateral leads.....T flat/neg, I aVL V5 V6
T0NS	Borderline T wave abnormalities.....T/QRS ratio < 1/20 or flat T
TTW30	Tall T waves, probably normal variant....T >1.2mV, age 16-30

Critical Value Statements

Introduction

This Appendix includes a listing of all interpretive statements generated by the Philips 12-Lead Algorithm version PH090A, and by the Philips DXL ECG Algorithm version PH100B, that will result in a *Critical Value* statement appearing on the ECG report. Use of the Critical Values feature makes it simple to align with the Joint Commission's National Patient Safety Goals to improve the timeliness of reporting critical test results and their receipt by a responsible licensed caregiver. The Critical Values feature is a configurable option that summarizes four critical values for ECG interpretation using simple terminology. When appropriate, the DXL Algorithm outputs an emphasized statement to advise caregivers of the need for urgent care, with the goal of reducing time from discovery of a critical cardiac event to intervention.

Thirty interpretive statements are summarized in the following four Critical Values:

- Acute Myocardial Infarction
- Complete Heart Block
- Very High Heart Rate
- Acute Ischemia (Philips DXL ECG Algorithm version PH100B only)

Table B-1 through Table B-7 on the following pages provide a list of all of the interpretive statements that will generate a Critical Value. Multiple interpretive statements can trigger an individual Critical Value, and this Critical Value statement appears in the interpretive statement block on the ECG report, and a second notation also appears at the bottom right of the ECG report for additional emphasis.

For more information on the Philips 12-lead Algorithm version PH090A, see the *Philips 12-Lead Algorithm Physician's Guide*. For more information on the Philips DXL ECG Algorithm version PH100B, see the *Philips DXL ECG Algorithm Physician's Guide* on the User Documentation and Training DVD, or download the file from the Philips InCenter web site (incenter.medical.philips.com). For information on using the Philips InCenter web site, see page 1-4.

Philips 12-Lead Algorithm Version PH090A Acute Myocardial Infarction Critical Value Statements

If any of the interpretive statements listed in Table B-1 result from the measurements generated by an ECG, the Critical Value statement **Acute MI** will appear on the ECG report.

**Table B-1 Philips 12-Lead Algorithm Version PH090A
Acute Myocardial Infarct Warning Statements**

Statement Code	Interpretive Statement
ALI50	Probable Anterolateral Infarct, Acute ST >0.15 mV, Q >30 mS, V2-V5
ALIA	Anterolateral Infarct, Acute Q >35 mS, ST >0.20 mV, V2-V6
ALIEA	Anterolateral Injury, Early Acute Infarct ST >0.15 mV, I aVL V2-V6
AMI21A	Probable Anteroseptal Infarct, Acute Q >30 mS, ST >0.15 mV, V1-V3
AMI22	Ant-sept Injury, Probable Early Acute Infarct ST >0.40 mV V1-V3
AMI32	Anterior Infarct, Acute Q >30 mS, ST >0.25 mV, V1-V4
AMIA	Anterior Infarct, Acute ST >0.25 mV, T neg, V1-V5
AMIEA	Anterior Injury, Early Acute Infarct ST >0.35 mV in V1-V5
AS Mia	Anteroseptal Infarct, Acute Q >30 mS, ST >0.25 mV, V1-V3
EAMIA	Extensive Anterior Infarct, Acute Q >35 mS, ST >0.15 mV, V1-V6
IMI50	Probable Inferior Infarct, Acute Q >25 mS, ST >0.10 mV, II III aVF
IMI67	Inferior Infarct, Possibly Acute Q >35 mS, ST >0.10 mV, II III aVF
IMIA	Inferior Infarct, Acute Q >35 mS, ST >0.10 mV, II III aVF

Table B-1 Philips 12-Lead Algorithm Version PH090A
Acute Myocardial Infarct Warning Statements (continued)

Statement Code	Interpretive Statement
IMIEA	Inferior Injury, Probable Early Acute Infarct ST>0.15 mV, II III aVF
IPMIA	Inferoposterior Infarct, Acute ST >.10 II III aVF, <-.05 V1-V4
LMIS0	Probable Lateral Infarct, Acute Q >25 mS, ST>0.10 mV, I aVL V5 V6
LMIA	Lateral Infarct, Acute ST >.20 mV, Q >35 mS, I aVL V5 V6
LMIEA	Lateral Injury, Probable Early Acute Infarct ST >0.10 mV, I aVL V5 V6
PINJA	ST Elevation, Probable Anterior Injury ST >0.25 mV in V1-V5
PINJAL	ST Elevation, Probable Anterolateral Injury ST >0.15 mV, I aVL V2-V6
PINJI	ST Elevation, Probable Inferior Injury inf ST>0.1 mV, lat ST<-0.05 mV
PINJL	ST Elevation, Probable Lateral Injury ST >0.08 mV, I aVL V5 V6
PMIA	Posterior Infarct, Acute prominent R T, ST <-.05 V1-V4
PPMIA	Probable Posterior Infarct, Acute prominent R T, ST <-.05 V1-V3

Philips 12-Lead Algorithm Version PH090A Tachycardia Critical Value Statements

If any of the interpretive statements listed in Table B-2 result from the measurements generated by an ECG, the Critical Value statement **Very High Heart Rate** will appear on the ECG report.

**Table B-2 Philips 12-Lead Algorithm Version PH090A
Tachycardia Interpretive Statements**

Statement Code	Interpretive Statement
ETACH	Extreme Tachycardia V-rate >(220-age)
TACHW	Wide Complex Tachycardia V-rate>***, QRSd>***
VTACH	Extreme Tachycardia With Wide Complex, No Further Rhythm Analysis Attempted

Philips 12-Lead Algorithm Version PH090A Complete Heart Block Critical Value Statements

If any of the interpretive statements listed in Table B-3 result from the measurements generated by an ECG, the Critical Value statement **Complete Heart Block** will appear on the ECG report.

**Table B-3 Philips 12-Lead Algorithm Version PH090A
Complete Heart Block Interpretive Statements**

Statement Code	Interpretive Statement
3AVB	Complete Av Block
3AVBIR	Complete Av Block With Wide Qrs Complex
3AVBFF	Atrial Flutter/fibrillation With Complete Av Block

Philips DXL ECG Algorithm Version PH100B

Acute Myocardial Infarction Critical Value Statements

If any of the interpretive statements listed in Table B-1 result from the measurements generated by an ECG, the Critical Value statement **Acute MI** will appear on the ECG report.

**Table B-4 Philips DXL ECG Algorithm Version PH100B
Acute Myocardial Infarct Critical Value Statements**

Statement Code	Interpretive Statement
AMIA	Anterior infarct, acute.....ST >0.25mV, V2-V5
AMIAP	Probable anterior infarct, acute.....ST >0.15mV, upright T, V2-V5
AMIPA	Anterior infarct, possibly acute.....ST >0.15mV, upright T, V2-V5
AMIAD	Anterior infarct, acute (LAD).....ST >0.25mV, V2-V5
IMIAP	Probable inferior infarct, acute.....ST>0.10mV, II III aVF
IMIPA	Inferior infarct, possibly acute.....Q >30mS, ST >0.10mV, II III aVF
IMIA	Inferior infarct, acute.....ST>0.10mV, T upright, II III aVF
IMIAR	Inferior infarct, acute (RCA).....ST>0.10mV in III > II
IMIAX	Inferior infarct, acute (LCx).....ST>0.10mV, II III aVF, STd V1-V3
PMIA	Posterior infarct, acute.....ST<-0.1 V1-V3 or ST>.05 V7-V9
PMIAP	Probable posterior infarct, acute.....ST<-.05 V1-V3 or >.05 V7-V9
PMIAX	Posterior infarct, acute (LCx).....ST<-0.1 V1-V3 or ST>.05 V7-V9
IPMIA	Inferoposterior infarct, acute.....ST>.1 inf, <-.1 V1-3 or >.05 V7-9
IPMIAR	Inferoposterior infarct, acute (RCA).....ST>.1 inf, <-.1 ant
IPMIAX	Inferoposterior infarct, acute (LCx).....ST>.1 inf, <-.1 V1-3 or >.05 V7-9
LMIAP	Probable lateral infarct, acute.....Q >28mS, ST>0.10mV, V5 V6 I aVL
LMIPA	Lateral infarct, possibly acute.....Q >28mS, ST >0.10mV, V5 V6 I aVL
LMIA	Lateral infarct, acute.....ST >.10mV, V5 V6 I aVL
LMIAD	Lateral infarct, acute (LAD).....ST >.10mV, V5 V6 I aVL
ILMIA	Inferolateral infarct, acute.....ST>.10mV, inf-lat leads
ILMIAX	Inferolateral infarct, acute (LCx).....ST>.10mV, inf-lat leads
ILMIAR	Inferolateral infarct, acute (RCA).....ST>.10mV, inf-lat leads
ASMIAP	Probable anteroseptal infarct, acute.....ST>0.15mV, T upright, V1-V2
ASMIPA	Anteroseptal infarct, possibly acute.....Q>35mS, ST>0.15mV, V1-V2

Table B-4 Philips DXL ECG Algorithm Version PH100B
Acute Myocardial Infarct Critical Value Statements (continued)

Statement Code	Interpretive Statement
ASMIA	Anteroseptal infarct, acute.....ST >0.20mV, V1-V2
ASMIAD	Anteroseptal infarct, acute (LAD).....ST >0.25mV, V1-V2
EAMIA	Extensive anterior infarct, acute.....ST >0.20mV, V1-V6
EAMIAD	Extensive anterior infarct, acute (LAD).....ST >0.20mV, V1-V6
EAMIPA	Extensive anterior infarct, possibly acute.....Q >35mS, ST >0.15mV, V1-V6
ALIAP	Probable anterolateral infarct, acute.....ST >0.15mV, V2-V6,I,aVL
ALIPA	Anterolateral infarct, possibly acute.....Q >35mS, ST >0.15mV, V2-V6,I,aVL
ALIA	Anterolateral infarct, acute.....ST >0.20mV, V2-V6, I, aVL
ALIAD	Anterolateral infarct, acute (LAD).....ST >0.20mV, V2-V6, I, aVL
RMIAP	Probable right ventricular infarct, acute...ST>.08, V3R-V5R, aVR & STd in lat
RMIA	Right ventricular infarct, acute.....ST>.10, V3R-V5R, aVR & STd in lat
RMIAR	Right ventricular infarct, acute (RCA).....ST>.08, aVR V3R-V5R & STd lat lds

Philips DXL ECG Algorithm Version PH100B Tachycardia Critical Value Statements

If any of the interpretive statements listed in Table B-2 result from the measurements generated by an ECG, the Critical Value statement **Very High Heart Rate** will appear on the ECG report.

**Table B-5 Philips DXL ECG Algorithm Version PH100B
Tachycardia Critical Value Statements**

Statement Code	Interpretive Statement
ETACH	Extreme tachycardia.....V-rate >(220-age)
TACHW	Wide-QRS tachycardia V-rate>***, QRSd>***
VTACH	Extreme tachycardia with wide complex, no further rhythm analysis attempted

Philips DXL ECG Algorithm Version PH100B Complete Heart Block Critical Value Statements

If any of the interpretive statements listed in Table B-3 result from the measurements generated by an ECG, the Critical Value statement **Complete Heart Block** will appear on the ECG report.

**Table B-6 Philips DXL ECG Algorithm Version PH100B
Complete Heart Block Critical Value Statements**

Statement Code	Interpretive Statement
3AVB	AV block, complete (third degree).....V-rate<***, AV dissociation
3AVBIR	Complete AV block with wide QRS complex.....V-rate<***, QRSd>***, AV dissociation
3AVBFF	A-flutter/fibrillation w/ complete AV block...A-rate>220, V-rate<***, AV dissociation

Philips DXL ECG Algorithm Version PH100B Acute Ischemia Critical Value Statements

If the interpretive statement listed in Table B-1 is generated by the measurements from a patient ECG, the Critical Value statement **Acute Ischemia** will appear on the ECG report.

**Table B-7 Philips DXL ECG Algorithm Version PH100B
Acute Ischemia Critical Value Statements**

Statement Code	Interpretive Statement
LMMVD	Repol abnrm, severe global ischemia (LM/3VD) STe aVR, STd & Tneg, ant/lat/inf

Specifications

Technical Specifications

ECG Acquisition

- Auto ECG (12 leads standard; up to 16 leads *optional*)
- Rhythm ECG (12 leads standard; up to 16 leads *optional*)
- Disclose (12 leads standard; 16 leads *optional*)

PageWriter TC70 Keyboard

- Full alphanumeric capability QWERTY keyboard

PageWriter TC50 Keyboard

- Three-quarter size full alphanumeric capability QWERTY keyboard

PageWriter TC70 Touchscreen Display

- 1024 x 768 pixel resolution
- 30.4 cm x 22.8 cm (11.96 x 6.22 in) color liquid crystal touch screen display with backlight

PageWriter TC50 Touchscreen Display

- 800 x 600 pixel resolution
- 21.1 cm x 15.8 cm (8.30 x 8.97 in) color liquid crystal touch screen display with backlight

Patient Interface Module

- Remote, microprocessor-controlled module
- ECG button with signal quality indicator allows user to take ECGs from the bedside

Patient Interface Module Signal Acquisition

- 8,000 samples per second per electrode/lead for standard 12 or up to 16 leads

Signal Processing/Acquisition

Sampling Rate

- 500 samples per second per electrode/lead
- 12 bit A/D conversion provides down sampled 5 μ V resolution, 500 samples per second measurement with no channel to channel skew

Auto Frequency Response

0.05-150 Hz, 0.15-150 Hz, 0.5-150 Hz

0.05-100 Hz, 0.15-100 Hz, 0.5-100 Hz

0.05-40 Hz, 0.15-40, 0.5-40 Hz

Rhythm Frequency Response

0.05-40 Hz, 0.05-100 Hz, 0.05-150 Hz

0.15-40 Hz, 0.15-100 Hz, 0.15-150 Hz

Minimum Amplitude or Value of Patient Physiological Signal

CAUTION The QRS wave must be a minimum of 100 μ V peak to peak or greater for the lead's complex to be measured. The operation of the cardiograph below this value may cause incorrect ECG analysis.

Filters

- AC noise
- Baseline Wander
- Artifact

Printer

Printer Resolution

- High-resolution, digital-array printer using thermal-sensitive paper
- 200 dpi (voltage axis) by 500 dpi (time axis)

Report Formats

Exam Profiles

- Up to 12 configured Exam Profiles can be specified

12 Lead Report Formats

- 3x4 (1R, 3R)
- 3x4, 1R 8ST
- 3x4, 1R 10ST
- 6x2
- Panoramic 12 (Cabrera sequence only)
- 12x1
- Extended Measurements

16 Lead Report Formats

- 3x5 (1R, 3R)
- 3x5, 1R ST
- 4x4 (1R)
- 4x4 1R, ST
- Extended Measurements

Rhythm Report Formats

- Rhythm (up to 12, or up to optional 16 selected leads)

Battery Operation

- SMBus compliant batteries

Voltage

- 9.0 to 12.6 VDC

Current

- 6.0 A max per battery (continuous)

Power

- 35 to 44 W max per battery (continuous)

- 54 W max per battery (2 second peaks)

PageWriter TC70/TC50 Two Battery Operating Capacity

- 45 minutes of continuous Rhythm printing, or a maximum of 237 individual sheets of ECG recording paper

PageWriter TC50 One Battery Operating Capacity

- The battery capacity for the PageWriter TC50 cardiograph with a single battery installed using the battery with Philips part number 989803170371, is 30 minutes of continuous Rhythm printing, or 30 total ECG reports

Status Display

- Full Charge Capacity (mAHR)
- Remaining Capacity (%)
- Temperature (deg C)
- Discharge Current (mA)
- Charge Current (mA)
- Low battery audio and visual alerts

Recharge

- Less than five hours if cardiograph is in Standby (not in active use) to at least 95% capacity
- Less than eight hours if the cardiograph is in active use to at least 95% capacity

Network Connection

- 10/100 Base-T IEEE 802.3 Ethernet via RJ45 connector (standard)
- Optional software required for wireless LAN connection. Wireless LAN connection is 802.11g compatible.

FAX Capability (optional)

- Group 3, Class 1 or 2 fax

Modem

- V.90, K56flex, enhanced V.34, V.32bis, V.32, V.22bis and below

Barcode Reader (optional)

- Reads Code 39 (standard and full ASCII)

Magnetic Card Reader (optional)

- Reads cards adhering to ISO 7810, 7811-1, -2, -3, -4, -5

Smart Card Reader (optional)

- Reads cards adhering to ISO/IEC 7816

ECG Storage

- XML File Format in version 1.03, 1.04, 1.04.01, and 1.04.02
- Up to 200 ECGs to internal flash memory
- Up to 200 ECGs per USB Memory Stick (optional)

Orders

- Up to 200 pending orders can be stored on the cardiograph

ECG File Formats

- XML and XML SVG

Power and Environment

PageWriter TC70 Cardiograph AC Adapter

- Input voltage: 100 to 240 VAC
- Input voltage frequency: 50 to 60 Hz
- Input current: 1.4A - 0.7A
- Output: 15 Volts DC, 5.33A, 80W

PageWriter TC50 Cardiograph AC Input Voltage

- Input voltage: 100 to 240 VAC
- Input voltage frequency: 50 to 60 Hz
- Input current: 1.2A

PageWriter TC50 Cardiograph AC Output Voltage

- Output: 15 Volts DC, 4.0A, 60W

PageWriter TC70 Cardiograph Environmental Operating Conditions

- 10° to 40 °C (50° to 104°F)
- 10% to 90% relative humidity (non-condensing)
- Up to 4,550 m (15,000 ft.) altitude, 572 hPA

PageWriter TC50 Cardiograph Environmental Operating Conditions

- 10° to 40 °C (50° to 104°F)
- 10% to 90% relative humidity (non-condensing)
- Up to 3,033 m (10,000 ft.) altitude, 697 hPA

PageWriter TC50/TC70 Cardiograph Environmental Storage Conditions

- -20° to 50 °C (-4° to 122°F)
- 10% to 90% relative humidity (non-condensing)
- Up to 4,572 m (15,000 ft.) altitude, 572 hPA

PageWriter TC50/TC70 Cardiograph Environmental Operating Conditions

- 10° to 40 °C (50° to 104°F)
- 10% to 90% relative humidity (non-condensing)
- Up to 3,048 m (10,000 ft.) altitude, 696.817 hPA

PageWriter TC70 Cardiograph Dimensions

- 330 mm wide x 405 mm deep x 135 mm height (12.99 inches wide x 15.94 inches deep x 5.31 inches height) with top cover in down position

PageWriter TC70 Cardiograph Weight

- 11 kg (28 lb) including accessories

PageWriter TC50 Cardiograph Dimensions

- 405 mm length x 310 mm width x 130 mm height (15.94 inches wide x 12.20 inches deep x 5.11 inches height) with top cover in down position

PageWriter TC50 Cardiograph Weight

- 9 kg (19.84 lb) including accessories

PageWriter TC70 and PageWriter TC50 Cardiograph Shipping Container Weight

- Maximum shipping weight of packaged PageWriter TC70 or PageWriter TC50 cardiograph (including all accessories) is 17.1 kg (37.69 lb)

Safety and Performance

Meets the following requirements for safety and performance:

- IEC 60601-1: 1988 +A1:1991 +A2:1995 Medical electrical equipment – Part 1: General requirements for Safety (Includes national differences for standards AS/NZS 3200.1.0: 1998, CAN/CSA-C22.2 No. 60601-1-M90 +B: 90 +S1: 94, EN 60601-1: 1990 +A1: 1993 +A11: 1993 +A12: 1993 +A13: 1996, JIS T 0601-1: 1999, UL 60601-1: 2003)
- IEC 60601-2-25: 1993 +A1:1999 Particular requirements for the safety of electrocardiographs (Includes national differences for standards AS/NZS 3200.2.25: 1993, CAN/CSA-C22.2 No. 60601-2-25: 1994 +A1: 2002, EN 60601-2-25: 1995 + A1: 1999)
- IEC 60601-2-51: 2003 Particular requirements for safety, including essential performance, of recording and analyzing single channel and multi-channel electrocardiographs (Includes national differences for standards CAN/CSA-C22.2 No. 60601-2-51: 2004, EN 60601-2-51: 2003)
- IEC/EN 60601-1-2 2001: 2nd ed Electromagnetic compatibility- Requirements and tests
- AAMI EC11: 1991 (R: 2001) Diagnostic Electrocardiographic Devices

Classification (IEC 60601-1)

PageWriter TC50 Cardiograph Class I (Internally Powered)

PageWriter TC70 Cardiograph Class II (Internally Powered)

Symbol	Meaning
	ECG physio isolation is type CF, defibrillator proof. Suitable for all patient applications including direct cardiac application. System is in continuous operation.
IPX0	Cardiograph has ordinary protection against the entry of liquids.
IPX4	The PIM (patient interface module) is protected against splashing water. Water splashed against the PIM from any direction shall have no harmful effect.

-
- Cardiograph is not suitable for use in the presence of flammable anesthetic mixture with air, oxygen, or nitrous oxide.
 - System is continuous operation.
-

WARNING When using additional peripheral equipment powered from an electrical source other than the cardiograph, the combination is considered to be a medical system. It is the responsibility of the operator to comply with IEC 60601-1-1 and test the medical system according to the requirements. For additional information contact Philips Medical Systems.

Electromagnetic Compatibility (EMC)

Electronic devices can either generate or receive electromagnetic interference. The PageWriter TC70 cardiograph and the PageWriter TC50 cardiograph have been evaluated for electromagnetic compatibility (EMC) with the appropriate accessories according to Medical Collateral standard IEC 60601-1-2, Edition 2 (with exceptions noted in proceeding tables). This IEC standard has been adopted in the European Union as the European Norm, EN 60601-1-2, Edition 2.

WARNING Radio frequency (RF) interference from nearby transmitting devices may degrade performance of the electronic equipment. Electromagnetic compatibility with surrounding devices should be assessed prior to using the equipment.

WARNING Fixed, portable, and mobile radio frequency communications equipment can also affect the performance of electrical equipment. See your Service Provider for assistance with the minimum recommended separation distance between RF communications equipment and the PageWriter TC70 or PageWriter TC50 cardiograph.

WARNING The use of accessories and cables other than those specified in the Philips PageWriter TC70 cardiograph or PageWriter TC50 cardiograph service and user documentation can result in increased emissions or decreased immunity of the system.

WARNING The PageWriter TC70 cardiograph or PageWriter TC50 should not be used next to or stacked on top of other equipment. If you must stack the product, you must check that normal operation is possible in the necessary configuration before the product is used.

Reducing Electromagnetic Interference

The PageWriter TC70 cardiograph and PageWriter TC50 cardiograph and accessories may become sensitive to interference from other RF energy sources including power lines. RF energy sources include other medical devices, wireless devices, information technology equipment, and radio/television transmission. Should interference be encountered, as demonstrated by artifact on the ECG trace, unintended change on operating state, or unit lockup, attempt to locate the source by assessing:

- if the interference is intermittent or constant?
- does the interference occur only in certain locations?
- does the interference occur only when in close proximity to certain medical devices?
- does the ECG signal quality change dramatically when the AC power cord is unplugged?

Once the source of the interference is located, attempt to attenuate the EMC coupling path by distancing the cardiograph from the source of the interference as much as possible. If further assistance is needed, contact the Philips Response Center nearest you.

Table C-1 PageWriter TC50 Cardiograph Guidance and Manufacturer's Declaration: Electromagnetic Emissions

The PageWriter TC50 cardiograph is intended for use in the electromagnetic environment specified in the table below. The customer or the user of the PageWriter TC50 cardiograph should assure that it is used in such an environment.

Emissions Test	Compliance	Electromagnetic Environment: guidance
RF Emissions CISPR 11	Group 1	The PageWriter TC50 cardiograph uses RF energy only for its internal function. Therefore, its RF emissions are very low and are not likely to cause any interference in nearby electronic equipment.
RF Emissions CISPR 11	Class B	The PageWriter TC50 cardiograph is suitable for use in all establishments, including domestic establishments and those directly connected to the public low-voltage power supply network that supplies buildings used for domestic purposes.
Harmonic Emissions IEC 61000-3-2	Class A	
Voltage fluctuations/ flicker emissions IEC 61000-3-3	Complies	

Table C-1 PageWriter TC70 Cardiograph Guidance and Manufacturer's Declaration: Electromagnetic Emissions

The PageWriter TC70 cardiograph is intended for use in the electromagnetic environment specified in the table below. The customer or the user of the PageWriter TC70 cardiograph should assure that it is used in such an environment.

Emissions Test	Compliance	Electromagnetic Environment: guidance
RF Emissions CISPR 11	Group 1	The PageWriter TC70 cardiograph uses RF energy only for its internal function. Therefore, its RF emissions are very low and are not likely to cause any interference in nearby electronic equipment.
RF Emissions CISPR 11	Class A	The PageWriter TC70 cardiograph is suitable for use in all establishments other than domestic and those directly connected to the public low-voltage power supply network that supplies buildings used for domestic purposes.
Harmonic Emissions IEC 61000-3-2	Class A	
Voltage fluctuations/ flicker emissions IEC 61000-3-3	Complies	

Table C-2 Guidance and Manufacturer's Declaration: Electromagnetic Immunity

The PageWriter TC70 cardiograph or PageWriter TC50 cardiograph is intended for use in the electromagnetic environment specified below. The customer or the user of the PageWriter TC70 cardiograph or PageWriter TC50 cardiograph should assure that it is used in such an environment.

Immunity Test	IEC 60601 Test Level	Compliance Level	Electromagnetic Environment: guidance
Electrostatic Discharge (ESD) IEC 61000-4-2	+/- 6 kV contact +/- 8 kV air	+/- 6 kV contact +/- 8 kV air	Floors should be constructed of wood, concrete, or ceramic tile. If floors are covered with synthetic material, the relative humidity should be at least 30%.
Electrical Fast transient/burst IEC 61000-4-4	+/- 2 kV for power supply lines +/- 1 kV for input/output lines	+/- 2 kV for power supply lines +/- 1 kV for input/output lines	Mains power quality should be that of a typical commercial or hospital environment.
Surge IEC 61000-4-5	+/- 1 kV differential mode +/- 2 kV common mode	+/- 1 kV differential mode +/- 2 kV common mode	Mains power quality should be that of a typical commercial or hospital environment.

Table C-2 Guidance and Manufacturer's Declaration: Electromagnetic Immunity (continued)

The PageWriter TC70 cardiograph or PageWriter TC50 cardiograph is intended for use in the electromagnetic environment specified below. The customer or the user of the PageWriter TC70 cardiograph or PageWriter TC50 cardiograph should assure that it is used in such an environment.

Immunity Test	IEC 60601 Test Level	Compliance Level	Electromagnetic Environment: guidance
Voltage dips, short interruptions and voltage variations on power supply input lines IEC 61000-4-11	<5% U_T (>95% dip in U_T) for 0.5 cycle 40% U_T (60% dip in U_T) for 5 cycles 70% U_T (>30% dip in U_T) for 25 cycles <5% U_T (>95% dip in U_T) for 5 seconds	<5% U_T (>95% dip in U_T) for 0.5 cycle 40% U_T (60% dip in U_T) for 5 cycles 70% U_T (>30% dip in U_T) for 25 cycles <5% U_T (>95% dip in U_T) for 5 seconds	Mains power quality should be that of a typical commercial or hospital environment. If the user of the PageWriter TC70 cardiograph or PageWriter TC50 cardiograph require continued operation during power mains interruptions, it is recommended that the PageWriter TC70 cardiograph or PageWriter TC50 cardiograph be powered from an uninterruptable power supply or a battery.
Power frequency (50./60 Hz) magnetic field	3 A/m	Complies	Power frequency magnetic fields should be at levels characteristic of a typical location in a typical commercial or hospital environment.

Note: U_T is the a.c. mains voltage prior to application of the test level.

Table C-2 Guidance and Manufacturer's Declaration: Electromagnetic Immunity (continued)

The PageWriter TC70 cardiograph and PageWriter TC50 cardiograph are intended for use in the electromagnetic environment specified below. The customer or the user of the PageWriter TC70 cardiograph or PageWriter TC50 cardiograph should assure that it is used in such an environment.

Immunity Test	IEC 60601 Test Level	Compliance Level	Electromagnetic Environment: guidance
Conducted RF IEC 61000-4-6	3 Vrms 150 kHz to 80 MHz	3 Vrms	<p>Portable and mobile RF communications equipment should be used no closer to any part of the PageWriter TC70 cardiograph or PageWriter TC50 cardiograph, including cables, than the recommended separation distance calculated from the equation applicable to the frequency of the transmitter.</p> <p>Recommended separation distance</p> $d = 1.2\sqrt{P}$
Radiated RF IEC 61000-4-3	3 V/m 80 MHz to 2,5 GHz	3 V/m	$d = 1.2\sqrt{P} \quad 80 \text{ MHz to } 800 \text{ MHz}$ $d = 2.3\sqrt{P} \quad 800 \text{ MHz to } 2,5 \text{ GHz}$ <p>Where P is the maximum output power rating of the transmitter in watts (W) according to the transmitter manufacturer and d is the recommended separation distance in meters (m).</p> <p>Field strengths from fixed RF transmitters, as determined by an electromagnetic site survey^a, should be less than the compliance level in each frequency range^b.</p> <p>Interference may occur in the vicinity of equipment marked with the following symbol:</p> 

Note 1: At 80 MHz and 800 MHz, the higher frequency range applies.

Note 2: These guidelines may not apply in all situations. Electromagnetic propagation is affected by absorption and reflection from surfaces, objects, and people.

- a. Field strengths from fixed transmitters, such as base stations for radio (cellular/cordless) telephones and land mobile radios, amateur radio, AM and FM radio broadcast and TV broadcast cannot be predicted theoretically with accuracy. To assess the electromagnetic environment due to fixed RF transmitters, an electromagnetic site survey should be considered. If the measured field strength in the location in which the PageWriter TC70 cardiograph or PageWriter TC50 cardiograph are used exceeds the applicable RF compliance level above, the PageWriter TC70 cardiograph or PageWriter TC50 cardiograph should be observed to verify normal operation. If abnormal performance is observed, additional measures may be necessary, such as re-orienting or re-locating the PageWriter TC70 cardiograph or PageWriter TC50 cardiograph.
- b. Over the frequency range 150 kHz to 80 MHz, field strengths should be less than 3 V/m.

Table C-3 Recommended Separation Distances Between Portable and Mobile RF Communications Equipment and the PageWriter TC70 Cardiograph or PageWriter TC50 Cardiograph: for equipment and systems that are not life-supporting

The PageWriter TC70 cardiograph and PageWriter TC50 cardiograph are intended for use in the electromagnetic environment in which radiated RF disturbances are controlled. The customer or the user of the PageWriter TC70 cardiograph or PageWriter TC50 cardiograph can help to prevent electromagnetic interference by maintaining a minimum distance between portable and mobile RF communications equipment (transmitters) and the PageWriter TC70 cardiograph or PageWriter TC50 cardiograph as recommended below, according to the maximum output power of the communications equipment.

Rated Maximum Output Power of Transmitter (W)	Separation Distance According to Frequency of Transmitter (m)	
	150 KHz to 800 KHz	800 MHz to 2.5 GHz
0.01	$d = 1.2 \sqrt{P}$	$d = 2.3 \sqrt{P}$
	0.1 m	0.2 m
0.1	0.4 m	0.7 m
1	1.2 m	2.3 m
10	4.0 m	7.0 m
100	12.0 m	23.0 m

For transmitters rated at a maximum output power not listed above, the recommended separation distance d in meters (m) can be estimated using the equation applicable to the frequency of the transmitter, where P is the maximum output power rating of the transmitter in watts (W) according to the transmitter manufacturer.

Note 1: At 80 MHz and 800 MHz, the separation distance for the higher frequency range applies.

Note 2: These guidelines may not apply in all situations. Electromagnetic propagation is affected by the absorption and reflection from structures, objects, and people.

Wireless LAN Card Specifications

The specifications in the following sections are applicable to the Summit wireless adapters that are offered as options for the PageWriter TC cardiographs. Two options are available:

- Option D21, Summit SDC-CF20G wireless adapter
- Option D22, Summit SDC-CF22AG wireless adapter (see page C-18)

Summit SDC-CF20G Wireless Adapter (Option D21)

Length

72.8 mm (2.87 inches)

Width

43 mm (1.69 inches)

Thickness

- Card body: 3.3 mm (0.13 inches)
- Antenna: 7.3 mm (0.29 inches)

Weight

21 grams (0.7 ounces)

System Interface

16-bit Compact Flash Type I with 50-pin connector

Antenna

0 dBi gain omnidirectional with diversity

Chipset

Broadcom BCM4318E

Input Power Requirements

3.3 VDC +/- 5%

Typical Power Consumption (at maximum transmit power setting)

- Transmit: 400 mA (1320mW)
- Receive: 180 mA (594mW)
- Standby: 10 mA (33 mW)

Operating Temperature

-30 °C to 75 °C (-22°F to 167°F)

Operating Humidity

10 to 90% (non-condensing)

Mounting

50-pin connector

Network Standards

IEEE 802.11b, 802.11g, 802.11i

Frequency Band

2.4 to 2.4897 GHz

Wireless Media

- Direct Sequence-Spread Spectrum (DSSS)
- Orthogonal Frequency Divisional Multiplexing (OFDM)

Media Access Protocol

Carrier sense multiple access with collision avoidance (CSMA/CA)

Data Rates Supported

- 802.11b (DSSS): 1, 2, 5.5, 11 Mbps
- 802.11g (OFDM): 6, 9, 12, 18, 24, 36, 48, 54 Mbps

Modulation

- 1, 6, 9 Mbps: BPSK
- 2, 12, 18 Mbps: QPSK
- 5.5, 11 Mbps: CCK
- 24, 36 Mbps: 16-QAM
- 48, 54 Mbps: 64-QAM

Regulatory Domain Support

- FCC (Americas, parts of Asia, and Middle East)
- ETSI (Europe, Middle East, Africa, and parts of Asia)
- TELEC (Japan)

Operating Channels

- FCC: 11 (3 non-overlapping)
- ETSI: 13 (3 non-overlapping)
- TELEC: 14 (3 non-overlapping)

Transmit Power Settings

NOTE Maximum transmit power will vary according to individual country regulations. All values nominal, +/-1.5dBm.

DSSS

19 dBm (80 mW)
 17 dBm (50 mW)
 15 dBm (30 mW)
 10 dBm (10 mW)
 0 dBm (1 mW)

OFDM

15 dBm (30 mW)
 10 dBm (10 mW)
 0 dBm (1 mW)

Typical Receiver Sensitivity

1 Mbps:	-96 dBm	12 Mbps:	-88 dBm
2 Mbps:	-95 dBm	18 Mbps:	-86 dBm
5.5 Mbps:	-94 dBm	24 Mbps:	-83 dBm
6 Mbps:	-94 dBm	36 Mbps:	-78 dBm
9 Mbps:	-91 dBm	48 Mbps:	-76 dBm
11 Mbps:	-90 dBm	54 Mbps:	-75 dBm

Delay Spread

1 Mbps:	600 ns	12 Mbps:	350 ns
2 Mbps:	500 ns	18 Mbps:	50 ns
5.5 Mbps:	400 ns	24 Mbps:	250 ns
6 Mbps:	400 ns	36 Mbps:	250 ns
9 Mbps:	400 ns	48 Mbps:	150 ns
11 Mbps:	200 ns	54 Mbps:	150 ns

Security

Standards

- Wireless Equivalent Privacy (WEP)
- Wi-Fi Protected Access (WPA)
- IEEE 802.11i (WPA2)

Encryption

- Wireless Equivalent Privacy (WEP, RC4 Algorithm)
- Temporal Key Integrity Protocol (TKIP, RC4 Algorithm)
- Advanced Encryption Standard (AES, Rijndael Algorithm)

Encryption Key Provisioning

- Static (40-bit and 128-bit lengths)
- Pre-Shared (PSK)
- Dynamic

802.1X Extensible Authentication Protocol Types

- LEAP
- EAP-FAST
- EAP-TLS
- PEAP-GTC
- PEAP-MSCHAPv2

Compliance

ETSI Regulatory Domain

- EN 300 328
- EN 301 489
- EN 60590
- EN 50371
- EU 2002/95/EC (RoHS)

FCC Regulatory Domain

- FCC Subpart B, Class B
- FCC Subpart C Part 15.247, 15.207
- ANSI C63.4-2003

Industry Canada

- RSS-210

TELEC Regulatory Domain

- RCR STD – 33
- ARIB STD - T66
- ARIB STD T71

Certifications**Wi-Fi Alliance**

- 802.11b, 802.11g
- WPA Enterprise
- WPA2 Enterprise

Cisco Compatible Extensions (CCX)

Version 4

Summit SDC-CF22AG Wireless Adapter (Option D22)**Length**

67 mm (2.64 inches)

Width

43 mm (1.69 inches)

Thickness

5 mm (0.2 inches)

Weight

28 grams (1 ounce)

System Interface

16-bit Compact Flash Type II with 50-pin connector

Antenna

0 dBi gain dual-band omnidirectional with diversity

Chipset

Broadcom BCM4318E

Input Power Requirements

3.3 VDC +/- 10%

Typical Power Consumption (at maximum transmit power setting)

- Transmit: 400 mA (1320mW)
- Receive: 180 mA (594mW)
- Standby: 10 mA (33 mW)

Operating Temperature

-30 °C to 85 °C (-22°F to 185°F)

Operating Humidity

10 to 90% (non-condensing)

Mounting

50-pin connector and standard compact flash rails

Network Standards

IEEE 802.11a, 802.11b, 802.11d, 802.11e, 802.11g, 802.11h, 802.11i

Frequency Band

FCC

2.412 to 2.473 GHz

ETSI/KCC

2.412 to 2.483 GHz

TELEC

2.412 to 2.495 GHz

Wireless Media

- Direct Sequence-Spread Spectrum (DSSS)
- Orthogonal Frequency Divisional Multiplexing (OFDM)

Media Access Protocol

Carrier sense multiple access with collision avoidance (CSMA/CA)

Data Rates Supported

- 802.11a and 802.11g (OFDM): 6, 9, 12, 18, 24, 36, 48, 54 Mbps
- 802.11b (DSSS): 1, 2, 5.5, 11 Mbps

Modulation

1, 6, 9 Mbps:	BPSK
2, 12, 18 Mbps:	QPSK
5.5, 11 Mbps:	CCK
24, 36 Mbps:	16-QAM
48, 54 Mbps:	64-QAM

Regulatory Domain Support

- FCC (Americas, parts of Asia, and Middle East)
- ETSI (Europe, Middle East, Africa, and parts of Asia)
- TELEC (Japan)
- KCC (Korea)

Operating Channels

- FCC: 11 (3 non-overlapping)
- ETSI and KCC: 13 (3 non-overlapping)
- TELEC: 14 (4 non-overlapping)

Transmit Power Settings

NOTE Maximum transmit power will vary according to individual country regulations. All values nominal, +/-2dBm

802.11a	802.11b	802.11g
15 dBm (30 mW)	18 dBm (63 mW)	15 dBm (30 mW)
10 dBm (10 mW)	17 dBm (50 mW)	10 dBm (10 mW)
0 dBm (1 mW)	15 dBm (30 mW)	0 dBm (1 mW)
	10 dBm (10 mW)	
	0 dBm (1 mW)	

Typical Receiver Sensitivity

NOTE Per <=10%

802.11a	802.11b	802.11g
6 Mbps: -85 dBm	1 Mbps: -96 dBm	6 Mbps: -94 dBm
9 Mbps: -84 dBm	2 Mbps: -95 dBm	9 Mbps: -91 dBm
12 Mbps: -83 dBm	5.5 Mbps: -94 dBm	12 Mbps: -88 dBm
18 Mbps: -80 dBm	11 Mbps: -90 dBm	18 Mbps: -86 dBm
24 Mbps: -76 dBm		24 Mbps: -83 dBm
36 Mbps: -73 dBm		36 Mbps: -78 dBm
48 Mbps: -70 dBm		48 Mbps: -76 dBm
54 Mbps: -65 dBm		54 Mbps: -75 dBm

Delay Spread

1 Mbps: 600 ns	12 Mbps: 350 ns
2 Mbps: 500 ns	18 Mbps: 350 ns
5.5 Mbps: 400 ns	24 Mbps: 250 ns
6 Mbps: 400 ns	36 Mbps: 250 ns
9 Mbps: 400 ns	48 Mbps: 150 ns
11 Mbps: 200 ns	54 Mbps: 150 ns

Security

Standards

- Wireless Equivalent Privacy (WEP)
- Wi-Fi Protected Access (WPA), Personal and Enterprise
- IEEE 802.11i, or WPA2, Personal and Enterprise

Encryption Protocols

- Wireless Equivalent Privacy (WEP, RC4 Algorithm)
- Temporal Key Integrity Protocol (TKIP, RC4 Algorithm)
- Advanced Encryption Standard (AES, Rijndael Algorithm)

Encryption Key Provisioning (40-bit and 128-bit key lengths)

- Static
- Pre-shared via WPA-PSK or WPA2-PSK
- Dynamic via EAP authentication

802.1X Extensible Authentication Protocol Types

- LEAP
- EAP-FAST
- EAP-TLS
- PEAP-GTC
- PEAP-MSCHAPv2

Compliance

ETSI Regulatory Domain

- EN 300 328
- EN 301 489-1, EN 301 489-17
- EN 301 893
- EN 60950-1
- EN 50371
- EU 2002/95/EC (RoHS)

FCC Regulatory Domain

- FCC Part 15.247 Subpart C
- FCC Part 15.407 Subpart E

Industry Canada

- RSS-210
- RSS-Gen Issue 2

TELEC Regulatory Domain

- RCR STD – 33
- ARIB STD - T66
- ARIB STD T71

Certifications**Wi-Fi Alliance**

- 802.11a, 802.11b, 802.11g
- WPA: Personal and Enterprise
- WPA2: Personal and Enterprise

Cisco Compatible Extensions (CCX)

Version 4

Numeric

- 12-Lead ECG report examples 4-22
- 12-lead report
 - 12x1 report with cabrera leads 4-26
 - 3x4, 1R report 4-1
 - 3x4, 1R report with cabrera leads and simultaneous acquisition 4-24
 - 3x4, 3R report with standard leads 4-23
 - 6x2 report with cabrera leads 4-25
 - algorithm version number 4-17
 - basic measurements 4-5
 - calibration information 4-13
 - configurable clinical information 4-9
 - device identification number 4-21
 - examples 4-22
 - extended measurements 4-43
 - institution information 4-8
 - interpretive statements 4-3
 - non-standard lead gains 4-14
 - order information 4-11
 - overview 4-1
 - pacing detection settings 4-15
 - panoramic (Pan-12) 4-28
 - Patient ID clinical information 4-6
 - Patient ID information 4-7
 - PH080A 4-17
 - PH090A 4-17
 - physician information 4-12
 - quality statements 4-3
 - report information 4-12
 - speed and sensitivity settings 4-21
 - time separator 4-15
- 12x1 report with cabrera leads 4-26
- 16-leads
 - attaching color clips to leads 1-27, 1-28
 - configuring PIM 1-26
 - options 1-28
- 3x4, 1R report 4-1
 - cabrera leads and simultaneous acquisition 4-24

- 3x4, 3R report with standard leads 4-23
- 6x2 report with cabrera leads 4-25

A

- AAMI electrode placement
 - female diagram 3-7
 - male diagram 3-6, 3-9, 3-10, 3-11, 3-12
- AAMI leads
 - part number 1-47
- accessories
 - disposal 5-15
 - ordering information 1-45
- acquisition
 - time separator 4-15
- Acute MI warning statement 4-4
- algorithm
 - version number printed on ECG report 4-17
- alligator clips
 - part number 1-47
- artifact filter
 - using with Rhythm 3-33
- attaching the lead wires to the electrodes 3-14
- Auto ECG, taking 3-25

B

- barcode reader
 - calibrating 5-16
 - removing extra carriage return 5-16
 - using with the cardiograph 1-37
- basic measurements 4-5
- batteries
 - battery gauge 1-45
 - battery status information window 1-33
 - charging 1-32, 1-33
 - charging indicator 1-33
 - installing 1-29
 - maintenance and care 5-8
 - part numbers 1-49
 - replacement 5-9
- Bazett's formula rate-corrected QT interval 4-5

C

- cables
 - cleaning 5-4, 5-5
- cabrera leads
 - 12x1 report 4-26
 - 3x4 report example 4-24
 - 6x2 report 4-25
 - panoramic (Pan-12) report 4-28
- calibration
 - touch screen 5-16
- calibration pulse 4-13
 - non-standard lead gains 4-14
 - scaling 4-13
 - shapes 4-13
- calibration pulse information 4-13
- caps lock feature
 - indicator on Status Bar 1-45
- cardiograph
 - configuring multiple, with same settings 2-2
 - disposal 5-15
 - identification number on printed report 4-21
- cleaning
 - approved cardiograph cleaning solutions 5-3
 - cables 5-4, 5-5
 - cardiograph 5-2
 - electrodes 5-4, 5-5
 - lead wires 5-3
 - patient data cable 5-3
 - Patient Interface Module (PIM) 5-2
- clinical information
 - on the printed report 4-6
- color-coded waveforms 3-19
- Complete Heart Block warning statement 4-5
- configurable clinical information 4-9, 4-10
- configuration
 - with a Philips TraceMasterVue ECG Management System 2-1, 2-2
- Configuring Cardiograph and TraceMasterVue Communication Guide 2-2
- configuring multiple cardiographs

- with same settings 2-2
- Critical 4-4
- Critical Value Warning Statements
 - listing B-1
 - on Preview screen 3-29
 - Very High Heart Rate calculation 3-29
- customer service
 - telephone numbers 1-51
- D**
- Device ID
 - on printed report 4-21
- Disclose
 - overview 3-33
- disconnected electrodes
 - Leads Map 3-20
- document downloads 1-5
- E**
- ECG acquisition
 - available modes 1-45
 - concurrent 4-15
 - Disclose 3-33
 - Rhythm 3-30
 - simultaneous 4-15
 - taking an Auto ECG 3-25
- ECG data transfer information 1-4
- ECG management functions 1-45
- ECG report
 - 12x1 report with Cabrera leads 4-26
 - 3x4, 1R report 4-1
 - 3x4, 1R report with Cabrera leads and simultaneous acquisition 4-24
 - 3x4, 3R report with standard leads 4-23
 - 6x2 with Cabrera leads 4-25
 - algorithm version number 4-17
 - basic measurements 4-5
 - calibration information 4-13
 - configurable clinical information 4-9, 4-10
 - device identification number 4-21
 - ECG order information 4-11
 - examples 4-22
 - extended measurements 4-43
 - institution information 4-8
 - non-standard lead gains 4-14
 - order information 4-11
 - overview 4-1
 - pacing detection settings 4-15
 - panoramic (Pan-12) report 4-28
 - Patient ID information 4-7
 - clinical information 4-6
 - PH080A 4-17
 - PH090A 4-17
 - physician information 4-12
 - report information 4-12
 - speed and sensitivity settings 4-21
 - STAT label 4-12
 - time separator 4-15
- editing
 - Patient ID information 3-18
- electrode placement
 - female diagram 3-7
 - male diagram 3-6, 3-9, 3-10, 3-11, 3-12
- electrodes
 - attaching to the patient 3-12, 3-14
 - cleaning 5-4, 5-5
 - disconnected 3-20
 - disposable part number 1-47, 1-48
- Emergency ECGs 3-24
- entering Patient ID information 3-16
 - selecting an order 3-17
 - with keyboard 3-17
- extended measurements report 4-43
- Extensible Markup Language (XML) information and tools 1-4
- extreme tachycardia warning statement 4-4
- F**
- Fridericia rate-corrected QT interval 4-5
- G**
- green waveform 3-19
- H**
- help, accessing online 2-4
- I**
- ID information (Patient)
 - editing 3-18
 - entering on cardiograph 3-16
 - on the printed report 4-7
- IEC electrode placement
 - female diagram 3-7
 - male diagram 3-6, 3-9, 3-10, 3-11, 3-12
- IEC leads
 - part number 1-47
- InCenter web site 1-5
 - document errors 1-5
 - errors opening PDF documents 1-5
 - using Adobe Acrobat 1-5
- institution information 4-8
- instructing the patient 3-4
- interpretive statements
 - suppressed A-1
- interpretive, reason, and severity statements
 - overview 4-3
- K**
- keyboard
 - entering Patient ID information 3-17
- L**
- LAN network connection status indicator 1-44
- Lead Map 3-20
- lead reversal 3-30
- lead reversal message on Preview screen 3-30
- lead wires
 - attaching 3-14
 - chest leads part number 1-47
 - cleaning 5-3
 - limb leads part number 1-47
- limb leads, axis measurements 4-5
- M**
- magnet paced 4-17
- maintenance
 - batteries 5-8
 - battery replacement 5-9
 - cleaning 5-2
 - touch screen 5-16
 - touch screen calibration 5-16
 - touch screen cleaning 5-16
- modem card
 - using with cardiograph 1-36

N

- network settings
 - connection status indicator 1-44
- non-paced 4-16
- non-standard lead gains 4-14

O

- online help, accessing 2-4
- orange waveform 3-19
- order information 4-11
- ordering information
 - supplies 1-45
- orders
 - information on printed report 4-11
 - searching for on Patient ID screen 3-17
 - selecting on Patient ID screen 3-17
- OrderVue
 - searching for orders on Patient ID screen 3-17
 - selecting order on cardiograph 3-17
- overreading 4-12

P

- P? 4-16
- paced 4-16
- paced unknown 4-16
- pacing detection settings 4-15
 - non-paced 4-16
 - on the printed report 4-15
 - paced 4-16
 - paced (magnet) 4-17
- Pan-12 ECG report 4-28
- panoramic (Pan-12) report 4-28
- paper
 - part number 1-49
- part numbers
 - supplies 1-46
- patient data cable
 - cleaning 5-3
 - part number 1-46
- Patient ID Information
 - on ECG report 4-6
- Patient ID information
 - changing 3-18
 - clinical codes 4-7

- clinical information 4-6
- configurable clinical information 4-9
- editing 3-18
- entering on cardiograph 3-16
- entering with keyboard 3-17
- not entering to take STAT ECG 3-24
- on the printed report 4-7
 - required 3-16
 - reviewing 3-18
- Patient ID screen
 - navigation 3-16
 - searching for orders 3-17
 - selecting order to begin patient session 3-17
- patient instructions
 - before taking ECG 3-4
- Patient Interface Module (PIM)
 - components 1-20
- patient preparation 3-4
 - skin preparation 3-4
- patient session
 - overview 3-1
 - steps 3-1
- pediatric Rhythm recording 3-30
- pediatric tab electrodes 1-48
- PH080A 4-17
- Philips 12-lead Algorithm
 - interpretive, reason, and severity statements on printed report 4-3
 - severity codes 4-3
 - suppressed borderline interpretive statement listing A-1, B-1
 - suppressed borderline interpretive statements listing A-1
 - version number on printed report 4-17
 - warning statements listed B-1
- Philips 12-Lead Algorithm Physician's Guide 1-3, 1-51
- Philips InCenter web site 1-5
 - document errors 1-5
 - errors opening PDF documents 1-5
- physician information, on ECG report 4-12
- PIM 1-20, 1-26

- 12-Lead 1-20
- 16-Lead 1-26
 - configuring the 16-lead 1-26
 - diagnostic test 5-14

- PM 4-17
- preparing the skin 3-4
- Preview screen
 - using 3-26
- printed report
 - 3x4 report with standard leads 4-23
 - algorithm version number 4-17
 - basic measurements 4-5
 - calibration information 4-13
 - configurable clinical information 4-9
 - device identification number 4-21
 - examples 4-22
 - extended measurements 4-43
 - institution information 4-8
 - non-standard lead gains 4-14
 - order information 4-11
 - overview 4-1
 - pacing detection settings 4-15
 - Patient ID information 4-7
 - PH080A 4-17
 - physician information 4-12
 - quality statements 4-3
 - red stripe appears 5-7
 - speed and sensitivity settings 4-21
 - time separator 4-15
- printer paper
 - part number 1-49
 - replacing 5-7
- pulse calibration 4-13

Q

- QTcF measurement 4-6
- quality indicator
 - green waveform 3-19
 - Leads Map 3-20
 - orange waveform 3-19
 - red dotted line 3-20
 - yellow waveform 3-19
- quality statements 4-3

R

R/T ECG

- split-screen display 1-42
- taking an Auto ECG 3-25

reason statements 4-3

red dotted lines 3-19

replacing

- batteries 5-9
- printer paper 5-7

report format

- overview 4-1

report information 4-12

reports,overview 4-1

required Patient ID information 3-16

Response Center, 01 telephone numbers 1-51

reviewing Patient ID information 3-18

Rhythm 3-30

- changing leads on the printed report 3-31
- pediatric 3-30
- using 3-30
- using the Artifact filter 3-33

Rhythm strips, recording 3-30

S

severity statements 4-3

- codes 4-3

signal acquisition issues

- troubleshooting 3-20

signal quality

- checking 3-19
- color-coded waveforms 3-19
- indicators 3-19

simultaneous acquisition

- report example 4-24

simultaneous time separator 4-15

skin preparation, before taking ECG 3-4

software

- downloads 1-5
- overview 1-38

speed and sensitivity settings 4-21

split-screen display 1-42

STAT ECG 3-24

- label on the printed report 4-12

Status Bar

icon description 1-43

LAN network connection status indicator 1-44

supplies

- ordering information 1-45
- part numbers 1-46

suppressed borderline interpretive statements

- listing A-1

T

technical specifications C-1

time separator 4-15

time sequential separator 4-15

touch screen

- calibration 5-16
- cleaning 5-16
- maintenance 5-16
- overview 1-38

troubleshooting

- Philips Response Center phone numbers 1-51
- red stripe on printed report 5-7
- signal acquisition issues 3-20

U

Unconfirmed Diagnosis, label on printed report 4-12

UPIN (Universal Physician Identification Number)

- on the printed report 4-12

USB memory stick

- cautions 1-36
- storage capacity 1-37
- using to save cardiograph configuration settings 2-2
- using with cardiograph 1-36

user documentation CD 1-4

W

waveform

- dotted red line 3-19
- green 3-19
- orange 3-19
- yellow 3-19

waveform size and sensitivity settings on printed report 4-21

welsh bulb electrodes 1-46

wireless LAN

- using with cardiograph 1-35

X

XML

- utilities and tools 1-4

Y

yellow waveform 3-19



Philips Medical Systems
3000 Minuteman Road
Andover, MA 01810 USA
Printed in USA

PageWriter TC70/TC50 Cardiograph
Instructions For Use
453564164431
Edition 2

