

How to Hear NASA Satellites

POPULAR ELECTRONICS

JUNE
1962

MAC 6

**35
CENTS**

- **Diode Checker**
- **Silicon Mood Lighter**
- **How to Make SWL Reports**
- **Improving \$25 Tape Recorders**
- **Speaker System in a Pipe**
- **Simple Sidebander**

(Cover story p. 53)

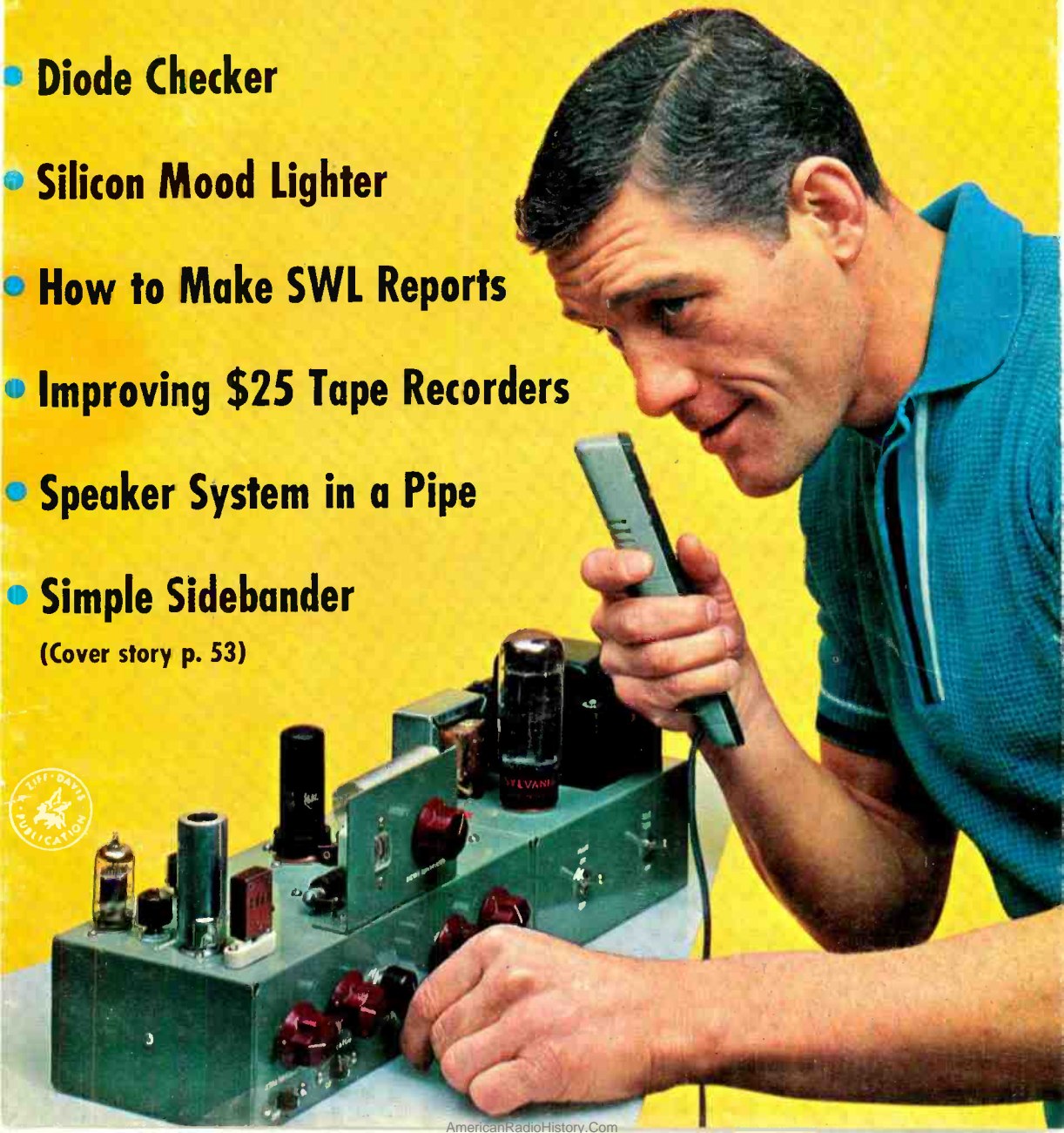

Prepare Now For The Higher Rewards The Electronics Age Offers You

There is an immediate and growing need for trained technicians in Industrial-Military Electronics, Radio-TV Servicing and Communications. Better than average jobs with high pay, interesting work, bright futures await you in the fast growing industry of the 1960's. Join thousands of NRI graduates now benefiting from career opportunities in this Electronic Age.

Training Equipment Included



NRI "learn by practice" training is the time-proved way to higher earnings and advancement. Except for FCC License course, all NRI courses include—at no extra cost—special training equipment to give shop and laboratory experience in your own home. Equipment is yours to keep. Makes NRI training come to life in an easy-to-grasp, interesting manner.

JOB COUNSELORS RECOMMEND

Today, a career in any branch of Electronics offers unlimited opportunity. Job Counselors advise, "For an interesting career, get into Electronics." The National Association of Manufacturers says: "There is no more interesting and challenging occupation in American industry."

NRI can provide the training—right in your own home and in your spare time. No need to go away to school. There are no special requirements of previous Electronic experience, or education in particular subjects. Mail postage-free card now. Read about Electronics opportunities, about NRI courses, about NRI trial plan.

Mail postage-free card.
National Radio Institute,
Washington 16, D. C.



Industrial ELECTRONICS

The NRI course in Electronics-Principles, Practices, Maintenance prepares you for a career as an Electronic Technician in industry, business, government, the military. Computers, telemetry, automation, missiles, rockets all employ the same basic Electronic principles . . . and that is what this NRI course stresses with illustrated lessons, special training equipment.



Commercial FCC LICENSE

You must have an FCC License if you want to operate or service transmitting equipment used in TV and Radio Broadcasting, aviation, marine, microwave, facsimile or mobile communications. Even a service Technician needs an FCC License today to work on C-Band Radio equipment. From Simple Circuits to Broadcast Operation, this new NRI course trains you quickly to take Government exams.



TV-Radio COMMUNICATIONS

In NRI's Communications course you get *actual experience* as NRI trains you for your choice of Communications fields. Commercial methods and techniques of Radio-TV Broadcasting; teletype; facsimile; microwave; radar; mobile and marine radio; navigation devices; multiplexing are some of the subjects covered. You work with special training equipment.

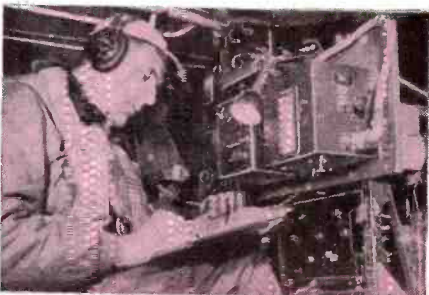

Radio and TV SERVICING

NRI's time-tested course in Servicing not only trains you to fix radios, TV sets, hi-fi, etc., but also shows you how to earn spare-time money starting soon after enrolling. Fast growth in number of sets means money-making opportunities for you in your own spare-time or full-time business, or working for someone else. Special training equipment at no extra cost. Mail postcard.

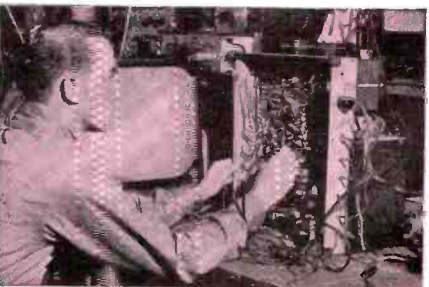

WHERE YOU TRAIN IS AS IMPORTANT AS YOUR DECISION TO TRAIN



NRI is America's oldest, largest home-study Electronics, Radio-Television school. NRI teaches *only* by home-study. The interests and efforts of our carefully-selected staff are devoted exclusively to this method of training. For nearly 50 years NRI has maintained the confidence and respect of students, graduates, and the Electronics Industry for constantly providing the best possible home-study training, at a cost most anyone can afford. For the complete NRI story, mail the postage-free card at the left. This could be the most profitable move you ever made.

For Nearly 50 Years NRI Has Been The Leader In Training At Home For Electronics, TV-Radio



J. E. Smith,
Founder—1914.

It takes a growing industry to give qualified men the best opportunity to advance and prosper. That's why so many men are deciding on a career in Electronics. But, even more important is *where* you get your training, and *how* the school of your choice teaches Electronics . . . how it trains and encourages men to reach their goals and realize their ambitions. It takes a growing

school—with years of specialized experience behind it—to do that for you.

This is a fast changing world, and a school offering Electronics courses must keep pace. The NRI staff of more than 150 is on the job every minute to see that course material is up-to-date . . . to see that you get all the help and advice you need . . . to assist you in job placement when you're ready, even to help you earn your way while you train. In short, whatever branch of Electronics you select, NRI is well qualified to help you grow in your new career . . . in usefulness, in prestige, in monetary gain.

NRI's Outstanding Staff Is Directed By These Men

DIRECTOR OF EDUCATION, William F. Dunn, supervises lesson preparation, training equipment development, consultation services, lesson grading. He heads a full staff of instructors and advisors.



SUPERVISOR OF TRAINING, J. B. Straughn, is particularly concerned with NRI home-training equipment and its integration into course subject matter.

CHIEF TECHNICAL EDITOR, James P. Tate, Jr., heads a staff whose concern is the careful writing, editing and illustrating of lesson texts, keeping lessons up-to-date.



DIRECTOR OF PUBLICATIONS, Oliver Read, was formerly editor and publisher of Electronics World magazine; publisher Popular Electronics and Hi-Fi Stereo Review magazines.

POPULAR ELECTRONICS



POPULAR ELECTRONICS is indexed
in the Readers' Guide
to Periodical Literature

This month's cover photo by Bruce Pendleton

VOLUME 16

JUNE 1962

NUMBER 6

Special Construction Feature

- The NASA-136.....*Tom Lamb, K8ERV* 39
This red-hot converter for the National Aeronautics and Space Administration
satellite band (136-137 mc.) can be used with any receiver tuning to 15 meters

Electronic Construction Projects

- Automatic Diode Checker..... *Keith Sueker* 49
The Mood Lighter..... *Frank A. Parker* 51
Simple Sideband..... *Hartland B. Smith, W8VVD* 53
De Luxe Your Portable Tape Recorder..... *Fred Blechman, K6UGT* 69

Audio and High Fidelity

- What's Wrong with American FM?..... *Robert Angus* 45
Clean Sound from the Drainpipe 8..... *David Weems* 59
The Tender Touch..... 68
Speeds Are Their Specialty..... *John F. Agee, K5ODN* 75
Sounds You Didn't Hear..... 81

Amateur, CB, and SWL

- You've Got to Know the Language..... *Tom Kneitel, W5KDR/WPE2AB* 63
Across the Ham Bands: A Word to Citizens-Band-"Hams"..... *Herb S. Brier, W9EGQ* 73
On the Citizens Band..... *Dick Strippel, 2W1452* 79
Short-Wave Report: With the Clubs..... *Hank Bennett, W2PNA/WPE2FT* 83
Short-Wave Monitor Certificate Application..... 84
CB Radio—Canadian Style..... 91

Electronic Features and New Developments

- POP'tronics News Scope..... 6
An "Eye" for Small-Boat Skippers..... 58
Hobnobbing with Harbaugh: The Store..... *Dave Harbaugh* 67
Transistor Topics..... *Lou Garner* 76
Coil Function Quiz..... *Robert P. Balin* 82
Pure Research Rewarded (a Carl and Jerry Adventure)..... *John T. Frye, W9EGV* 85

Departments

- Letter Tray 8
Electronics Datebook 14
Tips and Techniques..... 20
Coming Next Month..... 24
New Products 26
Hi-Fi Showcase 30
POP'tronics Bookshelf 92
Index to Volume 16 (January-June, 1962)..... 108

Copyright © 1962 by ZIFF-DAVIS PUBLISHING COMPANY. All rights reserved.

men
17-55

**JOB OPPORTUNITIES!
EXCITEMENT!
MONEY!**

All this
can be
Yours as a trained

Electronics TECHNICIAN

**OVER 6,000 FIRMS HAVE EMPLOYED
DeVRY TECH GRADUATES!**

Thousands of companies in the United States and Canada who have employed DeVry Tech men prove two most important facts: (1) Electronics is one of the biggest, fastest growing opportunity fields of our time; and (2) DeVry Tech graduates are "WANTED" MEN.

Whether DeVry Tech prepares you in spare time at home or in its modern Chicago or Toronto Laboratories, your training is designed to get you ready to meet the exacting standards of industry. You get practical training that not only helps to fit you for a job or a service shop of your own—but also gives you a foundation for a career that can be profitable the rest of your life.

You work over 300 learn-by-doing experiments at home, using DeVry Tech's exclusive Electro-Lab method. You build and KEEP valuable equipment. With another DeVry Tech exclusive, you have the benefit of training movies that you can show over and over until basic points are crystal clear. Special texts guide you every step of the way as well.

HOW DeVRY TECH CAN "BLUEPRINT" YOUR CAREER!

DeVry's faculty not only know how to teach Electronics, but they also understand men. They most likely know the type of problems you face. From this staff you get help, advice and understanding. It is this "human" side of DeVry's program that has caused many of our graduates to say: "DeVry Tech not only trains you for a job, they actually help you blueprint a profitable future!"

NO ADVANCED EDUCATION NEEDED!

Why don't you write for FREE FACTS today? Learn how you TOO can be a member of the great fraternity of DeVry Tech graduates across the continent... men who were properly trained, encouraged, appreciated and understood! SEND IN COUPON NOW!

EFFECTIVE EMPLOYMENT SERVICE

DeVry Tech's effective Employment Service is available to all graduates without additional cost.

**2 FREE BOOKLETS
Send Coupon TODAY!**

"One of North America's Foremost Electronics Training Centers"

Accredited Member of
National Home Study Council



**DeVRY TECHNICAL
INSTITUTE**
CHICAGO • TORONTO



TELEVISION



COMPUTERS



MICRO-WAVES



RADAR



BROADCASTING

**LET DeVRY HELP
YOU PREPARE
AND BLUEPRINT
A SOLID
CAREER IN
THIS
FAST-GROWING
FIELD!**



MAIL TODAY FOR FREE FACTS!

DeVRY TECHNICAL INSTITUTE

4141 Belmont Ave., Chicago 41, Ill., Dept. PE-6-5

Please give me your 2 FREE BOOKLETS, "Pocket Guide to Real Earnings" and "Electronics in Space Travel;" also include details on how to prepare for a career in one or more branches of Electronics.

Name _____ Age _____

PLEASE PRINT

Street _____ Apt. _____

City _____ Zone _____ State _____

Check here if you face military service.

Canadian residents address: DeVry Tech of Canada, Ltd.
2075 270 Lawrence Avenue West, Toronto 19, Ontario

POPULAR ELECTRONICS is published monthly by Ziff-Davis Publishing Company at 434 South Wabash Avenue, Chicago 5, Illinois. Subscription Rates: One year - United States and possessions, \$4.00; Canada and Pan American Union Countries, \$4.50; all other foreign countries, \$5.00. Second Class postage paid at Chicago, Illinois, and at additional mailing offices. Authorized as second class mail by the Post Office Department, Ottawa, Canada, and for payment of postage in cash. June, 1962, Volume 16, Number 6.

WEAK SIGNAL?



READY FOR UHF?

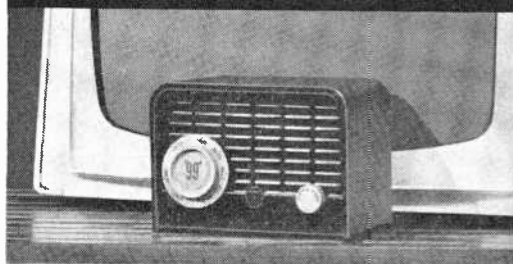

SELECT THE BLONDER-TONGUE TV PRODUCT TO DO THE JOB BEST

TV & FM AMPLIFIERS

MODEL	DESCRIPTION	GAIN AVERAGE	AMPLIFIER	MOUNTING	LIST PRICE
BTA	Home VHF/FM booster for single set.	8 db	Tube	Indoor	15.70
B-24c	Home VHF/FM booster for up to 4 sets.	9 db	Tube	Indoor	24.95
IT-3	Home VHF/FM booster for up to 4 sets.	12 db	Transistor	Indoor	33.00
AB-4AC	Home VHF/FM booster, remote AC power supply. Up to 4 sets.	12 db	Transistor	Indoor or Mast Mounted	34.95
AB-4	Battery powered				29.95
AB-2	Home VHF mast mounted booster. Remote power supply.	10 db	Tube	Mast Mounted	53.95
UB	UHF booster. 5 models ea. cover a portion of the UHF spectrum ch. 14 to 83.	15 db	2 Tubes	Mast Mounted	88.00

UHF CONVERTERS

MODEL	IMPEDANCE	INPUT CHANNELS	OUTPUT CHANNELS	GAIN	LIST PRICE
BTC-88R	300 Ohm	14 thru 83	5 or 6	—	23.95
BTU-2S	300 Ohm	14 thru 83	5 or 6	5 to 8 db	39.95
BT-70	300 Ohm	70 thru 83	5 or 6	5 to 8 db	41.50

engineered and manufactured by
BLONDER-TONGUE
8 Alling St., Newark, N. J.

Canadian Div.: Benco Television Assoc., Tor., Ont.
 Export: Roctec Int'l. Corp., N. Y. 16, N. Y.
 CABLES: ARLAB

POPULAR ELECTRONICS

World's Largest-Selling Electronics Magazine
 Average Net Paid Circulation 419,536

Publisher **PHILLIP T. HEFFERNAN**
 Editor **OLIVER P. FERRELL**
 Managing Editor **JULIAN M. SIENKIEWICZ, WA2CQL**
 Art Editor **JAMES A. ROTH**
 Associate Editors **MARC E. FINKEL**
RICHARD A. FLANAGAN
MARGARET MAGNA
 Draftsman **ANDRE DUZANT**
 Amateur Radio Editor **H. S. BRIER, W9EGQ**
 CB Editor **D. STRIPPEL, 2W1452**
 Semiconductor Editor **L. E. GARNER, JR.**
 Short-Wave Editor **H. BENNETT, W2PNA**
 Contributing Editor **J. T. FRYE, W9EGV**
 Editorial Consultant **OLIVER READ, W4TWV**
 Advertising Manager **WILLIAM G. McROY, 2W4144**
 Advertising Service Manager **ARDYS C. MORAN**

ZIFF-DAVIS PUBLISHING COMPANY

Editorial and Executive Office (ORegon 9-7200)

One Park Avenue, New York 16, New York

William B. Ziff, Chairman of the Board (1946-1953)

William Ziff, President

W. Bradford Briggs, Executive Vice President

Hershel B. Sarbin, Vice President and General Manager

M. T. Birmingham, Jr., Vice President and Treasurer

Robert P. Breeding, Circulation Director

Charles Hausman, Financial Vice President

Midwestern and Circulation Office (WAbash 2-4911)

434 South Wabash Avenue, Chicago 5, Illinois

Midwestern Advertising Manager **JAMES WEAKLEY**

Western Office (CRestview 4-0265)

9025 Wilshire Boulevard, Beverly Hills, California

Western Advertising Manager, **WILLIAM J. RYAN, 11Q3002**

Foreign Advertising Representative

D. A. Goodall Ltd., London, England



Member
 Audit Bureau of
 Circulations

SUBSCRIPTION SERVICE: All subscription correspondence should be addressed to POPULAR ELECTRONICS, Circulation Department, 434 South Wabash Avenue, Chicago 5, Illinois. Please allow at least six weeks for change of address. Include your old address as well as new—enclosing if possible an address label from a recent issue.

EDITORIAL CONTRIBUTIONS must be accompanied by return postage and will be handled with reasonable care; however, publisher assumes no responsibility for return or safety of art work, photographs or manuscripts.

Always say you saw it in—POPULAR ELECTRONICS

Outperforming everything else in the field!

Priced from \$109.50...

3 feature-packed Viking "Messenger" Transceivers!

For the sportsman or "on the job"... Viking "Personal Messengers" are delivering outstanding performance! Available in two compact hand-held units ... 100 milliwatt model for unlicensed use ... 1 watt model for longer range on the Citizens' Band. 11 transistors and 4 diodes. Superheterodyne receiver and exclusive tuned RF amplifier gives twice the sensitivity and 40% more range than similar units with conventional circuitry—more output than similar units with the same rated inputs! Operates on penlight or rechargeable nickel-cadmium batteries.

\$109⁵⁰
NET



VIKING
Messenger



For mobile or base station...

Here's the performance proved Viking "Messenger"—5 channel, crystal-controlled Citizens' Band transceiver. High efficiency design makes full use of maximum legal power—punches your signal home! Excellent receiver sensitivity and selectivity—built-in squelch—AVC—ANL. Only 5 7/8" x 7" x 11 3/8", easy to install anywhere. With tubes, push-to-talk microphone and crystals for 1 channel.

\$134⁹⁵
FROM
NET

WRITE TODAY
for information packed
4 Color Catalog



MANUFACTURERS OF THE WORLD'S MOST WIDELY
USED PERSONAL COMMUNICATIONS TRANSMITTERS.



E. F. JOHNSON COMPANY

2424 10th AVE. S.W. • WASECA, MINNESOTA

Please rush "Messenger" details to:

NAME _____

ADDRESS _____

CITY _____ STATE _____



LIGHT YARDSTICK—Formally called a "laser-ranger," this new lightweight radar is similar to a conventional radar in operation. Instead of microwaves, however, the laser-ranger uses a high-intensity light beam to pin-point battlefield targets such as tanks or artillery. Now being developed by the Orlando Division of the Martin Company, the proposed unit will be the size of a bread box and weigh only 35 pounds. The GI operator will simply aim the portable device at a target, press a button, and the distance to the target will be seen instantly on an indicator panel. Intended for use in conjunction with anti-tank weapons, the laser-radar will take the guessing out of gunnery.



DO-IT-YOURSELF TV TAPE may be in the home sooner than you think, thanks to Westinghouse and a new slow-scan vidicon camera tube, Type 7290. With this tube, the TV camera produces one picture every eight seconds which can be stored on an ordinary hi-fi tape recorder. It is expected to open up applications for televised pictures in education, commerce and journalism at reasonably low cost. The major advantage of the system is its ability to use telephone lines and mobile two-way radios to transmit pictures. Future home applications may make the candid camera a thing of the past.



NOW HEAR THIS—The new guided missile destroyer USS Charles F. Adams is equipped to tell her story to visitors on board ship in ten languages. The ship's striking verbal power is in the form of an audio-visual package requested by the skipper, Commander Bob Munroe, Jr., for the ship's European cruise earlier this year. The tapes and color slides were prepared by General Dynamics/Pomona, Calif., and offer a "canned" audio-visual presentation to VIP's or just plain people in their native tongues. The languages recorded are: Swedish, Danish, Dutch, German, French, Spanish, Portuguese, Italian, Greek and—last, but not least—English. After the audio-visual presentation, the visitors are conducted on a tour of the ship. Well done, USS Adams!

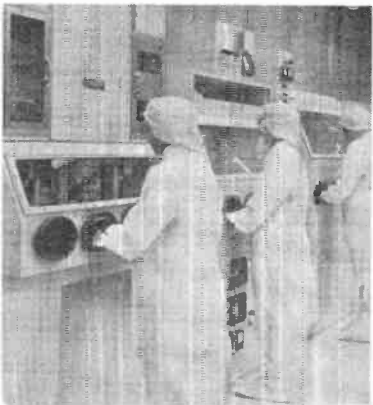

EASTER BUNNIES? No, just specially clothed "she" technicians assembling space-age microminiature relays in the "Clean Room" designed and built by the Automatic Electric Company of Northlake, Ill. To eliminate contamination due to dust, parts sent to the Clean Room are sealed in containers and pass through an air lock. Temperature, humidity and positive pressure in the room are closely controlled, and air entering it is filtered, eliminating all dust particles 1 micron or over in diameter—25,400 microns is about one inch. As for the bunny costumes, it seems that people in the Clean Room create dust particles. Hence, they don dust-free Dacron uniforms before coming in. Dust-generating cosmetics are shunned as well—so the bunnies have shiny noses.

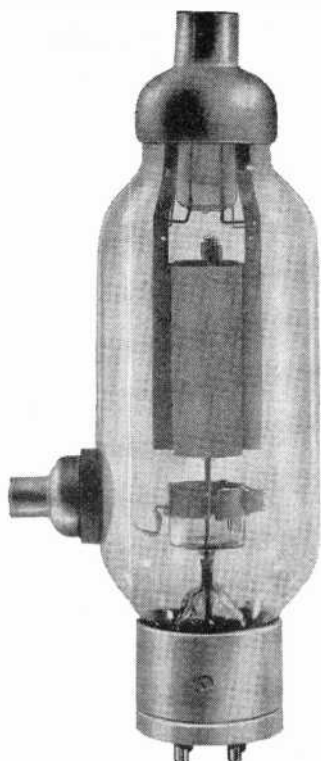

CB GALLON?

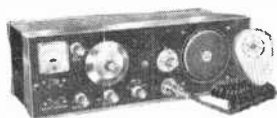

write for free brochure

\$189.50

Slightly higher west of Rockies

One gallon (thousand watt) output is something you would never expect the Courier 1 to deliver. But . . . you do get 68% transmitter efficiency, 3.4 watts out with 5 watts in! This is only one of the reasons why CBER's applaud the Courier 1 as the finest. Add to this the distinct advantages of a dual power supply (mobile and base — 110V and 12V) operation, a low noise front end (thanks to our use of the Nuvistor tube) and, of course, superior performance and reliability. Want more before you buy? Check these features . . .

- 12 CHANNEL TRANSMITTING
 - 23 CHANNEL TUNABLE RECEIVER
 - BUILT-IN "S" & "RF" METER
 - FRONT PANEL RF GAIN CONTROL
 - BUILT-IN SQUELCH
 - ELECTRONIC SWITCHING (NO RELAYS)
 - UNITIZED HAND WIRED CHASSIS
 - FULLY MODULATED (100%)
 - CADMIUM PLATED FOR MARINE USE
 - ENTIRE UNIT SLIDES OUT ON TRACKS
- ALSO AVAILABLE IN 110V and 6V



electronics communications, inc. 325 no. macquesten pkwy. mt. vernon, n.y.

**RESIDENT SCHOOL COURSES
IN NEW YORK AND LOS ANGELES**

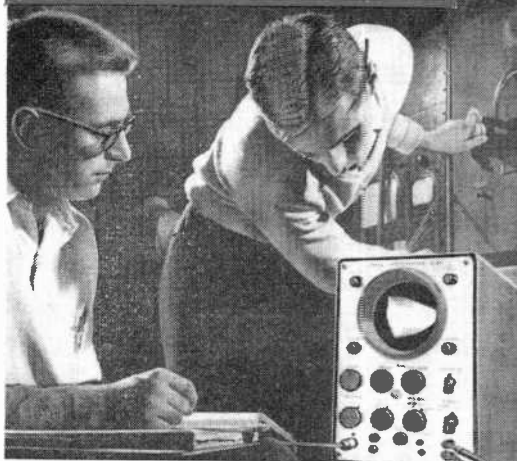

Industry needs Electronic Technicians!

Let RCA train you in Advanced Electronics

This is the college-level training you need to work with professional engineers on research, development, or production projects in such fields as: automation, guided missiles, radar, television, computers, and other advanced electronic applications.

RCA Institutes Resident Schools in New York City and Los Angeles offer this comprehensive course that prepares you for any field of electronics you may choose. Other courses in TV and General Electronics, Radio and Television Servicing.

Classes start four times each year. Applications now being accepted.



RCA INSTITUTES

SCHOOLS OF TELEVISION & ELECTRONIC TECHNOLOGY
A Service of Radio Corporation of America
Another Way RCA Serves Education Through Electronics

—Send to the school nearest you!—

RCA Institutes, Inc., Dept. PER-62

350 West 4th Street
New York 14, N. Y.

Pacific Electric Building,
Los Angeles 14, Calif.

Please send me your FREE catalog of Resident School courses.

Name _____ (PLEASE PRINT)

Address _____

City _____ Zone _____ State _____

For Home Study Courses See Ad On Opposite Page

I would like to report that we're pleased
ults To modify the chassis of Citizens
on, we changed L2 to 7 or 8 turns of #22
ve on a 1/4" dia. core. Constructio
its were cut somewhat by using the chassis

LETTER TRAY

"Emily"

■ "Emily—the Robot with a One-Track Mind" (March 1962 issue) is one of the most interesting projects I've ever built. My construction time was about six hours, and I made some modifications which might interest other readers. Increasing the value of resistor R1 to 3.3 ohms lengthened the



lives of lamp 11 and battery B2. And changing the gear reduction on the drive units to 150:1 increased Emily's speed and tracking ability. I left off the dish-pan shell and blinking eyes in order to keep weight down and conserve batteries. All in all, building Emily was a lot of fun—thanks a lot.

KEN GOODRICH
Toledo, Ohio

■ On receiving my March issue of P.E., I was amazed to find a line-following device similar to one I built three years ago. I'm enclosing a photograph of my version of "Emily," taken at the local high school science fair. It won first prize, as well as the "Most Original" award. The "brain" consists of two separate photoelectric-eye circuits—one for right turns, the other for left turns—and

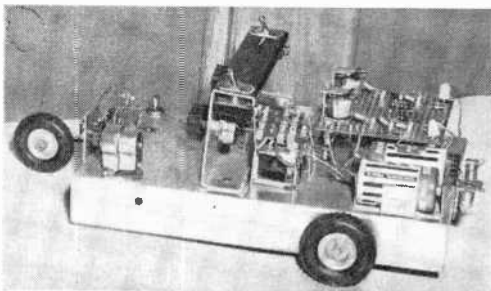

steering is accomplished by means of a pivoting rear wheel. This arrangement provides a very smooth response. To add to the coincidence, ironically enough, my mother's name is "Emily."

Ed BROTEK, WA2VKY, WV2VKY
Uniondale, L.I., N.Y.

Crystal Switcher

■ I've read your report on the CB-27 Citizens Band transceiver ("Regency CB-27 Ranks High," March 1962 issue), and note that your one criticism centers on the fact that the unit has only two "transmit" channels. You'll probably be interested

Always say you saw it in—POPULAR ELECTRONICS

NOW... RCA OFFERS A COMPLETE SELECTION OF HOME TRAINING COURSES IN ELECTRONICS

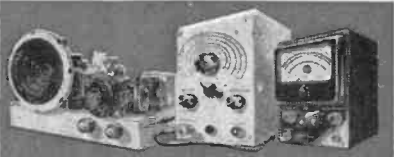

ELECTRONIC FUNDAMENTALS

40 theory lessons! 40 experiment lessons! 40 service practice lessons! Course includes 15 kits to build a Multimeter, AM Receiver and Signal Generator!

**2
new
courses
now
available**

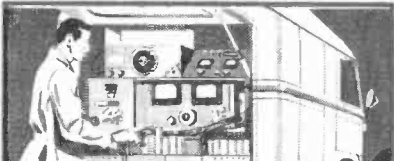

COMMUNICATIONS ELECTRONICS

9 study groups! 18 lessons! Covers oscillators, power amplifiers, AM, FM, SSB, Mobile Radio—prepares you for an FCC license!

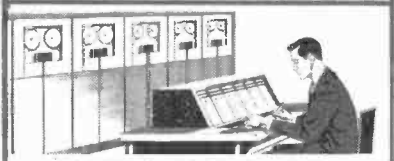

COMPUTER PROGRAMMING

5 study groups totaling 11 complete lessons, in principles and techniques of programming business computers! High School graduation and 1 year business experience required.



TELEVISION SERVICING

10 study groups totaling 27 lessons plus 6 complete kits for construction of a modern television receiver!

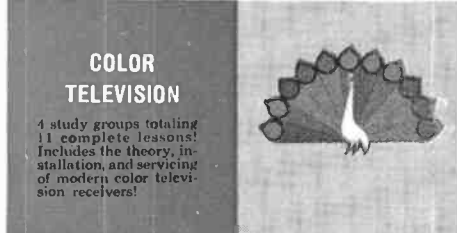

COLOR TELEVISION

4 study groups totaling 11 complete lessons! Includes the theory, installation, and servicing of modern color television receivers!

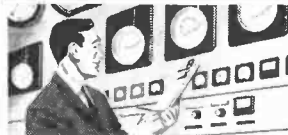

AUTOMATION ELECTRONICS

5 study units of 4 lessons each! Covers electronic devices used in industry to achieve automatic control of production systems and processes!



TRANSISTORS

5 study groups totaling 10 complete lessons! Fundamentals, operation, and construction of modern transistor and circuit devices!

With RCA Institutes Home Study training, you set your own pace in keeping with your ability, finances and time. All equipment and components provided are brand new and of prime quality . . . and you never have to take apart one piece to build another. Practical work begins with the very first lesson!

Most important to you, RCA offers a liberal Voluntary Tuition Plan—the most economical home study method available because you pay only for lessons as you order them . . . one study group at a time! If you drop out at any time, for any reason, you do not owe RCA one penny! No other obligations! No monthly installment payments! Licensed by the New York State Education Department. Approved for Veterans.

If you prefer, you may build your electronics career at one of RCA Institutes' Resident Schools in Los Angeles or New York City. Day and evening classes start four times each year. Resident School Catalog sent free on request.

SEND FOR THIS FREE HOME STUDY CATALOG TODAY!

RCA INSTITUTES, INC.,
A Service of Radio Corporation of America
350 W. 4th St., N. Y. 14, N. Y.
610 S. Main St., Los Angeles 14, Calif.



RCA INSTITUTES, INC., Home Study School, Dept. 1'E-62
A Service of Radio Corporation of America
350 West Fourth Street, New York 14, N. Y.

Without obligation, rush me the FREE 64-page illustrated booklet "Your Career in Electronics" describing your electronic home study training program. No salesman will call.

Name..... Age.....
Address.....
City..... Zone..... State.....

CANADIANS—Take advantage of these same RCA courses at no additional cost. No postage, no customs, no delay. Send coupon to: RCA Victor Company, Ltd., 5581 Royalmount Ave., Montreal 9, Quebec.

MARK Static Sheath*

Eliminates Precipitation Static
Improves Signal-to-Noise Ratio
Affords up to 20 db Operating Gain
Increases Receiver Sensitivity
Extends Intelligible Coverage
Easiest to Install*

INCREASE COVERAGE

on Citizens Band

MARK II SUPER BEACON FIXED STATION ANTENNA with exclusive Static Sheath*

Design advantages of the new MARK II now make it possible to step up the efficiency of your CB operation, and maintain clearer communication over greater distances. 19 feet overall, the omnidirectional MARK II makes fullest use of the 20-foot legal length limit. Requires no radials or skirts. Provides 1 db gain over ground plane antennas.

Employs a full half-wave radiator voltage fed through a special launcher-matcher cable section for excellent impedance match over the entire 11-meter citizens band. Low angle radiation insures utmost efficiency and maximum contact with mobile units. Improved mechanical features and extra-rugged base support pipe add to its reliability. Simplified clamp mounting makes installation easy.

Precipitation Static is caused by charged particles in the air impinging in a continuous stream on metal antenna radiator surfaces. The patented Mark Static Sheath is a tough, durable, dielectric plastic covering that eliminates this static interference.

Write for Catalog HW19-PE

MARK HELIWHIP®

Another Fine Product Line by



B & K MANUFACTURING

Dept. PE-6, 1801 W. Belle Plaine, Chicago 13, Illinois

Letter Tray

(Continued from page 8)

to hear that the number of channels can be increased to six with a push-button switcher now available as an accessory. The Model CS-6, while designed especially for Regency equipment, can be used with any other CB transceiver as well (or



even with ham radio rigs). It sells for \$19.95, less crystals. A picture of the switcher, mounted under the case of a CB-27, is enclosed for the benefit of any of your readers who may be interested.

GEORGE M. DRAKE
Burton Browne Advertising
Chicago, Ill.

Printed-Circuit P.A.

■ I believe that I have found an error in the schematic diagram of the "Printed-Circuit P.A." (April 1962 issue, page 70). The lead shown running from the left-hand side of switch *S1* to the junction of resistors *R14* and *R17* and the center tap of transformer *T1*'s secondary should run, instead, to the junction of *R17* and the center tap of transformer *T2*'s primary. Right?

W. R. SIMMONS
Sioux Falls, S.D.

Right, Mr. Simmons. The section of the schematic diagram in which the error appeared has

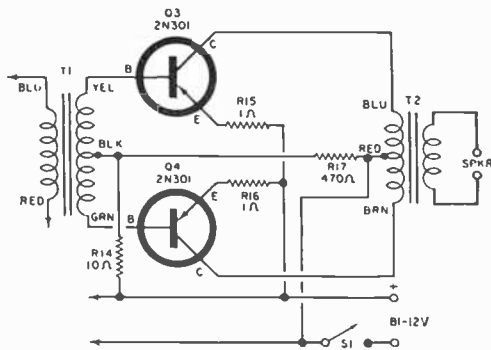

been corrected and is being reprinted here. Thanks for writing in and telling us about it.

Idiot Lights Out . . . Meters In

■ In my article entitled "Idiot Lights Out . . . Meters In" (March 1962 issue), there's an error

Always say you saw it in—POPULAR ELECTRONICS

ARE YOU "ON TARGET?"

Test Yourself.....

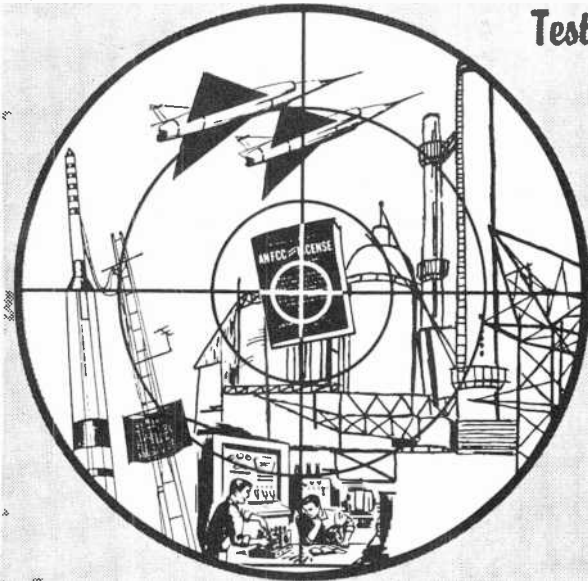

ANSWER THESE QUESTIONS:

- DO YOU want to get into ELECTRONICS?
- Do you have a SPECIFIC OBJECTIVE in mind ... Are you shooting at a particular target (such as an FCC License)?
- Do you want the kind of training that will take you straight to this objective QUICKLY... without wasting valuable time on non-essentials?

The Grantham Communications Electronics Course prepares you for your first class commercial

F.C.C. LICENSE

QUICKLY!

CORRESPONDENCE OR RESIDENCE CLASSES

Is Grantham Training for You?

CHECK THESE FEATURES:

- Grantham teaches the *theory* of electronics. Every basic concept of electronics fundamentals is covered in the Grantham course...whether you take it in resident classes or by home study. Grantham training "makes electronics yours."
- You can get your First Class FCC license IN ONLY 12 WEEKS in Grantham resident classes (or, in a correspondingly short time in the Grantham home-study program). THINK OF IT! A commercial U.S. Government license...PROOF OF YOUR qualifications in meeting these U.S. Government requirements as an electronics communications technician...a nationally recognized certificate. By preparing you for this license in only 12 WEEKS, Grantham conserves YOUR TIME!
- Mature men select Grantham Schools for electronics training. (The average age of Grantham Students is 28.8 years.) MATURE MEN want a definite objective (not a pot of gold at the end of the rainbow). Grantham training has this specific objective: To prepare you for your First Class FCC license and greater earning capability. The Grantham Course is for mature men who know what they want.
- Grantham Schools' tuition rates are low, yet the instructional service is not equalled by many of the *most expensive schools!* Grantham can do this because of highly efficient instructional methods and because Grantham has a sincere desire to out-do all others in service rendered per tuition-dollar. Grantham has established *reasonable* tuition rates. And, the percentage of students who successfully complete the Grantham course — and who get their FCC licenses — is one of the highest in the nation.
- YOU GAIN RESPECT by showing your Grantham diploma, once you earn it. YOU GAIN RESPECT by showing and posting your First Class FCC License — a nationally recognized certification of your electronics knowledge. Many companies which employ industrial electronics technicians require them to have this license. YOU CAN GET IT IN ONLY 12 WEEKS. Let Grantham show you how!

HERE'S PROOF: Here is a list of a few of our recent graduates, the class of license they got, and how long it took them:

Name	License	Weeks
James C. Bailey, 217 Behrends Ave., Juneau, Alaska	1st	12
Edward R. Barber, 907 S. Winnifred, Tacoma, Wash.	1st	20
M. A. Dill, Jr., 20 Cherry St., Gardiner, Maine	1st	12
Bernhard G. Fokken, Route 2, Canby, Minn.	1st	12
Kenneth F. Foltz, Broad St., Middletown, Md.	1st	12
James C. Greer, Mound City, Kansas	1st	12

Get your First Class Commercial F.C.C. License Quickly by training at



GRANTHAM SCHOOL OF ELECTRONICS

Accredited by the National Home Study Council

1505 N. Western Ave. Los Angeles 27, Calif. (Phone: HO 7-7727) 408 Marion Street Seattle 4, Wash. (Phone: MA 2-7227) 3123 Gillham Road Kansas City 9, Mo. (Phone: JE 1-6320) 821-19th Street, N.W. Washington 6, D. C. (Phone: ST 3-3614)

MAIL COUPON NOW — NO SALESMAN WILL CALL →

(Mail in envelope or paste on postal card)

TO: GRANTHAM SCHOOL OF ELECTRONICS

1505 N. Western • 408 Marion • 3123 Gillham Rd. • 821-19th, NW
Los Angeles • Seattle • Kansas City • Washington

Gentlemen:

Please send me your free booklet telling how I can get my commercial F.C.C. license quickly. I understand there is no obligation and no salesman will call.

Name _____ Age _____

Address _____

City _____ State _____

Interested in: Home Study, Resident Classes

23 G

Norelco® BRINGS YOU

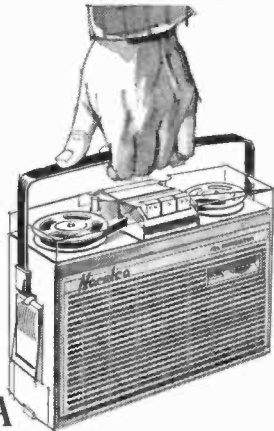

A PORTABLE TAPE RECORDER

that works on ordinary
FLASHLIGHT BATTERIES
so you can now record
anything, anytime, any-
where!

Only 7 lbs.—is worn over your shoulder like your camera. 100% transistorized. Records and plays back up to 2 hours on a 4" reel. Has constant speed motor and capstan drive. Combined indicator for modulation level and battery life. Input for mike/phono. Output for external amplifier. Response: 100 to 6000 cps. Signal-to-noise ratio: better than -40db. Completely self-contained with dynamic cardioid microphone, 4" speaker, patchcord assembly for recording and playback thru radio, TV or record player. Ruggedly built, handsomely styled, suprisingly low-priced. It's the new Continental '100'.

Write for brochure: E-5.

NORTH AMERICAN PHILIPS COMPANY, INC.,
High Fidelity Products Division,
230 DUFFY AVENUE, HICKSVILLE, L. I., N. Y.

In Canada and throughout the rest of the free world,
the Norelco Continental is known as the 'Philips'.

Letter Tray

(Continued from page 10)

which might cause a bit of consternation on the part of the P.E. readers who want to build the temperature gauge. The replacement face for the Lafayette TM-400 meter was reproduced at twice actual size—it should be $1\frac{1}{2}$ " x $1\frac{1}{2}$ ". I still have the negative for the contact print which served as the new meter face in my original model, however, and I would be happy to supply readers with similar prints for 50 cents each, postpaid.

CHARLES CARINGELLA
P. O. Box 1025
Ontario, Calif.

Aspirin-Sized Hearing Aid

■ In the April 1962 News Scope, you mention that the Zenith "Cameo" hearing aid is no larger than a child's aspirin. Actually, it's the unit's battery that's aspirin-sized.

THELMA RICHARDS
Skokie, Ill.

True. We guess that story was a little tough to swallow.

New Use for CB

■ Here's a use for the Citizens Band that probably hasn't been thought of by many people. I keep a Heathkit portable transceiver in my wheelchair to help me stay in touch with home! The base station is a Citi-fone unit feeding into a coax antenna. Results are good with this setup, but the

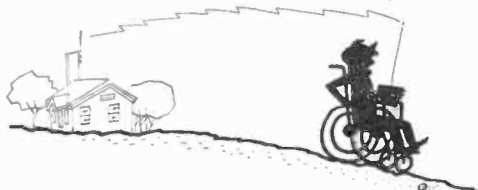

portable unit has a regenerative receiver which lacks a squelch. If any of your readers know of a portable set for sale (it can have a regen receiver, but should be equipped with squelch), I'd appreciate hearing from them.

ED GRUBGELD
P.O. Box 665
Solvang, Calif.

Tone Signals on CB

■ I've just finished reading "The Gabble Killer" in your April 1962 issue. While I like the selective calling idea, I thought it was illegal to put a tone on a CB carrier. Could you straighten me out on this?

HARRY J. CUNNINGHAM
Weirton, W. Va.

Tone signals are permitted on the Citizens Band if they serve a useful purpose. The "Gabble Killer" is legal, then, since its signal is used to activate a base station loudspeaker. Tone signals that serve only to attract attention (sometimes called "turkey calls") are definitely illegal and should not be used.

-30-

The Same School That Originated The RTS BUSINESS PLAN

...NOW
Proudly
Presents...

A SPECIAL COMPACT COURSE COVERING ALL THREE PHASES OF **ELECTRONICS**

The Entire Course Is Made Up Of The Following:

- 35 LESSONS COVERING BASIC AND INTERMEDIATE ELECTRONICS
- 9 EQUIPMENT KITS COMPLETE WITH TUBES AND BATTERIES
- SOLDERING IRON
- 25 LESSONS COVERING THESE ADVANCED ELECTRONIC SUBJECTS:
 - Thyratron Tubes • Semiconductors • Electronic Symbols and Drawings • Voltage-Regulators • Electronic-Timers • Control Systems • X-Rays • Photoelectric Devices • Dielectric Heating • Geiger Counters • Pulse Circuitry • Clippers and Limiters • Multivibrators • Electronic Counters • Radar • Magnetic Amplifiers • Analog-Computers • DC Amplifiers • Digital Computers • Storage Systems • Input and Output Devices • Servomechanisms • Telemetering
- 60 EXAMINATIONS
- UNLIMITED CONSULTATION SERVICE
- KIT MANUALS
- DIPLOMA UPON GRADUATION

AND MUCH MORE...

BASIC • INTERMEDIATE • ADVANCED
DESIGNED FOR THE BUSY MAN OF TODAY

This is MODERN training for the MODERN man. You'll find no "horse and buggy" methods here. Every page of this streamlined course is devoted to important Electronics principles and practical projects. You'll be amazed how fast you grasp Electronics the RTS way. RTS has combined modern THEORY and PRACTICE to make this the finest training program of its kind available!

SATISFIES NOVICE, TECHNICIAN OR HOBBYIST

Whether you're new to Electronics or an old "pro," chances are you'll find this to be the ideal course for you. The novice will appreciate the completeness of the training. It starts with the most basic considerations, covering each important point thoroughly, yet concisely. The technician will enjoy the practical review of fundamentals and profit from the 25 advanced subjects covered.

RTS GIVES YOU "TOP MILEAGE" FOR YOUR TRAINING DOLLAR

The price quoted below buys EVERYTHING — there are no extras to pay for. RTS has gone "all out" to give you the best training value in America. Why pay hundreds of dollars for training such as we offer when it's available for this LOW PRICE? If you can find a better training bargain... BUY IT!

CAN BE COMPLETED IN MONTHS INSTEAD OF YEARS

Some students will complete this course with "Jet-Like" speed but we allow up to two years if your circumstances require it. You study at your own rate. You are ENCOURAGED but not pushed. You'll find the lessons professionally written but easy to understand. LET US SEND YOU ONE OF THESE LESSONS ALONG WITH YOUR CAREER BOOKLET SO YOU CAN SEE FOR YOURSELF. NO OBLIGATION!

***TERMS ALSO AVAILABLE**

AS LITTLE AS...

\$5.00 DOWN

\$5.00 PER MONTH

THE FIRST TRAINING KIT IS SENT IMMEDIATELY UPON ENROLLMENT

COMPLETE
COST...
INCLUDES ALL KITS,
TUBES, BATTERIES, ETC.
\$125.00*

DON'T LOSE OUT — FIND OUT!

RTS ELECTRONICS DIVISION Dept. PE-62

815 E. ROSECRANS AVENUE LOS ANGELES 59, CALIFORNIA

Rush me full information by return mail. (Please Print)

Name _____ Age _____

Address _____

City _____ Zone _____ State _____

NO SALESMAN WILL CALL ON YOU!

RTS' Membership in The Association of Home Study Schools is your assurance of Reliability, Integrity and Quality of Training.



RTS ELECTRONICS DIVISION
815 E. ROSECRANS AVENUE
LOS ANGELES 59, CALIFORNIA

Est. 1922

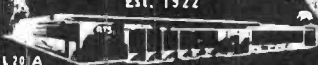

L 20 A

A
quality trio of
microphones for
"loud and clear"
communications



SONOTONE CERAMIKES

"Loud and clear" reception begins with quality-engineered Sonotone Ceramikes. That's because Ceramikes are designed to give maximum speech intelligibility — designed for greater sensitivity to the frequencies covering the human voice. This frequency selectivity, coupled with physical design, screens out background noises. Ceramikes are inherently immune to extremes of temperature or humidity — will operate even if immersed in water. The ceramic transducer is neoprene-encased, rendering it shock and impact-proof to withstand rough treatment. Here is a smartly engineered line-up of microphones tailored to communications requirements.

PERFECT CB TEAM

SONOTONE CERAMIKE CM-30 — Perfect for mobile use. Intelligibility unsurpassed. Sensitivity curve favors voice frequency range. High sensitivity from -49 db from 60 to 7000 cps. Ruggedly built to take the punishment of mobile use. Lightweight, shatterproof plastic case. Easy to handle — and control with convenient "Push-to-Talk" button and special dashboard mounting bracket. Supplied with spring-spiraled 4-conductor shielded cable. List \$14.00.

SONOTONE CERAMIKE CM-17A — 13" Flex-Mike, ideal base station microphone for CB or other communications applications. Gooseneck mounting makes it easy to talk while keeping hands free. Sharp clear communication with frequency response sensitivity of -56 db from 50 to 11,000 cps, ± 2 db. Equipped with 6' shielded cable. List \$24.50.

RUGGED MOBILE COMMUNICATIONS MICROPHONE

SONOTONE CERAMIKE CM-31 Budget-priced communications model in shatterproof plastic case features excellent intelligibility (90 to 6000 cps frequency range at -49 db sensitivity). Mike has a 2-conductor coil cable — no switch. List \$13.50.

Fixed communications or mobile, Sonotone Ceramikes provide top-flight, long term, maintenance-free performance.

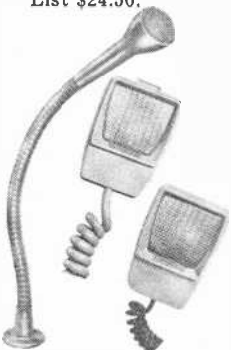

SONOTONE® CORPORATION ELMSFORD, NEW YORK
Electronic Applications Division

In Canada: Atlas Radio Corp., Ltd., Toronto
Cartridges • Speakers • Tape Heads • Mikes
Electronic Tubes • Batteries • Hearing Aids



ELECTRONICS DATEBOOK

JUNE 1-3

Southwestern Division
ARRL Convention
Disneyland Hotel, Anaheim, Calif.

JUNE 12-14

Armed Forces Communications
& Electronics Show
Sheraton Park & Shoreham Hotels,
Washington, D. C.

JUNE 17-22

American Institute of Electrical
Engineers Summer General Meet-
ing
Denver Hilton Hotel, Denver, Colo.

JUNE 24-28

Music Industry Trade Show
New York Trade Show Building and
Hotel New Yorker, New York, N. Y.

AUG. 13-16

Pacific Energy Conversion Confer-
ence
Fairmont Hotel,
San Francisco, Calif.

AUG. 21-24

Western Electronics Show & Con-
vention (WESCON)
Statler Hilton Hotel & Memorial
Sports Arena, Los Angeles, Calif.

AUG. 31-SEPT. 9

World's Fair of Music and Sound
McCormick Place, Chicago, Ill.

SEPT. 1-3

National ARRL Convention
Memorial Coliseum,
Portland, Oregon

OCT. 2-4

National Symposium on Space
Electronics & Telemetry
Fontainebleu Hotel,
Miami Beach, Fla.

OCT. 8-10

National Electronics Conference
(NEC)
McCormick Place, Chicago, Ill.

OCT. 15-19

Audio Engineering Society Fall Con-
vention & Exhibit
Barbizon-Plaza Hotel,
New York, N. Y.

Always say you saw it in—POPULAR ELECTRONICS

BREAK THROUGH TO HIGHER PAY

in ELECTRONICS

TV-RADIO

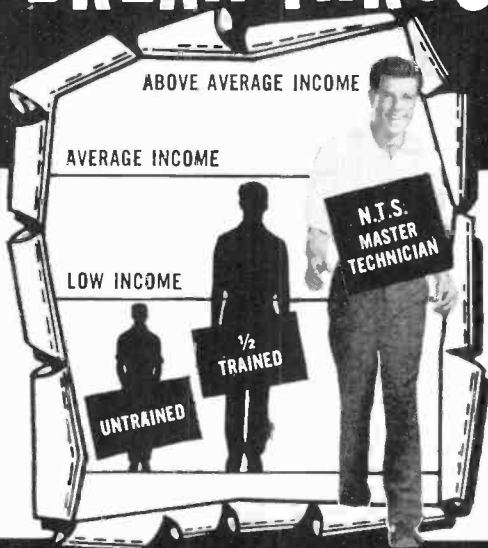

START NOW! Break through the Earning Barrier that stops half-trained men. N.T.S. "All-Phase" training prepares you — at home in spare time — for a high-paying CAREER in Electronics — TV — Radio as a **MASTER TECHNICIAN**. One Master Course at One Low Tuition trains you for unlimited opportunities in All Phases: *Servicing, Communications, Preparation F.C.C. License, Broadcasting, Manufacturing, Automation, Radar and Micro-Waves, Missile and Rocket Projects.*

A more rewarding job... a secure future... a richer, fuller life can be yours! As an **N.T.S. MASTER TECHNICIAN** you can go straight to the top in industry... or in your own profitable business.

You work on actual job projects

SUCCEED IN MANY HIGH-PAYING JOBS LIKE THESE...

- TV-Radio Sales, Service and Repair
- Profitable Business of Your Own
- Communications Technician — F.C.C. License
- Hi-Fi, Stereo & Sound Recording Specialist
- TV-Radio Broadcasting Operator
- Technician in Computers & Missiles
- Electronics Field Engineer
- Specialist in Microwaves & Servomechanisms
- Expert Trouble Shooter
- All-Phase Master Technician

19 BIG KITS YOURS TO KEEP

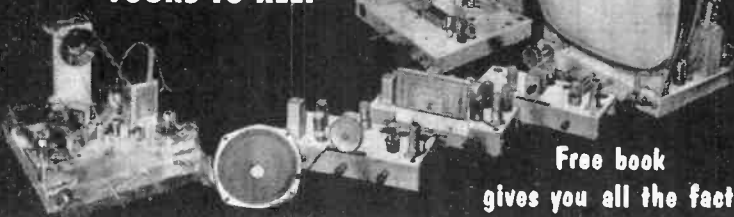

Free book gives you all the facts

NATIONAL TECHNICAL SCHOOLS

WORLD-WIDE TRAINING SINCE 1905
4000 SO. FIGUEROA ST., LOS ANGELES 37, CALIF., U. S. A.

Write Dept. R2G-62



N.T.S. Shop-Tested HOME TRAINING is **Better, More Complete, Lower Cost...** and it is your key to the most fascinating, opportunity-filled industry today!

YOU LEARN QUICKLY AND EASILY THE N.T.S. SHOP-TESTED WAY

You get lessons, manuals, job projects, unlimited consultation, graduate advisory service.

You build a Short Wave-Long Wave Superhet Receiver, plus a large-screen TV set from the ground up, with parts we send you at no addi-

tional cost. You also get a Professional Multimeter for your practical job projects.

EARN AS YOU LEARN... WE SHOW YOU HOW!

Many students pay for entire tuition — and earn much more — with spare time work they perform while training. You can do the same... we show you how.

SEND FOR INFORMATION NOW... TODAY! IT COSTS YOU NOTHING TO INVESTIGATE.

RESIDENT TRAINING AT LOS ANGELES

If you wish to take your training in our Resident School at Los Angeles, the world's TV capital, start NOW in our big, modern Shops, Labs, and Radio-TV Studios. Here you work with latest Electronic equipment — professionally installed — finest, most complete facilities offered by any school. Expert friendly instructors. Personal attention. Graduate Employment Service. Help in finding home near school — and part time job while you learn.

WRITE FOR SPECIAL RESIDENT SCHOOL CATALOG AND INFORMATION



ACCREDITED MEMBER
... the only nationally recognized accrediting agency for private home study schools.

N.T.S. HOME TRAINING is

- Classroom Developed
- Lab-Studio Planned
- Shop-Tested
- Industry-Approved
- Specifically Designed for Home Study

ACTUAL LESSON



MAIL COUPON NOW

for **FREE BOOK** and **ACTUAL LESSON**

**NO OBLIGATION!
NO SALESMAN WILL CALL**

NATIONAL TECHNICAL SCHOOLS

WORLD-WIDE TRAINING SINCE 1905

Mail Now To
National Technical Schools, Dept. R2G-62
4000 S. Figueroa St., Los Angeles 37, Calif.

Please rush **FREE** Electronics-TV-Radio "Opportunity" Book and Actual Lesson. No Salesman will call.

Name _____ Age _____
Address _____
City _____ Zone _____ State _____

Check here if interested ONLY in Resident Training at Los Angeles.
VETERANS: Give date of discharge _____

For Your Future in Electronics... You Need Training!



A Message from C. L. Foster, President Central Technical Institute, Kansas City, Missouri

"Today—while the need for skilled workers is skyrocketing, the need for unskilled workers is going down. Everywhere you look today you see changes brought about by the demands of the electronic

age in which we live. The rate at which business and industry are changing operational methods to take advantage of new electronics technology is amazing. New industries are springing up overnight. Automation is fast replacing outmoded methods of doing things, but at the same time, automation is creating thousands of new jobs. To keep pace with today's fast-moving changes, and move up to a position in high-demand with high-pay, untrained men must prepare for the skilled technical jobs that are constantly replacing unskilled jobs. This means Training!

"If you've read the informative articles on electronics schools which appeared in the February, March and April issues of this magazine, you found a thorough discussion of Home-study and Resident Electronics training schools. You also found revealing facts and figures on the many exciting jobs open

in electronics, and you got an idea of the big salaries you can earn in this field.

"Not too many years ago, the man who couldn't go away to school was left out in the cold. Not anymore. New teaching techniques make it easy for the part-time student to make rapid progress by studying at home. Fast, efficient mail service makes it possible to bring the classroom to the student. Today, there is real opportunity for the 'self-starter' to get the kind of electronics training he wants and needs.

"If you want electronics training; if you want to take your place in the exciting, dynamic Age of Electronics—I urge you to do something about it. Read all you can about the electronics field—investigate electronics schools—get the facts. Then make your decision, and you'll be on your way to success."

Sincerely,

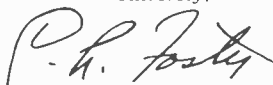

C. L. Foster, President

CENTRAL TECHNICAL INSTITUTE

Central Technical Institute Has Been a Leader in ELECTRONICS EDUCATION Since 1931!

SOME FACTS ABOUT CENTRAL:

CENTRAL TECHNICAL INSTITUTE was founded in 1931, when head-phone radio sets were still popular. Shortly after its founding, Central constructed and operated Station W9XAL, the FIRST Television Station west of Chicago to broadcast on a daily schedule. John Cameron Swayze, Verne Smith, Count Basie and Ted Malone were among the personalities to appear on this pioneer television station.

In 1934, Central was granted one of the FIRST THREE High Fidelity commercial broadcast station permits issued by the Federal Communications Commission. Central operated Station W9XBY on 1530 kilocycles, with Central's home-study students serving as listening posts.



This is Central's Computer Laboratory, showing the Remington-Rand UNIVAC Electronic Computer, left, and Bendix G-15 Computer, far right. Students make extensive use of this laboratory to learn Electronic Computer Technology.

Central's major resident curriculum is accredited by the Engineers' Council for Professional Development as a Technical Institute program. Central is an accredited member of the National Home Study Council, and is approved by the U. S. Department of Justice, Immigration and Naturalization for the admission of foreign students. Central is listed in the current U. S. Government publication "Accredited Higher Institutions", and in the U. S. Office of Education's "Directory of Institutions of Higher Learning" (Part 3).

In 1941, Central Technical Institute became the FIRST civilian school to be selected by the U. S. Signal Corps to train enlisted men as radio operators and repairmen. At war's end, Central had trained over 23,000 men and women for the Army Signal Corps and other branches of the military.

Central Technical was the FIRST Technical Institute in the United States to have a complete electronic computer system installed as a teaching aid. This Remington-Rand Univac stored-program computer system includes a Digital Computer, Tabulating Machine, Key Punch, Sorter and Interpreter, making an extremely high level of practical instruction available to resident students. Central also has a Bendix G-15 Computer, complete with Alphanumeric Typewriter and other accessory electronic data processing equipment.

AT&T; Ampex Computer Products; Bendix Radio Company; Bendix Computer Division; Boeing Airplane Company; Collins Radio Company; The Federal Aviation Agency; General Dynamics; General Electric Company; IBM; Honeywell Regulator Co.; RCA Service Company; Sandia Corporation; Texas Instruments; Western Electric Company, and Wilcox Electric Company are among the outstanding companies and agencies that employ Central graduates. The electronics field is wide open. There were not enough technically-trained personnel available in 1961 to fill all of the jobs open with electronics companies!

Today, Central has resident students from many parts of the United States and some foreign countries studying at Kansas City. Central has trained over 50,000 students for successful graduation through its resident and home-study courses since 1931! If you're interested in electronics training—and obtaining your training from one of the finest Technical Institutes in the United States, it will pay you well to investigate Central Technical Institute, of Kansas City, Missouri.

FOR INFORMATION ON CENTRAL'S "PRACTICAL ELECTRONICS" HOME-STUDY COURSE... SEE ADJOINING PAGE!

DON'T TURN ANOTHER PAGE until you clip out this coupon!

It could be the turning point in your life!

Make More Money Soon... with Electronics!



FREE

"PROFITS FROM ELECTRONICS"

Central Technical Institute's 64-page book on electronics is packed with free information on amazing career opportunities for you in: Industrial Electronics, Automation, Radio, Color TV, Radio-TV Broadcasting, Electrical Wiring, Appliance Servicing, Communications Electronics, Radar, Mis-

MAIL THIS NOW!

01062D

I am interested in your PRACTICAL ELECTRONICS home study course. Please send me your 64-page catalog and full enrollment information.

Name _____ Age _____

Address _____

City _____ Zone _____

State _____ County _____

Check here if you want information about Central's full-time resident program in Kansas City, Missouri.

CENTRAL TECHNICAL INSTITUTE
1644 Wyandotte, Kansas City 8, Mo.
Accredited Member National Home Study Council

CLIP OUT THIS COUPON, FILL IN YOUR NAME AND ADDRESS, AND MAIL TODAY... FOR FREE BOOK PACKED WITH EXCITING INFORMATION ON ELECTRONICS. NO OBLIGATION!

64-PAGE BOOK

siles, Computers, Nuclear Energy, and many others! This free book tells all about Central Technical Institute's different NEW Home Study Course, "PRACTICAL ELECTRONICS." This Home Study course is so complete, it even contains instructions on how to set up and run your own electronics servicing business. FREE "PROFITS FROM ELECTRONICS" book also contains full information on Central's new Instant Kits, below. All you need do to get this valuable book is fill in your name and address on the above coupon, and MAIL IT TODAY!

GET INTO THE DYNAMIC, \$11,000,000,000 FIELD OF ELECTRONICS! Gain Higher Income! New Prestige! A Fine Future!

BUILD CENTRAL'S NEW INSTANT KITS

Central Technical Institute's new INSTANT KITS are designed to teach you as you build. Each inexpensive kit comes complete, ready to assemble... in only a few short hours of building and learning, you have a piece of test equipment that meets commercial standards, can be used in your business, or sold to customers at a profit. And Central Technical is developing new kits for you to build. See the sample selection below:

VOM Tester	Appliance Tester	Transistorized Volt-Ohmmeter Tester	4-Transistor Portable Radio	Transistor Signal Generator	Transistor Photoelectric Switch	Transistor Code Oscillator	All-Purpose Oscilloscope

YOU CAN EARN EXTRA MONEY SOON!

Study at home in spare time—no High School diploma required!

With a sincere desire to get ahead, make more money and enjoy an interesting career... you can earn while you learn, keep your present job, and set your own pace. Find out how much fun electronics can be! See how you can add to your income! High income, prestige, and security for you and your family can be yours! Don't let a 4c stamp stand in your way. MAIL THE ABOVE COUPON TODAY and GET YOUR FREE BOOK NOW. The little time you spend mailing this coupon may be one of the best investments you'll ever make!

START A BUSINESS OF YOUR OWN... OR QUALIFY FOR A HIGH PAY CAREER!

Over 50,000 successful graduates since 1931!

"THANKS to my Central training, I have my First Phone (FCC) Ticket, which gives me an advantage over my competitors. I am a franchised RCA dealer, employ a bookkeeper and usually two servicemen." R. R. "Jack" Merrill, Pryor, Oklahoma.

Superintendent of Communications for the K. C. Southern Railway Company is Central graduate Lawrence D. Fry, with 15 years of railroad communications experience. "Central is a fine school," says Mr. Fry. "I've always recommended it, and have sent several students to Central."

Field Service Representatives for the Bendix Computer Division, L. A., California, are Central graduates E. John Kempf, left, and Robert Young. Mr. Kempf was employed as a maintenance man before he became interested in radio and TV. His first project was building test equipment at home. After enrolling with Central, he began to make extra money repairing radios, auto radios, etc. "The field of computers is expanding, and there's a real need for trained technicians," he says. "I have found the work to be both profitable and interesting!"

Central Technical Institute

1644 WYANDOTTE, KANSAS CITY 8, MISSOURI

RESIDENT TRAINING—Central also offers a full-time ECPD-Accredited Technical Institute program at its resident school in Kansas City, Missouri. Mail the coupon at page top for information.

Tips and Techniques



VEGETABLE PEELER IS INSULATION STRIPPER

A vegetable peeler of the type shown in the photo makes an ideal tool for stripping insulation from long lengths of wire, a job which conventional strippers can't do. And,

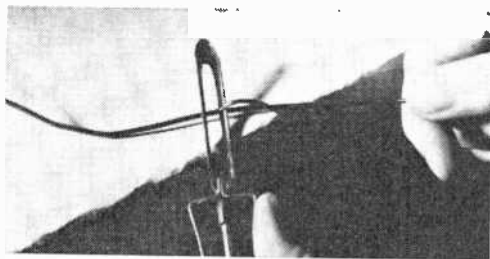

unlike a pocket knife, the peeler won't accidentally slip and cut through the wire. For best results, hold the peeler against your bench and pull the wire through it.

—Robert E. Kelland

HOLLOW RIVETS SERVE AS MINIATURE GROMMETS

If you're looking for a miniature grommet to feed a small wire through a chassis hole,

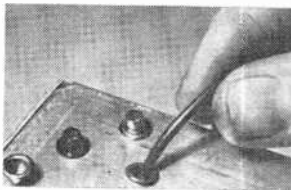

a small hollow rivet will do the job. You can get such rivets, in almost any size you might require, at any large industrial hardware store. And there's no need for a special crimping tool; the rivet works just as well for this purpose if it's simply cemented into a close-fitting hole.

—John A. Comstock

"FEELER GAUGE" WILL STRAIGHTEN BENT CAPACITOR PLATES

Use a mechanic's "feeler gauge" to restore proper clearances to variable capacitor plates which are bent and shorting. A

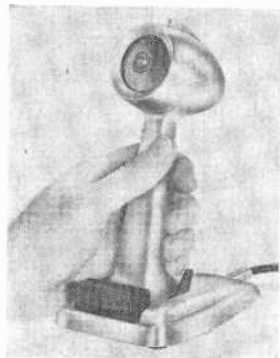

MODEL 254C

GET IMPROVED CB AUDIO, GREATER RANGE WITH TURNER CB MICROPHONES



MODEL 350C

Manufacturers know this — that's why more Turner microphones are used as original equipment on CB than any other. The Turner Model 350C (List \$16.80) for top mobile rig performance; the Model 254C (List \$23.50) ideal for base station operation.

The Turner Combo

Get both matched ceramic microphones in the Turner Combo, available at your Parts Distributor or Citizens' Band headquarters at \$40.30 List.



THE TURNER MICROPHONE COMPANY
946 17th St. NE
Cedar Rapids, Iowa

Gentlemen:
Please send me complete information and specifications on the Turner Mobile Model 350C the Turner Base Station Model 254C the Turner Combo.

NAME _____

ADDRESS _____

CITY _____ ZONE _____ STATE _____

THE  MICROPHONE COMPANY

946 17th Street NE, Cedar Rapids, Iowa
In Canada: Tri-Tel Associates, Ltd., 81 Sheppard Ave. West,
Willowdale, Ontario



Are You Interested In Electronics - TV - Radio?

CARL E. SMITH
E. E., President

then you will want to know

What IS The FCC?

It's amazing what the future holds for you in this modern world of electronics. Let me send you the entire story—FREE!

- How to pass the FCC Exam
- Successful Electronic Training

We can train you to pass the Valuable FCC exam in a minimum of time if you have any practical experience and a fair knowledge of mathematics.

Get All 3 Booklets Free



Get This Handy Pocket Electronics Data Guide Free . . .

Puts all the commonly used conversion factors, formulas, tables, and color codes at your finger-tips. Yours absolutely free if you mail the coupon today. No further obligation!

TO GET THIS FREE GIFT, MAIL COUPON TODAY!

Sorry—Not For Beginners

Please inquire only if you really want to get ahead and to add to what you have already learned in school, in the service, or on the job. Some previous schooling or experience in electronics, electricity, or related fields is necessary for success in Cleveland Institute programs.

Cleveland Institute of Electronics

1776 E. 17th St. Desk PE-91 Cleveland 14, Ohio

June, 1962

FCC Regulations Require
CITIZENS BAND
Maintenance Personnel
to be licensed
Get In on the Ground Floor . . .
Get Your License Now!

Your FCC Commercial License —or Your Money Back

Completion of the Master Course (both Sections) will prepare you for a First Class Commercial Radio Telephone License with a Radar Endorsement. Should you fail to pass the FCC examination for this license after successfully completing the Master Course, you will receive a full refund of all tuition payments. This guarantee is valid for the entire period of your enrollment agreement.

Cleveland Institute of Electronics

1776 E. 17th St. Desk PE-91 Cleveland 14, Ohio

Accredited by the
National Home Study Council



Cleveland Institute of Electronics
1776 E. 17th St., Cleveland 14, Ohio

Please send Free Career Information Material prepared to help me get ahead in Electronics and a free copy of your "Pocket Electronics Data Guide." I have had training or experience in Electronics as indicated below.

- | | |
|---|---|
| <input type="checkbox"/> Military | <input type="checkbox"/> Broadcasting |
| <input type="checkbox"/> Radio-TV Servicing | <input type="checkbox"/> Home Experimenting |
| <input type="checkbox"/> Manufacturing | <input type="checkbox"/> Telephone Company |
| <input type="checkbox"/> Amateur Radio | <input type="checkbox"/> Other _____ |

In what kind of work are you now engaged?

In what branch of Electronics are you interested? _____

Name _____ Age _____

Address _____

City _____ Zone _____ State _____

PE-91

ALL
NEW!

High
Quality
Performance
Low in
Cost

Grommes

STEREO-MONAUURAL HI-FIDELITY TUNERS & AMPLIFIERS

24LJ Stereophonic
Amplifier

Complete 24 watt stereo, pre-amplifier and amplifier in one low cost unit. Net, \$79.95 (Enclosure \$10.00 extra).

10LJ Amplifier . . . Low priced stereo and monaural amplifier. Net, \$59.95 (Enclosure \$10.00 Extra).

LJ8 Amplifier . . . 12 watt monaural amplifier with built-in pre-amplifier. Net, \$39.95 (Enclosure \$10.00 Extra).

501A Receiver . . . AM-FM Tuner, Stereo and Monaural Amplifier. Net, \$149.95 less Multiplex (Enclosure \$10.00 Extra).

Write today for FREE literature on the complete Grommes Line.

GROMMES Div. of Precision Electronics, Inc.
9101-P King Ave., Franklin Park, Illinois
Please rush details on the Grommes Line.

Name.....
Address.....
City..... Zone..... State.....

UTICA
top of the
totem pole

Model MC27 Town & Country 6 channel crystal controlled

Model Utica T&C II 4 channel & tunable ("S" Meter)

Buddy Whip (Model) 94" fiberglass—fold down rain gutter mount

Gizmost chp horizontal-vertical beam

SOLD AND HEARTILY RECOMMENDED BY
LEADING DISTRIBUTORS & DEALERS EVERYWHERE

UTICA COMMUNICATIONS CORP.

5055 N. Kedzie Avenue • Chicago 25, Ill.

Dept. TD-200

Tips

(Continued from page 20)

gauge leaf or a combination of gauge leaves will correspond to the normal plate clearance. To restore parallelism, just insert the leaf (or leaves) between the out-of-true plates and slide the gauge back and forth.

—W. C. Wilhite

TV FOCUS MAGNET MAKES CONVENIENT MAP HOLDER

Going on a long auto trip? Use the ring magnet from a junked TV focus yoke to hold the road map in place on your dashboard. You won't have to worry about finding and unfolding the map each time you want to refer to it, and the area in which you are driving can be pin-pointed inside the ring. Most TV servicemen have old focus yokes around their shops and are glad to give them away or sell them at a nominal price.



—David Held

SOLDER GUN CHECKS SPEAKER CONTINUITY

When you suspect that a speaker voice coil is "open," but don't have an ohmmeter handy, press your solder gun into service. Just place the tip of the gun across the two

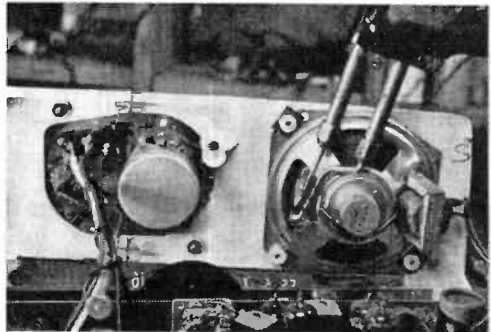

speaker terminals and pull the trigger a few times. If you don't hear any noise in the speaker, chances are it's defective; if you hear clicks, it's probably okay. Don't keep the trigger depressed for too long, of course, or you'll "de-solder" the speaker connections.

—Homer L. Davidson

(Continued on page 24)

Always say you saw it in—POPULAR ELECTRONICS

"A CREI Home Study Program helped me increase my salary by a factor of four (4)."

—Mearl Martin, Jr., SENIOR ENGINEER, Field Support Manager, Tektronix, Inc., Portland, Oregon

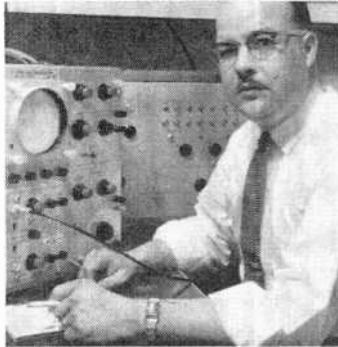

"I AM INDEED GRATEFUL TO CREI for my success," says Mearl Martin, Jr. "Since enrollment in a CREI Home Study Program in Electronic Engineering Technology, I have progressed from Junior Technician to licensed Senior Engineer. My present title is Field Support Manager and my salary has increased by a factor of four (4)."



DEMAND FOR CREI-PREPARED MEN today far exceeds the supply—and has for many years. CREI Home Study Programs, the product of 35 years' experience, include the latest advancements in the field. Here Martin discusses home study with company executive W. K. Dallas, V.P., Manager, Marketing Division, Tektronix, Inc.

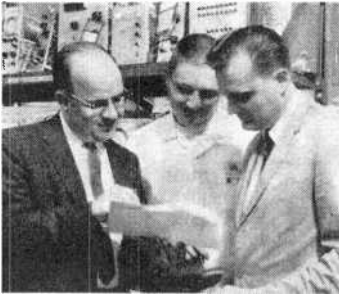

WHEN YOU ENROLL IN a CREI Home Study Program, you study courses to which a number of today's leading engineers and scientists have made substantial contributions. You are guided by qualified instructors. Robert Wruble, Group Manager (center) and Rollie Smith, (right) Field Training Manager at Tektronix, Inc., are shown here with Mearl Martin.

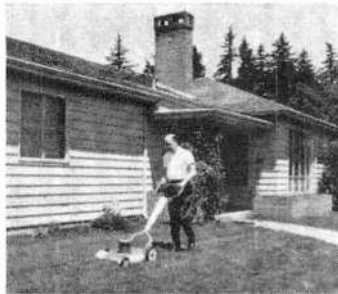

ASSURE A BETTER FUTURE and get more out of life with CREI Home Study. CREI alumnus Martin enjoys living in this comfortable home in Portland, Ore. CREI men are in such companies as Pan American Airways, Federal Electric Corp., The Martin Co., Northwest Telephone Co., Mackay Radio, Florida Power and Light, etc. This attests to the high calibre of CREI Programs.



YOUR WHOLE FAMILY BENEFITS when you achieve success through CREI Home Study. Here Martin relaxes with wife and family who share his success. Check the completeness of CREI Home Study Programs in Electronic Engineering Technology in our catalog, provided on request. For those who can attend, CREI maintains a Residence School in Washington, D.C.

INDUSTRY-RECOGNIZED CREI HOME STUDY PROGRAMS PREPARE YOU FOR INCREASED RESPONSIBILITIES, HIGHER-PAYING POSITIONS IN ELECTRONICS.

YOU CAN QUALIFY for a CREI Program if you have basic knowledge of radio or electronics and are a high school graduate or the equivalent. If you meet these qualifications, write for FREE 58-page book describing CREI Programs and career opportunities in advanced electronic engineering technology. Mail coupon or send your qualifications to: The Capitol Radio Engineering Institute, Dept. 1206-K, 3224 Sixteenth St., N. W., Washington 10, D. C.

Mail coupon today for FREE 58-page book

THE CAPITOL RADIO ENGINEERING INSTITUTE

Founded 1927

Dept. 1206-K, 3224 Sixteenth St., N.W., Washington 10, D.C.

Please send me details of CREI Home Study Programs and Free Book, "Your Future in Electronics and Nuclear Engineering Technology." My qualifications are noted to obtain immediate service.

CHECK Electronic Engineering Technology Nuclear Engineering Technology
 FIELD OF Servo and Computer Engineering Automation and Industrial Elec-
 GREATEST Technology tronic Engineering Technology
 INTEREST: Aero and Navigational Engineering Technology

Name Age

Address

City Zone State

Employed by

Type of present work

Education: Years High School Other

Electronics Experience

Check: Home Study Residence School G.I. Bill

27

COLOR CODED NUTDRIVER SETS

No fumbling — you reach for the right one every time!

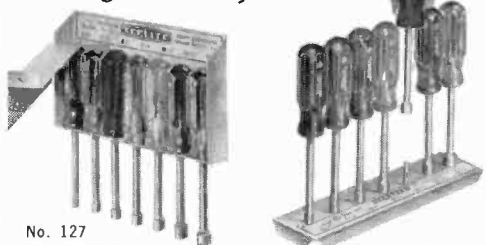

No. 12
space-saving
wall rack

No. 17
handy bench stand

7 most-used sizes — $\frac{3}{16}$ " thru $\frac{3}{8}$ "

High carbon steel. Precision sockets. Shockproof plastic handles (UL). Ask your distributor to show you these and other Xcelite sets. Also, full range of nutdrivers ($\frac{3}{32}$ " - $\frac{3}{4}$ ").

XCELITE, INC.

ORCHARD PARK, N. Y.

XCELITE

Canada: Charles W. Pointon, Ltd., Toronto, Ont.

Tips

(Continued from page 22)

SHOE BOXES STORE SPARE PARTS

Are you failing to get maximum value from your "spare parts box" because it's difficult to locate a component when you need it? Then try organizing your parts in shoe boxes. These boxes are commonly available, large enough for most purposes, and easily "stackable." For smaller components, use cigarette boxes of the "hard pack" variety and store these boxes, in turn, in the shoe boxes. A felt-tipped marking pen comes in handy for labeling.



—Fred Blechman, K6UGT

COMING NEXT MONTH



What's the latest word in kits? Easy—a 19" TV set that can be assembled in about 12 hours. Next month we'll answer some questions about TV kits—especially, how much money will they save you and how well will they work when the job is done.

ON SALE
JUNE 26

● BUILD ONE FOR THE ROAD

Small enough to get lost in the glove compartment, this mobile VHF receiver operates from your car's 12-volt battery. It tunes in CAP pilots, air control towers, and hams.

● FIRST AID FOR PRINTED CIRCUITS

With printed circuits appearing in everything but the "kitchen sink" these days, you'll welcome a timely article on ways to repair them.

● THE WHISTLE SWITCH

This "wireless" remote-control system won't need FCC approval. Build it and whistle to turn on (or off) electrical gear up to 100 feet away.

KUHN ... "LEADERS IN SPECIALIZED RECEIVING EQUIPMENT"

MOBILE FIXED CONVERTERS

- POLICE
- FIRE
- COMMERCIAL
- CITIZEN'S BAND

345A
Complete
\$29.95



A new high gain Crystal Controlled Converter. Excellent sensitivity. Rugged construction. Easy to install. Designed for standard transistor car radios. Requires no high voltage supply. 2-54 MC or 150-162 MC.

KUHN CONVERTERS . . . the most advanced line . . . designed for optimum performance.



348A
Complete
\$34.95

Transistorized, directly tunable Converter. Powered with self-contained mercury cell. Excellent sensitivity and stability. Designed for car, home or portable receivers. Two types available: Aircraft VHF 115-130 MC or 150-162 MC.



344A
Complete
\$23.95

A new low cost Crystal Controlled Converter designed for use with standard transistor car radios. Operates directly from 12V DC. Rugged construction. Good sensitivity. Range 2-54 MC.

ORDER TODAY or SEND FOR FREE CATALOG . . . containing complete information on a full line of: CONVERTERS AND RECEIVERS FOR EVERY APPLICATION



315A Complete \$14.95
A low cost Tunable Converter for any 10 MC area of: 26-34 MC. Aircraft VHF, or 150-160 MC. Easily installed. For use with home or auto sets. 315A Directly Tunable Converter. Available in four ranges: 26-30 MC, 30-50 MC, 115-130 MC, or 150-160 MC. Complete \$21.95



20 GLENWOOD
CINCINNATI 17,
OHIO

LAFAYETTE

AMERICA'S VALUE LEADER

HI-FI · AMATEUR · CB · RADIO

NEW! LAFAYETTE STEREO FM MULTIPLEX ADAPTER KIT

19⁵⁰

- Stereo Separation—30db @ 400 cps
- Less Than 1% Distortion
- Self-Powered
- Noise Filter (switchable)
- Prealigned Coils
- 3 Tubes—2 Dual, 1 Triple-Purpose Tube + Silicon Rectifier
- Ideal for any FM Tuner With Multiplex Output Jack

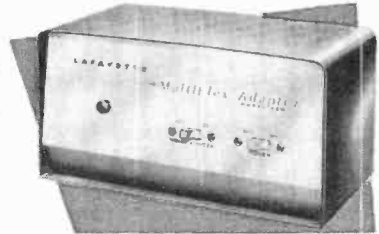

Enjoy thrilling FM stereophonic sound from any recent Lafayette Tuner or any other quality wide-band FM or FM-AM tuner with multiplex jacks. Hear the full range of audio frequencies in all the realism and magnificence of stereo sound by simply adding this low-cost Lafayette Multiplex adapter Kit. Engineered for anyone to build and operate, the KT-220 is easily connected to your tuners.

The KT-220 Multiplex adapter is supplied complete with shielded cable for input and output connections; metal case and all parts plus the famous Lafayette detailed kit instruction manual. Front panel is finished in beige and ivory trim with contrasting beige and brown cabinet. Size 8½" W x 4¾" D x 4¾" H for 110-125 volts, 60 cycles AC. KT-220 Shpg. wt., 4 lbs. Net 19.50

NEW! LAFAYETTE HE-20B CLASS D Deluxe CITIZENS BAND TRANSCEIVER

109⁵⁰

No Money Down

NOW WITH These ADDED FEATURES

- 8 Crystal - Controlled Receive Positions
- 8 Crystal - Controlled Transmit Positions
- Built-in 12 Volt Power Supply • Efficient Pi-Network
- Improved Series Gate — Noise Limiter

Quality engineering, design, and features give this Deluxe transceiver a place all-its-own in the Citizens Band Field. The HE-20B supplies you with a highly efficient 2-way radio-telephone communications system from your office, truck, auto, boat, store, home, etc. Shpg. wt., 14 lbs. HE-20B Net 109.50



FAMOUS "MIGHTY 9"™.M. 9 TRANSISTOR PERSONAL PORTABLE

19⁹⁵

- Complete with Carrying Case Batteries and Earphone
- 9 Transistors, 2 Diodes, 1 Thermistor
- Lightweight, Shirt Pocket Size • 3 Audio Stages

Lafayette's "Mighty-9" portable, the most powerful transistor radio, is the answer for those who want the best, without spending the most. Compare this portable with others selling for much more — compare feature for feature and you'll see why the Lafayette "Mighty-9" is your best buy. Size: 4½" H x 3 W x 1¼" D. Shpg. wt., 2½ lbs. FS-91L Net 19.95

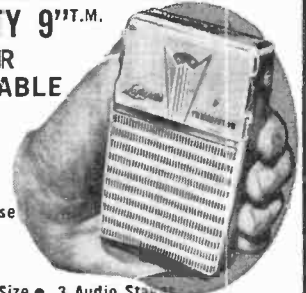

NEW LAFAYETTE 4 TRANSISTOR PUSH-BUTTON TAPE RECORDER

29⁹⁵

No Money Down

Complete with Microphone, Earphone 3" Reel of Tape, Empty Reel, Batteries

FOR HOME, SCHOOL, OFFICE

- Lightweight — A mere 2¼ lbs.
- Records and Plays Up to 20 Minutes With 1 Standard 3" Reel
- Pushbutton Play, Rewind, Off
- Completely Portable—Take It With You Anywhere
- Battery Operated

A real triumph in miniature recorders. Space age printed circuitry using a 4 transistor push-pull amplifier and built-in oval 2½x4" PM Speaker provides quality sound. Has all the most wanted features. Dimensions: 8Wx3½Hx 7¾"D. Shpg. wt., 4 lbs. RK-133L Net 29.95



LOW COST 4-BAND SHORTWAVE BROADCAST RECEIVER

In A Smartly Styled Durable Metal Cabinet

No Money Down

49⁹⁵

- Electrical Bandspread
- Built-in "S" Meter, BFO
- 3 Short-Wave Bands, 1 BC Band
- AVC — Noise Limiter • Big 5 Inch Speaker

Now, you can tune in the world with this fabulous new Lafayette HE-40 BC-SW receiver. Power packed superhet circuit covers the broadcast band (550-1600KC) and short-wave from 1600 KC to 30 MC in four bands. Features a precision electrical bandspread with slide rule band-spread dial. Separate bandspread tuning condenser and calibrated "S" meter for accurate tuning. Powered by 4 tubes plus a selenium rectifier. Operates on 105-125V; 50/60 cycle AC/DC. Size 13½" W x 5¾" H x 8¾" D. Shpg. wt., 10 lbs. HE-40 Net 49.95

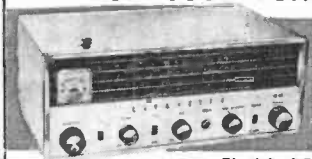

LAFAYETTE'S NEW MAIL ORDER and SALES CENTER

111 JERICHO TURNPIKE
(2 Blocks West of South Oyster Bay Rd.)
SYOSSET,
LONG ISLAND,
NEW YORK



LAFAYETTE RADIO DEPT. IF-2 P.O. BOX 10, SYOSSET, N.Y.

- Rush my FREE Lafayette Summer Catalog Supplement
- Please send me #..... Shipping Charges Collect I am enclosing \$.....

FREE!

Name _____
Address _____
City _____ Zone _____ State _____



New Products

TUBE TESTER ADAPTER

EICO's Model 610 tube tester adapter enables the Model 625 emission type tube tester or Model 666 dynamic conductance tube tester to handle 5- or 7-pin Nuvistors, 10-pin miniature tubes, 12-pin compactrons, and Novars. The adapter cable plugs into the 9-pin socket of either EICO tester, and an additional connection is made via the tester's grid-cap lead. Included with the Model 610 are roll-chart supplements for both testers covering the above tube types. The adapter is housed in a grey-wrinkle steel case having a brushed-aluminum panel. It's priced at \$5.95 in kit form, \$11.95 factory-wired. (EICO Electronic Instrument Co., Inc., 33-00 Northern Blvd., L. I. City 1, N. Y.)

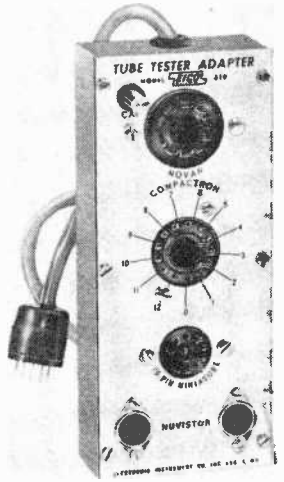

SINE/SQUARE-WAVE GENERATOR

A versatile tool for audio checking, Lafayette's Model TE-22 sine/square-wave generator combines two instruments in one. The 4-band unit has a sine-wave frequency range of 20-20,000 cycles ± 1.5 db, and a usable square-wave range of 20-25,000 cycles. A full-wave rectifier helps keep the distortion to less than 2% and the output (7 volts maximum) constant. Frequency accuracy is $\pm 5\%$. Among the other features of the Model TE-22 are its large,

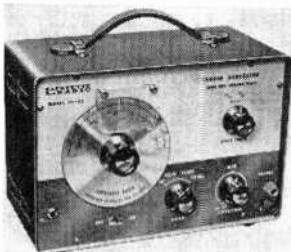

vernier-operated dial and variable output attenuator. Price, complete with a pair of test leads, \$32.50. (Lafayette Radio Electronics Corp., 111 Jericho Turnpike, Syosset, L. I., N. Y.)

QUALITY TV KIT

Hobbyists, experimenters, and even people with no technical knowledge at all should enjoy putting together the Conar "Custom Seventy" TV kit. Accompanying instructions are straightforward and include large picture diagrams and handy check lists. The set itself has a 19" aluminized picture tube, a factory-assembled and prealigned tuner, three stages of prealigned video i.f. amplification, a separate sound i.f. amplifier (also prealigned), and a two-stage video amplifier. Price, complete with cabinet, all tubes, and built-in "rabbit ears" antenna, \$135.00 (including 10% Federal tax). Or, if preferred, a "pay as you build" plan allows you to buy the set in four separate packages at \$36.00 per package. (Conar Instruments, 3939 Wisconsin Ave., Washington 16, D.C.)

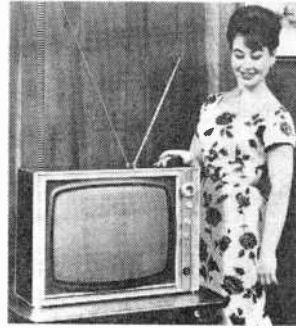

TRANSISTORIZED "GRID DIPPER"

The completely transistorized PEL "Dip Meter" is powered by an internal battery and small enough to permit one-hand operation. It can be used for circuit alignment, measuring resonant frequencies, checking antenna resonance, and locating parasitic frequencies. In addition, it serves as an r.f. detector, absorption wavemeter, or signal generator, and carries out all of the other functions performed by the more conventional tube-type "grid dippers." The five plug-in coils (covering a range of 3.1 to 180 mc.) are epoxy-coated for greater dependability and color-coded

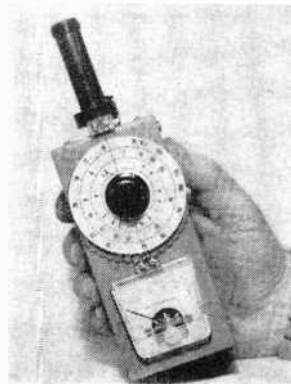

listen in on the world



.....on Your **MOSLEY CM-1** **Communications Receiver!**

For the ultimate in a communications receiver, there is none finer than the Mosley CM-1. A precision engineered receiver, the Mosley CM-1 covers a complete range of all amateur bands. The Mosley CM-1 is the first low-priced receiver with double conversion and crystal controlled first oscillator. It is the first receiver with 5 dual-purpose tubes of one type and 4 semi-conductor diodes which perform all functions usually requiring 12 or more tube sections.

FEATURES AND PERFORMANCE

Diode detector for a.m. and product detector for s.s.b. and c.w. . . . Calibration every 5 k.c. . . . WWV reception at 15 Mc. . . . Sensitivity: ½ microvolt for 10 db. signal-to-noise ratio on ten meters. Selectivity: 2.5 kc. at -6 db. Automatic noise limiter. . . . Stability: Less than 500 cycles drift after one minute warm-up. . . . Less than 200 cycles change for 10% line voltage change. . . . Image and i.f. rejection: 35 db. minimum. . . . "S"-meter functions on a.m., c.w. or s.s.b. with or without b.f.o. . . . Rear chassis accessory facilities: Transmitter relay terminals, accessory power socket, external speaker/VOX terminals. . . . Power consumption: 33 watts. (115 v.a.c., 50 to 60 c.p.s.) See your dealer soon or write Mosley Electronics Inc., 4610 North Lindbergh Blvd., Bridgeton, Mo.

Mosley CM-1 Amateur Net \$182.70

Matching Speaker - CMS-1 Amateur Net \$16.95



Prices subject to change without notice. All prices slightly higher west of the Rockies.

Products

(Continued from page 26)

to match the dial scales. In kit form (Model DM 201 K), the unit sells for \$25.90; a factory assembled and calibrated version (Model DM 201) is available at \$31.90. Postage prepaid if remittance is included with order. (PEL Electronics, Box 555, Ridgewood, N.J.)

CB MIKE PACKAGE

Intended especially for CB'ers, the Turner "Combo" consists of a Model 350C mobile microphone and a Model 254C desk microphone in one package. Both mikes use the same ceramic cartridge (frequency response, 80-7000 cycles; output level, -54 db), and both are wired for relay operation. The 350C is equipped with a hanger button, standard dash bracket, neoprene coiled cable, and momentary on-off switch. The 254C has both "touch-bar" and "lever-lock" on-off switches. Price of the package, \$40.30. (Turner Microphone Co., 901 17th St., N.E., Cedar Rapids, Iowa.)



STEEL BATTERY HOLDERS

Keystone Electronics is producing a line of nickel-plated steel battery holders to supplement its aluminum models. The new units hold the batteries in an especially firm grasp, assuring a low-resistance contact even when they are subjected to shock or vibration. There's a choice of two series (#1100 or #2100), each available in 1-, 2-, 3-, or 4-cell sizes (for either penlight, "C," or "D" cells). Both series are designed to hold cells in an "end-to-end" fashion, but the #1100 group has only one terminal insulated from the holder frame while the #2100 group has both terminals insulated. At a slight extra cost, carbon-steel spring retainers (illustrated on all three holders in the photo) are available. The holders range in price from 23 cents to 57 cents. (Keystone Electronics Corp., 49 Bleecker St., New York 12, N.Y.) -50-

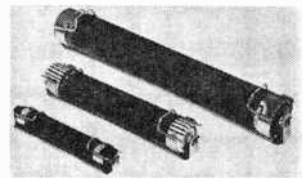

POPULAR ELECTRONICS

28

The Mullard
Master 10M Series
ELECTRON TUBES

TUBE-TO-TUBE UNIFORMITY
For the Balance
Originally Designed into the Circuit

The Master 10M Series is a special range of selected tubes, ideal for today's technically-advanced and exacting electronic equipment.

- Each tube Individually Laboratory-Tested
- Tube-to-Tube Uniformity and Section-to-Section Uniformity Assured
- Guaranteed Performance
- Long Life

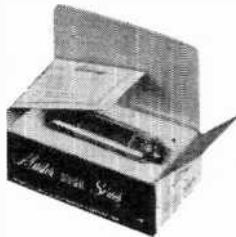

The Master 10M Series . . . guaranteed for 10,000 hours of effective performance, within two years from date of purchase . . . now available from 10M distributors or write direct for literature.

IEC : International Electronics Corporation

: 81 Spring Street, New York 12, N. Y.

Superior Performance

These two words . . . perhaps more than all others, describe the

INTERNATIONAL MODEL 100 EXECUTIVE CITIZENS BAND TRANSCEIVER

Superior performance is the product of efficient design, precision engineering, top quality components and construction. From interior to the clean attractive lines of its exterior, the Model 100 gives you that extra measure of reliability.

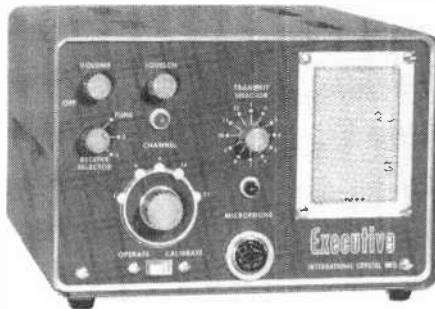

Check these outstanding features . . .

Crystal filter for minimizing adjacent channel interference. Built-in calibration circuit • 12-position crystal controlled transmit channel selector • Front panel microphone jack • Provision for connecting external speaker and S/meter • Tunable dual conversion superheterodyne receiver covering all 23 channels. • Two crystal controlled receive positions • Push-to-talk operation • Three way power supply for 6/12 vdc and 115 vac • Five watts plate input • Certified tolerance $\pm .005\%$ • Brown cabinet with brown and silver panel • Dimensions: 5½" H. x 8½" W. x 9" D.

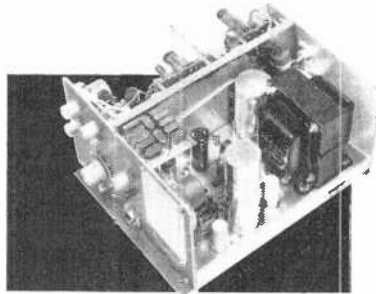

Complete with 1 transmit crystal, 1 receive crystal, new style ceramic microphone and coil cord \$199.50

External S/Meter and Speaker

This external S/meter and speaker is the perfect companion for the Model 100. Constructed with the same clean lines and fine craftsmanship. Utilizes a high impedance vacuum tube volt meter circuit. Connects to socket on rear of transceiver. S/meter reads in three ranges.

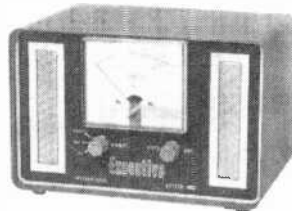

Complete with interconnecting cable \$49.50



18 NORTH LEE • OKLAHOMA CITY, OKLAHOMA

The next time you visit your International dealer ask him for a demonstration of the Model 100 Executive and the system-engineered accessories. A complete catalog of International equipment and crystals may be obtained by writing International Crystal Mfg. Co.

GIANT CB SALE!!!

Closing out our stock of CB kits. Originally advertised at \$39.95 up. Complete with power supply, tubes, crystal, cabinet, wire, instructions, etc. Less microphone. Note: transmitter must be tuned and tested by or under supervision of person holding a first or second-class FCC license. All sales final at this price. Thousands now in use. Rush your order in today while the supply lasts.

- 110 VOLT CB TRANSCEIVER KITS \$19.95
- 12 VOLT CB TRANSCEIVER KITS \$22.95
- 6 VOLT CB TRANSCEIVER KITS \$22.95
- 3-ELEMENT CB BEAM ANTENNA mounts verti-
cally or horizontally SALE \$10.99
- COMMAND CB GROUND PLANE ANTENNA
Model CGP-1. Heavy duty—solid alum. rods. SALE \$9.99
- COMMAND HOT-ROD CB ANTENNA 4-ft. Con-
tinuously loaded fiberglass whip + trunk lid mount.
Reg. \$11.98 SALE \$8.69
- COMMAND CORSAIR Model CCB-1. Bumper
mount + heavy spring + 102" st. steel whip.
Reg. \$19.98 SALE \$8.99
- COMMAND CORSAIR II Model CCB-2. Double
bumper mount + spring + 102" st. steel whip.
Reg. \$22.95 SALE \$9.99
- COMMAND STANDARD 11 Model CS-2. Heavy
duty body mount + spring + 102" st. steel whip.
Reg. \$9.98 SALE \$6.69
- GENERATOR NOISE SUPPRESSOR Model GNS
tunable for CB band. Reg. \$3.98 SALE \$1.99
- 14-PC. CB SILENCER Model SN-2. Com-
plete noise suppressor kit. Reg. \$9.95 SALE \$3.99
- RGSu COAXIAL CABLE..... 100 feet for \$7.99
- RGSu COAXIAL CABLE..... 100 feet for \$7.99

Check items wanted. Return ad or order w/check or money order (include postage, excess returned). 50% Deposit on C.O.D.s. *Shipped Railway Express Collect.

GROVE ELECTRONIC SUPPLY COMPANY
4103 W. Belmont Ave., Chicago 41, Ill.

- Rush items checked
- Send latest CB sale Catalog

Name..... (please print)
Address.....
City..... Zone..... State.....

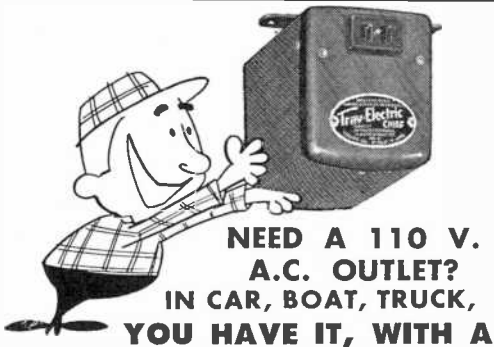

**NEED A 110 V.
A.C. OUTLET?
IN CAR, BOAT, TRUCK,
YOU HAVE IT, WITH A**

terado POWER CONVERTER

Actually gives you 110 volt, 60 cycle A.C. from your 6 or 12 volt D.C. battery! Plug converter into cigarette lighter, and operate lights, electric shavers, record players, electric tools, portable TV, radios, testing equipment, etc.

Models from 15 to 300
watts, priced as low as **\$12.95** LIST

See Your Electronic Parts Dealer or Jobber, or Write:

terado COMPANY
1057 RAYMOND AVENUE
ST. PAUL 8, MINNESOTA

In Canada. ATLAS RADIO CORP. LTD. — Toronto, Ont.

Hi-Fi Showcase

*A quick look at new products
in the stereo/hi-fi field**

MONEY stopping you from augmenting your stereo setup with an extension speaker or two? It needn't—not with *Anglo American Acoustics* offering a complete bookshelf speaker system at a "pin-money" price. Built around a 3" hardened-cone tweeter and an 8" woofer, these bookshelf units measure 10" x 24" x 9", and have a frequency range from 45 to 16,000 cycles. Ideal as extension speakers or even principal speakers in low-cost installations, the Anglo American units are available in two styles: an unfinished version, the "Kent," priced at \$15.95; and an oiled walnut version, the "Windsor," going for \$25.00. . . . "Bookshelf" hi-fi/stereo has been around for some time, but a complete stereo tuner/amplifier (less speakers) in a 6" x 15" x 13½" cabinet should make any space-conscious audiophile sit up and take notice. Completely transistorized, *Altec Lansing's* "Astro" contains AM and FM tuners, FM



Altec Lansing "Astro" stereo receiver

multiplex circuitry, dual preamplifiers, dual amplifiers—plus a complete range of controls, for performance to entice even the most demanding audio enthusiast. Delivering up to 55 watts of power in the mono connection, the "Astro" boasts less than 1% total harmonic distortion at 20 watts. Its built-in multiplex circuit provides 30 db of channel separation over the entire audio spectrum, and there is a monitor light behind the station indicator panel to show when an FM stereo signal is being received.

*Write to the manufacturers listed at the end of this column for more data on products mentioned

Always say you saw it in—POPULAR ELECTRONICS

Now! drive as the experts do!..

amazing *knight-kit*[®] ELECTRONIC TACHOMETER KIT

KEEP TABS ON YOUR ENGINE PERFORMANCE

- Tells you when to shift gears for peak efficiency
- Easy to install; does not affect engine performance
- Mounts above or below dash, or on steering column
- Helps you or your mechanic do better tune-up jobs

NOW ONLY

\$21⁹⁵

SEND NO MONEY
only \$5 per month

Get best engine efficiency; save fuel; reduce engine wear. Always accurate—absolutely unaffected by voltage or temperature changes.

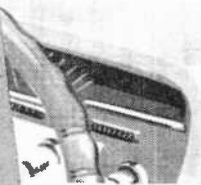
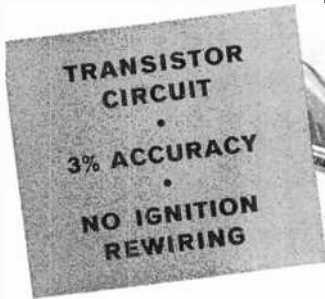
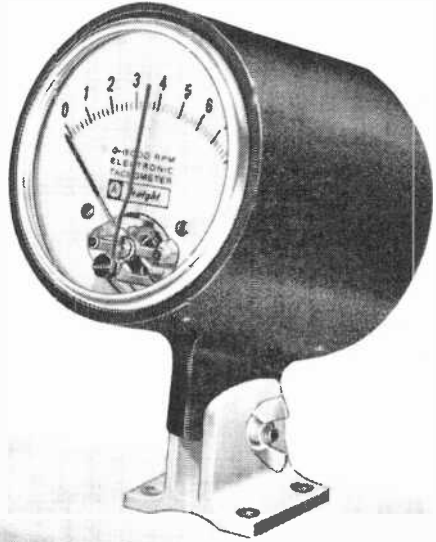

read what the experts say about the Knight-Kit Tachometer :



"Even the newcomer... should have no trouble with the assembly. Driving the car with the (Knight-Kit) tachometer installed you will find it gives new insight into the relationship between speed and power."

—Mechanix Illustrated, March, 1962

"Our assembled kit has just completed a 6,000-mile trip, during which it proved extremely useful. On the basis of our experience, the Knight-Kit seems to be a good value."

—Car Life, April, 1962

"... Easy on the pocketbook... could pay for itself if it wards off one trip to the car hospital... Calibration has been engineered for simplicity... unusual... zener diode regulation... provides 3% accuracy despite temperature or voltage variations."

—Science & Mechanics, Nov. 1961

Greatest "Tach" Value Ever!

Automotive and power-boating experts agree that for best fuel economy plus lower engine wear and peak performance, an accurate tachometer is a "must." Here is your best "tach" value. This easy-to-assemble precision instrument accurately registers engine speed in rpm—electronically! Has transistorized switching and zener diode regulation; maintains accuracy regardless of voltage or temperature changes. Big illuminated dial face has red reference pointer that may be set to any speed—lets you know at a glance when to shift gears.

For 1-8 cylinder, 2 cycle; or 1-16 cylinder, 4-cycle engines using ignition coil and distributor of 9-32 VDC; for magneto and 6-VDC systems with external 9-V battery (not supplied; see below). Available in positive-ground and negative-ground models (virtually all late-model American cars have negative-ground systems). With all cables, universal-mount swivel base, tension strap, easy-to-follow instructions. 4 1/4 x 3 1/4 x 3 1/8". Shpg. wt., 4 lbs.
83 Y 944AX. For Negative-Ground Systems
83 Y 980AX. For Positive-Ground Systems
 No Money Down. Each only.....**\$21.95**
83 Y 909. 6-V Battery & Accessories... **\$1.50**

typical of the value and quality of over 100 other great KNIGHT-KITS

ALLIED RADIO KNIGHT ELECTRONICS DIVISION

SEND NO MONEY
order today

ALLIED RADIO

100 N. Western Ave., Chicago 80, Ill.

Ship me the following:

- Tachometer for Neg.-Ground Systems 83 Y 944AX
- Tachometer for Pos.-Ground Systems 83 Y 980AX
- Ship No Money Down on Allied's Credit Fund Plan

Name _____
PLEASE PRINT

Address _____

City _____ Zone _____ State _____

SUPERIOR'S NEW MODEL 85 TRANS-CONDUCTANCE TYPE

TUBE TESTER

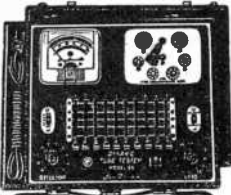

Model 85—Trans-Conductance Tube Tester. Total Price \$52.50 Terms: \$12.50 after 10 day trial, then \$8.00 monthly for 5 months if satisfactory. Otherwise return, no explanation necessary.

● **FREE FIVE (5) YEAR CHART DATA SERVICE.** Revised up-to-date subsequent charts will be mailed to all Model 85 purchasers at no charge for a period of five years after date of purchase.

Model 85 comes complete, housed in a handsome portable cabinet with slip-on cover. Only **\$52.50**

SHIPPED ON APPROVAL NO MONEY WITH ORDER — NO C.O.D.

Try it for 10 days before you buy. If completely satisfied then send \$12.50 and pay balance at rate of \$8.00 per month for 5 months. —No interest or finance charges added. If not completely satisfied, return to us, no explanation necessary.

MOSS ELECTRONIC, INC. All orders, P.O.O., N.Y.C. DEPT. 1-934, 3849 Tenth Ave. New York 14, N. Y. Please rush Model 85. If satisfactory, I will pay on terms specified. Otherwise I will return tester.
Name _____
Address _____
City _____ Zone _____ State _____

● Employs latest improved TRANS-CONDUCTANCE circuit. Test tubes under "dynamic" (simulated) operating conditions. An in-phase signal is impressed on the input section of a tube and the resultant plate current change is measured as a function of tube quality. This provides the most suitable method of simulating the manner in which tubes actually operate in radio, TV receivers, amplifiers and other circuits. Amplification factor, plate resistance and cathode emission are all correlated in one meter reading.

● **SYMBOL REFERENCES:** Model 85 employs time-saving symbols (*, +, •, Δ, □) in place of difficult-to-remember letters previously used. Repeated time-studies proved to us that use of these scientifically selected symbols speeded up the element switching step. As the tube manufacturers increase the release of new tube types, this time-saving feature becomes necessary and advantageous.

● **"FREE-POINT" LEVER TYPE ELEMENT SWITCH ASSEMBLY** marked according to RETMA basing, permits application of test voltages to any of the elements of a tube.

Showcase

(Continued from page 30)

Controls on the "Astro" include loudness, channel reverse, phase reverse, rumble filter, automatic frequency control, and AM bandwidth; its source selector allows inputs from tape decks and phono pickups as well as the built-in tuners. Price, \$597.00.

Latest FM stereo tuner from *Harman-Kardon* is the Citation III-X, available either as a kit or as a factory-wired and tested unit. A front-panel-mounted control allows you to select at will either "mono," "stereo," or "stereo SCA filter" (designed to remove stray noises in areas where background music is being broadcast by multiplex). Other controls include a.f.c. on/off and controls for interchannel muting and local or long-distance reception. The kit version, incidentally, features prewired and factory-aligned multiplex and r.f. sections. Price: \$219.95 in kit form; \$299.95, factory wired. . . . Just about everything on the "audio" airwaves is yours with *Heath's* new AJ-41 AM/FM tuner. Equipped with a built-in FM multiplex converter, it provides AM, FM, and FM stereo reception at the flick of a switch. A neon indicator light shows when an FM stereo signal is being received, and individual tuning meters for both AM and

YOU SAVE MONEY!

RUSH US YOUR LIST OF HI-FI COMPONENTS FOR A VERY SPECIAL GROUP QUOTATION

WRITE FOR FREE AUDIO DISCOUNT CATALOG A-15

New low prices on tape recorders, amplifiers, tuners, loudspeakers, cartridges, etc.

KEY ELECTRONICS COMPANY
120 LIBERTY STREET
NEW YORK 6, N. Y.

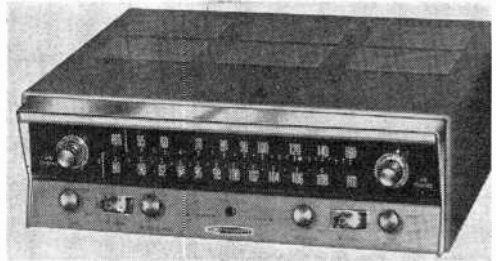

Heath Model AJW-41 stereo tuner

FM permit precise, "on the nose" tuning. An FM squelch circuit eliminates between-station "noise" when tuning across the FM band, and cathode-follower outputs minimize hum and high-frequency losses in interconnecting cables. Finished in a luggatean steel cabinet with polished anodized trim, the tuner is available either factory-assembled (as the AJW-41), or in kit form (as the AJ-41) with a preassembled and pre-aligned FM tuning unit. Prices: \$189.95 for the AJW-41; \$119.95 for the AJ-41. . . . Another tuner—this one a straight FM multiplex unit—is beautifully finished in gold and white with a contrasting black dial face. Distributed by *Lafayette Radio*, the LT-81 is hand-wired and individually tested

BUILD YOUR OWN RADIO

CIRCUITS AT HOME with the New PROGRESSIVE RADIO "EDU-KIT"®

only \$26.95

A Practical Home Radio Course



Training Electronics Technicians Since 1946

- Now Includes**
- ★ RECEIVERS
 - ★ TRANSMITTERS
 - ★ SQ. WAVE GENERATOR
 - ★ SIGNAL TRACER
 - ★ AMPLIFIER
 - ★ SIGNAL INJECTOR
 - ★ CODE OSCILLATOR
- ★ No Knowledge of Radio Necessary
 - ★ No Additional Parts or Tools Needed
 - ★ EXCELLENT BACKGROUND FOR TV
- ★ **SCHOOL INQUIRIES INVITED**
- ★ Sold In 79 Countries

YOU DON'T HAVE TO SPEND HUNDREDS OF DOLLARS FOR A RADIO COURSE

The "Edu-Kit" offers you an outstanding PRACTICAL HOME RADIO COURSE at a rock-bottom price. Our Kit is designed to train Radio & Electronics Technicians, making use of the most modern methods of home training. You will learn radio theory, construction practice and servicing. THIS IS A COMPLETE RADIO COURSE IN EVERY DETAIL. You will learn the basic principles of radio, you will work with the standard type of punched metal chassis as well as the latest development of Printed Circuit chassis. You will learn the basic principles of radio, you will construct, study and work with RF and AF amplifiers and oscillators. You will construct, study and work with practice code, using the Progressive Code Oscillator. You will learn and practice trouble-shooting, using the Progressive Signal Tracer, Progressive Signal Injector, Progressive Dynamic Radio & Electronics Tester, Square Wave Generator and the accompanying instructional material.

You will receive training for the Novice, Technician and General Classes of F.C.C. Radio Amateur Licenses. You will build 20 Receiver, Transmitter, Square Wave Generator, Code Oscillator, Signal Tracer and Signal Injector circuits, and learn how to operate them. You will receive an excellent background for television, Hi-Fi and Electronics.

Absolutely no previous knowledge of radio or electronics is required. The "Edu-Kit" is the product of many years of teaching and engineering experience. The "Edu-Kit" will provide you with a basic education in Electronics and Radio, worth many times the complete price of \$26.95. The Signal Tracer alone is worth more than the price of the entire Kit.

THE KIT FOR EVERYONE

You do not need the slightest background in radio or science. Whether you are interested in Radio & Electronics because you want an interesting hobby, a well paying business or a job with a future, you will find the "Edu-Kit" a worth-while investment. Many thousands of individuals of all ages and backgrounds have successfully used the "Edu-Kit" in more than 79 countries of the world. The "Edu-Kit" has been carefully designed, step by step, so that you cannot make a mistake. The "Edu-Kit" allows you to teach yourself at your own rate. No instructor is necessary.

PROGRESSIVE TEACHING METHOD

The Progressive Radio "Edu-Kit" is the foremost educational radio kit in the world, and is universally accepted as the standard in the field of electronics training. The "Edu-Kit" uses the modern educational principle of "Learn by Doing." Therefore you construct, learn schematics, study theory, practice trouble shooting—all in a closely integrated program designed to provide an easily-learned, thorough and interesting background in radio. You begin by examining the various radio parts of the "Edu-Kit." You then learn the function, theory and wiring of these parts. Then you build a simple radio. With this first set you will enjoy listening to regular broadcast stations, learn theory, practice testing and trouble-shooting. Then you build a more advanced radio, learn more advanced theory and techniques. Gradually, in a progressive manner, and at your own rate, you will find yourself constructing more advanced multi-tube radio circuits, and doing work like a professional Radio Technician.

Included in the "Edu-Kit" course are 20 Receiver, Transmitter, Code Oscillator, Signal Tracer, Square Wave Generator and Signal Injector Circuits. These are not unprofessional "breadboard" experiments, but genuine radio circuits, constructed by means of professional wiring and soldering on metal chassis, plus the new method of radio construction known as "Printed Circuitry." These circuits operate on your regular AC or DC house current.

THE "EDU-KIT" IS COMPLETE

You will receive all parts and instructions necessary to build 20 different radio and electronics circuits, each guaranteed to operate. Our Kits contain tubes, tube sockets, variable electrolytic, mica, ceramic and paper dielectric condensers, resistors, tie strips, hardware, tubing, punched metal chassis, Instruction Manuals, hook-up wire, solder, selenium rectifiers, volume controls and switches, etc.

In addition, you receive Printed Circuit materials, including Printed Circuit chassis, special tube sockets, hardware and instructions. You also receive a useful set of tools, a professional electric soldering iron, and a self-powered Dynamic Radio and Electronics Tester. The "Edu-Kit" also includes Code Instructions and the Progressive Code Oscillator, in addition to F.C.C.-type Questions and Answers for Radio Amateur License training. You will also receive lessons for servicing with the Progressive Signal Tracer and the Progressive Signal Injector, a High Fidelity Guide and a Quiz Book. You receive Membership in Radio-TV Club, Free Consultation Service, Certificate of Merit and Discount Privileges. You receive all parts, tools, instructions, etc. Everything is yours to keep.

PRINTED CIRCUITRY

At no increase in price, the "Edu-Kit" now includes Printed Circuitry. You build a Printed Circuit Signal Injector, a unique servicing instrument that can detect many Radio and TV troubles. This revolutionary new technique of radio construction is now becoming popular in commercial radio and TV sets.

A Printed Circuit is a special insulated chassis on which has been deposited a conducting material which takes the place of wiring. The various parts are merely plugged in and soldered to terminals.

Printed Circuitry is the basis of modern Automation Electronics. A knowledge of this subject is a necessity today for anyone interested in Electronics.

FREE EXTRAS

- SET OF TOOLS
- SOLDERING IRON
- ELECTRONICS TESTER
- PLIERS-CUTTERS
- ALIGNMENT TOOL
- WRENCH SET
- VARIABLE DISCOUNT CARD
- CERTIFICATE OF MERIT
- TESTER INSTRUCTION MANUAL
- HIGH FIDELITY GUIDE • QUIZZES
- TELEVISION BOOK • RADIO TROUBLE-SHOOTING BOOK
- MEMBERSHIP IN RADIO-TV CLUB: CONSULTATION SERVICE • FCC AMATEUR LICENSE TRAINING • PRINTED CIRCUITRY

SERVICING LESSONS

You will learn trouble-shooting and servicing in a progressive manner. You will practice repairs on the sets that you construct. You will learn symptoms and causes of trouble in home, portable and car radios. You will learn how to use the professional Signal Tracer, the unique Signal Injector and the dynamic Radio & Electronics Tester. While you are learning in this practical way, you will be able to do many a repair job for your friends and neighbors, and charge fees which will far exceed the price of the "Edu-Kit." Our Consultation Service will help you with any technical problems you may have.

FROM OUR MAIL BAG

J. Statitis, of 25 Poplar Pl., Waterbury, Conn., writes: "I have repaired several sets for my friends, and made money. The "Edu-Kit" paid for itself. I was ready to spend \$240 for a course, but I found your ad and sent for your Kit."

Ben Valerio, P. O. Box 21, Magna, Utah: "The Edu-Kits are wonderful. Here I am sending you the questions and also in the answers for them. I have been in Radio for the last seven years, but like to work with Radio Kits, and like to build Radio Testing Equipment. I enjoyed every minute I worked with the different kits; the Signal Tracer works fine. Also like to let you know that I feel proud of becoming a member of your Radio-TV Club."

Robert L. Shuff, 1534 Monroe Ave., Huntington, W. Va.: "Thought I would drop you a few lines to say that I received my Edu-Kit, and was really amazed that such a bargain can be had at such a low price. I have already started repairing radios and phonographs. My friends were really surprised to see me get into the swing of it so quickly. The Trouble-shooting Tester that comes with the Kit is really swell, and finds the trouble, if there is any to be found."

UNCONDITIONAL MONEY-BACK GUARANTEE

ORDER DIRECT FROM AD—RECEIVE FREE BONUS RESISTOR AND CONDENSER KITS WORTH \$7

- Send "Edu-Kit" postpaid. I enclose full payment of \$26.95.
- Send "Edu-Kit" C.O.D. I will pay \$26.95 plus postage.
- Rush me FREE descriptive literature concerning "Edu-Kit."

Name

Address

PROGRESSIVE "EDU-KIT" INC.
1186 Broadway, Dept. 593-D, Hewlett, N. Y.

Discover the exciting world of communication electronics with these

NEW

Basic Communication Kits

Kits anyone can use to acquire knowledge of communication electronics.

Starter Kit contains all parts necessary to experiment with communications circuitry and construct two control boxes with headphones and microphones, two speech amplifiers and one transistorized voltmeter. Only \$34.95 (including comprehensive manual).

AM Radio Add-On Kit lets you assemble an AM transmitter and an AM receiver for use with Starter Kit (above) to experiment with radio frequency modulation, detection and two way wireless communications. Only \$15.00.

Modulated Light Beam Add-On Kit consists of a transmitter and receiver for use with the Starter Kit in communications experiments using light as the sound transmitting medium. Only \$15.00.

THESE NEW KITS provide an introduction to communication techniques, electronic components and electronic communication systems.

FULLY GUARANTEED against defects in manufacture. In addition, these Kits carry a 10-day unconditional money-back guarantee. All prices F.O.B., Watertown, Mass.

EASY-TO-UNDERSTAND MANUAL accompanies each Starter Kit... gives a complete description of electronic components and their functions in clear, non-technical language. Easy-to-follow, step-by-step instructions and experiments. No prior knowledge of electronics is necessary.

SEND FOR DESCRIPTIVE LITERATURE — TODAY!

Scientific Development Corporation
Dept. PE-6, 372 Main Street, Watertown, Massachusetts
Please send literature on Basic Communication Kits.

Name.....
Street.....
City..... Zone..... State.....

Showcase

(Continued from page 32)

for 20 db quieting at 2 microvolts input. Employing a triode mixer, dual tuned limiters, and a Foster-Seeley discriminator, the LT-81 is equipped with an a.f.c. defeat switch as well as a tuning meter for pinpoint tuning accuracy. As for the multiplex circuit, it provides a stereo separation of 30 db with less than 1% harmonic distortion. Price, \$76.50.

NuTone now has a wall-mounting stereo tape recorder which actually folds into the wall when not in use. A perfect match for the company's wall-mounting tuner and amplifier, the recorder can be removed and used as a portable tape recorder if desired. A record lock prevents accidental tape crasures, and two vu meters allow accurate setting of channel levels, both on record and playback. The recorder operates at both 7½ and 3¼ ips and is ideal for use with four-track stereo tapes. Price, \$349.50. . . **Pickering's** astounding stereo cartridge (the D-3805AA, tracking at ½ gram) has a part-

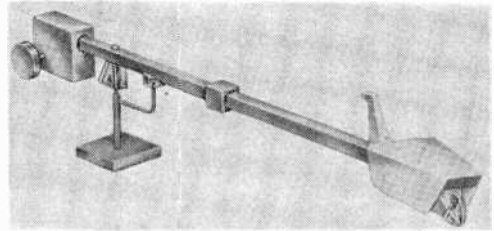

Pickering Model 200 tone arm

ner—the Model 200 Stanton Unipoise tone arm. Featuring an exclusive single-pivot bearing for friction-free motion in all planes and ultra lightweight construction for lowest possible mass, the new tone arm also incorporates a built-in arm rest. Stylus pressure can be readily adjusted over a ½- to 2-gram range, and installation requires only a single mounting hole. Price, \$36.00. . . A 3-way speaker system from **H. H. Scott** consists of a high-compliance 8" woofer and separate mid-range and high-frequency units. Like other speaker systems in the Scott line-up, the S-4 has a crossover network with separate controls for both mid-range and tweeters. Available in oiled walnut, mahogany, or unfinished pine or hardwood, it measures a compact 22" x 11" x 9" and is suitable for bookshelf or floor mounting. The S-4 comes wired and in kit form; prices range from \$114.95 to \$124.95 for the completed unit, and from \$84.95 to \$104.95 for the kit, depending on finish.

Stereosonic's universal remote control unit

Always say you saw it in—POPULAR ELECTRONICS

37 **MICRO**
¢
ea.
ELECTRON TUBE CO.

P.O. Box 55, Park Station
Paterson 3, New Jersey

\$35
PER
HUNDRED
ASSTD

*Fabulous Low Prices!
Large Select Stocks!
Dependable, Fast Service!*

SEND FOR FREE COMPLETE LIST OF TUBES

0A2	3Q4	6BC5	12A8	25Z5
0Z3		6BC8	12A05	25Z6
1A7GT	4BZ7	6BD6	12A7	26
1B4GT	5AS8	6C4	12A77	35A5
1H4G	5A78	6C5	12A06	35B5
1H5GT	5AV8	6C6	12A07	35C5
1L4	5AW4	6CB6	12AV6	35L6GT
1L6	5BK7	6CD6G	12AV7	35W4
1N5GT	516		12AX4GT	35Y4
1Q5GT	578	7A4/XXL	12AX7	35Z5GT
	5U4G	7A5		37
	5U8	7A6	198G6G	39/44
2A3		7A7	1916	42
2AF4		7A8	19T8	43
3BC5	6A7	7B4	24A	45
3BN6	6A8	7B5	25AV5	50A5
3BZ6	6AB4	7B6	25BQ6	78
3CB6	6AC7	7B7	25DN6	98
3CF6	6AF4	7B8	25L6GT	84/6Z4
3CS6	6B8	7C4	25W4GT	117Z3
3LF4	6BA6			

• All tubes lab-tested for mutual conductance, life test. • Guar. FREE 1 yr. replacement any tube failing under all operating cond. • Adv. tubes not necessarily new; may be elec. perf. fact. seconds or used—clearly marked.

POSTAGE PAID. Send 25c handlg. for orders under \$5. 25% dep. C.O.D. Send approx. post. on Can. & foreign orders.



If you were not among
the 10,123 kit-builders who
received this first issue

... you're
missing something

The first issue of the quarterly R·A·E Journal has now been received by more than 10,000 members of the R·A·E Society—the national organization devoted to the interests of radio, audio, and electronic kit-builders. From initial reports, the Journal is a resounding success. Comments from Society members say: "Bravo"—"Something we have really needed"—"It's a must for kit-builders"—"Filled with wonderful, original ideas."

The R·A·E Journal is available *only* to members of the Society. You can't buy a copy anywhere. However, more copies are being mailed out daily. You can have one, too. Here are the details:

WHY THE FIRST ISSUE OF THE JOURNAL SCORED A BULL'S EYE

Under the direction of Milton B. Sleeper, one of the radio-audio pioneers and a recognized authority on kit design, the R·A·E Journal is devoted exclusively to the interests of kit-builders (no record reviews or articles on music).

The new issue contains ten articles and departments on kit designs, kit construction, system planning, Society activities, and related subjects. The Journal serves beginners as well as advanced enthusiasts with how-to articles, reports, and comments written in a clear, concise manner, profusely illustrated with drawings and photographs handsomely printed on fine paper.

It is filled with original ideas, plans, and information on interesting things you can do with simple tools and a kitchen table for your workshop.

When the Journal gets into controversial subjects, no holds are barred. Parts of the "Notes and Comments" and "Members' Roundtable" might be labeled "Too Hot to Handle." Altogether, you will find the R·A·E Society's Journal unique, stimulating, authoritative.

Most valuable of all are the articles on new kits—kits unlike any you have ever seen because they incorporate developments and practices borrowed from precision instruments and military equipment, but in practical form, suited to home construction.

THE FIRST R·A·E KITS

The first R·A·E kits will be available in August. The overall design, assembly and wiring methods, appearance of the finished instruments, and even the instructions and diagrams are totally unlike any now available. *They are not instruments in kit form that were originally designed for factory production-line assembly.* R·A·E kits are designed by kit-builders, specifically for kit-builders.

June, 1962

R·A·E SOCIETY MEMBERS SERVE ON THE ADVANCE-TEST PANELS

Before a new R·A·E kit is released, it will be pre-checked by Society members in this way: Ten prototypes will be given to 10 members, some of whom are beginners, some advanced enthusiasts and professionals. Each will assemble his kit and report on his experiences. In return, he will keep the finished kit without charge. A new panel will be chosen for each new kit; no member may serve twice. Any Society member may apply to serve on an Advanced-Test Panel. No purchase of equipment is necessary.

YOU ARE INVITED TO JOIN THE R·A·E SOCIETY

Whether you are a beginner or an experienced kit-builder, you are invited to join the R·A·E Society. Details of the Society's activities are published in the Journal. Annual dues of \$1.00 entitle you to all privileges of membership, to receive four issues of the quarterly Journal, and to qualify for service on an Advance-Test Panel.

Use the coupon below or your own stationery. Read the UNCONDITIONAL GUARANTEE in the coupon.

TO GET THE FIRST ISSUE OF THE JOURNAL,
RUSH YOUR MEMBERSHIP APPLICATION TODAY!

R·A·E
SOCIETY

R·A·E SOCIETY
(sponsored by R·A·E EQUIPMENT, INC.)
COUNTY BANK BUILDING
GREAT BARRINGTON, MASS.

Yes I want to participate in all R·A·E Society's forthcoming activities. I enclose \$1. as my dues for one year, I understand that I will receive a Membership Card, the quarterly Journal issues for one year, and may qualify to serve on an Advance-Test Panel.

NAME

STREET

CITY ZONE STATE

I understand that I am not required to purchase any R·A·E kits to enjoy full membership privileges.
I am a Beginner Experienced kit-builder
 Professional.

UNCONDITIONAL MONEY-BACK GUARANTEE

If I am not completely satisfied after I receive and examine my first issue of the Journal, my money will be refunded promptly on request. No extra charge outside the USA.



DON'T THROW OLD RADIOS AWAY!

Here's the data you need to fix them FAST . . . and good as new!

Just look up the how-to-do-it data on that old radio you want to fix!

Four times out of 5, this giant, 3½-pound, 744-page Ghirardi RADIO TROUBLESHOOTER'S HANDBOOK gives exactly the information you need to fix it in a jiffy. Tells what is likely to be causing the trouble . . . shows how to fix it. No useless testing. No wasted time. Handbook covers practically every radio receiver model made by 202 manufacturers between 1925 and 1942. Using it, even beginners can easily fix old sets which might otherwise be thrown away because service information is lacking. With a few simple repairs, most of these old sets can be made to operate perfectly for years to come.

THE ONLY GUIDE OF ITS KIND

Cuts service time in half!

Included are common trouble symptoms and their remedies for over 3,800 models of old home, auto radios and record changers: Airline, Apex, Arvin, Atwater Kent, Belmont, Bosch, Brunswick, Clarion, Crosley, Emerson, Fada, G-E, Kolster, Majestic, Motorola, Philco, Pilot, RCA, Silvertone, Sparton, Stromberg and dozens more. Includes hundreds of pages of invaluable tube and component data, service short cuts, etc.

TRY IT 10 DAYS . . . see for yourself!

Department PE-62 623900

HOLT, RINEHART & WINSTON, INC.

P. O. Box 2334, Grand Central Station

New York 17, New York

Send Ghirardi's RADIO TROUBLESHOOTER'S HANDBOOK (#708297) for 10-day free examination. If I decide to keep book, I will remit the full price of only \$10 plus postage. Otherwise, I will return book postpaid and owe you nothing. (SAVE! Send \$10 with order and we pay postage. Same return privilege with money refunded.)

NAME

ADDRESS

CITY, ZONE, STATE

OUTSIDE U.S.A.—Price \$10.50 cash with order only.

Above offer expires Feb. 28, 1963

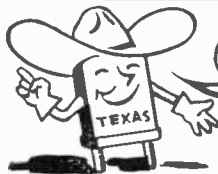

Send for NEW FREE CATALOG #961 with oscillator circuits

Citizen Band Class "D" Crystals

3rd overtone — .005% tolerance — to meet all FCC requirements. Hermetically sealed HC6/U holders. ½" pin spacing. .050 pins. (Add 15¢ per crystal for .093 pins). **\$2.95 EACH**

All 22 megacycle frequencies in stock: 26.965, 26.975, 26.985, 27.005; 27.015, 27.025, 27.035, 27.055, 27.065, 27.075, 27.085, 27.105, 27.115, 27.125, 27.135, 27.155, 27.165, 27.175, 27.185, 27.205, 27.215, 27.225.

Matched crystal sets for ALL CB units (Specify equipment make and model numbers) \$5.90 per set

RADIO CONTROL CRYSTALS in HC6/U HOLDERS—SIX FREQUENCIES

In stock for immediate delivery (frequencies listed in megacycles; tolerance .005%. ½" pin spacing. .050 pin diameter. .093 pins available, add 15¢ per crystal.) Specify frequency.

26.995, 27.045, 27.095, 27.145, **\$2.95 EACH**

27.195, 27.255

(add 5¢ per crystal for postage and handling)

ENGINEERING SAMPLES and small quantities for prototypes now made at either Chicago or Fort Myers plants with 24 hour service. IN CHICAGO, PHONE GLadstone 3-3555

IF YOUR PARTS DEALER DOESN'T STOCK Texas Crystals, order direct and send us his name.

RUSH YOUR ORDER NOW TO

TEXAS CRYSTALS

1000 Crystal Drive, Fort Myers, Florida

Dept. P-62

Phone WE 6-2100

FOR SHIPMENT VIA FIRST CLASS MAIL AT NO EXTRA COST ATTACH THIS ADVT. TO YOUR ORDER!

Showcase

(Continued from page 34)

permits remote operation of any component or console system at distances up to 800 feet. Although the device can be connected either "electronically" or mechanically, no audio signals pass through the cables, and no distortion, noise, or frequency losses are introduced. Both two- and three-channel models are available—the two-channel model (RM-2), priced at \$75.00, is supplied with a re-

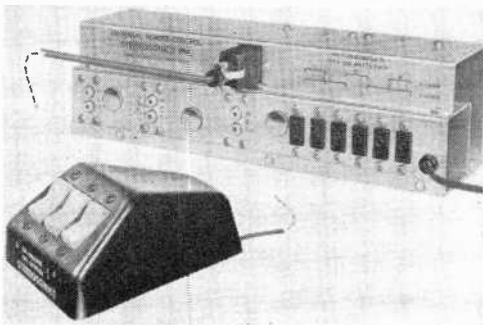

Stereosonics remote control unit

mote switch-control box, 40 feet of cable, and four audio connecting cables; the three-channel model (RM-3) lists at \$95.00, with extension cables, additional "control centers," and flexible shaft cables available as accessory items. . . . If you happen to have a stereo tape recorder with a three-conductor "dual" input (Norelco, Webcor, Revere, or Wollensak, for example), you'll be interested in the new 10FK25 molded cable assembly from *Switchcraft*. Made from high-quality, tandem stereo cable with individual shields, the 10FK25 enables you to interconnect a stereo mixer and your stereo recorder without soldering, wiring, or the use of any tools. It's only necessary to insert the 3-conductor phone plug into the "Mic input" on the recorder, and the color-coded plugs into the stereo mixer. Price, \$4.00.

Anglo American Acoustics Ltd., 129 Maryland Ave., Freeport, N.Y.

Altec Lansing Corp., 1515 S. Manchester Ave., Anaheim, Calif.

Harman-Kardon, Inc., 520 Main St., Westbury, N.Y.

Heath Co., Benton Harbor, Mich.

Lafayette Radio Electronics Corp., 111 Jericho Turnpike, Syosset, L.I., N.Y.

NuTone, Inc., Madison & Red Bank Rds., Cincinnati 27, Ohio.

Pickering & Co., Inc., Sunnyside Blvd., Plainview, N.Y.

H. H. Scott, Inc., Dept. P, 111 Powdermill Rd., Maynard, Mass.

Stereosonics, Inc., P.O. Box 4205, Long Island City 4, N.Y.

Switchcraft, Inc., 5555 N. Elston Ave., Chicago 30, Ill.

Always say you saw it in—POPULAR ELECTRONICS

The Fisher KX-200 80-Watt Stereo Control-Amplifier StrataKit, \$169.50.*



It has four things that others haven't.

1. StrataKit Construction. Assembly by totally error-proof stages (strata). Each stage corresponds to a *separate* fold-out page in the Instruction Manual. Each stage is built from a *separate* transparent packet of parts. Major components come already mounted on the extra-heavy-gauge steel chassis. Wires are *pre-cut* for every stage—which means every page. Result: Absolutely equal success by the experienced kit builder or the completely unskilled novice!

2. Built-In d'Arsonval Meter. For laboratory-accurate adjustment of bias and balance. Assures peak performance from the start; permits 'touching up' for continued peak performance throughout the years, regardless of tube aging. No other single-chassis control-amplifier kit has this vital feature.

3. Third-Speaker Output with Volume Control. Blends the two stereo channel outputs to feed a third loudspeaker system—at *any* desired volume level. Ideal for center-channel stereo fill-in or for a mono extension speaker in another room of the home. A Fisher exclusive among control-amplifier kits.

4. The Fisher Name. No comment necessary.

Walnut or Mahogany cabinet, \$24.95. Metal cabinet, \$15.95. Prices slightly higher in the Far West.

USE THIS COUPON FOR FURTHER INFORMATION

Fisher Radio Corporation
21-52 44th Drive, Long Island City 1, N. Y.

Please send me without charge the complete
Fisher StrataKit catalogue

NAME _____

ADDRESS _____

CITY _____ ZONE _____ STATE _____



PEB11

BEST BUYS IN STEREO AND MONO HI-FI

New Transistorized Stereo/Mono 4-Track Tape Deck RP100 Semikit (electronics in kit form) \$299.95 Wired \$399.95



New FM-AM Stereo Tuner ST96 Kit \$89.95 Wired \$129.95 Incl. FET

New 70-Watt Integrated Stereo Amplifier ST70 Kit \$94.95 Wired \$149.95



New 40-Watt Integrated Stereo Amplifier ST40 Kit \$79.95 Wired \$129.95

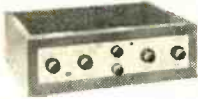

28W Integrated Stereo Amplifier HF81 Kit \$69.95 Wired \$109.95

FM Tuner HFT90 Kit \$39.95 Wired \$65.95 Incl. FET Metal Cover \$3.95

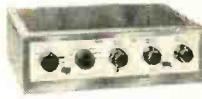

Stereo Preamplifier HF85 Kit \$39.95 Wired \$64.95

AM Tuner HFT94 Incl. FET Kit \$39.95 Wired \$65.95

Stereo Power Amplifiers Kit Wired
100W HF89: \$99.50 \$139.50
70W HF87: \$74.95 \$114.95
28W HF86: \$43.95 \$ 74.95

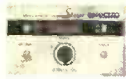
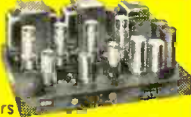

NEW FM-Multiplex Autodaptor MX99 Kit \$39.95 Wired \$64.95 Cover Optional. \$2.95 (Patents Pending)



Bookshelf Speaker System HFS1 Kit \$39.95 Wired \$47.95

BEST BUYS IN CITIZENS TRANSCEIVERS, HAM GEAR, RADIOS

Citizens Band Transceivers from Kit \$59.95 Wired \$89.95



New 60W CW Transmitter #723 Kit \$49.95 Wired \$79.95

NEW Walkie-Talkie Citizens Band Transceiver #740 Kit \$54.95. Wired \$79.95. Complete with rechargeable battery & charger.



BEST BUYS IN TEST EQUIPMENT

New Metered Variable Auto-Transformer AC Bench Supplies Model 1073 (3 amps) Kit \$35.95 Wired \$47.95 Model 1078 (7 1/2 amps) Kit \$42.95 Wired \$54.95



Peak-To-Peak VTVM #232 & Uni-Probe® Pat. #2,790,051 Kit \$29.95 Wired \$49.95 VTVM #221 Kit \$25.95 Wired \$39.95



DC-5 MC 5" Scope #460 Kit \$79.95 Wired \$129.50 5" Push-Pull Scope #425 Kit \$44.95 Wired \$79.95



Tube Tester #625 Kit \$34.95 Wired \$49.95



RF Signal Generator #324 Kit \$26.95 Wired \$39.95



1000 Ohms/Volt V-O-M #536 Kit \$12.90 Wired \$16.90



6- & 12V Battery Eliminator & Charger #1050 Kit \$29.95 Wired \$38.95



Extra-filtered for transistor eqpt. #1060 Kit \$38.95 Wired \$47.95

NEW AC Volt-Watt Meter #260 Kit \$49.95 Wired \$79.95



Multi-Signal Tracer #145A Kit \$19.95 Wired \$28.95



EICO

EXCELLENCE IN CREATIVE ELECTRONICS

Over 2 MILLION EICO instruments in use throughout the world. Compare, take them home — right "off the shelf" — from 1500 neighborhood dealers, most of whom offer budget terms.



EICO, 3300 N. Blvd., L. I. C. 1, N. Y. PE-6
 Send free Catalog describing over 106 top-quality products, free Stereo Hi-Fi Guide, free Short Course for Novice License, name of nearest EICO dealer. Send new 36-page GUIDEBOOK TO HI-FI for which I enclose 25¢ for postage & handling.

Name _____
 Address _____
 City _____ Zone _____ State _____
 Add 5% in the West

Listen to the EICO Hour, WABC-FM, N. Y. 95.5 MC, Mon.-Fri., 7:15-8 P.M.

©1962 by EICO, 3300 N. Blvd., L. I. C. 1, N. Y.

Always say you saw it in—POPULAR ELECTRONICS

THE NASA- 136

By **TOM LAMB, K8ERV**

Want to listen in on the satellites?

This little Nuvistor-powered converter

pulls them in on any 15-meter receiver

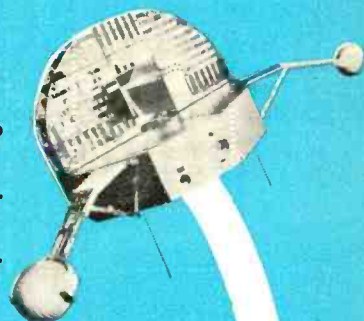

WITH the ever-increasing interest in space science, more and more experimental satellites are being blasted aloft each year. The general public can only marvel at these accomplishments, but those who have appropriate receiving equipment are more fortunate. They can actually listen in to the radio "voices" of the satellites.

The little "NASA-136" converter described on the following pages is designed to receive on the 136-137 mc. band now used by the National Aeronautics and Space Administration for satellite telemetering. Employing a Nuvistor r.f. stage, the unit has a sensitivity and signal-to-noise ratio more than adequate to pull in signals from milliwatt powered transmitters orbiting thousands of miles away. Use it with any communications receiver tuning 15 meters, and you'll have many hours of fascinating listening. But remember: this project is only for experienced builders.

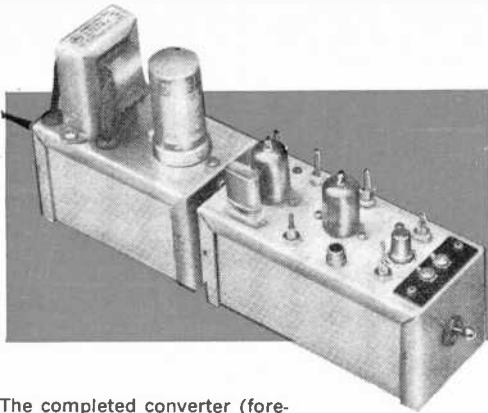

The completed converter (foreground) and power supply chassis plug together to make one efficient, integrated unit.

About the Circuit. The 136- to 137-mc. signal from the satellite passes from the antenna to triode *V1* (a 6CW4 Nuvistor), which is connected as a neutralized r.f. stage. From *V1*, the amplified signal is coupled to the control grid of *V2*, a triode-connected 6AK5 which serves as a mixer.

The screen grid of crystal oscillator *V3*, another 6AK5, is tuned (by coil *L11* and capacitor *C9*) to the 38 2/3-mc. fundamental frequency of crystal *X1*. Coil *L10* and capacitor *C8* tune the plate circuit of the tube to 116 mc., the third harmonic of the crystal frequency.

This 116-mc. signal, like the 136- to 137-mc. signal from *V1*, is injected into the control grid of mixer *V2*. In *V2*, a third signal is produced whose frequency is the difference between those of the first two. The third signal, which ranges

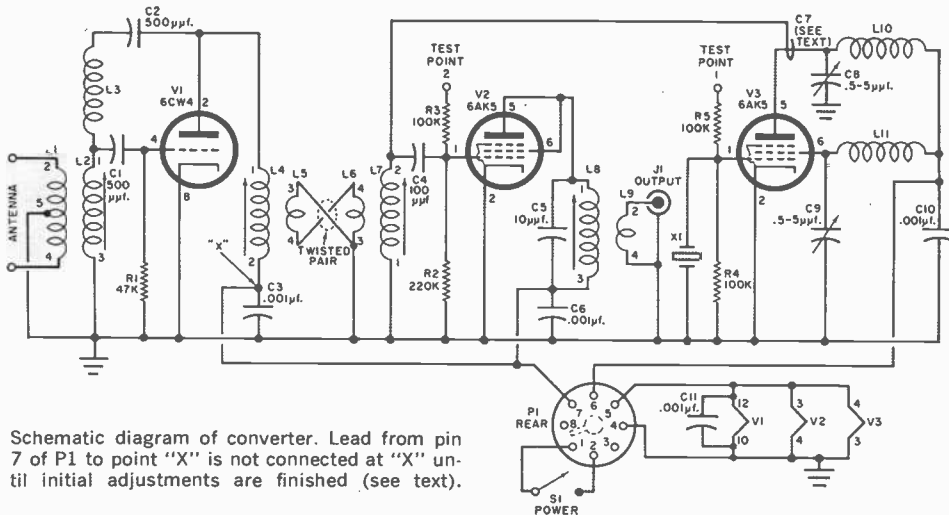

Schematic diagram of converter. Lead from pin 7 of P1 to point "X" is not connected at "X" until initial adjustments are finished (see text).

PARTS LIST FOR CONVERTER

- C1, C2—500- μ f., 600-volt ceramic capacitor
- C3, C10—0.001- μ f., 500-volt, silver-mica button capacitor (Eric 370-FA-102K or equivalent)
- C4—100 μ f. } 600-volt ceramic
- C5—10 μ f. } disc capacitors
- C6, C11—0.001 μ f.
- C7—1 turn of insulated wire around C8—see text
- C8, C9—0.5-5 μ f. tubular trimmer capacitor (Eric 532-A or equivalent)
- J1—RCA-type phono jack (Switchcraft 3501FP or equivalent)
- L1—5 turns of #24 enameled wire, center-tapped; bifilar wound with L2
- L2—4 turns of #24 enameled wire, wound in center of a Cambridge Thermionic PLS6/2C4L/D form
- L3—25 turns of #30 enameled wire, close-wound on a 1-megohm, 1-watt resistor

- L4—4 1/4 turns of #24 enameled wire, close-wound near top of a Cambridge Thermionic PLS6/2C4L/D form
- L5—1 turn of insulated hookup wire wound on L4
- L6—1 turn of insulated hookup wire wound on L7
- L7—3 3/4 turns of #24 enameled wire, close-wound near top of a Cambridge Thermionic PLS6/2C4L/D form
- L8—23 turns of #32 enameled wire, close-wound in center of a CTC PLS6/2C4L/O coil form
- L9—2 turns of insulated hookup wire wound on L8
- L10—11 turns of #24 enameled wire, close-wound on a 1-megohm, 1/2-watt resistor
- L11—37 turns of #32 enameled wire, close-wound on a 1-megohm, 1/2-watt resistor
- P1—Chassis-mounting octal plug (Amphenol 86-CP8 or equivalent)

in frequency from 20 to 21 mc. (depending on the frequency of the signal from *V1*), appears across output jack *J1*.

Power for the converter is furnished by a separate supply, and an octal output socket (*SO1*) on the supply chassis mates with a matching input plug (*P1*) on the chassis of the converter. Transformer *T1* provides heater power and a source of line-isolated plate voltage. A single selenium diode (*D1*) is connected as a half-wave rectifier and its output passes through a pi-network filter.

Note that, in case you want to use the power supply for other purposes, its full high-voltage output is available at pin 3 of *SO1*. No connection is made to the corresponding pin of converter power-input plug *P1*.

Building the NASA-136. Start construction by putting together the power sup-

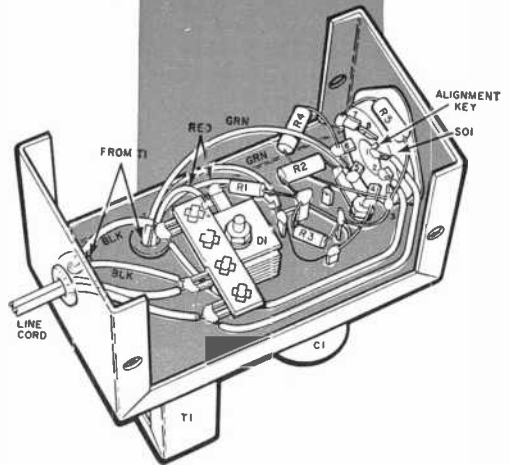
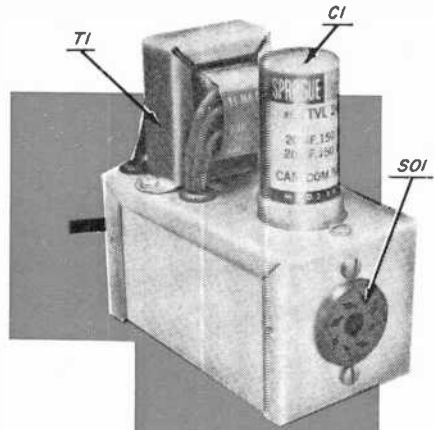

Photograph of power supply's exterior (top) and pictorial diagram of interior (above) show all essential construction details.

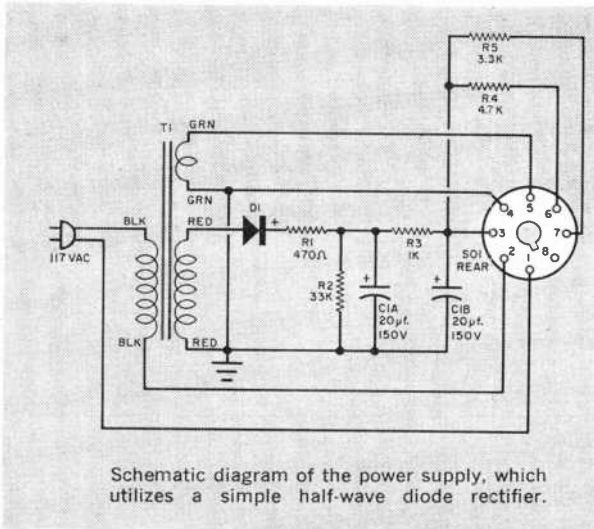

Schematic diagram of the power supply, which utilizes a simple half-wave diode rectifier.

- R1*—47,000 ohms
- R2*—220,000 ohms
- R3, R4, R5*—100,000 ohms } $\frac{1}{2}$ -watt resistors
- S1*—S.p.s.t. toggle switch
- V1*—6CW4 tube (RCA Nuvistor)
- V2, V3*—6AK5 tube
- X1*—38.66666-mc., 3rd-overtone crystal (International Crystal Type FA-5)
- 1—5" x 2 $\frac{1}{4}$ " x 2 $\frac{1}{4}$ " aluminum utility box (Bud CU-3004-A or equivalent)
- 1—Nuvisor socket (Cinch-Jones Type 5NS or equivalent)
- 2—7-pin miniature tube sockets, wafer-type
- 1—Socket for *X1* (International Crystal 150-100 or equivalent)
- Misc.—Scrap copper for tube shield, wire, 2-lug terminal strip (screw type), length of coax cable, hardware, solder, etc.

•••PARTS LIST FOR POWER SUPPLY•••

- C1a/C1b*—20/20 µf., 150-volt electrolytic capacitor (Sprague TVL-2415 or equivalent)
- D1*—65-ma., 130-volt (r.m.s.) selenium rectifier (Sarkes Tarzian Type 50 or equivalent)
- R1*—470-ohm, 1-watt resistor
- R2*—33,000-ohm, 1-watt resistor
- R3*—1000-ohm, $\frac{1}{2}$ -watt resistor
- R4*—4700-ohm, 1-watt resistor
- R5*—3300-ohm, 1-watt resistor
- SO1*—Octal socket (Amphenol 77MIP8 or equivalent)
- T1*—Power transformer; primary, 117 volts; secondaries, 125 volts at 15 ma., 6.3 volts at 0.6 amp. (Stancor PS-8415 or equivalent)
- 1—4" x 2 $\frac{1}{4}$ " x 2 $\frac{1}{4}$ " aluminum utility box (Bud CU-3003-A or equivalent)
- Misc.—Terminal strip, grommets, line cord and plug, hardware, solder, etc.

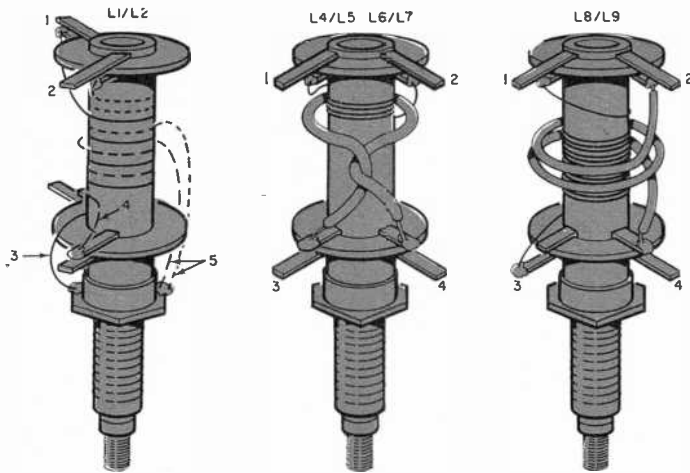

DETAIL A

Drawings of the converter's major coils are shown here. Coil L1/L2 is wound exactly as illustrated (L2 is solid winding; L1 is dotted 2-piece winding). In coils L4/L5, L6/L7, and L8/L9, make L5, L6, and L9 (the heavy windings) as shown but refer to parts list for exact number of turns on L4, L7, and L8 (the fine windings). Numbers on the coil terminals are keyed to corresponding numbers on the schematic diagram.

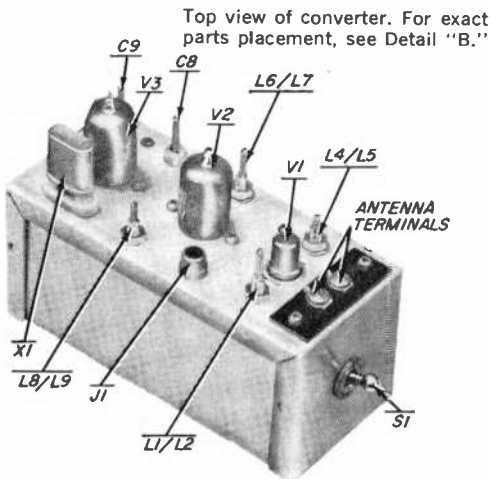

ply unit, which is housed in a 4" x 2 1/4" x 2 1/4" aluminum utility box. Generally speaking, neither the parts placement nor the wiring is at all critical. Be sure, however, to mount output socket SO1 in the exact center of one of the box ends and to position the holes for the socket mounting screws so that the alignment key faces the bottom of the box. It's necessary to take this care in the positioning of SO1 because the socket must mate with P1, which is similarly placed on the converter chassis.

When the power supply is completely wired up, temporarily jumper the remote-power-switch terminals (1 and 2) of SO1 and plug in the line cord. Use a multimeter to check for filament voltage

DETAIL B

Location of components on top of converter chassis is critical, and the dimensions given in this illustration should be closely followed.

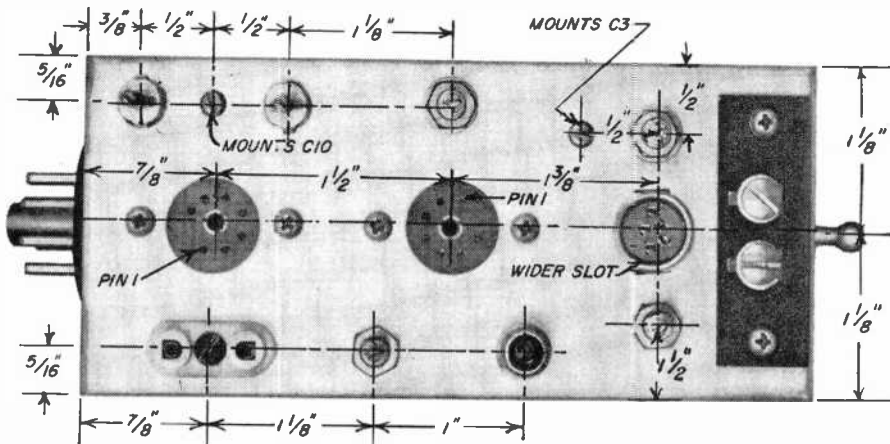

(about 6.3 volts a.c.) between terminals 4 and 5 of the socket, and for plate voltage between terminal 4 and terminals 3, 6, and 7, respectively. The latter three readings should all be roughly the same (about 150 volts d.c.) since there is almost no load on the supply and, consequently, no appreciable voltage drop across resistors R_4 or R_5 . If the supply passes these tests, disconnect it from the line, install the cover, and temporarily set the unit aside.

With the power supply taken care of, turn your attention to the construction of the converter itself. A logical first step is to wind the coils ($L1-L11$), specifications for which are given in the Parts List for the converter.

Three of the coils ($L3$, $L10$, and $L11$) are wound on resistors. The leads of each of these coils are cut short and soldered across the resistor leads at points not far from where the latter enter the body of the resistor (be sure to carry out the soldering as quickly as possible to avoid heat damage). The resistor leads will then be used to wire the coils into the circuit.

Coils $L1/L2$, $L4/L5$, $L6/L7$, and $L8/L9$ are wound on commercial slug-tuned forms. Diagrams of these coils (Detail "A") are given to supplement the in-

formation in the Parts List and should be followed as closely as possible. The forms for $L1/L2$, $L4/L5$, and $L6/L7$ are all of the same type. But the form used for $L8/L9$, though almost identical in appearance with the first three, is different. Be careful not to get them confused.

The converter is housed in a 5" x 2 1/4" x 2 1/4" aluminum utility box. All of the parts, except power switch $S1$ and plug $P1$, are mounted on the top of the box. Parts placement is critical, and the dimensions given in Detail "B" should be closely adhered to.

Plug $P1$ and switch $S1$ are mounted on the ends of the box. Center $P1$ and position its alignment key to match that of

DETAIL C ▼

Side and top views of shield and V1 socket show how shield is bent, soldered to the socket. Components C11 and R1, which have been moved aside for a better view, should actually be positioned flat against shield.

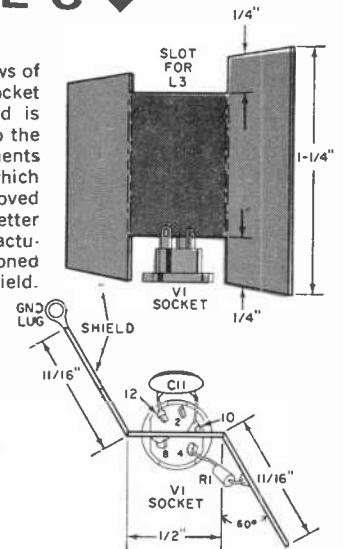

Crossed leads running between $L6/L7$ and $L4/L5$ in converter chassis (below) are shown separated for convenience; they should be twisted together, routed in front of $C3$.

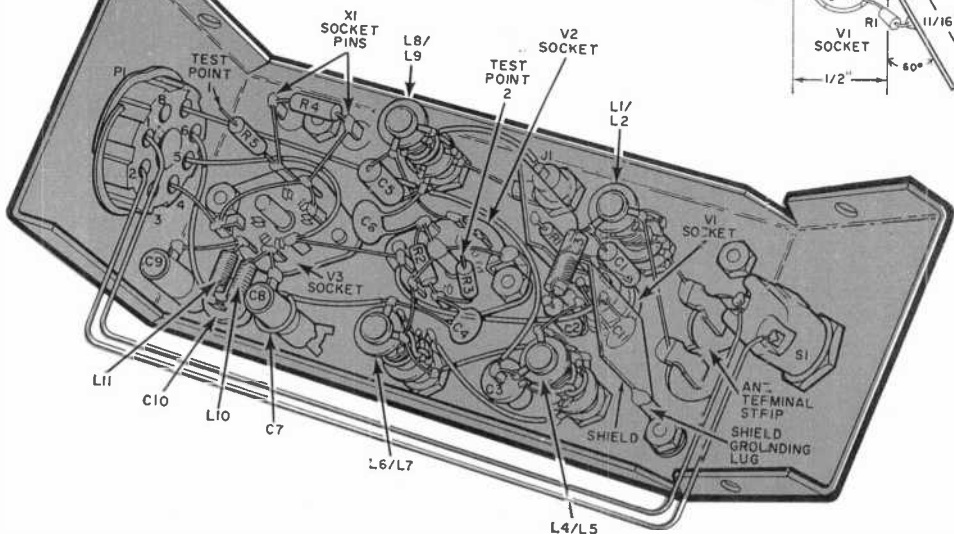

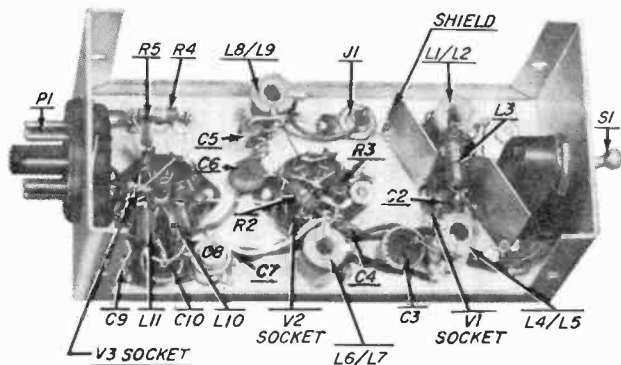

Parts placement shown in this photograph of the converter's interior, and in the pictorial diagram on the previous page, should be carefully studied and duplicated quite closely.

SO1 on the power supply chassis. A retaining-ring-mounted plug has been specified rather than a screw-mounted type so that P1 can be twisted, if necessary, to make it line up exactly with SO1. Switch S1 should be mounted slightly below center to insure enough clearance between it and the antenna terminal lugs.

When all the mounting holes have been drilled, install the Nuvistor (V1) socket. This socket has two slots (one wider than the other) to accommodate the alignment keys on the base of the Nuvistor. Be sure to place the socket so

that the wider slot is positioned as shown in Detail "B." The copper shield, which is formed and bent as shown in Detail "C," is placed over the Nuvistor socket and soldered to pins 8 and 10 (refer to Detail "C" and the pictorial diagram).

Before mounting any other parts, make all the necessary connections to the Nuvistor socket. Then, as you proceed with the parts installation and wiring, be sure not to block component terminals before you have a chance to solder to them. Try to orient all components exactly as shown in the pic-
(Continued on page 100)

TRACK THESE SATELLITES WITH THE NASA-136

As the payload weight of American satellites increases, so does the power output of the satellite transponders and beacon transmitters. More power and better antennas on the satellites enable SWL's to pick up these signals with greater ease.

Satellite beacon transmitters were originally scheduled to operate around 108.0 mc., but because of the number of satellites the United States has launched, the band between 136.0 and 137.0 mc. has been set aside to give each satellite frequency room. All future satellites will carry a beacon transmitter or transponder operating in this frequency band, which is now used in countries outside the Iron Curtain for satellite tracking.

Four satellites are transmitting as this is being written, and two more are likely to be launched and transmitting before this article is in print.

CODE NAME	FREQUENCY (mc.)	MODULATION
Explorer XII	136.020	Phase
Telstar I	136.050	(To be launched)
S-51	136.410	(To be launched)
Injun SR-3	136.500	AM
OSO	136.744	FM
TIROS IV	136.920	AM

WHAT'S WRONG WITH AMERICAN FM?

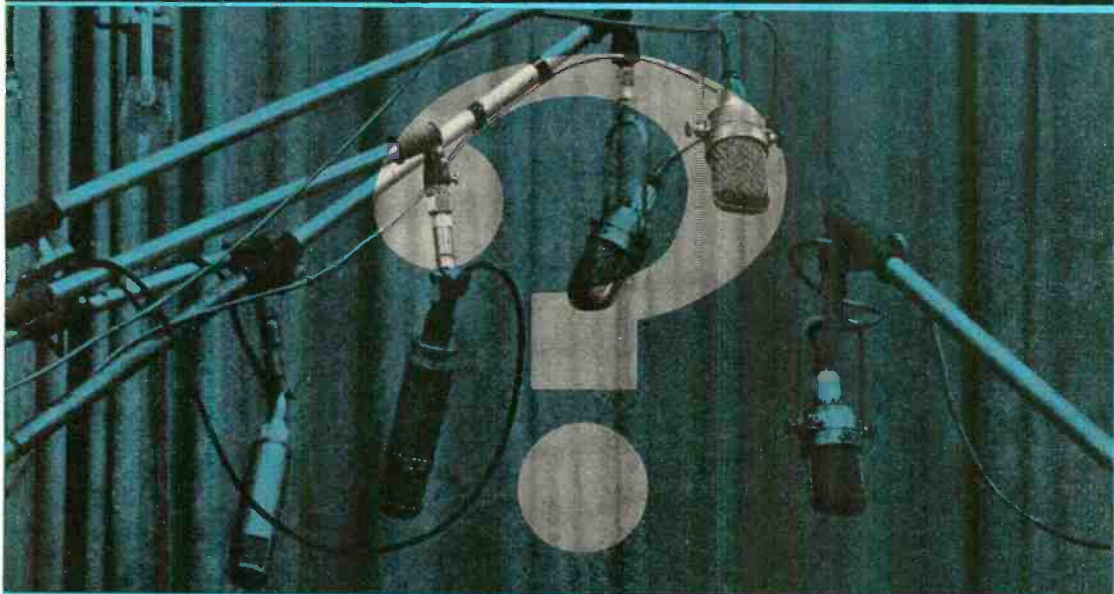

It's a classical "juke box," says this author, lagging far behind its European counterparts

By **ROBERT ANGUS**

“YOU AMERICANS had the technical ability to produce FM, but it takes us and the Europeans to show you how to use it.”

The speaker was B. F. Fediuk, a senior engineer at the Moscow Television Laboratories, and his view is a common one among broadcasters throughout Eastern and Western Europe. Is the United States lagging in the development and use of high-fidelity distortion-free FM broadcasting? Even the most partisan observer would be forced to answer in the affirmative.

A few figures help tell the story. At

the beginning of 1950, there were only four FM stations in all of war-torn Europe. The strongest of these, a station in Copenhagen, operated with a power of only 800 watts—less than that used by 70% of America's AM and FM stations. Today, over 1000 European stations are operating in an area about the same size as the United States. And the strongest boasts a power 150 times that of the 1950 Copenhagen station.

Meanwhile, the number of American FM stations declined from a high of 1020, late in 1948, to 912 as of a year or so ago. In other words, while the num-

"Live" concerts are the rule rather



Austria's love for good-music FM programming may stem from FM listeners enjoy rich music fare—the Salzburg Mozarteum

ber of European FM stations increased by more than 250 times, the American total actually decreased by 10%.

Europe Takes the Lead. Throughout Europe, on both sides of the Iron Curtain, FM has gained wider popular acceptance and wider usage than it has in the land of its birth. In Britain, France, the Netherlands, East and West Germany, Italy, Czechoslovakia, Austria, even the Soviet Union, nationwide government-owned FM networks are the rule rather than the exception.

In many cases, the broadcasters have had to overcome handicaps of language, politics, and financing to develop true high-fidelity programming. And because FM has gained such wide public acceptance, European broadcasters have felt justified in spending money to develop high-quality FM transmitters and microwave relays for program transmission.

In the United States, broadcasting's "Big Three"—the Columbia Broadcasting System, the National Broadcasting Company, and the American Broadcasting Company—have argued that public indifference to good sound on the air waves has prevented them from using high-fidelity telephone lines to link one affiliated station to another.

Using a top-quality tuner, one FM station can pick up and rebroadcast the full-frequency signal from a station as far away as 50 miles; such American organizations as the Concert Network and the WQXR Network have done so in

relatively small areas of the United States. But no American FM network is currently using microwave relay, because the broadcasters feel its cost is prohibitive. Yet such a system would allow full-frequency transmission over much greater distances.

France. An indication of what can be done with FM can be found in the *Radiodiffusion-Télévision Française* operations. France has three AM networks and four FM webs. Listeners to *Paris/Inter-France I* and *Regional France II* hear the same broadcasts of pop music, sports, comedy, and light drama on AM and FM (although *RTF* officials say most are AM listeners).

National France III, which features more serious music and drama as well as educational programs, is also an AM/FM network, but it is estimated that perhaps two-thirds of its listeners tune in on FM. The high-fidelity network, *France IV*, is all-FM and features live and recorded music—not only opera, symphony, and chamber music, but jazz, popular, and dance music by France's top artists as well.

By European standards, France got a late start in FM, with a single transmitter beaming broadcasts from the top of the Eiffel Tower to Paris and its suburbs only a few years ago. Today, there are no less than 38 FM outlets serving the four networks, with plans for more in the immediate future. A hallmark of the French system (as of other Euro-

than the exception on European FM



the fact that many of the world's greatest composers have been Austrians. Whatever the explanation, Austrian Orchestra (left), singer Adolf Vogel (seated, center), duo-pianists Paul Badura-Skoda and Joerg Demus (right).

pean systems) is the use of microwave relay to provide the full (50 - 15,000 cycles) spectrum to every station in each network.

The French acknowledge the higher cost compared to telephone lines. But, they point out, "FM enables the listener to hear everything there is. Eventually, people are going to demand top quality, so we may as well give it to them now. The audience for FM here is already large enough to warrant the expense of public money for a relay system, in our opinion." An RTF estimate suggests that about 400,000 Frenchmen (out of 45 million) own FM sets—"a remarkable figure when you consider that there were virtually none at the beginning of 1958."

Austria. Almost every FM/TV operation in the United States has better facilities than Austria's state-run broadcasting system (there is only one TV studio in all of Austria, for example). Yet the Austrian system provides one FM transmitter for every 280,000 Austrians—a ratio only slightly less than the U. S. rate of one transmitter for every 251,000 citizens.

Although Austria was one of the last nations to recover from the effects of World War II, it began FM transmissions as early as 1953 from a single station in Vienna. Today, it has a potential audience of one million.

An engineering director at *Radio Wien* comments, "FM is important in

Austria because it is the most effective way of servicing remote or isolated communities in the Alps. It is important to city dwellers because they can listen to our programs with little interference from stations in Czechoslovakia, Hungary, or Germany."

"Such interference," he continues, "can be intolerable on the AM band in Vienna after nightfall, and was one of the reasons we went to FM in the first place. Soon, our musically inclined listeners discovered that FM not only eliminated interference from other radio stations and from atmospheric conditions, but that it also enabled them to hear all the nuances of the music."

As in most other European countries, Austrian listeners pay for what they hear through an annual license issued by the Post Office. "Because they pay for the service," a government spokesman adds, "they feel they have a right to make demands, such as high fidelity."

When Austria added low-powered FM transmitters located on Alpine slopes to its two networks, it found that microwave relays in many cases were impractical. "Where it is possible," says the spokesman, "we do relay the signal from one station to another. Where it is not, we use first-class telephone lines. The result is a signal from every transmitter out to 15,000 cycles."

Germany. Nearby Germany has found that FM broadcasts, FM radios, and the tape recorder have become involved in

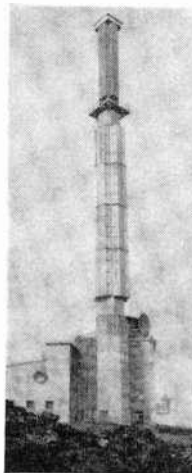

French Broadcasting System

France's FM hookup covers the country, as you can see from the map at left. There is at least one FM station in every city and town on the map, and major cities such as Paris have separate stations for each of the four different FM networks.

a "chicken-and-egg" affair. "It's hard to say where the stress on high fidelity came from," a director of city-owned *Radio Free Berlin (SFB)* states.

"At the end of 1949," he explains, "Germany was still down and out from the effects of the war. We had only two FM stations—one in Munich and one in Hamburg. We found, as the Cold War grew colder, that there was increasing interference with our AM stations—through jamming in the East and through the addition of hundreds of new stations to the band throughout Europe. It became obvious that something would have to be done."

When West Germany regained its sovereignty in 1955, it took over the stations which had been set up by the American, British, and French occupational authorities in their zones—including several FM transmitters. At the same time, German radio manufacturers, pushed by the quality of FM broadcasts at home and in markets abroad such as the United States, were producing top-quality FM table and console receivers. Thus, FM became an important part of virtually every radio or console manufactured in Germany from 1955 on, because domestic customers wanted it.

Top-quality radios meant that broadcasters had to offer top-quality programming. "We were unable to lay a cable between Berlin and the West which the Communists would agree not to touch," the *SFB* man explains, "so we were

forced to use microwave relay. Its advantages became so obvious that it was used elsewhere in Germany. This meant that listeners in Munich or Frankfurt could hear the Berlin Philharmonic with all the fidelity available to a listener in the hall. The radio sets reproduced it and the public demanded it."

No less than nine FM networks compete for the attention of German listeners. In addition to the two offered by Germany's affiliated state-owned stations, there are the programs of the American Armed Forces Network, the British Forces Network, the French Forces Network, *Radio Volga* (for Soviet occupation troops), and the stations in East Germany. An independent station, *Radio in the American Sector* in West Berlin (*RIAS*), makes two more programs available to listeners in the former German capital.

Despite their often inferior quality and signal strength, stations in the armed forces networks are strong favorites with many German listeners, particularly those partial to rock-and-roll and American jazz. So popular are the broadcasts, in fact, that they are credited by the German record and music-publishing industries with being a major cause for the country's interest in tape recorders.

According to industry figures, one out of every 18 West Germans owns a tape recorder (about three times the ratio in
(Continued on page 93)

AUTOMATIC DIODE CHECKER



... for silicon power rectifiers

By **KEITH SUEKER** *Manager, Product Planning
Semiconductor Div., Westinghouse Electric Corp.*

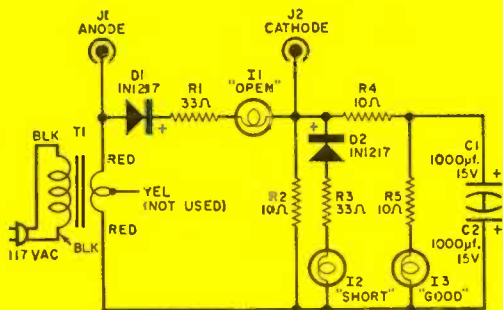

PARTS LIST

- C1, C2—1000- μ f., 15-volt electrolytic capacitor
 D1, D2—1N1217 diode (Westinghouse)
 I1, I2, I3—#49 pilot lamp
 J1, J2—Combination binding post and banana jack; one red, one black
 R1, R3—33-ohm, 1-watt resistor
 R2—10-ohm, 5-watt resistor
 R4, R5—10-ohm, 1-watt resistor
 T1—Filament transformer; primary, 117 volts; secondary, 6.3 volts @ 1.2 amp (Stancor P6134 with secondary CT unused, or equivalent)
 1—5 $\frac{1}{2}$ " x 3" x 2 $\frac{1}{8}$ " aluminum utility box (Bud CU-2106-A or equivalent)
 Misc.—Pilot lamp assemblies for I1, I2, I3, test leads, terminal strips, line cord, etc.

WITH the increasingly widespread use of silicon diode power-supply rectifiers, experimenters and servicemen alike find it handy to have a means for quickly checking them. This little unit was designed to do just that; all you have to do is plug it in and connect the suspected diode across its test jacks. Then, depending on which of the three pilot lamps lights up, you'll have an immediate indication of the condition and polarity of the suspected unit. The automatic checker will handle any silicon rectifier rated at 250 ma.—or greater—average current.

Construction. The checker is built in a 5 $\frac{1}{4}$ " x 3" x 2 $\frac{1}{8}$ " aluminum utility box. Parts layout and wiring are not critical; just use the photographs of the front and rear of the unit as a general guide.

In some cases, the author used two parallel resistors to make up a resistance value specified in the Parts List. This was done only to take advantage of the contents of his spare-parts box, however. All of the specified resist-

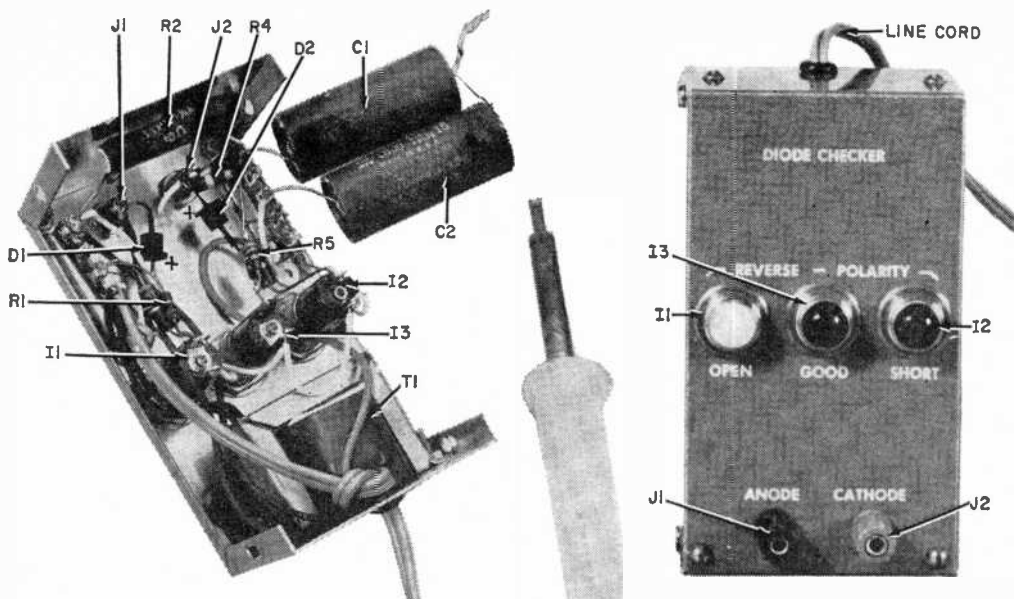

Photographs of diode checker's interior and front panel reveal construction details. Capacitors C1 and C2 (see photo at left) have been partially disconnected and moved aside for a better view.

ances are standard and appropriate single resistors are available.

While carrying out the construction, be sure to observe carefully the polarities of D1, D2, C1, and C2. Also check to see that no leads or connections are shorted to the cover (you may want to line the sides of the cover with wide adhesive tape).

Operation. No line switch is provided because the current drawn by the checker when it is not in use is negligible,

and it can be left running continuously.

To check a diode, connect it across test jacks J1 and J2. If only I1 lights, the diode is open; if only I2 lights, it's shorted; if only I3 lights, it's good. Should all three indicators light, the diode is good, but connected in reverse of the polarity marked on the jacks.

Never use the checker on a diode rated at less than 250 ma. average current. If you do, you stand a good chance of burning out the diode. -30-

HOW IT WORKS

Transformer T1 provides the 6.3-volt a.c. source needed to operate the checking circuit. With no connection across test jacks J1 and J2 (or with an open-circuit diode connected), d.c. current flows through diode D1, resistors R1 and R2, and "open" indicator I1 on the positive half-cycles. Indicator I1 then lights up, but no current flows through I2 because of reverse-connected diode D2, and the voltage drop across R2 is too small to allow I3 to light.

If a good diode is connected across J1 and J2 according to the polarity labeled on the jacks, D1, R1, and I1 will be shorted out on the positive half-cycles and D1 will be open on the negative half-cycles; therefore I1 will not light. And, once again, no current will flow through I2 because of reverse-connected diode D2. But now enough d.c. voltage appears across R2 to charge capacitor C1 to the point where "good" indicator I3 will light (the voltage applied to capacitor C2 is in reverse polarity, so C2 acts as a short circuit and does not charge).

If a shorted diode is connected across the jacks, D1, R1, and I1 will be shorted out—so I1 will remain dark. But the voltage across R2 is now a.c. and neither C1 nor C2 will charge. Instead, these capacitors act as a low-reactance shunt across I3 and resistor R5, and I3 also remains dark. Diode D2, however, conducts on the negative half-cycles and passes enough current to light "short" indicator I2.

If a good diode is connected across J1 and J2 with polarity opposite to that labeled on the jacks, a d.c. voltage will appear across R2 (with the upper end of the resistor negative) on negative half-cycles. Diode D2 will then conduct, lighting I2. Capacitor C2 also charges up enough to light I3 (capacitor C1 has voltage of reverse polarity applied to it and acts as a short circuit). On the positive half-cycles, the situation is the same as the open-circuit case first discussed; d.c. current flows through diode D1, resistors R1 and R2, and "open" indicator I1—illuminating the latter.

*Double the usefulness of
every incandescent lamp you own
with this practical little control device*

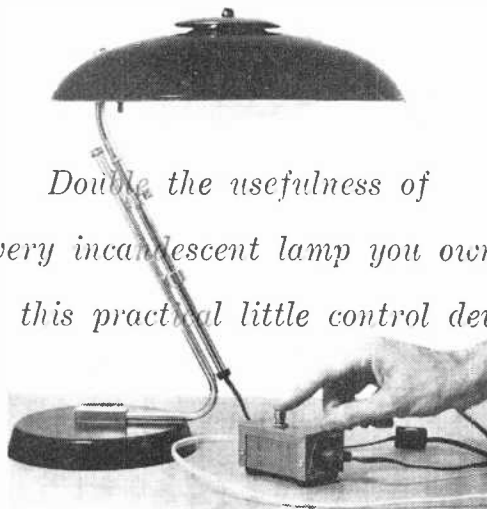

The MOOD LIGHTER

By FRANK A. PARKER

THINK you could use an inexpensive gadget that can dim a bright reading lamp for comfortable TV viewing? This same device can also “tone down” that lamp in the children’s bedroom and serve a dozen other lamp-dimming functions around the house. In fact, once you get used to the Mood Lighter,* you’ll wonder how you ever got along without it!

Let’s say, for example, that your evening TV session is about to begin. Simply press a button on the Mood Lighter, and the lamp in the room will instantly deliver a soft “background” light. When your TV session is over, all it takes is another press of the button to revert to “normal” lighting.

The Mood Lighter is so handy that you’ll probably want to build one for almost every lamp you own. What’s more, once you have the parts on hand, you should be able to put the gadget together

in about an hour. And since only a handful of components is needed, the total cost should be under \$5.00.

About the Circuit. The Mood Lighter uses only three electronic components: a diode (*D1*), a switch (*S1*), and a fuse (*F1*). When switch *S1* is closed, a lamp plugged into socket *J1* will work in the normal manner. When *S1* is opened, however, current from the a.c. line will be “blocked” by diode *D1* during half of every cycle. As a result, *D1* will pass only half the normal lamp current, “dimming” the lamp to about half its normal brilliance.

Construction. The unit is housed in a $3\frac{1}{4}$ ” x $2\frac{1}{8}$ ” x $1\frac{5}{8}$ ” aluminum box, and it’s best to drill and punch all holes in the cover “half” of the box before mounting the components. Holes for the fuse holder and line cord should be located at one end of the box, socket *J1* should be mounted at the opposite end, and switch *S1* should be installed on top of the box but offset from the center in order to clear the fuse holder. Four

*The circuitry of the Mood Lighter is very similar to that of General Electric’s “Hi-Lo” control, which also uses a silicon diode and is suitable for incandescent lamps drawing up to 300 watts.

rubber mounting feet attached to the lower "half" of the box will protect your furniture.

Since the diode becomes slightly warm in normal operation with a 150-watt lamp, a few "penny-" and "nickel-sized" metal washers should be placed on the mounting stud to act as a heat sink (see pictorial diagram). One lead from the diode should be soldered directly to the lug on the fuse holder, and a solder lug should be slipped over the mounting stud

for the other diode connection. A nut holds the washers and the solder lug securely in place.

Operation. Any incandescent lamp drawing up to 150 watts can be used with this device. Simply plug the lamp into *J1*, and plug the Mood Lighter into the a.c. line; the lamp, of course, must still be turned on and off in the regular manner.

Close switch *S1* to dim the lamp and open the switch to return the lamp to

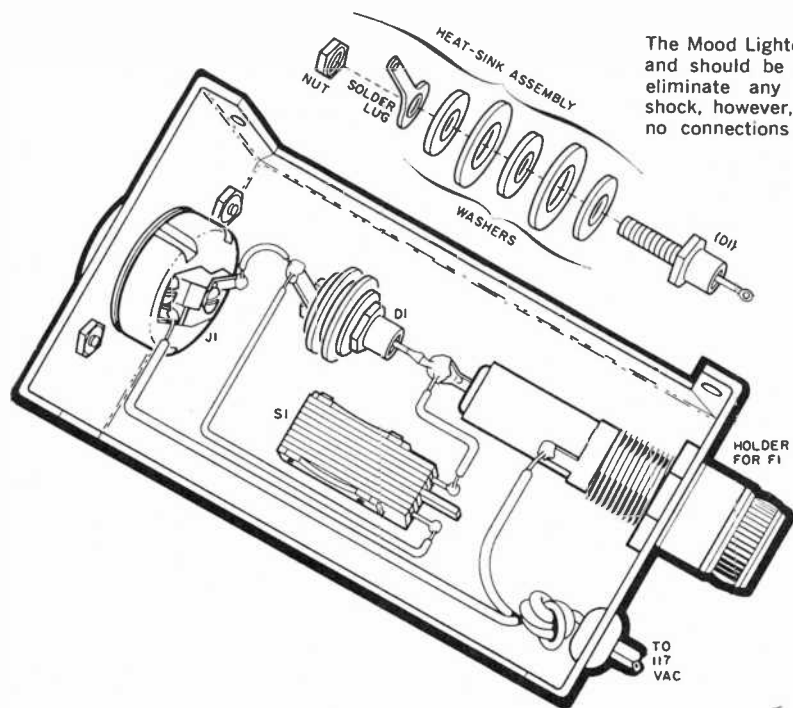

The Mood Lighter uses only a few parts and should be a "cinch" to build. To eliminate any possibility of electric shock, however, be sure that there are no connections to the metal chassis.

This circuit is so simple that the polarity of diode *D1* is actually of no significance. In fact, reversing connections to the cathode and anode would have no discernible effect.

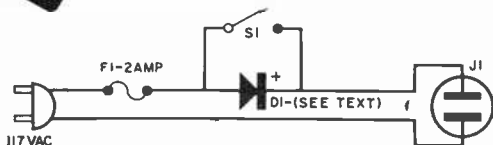

PARTS LIST

- D1*—2-ampere, 400 PIV silicon diode (Lafayette SP-242 or equivalent)
- F1*—2-ampere, Type 3AG fuse (Littlefuse 312000 series or equivalent)
- J1*—A.c. socket (Amphenol 61-F1 or equivalent)
- S1*—S.p.s.t. push-on, push-off push-button switch (Arrow-Hart & Hegeman 86710 or equivalent)
- 1—Fuse holder for 3AG fuse (Littlefuse 342001 or equivalent)
- 1—3¼" x 2½" x 1½" aluminum utility box (Bud CU-2101-A or equivalent)
- Misc.—Line cord and plug, hardware, rubber feet, grommet, etc.

"normal." If you want to make the light bulb last longer, always turn the lamp on when *S1* is in its "dim position."

The diode chosen by the author, incidentally, is rated at 2 amperes and should be adequate for lamps drawing up to 150 watts. Lamps consuming more power will naturally require a higher amperage diode; for example, a 300-watt lamp will call for a 4-ampere diode. In all cases, it's important that the diode be rated at 200 PIV or more.

-50-

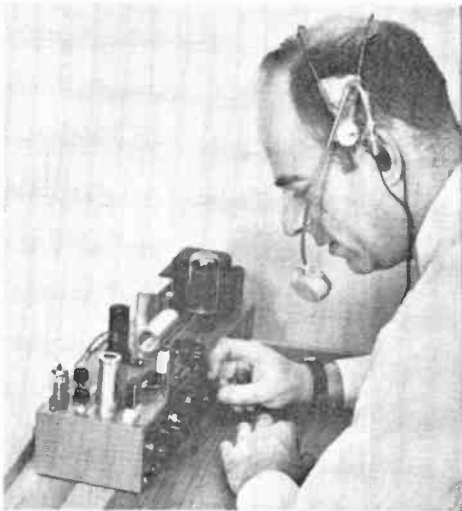

THE SIMPLE SIDEBANDER

COVER STORY

Suppressed-carrier transmitter uses few components

By **HARTLAND B. SMITH**, W8VVD

HERE'S a rig that proves you don't have to build complicated circuits or spend a great deal of cash in order to experiment with sideband transmission. Surprising as it may seem, the "Simple Sidebender" needs only three tubes to produce a 40- or 75-meter signal with "talk power" better than that of the average 25-watt AM phone transmitter.

How can this unit be so simple and inexpensive when the usual sideband rig is loaded with tubes and carries a purse-

flattening price tag? The answer lies in the fact that it generates a *double-sideband suppressed carrier* signal.

The "double-sideband" signal occupies twice the spectrum space as the more common "single-sideband" signal and, on a selective ham receiver, is about half an "S"-unit weaker. With these minor exceptions, DSB and SSB are equivalent. Over the air, they sound almost identical, and receiver adjustment is the same for either mode of transmission. As a

Completed transmitter (left), with companion power supply, is a neat-looking rig.

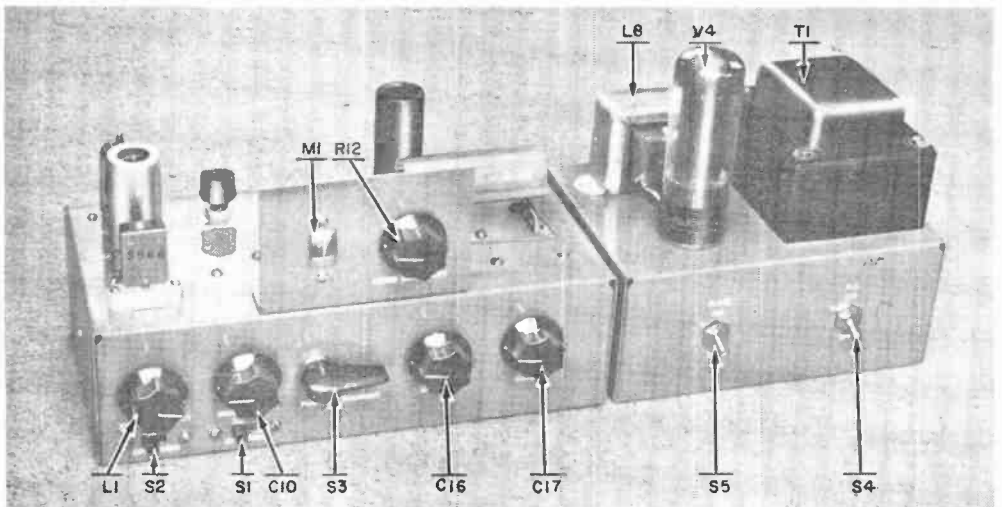

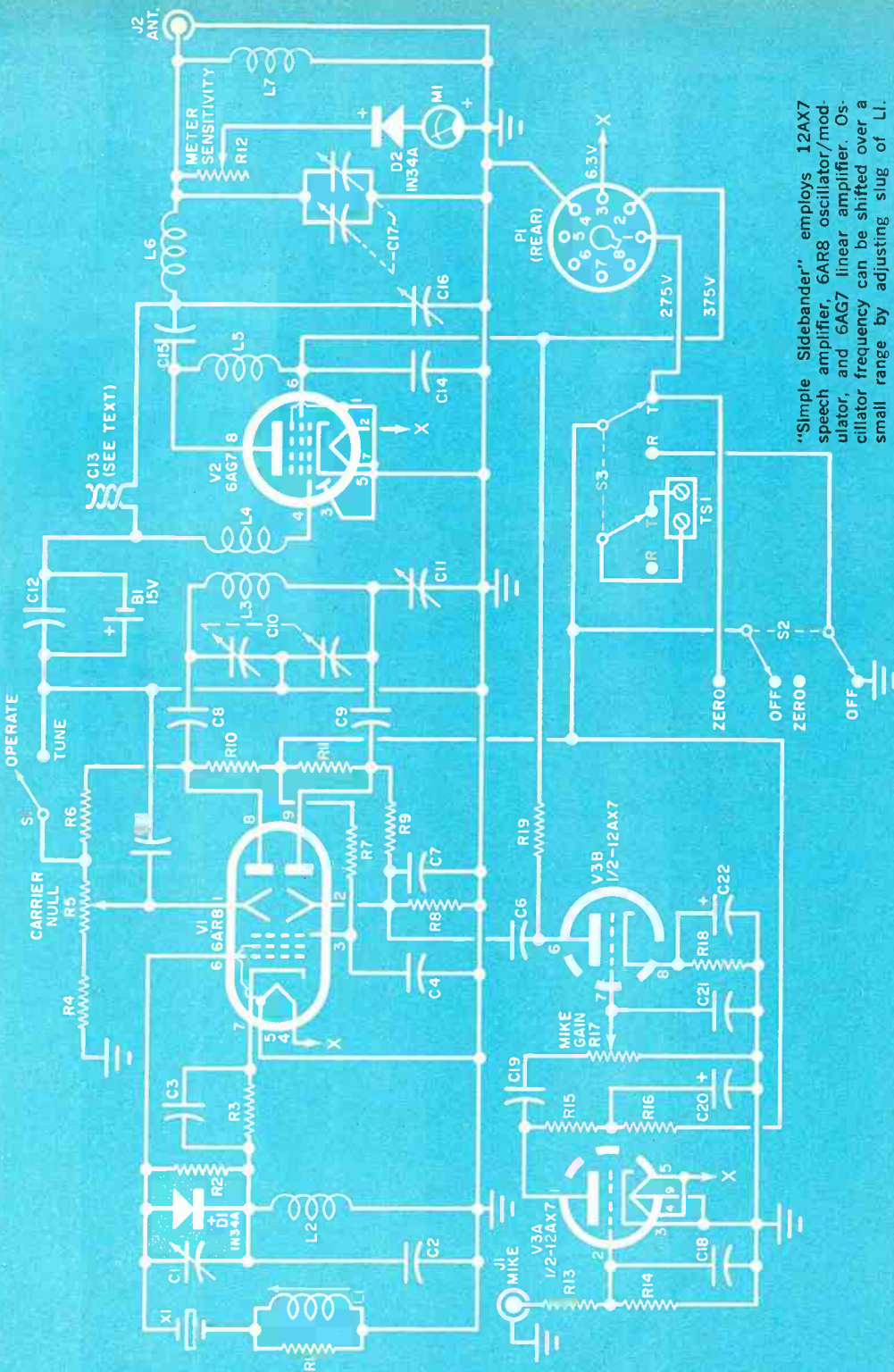

"Simple Sidebender" employs 12AX7 speech amplifier, 6AR8 oscillator/modulator, and 6AG7 linear amplifier. Oscillator frequency can be shifted over a small range by adjusting slug of L1.

matter of fact, very few people contacted with the Simple Sidebander have noticed the extra sideband.

Construction. First prepare coils *L1*, *L3*, *L4*, and *L6*. These coils should be constructed for the specific band on which the transmitter is to operate (40 or 75 meters), and complete specifications will be found in the Parts List.

In building the transmitter proper, follow the parts layout illustrated in the photographs as closely as possible. Since the area around tubes *V1* and *V3* is rather crowded, wire as much of this portion of the transmitter as you can before installing either coil *L1* or capacitor *C10*.

Orient *V1*'s socket with pins 8 and 9 nearest *C10*. Put ground lugs under both mounting nuts and place a 1-lug terminal strip on the side wall of the chassis near the socket; it should be positioned about $\frac{3}{4}$ " down from the chassis top. This tie point supports the junction of resistors *R7*, *R10*, and *R11* and the B-plus line. Be sure, incidentally, that you ground heater pin 5, rather than heater pin 4, on *V1*; pin 5 not only carries heater current, but is also internally connected to a shield and focus electrode.

Orient *V3*'s socket with pin 2 nearest jack *J1*, and put a ground lug under the mounting screw nearest potentiometer *R17*. A 4-lug (one grounded) terminal strip, mounted between terminal strip *TS1* and jack *J1* on the rear wall of the chassis, serves as a support for the capacitors and resistors associated with *V3*. Locate capacitor *C6* well away from *J1* in order to prevent feedback from the plate of *V3b* to the grid of *V3a*.

Fasten a 1-lug terminal strip under the crystal-socket mounting nut nearest *C10* and put a ground lug under the other nut. Use this terminal strip to make the junction between choke *L2*, capacitors *C1*, *C2*, and *C3*, diode *D1*, and resistors *R2* and *R3*. Connect the other end of choke *L2* to the ground lug, keeping the choke close to the chassis where it won't interfere with the later installation of *L1*. Support *C1* on $1\frac{1}{2}$ " leads so that it, too, will be positioned out of *L1*'s way.

Coil *L1* is mounted in a $\frac{3}{8}$ " hole drilled in the front panel. Push the coil through this hole until the ears spring out to hold it in place. Turn the coil adjusting screw

HOW IT WORKS

A conventional AM transmitter generates a carrier with two sidebands. Each of the sidebands is separated from the carrier frequency by an amount equal to the modulating frequency (or frequencies). Thus, a transmitter with a 4000-kc. carrier, when modulated by a 1-kc. tone, has a lower sideband at 3999 kc. and an upper sideband at 4001 kc.

But ordinary speech contains many frequencies and, when modulating an AM transmitter, creates "clusters" of signals separated from the carrier by varying amounts. These clusters, or sidebands, contain all of the intelligence we wish to transmit.

The carrier supplies no information, wastes two-thirds of the power generated by the transmitter, and causes severe heterodyne interference to signals on nearby channels. If the carrier is suppressed, however, heterodyne interference is eliminated and transmitter cost is cut.

In the "Simple Sidebander," a radio-frequency carrier is generated by *V1*'s cathode and control and accelerator grids, which are connected as a crystal-controlled Colpitts oscillator. Capacitor *C1* adjusts the drive voltage applied to the control grid. Diode *D1* prevents the grid from swinging positive, thus holding down accelerator current and improving modulation quality. The oscillator frequency can be shifted a maximum of approximately 1 kc. by adjusting coil *L1*'s slug.

A positive voltage applied to the plates of *V1* causes a beam of electrons, varying in intensity at the carrier frequency, to flow through the tube. When the d.c. voltages applied to *V1*'s deflectors (pins 1 and 2) are balanced by adjusting potentiometer *R5*, an equal amount of current flows through each plate. Since equal plate currents produce equal voltage drops across resistors *R10* and *R11*, the voltage difference between the plates is zero and the carrier is suppressed. Capacitor *C11* insures maximum carrier suppression by providing a means for balancing out stray capacities in *V1*'s plate circuit.

Since the carrier is required for tuning the transmitter, switch *S1* is provided. With this switch closed, the voltages on *V1*'s deflectors become unbalanced, allowing carrier energy to pass through.

A speech amplifier using tubes *V3a* and *V3b* applies an audio voltage, via capacitor *C6*, to one deflector of *V1*. This causes the d.c. voltage already on the deflector to vary at an audio rate, forcing the electron beam to swing back and forth between *V1*'s plates. The net effect is that upper and lower sidebands are produced, and appear at the plates of *V1*.

The sideband energy (minus the carrier) passes through capacitors *C8* and *C9* to tuned circuit *L3/C10*. Coil *L4*, inductively coupled to *L3*, transfers the sideband energy to the grid of tube *V2*. This tube is biased as a linear amplifier by battery *B1* and neutralized by capacitor *C13*. Greatly amplified, the sidebands appear at the plate of *V2* and are fed to antenna jack *J2* via pi-network tuning circuit *C16/L6/C17*.

Switch *S3* is the "Transmit-Receive" switch, controlling both the transmitter and any external relays connected at terminal strip *TS1*. Switch *S2* is provided for "zero beating": in the "Zero" position, it activates tubes *V1* and *V3*, but leaves *V2* disabled. Meter *M1*, the sensitivity of which is controlled by potentiometer *R12*, serves as an r.f. output indicator.

Operating voltages for the Simple Sidebander come from a separate power supply. The transmitter's power cable terminates in plug *P1*, which mates with socket *SO1* on the supply chassis. Switch *S4*, controlling the line voltage to transformer *TT*'s primary, is the main power switch. Switch *S5* is used to cut off the high voltage during extended standby periods.

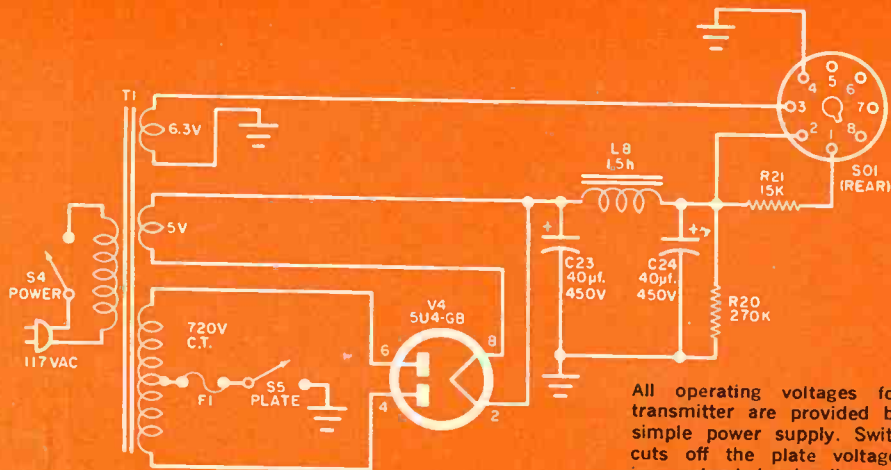

All operating voltages for the transmitter are provided by this simple power supply. Switch S5 cuts off the plate voltage during extended standby periods.

PARTS LIST FOR TRANSMITTER AND POWER SUPPLY

- B1—15-volt battery (Burgess U10 or equivalent)
 C1, C11—3-30 μf . mica trimmer capacitor
 C2, C21—150- μf . mica capacitor
 C3, C5, C15—0.01- μf ., 1000-volt ceramic disc capacitor
 C4, C7, C12, C19—0.001- μf ., 1000-volt ceramic disc capacitor
 C6—0.1- μf ., 600-volt paper capacitor
 C8, C9, C14—0.0047- μf ., 1000-volt ceramic disc capacitor
 C10, C17—2-gang variable capacitor, 467.8 μf . per section (Allied Radio 61 H 059 or equivalent)
 C13—Two 3½" lengths of insulated hookup wire twisted tightly together—see text
 C16—140- μf . variable capacitor (Bud 1856 or equivalent)
 C18—100- μf ., 1000-volt ceramic disc capacitor
 C20—12- μf ., 450-volt electrolytic capacitor
 C22—10- μf ., 25-volt electrolytic capacitor
 C23, C24—40- μf ., 450-volt electrolytic capacitor
 D1, D2—1N34A diode
 F1—¼-ampere, 3AG fuse
 J1—Chassis-type mike receptacle (Amphenol 75-PC1M or equivalent)
 J2—Chassis-type coax receptacle (Amphenol 83-1R or equivalent)
 L1—For 75 meters: 68 turns of #32 enameled wire close-wound on Superex C-3 coil form (Form available from Radio Shack Corp., 730 Commonwealth Ave., Boston 17, Mass.)
 For 40 meters: 25 turns of #32 enameled wire close-wound on Superex C-3 coil form
 L2, L5, L7—2.5-millihenry, 250-ma. r.f. choke (Millen 34103 or equivalent)
 L3—For 75 meters: 34 turns of #24 tinned wire, ¾" in diameter, spaced 32 turns per inch (cut from B&W 3012 "Miniductor" stock)
 For 40 meters: Same as above, but 22 turns
 L4—For 75 meters: 50 turns of #24 tinned wire, 1" in diameter, spaced 32 turns per inch (cut from B&W 3016 "Miniductor" stock)
 For 40 meters: Same as above, but 34 turns
 L6—For 75 meters: 48 turns of #20 tinned wire, 1" in diameter, spaced 16 turns per inch (cut from B&W #3015 "Miniductor" stock)
 For 40 meters: Same as above, but 24 turns
 L8—1.5-henry, 200-ma., filter choke (Stancor C2327 or equivalent)
 M1—Miniature "AM-Tuning" type meter (Lafayette TM-12 or equivalent)
 P1—Octal plug, cable type (Amphenol 86-PM8 or equivalent)
 R1, R13—150,000-ohm, ½-watt resistor
 R2—470,000-ohm, ½-watt resistor
 R3—330-ohm, ½-watt resistor
 R4, R8, R10, R11, R19—56,000-ohm, 1-watt resistor
 R5—25,000-ohm potentiometer, linear taper
 R6—100,000-ohm, 1-watt resistor
 R7—33,000-ohm, ½-watt resistor
 R9—120,000-ohm, 1-watt resistor
 R12—100,000-ohm potentiometer, linear taper
 R14—2.2-megohm, ½-watt resistor
 R15, R16—75,000-ohm, ½-watt resistor
 R17—500,000-ohm potentiometer, audio taper
 R18—1000-ohm, ½-watt resistor
 R20—270,000-ohm, 2-watt resistor
 R21—15,000-ohm, 10-watt resistor
 S1—S.p.s.t. slide switch
 S2—D.p.d.t. slide switch
 S3—D.p.d.t. spring-return switch (Centralab 1464 or equivalent)
 S4, S5—S.p.s.t. toggle switch
 SO1—Octal socket (Amphenol 78S8 or equivalent)
 T1—Power transformer; primary, 117 volts; secondaries, 720 volts CT @ 120 ma., 5 volts @ 3 amperes, 6.3 volts @ 3.5 amperes (Stancor PM-8410 with center tap of 6.3-volt winding unused, or equivalent)
 TS1—2-lug, screw-type terminal strip
 V1—6AR8 tube
 V2—6AG7 tube
 V3—12AX7 tube
 V4—5U4-GB tube
 X1—Quartz transmitting crystal, ground for operating frequency
 1—3" x 10" x 5" aluminum chassis for transmitter (Bud AC-404 or equivalent)
 1—3" x 7" x 5" aluminum chassis for power supply (Bud AC-429 or equivalent)
 2—Octal sockets for V2 and V4
 1—9-pin miniature tube socket
 1—9-pin miniature tube socket with 2¾" shield
 Misc.—Extension shaft for C10, crystal socket, ceramic or crystal mike, grommets, knobs, holder for F1, assorted terminal strips, etc.

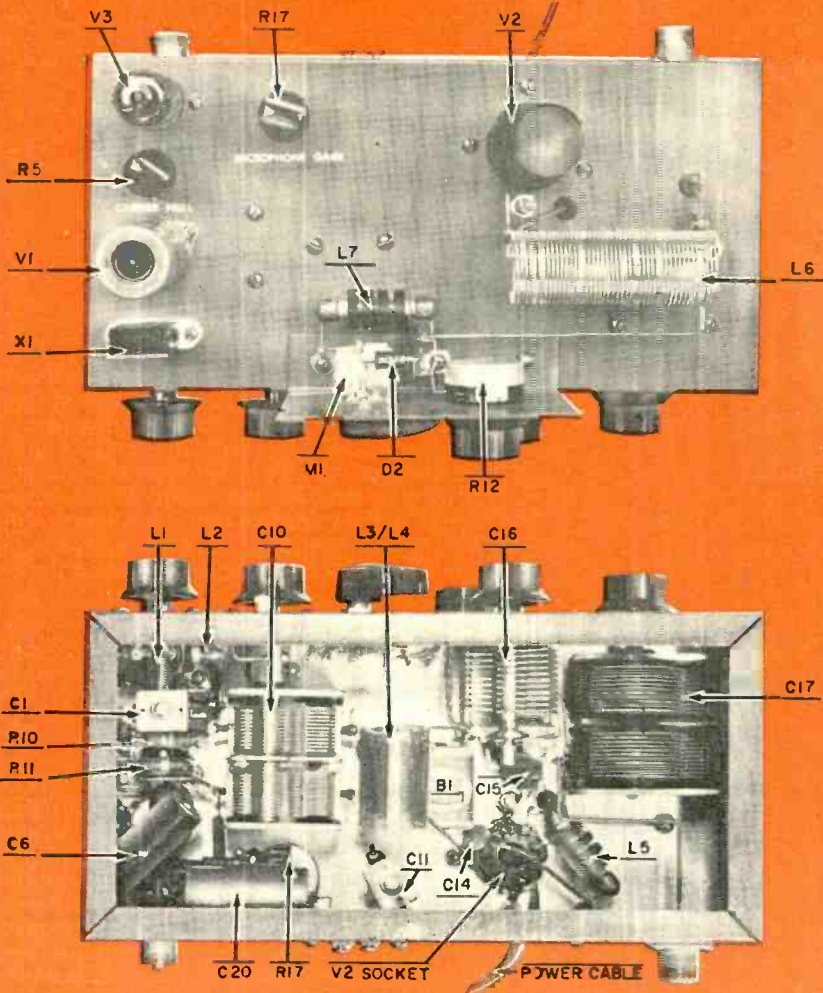

Views of top and bottom of transmitter chassis (above) show locations of most of the major components. Photograph below illustrates placement of parts on the back panel.

as far counterclockwise as you can. Next, cut a piece of scrap brass volume control shafting to a length of exactly $\frac{3}{8}$ " and drill out its center with a $\frac{1}{32}$ " bit. The shafting is then pushed over the coil adjusting screw and sweat-soldered in place. A conventional knob can now be installed over the shafting. For smooth operation, lubricate the threads of the coil adjusting screw with heavy oil or grease.

Remove and discard the mica trimmers on the sides of capacitors C10 and C17 before installation. It's necessary to
(Continued on page 96)

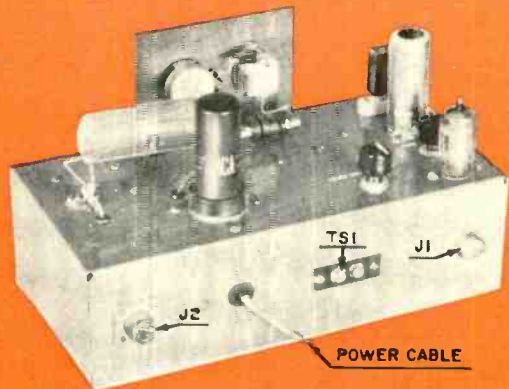

An "Eye" for Small-Boat Skippers

Televised radar tells you what's where on New York Bay

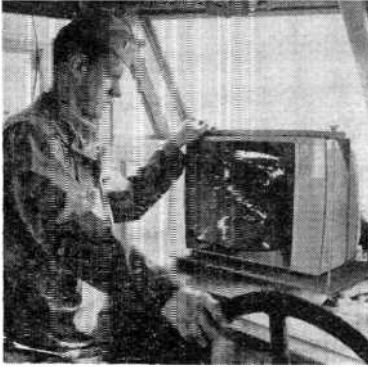

THE big television networks may soon find themselves in a new rating race with a televised radar map broadcast around-the-clock by the U. S. Coast Guard. The actors are ships and the set is always Lower New York Bay.

This unique broadcasting service is called RATAN, for Radar And Television Aid to Navigation. Experimental in nature, RATAN puts a "radar" aboard any vessel in the bay area equipped with an UHF television set. Here's how it's done.

A specially adapted Raytheon radar with boomerang-shaped antenna sends out microwave pulses that bounce back as echoes from fixed landmarks, buoys, and ships passing through the harbor. The radar video image is sent to a UHF television transmitter operating on Channel 47 via a special conversion unit

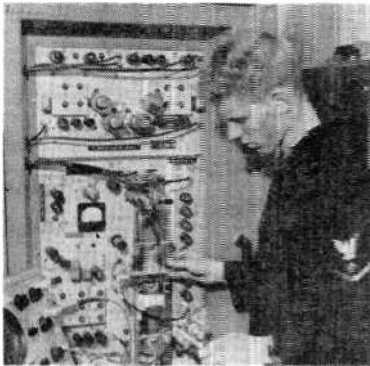

A Coast Guard skipper (top photo) navigates his cutter through Lower New York Bay with the help of a radar map viewed from a standard UHF television set. The tower-mounted 25'-long radar antenna (bottom) is the "eye" for the unique RATAN system. Coast Guard technician (left) checks Raytheon storage tube which "remembers" ships' positions.

which contains a storage tube. This tube "remembers" the positions of all targets on the radar scope and then posts them along with the present position echoes on TV. The remembered positions create an electronic trail behind moving ships. Resembling a ship's wake, the diminishing trail gives the TV shipboard viewer an immediate impression of the vessel's course and approximate speed.

Unlike ordinary radar screens which must be viewed in darkened rooms or with sun hoods, the RATAN televised radar map can be seen clearly in bright sunlight. The Coast Guard believes that if current tests are successful the system may be used in many of our major ports. Small boat skippers who cannot afford expensive shipboard radar equipment will find radar-TV a good "channel" to watch to stay in the channel. -50-



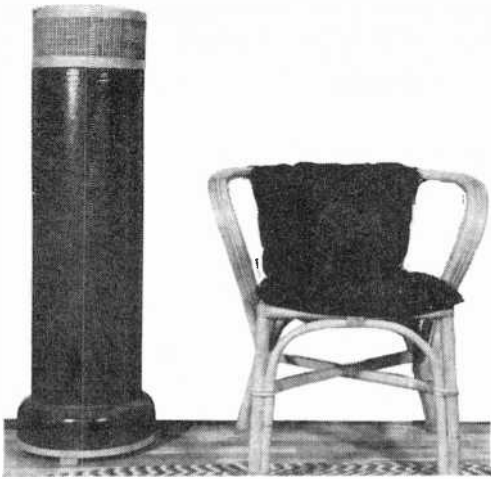

*Want to build a low-cost,
vibration-free speaker system?
Just take a single 8" speaker,
house it in (of all things!)
a 3-foot section of sewer pipe,
then sit back and enjoy . . .*

Clean sound from the

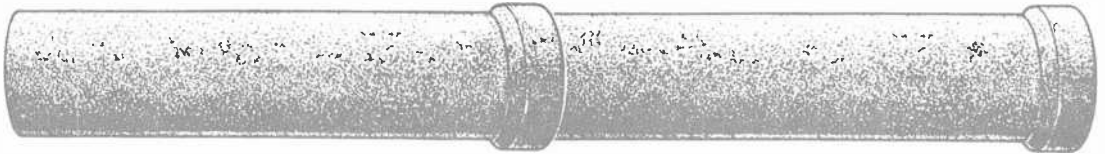

DRAINPIPE 8

FROM the many articles and books written by G. A. Briggs, Britain's famed authority on speakers, it is evident that he seeks the kind of solidity in speaker enclosures ordinarily found in his country's Rolls-Royce cars. When I first read of Mr. Briggs' sand-filled and brick baffles, I admired his thoroughness and uncompromising dedication to the art. However, still the victim of old habits, I then went out and bought some plywood.

The plywood made a very good "box," but the thought of Mr. Briggs' inflexible brick "walls" continued to obsess me. Every time I sat before a fireplace or crouched over the coals of a brick barbecue, I wondered how a hi-fi speaker would sound in them. I thought the fireplace idea had some merit, but stereo came in, and there just didn't seem to be many houses with twin fireplaces!

Considering how much I had been impressed with the possibilities of brick, it's remarkable how long I overlooked a good substitute—sewer pipe! After I

By DAVID WEEMS

got over the initial "shock" of my idea (a sewer pipe is a rather unlikely candidate for a speaker baffle, needless to say), I visited the local lumberyard. Sewer pipes were there all right, not displayed as prominently as the plywood, but definitely available.

The pipes, for your information, come in two kinds: smooth tile, and a rough concrete that they almost pay you to haul out. I chose the tile. And here, after some paper work, a number of trials, and quite a few errors, is the result—a speaker enclosure to satisfy even the proverbial "purist," and at a cost of less than \$10.00.

Materials and Dimensions. After experimenting with two sizes of pipe and various speakers, I fixed the inside diameter of the pipe at 10 inches, which happens to be a standard dimension. The "Drainpipe 8" was designed to accommo-

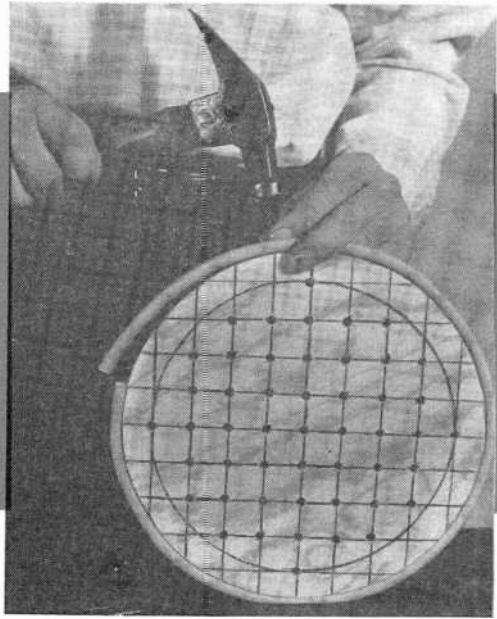

date an 8" speaker, so don't try to squeeze in a 10-incher—you'd probably be disappointed. And in case you're eyeing the dimensions and wondering if the internal volume is sufficient (as I did at first), don't give it a second thought. In spite of its small physical size, this enclosure *sounds* "big!"

Materials should be no problem. For the pipe, check with the nearest lumberyards or, if they don't have any, with distributors of concrete products. The polyurethane foam plastic can be obtained from many sources, but I got mine from an upholstery supplier for only \$1.25. The "Art Foam" that serves as gasket material is carried by many "dime" stores. Picking up the other materials should be routine procedure.

The dimensions for the various parts are listed in the Bill of Materials, but you may have to make minor changes due to variations in the pipe.

Marking and Cutting. A good fit can be insured by using the pipe as a pattern for marking out Parts A and C (the "end plugs" for the pipe—see photo at left, above, and the drawings on page 62). Although Part D (the plywood ring which forms the top) doesn't have to fit the pipe, it's best to make it perfectly round with a diameter equal to that of Part C.

Part B, the acoustic filter, should then

be marked on a radius of $4\frac{7}{8}$ " from the center of Part D. If you don't have a saw that makes its own opening, you can drill a small hole just inside the boundary line for Part B and plug the hole later. The acoustic filter, incidentally, is purposely cut smaller than the pipe's inside diameter. This allows the weather stripping to make the snug fit required to prevent unwanted air leakage and hold the part firmly in position.

After Part B has been cut from Part D, mark out the pattern for the 49 quarter-inch holes in Part B by first drawing two diameters at right angles to each other. Then draw lines parallel to each diameter at 1" intervals. Finally, using a 4" radius, draw another circle and drill at each cross-point that lies inside the circle or touches its boundary. When the weather stripping is attached, the filter can be placed into position in the pipe.

The base (Part A) should be prepared as shown; the 4"-diameter hole in its center serves as the bass-reflex port. For extra solidity, the short lengths of $\frac{3}{4}$ " x $1\frac{1}{2}$ " material (Part E) should be screwed as well as glued in place.

Note that the pieces used on the top of the base are set on edge to act as "ribs" or stiffeners as well as to locate the pipe on its base. They may have to be trimmed slightly with some kinds of

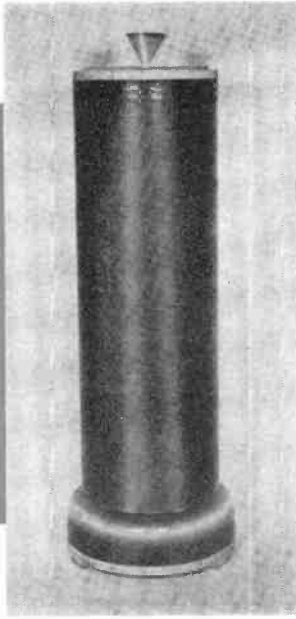
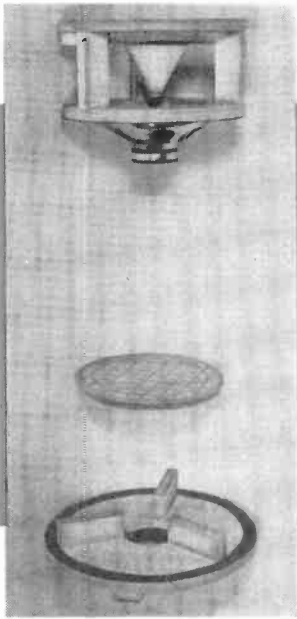

Because it requires a minimum of woodworking skills, the "Drainpipe 8" should be a pleasure to build.

To insure a proper fit for the top and bottom end plugs for the pipe, it's best to use the pipe as a pattern (see photo on page 60, left); the acoustic filter, Part B, should then be prepared exactly as described in text (see photo on page 60, right). Photos on this page show (1) various parts, minus pipe, as they appear in relation to one another, and (2) an open-top model without the top ring.

pipe, so check the fit before you mount them permanently. The bottom "feet" are turned on their sides to provide $\frac{3}{4}$ " clearance from the floor and spaced equally between each top rib; the edge and bottom of the base can be painted to match the color of the tile if you wish.

There is no mandatory plan for the top of the enclosure as there is for the bottom. After Part C has been cut out, you are ready to finish off the top as you like. For best results, you should use some kind of treble diffuser, such as the funnel shown in the photos.

Treble Diffuser. The simplest plan is to mount a 3" or 4" funnel on a narrow strip of wood over the speaker. This is done by cutting off the funnel neck at the bottom of its conical section, and screwing the funnel in place with a wood screw and a washer large enough to prevent the head of the screw from going through the funnel neck. Then mix enough plaster of Paris to fill the funnel. If you wish, you can also use some plaster of Paris to fill in any chips or unevenness in the pipe.

To improve the appearance of the enclosure, the ring (Part D) may be used, with the area between Parts C and D as well as the opening in Part D covered with grille cloth and trimmed with "wood tape." Part D is held at the correct

height by three of the nine pieces of $\frac{3}{4}$ " x $1\frac{1}{2}$ " material specified in the Bill of Materials.

A round piece of grille cloth may be cut and tacked under the ring (Part D), and a piece of the $\frac{3}{4}$ " x $1\frac{1}{2}$ " wood about 11" long (Part F) glued and screwed across the bottom of Part D. The funnel, in this case, can be fastened to the cross-piece with small nails in a position that will place it over the center of the speaker, or over the tweeter if you use a coaxial speaker.

It's possible that some kinds of pipe will require more than a 36" length of grille cloth. Of course, if the enclosure is to be set in a corner or against a wall, a slight gap will be no problem. But if all sides are to be visible, you may either have to buy a longer strip of grille cloth or use a vertical strip of wood tape to camouflage the gap.

Wood tape is very easily attached around the top ring (Part D) and the speaker board (Part C) because of its almost paper thinness and complete flexibility; small brads and glue should do the job nicely.

Finishing Touches. Before final assembly, the "Art Foam" which serves as a gasket for the speaker board (Part C) and the base (Part A) will have to be cut and glued in place. In the case of

BILL OF MATERIALS

- 1—3' section of 10"-i.d. sewer pipe, concrete or glazed tile
- 1—15" x 42" sheet of 3/4" plywood (for Parts A, B, C, and D)
- 9—1 1/2" x 4 1/2" pieces of 3/4" pine (for parts labeled E)
- 1—1 1/2" x 11" piece of 3/4" pine (for junnel holder F)
- 1—22" x 30" sheet of 1" polyurethane foam plastic (for lining above filter)
- 1—15" x 30" sheet of 1" polyurethane foam plastic (for lining below filter)
- 1—12" x 36" sheet of 1/8" foam plastic, known as "Art Foam" (for gaskets)
- 1—3' length of vinyl-covered foam plastic weather-stripping (for filter gasket)
- 1—5 1/2" x 36" length of grille cloth (for side grille)
- 1—11"-diameter round piece of grille cloth (for top grille)
- 1—Package of "wood tape" (for top trim)
- 1—4" or 5" plastic junnel (for treble diffuser)
- 1—Small lead swivel casting sinker or other conical plug (for use with junnel)
- 1—8" P.M. speaker
- Misc.—Plaster of Paris, glue, wood screws, licks, brads, additional material for padding, etc. (see text)

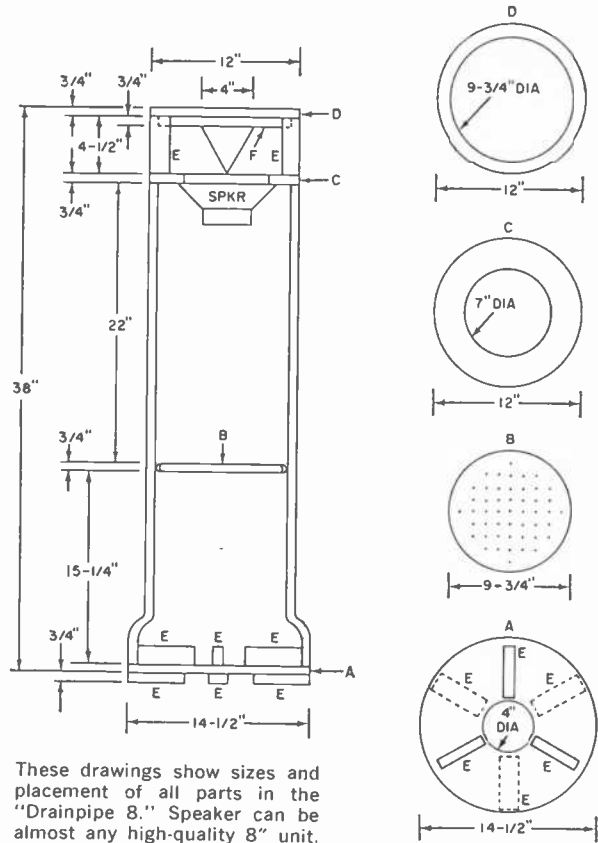

the speaker board, the art foam may be cut to the same diameter as the board and first glued to the entire surface, then trimmed away from the speaker opening. Used this way, it forms an extra gasket for the speaker itself as well as a gasket between the pipe and the board.

The walls of the pipe should be lined with the polyurethane foam plastic both above and below the acoustic filter; it isn't necessary to use glue here unless desired. When the glue has dried on the gasket material, set the pipe on its base, mount your speaker, and you're ready to listen.

A mismatch between your speaker and the enclosure is unlikely, because most good 8" speakers have similar fundamental resonances. If a mismatch should occur, however, there is an easy cure. Simply fill the entire pipe, above and below the filter, with some kind of padding. This will cut down on the efficiency somewhat, of course, but it will also

broaden the "Q" or tuning of the enclosure. Another solution is to tune the pipe as you would any bass-reflex enclosure by covering part of the hole in the base.

Actually, the shape of any enclosure will affect the sound, and the "Drainpipe 8" is no different than any other enclosure in this respect. The acoustic filter does much to eliminate any effects of the round "organ pipe" shape, which in itself is admittedly not ideal. Some people will prefer more padding—just remember to use the minimum amount of padding (except for the walls) that will remove peaks in the response, and you won't suffer any unnecessary loss in efficiency.

Bouquets and superlatives for this neat little system are hardly called for if you keep one fact in mind. Once you get used to listening to this vibration-free setup—as I have, you'll never again be satisfied with makeshift wooden "boxes."

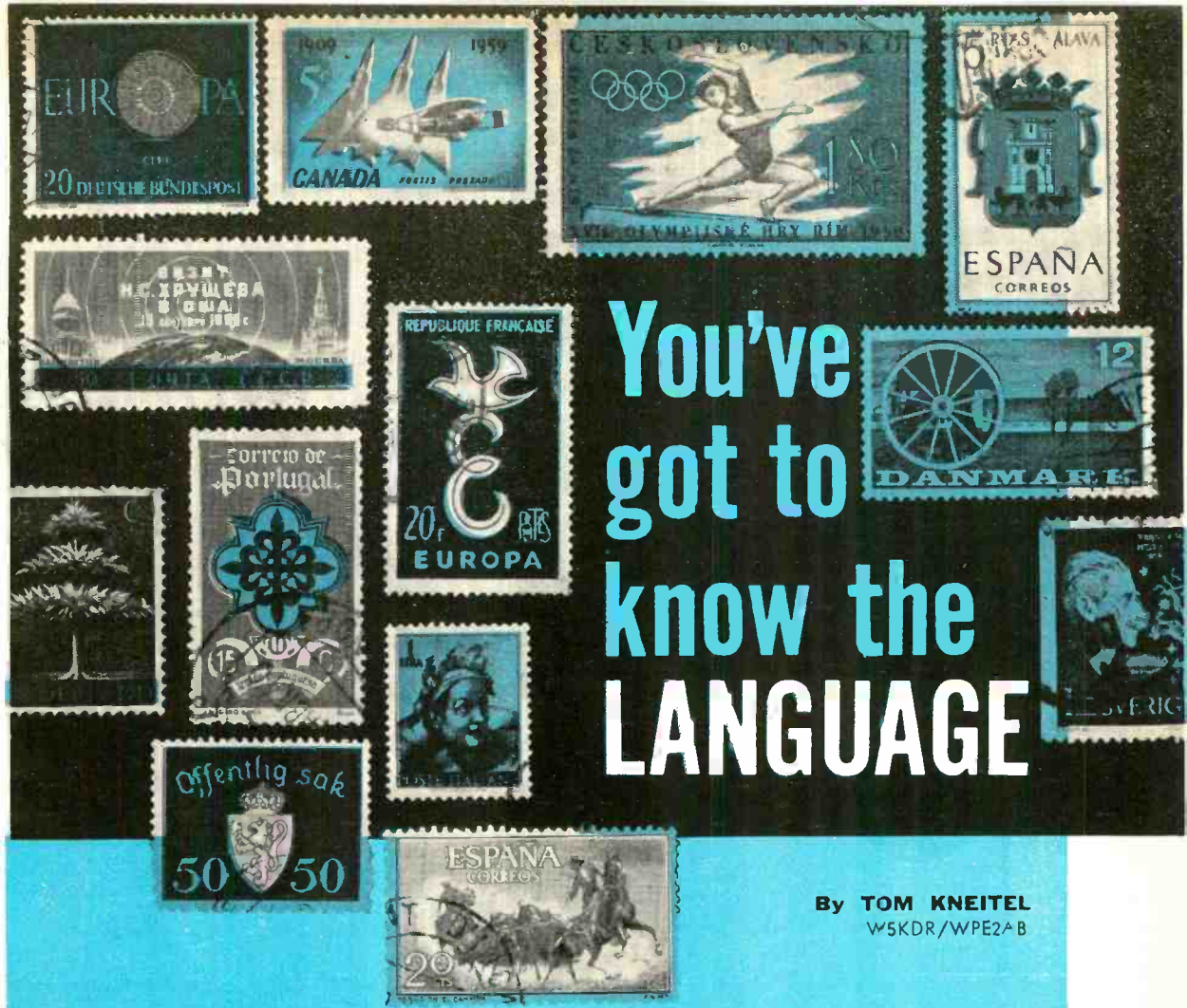

You've got to know the LANGUAGE

By **TOM KNEITEL**
W5KDR/WPE2A-B

Want QSL's from foreign hams? There's one sure-fire way to get them—by writing the ham in the language he speaks!

ANY SWL with even a few months' experience will agree that it's one thing to log a foreign amateur station and quite another to snag that station's QSL. Unlike most of the short-wave broadcast stations—which may actually solicit reception reports and then answer them with government funds, foreign hams usually don't much care if they ever hear from stateside DX'ers.

What's behind this apparent indifference on the part of foreign hams? Just this: they usually already know how well they are being received in the United States by the reports they receive from stations which they QSO here. A report from a U. S. DX'er is not only of very limited value,

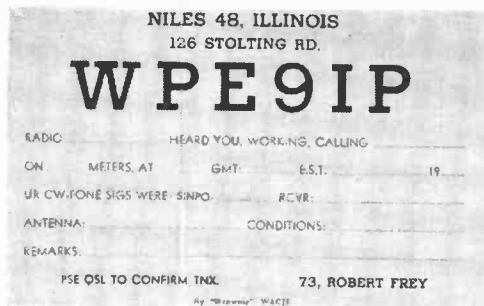

A comprehensive "WPE" card (right) will pull in many more QSL's than a run-of-the-mill card (left).

but a foreign ham has to deplete his QSL card stock and shell out hard cash for postage if he answers it.

Three Steps to a QSL. Obviously, the only possible way to achieve "success" in this field is to make it as easy as possible for a foreign ham to reply. Here are some tried and proven methods.

- First, never—but *never*—send a DX report and expect a QSL unless you enclose an International Reply Coupon (IRC). In case you're not familiar with the term, an "IRC" is simply a coupon which can be bought at most post offices throughout the world. It costs 15 cents in the United States.

Once purchased, the IRC can be exchanged for postage stamps at any other post office in the U.P.U. (Universal Postal Union), which means just about everywhere except in Iron-Curtain countries. And even Iron-Curtain hams appreciate IRC's, since they can be re-mailed to hams outside Russia and her satellites.

- Frequently, there are anguished cries from American DX'ers who send their multi-colored "DX cards" (or "SWL cards") to foreign hams and receive no reply. If you're among those who have a low average of returns, take a good look at your card. Does it contain all the information it should? Is it as neat and attractive as it might be?

For some unknown reason, foreign DX'ers generally have much more comprehensive DX cards than most of their Yankee counterparts. Overseas hams know this and give the old "heave-ho" to cards such as the "WØ-SWL" card above.

Most seasoned DX'ers have found that a "WPE" call sign dignifies their cards and lets foreign hams know that they

belong to the organized DX'ing fraternity. (See page 84 for details on how to obtain your own "WPE" call letters.) Just compare the WØ-SWL card with WPE9IP's card which is shown alongside of it. If you were a ham, which one would you QSL?

- Now here's the gimmick that can be the clincher. Since you have to enclose your DX card inside an envelope anyway (to include the IRC), why not drop the ham a short letter with the card, written *in his own language!* This personal touch will give your report the "plus" it needs

ENGLISH

Dear friend:

I had the pleasure of hearing your fone/CW signals on.....meters at.....GMT on / / . At the time, you called/worked Your signals were SINPO I would very much like to have your QSL. My receiver is a....., and my antenna is.....meters long.

73,

I believe that my first report has not reached you, so I'm writing again as I would like your QSL.

CZECH

Milý příteli:

Měl jsem radost, že jsem uslyšel Vaše zvukové/CW signály na.....metrech ve..... GMT dne / / . Když jste volal/operoval Vaše signály byly SINPO..... Velmi rád bych měl Váš QSL. Můj přijímač jea má antena je.....metrů dlouhá.

73,

Myslím, že jste neobdržel mou první zprávu, a proto Vám píši znovu, ježto bych rád dostal Váš QSL.

S	I	N	P	O
Signal Strength (QSA)	Interference (QRM)	Atmospheric Noise (QRN)	Propagation Disturbance (QSB)	Overall Merit (QRK)
5 Excellent	5 NIL	5 NIL	5 NIL	5 Excellent
4 Good	4 Slight	4 Slight	4 Slight	4 Good
3 Fair	3 Moderate	3 Moderate	3 Moderate	3 Fair
2 Poor	2 Severe	2 Severe	2 Severe	2 Poor
1 Barely audible	1 Extreme	1 Extreme	1 Extreme	1 Unusable

to set it apart from those of other DX'ers. In fact, if you don't have a DX card, the letter itself will suffice.

The English version of one letter you can write appears below, along with translations in a number of foreign languages. Note that each of these letters contains a postscript. If you are sending a "follow-up" (you wrote to the ham once before but received no reply, so you're writing him again), use the original letter *plus* the postscript. Obviously, in writing for the first time, you would *not* use the postscript.

The SINPO System. You'll notice that we've suggested the SINPO method of signal rating in the letters. In case you're not familiar with it, SINPO is an excellent system which was adopted in 1948 by the International Radio Consulting Committee (CCIR) in Stockholm, Sweden. It's much more thorough than the old "RST" method, and many amateurs now use it in preference to "RST."

A typical report in the SINPO system might read: SINPO 45544. This means that the Signal strength was "good," there was no Interference, no atmospher-

Kaere Ven:

DANISH

Jeg havde fornøjelsen at høre Deres telefon/CW signaler paa.....meters, paa.....GMT, paa / / . Da de kallade/arbejdede..... Deres signaler var SINPO..... Jeg ville meget gerne have Deres QSL. Min modtager er en....., og min antenna ermeters lang.

73,

Jeg tror at min første rapport ikke har naaet Dem, og derfor skriver jeg igen, da Deres QSL onskes.

Lieber Freund:

GERMAN

Ich hatte das Vergnügen, Ihre Telephon/CW Signale auf Meter.....um die..... GMT am / / zu hören. Als Sie anriefen/arbeiteten, waren Ihre Signale..... Ihre Signale waren SINPO..... Ich möchte sehr gerne Ihr QSL haben. Mein Empfänger ist ein....., und meine Antenne ist.....Meter lang.

73,

Ich glaube, dass mein erster Bericht Sie nicht erreicht hat, deshalb schreibe ich nochmals, da ich **Ihren QSL haben möchte.**

Beste vriend:

DUTCH

Ik had het genoegen Uw phone/CW signalen te hooren op.....meter om.....GMT op / / . Toen U opriep/transmissie..... Uwe signalen waren SINPO..... Ik zou graag Uw QSL hebben. Mijn ontvanger is een.....en mijn antenne is.....meter lang.

73,

Ik neem aan, dat mijn eerste rapport U niet bereikt heeft. Daarom schrijf ik U nogmaals, omdat ik graag Uw QSL zou willen hebben.

Cher ami:

FRENCH

J'ai eu le plaisir de recevoir vos signaux téléphoniques/CW sur.....mètres à..... GMT le / / . A l'heure où vous appelez/fonctionniez..... Vos signaux étaient SINPO..... J'aimerais obtenir votre QSL. Mon recepteur est un.....et mon antenne a.....mètres de long.

73,

J'ai tout lieu de croire que mon premier compte-rendu ne vous est pas parvenu; je vous écris donc à nouveau et désirerai votre QSL.

Caro amico:

ITALIAN

Ho avuto il piacere di sentire il vostro segnale telefonico/CW su metri.....alle..... GMT il / / . A tale ore avete chiamato/trasmesso..... I vostri segnali erano SINPO..... Apprezzerai moltissimo avere il vostro QSL. Il mio apparato ricevente e une la mia antenna e a.....metri.

73,

Credo che non abbiate ricevuto il mio primo rapporto, così vi scrivo nuovamente perché desidererei la vostra QSL.

Prezado amigo:

PORTUGUESE

Tenho tido o prazér de ouvir seus sinais telefônicos/CW sobre.....metros a..... GMT aos / / . Quando voce chamou/trabalhou..... Seus sinais foram SINPO..... Eu gostaria imensamente de receber sua QSL. Meu receptor é..... e minha antena é de.....metros longa.

73,

Acredito que a minha primeira emissão não tenha sido captada por voce, assim estou repetindo outra vez, pois, desejo receber sua QSL.

Mily Przyjacielu:

POLISH

Imalem przyjemność słyszeć Pana sygnały telefoniczne/CW na.....metrów o..... GMT, dnia / / . O tej porze Pan używał/pracował..... Pana sygnały były SINPO..... Bylbym zobowiązany otrzymać Pańskie QSL. Moj odbiornik jest..... a moja antena jest.....metrów długa.

73,

Mam wrażenie, że mój raport nie doszedł do Pana, idlatego piszę znowu ponieważ chciałbym mieć Pańskie QSL.

Querido amigo:

SPANISH

He tenido el gusto de oír sus telefónicas/CW señales en.....metros a.....GMT del / / . Cuando usted llamó/operaba..... Sus señales eran SINPO..... Me gustaria muchísimo tener su QSL. Mi receptor es un.....y mi antena tiene..... metros de largo.

73,

Creo que usted no ha recibido mi primer reporte, así que escribo a usted de nuevo porque me gustaria su QSL.

Käre vän:

SWEDISH

Jag hade nöjet att höra Edra telefoniska/CW signaler på.....metrar klockan..... GMT den / / . Då Ni kallade/arbetade..... Edra signaler hade varit SINPO..... Jag skulle gärna hava Edert QSL. Min mottagare är en.....och min antenna är.....metrar lång.

73,

Jag tror, att min första rapporten har inte nått Eder, därför jag skriver Eder igen, emedan jag skulle gärna hava Edert QSL.

Дорогой друг,

RUSSIAN

Я имел удовольствие слышать Ваши телефонные (CW) сигналы на метрах в GMT на / / . Когда вы вызывали/работали Ваши сигналы были SINPO..... Я очень желал бы иметь Ваше QSL (ЩСЛ). Мой приемник и длина моей антенны метров.

73,

Я полагаю, что мой первый рапорт не дошел до Вас, поэтому пишу снова, так как я хотел бы иметь Ваше QSL (ЩСЛ).

ic Noise (static), "slight" Propagation disturbance (fading), and that the Overall merit of the signal was "good."

Always report in Greenwich Mean Time ("GMT")—which is also known as Greenwich Civil Time ("GCT"), Universal Time ("UT"), and "Z" time, in some instances. It can be computed by adding 5 hours to local time if you live in the EST (Eastern Standard Time) zone, 6 hours in the CST zone, 7 in MST, and 8 in PST. For Daylight Saving Time (DST), you would add one hour less in each case.

Don't forget that when you reach mid-

night in your computations, you must also correct the date in your report. In other words, 9 p.m. EST, July 18, would go into a DX report as 0200 GMT 19/VII/62. And notice the way the date is written—with the day *first* and a Roman numeral for the month.

Let the ham know what type of receiver you have, and give him the approximate length of your antenna. Remember that non-English-speaking peoples usually measure length in terms of "meters" and not "feet," and that a meter is about 39 inches long.

Good DX'ing—in any language! —30—

Hobnobbing with Harbaugh

The Store



"He wants that one."

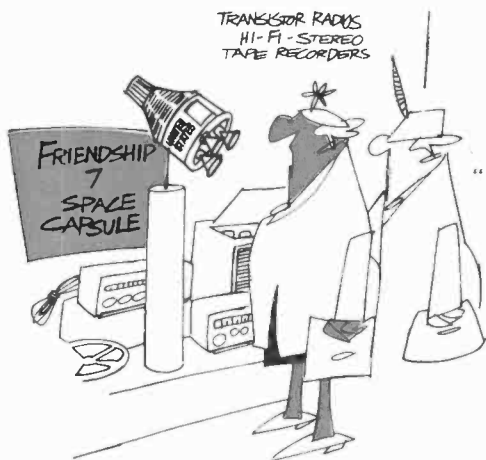

"I had no idea it was so small."

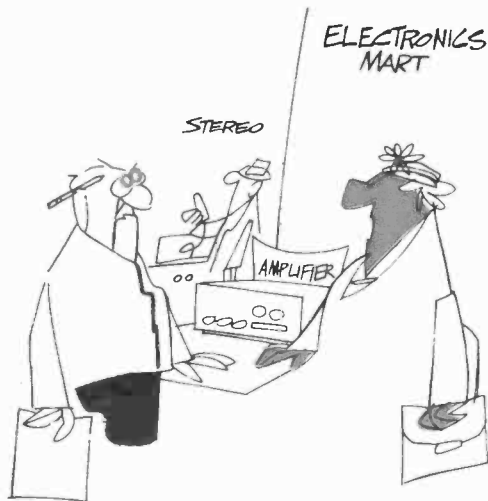

"My husband wants a selenium rectifier, a silicide capacitor, and a 16 nome appleflyer."

"... Madam!"

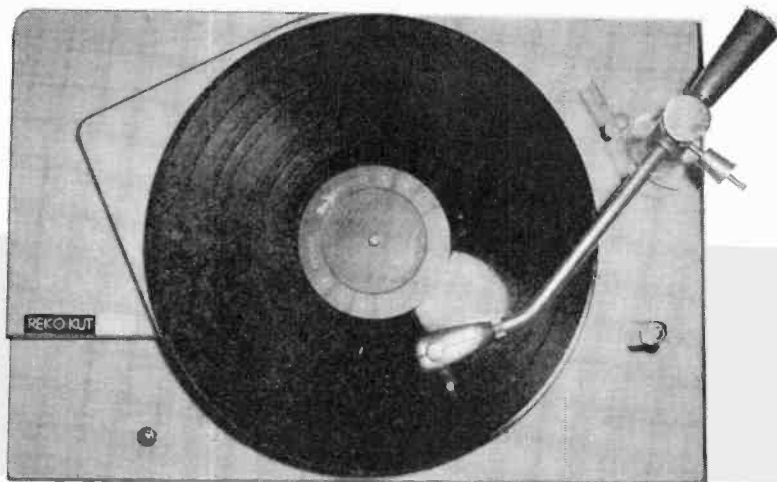

THE TENDER TOUCH

PEOPLE who treasure their records usually insist on having a manual player to play them on. And these people know only too well that it's not an easy matter to place the tone arm on the lead-in groove without damaging the record or stylus assembly—especially in view of the featherweight lightness of today's tone arms.

A perfect solution to this problem is Rek-O-Kut's "Auto-Poise," a well-designed accessory which actually gives you an automatic tone arm. Incorporating a small, clock-type motor, the Auto-Poise can be used with any quality turntable, but the arm must be one of the various Rek-O-Kut models.

With the Auto-Poise installed, a single push-button switch takes care of

everything. Pressing it causes the Auto-Poise to lift the arm from its rest, move it slowly over the lead-in groove, start the motor, and *gently* lower the arm. At this point, the Auto-Poise relinquishes control, and, as long as you don't press the switch, the second half of the cycle won't begin until the record has finished. When it has, the Auto-Poise raises the arm, brings it slowly back over the record, lowers it on its rest, and automatically shuts off the motor.

We found the Auto-Poise extremely smooth and foolproof in operation, and we were particularly pleased with its "tender touch." We think anyone who values records (not to mention operating convenience) will be, too. —30—

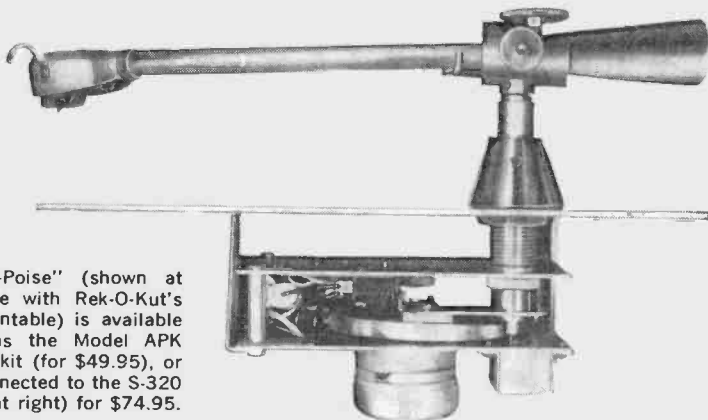

The "Auto-Poise" (shown at top of page with Rek-O-Kut's NL-33H turntable) is available by itself as the Model APK conversion kit (for \$49.95), or already connected to the S-320 tone arm (at right) for \$74.95.



By **FRED BLECHMAN**
K6UGT

*Greater operating convenience, even longer battery life
can be yours by following these hints on how to . . .*



DE LUXE YOUR PORTABLE TAPE RECORDER

THE Model RK-125AL portable tape recorder* is a very useful, practical, and inexpensive unit. Supplied complete with telephone pickup, earphone, patch cord, microphone, 3" reel of tape, an empty reel, and batteries, it's "camera-sized," fully transistorized, and weighs a mere 2½ pounds.

Moreover, the RK-125AL can be modified to increase its versatility beyond that of considerably more expensive units. The changes are easy to make, since the RK-125AL has plenty of spare room and its wiring is very accessible. And, significantly enough, most of the modifications are applicable to many similar tape recorders currently on the market.

*Available from Lafayette Radio Electronics Corp., 111 Jericho Turnpike, Syosset, L.I., N.Y., for \$24.95, plus postage.

About The Unit. A simplified schematic diagram of the RK-125AL, before modifications, is shown in Fig. 1. Note that the oscillator normally found in tape recorders doesn't appear; instead, d.c. bias is applied through resistor *R12* during recording, and the erase function is accomplished by means of a permanent magnet mechanically ganged to the record switch.

Since the motor turns at one speed and in one direction at all times, its drive mechanism is (of necessity) an ingenious tilting platform. The motor actually has a double-ended shaft, with a small diameter at one end, and a larger diameter at the other end.

The "Forward/Stop/Reverse" switch, *S2*, engages one end of the motor shaft with the rubber rim of the proper tape platform for either "forward" or "re-

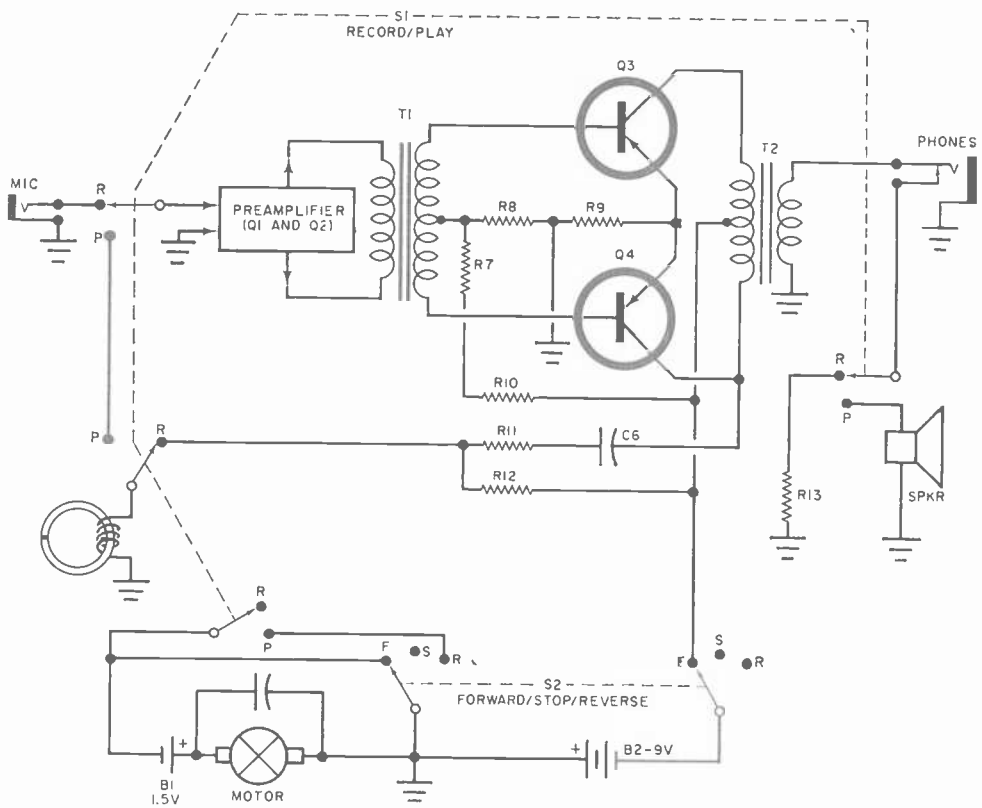

Fig. 1. Simplified schematic diagram of Model RK-125AL tape recorder, before modifications.

verse." Since the "reverse" shaft has the larger diameter, the rewind platform turns faster. When the switch is in the "stop" position, both ends of the shaft are held against both rubber rims by a spring, thus giving positive braking action.

The simplicity of the drive mechanism does create one disadvantage. The tape speed across the head is a function of the take-up reel and the amount of tape accumulated on that reel; therefore, as the amount of tape on the take-up reel increases, so does the tape speed! As a result, this type of recorder isn't "compatible" with a standard 3¾-ips tape machine, since its actual tape speed will vary from about 3 ips to 6 ips from the beginning to the end of a tape.

This disadvantage is compensated for, to a degree, by the built-in earphone jack, which allows direct playback of the RK-125AL into a standard tape recorder to make a "compatible" copy of the original tape.

So much for the unit; now for the conversions!

Reel Monitor. It's always a good idea to see what's going on in a tape recorder, even when its cover is closed. With the RK-125AL, however, the opaque plastic cover doesn't allow you to observe the reels turning or to see how much tape remains on the supply reel. The addition of a small plastic "window" above the supply and/or take-up reel, as shown in one of the photos on the next page, will eliminate this little problem.

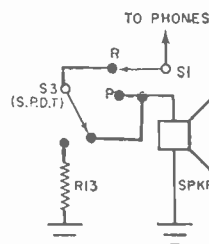
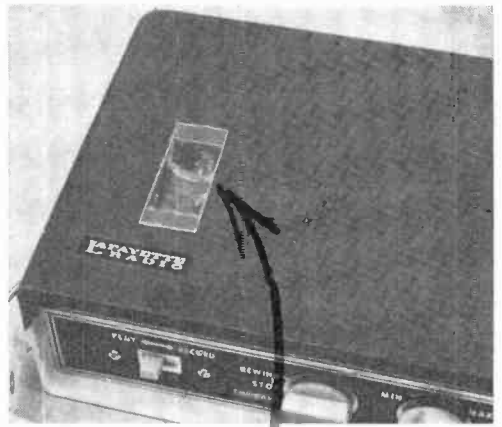

Fig. 2. Installing a s.p.d.t. switch is all it takes to add provisions for speaker monitoring.



Subminiature jack (J2) for monitoring battery voltage can be installed on top of panel.



Plastic windows can be glued in holes in cover over reels to show what's going on inside.

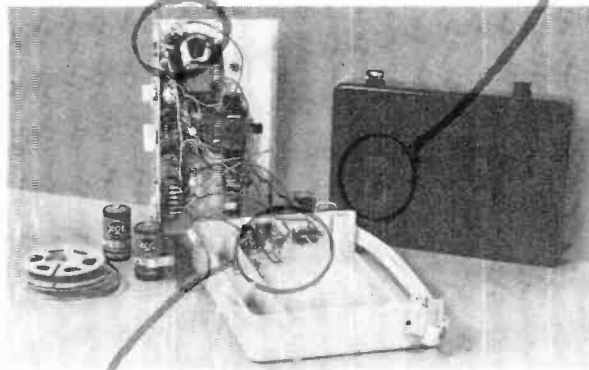

Monitor switch (S3), remote control jack (J1), and speed switch (S4) are mounted on one end of the recorder case.

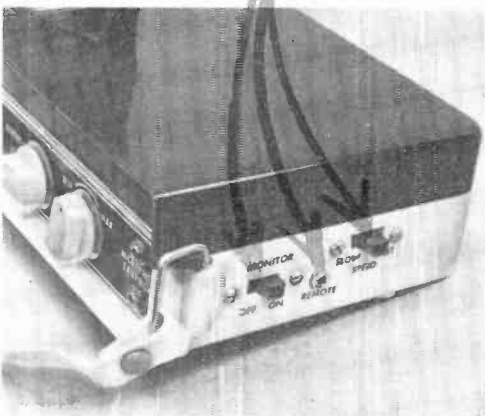

Recording Monitor. Although the RK-125AL already has provisions for ear-phone monitoring, there are many occasions when you may want to use a

speaker to listen to what is being recorded on the tape. Adding speaker-monitoring provisions to the RK-125AL is simple: just install a s.p.d.t. switch (S3), as shown in Fig 2.

In one position of the switch, resistor R13 serves as a 10-ohm "dummy" load; in the other position, the speaker is placed in the circuit.

Keep in mind that feedback will occur when a microphone is used with the monitor "on," unless the mike is kept far away from the speaker and the recording level is reduced. However, such feedback is one sure way to verify that the microphone is working.

If you attach an external speaker, the monitor switch will allow the recorder to operate as a low-power public address system. What's more, when the recorder is used with a telephone pickup (one

comes with the RK-125AL), the monitor switch will permit the recorder to act as a telephone amplifier for group listening!

Dual-Speed Operation. Frequently, you may want to sacrifice fidelity for extended recording time, especially with voice recordings. The recording time of the RK-125AL can be increased by approximately 25% by the addition of a 2-ohm resistor (*R14*), as shown in Fig. 3. This resistor slows the speed of the drive motor, thus slowing the tape speed and extending the recording time for a given length of tape.

The use of a s.p.s.t. switch (*S4*) to short out this added resistor gives the

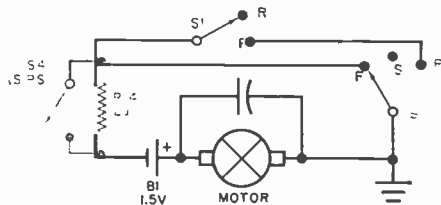

Fig. 3. A resistor (*R14*) and a switch (*S4*) equip your recorder for two-speed operation.

effect of a fast-forward speed, always a desirable feature if you rewind past the intended point. For greatest speed differential, record in the "slow" position, and rewind in the "fast" position.

A bonus feature here is that the motor draws less current when the speed switch is in the "slow" position, thus extending the life of the two 1½-volt batteries.

Remote Control. Often, you may want to transcribe a speech or letter directly from tape to a written or typed page. It's almost mandatory on these occasions to have some form of remote control, such as a hand- or footswitch. Figure 4 shows the very simple manner in which a remote-control jack can be added on the side of the tape recorder.

By plugging any sort of remote switch into jack *J1*, the motor on the tape recorder can be de-energized except when the remote switch is closed. Some slack in the tape will occur when the machine is stopped remotely, of course, but this won't cause any difficulty when you start it again.

It should be noted that when the re-

mote switch is used the amplifier battery will be "on" as long as the function switch is in the "Forward" position. This may shorten the life of the battery if you do a great deal of "transcribing," so you may prefer to use a separate 9-volt battery eliminator—such as the Lafayette F-790, which is available for \$2.95.

Battery Monitor. By installing a jack (see Fig. 5), an external voltmeter can be used to read the voltage of the ampli-

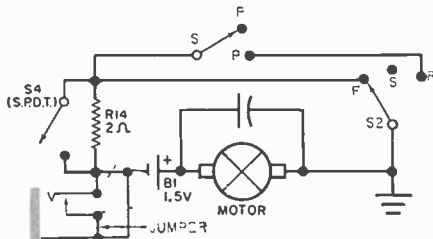

Fig. 4. Subminiature jack *J1* permits remote control with a hand- or a foot-switch.

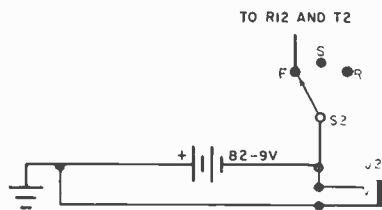
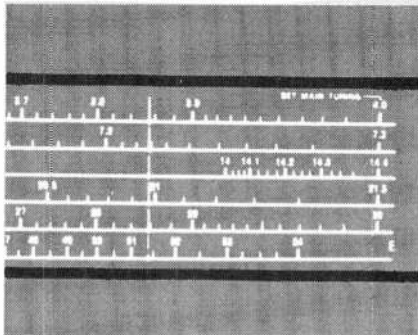

Fig. 5. Another subminiature jack (*J2*) simplifies checking battery *B2*'s voltage.

fier battery under load. According to the instructions furnished with the RK-125AL, battery *B2* should be replaced whenever its output drops to 7 volts with switch *S1* in the "record" position. With jack *J2* added, you'll find checking the battery voltage an extremely simple operation. About the only thing you'll have to do is add a plug to your voltmeter to match jack *J2*.

The changes described above are neither complicated nor expensive, and they involve very few additional parts. Once you've completed them, you'll find that they contribute a great deal toward making this handy little tape recorder even more useful.



Across the Ham Bands

By **HERB S. BRIER**, W9EGQ
Amateur Radio Editor

A WORD TO CITIZENS-BAND "HAMS"

IT'S NO SECRET that many CB operators "ham" on 11 meters. They use the band for rag-chews, random contacts, tests, etc., instead of for necessary short-distance communications as spelled out in the CB regulations. Legitimate users of CB—including doctors, small businessmen, volunteer fire departments, and private individuals—are very unhappy about this situation, since they often have trouble getting their calls through the resulting QRM.

More to the point, the Federal Communications Commission is unhappy too. Violation notices are being issued to guilty CB operators as fast as the comparatively small staff can process them. And the FCC will have to increase its enforcement actions, or perhaps close out the CB service entirely.

If your CB activities are both a hobby and a necessity, why not confine all of your CB transmissions to essential calls and transfer your hobbying to the ham bands? Rag-chewing, DX chasing, experimenting, transmitter hunts, and dozens of activities forbidden to CB'ers are legal for hams. In addition, you can raise your antenna as high as you wish, and use a transmitting power up to 1000 watts (75 watts for Novices).

Unfortunately, too many potential hams react to the suggestion that they get a license by saying, "I'd do it immediately if it weren't for the code part of the test. They tell me that learning the code is just plain murder." Don't you believe it! Learning the code at 5 wpm, the speed required to obtain a Novice or Technician Class license, is really not difficult at all.

With a Novice license, you can use phone or code on 2 meters, and three other bands are open for code use only.

A Novice license is good for one year, after which it expires and is not renewable. During that year, though, you'll have plenty of opportunity to increase your code speed and/or theory knowledge so that you can qualify for a permanent amateur license, such as the Technician or General Class ticket.

It's not necessary to go through the

•••Novice Station of the Month•••



Shown in this month's winning photo is the simple, but efficient, station of Carl D. Fuglein, KN3QNC, 42 Midland Ave., Berwyn, Pa. Carl uses an EICO 720 transmitter, a converted ARC-5 "surplus" receiver, and a 30'-high dipole antenna. He keeps a 1938 Hallicrafters "Sky Buddy" receiver in reserve. Essentially a 40-meter man, Carl operates on a high hill, so he "gets out" well. He prefers "rag-chewing" to chasing DX, however.

Carl will be awarded a one-year free subscription to P.E. for his photo. If you would like to try for a similar award, send us a picture of your station—preferably showing you at the controls, and be sure to include with your entry some information about yourself, your equipment, and your activities. You may be one of the lucky winners. Non-prize-winning photos will also be published as space permits. Entries should be sent to Herb S. Brier, Amateur Radio Editor, POPULAR ELECTRONICS, P. O. Box 678, Gary, Indiana.

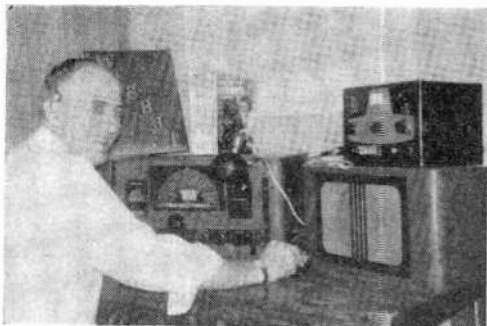

The QSL cards at right are in the shack of Ralph King, KIKOB, Portsmouth, N. H. He collected them by running 12 watts to a Lafayette HE-45 6-meter transceiver.

Russ Jones, WN8BJL, believes that any age is the right age to become a ham. See "News and Views" (page 103) for details on WN8BJL's station.



Novice stage, however, if you'd like to study immediately for a license in the "permanent" category. To find out more about requirements and privileges associated with the various license classes, consult any good handbook for prospective hams. The inexpensive *Radio Amateur's License Manual*, published by the American Radio Relay League, is available at most electronics supply houses.

Getting back to the code, it will also pay you to write for the Army/Air Force booklet: "International Morse Code (Instruction)," TM-11-459/TO-31-3-16. Available from the Superintendent of Documents, U. S. Printing Office, Washington 25, D. C., this booklet costs only 25 cents. In it you'll find much useful material to help you learn sending and receiving.

But the big thing in learning the code is getting started. Buy an instruction book, borrow or buy some code records, rent a code machine, twist the arm of a local ham for help—do anything to get yourself on the road. And remember, 95% of all students learn to send and receive five words per minute in less than 30 hours.

Contest News. Coming up this month are two of ham radio's big yearly events. They are the ARRL VHF QSO Party on June 9 and 10, and Field Day on June 23 and 24. Both activities are expected to attract thousands of participants.

The VHF Party starts at 2:00 p.m., local standard time, on the 9th, and continues until 10:00 p.m. on the 10th. To participate, you call "CQ contest" or answer such CQ's, and exchange ARRL section names with each station you work. You earn one point for each exchange on the 50- and 144-mc. bands, two points on the 220- and 420-mc. bands, and three points on the higher frequency bands. Your final score is the sum of your contact points multiplied by the number of ARRL sections worked.

Field Day is usually a club activity, but any ham or group of hams can participate. Activities start at 2100 GMT, June 23, and end at 2400 GMT, June 24. Each group sets up as many portable or mobile stations as they can handle, and operates them simultaneously—one per band—during any consecutive 24-hour period within the time limits mentioned above. You call "CQ FD" on CW, or "Calling any Field Day station" on phone, and exchange signal reports and locations with each station worked.

See the June issue of QST for complete Field Day rules. And if you plan to participate in either Field Day or the VHF Party, write now to the ARRL, 38 La Salle Rd., West Hartford, Conn., for appropriate log sheets. Mail your scores to the ARRL at the conclusion of each activity—and have fun!

(Continued on page 102)

SPEEDS ARE THEIR SPECIALTY

By JOHN F. AGEE, K5ODN

STROBE LIGHT

This handy tool is almost a "must" for the hi-fi/stereo enthusiast who wants to be sure that his equipment is operating "on speed." You can make your own strobe light by connecting an NE-2 neon bulb in series with a 220,000-ohm resistor to a line cord. After soldering, be sure to cover all bare wires with plastic tape.

STROBE DISC

To check turntable speeds, you'll need a standard strobe disc. Simply hold your strobe light near the strobe disc and follow the instructions supplied with the disc. Your turntable will be operating at the proper speed when the lines on the strobe disc appear to be stationary.

TIMING TAPE

To check tape recorder speeds, pick up a reel of timing tape, such as "Scotch" 43P-1.5 plastic leader and timing tape. Run the tape through the recorder by itself, or splice it into a full reel of tape, and hold your strobe light close to it. The lines on the tape will appear to be stationary when the speed is correct.

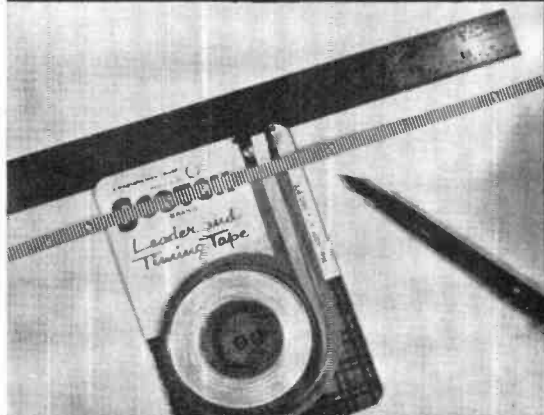
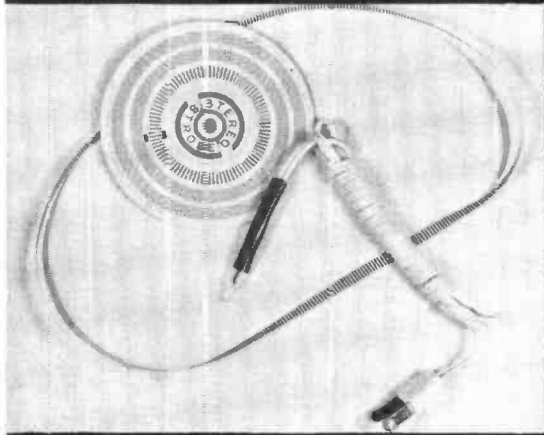
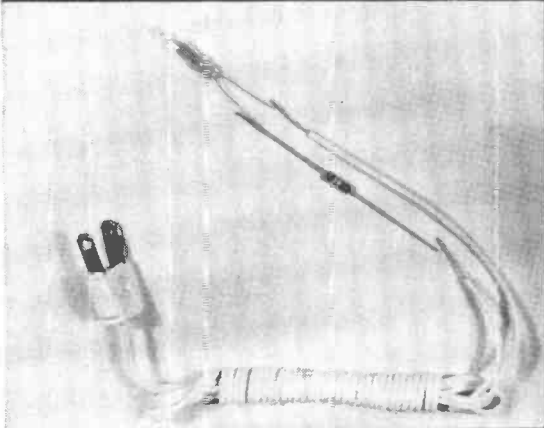

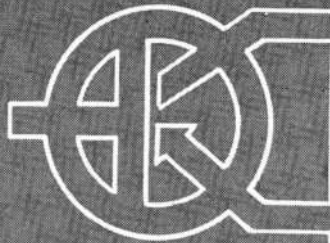

Transistor Topics

By **LOU GARNER**, Semiconductor Editor

DURING the past several weeks, we've looked over a number of transistorized CB transceivers of the "walkie-talkie" variety. By far the smallest one we've examined is the Model HT-2 offered by Keltner Electronics, Inc. (1045 West Hampden, Englewood, Colo.). Weighing but 12 ounces and measuring $4\frac{1}{4}$ " x $2\frac{3}{4}$ " x $1\frac{1}{4}$ " overall (exclusive of antenna), the HT-2 transceiver is only slightly larger than a pack of king-size cigarettes (see Fig. 1).

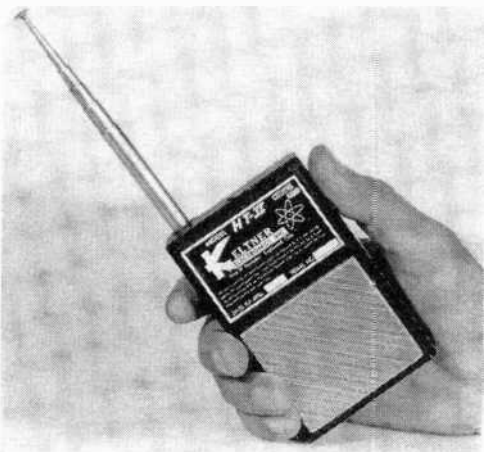

Fig. 1. One of the "Tiny Tim's" of the CB world, Keltner's HT-2 transceiver is a comfortable handful with an input of 100 milliwatts.

In spite of the instrument's small size and light weight, its operating range and general performance are comparable to those of many larger and more expensive units. Its superregenerative receiver has a rated sensitivity of 2 microvolts for a 50-milliwatt audio output, while the transmitter's final stage has an input of 100 milliwatts. In practical tests, the effective range between a pair of HT-2's varied between one-half and one mile, depending on field conditions.

A simplified block diagram of the HT-2 is given in Fig. 2. Five *pn*p transistors are used in the instrument, with operating power supplied by a single 9-volt battery. The antenna is a multi-section telescopic type, extending to 51 inches.

Referring to Fig. 2, the audio section for both the transmit and receive functions consists of a two-stage, transformer-coupled amplifier, *Q1* and *Q2*. The transmitter section is made up of a crystal-controlled oscillator, *Q3*, driving an r.f. power amplifier, *Q4*.

When the HT-2 is employed as a transmitter, audio modulation is applied to

Fig. 2. The HT-2 is a five-transistor transceiver with a two-stage audio section and a d.p.d.t. send/receive switch (S2). Degenerative feedback limits the modulation level to 80%.

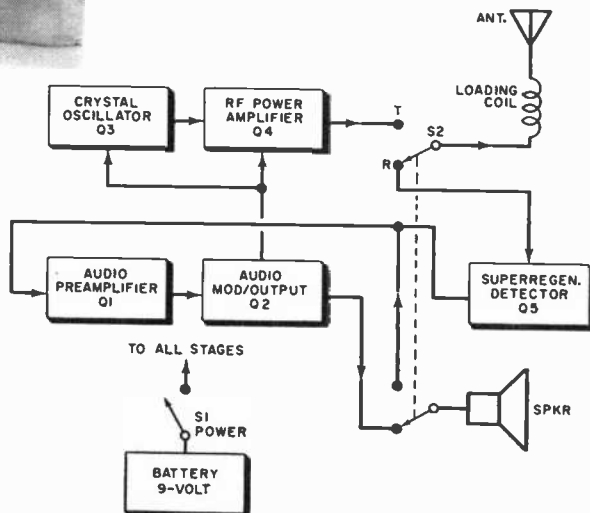

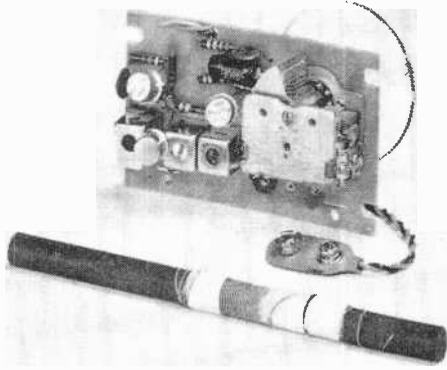

Fig. 3. Olson Radio's KB-138 AM tuner "semi-kit" can be assembled in less than ten minutes.

both the oscillator and power amplifier stages; a degenerative feedback circuit limits the modulation level to 80%, insuring good frequency stability. A single transistor, $Q5$, is used as a superregenerative detector, and the output from the two-stage audio section is fed into the speaker whenever the instrument is switched to its "receive" function.

The Keltner HT-2 is available directly from the manufacturer as well as through authorized distributors, and carries a suggested list price of \$59.95 as a fully assembled and tested instrument. As of this writing, it is *not* available in kit form.

Tuner Kit. An AM tuner kit (see Fig. 3) is now being offered complete with battery for \$4.50, plus postage, by Olson Electronics, Inc. (260 S. Forge St., Akron 8, Ohio). The Model KB-138

tuner isn't really a "kit" in the conventional sense, but rather a completely assembled circuit board to which you attach an antenna coil, battery, and volume control; total "assembly" time should be only five or ten minutes. The completed unit may be mounted in a small case and used with standard 2000-ohm earphones as a self-contained receiver, or, if preferred, as a tuner for a phonograph, intercom, p.a. installation, or hi-fi system.

Referring to the schematic diagram (Fig. 4), the Olson tuner employs three *npn* transistors in a standard superhet circuit. The r.f. signals picked up by ferrite antenna coil $L1$ are selected and applied to a 2N412 used as an "autodyne" converter. Capacitor $C2b$ (with trimmer $C2a$) tunes the antenna coil and is ganged with $C2c$ (and trimmer $C2d$) across oscillator coil $T1$.

The i.f. signal developed by the converter is fed into the first i.f. transformer, $T2$, and coupled to a neutralized i.f. amplifier stage. From here, the amplified signal is applied through the second i.f. transformer, $T3$, to a diode-connected transistor which serves as the receiver's second detector. The resulting audio signal is developed across load resistor $R8$ and coupled to the output through isolating resistor $R7$.

An a.g.c. bias current, representing the d.c. component of the detected signal, is coupled back to the i.f. amplifier through a standard filter network made up of $C6$, $C7$, $C8$, and $R6$. The intermediate frequency is 455 kc.

Physical connections needed for operating the Olson instrument as a broad-

Fig. 4. Schematic diagram of the KB-138 AM tuner. Although the circuit employs three transistors, the one at transformer $T3$'s output is actually diode-connected.

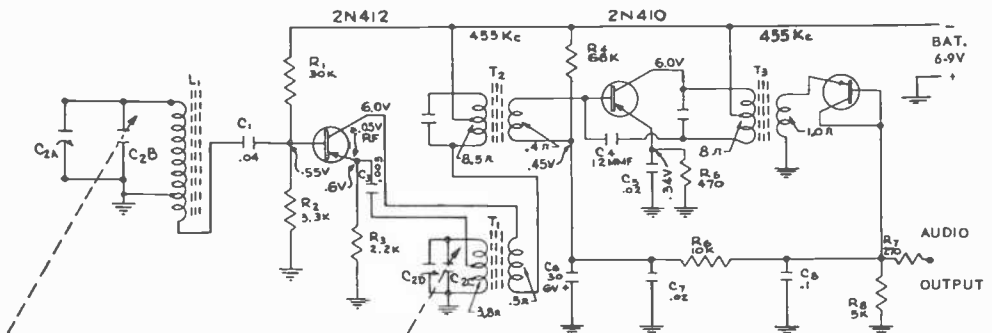

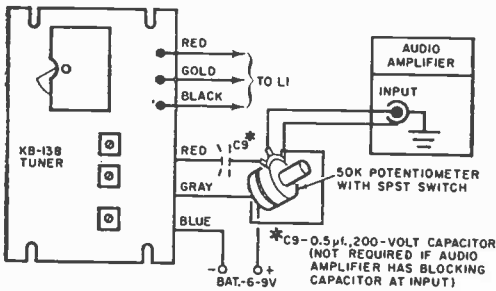
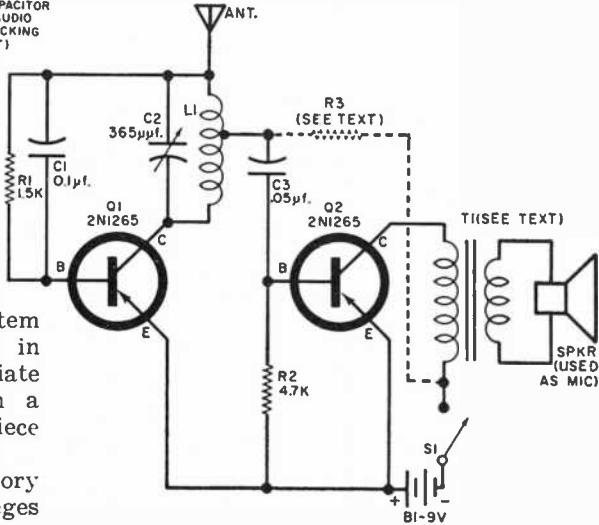

Fig. 5. Hookup of a KB-138 tuner and an audio amplifier.

Fig. 6. Wireless microphone circuit submitted by reader Earl Campbell, Jr., WPE8DVK.



base bias resistor. There doesn't seem to be a source of external d.c. bias for this stage, so we will assume that coupling capacitor $C3$ is slightly "leaky" and acts as a resistor shunted by a capacitor.

The modulator, transistor $Q2$, is con-

cast-band tuner for, say, a p.a. system or hi-fi installation, are illustrated in Fig. 5. A similar setup is appropriate when the tuner is employed with a phonograph, intercom, or related piece of equipment.

Reader's Circuit. An interesting story made the rounds of engineering colleges a few years ago. It seems that the bumble-bee, aerodynamically speaking, is unable to fly. The bee, however, unaware of the finer points of aeronautical engineering, doesn't know it can't fly . . . so it goes ahead and flies anyway!

This story, in a way, applies to the wireless microphone circuit shown in Fig. 6 and submitted by reader Earl Campbell, Jr., WPE8DVK (889 Southwind Dr., Fairfield, Ohio). At first glance, it appears that this circuit will not work, since the microphone preamplifier, $Q2$, seems to be connected in reverse. However, according to Earl, the circuit does work quite well, and he reports an effective range of up to 50 feet with a sensitive receiver, using a straightened wire coat hanger as a transmitting antenna. If you decide to build this circuit, keep in mind that it's strictly an experimental hookup, although of special interest because of its novel and unusual design.

Referring to the schematic diagram, $Q1$ is connected in the common-emitter arrangement as a modified Hartley oscillator, with its frequency determined by tuned circuit $L1/C2$. Resistor $R1$, bypassed by capacitor $C1$, serves as the

nected in "reverse" when compared to a standard arrangement, in that the input signal from the speaker used as a microphone is applied to its collector-emitter circuit, while the modulating output signal is obtained from the base-emitter circuit. If we examine the arrangement in detail, however, we see that the oscillator's return tap (from coil $L1$) to ground is through resistor $R2$, shunted by transistor $Q2$'s base-emitter circuit. Thus, any signal in $Q2$'s collector circuit which is reflected back to the base-emitter circuit will affect the oscillator's ground tap, achieving some degree of modulation.

Since all parts are standard, the circuit can be duplicated quite easily for experimental tests. Capacitors $C1$ and $C3$ are small ceramic or paper units, while $C2$ is an ordinary 365- μf . variable capacitor. Resistors $R1$ and $R2$ are $\frac{1}{2}$ -watt units, and transistors $Q1$ and $Q2$ are both 2N1265's. Output transformer $T1$ is designed to match a 1000- or 2000-ohm load to a speaker voice coil; almost any PM speaker can be used as the microphone, but most experimenters will
(Continued on page 98)

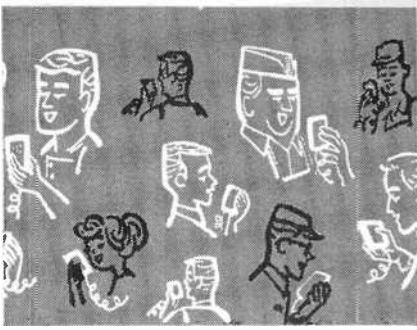

On the Citizens Band

with **DICK STRIPPEL**, 2W1452, CB Editor

WITH summer just "around the bend," one thought comes to most CB'ers—"skip" is on its way back. Although this season's distance haul won't be as good as last year's because we are entering a period of low sunspot activity, it's pretty certain that skip will still cause some trouble.

We all know the regulations covering DX operations on the Citizens Band—they're illegal! But what do you do if your message must get through, and you're being clobbered by someone half a continent away? The answer is simple—you just have to wait it out until the skip station's "five minutes" is up.

Unless you have a real honest-to-goodness emergency situation going on (by this we mean a true threat to life or property), *don't* try to contact the skip station and ask the operator to stand by. The first notation on the back of your FCC license makes this point quite clear.

Clean-Up Time. The beginning of summer is also a good time to "house-clean" your rig, especially the mobile set. Quite

a bit of dust and dirt can accumulate in a mobile rig, especially if it's located under the dash and near the output of your car's heater.

Start your clean-up by removing the chassis from the set. Take out all the tubes (remember where they came from) and clean them with a damp cloth. Next, take a soft brush (a 1" paint brush is excellent), and brush out all the dirt under and on top of the chassis.

Then visit your parts distributor and buy a container of "control cleaner." Apply it as directed to the volume control, squelch control, all switch contacts, and the bearings of your "receive" tuning capacitor. If your transceiver has any relays, you can clean their contacts easily with a few strokes of a burnishing tool.

If the chassis of your set appears to be covered with a thin film of grease, it can be removed by applying denatured alcohol with the soft brush. Denatured alcohol is probably the best and cheapest solvent you can get, and it doesn't leave a harmful residue.

After the set is completely cleaned and the tubes replaced, check it out. In all probability, this simple clean-up procedure will raise your received signals by as much as one "S-unit."

Tech Notes. Is there a theoretical limit to the distance at which a 5-watt signal can be picked up? In theory, no; in practice, yes.

If you took high-school physics, you may remember a formula which states that light reaching a surface is diminished four times each time the distance between the light source and the surface is doubled. The same formula, slightly modified, also holds true for radio waves. Even though attenuation is severe, the power from a 5-watt transmitter will never *theoretically* reach zero, no matter

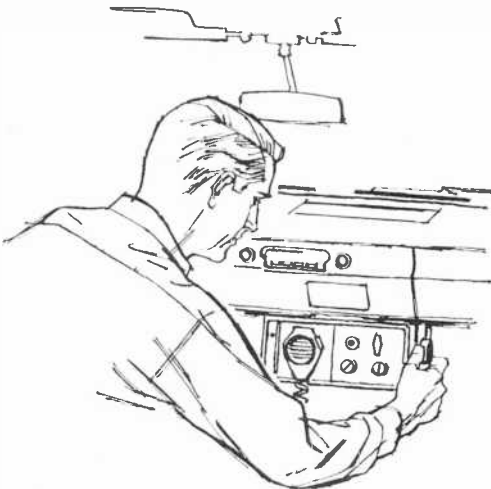

how far the receiver is from the transmitter.

Obviously, there are several practical "flies" in this particular "ointment," or stations on the east coast would continually be hearing stations from the west coast, and vice versa. The first "fly" is that radio waves, at our frequencies, behave like light rays most of the time, in that they travel in a straight line. Since the earth is a sphere, the waves will fly off into space unless something forces them back down. Sunspot activity can create the force necessary for the waves to follow the bending of the earth.

The second "fly" is the noise level near the receiver. If the noise level is high (as with a mobile set operating in a car with unsuppressed ignition), the overall sensitivity of the receiver will be drastically cut.

A third "fly" is the noise generated in the receiver itself. The flow of electrons through a circuit—any circuit, and even a minute flow of a few micromicroamperes—causes noise. The very act of the received signal flowing through the antenna and its lead contributes some noise. And vacuum tubes, with much larger currents flowing through them, cause more noise.

In practical circuits, this noise can be held to a minimum. However, several other factors besides noise enter the picture, the most important of which is receiver selectivity.

We worked out the practical range of a CB signal, using a "modified" version of the radiation formula outlined above. Assuming a 5-watt transmitter putting out a little over three watts, and an average receiver (a superhet with one r.f. and two i.f. stages), the distance came to a little less than 3000 miles. This figure, of course, represents "straight-line" distance.

The moral of the story is quite obvious: if you're having poor results in your area, the trouble-spots are likely to be the locations of the antennas or perhaps the antenna systems themselves. If you can't move your station (and most of us can't), do your best to make your antenna systems—probably the weakest links in your setup—function with as much efficiency as possible. Here, your trusty friend, the field strength meter, can be of immeasurable assistance to you.

New Products. To test a mobile rig on the bench when the rig doesn't have its own 117-volt a.c. power supply, the Rae Co., Inc., 1351 Deloss St., Indianapolis 3, Ind., is producing a 6- and 12-volt supply which will operate from your regular 117-volt a.c. line. The unit is fused, and has enough filtering to produce "pure" direct current. It's capable of delivering up to 3 amperes of d.c., and it can also be used for charging batteries.

Lafayette Radio Electronics Corp., 111 Jericho Turnpike, Syosset, L. I., N. Y., has added the HE-55 "Squelcher" to its CB line of equipment. The "Squelcher" is a noise eliminator and squelch which is designed to improve reception on all superheterodyne receivers; it's especially



valuable in mobile operations. And while specifically manufactured for Lafayette's own line of transceivers, the HE-55 can be adapted for use with any superhet.

Club Notes. Nine southeastern CB clubs joined forces recently to insure the success of a March of Dimes "telethon." The 18-hour program, broadcast over WCYB-TV (Channel 5) in Bristol, Va., went out to a large area in western Virginia and eastern Tennessee. Each city in this area maintained a telephone office where viewers could call for a CB'er to pick up their donations. In addition, a CB unit was placed at the TV transmitter site atop Holston Mountain to receive half-hourly reports from the units at the various telephone offices in the area.

A total of 166 CB units took part in the telethon collection net; they put in 1992 hours of operating time between 11:30 p.m. and 5:00 p.m. the following afternoon. Localities represented in this

(Continued on page 110)

Sounds You Didn't Hear

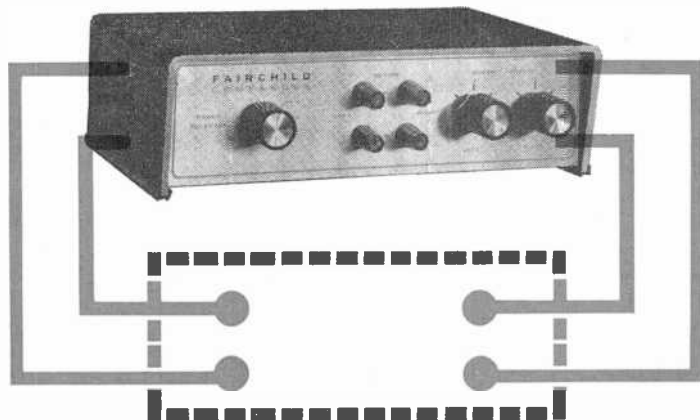

Unique compressor/expander from Fairchild restores suppressed subtleties to recorded and broadcast sound

VOLUME compressor/expander circuits date way back to the 1930's, and no audiophile who knows his decibels will deny the need for them. Recently, a new unit operating on a new principle arrived on the audio scene—Fairchild's "Compander." And, frankly, we're as impressed with this little black box as we've been with anything else since the advent of FM stereo.

Why is volume compression and expansion so important to realistic sound reproduction? Because the dynamic range of music is literally fantastic—so fantastic, in fact, that recording engineers have never been able to capture all of it *without* the aid of compressor/expander circuits.

By way of explanation, all recordings must be made at a certain minimum level or low-level passages will be swallowed up in "background" noise. And once this level is fixed, high-level passages—the floor-shaking finale of Tchaikovsky's "1812 Overture," or the lively "I'm Getting Married in the Morning" from "My Fair Lady"—are too loud to handle.

This means that every recording—whether disc or tape—is necessarily "limited" or "compressed," and so, too, are

all broadcasts. In playback or reception, some means to restore these "missing sounds" is clearly a "must."

Fairchild's Compander supplies this important function. Connected between your preamp and main amplifier or to an integrated amplifier, it decreases the gain of your system by 6 to 8 db.

Then, thanks to a unique circuit using neither tubes nor transistors, the internal resistance of the Compander changes whenever a loud note comes along, "re-inserting" varying amounts of the original 6 to 8 db loss. The result: restoration of the full dynamic realism to records, tapes, and FM broadcasts.

The Compander requires no power source of any kind, and you can change from volume expansion to volume compression at the flick of a switch. There are separate controls to govern the amount of expansion or compression on either channel, and four indicator lamps show precisely what the unit is doing.

Available factory-wired (for \$75.00) or in kit form (for \$59.95), the Compander is easily the best compressor/expander we've seen to date. In fact, we think this is one device that no serious audiophile will want to be without. —30—

COIL FUNCTION QUIZ

Coils used in electronic circuits often acquire special names which roughly describe their chief function. See if you can match coil drawings A - J with the "names" below.

By ROBERT P. BALIN

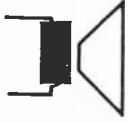

A

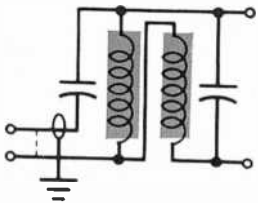

B

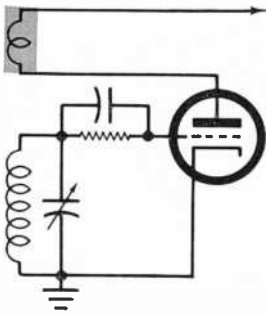

C

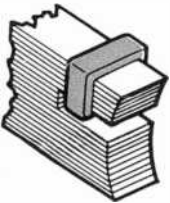

D

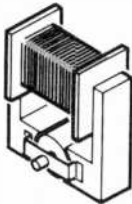

E

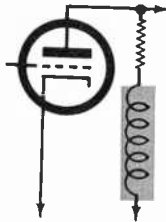

F



G

1 Deflection coil

2 Tickler coil

3 Relay solenoid

4 Loading coil

5 Quadrature coil

6 Voice coil

7 Field winding

8 Balun

9 Peaking coil

10 Shading coil

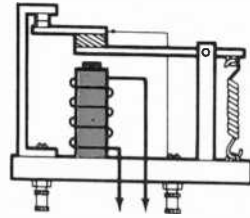

J

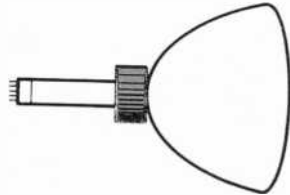

I

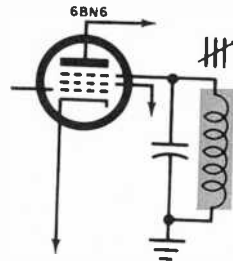

H

(Answers on page 99)

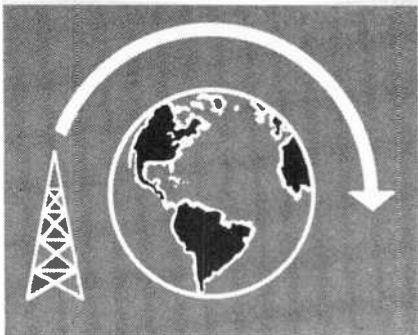

Monthly Short-Wave Report

By **HANK BENNETT**, W2PNA/WPE2FT
Short-Wave Editor

WITH THE CLUBS

YOUR Short-Wave Editor is frequently asked to give brief résumés on newly organized clubs. Some of these clubs may be completely bona-fide, in good "operating condition," and ready to accept any number of new members. Other so-called "clubs" are nothing more than a couple of DX'ers who have gotten together and decided to form a club. The latter usually last anywhere from a few days to a month or two, after which little or nothing is heard of them.

While we have no personal objection to publicizing new clubs—quite the contrary, as a matter of fact—we cannot do so until they have "proven" themselves. We have had experiences with clubs that accepted dues and then suddenly disappeared; fortunately, incidents of this type are few and far between. So, if you and your friends have formed a club, bear in mind that we will be glad to mention it in this column as soon as you

have become fully organized and able to accept a large number of new members.

Two of the newer clubs that have recently arrived on the radio scene are the MDXSWRC (Midwest DX Shortwave Radio Club), 2100 West William St., Decatur, Ill., and the CADX (Canadian DX Club), 24 Briscoe St. West, London, Ontario, Canada.

The Editor of the MDXSWRC, David Gants, WPE9ABH, informs us that his club is currently issuing a multigraphed bulletin averaging 8-10 pages and covering the broadcast, ham, and short-wave broadcast bands, utilities, and card swappers. Future plans include a country list, foreign-language and special amateur-type report forms, awards, and special club SWL cards. The dues are \$2.50 yearly, and Midwesterners in particular are invited to join.

Fred Woodley, of the CADX, writes

English Newcasts from Abroad

STATION	FREQUENCY (kc.)	TIMES HEARD (EST)
Leopoldville	11.755	1700-1714
Rome	9575	1930-1940
Hilversum	21,565	0900-0915
Cologne	15,275	0900-0915
Ankara	9515	1815-1825
Brussels	6140	1900-1915
Madrid	9360	2215-2230 2315-2330 0015-0030
Brazzaville	15,190 11,725	1430-1450 2015-2030
Moscow	*	*

**Schedule changes without notice. Frequencies used at time of compilation: 7150, 7180, 7390, 9570, 9620, 9650, 9680 and 9770 kc. Newcasts given every hour on the hour (roughly) from 1900 to 2300, and sometimes at 1930 and 2230.*



Harry Perlow, WPE2FOM, Brooklyn, N.Y., does most of his listening with a Knight-Kit "Span Master," but he also uses a 6-meter receiver occasionally. His three antennas include a 100' long-wire, a dipole, and a loop antenna. To date Harry has 12 countries verified out of 18 countries logged.



David Brown, WPE8ANS, Hico, W. Va., owns a National NC-60 receiver. David is another DX'er who boasts three antennas; the small box on his desk is for switching to any one of them. So far he has logged 59 countries, 22 of which are verified.

that his club is sending out an 8½" x 14" bulletin averaging around 14 pages and covering the BCB, ham, and SWBC bands, FM, utilities, QSL and tape swappers, contests, and technical items. Complete membership requirements may be obtained from Mr. Woodley at the address given above.

We would also like to remind you that

copies of our free leaflet H (Clubs and Publications) are still available. If you'd like to have one, write to your Short-Wave Editor at P. O. Box 254, Haddonfield, N. J., and enclose return postage.

Guatemala Stations. Last month we gave you the first part of a complete and up-to-date listing of short-wave stations in Guatemala compiled by Jack Perolo (PY2PE1C). Here are the remainder of these stations. As before, the number in each case indicates the frequency in kilocycles. You will note that reference is sometimes made to stations which were listed in the May issue.

6200 TGKN, *R. Novadades*, 17C. 16-21, Zona 10, Guatemala City. Formerly a 100-watt short-wave outlet; now operating as *R. Latina* in the standard broadcast band. New address: 12 Av. 30 C., San Pedrito, Guatemala City.

6200 *R. Tikal*, Peten. Known to have been wandering within the frequency range listed, but not heard at present. **6300** Reportedly off the air because of economic trouble.

9668 TGNB, *R. Cultural*. (See 5952.5-kc. listing.) Operation dual to the 49-

(Continued on page 104)

SHORT-WAVE MONITOR CERTIFICATE APPLICATION

To become a Short-Wave Monitor registered with POPULAR ELECTRONICS, just follow these simple directions:

1 Fill out the form below. (You must be a short-wave listener presently active in the hobby to be eligible for a Short-Wave Certificate.)

2 Send us 10 cents in coin to cover the cost of the certificate as well as the handling and registration

costs. If you live outside the United States and cannot obtain U. S. coins, send either 15 cents in Canadian currency or two International Reply Coupons (IRC's).

3 Insert the application form, coins (or IRC's) and a stamped, self-addressed envelope in another envelope and mail it to:

Monitor Registration, POPULAR ELECTRONICS
One Park Avenue, New York 16, N. Y.

(Please Print)		Ham Call-Area Prefix	
Name	
Address		City	Zone
.....		State	
Receivers	Make	Model
	Make	Model
Principal SW Bands Monitored	Number of QSL Cards Received	
Type of Antenna Used		
Signature	Date		

a Carl and Jerry Adventure



By
JOHN T. FRYE
W9EGV

PURE RESEARCH REWARDED

CARL AND JERRY were driving home from an electronic buying expedition to Center City on a beautiful warm June afternoon.

"Sure feels good to be driving again," Carl remarked, caressing the steering wheel. "I think I missed our car more than anything else down at school."

"Being cut off from Mom's cooking gave me that empty feeling," Jerry countered; "but if you want to keep on driving you'd better get some gas. That gauge has been bumping the pin for the last ten miles."

A couple of minutes later Carl pulled into a wayside filling station and stopped at the pumps. Two men in ordinary sports clothes were working on a car in the wash-and-lube area. Finally one of them, wearing an ill-fitting attendant's cap, came out to the car.

"Dollar's worth of gas, and you better check the oil and water," Carl said as he stepped out to stretch his legs. The

man put the nozzle into the gas tank and started the pump.

"Hey, we only wanted a dollar's worth!" Jerry exclaimed as he saw the little register wheels on the pump race past two dollars.

"Don't worry, Buster, you won't have to pay for it," the attendant said as he pulled a large-caliber snub-nosed revolver from his pocket and trained it on Carl. At the same time, what felt like the muzzle of a similar weapon was pressed against the back of Jerry's neck by the other man who had approached unnoticed.

"Get into the station and see that you make it snappy," the man wearing the cap ordered.

The boys were marched through the display room of the station into a small customers' lounge. Lying on the floor with his bare head resting in a small pool of blood from a cut over one eye was a bound, middle-aged man wearing

an attendant's uniform. His eyes were closed, and he was not moving.

While the bareheaded man kept a gun trained on the boys, the one wearing the attendant's cap tied their hands behind them, pushed them roughly down on a sofa, and started tying their legs securely. Things had happened so fast that neither Carl nor Jerry had uttered a word since they first stared into the yawning mouth of that short-barreled revolver.

"You boys just stopped at the wrong time—for you," the man with the cap said as he jerked at the ropes to see if they were tight. "We may need to get out of here fast, and if we can't get our car ready in time we may have to use that beetle of yours. Keep quiet and you won't get hurt. Bill, turn on the radio for our guests. Turn it up loud. That way no one will hear them if they're stupid enough to yell and make me come in here and silence them permanently."

The bareheaded man turned on a radio resting on a table beside a portable TV set. The other man, who was apparently the leader, grabbed up a telephone and jerked the cord loose from the wall button. "Just in case," he said mockingly, brandishing the telephone, as he and his partner left the room. He slammed the door behind them, and locked it.

At the sound of the banging door, the man lying on the floor groaned and opened his eyes.

"Boy! Am I glad to see you move!" Carl exclaimed soulfully. "I thought you were dead. What's going on around here?"

"Men escaped convicts . . . Going to kill Judge Granger, who sentenced them, when he comes at four o'clock for regular weekly service check . . . Had their car on lift when they told me . . . Managed to let it down with front tires on couple of big spikes . . . Hit me on head with pistol barrel . . . Have to change tires before. . . ." His voice died away as he lapsed into unconsciousness again.

"We're in a spot," Jerry offered. "I can't imagine their leaving any witnesses after they kill the judge."

"So let's do something about it," Carl suggested as he strained against the confining ropes. "I bunched my muscles while he was tying me, and that leaves

a little slack. Scoot over here so our backs are together and help me try to work my hands loose."

THIS sounded easier than it actually was; but, spurred on by the dark prospect Jerry had mentioned, the two boys finally managed to untie Carl's hands. In a few seconds he had freed his legs and had untied Jerry.

"Shall we untie *him*?" Jerry asked, pointing down at the unconscious man.

"Not yet. Being tied makes no difference to him, and he can't help. If we hear them coming back, we may be able to pretend we're still tied up and surprise them; but it won't work if they see him untied."

"Surprise won't help much against two men and two guns," Jerry pointed out. "That window is barred like a jail cell. The bars are intended to keep burglars out, but they do a fine job of keeping us in. Sure wish he hadn't thought to take that 'phone."

"Hey, maybe if we short-circuit the telephone wires, the operator will notice something's wrong and send someone to investigate."

"No good," Jerry objected. "She'd just think something was shorting the line and would cut it loose from the switchboard. Late in the day as it is, a repairman wouldn't be sent out until tomorrow. Even if one did come, he would only be tied up, slugged, or killed. If only we had some way of talking over that line—" his voice trailed off and his eyes took on the glassy look of concentration. "Keep an ear to the door," he told Carl as he slipped a penknife out of his pocket and began hurriedly removing screws from the back of the portable TV receiver.

"We're in luck!" he said a few min-



FREE!

WORLD'S BIGGEST KIT CATALOG!

SEND FOR YOUR COPY TODAY!

You'll find hundreds of low-cost, easy-to-build Heathkit products in this value-filled catalog... the world's largest and most complete! Over 250 different Money Saving kits are shown with complete descriptions, schematics, big photographs and full specifications. Send for your copy today! Save up to 50% of the cost of comparable products by doing the easy assembly yourself! All kits are fully guaranteed and available on no money down terms! Use the handy coupon below.

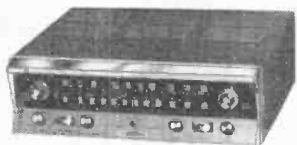

DELUXE FM STEREO TUNER: Brilliantly engineered. AM, FM and built-in FM Stereo Multiplex. Indicator light signals when FM stereo is being broadcast! Adjustable AFC and FM squelch; tuning meters, circuit boards.

Kit AJ-41...no money down \$11 mo. **\$119.95**
Assembled AJW-41, \$18 mo. **\$189.95**



CB TRANSCEIVER: Low-cost, two-way radio! Crystal controlled superhet receiver and transmitter; squelch and automatic noise limiter; Push-to-Talk microphone; built-in AC power supply; provision for plug-in DC supply.

Kit GW-12A (AC only) 8 lbs \$5 mo. **\$39.95**
Kit GW-12D (AC & DC) 11 lbs \$5 mo. **\$44.95**



MARINE RADIO TELEPHONE: Factory wired and tested! 50-watt transmitter. 5 crystal-controlled transmit and receive channels. Covers 2-3 mc marine and standard broadcast bands. Built-in vibrator power supply. An outstanding value! 25 lbs.

Assembled MWW-11A, no money down, \$24 mo. **\$259.95**



TUBE CHECKER KIT: Latest design. Tests all tubes including Compactron, Nu-vistor, Novar and 10-pin miniatures! Built-in roll chart. Individual tube element switches. Perfect for service. 11 lbs.

Kit IT-21...no money down. \$5 mo. **\$44.95**



SSB MOBILE AMATEUR TRANSMITTER: 90 watt input, 80 through 10 meters, crystal bandpass filter, dual conversion heterodyne circuitry, automatic level control, switch selection of USB, LSB and CW, VOX or PTT operation. 19 lbs.

Kit HX-20, No money down, \$19 mo. **\$199.95**



HEATHKIT
by Daystrom

World's oldest and largest manufacturer of do-it-yourself electronic kits



HEATH COMPANY
BENTON HARBOR, MICHIGAN

All prices and specifications subject to change without notice.

HEATH COMPANY

Benton Harbor 10, Michigan

Please send my free copy of the 100 page 1962 Heathkit Catalog

Name _____

Address _____

City _____ Zone _____ State _____

utes later. "The output transformer is mounted on the speaker, and the leads are easy to reach."

A couple of slashes of the penknife severed the two leads going to the primary of the transformer, and Jerry quickly stripped the insulation from the ends of the wires. Next he jerked a floor lamp plug from the wall socket and cut off the wire at the base of the lamp. The length of lamp cord thus obtained had all four wire-ends stripped of insulation, and the wires at one end were twisted around the bared transformer leads. A handkerchief was placed between the wire splices to keep them from shorting together.

Then Jerry removed the cap from the telephone junction button on the baseboard and connected one of the lamp cord wires to one of the screw terminals. When the other wire was touched to the other terminal, the hum of the dial tone came clearly from the speaker of the TV set.

"What are you doing?" Carl demanded.

"We're going to try to use the speaker of the TV set for both the microphone and earphone of a telephone," his friend replied. "You hear it working as the earphone now. When sound waves in the room here vibrate the speaker cone, the voice coil moves back and forth through the strong field of the speaker's permanent magnet. This generates alternating currents in the voice coil that flow through what is normally the secondary of the output transformer and induce corresponding currents in the primary. Since the transformer has a turns ratio of 30 or 40 to 1, the feeble voltages across the voice coil are amplified 30 or 40 times in the primary. The output voltage across the primary will still be considerably less than the output of a carbon-button-microphone-and-transformer combination, but I'm praying it will be enough for the job."

"That was a dial-phone. How are you going to dial?" Carl asked.

Jerry shut his eyes to concentrate and bumped his forehead with the heel of his hand to jog his memory. "I've got to remember how that telephone works," he muttered. "When the handset is on the cradle, the line is open-circuited to the 50 volts or so of d.c. present. A large capacitor and the ringer coils are in se-

ries across the line so the bell will respond to an a.c. ringer voltage. When the handset is picked up, the earphone, carbon-button mike, and the primary of the induction coil are connected in series across the line, and this drops the d.c. voltage to less than ten volts.

"When you put your finger in a dial opening," Jerry continued, "and pull it down against the stop, the line is short-circuited. As you release the dial, the spinning mechanism first disconnects the receiver-mike combination so you don't hear the clicks of the dial operation; and the line is open-circuited momentarily once for every unit in the number dialed. When the dial stops, the earphone-transmitter combination is reconnected and the short circuit is removed from the line."

"You'll never be able to do all that by just touching a pair of wires together," Carl said in a discouraged voice.

"I don't think I have to. I believe it's the amplitude and timing of the open-circuit pulses that work the automatic relays. I'm hoping I can dial by simply breaking the connection once momentarily for every unit dialed. Move that radio away from the TV set and be ready to explain the situation if I get someone on the line. Talk as loudly as you dare and right into the speaker. The book says 'Information' is 13; so I'll try for her. Ready?"

AT A NOD from Carl, Jerry lifted one of the leads off the connecting screw and replaced it instantly. There was a click in the speaker, and the dial tone disappeared. A gleam of hope shone in Jerry's eyes at this, and he jerked the wire back and forth rhythmically three more times. There was a clicking sound in the speaker; and then, after an agonizing pause, a woman's voice said faintly but clearly, "Information."

"Hello. Can you hear me?" Carl asked.

"Please speak louder," the woman's voice directed.

"Listen carefully. This is an emergency," Carl said, raising his voice as much as he dared. In a few sentences he explained the situation, told where they were, and asked the girl to contact the state police at once. The alert operator repeated all the information as a double-check, and Carl okayed it.

Jerry quickly unfastened the wires from the wall button, stuffed the line cord into the back of the TV receiver, and propped the back cover in place. Then he and Carl sat down on the sofa and looped the rope back and forth across their legs with the ends of the loops tucked between their limbs, so that to a casual glance they looked as though they were still tied. The clock on the wall said four o'clock.

A few minutes later the key turned in the lock, and the boys barely had time to thrust their hands behind them before the man with the cap came into the room. "Still here, huh?" he said. "I just wanted to be sure. We won't need your car after all. We have a couple of new tires mounted, courtesy of our friend there on the floor. Now, as soon as we take care of a little business, we shall be on our way, if you don't mind—and we'll make sure you don't mind! Guess I better check those ropes."

Jerry could feel Carl's body tensing beside him as the man took the revolver from his pocket and moved toward them, but at that instant the other man's voice called from outside: "Get out here, Carney! The judge is coming down the road!"

Carney's face twisted in a cold smile of anticipation as he turned on his heel and strode from the room. He closed the door but did not stop to lock it.

"We were too late with our call," Carl groaned, throwing off the ropes and turning down the radio so they could hear. Jerry already had the door open a crack and was looking through it at the driveway of the filling station. A gray-haired man in an old but well-cared-for businessman's coupe had stopped in front of the open door of the lubrication stall.

"Frank, the regular man, took sick suddenly," Carney was explaining glibly. "We're filling in for him. He told us to take good care of you, and we certainly intend to. Just drive in there on the lift, and we'll get started."

"Well, all right," the elderly man said after a little hesitation. "Frank always has me back onto the lift because it's easier to check the transmission that way. You two stand at either side and kind of guide me."

"They'll kill him as soon as they get him inside," Carl whispered. "We can't

First with professionals
who know performance

poly-comm "n"

CB TRANSCEIVER

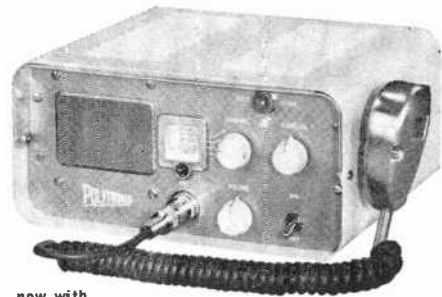

now with
RF NUVISTOR
STAGE for
matchless range

- Dual Conversion Superhet Circuit
- Sensitivity — .1 for 6 db S/N
- Super Sensitive Stable Squelch
- 60 db Adjacent Channel Rejection
- 70 db Image Rejection
- Better than 3W Power to 52-72 Ohm Antenna
- Advanced Design Noise Limiter

You'll see the new Poly-Comm N — or hear it discussed — wherever pros gather. It's been selected alike by stars of the entertainment world and by farmers, by engineers and boat captains, by outdoorsmen and by families out for fun.

The reasons for this wide appeal are simple: The Poly-Comm N — successor to the 11-G, and incorporating an advanced RF Nuvistor stage — has been engineered to provide the best CB performance on the market, regardless of price. It incorporates the most advanced circuitry for optimum performance in continuous duty. Engineered to withstand shock, vibration, high humidity and other rugged use-conditions, it has the range, power, selectivity, low noise, high rejection, and convenience of operation and maintenance that make it demonstrably superior for every CB application.

Mail Coupon for Important Data
To Guide You in Your CB Investment

Sirs: Please send complete data on the Poly-Comm N 27 mc transceiver by return mail.

NAME _____

ADDRESS _____

CITY _____ STATE _____

Intended use _____

POLYTRONICS LAB inc. 388 Getty Avenue
CLIFTON, NEW JERSEY



**SELL YOUR USED
EQUIPMENT Through
POPULAR ELECTRONICS'
Classified Columns!**

The 400,000 readers of **Popular Electronics** are interested in your used electronic gear or components. If you have something to sell, let the readers of **Popular Electronics** know about it through the classified advertising columns. It costs very little—**60 cents a word**, including your name and address. Minimum message—10 words.

For
further
information
write:

Martin Lincoln
POPULAR ELECTRONICS
One Park Avenue
New York 16, N. Y.

just stand here and let it happen. When I give the word, let's rush them. Grab one of those tire tools lying on the floor as you go through the door. It's not much to go against a gun, but it's all we've got. Ready?"

Before Jerry could answer, an astonishing thing happened. The big trunk lid of the judge's car flew up to reveal two state troopers crouched inside holding sawed-off shotguns trained on the astonished convicts. The hands of the latter shot above their heads as though jerked by puppet strings.

A state patrol car roared around the curve and screeched to a halt on the driveway. It was closely followed by an ambulance, and in a matter of minutes the two handcuffed convicts were on their way back to prison and the injured station attendant was on his way to the hospital.

LATER, taking advantage of the relative quiet that followed the crisis, the troopers explained to the boys how a cruiser just down the highway had received the information about the events at the gas station by radio, and how they had intercepted the judge and explained the situation to him. The old man had bravely insisted on the plan used in order to save lives. Carl and Jerry, in turn, tried to explain how they had used a TV set to talk on the telephone; but the state troopers were still scratching their heads in puzzlement as the boys drove away.

"I'm puzzled by one thing myself," Carl admitted as he pulled the car onto the highway. "How come you know so much about how a telephone works?"

"That's an unexpected dividend on pure research," Jerry answered with a grin. "One day three or four years ago, when my folks were conveniently away, I did some voltage and resistance measuring on our telephone and traced out the circuit printed inside the case. I had no notion whatever of using the information. I was just curious."

"Well, your curiosity possibly saved four lives—including two pretty important to us," Carl remarked. "In the future, when one of my Profs urges me to study something just for the sake of knowing it, I'm going to remember this day."

—30—

CB RADIO —Canadian Style

EVER since U. S. citizens were granted the Class D Citizens Radio Service back in 1958, a good many Canadians have been anxious to have a Citizens Band, too. Their hopes turned into fact in April when the Department of Transport (Canada's equivalent to the U. S. Federal Communications Commission, among other things) established the General Radio Service.

Under provisions of the General Radio Regulations, Part II, companies which are incorporated within the British Commonwealth, and persons who are either (1) British subjects or (2) landed immigrants of Canada may apply to the Department of Transport for a license in the General Radio Service. When this license is granted, the licensee (or any person over 15 years old who is also a British subject or a landed immigrant and who is authorized by the licensee)

can engage in 2-way phone communications within Canadian territorial limits.

As in the U. S., communications are restricted to business activities or personal affairs and are confined to ground-wave coverage. Transmissions in the Canadian service can be on any one of 19 channels between 27.005 and 27.225 mc. (corresponding to U. S. channels 4 through 22, inclusive).

The station call-sign must be transmitted at the beginning and end of each "exchange of communications" as well as at the end of each test transmission. And, much like U. S. regulations, communications are limited to five consecutive minutes, followed by a "lapse of two minutes" or "until interference will not be caused to other stations using the same frequency."

A license, incidentally, costs the licensee \$3.00 and is good for "three years following the first day of April of the fiscal year in which it is issued." For the purposes of this provision, a "fiscal year" is defined as a "twelve month period commencing on the first day of April and ending on the 31st day of the March following." —50—

The new Seco SIGNAL FILTER eliminates ignition equipment interference, steep wave front "hash" and background noise. It's the smallest, most rugged noise limiter and controllable squelch on the market. A dual high mu triode

- Increases reception range—in many cases up to several times.
- Produces effective quieting operation without audio distortion—even on very weak signals.
- Filters out noises from your own and passing vehicles without costly suppression installations.
- Make listening easier—increased intelligibility reduces fatigue.
- Defies vibration, shock, dust and dirt—encapsulated electronic circuit assembly.
- Adapts to most CB transceivers using tubes—all AM superheterodyne receivers with 6 or 12 volts AC or DC and 150 volts "B" power supply—mobile as well as base stations.

and dual diode circuit electronically clips noise pulses out of your signal.

Simple installation instructions with easy-to-follow two-color schematics included with each SIGNAL FILTER. See your electronic supply dealer—or if he doesn't have the SIGNAL FILTER, send in the coupon below.

SECO ELECTRONICS, INC.

1223 S. Clover Drive, Minneapolis 20, Minn.

Please send (Qty) _____ SIGNAL FILTERS postpaid
 check money order for \$ _____ (\$15.88 ea.)
 is enclosed.

PRINT

NAME _____

ADDRESS _____

CITY _____ STATE _____



POP'tronics Bookshelf

ESSENTIAL CHARACTERISTICS

by the General Electric Receiving Tube Department

The ninth edition of *Essential Characteristics*, a handbook on receiving tubes, television picture tubes and replacement capacitors, provides several completely new listings. Now included are the characteristics of G.E.'s new line of 430 "universal" replacement capacitors (used to replace more than 2000 standard types), cross-reference listings of the prototypes of "Five-Star" high reliability tubes and other special-purpose types (bringing the number of tubes listed to 1736), and the various G.E. service aids and technical publications. Like the previous editions, the book contains typical characteristics curves, tube outline drawings, circuit diagrams, and construction data for loudspeaker enclosures.

Published by the General Electric Co., Owensboro, Ky. 300 pages. Soft cover. \$1.50.



ELECTRONIC EQUIPMENT MADE EASY FOR THE BOAT OWNER

by John D. Lenk

John Lenk, co-author of the 3-part "Electronics Schools" article which was concluded in the April issue of POPULAR ELECTRONICS, has written this book to help boat owners get acquainted with marine electronic equipment. Presented in non-technical language, but reinforced with over 80 photographs and drawings, the text explains how to select, install, and use radiotelephones, radio direction finders, depth sounders, automatic pilots, radar and loran, and fuel-vapor detectors. A discussion of appropriate equipment for various types of boats is

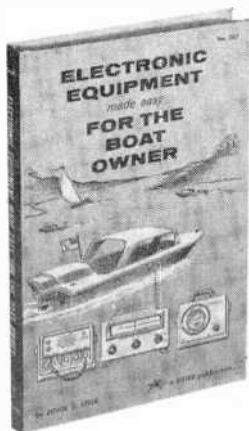

included, as are sections on power requirements and wiring, corrosion prevention, and emergency repairs. An appendix lists broadcast station locations and frequencies, and there's a glossary of electronic terms.

Published by John F. Rider Publisher, Inc., 116 W. 14th St., New York, N.Y. 200 pages. Hard cover. \$5.95.



AUTO RADIO MANUAL, Volume 14

by the Howard W. Sams Engineering Staff

The 14th volume in the *Auto Radio Manual* series provides service data on sixty auto radio models that were introduced in 1960-1961. Like the previous manuals in this series, the new one includes schematic diagrams, resistance charts, and chassis photos. In addition, detailed information on parts replacement, alignment, and push-button adjustments

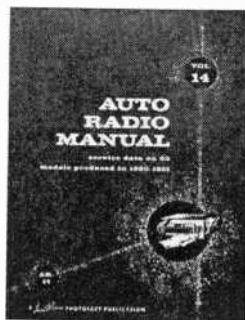

is given, as well as much other time-saving material. The following brands are alphabetically represented in the book: American Motors, Automatic, Blaupunkt, Buick, Chevrolet, Ford, Lafayette, Mopar, Motorola, Oldsmobile, Opel-Rekord, Pontiac, Riverside, and Stromberg-Carlson.

Published by Howard W. Sams & Co., Inc., 1720 East 38th St., Indianapolis 6, Ind. 160 pages. Soft cover. \$2.95.

New Literature

A 144-page "Spring and Summer Catalog and Sales Book" has been published by Radio Shack Corp., 730 Commonwealth Ave., Boston 17, Mass., which is free for the asking. The catalog covers a variety of hi-fi, stereo and electronic components as well as general merchandise. Some new "Realistic" components are introduced for the first time.

A new data sheet on National Radio Company's NC-155 amateur band receiver can be obtained free by writing to National Radio Company, Department RP, Melrose 76, Mass. The sheet gives full technical information and illustrates and discusses all important features of the receiver. -50-

What's Wrong with FM?

(Continued from page 48)

the United States). And pop music men feel that last year's decline in pop record sales was a direct result of tapes being made off the air by young Germans!

Although most West Germans have grown calloused to the continued blandishments of East German propagandists broadcasting on FM, they are quite willing to listen to—and record—vocal and instrumental recitals, concerts by East German orchestras, and performances of operas by the East Berlin or Dresden opera houses from East German stations. As it happens, the Communists have cornered much of Germany's best musical talent through the simple capitalist expedient of outbidding West German opera houses, broadcasters, and orchestras for their services.

"If the broadcast originates with the station to which you're listening," says a music lover in West Berlin, "the quality is, if anything, superior to that of *SFB* or *RIAS*, both of which have beautiful new transmitters and record-playing equipment."

The U.S.S.R. If Western Europe is doing this well with FM, how are the Russians doing? According to Russian engineer B. F. Fediuk (mentioned earlier), FM has replaced AM in most urban centers in the Soviet Union. A ring of low-powered FM stations provides the main news, weather, entertainment, and propaganda service for each major city. The ring serving Moscow, for example, said to be 50 miles in diameter, covers suburbs and nearby cities as well.

These FM transmitters pick up and re-transmit each other's programs, much as the Concert Network does in the United States. This means that programs of local origin are transmitted with a frequency spread of 50-15,000 cycles. However, relays of programs over long distances—the 500 miles from Moscow to Leningrad, for example, or the 400 miles from Kiev to Odessa—are left to a few 100- to 150-kw. AM stations supplemented by low-quality telephone lines. The former also service listeners in Russia's vast rural areas.

Canada. Nor is all of the progress in FM taking place in Europe. Canada claims only one-twentieth as many FM stations as the United States—yet it has one of the longest FM networks on the continent. Linked together by first-class telephone land lines are government-owned stations in French/English speaking Montreal and Ottawa, and in English-speaking Toronto.

"The problem," says Laurence Wilson, one of the Canadian Broadcasting Corporation's FM network program directors, "is to satisfy not only all types of listeners, but to provide programs which will satisfy two different language groups, each of which has its separate and distinct culture."

The CBC is solving the problem by keeping the FM network primarily for good music, with annotations in both French and English.

Until recently, the three stations which make up the FM network duplicated the CBC's AM programming. "We decided, two years ago," says Wilson, "that the growing number of people who own FM sets were entitled to hear something different. We asked ourselves what FM could do that AM couldn't, and the answer was high-fidelity music. So we spent money on first-class telephone lines and first-class equipment."

And the United States? To sum up, FM has already replaced AM as a primary program source in the population centers of the Soviet Union, and it threatens to do so throughout much of Western Europe. But American broadcasters

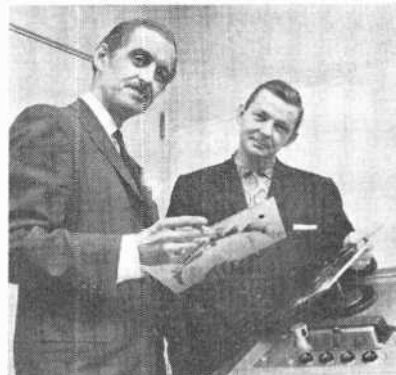

Laurence Wilson (left), English-language service coordinator of Canadian Broadcasting Corporation's FM network, discusses programming with announcer Bill Lorne.

have yet to establish the first national FM hi-fidelity network, or to put FM to some of the imaginative uses it has abroad.

Does this mean that American FM is hopelessly outclassed by its international competition? Not at all, in the author's opinion. But action must be taken *now*—by the broadcasters, by the Federal Communications Commission, by sponsors, and by FM listeners.

The FCC has shown great interest in recent months in helping FM become a truly national service. Currently, the Commission is studying an overall plan for future station allotment which will guarantee to listeners of each FM station a signal free from interference by other nearby stations. In the same vein, the agency is trying to determine whether continued duplication of the same program on AM and FM fills a public need and can further the growth of FM as a separate communications medium.

What can be done to improve FM broadcasting? Is there some way to help American FM come of age? Here is an eight-point program designed by the author to help America's privately owned FM stations keep pace with government-owned networks abroad.

- Use FM rather than AM as a primary program source in American urban centers where a limited signal can reach large numbers of people. Such practice will immediately improve the technical quality of much of American radio. By switching to FM, many of the daytime-only AM stations which serve the suburbs of our larger cities can provide their listeners with true high-fidelity sound.

At the same time, the withdrawal of these stations from the AM band will enable a few high-powered AM stations to provide an interference-free national broadcast service for listeners in smaller towns and cities as well as on farms. The daytime-only stations will benefit by being able to extend their broadcast schedules into the evening hours and thus extend their areas of coverage.

- Set a maximum period of ten years for the above changeover. During this period, manufacturers should be given tax incentives to produce AM/FM radios, tuners, and consoles. Such incentives would lower the prices of combination

units to the public, thus encouraging people to buy them. Broadcasters would be free to duplicate programming on both AM and FM, but would be required to drop one service or the other before the end of the ten-year period.

- Establish and actively police minimum standards for FM. Despite existing regulations, many an FM station today is overmodulating its signal. In others, distortion is at an intolerable level. Better than half of all FM stations on the air fail to transmit frequencies much above 8000 or below 100 cycles; since one of the purposes of FM is to transmit a full-frequency signal, why should broadcasters transmitting only a limited-frequency signal be allowed precious space in the FM spectrum?

- Encourage the growth of FM networks—not just small regional webs, crossing a state line or two, but truly national networks, which would allow a listener in Seattle or Santa Barbara (Calif.) to enjoy the Metropolitan Opera live and in stereo; or to hear a similar broadcast in New York originating from the Hollywood Bowl. Such networks could be set up today in one of three ways: by direct FM relay from station to station, by microwave relay, or by Class-A telephone lines. Live programming should be an important part of FM—and it can be, if broadcasters will cooperate to finance a network or lend their facilities to direct relays.

- Insist upon good, live programming. If the AM band has become the home of rock-and-roll, much of the FM band is nothing more than a classical juke box. American radio listeners are entitled to more than Bach or a beat—they're entitled to network news, to public service features, to quality comedy, to serious discussion, to plays, to exchange programs from abroad.

The Federal Communications Commission has a responsibility to the public to insure that would-be broadcasters not merely copy a successful program format, but provide some of the things now missing from radio. The job of producing some of these programs is too big and too expensive for any one local station. But a number of them could produce such material by forming a cooperative or a network.

- It would seem to be incumbent on the

Federal Communications Commission to see that those it licenses to broadcast have the financial resources to provide a varied diet of program material; that they be able to afford first-class broadcast equipment; and that they have the resources to cooperate with other broadcasters in creating network facilities. It would also seem to be incumbent on others in the industry to encourage station managements to use profits for furthering technical facilities and/or providing better programs.

● The FCC has authorized stereocasts on a permissive basis—i.e., a station may stereocast if it desires, but it need not do so. Would it be improper for the FCC to ask, on its license renewal forms, just how much stereocasting a station has done and how much it plans to do? At the same time, action by the public in the form of letters to broadcasters and local sponsors would help put more stereo on the air.

● There are several ways American FM stations could finance these developments and improvements—one of which would be by using secondary multiplex

carriers for supplementary services. A number of stations are already using these channels for background music services. A very few are using them to relay programs from station to station.

The National Broadcasting Company has pointed the way toward another profit-making, useful service—special programs of news and music for doctors. This idea could be expanded to provide services—or at least programs—for any number of similar groups, such as daily legal news for lawyers, a running commentary from the floor of stock exchanges for the nation's brokers; a special service for beauticians, and so on. Not only would it be a mistake from a revenue point of view to let these side channels go to waste; it would deny an otherwise useful service to a number of minority groups.

In short, FM was developed and pioneered in America. But unless American free-enterprise broadcasters are careful, European government-owned systems will leave them even farther behind in its use and future development. *Now* is the time for planning and action! —50—

LEARN

electronics theory this easy way.
No previous technical knowledge required.

BUILD

the finest professional quality TV Set
on a practical "pay-as-you-wire" plan.

SAVE

up to 1/2 on cost of equivalent
educational course plus TV set.

Build the Transvision "Professional" TV Kit described below and get this complete course of study for **\$7.95** (available only to Transvision Kit builders.)

Requires no previous technical knowledge. Prepared by experts in teaching novices about electronics.

YOU LEARN: About block diagrams... How to read and follow electronic circuits... How to use basic measuring instruments... Theory and operation of basic electronic circuits... How to service TV, Radio, and other types of electronic equipment





Prices range from \$119 to \$199.

The Transvision "Professional" TV Kit
Choice of 19", 23", or 27" Picture Tube... Easy "Pay as You Wire" Terms... Only \$15 for the Starting Package.

ASSEMBLY MANUAL—\$2.00
See how easy it is to assemble the Transvision Kit. Cost of Manual refunded on purchase of Kit.

A few of the **Professional Quality Features of Transvision TV Kits:**

Choice of push-pull 10-watt audio or output to your Hi-Fi System... D.C. restoration... Ultra linear sweep circuits... New Standard Coil Model PKO Automatic Tuner... Super-sensitivity for fringe areas... Complete line of Accessories for Custom Installations.

START NOW — MAIL THIS COUPON —

TRANSVISION Electronics, Inc. Grey Oaks Ave., Yonkers, N.Y. Dept. PE-L6

Send Free 12-page Catalog Enclosed is \$2 for Assembly Instructions so that I might see how easy it is to assemble the Transvision Kit. I understand that this will be refunded if I purchase a kit.

Enclosed is \$15 for the Starting Package. I understand that I can buy packages one at a time as I wire. (Models range from \$119 to \$199.)

Name..... Address.....
City..... Zone..... State.....



**Grey Oaks Ave.
Yonkers, N.Y.**

U. S. Armed Services and over 4000 schools and colleges have selected Transvision Receivers for educational television.

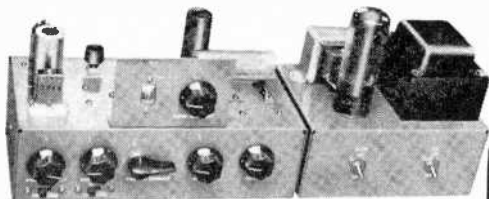

Simple Sidebander

(Continued from page 57)

mount *C10* about $1\frac{1}{4}$ " back from the front panel, so this capacitor must be provided with an appropriate extension shaft.

A 2-terminal tie point located midway between *C10* and *C16* supports coil *L4*. Slip coil *L3* inside *L4*, being careful to prevent shorts between the turns of the two coils. After soldering $1\frac{1}{4}$ " leads to battery *B1*, connect it between the *C12* end of *L4* and ground (positive lead grounded).

Mount *V2*'s socket with terminals 3 and 4 nearest the rear wall of the chassis. Install ground lugs close to terminals 1, 3, 5, and 7. Very short leads are used for the connections between the socket and the lugs. The power cable enters the chassis through a grommet-lined hole in the rear wall above the socket and terminates at a nearby 4-lug (one grounded) terminal strip.

A couple of 1-lug terminal strips support coil *L6* above the chassis. Leads to the coil pass through $\frac{1}{4}$ " holes drilled near the terminal strips and lined with grommets. An "L"-shaped bracket, the front dimensions of which are $2\frac{3}{4}$ " x 4", is fabricated from scrap aluminum to support meter *M1* and potentiometer *R12*. Choke *L7* is connected between a 1-lug terminal strip near *R12* and a ground lug fastened under one of the bracket mounting screws.

The construction of the Simple Sidebander's power supply is not critical and needs no special comment. Just follow the schematic diagram and use the photograph as a guide for the parts layout.

Adjustments. Meter *M1*, the r.f. output indicator, is the only instrument needed to make all tests and adjustments. When *R12*, the meter sensitivity control, is set

at minimum resistance, even a slight amount of unsuppressed carrier will deflect *M1*'s needle. By increasing the resistance of *R12*, the sensitivity can be set at a point where the full transmitter output can be safely handled. From time to time during the tune-up process, you'll find it necessary to adjust *R12* in order to keep *M1*'s needle near mid-scale, the position where changes in output are most readily noted.

To ready the transmitter for testing, set *R12* and *R17* for minimum resistance and gain, respectively, set *C1* and *C11* for maximum capacitance, and turn *L1*'s adjustment control fully counterclockwise. Then switch *S1* to "Tune" and *S2* to "Off," and connect the coaxial feedline from a dipole antenna to *J2*.

Now turn on *S4* and, after a 1-minute warm-up, turn on *S5* and depress the push-to-transmit switch (*S3*). Holding *S3* down, tune *C10*, *C16*, and *C17* for maximum indication on *M1*. As the tuning progresses, you will undoubtedly have to increase the resistance of *R12* to prevent the meter needle from going off scale.

With *C10*, *C16*, and *C17* tuned, throw *S1* to the "Operate" position and, continuing to hold down *S3*, set *R5* for minimum carrier output (minimum deflection of *M1*). Then reduce the capacity of *C1* and again adjust *R5* for minimum deflection. Continue the process until *R5* can be set at a position where there is little or no reading on meter *M1*.

To achieve this degree of carrier suppression, you will probably have to reduce the capacity of *C1* to a point where the crystal just goes into oscillation whenever *S3* is pushed. A reduction in the capacity of *C11* may also help to cut down the amount of residual carrier. If you should discover that minimum carrier occurs when the arm of potentiometer *R5* is at the *R4* end, reduce *R4* to 33,000 ohms. If the minimum occurs at the *R6* end, increase *R4* to 82,000 ohms.

To check for correct neutralization of *V2*, leave *S1* and *S2* at their previous settings, remove both the crystal and antenna, and set *R12* at maximum sensitivity. With *S3* depressed, no combination of the settings of *C10*, *C16*, and *C17* should produce a reading on *M1*.

If *M1*'s needle moves off zero during

the test, change the capacity of *C13* by untwisting the wires a bit. Should this fail to help, replace the capacitor with one made from longer wires twisted together over a greater distance. Changing the position of *C13* relative to *C16* will also affect the neutralization.

During the above operations, play it safe! Disconnect the a.c. plug and discharge the filter capacitors before you make an underchassis adjustment.

Operation. You're ready to go on the air. Plug in the crystal, reconnect the antenna, connect a ceramic or crystal mike at *J1*, and wire any external receiver-muting or antenna-changeover relays to *TS1*.

As before, peak *C10*, *C16*, and *C17* for maximum output, and null the carrier with *R5*. Then, while whistling loudly into the mike, advance *R17* until maximum r.f. output is obtained. Next, set *R12* for a full-scale reading on *M1* and stop whistling. Finally, adjust *R17* to the point where *M1* "kicks" up to a maximum of half-scale as you speak in a normal tone.

Now call CQ or, if you hear someone near your frequency with whom you'd like to chat, set *S2* to "Zero" and zero-beat the desired station by adjusting *L1*.

While operated at the author's southern Michigan QTH, the Simple Sidebander provided many solid-copy 75-meter QSO's with stations in Wisconsin, Illinois, Indiana, Ohio, and Kentucky. Even though its output drops a bit on 40 meters, the unit does an excellent job locally and has produced a number of 1000-mile contacts. It can't be adapted for 20, 15, or 10 meters, however.

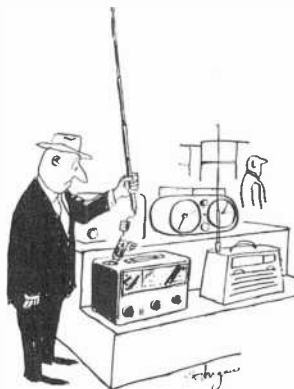

June, 1962

DEWALD



MFD. BY . . .

FOREMOST MANUFACTURERS IN
THE U.S.A. OF FINE ELECTRONIC
EQUIPMENT SINCE 1921!

CITIZENS BAND.



"RADIO-PHONE" TRANSCIVER



Model TR-910-B
10½" W. x 6½"
D. x 4⅞" H.

99⁹⁵ List—with
Microphone
and Crystal

R1103 HI-FI STEREO MULTIPLEX AM-FM TUNER



"The overture"
13" W. x 4⅞"
H. x 12" D.

119⁹⁵ List—
Case
Included

Write for Brochure and Name of Your Nearest Dealer

Made by . . . **UNITED SCIENTIFIC LABORATORIES, INC.**

35-09 37th AVE., LONG ISLAND CITY 1, N. Y.

Also Mfr's of DeWald Hi-Fi Stereo Components and FM Radio

GET INTO ELECTRONICS

V.T.I. training leads to success as technicians, field engineers, specialists in communications, guided missiles, computers, radar, automation, basic & advanced courses. Electronic Engineering Technology an E.T.P.D. accredited Technical Institute curriculum. Assoc. degree in 29 mos., B.S. obtainable. C.T. approved. Start Sept., Feb. Dorms. campus. H.S. graduate or equivalent. Catalog.

VALPARAISO TECHNICAL INSTITUTE
Dept. PE VALPARAISO, INDIANA

WALKIE-TALKIE RADIOPHONES



FROM \$59.98

Send for FREE literature on the complete line of VANGUARD radio phones, for industry, Civil Defense, C.A.P., Citizens and Amateur bands. Made in the U.S.A. and guaranteed 5 years.

Dept. E-6

VANGUARD ELECTRONIC LABS.
190-48 99th Ave., Hollis 23, N. Y.

ELECTRONICS

Learn more . . . earn more. *B.S. Degree in 27 Months in Engineering. IN 36 MONTHS B.S. in Business Administration. Costs low. Enter quarterly. Write for Catalog today.*

TRI-STATE COLLEGE 3662 College Ave.
Angola, Indiana



Send
**POPULAR
 ELECTRONICS**
 Every Month

NAME.....

ADDRESS.....

CITY..... ZONE... STATE.....

3 years for \$10

Check one: 2 years for \$7

1 year for \$4

in the U. S., and possessions.

Payment Enclosed Bill Me

Foreign rates: Canada and Pan American Union countries, add .50 per year; all other foreign countries, add \$1 per year.

New Renewal

Mail to:

POPULAR ELECTRONICS

Dept. PE-662H, 434 S. Wabash Ave.

CHICAGO 5, ILL.

Transistor Topics

(Continued from page 78)

probably prefer a small (2½" to 5") unit. Switch *S1* is a s.p.s.t. type, while battery *B1* is a standard 9-volt unit, such as a Burgess 2U6. If preferred, six pen-light or flashlight cells can be connected in series to make up the power pack.

Tuning coil *L1* is hand-wound and consists of 300 turns of #30 enameled wire scramble-wound on a form $\frac{5}{16}$ " in diameter and 1" long. A tap should be provided 100 turns from the "antenna" end.

For best results, a separate source of d.c. bias should be provided for *Q1*. This can be accomplished by adding a resistor (*R3*) between *L1*'s tap and the negative terminal of the power supply, as shown by the dotted line in Fig. 6. The resistor's value should be determined experimentally, but it will probably fall between 1000 and 20,000 ohms.

Product News. Transistorized stereo amplifiers are becoming more and more popular, partially because of their relatively small size when contrasted with vacuum-tube amplifiers of comparable performance. This is clearly illustrated in Fig. 7, where a Knight KX-60 50-watt all-transistor stereo amplifier is shown on top of a Knight KN-755 55-watt vacuum-tube unit. Both amplifiers are products of Allied Radio Corp. (100 N. Western Ave., Chicago 80, Ill.).

The Heath Co. (Benton Harbor, Mich.) has introduced an improved model of its famous marine radio direction finder (see Fig. 8). Model MR-21 covers the Beacon/Consolan, AM broadcast, and marine

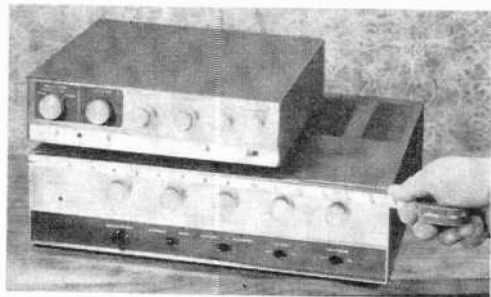

Fig. 7. These two Knight stereo amplifiers have about the same power rating, but the all-transistor unit (on top) is dwarfed by the vacuum-tube version.

Always say you saw it in—POPULAR ELECTRONICS

Fig. 8. Heath's improved marine radio direction finder (Model MR-21) has a normal bearing accuracy within ± 3 degrees.



radiotelephone bands, is equipped with both loop and whip antennas, and has a normal bearing accuracy of $\pm 3^\circ$. Using ten transistors and one diode, the direction finder operates on six standard flashlight cells, which, in normal use, will last from 500 to 1000 hours. The kit sells for \$109.95, plus postage.

A "universal" transistor mounting and heat sink has been introduced by Accel Electronic Products (P.O. Box 467, Monterey Park, Calif.). Dubbed the "Uni-Mount," it will support standard power transistors in any of several positions and will dissipate up to 12 watts.

That about covers events on the semiconductor front for now, fellows. More news next month.

—Lou

Answers to Coil Function Quiz

(Quiz on page 82)

- | | | |
|----|----------------------|---|
| 1 | Deflection coil..... | I |
| 2 | Tickler coil..... | C |
| 3 | Relay solenoid..... | J |
| 4 | Loading coil..... | G |
| 5 | Quadrature coil..... | H |
| 6 | Voice coil..... | A |
| 7 | Field winding..... | E |
| 8 | Balun..... | B |
| 9 | Peaking coil..... | F |
| 10 | Shading coil..... | D |

KIT BUILDERS!

New Rider Book helps you get

better performance from the equipment you build

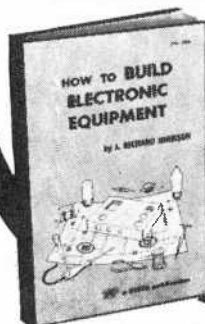

HOW TO BUILD ELECTRONIC EQUIPMENT by J. Richard Johnson. A most practical book—a most helpful book covering all the situations you'll ever face in building equipment — with sound, practical suggestions to meet these situations. For example—the common sense of placing a high frequency coil under the chassis to eliminate a heat problem; placement of heavy transformers at the corner of your chassis for greatest mechanical support and hundreds of other down-to-earth ideas that make this book indispensable to the kit builder, the newcomer to kit building and even the "pro" who builds equipment from "scratch." Covers what typical electronic equipment looks like, and describes its construction: tools and materials; selection and working of the chassis; layout, and checking, painting, marking and calibrating the finished equipment. #286, hard cover, \$6.95.

USING THE SLIDE RULE IN ELECTRONIC TECHNOLOGY by Charles Alvarez Finally! A book that reveals the secrets of developing top slide rule speed and accuracy. It is Rider-specially designed to show students — beginners and advanced — how to effortlessly solve practical electronic math problems with a slide rule. Twenty exciting chapters illustrate the fast, short-cut techniques that normally take years of on-the-job work to learn. Chapters like Transformer Turns Ratio, Power Gain, RC Circuits and Phase Angles help transform beginners into absolute masters of this time-saving tool. #253. \$2.50.

HOW TO SOLVE PROBLEMS IN ELECTRICITY AND ELECTRONICS by Henry Jacobowitz. This book lifts the veil of confusion preventing students from solving problems in electricity and electronics — simple DC through complex AC circuits. Readers quickly learn how to handle applied problems through proven step-by-step solution methods. Starting with simple DC problems, the text progresses through AC circuits, tubes, transistors, waveguides, antennas and other typical problems confronting technical students. In addition, it offers a concise review of principles and laws upon which solutions are based. It's like having a private tutor in the classroom or at home! #302. \$3.50.

Available at bookstores, electronic parts distributors or direct. Use convenient coupon below to order.

10-DAY MONEY-BACK GUARANTEE

JOHN F. RIDER PUBLISHER, INC. PE-6
a division of the Hayden Publishing Co., Inc.
116 West 14th Street, New York 11, New York

Enclosed is \$_____. Please send me postpaid:
() How To Build Electronic Equipment, \$6.95.
() Using The Slide Rule In Electronic Technology, \$2.50. () How To Solve Problems In Electricity and Electronics, \$3.50.

NAME _____

ADDRESS _____

CITY _____ ZONE _____ STATE _____

I must be satisfied, or I can return the books within 10 days for full refund.

NASA-136

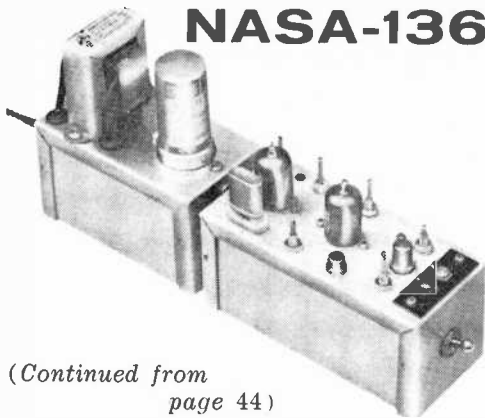

(Continued from
page 44)

torial diagram and photos, and note the positioning of the $V2$ and $V3$ sockets as shown in Detail "B."

A few points in the construction need special comment. First, capacitor $C7$ is nothing but a turn of insulated hook-up wire wrapped around the body of capacitor $C8$. Next, resistors $R3$ and $R5$ have nothing to do with the actual functioning of the circuit. They serve only to isolate the grids of $V2$ and $V3$, respectively, for test purposes. One end of each of these resistors is soldered to the appropriate grid; the other end, cut very short, is left free. Finally, do not connect the lead from pin 7 of $P1$ to the junction of capacitor $C3$ and coil $L4$ (point "X" in the schematic diagram). It must be left off temporarily in order to disable the r.f. stage during the initial steps in the adjustment procedure.

Adjustment. Besides your receiver (which should be equipped with an S-meter), you'll need two test instruments to carry out the adjustment: a d.c. meter with a range of approximately 0-100 microamperes (or a VTVM with a range of about 0-3 volts), and a signal generator which can be set at 136.5 mc. If the latter is unobtainable, a 2-meter ham transmitter tuned to 136.5 mc. will probably do the job.

If you must use the transmitter, be sure that it radiates only the minimal signal required for adjustment purposes. Connect a dummy load across the antenna terminals and, if possible, leave the final off. If the final must be on, be sure that it draws minimum power. A signal radiated into space on this frequency is not only illegal, but it could easily interfere with vital government

satellite telemetering. A word to the wise is sufficient.

All adjustments may be made with the chassis covers removed. Begin by plugging in the power supply to the converter and to the line, inserting the crystal and tubes, and checking to see that the lead to $L4$ and $C3$ is disconnected at point "X." The negative lead of your test meter should be connected to test point 1 and the positive lead to ground.

Turn on power switch $S1$ and, after the tubes have warmed up, adjust capacitor $C9$ for a maximum meter reading (this will probably occur somewhere near the minimum-capacity setting of $C9$). Now change the negative meter lead to test point 2 and adjust capacitor $C8$ for maximum reading (once again, this will probably occur near the minimum-capacity setting). At this point, without changing the meter connection, capacitor $C9$ should be repeaked.

Typical final readings at test point 1 are -2 volts (read on a VTVM) or $32 \mu\text{a}$. (read on a microammeter). At test point 2, the readings should be about -1 volt or $12 \mu\text{a}$. If the reading at the latter test point is a little low, try making the loop of wire ($C7$) around capacitor $C8$ a bit tighter.

This done, remove the meter and connect the antenna input of a receiver set at 20.5 mc. to the converter's output jack ($J1$); use a length of RG-58A/U coaxial cable. The receiver r.f. gain should be full on and the S-meter operating. Now adjust the slug of coil $L8/L9$ for maximum receiver noise.

Couple the output of a signal generator (or transmitter) tuned to 136.5 mc. to the converter's antenna input. If you're using a coaxial output cable, connect it between one of the antenna terminals and ground. You should now hear the generator's signal at the 20.5-mc. receiver setting (or near it, if the receiver's calibration is slightly off). A fairly strong signal will be needed from the generator, since the converter's r.f. stage is disabled.

With the signal tuned in, slowly adjust the spacing between the turns on neutralizing coil $L3$ for minimum S-meter reading. Use a plastic tool for this adjustment and be sure the receiver always stays tuned to the signal. Next, temporarily solder to place the lead left

off of point "X," reduce the generator's output, and tune the slugs of coils L1/L2, L4/L5, L6/L7, and L8/L9 for maximum S-meter reading.

Disconnect the lead from point "X" and readjust L3 for minimum reading. Then connect the lead again and readjust L1/L2, L4/L5, L6/L7, and L8/L9 for maximum readings. Repeat the procedure until there's no further change in the maximum and minimum readings. Finally, secure the turns of L3 with coil dope, permanently wire in the lead to point "X," and install the box covers. The converter is ready to go.

It may be, however, that your receiver is a "ham bands only" model, and you would prefer to set the converter's output in the 21-22 mc. band. In this case, just substitute a 38 1/3-mc. crystal for the 38 2/3-mc. unit specified for X1 and follow the identical procedure outlined above. The only difference is that the receiver should be set at 21.5 mc., rather than at 20.5 mc., during the adjustments.

Operation. Wire the converter's output to your receiver's antenna input as described in the "Adjustment" section. Then connect a TV antenna, a 2-meter beam, or a 41"-long folded dipole to the converter's antenna input. If the lead-in is 300-ohm line, connect it across the two antenna terminals; if it's a coaxial cable, connect it between one antenna terminal and the chassis.

Assuming that the receiver and crystal calibrations are accurate, the frequency of the received signal will be the receiver dial reading plus 116 mc. (115 mc. if you're using a 38 1/3-mc. crystal at X1). In other words, the 136-137 mc. satellite band will be tunable between either 20 and 21 mc., or 21 and 22 mc., depending on which crystal you use.

While the three tuned circuits between the converter's antenna terminals and mixer grid tend to eliminate image responses, you may still pick up an image from a local FM station. Should this be the case, try installing a stub-type wave trap. If you have a coaxial lead-in, use an 18 1/2"-length of coax cable with one end open and the other connected, at the converter, in parallel with the lead-in. If you're using a 300-ohm lead-in, the stub is a 24"-length of 300-ohm line connected in the same way.

ELECTRONICS

Train in the new shop-labs of the world famous
COYNE ELECTRICAL SCHOOL on a
 quarter of a million dollars
 worth of equipment. Est. 1899—Non-Profit Institute.
 Courses: Electronics • Electricity • TV-Radio.

Use this coupon to get our free book
 "GUIDE TO CAREERS"
 COYNE ELECTRICAL SCHOOL Educ. Serv. Dept. A2-M
 1501 W. Congress Parkway, Chicago 7, Ill.

NAME _____
 ADDRESS _____
 CITY _____ STATE _____

Unlike most other schools, we do not employ salesmen.



SONGS

into DOLLARS!
 NEW Songwriters, Poets, Composers may gain
 SUCCESS, FAME, WEALTH. Songs Composed,
 PUBLISHED. Appraisals, details FREE from...
NORDYKE SONGS & MUSIC
 6000 Sunset, HOLLYWOOD 283, California, U.S.A.

EARN Electronics DEGREE

Engineering
 You can earn an A.S.E.E. degree at home. College level HOME
 STUDY courses taught so you can understand them. Continue your
 education, earn more in the highly paid electronics industry. Mis-
 siles, computers, transistors, automation, complete electronics. Over
 27,000 graduates now employed. Resident school available at our
 Chicago campus—Founded 1931. Send for free catalog.
AMERICAN INSTITUTE OF ENGINEERING & TECHNOLOGY
 1137 West Fullerton Parkway, Chicago 14, Ill.

Say You Saw It In POPULAR ELECTRONICS

ERSIN Multicore
 5-CORE SOLDER
 WETS FASTER - MELTS FASTER
 SOLDERS BETTER!

B. S. DEGREE IN 36 MOS.

INDUSTRY AND GOVERNMENT NEED 50,000 NEW ENGINEERS EACH YEAR!
 Accelerated year-round program puts you in the job-market a whole year
 early! Also B.E. degree in 27 mos. Aeronautical, Chemical, Civil, Electri-
 cal, Mechanical, Electronics; Math, Chemistry, Physics. Quality instruction;
 widely recognized. Graduates employed from coast to coast. Self-help pro-
 gram. Modest rate. Start June, July, September, January, March. Catalog:
 288 E. Washington Blvd., Fort Wayne 2, Indiana.

INDIANA TECHNICAL COLLEGE

RADIO PARTS STORES & HI-FI SALONS!

Hundreds of dealers across the nation profit by selling **POPULAR ELECTRONICS** each month to their customers. Are you one of them? **POPULAR ELECTRONICS** helps build store traffic . . . keeps customers coming back month after month for the merchandise you sell—and, best of all, you earn a neat profit on each copy sold—**NO RISK INVOLVED.**

So get all the details on selling **POPULAR ELECTRONICS**, the world's largest selling electronics hobbyist magazine. Or, order your copies now. Just use the handy coupon below.

Direct Sales Department
POPULAR ELECTRONICS
One Park Avenue, New York 16, New York

- Send me.....copies of **POPULAR ELECTRONICS** for resale in my store each month. No risk involved on my part.
- Send me details on selling **POPULAR ELECTRONICS** in my store.

STORE NAME.....

ADDRESS.....

CITY.....ZONE.....STATE.....

SIGNATURE.....

PE-662

Across the Ham Bands

(Continued from page 74)

News and Views

Al Koblinski, KN7PFU, 307 South Spencer, Mesa, Ariz., has worked 42 states (including Hawaii), the Philippine Islands, Mexico, and Okinawa, in over 300 contacts with a transmitter similar to the one described in our January column. His power runs between 11 and 23 watts; he receives on a Hammarlund HQ-110. . . . You've probably wondered what life in a submarine is like; **Norris Sapp**, RM3(SS), U.S.S. Sea Leopard (SS-483), FPO, New York, N. Y., can give you the "scoop." He is **K7MRO/4**, operating out of Norfolk, Va., when he's not at sea. As a Novice, Norris steamed up his Globe Chief 90A and Hallicrafters HT-40 transmitters—not both at once—to work Ivor, VK3XB, and Jeff, VK5NQ, in Australia, several times on 40 meters. He also worked Hawaii a couple of times, and the Virgin Islands; a Hy-Gain 14-AVS vertical antenna did the radiating, and a National NC-300 did the receiving. . . .

Will E. Halpin, KN1SMF, Boxford Rd., Rowley, Mass., sticks to 80 meters most of the time but occasionally drops to 40 meters. A Heathkit DX-20 transmitter feeding a folded dipole antenna has put his call letters into ham logs in some 12 states and two Canadian provinces. A modified Heathkit AR-3 receiver with Q-multiplier accepts incoming calls.

Bill "Fuzz" Zavatsky, KN3QEQ, 725 Patterson Ave., Du Bois, Pa., keeps his EICO 720 transmitter "hot" on 80, 40, and 15 meters; 500 contacts in 45 states, Canada, and Ecuador are the result. A Collins 75A2 does the receiving, and two antennas, each over 200 feet long, take care of the outside work. . . .

Kenny Burger, WN4CYJ, 919 Mayfield St., Manchester, Tenn., is another of those who prefer 80 meters most of the time. In a month, his Knight T-60 transmitter and Hallicrafters S-38B receiver have racked up 23 states. A 90' end-fed antenna, helped along with a coupler, injects his signals into the ionosphere. . . . **Ian Ridpath, VE3E2M**, 34 Deepwood Cr., Don Mills, Ont., Canada, has been a ham

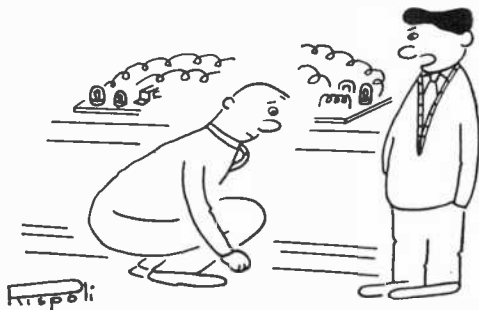

"What on earth are you looking for, stray capacitance?"

Always say you saw it in—**POPULAR ELECTRONICS**

for five months. Using one watt input on 80 meters, he made 380 contacts in 23 states and four Canadian provinces. His obviously efficient antenna is a dipole; it was 65' high until an ice storm brought it down to roof level, but I suspect he has it back in the air again now. Three weeks before writing us, Ian went "high power" with a Heathkit DX-20 and added seven more states to his total. A venerable Hallicrafters S-20R takes care of the reception. If you'd like to work Ontario on 80 meters, Ian is your boy. He's looking for the fifth and seventh call areas, especially.

Wanda Kimble, WV2USJ, Box #31, Mahopac Falls, N. Y., started out as a short-wave listener six months before getting her Novice ticket. She learned the code, without help, by listening on her receiver. Now, after six months as a ham, she has worked 40 states and 3 Canadian provinces—and has QSL cards from every one of them! A Heathkit DX-40 transmitter feeds a long-wire antenna on 40 and 80 meters (usually 40), and a National NC-303 picks out the signals Wanda wants to copy. A husband and a 3-year-old son limit her on-the-air time slightly. . . . Another lady ham, **Norma Frank, WV2YGI**, 209 Cook St., Dannemora, N. Y., has made over 220 CW contacts on 80 meters in less than three months. Her EICO 729 transmitter feeds a doublet antenna; she started with a Hammarlund HQ-129X receiver and now has an HQ-110. On 2 meters, Norma's Heathkit "Two-er" has worked 41 different stations.

A member of the Champlain Valley Amateur Club and of the Amateur Radio Emergency Corps (AREC), she functions as a housewife with five young children in her spare time. . . . **Sheri Conroy, WV6SVQ**, 980 Arbor, Costa Mesa, Calif., being seven years old, does her hamming after school and on week-ends. In six months on 40 and 15 meters, her Knight T-50 transmitter and R-100 receiver have worked 30 states (including Alaska and Hawaii), plus Canada and Puerto Rico. Drop Sheri a note if you need a California contact.

John Mutrux, KNØJPT, Rocky Comfort, Mo., runs 75 watts to his Heathkit DX-40 feeding a "trap" doublet antenna on 80, 40, and 15 meters; he receives on a Hallicrafters SX-99. John likes to work 40 meters at about 4:00 a.m. He has 30 states worked, 22 confirmed. . . . **Russ Jones, WN8JBL**, 701 Watkins St., S.E., Grand Rapids, Mich., started on 40 meters with a Johnson Adventurer transmitter, an RME 45 receiver, and a 40-meter "inverted-V" between two houses. In spite of the poor antenna location, Russ worked nine states in a few weeks. Now that the weather is better, he probably has the antenna in its permanent location. Russ's 15-year-old son and 10-year-old daughter are busy studying for their own licenses. How about Mom?

Mail your "News and Views" to: Herb S. Brier, W9EGQ, C/O POPULAR ELECTRONICS, P.O. Box 678, Gary, Ind. Until next month, 73, Herb, W9EGQ

NOW . . . AT LAST YOU CAN SAVE ON FAMOUS MAKE TUBES!

BRAND NEW FAMOUS MAKE

Radio & TV TUBES

65% To

90% OFF LIST

RCA
CBS
SYLVANIA
GE
RAYTHEON
WESTINGHOUSE
PHILCO
HYTRON

FREE Famous Make Tube
(of our choice) (List Price Up To \$10) With Every 10 TUBES or more!

ALL TUBES		Factory delivery Code		boxed dated	
• Immediate		• Standard R.M.A. guarantee (90-day)		• Standard R.M.A. guarantee (90-day)	
TYPE	PRICE	TYPE	PRICE	TYPE	PRICE
OZ4	.76	5C12A	1.10	6B8C	1.39
1A7GT	.89	5C25	1.05	6BE6	.77
1G3/1B3GT	.99	5FV6	1.10	6BG6GA	2.08
1N5GT	1.39	5J6	.95	6BH8	1.19
1LNS	1.49	5T8	1.15	6BJ6	.91
1N5GT	.89	5U4GB	.69	6BK1	2.49
1H5	.95	5L8	1.15	6BK5	1.29
1T5	.87	5V8	1.25	6BR7B	1.15
1U4	.87	5V1GA	1.22	6BL4	2.25
1U5	.75	5AN	1.14	6BL7GA	1.14
1X2B	1.05	5Y3GT	.44	6BN6	1.40
2CY5	.95	6AB1	.75	6BQ5	.79
3A1	1.15	6AC7	1.69	6BQ6GA	1.35
3AL5	.65	6AF4	1.40	6BGT4	1.19
3B6	.75	6AG5	.95	6BH8A	1.22
3BU6	.99	6AH4GT	1.15	6BS8	1.29
3BZ6	.65	6AH6	1.90	6C18	.95
3CB6	.10	6AK5	1.39	6BY5GA	1.59
3DK6	.98	6AL5	.64	6BZ6	.78
3V4	.85	6AM8A	1.99	6C27	1.59
4BC5	.82	6AN8	1.30	6C4	.44
4BU7A	1.40	6AQB5	.69	6CB3	2.79
4BZ6A	.65	6AS8	1.40	6CB6	1.01
4EHT	1.33	6AS8	1.33	6C19GA	1.99
6AMR	1.24	6AU6A	.69	6C17	.88
6AN8	1.40	6AU6A	1.19	6C18	1.15
6AQ5	.75	6AV5GA	1.39	6C18	1.25
6AS4A	.90	6AV6	.57	6C17	1.10
6AT8	1.13	6AW8A	1.90	6C9T	.59
6BR8	1.27	6AX4GTB	.90	6C16	1.49
6CQ8	1.10	6AX6	.69	6C16	1.49
6D4A	.80	6B8C	1.39	6D4A	.80
6E4	.98	6BE6	.77	6E4	.98
6F5	.85	6BF6	2.08	6F5	.85
6G7	.99	6BK1	1.19	6G7	.99
6H6	1.19	6BJ6	.91	6H6	1.19
6I6	1.39	6BK5	1.29	6I6	1.39
6J6	1.27	6BR7B	1.15	6J6	1.27
6K6	1.27	6BL4	2.25	6K6	1.27
6L6	1.69	6BL7GA	1.14	6L6	1.69
6M6	1.19	6BN6	1.40	6M6	1.19
6N6	.49	6BQ5	.79	6N6	.49
6P6	.98	6BQ6GA	1.35	6P6	.98
6Q6	1.21	6BGT4	1.19	6Q6	1.21
6R6	2.89	6BH8A	1.22	6R6	2.89
6S6	.71	6BS8	1.29	6S6	.71
6T6	.99	6C18	.95	6T6	.99
6U6	.79	6BY5GA	1.59	6U6	.79
6V6	.63	6BZ6	.78	6V6	.63
6W6	.91	6C27	1.59	6W6	.91
6X6	.85	6C4	.44	6X6	.85
6Y6	.57	6CB3	2.79	6Y6	.57
6Z6	.88	6CB6	1.01	6Z6	.88
6A7	.75	6C19GA	1.99	6A7	.75
6B7	.88	6C17	.88	6B7	.88
6C7	.98	6C18	1.15	6C7	.98
6D7	.33	6C17	1.10	6D7	.33
6E7	1.09	6C18	1.25	6E7	1.09
6F7	1.49	6C17	.88	6F7	1.49
6G7	1.09	6C18	1.15	6G7	1.09
6H7	1.09	6C17	.88	6H7	1.09
6I7	1.09	6C18	1.15	6I7	1.09
6J7	1.09	6C17	.88	6J7	1.09
6K7	1.09	6C18	1.15	6K7	1.09
6L7	1.09	6C17	.88	6L7	1.09
6M7	1.09	6C18	1.15	6M7	1.09
6N7	1.09	6C17	.88	6N7	1.09
6O7	1.09	6C18	1.15	6O7	1.09
6P7	1.09	6C17	.88	6P7	1.09
6Q7	1.09	6C18	1.15	6Q7	1.09
6R7	1.09	6C17	.88	6R7	1.09
6S7	1.09	6C18	1.15	6S7	1.09
6T7	1.09	6C17	.88	6T7	1.09
6U7	1.09	6C18	1.15	6U7	1.09
6V7	1.09	6C17	.88	6V7	1.09
6W7	1.09	6C18	1.15	6W7	1.09
6X7	1.09	6C17	.88	6X7	1.09
6Y7	1.09	6C18	1.15	6Y7	1.09
6Z7	1.09	6C17	.88	6Z7	1.09

SPECIAL OFFER . . .
For Limited Time Only! FREE Shipping on New SILVER DOLLAR With Order Of \$25 Or More!
Part Listing . . . Almost Every Famous Make Tube In Stock!

Money cheerfully refunded within five (5) days. If not completely satisfied! FREE POSTAGE ON ORDERS OF \$5 OR MORE IN USA AND TERRITORIES. 2% Handling Charge required on any order less than \$5. Send 25% deposit on C.O.D.'s. Ship approximate postage with Canadian and foreign orders. No minimum purchase required. . . . You get these low prices on any quantity you buy!

STANDARD BRANDS TUBE COMPANY

ROMANO BUILDING HARRISON, NEW JERSEY HU. 4-9848 Dept. PE 6



If you've recently changed your address, or plan to in the near future, be sure to notify us at once. We'll make the necessary changes on your mailing plate, and see to it that your subscription continues without interruption. Right now—print the information requested in the spaces below and mail it to:

**POPULAR ELECTRONICS,
434 So. Wabash Ave., Chi-
cago 5, Illinois.**

Name *Please PRINT!*

°Account No.

Old Address

City State

New Address

City Zone State

Mail copies to new address starting with
.....issue.

**(Your Account Number appears directly
above your name on the mailing label.)*

Short-Wave Report

(Continued from page 84)

meter outlet when on the air. Last heard in mid-1961; now off. Power rated at 5000 watts.

- 9685 TGWA, *R. Nacional*. (See 6177-kc. listing.) Channel no longer in use, presumably replaced by 9760 kc. Power rated at 10 kw.
- 9760 TGWA, *R. Nacional*. (See 6177- and 9685-kc. listings.) Strong signal evenings, but not daily. Normal s/off, 2300; to 0000 at Christmas time. Power, 10 kw.; may run only half power at times.
- 11,700 TQQB, *R. Nacional*, Quezaltenago. Like the 6110-kc. outlet, not heard at present. Last noted: Spring, 1961.
- 11,750 TGXC, *R. Cristal*, 3a C. 5-02, Zona 1, Guatemala City. Rated at 500 watts. Some sources say the transmitters were adapted for medium waves by *R. Jumay*; others that one transmitter was purchased by *R. Modelo* of Retahuleu and used on 1540 kc.; others that 11,750 kc. is still being used. Not heard on either channel, however.
- 11,850 TGNC, *R. Cultural*. (See 5952.5-kc. listing.) Not heard; presumed to be off the air. Rated at 5000 watts.

Many thanks to PY2PE1C for supplying us with the above listing.

Current Station Reports

The following is a resume of current station reports. At time of compilation all reports are as accurate as possible, but stations may change frequency and/or schedule with little or no advance notice. All times shown are Eastern Standard and the 24-hour system is used. Reports should be sent to P. O. Box 254, Haddonfield, N. J., in time to reach your Short-Wave Editor by the eighth of each month. Be sure to include your WPE call letters with your report.

Albania—*R. Tirana* has been noted on 14,771 kc. at 1115 with Albanian folk music, at 1130 with classical piano and violin music and a Russian ID; s/off at 1215.

Australia—The latest complete Eng. schedule from *R. Australia* reads as follows: to S.E. Asia on 25,735 kc. at 1714-0800, on 21,540 kc. at 1714-0430, on 17,870 kc. at 1915-0400, on 15,220 kc. at 1714-1915 and 0300-0800; to S. & S.E. Asia on 11,760 kc. at 0955-1230, on 11,740 kc. at 0800-1000, on 9570 kc. at 0459-1230, and on 7220 kc. at 0800-1215; to East Asia on 15,240 kc. at 1559-1915, and on 11,810 kc. at 0330-0500 and 0600-0700; to E. Asia and N.W. Pacific on 9580 kc. at 0600-0900; to Mid-Pacific Island on 15,315 kc. at 1500-1700, on 15,240

kc. at 2129-0230, and on 7190 kc. at 0245-0700; to South Pacific Islands on 11,840 kc. at 1500-1700, on 11,710 kc. at 0230-0415, and on 9570 kc. at 0230-0415; to Africa on 17,820 kc. at 2329-0045; to the British Isles and Europe on 11,710 and 9570 kc. at 0100-0230; to N.A. on 11,710 kc. at 0714-0815 (East Coast) and 1014-1115 (West Coast).

Austria—The latest schedule from *Osterreichischer Rundfunk*, Vienna, does not list all of the target areas, but it reads as follows: 2300-1700 on 6155 kc.; 1800-2300 on 6155 kc. (N.A.); 0100-0900 on 7200 kc.; 0900-1500 on 7245 kc.; 1900-2300 on 9540 kc. (N.A.); 0100-0400 on 9610 kc. (Mid-East); 0600-1200 and 1800-2300 on 9770 kc. (S.A.); 0300-0500 on 15,305 kc. (Japan); 1100-1300 on 17,765 kc. (S. Africa); 0800-0900 on 17,865 kc.; 0900-1100 on 17,865 kc. (India); and 0500-0700 on 21,475 kc. (Australia). There may also be a transmission at 0300-1200 on 11,785 kc.

Canada—One of our monitors is an operator at VCN, *Grindstone Marine Radio*. Grindstone, Magdalen Islands. This station operates all year round on 410, 440, and 500 kc., CW; and on 2118, 2134, 2182, 2192, and 2582 kc., phone.

Central African Republic—*R. Bangui* verified by letter and stated that their power would be increased soon, although neither date nor power was given. Their schedule: weekdays at 0100-0130 and 0630-0730 on 7220 kc., and at 1130-1600 on 5035 kc.; Sundays at 0100-0130 on 7220 kc. and at 1130-1600 on 5035 kc.

Dahomey—A beautiful QSL card from *Radiodiffusion Du Dahomey*, Cotonou, listed their schedule as: Sundays at 0200-1700; other days at 0015-0145, 0615-0715 (to 0745 on Thursdays and 0700-1800 on Saturdays), and at 1200-1600 (to 1630 on Fridays) on 7190 and 4870 kc. Languages used include French, Yoruba, Dendi, Fon, Bariba, and Mina.

Ecuador—*HCJB*, Quito, has a "DX Party Line" on the first Monday of each month at 2030-2130 on 15,115 and 11,915 kc.

French Somaliland—TYZ3, Djibouti, 4780 kc., has frequently been heard running past the scheduled 1500 s/off with special Arabic programs.

Greece—According to information on *R. Switzerland's* DX program, *R. Athens* is operating at 1220-1230 in French and to 1240 in Eng. on 11,720 kc.

Greenland—While this country has no s.w. outlet, it can be tuned on 650 kc. with an xmsn in Danish or Icelandic from 2045-2110 s/off. The 5-kw. station has a three-language ID at 2100, one of which is English. You'll have to dig deep for this one!

Haiti—4VEH, Cap Haitien, has turned up on 2490 kc. at 1757 with classical music and

SHORT-WAVE ABBREVIATIONS

B/C—Broadcasting	QSL—Verification
CW—Morse code	R.—Radio
Eng.—English	S.A.—South America
ID—Identification	s/off—Sign-off
kc.—Kilocycles	s/on—Sign-on
kw.—Kilowatts	s.w.—Short-wave
L.A.—Latin America	xmsn—Transmission
N.A.—North America	xmtr—Transmitter

FREE CAREER BOOKLET



To guide you to a successful future in

ELECTRONICS RADIO-TV COMPUTERS ELECTRICAL ENGINEERING

This interesting pictorial booklet tells you how you can prepare for a dynamic career as an Electrical Engineer or Engineering Technician in many exciting, growing fields:

MISSILES • AVIONICS • AUTOMATION
SALES • DEVELOPMENT
ELECTRICAL POWER • ROCKETRY
RADAR • RESEARCH

Get all the facts about job opportunities, length of study, courses offered, degrees you can earn, scholarships, part-time work — as well as pictures of the Milwaukee School of Engineering's educational and recreational facilities. No obligation — it's yours free.

MILWAUKEE SCHOOL OF ENGINEERING

MAIL COUPON TODAY!

Milwaukee School of Engineering
Dept. PE-662, 1025 N. Milwaukee St., Milwaukee, Wis.

Please send FREE "Your Career" booklet

I'm interested in

Electronics Radio-TV Computers
 Electrical Engineering Mechanical Engineering

Name _____ Age _____

PLEASE PRINT

Address _____

City _____ Zone _____ State _____

I'm eligible for veterans education benefits.

Discharge date _____ MS-117

SHORT-WAVE CONTRIBUTORS

Paul Gough (WPE1ASX), W. Newton, Mass.
 Anson Boice (WPE1BD), New Britain, Conn.
 Stanley Shantar, Jr. (WPE1DOK), Glen Brook, Conn.
 Erol Urbelis (WPE2AN), Greenlawn, N. Y.
 Thomas Campanile (WPE2CKI), Brooklyn, N. Y.
 Robert Biglands (WPE2CTS), Angola, N. Y.
 Dennis Kopecky (WPE2DRP), Linden, N. J.
 Jack Germain (WPE2EOL), New Milford, N. J.
 Douglas Frederick (WPE2EQV), Corona, N. Y.
 Edward Light (WPE2FBT), New York, N. Y.
 J. B. Sientz (WPE2FFC), S. Orange, N. J.
 Henry Marbach (WPE2FHU), White Plains, N. Y.
 Stephen Herman (WPE2FMH), Oceanside, N. Y.
 Bob Auerhahn (WPE2FNO), Jericho, N. Y.
 Arnold Skemer (WPE2FSI), Flushing, N. Y.
 Hugh Snodgrass (WPE2FVU), Cedar Grove, N. J.
 Robert Grill (WPE2FZJ), Huntington, N. Y.
 David Skinner (WPE2GHO), Belleville, N. Y.
 Richard Shannahan (WPE2GJC), Binghamton, N. Y.
 John De Pola (WPE2GMC), Lindenhurst, N. Y.
 Adolph Almsy (WPE2GMF), Mastic Beach, N. Y.
 Bruce Coleman (WPE2GNX), Westfield, N. J.
 Martin Rosenzweig (WPE2GOO), Levittown, N. Y.
 Irwin Karliner (WPE2GTO), Flushing, N. Y.
 Alan Camton (WPE2HAX), Great Neck, N. Y.
 Stewart West (WPE2LH), Union, N. J.
 C. Vernon Hyson (WPE3AGZ), Kensington, Md.
 William Dickerman (WPE3BEB), Watsonstown, Pa.
 William Beaver (WPE3BZJ), Mt. Pleasant, Pa.
 Robert Lyon (WPE3CCB), Levittown, Pa.
 Stuart Ruben (WPE3CMD), Philadelphia, Pa.
 Alfred Ioppolo (WPE3CUG), Philadelphia, Pa.
 Aaron Newman (WPE3CZA), Philadelphia, Pa.
 George Cox (WPE3XF), New Castle, Del.
 Grady Ferguson (WPE4BC), Charlotte, N. C.
 Mark Harris (WPE4DAD), Jacksonville, Fla.
 Richard Derrickson (WPE4DIT), Alexandria, Va.
 David Pope (WPE4DMY), Crescent Beach, S. C.
 Richard Jones (WPE4FFG), Fairfax, Va.
 Ferrell Cooper (WPE4FQ), McGuire A.F.B., N. J.
 William Mary (WPE4EGE), Miami, Fla.
 Charles Howard, Jr. (WPE4EHT), Tampa, Fla.
 J. R. Little (WPE4ELH), West Palm Beach, Fla.
 Ernest Childs (WPE4EMV), Charleston, S. C.
 Samuel Robertson (WPE5AON), Little Rock, Ark.
 F. Boyd Goldsmith (WPE5BKV), Oklahoma City, Okla.
 John Kincy (WPE5BVJ), Lowell, Ark.
 Earl Phillips, Jr. (WPE5BXT), New Orleans, La.
 Richard Allen (WPE5BZO), Billings, Okla.
 Clifford Hoobler (WPE6BYD), Reseda, Calif.
 Stewart MacKenzie, Jr. (WPE6AA), Long Beach, Calif.
 Mike Mellinger (WPE6DDO), Glendora, Calif.
 Kathi Backus (WPE6DEG), Santa Barbara, Calif.
 Richard Rush (WPE6DEF), Maywood, Calif.
 Phillip Birlaw (WPE7AIQ), The Dalles, Oregon
 Dick Housden (WPE7ARF), Wenatchee, Wash.
 Bruce Hubbard (WPE8AAK), Dayton, Ohio
 David Brown (WPE8ANS), Hico, Va.
 Robert Kipp (WPE8BBL), Detroit, Mich.
 Tim Daum (WPE8CUS), Portsmouth, Ohio
 Gary Cook (WPE8DJW), Lansing, Mich.
 Kenneth Hinkle (WPE8DL), APO, New York, N. Y.
 Robert Woodworth (WPE8EDB), Rome, Ohio
 Wayne Benkinney (WPE8EEI), Flint, Mich.
 Pat Montgomery (WPE8EEW), Cincinnati, Ohio
 Ken Boord (WPE8GB), Morgantown, W. Va.
 Mike Kander (WPE8MS), Dayton, Ohio
 Steven Rosenzweig (WPE9BDA), Skokie, Ill.
 Robert Miller (WPE9CBI), Milwaukee, Wis.
 Ray Fansler (WPE9CQC), Fairfield, Ill.
 Jon Lenard (WPE9CSB), Des Plaines, Ill.
 Jim Evans (WPE9DJM), Highland, Ind.
 Daniel Weinstein (WPE9DST), Madison, Wis.
 Richard Martens (WPE9DZK), Milwaukee, Wis.
 Bill Holscher (WPE9ATE), St. Louis, Mo.
 Owen Williamson (WPE9BSL), Minneapolis, Minn.
 Larry Lewis (WPE9CAT), Colorado Springs, Colo.
 Ron Moore (WPE9CCV), El Dorado, Kansas
 Dr. F. K. Fager (WPE9CEV), Worthington, Minn.
 Joe Norris (WPE9CGW), Coats, Kansas
 James Carr (WPE9CJL), Lincoln, Neb.
 W. D. Rodgers (WPE9ELI), Florissant, Mo.
 Carl Larson (WPE9EGB), Knoxville, Iowa
 Edward Tilbury (KL7PEIK), Eagle River, Alaska
 Jack Perolo (PY2PEIC), Sao Paulo, Brazil
 Frederick Seaman (VE1PE5S), Wolfville, N. S.
 Bernard Brown (BB), Derby, England
 Bruce Churchill (BC), Pensacola, Fla.
 Douglas Conrad (DC), Grandstone, Magdalen Islands, Quebec
 Richard Emison (RE), Cincinnati, Ohio
 Kenneth Goetz (KG), Floral Park, N. Y.
 Floyd Hale (FH), Chittenango, N. Y.
 David Knowlton (DK), Ellsworth Falls, Maine
 Bentley La Montagne (BL), N. Babylon, N. Y.
 Carl Niendorff (CN), Dallas, Texas
 Robert Nagle (RN), Allentown, Pa.
 Charles Runkle (CR), Center Valley, Pa.
 Robert Roux (RR), New Orleans, La.
 Vincent Smith (VS), Bronx, N. Y.

from 2200 to past 2240 with a "Letter" and DX program. There is severe QRM from the Miami marine radio at times. This channel is operating dual to 9770, 6120, and 1035 kc.

4VU, *R. Lumiere*, Aux Cayes, 2410 kc., is noted at 2000-2230 with English lessons and religious programs; 4VU also operates on 9635 kc. at 0800-0830 with Spanish programs directed to churches of the West Indies Mission in Cuba.

Indonesia—YDF, Djakarta, has moved from 6045 to 6051 kc. and is heard at 0830 with a native ID, after which a newscast or talk is given. The move may be only a temporary one, however.

Iraq—*R. Baghdad* is noted daily on 6148 kc. with Arabic news at 1700. This is definitely parallel to the 7180-kc. broadcast which is also tuned at 2045.

Jordan—Amman has a strong signal to N.A. at 2015-2045 in Eng. on 9560 kc. Arabic follows.

Mozambique—Lourenco Marques is heard well with Eng. pop tunes around 0000 on 9620 and 11,760 kc. CR7BV has moved from 4840 to 4847 kc. and has a fair signal at 2255 with pop music; Eng. ID at 2300. The latter runs parallel to 7249 kc.

New Zealand—Wellington is heard well at 0100-0345 in Eng. to the Pacific Islands on 11,780 kc. (formerly 9540 kc.) and at 0400-0645 to Australia. The Antarctic Sunday program at 0315-0345 is now broadcast on 6020 kc., a move from 11,780 kc. Reports go to: The Director, *Radio New Zealand*, P. O. Box 2396, Wellington.

Nigeria—A verification from Eastern Nigeria B/C Service, P.O. Box 350, Enugu, lists this schedule: Sundays at 0100-1730, weekdays at 0000-0300, 0500-0930, and 1030-1730 (to 1800 on Saturdays) on 4855 kc.

The 3395-kc. outlet of *R. Kaduna* is tuned at 1700-1715 with s/off at 1720; Eng. news is presented at 1715.

Pakistan—Karachi has dropped 7008 kc. and is airing Eng. now at 1345-1430 and 1445-1530 on 9740 and 11,674 kc. English is also beamed to the Middle East at 0835-0850 on 21,590 kc.

Peru—A new station is to be built in Lima by the Evangelical Alliance Mission; plans call for at least three s.w. outlets, with construction to be completed within a year. OAX6G, *R. Nacional*, Tacna, 9530 kc., was heard at 2200-2300 with semi-classical music. OAX7A, *R. Cuzco*, Cuzco, has moved from

6240 to 6211 kc. and was heard in Brazil after Peking s/off; Spanish ads and L.A. pop tunes were featured. OAX2H, *R. Popular*. 4910 kc., was noted at 2030 with an ID and a strong signal.

Philippines—The Far East B/C Co., Manila, carries Eng. at 1655-1845 (news at 1830) on 21,515. 17,805. 15,385, 11,855, 9730, and 6030 kc.; at 0930-1100 on 11,920 kc.; at 0130-0730 on 15,300 kc.; at 1830-1930 on 15,385 kc.; at 2000-2200 and 0130-0400 on 17,805 kc.; and at 0930-1100 on 21,515 kc.

Portugal—Lisbon continues to be heard at excellent levels with its "Voice of The West" Eng. program to N.A. at 2100-2130 and 2300-2330 on 6025 and 6185 kc. Many reports indicate that the 6185-kc. signal is somewhat stronger.

South Africa—Paradys has been heard on 3250 kc. at 2315 in the Commercial Service with pop dance music and English. The 9650-kc. outlet is tuned at 0200 in Eng. with pop music; 15,170 kc. at 1220 with Afrikaans regional news; and 4810 and 4895 kc. from 2330 s/on. The 4810-kc. channel opens with a scripture reading, time, then classical music and s/off at 0200; the 4895-kc. channel opens with a bird call and an ID is given with chimes at 2345.

Sudan—*R. Omdurman* has been heard on 4935 kc. (a move from 4993 kc.) at 1610 with chanting. The 9765-kc. outlet was also noted at 1800 with native music. at 1830 with native language talk, at 1845 with anthem, s/off at 1850.

Sweden—The newest Eng. schedule for Stockholm reads: 1700-1730, 2045-2115, and 2215-2245 on 6065 kc.; 1245-1315 and 1445-1515 on 11,705 kc.; 1115-1145 on 11,705 and 15,240 kc.; 0900-0930 on 17,840 kc.; and 0730-0800 and 0945 on 17,845 kc. There is a DX program on Mondays at 1715 beamed to Europe on 6065 kc.

Tchad Republic—*R. Tchad*, Fort Lamy, 4904 kc., is apparently testing a new xmtr. It was noted irregularly at 0020 in French, from 0040 with African music. S/off at 0100.

Togo—Lome has been heard on 5047 kc., but with difficulty. at 1712-1733 in French with semi-classical music.

Tonga Islands—A rare medium-wave station is ZCO, Nukualofa, 1020 kc. It is heard in Alaska at 0400-0430 in Eng. on Wednesdays with "The Voice of Prophecy."

Vatican City—*R. Vatican* has been found on a new frequency, 11,940 kc., at 1900 broadcasting in Spanish. Other xmsns (in Eng.) were noted on 9646, 11,740, and 15,120 kc. at 1000. There is another Spanish broadcast to Latin America at 1930-1945 on 11,740 kc.

Windward Islands—St. Georges has been noted on two new channels, 3280 and 9815 kc., with a schedule of 1745 to "midnight" (EST?). There is a news relay from London at 2100, a home news bulletin at 1845.

Clandestine—Mail being sent to *R. Libertad, La Voz de Anti-Comunista de America*, (741, 7322, and 14,820 kc.) at Box 135, Miami, Florida, is being returned with the notation that it is not a valid address.

-30-

1-YR. GUARANTEED RADIO & TV TUBES NEW LOW PRICE

\$30 PER 100 TUBES
Free Bonus! Plastic Universal alignment tool (regular 99c value) with every order of \$6.00 or more.



Factory Used or Factory Second Tubes! TRU-VAC will replace FREE any tube that becomes defective in use within 1 year from date of purchase!

ALL TUBES INDIVIDUALLY BOXED! CODE DATED & BRANDED "TRU-VAC"

Partial Listing Only . . . Thousands More Tubes in Stock!

024	3V4	6AC7	6AV6	6BR8	6C57	6SD7GT	7H7	12AX7	12Q7	
1A7GT	4BQ7A	6AF4	6AW8	6BS8	6CU5	6SF5	7A5	7N7	12A7	12R5
1B3GT	4BS6	6AG5	6AX4GT	6BY5G	6CG6	6SC7	7A6	7S7	12BA6	12S7
1H5GT	4BZ7	6AH4GT	6AX5GT	6BZ6	6D5	6SH7	7A7	7X6	12BA7	12SK7
1R5	4CB6	6AH6	6B8	6BZ7	6DE6	6S7	7A7	7X6	12BA7	12SK7
1S5	5AM8	6AK5	6BA6	6C4	6DG6GT	6SK7	7B4	7X7	12BD6	12SN7GT
1T4	5AN8	6AL5	6BC5	6CA8	6DQ6	6SL7	7B5	7Y4	12BE6	12SQ7
1U4	5AT8	6AM8	6BC8	6CB6	6FC	6SN7GT	7B6	7Z4	12BF6	12V6GT
1U5	5AV8	6AN8	6BD6	6CD6G	6H6	6SQ7	7B7	12AB	12BH7	12W6GT
1V2	5AZ4	6AQ5	6BE6	6CF6	6J5	6SR7	7B8	12AB5	12BL6	12X4
1X2	5CC8	6AQ6	6BF5	6CG7	6J6	6T4	7C4	12AD6	12BQ6	17AX4
2AF4	5R4	6AQ7	6BG6G	6CH6	6J7	6T8	7C5	12AF6	12BR7	17D4
2B4	5T8	6AR5	6BH6	6CB8	6KG7	6U5	7C6	12AQ5	12BY7	19AU4GT
2CY5	5U4	6AS5	6BJ6	6CM8	6K7	6U8	7C7	12AT6	12CA5	19BG6G
3AL5	5U8	6AT6	6BK5	6CL6	6N7	6V6GT	7E5	12A77	12CN5	19T8
3BC5	5V4G	6AU4GT	6BK7	6CM6	6Q7	6W4GT	7E6	12A81	12DA	25Z6GT
3BN6	5V6GT	6AUSGT	6BL7GT	6CM7	6S4	6W6GT	7E7	12A77	12F8	35A5
3BZ6	5X8	6AU6	6BN6	6CM7	6S6GT	6X4	7F7	12AV6	12K5	35B5
3CB6	5Y3	6AUB	6BQ6GT	6CQ8	6SA7	6X5GT	7F8	12AV7	12K7	35C5
3S4	6AB4	6AV5GT	6BQ7	6CR6	6SC7	6X8	7G7	12L6		35W4

BRAND NEW 1-YEAR GUARANTEED TV PICTURE TUBES. Below Listed prices do not include dtd. Add additional \$5.00 deposit on tube sizes to 20"; on 21" and 24" tubes—\$7.50. Deposit refunded immediately when dtd is returned prepaid. Aluminized tubes—\$4.00 extra. Picture tubes shipped only to continental USA and Canada—All tubes A.O.B. Harrison, N. J.

Sensational Offer!
"Self Service"
TUBE CHECKERS
\$37.95
Let your customers test their own tubes! These reliable, reconditioned 22-socket tube checkers will return your investment in one week or less with little or no effort on your part! Handsome, field-tested console models complete with key for bottom door and neon-lighted head!

USED TV CONSOLES
Require only minor adjustments. 16", 17" and 19" screens . . . none smaller! Special! TV Consoles 10", 12" and 14" while they last \$8.95 as is. Sets shipped FOB, Harrison, N. J.

\$16.95
(As Is)

ATTENTION QUANTITY USERS! Bulk Discounts Are Yours . . . Call or Write For Our 1000 Tube "Private Label" Special! Money cheerfully refunded within five (5) days, if not satisfied!

SHIPPING INSTRUCTIONS: TRU-VAC PAYS YOUR POSTAGE on orders of \$6 or more in U.S.A. and Territories. Send approximate postage on Canadian and foreign orders. Any order less than \$6 requires 50c handling charge. Send 25% on C.O.D.'s.

TRU-VAC Dept. PE-6
Harrison Avenue • Box 107 • Harrison, N. J. HUmboldt 4-9770

INDEX

TO VOLUME 16

Jan.-June, 1962

AMATEUR RADIO AND SWL

Across the Ham Bands (Brier)	
ARRL "Navice Roundup"	75 Jan.
Haw Ta Get Mare QSO's Per CQ	75 Feb.
Heath HX-11 Transmitter	79 Mar.
Masley CM-1 Receiver	63 Apr.
Amateur Radio and the Community	81 May
A Ward to Citizens-Band "Homs"	73 June
Control for Low-Power Stations (Brier)	83 May
CPO, Loud-Speaking (Robbins)	77 Apr.
CW Selectivity, Improving (Brier)	77 Feb.
DX'ing the Broadcast Band (Stanbury)	69 Feb.
430 and Down (Hatfield)	46 Mar.
Ground-Plane Antenna, 15-Meter (Brier)	64 Apr.
Language, You've Got To Know the (Kneitel)	63 June
Milliwatt on 6 (Caringella)	56 Feb.
NASA-136 (Lamb)	39 June
Regen Receiver, One-Tube (Brier)	80 Mar.
RF Power Indicator, Poor Man's (Zachary)	55 Apr.
S-9'er (Lee)	47 Feb.
Short Wave for Beginners (Bennett)	52 Jan.
Short-Wave Monitor Certificate Application	
101 Jan., 105 Mar., 84 Apr., 105 May,	84 June
Short-Wave Report (Bennett)	
Q-Multiplier and Receiver Kits	81 Jan.
What Kind of DX'er Are You?	81 Feb.
What Are the Facts About Radio Swan?	77 Mar.
Stations Behind the Iron Curtain	83 Apr.
Short-Wave Stations of Guatemala	85 May
With the Clubs	83 June
Sidebander, Simple (Smith)	53 June
Signal Monitor (Browning)	51 May
Sun Jenny (Parker)	59 May
"10-8" De Luxe (Smith)	41 Jan.
Transmitter, High-Performance (Brier)	76 Jan.

CITIZENS BAND RADIO

Call-Signs, New-Style CB	34 Mar.
Cat's Eye for CB-1 (Newton and Barnett)	97 Apr.
CB Radio—Canadian Style	91 June
CQ DX 11 (Moore)	81 Apr.
FCC Report (Tall)	8 Jan., 10 Mar., 8 May
Gabble Killer	41 Apr.
On the Citizens Band (Strippel)	
69 Jan., 73 Feb., 58 Mar., 81 Apr., 77 May,	79 June
Regency CB-27 Ranks High	50 Mar.
RF Power Indicator, Poor Man's (Zachary)	55 Apr.

CONSTRUCTION PROJECTS

Audio Breadboard	49 Jan.
Aunt Minnie, Introducing (Barbee)	52 Feb.
Control for Low-Power Stations (Brier)	83 May
CPO, Loud-Speaking (Robbins)	77 Apr.
CW Selectivity, Improving (Brier)	77 Feb.
Diode Checker, Automatic (Sueker)	49 June
Drainpipe 8, Clean Sound from (Weems)	59 June

Electronic Banjo—Revisited (Garaer)	71 Mar.
Emily—Robot with One-Track Mind (Dickman)	41 Mar.
Expanded Scale Voltmeter, Improved (Zachary)	51 Mar.
Flood Life Stretcher (Gephart)	61 Jan.
430 and Down (Hatfield)	46 Mar.
Gabble Killer (Smith)	41 Apr.
Ground-Plane Antenna, 15-Meter (Brier)	64 Apr.
Hang an Electronic Picture (Busse)	67 May
Hybrid Receiver—for the Locals (Robbins)	74 Apr.
Idiot Lights Out—Meters In (Caringella)	59 Mar.
Imp Sleuth (Traiana)	65 May
In-Car FM for MPL (Robson)	55 Jan.
Juniar's Portable (Patrick)	60 Feb.
Magic Matrix (Garner)	55 Mar.
Micro-Master (Marriner)	61 May
Milliwatt on 6 (Caringella)	56 Feb.
Mini-Mana/Stereo (Wartman)	56 May
Maad Lighter (Parker)	51 June
N-C Charger (Friedman)	51 Apr.
NASA-136 (Lamb)	39 June
Power Supply, TD (Turner)	72 Jan.
Printed-Circuit P.A. (Patrick)	67 Apr.
Q-D Tester (Burek)	89 Feb.
Regen Receiver, One-Tube (Brier)	80 Mar.
RF Power Indicator, Poor Man's (Zachary)	55 Apr.
S-9'er (Lee)	47 Feb.
Sensor-Matic (Hughes)	63 Feb.
Sidebander, Simple (Smith)	53 June
Signal Monitor (Browning)	51 May
Soundliner (Boston)	69 Mar.
Squarer (Calvert)	58 Jan.
Stereo Sixteen Plus Four (Kyle)	45 Jan.
Sun Jenny (Parker)	59 May
Tape Recorder, De Luxe Your Portable (Blechman)	69 June
Tape/Slide Synchronizer (Petersen)	46 May
"10-8" De Luxe (Smith)	41 Jan.
Transistor Controls Temperature (Ippolita)	46 Apr.
Transistor Substitution Box (Wartman)	79 May
Transistor Tester, Experimenter's (Caringella)	71 Apr.
Transistorized Power Flash (Kyle)	66 Feb.
Transmitter, High-Performance (Brier)	76 Jan.
Uncle Tim, Introducing (Rosner)	53 Feb.

CONSTRUCTION TIPS

AM Receivers, Souping up (Smith)	92 Feb.
Capacitor Stabilizes Solar Cell (Turner)	68 Feb.
Carillon, Pint-Sized (Trauffer)	54 Apr.
Cat's Eye for CB-1 (Newton and Barnett)	97 Apr.
FM Listening, Add "Realism" to (Trauffer)	33 Mar.
Hi-Fi Hints	59 Feb.
Leg Tips, Tips on (Camstock)	99 Mar.
Mike for "Big Ear" (Trauffer)	51 Jan.
Mikes, Coil-Card Your (Blechman)	50 May
Old Player, New Speed (Stillwell)	87 May
Picture Frame Mounts Grille Cloth (Goss)	64 May
Plastics, Please (Leff)	54 May
Power Supply for Transistor Radio, External (Cerrato)	28 Feb.
Resistance Box, More Uses for (Elliott)	102 Mar.
Speeds Are Their Specialty (Agee)	75 June
Why Tune By Ear? (Carlucci)	54 Jan.
Workshop Tips	62 Feb.

DEPARTMENTS

Across the Ham Bands (Brier)	
75 Jan., 75 Feb., 79 Mar., 63 Apr., 81 May, 73 June	
Carl and Jerry (Frye)	
82 Jan., 82 Feb., 83 Mar., 87 Apr., 88 May, 85 June	

Electronics Datebook	101 Apr., 104 May, 14 June
FCC Report (Tall).....	8 Jan., 10 Mar., 8 May
Hi-Fi Showcase	20 Jan., 14 Feb., 26 Mar., 22 Apr., 28 May, 30 June
Letters from Our Readers.....	28 Jan., 8 Feb., 20 Mar., 10 Apr., 22 May, 8 June
New Products	34 Jan., 34 Feb., 92 Mar., 28 Apr., 37 May, 26 June
On the Citizens Band (Strippel).....	69 Jan., 73 Feb., 58 Mar., 81 Apr., 77 May, 79 June
POP'tronics Bookshelf	96 Jan., 30 Feb., 16 Mar., 14 Apr., 14 May, 92 June
POP'tronics News Scope.....	6 Jan., 6 Feb., 6 Mar., 6 Apr., 6 May, 6 June
Short-Wave Report (Bennett).....	81 Jan., 81 Feb., 77 Mar., 83 Apr., 85 May, 83 June
Tips and Techniques.....	38 Jan., 24 Feb., 37 Mar., 34 Apr., 34 May, 20 June
Transistor Topics (Garner).....	78 Jan., 78 Feb., 74 Mar., 78 Apr., 74 May, 76 June

FEATURE ARTICLES

American FM, What's Wrong with (Angus).....	45 June
Audiometer, Quick-Check (Kutschbach).....	95 Jan.
Bypass Capacitor, Getting To Know the (Doyle).....	91 Jan.
Carl and Jerry (Frye).....	82 Jan., 82 Feb., 83 Mar., 87 Apr., 88 May, 85 June
Crossword Puzzle	60 Jan., 70 Mar.
Deutsche Mark for Your Thoughts (Kutschbach).....	78 May
DX'ing the Broadcast Band (Stanbury).....	69 Feb.
Electronics Schools (Lenk)	
Key to Your Future (Part 1).....	41 Feb.
Correspondence Schools (Part 2).....	63 Mar.
Residence Schools (Part 3).....	57 Apr.
"Eye" for Small-Boat Skippers.....	58 June
Fingertip Bulbs Light Space.....	78 May
Hobnobbing with Harbaugh (Harbaugh).....	74 Jan., 91 Mar., 66 Apr., 67 June
Language, You've Got To Know the (Kneitel).....	63 June
Music To Work By (Mandell).....	72 May
Plastics, Please (Leff).....	54 May
POP'tronics News Scope.....	6 Jan., 6 Feb., 6 Mar., 6 Apr., 6 May, 6 June
Quiz (Balin)	
Capacitor Function	54 Mar.
Coil Function	82 June
Electronic Unit	71 May
Magnetic Phenomena	72 Feb.
Resistor Function	64 Jan.
Transformer	73 Apr.
Radioactive Voice for the Northland.....	50 Apr.
Short Wave for Beginners (Bennett).....	52 Jan.
Transistor's Temperature, Taking Your (Fitchen).....	65 Jan.
TV Screens, "Line Blender" for.....	71 Jan.
UHF-TV, Must We Have (Gilmore).....	41 May
Wardronics (Ambrase)	95 Jan.

HI-FI/STEREO AND AUDIO

American FM?, What's Wrong with (Angus).....	45 June
Audio Breadboard (Trauffer).....	49 Jan.
Aunt Minnie, Introducing (Barbee).....	52 Feb.
Carillon, Pint-Sized (Trauffer).....	54 Apr.
Drainpipe 8, Clean Sound from (Weems).....	59 June
FM Listening, Add "Realism" to (Trauffer).....	33 Mar.
Hi-Fi Hints	59 Feb.
Hi-Fi Showcase	20 Jan., 14 Feb., 26 Mar., 22 Apr., 28 May, 30 June

Hybrid Receiver—for the Locals (Robbins).....	74 Apr.
Imp Sleuth (Troiano).....	65 May
In-Car FM for MPL (Robson).....	55 Jan.
Mike for "Big Ear" (Trauffer).....	51 Jan.
Mini-Mono/Stereo (Wartman)	56 May
Music To Work By (Mandell).....	72 May
Old Player, New Speed (Stillwell).....	87 May
Picture Frame Mounts Grille Cloth (Goss).....	64 May
Printed-Circuit P.A. (Frantz).....	67 Apr.
Regal Sound from Regal 300 Kit (Electra-Voice).....	82 Mar.
Saundliner (Baston)	69 Mar.
Sounds You Didn't Hear.....	81 June
Speeds Are Their Specialty (Agee).....	75 June
Squarer (Colvert)	58 Jan.
Stereo Sixteen Plus Four (Kyle).....	45 Jan.
Tape Recorder, De Luxe Your Portable (Blechman).....	69 June
Tape/Slide Synchronizer (Petersen).....	46 May
Tender Touch	68 June
Uncle Tim, Introducing (Rosner).....	53 Feb.
Why Tune By Ear? (Carlucci).....	54 Jan.

PRODUCT REPORTS

Q-Multiplier and Receiver kits (Heath HD-11 and GR-91)	81 Jan.
Receiver (Mosley CM-1).....	63 Apr.
Regal Sound from Regal 300 Kit (Electra-Voice).....	82 Mar.
Regency CB-27 Rank: High.....	50 Mar.
Sounds You Didn't Hear (Fairchild "Componder").....	81 June
Tender Touch (Rek-O-Kut "Auto-Pause").....	68 June
Transmitter (Heathkit HX-11).....	79 Mar.

TEST EQUIPMENT

Diode Checker, Automatic (Sueker).....	49 June
Expanded Scale Voltmeter, Improved (Zachary).....	51 Mar.
Imp Sleuth (Troiano).....	65 May
Micro-Master (Marriner)	61 May
Q-C Tester (Burek).....	89 Feb.
RF Power Indicator, Poor Man's (Zachary).....	55 Apr.
Signal Monitor (Browning).....	51 May
Transistor Tester, Experimenter's (Caringello).....	71 Apr.

TRANSISTORS

Audio Breadboard (Trauffer).....	49 Jan.
CPO, Loud-Speaking (Robbins).....	77 Apr.
Electronic Banjo—Revisited (Garner).....	71 Mar.
Emily—Robot with One-Track Mind (Dickman).....	41 Mar.
Hybrid Receiver—for the Locals (Robbins).....	74 Apr.
Imp Sleuth (Troiano).....	65 May
Junior's Portable (Patrick).....	60 Feb.
Micro-Master (Marriner)	61 May
Power Supply for Transistor Radio, External (Cerrato).....	28 Feb.
Power Supply, TD (Turner).....	72 Jan.
Printed-Circuit P. A. (Frantz).....	67 Apr.
Q-C Tester (Burek).....	89 Feb.
Signal Monitor (Browning).....	51 May
Sun Jenny (Parker).....	59 May
Tape/Slide Synchronizer (Petersen).....	46 May
Transistor Controls Temperature (Ippolito).....	46 Apr.
Transistor Substitution Box (Wartman).....	79 May
Transistor Tester, Experimenter's (Caringello).....	71 Apr.
Transistor Topics (Garner).....	78 Jan., 78 Feb., 74 Mar., 78 Apr., 74 May, 76 June
Transistorized Power Flash (Kyle).....	66 Feb.
Transistor's Temperature, Taking Your (Fitchen).....	65 Jan.

POPULAR ELECTRONICS

June 1962 Advertisers' Index

ADVERTISER	PAGE NO.
Allied Radio	31
American Institute of Engineering & Technology	101
B & K Manufacturing	10
Blonder-Tongue	4
Capitol Radio Engineering Institute, The	23
Central Technical Institute	16, 17, 18, 19
Cleveland Institute of Electronics	21
Coyne Electrical School	101
DeVry Technical Institute	3
E.C.I. Electronics Communications, Inc.	7
EICO (Electronics Instr. Co. Inc.)	38
Fisher Radio Corporation	37
Grantham School of Electronics	11
Grommes Div. of Precision Electronics, Inc.	22
Grove Electronic Supply Company	30
Heath Company	87
Holt, Rinehart & Winston, Inc.	36
Hy-gain Antenna Products	FOURTH COVER
Indiana Technical College	101
International Crystl Mfg. Co., Inc.	29
International Electronics Corporation	28
Johnson Company, E.F.	5
Key Electronics Company	32
Kuhn Electronics, Inc.	24
Lafayette Radio	25
Micro Electron Tube Co.	34
Milwaukee School of Engineering	105
Mosley Electronics Inc.	27
Moss Electronic, Inc.	32
Multicore	101
National Radio Institute	SECOND COVER, 1
National Technical Schools	15
Nordyke Songs & Music	101
North American Philips Company, Inc.	12
PACO Electronics Co., Inc.	THIRD COVER
Polytronics Lab Inc.	89
Progressive "Edu-Kits" Inc.	33
R.A.E. Society	35
RCA Institutes, Inc.	8, 9
RTS Electronics Division	13
Rad-Tel Tube Co.	114
Rider Publisher, Inc., John F.	99
Scientific Development Corporation	34
Seco Electronics, Inc.	91
Sonotone Corporation	14
Standard Brands Tube Company	103
Terado Company	30
Texas Crystals	36
Transvision Electronics, Inc.	95
Tri-State College	97
Tru-Vac	107
Turner Microphone Company, The	20
United Scientific Laboratories, Inc.	97
Utica Communications Corp.	22
Valparaiso Technical Institute	97
Vanguard Electronics Labs	97
Xcelite, Inc.	24

On the Citizens Band

(Continued from page 80)

net, perhaps the largest coordinated CB activity yet held, include (in alphabetical order) Bristol, Elizabethton, Erwin, Greenville, Johnson City, Jonesboro, Kingsport, and Morristown (all in Tennessee), and Abingdon, Bristol, Chilhowie, Damascus, Glade Springs, Marion, Norton, St. Paul, and Saltville (all in Virginia).

A challenging organization is the Radio Rescue Service of East Hartford, Conn. Members are receiving first-aid and rescue training, and their mobile units are not only equipped with radios but also with first-aid supplies; meetings are devoted to improving their proficiency in first-aid and disaster work. This organization has gained the recognition of several local police and fire departments.

The Niagara Frontier CB club has been taking applications from members wanting to join the Civil Defense team, and local officials are supporting the move. Contact Barb Urban, 20Q0619, 209 Fletcher St., Tonawanda, N.Y., if you're interested. This club also plans its annual PONY Jamboree on August 10, 11, and 12 at the National Hose Grounds in Tonawanda; admission is \$2.50 per person, but those under 18 years of age will be admitted free. -50-



Master control station of telethon collection net discussed above was located at WCYB-TV transmitter site atop Holston Mountain, near Bristol, Va. Photo and information were supplied by Tommy Miller, 6Q4427, of the Johnson City (Tenn.) CB Club.

ELECTRONICS MARKET PLACE

RATE 60¢ per word. Minimum 10 words prepaid. July issue closes May 6th. Send order and remittance to Martin Lincoln, POPULAR ELECTRONICS, 1 Park Ave., New York 16, N. Y.

FOR SALE

GOVERNMENT Sells Surplus: Electronics; Oscilloscopes; Transceivers; Test Equipment; Radar; Sonar; Walkie-Talkies; Boats; Jeeps; Aircrafts; Misc.—Send for "U.S. Depot Directory & Procedures"—\$1.00—Brody, Box 425(PE), Nanuet, New York.

TV Tuners—Rebuilt or Exchanged \$9.95 complete—all types—fast, guaranteed service. Send tuner with all parts to: L.A. Tuner Exchange, 4611 West Jefferson Blvd., Los Angeles 16, California.

GOVERNMENT Surplus Receivers, Transmitters, Snooper-scopes, Parabolic Reflectors, Picture Catalog 10¢. Meshna, Malden 48, Mass.

WPE-SWL-CB-QSL Cards — Samples 10¢ — "Brownie" W3CJ1, 3110A Lehigh, Allentown, Penna.

DIAGRAMS for repairing Radios \$1.00, Television \$2.00. Give make, model. Diagram Service, Box 672-PE, Hartford 1, Conn.

BEFORE You Buy Receiving Tubes or Hi-Fi Components send now for your giant Free Zalytron current catalog—featuring nationally known Zalytron First Quality TV-Radio Tubes, Hi-Fi Stereo Systems, Kits, Parts, etc. All priced to Save You Plenty—Why Pay More? Zalytron Tube Corp., 220 W. 42nd St., NYC.

"**SPECIAL!** WPE-SWL-CB-QSL cards, 3 colors, \$2.50 per 100—Free Samples, Garth, Jutland, New Jersey."

CITIZENS Band—Maximum quieting with OZCO "Snoozer." Largest selling add-on squelch still only \$2.00 each, \$3.95 pair postpaid! Guaranteed. OZCO, Canaan, Connecticut.

SAVE dollars on radio, TV-tubes, parts at less than manufacturer's cost. 100% guaranteed! No rebrands, pulls. Request Bargain Bulletin. United Radio, 1000-E, Newark, N. J.

RUBBER Stamps personal or Business write. N. Alberg 121-18 Rockaway Blvd. South Ozone Park 20, N.Y.

INVESTIGATORS, write for free brochure on latest subminiature electronic listening devices. Dept. 4A, Ace Electronics 11500 NW 7th Ave., Miami 50, Fla.

CB WPE QSL Cards, Finest Quality, Multicolor, 10¢ For Samples. Radio Press, Box 24, Pittstown, New Jersey.

CB—Now use just one mobile antenna for both CB and broadcast radio—even at the same time! OZCO 1-10'er Signal Divider guaranteed unsurpassed! Only \$5.95 postpaid. Free literature. Ozco, Canaan, Connecticut.

BARGAINS! Used CB, amateur equipment! List 10¢. Brands, Sycamore, Illinois.

TRANSFIRE Transistor electronic ignition. Saves gas, tune-ups. Points, plugs last to 100,000 miles. Top performance, improved starting. Parts, Complete systems, Kits, from \$34.95. Literature. Palmer Electronics, 40E, Carlisle, Massachusetts.

SMALL set builder's big information catalog—25¢, refundable. Laboratories, 1131-L Valota, Redwood City, California.

HiFi AMPLIFIERS, tuners, speakers, radios, telescopes, microscopes, cameras. Free Catalog. GM PhotoElectronics, 623 Gay, Knoxville 2, Tennessee.

CB'ERS dual conversion adapter kit, all parts, schematic, pictorial; hear only the channel you tune. For HE-15, 15A; TR-800, 910, etc. \$14.95, with tubes \$16.95. For HE-20, 20A; Mark VII \$15.50, with tubes \$17.50 or \$5.00 deposit plus C.O.D. Bainbridge Radio, 2649 Bainbridge Ave., New York 58, N. Y.

DIAGRAMS: TV \$1.25, Radio \$.50. Misc. Sales, 129 Cooper, Santa Ana, Calif.

CONVERT Any television to sensitive, big-screen oscilloscope. Only minor changes required. Simple plans \$1.95. Relco, Box 10563, Houston 18, Texas.

DIAGRAMS—For T.V. \$2. Radio \$1. Hiatt Diagrams, Box 816, Laredo, Tex.

CB'S—Want to transmit further? Add #5686 final RF tube to get maximum efficiency 75%. Plus diagrams information on many other ideas. \$1.00 C.B. Improvement Co. 70 Hill St., Bloomfield, N. J.

FREE—R.C.A., G.E., etc. tubes catalog. Discount to 75% from list. Picture tubes at 75¢ inch up. Parts, parts kits at 1/10 original cost. Needles, tube testers, silicones, seleniums, 7" TV bench test tube. \$6.99—and more. Arcurus Electronics Corp., P.E. 402—22nd Street, Union City, New Jersey.

PROFESSIONAL Electronic Projects—Organs, Timers, Computers, Industrial, etc. \$1 up. Catalog Free. Parks, Box 1665, Seattle 55, Washington.

PHOTO-MULTIPLIER power transistor. Complete Photo-electronic system in one unit. Make your own photo control systems, door openers, burglar alarms, door chimes, light controls, counters, motor activation, electronic targets, electronic toys. Includes complete instructions, manual with ten unusual applications. Only \$2.95 ppd. Photoelectronics, Box 301, Cedarhurst, N. Y.

BUILD amazingly sensitive transistorized treasure finder. Available partially wired. Inexpensive. Simple illustrated plans, details. \$2. Deekits, Box 7263-D, Houston 8, Texas.

TV tuners rebuilt \$9.95—Ninety day guarantee. Western Tuner Rebuilders, 4130 El Cajon Blvd., Los Angeles, California.

2 X 3 FCC warning decal against illegal use 35¢ each, 3/\$1.00. Code caller, (Q Bird), kit \$2.50, wired \$3.50. CB Products, Box 457, Encino, California.

CB QSLs—\$2.00 per 100 postpaid. Glossy, red and green. Free sample. Hobby Print Shop, Umatilla, Fla.

DIAL telephones, cradle type. Use for private systems, intercoms, etc. Recent Stromberg-Carlson. \$4.75 each. Guaranteed. 4476 Van Ness, Fresno 4, Calif.

POLICE radar detector parts cost only \$3.00. Send \$1 for plans which includes Jammer information to Radet, P.O. Box 7432, Cleveland 30, Ohio.

"**EMBOSSSED** business cards, 1,000 \$4.00; Miniature \$3.00. Card Service, Box 2131, Tulsa, Oklahoma."

TELEPHONE extension in your car. Answer your home telephone by radio from your car. Complete diagrams and instructions \$2.00. C. Carrier Co., 5880 Hollywood Blvd., Hollywood 28, Calif.

EAVESDROP with a pack of cigarettes. Miniature transistorized FM radio transmitter. Complete diagrams and instructions \$2.00. C. Carrier Co., 5880 Hollywood Blvd., Hollywood 28, Calif.

BE a spy. Correspondence course on wire tapping, bugging, telescopic sound pickup, recording techniques, microphotography, and invisible photography. Lessons in surveillance, tailing, and use of equipment. Complete course \$22.50. C. Carrier Co., 5880 Hollywood Blvd., Hollywood 28, Calif.

TV tape recorder. Build your own video recorder. Complete correspondence course and construction details. \$22.50. C. Carrier Co., 5880 Hollywood Blvd., Hollywood 28, Calif.

TELEPHONE voice switch (LS-500). Actuates automatically and unattended any tape or wire recorder. Pictorial installation instructions included. \$23.75. Post Paid US. WJS Electronics, 1130 N. Highlands Ave., Los Angeles 38, Calif.

INVESTIGATORS. Do your own sound work. Send \$1.00 for brochure of latest electronic equipment. WJS Electronics, 1130 N. Highland Ave., Los Angeles 38, Calif.

CONSTRUCTION details for all electronic projects: \$50 TV camera, transistorized automobile ignition, \$35 color TV converter, \$4.75 each. TV tape recorder construction details & correspondence course, \$22.50; Electronics course \$22.75; digital computer kit & course \$27.50. DB Enterprises, 8959 Wonderland Ave., Hollywood 46, Calif.

EMERGENCY Power Convert Auto Type Generator For 120V 60cy Output To 750W Instructions \$2.50 Winding Kit Less Generator \$7.95. W. Houck, Box 8331, Orlando, Fla.

POLICE radar detector, and legal jammer. Stop before those radar speed traps. Easy to build for less than \$10.00; used with your car radio. Complete construction details \$3.75. C. Carrier Co., 5880 Hollywood Blvd., Hollywood 28, Calif.

MORSE code by sleep teaching. Guaranteed. 4 taped lessons to 18 WPM; \$12.95 each. Electro-Sleep, 8959 Wonderland Ave., Hollywood 46, Calif.

CITIZENBANDERS. For the utmost in sensitivity and low noise, replace that noisy pentode R.F. amplifier tube with our New Plug-in Nuvistor stage. \$17.95 Complete. Specify set make, model, Tube number to be replaced. Free literature available. Raytronics, P.O. Box 938, Battle Creek, Mich.

TV Tuners—rebuild or exchanged \$9.95. Most tuners shipped same day received. Valley Tuner Service, 18530 Parthenia, Northridge, Calif.

DO secret investigative work with supersensitive directional microphone. Detects a whisper at great distances. Easily constructed for \$7. Illustrated plans \$2. Dee Company, Box 7263-F, Houston 8, Texas.

WASHING machine, Dryer parts, informative booklet, discounts, (Free "Trouble Diagnosis chart" included)—25c Refundable on first order. Basik Co., Dept. P.E.6, 1839 So. 22nd St., Phila. 45, Pa.

TELEPHONES—Antique, Modern, French, any Model—Also Parts & Misc. Telephone Equipment of all kinds—Price List 50c. Delta, Box 2262, Dallas 21, Texas.

TOP quality transistor broadcaster. Variable frequency! No license required. Kit—\$3.70 complete. Pp. Dean Radio, 3505 Crown Place, Spokane, Washington.

RADIO & Television Parts below wholesale. Request Free Bulletin. Buckeye, Fairlawn Station, Box 5122, Akron, Ohio.

SK-3-RF Preselector fits GW-10, GW-11, boosts sensitivity 3- to "S" units. Complete kit, \$8.99; wired \$11.99; postpaid. Holstrom Associates, Box 8640, Sacramento 22, California.

HAMS, SWL'S. Tunable 3.5-30 megacycle SK-20-RF pre-selector boosts receivers 20+DB without modification. Complete kit, built-in power supply, \$18.98 postpaid. Holstrom Associates, Box 8640, Sacramento 22, California.

C'BILERS. Use CB antenna for transceiver and auto radio simultaneously! DP-2 kit, \$4.49 postpaid. Holstrom, Box 8640, Sacramento 22, California.

LIGHTERS—European Imports—Zippo Type—Call Letters Beautifully Mounted—\$2.50 Each—Jordan—Box 3074, Philadelphia 50, Pa.

GARAGE Door Operator Kits—Edwards famous KR-50 kit. Easily assembled and installed. Available with or without remote car control. Thousands sold. Priced from \$59.95. Write for literature. Edward T. Fink Co., Inc., 284 Naperhan Ave., Yonkers, N. Y., Dept. PE.

CLOSING out test equipment, tubes, photofacts. Shaw, Box 1171, Poughkeepsie, N. Y.

POCKET sized, low impedance, square-wave generator. Variable Frequency, 200 to 4000 cycles. Build it yourself for \$9. Send \$1.00 and stamped envelope for schematic to, Ace, 11500-F NW 7th Ave., Miami 50, Florida.

RARE Tubes. Used Parts. Send Stamp. Airway, 10144 W. Jefferson, River Rouge 18, Michigan.

WANTED

TRIGGER—W9IVJ. We Buy Shortwave Equipment For Cash, 7361 North, River Forest, Ill., Phone PR 1-8616.

QUICKSILVER, Platinum, Silver, Gold. Ores Analyzed. Free Circular. Mercury Terminal, Norwood, Mass.

OLD Canadian Coins, Electronic Parts, Stamps, Radios, Etc. Send What you Have to: Howard A. Little, Bonavista, N.F.L.D.

GOVERNMENT SURPLUS

JEeps \$278, Airplanes \$159, Boats \$7.88, generators \$2.68, typewriters \$8.79, are typical government surplus sale prices. Buy 10,001 items wholesale, direct. Full details, 627 locations, procedure only \$1.00. Surplus, Box 789-C1, York, Penna.

GOVERNMENT Surplus, Radios, Jeeps, Walkie Talkies, Boats, Etc. Buy Direct. Send For Locations & Procedures. 50c. Why Pay More? Delta, Box 2262-J, Dallas 21, Texas.

HIGH-FIDELITY

DISGUSTED with "Hi" Hi-Fi Prices? Unusual discounts on your High Fidelity Requirements. Write Key Electronics, 120 Liberty St., New York 6, N. Y. Cloverdale 8-4288.

DON'T Buy Hi-Fi Components, Kits, Tape, Tape Recorders until you get our low, low return mail quotes: "We Guarantee Not To Be Undersold." Wholesale Catalog Free. Easy time payment plan, 10% down—up to 24 mos. to pay. Hi-Fidelity Center, 220 PC-E 23 St., New York 10, N. Y.

PROMPT Delivery, Lower Prices. Amplifiers, Tape Recorders, Tuners, etc. No Catalogs, Individual Quotes. Compare. L. M. Brown Sales Corp., Dept. P, 239 E, 24 St., N. Y. 10, N. Y.

PRICES? The Best! Factory-Sealed Hi-Fi Components? Yes! Send for free catalog. Audion, 25P Oxford Road, Massapequa, N. Y.

RECORDERS, Components. Free wholesale catalogue. Carston, 125-P East 88, N. Y. C. 28.

TAPE AND RECORDERS

SELF-Hypnosis may help you many ways. New tape or LP-record teaches you quickly, easily! Free literature. McKinley Company, Box 3038, San Bernardino, California.

TAPE Recorders, Hi-Fi, components, Sleep Learning Equipment, tapes. Unusual Values. Free Catalog. Dressner, 1523PE, Jericho Turnpike, New Hyde Park, N. Y.

SAVE 30% Stereo music on tape. Free bargain catalog/blank tape/recorders/norelco speakers. Saxitone, 1776 Columbia Road, Washington, D.C.

RENT Stereo Tapes—over 2,500 different—all major labels—free catalog. Stereo—Parti, 811-G Centinela Ave., Inglewood 3, California.

4/TR Stereo Tapes—bought, sold, rented, traded! Free Catalog/Bargain closeouts. Columbia, 9651 Foxbury, Rivera, California.

DISCOUNTS 73%! Quality recording tape. Catalog: Tape, 2028 Garth Avenue, Los Angeles 34, California.

GLOBAL Tape Recording Exchange Hobby Club most rewarding hobby known for all ages, music, educational knowledge, or small talk. Write Mailway Co., 216 W. Jackson Blvd., Chicago 6, Ill. or 51 W. 35th St., New York 1, New York.

PATENTS

PATENT Searches, \$6.00. For free Information Record, and "Information Inventor's Need, write: Miss Heyward, 1029 Vermont Avenue NW, Washington 5, D. C.

INVENTIONS WANTED

INVENTIONS wanted. Patented; unpatented. Global Marketing Service, 2420-P 77th, Oakland 5, Calif.

INSTRUCTION

NEW Trade? Electronic, Mechanical Drafting pay \$150 week. Send \$2 first lesson, complete home study course \$25. Prior Inc., 23-09 169th St., Whitestone 57, New York. **FCC LICENSE** in 6 Weeks, First Class Radio telephone. Results Guaranteed. Elkins Radio School, 2603B Inwood, Dallas, Texas.

LEARN While Asleep, hypnotize with your recorder, phonograph. Astonishing details, sensational catalog free! Sleep-Learning Association, Box 24-ZD, Olympia, Washington.

ELECTRONICS simplified. Amazing method. Complete course \$9.95. Stegotronics, Colchester, Connecticut.

WHATEVER your needs, Popular Electronics classified can solve them. Simply place an ad in these columns and watch your results pour in.

Always say you saw it in—POPULAR ELECTRONICS

PHOTOGRAPHY-FILM, EQUIPMENT, SERVICES

SCIENCE Bargains—Request Free Giant Catalog "CJ"—144 pages—Astronomical Telescopes, Microscopes, Lenses, Binoculars, Kits, Parts. War surplus bargains. Edmund Scientific Co., Barrington, New Jersey.

STAMPS AND COINS

FOR Sale—Newfoundland Stamps! 100 Fine Newfoundland Stamps—\$1.00. 100 all different—\$3.50. Harry Phillips Sales, Bonavista-2S, Nfld, Canada.

TOPS! Fascinating coin collection from Camerouns, Formosa, Vatican, etc. and foreign banknote. Catalog Price over \$1.50! Only 10¢ with exciting coin approvals! Littleton Coin Company, Littleton T-12, New Hampshire.

105 DIFF. U.S. only 25¢ Approvals, Inc. Shelton, P.O. Box 187-J, Hempstead, N. Y.

GIGANTIC Collection Free! Includes triangles, early United States, animals, commemoratives, British Colonies, high value pictorials, etc. Complete collection plus big illustrated magazine all free. Send 5c for postage. Gray Stamp Company, Dept. Z2, Toronto, Canada.

1960 UNITED NATIONS commemorative stamps, all mint 4c and 8c commemorative sets only one dollar with request for approvals. Adults only. Martin Stamp Co., Box 12-A, Gravesend Sta., Brooklyn 23, New York.

200 WORLDWIDE stamps 25c, satisfaction guaranteed, approvals, Juergens, 109 Mt. Holly, Amelia 2, Ohio.

LEATHERCRAFT

FREE "Do-It-Yourself" Leathercraft Catalog. Tandy Leather Company, Box 791-B44, Fort Worth, Texas.

PLASTICS

NEW Liquid Casting Plastic, clear, colors. Embed real flowers, butterflies, photos, coins. Send 25¢ for two handbooks "How to Cast Liquid Plastics" and "How to Make Extra Money at Home." Castolite, Dept. C-108, Woodstock, Illinois.

BUSINESS OPPORTUNITIES

BUY Direct from factories. Appliances, cameras, watches! Free details! Cam Co., 436 PE Bloomfield Ave., Verona, N. J.

VENDING Machines—No Selling. Operate a route of coin machines and earn amazing profits. 32-page catalog free. Parkway Machine Corporation, Dept. 12, 715 Ensor St., Baltimore 2, Md.

ELECTROPLATING equipment and supplies. All types for home work shops. Free Catalog. HBS Equipment Division, 3445 Union Pacific, Los Angeles 23, Calif.

MAKE \$25-\$50 Week, clipping newspaper items for publishers. Some clippings worth \$5.00 each. Particulars free. National, 81-EG, Knickerbocker Station, New York City.

FREE Book "990 Successful, Little-Known Businesses." Work home! Plymouth—455R, Brooklyn 4, New York.

SECOND Income From Oil Can End Your Toil! Free Book And Oilfield Maps! National Petroleum, Panamerican Bldg.—ZD, Miami 32, Florida.

EARN \$3.00 hour—home sparetime. Easy Pump Lamps assembling, No canvassing. Write: Ougor, Cabot 15, Arkansas.

MAKE Money Making Leathersgoods 1148 Ideas, Free information. Tandy Leather Co., Box 791-G2, Fort Worth, Texas.

MADE \$40,000.00 Year by Mailorder! Helped others make money! Start with \$10.00—Free Proof. Torrey, Box 3566-N, Oklahoma City 6, Oklahoma.

ASSEMBLE artificial lures at home for stores. Materials supplied free. Profitable! Write: Lures, Ft. Walton Beach 1, Florida.

ACCORDION amplification supplies: Earn extra money at home by custom amplifying accordions and pianos. We supply complete instructions, full kits or parts. Send 25c for brochure. Box 206, North Wales, Pa.

EDUCATIONAL OPPORTUNITIES

ENGINEERING Education for the Space Age. Northrop Institute of Technology is a privately endowed, nonprofit college of engineering offering a complete Bachelor of Science Degree Program and Two-Year accredited technical institute curricula. Students from 50 states, many foreign countries. Outstandingly successful graduates employed in aeronautics, electronics, and space technology. Write today for catalog—no obligation. Northrop Institute of Technology, 1179 West Arbor Vitae Street, Inglewood 1, California.

DETECTIVE Profession. Home Study. Lapel pin, Certificate, Future. Box 41197-AG, Los Angeles 41, Calif.

TAKE Bachelor's and Master's Degree correspondence courses from leading universities! Directory of 6,000 courses—\$2.00. College Research, North Highlands 3, California.

EMPLOYMENT INFORMATION

HIGH Paying Jobs in Foreign Lands! Send \$2.00 for complete scoop! Foreign Opportunities, Box 172, Columbus 16, Ohio.

EARN Extra money selling advertising book matches. Free samples furnished. Matchcorp, Dept. MD-12, Chicago 32, Illinois.

WORK in sunny Arizona. Information and current job listings, \$1.00. Thompson Enterprises, P.O. Box 6561, Dept. P.E., Phoenix 5, Arizona.

MISCELLANEOUS

INDEPENDENT Thinkers—investigate Humanism! Write American Humanist Association, Dept. PE, Yellow Springs, Ohio.

PEACH Brandy—Cherry Cordial—Wine—Beer—old rare formulas for personal use. Send \$1.00. Research Enterprises, Dept. D, 29 Samoset Road, Woburn, Mass.

"GIANT Arms." Dr. Young's, D.C. Revolutionary discovery. \$2. Satisfaction or refund. Gaucho, Box 9309-E8, Chicago 90.

HYPNOTIZE! Practical Instruction Course \$1 (guaranteed!). Crystal's, 28-PPE2, Millburn, New Jersey.

AUTHORS! Learn how to have your book published, promoted, distributed. FREE booklet "ZD," Vantage, 120 West 31 St., New York 1.

"HOME Brewing! Beers, Wines." Complete instructions \$1. (Guaranteed.) Crystal's, 28-BPE6, Millburn, New Jersey.

HYPNOTIZE Unnoticed, quickly, effortlessly or refund! Thousands satisfied! \$2. Timmer, Box 244, Cedarburg, Wisc.

RECEIVE Big Mail! Samples, magazines, catalogues. Get listed 25¢, Logan, (300-A), 8-288 Charles, Winnipeg 4, Manitoba.

NEW Vortex theory for elementary particles and forces. 30 pages. 25 cents ppd. C. F. Krafft, 4809 Columbia Road, Annandale, Virginia.

SONGWRITERS, with publisher contacts, want song ideas. Share royalties. No fees. Send poems: Songwriters' Associates, 1650 Broadway, N. Y. 19-V.

"HYPNOTIZE . . . One word . . . One Fingersnap," on stage. Satisfaction—or refund. \$2. Hypnomaster, Box 9309-E8, Chicago 90.

"HOMEBREW GUIDE" Complete Illustrated Instruction Manual, \$2.00. Supply Catalog Included. CalBrew Supplies, Box 1005, Seaside, California.

SIXTANTS aircraft fairchild jaguar watch powered shoots stars, astronauts \$37.50. VHF-FM transceiver 144-174MC including mike, speaker, control, antenna \$1.50. Other surplus aircraft parts applicable to marine, Write O'Keefe Surplus Aircraft, Box 284, Stanhope, N. J.

INVESTIGATORS, free brochure, latest subminiature electronic listening devices. Dept-6K, 11500 NW 7th Ave., Miami 50, Fla.

RAD-TEL

LEADING "DIRECT-BY-MAIL" TUBE CO.

UP TO **75% OFF** *

**RAD-TEL'S QUALITY
BRAND NEW TUBES
1-YEAR GUARANTEE • 1-DAY SERVICE
OVER 500 TYPES IN STOCK**



THE SIGN OF
RAD-TEL'S
RELIABILITY

*Manufacturers Suggested List Price

FREE!

Send For New Tube & Parts Catalog

Send For Trouble Shooting Guide

PUBLIC ADDRESS SYSTEM—50% OFF*

- WITH PLUG-IN CRYSTAL MIKE
- A MUSICAL INSTRUMENT AMPLIFIER
- P.A. SYSTEM IS EXCELLENT FOR MEETINGS, SPEECHES, SCHOOLS, GROUPS, etc.



MADE IN U.S.A.
Latest deluxe model has a specially designed heavy 8" speaker combined with 2 dual purpose tubes (equal to a 6 tube amp.) and output transformer to develop fine response in a 4-tube, 5 watt amplifier. Inputs for 2 instruments; 4 controls: volume, tone, tremelo speed & depth; on/off switch; fuse; all are mounted on top. New acoustically designed cabinets, covered with gray simulated leather, with woven acoustical grille cloth. Complete with crystal microphone ready to operate as public address system. Fully guaranteed against defects in parts and workmanship. Shipping weight 13 lbs. Size 15 1/2" x 13" x 6". Priced at ROCK-BOTTOM! List \$79.00.

NO. A5 \$39.50



RAD-TEL TUBE CO.

33 CHAMBERS ST., NEWARK 5, NEW JERSEY

TERMS: 25% deposit must accompany all orders, balance COD. Orders under \$5: add \$1 handling charge plus postage. Orders over \$5: plus postage. Approx. 8 tubes per 1 lb. Subject to prior sale. No COD's outside continental USA.

EACH TUBE INDIVIDUALLY & ATTRACTIVELY BOXED & BRANDED RAD-TEL

Qty.	Type	Price	Qty.	Type	Price	Qty.	Type	Price	Qty.	Type	Price
	D24	.79		6AU4	.82		6J6	.67		12CX6	.54
	1AX2	.62		6AU6	.52		6K6	.63		12D4*	.69
	1B3	.79		6AU7	.61		6C6	1.06		12DB5	.69
	1DN5	.55		6AU8*	.87		6N7	.98		12DE8	.75
	1G3*	.79		6AV6	.41		6S4	.51		12DL8	.85
	1J3*	.79		6AV8	.90		6SA7GT	.76		12D06	1.04
	1K3*	.79		6AX4	.66		6SG7GT	.41		12DS7	.79
	1R5	.62		6AX5	.74		6SH7GT	.49		12DT5*	.76
	1S4	.59		6AX7	.64		6SJ7	.88		12DT7*	.79
	1S5	.51		6AX8*	.92		6SK7GT	.74		12DT8*	.79
	1T4	.58		6BA6	.50		6SL7GT	.80		12DU7	1.01
	1U4	.57		6BA8	.88		6SN7GT	.65		12DW8*	.89
	1U5	.50		6BC5	.61		6SQ7	.73		12DX6	.56
	1X2B	.82		6BC7	.94		6T4	.99		12E05	.69
	2AF4	.96		6BC8	.97		6TB	.85		12EG6	.54
	2BN4	.64		6BD5	1.25		6U8	.83		12EK6	.56
	2EN5*	.45		6BE6	.55		6VG6T	.54		12EL6	.50
	3AL5	.42		6BF5	.90		6W4	.60		12EM6	.79
	3AUG	.51		6BF6	.44		6W6	.71		12EN6	.78
	3AV6	.41		6BG6	1.66		6X4	.39		12EZ6	.53
	3BA6	.51		6BH6	.65		6X5GT	.53		12F8	.66
	3BC5	.54		6BH8	.87		6X8	.80		12FA6	.79
	3BE6	.52		6BJ6	.62		7A8	.68		12FM6	.46
	3BN6	.76		6BJ7	.79		7AU7	.61		12FR8	.91
	3BU8	.78		6BK7	.85		7B6	.69		12FX8	.85
	3BY6	.55		6BL7	1.00		7EY8*	.73		12GC6	1.06
	3BZ6	.55		6BN4	.57		7F8	.90		12J8	.84
	3CB6	.54		6BN6	.74		7N7	.90		12K5	.65
	3CS6	.52		6BQ6	1.05		7S7	1.01		12L6	.58
	3DC4*	.85		6BQ7	1.00		7Y4	.69		12SA7	.92
	3DK6*	.60		6BS8	.90		8AU8	.83		12SF7	.69
	3DT6	.50		6BU8	.70		8AW8	.93		12SH7	.49
	3Q4	.63		6BX7	1.02		8BQ5	.60		12SJ7	.67
	3Q5	.80		6BY5	1.15		8CG7	.62		12SK7	.74

RAD-TEL TUBE CO. NOT AFFILIATED WITH ANY OTHER MAIL ORDER TUBE COMPANY

	3S4	.61		6BY6	.54		8CM7	.68		12SL7	.80
	3V4	.58		6BY8	.66		8CN7	.97		12SN7	.67
	4BQ7	1.01		6BZ6	.55		8CS7	.74		12SQ7	.78
	4BZ7	.96		6BZ7	1.01		8CX8	.93		12U7	.62
	4BZ8	1.10		6BZ8	1.09		8EB8	.94		12V6	.53
	4CS6	.61		6C4	.43		8SN7	.66		12W6	.69
	4DT6	.55		6CB6	.55		9CL8	.79		12X4	.38
	5AM8	.79		6CD6	1.42		11CY7	.75		17AX4	.67
	5AN8	.86		6CE5*	.57		12A4	.60		17B06	1.09
	5AQ5	.52		6CF6	.64		12AB5	.55		17D06	1.06
	5AS8*	.86		6CG7	.61		12AC6	.49		17W6	.70
	5AT8	.80		6CG8	.77		12AD6	.57		18FW6*	.49
	5AV8	1.01		6CK4*	.70		12AE6	.43		18FY6*	.50
	5BC8	.79		6CL8	.79		12AE7	.94		18FX6*	.53
	5BE8	.83		6CM6	.64		12AF3	.73		19AU4	.83
	5BK7	.82		6CM7	.66		12AF6	.49		19B66	1.39
	5BQ7	.97		6CMB*	.90		12AJ6	.46		19C8	1.14
	5BR8	.79		6CN7	.65		12AL5	.45		19T8	.80
	5BT8*	.83		6CQ8	.84		12AL8	.95		21EX6	1.49
	5CC8	.76		6CR6	.51		12A05	.60		25AV5	.83
	5CL8	.76		6CS6	.57		12AT6	.43		25AX4	.70
	5CM8*	.90		6CS7	.69		12AT7	.76		25B3	.91
	5CQ8	.84		6CU5	.58		12AU6	.51		25B06	1.11
	5CZ5*	.72		6CU6	1.08		12AU7	.60		25C5	.53
	5EA8*	.80		6CY5*	.70		12AV6	.41		25CA5	.59
	5EU8	.80		6CY7	.71		12AV7	.75		25CD6	1.44
	5I6	.68		6DA4*	.68		12AX4	.67		25CU6	1.11
	5T8	.81		6DB5	.69		12AX7	.63		25DN6	1.42
	5U4	.60		6DB6	.51		12AY7	1.44		25EH5	.55
	5U8	.81		6DE6	.58		12AZ7	.86		25L6	.57
	5V3	.90		6DGE	.59		12B4	.63		25W4	.68
	5V6	.56		6DK6	.59		12BA7	.84		32ET5	.55
	5X8	.78		6DN6	1.55		12BD6	.50		32L7	.90
	5Y3	.46		6DQ6	1.10		12BE6	.53		35B5	.60
	6AB6	1.20		6DT6	.53		12BF6	.44		35C5	.51
	6AB4	.46		6DT8*	.79		12BH7	.77		35L6	.57
	6AC7	.96		6EAB	.79		12BK5	1.00		35W4	.42
	6AF3	.73		6EB5*	.72		12BL6	.56		35Z5	.60
	6AF4	.97		6EM8*	.94		12B06	1.06		36AM3*	.36
	6AG5	.68		6EM5*	.76		12BR7	.74		50B5	.60
	6AH4	.81		6EM7	.82		12BV7	.78		50CS	.53
	6AH6	.99		6EU8	.79		12BY7	.77		50EH5	.55
	6AK5	.95		6EWE	.57		12BZ7	.75		50L7	.97
	6AL5	.47		6EY6*	.75		12C5	.56		70L7	.97
	6AM8	.78		6F5GT	.39		12CN5	.56		70Z5	.69
	6AQ5	.53		6FE8	.75		12CR6	.54		807	.70
	6AR5	.55		6GH8	.80		12CU5	.58		117Z3	.61
	6AS5	.60		6GK6*	.79		12C06	1.06			
	6AS6	.80		6GN8*	.94						
	6AT6	.43		6H6	.58						
	6AT8	.79		6J5GT	.51						

New Tube Types Offered by Rad-Tel*

PRINTED IN U.S.A.



C-25. IN-CIRCUIT CAPACITOR TESTER KIT. Reveals shorted or open capacitors in the circuit, including electrolytics. Also reveals dried-out electrolytics through the Electrolytic Capacitance Dial. **Kit: \$19.95; Factory Wired, ready to operate: \$29.95.**



V-70. VACUUM TUBE VOLTMETER KIT. Uses stabilized bridge circuit to provide measurements on 7 DC and 12 AC voltage ranges, plus 7 decibel and 7 wide-spread electronic ohmmeter ranges. **Kit: \$31.95; Factory Wired, ready to operate: \$49.95.**



G-30. RF SIGNAL GENERATOR KIT. Highly accurate, stable. Also designed for use as a Marker Generator in sweep-alignment procedures. Eight frequency ranges: 160 kc to 240 mc. **Kit: \$32.95; Kit with Prealigned Tuner: \$39.95; Factory Wired, ready to operate: \$44.95.**



MX-100. STEREO MULTIPLEX ADAPTER KIT. All critical circuitry factory adjusted and prealigned. Maximum stereo separation between 20-15,000 cps, with low distortion. Stereo switch permits either front-panel separation control or maximum separation adjusted at factory. **Kit: \$49.95; Factory Wired, ready to operate: \$69.95.**

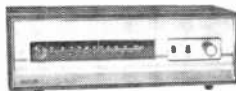

ST-26. FM TUNER/AMPLIFIER KIT. Low-cost combination hi-fi FM music system. Requires only the addition of external speaker (see L-3) to complete system. Pre-Built Front End fully adjusted and prealigned at factory. **Kit: \$54.95; Factory Wired, ready to operate: \$69.95.**



L-3. SPEAKER SEMI-KIT. Ultra-compact, graciously styled system. Lifelike response from high efficiency speakers. Walnut-finished cabinet. Size: 13 1/4" L x 6 1/2" H x 7 1/4" D. **Semi-Kit: \$19.95.**

PACO KITS

THE KITS YOU BUILD IN 1/3 LESS TIME



FROM BOX...



TO BEETHOVEN IN 1/3 LESS TIME!

In timed, competitive tests, twin brothers — with twin backgrounds and skills — proved that Paco kits are faster, easier and more fun to build than almost-identical kits sold by other kit makers. They discovered that there's no guessing with Paco: parts are neatly packaged and precisely labeled; instruction books are complete and easy to follow. Accurate drawings to actual scale and fold-out diagrams are printed right next to step-by-step directions. ■ The twins also proved that Paco pleasure doesn't end with the wiring. The ST-25 MX FM Stereo Multiplex Tuner^c, for example, looks and performs like twice the price: frequency response is 30 to 20,000 cps within 2 db; sensitivity is 1.5 μv for 20 db quieting. It features self-contained, prealigned and fully shielded front end, FM Stereo multiplex circuitry, dual limiters, AFC with panel switch for AFC defeat and "eye"-type tuning indicator. Why not put Paco to your test. **Kit: \$69.95 net, (factory wired, ready to operate: \$99.95).** See your dealer or write today for details to Paco Electronics Co., Inc., 70-31 84th Street, Glendale 27, New York, a division of Precision Apparatus Company, Inc. Export: Morhan Corporation, 458 Broadway, New York 13, New York. In Canada: Atlas Radio Corporation, 50 Wingold Avenue, Toronto, Canada.

*AS PICTURED ABOVE

PACO KITS



THE KITS YOU BUILD IN 1/3 LESS TIME

Hy-gain
antenna-products
Lincoln, Nebraska
DEPT. 236

ABC's OF MOBILE WHIPS FOR CITIZENS BAND

Loaded System is Best!

**FULL LENGTH
QUARTER
WAVE
WHIP**

**9 ft.
HIGH!**

**NOT
the best
mobile whip**

PLUS feed point impedance 15-20 ohms requires matching



COIL LOADED SYSTEMS

*** SHORTER** - only 50" - easier to mount higher on auto - allows better ground plane efficiency if mounted on trunk, top, fender, etc.

BUT... 78% of radiation is from bottom half of whip - only 22% from top half.

SO... least compromise comes from loading at top rather than at bottom

PLUS...

TOP LOADING CHARACTERISTICALLY HAS FEED POINT IMPEDANCE OF 50 ohms. NO MATCHING!

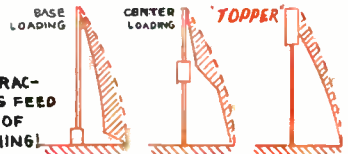

Solid Line: Loaded Whip Current Distribution.
Dotted Line: Full Size Whip Current Distribution.

Only The HY-GAIN Topper can offer this optimum transfer of energy! ... and radiation efficiency!

P.S. If you insist on a full length whip, body mount and spring- COMPARE OUR MODEL 55W OF 91955 List

The Hy-Gain "Toppers"

Rugged, stainless steel mobile whips, 50" in height, with polyethylene enclosed coil capsule sealed permanently to top portion.

- TLW-M: with chrome-plated, single hole, top mounting body mount. **\$14.90** List
- TLWT-M: identical to TLW-M but in three sections, for telescoping down to 28". **\$14.90** List
- TLW: with standard 3/8"x24 threaded base stud for use with adaptive mounts. **\$11.60** List
- TLW-T: identical to the TLW but in three sections for telescoping down to 28". **\$12.00** List



HY-GAIN RECOMMENDED SYSTEM

TLWM whip mounted in place of broadcast aerial with CPR Coupler - receives AM Radio, transceives CB simultaneously.

Write for complete technical bulletin

COMPLETE LINE OF ANTENNAS & ACCESSORIES IN STOCK AT LEADING ELECTRONIC DISTRIBUTORS